

NOVEMBER · 1952

PRICE 75 CENTS

electronics

A MCGRAW-HILL PUBLICATION



TUBES CONTROL MILLING CUTTER

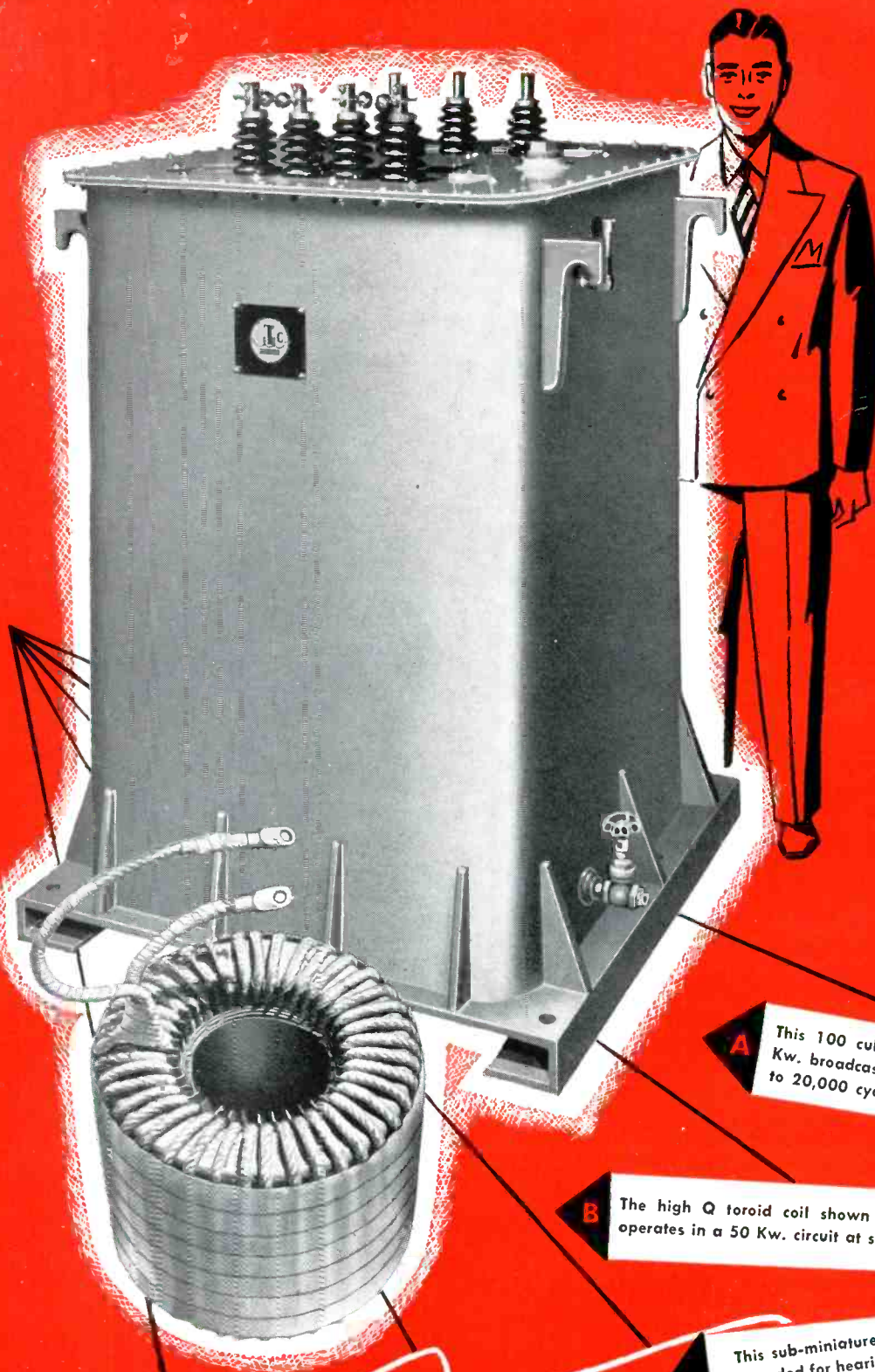

for every application

While the catalogue line of UTC components covers a wide variety of applications, many people are not familiar with the full range of products produced by UTC. It is impossible to describe the thousands of special UTC designs as they become available. The illustrations below are intended to indicate some of the range in size of these special products.

A This 100 cubic foot modulation transformer is for 50 Kw. broadcast service. Frequency response flat from 30 to 20,000 cycles.

B The high Q toroid coil shown is 12" in diameter. It operates in a 50 Kw. circuit at supersonic frequency.

C This sub-miniature (.18 cubic inch) output transformer is intended for hearing aid and other extreme compact service. While the dimensions are only 7/16" x 9/16" x 3/4", the fidelity is ample for voice frequency requirements.

D This sub-miniature (.18 cubic inch) permalloy dust core toroid is available in a wide range of inductances for frequencies from 1,000 cycles to 50 Kc.

United Transformer Co.

150 VARICK STREET • NEW YORK 13, N. Y.
 EXPORT DIVISION: 13 EAST 40th STREET, NEW YORK 16, N. Y. CABLES: "ARLAB"

electronics

NOVEMBER • 1952

A MCGRAW-HILL
PUBLICATION

COVER—Servomechanically controlled milling machine can be made to cut a block of metal into any desired shape in response to number code punched in paper tape and fed through an electronic decoder developed at Servomechanisms Laboratory, MIT. (See page 172)

FIGURES OF THE MONTH, Electronics Output Index.....	4		
INDUSTRY REPORT, Top-level news, trends and market interpretations.....	5		
ELECTRON BEAMS STERILIZE FOOD AND DRUGS, by E. Alfred Burrill and A. John Gale.....	98		
BROADCASTING TV IN THE UHF BAND, by Jess Epstein and D. W. Peterson.....	102		
DESIGNING AN EXPERIMENTAL 850-MC TV TRANSMITTER, by G. A. Olive.....	110		
TRANSISTORS OPERATE AT 300 MC, by G. M. Rose and B. N. Slade.....	116		
MAGNETIC-AMPLIFIER GAPLESS-CORE TESTS, by J. R. Conrath.....	119		
DIODE LIMITERS SIMULATE MECHANICAL PHENOMENA, by C. D. Morrill and R. V. Baum.....	122		
INVESTIGATING ANTENNAS FOR UHF MOBILES, by Edward F. Harris.....	127		
INDUSTRIAL FREQUENCY STANDARD, by H. W. Kline.....	130		
EVALUATING AFC SYSTEMS FOR TELEVISION RECEIVERS, by George Howitt.....	132		
RATIO METER MEASURES REFLECTION COEFFICIENT, by L. A. Rosenthal, J. L. Potter and G. M. Badoyannis.....	136		
PRINTED CIRCUITS FOR RADIO RECEIVERS, by Elmer Wavering.....	140		
GREY-SCALE GENERATOR, by G. Edward Hamilton and Ralph Ilowite.....	143		
SINGLE-SIDEBAND SYSTEM FOR OVERSEAS TELEPHONY, by N. F. Schlaak.....	146		
GERMANIUM PHOTODIODES READ COMPUTER TAPES, by Leroy Packer and William J. Wray, Jr.....	150		
UNIVERSAL SKIN-EFFECT CHART FOR CONDUCTING MATERIALS, by Harold A. Wheeler.....	152		
DIGITAL COMPUTER PLAYS NIM, by Herbert Koppel.....	155		
TEST PULSE GENERATOR FOR DIGITAL COMPUTERS, by Albert A. Gerlach.....	158		
CONTINUOUS RECORDER KEEP-ALIVE CIRCUIT, by Ronald L. Ives.....	161		
AIR-COOLING NOMOGRAPH, (Reference Sheet), by Eugene Slusser.....	164		
HIGH Q MEASUREMENT, (Reference Sheet), by William J. Spaven.....	166		
CROSSTALK..... 97	ELECTRONS AT WORK..... 168	PRODUCTION TECHNIQUES..... 266	NEW PRODUCTS..... 310
PLANTS AND PEOPLE..... 396	NEW BOOKS..... 414	BACKTALK..... 430	INDEX TO ADVERTISERS (Last Page)

W. W. MacDONALD, Executive Editor; VIN ZELUFF, Managing Editor; John Markus, A. A. McKenzie, James D. Fahnestock, Associate Editors; William P. O'Brien, Ronald K. Jurgen, John M. Carroll, William G. Arnold, Assistant Editors; Ann Mastropolo, Marilyn Wood, Mary J. Johnson, Editorial Director Assistants; Gladys T. Montgomery, Washington Editor; Harry Phillips, Art Director; Eleanor Luke, Art Assistant

KEITH HENNEY, Editorial Director

H. W. MATEER, Publisher; WALLACE B. BLOOD, Manager; R. S. Quint, Buyers' Guide Manager; N. F. Cullinan, Promotion & Research Assistant; H. E. Hilty, Classified Manager; D. H. Miller, James Girdwood, New York; Wm. S. Hodgkinson, New England; Warren W. Shew, Philadelphia; C. D. Wardner, Chicago; J. L. Phillips, Cleveland; T. H. Carmody, R. C. Alcorn, San Francisco; Carl W. Dysinger, Los Angeles; Ralph C. Maultsby, Atlanta



November, 1952

ELECTRONICS
Member ABC and ABP

Vol. 25, No. 11



Published monthly with an additional issue in June by McGraw-Hill Publishing Company, Inc., James H. McGraw (1860-1948), Founder. Publication Office, 99-129 North Broadway, Albany 1, N. Y.

Executive, Editorial and Advertising Offices: McGraw-Hill Building, 330 W. 42nd St., New York 36, N. Y. Curtis W. McGraw, President; Willard Cavalier, Executive Vice-President; Joseph A. Gerardi, Vice-President and Treasurer; John J. Cooke, Secretary; Paul Montgomery, Senior Vice-President, Publication Division; Ralph B. Smith, Vice-President and Editorial Director; Nelson Bond, Vice-President and Director of Advertising; J. E. Blackburn, Jr., Vice-President and Director of Circulation.

Subscriptions: Address correspondence to Electronics—Subscription Service, 99-129 N. Broadway, Albany 1, N. Y., or 330 W. 42nd St., New York 36, N. Y. Allow one month for change of address. Subscriptions are solicited only from persons engaged in theory, research, design, production, maintenance and use of electronic and industrial control components, parts and end products. Position and company connection must be indicated on subscription orders.

Single copies 75¢ for United States and possessions, and Canada; \$1.50 for Latin America; \$2.00 for all other foreign countries. Buyers' Guide \$2.00. Subscription rates—United States and possessions, \$6.00 a year; \$9.00 for two years. Canada, \$10.00 a year; \$16.00 for two years. Other western hemisphere countries, \$15.00 a year; \$25.00 for two years. All other countries \$20.00 a year; \$30.00 for two years. Entered as second class matter August 29, 1936, at the Post Office at Albany, N. Y., under act of Mar. 3, 1879. Printed in U. S. A. Copyright 1952 by McGraw-Hill Publishing Co., Inc.—All Rights Reserved. BRANCH OFFICES: 520 North Michigan Avenue, Chicago 11, Ill.; 68 Post Street, San Francisco 4; McGraw-Hill House, London, E.C. 4; Washington, D. C. 4; Philadelphia 3; Cleveland 15; Detroit 26; St. Louis 8; Boston 16; 1321 Rhodes-Haverty Bldg., Atlanta 3, Ga.; 1111 Wilshire Blvd., Los Angeles 17; 733-9 Oliver Building, Pittsburgh 22. ELECTRONICS is indexed regularly in The Engineering Index.



MODEL M-2

**marion's
NEW
metertester**

**MEASURES
SENSITIVITY AND RESISTANCE**

for testing and calibration of D. C. instruments in the laboratory and on production lines

Marion's New Metertester (Model M-2) retains proven Marion features but increases application flexibility. In addition to improved circuitry for sensitivity measurement it also measures internal resistance of sensitive instruments without exceeding full scale rating of the instrument under test.

FEATURES

- Regulated Power Supply
- Stepless Vacuum Tube Voltage Control
- Illuminated 8½" Mirror-Scale Standard Instrument, Hand Calibrated
- Marion Ruggedized Null Indicator movement for bridge balance indication
- Decade of .1% accurate Manganin Wire Wound Resistors
- Direct Reading Bridge Circuit using Helipot
- Complete. No accessories required

SPECIFICATIONS

ACCURACY: Overall better than ¼ of 1%
 RESISTANCE RANGE: 0-5000 ohms
 POWER SOURCE: 115V A C 60 cycles
 CASE SIZE: 15½" x 10½" x 5½"
 WEIGHT: 15 lbs.

SENSITIVITY RANGES

0-25UA	0-200UA	0-800UA	0-10 MA
0-50UA	0-400UA	0-1 MA	0-100 Volts
0-100UA	0-500UA	0-5 MA	

The New M-2 Model can also be used for additional purposes, such as a precise source of DC current and voltage and as a precision Wheatstone bridge in the 0-5000 ohm range.

For further information write Marion Electrical Instrument Co., 401 Canal Street, Manchester, N. H., U. S. A.

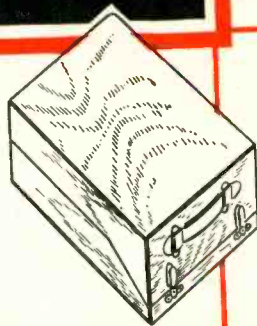

marion meters

Reg. U.S. Pat. Off.

MANUFACTURERS OF RUGGEDIZED, HERMETICALLY SEALED AND STANDARD PANEL INSTRUMENTS

November, 1952 — ELECTRONICS

MUIRHEAD

MAGSLIP RESOLVER No. 2

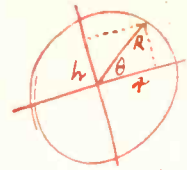

Given R & θ
 find h & r
 $h = R \sin \theta$
 $r = R \cos \theta$

Change of Axes
 $x' = x \cos d + y \sin d$
 $y' = y \cos d - x \sin d$



Given N, E
 determine R & θ
 $R = E \cos \theta + N \sin \theta$
 $Z_{\text{ero}} = E \sin \theta + N \cos \theta$

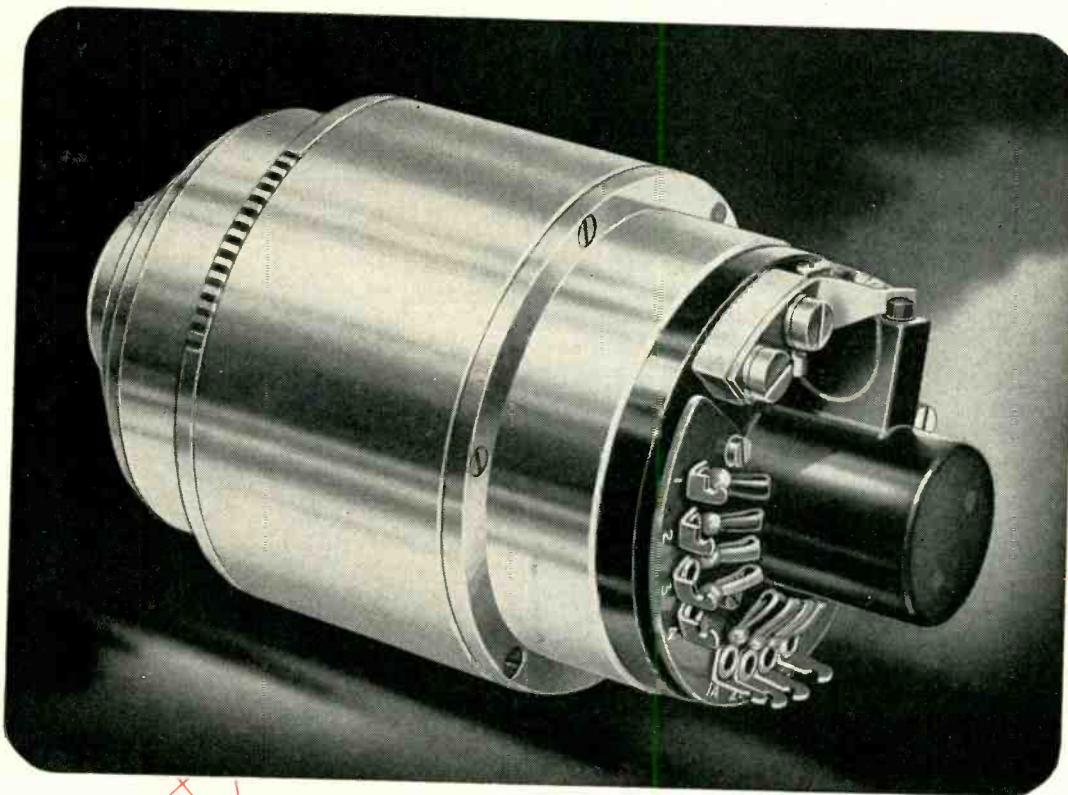
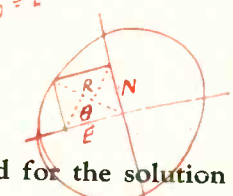

Hand-drawn diagram of a right-angled triangle with sides a and b , and hypotenuse x . The angle between a and x is d .

$x = \sqrt{a^2 + b^2}$
 $x = a \cos d + b \sin d$

THE RESOLVER No. 2 is a special type of Magslip used for the solution of trigonometrical problems, such as the conversion of polar to Cartesian co-ordinates.

Each stator phase is energized in accordance with an applied computing voltage. No power is taken from this source, energization being obtained by means of an amplifier and a second (feedback) stator winding. The rotor voltages are proportional to the exciting voltages and to the sine and cosine of the angle between the stator and rotor electrical axes. The error does not exceed 0.1%.

MAIL THIS COUPON

Please mail Bulletin B-690 fully describing
 MUIRHEAD MAGSLIP RESOLVERS.

NAME

POSITION

COMPANY

MAILING ADDRESS

MUIRHEAD & CO. LTD.
 BECKENHAM • KENT • ENGLAND

Precision Electrical Instrument Makers

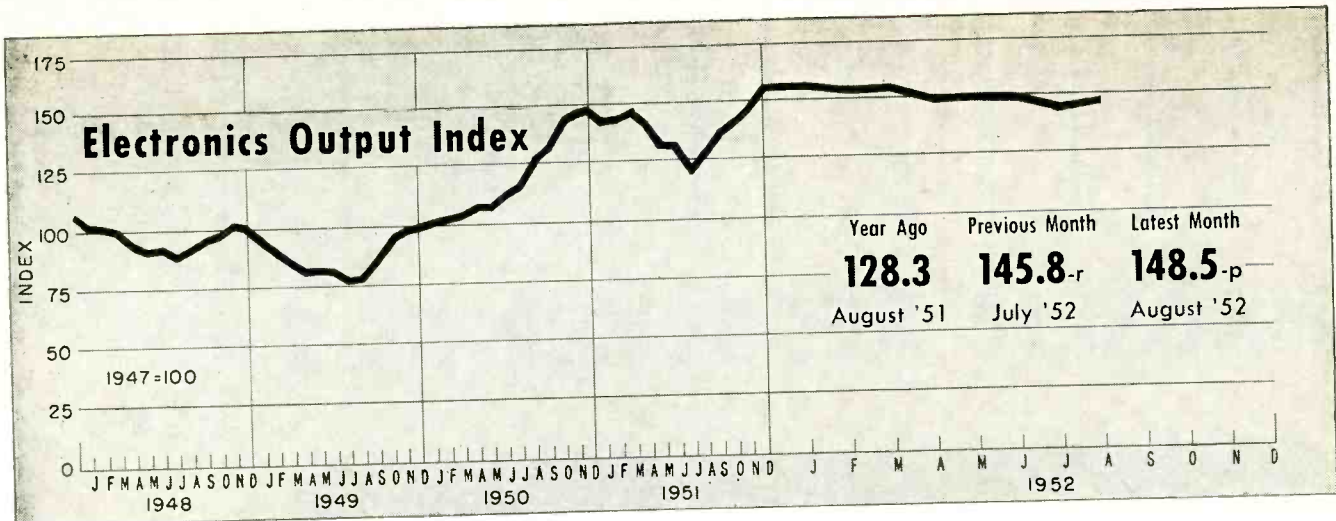

FIGURES OF THE MONTH

RECEIVER PRODUCTION

(Source: RTMA)

	Year Ago	Previous Month	Latest Month
	Aug. '51	July '52	Aug. '52
Television sets	146,705	198,921	397,769-p
Home Radio sets	295,587	265,163	344,481-p
Portable sets	77,568	81,353	105,006-p
Auto sets	190,252	95,220	94,315-p

RECEIVER SALES

(Source: RTMA)

	Year Ago	Previous Month	Latest Month
	Aug. '51	July '52	June, July & Aug. '52
Television sets, units	—	—	700,490
Radio sets (except auto)	—	—	1,139,467

RECEIVING TUBE SALES

(Source: RTMA)

	Aug. '51	July '52	Aug. '52
Receiv. tubes, total units	23,761,253	20,944,831	30,141,536
Receiving tubes, new sets	12,917,526	11,504,503	19,583,879
Rec. tubes, replacement	7,230,419	6,795,252	7,463,893
Receiving tubes, gov't.	845,514	1,956,905	1,706,868
Receiving tubes, export.	2,767,794	688,171	1,386,896
Picture tubes, to mfrs.	210,043	239,625	394,605

BROADCAST STATIONS

(Source: FCC)

	Sept. '51	Aug. '52	Sept. '52
TV Stations on Air	108	109	111
TV Stns CPs—not on air	0	34	51
TV Stns—Applications	444	855	855
AM Stations on Air	2,300	2,356	2,364
AM Stns CPs—not on air	101	112	119
AM Stns—Applications	280	291	276
FM Stations on Air	644	622	624
FM Stns CPs—not on air	9	21	18
FM Stns—Applications	8	12	10

NETWORK BILLINGS

(Source: Pub. Info. Bureau)

	Aug. '51	July '52	Aug. '52
AM/FM—ABC	\$2,210,352	\$2,082,666	\$2,281,852
AM/FM—CBS	\$4,440,261	\$3,238,256	\$3,991,490
AM/FM—MBS	\$1,329,375	\$1,339,276	\$1,325,059
AM/FM—NBC	\$3,808,906	\$2,878,196	\$3,338,843
TV—ABC	\$1,444,593	\$943,387	\$1,166,169
TV—CBS	\$3,734,551	\$4,163,245	\$5,105,929
TV—DuMont	\$763,071	\$653,415	\$845,780
TV—NBC	\$3,359,856	\$4,591,130	\$5,618,643

TV AUDIENCE

(Source: NBC Research Dept.)

	Year Ago	Previous Month	Latest Month
	Sept. '51	Aug. '52	Sept. '52
Sets in Use—total	13,556,000	18,354,300	18,711,800
Sets in Use—netw'k conn.	12,839,400	18,325,700	18,682,800
Sets in Use—New York	2,490,000	3,070,000	3,100,000
Sets in Use—Los Angeles	1,012,000	1,230,000	1,240,000
Sets in Use—Chicago	960,000	1,210,000	1,235,000

COMMUNICATION AUTHORIZATIONS

(Source: FCC)

	July '51	June '52	July '52
Aeronautical	33,007	32,603	33,462
Marine	30,174	35,500	36,068
Police, fire, etc.	9,310	11,143	11,274
Industrial	9,895	13,680	13,968
Land Transportation	4,324	5,027	5,120
Amateur	92,822	113,092	113,863
Citizens Radio	585	1,401	1,697
Disaster	9	71	80
Experimental	428	488	489
Common carrier	824	985	985

EMPLOYMENT AND PAYROLLS

(Source: Bur. Labor Statistics)

	July '51	June '52	July '52
Prod. workers, electronic	229,500	266,300-r	263,400-p
Prod. wkrs., radio, etc.	138,400	165,300-r	162,700-p
Av. wkly. earnings, elect.	\$60.34	\$64.52-r	\$62.52-p
Av. wkly. earnings, radio	\$57.35	\$61.58-r	\$60.68-p
Av. weekly hours, elect.	41.4	40.3	39.1-p
Av. weekly hours, radio	39.2	40.5-r	39.3-p

STOCK PRICE AVERAGES

(Source: Standard and Poor's)

	Sept. '51	Aug. '52	Sept. '52
Radio—TV & Electronics	259.5	291.1	304.3
Radio Broadcasters	244.8	279.6	288.3

INDUSTRIAL EQUIPMENT ORDERS

(Source: NEMA)

	Year Ago	Quarterly Figures Previous Quarter	Latest Quarter
	2nd '51	1st '52	2nd '52
Dielectric Heating	\$600,000	\$150,000	\$510,000
Induction Heating	\$3,140,000	\$2,400,000	\$2,410,000

INDUSTRIAL TUBE SALES

(Source: NEMA)

	2nd '51	1st '52	2nd '52
Vacuum (non-receiving)	\$7,750,000	\$11,320,000	\$12,110,000
Gas or vapor	\$2,700,000	\$3,100,000	\$3,150,000
Phototubes	\$360,000	\$500,000	\$480,000
Magnetrons and velocity modulation tubes	\$4,130,000	\$8,460,000	\$9,830,000

p—provisional; r—revised; e—estimated

INDUSTRY REPORT

electronics—NOVEMBER • 1952

Plants Push 'Rainy-Day' Planning

New-product ideas are being stockpiled against possible drop in military orders

THOUGH business is good today in the electronic industry, the spectre of possible military contract tapering off is once again dominating many engineering and executive planning conferences.

A surprisingly large number of post-cold-war projects have already reached the drafting board. These divide into four major categories.

► **Custom Engineering Jobs**—Here is maximum job security for engineering staffs, because special electronic control systems tailored to a particular machine come close to development contracts in engineer man-hour requirements.

In anticipation of custom engineering, engineering staffs are getting acquainted with general process requirements in the most promising fields. The textile, food, machine tool and chemical industries are getting major attention. These and other prospective fields can be parceled out among groups of engineers even today, to encourage the specialization needed for getting best results when the day for action arrives.

► **New Stock Products**—This is the obvious but tough answer to the problem. There'll always be some market for a newer and better test instrument, for improved communication equipment, or for new packaged electronic controls, but good new-product ideas here are hard to come by and generally require years to develop. Opportunities are good in the mass entertainment field, but existing large manufac-

turers with national distribution have a distinct edge on newcomers.

► **White Goods**—To counteract traditional summer slump in radio and television receiver business, larger manufacturers in this field have been adding or acquiring lines of refrigerators, air conditioners, dehumidifiers and other so-called white goods. This boosts business during the slack months.

► **Nonelectronic Products**—Some small firms are looking ahead with a maximum of flexibility and open-mindedness. They'll make any product, electronic or otherwise, that will hold together their engineering and production staffs long enough for transition from military boom business to normal commercial activity.

UHF Egg Hatches In Portland, Oregon

Market becomes commercial guinea pig for companies in the television industry

EYES of the electronics industry are closely watching every development in the nation's first commercial uhf television market, Portland, Oregon. Literally thousands of representatives of all segments of the industry have visited the city since KPTV took to the air on Sept. 18. Resulting comments of various observers of the Portland picture vary from "confused" to "very encouraging."

► **Shortages**—Despite recent experience with the vhf Denver market, some tv distributors were

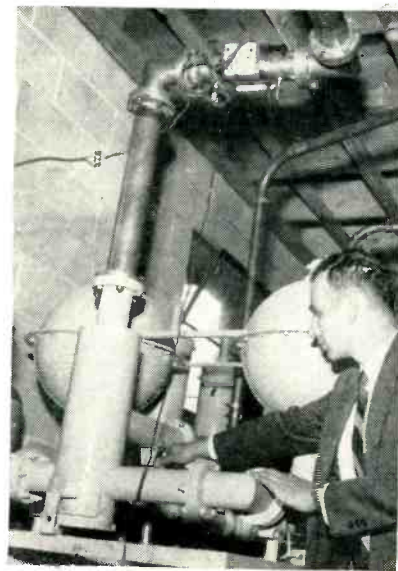

UHF filterplexer, which coordinates tv sound and picture for KPTV in Portland, is examined by one of the engineers who made the historic installation

caught without sets when commercial uhf television made its bow in Portland. However, shortages did not become as serious as in Denver, because sets were available in nearby Seattle and San Francisco.

But other shortages have hampered sales to some extent. Most bothersome has been the shortage of channel-27 tuning strips. Converters have also been in short supply.

► **Interference**—Some manufacturers have run into picture interference problems in the Portland market. Taxicab radio, which operates around 150 megacycles, has been partially responsible. But most manufacturers have already licked this problem by using 'stubs' of leadin wire serving as wave-traps.

Some uhf converters have themselves created interference.

► **Coverage**—Most manufacturers seem pretty happy with the coverage pattern of KPTV. RCA surveyed the Portland area to chart

reception as soon as the station began operating. They report that the station is radiating a good signal and actual coverage agrees surprisingly well with FCC predictions. There are, however, a few dead spots.

Grade A signals from Portland are reported in adjacent cities of Vancouver, Washington, and in St. Helens and Oregon City, Oregon. Even Salem, Oregon, 42 air miles from Portland, reports reception. With coverage better than ex-

pected, most tv manufacturers are optimistic about uhf tv sales in the Portland area. It is reported that set sales during the first three weeks reached nearly 2,000. Some predict that by the end of the year they will reach at least 50,000.

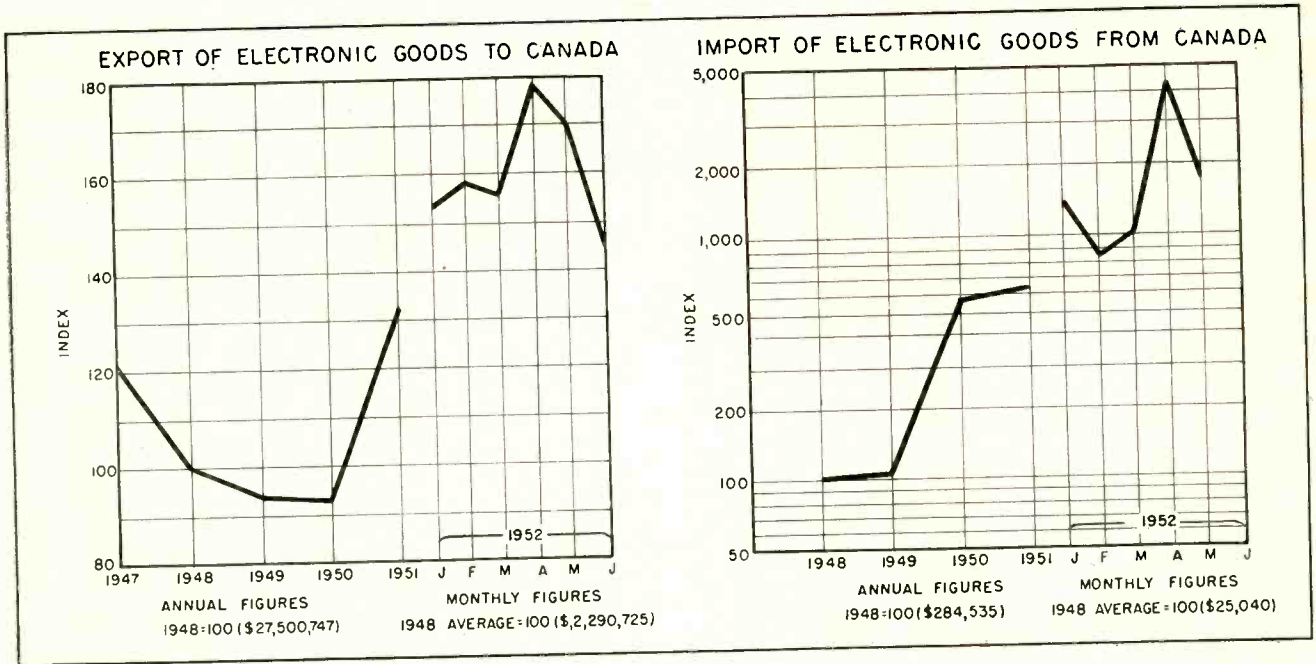

TRADE with our northern neighbor reaches new heights in both directions across the border as . . .

Electronic Business Booms in Canada

Exports rise steadily; many U.S. concerns open branch plants in the Dominion

CANADA'S SURGE towards industrial prominence means good business for electronics manufacturers on both sides of the border. Exports to Canada of electronic equipment and components are at an all-time high, topping \$36 million last year and increasing rapidly. Meanwhile, more than 100 Canadian plants are producing electronic parts and end products. About one-third of these plants are branch plants or subsidiary companies of U.S. concerns.

A rough gage of Canada's growing electronics production is the fact that U.S. imports from Canada promise to top \$4.5 million for 1952, representing a 20-fold increase over 1948 figures.

The graphs illustrate the astonishing growth of electronics business across America's northern border. Both graphs are plotted in index figures obtained by dividing yearly totals by the average figure for the corresponding period of 1948. The totals were obtained by summing Bureau of Census foreign trade figures for ELECTRONICS' list of electronic commodities.

► **Economic Growth**—Sparked by development of Canada's rich natural resources, her economic growth has snowballed during the last 12 years through reinvestment of national income in manufacturing industries. Canada's prosperity, reflected in every facet of her economic life, means improved living standards for her people, additional investment in new plants and

equipment and relentless pressure against her natural frontiers.

Canada's economic growth pattern is faithfully reflected by U.S. electronic exports to her. Basic electronic components such as resistors, capacitors and tubes to feed Canadian production lines comprise 36.2 percent of U.S. exports northward. Also high on the list of electronic exports are communications equipments needed to span the miles between Canada's new mines and factories and industrial electronic equipment and instruments needed to equip new plants and laboratories. Export of r-f heating equipment for industry shows the greatest percentage increase over 1950 figures of all electronic equipment.

► **Consumer Market**—The home instrument market in Canada directly

(Continued on page 8)

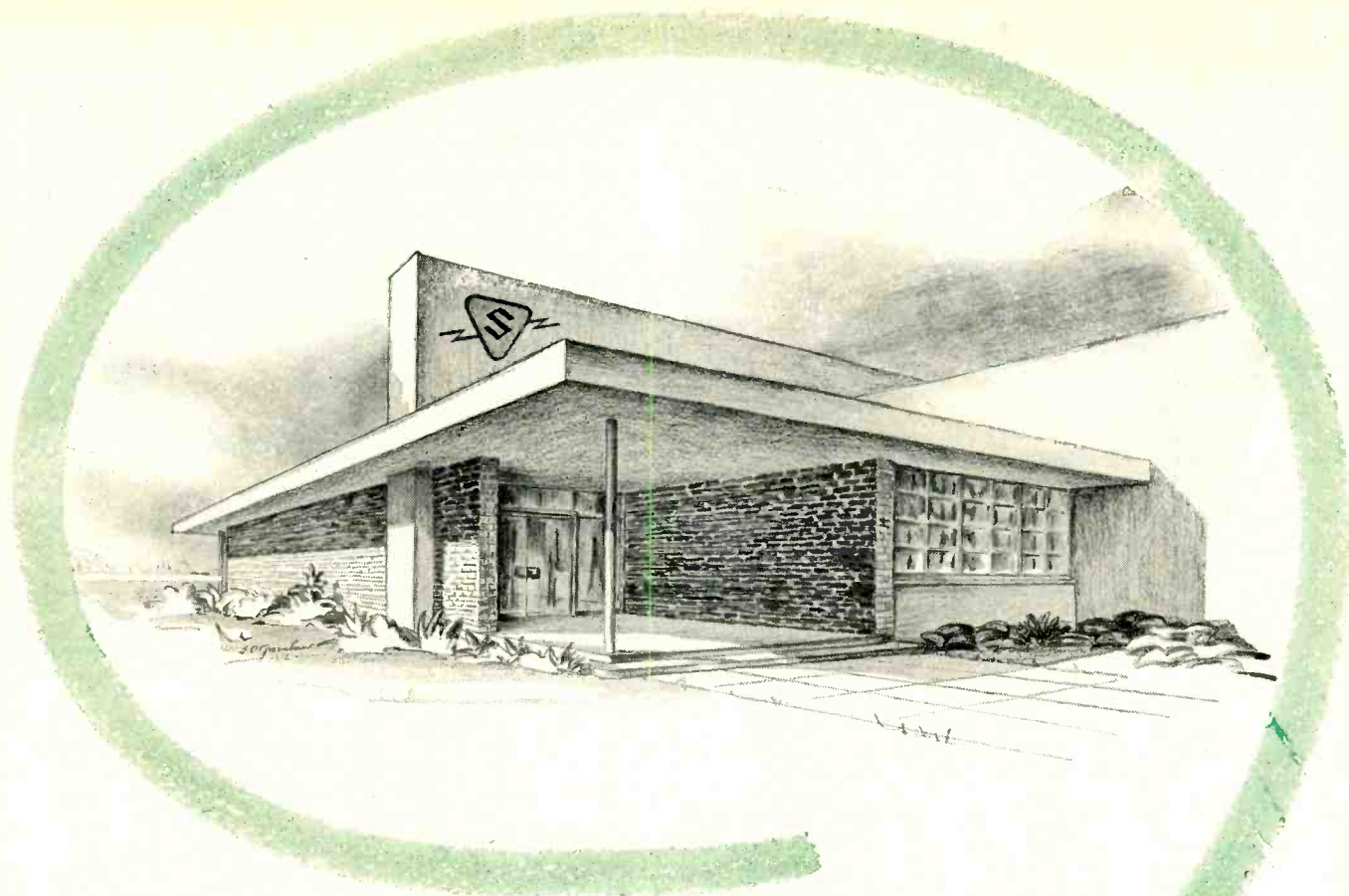

Sylvania to Serve West Coast Electronics Market from California Location



Sylvania has announced that construction is under way on a modern, completely equipped Electronics Division plant and laboratory in Mountain View, California.

This up-to-date facility of 35,000 square feet is being made available to West Coast manufacturers as a source of electronic components including semiconductor devices, microwave components, and special purpose tubes.

A research and development laboratory will be included to handle design and applications problems on these and other related products.

The addition of this California location to Sylvania's existing electronics facilities marks another step in the company's long-term plan to provide the finest quality products and fastest service to all markets.

For complete information on Sylvania Electronic Products, write Dept. E-2611, Sylvania Electric Products Inc., 1740 Broadway, New York 19, N. Y.

SYLVANIA



ELECTRONIC PRODUCTS; ELECTRONIC TEST EQUIPMENT; RADIO TUBES; TELEVISION PICTURE TUBES; FLUORESCENT TUBES, FIXTURES, SIGN TUBING, WIRING DEVICES; LIGHT BULBS; PHOTOLAMPS; TELEVISION SETS

accounts for barely three percent of U. S. electronic exports. Although much of this market is served by Canadian set manufacturers and branch plants of U. S. concerns, the outlook for increased export sales is encouraging. Television sets, auto radios and juke boxes closely follow r-f heating equipment among exports showing the greatest percentage increase.

► **Electronic Developments**—Upturn in Canada's electronics industry keys into several specific developments outside her overall economic growth. Always a good customer for electronic equipment, the aircraft industry is going great guns in Canada. Jetmakers at AVRO-Canada's Malton plant near Toronto are making headline news with both military and commercial models.

Handmaiden to nuclear energy, the electronics industry derives additional impetus as Canada forges ahead in this field. The Canadian AEC operates establishments at Chalk River and Petawawa, near Pembroke, Ont. Canadian rearmament opens still another field for

electronics. Much electronic equipment, particularly radar and microwave communications equipment, is going to Canada's armed forces.

Other significant developments on the Canadian electronics scene include Bell of Canada's Buffalo-Toronto and Toronto-Montreal microwave radio-relay systems, extensive use of broad-band vhf radiotelephone circuits in Western Canada and the recent inauguration of the Canadian Broadcasting Company's first television network that now has stations in Toronto and Montreal.

► **Pattern of Growth**—Canadian electronics manufacturers tend to cluster about her two largest cities, Toronto and Montreal. More than half the electronic business is concentrated in Toronto and its sprawling suburbs. Montreal, with its surplus of women workers, has 19 plants engaged in electronics manufacturing. Nearly all the remaining plants are concentrated in the highly industrialized province of Ontario, with the cities of Hamilton, Kitchener and London very much in the running.



Industrial television enables this B&O yard clerk to record freight car numbers without walking among the cars and tracks. Unattended camera set up alongside the tracks does all the work as the trains pass in front of it

plans for greater use of radio communications systems.

► **What's Ahead**—The railroad industry may become a substantial industrial television market in the future.

The Baltimore & Ohio recently conducted tests of such equipment in conjunction with RCA, to determine whether ITV could contribute to greater efficiency in the operations of a railroad classification yard.

Three new Vidicon cameras were used for the demonstration. One camera chain did the job pictured here. Two others gave an overall view of the classification yard so that the disposition and movement of all cars and switching engines could be watched and coordinated.

Military Plans Set For '54 Buying

ELECTRONICS buying for aircraft alone in fiscal 1954 will total at least \$1.7 billion and may exceed \$2 billion.

New defense appropriation requests will be delivered to Congress shortly after it convenes. The overall figure is about the same as that which the Pentagon requested for fiscal 1953, close to \$50 billion. Major change will be in the items bought.

► **Flying Figures**—The military has accumulated inventories on

(Continued on page 10)

American Railroads Go Electronic

Use of radio equipment increases. Industrial tv looms on the horizon

INDICATIVE of the growing use of electronics in the railroad business, the number of radio system licenses in this field increased from 97 in June, 1951 to 114 in June 1952. The number of transmitters used by railroad licensees reached a total of over 9,000.

► **Investments**—What the railroad market means to electronic manufacturers in terms of dollar volume can be judged from investment reports of representative roads.

The Pennsylvania has already invested \$9 million in two-way telephone equipment and plans to expand its use. The Denver & Rio Grande Western has spent over

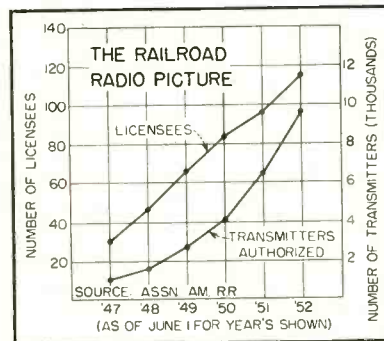

\$57,720 on radio and inductive communications systems since 1947. Investments prior to that totalled \$109,524. The Missouri-Kansas-Texas invested \$40,180 in radio systems in 1951 and Canadian Pacific spent about \$34,000. This year, the Northern Pacific completed its \$200,000 radio system and the Southern Pacific has announced

SPRAGUE[®] LEADS THE WAY

WITH RELIABLE HIGH TEMPERATURE

(250°C) MAGNET WIRE

250°C

200°C

150°C

105°C

Ceroc ST[®]

Magnet Wire, with its combination of ceramic base insulation and a single Teflon overlay, eliminates most problems met with all-plastic insulations.

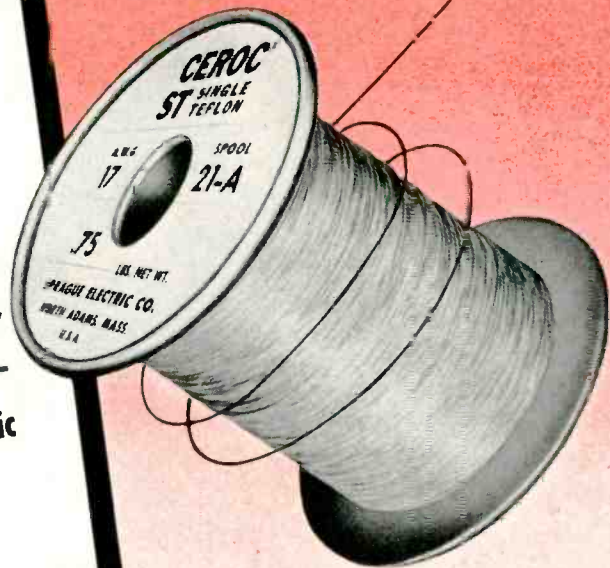

Designers of miniaturized transformers, motors, coils, solenoids, etc., are finding that Ceroc ST Magnet Wire leads the field in *tough* applications. Not only does Ceroc ST have superior abrasion resistance to commercial all-tetrafluoroethylene insulated wire, but it also has better cross-over characteristics, and a higher breakdown voltage. The Teflon overlay bonds more securely to the ceramic base insulation than is the case with Teflon bonded directly to copper. And with its years of experience in quality control, the Sprague Electric Company delivers to you a product of uniformly high quality.

Not only may Ceroc ST wire be operated *continuously* at temperatures up to 250°C, but it has

been successfully used in short-time military applications at temperatures as high as 350°C. Sprague's Application Engineering Dept. is ready to assist you in working out any problems you may have on the proper use of high temperature magnet wire.

For details on Ceroc ST wire, write for Engineering Bulletin No. 404. Where design requirements necessitate a heavier Teflon coating, investigate Ceroc T wire, with its double Teflon overlay on ceramic base insulation. It's described in Engineering Bulletin No. 402-F. Copies available without obligation on letterhead request to the Application Engineering Dept., Sprague Electric Co., 35 Marshall St., North Adams, Massachusetts.

ENLARGED CROSS-SECTION OF CEROC ST

Ceramic Base Insulation



Single Tetrafluoroethylene Overlay

SPRAGUE . . . PIONEERS IN ELECTRIC AND ELECTRONIC DEVELOPMENT

some weapons like tanks, ammunition and motor vehicles. These will be eased off. However, with a 143-wing Air Force approved by Congress, the tab for aircraft procurement will be close to the \$18-billion figure appropriated this year for Navy and Air Force planes.

Defense Secretary Lovett intends

to leave government service but offers to break in his successor and has asked the presidential candidates to name a defense secretary right after election. This would allow the new Pentagon boss to do some spade work on the budget he will have to explain to Congress next year.

Civilian Consultants Serve Uncle Well

Most make money on government contracts, but wrong choice can result in loss

THERE are three grades of consulting work in which electronic engineers assist the government's preparedness program. Remuneration for such work depends upon the kind of contract covering it.

► **Top-Drawer Engineering**—Highly specialized is the work of a consultant who advises a project group on a short-term basis. Under a subcontract, such a specialist might earn between \$100 and \$200 a day, depending upon the attitude of the contracting officer in allowing these rates as direct costs. They are considered reasonable for the expert who maintains his own staff, laboratory and model shop. Often such men are not called in until a program bogs down and a trouble-shooter is needed.

► **Intermediates**—Typified by continuous work on a project for a week to several month, the intermediate specialist's work may be done alone or using a supplemental staff. Especially if the consultant maintains an office and laboratory, such work usually commands a rate well in excess of \$50 a day.

► **Long-Term Consulting**—Least specialized is the work of a consultant working on a project from three months to several years. This type of work is exemplified by the so-called contract employee of some government agencies. No substantial overhead costs are involved since the consultant, often using space provided for him as, perhaps, a college professor, does not maintain a separate office. Compensation is limited, in general, to \$50 a day at most. This is the only type of consultation commonly employed directly by government or in quantity under prime contracts with industrial agencies.

Recommended by many con-

(Continued on page 14)

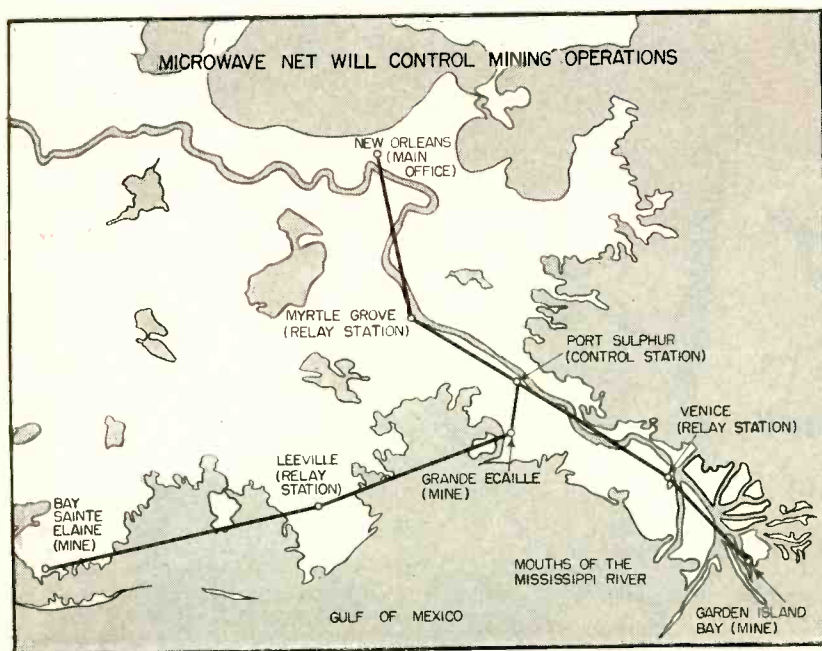

HURRICANE-prone marshland is no obstacle, as . . .

Microwaves Link Remote Mines

"Swamps rule out telephone lines in Louisiana delta," FCC rules in granting license

MICROWAVE system linking remote industrial operations has been approved by the FCC and will be installed this Fall. A \$173,000 Motorola system will link mines operated by Freeport Sulphur in the 300-square-mile marshland of the Mississippi delta with the company's offices in New Orleans and a shipping point at Port Sulphur.

Granting the license, the FCC ruled that marshy terrain coupled with prevalent hurricanes make construction and maintenance of telephone lines impractical.

The microwave network will tie into existing ship-shore radio facilities for communication with the

company's fleet of towboats and barges.

Work has already begun on preparing the tower foundations, which must be built on pilings. Equipment installation is scheduled for November.

► **Industrial Microwave**—Although most private microwave systems are owned either by electric-power companies or oil and gas pipeline operators, other industries are now finding them useful.

The Linton Summit Coal Co. of Terre Haute, Ind. is installing two stations for communication between their downtown office and the mine, 14 miles distant. In this case, according to the General Electric Co. who furnished the microwave equipment, the telephone company would not provide lines for a single customer.

Through the years
with one of the
electronic industry's
First Families



YEARS

(made
good in peacetime)



Company's first Tubular
coupling
capacitors -



Socket Mounted
Ceramic Capacitors

anything
new
(them)

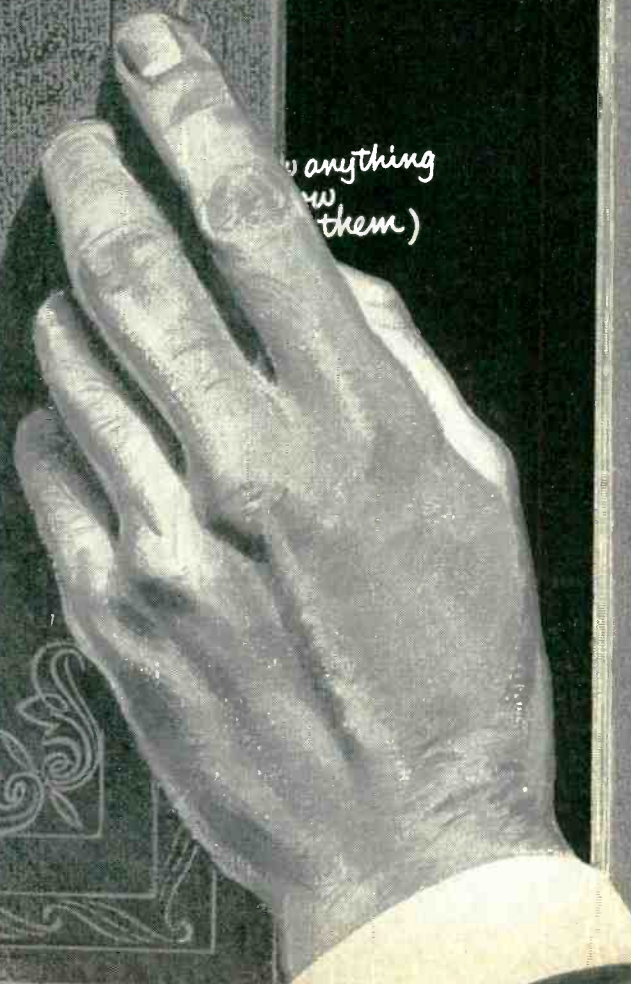

CENTRALAB'S ELECTRONIC FAMILY

Many members have made electronic history!

Today, many of the most advanced developments in electronic equipment -- from modern hearing aids to television, radar and X-ray -- are built around the revolutionary components pioneered and introduced by Centralab.

Tangible evidence of the ceaseless research that gives fresh

emphasis to the fact that many products bearing your trademark serve better -- last longer ... thanks to the continuing engineering advances of Centralab.

As in the past -- so in the future -- you can look to Centralab for leadership in electronic component research.

Variable Resistors

(Great grandad)



1922 First composition variable resistor ever built



1929 First combination variable resistor and switch

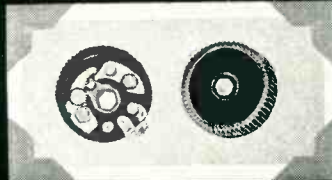

1946 Model 1 - World's smallest switch type variable resistor



1949 Model 2 Radiohm the most modern high quality variable resistor

(Latest addition to this part of the family)

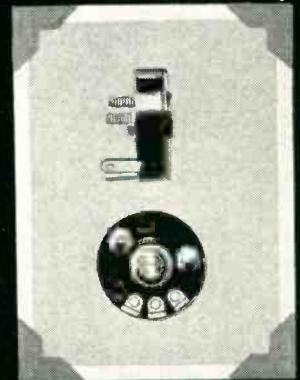

1951 New High Torque Variable Resistor - world's smallest - no bigger than a dime!

Switches

(She started this branch of the family)

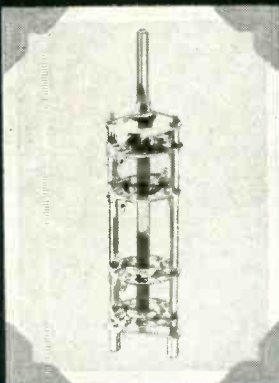

1936 A new and complete line of wave band switches

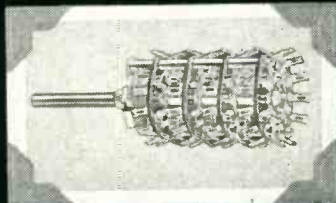

1938 The industry's first 24 contact per single section switch

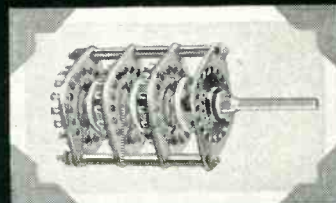

1943 The industry's first low-loss, high frequency medium duty powerswitch



1939 First multiple contact lever action switch

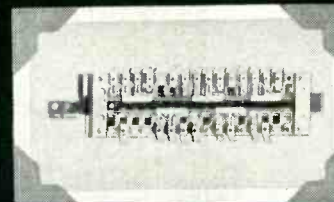

1947 The first slide switch introduced to the industry

(our most beautiful babies!)

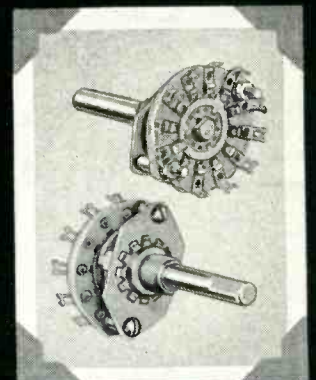

1951 New miniature rotary switch. (1 1/8" dia.)

HAS BEEN GROWING FOR 30 YEARS

Capacitors

(War babies who made more than good in peacetime)

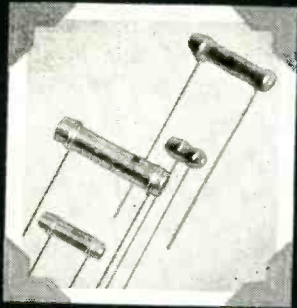

1936 Temperature Compensating Ceramic Capacitors

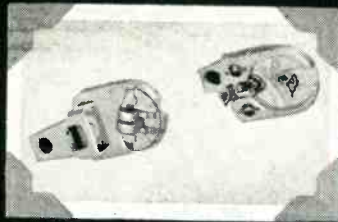

1939 Industry's first Ceramic Trimmer Capacitors



1941 Industry's first High Voltage Transmitting Ceramic Capacitors

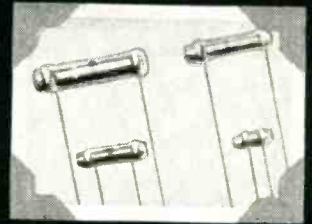

1945 Industry's first Tubular-Type, By-Pass coupling Ceramic Capacitors -

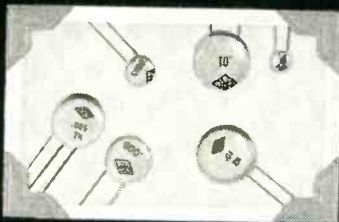

1946 The first Disc-Type By-Pass coupling ceramic Capacitors introduced to the electronic industry

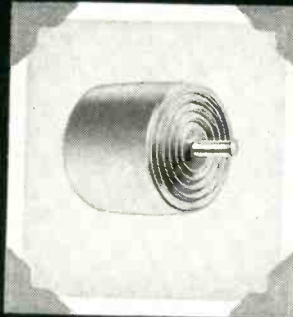

1947 Industry's first TV High Voltage Ceramic Capacitors

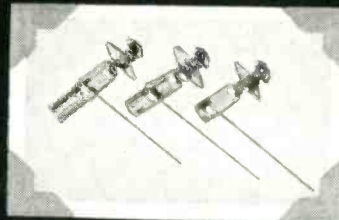

1949 Industry's first Ceramic Tubular Trimmer Capacitors

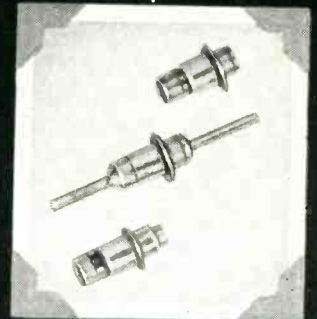

1951 New Eyelet Mounted Feed-Through Ceramic Capacitors

Printed Electronic Circuits

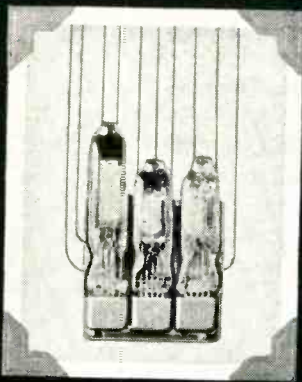

1943 Centralab originated the industry's first printed ELECTRONIC circuit

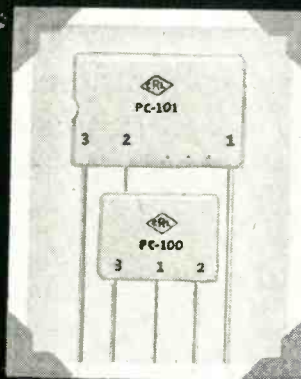
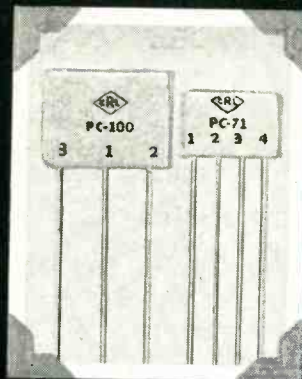

(Nobody ever saw anything like these, but now everybody wants them)

Ceramics

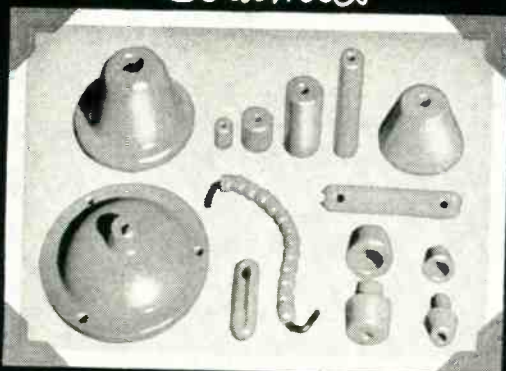

1942 First offered fine ceramics to industry. Actually, Centralab had been making ceramics for its own use since 1928... but in 1942 developed a grade L-5 Steatite Ceramic superior to the then existing Navy grade "G" specification. Centralab was the first to metalize ceramics. By 1945 Cordierite and Zirconite bodies with grade L-4 rating were developed.

(This branch of the family just grows and grows and grows and there's no room for all their pictures)

Centralab

A Division of Globe-Union Inc.
914 EAST KEEFE AVENUE • MILWAUKEE

sultants is the sale of service on the basis of negotiated rates for personal services and direct reimbursement for special materials (the so-called time-and-materials subcontract).

Prime contracts are frequently avoided. The usual 7 percent fixed fee allowed on cost-plus-fixed-fee prime contracts runs the risk of being wiped out by disallowances of cost items.

Communications Firms Scrape Labor Barrel

DUE to defense expenditures and strong tv set demand, communications equipment manufacturers expect to hire 35,000 more workers by December 15, increasing by 10 percent the 365,000 employees in this branch of the industry at mid-year. They still face severe shortages of professional, technical and skilled workers, according to a Department of Labor survey.

More than 40 percent of the companies surveyed, employing two-thirds of the workforce, have had difficulty in finding qualified workers. However, only a few manufacturers reported that the shortages were seriously impeding operations.

► **Area Gains**—A major labor expansion program is projected by electronics manufacturers in Boston, who plan to increase their production staffs by 20 percent. The largest proportional increase is employment in the communications equipment industry during the last year was in New York, with a gain of 33 percent.

WCEMA Celebrates 10th Anniversary

BOARD of directors of the West Coast Electronic Manufacturers Association will commemorate the Association's tenth year at a dinner at the new Statler Hotel in Los Angeles on Thursday, November 13. The celebration will climax "Western Electronics Week" set for November 10 to 14.

Freshman Enrollment Increases

Early returns from schools show increased quantity and quality of new registrants

INDICATIONS are that freshman enrollment in engineering colleges this fall is up 10 to 20 percent over 1951. Overall male college student admissions may show a slight increase over last year's figure despite low tide in supply of high-school graduates that reflects the low birth rate of depression years. The trend towards engineering and away from less technical studies continues.

► **Informed Guesses**—These estimates are based upon statements of several college deans of engineering. U.S. Office of Education survey reports are not yet available, although preliminary returns indicate a 13 percent rise in overall college freshman enrollment. This figure, based largely on returns

from smaller schools, will probably be pared down in the final analysis.

Indications, based upon entrance examination results, are that this year's engineering freshman is of slightly higher scholastic calibre than his 1951 predecessor.

► **Demand High**—Demand for young graduates stood at 40,000 this year. This reflected a leveling-off of the tooling-up stage of rearmament and improved utilization of engineers by industry. Engineering graduates totaled 30,000, with only 15,000 immediately available to industry. The balance sheet shows 16½ percent commissioned through ROTC, 22 percent draft eligible, 6½ percent headed towards advanced degrees and 4½ percent enrolled in enlisted reserve or national guard.

The future appears to hold 20,000 engineering graduates for 1953, 17,000 for 1954 and 20,000 for 1955. ROTC enrollees in these classes number 4,600, 7,650 and 11,000.

Tax Laws Favor Repair of Equipment

Maintenance costs can be deducted, but replacements must be capitalized or depreciated

EVEN though it may cost more to repair an old spot welder or electronic heating generator than to buy entirely new equipment, some tax-conscious executives are encouraging such work. The reason is that repair costs are deductible on income tax returns. Modifications, however, are not always classed as repairs by the U.S. Treasury Department.

► **Deductible Modifications**—If the intent is to continue ordinary operation or use of a piece of equipment, without appreciably prolonging its life or improving its performance, the cost of the repair is fully deductible on the tax return for the year in which the repair is made. The actual cost of a repair in rela-

tion to the cost of new equipment does not effect the tax interpretation if other facts prove it is a true repair.

Repairs made to avoid violating a law or requirement of a regulatory body are usually deductible. Thus, modifications of electron bombarders, diathermy equipment and electronically controlled welding equipment to suppress radiation banned by the FCC could be considered deductible.

► **Not Deductible**—Whenever a so-called repair adds materially to the value of a property, appreciably prolongs its life, improves efficiency or gives added functions, it becomes an improvement or replacement in the eyes of the law. The cost must then be capitalized or changed to a depreciation reserve. In the latter case, cost is not deductible in a lump sum but must be spread or depreciated over the reasonable expected life of the equipment.

Proof of intent generally influ-

(Continued on page 16)

SHOCK and VIBRATION NEWS

BARRYMOUNTS FOR ASSURED CONTROL OF SHOCK AND VIBRATION

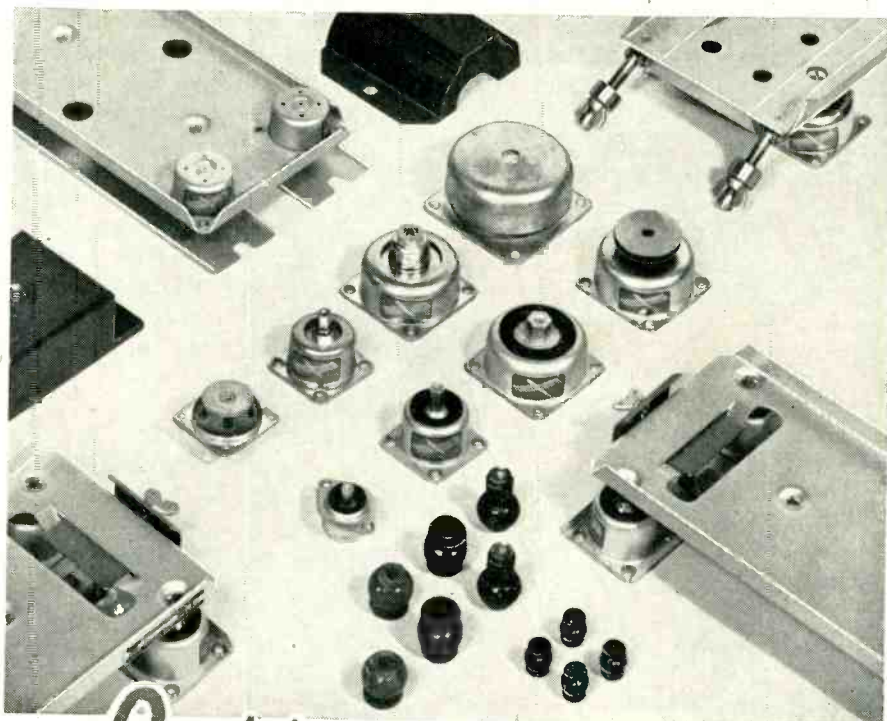

the *Right* answer

TO YOUR SHOCK AND VIBRATION PROBLEMS

will be found in this complete family of Barrymounts. From tiny, ounce-rated unit mounts . . . through ruggedized bases . . . to heavy-duty isolators for industrial machinery . . . Barrymounts meet all your needs. FREE CATALOGS give you details of dimensions, load ratings, and military specifications met by these effective vibration and shock isolators.

FOR AIRCRAFT SERVICE

Catalog 509 describes ALL-METL Barrymounts for use at extreme temperatures. Catalog 502-A covers Air-damped unit mounts and bases.

FOR INDUSTRIAL USES

Catalog 504-B describes the general line of Barrymounts rated from $\frac{1}{8}$ ounce to 3300 pounds. Catalog 607 covers the use of Barrymounts with heavy industrial machinery.

And for SPECIAL PROBLEMS

ask the advice of our Field Engineering department, organized to apply our wide experience to your particular needs.

Address all inquiries to:

THE **BARRY** CORP

707 PLEASANT ST., WATERTOWN 72, MASSACHUSETTS

SALES REPRESENTATIVES IN

Atlanta Chicago Cleveland Dallas Dayton Detroit Los Angeles
Minneapolis New York Philadelphia Phoenix Rochester St. Louis
San Francisco Seattle Toronto Washington

ences an examiner's decision on deductions. Here engineering memos and records become vital to prove intent to repair. Full records should be kept of transactions, contracts, notes of conferences, and other data pertinent to a repair job; even dictated personal thoughts on the issue are valuable

if dated and filed.

Where repairs are part of an overall factory project, Treasury tendency is to lump the whole cost as an improvement requiring capitalization. Two contracts help to avoid this—one for repairs and the other for replacement, substantiated by detailed records.

represents the equivalent aggregate market value of the stocks for the five year post-war period 1935-1939. The monthly average is computed from the closing price of each stock on the four or five Wednesdays of each month.

The chart shows the stock price trend from January 1950 to the present. These curves tend to show the state of the stock market in general and do not necessarily reflect the vicissitudes of the electronics and broadcasting industries as such.

Financial Roundup

BEST picture of the bread-and-butter side of the electronics business for the first six months of 1952 is reflected in the earnings statements of manufacturers in the field. In September five companies announced earnings for the period January-June:

Company	'52	Net Income '51
American Cable & Radio ...	\$ 377,408	\$ 807,732
AT&T ...	14,938,168*	17,643,448*
IT&T ...	9,666,002	8,693,096
I-T-E Circuit Breaker .	1,332,418	864,721
Westinghouse ...	31,507,000	31,564,000

* Net operating income.

Tung-Sol, which recently made its bow on the New York Stock Exchange, announced earnings of \$492,241 for the first quarter of 1952. For the 26-week period ending June 28, income was \$889,843 compared to \$1,305,113 for the same period in 1951.

IT&T received \$4,844,000 from the Spanish Government in partial payment for the sale of its investment in the Spanish Telephone Company. The company plans to invest \$12,000,000 in its Argentina subsidiary, *Compania Standard Electric Argentina*, for plant expansion and to supply the Government's telephone system with components and raw materials as part of a new agreement recently signed with the Argentine Government. Previous supply and advisory contracts were cancelled. As indemnification for the cancellation, *IT&T*

(Continued on page 18)

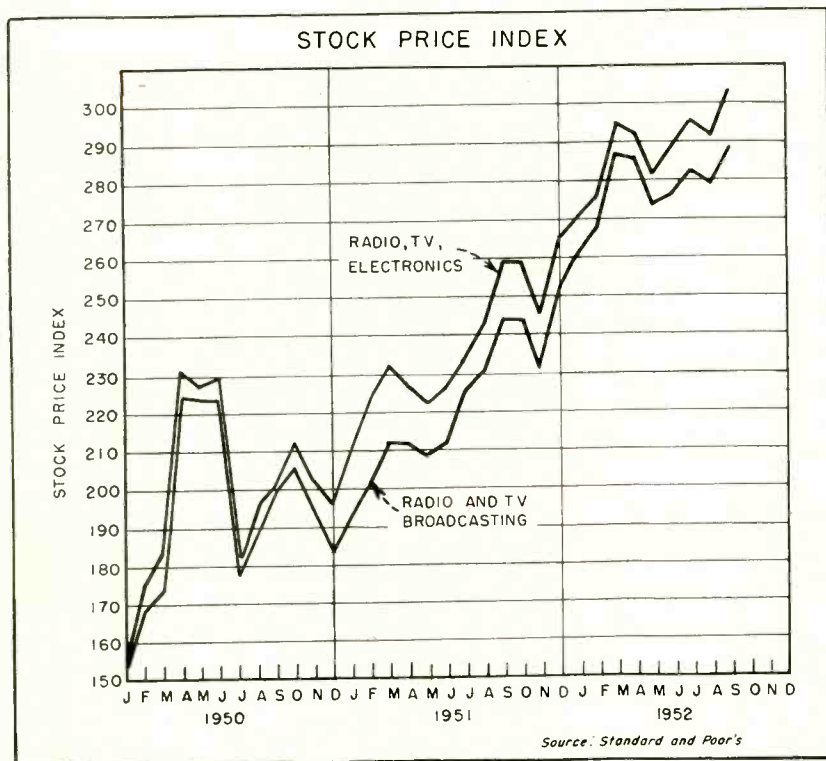

ELECTRONICS investors benefit by steady growth of industry that makes ...

Stock Price Averages Triple Pre-War Mark

RADIO, television and electronics stock prices soared to a new high in September, reaching an average value of three times that of immediate pre-war years, as shown in the accompanying chart. This increase compares with 1.9 times for all industrial stocks and 1.8 times for all stocks listed on the New York Exchange over the same period.

► **Source**—Stock price average figures are reported each month on page 4 of **ELECTRONICS**. They are based on a group of stocks selected as being representative of the in-

dustry. The figure for "Radio-TV and Electronics" is based on eleven stocks of the following corporations: Admiral, Cornell-Dubilier, Emerson, General Instrument, Magnavox, Motorola, Philco, RCA, Sylvania, Zenith and Raytheon. This list purposely omits certain large corporations, like General Electric and Westinghouse, whose electronic business is but a fraction of their total output. Only two stocks, those of RCA (NBC) and CBS, underly the "Radio Broadcasters" listing.

The values of the stock price averages are based on 100, which

Impedance measurements

FROM 10 TO 1500 Mc

The General Radio V-H-F Bridge and U-H-F Admittance Meter enable measurements of a variety of impedance types over a very wide frequency range—from 10 to 1500 Megacycles.

Measurements on antennas, transmission lines, coaxial systems and networks, impedance components, and on both v-h-f and u-h-f television circuits may be made to a high degree of accuracy. Reflection coefficient and standing-wave ratio may be readily determined with the aid of either of these instruments.



VHF BRIDGE

TYPE 1601-A \$395.

Frequency Range: 10 to 165 Mc, direct reading
 Reactance Range: ± 230 ohms at 100 Mc
 Resistance Range: 0 to 200 ohms
 Accuracy: Resistance — $\pm (2\% + 1 \text{ ohm})$
 Reactance — $\pm (5\% + 2 \text{ ohms})$

Features

- ★ Resistive and reactive components are independent—no sliding balance
- ★ Direct-reading resistive and reactive indicators insure convenience, rapidity and unusual ease in operation
- ★ Accurate low impedance measurements with the V-H-F Bridge — measures high impedance indirectly
- ★ Accurate measurements over a wide impedance and frequency range with the U-H-F Admittance Meter
- ★ Terminal arrangements and accessories permit measurement of both coaxial and lumped circuits — new constant-impedance adjustable line and balun greatly facilitate measurements
- ★ Coaxial adaptors eliminate connecting lead and residual terminal capacitance errors
- ★ Small size and light weight facilitate use in cramped locations such as antenna towers

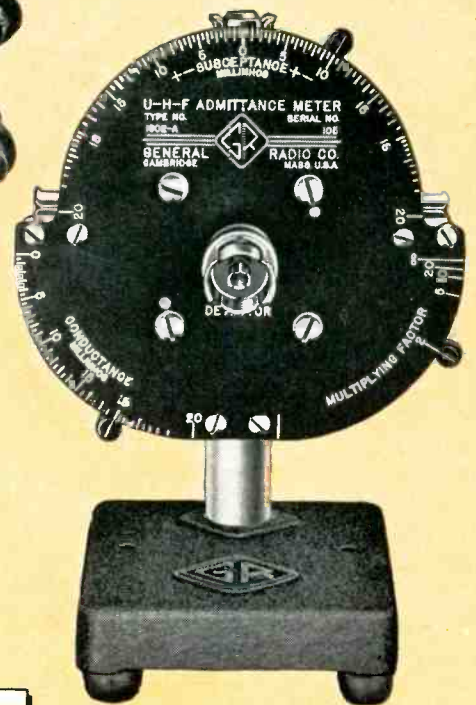

UHF ADMITTANCE METER

TYPE 1602 \$295.

Frequency Range: 66 to 1000 Mc, direct reading.
 Indirectly from 20 to 1500 Mc
 Conductance Range: 0.2 to 1000 millimho
 Susceptance Range: $\pm (0.2 \text{ to } 1000) \text{ millimho}$
 Accuracy: Conductance and susceptance
 0 to 20 millimho
 $\pm (5\% + 0.2 \text{ millimho})$
 20 to ∞ millimho $\pm 5 \sqrt{M} \%$
 (M is scale multiplying factor)



GENERAL RADIO Company

275 Massachusetts Avenue, Cambridge 39, Massachusetts
 90 West St. NEW YORK 6 920 S. Michigan Ave. CHICAGO 5
 1000 N. Seward St. LOS ANGELES 38

received \$3,800,000 from the Peron government.

► **Stock Offerings**—*Skiatron* offered 108,000 shares of additional common stock (par value 10 cents) of the Skiatron Electronics and Television Company at \$2.50 per share. Proceeds will be used to carry on a public test of its pay-as-you-see television system known as Subscriber-Vision in the New York Metropolitan area. Plans call for a 90-day test of the system in 300 homes. An initial charge of \$1.00 per show will be made during the test. In June, Skiatron entered into an agreement with Hanovia Chemical & Manufacturing Co. of Newark, N. J., a unit of Engelhard Industries and maker of ultraviolet medical and home equipment, which makes plant and production facilities of Hanovia and research and engineering facilities of the Engelhard companies available to Skiatron.

Admiral offers to exchange 1 share of its capital stock for 2 shares of Canadian Admiral Corp. A total of 42,654 shares of Canadian Admiral stock has been deposited in accordance with the exchange order. Admiral now owns 85.8 percent of the shares of Canadian Admiral.

RCA plans the acquisition of the Estate Stove Company of Hamilton, Ohio, a division of Noma Electric, subject to the approval of Noma Stockholders at a meeting scheduled for Nov. 5. RCA will form a new subsidiary, the RCA-Estate Appliance Co. Inc.

National Cash Register has a stock purchase agreement with the Computer Research Corp. of Hawthorne, Calif. under which it will acquire a controlling interest in the company. The transaction, involving \$1,000,000, is subject to Federal Court approval. The computer company employs 140 people.

Electronic Computer Corp., Brooklyn, N. Y. is offering an issue of 52,500 shares of Class B (non-voting) common stock (par one dollar) at \$3.00 per share. Proceeds are to be used for development work and working capital.

Electro-Components Corp. of America offers an issue of 2,000,000

shares of common stock (par one cent) at 12 cents per share. Net proceeds to be used to repay a loan from Electronic Devices, Inc. and for new equipment and working capital.

► **Stock Registrations and Filings**—*Penn-Allen Broadcasting Co.*, Allentown, Pa. files with SEC for 4,014 shares of common stock (par \$10) and 10,035 shares of Class A common stock (par \$10) offered in units of two common and five class A shares at \$70 per unit without underwriting. Proceeds will be used to construct and operate a television station.

Television Equipment Corp. files for 1,225,000 shares of common stock (par 5 cents) to be issued at 11 cents per share. Proceeds will be used for working capital.

Westinghouse registers with SEC a statement covering 150,000 shares of its \$12.50 par common stock offered under its "Employee Stock Plan". Workers can buy the stock on the installment plan by payroll deductions. For six months after issue in May, 1953 the stock will be offered for \$5.00 less than the average market price for it during the first days of April, 1953. The purchase price, in any event is not to be more than \$42 or less than \$30 a share.

Electronic Micro-Ledger Accounting Corp., Boston, Mass., files notification covering 299,900 shares of common (par 10 cents) to be offered at \$1. per share to pay for building equipment.

New UHF Lead-in Proves Out in Portland

Special design for tv works according to calculations of designers

TELEVISION engineers want an inexpensive, mechanically rugged, air-insulated two-wire waterproof cable to lead uhf picture signals from antenna to receiver. For vhf television they have found a useful compromise in the familiar 300-ohm ribbon. But losses in ribbon lead-

ins at the new-channel frequencies are extremely high if the ribbon is damp and covered with soot or salt spray.

Engineers of Anaconda Wire and Cable Co., working with those of RCA Service Corp., have come up with a cable that received its baptism during the opening of KPTV in Portland, Oregon, recently. As shown in the illustration, a pair of Copperweld conductors carry the voltage. They are each wrapped with a spiral of polyethylene thread and then surrounded by a clear polyethylene tube. In the final manufacturing process, a brown polyethylene covering is extruded over

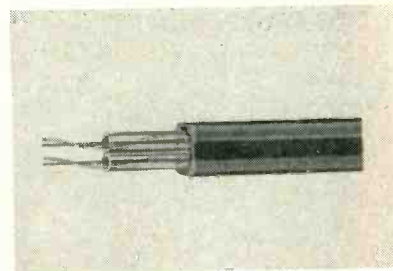

UHF-TV antenna lead-in uses maximum of air and minimum of insulation close to the conductors. They are wound with spiral plastic thread, inserted in tubes and the tubes are supported away from walls of outer casing

the pair of tubes laid side by side. In cross section, the cable resembles a rectangle with the corners rounded off. Inside each corner a ridge supports the round tubes away from the walls of the casing.

► **Electrical Characteristics**—Losses per hundred feet of dry cable range from 1.5 db at 100 mc to 5.2 db at 1,000 mc, which is above the high end of the uhf tv band. Wet, the losses run higher. Since there is no sure means, short of dumping the cable into a vat of salt water, to make comparable wet tests, engineers are cagey about mentioning figures in public. Based upon their experiences in Portland, they are content to say, "if reception is good when the line is dry, it is also good when the line is wet."

► **Where Do We Get It?**—The new line is now available in quantity, although probably not at the local radio store. It will cost, initially,

(Continued on page 20)

LABORATORY for ELECTRONICS, INC.

Research, Engineering and Production of Precision Electronic Equipment

MODEL 401 OSCILLOSCOPE

— a high gain, wide band, versatile, general purpose instrument for precise, quantitative studies of pulse waveforms, transients and other high or low speed electrical phenomena.

For complete information Ask for Bulletin O52



MODEL 101 MAGNETOMETER

Accurately measures magnetic field strength using the principle of nuclear resonance.

For complete information Ask for Bulletin M52

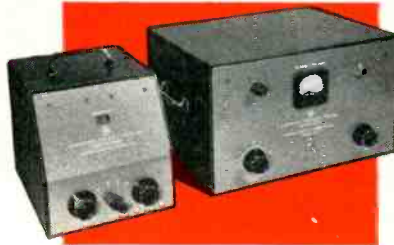

MERCURY DELAY LINES

Used for storage of information, comparison of two sets of information, correlations and sequential timing devices, they are the smallest, most compact lines available.

For complete information Ask for Bulletin MDL51



MODEL 802 STABLE MICROWAVE OSCILLATOR

Provides a highly stable source of microwave signals, suitable for use as a laboratory standard. Features a direct reading frequency dial, sine wave modulation input and self-contained power supply.

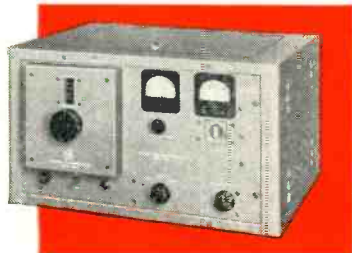

Engineering Representatives:

Albuquerque, New Mexico
Gerald B. Miller Company
302 1/2 West Central Avenue
Albuquerque 3-1998

Alexandria, Virginia
W. A. Brown & Associates
3834 Mt. Vernon Avenue
Overlook 6100

Atlanta, Georgia
W. A. Brown & Associates
1570 Northside Drive
Vernon 5395

Boston 15, Mass.
Walter T. Hannigan Company
43 Leon Street
Garrison 7-2650

Chicago 45, Illinois
Hugh Marsland & Company
6405 N. California Avenue
Ambassador 2-1555

Cleveland 15, Ohio
M. P. Odell Company
2536 Euclid Avenue
Prospect 1-6171

Dallas 1, Texas
J. Y. Schoonmaker Co.
2011-13 Cedar Springs
Sterling 3335

Dayton 6, Ohio
M. P. Odell Company
2676 Salem Avenue
Oregon 4441

Hollywood 28, California
Gerald B. Miller
1540 N. Highland Avenue
Hollywood 9-6305

Minneapolis 2, Minnesota
H. M. Richardson & Company
2210 Foshay Tower
Geneva 4078

New York 23, New York
Land-C-Air Sales Company
1819 Broadway
Plaza 7-7747

San Francisco 3, California
Gerald B. Miller Company
1355 Market Street, Space 280D
Klondike 2-2311

Wichita, Kansas
George E. Harris & Company
306 Lulu, P. O. Box 3005
Telephone 62-2731

*Phone or write your representative
for complete information on
LFE electronic equipment.*



LABORATORY
for
ELECTRONICS, INC.

75 PITTS STREET BOSTON 14, MASS.

PRECISION ELECTRONIC EQUIPMENT • OSCILLOSCOPES • MAGNETOMETERS • COMPUTERS • MICROWAVE OSCILLATORS • MERCURY DELAY LINES

three to four times as much as a good grade of ribbon line. Because it uses a copper-over-steel conductor, it saves critical material. The nearest comparable coaxial cable, for example, requires more than ten times the amount of copper.

When the serviceman installs this line he must seal off the outdoor end to prevent the air spaces filling with moisture. This is simply done by melting the polyethylene at the end with a cigarette lighter and pressing the molten material together into a mass.

Merrill In For Jones

FEDERAL Communications Commission is again up to team strength by the appointment of Eugene Hyde Merrill, Democrat of Utah, to fill the unexpired term of Robert F. Jones, Republican of Ohio. Although the position runs to June 30, 1954, Merrill's tenure is sure only until Congress reconvenes in January. His future depends both upon party in power and his future acceptability to his own party.

Commissioner Merrill graduated in 1932 from the University of Utah as a mining engineer. His experience in public utilities, from the government side, is extensive and he has held several positions under the Federal government. These include Office of Production Management, Foreign Economic Administration and most recently, in the National Production Authority.

TV Networks And CP Holders Press Bell

ANALYSIS of the locations of the first 68 new television-station construction permit holders reveals that more than half of them are not in cities on the Bell System's tv network routes, either planned, under construction or in operation. As a result, network broadcasters and new tv cp grantees are asking Bell for additional television network facilities.

► **Bell's Plans**—Bell says that its statement made when the freeze

was first lifted still holds true: "Further expansion of the Bell System's network will be governed by the needs of individual stations and the network broadcasters. Future steps also may be influenced by the availability of critical equip-

ment and material."

The company emphasizes the importance of receiving adequate advance notice of plans from the tv industry, to permit the scheduling of an orderly construction program, and requirements.



HELICOPTERS survey Brazilian jungle as . . .

Microwave Invades Latin America

LOFTY MOUNTAIN PEAKS with precipitous drops to steaming jungle make much of Latin America a line-of-sight propagation paradise. With notoriously bad interurban telephone service, it is not surprising that Latin America is turning to radio relay in a big way.

VHF has long-standing popularity in Latin America, aided in part by availability of channels. Microwave is catching on rapidly, however, with rising demand for increased channel capacity. Further, the Latin-on-the-street exerts much influence on his government's spending and tends often to favor most recent alternative systems.

► **Obstacles**—Major technical obstacles to microwave installation are lack of dependable power for unattended repeater stations and scarcity of trained technicians.

Financially, dollar-exchange restrictions are common and in some countries, import bans had to be met by shipping unfinished chassis

to local assembly plants.

In spite of these problems, 16 microwave systems are either operating or planned in eight different Latin American countries. Fully half the systems are used for remote control, linking studios with distant radio transmitters or receivers.

► **Brazil**—A nine-hop, 24-channel microwave system linking Rio de Janeiro and São Paulo will be Brazil's longest. Ordered from International General Electric by Senhor João do Amaral, local newspaper and radio magnate, the system will provide two high-fidelity channels to serve Amaral's Rio and São Paulo a-m outlets. Remaining channels will be used for telephone, facsimile and leased-wire teleprinter. Most likely leasee . . . the Brazilian army.

Complete plans call for an 850-mile system extending southward to Porto Alegre. Senhor Amaral, who is currently installing televi-

(Continued on page 22)

EXPERTS *in Filters for the Military*

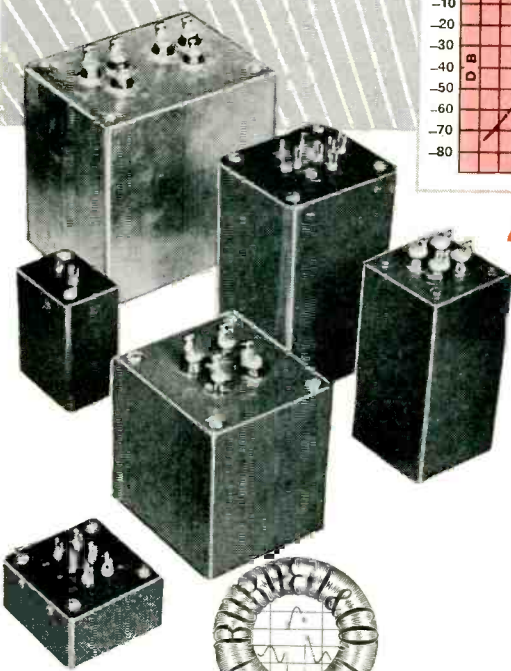
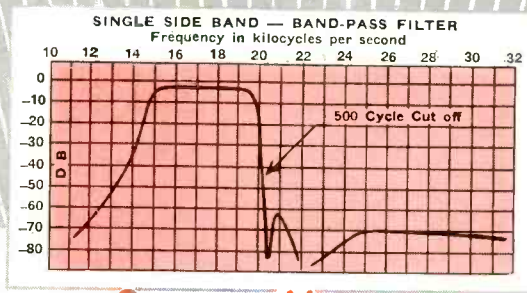
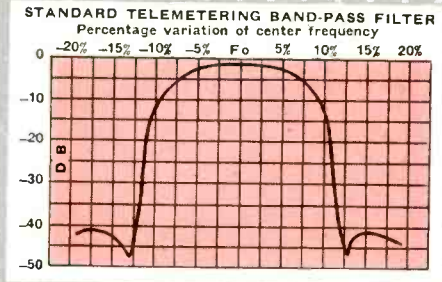
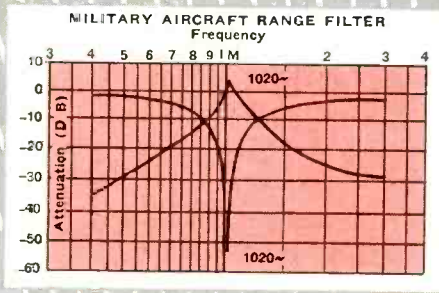
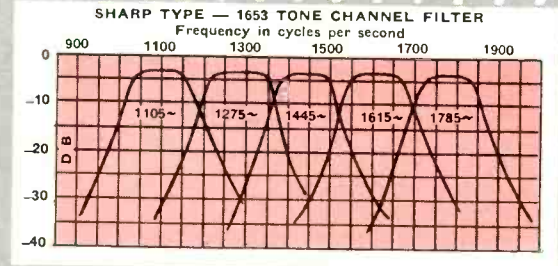
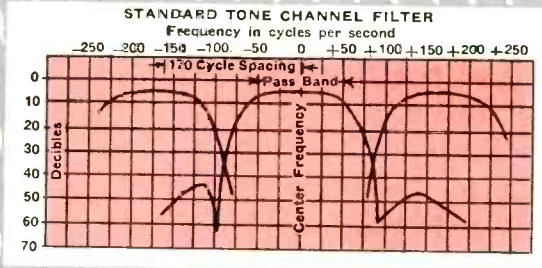

Burnell High Quality Toroids and Audio Filters

With each new technological advancement in military electronics the design engineer has had to cope with more difficult network problems.

Today it is not sufficient for the engineer just to know what signal to clean up or which to reject or separate.

His filter requirements have become increasingly complicated by other critical factors such as phase shift, linearity, transient response, extreme accuracy through wide temperature ranges etc.

True, these have always existed to a certain degree but their importance has become considerably amplified in such applications as Guided Missiles, Radar and Sonar.

The BURNELL & CO. engineering staff has won many friends among our customers through the valuable assistance they have rendered in the solution of their network problems. If YOUR application involves audio filters or similar networks write or call our engineers who will give prompt attention to your requirements.



EXCLUSIVE MANUFACTURERS OF COMMUNICATIONS NETWORK COMPONENTS

sion transmitters in both Rio and São Paulo, plans eventually to parallel his system with a microwave television relay.

► **Cuba**—Two rival Cuban television networks are planning parallel microwave television relays from Havana to Santiago, 500 miles distant. Both systems will use Philco equipment.

Radiotelevision El Mundo has ordered a 5-station, 110-mile network from Matanzas to Santa Clara. The system will furnish one tv channel and a service channel.

Circuito CMQ is beginning its network with a 7-station system linking Havana with Santa Clara. It will provide three tv channels and three service channels.

Denver's Second TV Station On Air

KBTV, Denver's second tv station, began regular programming on Oct. 12 with the programs of CBS and ABC. The station ran a series of engineering test programs previous to that date.

With its interim power of 12 kw erp, reception is reported at Cheyenne, Wyoming, Colorado Springs and across the continental divide at Granby, Colorado, indicating that eventual service will cover an area within a radius of 100 miles.

Wide coverage is attributed to the transmitter location on Lookout Mountain, 2,500 feet above Denver. TV receiver servicemen report that little adjustment of antennas is necessary to receive the channel 9 signal.

The Rocky Mountain Electrical League reports 57,964 sets in the area as of October 1. Predictions are that up to 100,000 sets will be sold there by January 1, next year.

Binaural Sound Is New Audio Market

Three-dimensional listening takes hold. Two-track discs and tapes appear

DEMONSTRATIONS of new multiple-channel audio equipment in New York City's Broadway Theater and by many different electronic manufacturers at the Audio Fair presage a new market for radio and audio equipment. Possibilities are doubly enticing dollar-wise because everything must be in duplicate, from the microphones that serve as twin ears right on through the audio system to the speakers that reproduce the illusion of directional sound.

Purists maintain that true binaural sound reproduction (each instrumental sound appears to be coming from the location of that instrument in the orchestra) can be obtained only with earphones fed by separate channels. With loudspeakers spaced the recom-

mended ten feet or more apart, each ear hears both sound sources to a varying extent, depending on listening position, and the effect is really stereophonic. However, industry favors the term binaural as a simpler designation.

► **Seven-Channel Theater Sound**—Most dramatic of all listening effects achieved to date is that of Reeves-backed 'Cinerama'. Here seven different magnetic sound tracks on 35-mm sprocketed film feed seven groups of speakers arranged behind a huge circular screen almost surrounding the audience. Synchronous motors insure lip-sync with the three projectors employed. During filming of scenes, microphone placement is carefully related to speaker locations in the theater. Thus, when filming the landing of a plane on an aircraft carrier, the seven microphones are equally spaced along the length of the carrier to pick up the sound as the plane roars past each. The resulting illusion in the theater is that the roaring plane goes right over the heads of the audience.

► **Two-Station Broadcasting**—Use of two separate microphones and sound channels when broadcasting a program simultaneously over an a-m radio station and its f-m affiliate permits reception on two receivers in opposite corners of a living room in a home, to give binaural broadcast reception. This technique was demonstrated by WQXR-AM and WQXR-FM in two broadcasts during the Audio Engineering Society's annual convention. Two wire lines were leased to carry one of the programs to Hartford for broadcasting there by F. M. Doolittle's f-m and a-m stations, to demonstrate feasibility of network binaural.

► **Twin-Groove Disc Recordings**—Use of two parallel grooves on 33 $\frac{1}{3}$ -rpm LP discs as a two-channel source for binaural sound was advocated by Emory Cook of Cook Labs in the opening paper at the convention. Two ordinary LP pickups are mounted one behind the other on a single arm, with their needles riding in adjacent grooves,

(Continued on page 24)

Microwave Systems in Latin America

Remote Control

Argentina (Army)	Federal	
(Navy)	RCA	4 terminals
Brazil (Navy)	RCA	6 terminals
Chile (Government)		
Cuba (Aeronautical Radio de Cuba)	Federal	2 terminals
Mexico (Government)		12 miles
Aeronautical Radio de Mexico	Federal	2 terminals
Guatemala (Tropical Radio)	Raytheon	2 terminals

Telephone

Mexico (Telephones de Mexico)	Federal	2 term., 1 rep.
Puerto Rico Telephone Co.	Federal	
Puerto Rico Water Resources Authority	Motorola	12 miles
Venezuela (Shell Petroleum)	Standard Elec. (Brit)	30 miles

Radio and TV Relay

Brazil (Amaral)	GE	2 term., 8 rep.
Cuba (Circuito CMQ)	Philco	2 term., 5 rep.
(El Mundo)	Philco	2 term., 3 rep.

Telegraph

Puerto Rico Communications Authority		2 term., 1 rep.
--------------------------------------	--	-----------------

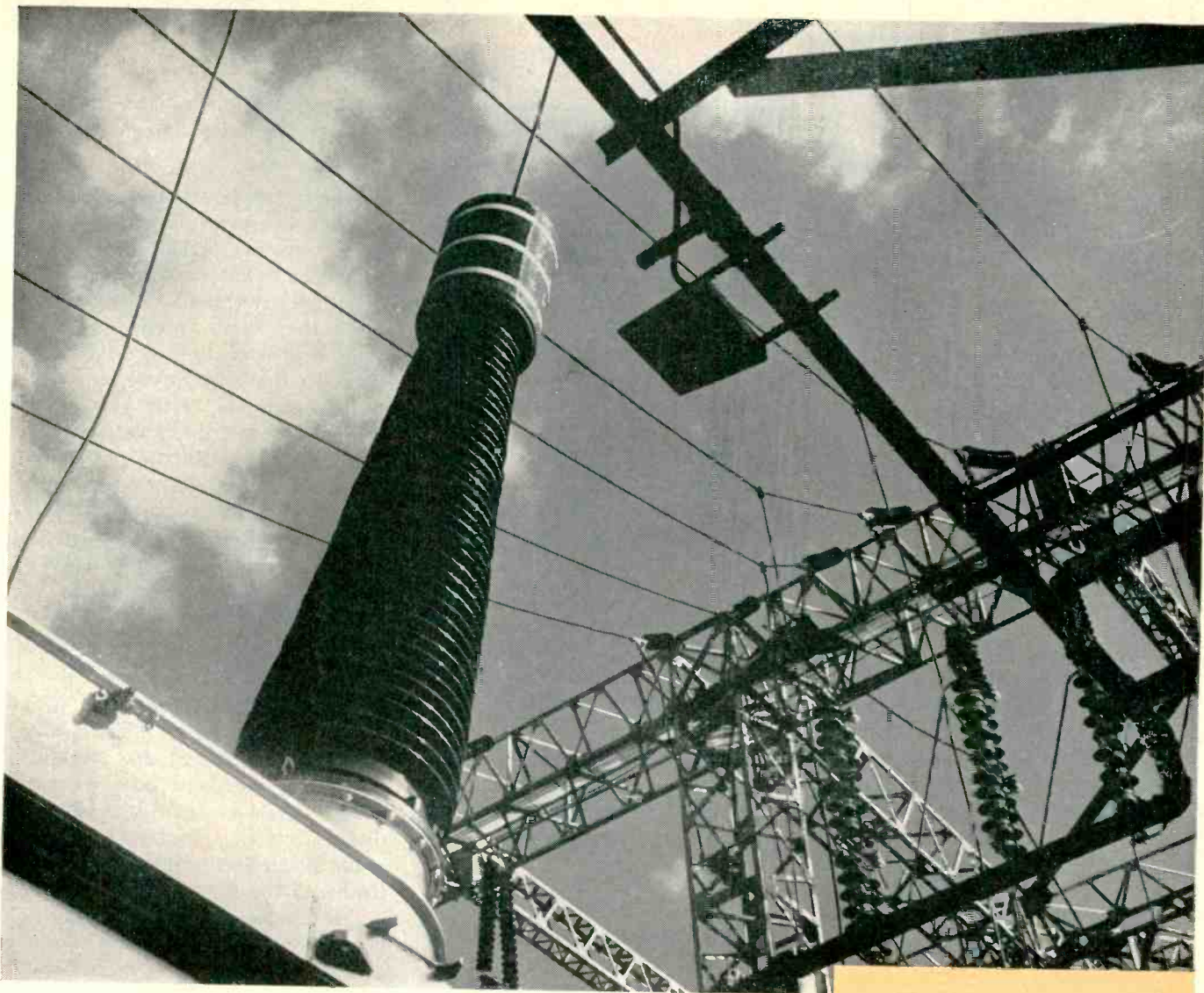

"More Power to You—Safely, with **SYNTHANE**"

Electrical energy is restless . . . would jump at any chance to escape—if it could.

The fact that voltage can be stepped up for transmission, stepped down for use; that current can be led to and from transformers, around switchboards, and steered into circuits safely you may credit to electrical apparatus builders. Important materials to them are Synthane laminated plastics.

Synthane laminated plastics are used in transformers for spacers and coil forms because it is an insulator unaffected by oils; in tap changer panels because it is a

machinable insulator with high dielectric strength; in "Glowtectors" because of high insulation resistance and abuse-resistance; in circuit breakers and bus bars for its arc resistance.

Synthane, an unseen essential to power-generation, transmission, and control, may be helpful to you. Send for your copy of the Synthane Catalog and learn all about Synthane's combination of electrical, chemical, physical and mechanical properties. Synthane Corporation, 6 River Road, Oaks, Pennsylvania.



PETTICOAT STANDOFF INSULATORS machined from Synthane square-hole tubing. Here, Synthane was specified for its good dielectric properties, machinability and rugged strength.

Synthane—one of industry's unseen essentials

SYNTHANE
S

LAMINATED PLASTICS

to play these records through two separate sound systems.

Several record manufacturers are coming out with binaural records, priced under \$5 per 12-inch disc; this is comparable to present LP prices, though twin-track recording necessarily cut playing time in half. One large receiver manufacturer is considering production of binaural phonographs having dual amplifiers and one remote speaker.

► **Twin-Track Magnetic Tape—**

Both Magnecord and Ampex have two-track tape equipment of high-fidelity professional quality, to sell in the \$850 and \$1,500 price ranges respectively. These models were widely used as signal sources for binaural demonstrations in the exhibit rooms at the Audio Fair. Both use standard magnetic tape and staggered heads to give two parallel tracks. Narrowed tracks give slightly poorer signal-to-noise ratio but do not affect fidelity.

The psychological effect of binaural listening on the ears is such that background noise and distortion become much less noticeable; the result is a tremendous impact on first-time listeners even with mediocre audio equipment.

Electronic Music Business Growing

Larger 1952 sales volume forecast as trend toward tube-equipped organs increases

ELECTRONIC musical instruments represent a substantial equipment market for manufacturers.

Instrument sales this year are expected to be at least 30 percent higher than 1951's substantial volume. Sales of electronic organs alone in 1951 were about \$35 million, and amplifiers which are now available for virtually every stringed instrument reached a volume of over \$1.5 million last year.

► **Assemblers—**Some musical instrument manufacturers assemble their own electronic equipment and have sizeable electronic departments



This 93 tube all-electronic organ, used at the political convention in Chicago, turned out volume equal to 50 ordinary pipe organs or 3,000 home radios

in operation. During World War II, when instrument manufacturing was curtailed, many produced military electronic equipment.

Parts Distributors Get Ready For UHF

NEDA convention airs UHF problems of distributors and manufacturers alike

ELECTRONIC parts distributors at the recent NEDA Convention were uneasy about the uhf television picture. Big questions on their minds concerned deliveries of converters, antennas and lead-in for uhf. Even though most of the cities they represented did not have uhf cp grants, distributors wanted to be ready for it.

Several distributors at the convention did come from cities with cp grants for uhf stations. They reported that telephones began ringing as soon as the grants were announced. Customers wanted samples of uhf antennas, converters and lead-in as well as special servicing instructions. As a result, some parts distributors in markets that may not have uhf

tv for years, find that the demand is substantial and supply is lacking.

► **On The Spot—**A panel of manufacturers representing antenna, lead-in, converter, tube and set companies were put on the spot at the convention to answer these delivery and supply questions. But on the whole they were unable to give definite answers. They did say, however, that by November such equipment would really start rolling, including full-channel tv sets as well. The manufacturers pointed out two main reasons why quantity deliveries of the equipment had not been made. First, they wanted to take up to the last minute to work on further improvements of the equipment; second, quantity demand was still very small, despite words to the contrary.

► **Outlook—**Regardless of uhf problems, electronic distributors and manufacturers are looking forward to increased sales volume. H. F. Bersche of RCA predicted that electronic renewal volume would reach \$600 million this year. He based the figure on the following estimates of electronic equipment in use as of the end of the year: Radio (home, auto, portable sets)—110 million, television sets—20,250,000, AM-FM stations—2,940, tv stations—125, Non-broadcast communications—500,000 and amateur stations—110,000. By 1955 electronic renewal volume is expected to reach \$1 billion and by 1960 a total of \$2 billion. Thus the outlook is bright for electronic distributors despite present uhf problems.

Drive-in Theatre TV Makes Its Debut

USE of theatre television in a Rutherford, N. J. drive-in theatre, for the Walcott-Marciano title fight telecast, opened a new field for the growing medium and set new attendance records for the theatre even though admission was \$10 per car. The pictures shown were said to be the largest ever projected (24 by 36 feet). The projection

(Continued on page 26)

NEW! Complete Line
of **ERIE**
BUTTON[®] MICAS
for **150°C**
Operation



THE addition of a new complete line of **ERIE** Button Silver-Mica Condensers, designed for operation at 150°C, is important news to manufacturers of military electronic equipment and specialized commercial applications. The new line greatly extends the range of applications for the popular **ERIE** Button Micras. The new line is available in the eight standard terminal and mounting styles, and in other styles on special order. Write for samples and literature.

SPECIFICATIONS

- Maximum Operating Temperature:** 150°C.
- Voltage Rating:** 500 DC.
- Capacitance Values:** All standard decade values from 10 mmf to 1000 mmf.
- Capacitance Tolerance:** ± 20%, ± 10%, ± 5%, ± 2%, or ± 1 mmf, whichever is greater.
- Q:** 1000 minimum for values above 30 mmf.
- Insulation Resistance:** 10,000 megohms minimum.
- Life Test:** 750 volts DC for 1000 hours at 150°C.
- Seal Test:** Moisture resistance conditioning in accordance with MIL M745. After this the following shall be met:
 - Insulation Resistance:** 500 megohms minimum.
 - Q:** 500 minimum for values above 30 mmf.
 - Capacitance Change Limit:** 3% or 0.5 mmf, whichever is greater.
- Temperature and Immersion Cycling:** In accordance with ASEA Project 114. After this the following shall be met:
 - Dielectric Strength:** 600 volts DC.
 - Insulation Resistance:** 3000 megohms minimum.
 - Q:** 750 minimum for values above 100 mmf.
 - Capacitance Change Limit:** 3% or 0.5 mmf, whichever is greater.



ERIE RESISTOR CORPORATION . . . ELECTRONICS DIVISION

Main Offices: ERIE, PA.

Sales Offices: Cliffside, N. J. • Philadelphia, Pa. • Buffalo, N. Y. • Chicago, Ill.
Detroit, Mich. • Cincinnati, Ohio • Los Angeles, Calif.

Factories: ERIE, PA. • LONDON, ENGLAND • TORONTO, CANADA

throw of 125 feet is the longest on record.

Equipment consisted of RCA's standard theatre television system mounted on a five-ton truck. The signal was microwaved to the mobile projection booth from the Empire State building, 5½ miles away.

Stretch-Out Hits New Panel-Instrument Firms

STRETCHING OUT of government contracts has adversely affected some manufacturers in the panel-instrument field.

The panel-instrument market is good, constituting about 90 percent of the total instrument business in this country in terms of units sold. Level of business activity has remained fairly steady for the past 12 months.

Old and established firms, in most cases, have not greatly increased their production capacity and are enjoying good business conditions. But new manufacturers built plants, anticipating a radical increase in demand due to military needs. This radical increase has not yet materialized.

Robot Stencil-Cutter



New photoelectric machine by Roneo Ltd., London, produces a ready-to-use stencil in a few minutes from almost any typewritten, drawn, printed or photographic copy. As a phototube scans the original line by line, an electric spark cuts a facsimile design spot by spot on the stencil

MEETINGS

- OCT. 29: Armed Forces Communications Association, New York Chapter, Officers Club, Governor's Island, New York.
- NOV. 5-7: Sixteenth Annual Time and Motion Study and Management Clinic, Sheraton Hotel, Chicago, Ill.
- NOV. 7: IRE Microwave Professional Group, Symposium On Microwave Circuits, Western Union Telegraph Co. Auditorium, New York, N. Y.
- NOV. 7: AIEE Symposium, The Science of Music and Its Reproduction, Engineering Societies Bldg., New York, N. Y. Other lectures scheduled for Dec. 11, Jan. 15, Feb. 20, Mar. 12 and Apr. 16.
- NOV. 10-13: NEMA, Haddon Hall, Atlantic City, N. J.
- NOV. 10-30: International Radio and Electronics Exhibition, Bombay, India.
- NOV. 17-18: AIEE, Technical Conference on Recording and Controlling Instruments, Benjamin Franklin Hotel, Philadelphia, Pa.
- NOV. 19: American Standards Association, 34th Annual Meeting, Waldorf Astoria, N. Y.
- NOV. 21-22: Fourth Annual IRE Regional Papers Technical Conference, President Hotel, Kansas City, Mo.
- NOV. 24-25: Fifth Annual Conference on Electronic Instrumentation and Nucleonics in Medicine, New Yorker Hotel, New York, N. Y.
- DEC. 10-12: IRE-AIEE Computer Conference, Park Sheraton Hotel, New York, N. Y.
- JAN. 14-16, 1953: Joint AIEE-IRE Conference on High Frequency Measurement, Washington, D. C.
- FEB. 4-6: Western Computer Conference, Hotel Statler, Los Angeles, Calif.
- FEB. 5-7: IRE Southwestern Conference and Electronics Show, Plaza Hotel, San Antonio, Texas.
- MARCH 9-12: NEMA, Edgewater Beach Hotel, Chicago, Ill.
- MARCH 23-25: Sixth Annual Conference for Protective Relay Engineers, A & M College of Texas, College Station, Texas.
- MARCH 23-26: IRE National Convention, Waldorf-Astoria Hotel and Grand Central Palace, New York, N. Y.
- APRIL 18: Seventh Annual Spring Technical Conference, Cincinnati IRE, Cincinnati, Ohio.
- MAY 11-13: National Conference on Airborne Electronics, Dayton, Ohio.
- MAY 18-21: 1953 Electronic Parts Show, Conrad Hilton Hotel, Chicago, Ill.
- MAY 24-28: NAED, 45th Annual Convention, Conrad Hilton Hotel, Chicago, Ill.

Business Briefs

► **Magnetrons** and klystrons will be manufactured in Europe under an agreement recently made by Raytheon with the Fabbrica Italiana Raddorizzatori Apparecchi Radiologici (F.I.R.A.R.) of Genoa, Italy.

► **FCC** may postpone the effective date of rules for medical diathermy equipment made before July 1, 1947 to June 30, 1953.

► **Import Quota** recently set by the Italian government limits shipments of U. S. tv receivers to 5,000 for the second half of 1952.

► **An Endless Loop** of magnetic tape is used by P. K. Tobin of Evanston, Illinois to teach his young parakeet to talk. The tape

player is turned on when the family goes out for the evening, so only the parakeet has to endure the endless repetition.

► **Largest** train communications system in the world, representing an investment of \$9 million, is operated by the Pennsylvania Railroad. Nearly 1,300 radiophones are in service on trains and in wayside control towers along 2,000 miles of line.

► **Analysis** of one typical electronic equipment order placed with Westinghouse revealed that 44 percent of the \$16,965,288 contract had been passed along to subcontractors and suppliers. The largest of these subcontractors in turn spent 41.6 percent of his contract with 254 other firms. In all, a total of 381 firms participated in filling this one defense order.

How HONEYWELL MERCURY SWITCHES

help put the "automatic" in MAYTAG Automatic Washers!

An automatic washer must give safe, trouble-free service day after day. Water inflow must be accurately regulated and washing action begun at the proper time. The machine must never start while the lid is raised, must stop if the spin-drying basket becomes unbalanced during the drying cycle.

The Maytag Automatic Washer performs these vital functions unfailingly—with the help of three Honeywell Mercury Switches located in the machine's cover. Glass enclosures fully protect the switches from the effect of water vapor and splash which may vary from 60° to 150° F.

Prevents operation if lid is open or clothes in drying cycle are off balance

When the cover of the washer is lifted, this mercury switch tilts and stops the machine until lid is closed again. Actuated by a trigger, it also shuts off power if the spin-drying basket becomes unbalanced.

Controls water level

Proper water level is maintained automatically by a float which tips this switch to an angle causing it to shut off the inflow of water and hold desired water level within 1-16 of an inch.

Starts washing action

When the float reaches proper water level, this switch starts the washer agitator and begins the washing cycle.

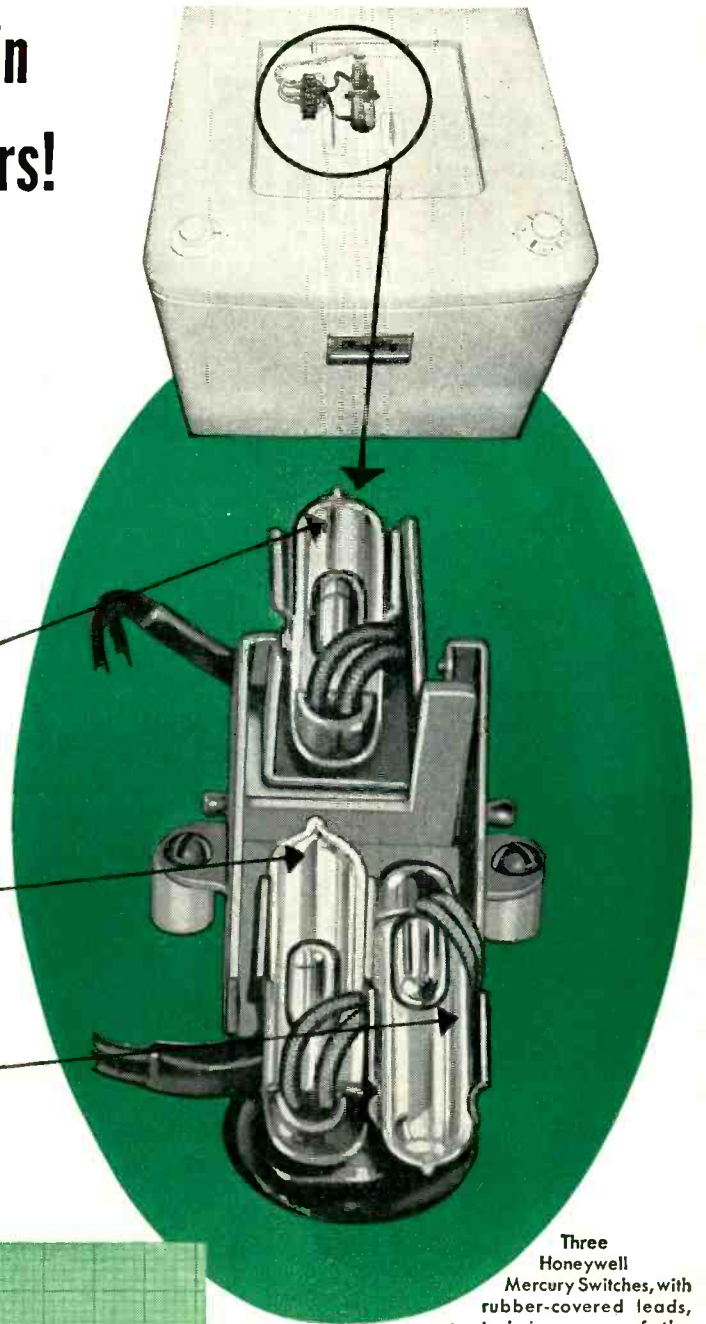

Three Honeywell Mercury Switches, with rubber-covered leads, mounted in cover of the Maytag Automatic Washer.

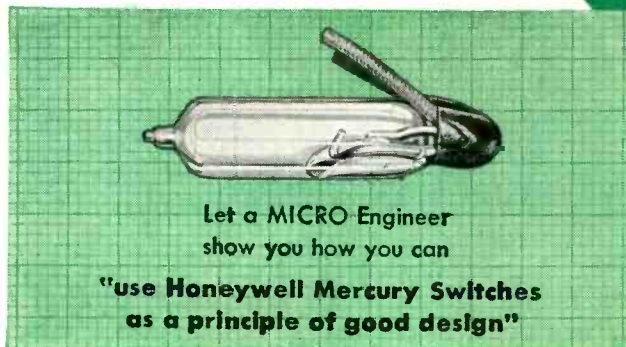

Your nearby MICRO field engineer will help select the *exact* mercury switch for your application from more than 90 Honeywell Mercury Switch designs. These include a wide variety of mountings, actuating linkages, lead supports, terminal blocks, enclosures. Contact your nearest MICRO branch office for information.

MICRO
MAKERS OF PRECISION SWITCHES
FREEPORT, ILLINOIS

A DIVISION OF
MINNEAPOLIS-HONEYWELL REGULATOR COMPANY



Unique **PHELPS DODGE** development

DRASTICALLY CUTS



- ✓ FAST WIRE-TO-WIRE BONDING INTO RIGID COIL.
- ✓ REDUCES FORMING AND ASSEMBLY OPERATIONS.
- ✓ FAR FEWER STEPS IN WINDING TYPICAL TV YOKE COIL.
- ✓ MAKES POSSIBLE UNUSUAL SHAPE COILS.



"Bobbin-less" coil



Fly-back coil



TV yoke coil



Hoop-shaped coil

"It takes the best

PHELPS DODGE COPPER PRODUCTS
CORPORATION

*in Magnet Wire--***BONDEZE**...*

COIL WINDING COSTS!

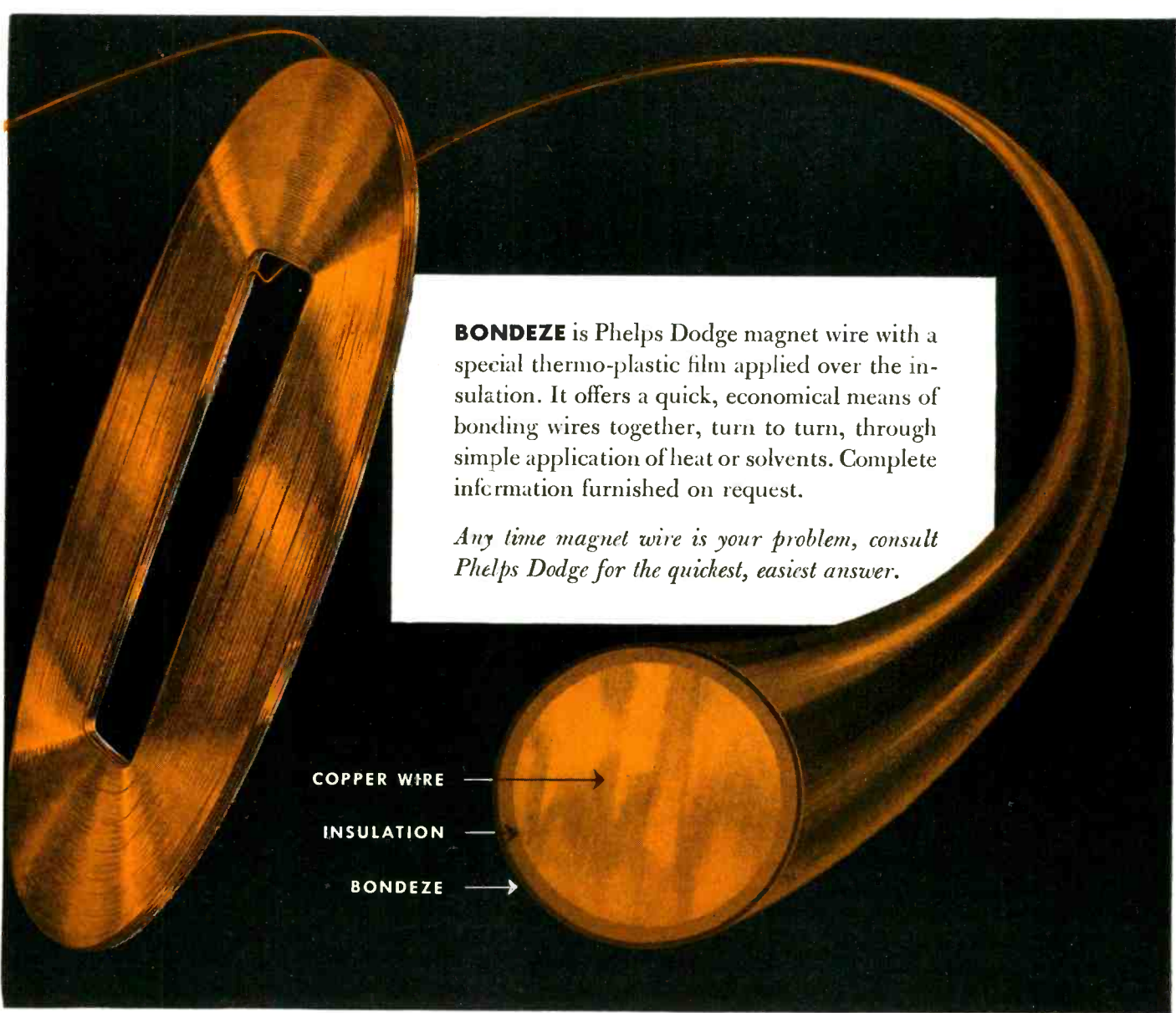

BONDEZE is Phelps Dodge magnet wire with a special thermo-plastic film applied over the insulation. It offers a quick, economical means of bonding wires together, turn to turn, through simple application of heat or solvents. Complete information furnished on request.

Any time magnet wire is your problem, consult Phelps Dodge for the quickest, easiest answer.

COPPER WIRE →

INSULATION →

BONDEZE →

*Bondeze is a Phelps Dodge Trade Mark

to make the best!"

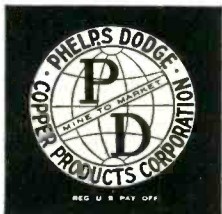

INCA MANUFACTURING DIVISION

FORT WAYNE, INDIANA



WHAT ABOUT

Temperature Coefficient

IN *PRECISION* RESISTORS

Specify a precision resistor for electronic equipment you are designing, and you frequently become involved in temperature coefficient. At this point, many engineers do not fully understand the temperature coefficient they select from a table.

First of all, the temperature coefficient (T.C.) of a resistor is the variation in resistance (ohmic value) as the temperature changes. It is expressed as a change per degree Centigrade—either Per Cent, Parts/Million, or Ohms/Ohm. It should not be confused with stability—the lack of resistance change at a given temperature after aging, temperature cycling, or overload testing.

SPECIFIED T.C. CAN BE INACCURATE: Temperature coefficient of a precision wire-wound resistor is dependent almost entirely upon the alloy of the wire used. However, it is *not* necessarily the *nominal* value specified by the wire manufacturers for a particular alloy. Wire manufacturers cannot economically control T.C. within the close limits required by many of today's highly precise applications. T.C. of a given alloy and diameter may vary from spool to spool, and even within the same spool.

The variation in T.C. is particularly great in the "E" alloys—commonly called "special low-T.C. wire." For example, Shallcross' laboratory tests have

shown T.C. to vary from higher than $\pm .004\%/^{\circ}\text{C}$. to lower than $\pm .001\%/^{\circ}\text{C}$. for resistors wound with "E" alloys *nominally* $\pm .002\%/^{\circ}\text{C}$.

THE ONLY WAY TO T.C. ACCURACY: Shallcross manufactures resistors wound with all commonly used alloys made in the following degrees of T.C. quality:

1. *Resistors wound with a designated alloy and offering no guarantee of T.C. other than the limits established by the wire manufacturer.*
2. *Resistors wound with wire from spools pre-tested and selected for T.C. Determination and recording of the T.C. of each spool of "E" alloy wire is part of the standard Shallcross inspection procedure. Selection assures only that the yield of resistors within specific T.C. limits will be high. It does *not* assure that all resistors wound with tested wire will be within the T.C. limits of selection.*
3. *Resistors with a guaranteed T.C. over a given temperature range. Pre-selected wire is used to wind these resistors, readings are taken at several temperatures, and the T.C. is computed. Only individual resistors within the customer's specified T.C. limits are released. Although time-consuming, this is the only known way to guarantee a particular temperature coefficient or, in the case of "E" wire, the much publicized range of $\pm .002\%/^{\circ}\text{C}$.*

Further details on T.C. and other resistor characteristics are available in Shallcross Bulletin R-3C.

SHALLCROSS MANUFACTURING COMPANY • 522 PUSEY AVENUE, COLLINGDALE, PA.



The first of a series to promote a better understanding of the performance characteristics of precision wire-wound resistors.

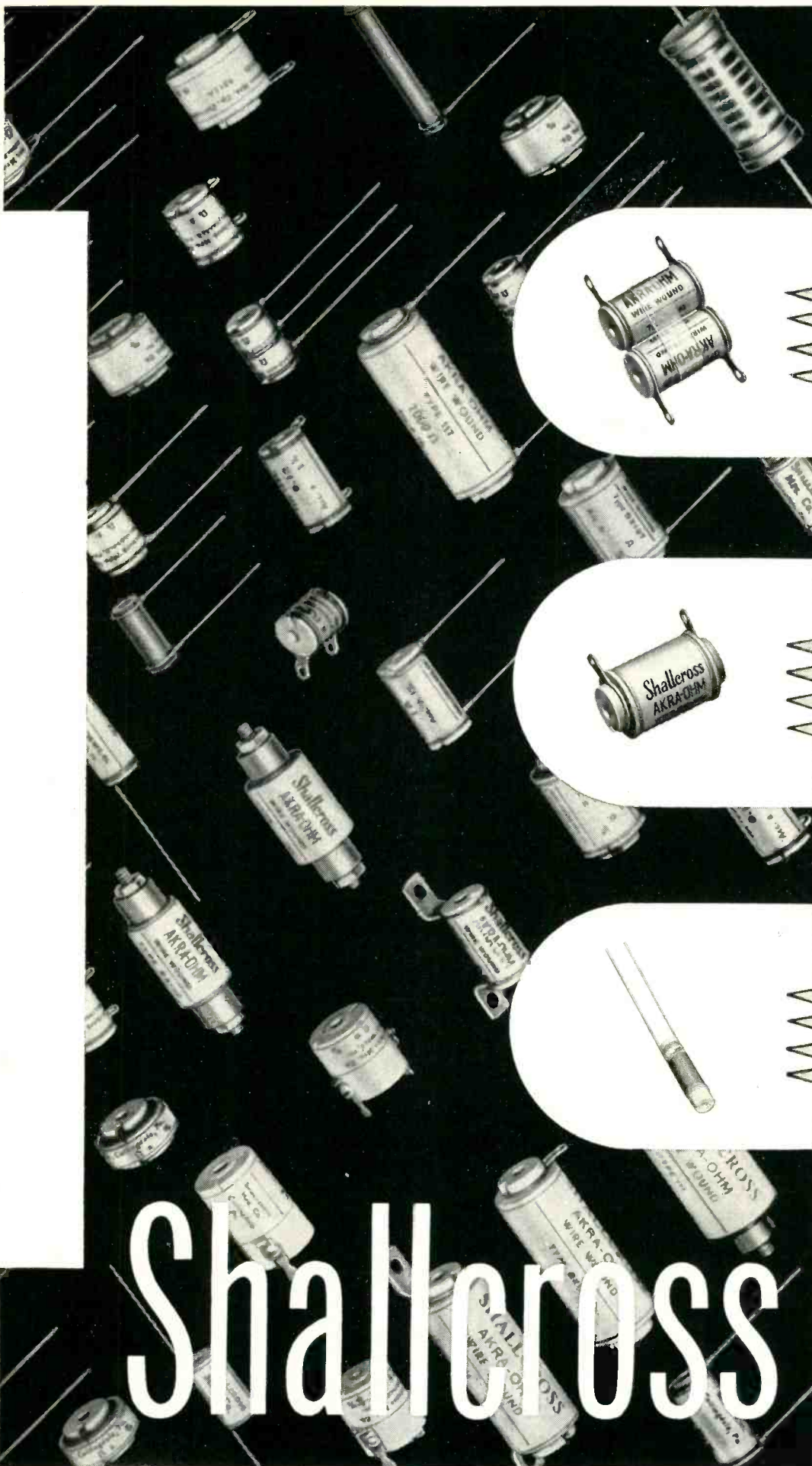

MATCHED T.C.

Shallcross regularly produces pairs of precision wire-wound resistors with closely matched temperature coefficients. Such pairs may be matched to within $\pm .005\%/^{\circ}\text{C}$.



SELECTED T.C.

Resistors may be made with practically any desired positive or negative temperature coefficient between $- .002\%/^{\circ}\text{C}$. and $+ .018\%/^{\circ}\text{C}$. A specified T.C. may be selected within $\pm .0005\%/^{\circ}\text{C}$. over a given temp. range.



NEW INSTRUMENT RESISTOR

This Shallcross Type 2455 1-watt instrument resistor measures $1\frac{1}{8}''$ L. x $\frac{3}{8}''$ Diam. It is designed for decades and other applications requiring resistance values from 0.1 to 1000 ohms with close tolerances, low temperature rise, and low inductance.



Shallcross

"ZERO" PHASE SHIFT

COMPUTER REFERENCE VOLTAGE TRANSFORMERS

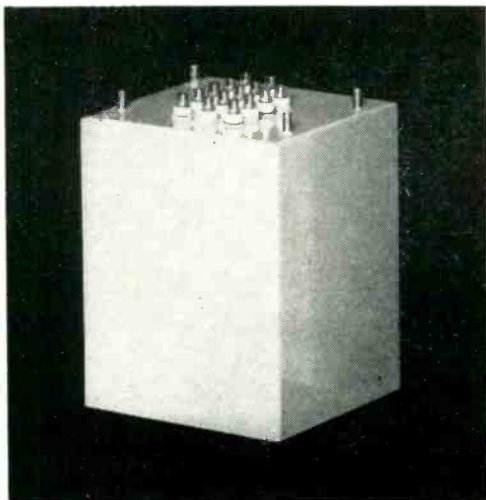

LESS THAN 0.1 MILLIRADIAN PHASE SHIFT
± .02% ACCURACY OF VOLTAGE RATIOS

A radical new approach to the design and manufacture of precision transformers makes it possible to have calculable minimum errors.

The actual measurement of phase shift and voltage ratio is in complete agreement with the calculation to lowest value that measurement is possible.

MIL-T-27 TRANSFORMERS

TOROIDAL TRANSFORMERS
INSTRUMENT TRANSFORMERS
PULSE TRANSFORMERS

VIDEO TRANSFORMERS
INPUT-INTERSTAGE-OUTPUT
POWER TRANSFORMERS

MAGNETIC AMPLIFIERS

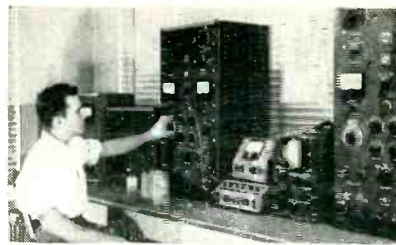

INDUCTANCE MEASUREMENT — Any operating condition can be simulated in the range of 0-1000V A.C. and 0-5 Amps. D.C.

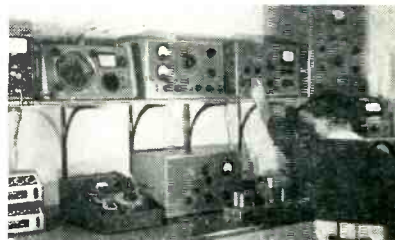

DEVELOPMENT OF AUDIO TRANSFORMERS — All characteristics of audio transformers in the range of .01 cycle to 10 Megacycle can be measured and evaluated.



POWER LOSS MEASUREMENT — Losses as low as 15 micro watts in the range of 20 c to 200 K.C. can be measured and analyzed and possible improvements effected.



PULSE TRANSFORMER DESIGN — The cut and try methods commonly used in the design of pulse transformers has been largely supplanted by the use of special equipment.



TRANSFORMERS INC.

532 NORTH STREET

ENDICOTT, NEW YORK

Telephone ENDICOTT 8-1801

STATIC ELECTROMAGNETIC DEVICES

HERTZ

... FIRST to prove the existence of Electromagnetic Waves

Heinrich Rudolph Hertz

1857-1894

A pupil of Helmholtz, and Professor of Physics at the University of Bonn, this eminent German physicist was first to intentionally produce and measure electromagnetic waves. They were named "Hertzian waves" in his honor.

His research, the basis for all modern electronics, gave Marconi the idea for the "wireless."

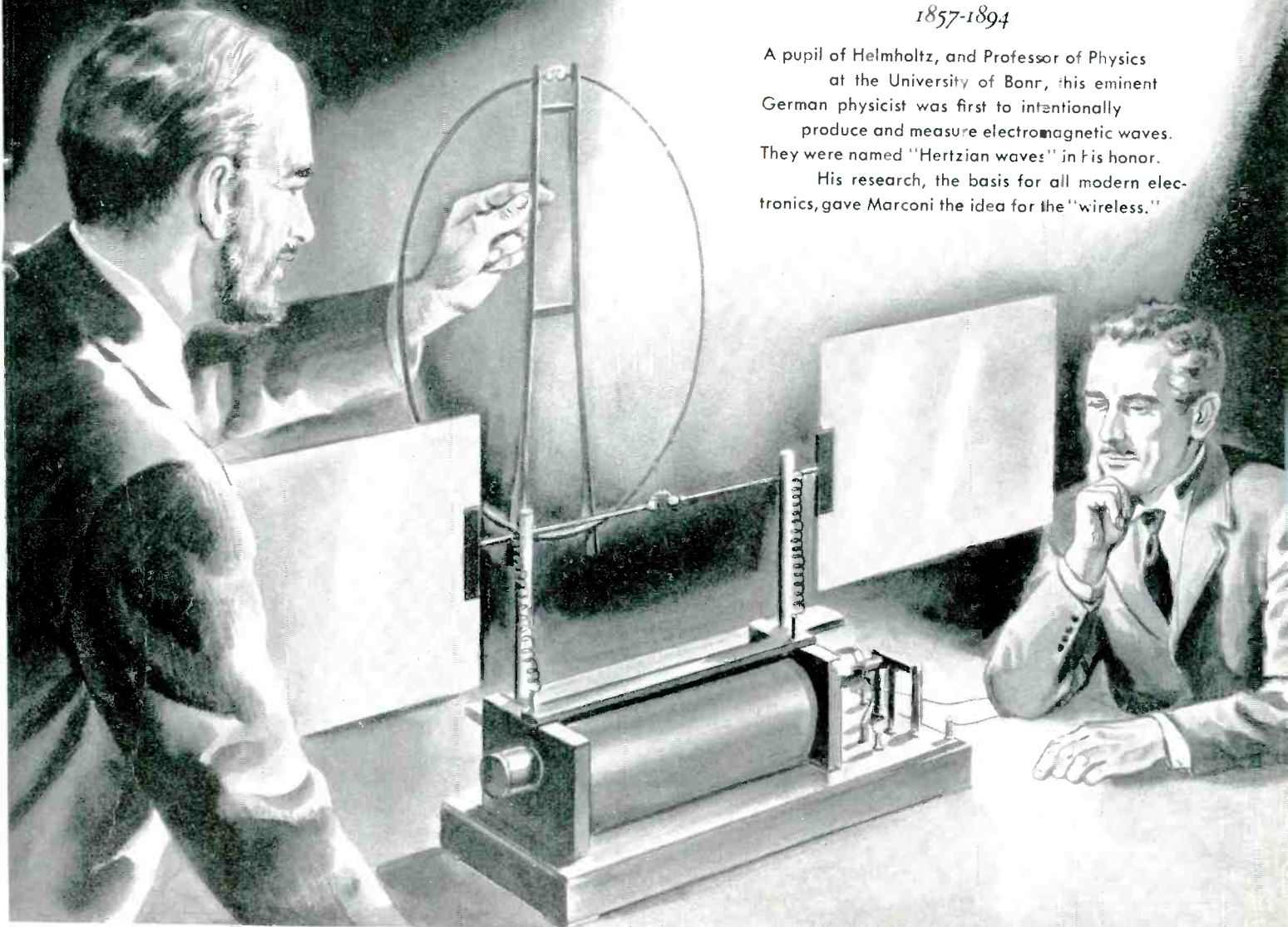

From an original drawing made for Ohmite

OHMITE

FIRST in Resistors

...today

Be Right with

OHMITE

RHEOSTATS

RESISTORS

TAP SWITCHES

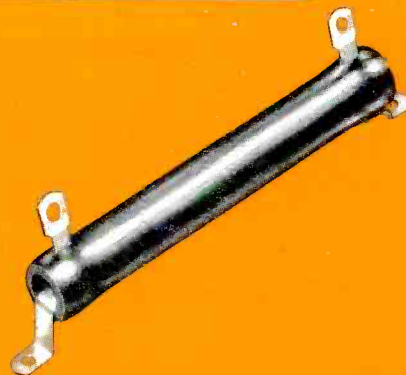

For its toughest resistance problems, industry turns to Ohmite wire-wound resistors . . . the most widely used resistors on the market today. Ohmite offers *greater dependability* and longer life, even under the most adverse conditions. Ohmite offers *wider assortment*, too—a complete selection of types and sizes for every need. Specify Ohmite resistors, and know you use the best!

◀ The Ohmite line of tab-terminal, ferrule-terminal, axial-terminal, and flat type resistors that meet JAN-R-26A, Characteristics "G" and "J."

OHMITE JAN TYPE WIRE-WOUND *Resistors*

Ohmite tab-terminal and ferrule-terminal type resistors that meet JAN-R-26A, Characteristic "F."

STYLES AND SIZES

**TAB-
TERMINAL
TYPE**
Characteristics
G, J, and F

Style	Over-all length	Diameter	*Watts
RW-29	1-3/4"	1/2"	8
RW-30	1"	19/32"	8
RW-31	1-1/2"	19/32"	10
RW-32	2"	19/32"	12
RW-33	3"	19/32"	18
RW-34	3"	29/32"	30
RW-35	4"	29/32"	38
RW-36	4"	1-5/16"	60
RW-37	6"	1-5/16"	78
RW-38	8"	1-5/16"	110
RW-39	12"	1-5/16"	166

**TAB-
TERMINAL
TYPE**
with terminal hole
to clear No. 8
screw Characteristics
G, J, and F

Style	Over-all length	Diameter	*Watts
RW-40	3"	29/32"	24
RW-41	4"	29/32"	37
RW-42	4"	1-5/16"	49
RW-43	6"	1-5/16"	74
RW-44	8"	1-5/16"	100
RW-45	12"	1-5/16"	160
RW-46	10-1/2"	1-5/16"	135
RW-47	10-1/2"	1-9/16"	145

**FERRULE-
TERMINAL
TYPE**
Characteristics
G, J, and F

Style	Over-all length	Diameter	*Watts
RW-10	11-7/16"	1-5/16"	140
RW-11	9-5/8"	1-5/16"	116
RW-12	7-7/16"	1-5/16"	86
RW-13	5-1/8"	1-1/16"	50
RW-14	4-7/16"	1-1/16"	40
RW-15	2-15/16"	3/4"	20
RW-16	2-3/8"	3/4"	14

**FLAT TAB-
TERMINAL
TYPE**
(Stack Mounting)
Characteristics
G and J

Style	Over-all length	Width of Core	Thickness of Core	†Watts
RW-20	2-1/2"	1-3/16"	1/4"	15
RW-21	3-1/4"	1-3/16"	1/4"	22
RW-22	4-3/4"	1-3/16"	1/4"	37
RW-23	6"	1-3/16"	1/4"	47
RW-24	7-1/4"	1-3/16"	1/4"	63

**AXIAL-
TERMINAL
TYPE**
Characteristics
G and J

Style	Length of Core**	Diameter	†Watts
RW-55	1-3/8"	5/8"	5
RW-56	2"	5/8"	10

**2-1/2" wire leads
*Watts free air JAN Characteristic "F" or "G"
†Watts free air JAN Characteristic "G"

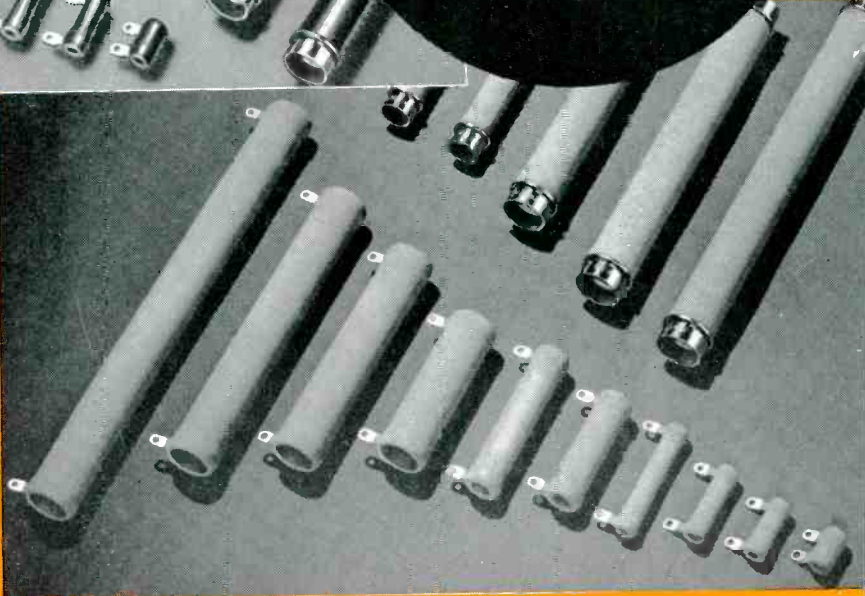

... MEET REQUIREMENTS OF JOINT ARMY-NAVY SPECIFICATION JAN-R-26A (Amendment 3)

Ohmite offers an unusually complete line of resistors that meet the most rigid requirements (characteristics "G," "J," and "F") of Joint Army-Navy Specification JAN-R-26A. To meet these requirements, resistors must pass severe moisture resistance and thermal shock tests. They are required to withstand strenuous vibration applied for five continuous hours, and satisfy the requirements of many other tests.

Of the 38 different resistor styles listed in JAN-R-26A, Ohmite offers 33 styles that meet these specifications, in a complete range of resistance values.

OHMITE MANUFACTURING COMPANY
4818 Flournoy Street, Chicago 44, Illinois

Be Right with...

OHMITE®

RHEOSTATS • RESISTORS • TAP SWITCHES

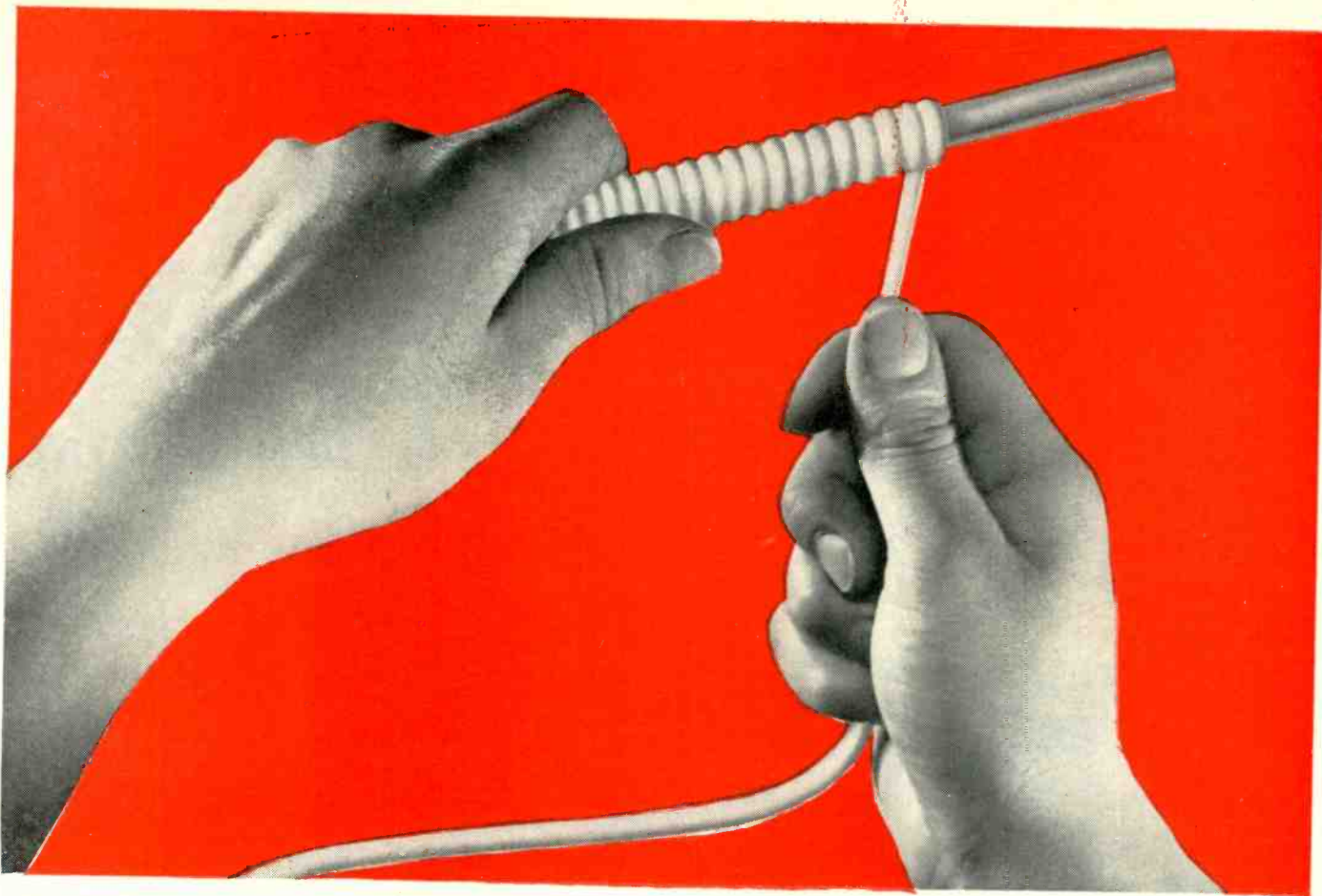

Now... an extremely **flexible** high-temperature tubing...
IRVINGTON Silicone Rubber-Coated Fiberglas*

If you need a *flexible* insulating tubing that meets Class "H" specifications—and particularly if you need it *now*—look into this new Irvington product!

With the introduction of Silicone Rubber-Coated Fiberglas Tubing, Irvington offers to the electrical industry a product that, like the resin-coated type, meets all NEMA Class "H" requirements. In addition, this new tubing has the advantage of extreme flexibility. Its white color is a plus wherever appearance is a factor.

AND... Irvington Silicone Rubber-Coated Fiberglas Tubing is available for immediate delivery!

Get the full story—just mail the coupon for technical data sheet.

Look to
IRVINGTON
 for Insulation Leadership
 INSULATING VARNISHES
 VARNISHED CAMBRIC
 VARNISHED PAPER
 VARNISHED FIBERGLAS
 INSULATING TUBING
 CLASS "H" INSULATION



*T.M. Reg. U. S. Pat. Off. by Owens-Corning Fiberglas Corp.

Send this convenient coupon now

Irvington

VARNISH & INSULATOR COMPANY

Irvington 11, New Jersey

Plants: Irvington, N. J.; Monrovia, Calif.; Hamilton, Ontario, Canada

Irvington Varnish & Insulator Co. E1-11/52
 11 Argyle Terrace, Irvington 11, N. J.

Gentlemen:
 Please send me technical data sheet on Irvington
 Silicone Rubber-Coated Fiberglas Insulating Tubing.

Name.....Title.....

Company.....

Street.....

City.....Zone.....State.....

AMPEX MODEL 500 SIMPLIFIES TELEMETERING

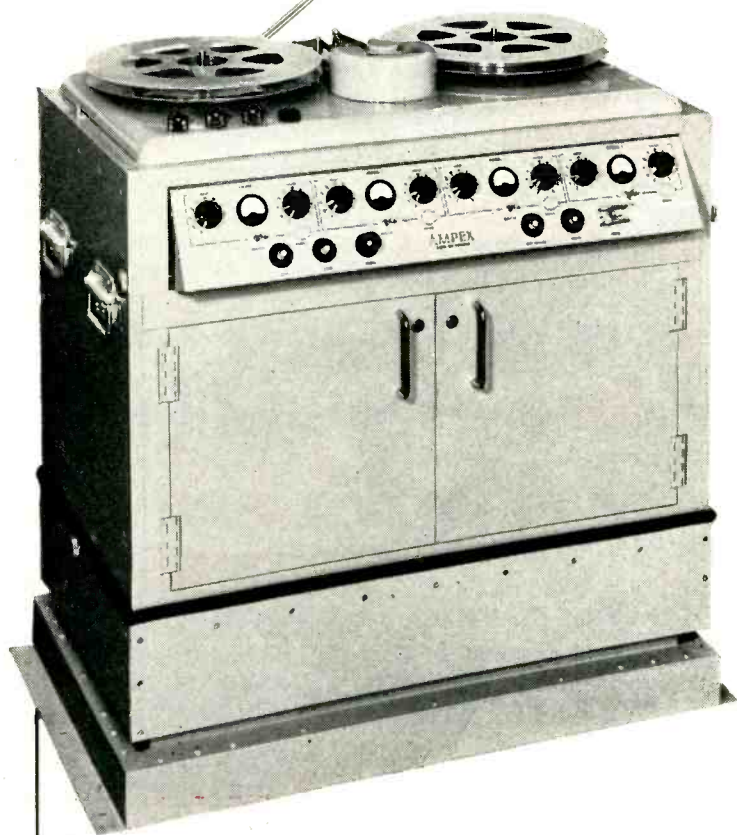

Features of the AMPEX Model 500

- Records frequencies up to 100 kc. (including all RDB bands)
- Records the output of one to four receivers
- Overall playback error less than 0.7% on final data
- Less than 0.1% peak-to-peak flutter and wow
- Ruggedly constructed to meet military requirements
- 16 minutes recording time at 60-inch tape speed

Entire output of FM-FM receivers is recorded on tape without detectable error or loss of data.

AMPEX magnetic tape permanently records data in electrical form. Data reduction can then be carried out any time, any place and in any way. This eliminates the need for complex filter and discrimination systems at each ground station. This frequently lowers ground station cost and complexity to one-third that of alternative installations. Use of fewer mechanical and electronic components also decreases the chance of losing any critical data.

The AMPEX Model 500 was developed to achieve the extremely steady tape motion and high frequency response required in FM-FM telemetering. This performance also serves other data recording fields that have similarly high demands. The Model 500 has a frequency response up to 100 kc. to simultaneously record all RDB telemetering bands. Its extremely low tape flutter and wow account for an overall playback error less than 0.7%, (using subcarrier frequencies deviated $\pm 7\frac{1}{2}\%$).

Write for further information to Department E

AMPEX

MAGNETIC RECORDERS

AMPEX ELECTRIC CORPORATION • 934 CHARTER STREET • REDWOOD CITY, CALIFORNIA



ELECTRONIC TEST INSTRUMENTS

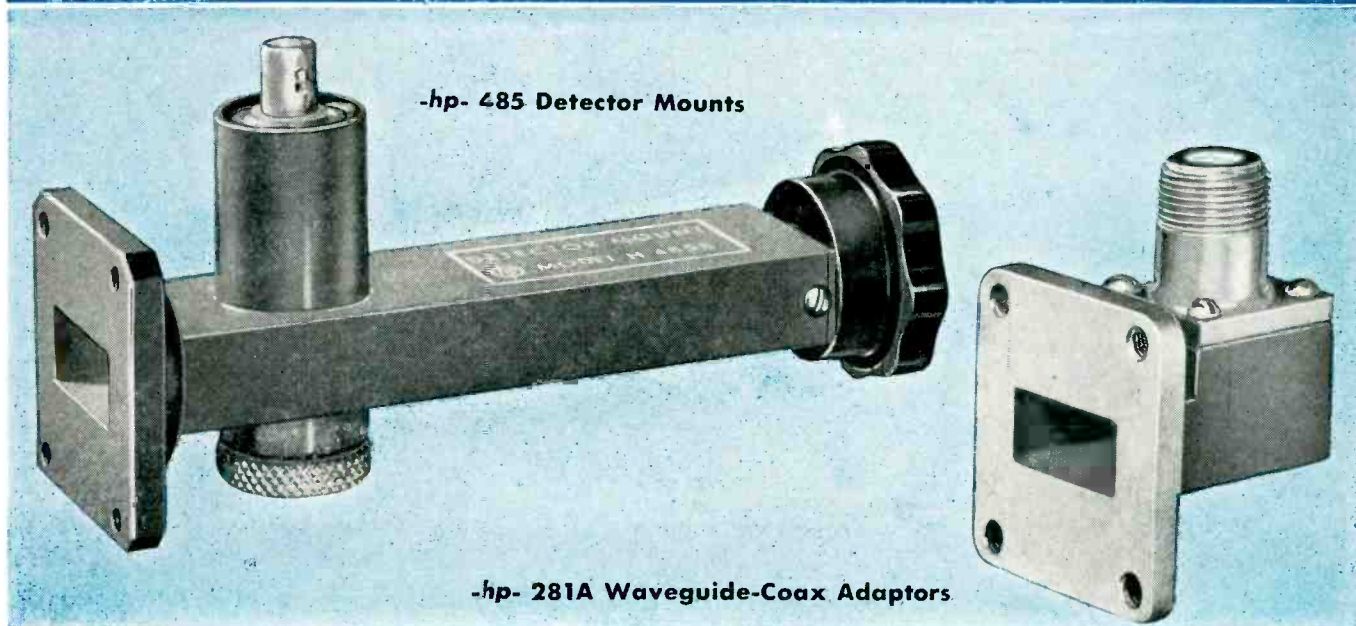

New broad band Adaptors and Detector Mounts offer high accuracy, easy operation, low cost

Model 485 Detector Mounts and 281A Adaptors typify the new *-hp-* line of precision waveguide test instruments. Each has the simplest possible construction consistent with its basic function. Each covers the complete frequency range of its waveguide size and is wholly integrated with other equipment for the same band. Novel circuitry plus simple mechanical design insure highest accuracy and stability, provide utmost operating ease and permit quantity production at low cost.

-hp- 485 Detector Mounts

These mounts offer new convenience in measuring microwave power with a bolometer, or detecting rf energy with a crystal. A single tuning control adjusts match easily and quickly. (See Figure 1.) For optimum match, mounts may be preceded by a slide-screw tuner such as *-hp-* 870A. Detected output appears at a BNC jack, and may be measured with an *-hp-* 430B Microwave Power Meter or an *-hp-* 415A Standing Wave Indicator.

-hp- 485B Mounts are tunable and available in waveguide sizes 2" x 1", 1½" x ¾", 1¼" x ⅝", and 1" x ½". Maximum VSWR when used with a Sperry 821 barretter is 1.25. These mounts also accommodate 1N21 and 1N23 crystals.

-hp- S485A Mount is for use with 3" x 1½" waveguide, and employs only a Sperry 821 barretter. It requires no tuning, and maximum VSWR is 1.25 at any point in the frequency band.

-hp- 281A Adaptors

These adaptors provide a convenient means of transmission between waveguide and coaxial systems. Power may be fed in either direction, and each unit covers the full frequency range of its waveguide size with VSWR less than 1.25. (See Figure 2.) Coaxial connections are made to a standard Type N plug, and waveguide connections to a plain AN flange. *-hp- 281A* Adaptors are offered in all waveguide sizes covering the frequency range from 2.6 to 12.4 kmc.

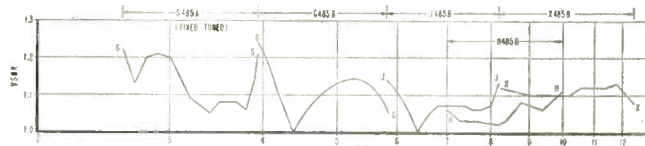

Figure 1. Typical VSWR vs. Frequency, *-hp-* 485A, when used with barretter.

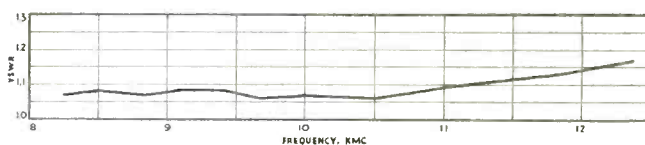

Figure 2. Typical VSWR vs. Frequency, *-hp-* X281A.

For complete details, see your *-hp-* field representative or write direct

HEWLETT-PACKARD COMPANY
2478A PAGE MILL ROAD • PALO ALTO, CALIFORNIA



Instruments for Complete Coverage

MINNEAPOLIS
Sept. 29, through Oct. 1.

MILWAUKEE
Oct. 7, through Oct. 10.



"BRINGING the mountain to Mohamet might best describe Dow Corning Corp.'s traveling exhibit . . . Free standing panels . . . separate the exhibit into nine bays, each emphasizing a property of silicones and showing where that property brings a benefit to an actual end product or operating unit . . ."
INDUSTRIAL MARKETING (June 1952)



"NEXT TO THE GREATEST SHOW ON EARTH . . . We could go on . . . reciting the fantastic properties of Silicones, but just as breathtaking as the materials were the display techniques used to demonstrate them . . ."
CIRCUIT RIDER (Vol. 6, No. 2, published by Electrical Construction and Maintenance)



" . . . Heat Stability Plus: Visitors . . . see, among other demonstrations, how Silastic (Dow Corning's silicone rubber) remains soft and flexible at temperatures far above the limits of organic rubber . . ."
CHEMICAL WEEK (Jan. 26, 1952)

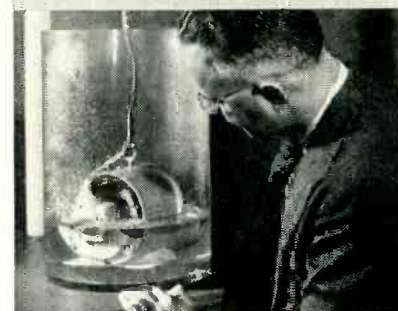

"IF YOU HAVEN'T already seen it, don't miss it when it comes around . . ."
POWER ENGINEERING (May 1952)

BUFFALO
Oct. 29, through Oct. 31.

NEW HAVEN
Nov. 11, through Nov. 13.

BALTIMORE
Nov. 18, through Nov. 20.

NEWARK
Nov. 4, through Nov. 7.

CINCINNATI
Oct. 21, through Oct. 23.

WINSTON-SALEM
Dec. 9, through Dec. 11.

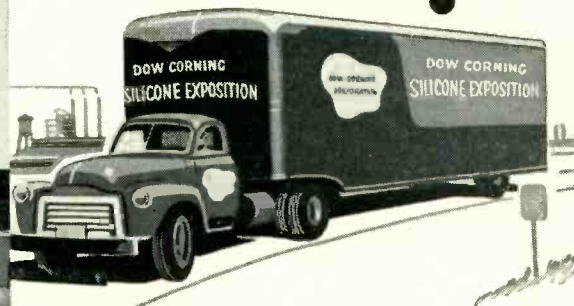

DOW CORNING SILICONES . . .

are no longer a mystery or a "future possibility" to the 17,000 executives and engineers, representing more than 4600 plants, who have already seen the Dow Corning Silicone Exposition.*

They learned that silicones are fluids and resins that keep clothes and shoes and brick walls dry in the rain. They're fluids that polish without rubbing.

They're rubber that won't melt on hot aircraft engine cylinders or freeze on switches that operate bomb bay doors at 100° below zero.

They're electrical insulating resins and varnishes that double the power of electric motors, or multiply by 10 the life of electric machines.

They're paints that protect metal at 1000°F. They're foam killers and release agents.

They're a whole family of new engineering materials that can help you to improve your product or to cut production costs.

*In Boston • Chicago • Cleveland • Dayton
Detroit • Fort Worth • Houston
Indianapolis • Los Angeles • New York
Philadelphia • Pittsburgh • Seattle
Washington, D.C. • or Wichita.

DON'T MISS IT
MAIL THIS COUPON TODAY

Dow Corning Corporation, Dept. BE-23
Midland, Michigan

Kindly include me among your guests at the private showing of the Dow Corning Silicone Exposition in

- | | |
|--|------------------------------------|
| <input type="checkbox"/> St. Louis | <input type="checkbox"/> Buffalo |
| <input type="checkbox"/> Minneapolis | <input type="checkbox"/> Newark |
| <input type="checkbox"/> Milwaukee | <input type="checkbox"/> New Haven |
| <input type="checkbox"/> Cincinnati | <input type="checkbox"/> Baltimore |
| <input type="checkbox"/> Winston-Salem | |

NAME _____
ADDRESS _____
CITY _____ ZONE _____ STATE _____

Atlanta
Chicago
Cleveland
Dallas
Los Angeles
New York
Washington D. C.

DOW CORNING



CORPORATION
MIDLAND, MICHIGAN

CANADA: Fiberglas Canada Ltd., 1200 Bay St., Toronto, Ontario
ENGLAND: Midland Silicones Ltd., 49 Park Lane, London, W.1

Innovation in Button Seals

ONE-PIECE LUGGED CONDENSER SEAL #1535



● Because there has been a consistent demand for a one-piece lugged condenser seal, Hermetic has developed a complete line of these important components, ranging from .152 diameter to .962 diameter. The seal provides a one-piece lugged tubing for positive external connections that allows minimum center to center assembly on smaller sizes. Handling and vibration will not affect the security of attachment of lug to tubing. The lug cannot come loose as in the case of a two-piece assembly. Lugged tubing is also available on individual feed-throughs and multi-headers.

This is another example of how Hermetic spares no pains to produce the most efficient, most foolproof headers in the electronics field. It is also another reason why Hermetic leadership, based on its many outstanding achievements and services, is widely recognized from coast to coast.

For the answer to your problems, contact Hermetic, the one and only dependable source of supply, and be sure that your

requirements will be given top engineering assistance.

Write for your FREE copy of Hermetic's colorful, informative, new, 32-page brochure, the most complete presentation ever offered on hermetic seals.

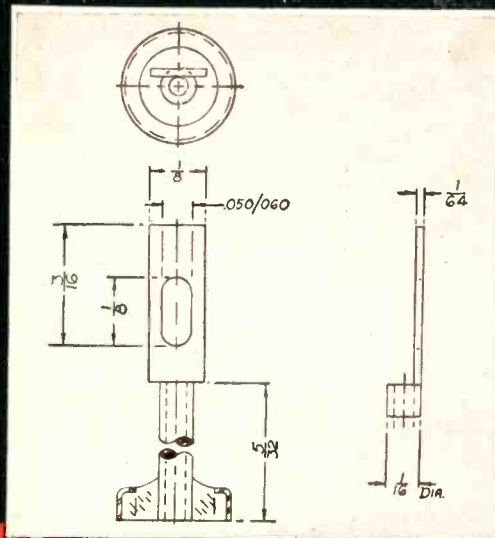

Hermetic Seal Products Co.

31 South Sixth Street
Newark 7, New Jersey

FIRST AND FOREMOST IN MINIATURIZATION

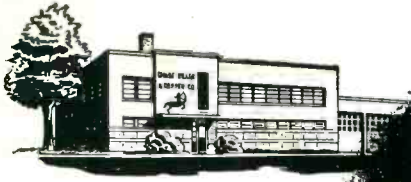

Items like these
available **QUICKLY** at
CHASE[®] warehouses



COPPER NAILS
and TACKS

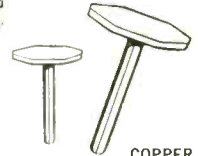

COPPER
STORM NAILS



BRASS and BRONZE
BOLTS and NUTS

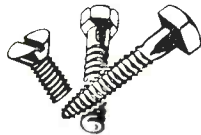

BRASS and BRONZE CAP,
MACHINE and LAG SCREWS



BRASS COTTER PINS
BRASS ESCUTCHEON PINS



BRASS and COPPER RIVETS, BURS

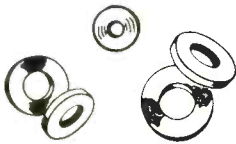

BRASS, BRONZE and
COPPER WASHERS

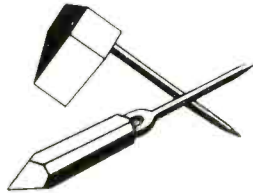

SOLDERING COPPERS

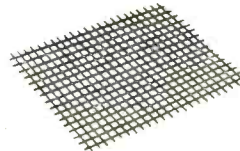

INDUSTRIAL WIRE CLOTH and
BRASS STRAINER CLOTH

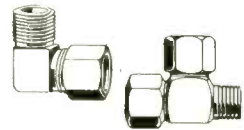

INDUSTRIAL and
AUTOMOTIVE FITTINGS



PERFORATED METAL IN
BRASS, BRONZE and COPPER



BEARING BRONZE BARS

CALL US FOR ANYTHING from Bearing Bronze Bars to Brass or Bronze Bolts . . . or any other brass or copper item for maintenance, repair, operating or production.

Twenty-three Chase warehouses are located in major industrial centers from coast to coast. Phone the one nearest you. We can usually fill your orders from stock.

Chase  **BRASS & COPPER**

WATERBURY 20, CONNECTICUT • SUBSIDIARY OF KENNECOTT COPPER CORPORATION

• The Nation's Headquarters for Brass & Copper

Albany†	Chicago	Denver†	Kansas City, Mo.	Newark	Pittsburgh	San Francisco
Atlanta	Cincinnati	Detroit	Los Angeles	New Orleans	Providence	Seattle
Baltimore	Cleveland	Houston†	Milwaukee	New York	Rochester†	Waterbury
Boston	Dallas	Indianapolis	Minneapolis	Philadelphia	St. Louis	(†sales office only)

beginning

NOW

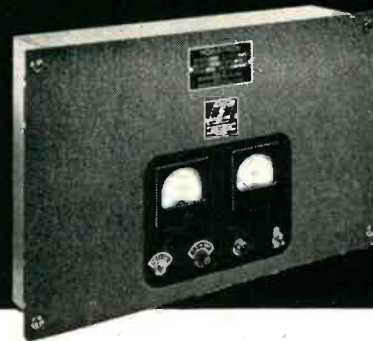

NEW PLANT CAPACITY at

SORENSEN

MEANS FASTER DELIVERY OF HIGHLY SOUGHT AFTER

SORENSEN

AC LINE REGULATORS

NOBATRONS

(regulated low-voltage,
high current DC sources)

NOBATRON-RANGERS

(regulated wide-range
variable DC sources)

• **B-NOBATRONS**

(regulated high-voltage,
low current DC sources)



We have been gratified by the electronics industry's acceptance of Sorensen & Co. as power regulation specialists. This acceptance has taken form as a heavy demand for our regulators that has frequently necessitated extensive delays in filling orders, a situation disliked by us as much as by our customers.

Long-range plans for increasing production were put into effect. They involved a series of **increases** — in plant area, personnel, product and process engineering departments, special tooling. The result — now — a drastic **decrease** in waiting time for standard catalog items.

Development engineering hasn't been neglected either. Within the next year new germanium tubeless power supplies, frequency changers, precision battery chargers will be introduced.

To summarize — better deliveries, lots of new stuff on the fire. A postcard brings you full information, puts you on our mailing list for advance data on new products.



For Complete Information Write

SORENSEN & COMPANY, INC.

375 Fairfield Avenue

Stamford 1, Conn.



NO OTHER textile for electrical insulation
resists oils and acids better than **FIBERGLAS YARNS!**

THE NAME **OWENS-CORNING**
FIBERGLAS IS A
TM REG. U.S. PAT. OFF.

IF YOU MAKE OR USE

ELECTRICAL EQUIPMENT

IT WILL PAY YOU TO SPECIFY

FIBERGLAS* *insulating materials*

Many electrical insulating materials used in apparatus, wire or cable soon break down under the ravages of oils and acids. This means costly down-time for repairs or complete replacement.

That's why today, more and more makers and users of electrical equipment are specifying insulating materials made with Fiberglas yarns. Because they are made of glass in fibrous form, Fiberglas yarns resist deterioration from oils and acids better than organic yarns.

Fiberglas tapes, varnished cloths, sleeving and tubing, cords, wire and cable insulations, and laminates, as used in electrical apparatus resist rot and corrosion from oils and acids . . . deliver top service at higher operating temperatures.

So, if you're a maker or user of electrical equipment, remember to specify Fiberglas.

Owens-Corning Fiberglas Corporation, Electrical Sales Division, Dept. 860, 16 East 56th St., New York 22, N.Y.

FIBERGLAS YARNS ALSO GIVE YOU THESE COST-SAVING ADVANTAGES

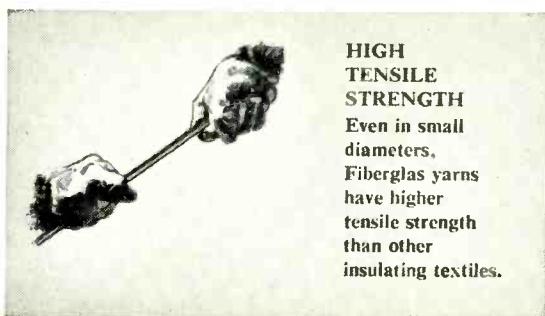
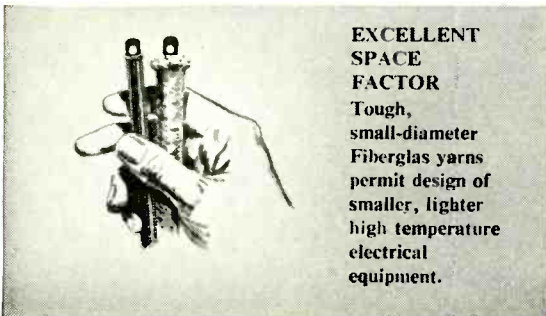
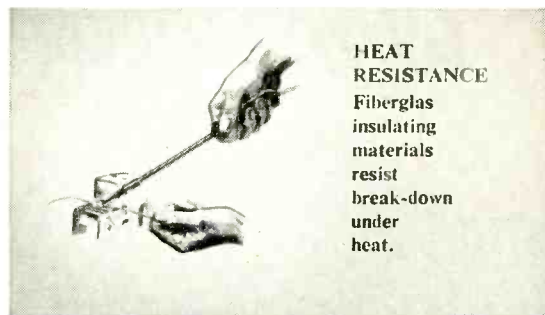
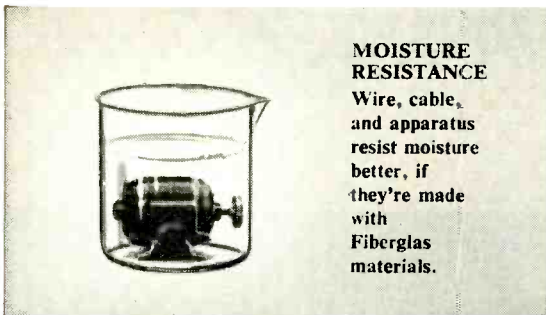

GOOD GUIDE TO A GOOD BUY!

*Fiberglas is the trade-mark (Reg. U. S. Pat. Off.) of Owens-Corning Fiberglas Corporation.

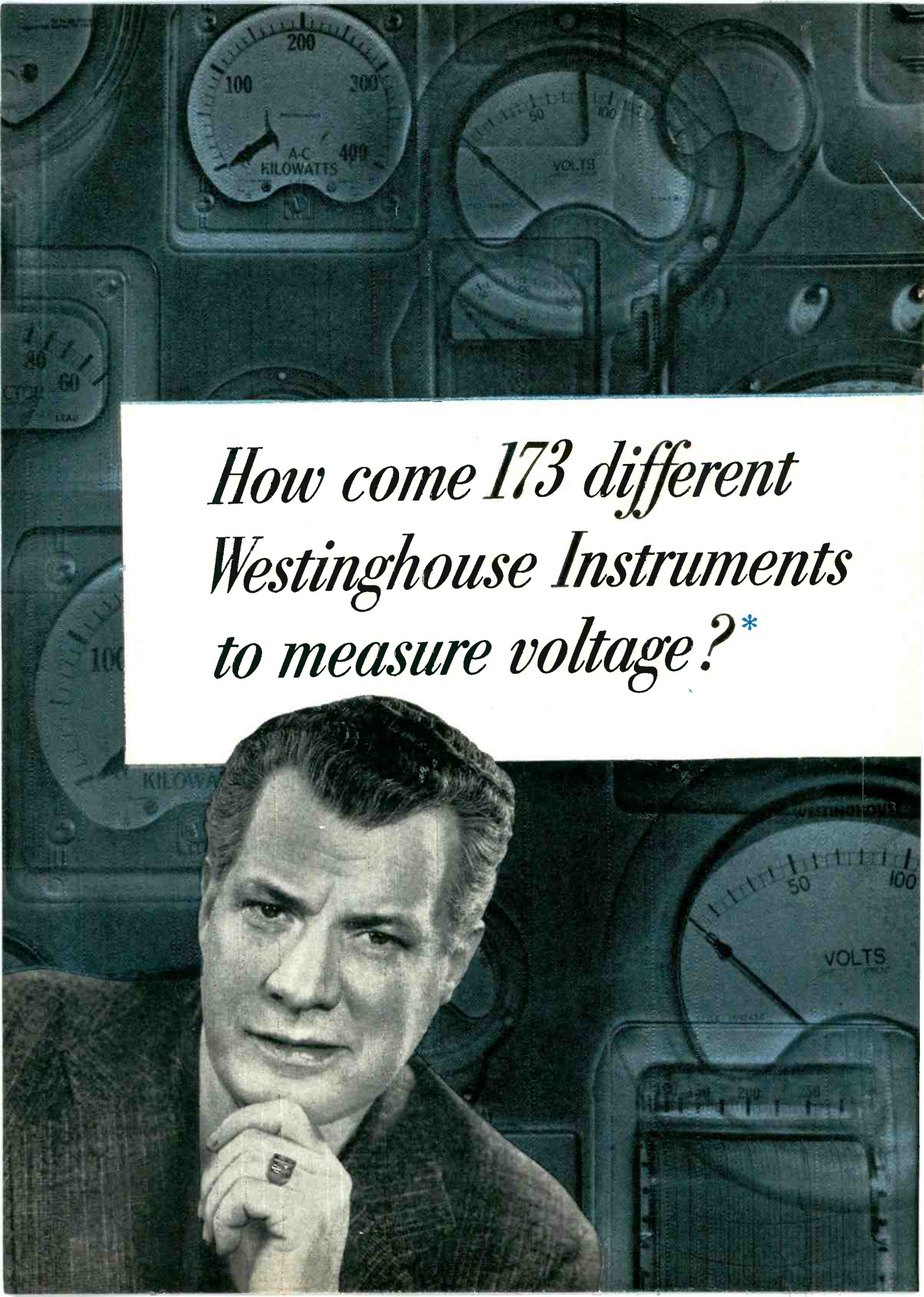
A black and white photograph of a man in a suit, looking thoughtful with his hand on his chin. He is surrounded by a dense array of Westinghouse electrical instruments, including various gauges and meters. One prominent gauge in the upper left is labeled 'AC KILOWATTS' with a scale from 0 to 400. Another gauge in the upper right is labeled 'VOLTS' with a scale from 0 to 100. Other gauges in the background show scales for 'LEAD', 'KILOWATTS', and 'VOLTS'. The overall scene suggests a technical or industrial setting.

*How come 173 different
Westinghouse Instruments
to measure voltage?**

Because

—a wider choice of instruments offers you . . . greater latitude in product design . . . the answer to more precise control of a process . . . an opportunity to boost the efficiency of plant facilities.

the proper instrument

Whether you want to measure amperes, volts, watts, vars, frequency, power factor or synchronism—you can always get the *right* instrument when you specify Westinghouse. It's the most complete line of electrical measuring instruments in the industry! The line also includes many types to measure position, time, temperature and speed.

properly engineered

For any instrument application, you want sustained accuracy . . . easy readability. Westinghouse designs are the result of over 60 years of instrument engineering aimed at giving you the ultimate in these essentials of fine instrumentation. The performance of all Westinghouse Instruments meets ASA Standards.

properly applied

You save engineering time and expense . . . gain more effective use of instruments when you have manufacturer's assistance in their application. A team of highly trained Instrument Application Engineers is available to work with you in applying all Westinghouse Instruments.

registers an advantage for you!

The experience of a large eastern manufacturer provides an example. By applying standard Westinghouse GY-40 Recording Wattmeters to predetermine load on mixers, they obtained a 15 percent saving in mixing cycle time! A typical pay-off when the proper instrument, properly engineered is properly applied! Next time, specify Westinghouse!

J-40418

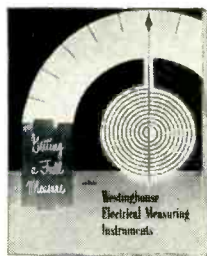

The extensive coverage of Westinghouse voltage measuring instruments is further emphasized by the fact that there are 36 different instruments just to measure d-c millivolts.

For complete information about all Westinghouse Instruments, wire for Booklet B-4696. Address: Westinghouse Electric Corporation, P. O. Box 868, Pittsburgh 30, Pennsylvania.

YOU CAN BE SURE... IF IT'S
Westinghouse

INSTRUMENTS



Accurate — Portable — **AVAILABLE**

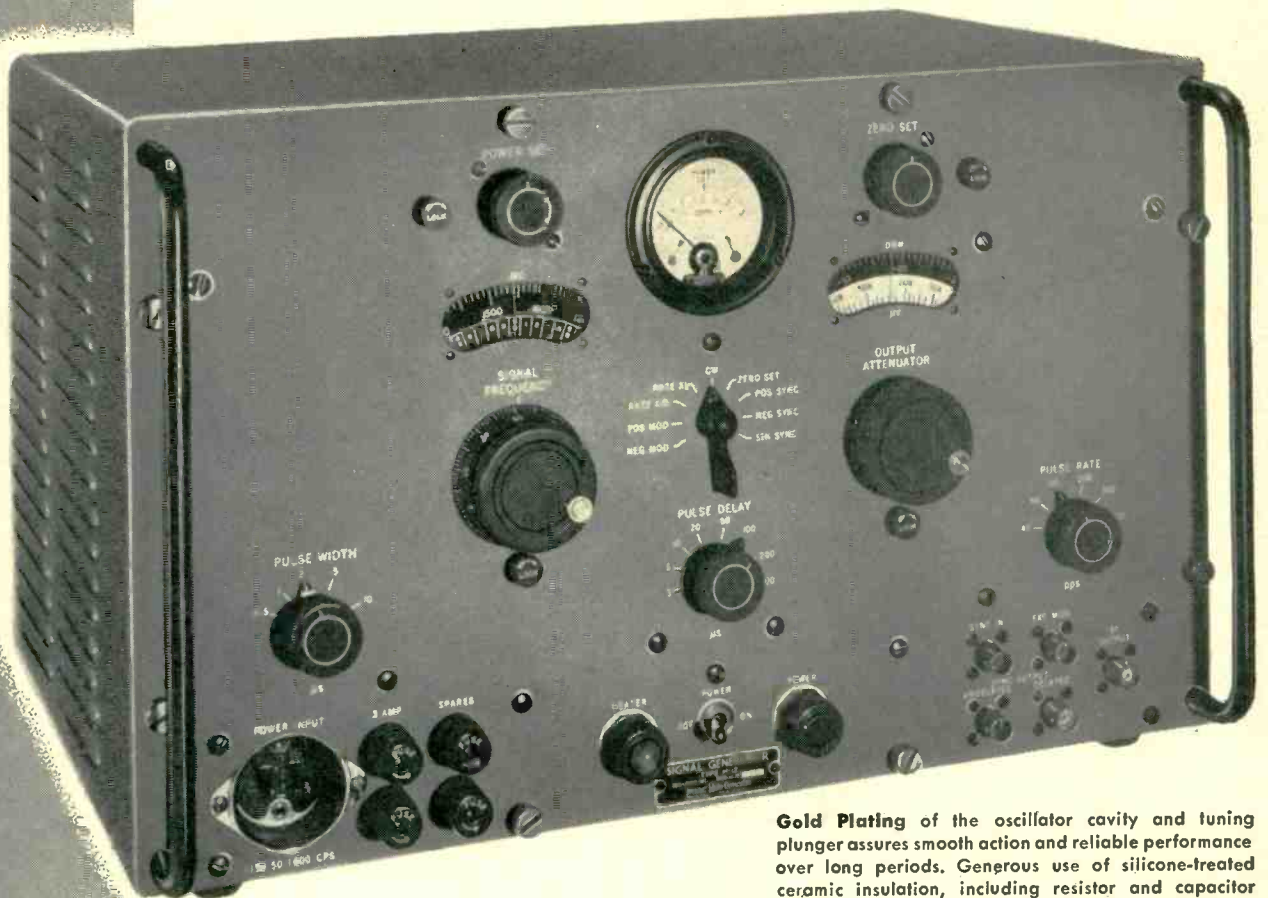

Gold Plating of the oscillator cavity and tuning plunger assures smooth action and reliable performance over long periods. Generous use of silicone-treated ceramic insulation, including resistor and capacitor terminal boards, and the use of sealed capacitors, transformers, and chokes, insures operation under conditions of high humidity for long periods.

The Type H-12 **UHF SIGNAL GENERATOR** 900-2100 Megacycles

This compact, self-contained unit, weighing only 43 lbs., provides an accurate source of CW or pulse amplitude-modulated RF. A well-established design, the Type 12 has been in production since 1948. The power level is 0 to -120 dbm, continuously adjustable by a directly calibrated control accurate to ± 2 dbm. The frequency range is controlled by a single dial directly calibrated to $\pm 1\%$. Pulse modulation is provided by a self-contained pulse generator with controls for width, delay, and rate; or by synchronization with an external sine wave or pulse generator; or by direct amplification of externally supplied pulses.

Built to Navy specifications for research and production testing, the Type H-12 Signal Generator is equal to military TS-419/U. It is in production and available for delivery.

Price: \$1,950 net, f.o.b. Boonton, N. J.

Type H-14 Signal Generator

(108 to 132 megacycles) for testing OMNI receivers on bench or ramp. Checks on: 24 OMNI courses, left-center-right on 90/150 cps localizer, left-center-right on phase localizer, Omni course sensitivity, operation of TO-FROM meter, operation of flag alarms.

Price: \$942.00 net, f.o.b. Boonton, N. J.



Aircraft Radio

CORPORATION — BOONTON, N. J.

Dept. 1

Dependable Electronic Equipment Since 1928

WRITE TODAY for descriptive literature on A.R.C. Signal Generators or airborne LF and VHF communication and navigation equipments, CAA Type Certified for transport or private use.

FERROXCUBE-3C

cores are nickel-free

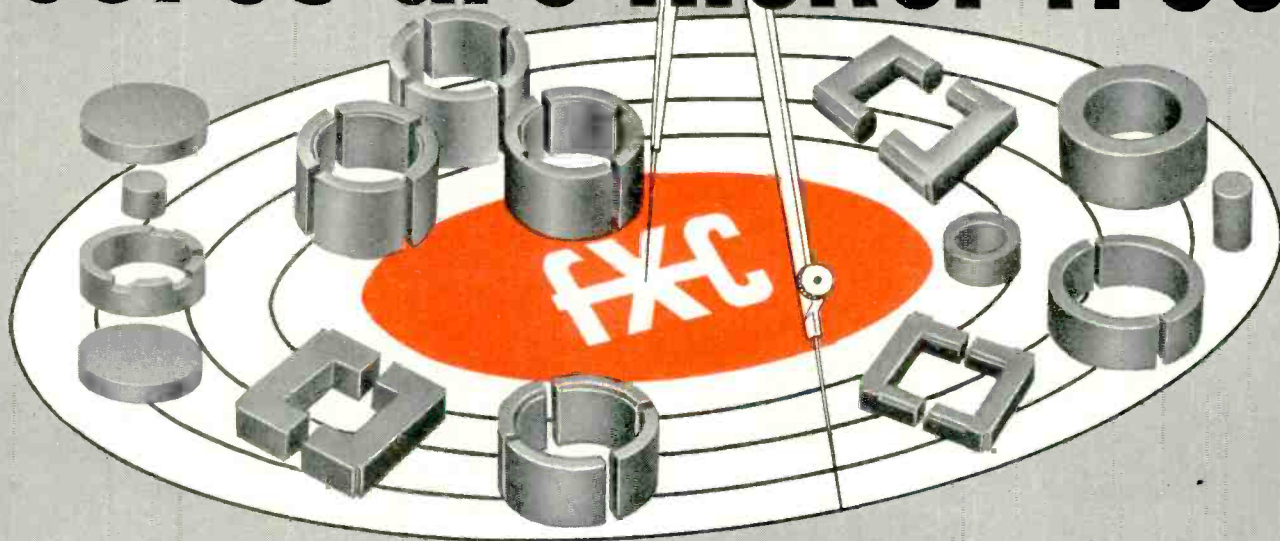

APPLICATIONS:

- I-F TRANSFORMERS
- PERMEABILITY TUNING DEVICES
- LOW-LOSS INDUCTORS
- SATURABLE CORE REACTORS
- HORIZONTAL OUTPUT TRANSFORMERS
- DEFLECTION YOKES
- TELEPHONE LOADING COILS

When your drawings call for Ferroxcube 3C cores for your TV deflection yokes and horizontal output transformers, you can forget about procurement problems. These ferrite cores are nickel-free . . . and delivery will be made exactly as scheduled by you!

Improved temperature stability, high saturation flux density, and high permeability are among the other advantages of Ferroxcube 3C.

Complete technical data is yours for the asking in Engineering Bulletin FC-5101A, available on letterhead requests. ★ ★ ★ ★ ★ ★ ★ ★

FERROXCUBE

THE MODERN CORE MATERIAL

FERROXCUBE CORPORATION OF AMERICA

• A Joint Affiliate of Philips Industries and Sprague Electric Co., Managed by Sprague •

SAUGERTIES, NEW YORK



DESIGNERS'

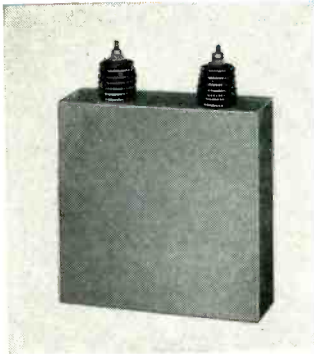

CAPACITORS



METERS AND INSTRUMENTS

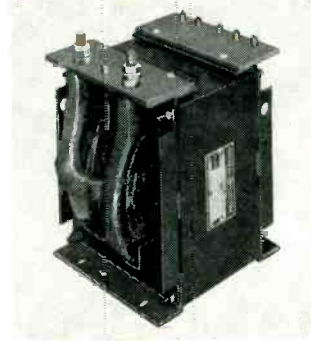

TRANSFORMERS

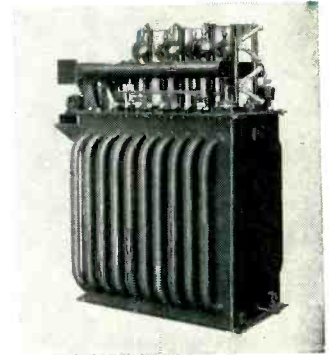

POWER SUPPLIES



VOLTAGE REGULATORS

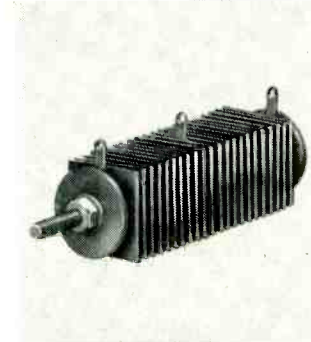

RECTIFIERS

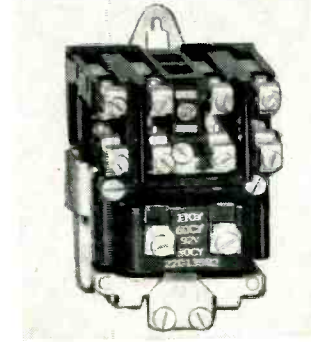

CONTROL

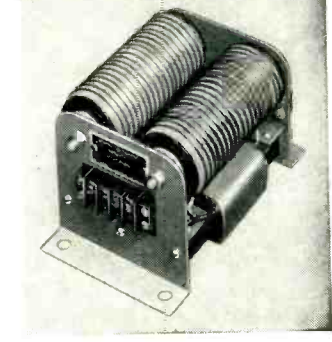

AMPLISTATS

Ready to serve expanding tv industry— G-E components for transmitter builders

Recent lifting of the freeze on new television stations has created many design and production problems for transmitter manufacturers. General Electric is ready to help designers solve one of these problems by providing a dependable supply of reliable, long-life electrical components.

To avoid costly delays, G.E. will plan output of its ample manufacturing facilities to match your production schedules. And recent design improvements and important new products resulting from continuing

G-E research and development activities will add to the performance of your equipment.

If you are engaged in supplying the huge demand for new tv station equipment, you'll find it worthwhile time-wise, cost-wise, and quality-wise to investigate the full line of applicable General Electric products. Your G-E Apparatus Sales Engineer has the story. Get in touch with him today, or write, giving full details and quantities involved, to General Electric Co., Sect. 667-22, Schenectady 5, N. Y.

GENERAL  ELECTRIC

DIGEST

TIMELY HIGHLIGHTS ON G-E COMPONENTS

New drawn-oval capacitors are 10 to 20% lower priced

Here's a new line of General Electric capacitors for electronic applications, housed in drawn-oval containers, that features size reductions up to 30 per cent and cost reduction up to 20 percent! These fixed paper-dielectric capacitors also weigh less and are mechanically stronger than conventional types because of the drawn-steel container's single seam, hermetically sealed by double rolling. What's more, shipments are shorter. Designed to replace case styles CP70 and CP53, the new units are available in ratings from 2.0 muf to 10.0 muf, 600 to 1500 volts d-c and 330 to 660 volts a-c. See Bulletin GEA-5777.



New G-E reactor makes d-c voltage measurement safer

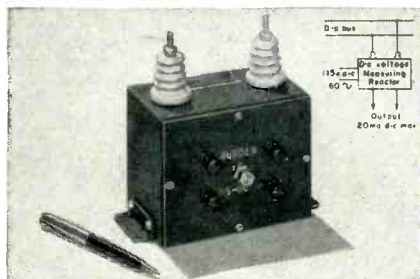

G.E.'s new d-c voltage measuring reactor minimizes hazard to personnel and equipment by isolating the instrument circuit from the d-c power source when making d-c voltage measurements. Since special safety precautions are not necessary, instrumentation costs are reduced. Available in six models for measurements up to 1200 volts. For complete application information, check Bulletin GEC-898.

New analog field plotter simplifies field studies

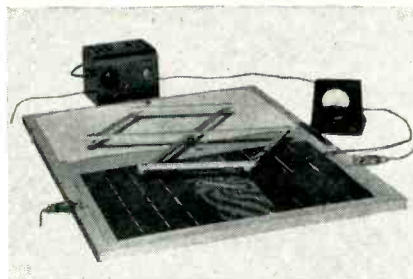

Electronics equipment engineers will find the General Electric analog field plotter a valuable aid in design work. Comprising plotting board and associated electric equipment, it speeds solution to problems such as electrode shapes in electronic tube design, field patterns in wave guides and electron lenses. Accompanying 50-page manual explains operation. See Bulletin GEC-851.

New G-E program boosts electronics in industry

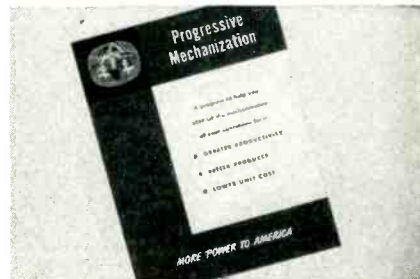

"Progressive Mechanization," a new G-E More Power to America program, has just been launched. Consisting of a color movie and an authoritative manual, its aim is to help step up industry's mechanization. One expected result is an expansion of the market for electronic controls. For details on this program which may mean added business for you, check Bulletin GEA-5789.



EQUIPMENT FOR ELECTRONICS MANUFACTURERS

Components
Meters, Instruments
Dynamotors
Capacitors
Transformers
Pulse-forming net-works
Delay lines
Reactors
Thyrite*
Motor-generator sets
Inductors
Resistors
Voltage stabilizers

Fractional-hp motors
Rectifiers
Timers
Indicating lights
Control switches
Generators
Selsyns
Relays
Amplidyne
Amplistats
Terminal boards
Push buttons
Photovoltaic cells
Glass bushings

Development and Production Equipment
Soldering irons
Resistance-welding control
Current-limited high-potential tester
Insulation testers
Vacuum-tube volt-meter
Photoelectric recorders
Demagnetizers

*Reg. Trade-mark of General Electric Co.

General Electric Company, Section C667-22
Schenectady 5, New York

Please send me the following bulletins:

Indicate: for reference only

X for planning an immediate project

- GEA-5777 Drawn-Oval Capacitors
 GEA-5789 Progressive Mechanization
 GEC-851 Analog Field Plotter
 GEC-898 DC Voltage-Measuring Reactor

Name.....

Company.....

City..... State.....

PROBLEM:

To get reliable automatic temperature control at low cost

SOLUTION:

GENERAL PLATE'S fabricated TRUFLEX[®] thermostat metal assemblies meet every temperature requirement

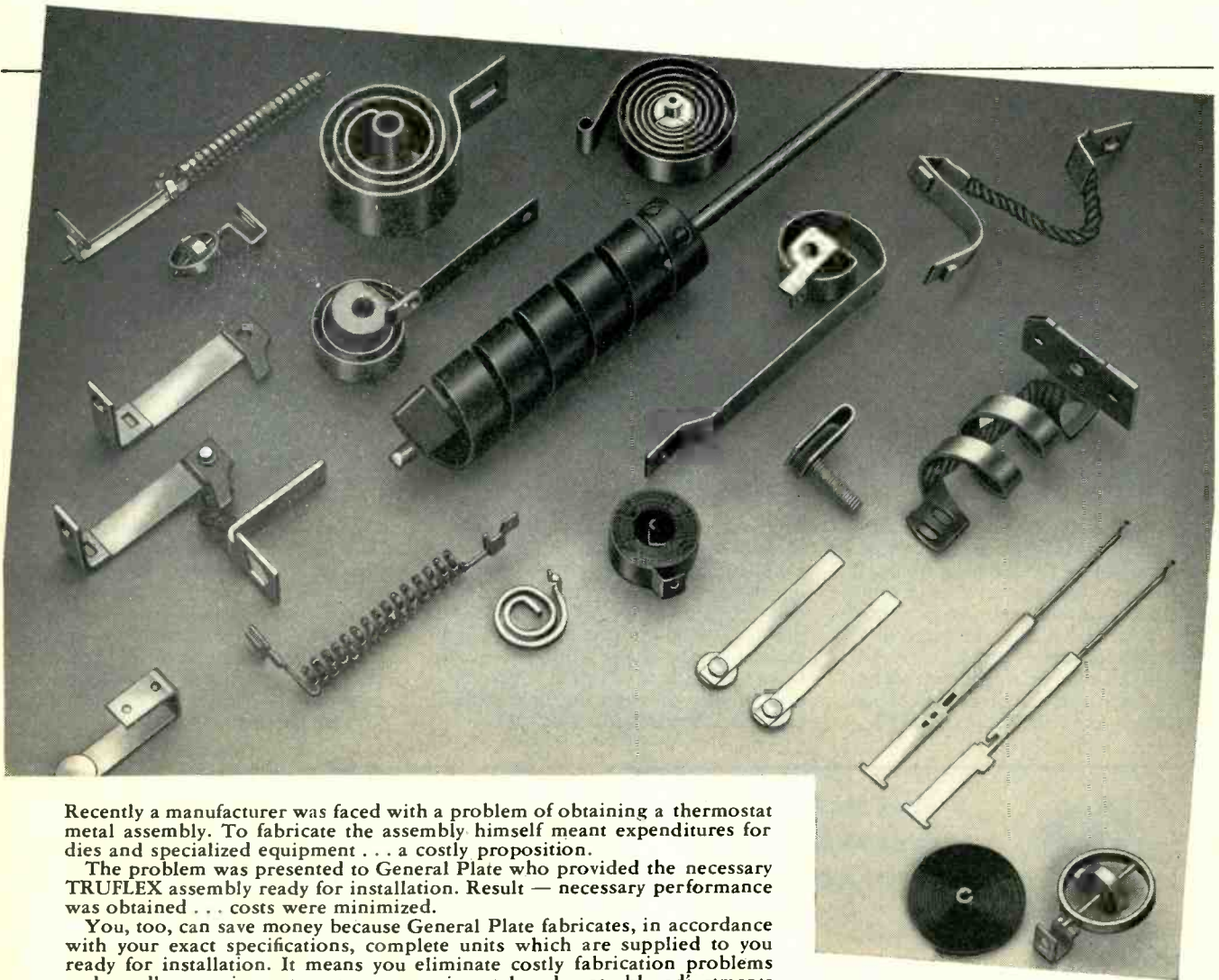

Recently a manufacturer was faced with a problem of obtaining a thermostat metal assembly. To fabricate the assembly himself meant expenditures for dies and specialized equipment . . . a costly proposition.

The problem was presented to General Plate who provided the necessary TRUFLEX assembly ready for installation. Result — necessary performance was obtained . . . costs were minimized.

You, too, can save money because General Plate fabricates, in accordance with your exact specifications, complete units which are supplied to you ready for installation. It means you eliminate costly fabrication problems and needless equipment costs . . . experimental and assembly adjustments are crossed from your books.

You get reliable performance because every order comes to you an exact duplicate of the original . . . consistently uniform in tolerances, temperature reaction and performance, thus preventing rejects and costly adjustments in assembly.

General Plate TRUFLEX Thermostat Metal Assemblies will be made to meet your specification requirements for temperature range, electrical resistance, corrosion resistance, etc. However, if you prefer to make your own assemblies, General Plate will produce sheet or strip to your material specifications. Write for information or engineering assistance.

**Have You a Composite Metal Problem?
General Plate can solve it for you**

GENERAL PLATE

Division of Metals & Controls Corporation
311 FOREST STREET, ATTLEBORO, MASS.

Westinghouse

announces a great new division to
manufacture a full line of
RELIATRON™ TUBES

**Receiving Tubes —
Television Picture Tubes —
Power Tubes**

Westinghouse proudly announces a completely new division—*THE ELECTRONIC TUBE DIVISION*. Its aim is this: To become the leader of the industry in providing better electronic tubes and better service to all tube users.

To provide this new standard of service to all branches of the electronic tube industry, Westinghouse has equipped its new tube division with completely new production, research, and distribution facilities.

*Westinghouse RELIATRON Tubes are now available,
many types are on their way at this moment to
distributors, dealers, equipment manufacturers,
government, government contractors.*



RELIATRON TUBES are backed by Westinghouse reliability

TUBE RESEARCH AND DEVELOPMENT

The Westinghouse position of leadership in electrical and electronic manufacturing is founded on the untiring efforts of its research staff. The Electronic Tube Division is already at work improving present tube types and developing new types for superior service and new applications, including UHF.

QUALITY CONTROL

RELIATRON tube performance is assured by an exacting program of quality control. Every step in the manufacture of RELIATRON Tubes—from raw materials to finished product—must meet standards which are the toughest in the industry.

ENGINEERING AND SALES SERVICES

Whatever your problem, whether you are an equipment manufacturer, government laboratory, or parts distributor, you will find Westinghouse sales representatives and application engineers in your area at your service. Sales and engineering offices are located strategically throughout the country to serve you.

ADVERTISING

Trade acceptance of Westinghouse RELIATRON Tubes will be supported by a nationwide advertising campaign second to none. Technical data, pricing service and application information are available to all tube users. Sales promotion programs for distributors and service dealers will be hard-hitting, sure sales builders. Your product or service will profit from consumer acceptance built by the tremendous national advertising of the name "Westinghouse."

DISTRIBUTORS, EQUIPMENT MANUFACTURERS, WRITE NOW

For complete information on the Westinghouse line of RELIATRON Receiving Tubes, Television Picture Tubes, and Power Tubes, write or wire Westinghouse Electric Corporation, Dept. 101, Elmira, New York. Or call your nearest Westinghouse Electronic Tube Division Sales Office.

YOU CAN BE SURE...IF IT'S

Westinghouse

WESTINGHOUSE ELECTRIC CORPORATION, ELECTRONIC TUBE DIVISION, ELMIRA, N. Y.

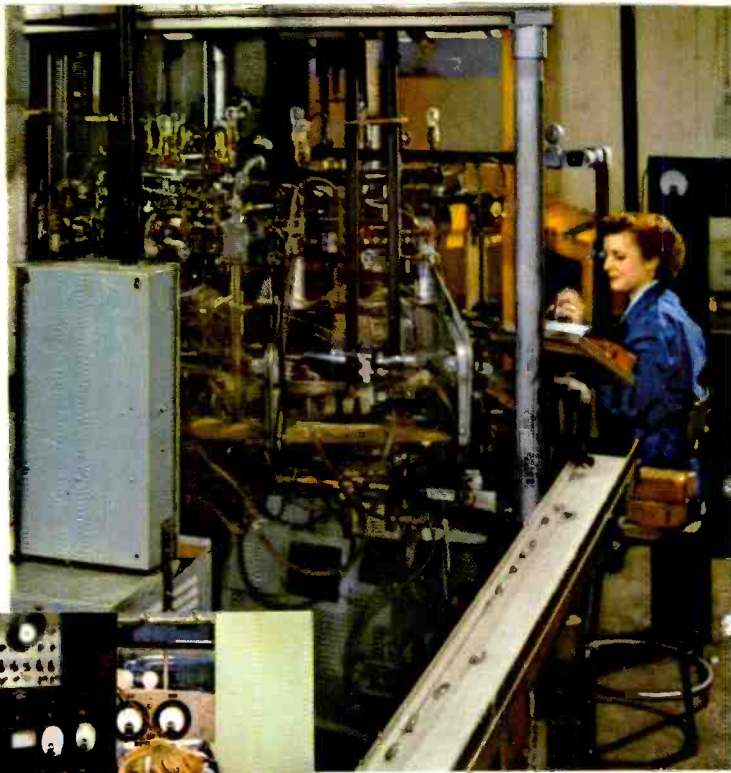

Sealex units at Bath, New York, turn out miniature tubes for government and commercial use. From here, tubes enter a rigorous program of checks and testing.

Here, an early Westinghouse WD-11 tube, one of the earliest types ever made, is shown just as it was used in the first commercial radio receivers.

This exclusively-Westinghouse quality control test set is one of a large battery of equipment which provide you with tubes of the highest quality and reliability.

Basic and application research are of prime importance in the Westinghouse Electronic Tube Division's plans. Such research has helped build the tube industry, and has made Westinghouse dominant in development.



Noise Suppression?

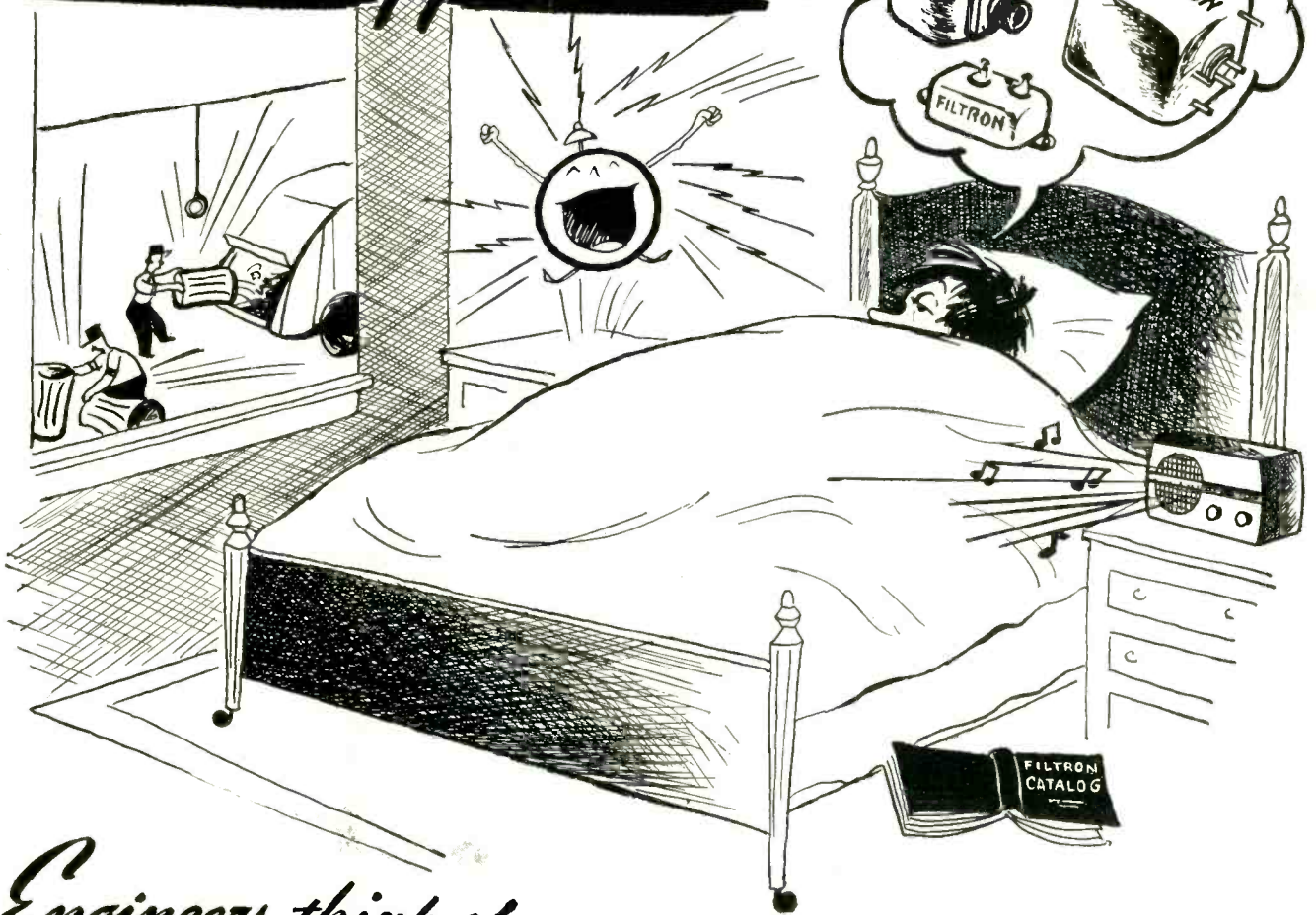

Engineers think of

FILTRON for RF Noise Suppression!

Sorry, but we are only able to solve all your RF Interference Suppression problems on electronic equipment!

FILTRON will *custom design* the proper filter, tested for your circuit conditions, to meet size, weight and overall configuration—and meet

military RF Interference Suppression limits and specifications.

FILTRON's advanced engineering, due to constant research and development, together with FILTRON's production know-how, insures quality components to meet your delivery requirements.

RF INTERFERENCE SUPPRESSION FILTERS FOR:

Motors
Generators
Inverters
Electronic Controls

Dynamotors
Power Plants
Actuators
Gasoline Engines

And other RF Interference producing equipment

filtered by **FILTRON**



CONVAIR YB-60

An inquiry on your Company letterhead will receive prompt attention

THE FILTRON COMPANY, INC. • FLUSHING, LONG ISLAND, NEW YORK
LARGEST EXCLUSIVE MANUFACTURERS OF RF INTERFERENCE FILTERS

INSUROK[®]

Rods and Tubes

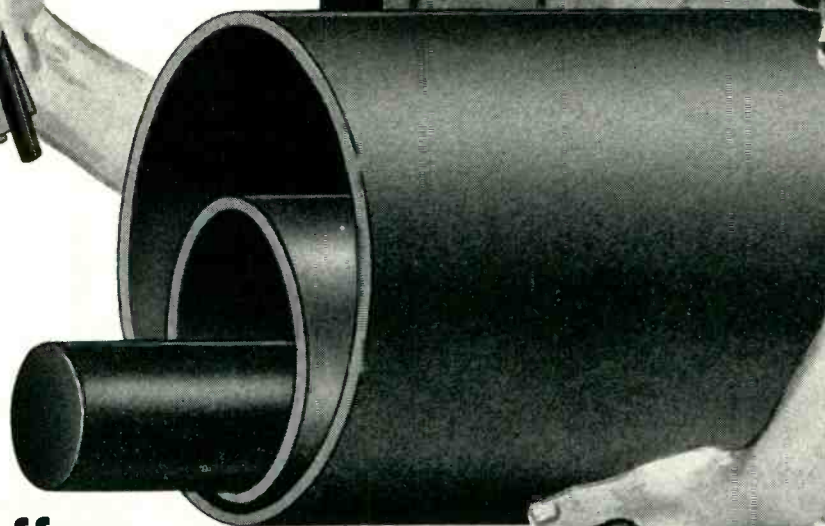
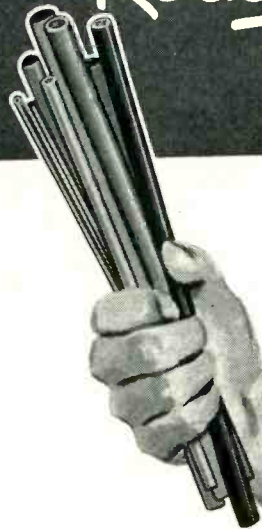

Richardson offers

a complete line of Laminated Plastic

Rods and Tubes to meet your needs

You'll find a large range of laminated plastic rods and tubes of various diameters in the Richardson line. Laminated tubes are available in fabric-base and paper-base grades, in 36" lengths and in diameters from $\frac{1}{8}$ " to $12\frac{1}{2}$ ". Special larger sizes can be made upon request. Laminated rods are available in molded-paper or fabric-base grades in diameters from $\frac{1}{8}$ " to 2". Diameters from 2" to 6" can be machined from sheet stock.

Whatever your plastics requirements, consult The Richardson Company. Richardson offers a *complete* plastics service—embracing materials development, design, molding, laminating, and fabricating. Write for 20-page booklet—"Laminated INSUROK."

The RICHARDSON COMPANY

FOUNDED 1858 — LOCKLAND, OHIO

2797 Lake Street, Melrose Park, Illinois (Chicago District)

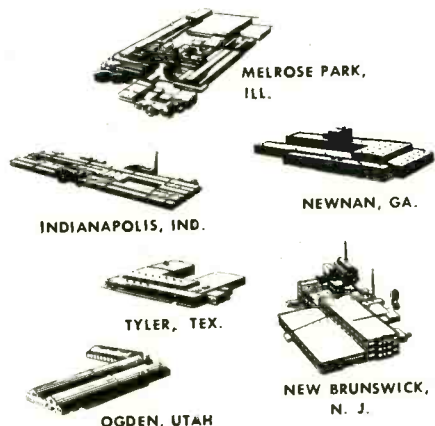

IF YOU'RE SINGING THOSE

“**case
and
cover
blues**”



LET
HUDSON



chase your troubles away!

IF waiting for cases, covers and specification metal stampings stymies your production, it will pay you to check with Hudson, now! For Hudson standard cases and covers—mass produced to meet all but the most unusual closure requirements—are available in scores of shapes and sizes.

Consult the new Hudson catalogs for a practical, economical solution to your problems. Just call or write today for complete information and data by return mail! Please address inquiries to Desk 210.

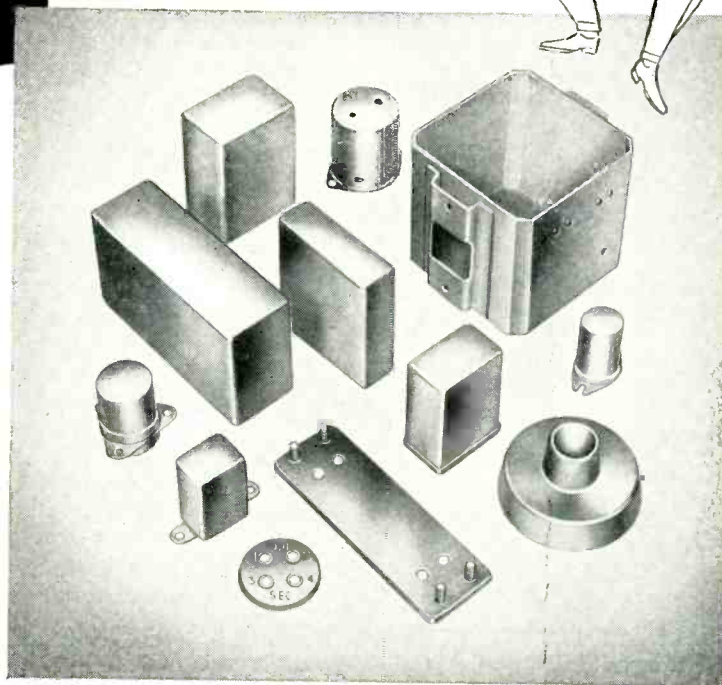

HUDSON TOOL AND DIE COMPANY • INC

PRODUCERS OF CASES, COVERS AND CUSTOM METAL STAMPINGS FOR ELECTRICAL, ELECTRONIC AND NUCLEONIC INDUSTRIES
118-122 SO. FOURTEENTH STREET, NEWARK 7, NEW JERSEY

CBS
HYTRON
ACTUAL SIZE

New CBS-HYTRON

Germanium Diodes

Guaranteed Moisture-Proof!

GENERAL PURPOSE TYPES

1N48

1N51

1N52

1N63

1N64

1N65

1N69*

1N70*

1N75

1N81*

*JAN TYPES

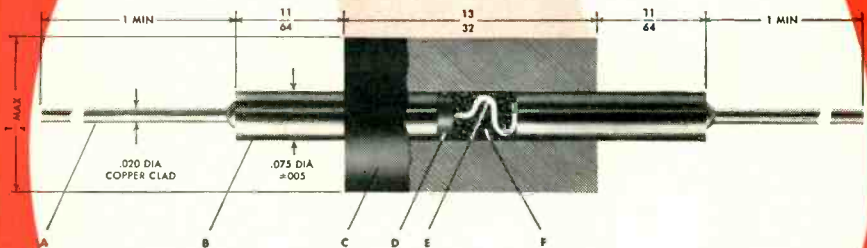

Mechanical Specifications

- A. .020" copper-clad wire
- B. Nickel-silver "clip-in" pin
- C. Glass-filled plastic case
- D. Germanium crystal soldered directly to base
- E. .005" tungsten cat whisker
- F. Moisture-resistant impregnating wax

WHY CBS-HYTRON GERMANIUM DIODES ARE BETTER RECTIFIERS

1. **MOISTURE-PROOF** . . . eliminates humidity and contamination problems
2. **SELF-HEALING** . . . self-recuperating from temporary overloads
3. **SUBMINIATURIZED** . . . only 1/2 inch long, 1/4 inch in diameter
4. **SOLDERED WAFER** . . . omission of plating eliminates flaking
5. **LOW SHUNT CAPACITY** . . . 0.8 μ fd average
6. **SELF-INSULATING CASE** . . . mounts as easily as a resistor
7. **EXCEPTIONAL LIFE** . . . 10,000 hours minimum under rated conditions
8. **NO FILAMENTS** . . . low drain, no hum

Vital germanium wafer in a CBS-Hytron diode is *guaranteed moisture-proof*. Sealed against deadly moisture . . . fumes . . . and contamination, a CBS-Hytron diode keeps moisture where it belongs . . . out! First, by a chemically and electrically inert impregnating wax. Second, by a glass-filled phenolic case. With *moisture-proof* CBS-Hytron germanium diodes, you can be sure of maximum trouble-free life.

Superior techniques also permit CBS-Hytron to omit plating of the germanium wafer. Soldering is directly to the base. Thus flaking is eliminated and quality improved. Universal design of CBS-Hytron diodes follows Joint Army-Navy specifications. "Clip-in" feature gives you versatility, ruggedness, and electrical stability. Flexible pigtailed of copper-clad steel welded into sturdy nickel pins also insure you against damage by soldering heat.

Check the eight important-to-you reasons why CBS-Hytron *moisture-proof* germanium diodes are better rectifiers. Send today for complete data and interchangeability sheets. Specify CBS-Hytron *guaranteed moisture-proof* diodes for superior, trouble-free operation.

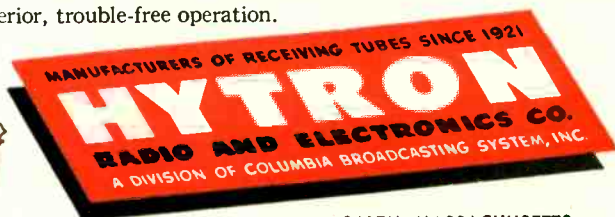

SALEM, MASSACHUSETTS



Variable
BAND-PASS FILTERS
for
SELECTIVE AMPLIFICATION

★
KROHN-HITE
 Models 310-A and 330-A

All Krohn-Hite Instruments fully guaranteed for one year against defective materials and workmanship. Prices net — f.o.b. Cambridge. Write for free catalog.

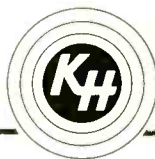

KROHN-HITE

INSTRUMENT COMPANY
 580 MASSACHUSETTS AVENUE
 DEPT. E, CAMBRIDGE 39, MASS., U.S.A.

FILTERS

OTHER INSTRUMENTS

OSCILLATORS

Model	Type	Frequency Range	Noise & Hum	Price
310-A	Band-Pass	20 cps to 200 kc	3 mv	\$275.00
330-A	Band-Pass	.02 cps to 2 kc	0.1 mv	\$450.00
	Band-Pass	0.2 cps to 20 kc	0.1 mv	\$450.00
340-A	Servo	.01 cps to 100 cps	10 mv	\$350.00
350-A	Rejection	.02 cps to 2 kc	0.1 mv	\$450.00
360-A	Rejection	20 cps to 200 kc	5 mv	\$275.00



20 cps to 200 kc

Specifications Model 310-A

BAND WIDTH: Continuously variable up to the maximum width covering the entire range from 20 cps. to 200 kc.
FREQUENCY RANGE: High and low cut-off frequencies independently tuned, continuous from 20 cps. to 200 kc, in four decade bands.
FREQUENCY ACCURACY: Calibration $\pm 10\%$.
GAIN: Unity (0 db) in pass band.
SLOPE: Each side 24 db/octave with peaking factor to reduce attenuation at the cut-off frequencies.
MAXIMUM ATTENUATION: Greater than 60 db.
INPUT CHARACTERISTICS:
 IMPEDANCE: Approximately 6 megohms in parallel with 50 mmfd.
 MAXIMUM INPUT AMPLITUDE: 5 volts rms.
OUTPUT CHARACTERISTICS:
 IMPEDANCE: 500 ohms.
 INTERNAL HUM AND NOISE: Less than 3 millivolts.
INPUT POWER: 105-125 volts, 50-60 cps, 40 watts.
FORM: Aluminum cabinet, overall dimensions: 12" wide, 7" high, 8" deep. Weight 14 lbs.
PRICE: \$275.00 Net, f.o.b. Cambridge, Mass.



.02 cps to 20 kc

Specifications Model 330-A

BAND WIDTH: Continuously variable up to the maximum width covering entire range: STANDARD MODEL: From 0.02 to 2,000 cps. MODIFIED UNIT: From 0.2 to 20,000 cps.
FREQUENCY RANGE: High and low cut-off frequencies independently tuned; continuous: STANDARD MODEL: From 0.02 to 2,000 cps. MODIFIED UNIT: From 0.2 to 20,000 cps.
FREQUENCY ACCURACY: Calibration $\pm 5\%$.
GAIN: Unity (0 db) in pass band.
SLOPE: Each side, 24 db/octave with peaking factor to reduce attenuation at the cut-off frequencies.
MAXIMUM ATTENUATION: Greater than 80 db.
INPUT CHARACTERISTICS:
 IMPEDANCE: Approximately 20 megohms in parallel with 200 mmfd.
 MAXIMUM INPUT AMPLITUDE: 10 volts rms.
OUTPUT CHARACTERISTICS: IMPEDANCE: 500 ohms.
 INTERNALLY GENERATED NOISE: 50 microvolts.
INPUT POWER: 105-125 volts, 50-60 cps, 50 watts.
PRICE: \$450.00 Net, f.o.b. Cambridge, Mass.



a *new* concept
in
OSCILLOGRAPHY

the new **DU MONT**
Type 304-A

The new Du Mont Type 304-A, succeeding the world-famous Type 304-H, is more than simply a new instrument — more than a new combination of established circuits.

It represents a significant development in the science of instrumentation. The Type 304-A is a true electronic voltmeter. This reflects a new concept in oscillography. Every feature of the Type 304-A has been evaluated with this concept in mind. All of the features that made the Type 304-H so valuable as a qualitative instrument have been preserved and augmented to enable not only qualitative analyses, but rapid, accurate quantitative amplitude measurement as well.

The novel amplitude calibrating system of the Type 304-A permits signal measurements from the screen directly in volts. Unlike electro-mechanical devices, the new Type 304-A is not restricted to measurement of sinusoidal signals — or peak-to-peak values of voltage. The Type 304-A may be used to measure any amplitude portion of signals within its performance specifications.

SPECIFICATIONS:

CATHODE-RAY TUBE — New Flat-Face Type 5ADP-
ACCELERATING POTENTIAL — 3000 volts.

Y-AXIS: Deflection Factor — Through amplifier, 0.1 p-p volts FULL SCALE (equivalent to 0.025 p-p volt/inch). Direct, 32-39 p-p volts/inch.
Frequency Response — Direct coupling: flat to 0. Down not more than 10% at 100,000 cps. Capacitive Coupling: down not more than 10% at 10 and 100,000 cps. Down not more than 50% at 300,000 cps. Provision for balanced input on 0.1 VOLT-FULL-SCALE range.
Undistorted Deflection — More than 4 inches.
Expansion — Equivalent to 20 inches.
Input Impedance — Amplifier: (single ended) 2 megohms 50 μ f; (balanced) 2 megohms, 35 μ f. Direct: (single ended) 1.5 megohms, 20 μ f; (balanced) 3 megohms, 20 μ f.

X-AXIS: Deflection Factor — Through amplifier, 0.3 p-p volt/in. Direct, 40-50 p-p volt/in.
Frequency Response — Direct coupling: flat to 0. Down not more than 10% at 100,000 cps; down not more than 50% at 300,000 cps. Capacitive coupling: Down not more than 10% at 10 and 100,000 cps. Down not more than 50% at 300,000 cps.
Undistorted Deflection — More than 4 inches.
Expansion equivalent to 30 inches.
Input Impedance — Amplifier: 2.2 megohms, 50 μ f. Direct: (single ended) 1.5 megohms, 20 μ f; (balanced) 3 megohms, 20 μ f.

LINEAR SWEEPS: Sweep Frequency — Recurrent and driven sweeps continuously variable from 2 to 30,000 cps. Maximum sweep-writing-rate, 1"/ μ sec. Provision for sweeps of extra-long duration; 1/2 sec. of sweep obtained for each microfarad of external capacitance.
Synchronization — from signal of either polarity.
Sync Limiting — on both driven and recurrent sweeps.

VOLTAGE MEASUREMENT — Squarewave standard applied for calibration by front panel push button.
Voltage Range: VOLTS FULL SCALE, 0 to 0.1, 1, 10, 100 volts.
MULTIPLIER: x1 to x10
Overall Accuracy: 5%

INTENSITY MODULATION — 15 volts blanks beam at normal intensity settings.

CALIBRATED SCALE — Variable illumination. Numbered calibrations for amplitude measurement.

PRIMARY POWER — 115 or 230 volts. 50-400 cps. 110 watts.

PHYSICAL CHARACTERISTICS — Metal cabinet with grey wrinkle finish. Dimensions: height 13 1/2", width 8 1/4", depth 19 1/2". Weight 50 lbs.

CALIBRATING the Type 304-A is as simple and easy as zeroing a vacuum-tube voltmeter. Depressing the CALIBRATOR push button on the front panel applies a square wave signal of precisely 0.1 p-p volt to the amplifier. The MULTIPLIER control is then adjusted for full scale deflection (4 inches) so that the peaks are at 0 and 100. Amplitude may now be read directly from the scale where four inches vertically indicate 0.1, 1, 10, or 100 volts, as determined by VOLTS FULL SCALE selector. Depressing the CALIBRATOR push button again, returns signal applied to Y-input terminals to the screen.

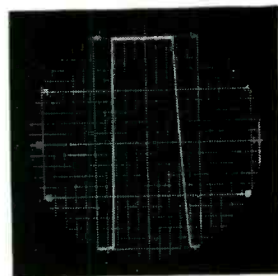

The MULTIPLIER control also permits calibration of the scale to other values. For, say, 200 volts-full-scale, the MULTIPLIER control is adjusted near 2 so peaks of squarewave are at zero and 50 on the scale. Amplitude may now be measured directly in volts simply by multiplying the scale reading by the setting of the MULTIPLIER control (2) and the VOLTS FULL SCALE setting (100). Use of the MULTIPLIER control extends the range of the Type 304-A to 1000 volts-full-scale.

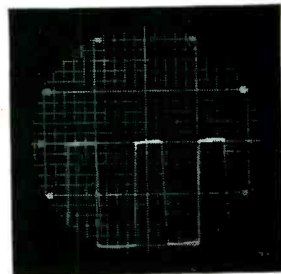

DOMESTIC PRICE \$333.00

ALLEN B. DU MONT LABORATORIES, INC., INSTRUMENT DIVISION - 1500 MAIN AVENUE, CLIFTON, NEW JERSEY



How IBM gets perfection outside to match its precision inside

IBM business machines are known the world over for their precision. And they *look* the part, too.

But the modern lines which make these machines so attractive make their fabrication a challenge to Karp Metal Products Co., Inc., one of IBM's sheet metal fabricators.

For only with its creative staff of sheet metal craftsmen...its ability to tool complex jobs...its 77,000 square feet of most modern plant facilities is Karp able to match IBM's precision inside with flawless fabrication outside.

These same facilities can solve *your* cabinet, housing or enclosure problems, too. Karp engineers can often show you the way to design modifications which cut initial costs and speed assembly; they can also show you how to take advantage of Karp's vast assortment of available dies.

Whether your needs are as large as IBM's or more moderate, you'll find it profitable to do business with Karp.

KARP METAL PRODUCTS CO., INC., 215 63rd ST., BROOKLYN 20, N. Y.

MOST COMPLETE FACILITIES FOR LARGE AND SMALL RUNS OF
ENGINEERED SHEET METAL FABRICATION

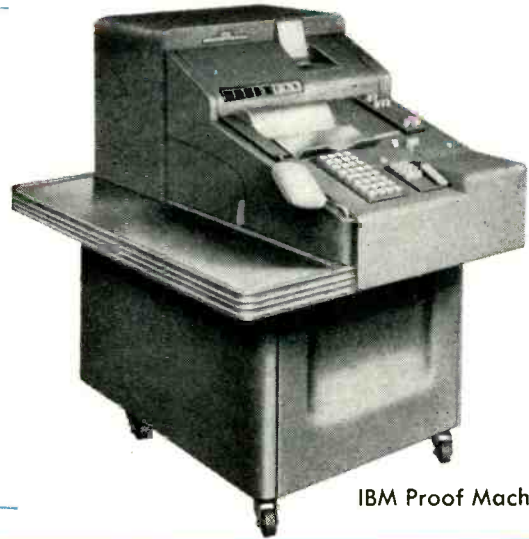

IBM Proof Machine



IBM Card Verifier

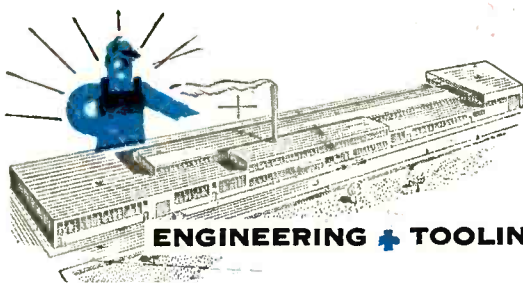

ENGINEERING + TOOLING + PRODUCTION + FINISHING =

KARP

Approval is

for resistors too!

Our tests at elevated
Temperatures indicate you
don't know how really
good your resistors are.



In all our experience, no resistor has been so extensively tested—and so *unanimously approved*—as IRC's new Type BOC Boron-Carbon $\frac{1}{2}$ -watt PRECISTOR. Of the 3,000,000 already manufactured, more than 100,000 were given the most stringent tests-in-production, including critical temperature cycling and 500-hour load-life tests. Result:— Type BOC conforms to *all* requirements of MIL-R-10509A! Also, customers have conducted their own laboratory and field tests—and they express their approval of Type BOC in letters like those shown here.

In the case of IRC's new JAN Type Precision Wire Wounds and Advanced Type BT Resistors, too, rigid quality control and continued testing have won industry-wide approval. Most stable and reliable of all precision wire wounds, Type WW's far surpass JAN-R-93 Characteristic B Specifications. And Type BT's continue to meet and beat JAN-R-11 Specifications.

Our test results
verify your data.

Approval for
Type BOC is
hereby granted.

The logo for IRC (International Resistor Corporation) is located in the bottom right corner. It consists of the letters "IRC" in a bold, serif font, enclosed within a black oval shape. The background of the entire advertisement is white, with a large red area at the bottom right corner.

important

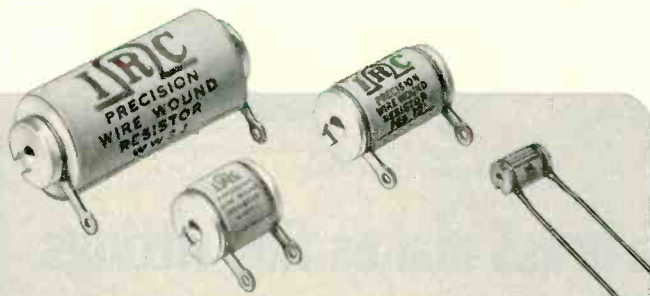

New JAN Type Precision Wire Wound Resistors Excel JAN-R-93 Characteristic B Specifications

	Original Resist.	1st Cycle % Chge	2nd Cycle % Chge	3rd Cycle % Chge	4th Cycle % Chge	Resist at End of 100 hrs load	Total % Chge	% Chge from Last Temp Cycle to End of 100 hrs. load	Resistance Chge at End of 100 Hrs Load only	% Chge (no cycling)
1	100.010	+04	+04	+05	+05	100.050	+04	-01	100.040	-02
2	100.000	+03	+04	+03	+05	100.060	+06	+01	100.000	0
3	100.000	+01	+02	+02	+05	100.000	0	+05	100.050	-02
4	100.000	+02	0	+02	+02	100.000	0	-02	100.040	-01
5	100.010	+03	+04	+04	+05	100.000	0	-05	100.030	-03
6	100.000	0	+03	+04	+04	100.100	+1	+06	99.980	0
7	100.000	+04	+05	+04	+04	100.070	+07	+03	100.000	0
8	100.000	+03	+05	+05	+05	100.050	+05	0	100.000	0
9	100.000	+04	+03	+05	+04	100.010	+01	-03	100.050	0
10	100.000	+02	+02	+02	+04	100.010	+01	-03	100.000	0
11	100.000	0	+01	+01	+03	100.000	0	-03		

Most reliable and stable of all wire-wound precisions, these new Type WW's have proved their superiority in unbiased tests. Severe cycling and 100-hour load tests resulted in virtually zero changes in resistance. Other stringent tests proved JAN Type WW's high mechanical strength, freedom from shorting, resistance to high humidity. New winding forms—new winding technique—new type insulation—and new terminations assure long life, accuracy, ruggedness in service. IRC JAN Type WW's are becoming the choice of leading producers of military equipment. Get full technical data in Catalog Bulletin D-3.

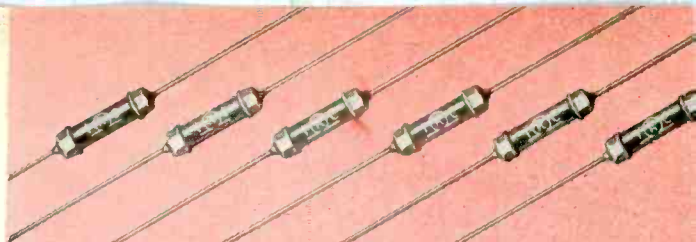

Type BOC Boron-Carbon 1/2-Watt Resistor Surpasses Signal Corps Specification MIL-R-10509A

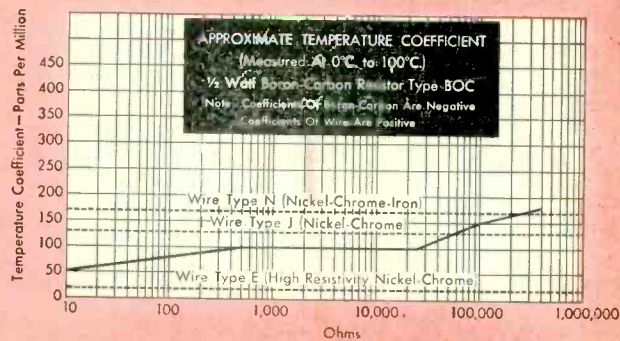

The ultimate in stable, reliable non-wire-wound resistors, Type BOC's are especially designed for military electronic equipment—radar, gunnery control, communications, telemetering, computing and service instruments. Greatly improved temperature coefficients of resistance permit their use in place of costlier wire wound precisions in many critical applications. Lower capacitive and inductive reactance suit them to circuits where wire-wound stability is needed. Small size makes them ideal in limited space. Tolerance:—1%, 2% and 5%. Resistance Values:—10 ohms to 1/2 megohm. Send for full technical data in Catalog Bulletin B-6.



Type BT Advanced Fixed Composition Resistors Meet and Beat JAN-R-11 Specifications

Type BTS Meets and Beats Rigid G Characteristic

These are the famous Advanced Type BT's whose characteristics set new performance records for fixed composition resistors. They combine a unique filament-type resistance element with exclusive construction features to assure extremely low operating temperature and excellent power dissipation. Yet they are compact, light in weight, fully insulated. Intensive tests by independent agencies have proved their superiority under actual field conditions. For full technical data, send for Catalog Bulletin B-1.

Mail Coupon Today for Full Details of These IRC Resistors

INTERNATIONAL RESISTANCE COMPANY
403 N. Broad St., Philadelphia 8, Pa.

Please send me full data on the following checked items:—

- Type BOC Boron-Carbon PRECISTORS
- Type WW Precision Wire Wound Resistors
- Type BT Advanced Fixed Composition Resistors
- Name and Address of Nearest IRC Distributor

NAME _____

TITLE _____

COMPANY _____

ADDRESS _____

CITY _____ ZONE _____ STATE _____

Boron-Carbon PRECISTORS • Power Resistors • Voltmeter Multipliers • Insulated Composition Resistors • Low Wattage Wire Wounds • Volume Controls • Voltage Dividers • Precision Wire Wounds • Deposited-Carbon PRECISTORS • Ultra HF and High-Voltage Resistors • Insulated Chokes • Selenium Rectifiers

Wherever the Circuit Says

INTERNATIONAL RESISTANCE COMPANY

403 N. Broad Street, Philadelphia 8, Pa.

In Canada: International Resistance Co., Ltd., Toronto, Licensee

J. E. SMITH & CO. ADV. AGENCY

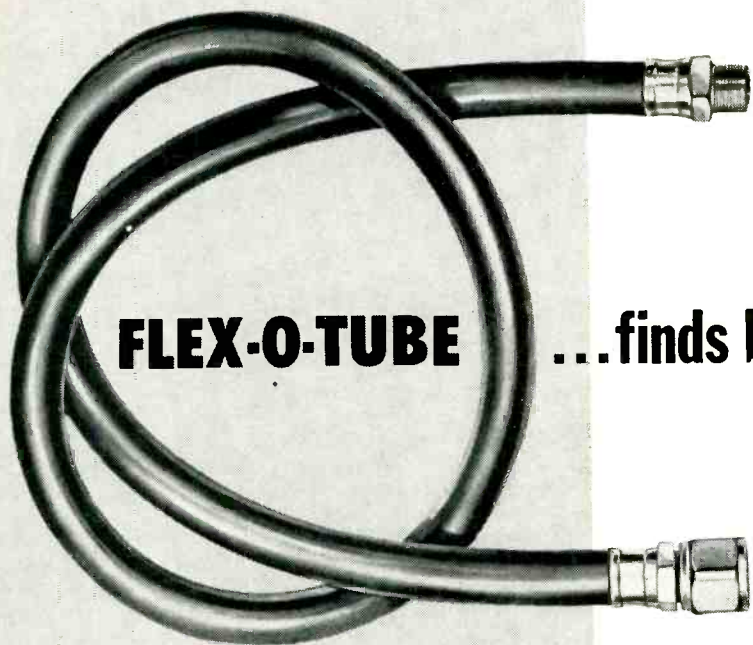

FLEX-O-TUBE

... finds brass makes fine fittings

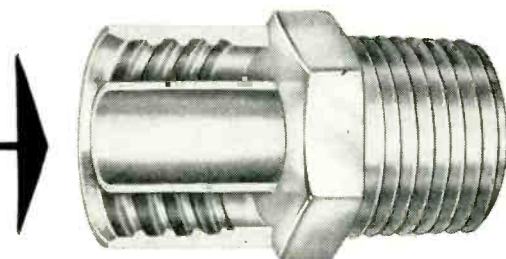

Flex-o-Tube Hose, and cross section of machined male fitting.

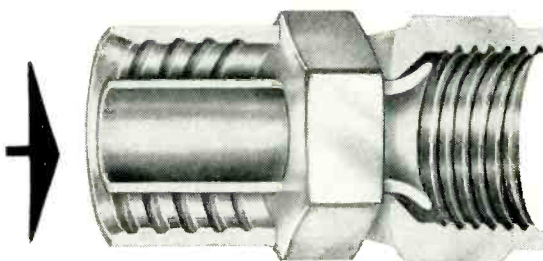

Cross Section of machined and flared female fitting.

For quick, accurate and economical machining, free-cutting brass rod is preferred by many companies, such as Flex-O-Tube, Division of Meridan Corporation, Detroit, Mich. This company makes hose assemblies and fittings to conduct air-oil-water-gasoline and hydraulic power for the automotive, farm implement, machine tool and aircraft industries. Some of these hoses have a minimum bursting pressure of 20,000 pounds per square inch, which gives an indication of the tightness required, which can be obtained only by strength and accuracy.

Flex-O-Tube has found six points of superiority for brass over other metals, as follows:

1. Brass "flows," or is ductile, so that no cracks result during the crimping operation required to fasten the fittings to the hose.
2. Ductility and strength inherent in brass act to provide a superior seat to fittings designed to control fluid flow. Competitive metals are either too hard or too soft to give positive closing and tend to leak.
3. Where the design of the fitting is intricate, necessitating removal of considerable metal by machining, the automatic screw machines can be run faster with free-cutting brass rod.
4. Brass has a high scrap value, and the scrap sold back to the mill increases brass supplies.
5. The break-even point between brass and other metals is especially favorable to brass in the sizes of rod that Flex-O-Tube buys.

6. Customer preference is for brass, which is universally recognized as a quality metal. Hence brass fittings are more readily sold, and in fact often are specified regardless of size or price differentials.

Included in the Flex-O-Tube operations are machining, flaring, crimping, and annealing to assure the proper ductility for flaring and crimping.

Revere is an important supplier of brass rod to Flex-O-Tube, and has also collaborated with this customer through the Revere Technical Advisory Service.

If you wish information about brass and how one or more of the Revere brasses can add to the economy and saleability of your product, get in touch with the nearest Revere Sales Office. See your telephone directory or write direct.

REVERE

COPPER AND BRASS INCORPORATED

Founded by Paul Revere in 1801
230 Park Avenue, New York 17, N. Y.

Mills: Baltimore, Md.; Chicago and Clinton, Ill.; Detroit, Mich.; Los Angeles and Riverside, Calif.; New Bedford, Mass.; Rome, N. Y. Sales Offices in Principal Cities, Distributors Everywhere.

SEE REVERE'S "MEET THE PRESS" ON NBC TELEVISION EVERY SUNDAY

The Ideal End Closure -

for resistors...

for capacitors...

for other tubular components!

E-I END SEALS

E-I END SEALS SIMPLIFY MANUFACTURE, SPEED PRODUCTION, LOWER UNIT COST

No special skill is required to apply E-I seals. Assembly is rapid since all metal parts are tin-dipped for easy soldering. Rugged construction plus carefully annealed glass permits rough handling without weakening or breakage.

E-I END SEALS PROVIDE POSITIVE HERMETIC SEALING AT ALL TIMES

Glass of the Pyrex family, chemically bonded to metal provides a permanently air-tight seal that readily withstands drastic pressure change, shock and vibration. All seals are silicone-treated for high resistance when exposed to salt-spray or humidity.

E-I END SEALS ARE AVAILABLE IN ALL SIZES AS STANDARD ITEMS

Standard stock items are available to economically meet practically any requirement. Both pigtail lead and terminal connection types of seal are included. A standard, self-describing coding system affords maximum customer convenience in ordering.

DIVISION OF AMPEREX ELECTRONIC CORP

WRITE TODAY FOR BULLETIN 952
containing complete information on E-I
End Seals including dimensional data
and coding system.



ELECTRICAL INDUSTRIES
44 SUMMER AVENUE, NEWARK 4, NEW JERSEY

Old Style
G10 SERIES



New Style
JA1A SERIES



NEW IMPROVED G-E GERMANIUM

1. HERMETIC SEAL

2. MINIATURE SIZE

- **Hermetically Sealed** against deteriorating elements. Glass-to-metal seals throughout.
- **Miniature Size** to facilitate use in all electronic equipments, yet heat losses are dissipated efficiently.
- **Re-designed** to meet all military humidity tests and shock and vibration requirements.
- **High Output Voltage** and improved back current characteristics.



Model 4JA2A4 designed for use in TV power supplies. DC output voltage 10 to 15 volts higher than with comparable selenium rectifiers in a typical voltage doubler circuit.

ABSOLUTE MAXIMUM RATINGS • T=25°C • RESISTIVE LOAD				
	4JA1A1	4JA1A2	4JA1A3	4JA2A4
PEAK INVERSE VOLTAGE (volts) *	100	200	300	400
PEAK FORWARD CURRENT (amps) *	0.5	0.5	0.5	1.3
D.C. OUTPUT CURRENT (Ma) *	150	150	150	400
D.C. SURGE CURRENT (amps)	2½	25	25	25
FULL LOAD VOLTAGE DROP (volts)	0.6	0.6	0.6	0.7
OPERATING FREQ. (kc)	50	50	50	50

* Typical absolute maximum ratings. For other combinations refer to Fig. 1.

DIFFUSED JUNCTION RECTIFIER

Suggested Application Fields

Originally developed for military use, the new JA1A and JA2A Rectifiers may be adaptable to fields other than radar and military communications. Among them: Computers, magnetic amplifiers, TV receiver power supplies, telephone switchboards. Application information on other uses can be supplied. Write or wire us!

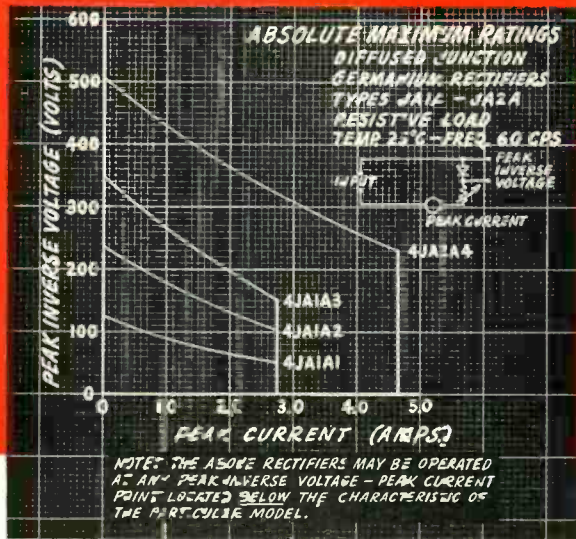
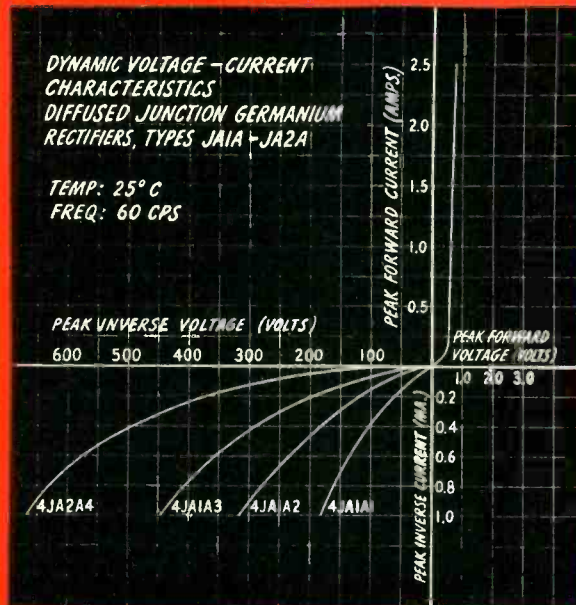
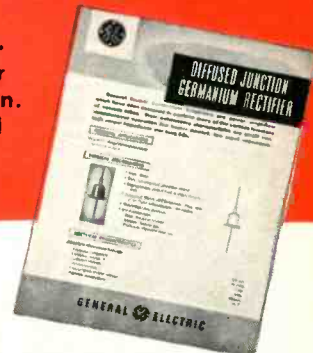

FIG. 1



NEW BULLETIN—Complete specifications on the diffused junction rectifier are contained in this illustrated bulletin. It's yours on request. Write: General Electric Company, Section 4112, Electronics Park, Syracuse, N. Y.



GENERAL  ELECTRIC

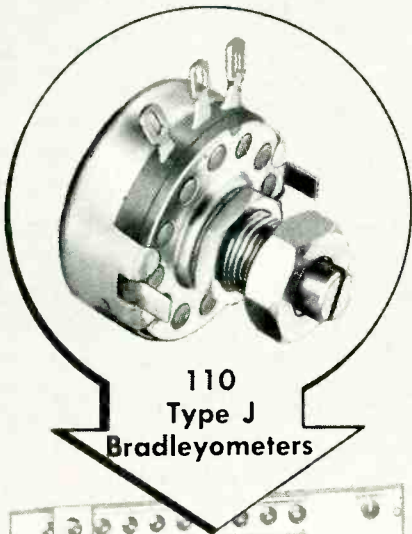

110
Type J
Bradleyometers

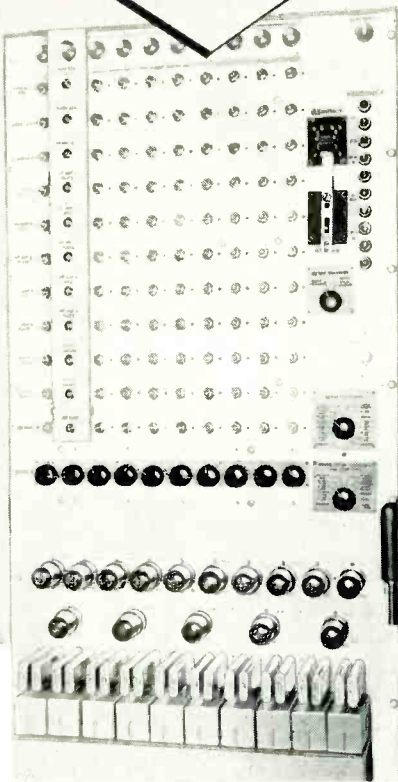

CLOSE-UP OF SERVO PANEL

The above panel contains 110 Allen-Bradley Type J potentiometers, each of which may be adjusted to meet transmitter operating requirements.

Type J Bradleyometers can be supplied in single, dual, or triple unit construction, with or without line switch.

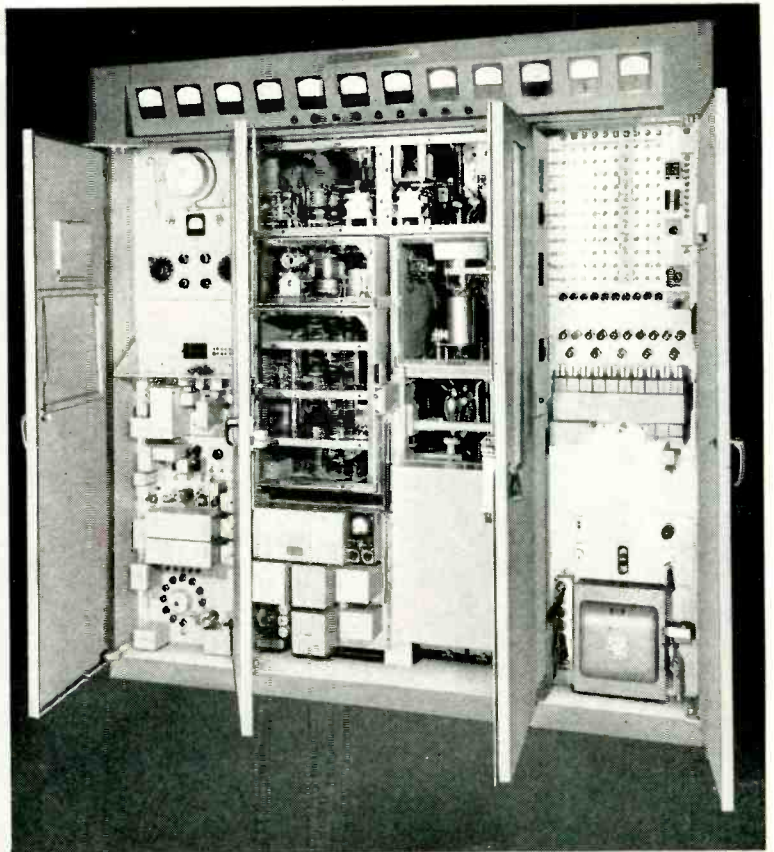

Western Electric Overseas Radio Telephone Transmitter Panel

OVERSEAS TRANSMITTER has 110 Type J Bradleyometers

The Bradleyometers used in this Western Electric panel board assure stability of transmitter performance because the solid molded resistor elements of these Bradleyometers are not affected by heat, cold, moisture, or age. The contact brush, which actually improves with age, is always noiseless in operation.

Bradleyometers can be built to

produce any resistance - rotation curve. During manufacture, the materials entering into the molded resistor can be varied in resistance throughout the circumference of the ring to meet your special electronic circuit requirements.

If you have a critical rheostat or potentiometer problem, be sure to investigate the Type J Bradleyometer.

Allen-Bradley Co., 110 W. Greenfield Ave., Milwaukee 4, Wis.



ALLEN-BRADLEY

FIXED & ADJUSTABLE RADIO RESISTORS

Sold exclusively to manufacturers

QUALITY

of radio and electronic equipment



IT'S NEWS!

EAI's Dataplotter . . .

An Electronic System That Converts Digital Data To An Analog Plot . . .

Here is a system that will save countless man-hours and costs, and will insure accurate and clear presentation of data. This new Dataplotter, designed and developed by Electronic Associates Inc., will automatically plot a cartesian curve composed of incremental points or symbols from IBM card data at maximum machine reading speed. It will accept data from other inputs — Magnetic tape, keyboards, digital computers, etc.

It will retain at all times the basic accuracy of the digital system. Here's what the Dataplotter system consists of:

- Variplotter Model 205G
- Digital-to-analog converter, Model 417
- Data input keyboard

For further information, clip out and mail the coupon below. No obligation.



Electronic Associates Inc.
Long Branch
New Jersey

Gentlemen: Would you be kind enough to send me detailed information on your Dataplotter.

Name Title.....
 Company.....
 Address.....
 City..... Zone..... State.....

Write →

ultra-high-frequency...
 w Piece ment
 n the labora-
 ic Associates,
 is week a new
 which should
 t to every per-
 th the tabula-
 information.
 amed by Elec-
 Inc., the Data-
 of a Variplotter
 ich was develo-
 nic Associates.
 on the market
 years now. The
 information
 which is easily
 is held on a
 g surface. The
 n to insure ac-
 Electronic As-
 ter, Data-
 onists of a digi-
 converter Model
 completely new
 ent developed by
 converter Informa-
 n be plotted on the
 ting board. This
 og converter, like
 equipment in this
 case in a metal
 lrd piece of equip-
 ystem is the data
 n for Electronic
 c. reported that
 appler system is
 to great many
 ar the recording
 accepted. "This sys-
 eokesman, "will
 uction problems re-
 he efficiency. This
 s a considerable
 or as far as data
 concerned, and will
 ut down the time
 ert data information.
 nt will undoubtedly
 ure for many, many
 an the work in a
 he time that would
 uire a large crew of
 lo."
 equipment has been
 any firms, and they
 d that it has result-
 adous savings of time
 An person inter-
 ting complete inform-
 ls system is urged to
 Electronic Associates
 ic Associates, Inc.
 cores in
 s announcement today
 were producing a
 to the commercial
 Electronic Associates,
 ong Branch, New Jer-
 one more new develop-
 eir history firsts.
 be remembered that
 Associates, Inc., was
 e first companies to de-
 otting board with the
 e commercial firm
 e research and
 t that they've de-
 e far out in plotting
 e had one successful
 a new development
 evelopment of the
 ent and for com-

Branch they have developed new
 equipment at industry speed
 needs.
 For so time now scientists
 been trying to develop an

to an analog
 plotter sys-
 cently by E
 Inc., will
 and with n
 the operat
 firms and
 to put this
 plants, for
 down time

Men Fr
 Electron
 inated r
 ers and
 w the f
 duary De
 na Corps
 Wa
 the
 ing
 ever
 prod
 mest
 dustr
 with
 lices o
 ernme
 to 50
 Th
 ciates,
 dated
 tific pr
 produce
 These
 ideal
 building
 feet of
 land in
 compan
 original
 well as
 research

H
 The
 laborat
 machin
 and te
 and to
 illary
 geared
 depart
 ciates
 fied
 Natio
 and
 Th
 Elec
 trini
 scie
 dev
 an
 o
 m
 m
 ssif
 ar.
 Th
 pren
 tron
 This
 mor
 per
 100
 Inc
 scie
 nev
 and
 me
 ple
 of
 fr
 du
 th
 fr
 to
 pe
 di
 ti



KENYON

TRANSFORMERS

for standard and
special applications

Kenyon quality transformers have always represented the highest standards of performance and durability. For more than a quarter century discriminating engineers who will settle for nothing but the best have consistently specified Kenyon.

KENYON TRANSFORMERS FOR

MIL Applications

Radar

Broadcast

Atomic Energy Equipment

Special Machinery

Automatic Controls

Experimental Laboratories

Write for details

KENYON TRANSFORMER CO., Inc.

840 Barry Street, New York 59, N. Y.

TUNG-SOL®

flashers

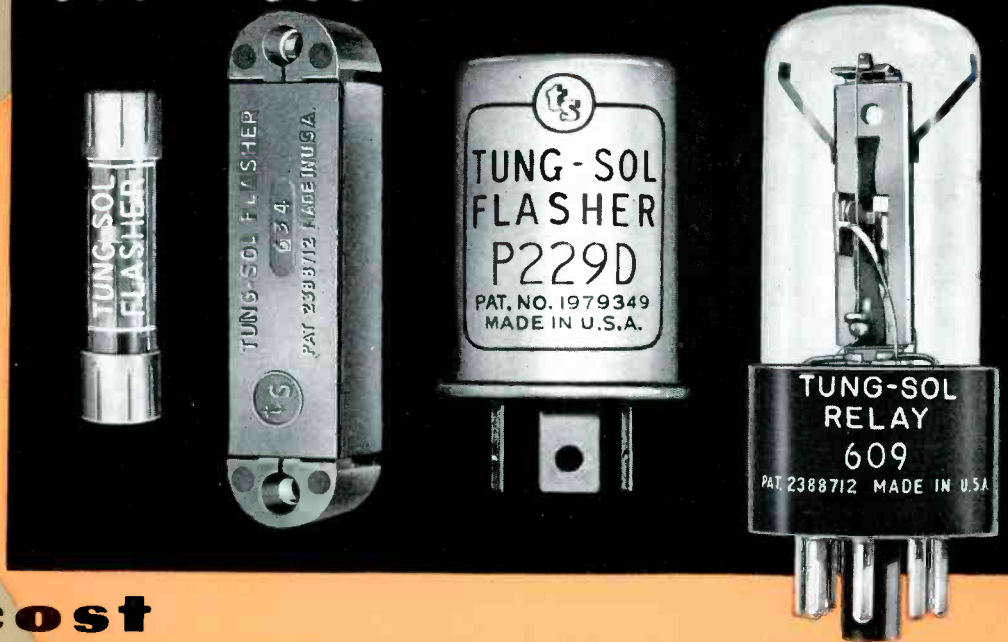
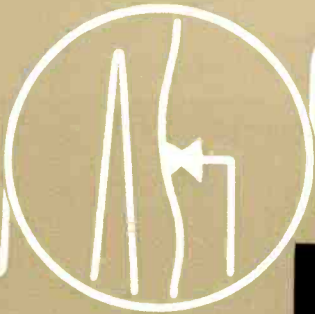

**new,
low-cost
circuit control devices
for electronic equipment**

see other side for additional information ▶

**Tung-Sol flashers
protect against voltage
overloads—facilitate
intermittent operation—
regulate automatic
switching**

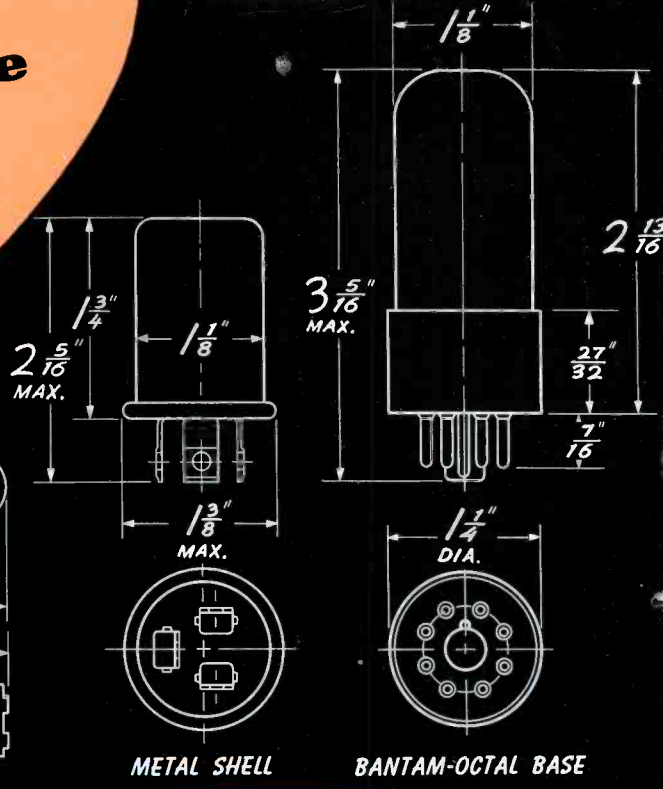
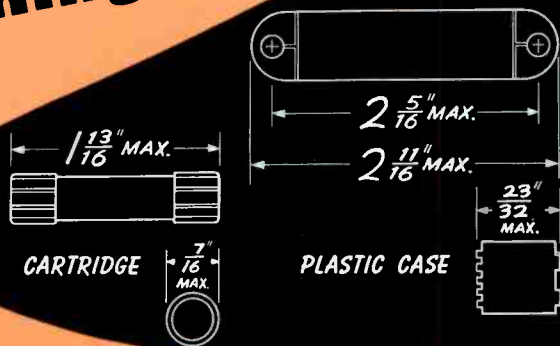

"Flasher" is the automotive name for this Tung-Sol product. Actually, it is the most simplified, most reliable thermal-operated relay ever developed.

If you own an automobile made since 1939 and it has directional signals, then you have already witnessed first-hand the virtually unflinching performance of the Tung-Sol Flasher. Tucked away under the instrument panel, this tube-size mechanism makes the turn signal lights blink on and off.

After 13 years, the 13 million flashers in automotive use have demonstrated that this device usually outlasts the car it is on, and the average life of a car is 7 years! Tung-Sol Flashers not only are more reliable than conventional types of relays—they are more compact and they cost less.

Now then, where can you use a "circuit breaker" or "fuse" or "relay" in your electronic equipment?

As a circuit breaker? For this type of application, Tung-Sol Flashers are built with normally closed contacts. Under the effect of a short or overload, there is an almost instantaneous response and the contacts are opened. With equal rapidity the device cools and the contacts close. As long as the disturbance within the circuit exists the Flasher will continue automatically to sample the condition

of the equipment, thus providing absolute safety against costly, damaging burn-out.

As a voltage limiter? When an overload surge raises voltage to a damaging level, the Tung-Sol Flasher will throw in a protective resistance. When the voltage returns to normal, the resistance is shorted out.

As a cycling control? Where it is desirable that equipment operate intermittently, the Flasher will cycle on and off at a predetermined rate.

As a time delay relay? This type is non-operative until a given voltage or current is reached, when the Flasher will make contact and activate a switch.

As a warning device? Tung-Sol Flashers provide for visual or audible warning, as well as mechanical protection through use of a pilot light, horn, or siren which may be installed on the equipment or at a remote point.

The circuit protection, freedom from service interruptions and lower maintenance which you could offer your customers by installing Tung-Sol Flashers in the equipment you make, will certainly warrant your obtaining complete information. Our staff will be glad to work with your engineers. Write today.

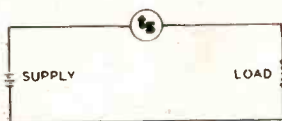

SINGLE CIRCUIT - SERIES ELEMENT

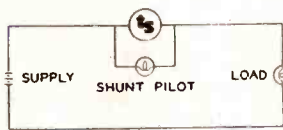

SINGLE CIRCUIT - SHUNT PILOT

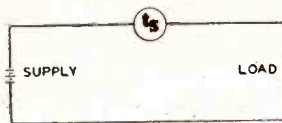

SINGLE CIRCUIT - SHUNT ELEMENT



SINGLE CIRCUIT

TYPICAL SINGLE CIRCUIT FLASHER DIAGRAMS

FLASHERS FOR APPLICATIONS WITH VOLTAGES BETWEEN 3 and 32 VOLTS AC or DC.

LOAD	CARTRIDGE	PLASTIC CASE
150 ma.		627
175 ma.	606	
175 ma.		625
200 ma.		617
220 ma.		634
250 ma.		633
300 ma.		623
400 ma.		619
600 ma.		624
.05 amp 110V (6W lamp)	608	
.2 amp 110V (25W lamp)	607	
Switching relay		609

**TUNG-SOL
FLASHERS**

TUNG-SOL ELECTRIC INC., Newark 4, New Jersey

Sales Offices: Atlanta, Chicago, Culver City, Dallas, Denver, Detroit, Newark, Philadelphia

TUNG-SOL makes: All-Glass Sealed Beam Lamps, Miniature Lamps, Signal Flashers, Picture Tubes, Radio, TV and Special Purpose Electron Tubes.

NOVEMBER, 1952

A COMPLETE STANDARD LINE

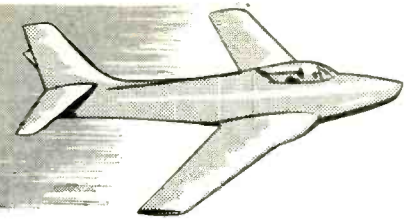

MIDGET FRAME SIZE—OPEN TYPE FOR 28 VOLTS, 400 CYCLES, SINGLE PHASE DUTY; 0-28 VOLTS, 4 AMPS. OUTPUT



1 KVA FRAME SIZE—OPEN TYPE FOR 115 VOLTS, 400/800 CYCLES, SINGLE PHASE SERVICE; 0-115 VOLTS, 3.0 AMPS. OUTPUT



1 KVA FRAME SIZE—OPEN TYPE FOR 230 VOLTS, 400/800 CYCLES, THREE PHASE DUTY; 0-230 VOLTS, 3.0 AMPS. OUTPUT

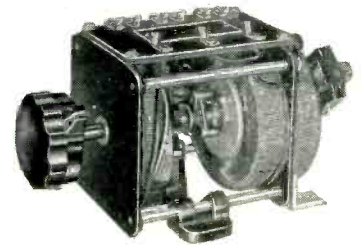

MIDGET FRAME SIZE—ENCLOSED TYPE FOR 120 VOLTS, 400 CYCLES, SINGLE PHASE DUTY; 0-120 VOLTS, 1.0 AMPS. OUTPUT

1 KVA FRAME SIZE—ENCLOSED TYPE FOR 115 VOLTS, 380/1600 CYCLES, SINGLE PHASE INPUT; 0-130 VOLTS, 4.0 AMPS. OUTPUT

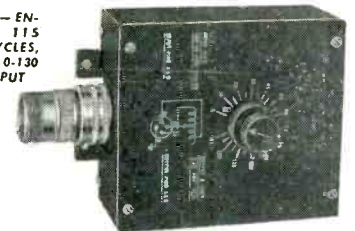

POWERSTAT

Variable Transformers

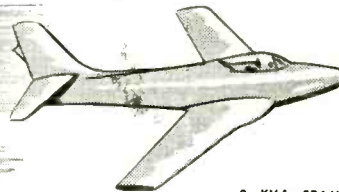

FOR 400-800 CYCLE OPERATION

... SHIPBOARD, AIRBORNE, GROUND, MOBILE EQUIPMENT WHERE SPACE AND WEIGHT SAVINGS ARE VITAL

2 KVA FRAME SIZE—ENCLOSED TYPE FOR 115 VOLTS, 400/800 CYCLES, SINGLE PHASE INPUT, 0-130 VOLTS, 15 AMPS. OUTPUT

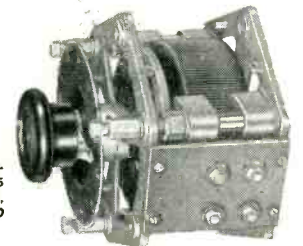

THREE BASIC FRAME SIZES

MIDGET	1 KVA	2 KVA
ENCLOSED AND OPEN CONSTRUCTION IN RATINGS UP TO 1/2 KVA	ENCLOSED AND OPEN CONSTRUCTION IN RATINGS UP TO 1-1/2 KVA	ENCLOSED AND OPEN CONSTRUCTION IN RATINGS UP TO 2-1/2 KVA

Weight and space must be conserved in shipboard, airborne and allied equipment for national defense needs. By operating electrical apparatus at 400 cycles and higher frequencies, this is accomplished. Since variable transformers are a necessary component in much of this equipment, a complete standard line of POWERSTAT variable transformers is now available. A wide range of types is offered to meet BU Air, BU Ships, Air Corps and Signal Corps specifications. Standard types are built to fulfill the demands of adverse operating conditions including excessive shock, vibration, bounce; high humidity; low and high ambient temperatures.

Standard types are described in Bulletin P552H. Send for your copy today. If a standard assembly does not meet your exacting requirements, our engineering department will work with you to build a POWERSTAT to your specifications.

WRITE TO:
211 THURE AVENUE,
BRISTOL, CONNECTICUT

THE SUPERIOR ELECTRIC CO.
BRISTOL, CONNECTICUT



• STABILINE AUTOMATIC VOLTAGE REGULATORS • POWERSTAT VARIABLE TRANSFORMERS • VARICELL D-C POWER SUPPLIES • VOLTBOX A-C POWER SUPPLIES • SUPERIOR 5-WAY BINDING POSTS • POWERSTAT LIGHT DIMMING EQUIPMENT

Announcing the **NEW** **Federal** SELENIUM RECTIFIER... with

36 VOLT (RMS) CELLS

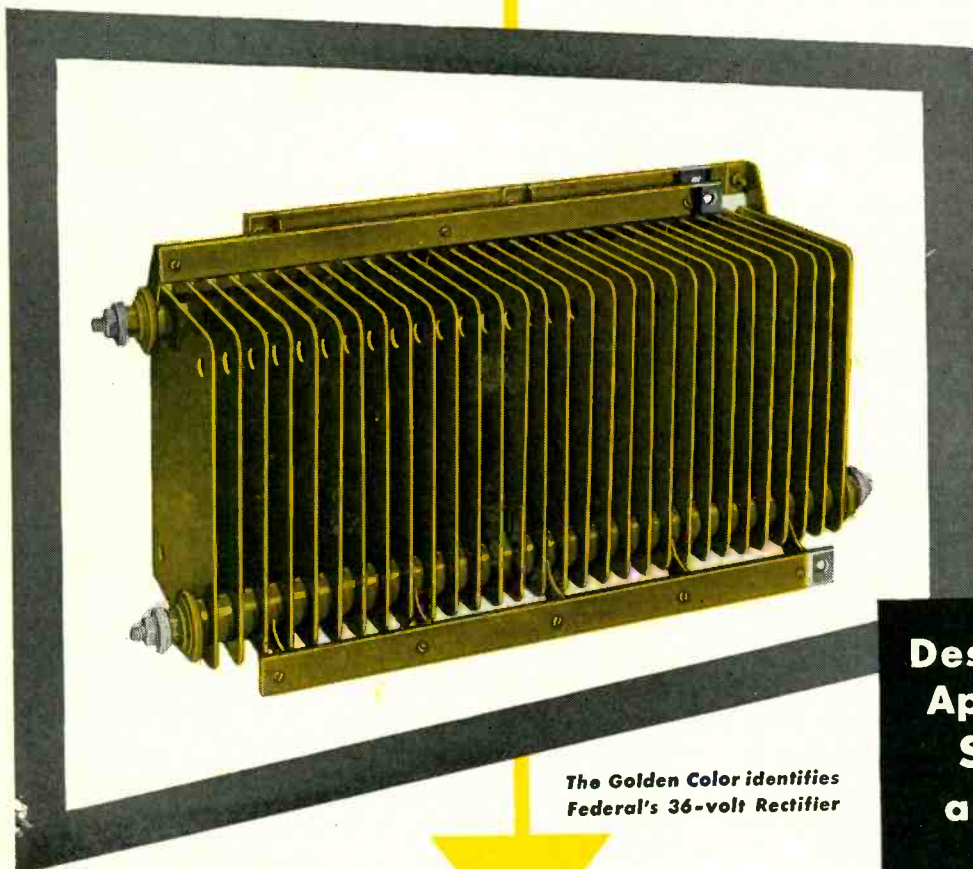

The Golden Color identifies
Federal's 36-volt Rectifier

Designed for Special
Applications where
SIZE—WEIGHT
and **EFFICIENCY**
are **TOP**
CONSIDERATIONS

ANOTHER *Federal* CONTRIBUTION

- Fewer plates
- Lighter weight
- Smaller size
- Greater Over-all Efficiency
- Dependable
"Federal Performance"

HERE'S THE ANSWER to your selenium rectifier stack requirements . . . for applications where *space* is at a premium . . . where *weight* is of prime importance. This is the ideal rectifier for many military end-use equipments . . . for aircraft . . . for compact, portable units.

Developed by America's *first* manufacturer of selenium rectifiers, you can depend on its quality, efficiency and economy.

Wherever you need DC from an AC source—look to Federal . . . from milliwatts to kilowatts! For details on Federal's new 36-volt rectifier cells of various sizes—or any other DC power requirement—write to Dept. F-113.

America's oldest and largest manufacturer of selenium rectifiers

Federal Telephone and Radio Corporation



FEDERAL TELECOMMUNICATION LABORATORIES, Nutley, N. J. . . . a unit of IT&T's world-wide research and engineering organization.

SELENIUM-INTELIN DIVISION
100 KINGSLAND ROAD, CLIFTON, NEW JERSEY

In Canada: Federal Electric Manufacturing Company, Ltd., Montreal, P. Q.
Export Distributors: International Standard Electric Corp., 67 Broad St., N. Y.



Ready for Your Circuit

Basic Foundation Components, Plug in, Connecting, Fastening Devices for the
ELECTRONIC CONTROL INDUSTRY

Making it possible to build quickly any electronic circuit into practical production design (you supply the circuit — we supply the components).

- by giving you basic components of tremendous flexibility which simplify layout time in production of your equipment.
- by providing you a technique to solve mechanical, space, connecting, interconnecting, fastening, sensing and indicating problems for you.

Giving you equipment that is easy to operate and maintain

- so that — with spares — your equipment never needs to be out of operation more than 30 seconds.
- so that non-technical personnel can set up, operate and maintain your equipment.



WORKING WITH "ALDEN'S HANDBOOK", THE DESIGN ENGINEER
AUTOMATICALLY CREATES PRACTICAL PRODUCTION DESIGN, as follows —

1. Anything electrical or electronic usually operates with an outside source of power and may be connected to outside circuits. So Alden provides for this with the efficient Detachable Line Cord for bringing in 110V AC power. Available in lengths to your specs for making a neat connection. Sure grip plug is self-piloting for quick mating.

SEE "ALDEN HANDBOOK" PAGES 4A & B FOR COMPLETE DETAILS

2. A great deal of equipment will have a front panel with such things as sensing controls, jacks for testing and fuseholders. For this Alden provides a basic slide-in chassis with a detachable front and back panel so that rheostats, indicator lights, test jacks, interwiring, etc. are all easy-to-work subassembly operations.

SEE "ALDEN HANDBOOK" PAGES PI-1E thru G FOR COMPLETE DETAILS

3. Sensing Units — telltales that all is well or not — in simple indicator light — fuse holders that glow when blown — memory or pulse circuits including Static Magnetic Memory that sense — or command — or keep on repeating so that units or elements almost assume brain functions.

SEE "ALDEN HANDBOOK" PAGES ES-5A & B; DL-5A & B; TE-3A & B; CG — all pages

4. The telephone, telegraph, electric light companies have always brought the incoming circuits to a bus bar or terminal board so that the incoming circuits could always be checked at one point — and equipment connected not being condemned because of imperfect outside circuits. So Alden provides in its Back Connectors and supporting Back Plates the one area in which all incoming circuits can be checked.

SEE "ALDEN HANDBOOK" PAGES PI-2A & B; 4D FOR COMPLETE DETAILS

5. The next problem is to house the components and have them do the electrical or electronic work required. Any such circuitry will have certain main functions and branching from it other functions. Many of these functions can be layered—so circuits go direct from back connector to front panel. Alden provides: simple component mounting panels for putting any circuit in layers. (And incidentally such component panel simplify the thinking, should the circuits give sufficient volume to be printed.) So Alden has the Terminal Panel Boards to make equipment easy to lay out by putting any function in one plane—plus the unit cables of correct lengths with stripped ends ready for interconnecting the Terminal Panels.

SEE "ALDEN HANDBOOK" PAGES PI-1B thru D FOR COMPLETE DETAILS

6. Not all circuits can be a simple, straight circuit from back connector to front panel because there are auxiliary functions and branches that have to be in the main functions. The usual chassis carries tubes, transformers and components that rise vertically from the chassis, often leaving vacant spaces. In these spaces can be placed the plug-in units which have these secondary circuits; using the plug-in technique usually removes the congestion of the wiring below the chassis, provides automatically for shielding and heat dispersion and yet gives you largest amount possible circuitry per cubic space, the circuits free from interaction.

SEE "ALDEN HANDBOOK" PAGES PI-1A thru H FOR COMPLETE DETAILS

7. Again these techniques often lead to putting one function such as a power supply and amplifier on separate chassis and so the back connectors or the chassis itself may need interconnecting unit cables to either chassis or racks. Alden provides sufficient variety of connectors to choose from—and designed so that any cable, no matter how involved, cannot be wrongly plugged in.

SEE "ALDEN HANDBOOK" Sec. PC - Sec. MP5 FOR COMPLETE DETAILS

8. To design so that no equipment — whether plug-in unit or slide-in chassis — needs to be out of operation for more than 30 seconds (having adequate spares on hand), Alden provides quick detaching and quick fastening devices for chassis. The Serve-a-Unit locks that will move chassis against weight or the resistance of gaskets. There is the Target Screw (coin operated), a Tool-less screw—the Captive Screw which becomes part of the equipment.

SEE "ALDEN HANDBOOK" PAGE PI-11 FOR COMPLETE DETAILS

9. Government designers and those in the electronic control industry want elements of equipment so that they can be portably operated or tested, can be carried by one man with spares, parts easily sent by mail or airborne and also prefer that the same design equipment can be used in conventional racks. Those designing for field operation use, at sea, prefer to have the equipment so it can be unloaded by two people, set up and immediately interconnected. This is provided by the Alden Basic Chassis using Back Connectors, Unit Cables and for the last purpose, the Uni-Rack which can be set on top of one another and immediately interconnected with each other.

SEE "ALDEN HANDBOOK" PAGE PI-11 FOR COMPLETE DETAILS



CORD LENGTH TO YOUR SPECS.

Avoid midget cords that compel added extension cords.

AVOID FULLBOWL OF OVER-LENGTH CORDS.

Avoid midget cords that compel added extension cords.

FRONT PANEL (VARIOUS SIZES) CARRIES CONTROLS, INDICATORS, SENSING ELEMENTS, WITH THEIR INTERWIRING.

Detachable front panel hinged giving accessibility for ease of assembly and servicing.

FUSES THAT INDICATE WHEN BLOWN.

Indicator lamps always easily replaced so always functioning.

INSULATED TEST POINT JACKS FOR PLATE VOLTAGES UP TO 6,000V.

Plug-in Memory or Pulse Circuits.

ALDEN BACK CONNECTORS, COLOR CODED, WITH ACCESSIBLE UNCONGESTED SOLDER TERMINALS — PERMIT EASY SERVICING AND RAPID CIRCUIT CHECKS AT CENTRAL POINT.

Back Connectors permit direct efficient wiring — avoid conventional rat's nest wiring.

BACK CONNECTORS MOUNT ON BACK PLATE TO GIVE ONE POINT TO CHECK ALL CHASSIS CONNECTIONS.

TERMINAL PANEL BOARD WITH ALL COMPONENTS MOUNTED IN ONE PLANE, AND ALDEN UNIT CABLE FOR INTERCONNECTING ALL PANEL ELEMENTS WITH LEADS.

Layering of circuits using Alden Terminal Panels to segregate each main function and associate elements in one plane—for ease of assembly and check.

ALDEN "20" PACKAGES HOUSE PLUG-IN UNITS GIVE INDEPENDENT SHIELDING AND HEAT DISPERSION.

MASSING OF ESSENTIAL ELECTRONIC ELEMENTS YET WITH EFFICIENT HEAT DISPERSION AND FREEDOM FROM INTERACTION, IN A BASIC CHASSIS.

How Alden Terminal Panel groups main functions and how plug-in units have parallel functions for largest amount circuitry per cubic space.

ALDEN UNIT CABLE — WITH VARIETY OF PLUG-IN CONNECTORS. CARRIES WIRING FROM CHASSIS TO CHASSIS OR RACK TO RACK.

SEPARATE CHASSIS MAY BE STACKED IN ALDEN UNI-RACK CABINET. CABINET CAN BE INTERCONNECTED WITHIN BY ALDEN UNIT PLUG-IN CABLES.

ALDEN TARGET SCREW THE TOOLLESS SCREW

The Captive Screw, never lost.

A TURN OF THE SERVE-A-UNIT LOCK HANDLE — LOCATED IN FRONT PANEL — DRAWS IN UNIT AGAINST PRESSURE — REVERSE TURN EJECTS.

SOME CHASSIS FITS IN UNI-RACK CABINET FOR FIELD OR PERMANENT USE. IN FIELD ALL ELEMENTS CAN BE CONNECTED AS FAST AS YOU CAN UNLOAD THEM.

CHASSIS IN CARRYING OR SERVICEMAN'S CASE OR CASE TO HOUSE SPARE.

SEND FOR the Alden Handbook—your key to practical production design—with components already tooled—yet can be modified—ready for volume production without delays or procurement headaches.



ALDEN PRODUCTS COMPANY 127 North Main Street, Brockton, Massachusetts

E+TH

and

ZENITH RADIO CORPORATION

PHONE
BERKSHIRE 7-7100

6001 DICKENS AVENUE CHICAGO 39, ILLINOIS

CABLE ADDRESS
"ZENITHRAD"
ALL CODES

August 14, 1952

Antara Chemicals Division
General Dyestuff Corporation
435 Hudson Street
New York 14, N. Y.

Gentlemen:

We consider our new "Super-X" radio chassis to be the finest, most dependable in radionic history — second to none for power and sensitivity. For all our IF circuits we make our own IF Units — using threaded cores molded of G A & F Carbonyl Iron Powders. We use your E and TH types — as we have for some 10 years.

In our Armstrong FM Core Tuning Units we have recently switched from your SF type to your newly developed "J" Powder. We find that we get the same stability with a higher Q value.

We are always on the search for finer materials. We are happy to acknowledge and give credit, when we find them.

Very truly yours,

ZENITH RADIO CORPORATION

G. E. Gustafson
G. E. Gustafson
Vice President in Charge of Engineering

GEG:EP

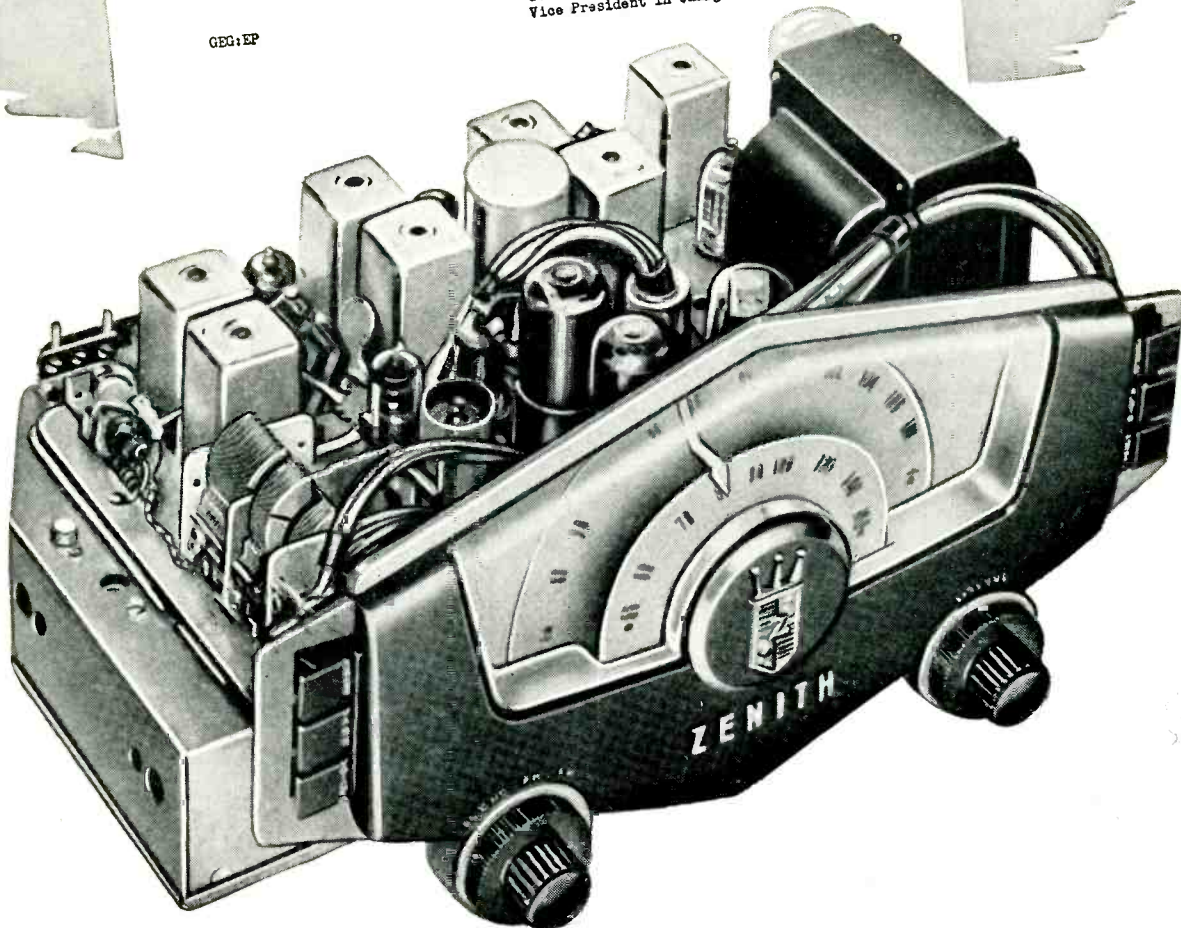

G A & F Carbonyl

SF VS J

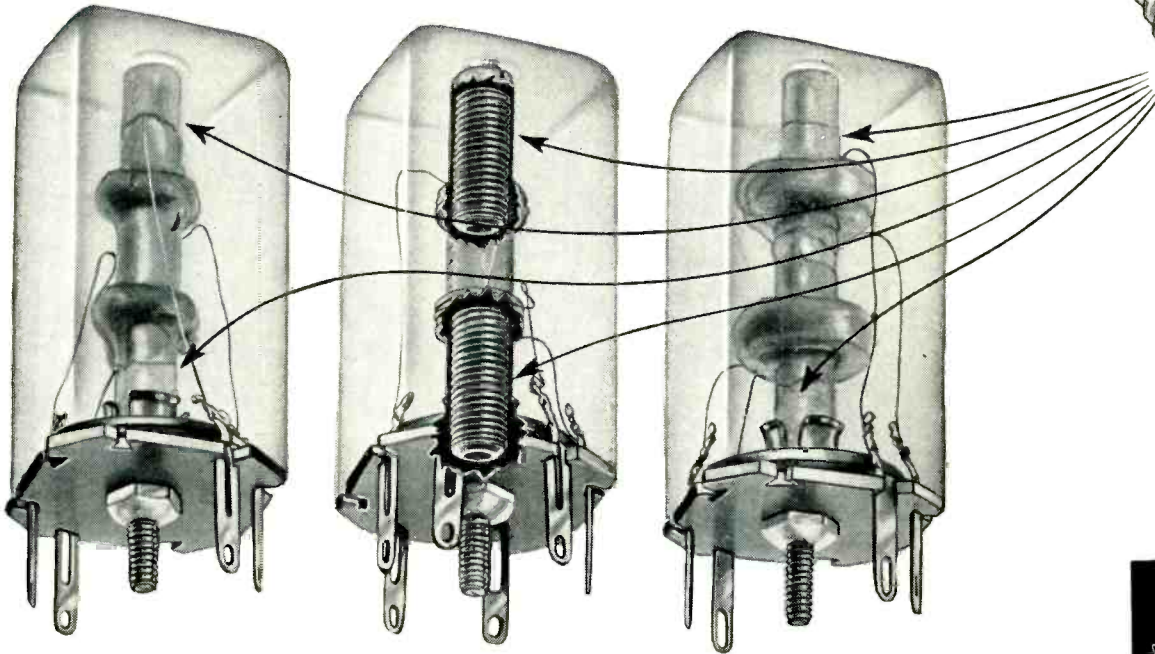
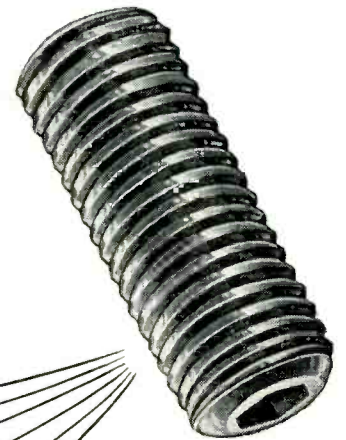

GA&F Carbonyl Iron Powders are used to produce cores for transformer and inductor coils of every form—to increase Q values, to vary coil inductances, to reduce the size of coils, to confine stray fields and to increase transformer coupling factors.

For use in TV and in Radio, including FM, the extremely small size of the particles is of enormous value, since eddy currents develop only within each particle—proportional to the square of the particle diameter. In core-making, the particles are insulated from each other by coating them, before compounding, with an efficient insulating agent.

These powders are microscopic, almost perfect spheres of extremely pure iron. They are produced in seven carefully controlled types, rang-

ing in average particle-size from three to twenty microns in diameter.

Similarly, their properties vary, making them useful in many different applications. Engineers have commented on the fact that cores made from these powders lend themselves to smoothness of adjustment and to ease of grinding. The new Ferromagnetic Powder "J" was designed for high Q cored coils at VHF. At high frequencies, it has the lowest losses for its relatively high permeability.

* * *

We are proud to serve the Zenith Radio Corporation... We urge you to ask your core maker, your coil winder, your industrial designer, how GA&F Carbonyl Iron Powders can increase the efficiency and performance of the equipment or product you make, while reducing both the cost and the weight.

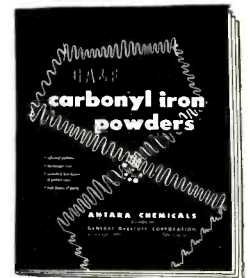

THIS WHOLLY NEW 32-PAGE BOOK offers you the most comprehensive treatment yet given to the characteristics and applications of GA&F Carbonyl Iron Powders. 80% of the story is told with photomicrographs, diagrams, performance charts and tables. For your copy—without obligation—kindly address Department 33.



ANTARA® CHEMICALS

DIVISION OF

GENERAL DYESTUFF CORPORATION

435 HUDSON STREET • NEW YORK 14, NEW YORK

Iron Powders...



SYLVANIA TUBE SOCKETS



for Rugged Military Service

HIGH QUALITY SYLVANIA SOCKETS IMMEDIATELY AVAILABLE



JAN 7- AND 9-PIN MINIATURE TUBE SOCKETS

These sockets are available in grade L-4B or better ceramic, or type MFE low loss plastic. The contacts are either phosphor bronze or beryllium copper, silver plated. Contacts and center shield tab are hot tin dipped. Nickel plated brass shields equipped with sturdy springs are available for all 7- and 9-pin sockets.

JAN OCTAL TUBE SOCKETS

Saddles of these sockets are nickel plated brass, either top or bottom mounted, with or without ground lugs. Body and contacts are of the same materials as the JAN miniature tube sockets. Contact tabs and saddle ground lugs are hot tin dipped.

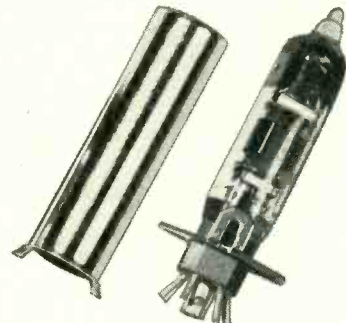

BUTTON TYPE SUBMINIATURE (T3) TUBE SOCKETS

These sockets are available for round 8-pin subminiature tube types. Insulation is type MFE low loss plastic and contacts are beryllium copper silver plated with gold flash covering. Contacts especially designed for positive connection and high pin retention even after many insertions. Sockets are of rugged construction for long life.

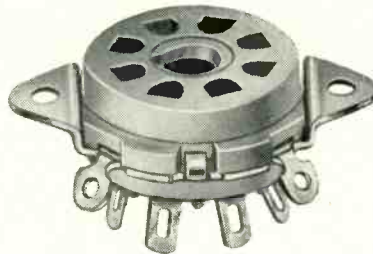

When you order Sylvania Tube Sockets you get the extra value of Sylvania's experience and know-how at no extra cost. Designed for maximum strength and optimum electrical properties, Sylvania Sockets assure high tube retention and tube pin contact even under severe vibration.

Highest quality is guaranteed by Sylvania's own exacting quality control.

For full information on the complete line of Sylvania Tube Sockets write: Sylvania Electric Products Inc., Dept. A-1011, Parts Sales Division, Warren, Pa.

SYLVANIA

DESIGN ENGINEERS LIKE TAYLOR LAMINATED PLASTICS BECAUSE...

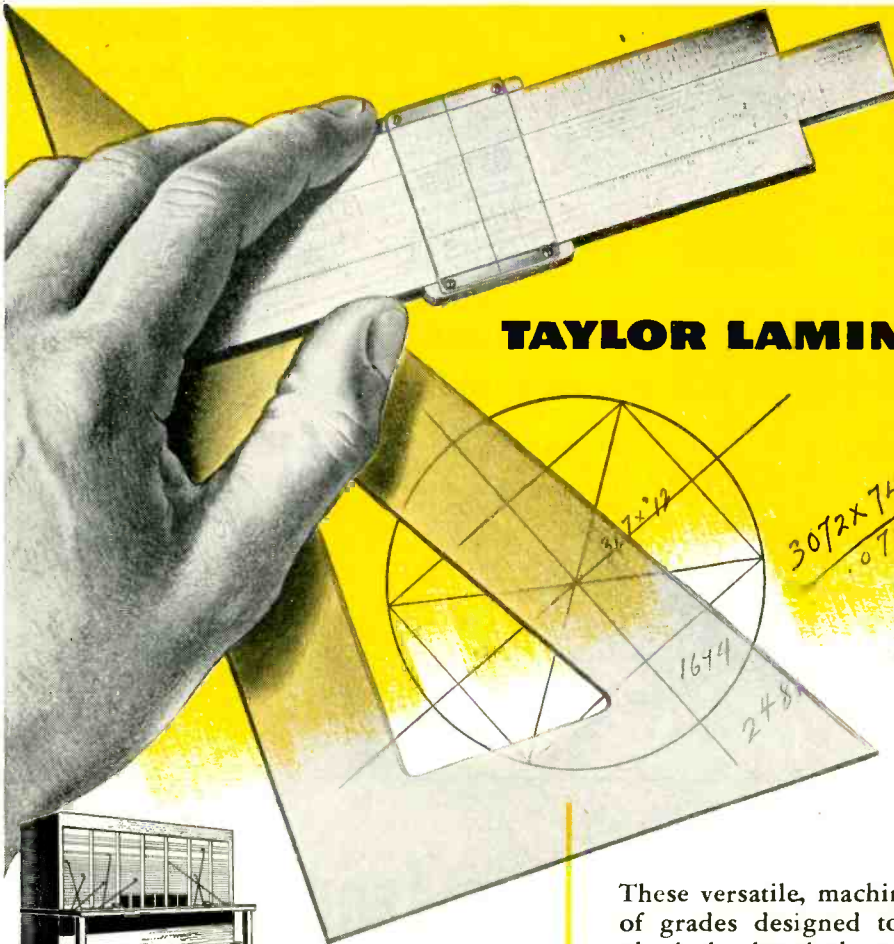

$$\begin{array}{r} 3072 \times 743 \\ \cdot 0765 \\ \hline 78.55 \\ \cdot 76 \\ \hline 89.46 \end{array}$$

$$\frac{4679.41}{2} = 2339.705$$

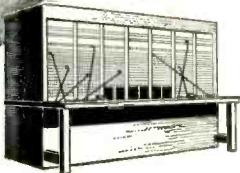

In the communications industry...

Parts made from Taylor Laminated Plastics are doing vital jobs in panel boards, insulation blocks and thousands of allied applications because of their excellent electrical characteristics and their resistance to moisture absorption. Have you considered these basic materials for making *your* product better?



This 62-page Taylor catalog describes how the many Taylor Laminated Plastics are made, how and where they're used, and more important, how you can use these basic materials to make your product better... at lower cost! Write today for a copy of catalog E11.

These versatile, machinable materials offer a wide variety of grades designed to meet numerous combinations of physical, electrical, mechanical and chemical properties as required. For example:

Taylor *Phenol* Laminates meet the need for waterproof insulation possessing outstanding electrical properties and great mechanical strength. They are unaffected by normal ranges of heat and cold and are resistant to oil and chemicals.

Taylor *Melamine* Laminates are especially suited for resistance to flame, heat and corrosion, have excellent electrical qualities, and are particularly good in arc resistance.

Taylor *Silicone* Laminates have very high heat resistance, excellent mechanical and electrical properties, and offer great resistance to acids and alkalis.

Combinations of these laminates can be used to produce a material with the particular property or group of properties desired.

Why not explore the possibilities of designing Taylor Laminated Plastics in your product today? Write for complete engineering data and a generous assortment of samples. Ask, too, about Taylor Vulcanized Fibre, Taylor Insulation, and the cost-cutting Taylor Fabricating Service.



TAYLOR FIBRE CO.

NORRISTOWN, PA. • LA VERNE, CALIF.

VULCANIZED FIBRE • TAYLOR INSULATION

PHENOL, SILICONE & MELAMINE LAMINATES • FABRICATED PARTS



TYPE 252, JAN-R-19, Type RA20

2 watt, 1 $\frac{1}{4}$ " diameter variable wirewound resistor. Also available with other special military features not covered by JAN-R-19. Attached Switch can be supplied.

Resistance
50 \pm 10%
100 \pm 10%
250 \pm 10%
500 \pm 10%
1000 \pm 10%
1500 \pm 10%
2500 \pm 10%
5000 \pm 10%
10,000 \pm 10%

RA20, JAN Shaft Type SD	CTS Part	JAN-R-19 TYPE
	B8079	RA20A1SD500AK
	W6929	RA20A1SD101AK
	X3497	RA20A1SD251AK
	W6931	RA20A1SD501AK
	W6932	RA20A1SD102AK
	W6933	RA20A1SD152AK
	W6934	RA20A1SD252AK
	W6935	RA20A1SD502AK
	W6936	RA20A1SD103AK

RA20 High Torque, JAN Shaft Type SD	CTS Part	JAN-R-19 TYPE
	X3496	RA20A2SD500AK
	L9388	RA20A2SD101AK
	M9879	RA20A2SD251AK
	X3498	RA20A2SD501AK
	X3499	RA20A2SD102AK
	M9809	RA20A2SD152AK
	L9103	RA20A2SD252AK
	L9104	RA20A2SD502AK
	H8979	RA20A2SD103AK

TYPE 25, JAN-R-19, Type RA30 (May also be used as Type RA25)

4 watt, 1 $\frac{1}{2}$ " diameter variable wirewound resistor. Also available with other special military features not covered by JAN-R-19. Attached Switch can be supplied.

Resistance
50 \pm 10%
100 \pm 10%
250 \pm 10%
500 \pm 10%
1000 \pm 10%
1500 \pm 10%
2500 \pm 10%
5000 \pm 10%
10,000 \pm 10%
15,000 \pm 10%

RA30, JAN Shaft Type SD	CTS Part	JAN-R-19 TYPE
	X3502	RA30A1SD500AK
	X3503	RA30A1SD101AK
	X3505	RA30A1SD251AK
	X3507	RA30A1SD501AK
	X3508	RA30A1SD102AK
	X3509	RA30A1SD152AK
	X3511	RA30A1SD252AK
	Q1409	RA30A1SD502AK
	X3513	RA30A1SD103AK
	X3514	RA30A1SD153AK

RA30 High Torque, JAN Shaft Type SD	CTS Part	JAN-R-19 TYPE
	W2837	RA30A2SD500AK
	X3504	RA30A2SD101AK
	X3506	RA30A2SD251AK
	M7566	RA30A2SD501AK
	S2444	RA30A2SD102AK
	X3510	RA30A2SD152AK
	S2736	RA30A2SD252AK
	X3512	RA30A2SD502AK
	R1561	RA30A2SD103AK
	L9107	RA30A2SD153AK



Immediate delivery from stock

JAN-R-94 AND JAN-R-19 TYPE MILITARY VARIABLE RESISTORS

167 types

Preference given to orders carrying military contract number and DO rating. Other JAN items or special items with or without associated switches can be fabricated to your specifications. Please give complete details on your requirements including electrical and mechanical specifications.

UNPRECEDENTED PERFORMANCE CHARACTERISTICS
Designed for use in military equipment subject to extreme temperature and humidity ranges including jet and other planes, guided missiles, tanks, ships and submarines, telemetering, microwave, portable or mobile equipment and all other military communications.

For further information, write for Stock Sheet No. 162



NEW 38-PAGE ILLUSTRATED CATALOG—Describes Electrical and Mechanical characteristics, Special Features and Constructions of a complete line of variable resistors for military and civilian use. Includes dimensional drawings of each resistor. Write today for your copy.

REPRESENTATIVES
Henry E. Sanders
John B. McClatchy Bldg.
69th & Market St.
Upper Darby, Penna.
Phone: Flanders 2-4420

W. S. Harmon Company
1638 So. La Cienega Blvd.
Los Angeles 35, Calif.
Phone: Bradshaw 2-3321

John A. Green Co.
6815 Oriole Drive
Dallas 9, Texas

IN CANADA
C. C. Meredith & Co.
Streetsville, Ontario

SOUTH AMERICA
Jose Luis Pontet
Buenos Aires, Argentina
Montevideo, Uruguay
Rio de Janeiro, Brazil
Sao Paulo, Brazil

OTHER EXPORT
Sylvan Ginsbury
8 West 40th Street
New York 18, N. Y.



specialists in precision mass production of variable resistors

FOUNDED 1896 • ELKHART, INDIANA

SHAFT TYPES
AVAILABLE
ON STOCK CONTROLS

CTS SHAFT TYPE LT-2 LOCKING BUSHING

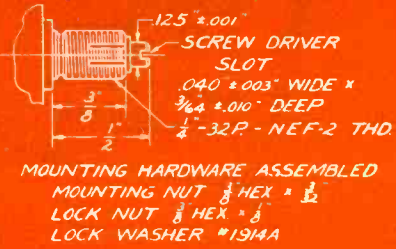

CTS SHAFT TYPE RE

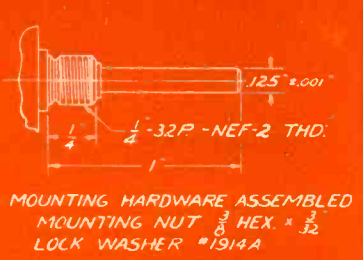

Resistance
250±10%
500±10%
1000±10%
2500±10%
5000±10%
10,000±10%
25,000±10%
50,000±10%
100,000±10%
250,000±10%
500,000±10%
1 Meg±20%
2.5 Meg±25%

CTS Part	CTS Shaft Type RE
X3516	X3516
X3517	X3517
X3518	X3518
X3519	X3519
X3520	X3520
X3521	X3521
X3522	X3522
X3523	X3523
X3524	X3524
X3525	X3525
X3526	X3526
X3527	X3527
X3528	X3528

CTS Part	Locking Bushing	CTS Shaft Type LT-2
X3530	X3530	X3530
X3531	X3531	X3531
X3532	X3532	X3532
X3533	X3533	X3533
X3534	X3534	X3534
X3535	X3535	X3535
X3536	X3536	X3536
X3537	X3537	X3537
X3538	X3538	X3538
X3539	X3539	X3539
X3540	X3540	X3540
X3541	X3541	X3541
X3542	X3542	X3542

TYPE 65

½ watt 70°C, ¼" diameter miniaturized variable composition resistor.

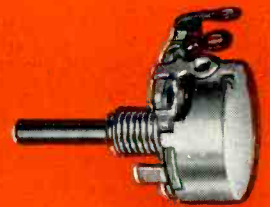

TYPE 95, JAN-R-94, Type RV4

Resistance

100±10%
250±10%
500±10%
1000±10%
2500±10%
5000±10%
10,000±10%
25,000±10%
50,000±10%
100,000±10%
250,000±10%
500,000±10%
1 Meg±20%
2.5 Meg±20%
5 Meg±20%

JAN-R-94 TYPE RV4 JAN Shaft Type SD

RV4ATSD101A
RV4ATSD251A
RV4ATSD501A
RV4ATSD102A
RV4ATSD252A
RV4ATSD502A
RV4ATSD103A
RV4ATSD253A
RV4ATSD503A
RV4ATSD104A
RV4ATSD254A
RV4ATSD504A
RV4ATSD105B
RV4ATSD255B
RV4ATSD505B

JAN-R-94 TYPE RV4 JAN Shaft Type RJ

RV4ATRJ101A
RV4ATRJ251A
RV4ATRJ501A
RV4ATRJ102A
RV4ATRJ252A
RV4ATRJ502A
RV4ATRJ103A
RV4ATRJ253A
RV4ATRJ503A
RV4ATRJ104A
RV4ATRJ254A
RV4ATRJ504A
RV4ATRJ105B
RV4ATRJ255B
RV4ATRJ505B

CTS Part Non-JAN Locking Bushing CTS Shaft Type LT-1

W3160
W3161
W3162
W3166
W3163
W3164
W3167
W3168
W3169
W3170
W3171
W3172
W3173
W3165
W3159

2 watt 70°C, 1 1/8" diameter variable composition resistor. Also available with other special military features not covered by JAN-R-94. Attached Switch can be supplied.

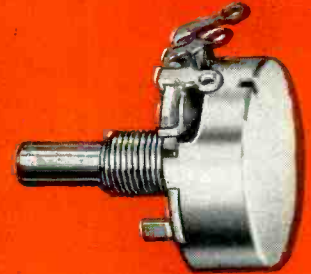

TYPE 45, JAN-R-94, Type RV2

Resistance

100±10%
250±10%
500±10%
1000±10%
2500±10%
5000±10%
10,000±10%
25,000±10%
50,000±10%
100,000±10%
250,000±10%
500,000±10%
1 Meg±20%
2.5 Meg±20%

RV2, JAN Shaft Type SD

CTS Part	JAN-R-94 TYPE
A5876	RV2ATSD101A
A5877	RV2ATSD251A
A5878	RV2ATSD501A
A5879	RV2ATSD102A
A5880	RV2ATSD252A
A5881	RV2ATSD502A
A5882	RV2ATSD103A
A5883	RV2ATSD253A
A5884	RV2ATSD503A
A5885	RV2ATSD104A
A5886	RV2ATSD254A
A5887	RV2ATSD504A
A5888	RV2ATSD105B
A5889	RV2ATSD255B

CTS Part Non-JAN Locking Bushing CTS Shaft Type LT-1

A5922
A5923
A5924
A5925
A5926
A5927
A5928
A5929
A5930
A5931
A5932
A5933
A5934
A5935

¼ watt, 15/16" diameter variable composition resistor. Also available with other special military features not covered by JAN-R-94. Attached Switch can be supplied.



TYPE 35, JAN-R-94, Type RV3

Resistance

100±10%
250±10%
500±10%
1000±10%
2500±10%
5000±10%
10,000±10%
25,000±10%
50,000±10%
100,000±10%
250,000±10%
500,000±10%
1 Meg±20%
2.5 Meg±20%
5 Meg±20%

RV3, JAN Shaft Type SD

CTS Part	JAN-R-94 TYPE
A5861	RV3ATSD101A
A5862	RV3ATSD251A
A5863	RV3ATSD501A
A5864	RV3ATSD102A
A5865	RV3ATSD252A
A5866	RV3ATSD502A
A5867	RV3ATSD103A
A5868	RV3ATSD253A
A5869	RV3ATSD503A
A5870	RV3ATSD104A
A5871	RV3ATSD254A
A5872	RV3ATSD504A
A5873	RV3ATSD105B
A5874	RV3ATSD255B
A5875	RV3ATSD505B

CTS Part Non-JAN Locking Bushing CTS Shaft Type LT-1

A5907
A5908
A5909
A5910
A5911
A5912
A5913
A5914
A5915
A5916
A5917
A5918
A5919
A5920
A5921

½ watt, 1 1/8" diameter variable composition resistor. Also available with other special military features not covered by JAN-R-94. Attached Switch can be supplied.



JAN SHAFT TYPE SD

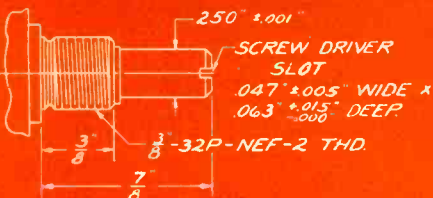

MOUNTING HARDWARE ASSEMBLED
MOUNTING NUT 1/2" HEX. x 3/2"
LOCK WASHER #1920A

JAN SHAFT TYPE RJ

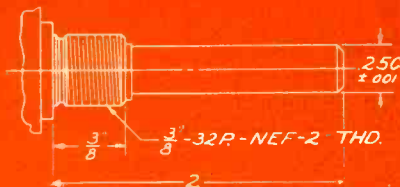

MOUNTING HARDWARE ASSEMBLED
MOUNTING NUT 1/2" HEX. x 3/2"
LOCK WASHER #1920A

CTS SHAFT TYPE LT-1

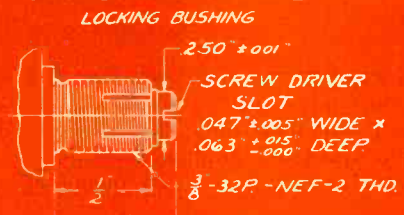

MOUNTING HARDWARE ASSEMBLED
MOUNTING NUT 1/2" HEX. x 3/2"
LOCK NUT 1/2" HEX. x 3/2"
LOCK WASHER #1920A

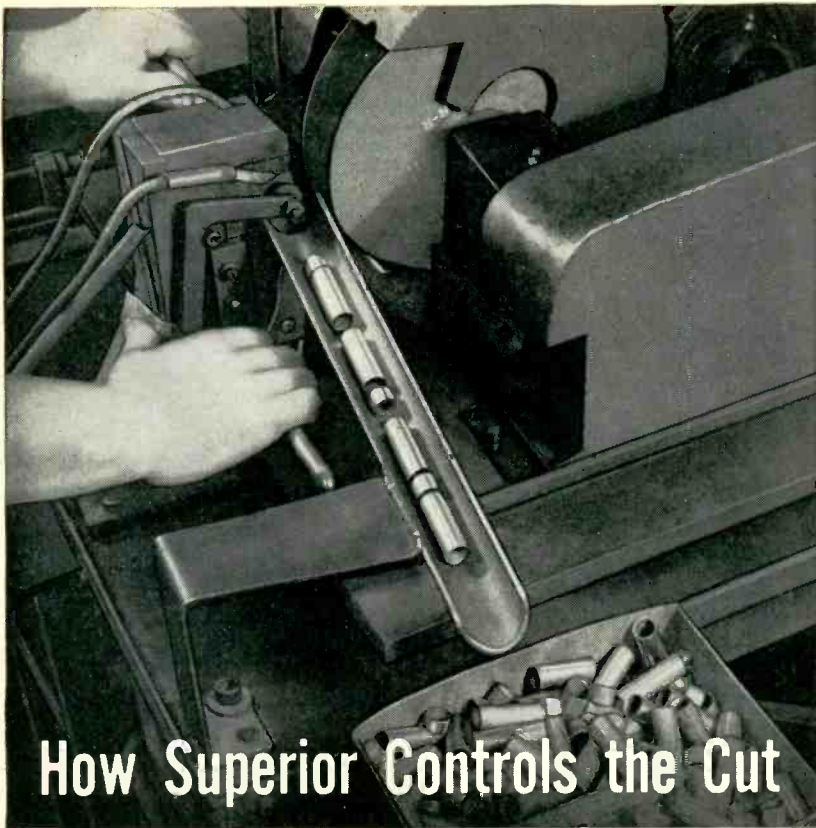

How Superior Controls the Cut

to give you better tubular parts

● Cutting tubing into exact lengths as the first step in the fabrication of tubular Electronic parts is a simple operation. Or is it?

Complications set in when the temper of the tubing is changed to meet customer specifications; when the tubing to be cut has a wall .010" or thinner; when length tolerances as close as .010" are required; when a 3° to 10° angle cut with a tolerance of $\pm 1/2^\circ$ is called for; and when flattening, denting or other distortion must be prevented.

But overcoming complications in simple operations . . . and finding ways around them in other basically more difficult ones, is a specialty of the Electronics Division of Superior.

Our customers for Electronics parts have come to expect us to deliver the goods, exactly to specifications, whether standard production or complex experimental parts. What's more, they frequently ask us for suggestions about improvement on their designs and specifications . . . and they get them.

There is nothing unusual about all this—it's our job and we know how to do it. If you are a manufacturer or experimenter in the Electronics Industry and you need a tubular part that presents a problem, tell us about it. We'll probably be able to help and will gladly do so. Write The Superior Tube Company, 2500 Germantown Ave., Norristown, Pennsylvania.

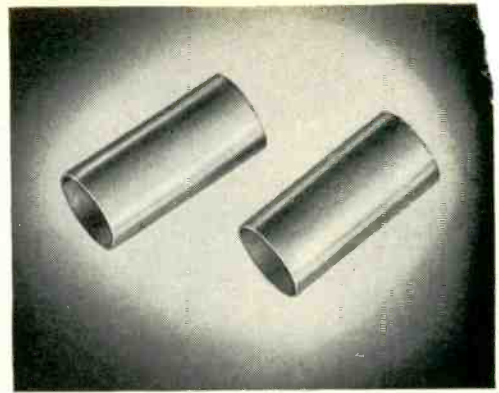

Cutting and Tumbling. Cutting machines and jigs of many types and sizes are combined with extensive tumbling equipment to permit fast accurate production of quantities of parts at Superior.



Fabrication: Parts can be readily rolled at either or both ends, flared, flanged, expanded, or beaded (embossed) as required. The anode above is one of many such parts we produce at high speed and low cost.



The Finished Part. Final stage in the fabrication of the part shown above at three stages of production is a bend nicely controlled for both precise angle and freedom from other, unwanted distortion.

**This Belongs in Your Reference File
... Send for It Today.**

NICKEL ALLOYS FOR OXIDE-COATED CATHODES: This reprint describes the manufacturing of the cathode sleeve from the refining of the base metal. Includes the action of the small percentage impurities upon the vapor pressure, sublimation rate of the nickel base; also future trends of cathode materials are evaluated.

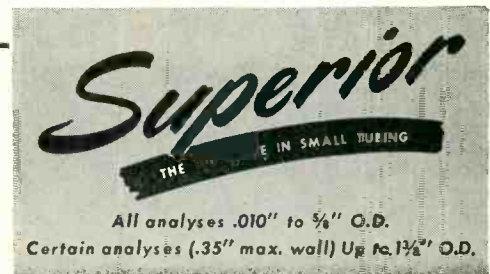

SUPERIOR TUBE COMPANY • Electronic products for export through Driver-Harris Company, Harrison, New Jersey • Harrison 6-4800



**WORLD'S LARGEST
CAPACITOR MANUFACTURER**

now offers you—in one compact catalog—all the information you need to specify transmitter-type mica dielectric capacitors for military uses. Thirty-two easy-to-read pages give you illustrations, engineering drawings, and full characteristics of each unit.

For your copy of Sprague's new catalog No. 31, just send a letterhead request to Application Engineering Department, Sprague Electric Co., 35 Marshall Street, North Adams, Massachusetts.



Obvious choice in the power supply of Ward Leonard's revolutionary Chromaster



SELENIUM RECTIFIERS

Ward Leonard Electric Co.'s compact new unit for industrial chrome plating of cutting tools, gauges, etc., within the shop is a miniature powerhouse. It embodies all the necessary electric controls, and power in DC form is delivered across the bath by a full wave, metallic selenium rectifier.

Because Chromaster's performance depends on component quality, rectifier choice of Ward Leonard engineers is SELETRON — famous for ruggedness and dependability . . . for its "Safe Center" contact construction and decreased bulk . . . for its high standard of quality control.

Wherever rectification is the key to your new or established products, it will pay to

investigate SELETRON. Available in a large range of sizes for radio, TV and industrial electronic circuits from a few mils up to thousands of amps.

SELETRON application engineers will be glad to assist you in selection of the right rectifier for that job on the board. Drop us a line today!



A SELETRON Selenium Rectifier, Model H1C2N2B Full Wave Center Tap, helps Ward Leonard's A-20 Chromaster maintain accurate chrome deposits from .00005" to several thousandths.

**Seletron
and Germanium
Division**

RADIO RECEPTOR COMPANY, INC.



Since 1922 in Radio and Electronics



Sales Dept.: 251 W. 19th St., New York 11, N. Y. • Factory: 84 N. 9th St., Brooklyn 11, N. Y.

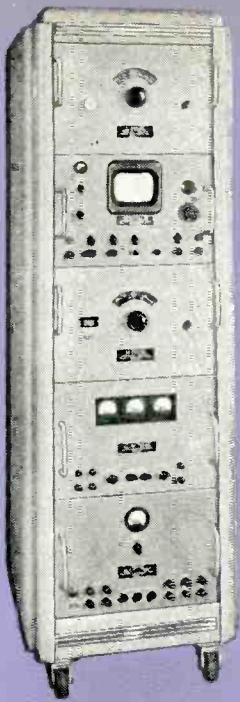

All Band, Direct Reading
SPECTRUM ANALYZER

10 MC to 21,000 MC

The Model LSA is the result of years of research and development. It provides a simple and direct means of rapid and accurate measurement and spectral display of an rf signal.

Outstanding Features:

- Continuous tuning.
- One tuning control.
- 5 KC resolution at all frequencies.
- 250 KC to 25 MC display at all frequencies.

Model LSA

The instrument consists of the following units:

Model LTU-1 RF Tuning Unit—10 to 1000 MC.

Model LTU-2 RF Tuning Unit—940 to 4500 MC.

Model LTU-3 RF Tuning Unit—4460 to 16,520 MC.

- Tuning dial frequency accuracy 1 percent.
- No Klystron modes to set.
- Broadband attenuators supplied from 1 to 12 KMC.
- Frequency marker for measuring differences 0-25 MC.
- Only three tuning units required to cover entire range.
- Microwave components use latest design non-contacting shorts for long mechanical life.
- Maximum frequency coverage per dollar invested.
- 5 inch CRT display.

Model LTU-4 RF Tuning Unit—15,000 to 21,000 MC.

Model LDU-1 Spectrum Display Unit.

Model LPU-1 Power Unit.

Model LKU-1 Klystron Power Unit.

Polarad

PRECISION LABORATORY INSTRUMENTS

MICROWAVE RECEIVERS

1000—10,750 mc



Features:

- Single Dial Tuning
- Low Noise Figure
- Tracked R. F. Preselection, Triple-Tuned
- Linear Db Output Indication
- AM-FM Reception
- Video Output — 10 v Pulse across 100 ohms
- Audio — BFO

Four microwave receivers of high sensitivity, wide tuning range and selectivity. Image rejection is greater than 60 db. Gain stability better than ± 2 db, permits application as a field intensity meter. Extra large dials enable frequency to be clearly read to an accuracy of 2%. Video bandwidth is 3.0 mc. Input power required is 105-125 v, 50/1000 cps.

- Recorder Output
- Provisions for Using External Attenuators in I.F. Channel
- Frequency Calibration Accuracy — 2%
- Separate Audio & Video Channels
- AFC
- Calibrated Tuning Meter

WIDE BAND VIDEO AMPLIFIER

Model VT 10 CPS to 20 MC

Designed for use as an oscilloscope deflection amplifier for the measurement and viewing of pulses of short duration and rise time. Excellent for TV, both black and white and color applications.

Features:

- Flat frequency response from 10 cps to 20 mc ± 1.5 db.
- Uniform time delay of .02 microseconds.
- Gain of 50 db.
- Frequency compensated high impedance attenuator calibrated in 10 db steps from 0-50.
- Fine attenuator covers a 10 db range.
- Phase linear with frequency over entire band.



Model VT

MICROWAVE SIGNAL SOURCES

Models SSR, SSL, SSS, SSM, SSX
 634 MC to 10,750 MC

For use as a reliable source of microwave energy in trans-



mission loss measurements, standing wave determination, etc. Unidial Control for accuracy and ease of operation. Direct reading (no mode charts to consult). Frequency determination accurate to 1% through use of present calibration and temperature compensated klystrons.

Five Microwave Signal Sources are available to cover the frequency range from 634 MC to 10,750 MC. Units ruggedly constructed, mounted on aluminum castings to insure mechanical stability. Klystron reflector voltage automatically tracked with tuning of the klystron cavity to provide unidial control. Signal sources supplied complete with klystron.

MICROWAVE SIGNAL GENERATOR

Model MSG-4

7,000 mc — 10,750 mc

Polarad's Microwave Signal Generator, Model MSG-4, is an ideal source of an accurately known signal voltage, precisely modulated. Sensitivity, frequency and performance of radio and radar equipments in the frequency range from 7 to 10.75 kmc can be readily measured on this continuously variable, direct reading signal generator.

Features:

- Continuous tuning
- One tuning control
- Tuning dial accuracy — 1%
- No Klystron modes to set
- Accurate stable power measurement
- Non-contacting shorts guarantee long life
- Modulation — Internal Pulse, FM and external
- Sync output — delayed and undelayed.



100 METROPOLITAN AVE., BROOKLYN 11, N. Y. • STagg 2-3464



Triple-thick plastic tape

It tames high voltage in Motorola TV shields

All plastic tapes are not alike! "Scotch" Electrical Tape No. 21 is *three times thicker* than ordinary plastic tape. That's why Motorola engineers find it ideal for insulating high-voltage shields.

Triple thickness means remarkable dielectric strength (22,500 volts). It means added mechanical protection—a cushion against shocks and scrapes.

And still this is a *tape* that sticks quickly, easily—

right off the roll. Adhesive grips tight and *holds*.

No wonder that more and more manufacturers are turning to tapes—"Scotch" Electrical Tapes for all kinds of insulating and protecting jobs. Tape's a new tool, and "Scotch" Brand is America's most complete tape line.

Think of tape for *your* job! And for the *right* tape for your job, write Minnesota Mining & Mfg. Co., Dept. ES-112, St. Paul 6, Minn.



The term "Scotch" and the plaid design are registered trademarks for the more than 200 pressure-sensitive adhesive tapes made in U.S.A. by Minnesota Mining & Mfg. Co., St. Paul 6, Minn.—also makers of "Scotch" Sound Recording Tape, "Underseal" Rubberized Coating, "Scotchlite" Reflective Sheeting, "Safety-Walk" Non-slip Surfacing, "3M" Abrasives, "3M" Adhesives. General Export: 122 E. 42nd St., New York 17, N. Y. In Canada: London, Ont., Can.



Tests show

100 TIMES GREATER FATIGUE ENDURANCE

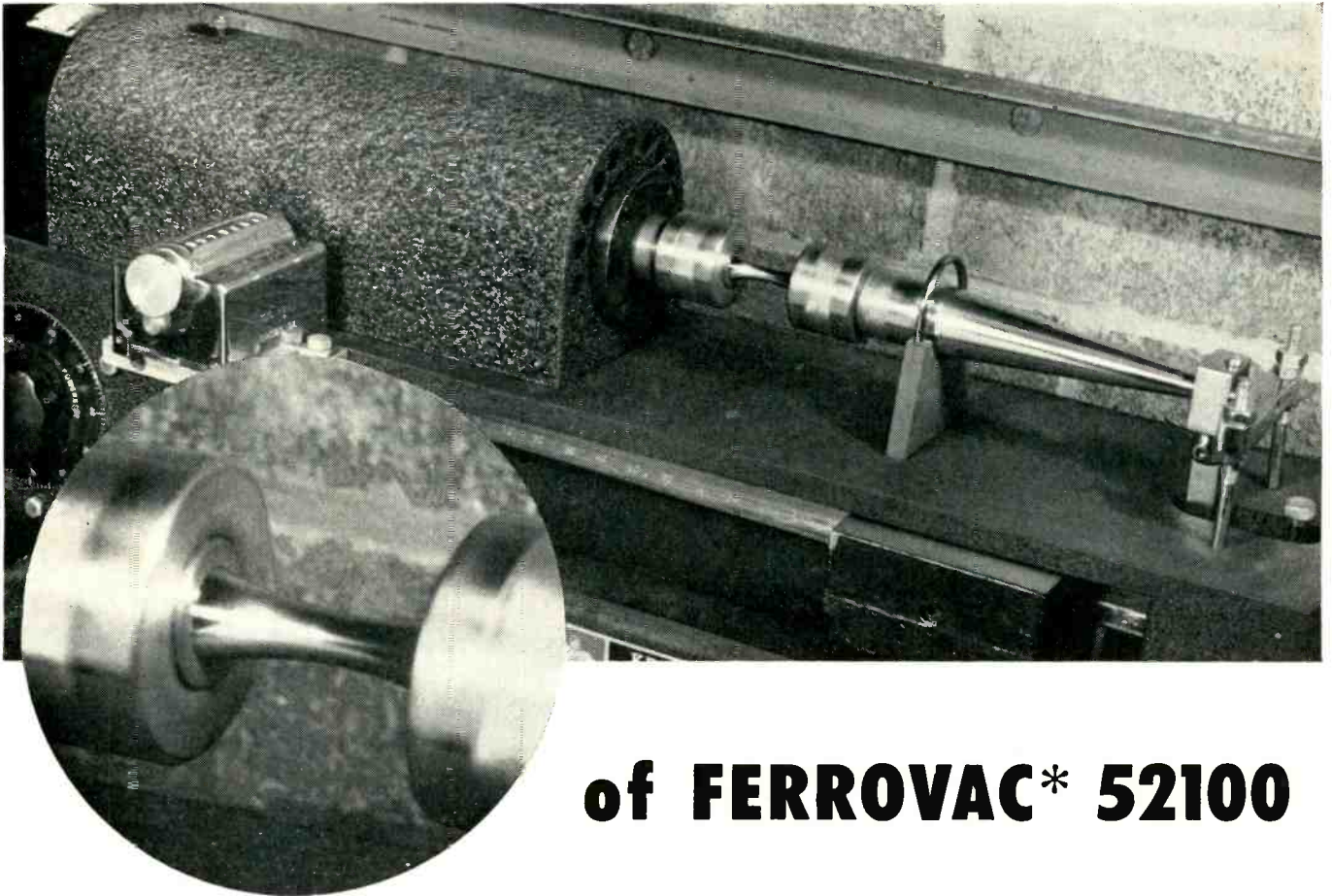

of FERROVAC* 52100

Fatigue tests conducted in the laboratories of the National Research Corporation on Ferrovac* 52100 showed that vacuum melting increases endurance limits over 100 times that of commercial grade SAE 52100 steel.

Improved performance characteristics such as these are typical of the products of Vacuum Metals Corporation. Vacuum melting removes gases and oxide inclusions and permits new standards of composition tolerance.

The result — improved physical,

*T. M. appl'd for.

chemical, and electrical properties. These high performance characteristics may eliminate the need for redesign or be the answer to the "impossible-to-do" specifications that have been handed to you.

Commercial quantities of ferrous and non-ferrous metals and alloys are

now being vacuum cast at pressures as low as one millionth part of atmospheric by Vacuum Metals Corporation. They are now available in either billet or fabricated forms. We may have the answer to some of your metals problems. Write us for more information.

VACUUM METALS CORPORATION

Subsidiary of National Research Corporation

70 MEMORIAL DRIVE • CAMBRIDGE 42, MASSACHUSETTS

HIGH PURITY METALS • HIGH VACUUM CASTING • SPECIAL ALLOYS • GF (Gas Free) METALS



ONE OF U. S. A's LEADING MAKERS OF ELECTRONIC TUBES
AND MICROWAVE COMPONENTS

Bomac is 100% High-Vacuum-Equipped by NATIONAL RESEARCH

Type 710 Thermocouple-Ionization Gauge Control.
One instrument for scientific and industrial vacuum gauging. Incorporates two thermocouple gauges. (1-1000 microns) and one ionization gauge (10^{-3} mm to 10^{-8} mm. Hg. range) in one control.

Alphatron* Vacuum Gauge. Accurate gauging from 10 mm. to 1 micron. Specially fabricated for low leak rate and calibrated for hydrogen.

Vacuum Seals. For connecting pump and manifold.

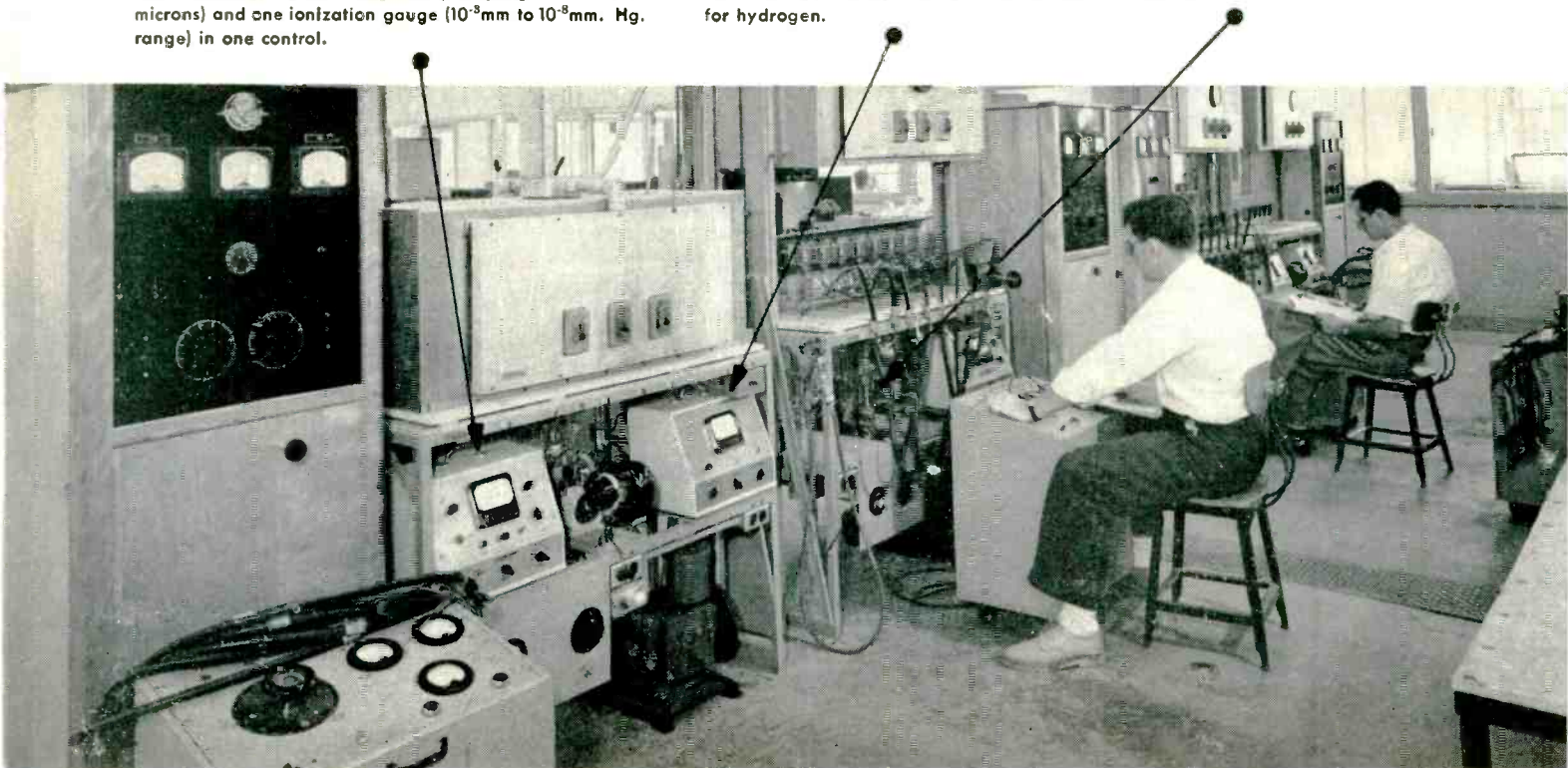

As one of U.S.A.'s fastest growing electronic tube manufacturers, Bomac has established severe standards for their production equipment to assure an uninterrupted flow of tubes with minimum rejects.

National Research high vacuum equipment meets these rigid standards so well that it was again specified exclusively in Bomac's

recent expansion of facilities.

When you want the same — a single source for all your high vacuum equipment needs . . . with a single unexcelled standard of quality — look to National Research. For further details write National Research Corporation, Memorial Drive, Cambridge, Massachusetts.

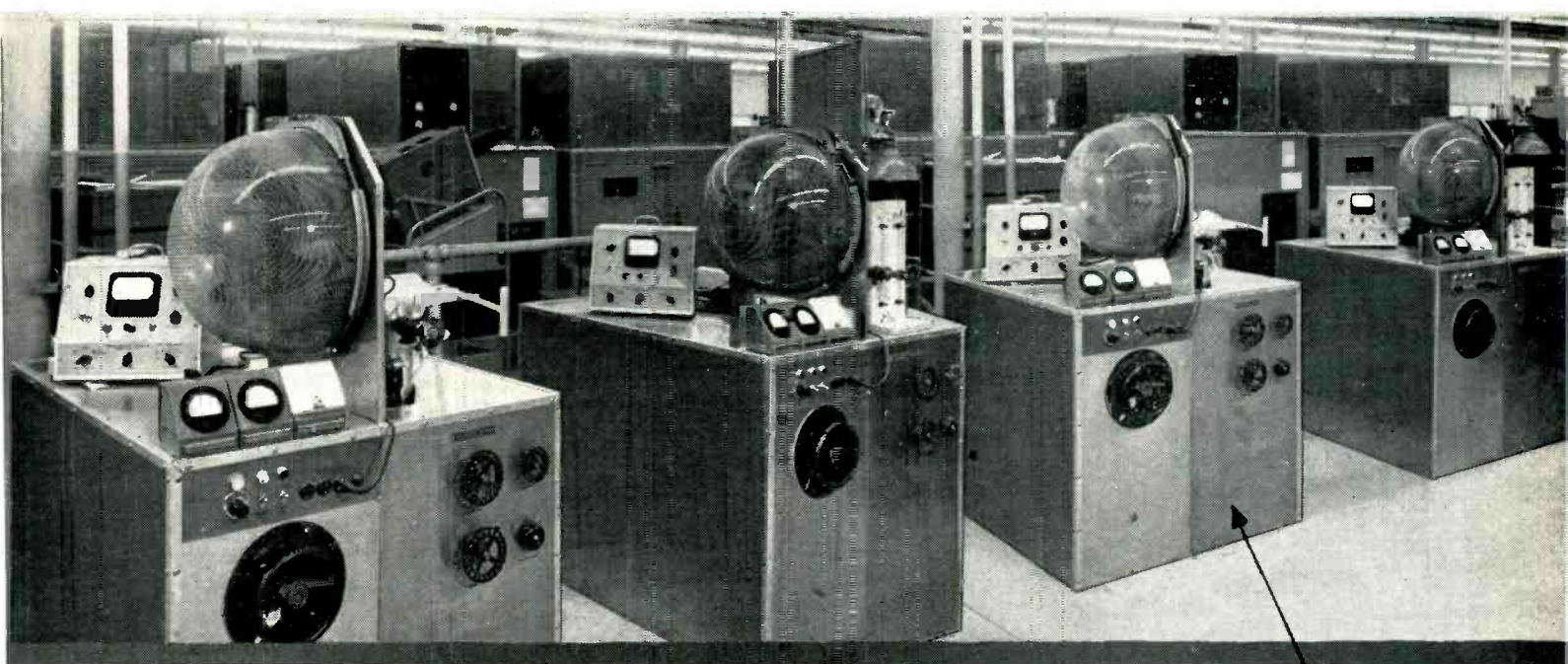

H-2-P Purifying Diffusion Pump. Over 50 liters per second from 10^{-8} to 10^{-6} mm. range. Operates against forepressures as high as 0.300 mm. Blank-off 2×10^{-7} mm.

Standard Vacuum Furnace. A versatile packaged unit to melt, pour, heat treat, degas, sinter, and anneal under high vacuum or controlled atmospheres. Temperatures up to 2000°C.



INDUSTRIAL RESEARCH • PROCESS DEVELOPMENT
HIGH VACUUM ENGINEERING AND EQUIPMENT



METALLURGY • DEHYDRATION • DISTILLATION
COATING • APPLIED PHYSICS

National Research Corporation

Equipment Division

SEVENTY MEMORIAL DRIVE, CAMBRIDGE, MASSACHUSETTS

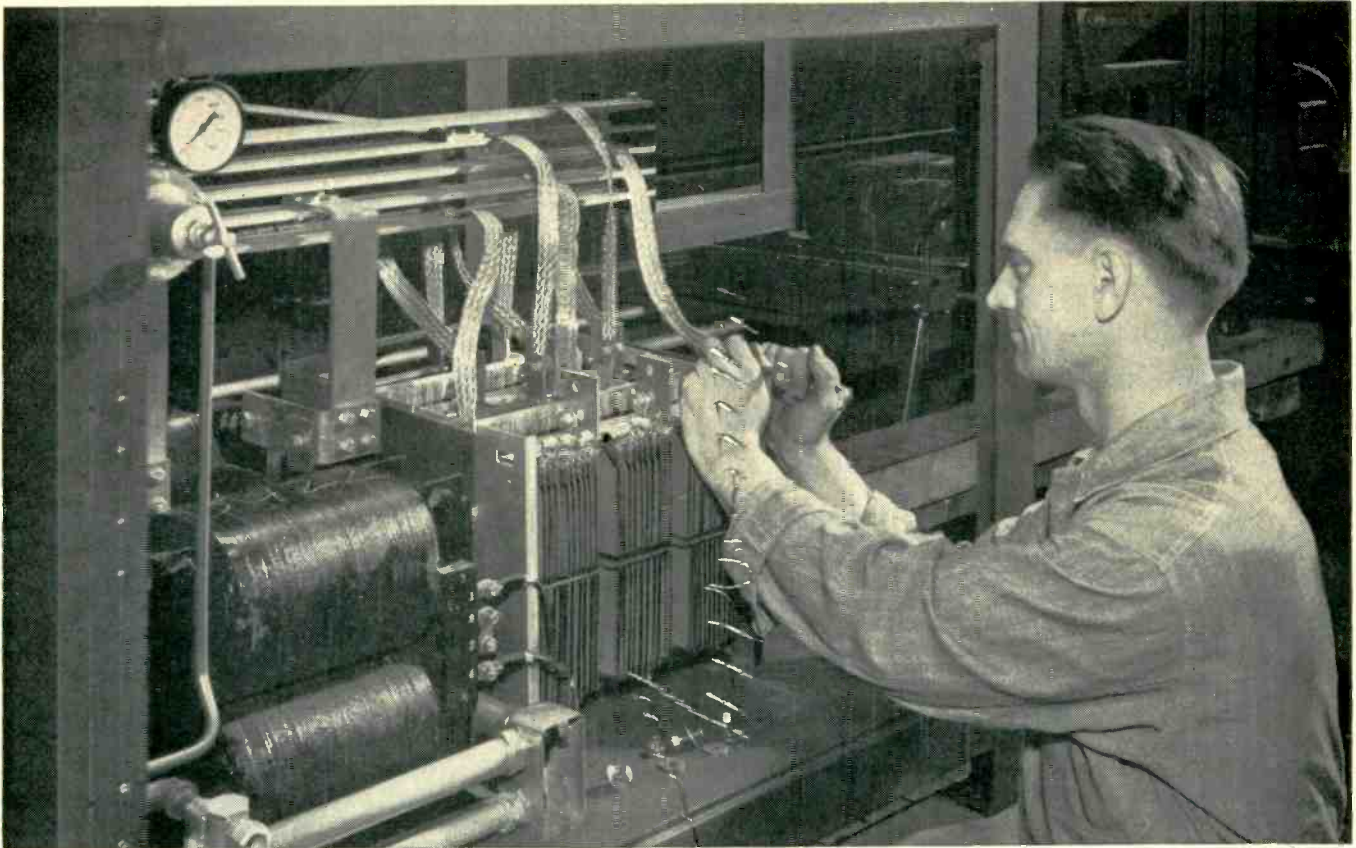

G-E COPPER-OXIDE RECTIFIER STACKS, BEING INSTALLED BY MAGNAFLUX' H. E. SCHREIBER, PROVIDE HIGH CONVERSION EFFICIENCY.

Magnaflux Corp. Relies on G-E Rectifiers

COPPER-OXIDE STACKS MEET SEVERE SERVICE REQUIRED BY MAGNAFLUX TESTING EQUIPMENT

As pioneer developer and world leader in the manufacture of non-destructive testing equipment, the Magnaflux Corporation insists on dependable rectifiers.

These rectifiers supply the d-c current that sets up the magnetic field for detecting sub-surface defects. G-E copper-oxide rectifier stacks were selected because tests proved that they can take heavy current overloads for short periods without over-heating or deteriorating.

Mr. W. D. Reid, second vice-president and plant manager at Magnaflux, enthusiastically reports, "In our application, rectifiers are subjected to extremely severe service because of the high currents drawn from them for the magnetization of parts to be inspected. They must have the highest conversion efficiency to assure maximum voltage output with lowest losses in operation. G-E copper-oxide rectifiers meet all these requirements."

"We have several thousand copper-oxide rectifiers in service. Failures have been almost unknown."

YOUR PRODUCT, too, will benefit from the many operating advantages and extremely long life of G-E copper-oxide rectifiers. For information on how to apply them, contact your nearest G-E Apparatus Sales Office, or write Section 461-23, General Electric Co., Schenectady, N. Y.



STABLE ELECTRICAL CHARACTERISTICS of General Electric copper-oxide rectifier stacks help maintain customer good will, says W. D. Reid, Magnaflux second vice-president and plant manager.

GENERAL  **ELECTRIC**

RADAR *Control*

Test SET radar

S AND X BAND

MICROWAVE EQUIPMENT
FROM V. H. F. to S. H. F.



LABORATOIRES

OFFICE AND FACTORIES
6, RUE JULES-SIMON, BOULOGNE-SUR-SEINE
TÉL. : MOLITOR 37-00 FRANCE

LABORATOIRES



R. DERVEAUX

LABORATOIRES
64, RUE DU CHATEAU-BOULOGNE-SUR-SEINE
TÉL. : MOLITOR 73-91, 92 et 93 FRANCE

Ag. PUBLÉDITEC-DOMENACH



From the
HAMMARLUND LABORATORIES

The SP-600-JX

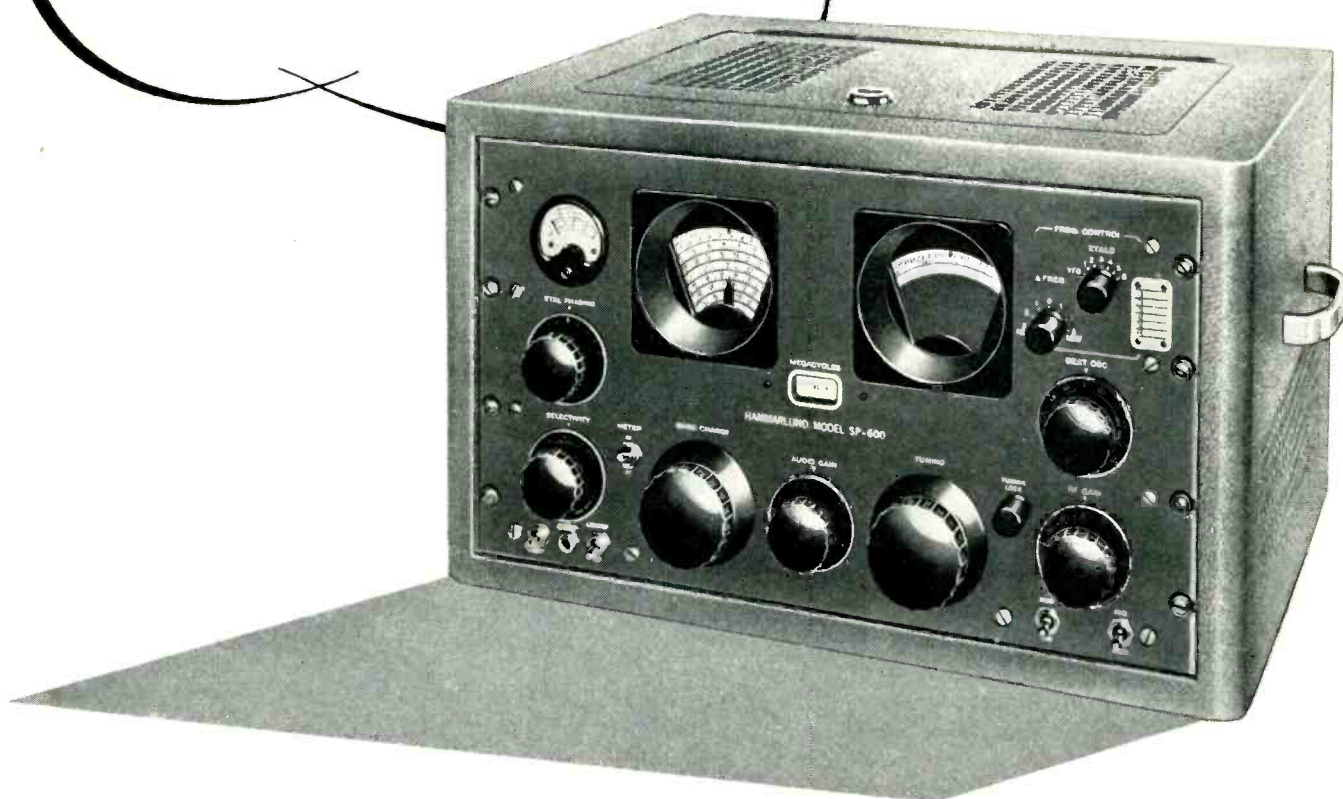

for selective channel operations

With its six crystal-controlled fixed-frequencies, the "SP-600" is the perfect receiver for point-to-point and network applications. Pre-arrange day and night fixed-frequencies. With crystal control you can select your desired channels immediately without searching. You'll always be on the nose because of crystal control.

The "SP-600-JX," built to JAN specs and specially ruggedized to provide years of day-in-day-out competent perform-



ance, is the most carefully engineered receiver available anywhere for selective channel operation.

But whether you want to operate on a fixed-frequency for contact with an individual station or network, or roam the entire receiver range from 540 Kc to 54 Mc in search of other contacts, you just can't operate a finer receiver than the "SP-600-JX."

Write to the Hammarlund Manufacturing Company for further details.

HAMMARLUND

HAMMARLUND MANUFACTURING COMPANY, INC.
 460 WEST 34th STREET • NEW YORK 1, N. Y.

CP GLASSMIKES*

the capacitors with the exclusive glass housing and plastic dielectric film

*Preferred where
High Temperatures,
High Resistance, and
Low Loss are Essential!*



Glassmike capacitors are wound with the plastic film which accentuates the electrical characteristics you require, and results in capacitor design of minimum size. The metal ferrules, soldered to silver bands at each end of the hermetically-sealed glass tubes, eliminate mounting problems.

Applications:

audio and RF coupling
pulse forming and de-spiking networks
radio frequency bypass
low and high pass filter networks
audio frequency coupling
electronic computers
electrometer and oscillator circuits
etc.

Send us your requirements and we will recommend the proper capacitor.

MANUFACTURERS
Glassmike Capacitors
Plasticon Capacitors
Hi Volt Power Supplies
Pulse Forming Networks

Condenser Products Company
Division of New Haven Clock & Watch Co.



7517 North Clark Street • Chicago 26, Illinois

* *Glassmikes* . . . an exclusive capacitor line originally designed by our engineers

ACME ELECTRIC CORPORATION REDUCES TRANSFORMER SIZE

Saves **40%**
on steel...

Saves **42%**
on copper...

Saves **44%**
on weight...

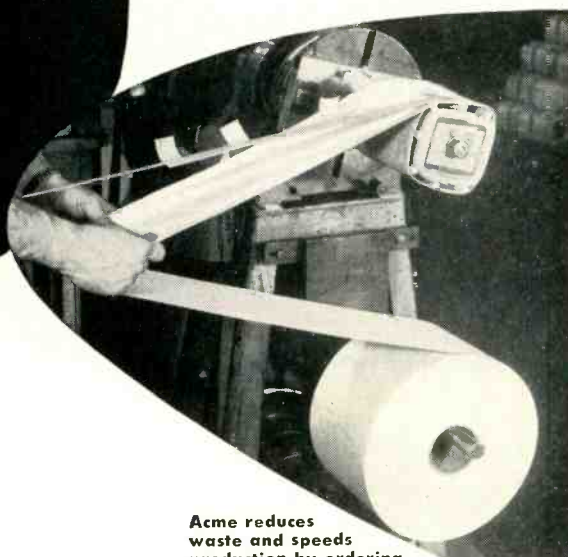

Acme reduces waste and speeds production by ordering Quinterra to exact width required—Production efficiency has been increased and waste has been reduced to an absolute minimum—without equipment changeover—by using Quinterra Type 6, factory-cut to Acme's dimensional specifications.

—by insulating coils with

Quinterra® TYPE 6

the purified asbestos electrical insulation

How have these tremendous savings in critical materials, weight, space, and production time affected the quality of Acme transformers?

The manager of Acme's Dry Type Transformer Division advises that not a single failure in operation of an Acme Quinterra-insulated transformer has been reported in the two years that they have been produced. Since several thousands of these units have been manufactured in this time, their quality is evident.

Here are the reasons why this Johns-Manville purified asbestos insulation has helped the Acme Electric Corporation,

and many other well-known manufacturers, turn out better products and at the same time lower production costs.

Quinterra Type 6 possesses high thermal stability and lasting dielectric strength. It is a twin-ply, polyvinyl, acetate-treated, purified asbestos insulation with a dielectric strength of 300 VPM. Even when its saturant is baked out by continuous exposure to 200 C, it retains the inherent dielectric of the base sheet which is at least 200 VPM . . . and it remains a dielectric up to 400 C.

Type 6 has high mechanical strengths because it is made by combining and

calendering two layers of Quinterra together into a dense, smooth-surfaced insulation. Its good tensile and bursting strengths enable operators to achieve favorable production rates. Further economies result from its large square-foot-per-dollar coverage.

If you are a manufacturer of magnetic or resistance devices, Quinterra Type 6 . . . or one of the other Quinterras . . . may enable you to lower production costs and also to improve your product's performance. For samples and additional information, write to Johns-Manville, Box 60, New York 16, New York.



Johns-Manville ELECTRICAL INSULATIONS

PRECISION

Controls

At the *very heart* of highly critical equipment such as electronic computers, electronic gunsights and radar assemblies, the control requirements call for outstanding electrical and mechanical precision. Indeed, from single section to as many as twenty sections, the precision controls must track with mathematical accuracy.

Clarostat Series 42 Controls fully meet these requirements. Thus *the climax in precision controls*.

Clarostat has made the major portion of such precision controls in use today. Many were supplied to the armed forces in World War II. Many more have been supplied for civilian purposes since then. And now, *based on an unparalleled experience background*, Clarostat engineers offer you further refinements in their latest Series 42 design.

You can stand pat with CLAROSTAT

Engineering Bulletin No. 142 sent on request. And remember, when your control or resistor requirements call for *quality, quantity and economy*, you can meet them with Clarostat's engineering and production facilities. *Submit that problem!*



New Clarostat Series 42 potentiometer. Available in single and multiple assemblies up to 20 sections. Precision windings to plus/minus 0.5% and better. Positive contact rotor, smooth rotation, minimum wear. Perfect tracking of all units in assembly. No backlash or play. Rotor of each potentiometer mounted on centerless-ground shaft passing through all sections.

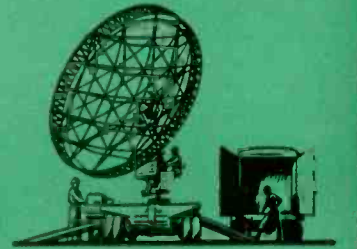

Controls and Resistors

CLAROSTAT MFG. CO., INC., DOVER, NEW HAMPSHIRE
In Canada: Canadian Marconi Co., Ltd., Toronto, Ontario





CAST-PERMAFIL TRANSFORMERS

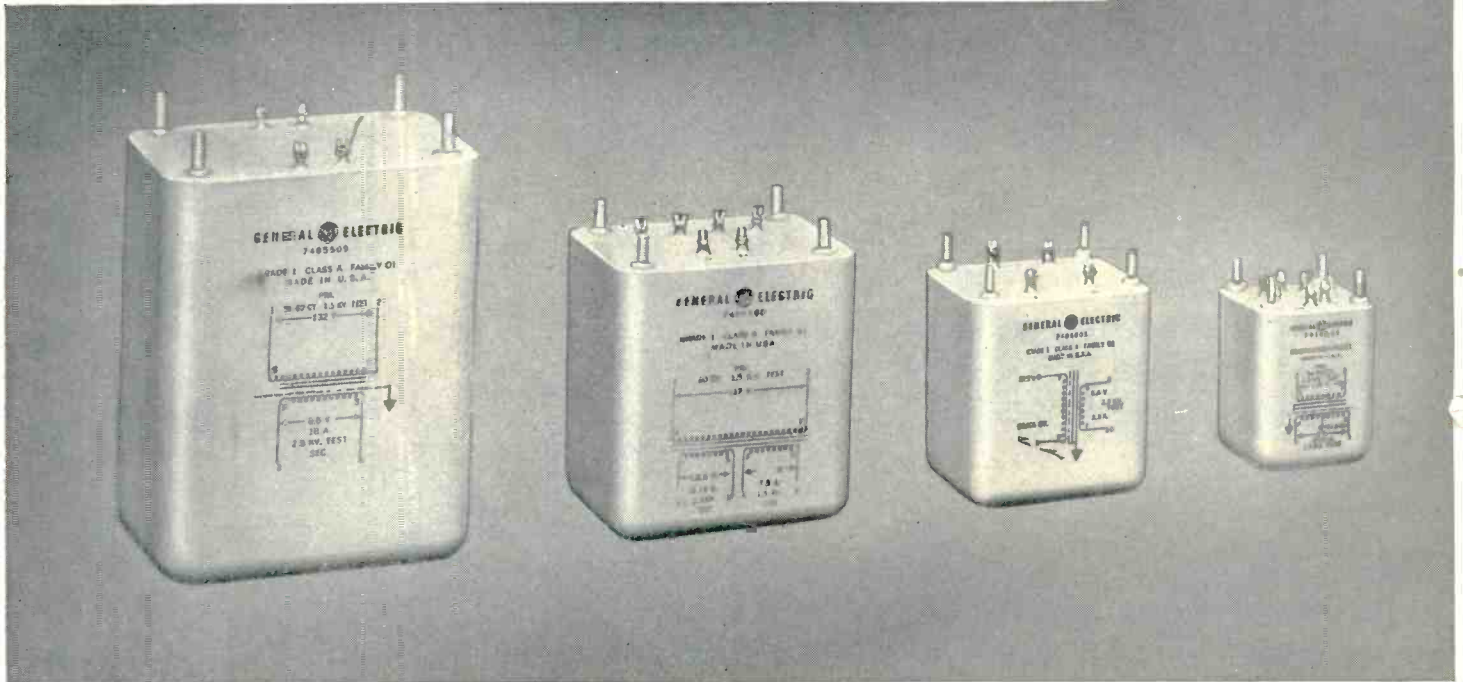

NEW LINE of G-E cast-permafil electronic transformers does away with the need for hermetically sealed metal enclosures.

Cast construction, lighter weight and smaller size offer the designer greater flexibility in many types of electronic designs.

New G-E designs available

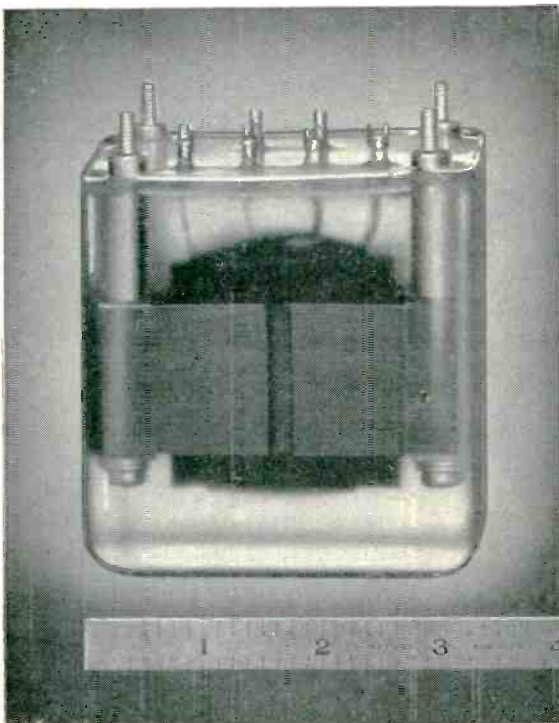

SIMPLER CONSTRUCTION of G-E cast-permafil transformers shows up dramatically in this model cast in clear resin. Note how the resin anchors the terminals, eliminating need for a steel enclosure.

Smaller, Lighter Cast-Permafil Transformers Designed to MIL-T-27 "Specs"—Need No Fungus-Proof Coatings

Interchangeable with existing hermetic designs, General Electric's new line of cast-permafil transformers—solventless resin type—offer many design advantages.

MOISTURE PROOF—"Cast-in" construction seals transformer permanently against moisture as required in MIL-T-27 Grade 1 Performance Specifications. Permafil forms a tough, shatter-resistant, solid casing.

AVERAGE 20% SMALLER because they eliminate metal enclosures, and because their terminals can be anchored directly in permafil mixture, the new G-E cast-permafil transformers are smaller and lighter weight. The complete line—which includes 11 sizes, 9 of them in two heights—averages about 20% smaller than previous models.

MORE FLEXIBLE with fewer machined and punched parts, greater flexibility in design and construction is possible. Terminal arrangements can be varied. Color can be "built in" by adding pigment to the permafil mixture. Permafil makes fungus-proof coatings unnecessary.

ACCELERATED LIFE TESTS indicate that G-E cast-permafil transformers will stand up as long as Class A hermetics at 105 C. And at 130 C. ultimate, they have an expected life of 1000 hours or more.

For complete information on the application, ratings and availability of G-E cast-permafil transformers, write to **Section 411-102, General Electric Company, Schenectady 5, N. Y.**



AUTOMATIC VOLTAGE STABILIZERS

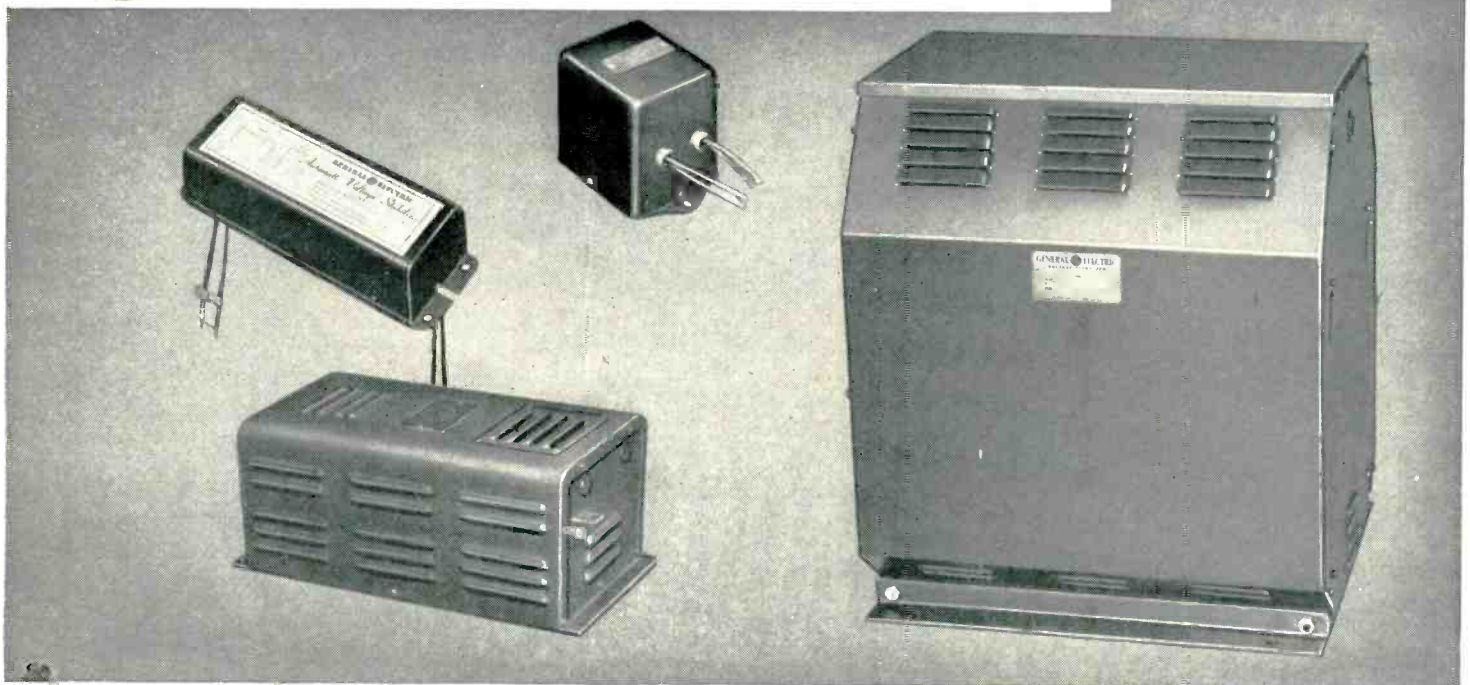

NEW LINE rated from 15 VA to 5000 VA. Stabilizers feature greater flexibility for designs involving voltage ratios other than 1:1. A wide range of voltage correction is offered.

for electronics use

Lighter G-E Automatic Voltage Stabilizers Feature Inherent Input-Output Isolation—More Voltage Ratios

SINGLE-CORE CONSTRUCTION in General Electric's new standard line of 60-cycle automatic voltage stabilizers provides inherent input-output isolation—eliminates the need for an additional isolating transformer. You get substantial weight reduction over previous units in the 1000 to 5000 VA ratings.

TOTALLY ENCLOSED construction of the new design cuts down stray magnetic fields—allowing use near sensitive electronic devices like oscilloscopes.

VOLTAGE RATIO FLEXIBILITY has also been increased in the new line. Standard stabilizers—with ratings from 1000 VA through 5000 VA—are provided with series multiple input and series multiple output.

IN ADDITION, these new units offer a wide-range of voltage correction, plus rapid stabilization, ease of installation and maintenance-free operation.

For further information on this new line of standard automatic voltage stabilizers call your local G-E distributor. Or write for bulletin GEA-5754 G-E Automatic Voltage Stabilizers. Section 411-102, General Electric Co., Schenectady 5, N. Y.

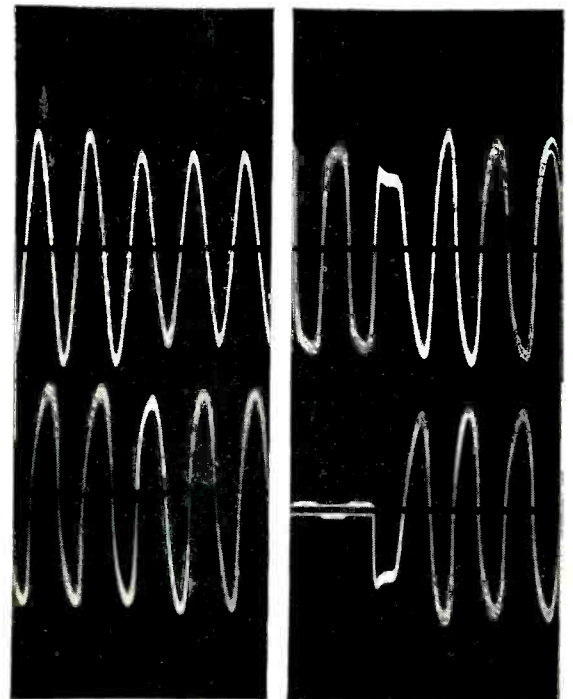

RAPID RESPONSE of G-E Automatic Voltage Stabilizers. *Left:* Stabilization within 1½ cycles as input drops from 130 to 95 volts. *Right:* Stabilization in 2 cycles as load current jumps from 0 to full load.

GENERAL ELECTRIC



all nature's "housings"
are

CUSTOM-BUILT

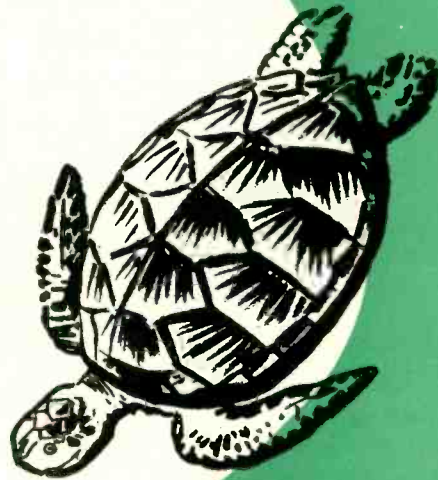

... your product also deserves
custom-built metal cabinets ... by **BALTIC**

It's only natural that an important part of your product should be a sheet metal housing or enclosure fabricated to individual needs by master craftsmen.

CUSTOM-BUILT cabinets by Baltic permit your own exclusive styling, correct dimensions, special design features that make the equipment function efficiently and afford easy access to components for servicing.

CUSTOM-BUILT cabinets by Baltic are completely uniform in every detail, making the units easier and less costly to assemble.

Our large collection of standard and special die combinations can save unnecessary tooling charges and speed production. Our modern facilities include careful welding of all types and expert finishing. We work in any metal, any gauge. Our estimates are in line.

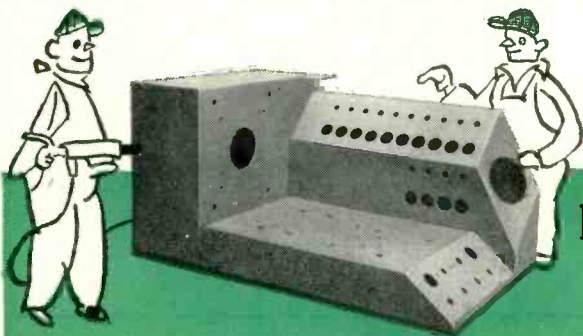
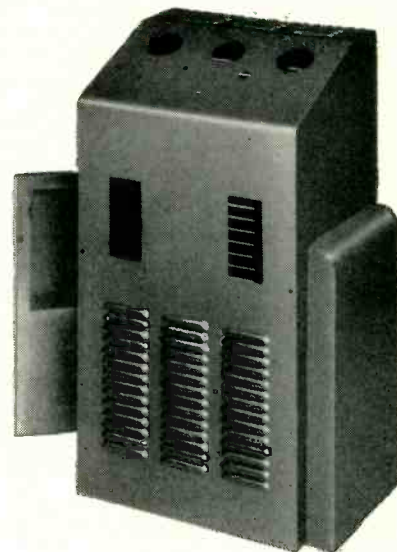

"Perfectioners" in Sheet Metal Fabrication

BALTIC METAL PRODUCTS CO.

120 SUTTON ST., BROOKLYN 22, N. Y.

An Open Letter To—

TOP MANAGEMENT

Of Industrial Concerns

A. W. FRANKLIN

43-20—34th Street
Long Island City 1, N. Y.

Phone: STillwell 4-1059

Subject: LICENSE AVAILABLE—

FRANKLIN STAMPED WIRING PROCESS

Gentlemen:

Top Management should thoroughly investigate the so-called printed techniques—photo-etching; spraying; printing; etc.; and compare them with the 10 Important Advantages of the Franklin Stamped Wiring Process.

THERE IS NOW AVAILABLE TO A LIMITED NUMBER OF MANUFACTURERS, A LICENSE AND KNOW-HOW ON A NOMINAL ROYALTY BASIS.

The Franklin Stamped Wiring Process is a proven method and has been successfully used, producing millions of parts for the past 5 years. It is covered by numerous patents in the United States, Europe, Canada and South America with many patent applications pending on new and improved methods, tools, applications, etc.

All that is required is a press equipped with an automatic device for feeding the copper and the insulated material. The circuits are stamped out in this machine at the rate of 1800 per hour. The scrap is automatically reclaimed and no other operations are necessary.

There is no need for your company to expend large sums of money on development work on other methods that require many operations because the Franklin Stamped Wiring method is now available to you.

One of the leading manufacturers in electronics is presently licensed on a non-exclusive basis.

Further information including all details will be given to responsible manufacturers.

Yours very truly,

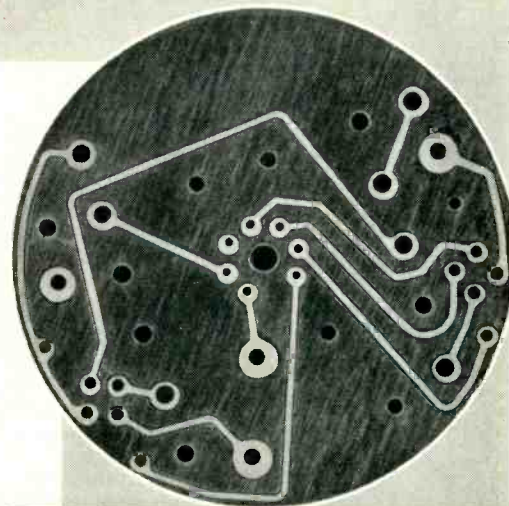

This FRANKLIN STAMPED WIRE
CIRCUIT is shown in actual size.

10 IMPORTANT ADVANTAGES

- Low Cost
- High Speed Production
- All Scrap Copper Reclaimed Automatically
- Insulated Material Not Subjected to Acid Deterioration
- Tinned or Plated Copper Can Be Used for Ease of Soldering
- Metal Can Be Drawn into Holes for Connection to Reverse Side
- Limited Space and Equipment for Manufacturing
- Fabrication of Insulated Piece and Embossing Circuit Made Automatically in One Operation
- Made with Tools—All Parts Identical in Performance and Quality
- Strong Adhesion for Dip Soldering

PATENTS

UNITED STATES

2401472	6/4/46
2431393	11/25/47
2431725	10/19/48
2535674	12/26/50

FOREIGN

Argentina	62605	12/27/49
Australia	129783	3/24/45
Canada	553181	1/23/51
Great Britain	610058	3/25/45
France	918587	11/4/46
Italy	420575	4/26/47

Communications	P. 62	Nov. '45
Business Week	P. 50	May 31, '47
Electronics	P. 82	June '47
N. Y. Herald Tribune — Sec. 4	P. 7	June 8, '47
Electrical Manufacturing	P. 98	July '47
McGraw-Hill Digest	P. 11	July '47
Life	P. 11	Sept. 8, '47
Popular Science Monthly	P. 91	Oct. '47

Stanford Research Institute

Office of Naval Research—Task Order #3—Terminal Report June 1, 1950

Wright Air Development Center—Interim Report #1 Project 597 May 1952

Wright Air Development Center—Final Report—Project 413 Feb. 15, 1952

Bureau of Ships—Pacific Division of Bendix Aviation—Electronic Subminiaturization Navships 900.174 March 1951

BIBLIOGRAPHY

Nat. Bur. of Standards Circular	P. 468	Nov. 15, '47
Tele-Tech		Sept. '48
Tele-Tech	P. 26	Oct. '48
Electronics	P. 76	Sept. '48
Tele-Tech	P. 47	Nov. '48
Nat. Bur. Standards Publication	P. 192	Nov. '48
Popular Science Monthly	P. 221	June '49
Westinghouse Engineering Highlights of 1949	P. 29	

MITCHELL-RAND

announces its most significant
compound development of the decade

RANDAC

the thermosetting encapsulating plastic

In the past ten years Mitchell-Rand has developed a great many electrical insulating compounds for the protection of electronic and electrical components. However, in RANDAC Mitchell-Rand makes its most significant contribution to the electrical and electronic industries... the development of RANDAC is an outstanding achievement!

RANDAC is a 100% solid resin for encapsulating and sealing electrical and electronic components... its sharp thermoplastic melting point permits "hot melt" dip-coating in thicknesses from 25 mils to more than 1/4 inch without danger of resin flow or damage and without the use of a cast or mold. After a single cure the RANDAC becomes tough and infusible contributing everlasting protection to the equipment it encases.

RECOMMENDED APPLICATIONS for RANDAC

- 1 Coating and encapsulating for purpose of moisture resistance, mechanical shock resistance, and electrical insulation on: Transformers, Resistors, Rectifiers, Capacitors, Transistors, Printed circuitry, Electronic assemblies.
- 2 Corona control by void filling and coating high voltage transformers, parts, and assemblies.
- 3 Sealing parts such as capacitors resistors, and rectifiers, into metal, ceramic, and plastic cases.
- 4 Cast embedment of electronic parts and assemblies.

	RANDAC	features	
	<p>RESISTANCE TO THERMAL SHOCK</p> <p>Transformers coated with RANDAC have withstood thermal shock tests from room temperature to -65 C.</p>	<p>HIGH TEMPERATURE STABILITY</p> <p>Maximum unit operating temperatures of above 150 C are indicated for RANDAC encapsulated units.</p>	<p>ELECTRICAL PROPERTIES</p> <p>RANDAC exhibits a high dielectric strength and is well suited for corona suppressing applications.</p>
	<p>LOW MOISTURE ABSORPTION</p>	<p>ADHESION</p> <p>RANDAC shows excellent adhesion to most metals, ceramics, and plastics.</p>	<p>LOW SHRINKAGE AFTER GEL</p>

RANDAC HERMETICALLY SEALS AND ENCASES ELECTRONIC AND ELECTRICAL PARTS IN THICKNESSES FROM 25 MILS TO MORE THAN 1/4 INCH WITHOUT THE USE OF CASTS OR MOLDS OR THE NECESSITY TO EMPLOY MULTIPLE DIP AND CURE CYCLES.

A working sample of RANDAC will be sent on letterhead request.



MITCHELL-RAND INSULATION COMPANY, INC.

51 MURRAY STREET

Corlanti 7-9264

NEW YORK 7, N. Y.

A PARTIAL LIST OF M-R PRODUCTS: FIBERGLAS VARNISHED TUBING, TAPE AND CLOTH • INSULATING PAPERS AND TWINES • CABLE FILLING AND POTHEAD COMPOUNDS • FRICTION TAPE AND SPLICE • TRANSFORMER COMPOUNDS • FIBERGLAS SATURATED SLEEVING • ASBESTOS SLEEVING AND TAPE • VARNISHED CAMBRIC CLOTH AND TAPE • MICA PLATE, TAPE, PAPER, CLOTH, TUBING • FIBERGLAS BRAIDED SLEEVING • COTTON TAPES, WEBBINGS AND SLEEVINGS • IMPREGNATED VARNISH TUBING • INSULATING VARNISHES OF ALL TYPES • EXTRUDED PLASTIC TUBING

NEW

To AM Broadcasting

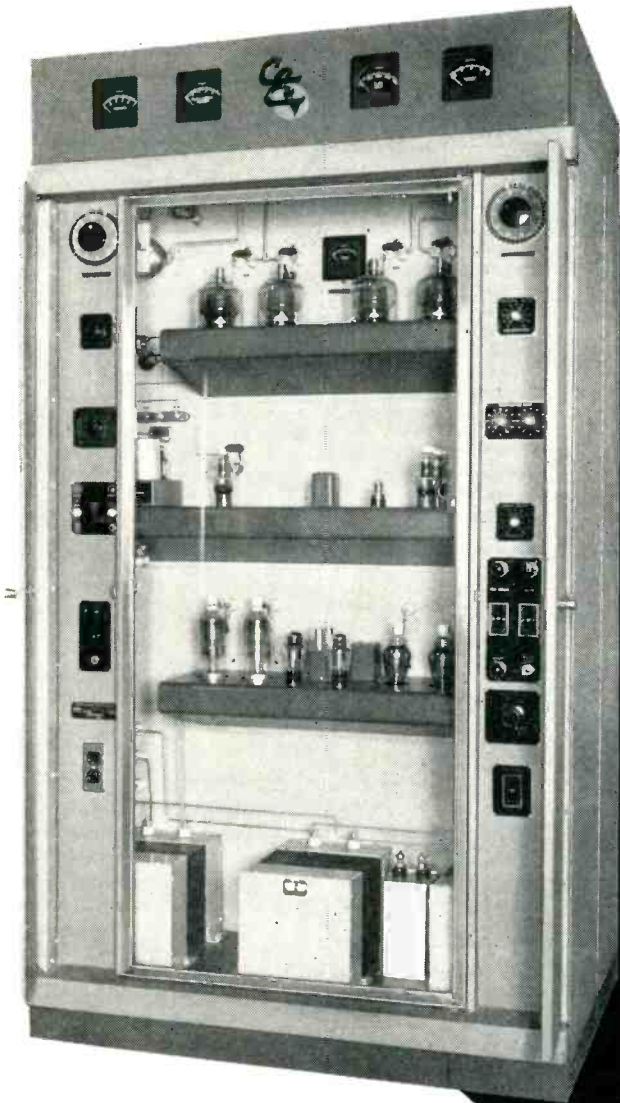

Continental Electronics type 314-2 transmitter

Continental Electronics'
One kilowatt transmitter
goes
On the Air
with
Eimac Tetrodes

By employing 4-400A radial-beam power tetrodes, and other up-to-the-minute developments in its one kilowatt transmitter, Continental makes a significant advancement in the field of AM broadcasting.

As power amplifiers a pair of Eimac 4-400A tetrodes give outstanding performance. Only two RF amplifiers are used in the 314-2, including the output stage which takes advantage of the low driving power requirements, high power gain and stability of Eimac 4-400A's.



Eimac 4-400A's in high level stages.

As modulators two 4-400A's are driven by a high quality, resistance coupled audio amplifier with fixed audio feed-back. As in the power amplifier these tetrodes make possible the adaptation of simple, straight-forward circuitry.

For data about the 4-400A write
Eimac's Application Engineering
department.

Follow the Leaders to

Eimac
TUBES

EITEL-McCULLOUGH, INC.
SAN BRUNO, CALIFORNIA

Export Agents: Frazer & Hansen, 301 Clay St., San Francisco, California



CHATHAM

ELECTRONIC TUBES

Hydrogen Thyratrons

— for Pulse Voltage Generation



TYPE VC-1257

Hydrogen filled, zero bias thyatron with hydrogen generator for generation of pulse power up to 40 megawatts.



TYPE 5948/1754

Hydrogen filled, zero bias thyatron with hydrogen reservoir for generation of peak pulse power up to 12.5 megawatts.



TYPE 5949/1907

Hydrogen filled, zero bias thyatron with hydrogen reservoir for generation of peak pulse power up to 6.25 megawatts.



TYPE VC-1258

Zero bias miniature hydrogen thyatron for the generation of peak pulse power up to 10 KW.

ELECTRICAL DATA*

Type	VC-1258	5949/1907	5948/1754	VC-1257
Maximum Peak Forward Anode Potential	1000 volts	25000 volts	25000 volts	38000 volts
Maximum Peak Anode Current	20 amps	500 amps	1000 amps	2000 amps
Maximum Average Anode Current	0.05 amps	0.50 amps	1.0 amps	2.0 amps
Maximum Heating Factor (epy x prr x ib)	1.0x10 ⁸	6.25x10 ⁹	9.0x10 ⁹	—
Nominal Filament Power	12.6 watts	95 watts	190 watts	230 watts
Hydrogen Reservoir	No	Yes	Yes	Yes

*More detailed information on electrical and mechanical data will be supplied on request.

● A NEW CONCEPT OF HYDROGEN THYRATRON DESIGN! The tubes illustrated represent a departure from conventional hydrogen thyatron designs and are a result of several years of concentrated development work.

They are primarily employed in the generation of peak voltages with durations in the order of microseconds.

Custom-built Electronic Equipment



← 20 Megawatt Hydrogen Thyatron Test Equipment built by CHATHAM to customers' specifications.

● CHATHAM specializes in the development, design, and construction of custom-built electronic equipment to exactly meet customers' requirements. Our capable staff of engineers will furnish prompt estimates or, if desired, will call to discuss your problem personally. Call or write today.

Pulse life test equipment built by CHATHAM checks receiver type tubes under pulse conditions. →

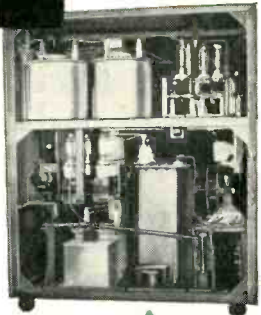

↑ 5 Megawatt radar modulator built by CHATHAM to rigid government standards.



ELECTRONICS

AND EQUIPMENT

Electronic Tubes



Ruggedized Type Tubes

The following tubes are JAN approved and can be supplied promptly, usually direct from stock:

5R4WGY	2D21W
6AL5W	OC3W
6H6WGT	OD3W
25Z6WGT	2050W

TYPE 395-A COLD CATHODE GAS TRIODE

Requires no filament supply and is used in many grid controlled rectifier and relay applications. Maximum D.C. anode current—10 ma. Maximum D.C. anode voltage—150 volts



TYPE 719-A HIGH VACUUM CLIPPER DIODE

This tube is used primarily for clipper diode service in hard tube modulator circuits. Filament 7 volts, 7 amps... Inverse peak anode voltage 25 kv, Max., peak anode current 10 amps, Max., anode dissipation 75 watts.

TYPE 4B32 RECTIFIER

A rugged half-wave Xenon filled rectifier. Operates in any position throughout an ambient temperature range of -75°C to $+90^{\circ}\text{C}$. Filament 5 volts, 7.5 amp... Inverse peak anode voltage 10,000 average anode current 1.25 amps.



TYPE 1Z2 RECTIFIER

A small bulb high voltage vacuum rectifier. Low cathode heating power and low dielectric losses make tube suitable for radio frequency supply circuits. Filament 1.5 volts, 290 amps... Inverse peak anode voltage 20,000, average plate current 2 ma... peak plate current 10 ma.

TYPE 394-A THYRATRON

A Mercury vapor and Argon filled thyatron for grid controlled rectifier service. Operates over wide ambient temperature range. Heater 2.5 volts, 3.2 amps... Inverse peak anode voltage 1250, average anode current 640 ma.



TYPE 1B46 REGULATOR

A cold cathode glow discharge tube designed for voltage stability. DC operating voltage 82 volts, operating current range 1 ma minimum, 2 ma maximum. Regulation 3 volts.

TYPE 3B28 RECTIFIER

This rugged half-wave Xenon filled rectifier will operate in any position and throughout an ambient temperature range of -75°C to $+90^{\circ}\text{C}$. Filament 2.5 volts, 5.0 amps... Inverse peak plate voltage 10,000, average anode current .25 amp.

Chatham Vacuum Switches

TYPE 1S22 (illustrated) is a mechanically actuated, single-pole, double-throw, glass vacuum switch. This and other types can be supplied.

SPECIFICATIONS

HOLD OFF VOLTAGE: Internal—10,000 volts rms; External* (at 27,000 feet altitude)—10,000 volts rms; External* (at 40,000 feet altitude)—7,500 volts rms.

INTERRUPTING RATING, RESISTIVE LOAD: 1,000 operations life at 10,000 v, ac, rms—10 amp, ac, rms; 1,000,000 operations life at 10,000 v, ac, rms—2 amp, ac, rms; 500,000,000 operations life at 10,000 v, ac, rms—0.1 amp, ac, rms.

NET WEIGHT (approx.) _____ 2 ozs. MAXIMUM WIDTH (overall) _____ $4\frac{1}{8}$ ins.
MAXIMUM LENGTH (overall) _____ $3\frac{3}{8}$ ins. MAXIMUM THICK. (overall) _____ $1\frac{1}{8}$ ins.

*at 50% humidity

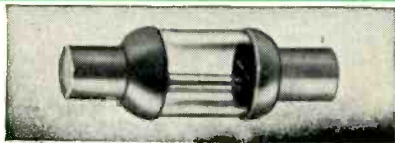
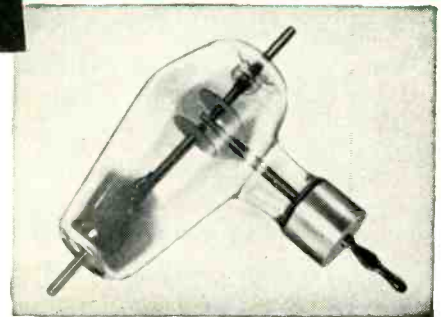

HIGH VOLTAGE VACUUM FUSES

Can be supplied by Chatham to exact customers' specifications if ordered in adequate quantity. Call or write for full particulars and quotes.



CHATHAM ELECTRONICS CORP.

475 WASHINGTON STREET • NEWARK 2, NEW JERSEY

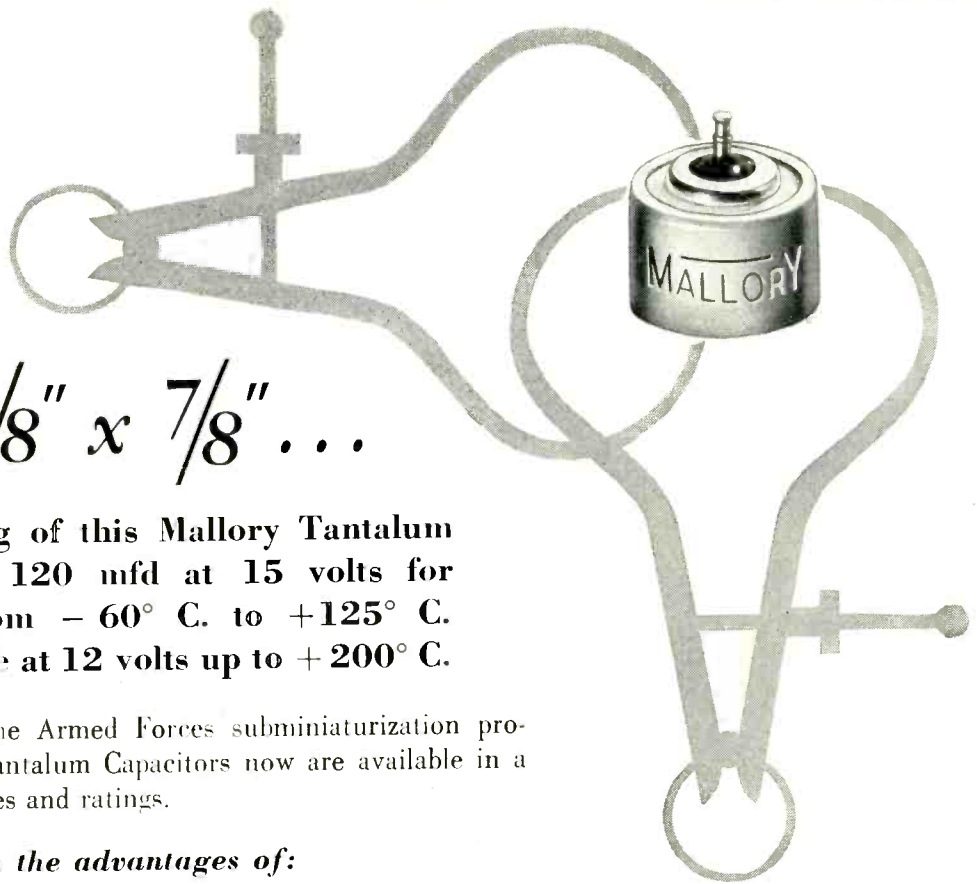

Just $5/8'' \times 7/8'' \dots$

yet the rating of this Mallory Tantalum Capacitor is 120 mfd at 15 volts for operation from -60°C. to $+125^{\circ} \text{C.}$ It will operate at 12 volts up to $+200^{\circ} \text{C.}$

Developed for the Armed Forces subminiaturization program, Mallory Tantalum Capacitors now are available in a wide range of sizes and ratings.

They offer you the advantages of:

Compactness

Continuous performance over a temperature range of -60°C. to $+200^{\circ} \text{C.}$

High resistance to shock and vibration

Proof against thermal shock from -60°C. to $+200^{\circ} \text{C.}$ without damage

Double sealing for absolute protection under all operating conditions

Now that Mallory Tantalum Capacitors are available in quantity, check their advantages for your equipment. Don't hesitate to consult Mallory on any problem involving the application of capacitors, the development of special types or the simplification of related circuits.

Get complete information...

Write for your copy of the Technical Information Bulletin on the Mallory Tantalum Capacitor. It is complete with sizes, mounting arrangements, surge voltages and performance curves.

P. R. MALLORY & CO. Inc.
MALLORY

SERVING INDUSTRY WITH THESE PRODUCTS:

Electromechanical—Resistors • Switches • Television Tuners • Vibrators
Electrochemical—Capacitors • Rectifiers • Mercury Dry Batteries
Metallurgical—Contacts • Special Metals and Ceramics • Welding Materials

P. R. MALLORY & CO., INC., INDIANAPOLIS 6, INDIANA



CROSS TALK

► **SWITCH** . . . Most economists see good business ahead through this winter and next spring. Certainly all the signs point that way in the field of electronics.

Along about mid-summer on the 1953 calendar there appears to be a veil that even the keenest eyes cannot completely penetrate. One of the components of the veil is possible tapering off of military orders if the stretched-out procurement program gets on schedule and passes its peak.

Perhaps this is the reason why so many manufacturers to whom we have talked in the last month seem to be thinking about civilian rather than military equipment business, why so many are searching for new things to build at prices the public can pay, and why so many are increasing sales pressure behind items already designed.

It seems like the thing to do.

► **GROWTH** . . . West Coast electronics industry is rapidly coming of age. Noted on our most recent editorial swing through the area was the particularly heavy attendance at the Long Beach convention, substantial growth in the size of many plants visited less than a year before and a continued though more modest influx of new companies.

Even more significant from a long-range point of view is the far west's growing interest in the mid-west and even the east-coast

market for its goods; manufacturing capacity in some instances already far exceeds the needs of local aircraft plants that gave many people in our field their start. Most significant of all, the first substantial signs of a west-coast component-parts business can now be seen; parts are in the main rather specialized, but new manufacturers must start where competition is not too keen and where required investment is not too large.

An indication of growth particularly visible to us is the sharp increase in the number of technical papers emanating from the west coast; **ELECTRONICS** itself has published 18 since January in its feature pages alone.

► **TWINS** . . . Use of the airplane in surveying and mapping has been one of the outstanding developments in that phase of civil engineering, according to the ASCE. "Furthermore," says the Society, "the use of electronics will be one of the dominant developments in the next quarter century."

► **MECHANIZATION** . . . Just a few short years ago people frequently asked us why so-called printed circuits, already widely used in military electronic apparatus, had not yet made a deep dent in civilian equipment design. We told them that in our opinion the chief reason was because they were

inflexible; it was too hard or too expensive to modify existing circuits.

Now there are signs that all this is changing. Several manufacturers of radio and television sets are using such circuitry extensively in equipment already on the market. What has happened to bring about the change? Designers are beginning to concentrate upon the machinery for producing circuits, rather than upon the circuits themselves. And they are seeing to it that the machinery is sufficiently flexible so that the boss is not nailed to the cross for dies or other appurtenances every time the engineering department wants to alter wiring.

At least one large independent research organization is known to have an important contract calling for development of machinery for the production of printed circuits, and setup and alteration time is to be the criterion. The program still has a long way to go, but it is well on its way.

► **BAGS** . . . At this, the height of the convention and trade-show season, we are reminded that a friend of ours once had occasion to check the contents of bags provided for literature collectors. Estimating the cost of circulars contained therein at rock-bottom preparation, printing and paper prices, he came up with the startling statistic that the average bag contained printed matter valued at \$17.50!

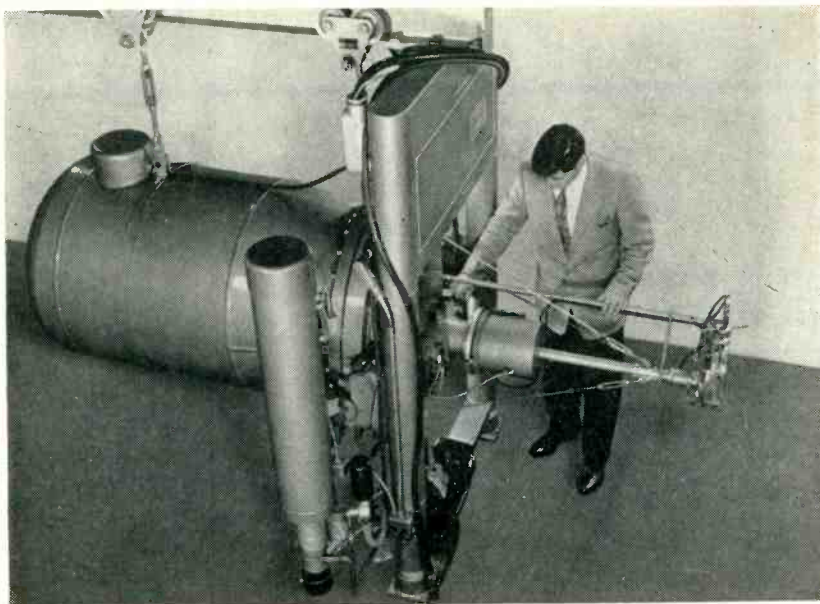

Commercial version of small electron-beam sterilizer for research and limited production. Mounting 2,000,000-volt generator on its side permits use in average-height room



High-intensity 3,000,000-volt electron sterilizer with three charging belts and two acceleration tubes. Electron power is 12 kw

ELECTRON BEAMS

High-current coils sweep electron beam through 8-deg arc in air 200 times per second to give uniform sterilization of sealed products moving through beam on high-speed conveyor belt. Scanning circuit includes elaborate fail-safe provisions

THE USE of high-energy electron beams for the sterilization of foods, pharmaceuticals and sanitary products is being made practical by the Van de Graaff electron accelerator with a scanned electron-beam output. There are many inherent advantages in the electron-sterilization process, as shown in the considerable amount of research¹ that has been conducted to develop techniques for treating materials with ionizing radiations.

An electron accelerated by potentials of several million volts is capable of penetrating substances to a considerable depth. As it passes through the material, this high-energy electron upsets the natural electrostatic balance of the atoms or molecules, ionizing them so that their chemical relationships are momentarily altered. The complex high-molecular-weight chemical structures essential to living

organisms are particularly sensitive to this type of ionization. Its results are accordingly fatal under treatment conditions producing far less, and often negligible, effect on nonliving material.

Advantages of Process

Interest in this method of preserving and purifying foods and drugs centers around the following characteristics:

(a) Electron sterilization of a product can be done in the final sealed package without damage to the container and with no possibility of recontamination prior to use.

(b) The temperature rise in the irradiated product, caused by the bombarding electrons, is negligible in comparison to the temperatures needed for normal heat sterilization; foods can be electron-sterilized while frozen.

(c) The packaged or bulk material to be sterilized can be conveyed

in an uninterrupted flow beneath the electron beam, as contrasted with the normal batch-processing method.

(d) With a properly regulated electron beam, complete sterility can be reproducibly assured in each product.

(e) The electron dose received by each product can be metered, thereby providing a continuous record and control of sterility.

Electron Accelerator Design

A continuous, well-collimated beam of high-energy electrons is produced by a Van de Graaff electrostatic accelerator. This apparatus has been developed to commercial practicality out of the results of years of research at Massachusetts Institute of Technology and University of Wisconsin². In principle, a controllable constant potential of millions of volts is generated by transferring electric

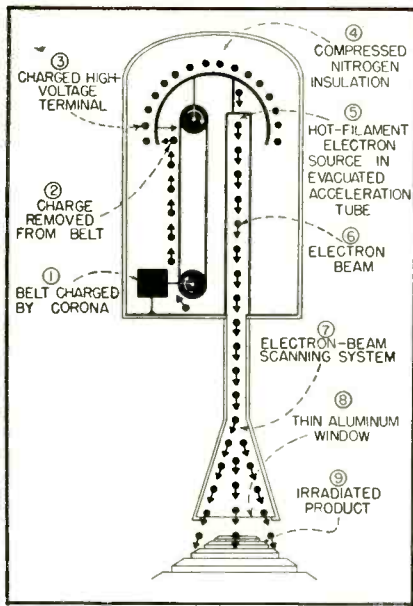

FIG. 1—Operating principle of Van de Graaff electron accelerator as used for sterilizing packaged products

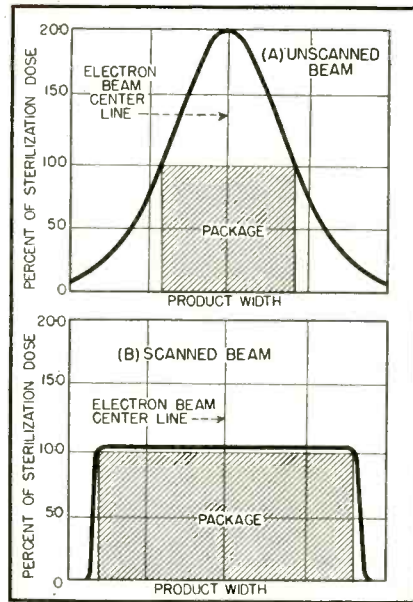

FIG. 2—Effect of scanning on distribution of ionization intensity. Area under both curves is the same

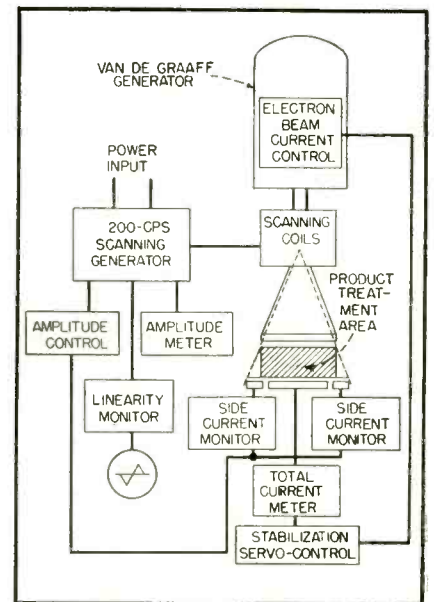

FIG. 3—Complete electron-irradiating system. Manual and automatic monitoring insures uniform sterilization

Sterilize Food and Drugs

By E. ALFRED BURRILL and A. JOHN GALE

*Physics Department
High Voltage Engineering Corporation
Cambridge, Massachusetts*

charges on a rapidly moving belt from ground to the inside of a high-voltage terminal, as shown in Fig. 1. By balancing the current into the terminal with that flowing back to ground through potential-dividing resistors and an evacuated acceleration tube, a direct current of electrons is accelerated to a homogeneous energy by the voltage drop established between the well-insulated high-voltage terminal and ground. This type of equipment has been widely used for the acceleration of electrons and positive ions and for the production of x-rays and neutrons. It finds applications in cancer therapy, industrial radiography, nuclear research, radiation chemistry, biology and food technology. Over one hundred of these electrostatic accelerators are in active use today in research laboratories throughout the world.

A compact, two-million-volt Van de Graaff electron accelerator has

been developed for use in sterilization research and for small production-line irradiation of foods and drugs. This unit consists mainly of a voltage generator contained in a

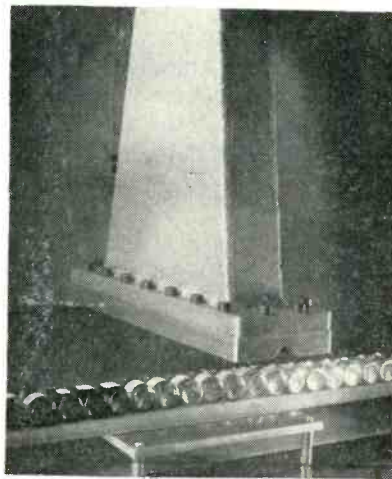

Electron-beam scanner being used for irradiation of glass vials containing powdered pharmaceuticals at rate of about 2 a second using small 2-mev machine

pressurized housing 6 feet long and 3 feet in diameter, mounted horizontally for installation in a room with nominal ceiling height. A pressure of 25 atmospheres of nitrogen and carbon dioxide is used to insulate the high voltages generated within the relatively small pressure vessel. Protruding from the base of the generator is the grounded end of the acceleration tube, through which high-energy electrons are impelled by the high voltage inside the tank. For the production of penetrating x-rays, these electrons are stopped by a thick gold target at the end of the tube. This target can be retracted, however, to permit the electrons to emerge, with negligible loss in energy, into the atmosphere through a thin aluminum window.

The accelerator produces 0.5 kw of monoenergetic electron power at 2-mev energy, with an input power of 4 kw. About half the input

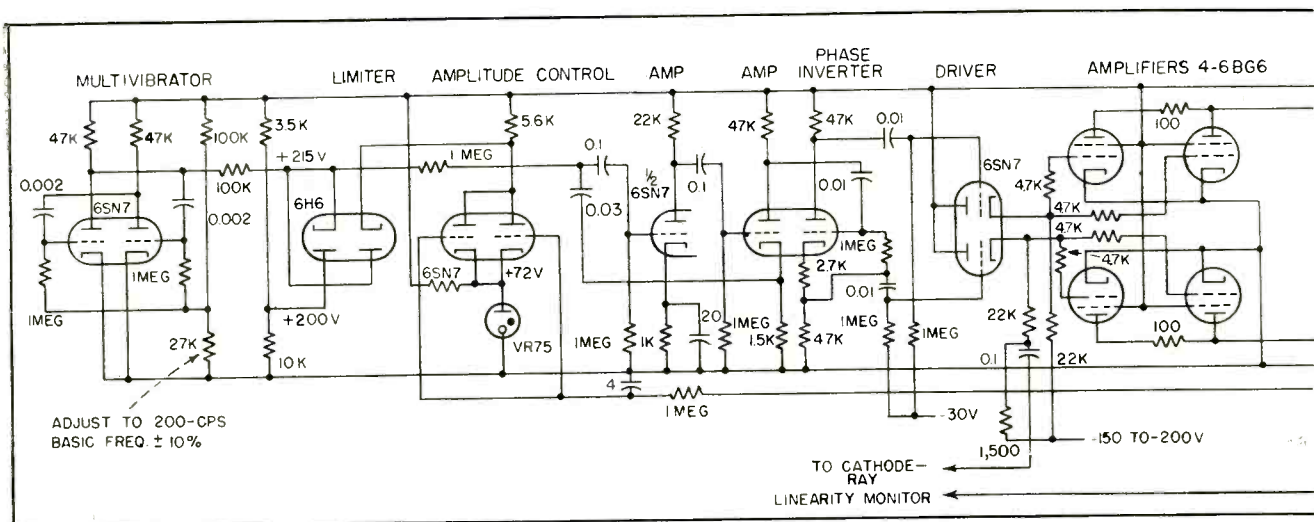

FIG. 4—Scanning circuit used for generating 3-ampere, 200-cps sawtooth current for sweeping electron beam through controllable angle up to 8 degrees to obtain uniform irradiation without wasting electron-beam power beyond outlines of the product. The conveyor-belt motion provides the equivalent of vertical scanning. To protect aluminum window against burning by stationary electron beam, full-

power is required for controls and for evacuating the electron-acceleration tube. The output power produces in materials an ionization equivalent to over 50 million gram-rep (roentgen-equivalent-physical units) per second, and can completely sterilize over 200 pounds of foods or drugs per hour. The 2-mev electrons have a practical penetrating range of about 0.3 inch in water. This range can be increased to 0.7 inch by the technique of bombarding the product from both sides. In general, the range of high-energy electrons in material is proportional to the electron energy and inversely proportional to the density of the material.

Electron-Beam Scanner

The high-energy electron beam, as it is normally propagated into the atmosphere, has a lateral intensity distribution that is roughly Gaussian, as shown in Fig. 2A. To deliver electron energy adequate for sterility to all regions of the product, some portions must receive an overdose, sometimes as high as a factor of four. If only the central region of the beam is used, the remainder is wasted energy, causing the process to be uneconomical. To irradiate a product with any appreciable lateral dimension, the beam must be allowed to be scattered by the atmosphere or by thin foils, to broaden the intensity distribution for adequate coverage. The scattering process is extremely wasteful in energy.

By magnetically deflecting the electron beam rapidly back and forth before it emerges from the aluminum window, the lateral intensity distribution can be controlled. Accurate regulation can be applied only to a continuous beam of monoenergetic electrons, obtainable with a Van de Graaff accelerator. A desirable mode of scanning is the linear sawtooth waveform, which causes the electron beam to be painted on the moving product in even strokes. Figure 2B shows the uniform intensity distribution obtained across the product when a scanned, concentrated electron beam irradiates the material directly below the window.

The scanning circuit is shown in Fig. 3 and 4. A driver supplies the alternating current to a pair of coils surrounding the electron beam in much the same manner as in a television set. The amplitude is manually controllable, so that the scanned beam can fit the type of product being irradiated.

Scanning System

The most straightforward check on the performance of the scanning circuit is to monitor the linearity. The extent of the scan is measured by differentiating the signal from the scanning-coil driver and reading the rectified signal on a milliammeter. The linearity can be checked by observing the differentiated signal on an oscilloscope. Details of the scanning-coil assembly and electron window are shown in Fig. 5.

An oscillation frequency of 200 cps is sufficiently rapid to prevent intensity striations on materials moving under the window as fast as 30 feet per minute. Higher frequencies would require heavy-duty electron tubes to drive the scanning coils. At 200-cps scanning frequency the coils carry about 3 amperes, sufficient to deflect a 2-mev electron beam through 8 degrees. The scan is limited to this value to prevent excessive penetration distortion by electrons entering the product at an angle. At 8 degrees, the effective penetration is reduced by only 1 percent.

For practical purposes the width of scan on the product depends only

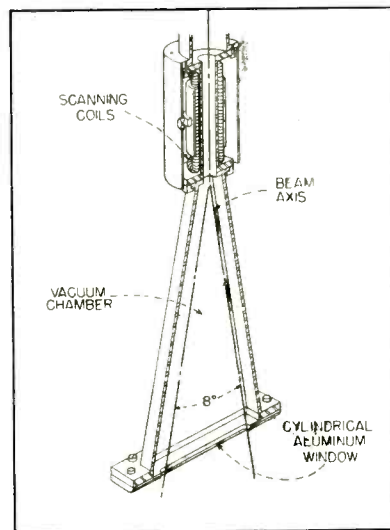
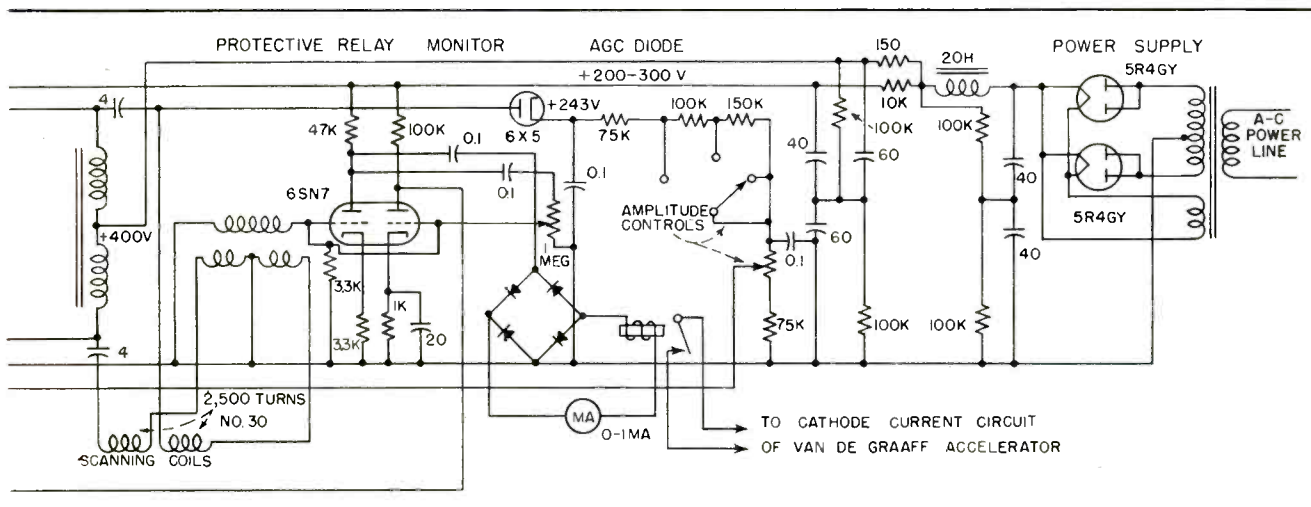

FIG. 5—Scanning assembly for 3-mev beam. Electron currents as high as 6 ma have been scanned and brought into the atmosphere through the window



wave dry-disk rectifier releases relay when scanning current fails, thereby breaking cathode circuit of accelerator. Tachometers on conveyor system generate power to energize other protective relays; if the belt stops for any reason, these relays similarly break accelerator cathode circuit. If product becomes jammed under electron beam, switches activate fail-safe protective relay system

on the distance between the scanning coils and the electron window. Scanned widths of over 10 inches are reliably obtained. The thin aluminum of the window is preformed into a semicylindrical configuration to withstand the atmospheric pressure without strain. The width of the window is one inch, which is ample to permit the 3/16-inch diameter beam to emerge.

Practical Electron Sterilization

The reduction to practice of the electron-sterilization process depends on careful research on individual products, because of the many characteristics which must be maintained or improved to satisfy

the consumer and to meet the standards of the Food & Drug Administration. The potential advantages of the electron-sterilization process are attractive from both the economic and the packaging viewpoints. Products that cannot normally be sterilized today because of their heat sensitivity may be effectively processed by high-energy electrons in their final packages.

A complete Van de Graaff electron accelerator for sterilization research and small production-line use is being designed as shown in Fig. 6, with radiation protection surrounding only the product-treatment area. Interlocks in the generator circuits will shut the equipment

off in the event of faulty operation, poor vacuum or extraneous radiation outside the protected zone. Larger accelerators, for heavier duty and the irradiation of thicker products, are under development. The most recent achievement in this field is a 3-million-volt Van de Graaff accelerator that produces more than 12 kw of scanned electron power into the atmosphere, a continuous ionizing radiation output greater by more than a factor of two than any other machine-produced source in the world. This equipment is capable of sterilizing over 5,000 pounds of material per hour, and can kill weevils and their larvae in over 340,000 pounds of flour per hour.

With apparatus of this scope, and with the technique of distributing the ionizing energy by a scanned beam, the electron-sterilization process is, for many products, in the range of commercially acceptable sterilization costs. Even at the present stage of development, total treatment costs, including capital amortization, are now resolved to a few cents per pound for the small units, and to a few tenths of a cent per pound for the largest.

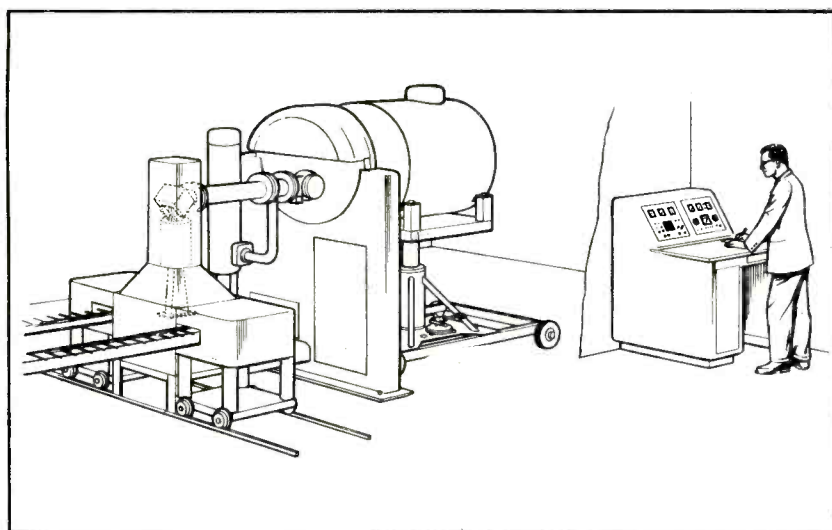

FIG. 6—Horizontally mounted Van de Graaff accelerator and electron sterilizer for research and small-scale production, rated at 2 mev and 0.5 kw electron output. Control console is located in adjoining room. With automatic electronic control, this accelerator is capable of continuous stable operation over extended periods of time

REFERENCES

- (1) B. E. Proctor and S. A. Goldblith, *Electromagnetic Radiation Fundamentals and Their Application in Food Technology, Advances in Food Research*, Vol. III, edited by E. Mrak and G. F. Stewart, Academic Press Inc., New York, 1951; 78 pages containing 174 references.
- (2) R. J. Van de Graaff, J. G. Trump, and W. W. Buechner, *Electrostatic Generators for the Acceleration of Charged Particles, Reports on Progress in Physics*, Vol. XI, Physical Society, London, 1948.

Broadcasting TV

Survey of propagation data including experiments with tilting antenna shows that techniques for successful uhf broadcasting will differ from those currently employed at vhf. Lack of available power may require unidirectional transmitting antennas. Field distortion indicates need for small-aperture receiving antennas

How can radio energy be effectively broadcast in the hitherto unexploited ultrahigh frequency range?

Specifically the problem is to study propagation effects between 470 and 890 mc and to determine how to achieve an effective as well as efficient and economical television broadcasting service. This leads to a consideration of the use of high-gain transmitting antennas and examination of electric field-intensity conditions at probable receiving sites.

It has been shown that the disparity of such measured field strengths with respect to the predictions of simple theory increases with frequency.^{1,2,3,4} Theoretical predictions, which must therefore be used with considerable caution, are useful in serving as a reproducible reference and to help explain some of the observations in a general way.

Important theoretical differences will be clarified by first examining theoretical field-intensity relations in both the lower vhf and the upper uhf ranges. The theoretical relations so oversimplify the case that practical field situations do not usually yield field strengths as high as predicted. A field survey will be cited to illustrate a practical comparison of measured with theoretical data. It is then shown that the vertical beam of the transmitting antenna may become so sharp as to reduce the effective gain of the antenna except at distance ranges where the maximum of the beam is employed.

This is illustrated in another theoretical comparison of propaga-

tion at a high and a low frequency with antennas of the same vertical dimensions and with respective vertical beams either horizontal or tilted downward. Experimental verification of the improvement in field strength available from tilting is then offered in a field survey. The data is divided into two distance ranges, a close range (1 to 5 miles) with important effects from antenna beam sharpness and tilt and a far range (5 to 21 miles) which is less affected by these factors.

It is helpful to review propaga-

tion theory curves for two widely separated frequencies, 85 mc and 850 mc. Because the theoretical relations are complicated by changes with frequency, there is no strictly fair comparison where there is wide separation of frequencies. Antenna power gain (for a given horizontal radiation pattern) is obtained by compression of the vertical radiation pattern into a narrow vertical angle. This is accomplished by distributing radiation sources over a vertical aperture with power gain linearly related to the length in wavelengths. The comparison of widely separated frequencies is difficult because two mutually exclusive criteria need to be satisfied.

In such a comparison the beam widths should be the same to make the effects of pattern shape identical. It seems fair to give the higher-frequency antenna the same vertical physical dimension as the low thereby making the power gain proportional and the vertical beam width inversely proportional to the frequency. The first choice penalizes the higher frequency with a smaller antenna than that of the lower frequency and consequently less power gain than it could justly have. The second choice inflicts a penalty, again on the higher frequency, by sharpness of the beam which may adversely affect close-in coverage.

It will be assumed that transmitting antennas have the same heights above smooth spherical earth and the same vertical, effective apertures. Both antennas consist of uniform, cophased current sheets. Transmitter power outputs are equal, and filters, diplexers, and transmission lines are assumed to

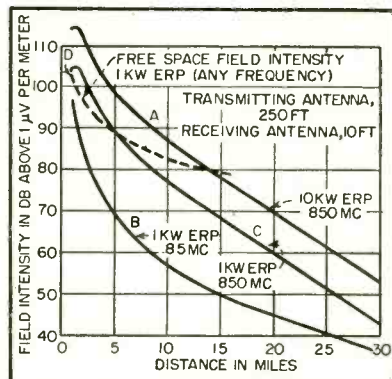

FIG. 1—Field intensities predicated upon a smooth spherical earth

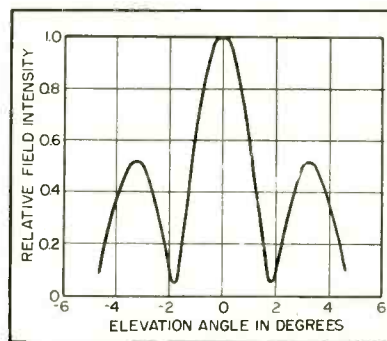

FIG. 2—Free-space vertical field pattern for omnidirectional antennas at 530.25 mc

in the UHF Band

By **JESS EPSTEIN**
and **D. W. PETERSON**

*RCA Laboratories Division
Radio Corporation of America
Princeton, N. J.*

be lossless. Because the 850-mc antenna is ten times as many wavelengths in its vertical dimension as the 85-mc antenna, the high-frequency antenna free space gain will be theoretically 10-db greater than that of the low-frequency antenna. Thus, in Fig. 1 curves (A) and (B), very substantially higher fields are shown for the higher frequency, 10 db of which is attributable to antenna gain.

Phasing Improvement

In addition to the improvement from greater transmitting antenna gain (10 db) there is theoretical improvement from more favorable phase relations at the higher frequency. This occurs because at a given receiving antenna height (within the range of heights that are of concern) the earth-reflected and direct rays are more nearly in phase at the higher frequency. Thus according to Fig. 1, curves (B) and (C), the higher-frequency antenna yields greater fields even when both antennas have the same gain.

To evaluate the theoretical curves of Fig. 1 it is assumed further that the receiving antennas have the same effective apertures, in which case equal field strengths produce equal receiver terminal voltages. The receiving transmission lines are assumed lossless, and the receivers have the same noise factors.

Under the idealized postulated conditions, television receiver performance with respect to thermal noise in the picture is predicted by the two field-strength curves. Thus the difference of the two curves (A) and (B) represents improve-

ment of theoretical performance of 850 mc over 85 mc. Along a line between one and twenty miles range, theoretically the median 850-mc field strength will be 28 db greater than the corresponding median for 85 mc for the specified conditions.

Smooth-Earth Calculation

The theoretical field-strength curves have been calculated for smooth spherical earth,^{5,6} by K. A. Norton and others. The measured field data⁷ more closely approach this smooth-earth theoretical data at 85 mc than at 850 mc. This may be taken as evidence that the postulated theoretical conditions are more adequately satisfied under practical operating conditions at 85 mc than at 850 mc. However,

sufficient smoothness to corroborate simple theory has also been obtained under special conditions at 530.25 mc and 850 mc.

Other data measured under more typical receiving conditions have shown wide departure from smooth spherical earth theory. An analysis of data shown in "Comparative Propagation Measurements; Television Transmitters at 67.25, 288, 510, and 910 megacycles"⁸ will show that for a specified effective radiated power the median field intensity is actually inversely proportional to frequency under some conditions.

Because of the present difficulty in obtaining high transmitter power at ultrahigh-frequencies and the apparent propagation handicaps, it seems reasonable to make a

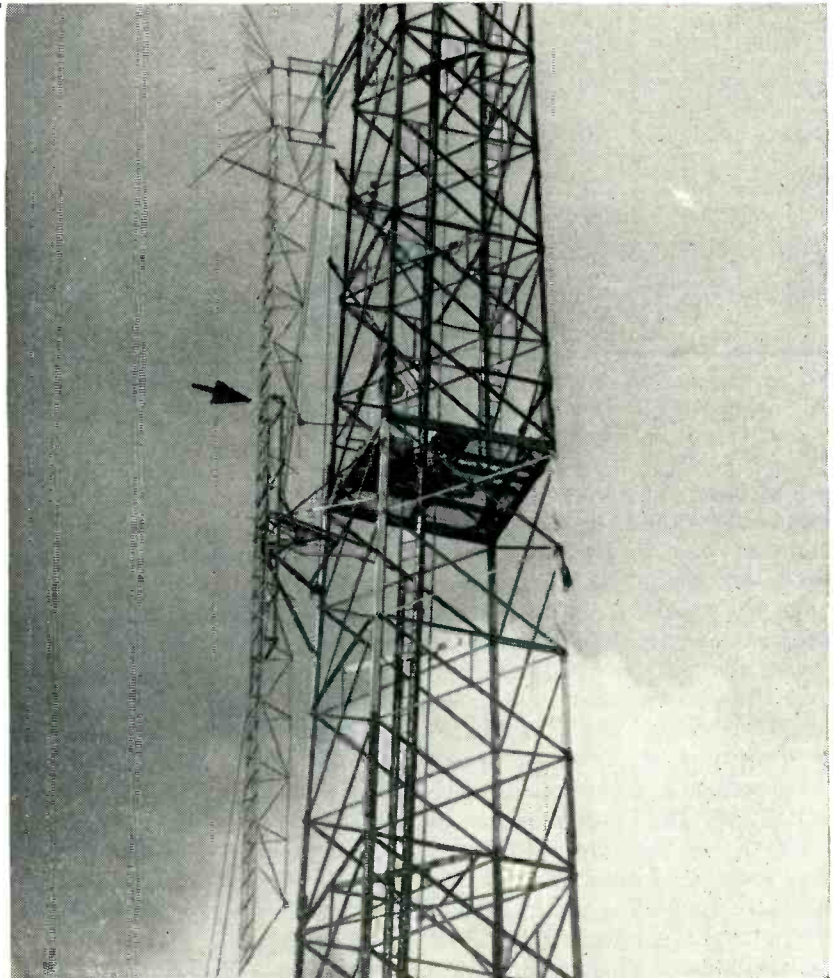

Tilting antenna boom was mounted vertically on Success Hill tower near Bridgeport, Conn.

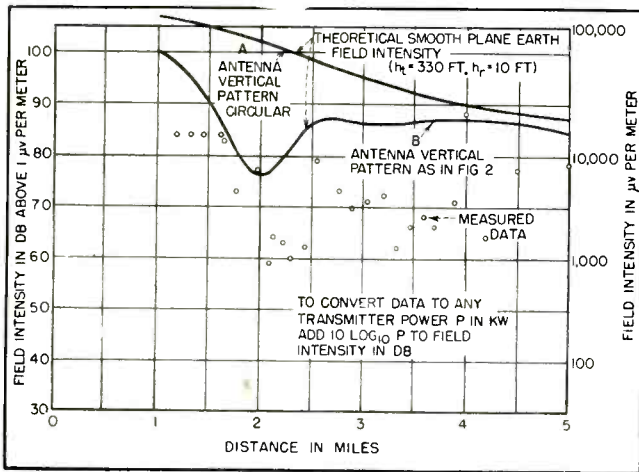

FIG. 3—City field intensity for 1 kw erp (based on actual 13.9-kw erp) at 530.25 mc

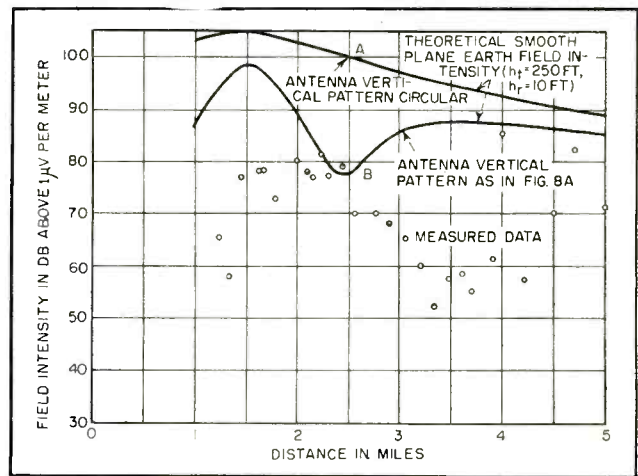

FIG. 4—City field intensity for 1-kw effective radiated power at 850 mc

careful study at ranges relatively close to the transmitter. A distance range of one to five miles was chosen for special study since this range has special interest and can encompass a city in the order of several hundred thousand population. The frequencies used are 530.25 mc and 850 mc. The 530.25-mc transmitting antenna, which was described in a previous investigation⁹ of the performance of KC2XAK, is omnidirectional and has a gain of 12.4 db referred to a half-wave dipole. The vertical radiation pattern is shown in Fig. 2. The 850-mc antenna, illustrated, is unidirectional and has a gain of 19.2 db. The horizontal radiation pattern is 65 degrees at the half-field points and the vertical pattern is shown in Fig. 8A.

The theoretical smooth-plane-earth fields for the two frequencies and the respective antenna heights are shown in Fig. 3 and 4. The curves designated (A) in the two figures were calculated by assuming that the antennas had no vertical directivity and adding in db the respective nominal antenna gains. An antenna with gain independent of vertical angle is thus supposed. Such a procedure might have been valid at low frequencies for apertures commonly used.

Because of the vertical directivity of the antennas, however, it will be necessary with the 530.25-mc and 850-mc antennas to reduce the theoretical fields by an antenna-pattern factor as has been done for curves designated (B), Fig. 3 and

4. The field intensities were measured along a line through Bridgeport, Connecticut, at the maximum of the pattern, using a method to be described below. The normalized measured fields are also shown in Figs. 3 and 4. The 530.25-mc measured data is lower than the theoretical curve by a median value of 13 db along the one-to-five-mile line.

The 850-mc measured data is correspondingly 17 db below its theoretical curve. This means that 50 per cent of the measured field strengths are lower than the smooth-plane-earth theoretical curves by the specified value or more. It should be remembered in comparing measured data of the two frequencies with their respective theoretical curves that propagation from the 530.25-mc antenna may have been favored by its greater height.

Although exhibiting reduction of

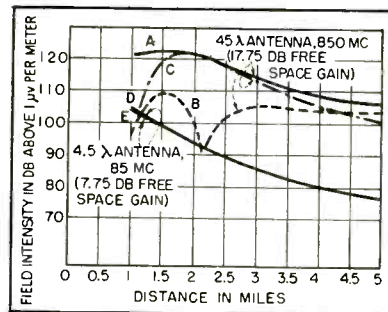

FIG. 5—Theoretical curves for 1-kw transmitter using 250-foot antenna and receiver at 10 feet. Curves A and D are vertical pattern for maximum field at all distances; curves B and E are for zero tilt; C is for 1.25-degree downward tilt

field strength at the distance range of the null of the vertical pattern, the close-in coverage of KC2XAK was quite adequate. The erp was 13.9 kw or 11.4 db above 1 kw. By adding 11.4 db to the measured data of Fig. 3, the null of the vertical pattern yielded close to grade-A service of 74 db above 1 μv per meter.

Effective Power Concept

The importance of the antenna's vertical directivity has been shown in Fig. 3 and 4. Substantial reduction in theoretical field strength results from sharpness of the vertical beam of the transmitting antenna. There is evidently need to review the meaning of effective radiated power. The effective radiated power is commonly considered to be the transmitter power increased by the free-space maximum gain of the transmitting antenna and is not, under the conditions here described, really effective radiated power.

The theoretical data of Fig. 3 and 4 suggest beam tilting for improving coverage in a limited distance range by aiming the maximum of the vertical radiation pattern at some point within the range served by the transmitter. In this manner the nominal effective radiated power becomes actually realized within some limited but useful range. Such a beam-tilting procedure has been used in a number of instances but usually there has been no opportunity to study the results.

To look into the possibilities of

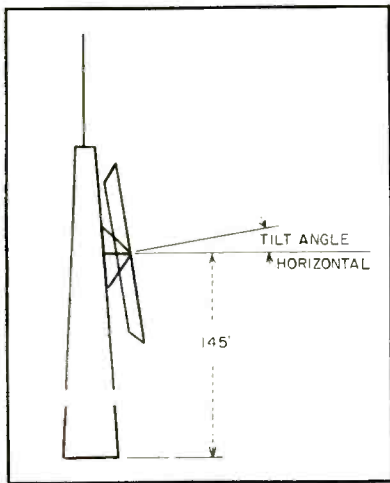

FIG. 6—Tilting-beam antenna with 6-minute period of oscillation

beam tilting, another comparison of the theoretical fields at 850 mc and 85 mc will be made. Assume an 850-mc antenna of 45λ vertical dimension and an 85-mc antenna of $4:5\lambda$ vertical dimension. The vertical radiation patterns will be as calculated for a constant co-phased current sheet, Fig. 11. The gains will be 17.75 db and 7.75 db respectively with the vertical physical dimensions the same for the two antennas.

Calculating the smooth-plane-earth fields in the 1-to-5 mile range produces curves (A) and (D) of Fig. 5. It has been assumed that the antenna gain is fully realized as it would be if the antenna maximum were aimed by tilting at the receiving antenna in every instance.

If the beam is aimed horizontally as in conventional practice, the field-strength curves are shown in Fig. 5B and 5E. At 85 mc the re-

sulting reduction in field is negligible, but at 850 mc the field is considerably below that obtainable by tilting the beam.

Since for a broadcast service, the antenna cannot be tilted a different amount for every distance along the 1-to-5 mile radial line, there must be a compromise. Suppose the 850-mc antenna is arbitrarily tilted down 1.25 deg., then curve (C) describes the theoretical field. It can be seen in Fig. 5 that in a 1.1-to-4.3-mile range the theoretical field is increased by tilting the antenna down 1.25 deg. At greater distance there will be reduction of field, which is the price paid for improved field from 1 to 4.3 miles.

Beam Tilting Experiments

To learn if the improvement in performance predicted by the theory can in fact be realized in a practical situation, beam-tilting patterns were made at 530.25 mc and 850 mc. The antennas, mounted as in Fig. 6, were 49 feet in height, which is 26.4λ at the lower and 42.3λ at the higher frequency. The 850-mc antenna has been described above. The 530.25-mc antenna consisted of another set of dipoles previously mounted on the same frame with the horizontal pattern nearly the same as that for the 850-mc antenna and the vertical pattern as shown in Fig. 7A. Unidirectional antennas were used to eliminate supporting tower effects. Mechanical rather than phase-shift tilting was used for ease of measurement of tilt angles. This involved a single measurement of the vertical radia-

tion pattern and a simply obtained tilt calibration.

Similar beam tilting could have been accomplished by phase shifting with the attendant complications not warranted for this experiment. To facilitate measurements the beam was tilted periodically ± 6 deg over a 6-minute period. The transmitter was keyed off 10 seconds once during each tilting cycle to communicate to the receiving site the time of an exactly predetermined angular position of the transmitting antenna. In this manner recordings of relative field strength as a function of time could be made at any receiving site with a recorded time reference. From a tilt-angle-versus-time calibration of the transmitting antenna, the relative field intensity as a function of tilt angle could thus be readily determined.

Data obtained in this manner for both frequencies are shown in Fig. 7 and 8. It was found that in the city and at distances up to about 20 miles the field intensity maximized with the free-space beam aimed at the receiving antenna. It was also learned that at distances well beyond line-of-sight, 90 miles and 140 miles, the field maximized with the transmitting antenna beam aimed horizontally. Figure 9 shows the 90-mile patterns, which were recorded under unusually high field-strength conditions.

To profit from these facts the 850-mc antenna beam was tilted down 1.3 deg to direct horizontally the first null above the main beam. The improvement in field strength

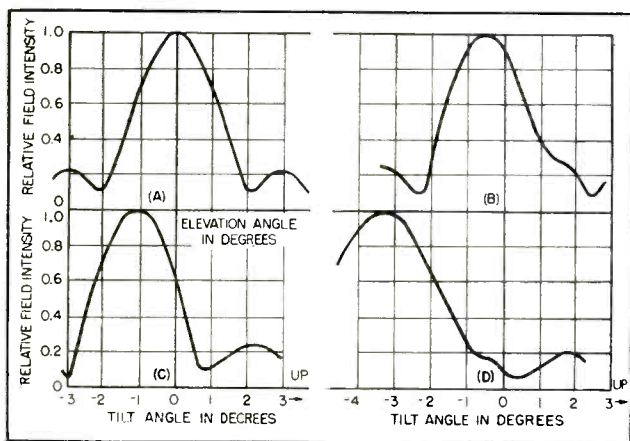

FIG. 7—Unidirectional 530.25-mc antenna free-space field pattern for (A) elevation 60 feet at 12 miles (B) at 3 miles (C) and 1.1 miles (D) from the transmitter

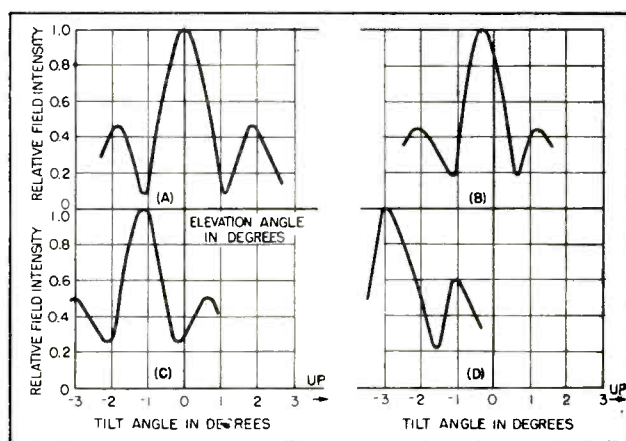

FIG. 8—Unidirectional 850-mc antenna free-space field pattern (A) elevation 20 feet at 15 miles (B) 120 feet at 3.7 miles (C) and 60 feet, 1.2 miles (D)

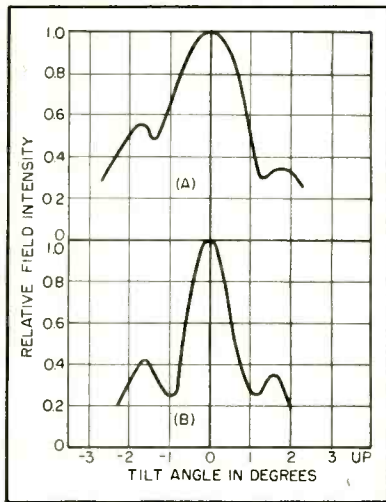

FIG. 9—Tilt pattern, 530.25 mc at 90 miles, elevation 50 feet (A) and for 850 mc (B)

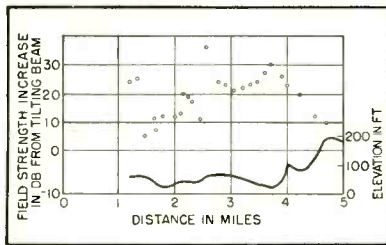

FIG. 10—Effect of beam tilting from antenna 330 feet high tilted downwards 1.3 deg

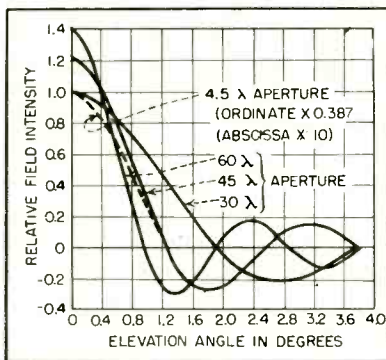

FIG. 11—Free-space radiation patterns for constant cophased current distribution

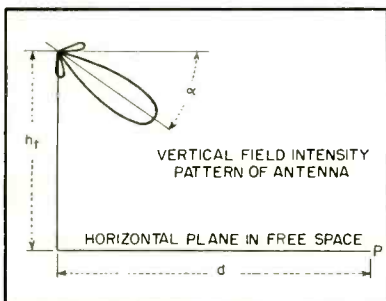

FIG. 12—Propagation curves of Fig. 13 are based upon these antenna characteristics

in the 1-to-5-mile range from tilting is shown in Fig. 10. The median value of improvement was 11 db. From recordings of field strength at 90 miles the tilting also yielded a reduction of troposphere-propagated field in the order of 12 db because the vertical radiation pattern null was directed horizontally.

Beam Tilting In Free Space

The tilt patterns of Fig. 7 and 8 look somewhat like free-space theoretical patterns that would be measured in an imaginary plane in free space below the transmitting antenna. In Fig. 11 are free-space calculated patterns for various apertures. Relative field versus distance for these theoretical patterns as calculated for a plane h feet below the transmitting antenna, see Fig. 12, are shown in Fig. 13.

The antenna pattern for a 45λ aperture and the transmitting antenna height 250 feet corresponds approximately to the pattern and height for the 850-mc surveyed radial. A reasonable correspondence for improvement from tilting between measured data of Fig. 10 and the free-space theoretical data of Fig. 13 will be seen. Reference to the plane-earth theoretical data of Fig. 4 may also be made.

The propagation curves of Fig. 13 illustrate the range of array apertures and heights for which the sharpness of the vertical radiation pattern may be of concern. The limitations of beam tilting are also evident.

It may be concluded from foregoing measured data and theoretical considerations that for limited-area coverage of improved efficiency and for reduced tropospheric signals (at least some of the time) uhf transmitting antennas can be designed to take advantage of narrower vertical beams than heretofore used.

Shaped Beam Antennas

The field intensity throughout the area to be served should probably be constant. This assumes that there will be no high interference zones. The experience with vhf television has been that the downtown city areas require higher field strengths than the suburban areas.

The lessened interference at higher frequencies from local sources makes it appear likely that the same requirement need not be imposed on uhf television.

The beam-tilting experiments show how average field distributions in an area the size of a fair-sized city depend on vertical beam shape. It follows that one may sometimes use specially shaped vertical beams to obtain constant field strength in a limited area. A somewhat idealized free-space vertical radiation pattern is shown in Fig. 14A, which in a plane 500 feet below the antenna yields nearly constant field from 0 to 6 miles, as in Fig. 15A and reduction of troposphere propagated field.

A similar but conventional radiation pattern main beam is also shown in Fig. 14B and the resulting field as a function of distance for $h = 500$ feet and tilt angle = 0 is given in Fig. 15B. This would be the coverage data of conventional practice. The efficiency of the shaped pattern for limited-area coverage is quite apparent by comparison in Fig. 15 with curve (B) and the coverage data of Fig. 15C for a tilted conventional beam. The additional feature of reduction of tropospheric propagated fields could be advantageous in allocations.

Unidirectional Telecasting

In the establishment of any broadcast service the choice of the radiation pattern is governed both by the location of the antenna and the service area that it is desired to cover. In the vhf range the common practice has been to use an omnidirectional antenna placed on the highest available structure centered in the service area.

Although one might conclude that the same factors would govern the choice of a site for the uhf range there are several reasons that strongly indicate some use of unidirectional radiating systems. The most obvious reason is that a number of stations will be forced to find locations on one side of their service area because of the lack of suitable structures centrally located or because of the financial problems associated with constructing one. Although we lack a comprehensive

study of all the propagation factors involved in such a situation we do have sufficient experimental data to indicate that adequate coverage can be obtained with such an arrangement.

In general the technical and constructional problems of building a high-gain uhf unidirectional antenna are considerably easier than for an omnidirectional antenna.

Because tilting for improved coverage in a limited-distance range may be accomplished with either uni- or omnidirectional antennas mechanical or phase-shift tilting can readily be used with the former types while the latter antennas will usually require phasing networks.

The concept of designing a telecasting system to serve a specified area with constant field strength can be employed with either type but the indications are that it can more easily be accomplished with a unidirectional type of antenna.

It cannot be emphasized too strongly that the problems associated with uhf coverage should be approached without bias. Experience and practice of vhf are not an adequate guide for procedures in this new range. The compelling reason that makes serious consideration of unidirectional telecasting as well as other innovations advisable is the present technical

difficulty of obtaining sufficient radiated power to perform on a par with vhf systems.

Measurements Beyond Five Miles

Field-strength measurements beyond five miles are shown separately from the 1-to-5-mile data because with the conventional practice of aiming the beams horizontally the received signals come from on or near the maximum of the vertical pattern. This was the result of the choice of transmitting antenna heights and the vertical beam widths. From 5 to 20.7 miles the average terrain elevation was 80 feet. The 530.25-mc antenna was 340 feet and the 850-mc antenna 260 feet above the average 5-to-20.7-mile terrain elevation.

The smooth spherical earth theoretical field strengths and the measured data are shown in Fig. 16 and 17. The 530.25-mc measured data have a median value of 19 db below the theoretical curve. The 850-mc data are correspondingly 25 db below the theoretical curve. The difference between 19 and 25 db may be in part due to more favorable propagation conditions from the higher 530.25-mc antenna because of its greater height.

Also shown in Fig. 17 are the measured field-strength data with the 850-mc beam tilted down 1.3

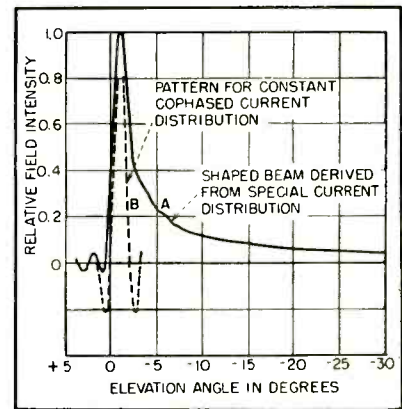

FIG. 14—Free-space vertical field patterns for 50-wavelength aperture

deg. The median value of reduction cost of the 11-db increase in median field strength that was measured in mile range was 5 db. This is the the 1-to-5-mile range.

Method of Making Survey

The ultimate objective in field surveying is to study the capability of a given transmitter and transmitting antenna to serve the homes of the area in question with useful television signals. For this purpose no fully satisfactory method of sampling fields in a uhf survey has been devised. A method used in vhf surveys is to make continuous recordings from which sector medians are plotted. The radial plots of sector medians are used to derive constant-field contours. Experience indicates that the use of these methods in the uhf range will be misleading.

Some observations about the nature of uhf fields in and above a residential area will help to choose a sensible method of making the survey measurements and show inadequacies of vhf methods. Of great importance is the fact that even in sparsely settled residential areas the field distributions are exceedingly complicated. Every object in sight apparently contributes to the net field either by reflection or diffraction. In a locality consisting of well-spaced one-story houses relative receiver terminal voltages as a function of position along a straight line are shown in Fig. 18A. At a 40-foot height, which is 25 feet or more above the roof tops, there is apparently as much varia-

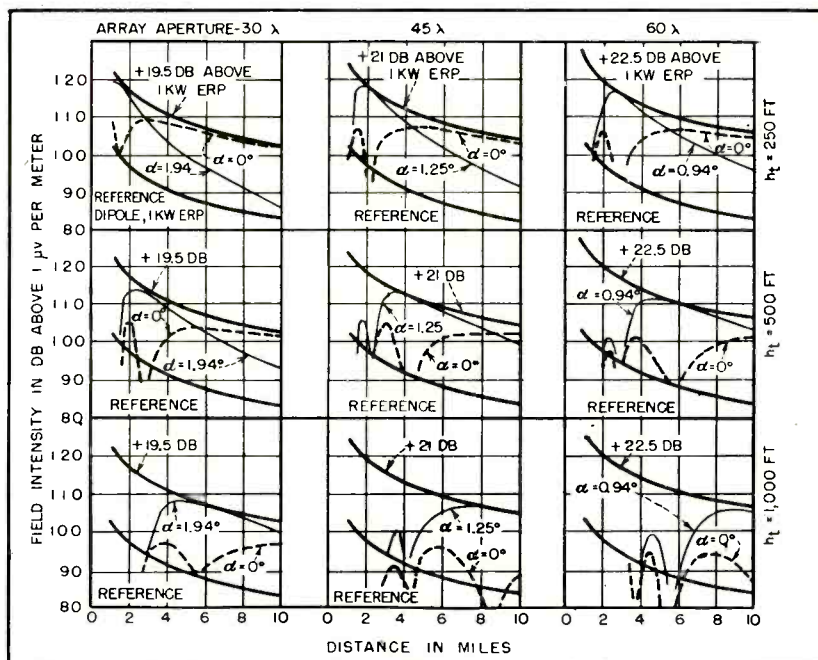

FIG. 13—Free-space propagation for antenna characteristics shown in Fig. 12 and explained in text

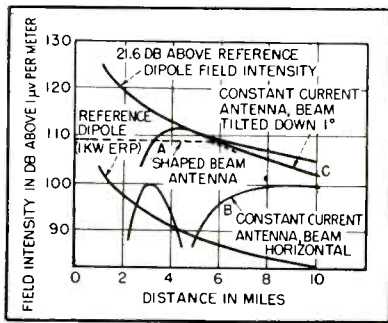

FIG. 15—Free-space field intensity in plane 500 feet below antenna

tion as at 10 feet. These data are typical; in fact, one may usually expect comparable or greater variations in a city. Terminal voltage as related to height in Fig. 18C shows similar quite unpredictable variations.

An ideal receiving site would have field strength proportional to height, substantially constant field strength in any horizontal plane, and constant phase in a plane normal to the line of propagation. Under these conditions the field strength indicated by either a dipole or an array will be the same provided the ratio of the height of the array to its vertical aperture is large.

With distorted fields as usually encountered, a dipole indicates a field strength that is extremely variable with position. An array exhibits normal gain only with the ideal receiving conditions. Thus, the two antennas will indicate different apparent field strengths.

A little consideration of the nature of reflections from a simple planar reflector in free space will help to show why the effectiveness of receiving antennas diminishes with frequency. Such a reflector, if

perpendicular to the line of propagation, produces standing waves with maxima every half wavelength in space. The reflector acts like a uniformly excited antenna and thus the standing wave produced will exist in a space corresponding in shape to the radiation pattern of such an antenna. Thus, a given reflector produces a beam of standing waves that increases in sharpness with frequency.

The evidence from probing at receiving sites at say 850 mc, is that the field distributions are exceedingly complicated configurations as if many reflecting objects made contributions to the net field. To again compare 850 mc and 85 mc, one may reasonably consider a half wavelength 85-mc dipole as a standard. An 850-mc antenna to deliver the same terminal voltage if exposed to a uniform field distribution requires 10 times the area (in square wavelengths) of uniform field as the 85-mc antenna.

Antenna Comparisons

Having started with an antenna that was practical at 85 mc because it required a relatively small area of uniform field (in square wavelengths) it becomes evident that in fields as commonly distorted by reflecting objects and diffraction the comparable 850-mc antenna will suffer from field distortion because it will require a much larger area of uniform field (again in square wavelengths).

At a given receiving site one may either probe with a small antenna for maxima of the field distribution or use an unwieldy, large antenna that will ordinarily be subjected to

fields so far from the uniform field for which it was designed as to be rendered almost useless. A small unidirectional antenna like a half-wave dipole employing a sheet reflector appears to be a reasonable compromise and such antennas were used in all measurements described. This antenna may reduce many reflected components of field and does not require a large area of uniform field.

The amount of probing done at each site in a field survey is arbitrary and, of course, will affect the results. The maximum receiver terminal voltage obtainable along a 25-foot line 10 feet above the ground has been chosen as a practical value from which to compute effective field strength. A similar amount of probing may ordinarily be done on the roof of a house in actual installations if found necessary.

The receiving antenna for the survey should be on the roof tops but since this is impractical, it appears that a ten-foot height above ground is as good a value as can be used and has the advantage of convenience for automobile measurements. Peak values are here used instead of the more usual medians because peaks are available for use in practical installations and the ineffectiveness, bulk, and cost of large-aperture antennas make it likely that small antennas will be used ultimately in most installations.

Field vs Receiving Antenna Height

The theoretical relationship of field and height becomes increas-

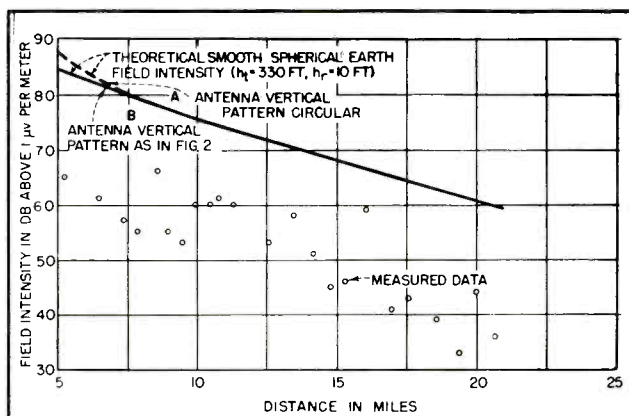

FIG. 16—Country field intensity for 1 kw erp at 530.25 mc

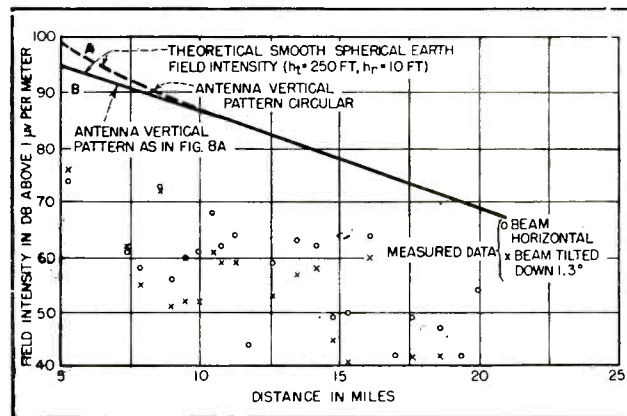

FIG. 17—Country field intensity for 1 kw erp at 850 mc

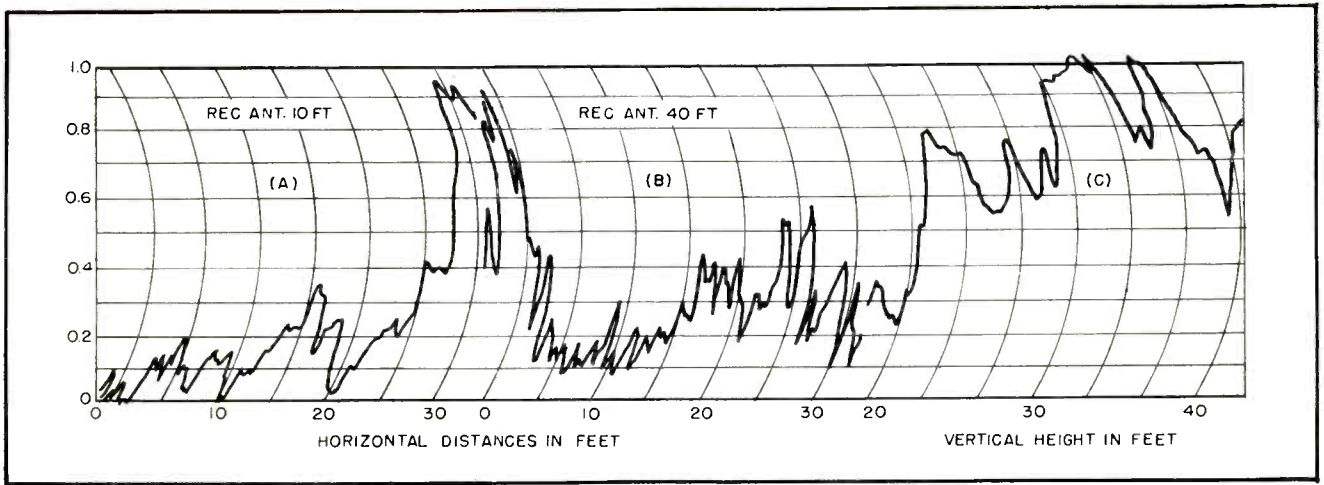

FIG. 18—City field-intensity distribution for receiving antenna at 10 feet (A) at 40 feet (B) and with vertical height at a fixed location (C)

ingly complicated at heights and distances that here concern us, as frequency is increased. Smooth, curved-earth theory yields the curves of Fig. 19 for 850 mc and 85 mc. Transmitting antennas having the same vertical radiation patterns of circular form have been assumed.

Field measurements under the most ideal conditions confirm the theoretical relations but with surroundings ordinarily encountered at receiving sites no such simple relations exist.⁸ If there is any connection at all between the idealized theory and the actual field-height relations commonly existing, it is well obscured by diffraction and reflection from nearby objects.

Summary of Tests

The establishment of television broadcasting service in the uhf range must contend with different fundamental limitations than those of vhf broadcasting: (1) uhf propagation is demonstrably poorer under practical receiving conditions than predicted by smooth-spherical-earth theory; (2) vertical beam sharpness reduces the effectiveness of the power gain of large-aperture high-frequency broadcasting antennas; (3) field distortion reduces the effectiveness of large-aperture receiving antennas.

Important differences with respect to lower frequencies that may be advantageous for uhf telecasting are: (1) unidirectional telecasting is more easily accomplished in the

uhf range than previously at lower frequencies so that unidirectional antennas will probably find increasing application; (2) The lack of man-made interference in the uhf range is of importance and may affect the approach to uhf telecasting by relaxing the usual requirement of higher field strength in built up areas.

To compensate for inherent

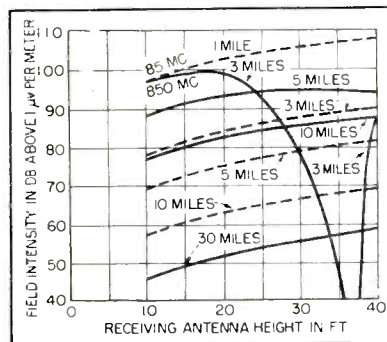

FIG. 19—Smooth-spherical-earth field intensity based upon 1 kw erp from a dipole antenna

limitations of conventional practice, beam tilting and shaping can evidently be employed. Tilting and shaping techniques may be desirable for three reasons: (1) improved system efficiency (more receiving sites get usable signals); (2) field strength may be made independent of distance in the service area; (3) troposphere-propagated signals may be reduced. Vertical half-field beam widths in the order of two degrees become possible and may be practical if properly em-

ployed, to improve system performance in the uhf range.

There are still unresolved questions about uhf broadcasting. We can be assured, however, that there will be uhf television service on a large scale. The feasibility has been convincingly demonstrated by KC2XAK in Bridgeport. Proper use of high towers, high transmitting antenna gains, and shaped, tilted beams will be of increasing importance.

Acknowledgment

The field tests in the Bridgeport area were conducted with the cooperation of John L. Seibert of the National Broadcasting Company. The special transmitter used was built by George Olive and William Behrend of RCA Laboratories. Transmitters were operated by Victor Bary and others of the National Broadcasting Company.

REFERENCES

- (1) Edward W. Allen, Jr., UHF Propagation Characteristics, *ELECTRONICS*, p 86, Aug. 1949.
- (2) R. N. Harmon, UHF Coverage in Pittsburgh, *FM-TV Radio Communication*, p 14, May 1950.
- (3) Joseph Fisher, Field Tests of UHF Television, *ELECTRONICS*, Sept. 1949.
- (4) Harry Fine, UHF Propagation Within Line of Sight, T.R.R. Report No. 2.4.12 of FCC Technical Research Division.
- (5) K. A. Norton, Ground Wave Field Intensity, *Proc. IRE*, p 623, Dec. 1941.
- (6) Frederick W. Smith, Calculating UHF Field Intensities, *ELECTRONICS*, p 110, Oct. 1950.
- (7) G. H. Brown, J. Epstein, and D. W. Peterson, Comparative Propagation Measurements 67.25, 283, 510, and 910 mc, *RCA Review*, p 177, June 1948.
- (8) R. F. Guy, Investigation of UHF TV Transmission and Reception in the Bridgeport, Conn., Area, *RCA Review*, p 98, March 1951.
- (9) John F. Dreyer, Jr., Technique for TV Field Surveys, *ELECTRONICS*, p 82, Oct. 1949.

Experimental

A low-power uhf television transmitter installed at Stratford, Conn., near Bridgeport for propagation and antenna tests uses a triode grounded-grid power-output tube and single-tuned cavity. Neutralization suitable for cavity circuits is detailed

LATE in 1949, RCA and NBC put into operation in Bridgeport, Connecticut, an experimental uhf television transmitter, Station KC2XAK, operating in the frequency band 529-535 mc.¹ In the period of over two years that it was in operation a great deal of information about many phases of uhf television has been obtained.^{2,3} In the case of the beam-tilt experiments by Peterson and Epstein, the data from the low end of the uhf television band was obtained using the KC2XAK transmitter. It was

felt desirable to continue these experiments in the upper end of the band for the purpose of obtaining comparative data. Accordingly a television transmitter for the upper end of the band was built and installed, under the call letters KC2XCY, in the same building as KC2XAK. The carrier frequencies were 850.00 mc visual and 854.50 mc aural.

Final Stage

The type 5588 tube was selected for the final power amplifier, be-

cause at the time of construction of the transmitter it was the tube with the highest power capabilities at 850 mc that was readily available. Although it is a triode requiring neutralization it was decided that this disadvantage compared to the multiple operation of tetrodes was outweighed by the advantage of the compactness and convenience of a single-tube cavity. Before the transmitter was finished, however, a new tube, the type 6161, was made available. The type 6161 tube is electrically similar and mechanically identical to the 5588, the difference being that the 6161 has an improved cathode that makes possible higher maximum plate voltage and higher maximum cathode-current ratings. The type 6161 triode is used in the Bridgeport transmitter. It has a coaxial construction that makes it suitable for use in cavity type circuits.

The final stages in both visual and aural transmitters are identical and consist of one type 6161 tube operated with grounded grid. The final stage in the visual transmitter is grid modulated.

A cross-sectional view of this stage is shown in Fig. 1. The input (cathode) circuit is a shorted three-quarter-wavelength coaxial line, foreshortened by tube capacitance. The output (plate) circuit is a re-entrant cavity. The driving power is coupled directly to the inner conductor of the cathode tank at a point that gives a nominal 50-ohm input impedance. The output power is taken from the plate cavity by means of a tuned coupling loop.

The cathode circuit is tuned by means of a movable plate that changes capacitance at a point of maximum voltage in the cathode

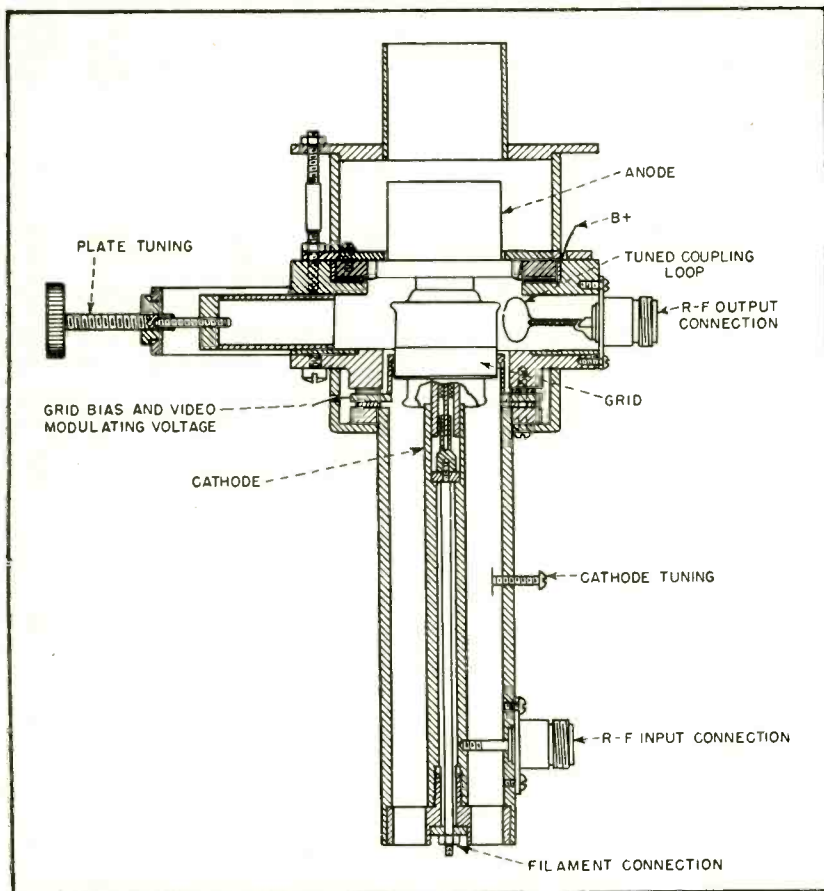

FIG. 1—Cross-section of final power amplifier stage

50-Mc TV Transmitter

by G. A. OLIVE

Laboratories Division
of Corporation of America
Princeton, N. J.

circuit. The plate circuit is tuned by means of cylindrical plungers that move radially into the plate cavity.

Neutralization

It is known that a grounded-grid amplifier cannot easily be plate modulated 100 percent. With the plate voltage zero there are intervals during the r-f cycle when the cathode is negative with respect to the plate and grid owing to the driving voltage. During these intervals pulses of plate current flow to the plate and develop r-f power in the load. The source of this power is the driver of the stage. It is characteristic of grounded-grid amplifiers that a portion of the driving power appears in the load.

In Fig. 2 is an equivalent circuit of a grounded-grid amplifier, which is useful in a qualitative way. It is seen that the load impedance Z_L is in series with the driving voltage and that unless r_p can be made very large by the action of a modulating voltage, deep modulation cannot be obtained. Conventional plate modulation alone will not increase r_p sufficiently to secure 100 percent modulation. Normally, if a grounded-grid amplifier is to be plate modulated, its driver must be modulated simultaneously.

If the grounded-grid amplifier is to be grid modulated, as in Fig. 3, it is possible to make μ go to zero and r_p go to infinity by the action of a modulating voltage on the grid simply by swinging it sufficiently negative to cut the tube off regardless of the cathode swing. It is therefore possible to grid modulate a grounded-grid amplifier and obtain 100-percent modulation, without the necessity of simultaneously modu-

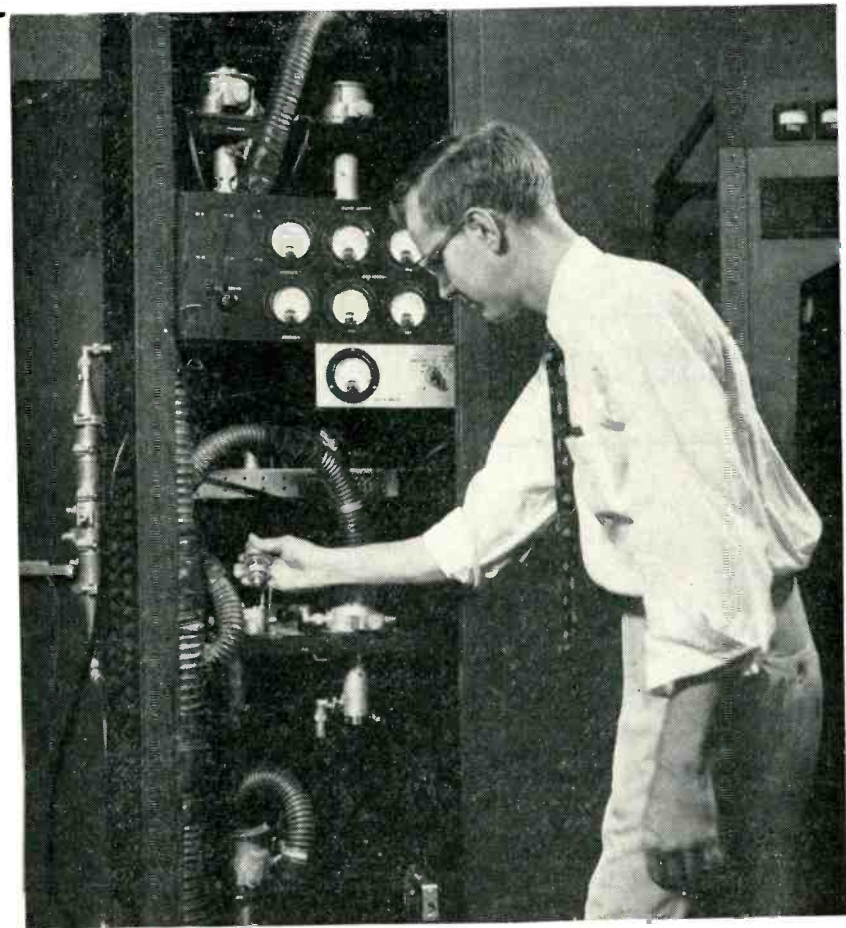

Bridgeport experimental transmitter final amplifiers. Ducts blow air into r-f cavities

lating the driver amplifier stage.

Considering the interelectrode capacitances of the tube, it is seen that with the tube cut off there is still the network shown in Fig. 4A connecting the input and output circuits. In general it is necessary to neutralize the plate-cathode capacitance, for it adversely affects the performance of the modulated amplifier in three ways. It prevents the attainment of 100 percent modulation, causes the phase of the carrier to vary with power level and decreases its stability. There are several methods by which complete neutralization can be achieved.^{4, 5} In this transmitter a system of partial neutralization⁶ was used that is particularly well adapted for single-tube cavity circuits for grounded-grid operation.

In Fig. 4B the interelectrode ca-

pacitances are arranged in their equivalent wye. In Fig. 4C there is inserted a neutralizing inductance, L_n , between grid and ground, which effectively isolates the input and output circuits under cutoff conditions. The neutralization is not complete however for an element has been introduced that causes a voltage to appear in the input circuit in response to a current in the output circuit and vice versa. The addition of this neutralizing inductance has made 100 percent amplitude modulation possible. The effect of the inductance on the stability and incidental phase modulation will be analyzed further.

Consider the equivalent circuit in Fig. 5. Here are included the interelectrode capacitances in their equivalent wye form and a neutralizing inductance. This network

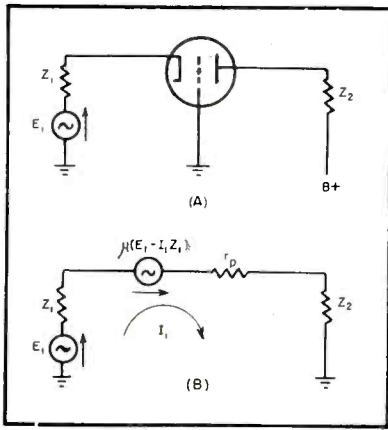

FIG. 2—Grounded-grid amplifier (A) and equivalent circuit (B)

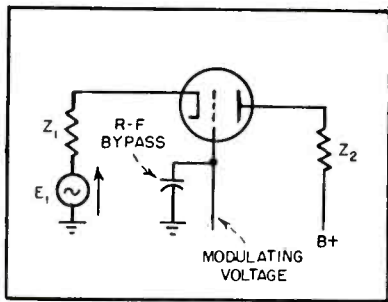

FIG. 3—Grid-modulated grounded-grid amplifier

is solved at a single frequency ω_0 , where $\omega_0^2 L_n C_3 = 1$, $\omega_0^2 L_1 C_1 = 1$, $\omega_0^2 L_2 C_2 = 1$ and Y_1 and Y_2 are pure conductances.

The stability under more general conditions will be discussed later.

Corollaries of the above restrictions are

$$E_3 = 0$$

$$E_0 = -[\omega_0^2 L_n C_1 E_1 + \omega_0^2 L_n C_2 E_2]$$

$$= -\left[\frac{C_1}{C_3} E_1 + \frac{C_2}{C_3} E_2\right]$$

Since $E_3 = 0$, the system is described by the equations

$$E_1 \left[Y_1 + \frac{1}{j\omega_0 L_1} + j\omega_0 C_1 \right] + (E_1 - E_2) g_p + (E_1 - E_0) g_m = I_1 \quad (1)$$

$$E_2 \left[Y_2 + \frac{1}{j\omega_0 L_2} + j\omega_0 C_2 \right] + (E_2 - E_1) g_p - (E_1 - E_0) g_m = 0 \quad (2)$$

$$E_0 = -\left[\frac{C_1}{C_3} E_1 + \frac{C_2}{C_3} E_2\right] \quad (3)$$

By substituting Eq. 3 in Eq. 1 and Eq. 2

$$E_1 \left[Y_1 + g_p + g_m + \frac{C_1}{C_3} g_m \right] - E_2 \left[Y_2 + g_p - \frac{C_2}{C_3} g_m \right] = I_1 \quad (4)$$

$$- E_1 \left[g_p + g_m + \frac{C_1}{C_3} g_m \right] + E_2 \left[Y_2 + g_p - \frac{C_2}{C_3} g_m \right] = 0 \quad (5)$$

The solution of Eq. 4 and Eq. 5 for E_2 is

$$\Delta = \left[Y_1 + g_p + g_m + \frac{C_1}{C_3} g_m \right] \left[Y_2 + g_p - \frac{C_2}{C_3} g_m \right] - \left[g_p + g_m + \frac{C_1}{C_3} g_m \right] \left[g_p - \frac{C_2}{C_3} g_m \right]$$

$$= Y_1 \left[Y_2 + g_p - \frac{C_2}{C_3} g_m \right] + Y_2 \left[g_p + g_m + \frac{C_1}{C_3} g_m \right] \quad (6)$$

$$\Delta \times E_2 = I_1 \left[g_p + g_m + \frac{C_1}{C_3} g_m \right] \quad (7)$$

Equations 6 and 7 can be written in terms of the tube interelectrode capacitances as follows:

$$\Delta = Y_1 \left[Y_2 + g_p - \frac{C_{pk}}{C_{gp}} g_m \right] + Y_2 \left[g_p + g_m + \frac{C_{pk}}{C_{gp}} g_m \right] \quad (8)$$

$$\Delta \times E_2 = I_1 \left[g_p + g_m + \frac{C_{pk}}{C_{gp}} g_m \right] \quad (9)$$

The equations describing an amplifier using an ideal tube, that is, one with no plate-cathode capacitance (and no neutralizing inductance) can be obtained from Eq. 8 and Eq. 9 by setting $C_{pk} = 0$

$$\Delta = Y_1 [Y_2 + g_p] + Y_2 [g_p + g_m] \quad (10)$$

$$\Delta \times E_2 = I_1 [g_p + g_m] \quad (11)$$

We can now draw several conclusions about the operation of the properly tuned amplifier from Eq. 8, 9, 10 and 11. If the amplifier is to be stable the system determinant, Δ , must not be zero. Equation 10, where Δ can never be zero, is a mathematical expression for a fact we already know, namely that a grounded-grid amplifier with no plate-cathode capacitance in the tube is absolutely stable. If the amplifier has plate-cathode capacitance in the tube and has a neutralizing inductance, the determinant is modified by the addition of the terms

$$- Y_1 g_m \frac{C_{pk}}{C_{gp}} + Y_2 g_m \frac{C_{pk}}{C_{gp}}$$

as in Eq. 8. The negative term indicates the possibility of insta-

bility. However the added terms tend to cancel and moreover the ratios $\frac{C_{pk}}{C_{gp}}$ and $\frac{C_{pk}}{C_{gp}}$ are usually very small; in the type 6161 they

are $\frac{C_{pk}}{C_{gp}} \cong \frac{C_{pk}}{C_{gp}} \cong 0.025$ so that the

likelihood of the neutralized stage taking off is quite remote.

Equation 3 is the grid voltage developed across the neutralizing inductance. It is seen from Eq. 3 that a plate voltage E_2 causes a grid-cathode voltage that reinforces E_2 . The neutralizing inductance is therefore a regenerative impedance.

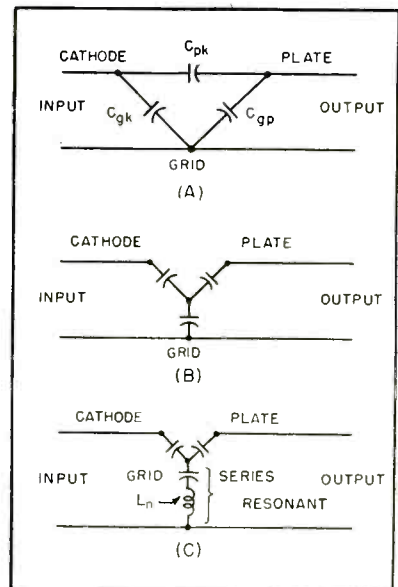

FIG. 4—Tube interelectrode capacitances (A) arranged in equivalent wye (B) with input and output decoupled with inductance (C)

By comparing Eq. 9 and 11 it can be seen (with tubes for which C_{pk}/C_{gp} is small) that the regeneration is small. This is consistent with the conclusion that the neutralized amplifier is stable. A further conclusion that can be drawn, since all terms of Δ and $\Delta \times E_2$ are real, is that the addition of the neutralizing inductance does not cause incidental phase modulations.

We will now investigate the stability of the amplifier under more general conditions. Referring to Fig. 5, if, because of the limited tuning range of the input and output circuits, we assume that any

sustained oscillations have a frequency close to the carrier frequency, ω_o , then (with tubes with $C_{pk} \ll C_{gp}$ and $C_{pk} \ll C_{gk}$) we can neglect E_s as we did before. The feedback voltage is a function of frequency

$$E_g = -\frac{\omega^2}{\omega_o^2} \left[\frac{C_1}{C_3} E_1 + \frac{C_2}{C_3} E_2 \right]$$

We can further simplify the solution by letting $\omega^2 L_1 C_1 = 1$ and $\omega^2 L_2 C_2 = 1$ at all frequencies and making Y_1 and Y_2 complex functions of frequency.

The system determinant under these conditions becomes

$$\Delta = Y_1 \left[Y_2 + g_p - \frac{\omega^2}{\omega_o^2} \frac{C_{pk}}{C_{gk}} g_m \right] + Y_2 \left[g_p + g_m + \frac{\omega^2}{\omega_o^2} \frac{C_{pk}}{C_{gp}} g_m \right]$$

For oscillations to exist, Δ (both real and imaginary parts) must be zero. This indicates again that oscillations are unlikely, at least near the carrier frequency.

This analysis gives no information about parasitic or higher-mode oscillations that might occur at

frequencies far removed from the carrier frequency. However oscillations of these types are not likely to occur in small single-tube cavities.

In practice, the neutralizing inductance is quite small. In the type

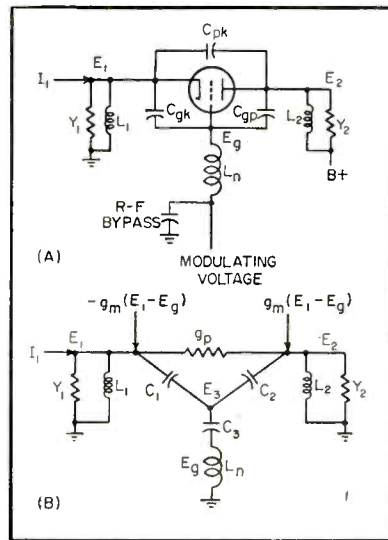

FIG. 5—Neutralized grounded-grid amplifier (A) and equivalent (B)

6161 amplifier in this transmitter, contact was made to the grid terminal of the tube by a number of spring fingers. To insert an inductance between grid and ground these fingers were bent away from the grid terminal (thus increasing the inductance) one at a time until neutralization was achieved.

It should be emphasized that the foregoing discussion based on equivalent circuits is useful in a qualitative way only. With large signals a vacuum tube is decidedly nonlinear, and can be represented by an equivalent circuit only approximately. Furthermore, at high frequencies, transit-time effects become important. Transit-time effects cause an increase in driving power requirements and cause the cathode current pulses to be unsymmetrical. The degree of symmetry of these pulses varies over the modulating cycle, resulting in some incidental phase modulation of the carrier. The unsymmetrical pulses also cause some peculiar operating conditions. For example, the maximum efficiency and power

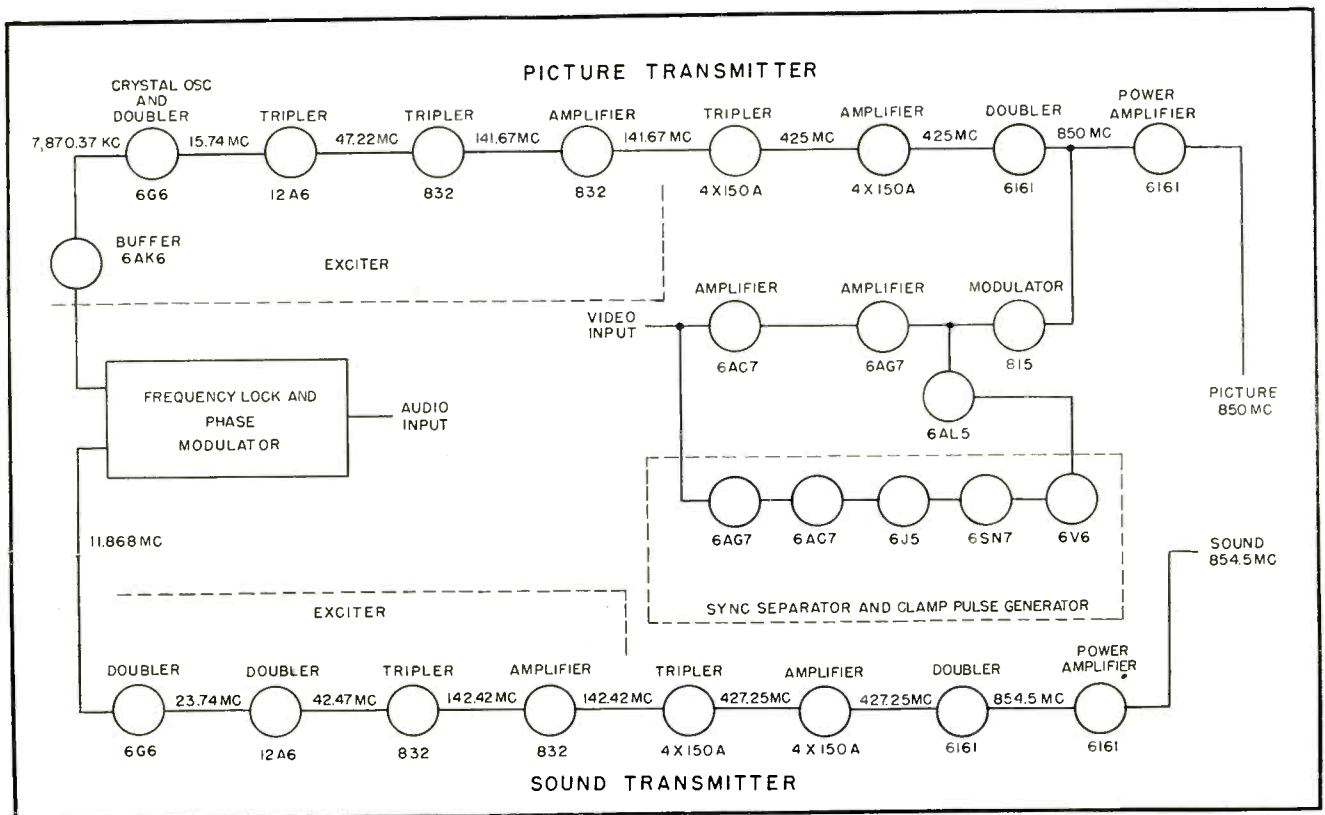

FIG. 6—Block diagram of the picture and sound transmitter frequency control

do not occur when the plate is tuned for a plate-current dip.

Cooling

The type 6161 is a forced-air-cooled tube. The following provisions were made in the tanks for circulation of cooling air. Air is forced into the air chamber at the top of the tank. From there all the air flows through the cooling fins on the anode of the tube into the plate cavity. Most of the air in the plate cavity flows out through the hollow tuning plungers. A portion of the air in the plate cavity flows into the cathode cavity through holes at the base of the spring fingers on the grid connector. These holes are at such an angle that the air stream is directed at the glass seal on the cathode terminal of the tube. The air leaves the cathode cavity through holes in the bottom of the cavity.

Power

The aural transmitter runs with a power output of 150 watts into an antenna with a gain of 16.2 db, giving an effective radiated power of 6.2 kw. When modulated with a video signal the visual transmitter has a peak power output of 300 watts into an antenna with a gain of 19.2 db, giving an erp of 25 kw. However, like most commercial transmitters, this transmitter cannot put out peak power continuously and still stay within the tube ratings. During most of the propagation tests the visual transmitter has been run unmodulated with a continuous power output of 200

watts. At this power the final power amplifier stage has a plate circuit efficiency of about 58 percent and the tube is operating well within its ratings.

Drivers

The block diagram of the transmitter is shown in Fig. 6 and 7. The two stages using type 4X150A's and the doubler stage using a type 6161 all of which drive the finals are of the resonant-cavity type. The type 6161 doublers are operated grounded grid and have plate cavities identical with those on the final stages. The cathode cavities are resonant half-wave coaxial lines.

The 4X150A cavities are operated grounded cathode. The plate cavities are identical and are a type that is best described as being the transition between foreshortened coaxial and re-entrant cavities. The grid tanks of the 4X150A amplifiers are resonant half-wave coaxial lines. The final power-amplifier stages were the only cavity type amplifiers that required neutralization. The rest of the transmitter utilizes conventional lumped-constant circuits.

Generation of Carriers

The frequency lock and phase modulator portion of the transmitter deserves special discussion both because of its advantages and pitfalls.

Receivers employing intercarrier sound require that the difference between picture and sound carriers be accurately maintained at the transmitter. Present FCC regula-

tions require that the picture carrier be maintained within 1 kc of its assigned value and that the difference between picture and sound carriers be $4.5 \text{ mc} \pm 5 \text{ kc}$. The frequency stabilities corresponding to these tolerances on the upper vhf channels are approximately ± 0.0005 percent for the picture carrier and ± 0.002 percent for the sound carrier. The frequency stabilities required for the upper uhf channels are four times as great or approximately ± 0.0001 percent for the picture carrier and ± 0.0005 percent for the sound carrier.

The frequency lock is a circuit, shown in Fig. 7, that causes the picture and sound carriers to drift together, always maintaining the difference accurately. The picture carrier is generated by a chain of frequency multipliers ($\times 108$) following a crystal oscillator at 7,870.370 kc. This picture crystal frequency is also used in the frequency lock in generating the sound carrier. On the frequency lock chassis a 100-kc crystal oscillator is doubled to 200 kc and phase modulated.

This 200-kc signal is mixed with a signal from a second crystal oscillator at 1,798.843 kc. The upper sideband of 1,998.843 kc is selected and doubled to 3,997.686 kc. This signal is then mixed with a signal from the picture crystal oscillator in a second mixer. The upper sideband of 11,868.056 kc is selected and multiplied 72 times to produce the sound carrier. A little arithmetical manipulation will show that this process has reduced the sensi-

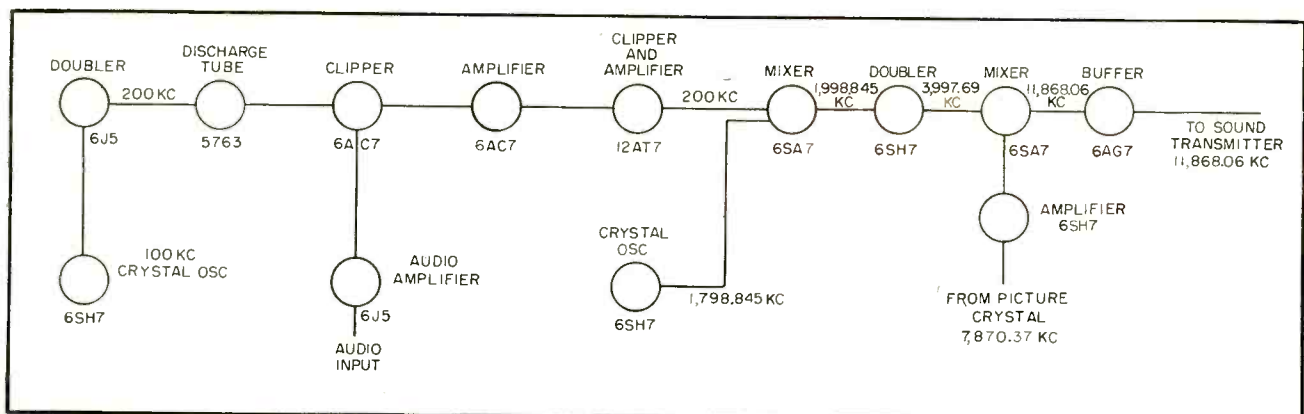

FIG. 7—Frequency-lock and phase modulator for sound transmitter

tivity of the difference between picture and sound carriers to drift in the picture crystal by a factor of one third.

There are other arrangements of the frequency lock that give more stability to the difference between picture and sound carriers. For example, it can be seen that if the frequencies in the frequency lock are chosen such that the multiplying factor following the second mixer is the same as the multiplying factor following the picture crystal that the difference between picture and sound carriers is entirely independent of drift in the picture crystal. This possibility dictates a different arrangement of the block diagram to circumvent the limited selectivity obtainable in mixer plate circuits. Since only the difference between the two auxiliary crystal frequencies is of interest, we have a great deal of leeway in choosing these frequencies. Furthermore, the block diagram can be arranged in many ways that further increase the leeway in the design of the frequency lock. That it is desirable to have several possibilities from which to choose will be shown below.

Undesired Modulation

One unfortunate and unanticipated difficulty was encountered in the frequency-lock unit. It was found that the sound carrier was frequency modulated with a large frequency deviation at a modulating frequency of 125 kc. This undesired modulation of the sound carrier caused noticeable bars in the picture on receivers, especially if the receivers were not properly tuned. The trouble was found to arise in the second mixer in the frequency lock portion of the transmitter.

In this mixer a 3,997.686-kc signal is mixed with a 7,870.370-kc signal to produce an 11,868.056-kc signal that is multiplied up to obtain the sound carrier. Now there also appears in the plate circuit of this mixer an 11,993.058-kc signal derived from the product of $3 \times 3,997.686$ and an 11,743.054-kc signal, the product of $2 \times 7,870.370 - 3,997.686$. Both of these differ from the desired frequency by 125 kc. The presence of these higher-order

mixer components results in a phase modulation of the desired signal.

Furthermore, this undesired phase modulation must be kept to a very small value in order not to affect adversely the performance of the transmitter. This is especially true if the beat is at an audio rate. In this transmitter the frequency deviation at the sound-carrier frequency due to this beat in the mixer was nearly 2 megacycles.

There are at least three methods by which trouble from higher order mixer components can be minimized. The first, of course, is by adequate filtering, although in

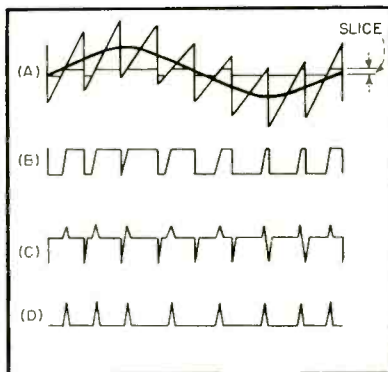

FIG. 8—Audio modulation with crystal sawtooth superimposed showing slicer action (A) sliced wave (B) differentiated (C) and resultant pulses of slope portion

many cases selectivity requirements will be too great for practical circuits. A second method is by selecting the mixer frequencies so that all higher order components fall far away from the desired frequency. This is why, as is pointed out above, it is desirable to have several methods from which to choose. There are a great many possible ways of laying out the block diagram so that this can be done. The searching for the right frequencies is greatly facilitated by the use of a mixer frequency chart.⁶ A third method is by the use of true square-law mixers. This condition, like the adequate filtering, is also usually difficult to achieve in practice.

The sound transmitter is frequency-modulated by a phase-modulation system. The audio modulat-

ing voltage is passed through an inverse-frequency network so that true f-m results. The method of phase modulation that was used for the sound transmitter has been described previously^{7,8,9} but will be briefly explained here. References will be made to Figs. 7 and 8.

Serrasoid Principle

The output of the discharge tube is a 200-kc sawtooth wave whose frequency is controlled by the 100-kc crystal oscillator. This sawtooth wave superimposed upon the modulating voltage, Fig. 8A, is fed to the 6AC7 clipper which takes a thin slice, amplitudewise, out of the sawtooth. The position of this slice in the sawtooth varies according to the audio modulating voltage. This slice is amplified. The output of the amplifier is a trapezoidal wave, Fig. 8B, with width varying according to the audio modulating voltage. The edge of the trapezoidal wave corresponding to the steep side of the sawtooth wave has a relatively constant phase.

The edge of the trapezoidal wave corresponding to the sloping side of the sawtooth wave has a phase that varies up to nearly 180 deg from its center position, depending on the amplitude of the audio modulating voltage. A pulse is derived from the phase-modulated edge of the trapezoidal wave by means of differentiators, as shown in Fig. 8C, and clippers, Fig. 8D, and is used to drive a 200-kc amplifier. This phase-modulated signal is used in the generation of the sound carrier as described above. The inverse-frequency network is contained in the audio amplifier.

REFERENCES

- (1) J. R. Bennet, and L. S. Lappin, A New Ultra-High-Frequency Television Transmitter, *RCA Review*, June 1950.
- (2) R. F. Guy, Investigation of UHF TV Transmission and Reception in the Bridgeport, Conn., Area, *RCA Review*, March 1951.
- (3) D. W. Peterson and Jess Epstein, Effective UHF Television Broadcasting, p. 102 this issue.
- (4) C. E. Strong, The Inverted Amplifier, *ELECTRONICS*, July, 1940.
- (5) P. A. T. Bevan, Earthed Grid Power Amplifiers, *Wireless Engineer*, June 1949.
- (6) R. S. Badessa, Mixer Frequency Charts, *ELECTRONICS*, Aug. 1946.
- (7) R. D. Kell, U. S. Patent No. 2,061,734.
- (8) G. H. Brown, and W. C. Morrison, The RCA Antennalyzer, *Proc. IRE*, Dec. 1946.
- (9) J. R. Day, Serrasoid F-M Modulator, *ELECTRONICS*, Oct. 1948.

Transistors Operate at 300 MC

With proper control of germanium resistivity and spacing between the emitter and collector, point-contact transistors have been made to oscillate as high as 302 mc. This development opens the field for high-frequency transistor applications

By G. M. ROSE and B. N. SLADE

*Tube Department
Radio Corporation of America
Harrison, N. J.*

MANY engineers, as well as laymen, have an impression that transistors are simple to make. This impression of simplicity has led to a considerable amount of impatience because transistors are not more readily available.

Inside the transistor, however, is a complex electrical system that is as yet far from being fully understood. Many investigations are currently being made to determine the nature and cause of a variety of phenomena observed during transistor operation. It is apparent that transistors intended for use in certain classes of applications should be specifically designed for those applications. For example, transistors designed for r-f systems will

probably be different from those for computer applications because the basic requirements for the two uses are not altogether similar.

Requirements for transistors used in r-f systems are gradually being met in developmental types.¹ This article discusses recent progress made in this direction on developmental point-contact transistors.

For use in r-f systems, transistors must meet two primary requirements. They must amplify substantially at the intended operating frequency and they must be electrically stable. Other desirable characteristics such as low noise, long life and low power drain are important but are of necessity sec-

ondary to the two primary requirements—frequency response and stability.

Frequency Response

Power gain of 20 db or more can readily be obtained at frequencies of a few hundred kilocycles with point-contact transistors. As the operating frequency is increased to megacycles or tens of megacycles, however, maintenance of gain becomes an important problem for consideration.

At elevated frequencies, gain is affected by several factors. Some of these factors are included in the expression given by Shockley² for the transit time of electrons or holes through the germanium of

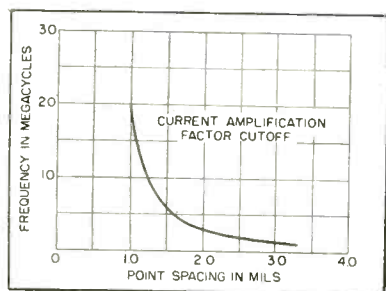

FIG. 1—Effect of variation in point spacing on frequency response of a point-contact transistor

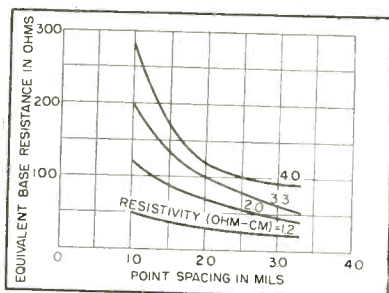

FIG. 2—Effect of variation in point spacing and germanium resistivity on equivalent base resistance

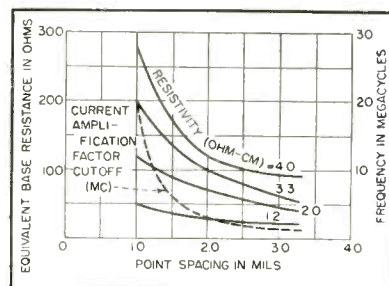
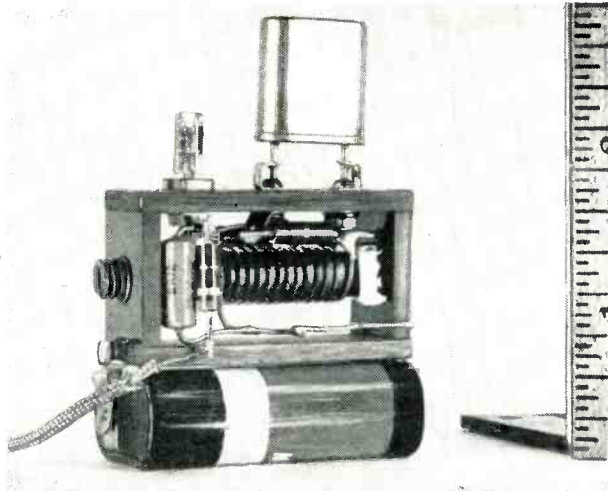
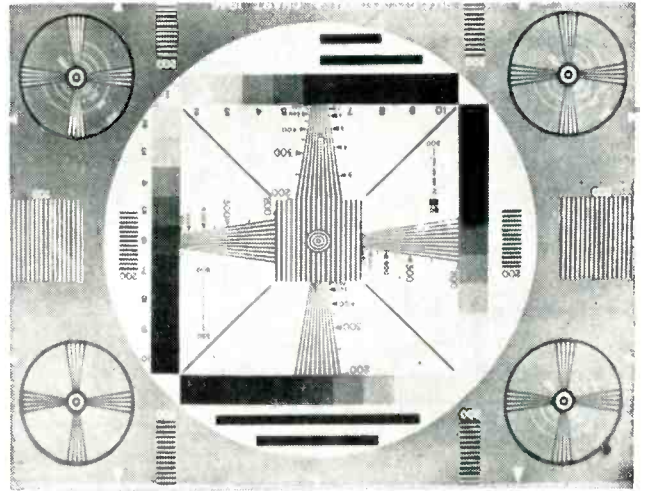

FIG. 3—Effect of variation in point spacing on frequency response and equivalent base resistance



A crystal-controlled 110-mc transistor oscillator. Developmental point-contact transistor (left), quartz crystal in metal can (right)



Test pattern illustrating frequency response of developmental point-contact transistor in a 20-mc video amplifier system

point-contact transistors. In this expression $T = \frac{S^2 \sigma}{\mu I_e}$, T is the time in seconds required for the holes or electrons to travel from the emitter to the collector, S is the contact spacing or the distance between the emitter and collector in centimeters, σ is the conductivity of the germanium in reciprocal ohm-centimeters, μ is the mobility of the holes or electrons in centimeters squared per volt-second and I_e is the emitter current in amperes.

Qualitatively, this expression indicates that the spacing between the emitter and the collector plays a major role in determining the frequency response of transistors. Other factors remaining constant, the transit time decreases rapidly as the spacing is decreased and the frequency response increases to a corresponding degree.

Because actual power gain involves considerations of circuitry, it has been found more informative to express the frequency response of transistors in terms of a current amplification factor α which is a characteristic of the transistor alone. The cutoff frequency is then defined as the frequency at which the current amplification factor is three db down from or 70 percent of, its low-frequency value.

Figure 1 shows a curve giving the variation of frequency cutoff with point spacing for germanium specimens having resistivities within the range of 1.2 to 4 ohm-

centimeters. It would appear from the expression for transit time that, as the germanium resistivity increases, the frequency response also increases. Actual measurement, however, indicates that an increase in resistivity from 1.2 to 4 ohm-centimeters has little effect on the frequency response. These measurements were made by varying the spacing of two point contacts on specimens of single-crystal germanium.

The curve in Fig. 1 follows the S^2 function fairly closely. Because the frequency-cutoff values increase rather rapidly as the contact spacings become relatively narrow, it might be assumed that there would be almost no limitation to frequency response if extremely narrow spacings could be achieved. Extremely narrow spacings, however, introduce both mechanical and electrical problems. The mechanical problem lies in the difficulty of maintaining adequate control of such small spacings. The electrical problem involves considerations of transistor gain and stability.

Stability

Both the stability and the frequency response of point-contact transistors are affected by the characteristics of the germanium as well as by the contact spacings. These transistors have a tendency to become unstable and to oscillate in amplifier circuits in which there is little or no impedance in series

with the emitter or the collector. This oscillation is undesirable in r-f stages having parallel-tuned circuits in both the input and output of the transistor because the impedance of the tuned circuits approaches zero during off-resonance.

Feedback Considerations

The instability of the point-contact transistor is due to an internal positive feedback that is a function of both the current amplification factor and an internal feedback resistance. The value of this feedback resistance is a measure of the effect of the output current on the input voltage. The stability of the transistor can be improved by reducing either the feedback resistance or the current amplification factor. If the latter becomes equal to or less than unity, the transistor is unconditionally stable.

In junction transistors, the current amplification factor is always equal to or less than unity and, therefore, there is no problem of instability. In point-contact transistors, however, it is not practical to obtain very low values of current amplification factor because a corresponding loss in power gain would result. Current-amplification-factor values for point-contact transistors usually are greater than two. By properly controlling the resistivity of the germanium, the feedback resistance may be maintained at sufficiently low values to permit stable amplifier operation at

radio frequencies.

Figure 2 shows a measured relationship between the feedback resistance and the point spacing for several pieces of monocrystalline germanium having varying resistivities. These curves illustrate two facts. At the higher values of resistivity, the feedback resistance increases rapidly with decreasing point spacing. At values of resistivity of two ohm-cm or less, the feedback-resistance values approach a more linear relationship with the point spacing.

For a given value of point spacing, the feedback resistance decreases with decreasing resistivity values. If Fig. 1 and 2 are superimposed, as shown in Fig. 3, it becomes apparent that if a very small value of point spacing (say 0.001 inch) is selected in order to get a high value of frequency cutoff, it would be necessary to use a low value of germanium resistivity to maintain a low value of feedback resistance.

A feedback resistance of 100 ohms or less will usually be sufficiently small to assure stable transistor amplifier operation. With a spacing of 0.001 inch, a resistivity less than 2 ohm-cm would be necessary to obtain such a value of feedback resistance. Figure 4 shows the frequency-response characteristic of a stable transistor having a frequency cutoff of 30 mc made using these techniques.

Switching Circuits

Although the technique of proper selection of point spacing and germanium resistivity discussed is used primarily to produce the stable transistors required for r-f applications, this technique is also useful in the design of point-contact transistors for certain other applications such as switching circuits. In such applications the internal feedback of the transistor can be high because short-circuit stability is not required. Suitable values of resistivity and point spacing for this type of application may also be selected by this technique.

Transistors will oscillate at frequencies somewhat higher than the frequency at which the current amplification factor drops three db.

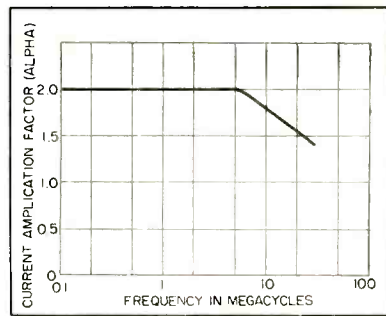

FIG. 4—Frequency-response characteristic of developmental point-contact transistor

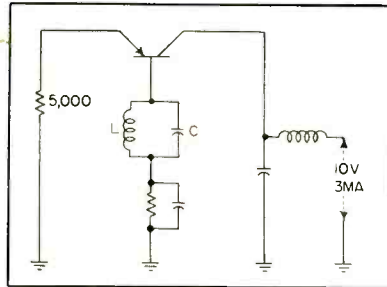

FIG. 5—Schematic diagram of transistor oscillator circuit

For instance, a transistor having a frequency cutoff of four mc may oscillate at frequencies as high as 10 megacycles or more because the current amplification factor and the power gain at these higher frequencies would be sufficient to enable oscillations to occur. By utilizing point spacings of less than 0.001 inch, it is possible to achieve cutoff frequencies of 30 mc or more and thus make possible oscillations at even higher frequencies.

With spacings of approximately 0.0005 inch, transistors have been made that will oscillate at frequencies well above 100 mc. A number of units have oscillated at frequencies greater than 200 mc and the highest oscillation frequency reached to date has been 302 megacycles.

Oscillator Circuit

Figure 5 shows the schematic diagram of the oscillator used in these tests. This circuit is interesting in that the emitter is apparently isolated for r-f by the 5,000-ohm resistor. The feedback required for oscillation is provided by the internal capacitance between emitter and collector. The bypassed resistance in the base circuit together with the series resistance in the emitter circuit determines the

emitter bias. With suitable choice of L and C , an oscillation range from 5 to 300 mc has been achieved, with a single transistor.

One photograph shows a crystal-controlled demonstration oscillator that operates at 110 megacycles. The seventh-overtone quartz crystal, operating in its low-impedance mode, replaces the bypass capacitor across the series base resistor.

Transistor R-F Amplifier

Performance of transistors in r-f amplifiers is more difficult to evaluate than oscillator performance because of the more complicated circuitry. There are indications, however, that stage gains of 20 db at frequencies well above five mc are possible with no instability arising from internal feedback in the transistor.

Developmental point-contact transistors have been tested in a wide-band video system. A second photograph shows a television test pattern after transmission through a 20-mc chain, one stage of which was a point-contact transistor. The gain of this stage was not maximized and was only slightly greater than the α , or current amplification factor of the transistor. Nonstandard scanning rates were used to give an equivalent balanced resolution of almost 900 lines. The presence of the transistor stage did not visibly degrade the pattern.

From the data given in this paper, it is apparent that the point-contact transistor can be successfully used in r-f applications. At the present time, junction transistors are somewhat superior to point-contact types with respect to stability and thus promise greater flexibility in amplifier applications. So far, point-contact transistors are capable of operation at higher frequencies than junction transistors, particularly as oscillators. With the proper control of point spacings and germanium resistivity, point-contact types can be made having a high degree of stability in suitable applications.

REFERENCES

- (1) E. N. Slade, The Control of Frequency Response and Stability of Point-Contact Transistors, *Proc. IRE*, Nov. 1952.
- (2) W. Shockley, "Electrons and Holes in Semiconductors", D. Van Nostrand, 1950.

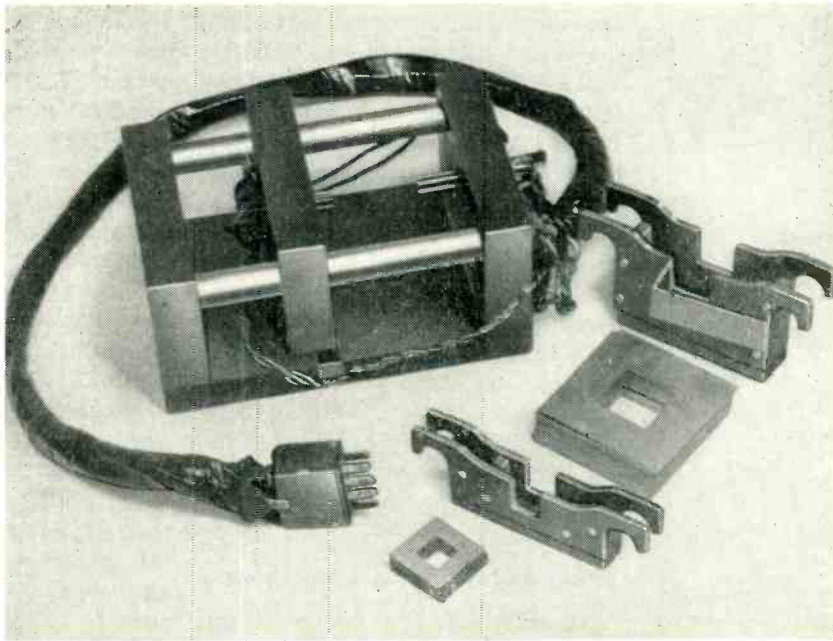

Fixture incorporating the four-contact plug. Two sizes of cores of square gapless laminations together with the appropriate jigs for holding them are shown

Magnetic-Amplifier Gapless-Core Tests

Production test method approximates actual amplifier operating conditions without requiring use of test coils on closed cores. Provides basis for matching sets of cores for balanced amplifiers as well as for acceptance or rejection of individual cores

AN IDEAL METHOD of testing cores for magnetic amplifier reactors would be one providing sufficient data to predict accurately the control characteristic of the amplifier.

Some early analyses replaced the actual B-H relationship in the core with the normal d-c magnetization curve while others employed simplified curves consisting of three straight-line portions. Neither of these assumptions gives satisfactory results for materials having rectangular hysteresis loops since they do not predict maximum output for zero control current.

A more realistic analysis' em-

By J. R. CONRATH

*Vickers Electric Division
Vickers, Inc.
St. Louis, Missouri*

loys the d-c hysteresis loop of the core material in predicting the control characteristic of a self-saturating amplifier. It is assumed that the flux at the start of the supply-voltage cycle, the premagnetization, varies along the back flank of the d-c hysteresis loop as the control current is varied. Although there is a substantial correlation between predicted and measured curves, this method is in error because it neg-

lects the effect of eddy currents. When high-permeability core materials are used, the eddy-current effect is important even with lamination thicknesses of a few thousandths of an inch and at a frequency of 60 cycles.

It has been shown² that the premagnetization in a self-saturated magnetic amplifier is indicated not by the back flank of the d-c hysteresis loop nor by the symmetrical a-c loop, but by an intermediate curve. This has been called the control magnetization curve. It is the locus of the tips of the biased dynamic hysteresis loops through which the core material is driven

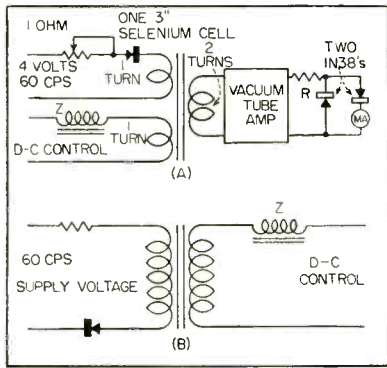

FIG. 1—Core test circuit (A) and half-wave amplifier circuit (B)

when the control current of the amplifier is varied.

If the foregoing is accepted, the choice of an efficient core-test method may be reduced to consideration of the most convenient way of measuring the control magnetization curve. This can be done readily by operating the reactor in an actual half-wave self-saturating amplifier. The voltage induced in a pickup coil can be integrated by an R-C network to provide the flux wave and permit the tracing on a cathode ray oscilloscope of the dynamic hysteresis loops.

Test-Winding Requirements

The foregoing method, in common with other test methods involving hysteresis curve tracing, requires a pickup coil of a considerable number of turns. The induced voltage at 60 cycles is only a few millivolts per turn for small magnetic amplifier reactors, particularly those employing core materials such as Mumetal, which has a low value of saturation induction. Since there is necessarily a high attenuation in the integrating networks of circuits for hysteresis curve tracing, the need for a pickup coil of many turns is apparent.

This requirement may present no serious difficulty in the case of cores in which an air gap is present because the laminations may be stacked around coil forms on which any desired number of turns have been wound. If only a limited number of closed cores are to be tested, the expense of winding the requisite number of turns might not be too great. Where thousands of ampli-

fiers employing closed cores are produced and where each core must be individually tested, it is impractical to provide a winding of many turns. Instead of using coils for these closed cores a winding for test purposes may be obtained by passing a plug through the window of the core and into a socket.

Since it is necessary in the production of Vickers magnetic amplifiers to test cores having window openings as small as about $\frac{3}{8}$ -in. square, a plug having four contacts was deemed the most practical. This can be used to provide one or more windings having a total of four turns.

Plug-and-Socket Arrangement

An early core test method using the plug-and-socket arrangement involved measuring the normal a-c magnetization curve. Two of the turns were used as an excitation winding through which a specified sinusoidal alternating current was passed. The other two turns were employed as a pickup winding and the voltage induced in them was measured with a vacuum-tube voltmeter. In this way several points on the magnetization curve were obtained.

A single four-turn winding could have been used for both excitation and pickup, but the isolated windings are better because they avoid

errors due to voltage drop in the contact resistance of the plug and socket. This type of test is useful in matching sets of cores for balanced amplifiers and provides some indication of the performance of cores in self-saturating amplifiers. The correlation between test results and amplifier characteristics was not considered satisfactory since this method gives no indication of either coercive force or residual induction.

Another circuit requiring only a few turns to test a magnetic amplifier core is shown in Fig. 1A. The circuit configuration here resembles that of an actual half-wave self-saturating magnetic amplifier. An a-c potential of a few volts is applied to an excitation circuit consisting of a half-wave rectifier and a current-limiting resistor. Voltage is held to a low value so that rectifier leakage will be negligible. A control winding is provided through which an adjustable amount of pure d-c is caused to flow. This circuit contains a high impedance to prevent appreciable current from flowing as a result of voltage induced in the control winding. A vacuum-tube amplifier and a germanium diode rectifier voltmeter permit the measurement of the voltage induced in the pickup winding.

Control Current

The control current sets the initial value of flux in the core. A half-wave current flows in the excitation winding which, during each cycle, drives the flux from this initial value into saturation and back again. The amplitude of this flux wave is indicated by the diode voltmeter since it measures the average value of the induced voltage. By measuring the flux change for several values of control current and subtracting it from the saturation flux, points on the control magnetization curve may be obtained. It is more convenient, however, to plot the induced voltage per turn against the control ampere-turns.

The pickup voltage curve is a good indication of the maximum supply voltage which can be used in an actual half-wave magnetic-amplifier circuit, Fig. 1B, as a function of control ampere-turns at cut-

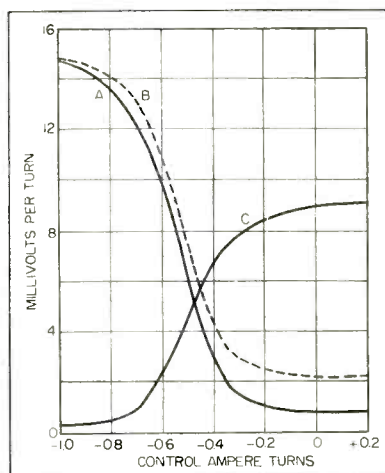

FIG. 2—Correlation of core test data with performance of half-wave magnetic amplifier. Pickup voltage in core test at 60 cycles (curve A), maximum supply voltage to amplifier for cutoff (curve B) and d-c output voltage times 2.2 of amplifier with supply voltage of 13.2 mv per turn (curve C)

off. An experimental illustration of this is offered in Fig. 2. Curve A represents the pickup voltage per turn at 60 cps of a AEM4750 core having a cross-section of 0.08 square inch and a mean-length magnetic path of 3 inches, when an average half-wave excitation of 1.3 ampere-turns is applied. Curve B shows the measured value of supply voltage per turn in the amplifier of Fig. 1B which for each value of control allows a load current to flow whose mmf corresponds to that used in testing the core. The fact that the measured supply voltage slightly exceeds the pickup voltage can be ascribed mainly to the forward voltage drop of the rectifier in the amplifier circuit.

The control swing required to drive the amplifier from cutoff to full output with a given supply voltage may be determined from this type of core test, if rectifier leakage is negligible. The control ampere-turns for cutoff are determined from the pickup voltage curve, Fig. 2, curve A, knowing the supply voltage per turn of the output winding and making a suitable allowance for rectifier forward voltage drop. The control ampere-turns for full output of the amplifier can be found by taking the abscissa of a point at the lower knee of the pickup voltage curve.

The control characteristic of a half-wave self-saturating amplifier using the same core appears as curve C of Fig. 2. In this case, the output is plotted on a voltage-per-turn basis and the load resistance is assumed to include the output winding resistance. Sufficient cells were used in the rectifier to insure negligible leakage current.

A definite correlation can be noted between the shape and position of the control characteristic and the pickup voltage curve. This can be seen from the fact that in the amplifier, the sum of the reactor voltage, the output voltage and the rectifier forward voltage drop should equal the supply voltage. Therefore, the output voltage of the amplifier increases as the reactor voltage decreases and the knee of the control characteristic occurs at the same value of control mmf as the lower bend of the pickup voltage curve.

The difference between the amplifier full output voltage and the supply voltage is due to rectifier forward voltage drop and to the fact that the reactor still possesses appreciable inductance at points above the knee of the control characteristic.

To get a direct comparison of curves A, B and C of Fig. 2, certain conventions must be observed. The vacuum-tube amplifier and diode voltmeter combination is calibrated on sine wave a-c, therefore the voltmeter indications show 1.1 times the average value of the induced voltage. The load voltage for curve C was obtained by multiplying by

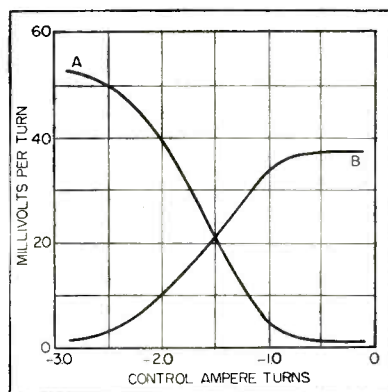

FIG. 3—Correlation of core test data with performance of half-wave magnetic amplifier with Deltamax core. Pickup voltage in core test at 60 cycles (curve A) and d-c output voltage times 2.2 of amplifier with supply voltage of 52.8 mv per turn (curve B)

2.2 the actual load voltage as measured with a d-c meter. The use of these factors results in the comparison in Fig. 2 of 1.1 times the average value of each voltage taken over the forward half cycle of supply voltage.

Figure 3 shows the pickup-voltage curve obtained in the core test and a control characteristic for a half-wave amplifier using a reactor wound on a core of square Deltamax laminations. The cross-section of this core is 0.174 square inch and the mean length of magnetic path is 4.4 inches. The output winding has 700 turns. As before, there is a good correlation of results in the core test and the amplifier characteristic.

It should be pointed out that

operating conditions in this core test circuit differ in at least two respects from those in the actual amplifier. In the amplifier the core excitation varies with control signal; at cutoff the core is driven only slightly beyond the knee of the hysteresis curve, while at full output it is driven far into saturation.

In the core test, a constant excitation was used for all values of control. It corresponds to that at cutoff in the amplifier. For this reason, the pickup voltage curve as measured in the core test has a somewhat lower value than the induced voltage in the amplifier for the full output condition. It would probably be worth while to increase the excitation in obtaining points at the lower end of the curve in the core test.

Since the reactance of the excitation winding is negligible compared with the current-limiting resistor, the excitation current will have the waveform of a rectified sine wave. This means that if the excitation is sufficient to drive the core considerably beyond the knee of the hysteresis curve, the core will traverse the steep part of the curve in a relatively short part of the cycle. The flux wave in the core test circuit will then be much steeper than that in the amplifier circuit, and the induced voltage wave will be sharply peaked instead of being a sine wave or portion of a sine wave. The more sudden change of flux will evidently modify the effect of eddy currents in the core test circuit as compared with the actual amplifier circuit. However, in view of the test results obtained, this difference in the eddy-current effect is not thought to be of great importance.

It is believed that the method described in this paper provides a test which satisfactorily approximates actual amplifier operating conditions without requiring the use of test coils on closed cores. It provides a basis for matching sets of cores for balanced amplifiers as well as for the acceptance or rejection of individual cores.

REFERENCES

- (1) W. J. Dornhoefer, Self-Saturation in Magnetic Amplifiers, *AIEE Transactions*, 68, 1949.
- (2) Henry Lohman, Predetermination of Control Characteristics of Half-Wave Self-Saturated Magnetic Amplifiers, *AIEE Technical Paper No. 51-387*.

Diode Limiters Simulate

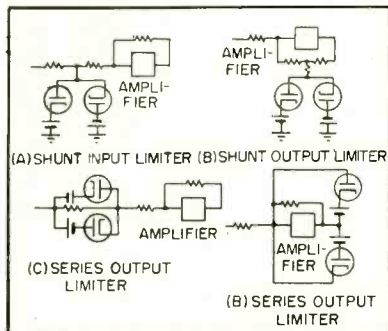

FIG. 1—Basic amplifier-diode circuits

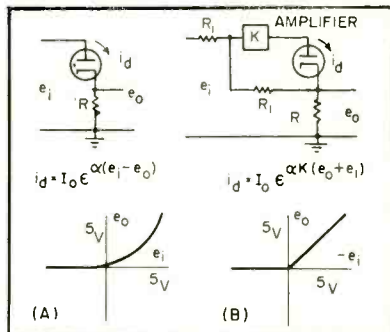

FIG. 2—Idealized diode circuits

By **C. D. MORRILL**
and
R. V. BAUM

Goodyear Aircraft Corp.
Akron, Ohio

THERMIONIC DIODES are useful in analog computers for simulation of nonlinear characteristics. Amplifier-diode circuits may be used to represent systems having two or more discrete operating regions. They may be made accurate and precise and their speed is better than that of corresponding relay circuits. Standard stabilized computing amplifiers may be used.

Basic Circuits

Figure 1 shows four basic amplifier-diode circuits that will be used as prototypes of other electronic switching circuits to be described. Input limiters are amplifier-diode circuits employing one or more diodes in the input circuit. Output limiters are those employing one or more diodes in the feedback circuit. Shunt limiters decrease current through the summing node by diode conduction. Series limiters increase current through the summing node by diode conduction.

The shunt-input limiter shown in Fig. 1A is probably most familiar to users of electronic differential analyzers. Normal scale changing is provided until the input voltage reaches a certain value above or below which one or the other diode conducts. For inputs in excess of this limiting value, output is nearly constant. Similar performance is obtained with the series-output limiter which is approximately the dual of the shunt-input limiter. The advantage of the shunt-input limiter is that single-ended, low-

impedance bias sources are easily furnished. An advantage of the series-output limiter is its higher switching speed and greater operational flexibility. The circuit of Fig. 1D may have extremely high gain for small signals and almost zero incremental gain for large signals. This type of operation is less feasible with the circuit of Fig. 1A.

The circuits of Fig. 1B and 1C perform similar operations. Incremental gain is small for small signals and large for large signals. The series limiter, however, offers greater flexibility since, by eliminating the resistor shunting the diodes of Fig. 1C, zero gain for small signals is possible.

Many variations of the four basic

circuits are possible. A resistor may replace a short circuit, or a short or open circuit may replace a resistor. One important variation is shown in Fig. 2, which illustrates a method of idealizing the characteristics of a thermionic diode. The departure from the ideal, neglecting leakage, is twice the voltage across the diode divided by the gain of the amplifier. This error will usually be on the order of tens of microvolts. The idealized diode will be applied in some of the computing circuits to follow.

The circuit shown in Fig. 3A is a dead-space simulator. Its operation is analogous to devices having a definite threshold of sensation or activity. The circuit of Fig. 3B has similar characteristics but offers

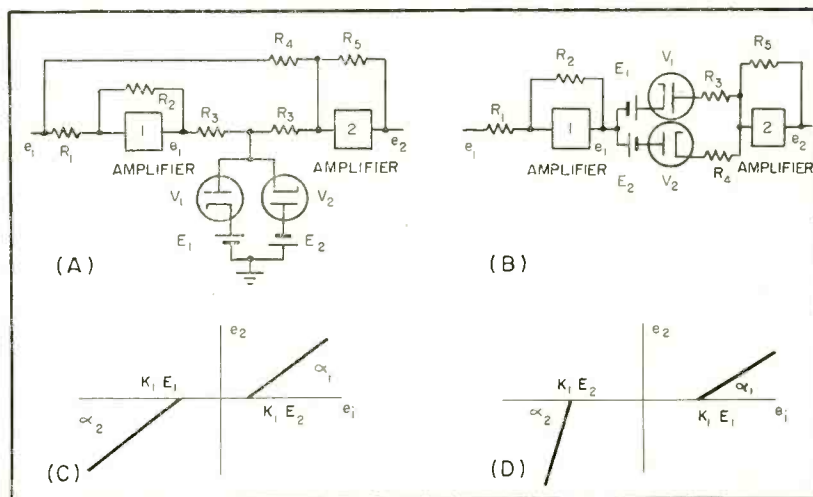

FIG. 3—Electronic dead-space simulator is analogous to mechanical devices having definite threshold of sensation or activity

Mechanical Phenomena

Analog computers use diode limiters to simulate apparatus characterized by two or more discrete operating conditions. Basic limiter circuits are described. Applications are shown in study of cam-operated engine valve and simulation of static and coulomb friction

two advantages. First, no resistor matching is required to produce zero gain at small input signals. In some applications, mismatched resistors in the circuit of Fig. 3A may cause an undesirable drift. Second, in the series limiter it is more con-

e_i has changed by a quantity sufficient to turn on V_1 . The action continues in this way, tracing a loop or loops, as shown in Fig. 4B.

Figure 5A is a simple comparator circuit. Amplifier gain is sufficiently high that the output e_B is limited by either V_1 or V_2 except for negligibly small inputs. Thus, e_B must be either E_1 or E_2 , depending on the sign of $(e_i + K)$. The circuit has high gain during the transition from one state to another and almost zero gain in either of the stable states. The voltages e_A , e_B and e_C are shown in Fig. 5B, 5C and 5D respectively. Any one of the three output voltages may be used to switch other amplifier-diode circuits or may be applied to an integrator for initiating a timing operation. It should be noted that K may be replaced by a variable to obtain an indication or initiate a process when one variable exceeds another.

The comparator is applied in a bistable multivibrator as shown in Fig. 6A. Comparison voltage is zero. Positive feedback is provided by amplifier 2 during the transitions and stability is reached when e_i is either E_1 or E_2 . If R_2 is equal to R_3 , switching will occur whenever e_i is equal to e_1 . A graph of the output voltage is given in Fig. 6B.

Sweep Generator

The bistable multivibrator is used in the sweep generator shown in Fig. 7A. Assume all resistors are equal, and that E_1 is equal to E_2 . If e_i is positive, the output of amplifier 3 will decrease until it is equal in magnitude to e_i . At that point, e_2 changes sign and e_1 steps to a negative voltage, reversing the

process. Steady-state waveforms are shown in Fig. 7B.

Figure 8A is a precision version of the sweep generator shown in Fig. 7. It shows that precision versions of amplifier-diode circuits are generally possible. The trick in

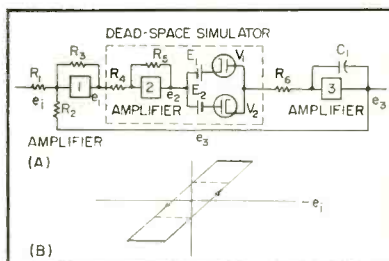

FIG. 4—Dead-space simulator presents analogy of backlash in gear assembly

venient to control independently the gains for positive and negative signals. This effect is shown in Fig. 3D.

Figure 4A illustrates a circuit for simulating backlash as may occur in a gear assembly. It employs the dead-space simulator. Assume that R_1 , R_2 , R_3 , R_4 and R_5 are equal and that the time constant R_6C_1 is very small. Assume further that the voltage across C_1 is initially zero. If the input voltage is zero and increasing positively, the output voltage e_3 will remain zero until the input voltage is equal to E_2 . At this point, V_2 conducts, and amplifier 3 integrates until the output voltage e_3 is just large enough to cause V_2 to cut off. Further increases in e_i result in equivalent decreases in e_3 , and voltage e_3 may be said to follow e_i . This action continues until e_i reverses direction; e_3 then remains constant until

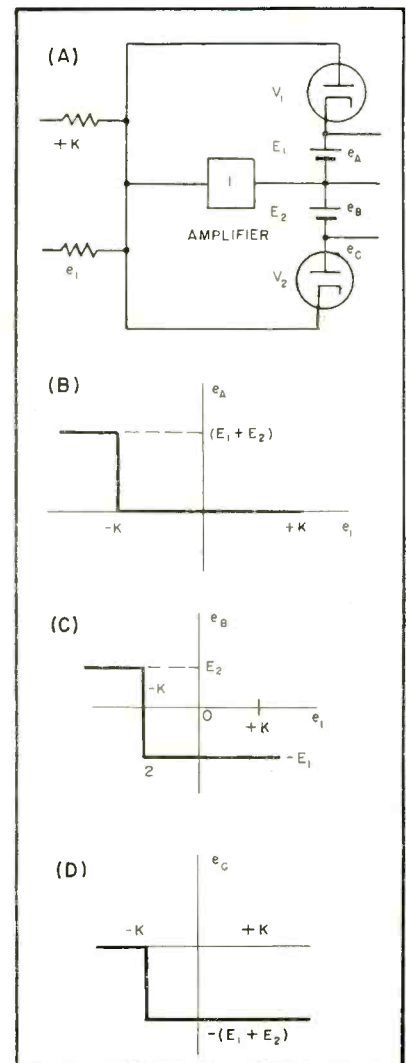

FIG. 5—Comparator circuit shows diodes used in another switching operation

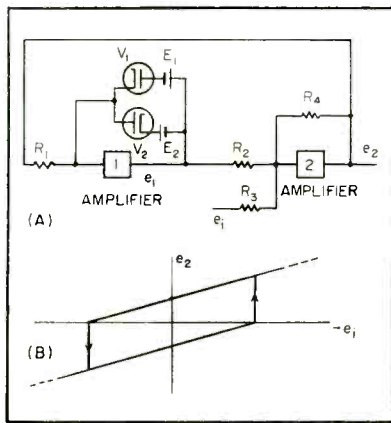

FIG. 6—Bistable multivibrator uses comparator circuit

such applications is to use ordinary diodes as switches to control idealized diodes. This basic method may be used to turn a variable voltage on or off as a result of coincidence of two other variables.

Usually the use of the idealized diode to secure precise operation will require more equipment. Quite often, however, precision circuits may require no more, or even less, equipment. Figure 9A is a modification of the idealized diode and produces the absolute value of a variable voltage. Amplifier 1 is called a sign-separator since each of the two outputs, A and B, furnishes only one sign of the variable. The output of amplifier 1 is applied to the input of amplifier 2 only if e_1 is positive. The gain from input to output through amplifiers 1 and 2 is $+2$ if the input is positive and zero if the input is negative. The gain from input to output through amplifier 2 is always -1 . Under these conditions the output is the absolute value of the input, as in Fig. 9D. Variations of this circuit permit the rotation and translation of the origin.

Examples

One application of amplifier-diode circuits is the simulation of static and coulomb friction. A typical situation is illustrated in Fig. 10. Two cases are considered: the first involves use of a double-acting spring that provides a restoring force for both positive and negative deflections. In the second case, a single-acting spring is used. The equations of motion for each case are shown. These equations imply

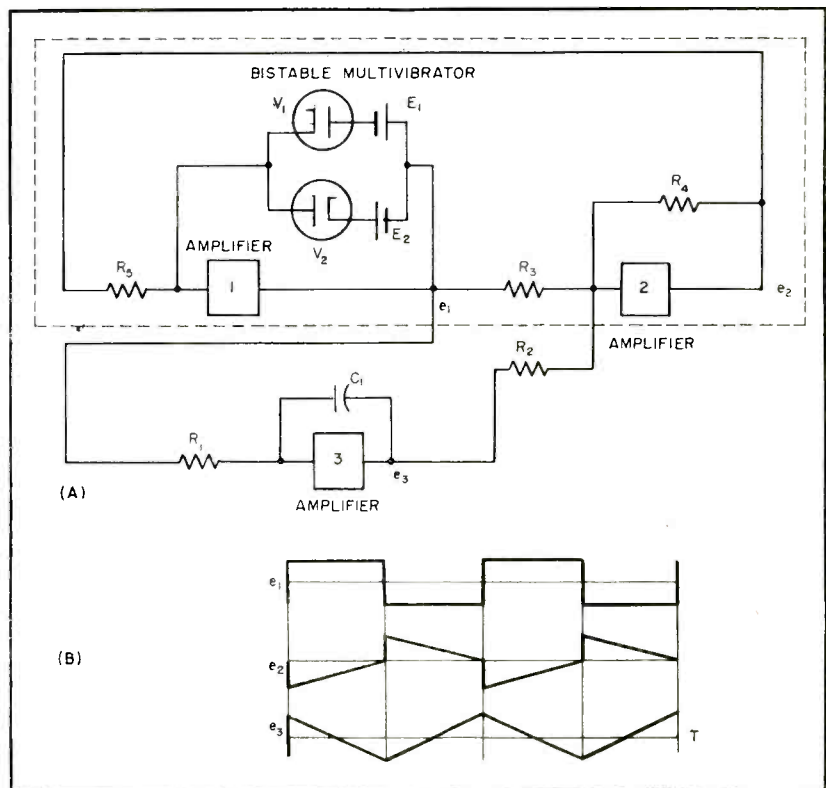

FIG. 7—Sweep generator employs bistable multivibrator circuit. Steady-state waveforms are shown

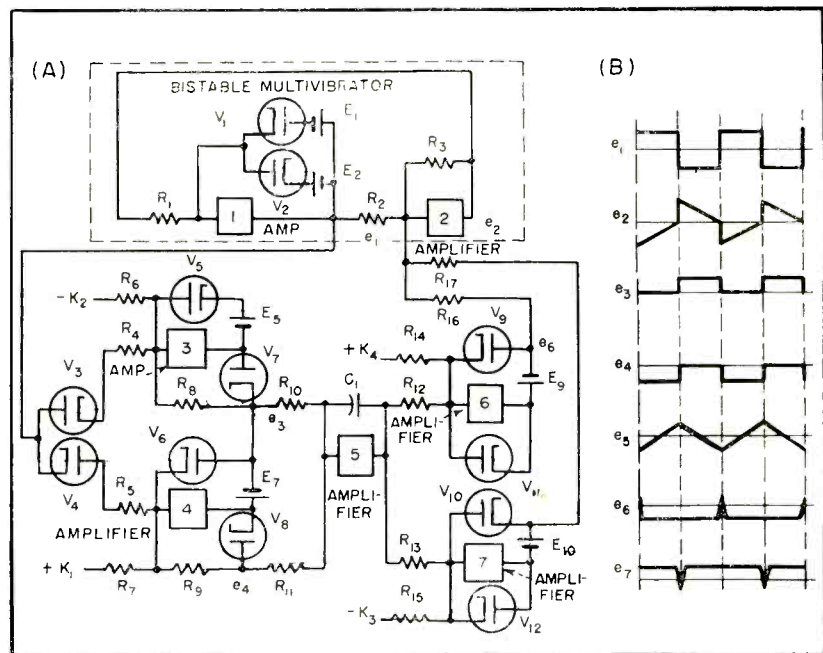

FIG. 8—Precision sweep generator uses ordinary diodes as switches to control idealized diodes

statements such as: the frictional force is equal and opposite to all applied forces as long as the velocity of the block is zero, and until the sum of the applied forces is equal to or greater than some fixed value.

The circuit for solving the double-acting spring problem is

shown in Fig. 11. It is assumed that stiction is equivalent to infinite viscosity, a condition which may be simulated by a short circuit across C_1 for zero velocities. A very close approximation to a short circuit across C_1 is effected by a high-gain negative-feedback path around

amplifier 1 provided by amplifiers 3 and 5. The effective resistance across C_1 is then R_1 divided by the gain through amplifiers 3 and 5. Since this gain may easily be 10,000 or more, the effective resistance across C_1 may be approximately 100 ohms. The error due to this approximation is less than that which would be caused by an amplifier 2 grid current of 10^{-9} ampere.

Spring Problems

When the velocity, \dot{X}_0 , is zero, all diodes are off. As \dot{X}_0 is increased, a point is reached when the output of amplifier 3, which is following \dot{X}_0 , is limited by either V_1 or V_2 . At this point the large damping is removed and the velocity is free to change. A very small change in \dot{X}_0 turns on one diode of each pair. Diodes V_3 and V_4 prevent overload-

ing of amplifier 3. When V_6 or V_7 is on, V_6 and V_7 or V_6 and V_8 are also on, and the limited outputs of amplifiers 3 and 4 provide a steady opposing voltage corresponding to the coulomb friction. Voltage dividers have replaced the batteries used with diodes in previous illustrations.

The input and output functions are also shown in Fig. 11. No motion occurs until the wheel has moved sufficiently far to break static friction. There is overshoot and restoring action due to the spring. The block comes to rest with a small positive force still applied. In this particular example, sliding friction was approximately half static friction.

Figure 12 shows the single-acting spring problem. Amplifier 5 is sensitive only to positive errors. Be-

cause of gating action of amplifier 5, a separate feedback path must be provided for frictional forces. This is accomplished by amplifier 6. Results of this simulation are also shown in Fig. 12. The block moves in spurts and although there is overshoot, there is no restoring action.

Cam Problems

As a second example of the use of diodes in computing circuits, consider the motion of a valve operated by a cam. This problem involves stiffness ratios on the order of 2,000 to 1. The data for this problem were obtained from the HAL engine, well known in the racing engine field. Top speed of this engine is about 4,000 rpm.

Figure 3 illustrates the problem, defines the quantities and lists three

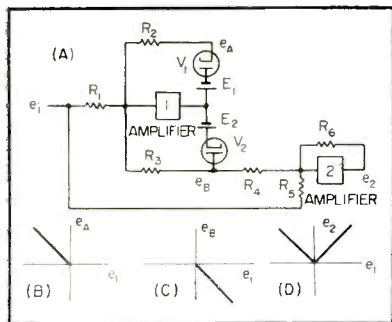

FIG. 9—Idealized diode gives absolute value of variable voltage

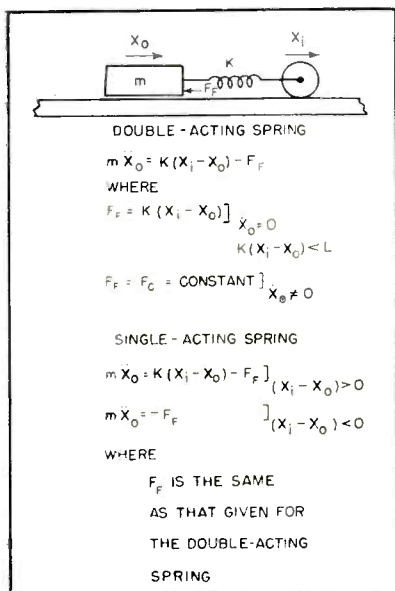

FIG. 10—Problem requiring simulation of static and coulomb friction

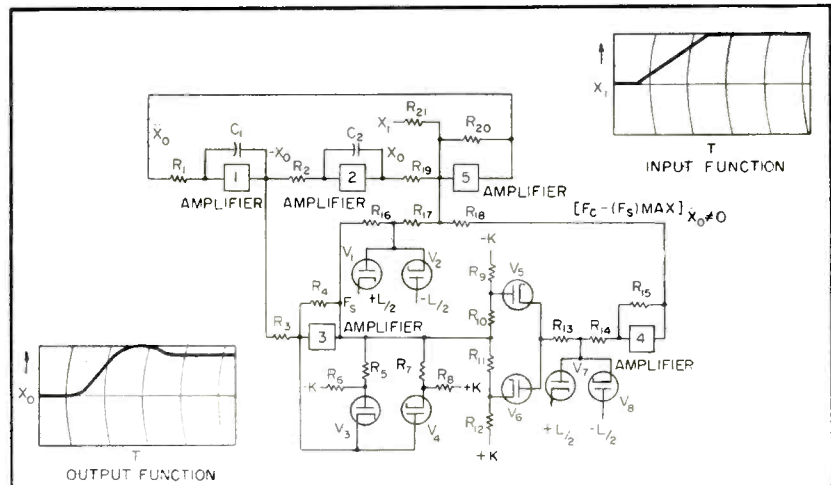

FIG. 11—Solution for case wherein block is accelerated from rest by force applied through double-acting spring

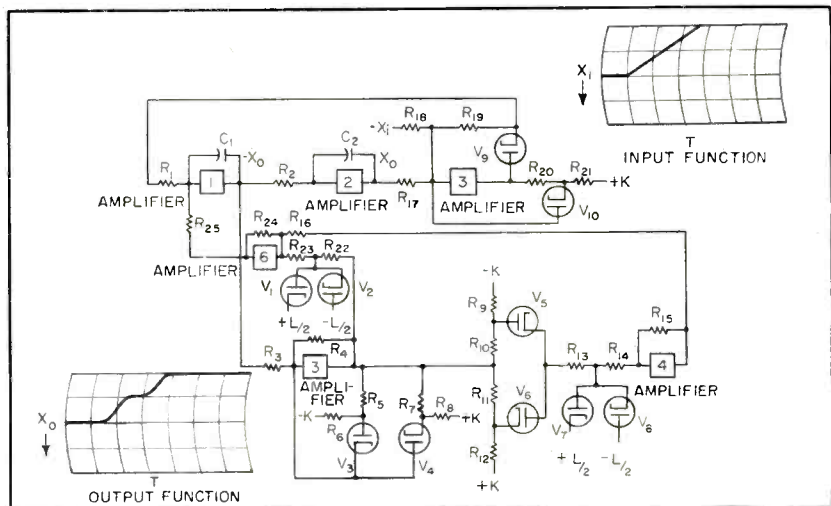

FIG. 12—Solution for case wherein block is accelerated from rest by force applied through single-acting spring

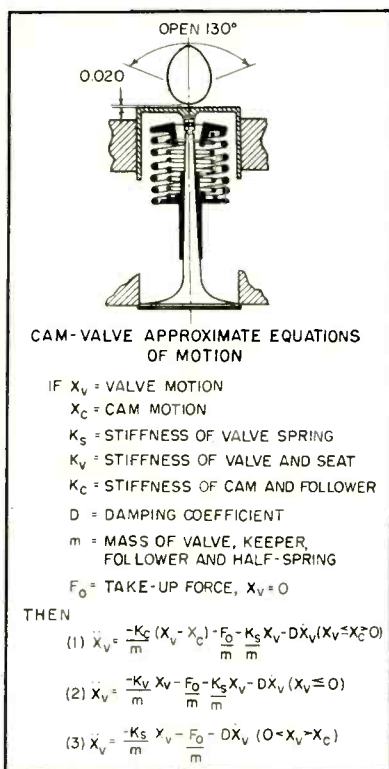

FIG. 13—Problem involving cam-operated engine valve

equations of motion only one of which is valid at any particular instant. When the X -position of the cam is greater than that of the valve, Eq. 1 holds. If the cam follower and cam are not engaged, Eq. 3 holds unless the valve is seated, in which case Eq. 2 holds.

These equations are solved as shown in Fig. 4. Amplifiers 1 and 2 are the two integrators required for solution of second order equations. The terms common to all three equations, those due to the valve-spring, are provided by amplifier 3 and the potentiometer marked F_0 . Cam motion is provided by a function generator. When the magnitude of X_c is greater than that of X_v , the difference is amplified by amplifier 5 and applied to the input of amplifier 1, thus solving Eq. 1. When the valve position is equal to or less than zero, the valve is seated and X_v is amplified by amplifier 4, thus solving Eq. 2. The gains through amplifiers 4 and 5 are high. When neither of the above conditions pertain, both V_1 and V_2 are cut off and Eq. 3 is solved.

Amplifiers 4 and 5 may be replaced by idealized diodes thereby eliminating the need for V_1 and V_2 . This further shows that the more

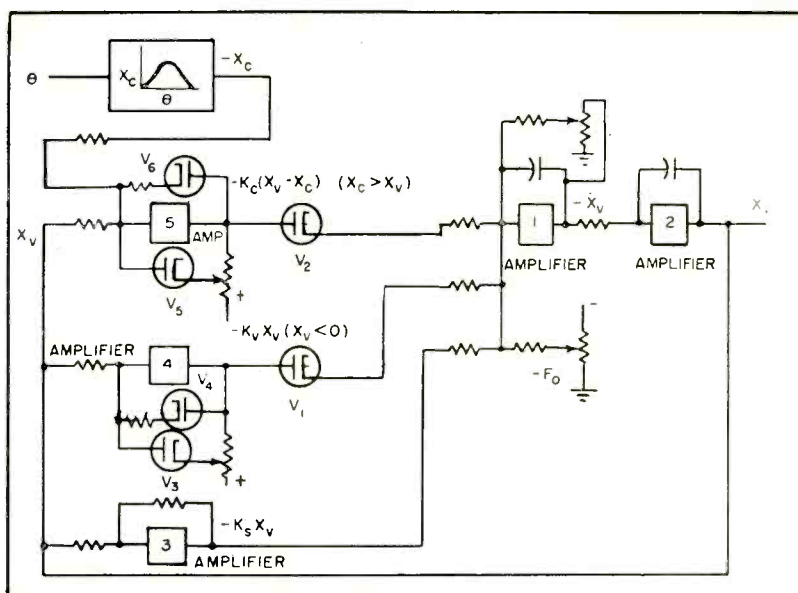

FIG. 14—Solution of cam-operated engine-valve problem using amplifier-diode circuits. Cam motion is provided by function generator

precise method will often be the simpler one.

The results of the cam-valve simulation are shown in Fig. 15. The solid line is a development of the cam surface and is also the path traced by the cam follower and valve. As the speed of the engine is increased, a point is reached beyond which the valve cannot follow the cam. Hammering, override and bounce result as shown by the broken line. Since this was part of a racing engine, it was running near top speed much of the time. It had been observed that the cam showed very little wear on one side and there was evidence of hammering near the peak of the cam. This fact had not previously been explained. Furthermore, valve stems had occasionally broken, due, perhaps, to the final bouncing. In the simulated valve, the bouncing rapidly increased in magnitude as the speed of the engine was raised. Increasing the engine speed by

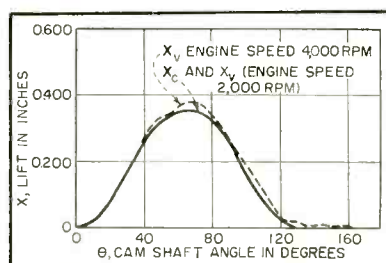

FIG. 15—Results of cam-valve simulation

about 10 percent increased the height of bouncing about 300 percent.

Conclusions

The thermionic diode is a useful circuit element in simulating nonlinear characteristics. Amplifier-diodes may be used to simulate systems characterized by two or more distinct operating regions or conditions separated by abrupt boundaries. They can be made quite accurate and precise. Their speed is at least of an order of magnitude faster than that of corresponding relay circuits and standard stabilized computing amplifiers may be used.

BIBLIOGRAPHY

- J. R. Ragazzini, R. Randall and F. A. Russell, Analysis of Problems in Dynamics by Electronic Circuits, *Proc IRE*, May 1947.
- G. A. Korn, Elements of D-C Analog Computers, *ELECTRONICS*, Apr. 1948.
- G. A. Korn and T. M. Korn, "Electronic Analog Computers", McGraw-Hill Book Co., New York, 1952.
- G. D. McCann et al., Electrical Analogy Methods Applied to Servomechanisms Problems, *Trans AIEE*, p 91, Feb. 1946.
- G. D. McCann and C. H. Wilts, Analysis of Nonlinear Control System with the Analog Computer, *Electronic Eng.*, p 1,104 Nov. 1948.
- G. D. McCann et al., Electronic Techniques Applied to Analog Methods of Computation, *Proc IRE*, p 954, Aug. 1949.
- E. L. Harder and G. D. McCann, A Large-Scale General-Purpose Electric Analog Computer, *AIEE Tech Paper* 48-112, 1948.
- D. Fidelman, Electronic Computer Applications, *Radio-Electronic Eng.*, p 3, March 1949 and p 6, Apr. 1949.
- G. A. Philbrick, Designing Industrial Controllers by Analog, *ELECTRONICS*, p 108, June 1948.
- A. C. Cook and F. J. Maginniss, More Differential Analyzer Applications, *GE Review*, p 14, Aug. 1949.
- E. Lakatos, Problem Solving with the Analog Computer, *Bell Labs Record*, March 1951.

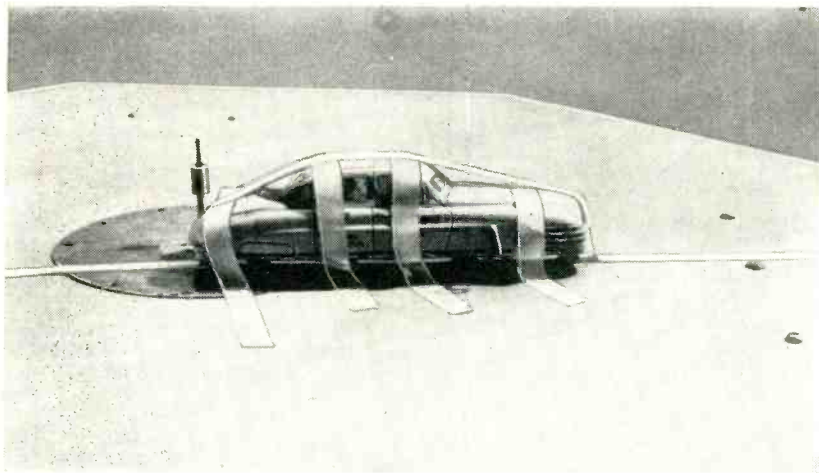

Toy auto provides scaled-down vehicle for antenna measurements using micro-waves to check vhf and uhf systems



Turntable ground plane permits use of stationary measuring equipment

Investigating Antennas For UHF Mobiles

Scale-model test setup using inexpensive toy car mounted on turntable ground plane yields useful information on radiator characteristics for mobile services in present 150-mc band and new 450-mc band

By **EDWARD F. HARRIS**

*Chief Engineer
Mark Products Company
Lincolnwood, Illinois*

WHEN the mobile services were confined to frequencies below 30 megacycles the antenna problem was mainly one of providing enough physical length to obtain a reasonable degree of radiation efficiency. Pattern considerations were secondary and almost nonexistent since there was little choice in the mode of operation.

The move to higher frequencies in the 150-mc region came as the mobile services were about to experience a large expansion and vehicular antennas seem to have evolved from their low-frequency

predecessors to the familiar quarter-wave roof mounted whip. Recently, units such as the bumper mounted coaxial dipole have seen application but so far as is known there has been no real effort to manufacture more useful radiators or even to investigate thoroughly the pattern properties of those in general use with a view toward an evaluation of system efficiency.

450-Mc Mobile

At this time the field is about to experience another expansion to still higher frequencies in the

450-mc region. Early experimenters have carried the old antenna techniques a step further and are employing the quarter-wave whip antenna with fair results. The physical length of this unit is now about 6 inches overall and it becomes apparent that some means of increasing the aperture and thus gain is generally to be desired. The physical length of an 18-inch whip has been well accepted and it is possible that even longer units would not be objectionable from an appearance standpoint.

This paper approaches the an-

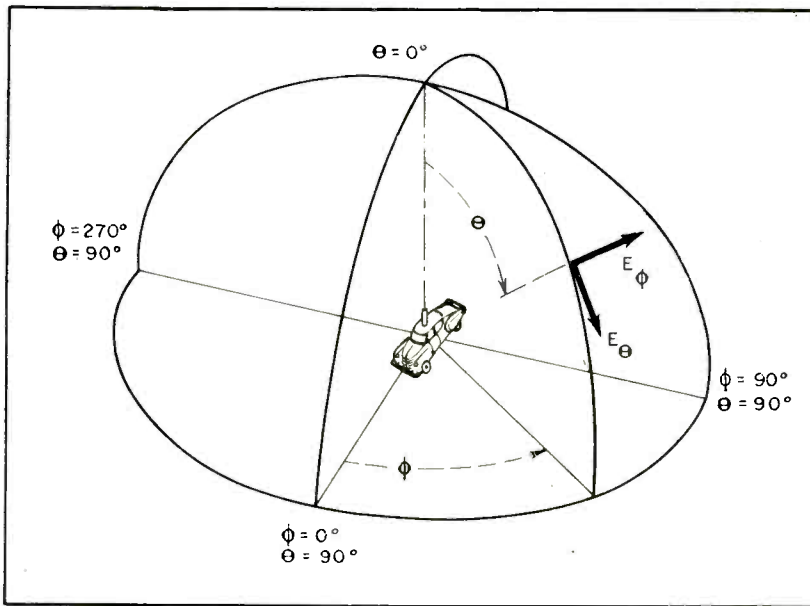

FIG. 1—Vehicle is assumed to be in center of co-ordinate system as shown

tenna problem from the standpoint of an analysis of systems in use today with the thought that an understanding of the properties available at the present state of the art will point the way to avenues of attack in an effort to improve performance. Such antenna design work is now feasible in view of the small wavelengths involved and the opportunities for the antenna engineer to exercise his ingenuity are unlimited.

The problem generally involves vertical polarization exclusively, omniazimuth coverage in general, with land station to mobile unit and mobile unit to mobile unit communications. Figure 1 shows the generalized coordinate system used and the positioning of the mobile unit and antenna within the coordinates.

In considering the primary coverage area of a central station communicating with mobile units, refer to Fig. 2 which shows a simplified flat earth consideration of the path of propagation. Although the direct and reflected ray are to be considered, the important point is that at ranges over a mile, communication via the direct ray takes place within an angle of plus or minus one degree from the horizon.

In a service that requires uni-

form or omniazimuth coverage, the only avenue for the increase in gain is that which narrows the beam width in the vertical or θ -plane. To provide for the analysis of arrays which might produce a narrow vertical pattern, and also illustrate the effects of beam width in the vertical plane upon the gain for the omniazimuth radiator, Fig. 3 has been prepared. A hypothetical radiation pattern has been assumed which is completely omniazimuth in its radiation and furthermore its vertical pattern is uniform between specified limits (θ_1 to θ_2) and then drops off immediately to zero beyond these limits.

This radiator will be termed to

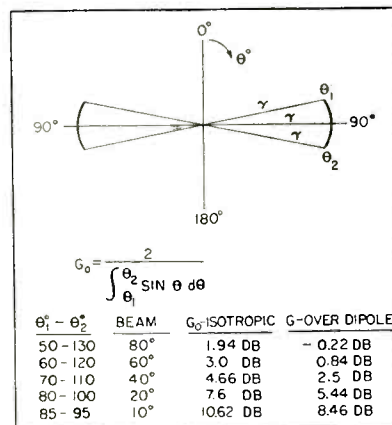

FIG. 3—Gain analysis for hypothetical omniazimuth isovetical radiator

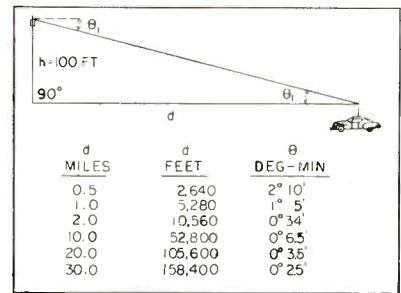

FIG. 2—Over flat earth, most direct-ray communication takes place within one degree of horizon

have an isovetical pattern which is unattainable in practice but is very convenient for analysis. The table in Fig. 3 permits evaluation of the theoretical system gain to be expected under several conditions of reduction in the total vertical beamwidth of the omniazimuth radiator.

From the data shown in Fig. 2 it may be concluded that it is entirely practical and desirable to confine the radiation within 10 degrees or even less. Such a radiation pattern should produce somewhat over 8-db gain over an ideal dipole. In practice an array which produces a 10-degree vertical beam width would not be isovetical by any means and its actual gain must be evaluated by other means. Figure 3 however is an excellent guide in the discussion of system improvements by restriction of vertical radiation.

Scale Models

Radiation patterns of mobile units have been investigated by conventional scale model techniques. The average automobile is about 20 feet long. A scale model auto was obtained at the local dime store, which was 1 foot long or 1/20 the full size. Therefore a scale frequency of 20 times 150 or 3,000 mc was employed (9,000 mc for the 450-mc band) for the model pattern measurements.

The auto was mounted at the center of a large ground plane and both the quarter-wave whip and the rear bumper mounted coaxial dipole were modeled and measured. There are limitations to this technique in that the ground plane is finite and that the conductivity of the ground

has not been modeled perfectly, however, surprisingly good results were obtained. The measurements shown are necessarily a first approach to the problem.

The photographs show the model auto in position on the ground plane and the assembly mounted on the tower for measurements. Figure 4 contains sets of the principal plane patterns for the two cases of the roof-mounted quarter-wave whip antenna and the bumper-mounted coaxial dipole. These are relative patterns in that the relative values of voltage are recorded at each angle. Note that in both cases a large proportion of the radiation is propagated at the higher angles and that a rather small part is in the useful directions as shown in Fig. 2.

Test Results

To reduce the data to an absolute basis so that actual gain figures may be assigned to the patterns it is necessary to take a complete set of integration patterns to show the space distribution of radiation. This has been done for the case of the roof-mounted quarter-wave whip antenna and the set consisting of ϕ patterns taken for ten-degree steps in θ from zero to 90 degrees is shown in Fig. 5. Referring to the $\theta = 90$ degree pattern of Fig. 5, the gain of this pattern varies from 1.1 db above a dipole at the maxi-

imum of the pattern to 6 db below a dipole at the minimum point of the pattern. These figures of gain result from planimeter integrations of the θ pattern areas and the proper numerical summations to reduce the pattern data to absolute values. Due to the high angle radiation and the power lost at these unusable angles, the gain in the $\theta = 90$ degree plane (the azimuth or horizon plane) suffers considerably. The fact that the pattern is not perfectly circular is of secondary importance since there is appreciable radiation in all directions of azimuth. However the fact that the level is down due to the higher angle radiation is a serious

consideration in design.

On the basis of the data presented it is felt that proper design of the mobile-mounted antenna can produce effective gains over presently used systems of the order of 6 to 10 db at those angles which are effective in the communication zone. From past experience it is known that the factors causing high-angle radiation will become more severe at the new 450-mc range than at the 150-mc range studied so that the need for improvement of the vehicular antenna system becomes even more important and the possibilities for improvement proportionately greater.

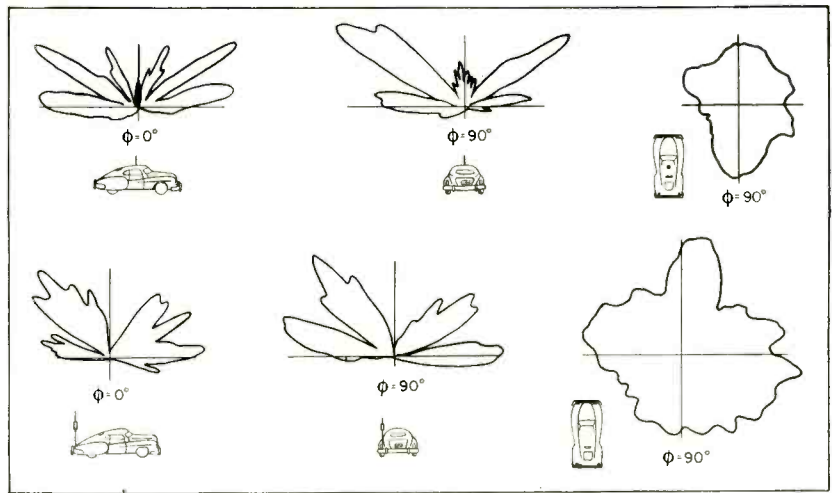

FIG. 4—Typical patterns of roof-top quarter-wave and bumper-mounted coaxial vehicular antennas scaled 20 to 1

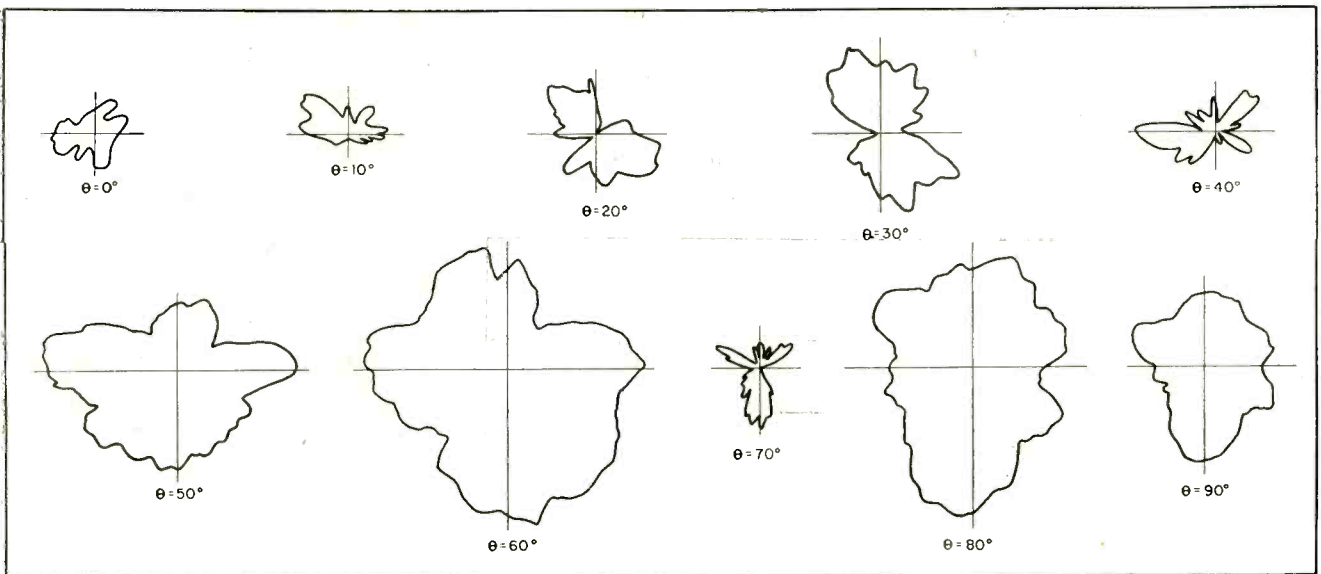

FIG. 5—Typical patterns for roof-top quarter-wave whip at different vertical angles made with scaled system agree closely with measurements on full-size equipment

Industrial Frequency

Locked oscillator-divider synchronized directly with 5-mc carrier from WWV provides inexpensive but accurate source of frequencies for industrial or communications laboratory. System depends upon trf receiver equipped with selective input filter and clipper-limiter to make device independent of noise

SYNCHRONIZED directly by the 5-megacycle carrier received from WWV, Beltsville, Maryland, a novel type of frequency standard has been placed in operation in a laboratory of the General Electric Company at Schenectady. The 5-mc carrier received from WWV is divided to 1 mc by use of a locked-oscillator-divider. The output from this divider is then reduced to lower frequencies by means of conventional multivibrator dividers.

This standard eliminates the necessity of maintaining crystal-frequencies that must be regularly checked and which at best serve as subfrequency standards. The system preserves the original stability obtained by the Bureau of Standards for the 5-mc carrier that is maintained at ± 1 cycle in 10^8 cycles.

During the course of developing this unit, an extended recording of signals from WWV was made. A tuned-radio-frequency receiver with limiter was used in making records. The limited 5-mc, radio-frequency

signal was rectified by a crystal diode and the output fed to a d-c amplifier. A photoelectric recorder was connected in the plate circuit of the d-c amplifier and the gain of the amplifier adjusted until the limited value approached full scale of the recorder. The receiver contained three stages of trf with a three-stage input filter.

Reception Characteristics

The recordings show appreciable signal level over a twenty-four hour period. There are short-period fades around midday and more numerous short-period fades between the hours of 10 p.m. and 5 or 6 a.m. Throughout the working day, however, the signals were substantially up to the limited value.

The antenna used was a 5-mc dipole mounted 30 feet above the roof. The antenna was oriented broadside to Beltsville, Maryland. It was delta-matched to 300-ohm, ribbon-type transmission line.

Since the signal levels were sub-

stantial over normal working hours, it was decided to proceed further with the system. In the development, it was foreseen that it would be desirable to employ limiters to clip approximately 90 percent of the receiver output envelope, thus giving a wide range of age and elimination of unwanted modulation, which in this case consists of the clock ticks, audio tones and voice modulation of WWV.

It will be noted from the block diagram that an audio-frequency branch is taken from the trf output for purposes of aural monitoring and to furnish audio signal service to the various parts of the plant requesting it. This signal does not pass through a limiter.

Owing to the noise level of industrial equipment operating in the plant, a high degree of selectivity is required. For this reason, a selective input filter was carefully designed and matched. Further to increase the selectivity, it was decided to employ a 5-mc crystal filter in the trf amplifier.

Certain fast transients of noise had a tendency to get through to the synchronizing grid of the locked-oscillator-divider at amplitudes higher than the limiting level. This effect seemed to depend upon the time constant of the limiter. It was found, however, that such transients could be greatly attenuated by the insertion of a resistor in series with the coupling capacitor to the synchronizing grid of the locked-oscillator-divider. Practically all momentary loss of synchronization was, by this means, eliminated.

The photograph shows a top view

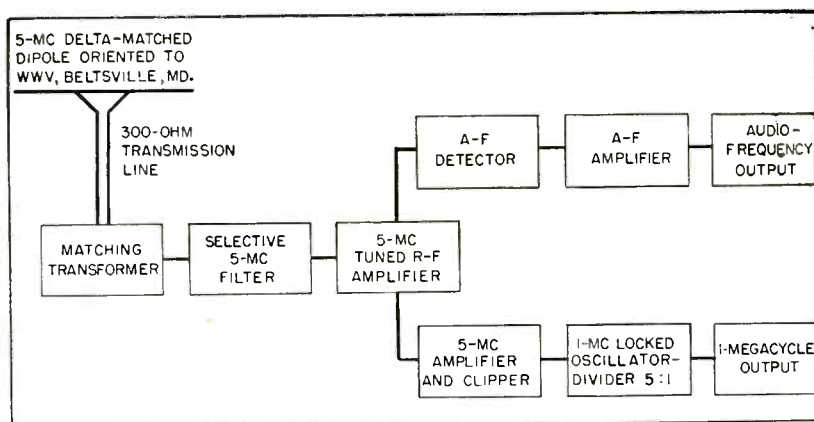

Block diagram of the standard-signal synchronizing system showing audio tone output for general plant use and 1-mc output for further frequency division

Standard

By H. W. KLINE

General Engineering Laboratory
General Electric Co.
Schenectady, N. Y.

of the equipment containing all essentials up to the locked, 1-mc output. Equipment for further division of the 1-mc output is not shown. It consists essentially of conventional multivibrator dividers or multipliers, as desired at lower frequencies. It is practicable to reduce the 1-mc output to 10 kc, multiply by 3 to 30 kc and by a chain of multivibrators divide by 500 to get 60 cycles. This output could be used to operate a clock directly synchronized by WWV.

The standard, including multivibrators providing outputs of 1 mc, 100 and 10 kc or other frequencies, can be built as compactly as the better class of communication receiver and with about equivalent weight.

Synchronization

In normal operation, during instants when the signal-to-noise ratio becomes unfavorable, there are instantaneous losses of synchronization that do not seriously interfere with employing the output for accurate frequency measurements. Such periods would affect the operation of a clock, however, and where clock operation is the end result desired, antenna equipment should be erected in quiet zones and where sufficient signal level is available.

It is also possible to multiply directly the 5 or 1-mc outputs of the unit to higher frequencies for use in calibrating microwave equipment throughout the spectrum.

Another application of the system when good signals from WWV are obtained could be in the direct control of transmitting stations by

means of the emissions direct from WWV. For example, radio broadcast station WGY transmits on a carrier frequency of 810 kc. The 10-kc output of a synchronized frequency standard could be reasonably multiplied by 81 to produce 810 kilocycles for directly regulating the transmitter frequency.

In practice, a receiver, with bfo tuned to 1 megacycle, is used to pick up the 1-mc signal from the locked-oscillator-divider. Synchronization is observed by slowly varying the frequency of the oscillator within a small audio tolerance. When synchronous frequency is attained, the oscillator abruptly falls into step giving a constant beat note over part of its vernier scale.

A further test of synchronization can be obtained by disconnecting the antenna line. The first oscillator then operates unsynchronized and a change in beat-note is observed at the receiver. Further observations have been made employing a 1-mc commercial frequency standard. The frequency beats between the commercial standard and the synchronized oscillator of the standard could be reduced to zero only by extremely careful tuning of the zero-set of the commercial standard. It was found that adequate stability in standards of this type was not

reached until after more than two hours of continuous run. This disadvantage is not present in the synchronized frequency standard.

Limits of Usefulness

Certain limitations of this system should be pointed out. Reliability of operation depends upon adequate signal strength being obtained from WWV. Thus, it should not be installed until it is known for certain that the signal intensity will be sufficient. Furthermore, reliability depends upon freedom from interfering signals of injurious strength in the 5-mc channel used for the frequency standard emissions. One of the major problems involved in the design of the input filter to this equipment was the elimination of broad interference from experimental telephone signals on an adjacent channel.

The major problem is, of course, to obtain that degree of selectivity necessary to produce a favorable signal-to-noise ratio owing to the level of industrial plant noise. However, the system has been installed to operate under probably the most adverse conditions that would be encountered. The most favorable conditions would be in isolated regions using an antenna of good directional characteristics and possibly diversity pick-ups.

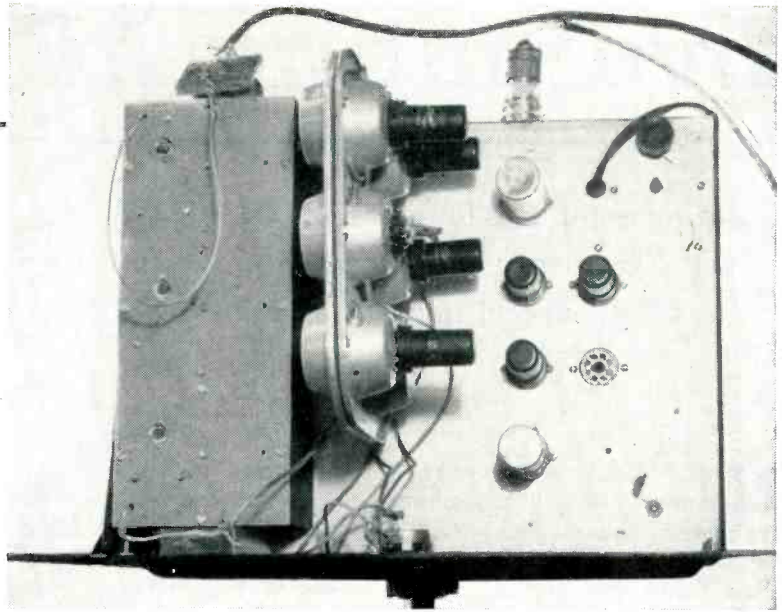

Top view of model synchronized standard with three-stage filter at left, receiver in center and locked oscillator-clipper components at right

Evaluating AFC Systems

Measuring techniques for obtaining useful performance data on various types of horizontal automatic frequency control systems. Resulting curves and values facilitate comparison of system and improve evaluation of design changes in a given receiver

WITH the increased desire to improve fringe-area performance and to decrease the cost of a television receiver, it has become increasingly important to the designer to be able to evaluate quantitatively the operation of a receiver's individual circuits. This paper presents some essential characteristics of a horizontal afc system and a means to measure and examine them.

Typical System

A block diagram of an afc system is shown in Fig. 1. It represents a conventional system in which the relative time of occurrence of the incoming sync-signal information T_1 is compared to the relative time of occurrence of the system's output T_2 and applied to a phase detector. The phase detector output is a d-c voltage E , which is proportional to the relative difference T_d in time of occurrence of T_1 and T_2 . The voltage E controls the frequency of the local oscillator and under proper operating conditions locks it to the incoming sync-signal frequency.

The low-pass filter serves to integrate out horizontal sync pulses and noise, and thereby improve the system's noise immunity. Balanced phase detector operation, in which the sync pulses and associated noise tend to cancel out, will make further improvement in noise response.

The phase detector characteristic θ is the change in the d-c output voltage E due to a change in the relative time difference T_d between local oscillator and transmitter. The value of $\theta = dE/dT_d$ may be measured in volts per microsecond.

The video amplifier, sync clippers and horizontal output circuits will

alter the relative time of occurrence of picture-to-sweep information by adding a constant though different time delay to each. However, the change in time delay, with the small frequency changes (15,750 cps \pm 5 percent) that are involved, will be very small for all the circuits except the afc and therefore may be neglected.

The value of T_d may be measured as the difference in relative time of occurrence of two events, the sync-signal information at any point before the afc circuit and the sweep information at any point after the afc circuit.

The static time delay T_s may be defined as the relative time difference of the sync-signal information at the cathode-ray tube and the sync-signal information at the input to the afc system. It is well to keep this value small, for the afc system must compensate for it to keep the picture information properly phased in the raster.

The local oscillator characteristic β may be defined as the change in the local oscillator frequency due to a change in the phase detector output voltage E . The value of $\beta = df/dE$ may be expressed in cps per volt.

The overall transfer function α

may be defined as the change in the local oscillator frequency f due to a change in T_d . The value of $\alpha = df/dT_d$ may be expressed in cps per microsecond. It is the product of the oscillator characteristic and the phase detector characteristic, hence

$$\alpha = \beta \theta = \left(\frac{df}{dE} \right) \left(\frac{dE}{dT_d} \right) = \frac{df}{dT_d}$$

The concept of α , β and θ may be used only when the local oscillator is in synchronism with the transmitter. They represent the steady-state characteristics of the system.

Picture Phasing

Some idea of the values of α necessary may be gotten by a simple calculation. Assuming that the maximum return time of the horizontal trace is 8.5 microseconds and the transmitted sync-signal has minimum allowable horizontal blanking of 10.15 microseconds as recommended by the Federal Communications Commission,¹ the amount of picture phasing allowable is 1.65 microseconds. Since the FCC does not specify the allowed horizontal sync-signal frequency tolerances, the recommendations of \pm 1 percent by the RTMA Studio Facilities Subcommittee² may be used. There-

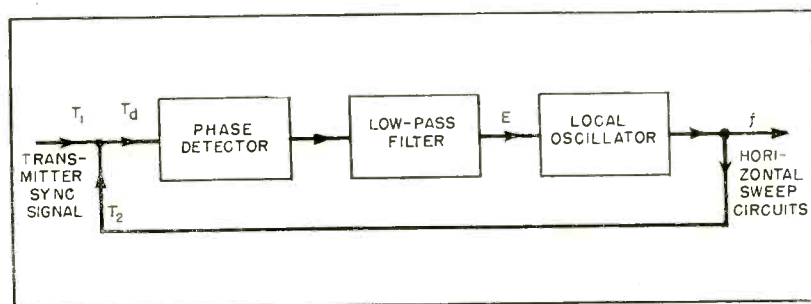

FIG. 1—Block diagram of typical afc circuit used in television receivers

for Television Receivers

By **GEORGE HOWITT**

Television Receiver Division
Allen B. DuMont Labs., Inc.
E. Paterson, N. J.

fore the value of α necessary to produce no picture foldover is 191 cps per microsecond. If it is desired to restrict the amount of phasing to a $\frac{1}{16}$ -inch shift on a 21-inch cathode-ray tube, α must be approximately 1,700 cps per microsecond.

The above values assume no attempted change in local oscillator frequency. When changes in the oscillator try to take place, due to temperature, voltage, humidity or time effects, the value of α must be increased. It is possible to lower the value of α required, by either allowing foldover to occur and applying a pulse to the cathode-ray tube to blank it out or by using a front-panel horizontal hold control.

Typical values of α used in the field are approximately 100 cps per microsecond for the Synchro-guide type of afc, 200 cps per microsecond for the balanced phase detector-multivibrator type of afc and 700 cps per microsecond for the sine-wave oscillator-reactance tube type of afc.

Lock-in Range

The lock-in range may be defined as the difference between the maximum and minimum frequency that the system will always synchronize to from the nonsynchronized state. The value of the lock-in range required depends on the amount of change of transmitter sync-signal frequency allowed and the amount of local oscillator drift due to the causes listed above. Ideally, the lock-in range should allow the system to synchronize over the full range of expected frequency variations. However, it is possible to reduce the amount of lock-in range required by using a front-panel hold control.

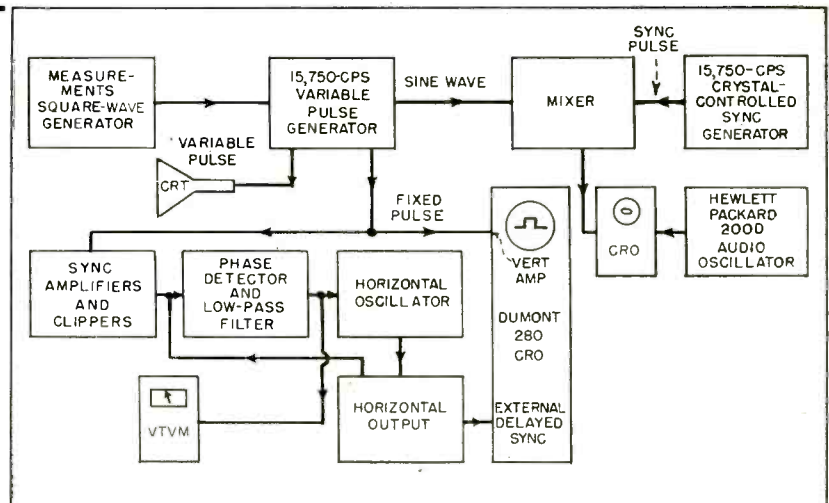

FIG. 2—Arrangement of equipment for measuring performance of afc systems

If the lock-in range is greater than the ± 1 percent transmitter frequency stability recommendation plus the expected local oscillator drifts, and if the transfer function α is great enough to prevent foldover from occurring during the lock-in range, then a horizontal hold control that is readily available to the customer is not necessary.

If sufficient lock-in range is available, but the α of the system is low enough so that foldover can occur within the lock-in range, then a front-panel hold control is necessary. The system need not drop out of synchronization for any setting of this control and it is essentially a phase correction control.

However, if sufficient lock-in range is not available, then it is necessary that the system go out of synchronization for some setting of the front-panel hold control range if proper operation of the receiver is to be expected without service adjustments.

In addition, a front-panel hold control will allow the consumer to minimize horizontal shape distortions due to field frequency components or other frequency transients in the input sync-signal wave-form.

The following range may be defined as the difference between the

maximum and minimum frequency at which the system will remain in synchronism, starting from a synchronized state. The ratio of the following range to lock-in range will give an indication of the relative noise immunity of the system as compared with other systems of the same type. The low-pass filter must pass some information at the difference frequency between the received horizontal frequency and the local oscillator frequency for the system to be brought into synchronism. The higher the cutoff frequency of the filter, the closer the lock-in range will approach the following range. However, with a high cutoff frequency, the filter will pass more noise components and consequently the noise immunity of the system will be poorer.

Noise Response

The response of the low-pass filter is only one factor affecting the noise response of the system. The ratio of the time interval during which the incoming transmitter signal has an effect on the circuit, to the total period and any balancing effects such as occur in bilateral type phase comparators will influence the noise immunity of the afc system. The effects of noise are usually evaluated by subjective tests, generally involving compari-

tained by measuring the maximum and minimum frequency at which the system falls into lock. These points are indicated on the graph for both the clockwise and counterclockwise settings of the hold control.

The relative voltage output ΔV from the low-pass filter is shown as zero when $\Delta f = 0$. This is done for simplicity of plotting. Actual values of the voltage E at the output from the filter, when the incoming frequency is 15,750 cps, are approximately 0 volt for balanced phase detectors and in the order of 50 volts for unilateral phase detectors such as are used in the Synchro-guide.

When Δf vs ΔV is plotted as in curve C of Fig. 4, the slope of this curve at any point is the oscillator characteristic β at that point. The phase detector characteristic θ may be gotten at any point by dividing the α of the point by the β of the point.

The static time delay T_s may be obtained by measuring the time difference, at any locked-in frequency, between the sync-signal at the input to the afc system and the fly-back pulse, then getting the same data for the sync-signal at the cathode-ray tube and the flyback pulse and taking the difference between these measurements.

Since the horizontal blanking interval and the horizontal retrace time are known, the amount of phase shift without foldover occurring may be indicated on the graph in Fig. 4. For this example, as was calculated above, the value is 1.65 microseconds. This afc system will be able to lock-in to a maximum sync-signal frequency of $\Delta f = +500$ cps and a minimum sync-signal frequency of $\Delta f = -600$ cps. A picture without fold-over can be obtained, by adjustment of the hold control, from a maximum frequency of $\Delta f = +310$ cps and to a minimum frequency of $\Delta f = -320$ cps.

Performance Data

Figure 5 shows the values of α , β and θ , for the curves of Fig. 4, plotted against Δf . The maximum value of α within the lock-in range occurs at $\Delta f = -600$ cps and is 145 cps per microsecond for the hold control full counterclockwise.

For the hold control full clockwise, the corresponding values are $\Delta f = +100$ cps and $\alpha = 113$ cps per microsecond. The maximum value of the oscillator characteristic β within the lock-in range occurs at $\Delta f = -600$ cps and is 222 cps per volt. The phase detector characteristic is a constant over the frequency range covered. This is generally true of the typical afc systems now in use. Its value in this case is 0.666 volt per microsecond.

An increase in transmitter sync-signal frequency corresponds to an attempted decrease in local oscillator frequency and vice versa, so that these curves may be used to find the effect of a frequency change at either location or both. The direction moved along the curve with a given change in incoming frequency is the same direction that the picture information on the face

of the cathode-ray tube will phase.

To check the transient response of the system, the reactance tube in the pulse generator is modulated at a 20-cps rate with a square wave of sufficient amplitude to give a total frequency deviation of 100 cps. The phase displacements are viewed on the face of the cathode-ray tube as shown at the upper right in Fig. 6A. These displacements may be converted into time when the sweep width and sweep time are known, and may be plotted as in Fig. 6. The transient lock-in point is the point at which the maximum phase excursion, with a given square wave of frequency modulation, remains in synchronism. This point is found by varying the front-panel hold control.

AFC Systems

Figure 6A is typical of a unilateral sync-signal input afc system such as the Synchro-guide. It is not possible to balance the phase excursions under any conditions. This means that abrupt changes of sync-signal frequency in one direction will always have a much greater effect than changes in the other direction.

Figure 6B is typical of a bilateral sync-signal input afc system such as the balanced phase detector-multivibrator type. In this case it is possible to get phase excursions that are balanced or unbalanced, depending on the setting of the hold control and the incoming sync-signal frequency.

Complete correlation between some of the characteristics, particularly transient response, and some types of field conditions has not yet been achieved. Additional work still needs to be done.

The author is indebted to E. Campbell of the Allen B. DuMont Laboratories for his constructive criticism and his continued interest, and to A. Bissonette, also of the Allen B. DuMont Laboratories, who obtained the necessary data involved in the experimental work.

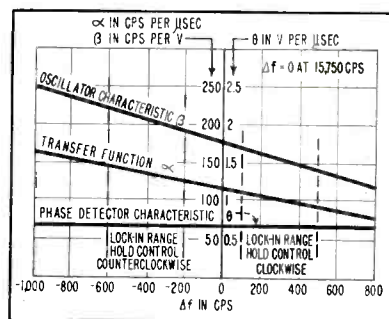

FIG. 5—Curves obtained by plotting frequency change against values obtained from curves of Fig. 4

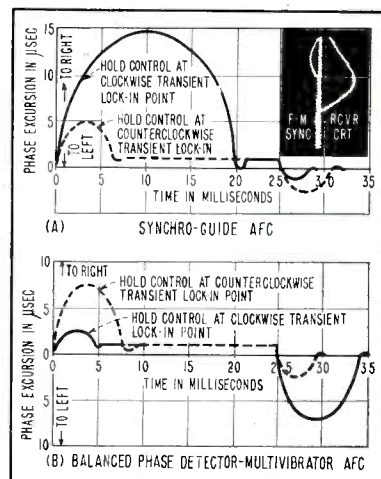

FIG. 6—Transient response of two types of afc systems to 100 cps total deviation at a 20-cps modulating frequency. Oscillogram at upper right shows phase displacement due to square-wave frequency modulation of the sync signal

REFERENCES

- (1) Federal Communications Commission, "Standards of Good Engineering Practice Concerning Television Stations".
- (2) RTMA Engineering Department, "Draft of Electrical Performance Standards for Television Studio Facilities."

Ratio Meter Measures

Measurements may be made directly and continuously while making adjustments in the line with system employing two electronic voltmeters, a conventional ratio meter movement and two directional couplers

THE RATIO meter described consists of two vacuum-tube amplifier-voltmeter channels working into a ratio meter movement. The meter deflection depends solely on the ratio of the full rectified average values of the channel signals. In addition, the individual signals can be determined when desired by a voltmeter inserted in either channel. Attenuators in each channel adjust the signal level and at the same time extend the instrument's range.

A particularly interesting application of the instrument is for reflection-coefficient measurements on high-frequency transmission systems. The meter indication can be calibrated in reflection coefficient or voltage standing wave ratio, as desired.

Meter Movement

The ratio meter movement as a d-c indicating instrument, has found noteworthy applications as a stretch indicator and as a temperature indicator.

Two versions of the meter movement are commercially available. Figure 1 indicates schematically their operating principles. The nonuniform air-gap instrument¹ has two coils rigidly connected together and free to rotate about the inner core axis. By keeping the spring restoring forces at a minimum, the coil currents I_A and I_B will produce torques which tend to move the coils to an air-gap position where the torques balance. At an equilibrium position torque side $A =$ torque side B and

$$KI_A\Phi_A = KI_B\Phi_B$$

The coils will move to an air-gap position where

$$\Phi_A/\Phi_B = I_B/I_A$$

The deflection characteristic and sensitivity depend on the air-gap flux distribution. In a recent variation of this type of movement, the air gap is kept constant while the axial length of the pole pieces² is varied. In the Edison meter, as shown in Fig. 1, two orthogonal fields will produce a resultant field which is in the direction

$$\theta = \tan^{-1} \Phi_B/\Phi_A$$

The small magnet attached to the pointer will orient itself in the direction of the resultant field. In the actual movement, the field coils are wound so that one encloses the other. Individual coil connections allow for an improved driving circuit. The maximum sensitivity is fixed by the field-coil positions and the deflection follows an arc-tangent function. This Edison movement is employed in the described instrument.

A complete circuit diagram of the electronic ratio meter is shown in

Fig. 2. Each channel consists of a pentode voltage amplifier driving a triode power amplifier. The full rectified signal current passes through the movement coil and is returned to the input of the amplifier for overall feedback. With this circuit arrangement the crystal nonlinearities are minimized and the meter is driven by a virtual constant-current source.

Without feedback, the overall circuit can be thought of as having a transconductance of

$$g_{m0} = A_o g_m$$

where A_o is the gain of the first stage and g_m is the output triode's transconductance.

Feedback results in a transconductance

$$g_{mf} = \frac{g_{m0}}{1 + g_{m0}R_f}$$

where g_{mf} is the channel transconductance with feedback and R_f is the feedback resistor. This equivalent transconductance, with 20 db



Front-panel view of the experimental model of the ratio meter. Meter indication may be calibrated in reflection coefficient or vswr

Reflection Coefficient

By L. A. ROSENTHAL, J. L. POTTER and G. M. BADOYANNIS

Department of Electrical Engineering
Rutgers University
New Brunswick, N. J.

of feedback, is insensitive to tube aging and supply voltage variations and is not affected by crystal nonlinearities. The experimentally measured value of g_{mf} was 0.126 mhos; 100 millivolts at the input would cause 12.6 ma of a-c feedback current. The average value of this current (assuming a sine-wave signal) is obtained by multiplying by the factor $2\sqrt{2}/\pi$.

Coil-Current Level

The ratio meter movement requires a coil-current level of at least one ma for accurate readings. This value of current is sufficient to overcome the meter's asymmetry due to spring restoring forces and stray fields. The 5687 output tube is designed to pass a quiescent current of 37 ma. This corresponds to 26 rms ma of feedback current and 23.5 d-c ma of coil current at the clipping level, an input signal level of 0.187 volts.

The clipping level can vary with

potential variations but is nearly twice the nominal full-scale sensitivity of 100 mv. For sinusoidal input signals the direct current is related to the rms input signal by

$$i = 0.113 e_s$$

and 10 millivolts represents a minimum signal level for accurate meter indications. Further channel amplification and reduction of the feedback factor will result in higher sensitivities with the same accuracy and stability.

To equate channel gains, the feedback resistors R_F are adjustable by means of the 50-ohm potentiometer which simultaneously increases R_F for one channel as R_F for the other channel is decreased. Each channel current is measured by means of a pair of matched precision resistors R_v . A 0 to 150- μ a meter, connected as a voltmeter, is placed across this resistor in either channel, and the meter calibration is adjusted to correspond to the

values 0 to 150 millivolts at input.

A variable resistor is placed across the inner coil of the ratio meter movement. The inner coil has a slightly stronger field than the outer coil and some of the current must be by-passed for zero scale calibration. The three adjustments described are located at the rear of the ratio meter chassis. To adjust the instrument, the same signal is fed into both channels. The feedback resistor is then set to give the same voltmeter reading (channel current) in each position. With equal channel currents, the ratio-meter indication should be zero at center scale and can be so adjusted by the coil-current shunt. The voltmeter can be calibrated by knowing the input signal level.

The input attenuator is a potentiometer type of 100,000 ohms impedance. Signals can be attenuated by a factor of 1/10, 1/100, 1/1,000 or the voltmeter reading must be multiplied by a factor of 10, 100

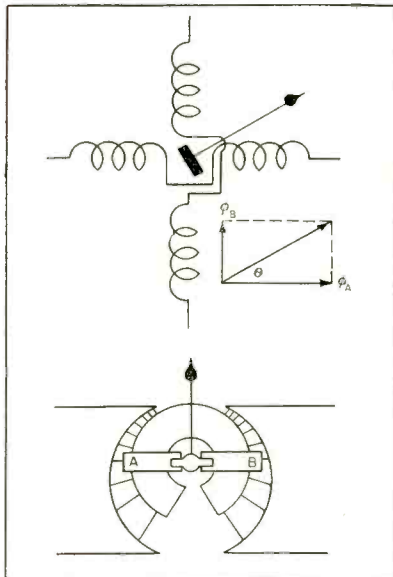

FIG. 1—Edison (upper) and Weston (lower) ratio meter movements

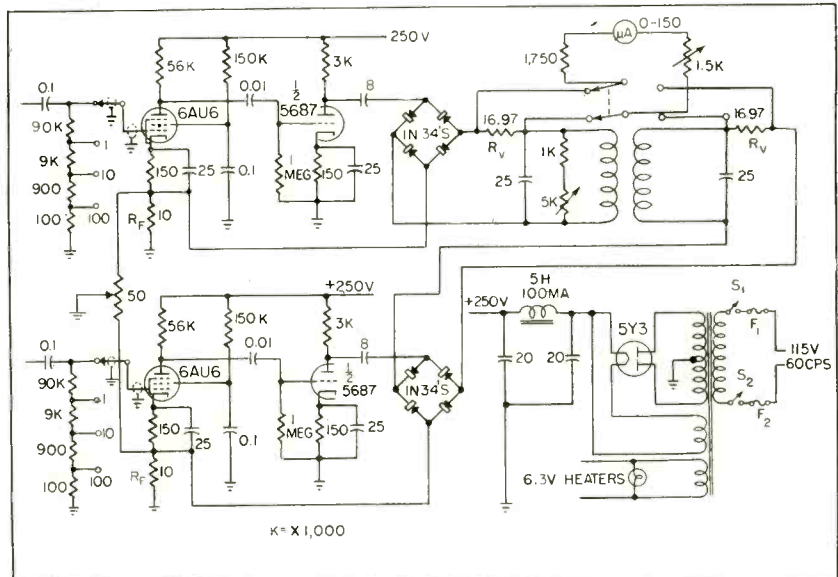

FIG. 2—Complete circuit diagram of the electronic ratio meter. Each channel consists of a 6AU6 voltage amplifier driving a 5687 power amplifier

or 1,000 for the individual voltage measurements.

The voltmeter serves two important functions. Besides measuring the individual channel voltages, it indicates the channel current level. As long as the voltmeter reads above 10 mv and is on scale, the ratio-meter coil current is above the one-ma level and below the amplifier's clipping level. The circuit power supply is conventional and capable of supplying 90 ma at 300 volts.

Performance Characteristics

The Edison ratio-meter movement had been intended for temperature measurements and is calibrated symmetrically from -50 to +50 with the center of the scale marked 0. A calibration curve of meter reading versus coil-current ratio is shown in Fig. 3 and the meter can accommodate a ratio of 0.16/1 to 5.5/1. There is a slight asymmetry due to stray magnetic fields. In the vicinity of the center, the scale is linear to ± 7.5 db (scale reading ± 30) and the extremities of the scale correspond to ± 15 db.

Frequency response of each channel is down by one db at 40 and 200,000 cps. The input attenuator may slightly alter this response characteristic at the high-frequency end. These effects are not significant at frequencies under 100 kc.

Moderate line-voltage variations have little effect on the voltmeter indication and no effect on the ratio indication. Changing the line voltage from 100 to 130 volts resulted in a three-percent voltmeter error while the ratio meter error was not measurable. The meter is readable to one percent at center scale and is slightly poorer at the ends of the scale. Since in all cases the -50 to +50 scale will be recalibrated into other units, the final accuracy is controllable.

Minimum Level

Signal amplitudes must be above a certain minimum level. Whereas a 100-mv signal applied to both channels will result in a ratio indication of 1.00, reducing the level to 10 mv will introduce an error of 5 percent (0.95). The error decreases rapidly above 10-mv levels

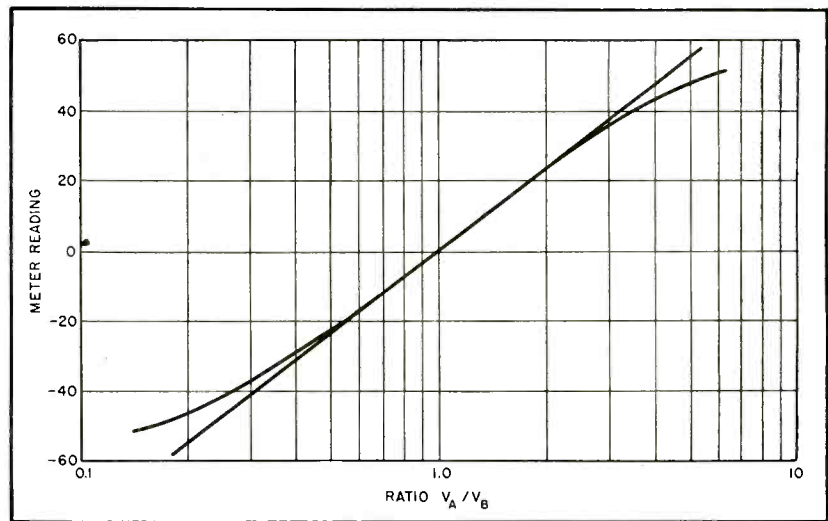

FIG. 3—Basic meter calibration curve

and 20 mv results in an error of two percent (0.98).

To extend the usefulness of the instrument to d-c applications, the accessory shown in Fig. 4 converts d-c to a-c signals. The signal at A is periodically shorted to ground at A' by means of the 60-cps contact modulator. The d-c component of the signal is lost in passing through the high-pass filter on to A". Waveforms are shown in Fig. 4. The same operation is repeated in channel B, 180 deg out of phase. The signals at A" and B" are directly proportional to the A and B

input signals and can be applied directly to the ratio meter.

Reflection Coefficients

A specific application of the electronic ratio meter is the measurement of reflection coefficient or vswr. A block diagram of the method is shown in Fig. 5. The impedance to be examined terminates a Federal Impedometer[®] (bi-directional coupler), driven by a General Radio r-f oscillator that can be amplitude modulated. Two signals that are proportional to the incident and reflected waves are obtained from the coupler, passed on to peak rectifiers and then sent into the ratio meter. It is the modulation components of the incident and reflected signals that are compared.

As shown in Fig. 6, an r-f signal with a particular modulation can yield different outputs depending on the detection efficiencies. The curves shown relate output voltage as a function of r-f amplitude. Differences in slopes M_1 and M_2 can be equalized in the ratio meter by adjusting the channel gains. It is desirable that these detection characteristics be as linear as possible.

In Fig. 7, a method of linearizing the detectors is shown. The peak rectifier will be most linear when the load resistance is large compared to the crystal resistance. Three curves taken for various loads indicate this fact. As the load resistance increases, the output current decreases while the output voltage is nearly constant.

Since the ratio meter has a high

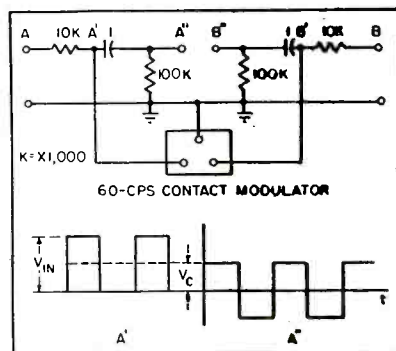

FIG. 4—The d-c to a-c converter and resulting waveforms extend the usefulness of the instrument to d-c measurements

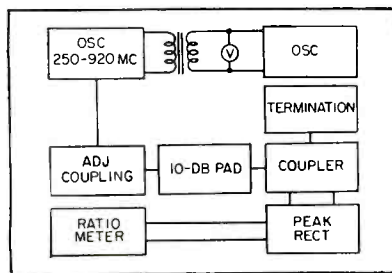

FIG. 5—Block diagram of the experimental setup for reflection-coefficient measurements

input impedance, large load resistances can be tolerated. The highest resistance produces the most linear detector but the improvement is slight because the crystal resistance can vary through wide limits as the input voltage varies from 0 to 0.1 volts. A load of 10,000 ohms was found to be convenient.

Modulation of the r-f source may not be necessary if the signal level is sufficiently large to minimize crystal nonlinearities. In this case, the signal can be peak-rectified and then passed through the described d-c to a-c converter. In all cases, loads presenting a reflection coefficient close to zero are bound to produce errors since the reflected signal may operate the crystal in its nonlinear region.

For greatest accuracy, it is desirable to keep the power level sufficiently high so that the crystal voltages are not less than 0.1 volt in average amplitude. If the crystal nonlinearities are predictable and, for example, are square law, the scale can be recalibrated with some loss in accuracy.

To evaluate the technique, a series of loads was made by mounting small half-watt resistors coaxially in a type-N connector with the end of the fitting short-circuited. The vswr for each of these loads was first measured on a slotted line. It was observed that resistors above the characteristic impedance of the line appeared partly reactive (capacitive) and resistors below the characteristic impedance were resistive but measured larger than the d-c resistance. At one extreme

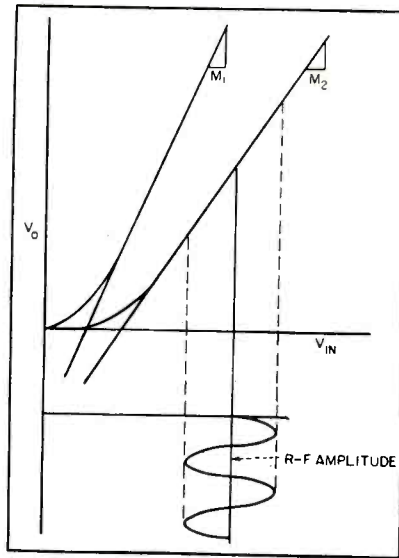

FIG. 6—Indication of the problem of demodulation efficiency and linearity

the mounting throws capacitance across the load and at the other extreme the short circuit losses become apparent. These loads were then measured as shown in the circuit of Fig. 5, and the results obtained are given in Table I.

The theoretical vswr is based on a pure resistance termination equal to that of the resistor value. Slotted-line results compare very favorably with those of the ratio meter. It was observed in setting up the apparatus that the Impedometer can be terminated better in an open circuit than short circuit. Results were more accurate when based on an open-circuit presetting. With no load on the bidirectional coupler, the reflection coefficient should be unity and the ratio meter should read zero, Fig. 3. This adjustment was made by setting the channels'

feedback resistors R_p to equalize any differences in the coupling coefficients and in the detection efficiencies.

It is practical to calibrate the ratio meter directly in vswr. By attenuating the incident signal, the center-scale position, which corresponds to a ratio of unity or infinite vswr, can be shifted off scale to the meter's right. Small vswr values would be located at the left. Since the meters full-scale ratio is fixed at about 35 to 1, the vswr scale limits are fixed. A convenient range can be readily found for the vswr readings of interest and this range is selected by the proper attenuation of the incident signal. A typical set of scales chosen for one application are 1.02 to 1.3 and 1.13 to 10.0, using the region from -40 to $+40$. Best resolution is obtained for small vswr values.

Application of the ratio meter to vswr measurements is practical for cases where termination adjustments are to be made on a transmission system. When permanently installed in the line, it offers a continuous performance monitor.

The authors wish to thank the Rome Air Development Center, Griffiss Air Force Base, who sponsored this work under contract AF28 (099)-33.

REFERENCES

- (1) "Electrical Aircraft Instruments," Weston Electrical Instrument Co. Publication, p 33.
- (2) E. W. Clark, A Ratio Instrument for Resistance Thermometers, *Elec. Engr.*, p 406, May 1952.
- (3) B. Parzen, Impedance Measurements with Directional Couplers and Supplementary Voltage Probe, *Proc. IRE*, 37, p 1,208, Oct. 1949.

Table I—Standing Wave Ratios for Varying Loads

Load in ohms	Theoretical vswr	Slotted-Line vswr	Ratio Meter vswr
10	5.2	3.95	3.90
18	2.88	2.91	2.88
27	1.92	1.90	1.96
100	1.93	2.04	2.01
150	2.88	2.76	2.67
220	4.23	3.46	3.45
330	6.35	5.20	5.25

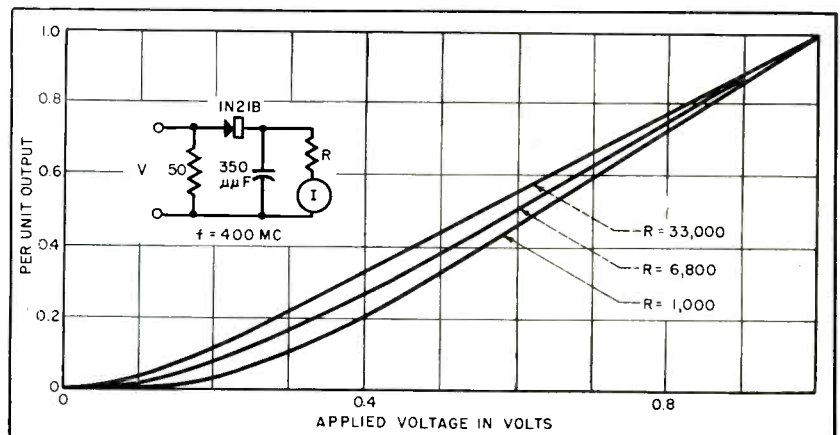
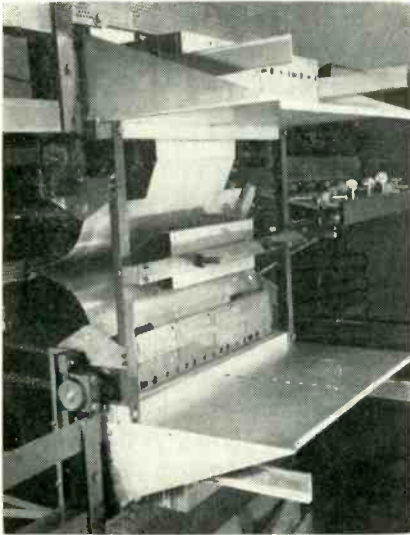
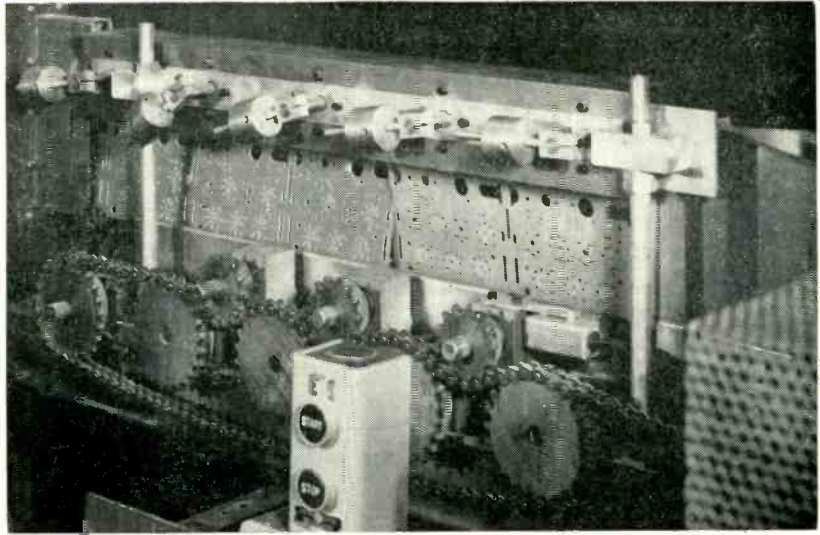

FIG. 7—Linearity can be improved by increasing load resistance. The curves have been normalized to indicate the improvement

Printed Circuits for



Starting point of nearly automatic plated circuit production line is machine that forms strips containing several bases



Strips proceed into processing where partial punching of holes and edges to be left unplated is achieved. Extreme accuracy in mechanical positioning is of paramount importance in the system

ALL METHODS of printing electronic circuits depend upon some means of delineating the conductor areas on an insulator. The method to be described uses a plating process (called "Pla-cir") that offers several advantages by providing through-hole metal.

In this process, foil-thickness copper is electroplated on the insulating base where conductors are desired and concurrently on the walls of previously punched holes through the base. Circuits are continuous from hole to hole, and through holes to the other side for further extensions of the circuits or to component tie points. Component leads are preformed to match hole separations. The resulting accurate mechanical placement of parts permits the use of machine soldering with its attendant advantages.

Circuit Design

Careful circuit layout is necessary to make most advantageous use of the potentialities of the system. Conductor widths become important only when they are reduced to fine lines, as in the case of plated coils where the most compact line-space arrangement will provide the best inductance to area ratio.

Voltages encountered in the cir-

cuit dictate insulating space between conductors. Proximity of signal-carrying metal and grounded portions of the circuit must also be considered where undesirable bypassing of the signal may result from the presence of large grounded areas. Holes must be accurately placed for use as component tie points, tube sockets and conductor anchors.

As in other printed circuit techniques, layout work is greatly simplified by the use of photographic copying. The desired circuit is drawn to a large scale and photographed down to size. Circuit changes, such as route alterations and modifications of conductor sizes, may be made in this intermediate stage without going back to the original. Through this means

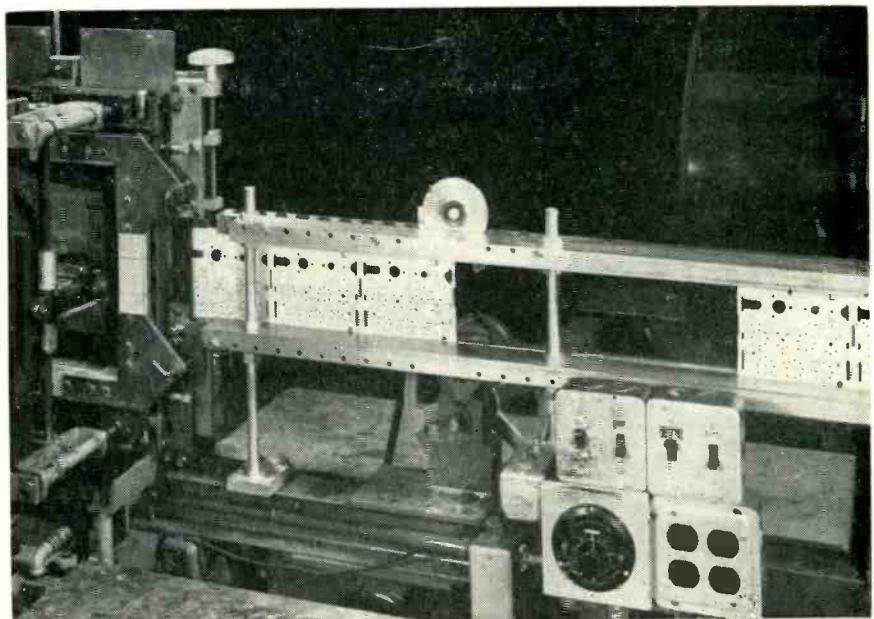

Chassis strips are fed one at a time into the printer which applies resist material to surfaces to be left unplated

Home Radio Receivers

Plating process passes commercial test in 5-tube superheterodyne and shows promise for future use in other equipment including tv sets. Circuits are electroplated on plastic base. Holes through base provide machine-soldering terminals for components and through-chassis paths for circuit connections

By **ELMER WAVERLING**

*Vice-President
Products Division
Motorola, Inc.
Chicago, Illinois*

new circuits may be evaluated quickly and easily.

Fabrication

The layout gives the punching information for making the chassis base. To produce an outline shape from flat sheet with any internal cut-outs, without having plating on the edges, the cutting machines employ partial punching and flush

re-insertion while in the die, never losing orientation of internal parts to the piece or of the piece to the scrap. This technique is highly useful since it is convenient to carry pieces in a chassis-carrying strip until finished. Punched registry marks are provided in the edge of the strip, so that printing can be done without removing the chassis from the strip.

From the punched piece to the final chassis bases, the steps are carried out largely by machine as shown in the photographs. Strips of bases are fed from a stack into a conveyor and through stations that do all the work of surface preparation, conductive coating, and printing the resist material. Resist is stencilled in accurate registry with punching by means of a centering action in the two-sided screen printer, using the registry marks of the strip made in the punching process.

Plating follows, with a controlled process of solution maintenance, timing and current-density to form the required deposit. This forms the copper circuit. Subsequently the resist and the underlying unplated conductive coat are removed, also by travel through mechanical stages, to expose the insulator surface again. It is possible to over-plate the copper with another metal, if desired, before removal of resist and coating, while all areas still are electrically joined.

The chassis and partially punched cutouts are knocked out in a die as a final operation. Pieces occupying the whole of the strip in multiple are sheared apart.

Shapes other than flat may be made on special machinery, but

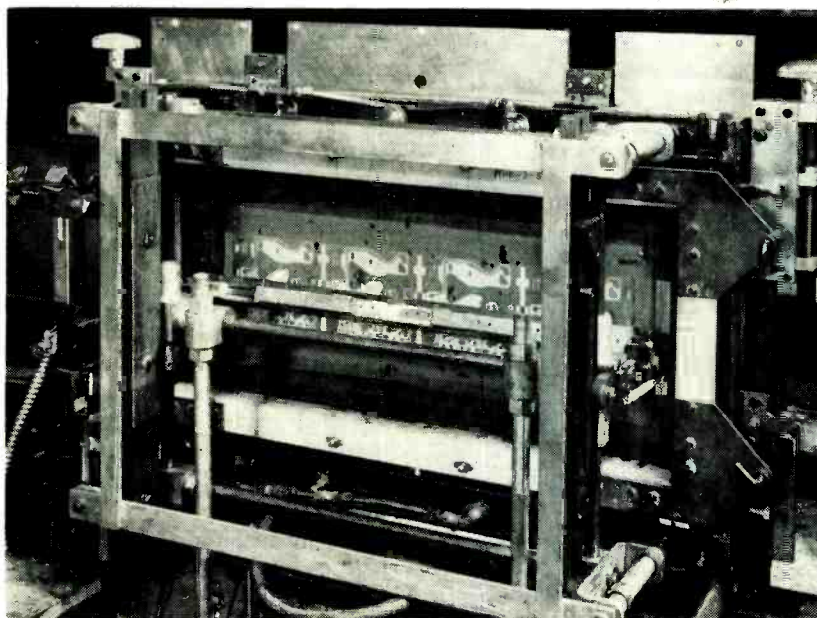

In the printer all action is automatic. Accurately positioned strips are printed using exactly-registered precision stencils

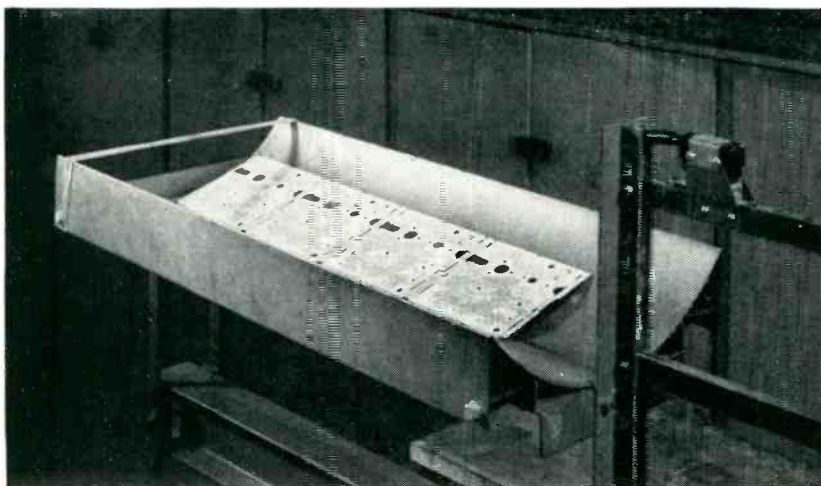

After ejection from printer, strips are ready for plating. Cylindrical trough holds strip without touching surface

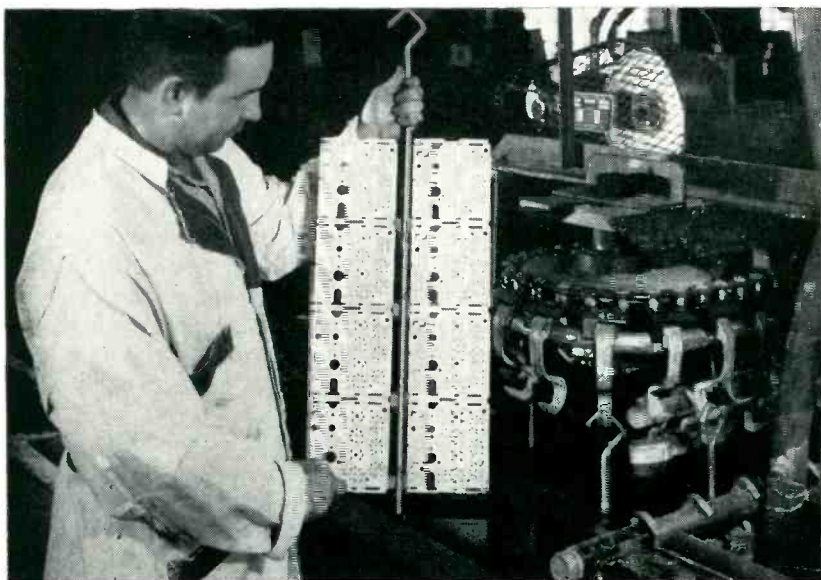

Strips are hung in dipping tank so that metal is applied to both surfaces of base and on walls of holes through base



Finished cut-apart bases are checked in two seconds by a stepped test set that picks up leakage, shorts and opens

plane pieces will probably be more useful, since three-dimensional construction is obtainable by joining flat sections.

Assemblies

Components used with the plated-circuits can be those now commonly in use or special new or adapted versions.

Where lugs are provided, they are plugged into appropriately spaced holes. In a volume control, reversal of lugs from the customary allows setting the control in a mounting hole with its lugs in terminal holes of the circuit. Intermediate-frequency transformers already carry terminals generally suited to the purpose. Pig-tail coils, resistors and capacitors lend themselves to dimension forming in U shapes for staple-like insertion.

Tube sockets are made up from clips which are soldered or pressed into the metal-lined circuit terminal holes.

Automatic soldering is practically a requirement for the full utilization of the system. With other methods, all parts must be arranged on one face, so that floating the plane assembly on molten solder effects the joining. The present scheme is predicated upon spot soldering, only where needed, unhampered by a rigid requirement of single-sided mounting. Metal-lined holes send the solder through to the opposite face by capillary action completely filling the hole. Spot soldering leaves room between points for projection of mechanical parts such as shafts and for placement of components at convenience even on the side presented to the soldering equipment.

Application

Connection of units may be accomplished by plating interconnecting terminals along common chassis edges. The formation of perfectly identical bus-bar strips with specialized points of contact and dispersion of circuits is a further possibility for ultra-complex equipment.

Using techniques such as these, a wide variety of equipments of any conceivable degree of complexity could be produced by machine methods.

Grey-Scale Generator

Television studio equipment, kinerecordings and overall system performance can be standardized using a generator to produce composite synthetic grey-scale signals. Testing can be done under normal conditions for picture signal without disabling clamp circuits

By **G. EDWARD HAMILTON** and **RALPH ILOWITE**

Eastern Div. Television Engineer Television Recording Engineer

*American Broadcasting Co.
New York, N. Y.*

IN ATTACKING the problem of measurement and control of the transfer characteristic in tv picture-signal systems¹ a means is needed for obtaining the relationship between the grey tones or brightness scale and the output—a means for determining the system

From a paper presented at the Sixth Annual Broadcast Engineering Conference, NARTB, Chicago, 1952.

or individual element performance. A standard electronic grey scale whose individual steps may be determined and measured is essential. The equipment to be described is such a device.

The function of the grey-scale generator is to produce a linear step-function signal combined with blanking and synchronizing impulses in a manner such that a syn-

thetic television signal results. Figure 1 shows all the waveforms. Figures 1H and 1I show the composite output signal during the vertical and horizontal intervals. Figure 2 is a photographic reproduction of (A) the picture tube raster presentation, and (B) a sample strip of 16-mm control film.

Circuit Diagram

The manner in which the step-function, synchronizing and blanking signals are mixed, to produce the composite signal, is shown schematically in Fig. 3. Three input signals are used to control and generate the synthetic signal, namely: vertical timing pulses, composite blanking and sync pulses. The vertical timing pulses are used to trigger the step-generating oscillator and to re-establish the zero base of the step-function signal. Blanking pulses are used to provide for pedestal and clipping functions. Sync pulses are mixed with the non-composite output signal so that a complete television signal is available.

The number of steps in the grey scale is derived from a thyatron pulse generator (V_1), which is a controlled relaxation oscillator. Capacitor C_1 charges exponentially until the firing potential is reached (as a function of the bias-control potential) at which time C_1 is discharged through V_1 and R_0 , which develops a positive pulse across R_0 , as shown in Fig. 1A. The frequency of discharge is determined by the

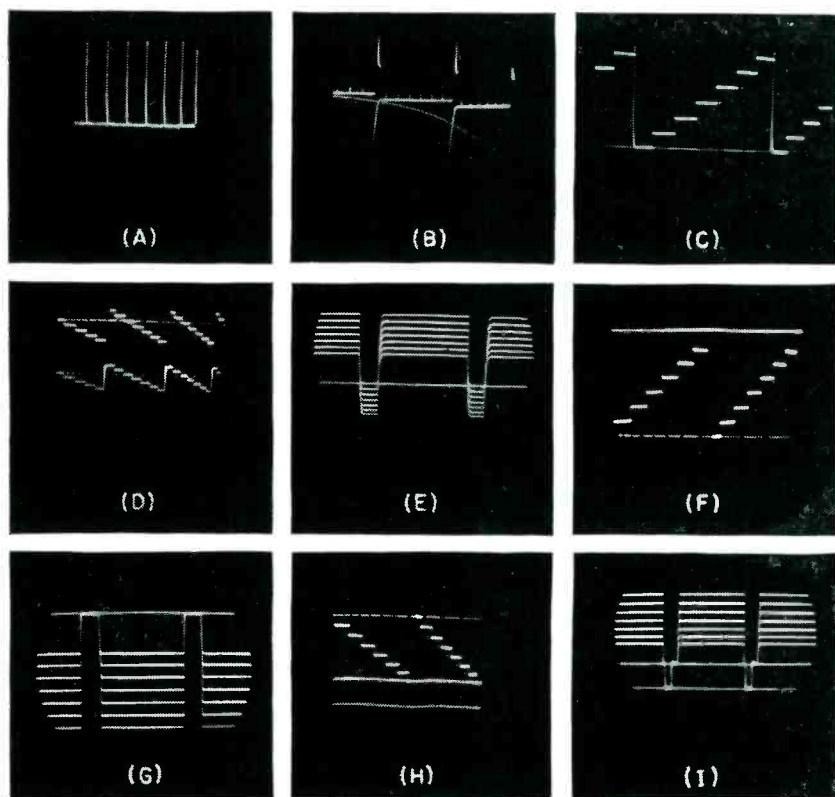

FIG. 1—Waveforms appearing at various points in the grey-scale generator as noted on the circuit diagram (Fig. 3) and described in the text

thyatron bias potential, the plate circuit constants and the vertical driving pulses applied to the grid of V_1 .

The pulse is coupled through C_1 to a capacitive accumulator circuit consisting of two diodes V_2 and capacitor C_6 . The diode V_{2A} re-establishes normal quiescent potential across C_2 while V_{2B} conducts, charging C_2 in steps of equal increment. Capacitor C_5 is discharged during the vertical blanking interval by V_{3A} which conducts when its grid is driven positive by differentiated vertical driving impulses from V_{3B} as shown in Fig. 1B. Tube V_{3A} is nonconducting during the vertical interval. A linear stair-step signal is thereby produced at the plate of V_{3A} as shown in Fig. 1C.

The stair-step signal is coupled through C_7 to V_4 , a cathode follower with provision for control of signal amplitude by potentiometer R_{10} . The other half, V_{4B} , serves as a mixer for blanking and stairstep signals. Negative blanking signals

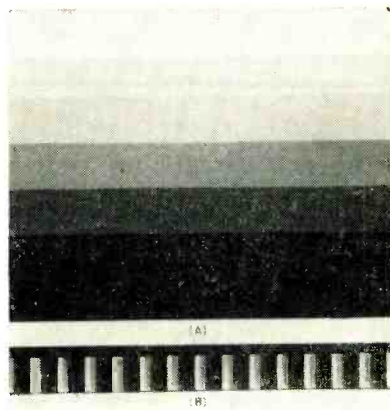

FIG. 2—Photograph of picture-tube raster (A) obtained from generator and sample of 16-mm control film strip

are obtained from V_{17A} , which is coupled to the cathode of V_{4B} while the cathode of V_{4A} is coupled to the grid. The output of V_{4B} contains mixed blanking and step-function signals as shown in Fig. 1D and 1E.

Clipper System

The output of V_{4B} is coupled to the clipper amplifier V_6 in whose

plate circuit is a biased diode clipper system. The clipper waveform containing the step-function signal plus mixed blanking is shown in Fig. 1F and 1G.

The clipping level is determined by adjustment of the blanking clipper bias control R_{30} . The clipped output of V_6 is coupled to V_7 , which serves as video signal amplifier and phase inverter, providing an output signal of black negative.

Sync Amplifier

Tubes V_8 and V_9 constitute a two-stage sync amplifier, the output of which comprises a complete synthetic signal composed of stair-step, blanking and synchronizing components.

Amplitude of sync is adjusted by the sync input potentiometer R_{35} . The resulting synthetic signal is shown in the oscillograms of Fig. 1H and 1I.

This test signal has numerous uses. Currently it is an operations tool used for periodically testing overall system performance. As

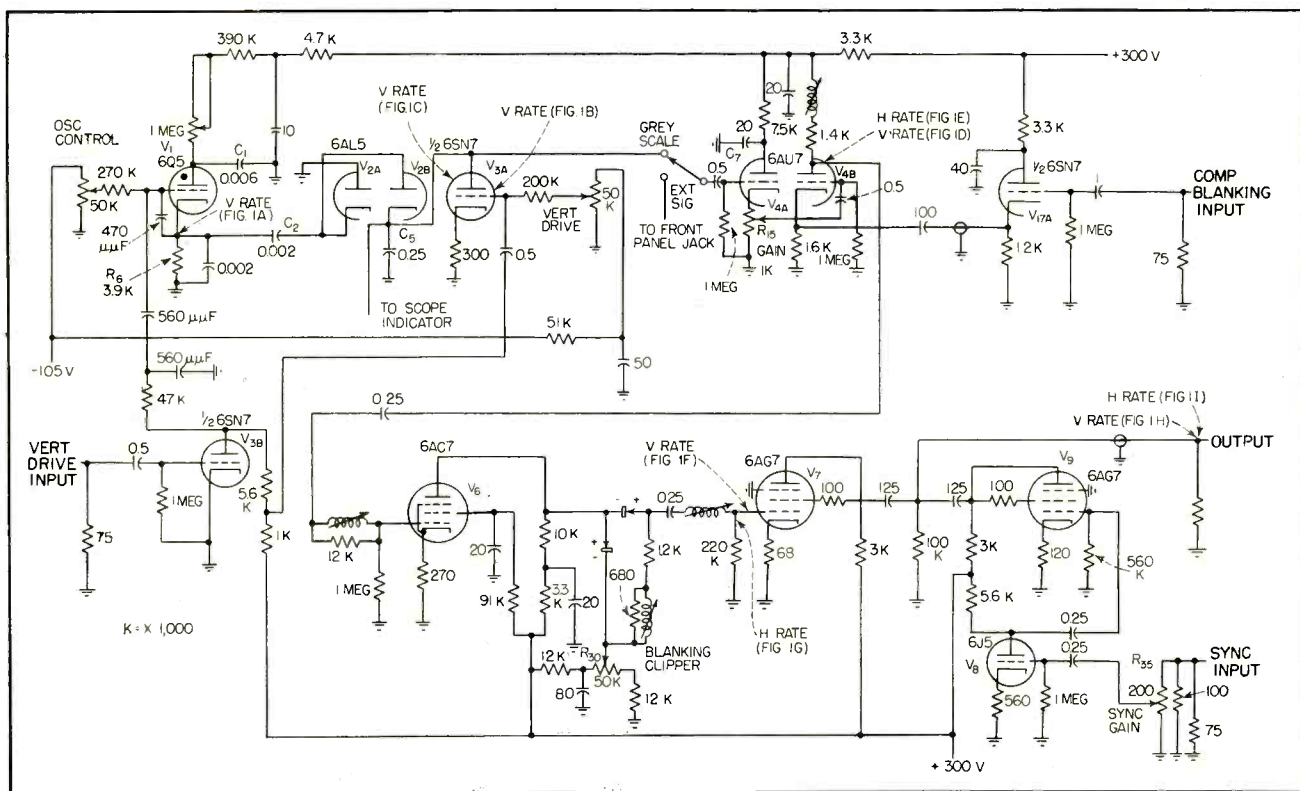

FIG. 3—Sources of detailed oscillographs shown in Fig. 1 are indicated at various points on this complete circuit diagram of the grey-scale generator

such, the signal is fed into a typical studio input and passed through all normal equipment to and including the transmitter. Since the steps may be easily adjusted to coincide with the IRE standard oscilloscope video scale, any discrepancy can be easily detected and observed either at the end of the transmission system or at any of the junction points.

Long-Line Test

Of special value is the ability it provides to appraise the transfer characteristic of long-line circuits because any tendency of the circuit to introduce compression, frequency discrimination or phase shift is immediately apparent. Since the number of steps is adjustable and occupies a time duration in the order of 60 to 600 cycles, a relatively low-frequency square-wave test is simultaneously available which, by virtue of tilt and overshoot, describes deficiencies in the system. This, too, is useful in determining the low-frequency response of long lines since the harmonics required to pass this frequency range accurately may fall in the region of discrimination.

Kinerecording Standards

Of prime importance for the standard grey-scale generator is its usefulness in television recording. Knowing the input characteristic, the light output characteristic of a recording kinescope may be determined. The standard input signal allows adjustment for absolute exposure control over the entire latitude.

Inclusion of the standard signal on each television recording film negative provides a means for signal control within close limits with respect to film processing. Printing the grey scale onto the positive film gives an overall control measure of the system performance.

All circuits following V_1 are frequency compensated. A selector switch at the input to V_1 permits use of an external signal input. This arrangement furnishes a means for injecting any type of test signal into the unit and deriving a composite television signal at

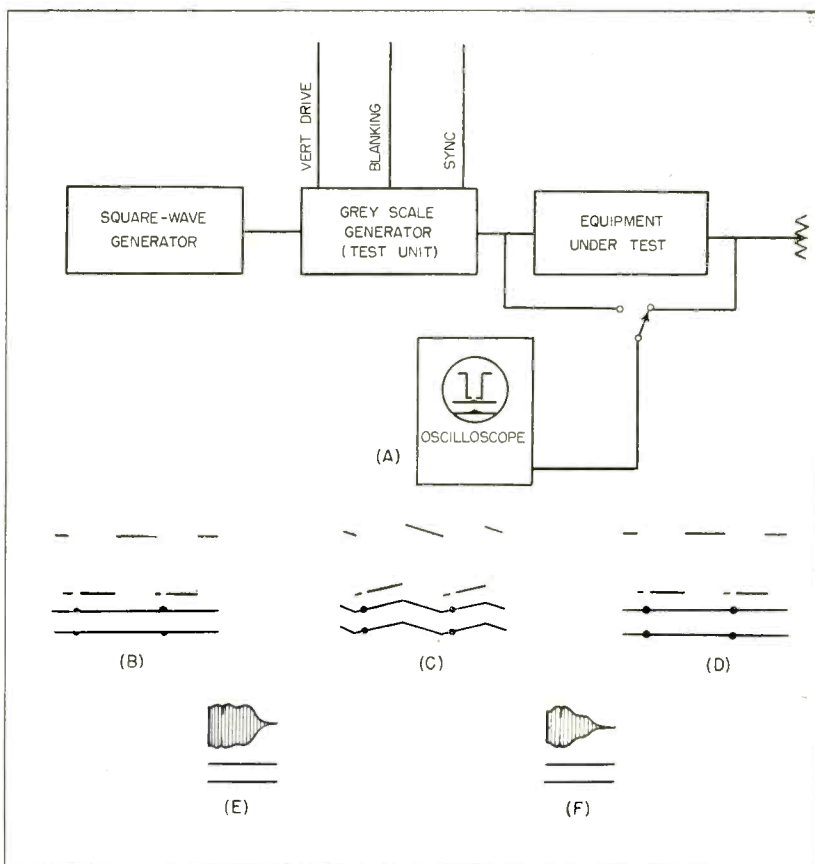

FIG. 4—Block diagram (A) shows use of grey-scale generator with conventional test signals. Input signal (B) and output signal (C) show low-frequency degradation owing to equipment malfunction. Output signal at (D) after replacing faulty component. Sweep-generator presentations (E) input and (F) output of video equipment are described in text

the output. Typical special inputs are: square waves, sine waves and sweep-generator signals.

Clamped Tests

The desirability for such a composite synthetic signal is immediately apparent when it is realized that under test conditions all of the television system components are operating in their normal manner. Especially does this apply to clamp circuits where it is usual practice to disable the clamp circuit while making frequency-response measurements. Figure 4A shows a block layout for determining square-wave system performance as well as the input and output characteristic of a tv studio system. The trace at (B) shows the input signal, that in (C) shows severe low-frequency degradation, and (D) shows the system performance after correction was effected. Curves of Fig. 4E and 4F

show the test instrument being used as a swept frequency-synthetic-composite tv signal where (E) represents the input response to a video amplifier and (F) shows high-frequency degradation at the output. A note of caution is injected at this point to consider the response characteristics of particular oscilloscopes used for the presentation since deficiencies therein will also be apparent by the test method described.

Appreciation is expressed to Charles A. Younger, New York supervisor of television recording and to Arthur Nace for their valuable suggestions and aid in bringing about the described generator, and to Joseph R. Lewis for the photographs.

REFERENCE

- (1) D. G. Fink, "Television Engineering," Second Edition, McGraw-Hill Book Co., Inc., New York, 1952.

Single-Sideband System

Single-sideband transmitter furnishes four voice channels for overseas telephone service. Pushbutton tuning permits rapid frequency shifts and load-control circuit minimizes interchannel crosstalk and out-of-band radiation. Copper-oxide and germanium varistors replace modulator tubes

By **N. F. SCHLAAK**

*Bell Telephone Laboratories
Deal, N. J.*

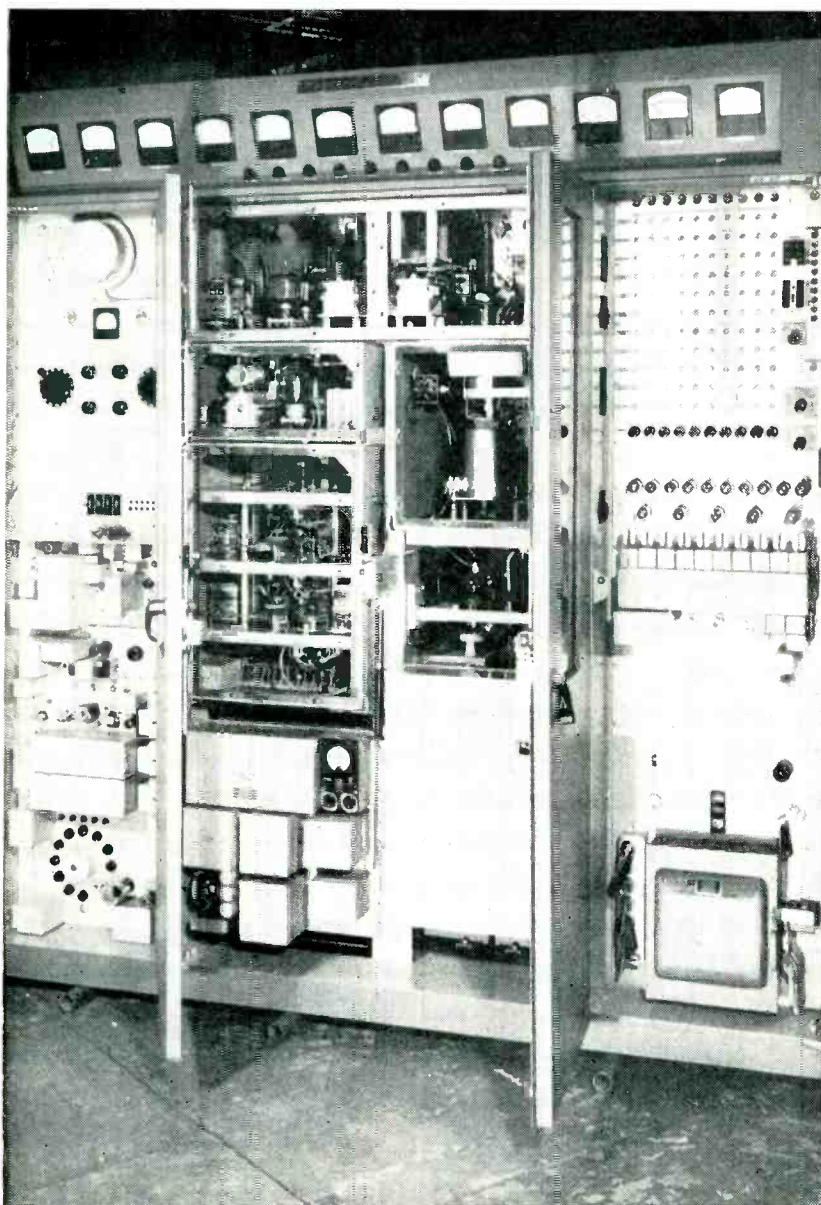

Single-sideband transmitter consists of four bays. Modulators are at extreme left followed by the six-stage, high-frequency amplifier (center). Automatic tuning circuits fill right-hand bay

DESIGNED to furnish long-distance, point-to-point, radiotelephone service, the multichannel, single-sideband transmitter to be described incorporates several innovations of interest to design engineers.

The transmitter provides four-kilowatts peak envelope power in the frequency range from four to 23 mc. Improvements over earlier single-sideband transmitters include: automatic selection of any of 10 preselected output frequencies, use of varistors instead of vacuum tubes for modulators, and ability automatically to utilize its full output whether transmitting only one or all four of its voice channels. The performance of the transmitter likewise has been improved with respect to out-of-band radiation and interchannel crosstalk.

Sideband System

The complete LD radiotelephone system, of which the LD-T2 transmitter is one unit, includes the LD-R1 receiver and LD-B1 branching amplifier. The transmitter accepts, and the receiver delivers, two independent voice-frequency bands from 100 to 6,000 cps, which appear as upper and lower sidebands in the radio-frequency signal. A reduced carrier is transmitted for automatic frequency control and automatic volume control at the receiver.

The two voice-frequency bands may be used for program channels or for group transmission of several narrower channels for either tele-

For Overseas Telephony

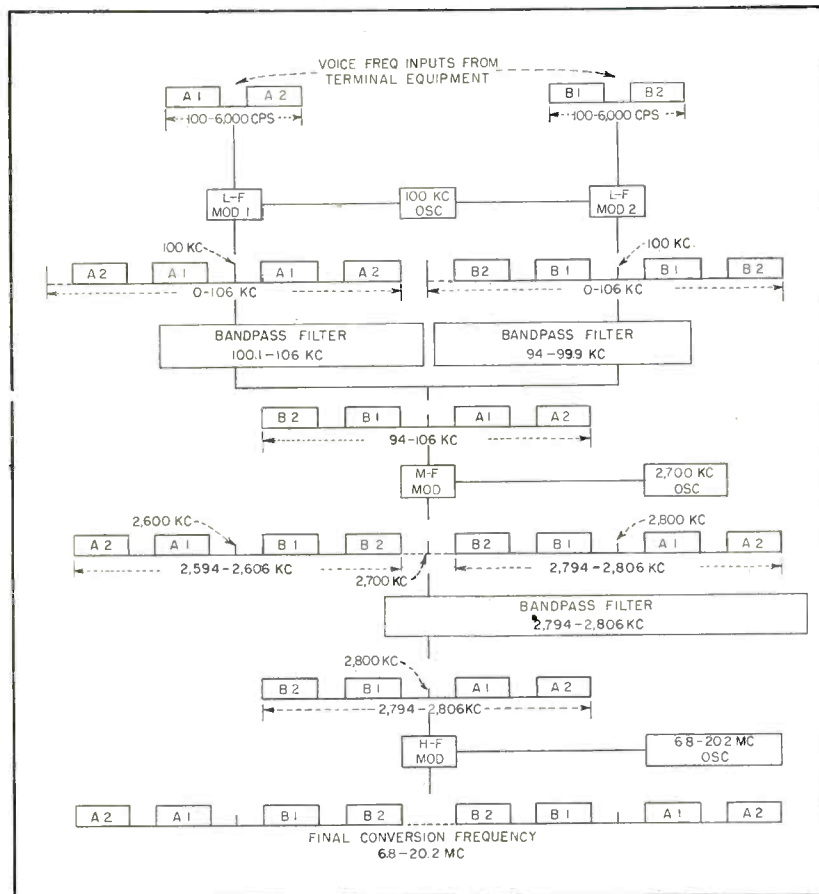

FIG. 1—Frequency block diagram shows action of modulators and filters. High-frequency amplifiers are tuned to accept either upper or lower sideband from h-f modulator. Group-interchange relay (see Fig. 2) when actuated interchanges position of A and B bands

phone or tone-telegraph circuits. Channel grouping must be accomplished by suitable terminal equipment. Any type of terminal equipment and speech-privacy equipment suitable for single-sideband service may be used. Rhombic antennas are usually employed for both transmitting and receiving. Figure 1 shows frequency allocations in the single-sideband system.

The transmitter employs three low-level modulation stages followed by a six-stage linear amplifier. For selection of the desired sidebands, this transmitter, like earlier equipment, uses bandpass filters because of their increased stability and greater selectivity as contrasted with the Hartley balanced-phase system¹. Each of the

10 preselected frequencies, after calibration, will remain within ± 0.003 percent of assigned frequency for long periods of time.

A block diagram of the transmitter is shown in Fig. 2. The two voice-frequency inputs are shown at the top left as Group A and Group B. A gain control, not indicated in the diagram, allows the inputs to the two modulators to be adjusted to their proper value. A relay allows them to be interchanged when necessary to comply with international practices relating to single-sideband transmission.

L-F Modulators

In the low-frequency modulator, the two voice-frequency inputs modulate the 100-kc carrier in

separate modulators employing copper-oxide varistors. The upper sideband extending from 100.1 to 106 kc is selected from the output of modulator No. 1 by a crystal filter while the lower sideband extending from 99.9 to 94 kc is selected from the output of modulator No. 2 by another crystal filter. This frequency allocation is portrayed in the upper part of Fig. 1.

The outputs from the filters are combined in a hybrid coil and impressed on the load-control amplifier. This is a variable gain device that operates with its gain either fixed or controlled by the magnitude of the combined sideband peaks. The gain is controlled by the grid bias. When the amplifier gain is controlled by the magnitude of the

sideband peaks, its bias is obtained from the load-control rectifier, located at the output of the transmitter. Its value, accordingly, varies with the peak amplitude of the output signal. The gain reduction rate is fast, whereas the gain recovery rate is much slower. This helps reduce cross modulation and out-of-band radiation, since it virtually prevents the transmitter from being overloaded at any time. Its effect on quality and intelligibility of speech has been found by rapid comparisons made with and without the device to be negligible.

M-F Stages

The output of the load-control amplifier is impressed on the combining amplifier where it is further amplified and combined with the desired amount of carrier. Since the carrier is introduced after the signal has passed the load-control amplifier, the action of the load-control amplifier has no direct effect on the carrier output level. One of the positions of the carrier-level control switch permits the transmitter to be used for double-sideband transmission by connection to the double-sideband modulator. The double-sideband modulator, is a copper-oxide varistor without any crystal filter in its output. Bandwidth with double-sideband transmission is limited principally by the bandwidth of the medium-frequency equipment.

Following the reintroduction of the carrier, the signal is next impressed on the medium-frequency modulator, where it is used to modulate a 2,700-kc conversion frequency. The upper sideband resulting from this modulation, centered at 2,800 kc, is selected by a series of bandpass filters in tandem with three medium-frequency amplifiers. The medium-frequency modulation products and the resulting signal are shown in the center of Fig. 1. The second modulator uses germanium varistors. All of the equipment up to this point in the circuit remains fixed, regardless of the final operating frequency.

The signal is next impressed on the high-frequency modulator where it modulates a selected conversion frequency in the range from

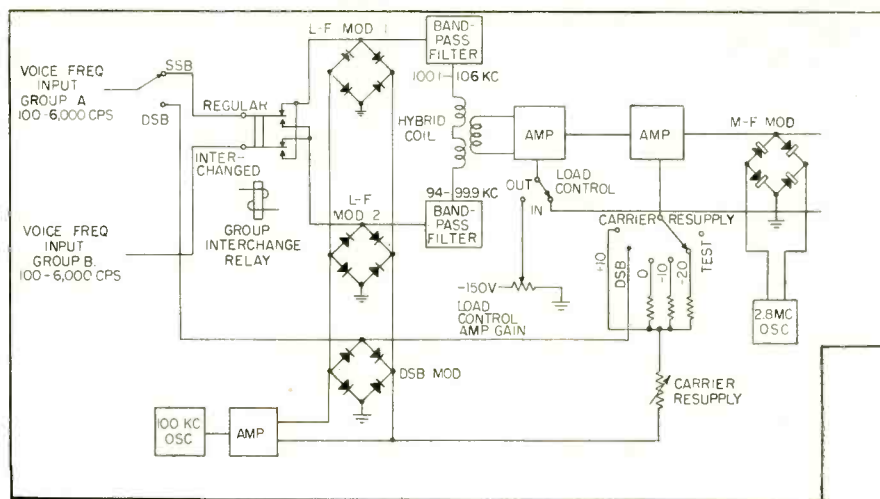

6.8 to 20.2 mc depending on the desired output frequency. This modulator employs germanium varistors. The correct conversion frequency is selected by a switch that connects one of 10 piezoelectric crystals into the oscillator circuit. Since, at the input to the high-frequency modulator, the original 100-kc carrier is at 2,800 kc, it will be at four megacycles when the lower sideband of a 6.8 mc conversion frequency is selected, and will be at 10 mc when the lower sideband of the 12.8 mc conversion frequency is selected. The carrier will be at 23 mc when the upper sideband of a 20.2 mc conversion frequency is selected. For conversion frequencies higher than 12.8, the second harmonic of a crystal is employed.

H-F Amplifiers

The h-f modulator is followed by a gain-control potentiometer and a six-stage, linear amplifier. The tuned circuits associated with this amplifier are set to select either the upper or lower sideband as desired. The output of the h-f modulator is portrayed at the bottom of Fig. 1. The first three amplifier stages employ 807 tubes and the circuits are gang tuned. The fourth stage uses two 4E27s and has a π -type output circuit to permit impedance transformation. Amplifier No. 5 uses two 4-400A tubes and the final stage uses one 3X2500F3 forced-air-cooled triode operating with its grid grounded. The last two stages also employ the π -type

output circuit. Each of the amplifier tuning coils is provided with eleven taps and the circuit inductance may be switched. An unbalanced to balanced line converter follows the π -type tuned output circuit of the final amplifier. A shielded dummy load, which will dissipate the full output of the transmitter, is supplied for checking transmitter performance before connection to the antenna.

A built-in monitor consisting of a simple triple-detection, single-sideband receiver utilizes the conversion frequency and carrier sources in the transmitter to demodulate the signal and recover the original voice frequencies. Figure 3 is a block diagram of the monitor. No facilities are provided in the monitor for selection of sidebands since the monitor is usually used for making two-tone distortion measurements. The monitor incorporates a carrier alarm that is actuated if the carrier amplitude falls below a predetermined value.

Automatic Tuning

Selection of the operating frequency is by a servo system with pushbutton control. Tuning information is stored in a bank of 110 potentiometers connected into the servo system in groups of 11 by means of relays and a selector switch. Ten continuous servos and six switching servos are employed. Each of the sixteen small shaded-pole, reversible motors that are used to change circuit elements is located

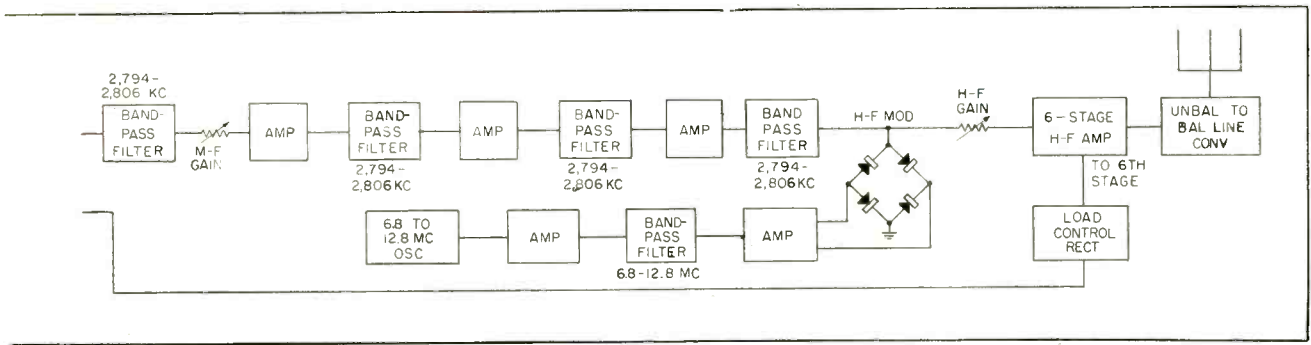

FIG. 2—Multichannel, single-sideband transmitter uses varistors instead of vacuum tubes for modulators. Double-sideband emission is available if desired. Load-control circuit minimizes interchannel crosstalk and out-of-band radiation

near the element to be switched. The servo system thus gives the designer freedom to place each circuit element in its most advantageous location from a circuit-design standpoint without regard to the problem of bringing out a mechanical control in a convenient location. About fifteen seconds are required to select any one of the ten available frequencies, and about the same time is required to put the transmitter into standby condition or to remove it from standby condition.

The transmitter will operate under temperature and humidity conditions encountered in a normal station building, including locations in the tropics. It will operate satisfactorily in ambient temperatures between 15 and 50 degrees C and at altitudes up to 5,000 ft. It requires

10 kva of three-phase power at 230 volts, 50 or 60 cycles.

Receiver

The companion single-sideband receiver is of the triple detection type with intermediate frequencies the same as in the transmitter. This permits the same type of bandpass filters to be used as are used in the transmitter. To give adequate selectivity, the receiver has additional filters not required in the transmitter. The receiver has several novel features, such as the choice of either a crystal-controlled or variable-frequency first beating oscillator, limiters for reconditioning the received carrier, an automatic-frequency-control circuit requiring few adjustments, a squelch circuit that prevents false operation of the automatic frequency control

during periods, of poor signal-to-noise ratio, a common main amplifier for both sidebands and carrier, and a distribution of selectivity and automatic-volume-control action that minimizes cross modulation and maintains maximum signal-to-noise ratio. The nominal input impedance of the receiver is 75 ohms unbalanced.

The receiver is seven feet high, 21½ inches wide and 17 inches deep. It operates on 115 volts, 50-60 cycles.

Branching Amplifier

Since it is often advantageous to connect more than one receiver to a single antenna without interaction or appreciable loss of signal-to-noise ratio, the complete equipment includes a branching amplifier. This consists of six independent, two-stage amplifiers with their input grids connected to the 75-ohm coaxial transmission line by the same type of wide-band transformer used with a rhombic antenna to transform its impedance to the 75-ohm unbalanced transmission line impedance. Six independent 75-ohm output connections are provided to connect as many as six receivers to the same antenna. More receivers can be connected by connecting branching amplifiers in tandem. The branching amplifier is 19 inches wide, 5¼ inches high and 8 inches deep. It has no controls and operates on 115 volts, 50-60 cycles.

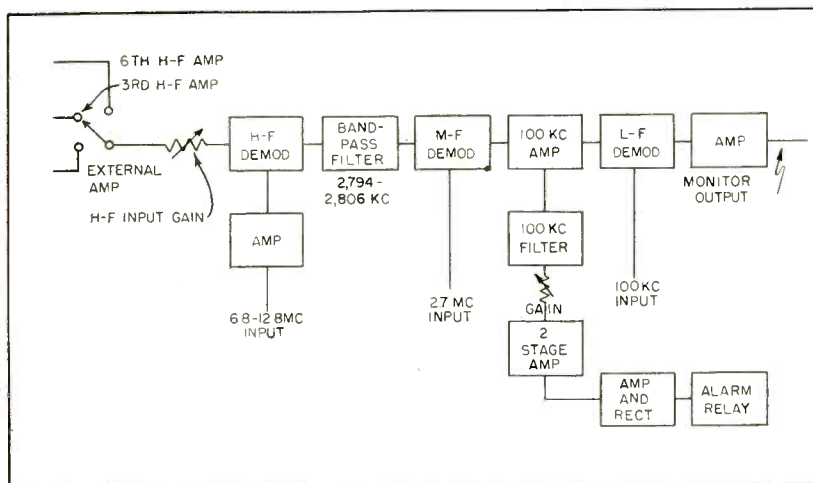

FIG. 3—Output monitor restores original voice channels. Alarm is actuated if transmitter output falls below desired level

REFERENCE

- (1) U.S. Patent No. 1666206 application filed Jan. 15, 1925.

Germanium Photodiodes

By **LEROY PACKER**

*Columbia University Engineering Center
Electronics Research Laboratory
New York, New York*

and

WILLIAM J. WRAY, JR.

*Research Activity
Burroughs Adding Machine Company
Philadelphia, Pa.*

TELETYPEWRITERS are the logical choice for use as input-output units in many digital computers because of reliability, economy and availability. However, it is often desirable to feed tape into an electronic computer at speeds higher than those obtainable with the mechanical sensing elements used in such equipment. By using photoelectric sensing elements, input speeds high enough for most applications can be obtained.

The difficult task of constructing a photoelectric reader for tape has been simplified by the advent of the germanium photodiode and the photo transistor. These semiconductor transducers are much smaller and more sensitive than the smallest phototube commercially available.

A typical germanium photodiode measures 0.080 inch in diameter and 5/16 inch long. Since the incident light is applied to the 0.080-inch diameter face, six of these photodiodes can be mounted directly above six-channel tape. Such a mounting eliminates the need for lenses and reduces the problem of packaging the device. With the type of construction used, repairing is easy. If the equipment fails, it can be put back into operation simply by replacing a plug-in amplifier.

Germanium Photodiode

The 1N77 diode used in the punched-tape reader makes use of the photo effects found in high-resistivity germanium. The photo-conductivity is most pronounced in the boundary region separating

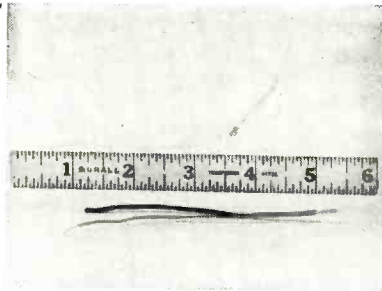

Evidence of the small size of the 1N77 photodiode, visible here between 5 and 6

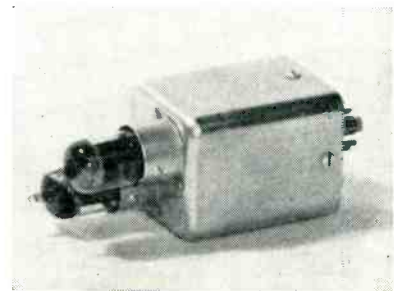

One of the six plug-in amplifier units used in the equipment

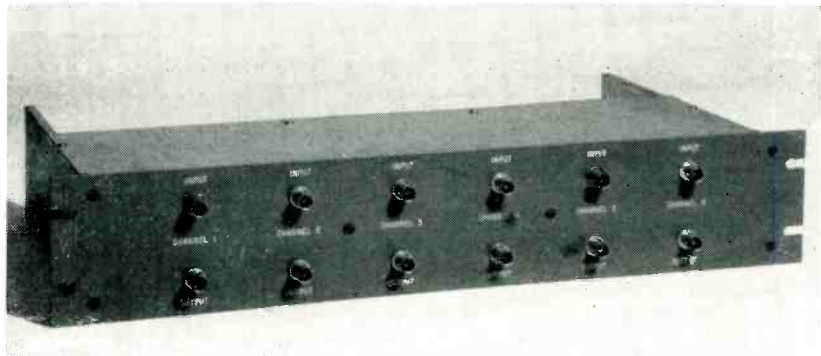

Front panel of the six-channel amplifier for the punched-tape reader

n-type and *p*-type germanium¹. The type 1N77 is made by doping a small layer of *p*-type germanium onto the surface of an *n*-type germanium crystal. The point contact is then made to the *p*-type layer. The photosensitive region is in the immediate vicinity of the point contact and is about 0.005 inch in diameter².

The back resistance of the photodiode is sensitive to the pressure of the point contact. Twelve type 1N77 diodes showed variations in back resistance of from 0.12 to 1.8 megohms. The back resistance is also quite sensitive to changes in temperature. After the initial decrease in back resistance when the light is turned on, the back resistance continues to decrease at a slow rate. When the light is turned off, the back resistance suddenly increases because of the sudden decrease in the generation of photoelectrons and then decreases more slowly, due to the decrease in the temperature of the photodiode.

Dependence of the back resistance and the quiescent operating

potential of the 1N77 on temperature and contact pressure restrict its use to situations in which the presence or absence of light is important. Sensitivity of the 1N77 to chopped light has been found to be fairly constant over a wide range of quiescent operating potentials.

Variation of output signal with twelve photodiodes tested under the same operating conditions was found to be 60 percent about the mean value. The maximum noise inherent in the photodiodes was 50 millivolts. An increase in temperature did not affect the noise generation appreciably. The signal-to-noise ratio in the present application is not limited by the noise generated in the photodiode, since the mean signal level is 2.5 volts.

Amplifier Circuit

A simplified schematic diagram for the six-channel plug-in amplifier is shown in Fig. 1. This circuit shows one amplifier with its power supply connections. It does not indicate the plug-in arrangement.

The amplifier has been designed

Read Computer Tapes

Light-sensitive semiconductor elements and plug-in amplifier units, together provide continuous reading of paper tapes at speeds up to 1,000 characters per second and quick, easy maintenance. Photodiodes are mounted side by side directly under the character holes of six-channel tape

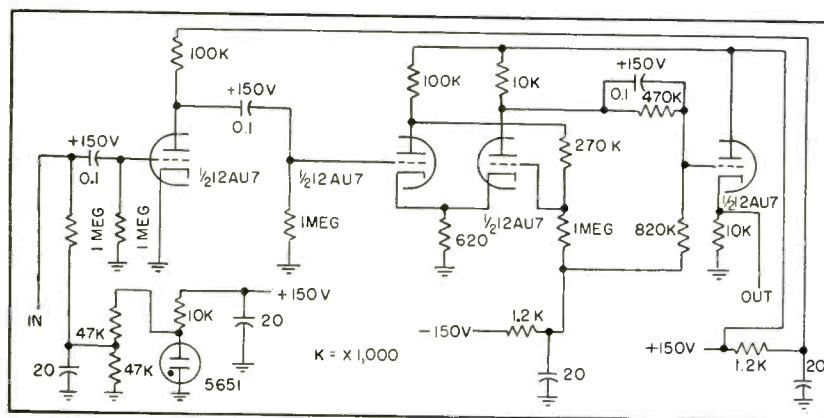

FIG. 1—Simplified schematic diagram of an amplifier channel

to produce a uniform output for 1N77 photodiode input pulses of varying waveforms and with peak values of from one to four volts negative. The output is a square pulse, 60 volts peak, with a rise time of about two μ sec and somewhat less fall time. The input is supplied as a negative pulse to the first stage, which reverses polarity and provides an amplification of about 12.

Output from the first stage is supplied to a Schmitt trigger circuit based on feedback between two triodes. With no signal, the first triode is cut off by the voltage across the common cathode resistor, maintained by the conduction of the second triode. When the input pulse reaches a value determined by the circuit parameters, the first triode conducts and cuts off the second. This state is maintained until the input pulse falls below a value determined by the circuit parameters, at which point the second triode conducts, and the first is again cut off.

If the value of the cathode resis-

tor is too low, both tubes conduct, the trigger action is not present and the circuit is a sensitive d-c amplifier³. The output from the trigger circuit is supplied to a cathode

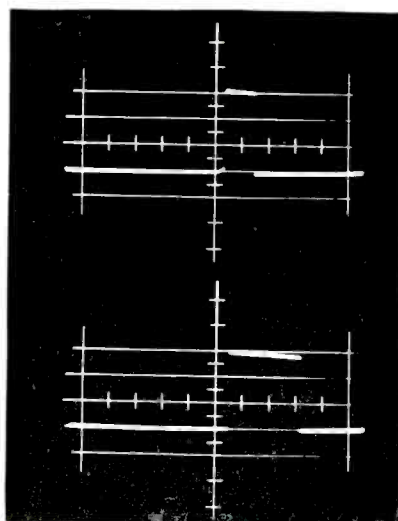

FIG. 2—Amplifier output waveforms at input pulse repetition rate of 100 per second. Scale: ordinate is 20 v per cm and abscissa is 930 μ sec per cm. Input for the upper graph is -2 v peak and for the lower is -20 v peak

follower biased to cutoff to allow d-c coupling.

The circuit, intended for use at 100 pulses per second, operates in the range of from one to 35,000 per second. Higher repetition rates are possible with modification of the trigger circuit. With negative input pulses of from one to four volts peak at 100 per second, the square output pulse occupies 15 percent of the period. As the input increases in magnitude, the output pulse widens. At 22 volts input the output pulse occupies about 35 percent of the period, as shown in Fig. 2.

Regardless of the input, output pulses maintain the two- μ sec rise time and the 60-volt peak value. For input voltages less than 0.28 volt, there is no triggering. This is the maximum allowable noise figure. In the range of from 0.28 to 0.92 volt at the input terminals, the output fails to include a percentage of the input. Above 0.92 volt, the output is reliable.

Tests indicate that in a practical device, 1.75 volts is a reasonable value of peak signal from a 1N77. A value of less than 1.5 volts indicates a poor photodiode or, what is far more likely, a poor light adjustment.

The circuit has been operated into loads from open circuit to 10,000 ohms with no change in output waveform or magnitude. At lower load resistance, the magnitude is reduced.

REFERENCE

- (1) Terren and Whitmer, "Crystal Rectifiers," Radiation Laboratory Series, Vol. 15, McGraw-Hill Book Co., New York, p 392.
- (2) George D. O'Neill, Germanium Photocells, *Proc. NEC*, 6, p 266.
- (3) O. S. Puckle, "Time Bases", John Wiley and Sons, Inc., 1951.

Universal Skin-Effect Chart

Gives skin depth, napier depth and depth of penetration of current in various metals, solutions and ground at frequencies ranging from 1 cps to 1,000,000 mc. One use is estimating transmission between underwater loop antennas, such as for sub-to-sub or sub-to-ship radio communication through salt water

By HAROLD A. WHEELER

Wheeler Laboratories, Inc.
Great Neck, N. Y.

THE CHART in Fig. 1 and the accompanying equations present the skin effect over a wide range of frequencies in various conducting mediums such as metals, water solutions and the ground.

The simple skin effect fails above a certain transition frequency depending on the product of electric ratio \times magnetic ratio of the material. The 45-deg dashed lines at the top mark the corresponding upper limits of validity determined by the indicated values of these ratios.

The transmission between two loop antennas in a conductive medium may be estimated on the basis of the napier depth given on the chart, if the dimensions of the loops are much smaller than the napier depth. Add to the free-space attenuation (based on usual formulas) an attenuation of 1 napier (8.7 db) for every napier depth of distance between the loops.

All changes of conditions required for similar skin effect in scale models may be read on the chart by a simple rule. Through the point representing one set of conditions, draw a line parallel to the 45-deg dashed lines at the top. Any other point on this line represents another set of conditions for a scale model with length dimensions changed in proportion to the napier depth.

The chart is supplemented by a variety of formulas and by tables

of conductivity and electric ratio (dielectric constant) for metals, solutions and ground.

Symbols and Terminology

(mks units unless otherwise specified)
 d = napier depth (skin depth, depth of penetration) (meters)
 λ = Wavelength in free space (meters)
 f = frequency (cps)
 $\omega = 2\pi f$ = radian frequency (radians per second)
 $\sigma = 1/\rho$ = conductivity (mhos per meter)
 $\rho = 1/\sigma$ = resistivity (ohm-meters)
 $G_o = 1/R_o = 0.00265$ = wave conductance in free space (mhos)
 $R_o = 1/G_o = 377$ = wave resistance in free space (ohms)
 μ = magnetivity (henrys per meter)
 ϵ = electrivity (farads per meter)
 $k_m = \mu/\mu_o$ = magnetic ratio (unity for all nonmagnetic materials)
 $k_e = \epsilon/\epsilon_o$ = electric ratio
 sub-o = free space
 sub-c = transition between simple skin effect and electromagnetic-wave propagation.

Formulas

Napier Depth (skin depth, depth of penetration). The depth at which the current density is $1/e$ or 0.368 of its value at the surface; the effective thickness of the layer of current just under the surface. It is equal to the radian depth, at which the phase angle of the current density is retarded one radian from its value at the surface.

$$d = \sqrt{\frac{2}{\omega \mu \sigma}} = \frac{1}{\sqrt{\pi f \mu \sigma}}$$

$$= \sqrt{\frac{\lambda G_o}{\pi \sigma k_m}} = \sqrt{\frac{\lambda}{\pi R_o k_m}} \text{ meters} \quad (1)$$

The last two forms involve only

the dimensions of length and conductance or resistance. Substituting numerical values for G_o and R_o :

$$d = \frac{1}{2\pi} \sqrt{\frac{\lambda}{30 \sigma k_m}} = \frac{1}{2\pi} \sqrt{\frac{\lambda \rho}{30 k_m}}$$

$$= \frac{1}{34.4} \sqrt{\frac{\lambda}{\sigma k_m}} = 0.0291 \sqrt{\frac{\lambda}{\sigma k_m}}$$

meters (2)

As an example, at 1 mc $d = 0.503/\sqrt{\sigma k_m}$ meters. Units of d and σ are meters and mhos per meter or millimeters and megamhos per meter. The former units are convenient for ground and water, the latter for metals. This formula is convenient for plotting the inter-sections used in drawing the chart. As another example, the napier depth in copper ($\sigma = 58$ megamhos per meter) is

$$d_{Cu} = \frac{0.066}{\sqrt{f k_m}} \text{ mm} = \sqrt{\frac{4.36}{f k_m}} \text{ microns}$$

$$= \sqrt{\frac{4.36}{f k_m}} \text{ mm} = \sqrt{\lambda_m} 3.81 \text{ microns} \quad (3)$$

$d_{Cu} = 0.066$ mm	at 1 mc
1 mm	at 4.36 kc
1 mil-inch	at 6.8 mc
1 micron	at 4.36 kmc

Frequency and Wavelength.

$$f = \frac{1}{\lambda \sqrt{\epsilon_o \mu_o}} ; \lambda = \frac{1}{f \sqrt{\epsilon_o \mu_o}} \quad (4)$$

Transition Frequency. The frequency at which the simple skin effect (at lower frequencies)

for Conducting Materials

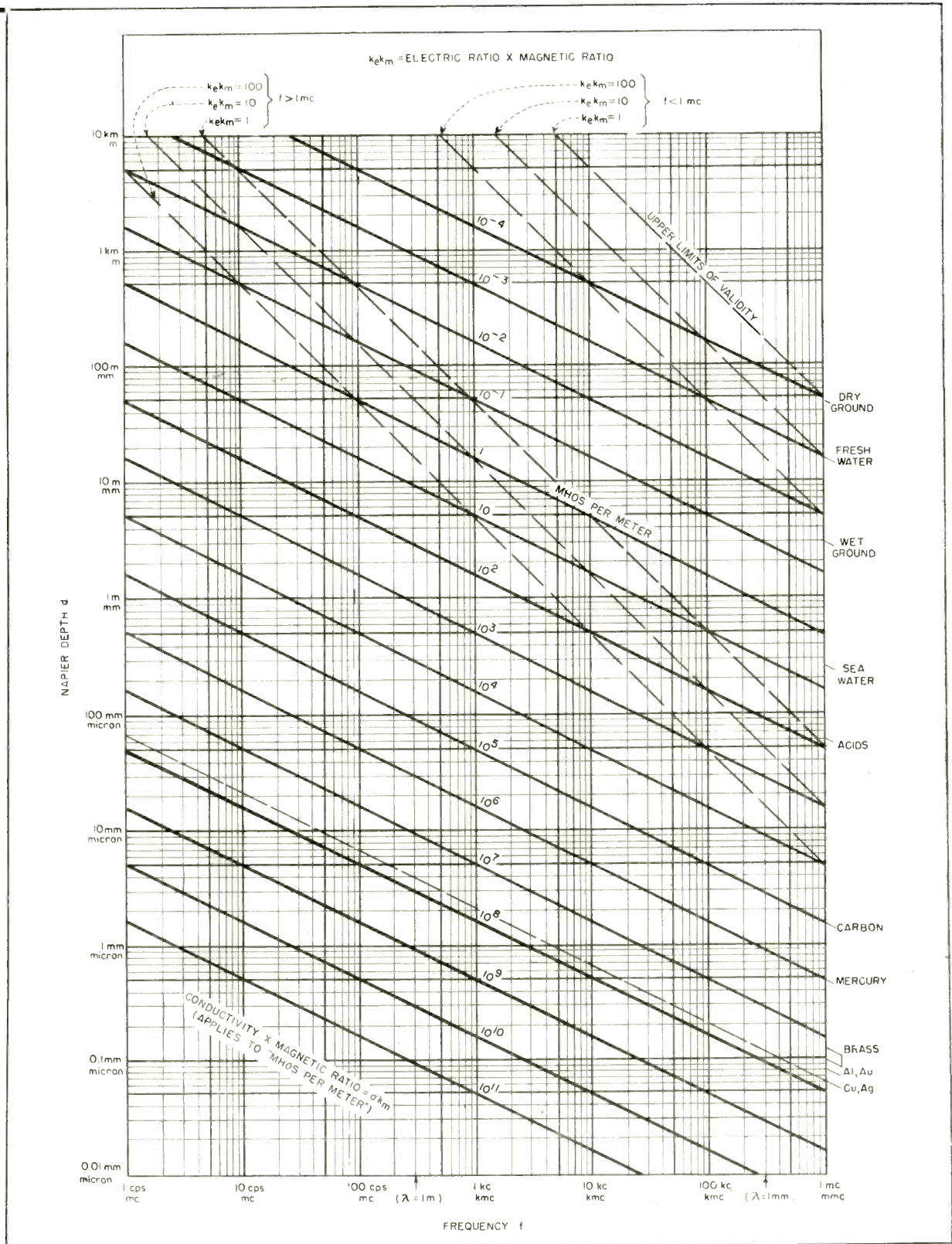

FIG. 1—Solid lines are contours of conductivity \times magnetic ratio, identified for typical materials in right-hand margin. Dashed lines give transition frequency above which dielectric currents complicate the simple conduction-current skin effect in poor conductors. Horizontal scale of frequency and vertical scale of napier depth have two sets of units, divided at 1 mc; use upper set of units for lower frequencies, and lower set for higher frequencies

merges with wave propagation (at higher frequencies). At this frequency, the average loss tangent of the magnetic and electric fields is unity. In low (poor) conductors, it is assumed that the material is nonmagnetic and hence has no magnetic loss. Therefore, at the transition frequency, the loss tangent (1/Q) of the dielectric is 2 (or Q = 1/2).

If the dielectric had uniform effective conductivity at higher frequencies, the napier depth would be constant, but usually the effective conductivity increases at higher frequencies, reducing the napier depth. The transition frequency in the ground is of particular interest, determining the upper limit of validity of the simple skin effect based on conduction currents exceeding the dielectric currents.

$$f_c = \frac{\sigma}{4\pi\epsilon_0 k_e} \quad \text{cps} \quad (5)$$

$$f_c = 9,000 \sigma / k_e \quad \text{mc} \quad (6)$$

$$\lambda_c = \frac{4\pi G_0 k_e}{\sigma} = \frac{4\pi \rho k_e}{R_0} \quad \text{meters} \quad (7)$$

$$\lambda_c = \frac{k_e}{30\sigma} = \frac{\rho k_e}{30} \quad \text{meters} \quad (8)$$

$$d_c = \frac{\lambda_c}{2\pi\sqrt{k_e k_m}} = \frac{47.7}{f_c(\text{mc})\sqrt{k_e k_m}} \quad \text{meters} \quad (9)$$

This transition value of the napier depth (d_c) is equal to one radian-length in the material at the transition frequency. It is used for

Table I—Nonmagnetic Metals

Material (Temp 20° C)	Conductivity σ megamhos per meter	Napier Depth d at 1 mc mm
Silver.....	61	0.064
Copper.....	58	0.066
Gold.....	42	0.078
Chromium.....	36	0.084
Aluminum.....	35	0.085
Brass (red; 91 Cu, 9 Zn).....	26	0.10
Tungsten.....	23	0.10
Magnesium.....	22	0.11
Manganin (84 Cu, 12 Mn, 4 Ni).....	21	0.11
Constantin (60 Cu, 40 Ni).....	20	0.11
Rhodium.....	18	0.12
Zinc.....	17	0.12
Brass (yellow; 66 Cu, 34 Zn).....	15	0.13
Cadmium.....	13	0.14
Phosphor Bronze Beryllium Copper (2% Be).....	11	0.15
Platinum.....	10	0.16
Palladium.....	9	0.17
Tin.....	9	0.17
Nickel Silver (61 Cu, 18 Ni, 18 Zn).....	3.0	0.29
Silicon (approx).....	1.7	0.39
Mercury.....	1.04	0.49
Carbon (approx).....	0.1	1.6

plotting the 45-deg dashed lines at the top of the chart for several values of the electromagnetic product ($k_e k_m$). In the dielectric:

$$\text{Loss tangent} = \frac{\sigma}{\omega\epsilon} = \frac{\sigma\lambda}{2\pi G_0 k_e} = \frac{R_0\lambda}{2\pi\rho k_e} \quad (10)$$

$$\text{Loss tangent} = \frac{60\sigma\lambda}{k_e} = \frac{60\lambda}{\rho k_e} \quad (11)$$

BIBLIOGRAPHY

C. B. Feldman, Optical Behavior of the Ground for Short Radio Waves, *Proc IRE*, p 764, June 1933; *Bell Mono.* B-746.
 F. E. Fowle, "Smithsonian Physical Tables," 8th ed, 1934. (Conductivity of solutions, long tables, p 432.)
 C. A. Heiland, "Geophysical Exploration," Prentice-Hall, 1940. (Excellent tables of resistivity and dielectric constant of minerals, some information on waters, p 638, 657. Chart of depth penetration, p 685.)
 C. R. Burrows and M. C. Gray, Ground-wave Propagation, *Proc. IRE*, p 16, Jan. 1941; *Bell Mono. B-1285*. (Dielectric constant and conductivity of land and water, short table.)
 Harold A. Wheeler, Skin Effect Chart, *ELECTRONICS*, Dec. 1941, p 32. First publication of this type of chart; part of report on paper presented at the 1941 Rochester Fall Meeting.
 J. A. Stratton, "Electromagnetic Theory," McGraw-Hill, 1941. (Conductivity of metals, land and water, short table, p 605.)
 J. R. Whinnery, Skin Effect Formulas, *ELECTRONICS*, p 44, Feb. 1942. (Chart of depth of penetration in metals.)
 H. A. Wheeler, Formulas for the Skin Effect, *Proc IRE*, p 412, Sept. 1942. (Chart of depth of penetration in metals.)
 S. A. Schelkunoff, Electromagnetic Waves," Van Nostrand, 1943. (Formulas for skin effect, p 83. Conductivity and dielectric constant of land and water, p 85.)
 S. Ramo and J. R. Whinnery, "Fields and Waves in Modern Radio," Wiley, 1944. (Skin effect in conductors, chart, p 196.)
 H. A. Wheeler, Radio Wave Propagation in the Ground, *Hazeltine Report* 2009W, Dec. 6, 1945. (Formulas for skin effect, wave attenuation, and transition frequency.)
 H. A. Wheeler, Radio Pulse Reflection in the Ground, *Hazeltine Report* 2012W, Dec. 26, 1945. (Theory of skin effect in the ground, limits on validity imposed by dielectric constant, chart and table of depth of penetration in land and water.)
 "Van Nostrand's Scientific Encyclopedia," 2nd ed, 1947. (Water, analysis of sea and river waters, p 1,553. Atlantic Ocean, 3.5% salts.)
 G. P. Harnwell, "Electricity and Electromagnetism," McGraw-Hill, 2nd ed., 1949. (Conductivity of metals, p 95; solutions, p 189; excellent short tables.)
 J. J. Jakosky, "Exploration Geophysics", 2nd ed., Trija Publ. Co., 1950. (Charts and tables of resistivity of minerals, p 437.)
 K. McIlwain and H. Pender, "Electrical Engineers' Handbook", Wiley, 4th ed., 1950. (Conducting materials, excellent table, p 2-04.)

Table II—Water Solutions and Ground

Material (Temp 20° C)	Conductivity σ mhos per meter	Napier Depth d at 1 mc meters	Electric Ratio k_e	Max Freq f_c mc	Material	Conductivity σ mhos per meter	Napier Depth d at 1 mc meters	Electric Ratio k_e	Max Freq f_c mc
Acids (20%) HCl, HNO ₃ , H ₂ SO ₄	70	0.059	81 (?)	3,000	Wet ground (max).....	0.03	2.9	25	11
Alkali (20%) NaOH.....	33	0.086	81 (?)	3,700	Wet soil.....	0.02	3.6	32	5.6
Salt (20%) NaCl Great Salt Lake.....	20	0.11	81 (?)	2,200	Fertile land.....	0.005	7.1	15	3.0
Salts (3.5%) Atlantic Ocean.....	4	0.25	81	450	Average ground.....	0.002	11	16	1.1
Fresh water (approx) lakes, rivers.....	0.001	16*	81	0.11*	Rocky ground, dry soil...	0.001	16	7	1.3
Distilled water.....	0.0002	36*	81	0.022*	Very dry soil.....	0.001	16	4	2.2
					Dry ground (min).....	0.0001	50*	9	0.10*
					"Good conductors" minerals such as some sulfides and oxides.....	10 ⁵ - 1			
					"Intermediate con- ductors" clay, shale, stone, rocks, ores.....	1 - 10 ⁻⁸			

* d (1 mc) is not valid if $f_c < 1$ mc, but is still useful as a basis for computing d at $f < f_c$.

DIGITAL COMPUTER

Plays NIM

Engineers design glorified pinball machine in breather from classified work. Binary-counter system may be set to win regardless of opponent's skill, or to allow opponent to win if he plays a perfect game

By **HERBERT KOPPEL**

*W. L. Marson Corp.
New York, N. Y.*

AN AUTOMATIC DIGITAL computer matches wits with its human operator in playing the old game of NIM.

Only perfect play by the operator can defeat the machine and its moves are sufficiently random to minimize the possibility of defeat by mere memorization of a particular sequence of play. If desired, the starting conditions of the game can be so adjusted that it is impossible for the player to defeat the machine.

The game of NIM is played with stacks of chips, each stack having a random number of chips. The two players take turns removing chips from the stacks. The player removing the last chip from the table wins. During his turn, a player removes chips from one stack only. He may remove any desired number of chips, from one to the whole stack

How To Win at NIM

The number of chips in each stack can be expressed in binary notation as the sum of different powers of two. If a safe condition is defined as one where, in the sum of all the stacks, each power of two appears an even number of times, with zero considered an even number, then¹: Any safe condition, followed by any legal move, must bring about an unsafe condition. Any unsafe condition may be turned into a safe condition by re-

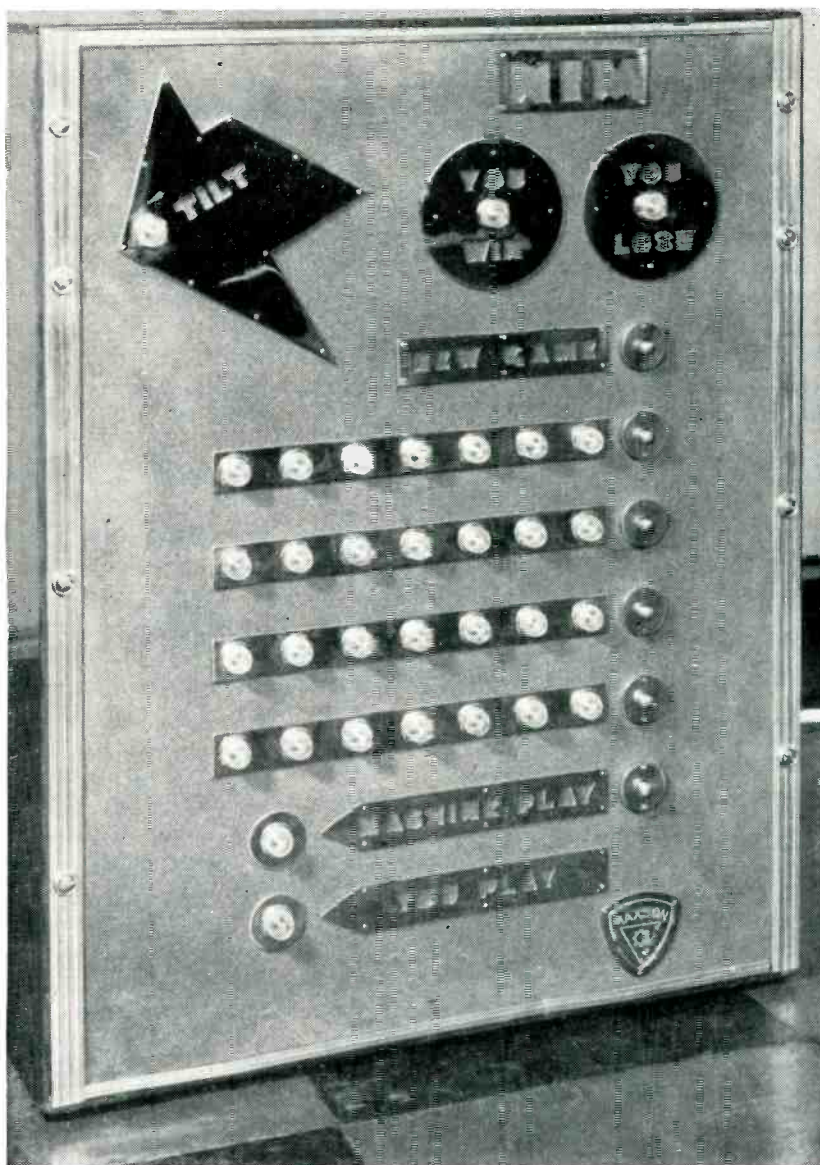

Game-playing digital computer is a skillful and relentless opponent

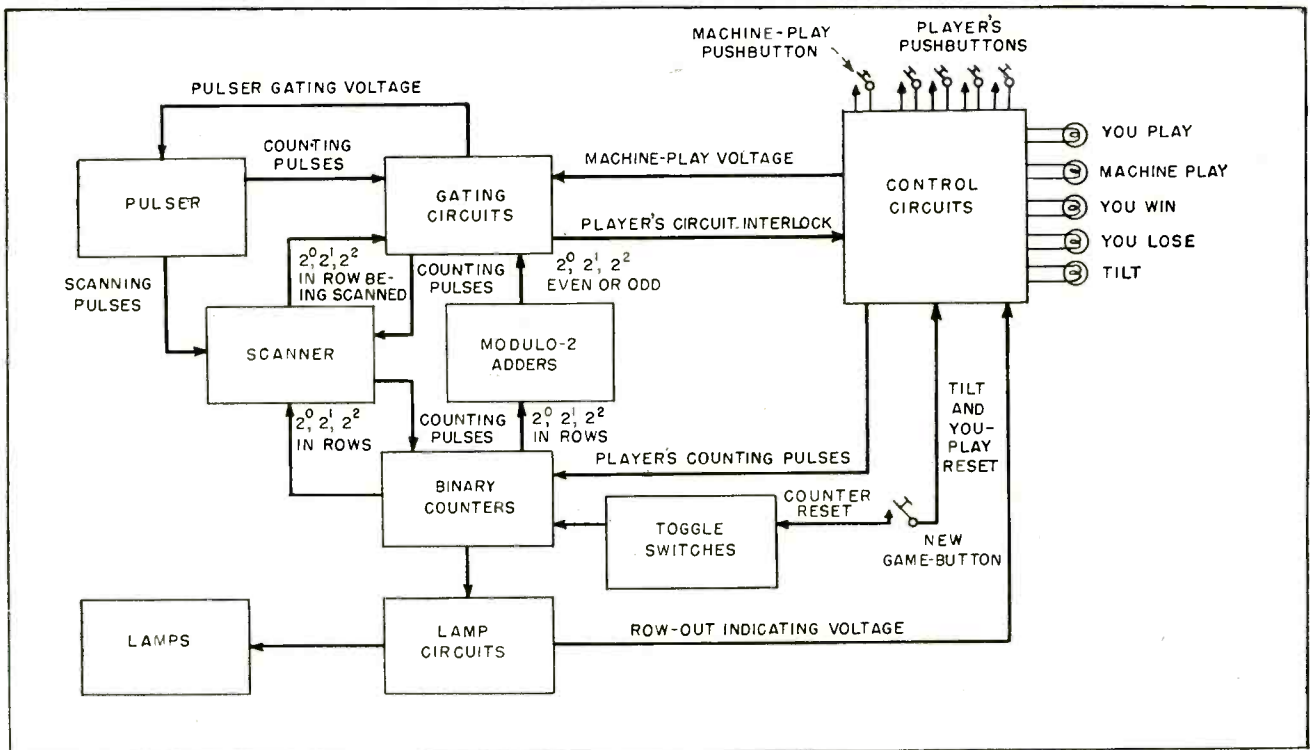

FIG. 1—Block diagram shows circuits that comprise the NIM machine's electronic brain

moving from any group containing the highest power of two appearing an odd number of times, a number of chips such as to cause all powers of two to appear an even number of times. The player who presents his opponent with a safe condition, and continues to do so at each turn of play, will win.

Operating the Machine

The front panel of the machine contains four rows of seven neon lamps each. These serve as stacks of chips, removal of which is accomplished by extinguishing the lamps. A pushbutton is provided for each row. The player pushes the button corresponding to the row that he selects once for each lamp he wishes to extinguish. If he attempts to cheat by operating upon more than one row during any one turn of play, the TILT indicator lights and the game is automatically ended.

When the player has made his move, the MACHINE PLAY indicator lights, and the machine is ready to take its turn. When the MACHINE PLAY button is pushed, the machine automatically selects the row upon

which it wishes to operate, and extinguishes a number of lamps in that row. The player's next turn is then indicated as the MACHINE PLAY indicator goes out and the YOU PLAY indicator lights.

When presented with an unsafe condition, the machine will always move to bring about a safe condition. It will read the number of lamps lit in each row as a binary number, select a row containing the highest power of two appearing an odd number of times in the total of all the rows, and remove a number of lamps from the selected row such as to cause every power of two to appear an even number of times. Since its human opponent must then convert this safe condition into an unsafe condition, the machine will consistently maintain its advantage and eventually win the game.

When presented with a safe condition, the machine must in turn present its opponent with an unsafe condition. It therefore selects a row at random and extinguishes one lamp, thus prolonging the game in the hope that its opponent will eventually make a mistake. The

entire machine-play cycle takes less than 0.4 second.

If the human player is successful in extinguishing the last of the lamps, the YOU WIN indicator lights. If the last lamp is extinguished by the machine, the YOU LOSE indicator lights.

Player Beaten At Start

The NEW GAME pushbutton sets up the game by lighting certain lamps and the YOU PLAY indicator. The initial configuration of lamps is determined by the settings of a bank of toggle switches at the rear of the machine.

Since the human player must make the first move, presenting a safe condition at the start of the game will force him to lose, while starting the game with any unsafe condition will enable him to win by playing properly throughout the game. Having all lamps lit in each row constitutes a safe condition.

Interlock circuits prevent improper or unfair play, such as attempting to make the machine take two consecutive moves, or actuating the MACHINE PLAY and player's

pushbuttons simultaneously. Figure 1 is a block diagram of the NIM machine.

Lamp and Counter Circuits

A three-stage binary counter, using the conventional Eccles-Jordan circuit, controls each of the four rows of seven lamps. The number of lamps lit in each row corresponds to the condition of the three-stage counter controlling that row. All seven lamps are lit when the counter is in zero position. The lamps are extinguished in sequence from left to right as the counter is triggered. Each lamp is connected in the plate circuit of a triode. Counter-tube plate voltage is used to bias the triodes to cutoff in proper sequence. The lamp circuit for each row also provides a "row-out" indicating voltage when the row has been completely extinguished.

Pushing the NEW GAME button causes a predetermined number of lamps to light in each row by opening the grid return circuit of one of the two tubes in each binary-counter stage. Twelve toggle switches (one for each of the three stages that actuate each of the four rows) permit selection of either of the two tubes in each stage. Thus any combination of counter settings, and therefore any desired configuration of lamps, may be chosen. In addition, the NEW GAME button de-energizes the tilt circuit if it has been activated previously.

Control Circuits

Each time one of the player's four pushbuttons is actuated, a pulse is sent to the binary counter of the corresponding row of lamps. Thus each push of the button extinguishes one lamp. The row-out indicating voltage from the lamp circuits prevents formation of pulses for any row after that row has been completely extinguished.

The player may end his move after extinguishing only one lamp in the selected row. Therefore the first push of any of the player's four buttons actuates a change-over relay that prepares the machine to take its turn. This does not, however, prevent the player from finishing his move by putting out addi-

tional lamps in the selected row if he so desires. The row-out voltage prevents actuation of the change-over relay if the player makes his move in a row already empty. Otherwise the player could cheat by forcing the machine to make two consecutive moves.

Tilt Circuit

If the player attempts to extinguish lamps in more than one row without allowing the machine an intervening move, the tilt relay is actuated. This lights the TILT indicator and extinguishes all other indicators.

The MACHINE PLAY button applies voltage to gating circuits, causing the machine to make its move. A relay continues application of this voltage for the duration of the machine-play cycle. The player's pushbuttons are disabled throughout this cycle. At the conclusion of the cycle, the player's pushbuttons are reactivated.

Why Engineers Play Games

With most of the Maxson Corporation's computer business under security wraps, the NIM machine was designed principally as a demonstration device to show a few of the many things computer circuits can do

Row-out indicating voltages are applied to end-of-game adder circuits. When all lamps in all rows have been put out, these adders extinguish the YOU PLAY and MACHINE PLAY indicators, and illuminate either the YOU WIN or YOU LOSE indicator, depending upon whether the player or the machine has extinguished the last of the lamps.

Pulser and Scanner

The pulser utilizes multivibrators and shaping circuits to generate pulses used by the machine to actuate the binary counters and thus extinguish lamps. Scanning pulses are also generated. These cause the scanner to sample the rows until it finds one upon which the machine wishes to operate. The pulser is gated by a voltage from the gating circuits.

The scanner is a four-position ring counter actuated by scanning pulses from the pulser. One of four scanning relays is closed in each scanner position. Each relay corresponds to one of the four rows of lamps.

Voltages taken from the binary-counter plates are used to indicate the powers of two contained in the number of lamps lit in each row. This information is fed to the scan relays. In each scanning position, the closed scan relay conveys this information to the gating circuits. Since the number of lamps lit in any row cannot exceed seven, 2^0 , 2^1 , and 2^2 are the only powers of two that may appear.

The scan relays serve also to connect the pulse output from the gating circuits to the input of the binary counter that extinguishes lamps in the row being scanned.

There are three sets of modulo-2 adders, one for each power of two used. Information as to whether any of these three powers of two appears in a given row is obtained in terms of voltage from each counter-stage plate circuit and fed to the adders. The adders compare these voltages and feed to the gating circuits information that indicates whether or not each power of two appears an even number of times.

Gating Circuits

Gating circuits perform logical operations that enable the machine to play NIM with greatest possible proficiency.

The gating circuits continuously receive information as to which powers of two appear in the row being scanned, and whether each power of two appears an odd or even number of times in the aggregate of all rows. They use this information to control the transmission of pulses to the counters and to the scanner.

Design of this computer resulted from the joint efforts of several members of the W. L. Maxson Corp. engineering staff, particularly F. Alterman, J. Fishel, E. F. Grant, and S. Schmerler.

REFERENCE

(1) C. L. Bouton, "Annals of Mathematics", Series 2, III, p 35, 1902.

Test Pulse Generator

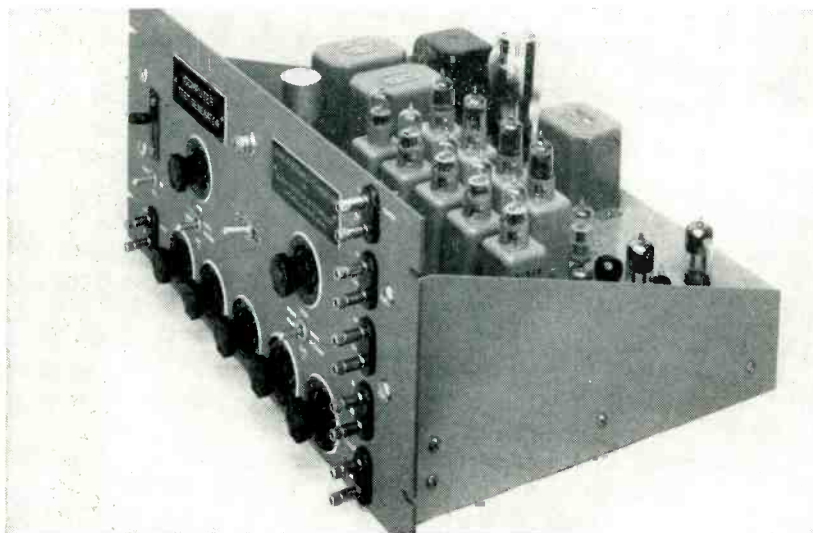

Photograph of digital computer test pulse generator shows multiple output terminals, front-panel adjustments and plug-in units on chassis

By **ALBERT A. GERLACH**

*Armour Research Foundation
Illinois Institute of Technology
Chicago, Illinois*

IN THE DEVELOPMENT and testing of digital computer components and systems, a generator which can simulate digital information becomes an invaluable tool. Such an instrument must be quite versatile to handle the many situations required in digital computer work. The pulse generator described was designed for such a purpose.

Available Outputs

There are a total of five outputs, two source outputs *A* and *B*, and a clock output. The two source outputs each have a direct output and a complement output where the complement output provides a pulse (one) where the direct output has a no-pulse (zero), and a no-pulse (zero) where the direct output has a pulse (one). The clock output provides a pulse for each input trigger. Provisions have been made for random statistical output for each source.

The pulse width of each output is individually variable from about two to forty microseconds by an internal adjustment. The amplitude of each output is variable by a front panel control up to a maximum output of about sixty volts. The clock output may be advanced to occur ahead of the source outputs by as much as forty microseconds by an internal control. Statistical ran-

domness of the *A* and *B* outputs is achieved by periodically opening and closing gates in the *A* and *B* initiating channels and the rate of this operation is controlled by two independent front panel controls from about 1,000 cps up to about 20 k.c.

Provision is made to trigger the outputs either manually (by a front-panel lever switch), from an internal sixty-cycle source, or by an external source where the rate of initiation may be varied over a wide

range of frequencies.

The basic idea of the pulse generator is illustrated in Fig. 1. The trigger initiator is activated by an internal 60-cycle sine wave, by a manual lever switch, or by a ten-volt external source, and supplies a sharp output pulse to trigger the delay multivibrator. The latter is a monostable multivibrator whose pulse width is variable by a potentiometer located on the chassis. The output pulse of the delay multivibrator is differentiated and the positive leading edge pulse is used to trigger the clock output multivibrator while the negative trailing-edge pulse is first inverted and then fed to the four gates of the source *A* and *B* outputs.

By a front-panel switch, either or both pairs of gates may be left

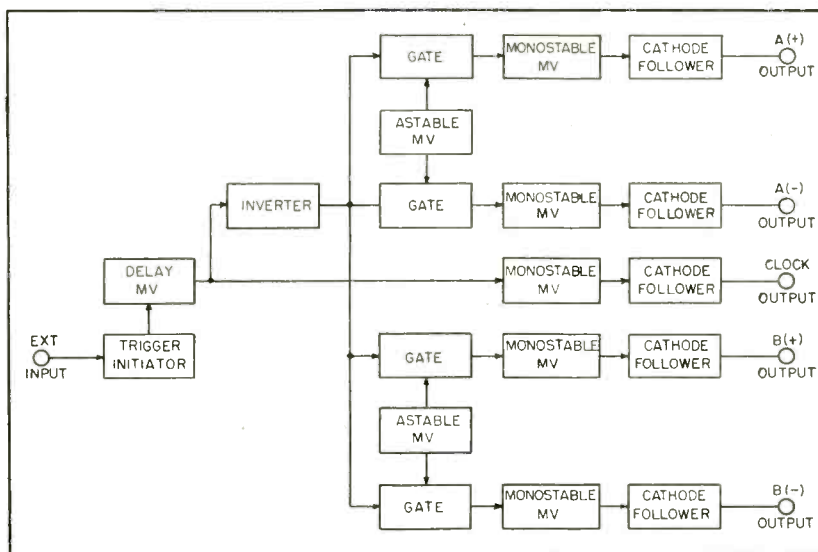

FIG. 1—Pulse generator block diagram. Symbols *A+*, *A-*, *B+* and *B-* refer to positive and negative pulse outputs from complementary sources *A* and *B*

for Digital Computers

Random pulses simulating digital information are made available for testing computer elements without tying up actual computer to produce appropriate signals. A wide variety of outputs is obtainable including a pulse coinciding with each input trigger for actuating any auxiliary test equipment

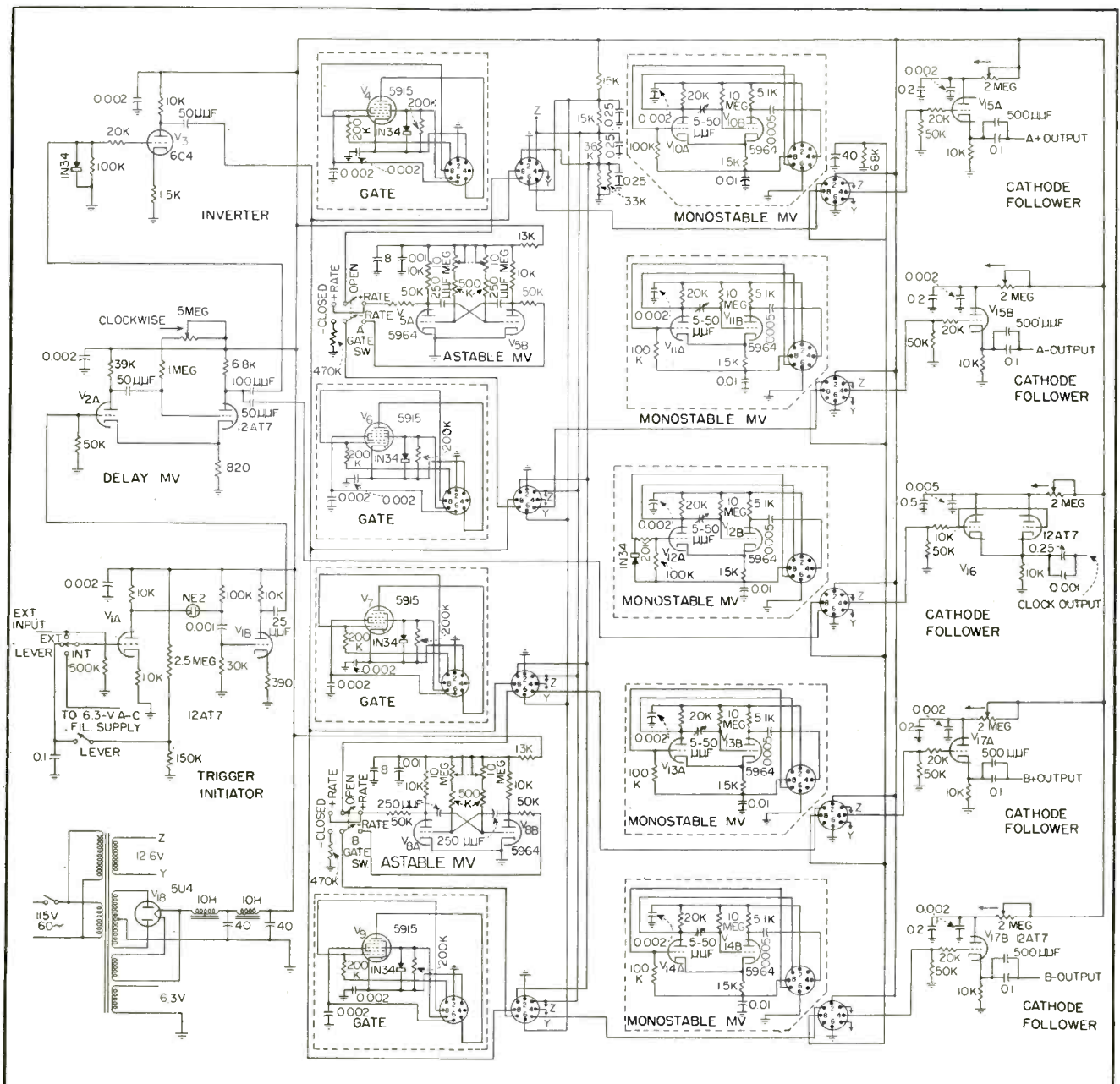
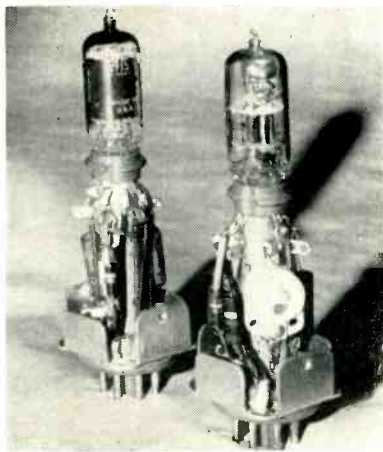

FIG. 2—Complete circuit diagram of pulse generator shows use of plug-in circuits for quick servicing and compactness. Circuit layout follows form shown in block diagram of Fig. 1



Typical plug-in units containing gate (left) and width (right) circuits. Similar plug-in assemblies are used for other circuits, as shown in Fig. 2

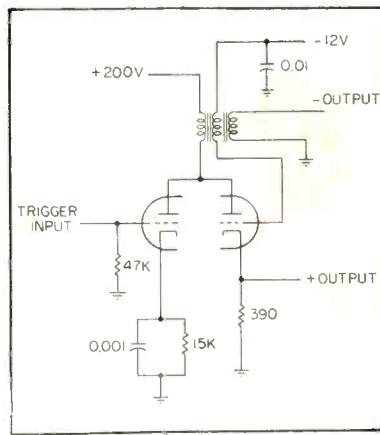

FIG. 3—Blocking oscillator pulse former for producing low-impedance pulses of 0.1- μ sec duration for special testing purposes. Tube is a 12AU7 dual triode

lators of the type illustrated in Fig. 3. This circuit provides low-impedance positive and negative pulses of 0.1-microsecond duration and about fifty volts amplitude.

Typical Test Signals

As an example of the statistical output of the pulse generator Fig. 4 illustrates a series of output sequences which were stored in an eighty bit sonic delay line storage register.

In each of the nine sequences there are eighty possible positions for a pulse (one) or a no-pulse (zero), each spaced one microsecond apart. The clock output of the pulse generator was used to in-

always in the open position, or the astable multivibrators may be employed to alternately open and close the + and - outputs respectively at a rate determined by two independent front-panel controls. The gates that are open at the time the initiator pulse occurs will pass the pulse on to the output monostable multivibrators which produce the output pulses.

Cathode followers are employed to provide a low-impedance output. A photograph of the completed generator is shown on the first page of this article.

Circuit Details

The circuit diagram of the pulse generator is illustrated in Fig. 2. The trigger initiator consists of an amplifier, a neon discharge tube, and a differentiating amplifier. A positive voltage input to the first amplifier will lower its plate voltage and cause the gas discharge tube to fire.

The steep wave front so created is differentiated and amplified by the second amplifier and used to trigger the delay multivibrator. This circuit is a conventional monostable multivibrator whose pulse width is variable by the potentiometer in the grid circuit of the tube. The leading and trailing edge of this pulse is differentiated and used for further triggering.

Gate Circuits

The gate circuit utilizes a pentagrid converter as a transfer tube

with the third grid acting to control the transmission or rejection of a pulse occurring at the first grid.

The gate is normally in the open position when it is disconnected from the astable multivibrator.

However, when connected to the astable multivibrator, negative pulses alternately close the + and - gates so that when one is closed the other is opened and vice versa. Thus the - output is the complement of the + output. The output pulses are generated by monostable multivibrators with the pulse width adjustable by a small trimmer capacitor in the grid circuit as shown in Fig. 2.

For layout convenience, interchangeability of components, and ease of circuit modification the gate circuits and output multivibrators were constructed as plug-in components.

Refinements

The pulse generator has proved to be exceedingly useful as a tool for the testing of digital computer systems and components. However, with such a broad field as computers there are times when even greater versatility is desirable. One such instance in the author's experience occurred when it was desired to produce output pulses of about 0.1 microsecond width.

To get the desired pulses, the cathode follower outputs (see Fig. 2) were replaced by blocking oscil-

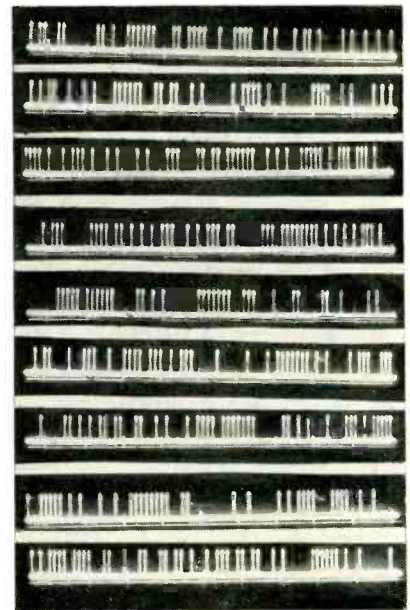

FIG. 4—Samples of random outputs from test generator

lators of the type illustrated in Fig. 3. This circuit provides low-impedance positive and negative pulses of 0.1-microsecond duration and about fifty volts amplitude.

dex the positions over one microsecond, and for each clock output there was equal probability for a pulse (one) or a no-pulse (zero) entering the storage register. The resulting binary numbers may be considered random.

Acknowledgments

The author acknowledges the valuable assistance of Joseph J. Miller who constructed and assisted in the final testing of the pulse generator. This work was performed under contract with the United States Department of Defense, Washington, D. C.

Continuous Recorder Keep-Alive Circuit

Multiple-output unit injects 10-cps signal into recording systems to improve performance by keeping pens in constant motion. High reliability and long life are ensured by conservative circuit design and construction

By **RONALD L. IVES**
Williamsville, N. Y.

MORE than a decade ago, several users of chart-recording milliammeters discovered, independently, that the pen response to position changes was greatly improved if the movement was kept in oscillation.

Various-mechanical and electrical oscillation injectors were studied and applied.

Perhaps the simplest oscillator consists of an electric bell movement, with bell removed, bolted to the back of the instrument case. This supplies the desired oscillation mechanically, and also generates electrical noise detectable for several hundred feet from the instrument. Another expedient is to inject a small 60-cycle component into the meter circuit, usually by use of capacitors. This also worked after a fashion, but switching transients in the line were recorded along with the desired signal.

Relay Oscillators

For field use, where recorders are clock-driven, and instruments battery operated, a very effective keep-alive, using a relay oscillator, was developed by S. W. Grinnell in 1942.^{1,2,3} This type of keep-alive is so satisfactory, for field use, that it is being incorporated in modern field meteorological instruments.⁴ Two workable relay-type keep-alive circuits, with their output characteristics, are shown in Fig. 1.

Frequency is usually between five and fifteen cycles per second.

Station Recording

Although the relay-type keep-alive is very satisfactory for field use, its life is not great enough for continuous recording at a fixed station.

The nominal life of a good telephone-type relay (10,000,000 operations) is completely used up, at ten cycles per second, in about 11.6 days (of 24 hours). In consequence, when continuous records are required for a period of months or years, some other keep-alive system is economically desirable.

Various tests indicate that the

keep-alive frequency should be between five and fifteen cycles per second, and that the wave form should be nonsinusoidal, but symmetrical. Frequencies of less than five cycles per second require considerable amplitude to be effective, and insert sawteeth into the record. Frequencies of much more than fifteen cycles per second interfere with ink flow in pens of several designs, converting the recorder into a very efficient ink-thrower. When frequencies are in the range from 400 cycles per second and up, the pen makes a continuous excavation in the chart, instead of a continuous trace.

Frequency and continuity re-

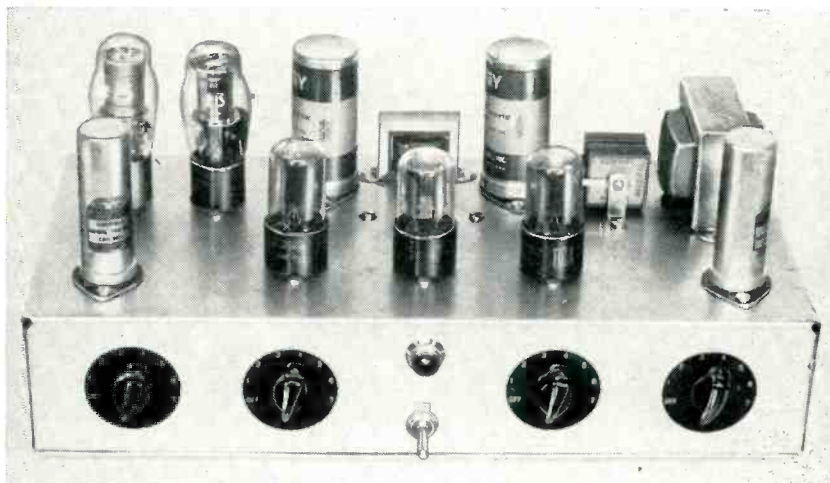

Conventional tubes should be replaced every 1,000 or 1,500 hours. Red tubes may be used continuously for as long as 13 months

quirements for station operation having indicated that a symmetrical multivibrator would be suitable for this use, several experimental models were made and tested. All of them worked, but only the model having the widest application will be described.

The station model keep-alive for general use consists of a symmetrical multivibrator, with a nominal frequency of ten cycles per second, and four independent cathode-follower outputs. The circuit is shown in Fig. 2.

The multivibrator, used as a square-wave generator, uses a high- μ dual triode, conventionally connected for low-frequency operation. The 100,000-ohm resistors, shunted by 0.001- μ f capacitors between the grids and the plate capacitors of the opposite triodes are to limit the grid current flow without rounding the voltage peaks. If these R-C elements are omitted, the multivibrator may mode or block.

Frequency of this oscillator, determined by actual test, is found from

$$F = \frac{1}{4.5 RC}$$

R being in ohms and C in farads.

So that the outputs will not interact, four separate cathode-follower outputs are provided, each being one half of a 6SN7 or 5692. Output peaks are approximately 100 volts, exact waveform being a function of the properties of the load, and an almost perfect square wave when the load is a pure resistance of more than 0.25 meg.

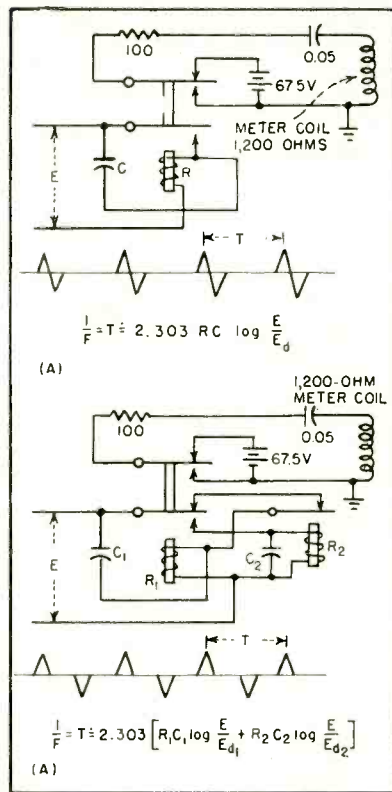

FIG. 1—Relay keep alive's have disadvantage of short life. Typical circuits are shown with waveforms and equations for frequency of operation in terms of supply voltage E and relay drop-out voltage E_d .

The two halves of each triode buffer tube are connected in opposite phase to equalize the load on the power supply. With the circuit used, almost any number of dual triodes can be controlled by a single multivibrator. Practical limitations, such as the capacity of standard power transformers, space available on a standard chassis, and

heat dissipation suggest that not more than a dozen dual triodes (24 outputs) be embodied in a single unit.

The power supply consists of a conventional voltage doubler isolated from the line, a pair of OD3 tubes in series to provide a regulated voltage for the multivibrator, and a single-section L-C filter in the plate supply for the buffer tubes. Filter capacitors are made much larger than theoretically necessary to reduce the effects of line surges and switching transients, and so that the filter will still be effective after the electrolytic capacitors age.

Allowing for heat radiation and servicing ease, a completely self-contained four-channel keep-alive can be constructed on a 3 x 9 x 15-inch chassis, as shown in the photographs. Eight channels can be built in the same space without undue crowding or overheating in use. Because uninterrupted service was important, rugged constructional methods were used, with all components rigidly tied down, and connections cabled. In general, any shock that will not damage the tubes will not hurt the other components. Smaller components were mounted on socket turrets, making terminal strips unnecessary.

Performance

Operational tests of this keep-alive indicate that its performance leaves little to be desired. Its versatility makes it suitable for a large number of instrument applications.

Test runs of a square wave, both

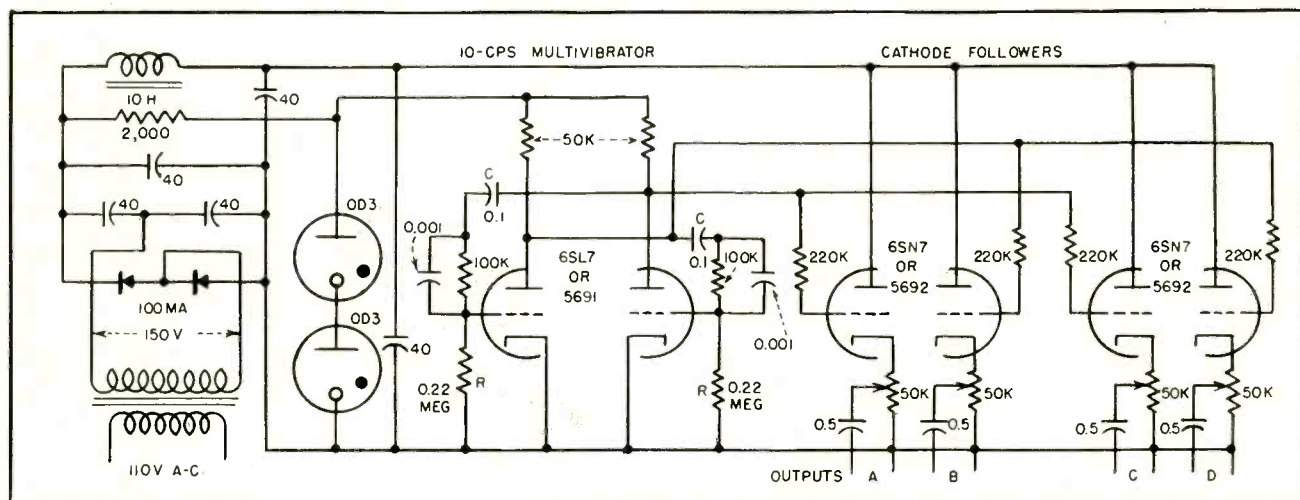

FIG. 2—Complete circuit of electronic keep alive. Additional outputs may be obtained by adding cathode followers

with and without a keep-alive are shown in Figs. 3 and 4. Similar results were obtained by West⁴ and both of these parallel findings by Grinnell.¹ Note, in Fig. 3, the rounded noses on the leading edges of the curves, and the asymptotic approach of the tops of the waves to their ultimate maximum position. In Fig. 4 the maximum values are reached in much less time, and retained thereafter until the current through the instrument changes. Both curves were run on the same instrument, an Esterline-Angus 0-to-1 recording milliammeter, that had been adjusted for optimum operation prior to running the curve of Fig. 3.

Connections are quite simple. Instruments that have one side grounded are connected across any desired output, with the hot side of the instrument connected to the hot side of the output, from which it is isolated with respect to d-c by a capacitor in the keep-alive chassis. When both sides of the instrument are hot with respect to ground, as in a difference amplifier, each side of the instrument is connected to a hot output terminal, the phases of the terminals being opposite. As constructed, adjacent hot output terminals are of opposite phase.

With continuous recording, standard tubes should be checked weekly, and replaced when they test about 10 percent low. An average tube life of 40 days of continuous service is to be expected from manufacturers' ratings (1,000 hours), and actual tube life, when operation is truly continuous, usually exceeds 1,500 hours if the tube survives its first 200 hours of service. When red, or 10,000-hour, tubes are used, testing once a month is indicated, and replacement every 13 months is suggested by manufacturers' ratings.

REFERENCES

- (1) S. W. Grinnell, "Some Instruments Used by Division 10, NDRC, at Dugway Proving Ground for the Continuous Recording of Micrometeorological Conditions," OSRD 6088, 1945.
- (2) R. L. Ives, "The Relay Oscillator and Related Devices," *Jour. Franklin Inst.*, 242, p 243, 1946.
- (3) Similar developments were independently arrived at by Philip Nourse, of Douglas Aircraft Corp. and Wardell M. Smith, now of Thomas A. Edison, Inc.
- (4) George West, "Wind Recorder for Microclimatology," *ELECTRONICS*, 26, p 136, June 1952.

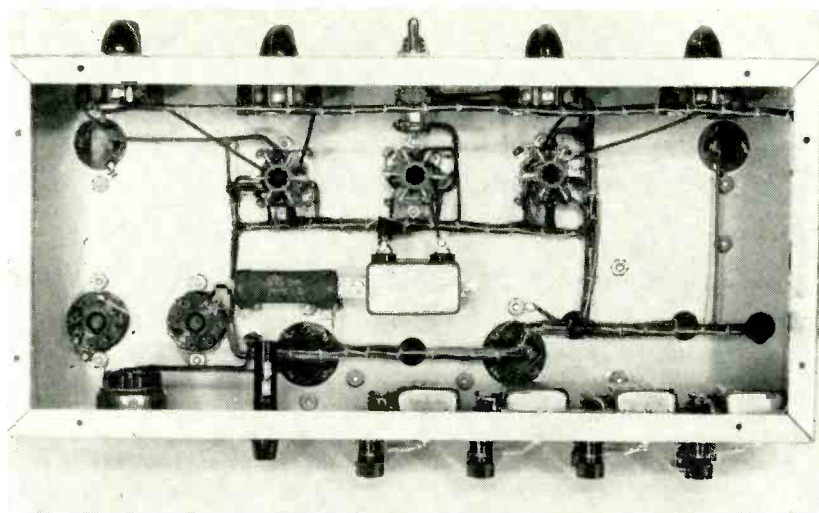

Under chassis view shows simplicity of electronic keep alive. Turret-type tube sockets hold small parts

MADE IN U.S.A. THE ESTERLINE-ANGUS CO., INC. INDIANAPOLIS, IND. U.S.A.

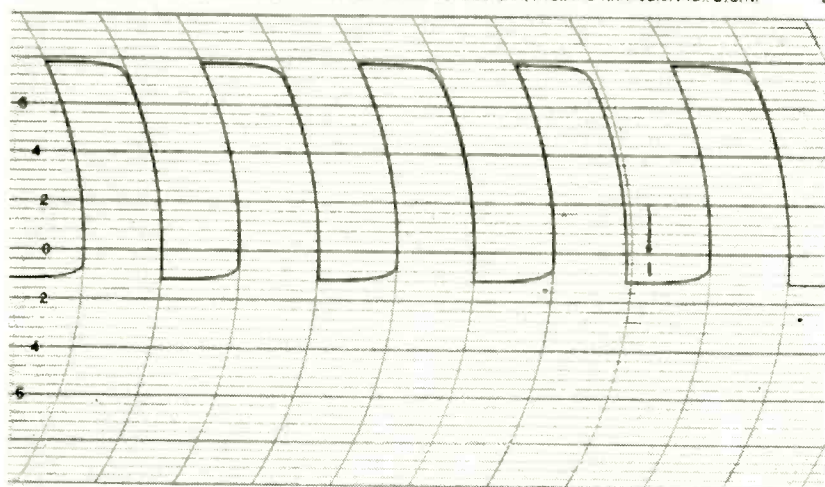

FIG. 3—Recordings made of square wave at 3-inch per minute chart speed without keep alive

THE ESTERLINE-ANGUS CO., INC.

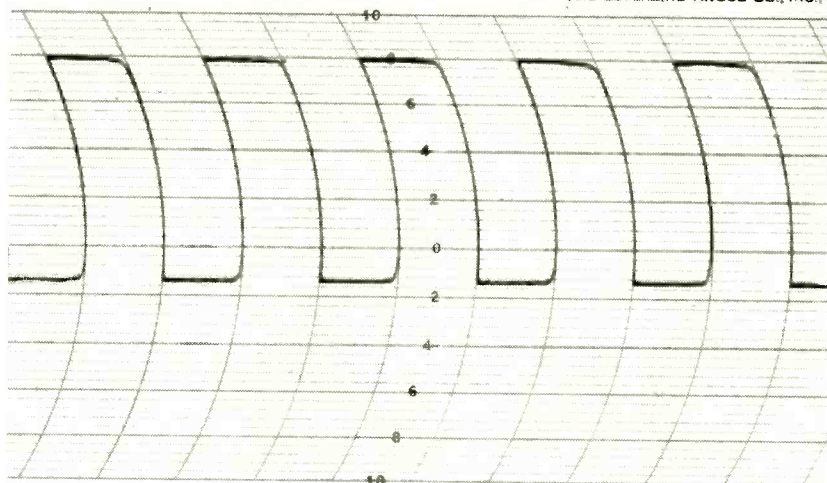

FIG. 4—Recording made under same conditions as Fig. 3 but with keep alive

Air-Cooling Nomograph

Gives cubic feet per minute of air flow needed to keep temperature rise in electronic equipment at specified value when wattage dissipation and air density are known.

Supplementary graph gives air density at any altitude and temperature

By **EUGENE SLUSSER**

*Northeast Electronics Corp.
Tuckahoe, N. Y.*

AT SEA LEVEL under standard conditions (760 mm mercury, 0 deg C and 0.079 lb per cu ft air density) the temperature rise in deg F is approximately $3,000 P/Q$, where P is the power dissipated in the unit in kw and Q is the air flow through the unit in cubic feet per minute. The nomograph gives this rise on a dual Centigrade-Fahrenheit scale.

Variation of air density with pressure and temperature is shown in the graph. For operation at high altitude, the air density at the maximum altitude should be used to compute the maximum temperature rise or the blower capacity.

As an example, it is desired to determine the blower capacity required to cool a unit which dissipates 420 watts. To maintain a minimum wattage derating on certain resistors and selenium rectifiers, temperature rise must be held to 18 deg C. The equipment must be designed to operate at 10,000 feet and 30 deg C. For these conditions, the graph gives an air density of 0.05 lb per cubic ft, and the nomograph gives a minimum air circulation of 60 cfm.

The temperature at a given altitude can be estimated by assuming a dry adiabatic lapse rate of 3 deg C per thousand feet. On this basis a sea-level temperature of 20 deg C would correspond to -10 deg C at an altitude of 10,000 ft.

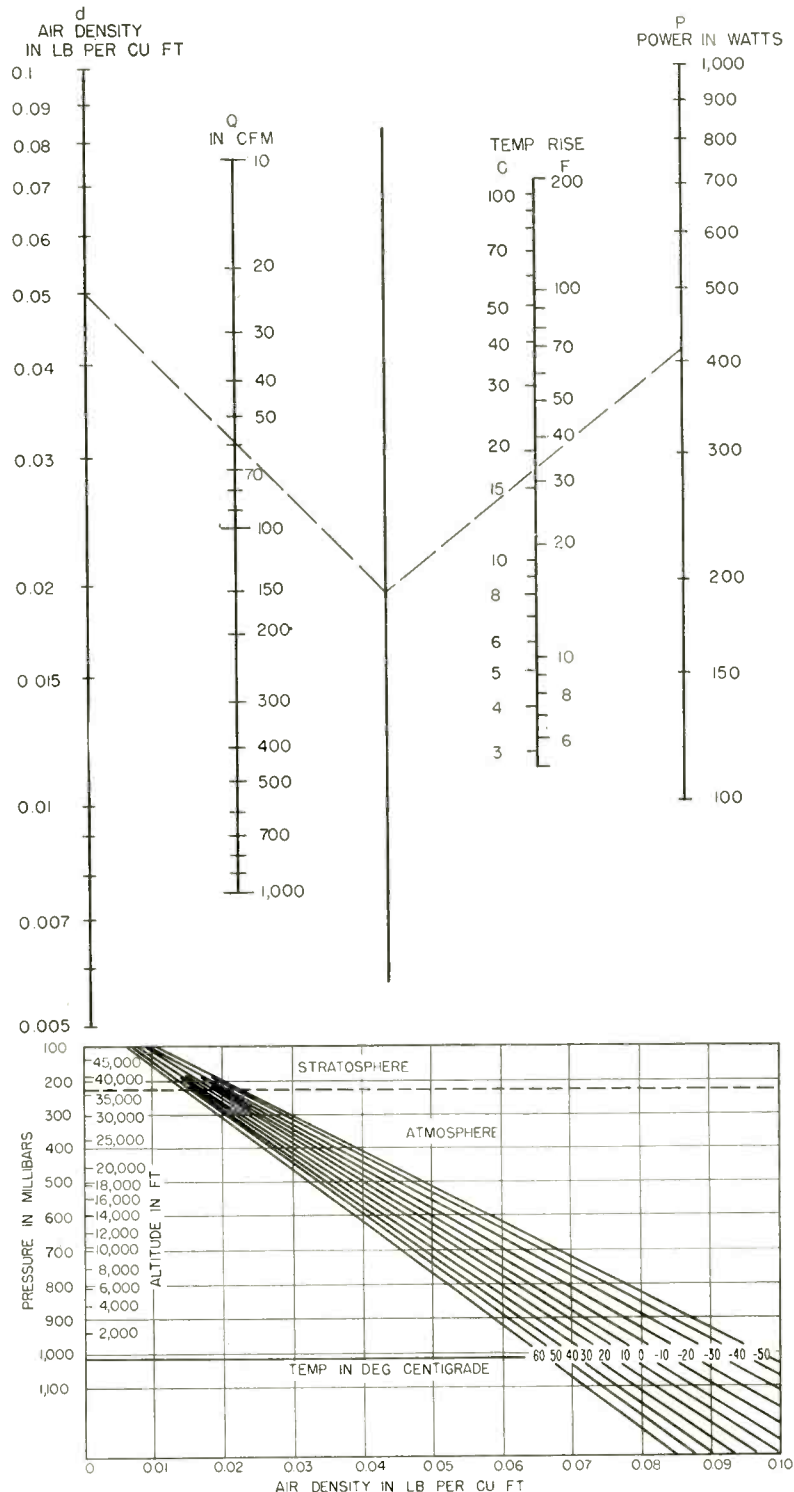



STANDARD ELECTRONIC COMPONENTS

For the past quarter of a century CINCH Components have filled the requirements developed by the rapid changes in the Electronics industry. Today, judged by demand and performance, CINCH is producing the STANDARD metal plastic assembly.

Consult Cinch

Cinch components are available at leading Electronic jobbers—everywhere



Cinch
ELECTRONIC
COMPONENTS

CINCH MANUFACTURING CORPORATION

1026 South Homan Ave., Chicago 24, Illinois

Subsidiary of United-Carr Fastener Corporation, Cambridge, Mass.

High Q Measurement

Decay of oscillations in pulsed resonant circuit is measured oscillographically, and result is applied to nomograph to obtain Q directly. Technique has been applied to measure values of Q of resonant circuits at frequencies as high as 15 mc

HIGH VALUES of Q (in excess of 1,000) cannot easily be determined under steady-state conditions, however, the transient characteristics of a resonant circuit suggest a method.

When a series resonant circuit is excited by a unit impulse, a train of damped oscillations is generated, as indicated by the waveform shown on the accompanying nomograph. The amplitude of the envelope of this wave train at time t_1 may be expressed as

$$A_1 = A_0 e^{-\frac{R t_1}{2L}} \quad (1)$$

where A_1 = the amplitude of the envelope at time t_1 , A_0 = the amplitude of the envelope immediately following excitation, R = total equivalent series resistance of the circuit, and L = the equivalent series inductance of the circuit.

The Q of a shock-excited series circuit may be expressed by

$$Q = \frac{2\pi f_0 L}{R} \quad (2)$$

where f_0 is the natural series resonant frequency. Combining Eq. 1 and 2 and choosing an excitation pulse repetition frequency such that

$$prf = 1/t_1$$

then

$$Q = \left(-\frac{\pi}{\ln(A_1/A_0)} \right) \left(\frac{f_0}{prf} \right) \quad (3)$$

The accompanying nomograph solves this equation.

Sample Measurement

The laboratory equipments required to obtain the necessary data are a signal generator to set the prf, a pulse generator, and an oscilloscope to measure the train of damped oscillations.

By **WILLIAM J. SPAVEN**

*Government Division
Fada Radio and Electric Company
Belleville, New Jersey*

The equipment is arranged so that the signal generator drives the pulse generator at the required prf. The pulse generator drives the circuit under test, and the oscilloscope reads the output of the circuit, as shown in the

block diagram on the nomograph.

A high-Q circuit, resonant at 20 kc, was to be tested. The ratio A_1/A_0 was determined from the oscilloscope pattern to be 0.90. The prf was 250 cps, or $f_0/prf = 80$. A straight line drawn from $A_1/A_0 = 0.90$ to $f_0/prf = 80$ intersects the Q line at $Q = 2,500$. Verifying with Eq. 3,

$$Q = \left(-\frac{\pi}{\ln 0.90} \right) (80) = 2,420$$

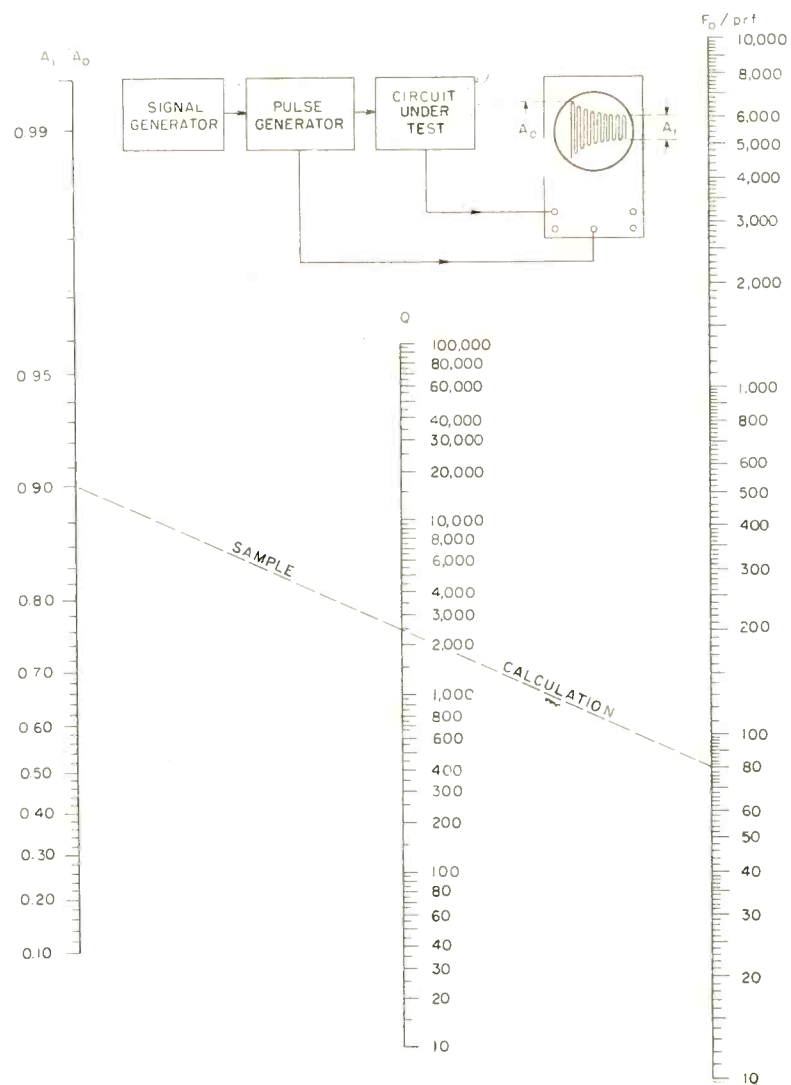

To avoid vibrator power supply troubles...

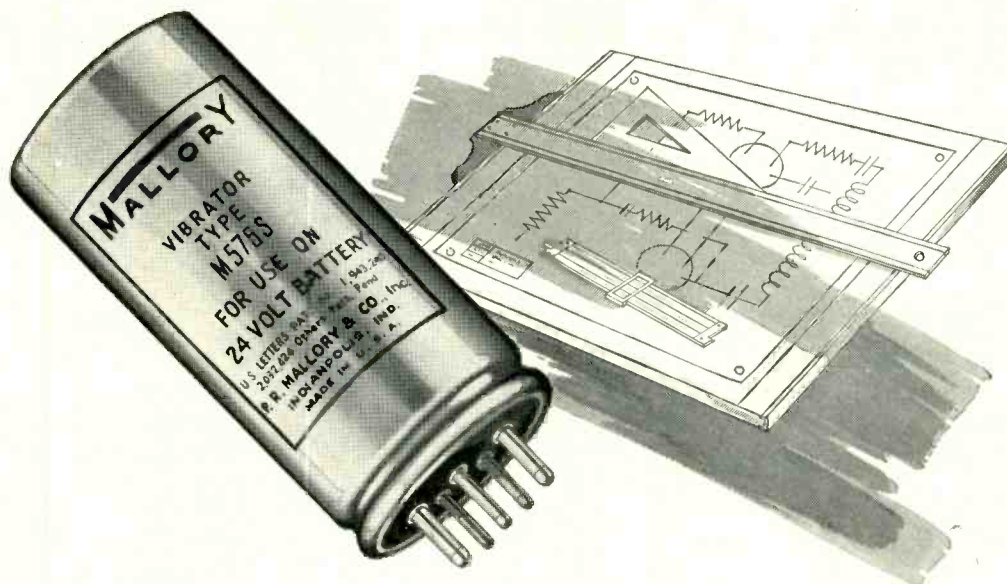

Call on MALLORY in the design stage

Vibrator power supplies need the best in design to meet the tough performance requirements of battery-operated electronic equipment. Experienced engineering must go into the selection of each element... transformer, vibrator, buffer capacitor... so each will perform its own function and operate with the others to provide maximum performance.

You can end your power supply worries by calling on Mallory to translate your power needs into a precisely engineered design. You'll save engineering time and reduce production costs. And you'll be assured of getting the power performance your equipment needs.

In vibrator design and production, Mallory offers you...

EXPERIENCE gained through years of working with leading manufacturers on a broad variety of vibrator applications... an unmatched fund of engineering skills in this field.

VIBRATORS for civilian and military use... produced by the organization which pioneered the development of commercial vibrators over 20 years ago and now supplies more vibrators for original equipment than all other makes combined.

ENGINEERING AND PRODUCTION FACILITIES that can design complete vibrator power supplies and manufacture them from start to finish... to your exact requirements.

Investigate Mallory's facilities now, whether your equipment is in production or still on the drawing board. Write or telephone today.

Vibrators
and Vibrapack®
Power Supplies

P. R. MALLORY & CO. Inc.
MALLORY

SERVING INDUSTRY WITH THESE PRODUCTS:

Electromechanical—Resistors • Switches • Television Tuners • Vibrators
Electrochemical—Capacitors • Rectifiers • Mercury Dry Batteries
Metallurgical—Contacts • Special Metals and Ceramics • Welding Materials

P. R. MALLORY & CO., INC., INDIANAPOLIS 6, INDIANA

ELECTRONS AT WORK

Including INDUSTRIAL CONTROL

Edited by RONALD K. JURGEN

Experimental UHF Broadcast.....168	Ultrasonic Therapy Unit.....202
High-Voltage Power Supplies.....170	Definitions for Color Television.....208
All-Triode Electronic Switch.....172	Latest Disc-Cathode Developments.....236
Speed-Sensing Relay.....174	New Casting Resin for Potting Components.....252
Design of Slug-Tuned Superheterodyne Receivers.....176	Linear Current Regulator.....256
Improved Blanking Circuit.....260	

Experimental UHF Broadcast

BY ROBERT P. WAKEMAN
 Head, Propagation Department
 Allen B. Du Mont Laboratories, Inc.
 Passaic, New Jersey

A STEP IN the determination of the efficacy of television as an educational tool was made on April 30, 1952. On this day, a complete set of programs designed for classroom use were originated at the State Teachers College, Montclair, New Jersey, relayed to New York City and broadcast over uhf Channel 54. These programs were received in the classrooms of 13 Montclair and Bloomfield schools.

From the point of view of a practical problem in uhf television, the technical aspects are of interest and will be reviewed here.

Figure 1 is a block diagram showing the equipment and transmission paths utilized. The Teachers College gymnasium served as a combined studio and master control room. The video equipment was a standard Du Mont dual orthicon camera chain.

OTHER DEPARTMENTS

featured in this issue:

	Page
Production Techniques...	266
New Products	310
Plants and People.....	396
New Books	414
Backtalk	430

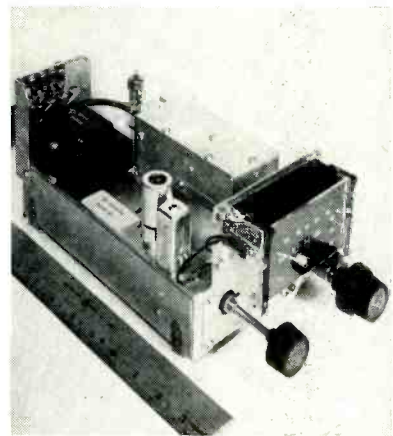

Continuously tuned uhf converter used in the experiment

The composite video signal was fed over a 200-foot line to a 7,000-mc microwave transmitter, utilizing a 4-foot parabolic antenna located in a cupola atop the building. The 12-mile transmission path to 515 Madison Avenue in New York City is well above line of sight and a noise-free picture was received in New York. The demodulated signal was simultaneously fed to the tele-transcription unit and to the uhf transmitter.

The uhf transmitter has been described elsewhere.¹ The power output is of the order of 275 watts. The transmission line and sideband filter losses total approximately 0.2 db. The antenna consists of two slot waveguide antennas back to back, each having 20 half-wave slots along one flat side. This structure is mounted vertically and has a power gain in the vertical plane

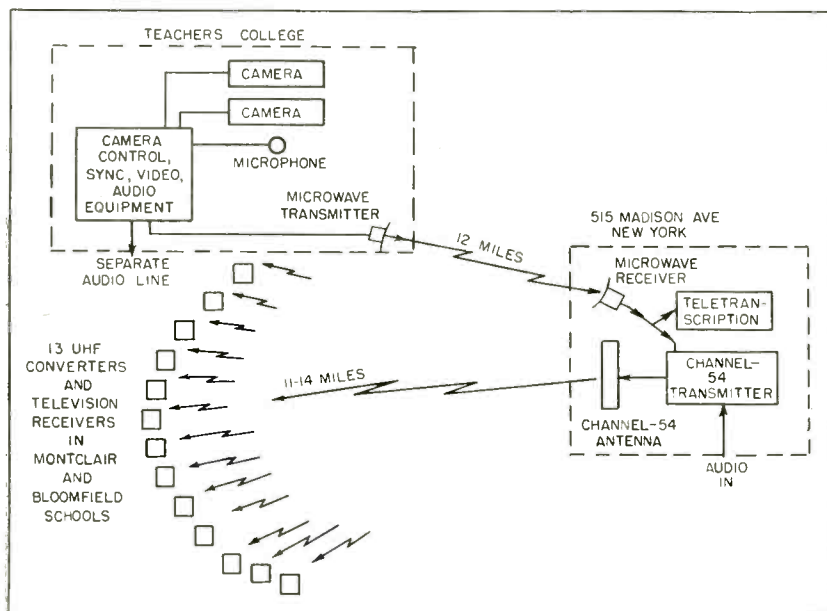

FIG. 1—Block diagram showing equipment used and transmission paths

Measure Difference In

Q

with

The Q METER Type 190-A

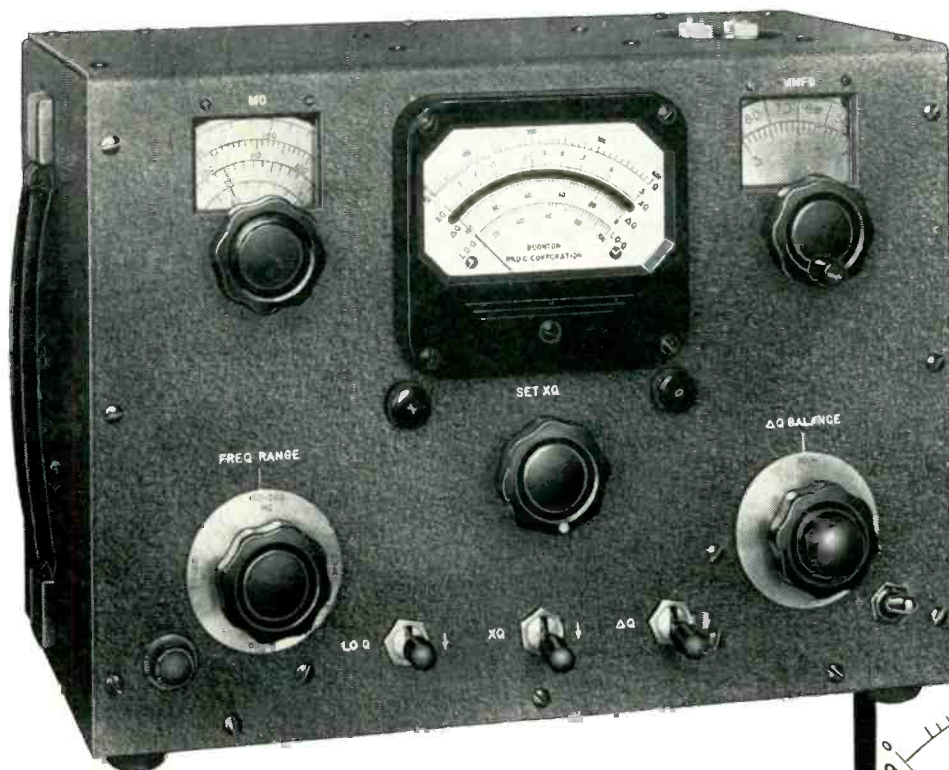

In *Designing Tuned Circuits* the effect on Q of adding capacitors, iron cores, or resistors must frequently be determined. The Q of the separate components is also often needed. These measurements made on Q Meters formerly available required the use of a small difference between two large Q values in various formulas. This led to large errors. The Q Meter Type 190-A reads the difference between the Q of a reference circuit and the Q of this circuit when new components are added. The scale that indicates this *Differential Q* has a sensitivity 4 times as great as the scale which reads Q. The accuracy and ease with which *Differential Q* can be read is greatly improved by use of the 190-A Q Meter.

The Q Meter Type 190-A has a "Lo Q" scale which reads Q down to a value of 5. The internal resonating capacitor is directly read and has a vernier arrangement for accurate reading of capacitance. The dial rotates approximately 10 times in covering the capacitance range. All readings are made on a single meter corrected for parallax.

SPECIFICATIONS

FREQUENCY COVERAGE: 20 mc to 260 mc. Continuously Variable in Four Ranges.

FREQUENCY ACCURACY: Calibrated to $\pm 1\%$.

RANGE OF Q MEASUREMENTS: 5 to 1200.

RANGE OF DIFFERENTIAL Q MEASUREMENTS: 0 to 100.

ACCURACY OF Q MEASUREMENTS: Circuit Q of 400 read directly on meter can be determined to accuracy of $\pm 5\%$ to 100 mc and to $\pm 12\%$ to 260 mc.

INTERNAL RESONATING CAPACITANCE RANGE: 7.5 mmf to 100 mmf (direct reading) calibrated in 0.1 mmf increments.

ACCURACY OF RESONATING CAPACITOR:
 ± 0.2 mmf to 20 mmf
 ± 0.3 mmf to 50 mmf
 ± 0.5 mmf to 100 mmf

POWER SUPPLY: 90-130 volts—60 cps (internally regulated). Power Consumption—55 watts.

(Specifications subject to change without notice)

PRICE: \$625.00 F.O.B. Factory

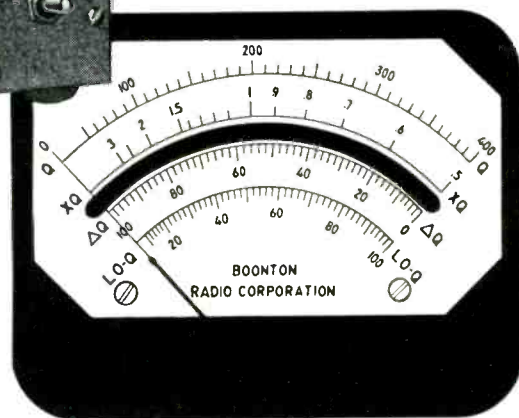

SINGLE, EASY-TO-READ METER WITH PARALLAX CORRECTION FOR ALL FUNCTIONS

- Q indicating voltmeter: 50 to 400.
- Multiply Q scale: 0.5 to 3.0.
- A differential Q scale for accurately indicating the difference in Q between two test circuits.
- Additional accurate expanded scale for measuring low values of Q.
- A counter type resonating capacitor dial for improved setting and reading accuracy.
- Regulated power supply for increased stability and accuracy.
- Careful design to minimize instrument loading of circuit under test.



BOONTON RADIO

BOONTON · N.J. · U.S.A. *Corporation*

of approximately 17 (12.3 db) over a dipole. The horizontal pattern is essentially omnidirectional with the exception of two small areas in the plane of the surface containing the slots where nulls appear.

The area covered in this experiment was well within the major lobe of the west element and effective radiated power in this direction was approximately 4.5 kw.

The uhf receivers used in this experiment were standard commercial vhf receivers with the addition of a continuously tuned uhf converter. Some trials were made using a uhf strip in place of one of the regular vhf strips. It was found that the noise figure of this arrangement was much too high in view of the relatively low transmitter power and the long receiving transmission lines. These lines varied from 50 to 200 feet and at 700 mc, with the cable available, represented a prohibitive loss. The noise figure of the uhf converter

was much better and the converters could be placed in the antenna locations.

The ultimate receiver setup was as follows: A uhf 12-element broad-side array antenna and reflector having a gain of 15 db was installed at a selected point on the school roof. A short length of RG-8/U (10 feet or less) connected the antenna and converter. The output of the converter (channel 6) was fed to the long RG-59/U transmission line. This line terminated at the receiver in the classroom.

Drift Considerations

After an initial 15-minute warm up period, the drift of the converter was found to be negligible. Any slight residual drift during the day could readily be compensated by adjusting the fine tuning control on the vhf receiver.

Technically, this experiment confirms the feasibility of uhf television broadcasts over an area of near

line-of-sight conditions. Three of the receiving antennas were actually below line of sight. Considerable effort was required to obtain satisfactory pictures but the pictures finally received were of excellent quality and entirely free of multipath effects.

Much of the difficulty encountered will be automatically eliminated when stations have an effective radiated power of 1,000 kw instead of the 4.5 kw used for this experiment. As the art advances, noise figures will almost certainly improve with the resulting effect being the same as a further increase in erp. There will always be fringe areas and it is anticipated that under these adverse conditions, home installations will present somewhat more of an engineering problem than is currently true of fringe area vhf installations.

REFERENCE

(1) Engineering Staff of Varian Associates. High-Power UHF-TV Klystron, *ELECTRONICS*, 24, p 117, Oct. 1951.

High-Voltage Power Supplies

INTERESTING DESIGN factors are illustrated in the circuits of two high-voltage power supplies developed by North American Philips Company, Inc., Mount Vernon, N. Y.

Figure 1 shows the first supply under discussion. This circuit was originally designed for the 3NP4 picture tube and has an output of 25 kv. Basically, the supply is an interrupted r-f oscillator with a rectifier-tripler combination. The r-f oscillator is pulsed by a blocking oscillator at 1,000 cycles.

Damped wave trains set up by the triggering action have a fre-

quency of approximately 25 kc. These wave trains result from the shock excitation of a circuit containing a low-loss step-up transformer with a peak r-f output of about 8.5 kv. This peak output is tripled and rectified by three EY51 tubes which derive filament power from separate transformer winds.

Transformer Design

Functioning of the transformer was made possible by designing it with a Ferroxcube core and a molded enclosure of the same material. Regulation of the output

was accomplished by coupling an additional winding to the high-voltage transformer. The rectified and filtered output of this winding controls bias on the driver tube which has the primary of the high-voltage transformer as its plate load.

Power input for the circuit consists of a 6.3-v heater supply and a 350-v d-c source with a capacity of approximately 55 ma. The character of the circuit permits variation of the 350-v supply to an extent without interfering with operation. This makes it possible to control

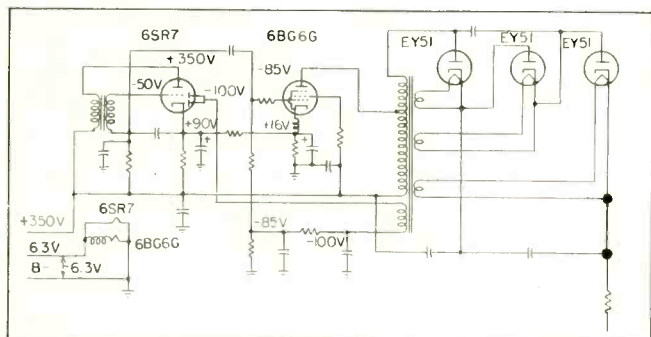

FIG. 1—Schematic diagram of the oil-immersed high-voltage supply

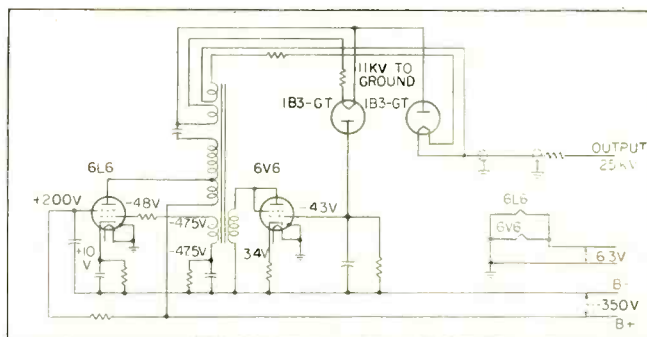

FIG. 2—Schematic of second supply free from an oil dielectric



come to **Helipot**
for the largest selection of
single turn
precision potentiometers

The same engineering know-how and precision manufacturing facilities that have made HELIPOT the world's largest manufacturer of multi-turn potentiometers, have also established its leadership in the design and production of high precision *single*-turn potentiometers. These single-turn units are built with the same infinite care . . . on the same types of specially-designed equipment . . . by the same highly trained personnel that have made Helipot multi-turn potentiometers the world's standard. *Result*—a wide selection of single-turn potentiometers, available in volume, built to the highest-possible standards—at mass-production economies!

Most of the units shown at right are readily adaptable to special requirements—servo mountings, ball or sleeve bearings, ganged assemblies, single or double shaft extensions, taps spot-welded to a *single* turn of winding at virtually any desired point, and many other optional features to meet the needs of *your* applications.

So, no matter what your requirement in precision potentiometers, bring it to Helipot!

Duodials
for
every
application

Duodial turn-indicating knob-dials are ideal for Helipots and other multi-turn applications. Available in a wide range of sizes and turns ratios . . .



MODEL RA:

The beautiful new 10 turn Precision Duodial with a "feel" and appearance that add distinction to the finest instrument panels. Features excellent readability, positive locking lever, easy assembly. Available in 10:1 ratio only.



MODEL R:

Standard 2" Duodial in 10:1, 15:1, 25:1, 40:1 turns ratios for various Helipot ranges. Locking device, if desired.



MODEL W:

Large 4 3/4" Duodial for primary control applications. Easy to adjust and read. Finger hole for rapid rotation. Available in turns ratios of 10:1, 15:1, 25:1, 40:1.

ADVANCED ENGINEERING! VOLUME PRODUCTION!



MODEL L SERIES (3" DIA.):

A high-precision single-turn unit with continuous mechanical rotation and minimum electrical dead space. Model L has bushing mounting, sleeve bearings . . . LS, servo mounting, sleeve bearings . . . ISP servo mounting, ball bearings. All are gageable to 8 sections, sections phaseable after assembly to within $\pm 1^\circ$. Many other features.*



MODEL J (2" DIA.):

The first production designed potentiometer with ball bearings as a standard feature—also versatile three-way servo mounting. Individual sections can be easily ganged and independently phased by the user after installation without external brackets or clamps. Many other unique features.*



MODEL G (1 5/16" DIA.):

A compact, single-turn precision potentiometer—low in price, extra rugged. Developed initially for remote positioning and indicating in aircraft applications—now also used for general instrumentation and servo mechanisms. Continuous 360° rotation. In certain resistance values is excellent for high temperature applications—at ambient temperatures as high as 165°C. under certain conditions.*

miniature



MODEL T "TINYTORQUE" (7/8" DIA.):

A miniature ultra-low-torque unit for guided missiles and aviation electronics. Features shielded ball bearings, highest possible precision and quality, long life, rugged dependability. Length only 25/32"—weight only 0.56 oz.—starting torque only 0.005 oz. in., when specified—negligible running torque. Sliders phaseable to within 3°. On vibration tests units have successfully withstood frequencies 0 to 2000 c.p.s. in 3 planes, accelerations up to 20 G's for periods to 1 hr.*

See your nearest Helipot Representative for complete details. Or write direct!

THE LABORATORY HELIPOT[®]
(MODEL T-10):



A 10 turn Helipot, "R" Duodial and 3-way binding posts combined in a handsome walnut-cased unit ideal for laboratory and instruction purposes. Simplifies making and changing experimental circuits. More compact and 5 times faster to set than decade boxes. Linearity 0.1%. Power Rating 5 watts, Standard Resistance Ranges 100 to 100,000 ohms—others on order.

THE Helipot CORPORATION
SOUTH PASADENA 2, CALIFORNIA

Field Offices: Boston (CO. 7-1961), New York (Rockville Center 6-1014), Philadelphia (COLLINGSWOOD 5-3515), Rochester (CU. 7640), Schenectady (DE. 2319), Cleveland (PR. 1552), Detroit (TO. 8-3130), Chicago (PA. 5-1170), St. Louis (SW. 5584), Los Angeles (RY. 1-8345), Seattle (FR. 7315), Dallas (ST. 3335), Ft. Myers, Fla. (FO. 1269-M), Canada: Cassor, Ltd. Toronto (PR. 1226) and Halifax (4-6488). Export Agents: Frathom Co., New York City 18, (BR. 9-1296).

THE FRONT COVER

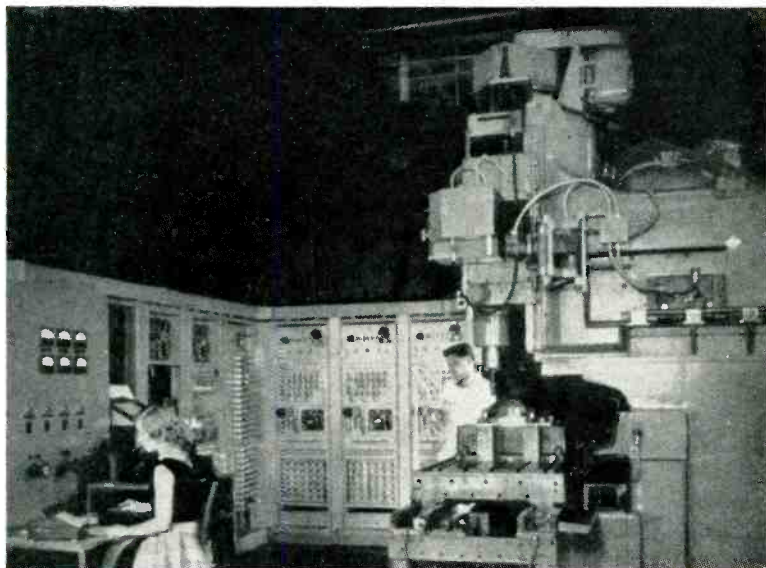

THE tube-controlled milling machine shown in the cover and accompanying photographs comprises a converted 28-inch Cincinnati Hydro-Tel and a director containing 250 electron tubes and 175 relays. The contouring equipment removed from the miller has been replaced by three servomechanisms that move the table, cross slide and spindle head.

The director consists of a data-input system that operates from the pattern of holes punched in a paper tape, a data-interpreting system and a set of three decoding servomechanisms. Directions punched into the tape are, therefore, converted into shaft rotations. Checking pulses are fed back from the rotating shafts.

The so-called numerical control technique used in this system is particularly attractive for machine-tool applications in that the numerical instructions may be of unlimited precision.

12.5 kv. This is then rectified and doubled to furnish approximately the same output as that obtained from the previous unit.

With regulation circuits working, potential varies about 600 volts between no load and full load of 200 microamperes. This is accomplished by means of a loss circuit in which a triode-connected 6V6GT is coupled to the r-f transformer.

Adjustment of coupling and plate current reduces no-load voltage to a desired value. Rectified output current flows through a resistor in the grid circuit of the regulator tube. As output current increases, bias on the regulator is increased until the tube cuts off at a desired value of load current. Above this value, the power-supply unit operates on an unregulated curve. Where very close regulation is required for a specific purpose, it is not difficult to choose tubes which make the curve flat from no load to full load.

All-Triode Electronic Switch

By CHARLES W. SPINDLER, JR.
*Engineering Department
Leeds and Northrup Co.
Philadelphia, Pa.*

IN THE COURSE of investigation of servo-systems, a need was felt for a simple low-gain electronic switch to allow the simultaneous observation of two signals. The following circuit has proved satisfactory for the purpose and may be refined by the addition of amplifier stages to extend its range of application.

The heart of the unit is a cathode-coupled gate circuit, Fig. 1, which uses a high- μ tube (V_{2A} and V_{2B}) as an amplifier, cathode-coupled to a high- g_m tube (V_{3A} and V_{3B}). If the grids of V_3 are R-C coupled to opposite plates of a free-running multivibrator (V_{1A} and V_{1B}) the two halves of V_3 will be alternately cut off and driven to a high level of current. As a result of this high level of current, the voltage on the common cathode resistors is more than enough to cut off the high- μ tubes.

When V_{3A} and V_{3B} are cut off by the multivibrator, the amplifiers operate as current-feedback circuits;

nominal output voltage for different applications. Normal output is approximately 25 kv with a capacity of 200 microamperes. Regulation is about 600 volts from no load to full load.

The output curve for the supply is such that voltage falls off rapidly after the maximum output current is reached. This was a deliberate part of the design to protect the tube and to afford some measure of safety to personnel. Output is obtained from a shielded high-voltage lead with a connector which incorporates a one-megohm resistor for additional protection.

All of the high-voltage circuits are housed in an oil-filled metal container. This includes the high-voltage transformer, the EY51 tubes and the filter capacitor. The metal container measures 3 by 3 by 3 $\frac{1}{2}$ in.

Although no field complaints were encountered due to presence of oil in the unit, it was considered objectionable by the Underwriters Laboratories, so a new design was developed.

New Supply

The second high-voltage unit is completely free from oil dielectric but, of necessity is somewhat larger. Electrical characteristics are practically the same as for the oil immersed unit since the device was designed primarily to supply anode voltage to the same tube.

The r-f oscillator in the new circuit, Fig. 2, is continuous in its operation at approximately 28 kc. The ferrocube-core transformer was used again both to supply coupling from oscillator plate to grid and to step up the r-f output to a peak value of approximately

pioneers in precision

Lear, Incorporated

Manufacturers of Precision Engineered Products, Lear has pioneered in the miniaturization of aviation instruments since 1930.

Lear designed and produced automatic pilots have been accepted for use in jet fighter planes as well as in commercial aircraft for single engine or multi engine airplanes. The Lear Automatic Pilot and Approach Coupler permits safe landings despite extreme weather or visibility conditions.

Miniature Precision Bearings

incorporated, are the originators and pioneer manufacturers of radial ball bearings in miniature sizes. For and with Lear, **MPB** designed the first miniature flange bearings and has supplied many thousands of this and additional types.

A pioneer in other designs and dimensions now being internationally standardized, **MPB** has also originated many precision manufacturing techniques. High speed bore grinding was first explored and finally perfected in this plant. For nearly ten years, this recently publicized method has been standard practice at **MPB**. In fact, the original concept of practically every development in this field has been by **MPB**.

Regularly supplied in more than 120 types, sizes, and materials, from 1/10" to 7/16". Special designs are supplied where specifically indicated. They are fully ground, lapped, honed, and/or burnished to ABEC 5 tolerances or better.

MPB ball bearings have been installed in more than a million precision mechanisms. Design engineers are assured of full cooperation. Write, requesting Catalog 52B—shows complete range and selection data—engineering sheet E 11

Quality improvement, continued thru an extensive expansion program has prompted a demand greater than ever. Enlarged facilities however, and newest exclusive processes will soon enable us to serve you better than ever.

Miniature precision Bearings

Incorporated

Keene, New Hampshire



"pioneer precisionists to the World's foremost instrument manufacturers"

**save
space
weight
friction**

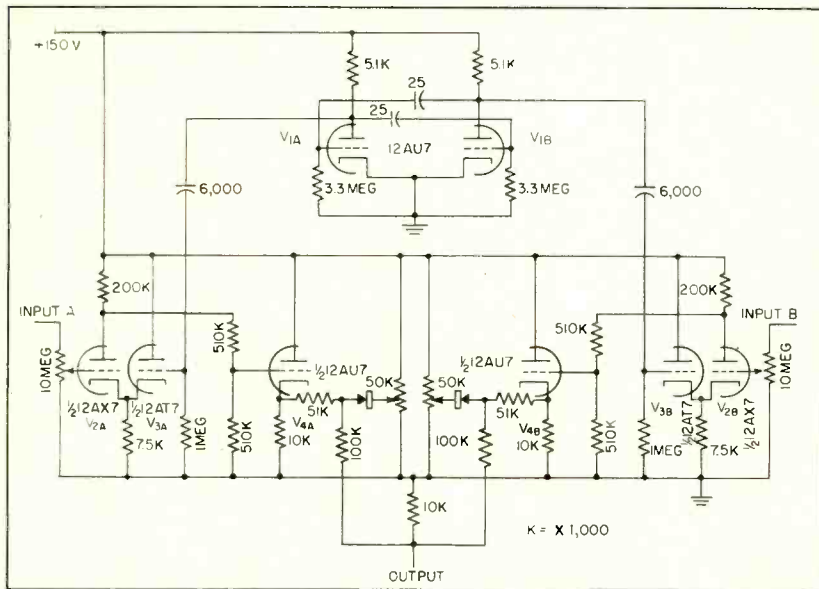

FIG. 1—Schematic diagram of the electronic switch

in this way, square waves are generated by the gate circuits. The level of the positive half cycle is determined by the plate supply voltage and is constant. The level of the negative half cycle is set by the grid-cathode voltage of the amplifier tube at that time.

Square waves generated by the two gating circuits are 180 deg out of phase and, if the amplitudes are made different, linear mixing will result in a square wave in which the level of the positive half cycle is fixed by the input to one gate and the negative by that on the other gate.

To achieve the decoupling necessary for mixing, outputs of the two gates are fed to cathode followers V_{4A} and V_{4B} . Signals from the cathode followers go to biased clippers in which the clipping levels are adjusted by potentiometers. Since the clippers remove only the positive portion of the waves, only the peak amplitude is affected and the variations on the negative part are undisturbed.

Passing the outputs of the clippers through a mixing circuit results in a square wave which, when applied to an oscilloscope, shows a reproduction of the input signals to the electronic gate unit. Spacing of the traces may be adjusted by varying the relative peak amplitudes of the individual gating-circuit outputs by using the potentiometers in the clipping circuits.

The unit, exclusive of power supply, was built on a 5 by 4 by 3-in. box and the output terminated in banana plugs. The unit is arranged so that it plugs directly into and is supported by the input terminals of the oscilloscope.

Speed-Sensing Relay

BY JOHN H. PORTER
Office of Naval Inspector of Ordnance
Rochester, New York

FOR A CERTAIN laboratory application, it was desired to develop a relay which would trigger an external circuit at certain predetermined speeds of a motor. The motor speed is sampled photoelectrically by light bands on the shaft and the resulting alternating voltage fed to a thyatron through an adjustable frequency sensitive network.

Negative d-c voltage developed by a rectifier in the output of this network, Fig. 1, is used as hold-off bias on the thyatron grid, so that when the combination of grid and fixed cathode bias voltages becomes a minimum, the tube will fire. An a-c anode supply is used for the thyatron in order that the grid may retain control of the tube.

Because of the difficulty in obtaining the same attenuation from a parallel-T network at all null frequencies, the network, Fig. 1, was designed to present a constant input impedance to the phototube at

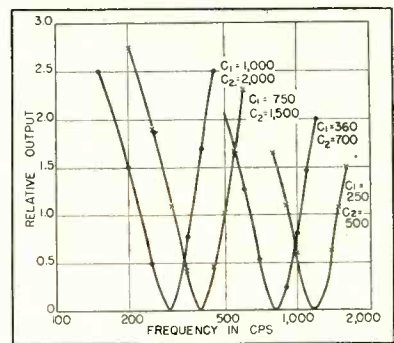

FIG. 2—Relative output vs frequency for different capacitor values. All C 's are in μf

all such frequencies considered. At balance

$$f = 1/2\pi R_1 C_1$$

and the usual design equations hold

$$R_1 = 2R_2$$

$$C_2 = 2C_1$$

If the network is terminated in a sufficiently high impedance, in this case 10 megohms shunted by a crystal rectifier, the input impedance can be approximated by

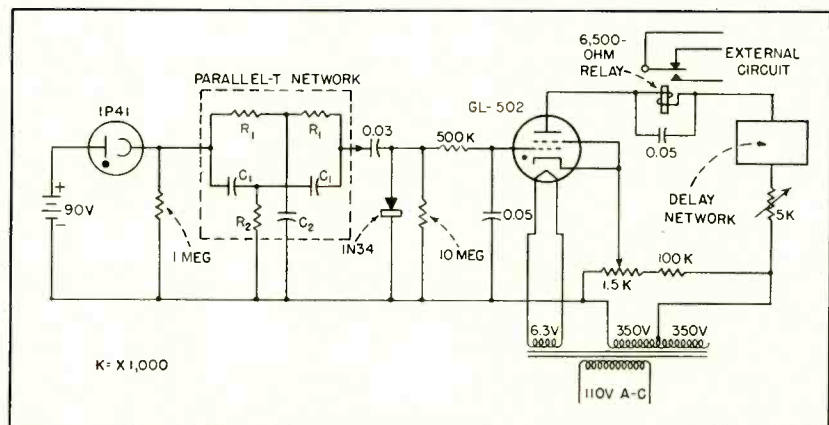
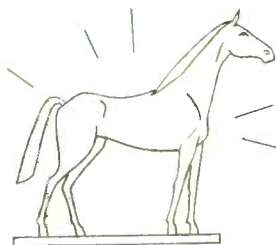
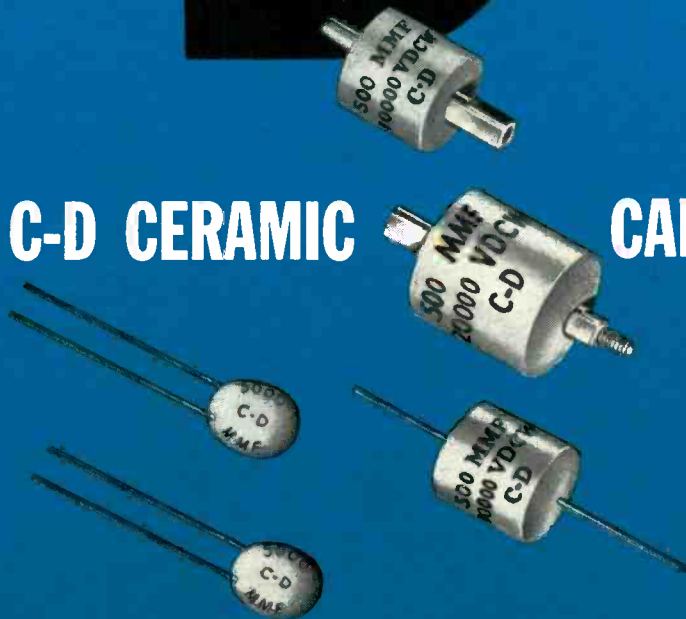

FIG. 1—Schematic diagram of the speed-sensing relay circuit

C D

onsistently
ependable

C-D CERAMIC CAPACITORS



The ceramics with the "million dollar" body! Even the body is made by C-D, in the newest, most modern ceramic body plant in the world. You'll be as thoroughly "sold" on C-D ceramics as you are on C-D Dykanols*, micas and electrolytics. Write for Engineering Bulletins to: Dept.K-112, General Offices, Cornell-Dubilier Electric Corp., South Plainfield, New Jersey.

CORNELL-DUBILIER

world's largest manufacturers of capacitors



ANTENNAS

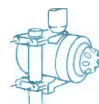

ROTATORS



CAPACITORS



VIBRATORS



CONVERTERS

SOUTH PLAINFIELD, N. J. • NEW BEDFORD, WORCESTER AND CAMBRIDGE, MASS. • PROVIDENCE, R. I. • INDIANAPOLIS, IND. • FUQUAY SPRINGS, N. C. • SUBSIDIARY, THE RADIART CORP., CLEVELAND, O.

RG/coaxial cables

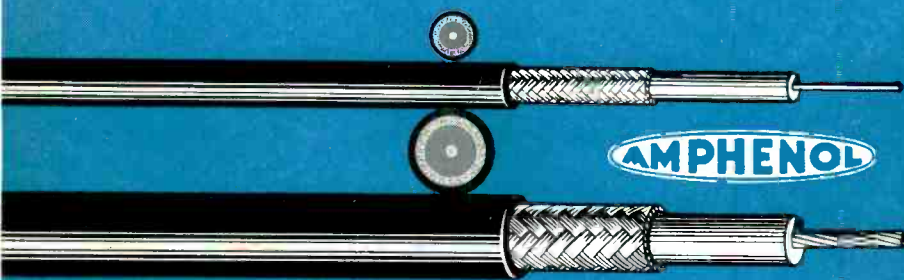

AMPHENOL

Whatever the size RG coaxial cable you need, you'll get a better cable when you buy from Amphenol. Every stage of cable manufacture, from the testing and selection of raw materials through to the final loading and shipping, is done by Amphenol's experienced workers in Amphenol's own modern cable plant under the watchful eye of Amphenol's technicians and engineers. There is no opportunity for outside errors to creep in.

Amphenol RG coaxial cables are available with either high quality polyethylene or Teflon dielectric. The polyethylene cables are jacketed with tough, weatherproof vinyl to military specifications. The Teflon dielectric type cables have an outer covering of silicone varnish impregnated glass fibre for high temperature applications up to 500°F. These Amphenol cables satisfy every environmental need for military and civilian use from the Arctic to the Tropics.

Amphenol solid dielectric coaxial cables are providing the best in RF transmission, *without maintenance expense*, in communication service everywhere!



A few of the popular sizes of Amphenol RG/Coaxial Cables

MIL NUMBER	AMPHENOL NUMBER	NOMINAL IMPEDANCE	NOMINAL O.D.	DIELECTRIC MATERIAL
RG-122/U	21-441	50 ohm	.160	Polyethylene
RG-58/U	21-024	53.5 ohm	.195	Polyethylene
RG-59/U	21-025	73 ohm	.242	Polyethylene
RG-62/U	21-026	93 ohm	.242	Polyethylene
RG-8/U	21-004	52 ohm	.405	Polyethylene
RG-17/U	21-013	52 ohm	.870	Polyethylene
RG-87A/U	21-250	50 ohm	.425	Teflon
RG-141/U	21-382	50 ohm	.195	Teflon

This plastic cable and connector selector is designed to help the engineer or designer to choose the proper cable or combination of cable and connector. Listed on this selector are several hundreds of cables, connectors and combinations. This handy selector will be furnished at no charge to designers and engineers working with radio frequency cables and connectors. Address your request on your company letterhead to Department 13L.



AMERICAN PHENOLIC CORPORATION
1830 SOUTH 54TH AVENUE • CHICAGO 50, ILLINOIS

Table I—Component Values vs. Frequencies

Freq. (cps)	R ₁	R ₂	C ₁ (μμf)	C ₂ (μμf)
260	669K	333K	900	1,800
400	669K	333K	600	1,200
600	669K	333K	400	800
900	669K	333K	265	530

$$Z_{in} = \frac{(R_2 + X_{C1})(R_1 + X_{C2})}{(R_2 + X_{C1}) + (R_1 + X_{C2})}$$

Making the proper substitutions from the balance equations

$$Z_{in} = \frac{3}{4} R_1$$

An input impedance of 500,000 ohms was chosen for this circuit, and Table I shows the values of *R* and *C* used for the various null frequencies to be encountered.

The network sensitivity with silver mica capacitors is such as to produce a d-c voltage of approximately 0.1 volt at a frequency 5 percent from any chosen null. Selectivity is shown on the curves of Fig. 2.

A slight amount of phase shift is obtained on the fixed cathode bias by the R-C grid network to increase the sensitivity of the grid to small changes in the negative d-c from the parallel-T. A delay network is shown in the anode circuit of the thyatron, Fig. 1, to keep the tube from firing at zero speed. This delay is initiated by the motor starting switch.

Design of Slug-Tuned Superheterodyne Receivers

By PHILIP S. WESSELS
Electronics Engineer
Guided Missile Division
Consolidated Vultee Aircraft Corp.
San Diego, Calif.

MINIATURIZATION of receiver components has made the iron-core tuning unit a necessity in the continuously tuned superheterodyne front end. Some developments in experimental technique that proved of considerable value are presented in this article.

In the absence of external influences, such as tickler coils and

**ASSEMBLE AND INSPECT
UNDER MAGNIFICATION
in one operation...**

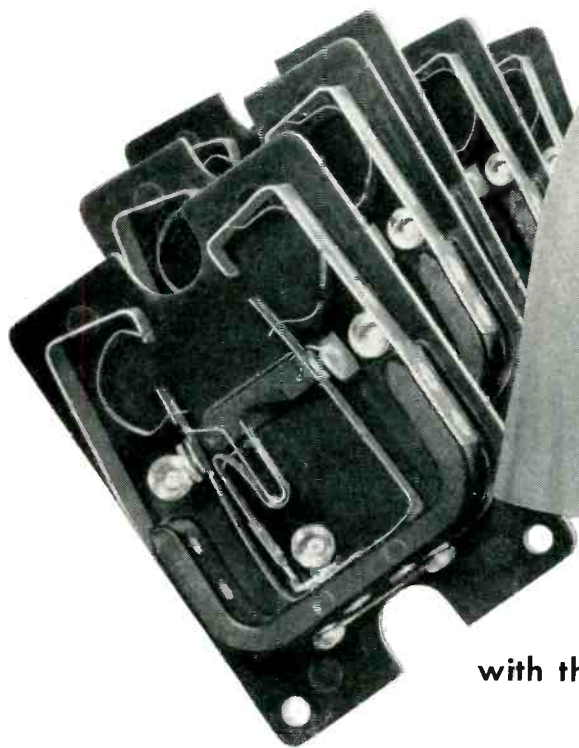

with the **Kodak Contour Projector**

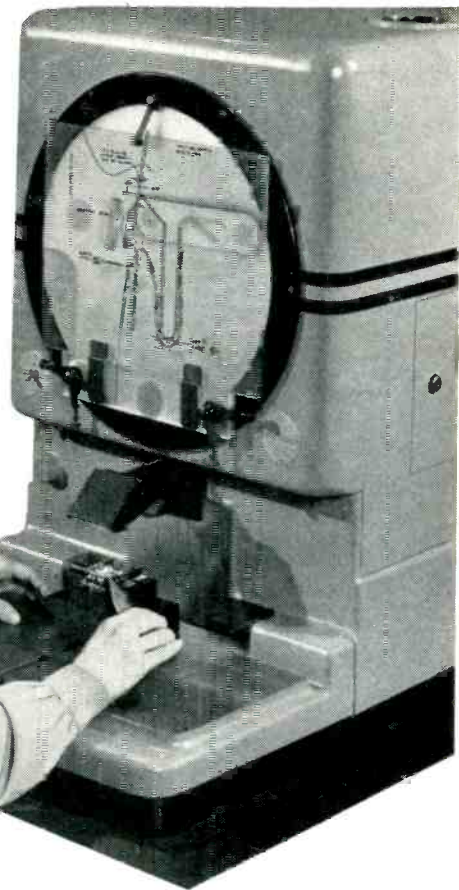

This starter switch for a refrigerator motor presents a tough assembly and inspection problem. The springs must be accurately bent and adjusted by hand—tolerances are close.

With the Kodak Contour Projector the whole operation—bending and checking—may be done at the same time and under the magnification that's most convenient.

Since the Kodak Contour Projector has provisions for surface illumination from the same lens that picks up the image, every detail of the switch is shown on the screen. A 45° mirror permits the part to be mounted flat for easy accessibility. Both to adjust the part and check tolerances, the operator simply compares the magnified image with a chart-gage laid on the bright screen.

Whether your interest is in large parts or small

parts, simple parts or complex parts with many dimensions, a Kodak Contour Projector will do the job quickly, completely, and accurately. The operator can work in a lighted room unhampered by hoods or curtains. And little training is required to get the work out in a hurry.

For rapid, routine inspection and adjustment work, the economical, stripped-down Kodak Contour Projector, Model 3, will meet your requirements. For toolroom measurement, the versatile Model 2A is what you need. In your area there is an experienced field engineer who will be glad to discuss your own particular problems. You can get in touch with him by writing Eastman Kodak Company, Industrial Optical Sales Division, Rochester 4, N. Y.

the KODAK CONTOUR PROJECTOR



A new sound movie shows how to simplify complex inspection problems. We'll tell you how to get it for a showing.

Kodak
TRADE-MARK

INDIANA

PERMANENT MAGNETS

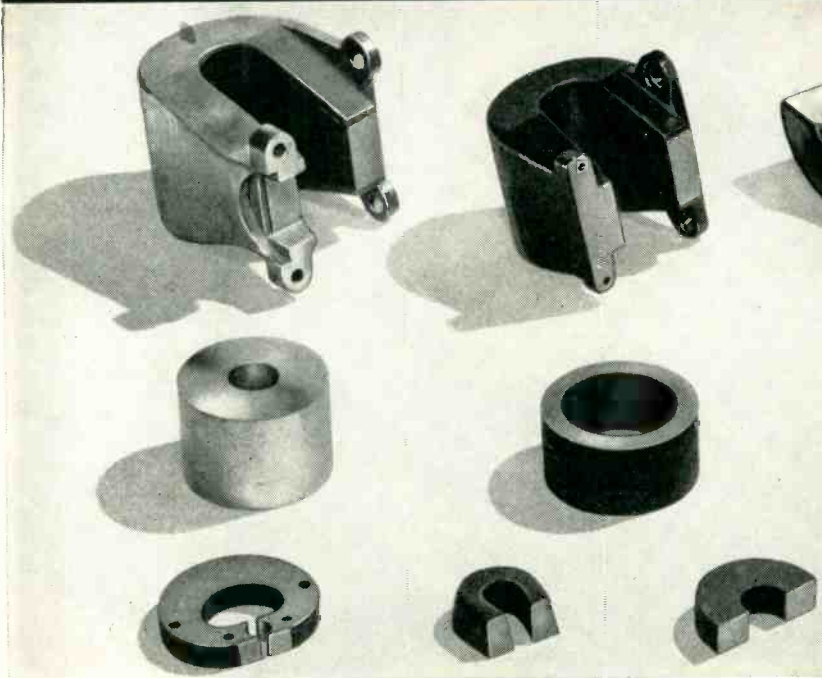

24 Hour Service

ON CATALOG MAGNETS

Write for this handy reference book full of detailed permanent magnet information. Ask for Catalog No.11.

MATERIALS

Indiana's wide variety of magnet alloys permits precise selection.

HYFLUX Alnico V
Cast Alnico
Sintered Alnico
Cunife

Cunico
Chrome Steel
Cobalt Steel
Tungsten Steel

FOR ALL APPLICATIONS

Indiana Permanent Magnets provide uniform high energy for:

RADAR MAGNETRONS

All types and sizes, horns, "U's" and "E's". Indiana quality insures a strong, uniform magnetic field.

LOUDSPEAKER MAGNETS

Indiana Hyflux Alnico V speaker magnets offer a guaranteed energy product of $5\frac{1}{4}$ million BHmax as contrasted with an industry minimum of $4\frac{1}{2}$ million.

MAGNETS FOR METERS, INSTRUMENTS AND CONTROLS

A complete variety for ammeters, indicating instruments, galvanometers, switches, etc.

TV FOCUS COIL MAGNETS

All types and sizes of segmented rings, thin wall rings, etc. for focus coils, ion traps and centering devices.

MAGNETS FOR MOTORS, GENERATORS AND MAGNETOS

Rotors and assemblies in all grades of Alnico.

SEPARATOR MAGNETS

Magnets for all types of industrial processing . . . from pulley separators to can-making machinery.

All materials . . . all sizes . . . all shapes . . .

Look to INDIANA for quality permanent magnets — for skill in manufacture — for cost-cutting engineering aid. Strict supervision in every step of production is your assurance of exact magnetic and mechanical characteristics.

Complete Engineering Service

Indiana offers a complete engineering service to help select the best permanent magnet for your application. Backed by years of research and experience gained in the development of thousands of magnetic designs, Indiana engineers have the "know-how" to select the best permanent magnet material and to properly design the magnet. This service involves no obligation on your part.

Sales Offices Coast to Coast

Boston 16, Mass., Park Square Building
Chicago 2, Ill., 6 North Michigan Avenue
Cleveland 14, Ohio, Hippodrome Building
Los Angeles 15, Calif., 1151 S. Broadway

New York 17, New York, 51 East 42nd St.
Philadelphia 7, Pa., Real Estate Trust Bldg.
Rochester 4, New York, Sibley Tower Bldg.

**INDIANA
PERMANENT
MAGNETS**

THE INDIANA STEEL PRODUCTS COMPANY

VALPARAISO, INDIANA • • • Sales Offices Coast to Coast

SPECIALISTS IN "PACKAGED ENERGY" SINCE 1908

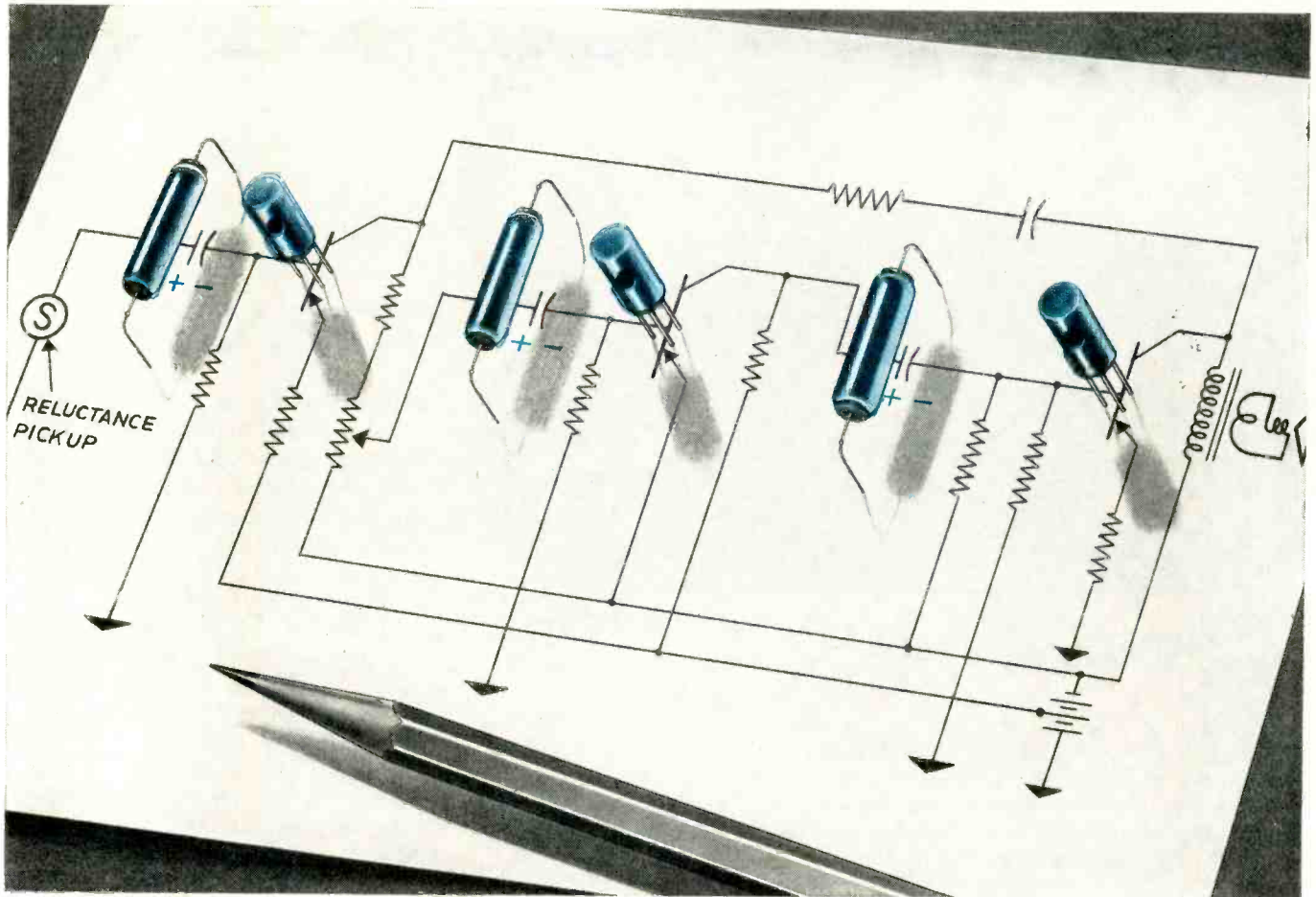

TRANSISTORS . . . TANTALYTIC CAPACITORS

teamed in 100-milliwatt tubeless amplifier

General Electric engineers at Electronics Park, Syracuse, have developed a new tubeless audio amplifier circuit that utilizes three junction transistors and three Tantalytic capacitors.

Although still experimental, this 3-stage amplifier promises significant advances in miniaturized equipments. It has a power output of 100 milliwatts—less than 10% distortion—and a power gain of 70 db.

Tantalytic capacitors were a “natural” for inter-stage coupling in the circuit because of their small size, large capacitance and low leakage current. They match the transistors in ruggedness and long operating life. And they will operate over a wide temperature range (–55°C to +85°C with at least 65% capacitance at –55°C). Other features include light weight, long shelf life, and hermetic sealing.

If you have a capacitor application where you need small size and superior performance, it will pay you to investigate Tantalytic capacitors. They're available in polar and non-polar construction and in

ratings from 175 muf at 5 VDC to 12 muf at 150 VDC. For additional information use the convenient coupon below.

General Electric Company, Schenectady 5, New York.

**General Electric Co., Section A 407-313
Schenectady 5, New York**

Gentlemen: Please send me a copy of your free Bulletin(s)

- GEC-808 and GER-451 "Tantalytic Capacitors"
- ECG-1 "Germanium Transistors"

Name _____

Company _____

Street _____

City _____ Zone _____ State _____



Berkeley
**PRINTED
READOUT**

13273
25182
25173*

2 5 7 *
1 3

FOR
ELECTRONIC
COUNTERS!

• DIRECT READING • RAPID CYCLING • LOW COST



PRINTED READOUT for high speed electronic counters is now available at low cost as a standard BERKELEY product! This Digital Recorder provides a direct means of permanently recording sequential count information in arabic numeral form on a standard adding machine tape. It is designed to operate from electronic counters, Time Interval Meters, Events-per-Unit-Time Meters, nuclear scalars, and other electronic totalizing devices. Most standard BERKELEY instruments now in use can be readily adapted for operation with the BERKELEY Series 1550 Digital Recorder, thus eliminating the need for purchase of new counting equipment.

DIGITAL RECORDER . . . Series 1550 is composed of a Readout unit and a Printing Recorder. The first unit consists of a bank of readout decimal counting units essentially paralleling the totalizing function of the basic counting instrument from which they operate, and a selecting relay matrix to channel information from the counting circuit to the Printing Recorder. This second unit presents a sequence of total counts in direct reading digital form on a standard adding machine tape.

A COMPLETE SYSTEM . . . of Electronic Counter and Digital Recorder then consists of three elements: a suitable electronic counting device, Readout unit, and Printing Recorder. The latter two elements comprise the complete Digital Recorder. Under certain conditions a special modification of the system will permit original count information to be channeled directly into the Readout unit, thus eliminating the need for a separate electronic counter.

SPECIFICATIONS . . . Minimum counting period determined by the characteristics of the basic counting instrument. Maximum cycling rate: 1 printout every 3/4 second. Indicating capacities 3, 4, 5 or 6 columns. Readout Unit—20 3/4" x 10 1/2" x 15" cabinet, wt. 60 lbs., standard 19" relay rack panel. Printing Recorder—7 1/2" x 8 3/4" x 14 1/2" cabinet, wt. 20 lbs. Price, Digital Recorder, Model 1553 (3-column), \$1050; Model 1554 (4-column), \$1125; Model 1555 (5-column), \$1200; Model 1556 (6-column), \$1275, f.o.b. factory.

Please request Bulletin 1011

Berkeley Scientific
division of **BECKMAN INSTRUMENTS INC.**
2200 WRIGHT AVENUE • RICHMOND, CALIFORNIA

"DIRECT READING DIGITAL PRESENTATION OF INFORMATION"

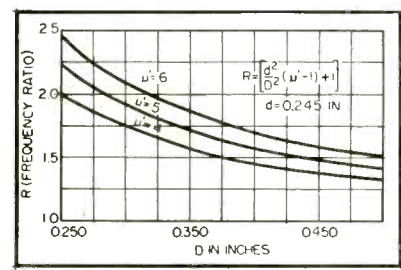

FIG. 1—Graph for predicting frequency ratios obtained by plotting right side of Eq. 1 in text versus coil diameter

antenna coupling circuits, two slug-tuned coils with their associated capacitors can be made to tune with a constant frequency difference within reasonable limits by a simple adjustment of their diameters to give the proper frequency ratio to each unit.

If the tuning range of the low-frequency unit is to be f_2 to f_1 giving a ratio of f_2/f_1 , then the high-frequency unit will tune over the range of $f_2 + f$ to $f_1 + f$ giving a ratio of $(f_2 + f)/(f_1 + f)$ where f is the constant difference frequency, or i-f frequency, to be maintained.

It has been shown that the inductance ratio obtainable from a powdered-iron-core coil is given by

$$L_n/L_o = \frac{d^2}{D^2} (\mu' - 1) + 1 \quad (1)$$

where L_o is the inductance without iron, μ' is effective permeability of iron, d is core diameter, $D = \frac{D_1 + D_2}{2}$, D_1 is outer diameter of winding and D_2 is inner diameter of winding.

When μ' is relatively large and d^2/D^2 does not differ greatly from unity, it is apparent that the in-

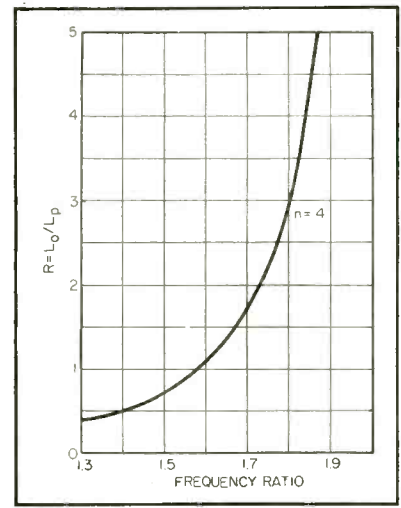

FIG. 2—Frequency ratio versus L_o/L_p

Vibration Engineering that solves your problems

PROBLEM: To perform vibration tests to MIL-E-5272 specification.

SOLUTION: The MB Model C-25 Vibration Exciter rated at 2500 lbs. force.

Shake testing gives a quick method of developing a product to withstand vibration. Such testing is vital for military equipment — and a good idea for any product. To meet this need, MB has applied its specialized vibration engineering to develop a range of shakers in various ratings for testing everything from electron tubes to airframes.

The big C-25 model illustrated develops large "brute forces" to satisfy specification MIL-E-5272. It has heavy duty capacity for a wide range of work, including fatigue testing. It features accurate, continuous control of force and frequency. Its control panel is available with an automatic cycling system for specific cycling tests called for in the MIL-E-5272 specification.

One of the largest and most dependable electromagnetic shakers available, the C-25 model

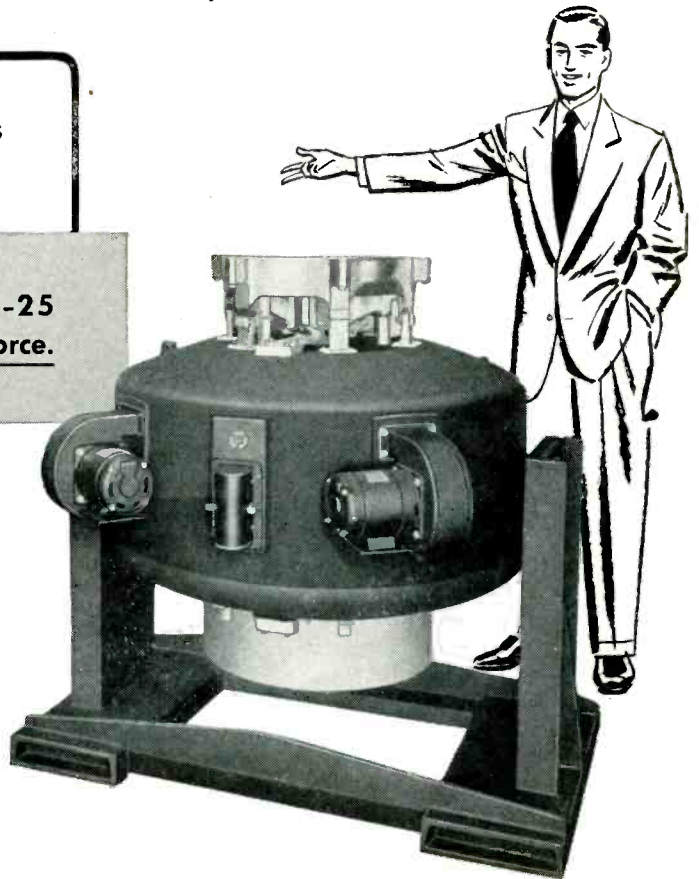

is a good example of the quality of vibration engineering that has made MB "headquarters" for products to isolate, control, reproduce, detect, or measure vibration. More information on MB Vibration Exciters in Bulletin 1-VE-5. Write us.

Want a standard mount for vibration isolation in the special class?



With the Isomode* Type 17 Isolator, you not only conform to MIL-I-5432 specification but also get an unusual degree of isolation efficiency. It has equal spring rates in every direction. This means better control of all modes of motion. For details on this mount, write to Dept. 5.

*Trade Mark Reg. U.S. Pat. Off.

THE MB MANUFACTURING COMPANY, INC.
1060 STATE STREET, NEW HAVEN 11, CONN.

PRODUCTS AND EQUIPMENT TO CONTROL VIBRATION • TO MEASURE IT • TO REPRODUCE IT



Marchant Calculating Machine Company

*“They make no mistake
in figuring resistor costs”*

says L. F. Church, L. F. Church Company, San Francisco,
representative for Ward Leonard Electric Company

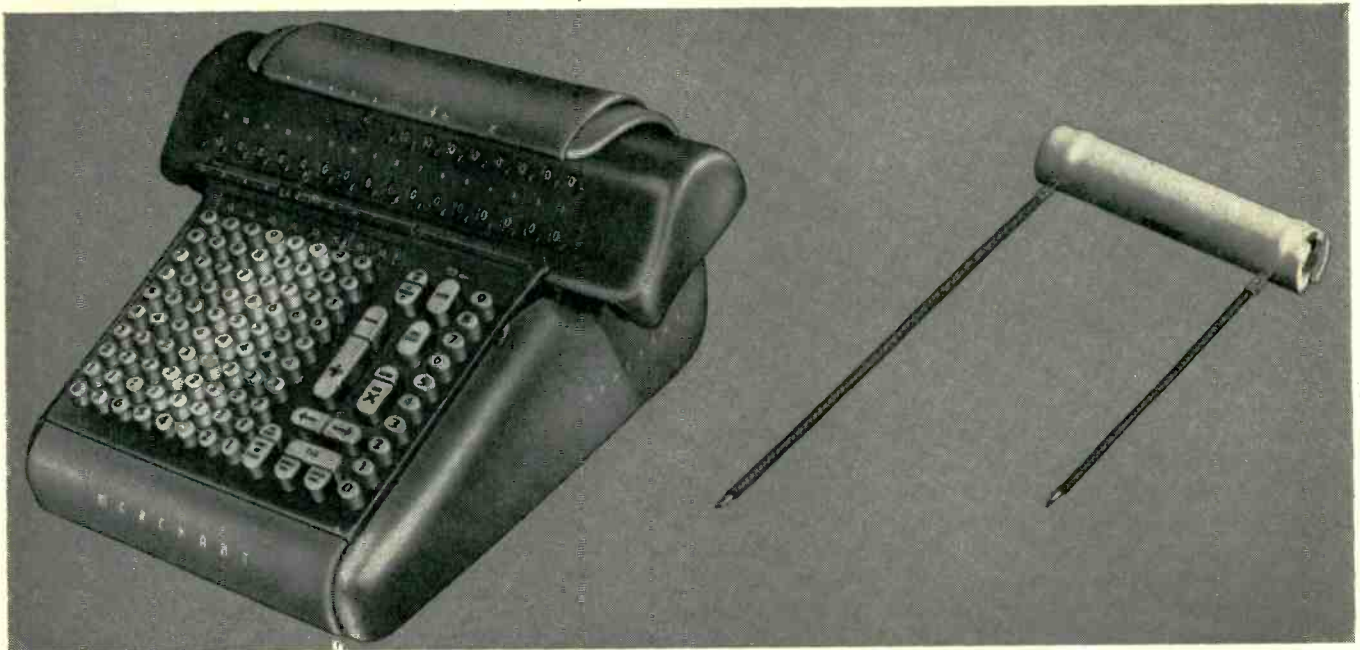

It's *cost in terms of performance* that counts with the makers of Marchant calculators.

A lot of arithmetic would be delayed if resistors failed to work in these push-button multiplication calculators. That's why Marchant insists upon quality resistors, rather than taking a chance with bargains.

How do you *tell* a quality resistor?

It's true that most resistors look alike. A resistor is a simple piece of equipment—really nothing more than a piece of ceramic tubing . . . a couple of terminals . . . a piece of resistance wire . . . and a protective coating.

But there the similarity ends, because in the *important* things that really count, resistors are miles apart! And the biggest difference is that all of the resistor is actually *made* by the company that sells it.

The only way to be sure that all components will react the same to changes in temperature is to balance their thermal characteristics.

Take the tube. Companies like Marchant are depending on that high-density, non-porous, high-dielectric strength, perfectly cylindrical Ward Leonard ceramic core, with smooth surface and straight ends.

They also know the terminals are made of the right alloy to permit proper expansion . . . and that they're securely, rigidly, clamped to the core.

They know the wire is drawn especially for their type of resistor . . . is capable of withstanding great overloads . . . has uniformly low coefficient of resistivity. They also know the coating provides a complete hermetic seal, highly resistant to thermal shock and to high humidity, acids, alkalies, electrolysis.

You can be sure of quality, by buying your resistors from the *one* manufacturer who manufactures, not just assembles, all the components that go into resistors. Play it safe and sound—insist upon VITROHM resistors.



WARD LEONARD ELECTRIC COMPANY

MOUNT VERNON, NEW YORK

Result-Engineered Controls Since 1892

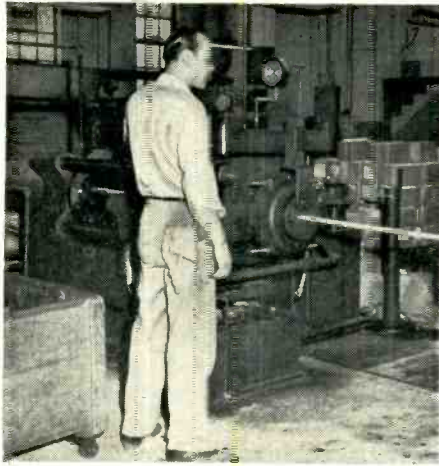

CERAMIC CORES are made by extruding refractory material from hydraulic presses such as this in Ward Leonard's plant.



RESISTANCE WIRE sample is being processed in the combustion furnace to insure accuracy of alloy formula.



VITREOUS ENAMEL for coating is fritted, then ground to exact fineness in these revolving "ball mills."



VITROHM vitreous enamel is measured by interferometer for coefficient of thermal expansion, melting and annealing points.

Uniform Quality—Matched Thermal Characteristics— Long Service Life of VITROHM Resistors— Result From Unified Manufacture

All components of a VITROHM resistor are made by Ward Leonard, the only manufacturer who *makes*, not just assembles, all parts.

Vitreous enamel coating and ceramic cores are formulated and made by Ward Leonard—wire is drawn to their specifications.

This means that all parts are uniform in quality, balanced in respect to thermal coefficient of expansion.

There's no loosening, no failure, due to unbalance of thermal characteristics, heat affects all parts the same way, which in turn means longer life.

VITROHM resistors will stay on the job under the most adverse operating conditions where a less carefully made resistor would break down. Thermal shock, vibration, corrosive atmosphere, overloads, even prolonged exposure to humidity and electrolysis will not affect their performance.

DISTRICT OFFICES AND REPRESENTATIVES

- Atlanta 5, Ga.
C. B. Rogers and Associates, 1000 Peachtree St., N. E.
- Baltimore 18, Maryland
Durling Electric Co., 2322 No. Charles St.
- Charlotte 1, No. Carolina
James L. Highsmith & Co., P. O. Box 1011
- Chicago 4, Illinois
Ward Leonard Electric Co., 53 West Jackson Blvd.
- Cincinnati 2, Ohio
Sheldon Storer and Assoc., Trans. Bldg., 307 E. 4th St.
- Cleveland 14, Ohio
The Ambos-Jones Co., 1085 The Arcade
- Corpus Christi, Texas
Brance-Krachy Co., Inc., 126 North Staples St.,
P. O. Box 463
- Denver 2, Colorado . . . Mark G. Mueller, 1644 Blake St.
- Detroit 21, Michigan
Jesse W. Eakins Co., 16575 James Couzens Highway
- Hartford 6, Conn.
Ward Leonard Electric Co., 37 Webster St.
- Houston 1, Texas
Brance-Krachy Co., Inc., 4411 Navigation Blvd.
P. O. Box 1724
- Kansas City 2, Mo. . . Maury E. Bettis Co., 406 W. 34th St.
- Knoxville, Tenn.
John G. Pettyjohn, 1243 North Broadway,
P. O. Box 395
- Los Angeles 13, Calif.
Ward Leonard Electric Co., 420 So. San Pedro St.
- Memphis 3, Tenn.
E. E. Torkell, 19B So. Main St., P. O. Box 4020
- Minneapolis 5, Minn.
Marvin H. Kirkeby, 437 Oliver Ave., S.
Ward Leonard Electric Co., 1060 Broad St.
- Newark 2, N. J.
Ward Leonard Electric Co., 1060 Broad St.
- New Orleans 13, La.
Electron Engineering Co., 1050 Constance St.
- Philadelphia 2, Pa.
Ward Leonard Electric Co., 112 South 16th St.
- Pittsburgh 16, Pa. W. A. Bittner, 3045 W. Liberty Ave.
- Roanoke, Va. . . Lynn H. Morris, 2603 Dorchester Dr., Rt. 2,
P. O. Box 5097
- Rochester 7, N. Y.
Ward Leonard Electric Co., 66 South St.
- St. Louis 10, Mo.
Ward Leonard Electric Co., 4030 Chouteau Ave.
- Salt Lake City 1, Utah
Leonard M. Slusser, 318 Daaly Bldg.
- San Antonio, Texas
Brance-Krachy Co., Inc., 434 Transit Tower Bldg.
- San Francisco 3, Calif. L. F. Church Co., 750 Natoma St.
- Seattle 4, Wash.
Northwestern Agencies, Inc., 4130 First Ave., So.
- Tucson, Arizona
Central Station Equipment Co., 2323 Aviation Highway
- Washington 5, D. C.
Federal Engineering Co., Inc., 1109 K. St., N. W.
- CANADA**
- Edmonton, Alta D. M. Fraser, Ltd., 10627-101 St.
- Halifax, N. S. D. M. Fraser Ltd., 702 Robie St.
- Montreal 25, P. Q.
D. M. Fraser, Ltd., 1570 St. Matthew St.
- Toronto 1, Ont. D. M. Fraser, Ltd., 54-56 Lombard St.
- Vancouver, B. C. D. M. Fraser, Ltd., 716 Cambie St.
- Winnipeg, Man. D. M. Fraser, Ltd., 401 Ave. Bldg.
- EXPORT**
- New York 4, N. Y. Ad. Auriama, Inc., 89 Broad St.

RHEOSTATS RELAYS MOTOR CONTROLS CHROMASTER

Ward Leonard's complete engineering textbook, "Handbook of Power Resistors," \$3. per copy.

New!

B&W

Dip Meter

Model 600

PRICE \$48 net



VERSATILITY, COMPACTNESS, QUALITY

Few instruments will prove so handy in so many ways as this versatile B&W Model 600 Dip Meter! Ideal for lab, production, service or ham shack use, it provides a quick, accurate means for measuring resonant circuit frequencies, spurious emissions and many other tuned circuit characteristics. Shaped for easy use in today's compact electronic assemblies, highly sensitive and accurately calibrated, it incorporates many features previously found only in higher-priced instruments. You'll find dozens of uses for it as ...

A Grid Dip Oscillator for determining resonant frequencies of tank circuits, antennas, feed line systems, and parasitic circuits; align-

ing filters and traps; peaking coils, neutralizing and tuning transmitters before power is applied.

An Absorption Wave Meter for accurately identifying the frequency of radiated power from various transmitter stages; locating spurious emissions causing troublesome TV and radio interference, and many similar uses.

An Auxiliary Signal Generator providing a signal for tracing purposes and for preliminary alignment of receivers, converters, and I-F stages.

An R-F Signal Monitor for audible observation of hum, audio quality, and other audible characteristics of radiated power.

For Capacity, Inductance, and "Q" measurements in conjunction with other components of known value.

TECHNICAL FEATURES

- ✓ Covers 1.75 to 260 mc. in 5 bands.
- ✓ Adjustable sensitivity control.
- ✓ Size 3" x 3" x 7". Weight 2 lbs.
- ✓ Handy wedge-shape for easy access in hard-to-get-at places.
- ✓ Monitoring jack and B+ OFF switch.
- ✓ Rust-proofed chassis, aluminum case.
- ✓ Built-in power supply for 110 volts A.C.

Sold by leading distributors throughout U. S. A. and Canada
Data bulletin sent on request.

BARKER & WILLIAMSON, Inc.

237 Fairfield Avenue

Upper Darby, Penna.

ductance ratio of Eq. 1 is approximately proportional to d^2/D^2 , giving a frequency ratio of d/D , since f is proportional to $1/\sqrt{L}$. If the low-frequency unit, generally the r-f circuits, has a core-to-coil diameter ratio of

$$d/D = f_2/f_1 \quad (2)$$

the high-frequency unit, or the local oscillator, will have a ratio of

$$d/D' = (f_2 + f)/(f_1 + f) \quad (3)$$

where it is assumed that other dimensions and physical constants are the same for both units and D' is the diameter of the larger oscillator coil.

A graph such as shown in Fig. 1 is a convenient method of predicting frequency ratios and recording experimental data. The curves are theoretical and are obtained by plotting the square root of the right side of Eq. 1 versus the diameter of the coil.

Padding Inductance

Adjustment of tuning ratio may be accomplished also by the use of a series inductance that is not tuned by the main slug. If this external series inductance is variable, it will function in the same manner as the padder in the capacitor tuned case so that the antenna and oscillator coil can be identical. Its value is found as follows.

Assuming the main oscillator inductance has no magnetic coupling to the padding inductance, their combined inductance with the slug removed will be

$$L = L_o + L_p \quad (4)$$

When the slug is inserted, the inductance of L_o will be increased by a factor $n = L_n/L_o$ as determined from Eq. 1. This gives a new total inductance of

$$L' = nL_o + L_p \quad (5)$$

The ratio of L' to L will be propor-

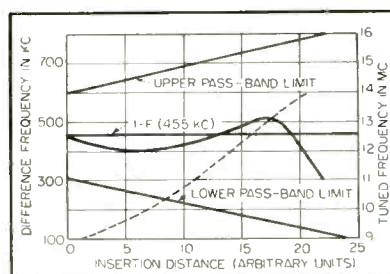
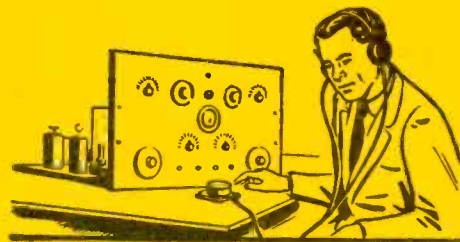

FIG. 3—Typical results obtained from Colpitts circuit

As old as
RADIO
yet as young as
ELECTRONICS...

AEROVOX CAPACITORS



1922 At the very dawn of radio—30 years ago, Aerovox came into being to meet capacitor needs. Pioneer radiophone transmitters and earliest radio receivers specified Aerovox capacitors. Such collaboration has continued down through the first three decades of radio-electronic progress.



1952 Today, giant atom-smashing betatrons . . . radar gear spotting unseen targets . . . transoceanic radio-guided rocket bombs . . . world-wide radio communications . . . electronic computers reducing thousands of calculation man-hours to mere seconds . . . the modern miracle of television — for all facets of the Electronic Age, Aerovox capacitors are still engineered to customer specifications.

Indeed, from tiny precision “ceramics” and metallized-paper “space-savers,” to giant power-handling “oils” and “micas,” Aerovox remains the time-proven source for ALL capacitor needs.

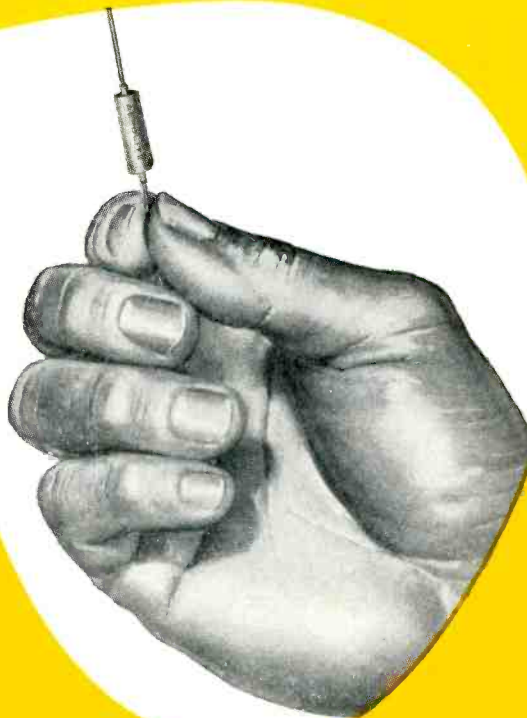

Sub-miniature vitrified ceramic terminal end-seal Type P123ZN Aerolene-impregnated metallized-paper tubular capacitor.



AEROVOX CORPORATION

NEW BEDFORD, MASS.

Hi-Q[®] DIVISION
 OLEAN, NEW YORK

WILKOR DIVISION
 CLEVELAND, OHIO

JOBBER ADDRESS: 740 Belleville Ave., New Bedford, Mass.

Export: 41 E. 42nd St., New York 17, N. Y. • Cable: AEROCAP, N. Y. • In Canada: AEROVOX CANADA LTD., Hamilton, Ont.

FOR

FASTER

**SERVICE
GREATER VARIETY
HIGHER QUALITY**

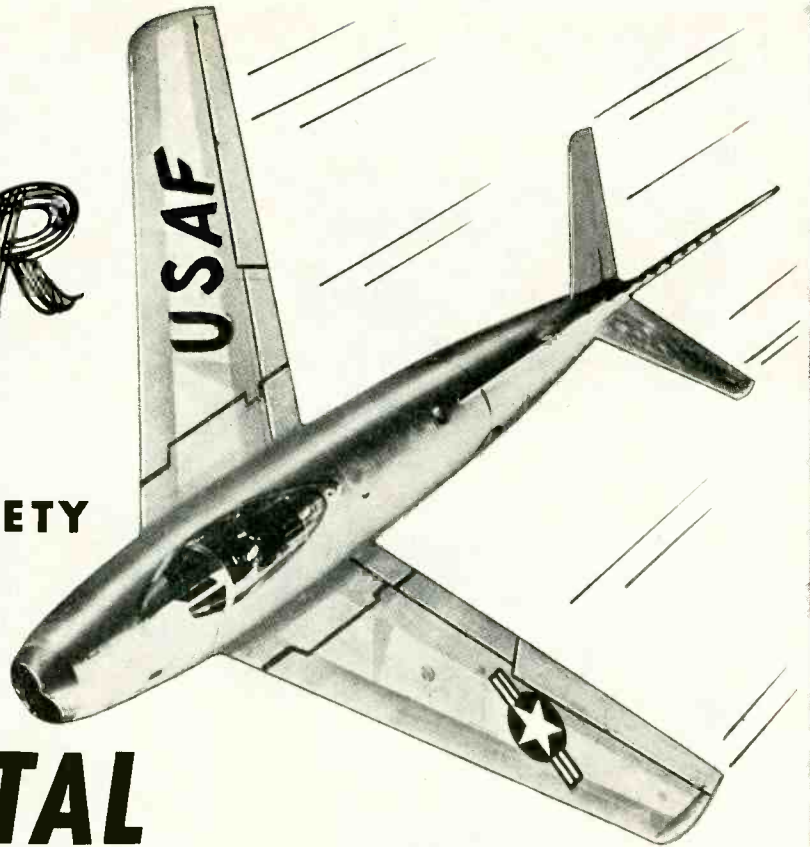

ALLMETAL "AN"

STAINLESS STEEL FASTENERS

MACHINE SCREWS • NUTS • BOLTS • WASHERS • PINS • RIVETS

AVAILABLE IMMEDIATELY FROM STOCK, an endless stream of first quality "AN" stainless fasteners is Allmetal's answer to the exacting demands of defense production . . . in aircraft, electronics, ordnance, in industry everywhere. Always remember Allmetal, to get the fasteners you want—when you want them.

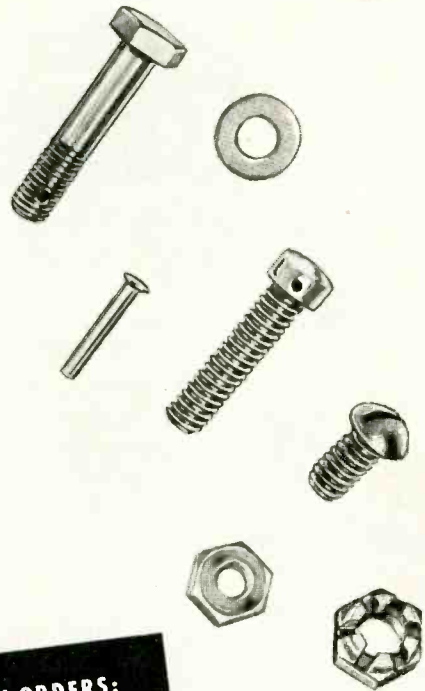

OFFICIAL DEPT.
OF DEFENSE PHOTOGRAPHS

WRITE FOR
CATALOG,
ON YOUR
LETTERHEAD,
TODAY!

**FOR EMERGENCY ORDERS:
WIRE Allmetal Screw Products Co.
WUX, New York
or PHONE WOrth 4-6444**



MANUFACTURERS SINCE 1929
ALLMETAL
SCREW PRODUCTS COMPANY, INC.
33 GREENE STREET NEW YORK 13, N. Y.

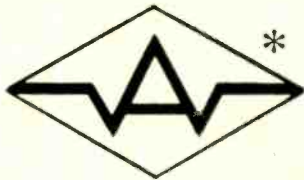

Carbofilm[®] RESISTORS

HERMETICALLY SEALED



TOUGH FOR ROUGH GOING!

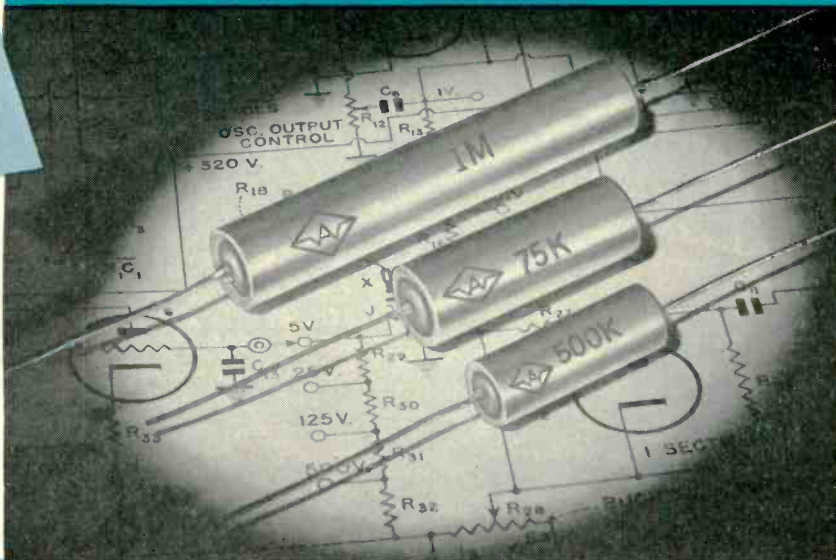

SPECIFICATIONS

1. **Hermetically sealed.** Metal case. Vitrified ceramic end seals, pigtail leads. Thoroughly protected — mechanically, electrically, climatically.
2. **Temperature Coefficient** not exceeding .0003 ohm per ohm per °C. over temperature range of -40°C. to +60°C. up to 15 megohms. Not exceeding .0005 ohm per ohm per °C. up to 100 megohms.
3. **Voltage Coefficient** does not exceed .002% per volt.
4. **Overloads** up to 200% of rated voltage, without showing permanent change in resistance.
5. **Accuracy:** guaranteed tolerance of plus/minus 1% at 25°C. (77°F.).
6. **Aging Changes** negligible. Average change in resistance for self-aging, approximately 0.2% in a year.
7. **Noise:** Silver-to-silver contacts insure very high stability and correspondingly low noise levels.
8. **In Four Sizes:** Two 1/2 watt, 1 watt and 2 watt. Cased or uncased.

Wilkor, the first licensee under Western Electric patents to produce carbon deposited precision resistors, takes another step forward. Wilkor now offers hermetically-sealed Carbofilm Resistors, the first fully-protected precision resistors available on a production basis.

Primarily intended for circuits calling for the accuracy and stability of wire-wound resistors, yet with the compactness of carbon or composition-element resistors. Excellent for measuring-instrument applications; in test and lab equipment; in oscillography and other critical electronic circuits; in electronic computers and allied techniques; and now, in the encased, hermetically-sealed construction, particularly in applications where resistance values must be critically maintained over long service life, regardless of climatic conditions.

TEMPERATURE COEFFICIENT OF RESISTANCE (TYPICAL)

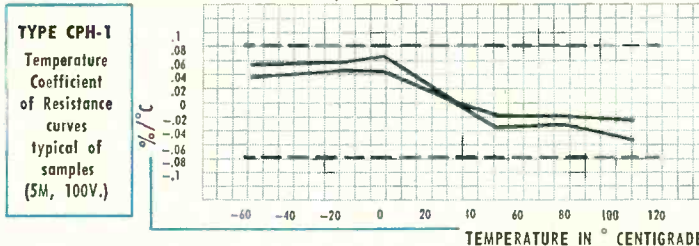

Literature on request. Let us collaborate in your precision-resistor requirements.

WILKOR
DIVISION

*Trade Mark

AEROVOX CORPORATION

CLEVELAND, OHIO

AEROVOX CORPORATION
NEW BEDFORD MASS.

Hi-Q[®] DIVISION
OLEAN, N. Y.

Export: 41 E. 42nd St., New York 17, N. Y. • Cable: AEROCAP, N. Y. • In Canada: AEROVOX CANADA LTD., Hamilton, Ont. JOBBER ADDRESS: 740 Belleville Ave., New Bedford, Mass.

★ meeting JAN specifications ★

official Army, Navy and Air Force photos, released by Dept. of Defense

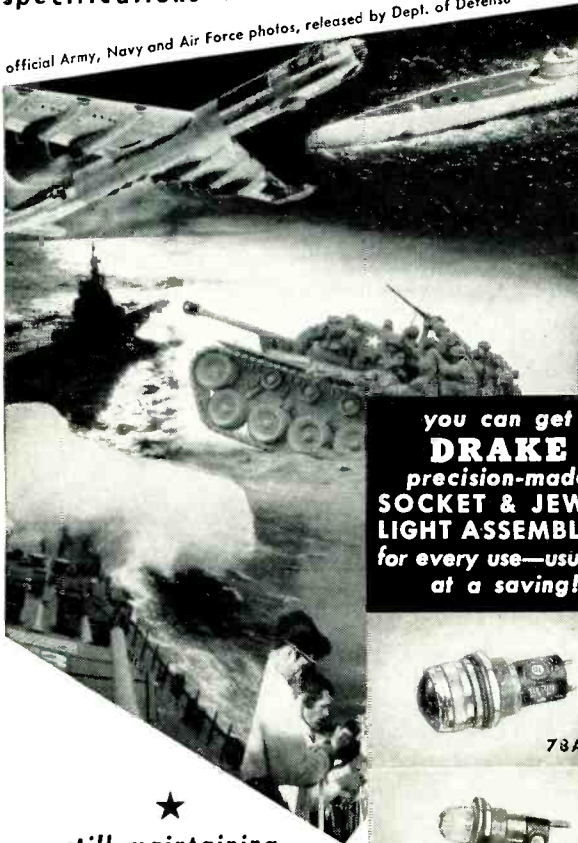

you can get
DRAKE
precision-made
**SOCKET & JEWEL
LIGHT ASSEMBLIES**
for every use—usually
at a saving!

★
still maintaining
full service on non-
defense orders with
ON-TIME deliveries

★
**HUNDREDS
OF STYLES,
SIZES and
COMBINA-
TIONS . . .**

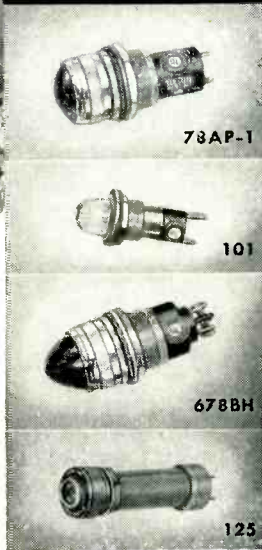

..are already available in the DRAKE line. It's usually easy to select from them the exact unit to fit your requirement best. But should your application need a special design, DRAKE can develop a unit especially for you . . . just as we have done countless times for our customers during more than 20 years of specialization.

★ Why not write on your company letterhead for samples and full data—now? No obligation.



DRAKE
MANUFACTURING COMPANY
1711 WEST HUBBARD ST. • CHICAGO 22, ILL.
SOCKET & JEWEL LIGHT ASSEMBLIES

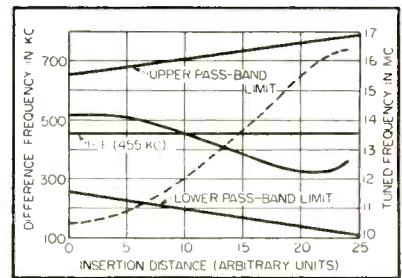

FIG. 4—Typical results obtained from tickler-type circuit

tional to the square root of the frequency ratio as determined by Eq. 3. If Eq. 5 is divided by Eq. 4 and the resulting equation is solved for L_p , there results

$$L_p = L_o(n - R)/(R - 1) \quad (6)$$

where R is the ratio of L' to L , and L_p is the desired value of the padding inductance. Figure 2 is a plot of the square root of R , or frequency ratio, versus L_o/L_p for $n=4$. This construction provides a convenient means of calculating the value of L_p , and will be used subsequently in choosing a value for the loop-antenna inductance.

From a more rigorous point of view, an adjustment of tuning ratio as described does not result in what is considered an optimum error curve.² While the systems described have the necessary three degrees of freedom for three-point tracking, it was not of practical importance to consider anything but the tuning ratio.

An examination of Fig. 3 and 4 reveals that three-point tracking was approached in both cases. The two figures suggest that any change could have given only a slight improvement in gain. The degrees of freedom are diameter or padding inductance adjustment, capacitance adjustment and adjustment of the relative slug positions.

Available Band Coverage

In the design of a specific unit, reference can be made to a manufacturer's table of recommended frequency ranges and approximate permeability of iron cores. After a particular mix is chosen as recommended for a desired frequency range, the approximate permeability may be referred to Fig. 5 and 6 to determine the effective permeability in terms of the length to

The *NEW* Collins Mechanical Filter...

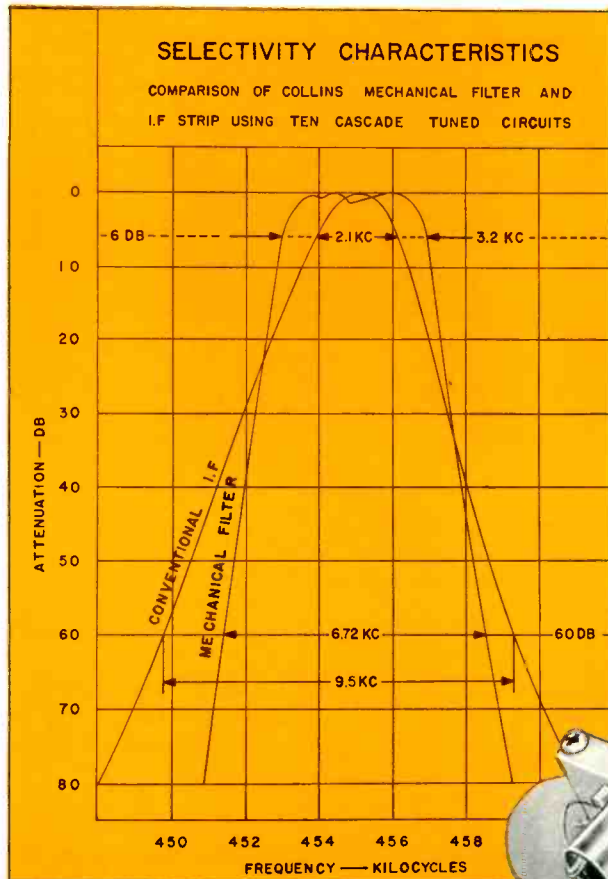

ANOTHER outstanding result of Collins Research and Development — the Mechanical Filter — has been engineered to fill a long-standing need in the field of electronics for a compact, permanently tuned band pass filter for intermediate frequency amplifier applications. Mechanical elements of the Collins Filter provide selectivity characteristics approximating the ideal rectangular shape needed for very close spacing of adjacent voice communication channels. Space requirements are reduced to a minimum with this hermetically sealed component that *requires no adjustment*.

Production of the Collins Mechanical Filter in quantity is going ahead at an increased rate in anticipation of the many applications in industry for which this NEW Filter will be found ideally suited. Characteristics of Filters in current production are shown in the specifications below. Filters having other characteristics are in development and will be announced in the future.

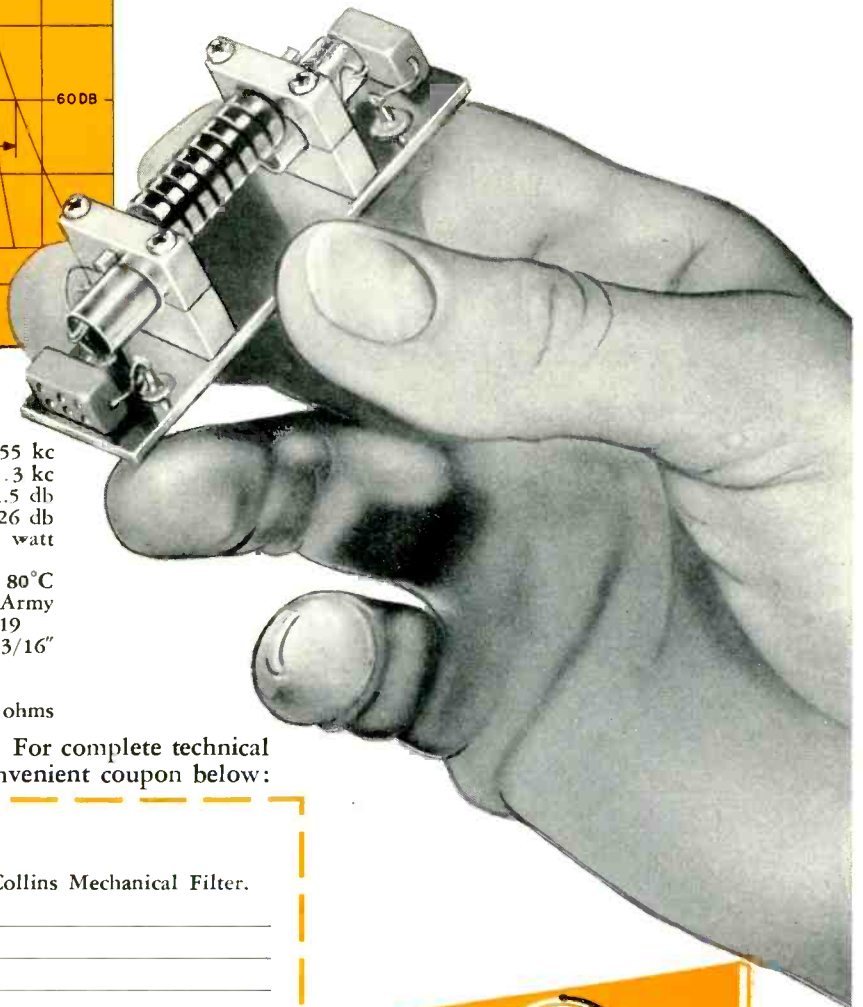

SPECIFICATIONS

Operating Frequency 455 kc
 Nominal Band Width 3 kc
 Peak to Valley Ratio 1.5 db
 Insertion Loss26 db
 Overload Input Power Level035 watt
 Operating Temperature Range (without temperature compensation) 15°C to 80°C
 Vibration Satisfies Requirements of Army Navy Specification AN-E-19
 Case Size 1" x 15/16" x 2-13/16"
 (Filter Shown with Hermetically Sealed Shield Removed)
 Input and Output Impedance 6,500 ohms

Engineering samples are now available. For complete technical data and price information, use the convenient coupon below:

Collins Radio Company (Dept. 22)
 Cedar Rapids, Iowa

Please send complete Information on The Collins Mechanical Filter.

NAME _____
 TITLE _____
 ADDRESS OR FIRM _____
 CITY _____ STATE _____

For advanced electronic development, it's ...



COLLINS RADIO COMPANY, Cedar Rapids, Iowa

11 W. 42nd Street, NEW YORK 36

1930 Hi-Line Drive, DALLAS 2

2700 W. Olive Avenue, BURBANK

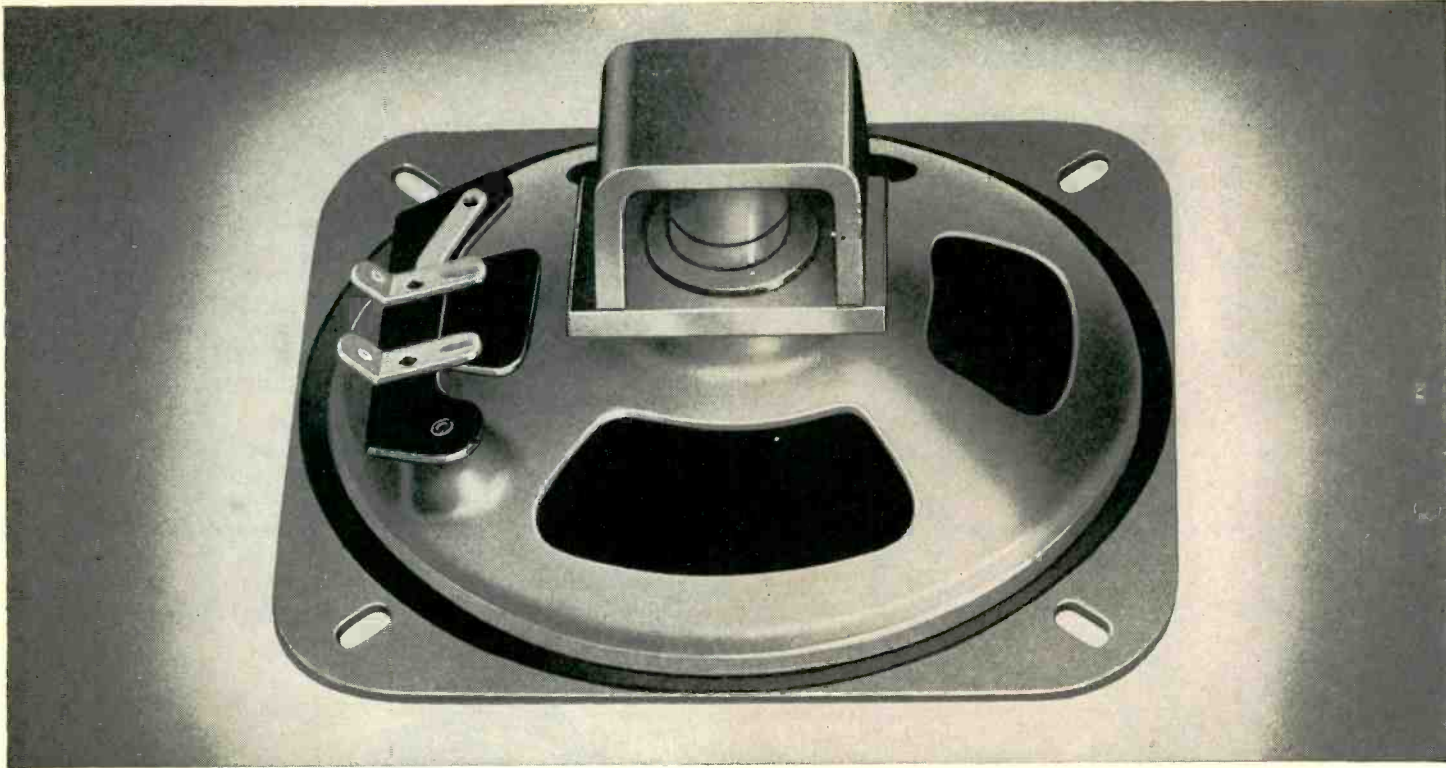

SPEAKERS—In radio and TV speakers, Carboloy Permanent Magnets replace larger electro magnets in the field structure. Current passing through uniform field of these high-energy magnets causes

voice coil and cone to vibrate in proportion to voltage; *tone is truer!* Carboloy Permanent Magnets never fail; never need maintenance. Are also used in TV focusing assemblies.

How Carboloy permanent magnets improve electrical products

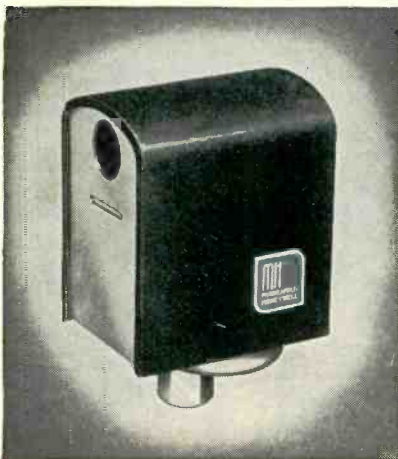

CONTROLS—Switches in compact Minneapolis-Honeywell controls use permanent magnets to give safer snap action, help quench arcs. The magnets are exceptionally stable; provide uniform high energy for the life of the control.

Want to cut down product size, weight? Build a better-performing product for less money?

Then check the possibility of using Carboloy Alnico permanent magnets wherever you need *lasting* magnetic energy.

Carboloy permanent magnets are simple, self-containing sources of energy that *never* fail. They are powerful in small sizes. Need no outside power supply, no maintenance. They help reduce fabrication costs by eliminating wires, coils and operating parts. Above all, they let you simplify design . . . build a lighter, more compact, finer-performing product at a saving.

On these pages you'll see how others got the jump on competitors by using permanent magnets. Perhaps you'll get an application idea from reading about them.

FREE SERVICES

If so, check Carboloy magnet engineers for free, expert advice and an assist in design and application. Look to Carboloy production lines, too, for the uniform, high-energy Alnico magnets you'll need for best results — all sizes, all shapes; cast or sintered to your specifications.

Send coupon for free Magnet Design Manual PM-101 and Standard Stock Catalog PM-100.

CARBOLOY

DEPARTMENT OF GENERAL ELECTRIC COMPANY

11139 East 8 Mile Road, Detroit 32, Michigan

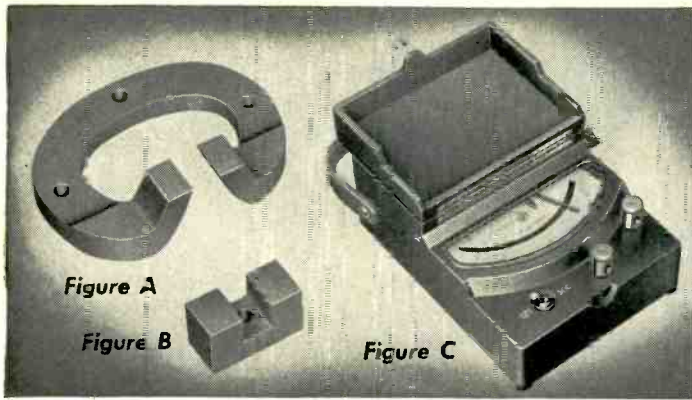
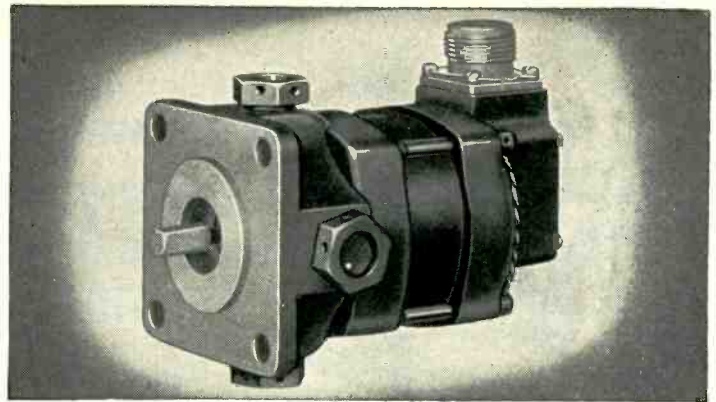

Figure A

Figure B

Figure C

INSTRUMENTS—Fig. A is damping magnet once used in GE indicators. Fig. B is tiny CarboLOY magnet now used. It permits smaller indicator design (Fig. C), cuts materials and assembling costs . . . speeds up calibrations.



GENERATORS—When GE engineers had only 6" x 6" area for jet's tachometer generator, they whipped design problem with a tiny permanent magnet. It eliminated coils and wires, supplied the powerful energy required.

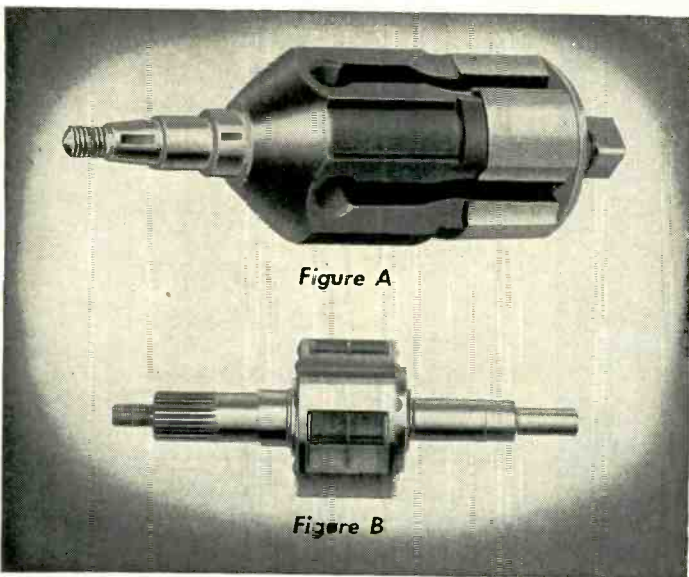

Figure A

Figure B

MAGNETOS—To Scintilla Magneto Division, Bendix Aviation Corp., weight savings are vital in their aircraft products. Fig. A shows chrome rotor weighing approximately 4 lbs. 9 ozs. Fig. B shows newer model rotor using CarboLOY Alnico. It weighs only 2 lbs. 4 ozs.

ADVANTAGES OF CARBOLOY PERMANENT MAGNETS

- | | |
|--------------------------------------|---|
| 1 Simple — no operating parts | 7 No power failures |
| 2 Uniformly powerful | 8 Combine electrical and mechanical features |
| 3 Permanent source of energy | 9 Simplify mechanical assemblies |
| 4 No coils to wire | 10 Uninterrupted operation |
| 5 Cool-running | 11 Moisture-resistant |
| 6 No operating costs | 12 Create savings |

"CarboLOY" is the trademark for the products of CarboLOY Department of General Electric Company

Plants at Detroit, Michigan; Edmore, Michigan; and Schenectady, New York

**CARBOLOY
ALNICO
PERMANENT
MAGNETS**

*Mail
Coupon
Today*

CarboLOY Department of General Electric Company
11139 East 8 Mile Road, Detroit 32, Michigan

Gentlemen:

Please rush me, without cost or obligation, copies of Permanent Magnet Design Manual PM-101 and Standard Stock Catalog PM-100.

NAME _____

POSITION _____

COMPANY NAME _____

ADDRESS _____

CITY _____ ZONE _____ STATE _____



Write today for your New ACE SCREEN ROOM GUIDE

This helpful booklet brings you the latest data on shielded enclosure construction, selection and use. Prepared by Ace screen room specialists, it includes latest Ace design features, an analysis of the factors influencing measurements of attenuation versus frequency, and suggestions for assuring maximum shielded enclosure efficiency. Ask for Ace Bulletin No. 3.



ELIMINATE RADIO INTERFERENCE INFLUENCE

in meeting JAN-I-225, MIL-I-6181, 16E4 (SHIPS)
and other stringent specification requirements

As long-time leaders in modern shielded enclosure development, Ace offers a complete range of "cell type" screen room shapes and sizes. Ace rooms are guaranteed to produce a minimum attenuation of 100 db from 0.15 to 1000 mc., and to closely approach this attenuation at 10,000 mc. Supplied in pre-built sectional form, they incorporate the latest developments in door design, line filters and service entrances. The list of Ace users includes top-ranking military and civilian equipment producers and laboratories throughout the world.

ACE ENGINEERING and MACHINE CO., INC.

3644 North Lawrence St., PHILADELPHIA 40, PA. • Telephone REgent 9-1019

PIONEERS IN SHIELDED ENCLOSURE DEVELOPMENT

diameter ratios or form factors. The approximate inductance range may then be determined by substituting this value of μ' into Eq. 1. The frequency ratio will then be approximately the square root of this value.

Since the interpolar distance of an iron core is less than its length, the core should be approximately 1.18 times longer than the coil when the winding consists of a few layers close to the core and greatest inductance ratio is desired. If the core length is different from this optimum value, the value of μ' should be altered according to the following relation:

$$\mu'' = \mu'(L/l)^{1/3} \quad (7)$$

Where L is the length of the core, l is the length of the coil and μ'' is the corrected value of the effective permeability.

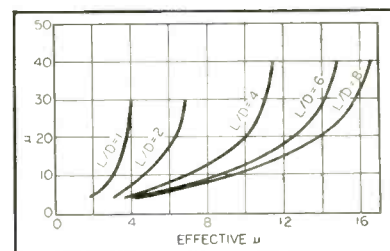

FIG. 5—Approximate permeability as a function of effective permeability for a range of L/D ratios

A procedure which facilitates checking these suggested solutions has been described in a previous article.²

Oscillator Circuits

The local oscillator in a permeability-tuned system can be of almost any type. Since the circuitry used required the use of a filament-type mixer tube, the Colpitts and tickler type of oscillators proved most suitable. When an interwound tickler is used, its grounded end should be at one end of the coil as opposed to locating the grounded end toward the coil center. When this precaution is not observed, serious deviations from what would be considered a normal insertion distance versus resonant-frequency curve are experienced. In general, it will still be necessary to correct for the distortion caused by the

*Latitude? Longitude?
Azimuth? Angle?*

**...They Count on this Counter
to tell exactly**

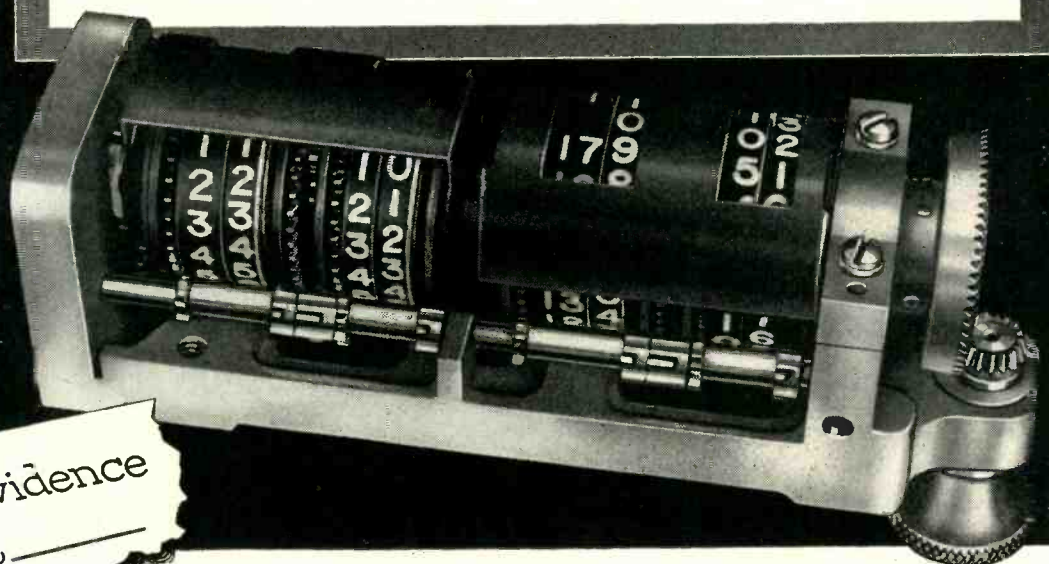
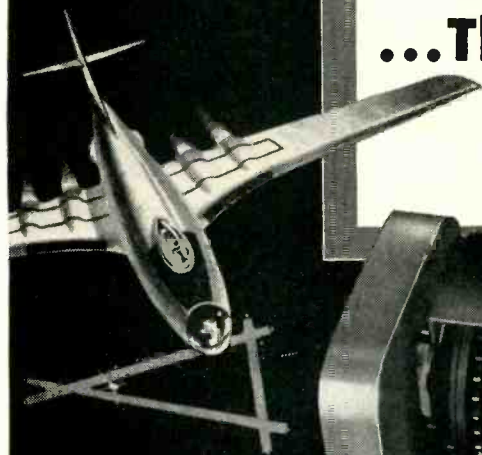

Added Evidence
that _____

Everyone Can Count on **VEEDER-ROOT**

Aerial navigators and bombardiers rely on the figures that keep turning up on this Veeder-Root Counter, specially designed for the Armed Forces. And if you need to know exactly where you are, with any product or mechanism that's vital to Defense, then you can

count on Veeder-Root to help you, to the utmost limits of ability . . . and of available capacity. Write:

VEEDER-ROOT INCORPORATED
"The Name That Counts"
HARTFORD 2, CONN.

Chicago 6, Ill. • New York 19 • Greenville, S. C.
Montreal 2, Canada • Dundee, Scotland

Offices and agents in principal cities



"Counts Everything on Earth"

MINIATURE AIRCRAFT TRANSFORMERS

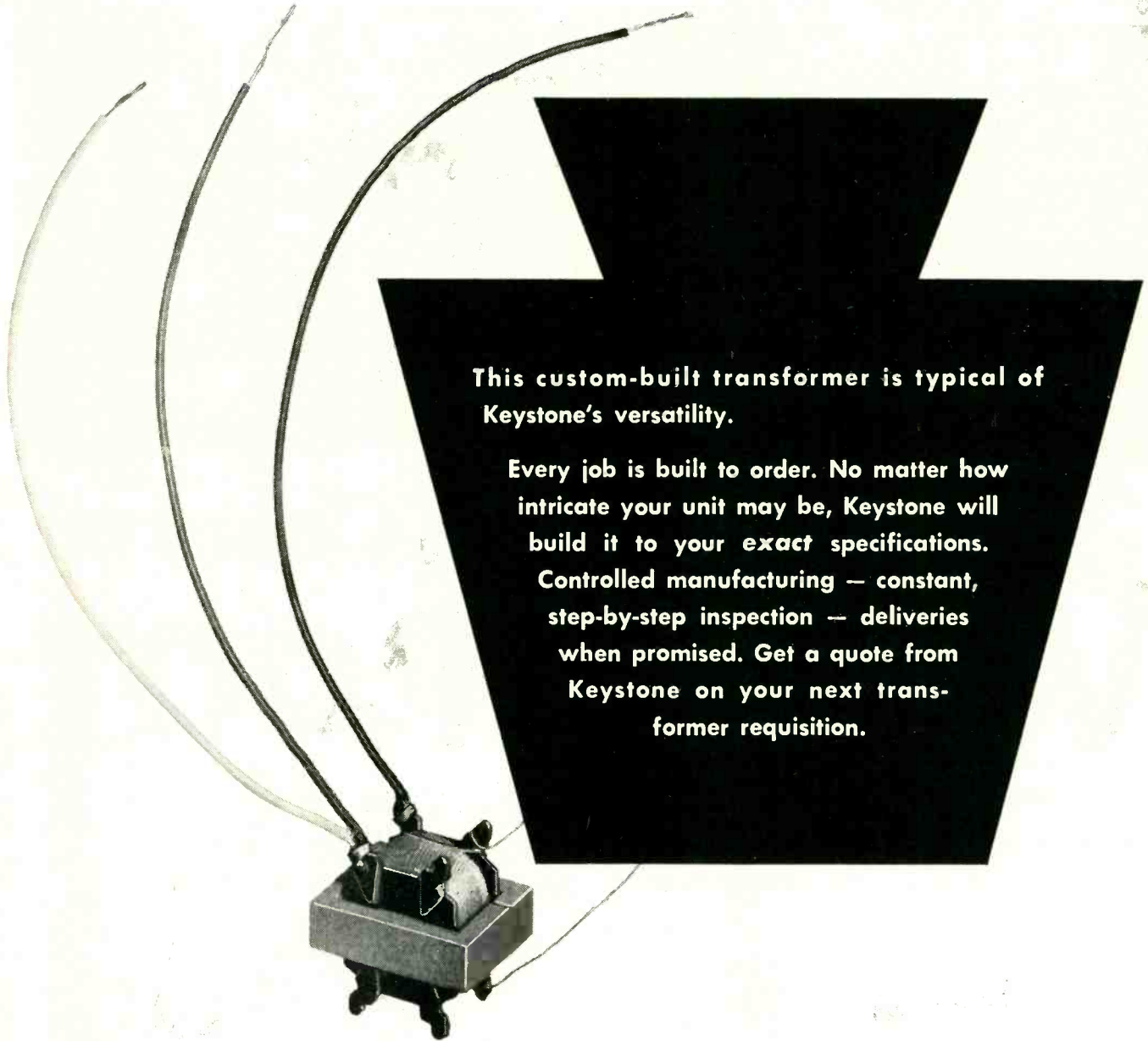

This custom-built transformer is typical of Keystone's versatility.

Every job is built to order. No matter how intricate your unit may be, Keystone will build it to your exact specifications.

Controlled manufacturing — constant, step-by-step inspection — deliveries when promised. Get a quote from Keystone on your next transformer requisition.

KEYSTONE PRODUCTS COMPANY

UNION CITY 2, N. J.

UN ion 6-5400

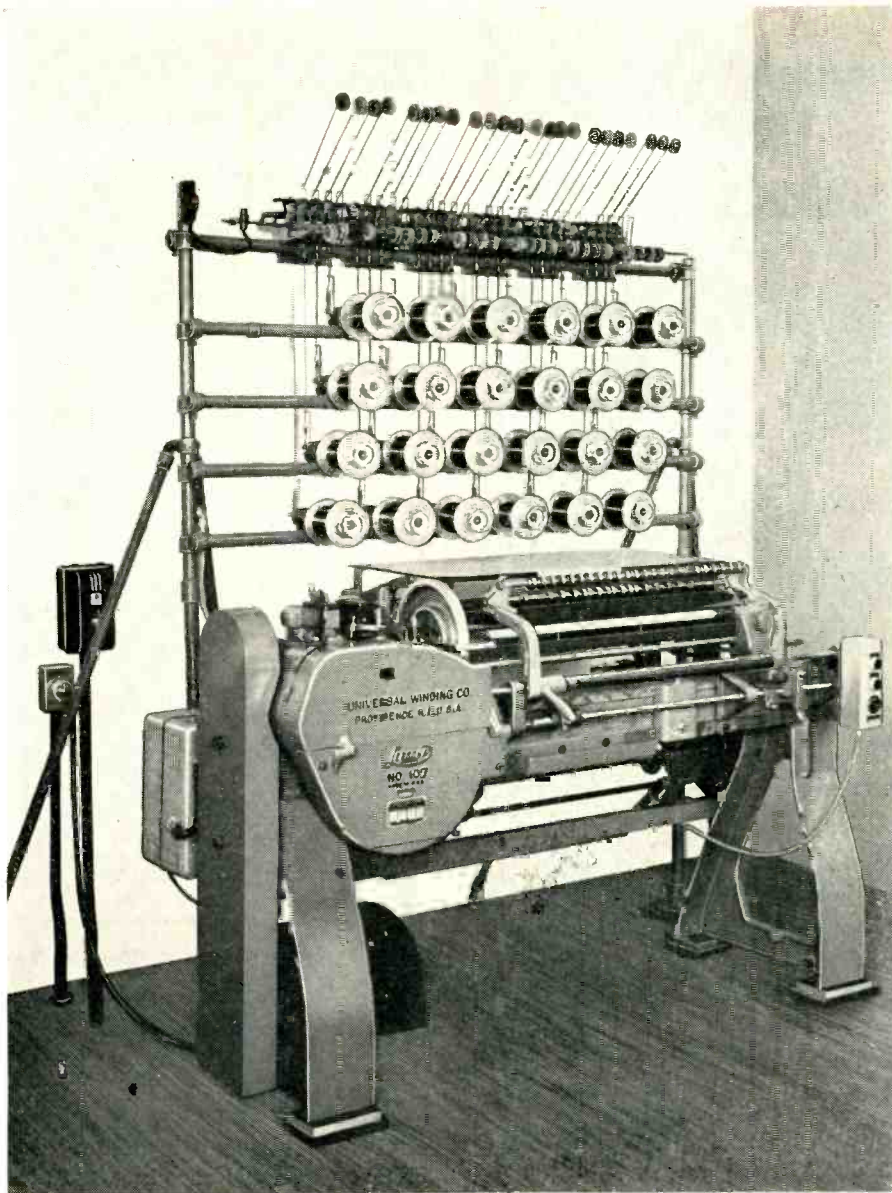

**Automatic
features**

**SPEED UP
COIL
WINDING**

**Assure accuracy
and low cost**

Leesona[®] No. 107 Coil Winder Offers Many Advantages

1. Automatic Delivery Shelf does it! New shelf feeds the paper inserts to the coils, exerting uniform tension on the paper as it is fed into the coil. This means tighter finished coil. Staggered overlaps to insure perfectly round or square coils. Delivery shelf automatically lengthens each insert

as the coil diameter increases. This makes certain that the coils produced are within the maximum allowable outside diameter.

2. Automatic Electronic Speed Control. Slow, cushioned start . . . gradual speed build-up . . . constant high running speed for uniform wire tension and coil density.

3. Automatic Stop Motion — stops the machine whenever a spool runs out or a wire break occurs.

4. Automatic Counter stops the machine when the required number of turns have been reached.

Send for *Bulletin 107* — get the details on this fully automatic Leesona[®] No. 107. It will show you how to get the exact electrical characteristics you want in either paper or acetate insulated coils, at the highest production rate, and lowest cost.

UNIVERSAL WINDING COMPANY

P. O. Box 1605, Providence 1, R. I.

Chicago office and Demonstration Room, 9 So. Clinton St., Chicago 6, Ill.

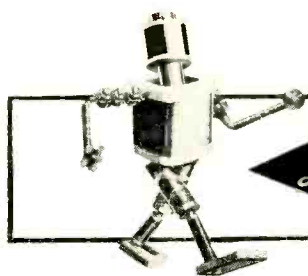

For winding coils in quantity accurately . . . automatically use Universal Winding Machines

7 good reasons for specifying MEPCO Precision Resistors

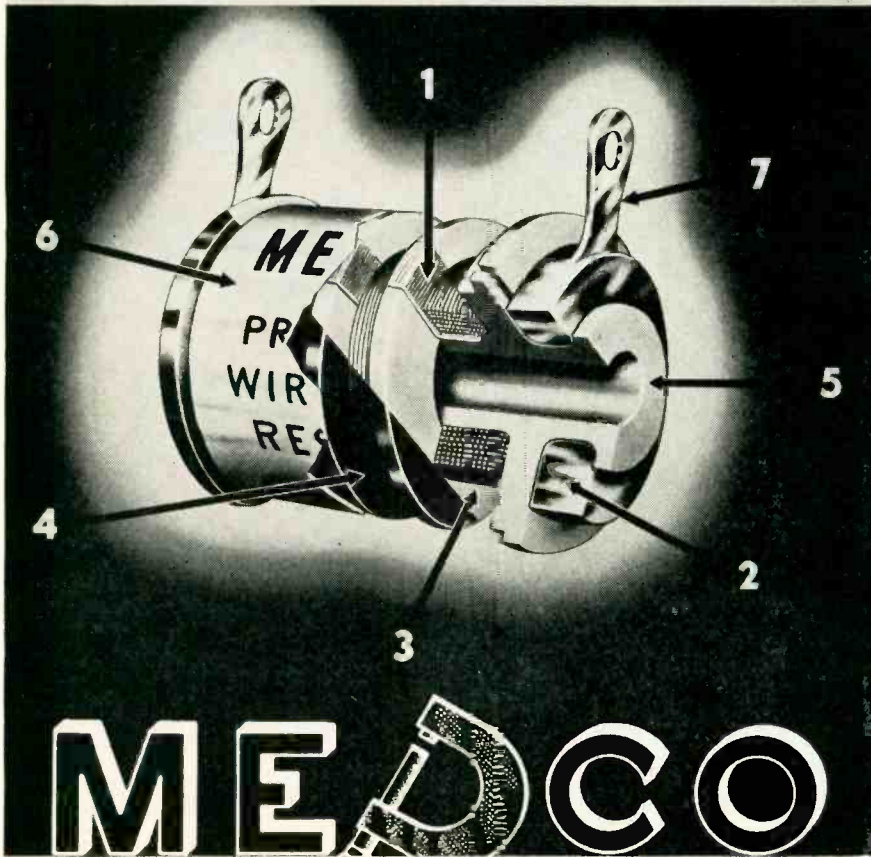

- ① Crossover wire insulated from each winding by 2000v. insulation (patented).
- ② Special metal molded connecting feature, which bonds end of winding and terminal in a non-corrosive and mechanically secure manner—no solder or flux used.
- ③ Reversed and balanced PI-windings for low inductance, with use of only the finest resistance alloys.
- ④ Impregnated with approved fungus, moisture and salt water-proofing compounds.
- ⑤ JAN approved non-hygroscopic steatite bobbin, specially treated prior to winding in order to provide additional protection for fine enameled wire.
- ⑥ Protective fungi resistant acetate label.
- ⑦ Rigid hot solder coated brass terminals for easier soldering.

MEPCO, INC.,
MORRISTOWN, NEW JERSEY

presence of the tickler winding on the oscillator coil especially if a high degree of selectivity is employed.

The graphs of Fig. 3 and Fig. 4, respectively, give typical results obtained from the Colpitts and tickler-type circuits. It was found that one of these graphs could be constructed in about ten minutes using the procedure described. The points along the solid line are read along the left-hand ordinate and represent the signal generator reading when its beat note with the local oscillator rests on the peak of the response curve of the r-f amplifier.

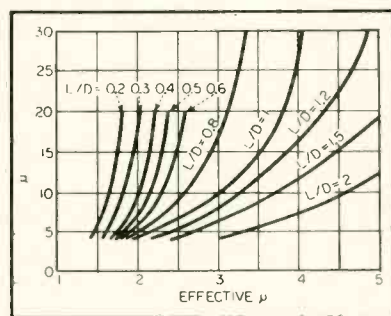

FIG. 6—Curves similar to those in Fig. 5 but for different L/D ratios

The horizontal straight line through the center of the graph is drawn at the i-f frequency as read along the left-hand ordinate. The distance between this line and the solid curved line represents tracking error as a function of insertion distance, which is plotted along the abscissa. The two lines diverging to the right represent the approximate passband of the antenna coil on the assumption that it has a Q of 25. Since the Q is not necessarily constant across the band, these lines would actually be curved but are for the sake of simplicity drawn here as straight lines. They represent minimum rather than true passband. The dash lines are read along the right-hand ordinate and represent the resonant frequency of the antenna coil as a function of insertion distance.

The author acknowledges the consideration of W. J. Polydoroff of the Stackpole Carbon Company.

REFERENCES

- (1) K. R. Sturley, "Radio De-
(Continued on page 202)

Here's what

FRANCE

brings you



FÉDÉRATION FRANÇAISE DES SYNDICATS
NATIONAUX DE L'INDUSTRIE RADIOÉLECTRIQUE

23, RUE DE LUBECK - PARIS XVI^e

GEAD

Front of technical progress...

SOCIÉTÉ INDUSTRIELLE
S. A. AU CAPITAL DE



DES PROCÉDÉS LOTH
150.006.000 FRANCS

TÉL. : MEN. 62.94



RADIO-BEACON 75 Mc/s



V.H.F. TRANSMITTER
for airport control tower

ALL
PROFESSIONAL
MATERIAL
OF
TELECOMMUNICATIONS

DETAILED
LEAFLETS
ON
REQUEST



COMMUNICATIONS RECEIVER

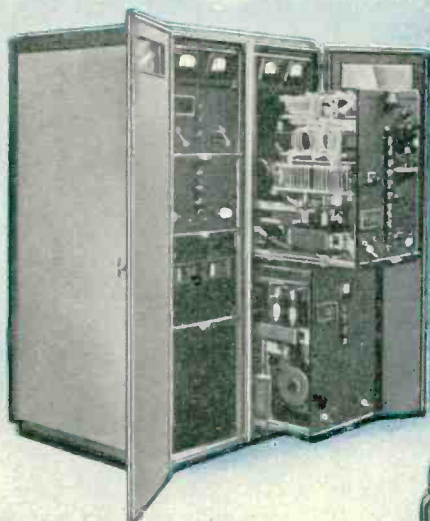

1 KW Standard
TRANSMITTER
Simultaneous emissions



500—700 W.
1 KW
TRANSMITTER
with several frequencies



26, RUE BOYER

PARIS-XX^e

ADR. TÉL. : SOCINDLOTH

Our job:

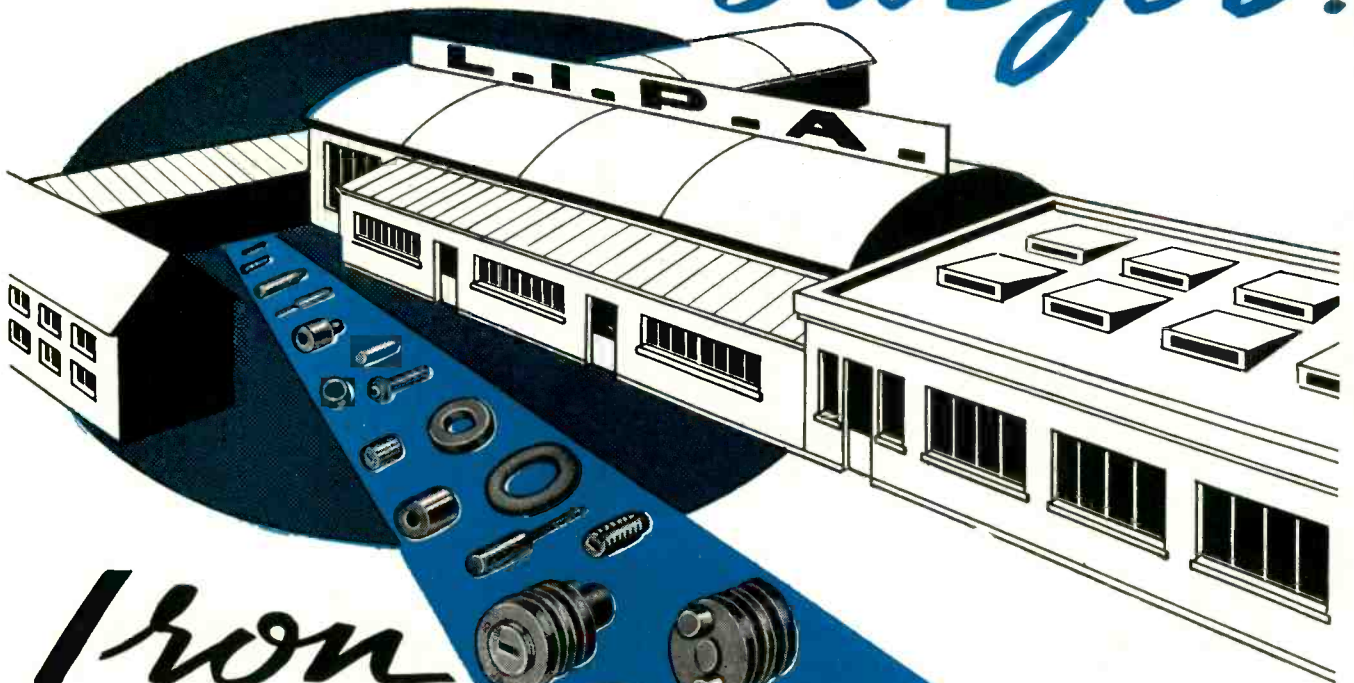

Iron CORES

The manufacture of injection-molded powdered-iron cores, just as in any other high-grade industrial operation, requires carefully designed production machinery that turns out each item exactly the same as the last.

Our equipment, contrived to serve the diverse needs of the European market, is versatile enough to take on the problems of American designers, however complex or in whatever volume.

Our large Research Department stands ready to give immediate technical assistance. Why don't you submit your model specifications to us and let us quote you prices for volume production, based on our study and previous wide experience?

A glance through our descriptive brochure, sent to you without obligation, will show you the characteristics of the hundreds of standard parts we have already turned out for discriminating manufacturers.

Laboratoire Industriel de Physique Appliquée
67, Rue M. A. - Colombier - BAGNOLET (Seine) FRANCE



*ask for
our free booklet*

Please send me free booklet on dust iron cores

NAME.....

COMPANY.....

ADDRESS.....

CITY..... ZONE.....

STATE.....

Pub. GEAD - Paris

THE
Big Four
FRENCH RADIO MANUFACTURERS
GUARANTEE

- ★ MASS PRODUCTION
- ★ ATTRACTIVE PRICES
- ★ HIGHEST STANDARDIZED QUALITY
- ★ RELIABLE ON TIME DELIVERY

ARENA



ALL TYPES OF VARIABLE CONDENSERS FOR RADIO BROADCASTING AND ALL ELECTRONICS APPLICATIONS BY THE GREATEST PRODUCTION IN EUROPE



AUDAX



ALL TYPES OF LOUDSPEAKERS BY THE MOST IMPORTANT PRODUCTION ON THE CONTINENT



SAFCO-TREVOUX



CAPACITORS OF ALL TYPES BY THE MOST IMPORTANT SPECIALIZED PLANTS ON THE CONTINENT



VEDOVELLI



TRANSFORMERS AND COILS FOR RADIO - T.V. AND ALL ELECTRONICS AND INDUSTRIAL APPLICATIONS



DEAL WITH THEIR

SIEMAR

EXCLUSIVE EXPORT DEPARTMENT

62, RUE DE ROME, PARIS-8^e - TEL. LAB. 00-76

ARENA - AUDAX - SAFCO-TREVOUX - VEDOVELLI

MEMBER FEDERATION NATIONALE DES SYNDICATS DES INDUSTRIES RADIOELECTRIQUES ET ELECTRONIQUES

High stability
Resistors

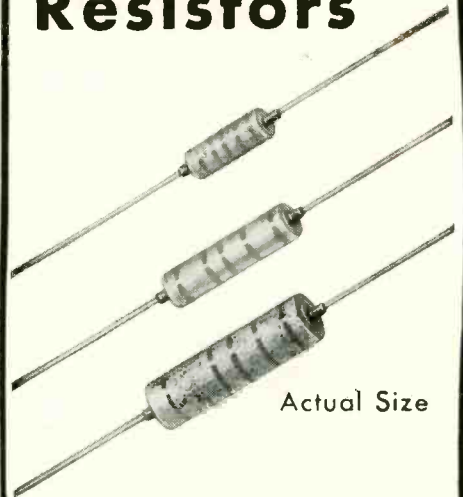

Actual Size

Very low noise level and temperature coefficient 1/4, 1/2, 1 watt and 2-3 watts models.

Available from $\pm 10\%$ to $\pm 0,5\%$ tolerance.

Noiseless
Potentiometers

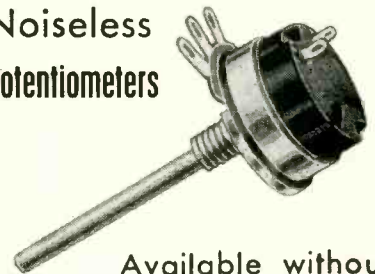

Available without switch and with multi-pole switch - Every variation curve obtainable.

Ask for free catalog

Name _____

Address _____

City _____

State _____

Distributor for U.S.A. :

ARNHOLD CERAMICS INC.

11-54, 44th. Drive
LONG ISLAND CITY-1

N. Y.

U. S. A.

RADIAC S. A.

206, Rue Lafayette, PARIS-X^e
(FRANCE)

CABLES : SARADIAC-PARIS

There are hundreds of jobs open to engineers today! *but few opportunities like these*

Westinghouse is in nuclear power to stay. We believe in the development of atomic energy as man's next great source of power. If you want to get in on a new era in industry, we want to talk to you.

**Atomic power opportunities are waiting
for electronic engineers
with 4 to 10 years of this kind of experience...**

ELECTRONIC COMPUTERS, employing pulse amplifying wide range linear amplifying and rate circuits.

NULL BALANCE DEVICES, employing both vacuum tube and magnetic amplifiers, **SERVOMECHANISMS**, **PLANT CONTROL SYSTEMS**.

LIAISON with customers, contractors, designers of component equipment.

SUPERVISION of drafting work.

REMEMBER! We are primarily interested in good experienced application and development engineers—**lack of previous reactor development experience is no handicap in this type of work.**

HOW TO APPLY! What Westinghouse wants to know is: Where and when you obtained your degree . . . how you did in school . . . where you have worked at your profession . . . what kind of work you have done.

In other words, right now we're more interested in your ability to fill current openings and to develop in the Westinghouse Atomic Power Division than we are in your vital statistics. Write your letter of application accordingly.

You will be in communication with men who are experienced in keeping secrets. All negotiations will be discreet, and your reply will be kept strictly confidential.

Address your application letter to: Manager, Industrial Relations Department, Westinghouse Electric Corporation, P. O. Box 1468, Pittsburgh 30, Pennsylvania.

What do you want?

MONEY? Good jobs are open here now—waiting for good men who want to make a permanent connection.

A PERMANENT JOB? Many of the engineers who joined Westinghouse 20 and 25 years ago are still with Westinghouse—and in key positions—and engineers who join us now will have the opportunity to make this work their lifetime careers. When many other industries may be going through slack times, atomic energy will still be in a stage of expansion.

SUBURBAN LIVING? It's here—within easy driving distance of your work. Within a few minutes of shopping centers . . . schools . . . metropolitan centers.

JOB EXTRAS? Westinghouse offers: Low cost life, sickness and accident insurance with hospital and surgical benefits. A *modern* pension plan. Westinghouse stock at favorable prices. Westinghouse appliances for your home at discount.

YOUR KIND OF ASSOCIATES? Every fourth person in the Division is an engineer or scientist. More than half the top Westinghouse executives are engineers.

FASCINATING WORK? What other branch of science offers such exciting challenges? So many opportunities for discovery? So many chances to benefit mankind? So many opportunities for original work?

GROWTH OPPORTUNITIES? Never again in your lifetime will you be able to get into such a sure-to-expand industry so early in its development.

YOU CAN BE SURE.. IF IT'S **Westinghouse**

New CERAMIC POWER CONDENSERS...



AR

up to
25 KVA
DiA :
20 to 42 m/m
Test voltage:
in air 5.000 VRMS
in oil 25.000 VRMS
By pass up to 6.800 mmF 30A



A

up to
25 KVA
DiA :
20 to 55 m/m
Test voltage:
in air 7.500 VRMS
By pass up to 7.500 mmF 30A



POT

IHF up to
25 A

Test voltage :
10.000 VRMS



TUBE

up to
30 KVA
and
100 KVA

IHF up to 50 A
Test voltage 12.000 VRMS



HT

IHF up to
25 A

Test voltage:
up to 20.000 VRMS

LE CONDENSATEUR CÉRAMIQUE
PARIS FRANCE

LCC

AMERICAN REPRESENTATIVE

AMERICAN - RADIO - CO - 135 BROADWAY N. Y. (6)

A member of the Federation S. N. I. R.

Agence Publeditec

ELECTRONS AT WORK

(continued)

sign," John Wiley & Sons, Inc., New York, p. 273.

(2) Philip S. Wessels, Visual Tracking of Superheterodyne Front Ends, ELECTRONICS, p 153, July 1952.

Ultrasonic Therapy Unit

By THOMAS A. DICKINSON
Los Angeles, Calif.

A PRODUCTION-TYPE unit for ultrasonic therapy is now being manufactured by The Birtcher Corporation of Los Angeles.

In essence, this unit comprises an electronic oscillator and crystal transducer. The transducer is installed in a chrome-plated brass gun so that its output vibrations can be utilized manually, like the output of an electrical scalp-massage vibrator.

The potentialities of ultrasonic therapy have been known to the medical profession in general since 1927, and ultrasonic therapy units have been commercially manufactured and used in Europe for at least ten years.

The therapeutical effectiveness of ultrasonic energy in alleviating tuberculosis, arthritis, ulcers and many other organic diseases is in many respects due to the ability of the human nervous system to conduct high-frequency vibrations. This process causes damaged portions of the body to resume their normal functions.

Compared with the ultrasonic generators that have been produced for therapeutical usage in Europe,

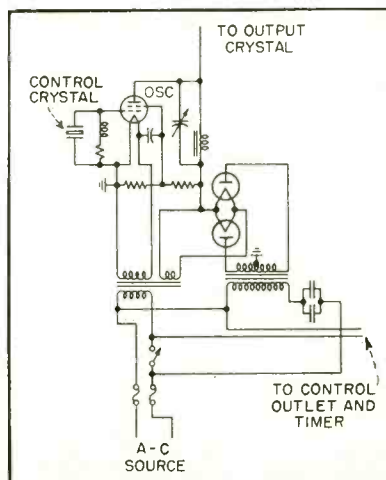

FIG. 1—Simplified schematic diagram of the therapy equipment

On a Coast-to-Coast Hook-up



PHALON
TRADEMARK
ELECTRONIC THERMOPLASTIC HOOK-UP WIRE

There is no mistaking quality performance . . . and PHALON hook-up wires are proving their quality in top performances coast-to-coast.

Hook-up, lead or fixture wires . . . whatever your requirement, there is a PHALON wire just made for the job! Get strong, tough, easy stripping with PHALON hook-up wires.

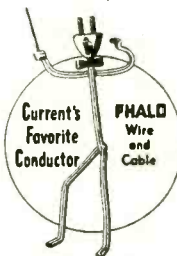

PHALO PLASTICS CORPORATION

CORNER OF COMMERCIAL STREET
WORCESTER, MASS.

Manufacturers of Thermoplastic Insulated Wire, Cables, Cord Sets and Tubing

PHALO
TRADEMARK

You can bring crystals to frequency quickly, accurately . . . by high vacuum coating

Here's a way to bring piezo-electric crystals to an exact frequency without the usual time-consuming grinding, testing, grinding method.

It works like this: In a high vacuum coating chamber, silver is evaporated on a number of crystal blanks simultaneously through masks used to build the metal up solidly in the center. Then, in another vacuum unit, each crystal is individually brought down rapidly to required frequency by further coating. Frequency can be checked continuously during the second operation—there's no grind-and-try experimentation required.

DPi makes the high vacuum equipment you need to set up a complete crystal coating system. Units are easy to operate and capable of turning out highly accurate crystals on an economical mass-production basis. For complete information on this, or any application of high vacuum in the electronics industry, write to *Distillation Products Industries*, Vacuum Equipment Department, 727 Ridge Road West, Rochester 3, N. Y.

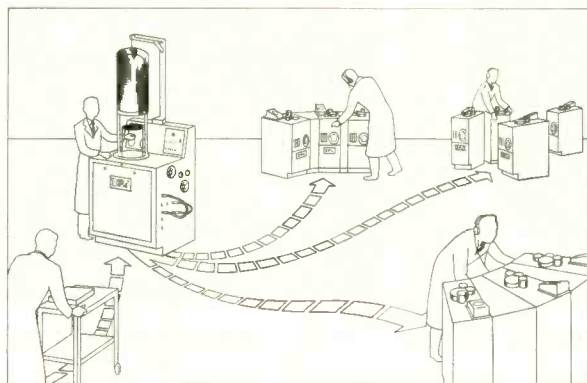

▲ Typical layout for a complete crystal coating system. Work flows through a base coating unit which handles a number of crystals at a time to final coating units which bring each crystal down to exact frequency.

DPi base coating unit Model LC1-14. Completely self-contained with mechanical pump and operating controls, it uses a highly efficient DPi oil diffusion pump. Vacuum is quickly achieved, coating is rapid. ▶

**high vacuum research
and engineering**

DPi

BALLANTINE

STILL THE FINEST

in

ELECTRONIC VOLTMETERS

Ballantine pioneered circuitry and manufacturing integrity assure the maximum in
SENSITIVITY • ACCURACY • STABILITY

- All models have a single easy-to-read logarithmic voltage scale and a uniform DB scale.
- The logarithmic scale assures the same accuracy at all points on the scale.
- Multipliers, decade amplifiers and shunts also available to extend range and usefulness of voltmeters.
- Each model may also be used as a wide-band amplifier.

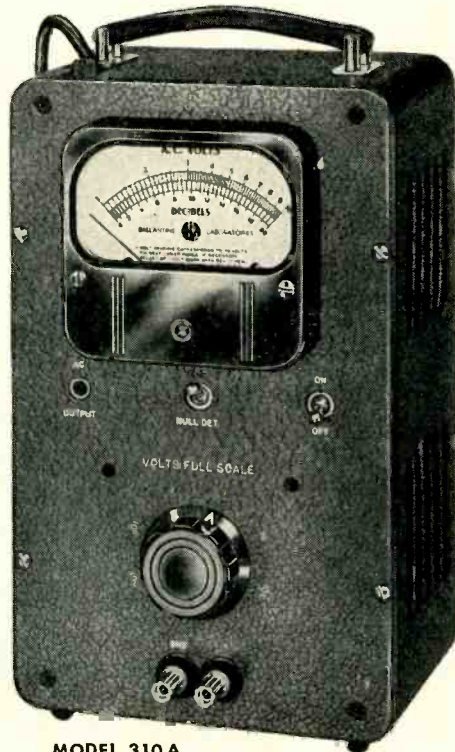

MODEL 310A

MODEL	FREQUENCY RANGE	VOLTAGE RANGE	INPUT IMPEDANCE	ACCURACY	PRICE
300	10 to 150,000 cycles	1 millivolt to 100 volts	1/2 meg. shunted by 30 mmfds.	2% up to 100 KC 3% above 100 KC	\$200.
302B Battery Operated	2 to 150,000 cycles	100 microvolts to 100 volts	2 megs. shunted by 8 mmfds. on high ranges and 15 mmfds. on low ranges	3% from 5 to 100,000 cycles; 5% elsewhere	\$225.
305	Measures peak values of pulses as short as 3 microseconds with a repetition rate as low as 20 per sec. Also measures peak values for sine waves from 10 to 150,000 cps.	1 millivolt to 1000 volts Peak to Peak	Same as Model 302B	3% on sine waves 5% on pulses	\$280.
310A	10 cycles to 2 megacycles	100 microvolts to 100 volts	Same as Model 302B	3% below 1 MC 5% above 1 MC	\$235.
314	15 cycles to 6 megacycles	With probe, 1 millivolt to 1000 volts. Without probe, 100 microvolts to 1 millivolt	With probe, 11 megs. shunted by 6 mmfds. Without probe, 1 meg. shunted by 25 mmfds.	3% except 5% above 3 megacycles	\$265

For further information, write for catalog.

BALLANTINE LABORATORIES, INC.

100 FANNY ROAD, BOONTON, NEW JERSEY



this unit is remarkably simple and inexpensive. It can be powered by means of a plug-in attachment on any alternating power circuit, and its ultrasonic output can be regulated accurately for values of 0.14 to 3½ watts per square centimeter at a constant frequency of one megacycle.

The basic electronic power circuit, Fig. 1, includes a high-voltage transformer, filament transformer, a pair of half-wave rectifier tubes and an oscillator. The output of the oscillator is conveyed to a quartz crystal in the aforementioned gun by means of a coaxial cable and may be limited to periods of 1 to 30 minutes by means of a mechanical timer.

Aside from the timer, only two manual knobs are used in operating



Quartz crystal being inspected prior to installation in output gun

the unit. Of these, a primary control knob actuates filament and plate switches as required while an output control knob determines the amount of ultrasonic power that will be produced.

A pair of signal lights on the instrument panel glow when the filament and plate circuits are properly energized, while a milliammeter indicates the actual output of oscillating current at all times.

The normal method of using the ultrasonic gun consists of smearing vaseline or a similar substance over the skin area to be treated, so that there will be no air space between the gun and the skin. The vibrating head of the gun is then rotated gently over the grease-coated skin;

ALLIED'S NEW 50 G *Sub-Miniature Relays*



Approved by U.S.A.F.
Spec. MIL-R-5757A

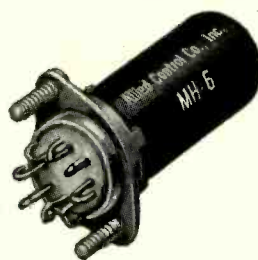

Type MH-6



Type MH-12



Type MH-18

2#-6-32 STUDS
FOR MOUNTING

RED WHT

Developed specifically to meet the rigid requirements of U.S.A.F. Spec. MIL-R-5757A, the new Allied line of sub-miniature double throw relays includes the MH-18 (6-Pole), the MH-12 (4-pole), and MH-6 (2-pole). • Contacts are rated at 2 amps resistive or 1 amp inductive at 28 volts D.C. • The high performance of these relays has been achieved in an extremely compact, unitized construction and parallels the most recent advances in airborne equipment design.

*For detailed specifications
and drawings of these new relays,
write for Bulletin 1002*



ALLIED CONTROL COMPANY, INC. 2 EAST END AVE., NEW YORK 21, N. Y.

EVENLY

Wind

SMALL TOROIDAL COILS AT HIGH SPEEDS WITH MINIMUM WIRE BREAKAGE

The MICAFIL Model RW-0 Toroidal Coil Winder automatically winds toroidal coils continuously around 360° and sector coils from 30° to 270°. To produce smooth, even layers of wire, the winder is adjusted easily to wind any wire size between 26 and 44 AWG and to obtain the proper pitch. Winding direction can be changed and feeds can be adjusted while machine is in operation.

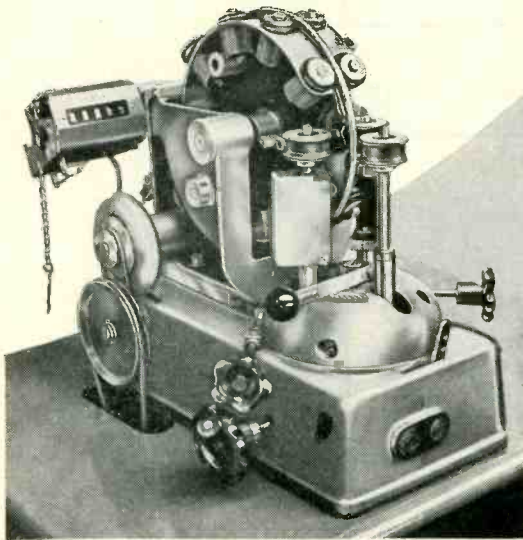

CAPACITY

- Coil Sizes
- Minimum finished I.D. 1/4"
- Maximum finished O.D. 2"
- Minimum finished O.D. 1/2"
- Wire Sizes 26 to 44 AWG
- Winding Speed—
according to wire size . . up to 1000 rpm
- Shuttle Capacity—
according to wire size . . . 60 to 800 feet

MICAFIL Toroidal Coil Winders are made in three larger sizes for winding coils up to 8" O.D. and with 10 AWG Wire.

9/16" O.D. x 3/8" I.D.
Wire—44 AWG
Winding Speed—800 rpm

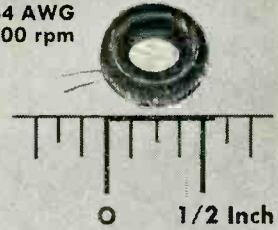

1-1/8" O.D. x 3/4" I.D.
Wire—44 AWG
Winding Speed—800 rpm

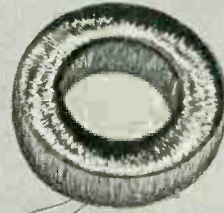

1-1/8" O.D. x 3/4" I.D.
Wire—38 AWG
Winding Speed—1000 rpm



O.D. 1-5/8" x 7/8" I.D.
Wire—38 AWG
Winding Speed—1000 rpm

SPIRALING DEVICE—Device winds spirals for shuttle loads—in advance . . . Newly developed to permit continuous operation of Coil Winder . . . Winds to pre-determined lengths.

SHUTTLES—Made in four different ring diameters to accommodate range of spiraled wire sizes . . . Larger wire capacities . . . *More than one coil can be wound with single loading* . . . Changed within 30 seconds . . . Loaded in less than a minute.

ACCURATE TURNS COUNTER—Preset for required number of turns . . . Automatically stops winder when turn count is reached.

Let Cosa Engineers study and recommend the winder for your needs. Or, write for Literature.

COSA CORPORATION

405 Lexington Ave., New York 17

Your source for all Precision Machine Tools—
from Small Bench Lathes to Large Boring Mills

IN DETROIT AREA contact DETROIT-COSA CORPORATION, 16923 James Couzens Highway, Detroit 35, Mich.

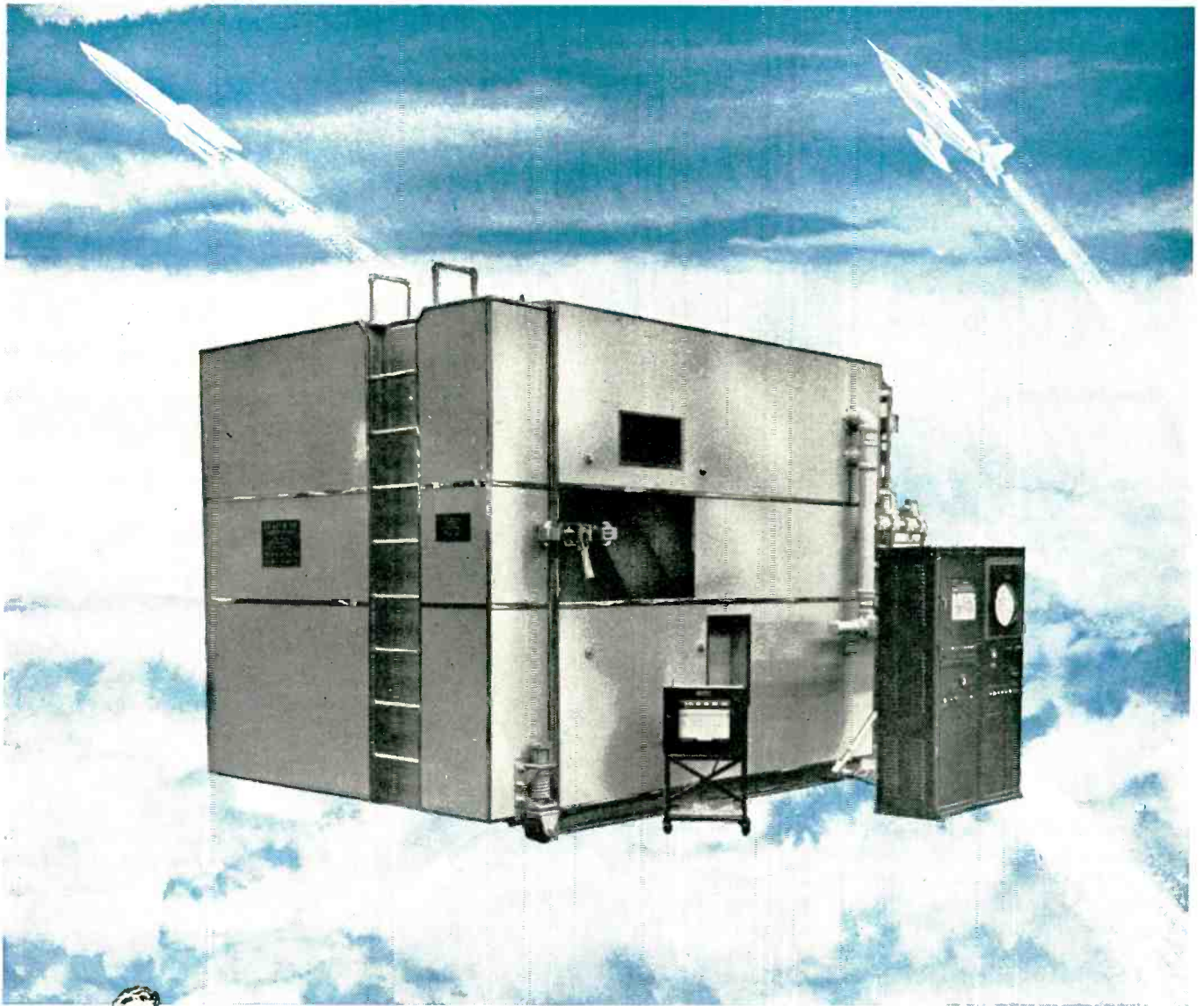

cabin in the **SKY?**

Not quite . . . but this "cabin" duplicates the conditions of pressure, temperature and humidity found from sea level to 100,000 feet *plus* with a temperature range of -100 to $+200^{\circ}\text{F}$. It is Consolidated Vultee's new high altitude test chamber . . . designed, developed and produced by Merritt & Zaleski. This complete environmental duplication facility enables test engineers at Convair's Fort Worth plant to predetermine the effects of environmental conditions on aircraft parts and assemblies in accordance with JAN and MIL specs. The importance of its contribution to avionic design, development and production is beyond calculation.

This is but one of the many Merritt & Zaleski test chambers serving industry today. Both stock and custom-built models are available with virtually limitless ranges . . . low and high temperature, humidity, pressure and complete environmental duplication. Discover, without obligation, how Merritt & Zaleski can solve your particular testing problem. *Write, in detail, for an analysis and specific proposal.*



MERRITT & ZALESKI INC.

ATMOSPHERE
UNLIMITED

33-66 12TH STREET, LONG ISLAND CITY 6, N. Y.

Stable as a Wirewound Resistor*

MODEL "R" VOLTMETER

SIE

DC VOLTS
DC MILLIVOLTS
AC VOLTS
AC MILLIVOLTS
OHMS
MEGOHMS
STANDARD CELL
DC AMPLIFIER



THE MODEL "R" VOLTMETER

The Model "R" is primarily intended for the precise measurement of DC potentials, providing DC voltage ranges from one volt full scale to 1,000 volts full scale; however, to allow the instrument its greatest possible utility, the following auxiliary functions have been included in its design:

Distended DC Voltage Ranges: Bucks out 99% of measured voltage and indicates 1% of measured voltage full scale.

DC Millivolt Ranges: One millivolt full scale to 1,000 millivolts full scale.

AC Volt and Millivolt Ranges: One Millivolt full scale to 1,000 volts full scale.

Self-Contained Standard Cell: For instant check of voltmeter calibration.

Ohms Ranges: Times one to times 10^6 .

Distended Ohms Ranges: Reads bottom half of ohms scale full scale.

DC Amplifier: Will drive a one ma recorder, has gain of 200, and frequency range of zero to 100 kc.

*This statement refers to the fact that precision wirewound resistors are used for all attenuators and range resistances, and that the DC Amplifier is a highly degenerative system employing wirewound resistors for the beta network. It has been found that changes in gain with warm-up are in the order of .1 of 1% and are primarily due to the temperature coefficient of the resistors in the beta network.

SIE

SOUTHWESTERN INDUSTRIAL ELECTRONICS CO.

massaging action is necessary to prevent cavitational effects which might cause pain.

In some circumstances, vibrations are applied directly over damaged areas of the body. In most cases, best results have been attained by ultrasonically massaging the spinal column near the base of the neck.

Definitions for Color Tv

THE FOLLOWING are approved working definitions for color television, submitted by Panel 19 to the N.T.S.C. at the meeting of June 23, 1952.

BLACK-AND-WHITE

Deprecated (see Monochrome)

BRIGHTNESS

The attribute of visual perception in accordance with which an area appears to emit more or less light.

Note: Luminance is recommended for the photometric quantity which has been called brightness. Luminance is a purely photometric quantity. Use of this name permits brightness to be used entirely with reference to the sensory response. The photometric quantity has been confused often with the sensation merely because of the use of one name for two distinct ideas. Brightness will continue to be used properly in nonquantitative statements, especially with reference to sensations and perceptions of light. Thus, it is correct to refer to a brightness match, even in the field of a photometer, because the sensations are matched, and only by inference are the photometric quantities (luminances) equal. Likewise, a photometer in which such matches are made will continue to be called an equality-of-brightness photometer.

A photoelectric instrument calibrated in foot-lamberts should not be called a brightness meter. If correctly calibrated, it is a luminance meter. A troublesome paradox is eliminated by the proposed distinction of nomenclature. The luminance of a surface may be doubled, yet it will be permissible to say that the brightness is not doubled, since the sensation which is called



JOHNSON

Broadcast/Communication Transmitting Accessories

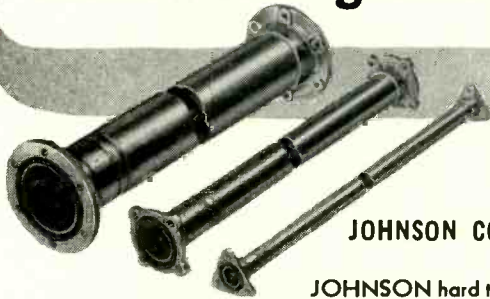

JOHNSON COAXIAL LINE

JOHNSON hard temper, 70 ohm and 51.5 ohm, flange type line is supplied in 20' lengths. Has precision mechanical assembly, low loss and low standing wave ratio. The 70 ohm line is intended primarily for AM service and has grade L-4 or better Steatite insulators. The 51.5 ohm line was designed primarily for high frequencies, has grade L-5 or better Steatite insulation. Meets RTMA standards for FM and TV.

In addition, JOHNSON manufactures a complete line of elbows, fittings, gas equipment and hardware for the above as well as semi-flexible, soft temper line in continuous lengths up to 1200 feet in 5/16", 3/8" and 7/8".

Whatever your coaxial line requirements may be, JOHNSON can meet them to your utmost satisfaction.

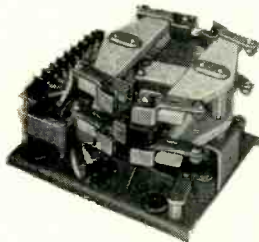

JOHNSON RF CONTACTORS

Rugged, compact with fast, snappy action. Designed for high voltage RF switching; suitable for many other applications.

Available in two sizes with ratings of 17 KV and 22 KV peak. Current rating, 25 amperes per contact. SPDT or DPDT contact arrangement. No holding current required.

Features toggle actuated balanced rotary armature and wiping contacts designed to stay aligned and withstand heavy vibration.



JOHNSON manufactures a wide range of components and equipment for broadcast and commercial transmitter applications. These accessories in many cases offer the combined advantages of tailored design—to suit your particular requirements—plus the modest cost usually associated with standardized equipment.

Highest quality materials, skillfully fabricated, and the experience gained through many years of supplying broadcasters with outstanding equipment are assurance of complete satisfaction—utmost dependability!

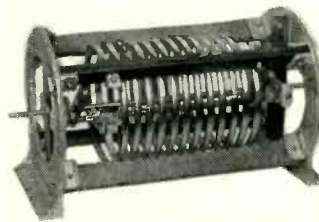

224-2-1

VARIABLE INDUCTOR

For High Power Applications

Rated to 50 amps. and variable to 16.5 mh. Spring loaded silver plated roller contact permits adjustment with full power applied. Cast aluminum end-frames slotted to minimize Eddy current losses. Available in eight standard models, maximum inductances 10 thru 110 mh.

The JOHNSON line includes many other variable and fixed inductors for low, medium and high power. Fixed inductors are available with single or multiple windings, fixed or variable coupling windings and with electrostatic shields.

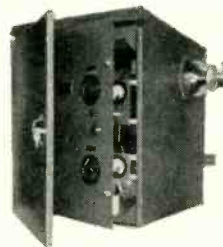

ANTENNA COUPLING UNITS

JOHNSON designs and builds antenna coupling units for any power rating in exact conformance to engineers' or consultants' specifications. This "custom-type" construction costs no more than less flexible standard types and is your assurance of optimum performance.

Illustrated, is a remote coupling unit featuring an interior door that remains closed during adjustments to provide complete weather-proofing at all times. Write for full information on these and other JOHNSON Broadcast Components.



TOWER LIGHTING FILTERS

These filters prevent flow of RF energy via the lighting circuit to ground. Comply with FCC regulations by effecting less than 1% change in antenna radiation resistance. Variable tuning capacitor provides maximum RF reactance.

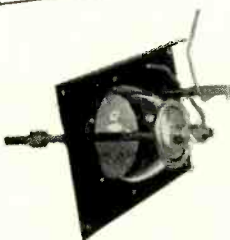

FEED-THRU BOWL ASSEMBLIES

Heavy duty low-loss glass feed-thru bowl available with or without fittings. Bowl measures 6-15/16" O.D., 4-3/8" high. Available with studs for 4" to 12" walls. Fittings include spun aluminum corona shield, steel flange and cork gaskets. Illustrated is special model with static discharge gap.



JOHNSON ANTENNA INSULATORS
Commercial Type

Made of wet process porcelain with smooth white glazing. End bells of non-corrosive aluminum alloy. Available in three sizes; 8", 12" and 20" net length. Diameter 1 1/2". Breaking strength 5000 lbs.

For full information on the complete JOHNSON line of Broadcast Transmitter Accessories, write Dept. D9.



JOHNSON

E. F. JOHNSON CO.

WASECA, MINNESOTA

CAPACITORS, INDUCTORS, SOCKETS, INSULATORS, PLUGS AND JACKS, KNOBS AND DIALS, AND PILOT LIGHTS.

Minimize Effects of varying supply voltage the simple way

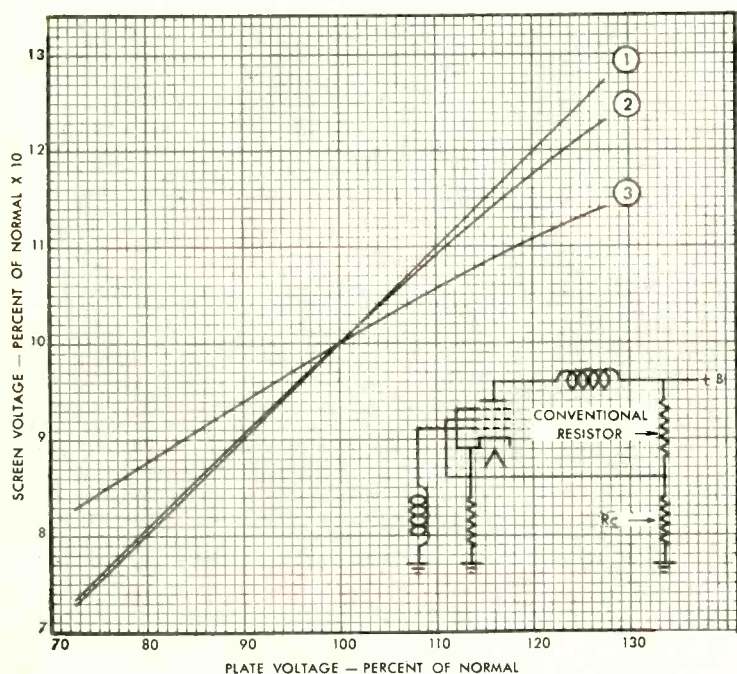
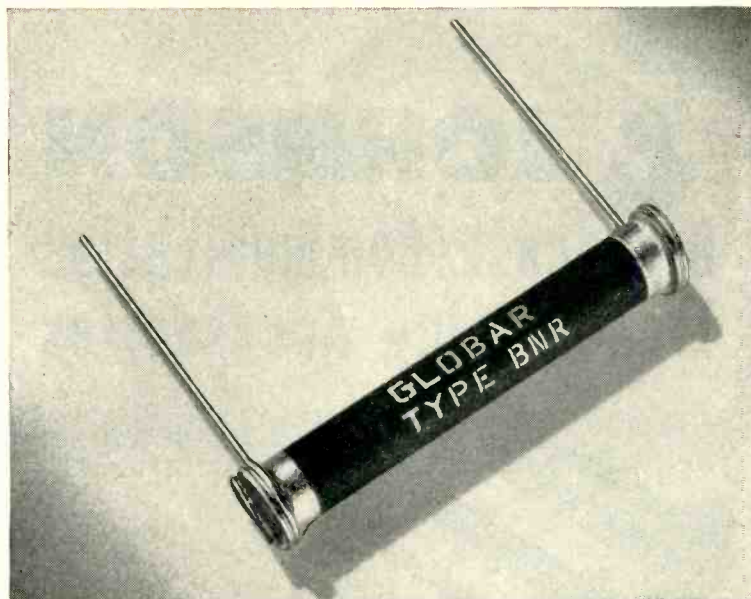

Performance of Various Voltage Reducers for Pentode Screen Supply

- 1 Divider with conventional composition Resistor at R_c .
- 2 Plain series dropping Resistor (R_c omitted).
- 3 Divider with GLOBAL type BNR Resistor at R_c .

● Variation in supply voltage which impairs pentode amplifier performance is especially serious in cathode ray tube applications where the effect on sweep amplifier output is visible. This is where the voltage sensitive characteristics of GLOBAL type BNR resistors prove extremely valuable. Employed in a voltage divider as shown here, they help to stabilize gain of amplifiers against supply voltage variations. Often, they reduce screen voltage variations by as much as *one half*.



● WRITE to Dept. E 87-121 for a copy of Bulletin GR-2 which contains useful engineering data on GLOBAL type BNR resistors.

GLOBAL

TRADE MARK

TYPE BNR VOLTAGE SENSITIVE

Ceramic Resistors by CARBORUNDUM

Engineered today for your needs tomorrow!

MYCALEX

PRECISION-MOLDED MYCALEX 410

TRANSISTOR SOCKETS

— now in the pilot production stage
— engineered in advance of actual need

In keeping with the MYCALEX policy of progressive design in advance of needs, these Transistor Sockets were engineered months ago and are now in small scale pilot production. They'll be available in quantity in advance of actual needs.

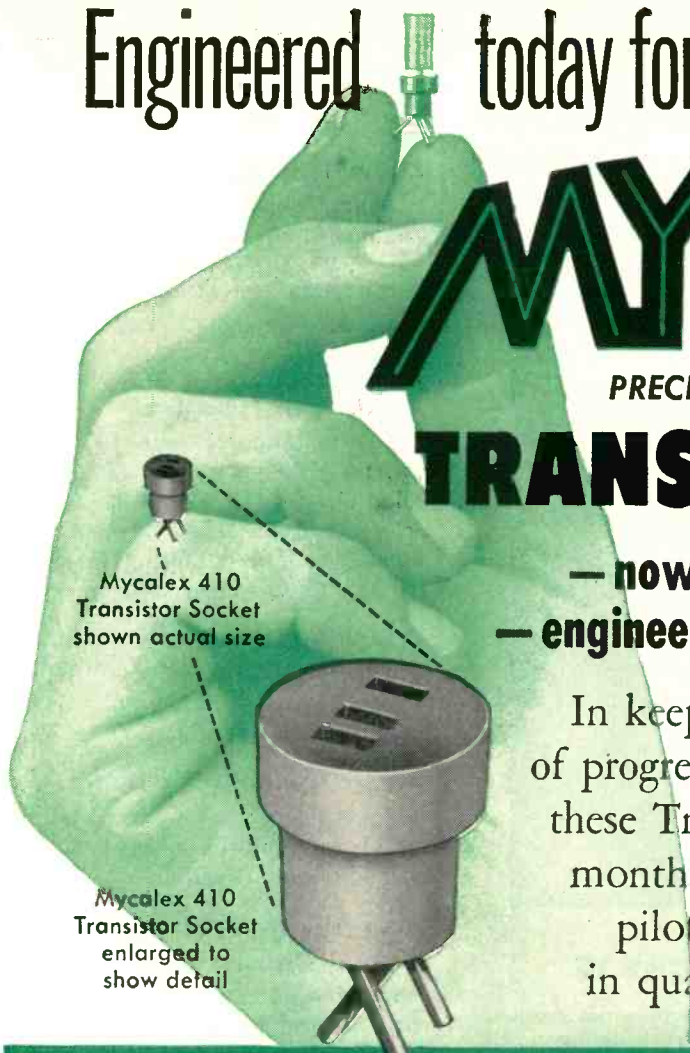

Mycalex 410 Transistor Socket shown actual size

Mycalex 410 Transistor Socket enlarged to show detail



Achievement in PRECISION MOLDING!

The production of Mycalex Transistor Sockets is a real accomplishment of precision molding in miniature. The holes for the leads are the smallest ever molded. All tolerances are exceedingly close. Mycalex production engineers are proud of their achievement... particularly because low-cost, mass production techniques can be adhered to.

The body is precision-molded of MYCALEX 410, glass-bonded mica insulation for lasting dimensional stability, low dielectric loss, immunity to high temperature and humidity exposure combined with maximum mechanical strength. The loss factor is only 0.014 at 1 MC and dielectric strength is 200 volts/mil.

Contacts can be supplied in brass or beryllium copper. The sockets are readily solderable. The socket bodies will not warp or crack when subjected to high soldering temperature. They function in ambient temperatures up to 700° F.

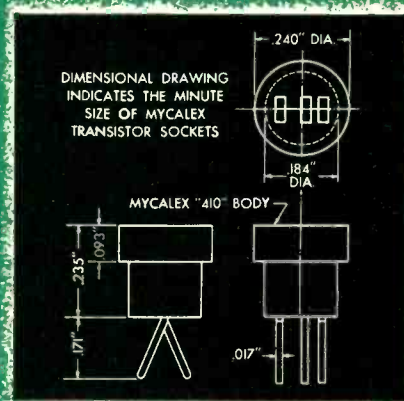

Mycalex Low-loss Tube Sockets and Multiple Headers

A complete line of tube sockets including sub-miniature types is available in Mycalex 410 and Mycalex 410X glass-bonded mica insulation. Comparative in cost to ordinary phenolic sockets they are far superior in every respect. Dimensional accuracy is unexcelled. For complete information on standard

and custom Tube Sockets or Multiple Headers, call, wire or write... there is no obligation, of course.

MYCALEX TUBE SOCKET CORPORATION

Under Exclusive License of Mycalex Corporation of America
30 ROCKEFELLER PLAZA, NEW YORK 20, N. Y.



MYCALEX CORPORATION OF AMERICA

Owners of 'MYCALEX' Patents and Trade-Marks

Executive Offices: 30 ROCKEFELLER PLAZA, NEW YORK 20—Plant & General Offices: CLIFTON, N. J.

brightness is generally judged to be not doubled.

BRIGHTNESS CHANNEL

Deprecated (see Monochrome Channel, Luminance Channel)

BRIGHTNESS SIGNAL

See Monochrome Signal

BURST PEDESTAL

(Color-Burst Pedestal)

The rectangular pulse-like component which may be part of the color burst. The amplitude of the color-burst pedestal is measured from the a-c axis of the sine-wave portion to the horizontal pedestal.

BYPASS MIXED HIGHS

The mixed-highs signal that is shunted around the color-subcarrier modulator or demodulator.

BYPASS MONOCHROME SIGNAL

A monochrome signal that is shunted around the color-subcarrier modulator or demodulator.

CAMERA SPECTRAL CHARACTERISTIC

The sensitivity of each of the camera color separation channels with respect to wavelength.

Note: It is necessary to state the camera terminals at which the characteristics apply.

Because of nonlinearity, the spectral characteristics of some kinds of cameras depend upon the magnitude of radiance used in their measurement.

Nonlinearizing and matrixing operations may be performed within the camera.

CAMERA TAKING CHARACTERISTICS

Deprecated (see Camera Spectral Characteristic)

CARRIER COLOR SIGNAL

The sidebands of the modulated color subcarrier (plus the color subcarrier, if not suppressed) which are added to the monochrome signal to convey color information.

CHROMINANCE

The colorimetric difference between any color and a reference color of equal luminance, the reference color having a specified chromaticity.

Note: In N.T.S.C. transmission, the specified chromaticity is the

MINIATURE QUICK-DISCONNECTING CONNECTOR

ACTUAL SIZE

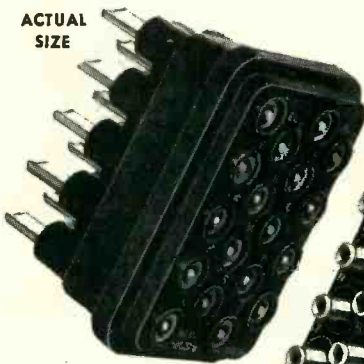

RECEPTACLE
MAQRE 18S

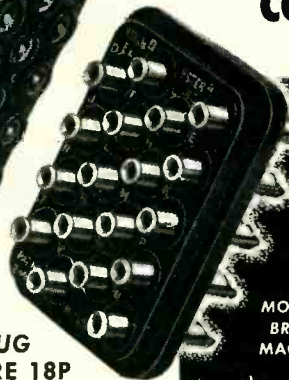

PLUG
MAQRE 18P

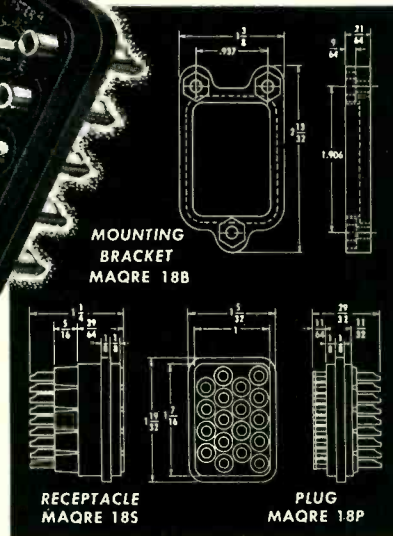

MOUNTING
BRACKET
MAQRE 18B

RECEPTACLE
MAQRE 18S

PLUG
MAQRE 18P

Here is a MINIATURE connector—designed for limited space applications—which incorporates all of the features of our well known quick-disconnecting, self-aligning (type QRE) connectors. Rearrangement of contacts and omission of guides has resulted in a 35% space saving over the QRE connector with the same number of contacts.

QUALITY FEATURES of the MAQRE 18

QUICK DISCONNECTING. The separately spring loaded contacts used in this connector eliminate the annoying prying and pulling necessary when separating ordinary multi-contact connectors. Forcing, which frequently results in serious damage, is eliminated and special levers are not required.

SELF-ALIGNING. Individually floating contacts assure self-alignment and contact arrangement provides positive polarization.

PRECISION MACHINED CONTACTS. Pins are from brass bar (QQ-B611) and sockets from spring temper phosphor bronze bar (QQ-B746a). They are gold plated over silver for consistent low contact resistance, reduction of corrosion and ease of soldering.

MONOBLOC* CONSTRUCTION eliminates unnecessary creepage paths, moisture and dust pockets and provides stronger molded parts.

MOLDED MELAMINE BODIES (in accordance with MIL-P-14) Mineral-filled—are fungus-proof and provide mechanical strength as well as high arc and dielectric resistance.

MOUNTING. A die cast aluminum, black anodized bracket for rack and panel mounting permits necessary float for self-alignment.

PHYSICAL AND ELECTRICAL DATA

Receptacle Code No.	Plug Code No.	Number of Contacts	Shell Cup Hole Dia. In.	Weight Oz.		D. C. Volts Breakdown Between Contacts (Connector Engaged)	
				Receptacle	Plug	Sea Level Normal Humidity	60,000 Feet Altitude
MAQRE 18S	MAQRE 18P	18	.073	1.8	1.1	5400	1350

Patent Number 2466370

Wire or write for catalog on other types or advise your special requirements.

**WINCHESTER
ELECTRONICS
INCORPORATED**

West Coast Branch: 1729 Wilshire Blvd.,
Santa Monica, California

★ Trademark

GLENBROOK, CONN., U.S.A.



Sangamo's dry tubular electrolytic capacitor *that fits anywhere*

Type MT and MTD electrolytic capacitors, "Chieftains" of the Sangamo line, are built to provide longer life, greater dependability, and better electrical characteristics in television and other electronic applications. Their small physical size makes them a "natural" for application in tight spots beneath a chassis, and the bare tinned-copper wire leads make them easy to mount.

Sangamo "Chieftains" are contained in hermetically-sealed round aluminum cans and are tightly encased in heavy cardboard sleeves on which polarity is clearly indicated. Double, pure paper spacers assure adequate breakdown characteristics

and all sections are tightly held in place within the container. Multiple staking connects the terminal tabs to the electrodes, providing permanent low resistance contact throughout the life of the capacitor. The low voltage units are supplied with etched cathodes to maintain uniform capacity when the capacitor is subjected to heat and high ripple currents.

"Chieftains" are manufactured under controlled conditions of almost surgical cleanliness, utilizing the very finest materials and production procedures available in the industry, for your assurance of quality in every respect.



Tomahawk



Warrior



Mohican

Your own trial-use will convince you that new standards of dependability and longevity have been built into Sangamo Electrolytics. Order from the new Sangamo Capacitor Catalog No. 800A which is yours for the asking, and without obligation.

Those who know

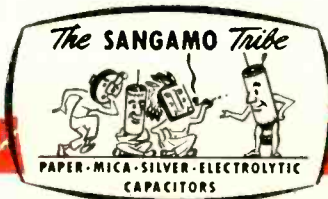

...choose Sangamo

SANGAMO ELECTRIC COMPANY

MARION, ILLINOIS

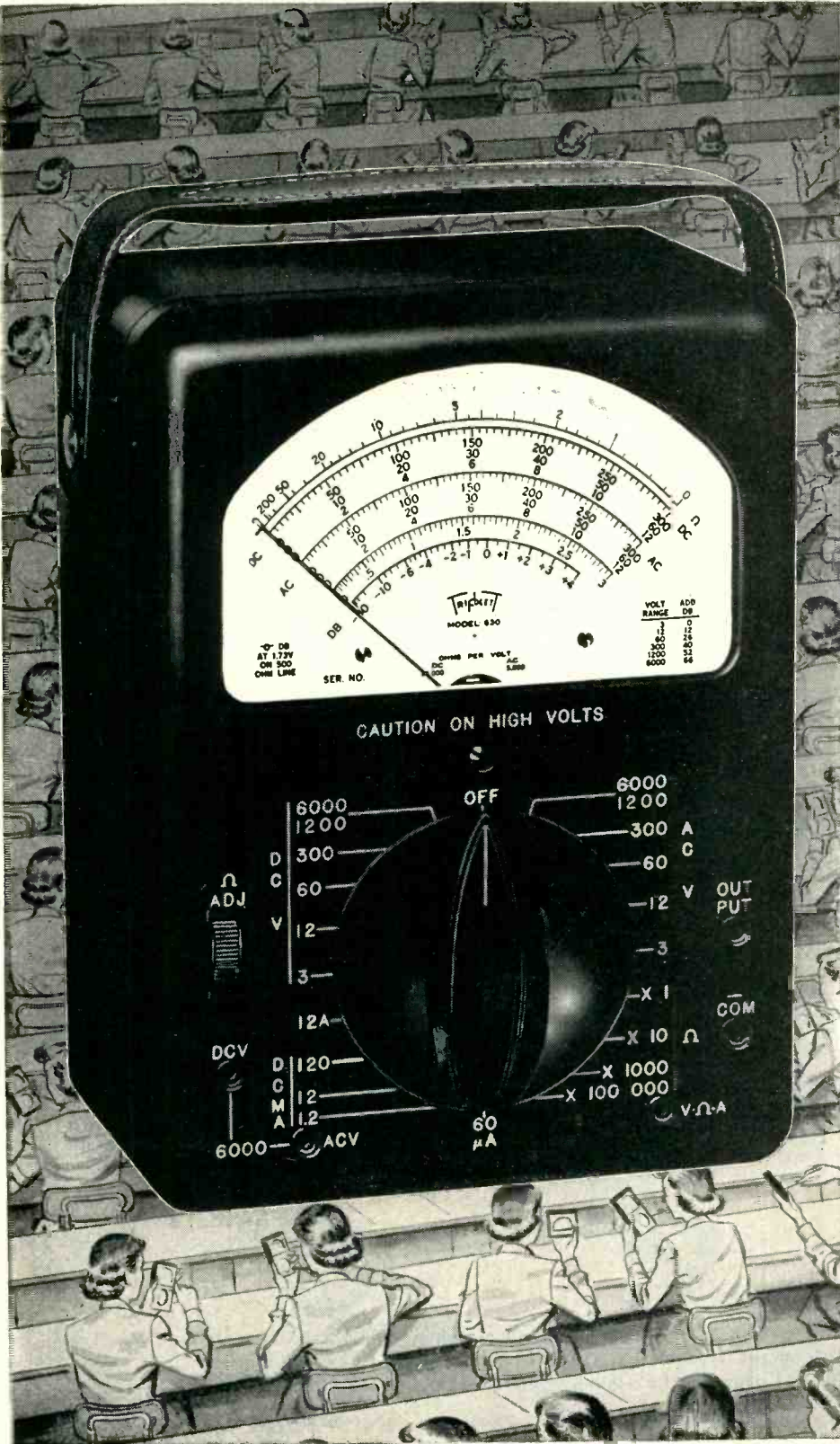

Your dollar buys
more "instrument"
...in our Model

630



Volt-Ohm-Mil-Ammeter
by R. L. Triplett
PRESIDENT

Because we build every major part of our instruments the quality is carefully controlled. For example, we know we have more torque driving our pointers because we designed and built the complete instrument. We know we have sustained dependence in the shafts and switch contacts of our test equipment for the same reason. Cycle tests for switches exceed several times the rigid requirements of the armed forces.

There is another important value to you. Because we make our own components we eliminate the profit another manufacturer would make in selling them to us. And this "profit" is passed on to you.

Consider these features of Model 630 V.O.M., for example—

One Hand Operation—One switch with large recessed knob has a single position setting for each reading. Leaves one hand free. Eliminates switching errors, trouble, saves time.

Ranges—AC-DC Volts: 3-12-60-300-1200-6000 (AC, 5000 Ohms/Volt; DC, 20,000 Ohms/Volt). 60 Micro-Amps. 1.2, 12, & 120 Mil Amps. DB scales at 1.73V on 500 Ohm line, 0-66 DB output.

Highest Ohm Reading—To 100 Meg. in steps of 1000-10,000-100,000 Ohms—100 Megohms.

Yes, with us it's a matter of personal pride to make "Triplett" stand for better construction and more service for your test equipment dollar.

R. L. Triplett

PRESIDENT
TRIPLETT ELECTRICAL INSTRUMENT CO.
Bluffton, Ohio

TRIPLETT 630 V.O.M.

only \$39.50



Triplett

For service, accuracy, highest dependability, buy

fine wire

made finer



custom drawn
custom insulated
custom spooled
to your most exacting
requirements

For the past fifty years (1901 - 1951) we have specialized in "Fine Wire Made Finer." That is why Hudson-Winsted fine wires are the first choice of electrical, radio, television and electronic manufacturers whose products are noted for performance, reliability and long life.

So just specify the electrical properties, flexibility, tensile strength, laying speed, uniformity and other characteristics you must have. Our Hudson and Winsted Divisions will meet and maintain your specifications.

● Tell us your wire problems and requirements. Our research, engineering and production facilities are at your disposal. Let us quote!

BARE WIRES

(Hudson Wire Division)

Copper	Silver-plated
Brass	Bronze
Zinc	Phosphor-Bronze
Tinsel	Silver
Tin	Monel
Nickel-Silver	Lead Wire
Cadmium	Fuse Wire
Oxygen-free	Specialty
Copper	Wires

TEXTILE-COVERED WIRES

(Winsted Division)

Nylon	Cotton
Celanese	Rayon
Silk	Fiberglas

All available on bare or enameled wire, single or double covered.

INSULATED WIRES

(Winsted Division)

MATERIALS	TYPES	COVERINGS
Copper	Instrument	Plain and Heavy
Aluminum	Tubing	Enamel
Iron	Litz	Formvar
Copper-clad	Multiplied	EZsol (Liquid Nylon)
Steel	and Twisted	Cement-coated Enamel

FINE WIRES

(Hudson and Winsted Divisions)

Specializing in fine wires, custom-drawn and insulated, to critical needs — size, material, insulation. Your consideration is called particularly to the finest wire sizes — Nos. 44 to 50.

HUDSON WIRE COMPANY

GENERAL OFFICES: OSSINING, N. Y. • WINSTED DIVISION: WINSTED, CONN.



604 604B And now—it's the ALTEC 604C



Since the introduction of the original 604 speaker in 1943 the Altec 604 "duplex" has been known to all as the finest loudspeaker that money can buy. Now, after years of continuing research, the new Altec 604C "duplex" is here to set even higher standards for audio reproduction... for the 604C will faithfully reproduce tones from 30 to 22,000 cycles and handle 50 watts of peak power! Listen to the amazing Altec 604C soon. Your ears will agree it's the finest loudspeaker in the world.

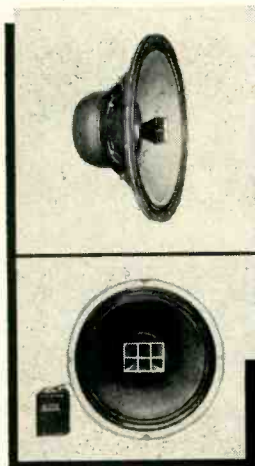

604C SPECIFICATIONS:

Power rating.....35 watts (50 watts peak)
Network impedance.....16 ohms
Maximum diameter.....15 $\frac{3}{8}$ inches
Maximum depth.....11 $\frac{1}{8}$ inches
Weight with network.....40 pounds

Don't forget to listen to these new members of the "duplex" line, the 12" 601A and the 15" 602A. They are designed especially for the home.

ALTEC
LANSING CORPORATION

9356 Santa Monica Boulevard,
Beverly Hills, California
161 Sixth Avenue,
New York 13, New York

ALL THREE SPEAKERS ARE GUARANTEED TO REPRODUCE ALL OF THE TONES FROM 30 TO 22,000 CYCLES!

zero subcarrier chromaticity.

CHROMINANCE CHANNEL

In a color-television system, any path which is intended to carry the carrier color signal.

COLOR BURST

That portion of the composite color signal comprising the few sine-wave cycles of color subcarrier frequency (and the color burst pedestal, if present) which is added to the horizontal pedestal for synchronizing the color-carrier reference.

COLOR CARRIER

See Color Subcarrier

COLOR-CARRIER REFERENCE

A continuous signal having the same frequency as the color subcarrier and having fixed phase with respect to the color burst. This signal is used for the purposes of modulation at the transmitter and demodulation at the receiver.

COLOR COORDINATE TRANSFORMATION

Computation of the tristimulus values of colors in terms of one set of primaries from the tristimulus values of the same colors in another set of primaries.

Note: This computation may be performed electrically in a color television system.

COLOR DIFFERENCE SIGNAL

An electrical signal which when added to the monochrome signal produces a signal representative of one of the tristimulus values (with respect to a stated set of primaries) of the transmitted color.

COLOR EDGING

Spurious color at the boundaries of differently colored areas in the picture.

Note: Color edging includes color fringing, misregistration, etc.

COLOR PHASE

(of a given subcarrier component)

The phase, with respect to the color-carrier reference, of that component of the carrier color signal which transmits a particular color signal.

COLOR PHASE ALTERNATION (CPA)

The periodic changing of the color phase of one or more compo-

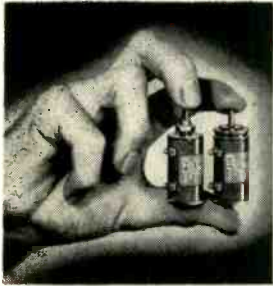

Series AJ Helipot models are only $\frac{3}{4}$ " in diameter and $1\frac{1}{2}$ " long; weight 1.0 oz. Ten-turn 18" slide wire gives adjustment accuracy of 1/3000 in a 100-ohm unit—1/6500 in a 50,000-ohm unit.

Helipot
 achieves
**"HIGHEST
 PRECISION"**
 with
**DRIVER-HARRIS
 RESISTANCE
 WIRE**



Cutaway view of Model A 10-turn Helipot precision helical potentiometer. Resistance element 45" long is contained in case 2" x $1\frac{13}{16}$ " diameter. On element are wound 3000 to 9800 turns of resistance wire, depending on total resistance value required. Adjustment accuracy is 12 to 14 times that of conventional single-turn potentiometer of equal diameter.

To win consumer preference and assure customer satisfaction, Helipot Corporation is guided by a basic policy that has proved as effective as it is simple. It is: (1) to produce components of the highest precision, and (2) to realize the economies inherent in mass production.

By following these objectives, Helipot has become the world's largest maker of precision potentiometers, producing the widest selection of single-turn and multi-turn units available anywhere.

States Helipot: "Our policy of mass producing the highest precision potentiometers practicable, in order to deliver top quality at moderate cost, is reflected in the fact that standard linearity accuracy of all our stock models, selling competitively, is held to $\pm 0.5\%$. Our reliance on Driver-Harris alloys such as Nichrome V, Advance, and

Karma to provide resistance windings for many of our products constitutes a strong endorsement of Driver-Harris skills and reliability."

Driver-Harris takes particular pride in having played so important a role in the Helipot story, and is fully conscious of the responsibility the confidence of this famous manufacturer imposes.

Nichrome*, Advance*, and Karma* are at your service, too; as are more than 80 other alloys developed exclusively by Driver-Harris for application in the electrical and electronic fields. We feel confident that, like Helipot, you will realize outstanding advantages by putting one or more of them to work for you. Let us have your specifications. We'll be glad to make recommendations based on your specific requirements.

*T.M. Reg. U.S. Pat. Off.



Sole producers of Nichrome, Advance, and Karma

Driver-Harris Company

HARRISON, NEW JERSEY

BRANCHES: Chicago, Detroit, Cleveland, Los Angeles, San Francisco

In Canada: The B. GREENING WIRE COMPANY, Ltd., Hamilton, Ontario.

MAKERS OF THE MOST COMPLETE LINE OF ELECTRIC HEATING, RESISTANCE, AND ELECTRONIC ALLOYS IN THE WORLD

Specialists in the design and volume manufacture of SPECIAL ELECTRICAL ASSEMBLIES

Ucinite has years of specialized experience in the electronics field plus complete facilities for volume production of small metal stampings as well as assembly of metal to plastic and ceramic components. For special electrical parts and assemblies . . . designed, assembled, wired and marked to your specifications . . . call your nearest Ucinite field engineer.

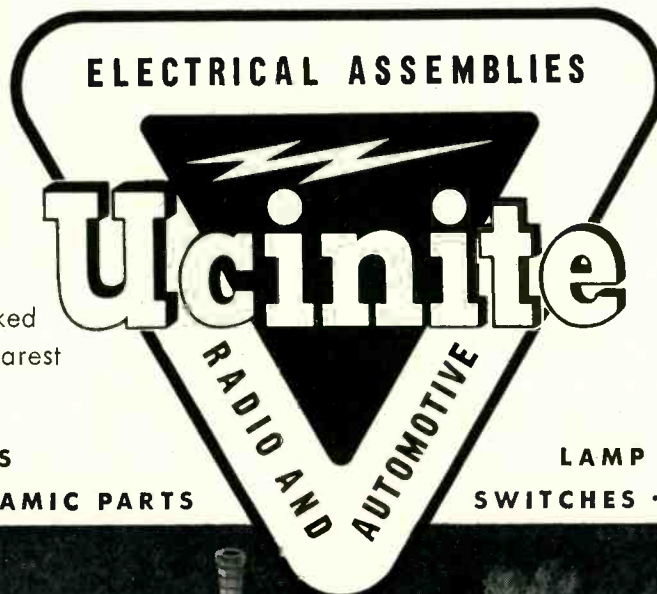

SPECIAL METAL STAMPINGS
MOLDED PLASTIC AND CERAMIC PARTS

LAMP SOCKETS
SWITCHES · CONNECTORS

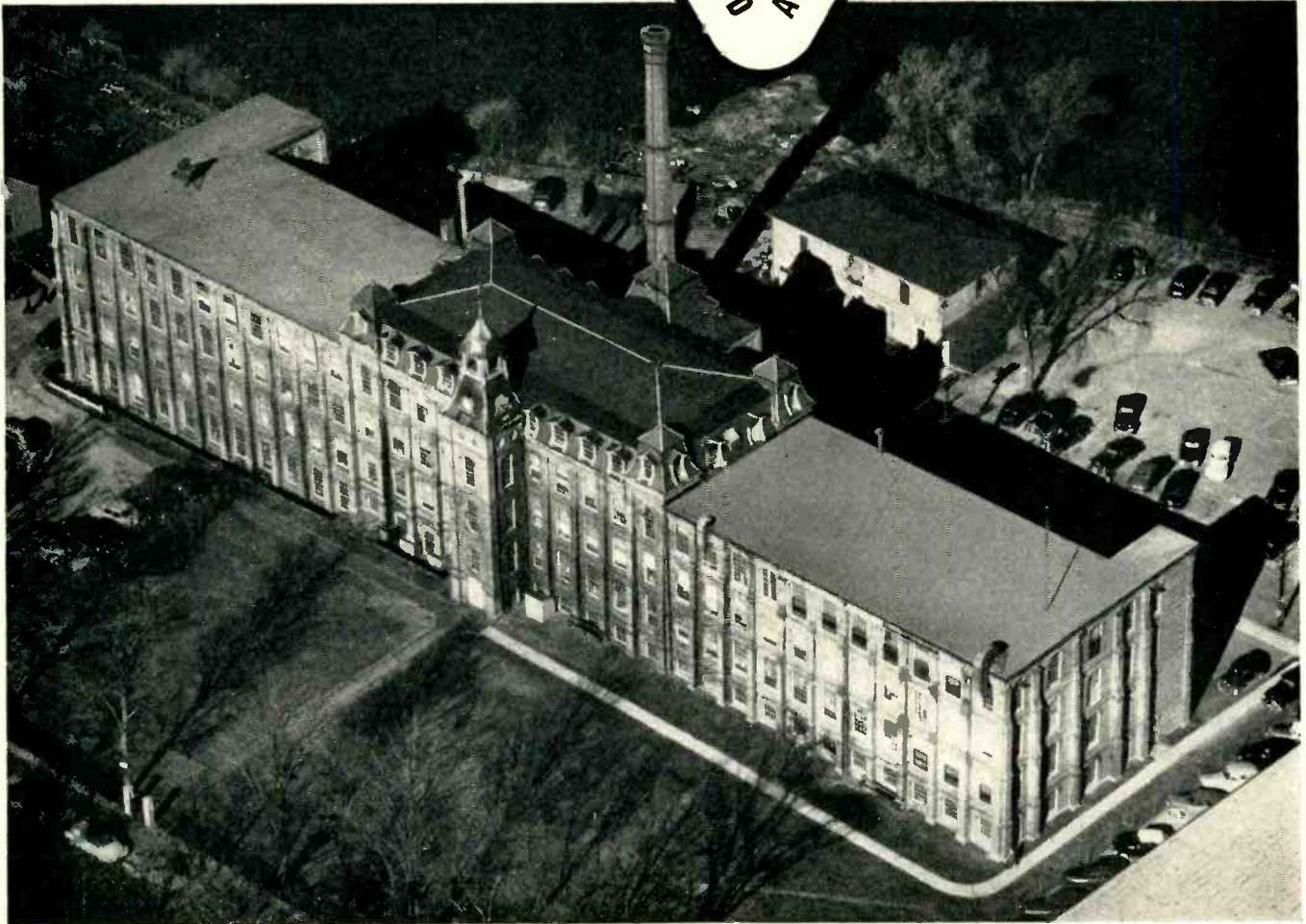

The UCINITE COMPANY

NEWTONVILLE 60, MASS.

Division of the United-Carr Fastener Corp.



Tailor-made fasteners **DESIGNED AND PRODUCED IN VOLUME**
 by the **WORLD'S LEADING SPECIALISTS**
 in **SPECIAL FASTENERS AND ALLIED DEVICES**

United-Carr's design and production engineers have years of experience in the specialized field of fastener engineering. United-Carr's plants are equipped for volume production of metal stampings and for the assembly of metal to plastic and ceramic components. Call in United-Carr and you have at your command an integrated team capable of meeting practically any requirements for special fasteners and allied devices.

UNITED-CARR FASTENER CORP.
 CAMBRIDGE 42, MASSACHUSETTS

MAKERS OF **DOT** FASTENERS

TINY-TRIM and TERRIFIC

THE TURNER 80

THIS is the new Turner 80 — a crystal microphone so tiny it hides in the palm of your hand, yet so strikingly designed it is the very picture of scintillating symmetry. Weighs less than 5 ounces, yet its high output and unusually fine response characteristics make it a natural for announcing and mobile public address systems, for home recording, dictating machines, amateur communications, portable recorders and dozens of other applications. Finished in beautiful satin chrome. Level: Approximately 58 db below 1 volt/dyne/sq. cm. Response: 80 — 7000 c.p.s. 7 foot attached single conductor shielded cable.

List Price.....\$15.95

The Model 80 is pictured with the C-2 desk stand—a good combination for paging, dictaphone, home recording, etc.
C-2 stand. List Price \$2.75

Model 83 — Same technical specifications as Model 80. Ideal for use wherever a hand microphone is required.
List Price\$15.95

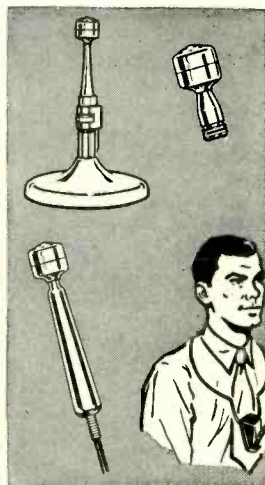

Model 81 — smaller than Model 80. Same technical specifications, but with a PC1M Amphenol connector attached.
List Price\$13.95

Model 82-3H — Same technical specifications as Model 80. Furnished with famous Turner "Third Hand" and 20 foot attached single conductor shielded cable.
List Price\$22.75

ACTUAL SIZE

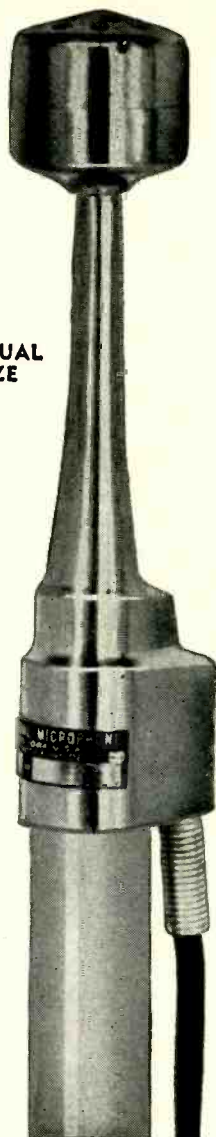

ELECTRONS AT WORK

(continued)

nents of the color subcarrier between two sets of assigned values.

Note: In the N.T.S.C. system, the color phase is changed after every field.

It is recommended that the term "Color Phase Alternation" be used in place of the terms Oscillating Color Sequence and Flip-Flop, which have been used with this same meaning.

COLOR PICTURE SIGNAL

The electrical signal which represents color picture information, consisting of a monochrome component plus a subcarrier modulated with color information, excluding synchronizing signals.

COLOR SUBCARRIER

The carrier whose modulation sidebands are added to the monochrome signal to convey color information.

COLOR SYNC SIGNAL

See Color Burst

COLOR TRANSMISSION

In television, the transmission of a signal wave for controlling both the luminance values and the chromaticity values in a picture.

COMPATIBILITY

The nature of a color television system which permits substantially normal monochrome reception of the transmission by typical unaltered monochrome receivers designed for standard monochrome.

COMPOSITE COLOR SIGNAL

The color picture including blanking and all synchronizing signals.

CONSTANT LUMINANCE TRANSMISSION

A method of color transmission in which the carrier color signal controls the chromaticity of the produced image without affecting the luminance, the luminance being controlled by the monochrome signal.

DELAY DISTORTION

That form of distortion which occurs when the envelope delay of a circuit or system is not constant over the frequency range required for transmission.

ENVELOPE DELAY

The first derivative of the phase

THE TURNER COMPANY 905 17th St., N. E. Cedar Rapids, Iowa

IN CANADA:
Canadian Marconi Co., Ltd. Toronto, Ont., and Branches

EXPORT:
Ad. Auriema, Inc. 89 Broad Street, New York 4



Crystals licensed under patents of the Brush Development Company



When it comes to making a *Real Saving* in space...



Stackpole cup cores with their self-shielding characteristic can be mounted close to the chassis or any other metal part for maximum results in extremely close quarters. In some instances, the high Q circuits made possible through their use permit reduction in the number of tubes needed.

Standard types include numerous shapes and sizes, each available in a wide range of permeability possibilities. Highly specialized types to meet the most critical specifications can be engineered and produced from a broad background of experience in this exacting field.

Electronic Components Division

STACKPOLE CARBON COMPANY
St. Marys, Pa.

STACKPOLE

Cup Cores

Other Stackpole core types include:

ALL STANDARD MOLDED IRON CORE TYPES, SIDE-MOLDED, CHOKE COIL CORES, SLEEVE TYPES, THREADED TYPES and COIL FORMS. . . also Stackpole CERAMAG® CORES (FERRITES).

Write for Electronic Components Catalog RC-8

THERE IS PLENTY OF TIN IN MALAYA

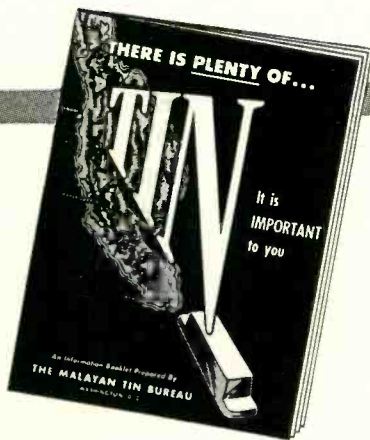

Only a deliberate distortion of facts could give rise to the false impression that tin is in short supply.

You should know the truth.

We have prepared a 20-page booklet that graphically and concisely presents the complete story. A copy is yours for the asking.

THE MALAYAN TIN BUREAU

1028 Connecticut Avenue Department 38 Washington 6, D.C.

There Is Plenty of Tin in Malaya



Let **JOY** handle Your **FAN ENGINEERING** on **ELECTRONIC COOLING PROBLEMS**

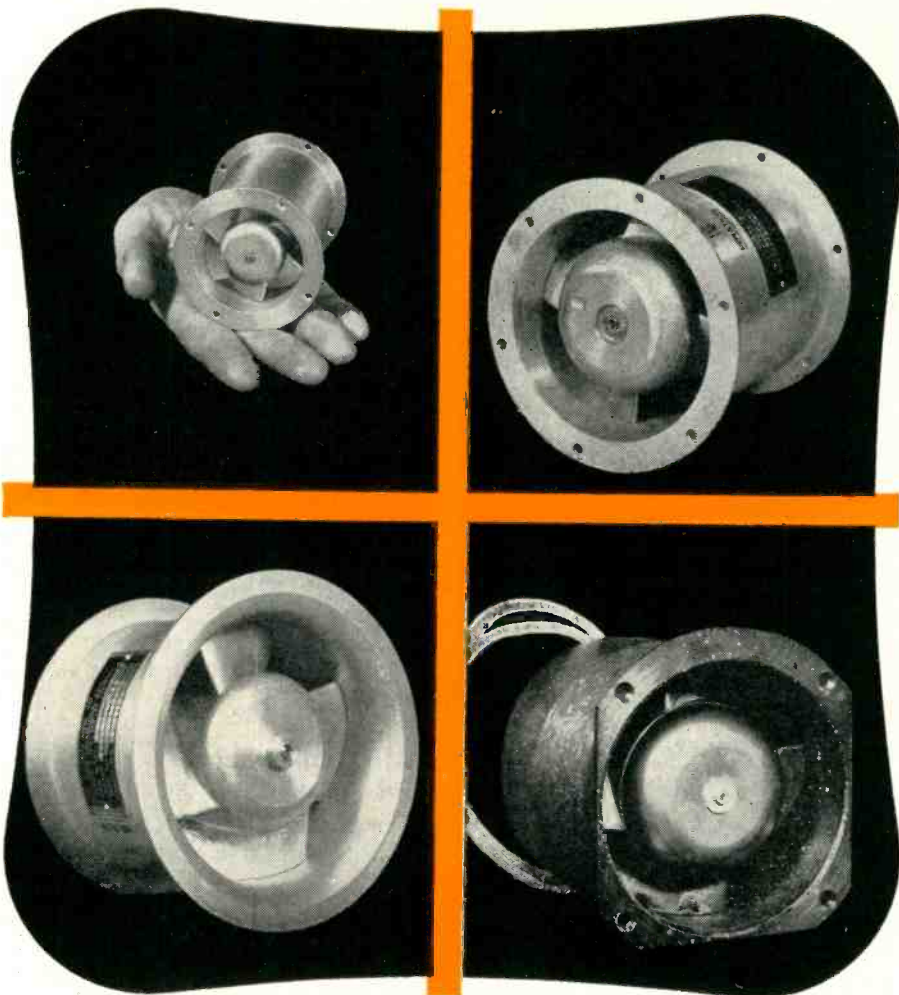

*Reg. U. S. Pat. Office

W&D 1-4010

JOY AXIVANE* Fans offer you advantages in electronic equipment cooling which have been thoroughly proved in service. The higher pressure-output of these vaneaxial blowers generally permits more compact arrangement of the equipment. Additional advantages are: light weight, high strength, high shock and vibration resistance, and high efficiency in low or high pressure service.

For minimum weight, JOY electronic cooling fans are made of aluminum, magnesium, or combinations of these metals. They are designed to meet all present Air Force and Naval electronic specifications, and are available in fan sizes from 2" I.D. up. Totally-enclosed or explosion-proof motors can be furnished where required.

● If you have a problem in heat dissipation from electronic units, no matter what the service conditions may be, let us place at your disposal JOY'S experience as the world's largest manufacturers of vaneaxial-type fans.

*Consult a Joy
Engineer*

Over 100 Years
of Engineering Leadership



JOY MANUFACTURING COMPANY

GENERAL OFFICES: HENRY W. OLIVER BUILDING · PITTSBURGH 22, PA.

IN CANADA: JOY MANUFACTURING COMPANY (CANADA) LIMITED, GALT, ONTARIO

BRUSH and the future of high fidelity...

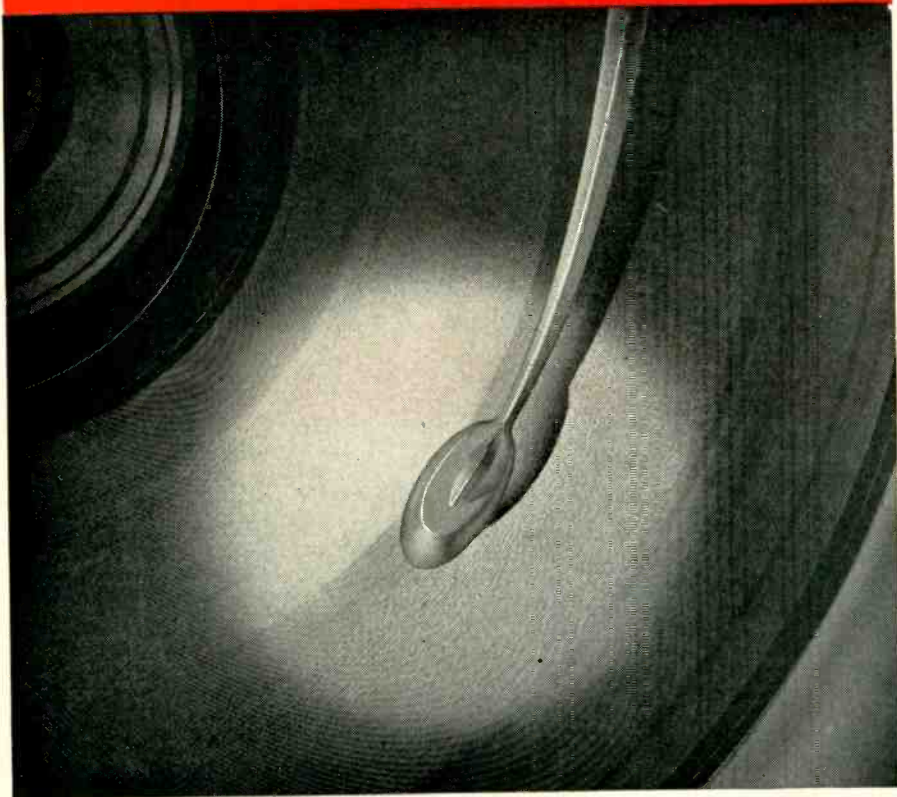

With use of Brush crystal elements, phonograph pick-ups can be made feather-light, meeting the requirements of micro-groove records.

BRUSH piezo-electric crystals make possible many refinements in design of high fidelity sound recording and reproducing equipments.

As the heart of pick-ups, Brush crystal elements permit the designer to make smaller, lighter weight pickup arms, and to eliminate the problem of hum. He can achieve the ultimate in faithful tonal reproduction.

In other audio applications, Brush crystals open the way to smaller, more uniformly responsive microphones, and lighter, more sensitive headphones.

Brush is the world's largest producer of man-made crystals. There is a complete line to help you develop new and improved audio products. To acquaint yourself further with the scope of Brush's activities in this and other fields, write for the brochure "This Is Brush".

THE **Brush**
DEVELOPMENT COMPANY
3405 Perkins Avenue • Cleveland 14, Ohio



Piezo-electric Crystals and Ceramics
Magnetic Recording Equipment
Acoustic Devices
Ultrasonics
Industrial & Research Instruments

shift with reference to the frequency.

Note: If the phase is measured in radians and the frequency in radians per second, the envelope delay will be in seconds.

FIELD

One of the two (or more) equal parts into which a frame is divided in interlaced scanning.

FLIP-FLOP

Deprecated (see Color Phase Alternation)

FREQUENCY OVERLAP

In a color television system that part of the frequency band which is common to the monochrome channel and the chrominance channel.

Note: Frequency overlap is a form of band-sharing.

GAMMA

In color or monochrome channel, or part thereof, the coefficient expressing the selected evaluation of the slope of the used part of the log vs log plot relating input (abscissa) and output (ordinate) signal magnitudes as measured from the point corresponding to some reference black level.

Note: As the log vs log plot is usually not entirely straight in the used region it is necessary to formalize that evaluation of the slope, for example, by the use of the value at a particular point, maximum, mean, or other value. The method of evaluation must be stated.

At some points the signal may be in terms of light intensity or light transmission.

GAMMA CORRECTION

The modification of a transfer characteristic for the purpose of changing the value of gamma.

LUMINANCE

Luminous flux emitted, reflected or transmitted per unit solid angle per unit projected area of the source.

Note: Usual units are the lumen per steradian per square meter, the candle per square foot, the lambert, the millilambert and the footlambert.

This quantity is also called photo-

Sensational Advancements In Science & Industry

Created the Need for **THE NEW** *Stabelex "D"* **CAPACITORS**

YOUR FREE
INDUSTRIAL CONDENSER CORPORATION
Stabelex "D" Capacitor Catalog
may prove to be the most important
new single piece of literature for
you this year!

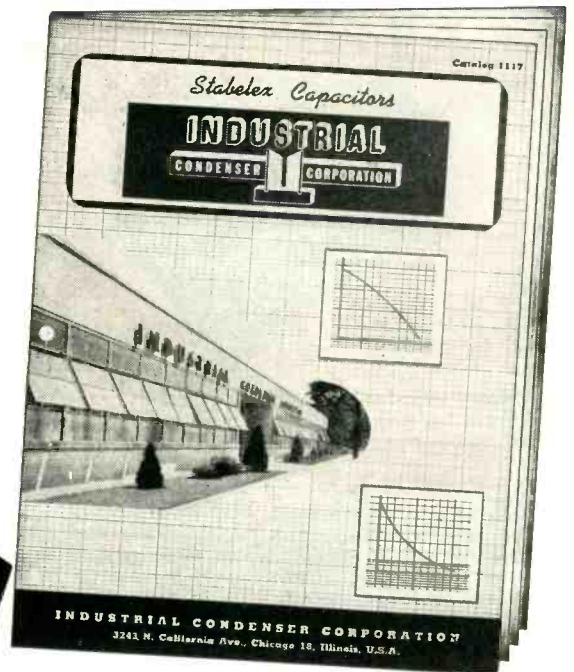

The low losses of Stabelex "D" capacitors are shown in Curve # 1112, which indicates the effect of frequency on the "Q" and also compares it with mica and paper capacitors.

Performance curves illustrating various characteristics of the Stabelex "D" Capacitor will appear in this magazine each month.

OUTSTANDING FEATURES

INSULATION RESISTANCE AT 20° C. AFTER THREE MINUTES CHARGE—900,000 megohm microfarads

INSULATION RESISTANCE AT 75° C.—78,000 megohm microfarads

INSULATION RESISTANCE AT -75° C.—In excess of 5 million megohm microfarads

CHANGE IN CAPACITANCE FROM 25° C. TO -80° C; +0.76%

SELF TIME CONSTANT OF 10 MFD CAPACITOR—4800 hours

Q AT 50 KILOCYCLES—10,000

POWER FACTOR AT 1 KC—0.00025

SEND FOR CATALOG 1117 TODAY

After a long period of research, Industrial Condenser Corporation now offers to industry for the first time the first of their family of Stabelex capacitors, Stabelex "D", which has been produced for special applications for some time.

Complete information performance curves, characteristics, and suggested applications of the various types now available will be found in this catalog.

Mfrs. of **OIL, WAX, ELECTROLYTIC, PLASTIC**

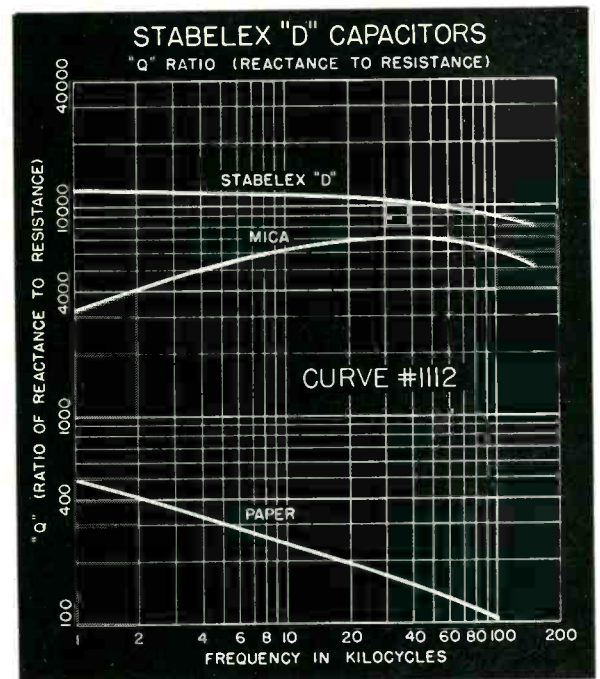

INDUSTRIAL CONDENSER CORPORATION

3244 N. California Avenue
Chicago 18, Illinois, U.S.A.

Please send me my FREE copy of your new Catalog 1117 on Stabelex "D" Capacitors.

Name

Company Position

Street

City Zone State

CAPACITORS and RADIO INTERFERENCE FILTERS

ENGRAVING and MARKING

The Green Engraver



ENGRAVES,
ROUTES,
PROFILES and MODELS

A real money saver for industry. Proven by the experience of tool and die, electronic machine, radio, electrical and instrument manufacturers.

The Green Engraver zips out precision work on metal, plastics, wood, glass, hard rubber etc. . . . engraves panels, name plates, scales, dials, molds, lenses, instruments, instruction plates, directional signs . . . by simple tracing. *Routing, profiling and three dimensional modeling indicate its versatility.* Electric etching attachment available.

FREE — Fact-packed folder yours upon request.

Green Instrument Company
INCORPORATED

363 PUTNAM AVENUE • CAMBRIDGE, MASS.

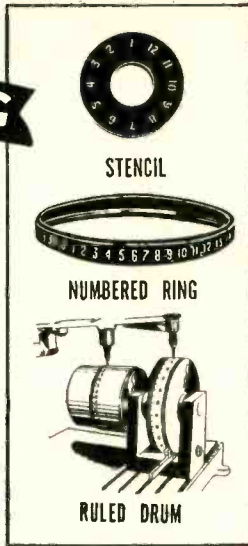

Specify the Green Engraver for the best in low cost performance. Special attachments and engineering service available for production work.

- ELECTRONIC DESIGN ENGINEERS
- TECHNICAL WRITERS
- DESIGN DRAFTSMEN
- PHYSICISTS

Westinghouse offers you SECURITY AND OPPORTUNITY

EE's and ME's with over 3 years experience . . . a number of excellent positions are now available in our Electronic & X-ray and Air-Arm Divisions for work on:

- Broadcast Transmitters
- Power Line Carrier Communication Equipment
- Railroad Radio
- Radio Frequency Heating
- Medical and Industrial X-ray
- Commercial Radar
- Balancing Equipment
- Military Radar (ship, ground, airborne)
- Military Transmitters
- Specialized Electronic Equipment
- Fire Control Systems
- Automatic Pilots
- Guided Missiles

Check These Outstanding Benefits: Top pay, ideal working conditions, advancement on merit, graduate study opportunities, employee scholarships, paid relocation expenses, Baltimore location.

Send resume of experience and education to: Manager of Industrial Relations, Westinghouse Electric Corp., 2519 Wilkens Ave., Baltimore 3, Md.

If you are using your greatest skill in a defense industry, do not apply.

YOU CAN BE SURE... IF IT'S
Westinghouse

Century MODEL 408

RECORDING OSCILLOGRAPH FOR VIBRATION, TEMPERATURE, STRESS, STRAIN ANALYSIS

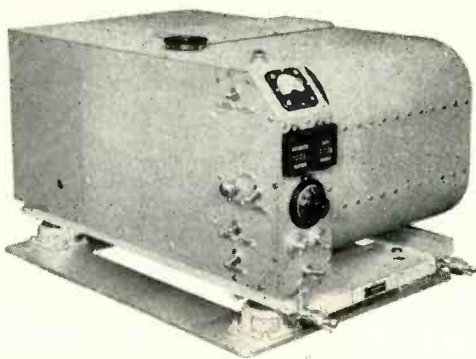

After conducting a nation-wide survey among the users of oscillograph equipment and carefully considering the problems which have confronted them for a number of years, Century is proud to offer the Model 408 Oscillograph. This Oscillograph has been designed and built expressly for mobile and airborne operation. As with all Century products,

this oscillograph incorporates the utmost in modern design and workmanship, yet it remains simple in its operation and maintenance.

Write for Bulletin CGC-302
REGISTER and VOTE—it's YOUR country

Century **GEOPHYSICAL CORPORATION**
TULSA, OKLAHOMA

4447 No. Bodine Philadelphia 40, Po. 3406 W. Washington Blvd. Los Angeles 18, Calif. 238 Lafayette St. Dayton 2, Ohio 309 Brawder St. Dallas, Texas EXPORT OFFICE 149 Broadway, N. Y. City

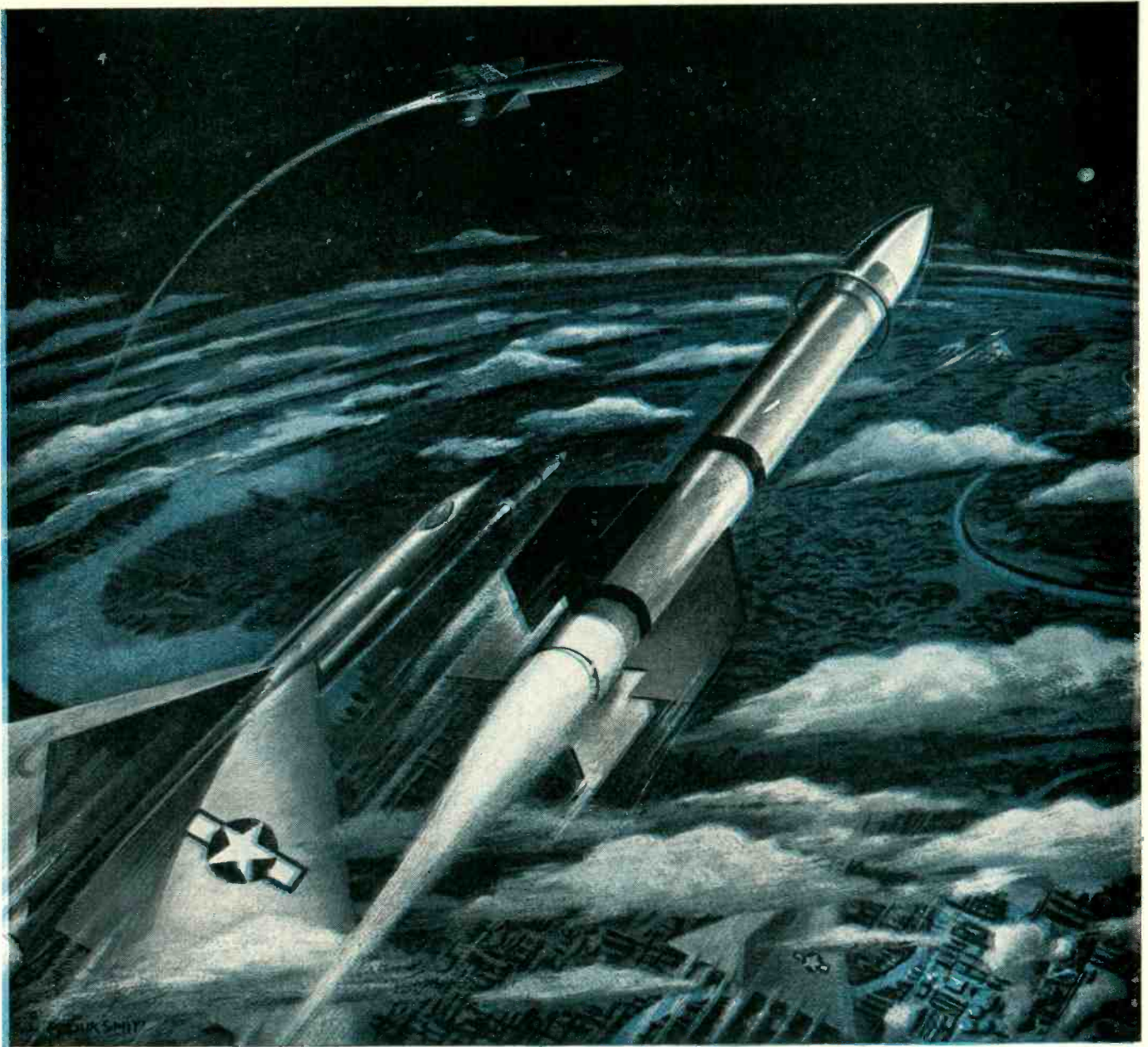

Missile with a "one track mind" ... Bomber Defense

Defensive guided missiles launched from supersonic aircraft will depend upon electronic marvels that come as close to simulating human intelligence as any mechanism ever devised. Important functions of these "weapons of the future" are typical of those entrusted to systems made by Arma Corporation.

Complex electronic and electro-mechanical con-

trols from Arma are an integral part of many of America's most advanced weapons. In basic research, design, development and manufacture, Arma Corporation has worked in close cooperation with the Armed Forces since 1918—and more recently, the Atomic Energy Commission. *Arma Corporation, Brooklyn, N. Y.; Mineola, N. Y. Subsidiary of American Bosch Corporation.*

ARMA

ADVANCED ELECTRONICS FOR CONTROL



meets

MIL-T SPECS

52

TRANSFORMERS

CHICAGO HERMETICALLY SEALED TRANSFORMERS MEET GRADE I, MIL-T-27 CLASS A REQUIREMENT

Meeting all requirements of Grade I, MIL-T-27 specific items operation, Chicago hermetically sealed transformers are approved airborne, marine and ground communication equipment, basic research and development applications, pilot line, production run. Also ideal where maximum sealing and quality are desired for C-D items designed for tropical and subzero climates, etc. Seamless drive cases with bonded one piece steel base covers. Rubber gasket on terminals. Right internal mounting brackets.

POWER TRANSFORMERS FOR CAPACITOR INPUT SYSTEMS—PRIMARY 117 VOLTS, 50-60 CYCLES

Cat. No.	Type	AC Volts	DC Output	DC Output	No. 2	No. 3	Case	Net
			Ma.	V. A.	V. A.	V. A.	Type	Wt.
								1.00
13-770	PHC-10	250-0-250	10	320	—	—	14	R 14
13-771	PHC-20	250-0-250	20	400	—	—	15	R 15
13-772	PHC-40	225-0-225	40	210	5	2	17	R 17
13-776	PHC-55	270-0-270	55	260	5	2	17	R 17
13-727	PHC-70	315-0-315	70	320	5	2	19	R 19
13-728	PHC-85	340-0-340	85	320	5	2	20	R 20
13-729	PHC-105	450-0-450	105	320	5	2	21	R 21
13-730	PHC-120	375-0-375	120	480	5	2	22	R 22
13-731	PHC-150	470-0-470	150	490	5	2	22	R 22
13-732	PHC-200	485-0-485	200	490	5	2	22	R 22
13-733	PHR-55	450-0-450	55	260	5	2	17	R 17
13-734	PHR-70	425-0-425	70	420	5	2	19	R 19
13-735	PHR-85	440-0-440	85	425	5	2	20	R 20
13-736	PHR-105	445-0-445	105	425	5	2	21	R 21
13-737	PHR-120	500-0-500	120	400	5	3	22	R 22
13-738	PHR-150	505-0-505	150	400	5	3	22	R 22
13-739	PHR-200	520-0-520	200	410	5	3	22	R 22
13-740	PHR-300	550-0-550	300	425	5	3	24	R 24

FILAMENT TRANSFORMERS

Cat. No.	Type	Volts	Amps	Ins. Test	Case	Term.	Wt.	Net
				RMS	Size	Type	Lbs.	1.00
13-750	FH-210	2.5CT	10	5000	16	S*	14	R 14
13-757	FH-210H	2.5CT	10	9000	19	T*	14	R 14
13-756	FH-54	5.0CT	4	2500	15	R	2	R 2
13-759	FH-38	5.0CT	10	2500	17	R	3	R 3
13-760	FH-516	5.0CT	20	2500	21	R	6	R 6
13-761	FH-530	5.0CT	30	2500	22	R	10	R 10
13-762	FH-65	6.3CT	5	2500	16	R	3	R 3
13-763	FH-610	6.3CT	10	2500	19	R	5	R 5
13-764	FH-104	10.0CT	4	2500	17	R	3	R 3
13-765	FH-1010	10.0CT	10	2500	21	R	6	R 6

* Terminal Types Indicated are for secondaries, primaries have R Type Terminals

FILTER REACTORS

Cat. No.	Type	Inductance	Max. DC Current	DC Resistance	Insulation Test	RMS	Wt.	Net
		henries*	Ma.	In Ohms	Test Volts		Lbs.	1.00
13-734	RH-1510	15	10	680	1000	1000	10	R 10
13-735	RH-1520	15	20	680	1000	2500	10	R 10
13-742	RH-1540	15	40	475	2500	2500	10	R 10
13-743	RH-1055	10	55	240	2500	2500	10	R 10
13-744	RH-1555	15	55	420	2500	2500	10	R 10
13-745	RH-1085	10	85	175	2500	2500	10	R 10
13-746	RH-1585	15	85	285	2500	2500	10	R 10
13-747	RH-8105	8	105	100	2500	2500	10	R 10
13-748	RH-12105	12	105	170	2500	2500	10	R 10
13-749	RH-8150	8	150	95	2500	18	R 18	
13-750	RH-12150	12	150	150	2500	18	R 18	
13-751	RH-8200	8	200	85	2500	20	R 20	
13-752	RH-12200	12	200	140	2500	20	R 20	
13-753	RH-8300	8	300	70	2500	22	R 22	

* Inductance measured at 10 volts, 60 cycles.

CHICAGO HERMETICALLY SEALED DIMENSION DATA

In the scale below, the dimension letters apply as follows: "A"—width; "C"—depth; "D"—case height not including mounting studs; "H"—distance between mounting studs along "A" width; "K"—distance between mounting studs along "C" depth.

Case Size	C	D	H	K
8	1.50	1.50	1.93	1.40
12	2.23	2.09	2.66	1.93



FREE! RADIO SHACK AND CHICAGO CATALOGS

Please send me the new 1953 Radio Shack Catalog and the new 1953 Chicago Transformer Catalog.

NAME

COMPANY

STREET

CITY STATE

RADIO SHACK CORPORATION
167 Washington St., Boston 8, Mass.

CHICAGO Hermetically Sealed Transformers meet all requirements of Grade I MIL-T-27 specifications for Class A operation.

RADIO SHACK'S stock of Chicago transformers meets your entire need — for any type — and for production quantities.

metric brightness.

LUMINANCE CHANNEL

In a color-television system, any path which is intended to carry the luminance signal.

Note: The luminance channel may also carry other signals; for example, the carrier color signal, which may or may not be used.

LUMINANCE SIGNAL

A signal wave which is intended to have exclusive control of the luminance of the picture.

LUMINOSITY

Ratio of photometric quantity to corresponding radiometric quantity in standard units (lumens per watt).

LUMINOUS FLUX

The time rate of flow of light. When radiant flux is evaluated with respect to its capacity to evoke the brightness attribute of visual sensation, it is called luminous flux, and this capacity is expressed in lumens.

MATRIX

(Noun) In color television, an array of coefficients symbolic of an operation to be performed, which operation results in a color coordinate transformation. (This definition is consistent with mathematical usage).

(Verb) In color television, to perform a color coordinate transformation by computation or by electrical, optical or other means.

MATRIXER (Matrix Unit, Matrix Circuit, etc.)

A device which performs a color coordinate transformation by electrical, optical or other means.

MIXED HIGHS

Those high frequency components of the picture signal which are intended to be reproduced achromatically in a color picture.

MODULATED COLOR SUBCARRIER

See Carrier Color Signal

MOIRE

In television, the spurious pattern in the reproduced picture resulting from interference beats between two sets of periodic struc-

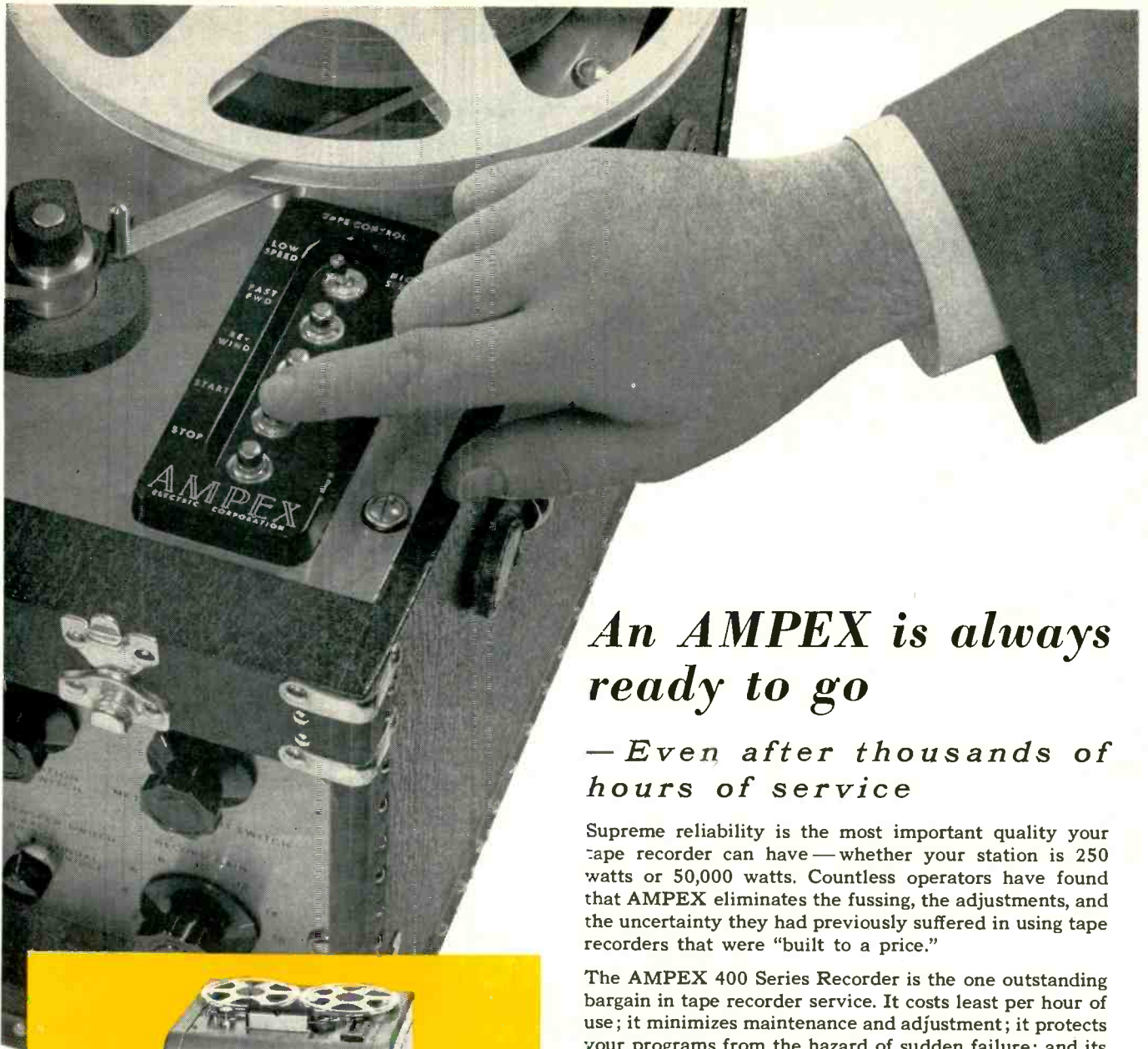

An AMPEX is always ready to go

— Even after thousands of hours of service

Supreme reliability is the most important quality your tape recorder can have—whether your station is 250 watts or 50,000 watts. Countless operators have found that AMPEX eliminates the fussing, the adjustments, and the uncertainty they had previously suffered in using tape recorders that were “built to a price.”

The AMPEX 400 Series Recorder is the one outstanding bargain in tape recorder service. It costs least per hour of use; it minimizes maintenance and adjustment; it protects your programs from the hazard of sudden failure; and its reliability frees your engineer's attention for other tasks.

Even after thousands of hours of service, your AMPEX Recorder will be reliable in these important ways:

- *When you press the button, it operates*
- *Program timing stays accurate*
- *Starting, stopping, and rewind will operate smoothly*
- *Fidelity will still be high*
- *Maintenance costs will still be low*

For new broadcast application bulletin, write Dept. E-1041



Model 403C

Model 403P

If you plan for tomorrow, buy an AMPEX today.

AMPEX

MAGNETIC RECORDERS

AMPEX ELECTRIC CORPORATION
934 CHARTER STREET • REDWOOD CITY, CALIF.

NEW 2 new D.C.
REGULATED
POWER SUPPLIES
By **mercury**

Featuring — Continuously Variable output voltage (without switching)

MODEL 304-B



Regulated Power Supply
0-600 VDC @ 300 MA

OUTPUT VOLTAGES: #1 0-600 VDC @ 300 MA Regulated. #2 0-150 VDC @ 5 MA Regulated. #3 6.3 VAC @ 10 Amps Unregulated.

REGULATION: Within .5% from 20-600 VDC. From no load to full load. At 10 volts. Regulation 1%.

HUM VOLTAGE: Less than 8 millivolts.

METERS: High Voltage and Bias Voltage readable on voltmeter. Milliammeter included.

OUTPUT TERMINATIONS: Positive or Negative ground.

OUTPUT IMPEDANCE: Less than 2 ohms at 20 cycles or more for all output voltages.

DIMENSIONS: Length 19" x Height 10 1/2" x Depth 13". Panel size 19" x 10 1/2". WE Notching.

MODEL 308-A



Regulated Power Supply
0-600 VDC @ 200 MA

OUTPUT VOLTAGES: #1 0-600 VDC @ 200 MA Regulated. #2 0-150 VDC @ 5 MA Regulated. #3 6.3 VAC @ 10 Amps Unregulated.

REGULATION: Within .5% from 20-600 VDC from no load to full load. At 10 volts Regulation 1%.

HUM VOLTAGE: Less than 5 millivolts.

METERS: High Voltage and Bias Voltage readable on voltmeter. Milliammeter included.

OUTPUT TERMINATIONS: Positive or Negative ground.

OUTPUT IMPEDANCE: Less than 2 ohms at 20 cycles or more for all output voltages.

DIMENSIONS: Length 19" x Height 8 3/4" x Depth 13". Panel size 19" x 8 3/4". WE Notching.

WRITE FOR COMPLETE DETAILS ON THESE TWO NEW UNITS AND A COPY OF OUR LATEST CATALOG

Designers, Developers, Producers of Fine Electronic Equipment

mercury electronic company
RED BANK NEW JERSEY

FOR MARKING...



PLASTIC • METAL
GLASS • PAPER
RUBBER • CERAMIC
CARDBOARD

in such products as Resistors, capacitors, valves, tubes, labels, sleeves, spark plugs, cartons, etc., etc.

THESE PRODUCTS AND MANY OTHERS OF ALMOST ANY MATERIAL AND SHAPE CAN BE IMPRINTED

ON THE
REJAFIX
MARKING MACHINE

Why not send us samples of your products? They will be test-printed and returned to you for your examination!

- REJAFIX HAND-OPERATED MODELS FOR SMALL RUNS. FULLY AUTOMATIC MODELS FOR MASS PRODUCTION.

EST. 1922

POPPER & SONS INC. 300 FOURTH AVENUE
NEW YORK 10, N. Y.

ATTENUATORS
by
TECH LABS

MIDGET TYPE 600

STANDARD TYPE 700

TECH LABORATORIES, INC.

Manufacturers of Precision Electrical Resistance Instruments
PALISADES PARK • NEW JERSEY

"Midget" model is especially designed for crowded apparatus or portable equipment.

- Solid silver contacts and stainless silver alloy wiper arms.
- Rotor hub pinned to shaft prevents unauthorized tampering and keeps wiper arms in perfect adjustment.
- Can be furnished in any practical impedance and db. loss per step upon request.
- TECH LABS can furnish a unit for every purpose.
- Write for bulletin No. 431.

Exclusive Canadian Dist.: RCA Victor, Ltd



Temperature Compensating
as well as By-Pass

DISCAPS[®]

are Rated at
1000 Working Volts!

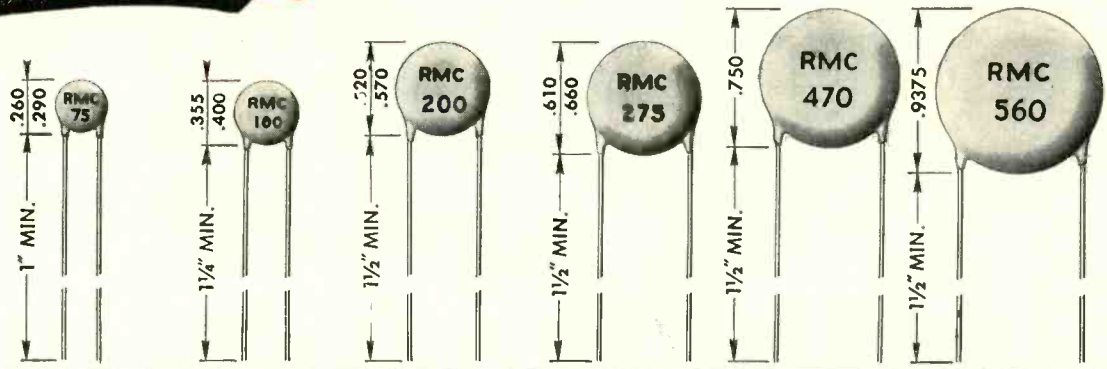

TC	1/4 Dia.	5/16 Dia.	1/2 Dia.	5/8 Dia.	3/4 Dia.	7/8 Dia.
P-100	—	2- 9 MMF	10- 30 MMF	—	—	—
NPO	2- 12 MMF	13- 27	28- 60	61- 75 MMF	76-110 MMF	111-150 MMF
N- 33	2- 15	16- 27	28- 60	61- 75	76-110	111-150
N- 80	2- 15	16- 27	28- 60	61- 75	76-110	111-150
N- 150	2- 15	16- 30	31- 60	61- 75	76-110	111-150
N- 220	2- 15	16- 30	31- 75	76-100	101-140	141-190
N- 330	2- 15	16- 30	31- 75	76-100	101-140	141-190
N- 470	2- 20	21- 40	41- 80	80-120	121-170	171-240
N- 750	5- 25	26- 50	51-150	151-200	201-290	291-350
N-1400	15- 50	51-100	101-200	200-250	251-470	480-560
N-2200	47- 75	76-100	101-200	201-275	276-470	471-560

If the samples you need are not here — send for them.

SPECIFICATIONS

POWER FACTOR: LESS THAN .1% AT 1 MEGACYCLE	LEAKAGE RESISTANCE: INITIAL 7500 MEG OHMS
WORKING VOLTAGE: 1000 VDC TEST VOLTAGE: 2000 VDC	AFTER HUMIDITY 1000 MEG OHMS
DIELECTRIC CONSTANT: P-100 14K N-750 88K N-2200 265K NPO 35K N1400 165K	LEADS: # 22 TINNED COPPER (.026 DIA.)
CODING: CAPACITY, TOLERANCE AND TC STAMPED ON DISC	LEAD LENGTH: 1/4" BODY 1", 5/16" BODY 1 1/4", 1/2" AND LARGER BODY 1 1/2"
INSULATION: DUREZ PHENOLIC—VACUUM WAXED	TOLERANCES: ± 5%, ± 10%, ± 20%

RMC DISCAPS are Designed to Replace Tubular Ceramic and Mica Condensers at LOWER COST

SEND FOR SAMPLES AND TECHNICAL DATA



RADIO MATERIALS CORPORATION

GENERAL OFFICE: 3325 N. California Ave., Chicago 18, Ill.

FACTORIES AT CHICAGO, ILL. AND ATTICA, IND.

Two RMC Plants Devoted Exclusively to Ceramic Condensers

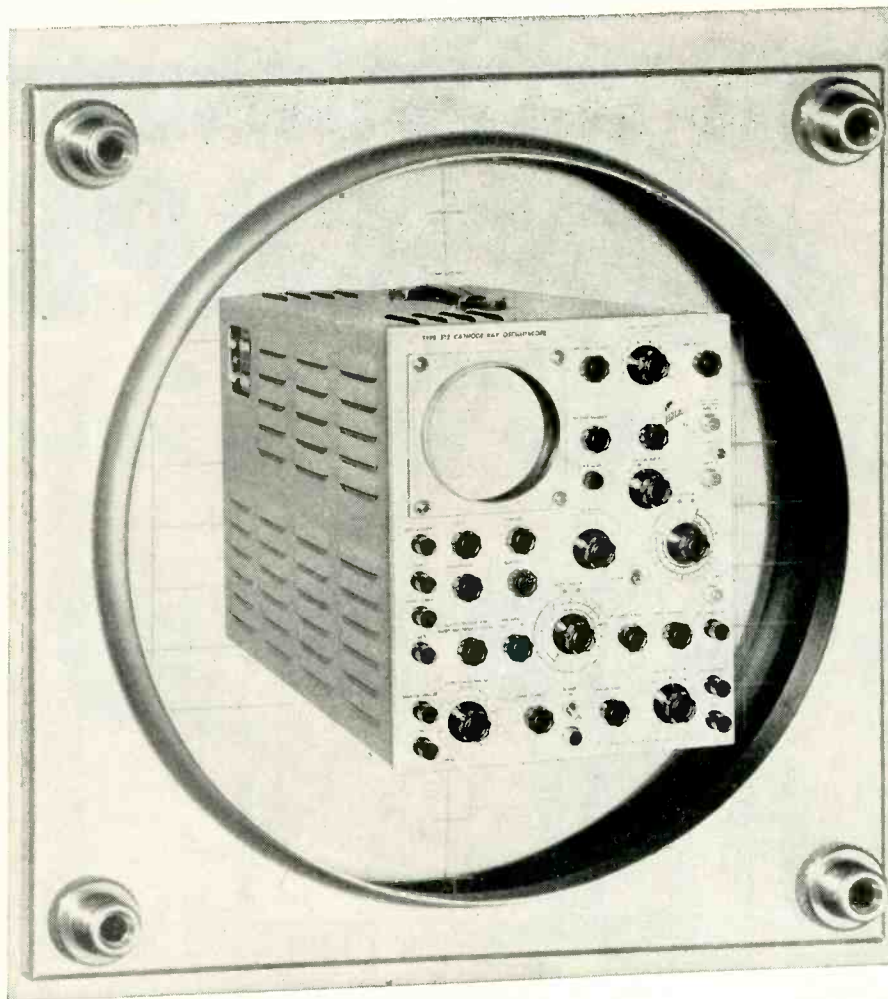

TYPE 512

CATHODE-RAY OSCILLOSCOPE

This precision laboratory oscilloscope is preferred by development engineers for all work within its time base and frequency response capabilities. In addition, the Type 512 has characteristics that make it highly desirable for work in special fields.

Balanced differential input to the direct coupled vertical amplifier is useful to attenuate in-phase components or to mix two signals without interaction or frequency discrimination. High sensitivity permits observation of low level phenomena. Slow sweeps, coupled with a P7 crt screen, provide maximum utility in low frequency pulse work. An adjustable delayed trigger, a positive gate, and the sweep waveform are available at the front panel for external use. The calibration voltage, a square wave of about 1 kc, is also useful for rc attenuator adjustment and external test purposes.

SPECIFICATIONS

Vertical Amplifier

Sensitivity, dc to 1 mc, 5 mv/cm
Risetime 0.4 μ sec
Sensitivity, dc to 2 mc, 0.15 v/cm
Risetime 0.2 μ sec

Time Base

Single, triggered, or recurrent,
0.3 sec/cm to 3 μ sec/cm in ten
ranges, continuously variable, accurate
within 5% (1 sec/cm or 3 sec/cm
available on special order)

Calibration Voltage

Square wave, approximately 1 kc,
continuously variable in 9 ranges,
5 mv to 50 v full scale, accurate
within 3%

All dc voltages electronically regulated.

Two 10x rc probes, 1 blue and 1
amber filter furnished as standard
equipment.

TYPE 512 — \$950, f.o.b. PORTLAND, OREGON



TEKTRONIX, Inc.

P. O. Box 831 A, Portland 7, Oregon • Cable: TEKTRONIX

tures in the image.

Note: Moires may be produced, for example, by interference between regular patterns in the original subject and the target grid in an image orthicon, between patterns in the subject and the line pattern and the pattern of phosphor dots of a three-color kinescope, and between any of these patterns and the pattern produced by the carrier color signal.

MONOCHROME BANDWIDTH (of the signal)

The video bandwidth of the monochrome signal.

MONOCHROME BANDWIDTH (of the monochrome channel)

The video bandwidth of the monochrome channel.

MONOCHROME CHANNEL

In a color television transmission, any path which is intended to carry the monochrome signal.

Note: The monochrome channel may also carry other signals; for example, the carrier color signal which may or may not be used.

MONOCHROME SIGNAL

In monochrome television transmission, a signal wave for controlling the luminance values in the picture but not the chromaticity values.

In color television transmission, that part of the signal wave which has the major control of the luminance of the color picture and which controls the luminance of the picture produced by a conventional monochrome receiver.

MONOCHROME TRANSMISSION

In television, the transmission of a signal wave for controlling the luminance values in the picture, but not the chromaticity values.

OSCILLATING COLOR SEQUENCE

Deprecated (see Color Phase Alternation)

PICKUP SPECTRAL CHARACTERISTIC

The set of spectral responses of the device, including the optical parts, which converts radiation to electric signals prior to any non-linearizing and matrixing operations.

RECEIVER PRIMARIES

The colors of constant chromati-

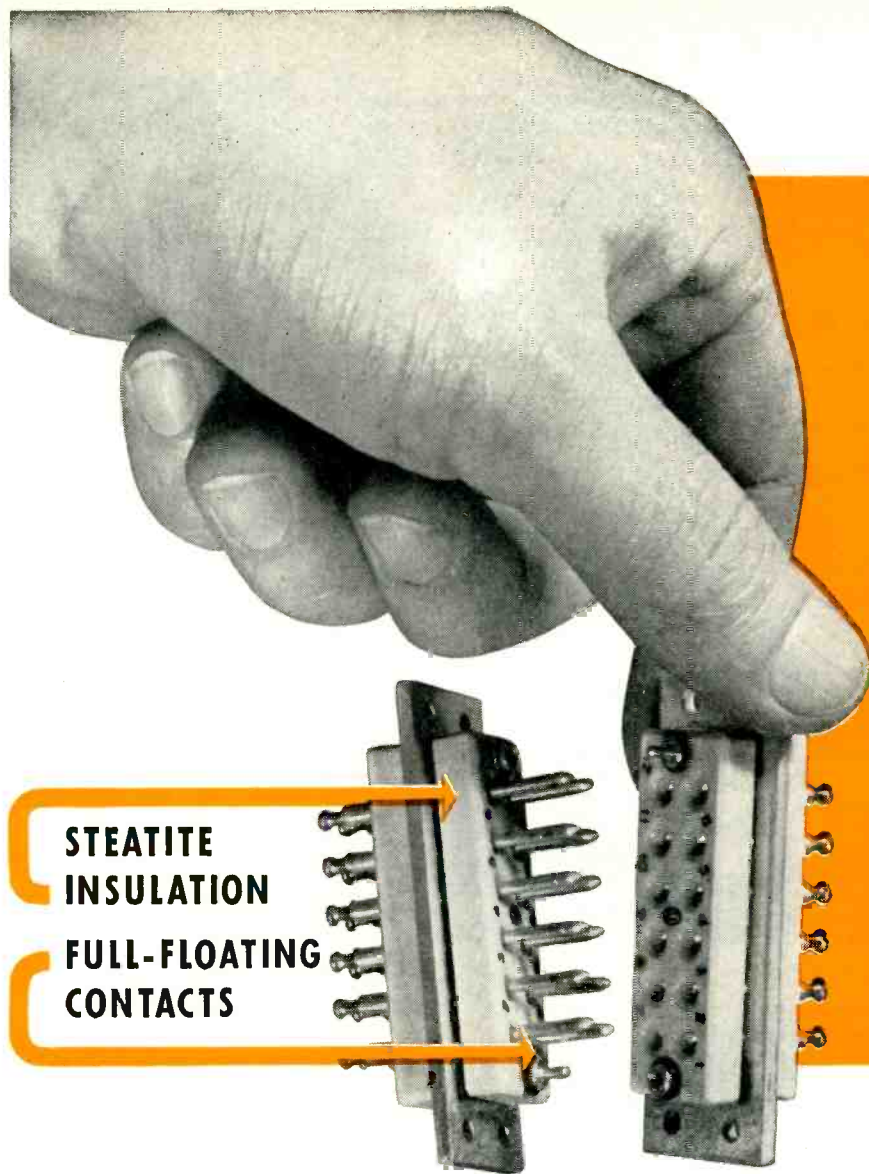

Lapp

PLUG-AND-RECEPTACLE

for

Sectionalizing Circuits

SIMULTANEOUS contact of any number of leads can be made or broken by use of Lapp Plug-and-Receptacle units, for panel-rack assembly or other sectionalized circuits. Insulation is Steatite, the low-loss ceramic which is non-carbonizing, even when humidity, moisture or contamination sets up a leakage path. The unit shown above provides twelve contacts, rated for operation at 2.5Kv peak terminal-to-terminal, 1.5Kv peak terminal-to-ground, 25 amps at 60 cps. All contacts are silver-plated; terminals are tinned for soldering. Polarizing guide pins assure positive alignment. Write for specifications of this and other available units, or engineering recommendations for special units for your product. Lapp Insulator Company, Inc., LeRoy, New York

Lapp

versatile

Multi-channel
telegraph A1 or
telephone A3.

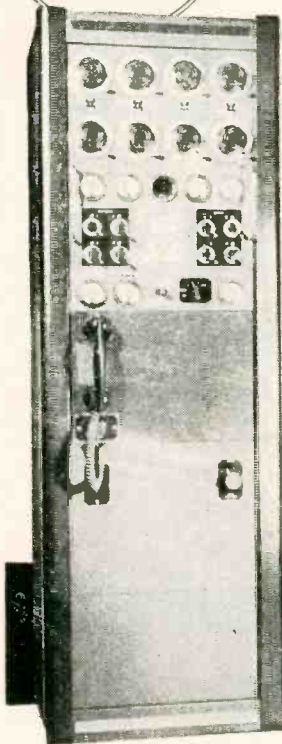

FROM GROUND TO AIR OR POINT TO POINT

STABLE

High stability (.003%) under
normal operating
conditions.

RUGGED

Components
conservatively
rated. Completely
tropicalized.

Model 446 transmitter operates on 4 crystal-controlled frequencies (plus 2 closely spaced frequencies) in the band 2.5-13.5 Mcs (16-2.5 Mcs available). Operates on one frequency at a time; channeling time 2 seconds. Carrier power 350 watts, A1 or A3 AM. Stability .003% using CR 7 (or HC-6U) crystals. Operates in ambient 0° to +45° C using mercury rectifiers; -35° to +45° C using gas filled rectifiers. Power supply, 200-250 volts, 50/60 cycles, single phase. Conservatively rated, sturdily constructed. Complete technical data on request.

Here's the ideal general-purpose high-frequency transmitter! Model 446... 4-channel, 6-frequency, medium power, high stability. Suitable for point-to-point or ground-to-air communication. Can be remotely located from operating position. Co-axial fitting to accept frequency shift signals.

Consultants, designers and manufacturers of standard or special electronic, meteorological and communications equipment.

AER-O-COM

Reg. U. S. Pat. Off.

AERONAUTICAL COMMUNICATIONS EQUIPMENT, INC.
3090 Douglas Road, Miami 33, Florida

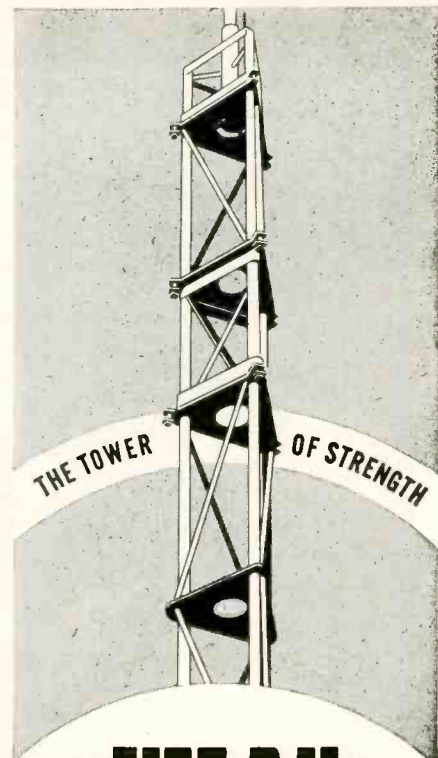

VEE-D-X

Sectional Tower

*MOST ECONOMICAL FOR
MICROWAVE · FM · TV
COMMUNICATIONS · RADAR*

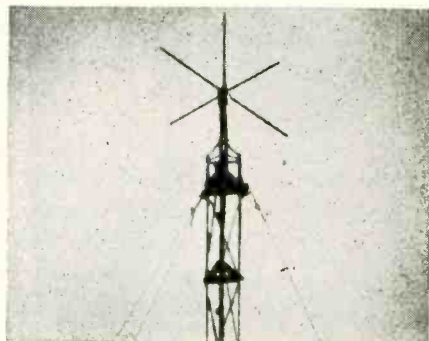

Actual photograph of VEE-D-X Sectional Tower installation showing 152 MC ground-plane antenna suited for ground-to-plane, ship-to-shore, and mobile communications.

THE LaPOINTE-PLASCOMOLD CORP.
ROCKVILLE, CONNECTICUT

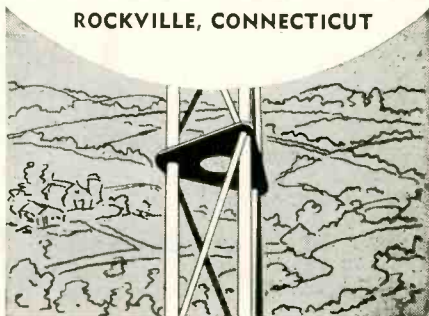

UPON ACCURACY OF THE DIE Depends Quality and Finish

In This Instance Silver Clad Copper Wire

ANOTHER behind the scenes service that is part of the every day routine at "Improved" is shown here. This is the die checking room where dies for all our wire and tubing products are scientifically checked to assure the accuracy fundamentally necessary for the high quality and finish traditional with this fifty-three-year-old, owner-managed company. We will be pleased to answer inquiries on how our many services may be of useful assistance to you.

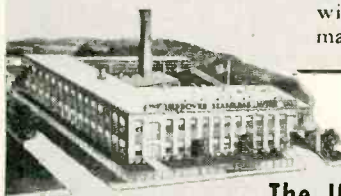

The Home of IMPROVED Service
Rhode Island's largest manufacturer
of Laminated Metals.

The IMPROVED SEAMLESS WIRE COMPANY
INCORPORATED 1898
775 Eddy Street, Providence 5, Rhode Island

HOW MANY *db-* AT 5,000
MEGACYCLES?

AT 25,000
MEGACYCLES?



PRD

precision variable attenuators

- METALLIZED GLASS ATTENUATING ELEMENTS
- PRECISE, PERMANENT CALIBRATION
- BROADBAND CHARACTERISTICS
- NEGLIGIBLE INSERTION LOSS
- BACKLASH-FREE
- LOW REFLECTION
- WELL SHIELDED CASING

The use of metallic-film-on-glass techniques to provide attenuation at microwave frequencies is no longer new. This type of PRD attenuator is now well recognized for its constancy of attenuation with time as well as for its insensitivity to variations of humidity and temperature.

PRD has now augmented this line of attenuators with units employing metallized mica elements to provide broader-band characteristics for the millimeter region of the microwave spectrum. As a consequence, it is now possible to offer complete coverage of the range from 2,600 to 40,000 megacycles per second in designs varying from a simple level set attenuator to a precisely calibrated secondary standard. Write today for our complete new catalog of microwave test equipment — address Dept. E-10.

Polytechnic



**RESEARCH
& DEVELOPMENT
COMPANY, Inc.**

55 JOHNSON STREET, BROOKLYN 1, NEW YORK

WESTERN SALES OFFICE

737 NO. SEWARD STREET, HOLLYWOOD 38, CALIF.

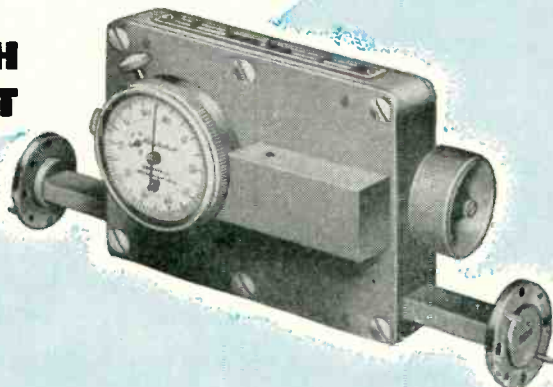

Ewing Galloway

"PROFITS not losses!"

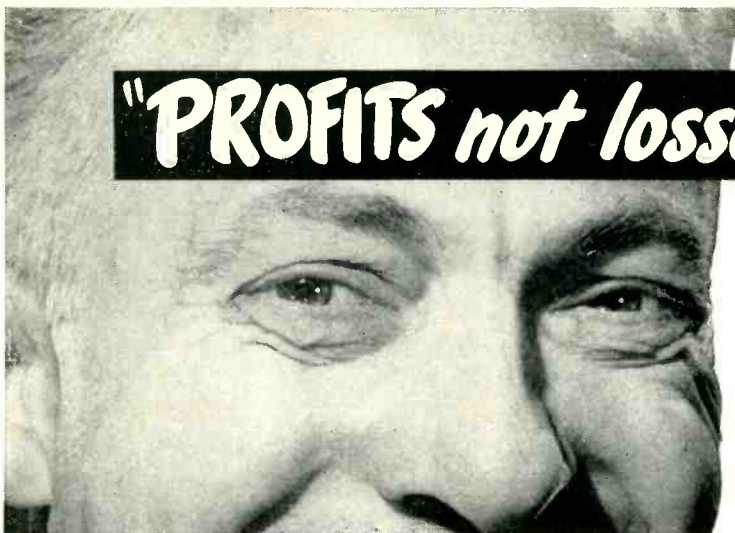

"We minimized scrap loss...

...cut fabricating costs 23.9%

by letting

Fansteel

fabricate our

**TUNGSTEN and
MOLYBDENUM**

COMPONENTS

More and more tungsten and molybdenum users are finding Fansteel fabrication the answer to complicated and costly production problems. Fansteel's long-experienced engineers and technicians not only recommend the material to be used but also the shape best adapted to solve a specific problem. Why not use Fansteel fabrication to your advantage, too? Fansteel will help you effect important cost savings by eliminating the scrap and reject problem, minimizing inspection costs, and releasing equipment and personnel for other work.

Write for the informative booklet: "FANSTEEL TUNGSTEN AND MOLYBDENUM"

TUNGSTEN & MOLYBDENUM

22503C

FANSTEEL
WORLD'S LARGEST
PRODUCER OF
REFRACTORY
METALS



Fansteel Metallurgical Corporation NORTH CHICAGO, ILLINOIS, U.S.A.

city and variable luminance produced by the receiver which, when mixed in proper proportions, are used to produce other colors.

Note: Usually three primaries are used: red, green, and blue.

STATIONARY CPA AXIS

A fixed reference phase with respect to which a carrier color signal of constant chrominance makes equal and opposite angles for successive fields, this reference phase being the same for all chrominances.

TAKING CHARACTERISTIC

See Camera Spectral Characteristic

ZERO SUBCARRIER CHROMATICITY

The chromaticity which is intended to be displayed when the subcarrier amplitude is zero.

Latest Disc-Cathode Developments

RECENT electronics research and development at Superior Tube Company, Norristown, Pa. have made significant advances in disc cathodes.* Manufacturing techniques have been perfected for maintaining a critical E dimension tolerance, Fig. 1, ± 0.0005 in. during long production runs. New and more efficient alloys for electron-emitting cathode caps have been developed. Sublimation effect leakage of electrons across the ceramic disc of the cathode and heater-to-cathode electron leakage has been reduced. Heater shrinkage due to improper insertion during assembly has been eliminated.

As a result of these five basic innovations, the disc cathode now seems to be ready for the more stringent electronic tasks to which it may be applied in the near future.

The disc cathode may be described as a cathode sleeve material which is crimped or fastened to a ceramic disc. The disc part of the name comes from the ceramic disc used as an insulator between the cathode and the grid No. 1 electrode.

The disc cathode is used in the

* Manufactured under U. S. Patents No. 2551871 and 2608743.

A short molybdenum rod (1) was hot forged to form basic cone (2), and the part (3) was finished by machining and drilling.





**THE BROWN
ELECTROMETER**

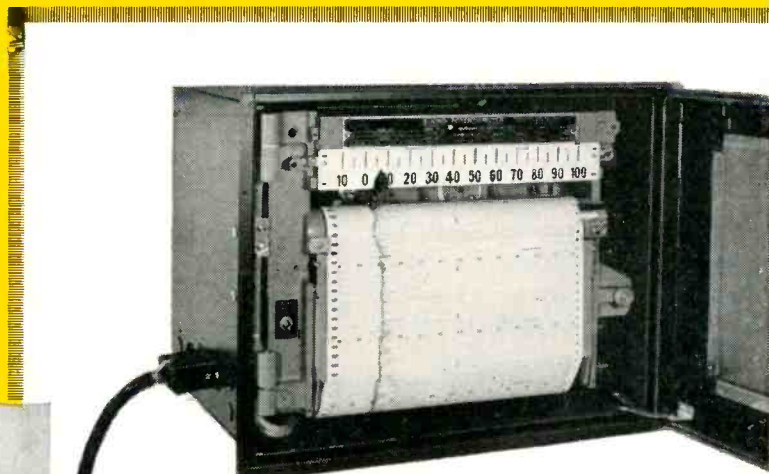

Brown Electrometer showing recorder with door ajar and preamplifier at left.

for measuring and recording currents as low as 10^{-15} amperes

Electrical Characteristics

- Full Scale Current Ranges Available: 10^{-15} amperes with 10^{11} ohm resistor, and selector switch adjustment for full scale of 10^{-12} or 10^{-11} amperes. Using other resistors, full scale current ranges up to 10^{-7} amperes can be supplied with selector switch adjustment up to 10^{-5} amperes.
- Input Resistor: 10^{11} ohms for most sensitive current measurement. (Also supplied in values down to 10^5 ohms.)
- System Accuracy: Approximately 1 per cent of scale.
- Zero Drift: Should not exceed 0.3 millivolt per day.
- System Noise: Approximately 5 microvolts.
- Instrument Speed of Response: Available for either 24, 12, or $4\frac{1}{2}$ seconds full scale.
- Maximum Speed of Response Using $4\frac{1}{2}$ Second Instrument Speed: 5 seconds for 90 per cent of change, with preamplifier located at source.
- Power Supply: 115 volts, 60 cycles. Also dry cell supplied in instrument.
- Power Requirements: 65 watts.

ACCURATE measurement of extremely small currents is accomplished in this instrument through the use of a null balance servo system and a-c amplifiers that prevent drift and consequent instability. It is the only such system that incorporates a recorder as an integral part of the circuit. Designed to measure and record minute currents in ionization chambers, the Brown Electrometer may be used in any application where currents as low as a billionth of a microampere are encountered.

Features of the instrument include a special power supply to prevent false measurements from stray signals which might originate in an a-c power source . . . vibration frequency carefully selected to prevent phase shift . . . and automatic standardization of voltage across the slide-wire.

MINNEAPOLIS-HONEYWELL REGULATOR Co., *Industrial Division*, 4428 Wayne Ave., Philadelphia 44, Pa.

Honeywell
MINNEAPOLIS
BROWN INSTRUMENTS



First in Controls

● *Important Reference Data*

Write for Data Sheet No. 10.0-4 . . . and for Bulletin No. 15-14. For valuable information on analytical and research instrumentation.

2 MUSTS

*For Low-Cost Servicing
of Mobile Radio Systems*

Lampkin equipment gives you the lowest cost per channel, whether you supervise a large multiple-frequency system, or whether you service numerous smaller installations! Lampkin equipment measures center frequency and modulation deviation, to FCC specifications!

The Type 205 FM Modulation Meter For Multiple Mobile Frequencies.



The Type 205 FM Modulation Meter measures peak frequency swing due to voice modulation of FM transmitters, as required by the FCC. Indicates 0-25 KC. deviation. Instantly tunable to any frequency from 25 MC. to 200 MC. Simple to use. Direct reading. No charts. No tables. \$240.00.

For Any Number of Frequencies, AM or FM. The Type 105-B Micrometer Frequency Meter



The Type 105-B Micrometer Frequency Meter measures center frequency deviation on any number of transmitters, AM or FM, from 0.1 MC. to 175 MC. The accuracy, determined by over 500 field tests, is conservatively guaranteed better than 0.0025%, surpassing FCC requirements. Readily checked against WWV. \$220.00

Return coupon TODAY for complete literature.



LAMPKIN LABORATORIES, INC.
Instruments Div., Bradenton, Florida

Please send me complete technical literature and delivery information on the following Lampkin-designed instruments:

- Type 205 FM Modulation Meter
- Type 105-B Micrometer Frequency Meter

Name

Address

City Zone State

drawn cases

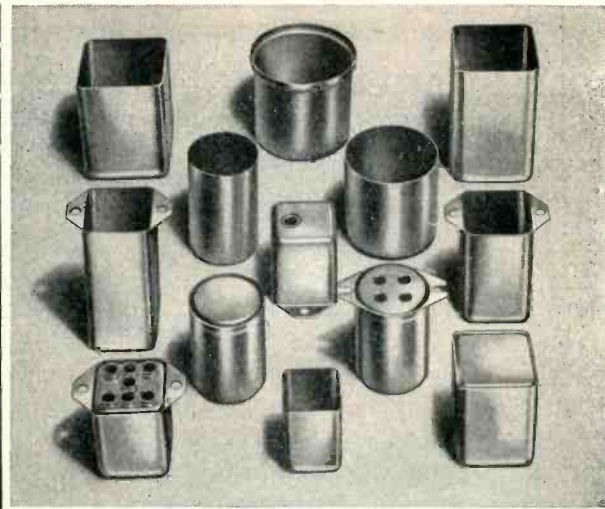

hot tin dipped . . . fabricated terminal and vent holes . . . smooth, one-piece construction using cold rolled steel . . . draw depths up to 2½" . . . inside fit covers for easy hermetic sealing in all sizes . . . available as stock sizes and as special fabrications.



METAL PRODUCTS COMPANY, INC.

P. O. BOX 71A

PHILLIPSBURG, N. J.

Boost Your Quality Standards with **DX** ELECTRONIC COMPONENTS

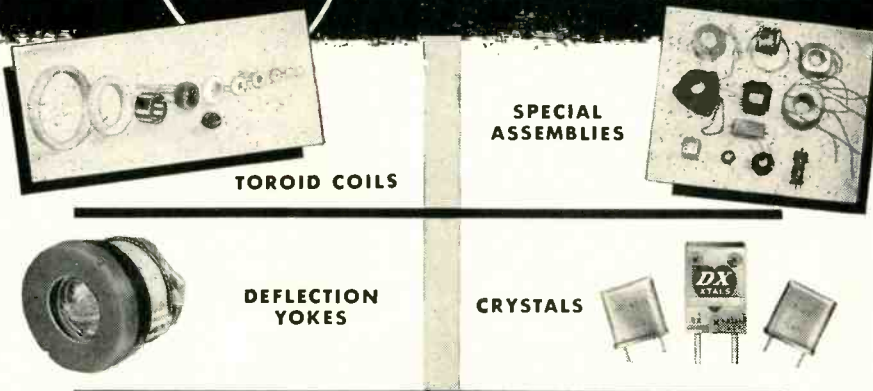

TOROID COILS

SPECIAL ASSEMBLIES

DEFLECTION YOKES

CRYSTALS

TOROID FILTERS . . . I. F. TRANSFORMERS . . . R. F. COILS . . . DISCRIMINATORS
TRANSFORMERS . . . TV TUNERS . . . ION TRAPS . . . SPEAKERS

If you require exacting quality and dependable performance, let DX engineers figure with you on your next production run. Users of DX components enjoy exceptional freedom from field failures. This advantage can be yours at no extra cost. Write today.



DX RADIO PRODUCTS CO.

GENERAL OFFICES: 2300 W. ARMITAGE AVE., CHICAGO 47, ILL.



Jackson TELEVISION

Channels 63% Savings

WITH TINNERMAN SPEED NUTS®

● Engineers at Jackson Industries, Inc., Chicago, Ill. are "on the beam" when it comes to maintaining TV quality at production line speeds. They found the SPEED NUT way of attaching their new Tri-Lok television chassis to the cabinet picked up a neat 63% production savings! This attachment was one of their toughest fastening problems... to solve it Jackson found a standard Tinnerman part tailor-made and engineered for the job!

Four angle brackets are used to fasten the chassis to the cabinet. In the old way, an angle bracket was threaded to receive a machine screw, and it was necessary to align the screws perfectly with the threaded holes since the attachment is in a "blind" position.

SPEED NUTS eliminate the tapping operation required

in threading the angle brackets, making hole alignment easier, faster! Now Jackson has adapted this part into their standards along with a 63% savings in time and materials-handling!

You can turn your fastening problems into production savings... do as thousands of manufacturers are doing... turn to Tinnerman for a FREE FASTENING ANALYSIS of your products. The Tinnerman representative in your area will be happy to give you the full details on this great service. Call on him today or write direct to: TINNERMAN PRODUCTS, INC., Dept. 12, Box 6688, Cleveland 1, Ohio.

In Canada: Dominion Fasteners Ltd., Hamilton, Ontario. *In Great Britain:* Simmonds Aerocessories, Ltd., Treforest, Wales. *In France:* Aerocessoires Simmonds, S.A. - 7 rue Henry Barbusse, Levallois (Seine.)

THE OLD WAY:
The 4 angle brackets were drilled and tapped to receive machine screws in attaching the chassis to the cabinet; hole alignment was always a problem since brackets are in "blind" positions.

THE SPEED NUT WAY:
The SPEED NUT Principle of Spring Tension fastening applied to the 4 angle brackets eliminates these hole alignment problems providing sturdy, vibration-proof attachment.

TINNERMAN *Speed Nuts*®
FASTEST THING IN FASTENINGS®

FOR BETTER NO LOAD TO FULL LOAD REGULATION

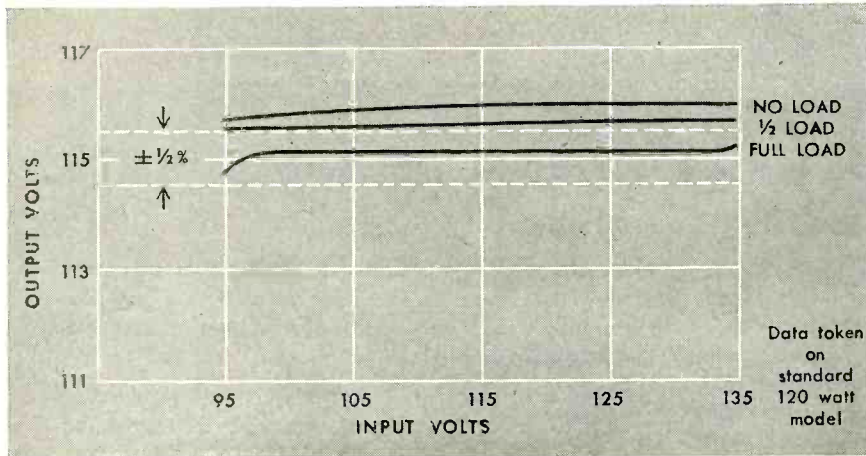

When tested under both hot and cold conditions, from no load to full load, standard Raytheon Voltage Stabilizers held output voltages between 114.6 and 115.6 volts or only 1.0 volt change. Ordinary voltage regulators varied as much as 5.2 volts under the same conditions.

Specify **RAYTHEON**

VOLTAGE STABILIZERS

Watt for watt, Raytheon Magnetic Voltage Stabilizers are smaller, lighter, more compact than other makes. Comparative tests show that they are also more efficient. Check them any way you like and you, too, will find Raytheon Voltage Stabilizers ten ways better. Specify Raytheon Voltage Stabilizers when you want to insure reliable operation of any electrical equipment.

Standard catalog models in ratings from 15 to 2000 watts are carried in stock by 125 parts distributors from coast to coast... can be built into your equipment or used as an accessory. Custom engineered units from 5 to 10,000 watts can be designed and built for any military or commercial application.

Write for complete information and performance data



TESTS PROVE 10 POINTS OF RAYTHEON SUPERIORITY

1. Deliver accurate AC voltage within $\pm 1/2\%$
2. Stabilize output with more precision
3. Regulate better at full load
4. Hold up better under over-load
5. Better no-load to full-load regulation
6. Accept wider input voltage range
7. Less voltage change as units heat up
8. Less change in output as frequencies fluctuate
9. Smaller, lighter, more compact, no moving parts
10. Cost less to operate



Excellence in Electronics

RAYTHEON

MANUFACTURING COMPANY

EQUIPMENT SALES DIVISION

DEPT. 6270-A, WALTHAM 54, MASSACHUSETTS

DISTRICT OFFICES: BOSTON, NEW YORK, CLEVELAND, CHICAGO, NEW ORLEANS, LOS ANGELES (WILMINGTON), SAN FRANCISCO, SEATTLE
INTERNATIONAL DIVISION: 19 RECTOR ST., NEW YORK CITY

RAYTHEON PRODUCTS INCLUDE: WELDPower* welders; Voltage stabilizers (regulators); Transformers; Sonic oscillators for laboratory research; Standard control knobs; Electronic calculators and computers; Radio, television, sub-miniature and special purpose tubes and other electronic equipment.

*Reg. U.S. Pat. Off.

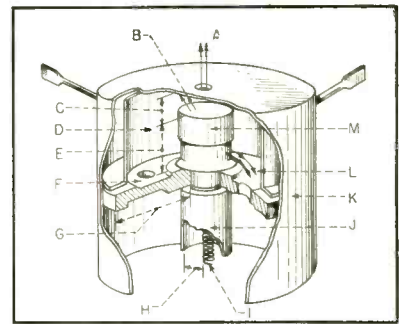

FIG. 1—Construction of a disc cathode. Electrons emitted to gun structure (A), barium sublimates to give grid emission (B), grid-cathode spacing (C), spacer (D), E dimension (E), shaded groove (F), ceramic insulator (G), heater-cathode leakage current (H), heater (I), alloy sleeve (J), grid cup (K), nickel sublimates to give low-resistance path across ceramic (L) and alloy cap (M)

cathode-ray picture tube as a source of electrons. Electrons are emitted from the cap or top surface of the disc cathode.

The cathode sleeve is hollow, so that it can be beaded easily to the ceramic disc and a heater may be conveniently inserted. The heater maintains a temperature of approximately 775 C, the usual operating temperature at which electrons are emitted from the surface. The electron-emitting end of the cathode sleeve or cylinder is closed by continuous metal or by a special cap. The metal cap or closed end of the cathode sleeve is coated with a barium-strontium oxide coating which emits electrons in the same manner and practice that is used in the receiving-tube industry.

The disc cathode is spaced within the grid cup during assembly where care must be taken to maintain a fixed grid-to-cathode spacing. This spacing, in turn, is controlled by a critical E dimension of the disc cathode.

E -Dimension Tolerances

As applied to the final assembly of a disc cathode, the E dimension is the critical distance between the ceramic surface and the surface of the emitting cap. In operation of the cathode-ray tube, the E dimension controls the cut-off voltage since it determines the grid-to-cathode spacing. It is necessary to control the E dimension to within narrow limits to add uniformity to the characteristics of cathode-ray tubes in production and circuit

AVAILABLE NOW
in a wide range
of sizes!

GOVERNMENT APPROVED

MIL-W-5086

AIRCRAFT WIRE

AWG SIZES

24-22-20-18-16-14

12-10-8-6

ALSO

MIL-C-7078 (MIL-W-5086)

WITH SHIELD

**COMPLETELY EXTRUDED
INSULATIONS**

Primary Insulation: Polyvinylchloride
Overall Insulation: Nylon Jacket

Write for samples
and complete test data.



RHODE ISLAND INSULATED WIRE CO., Inc.

50 BURNHAM AVENUE

CRANSTON, RHODE ISLAND

National Sales Offices: 624 S. Michigan Blvd., Chicago, Ill.

HYCOR

the **NEW**
700 series

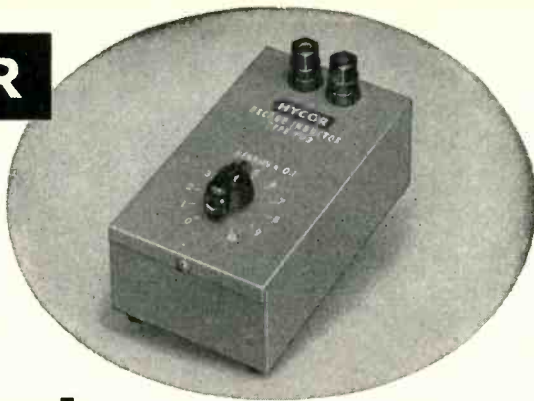

Decade-Inductor units

- HYCOR DECADE — INDUCTOR units are indispensable for design and experimentation work on audio filters.
- The units are available in four ranges up to 10 henries. Units may be used individually or all four may be connected in series to obtain 11.11 henries in 1 millihenry steps.
- Toroid coils are used to obtain high "Q", stability and low pickup from external fields. Inductance accuracy is 2%.

Send for bulletin D-2

HYCOR COMPANY, INC.

11423 VANOWEN STREET, NORTH HOLLYWOOD, CALIFORNIA • SUNset 3-3860

Manufacturers of Toroid Inductors, Decade Inductor Instruments, Wave Filters, Resistive Networks, and Precision Resistors

speed up production...
bring your
costs down!

ALPHA

SOFT SOLDER PREFORMS

Alpha's preformed solders, in any shape or size, cut many hours from your production time. You can select washers, rings, coils, cut shapes, drops, pellets, solder foil, to fit your specific needs. They save you considerable money and materials in repetitive soldering processes.

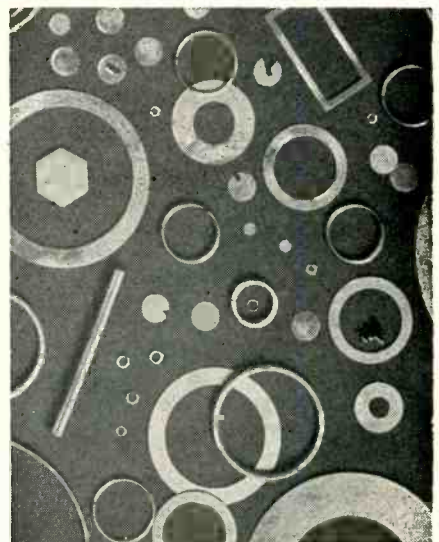

SPEED AUTOMATIC SOLDERING for flame, oven or induction heating

Increase Production • Melts Faster • Guarantee Product Precision • With Or Without Self-Flux Save Labor Costs • Designed For Your Application All Sizes, Shapes, Alloys • Stronger, Smoother Joints

AVAILABLE IN

- ★ CEN-TRI-CORE
- ★ TRI-CORE
- ENERGIZED
- LEAK-PRUF
- ROSIN-FILLED
- ACID-FILLED
- ★ SINGLE-CORE
- ★ SOLID WIRE
- ★ SHEET SOLDER

Please consult us on your soldering problems. Trained Field Engineers always available to assist you. Small or large quantities.

write to **ALPHA** for further information

ALPHA METALS, INC.
58 Water St., Jersey City 4, N. J.

MAKE IT
ARROW!
Single Source
INDUSTRIAL
ELECTRONICS
SUPPLIER

SAME DAY
SHIPMENTS
of over 75,000
different items!

COMPLETE
STOCKS
of over 300
National
Brands

ONE
ORDER
brings you
Everything
in the
INDUSTRY

ONLY
1 INVOICE
•
SAVE TIME,
BILLING,
SHIPPING
COSTS

COMPETENT
TECHNICAL
STAFF —
AT YOUR
SERVICE

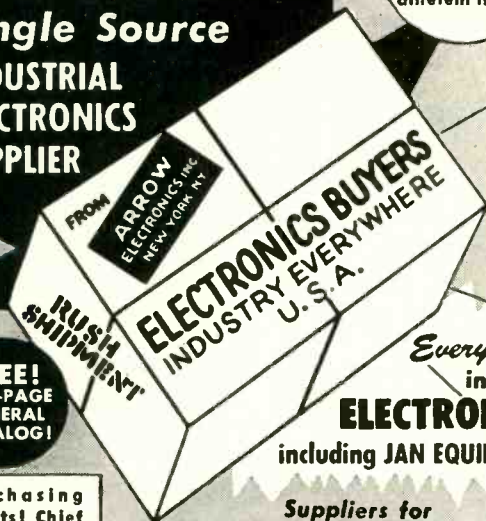

Everything
in
ELECTRONICS
including JAN EQUIPMENT

Suppliers for
RESEARCH • PRODUCTION
DEVELOPMENT • PROCESSING
CONTROL and MAINTENANCE

For FAST SERVICE • Teletype: NY1-472
Western Union: WUX-N. Y. • Cable: "AROELECTRO-N. Y."

FREE!
1100-PAGE
GENERAL
CATALOG!

Purchasing
Agents! Chief
Engineers!
Write today on
your company
letterhead for
your copy of
our gigantic
buying guide.
Address Dept. E-11

ARROW ELECTRONICS INC.

82 CORTLANDT ST., NEW YORK 7, N. Y. • DIGBY 9-4714

**Rugged GPL Camera
withstands a
Rugged Trip**

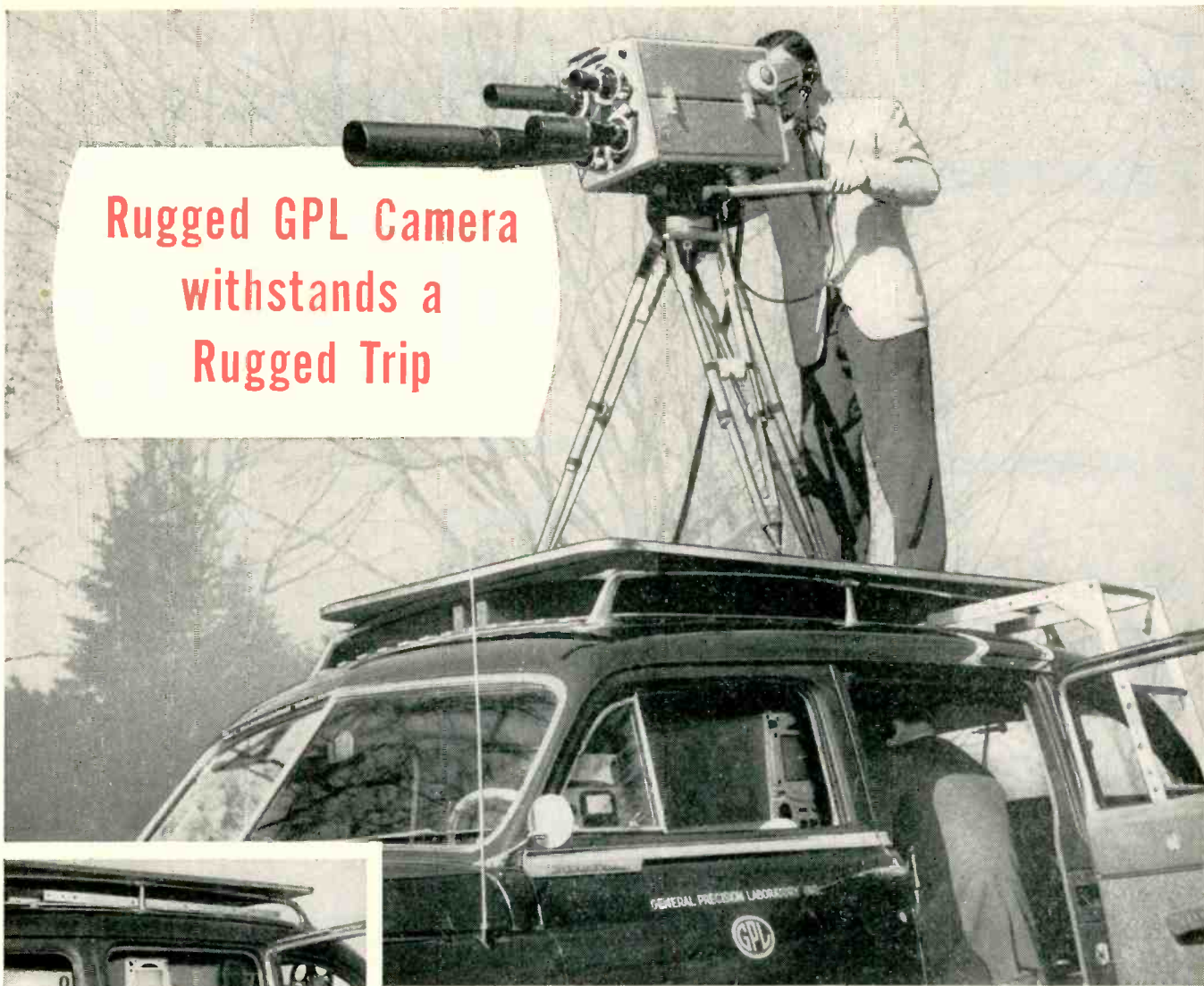

EQUALLY RUGGED and service-free on trip was GPL Utility Projector with "3-2" intermittent which permits use with I. O. camera for film telecasting from remotes.

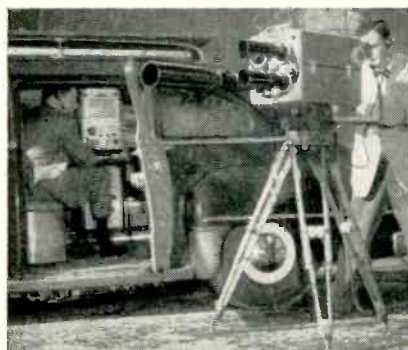

GPL STUDIO CAMERA CHAIN was packed in station wagon . . . demonstrating mobility of entire chain for fast coverage of news events, sports, other programs in the field.



**20,000 Miles Cross-Country
Without Camera Service**

This GPL image orthicon camera has just completed a demonstration tour to studios in 67 cities from Maine to Mexico . . . Michigan to Miami.

Without a single service operation, it took the bumps of 20,000 miles of hard driving. It was loaded and unloaded more than 150 times. Every working element received far more than normal wear and tear, as usual on demonstrations. Yet nothing failed, nothing needed replacing.

This is the kind of ruggedness you

may have for both studio and field operations, PLUS all the precision of GPL camera design. This unit is engineered for smooth, fast control, from pushbutton turret change to remote adjustment or iris and focus.

For the stations just starting, it has many special advantages: in compactness of chains, ease of operations.

Write, wire or phone, for full details of the camera equipment that is the "industry's leading line—in quality, in design."

General Precision Laboratory

INCORPORATED

PLEASANTVILLE NEW YORK



Export Department: 13 E. 40th St., New York, N. Y.

TV Camera Chains • TV Film Chains • TV Field and Studio Equipment • Theatre TV Equipment



Cable address: Arlab

YOU CAN DO THIS *automatically*



1 As the process speeds by, very clever fellow counts parts, inches, revolutions or machine operations up to 60,000 per minute without a mistake . . .

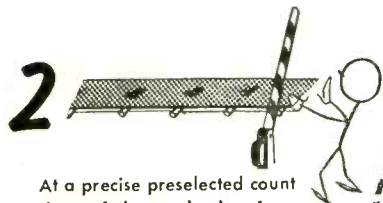

2 At a precise preselected count short of the total, alert foreman signals for reduced speed or other preliminary control action . . .

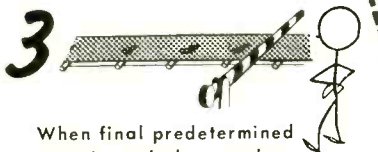

3 When final predetermined count is reached, gates close, shears cut or other machine control takes place—on the fly, without stopping . . .



4 With operation completed, tireless manager instantaneously calls for complete recycle without missing a count.

with a



Two Sequence Predetermined Electronic Counter



faster
without human error

Potter instruments are working for manufacturers in every industry—controlling everything from the number of zips in a zipper to the number of pills in a bottle.

Potter counters can solve your problem if high speed and precise control are needed. No more flexible method of preselecting one, two or more counts in sequence exists. There are no moving parts, therefore wear, slippage and inertial effects are eliminated.

Have you a counting problem? We'd like to help.

WRITE FOR DESCRIPTIVE CATALOG 11-C

POTTER INSTRUMENT COMPANY

INCORPORATED
115 CUTTER MILL ROAD, GREAT NECK, NEW YORK

work. During assembly, it is desirable to control to ± 0.0005 in. tolerance limits the spacing between the surface plane of the ceramic disc and the parallel plane of the emission cap.

With the shank and cap separated until final assembly, manufacturing operations may all be accomplished prior to establishment of the E dimensional tolerance. In the final step of disc-cathode assembly, the subassembly containing the seamless shank crimped to the ceramic disc and the cap are positioned by special equipment. Four electric spot welds are applied at 90-deg intervals around the cap, fastening it to the shank at a position well within the required tolerance of the E dimension.

By establishing the precision of the E dimension spacing in the disc cathode itself, the necessity for matching spacers with disc-cathode assemblies of the proper E dimension to produce the desired grid-to-cathode spacing corresponding to a given cut-off voltage is eliminated. The interchangeability of disc cathodes and uniform spacers now employed in cathode-ray-tube assembly virtually eliminates waste and has reduced labor costs by more than 20 percent for this operation.

Choice of Cap Alloys

The choice of various alloys in the cap material allows a greater specialization in application of the disc cathode. Active, normal or passive alloys can be used to meet the various needs of rapid cavitation, high emission level, reliable long life or undesirable rigid emission.

Sublimation Effect

The tendency of all nickel alloys to sublime slightly during processing and activation of the disc cathode, when the metal is held at high temperatures, causes a movement of metal molecules from a cathode shank to the surface of the ceramic disc to occur. This sublimation effect, occurring over long periods of time, may result in a significant buildup of deposited metal across the surface of the ceramic insulator disc. As this metal film deposits, electrical leakage occurs between the cathode shank and the

MOLONEY *HiperCore* ELECTRONIC CORES

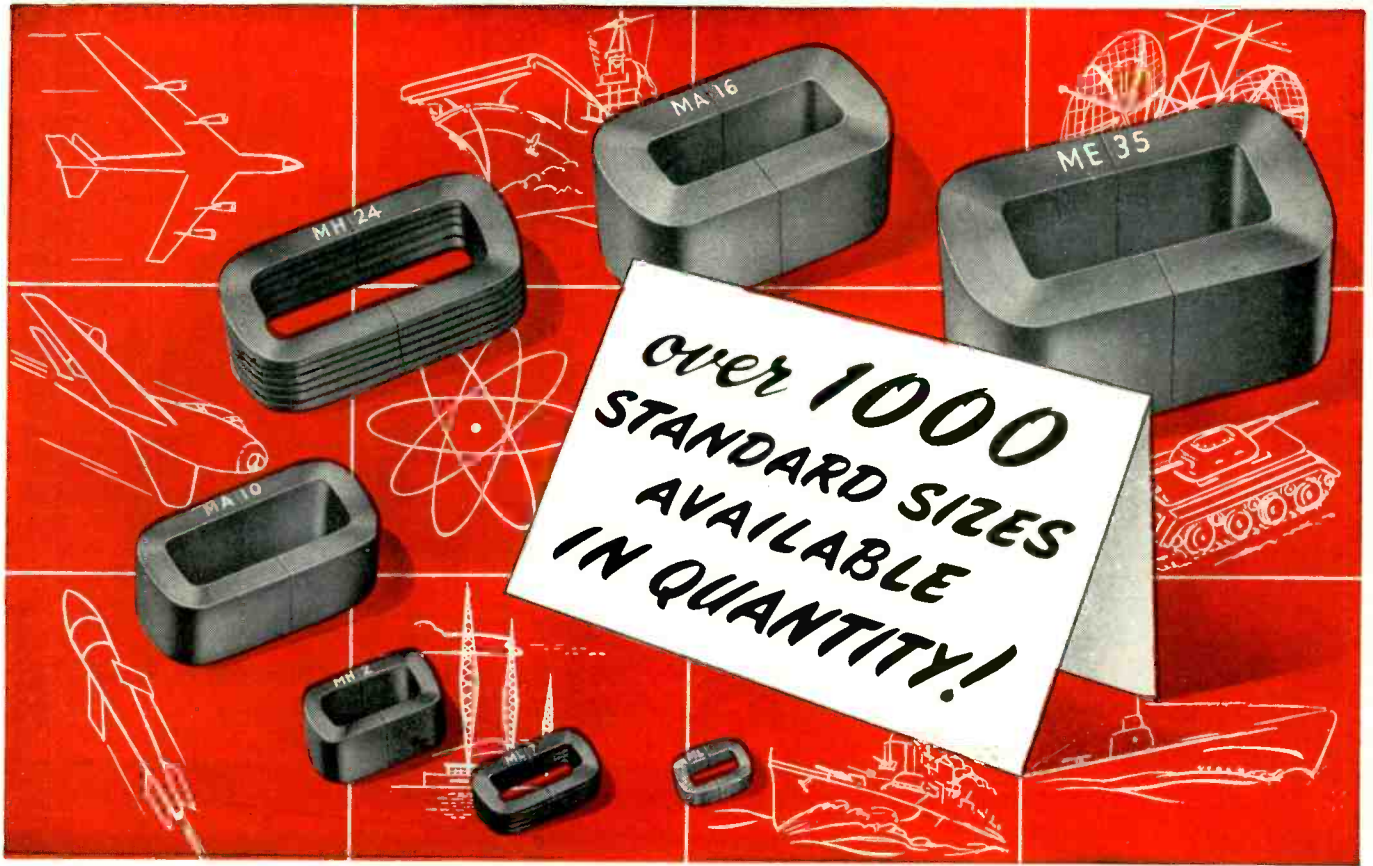

Over 200 manufacturers of electronic products for ultimate use by the U. S. Government are now using Moloney HiperCore Cores for Electronic Transformers.

More than 1000 standard sizes are available in quantity to such manufacturers in thicknesses from 1 mil to 12 mil and in widths from 1/4". HiperCore Electronic Cores are of wound core construction using oriented-grain, cold-rolled silicon steel which results in greater flux carrying capacity and lower losses than other type cores of comparable sizes. These smaller, lighter cores perform better and permit increased production by savings in assembly time.

Rigid control of core production permits these cores to test well within industry tolerances. Table at right shows typical test requirements. Special tests for specific operating conditions are made when desired.

Write today for further information.

ME-B2-27

MOLONEY ELECTRIC COMPANY

Manufacturers of Power Transformers • Distribution Transformers • Load Ratio Control Transformers Step Voltage Regulators • Unit Substations

SALES OFFICES IN ALL PRINCIPAL CITIES • FACTORIES AT ST. LOUIS, MO. AND TORONTO, ONT., CANADA

ELECTRONICS — November, 1952

STANDARD TESTS

All 12 mil cores are tested for core loss (true watts) and exciting volt-amperes (apparent watts) at 60 cycles. 4 mil cores are tested at 400 cycles. Following table gives maximum test values. Average values are approximately 20% less than maximum.

	12 Mil—60 Cycle @ 15000 gauss	4 Mil—400 Cycle @ 10000 gauss
Core Loss (TW)	0.95 x lbs.	4.4 x lbs.
Exciting Volt-Amps (AW)	1.75 x lbs. + 6.25A*	5.0 x lbs. + 16.8A*

* A = Gross Area of core face in Sq. In.

All 2 mil cores are tested for pulse permeability by using a 2 microsecond pulse width at 400 P. P. S. and maximum flux density of 10000 gauss. The minimum permeability will be 500.

All 1 mil cores are tested for pulse permeability by using a 0.25 microsecond pulse width at 4000 P. P. S. and maximum flux density of 3000 gauss. The minimum permeability will be 175.



Silicone

DIFFUSION PUMP FLUIDS

Dow Corning 702 and 703
Stable to Air and Moisture
at 150° to 225°C



After almost 4 years' service in an electron microscope, Dow Corning 702 has yellowed slightly but is still as clear and liquid as ever.

SECOND only to mercury in chemical and thermal stability, Dow Corning Silicone Diffusion Pump Fluids withstand operating conditions which completely decompose organic oils. So resistant to oxidation and moisture that they remain clear even after distillation at atmospheric pressure, these fluids are unaffected by the accidental admission of air to a hot system. Chemically unable to break down and form carbonaceous deposits on jets, boilers or fore pumps, they remain in usable condition almost indefinitely.

Pump speeds and limiting back pressure for these silicone fluids equal those for the best organic oils, as do the ultimate vacua attainable with Dow Corning 703. For applications which do not require the lowest pressures, the economical Dow Corning 702 has a lower boiling point and operates against higher forepressure.

The rapid recovery of these fluids, plus their resistance to decomposition, means increased production and reduced maintenance costs in lens coating equipment, metallizing units, electron microscopes and vacuum tube manufacture.

Write Department BD-23
for data sheet.

**DOW CORNING
SILICONES**

**DOW CORNING
CORPORATION**
Midland, Michigan

GOAT Electronic Components

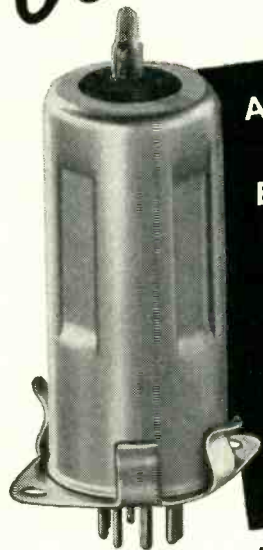

GOAT lanced tube shield
G1702-2 and clip G1770

An example of GOAT engineering
—THE TUBE SHIELD WITH
BUILT-IN SPRING ACTION GRIP

Particularly suited for high vibration situations involving uhf tubes, the four spring-like lances of this shield expand with the tube without sacrificing full shielding efficiency.

This is only ONE of a wide variety of stock miniature and standard size GOAT shields.

A complete design service is available for those long-run, tough-spec custom jobs.

For a full description of tube shields, clips and other GOAT electronic components, send for GOAT catalog E52.

The Fred Goat Co., Inc.
308 DEAN ST. BROOKLYN 17, N. Y.

Pioneers in metal stamping
Serving the electronics industry since 1926



Established 1893

Build YOUR OWN **Heathkit TEST EQUIPMENT**

Heathkits are completely engineered instruments supplied unassembled. Every kit goes together smoothly and easily. All drilling, punching, and painting has already been done for you.

It's easy and fun to build a Heathkit. All parts are furnished and are of highest quality for years of trouble-free, dependable operation.

Save money by constructing your own. All expensive wiring and assembly costs are completely eliminated.

Detailed construction manual shows clearly where each wire and part goes and tells exactly how to build the kit. Write for free catalog.

- Heathkit AUDIO GEN. KIT \$34.50
- Heathkit TUBE CHECKER KIT \$29.50
- Heathkit TELEVISION GENERATOR KIT \$39.50
- Heathkit SIGNAL TRACE KIT \$19.50
- Heathkit CONDENSER CHECKER KIT \$19.50
- Heathkit IMPEDANCE BRIDGE KIT \$69.50
- Heathkit R.F. SIGNAL GEN. KIT \$19.50
- Heathkit VACUUM TUBE VOLTMETER KIT \$24.50
- Heathkit BATTERY ELIMINATOR KIT \$24.50
- Heathkit PUSH-PULL OSCIL. SCOPE KIT \$43.50
- Heathkit ELECTRONIC SWITCH KIT \$19.50
- Heathkit HAND TESTER KIT \$13.50

HEATH COMPANY
BENTON HARBOR 14, MICHIGAN

EXPORT AGENT
ROCKE INTERNATIONAL CORP.
17 E. 40th St.
NEW YORK CITY (16)

resistors rheostats



TRU-OHM PRODUCTS

Division of Model Engineering & Mfg., Inc.

General Sales Office:

2800 N. Milwaukee Avenue, Chicago 18, Ill.

Factory: Huntington, Indiana

MANUFACTURERS: Power Rheostat, Fixed Resistors,
Adjustable Resistors, "Econohm" Resistors

Write for FREE Engineering Catalog NOW!

★ POWER RELAYS
 ★ SMALL RELAYS
 ★ SENSITIVE RELAYS
 ★ LATCH RELAYS
 ★ INSTRUMENT-CONTROLLED
 RELAYS and SETS
 ★ SEQUENCE RELAYS
 ★ TIMING UNITS
 ★ SPECIAL-PURPOSE RELAYS

5,348 RELAY TYPES

*...mean that you get
exactly the right relay
for the job!*

STRUTHERS -DUNN

Struthers-Dunn, Inc., 150 N. 13th St., Philadelphia 7, Pa.

BALTIMORE • BOSTON • BUFFALO • CHARLOTTE • CHICAGO • CINCINNATI
 CLEVELAND • DALLAS • DETROIT • KANSAS CITY • LOS ANGELES
 MINNEAPOLIS • MONTREAL • NEW ORLEANS • NEW YORK • PITTSBURGH
 ST. LOUIS • SAN FRANCISCO • SEATTLE • SYRACUSE • TORONTO

No. 1 grid electrode, with eventual change in grid bias and short circuiting.

In order to reduce this undesirable tendency, a shadow groove is molded around the ceramic disc face at a prepositioned radius between the shank and tube. The side of the groove falls within the shadow of the subliming shank material so that very few molecules can be deposited on the unexposed groove side. A clean ceramic surface having the original high resistance of the ceramic is left in the shadow groove to give a large resistance between grid and cathode electrodes.

The sublimation or deposition of metal film during processing operation of the cathode ray tube can be further reduced by the choice of alloy in the seamless shank material. It is desirable to use cathode alloys of normal or passive materials whose sublimation rate is very much less than some active alloys. Thus, thinner films and smaller grid cathode resistances are obtained in the normal activation and use.

With the successful overcoming of cathode-ray-tube failures due to sublimation short circuiting, the life expectancy and service potential of these tubes has been greatly increased.

Heater-Cathode Leakage

The newest and most promising solution to the heater-to-cathode leakage problem involves the relatively simple expedient of assuring absolute cleanliness of the cathode-shank inside-diameter surface. During repeated experiments, both in the laboratory and in end-product use, good results have been obtained with disc cathodes whose shank inside-diameter surface has been carefully polished and chemically cleaned to remove all surface contamination. The use of seamless nickel tubing in the shank does provide a clean metal surface to aid in the reduction of heater-cathode leakage.

Flared Shank

To reduce direct shorts between the heater and the cathode shank, the uncapped open end of the cathode shank should be flared.

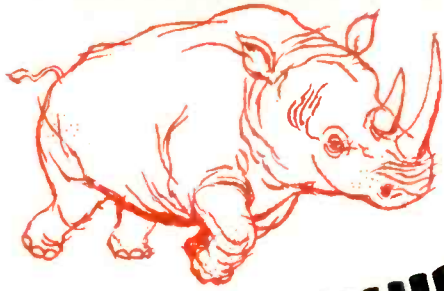

RUGGED as a **RHINO** . . .

Quick as a **Fox!**



Two Special Purpose Connectors by

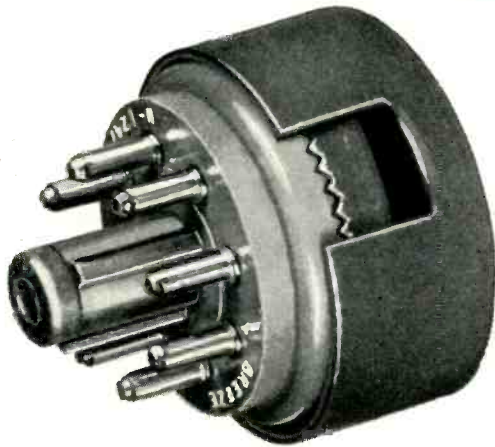

Battery Connectors

8-pin type for both A and B batteries used in all types of field communication equipment. "RUGGEDIZED" for extra security and long service life: polarizing stud is ALL METAL and all metal parts are cadmium plated and sealed with an iridite sealer. Cable may be brought out at any desired side position and locked. Handy bail makes removal from inaccessible places easy.

Quick Disconnect

Simply push male and female members together and lock. To disconnect with minimum resistance, pull back sleeve on plug shell and disconnect. Exceptionally low disengaging force required (less than 6 lbs., excepting pin friction). Vibration proof, moisture-proofed with synthetic rubber insert. Meets AN pin pattern and voltage requirements, in accordance with MIL C-5015. Plug shell and coupling sleeve are aluminum alloy, cadmium plated and iridite-sealed. (Federal Spec. QQP - 416, Type 2.)



Receptacle Types:

Round flange single hole panel-mounted, square flange for 4 bolts, or specially flanged to specification. All contacts silver plated.

We invite your inquiries on any problems concerning connectors. Our wealth of engineering experience in this specialty is at your service.

BREEZE

CORPORATIONS, INC.

41 South Sixth Street, Newark, N. J.

SERVOTHERM PRODUCTS

BOLOMETER AND PREAMPLIFIER

Thermistor bolometers are FAST, sensitive INFRARED and HEAT detectors. Especially RUGGED for industrial, scientific, and military applications. PREAMPLIFIER provides NOISE-FREE initial amplification and mount.

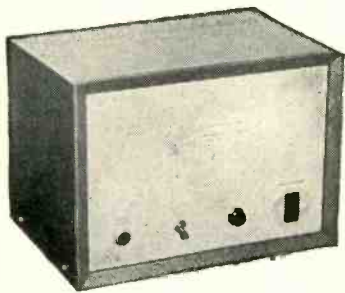

THERMISTOR POWER SUPPLY

Provides voltages required by BOLOMETER bridge and PREAMPLIFIER. Regulated and filtered permitting THEORETICAL NOISE LIMITS of amplification, while operating from 60 CYCLE line.



SERVO CORPORATION OF AMERICA

DEPT. E-11

NEW HYDE PARK, N.Y.



**Aerophysicists,
Designers,
Engineers**

**YOUR IDEAS
WILL COUNT AT
NORTH AMERICAN**

North American encourages advanced thinking, because they know looking ahead is the only way to maintain leadership in the aviation industry. That's why North American needs men of vision. If you like hard thinking and would like to work for a company that will make the most of your ideas, you'll find real career opportunities at North American. North American offers you many extra benefits, too.

North American Extras —

Salaries commensurate with ability and experience • Paid vacations • A growing organization • Complete employee service program • Cost of living bonuses • Six paid holidays a year • Finest facilities and equipment • Excellent opportunities for advancement • Group insurance including family plan • Paid sick leave • Transportation and moving allowances • Educational refund program • Low-cost group health (including family) and accident and life insurance • A company 24 years young.

Write Today

Please write us for complete information on career opportunities at North American. Include a summary of your education, background and experience.

IS YOUR FIELD LISTED HERE ?

Airborne Electronic Equipment
Equipment Flight Tests
Precision Instruments
Automatic Controls
Propulsion Systems
Servo-Mechanisms
Airframe Studies
Radar Devices
Instrumentation
Micro Wave Techniques
Metallurgical
Electroplating
Engineering Planning

NORTH AMERICAN AVIATION, INC.

Aerophysics, Electro-Mechanical Research Division

Dept. 3, Personnel Section,
12214 Lakewood Blvd., Downey, California
*North American Has Built More Airplanes
Than Any Other Company In The World*

**CONTROLLED
QUALITY ...**

**CUSTOM BUILT
FOR GOVERNMENT
AND INDUSTRY**

TRANSFORMERS REACTORS RESONANT FILTERS

Top Engineering and Workmanship

*We have been
solving the
transformer
engineering
problems of
government
and industry
since 1938!*

*Write or phone us
regarding your
special requirements.*

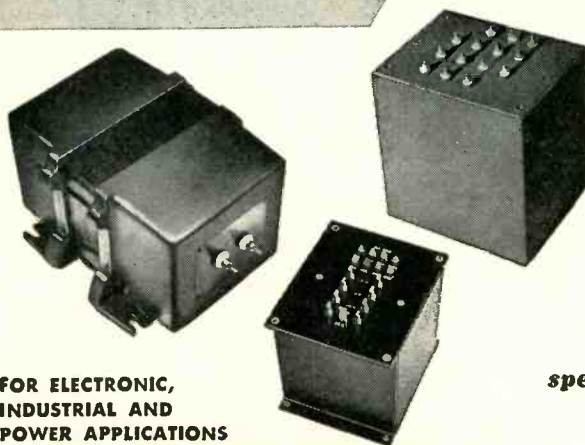

FOR ELECTRONIC,
INDUSTRIAL AND
POWER APPLICATIONS

ELECTRONIC TRANSFORMER COMPANY, INC.
209 West 25th Street • WAtkins 4-0880 • New York 1, N. Y.

FREE

to every engineer with an industrial fastening problem! The most complete catalog on retaining rings ever published!

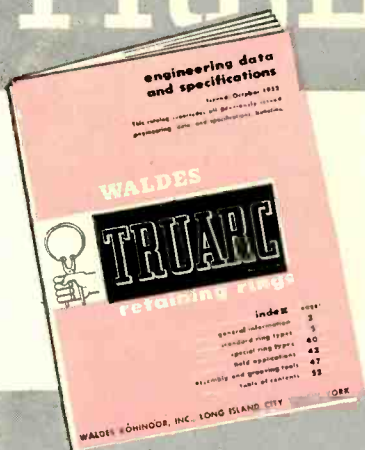

This encyclopedia of retaining rings combines—in one 52 page volume—engineering specifications and data for 17 different ring types—more than 600 different sizes. Gives assembly data, typical applications, everything you need to know about selection and use of Waldes Truarc Retaining Rings.

28 pages of charts giving complete engineering data and specifications. Dimensions of Rings, Grooves, Shafts, and Housings; Clearances; Allowable Thrust Loads; Safety RPM Limits. Data on end-play take-up. Countless other engineering data, arranged in easy-to-read, easy-to-use table form.

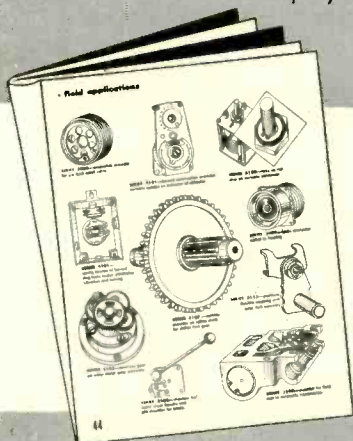
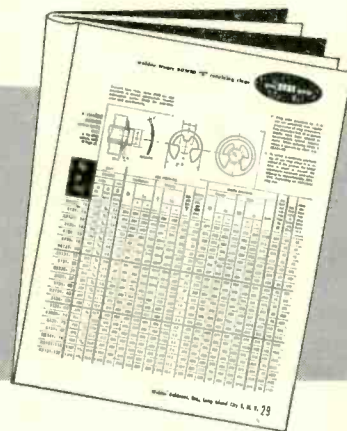

6 pages showing typical cost-cutting applications and case histories, covering self-locking rings; basic type rings; rings for taking up end-play; rings for radial assembly; and special rings.

5 pages showing drawings of assembly and accessory tools, designed to handle Truarc retaining rings on a speedy, production line basis. There are data on tools for recessing grooves, pliers and applicators for assembly, and the new Truarc "E"-ring dispenser. You will find the new Waldes Truarc Retaining Ring Catalog invaluable in selecting and specifying Truarc retaining rings, the better way to hold parts together.

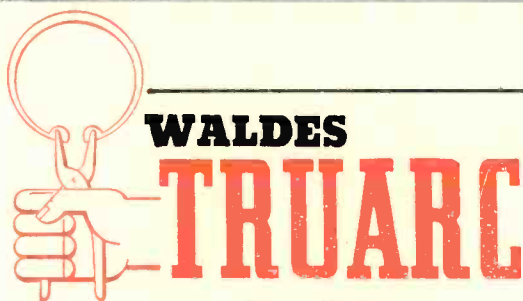
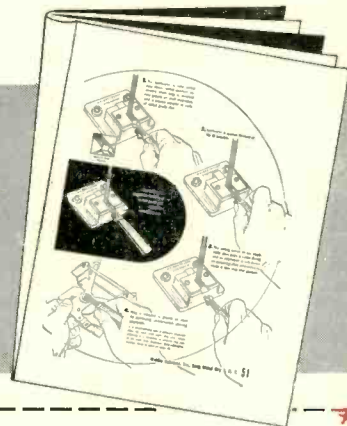

REG. U.S. PAT. OFF.

RETAINING RINGS

WALDES KOHINOOR, INC., LONG ISLAND CITY 1, NEW YORK

WALDES TRUARC RETAINING RINGS AND PLIERS ARE PROTECTED BY ONE OR MORE OF THE FOLLOWING U.S. PATENTS: 2,382,947; 2,382,948; 2,416,852; 2,420,921; 2,428,341; 2,439,783; 2,441,846; 2,455,165; 2,483,380; 2,483,383; 2,487,802; 2,487,803; 2,491,306; 2,509,081 AND OTHER PATENTS PENDING.

MAIL THIS COUPON TODAY FOR YOUR COPY!

Waldes Kohinoor, Inc., 47-16 Austel Place, L. I. C. 14, N. Y.

Please send the new complete Waldes Truarc Retaining Ring Catalog. (PLEASE PRINT)

Name _____

Title _____

Company _____

Business Address _____

City _____ Zone _____ State _____

- plots speeds up to 20 cps . . .
- permits instant manual pen positioning . . .

THE NEW
LOGRINC
Digital Graph Plotter



THE LOGRINC DIGITAL GRAPH PLOTTER automatically plots one variable against another algebraically in incremental steps, in response to electrical impulses. It is ideally adapted for use as a read-out device for electronic digital computers, especially digital differential analyzers, and for use in connection with such problems as aircraft tracking and automatic data reduction.

- plots at speeds up to 20 steps per second, in incremental steps of 1/64 of an inch.
- simultaneous movement on both axes in either direction.
- can be controlled electronically or by external or remote switches or relays.
- will make several carbon copies or duplicating stencil.
- instant manual positioning of pen and drum.
- takes 12" x 18" paper or continuous 12" strip.

Mechanical simplicity . . . high reliability . . . digital accuracy . . . quick pen cartridge change . . . self-contained power supply.

Additional information supplied on request.

LOGISTICS RESEARCH COMPANY

141 South Pacific Avenue
Redondo Beach, California

Even a slight flare permits insertion of the insulated heater coil without damage to the insulating coating by scraping or cutting. This simple innovation has reduced cathode-ray-tube failures in service and rejections in production.

**New Casting Resin
for Potting Components**

Low COST is one of the advantages of a new National Bureau of Standards' casting resin for embedding or potting electronic components and assemblies. The resin, known as AN-5, has good storage properties even without refrigeration and its physical properties and electrical characteristics at both high and low frequencies are in general as good as those of expensive and hard-to-store casting resins.

The new resin meets the need for a material that may be manufactured economically from available ingredients. It is essentially a styrene to which are added distilled acrylonitrile and divinylbenzene (from which nearly all the inhibitor has been removed by passing it through a column of activated alumina), hydrogenated terphenyl, polystyrene and cobalt drier.

Refrigeration is not necessary unless an unusually long storage life is required. Storage at about 60 F in a dark place gives a shelf-life of about eight to 18 months. Small amounts of benzoyl peroxide and a polymerization promoter are added just before use to catalyze the curing process.

Although satisfactory cures can

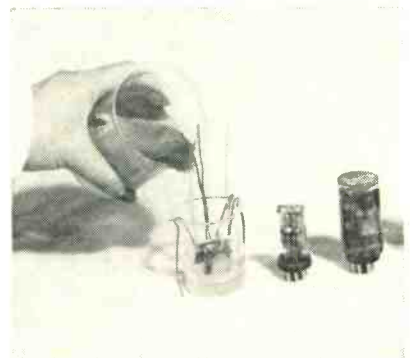

Shown from left to right: a two-stage printed-circuit amplifier being potted with casting resin; a complete two-stage plug-in amplifier before potting and the two-stage plug-in amplifier after potting

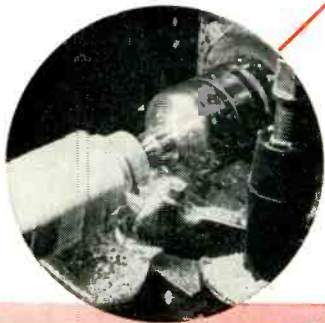
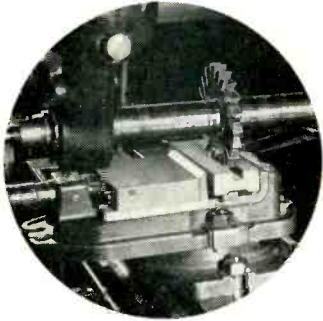
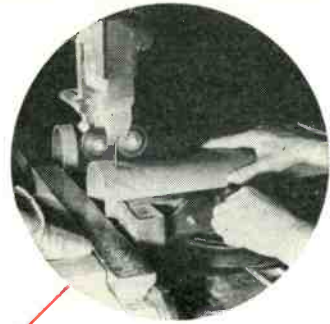
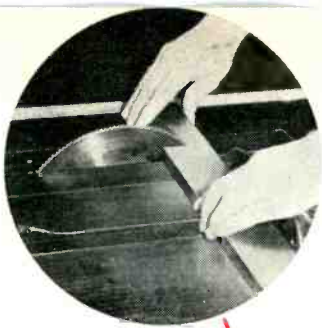

At your service

National's complete fabricating facilities

First objective in our fabricating service is to save you time, money and production headaches. Second objective is to make the service useful, but economical. Adequate facilities, modern laboratory plant and equipment, technical skills and the knowledge gained through 79 years of experience all play a part in helping us meet these objectives. Hundreds of successful customer case histories form our record. Next time you need fabricated parts—one or one million—whether of National Vulcanized Fibre or Phenolite laminated plastic, get in touch with National. We're at your service.

NATIONAL VULCANIZED FIBRE CO.

Wilmington



Delaware

Offices in

principal cities

since 1873

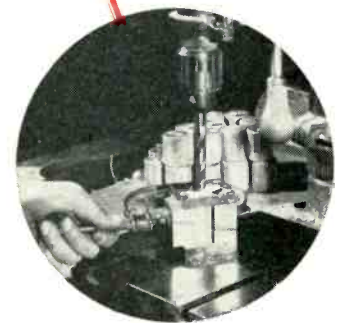

NATIONAL VULCANIZED FIBRE

PHENOLITE
Laminated PLASTIC

THE *Reliable* ELECTRONIC MEMORY

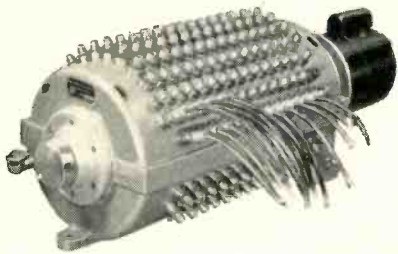

ERA MAGNETIC DRUM STORAGE SYSTEMS

for

- DIGITAL COMPUTERS
- AUTOMATIC PROCESS CONTROL SYSTEMS
- DATA-HANDLING SYSTEMS

In the past, the rapid development of modern automatic information-processing systems has been handicapped by the high cost and marginal reliability of the associated high-speed information-storage equipment.

Today, fully-engineered, operationally-proved ERA Magnetic Drum Storage Systems are available which provide the reliability, the large storage capacity, the economy in dollars and in space, and the high speed required for many applications.

Investigate the possibility of replacing storage relays, stepping switches, punched tape, or other bulky forms of storage with an ERA Magnetic Drum Storage System. ERA's experienced engineers will be pleased to assist you in the application of ERA Magnetic Drum Storage Equipment to your particular system requirements.



Write today for descriptive brochure.

Engineering Research Associates, Inc.

A Subsidiary of **Remington Rand**
Department E-5, 1902 West Minnehaha Avenue
St. Paul 4, Minnesota

Digital Computers..Data-Handling Systems..Magnetic Storage Systems..Instruments..Analog Magnetic Recording Systems..Communications Equipment

MICO ENGRAVERS



An accurate, inexpensive and portable machine for engraving name plates and panels, forming small molds and dies, and profiling small parts. Geometrically correct for true three dimensional work. Accurately duplicates master copy in metals, plastics or wood. Rugged, sturdy construction.

COMPARE THESE SUPERIOR FEATURES

- Engraves in 2 or in 3 dimensions.
- Pantograph permits 4 reduction ratios.
- Micrometer depth control graduated in thousands of an inch.
- High speed, ball bearing spindle.
- Chuck $\frac{1}{8}$ " to take variety of small tools, burrs, mounted points as well as standard cutters.

Send for Illustrated Catalog

MICO INSTRUMENT COMPANY

76E Trowbridge St.

Cambridge, Mass.

hand-wound
COILS
of Tungsten
and Molybdenum

quality
"precision"
LEADS
of

TUNGSTEN
MOLYBDENUM
NICKEL
NICKEL-CLAD
COPPER
and ALLOYS

quality
**MACHINED
TUBE
COMPONENTS**
to customers' specifications

Your products can only be as good as the parts you put into them!
SEND US YOUR BLUEPRINTS or SPECIFICATIONS FOR QUOTATIONS!

ELECTRONIC PARTS MANUFACTURING CO.
508 25th St., Union City, N. J.

International RECTIFIER

C O R P O R A T I O N

EL SEGUNDO
CALIFORNIA

Selenium

Diodes



TYPE U SERIES

TYPE 1T1
Output 20V - 200 μ a
Specifications at 45° C
Max. Reverse Current 6.0 μ a at 26V
Rated Forward Current 200 μ a
Shunt Capacitance at 200 Kc. 0.000057 μ f

Maximum Ratings
Peak Inverse Voltage 60 volts
Max. Average Rectified Current 200 μ a
Peak Rectified Current 2.6 ma
Max. Surge Current (1 sec) 10 ma
Ambient Temp. Range -50 to 100° C
Max. RMS Applied Voltage 26 volts
Max. RMS Input Current 500 μ a
Max. DC Output Voltage 20 volts
Voltage Drop at Full Load 1 volt
Reverse Current at 10 V RMS 0.6 μ a
Frequency, Max. 200 Kc
Also available in 2T1

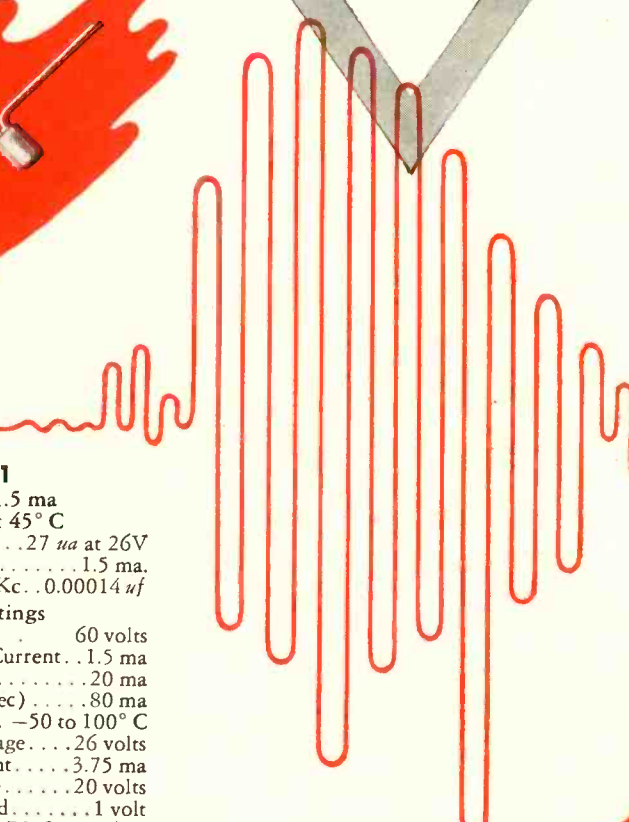

TYPE 1U1
Output 20V - 1.5 ma
Specifications at 45° C
Max. Reverse Current 27 μ a at 26V
Rated Forward Current 1.5 ma.
Shunt Capacitance at 100Kc. 0.00014 μ f

Maximum Ratings
Peak Inverse Voltage 60 volts
Max. Average Rectified Current 1.5 ma
Peak Rectified Current 20 ma
Max. Surge Current (1 sec) 80 ma
Ambient Temp. Range -50 to 100° C
Max. RMS Applied Voltage 26 volts
Max. RMS Input Current 3.75 ma
Max. DC Output Voltage 20 volts
Voltage Drop at Full Load 1 volt
Reverse Current at 10 V RMS 2.4 μ a
Frequency, Max. 100 Kc
Also available in 2U1, 3U1, 4U1

TYPE T SERIES



WRITE FOR BULLETIN SD-1

INTERNATIONAL RECTIFIER

C O R P O R A T I O N

General Offices: 1521 E. Grand Ave., El Segundo, Calif. • Phone: El Segundo 1890
Chicago Branch Office: 205 West Wacker Drive • Phone: Franklin 2-3889
New York Branch Office: 12 West 32nd Street, N. Y. 1 • Phone: Chickerling 4-0017



Western Auto



Philco

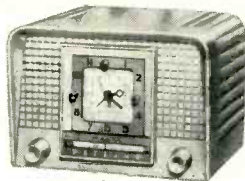

Regal



Steelman

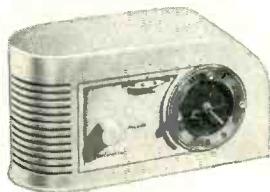

Continental



Admiral

**The value leaders
in Clock-Radios
continue to be the
brands equipped
with**



SESSIONS TIMERS



Because Sessions Timers are lower-priced than other dependable makes, more and more clock-radio manufacturers are offering buyers a better value for their money.

Make any comparison. Take this initial price advantage and add Sessions-quieter operation, unbeatable accuracy, and attractive styling, and you have a total number of important features unmatched by any other clock-radio timer. For details write the Sessions Clock Company, Timer Division, Dept. 48, Forestville, Connecticut.



Esquire

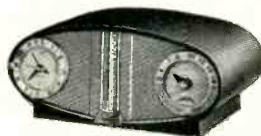

Spartan



Philco



Sears Roebuck

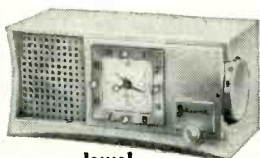
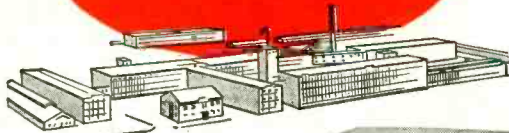

Jewel



Sylvania

be obtained at room temperature within several days, the curing rate is hastened by the application of a moderate amount of heat. At 50 C, the resin gels in about two hours and is almost completely cured in about 20 hours. Choice of curing technique depends on the type of component being embedded and on the amount of resin required.

Linear Current Regulator

LINEARITY of current control provided by the circuit shown in Fig. 1 depends only upon a single helical potentiometer available, inexpensively, to linearity tolerances of 0.1 percent or better.

The circuit is similar to conventional current regulators but uses an a-c supplied thyatron followed by a diode and an integrating circuit in place of the usual d-c amplifier. Because the thyatron plate current is either zero or some constant value, the operating point of the thyatron does not change over the controlling range and may be regarded as accounting for the linearity of the circuit.

When there are no thyatron pulses, the load current I increases gradually toward its zero bias value as the grid potential of the 6L6 decays through the integrating network. A point is reached eventually beyond which the thyatron is allowed to fire on each peak of its alternating plate voltage. The negative pulses which appear on the plate of the diode recharges the 6L6 grid-leak capacitance until the thyatron grid returns to the cut-off region and I drifts toward saturation again. If R_1 is rotated slowly, the controlled current follows in a linear manner.

The original regulator model was used to provide a linear time variation of magnetic field in a nuclear

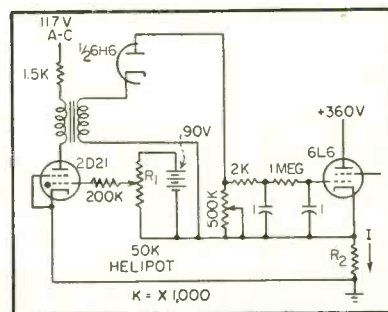

FIG. 1—Current regulator circuit

insuline

... world's
largest producer
of TEST LEADS
and PROBES!

INSULINE manufactures over 2000 items for the radio, automotive, electronic, aircraft, television and marine industries. For over 30 years, INSULINE has been the leading producer of test leads and probes (standard and special types) . . . outselling the combined production of the next three leaders.

Whether it be test leads, probes, tools, metal goods or antennas, insist on INSULINE . . . a respected name since 1921.



Write Dept. E-11 for latest catalog, illustrating and describing one of the largest selections of electronic equipment made by one manufacturer.

You will find a plug, jack or connector for your specific need in our latest catalog. INSULINE products are sold through radio and electronic jobbers throughout the United States and Canada.

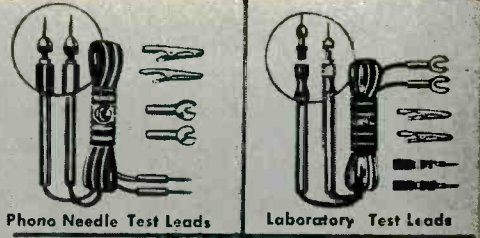

Phono Needle Test Leads

Laboratory Test Leads

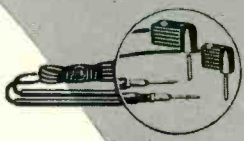

Pencil Type Test Leads

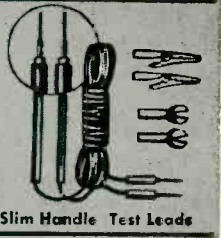

Slim Handle Test Leads



Slim-Line Test Leads

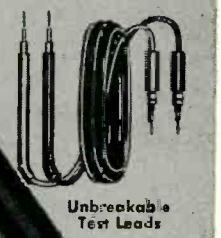

Unbreakable Test Leads

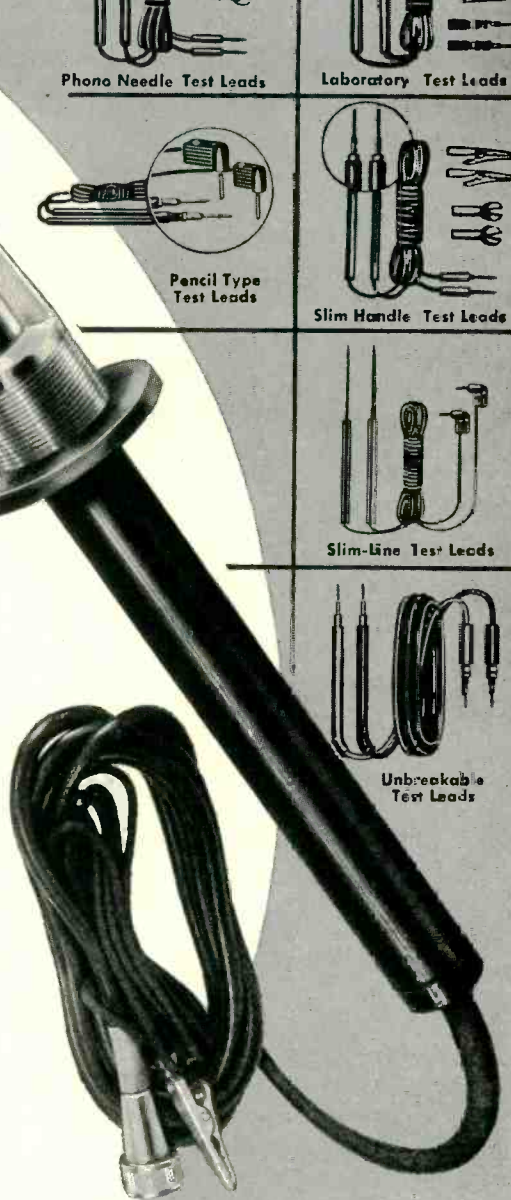

PLUGS

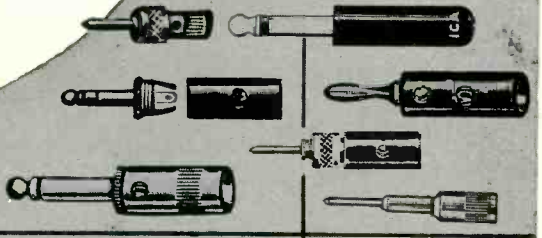

CONNECTORS

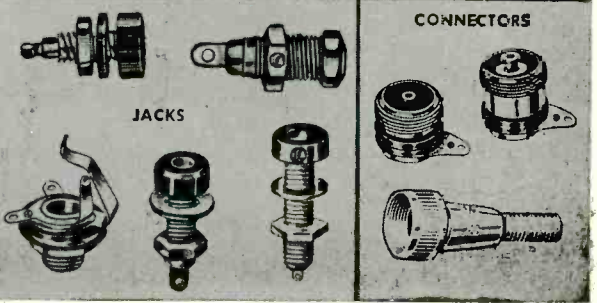

JACKS



insuline

CORPORATION OF AMERICA
 INSULINE BUILDING • 36-02 35th AVENUE • LONG ISLAND CITY, N. Y.
 West Coast Branch and Warehouse:
 1335 South Flower Street, Los Angeles, Calif.
 Exclusive Canadian Sales Agents: CANADIAN MARCONI COMPANY, Toronto

**wanted:
something
better!**

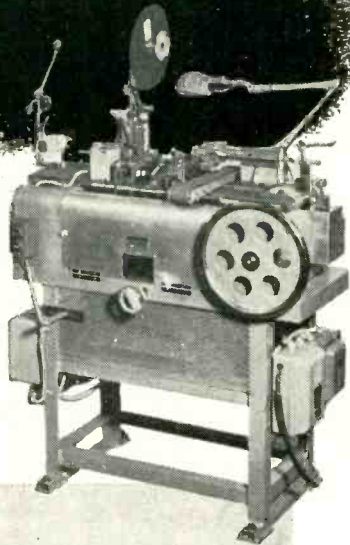

Although several filament making and tabbing machines were already available, a recent Kahle client wanted something better. The client ordered a machine that would be more positive in operation, faster—and that would cover a greater range of filament sizes. Kahle's solution was to build the fully automatic machine shown above, Model 2036. This machine, producing 1200 to 3000 units per hour, handles coated filament wire from .0006" diameter up and cuts lengths from 14 mm. to 40 mm.

This is but one of hundreds of problems solved by Kahle. Working closely with your organization, Kahle's experienced staff of electronic and equipment engineers will, at your request, recommend a solution to your own specialized production problems. Learn how Kahle's more than 40 years of practical experience can benefit you . . . Write Kahle now.



Kahle
ENGINEERING
COMPANY

1310 SEVENTH STREET
NORTH BERGEN N. J.

AMRECON ALL-PURPOSE RELAYS

... for the most diverse applications

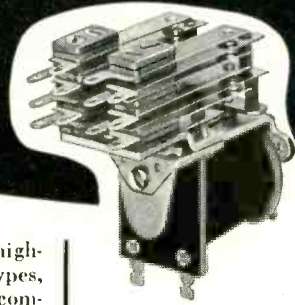

A wide selection of high-quality relays—of many types, capacities, and contact combinations—makes Amrecon your ideal relay source. Standard units are available, rated from 1 to 25 amp at 115 VAC, or 32 VDC, noninductive. In addition, special units can be quickly assembled of Amrecon precision components to meet your most exacting requirements. Write to us about your particular design problems—we are well equipped to help you.

TYPE CRU: Normally rated at 2.75 watts DC, 5.6 watts AC. Coil voltages up to 230 VDC or 440 VAC at 60 cycles. Std. contact comb: 4 pole, double throw. Contact rating: 5 amp at 115 VAC or 32 VDC, non-inductive load. Size: 2-7/16" long, 1-3/32" wide. Height varies with contact combinations.

SEND FOR CATALOG NO. R-10



American Relay & Controls, Inc.
4911 W. Flournoy St., Chicago 44, Ill.

new

development in—

SOLDER PREFORMS

lower cost

more exacting precision standards

● The new Art Wire Solder Preforms reduce your costs, eliminate variability in soldering, insure sounder, stronger joints, and minimize hand labor. Precision made to every specification including Military and Federal for soft solder . . . in shapes that meet the requirements

Complete information on request. Send blueprints or samples for estimates.

of your induction soldering operation.

ART WIRE & STAMPING CO.

1 Boyden Place

Newark 2, N. J.

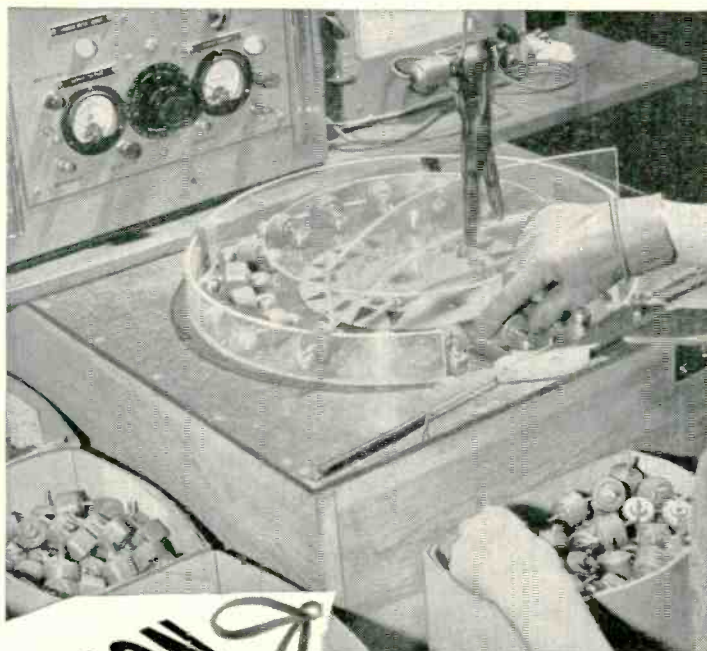

100% INSPECTION

.....assures top performance of
JEFFERS
 high voltage capacitors

Other Jeffers Products

ceramic capacitors • disc capacitors
 high voltage condensers • capristors

**Other Speer Products
 for the Electronics Industry**

anodes • contacts • resistors • iron
 cores • discs • brushes • molded
 notched* coil forms • battery carbon
 graphite plates and rods

*Patented

Other Speer Divisions: Speer Resistor,
 International Graphite & Electrode

You can be sure of maximum results from Jeffers high voltage television capacitors for two reasons:

FIRST—every unit is 100% inspected for capacity, power factor, leakage, and voltage. The testing device is adjustable, permitting each capacitor to be held at high test voltage for any specified length of time. Thus there is no chance for a defective part to get by.

SECOND—these high voltage capacitors are extremely well made. They are completely encased in a special thermosetting molding material of exceptional strength. All terminals are securely soldered to the high dielectric constant ceramic body. The entire unit is impregnated under vacuum with a micro-crystalline wax to give extra protection against moisture.

Jeffers high voltage capacitors are ideal in circuits for filtering or by-passing, where the AC component is small. Why not put them to work for you? Write today for our specification sheets.

Jeffers Electronics Division
 Speer Carbon Company
 Du Bois, Pennsylvania

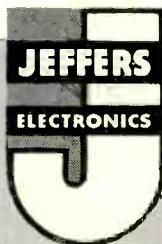

SUB-MINIATURE PILOT LIGHTS

Approved for AIRCRAFT

AND IMPROVED IN
IMPORTANT DETAILS

DIALCO

SUB-MINIATURE INDICATOR ASSEMBLIES

A great aid to your miniaturization program

MOUNT IN 15/32" HOLE
ALL LENS COLORS

Easy lamp replacement
with any midget flanged
base lamp types

Complete blackout
or semi-blackout
dimmer types

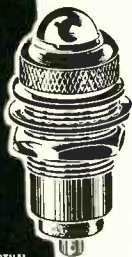

ACTUAL
SIZE

NON-DIMMING
No. 8-1930-621



ACTUAL
SIZE

MECHANICAL
DIMMER
No. 11-1930-621

THESE ASSEMBLIES LOGICALLY REPLACE
LAMPS NO. 319, 320, and 321

REPLACE
WITH THIS



NOT
THIS



OR
THIS

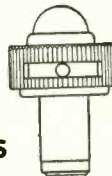

PLASTIC PLATE (EDGE) LIGHT ASSEMBLIES

AIR FORCE and BUREAU of AERONAUTICS
MIL-L-7806 DRAWING MS-25010

DIALCO No. TT-51 (Red filter-black top)
... or, No. TT-51A, complete with No. 327 Lamp

ALSO MADE
with other filter colors
and with light-emitting
top (for indication)

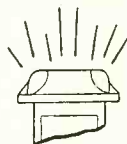

ALL OF THE ASSEMBLIES ILLUSTRATED
ACCOMMODATE LAMPS NOS. 327, 328, 330, and 331.

ANY ASSEMBLY AVAILABLE COMPLETE WITH LAMP

SAMPLES ON REQUEST — NO CHARGE

Foremost Manufacturer of Pilot Lights

The DIAL LIGHT COMPANY of AMERICA

60 STEWART AVENUE, BROOKLYN 37, N. Y.

HYACINTH 7-7600

© 1952

magnetic resonance spectrometer. Circuit values shown in Fig. 1 were used. Component R_2 is a magnet winding of several thousand henrys inductance. A one-rpm synchronous motor operating through a gear train drove R_1 .

This material was abstracted from an article entitled "A Linear Current Regulator" by John S. Waugh, James N. Shoolery and Don M. Yost which appeared in the August, 1952, issue of *The Review of Scientific Instruments*, page 441.

Improved Blanking Circuit

BY SEYMOUR CUKER

Chief Engineer
Gem Radio and Television Corp.
Jersey City, N. J.

WITH THE ADVENT of higher voltage requirements for large picture tubes, it has become necessary to relax the retrace time requirements of the horizontal sweep circuits. To maintain a short retrace, the number of components in the sweep and high-voltage circuits must be increased. The only economical procedure at present is to allow longer retrace time.

Allowing longer retrace time creates the problem of horizontal foldover, introducing an objectionable flaw in the picture presentation. To counter this defect, television engineers have utilized horizontal retrace blanking. This device introduces a so-called curtain effect on the left half of the picture because of horizontal transformer leakage reactance. The effect is most prominent and annoying at low and medium brightness levels. At high brightness levels it becomes

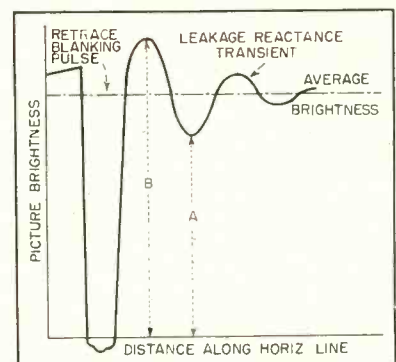

FIG. 1—Relative brightness on left side with flat subject and superimposed retrace blanking

These Transformers Have Identical
Performance Specifications —
BOTH are Grade 1
MIL-T-27



FORM FLEX®
Patent Pending

TRANSFORMERS

save:

● *over 30% in space*

● *over 40% in weight*

Where space is at a premium and weight is critical, specify **FORM FLEX** Transformers. Our engineers will discuss your problems with you at your request. Considerable performance data is available.

FORM FLEX Transformers are manufactured exclusively by Aircraft Transformer Corporation and its licensees.

Write for details

AIRCRAFT TRANSFORMER CORPORATION



MANUFACTURERS OF INDUCTIVE EQUIPMENT • LONG BRANCH, NEW JERSEY, LONG BRANCH 6-6250

Communication Products Company • Inc

Announces

We're on the march with

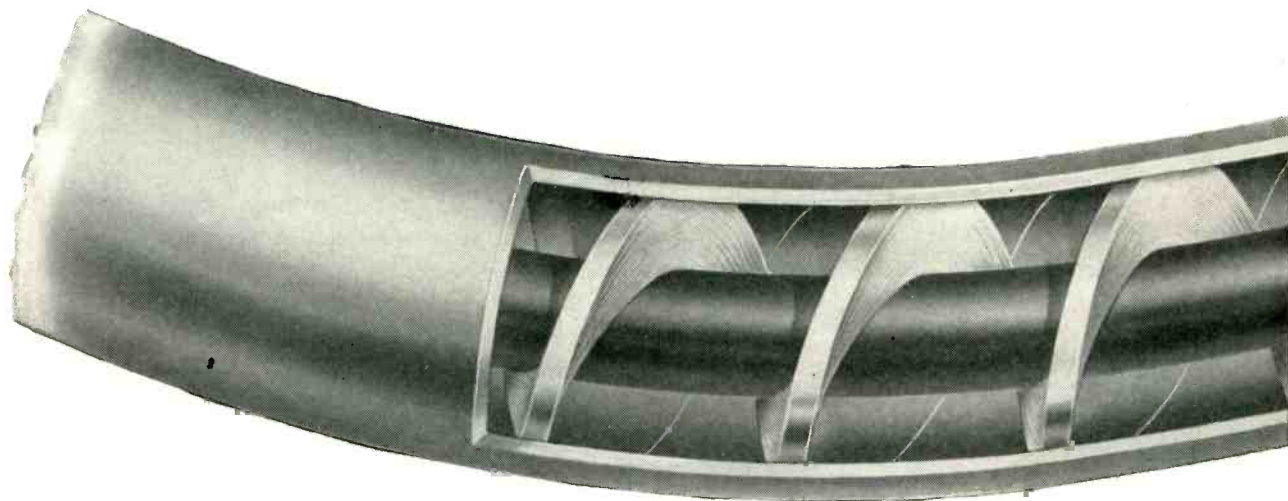

**Popular size Styroflex
Coaxial Cables, now available, include —**

OUTSIDE DIAMETER	INNER CONDUCTOR TYPE	APPROXIMATE WEIGHT PER 1000 FEET	
		NET	GROSS
50 OHM IMPEDANCE			
1/2"	SOLID	161	497
3/4"	SOLID	370	706
7/8"	SOLID	484	862
1-1/8"	TUBE	500	1185
1-3/8"	TUBE	914	1719
3-1/8"	TUBE	2728	8682
70 OHM IMPEDANCE			
1/2"	SOLID	121	457
3/4"	SOLID	276	612
7/8"	SOLID	349	727
1-1/8"	SOLID	520	1205
1-3/8"	TUBE	786	1591
3-1/8"	TUBE	2540	8440
77.5 OHM IMPEDANCE			
1/2"	SOLID	114	450
3/4"	SOLID	249	585
7/8"	SOLID	316	694
1-1/8"	SOLID	470	1155
1-3/8"	SOLID	950	1755
3-1/8"	TUBE	2460	8360

Styroflex Coaxial Cable

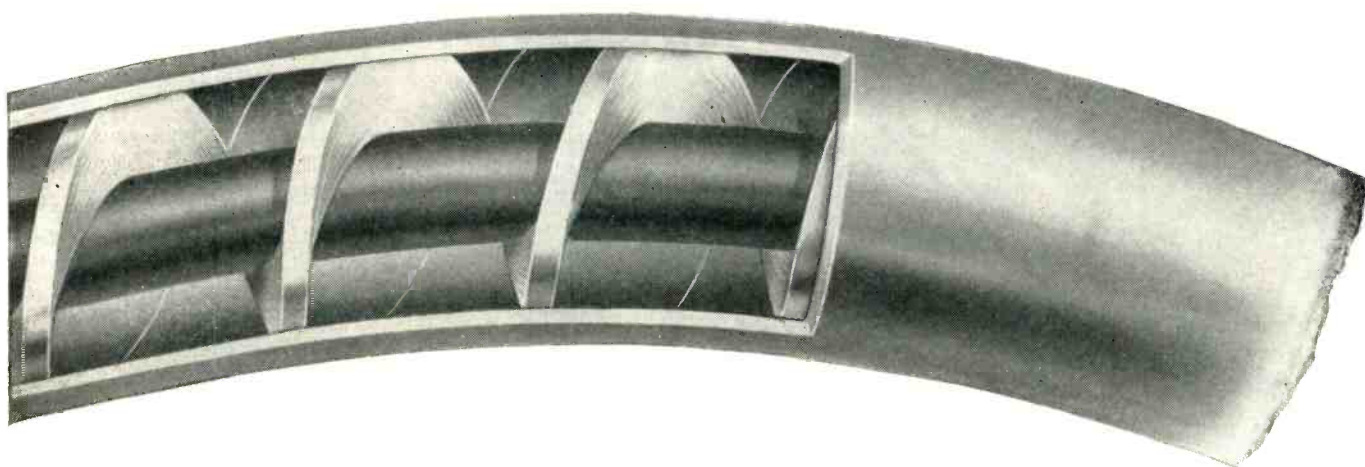

Now come to us for small or large quantities of Styroflex coaxial cable. We are ready to fill your needs with this new aluminum sheath cable as distributors for the producers — Phelps Dodge Copper Products Corporation.

We stock Styroflex cable for immediate shipment from our plant cut to length, supplied in coils or on reels, formed, fitted or otherwise fabricated to your requirements. We have developed a line of fittings for Styroflex cable soon to be available.

For a full description of Styroflex cable or its fittings send for technical literature which will be mailed at once. It includes data on losses throughout the VHF, UHF and Microwave ranges to 8000 megacycles. A price list is included.



**COMMUNICATION PRODUCTS
COMPANY • Inc**

MARLBORO, NEW JERSEY Telephone: FReehold 8-1880

minute
: or

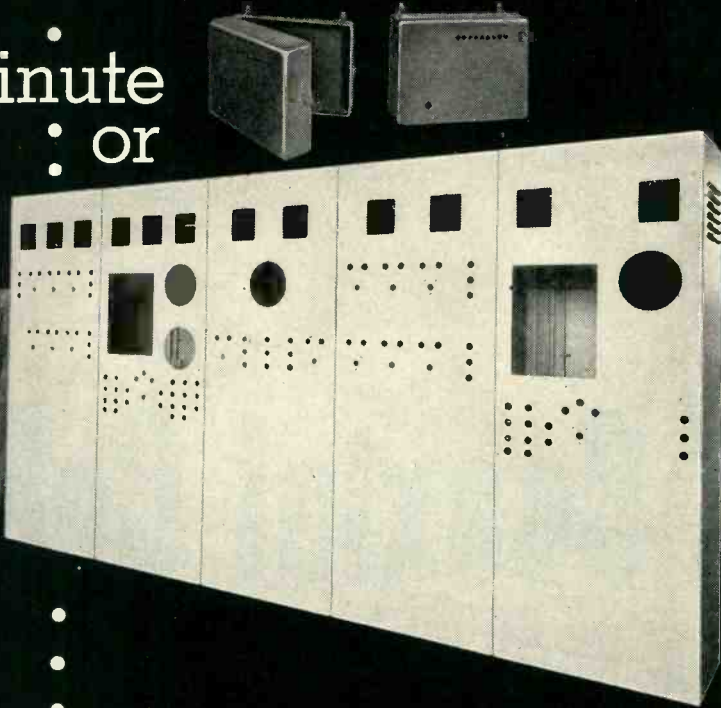

MASSIVE

KIRK AND BLUM

Electrical Enclosures

Any size . . . any shape . . . any number . . . for whatever requirement . . . KIRK & BLUM fabricating experience and facilities are at your service. Built to exacting specifications . . . we custom fabricate sheet steel, light plate, stainless, aluminum, monel and other alloys to $\frac{1}{2}$ " in thickness.

Write for your copy of the latest KIRK & BLUM Electrical Enclosures Booklet . . . for prompt quotation on any job send prints to The KIRK & BLUM MFG. CO., 3211 Forrer Street, Cincinnati 9, Ohio

Control Desks • Instrument Panels
Electrical Enclosures • Cubicles
Control Panels • Transformer Tanks
Outdoor Electrical Enclosures
Switch Gear Housings • Test Stands

KIRK AND BLUM

METAL FABRICATION

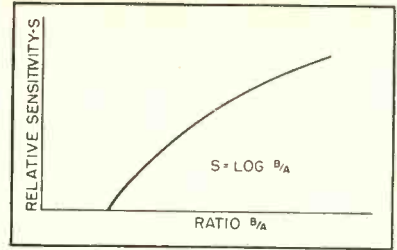

FIG. 3—Schematic diagram of the circuit with improved blanking

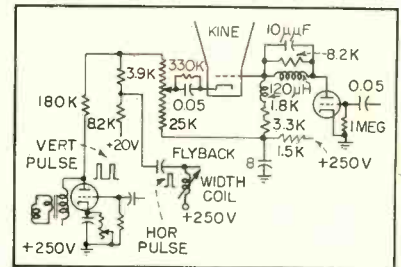

FIG. 2—Relative response to two brightness levels

almost invisible to the naked eye.

The idea described herein proposes that the retrace blanking should be reduced proportionally with the brightness level. Figure 1 shows the curtain effect in terms of a flat picture and the superimposed retrace blanking component. If the average brightness level were reduced to near zero, the half cycles above the average brightness would be light and those below the average brightness would be dark.

The eye responds to brightness logarithmically. Response is proportional to the logarithm of brightness. The relative response to two brightness levels is shown in Fig. 2. To reproduce a flat picture faithfully, the ratio B/A , Fig. 2, must be close to unity. With varying picture brightness, the perturbation must be reduced proportionally to maintain the near unity ratio of B/A .

A circuit which accomplishes the desired effect is shown in Fig. 3. This circuit also includes vertical blanking. The main advantage of vertical blanking is the complete removal of the vertical retrace lines.

Vertical blanking also introduces vertical shading at low brightness levels. Here again, the thinking applied previously to horizontal perturbation is valid. The circuit shown in Fig. 3 is one which gives, in a single stroke, positive blanking minus the usual defects attributed to blanking circuits.



ARE YOU, TOO, USING
CLEVELITE*

... the dependable Laminated Phenolic Tubing?

Products containing CLEVELITE are in use the world over

Possibly right now we can be of service to you through our Research and Engineering Laboratory on some new product, or in helping you to improve performance and lower costs.

Yes, Clevelite will be made to your exact specifications, meeting the required tolerances.

Clevelite assures you of uniformity and continued, dependable performance at lower production costs.

Hundreds of thousands of Clevelite coil forms, collars, bushings, spacers, tubes and other items are giving continuous satisfaction. Play safe! Be sure you use CLEVELITE!

Our laboratory is at your service.
 *Reg. U. S. Pat. Off.

The CLEVELAND CONTAINER Co.
 6201 BARBERTON AVE. CLEVELAND 2, OHIO

PLANTS AND SALES OFFICES at Plymouth, Wisc., Chicago, Detroit, Ogdensburg, N.Y., Jamesburg, N.J.
 ABRASIVE DIVISION at Cleveland, Ohio
 CANADIAN PLANT: The Cleveland Container, Canada, Ltd., Prescott, Ontario

REPRESENTATIVES

NEW YORK AREA R. T. MURRAY, 604 CENTRAL AVE., EAST ORANGE, N. J.
 NEW ENGLAND R. S. PETTIGREW & CO., 62 LA SALLE RD., WEST HARTFORD, CONN.
 CHICAGO AREA PLASTIC TUBING SALES, 5215 N. RAVENSWOOD AVE., CHICAGO

Production Techniques

Edited by JOHN MARKUS

OTHER DEPARTMENTS

featured in this issue:

	Page
Electrons At Work.....	168
New Products.....	310
Plants and People.....	396
New Books.....	414
Backtalk.....	430

Automatic Transformer-Testing Turntable.....	266	Wire Tension Meter Reduces Coil Re-	282
Printed TV Antenna Applied with Air-gun Stapler.....	268	jects.....	286
Photoelectric System Controls Loud-speaker Magnetizer.....	268	Chassis-Holding Fixtures.....	288
Twisting Coil Leads.....	270	Tube Burn-in Setups.....	292
Assembly Fixtures.....	270	Strand Twister.....	292
Socket Terminal Spreader.....	272	Slide-in Subassemblies Simplify Wiring and Soldering.....	298
Coil-Handling Trays.....	274	Socket-Holding Fixtures.....	300
Window-Washing Rack.....	278	Vise on Powrarm.....	302
Metering Pump for Potting Compound.....	280	Mesh-Crimping Machine.....	302
Ventilating Screen Stapler.....	308	Rack for Line Cords.....	304
		Assembling Dial Drive Cords.....	304

Automatic Transformer-Testing Turntable

POWER transformers for television and radio receivers are automatically run through six different types of tests by a new six-foot-high machine having a 15-foot diameter motor-driven turntable. On this turntable are 32 small platforms, each having a set of terminal clip-boards into which the leads of a transformer are quickly inserted. The contact clips are made of spring brass or phosphor bronze, and are so arranged that a downward pressure with a lead gives a good electrical contact. After testing, a simple upward sweep of the hand under the leads disconnects them all.

Behind each terminal clip-board are contact arms. As a particular transformer-bearing platform

passes a test position, these arms make contact with conducting bars that connect the transformer into the test circuit.

As designed by test equipment engineers of the RCA Victor Division plant in Camden, N. J., the machine has 8 test positions in all, for the following six different types of tests: turns ratio, exciting current, impedance, core loss, induced voltage breakdown and polarity, and three separate high-potential breakdown tests. Exciting current and core loss are measured only on the primary.

Each of the 32 platforms has its own roll of marking tape for indicating and identifying the nature of a reject. At each of the six test positions is a marking solenoid

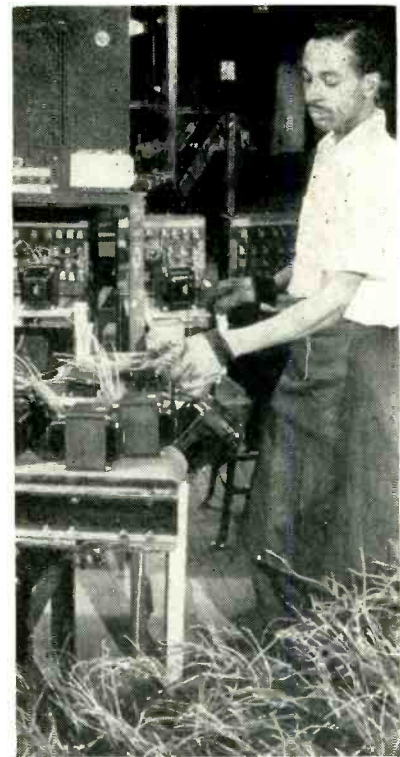

Tested transformers are placed on a conveyor belt which carries them to the packaging department. At the same time, the operator reloads the machine with untested transformers from the lift in the foreground. Other operators connect the transformer leads to the terminal clip board



Over-all view of transformer tester. The six different test positions are located above the turntable at the left

that is actuated when a transformer fails to meet specifications for that test. The solenoid brings an inked brush in contact with the paper tape when actuated by the electronic test circuit. A different color of ink is used at each test position, to identify the nature of the reject. The inking brushes are set at six different levels so that marks do not overlap, eliminating the need

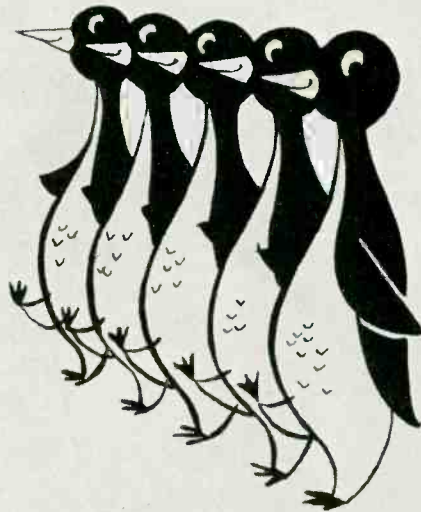

UNIFORM



KESTER FLUX-CORE SOLDER

UNIFORM In Alloy

UNIFORM In Flux Content

Right down the line, spool after spool, Kester "44" Resin, "Resin-Five" and Plastic Rosin-Core Solders offer these features of uniformity so necessary to the best in soldering.

Alloy . . . just the right amount of Tin and Lead, complying with your specifications *every time*, and only the best metals used!

Flux content . . . not a single inch of the solder is without uniform flux distribution . . . and remember, *only* Kester can give you that flexibility in core size or flux content, more or less as needed, the exact *predetermined amount*. Kester is truly an engineered Solder.

Kester meets all applicable Government Specifications.

Free Technical Manual—write for your copy of "SOLDER and Soldering Technique."

KESTER SOLDER COMPANY

4204 Wrightwood Ave., Chicago 39
Newark 5, New Jersey • Brantford, Canada

**KESTER
SOLDER**

Over 100,000 types
Kester Flux-Core Solder
Available



for automatic paper feed. For each reject, the operator tears out the marked paper and places it with the defective transformer, then pulls down more paper to the marking position.

The number of transformer-carrying platforms has little bearing on the number of test positions. Some of the factors considered in

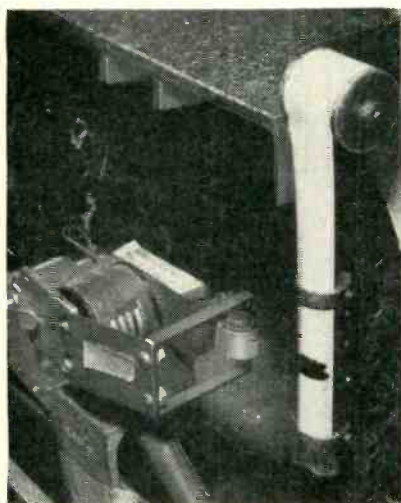

Marking solenoid at one of the test positions. One reject mark has already been made on the paper tape at the right by the inked brush of an actuated solenoid. Ordinary relay was converted to give solenoid action by bolting extension arm on armature

Printed TV Antenna Applied with Air-Gun Stapler

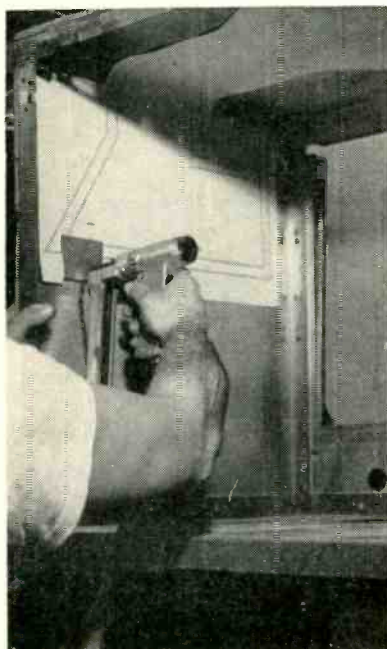

Fastening printed antenna to inside of steel-reinforced console television receiver cabinet with air-gun stapler



Transformer-carrying platform, showing how leads are inserted in terminal clips

arriving at this 32-platform design were rotary speed, desirable turntable size, sufficient time and working space for loading and unloading transformers, and provisions for installing additional test positions later if needed. The present design is entirely flexible, and can be quickly readjusted for testing various other types of transformers. The machine has increased testing efficiency more than 200 percent over previous manual testing methods.

A BUILT-IN television receiver antenna made by silk-screening aluminum paint onto heavy waterproof paper is fastened inside the cabinet of a television receiver in less than a minute with an air-operated stapler. Each time the trigger is pulled, a staple is automatically fed to driving position and driven into the wood walls of the cabinet.

A heavier power stapler and larger staples are used in assembling the cabinet itself. The cabinet framework consists of angle irons welded together. Previously punched holes in the angle-iron members are appropriately positioned so that staples can be driven through them into the plywood side walls and top of the cabinet. This eliminates costly, time-consuming gluing operations and at the same time gives a sturdy steel-reinforced cabinet construction. The chassis

shelf is all steel, welded to the angle-iron uprights.

Use of combination wood and steel construction was started in the Crosley Division of Avco Mfg. Corp. because of a wood shortage some time ago. The new technique proved so successful that it is being continued.

Wood screws are used to supplement the staples for fastening the front of the cabinet. Glued reinforcing blocks are still used behind the joining of front and top panels, this being the most exposed joint in the cabinet. For additional cabinet rigidity, the bottom steel framework is screwed to a wood base. This has the added advantage of eliminating the need for a wood pallet when shipping these consoles in corrugated cardboard cartons.

Photoelectric System Controls Loudspeaker Magnetizer

COMPLETED loudspeakers in a variety of sizes are placed face down on a heavy canvas conveyor belt for transport between the poles of the huge electromagnet used in Crosley's Cincinnati television receiver plant to magnetize the Alnico permanent-magnet fields. As a speaker moves under the electromagnet, it breaks the light beam of a GE photoelectric control system, thereby actuating the contactors that

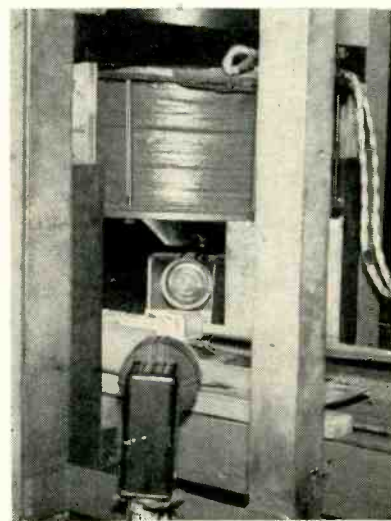

Loudspeaker magnetizing position on conveyor line. Light source is in foreground, and phototube housing is on far side of conveyor

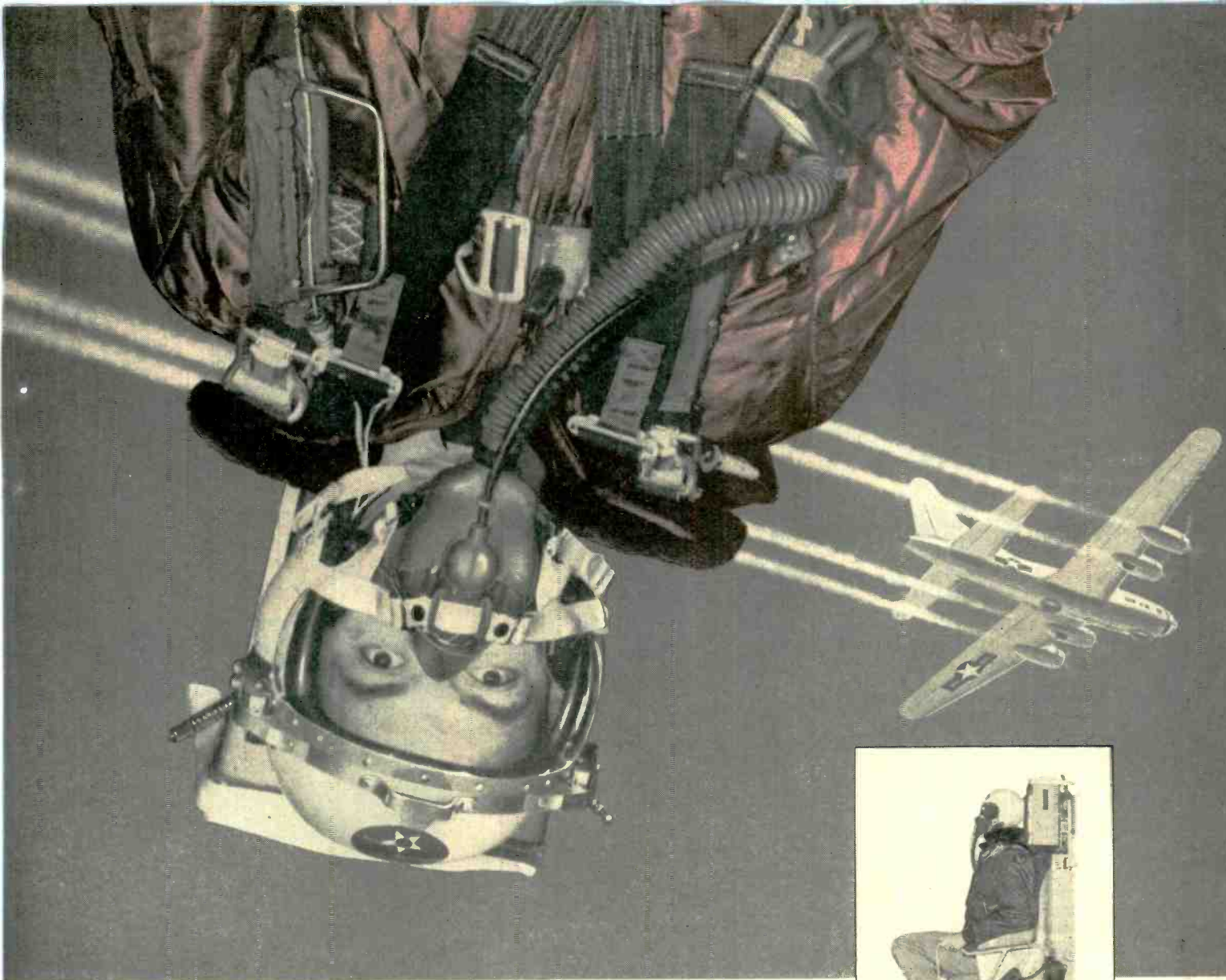

FINGER ON THE PULSE...

at more than 40,000 feet!



Can a man jump from eight miles up—and live? In its exhaustive study of high altitude bail-outs the Aero Medical Laboratory of the Air Research and Development Command's Wright Air Development Center has conducted numerous tests. Few of these were more spectacular than the world's record jump of Major Vincent Mazza, USAF.

Major Mazza fell free in his special ejection seat for 27,576 feet before his chute automatically opened, bringing him down the additional 14,600 feet in safety. And at every instant of this drop the Air Force had its finger on his pulse... and temperature... and respiration. His equipment

weighed only 70 pounds yet it included a complete Bendix-Pacific Telemetering System which radioed his physical condition to the ground station.

Bendix-Pacific developments, like its sub-miniature Telemetering Systems, are meeting today's control problems with advanced and practical electronic developments.

This division specializes in radar, radio control, electronic servo components and telemetering systems which can serve you *better*, too.

* * *

Write for a free copy of a booklet describing this division's contribution to electronics.



Bendix
Pacific Division

Bendix Aviation Corporation
NORTH HOLLYWOOD, CALIF.

high gain

LOW COST

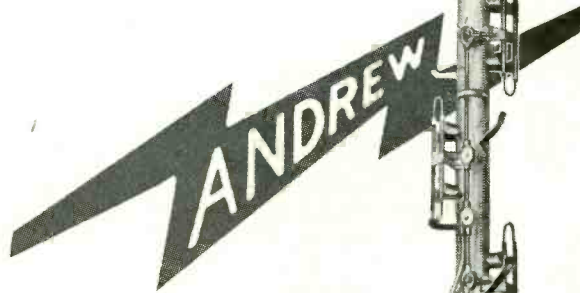

Andrew Omnidirectional Antenna for VHF Communications

No, this new High Gain Communications Antenna isn't cheap, but it does offer the most economical solution to your coverage problem. Whether you want maximum coverage for a specific transmitter power, minimum power or shortest tower for a specific coverage, or freedom from dead spots, the ANDREW Type 3000 Antenna is the least expensive solution. Why? Because talk-back is the limiting factor in mobile communications. Gain in the central station antenna costs less than increased power in every mobile unit.

ANDREW Type 3000 High Gain Communications Antenna offers better than 6 db gain in the 148-174 MCS band. This means that the power delivered to the receiver on both talk-out and talk-back is increased four times. The horizontal radiation pattern is circular.

Write for the ANDREW High Gain Antenna bulletin today!

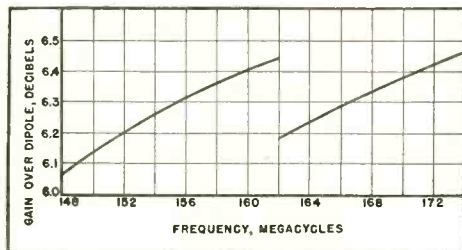

Andrew

CORPORATION

363 EAST 75TH STREET, CHICAGO 19

ANTENNA SPECIALISTS

TRANSMISSION LINES FOR AM-FM-TV-MICROWAVE • ANTENNAS • DIRECTIONAL
ANTENNA EQUIPMENT • ANTENNA TUNING UNITS • TOWER LIGHTING EQUIPMENT

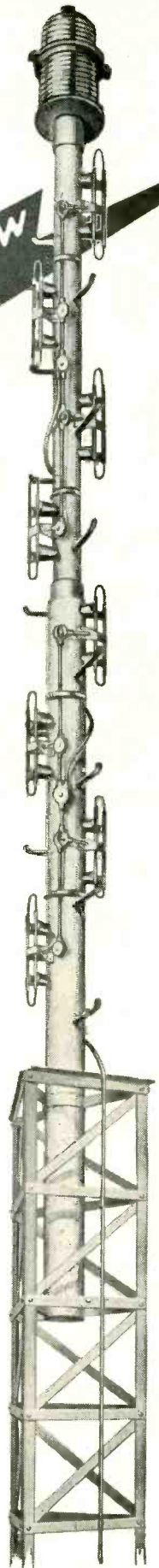

send magnetizing current through the electromagnet.

Flat copper guide sheets mounted over the belt in the magnetizing region serve to move off-center speakers into position. The copper sheets also hold down speakers that might otherwise be pulled up to the magnet pole.

Twisting Coil Leads

A MOTOR-DRIVEN chuck with a hook in its jaws is used in Crosley's Cincinnati plant to twist a tap coil lead for about two inches of its length, during production of 45-mc oscillator coils for uhf television tuners. During winding, the operator puts in only two or three turns when pulling out a loop of wire for

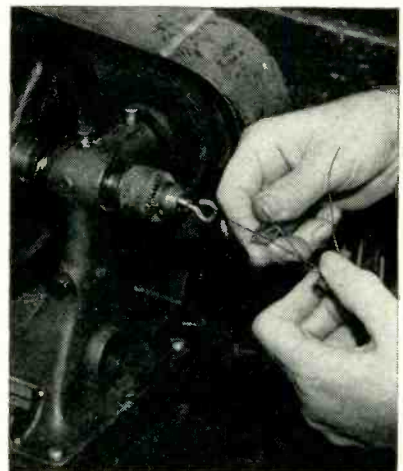

Motor-driven setup for twisting tap coil lead prior to tin-dipping

this tap. Twisting the wires by machine reduces operator fatigue and increases production about 370 percent over manual operation.

In the twisting operation, the operator loops the wire over the hook in the chuck and presses a foot switch to start the winding motor. After twisting, the wire is cut off the hook.

Assembly Fixtures

DURING final assembly of the components and subassemblies for a military radio transmitter having a cast aluminum housing with deep, narrow compartments, several different types of fixtures are used to hold the units outside of the chassis while wiring and soldering the master cable harness.

Tubular wire-wound resistors

A NEW
OPPORTUNITY
TO REDUCE
ASSEMBLY COSTS!



KEPS®

...THE PRE-ASSEMBLED NUT AND SHAKEPROOF® LOCK WASHER



SAVE TIME

Only one unit to handle
... free spinning action
assures fast, easy driving!

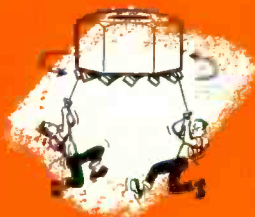

SAVE PARTS

The lock washer can't
drop off ... every nut
is locked tight!



SAVE PAPER WORK

One order does the work of
two ... nut and lock washer
inventories always balance!

Send for this
Free Sample Kit!



for Better Fastenings and Lower Assembly Costs Come to...

SHAKEPROOF

"Fastening Headquarters"

DIVISION OF ILLINOIS TOOL WORKS

St. Charles Road, Elgin, Illinois

Offices in principle cities

In Canada: Canada Illinois Tools Limited, Toronto, Ontario



TEST KEPS YOURSELF!
... see how easy they are to handle and
drive. See how much you can save!

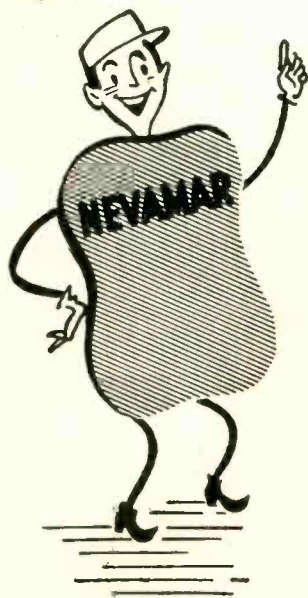
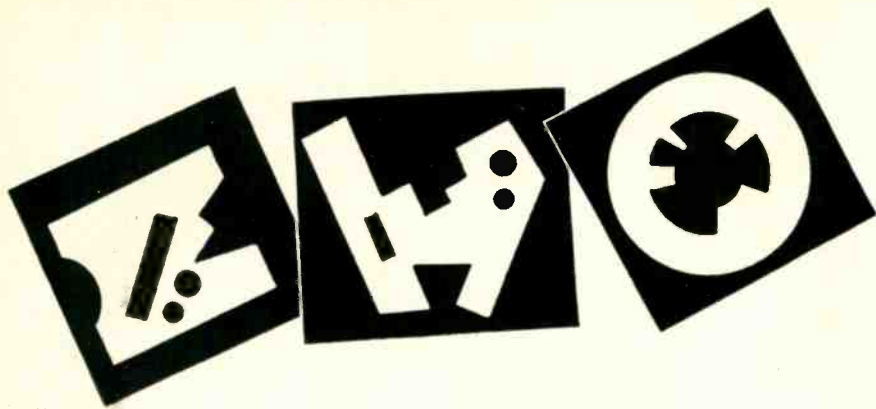

Puzzled about Industrial Laminates? **NEVAMAR**[®] has the answer for you!

Specify NEVAMAR industrial grade laminates and take all the guesswork out of making the right choice for any particular application. Produced in many different grades to meet a wide variety of requirements, NEVAMAR is backed by the engineering and manufacturing "know how" of one of America's foremost makers of high-pressure decorative laminates. This is your assurance of obtaining a superior laminate with the properties essential to numerous electrical and mechanical assemblies.



NEVAMAR meets or exceeds the standards of the National Electrical Manufacturers Association. Would you like to see samples?

The NATIONAL Plastic Products Company

Manufacturers of Nevamar Decorative and Industrial Laminates • SARAN FILAMENTS • Wynene Molded Products
 ODENTON, MARYLAND • NEW YORK: EMPIRE STATE BUILDING • LOS ANGELES: 5025 HAMPTON STREET

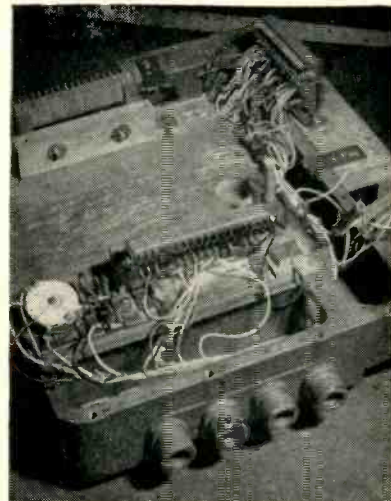

Use of fixtures to permit soldering of wiring harness outside of combination housing and chassis. All wood is treated to prevent warpage. With wood fixtures, reworking is usually possible when specifications are changed

are slipped over metal pegs on the fixture board. Controls are supported by inserting their shafts in drilled holes. Two small, closely-spaced wood blocks grip the soldering-lug termination of a lead. Swinging metal tabs hold other parts in position for this operation in the Clifton, N. J. plant of Federal Telephone and Radio Corporation.

Socket Terminal Spreader

AFTER completion of socket terminal wiring for an IBM electronic calculator panel having over 200 closely spaced tubes, the terminals are spread outward at a uniform angle with a special conical-face tool de-



Using conical tool to spread out tube socket terminals after wiring is completed

"27 inches! If our tube is to be that big, how about cost?"



NEW 27EP4 PROVIDES GIANT-SCREEN TV AT A PRICE YOU CAN AFFORD!

TUBE PLUSSES ARE:

- ★ Extremely short length, for compact cabinet construction.
- ★ Aluminized to give you a bright, sharp picture at 16,000 v!

DESIGNERS and manufacturers now can plan production of that deluxe TV with super-size picture! Distributors will order your new set in volume, for 27EP4 cost—only *one-third* that of a 30-inch type—permits, for the first time, real giant-screen TV at a sensible retail level.

Over 400 square inches of picture, or $\frac{3}{4}$ the viewing area of a 30-inch round tube! Compact, because of the 90-degree deflection angle—so short that tube length is the same as picture width, 24 inches! Means a trimmed-down, practical cabinet.

Filter-glass face, *aluminized* for maximum brightness and contrast at moderate voltage—16,000 v, no more than a 21-inch standard tube requires for top-quality viewing!

Get all the facts without delay. Phone, wire, or air-mail *Tube Department, General Electric Company, Schenectady 5, N. Y.*



27EP4

Picture width	24 inches
Picture height	18½ inches
Deflection angle	90 degrees
Tube length	24 inches
Recommended operating voltage	16,000 v
Focus	magnetic
Screen	Filter glass, aluminized



GENERAL  ELECTRIC

162-146

Here's why those in the know

—demand

CANNON PLUGS

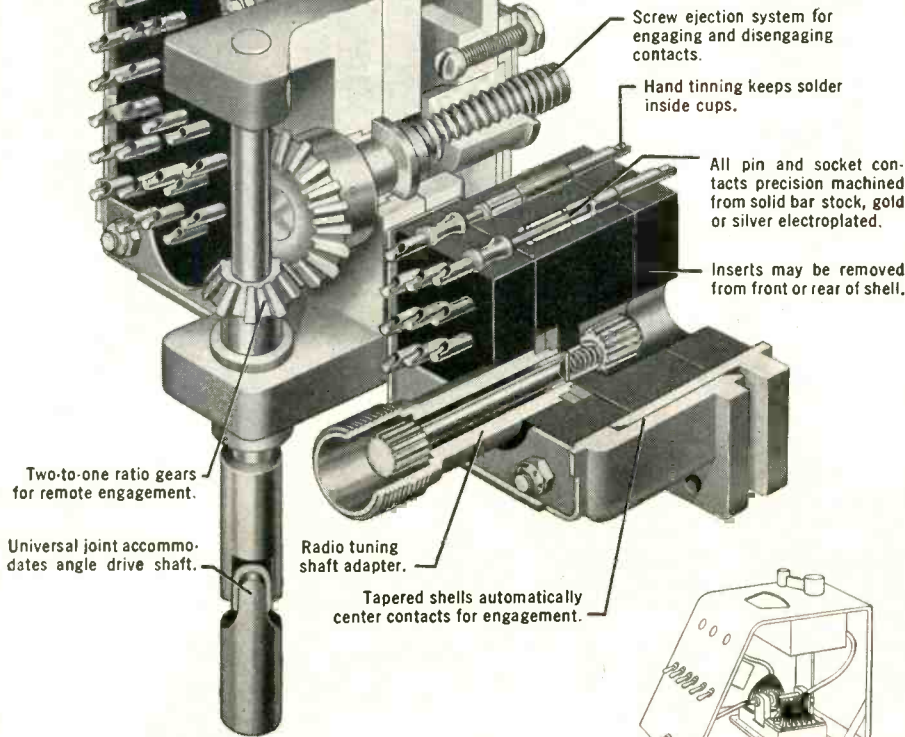

This highly specialized DPD2 Cannon Plug, a member of the DP Series, has its principal use in aircraft instrument panels and remote radio control equipment. But, like many other Cannon Plugs, it has found its way into other fields where the highest quality is needed and where the value of long, trouble-free performance is recognized.

Originally this 2-gang connector was designed to assist in the standardization of radio and instrument assemblies so that such equipment might be interchangeable between similar aircraft. It allows for compact design in close quarters with access from the front only. This type of application and variations of the fittings are shown at right. Any Cannon DPD insert may be placed within the shell, with or without tuning shaft, coax, twinax, large or small contacts, provided the separation forces of both halves are similar.

This plug typifies the close attention to important detail that distinguishes every Cannon Plug—the world's most extensive line. If you are looking for real value, regardless of the field you work in, your best bet is Cannon.

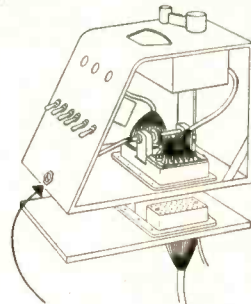

Connector is separated by turning slotted shaft here. Complete unit may then be removed from pedestal, shown below.

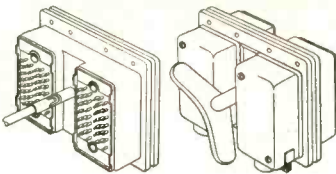
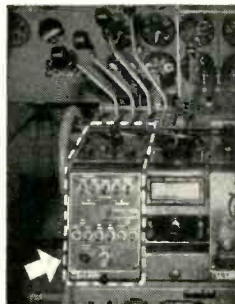

(Left) Same Cannon Plug without tuning shaft. Straight drive instead of 90° gear. (Right) Similar DPD2 with Dzus wing nut extraction method and junction shells. There are several other variations. Write for details.

CANNON ELECTRIC

Since 1915

CANNON ELECTRIC COMPANY
LOS ANGELES 31, CALIFORNIA

Factories in Los Angeles, Toronto, New Haven. Representatives in principal cities. Address inquiries to Cannon Electric Company, Dept. K-120, P.O. Box 75, Lincoln Heights Station, Los Angeles 31, California.

vised for this purpose.

This tool is pushed against the bottom of each socket in turn and twisted slightly. It serves to spread out terminals that may have been bent inward during wiring, insuring exactly uniform clearance between all terminals. With this tool, the operation takes only a few minutes for an entire panel in the Poughkeepsie plant of International Business Machines Corp.

Coil-Handling Trays

FOUR different types of Crosley-designed trays are used to protect television receiver coils from damage while they are being transported from one assembly station to another in this firm's Cincinnati plant. The trays also serve for transporting the coils in large

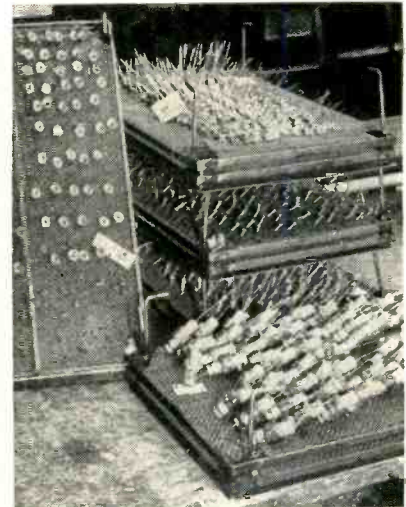

Wire-screen trays for holding, moving and storing coils and other parts having axial leads

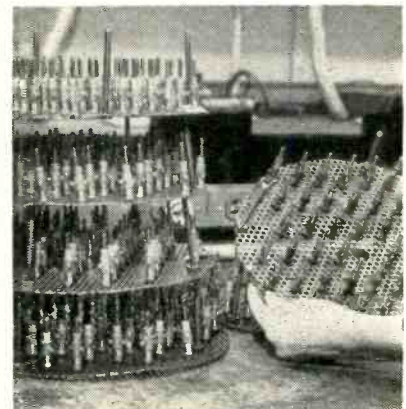

Coil-holding trays made from perforated metal and stove bolts. Round shape permits use on stem of spinner in wax-impregnating tank

HERE'S THE WIRE THAT CUTS YOUR PRODUCTION COSTS



FOR 50 YEARS
Wiremaker for
Industry

To You,
Belden's Golden Anniversary Means

—product performance that can come only from a "know-how" that has grown through actual service since the early days of the electrical industry.

—an ability to cooperate in pioneering new wires to meet or anticipate industry's growing needs.

In the years that follow
This Belden Program Is—
TO BE CONTINUED



No stripping problem. Celenamel Film removed when dipped in solder. Large economies effected in your production.

Belden Manufacturing Company
4625 W. Van Buren Street
Chicago 44, Illinois

Belden
CELENAMEL



TRADEMARK REGISTERED

Belden
WIREMAKER FOR INDUSTRY

New 8020 TAYLOR HIGH VOLTAGE RECTIFIER

... Custom Built Companion
to Insure the Efficiency
of Your Own
Excellent Design

Taylor's reputation in the rectifier field has long been associated with operating efficiency and dependable service.

The new type 8020 high voltage rectifier is well up to Taylor's established quality standards. Its construction features a specially treated tantalum anode for stability and long life. The 5 Volt-6 Ampere filament is of the thoriated tungsten type. Envelope is of nonex glass and the standard four-prong base is securely fastened with an oil resisting silicone basing compound. Life expectancy of the 8020 is over 5000 hours when operated within ratings.

The Taylor 8020 warrants your consideration.



Taylor 8020 Ratings

The 8020 is rated at 40 KVP inverse or forward in air, 60 KVP in oil. Average current: 100 MA, with instantaneous peak current capacity of 2 Amp.

★ TRANSMITTING
★ RECTIFIER

★ INDUSTRIAL
★ ELECTRONIC

As always, Taylor is producing tubes of superior quality and outstanding performance. The Taylor Representative nearest you is ready and willing to discuss your particular requirements. Call on him for information any time.

Taylor HEAVY CUSTOM BUILT DUTY **Tubes**

TAYLOR TUBES INC., 2312-18 WABANSIA AVE., CHICAGO 47, ILL.

Canada: Atlas Radio Corp., Ltd.
560 King St., W., Toronto 2-B
Cable: ATRADCO

Export: Royal National Company
75 West St., New York 6, N. Y.
Cable: NATVARNCO

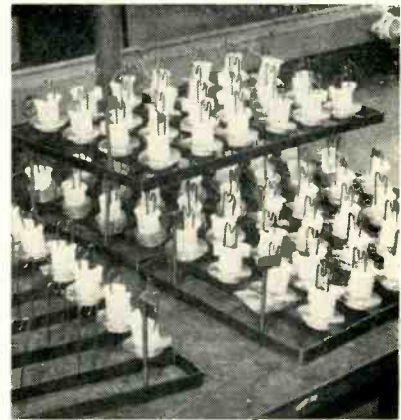

Welded tray using lead-holding wire loops as coil supports

batches through a wax-impregnating operation.

For coils with pigtail leads, such as those wound around a resistor, a paper capacitor or a plain coil form, the tray consists of two layers of $\frac{1}{8}$ -inch-mesh wire screen. The layers are spaced about an inch apart on a metal framework. The leads of the coils are pushed through the holes in the screen. Metal studs with bent tops are welded to each corner of a tray to permit stacking without risk of crushing coils.

Another type of tray, used for small coils having center holes, requires no welding. The tray is a single disk of perforated sheet metal. Bolts inserted in the punched holes serve as individual supports for the coils. Each bolt is locked in position with a single nut. Four longer and heavier bolts spaced equidistant around the circumference serve as standoffs to permit stacking of the trays. Each tray has a large center hole that goes on the stem of the spinner in the impregnating tank, so that excess

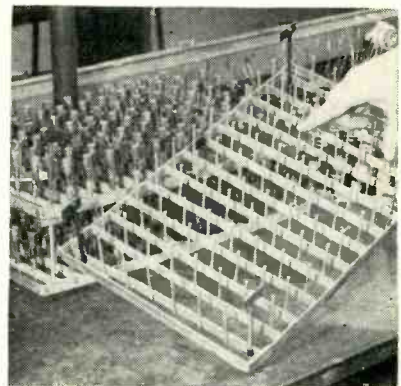

All-welded tray construction using metal rods as coil supports

for electronic advancement

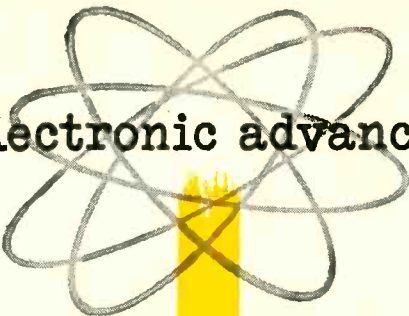

28 Volt D.C. Motor Actuated Coaxial Switch Model CA-71



Lobing Switch Model CA-31



Manual Coaxial Switch Model CA-36



Motor Actuated Coaxial Switch Model CA-26



1P-2T Coaxial Switch Model CA-20

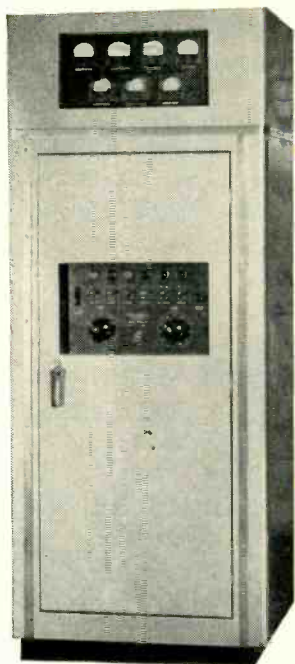

High Voltage Power Supply Unit Model BP-01

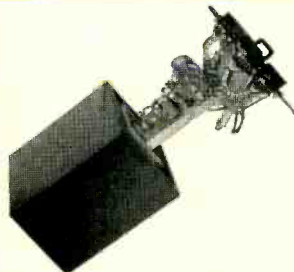

RF & Power Switch Model CA-60



Antenna Switch Model CA-57



Transfer Switch Model CA-19

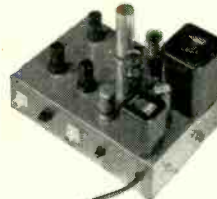

Logarithmic Amplifier Model BA-01

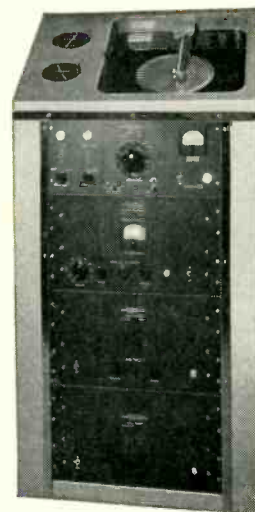

Polar Recorder Model BU-02

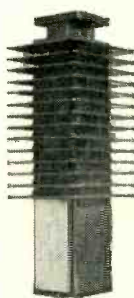

Dummy Load Model BL-07

The research facilities of Thompson Products are helping in the development of the electronic industry. In fact, many electronic developments owe part of their creation to Thompson research or Thompson-made equipment.

We are proud of our contributions—and, we think, justly so. On the other hand—we *should* do a top job! We are equipped to solve tough problems. Thompson has two plants—one in Cleveland, another in Columbus, Ohio—devoted exclusively to research engineering and manufacturing of electronic equipment. And our facilities stand ready, willing and able to help you solve your every problem—whether today's production or tomorrow's design—in coaxial switches, antennae, specialized test equipment or wave guide and coaxial components and accessories.

For complete information, we invite you to write, wire or telephone!

YOU CAN COUNT ON THOMPSON



Thompson Products, Inc.
ELECTRONICS DIVISION

2196 Clarkwood Road

Cleveland 3, Ohio

These American Electric Miniatures do **BIG** jobs!

Cooling and Ventilating

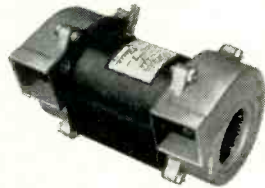

CENTRIFUGAL BLOWERS

400 cycle, 60 cycle, or variable frequency types (320 to 1000 cps.)

Substantially flat output over full frequency range on variable frequency models with minimum watts loss.

Blower scrolls of latest design are molded of fibre-glass reinforced plaskon: practically unbreakable, highly resistant to impact, deformation, heat and cold. Blower unit unusually small in size and weight for compact installations. Generally used when working against pressure heads ranging up to 1.2" water. Single or double end blowers. Clockwise or Counterclockwise rotation. Output range: 24 to 200 cfm. Made in sizes: Numbers 1½, 2, 2½, 3.



AXIAL FLOW FANS

400 cycle operation

In its smallest size this compact, light weight unit is equipped with a 2" fan protected with 18" mesh 2¼" O.D. screen shroud. Other larger sizes special. Air stream is conical. Recommended for use at 0 static pressure where semi-directed air flow is required. Motor diameter 1.45". Rotation: Clockwise or Counterclockwise. Output: 30 cfm.



PROPELLER FANS—400 cycle operation

Built for limited space applications requiring maximum air movement widely dispersed.

Operates at 0 static pressure in ambient temperatures from -65° to +65° C. Made in 2, 3, 4 and 5½" fan diameters. Output range: 33 to 680 cfm.

Motivating Cams, Timing Devices, Antennas, Clutches, Optical Equipment, etc.



MINIATURE INDUCTION MOTORS

400 cycle, 60 cycle, single and poly phase, 2 to 8 pole. Frame diameters: 1.45", 1.75", 2", 2½" & 3-5/16". Output torque range: ½ in. oz. to 50 in. oz.



SYNCHRONOUS MOTORS

400 cycle, 60 cycle, hysteresis and reluctance types. Single and poly phase: 2, 4 and 6 pole. Frame diameters: 1.45", 1.75", 2", 2½", 3-5/16". Output torque range: .01 in. oz. to 10 in. oz.

Both induction and synchronous motors can be supplied for intermittent or continuous duty, with standard or high temperature insulation. Drive and synchronous motors: any standard shape.

Manufacturers also of
INSTRUMENTS,
SERVO-MOTORS AND
SYNCHROS,
HIGH FREQUENCY
POWER SUPPLIES
(Inductor—Alternator type—
500 watt to 75 KVA output).



wax can be driven out from all coils on a stack of trays in one operation.

All-welded construction is used on a rectangular tray also intended for coils having center holes through the forms. Coil-supporting metal rods are welded to strap iron strips and these in turn are welded inside a rectangular strap iron frame. Larger rods welded to the four corners serve as standoffs; these have sign-like metal pieces welded to their tops to get greater bearing surface.

A modified rectangular tray uses wire loops instead of rods as supports for larger coils. The loops have double peaks to provide a valley in which the delicate leads of the coils can be placed, to prevent these leads from getting tangled and broken.

Window-Washing Rack

CLEANING of safety glass windows for television receivers is speeded by use of a grooved wood frame which holds the glass rigidly in a vertical position. The operator can then clean and dry both sides of the glass simultaneously, using both hands. A better cleaning job is obtained because any remaining spots and smears can be cleaned from both sides without trying to figure



Window-cleaning rack. Safety dispenser for cleaning fluid can be seen on other side of glass

New!

UNITED High Voltage Power Diodes

Much Smaller—Same Ratings

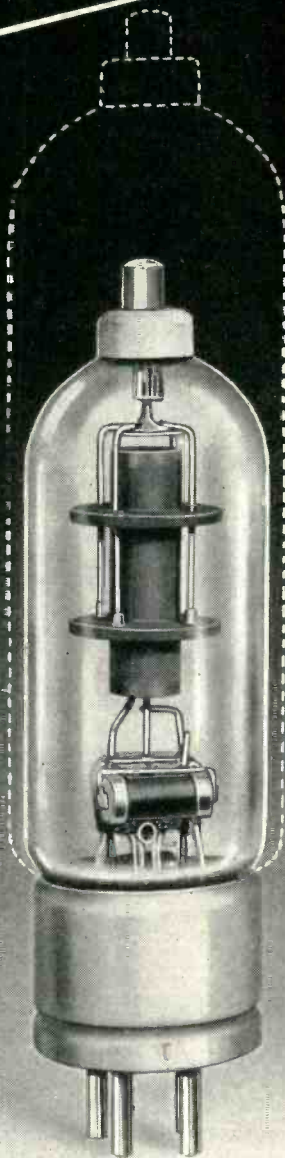

TYPE 577
New small version
of 371-B

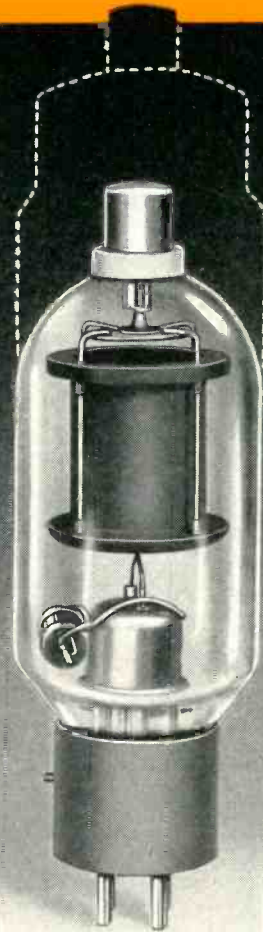

TYPE 578
New small version
of 8020

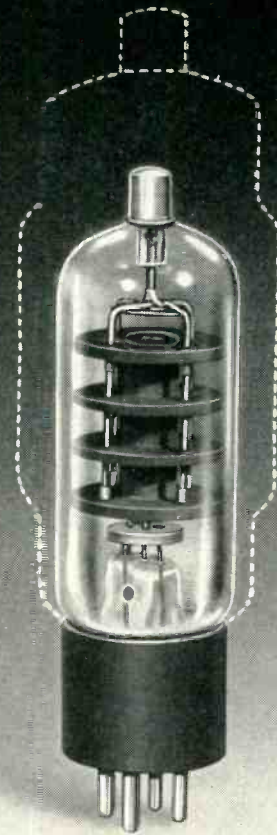

TYPE X-22
New small version
of 1616

Illustrations show relative sizes

AIRBORNE radar and other electronic equipment can be made much smaller and lighter by use of these modern, smaller tubes. UNITED has designed types 577, 578 and X-22 as exact elec-

trical replacements for JAN preferred list types 371-B, 8020 and 1616, in applications where space and weight conservation is important.

Write for full specifications.

UNITED



ELECTRONICS, 42 Spring Street, Newark 2, N. J.

(TRANSMITTING TUBES EXCLUSIVELY Since 1934)

HOW TO SQUEEZE PENNIES OUT OF UPSET SPECIALS COSTS

Specially designed upset products are solving thousands of problems. Dozens of design pointers on them are yours for the asking. Send us your sketches, prints, finished products for suggestions.

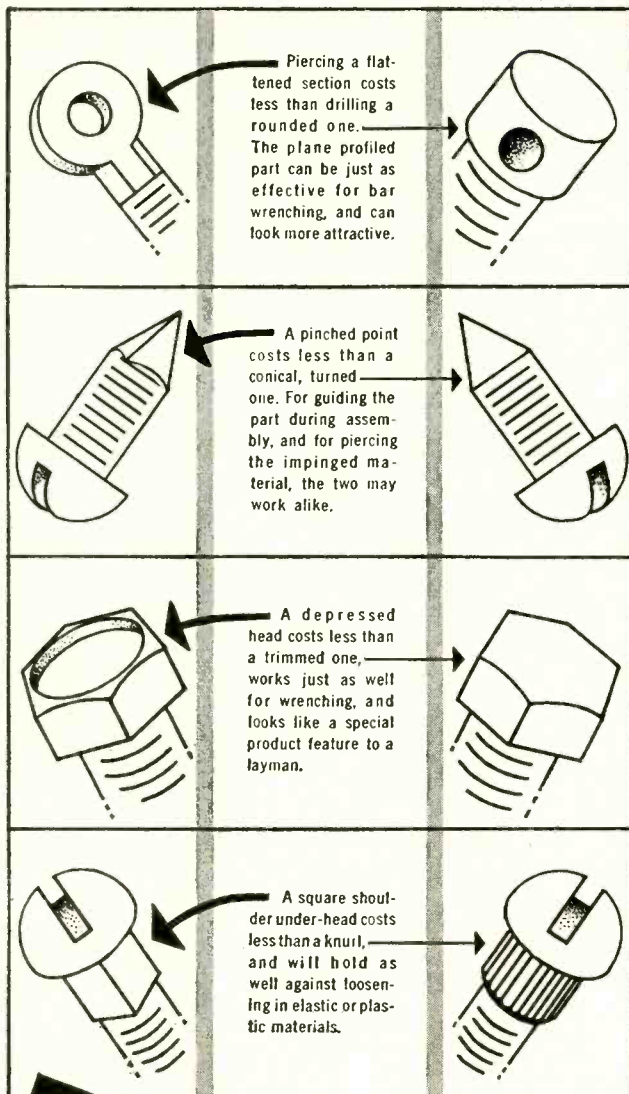

REPRINTS

of this chart are available on request for use in drafting and purchasing departments.



MACHINE SCREWS AND SPECIAL FASTENERS ARE OUR BUSINESS

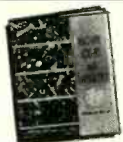

WRITE FOR OUR CATALOG

**THE PROGRESSIVE
MANUFACTURING COMPANY**
50 NORWOOD ST., TORRINGTON, CONN.

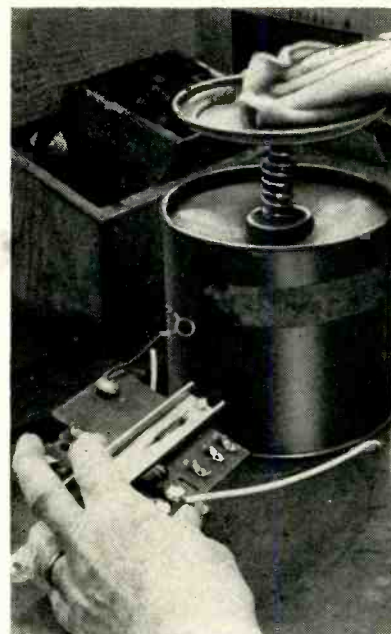

Safety dispenser for cleaning fluid, being used here with a solvent for removing smeared rubber-stamp markings from a subassembly panel

out on which side of the glass they are.

The cleaning fluid used for this operation is So-Clear, made by SOHIO Labs. in Cleveland. The fluid is kept in a special dispensing can made by Protectoseal Co., Chicago. The operator merely presses the cloth down on a sprinkler-type head to actuate a pump inside that forces the fluid up into the cloth.

Metering Pump for Potting Compound

FILLING of television divider network molds with Plastisol potting compound is speeded up in the plant of LaPointe-Plascomold Corp., Windsor Locks, Conn. through use of a metering pump made by E. E. Robinson Inc., Nutley, N. J. Accuracy of metering resulted in a saving of material along with increased production and reduced unit costs.

The pump employs a thermostatically-controlled heated tank that can liquify most solid waxes in less than an hour from a cold start. The pump has a positive gear drive which forcibly ejects fluid compounds with a volume accuracy of three percent and a rate of up to 88 ejections per minute.

In this example, the potting com-



MICROTRAN[®]

hermetically sealed transformer available as stock items

These ruggedized military type units were developed to meet demands of a growing miniaturization program.

All units are available from stock in hermetically sealed cans, although open frame units may be ordered. Open frame units are Epoxy Resin impregnated to provide thorough protection from adverse climatic conditions and are supplied with flexible 3" color coated leads.

Also available on special order for MIL applications are standard MIL type cases.

MINIATURE TRANSFORMERS

PART NO.	MIL TYPE	APPLICATION	PRIMARY IMPED.	SECONDARY IMPED. Ω	RESPONSE ± 2 db. (C.P.S.) MAX. LEVEL 10 db.	LIST PRICE
M1	TF1A10YY	Mike pickup or line to 1 grid	50, 200, 500	50,000	20-20,000	\$15.40
M2	TF1A10YY	Mike pickup or line to 2 grids	50, 200, 500	50,000	20-10,000	15.40
M3	TF1A10YY	Dynamic mike to 1 grid	7.5, 30	50,000	20-20,000	14.30
M4	TF1A15YY	Single plate to 1 grid	15,000	60,000	20-15,000	12.10
M5	TF1A15YY	Single plate to 1 grid	15,000 4MA.D.C.	60,000	200-20,000	12.10
M6	TF1A15YY	Single plate to 2 grids	15,000	95,000	20-15,000	14.30
M7	TF1A15YY	Single plate to 2 grids	15,000 4MA.D.C.	95,000	200-20,000	14.30
M8	TF1A13YY	Single plate to line	15,000	50, 200, 500	20-20,000	15.40
M9	TF1A13YY	Single plate to line	15,000 4MA.D.C.	50, 200, 500	150-20,000	15.40
M10	TF1A13YY	Push pull plates to line	30,000 ohms P.-P.	50, 200, 500	30-50,000	15.40
M11	TF1A10YY	Crystal mike to line	50,000	50, 200, 500	20-20,000	15.40
M12	TF1A16YY	Mixing and matching	50, 200	50, 200, 500	30-40,000	14.30
M13	TF1A20YY	Reactor 300 HYS. - No D.C.: 50 HYS - 3MA. D.C.		6,000 ohms D.C. res.		11.00
M14	TF1A10YY	50: 1 mike or line to 1 grid	200	1/2 Megohm	80- 3,000	15.40
M15	TF1A15YY	10: 1 single plate to 1 grid	15,000	1 Megohm	100-2,500	15.40

SUB MINIATURE TRANSFORMERS

PART NO.	MIL TYPE	APPLICATION	PRIMARY IMPED. Ω	SECONDARY IMPED. Ω	RESPONSE ± 2 db. (C.P.S.) MAX. LEVEL 6 db.	LIST PRICE
SM1	TF1A10YY	Input	200, 50	250,000, 62,500	80-10,000	\$12.90
SM2	TF1A15YY	Interstage 3:1	10,000	90,000	100-10,000	12.90
SM3	TF1A13YY	Plate to line	10,000 (3MA.)-25,000 (1.5MA.)	200, 500	150-10,000	12.90
SM4	TF1A13YY	Output	30,000 1MA.D.C.	50	70-10,000	12.90
SM5	TF1A20YY	Reactor 50 HY at 1 mil D.C.	4,000 ohms D.C. res.			10.90
SM6	TF1A13YY	Output	100,000 .5MA.D.C.	60	100-10,000	12.90

MICRO MINIATURE TRANSFORMERS

PART NO.	MIL TYPE	APPLICATION	PRIMARY IMPED. Ω	SECONDARY IMPED. Ω	RESPONSE ± 2 db (C.P.S.) MAX. LEVEL 0 db.	LIST PRICE
MM1	TF1A10YY	Input	200, 50	250,000, 62,500	200-10,000	\$12.90
MM2	TF1A15YY	Interstage 3:1	10,000	90,000	150-10,000	12.90
MM3	TF1A13YY	Plate to line	10,000 (3MA.)-25,000 (1.5MA.)	200, 500	150-10,000	12.90
MM4	TF1A13YY	Output	30,000 1MA.D.C.	50	150-10,000	12.90
MM5	TF1A20YY	Reactor 50 HY at 1 mil D.C.	3,500 ohms D.C. res.			10.90
MM6	TF1A13YY	Output	100,000 .5MA.D.C.	60	200-10,000	12.90

TRANSISTOR TRANSFORMERS

PART NO.	MIL TYPE	APPLICATION	PRIMARY IMPED.	SECONDARY IMPED.	N	LIST PRICE SM & MM
*T1	TF1A10YY	Input-Line to emitter	500	500		\$14.50
*T2	TF1A10YY	Input-Hi impedance mike to emitter	50,000	500		15.70
*T3	TF1A15YY	Interstage-collector to emitter	50,000	500		15.70
*T4	TF1A13YY	Output-collector to line	50,000	500		15.70
*T5	TF1A13YY	Output-collector to speaker	50,000	6		14.50

* Add M Prefix to indicate miniature size, SM for sub-miniature size, MM for micro-miniature size. Size to be used depends on D.C. current, frequency response and power output requirements. Write for full details.

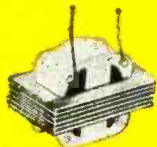
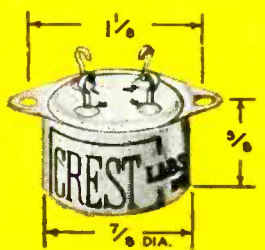
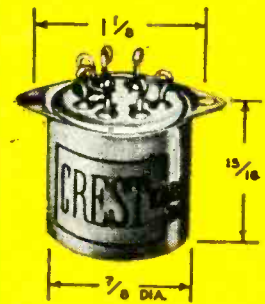

Open Frame Construction

Immediate delivery of stock items!

Our circuit design department can assist you in your miniaturization problems. Our recent developments of HI "Q" audio transformers for single frequency applications have permitted substantial reduction in equipment complexity.

CREST

Write for Catalogue M and name of nearest representative.

LABORATORIES, INC.

Whitehall Building, Far Rockaway 91, N. Y.

Standard push button ATTENUATOR



for true **V.H.F.** measurements

This outstanding "Standard" V.H.F. Attenuator now in its second year of production remains the first and only accurate instrument of its kind and continues to meet a heavy demand from leading organisations and authorities the world over.

Four models now available

Characteristic Impedance	75 ohms	50 ohms
0-9 db in 1 db steps	Type 74600-A	Type 74600-E
0-90 db in 10 db steps	Type 74600-B	Type 74600-F

All types will handle inputs up to 0.25 watts.

Accuracy of D.C. adjustment

0-9 db Models: The insertion loss error will not exceed ± 0.05 db for any setting.

0-90 db Models: The insertion loss error for the 90 db setting will not exceed ± 0.3 db. For other settings this limit falls linearly to a value of ± 0.06 db at the 10 db setting.

High frequency performance

0-9 db Models: At 50 Mc/s the insertion loss error for the 9 db setting will not exceed ± 0.15 db. For other settings this limit falls linearly to a value of ± 0.05 db for the 1 db setting.

0-90 db Models: At 50 Mc/s the insertion loss error will not exceed ± 0.1 db per step. N.B. All insertion loss errors are relative to zero db setting.

Ready for Building into your own equipment. Calibration charts for frequencies up to 100 Mc/s for the 0-9 db models or 65 Mc/s for the 0-90 db models can be supplied on request.

Standard Telephones and Cables Limited

(An I.T. & T. Associate)

TRANSMISSION DIVISION, NORTH WOOLWICH, LONDON, E16



Method of using metering pump for filling large number of Vee-D-X television divider network molds one after another. Molds are held rigidly in metal frame having locking nut at one end

pond is a vinyl copolymer dispersion made by New England Tape Co., Hudson, Mass. When subjected to fusing heat of about 375 F and allowed to cool, it jells to a solid mass that is thermoplastic. Cooling may be hastened by immersing in cold water.

Wire Tension Meter Reduces Coil Rejects

BY ERWIN J. SAXL
President, Saxl Instrument Co.
Harvard, Mass.

IN WINDING coils, wire-wound resistors and tube grids, the tension of the wire is a critical factor affect-



Saxl tension meter in use on coil winder in plant of New England Transformer Co.

if you need a
BIG QUANTITY OF SMALL PARTS
IN A HURRY at LOWEST COST
then your best bet is probably

ALSIMAG[®]

CUSTOM MADE
TECHNICAL CERAMICS

Most people seem to think of us as quality manufacturers with a lot of ability to produce just the right ceramic for any specific job. We're glad it's that way. Quality and versatility are mighty important.

But sometimes the first requirement is for a lot of small parts in a big hurry and at the lowest possible cost. That is another place we shine. And we're pretty good on smaller quantities too.

You'll have to look a long time to find another outfit with as much high speed automatic equipment. Some of it was designed and built in our own shop. Our one machine we are currently producing 1,800,000 pieces a day and meeting high quality standards . . . at a mighty low price. We believe it would pay you to check with us . . . especially when you need big quantities.

• Send your sketch, outline of requirements and quantity and let us show you what we can do for you.

51ST YEAR OF CERAMIC LEADERSHIP

AMERICAN LAVA CORPORATION

CHATTANOOGA 5, TENNESSEE

OFFICES: METROPOLITAN AREA: 671 Broad St., Newark, N. J., Mitchell 2-8159 • PHILADELPHIA, 1649 North Broad St., Stevenson 4-2823
SOUTHWEST: John A. Green Co., 6815 Oriole Drive, Dallas 9, Dixon 9918 • NEW ENGLAND, 1374 Massachusetts Ave., Cambridge, Mass., Kirkland 7-4498
LOS ANGELES, 5603 North Huntington Drive, Capitol 1-9114 • CHICAGO, 228 North LaSalle St., Central 6-1721 • ST. LOUIS, 1123 Washington Ave., Garfield 4959



TIME DELAY RELAYS

400 CYCLE
TIMING
MOTORS

HAYDON
AT TORRINGTON
HEADQUARTERS FOR
TIMING

INTERVAL
TIMERS

ELAPSED TIME
INDICATORS

60 CYCLE
TIMING MOTORS



**400 CYCLE
HERMETICALLY SEALED
ELAPSED TIME
INDICATORS**

FOR *Airborne Applications*

The HAYDON* 7008 Elapsed Time Indicator indicates operating time of components with specific life or servicing requirements. This unit offers the unusual advantages of small size, hermetic sealing and 400 cycle operation for such applications as electronic devices, where tubes or other components should be replaced at specified intervals. Running time indicators can prevent unnecessary servicing, insure timely maintenance that protects against failure in operation.

HAYDON specializes in the manufacture of timing components for standard applications and in the design and production of custom-engineered timers for volume applications. The basic element of all HAYDON timers is our own rugged industrial-type motor which assures long, quiet operation. Their compact design and ability to operate in any position afford designers unusual latitude.

HAYDON also manufactures a variety of timers specifically designed for 60 cycle, 400 cycle or D.C. operation in military applications. The 5103 Series "trigger-trip", hermetically sealed Time Delay Relays are available in a wide range of delays from seconds to hours.

COMPLETE INFORMATION

Write for information you need: catalogs on motors or devices; bulletins on D.C. motors, 400 cycle motors, time delay relays, and elapsed time indicators.

*TRADEMARK. REG. U.S. PAT. OFF.



HAYDON Manufacturing Co., Inc.

Subsidiary of GENERAL TIME CORPORATION

2435 ELM STREET

TORRINGTON,

CONNECTICUT

ing product quality and output.

If tension is excessive, the wire breaks and has to be butt-welded, resulting in down-time of the machine and a pieced-up wire of lower quality. If the tension is not sufficiently high, the machines are not running at their greatest speed and efficiency; here the cost of direct labor and overhead per foot of wire is increased, and the loose or uneven windings impair quality as well. There is a comparatively limited range of correct tension tolerances within which wire-processing methods should be engineered.

The finer the wire, the greater is the importance of uniform tension during the winding of precision coils. In wire-covering machines also, whether for enamel, tin or yarn insulation, maintenance of standard tensions means freedom

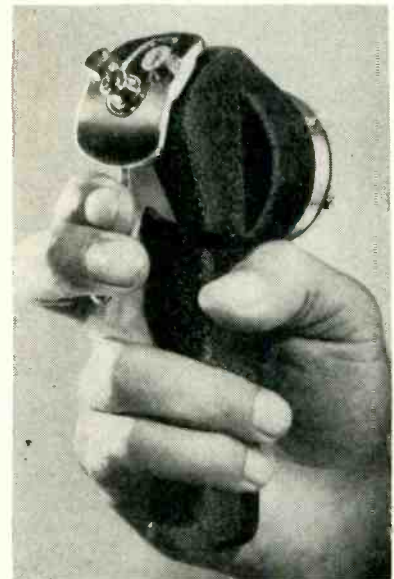

Closeup view of tension meter, showing the three rollers around which the wire runs. Trigger is in released position; when pulled, outer two rollers come down below sensing roller

from insufficiently covered wires and better yield from wire and insulation materials.

The best wire tension for a particular component is generally known to at least one experienced operator. The problem then involves measuring that tension in order to maintain it during the entire run and to achieve it on other similar machines or on reruns at some future date, independently of availability of the experienced operator. For this purpose, a tension-measuring instrument called the tension

THREE WAYS BETTER!

A New Calibrated Mega-Sweep

1. Much Higher Output
2. Wider Sweep Width
3. Zero Level Baseline

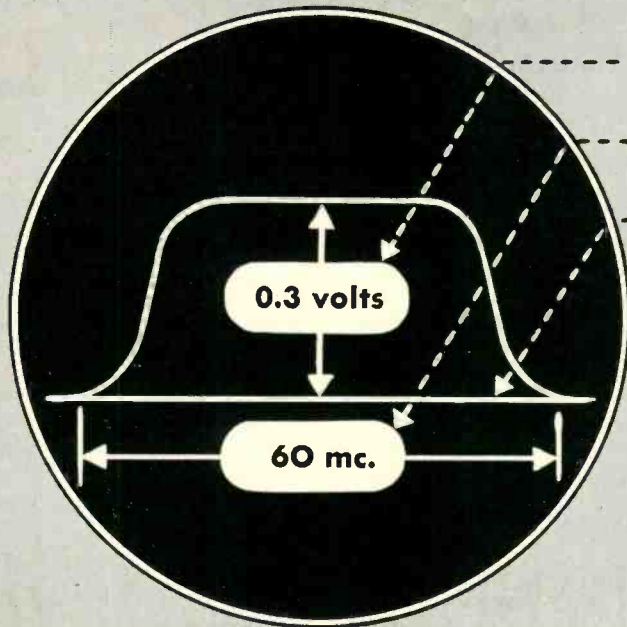

FOR MILITARY PROJECTS VHF-UHF TELEVISION and COUNTLESS LABORATORY APPLICATIONS

This new model of the Calibrated Mega-Sweep has, for work in the UHF range, many advantages over the standard model. The output impedance is 70 ohms unbalanced (over the whole frequency range) or 300 ohms balanced (for the range 450-900 mcs). The output of 0.3 volts into a 300 ohm balanced termination in the UHF range is adequate for frequency response testing of TV converters or tuners. The zero level baseline provides convenience in measuring gain of the circuits being tested. The great sweep width allows viewing the response of several channels at one time.

111A CALIBRATED MEGA-SWEEP

SPECIFICATIONS

Frequency Range	Output Impedance	Output Voltage
10 mc-950 mc	70 ohms unbalanced	0.15 volts
450 mc-900 mc	300 ohms balanced	0.3 volts

SWEEP WIDTH: Continuously variable to approximately 60 mc maximum.

BLANKING: Provides zero level reference baseline.

GENERAL SPECIFICATIONS: Similar to those of standard model Calibrated Mega-Sweep.

PRICE: \$575.00 f.o.b. factory.

NOW IN DEMAND MORE THAN EVER! Standard Calibrated Mega-Sweep

- ★ **FREQUENCY RANGE:** 50 kc. to 950 mc.
- ★ **SWEEP WIDTH:** Variable to 30 mc.
- ★ **OUTPUT:** 0.05 volt into 53.5 ohms
- ★ **CALIBRATED TUNING DIAL:** Easy operation.
- ★ **AMPLITUDE MODULATION:** Less than 0.1 db per mc.
- ★ **RUGGED CONSTRUCTION:** Reliable performance.

Price: \$425.00 f.o.b. Factory

KAY

KAY ELECTRIC COMPANY

25 Maple Avenue

Phone CAldwell 6-4000

Pine Brook, New Jersey

TIC of INSTRUMENTS

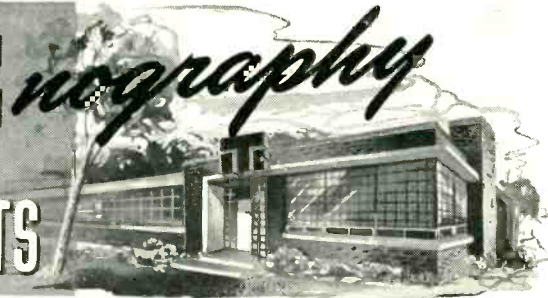

Technology Instrument Corp. Presents a Compactly-Built Wide-Band Decade Amplifier

Featured by its wide band response, high input impedance, low output impedance, and compact dimensions, TIC's Type 500-A wide band decade amplifier is excellent as a general purpose laboratory instrument. Here is an instrument for special applications requiring a zero phase shift and high stability of gain. TIC increases the general utility of this amplifier by including a self-contained power supply and cabinet or rack mounting.



SPECIFICATIONS:

Amplification: 10, 100 and 1000 times, selected by 3-position rotary switch.
Frequency Response: Flat to $\pm .5$ db from 5 cycles to 2 mc on gain of 10; Flat to $\pm .5$ db from 5 cycles to 1.5 mc on gain of 100; Flat to $\pm .8$ db from 5 cycles to 1 mc on gain of 1000.

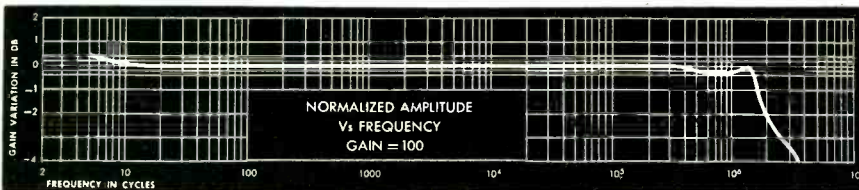

Amplification Accuracy: $\pm 2\%$ of nominal — dependent on precision resistors only; Unaffected by normal tube characteristics or line variations.

Phase Shift on All Ranges: 0 to $\pm 2^\circ$ from 20 cycles through 100 kc
Gain Stability on All Ranges: Constant with line voltages of 105 to 124 volts.
Noise and Hum: 60 db below maximum output voltage with input shorted.
Input Impedance: Approximately 160 megohms shunted by $7 \mu\text{mf}$.
Output Impedance: Approximately 200 ohms.
Output Voltage on All Ranges: 20 volts maximum output across a load of 20 k Ω or greater.
Power Supply: 105-125 volts, 50-60 cycles self-contained power supply requiring approx. 30 watts. (230 volt, 50-60 cycles models available).
Mounting Dimensions: Single, in cabinet: $13\frac{1}{4}$ " wide x 5" high x $9\frac{3}{8}$ " deep. ($11\frac{1}{4}$ " x $3\frac{1}{2}$ " panel) Single, for rack: 19" wide x $3\frac{1}{2}$ " high x $8\frac{1}{2}$ " deep.

The low distortion is a feature much desired in amplifiers of this type.

Further information and details gladly sent upon request.

Engineering Representatives

Chicago, Ill. — Uptown 8-1141	Arnprior, Ont., Can. — Arnprior 400
Cleveland, Ohio — PRespect 1-6171	New York, N. Y. — Murray Hill 8-5858
Waltham, Mass. — WAltham 5-6900	Hollywood, Cal. — HOllywood 9-6305
Boonton, N. J. — Boonton 8-3097	Dallas, Texas — DIxon 9918
Dayton, Ohio — Michigan-8721	

meter is being used in many coil-winding departments. This instrument is a simple hand-operated dial indicator that can be quickly inserted in the path of the running wire by simple trigger action.

Pulling the trigger of the meter lowers the outer two guide rollers, so that the wire to be checked can be easily inserted between these and the sensing roller. Releasing the trigger brings the moving wire automatically into measuring position. The rollers maintain the correct angle at which the wire passes the center sensing roller, regardless of how the meter is held.

Motion of the sensing roller is kept at a minimum to insure lasting accuracy of the restraining spring in the meter. This small motion is amplified through a zero-backlash gear train to actuate the dial pointer. The scale range is 0-250 grams tension; another meter model has a 0-1,000 gram range for larger wires.

Other factors indicating the necessity of tension measurement and adjustment are the build-up of multilayer coils and the continually reducing diameter of the wire supply spool.

With the aid of a tension meter, the operator can make such adjustments as will keep tensions within practical limits throughout the entire winding operation. This results in better quality, faster production, better utilization of a given quantity of materials and fewer rejects.

Chassis-Holding Fixtures

A SIMPLE strap iron fixture holds a television receiver chassis at a pitched angle on a moving conveyor line in Crosley's Cincinnati plant. After bending the iron strap at

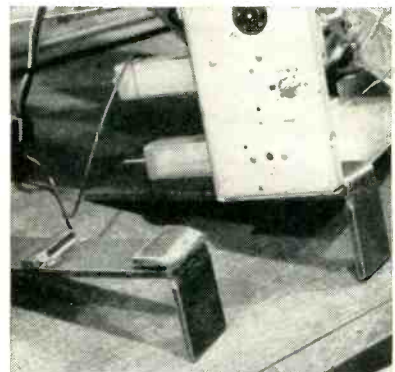

Crosley-designed chassis-holding fixture

TECHNOLOGY INSTRUMENT CORP.

533 Main Street, Acton, Massachusetts, Telephone: Acton 600



Information Wanted...

about your uses for

C-D-F METAL CLADS

Grade of laminate
 Sheet size
 Overall thickness
 Thickness tolerances
 a. Standard NEMA
 b. Closer tolerances requiring sanding
 Metal: Copper Aluminum
 Other Thickness
 Metal facing: One side Both sides
 Minimum bond strength
 Punching requirements
 Any other specifications

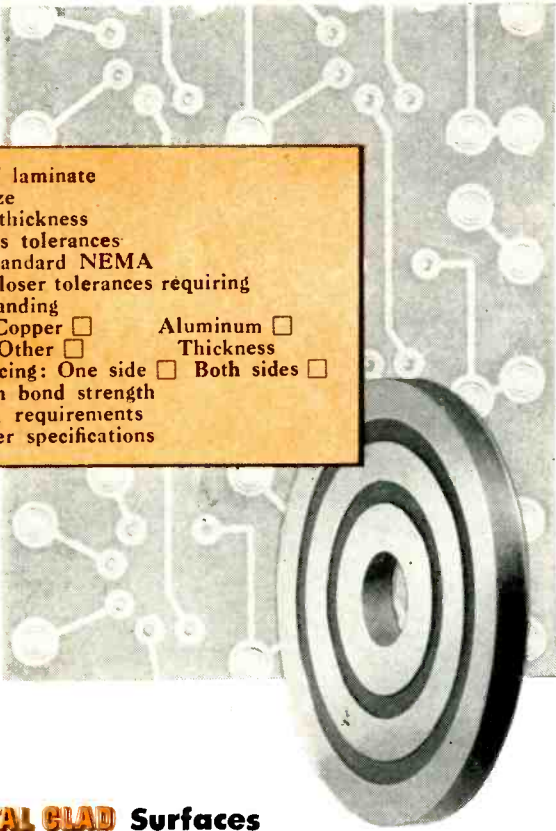

Did you know that C-D-F supplies a full range of metal clad laminates in both Dilecto and Teflon grades? With mounting interest in printed circuits it pays to consider the respective advantages of these new C-D-F materials . . . it also pays to line up all the Information Wanted facts and discuss your specific application with your C-D-F sales engineer (Offices in principal cities). He's a good man to know!

Dilecto METAL CLADS

Printed circuits depend upon stable, uniform core material and Dilecto has years of proven insulation service (Dilecto is a laminated thermosetting plastic made only by C-D-F from paper, cotton, glass or asbestos fabric base, or a mat base). Normally phenolic or melamine impregnating resins are used for METAL CLAD sheet stock. There are many grades of Dilecto, but only the better electrical grades are supplied with metal foil surfaces. Outstanding is C-D-F grade XXXP-26, a hot punching grade with high insulation resistance, low and stable dielectric losses and excellent moisture resistance. Green color. New C-D-F Catalog GF-53 gives complete data on Dilecto grades. Write for your copy today.

Teflon* METAL CLADS

Glass fiber cloth is first coated with Teflon resin and laminated into C-D-F GB-112T sheet stock. This base withstands high heat (200°C. maximum operating temperature) with the dissipation factor and dielectric constant extremely low over a wide frequency range. No adhesive film is needed to bond metal to the Teflon laminate, thus the inherently good electrical properties of the core material are maintained. GB-112T has practically zero water absorption, so a METAL CLAD with this core offers consistent high insulation resistance with excellent stability of dielectric loss properties.

METAL CLAD Surfaces

Copper foil (usually .00135" or .0027" thick) is bonded on one or both faces of the sheet grade of Dilecto selected. The foil used is a special grade of electrolytic deposition copper particularly adaptable for cementing onto laminated materials. An adhesive film is placed between the metal and the Dilecto, and cemented during the pressing and curing cycle. When closer tolerances are required C-D-F sands the Dilecto to the required thickness before bonding. Aluminum, silver, or other alloys of various metals may be supplied.

Better Bond Strengths

One of the most important physical properties of a metal clad product is its peel strength, the pounds pull required to separate the foil surface from the core material. Working with years of laminating know-how, C-D-F has been successful in obtaining the following average test values for its METAL CLAD sheet stocks:

	Lbs. pull per 1" width
XXXP-26 plus .00135" copper	5 to 8
XXXP-26 plus .0027" copper	7 to 10
XXXP-26 plus .0015" aluminum	9 to 12
GB-112 Teflon plus .00135" copper	6 to 9

Sheet sizes: Dilecto grades — 38 x 38", 38 x 42"
 Teflon grades — 16 x 36"

THE NAME TO REMEMBER . . . FOR PRINTED CIRCUIT METAL CLAD STOCK

Continental-Diamond Fibre Company
 NEWARK 16, DELAWARE



*DU PONT TRADE MARK

Write for new C-D-F General Catalog GF-53, new C-D-F Teflon folder T-52, and talk METAL CLADS with your C-D-F sales engineer.



MILLION-DOLLAR DIALS

... for pennies!

Self-luminous, fluorescent, phosphorescent, or nonluminescent—etched, lithographed, or screened—whatever type of dial you need, U. S. Radium Corporation can produce it . . . with “million-

dollar” accuracy and finish, at mass-production cost.

Yes, even though they cost less than you’d think, U. S. Radium dials look like a million dollars. That’s because, in producing millions of dials for instruments and timepieces, we’ve learned how to apply precise markings with big-volume methods that are a boon to the budget. We also make high-accuracy dials, in as small quantity as desired, for scientific requirements.

To find out how our dial experience can benefit your instruments — with better dial design, or lower cost, or both — write Dept. E11, U. S. Radium Corp., 535 Pearl Street, New York 7, N. Y.

Other Products of U. S. Radium

RADIOACTIVE FOILS
(alpha-ray ionization sources)

IONOTRON STATIC ELIMINATORS

RADIUM LOCATORS:
pendants, lenses, buttons, screws, markers

LUMINOUS RETICLES
and other specialties

POWDERS:
cathode-ray tube and television tube

SILHOUETTE ILLUMINATION
of clocks, watches and instruments



UNITED STATES RADIUM CORPORATION

BETTER DIALS AT LOWER COST

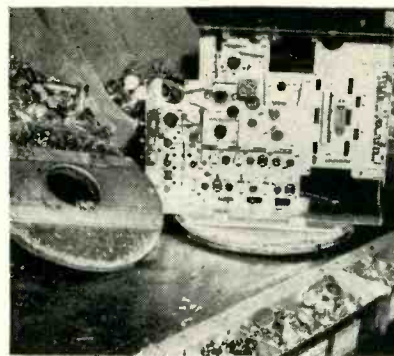

DuMont-designed chassis-holding fixture

right angles, a chassis-gripping lip is welded to the bend and a metal stop is welded in position halfway down the slope. Once in position, the chassis cannot slide out unless it is first lifted up. Though simple and inexpensive, this fixture supports the chassis at the optimum angle for final wiring work.

A modified version of this chassis-holding technique is used on circular wood pallets employed on both pass-along and moving-conveyor lines in DuMont’s East Paterson, N. J. television receiver plant. Here two different arrangements of the holding clips are used, to accommodate two different types of chassis. One set of clips serves as the back stop for the other set.

Tube Burn-in Setups

By CURTISS R. SCHAFER
The Liquidometer Corp.
Long Island City, N. Y.

RUGGEDIZED and Arinc tube types are not always available, even for military equipment. In the event that regular JAN types must be used, it is desirable to operate them for at least 50 hours under somewhat more severe conditions elec-

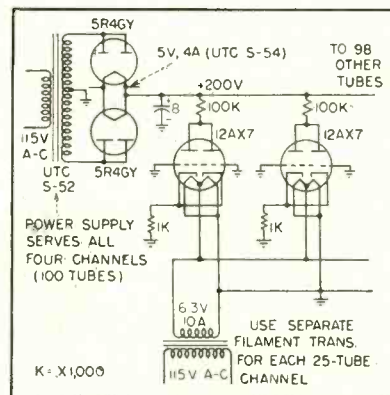

Circuit for aging 100 type 12AX7 tubes simultaneously



Plastic Film Dielectric CAPACITORS*

—because the solid film is chemically stable, dielectrically strong, and non-porous—

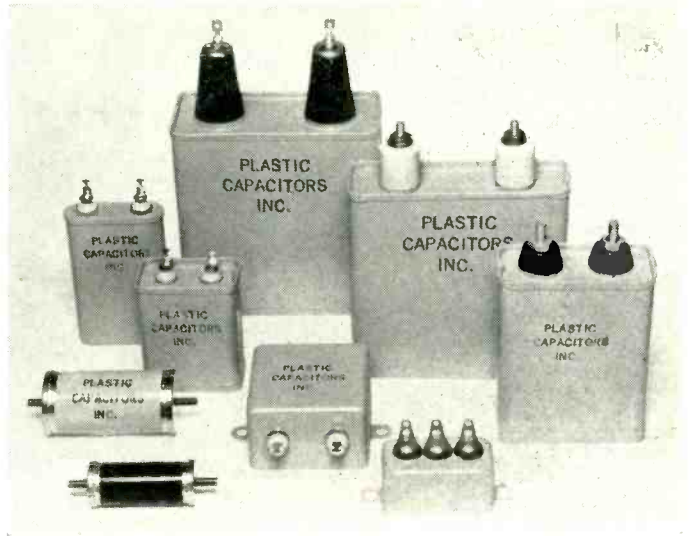

GIVE YOU these IMPORTANT CHARACTERISTICS

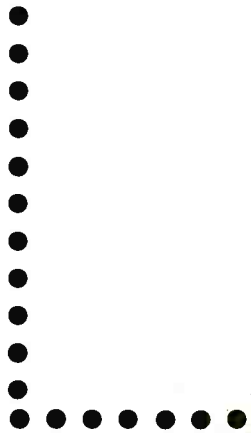

Smaller size and lighter weight for a given value.

Operation up to 150° C and more without voltage derating.

Series resistance exceeding 10¹² megohms/mfd and as high as 10¹⁴ for small capacitance values.

Dielectric absorption as low as 0.02%.

Power factor at 60 cycles as low as 0.01%.

Q factors exceeding 500 at 100 KC.

Capacitance stability to within 0.5% for a period of one year.

Voltage range 100 volts to 60 KV.

High current (continuous or intermittent) service for r. f. or pulse circuits.



Get this **FREE** Catalog

Contents: Temperature range; Capacitance tolerances; Capacitance stability; Temperature coefficient; Power and Q factors; Dielectric absorption; Permissible ripple; Life; Containers; Impregnant; Insulators and terminals; Mounting brackets; Vibration and shock; Salt spray and immersion; plus HIGH-VOLTAGE LOW-CURRENT POWER SUPPLIES and PULSE FORMING NETWORKS.

**Choice of solid dielectric film and impregnant accentuates the electrical characteristics and increases the effectiveness of the circuit.*

Plastic Capacitors, Inc.

PLASTIC FILM CAPACITORS • HIGH VOLTAGE POWER SUPPLIES
• PULSE FORMING NETWORKS

2511 WEST MOFFAT STREET • CHICAGO 47, ILLINOIS

KLEINS

*Quality pliers for radio-
television-amplifier work*



**No. 301 KLEIN
LONG NOSE PLIERS**

Extra long reach of jaws permits getting into difficult places. Hardened and tempered to assure positive grip at point. Available in 5, 6 and 7 inch lengths.

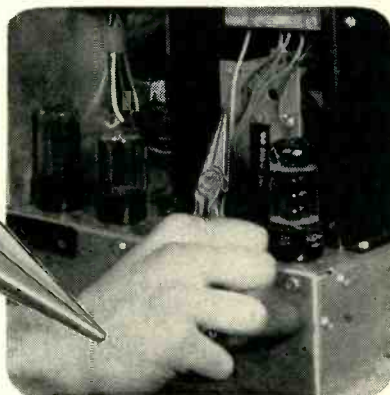

**No. 202 KLEIN NARROW
NOSE OBLIQUE CUTTING
PLIERS**

One of the most useful tools in your kit. Narrow head permits use in confined places. Individually honed knives meet accurately at all points and stay sharp. Available in 5 or 6 inch sizes.

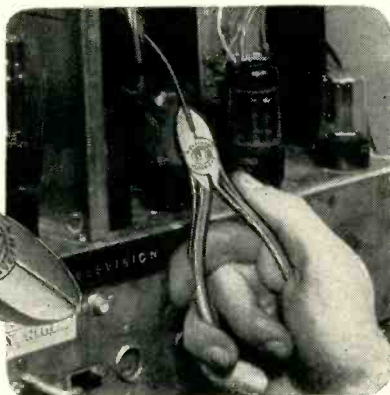

• There is a Klein Plier made for every job in wiring radios, television or sound system amplifiers. Long nose pliers that assure a tight grip even in confined spaces. Keen edged cutters that stay sharp even after continued service. Flat nose pliers, duck bill pliers, curved nose pliers—many types and sizes to meet every wiring need. By having a full selection of these quality tools, you will save valuable time in any wiring work.

This Klein Pocket Tool Guide gives full information on all types and sizes of Klein Pliers. A copy will be sent without obligation.



ASK YOUR SUPPLIER

Foreign Distributor
International Standard
Electric Corp.
New York

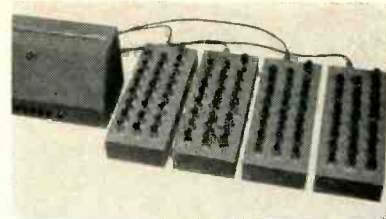

Burn-in setup for 100 type 12AX7 tubes



Burn-in setup for 15 type 6005 tubes

trically than they are subject to in normal use. The equipment shown is used to burn-in 12AT7 and 12AX7 tubes, 100 at a time and for a period of 100 hours. About 18 percent of all 12AT7 tubes received from the manufacturer showed one defect or another after the burn-in. These tubes checked OK on a standard tube checker when they were received, but they would undoubtedly have resulted in many equipment failures if they had been used.

The burn-in equipment consists of a power supply and four tube racks. Separate plate and cathode resistors are necessary to prevent oscillation.

A similar piece of equipment is

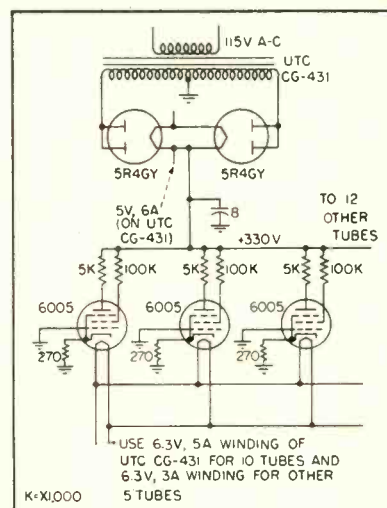

Circuit for aging 15 type 6005 tubes simultaneously



Since 1857

Mathias KLEIN & Sons
Established 1857 Chicago, Ill., U.S.A.

3200 BELMONT AVENUE, CHICAGO 18, ILLINOIS

SYLVANIA PICTURE TUBES

Out-perform, out-last all others tested!

Fifty minutes *on* . . . ten minutes *off* . . . hour after hour for 500 consecutive hours, Sylvania Picture Tubes were tested side by side with the tubes of other leading manufacturers.

These intensive tests, made under punishing, accelerated voltages were conducted under supervision of an outside, independent laboratory. Checks were also taken over a 3-month period for emission, leakage, color, light out-put, grid control, and other characteristics.



impartial testing company
proves **SYLVANIA**
picture tubes
are Finest!

Read the remarkable record.

The chart at right tells the story. Note that *only* Sylvania Picture Tubes showed no failures. And, in over-all point quality, *Sylvania won over all other brands by a wide margin.*

These important conclusions definitely place Sylvania Picture Tubes in the highest rank. They also mean the highest in trouble-free operation . . . better business . . . more satisfied customers for every set manufacturer who uses Sylvania Picture Tubes. For full details about these important tests write today to: Sylvania Electric Products Inc., Dept. R-1411, 1740 Broadway, New York 19, N. Y.

SYLVANIA



RADIO TUBES; TELEVISION PICTURE TUBES; ELECTRONIC PRODUCTS; ELECTRONIC TEST EQUIPMENT; FLUORESCENT TUBES, FIXTURES, SIGN TUBING, WIRING DEVICES; LIGHT BULBS; PHOTOLAMPS; TELEVISION SETS

United States Testing Co. 1415 Park Ave., Hoboken, N. J.			Test No. E-5095 August 8, 1952
Manufacturer	Number of Tubes Tested	Number of Failures	Overall Point Quality
A	8	1	81
B	8	1	78
C	8	6	62
D	8	1	83
E	8	4	67
F	8	5	42
G	8	4	52
H	8	5	30
SYLVANIA	8	NONE	92

Precision

ATTENUATION to 3000 mc!

- VSWR less than 1.2 at all frequencies to 3000 mc.
- **TURRET ATTENUATOR** featuring "Pull - Turn - Push" action with 0, 10, 20, 30, 40, 50 DB steps.
- Accuracy $\pm .5$ DB, no correction charts necessary.
- 50 ohm coaxial circuit. Type N Connectors.

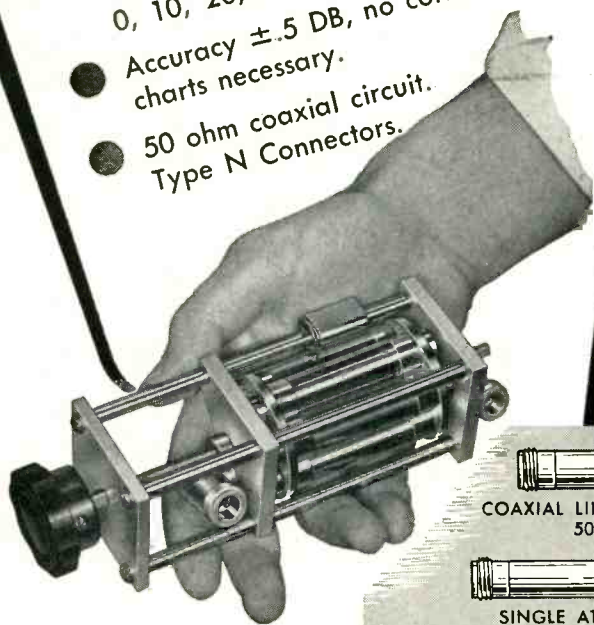

Inquiries are invited concerning single pads and turrets having other characteristics

COAXIAL LINE TERMININATION
50 ohms

SINGLE ATTENUATOR PAD
50 ohms

VSWR ± 1.2 to 3000 mc.
One watt c.w. power dissipation

STODDART AIRCRAFT RADIO CO.
6644-A SANTA MONICA BLVD., HOLLYWOOD 38, CALIFORNIA
Hillside 9294

used for burning in 6AQ5 tubes. In this case the power requirements are so great that only 15 tubes are handled by each unit. Both aging setups are being used for tubes required in capacitance-type aircraft fuel gages made by The Liquidometer Corp.

Strand Twister

A MOTOR-DRIVEN wire twister rolls loose strands together on stripped wire at high speed in Crosley's Cincinnati plant. A cone-shaped hole in the end of the twister guides



Twisting loose strands together on shielded cable after stripping. Next operation is tin-dipping. Operator picks up handful of conductors, twists them individually, then lines up ends and dips entire handful into solder pot

the strands between a rotating pair of flat jaws as the conductors are inserted one by one. The twister is made by The Wire Stripper Co., Cleveland, Ohio.

Slide-in Subassemblies Simplify Wiring and Soldering

By WILLIAM F. WEBER
Project Supervisor
Ford Instrument Company
Division of the Sperry Corporation

A NEW packaging system for electronic components of a Navy aircraft computer features standardized miniature units, readily producible, extremely flexible, compact and light in weight. Equally important is the ease of assembly and disassembly, making for fast, uncluttered maintenance in the field by personnel with limited training. This equipment was evolved under

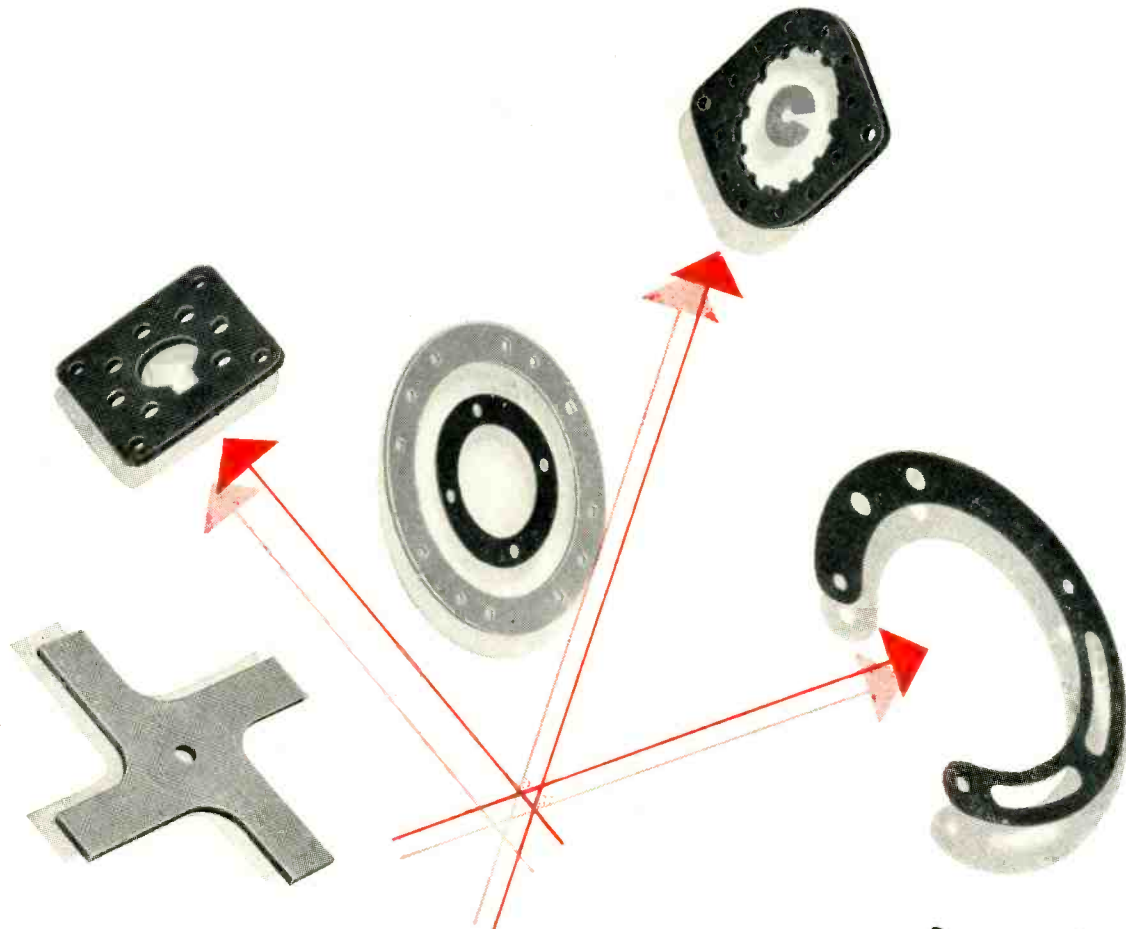

the properties you want are "built-into" Lamicoid®

High Dielectric Strength
 Low Power Factor
 Heat Resistance
 Low Moisture Absorption
 High Impact Resistance
 Dimensional Stability
 Light Weight
 Tensile Strength
 Abrasion Resistance
 Good Machinability
 Punchability

Many specific properties and combinations of properties—to suit the exact requirements of *your* product—are built into LAMICOID. This thermosetting laminated plastic (made with such fillers as glass, nylon, fabric, paper, etc., with a variety of synthetic resins) has solved the problem of material shortages in many fields.

LAMICOID may be the answer to the mechanical, structural and insulating needs of *your* application. Here are just a few of its many uses: dials, antenna parts, coil

forms, tube socket supports, panels, motor and transformer parts, switch gear and relay parts.

Take advantage of the versatility of LAMICOID; put it to work for you. LAMICOID is supplied in standard sheets, rods and tubes, or fabricated into parts to your specifications. Whatever your electrical insulation problem may be, let us put our 58 years of experience at your disposal. For a prompt quotation, send blueprints or specifications.



MICA *Insulator* **COMPANY**

Schenectady 1, New York

Offices in Principal Cities

LAMICOID (Laminated Plastic) • MICANITE® (Built-up Mica) • EMPIRE® (Varnished Fabrics and Paper) • FABRICATED MICA

HERE'S THE BASIS FOR A MICROWAVE TEST SETUP

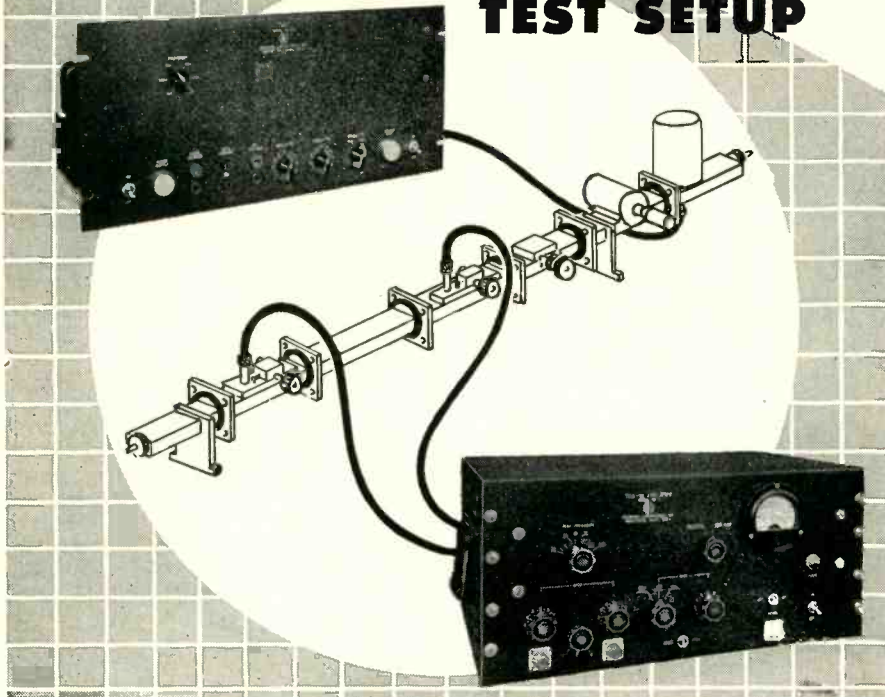

A VERSATILE, dependable laboratory set-up for microwave testing can easily be built around these two Browning instruments.

The basis of a signal generator in the super-high-frequency range is provided in the Model TVN-7 square-wave modulator and power supply. This unit is used as a square-wave modulator at 600 to 2500 cycles for low-power velocity-modulated tubes, such as the 417A, 2K28, and 2K25. Provision is also made for external modulations: for grid pulse modulation at amplitudes up to 60 volts, and for reflector pulse modulation at up to 100 volts maximum. The power supply delivers regulated cathode voltage continuously variable from 280 to 480 volts, with provision for a 180-300 volt range.

Measurement of standing-wave ratios, with slotted lines, is easily accomplished with the Model TAA-16A amplifier — a high-gain a-c voltmeter, covering 500 to 5000 cycles per second. Front-panel controls can be set for broad-band or selective operation; sensitivities are: 15 μ v in broad-band and 10 μ v in selective position. The 4 inch output meter with illuminated scales is graduated in standing-wave voltage ratio and with a 0-10 linear scale. A panel switch is provided for convenience in applying bolometer voltage. The master gain control switch provides attenuation factors of 1, 10, and 100. Unit and regulated power supply are contained in black wrinkle steel cabinet 9 x 20 x 12 inches.

Both of these instruments are designed for 115-volt 50/60 cycle operation.

Write today for data sheets giving detailed specifications of the TVN-7 and TAA-16A equipments.



ENGINEERED
FOR
ENGINEERS

BROWNING
Laboratories, Inc.
Winchester, Mass.

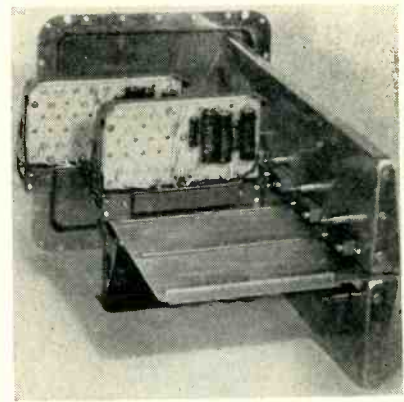

Type of T-shaped frame used to support subassemblies. This frame slides into a container which may be sealed for pressurizing

a development contract with the Navy Bureau of Aeronautics as part of a continuing program to equip Navy aircraft with reliable scientific instrumentation without further complicating the already highly complex chore of maintaining airborne equipment.

The development involves an electronic computing network, the basic packaging form of which may contain a dozen or more subassemblies. The mounting frame supporting the subassembly chassis is T-shaped. It mounts into a container that can be sealed, permitting pressurizing or the use of dry inert gas.

The subassemblies are built around standard chassis, terminal boards and plug-in connectors. Design of the chassis is such that resistors, capacitors, sockets and other components can be completely wired on a layout board before assembly onto the chassis. This expedient simplifies wiring and soldering operations, making for

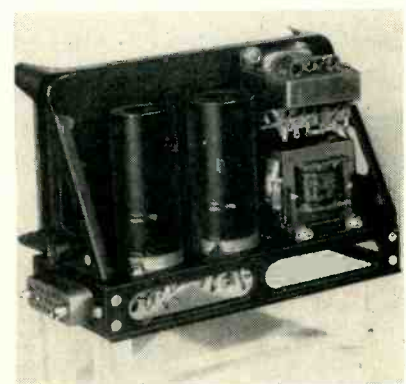

Example of amplifier subassembly. Its chassis slides on rails and is locked in position on the main frame with the jack-screw at the left, which also serves to mate plug-in members

HERE'S GOOD NEWS!

NEW TVOR

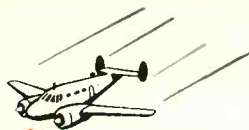

- increases plane let-down safety for any airfield
- changes "fair-weather" to all weather airline service
- permits marginal weather landings by private and executive aircraft.

AT LESS THAN

one fourth the cost of **VOR!**

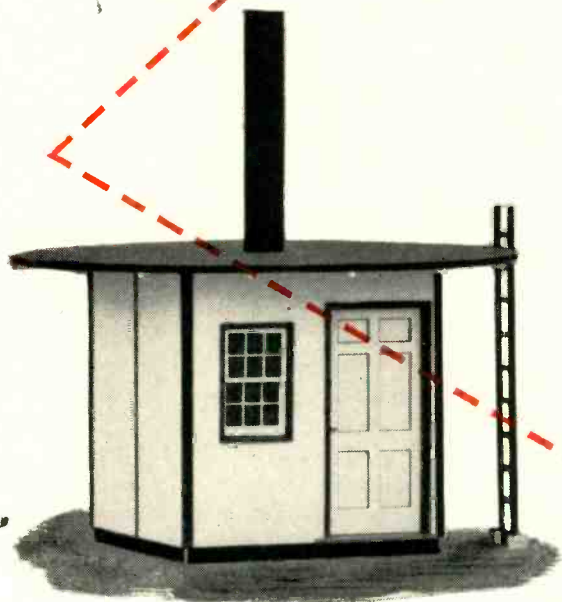

This new terminal VHF omnidirectional radio range adds safe instrument approach facilities to any airport. CAA approved. Installs directly on the airfield. Includes field detector, antenna and installation test equipment. *And is available on 90 day delivery.*

Made by a company specializing in VOR systems for the CAA and foreign governments, TVOR radiates 50 watts of power, ample for most installations. Time tested circuits, using the same quality components and given the same rugged tests as CAA equipment, are easy to maintain and service. Installation operates almost entirely without attention. Any plane with standard VOR instrumentation can make precision approaches to a TVOR equipped field.

TVOR can build your field's air traffic by extending service through marginal weather . . . increase airline passenger service by eliminating flights lost due to rain and fog . . . brings corporation aircraft to their home field in spite of low ceilings.

Flight test TVOR with your own plane at the College Park Airfield. Visit our factory at the edge of the field. Inspect the equipment. Convince yourself that your group can not afford to be without low cost, high quality TVOR.

TVOR single unit installation needs only an inexpensive shelter on the field.



TVOR changes fair-weather to all weather airline service.



TVOR guides corporation aircraft to their home fields, in spite of low ceilings.

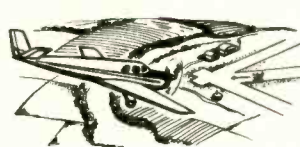

TVOR works with standard instrumentation. Private planes "home" on their own airfield.

TVOR commercial transmitters are the same as those designed and built for the CAA.

MARYLAND ELECTRONIC MANUFACTURING CORPORATION

COLLEGE PARK 14, MARYLAND

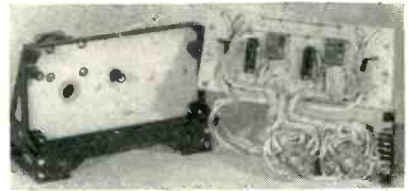

New packaging technique permits wiring resistors, capacitors and other parts on a convenient layout board before assembly onto the chassis

clean, well-soldered connections and uniform cable layout. This feature enhances miniature design, allowing for more compact construction through the elimination of inaccessible areas.

Assembly after wiring merely involves securing the terminal board, sockets and plug-in connector to the chassis and tightening several screws.

Interlocking rails and guards are used for mounting subassemblies on the T-shaped frame. A subassembly is installed by aligning the rails and guards, sliding the unit in place and tightening a jack screw. Electrical connections are made by plug-in connectors whose male and female members mate when the subassembly is secured. The T-shaped frame provides rigidity with a minimum of material and allows for even distribution of weight.

The flexibility of this type of construction makes it possible to build a complete computer to any degree of complexity by combining readily assembled, integral units. Modifications can be performed by simply exchanging one or more units and/or subassemblies.

The assembly of units in convenient rack-type structures with small intervening air spaces presents

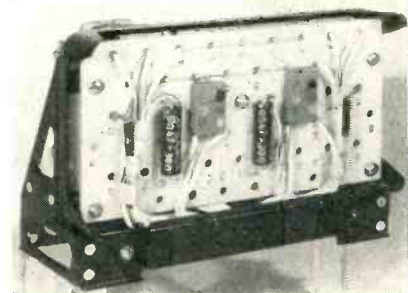

After wiring is completed, the layout board, sockets and plug-in connector are fastened to the chassis with bolts. Further speed-up in production could be achieved by use of dip-soldering if quantities warranted use of such high-speed fixtures

GTC Transformers

demanded for

Unusual Applications



The illustrated new automatic pin-spotter is a product of the American Machine & Foundry Company. An exceptionally high degree of precision is necessary for proper performance.



"GTC" Transformers are used in the AUTOMATIC PIN-SPOTTER because of their accepted ability to meet the most rigid specifications. If your application is most unusual or standard, we suggest you consider "GTC" — proven transformers where maximum performance is essential.

We welcome your inquiries.

GENERAL TRANSFORMER COMPANY
 serving industry since 1928
 18240 Harwood Avenue, Homewood, Illinois
 (Suburb of Chicago)



Where Application Requires Really Flexible Class H Electrical Insulation . . .

BH "1151"

SILICONE RUBBER COATED FIBERGLAS TUBING

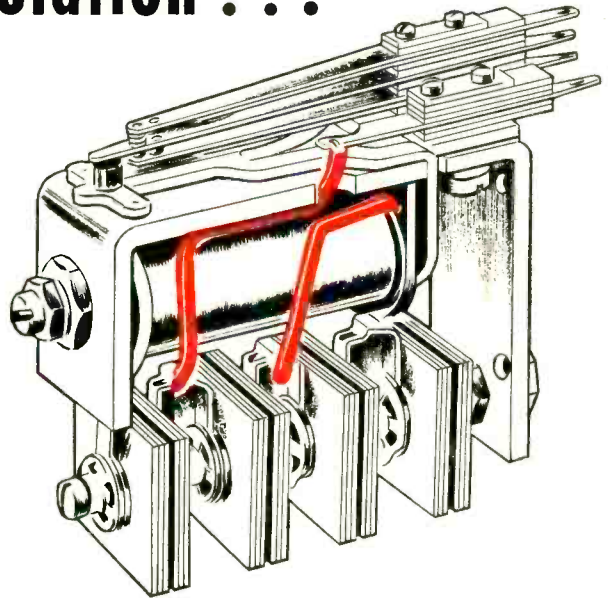

BH "1151" Silicone Rubber coated Fiberglas tubing is flexible when manufactured and *stays* flexible through all applicable NEMA Class H tests. This long-lasting union of two great inorganic materials assures maximum product protection.

BH "1151" withstands bending, required in normal assembly, without loss of dielectric strength—will not craze or crack. It remains unchanged through continuous product operation in a temperature

range of -90° F. to 400° F. . . takes 600° F. for 15 minutes without physical or dielectric failure.

Are you looking for a product with high dielectric, chemical and fungus resistance? . . . Use BH "1151".

Available in colors; in economical coils, 36 inch lengths, or cut without wastage to your specifications. Send for samples and data sheets today.

Address Dept. E-11
Bentley, Harris Manufacturing Co.
Conshohocken, Pa.

BH *Fiberglas** SLEEVINGS

*BH Non-Fraying Fiberglas Sleeveings are made by an exclusive Bentley, Harris process (U. S. Pat. No. 2393530). "Fiberglas" is Reg. TM of Owens-Corning Fiberglas Corp.

relatively large heat-dissipating areas, adapting the instrument to convectional cooling systems.

Grouping of accessible units simplifies maintenance. In the event of failure, units or subassemblies rather than isolated components can be checked and the fault remedied by the insertion of a new unit or subassembly. The testing of units rather than components allows for simplification of maintenance test equipment, making feasible the adaptation of built-in fault-locating systems.

Unit maintenance minimizes field servicing time and does not require the ability of highly trained personnel.

Structural parts are designed for simplicity and ruggedness. All parts can be readily produced by punching and die-forming operations, resulting in maximum production rates with a minimum of man effort.

Structural assemblies are of riveted construction. Rivets appearing at the surface of a unit are solder-sealed to prevent gas or pressure leakage.

The above-described packaging system has made possible great saving in weight and space, while still providing a frame rigid enough to withstand all stress in military aircraft and enough room for heat dissipation and clearance between electronic parts.

Socket-Holding Fixtures

ASSEMBLY of four corona shield and socket assemblies simultaneously is made possible by use of a simple



Socket subassemblies plug into up-ended tube bases on these holding fixtures



(trifluorochloroethylene)

loses none of its properties in temperatures as high as 390°F. Matter of fact, it runs the temperature gamut all the way up from -320°F. . . . a range of 710 fahrenheit degrees!

You'll find reason upon reason for liking this high polymer thermo-plastic. For one thing, it has an excellent memory. Press it out of shape and it returns, once pressure is released, to its original form.

KEL-F has unusually high chemical and electrical resistance. Conducts little heat. Resists "wetting". Humidity, moisture and fungus bother it not at all.

Largest Single Sheet

Besides rods, tubes, compression and injection molded forms, we are now making this versatile insulating material in the *biggest single sheets* ever known—up to 5 ft. discs.

Lowest Cost Ever

Expanded production now enables us to offer KEL-F in all its forms at the *lowest prices* in history. We'll be glad to quote on your own requirements. Write today for KEL-F Brochure #202.

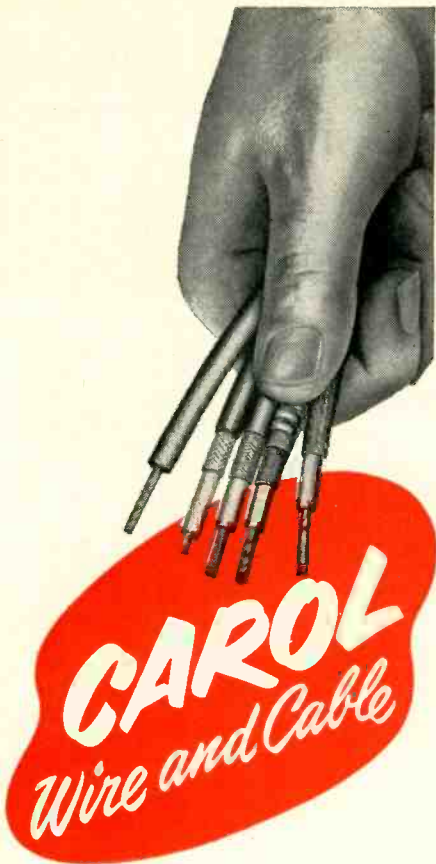

...for every application

Whatever your requirements may be, Carol Cable will engineer wire, cable or wiring assemblies to your particular specifications.

Carol manufacturing facilities are complete—from drawing of copper, copperweld and aluminum wire to formulation of our own insulating materials from natural rubber, synthetic rubber or plastics. Carol is a complete wire mill with all the necessary adjuncts to be completely independent and without intermediate profits.

Constant laboratory control over raw materials, work in process and finished product assures dependable performance.

Your wire and cable problems will receive our prompt attention. Write to us today!

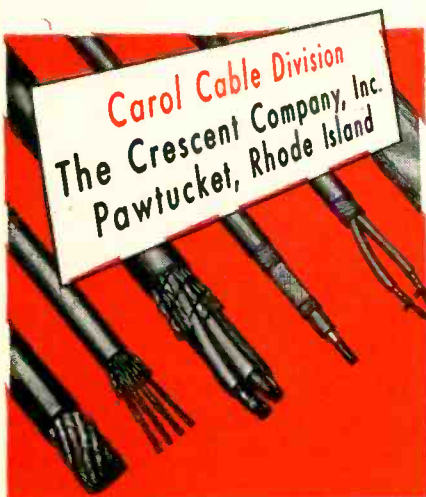



ON THE "FRONT LINE" IN COMMUNICATIONS

The rich experience and vast facilities of Delco Radio are again at the service of the nation!

Delco Radio has a major part in the current rearmament program . . . is currently producing advance-type radio equipment for many branches of the military. Delco Radio products serve equally well in civilian communications . . . in millions of passenger cars and trucks . . . in untold numbers of homes. Yes, in peace as in war, Delco Radio is on the front line in communications with on-time production of *superior* products. See for yourself!

DELCO RADIO

DIVISION OF GENERAL MOTORS, KOKOMO, INDIANA

LEADER...

IN PRODUCTION

Delco Radio is the world's largest builder of automobile radios . . . the leader in production and assembly of component parts.

LEADER...

IN ENGINEERING

Delco Radio developed many of the most important advances in automotive radio . . . has unsurpassed experience in this field.

LEADER...

IN QUALITY

Every step in the manufacture of Delco Radio products is closely supervised to maintain high, uniform product quality.

LEADER...

IN MANUFACTURING

Completely integrated for efficient production, from raw material to finished product, Delco Radio meets any customer need.

Put dependable **MOSINEE** Forest Fibres to work for you!



Remember . . . MOSINEE means more than "paper" in the field of electronics and electrical products. MOSINEE stands for FIBRES that have scientifically controlled electrical, chemical and physical properties, to perform specific functions . . . fibres of dependable technical uniformity vital to your quality standards and production requirements.

MOSINEE fibres can be made to your specifications, with

- good dielectric strength, high tensile or tear strength . . .
- specified pH for maximum-minimum acidity or alkalinity . . .
- accurate caliper or density . . .
- proper impregnation characteristics for resin, wax or other substances . . .
- proper characteristics for plastics operations and parts . . .
- uniform softness, stiffness, flexibility, toughness . . . or other vital technical characteristics.

MOSINEE has its sources of quality forest fibres, practical experience, laboratory facilities, and scientific production controls to create and produce the type of fibres your operations require. Contact MOSINEE.



MOSINEE PAPER MILLS COMPANY
MOSINEE, WISCONSIN

MOSINEE

makes fibres work for industry

wood fixture in Crosley's Cincinnati television receiver plant. Each socket is held upside down on the fixture by a tube base that has been bolted to the base of the fixture. Metal-covered wood rails alongside the tube bases serve as supports for the socket flanges, to protect socket terminal clips while pressure is applied during soldering of the heavy-wire corona shields.

On most fixtures of this type, all but two of the tube base pins have been clipped off to make insertion and removal of the socket easier. Octal tube bases are used. The aligning key is also removed since sockets can be oriented visually by glancing at the irregular-shaped socket mounting plate.

The metal plates on top of the rails serve to chill any solder running through the tubular rivets in which the corona shields are set and soldered. These same rivets also serve to fasten the socket to its plate.

Vise On Powrarm

A SIMPLE arrangement welded onto the stud of a Powrarm Junior work-positioning tool gives a universal holding fixture for assembly work on almost any type and size of small chassis or subassembly. As used at the Poughkeepsie, N. Y. plant of International Business Machine Corp., the vise jaws are tightened by an ordinary machine nut to



Vise-type holding fixture grips wide variety of subassemblies

ENGINEERING PLUS CRAFTSMANSHIP SOLVED THIS UNUSUAL REQUIREMENT

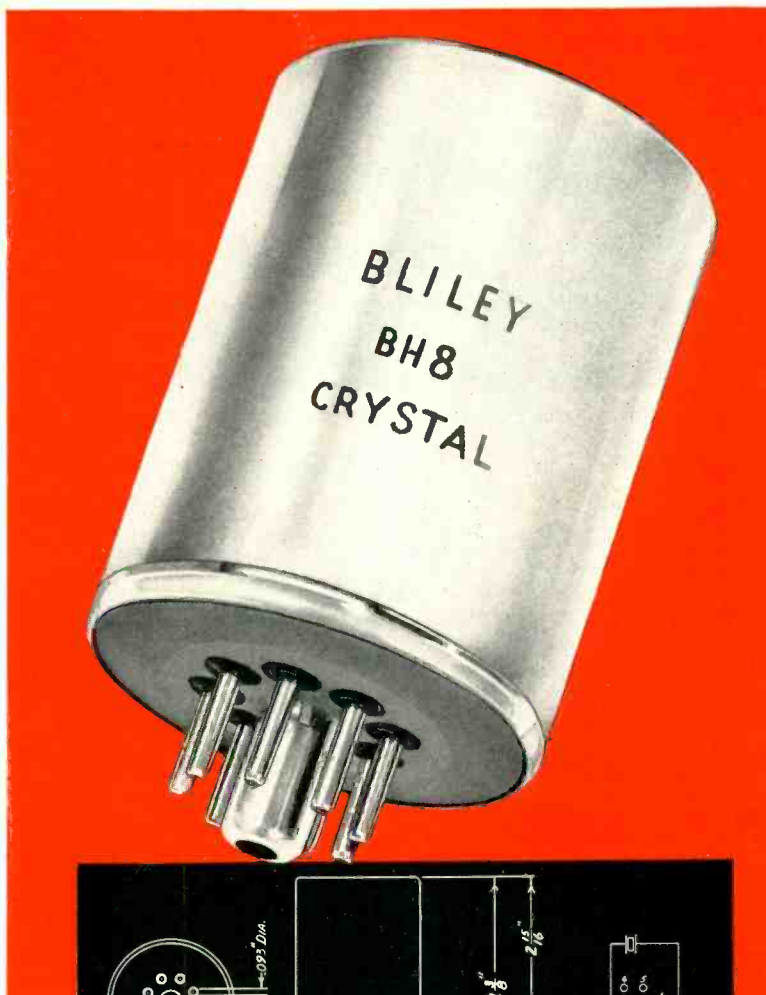

THE PROBLEM:

The problem was to develop a crystal unit for AM broadcast (550-1600 kc) which would maintain frequency tolerance per FCC requirement (± 20 cycles) *without temperature control.*

THE SOLUTION:

When designing the crystal oscillator, the transmitter manufacturer gave primary consideration to voltage stability and low r.f. current. The resultant design provided an ideal environment for realization of the inherent stability of the crystal unit employed.

Bliley designed a plated crystal utilizing precision orientation to achieve the low drift characteristic needed. Contrary to ordinary practice in this frequency range, the crystal was soldered between rigid supports to prevent frequency deviation due to physical displacement. The assembly was then hermetically sealed in a dry nitrogen atmosphere to prevent contamination and minimize aging.

The resultant production units, type BH8, are calibrated at 30°C with maximum deviation not exceeding ± 10 cycles thru the temperature range from +10°C to +50°C.

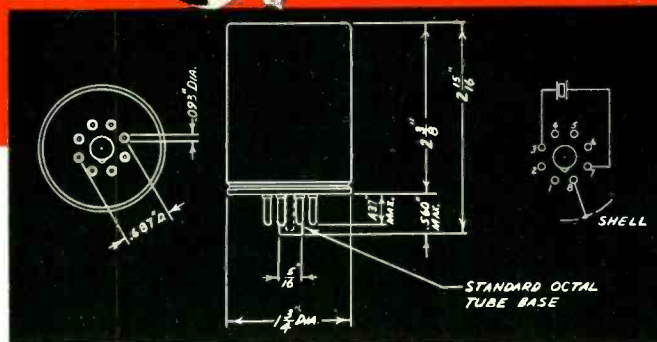

TYPICAL STABILITY DATA

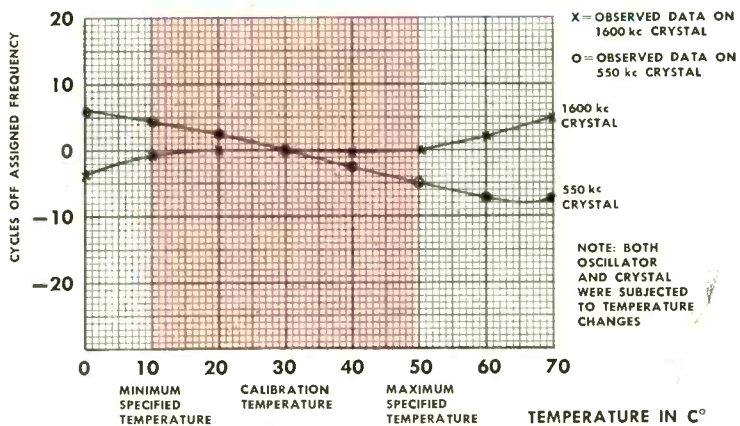

Bliley CRYSTALS

BLILEY ELECTRIC COMPANY • UNION STATION BUILDING • ERIE, PA.

Plenty of advantages
in using...

S.S. WHITE FLEXIBLE SHAFTS
For remote control

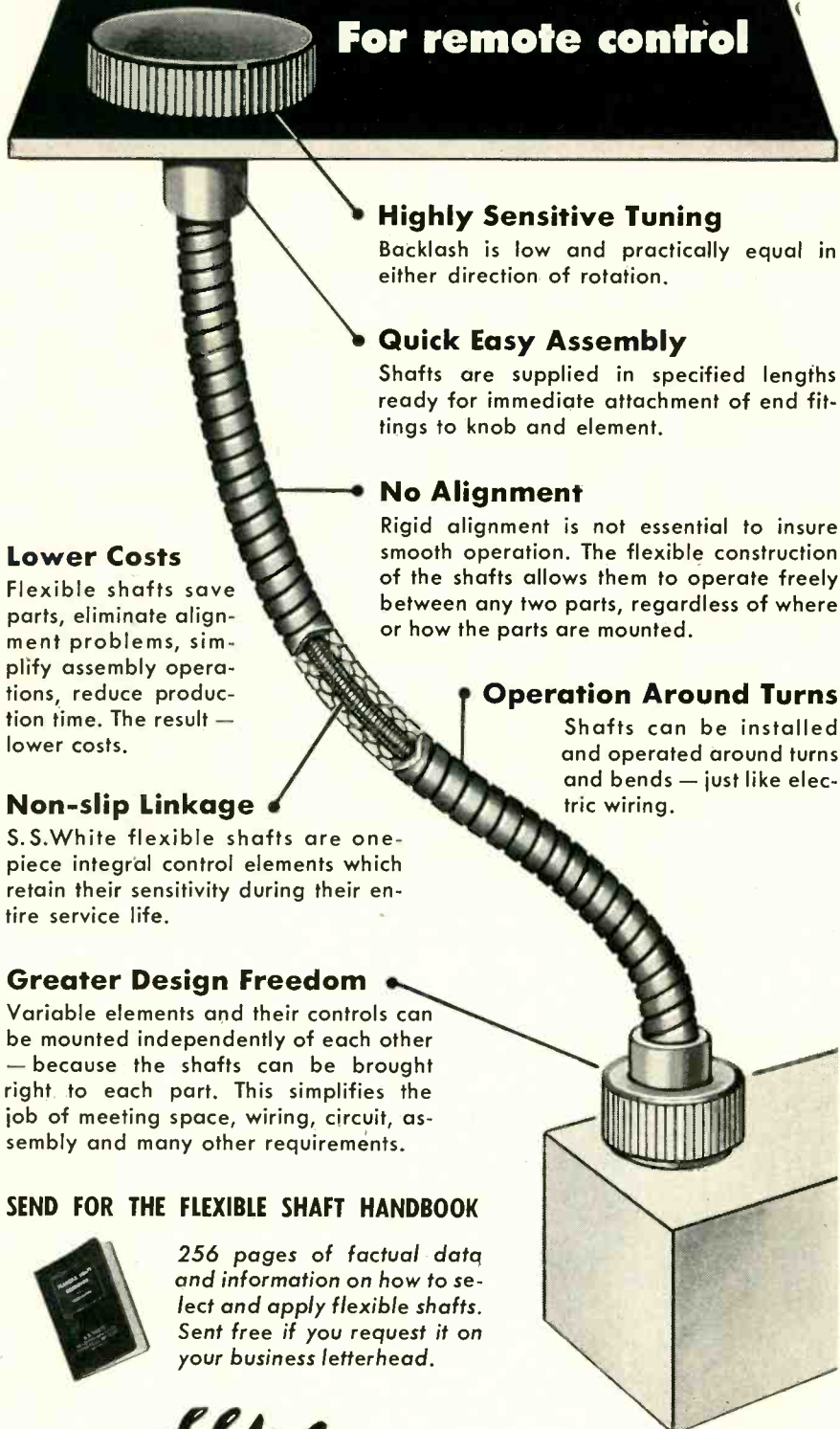

Highly Sensitive Tuning

Backlash is low and practically equal in either direction of rotation.

Quick Easy Assembly

Shafts are supplied in specified lengths ready for immediate attachment of end fittings to knob and element.

No Alignment

Rigid alignment is not essential to insure smooth operation. The flexible construction of the shafts allows them to operate freely between any two parts, regardless of where or how the parts are mounted.

Operation Around Turns

Shafts can be installed and operated around turns and bends — just like electric wiring.

Lower Costs

Flexible shafts save parts, eliminate alignment problems, simplify assembly operations, reduce production time. The result — lower costs.

Non-slip Linkage

S.S.White flexible shafts are one-piece integral control elements which retain their sensitivity during their entire service life.

Greater Design Freedom

Variable elements and their controls can be mounted independently of each other — because the shafts can be brought right to each part. This simplifies the job of meeting space, wiring, circuit, assembly and many other requirements.

SEND FOR THE FLEXIBLE SHAFT HANDBOOK



256 pages of factual data and information on how to select and apply flexible shafts. Sent free if you request it on your business letterhead.

THE S.S. White INDUSTRIAL DIVISION
DENTAL MFG. CO.



Dept. E, 10 East 40th St.
NEW YORK 16, N. Y.

Western District Office • Times Building, Long Beach, California

which has been welded a rod that serves as a handle, eliminating need for a wrench. A spring between the jaws keeps them separated for ease in loading a new part.

Mesh-Crimping Machine

A VARIATION of the old hand-cranked clothes wringer is used to crimp nickel mesh ribbon in the Newark, N. J. plant of Chatham Electronics Corp. Both rollers have longitudinal ridges machined out of the solid metal. Spacing between rollers is such that the ridges mesh



Gloved hands and paper under crimping machine insure cleanliness of crimped mesh ribbon

like gear teeth, with only enough clearance to equal the thickness of the nickel ribbon. A crank arm is attached to one roller. Knurled lock nuts permit raising or lowering the upper roller to adjust for different thicknesses of materials.

The crimped ribbon serves as the hydride coil for the type 1907 hydrogen thyratron tube made by this firm for pulsing high-power radar magnetrons.

Rack for Line Cords

TOTE rods mounted on casters facilitate transporting of line cord assemblies to the next operating position on the television receiver assembly line in Crosley's Cincinnati plant. The tote rods are nailed at one end to a wood framework, and are spaced just far enough apart so that line cords go between them easily. The metal mounting

Now available

the revolutionary
ELECTRO TEC
 process* for your
LARGE
SLIP RING
ASSEMBLIES

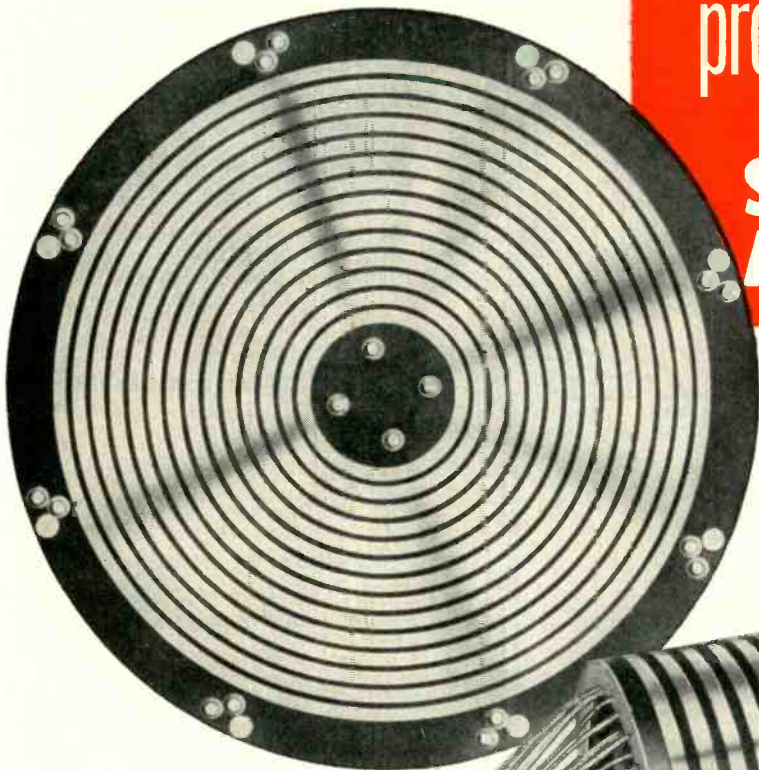

↑ An assembly with 14 concentric, hard silver rings electro deposited into machined plastic blank. Dovetail locks rings in place. Machined blank insures accuracy. Diameter approx. 11", thickness approx. 5/16".

↑ Cylindrical assembly with 25 rings. Three wide rings accommodate large contact area brushes for high current capacity. Length 14", O.D. approx. 5 3/8".



Now a Complete Service
 in all sizes of Slip Ring Assemblies

- featuring*
- LOWER COST • CLOSER TOLERANCES
 - ONE-PIECE CONSTRUCTION • JEWEL-LIKE FINISH • UNIFORM RING HARDNESS
 - REDUCED WEIGHT

↑ An assembly with 30 rings of various widths to accommodate various current requirements. Unit is approx. 4-5/16" long, designed for flange mounting.

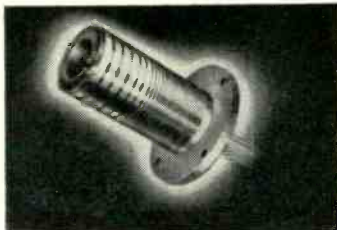

↑ Cylinder type assembly approx. 3 3/4" long with 24 hard silver rings. 1 5/8" O.D. with wall thickness less than 1/4".



*PATENTS
 PENDING

Our Engineering Department is available for consultation on any of your slip ring problems without obligation.



ELECTRO TEC CORPORATION
 SOUTH HACKENSACK • NEW JERSEY

ELECTRO TEC is now tooled up, with new expanded facilities for production of large Slip Ring Assemblies to exact customer specification. Sizes range up to 24" in diameter, either cylindrical or disc type.

The exclusive ELECTRO TEC PROCESS*—the electro-deposition of hard silver rings into an accurately machined plastic blank—consistently yields a high degree of dimensional accuracy, excellent concentricity, and a jewel-like ring finish. This process also eliminates expensive tooling and mold charges, frequently lowers costs to 30% of other methods of manufacture. The silver rings are uniformly hard for long life—75-90 Brinell.

ELECTRO TEC one-piece construction precludes dimensional variation due to accumulated errors. The plastic base is fully cured before rings are plated into it, thus preventing separation of base material from the rings.

ELECTRO TEC LARGE SLIP RING Assemblies are widely used in Radar Equipment, Fire Control Systems, Test Tables and many other critical applications. Light weight combined with rugged durability recommends their use in airborne applications.

Every user knows the ELECTRO TEC reputation for quality and superiority in miniature and sub-miniature slip ring assemblies.



A NEW
twist
FOR YOUR PRODUCT

Lewis

can help YOU improve
YOUR product . . .
simplify production!

It's amazing what things as commonplace as springs, coils and wireforms can do to help product performance and sales appeal! But, as Lewis Engineers can show you, there's more to a spring than just a coil of wire. The design and selection of material can "make or break" an otherwise good product. That's why it pays to choose a supplier who has the experience, reputation and facilities to furnish you with springs, coils and wireforms that are expertly designed and engineered to fit your product's exact needs.

Call on Lewis! Show us your product . . . tell us your problems . . . see how Lewis Engineers come up with the perfect answer to increased product performance and lower production costs! Drop us a line today!

LEWIS SPRING & MANUFACTURING COMPANY
2656 W. NORTH AVENUE, CHICAGO 47, ILLINOIS

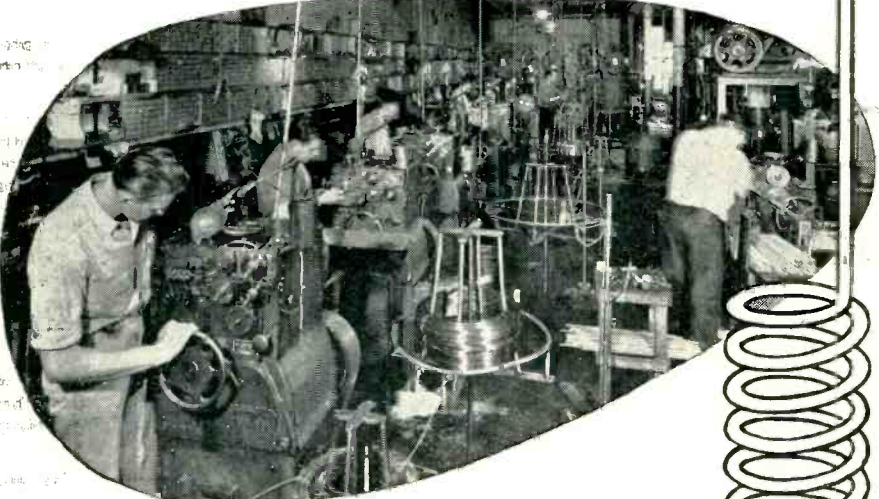

Lewis **PRECISION SPRINGS**
THE FINEST LIGHT SPRINGS AND WIREFORMS OF EVERY TYPE AND MATERIAL



Rolling rack for television receiver line cords. Operator places cords on it after stapling the metal back-cover plate to the female end of the cord

plate assemblies stay on top of the rods, and the coil cords hang down below. The construction reduces tangling of cords.

With 17 slots and a capacity of 10 cords per slot, the total capacity of the rack is 170 cords. The rack is called a xylophone by plant workers because of its resemblance when empty to this instrument.

Assembling Dial Drive Cords

A RIVETING-MACHINE setup in Crosley's Cincinnati plant automatically produces finished dial drive cords cut to correct length and having securely riveted end loops. The operator needs only to unload and rethread the machine. Two loops are formed at each operation, one for the end of a finished cord and one for the start of a new cord.

As the first step, the operator hooks the loop (formed on the end of the cord coming from the spool during the previous operation) over

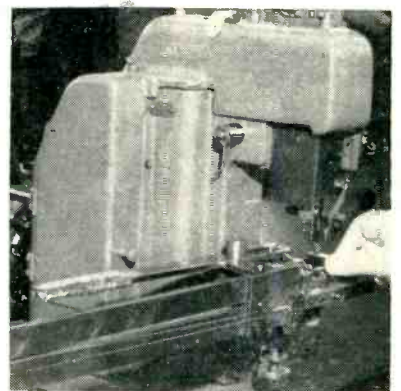

Riveting machine setup used for forming loops in drive cords for radio and television dial tuning

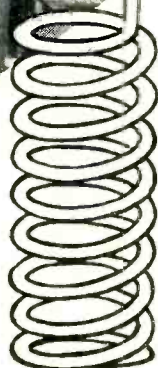

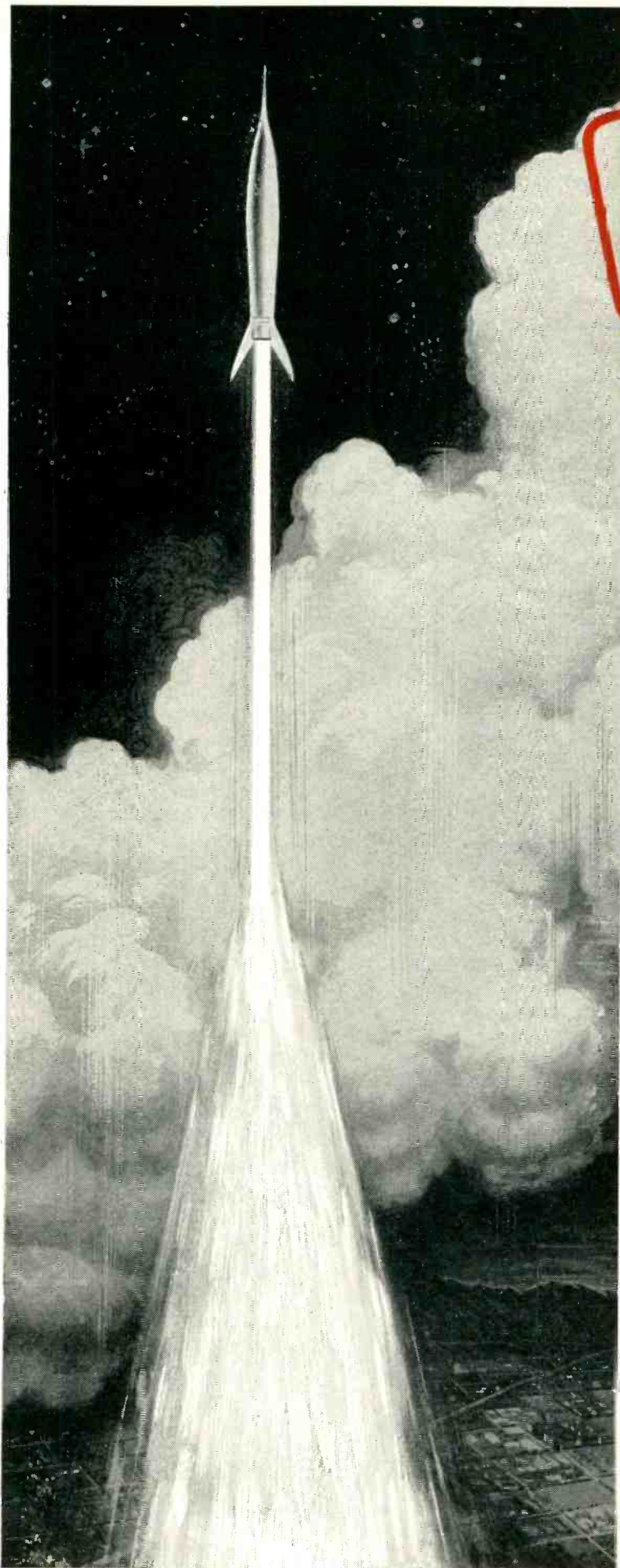

**IMPORTANT
ANNOUNCEMENT**

...to Engineers and Scientists

***You can now fill vital positions
in our guided missile projects***

Chance Vought Aircraft, a supplier of high performance Navy aircraft for 35 years, is presently engaged in highly classified work on guided missiles under Navy contract. These missiles are in restricted production for intensive experimental use. They are flying and their performance has been excellent.

Engineering and scientific personnel with backgrounds in Aerodynamics or Electronics will find exceptional opportunities for employment on these interesting projects. Openings are available to personnel with Ph.D. and M.S. degrees, or B.S. degrees with related missile experience.

For further information write Engineering Personnel Section, Chance Vought Aircraft, P. O. Box 5907, Dallas, Texas.



CHANCE VOUGHT AIRCRAFT

Division of United Aircraft Corporation
DALLAS, TEXAS

Here's how the **BECKMAN EASE COMPUTER** helped simplify **F-86 Sabre jet design**

$e_1 \propto \delta a$ **AILERON**

at North American Aviation

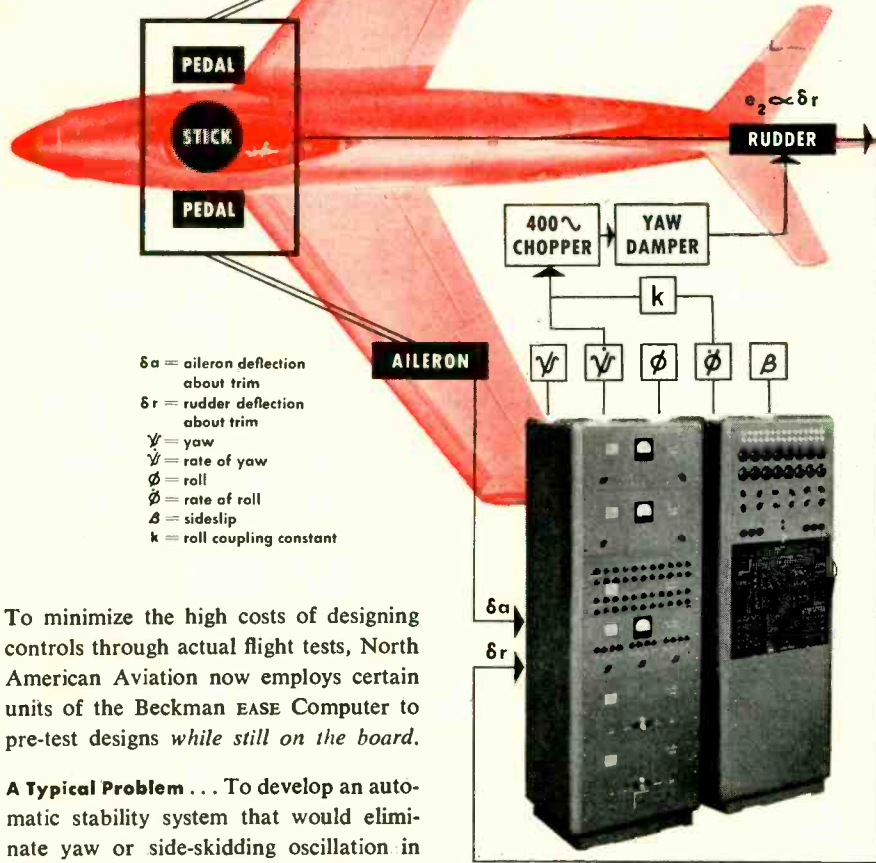

- δa = aileron deflection about trim
- δr = rudder deflection about trim
- ψ = yaw
- $\dot{\psi}$ = rate of yaw
- ϕ = roll
- $\dot{\phi}$ = rate of roll
- β = sideslip
- k = roll coupling constant

To minimize the high costs of designing controls through actual flight tests, North American Aviation now employs certain units of the Beckman EASE Computer to pre-test designs while still on the board.

A Typical Problem . . . To develop an automatic stability system that would eliminate yaw or side-skidding oscillation in piloting the F86-D Sabre Jet over a wide range of speeds and at altitudes from sea level to the stratosphere.

How North American Solved It . . . The diagram above shows how North American used certain units of the Beckman EASE Computer to quickly solve the problem by flight simulation. A control-system mockup was designed by engineers at North American which generated voltages proportional to aileron and rudder deflections made by movement of mockup stick and pedals. These voltages were fed into the computer so that its electrical response was analogous to the response of the F86-D in flight. Flight conditions—speed and altitude—were varied on the computer by merely turning knobs.

Airborne performance confirmed the results as developed by flight simulation!

WHAT ABOUT YOUR DESIGN PROBLEMS?

The Beckman EASE Computer is currently being used to solve design problems on such products as guided missiles, submarines, railroad cars, automobiles, military vehicles—and has many other time and money-saving applications in industry and research. It is not only, by far, the lowest priced quality instrument in the field . . . but its unutilized design, employing compact rack-mounted components, permits the user to select a custom computer which meets his exact requirements—whether as equation solver, simulator, or tester. Let us study your design problems and make helpful suggestions on applying the EASE to your operations!

Get complete details on this new Beckman advancement by writing for Data File 18-59

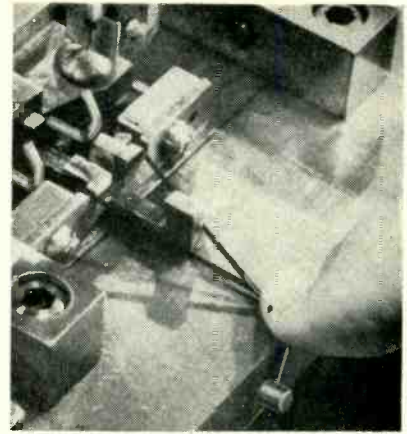

Closeup of riveting machine after cord has been strung. Retractable metal peg is just under finger. Cutter bar is just in front of finger, and moves away from finger when hand lever is operated

a spring that is clamped to the machine. She then brings the cord around a pulley mounted on an outrigger at the left end of the machine; the position of this pulley is adjustable for changing the total length of a cord.

From the pulley, the cord is brought back around a metal peg in front of the operator, brought around one loop-forming hook, run across a gap through which the cutting tool later passes, then brought around the other loop-forming hook and back toward the operator. She holds her finger on this end of the cord to maintain tension, then operates the foot pedal of the press. This applies the rivet



Rack for storing and transporting finished drive cords



Special Products Division
BECKMAN INSTRUMENTS, INC.
 SOUTH PASADENA, CALIFORNIA
 Factory Service Branches: New York—Chicago—Los Angeles

Beckman Instruments include: pH Meters and Electrodes — Spectrophotometers — Radioactivity Meters — Special Instruments

“DOUBLE-TEAMED”

for
quality

GENERAL TRANSFORMERS

manufactured with

Heldor
**CANS &
TERMINALS**

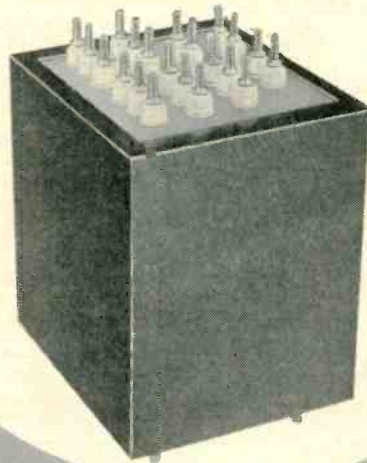
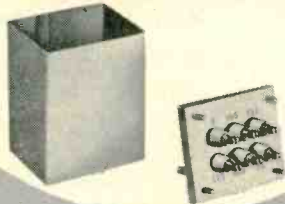

Built to Meet MIL-T-27 SPECIFICATIONS

General Transformer Company uses Heldor transformer cans and compression-type, hermetic seal bushings as a practical solution to many assembly problems. From design through every step of production, they know

that their finished transformers will meet MIL-T-27 specifications.

Take advantage of HELDOR's new "PACKAGE"—transformer cans with hermetic seal bushings ASSEMBLED in can covers, all ready for final assembly operations—to save time, money and inventory problems. Don't buy merely cans and terminals—buy this new Heldor "PACKAGE". Mail specifications of your present can and terminal assemblies for a money-saving quotation.

Enclosed are specifications.
Quote on..... Heldor "PACKAGES"
(Quantity)
 Send new Heldor Bushing Catalog.
Name.....
Title.....
Company.....
Street.....
City..... Zone.....
State.....

**WRITE
FOR
DATA**



HELDOR MANUFACTURING COMPANY
Division of HELDOR BUSHING & TERMINAL CO., INC.
225 Belleville Avenue, Bloomfield, New Jersey

for best marking results use

MARKEM[®]



METHODS

MARKEM MACHINES • MARKEM TYPE • MARKEM INKS

FOR MARKING PRODUCTS, PARTS, PACKAGES, TAPES, TAGS, LABELS

Markem Methods are engineered to solve *specific* marking problems. The proper combination of a Markem marking machine, Markem type and Markem ink is matched to the individual requirements. Not only are the properties of the surface itself considered, but also local conditions of temperature and humidity together with your own handling techniques during production, storage and packaging. That is why it is so important that the Markem Method be followed completely.

When you have a marking problem, ask Markem about it. Send a sample of the item to be marked and details of your needs. Markem engineers have worked out practical solutions for many manufacturers. Markem Machine Company, Keene 5, N. H.



MARKEM
BETTER MARKING SINCE 1911

over the final loop to complete the cord.

With her left hand, the operator then moves the hand lever on the machine enough to bring the starting loop for the new cord under the riveting head, and operates the foot pedal again to apply the second rivet. Moving the hand lever still farther now pulls the cutting blade back through the cord, shearing it. A final movement of the lever retracts the metal peg on the front of the machine, releasing the tension so that the finished loops can be unhooked easily.

At another work position, a spring is hooked on to each end of the finished cord. The cords are then stored on an adjustable tote board. This has headless nails at one end over which the spring eyes are placed. Each cord is hooked over one of the wooden pegs on a sliding board at the other end. The peg board is positioned correctly for a particular length of cord, then locked in position with a thumb screw.

Ventilating-Screen Stapler

PROTECTIVE wire screens are stapled over ventilating openings in the composition backs of television receivers at a production rate of less than one minute per set, in Crosley's Cincinnati plant. This is made possible through use of a heavy-duty Bostitch power stapler controlled by a foot pedal. The machine uses spools of wire rather than staples, thereby reducing material costs for the operation.

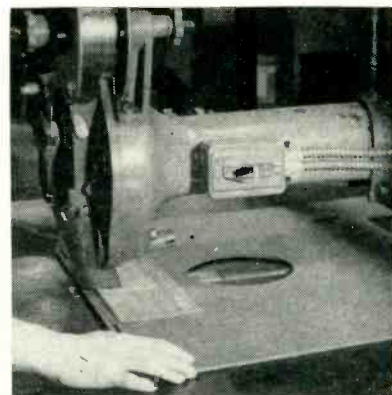

Stapling protective screen to back cover for television receiver

only \$650

2KW
VACUUM TUBE
BOMBARDER
OR
INDUCTION
HEATING UNIT



Simple . . . Easy to Operate . . . Economical
Standardization of Unit Makes This New
Low Price Possible

Never before a value like this new 2-KW bench model "Bombarder" or high frequency induction heater . . . for saving time and money in surface hardening, brazing, soldering, annealing and many other heat treating operations.

This compact induction heater saves space, performs with high efficiency. Operates from 220-volt line. Complete with foot switch

and one heating coil made to customer's requirements. Send samples of work wanted. Specify time cycle required for your particular job. We will quote on proper size unit for your requirements. Immediate delivery.

Scientific Electric Electronic Heaters are made in the following ranges of power: 1-2-3½-5-7½-10-12½-15-18-25 40-60-80-100-250KW.

Scientific Electric

DIVISION OF "S" CORRUGATED QUENCHED GAP CO.
107-119 MONROE STREET GARFIELD, NEW JERSEY



Application Report #4

... how the unique thermoplastic — TRIFLUORO-CHLORO-ETHYLENE — has been used to solve tough design problems

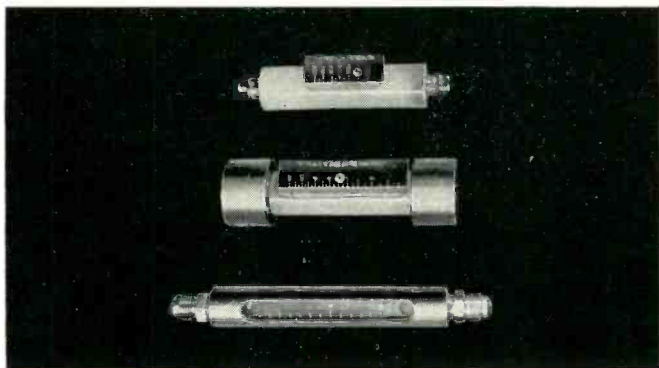

1. Glass won't do in these gauges which measure the rate of flow of hydrofluoric acid. Chemical inertness . . . transparency to permit reading liquid levels . . . shatter-resistance . . . and easy machinability of both rod and tube are the reasons for specification of Kel-F.

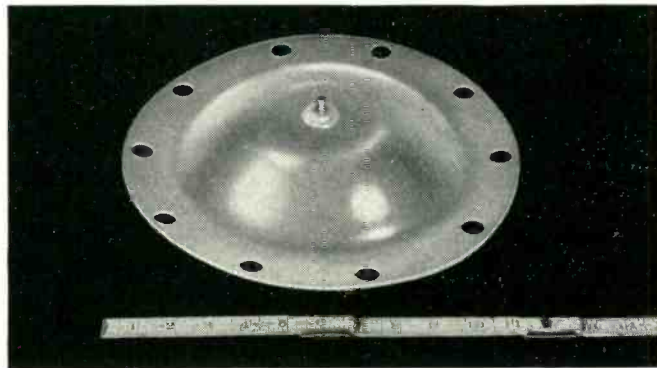

2. Superior flexibility over a wide temperature range, combined with chemical inertness, make Kel-F the natural specification for this large valve diaphragm to be used for corrosive service. Measuring *twelve* inches in diameter, the diaphragms are compression molded around metal inserts.

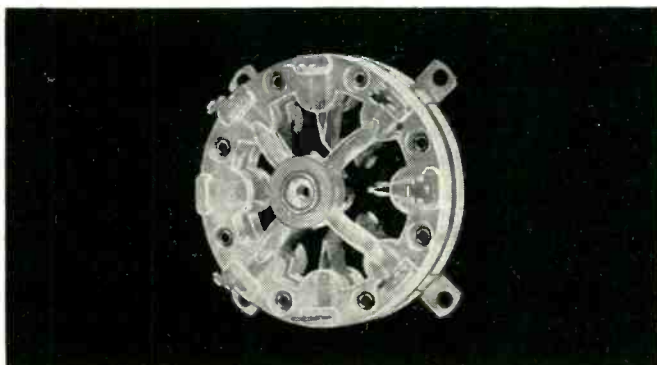

3. Mass production is possible with Kel-F because of its ready moldability. Electronic parts, like this tube base, may be injection molded in short cycles. No finishing, aside from sprue-removal, is required to assure close tolerance fits with metal parts.



4. A hermetical seal between insulation and contacts is required in these multi-lead terminals. Other major "specs" include superior electrical and heat resistance. Today, Kel-F is specified for such applications—because the seal is easily achieved through compression molding about metal contacts.

A Capsule Report on the Properties of KEL-F

- ★ Chemical Inertness
- ★ Wide temperature range — minus 320 F to 390 F
- ★ High electrical resistance
- ★ Low Cold Flow
- ★ Zero Moisture Absorption
- ★ Variable transparency and flexibility properties
- ★ Readily molded, extruded and machined

Basic Kel-F Products Available

MOLDING POWDERS

Unplasticized

- #300 . . . for high temperature service
- #270 . . . for less severe temperatures

Plasticized

- (in either #300 or #270)
- P 20 . . . with 20% plasticizer
- P 25 . . . " 25% "
- P 30 . . . " 30% "

DISPERSIONS

- NW-25 . . . flows readily at fusion temperatures
- N-1 . . . High molecular weight

OILS, WAXES and GREASES

- #1 . . . Light Oil
 - #3 . . . Medium Oil
 - #10 . . . Heavy Oil
 - #40 . . . Waxy Oil (pour point 80-90 F)
 - #150 . . . Hard Wax at 70 F
- (Greases compounded to order)

Standard Fabricated Kel-F Materials and Parts Available from Commercial Sources

- Molded Sheets ★ Extruded and Molded Rod ★ Extruded Tubing
- Thin Film (extruded as lay-flat tubing) ★ Strip
- Gaskets ★ Washers ★ Valve Discs ★ "U" Packing
- "O" Rings ★ Kel-F coated Resilient-core "O" Rings
- Valve Diaphragms

- Transformer Terminals ★ Rotary Electric Switches ★ Hook-up Wire
- Electronic Terminals, Tube Bases and Coil Forms

For full information on various molders, extruders and fabricators of Kel-F products; also technical data on detailed properties, molding and application techniques—write

Chemical Manufacturing Division

THE M. W. KELLOGG COMPANY
P. O. Box 469,
Jersey City 3, N. J.



NEW PRODUCTS

Edited by WILLIAM P. O'BRIEN

Recently Developed Test Instruments, New Materials and Components and Several of the Latest Tubes Are Included . . . Twenty-four Trade Bulletins Reviewed Under *Literature* (p 381)

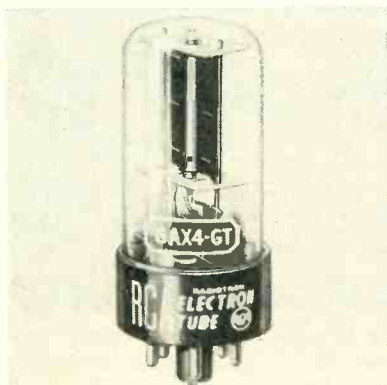

Half-Wave Vacuum Rectifier

RADIO CORP. OF AMERICA, Harrison, N. J., has announced the 6AX4-GT, a half-wave vacuum rectifier tube of the heater-cathode type. It is intended chiefly for use as a damper tube in horizontal deflection circuits of tv receivers. Designed to withstand negative peak pulses between heater and cathode of as much as 4,000 volts with a d-c component up to 900 volts, the tube provides flexibility in choice of deflection circuits.

Response of the amplifier from 0 to 200,000 cps is within 10 percent down; from 0 to 500,000 cps, within 6 db down from maximum response. The horizontal amplifier provides 3 stages of push-pull amplification, giving sensitivity to 100 mv rms per in. Sinusoidal frequency response of the amplifier from 0 to 100,000 cps is within 10 percent down; and from 0 to 300,000 cps, within 6 db down from maximum response. Test signals are provided for in the form of a 0.5-v rms sine wave at the line frequency and 3.5 v peak-to-peak sawtooth wave at the horizontal sweep frequency.

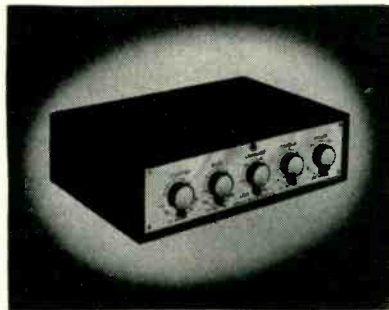

Equalizer Preamplifier

THE RADIO CRAFTSMEN, INC., 4401 N. Ravenswood Ave., Chicago 40, Ill. Model C300 equalizer preamplifier features five-position low-and-high record equalization, five-position low-and-high sharp-frequency-cut-off filters for reduction of rumble and record scratch respectively, choice of loudness or straight volume-control action, continuously variable bass and treble controls and five different audio inputs. Other features include a self-contained shielded power supply, tube filaments powered by d-c to reduce hum to a minimum, tubes mounted on a shock-mounted subchassis, and an all-triode circuit with cathode-follower output.



General-Purpose Oscilloscope

TELETRONIC LABORATORIES, INC., 1835 W. Rosecrans Ave., Gardena, Calif. Model 101 general-purpose rack-mounted oscilloscope features a 7-in. viewing screen. The vertical amplifier provides 5 stages of push-pull amplification, giving sensitivity of 10 mv peak-to-peak per in. The sinusoidal frequency re-

OTHER DEPARTMENTS

featured in this issue:

	Page
Electrons At Work	168
Production Techniques	266
Plants and People	396
New Books	414
Backtalk	430



Miniature Relay

TERADO Co., 1068 Raymond Ave., St. Paul 8, Minn., has announced a miniature relay that is hermetically sealed and has an extreme sensitivity because of its high-efficiency coil. It will operate on 75 mw or less. The switch is spdt. Contacts are of solid coined silver. Other features include: maximum coil resistance, 10,000 ohms; insulation, 500 volts any terminal to ground; and base, the standard 7-pin miniature.



Synchronous Inverter

THE BRISTOL Co., P. O. Box 1790, Waterbury 20, Conn., has developed a synchronous inverter having a

Here's what makes



RELIABLE SUBMINIATURE TUBES

Reliable!

RAYTHEON RELIABLE SUBMINIATURE TUBES

CK5702WA

RF Amplifier Pentode

CK5703WA

High Frequency Triode

CK5744WA

High Mu Triode

CK5783WA

Voltage Reference

CK5784WA

RF Mixer Pentode

CK5787WA

Voltage Regulator

CK5829WA

Dual Diode

CK6021

Medium Mu Dual Triode

CK6111

Low Mu Dual Triode

CK6112

High Mu Dual Triode

CK6152

Low Mu Triode



- ✓ **EXPERIENCE** Raytheon has been in constant, large scale production of subminiatures for fourteen years — has made millions of them.
- ✓ **ENGINEERING** Many Raytheon engineers have worked exclusively on the development and improvement of Subminiature tubes. Raytheon designs have proved themselves in the field.
- ✓ **EQUIPMENT** Raytheon's production, testing and inspection facilities are custom built. Improved welding, sealing and exhaust procedures

are among the many exclusive Raytheon advances.

- ✓ **EXCLUSIVE SUBMINIATURE TECHNIQUES** Include closer production tolerances for all parts; separate production and inspection personnel free of production-incentive pressure; grid inspection with high optical magnification; microscopic inspection of each assembly; longer, more complete electrical aging; rigid tests for shock, vibration, acceleration and all other factors affecting performance and life.



Excellence in Electronics

RAYTHEON MANUFACTURING COMPANY

Receiving Tube Division — for application information call

Newton, Mass. Bigelow 4-7500 • Chicago, Ill. National 2-2770 • New York, N.Y. Whitehall 3-4980 • Los Angeles, Calif. Richmond 7-5524

RAYTHEON MAKES ALL THESE:

RELIABLE SUBMINIATURE AND MINIATURE TUBES • GERMANIUM DIODES AND TRANSISTORS • NUCLEONIC TUBES • MICROWAVE TUBES • RECEIVING AND PICTURE TUBES

sensitivity of 0.05 μ v and a dissymmetry of less than 0.5 percent. It is capable of converting low-power d-c signals to alternating voltages that can be amplified and applied to electronic, electrical and servo systems. The Syncroverter Switch will operate at any frequency from 0 to 3,500 cycles. It is designed for precision use in electronic computers, instruments, gun directors, null detectors and many other similar uses. Instantaneous operation and length of life are not affected by vibration or shock. Errors due to thermal emf are eliminated by the use of two spdt contacts.



Voltmeter

THE DAVEN CO., 191 Central Ave., Newark 4, N. J., announces its improved electronic voltmeter, type 170-A, for general laboratory and production use. Amplifier and power supply sections are separate subassemblies. The amplifier is completely shockmounted, reducing microphonic effects to a minimum. Both amplifier and power supply are electrostatically and magnetically shielded from each other and from external fields. This eliminates pickup and reduces hum in the amplifier and also prevents disturbance of nearby equipment due to radiation. Another new feature of the unit is the fact that selected tubes are not necessary for replacement. Any standard vacuum tube may be substituted without affecting the characteristics of the voltmeter. The improved instrument measures accurately a-c sinusoidal

voltages over a frequency range from 10 to 250,000 cycles, and a voltage range from 0.001 to 100 v. Accuracy is ± 2 percent over the entire frequency range.

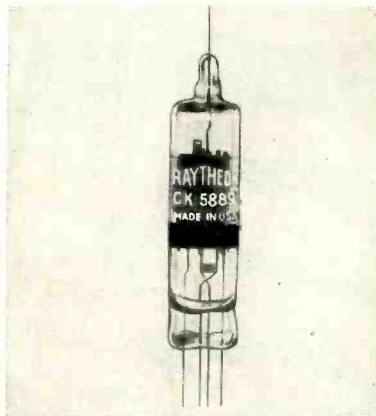

Electrometer Pentode

RAYTHEON MFG. CO., 55 Chapel St., Newton 58, Mass. Type CK5889 is a subminiature pentode electrometer tube with a control-grid current rating of 3×10^{-10} ampere maximum. A minimum of filament power is required by the 1.25-v, 0.0075 ampere filament. The conducting ring around the bulb may be grounded through a connecting clip to provide complete isolation of the grid lead, which is at the top of the tube. Full technical information is given in a data sheet now available.

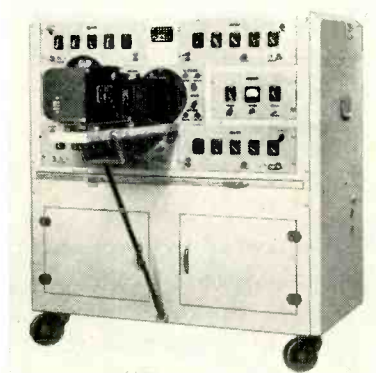

Four-Channel Oscilloscope

ELECTRONIC TUBE CORP., 1200 E. Mermaid Lane, Philadelphia 18, Pa., has available a new high-gain, four-channel oscilloscope for measuring the minute potentials from brain waves, heart waves and other

neuromuscular reactions studied in encephalography, biophysics and allied fields of medical research. Model E4GAM has a high input impedance and a maximum gain of 1.8 million. Signals from all four channels are displayed on the face of a single 7-in. crt that may be readily photographed with an oscillo-record camera. The sweep generator is common to all channels and has a continuously variable range from 1 sweep per minute to 50,000 sweeps per second plus provisions for blanking, external synchronization and either common or individual positioning.



Pulse Generator

RUTHERFORD ELECTRONICS CO., 3707 South Robertson Blvd., Culver City, Calif. Model B-2 pulse generator is an instrument for the generation of pulses of variable width, amplitude, delay and repetition rate, with very accurate control of all factors by means of helical potentiometers. It features duty factors as high as 25 percent, and repetition rates as high as 100 kc. It has an internal oscillator giving rates from 10 cps to 100 kc in four decade ranges. It may be externally triggered or used in single pulse operation. The main pulse may be delayed from 0 to 10,000 μ sec from the synchronizing pulse in five decade ranges. The main pulse is variable in width from 0.2 μ sec to 1,000 μ sec in four decade ranges, has a rise time of 0.02 μ sec, a fall time of 0.05 to 0.1 μ sec (depending on width), and maximum amplitude of 100 v into an open circuit. The internal impedance of the main pulse output is 100 ohms. Amplitude of the outputs is adjusted by a constant-impedance 100-ohm step attenuator,

NEW 7" REELS OF
audiotape* give you

EXTRA VALUE

at no extra cost!

GUARANTEED SPLICE-FREE

SPLIT-SECOND TIMING with New 2 $\frac{3}{4}$ " Hub

Timing errors are virtually eliminated by this improved reel design which minimizes tension and speed changes throughout the winding cycle. Ratio of O.D. to hub diameter is the same as on the standard NAB aluminum reel.



PERFECTED ANTI-FRICTION PROCESS.

Reduces head wear—eliminates annoying tape "squeal" — prevents "tackiness" even under extreme temperature and humidity conditions.

MAXIMUM UNIFORMITY OF OUTPUT.

All 7" and 10" reels of plastic-base Audiotape are guaranteed to have an output uniformity within $\pm \frac{1}{4}$ db — and reel-to-reel-variation of less than $\pm \frac{1}{2}$ db. What's more, there's an actual output curve in every 5-reel package to prove it.

With Audiotape, all of these extra-value features are *standard*. There's no extra cost — no problem of separate inventories or variations in tape quality.

For there's *only one* Audiotape — the finest obtainable anywhere. Test it — compare it — let Audiotape speak for itself.

The new 7-inch plastic reel with large diameter hub for greater timing accuracy is now being supplied on all orders unless otherwise specified. Because of increased hub diameter, maximum reel capacity is slightly over 1200 feet. Older style Audiotape reels with 1 $\frac{3}{4}$ " hub and 1250 feet of tape will continue to be furnished on request at the same price.

*Trade Mark

AUDIO DEVICES, Inc.

444 Madison Ave., New York 22, N. Y.

Export Department, 13 East 40th St., New York 16, N. Y., Cables "ARLAB"

audiorecorders • audiotape • audiofilm • audiopoints

**how
fast
is
it?**

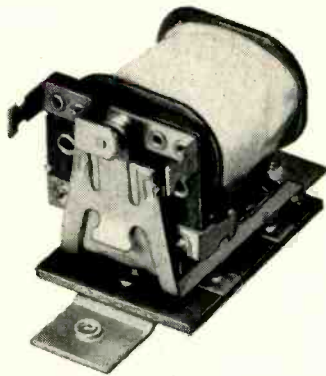

The speed of any relay, including the Sigma Series 41 Sensitive Relay pictured above, varies widely depending on circuit conditions.

Here are two test circuits. In each case, the same relay is used, the coil current is the same and the oscillogram shows the operating time.

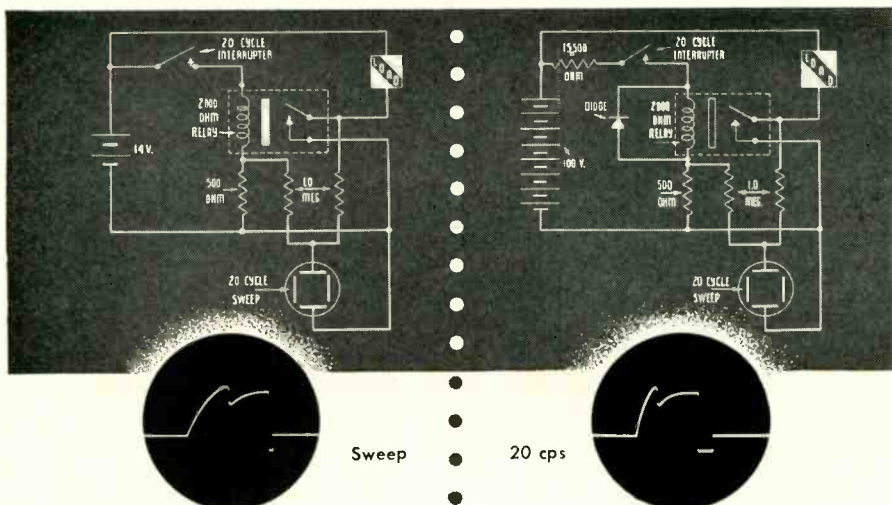

IN THIS CASE —

The oscillogram shows a gradual rise of coil current, based on the signal derived across the 500 ohm resistor. The first downward step is caused when the relay contact in closing grounds the load and removes some of the input voltage from the scope. Reverse curvature in the trace is due to back emf induced in the relay winding by the armature motion. The next and much larger downward step is the result of opening coil circuit by the interrupter. The small dot at its lower end indicates the delay in breaking the load circuit, after which the trace moves upward from reappearance of voltage across open contacts. The whole cycle shows a substantial operating delay, and a period of contact closure much shorter than that in which voltage is applied to the coil.

HERE HOWEVER —

Although the final relay current is identical, as is the relay, it is obvious that the electrical time constant is much shorter, the current rises faster, and the contacts close sooner. Another "wrinkle" has been introduced in the diode shown across the coil. It is polarized so as not to pass battery current; but upon interruption of the circuit, it provides a low impedance path for dissipation of the stored energy in the relay, which in the other case was dissipated in an arc at the interrupter contacts at high voltage without significant current flow. In this case, the current flow is appreciable and holds the relay on for a considerable length of time.

Not only is the relay now much faster, but the contacts are now closed for a time approximately equal to that during which the coil is energized.

Thus it is evidently difficult to state operating time of a relay unless circuit conditions are prescribed — and this is no academic qualification. (Those wishing to duplicate the above displays will recognize that the two resistors shown as 1.0 megohm should be varied to give a desirable relative magnitude to the two signals, and may in fact take the form of a potentiometer.)

SIGMA

SIGMA INSTRUMENTS, INC.

62 PEARL ST., SO. BRAintree, BOSTON 85, MASS.

having a 60-db range, together with a 10-db fill-in attenuator.



Hydrogen Thyatron

RADIO CORP. OF AMERICA, Harrison, N. J. The 3C45 is a hot-cathode, three-electrode hydrogen thyatron designed for pulsing service involving high repetition rates, high peak currents and low average currents in low-impedance circuits. It is especially useful for pulsing magnetron oscillators and other oscillators having a power input up to 50 kw. Features include short deionization time, low voltage drop, high peak anode current capability, ambient-temperature operating range of -50 to $+90^{\circ}\text{C}$, and positive-control characteristic which permits zero-bias operation utilizing positive triggering pulses.



Radiation Measurement Instrument

RADIATION COUNTER LABORATORIES, INC., 5122 W. Grove St., Skokie, Ill. The Omnimeter is a new, single, all-purpose instrument for the measurement of radiation. It may be employed with all types of sensing elements such as Geiger,

FOR RADIO

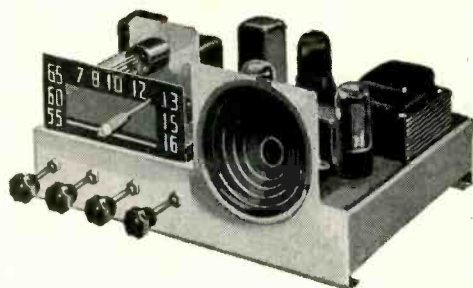

AND

TV

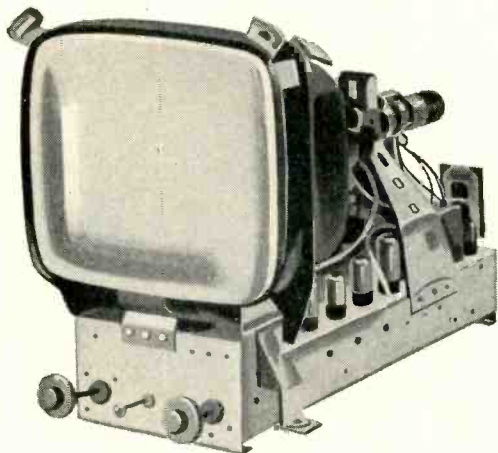

SOLDERING THAT LASTS...

USE...

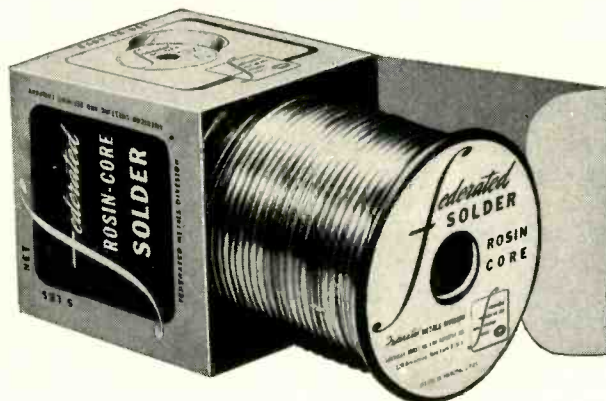

For any soldering job that demands freedom from corrosion and conductive flux residue . . . for ease of working and unequalled consistency . . . there is nothing better than Federated Rosin Core Solder.

Each Rosin Core Solder composition . . . there is a variety for different purposes . . . is a tin and lead alloy with a rosin flux that is effective but not corrosive. Because the rosin residue is chemically inactive, current leakage at radio and television frequencies is prevented.

Federated Rosin Core Solder is a quality product that is unsurpassed for the permanence of the bond it produces . . . for the consistently easier soldering job it does! Look for it in 1, 5, 20, 25, and 50-pound sizes on the familiar orange and black metal spool. Listed by Underwriters' Laboratories Inc.

Federated Metals Division



AMERICAN SMELTING AND REFINING COMPANY • 120 BROADWAY, NEW YORK 5, N. Y.

HOW EDISON HELPED RCA BEAT the DOPPLER EFFECT



Edison Temperature Control in RCA Crystal Oven Maintains Oscillator Frequency to Accuracy of 0.00005%.

Equipment used in the monitoring of television transmitters employing the offset carrier system requires a degree of frequency accuracy and long term stability unheard of a short time ago. The most exacting requirements are imposed at the upper end of the newly assigned U.H.F. channel, where monitor accuracy must be held to 5 parts in ten million.

At this high order of accuracy, single checks against a stable reference source such as WWV are inadequate because the Doppler effect in transmissions reflected from the ionosphere causes variations amounting to 50% of the allowable monitor tolerance over a 24 hour period.

Engineers at the Radio Corporation of America found the solution in a new crystal oscillator so stable that

readings can be taken over a relatively long period of time without recalibration. In this way accurate average frequency values can be obtained which cancel out the variations caused by the Doppler effect.

The heart of this oscillator is the new RCA VC-1-F crystal unit. Mounted in the TMV-129-P oven and temperature-controlled by an Edison sealed-in-glass thermostat, the oscillator maintains the required accuracy of 0.00005% for periods in excess of the 30 day minimum specified.

Let us send you, free, specifications on Edison sealed thermostats. Ask for bulletin No. E-3009. Edison thermostats feature stability measured in years; control within $\pm 0.1^\circ\text{F}$ and capacity to 115 volts 8 amperes d.c. or 1000 watts.

Thomas A Edison
INCORPORATED

INSTRUMENT DIVISION

Lakeside Avenue, West Orange, N. J.

MANUFACTURERS OF

Electrical Resistance Bulbs

Temperature Indicating and Alarm Systems

Time Delay Relays

— YOU CAN ALWAYS RELY ON EDISON —

NEW PRODUCTS

(continued)

proportional and scintillation counters. The meter incorporates two h-v supplies which provide overlapping voltage ranges from 500 to 5,000 v. Changeover can be accomplished by a simple switch. If the sensing element delivers $\frac{1}{4}$ volt pulses or higher, then access is direct to the scaling circuit. For counting apparatus delivering voltage pulses of smaller magnitude, the pulses are fed into the amplifier input, and then to the scaler.

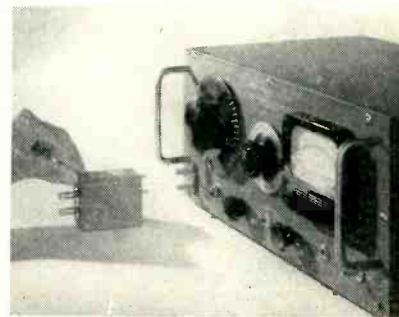

Line-Bridging Transformer

SIERRA ELECTRONIC CORP., 810 Brittan Ave., San Carlos, Calif. Converting an unbalanced to a balanced input, the model 122 line-bridging transformer is arranged for direct plug-in attachment to such measuring instruments as carrier-frequency voltmeters, vacuum-tube voltmeters and similar instruments having standard input terminals on $\frac{3}{4}$ -in centers. Flat within 0.5 db from 15 to 500 kc, the new unit is capable of handling a maximum voltage of 100 v. Three styles are supplied for input impedances of 135, 500 and 600 ohms.

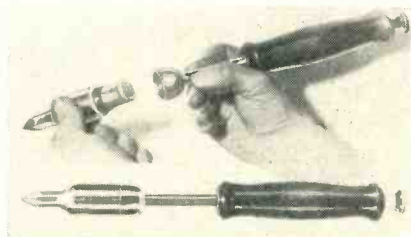

Compact Soldering Iron

KEMODE MFG. CO. INC., 161 W. 18th St., New York 11, N. Y. Requiring no electric current or external heat of any kind, the Quik-Shot soldering iron utilizes a chemical cartridge that heats the iron to working

The Standard of Quality

HICKOK



**Model 292X
SIGNAL GENERATOR**

Frequency Coverage:
125 KC to 220 MC

Calibrated Output:
Less than 1 microvolt,
up to 100,000
microvolts.

Professional engineers and technicians everywhere constantly rely on the accuracy of calibration and long dependability of HICKOK instruments.

In electronic instruments, HICKOK pioneering leadership has been acknowledged for over 42 years.

THE HICKOK ELECTRICAL INSTRUMENT COMPANY
10514 Dupont Avenue • Cleveland 8, Ohio

The Spotlight's On

DALOHM

Miniature

POWER RESISTORS!

WIRE WOUND— SILICONE COATED RESISTORS

Complete welded construction from terminal to terminal. Temperature coefficient 0.00002/deg. C. Ranges from 0.1 Ohm to 55,000 Ohms, depending on Type. Tolerance 0.05%, 0.1%, 0.25%, 0.5%, 1%, 3%, 5%.



RH TYPE — Available in 25, 50 and 250 watt sizes. Silicone sealed in die-cast, black anodized radiator finned housing for maximum heat dissipation.



RS TYPE — Available in 2 watt, 5 watt, and 10 watt sizes. Silicone sealed offering maximum resistance to abrasion, high thermal conductivity and high dielectric strength.

DEPOSITED CARBON RESISTORS



Dalohm precision deposited carbon resistors offer the best in accuracy, stability, dependable performance and economy. Available in 1/2 watt, 1 watt and 2 watt sizes.

Carefully crafted in every respect, Dalohm resistors are true power in miniature — provide the answer to those space problems.

Write, wire or phone George Risk
1300 28th Ave., Columbus, Nebr.
for price and delivery
Telephone 2139



DALE PRODUCTS, INC.

In Canada: Teletronics Corp. Ltd.
Toronto and Montreal

NEW PRODUCTS

(continued)

temperatures in 10 seconds and maintains the iron at an average soldering temperature of 800 F for seven minutes. The cartridge is ignited by the impact of a spring rod that is pulled out and released at the back of the handle. The iron is adaptable to all kinds of soldering work where line power is neither available or convenient. Five interchangeable tip sizes from 3/8 to 1 in. are featured.



Magnetrons

MICROWAVE ASSOCIATES INC. 22 Cummington St., Boston 15, Mass., has available two 3-cm magnetrons, the 2J42 and its similar but higher powered sequel, the 2J42A (RTMA type 6027). Type 2J42 is a low-powered, 17-w average, packaged magnetron, with a coaxial-to-waveguide output that is stabilized by a cavity integral to the assembly. The anode is of the double-ring type and is fabricated from a new vacuum-cast copper. The 2J42A is identical physically to the 2J42 but is supplied with an additional magnet permitting an increase of average power to 21 watts.



Insulating Material

THE GLASTIC CORP., 1823 E. 40th St., Cleveland 3, Ohio. A new thin-gage insulating material made from glass fiber reinforced polyester, Glastic-940, is resistant to elevated

let WILLIAMS
help you apply
ferric oxides to
the manufacture
of your

ferrites

You'll be well repaid by getting the facts on a special group of Pure Ferric Oxides, developed by Williams especially for use in the manufacture of ferrites.

Williams Ferric Oxides analyze better than 99% Fe₂O₃. They contain a minimum of impurities. They are available in a broad range of particle sizes and shapes. Among them, we're certain you'll find one that's "just right" for your requirements. The proper application of Ferric Oxides to the manufacture of Ferrites is our specialty.

Tell us your requirements... we'll gladly send samples for test. Chances are good that our Ferric Oxide "Know How" can save you considerable time and money. Address Dept. 25, C. K. Williams & Co., Easton, Pa.

WILLIAMS COLORS & PIGMENTS

C. K. WILLIAMS & CO.
Easton, Pa. • East St. Louis, Ill.
Emeryville, Cal.

P. S. We also produce IRN Magnetic Iron powders for the Electronic Core Industry, the Magnetic Tape Recording Industry and others. Write for complete technical information.

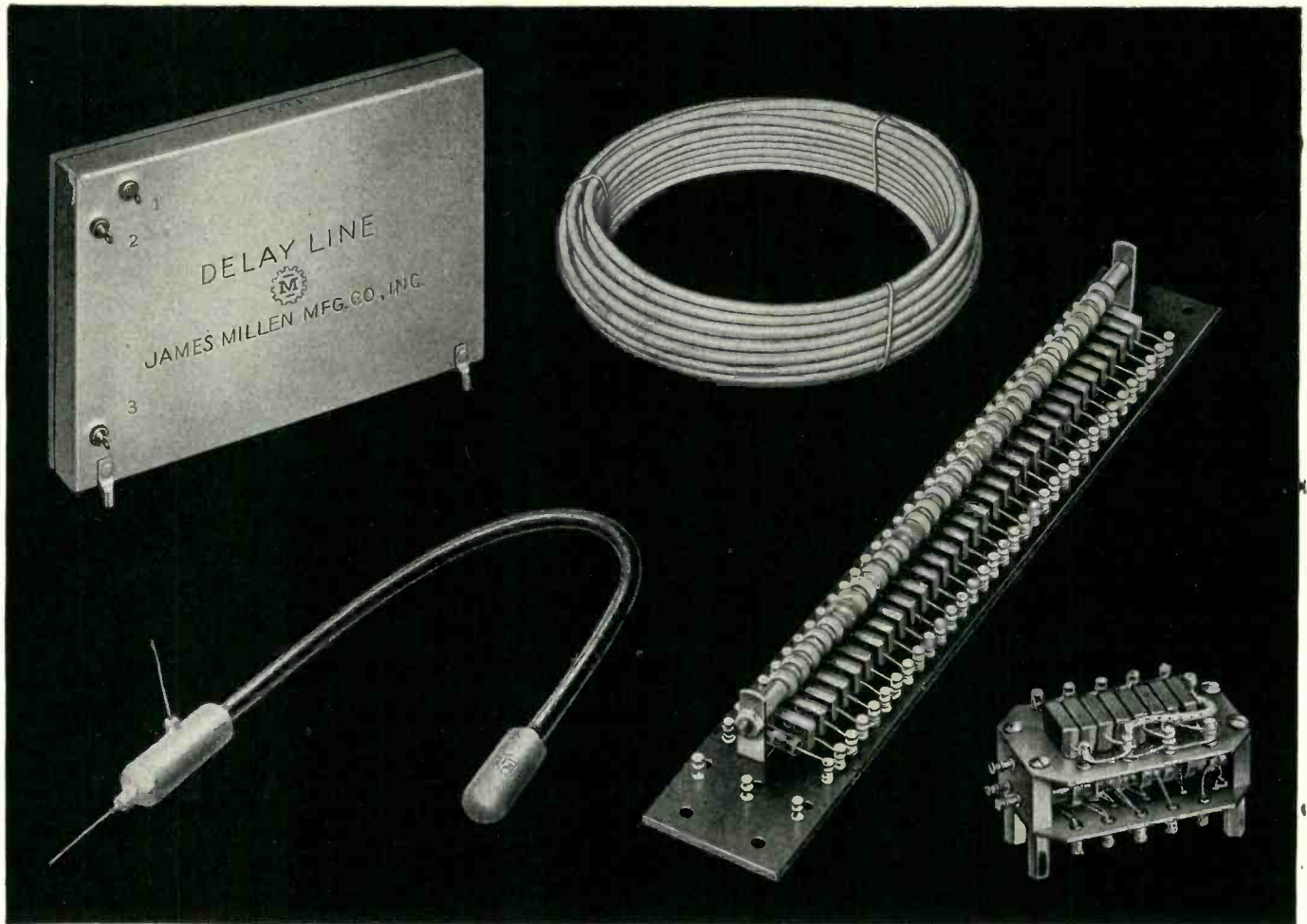

"Designed for Application"

Delay Lines and Networks

The James Millen Mfg. Co., Inc. has been producing continuous delay lines and lump constant delay networks since the origination of the demand for these components in pulse formation and other circuits requiring time delay. The most modern of these is the distributed constant delay line designed to comply with the most stringent electrical and mechanical requirements for military, commercial and laboratory equipment.

Millen distributed constant line is available as bulk line for laboratory use and in either flexible or metallic hermetically sealed units adjusted to exact time delay for use in production equipment. Lump constant delay networks may be preferred for some specialized applications and can be furnished in open or hermetically sealed construction. The above illustrates several typical lines of both types. Our engineers are available to assist you in your delay line problems.

JAMES MILLEN

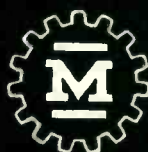

MFG. CO., INC.

MAIN OFFICE

AND FACTORY

MALDEN, MASSACHUSETTS, U. S. A.



● If your requirements are for extra fine-pitch gears and pinions with precision tolerances, send us your prints for quotation. Beaver Gear engineers are trained to assist you in the design and application of this type gear. Our workmen are specialists in manufacturing small and medium size, fine and extra fine-pitch gears to your most exacting specifications.



THE *Finest* IN GEARS

Beaver Gear Works Inc.

1021 PARMELE STREET, ROCKFORD, ILLINOIS

Fine Wire
for
TRANSISTORS

In line with our specialization in wire for new applications, we produce wires of composition suitable for the manufacture of Transistors; including GALLIUM GOLD and ANTIMONY GOLD. These alloys have been made to fill a specific need arising from new developments in this field.

Other wires we make regularly for similar application are PHOSPHOR BRONZE, bare or electroplated, and PLATINUM. Alloys produced to meet rigid specifications of tensile strength, size and straightness.

SIGMUND COHN CORP.
121 SOUTH COLUMBUS AVENUE • MOUNT VERNON, NEW YORK

Write for Latest List of Products

temperatures in electrical apparatus. It has good arc-tracking resistance and dimensional stability. It is available in standard sheet sizes of 24 in. x 36 in. The material may be obtained in $\frac{1}{8}$ -in. thickness as required for special insulating applications such as relay build-ups, resistance welding transformer barrier insulation, top-stick material in d-c motors, transformer end wrapping and various tv parts. It is also well suited to applications requiring dimensional stability and heat resistance encountered in aircraft generators, class B' motor insulation and small electrical unit manufacturing. Technical data and samples are available.

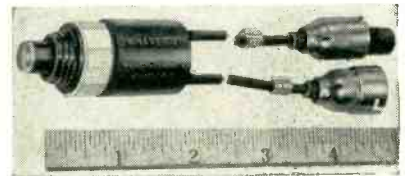

Pushbutton Switch

RIVERSIDE MFG. AND ELECTRICAL SUPPLY Co., 10228 Michigan Ave., Dearborn, Mich., has developed a pushbutton switch, to meet military specifications, that opens and closes electrical circuits underwater, functions from 65 F below zero to 165 F above, and withstands salt spray, shock and vibration. The switch has a continuous rating of 10 amperes at 15 v d-c, 30 v d-c, or 125 v a-c. It is a single throw, one circuit switch, furnished either normally open or normally closed. The company has available complete information on this pushbutton switch and on waterproofed toggle switches up to 200-ampere rating.



Portable Broadcast Amplifier

GENERAL ELECTRIC Co., Syracuse, N. Y., has announced the type BA-

The
PERFECT
Wedding

**TYPE
2003
FREQUENCY
STANDARD**

The Type 2003 contains, in addition to the tuning fork, all circuit components which are selected or critical.—The tube and remaining components — three resistors and two .01 capacitors — are external and can be laid out and integrated with your equipment.

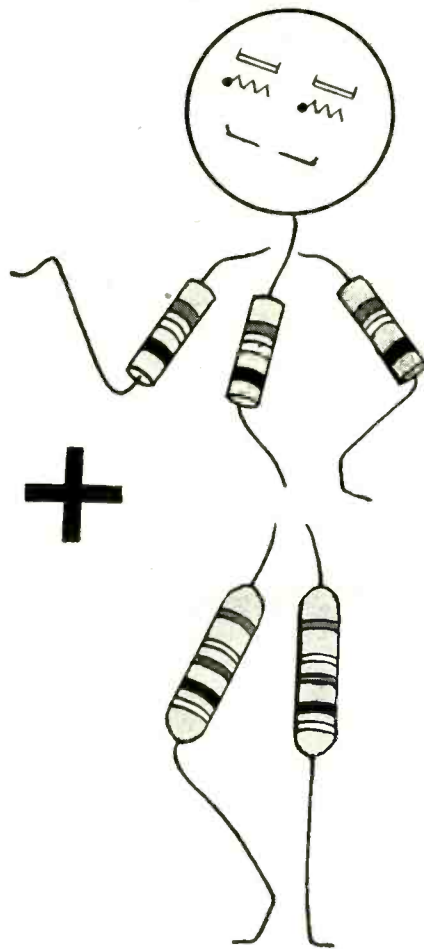
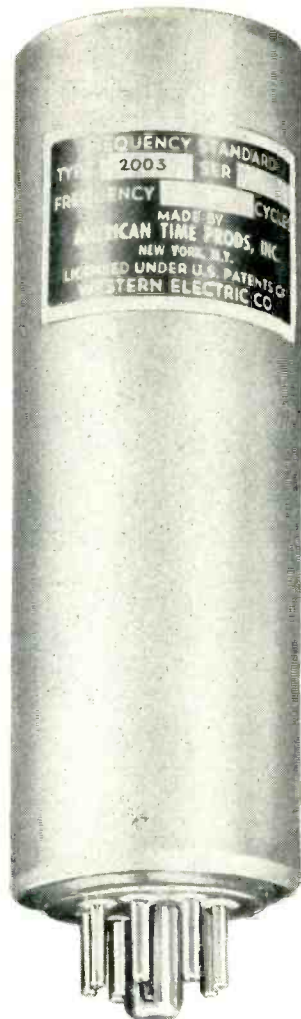

TUNING FORK STANDARD, hermetically sealed.

SIZE — 4½ inches long. 1½ inches diameter.

SIMPLE EXTERNAL CIRCUIT, 1 tube, 3 resistors, 2 capacitors.

TUBE — Choice of 12AT7, 6201, 5751, 6BF7, 6BG7 or 6021.

POWER REQUIRED, 75 to 300 V at 1 to 5 m.a. — 6.3 V at 300 or 350 m.a.

AVAILABLE — in 400 or 500 cycles

ACCURACY guaranteed to .002%,
15° to 35° C.

Write for descriptive literature,
specifying Type 2003.

Manufacturer of high precision
frequency and timing instruments
controlled by tuning fork oscillators.



Also
**TYPE
2007**

(4½" x 1½")

COMPLETELY SELF-CONTAINED
INCLUDING VACUUM TUBE

American Time Products, Inc.

580 Fifth Avenue

New York 36, N. Y.

OPERATING UNDER PATENTS OF THE WESTERN ELECTRIC COMPANY

TRANSFORMERS

NEW PRODUCTS

(continued)

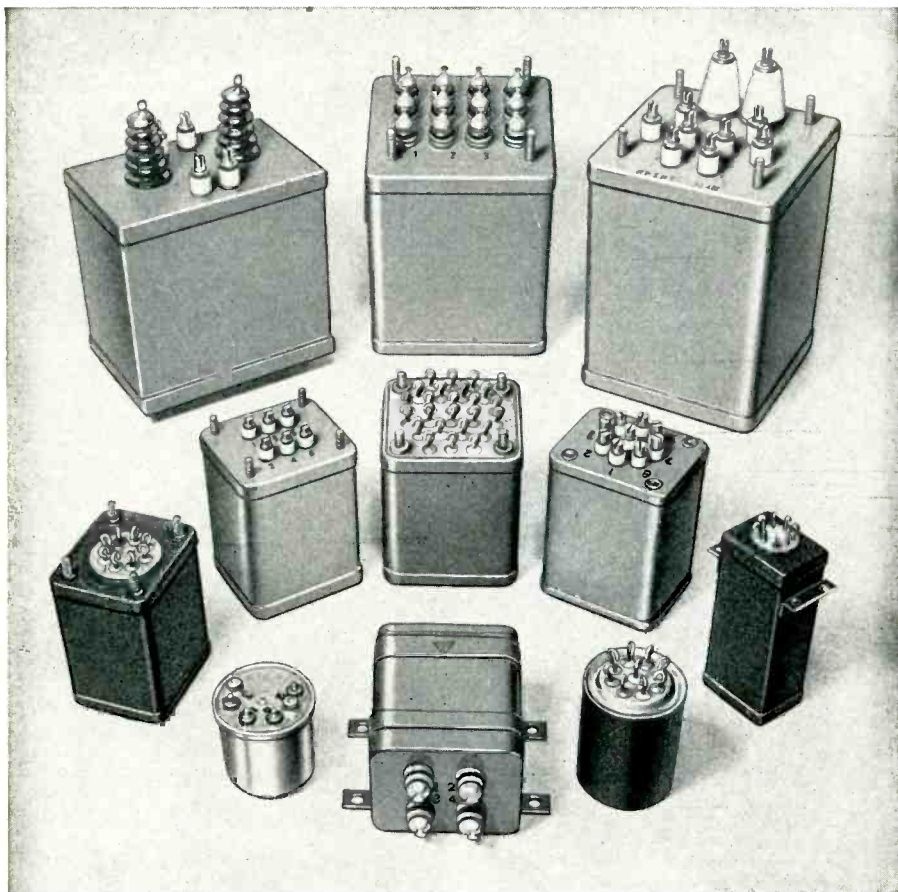

HERMETICALLY SEALED TO MIL-T-27 SPECIFICATIONS

NYT offers a wide variety of transformer types to meet military and civilian specifications, designed and manufactured by specialists in transformer development.

Latest NYT service for customers is a complete test laboratory equipped and approved for on-the-spot MIL-T-27 testing and faster approvals.

**NEW YORK
TRANSFORMER CO., INC.**
ALPHA, NEW JERSEY

6-B portable broadcast amplifier for use in a studio as well as on remotes. Flexibility for both types of operation is provided by four built-in preamplifiers and a master mixer. The unit has a built-in a-c power supply, in addition to battery provisions, and it uses low-noise miniature tubes. A built-in 400-cycle tone oscillator permits easy level setting. A new cue amplifier gain control facilitates operation in noisy locations. The entire amplifier is enclosed in a steel case and weighs only 35 lb, including batteries.



Two-Set TV Coupler

RADIO MERCHANDISE SALES, INC., 1165 Southern Blvd., New York 59, N. Y. The AC-2 two-set coupler is a newly designed unit that permits operation of two sets from a single antenna. The unit equally distributes the signal to both receivers, and there is no limitation as to its location or length of lines between the coupler and either set. It also operates with coaxial cable.

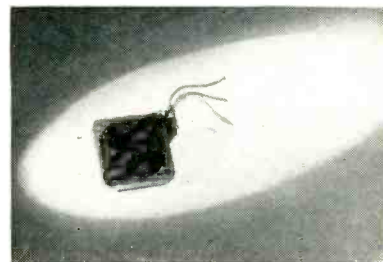

Reversible Motor

THE GENERAL INDUSTRIES CO., Elyria, Ohio, is producing a reversible 2-pole, four-coil motor for both remote control tv tuner and

HIGH STABILITY I-T-E RESISTORS FOR CRITICAL ELECTRONIC APPLICATIONS

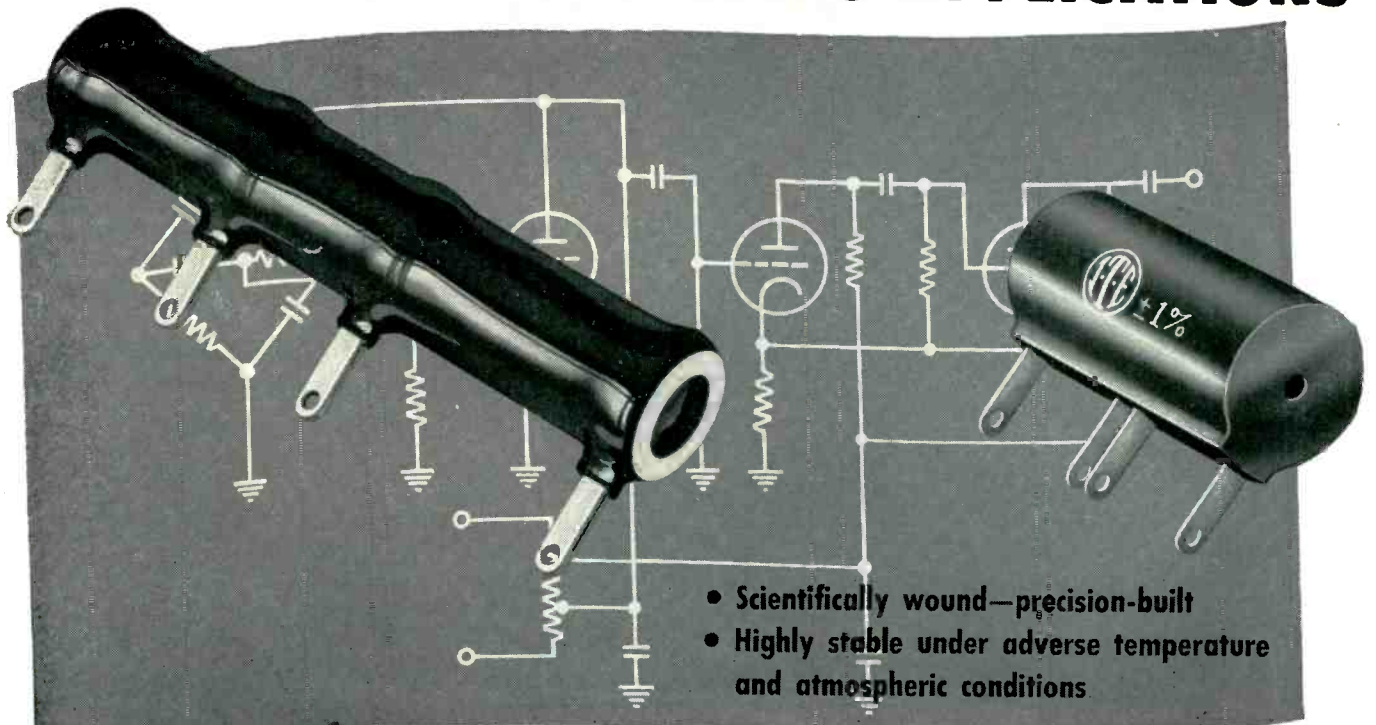

- Scientifically wound—precision-built
- Highly stable under adverse temperature and atmospheric conditions

I-T-E power and precision wire-wound resistors give you maximum stability in critical electronic applications. Here's why:



POWER RESISTORS

Non-hygroscopic ceramic foundations are highly resistant to heat, shock, and vibration. Purest resistance wires are uniformly wound and mechanically tied to prevent shorted turns and excessive hot spots. Vitreous enamel coating (organic, if required) provides a glazed moisture-repellent surface with fast heat-dissipation qualities. Advanced production methods assure high stability, long life.

Standard fixed resistors: 5-200 watts
Adjustable resistors: 10-200 watts
Oval resistors: 30-75 watts
Ferrule resistors: 12-200 watts
Special resistors: built to specifications

Standard tolerance: $\pm 10\%$, $\pm 5\%$ and less made to order.

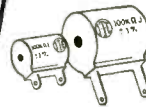

PRECISION RESISTORS

High quality wire alloys are used—free from internal stresses and strains. Automates precision winding assures even tension—eliminates hot spots. Hermetic sealing protects against destructive effects of salts, moisture, and atmospheric conditions. Accelerated aging process prior to calibration assures accuracy. Critical quality control eliminates all resistors which do not come up to high I-T-E standards.

Lightweight—for precision operation up to 125 C.
Surpass JAN R-93 and MIL R-93A specs.
Ratings from 0.01 ohms - 10 megohms, 0.125-5 watts.

Standard tolerance: $\pm 1\%$. Available in specified tolerances down to $\pm 0.05\%$.

For detailed information—get in touch with your nearest I-T-E representative. Or, write direct to:

I-T-E Resistor Division
1924 Hamilton Street
Philadelphia 30, Penna.

specify



RESISTORS

I-T-E CIRCUIT BREAKER COMPANY • RESISTOR DIVISION • PHILADELPHIA 30, PA.



A Research Frontier... -452° F*

THE BASIC TOOL OF LOW-TEMPERATURE RESEARCH IS THE ADL COLLINS HELIUM CRYOSTAT. IT PROVIDES 4 LITERS OF LIQUID HELIUM PER HOUR AND MAINTAINS A TEST CHAMBER TEMPERATURE FROM AMBIENT TO -271° C.

*Boiling point of helium.

IN THEORY:

Atoms and electrons are in a state of more perfect order at extremely low temperatures. One can then study more precisely and effectively a number of variations in behavior which may at higher temperatures be masked by thermal motion.

SUPPOSE THAT:

Industrial research laboratories apply extreme low-temperature phenomena to your industry. Today, superconductors, chemical kinetics, heat capacities, property studies, are research projects . . . tomorrow, look for advances in instrumentation, metals of extraordinary hardness, accurate previews of chemical reactions. The rapid growth of this new research frontier may well affect your industry . . . how, when, or where is up to the research scientist, who, by using liquid helium, can more effectively and precisely study this new world near absolute zero.

Send for Cryostat Folder E12-1 and booklet on Low-Temperature Physics.

ARTHUR D. LITTLE, Inc.
Mechanical Division

30 MEMORIAL DRIVE • CAMBRIDGE, MASS.



rotating antenna applications, as well as other small motor applications in which accurate reversing action is required. Designated the model O, it can be furnished either as split-phase capacitor type or split-phase resistance type, depending upon application requirements. It is designed for 24-v a-c or less, 6 cycles, and may be used either horizontally or vertically without affecting performance characteristics. The model illustrated with 3 leads is designed for use with spdt switch. Adaptation with 4 leads for use with dpdt switch is available where increased output is desired.

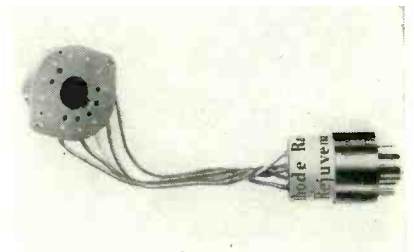

Picture Tube Rejuvenator

CREST LABORATORIES, INC., Whitehall Building, Far Rockaway, N. Y., has introduced the model C picture tube rejuvenator that can be used on all standard cathode-ray tubes regardless of size. It is a simple plug-in unit that can serve a dual purpose: it can be used either as a flasher type reactivator or as a permanently installed rejuvenator.

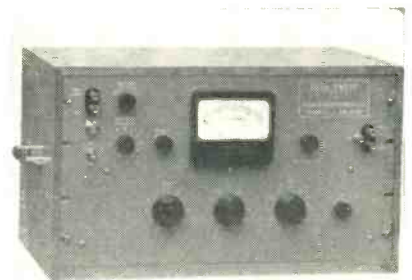

Sweeping Oscillator and Signal Generator

DECADE INSTRUMENT Co., Caldwell, N. J., has announced a precision combined h-f decade-switched sweeping oscillator and signal generator. The Deca-Sweep eliminates

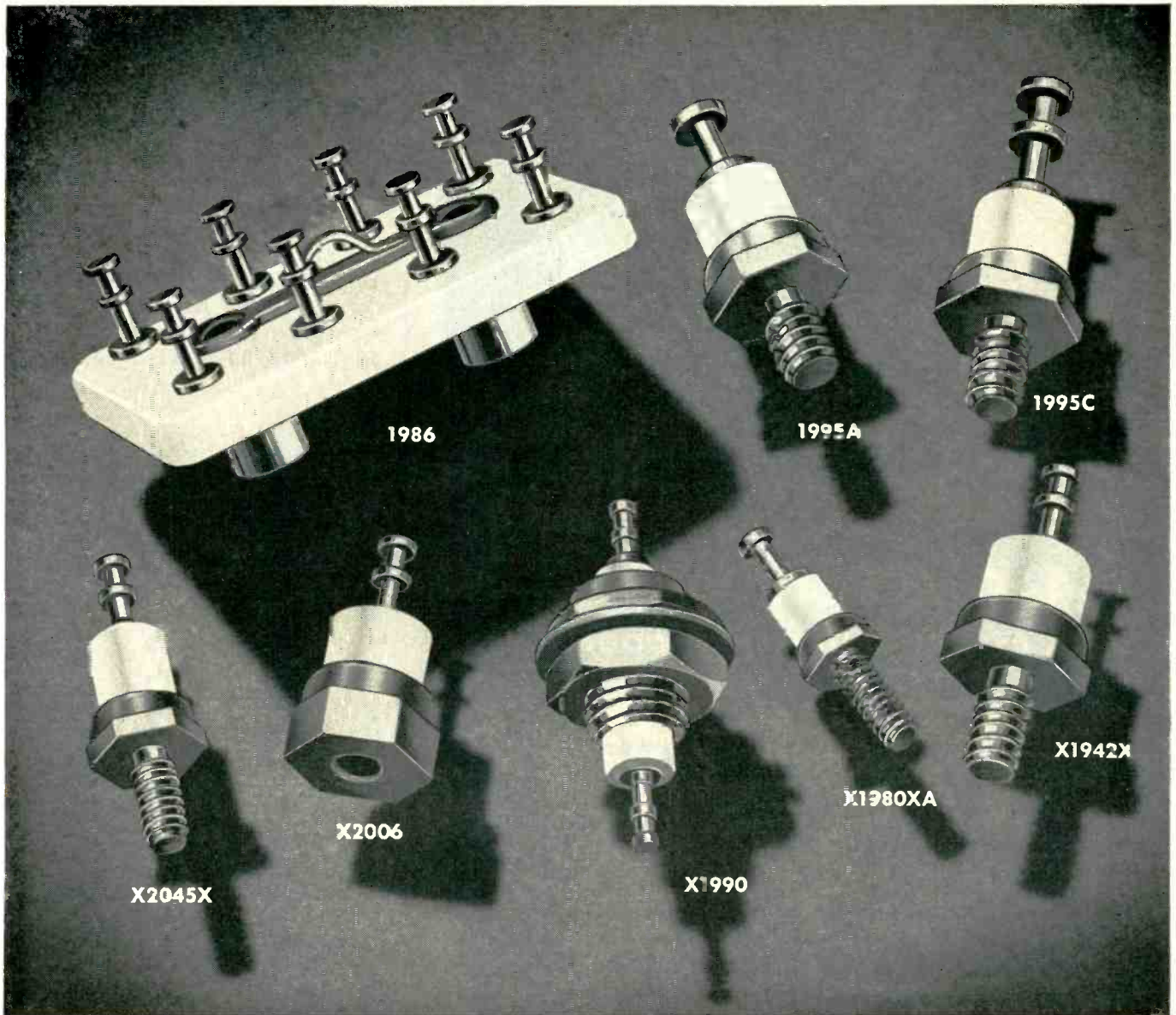

Units shown magnified approximately 2½ times

Make sure of meeting government "specs" . . . see C.T.C. for ceramic insulated components

You have to be 100% on-the-beam if your equipment is to withstand the conditions it must undergo in military service.

That's why manufacturers using electrical and electronic components turn to C.T.C. for their ceramic insulated units. Our long experience and constant dealing with government requirements have gained us a wide acceptance as an outstanding supplier to those working on U. S. contracts . . . especially for the armed forces.

Whatever your needs in ceramic insulated terminals, feed-throughs or terminal boards you can depend on C.T.C. We meet the most exacting government standards for materials, tolerances, finishes, moisture prevention and anti-fungus treatment. Fin-

ishes on metal surfaces for instance, can be hot tinned, electro-tinned, cadmium plated, silver plated or gold plated to your requirements. All ceramic units in our standard line are grade L-5, silicone impregnated.

C.T.C. offers a consulting service at no extra charge to help solve your spe-

cial problems. For all specifications and prices, write to Cambridge Thermionic Corporation, 437 Concord Avenue, Cambridge 38, Mass. West Coast Manufacturers contact: E. V. Roberts, 5068 West Washington Boulevard, Los Angeles 16 and 988 Market Street, San Francisco, California.

C A M B R I D G E T H E R M I O N I C C O R P O R A T I O N

custom or standard . . . the guaranteed components

For our complete listing of C.T.C. electronic and electrical components, see Electronics Buyers Guide.

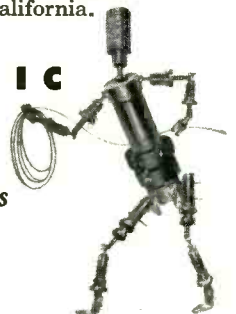

The Simple and Economical...

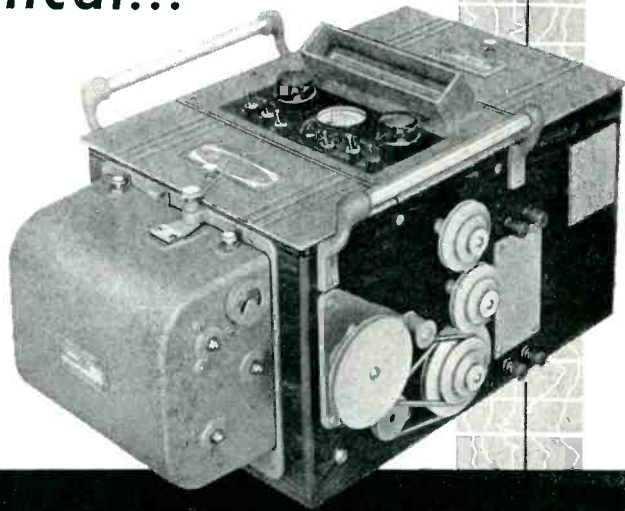

S14-C OSCILLOGRAPH
is an essential in every laboratory
 6 or 12 elements

For general laboratory use in industry and in colleges, for testing and research everywhere, the New S14-C Economy Oscilloscope is doing the job.

This versatile high-quality oscilloscope is opening up new and wide fields for oscillography because it is so easy to use and because its cost is so low. Attachments of many kinds are available for every possible need.

Many types of galvanometers are available for almost any sensitivity or frequency response requirement.

- Daylight loading and unloading
- 9 record speeds, 1/10 to 40 inches per second
- 6-inch chart, sensitized paper or film
- Smooth and positive chart drive
- Viewing screen
- Precision optical components
- Fine-line and accurate records
- Precision time-coordinate device
- Operates from a light socket

WRITE FOR BULLETIN 2D1-K FOR DETAILS

Write for your free copy of Hathaway Engineering News



point-by-point measurements of high frequencies. It is equipped with a precision attenuator and output meter. A maximum output of 3 volts is available at 600 ohms. A variable output impedance down to a few ohms (for low output levels) is provided on a second jack, permitting any load impedance. The output level is constant within 1 db for all output frequencies. Full-scale meter ranges are provided for 10, 3, 1, 0.3, 0.1, 0.03 and 0.01 volts.

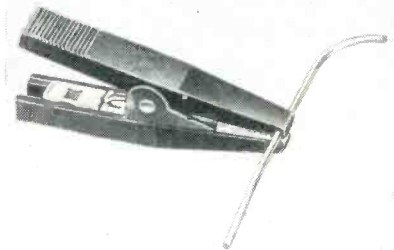

Non-Short Test Clip

GRAYHILL, 4524 West Madison St., Chicago 24, Ill. Completely insulated, the series No. 16 alligator-type test clip can be freely used side by side without danger of shorting out. The new clip also offers such features as silver contacts for low-contact resistance, brass current-carrying members silver soldered for easy soldering of the lead and positive spring action for good contact. The finger grips are of general purpose thermosetting phenolic.



UHF Attenuators

EMPIRE DEVICES, INC., 38-25 Bell Blvd., Bayside 61, N. Y., present

it's a magic world for homemakers!

—thanks to the accuracy, dependability and

long life of *Telechron*[®] motors



Pressure cookers speed cooking—
but timing must be accurate.

To be dependable, automatic timers on
washing machines must start instantly.

Refrigerators last a long time.
So should the automatic defrost timer.

Accurate timing by Telechron motors has helped take much of the drudgery out of household chores.

Telechron timing motors are true synchronous motors. Rotors make one complete rotation for each cycle of the alternating current source—and are instantly self-starting (reach full speed in 1/20th of a second). This is especially advantageous for such uses as home appliances where many applications require intermittent operation of the timing motor, and demand instant, dependable starting.

Similarly, because Telechron synchronous motors do not need close clearances between rotor and stator, they will remain quiet throughout their long life.

Get complete facts on the broad line of Telechron synchronous timing motors. Application engineering service assures proper selection. Write for catalog IS-120. Telechron Department, General Electric Company, 411 Homer Ave., Ashland, Mass.

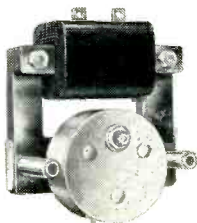

Type H3 Motor—Used for the range timer and refrigerator defrost timer. Also recommended for such light-duty applications as timing and switching.

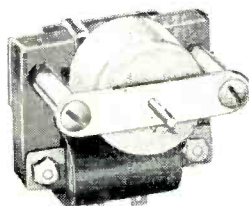

Type B3 Motor—A medium-duty motor that's ideal for washing machine timers, and other switching applications. Also recording and controlling mechanisms.

Telechron[®]

MARK OF TIMING LEADERSHIP



All of us here at the Rectifier Division are rather proud of the parts we play in the production of Sarkes Tarzian "Centre-Kooled" Selenium Rectifiers. Barbara, shown here color-coding, is no exception.

If you are not familiar with the wide variety of applications of Sarkes Tarzian Rectifiers, your inquiry is invited.

Our staff of engineers is ready to assist you with your power conversion problems.

A most complete Selenium Rectifier Handbook is available at 50c. Write us or see your dealer.

Sarkes Tarzian, Inc.

RECTIFIER DIVISION

Dept. E-5, 415 North College Ave., Bloomington, Indiana

Where
#1's
are used
Specify

Sarkes
Tarzian

their new laboratory standard uhf attenuator, model AT-50. This is a resistive T-network of concentric line construction, with a frequency range from d-c to 4,000 mc. Vswr is better than 1.1 to 1.0 at all frequencies within said range; attenuation-standard: 3, 6, 10, 20, 40, 60 db, with an accuracy to ± 0.5 db. Rated power is 250 mw continuous, 500 w peak dissipation. The company also has available model AT-60 uhf power attenuator, which has a power dissipation of 2 w continuous, 2 kw peak.

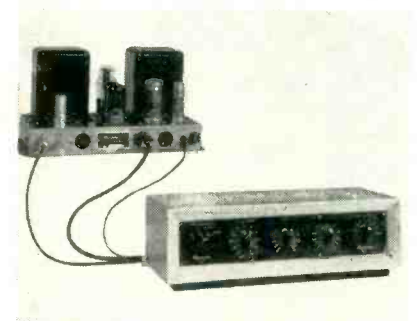

High-Fidelity Amplifier

WAVEFORMS, INC., 333 Sixth Ave., New York 14, N. Y., offers a new model of its high-fidelity amplifier system. The A-20-6 amplifier features a continuously-variable electronic filter for sharp treble cutoff of high-frequency noise and distortion, with a cut off range of 2,500 cycles to full 20,000-cycle response. A 20-db boost or cut bass and treble controls, a loudness control, and a four-channel input selector with independent level adjusts for each input channel are also included. An output is provided for a tape recorder.

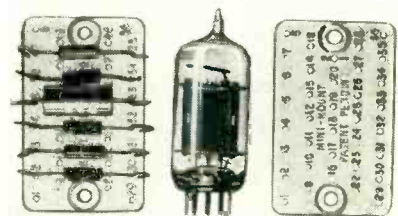

Resistor Board

MINI-MOUNT Co., 773 Driggs Ave., Brooklyn 11, N. Y., has developed

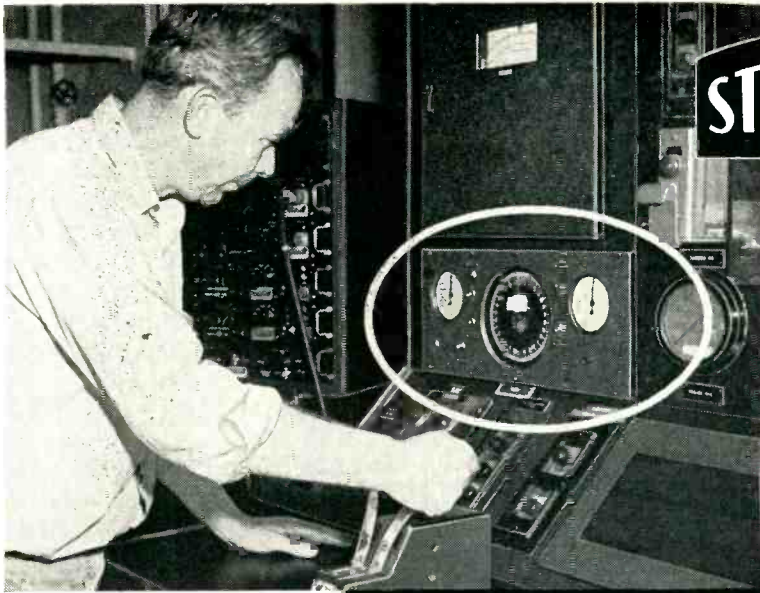

STANDARD

SINCE 1884

WRIGHT AERONAUTICAL DIVISION
CURTISS-WRIGHT CORPORATION

This photograph, taken in one of the experimental cells of the Wright Aeronautical plant at Woodridge, N. J., shows a STANDARD Chronotachometer installed in their test panel.

Not Only Chronotachometers . . .

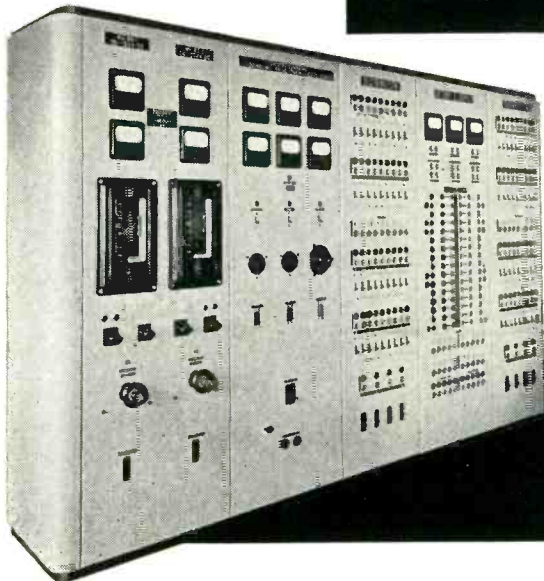

WILSON DAM (T. V. A.)

This experimental control and distribution switchboard handles various power supplies for their Chemical Laboratory Building.

plus "flexlab" Control and Distribution Switchboards

WESTINGHOUSE ELECTRIC COMPANY

This specially designed unit is for the control and test of aircraft timers, series relays, contactors, servo motors, and booster coils. It is typical of the wide range of custom-built equipment by STANDARD.

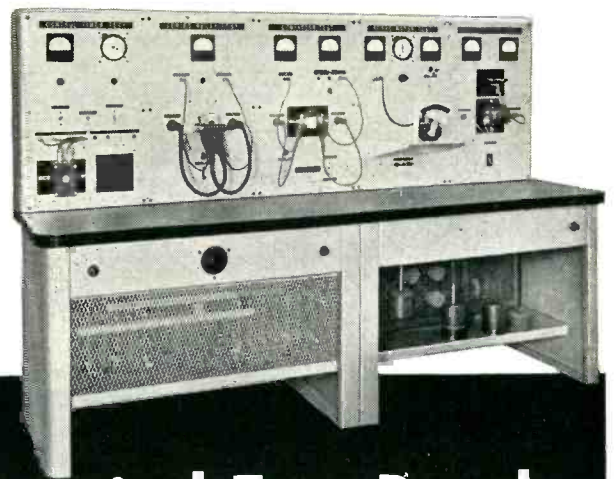

**. . . but all kinds
of Custom-built Electrical Test Panels**

THE STANDARD ELECTRIC TIME COMPANY

97 LOGAN STREET • SPRINGFIELD 2, MASSACHUSETTS

What is your Delay or Regulating Problem?

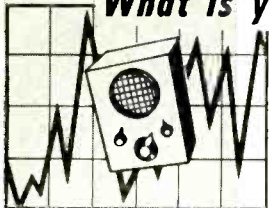

For the most effective solution use the
SIMPLEST, MOST COMPACT
MOST ECONOMICAL
HERMETICALLY SEALED

AMPERITE

THERMOSTATIC DELAY RELAYS



STANDARD

Provide delays ranging from 2 to 120 seconds.

- Actuated by a heater, they operate on A.C., D.C., or Pulsating Current.
- *Hermetically sealed.* Not affected by altitude, moisture, or other climate changes.
- Circuits: *SPST only*—normally open or normally closed.

Amperite Thermostatic Delay Relays are compensated for ambient temperature changes from -55° to $+70^{\circ}$ C. Heaters consume approximately 2 W. and may be operated continuously. The units are most compact, rugged, explosion-proof, long-lived, and—very inexpensive!



MINIATURE

TYPES: Standard Radio Octal, and 9-Pin Miniature.

PROBLEM? Send for Bulletin No. TR-81

BALLAST-REGULATORS



T9 BULB

- Amperite Regulators are designed to keep the current in a circuit *automatically regulated* at a definite value (for example, 0.5 amp).
- For currents of 60 ma. to 5 amps. Operates on A.C., D.C., or Pulsating Current.
- Hermetically sealed, light, compact, and most inexpensive.

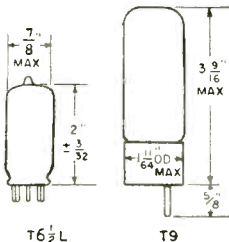
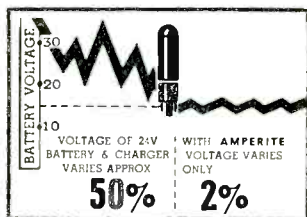

Maximum Wattage Dissipation: T6 $\frac{1}{2}$ L—5W. T9—10W.

Amperite Regulators are the simplest, most effective method for obtaining *automatic regulation* of current or voltage. *Hermetically sealed*, they are not affected by changes in altitude, ambient temperature (-55° to $+90^{\circ}$ C), or humidity. Rugged; no moving parts; changed as easily as a radio tube.

Write for 4-page Technical Bulletin No. AB-51

AMPERITE CO., Inc. 561 Broadway, New York 12, N. Y.

In Canada: Atlas Radio Corp., Ltd., 560 King St., W., Toronto B8

a new type of molded resistor board, a method of mounting electronic components in a very small space. The board measures $1\frac{1}{4}$ in. \times 2 in. \times $\frac{1}{8}$ in. with two standoffs provided for mounting. The standoffs have holes provided for No. 5 screws and can be stacked in tiers. The 36 holes are numbered to provide a convenient means for both initial layout and servicing. There are no metal lugs required—the pigtailed on the electrode components provide the soldering terminal points. Once it is inserted and looped over, the electronic component is rigidly mounted to the board and can be conveniently soldered to. Ten to fifteen components can easily be mounted on each board and pre-assembled into subassemblies.

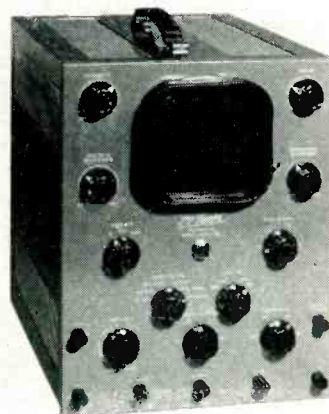

Precision Oscilloscope

EL-TRONICS, INC., 2665 N. Howard St., Philadelphia 33, Pa. A recent low-priced laboratory precision oscilloscope combines flexibility and accuracy in a new design; a vertical amplifier of 5-mc bandwidth with 4 in. of vertical deflection without overload; and a sweep oscillator variable from 10 cycles to 150 kc. The vertical amplifier has a sensitivity of 20 mv rms per inch of deflection; a frequency response (sine wave) of 20 cycles to 5 mc that is down 3 db at 5 mc; a square-wave response that is an excellent duplication of all square waves between 50 cycles and 1 mc with a maximum tilt of 5 percent for 50 cycle square wave; and a maximum input potential of 1,000 v peak-to-peak. The horizontal amplifier has a sensitivity of 0.3 v rms



Ever try to price-tag precision?..

Absolute precision in a vital instrument—what's it worth?

... to the bomber pilot trusting to Kollsman, instruments checked to one-ten-thousandth of an inch for accuracy.

... to the ship's captain, banking all on the precision of his Kollsman sextant.

At times such as these, can precision ever be price tagged? Yet its vital presence, or absence, is oft-times the margin between victory or chaos.

Today—to maintain a free, strong America—

Kollsman is devising, developing and manufacturing instruments of utmost precision, dependability and quality in the fields of:

Aircraft Instruments and Controls • Miniature AC Motors for Indicating and Remote Control Applications • Optical Parts and Optical Devices • Radio Communications and Navigation Equipment

And to America's research scientists, seeking the answer to problems of instrumentation and control—the facilities of Kollsman Research Laboratories are immediately available.



KOLLSMAN INSTRUMENT CORPORATION

ELMHURST, NEW YORK

GLENDALE, CALIFORNIA

SUBSIDIARY OF

Standard COIL PRODUCTS CO. INC.

NEW! Type 2004 Voltage Calibrator MAKES YOUR OSCILLOSCOPE AN ACCURATE VISUAL VOLTMETER!



- MEASURES PEAK TO PEAK VOLTAGE MAGNITUDE OF COMPLEX OR SINUSOIDAL WAVEFORM FROM 10 MILLIVOLTS TO 100 VOLTS WITHIN $\pm 2\%$.
- DIRECT READING FRONT PANEL METER INDICATES LOCATION OF AC AXIS WITH RESPECT TO NEGATIVE VOLTAGE PEAK. ACCURACY $\pm 3\%$.
- PROVIDES EXTERNALLY AVAILABLE SQUARE WAVE FOR CHECKING AND RECOMPENSATING SCOPE PROBE ATTENUATOR.
- ELIMINATES REPEATED DISCONNECTION OF CALIBRATOR LEADS BY USE OF FRONT PANEL SWITCHES.

SPECIFICATIONS

Voltage Ranges: 100, 30, 10, 3, 1, 0.3, 0.1, 0.03, 0.01 volts peak-to-peak full scale.

Duty Cycle Range: 5% to 95%, direct reading.

Accuracy: Voltage — $\pm 2\%$ of full scale. Duty cycle — $\pm 3\%$.

Calibrator Frequency: Approximately 1 KC.

Input capacity: The internal wiring of the calibrator will add approximately 20 mmf to the signal lead.

Power Source: 105 — 125 volts AC, 60 cps, 65 watts.

Size: 10½" H x 7" W x 8" D.

Price: \$165. F.O.B. Plant.

WRITE FOR BULLETIN C852 TODAY!



Manufacturers of a complete line of TV and Radar Test Equipment

Tel-Instrument Co. Inc.

50 PATERSON AVENUE • EAST RUTHERFORD, N. J.

per inch of deflection, and a frequency response that is flat to 300 kc. The recurrent sweep oscillator has a frequency range from 10 cycles to 150 kc in 6 steps.



Small TV Camera Tube

RADIO CORP. OF AMERICA, Harrison, N. J., has announced a small tv camera tube for industrial television applications. Utilizing a photoconductive layer as its light-sensitive element, the type 6198 Vidicon has a sensitivity which permits televising scenes with 100 to 200 foot-candles of incident illumination on the scene. The new tube provides 400-line resolution, employs magnetic focus and magnetic deflection, and operates with relatively low d-c voltages. It measures about 1 in. in diameter and 6¼ in. in length.

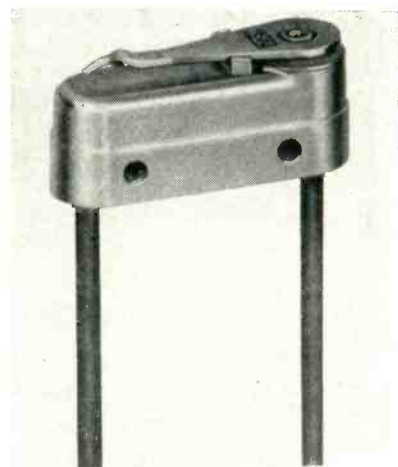

Snap-Action Switch

MICRO SWITCH, a division of Minneapolis-Honeywell Regulator Co., Freeport, Ill., has announced a waterproof, snap-action switch incorporating potted, waterproof

Flexible



Improved New **VARGLAS SILICONE** Tubing and Sleeving

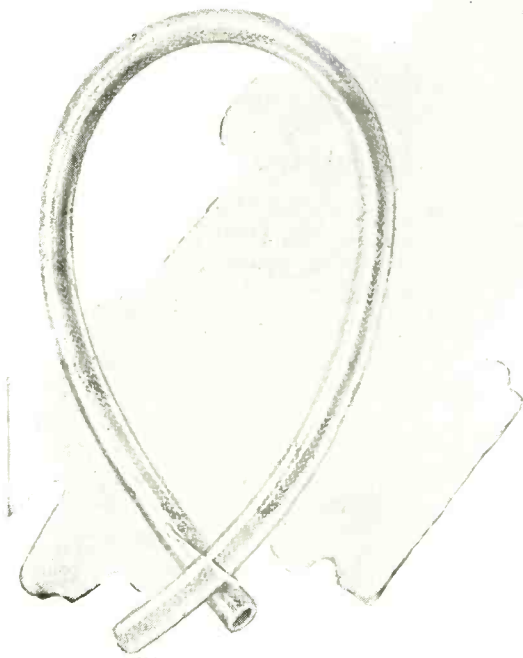

Now Varglas Silicone has been made more flexible. Sharp turns and 90° bends cause no cracking or peeling — no loss of dielectric strength. As pioneers in the manufacture of silicone sleeving and tubing, we know this is the greatest improvement made during the past ten years. Unexcelled where high temperatures must be withstood for several hours — not just for 15 minutes. You need not sacrifice abrasion resistance and toughness to get flexibility. The new Varglas Silicone sleeving and tubing will pass cold bend tests at 35° to 40° LOWER temperature than formerly.

*The only Class H insulation
with all these features:*

Efficient from 500° F. to — 85° F.

Moisture and Fungus Resistant

Flame Resistant — Self extinguishing

Abrasion Resistant

Dielectrically Strong with average readings up to 7,000 volts.

Available in 10 colors — at no extra cost.

Samples of Varglas Silicone products as well as samples of our complete line of tubing and sleeving are available in a convenient sample folder. Just drop us a line telling us your problem and its peculiarities.

Varflex CORPORATION

Makers of
Electrical Insulating
Tubing and Sleeving

VARFLEX Sales Co., Inc.

308 N. Jay St., Rome, N. Y.

**15
MILES
OF
TOROIDS**

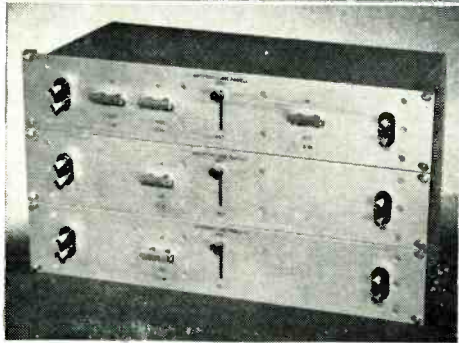
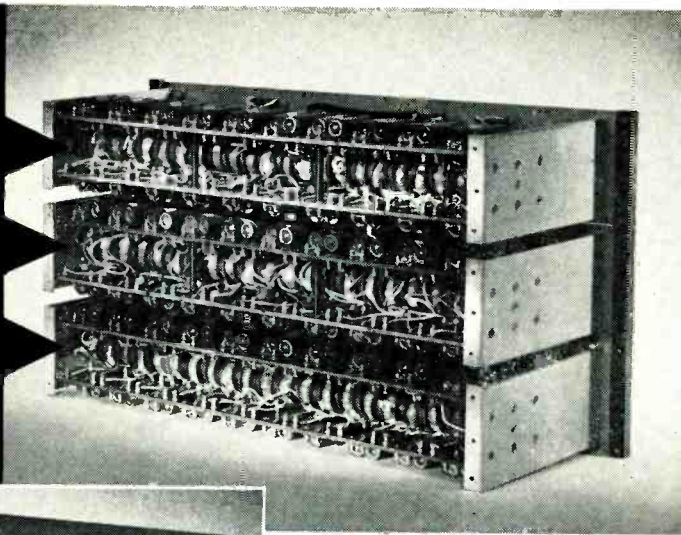

Between input and output terminals of this Signal Corps test instrument, design engineers used 65 Lenkurt wedding-ring toroids to simulate 15 miles of wire line. The unit brings field conditions into the laboratory for testing communications systems. Composed of 1-, 2-, and 5-mile sections, the set offers a choice of line lengths and provides facilities by which either dry- or wet-weather conditions can be reproduced at the flip of a switch.

TYPIFYING OUTSTANDING ADVANTAGES of Lenkurt precision-molded cores and precision-wound toroidal coils, this application features compactness and light weight, ease of mounting and assembly.

WHEN YOUR DESIGN problems call for maximum performance from filters, tuned circuits, and inductors, we invite you to draw upon Lenkurt's rich experience in obtaining the maximum performance from available materials.

MODERN FACILITIES at Lenkurt, one of the largest installations of its kind in the world, offers a dependable source of supply—geared to your largest quantity needs and your most-exacting quality requirements. Ask for literature on these outstanding components; recommendations and quotations on your specific problems.

**LENKURT ELECTRIC
SALES COMPANY**
San Carlos 1 California

Lenkurt

terminal leads and a hermetically sealed contact chamber. Electrical rating of the type 4HS switch is as follows: 10 amperes inductive load, or 25 amperes resistive load, 28 volts d-c; 1 ampere inductive or resistive load, 125 volts a-c. The switch can be had with single-pole, single-throw or double-throw contact arrangement.



Decade-Inductor Units

HYCOR Co., INC., 11423 Vanowen St., North Hollywood, Calif. The 700 series decade-inductor units are necessary for design and experimental work on audio filters, equalizers and tuned circuits at frequencies between 150 and 20,000 cycles. Four units are available in ranges from 10×0.001 henry to 10×1.0 henry. When all four units are connecting in series, 11, 110 steps from 0.001 henry to 11.11 henrys are obtained. Dimensions are $5\frac{1}{4}$ in. long \times 3 in. wide \times $2\frac{1}{2}$ in. high.

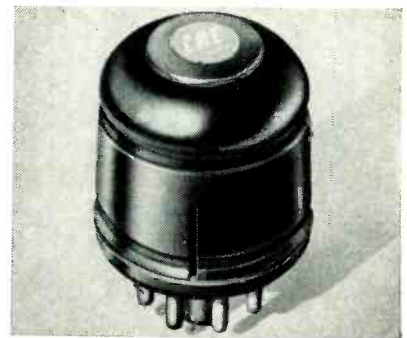

Ferro-Resonant Flip Flop

COMPUTER RESEARCH CORP., 3348 W. El Segundo Blvd., Hawthorne,

NEW COMPACT, LIGHTWEIGHT HIGH-VOLTAGE RECTIFIERS

One-third the size of existing tubes.

These exclusive new Westinghouse heavy-duty, high-voltage rectifiers permit more efficient design of mobile equipment where reduced weight and space are desired.

They are one-third the size of existing tubes with comparable ratings!

This advanced design permits the tubes to carry peak currents of 900 ma. (average currents of 150 ma.) without overloading. The high-wattage thoriated tungsten filaments require only three seconds' heating. Filament terminals may be operated either up or down.

Designers should evaluate these and other unique advantages of the Westinghouse WL-6102 and WL-6103 rectifiers. For further information write Westinghouse Electric Corporation, Electronic Tube Division, Dept. A-111, Elmira, N. Y.

Maximum Ratings		
	WL-6102 Oil Immersed	WL-6103 Air Cooled
Peak Inverse Voltage	40 KV.	20 KV.
Peak Current	900 MA.	900 MA.
Average Current	150 MA.	150 MA.
Filament Voltage	5.25 V. (5.0 V. Center)	5.25 V. (5.0 V. Center)
Filament Current	7.6 AMP. (7.2 AMP. Center)	7.6 AMP. (7.2 AMP. Center)
Height	2-13/16 IN.	2-15/16 IN.
Diameter	2-1/16 IN.	2-1/16 IN.
Weight	3½ OZ.	8½ OZ.

Typical Operation		
Single Phase, Full-Wave		
	WL-6102	WL-6103
Full Transformer Secondary Voltage (RMS)	28,300 V.	14,100 V.
DC Output Voltage to Filter	12,700 V.	6,300 V.
DC Output Current	.300 AMP.	.300 AMP.
3-Phase, Half-Wave		
Transformer Secondary Voltage (RMS)	16,400 V.	8,200 V.
DC Output Voltage to Filter	19,100 V.	9,500 V.
DC Output Current	.450 AMP.	.300 AMP.



Westinghouse WL-6102
Oil Immersed 40 KV Rectifier:
Only 2¾" high,
Weighs only 3½ ounces



Westinghouse WL-6103
Air-Cooled 20 KV Rectifier:
Weighs only 8½ ounces
Tubes pictured in actual size

RELIATRON™ TUBES

ELECTRONIC
TUBE DIVISION

Westinghouse Electric Corporation
Box 284, Elmira, N. Y.

YOU CAN BE SURE...IF IT'S
Westinghouse

ET-95005

BOGART

MANUFACTURING CORPORATION

Since
1942

Engineers and Manufacturers of the finest
MICROWAVE COMPONENTS and PRECISION EQUIPMENT



COAXIAL TERMINATION

MICROWAVE TRANSMISSION COMPONENTS

and
SPECIALIZED
ELECTRONIC
ASSEMBLIES

- DUPLEXERS
- ROTATING JOINTS
- DIRECTIONAL COUPLERS
- CRYSTAL MIXERS
- FEEDHORNS
- MAGNETRON COUPLERS
- PHASE SHIFTERS
- OSCILLATING JOINTS
- BROADSIDE ARRAYS
- DOUBLE-STUB TUNERS
- CAVITIES
- WAVEGUIDES
- —AND SPECIAL DESIGNS

Bogart is fully equipped to execute stamping, spinning, electroplating, and special precision machine work. Our laboratory is fully equipped to electrically test all products of our manufacture.

Inquiries and problems concerning the manufacture, development and calibration of any microwave units are cordially invited. *Write to...*

BOGART MANUFACTURING CORPORATION
315 SIEGEL STREET • BROOKLYN 6, N. Y.



Calif. A new model MC, 100 kc ferro-resonant flip-flop has been developed as an efficient replacement for the vacuum tube in certain counting, amplifying and control applications. By using non-dissipating reactive elements the problem of heat dissipation is virtually eliminated. The new unit will not wear or burn out, and can be mounted in any circuit. It is also immune to high acceleration and shock. Specifications include: a-c requirements—1.6 mc, 1 watt at 12 v rms; trigger input impedance—5 mh in series with 25 ohms d-c resistance; trigger power requirements—pulse, 8 to 16 v and 1 to 5 μ sec duration; outputs may swing between -3 and +21 v or between -3 and -21 v (by reversing output rectifier diode). The two outputs, opposite in phase, are capable of delivering 30 ma at 21 v each. Rated pulse frequency is 100,000 pps.



Toggle Switch

MICRO SWITCH, Division of Minneapolis-Honeywell Regulator Co., Freeport, Ill., has developed a hermetically sealed precision toggle switch whose performance and operating characteristics are unaffected by environmental conditions. Although designed especially for aircraft, it can be used in a wide variety of installations for which other switches are unsuitable. Mechanical life tests indicate the switch has a life expectancy far greater than the 25,000 operations normally anticipated for hand-operated switches. The basic switch has a spdt contact arrangement. Tentative ratings are: 5 amperes motor

NEW COMPACT...DEPENDABLE



34 kw 17,000 V. D.C.

UNITIZED RECTIFIERS

For high voltage D.C. sources . . . lower initial cost . . . minimum upkeep . . . convenient — ready to connect to A.C. line and D.C. load . . . compact — requires minimum floor space.

Dependability and long life factors are:

- Filament and plate transformers immersed in Askarel provide increased cooling and insulation.
- Special winding and insulation arrangements to withstand impulse surges.
- Vacuum filling removes all moisture
- Connected for out of phase filament operation to prolong tube life.

Independent bushing for plate and filament A.C. source.

Fireproof vaults are not required with Askarel . . . Output voltages available to 20 K.V.D.C. . . . Companion filter chokes obtainable in suitable ranges.

—all your large or high voltage magnetic equipment can now be supplied and co-ordinated by ONE DEPENDABLE SOURCE

Magnatran is operated by personnel having unusual and outstanding knowledge in the transformer engineering and manufacturing field. Thus Magnatran, a new name, is backed by reputation and experience requiring little further introduction to the industry.

A partial list of Magnatran quality products is shown below. Submit your requirements for our informational details.

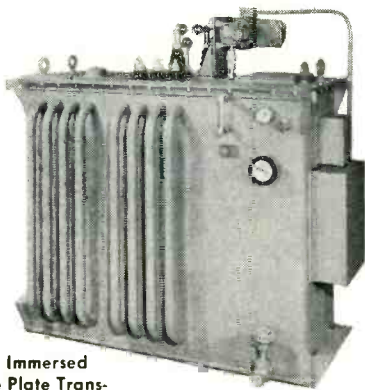

Askarel Immersed 3-Phase Plate Transformer. Motor Driven Tap Changer 50,000 Volt Test



Askarel Immersed Filter Reactor 50,000 Volt Test



Oil Immersed Modulation Transformer

AIR...OIL...ASKAREL

MAGNATRAN PRODUCTS

- Plate Transformers . Filament Transformers
 Filter Reactors . Modulation Transformers
 Distribution Transformers
 Pulse Transformers . Testing Transformers
 Precipitation Transformers
 General Purpose Transformers
 Hi-Voltage Power Rectifiers

A NAME SYNONYMOUS WITH EXPERIENCE

MAGNATRAN INCORPORATED

TRANSFORMERS AND ELECTRICAL EQUIPMENT

WALTER GARLICK, JR., PRESIDENT

246 SCHUYLER AVE., KEARNY, NEW JERSEY



Trade Mark Pending

EAD ENGINEERING gives you "2 for 1"

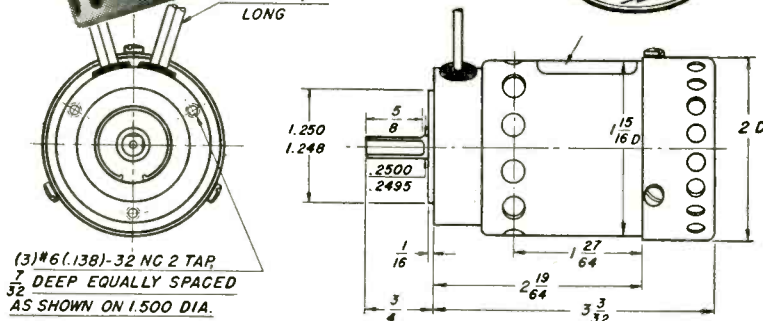

MODEL J31E-23

(5) LEADS, 10"
LONG(3) #6 (.138) -32 NG 2 TAP
7/32 DEEP EQUALLY SPACED
AS SHOWN ON 1.500 DIA.

Here, designed into one small frame, is a variable frequency capacitor motor capable of operating at dual frequency ranges of 50/60 cycles or 360/1600 cycles. Another outstanding EAD engineering achievement . . . one motor that does the work of two!

SPECIFICATIONS

Continuous duty • single phase • 115 volts AC • Ambient temperatures: -55°C to $+85^{\circ}\text{C}$ • Weight: 1 lb., 1 oz. • Meets military specifications for humidity, salt, shock, vibration and tropicalization.

Applications: Airborne equipment (fans, blowers, pumps and other suitable uses.)

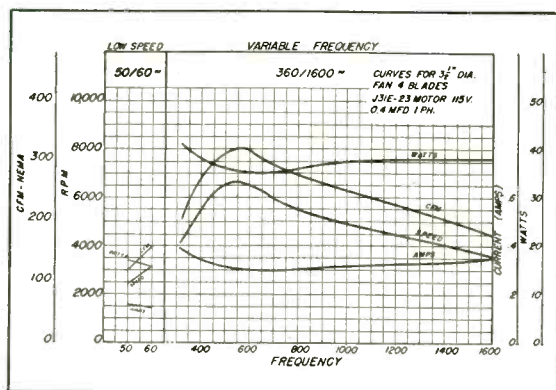

Solving special problems is routine at EAD.

If your problem involves rotating electrical equipment, bring it to EAD. Our completely staffed organization will modify one of our standard units or designs and produce a special unit to meet your most exacting requirements.

EASTERN AIR DEVICES, INC.

585 DEAN STREET, BROOKLYN 17, NEW YORK

load 30 v d-c; 10 amperes inductive load 30 v d-c; 25 amperes resistive load 30 v d-c; 1.0 ampere a-c for any type of load, 125 v a-c.

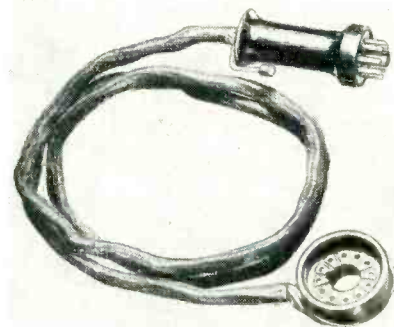

TV Picture-Tube Test Adapter

ELECTRONIC INSTRUMENT CO., INC., 84 Withers St., Brooklyn 11, N. Y., has released the new model CRA television picture-tube test adapter. Carefully designed for accuracy and safety, it gives a quantitative measurement of cathode emission, and tests for filament continuity and interelement shorts. It comes complete with standard 12-pin tv tube socket, octal plug-in connector and features an extra long 4-ft cable that enables the picture tube to remain in the set while testing.

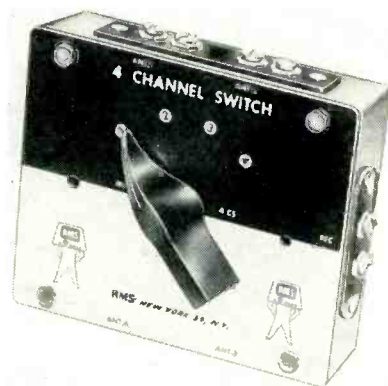

Four-Channel Switch

RADIO MERCHANDISE SALES, INC., 1165 Southern Blvd., New York 59, N. Y. Model 4CS four-channel switch will switch four antennas into one receiver, or will operate any one of four receivers from a single antenna. The unit is engineered to reduce the coupling effect between the antenna in use and those that are idle—an effect that

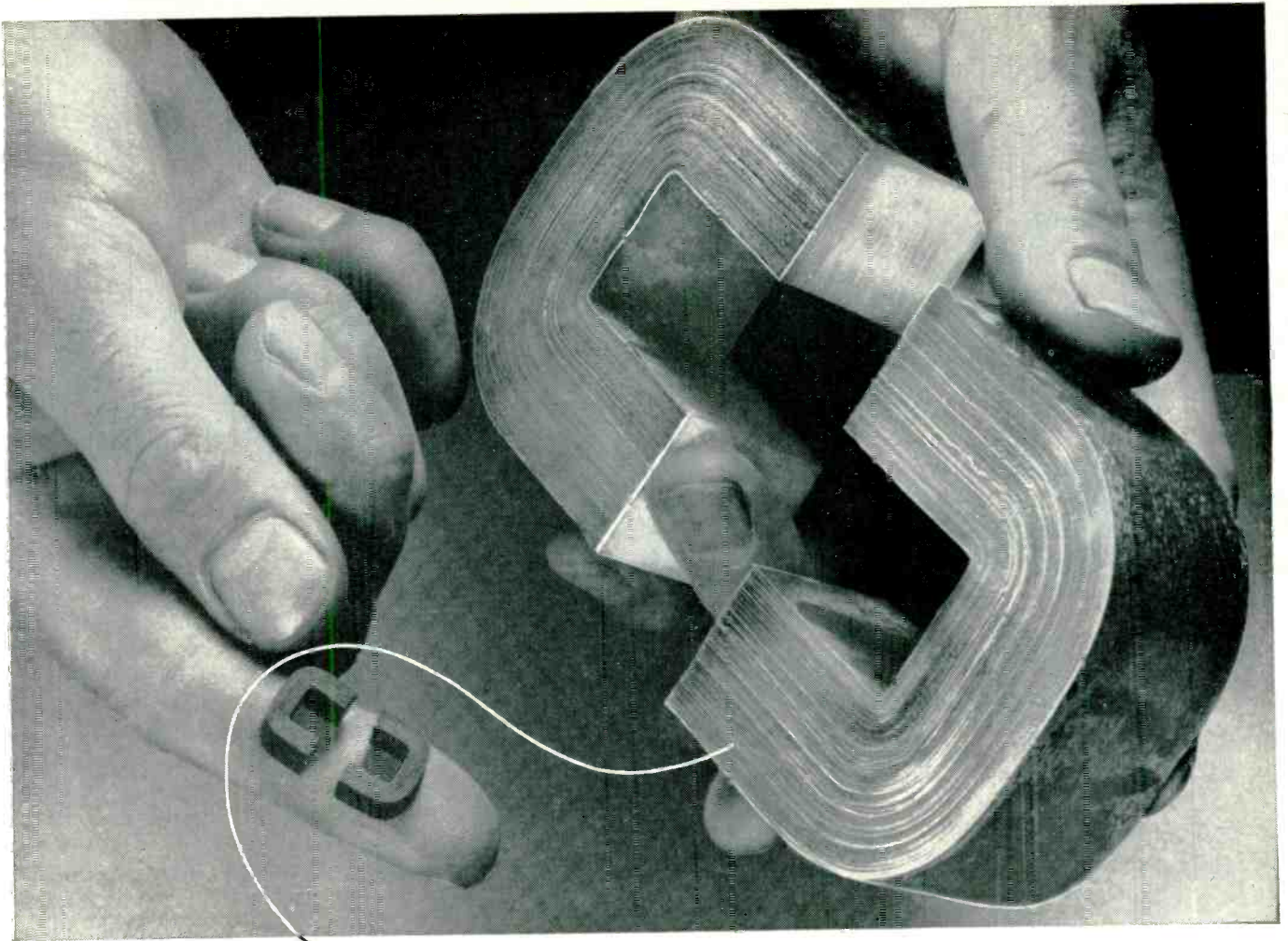

SILECTRON C-CORES... **BIG** or LITTLE

...any quantity and any size

*Wound from
precision rolled
oriented silicon
steel strip as thin
as .00025"*

For users operating on government schedules, Arnold is now producing C-Cores wound from 1/4, 1/2, 1, 2, 4 and 12-mil Silectron strip. The ultra-thin oriented silicon steel strip is rolled to exacting tolerances in our own plant on precision cold-reducing equipment of the most modern type. Winding of cores, processing of butt joints, etc. are carefully controlled, assuring the lowest possible core losses, and freedom from short-circuiting of the laminations.

We can offer prompt delivery in production quantities—and size is no object, from a fraction of an ounce to C-Cores of 200 pounds or more. Rigid standard tests—and special electrical tests where required—give you assurance of the highest quality in all gauges. • *Your inquiries are invited.*

THE ARNOLD ENGINEERING COMPANY



SUBSIDIARY OF ALLEGHENY LUDLUM STEEL CORPORATION

General Office & Plant: Marengo, Illinois

WAD 4363

NEW STEVENS THERMOSTAT

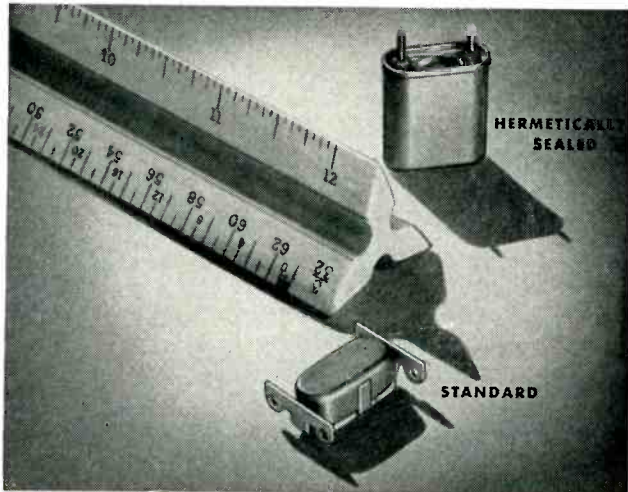

- close temperature control
- clean make and break
- fast response

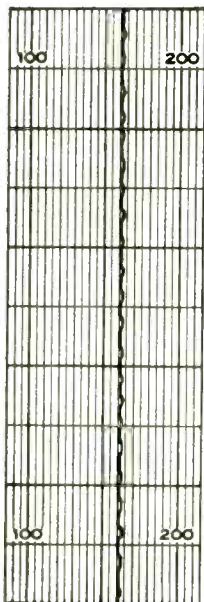

Compactly designed for use in communications equipment, electronic devices and apparatus demanding a high degree of temperature stability, Stevens Type C* thermostats feature an electrically independent bi-metal that responds *only to heat from controlled device.*

Typical temperature curve at left shows how this construction completely eliminates artificial cycling or life-shortening "jitters." Current flows readily through stainless steel or alloy contact spring . . . does not pass through high resistance bi-metal. Contacts open only when bi-metal overcomes spring pressure and friction of bi-metal strip against contact spring surface—for a clean, positive break.

Components are permanently riveted to dimensionally stable Alsimag base to further insure against erratic operation. Heavy-duty silver contacts assure long life.

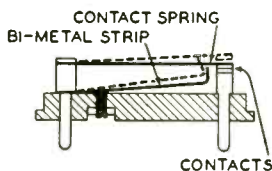

Standard and hermetically sealed Stevens Type C thermostats are carefully pre-calibrated in pots simulating actual service conditions; spot life-tests assure quality control. Specify Stevens Type C thermostats for closer temperature control—*longer life.*

A-2259

* PATENT APPLIED FOR

STEVENS manufacturing company, inc.
MANSFIELD, OHIO

generally has been considered one of the drawbacks in the use of conventional types of switches.



High-Frequency Counters

DECADE INSTRUMENT CO., Caldwell, N. J. Frequency counting in higher ranges, with equal precision, is now possible with Decaviders. No additional signal level is required and there is no loss of accuracy. Decaviders are connected in series with the input of standard frequency counters. Standard counter ranges of up to 10 mc, up to 1 mc and up to 100 kc can be extended by several Decavider models respectively to: 10 to 20 mc, 10 mc to 100 mc, 1 mc to 10 mc and 100 kc to 1 mc. The last three have 9 ranges. Decaviders also respond to transient waveforms, providing the spectrum is within the pass band of the Decavider amplifier and within the ranges listed above.



Toroidal Power Transformer

MILLIVAC INSTRUMENT CORP., 444 Second St., Schenectady 6, N. Y. has introduced a new toroidal power transformer that eliminates hum pickup in audio amplifiers. Transformer MT-1001 replaces ordinary

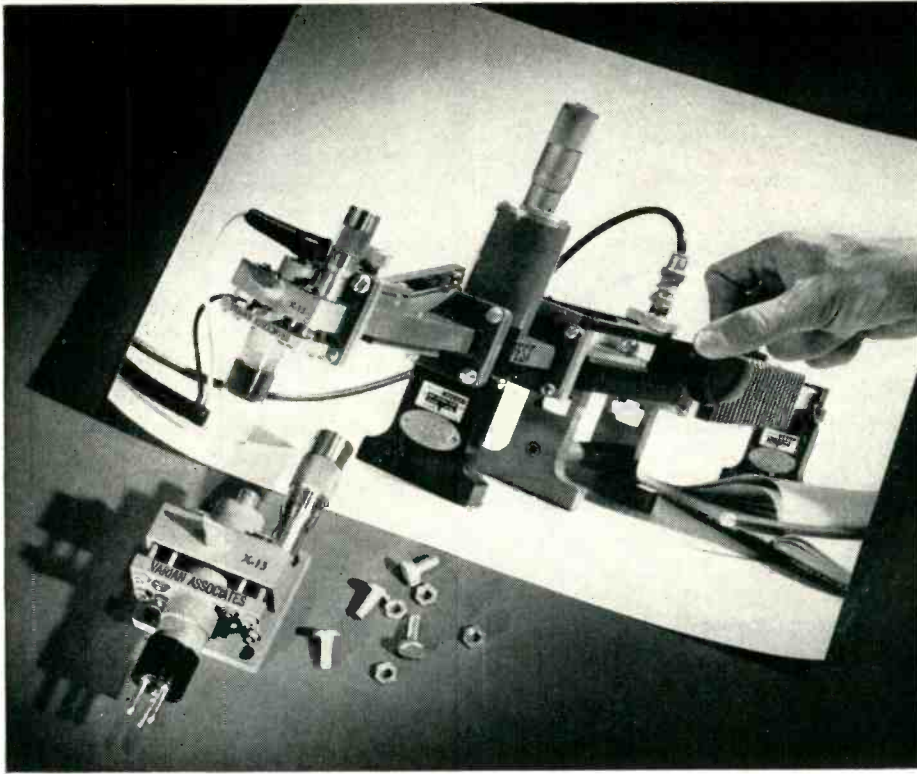

IN LABORATORIES throughout the electronic field, the Varian X-13 Klystron is widely used as a general-purpose x-band signal source. In the typical setup above (checking load reflection), note the compactness, the convenience of connection, and the way the tube bolts directly to the waveguide.

OUTPUT POWER typically reaches half a watt at center frequency and exceeds 150 milliwatts over the full frequency range 8.2 to 12.4 kmc. The X-13 exhibits extremely low microphonic levels and operates directly into matched waveguide. Tuning is done with a single control. The tube is air cooled and has clearance dimensions of $4\frac{1}{2}$ by $2\frac{1}{2}$ by $2\frac{1}{2}$ in., weight of only 6 oz.

Typical Power Output - Varian X-13 Klystron
 (Beam Voltage, 500 v)

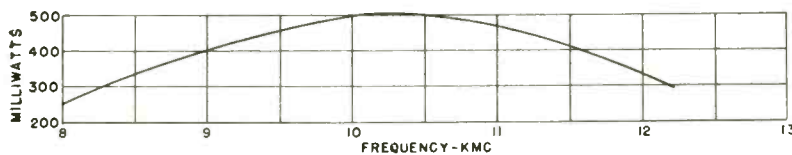

OTHER VARIAN KLYSTRONS extend and expand the functions of the X-13. An extensive line of tubes with designs based on that of the X-13 offers a wide selection of output powers, types of tuning devices and terminations, as well as capabilities for withstanding vibration and shock ranging far beyond 30 times gravity.

SEND FOR DATA on these or other klystrons from the extensive Varian line, many of which are necessarily unpublicized. You are invited to submit your microwave problems to the Varian application-engineering group for recommendations.

VERSATILE X-BAND SIGNAL SOURCE

Varian X-13
 reflex klystron

... 8.2-12.4 kmc

... 150-500 mw

* TRADE MARK

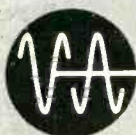

VARIAN associates

990 VARIAN STREET • SAN CARLOS 1, CALIFORNIA

**FIELD ENGINEERING
 REPRESENTATIVES
 IN PRINCIPAL CITIES**

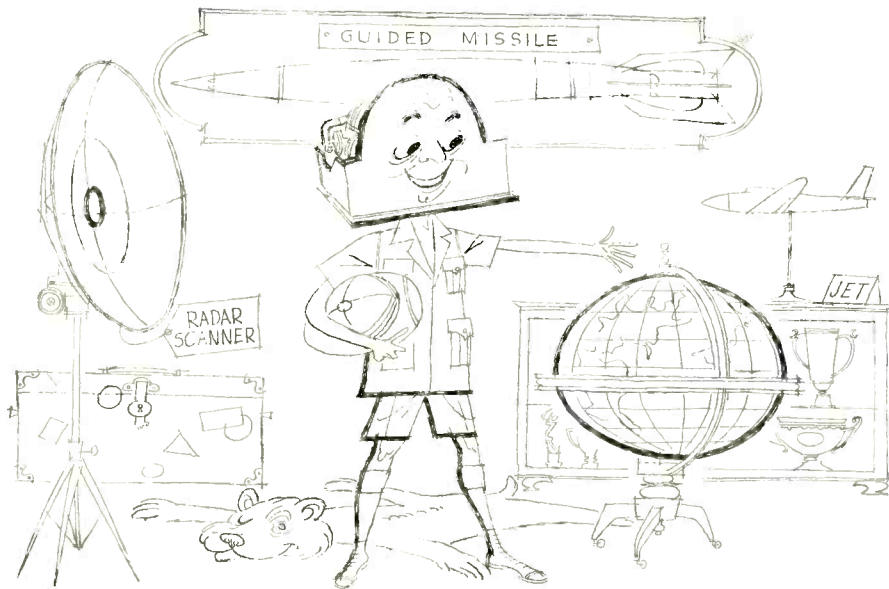

GYRO LOOKING FOR NEW WORLDS TO CONQUER

We're mighty happy with the performance of our Cageable Vertical Gyro as an autopilot component in fighters and guided missiles—and in radar stabilization systems.

But we feel that this gyro—which can be caged in under ten seconds, uncaged in only three seconds—has a lot of undeveloped possibilities.

Some of them we know. But you may have problems and applications of which we are not aware.

So if you get any ideas after you've looked over the specs below, drop us a line.

And remember, here at Honeywell we're specialists in gyros, have become one of the leaders in the field. Our gyro "family"—which includes other vertical, rate and the extremely sensitive Hermetic Integrating Gyros—is now available to manufacturers who require precision performance.

If you'd like to know more about any of the products in our gyro line, we'd be pleased to send details. The address is Honeywell Aero Division, Dept. 401 (E), Minneapolis 13, Minnesota.

Cageable Vertical Gyro JG 7044A Specifications

Power Requirements: Gyro motor: 115 volts, 400 cps $\pm 10\%$, single-phase. Erection motors: 30 volts, 400 cps, single-phase. Caging circuit: 28 volts dc.

Power Load: Gyro motor: 50 watts max. (starting); 20 watts max. (running).

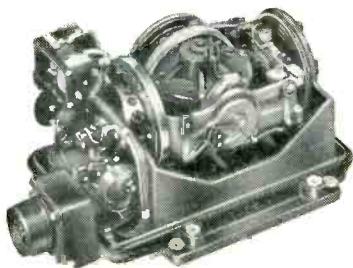

Erection motors: 5 watts (each). Caging operation: 12 watts (operating); 6 watts (standby).

Gyro Speed: 22,000 rpm. (minimum).
Angular Momentum: 4.75×10^6 gm-cm²/sec.

Roll Axis Freedom: 360°.
Pitch Axis Freedom: $\pm 85^\circ$.

Caging Time: 10 seconds. (max.).

Gyro Run-down Time: 8 min. (min.).

Erection Rate: 2° to 6° per minute (factory adjustment).

Drift Rate: 30° per hour (maximum).

Accuracy: 0.15° of true vertical in each axis.

Resolution: 1/13° each axis.

Environment: Designed to meet AAF Spec. 27500D.

Weight: 5 lbs.

power transformers in high gain amplifiers where an absolute minimum of hum pickup through magnetic field radiation is desired. It is precision wound on a ring core without air gaps and radiates less than 0.01 gauss at 5 in. from its surface. By parallel or series connection and doubler or tripler circuits the following d-c voltages for plate supply may be obtained: 350, 700, 1,200 and 1,800. The transformer has 2 separate heater windings which are rated 6.3 v and 1.5 amperes.

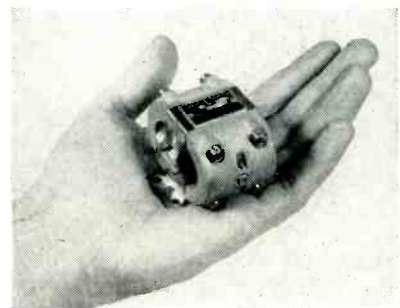

Small Torque Motor

MIDWESTERN GEOPHYSICAL LABORATORY, Tulsa, Oklahoma. The model 9, a small and powerful torque motor, is a precision linear actuator primarily designed to stroke pistons in hydraulic servovalves. However, it is being utilized in many engineering fields as a basic transducer to convert a few watts of power from an electronic amplifier to a linear mechanical motion with considerable force. Specifications are: midposition force, 9.5 lb; stroke, ± 0.015 in.; weight, 19 oz; no-load natural frequency, 425 cps; coil resistance, 3,400 ohms each; and balance current, 20 ma.

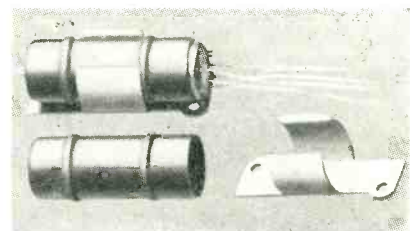

Subminiature Shield

THE STAVER CO., INC., Bay Shore, Long Island, N. Y., has introduced

MINNEAPOLIS
Honeywell



Aeronautical Controls

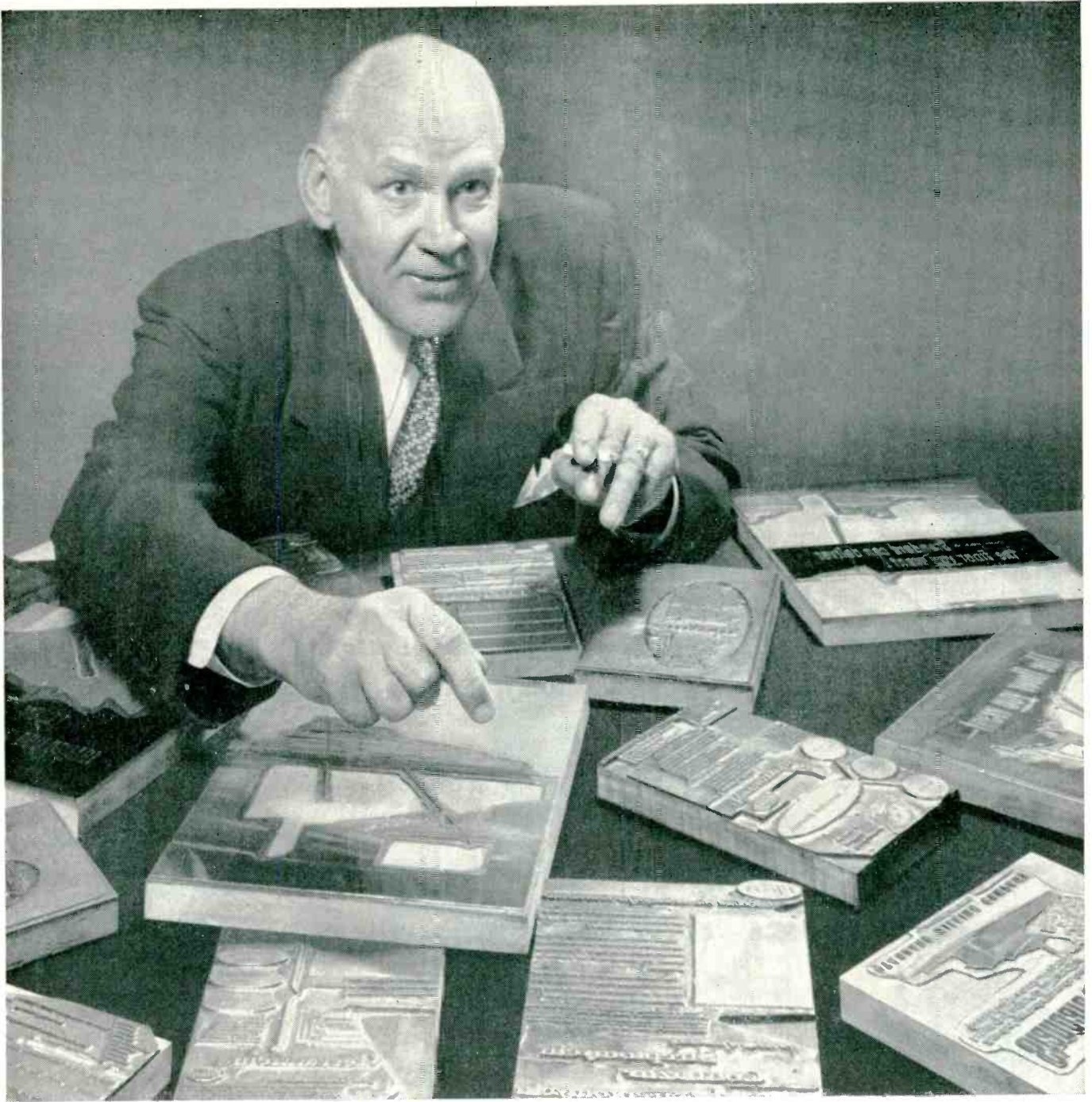

**"We want speed at any price
...yet we use the cheapest air service!"**

—Richard E. Crowe, President, Globe Electrotpe Company

"We ship electrotypes to publications all over the country—from 30 to 300 in a single day. That's a lot of deadlines!

"We've made it a rule to specify Air Express.

"When Air Express started in 1927, we were among its first customers. We've used it ever since. And, in all that time, we've NEVER HAD ONE SINGLE KICK on an Air Express shipment! That's quite a record, and I've checked it with our people here.

"We've tested other air services. Air Express is consistently faster and more dependable. AND COSTS LESS! On most of our shipments, Air Express rates are the *lowest*, by a few cents to several dollars. Those differences add up to thousands of dollars in a year's shipping.

"I would advise anyone who is confused about shipping claims to test Air Express and keep a record of results. It convinced us."



AIR EXPRESS

GETS THERE FIRST

*Division of Railway Express Agency
1952 — our 25th year of service*

inside this package on your Jobber's shelf...



is the world's toughest transformer

CHICAGO



S-TYPE

Steel base cover fitted with phenolic terminal board. Convenient numbered solder lug terminals. Flange-mounted unit.

there's nothing **TOUGHER**
THAN CHICAGO "Sealed-in Steel" CONSTRUCTION



H-TYPE

Hermetic sealing meets all MIL-T-27 specs. Steel base cover is deep-seal soldered into case. Ceramic bushings. Stud-mounted unit



G-TYPE

With 10" color-coded leads brought out through fibre board base cover. Lead ends are stripped and tinned for easy soldering. Flange-mounted unit

CHICAGO "New Equipment" transformers (available in 3 mountings) feature one-piece drawn-steel cases—the strongest, toughest, best-looking units you can buy. The one-piece seamless design, enclosing an electronically perfect construction, provides the best possible electrostatic and magnetic shielding, with complete protection against adverse atmospheric conditions. For every application: Power, Bias, Filament, Filter Reactor, Audio, MIL-T-27, Stepdown—ask your electronic parts distributor for CHICAGO "Sealed-in-Steel" Transformers—the world's toughest with that extra margin of dependability.

Free "New Equipment" Catalog

Get the full details on CHICAGO'S *New Equipment Line*—covering "Sealed-in-Steel" transformers for every modern circuit application. Write for your Free copy of this valuable catalog today, or get it from your distributor.



the Sub-Mini-Shield, a combination shield, clip and mount. Heat is effectively dissipated through an aluminum wrap-around shield. Tube diameters from a minimum 0.366-in. diameter to a maximum 0.400-in. diameter are held securely since the shield is of the overlap type, thus allowing for close contact between tube and shield. The shield mount, made of spring brass or phosphor bronze as an alternate material, serves to clamp the shield firmly to insure good contact between tube and socket under severe conditions of vibration. Minimum mounting center distances between mounts is $\frac{1}{8}$ in. Shield lengths are obtainable for tube types T3-1, T3-2, T3-3 and T3-4.

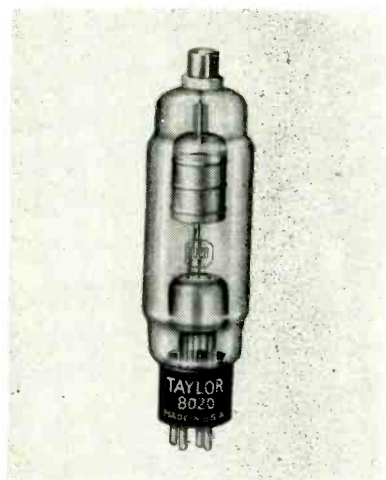

H-V Rectifier

TAYLOR TUBES, INC., 2312 West Wabansia Ave., Chicago 47, Ill., has introduced the type 8020 high-voltage rectifier tube. It is rated at 40 kvp inverse or forward in air, 60 kvp in oil, an average current of 100 ma, with instantaneous peak-current capacity of 2 amperes. The tube construction of Nonex glass with standard four-prong base uses special oil-resisting silicone basing compound to eliminate loose bases caused by oil immersed operation. The construction also features a treated tantalum anode for stability and long life and a filament of the thoriated tungsten type to operate at 5 volts, 6 amperes. Life expectancy of the tube is over 5,000 hours if operated within ratings. Its maximum physical dimensions are

CHICAGO TRANSFORMER

DIVISION OF ESSEX WIRE CORPORATION

3501 ADDISON STREET • CHICAGO 18, ILLINOIS



TRADE MARK REG

**When it's
Electrical
Protection —**

*Rely
on*

**BUSS
FUSES**

for TELEVISION • RADIO • RADAR • INSTRUMENTS • AVIONICS

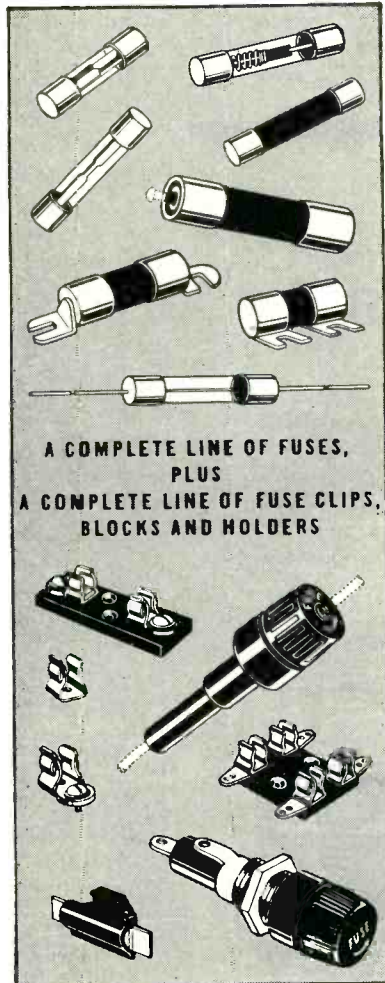

**A COMPLETE LINE OF FUSES,
PLUS
A COMPLETE LINE OF FUSE CLIPS,
BLOCKS AND HOLDERS**

The most vital quality of a fuse is *dependability*, for the sole purpose of a fuse is to protect wiring and equipment far more costly than the fuse itself.

If the fuse cannot be depended upon to *open when it should* — but not before — it may become a hazard or a nuisance.

To be sure that a BUSS fuse will always operate as it should under service conditions, each and every BUSS fuse is individually tested in a highly sensitive electronic device that automatically discards any fuse that is not correctly calibrated, properly constructed and right in all physical details.

That is why manufacturers and service men throughout the nation have learned that they can best rely on BUSS Fuses.

GOT A PROTECTION PROBLEM?

BUSS Fuse engineers have more than a third of a century's experience behind them, in designing and developing the right fuses to meet industry's ever-expanding need. Send us your drawings and specifications. We'll be glad to work with you.

GET THE FACTS — mail this handy coupon today . . .

■ BUSSMANN Mfg. Co. (Division of McGraw Electric Co.)
 University at Jefferson, St. Louis 7, Mo.

■ Please send me bulletin SFB containing complete facts on
 ■ BUSS small dimension fuses and fuse holders.

■ Name.....
 ■ Title.....
 ■ Company.....
 ■ Address.....
 ■ City & Zone..... State..... 1152
 ELRC

BUSSMANN MANUFACTURING CO., University at Jefferson, St. Louis 7, Missouri *Division McGraw Electric Company.*



CAPTIVE NUTS

National Captive Nuts of stainless steel may be pressed into aluminum and certain types of brass sheet metal to provide integral flush-mounted tapped holes in a wide variety of sizes. Four basic types have been designed for metal thicknesses of $\frac{1}{16}$ ", $\frac{3}{32}$ ", $\frac{1}{8}$ ", $\frac{3}{16}$ " and $\frac{1}{4}$ ".

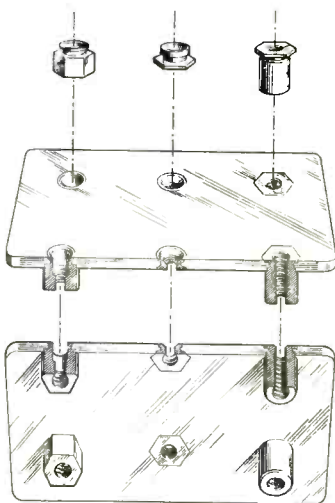

8 in. in length and 2 5/6 in. in diameter.



Small D-C Relay

RADIO CORP. OF AMERICA, Harrison, N. J. Type 203W1 hermetically-sealed miniaturized d-c relay was designed for use throughout the electrical systems of military aircraft. It is designed to meet the requirements of MIL-R-5757. Weight is only 3 oz and the relay can be operated in any position. Its 6-pole, double-throw construction features palladium contacts rated to handle 2 amperes with a resistive load at 26.5 volts d-c and 1 ampere with an inductive load at the same voltage. Contacts are arranged in a break-before-make sequence.

VARIABLE CONDENSERS

National makes a complete line of quality variable condensers covering a wide range of capacities and uses. A few types are shown.

Type ST (180° rotation) has straight line wave-length plates. Type SS has straight-line capacity plates. Both types are available in single bearing, double bearing and split stator double bearing models.

Type SE (270° rotation) has straight-line frequency plates.

National's engineering staff is available to manufacturers for designing condensers to special requirements.

Write for drawings and specifications.

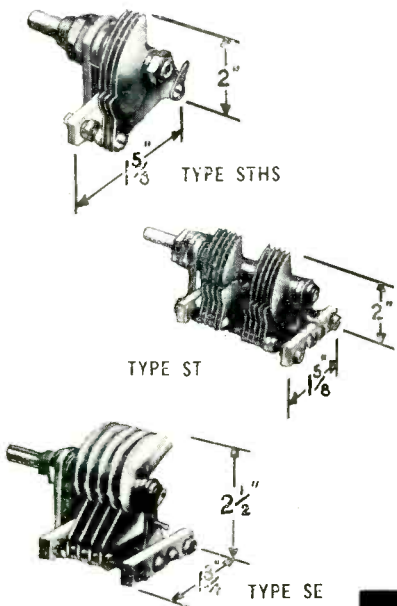

Write for drawings



Voltage Booster

I.D.E.A., Inc., Regency Division, 7900 Pendleton Pike, Indianapolis 26, Ind. To solve the problem of annoying fluctuations in tv picture size due to drops in line voltage, the company has designed a new voltage booster which maintains a 117-v power supply regardless of

Magnetostriction

ONCE A LABORATORY CURIOSITY . . . NOW SERVING SCIENCE
IN SURPRISING WAYS . . . WITH THE HELP OF

Nickel

Like Hertzian waves, Roentgen rays, and radioactivity . . . magnetostriction was once just a physicist's plaything.

Early experimenters noted with interest the unusual behavior of magnetized ferromagnetic materials . . . the "spontaneous" dimensional changes; and inversely, the permeability changes when dimensions were forcibly altered.

But as magnetostriction developed from laboratory demonstration to practical application, it was discovered that few materials offered sufficiently high magnetostrictive response. When the essentials of economy, workability, and availability were considered, the number of suitable materials was still more limited.

Both research and practice have now established Nickel as a satisfactory solution to this problem. Nickel's magnetostrictive contraction of approximately thirty parts per million is exceeded only by a few special alloys.

Nickel offers, in addition, excellent corrosion resistance, good resistance to the destructive effects of extreme temperatures, plus strength and hardness equal or superior to that of low-carbon steel. For special applications, even greater hardness can be obtained in Permanickel through heat treatment, with only a small loss in mechano-magnetic characteristics.

Nickel is in short supply because of defense needs, but if you are interested in magnetostrictive oscillators . . . either for manufacture or application . . . INCO's Technical Service Department will gladly put at your disposal data accumulated from both research and practice.

For your reference files, write for: "*Magnetostriction*" and "*66 Practical Ideas for Metal Problems in Electrical Products.*" The International Nickel Company, Inc., 67 Wall Street, New York 5, N. Y.

A FEW OF MANY APPLICATIONS FOR MAGNETOSTRICTIVE EQUIPMENT

- "Sonar" and related devices for detecting submarines and ships.
- Raytheon's "Fathometer", for determining depth of waters; locating schools of fish.
- Electrical filters, such as band pass filters for radio receiving sets.
- Homogenization and sterilization of milk.
- Acceleration of chemical reactions and cavitation effects.
- Strain gages.
- Vibration and engine detonation.
- Phonograph pick-ups.
- Frequency control of oscillators operating below 100 Kc.
- Dust and smoke precipitation.

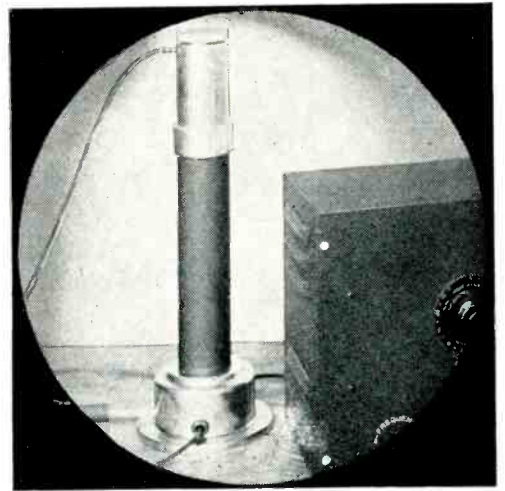

Bacteria Killer. A 9 Kc magnetostrictive oscillator used for sterilization in the chemical and pharmaceutical industries. The magnetostrictive material is laminated Nickel. Made by Raytheon Manufacturing Co., Waltham, Mass.

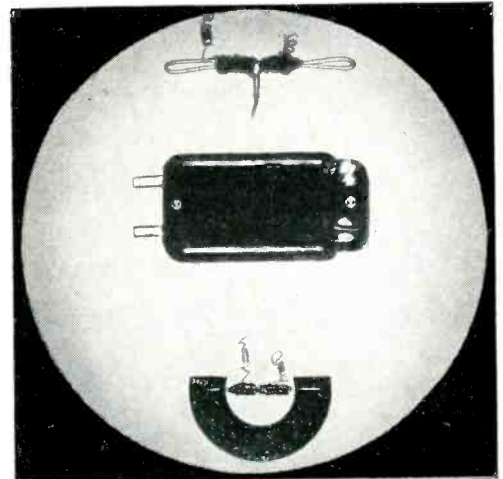

Phonograph Pick-Up: The magnetostrictive unit in this device is a 20-mil Nickel wire which is stretched between the poles of a horseshoe magnet. Variations in torsion caused by deflections of the needle produce flux variations in two pick-up coils that are wound around the stretched Nickel wire.

Nickel  Alloys

MONEL® • "R"® MONEL • "K"® MONEL • "KR"® MONEL
"S"® MONEL • NICKEL • LOW CARBON NICKEL • DURANICKEL®
INCONEL® • INCONEL "X"® • INCOLOY • NIMONICS® • PERMANICKEL®

Look to Hetherington for the Latest, Most Dependable Switches!

New!

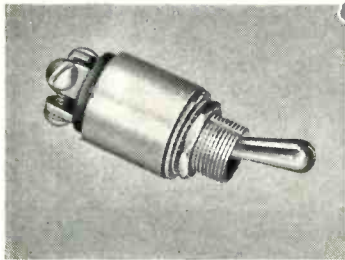

Cylindrical toggle switch is a real space saver

T1000 Designed for MIL-S-6745 uses

This sturdy little T1000 Hetherington toggle switch reduces size and weight approximately 25% by comparison with rectangular switches. Features include exceptionally positive cam-roller snap action; effective contact wipe; maximum protection against contact wear or arcing damage and strong lever operating action. Only 2 3/8" long x 3/4" diameter. Weighs 1 ounce. Write for Bulletin S-1.

New

Miniature "Push-Push" and Rotary Types J100 and R1000



Compactness, light weight and maximum durability characterize these unique Hetherington switches. Widely used for aircraft seat light control, the Series J100 "push-push" switch utilizes a sturdy cam-roller design operated by a positive escapement-type push-button action and is readily adaptable to many uses. The Series R1000 switch is a rotary action unit with indicator knob. Both types operate on either 28 v.d.c. or 115 v.a.c. 60 cycles current. Rated 20 amperes resistive. Write for Bulletin S-1.

HETHERINGTON SWITCHES

FINE-PUSH-BUTTON AND SNAP-ACTION TYPES
PANEL INDICATOR LIGHTS
SWITCH-INDICATOR LIGHT COMBINATIONS
AIRCRAFT AND ELECTRICAL EQUIPMENT ASSEMBLIES

HETHERINGTON, INC., Sharon Hill, Pa.

West Coast Division: 8568 W. Washington Blvd., Culver City, Calif.

line voltage variations from 90 to 130 v. The VB-1 booster can also be used to get peak performance from any electrical device drawing 350 w or less. Since it is an automatic transformer with tapped primary, it can be used with equal efficiency in high-voltage areas to decrease line voltage.

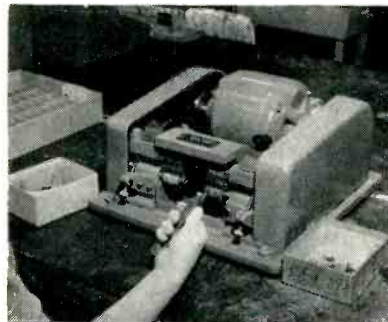

Twin-Headed Wire Stripper

THE ERASER CO., INC., 110 S. State St., Syracuse 2, N. Y. Model D-8 twin-head stripper uses proper wheel grades and settings for high-production stripping of leads of two different gages. The space regulator screw (at front of head) adjusts the minimum spacing to the bare diameter of the wire and prevents damage to the wire. A pressure regulator (on top of head) permits stripping all the wires in the lead with one pass. The stripper shown is equipped with a single wheel and stripper blade for stripping close to the coil. Two-wheel heads are also available. The wheels are specially engineered for the exact type and gage of wire being stripped.



Crystal Calibrated Standard

THE HICKOK ELECTRICAL INSTRUMENT Co., 10514 Dupont Ave., Cleveland 8, Ohio. Model 680 r-f marker and crystal calibrator is designed for use in the shop, labora-

WORKSHOP...

*is proud to announce
its new UHF antenna**

the ultimate in—

SIMPLICITY
RUGGEDNESS
RELIABILITY

Simplicity—because the radiating and structural portions are coincidental. Cross sectional view at lower left clearly illustrates its clean cut revolutionary design.

Ruggedness & Reliability—come from complete elimination of small, delicate connectors and breakable insulators. Antenna breakdowns are virtually impossible.

High Gain of 11 db over a tuned dipole for the 12 wavelength model. Power gain of 14.

Perfect Circularity—maximum variations of less than 0.5 db from mean value in horizontal pattern.

Vertical Pattern . . . 4.2° . . . VSWR less than 1.1 to 1 with best match at video carrier frequency . . . will handle 50 KW power . . . and a host of other features.

This is only part of the story on this new development. Specifications indicate its unusually high performance and operating dependability. Write or call for complete information.

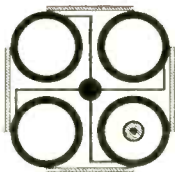

◀ Cross-sectional view showing the four vertical tubes that form the radiating system. These tubes are actually slots and are further subdivided into resonant sections. They are fed by a single vertical inner conductor.

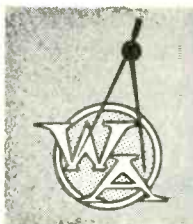

WORKSHOP ASSOCIATES DIVISION
THE GABRIEL COMPANY

Endicott Street • Norwood, Mass.

DESIGNERS AND MANUFACTURERS OF A
COMPLETE LINE OF MICROWAVE ANTENNAS

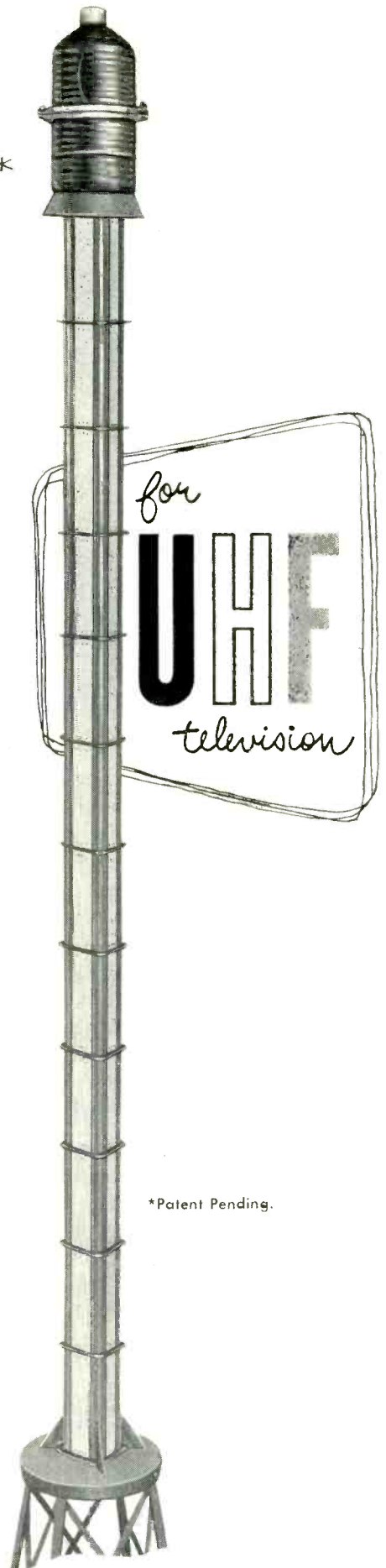

*Patent Pending.

Abnormal Temperatures No Problem



LORD BONDED-SILICONE PARTS

As the result of several years of investigation and research, Lord engineers have developed successful techniques for bonding silicone to metal. This extends the advantages of bonded rubber into the wider temperature range from -100° to $+500^{\circ}$ F.

A number of Lord Vibration-Control Mountings are available with silicone elastomers, and new designs are being engineered to take full advantage of the properties of this new material.

You can solve many product problems with Lord bonded-silicone parts which are used to isolate vibration and reduce operating noise, and protect parts from excessive stresses.

20th National Exposition of Power and Mechanical Engineering
Grand Central Palace, N. Y., Booth No. 558 December 1-6 1952

The easiest way to get the full story of the advantages of LORD BONDED SILICONES is to write or call . . .



BURBANK, CALIFORNIA
Joe B. Hartley
George E. Behlmer
233 South Third Street
HOckwell 9-2151
CHarleston 6-7481

DAYTON 2, OHIO
W. Webster Dalton
238 Lafayette Street
Mlchigan 8871

PHILADELPHIA 7, PENNSYLVANIA
George P. Harrington
725 Widener Building
LOcust 4-0147

CHICAGO 11, ILLINOIS
Robert T. Daily
Kenneth L. Hanson
Perry C. Goodspeed, Jr.
520 N. Michigan Ave.
Mlchigan 2-6010

DETROIT 2, MICHIGAN
Everett C. Vallin
7310 Woodward Ave.
TRinity 5-8239

ERIE, PENNSYLVANIA
Paul E. Dailey
Harry C. Sapper
1635 West 12th Street
2-2296

DALLAS, TEXAS
Bruce O. Todd
1613 Tower Petroleum
Building
PRospect 7996

NEW YORK 16, NEW YORK
Vincent Ellis
Jack M. Weaver
280 Madison Avenue
MUrray Hill 5-4477

LORD MANUFACTURING COMPANY • ERIE, PA.



HEADQUARTERS FOR
VIBRATION CONTROL MOUNTINGS
... **BONDED RUBBER PARTS**

tory and factory, to check oscillators, generators and front-end or overall response curve of a tv receiver. The heterodyne detector and magic eye tube, which is a built-in feature, gives a visual zero-beat indicator to be used for calibration. A phone jack is provided at the back for an audible zero-beat. The 2.5-mc crystal, when beat with the vfo, gives an r-f generator calibrated to ± 0.05 percent at 2.5-mc intervals over the range 53 to 89 mc and 174-217 mc on fundamentals, and to 868 mc on harmonics.

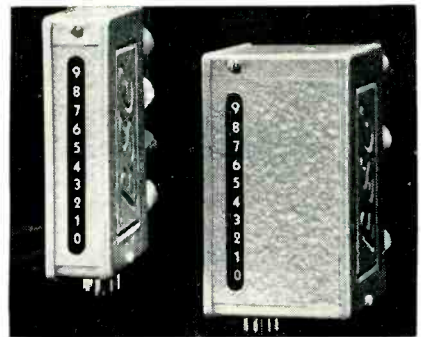

Decimal Counting Units

BERKELEY SCIENTIFIC CORP., 2200 Wright Ave., Richmond, Calif., has available a line of decimal counting units that are plug-in type, direct-reading, electronic counters capable of operating at speeds up to 1,000,000 counts per second and resolving paired pulses separated by as little as $0.8 \mu\text{sec}$. The decimal counting unit counts from 0 to 9 and presents an illuminated numerical reading on the front panel. No interpolation is necessary. The tenth pulse resets the counter to 0 and simultaneously generates one pulse, which may be applied to the input of a following counter or other device. Reset to 0 of one or more units is accomplished by momentarily opening the grid return circuit. The units may be connected in cascade indefinitely to create an electronic counter or scaler having any desired number of decimal places.

Record Measurements

TELECOMPUTING CORP., Burbank, Calif. Faster, more accurate meas-

Starting electronic nose on its way. It is pulled from pole to pole by line extending toward the ground. Previously workmen had to paint the cable with soap solution, so bubbles would disclose leaks.

THIS ELECTRONIC NOSE SNIFFS OUT LEAKS

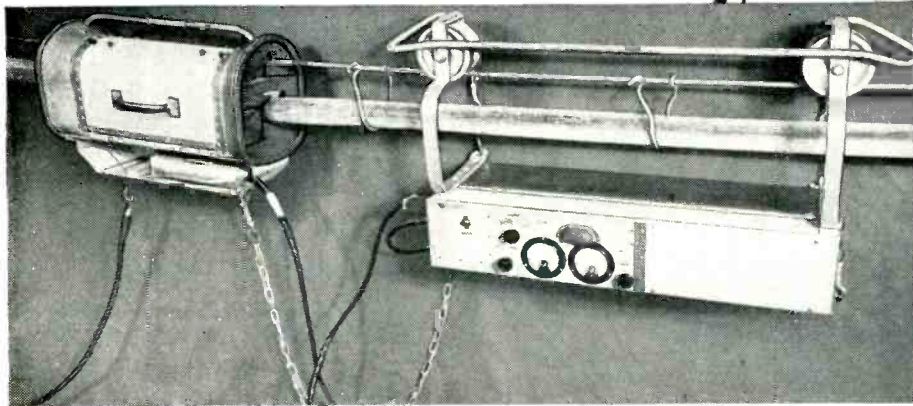

For test, the cable is cleared of protective nitrogen or air, and filled with Freon gas. Case at left collects escaping gas which operates Freon-sensitive detector underneath. At points where Freon escapes through sheath cracks, the box at right—a combined control unit and power supply—rings a bell. Workmen mark the point of leak for later repair.

AFTER years of buffeting by the wind, even tough telephone cable sometimes shows its age. Here and there the lead sheath may crack from fatigue or wear through at support points. Before moisture can enter to damage vital insulation, leaks must be located and sealed.

To speed detection, Bell Laboratories scientists constructed an electronic nose which *sniffs* out the leaks. Using an electrically operated element developed by the

General Electric Company, the device detects leaks of as little as 1/100 cubic foot per day. Sheath inspection can be stepped up to 120 feet per minute.

Thus Bell scientists add findings in other fields to their own original research in ways to make your telephone system serve you better. On the other hand their discoveries are often used by other industries. Sharing of scientific information adds greatly to the over-all scientific and technological strength of America.



BELL TELEPHONE LABORATORIES

Improving telephone service for America provides careers for creative men in scientific and technical fields



We're sorry, but we think it's only fair to tell possible new customers our Standing Room Only sign must be changed to Sold Right Out!

The design and production facilities of our microwave department are now taken over by the increasing requirements of our present customers. Because of our responsibility to them, this situation may continue quite a while.

We are sorry to say this because we enjoy making new friends. But we feel that we should tell those who might be interested in our engineering and manufacturing facilities, that for some time we may not be able to serve them.

Any change in the situation will be announced in this publication.



L. H. TERPENING COMPANY

DESIGN • RESEARCH • PRODUCTION

Microwave Transmission Lines and Associated Components

16 West 61st St. • New York 23, N. Y. • Circle 6-4760

TRADE MARK

Measurements of film and oscillograph records are now possible with the development of the Universal Tele-reader. The unit measures records ranging from 16 and 35-mm film to 12-in. oscillograph paper up to 100 ft in length. It can handle either translucent or opaque records. Three interchangeable projection lenses are provided with the Tele-reader to permit record magnification of 2X, 4X and 11X, depending on the need. When used with companion instruments such as the Telecordex and a summary punch, the Telereader can print its measurements in decimal form on a typewriter supplied with the Telecordex, as well as recording such information into punched cards.



Magnetic Tape Recorder

ECTRO, INC., Delaware, Ohio. The Parlo-Tape is a completely portable, two-speed tape recorder operating from self-contained batteries. Recordings can be started instantly by turning the knob to RECORD position, or played back by turning the knob to LISTEN position. Its automatic volume control feature provides for a stable recording level at various distances from the microphone. The 3½-in.-per-second tape speed is for general use, and at this speed the recording time on 5-in. 600-ft reel will be 30 minutes. By reversing the reels on the reel spindles an additional 30 minutes of recording time can be added to the same tape, a total of one hour recording on one 5-in. reel of tape. The 7½-in. speed allows a total of ½ hr recording on the 5-in. reel at maximum fidelity and full frequency range. All or part of the

TRAN-COR 3X-0 doubles transformer capacity

In Delft, Holland, an x-ray machine manufacturer recently increased the rating of this portable x-ray unit 100 per cent without increasing its weight. He did it by changing transformer core material from the equivalent of AISI Hot-Rolled Type M-14 to Armco TRAN-COR 3X-0. Machine rating increased from 600 volt-amperes to 1200 volt-amperes.

CAPACITY LIMITED BY WEIGHT

As long as this manufacturer was limited to the old magnetic material there was no way to raise machine capacity without increasing transformer weight. A heavier transformer would mean a heavier unit—too difficult for women operators to push around. Armco TRAN-COR 3X-0 with its advanced magnetic properties solved the problem.

Perhaps you would like to decrease transformer weight, increase capacity, or maybe design for a combination of these benefits. If so, write for the booklet, "Armco Oriented Electrical Steels." It has complete design data on the 14 mil thick Armco TRAN-COR 3X-0 and 2X-0, suitable for wound or stamped laminations. For wound cores only, ask about Armco TRAN-COR 4W-0 and 3W-0 in 12 mil thickness.

Without
Increasing
Weight



ARMCO
STEEL
CORPORATION

4512 CURTIS STREET, MIDDLETOWN, OHIO • PLANTS
AND SALES OFFICES FROM COAST TO COAST • EX-
PORT: THE ARMCO INTERNATIONAL CORPORATION

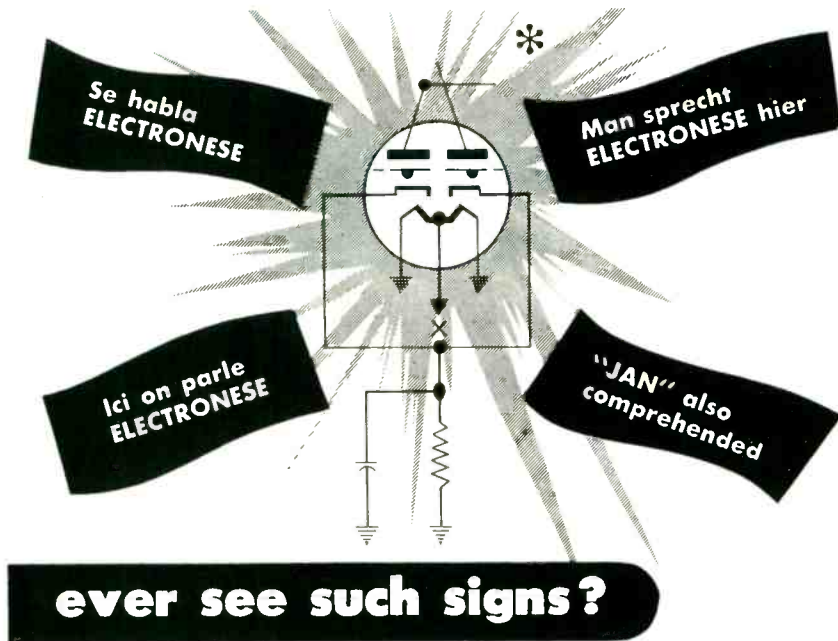

We might display their like at MILO. Our men know components! Recognize them because they have used them. Know the lines by name, catalog number, purpose, JAN-specs; and by more conventional description. Our resistor men won't "stick" you. We have the best makes, in a greater variety of values and tolerances. Our "pot" men know A-curves from C-tapers—are shaft experts, too.

With our stock and our staff we ourselves could design and produce electronic devices. We have engineers, technicians and skilled workers from various branches of electronics — now devoted to making MILO the smartest place to buy components and test equipment.

We do not claim ENIAC. We do not understand Einstein on Mass vs. Energy, unless it means fat men aren't necessarily lazy. We do speak your language when you talk of electronic parts.

Save time and temper and legal tender, too. Order from MILO.

Check List (P-X) of Leading Brands in Stock

Par-Metal	Simpson Electric	Ungar Electric
Potter & Bromfield	Sola Electric	United Transformer
Precision Apparatus	Sprague	Ward Leonard
RCA	Standard Transformer	Weller
Raytheon	Superior Electric	Westinghouse
Sangamo	Sylvania	Weston
Shallcross	Tung-Sol	Xcelite
Shure Bros.	Triplet	(others)

JAN-APPROVED COMPONENTS



FREE CATALOG!

Chief Engineers, Purchasing Agents, Qualified Executives! Write now on your company letterhead for MILO's edition of the 1953 Master. Please address Dept. E-11.

*If you haven't guessed: Our coy "Primitive" is just a 12AU7 in a Vertical Sweep Generator — with overloaded grids.

The ONE source for ALL your electronic needs

MILO RADIO & ELECTRONICS CORP.
Electronics for Industry

200 GREENWICH STREET, NEW YORK 7, N. Y. • Phone BEekman 3-2980
Teletype NY1-1839 • Wire MILO-WUX-N.Y. • Cable MILOELECTRO-N.Y.

tape can be erased right on the machine and reused again and again.

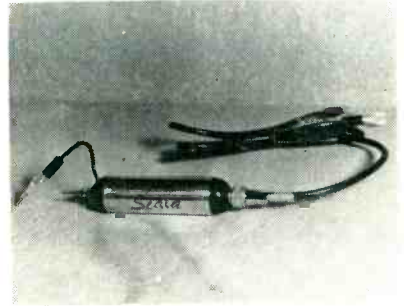

Oscillograph Probes

SCALA RADIO Co., 2814—19th St., San Francisco 10, Calif. The B.Z.1 signal-tracing probe can be used to locate dead i-f stages, mark ratio-detector curve, calibrate marker generator, adjust video amplifiers, check output of a sweep generator, view response of single i-f stage and trace buzz pulse in sound i-f strip. It can also be used with vtvm. The unit contains a demodulator of low-capacitance, high-impedance design, useful to 225 mc. Other models are the B.Z.2 low-capacitance probe, and the B.Z.3, a 100-to-1 voltage-divider probe.

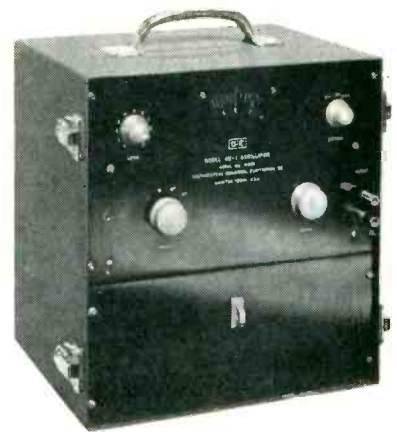

Portable Oscillator

SOUTHWESTERN INDUSTRIAL ELECTRONICS Co., 2831 Post Oak Road, Houston 19, Texas, has available a new portable oscillator designed as a source of signal power for field use. Model MB-1 oscillator derives its operating power entirely from self-contained batteries and covers a frequency range of 2 to 20,000

A Molehill of Difference Can Make a Mountain of Trouble in Waveguides

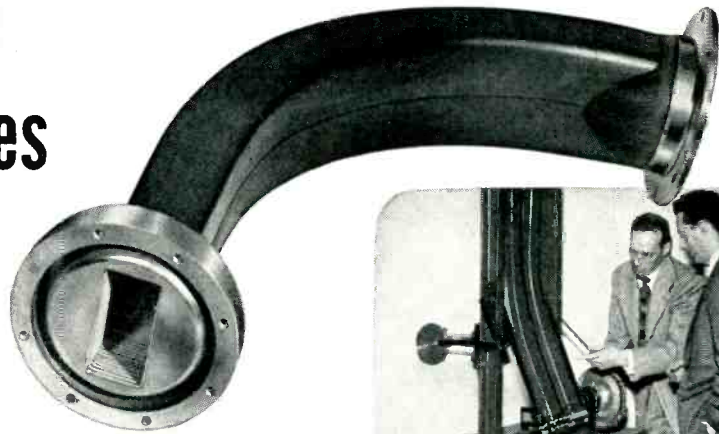
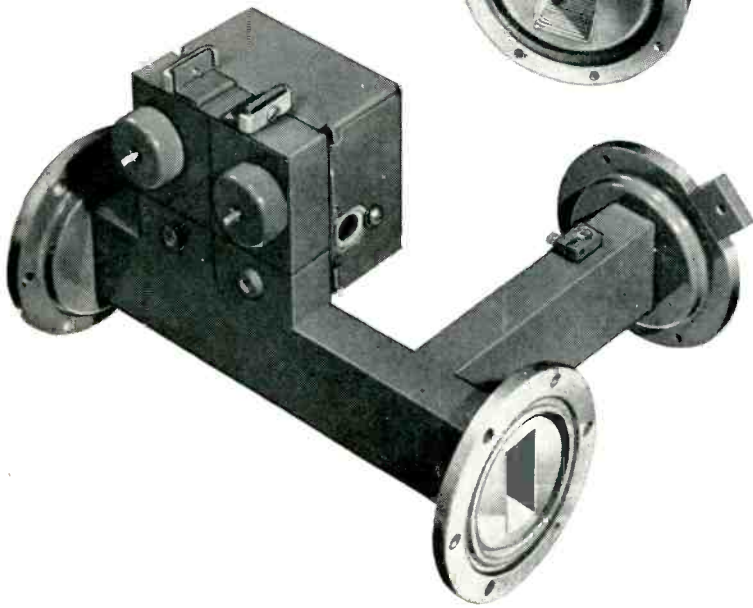

Remember this traffic-stopper at the 1952 IRE Show in Grand Central Palace? It's a torture test. Flexed well over 1,000,000 times, Waveflex flexible Waveguides gave no evidence of failure or loss of physical or electrical properties.



Fabricated to precision methods, Titeflex flexible and rigid Waveguides are produced to the closest tolerances and to exacting specifications. Titeflex maintains strict quality control and inspection from raw materials to finished products.

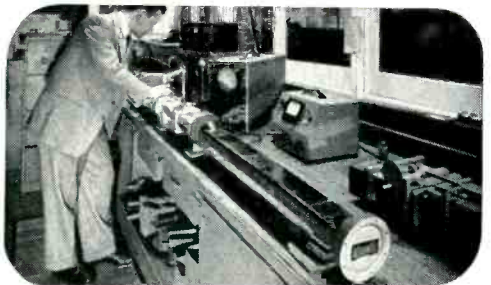

No Waveguide gets by this department without a thorough electrical check-up. Every single Titeflex Waveguide is tagged before shipment with its test score on JAN-W-287 specifications for flexible Waveguides or JAN-W-85A for rigid Waveguides.

... A little difference in waveguides—imperceptible to the eye—can jeopardize a costly investment.

If you want to be sure of your electronic equipment, if you want to reduce operational failures, insist upon Titeflex microwave components.



Send for free catalog of uses, properties, and specifications.

Let Our Family of Products Help Yours

Titeflex

✓ Check products you are interested in.



SEAMED AND SEAMLESS METAL HOSE

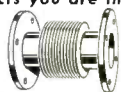

PRECISION BELLOWS



IGNITION HARNESS



IGNITION SHIELDING



ELECTRICAL CONNECTORS



RIGID AND FLEXIBLE WAVE GUIDES

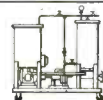

FILTERS



FUSES

TITEFLEX, INC.

524 Frelinghuysen Ave.
Newark 5, N.J.

Please send me without cost information about the products checked at the left:

NAME _____

TITLE _____

FIRM _____

ADDRESS _____

CITY _____

ZONE _____ STATE _____



Molded Coil Forms

BY MOLDITE

Another Moldite component, made with uncompromising adherence to quality and complete assurance of punctual delivery! Moldite molded coil forms are available in sizes from .125 to .375 OD.

- Magnetic Iron Cores
- Filter Cores
- Molded Coil Forms
- Threaded Cores
- Sleeve Cores • Cup Cores

NATIONAL

MOLDITE

COMPANY

1410 Chestnut Ave., Hillside 5, N. J.

Samples promptly submitted upon request for design, pre-production, and test purposes.

SEND FOR CATALOG 112

Robert T. Murray 614 Central Ave. East Orange, N. J.	Jerry Gollen Co. 2750 W. North Ave. Chicago 22, Ill.	Martin P. Andrews Mott Road Fayetteville, N. Y.	Perimuth-Colman & Assoc. 1335 South Flower Los Angeles, Cal.	Jose Luis Pontet Cardoba 1472 Buenos Aires
--	--	---	--	--

cps in 4 decade ranges. An output voltage of 5.5 v is delivered to a 2,000-ohm load and the instrument has an internal impedance of approximately 400 ohms. Distortion is less than 1 percent in the audio spectrum and the dial is accurate to within 2 percent of its indication. The unit is equipped with a switch that decreases the battery gain when the full output is not required, and thereby increases battery life to 100 hours or more for intermittent service.



Power Pentode

RADIO CORP. OF AMERICA, Harrison, N. J., has introduced a power pentode of the 9-pin miniature type for use in the final video-amplifier stage of tv receivers. The type 6CL6 has very high transconductance, low interelectrode capacitances and high output-current capability. These features make possible the design of wide-band video circuits having a voltage gain of 40 to 45. Providing high plate current at low plate voltages, it can supply sufficient peak-to-peak output voltage to drive large picture tubes with high efficiency and low amplitude distortion.

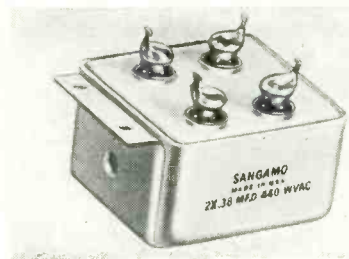

Capacitive Network

SANGAMO ELECTRIC CO., Marion, Ill., has developed type BTN capacitor

Want an oscilloscope camera NOW?

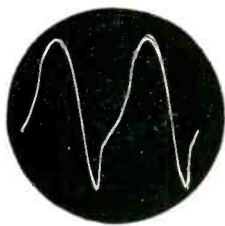

Scope Image

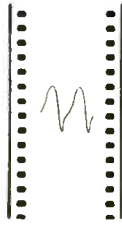

Film Recording

1. Single-frame photography of stationary patterns using a continuously running sweep.

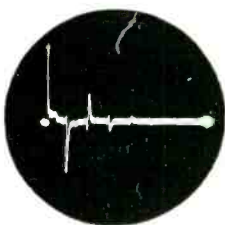

Scope Image

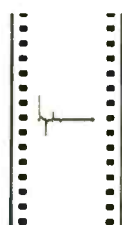

Film Recording

2. Single-frame photography of single transients using a single sweep.

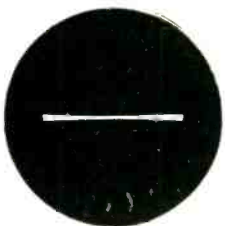

Scope Image

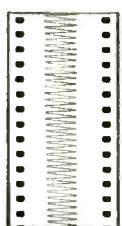

Film Recording

3. Continuous-motion photography employing film motion as a time base.

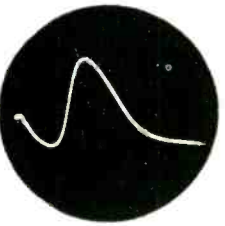

Scope Image

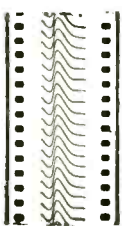

Film Recording

4. Continuous-motion photography employing oscilloscope sweep as a time base.

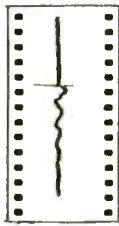

FILM MOTION TIME BASE

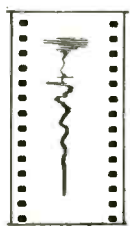

FILM MOTION AND SCOPE SWEEP

5. Continuous-motion photography employing combination of film motion and oscilloscope sweep as a time base.

Fairchild Oscillo-Record Cameras are now available *from stock* for immediate shipment. With these units you can make *permanent* photographic records of oscilloscope traces, thereby eliminating possible errors in making hand sketches from memory. In time-saving and convenience alone, these cameras will pay for themselves many times over.

FAIRCHILD OSCILLO-RECORD CAMERA IS UNUSUALLY VERSATILE

Users of the Fairchild Oscillo-Record Camera like its versatility. Designed for both still and continuous-motion photography on 35-mm film, it records non-recurring phenomena that are too rapid for visual study, others that are so slow that continuity is lost, and the occasions where very high-speed transients are combined with very slow-speed phenomena. For some idea of the types of jobs this instrument can do, study the examples at the left. Each solves a particular problem. Oscillo-Record camera users especially like its:

● CONTINUOUSLY VARIABLE SPEED CONTROL — 1 in./min. to 3600 in./min.

● TOP OF SCOPE MOUNTING that leaves controls easily accessible.

● PROVISION FOR 3 FILM LENGTHS—100, 400 or 1,000 feet.

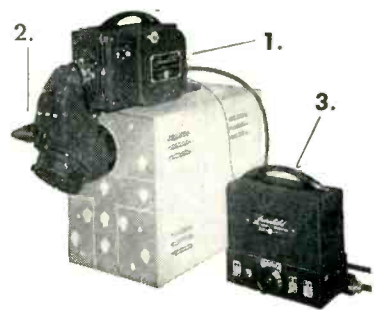

1. Camera, 2. periscope, 3. electronic speed control. Accessories include 400- and 1,000-ft. film magazines, magazine adaptor and motor, universal mount for camera and periscope, binocular split-beam viewer.

FAIRCHILD TAKE-UP CASSETTE FOR SHORT RUNS

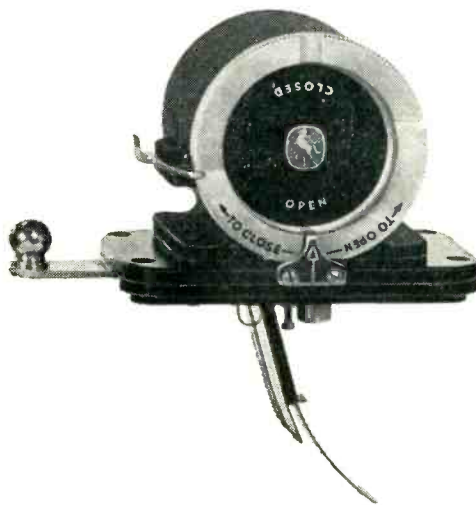

Where only a few pictures are required for quick development and study, a small Take-up Cassette is available as an accessory. The convenience afforded by this unit results in the saving of considerable time in handling short runs and reduces film wastage to a minimum. It is easily attached to the top of the camera by means of an adapter. A built-in knife permits short lengths of exposed film (up to 10 feet) to be cut off and removed with the cassette for developing.

Complete information about applications and operation of both the Fairchild Oscillo-Record Camera and the Fairchild-Polaroid Oscilloscope Camera is available. Write today to Fairchild Camera and Instrument Corporation, 88-06 Van Wyck Boulevard, Jamaica 1, New York, Department 120-18A3.

FAIRCHILD
OSCILLOSCOPE RECORDING CAMERAS

3 WAYS TO MAKE PANELS, LIDS and DOORS RF TIGHT

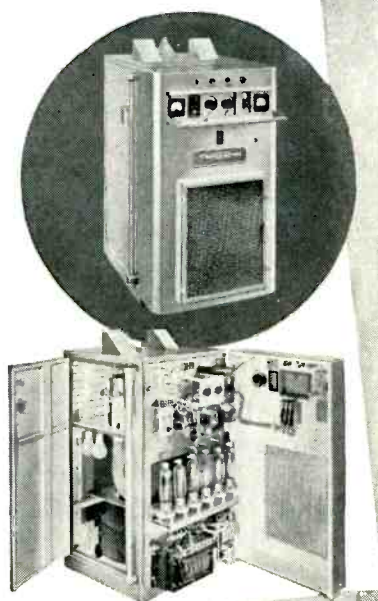

Thermatron built by Radio Receptor Co., Inc.

1

Machine mating surfaces to closest tolerances.

Costly and difficult! And the close fit is often destroyed by warping, corrosion and normal use.

2

Install numerous latches, screws, bolts or other fastenings.

Also costly! And makes maintenance more difficult, more time-consuming.

3

USE METEX ELECTRONIC WEATHERSTRIPPING.

The simple, sure, economical way!

Made of resilient, compressible *knitted* metal wire mesh, METEX strips and gaskets "close" these openings just as a weatherstrip "closes" windows and doors.

Because they are metallic, METEX strips and gaskets are conductive. Because they are knitted, they are flexible and resilient. They will conform to surface irregularities with no loss in shielding efficiency.

Close manufacturing control assures uniformity in the resiliency and dimensions best adapted to specific applications.

METEX electronic strips and gaskets are easy to install. They are not expensive—in fact, they may well save more than their cost by eliminating the need for many operations formerly thought necessary.

It will pay you to investigate the production and performance advantages of METEX Electronic Weatherstripping. A bulletin giving detailed information is yours for the asking—just write on your company letterhead.

METAL TEXTILE CORPORATION

KNITTERS OF WIRE MESH FOR MORE THAN A QUARTER CENTURY



Main Office & Plant, Roselle, New Jersey Canadian Plant, Hamilton, Ont.

network, a multisection, metal encased, hermetically sealed paper dielectric unit. Its multiple sections can be internally connected to provide a selection of either capacitive pi, Y or delta networks. Type BTN can be provided with mineral oil, pentachlordiphenyl, or electrical grade waxes as impregnants. It is claimed to be advantageous for use in airborne equipment power frequency circuits where the compact single-unit construction offers space and weight saving advantages.



Secondary Standards of Low Capacitance

MACLEOD AND HANOPOL, INC., 10 Roland St., Charlestown 29, Mass. Convenient means for calibrating instruments used for measuring low values of capacitance are now available in the model 388 set of secondary standards of low capacitance. The set comprises two T networks, three auxiliaries and a set of cables for connecting the standard to various instruments. The nominal values of the networks are 0.075 and 7.5 μf ; the auxiliaries modify the networks so that values of 0.001, 0.0075 and 0.75 μf can be obtained. All elements have Q of 200 or better and temperature coefficient of less than 0.05 percent per deg C.

High Temperature Coils

DOUGLAS-RANDALL, INC., 102 High St., Westerly, R. I. Capable of continuous operation in the 450 to

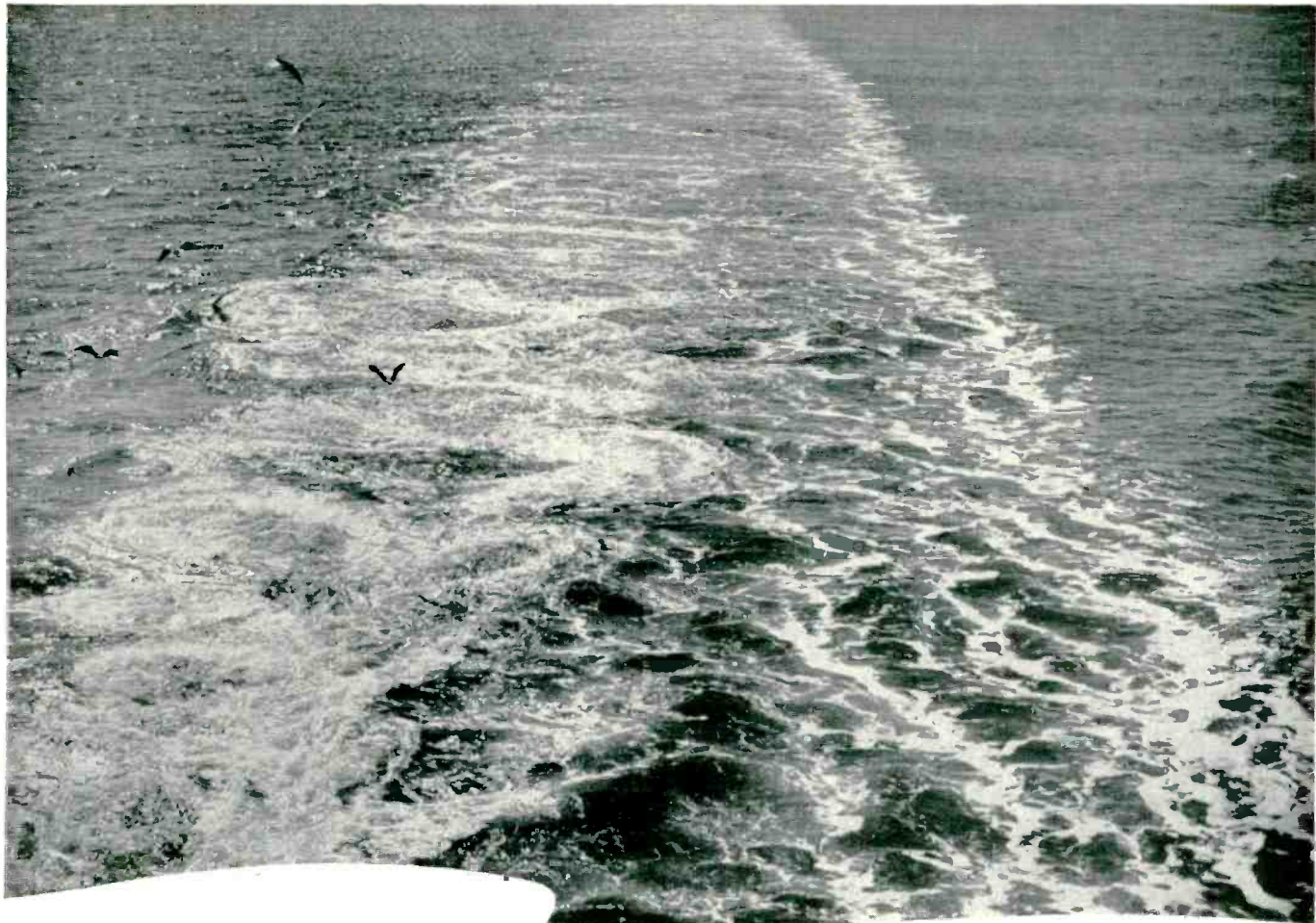

SONAR



THE WAKES ... of more and more vessels churn over water accurately scanned by Edo sonar. A major electronic development in underwater detection equipment, Edo sonar will measure depths over far greater ranges with accuracy, clarity and legibility never before achieved.

Because of such development work in its electronics laboratories, Edo has become a major supplier of sonar equipments for the United States Navy.



EDO CORPORATION College Point, L.I., N. Y. SINCE 1925

DIGITAL COMPUTER RESEARCH

Your inquiry is invited concerning a position on our staff if you are experienced in the design and development of automatic data processing systems for military, industrial and commercial applications.

Logical Design
Component Development
Programming
Magnetic Recording
Circuit Design
Input & Output Devices

HUGHES

Research and Development Laboratories

Engineering Personnel Department

Culver City, Los Angeles County, California

Assurance is required that the relocation of the applicant will not cause the disruption of an urgent military project.

650 F range, yet occupying little more space than conventional windings, the high-temperature coils now available satisfy many needs in the construction of electrical and electronic apparatus for use in jet aircraft and guided missiles. They are particularly suited to solution of miniaturization problems since their ability to operate at high temperatures allows increased self-heat in magnet coils and in field coils of induction or synchronous motors. These coils, wound, with wire sizes 30 through 44, can be furnished on round or rectangular bobbins or as interleaved windings, with lug terminals or flexible leads, and for a-c or d-c service. They will withstand accelerations of 10 to 20 g.

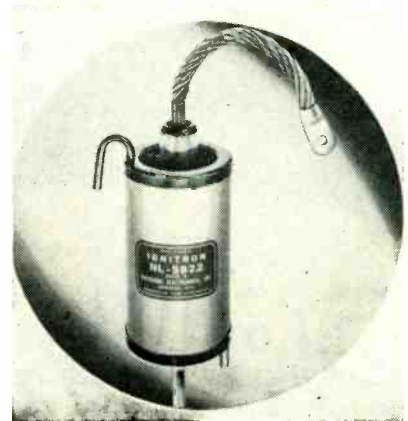

Ignitron

NATIONAL ELECTRONICS, INC., Geneva, Ill., recently announced an addition to its line of industrial tubes. Model NL-5822 ignitron is a metal, water-cooled mercury pool tube designed especially for frequency-changer resistance welders. It utilizes an all-copper cooling system that provides exceptional cooling efficiency. The mercury-pool cathode permits the tube to handle extremely high currents on an intermittent basis. The baffle construction reduces deionization time and permits satisfactory operation under severe conditions of commutation. A technical data sheet is available.

Labeling Machines

POPPER & SONS, INC., 300 Fourth Ave., New York 10, N. Y., are now

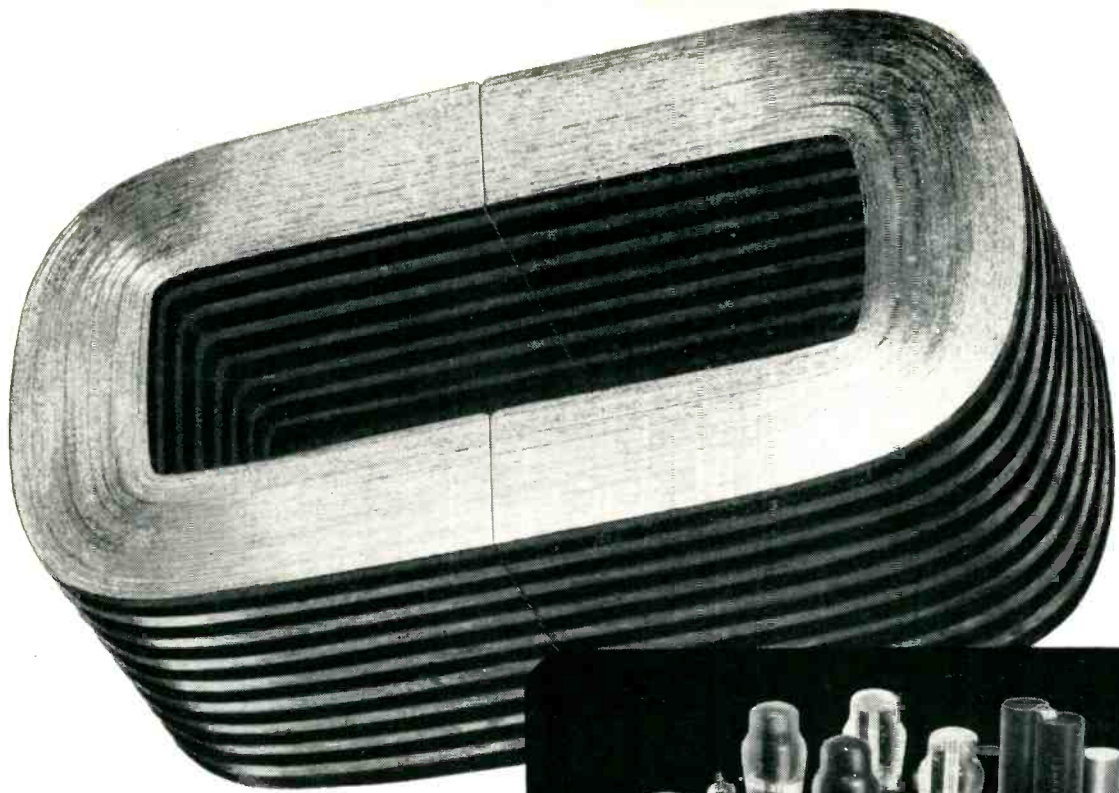

"HIPERSIL[®] CORES

helped us design $99\frac{96}{100}\%$ Perfect Amplification!"

McIntosh Engineering Laboratory, whose new output circuit is the first major advancement in years of audio amplifier design, credits Hipersil Cores with a vital contribution to its development.

"Hipersil Cores reduced the weight of our driver and output transformers by 30 pounds; enabled us to cut the height of our assembly from 20 to 7 inches. Further, by holding losses to a minimum, these cores eliminated the high distortion which is characteristic of larger cores at low output levels."

You can cut size, weight and assembly costs in all types of electrical and electronic transformers with Hipersil Cores. They combine highest permeability

with lowest losses in a wide range of sizes, all frequencies (1 through 12 mil cores). Greater flux-carrying capacity and increased mechanical strength help to make them the best cores on the market. For specific information on how to apply them to your product, write Westinghouse Electric Corporation, P. O. Box 868, Pittsburgh 30, Pennsylvania. J-70630

YOU CAN BE SURE... IF IT'S

Westinghouse

HIPERSIL CORES



GIANT in miniatures



The inevitable process of "separating the men from the boys" is still going on in the comparatively new electronics industry. Yet Volkert has already established itself as the leading independent supplier of stamped components for miniature tube sockets, and other precision stampings.

Volkert was the *first* to produce shield bases for sockets on a progressive die in a one-press setup. Through Volkert's creative die engineering, a cost-saving method was initiated to stamp the tiny contacts *two at a time*. And now Volkert turns out over

For design...tooling...production and assembly of precision stampings

one hundred million contacts every year.

Add to these achievements Volkert's modern production facilities, its ability to work with all types of specialty metals, and its emphasis on precision *plus* automaticity—and you have the reasons why Volkert is your *best* source for *all* precision stampings at low cost.

Volkert's outstanding facilities for design engineering, tooling, production, assembly and inspection—all combined under a single roof—are described in a 16-page booklet, "3-Way Facilities for Precision Stampings." Write for your copy.

John Volkert Metal Stampings, Inc.
222-34 96th Avenue
Queens Village 8,
L. I., N. Y.



Volkert

distributing in the U. S. the Rejafix marking and printing machines. The machine will, by use of metal types or cuts, mark, print or decorate any material such as glass, plastics, ceramics, rubber, metal or paper. The impressions may be indelible or washable as desired. Standard machines range from small hand operated ones to large fully automatic units. Rejafix machines are in operation in many places and are successfully marking and printing on products such as capacitors, resistors, tubes and cable.



Diode Tester

COMPUTER RESEARCH CORP., 3348 W. El Segundo Blvd., Hawthorne, Calif., has developed an instrument for testing the dynamic as well as static characteristics of crystal diodes. The new instrument tests both forward and back characteristics under static and dynamic conditions, telling how the diode will perform before one mounts it in the circuit. The diode tester occupies a space less than one-half cu ft, and will accommodate diodes with forward currents of 0 to 100 ma and back currents of 0 to 1,000 μ a. Forward voltage is measured to an accuracy of 2 percent and back current to 3 percent. The tester is adaptable to high speed, volume testing and operates on 115-v, 60-cycle current, using 100 w or less.

Digital Computer Tube

GENERAL ELECTRIC Co., Syracuse, N. Y. Type GL-5965 miniature twin triode is designed for use in several of the different circuits used in digital computers. It incorporates a special heater-cathode construction designed for depend-



JFD MFG. CO.
 BROOKLYN 4, N. Y.
 BENSONHURST 6-9200

*world's largest manufacturer
 of tv antennas & accessories*

leading manufacturers use

JFD PISTON TYPE VARIABLE TRIMMER CAPACITORS
in both civil and military equipment

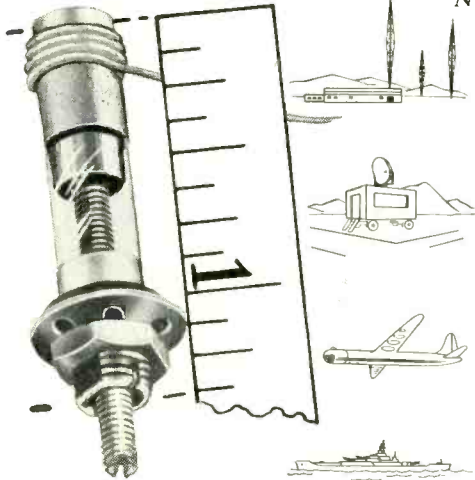

NO OTHER LIKE IT!

- Spring loaded piston made of special invar alloy having extremely low temperature coefficient of expansion.
 - Silver band fused to exterior of precision drawn quartz or glass tube serves as stationary electrode.
 - Piston dimensional accuracy is held to close tolerance maintaining minimum air gap between piston and cylinder wall.
 - Approximately zero temperature coefficient for quartz and ± 50 P.P.M. per degree C. for glass units.
 - "Q" rating of over 1000 at 1 mc.
 - Dielectric strength equals 1000 volts DC at sea level pressure and 500 volts at 3.4 inches of mercury.
 - 10,000 megohms insulation resistance minimum.
 - Operating temperatures, -55 C. to $+125$ C. with glass dielectric. And -55 C. to $+200$ C. with quartz dielectric.
 - Over 100 megohms moisture resistance after 24 hours exposure to 95% humidity at room temperature.
- Write for Form No. 199

**4 Channel
 Recording
 on 1/4" Tape**

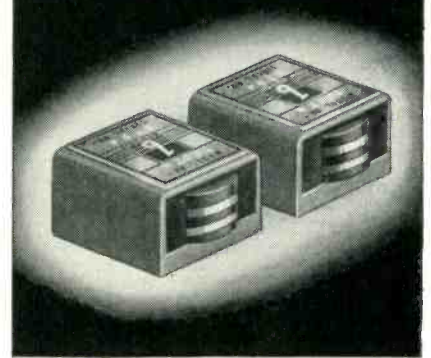

The Brush Models BK-1502N Magnetic Record/Reproduce Heads are precision aligned, dual channel units. They are designed so that they may be step-mounted side-by-side to provide 4 channels of 1/4" tape.

- Individual channels are cast into one integral block of especially selected synthetic resin
- All gaps in precise alignment
- Mu metal shields between individual channels
- Individual channel width, 0.044"
- Center to center spacing between channels 0.125"
- Gap width 0.0004"
- Total inductance, 75 millihenrys
- Total resistance 85 ohms
- Special design features can be supplied to meet your requirements

Model BK-1502N Record/Reproduce Heads, like all other Brush Magnetic Recording Components, are the products of Brush engineering leadership and Brush skills in precision production.

Write us for help on your magnetic recording problems. Your inquiries will receive the attention of capable engineers.

THE **Brush**



DEVELOPMENT COMPANY
 3405 Perkins Ave. • Cleveland 14, Ohio
 Piezoelectric Crystals and Ceramics
 Magnetic Recording Equipment
 Acoustic Devices • Ultrasonics
 Industrial & Research Instruments

**HIGH CAPACITY (300 Liters Per Minute)
 assured with this New WELCH
 TWO-STAGE DUO-SEAL® VACUUM PUMP**

**GUARANTEED VACUUM—.0001 mm (0.1 Micron)
 FASTER PUMPING AT ALL PRESSURES**

**Exceptionally Quiet
 Operation**

**Built-in Trap prevents
 oil from backing up
 into system.**

**Indicator window shows oil
 level at all times.**

**Convenient oil drain permits
 oil change without disman-
 tling system.**

COMPACT
 Size 26 x 14½ x 18½ inches

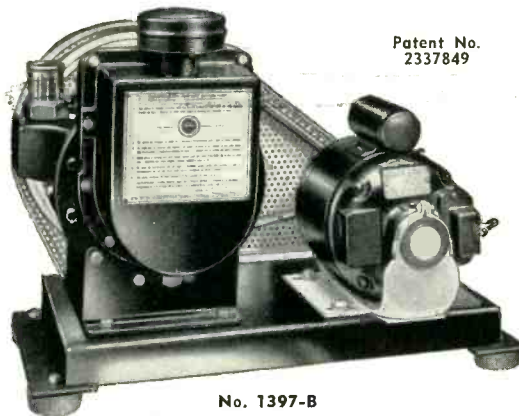

Patent No.
 2337849

No. 1397-B

COMPLETE \$515.00

W. M. WELCH SCIENTIFIC COMPANY

DIVISION OF W. M. WELCH MANUFACTURING COMPANY

ESTABLISHED 1880

1515 SEDGWICK STREET, DEPT. H

CHICAGO 10, ILLINOIS, U.S.A.

FILTER PACKS

simplify miniaturization of radio-interference filters for multiple circuits

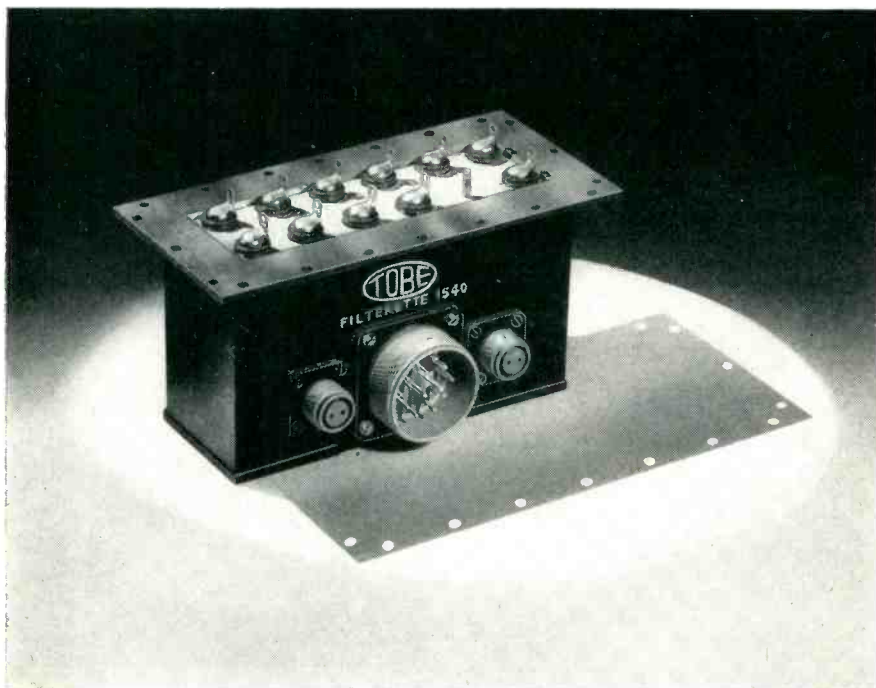

TOBE FILTER PACKS combine, in a single, compact case, all the elements needed to suppress radio interference in many separate circuits. The result — better miniaturization than can be obtained with individual filters in each circuit, plus reduction of space that must be pressurized, yet no sacrifice of filter performance.

Tobe Filterette No. 1540 is typical of the filter packs we can build to *your* requirements. In a housing only $6\frac{3}{8} \times 3\frac{3}{4} \times 2\text{-}7/16$, with a mounting flange flat to ± 0.010 inch for lead-in to pressurized chambers, this unit provides eleven circuits rated up to 12 amperes at 115 volts a. c. and having the attenuation shown in the curve below.

For help with any interference problem, call on Tobe — specialist in filtering since 1929, originator of modern filtering methods.

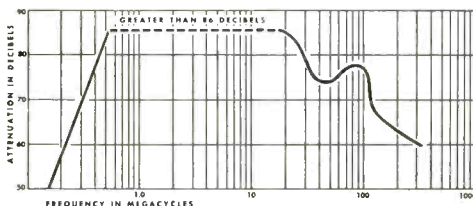

TOBE DEUTSCHMANN
CORPORATION
NORWOOD, MASSACHUSETTS

NEW PRODUCTS

(continued)

ability under frequent "on-off" switching conditions. When used in "on-off" control applications it will maintain its emission capabilities after long periods of operation under cutoff conditions. Average characteristics with 150 v on the plate are: cathode bias resistor, 220 ohms; amplification factor, 47; approximate plate resistance, 7,250 ohms; transconductance, 6,500 microhms; and plate current, 8.2 ma.



Picture Tube Tester

VIDAIRE ELECTRONICS MFG. CO., Lynbrook, N. Y. The Kine-Test quickly and accurately determines any defects in a tv picture tube. It is also designed to check simultaneously filament voltage, first-anode voltage, bias voltage and the video signal. With a Kine-Lite, which is about the size of a radio tube, it is intended that the tv picture tube be checked without removing it or the chassis from the cabinet. It is meant to let the serviceman merely plug his pocket-sized Kine-Lite into the picture tube socket and have all the necessary information revealed in a matter of seconds.



Standing Wave Detector

MICROWAVE ASSOCIATES INC., 22 Cummington St., Boston 15, Mass. Type 1022 standing-wave detector is designed for precision low-level

impedance measurements in the millimeter region when used with a suitable source and amplifier. Vswr's as low as 1.01 can be read accurately in the region from 34 to 36 kmc. The unit consists of a slotted section of RG-96/U waveguide milled from a solid piece of brass and silver plated. A movable carriage is provided carrying a spring-loaded adjustable coupling probe, a silicon diode detector socket, and coaxial output fitting that will mate with a UG-88/U or equivalent BNC cable connector. A total longitudinal probe displacement of 0.750 in. is available. Probe position can be read accurately to 0.001 in. Total insertion length of the unit is 3.25 in.



Equalizer Preamplifier

MCINTOSH LABORATORIES, Binghamton, N. Y., has introduced a new equalizer preamplifier, model C-104 and C-104A. It is similar to the previous model, AE-2A, but incorporates greater simplicity of control and an additional turnover frequency. The unit can be used as the control center for any sound reproducing system. Five input channels are provided: for tv audio, f-m/a-m tuner, low-level microphone, high-level magnetic cartridge and low-level magnetic cartridge. There are separate, continuously variable bass and treble controls, providing 20-db bass attenuation and 20-db accentuation, independent of treble control; 15-db treble accentuation, 20-db attenuation, independent of bass control.

Miniature Microphone

THE ASTATIC CORP., Conneaut, Ohio. Model 54M3 miniature microphone employing crystal element is a high-

DELAY LINES

lumped-constant type

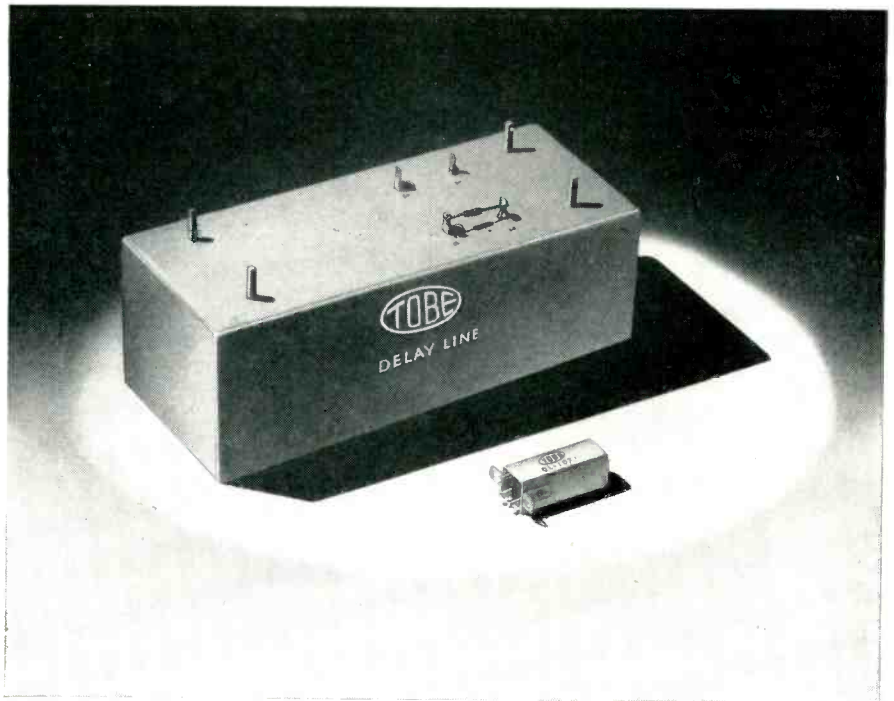

TOBE DELAY LINES

Typical delay lines, designed and manufactured by Tobe, are shown above. Available in large and small sizes, with performance characteristics to meet your specifications, Tobe delay lines have all the structural features required for modern military and commercial applications. Let us quote on your requirements.

Call on Tobe, also for pulse capacitors, pulse-forming networks, radio-interference filters, and capacitors for all electrical and electronic uses.



TOBE DEUTSCHMANN
CORPORATION
NORWOOD, MASSACHUSETTS

Original
BEEDE
ELECTRIC
METERS

HAVE STOOD
THE TEST
FOR OVER

45 years

**ACCURACY
DURABILITY
MODERN DESIGN
HAVE KEPT THEIR
REPUTATION CLEAN
ALL THESE YEARS**

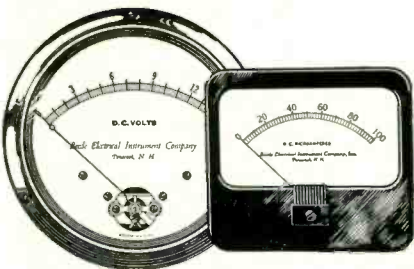

CATALOG or INFORMATION
on REQUEST

BEEDE

ELECTRICAL INSTRUMENT CO., INC.
PENACOOK, N. H.

**ELECTRONIC GLASS WORKING EQUIPMENT for RADIO, TELEVISION TUBES,
INCANDESCENT LAMPS, GLASS LATHES for TELEVISION TUBES**

We make Transformers, Spot and Wire Butt Welders, Wire Cutting Machines and 500 other items, indispensable in your production. Eisler Engineers are constantly developing New Equipment. If you prefer your own designs, let us build them for you. Write to Charles Eisler who has served The Industry over 32 years.

Machines for small Radio Tubes of all kinds:

High Temperature Hydrogen Electric Furnaces

Hydrogen atmosphere heating chamber, hydrogen drying tower, water cooled unloading chamber, heat control with air cooled transformer with 11 position tap switch. Automatic temperature control (optional) standard furnaces from 1" bore 1800° C. to 8" bore 1100° C. Molybdenum wound heating units, loading and unloading chambers equipped with safety doors. Supplied with hydrogen flow gauges. Made to order in many sizes.

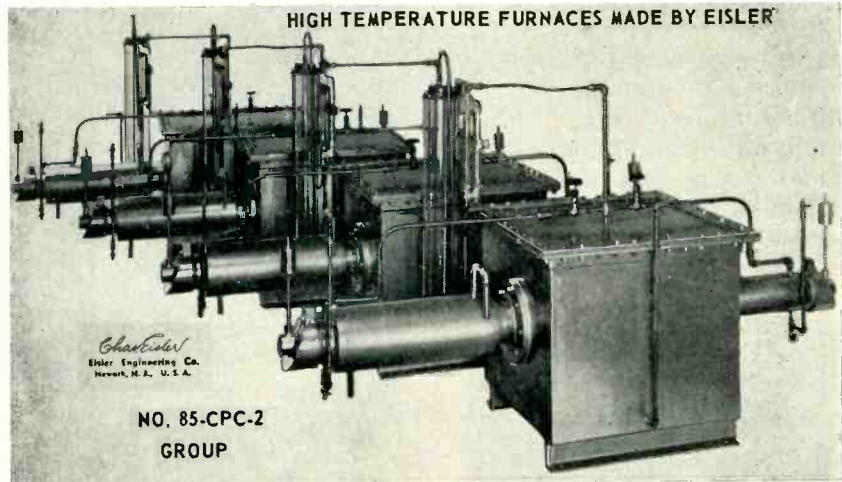

EISLER ENGINEERING CO., Inc. 751 So. 13th St.
Newark 3, N. J.

— There is Always One Leader in Every Field —

BODNAR INDUSTRIES, INC.

Leads in the Field of

TRANSILLUMINATED PLASTIC LIGHTING PLATES

because of

**QUALITY • UNIFORMITY • PERFORMANCE • QUANTITY PRODUCTION PROMPTLY
DESIGN AND LAYOUT "KNOW-HOW SERVICE"**

NEW YORK — 19 Railroad Ave., New Rochelle (Home Office)

TEXAS — Box 4116 Station A, Dallas

CALIFORNIA — 11055 Cumpston St., N. Hollywood

OHIO — 2001 Maiden Lane, Springfield

CANADA — 313 Montreal Trust Bldg., 67 Yonge St., Toronto

DEMONSTRATION PANEL MIL-P-7788 (AN-P-89) Sent on Letterhead Request

TYPE
"M"

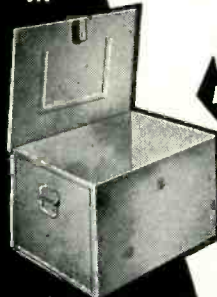

19 STOCK SIZES AT
PUBLISHED PRICES!

NOW available to you . . . without
costly sub-contracting problems
MIL-B-233A SPARE-PARTS BOXES...

FOR THE PROTECTION OF ON-BOARD REPAIR PARTS
Stock standard TYPE M — To better service your
STEEL SPARE OR REPAIR need for Specification
PARTS BOXES, made in Spare-Parts Boxes we
strict accordance with have put them on a mass
Military Specifications. production line.

Write for Size and Price Chart

DOLIN METAL PRODUCTS INC.
319 LEXINGTON AVE., BROOKLYN 16, N. Y.

output unit (-51 db below 1 v per microbar). The top grille is a circular metal stamping, 1 $\frac{3}{4}$ in. diameter and $\frac{1}{2}$ in. deep. Housing and handle are combined in a single die cast unit. The microphone is nondirectional when mounted in its base. Recommended for recorder, p-a, conference and other uses, its response (30 to 10,000 cps) is flat to 1,000, gradually rising to 6,000 cps. It is furnished with 5 ft of rubber covered, single-conductor shielded cable and protector sleeve at the microphone.

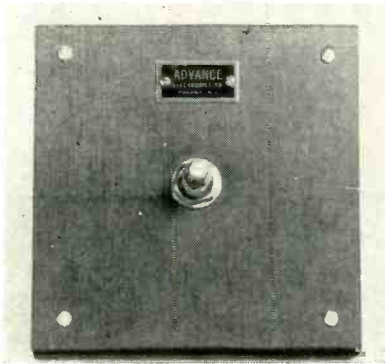

Miniature Delay Line

ADVANCE ELECTRONICS Co., P. O. Box 394, Passaic, N. J. Type 506 miniature continuously variable delay line is essentially a condensed r-f cable with one conductor changed into a long thin coil and the other conductor spaced closely to the first, thus producing a large amount of time delay yet maintaining low attenuation at high frequencies. It provides continuously variable time delay from zero to several hundreds of millimicroseconds. It features small size and weight, fast rise time, excellent stability, hairline accuracy and complete freedom of time jitter.



Radar Range Computer

GENERAL ELECTRIC Co., Syracuse, N. Y., has available a new circular

from
millivolts to hundreds
of volts
AIRPAX CHOPPERS
operate well
and reliably

A-580 400 CYCLES 120 VOLTS

Normal angle is 80°, with an external .039 capacitor a ZERO angle is obtained, drive to square wave. Hermetically sealed, SPDT contacts. Contacts are rated at 2ma, 100 volts. Voltage may be as high as 200.



A-586 60 CYCLES 6 VOLTS

Remarkably long life chopper! Hermetically sealed with a 6.3 volt coil; adjusted to a 45° phase lag at 60 cycles; contact dwell time about 160°. Operates over tremendous temperature range of our other units.



A-589 400 CYCLES 6 VOLTS

Withstands 10g vibration operating; 50g non-operating; can be used reliably from -70 to 100° C. Phase lag 65°, drive to square wave, adjusted for 380 to 420 cycles. Hermetically sealed; rugged, stable.



positive performance
from 70° below
to 100° C
or while being
vibrated or shocked
far beyond
usual test extremes!



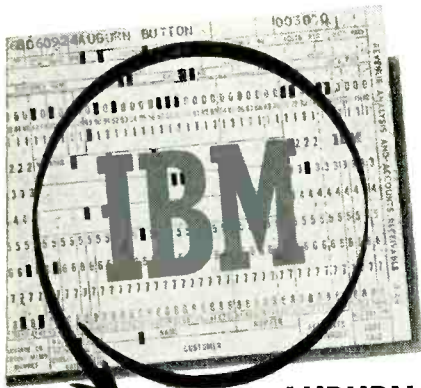

... using **AUBURN**
molded plastics for 26 years

AUBURN BUTTON WORKS had already celebrated its 50th anniversary in 1926 when it received the initial order for compression molded parts from the Tabulating Machine Company of Binghamton, N. Y., a wholly-owned operating subsidiary of INTERNATIONAL BUSINESS MACHINES CORPORATION.

From that first order, and to the present, AUBURN has been a major producer of plastic components for IBM. Today, using processes of injection, transfer and compression molding, extrusion and reinforced plastics, AUBURN supplies custom molded parts for IBM products.

- Outstanding versatility in the design and production of plastics to meet both volume and precision specifications explains why many of America's foremost corporations have chosen AUBURN for custom molded plastics.

- We at AUBURN have steadily expanded facilities and modernized equipment to remain a leader in plastics. Equipped to mold any material by any modern method, AUBURN maintains high quality control standards.

- For the complete story of AUBURN and how it can solve your problem in plastics, plus information on our newest molding facility, vacuum forming of thermo-plastic sheets, write today for a free illustrated booklet.



Auburn Button Works, Inc.
550 McMaster Street, Auburn, N. Y.
Founded in 1876 Telephone 3-5320

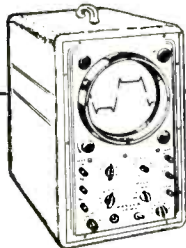

see your distributor or write directly for free booklet on "using your oscilloscope in vibrator maintenance."



JAMES
VIBRAPOWR COMPANY

4036 N. Rockwell St. • Chicago 18, Ill.

7 out of 10
major
police
departments
use



JAMES

the picture
tells why...

PATENTED POSITIVE CONTACT ACTION, SUPERIOR PERFORMANCE OF JAMES "RED BALL" COMMUNICATIONS VIBRATORS IS BEST SEEN BY THEIR CLEAN OSCILLOSCOPE WAVEFORM PICTURE—YOUR INSURANCE AGAINST EXCESSIVE "HASH" AND LOW OUTPUT VOLTAGE. JAMES PERFORMANCE MEANS BETTER COMMUNICATIONS.

CABINETS • CHASSIS • PANELS • RACKS

Planning **ELECTRONIC EQUIPMENT** ?
Investigate the **ECONOMIES**
of **PAR-METAL HOUSINGS** !

We manufacture Metal Housings for every purpose — from a small receiver to a deluxe broadcast transmitter. And the cost is low!

Because we specialize in the Electronics field, Par-Metal Products excel in functional streamlined design, rugged construction, beautiful finish, and economy.

Remember, Par-Metal equipment is made by electronic specialists, not just a sheet metal shop.

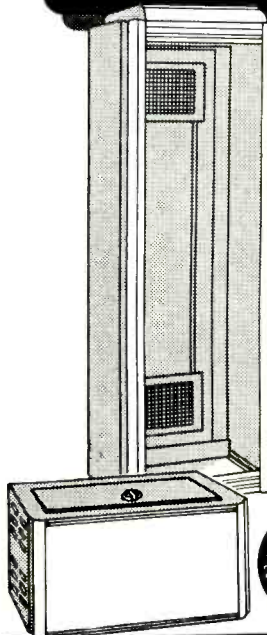
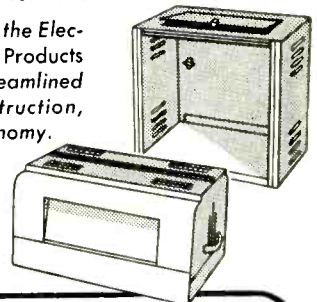

PAR-METAL

PRODUCTS CORPORATION
32-62 — 49th ST., LONG ISLAND CITY 3, N. Y.
Export Dept.: Rocke International Corp.
13 East 40 Street, New York 16, N. Y.

WRITE FOR CATALOG !

type slide computing rule, which solves quickly the equation for determining the maximum detection range of radar. The device, about 8 in. in diameter, is for calculating the free-space maximum range when the equipment design characteristics are known. On the reverse side of the circular calculator are provisions for determining antenna gains, power ratios and vertical coverage. The numerical calculation of the performance of a pulsed radar involves seven variables, all raised to exponential powers between one and three, a tedious and time-consuming task. The new slide rule provides a means for drastically reducing the time necessary to perform the same calculations many times, with varied quantities.

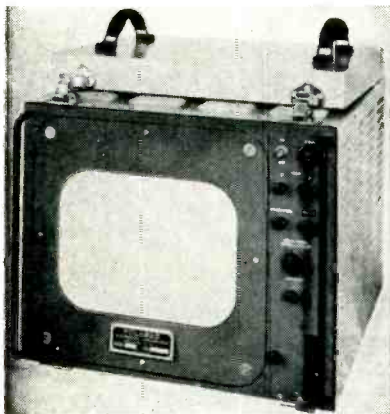

Studio Picture Monitor

POLARAD ELECTRONICS CORP., 100 Metropolitan Ave., Brooklyn 11, N. Y., announces a studio picture monitor, model M-104C, using a 12-in. kinescope. The unit consists of a prelined screen kinescope removable from the front. It is ideal for studio use or remote monitoring of telecasts. It is completely self-contained and presents a tv picture of black and white or color signals in black and white at the turn of a switch. The input signal is 1 volt peak-to-peak and the input impedance is 470,000 ohms. Resolution is in excess of 450 lines.

Combustion Analyzer

VICTORY ENGINEERING CORP., Springfield Road, Union, N. J. Model 140-A combustion tester com-



Simplifies Your Instrumentation

with this *New*

Expandable Console Recorder



Start with a 2 Channel System

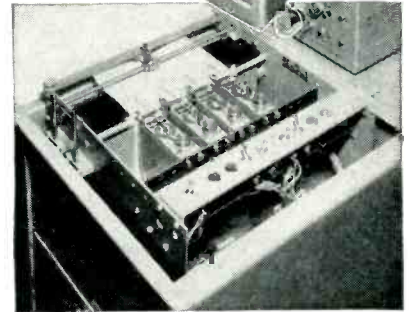
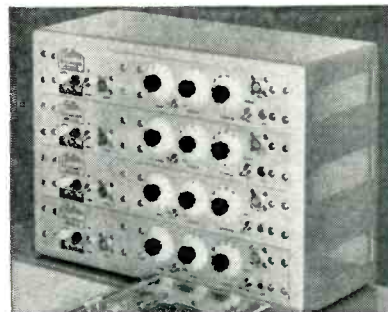

Add units, as you need them, to make a 4, 6 or 8 Channel System.

The Console gives you rack mounted dimensions with option of Direct Coupled, Condenser Coupled or Carrier Amplifiers; a wide variety of chart speeds and galvanometer types; full writing desk for review of intelligence; and an efficient, modern and beautifully designed instrument.



THE EDIN COMPANY
 207 Main St., Worcester 8, Mass., Dept. B
 Gentlemen:

Send complete information on the new Edin Consolelette Recording Instruments Companion Amplifiers.

Name.....

No.....Street.....

City.....State.....

Position.....

THE



COMPANY

207 Main St. • Worcester, Mass.

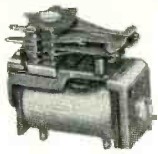

*a rugged little
space saver...*
MIDGET TELEPHONE TYPE RE-
LAYS SERIES (80)—OPEN TYPE
FOR SURFACE MOUNTING, OR
IN HERMETICALLY SEALED
CONTAINERS.

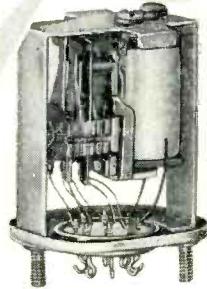

This vibration and shock-proof Midget Type Relay is the answer to numerous applications where unfailing operation is necessary. In fact, it is built to meet rigid Army and Navy specifications. This "rugged little space saver" is a compact, multiple contact relay which has been developed over years of specialized engineering in the field by Signal Engineering and Mfg. Co., manufacturers of a comprehensive line of relays and signals of various designs and sizes.

Write for Bulletin MTR-6

Engineering Representatives in Principal Cities.



ENGINEERS!

Mechanical
Electrical
Electronic
Instrument

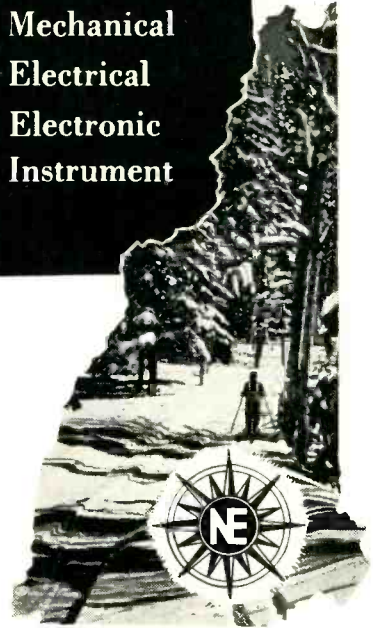

*Come to
New Hampshire
to Work!*

Escape from the nerve-racking, ulcer routine of the city — *come to New Hampshire to work!* Live in a quiet country village with good schools, healthy climate, low cost of living. Enjoy, within a short drive, the beautiful lake region . . . the magnificent beaches . . . the incomparable mountains . . . or the nearby cultural advantages of a big city.

Yes, as an experienced engineer, *you will like New Hampshire* — and the opportunities it affords for **BETTER LIVING** with a **BETTER FUTURE** for you.

Northeastern Engineering, Inc. is a young, progressive company that is offering excellent positions to qualified engineers. If this advertisement interests you, send us a resume and salary requirements, along with a photograph.

**NORTHEASTERN
ENGINEERING, INC.**

MANCHESTER,
NEW HAMPSHIRE



HEAT RESISTANT WIRES FOR EVERY APPLICATION . . .

DON'T DELAY

Winter will soon be here and you will be glad if you have protected vulnerable pipe lines with Lewis heating cable. Specially insulated Nickel Chrome conductor will operate satisfactorily at 500°F.

Write for quote

Send your electronic control, communications or appliance wiring specifications for a recommended solution by our engineers.

FOR A TRIAL ORDER OR A CARLOAD consult



THE LEWIS ENGINEERING CO.

Wire Division
NAUGATUCK CONNECTICUT

HEATING UNITS
HEATING ELEMENT
RESISTANCE
LINE CORD
THERMOCOUPLE WIRE
ASBESTOS LEAD
& FIXTURE WIRE
INSULATED
RESISTANCE WIRE
FIBERGLAS
INSULATED WIRE
WIRE TO ANY
SPECIFICATIONS

bins the accuracy of a laboratory Orsat-type tester with ease of operation. All three important factors in furnace operation—CO₂ content of flue gas, temperature of flue gas and draft over fire—are measured by this improved two-probe instrument. Features include: a glass-coated electronic thermistor; a gas analysis cell with built-in temperature compensator; and a filter drier requiring only 6 to 8 squeezes of a hand aspirator. The unit is vibration and shock proof.

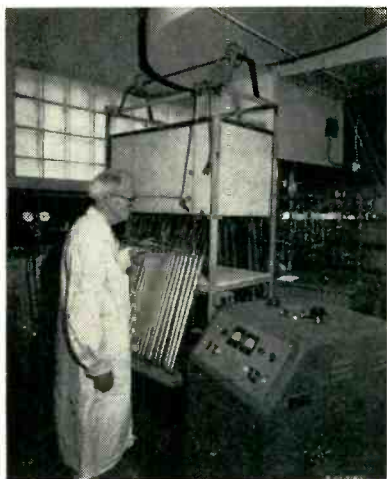

Boron Trifluoride Counters

RADIATION COUNTER LABORATORIES, INC., 5122 West Grove St., Skokie, Ill., has available a new boron trifluoride neutron counter. This two atmosphere (150 cm Hg) enriched BF₃ counter is of all aluminum construction (except for the anode, Kovar seal and connector), which insures minimum neutron capture in the counter shell. The end sections of the counter are "heli-arc" aluminum-welded, and the whole counter is helium leak-tested before filling. It is baked at 100 C for 12 hours while being evacuated. A guard ring type construction is utilized. Three counters are available in pressures of 150 and 12 cm Hg., and in three standard sizes: 1 in. x 6 in.; 1 in. x 12 in.; and 1 in. x 20 in. active length.

Small Triode-Pentode

SYLVANIA ELECTRIC PRODUCTS INC., 1740 Broadway, New York 19, N. Y., is producing a miniature



PROTECTED

Every step of the way

From our mill right up to your machines Republic Aluminum Foil is Guarded from Damage.

Coils of Republic Aluminum Foil in sturdy individual boxes are protected right up to the moment of use. This Republic development guards the famous clean, straight-cut edges of Republic foil against nicks and dents so that maximum production is the rule.

Gage uniformity is another trademark of Republic Aluminum Foil. Modern electronic devices maintain a constant check that assures accuracy and maximum yield from every coil.

Republic capacitor foil is available in widths of 1/4" and wider, and in gages from .00017" to .005".

REPUBLIC FOIL & METAL MILLS INCORPORATED

DANBURY

CONNECTICUT

Branch Sales Offices: 209 W. Jackson Blvd., Chicago 6, Ill.
666 Mission St., San Francisco 5, Cal.



S.S. White MOLDED RESISTORS

The All-Weather Resistors

TYPE 65X
(Actual Size)

The resistors that give you...

- Inherent low noise level
- Good stability in all climates

STANDARD RANGE

1,000 OHMS TO 9 MEGOHMS

These resistors are used extensively in commercial equipment, including radio, telephone, telegraph, sound pictures, television, etc. They are also used in a variety of U.S. Navy equipment.

HIGH VALUE RANGE

10 TO 10,000,000 MEGOHMS

This unusual range of high value resistors has been developed to meet the needs of scientific and industrial control, measuring and laboratory devices — and of high voltage applications.

SEND FOR BULLETIN 4906

It gives details of Standard and High Value Resistors, including construction, characteristics, dimensions, etc. Also described are S.S. White 80X Resistors, designed for extremely high voltage equipment. Copy with Price List sent on request.



THE **S.S. White** INDUSTRIAL DIVISION
DENTAL MFG. CO.



Dept. R, 10 East 40th St.
NEW YORK 16, N. Y.

WESTERN DISTRICT OFFICE: Times Building, Long Beach, Calif.

"FLY" VHF

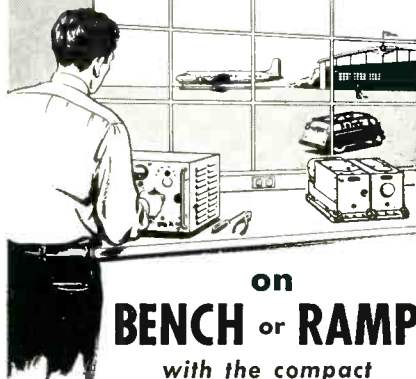

on
BENCH or RAMP

with the compact

ARC SIGNAL GENERATOR

ARC Signal Generators permit quick, accurate check-out of aircraft before take-off, as well as fast, dependable bench checks and trouble shooting.



TYPE H-14 108-132 Megacycles

Standard signal source for complete testing of VHF Airborne omnirange and localizer receivers in aircraft or on the bench. Checks up to 24 omni courses, omni course sensitivity, to-from and flag-alarm operation, left-center-right on 90/150 cycle and phase-localizers, and all necessary quantitative bench tests. For bench checks, 0-10,000 microvolts; for ramp checks, RF output 1 volt into 52 ohm line. Equal to Mil. SG-66/ARM-5.

Price: \$942.00 net, F.O.B. Boonton, N. J.

TYPE H-12—VHF Signal Generator, a

900 to 2100 mc source of cw or pulse amplitude-modulated RF. Power level 0 to -120 dbm. Internal pulse circuits with controls for width, delay, and rate, and provision for external pulsing. Frequency calibration better than 1%. Built to Navy specs for research, production testing. Equal to Military TS-419/U.

Price: \$1,950.00 net F.O.B. Boonton, N. J.

Write today for complete details

Aircraft Radio



CORPORATION
Boonton, New Jersey

Dependable Electronic Equipment Since 1928

AGASTAT

TRADE MARK

TIME DELAY RELAY

Instantaneously
recycling

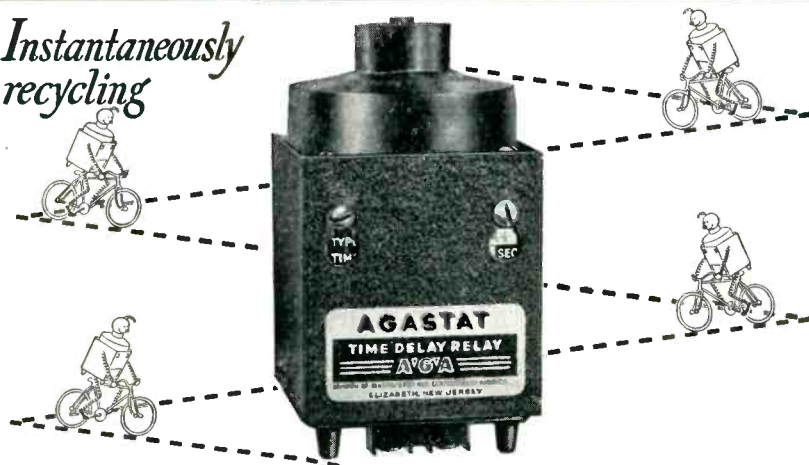

Small ~ Compact ~ Few moving parts ~ Easily mounted
Operates in any position
Time delay range, 1 second to 5 or more minutes

AGA® DIVISION OF ELASTIC STOP NUT CORPORATION OF AMERICA
1027 NEWARK AVENUE • ELIZABETH 3 • NEW JERSEY

9-pin medium- μ triode and sharp cutoff pentode contained in one envelope, designated 6 X 8. The tube is designed as a combined mixer and oscillator in tv receivers using an i-f of approximately 40 mc. The pentode mixer section of the 6 X 8 provides low grid No. 1 to plate capacitance as compared with a triode mixer. This reduces feedback problems often encountered in mixers when using an i-f in the vicinity of 40 mc. The low output capacitance enables the tube to work into a high impedance plate circuit resulting in higher mixed gain. The type 6 X 8 is also well suited for use as a mixer in a-m/f-m receivers.

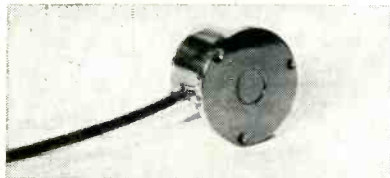

Pressure Transducer

THE BETA CORP., P.O. Box 8625, Richmond 26, Va. The type 3 electrokinetic transducer makes use of the streaming potential developed by a polar liquid flowing through a porous plug to provide a high-sensitivity means of measuring fluctuating or transient pressures over extended ranges of both amplitude and frequency. In the configuration shown the case may be baffle mounted for measuring air blasts and shock waves up to 100 psi or adapted to measure pressures in pipes or tubing. The unit provides a sensitivity of 250 mv per psi at a resistive output impedance of less than 100,000 ohms. The frequency response at the diaphragm extends from 0.25 cps to above 30 kc.

Audio Oscillator

WAVEFORMS, INC., 333 Sixth Ave., New York 14, N. Y., announces a new model 510-B wide-range audio oscillator, featuring improvements in stability and precision. Frequency changes less than 0.5 percent with line-voltage variations from 95 to 130 v and less than 1.0 percent with temperature variations of 0 to 150 F. Standard calibration accuracy is 2.0 percent, but

Accessibility UNLIMITED... with GRANT ELECTRONIC EQUIPMENT SLIDES

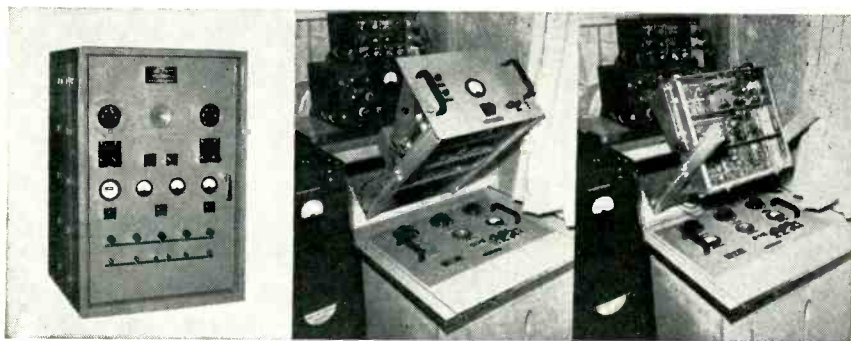
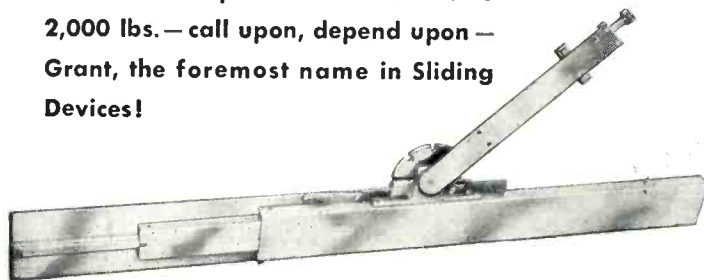

Photo shows Raydist navigation, tracking and surveying system master station where components are installed in vertical position, using Grant Slides at top and bottom of rack. Developed by Hastings Instrument Co., Inc., Hampton, Va.

Grant No. 363 Slide applicable where unit is desired to slide fully out of chassis and tilt for servicing of parts otherwise inaccessible. Capacity: 100lbs./pair. Telescoping, 3 section slide with ball bearing action. Aluminum with steel ball spacers.

There is a Grant Slide to meet every requirement... whether to tilt a unit a total of 180 degrees, lock unit in closed, open or pivoted position or meet load requirements from 25 to 2,000 lbs. — call upon, depend upon — Grant, the foremost name in Sliding Devices!



The foremost name in Sliding Devices

Write Electronic Design Division for Complete Catalogue

GRANT PULLEY & H'DW'E. CO.

31-87 Whitestone Parkway, Flushing, L. I.





when timing gives you a hard time

Turn your problem over to the
A. W. HAYDON COMPANY — past masters at solving the tough ones.

The know-how of A. W. Haydon Engineers is your assurance of prompt, accurate service regardless of the intricacies of the problem.

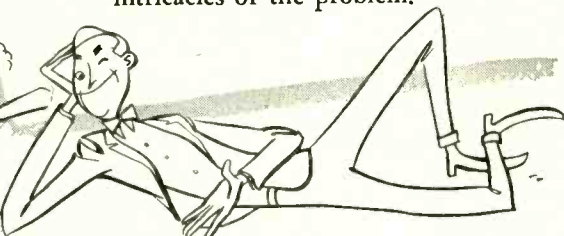

Send for catalog.

Would you like to work with us? We need qualified engineers and skilled model makers *now*. Excellent opportunities for men who are looking to the future.



The
A. W. HAYDON
COMPANY

235 NORTH ELM STREET
 WATERBURY 20, CONNECTICUT
 Design and Manufacture of Electrical Timing Devices

REGULATED DC SUPPLY

FOR

SCHOOLS — LABORATORY — INDUSTRIAL
MODEL PR-248B

- ✓ OUTPUT VOLTAGE DC: 190 to 275
- ✓ OUTPUT CURRENT DC: 250 milliamperes
- ✓ HEATER SUPPLY: 6.3 volts @ 6 amp
- ✓ REGULATION: ½% for line or load variation
- ✓ RIPPLE: Less than 5 millivolt
- ✓ IMPEDANCE: Output less than 2 ohms
- ✓ FUSED: Line and output

ALSO AVAILABLE FOR RACK MOUNTING

Specially Priced At \$88.50

ALCO ELECTRONICS MFG. CO.
 102 Marston St. Lawrence Mass.

MIL-B-233A
 JOINT ARMY-NAVY
 SPECIFICATIONS

SPARE AND REPAIR PARTS BOXES



Write for Catalog and Price List.

ART-LLOYD
 Metal Products Corp.

2973 CROPSY AVE., BROOKLYN 14, N. Y. • CO 6-5100
 PRECISION SHEET METAL PRODUCTS, MASS PRODUCTION SPECIALISTS.

Manufactured to meet material, workmanship and finish requirements of Army-Navy specifications.

Accessories: Internal framing, partitions, trays and wood chucks as required.

Complete Facilities under one roof for quality mass production, including Heliarc welding, baking and finishing. Whistler and Wiedermann equipment for short runs. Tool and die engineering and designing. Completely conveyerized finishing facilities. Large assortment of stock and special dies for radio and television and electronic field.

for the ELECTRONIC INDUSTRIES

Quality

Ribbons STRIPS

**MOLYBDENUM
 TUNGSTEN
 TANTALUM
 FORMED PIECES**

Your Special Metals Rolled to Thin Sizes & Close Tolerances

YOUR INQUIRIES WILL RECEIVE PROMPT ATTENTION

H. CROSS CO.
 15 BEEKMAN ST., N. Y. 38, N. Y.
 WOrth 2-2044 and COrtlandt 7-0470

accuracy of 1.0 percent is available on special order. Other features include miniature size, only 6 in. high, 4½ in. wide, and 5 in. deep; unusually wide frequency range of 18 cycles to 1.2 mc; distortion under 0.2 percent over most of the useful range; and constant output within ± 0.5 db. A 600/150 ohm line matching transformer is available. Total weight is 6 lb and the instrument operates on any power-line frequency from 50 to 400 cycles.

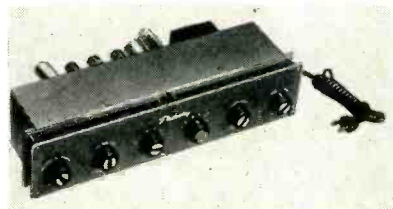

Audio Input System

PICKERING AND Co., INC., Ocean-side, L. I., N. Y. Type 410 audio input system (equalizer-preamplifier) is designed to serve as an audio control center. Three input channels are provided; two are for high-level audio signals, and one for magnetic-type pickups. The pickup channel provides 40-db gain at 1,000 cycles and 6 db per octave of bass boost below the low-frequency turnover. Used with a high quality power amplifier the controls provide complete flexibility for volume and tone balance. It is self-powered and operates from a 115-v a-c line. Three a-c outlets on the rear of the chassis are controlled by the a-c switch on the panel, permitting this unit to be used as a master power control for the other components of the system.

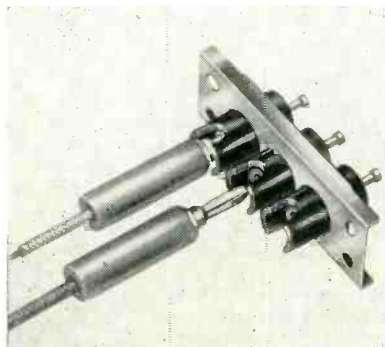

Terminal Block

CURTIS DEVELOPMENT AND MFG. CO., 3266 North 33rd St., Milwau-

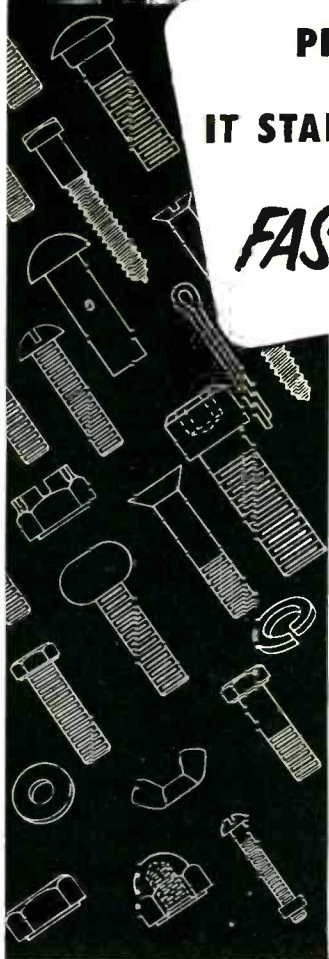
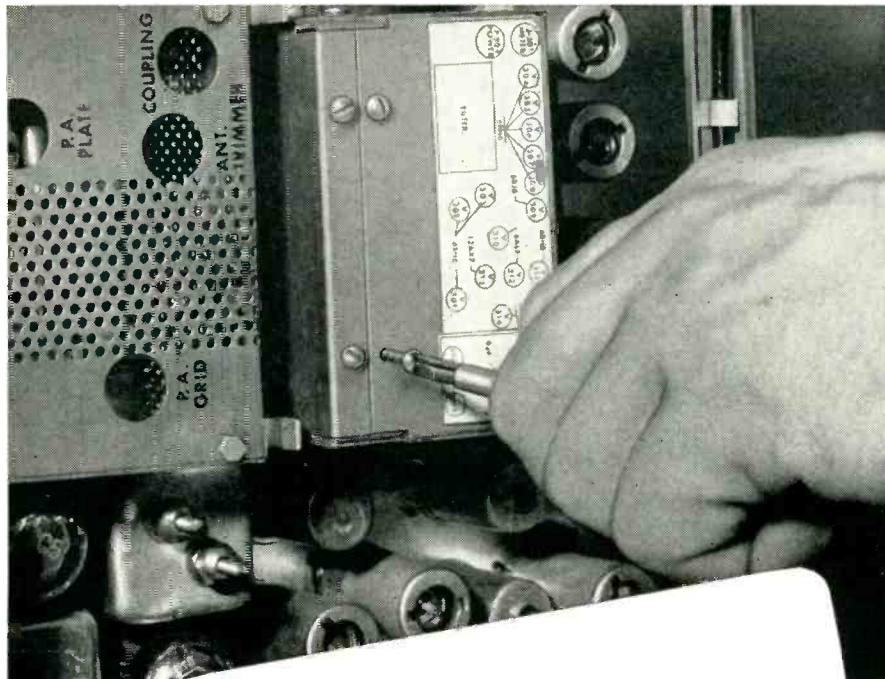

**PREVENT TROUBLE BEFORE
IT STARTS...WITH NON-CORROSIVE
FASTENINGS by HARPER**

The successful continuous operation of electronic equipment depends upon a multitude of small parts. Of major importance are the bolts, nuts, screws, washers, and rivets used in its assembly.

Harper has had years of experience in producing standard and special fastenings for manufacturers of electronic equipment. Today this company is the largest producer specializing in fastenings of brass, naval bronze, silicon bronze, Monel, nickel, stainless steels, and aluminum. Over 7,000 different items are carried in stock.

There is a Harper distributor near you with stocks ready to fill your order. For better fastenings, write The H. M. Harper Company or see your Harper distributor.

THE H. M. HARPER COMPANY
8244 LEHIGH AVE., MORTON GROVE, ILL.

Mail coupon below for complete catalog on Harper Everlasting Fastenings. Harper metallurgists and engineers will work with you on any fastening problem.



EVERLASTING FASTENINGS

**Specialists in all
Non-Corrosive Metals**

The H. M. Harper Company
8244 Lehigh Avenue
Morton Grove, Illinois
Please send me catalog on Harper Everlasting Fastenings.

Name.....
Position.....
Company.....
Address.....
City..... Zone..... State.....

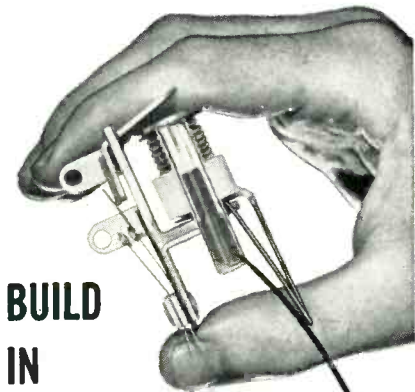

BUILD IN OVERLOAD PROTECTION

...or prevent single-phasing

This tiny, low cost Heinemann Silic-O-Netic Relay puts overload protection right into your circuits... or it can prevent single-phasing on three-phase motor applications.

TIME DELAY to allow for starting in-rush or temporary overloads is provided by a hydraulic-magnetic principle... and the complete time element is hermetically sealed, forever free of dirt and atmospheric conditions. Delay characteristics are inversely proportional to overload. They are unaffected by ambient temperature... and available with curves to suit your requirements.

Send for informative Bulletin 5001A.

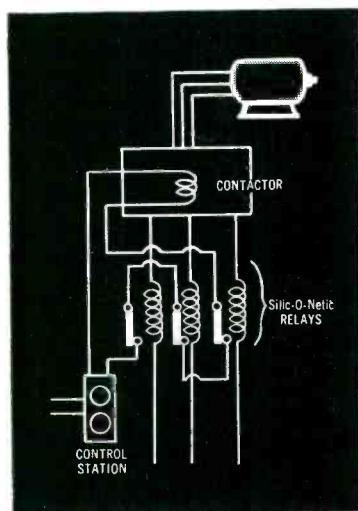

HEINEMANN

ELECTRIC COMPANY

97 Plum Street, Trenton 2, N. J.

Armor Clad Tips CUT SOLDERING COSTS

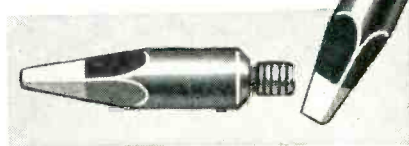

last up to
10 times
longer

Sheathed in a special protective metal, Stanley Armor Clad Tips never lose their shape. There's no time lost resharpening tips, production soldering moves "non-stop". And many industrial users report Armor Clad Tips last from 3 to 10 times longer than ordinary all-copper tips. Made in a variety of shapes and sizes, screw and plug-in types, for all standard make irons. See your distributor.

FREE!

New illustrated folder on Stanley Soldering Irons and Armor Clad Tips.

STANLEY TOOLS, NEW BRITAIN, CONN.

THE TOOL BOX OF THE WORLD

STANLEY

Reg. U.S. Pat. Off.

HARDWARE • TOOLS • ELECTRIC TOOLS • STEEL STRAPPING • STEEL



sub-miniature AND moisture-proof

IN-RES-CO S-15 & S-30 WIRE WOUND RESISTORS

THE ECONOMICAL SOLUTION where moisture proof resistive elements of comparatively small size are required for commercial applications. Type S-15 is $\frac{3}{8}$ " long by $\frac{1}{4}$ " diameter; type S-30 measures $\frac{3}{4}$ " by $\frac{1}{4}$ " diameter. Both types are moisture proof and capable of high performance over long periods of continuous service. IN-RES-CO Resistors for every ordnance or civilian requirement are available at a cost that solves circuit design problems both performance-wise and cost-wise. Check up now, on the complete line of IN-RES-CO quality wire wound resistors.



TYPE S-15
 $\frac{1}{4}$ " DIA. x $\frac{3}{8}$ " LG.



TYPE S-30
 $\frac{1}{4}$ " DIA. x $\frac{3}{4}$ " LG.

INSTRUMENT RESISTORS CO.

COMMERCE
AVENUE



UNION
NEW JERSEY

APPLICATION-DESIGNED RESISTORS FOR ELECTRONICS AND INSTRUMENTATION

FOR JAN SPECIFICATION RESISTORS — consult the new illustrated literature describing the complete In-res-co line. Write for your copy today!



kee 16, Wisc. The FTB terminal block has been developed to satisfy the quick connect and disconnect requirements in experimental work. It is of the feedthrough type with solder or screw connections on one side and has provisions to receive banana plugs on the other. The new unit is factory assembled in any number from 1 to 16 terminals. Terminals are separately insulated and held permanently in a metal strip. It is conservatively rated at 300 v between terminals of opposite polarity and to ground, 20 amperes.

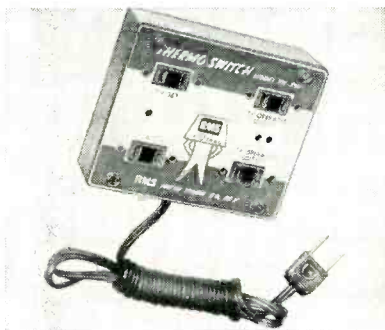

Thermal Switch

RADIO MERCHANDISE SALES, INC., 1165 Southern Blvd., New York 59, N. Y. Introduced primarily as a televiewing convenience device, the model TH-SW thermal switch permits automatic operation of lamps, rotor, booster and similar devices through operation of the tv receiver. In addition to this convenience, neatness of wiring arrangement and protection against operating electrical units overnight are other advantages claimed for the unit. The switch is compact and mounts easily to the wall. A spare outlet is provided for independent operation of other electrical devices.

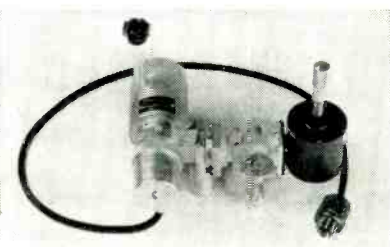

Spectrum Analyzer Adapter

MICROWAVE ASSOCIATES INC., 22 Cummington St., Boston 15, Mass. Type P-530 spectrum analyzer

High Temperatures? Small Space? Severe Conditions?

HERE'S YOUR ANSWER...

Rome Synthinol® 901

Hook-Up Wire

Today's trend towards miniaturization makes severe demands on electronic wiring. That is why so many leading electronic equipment manufacturers specify Rome Synthinol 901. A resin plasticized polyvinyl chloride thermoplastic compound, it is Underwriters' approved for temperatures up to 105° C., as a special small-diameter type with no assigned voltage, as well as for regular 300 and 600 volt ratings.

Where space is a problem, Rome Cable engineers have developed a small-size hook-up with with an 8 mil wall of Rome Synthinol 901 insulation and an exceptionally small over-all diameter. With nylon sheath maximum diameters run from as small as .051" for 24 AWG to .100" for 16 AWG.

What's more Rome Synthinol 901 has greater resistance to heat deformation, baking embrittlement, shrinkage, cracking, solvents, moisture and flame, plus improved solderability. It is available in distinct, permanent colors, either plain or with outer coverings.

MILITARY TYPE HOOK-UP WIRE

Rome Cable is a manufacturer of military types SRIR, SRHV and WL, complying with Army-Navy-Joint Specification JAN-C-76, as well as shipboard types SRI and SRIB conforming to Specification MIL-C-915. Insulated with Rome Synthinol thermoplastic compound, these wires are manufactured in the complete range of specification sizes.

Whatever your requirements, you can depend on Rome for electronic wires of the highest quality. The coupon will bring you descriptive literature.

MAIL IT TODAY.

ROME CABLE CORPORATION
DEPT. E-11, ROME, N. Y.

Please send me information on Electronic Wiring.

Name

Company

Address

City State

IT COSTS LESS TO BUY THE BEST

ROME CABLE CORPORATION
ROME, NEW YORK and TORRANCE, CALIFORNIA

CLIMATE-PROOF PACKAGING

CARGO



Here's a quick solution to MILITARY PACKAGING

CARGO PACKERS CLIMATE-PROOF PACKAGING

Meets all Specifications for Signal Corps, Navy and Air Force Shipments of Electronic Equipment with Facilities that include—

- SPECIAL PACKAGING EQUIPMENT
- EXPERTS IN MILITARY SPECIFICATIONS
- ECONOMICAL ASSEMBLY LINE METHODS
- FULL COMPLIANCE IN EVERY DETAIL
- COMPETENT CONSULTING SERVICE

NEW ILLUSTRATED BROCHURE explains in detail how Cargo Packers can economically handle all details of your military packaging problems. You save valuable plant space, costly equipment and the need for experienced specification packaging experts. Find out now, how Cargo Packers production line methods save you time, money, endless detail work, and costly errors. Request your copy, now!

CARGO PACKERS

INCORPORATED

73 RUTLEDGE STREET
BROOKLYN 11, NEW YORK

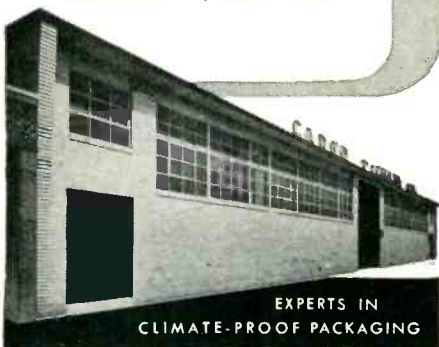

EXPERTS IN
CLIMATE-PROOF PACKAGING

Whatever the Weather—
aloft or aground—Be sure of
reliable precision control
with



HERMETICALLY-SEALED LIMIT SWITCHES

Reliable in any environment. Electric-Snap *Hermetically-Sealed* Limit Switches with working parts sealed in an atmosphere of dry, inert gas are unaffected by heat, cold, moisture, dirt and temperature cycling. Available with both mountings and actuators to fit them to *retro-fit programs* as well as *new aircraft designs*. Also preferred for industrial precision-switch applications where utmost dependability is essential.

Write for FREE Basic Switch and Catalog



ELECTRO-SNAP SWITCH & MFG. CO.

4218 WEST LAKE STREET • CHICAGO 24, ILLINOIS



Environment FREE! PROOF AGAINST

- Cold and Heat—from -100° to $+250^{\circ}$
- Altitude • Dirt
- Moisture • Oil • Corrosion
- Ice Jamming

PIX

WIRE FORMING SPECIALISTS

Precision Parts to meet your Production and Engineering needs. From .002" dia. to .125" dia. Radio tube parts—Stampings—Drawings Modern facilities, high-production equipment.

Metal Crystal Holder Parts

Send sketch or print for quotation.

PIX MANUFACTURING CO., Inc.
24-B Bedford St., Newark 3, N. J.

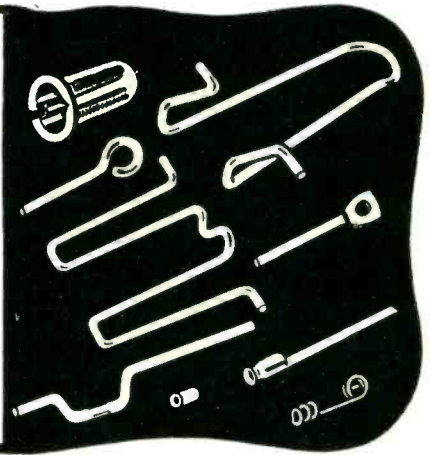

FS

MICROMETER HEAD

for the Electronics Industry

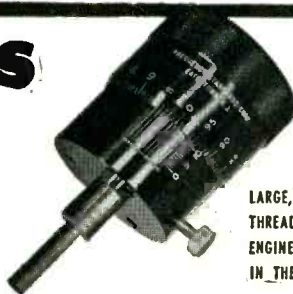

LARGE, LEGIBLE, EASY TO READ CALIBRATIONS, PLUS A THIMBLE STOP TO PREVENT THREAD JAMMING, ARE FEATURES FOUND IN FS MICROMETER HEADS WHICH HELP ENGINEERS SPEED UP THEIR WORK. THESE AND MANY OTHER FEATURES ARE DESCRIBED IN THE NEW BULLETIN ON FS MICROMETER HEADS, OBTAINABLE ON REQUEST.

FREQUENCY STANDARDS

P. O. BOX 66, EATONTOWN, N. J. • TELEPHONE ASBURY PARK 1-1019

3

adapter consists of a complete set of r-f plumbing to convert any existing S or X band spectrum analyzer to the frequency range centered at 35,000 mc. Input sensitivity will vary with the noise figure of the spectrum analyzer receiver with which it is used, but threshold sensitivities of 70 db below 1 mw are to be expected. The unit is composed of a 2K25 klystron operating at X-band and powered from the spectrum analyzer power supply. Oscillator output is fed through a variable attenuator to a mixer where its fourth harmonic is mixed with the incoming millimeter signal. Signal input enters through a UG-381/U connector and RG-96/U waveguide. The i-f output of the mixer is a type N connector.

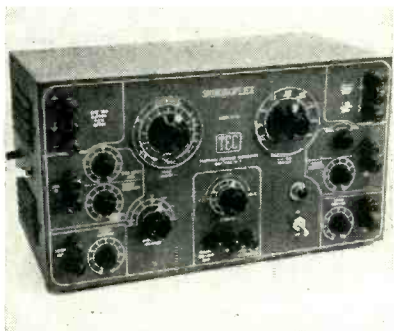

Versatile Test Instrument

TELEVISION EQUIPMENT CORP., 238 William St., New York 38, N. Y., announces a new type of test instrument, the Syncroplex, a multiwaveform generator and pulse synchronization unit. At repetition rates of 1 cps to 100 kc it provides: (1) sawtooth waves; (2) square waves or square pulses, 1 μ sec to 1 second duration with rise time of 0.15 μ sec; and (3) integrated or differentiated versions of the square waves and pulses. Other applications of the unit include: oscilloscope sweep phaser, delayed pulse generator, oscilloscope trace expander, frequency divider, and pulse-time or pulse-width modulator.

Square-Wave Generator

NEW LONDON INSTRUMENT Co., P.O. Box 189, New London, Conn. The compact type 150-A square-wave

Headquarters for ...

HUDSON
RADIO & TELEVISION CORP.



In Stock for Prompt Delivery!

Hudson carries a complete line of

RCA TUBES

to meet every Industrial, Laboratory and Communications requirement.



- VOLTAGE REGULATORS • RECTIFIERS
- POWER TUBES • THYRATRONS
- MONOSCOPES • CAMERA TUBES
- IGNITRONS • PHOTOTUBES
- CATHODE RAY TUBES
- OSCILLOGRAPH TUBES
- COLD-CATHODE TUBES
- VACUUM POWER TUBES
- VACUUM & GAS RECTIFIERS
- and ALL SPECIAL-PURPOSE TUBES



- Complete Line of
- RCA TEST EQUIPMENT
- RCA BATTERIES
- RCA PARTS

FOR FAST SERVICE on RCA TUBES, TEST INSTRUMENTS, BATTERIES, PARTS . . . Call Hudson your complete, dependable source!

FREE!

New 1953
HUDSON
CATALOG

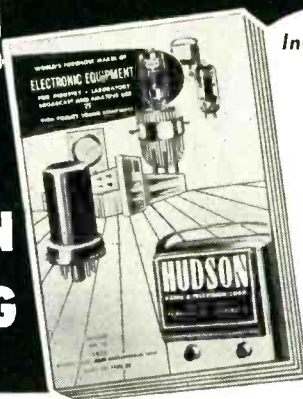

Includes The New, larger edition of

JAN Cross Reference **GUIDE**

The most complete buying guide of its kind! INCLUDES the latest JAN CROSS-REFERENCE GUIDE and all types of fully approved JAN COMPONENTS. Over 196 pages of the latest and largest selection of Industrial Electronic Equipment, Tubes, Test Instruments, Recording and High Fidelity Audio and Sound Equipment. Complete lines. Wide selection. All Standard Makes in Stock for Prompt Delivery at LOWEST PRICES!

Send for your FREE Copy Today

One Call for All!

HUDSON
RADIO & TELEVISION CORP.

48 WEST 48th ST. • 212 FULTON ST.
New York 36, N. Y. New York 7, N. Y.
Circle 6-4060

Hudson Radio & TV Corp. Dept. M-11
48 West 48th St., New York 36, N. Y.

Please send FREE copy 1953 Hudson Catalog

Ship the following:

Name Title

Firm

Address

City Zone State

ATR

Makes
it easy
to DEMONSTRATE
AND TEST
D.C. APPARATUS
FROM A.C. LINES



"A" BATTERY ELIMINATORS

For DEMONSTRATING AND TESTING
AUTO RADIOS

New Models . . . Designed for testing D.C. Electrical Apparatus on Regular A.C. Lines. Equipped with Full-Wave Dry Disc Type Rectifier, Assuring Noise-less, Interference-Free Operation and Extreme Long Life and Reliability.

ATR

✓ NEW MODELS

✓ NEW DESIGNS

✓ NEW LITERATURE

"A" Battery Eliminators, DC-AC
Inverters, Auto Radio Vibrators

See your jobber or write factory

AMERICAN TELEVISION & RADIO CO.

Quality Products Since 1931

SAINT PAUL 1, MINNESOTA-U.S.A.

MICROWAVE RESISTORS TELEWAVE TYPE R

**SMALLEST
RESISTOR
AVAILABLE**

(Ideal for Miniaturization)

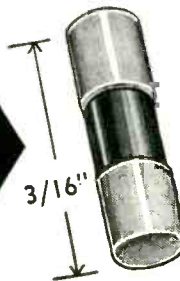

TYPICAL APPLICATIONS

- Power measurement at any frequency
- Matched terminations for waveguides or coaxial lines
- Resistive power pickup loops
- RF pads or attenuators
- Dummy loads
- Temperature measurements
- Impedance matching

SPECIFICATIONS

Resistance: 50 ohms standard, other values on request.
Tolerance: 5% or 10%
Wattage: 1/4 watt continuous duty at 25°C
Size: 1/16 inch diam. x 3/16 inch long
Terminals: Tinned sections 1/16 inch long
Film Length: Type R-063 — 1/16 inch
Type R-093 — 3/32 inch
Temperature Coefficient:
approx. 0.0019 ohms/ohm/°C.
Power Sensitivity: Approx. 10 ohms/watt

TYPE R RESISTORS employ noble metal film deposits on specially selected heat resistant glass.

FILM THICKNESS offers negligible skin effect, at microwave frequencies.

POWER CAPACITY of 1/4 watt provides high power handling ability.

PHYSICAL STRUCTURE is ideally suited to impedance matching in standard coaxial line and waveguides.

FINISH. Coated with a special silicone varnish to protect the film.

TELEWAVE LABORATORIES, INC.

100 Metropolitan Ave. • Brooklyn 11, New York

AVAILABLE
FOR
IMMEDIATE
DELIVERY

SEALING
DIPPING
POTTING
IMPREGNATING



INSULATING
FUNGUSPROOFING
MOISTUREPROOFING
HEAT CONDUCTING

WAXES **BIWAX** COMPOUNDS

Developed and produced for manufacturers of electronic components and other electrical units.

Specifications and samples available on request. Information relative to your problem or application will enable us to make suggestions and recommendations.

BIWAX CORPORATION

3445 HOWARD STREET
SKOKIE, ILLINOIS

SCOPE DOLLY

Model 1

Convenient Height and Viewing Angle
Adjustable to Hold Portable Scopes
Ball Bearing Swivel Rubber Tired Casters
Lightweight Aluminum Construction
Recommended by Laboratories Wherever Used

\$35.00 FOB LOUISVILLE, KY.

Formerly manufactured by UNIQUE DEVICES

Now manufactured and sold by

TECHNICAL SERVICE CORPORATION

3116 Michigan Drive Louisville 5, Kentucky

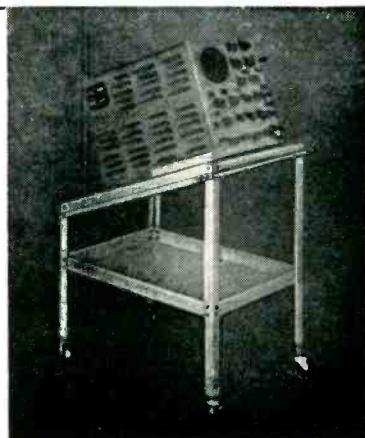

generator provides square waves at frequencies from 50 cps to 1 mc with a maximum rise time of 0.05 microsecond on all frequencies. Fixed frequencies are 50, 1,000, 10,000, 100,000 and 1,000,000 cps. Other frequencies are obtainable through the use of an external frequency-control capacitor for which terminals are provided. A pulse for oscilloscope synchronization is available. Output is controllable from 0 to 20 v peak-to-peak and is constant at all frequency settings. Tilt and overshoot are negligible.



Multiplier Phototube

RADIO CORP. OF AMERICA, Harrison, N. J. Model 6199 is a small, 10-stage multiplier phototube of the head-on type, intended for use in scintillation counters and in other applications involving low-level, large-area light sources. Spectral response covers the range from about 3,000 to 6,200 angstroms with a peak value at approximately 4,000 angstroms. Design features include a semitransparent cathode having a diameter of $1\frac{1}{4}$ in. on the inner surface of the face end of the bulb; a face with a flat surface 1 in. in diameter to facilitate the mounting of flat phosphor crystals in direct contact with the surface; and 10 electrostatically focused multiplying stages.

Literature

Electrical Computer. Consolidated Engineering Corp., 300 N. Sierra Madre Villa, Pasadena 8, Calif. Bulletin 1802A describes the model 30-103 electrical computer that is designed for rapid solution of as many as 12 simultaneous

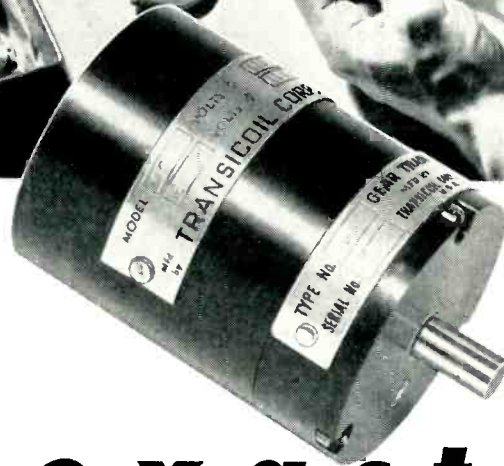
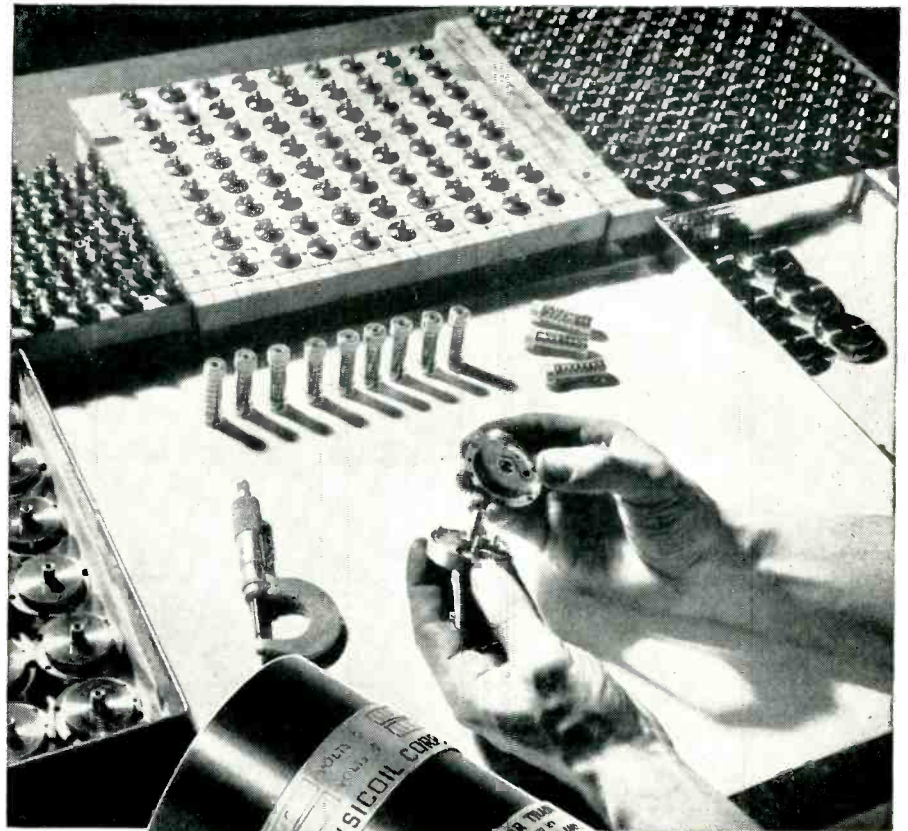

e-x-a-c-t-l-y!

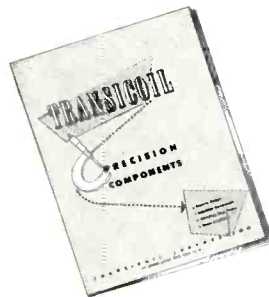

Write for new data bulletin on Transicoil control motors, gear trains, motor-driven inductor generators and servo amplifiers.

Transicoil's specialized service in the fast-growing control field has played an important part in advancing the control art. From the outset "standard" control types were avoided in favor of highly adaptable basic types. Maximum efficiency has been assured by modifying these basic units to any needed extent to meet the exact requirements of the applications for which they were intended.

Thus, Transicoil control components are invariably fitted for the job. Their use does not entail any lowering of performance standards as often happens where inflexible, highly standardized components are employed.

Control engineering horizons have been expanded materially as a result of this policy.

TRANSICOIL

CORPORATION

107 GRAND STREET

NEW YORK 13, N. Y.

more LISTENING
COMFORT with
lightweight TELEX headsets!!

THE ONLY
PERSONAL PART
OF ANY
COMMUNICATION
SYSTEM



Modern, light-weight, durable . . . Easily adjustable and built for hard usage, TELEX Headsets give top quality reception without the punishment of extra weight and pressure.

***MONOSET**

The modern styling and dependability and superior performance of the TELEX Mono-set have made old fashioned head-phones obsolete. Magnetic.



***DYNASET**

New dynamic under-chin TELEX Dynaset, with more highs and lows of both music and speech, is the delight of radio and TV monitors. Weighs only 1.25 oz.



***TWINSET**

This lightweight 1.6 oz. TELEX Twinset pipes signal directly into the ear, blocking out background noises and banishing listening fatigue. Magnetic.



***EARSET**

Sensitive TELEX Earset slips onto ear and is preferred by all who use single-phone headsets. Weighs only 1/2 oz. and leaves other ear free for phone calls or conversation.



STANDARD OF THE
WORLD FOR
QUALITY HEADSETS

*Trade Mark

Telex produces headsets to manufacturers' specification

TELEX
HEARING AT
ITS BEST

Commercial Communications - Electronic Laboratories
Office Transcribing Machines - Radio Monitoring
Telecasting - Amateur Radio - Record Stores - Theaters
Phone-Order Boards - Wired Music Installations

For complete information on any of the above headsets, write

TELEX, ELECTRO-ACOUSTIC DIV.

Department 9-C • St. Paul 1, Minnesota
In Canada, ATLAS RADIO CORP., Toronto

ONE OF A SERIES OF
Modernized...
**REGULATED
POWER SUPPLIES**

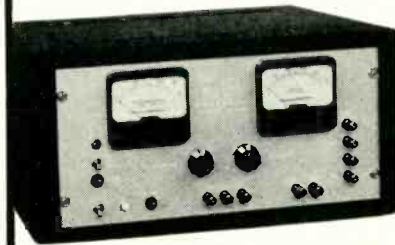

MODEL 300A

A laboratory instrument designed to meet research requirements

- 0 to 500V DC at 0 to 300MA
- HV regulation within 0.2V at any setting
- HV hum level within 2MV
- 0 to -150V bias, stabilized, 5MA max.
- 6.3V AC filament, 6A

Send for Bulletin E-300A

Also available: general purpose units for industrial or laboratory use.

Universal 
Electronics Co.
2012 South Sepulveda Boulevard
Los Angeles 25, California

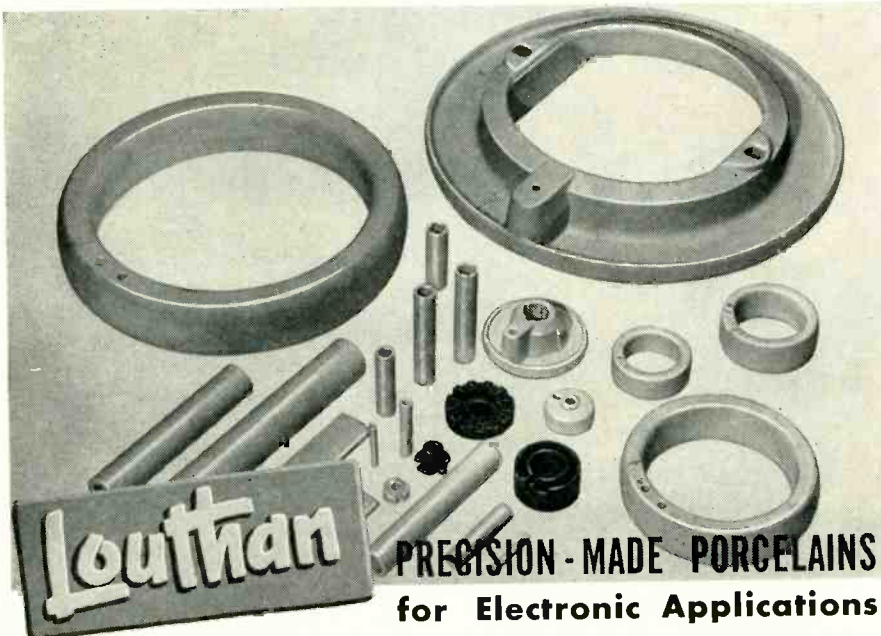

Louthan

**PRECISION-MADE PORCELAINS
for Electronic Applications**

The high quality porcelain insulators you need are assured by Louthan's careful workmanship and close inspection. Louthan specializes in Vitrified, Refractory, and low-loss Steatite porcelain insulating parts, with the clean, smooth surfaces, the good mechanical strength,

the specified electrical properties, and the dimensional accuracy your applications demand.

Louthan production facilities are geared for volume production and prompt deliveries. Send us your inquiries today.

EXCLUSIVE REPRESENTATIVES:

H. B. ZEIGER, New York 17, N. Y. • GLENN GARNER CO., Chicago 6, Ill. • WM. F. HOEFER, Pasadena, Calif.

THE LOUTHAN MANUFACTURING COMPANY

A Subsidiary of Harbison-Walker Refractories Co.

EAST LIVERPOOL, OHIO

• for RESEARCH •
DEVELOPMENT
SOLID
ULTRA-SONIC
DELAY LINES

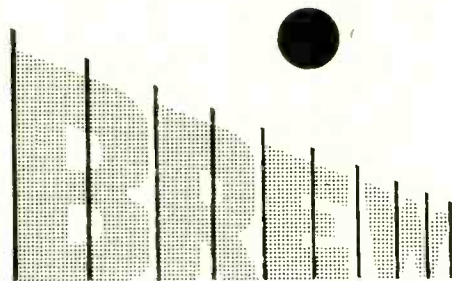

RICHARD D. BREW and CO., INC.
106 CONCORD AVE., BELMONT 78, MASS.

linear equations. The computer described, applicable to many fields such as electrical circuit study, aircraft flutter analysis, and statistics, is fast and accurate, yet priced within the budget of the average laboratory. It has been used widely for rapid reduction of mass spectrometer and infrared spectrophotometer data.

Laminated Plastics. The Formica Co., 4614 Spring Grove Ave., Cincinnati 32, Ohio, has issued a new general catalog describing 50 standard grades of Formica laminated plastics for industrial usage. Printed in colors, the 16-page illustrated publication features a new edition of the Formica comparator chart. In this chart the major characteristics of each grade are described and a quantitative grading system permits easy choice of the material best suited to special requirements. The catalog also shows typical uses of Formica in sheets, tubes, rods, molded and postformed shapes for electrical, chemical and mechanical applications.

Microwave Equipment. Radio Corp. of America, Camden 2, N. J. A new 20-page informational booklet provides a semitechnical description of microwave radio systems. It is fully illustrated with photographs, diagrams, charts, graphs and maps. Seventeen chapter headings include terse descriptions of microwave radio, how it works, propagation characteristics, operational advantages, economic factors influencing choice of frequencies and desirable design characteristics. Other chapters deal with multiplexing, telemetering and remote control features of microwave systems, while in other categories practical information as to who can use microwave, how to plan a microwave system, selecting station sites and other valuable information is presented.

Subminiature Tubes. Raytheon Mfg. Co., 55 Chapel St., Newton 58, Mass., has announced six new reliable subminiature tube types in a booklet just off the press. Included are a dual diode, three dual triodes of amplification factors of 20, 35 and 70, a voltage regulator tube,

production and maintenance ECONOMY....

Adapter to tailor standard components to specific systems.

POWER SUPPLY

ADAPTER

Mechanisms to accommodate components to specific systems.

MECHANISM

MODULATOR

AMPLIFIER

Complete line of 60 and 400 cycle amplifiers and associated power supplies for servo motors in the 3 and 10 watt range. Others on special order.

The complete 5-unit servo system with chassis and shock mount.

... in advanced
automatic control systems,
computers and instrumentations with
SMI's standard line of pre-designed electronic
plug-in packaged functions!

SERVOMECHANISMS, Inc., packaged function or "building block" technique divides the systems' circuitry into basic circuits... power supply, adapter, modulator, amplifier, positioning mechanism... and assembles them into standardized plug-in, compact units. Standardization of units allows for multiple applications and combinations to effect desired systems or instrumentations. Units plug into pre-wired chassis and lock into position with quick-acting fasteners. Maintenance becomes a plug-in or -out operation... This design philosophy provides for:

- Performance Reliability
- Installation Flexibility
- Ease of Maintenance
- Interchangeability

Write for information on specific military and industrial applications.

SERVOMECHANISMS INC.

POST AND STEWART AVES., WESTBURY, N. Y.
NEW CASSEL, N. Y. EL SEGUNDO, CAL.



for HIGH MEGOHM RESISTORS

Type H Resistors are furnished with resistance values as high as 50 million megohms (5×10^{13} ohms). Their advanced design insures highest stability with extremely low noise level, polarization effects, and voltage and temperature coefficients. Available in sizes suitable for any circuit requirement. Standard resistance tolerance $\pm 10\%$.

RPC Type H Resistors are rugged, durable units jacketed in polyethylene to provide maximum protection against mechanical damage and humidity. These resistors are eminently suited for electrometer circuits, radiation equipment, photo cell circuits and as high resistance standards. Moderately priced. Write for catalog today.

ALSO MANUFACTURERS OF HIGH QUALITY PRECISION WIRE WOUND RESISTORS, HIGH FREQUENCY RESISTORS AND HIGH VOLTAGE RESISTORS. WRITE TODAY FOR CATALOG.



RESISTANCE PRODUCTS CO.
714 RACE STREET • HARRISBURG 2, PA.

Precision drilling made easy!

Phillips & Hiss 204-C

6" Throat
0-1/8" Capacity
1" Quill Travel

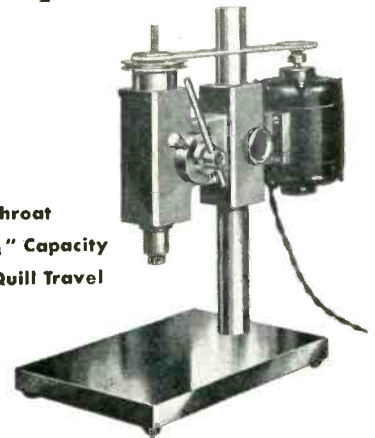

Sensitive "Feel"

Sensitive Speed Control:
Foot-operated, leaves both hands free

High Precision: Selected Chuck and Bearings. Spindle true within .0004". Table square .0006" in 5" circle. Permanent accuracy, castings annealed and ground.



WRITE: Bulletin E2
Phillips & Hiss Co., Inc.
1155 N. McCadden Place
Hollywood 38, California

PRIMARY BATTERIES for your Specialized Needs

DRY TYPES

78 Standard Industrial, Laboratory and Government Types.



LAB-BILT BATTERIES

Our engineers will design and create to your requirements. Send us your specifications.

HI-DRIVE MINIATURE MOTOR



Precision-built, low-cost, battery-operated—available for delivery now.

RESERVE TYPES

Water activated "One Shot" Batteries.

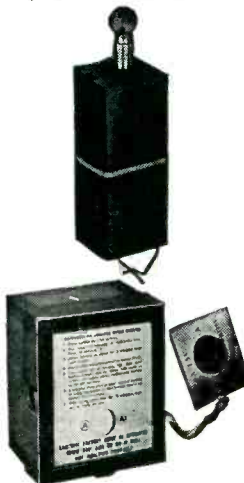

Send for FREE Catalog

SPECIALTY BATTERY COMPANY

A Subsidiary of the **RAYOVAC** Ray-O-Vac Company
MADISON 10, WISCONSIN

INSTRUMENT HOUSINGS PANELS • CHASSIS

*Manufactured to
your Requirements*

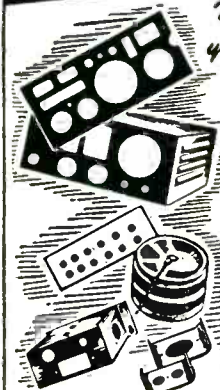

**MECHANICAL
& ELECTRICAL
ASSEMBLIES**

**STAMPINGS,
ALL METALS**

A complete manufacturing service: Fabricating, Stamping, Screw Machine Work, Assembling.

Precision work, experienced fabrication, dependable service.

SEND DRAWINGS FOR ESTIMATES!

STAMFORD METAL SPECIALTY COMPANY

Metal Work of Every Description
429 West Broadway, New York 12, N. Y.

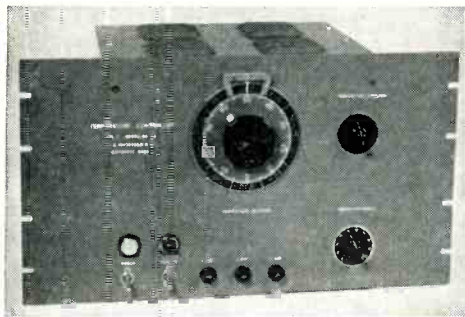

MACDONALD Proportional TEMPERATURE CONTROL

The THYRATRON Control allows PROPORTIONAL regulation of output power to electrically heated furnaces. Instead of turning current on-and-off, or adjusting the time of application of full power, the power level is continually monitored in accordance with the furnace demand. In this way the number of expansions and contractions of the heated elements is greatly reduced, increasing heater element life. The controller operates proportionally from a resistance thermometer, and thus insures maximum sensitivity of control.

SPECIFICATIONS:

Resistance Thermometer Actuated
Controls up to $7\frac{1}{2}$ amperes @ 220V
Standard Ranges: -55 to 200°C ; 0 - 1000°F ; 0 - 1000°C
Controls to 0.1°C (0.01°C or better with improved furnaces)

W. S. MACDONALD CO., INC.

University Road • Cambridge • Massachusetts



Build your future at **BOEING!**

THE revolutionary B-47 medium jet shown above, and the new, still-classified B-52 eight-jet heavy bomber, are two striking examples of Boeing engineering leadership. Other Boeing engineering projects include secret guided missiles programs, nuclear-powered aircraft, and exploration of supersonic flight.

If you are an engineer interested in exciting, long-range projects with a future, look into Boeing opportunities.

Here at Boeing you'll share the prestige of Boeing leadership that has been growing for 35 years.

There are opportunities at Boeing right now for experienced and junior engineers in all fields, for aircraft

- DESIGN
- DEVELOPMENT
- RESEARCH
- PRODUCTION
- TOOLING

also for servo-mechanism and electronics designers and analysts, and for physicists and mathematicians with advanced degrees.

Work in Seattle or Wichita. Boeing provides a moving allowance, offers special training, a salary that grows with you—and a future of almost limitless range. You'll be proud when you say, "I'm a Boeing engineer!"

Write today to address below or use coupon

JOHN C. SANDERS, Staff Engineer—Personnel
Dept. H-11

Boeing Airplane Company, Seattle 14, Wash.

Engineering opportunities at Boeing interest me. Please send me further information.

Name _____
Address _____
City and State _____

T TRANSFORMERS

built to **MIL-T-27** specifications

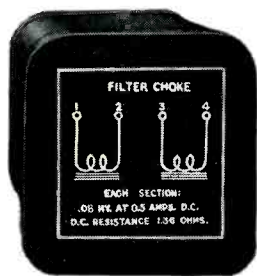

We have had considerable experience in designing and building transformers to MIL-T-27 specifications.

Our testing equipment includes facilities to test over a temperature range from minus 50°C to plus 85°C . In addition, Corona test equipment, hot, cold, salt water bath equipment, and vacuum equipment to conduct impregnation tests and assimilate high altitude conditions are available.

ACME ELECTRIC CORPORATION
3111 WATER ST. CUBA, N. Y.

Aeme  **Electric**

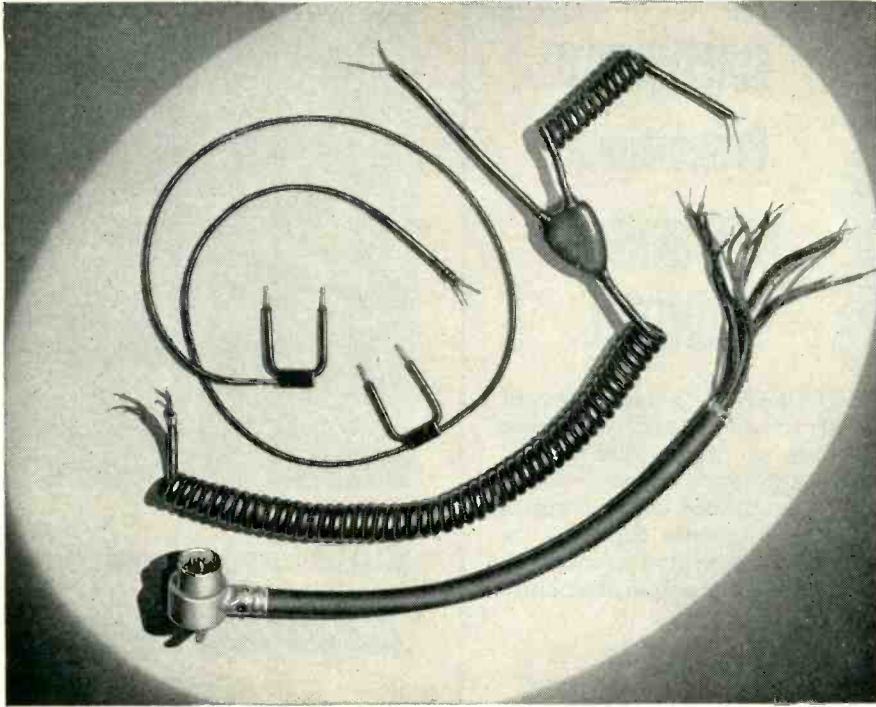

FOR *Special* CORD SETS
CALL ON
WHITNEY BLAKE

Special cord sets of flexible cord, shielded communications wires and multiple conductor cables, equipped with molded rubber or plastic fittings are among the many quality products offered by Whitney Blake.

If standard molds cannot be adapted to individual applications, Whitney Blake is prepared to design and make special molded junctions and other fittings to provide the water and impact resistance, small size, light weight and protection from tampering so important to many of today's applications.

Whitney Blake has over thirty years experience in the cord set field and more than fifty years in producing well built wires. The close control exercised in the production of Whitney Blake cord and cable and the extensive testing facilities make Whitney Blake Cord Sets completely dependable.

If you have a cord set problem our design engineers will be glad to help you solve it.

WELL BUILT WIRES SINCE 1899



WHITNEY BLAKE CO.

NEW HAVEN 14, CONNECTICUT

and a voltage reference tube. With the five reliable subminiature types previously announced the booklet describes a total of eleven types, all of which are available for prompt delivery.

Instrumentation Bulletin. The Gulton Mfg. Corp., 200 Durham Ave., Metuchen, N. J., has available technical bulletin KA-1, dealing with instrumentation for shock and vibration testing of electron tubes. Also described is a new test set, which includes accelerometers, amplifiers and filters. The instrument discussed can be used directly with galvanometers, oscilloscopes, or electronic voltmeters, for direct evaluation of shape and magnitude of accelerations.

Industrial Television. Diamond Power Specialty Corp., Lancaster, Ohio. Bulletin 1025-A covers the new model 300-B Utiliscope (wired television), the complete installation of which consists of a camera, a small power unit and the monitor or viewing unit. The bulletin is fully illustrated and includes the Utiliscope's advantages, typical uses, circuit design and general information.

Tubular Trimmers. JFD Mfg. Co., Inc., 6101 Sixteenth Ave., Brooklyn 4, N. Y. Form No. 199 is a single-page bulletin dealing with a line of piston-type variable trimmer capacitors. Approximately one inch in length, the tubular trimmers described deliver uniform change of capacitance in relation to rotation with excellent resettability. The literature includes illustrations and outstanding features of the units.

Motor Speed Controls. General Radio Co., 275 Massachusetts Ave., Cambridge 39, Mass., has issued an 8-page bulletin illustrating and describing in detail all of its Variac motor-speed controls. Technical information including speed-torque curves and typical applications are given on all models. Prices are included.

Direct-Writing Recorders. Sanborn Co., 39 Osborne St., Cambridge 39, Mass., has issued a 16-page booklet covering the seven

**RUGGED
CONSTRUCTION
FOR SUPERIOR
PERFORMANCE**



The Burlington "Hermetically Sealed" Instrument was designed and is manufactured to conform to JAN specifications for sealed instruments.

Burlington **HERMETICALLY AC - SEALED - DC INSTRUMENT**

- Steel case (DC), Brass Case (AC) with copper-cadmium-dichromate finish.
- Excellent shielding due to case material and construction.
- Double strength clear glass.
- Black satin anodized aluminum bezel.
- Glass to metal seal under controlled humidity and temperature conditions.
- D'Arsonval permanent magnet type movement for DC applications.
- Magnetically damped, moving iron vane type movement for AC applications.
- Available in 1½" square, 2½" and 3½" round case types.
- Guaranteed for one year against workmanship and materials.

BURLINGTON INSTRUMENT COMPANY

Dept. F-112, Burlington, Iowa

Pulse Generator and Calibrator



**MODEL
PC-100R**

- Paired pulses 5 to 5000 microseconds interval, 50 cycles to 5 Kc. recurrence rate with meter indication
- Width 1 microsecond, rise and decay times 0.1 microsecond, amplitudes 0-75 volts open circuit, 220 ohm internal impedance
- Polarities and amplitudes independently controlled, separate or mixed outputs
- Sync internal or from external positive 10 volt trigger
- Positive 50 volt sync output trigger coincident with fixed pulse, 220 ohm internal impedance
- Time markers 1, 10 or 100 microseconds; negative pulses 0 to 10 volts, 220 ohms internal impedance
- Amplitude calibration 60 cycle square wave, 0.1 to 100 volts in steps
- Model PC-100 cabinet mounted, PC-100R relay rack panel mounted

Incorporates design of
HAZELTINE ELECTRONICS CORP.
Model 1456 Senior Pulser

TELETRONICS LABORATORY INC.
WESTBURY, L. I., N. Y.

MANUFACTURERS OF ELECTRONIC INSTRUMENTS AND PRODUCTION TEST EQUIPMENT

DC - AC CHOPPERS

A model for every use.

10 - 500 cycles

Single pole

60 cycles

Single pole and double pole

Make-before-break contacts

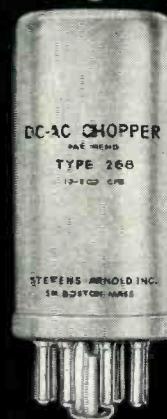

These Choppers convert low level DC into pulsating DC or AC so that servo-mechanism error voltages and the output of thermocouples and strain gauges, may be amplified by means of an AC rather than a DC amplifier.

They are hermetically sealed, precision vibrators having special features which contribute to long life and low noise level.



WRITE FOR THESE
CATALOGS . . .

- #280A 10-500 cycle
- #246C 60 cycles

**STEVENS
ARNOLD
INCORPORATED**

22 ELKINS STREET
SOUTH BOSTON 27, MASS.

SA-5

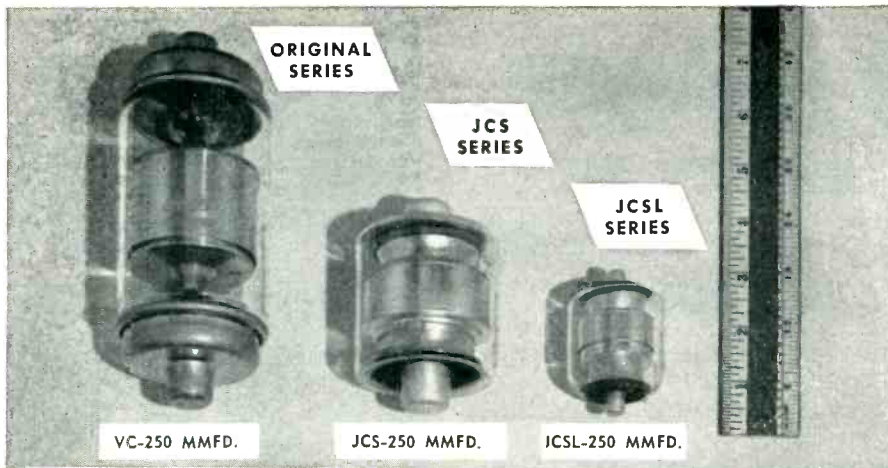

Jennings
—RADIO—
VACUUM ELECTRONIC COMPONENTS

Vacuum

FIXED CAPACITORS MINIATURIZED

For applications involving:

- High frequency operation
- Low inductance
- High voltages and currents
- Temporary overloads
- Negligible power factor

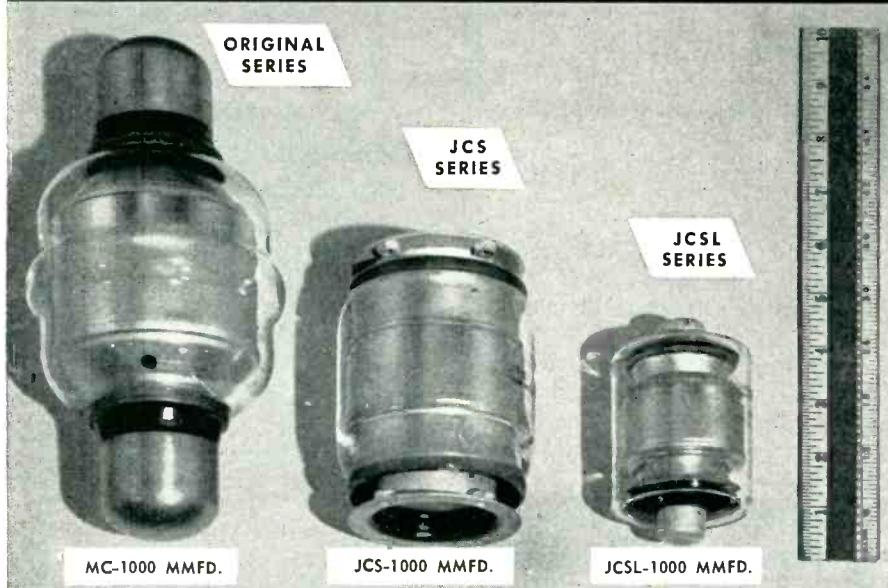

JENNINGS RADIO MANUFACTURING CO. • 970 McLAUGHLIN AVE. • P. O. BOX 1278 • SAN JOSE 8, CAL.

advantages of its direct-writing recorders for industrial users. The recording equipment described and illustrated is available in completely assembled systems that are ready for use in the laboratory or on the job, or as separate instruments fitted with proper connectors for use or integration with other equipment already owned. Typical users are listed, and chief applications and technical data are included.

Acoustical Lens. James B. Lansing Sound, Inc., 2439 Fletcher Drive, Los Angeles 39, Calif. Distributing a uniform sound wave over the entire audio spectrum, the new acoustical lens described in a single-sheet bulletin smooths out the high frequencies. An illustration, dimensional diagram and specifications are included. Also shown are polar diagrams of the directional characteristics of an acoustic lens and a multicellular horn.

Graphic Recorder. Francis L. Moseley, 1136 No. Las Palmas Ave., Los Angeles 38, Calif. A single data sheet presents an instrument that combines in convenient form all facilities needed for the graphic recording of test measurements. In seconds the Autograf illustrated and described in the bulletin will plot curves showing the relationship between a dependent and an independent variable—no reading of meters, no columns of data, no French curves. Complete specifications are given.

TV Studio Lighting. Kliegl Bros., 321 W. 50th St., New York 19, N. Y. A new tv studio lighting and associated facilities planning manual is now available. The manual, in folder form, is complete with tested sample studio plans and informative pictures of actual studios showing lighting facilities in use.

Coating Thickness Gage. Branson Instruments, Inc., 430 Fairfield Ave., Stamford, Conn., has released a 6-page folder describing the theory and operation of the model 600 Coatingage, a portable instrument that is used to measure the thickness of nonmagnetic coatings on magnetic bases and to detect pin-

Why use
microwaves?



READ
ESSENTIALS OF

MICRO- WAVES

By Robert B. Muchmore
Hughes Aircraft Co.

A new book presenting in basic terms—without mathematics—the physical principles and applications of microwaves. Covers wave propagation and reflection, cavity resonators and filters, microwave antennas, electronic devices, noise, microwave radio systems and relays, radar, and microwave measurements.

1952, 236 pages, \$4.50

Write for a copy on 10-day approval

JOHN WILEY & SONS, INC.
440 Fourth Ave. New York 16, N. Y.

SECON

**DEVELOPMENT and PRODUCTION
METALLURGISTS**

Fine wire and ribbon in base, rare, and precious metals, and alloys for new and highly engineered applications. In small units and sizes, and to close tolerances.

Further details on request.

SECON

SECON METALS CORPORATION
228 East 45th Street, N. Y. 17, N. Y., MU 7-1594

BE SAFE WITH

Q-max A-27

LOW-LOSS LACQUER & CEMENT

- Q-Max is widely accepted as the standard for R-F circuit components because it is chemically engineered for this sole purpose.
- Q-Max provides a clear, practically loss-free covering, penetrates deeply, seals out moisture, imparts rigidity and promotes electrical stability.
- Q-Max is easy to apply, dries quickly and adheres to practically all materials. It is useful over a wide temperature range and serves as a mild flux on tinned surfaces.
- Q-Max is an ideal impregnant for "high" Q coils. Coil "Q" remains nearly constant from wet application to dry finish. In 1, 5 and 55 gallon containers.

*Communication
Products Company, Inc.*

MARLBORO, NEW JERSEY
(MONMOUTH COUNTY)
Telephone: FReehold 8-1880

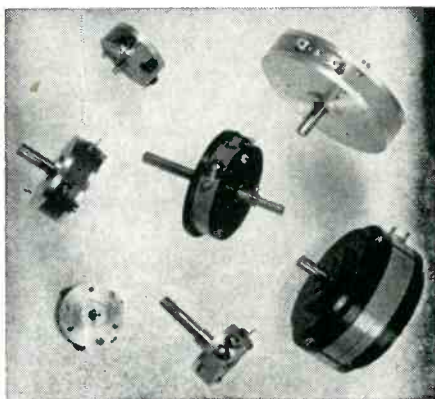

PRECISION POTENTIOMETERS

Type RL-270:

Wedding ring type . . . five sizes charted below. Gamewell Potentiometers are precision instruments in every respect. They feature close limits in electrical characteristics and mechanical construction, low electrical noise, low torque, and long life. All types operate at -55°C . to $+55^{\circ}\text{C}$., 95% relative humidity at altitudes up to 50,000 ft. Non-linear windings are available.

CONDENSED SPECIFICATIONS

	RL-272	RL-270	RL-271	RL-275	RL-277
Diameter (in.)	5	3	2	1 1/2	1 1/4
Rating (watts)	12	6	3	2	1.5
Torque, max. (oz. in.)	1	1	1	1/2	1/2
Weight (oz.)	15	6	3	2	1
Mountings: 3 holes 1/2" deep	#8-32	#8-32	#8-32	#6-32	#4-40
Mounting circle diam. (in.)	3.250	1.750	1.250	1.000	1.000
Max. resistance (ohms) $\pm 10\%$	500,000	275,000	160,000	105,000	64,000
Min. resistance (ohms) $\pm 10\%$	460	250	150	105	80
Max. useful angle (deg.)	358 $\pm 1/2$	356 $\pm 1/2$	354 $\pm 1/2$	352 $\pm 1/2$	350 $\pm 1/2$
Max. resolution (%)	0.05	0.08	0.15	0.2	0.25
Min. resolution (%)	0.01	0.015	0.025	0.04	0.05
Linearity (%)	± 0.10	± 0.10	± 0.15	± 0.25	± 0.30

Standard Shaft: single end, 1/4" extension, specify if otherwise.

Double ended shaft special, specify diameter and length.

Multiple sections can be ganged, add 1/8" to the overall length for each additional section.

Terminals will be positioned on the circumference as required for taps and winding angle.

Expected life of all types over 1,000,000 cycles.

FOR COMPLETE DETAILS SEND FOR BULLETIN F-68-A



THE GAMEWELL COMPANY
NEWTON UPPER FALLS 64, MASSACHUSETTS

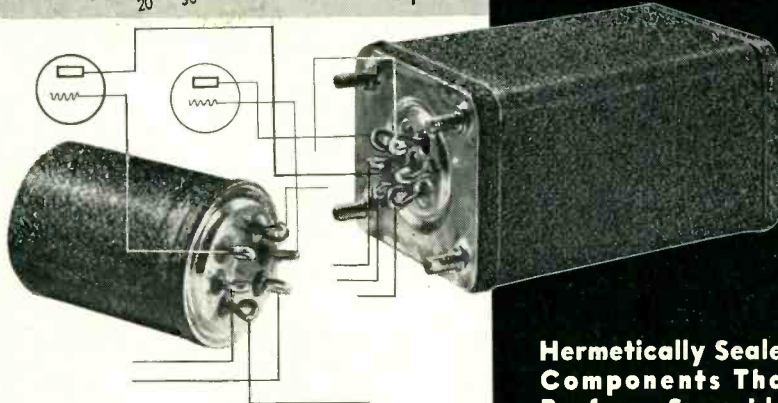

More and more exacting engineers and designers are getting first-hand, *proof* of the rigid, round-the-clock performance standards built into every Milwaukee Transformer Co. product.

Stringent quality control methods combined with modern production facilities and skilled engineering are reasons why you can expect and get "Performance that Exceeds the Demand."

Custom-engineered components for MIL-T-27 government, and commercial requirements.

Quotations submitted upon request.

SPECIALTY ENGINEERING . . . DESIGN,
DEVELOPMENT AND PRODUCTION



Write for your
Free
copy of Catalog
MTR-1

**Hermetically Sealed
Components That
Perform Superbly,
Lastingly In Air-
borne, Ground Ap-
plications.**

**AUDIO, POWER, PULSE
TRANSFORMERS —
REACTORS,
FILTER NETWORKS**



holes in nonconductive coatings on conductive bases. One of the most important applications for the versatile instrument described has been the examination of corrosion-protective coatings for thickness and film continuity. Detailed information on the operation of the equipment is included.

Metal Fasteners. Prestole Corp., 1345 Miami St., Toledo, Ohio, has released a series of engineering application bulletins on patented metal fasteners. Both latching and non-latching types of the "C" and "J" clip fasteners are described, with engineering type of illustrations showing complete details of assembly. Engineering application data including dimensions, minimum panel hole sizes, material weights and screw sizes have been tabulated for easy reference.

Electrical Contact Rivets. Gibson Electric Co., Pittsburgh 21, Pa. Catalog C-521, just published describes the company's line of electrical contact rivets. Discussed in the 6-page folder are contact rivets made from fine silver, coil silver, silver alloys, palladium and powdered metal compositions designated as Ductile Gibsilloys. Standard sizes of flat, crowned and pointed contact rivets are also listed.

Medium-Mu Triode. Lewis and Kaufman, Inc., 50 El Rancho Ave., Los Gatos, Calif. A recent data sheet describes the type 254 medium-mu triode. The tube is illustrated, given outline dimensions and general electrical characteristics. Operating curves are provided for average static characteristics while maximum ratings and typical operation parameters are supplied over three modes of operation: (1) class-B a-f power amplifier; (2) class-C r-f power amplifier, plate unmodulated; and (3) class-C r-f power amplifier, plate modulated.

Transformers and Reactors. Southwestern Industrial Electronics Co., Inc., 2831 Post Oak Road, Houston 19, Texas. An 8-page folder technically describes a line of precision engineered transformers and reactors that feature high induc-

MILWAUKEE TRANSFORMER CO.

5231 NORTH HOPKINS STREET
MILWAUKEE 9, WISCONSIN



RANGE RATE CALIBRATOR



MODEL 312

PROVIDES RAPID CALIBRATION OF BOTH RANGE, AND RANGE RATE OF RADAR RANGING SYSTEMS

RANGE:
0—50,000 yds.
Accuracy .25%

RATE:
0—1,500 knots
Accuracy .5%

PRF
100—10,000 PPS

TRIGGER and TARGET PULSE

INTERNAL or EXTERNAL TRIGGER



Write for Bulletin C-3

MISSOURI RESEARCH LABORATORIES

2109 Locust
St. Louis, Missouri

Test Proven Hermetic Sealing

E-3LW TERMINAL
"E-Series terminals are applicable on MIL requirements and will withstand thermal shock, vibrations, mechanical strains, and excessive pressures with no impairment of the seal or other functional characteristics. E-3LW terminals are now being used at 1000 psi static oil pressure and undergo 5000 psi tests."

1/4" SHAFT WATERSEAL BUSHING
"Rotary Waterseal Panel Assemblies, with GRAF-SIL Packing Glands, have an excellent seven year customer history on gas filled pressurized components. They are available for 1/4" shafts and for potentiometers and switch bushings."

We welcome your inquiries on any phase of design, development or production.

NEO-SIL CORPORATION
26 CORNELISON AVE., JERSEY CITY 4, N. J.

Over 85% of the torque wrenches used in industry are

STURTEVANT TORQUE WRENCHES

Read by Sight, Sound or Feel.

- Permanently Accurate
- Practically Indestructible
- Faster—Easier to use
- Automatic Release
- All Capacities

in inch ounces . . . inch pounds . . . foot pounds
(All Sizes from 0-6000 ft. lbs.)

STURTEVANT TORQUE MANUAL

Every manufacturer, design and production man should have this valuable data. Sent upon request.

PA **STURTEVANT CO.**
ADDISON QUALITY ILLINOIS

PRECISION MOTOR PERFORMANCE

Axial fan blower, 3 phase self-cooled motor is designed to start at a -55°C and feature maximum possible H P per unit weight and volume. The temperature will rise 45°C when fully loaded with 4" 4 blade, 29 degree pitch fan; Silicone wire and impregnation. At full load the input is 94 watts, the line current .54 amperes and the efficiency is 60%.

SPECIFICATIONS
Conform to NEMA Standards and other Gov't specifications.
Continuous duty
WEIGHT 22 oz.
C F M 22 Average
R P M 6250 Average
VOLTS 115
CYCLES 320-1000
can be supplied CW and CCW suitable for 50 to 60 CPS

TYPE A15AF-X1

PERFORMANCE CHARACTERISTICS A15AF-X1

FREQUENCY IN CYCLES PER SECOND	AMPERES	CFM	WATTS INPUT	RPM
300	0.5	25	0	0
400	0.4	20	10	1000
500	0.35	18	15	2000
600	0.3	16	20	3000
700	0.28	15	25	4000
800	0.26	14	30	5000
900	0.25	13	35	6000
1000	0.24	12	40	7000

AIR MARINE MOTORS INC.
2183 JACKSON AVENUE, SEAFORD, L. I., N. Y.
WAntagh 2-7309

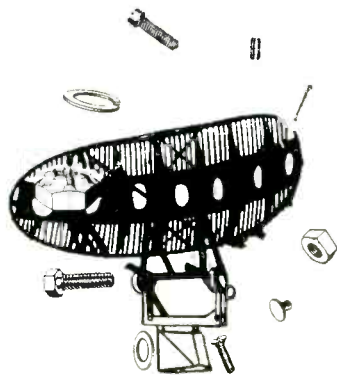

When
you think of
**STAINLESS STEEL
FASTENINGS**
think first
of
ANTI-CORROSIVE

Anti-Corrosive has millions of stainless fastenings in stock (probably the largest selection of varieties and sizes in the world) for immediate delivery. Anti-Corrosive has the exceptional production capacity that can fill your requirements beyond stock items faster, better!



FREE—A-N Stainless Fastening Selector

This handy slide-chart instantly identifies A-N Nos. pertaining to stainless steel nuts, screws, bolts, rivets, cotter pins, washers; gives sizes and other data. Write for "Chart 52H" TODAY!

**25 YEARS OF
LEADERSHIP
IN FASTENINGS OF
STAINLESS STEEL**

Anti-Corrosive
Metal Products Co., Inc.
Manufacturers of **STAINLESS STEEL FASTENINGS**
CASTLETON-ON-HUDSON, NEW YORK

tances, small size, low frequency response, precisely matched characteristics, hermetic sealing, vacuum impregnation, dual coil (hum-bucking) construction, high-permeability cores and drawn mu-metal shields. The catalog also gives information on the company's special transformers and reactors with detailed specifications of some recent designs.

Pulse Transformers. Engineering Research Associates, Inc., 1902 W. Minnehaha Ave., St. Paul 4, Minn. Chief features and characteristics of the type 130A1 three-winding pulse transformer are shown in a single-sheet bulletin. The transformer described is intended for use in triggering and counting circuits, as a blocking oscillator transformer, and for d-c isolation, inversion, pulse-shaping and pulse-transmission circuits.

Snap-Action Switches. Micro Switch, a division of Minneapolis-Honeywell Regulator Co., Freeport, Ill., has published a 24-page, two-color, catalog No. 82 of precision snap-action switches. It covers safety, limit and interlock switches designed especially for switching a-c circuits in industrial and commercial applications. The publication gives complete information on each switch including description, dimensions, mechanical characteristics, electrical characteristics and electrical capacities. Also included are technical data and application ideas.

Soldering Iron. The Kemode Mfg. Co., Inc., 161 W. 18th St., New York 11, N. Y. A single-sheet bulletin covers the new Quik-Shot soldering iron, listing many of its emergency uses. The unit described reaches working temperature in 10 seconds, maintains soldering temperature for 6 to 8 minutes, has a peak wattage rating exceeding 250 watts and accepts 3/8-in., 5/8-in. or 1-in. tips.

Attenuators. The Daven Co., 191 Central ve., Newark 2, N. J., announces availability of its latest brochure on attenuators. A wide variety of controls is shown, in-

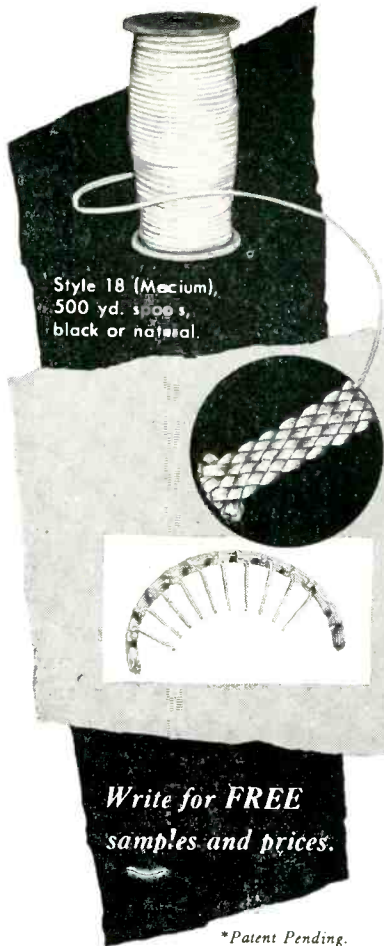

for lacings that stay put!

GUDELACE

BRAIDED NYLON LACING TAPE*

A New and Revolutionary Type of Lacing

- Saves time, saves money, greatly reduces the number of rejects
- Won't "bite through" insulation
- Won't cut wiremen's fingers or cause dermatitis
- Ties easier, ties tighter and cuts down on slipping of knots

Let **GUDELACE** answer your lacing problems.

GUDEBROD BROS. SILK CO., INC.

Electronics Division

Main Office: 12 South 12th Street, Philadelphia 7, Pa.

225 West 34th Street, New York 1, N.Y.

*Patent Pending.

WASHERS—ALL KINDS

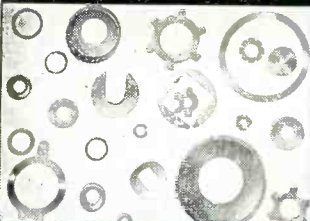

WASHER SPECIALISTS for nearly half-a-century. Dies in stock will produce most sizes. Big runs made with automatic presses. An economical, accurate, and highly reliable source for washers, also all kinds of metal stampings. **HAVE WHITEHEAD'S CATALOG ON FILE;** write for it.

BEVELED CUP
D-HOLE RETAINER
LOCK SPACERS
SPRING TENSION
SQUARE HOLE
STAR LOCK
THRUST TONGUE



EST. 1903

WHITEHEAD STAMPING COMPANY

1691 W. LAFAYETTE

DETROIT 16, MICH.

FOR QUALITY • QUANTITY — QUICKLY

SPECIFY

DAGE

RADIO FREQUENCY CONNECTORS

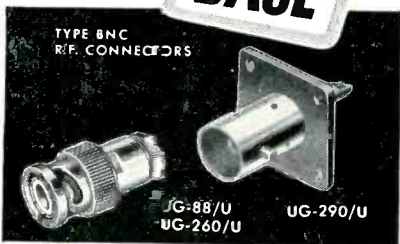

TYPE BNC R.F. CONNECTORS

JG-88/U
UG-260/U

UG-290/U

• Dage specializes in the manufacture of the *finest* in Type BNC, Type N and special radio frequency connectors. Your requirements for radio frequency connectors will be met quickly and efficiently by Dage. All Dage connectors are manufactured in strict accordance with military specifications. Write Dage today.



QUALITY
QUANTITY
QUICKLY

DAGE

DAGE ELECTRIC COMPANY, INC.

62 North Second Street • Beech Grove, Indiana

THE SAR PULSESCOPE

BY WATERMAN

MODEL S-4-A



Weight 31.5 lbs.
9 1/4" x 11 1/4"
x 17 1/4"

Another example of **WATERMAN** pioneering, a compact, portable instrument for precision pulse measurements adaptable for all electronic work, including radar and TV. **S-4-A SAR PULSESCOPE** will portray all attributes of the pulse; such as shape, amplitude, duration and time displacement. In **S** mode of operation, the unit functions as a wide band oscilloscope, with optional video delay, in either repetitive or triggered sweep conditions. In **A** mode of operation the unit functions as a precision time measuring device, with internal crystal controlled markers available for self calibration. In **R** mode of operation a desired small segment of **A** Sweep is expanded to fill the face of the tube for detailed observation.

Video Amplifier band pass up to 11 mc... optional Video delay 0.55 μ s... Pulse rise and fall time better than 0.07 μ s... Video sensitivity of 0.5 p to p/inch... **S** Sweep 80 cycles to 400 KC either triggered or repetitive... **A** Sweep 1.2 μ s to 12,000 μ s, **R** Delay 3 μ s to 10,000 μ s... Directly calibrated on a precision dial... **R** Pedestal (or sweep) 2.4 μ s to 24 μ s... **A** & **R** Sweep Triggers available externally... Internal crystal markers of 10 μ s \pm 50 μ s... Built in precision amplitude calibration... Operates on 50 to 1000 cycles at 115V AC.

WATERMAN PRODUCTS CO., INC.

PHILADELPHIA 25, PA.
CABLE ADDRESS: POKETSCOPE

WATERMAN PRODUCTS INCLUDE:

S-5-A LAB	PULSESCOPE
S-10-B GENERAL	POKETSCOPE
S-11-A INDUSTRIAL	POKETSCOPE
S-14-A HIGH GAIN	POKETSCOPE
S-14-B WIDE BAND	POKETSCOPE
S-15-A TWIN TUBE	POKETSCOPE

Also **RAYONIC** Cathode Ray Tubes
RAKSCOPES and other equipment



Everybody likes the TARZIAN TUNER!

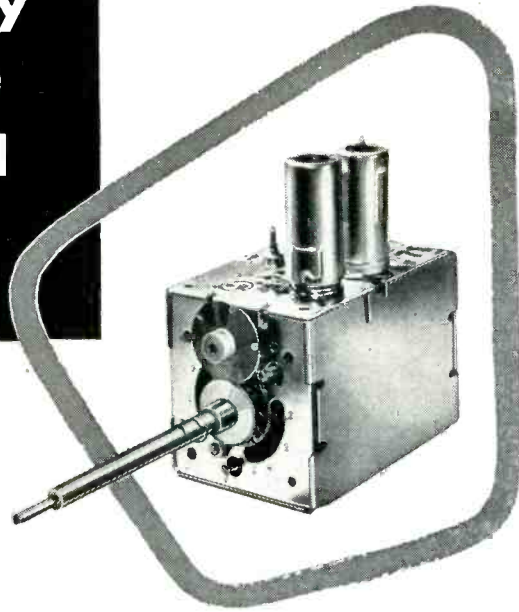

ENGINEERS like it because they appreciate the fine, scientifically-engineered qualities and features found in no other commercial tuner unit. And, they are especially enthusiastic about the Tarzian approach to UHF.

PURCHASING AGENTS like it because it's competitively priced and offers more value per dollar than any other commercial tuner.

THE CONSUMER or set buyer is happy with the excellent performance of his receiver, although he doesn't have the slightest idea of the importance of the TARZIAN TUNER in the satisfactory operation of his set.

SERVICEMEN like it because of the simplicity in servicing and aligning.

SARKES TARZIAN, INC.

Tuner Division, Bloomington, Indiana

TARZIAN MADE PRODUCTS



Tuners



Air Trimmers



Selenium Rectifiers



Cathode-Ray and Receiving Tubes

STATIONS WTTs (5000 WATTS) AND WTTV (CHANNEL 10)
OWNED AND OPERATED BY SARKES TARZIAN IN BLOOMINGTON

cluding r-f attenuators, special units for precision measuring equipment, tone-compensating attenuators, stereophonic controls and "T", balanced-"H", ladder and potentiometer type audio attenuators. Each unit is discussed separately with photographs of the unit, complete descriptions, charts and diagrams.

TV Broadcast Equipment. Allen B. DuMont Laboratories, Inc., 1500 Main Ave., Clifton, N. J. A new 20-page booklet on the universal image orthicon tv camera chain model TA-124-E is now available to tv station personnel, prospective tv broadcasters and others in the tv and radio industry. The booklet, profusely illustrated with photos and drawings of the camera and its associated equipment, explains how a single triple-duty chain can be used in studios, in the field and for film pickup. A clearly written specifications section of the booklet gives pertinent facts and figures on power supplies, monitors, generators and similar associated equipment together with the camera unit itself.

Toroidal Inductors. Lenkurt Electric Sales Co., 1113 County Road, San Carlos, Calif. Precision-wound high-Q toroidal inductors are listed in the new 4-page bulletin TL-P4. Five different types of coils are available with or without hermetically sealed cases. Included in the bulletins are Q curves and other design data for representative standard values of the varied coil types. The coils listed make available a wide range of inductance values between 1 imh and 80 henrys. Information is also included about the effect of direct current on the inductance values of each type of coil.

Identification Markers. Westline Products Division of Western Lithograph Co., 600 E. Second St., Los Angeles 54, Calif. The use of pressure-sensitive self-adhering printed identification for cable, conduit and pipe is described in a recent folder. Method of application and chief features are outlined. A stock list and order form are included.

U. G. CONNECTORS

*Our Coaxial Cable
Connectors Meet All
Government Specifications*

★ ALL ORDERS DELIVERED PROMPTLY ★

*Manufacturers of
Highest Quality Connectors*

ALLIED INDUSTRIES, INC.

1023 S. 21st STREET
LOUISVILLE 10, KY.

Phone Arlington 4640

DIGITAL COMPUTER ENGINEERS

ELECTRICAL ENGINEERS and PHYSICISTS

needed for circuit design and development. Engineers and Physicists with 1 to 4 years experience in pulse circuits, pulse handling techniques, and systems development. Openings also for recent graduates.

● Replies strictly confidential

● Interviews arranged at our expense

Engineering Research Associates, Inc. 

A Subsidiary of Remington Rand

Leaders in the Development of Digital Computers

1902 W. Minnehaha, St. Paul 4, Minn. ● "You Will Enjoy Living in Minnesota"

MODEL B-2

PULSE GENERATOR

- 10 cycles to 100 kc repetition rate
- .2 μ s to 1,000 μ s pulse widths at 100 ohms impedance—100 volts open circuit
- 0 to 10,000 μ s delays
- 6 output pulses for synchronizing at various intervals during single repetition period



Write for complete data: our bulletin E-B-2

Rutherford ELECTRONICS CO. 3707 S. ROBERTSON BLVD.
CULVER CITY, CALIFORNIA

**ASSEMBLY
SAVINGS**
Pay for
PEMS

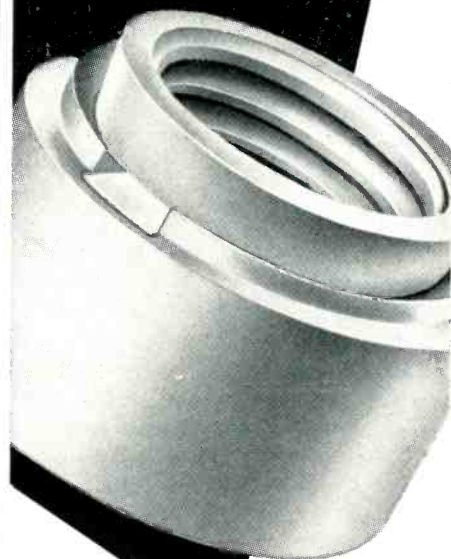

"Clinched by a squeeze, with the Greatest of Ease"—PEM Nuts are the answer to load bearing threads in steel, aluminum, brass or copper sheets —"Too thin to Thread".

More than 600 leading manufacturers have standardized on these self-clinching fasteners because simplified assembly of one or several at a time, with standard tools, soon pays for their low cost.

Positive lock prevents turning of fasteners. Reverse side of sheet remains flush. No swedged rim projects.

Write for literature and samples for trial, Penn Engineering & Manufacturing Corp., Doylestown, Pa.

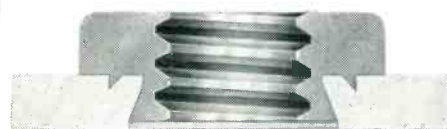

PEM



PLANTS AND PEOPLE

Edited by WILLIAM P. O'BRIEN

West Coast Firm Changes Hands

KAAR ENGINEERING CORP. of Palo Alto, Calif., manufacturer of radio-telephone equipment, has been purchased by Pacific Associates, Inc., San Francisco, Calif.

John M. Kaar, who founded the firm 16 years ago, will retain one-sixth interest and will be vice-president, chief engineer and a director.

Pacific Associates plans to supply additional capital for expansion through public offering of its prior preference stock. Sales of some \$500,000 are expected in 1952 of which about 90 percent will be two-way mobile radio equipment, with the balance in marine depth sounders, direction finders and accessories.

Jensen Honored

AXEL G. JENSEN, director of television research at Bell Telephone Laboratories, has been named winner of the David Sarnoff Gold Medal. The award is presented each year by the Society of Motion Picture and Television Engineers "in recognition of recent technical contributions to the art of television."

In July Mr. Jensen was honored for his work in tv research when the Royal Technical University of Denmark awarded him the George A. Hagemann Gold Medal.

He celebrated his 30th anniversary



A. G. Jensen, winner of SMPTE award

sary with Bell Labs this year. Joining the Labs in 1922, he spent about four years in radio work. For the next five years he was in charge of a London test station operated in connection with the development of transatlantic short-wave telephone service. In 1930 he returned to the U.S. to work on coaxial cable projects. He has been engaged in tv research since 1935.

Companies in Northwest Pool Facilities

THE Northwest Association of Electronic Manufacturers was formed recently in Portland, Ore., with membership open to firms operating in Oregon, Washington and Idaho. Purpose of the organization is trade promotion, attraction of new electronic industry to the area and mutual assistance.

The 17 manufacturing firms now included in the group are planning to pool their facilities for large contracts, pool orders for common supply items, establish industry job classifications and act as a clearing house for available surplus inventory facilities.

Electric Regulator Completes Plant

CONSTRUCTION of the new 15,600-sq ft plant and administrative building of the Electric Regulator Corp. in Norwalk, Conn., has been completed. The modern plant houses extensive laboratory, toolroom and assembly facilities for the production of the Regohm, an electric circuit controller that has found wide application in power equipment for government and industrial use. Other products will be developed here in addition to the basic Regohm unit, including associated control equipment and regulating and control systems.

The plant is currently employing

OTHER DEPARTMENTS featured in this issue:

	Page
Electrons At Work.....	168
Production Techniques.....	266
New Products.....	310
New Books.....	414
Backtalk.....	430



Electric Regulator's new plant

more than 110 people. It is expected that this number will be substantially increased under the impact of defense production demands and a rapidly expanding civilian business.

Williams Joins Telecomputing Corp.

JAMES V. WILLIAMS has been named project engineer for the Telecomputing Corp., Burbank, Calif., manufacturer of electronic data analysis equipment. He was former senior development engineer with International Business Machines Corp., and will be working with Telecomputing's development agreement between that company and IBM.

CEC's New Plant in Operation

CONTROL ENGINEERING CORP., formerly of Canton, Mass., is now in operation at its new enlarged headquarters located on a seven-acre tract in Norwood, Mass.

The new building provides space for the development of a new line

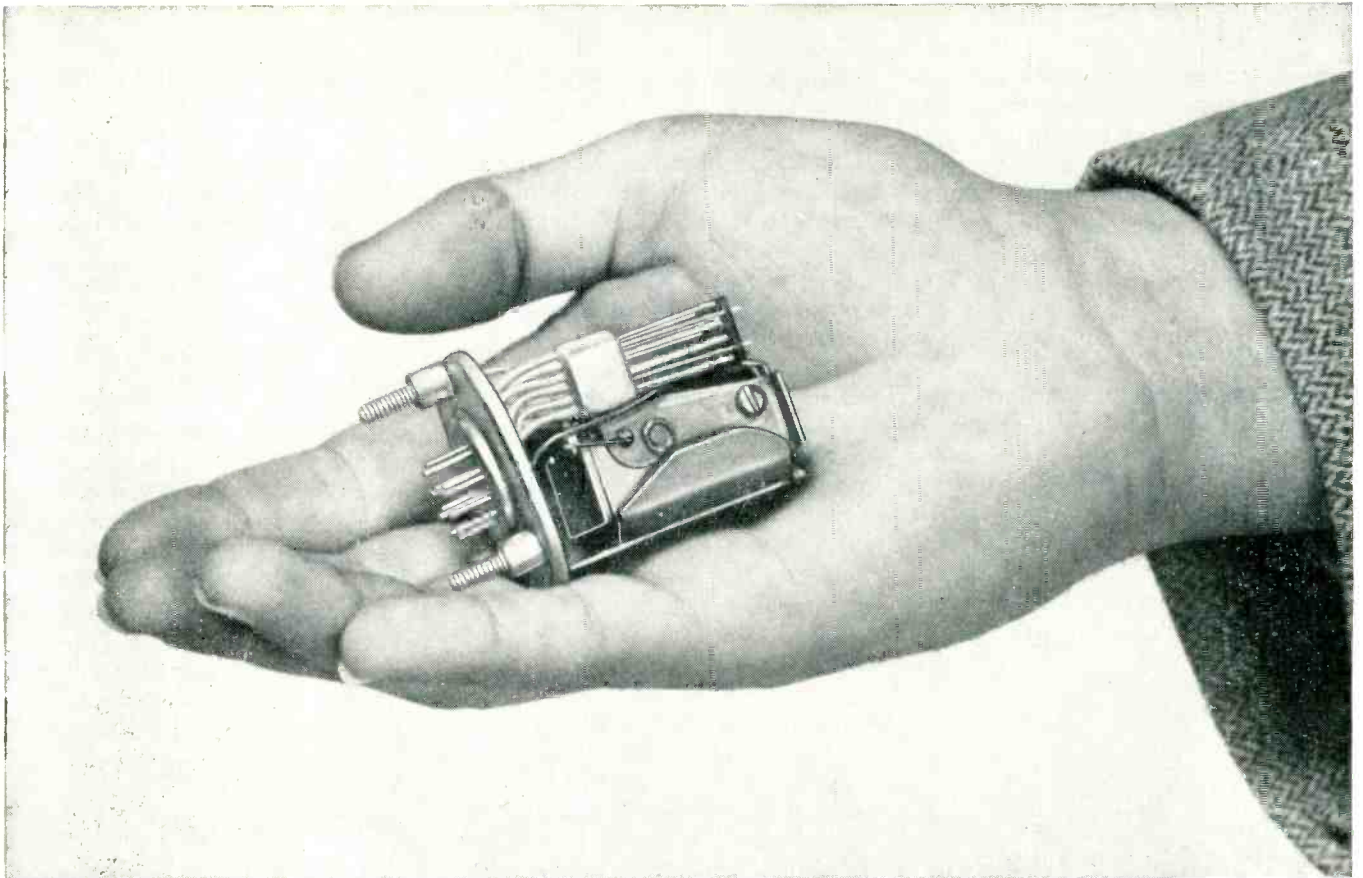

New G-E Relay Doubles Tip Pressure

Hermetically-sealed unit has larger magnet, no extra weight

Double the average tip pressure, 40-55 grams, is delivered by the larger magnet structure of the new G-E relay without exceeding Air Force-Navy specifications for size and weight.

The new relay, the first specifically designed for hermetic sealing, will withstand 50g operational shocks and instantaneous voltage surges up to 1500 volts rms *without failure*.

LONGER RELAY LIFE

The large magnet, polyester stack insulation, and silver-tipped contacts assure reliable, long-lived operation in aircraft, shipboard, portable land-based equipment and other systems which must meet Air Force-Navy specifications.

In every way, this new G-E relay is in a world of its own—sealed in a standard size enclosure against dirt, salt spray, high humidity, and widely varying air pressures.

RELIABLE SHIPMENT

This new device is now in full production and shipment can be made to meet your schedules.

Ask your nearest G-E office for more information, and send the attached coupon today. *General Electric Company, Schenectady 5, New York.*

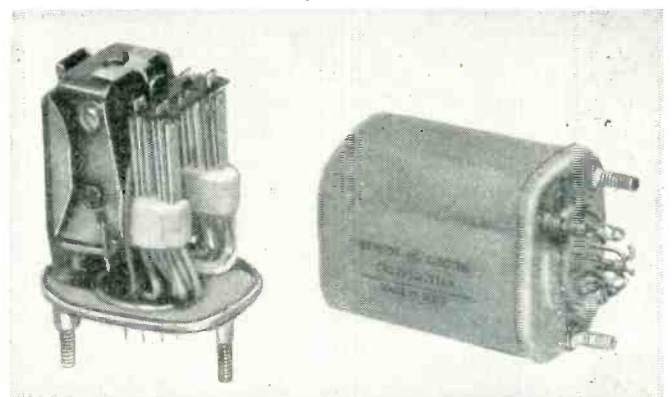

THE LARGER MAGNET is made possible by an exclusive G-E design which utilizes the relay housing for structural support, thus eliminating much of the weight of internal bracing.

General Electric Company
Section C 730-41
Schenectady 5, New York

Gentlemen:

I would like copies of Bulletin GEA-5729 on hermetically-sealed relays for:

reference only an immediate project

Name Title

Company

Address

City State

GENERAL  **ELECTRIC**

of instrumentation for the commercial market to supplement the company's current industrial instrument line and its electronic equipment manufactured under government contract for use in radar installations, guided missiles and gunfire control systems.

Giannini & Co. Adds to Staff

Two appointments were recently announced by the G. M. Giannini & Co., Inc. of Pasadena, Calif., manufacturers of precision instruments and controls for aircraft, missile and industrial measuring applications.

B. J. Garnett was named assistant chief engineer, airborne equip-



B. J. Garnett, assistant chief engineer

ment. For the past ten years he had been in charge of design of aircraft and missile components for Vard Inc. of Pasadena.

John Bodnar is now manager of potentiometer sales. He was for-



J. Bodnar, manager of potentiometer sales

merly an engineer with Radio Corp. of America, and also served as sales engineer for the Brush Development Co.

Transducer Corp. Made AMF Division

MERGER of Transducer Corp. of Boston, Mass., with its parent company, American Machine & Foundry Co., has been announced. Transducer, formerly AMF's electronic subsidiary, now becomes the company's electronic division.

A leading manufacturer of electronic and ultrasonic trainers for the Air Force, Transducer was purchased by AMF as its electronic subsidiary in 1948. Its products are employed for instruction of radar gunners and navigational bombardiers. It also makes radar systems and precision computers adaptable to radar work on a sub-contract basis.

Currently the new AMF electronic division is working on more than \$17,000,000 worth of government contracts in 315,000 sq ft of floor space at 1085 Commonwealth Ave., Boston, Mass., with a labor force of more than 1,400 employees.

Consulting Office Opened

LEONARD R. KAHN announces the opening of an electronics and communications consulting office at 22 Pine St., Freeport, L. I., N. Y.

Before opening his office Mr. Kahn was associated with Crosby Laboratories where he specialized in communication studies. While with Crosby Labs he worked on diversity receiving systems, single-sideband reception, the design of phase - modulation transmitting equipment, frequency modulation analysis and classified Armed Forces projects.

Westinghouse Engineer Receives Award

PHILIP E. VOLZ, section engineer for the Westinghouse Electronic Tube Division, has been named a winner of the \$200 award in a continuous contest for the best patent disclosure out of each 50 submitted by engineers of the Division. Mr. Volz's disclosure concerned an improved method of increasing the power and efficiency of high-fre-

quency generating tubes salient to the operation of radar.

He has been with the company's Electronic Tube Division since 1951, and is currently an engineer in the microwave generators section of the division.

Philco Inaugurates Radio Division

IN RECOGNITION of the size and importance of its radio business, Philco Corp. is establishing a separate Radio Division so that even greater emphasis can be put on all phases of the company's activities in the home and auto radio field.

William H. Chaffee has been appointed vice-president of the newly-formed division, which is under the direction of Frederick D. Ogilby.

Engineer Becomes Sales Exec

TO HEAD UP a newly created national sales engineering organization, Bendix Aviation Corp. has named Lawrence J. Straw as Mobile Sales Manager.

Straw joined Bendix in February 1952, having previously been associated with Capehart-Farnsworth. Prior to this he had been associated with Raymond Rosen Engineering



L. J. Straw, new Mobile Sales Manager for Bendix Radio

Products in Philadelphia as an electronic engineer responsible for equipment and system design of telemetry projects for the U. S. Air Force and the AEC, and as an electronic engineer at the Philadelphia

BRASS
CO.

for "Bridgeport" Service



OFFICES AND
WAREHOUSES IN
PRINCIPAL CITIES



Brass with a higher "I. Q."

Are you using metal with a sufficiently high "I.Q." (Inner Quality) to give your product

- ... the quality you are aiming for?
- ... lower production cost?
- ... fewer rejected parts?
- ... greater metal economy?
- ... higher strength, toughness and resistance to wear and corrosion?

BRING YOUR METAL PROBLEMS TO BRIDGEPORT BRASS

Bridgeport metals have the high "I.Q." you need. They are specially made to meet your particular requirements in alloy composition ... width and gauge tolerances ... temper ... grain size ... surface ... ductility ... machinability ... and other physical, mechanical and electrical properties.

Bridgeport mill products are made under strict laboratory control to meet customer specifications *exactly*.

The Bridgeport laboratory will gladly work with you to help solve your metal problems.

Mills in Bridgeport, Conn. and Indianapolis, Ind.
In Canada: Noranda Copper and Brass Limited, Montreal

BRIDGEPORT BRASS COMPANY



30 GRAND STREET, BRIDGEPORT 2, CONNECTICUT

pyroferric iron cores

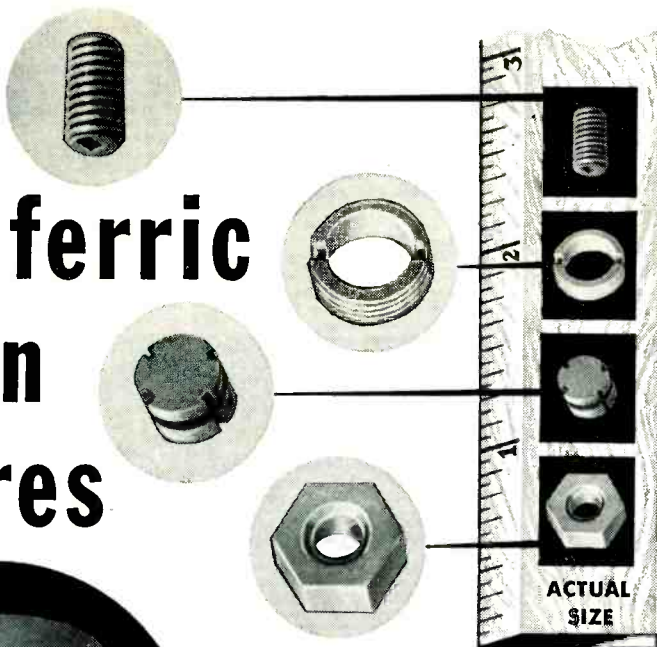

PYROFERRIC IRON CORES are scientifically manufactured, under strictest quality controls and rigid maintenance of close electrical and mechanical tolerances.

PYROFERRIC services are available for the engineering of your core production requirements . . . your letterhead request for Catalog 22A will bring you complete information including the manufacture of iron cores, their electrical properties, materials, design considerations, standardization data, uses and other helpful data.

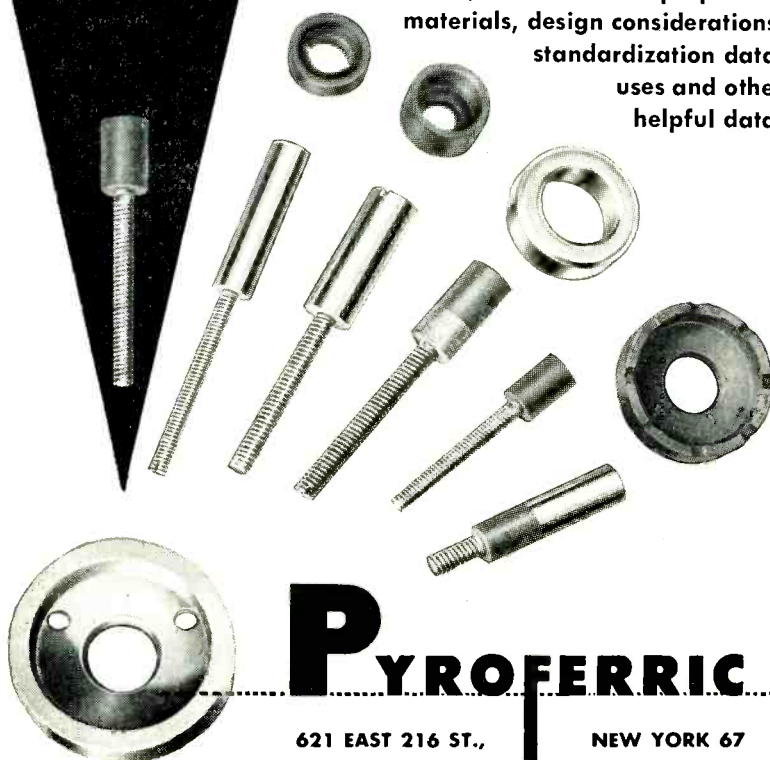

PYROFERRIC

621 EAST 216 ST., NEW YORK 67

Naval Base where he was responsible for vhf, uhf and radar systems design on the Aircraft Carrier Conversion Program.

Pettit Wins Achievement Award

ANNOUNCEMENT of the new Western Electronic Achievement Award to Dr. J. M. Pettit of Stanford U. was the culmination of the recent Pacific Region IRE conclave at the Long Beach, Calif., Municipal Auditorium.

The award, first to be made by the 7th Region of IRE, honored Dr. Pettit for major contributions to electronics. Selection was made from among 5,000 IRE members in the Pacific Region.

In 1949 Dr. Pettit was awarded the Presidential Certificate of Merit for his outstanding work during World War II and since in the field of electronics. His war work at Radio Research Laboratories involved detailed supervision of the development of the AN/APR-1 and AN/APR-4 radar search receivers. He also assisted in getting them into production.

Skiatron Gets Research Director

HENRY F. IVEY, formerly associated with the Westinghouse Electric Corp., was recently appointed director of research and development of the Skiatron Electronics and Television Corp.

In his new post he will coordinate Skiatron's activities in the field of subscription television, where the company has developed a pay-as-you-see system, and will also jointly develop, with Wayne B. Nottingham, the company's dark-trace tube for use in the military and industrial fields.

Raytheon to Lease New Plant

NEGOTIATIONS are being completed by Raytheon Mfg. Co., of Waltham, Mass., for a lease of the South Lowell Ordnance Plant previously occupied by Davis Aircraft Co. on Woburn St. in South Lowell, Mass.

Engineering and production work

TRANSFORMERS

MIL-T-27

& COMMERCIAL

- Pulse
- Audio
- Power
- Filter Choke
- Filament
- RF Coils

Custom Built to Your Specifications

**WE SOLICIT ONLY
SAMPLES and SHORT
RUN PRODUCTION**

Present Delivery Schedule:
2-4 weeks

**STERLING TRANSFORMER
CORP.**

297 North 7th St., Brooklyn 11, N. Y.

IS ELECTRIC COMPONENT COORDINATION

YOUR JOB?

Live and work in California's most favorable smog-free region. Well-established expanding company with unlimited opportunity for advancement.

Applications engineer capable of analyzing large-scale customer requirements and making engineering decisions concerning filters, transformers, and associated components. Familiarity with toroidal inductors using powder-iron cores desirable.

Send full background particulars to:

Gerd D. Wallenstein
LENKURT ELECTRIC COMPANY
1105 County Road
San Carlos, California

ACME'S *New* REGULATED D.C. POWER SUPPLIES

NO TUBES

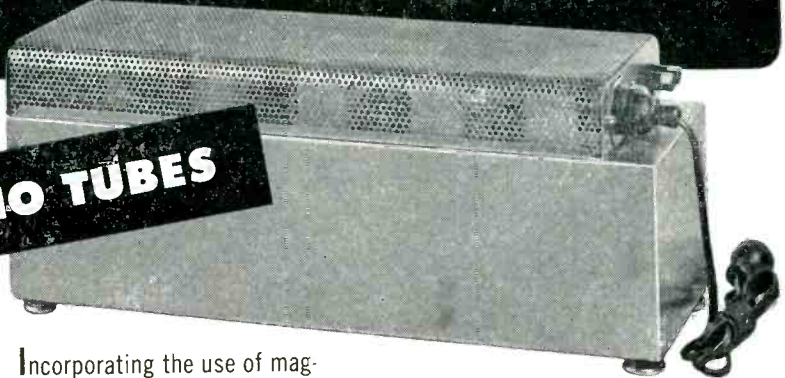

Incorporating the use of magnetic amplifier techniques — eliminating all vacuum tubes — this new Acme Regulated Power Supply provides an extremely dependable, trouble-free precision unit for both industrial and laboratory use. Because of the absence of all tubes, the equipment will give a minimum of 20,000 hours continuous service. It is available in a variety of voltages and frequencies.

Write for complete information.

ACME ELECTRONICS, INC., 300 N. LAKE AVENUE, PASADENA 4, CALIF.

Acme Model S-715 60-cycle Regulated Power Supply. 300 volt D.C. output with $\pm 1\%$ regulation from 0 to 200 MA, with less than .1% ripple.



- EXTRA FLEXIBILITY
- FREE STRIPPING
- HIGH DIELECTRIC
- RATING -55 TO +250°C

*Black, brown, red, orange, yellow, green, blue, violet (purple), grey (slate), white, tan, pink (flesh), light green, light blue.

Built to meet rigid government requirements, Tensolon Hook-up Wires are available in sizes from AWG30 through 20 with stranded silver-plated copper conductors and the patented Tensulated Teflon® covering which eliminates pin holes and other irregularities.

SPECIAL KIT FOR LABORATORY REQUIREMENTS —

Twelve 100 ft. rolls of AWG 22, in assorted colors in convenient compact container

\$124.00



TENSOLITE INSULATED WIRE CO., INC., TARRYTOWN, N. Y.

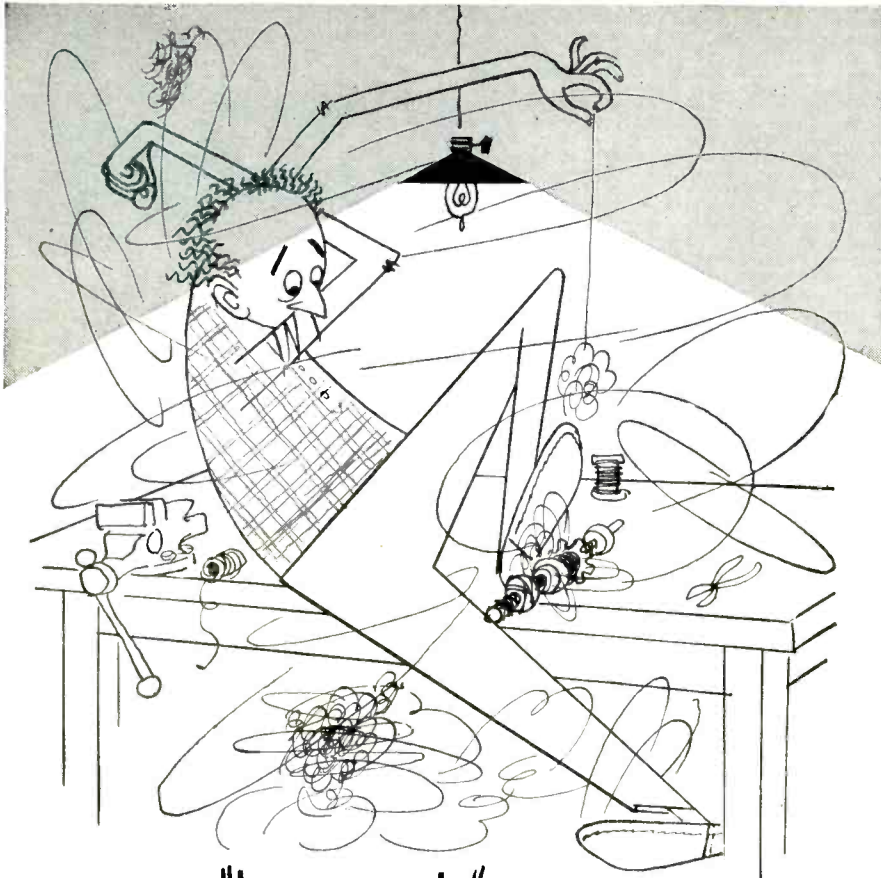

what are "home-made" coils costing you?

"Home-made coils cost us far too much", you'll say when you balance *all* the costs, wasted time and materials, production delays and excessive rejects against Clippard production-engineered coils.

Clippard specialists have made a career of coil and sub-assembly work... quickly turn out runs of 1,000... 10,000... 1,000,000 or more units using specially designed high-speed equipment of laboratory accuracy.

For you, as for many of the nation's leading electronic and electrical manufacturers, they'll whip production delays, hasten delivery dates, cut costs.

Often, Clippard works out design improvements that save money, critical materials and valuable time.

Devote your production facilities to more profitable work. Turn your coil winding and sub-assembly jobs over to Clippard. Savings will be greater than you thought possible.

WRITE TODAY,
describing your requirements.



PRODUCTION TESTING Resistors and Condensers?

Send for catalog sheets describing Clippard PR-5 Resistance Comparator and PC-4 Capacitance Comparator. Each will soon earn its keep in your plant by allowing unskilled operators to check more than 30 components per minute with laboratory accuracy.

Clippard

INSTRUMENT LABORATORY INC.

7350-90 Colerain Road • Cincinnati 24, Ohio

MANUFACTURERS OF R. F. COILS
AND ELECTRONIC EQUIPMENT

Phone JACKSON 4261

of an undisclosed nature for the U.S. government will be carried out there initially, with about 700 employees, but it is expected that operations will be enlarged on a gradually increasing scale as new employees are added and trained.

Weathers Opens New Plant

WEATHERS INDUSTRIES, manufacturers of f-m phonograph pickups, announce the opening of a new one-story modern factory at 66 E. Gloucester Pike at Barrington, N. J. The plant was formerly located in West Collingswood, N. J.

One of the new plant's many features is the series of sound laboratories and listening rooms devoted to the perfection of sound reproducing equipment.

Motorola Promotes Samuelson

ROBERT E. SAMUELSON has been promoted to chief engineer, Motorola Research Laboratory, Phoenix, Arizona.



R. E. Samuelson, new chief engineer

Immediately prior to this recent appointment Dr. Samuelson was head of the Communications Research Section.

Culver Joins Trinity U.

CHARLES A. CULVER, senior physicist for Southwest Research Institute and dean of professional development at the Essar Research Center, has been appointed chairman of the department of physics at Trinity University, San Antonio, Texas.

He was chief high-frequency

XCELITE Hand Tools
 PREFERRED BY THE EXPERTS

Get XCELITE Nutdrivers
 in a complete range of sizes!



You'll wish you'd
 done it sooner when
 you see how a

complete set of XCELITE Nutdrivers speeds—
 and eases the job! You can choose from a
 blade length of 6" down to Stubby (3 1/4" over-
 all). You can get all regular nut drivers in
 nine nut sizes, 3/16" to 1/2", Stubby drivers in
 1/4", 5/16" and 3/8". And XCELITE hollow
 shaft nut drivers come in seven nut sizes—
 insulated if desired. WRITE today for our
 complete catalog!

XCELITE INCORPORATED

(formerly Park Metalware Co., Inc.)
 Dept. C
 ORCHARD PARK, N. Y.

Originators—
 Nat Imitators

For Originality
 LOOK TO **XCELITE**

*Here's the
 Answer...*



to your
**OPEN WIRING
 CABLE SUPPORT
 PROBLEMS**

Use the
**ALL NYLON
 "NyLoc"
 CABLE CLIPS**

for tough
 conditions
 and unusual
 heat, etc.

NEW!

Use the
**ETHYL CELLULOSE
 "EthoLoc"
 CABLE CLIPS**

for average
 conditions
 and maximum
 economy



Send for details and FREE samples.
WECKESSER COMPANY
 5267 N. Avondale Ave. Chicago 30, Ill.

Presenting

OPPORTUNITIES
 for
ENGINEERS
 and
SCIENTISTS

The
Franklin Institute

FOUNDED 1824

In Our Research & Development Laboratories

FIELDS OF INTEREST ARE:

- Electrical Computer Design & Development
- Mathematical Analysis of Physical Problems
- Industrial & Military Instrument Design
- Industrial & Marine Power Drives
- Modern Communications Theory
- Electrical Machinery Design
- Circuit Analysis • Servomechanisms
- Air Traffic Control

Permanent Employment, Liberal Em-
 ployee Benefits, Opportunity for Study
 in Local Colleges.

Send Resume of Education & Experience,
 Salary Desired & Photograph to PER-
 SONNEL DEPARTMENT, BENJAMIN
 FRANKLIN PARKWAY at 20th ST.,
 PHILADELPHIA 3, PA.



photograph it!

*A photo record is quicker, more accurate;
 and it may prove to be priceless.*

THE ADVANCED single-lens reflex design of the 35-mm.
 PRAKTIKA FX makes it easier for you to get expert
 photomicrographs, oscillographs, extreme close-ups, copy work,
 etc., in black and white or natural color. Use it for:
 Recording lab and field observations, quality control,
 inspections, photographing equipment in field, training
 personnel, etc. Excellent for the home photographer, too.
 From \$99.50 to \$199.50 (tax incl.).
 The Praktica Co., Inc.,
 48 W. 29 St., N. Y. 1, N. Y.

**39 tested ideas
 Free for you!**

**PRAKTIKA
 FX**

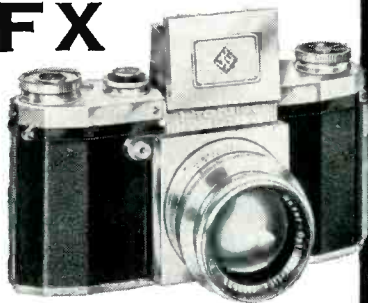

35-MM. SINGLE-LENS REFLEX CAMERA

The Praktica Co., Inc. Dept. F-112
 48 West 29th Street, N. Y. 1, N. Y.

Please send me a copy of "PHOTO-
 GRAPHY IN SCIENCE AND INDUSTRY."

Name.....
 Position.....
 Company.....
 Address.....
 City..... Zone... State.....

Autosyn* SYNCHROS Precision-Built by ECLIPSE-PIONEER



For more than 18 years, Eclipse-Pioneer has been a leader in the development and production of high precision synchros for use in automatic control circuits of aircraft, marine and other industrial applications. Today, thanks to this long experience and specialization, Eclipse-Pioneer has available a complete line of standard (1.431" dia. X 1.631" lg.) and Pygmy (0.937" dia. X 1.278" lg.) Autosyn synchros of unmatched precision. Furthermore, current production quantities and techniques have reduced cost to a new low. For either present or future requirements, it will pay you to investigate Eclipse-Pioneer high precision at the new low cost.

*REG. TRADE MARK BENDIX AVIATION CORPORATION

AVERAGE ELECTRICAL CHARACTERISTICS—AY-200 SERIES**

	Type Number	Input Voltage Nominal Excitation	Input Current Milliamperes	Input Power Watts	Input Impedance Ohms	Stator Output Voltages Line to Line	Rotor Resistance (DC) Ohms	Stator Resistance (DC) Ohms	Maximum Error Spread Minutes
Transmitters	AY201-1	26V, 400~, 1 ph.	225	1.25	25+j115	11.8	9.5	3.5	15
	AY201-4	26V, 400~, 1 ph.	100	0.45	45+j225	11.8	16.0	6.7	20
Receivers	AY201-2	26V, 400~, 1 ph.	100	0.45	45+j225	11.8	16.0	6.7	45
Control Transformers	AY201-3	From Trans. Autosyn	Dependent Upon Circuit Design				42.0	10.8	15
	AY201-5	From Trans. Autosyn	Dependent Upon Circuit Design				250.0	63.0	15
Resolvers	AY221-3	26V, 400~, 1 ph.	60	0.35	108+j425	11.8	53.0	12.5	20
	AY241-5	1V, 30~, 1 ph.	3.7	—	240+j130	0.34	239.0	180.0	40
Differentials	AY231-3	From Trans. Autosyn	Dependent Upon Circuit Design				14.0	10.8	20

**Also includes High Frequency Resolvers designed for use up to 100KC (AY251-24)

AY-500 (PYGMY) SERIES

Transmitters	AY503-4	26V, 400~, 1 ph.	235	2.2	45+j100	11.8	25.0	10.5	24
Receivers	AY503-2	26V, 400~, 1 ph.	235	2.2	45+j100	11.8	23.0	10.5	90
Control Transformers	AY503-3	From Trans. Autosyn	Dependent Upon Circuit Design				170.0	45.0	24
	AY503-5	From Trans. Autosyn	Dependent Upon Circuit Design				550.0	188.0	30
Resolvers	AY523-3	26V, 400~, 1 ph.	45	0.5	290+j490	11.8	210.0	42.0	30
	AY543-5	26V, 400~, 1 ph.	9	0.1	900+j2200	11.8	560.0	165.0	30
Differentials	AY533-3	From Trans. Autosyn	Dependent Upon Circuit Design				45.0	93.0	30

For detailed information, write to Dept. C.

ECLIPSE-PIONEER DIVISION of
TETERBORO, NEW JERSEY



Export Sales: Bendix International Division, 72 Fifth Avenue, New York 11, N. Y.

engineer for Canadian Radio Corp. from 1920 to 1923, professor of physics at Carlton College from 1923 to 1946, and professor at Park College from 1947 to 1951. Dr. Culver holds various U. S. and foreign patents relating to communications engineering.

Melpar Staff Additions

RALPH I. COLE, formerly technical director of the Rome Air Development Center, and Vernon C. Weihe, formerly systems engineer for the Air Transport Association, have joined the engineering staff of Melpar, Inc., Alexandria, Va.

Mr. Cole is chairman of the IRE Professional Group on Engineering



R. I. Cole

Management and a member of the Research and Development Boards Radar Panel.

Vernon Weihe was formerly chief engineer of the Communications and Navigation Laboratory at the



V. C. Weihe

DANDUX
specification designed

**CANVAS
and leather
PRODUCTS**



Carbine
Clip Bag

Padded
Instrument Bag

BG BAGS—CW BAGS
CARBINE CLIP BAG
TOOL ROLLS—BAGS & CASES

for

Ordnance Equipment
Radio Equipment
Electronic Equipment
Radar Equipment

C. R. DANIELS, INC.
DANIELS, MD.

75 West St.
549 W. Randolph St.

New York 6, N. Y.
Chicago 6, Ill.

**LICK
SOLDERING FATIGUE!**



—with the new **HEXAACON
FEATHERWEIGHT
MODEL 30H**

So light its weight is hardly noticeable, but more powerful than its wattage rating indicates. Hatchet design makes it more comfortable and practical to use than a soldering pencil. No transformer required.

WEIGHT—5½ OUNCES (LESS CORD);
WATTS—40 OR 60; TIP DIA.—BOTH
⅛" AND ¼" TIPS FURNISHED WITH
EACH IRON; PRICE— **\$550**

Write today for catalog describing
the complete line of screw tip, plug
tip and hatchet irons.

**HEXAACON
ELECTRIC CO.**

130 WEST CLAY AVE.,
ROSELLE PARK, N. J.



Check the
performance
of this
**HERMETICALLY SEALED
TERMINAL***
Kel-F molded
by
BRILHART

See why over 1,000,000
are now in use by the
biggest names in industry!



- 2000 volts, RMS-Corona Free
- Flashover . . . 7500 volts RMS Min.
- Insulation Resistance . . . 1,000,000 Megohms
- 60 Cycle test . . . 5000 volts (RMS)
- Current rating . . . 15 Amperes
- Air, helium, oil pressure tests . . . 20 lbs per sq. inch
- Temp. . . -100°C. to +150° C. cont.

Custom problem? Write today!

*PAT. PENDING.

**BRILHART RESEARCH
CORPORATION**
MINEOLA, L. I., N. Y.

IF THE WIRING FAILS

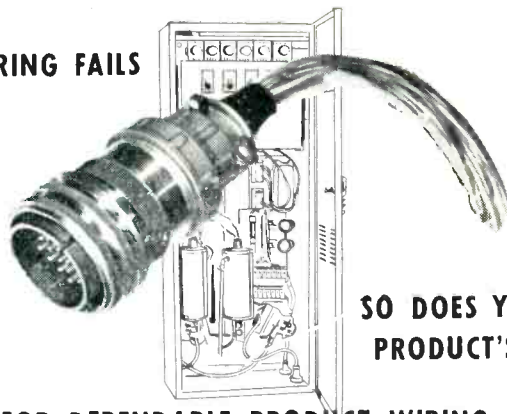

SO DOES YOUR
PRODUCT'S REPUTATION

FOR DEPENDABLE PRODUCT WIRING USE

UNILECTRIC WIRING SYSTEMS

Year after year — for over ten years — UNILECTRIC has produced millions of wiring systems, for more than 150 leading manufacturers of electric and electronic products. From controls to complex armed forces equipment, these wiring systems have consistently met the most exacting requirements and provided substantial savings to each customer.

To assure utmost dependability plus cost saving engineering assistance, low cost production and "on-schedule delivery" investigate UNILECTRIC today.

UNILECTRIC WIRING SYSTEMS
TRADE-MARK

Manufactured by
UNITED MANUFACTURING & SERVICE COMPANY
409 SOUTH 6th STREET • MILWAUKEE 4, WISCONSIN

WHAT'S
GOING
TO
INFLUENCE
**your choice
of fasteners?**

Speedier assembly . . .
better appearance . . . fewer
rejects . . . greater strength . . .
quantity runs?

Whatever your choice, you will
benefit by investigating
THE MILFORD METHOD,
an integrated service of
fastener research, design,
engineering, and production
collaboration.

Give wings to work . . . use rivets
and rivet-setters identified by
the flying "M" trade mark . . .
a symbol of quality for
quality products of metal,
leather, cloth, plastic, wood
and paper. With an eye to
the future, inquire about
THE MILFORD METHOD to-day!



the name
to rivet in your memory
for fasteners

the  **MILFORD** EST. 1919 **RIVET & MACHINE CO.**



MILFORD, CONN., 855 Bridgeport Avenue



AURORA, ILL., 806 Ill. Avenue



ELYRIA, O., 1106 W. River Street



HATBORO, PA., 26 Platt Street

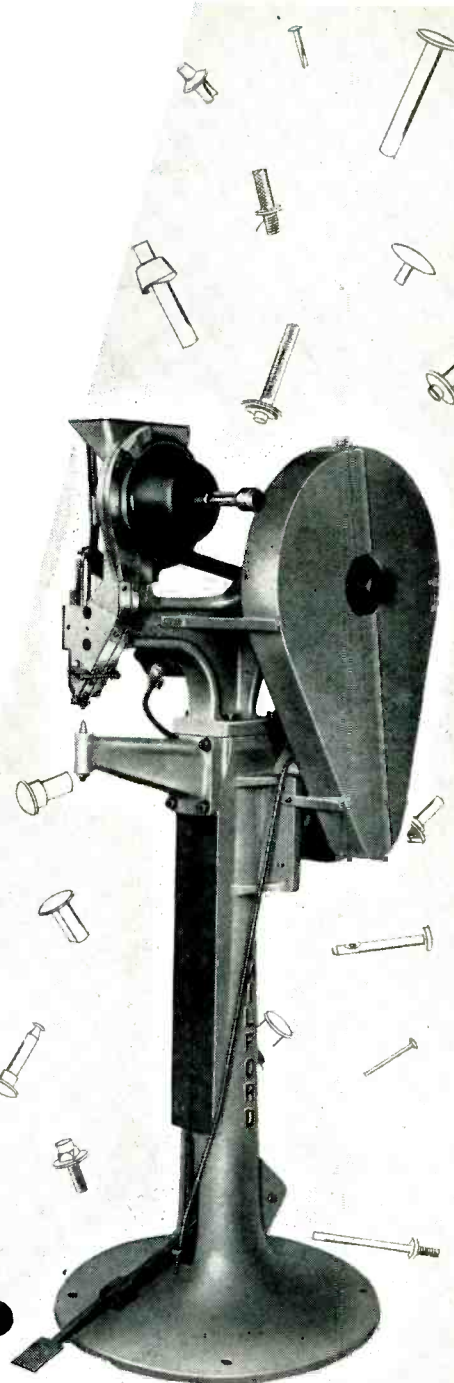

Wright Air Development Center. He was a member of the American delegation to the Civil Aviation Organization, and technical advisor to the American Government at several international conferences.

RTMA Continues to Grow

SEVEN new members, five active and two associate, were submitted to RTMA membership by the board of directors at a recent meeting in New York City. The new members are:

Daystrom Electric Corp. of Poughkeepsie, N. Y.; Delco Radio Div. of General Motors Corp., Kokomo, Ind.; Eldico of New York, Inc., of Douglaston, N. Y.; Investors Diversified Services, Inc., of Minneapolis, Minn.; Johnson Electronics of Orlando, Fla.; Lyman Electronic Corp. of Springfield, Mass.; and Rockbar Corp. of New York, N. Y.

**IRE Announces 1953
Fellow Awards**

FORTY-NINE leading radio engineers and scientists were named Fellows of the Institute of Radio Engineers by the board of directors at a meeting held in September in New York City. The Institute annually bestows the award of Fellow, its highest membership grade, on those who have made outstanding contributions to radio engineering or allied fields.

Presentation of the awards with citations will be made by the president of the Institute at the annual banquet on March 25, 1953 at the Waldorf-Astoria Hotel in New York during the 1953 IRE National Convention.

Recipients of the Fellow Award, which takes effect Jan. 1, 1953, are as follows:

Edward W. Allen, Jr., of the FCC; Jean P. Arnaud of Direccion General Fabricaciones Militares (Argentina); Benjamin B. Bauer of Shure Brothers, Inc.; J. W. Bell of Smith & Stone, Ltd., Canada; Leonard J. Black of the U. of California; H. G. Booker of Cornell University; William E. Bradley of Philco Corp.; John L. Callahan of

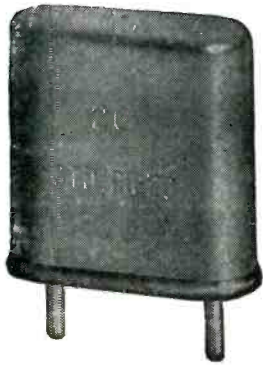

FOR
FREQUENCY
Stability
IN
Mobile
EQUIPMENT

make sure your crystals are made by Standard Piezo.

For years, our Crystals have been standard as original equipment with leading manufacturers and for replacement purposes by large operators of mobile equipment.

Precise, accurate, Standard Piezo Crystals are available for ALL types of mobile communication equipment.

Request catalog E for complete details.



Standard Piezo
COMPANY
CARLISLE, PENNSYLVANIA

Portable
**12-channel
Oscillograph Recorder**

for applications requiring an instrument of minimum size and weight



Type
A-500
12-channel

6-3/4" x 9-13/16" x 12-3/4"
33 lbs.

The Heiland A-500 Portable Oscillograph Recorder has been designed and developed for recording strains, pressures, accelerations, temperatures, etc. under conditions requiring an instrument of minimum size, light weight and extreme versatility. Incorporated in the "500" are many features found only in much larger instruments... simultaneous viewing and recording... four "quick change" paper speeds... easy loading and operation...

For complete information on the Heiland A-500 and the possible application of this instrument to your particular problem, write or wire...

The Heiland Research Corporation
130 East Fifth Avenue, Denver 9, Colorado

dependable instruments



SAVE EXPEDITING!
CALL
E. C. I.

BARclay 7-2241
Serving the industrials with direct
distribution of electronic parts



The **DIRECTORY**
of **ELECTRONICS SUPPLY**

Your Center for

Components
Military



Test
Equip-
ment
Com-
mercial

- Germanium Diodes
- Five Star Tube Line
- Receiving — Transmitter Industrial Tubes

Electronics Center, Inc.

118 Duane Street, New York 7, N. Y.

Specify **GM** **SERVO MOTORS** PRECISION ENGINEERED

RELIABLE PERFORMANCE • RUGGED CONSTRUCTION

In the operation of • GUNFIRE CONTROLS • ROCKET CONTROLS
GUIDED MISSILES • AIRCRAFT CONTROLS • INDUSTRIAL CONTROLS

G-M Servo Motors can be supplied to meet rigid military specifications with regard to humidity, temperature range, vibration and altitude. Available in 2, 4 or 8 pole construction and for frequencies from 60 to 400 cycles.

Write today for complete information.

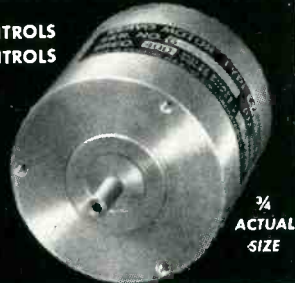

¾
ACTUAL
SIZE

Another product of **GM** **LABORATORIES INC.**

4336 NORTH KNOX AVENUE
CHICAGO 41, ILLINOIS

MARCONI



TELEVISION

VENEZUELA INSTALLS MARCONI



Dr. Rodriguez Jimenez, Venezuela Consul-General in London, at the signing of a contract in the London consulate on 9th July, 1952, to provide British equipment for a television service at Caracas.

Equipment for the Caracas Television Station, sponsored by "Televisa," includes

- 5 kW vision transmitter
- 3kW sound transmitter
- Associated aerial system
- Complete studio installation
- Complete mobile O/B television unit, with two camera channels and micro-wave links

MARCONI of England
television transmitting equipment

MARCONI'S WIRELESS TELEGRAPH CO LTD · CHELMSFORD · ESSEX · ENGLAND

RCA; K. A. Chittick of RCA; Arthur A. Collins of Collins Radio Co.; Edward U. Condon of Corning Glass Works; W. W. Eitel of Eitel-McCullough, Inc.; Harry Faulkner of the British Post Office, London, England; Enoch B. Ferrell of Bell Labs; Warren R. Ferris of Naval Research Laboratory; Lyman R. Fink of General Electric Co.; Lawrence R. Hafstad of the Atomic Energy Commission; F. Hamburger, Jr., of Johns Hopkins U.; Lewis B. Headrick of RCA; Philip J. Herbst of RCA; John Hessel of Signal Corps Engineering Labs; Hans E. Hollmann of U. S. Naval Air Missile Test Center, Point Mugu, Calif.; T. A. Hunter of Hunter Mfg. Co.; Eric J. Isbister of Sperry Gyroscope Co., Div. of Sperry Corp.; Edward C. Jordon of the U. of Illinois; Frank G. Kear of Kear and Kennedy, Washington, D. C.; Ronold W. P. King of Cruft Laboratory, Harvard U.; Royce G. Kloeffler of Kansas State College; Edmund A. LaPort of RCA; Russell R. Law of RCA; William A. MacDonald of Hazeltine Electronics Corp.; Jack A. McCullough of Eitel-McCullough, Inc.; J. A. Morton of Bell Labs; Allen B. Oxley of RCA Victor Co., Ltd., Canada; Albert Preisman of Capitol Radio Engineering Institute, Washington, D. C.; John C. R. Punchard of Northern Electric Co., Ltd., Canada; Jan A. Rajchman of RCA; J. A. Ratcliffe of Cambridge U., England; Stephen O. Rice of Bell Labs; Walther Richter, consulting engineer of Milwaukee, Wisc.; A. A. Roetken of Bell Labs; William M. Rust, Jr. of Humble Oil & Refining Co.; Jorgen Rybner of the Royal Technical U. of Denmark; Daniel Silverman of Stanolind Oil & Gas Co., Tulsa, Okla.; Archie W. Straiton of the U. of Texas; Irvn Travis of Burroughs Adding Machine Co., Philadelphia, Pa.; Bertram Trevor of RCA Labs; Harry W. Wells of Carnegie Institution of Washington, D. C.; and Charles J. Young of RCA.

Board Reorganizes RTMA

SINCE his election as chairman of the RTMA board of directors at the June convention, A.D. Plamondon, Jr., has assumed the additional

you can count on
Laboratory Control...



to bring you finer
PRECISION
COIL BOBBINS

Never-ending Laboratory Control of all materials assures you of Precision Bobbins that are lighter in weight, yet up to 20% stronger—better insulated bobbins that have more resistance to moisture and greater heat dissipation qualities. Increased coil winding space is a feature, too. Bobbins made round, square, rectangular; any ID, OD, length; of dielectric Kraft, Fish Paper, Cellulose Acetate or combinations.



Send for New Arbor List of over 1,500



PRECISION PAPER TUBE CO.

2041 W. CHARLESTON ST., CHICAGO 47, ILL.
Plant #2: 79 Chapel St., Hartford, Conn.
Also Mfrs. of Precision Paper Tubes

40 MC TO 225 MC TV AMPLIFIERS

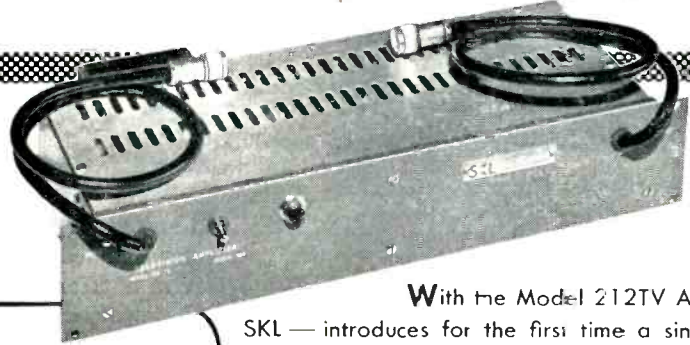

SPECIFICATIONS

- **BANDWIDTH**
40 MC — 225 MC
- **IMPEDANCE**
180, 52 and 72 ohm unbalanced, 300 ohm balanced
- **GAIN** 21 db
- **OUTPUT VOLTAGE**
6 volts peak maximum
- **RESPONSE**
± 2 db over bandwidth
- **POWER SUPPLY**
117V, 60 cps, 55 watts

With the Model 212TV Amplifier — SKL — introduces for the first time a single broad band chain amplifier type booster capable of amplifying all 13 television channels simultaneously. Because of its stability and reliability — a tube failure means only a slight loss of gain, not amplifier failure — the Model 212TV Amplifier can be safely left unattended for long periods of time. Its low noise level, high output, and low impedance make the Model 212TV Chain Amplifier ideal for television distribution systems in hotels, apartment houses, sales rooms, television stations, cities and towns.

Write today for further information

SKL SPENCER-KENNEDY LABORATORIES, INC.
186 MASSACHUSETTS AVE., CAMBRIDGE 39, MASS.

Just Published!

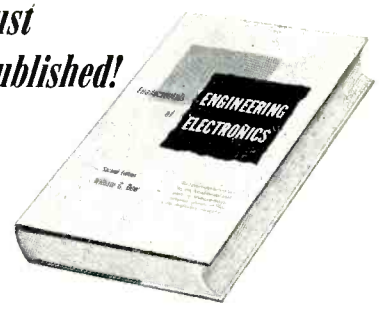

REVISED SECOND EDITION OF
FUNDAMENTALS OF ENGINEERING ELECTRONICS

By WILLIAM G. DOW,
University of Michigan

Here is a realistic and quantitatively usable conception of the principles that govern the internal behavior of electronic devices—a concept essential to the engineer who is to work logically and effectively with electronic circuits.

Basing his presentation on a clear, accurate, and authoritative knowledge of the fundamentals of charged-particle behavior, Professor Dow has arranged and described these fundamentals to appeal to the engineer's analytical approach. Principles of particular importance are selected for study; illustrations of these principles are drawn from engineering practice; and physical concepts are treated to permit ready determination of magnitudes. A great many changes and additions have been made in this second edition, making it an even more valuable reference than the first edition.

CONTENTS — Potential Distribution Diagrams
★ Electron Ballistics ★ Cathode Ray Devices
★ Electrostatic Fields in Space-Charge Control Tubes ★ Space-Charge Control of Current ★ Triodes, Tetrodes, Pentodes ★ Thermionic Cathodes ★ Electrons in Metals and Semiconductors ★ Amplifier Circuit Principles ★ Amplifier Coupling ★ Oscillators ★ Microwave Electron Tube Principles ★ Random Velocities ★ Ionization and Excitation of Atoms ★ Photosensitive Devices ★ Current Flow in Gases ★ Plasma Boundary Regions ★ Arc and Glow Transient Phenomena ★ Gaseous-Conduction Rectifying Devices

1952 626 pages, illustrated \$8.50

Mail coupon for copy on 10 day approval

..... APPROVAL COUPON

JOHN WILEY & SONS, INC.
440 Fourth Ave., New York 16, N. Y.

On 10 days' approval, send Dow's *Fundamentals of Engineering Electronics*. I will remit \$8.50 plus postage, or return book postpaid. (Offer valid only in U. S.)

Name

Firm name

Address

City..... Zone..... State.....

E-102

SAVE POSTAGE: We pay postage if payment is enclosed. Same money-back return privilege.

RVC-2* PRECISION POTENTIOMETERS



Featuring "UNITIZED" CONSTRUCTION

- Each potentiometer a complete unit
- Individual units may be stacked in any desired combination
- No common shaft — Shaft coupling by means of drive pin and spring loaded crank arm assembly[‡]
- Units held together with cast aluminum two-section clamp ring[†]
- Universal mounting plate unit machined to servo precision

Quantity production, prompt deliveries, standardization and economy — achieved through "Unitized" Design — no sacrifice of quality, accuracy or reliability.

Write for Bulletin A11 today.

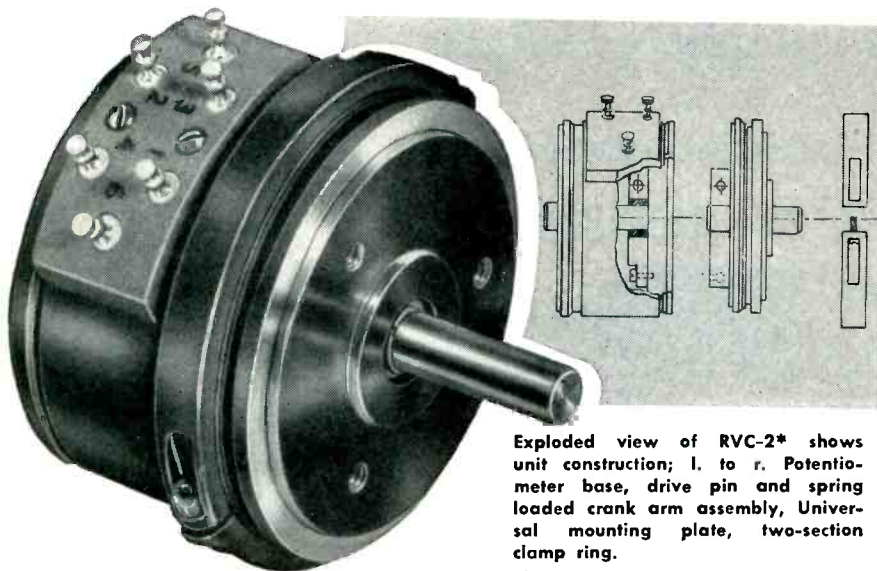

Exploded view of RVC-2* shows unit construction; l. to r. Potentiometer base, drive pin and spring loaded crank arm assembly, Universal mounting plate, two-section clamp ring.

DESIGN FEATURES:

Dual Paliney spring contacts to winding, precious metal take-off contacts; Bases—precision machined aluminum, black Alumilite finish; Oilite bushings, stainless steel shaft.

Servotrol manufactures under license agreement with Technology Instrument Corp.

§ PAT. NO. 2,543,228

† PAT. NO. 2,543,673

See us at Booth 91 National Electronics Conference

ENGINEERING REPRESENTATIVES

Cleveland, Ohio — Prospect 1-6171
Chicago, Ill. — UPTown 8-1141
Rochester, N. Y. — Monroe 3143
Canaan, Conn. — Canaan 649
Dayton, Ohio — Michigan 8721

Amrrior, Ontario, Can. — Amrrior 400
New York, N. Y. — MURray Hill 8-5858
Cambridge, Mass. — Eliot 4-1751
Hollywood, Cal. — HOLlywood 9-6305
Dallas, Texas — Dixon 9918



SERVOTROL COMPANY

114 WEST ILLINOIS STREET, CHICAGO 10, ILLINOIS • TEL. SUPERIOR 7-3082
EASTERN BRANCH OFFICE—FRAMINGHAM CENTRE, MASS. • TEL. FRAMINGHAM 4421

duties of president of the association under a reorganization plan adopted in September.

Upon recommendation of the special Organization Committee, headed by former board chairman Robert C. Sprague, the board of directors also elected Glen McDaniel, who had resigned as RTMA president, to be RTMA general counsel, and promoted general manager James D. Serrest to executive vice-president.

The board of directors also voted to expand the special Organization Committee to include representatives of the Technical Products and Amplifier and Sound Equipment Division, after which president Plamondon appointed director Fred R. Lack as a member of the committee for the Technical Products Division, and director Arie Liberman as a member for the Amplifier and Sound Equipment Division. Other members of the Organization Committee, all past RTMA presidents, are: directors Max F. Balcom, Paul V. Galvin, Leslie F. Muter and chairman Robert C. Sprague.

High Award Winners Named by IRE

WINNERS of three high awards to be presented during the IRE National Convention in March 1953 in New York were recently announced by the Institute.

John M. Miller, superintendent of Radio Division 1 of the Naval Research Laboratory, Washington, D. C., has been named the recipient of the Medal of Honor for 1953, the highest award of the radio engineering profession. The Institute gave the award "in recognition of his pioneering contributions to our basic knowledge of electron tube theory, of radio instruments and measurements, and of crystal oscillators."

The 1953 Morris Liebmann Memorial Prize, given annually by the Institute for a recent important contribution to the radio art, went to John A. Pierce, senior research Fellow at Harvard U. He is noted for his contributions to the development of the loran system of long range radio navigation which

Runzel WIRE CORD and CABLE



**"Products of
Science"**

The Runzel Laboratory insures that every inch of Runzel wire, cord and cable is thoroughly tested before shipping. Your wiring needs in hook-up, lead-in, shielded wire and cords, speaker cords and all types of insulated wire products, in almost endless variety of colors, sizes and specifications, are available from this centrally located plant.

WRITE FOR
SAMPLES



RUNZEL CORD & WIRE CO.
4723 Montrose Avenue
Chicago 41, Illinois

You'll SAVE MONEY in Your SHOP With

PALMGREN

**The Only Table Having Rotary Feed
Combined with DUAL CROSS FEEDS!**

This PALMGREN TABLE is sensational in price, construction and performance. Just what shops need for accurate, precision work. You can rout straight or curved, rabbet, drill, sand or mortise. Do hundreds of jobs as milling slots, grooves, keyways, squares, hexagons, curves, flats, dovetails, indexing and laying out work.

Designed for use on Drill Press or Milling Machine. It handles all types of metal and woodworking operations and makes your drill press a vertical milling machine. Precision built. It permits close tolerances. Rotary Feed is calibrated in degrees. Cross Feeds in thousandths. Cross slides and feeds are 2 1/2" each side of center—1 1/2" overall. Adjustable gibs on cross slides—4 to 1 worm and gear ratio in rotary feed. 4 Bolt slots—2 lock screws.



No. 83 ROTARY TABLE Only \$54.50

No.	BASE KEYWAY	T-Slots	TABLE DIA.	BASE DIA.	HEIGHT	WEIGHT	PRICE
83	5/8"	5/8"	8"	6 1/4"	5"	28 lb.	\$54.50
82	Same as above without Rotary Feed					26 1/2 lbs.	\$39.75

QUICK, ACCURATE Setups—End Delays—Spoilage



only \$8.75
"M" Base
\$3.00

with this Angle Vise

Solve all your difficult angle jobs! End make shift methods, delays and spoilage with this famous PALMGREN ANGLE VISE. Ideal for Drilling, Milling, Grinding, Filing, Planing, Marking and hundreds of jobs requiring speed and accuracy of angles on machine or bench. Set at any angle up to 90 degrees and lock—it's ready for use. Accurately graduated, every part of vise is accurately machined. Jaws of steel 2 1/2" wide. 1 Plain, 1 Grooved for holding round pieces. Auxiliary Bases for machine or bench use. Swivel "M" Base shown \$3.00 Extra. Order NOW! Today!

Write for Circular No. 302

CHICAGO TOOL and ENGINEERING CO.

No. 000 Vise Mounted on SWIVEL "M" BASE Mfrs. of PALMGREN PRODUCTS Since 1918
8380 South Chicago Avenue Chicago 17, Ill.

Opportunities at
BECKMAN
for
ENGINEERS - SCIENTISTS

**To Develop Instruments
and Electronic Components**

Use your training, aptitudes and experience in the following (or allied) fields:

Spectroscopy . . . Precision Electronics
Optics . . . Physics . . . Electromechanics
Mechanics . . . Feedback Systems

Men who combine fields will find our projects especially interesting. Typical developments include spectrophotometers at all wavelengths, pH meters, electrometers, flame photometers, computers, radiation instruments, titrators and others to be announced.

Unusual opportunities in all divisions: Helipot and Beckman Instruments—So. Pasadena, California; Berkeley Scientific—Richmond, California. Our company is a leader in the fast growing instrument industry, which is not dependent for its future on military contracts, but is of fundamental importance to all types of research and industry.

Write for application and information about our company.

Personnel Department

Beckman Instruments, Inc.

1001 El Centro Street
South Pasadena 59, California

ELECTRIC INSTRUMENT & CONTROL HEADQUARTERS

YES, OFF-THE-SHELF SERVICE



Electro-Tech maintains one of the largest and most complete stocks in the country of electrical meters, instruments and industrial control equipment—representing over 250 top lines.

Yes, our warehouse is bulging with standard stocks of

Counters	Solenoids	Toggle Switches
Panel Meters	Tachometers	Shunts (Electrical)
Transformers	Thermometers	Meggers
Switchboard Meters	Thermostats	Solenoid Valves
Micro Switches	Rectifiers	Pyrometers
Photo Electric Equipment	Rheostats	Multimeters
Relays	Timers	Oscilloscopes

and Laboratory Standard Instruments

In addition, we manufacture and stock **Special Test Equipment** • Electric Heating Units • Current Transformers • Pyrometers • Thermocouples • Rectifiers.

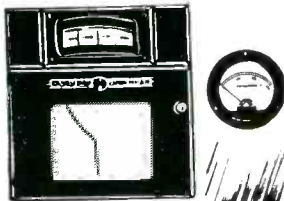

FOR SPEED

Wire—Code RDL
Teletype—NY 1-2906
Phone—BArcly 7-4209

CONSULT US ABOUT YOUR REQUIREMENTS

Our laboratory is available for repair work, rescaling, recalibration and special calibration of your electrical and industrial instruments. Often months are saved by rescaling and calibrating stock instruments to your specifications.

"The
Industries
Buying Guide"
our
GENERAL
CATALOG E-11
FREE

ELECTRO-TECH EQUIPMENT CO.

55 LISPENARD ST., NEW YORK 13, N. Y.

For Parts that must be
TAKEN OFF—PUT BACK—BUTTONED TIGHT

LION FASTENERS

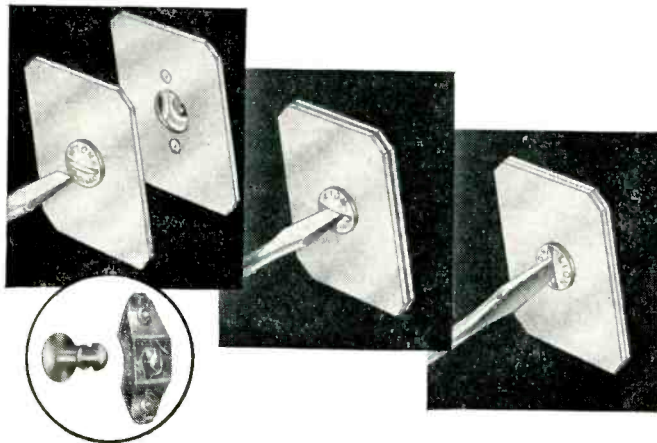

LOCKS TIGHT WITH A QUARTER TURN

Always at correct tension

Lion Fasteners are *right* for buttoning parts that must be removed repeatedly for inspection, maintenance, or other reasons.

Vibration and shock can't loosen a Lion Fastener. Even an inexperienced service man can't replace it wrong. A quarter turn opens it. Another quarter turn locks it. The tension is designed into it.

Lion Fastener Spring Assembly is quickly spot welded or riveted in place. The stud cannot be lost. It is grommeted tight to the sheet. They will button sheets .040 plus or .020 minus over or under standard rating. The misalignment is as much as .156. The one-piece forged stud is tested to 1425 lbs. Write today for demonstration kit and application data.

TYPICAL APPLICATIONS: INSPECTION PLATES • COWLING
 ELECTRICAL PANELS • CABINETS • DUCTWORK



Free DEMONSTRATION KIT contains sample Lion Fasteners to help you visualize their adaptability to your product. Write on your company letterhead. No obligation.



L I O N
FASTENERS, INC.
 500 MAIN ST., HONEOYE FALLS, N. Y.

was widely used by the armed services during World War II, and more recently for his conception of the RADUX system of long range navigation now under development for the government.

Frank Gray, research engineer of Bell Telephone Laboratories, was awarded the Vladimir K. Zworykin Television Prize Award for 1953, given annually by the Institute for an outstanding contribution to television. A pioneer in the tv field, Mr. Gray early in the 1930's developed principles, the importance of which has only recently been recognized, and which are embodied in the color television system currently under development by the industry-sponsored National Television System Committee.

RTMA Names Thirteen to TV Committee

THE BOARD chairman of the RTMA, A. D. Plamondon, Jr., has appointed a 13-man television committee and renamed Dr. W. R. G. Baker as chairman of the group for the ensuing year. The top-level committee directs the tv activities of the RTMA.

Following is the membership of the committee:

W. R. G. Baker (chairman) of General Electric Co.; Benjamin Abrams of Emerson Radio & Phonograph Corp.; Robert S. Alexander of Wells-Gardner & Co.; Max F. Balcom of Sylvania Electric Products Inc.; H. C. Bonfig of Zenith Radio Corp.; John W. Craig of Crosley Div., Avco Mfg. Corp.; Allen B. Du Mont of Allen B. Du Mont Laboratories, Inc.; J. B. Elliott of RCA Victor Division of RCA; E. K. Foster of Bendix Radio Division; Paul V. Galvin of Motorola Inc.; W. J. Halligan of The Hallicrafters Co.; L. F. Hardy of Philco Corp.; and W. A. MacDonald of Hazeltine Electronics Corp.

Telecommunication Services Made Available

FORMATION of Microwave Services, Inc., New York City, was recently announced. It will provide consulting and construction services in the field of telecommunication.

Fine Wire Specialists

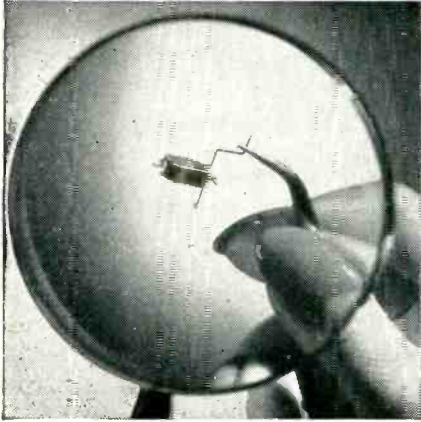

1700 Inches of No. 50 Wire on This Meter Coil

Want really micro-fine wire? Write for price list on our full line of highest quality enameled magnet and Litz wire. Immediate delivery. All sizes—Numbers 44 to 52 (.002" to .0008").

THE INSTRUMENT WIRE COMPANY

150 Church Street • Guilford, Conn.

ZOPHAR

WAXES

COMPOUNDS

Zophar Waxes, resins and compounds to impregnate, dip, seal, embed, or pot electronic and electrical equipment or components of all types; radio, television, etc.

Cold flows from 100°F. to 285°F.

Special waxes non-cracking at -76°F.

Compounds meeting Government specifications plain or fungus resistant.

Let us help you with your engineering problems.

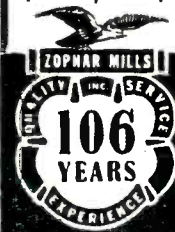

ZOPHAR MILLS, INC.
112-130 26th Street,
Brooklyn 32, N. Y.

Now PL-4D21

POWER TETRODE



125 WATT PLATE DISSIPATION.
FULL RATINGS TO 120 Mc.
HIGH OVERLOAD CAPABILITIES.
AVAILABLE IMMEDIATELY.

For data, Write:



PENTALABORATORIES INC.
216 North Milpas Street
SANTA BARBARA, CALIFORNIA

For PRECISION Requirements

WELWYN

HIGH STABILITY
CARBON RESISTORS

Welwyn carbon deposit resistors are made to conform to tolerances dictated by the most exacting electronic requirements. Rigid quality controls maintain these precise standards to within the narrowest margins.

Values range from 10 ohms to 50 megohms, in ratings of 1/4, 1/2, 1, and 2 watts, and at tolerances of 1%, 2% and 5%. Welwyn Resistors have a high order of stability and retain their characteristics over widely changing conditions of load, temperature, voltage, and ageing processes. Inductive and capacitive reactances, and Johnson Effect are exceedingly low to extremely high frequencies.

For Complete Data and Specifications, Write to:

SALES REPRESENTATIVE

ROCKBAR CORPORATION
211 EAST 37th STREET, NEW YORK 16, N. Y.



MINIATURE HIGH-RELIABILITY WIRE-WOUND TRIMMER POTENTIOMETERS

Precision-built by Waters, of Waltham

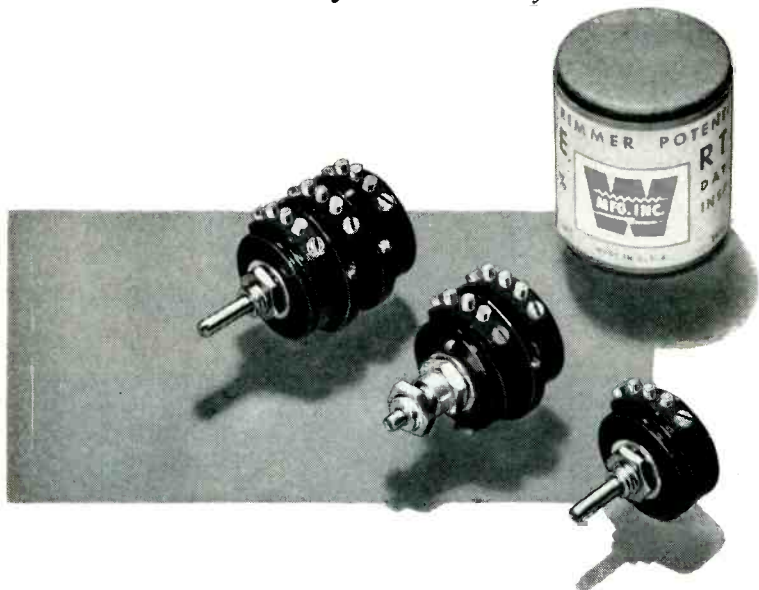

THE WATERS TYPE RT-7/8 SERIES of miniature, wire-wound potentiometers will satisfy your most stringent requirements. Anodized-aluminum bodies with sealed, line-reamed shaft bushings and sealed terminal plates enable these units to meet severe environmental tests — immersion, salt spray, fungus, shock, vibration, wide range of ambient temperatures.

CHECK THESE SPECIFICATIONS of the RT-7/8

- *Size . . .*
1/8" diameter, 3/8" depth
- *Weight . . .* only 5/16 ounce
- *Dissipation . . .* 3 watts
- *Temperature . . .*
—55C to +80C ambient
- *Rotation . . .*
360-degree continuous
- *Ganging . . .* dual or triple
- *Resistance . . .* ranges:
100 to 50,000 ohms max.,
linear only

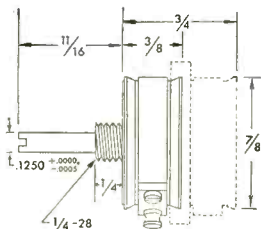

Waters potentiometers are made in Waltham, the watch city, home of fine workmanship.

WATERS MANUFACTURING, inc.

Waltham 54, Massachusetts

APPLICATION ENGINEERING OFFICES IN PRINCIPAL CITIES

NEW BOOKS

Primer of Electronics and Radiant Energy

BY DON CAVERLY. *Second edition, 1952. McGraw-Hill Book Co., New York, 343 pages, \$5.50.*

THIS is indeed a primer and one of the easiest to read. It is aimed at the people who, having no fundamental business with electrons, protons, neutrons and their varied and magnificent manifestations, yet have a basic curiosity as to what it is all about. The author makes a serious and honest effort to remove the complexities and technicalities that surround the subject and, while he often forgets that his readers are supposed to be abysmally ignorant although anxious to learn and dives off the deep end, in general he succeeds in writing material that virtually anyone can read.

The subjects treated sound technical—electricity, magnetism, radiant energy of all kinds, electron tubes—yet he describes them in terms of one's daily life—sunburn, cooking with infrared, flash lamps, plant growth. At the same time he gives the reader a chance to understand such modern devices as the TR tube, loran, nuclear reactors, the image orthicon or the hydrophone. Even the engineer can find out some things he should know but probably doesn't.—K.H.

Electrical Engineering Theory and Practice

BY WILLIAM D. ERICKSON AND NELSON H. BRYANT, *Cornell University. John Wiley & Sons, Inc., New York, 523 pages, \$6.00, 1952.*

BASED on courses at Cornell for mechanical, civil and chemical engineering students, it is essentially nonmathematical, the stress being on physical analysis. Appendices contain sufficient explanation of the methods of complex notation to the solution of a-c problems to equip the student with this tool.

Aside from straight d-c and a-c theory and the effects of the basic *R*, *L* and *C* components on circuits, there are chapters on d-c machines, electrical instruments and measurements, a-c motors and transformers, a nice chapter on control (synchro

MINIATURE SLIP RING ASSEMBLIES

Commutators and other Electro-Mechanical Components
PRECISION MADE TO YOUR OWN SPECIFICATIONS

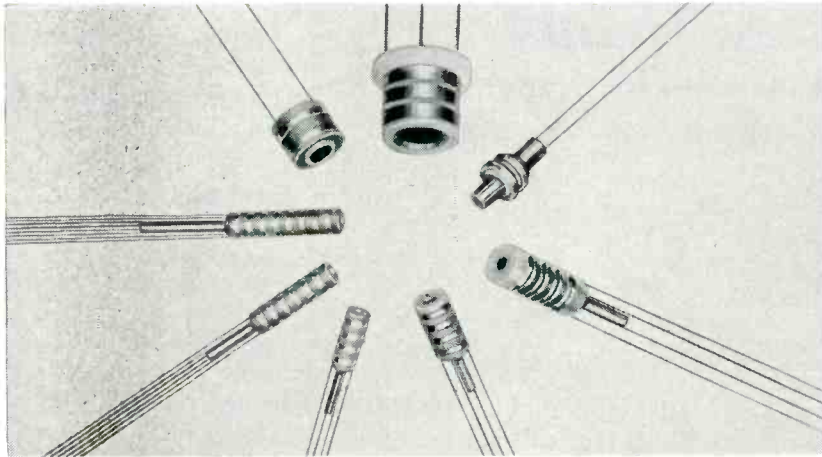

Our Swiss methods and techniques are geared to meet exacting requirements. We invite your inquiries.

COLLECTRON CORPORATION

216 EAST 45th STREET • NEW YORK 17, N. Y.

MURRAY HILL 2-8473



MULTI-CHANNEL OSCILLOSCOPES

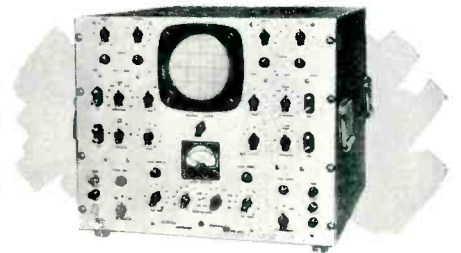

...for more accurate
farther-reaching TEST,
RESEARCH and CONTROL

By facilitating simultaneous observation or strip-film recording of 2, 4 or more transients, ETC multi-channel oscilloscopes pave the way to more accurate research, test and visual control along many lines. Available types cover a broad range of requirements in laboratory research, production testing, electroencephalography, neurophysiology, seismology, explosives, strain and vibration analysis and other fields. Catalog on request to Electronic Tube Corporation, 1200 E. Mermaid Lane, Philadelphia 18, Pa.



MULTI-GUN C-R TUBES

Teflon*

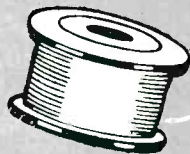

MAGNET, RESISTANCE and ALLOY WIRE

- Small space factor
- Unaffected by chemicals or corrosive atmosphere
- Capable of withstanding 250° centigrade
- High dielectric
- Excellent flexibility and abrasion resistance
- Sizes: 10 through 50 A.W.G.

Send for NEW Warren Wire Specification 1001

WW

WARREN WIRE CO.
POWNAI VERMONT

Producers of Nylon, Plain Enamel and Served Magnet Wire, Tinned and Bare Copper Wire.

*Du Pont trademark for Polytetrafluoroethylene Enamel



POLYPENCO TEFLON*

available for economical fabrication

ROD	Extruded .187" dia. to 2.0" dia. Tolerance +.002" — .000" up to 1" dia. Molded 2.25" dia. to 4.0" dia. Beading .030" to .187" dia.
TUBING	Extruded .50" to 2.0" O.D. 3/16" to 1.0" I.D. min. wall 1/8" Molded 1 1/4" to 8" O.D. at 1/4" intervals Wall thickness 3/8" — 2 3/4"
OTHER SHAPES	Strip thickness .002" to .060" Slab thickness 1/8" to 1 1/2" Special extruded shapes to customer specifications

Outstanding properties of TEFLON

Advantage

WIDE SERVICE TEMPERATURE RANGE	-100°F to +500°F
CHEMICALLY INERT	Resists all known acids, alkalis and commercial solvents over the service temperature range.
ZERO WATER ABSORPTION	Water will not wet the surface.
LOW POWER FACTOR	.05% p.f. constant over entire frequency spectrum.
STABLE DIELECTRIC CONSTANT	2.0 unchanged over entire spectrum.
TOUGHNESS AT LOW TEMPERATURE	Izod impact strength -70°F 2 ft. lbs./in.

*Teflon is a trademark of the E. I. DuPont Co.

also available to your specifications

MACHINED PARTS • MOLDED PARTS

POLYPENCO / nylon teflon

- Write for technical data and prices on Polypenco Teflon and Nylon
The POLYMER CORPORATION of Pennsylvania • Reading, Penna.

NEW BOOKS

(continued)

systems) and about one-third of the book on electronics aimed to equip the student with an approach to industrial circuit engineering. These chapters are divided essentially into the several kinds of tubes and their functions.

Final chapters cover communications and electronic control systems as used with motors, power supplies and welding machinery.—K. H.

Radio Astronomy

By BERNARD LOVELL AND J. A. CLEGG, *University of Manchester. John Wiley & Sons, Inc., New York, 1952, 237 pages, \$4.00.*

AN extraordinarily interesting book for any radio engineer possessed with man's natural awe of the universe in which he lives, plus his own interest in the field of radio techniques. It deals with the application of radio measurements to universe exploration.

The first two chapters constitute a brief introduction to astronomy which can be read by anyone, followed by two chapters on the basic radio techniques employed in astronomical research. Then come some 18 chapters on comets and meteors and what has been found out about them by radio, solar disturbances, radio emissions from sunspots and from various parts of the heavens, radio and the aurora borealis, lunar investigation by radio, etc.

Man's use of radio to look further into space has only begun, and as his thirst for more knowledge of what surrounds him is very great, it would be strange indeed if radio-astronomers did not come up with much new and fascinating knowledge.

This book is not for the high-powered experts; rather, it is for the average individual who, perhaps, knows more about radio than astronomy, and is not averse to learning something more about each subject.—K.H.

An Introduction To Acoustics

By ROBERT H. RANDALL. *Addison-Wesley Press, Inc., 1951, 340 pages, \$6.00.*

WHILE intended primarily as an intermediate college-level physics text, this book provides useful supplemental reference and study material for the engineer. It does

Only with **CO-AX**

AIR SPACED ARTICULATED

R.F. CABLES



THE LOWEST EVER CAPACITANCE OR ATTENUATION

We are specially organized to handle direct enquiries from overseas and give **IMMEDIATE DELIVERIES FOR U.S.A.** Billed in dollars Settlement by your check.

TRANSRADIO LTD

CONTRACTORS TO H.M. GOVERNMENT.
138A CROMWELL ROAD, LONDON SW.7 ENGLAND
CABLES: TRANSRAD LONDON.

LOW ATTEN. Types.	IMPED. Ohms.	ATTEN. db/100ft. of 100 Mcs.	LOADG. K.W. of 100 Mcs.	OD"
A.1.	74	1.7	0.11	0.36
A 2	74	1.3	0.24	0.44
A 34	73	0.6	1.5	0.88

LOW CAPAC. Types.	CAPAC. mmf/ft.	IMPED. Ohms.	ATTEN. db/100ft. of 100 Mcs.	OD"
C 1	7.3	150	2.5	0.36
PC 1	10.2	132	3.1	0.36
C 11	6.3	173	3.2	0.36
C 2	6.3	171	2.15	0.44
C 22	5.5	184	2.8	0.44
C 3	5.4	197	1.9	0.64
C 33	4.8	220	2.4	0.64
C 44	4.1	252	2.1	1.03

HIGH POWER FLEXIBLE

PHOTOCELL CABLE

VERY LOW CAPACITANCE

Available NOW!

RUGGEDIZED METERS

... TO MEET SIG. C. SPEC.

MIL-M-10304

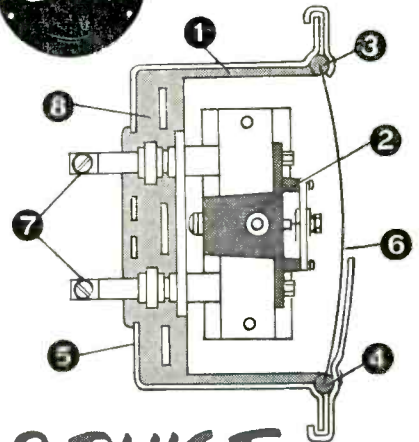

8 PLUS Features

EXTRA "RUGGEDIZED" FEATURES

- Meter movement shock-mounted and housed in rubber-lined case
- Meter movement supported by die-cast frame for greater strength and increased accuracy.
- Observation window rubber grommetted and sealed to rubber lining of case—providing hermetical seal of high dielectric materials.
- Non-rigid mounting of observation window with rubber grommet increases resistance to shock.
- Each meter designed and built by SUN to highest

quality and precision standards.

EXTRA INSTALLATION ADVANTAGES

- Slight convexity of observation window reduces chance of accidental breakage during installation or shipment.
- Terminals side-tapped and provided with lined binding screws to facilitate wiring with or without wire lugs or by pressure, soldering or both.
- Breakage or damage in wiring is reduced through non-rigid mounting of terminals and use of flexible interior conductors.

Building rugged electric meters is not new to SUN. For over 20 years, the automotive industry has depended on SUN as one of the largest "D'Arsonval-type" meter manufacturers—to produce rugged, tough meters that will stand up under the abuse and rough handling of portable field instruments used in automotive repair work. SUN "Ruggedized" Meters not only meet Specification MIL-M-10304 (Sig. C)—but also embody many plus features that make installation easier, faster and help prevent assembly or shipping damage. Complete data bulletin on SUN "Ruggedized" Meters available on request.

SUN "Ruggedized" Meters are available as D-C Volt Meters, Ammeters, Milli-ammeters and Micro-ammeters and also may be ordered as rectifier type A-C instruments.

SUN ELECTRIC CORPORATION

6383 Avondale Avenue, Chicago 31, Illinois

WESGO

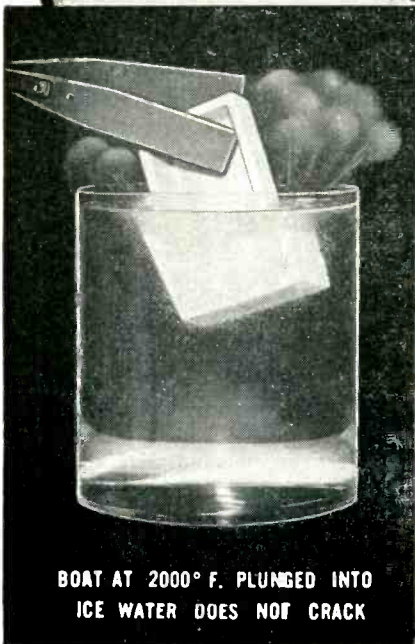

BOAT AT 2000° F. PLUNGED INTO ICE WATER DOES NOT CRACK

WRITE for DETAILS

CRACK-PROOF CERAMIC SHAPES for Furnace Brazing

- withstand any amount of thermal shock without cracking
- have proven superior to carbon or metal brazing fixtures in positioning vacuum tube components for furnace brazing
- are non-reactive with most metals
- will retain shape at high temperatures
- are clean . . . will not rub off on hands or workpiece
- are permanent . . . will not react with air or reducing gases

Available in stock forms of boats or slabs. Special shapes made to your individual specifications.

WESTERN GOLD & PLATINUM WORKS
589 BRYANT ST. • SAN FRANCISCO, CALIF.

Announcing a *NEW*, Different kind of Capacitor

Johanson

Concentric High Ratio Air Capacitor

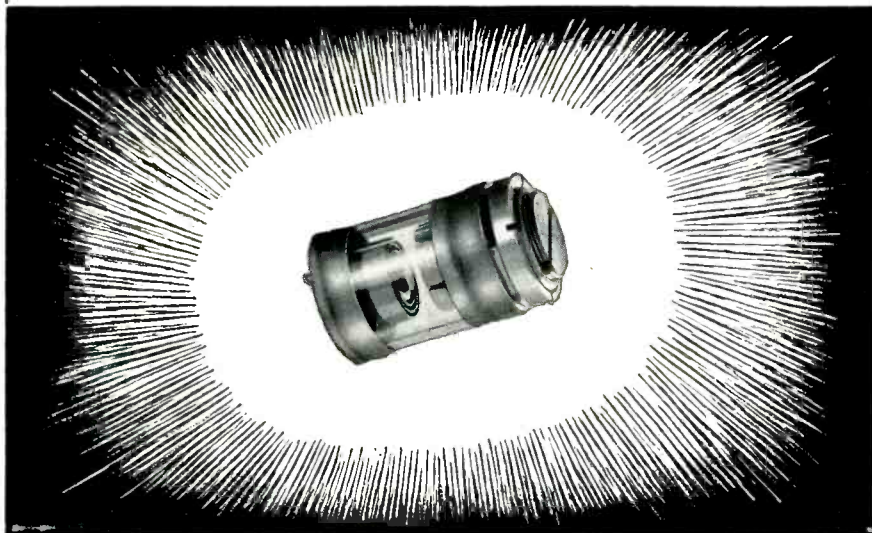

The new Johanson Concentric High Ratio Air Capacitor recommends itself to applications requiring a low minimum capacity, high Q, and stability. It has a maximum capacity of 35 mmfd. and a minimum capacity of 1 mmfd. Because of this ratio of capacity, it has many varied applications in electronic equipment where capacitive adjustments need to be made over a wide range with great accuracy.

The new Johanson capacitor is constructed entirely of silver-plated brass and Pyrex glass, which makes it ideally suited for all applications of a high frequency nature. It is a high Q capacitor at and above 200 mc.

The friction spring of the new capacitor assures a permanent setting of the rotor. The vernier action of the rotor screw allows all adjustments up to eight full turns to be made quickly and precisely.

SPECIFICATIONS

- | | |
|---|--|
| Low minimum capacity, 1 mmf. | High maximum capacity, 35 mmf. |
| High Q — better than 10,000 at 15 mc. | Voltage breakdown over 500V DC. |
| High stability. | High ratio — capacity at maximum is 35 times its minimum capacity. |
| Vernier action — better than 8 turns to accomplish the capacity change. | |
| Capacity against rotation is a linear function. | |

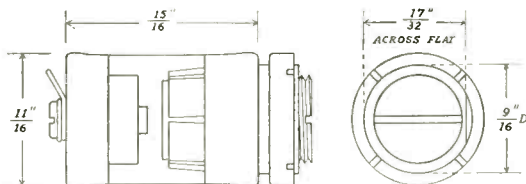

Requires space .700 x 1" long behind panel.

Johanson

Write for complete information
MANUFACTURING CORPORATION
10 ROCKAWAY VALLEY ROAD, BOONTON, N. J.

much to help fill the need for texts at this level. Most of the recent works in the field of acoustics have been directed at more advanced specialists or largely at applied or engineering fields.

Easy informal style and good illustrations make is easy reading. Most of the material on applications, which comprise about half of the book, and much of the material on theory can be followed by the practicing engineer who has neglected his math. The usefulness of the book for self study or review is considerably enhanced by the large number of problems on important topics and by the answers which are given to half of them.

Objective Acoustics

The choice of topics seems well balanced and this is important since a 28-page chapter on Speech and Hearing leaves 312 pages for the entire field of objective acoustics. The topics and their treatment in the chapters on theory are conventional. Somewhat less space than usual is devoted to systems with more than one degree of freedom, and somewhat more space is given to interference and diffraction. Here the author draws heavily on the field of optics for analogies.

There is a brief introduction to the velocity potential which is amplified in the appendix. Lumped parameter approximations in acoustic circuits are treated briefly in connection with the Helmholtz resonator, the phase-inverting loud-speaker enclosure and acoustic filters.

Horns

The section on horns treats the conical and the exponential but fails to treat the "hyperbolic" family reported by Salmon. Since the conical and exponential are special cases of this family and Salmon's work provides a powerful tool for studying the effect of boundary shapes on performance, it would be desirable to refer to this work.

References

More references than are frequently given in texts at this level are included. Some of the references are to recent books of the survey type, so that unfortunately credit to the original workers has been left out. For example, Ballantine's

INSULATION

FORMVAR • FORMEX • ENAMEL

STRIPPED CLEAN IN SECONDS

with **X-VAR**



1. DIP WIRE in X-VAR for 3 seconds.



2. WITHDRAW and watch coating disintegrate.



3. WIPE CLEAN. Operation completed in seconds.

X-VAR is non-corrosive, non-creeping — leaves wire ready for soldering. Now in use by leading manufacturers of electrical products. Write for FREE SAMPLE for testing.

FIDELITY CHEMICAL PRODUCTS CORP.

472 Frelinghuysen Avenue, Newark 5, New Jersey

SHOCKPROOF VACUUM TUBE RETAINERS

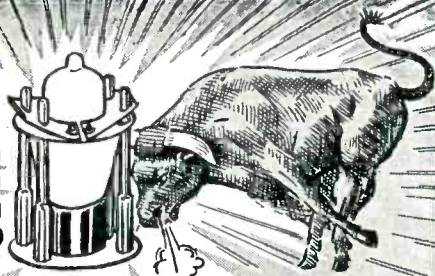
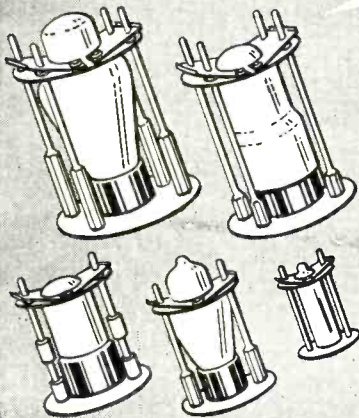

These retainers are used to secure Vacuum Tubes and to resist side motion of Vacuum Tubes used in radio equipment which is subject to shock and vibrations. These retainers meet the requirement of all JAN specifications. The insulated portion is made of a melamine base Fibre Glass Phenol which provides 300 volts insulation to ground and withstands a temperature of 350 F. The insulated plate can readily be fastened or released by hand.

Available for envelope types T7, T8, MT8, T9, T12, ST12, T12ZDI, ST14, S14, ST16, T5½, T6½, MT-IC, ST19, T14, ST128CT-9.

Manufacturers of Electronic Components

JAMES IPPOLITO & CO., INC.
401 CONCORD AVENUE, BRONX 54, N. Y.



WIRES & CABLES

for ALL your **ELECTRONIC** wiring needs!

Govt. Spec. Hookup Wire

JAN-C-76 SRIR-SRHV PLASTIC
Solid Colors or Spiral Markings

AIRCRAFT WIRE-NYLON JACKET
MIL-W-5086 (Supersedes AN-J-C-48a)

105° C. U.L. APPROVED
Thermoplastic Hookup Wire

JAN-C-76 WL GLASS BRAID
Also EXTRUDED NYLON JACKETED
Solid or Tracer Colors

Multiconductor, Shielded Cables
To meet Govt. Spec. #71-4945



COMPLETE WAREHOUSE STOCKS

- Multiconductor Rubber Covered Cables
- Tinned & Bare Wire
- Magnet Wire
- Formvar Wire
- Vinyl Extruded Tubing
- Shielded Wires
- Insulated Hardware
- Plugs, Jacks, Sockets
- Test Leads, Switches
- Insulators, Steatite, Ceramic
- Terminal Strips

Quality Products for the Electronics Industries Since 1923

Write for Catalog 52-E

BIRNBACH

BIRNBACH

RADIO CO. Inc.

145 HUDSON STREET NEW YORK 13, N.Y.

MICROPOT

PRECISION TEN-TURN POTENTIOMETER

1. You get permanent accuracy because the resistance wire is locked in place. It is precision positioned and moulded integrally with the housing.
2. You get permanently accurate settings, smooth action and low uniform torque provided by the stainless steel, precision ground, double thread lead screw guiding the moving contact.
3. You get precise positioning of the moving contact because of the two bearings supporting the rotor assembly.
4. You get good rigid terminals because they are moulded integrally with the housing.
5. Terminals soldered to ends of resistance element before moulding. Entire resistance circuit is an integral part of the housing.
6. You get accurate setting and re-setting due to anti-backlash spring in contact guide.
7. You get a fine resolution because of the $43\frac{1}{2}$ " length of resistance wire in the spiral element.
8. You get a resistance output directly proportional to shaft rotation within $\pm 0.1\%$ of the total resistance. Every potentiometer is automatically machine tested for linearity at 101 points.

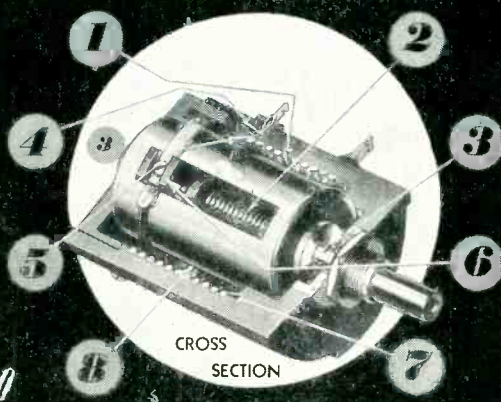

LINEARITY ACCURACY $\pm 0.1\%$

Units for immediate shipment:
1,000 to 30,000 ohm range.
Special resistance values made to order.

WRITE TODAY FOR ENGINEERING INFORMATION



**BORG EQUIPMENT DIVISION
THE GEORGE W. BORG CORPORATION
JANESVILLE • WISCONSIN**

important contributions to precise microphone measurements, namely the recognition and computation of the pressure rise due to diffraction and his corrections which made the thermophone a precision device, go unrecognized.

Errors

Only minor obscurities and errors which are to be expected in any first edition were observed. Under the discussion of pressure gradient microphones, the orientations of the diaphragm for no and for maximum response are reversed. Although the decibel is a very useful unit in describing hearing, it was historically the sequel to the TU or transmission unit introduced by the Bell Telephone Laboratories in 1923 which in turn superceded the transmission loss of a standard mile of cable.

Conclusions

The author points out the value of training in acoustics as a background for more advanced study in nearly all branches of physics and engineering. Brief references to the relation of acoustics to other branches of physics, other branches of science and to industry are made but these might well be expanded if the student and many faculty members are to be convinced that progress in theoretical acoustics did not die with Rayleigh.

The book is not only recommended as a text but as a reference work for the engineer with acoustical interests and the physicists with other specialized interests.—HUGH S. KNOWLES, *Director of Research, Industrial Research Products, Inc., Franklin Park, Illinois.*

Imperfections in Nearly Perfect Crystals

By W. SHOCKLEY, J. H. HOLLOWOM, R. MAURER, F. SEITZ. *John Wiley & Sons, Inc., New York, 1952, 490 pages, \$7.50.*

IN October, 1950, a symposium was held at Pocono Manor, Pa., on the subject of imperfect crystals. The symposium was sponsored by the National Research Council and was organized by W. Shockley of the Bell Telephone Laboratories with the help of J. H. Hollowom of the General Electric Research Laboratories, and R. Maurer and F. Seitz

COILS to exact specification for every requirement

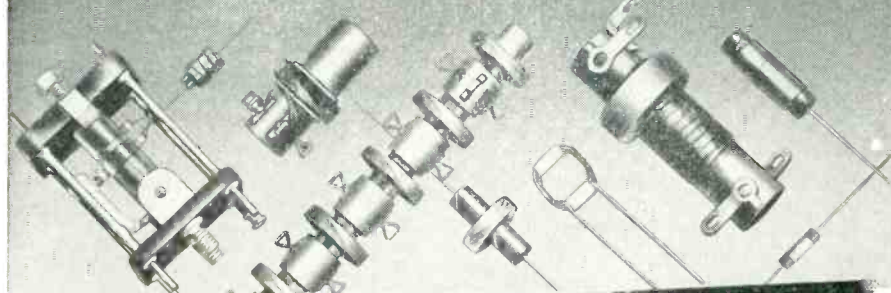

QUALITY BUILT COILS FOR RADIO, FM, TV AND GOVERNMENT APPLICATIONS

Uniform high quality, fast delivery and low cost have made Fugle-Miller coils the choice of many leading manufacturers in the radio and electronics industry. All types are supplied including Universal, Bank Wound, Universal Progressive and solenoid coils. JAN specifications are our specialty. Call, wire or write today for prompt quotations.

FUGLE-MILLER LABORATORIES

MAIN STREET, METUCHEN, NEW JERSEY
Telephone: Metuchen 6-2245



Do You Want to Measure Or Generate Any Frequency

From 20 — 640 M. C.*
Within 10 Parts Per Million?

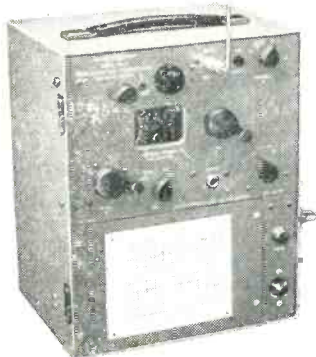

Direct Reading VHF Frequency Meter Model FM-3

Accuracy: $\pm 0.001\%$
Stability: $\pm 0.001\%$
Resetability: . . . $\pm 0.0005\%$

*Under certain conditions can be used below 20 mc and above 640 mc.

GERTSCH PRODUCTS
INC.

11846 Mississippi Avenue
P.O. Box 13856
Los Angeles 25, California

MICRODIAL

TEN TURN-COUNTING DIAL

Microdial is composed of two concentrically mounted dials... one for counting increments of each turn and the other for counting turns. The mechanical dial has 100 equal divisions and is attached rigidly to the shaft so there is no backlash. Thus the contact position is indicated to an indexed accuracy of 1 part in 1000. Rotation is continuous in either direction. There are no stops on the Microdial assembly.

COMPACT... Microdial has same O.D. as Micropot... requires no more panel space.

CLEAR READING... Forced fast-reading tests showed only 1/20th as many errors with Microdial open window as with next most legible dial. Turn counter distinguishes between 0 and 10 turn readings, and accelerates to avoid confusion on readings near integral turns. Precise readings are made from larger dial with maximum separation of graduations and wide angle visibility.

CONVENIENT... delivered completely assembled with dials synchronized. Easily mounted in a few seconds. All dials may be locked.

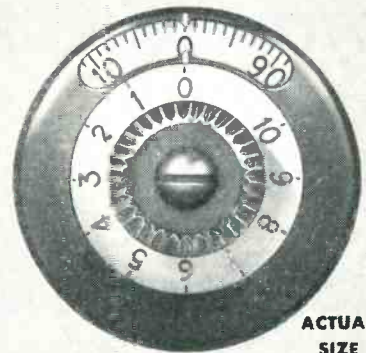

ACTUAL SIZE

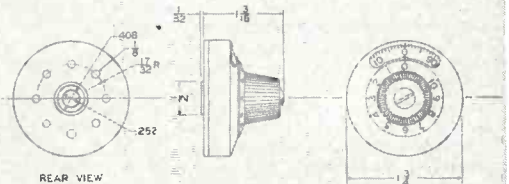

Microdial... turn-counting dial, primarily designed for use on Micropot ten turn linear potentiometers... use it on any multitem device having ten turns or less.



BORO EQUIPMENT DIVISION
THE GEORGE W. BORG CORPORATION
JANESVILLE • WISCONSIN

Roanwell



Style No. 2906

CLOTHES CLIP

Sturdily constructed for maximum life. Finished in semi-gloss black enamel. Ribbed, firm-gripping clamping pads made of hard neoprene. Mounting plate enables clip to be attached to hard surface, such as a switch case. Hard drawn steel spring wire insures optimum spring action.

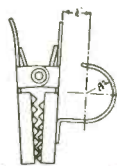

WITH MOUNTING HOOK FOR USE ON CORDSETS. This model utilizes a steel mounting hook which can be hooked directly on a cordset molded for this purpose.

DATA SHEETS ON REQUEST.

ROANWELL CORPORATION
27 SIXTH AVENUE, BROOKLYN 17, NEW YORK

Available for Early Delivery!

COMPLETE LINE OF UNIVERSAL PICTURE GENERATING AND MONITORING EQUIPMENT FOR

COLOR TELEVISION

SIMULTANEOUS, NTSC, FIELD SEQUENTIAL AND OTHER SYSTEMS
TYPICAL SIGNAL SOURCE

1 AUXILIARY UNIT
Three 401-AR Gamma Amp.
615-AR NTSC Matrix Adder
402-CR Keyed Clump Gen.
606-BR Color Burst Gen.
609-BR NTSC Color Keyer
507-BR Sequential Color Keyer
613-BR Regulated Power Supplies

2 BASIC COLOR SCANNER
600-P3R Simultaneous Tri-Color Pickup
600-S1R Universal Color Scanner
604-AR Control Panel
616-BR CRT Power Supply
612-BR Regulated Power Supply

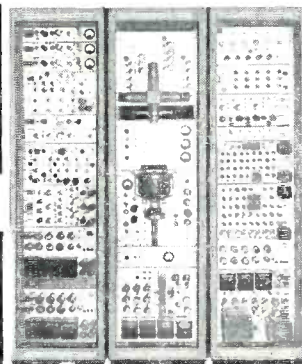

3 DRIVING UNIT
509-AR-1 Universal Color Bar Generator
605-AR Color Carrier Gen. & Sampling Divider
603-AR Sync Generator
613-BR Regulated Power Supplies

TELECHROME'S COLOR EQUIPMENT IS NOW BEING USED BY MANY OF THE NATION'S LEADING BROADCASTERS, RECEIVER MANUFACTURERS AND LABORATORY GROUPS.

Laboratory Quality Instrumentation; also custom made to any specific requirements.

COLOR TV **TELECHROME** THROUGH ADVANCED RESEARCH & DEVELOPMENT
INCORPORATED
38 MERRICK ROAD, AMITYVILLE, N. Y.
TELEPHONE AMITYVILLE 4-4446

of the University of Illinois. The important parts of the papers and discussions presented at Pocono Manor are summarized in this book. The list of titles and authors follows:

I. On the Nature of Imperfections in Nearly Perfect Crystals

1. Imperfections in Nearly Perfect Crystals: A Synthesis, Frederick Seitz

2. On the Geometry of Dislocations, W. T. Read, Jr., and W. Shockley

II. The Role of Imperfections in Deformation

3. Imperfections from Transformation and Deformation, C. S. Barrett

4. Experimental Information on Slip Lines, W. T. Read, Jr.

5. X-Ray Diffraction Studies of Cold Work in Metals, B. E. Warren and B. L. Averbach

6. Mechanical Strength and Creep in Metals, N. F. Mott

7. The influence of Dislocations and Impurities on the Damping and the Elastic Constants of Metal Single Crystals, J. S. Koehler

III. Diffusion and Related Phenomena

8. Relaxation Effects in Ionic Crystals, R. G. Breckenridge

9. Studies of Alkali Halides by Photoelectric Methods, L. Apker and E. Taft

10. Diffusion in Alloys and the Kirkendall Effect, J. Bardeen & C. Herring

11. Theory of Diffusion, Clarence Zener

IV. On the Properties and Effects of External and Internal Surfaces of Crystals

12. Surface and Interfacial Tensions of Single-Phase Solids, J. C. Fisher and C. G. Dunn

13. Dislocation Models of Grain Boundaries, W. T. Read, Jr., and W. Shockley

14. Interphase Interfaces, Cyril Stanley Smith

15. Substructures in Crystals, A. Guinier

16. The Properties and Effects of Grain Boundaries, Bruce Chalmers

17. Movement and Diffusion Phenomena in Grain Boundaries, R. Smoluchowski

This book was prepared mainly for specialists in metallurgy and

Simplifying HF Power Measurement

Model 67 TERMALINE DIRECT-READING R-F WATTMETER

30 mc to 500 mc
(to 1000 mc if specified)

50 ohms

Triple Range 0-25 watts
0-100 "
0-500 "

Type N Input Connector
(Adaptor for PL-259 supplied)

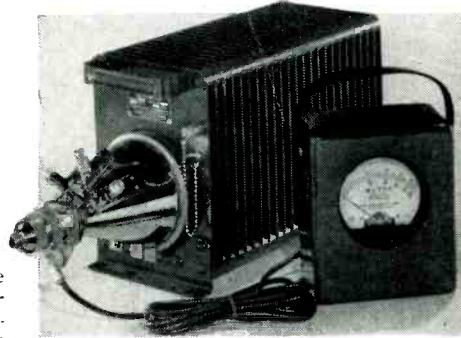

NON-RADIATING

... Accuracy - 5%

RUGGED CONSTRUCTION

... Size - 17" x 9" x 6"
Wght. - 30 pounds

• Model 67 is a larger type Wattmeter than the well-known AN-ME-11/U (our Model 611) R-F Wattmeter. Specifically designed for fixed station transmitters to 500 watts output, it may be used nicely on low range for mobile gear. Provided with an aluminum cased, shock-mounted meter, Model 67 is as simple to use as a DC voltmeter. Now in general use throughout the industry, TERMALINE Wattmeters may be depended upon for fast, accurate and repeatable power readings.



BIRD

ELECTRONIC CORP.

TERMALINE COAXIAL LINE
INSTRUMENTS

1800 EAST 38TH ST.
CLEVELAND 14,
OHIO

West Coast:
NEELY ENTERPRISES
HOLLYWOOD 46, CAL.

optimum solution

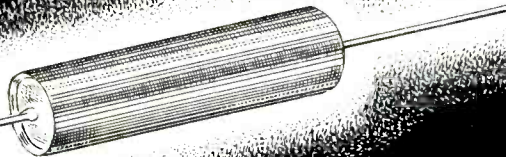

Unicon Type D capacitors employ a newly developed plastic resin film as a dielectric.

The power factor, dielectric absorption, and temperature co-efficient of these condensers are much better than those of oil paper capacitors. They compare favorably in size with metallized paper capacitors of equal ratings and give far superior performance. Operation to 125°C is permissible. When high insulation resistance, without simultaneous low "soakage" and/or low power factor, is required, Type D capacitors make an excellent low-price substitute for Polystyrene or Teflon capacitors.

Unicon always gives your capacitor problems the Optimum Solution.

unicon PLASTIC DIELECTRIC capacitors

TYPES IMMEDIATELY AVAILABLE			
Property	Poly-styrene	Teflon	Synthetic D
Capacity	.001 up	.001 up	.01 up
Voltage	100 up	300 up	200 up
Power Factor	.01%	.01%	0.5%
I. R.	10 ⁶ meg/mf	10 ⁶ meg/mf	10 ⁶ meg/mf
Max. Op. Temp.	90°C	125°C	125°C
Soakage	.02%	.02%	1.0%
Temp. Coef.	-100 ppm/°C	-100 ppm/°C	+500 ppm/°C
Bulk at lowest voltage given	5 in ² /mf	10 in ² /mf	1.2 in ² /mf

Capacitors made to your specifications.

Write for catalog EE

united condenser corp.

UNICON

337 EAST 139th STREET NEW YORK 54, N. Y.

SYNTRON

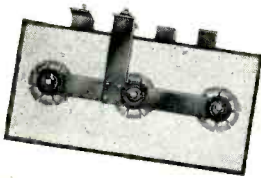

SELENIUM RECTIFIERS

Made by a new vacuum process that insures a smooth, uniform selenium film, free from flaws and impurities, and permits the production of larger cells than have been practical heretofore.

Of proven dependability to withstand continuous heavy-duty service, they are available in one inch square to 12" by 16" cells, in stacks or for customer assembly.

Write for Free Catalog Folder

SYNTRON CO.
241 Lexington Ave. Homer City, Pa.

ELECTRONIC ENGINEERS PHYSICISTS TECHNICIANS

Are you interested in a permanent, challenging position where you can master a wide variety of problems in the field of instrumentation and special equipment?

Would you like to work for a moderate sized, long established, progressive company where your capabilities will be fully recognized financially and professionally?

We offer you the opportunity in our Research Department. Send us a statement of your qualifications and experience. We will keep it strictly confidential.

COLEMAN INSTRUMENTS, INC.
310 MADISON STREET
MAYWOOD ILLINOIS

NEY'S

SMALL PARTS PLAY A **BIG** PART IN PRECISION INSTRUMENTS

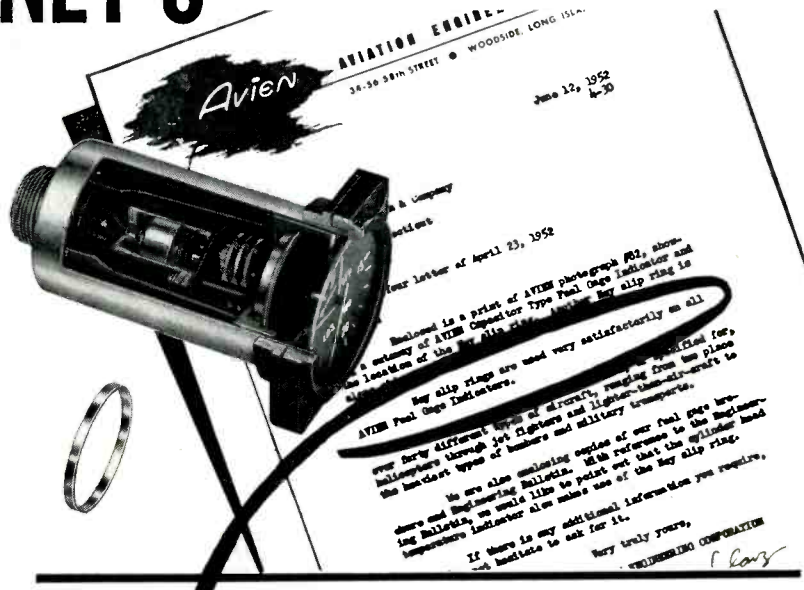

NEY slip rings are used very satisfactorily on all AVIEN Fuel Gage Indicators.

Do you have our Bulletins R-12, R-13, and R-14?

THE J. M. NEY COMPANY, 179 Elm St., Hartford 1, Conn.
Specialists in Precious Metal Metallurgy Since 1812

15NY62A

made right to work right BENDIX-FRIEZ high-precision thermistors

Whether you use these temperature responsive resistors in standard or special models, you can be sure of this. They'll match your needs for resistance values, size, temperature coefficient, mountings and quality. Made in our own plant under carefully controlled conditions, Bendix-Friez Thermistors know no equal.

STANDARD TYPES FOR IMMEDIATE DELIVERY

Size (inches)	@ +30°C.	@ 0°C.	@ -30°C.
.140 x .75	45.0 ohms	86 ohms	194 ohms
.040 x 1.5	12,250 ohms	26,200 ohms	65,340 ohms
.018 x 1.5	35,000 ohms	82,290 ohms	229,600 ohms

Write for details.

FRIEZ INSTRUMENT DIVISION of . . .
1454 Taylor Avenue, BALTIMORE 4, MARYLAND
Export Sales: Bendix International Division
72 Fifth Avenue, New York 11, N. Y.

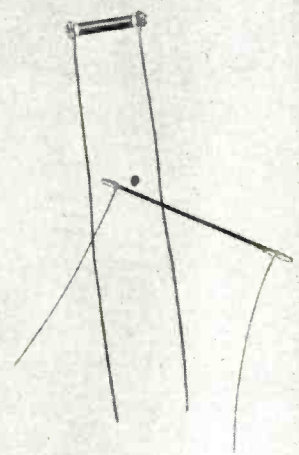

Used in this typical application for sensing the temperature of hydraulic oil.



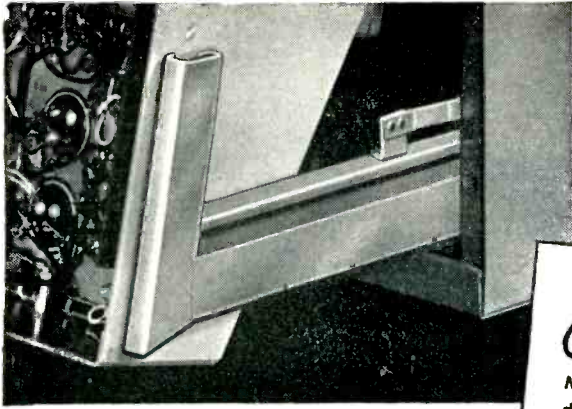

Try Remler for
Service-Tested
"Hard-to-Get"
Components

*Custom
Components*

Metal-plastic components
designed and manufactured
to order. Write for quotations
specifying electrical
and mechanical characteristics.
Describe application.
No obligation.

FOR EFFICIENT MAINTENANCE
SPECIFY REMLER **TILT-UP**
EQUIPMENT SLIDES

Remler slide rails for rack or cabinet mounting permit complete withdrawal or inspection of top and bottom of apparatus chassis. Positive... self-locking. Full roller type... handles equipment up to 50 lbs. Stainless steel for

military applications; cadmium plated cold rolled steel or bonderized cold rolled steel. Nickel plated brass rollers; roller studs in stainless or copper flashed cold rolled steel.

Remler Company Ltd. 2101 Bryant St. San Francisco 10, Calif.

Remler
Since 1918 PIONEERS IN ELECTRONICS AND PLASTICS

ULTRASONIC SPECTRUM ANALYSIS

- Ultrasonic Vibration Measurements
- Harmonic Analysis
- Cross Modulation Studies
- Noise Investigations
- Determining Transmission Characteristics of Lines and Filters
- Monitoring Communications Carrier Systems
- Checking Interference, Spurious Modulation, Parasitics, Effects of load changes, shock, humidity, component variations, etc. upon frequency stability.
- Telemetering

SPECIFICATIONS

Frequency Range: 2KC-300KC, stabilized linear scale
Scanning Width: Continuously variable from 200KC to zero
Four Input Voltage Ranges: 0.05V. to 50V. Full scale readings from 1 millivolt to 50 volts
Amplitude Scale: Linear and two decade log
Amplitude Accuracy: Within 1 db. Residual harmonics suppressed by at least 50db.
Resolution: Continuously variable. 2KC at maximum scanning width, 500 c.p.s. for scanning width below 8KC.

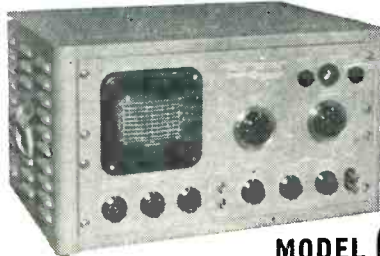

MODEL
**PANORAMIC
ULTRASONIC
ANALYZER**

**EASY
FAST
SB-7**

An invaluable new direct reading instrument for simplifying ultrasonic investigations, the SB-7 provides continuous high speed panoramic displays of the frequency, amplitude and characteristics of signals between 2KC and 300KC. The SB-7 allows simultaneous observations of many signals within a band up to 200KC wide. Special control features enable selection and highly detailed examination of narrower bands which may contain signals separated by less than 500 c.p.s. SB-7 is unique in that it provides rapid indications of random changes in energy distribution. WRITE NOW for Complete Information, Price, Delivery 10 South Second Ave., Mount Vernon, N.Y. MOUNT VERNON 4-3970



solid-state physics. The contributors are among the outstanding leaders in their fields.

The work of compiling and editing the manuscripts has been an important and worthwhile task; the result is a valuable contribution to physics and physical metallurgy. —EDWARD N. CLARKE, *Physics Laboratories, Sylvania Electric Products Inc., Bayside, New York.*

The Nature Of Number

BY ROY DUBISCH, *Fresno State College, California. The Ronald Press Company, Inc., New York, 1952, 159 pages, \$4.00.*

THIS book encompasses a well-written and precisely-stated account of the gradual development of the concept of number through the ages and of its rapid flowering in the last century to yield the bases of the modern linear associative algebras of today. Although couched in semi-textbook style, it can yet be read with interest by that large non-classroom audience whose eagerness for mathematical exposition is evidenced by the substantial sales of several editions of books such as Tobias Dantzig's "Number, the Language of Science: A Critical Survey Written for the Cultured Non-Mathematician," Eric T. Bell's "The Magic of Numbers" and Levi L. Conant's "The Number Concept: Its Origin and Development." The present text—less pedestrian in style than Conant's book, somewhat soberer in language and expression than Bell's, and not as concerned with points of philosophical interest as Dantzig's—reads easily; develops its theme fluently, chronologically, and accurately; and offers, *in toto*, an easily-grasped, well-delineated précis of the evolution of a branch of mathematics of prime usefulness to all mankind.

The book has twelve chapters. The semi-popular approach is indicated in the titles: Thus, Chapter 8: "The Great i Solves All" and Chapter 9: "A Shot in the Arm for Complacent Algebraists of the Nineteenth Century." However, despite the nature of these titles, the writing is not facetious nor is the author an amateur of mathematics. Rather, it is that a somewhat

PATENT ATTORNEYS

Because of our rapid growth and expansion of commercial interests, we've gotten a late start in building an appropriately large patent department. So we now have openings for patent attorneys that carry an unusual opportunity for rapid advancement. And the fact that our organization is one of the more prominent electronics laboratories in the country, provides a degree of security not usually associated with rapid individual growth.

If you are professionally qualified in the field of electronics, we would like to give you more information concerning these positions. You are invited to write:

HUGHES

Research and Development Laboratories
Engineering Personnel Department
Culver City, Los Angeles County
California

HERE'S BIG HELP IN TERMINAL WIRING!

The New JONES FANNING STRIP

Connections are made through Fanning Strip, on bench or anywhere apart from barrier strip, and quickly slipped into assembly.

Use with Jones Barrier Terminal Strips, Nos. 141 and 142, for 1 to 20 terminals.

Simplifies soldering. Insures correct connections. Saves time. Ideal for harness or cable assembly. Brass terminals, cadmium plated. Bakelite mounting. Send for complete data.



9-141 Barrier Strip

9-161 Fanning Strip. Pat. applied for.

The correct wire to correct terminal every time!

Jones HOWARD B. JONES DIVISION
CINCH MANUFACTURING CORPORATION
CHICAGO 24, ILLINOIS
SUBSIDIARY OF UNITED-CARE FASTENER CORP.



Attenuators

Precision and General Purpose, "T" Type

Both with impedance range from 30 to 600 ohms. Precision resistors held to within $\pm 1\%$ accuracy . . . general purpose within $\pm 5\%$. Also Bal. H types.



Range Extending

For use with all makes of V.U. and D.B. meters. All resistors within $\pm 1\%$.



Potentiometers

Precision and General Purpose grid control types with non-inductive, wirewound resistors. Also dual precision wirewound grid potentiometers.



Write for Complete Catalog

N. Y. Stock:
Audio & Video Products Corp. • 730 Fifth Ave., Plaza 7-3091



CINEMA ENGINEERING COMPANY
1510 WEST VERDUGO AVENUE, BURBANK, CALIFORNIA

Export Agents: Frazer & Hansen, Ltd. • 301 Clay St • San Francisco, Calif. U.S.A.

JELLIFF RESISTANCE WIRES

ARE VERY MUCH AT HOME IN A **HOT • SPOT**

ALLOY	OHMS PER CMF	MAX. OPER. TEMP.	FORMS †	USES
1000	1000	500° F	W-R	Compact, stable precision Resistors
ALLOY C	675	1700° F	W-R	Appliances and Resistors
ALLOY	650	2100° F	W-R	High-temp. Furnaces and Resistors
ALLOY 45	294	930° F	W-R	Precision Applications

† W—wire R—ribbon

★
Whether the heat is literal (up to 2100F), or figurative in the sense that performance under difficult condition is a *must*, we have an alloy for almost any conceivable requirement. The above Table may suggest possible applications to your products.

★
Complete Technical Data are available from Department 17.



NOTHELFER "NWL" Special TRANSFORMERS

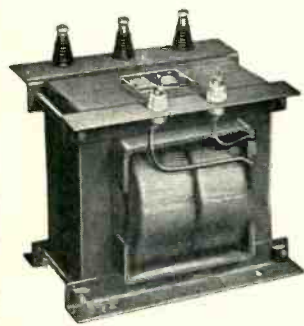
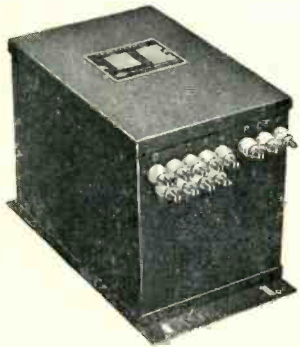

*Proven by
Past Performance*

Over 28 years' experience in the manufacture of special transformers to meet individual requirements. Built in quality proved by years of actual use.

From 10 VA to 300 KVA Dry-Type only. Both Open and Encased. 1, 2, and 3 Phase. 15 to 400 cycles.

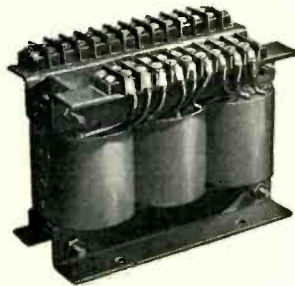

Send for NEW 8 page BULLETIN



NOTHELFER
WINDING
LABORATORIES



9 ALBEMARLE AVE., TRENTON 3, N. J.

TELEVISION SIGNAL GENERATOR

Model 90

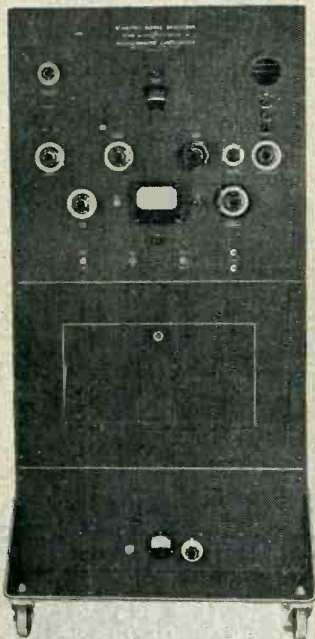

The first commercial wide-band, wide-range Signal Generator to be developed to meet the exacting standards of high definition television use.

Specifications:

CARRIER FREQUENCY

RANGE: Continuously variable from 20 to 250 megacycles, in eight ranges.

MODULATION

PERCENTAGE: Continuously variable from 0 to 100%.

ENVELOPE: Sinusoidal, or composite television.

OUTPUT

LEVEL: Continuously variable from 0.3 microvolt to 0.1 volt balanced to ground (measured at 100% modulation level).

DIMENSIONS: Height—58 3/4"
Width—28 1/4" Depth—25 1/2"

POWER SUPPLY: 117 volts, 60 cycles, 700 watts.

Complete Data On Request

MEASUREMENTS CORPORATION

BOONTON



NEW JERSEY

formidable span of mathematical content is set out with authority, but in rather non-formal style, by one with thorough professional grounding in the mathematical area he covers.

Intelligible reading of this book requires little prior mathematical background other than that gained in the usual course in college algebra. In consequence, the average communications engineer ought to be able to read it without difficulty. The book may be epitomized as affording an easy and interesting introduction to the course of development of the bases of a branch of mathematics (modern algebra) which comprises a powerful tool of analysis for such currently-active areas of communications engineering as network synthesis and information theory.—THOMAS J. HIGGINS, *Professor of Electrical Engineering, University of Wisconsin.*

THUMBNAIL REVIEWS

DIRECT CURRENT MACHINES. By Charles S. Siskind, Assistant Professor, Electrical Engineering, Purdue University. McGraw-Hill Book Co., 306 pages, \$6.00, 1952. Fundamental, up-to-date clearly-presented material for a one-semester course. Mathematical derivations are rigid and widely used.

1952 MODERN PLASTICS ENCYCLOPEDIA AND ENGINEER'S HANDBOOK. Reskin Publications, New York, 1952, 848 pages, \$6.00. Designed as a working guide to all phases of plastics production and material selection for companies using or contemplating the use of plastics products or components. Chapters covering molding, extruding, casting, fabricating, finishing and assembling operations and the machines and equipment presently available for plastics processing.

FERNSEHTECHNIK. By F. Kirschstein and G. Krawinkel, S. Hitzler, Stuttgart, Germany. 288 pages, DM 25, 1952. In German. What appears to be a thorough-going text on all aspects of television from the photoelectric effect to the color processes much in recent public discussion. Latest reference is to the literature of January 1950, so it seems to be up to date.

ECONOMICS OF AMERICAN MANUFACTURING. By Edward L. Allen. Henry Holt and Co., New York, 1952, 566 pages, \$6.95. Penetrating cross-section view of American industry. Examines nineteen representative industries within five general categories: basic metal, basic nonmetallic, metal-working, textile and allied, and consumer specialty. Topics discussed include export-import, corporate ownership and control, location and capacity of plants, pricing policy, profits, and future outlook. Concludes with extensive bibliography.

CONTROLLERS FOR ELECTRIC MOTORS. 2nd ed. By H. D. James and L. E. Markle. McGraw-Hill Book Co., New York, 1952, 418 pages, \$7.00. Retains first edition information about the design, ap-



LOOKING AHEAD?

If you're a top performer in the field of physics, electronic engineering or design, and you're looking for a career as well as a well-paid position, it will pay you to investigate the excellent opportunity we offer.

BASIC QUALIFICATIONS:

Minimum of four year's experience in advanced research or development related to:

- PULSE CIRCUITS
- COMPUTERS
- NUCLEAR INSTRUMENTS
- MINIATURIZATION

• • •

ILLUSTRATED BROCHURE on request. Please write (giving summary of your education and experience, plus salary requirements) to:

BERKELEY SCIENTIFIC

division of
Beckman Instruments Inc.
2200 Wright Avenue
RICHMOND, CALIFORNIA

ENGRAVING • PROFILING

for heavy production

with the **Engravo**
graphTM



NEW HERMES, Inc.

13-19 University Place, New York 3, N.Y.

DOUBLE BARREL ADVERTISING

Advertising men agree—to do a complete advertising job you need the double effect of both Display Advertising and Direct Mail.

Display Advertising keeps your name before the public and builds prestige.

Direct Mail supplements your Display Advertising. It pin-points your message right to the executive you want to reach—the person who buys or influences the purchases.

In view of present day difficulties in maintaining your own mailing lists, our efficient personalized service is particularly important in securing the comprehensive market coverage you need and want.

Ask for more detailed information today. You'll be surprised at the low overall cost and the tested effectiveness of these hand-picked selections.

for Results



Mc GRAW-HILL
DIRECT MAIL LIST SERVICE

McGraw-Hill Publishing Co., Inc.
330 West 42nd St., New York 36, N. Y.

Engravo

graphTM

Write for literature describing:

1. Heavy Duty model (as illustrated) — Catalog H 29
2. Portable models — Catalog IM 29

NEW HERMES, Inc. 13-19 University Place, N.Y. 3, N.Y.

In Canada: 359 St. James St., Montreal

World's Largest Manufacturer of Portable Engraving Machines

"PERFECT..."



That's What Production Engineers Say about **DANO COILS**

And, it's no accident, of course. The Dano rigid policy of attentive testing and inspecting every coil in all vital stages of production guarantee perfect performance.

Send us samples or specifications with quantity requirements for our recommendation. No obligation!

- Form Wound
 - Paper Section
 - Acetate Bobbin
 - Molded Coils
 - Bakelite Bobbin
 - Cotton Interweave
 - Coils for High Temperature Application.
- Also, Transformers
Made To Order



THE DANO ELECTRIC CO.
93 MAIN ST., WINSTED, CONN.

Make a **GM** PORTABLE D'ARSONVAL
GALVANOMETER

*the Heart
of Your
Instrument*

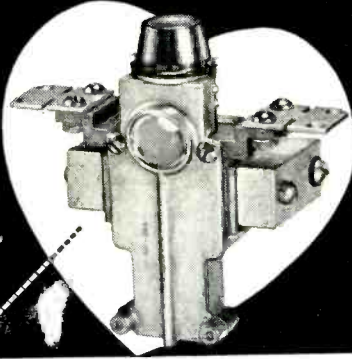

IN THE AUTOMOTIVE FIELD, the Bear Manufacturing Co. of Rock Island, Ill. uses Series 500 G-M Galvanometers in its new remote-reading Electric Wheel Alignment System (left). Whatever your own particular instrument field, you can achieve this same self-contained portability, ruggedness and high sensitivity with G-M Galvanometers. Complete catalog on request.

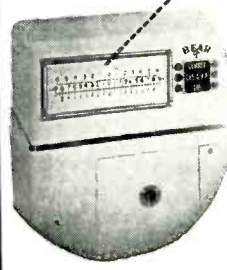

GM LABORATORIES • INC.
4336 NORTH KNOX AVENUE, CHICAGO 41
In Canada: Cossor (Canada) Ltd., 301 Windsor, Halifax

plication, operation, and maintenance of industrial controllers. In addition, it includes chapters on such recent developments as the magnetic amplifier, the dynamo electric amplifier, magnetic clutches, a-c and d-c crane control, and remote and supervisory control.

TELEVISION TECHNICALS. By Martin Clifford, Gernsback Library Book Number 46. Radercraft Publications, Inc., New York, N. Y. 128 pages, \$1.50, 1952. For the technicians who have to fix TV sets that get out of whack. Notes on individual models of all manufacturers from Admiral to Westinghouse (in alphabetical order) and literally thousands of models.

THE MEASUREMENT AND CONTROL OF TEMPERATURES IN INDUSTRY. R. Royds. Chemical Publishing Co., Inc., New York, N. Y. 260 pages, \$5.00, 1952. Revision of older volume of somewhat different title. Chapters on temperature scales, expansion and electrical thermometers, pyrometers, galvanometers and other indicators and the measurement of rapidly fluctuating temperatures.

AUTOMATIC RECORD CHANGER SERVICE MANUAL. Vol. 4 (1951-1952). Howard W. Sams & Co., Inc., Indianapolis, Ind., \$3.00. Comprehensive service information, with increased emphasis on new models of wire and tape recorders.

INDUSTRIELLE ELEKTRONIK. By R. Kretzmann, Elektro Spezial, G.m.b.H., Hamburg, Germany. Verlag fuer Radio-Foto-Kinotechnik, Berlin. Describes, in German, electronic apparatus employed in industrial process control, especially switching methods.

MANAGEMENT CONTROLS IN INDUSTRIAL RESEARCH ORGANIZATIONS. By Robert N. Anthony, Associate Professor, Business Administration, Harvard Business School. 538 pages, \$6.75, 1952, Harvard Business School, Boston 63, Mass. How to find "the proper balance between freedom at the laboratory level and direction from the top" for research administrators.

PROCEEDINGS, NATIONAL ELECTRONICS CONFERENCE, 1951, Vol. 7. National Electronics Conference, 852 E. 83rd Street, Chicago 19, Illinois. 736 pages, charts, diagrams, tables, 9 1/4 by 6 1/4 inches, cloth, \$5.00. Papers—or digests—presented at the 1951 conference. The seventy-nine papers cover electronic research, audio systems, components, computers, high-frequency measurement, information theory, magnetic amplifiers, medical and industrial applications, microwave propagation, servo theory, signal detection, television and tubes.

SURVEY, R-F TRANSMISSION LINES AND WAVEGUIDES. E. S. Winlund. Radio Club of America, 11 West 42 St., New York 18, N. Y., 88 pages, 1951, \$1.00. Historical survey, technical data and bibliography through 1951.

THE MANUAL OF CORPORATE GIVING. Edited by Beardsley Ruml in collaboration with Theodore Geiger. National Planning Association, 800-21st Street, N.W., Washington, D. C., 1952, 416 pages, \$6.75. Contains sections by 26 experienced donors and recognized experts. Primarily concerned with explaining the specific ways in which gifts can be made to yield the maximum benefits both to the recipient and to the donor.

ULTRAVIOLET RADIATION. By Lewis R. Koller. John Wiley & Sons, Inc., New York, 1952, 270 pages, \$6.50. Written for nonspecialists in radiation, to describe available sources of ultraviolet, discuss application techniques, and give pertinent data on filters, mirrors and other accessories used. Many tables and graphs increase the reference value of the book.

KUPFRIAN LIGHT DUTY **FLEXIBLE SHAFTS**

AND COUPLINGS

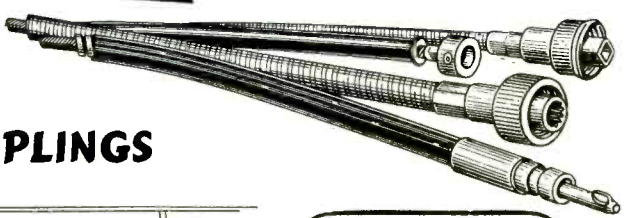

- AUTOMOTIVE
- ELECTRONIC
- AERONAUTICAL
- INDUSTRIAL

KUPFRIAN Light Duty Coupling (type CB-82) With Panel Bushing

TYPICAL APPLICATIONS

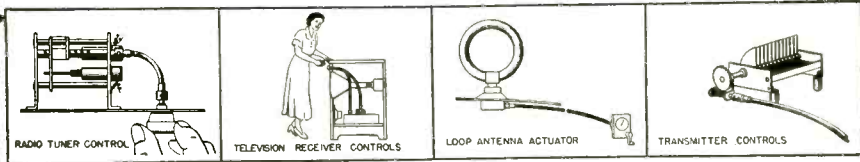

SIMPLIFY YOUR MOTION TRANSMISSION PROBLEMS

- ALLOW GREATER FREEDOM IN PLACEMENT OF PARTS
- USE ASSEMBLIES PREPARED FROM LOW-COST STANDARD COMPONENTS

Write for Bulletin 5194

KUPFRIAN MANUFACTURING COMPANY
398 STATE STREET BINGHAMTON, N. Y.

"Wow-Meter"



Improved direct-reading instrument simplifies measurements of wow and flutter in speed of phonograph turntables, wire recorders, motion picture projectors and similar recording or reproducing mechanisms. It is the only meter in existence giving direct steady indication of meter pointer on scale.

The Furst Model 115-R "Wow-Meter" is suitable for both laboratory and production application and eliminates complex test set-ups.

A switch on the front of the panel permits selection of low frequency cut-off and corresponding meter damping for use on slow speed turntables.

*Inquiries Invited on our line of Regulated Power Supplies
Frequency Response: 1/2 to 120 cycles or 10 to 120 cycles
Sensitivity: 0.2, 0.5, and 2.0% Wow Full Scale*



FURST ELECTRONICS

3324 W. LAWRENCE AVE., CHICAGO 25, ILL.

ONLY Heminway & Bartlett Produces this Sensational NEW FUNGUS-PROOF NYLON LACING CORD

Meets Army, Navy and Civilian Requirements

The special synthetic resin coating on Heminway & Bartlett's Nylon Lacing Cord resists the growth of mold and microorganisms—factors most often responsible for the deterioration of linen and cotton lacing cords. In addition, Heminway & Bartlett's Nylon Lacing Cords have high abrasion resistance, low moisture absorption and the finish has the desirable malleability of wax. The finish is also non-toxic to humans.

For fine wire lacing, we have developed a Nylon Flat Braided specially treated Tape. We'll be glad to send you samples of both the Nylon Lacing Cords and the Nylon Flat Braided Tape. Why not write us today!

The Heminway & Bartlett Mfg. Co., 500 Fifth Avenue, New York 36. Sales Offices: Chicago, Boston, Philadelphia, St. Louis, Cincinnati, San Francisco, Charlotte, N. C., Gloversville, N. Y.



TYING TWINE

TAKE A GOOD LOOK!

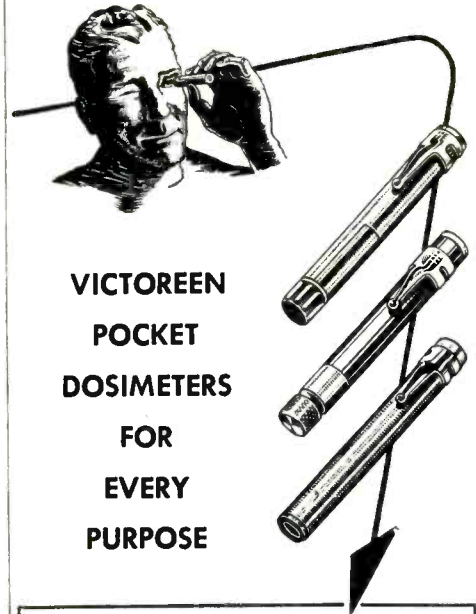

VICTOREEN
POCKET
DOSIMETERS
FOR
EVERY
PURPOSE

LOOK at the Victoreen dosimeters that have served the medical profession for over twenty-five years.

LOOK at the Victoreen dosimeters that serve Government and Atomic Energy Industrial Laboratories.

LOOK at the Victoreen dosimeters in "Olive Drab" and in "Navy Gray."

A dosimeter is an instrument which measures the total accumulated quantity (dosage) of X or gamma radiation. The reading is in roentgens regardless of exposure time. Pocket dosimeters, sometimes called pocket chambers, are either direct reading or indirect reading. Direct reading pocket chambers have a built-in optical system and electrometer, which permits the wearer to periodically observe the dosage which has accumulated since the chamber was last charged, thus enabling him to retreat from a hazardous area when the dosage approaches the average daily tolerance. Indirect reading dosimeters require a Minometer (charger-reader) to observe the reading. This reading is usually checked at the end of the working day by a competent technician.

Model	Type	Full Scale Sensitivity	Conditions
362	Indirect	0.2 r	At or below daily Tolerance Rate
541	Direct	0.2 r	At or above daily Tolerance Rate
547	Direct	5. r	Emergency
548	Direct	50. r	Trained personnel — Emergency
534	Direct	5. and 50. r	Civil defense, etc.
506	Indirect	100. r	Untrained personnel — Emergency
507	Indirect	200. r	Untrained personnel — Emergency

Write for Bulletin 3012 B



Victoreen Instrument

5806 HOUGH AVE. CLEVELAND 3, OHIO

A NEW PRODUCT

from

A NEW ADDRESS

CML is pleased to announce
**THE MODEL 1440
OMNIPHASE GENERATOR**



This unique instrument was developed primarily to make it possible to use two or three CML high power single phase variable frequency generators in combination as a source of variable frequency 2 or 3 phase power. In its own right, the Model 1440 has many uses in the development laboratory.

It covers a range of 17 cycles to 18,000 cycles in 5 ranges. Three output voltages are developed throughout the frequency range (10 volts across 5,000 ohms). The phase of all three voltages is continuously adjustable through 360 degrees by means of panel controls. This makes it possible to set up any desired relationship between the three phases.

In case you missed previous announcements, after 14 years in New York City we have moved to our own modern plant at the address indicated below. Read about other new CML products in our new catalog. Write for yours today.

COMMUNICATION MEASUREMENTS LABORATORY, INC.

350 Leland Ave., Plainfield, N. J.
Plainfield 4-5502

BACKTALK

Tube Testers

DEAR SIR:

I NOTE an article on page 139 of the June issue of *ELECTRONICS* entitled "Vacuum-Tube Testers". This article mentions "proposed classification (of tube testers) by RTMA" and lists "RTMA Tube Tester Classifications". I wish to point out that this list of classifications does not in any way constitute a proposal by RTMA. The list was formulated by a committee in an effort to see if agreement among tube tester manufacturers could be reached on such a classification. An agreement was not reached accepting this list and, therefore, this material has been set aside. At the moment there is no proposal under consideration.

VIRGIL M. GRAHAM
*Associate Director
RTMA Engineering Department*

New Diotron

DEAR SIR:

A RECENT article by Rosenthal and Badoyannis (*ELECTRONICS*, Sept. 1952, p 128) mentions the Diotron mean-square voltmeter and points out two objectionable properties of the original instrument: zero drift and indeterminate behavior after overload. Later design has successfully dealt with both of these problems and we feel these criticisms do not apply to our instruments now on the market.

In addition, we have offered to rebuild instruments already in the field or to provide copies of the revised circuit diagram to users of the instrument who prefer to do the modifications themselves.

R. D. CAMPBELL
*Electro-Physics Dept.
Reed Research
Washington, D. C.*

Delete Five Words

DEAR SIR:

THE ARTICLE "Nonsynchronous Pulse Multiplex System" in the August 1952 issue of *ELECTRONICS* is based on a paper presented at the March IRE Convention by Dr. J. R. Pierce and the writer. Quite extensive condensation was required

SILVER GRAPHALLOY

BRUSHES

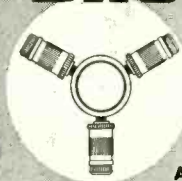

AND

CONTACTS

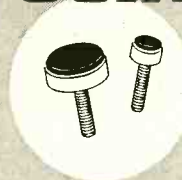

... for applications requiring low electrical noise, low and constant contact drop, high current density and minimum wear.



EXTENSIVELY USED IN

**SELSYNS
ROTATING THERMOCOUPLE and
STRAIN-GAGE CIRCUITS
ROTATING JOINTS
GUN-FIRE CONTROLS
DYNAMOTORS etc.**

Wide range of grades available for standard and special applications.

Brush holders and coin silver slip rings available for use with Silver Graphalloy Brushes.

OTHER GRAPHALLOY PRODUCTS:

Oil-free self-lubricating Bushings and Bearings, Oil-free Piston Rings, Seal Rings, Thrust and Friction Washers, Pump Vanes.



Write us for Data Sheets and further information. Outline your problem and we will apply our years of accumulated experience toward its solution.

GRAPHITE METALLIZING CORPORATION

1055 NEPPERHAN AVENUE • YONKERS, N. Y.

LABORATORY POLI-SCALER

"Model DS-606 Poli-Scaler," for GM or scintillation counting, has plug-in power supply adjustable to any voltage from 0 to 2.5 kv, positive or negative, with two plug-in "Model TU-9" Decade Totalizers feeding into a mechanical register. Resolution time 5μ sec. per pulse pair; direct readings to 8 places.

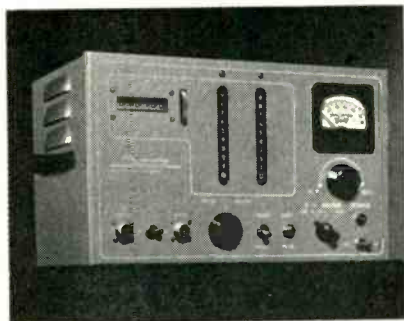

Additional totalizers may be added to increase counting rate and total count capacities. Includes pulse height discriminator and shaper (0 to 100v) voltage regulator, outlets for time and elapsed time clocks, speaker, remote control, and accessory count rate meter. For descriptive folder write to Dept. 78.

THE Detectron CO.

5631 Cahuenga Blvd., No. Hollywood, Calif.

ELECTRONICALLY REGULATED LABORATORY POWER SUPPLIES



BENCH MODEL 25

• STABLE
• DEPENDABLE
• MODERATELY PRICED

- **INPUT:** 105 to 125 VAC, 50-60 cy
- **OUTPUT #1:** 200 to 325 Volts DC at 100 ma regulated
- **OUTPUT #2:** 6.3 Volts AC CT at 3A unregulated
- **RIPPLE OUTPUT:** Less than 10 millivolts rms

WIDTH 14"
DEPTH 6"
HEIGHT 8"
WT: 17 LBS.

For complete information write for Bulletin E



LAMBDA ELECTRONICS CORPORATION
CORONA NEW YORK



ROTARY ELECTRICAL EQUIPMENT

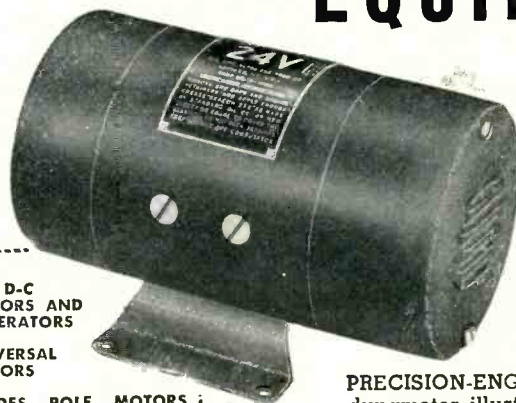

DYNAMOTOR DY-85, 24 Volt

Built to rigid military specifications . . . operates from 24 V input . . . output 600 V at 175 milliamperes continuous duty. Temperature range -20° C to 85° C. Armature dynamically and statically balanced. Two pole construction, with separate removable pole pieces.

P-M D-C MOTORS AND GENERATORS

UNIVERSAL MOTORS

SHADES POLE MOTORS (2-4-6 POLE)

D-C MOTORS AND GENERATORS

P-M A-C GENERATORS

CAPACITOR TYPE MOTORS

MOTORS DESIGNED FOR SPECIAL APPLICATIONS



PRECISION-ENGINEERED describes the dynamotor illustrated above. It is typical of the many special problems which

EEPCO engineers have solved in military and industrial applications.

Whether your power problem relates to a highly developed radar unit or an industrial control device, EEPCO is set up to save you time and money. This is possible because of EEPCO's specialized engineering experience in the design and manufacture of precision rotary electrical equipment.

If you have a power problem, simple or complex, we'd like the opportunity to work it out for you.

ELECTRO ENGINEERING PRODUCTS CO.

Makers of Precision Rotary Electrical Equipment

609 W. LAKE STREET

DEPT. E

CHICAGO, ILL.

PRECISION IN MINIATURE!



Extended Range AUDIO OSCILLATOR

- Only 6" x 4 1/4" x 5".
- 18 cycles to 1.2 megacycles.
- Distortion less than 0.2%.
- Constant output ± 0.5 db.
- 600/150 ohm transformer available.

Price \$150

Literature on request

Waveforms, inc.

333 Sixth Avenue
New York 14, N. Y.

WHAT MAKES A MAILING CLICK?



Mc GRAW-HILL
DIRECT MAIL LIST SERVICE

Advertising men agree . . . the list is more than half the story. McGraw-Hill Mailing Lists, used by leading manufacturers and industrial service organizations, direct your advertising and sales promotional efforts to key purchasing power.

In view of present day difficulties in maintaining your own mailing lists, this efficient personalized service is particularly important in securing the comprehensive market coverage you need and want. Investigate today.

McGraw-Hill Publishing Co., Inc.

DIRECT MAIL DIVISION

330 West 42nd Street

New York, 18, New York

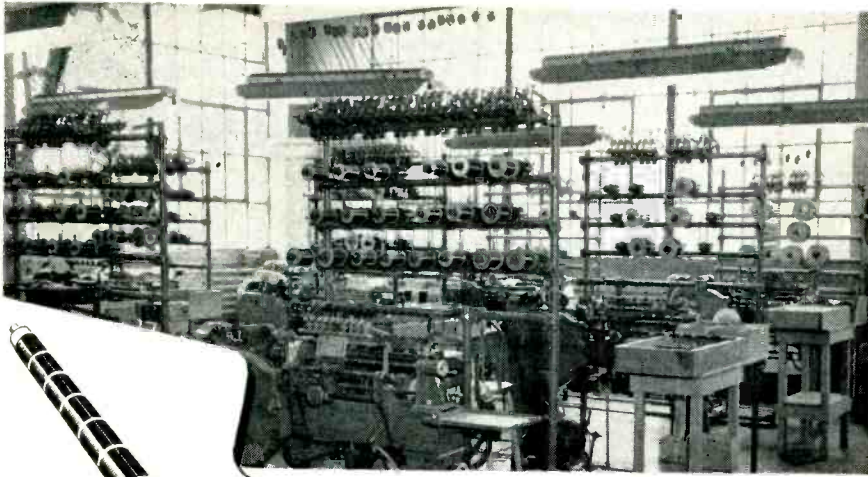

Seven interleave coils as removed from winder

Here at Coto-Coil . . .

. . . interleave coil winding machines like these can wind up to 20 coils at a time. Top quality paper or acetate film interleaves insure a high dielectric between layers. After removal from these machines, the coils are separated, leads are extracted, and the coils proceed to the assembly and finishing operations. Such modern production facilities, plus 35 years of experience, combine to make Coto Coils the first choice for engineered coils. Coto-Coil Company, 65 Pavilion Avenue, Providence 5, R. I.

Coto  **Coils**

NEW!

. . . an instrument for all your magnetic measuring problems.

Dyna-Labs D-79 GAUSSMETER

This precision built instrument measures flux density, determines direction of flow. It locates and measures stray fields and plots variations in strength and checks production lots against a standard. Simple to operate. No ballistic readings . . . no jerking or pulling. Supplied with protective carrying case.

- Other Features -

- Reads 10 to 30,000 Gauss Flux Fields
- Probe is only .025" thick
- Active area .01 square inches
- Overall size 13" x 6-3/4" x 10-1/2"
- Net weight only 10-1/2 lbs
- Power supply 105-125 volts, 50-60 cycles

We invite inquiries. For literature write Department E-11.

Dyna-Labs INC.

1075 STEWART AVENUE, GARDEN CITY, L. I., N. Y.

GARDEN CITY 3-2700



to prepare this paper for publication and, in general, the editors of **ELECTRONICS** are to be complimented on this work. Unfortunately, however, a serious error appears in the published article.

On page 120, in the sentence just before the "Conclusion" heading, delete the last four words—"with a synchronous system". In the preceding sentence delete the word "outstanding". It is the nonsynchronous system which has the very large number of distinct and always available separate channel assignments. This tends to offset the lack of economy in the simultaneous use of channel capacity (bandwidth) so that this is not an "outstanding" disadvantage.

The difference between the two types of systems may be clarified by the following example. In an assumed synchronous system, there are exactly 50 separate channel assignments, any or all of which may be used simultaneously. In an assumed nonsynchronous system, there may be upwards of 500 separate channel assignments but only about 10 may be used simultaneously.

Thus the nonsynchronous system is attractive for relatively light traffic use where many stations must have continuous access to the common medium.

ANDREW L. HOPPER
Bell Telephone Laboratories
Murray Hill, New Jersey

Aftermath

DEAR SIRS:

I WOULD LIKE to offer a comment on L. E. Garner's description of the improvement in the transient performance of amplifiers by the addition of positive capacitive feedback in his article, "Improving Amplifier Response" (**ELECTRONICS**, p 213, Sept. 1952).

While the positive feedback usually has to be taken around two stages, suppose, for simplicity, at first, that only one stage is involved. Let the following symbols be used:

- $g_m r L$ = low-frequency gain of one stage
- C_s = strong capacitance shunting the load resistance
- C_f = capacitance in series with the feedback loop
- r_f = resistance in series with the feedback loop
- r_g = grid resistance, across which the

NECO VICTORY Thermistors

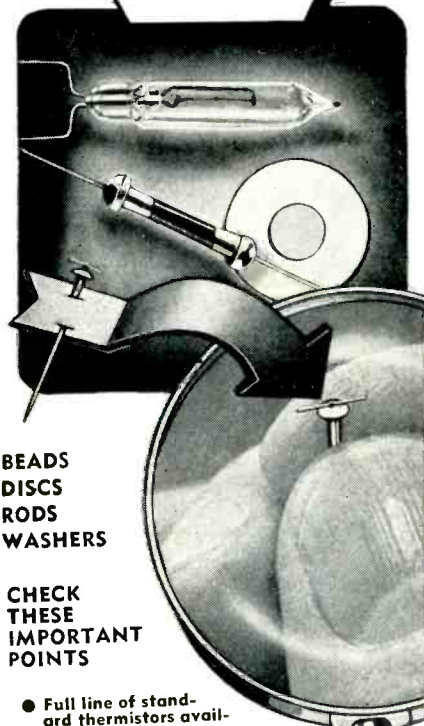

BEADS
DISCS
RODS
WASHERS

CHECK
THESE
IMPORTANT
POINTS

- Full line of standard thermistors available from stock
- Special thermistors engineered to customers' requirements
- We make all Western Electric type thermistors
- Our thermistors have exceptionally high temperature coefficient and stability
- Technical assistance in your design and engineering problems

A Few Common Uses:

- Time delay
- Gas analysis
- Volume limiting
- Surge protection
- Vacuum manometry
- Flow measurement
- Temperature control
- Temperature measurement
- Radar power measurement
- Temperature compensation
- Oscillator stabilization
- and a host of new applications being developed every day.

Send for free literature.

Victory

ENGINEERING CORPORATION
Springfield Road
UNION, NEW JERSEY

Telephone UNIONVILLE 2-7150

Phaostron

CARB-OHM

A DEPOSITED CARBON RESISTOR

HERMETICALLY SEALED

1% PRECISION RESISTOR



AVAILABLE FROM 1/3 to 2 WATTS

"Here is a resistor that will withstand ambient temperatures of 105°C for at least 1000 hours with full rated loads.

"Certified inspection after 1000 hours found these resistors remained within 1% of their original resistance."

Technical information available upon application

ENVIRONMENT FREE
ELECTRICAL EQUIPMENT by



PHAOSTRON COMPANY, 151 PASADENA AVE., SOUTH PASADENA, CALIF.

TEST-ADJUST TELEVISION SETS at YOUR Convenience

Even Without Station Test Pattern or in Remote, Weak Signal Areas

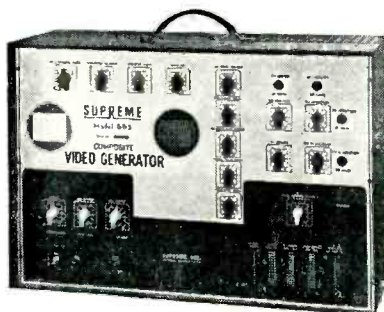

SUPREME MODEL 665

Net Price \$389.50

The SUPREME COMPOSITE VIDEO GENERATOR provides the same type of sync and blanking signal as the TV station—even the equalizing pulses. In addition, it incorporates a video section which generates a special test pattern for analysis and adjustment of TV sets. Other patterns or pictures can be presented by using auxiliary equipment connected to the special "gated" video input section of this versatile instrument. The Model 665 should not be confused with the cross-hatch or bar-pattern generators. The Supreme Model 665 supplies a COMPOSITE VIDEO SIGNAL.

Every TV station sends a COMPOSITE VIDEO SIGNAL when telecasting a program or a test pattern. This COMPOSITE VIDEO SIGNAL is composed of—(1) a synchronizing and blanking signal to lock the free running raster into a frame of two interlaced fields, and—(2) a video signal to control the amount of light and produce the picture (which may be a program scene or a test pattern for analysis purposes).

A television set will produce a picture only when it is supplied with a COMPOSITE VIDEO SIGNAL. To check any TV set properly, you must have a COMPOSITE VIDEO SIGNAL.

Why lose time and money waiting for that ideal scene or test pattern to check a TV set? In fringe or weak signal areas, you are strictly in the "driver's seat" with a SUPREME COMPOSITE VIDEO GENERATOR. Write SUPREME, Inc., Dept. 18, GREENWOOD, MISSISSIPPI for descriptive folder.

Since 1927

SUPREME

Testing Instruments

"SUPREME BY COMPARISON"

Tube Testers Oscilloscopes
Signal Generators Multi-Meters
For Radio and Television

CONTINENTAL

MINIATURE Power CONNECTORS

SERIES 14

RACK TO PANEL TYPE

7-9-10-15 CONTACTS

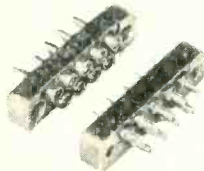

SERIES 14 FOR #14 AWG WIRE

These precision power connectors were developed to employ the same electrical and mechanical properties as our series 16 but were reduced by 25% in height with a larger solder cup for #14 AWG wire. The disengagement force is also considerably reduced.

CABLE TO PANEL TYPE

7-9-10-15 CONTACTS

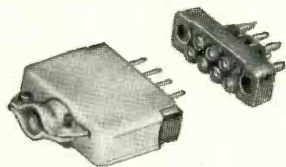

SPECIFICATIONS

MAXIMUM WIRE SIZE... #14 AWG
Creepage between contacts 7/32" MIN.
Air Space between contacts 3/32" MIN.
Breakdown voltage between contacts with connector engaged at sea level, normal conditions... 5500 V.R.M.S.

CABLE TO PANEL TYPE

7-9-10-15 CONTACTS

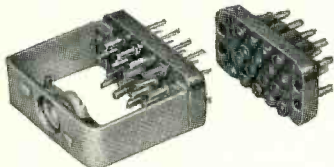

ALUMINUM HOOD AND CABLE CLAMP IS AVAILABLE FOR ALL TYPES DESIGNATED BY ADDING "H" TO TYPE DESIRED, i.e.: 7-14 PH, Plug with Hood, 7-14 SH, Receptacle with Hood, 7-14 H, Hood only.

CATALOG WITH COMPLETE DETAILS - AVAILABLE ON REQUEST. TO DEPT. E-11-P



DeJur AMSCO CORPORATION

45-01 NORTHERN BOULEVARD, L. I. C. I., N. Y.

BACKTALK

(continued)

feedback and signal are applied
 L_p = peaking inductance, if used
 p = complex angular frequency
 G = gain

With neither inductive peaking nor feedback, the gain of one stage is given by

$$G = \frac{g_m r_L}{1 + C_s r_L p} \quad (1)$$

If peaking is provided by an inductance L_p in series with the load resistance, the gain becomes

$$G = \frac{g_m (r_L + p L_p)}{1 + C_s p (r_L + p L_p)} \quad (2)$$

Instead of inductive peaking, now let positive feedback be applied through the resistance r_f and the capacitor C_f in series. The gain is then given by the feedback formula* as

$$G = \frac{g_m r_L}{1 + C_s r_L p} \quad (3)$$

$$1 - \frac{g_m r_L}{1 + C_s r_L p}$$

$$\frac{r_o C_F p}{1 + (r_o + r_F) C_F p}$$

$$= \frac{g_m r_L + g_m r_L (r_o + r_F) C_F p}{1 + [C_F (r_o + r_F) + C_s r_L - g_m C_F r_L r_o] p + C_s r_L C_F (r_o + r_F) p^2}$$

Comparison shows that Eq. 3 is identical with Eq. 2 provided

$$C_F = \frac{L_p}{r_L^2 r_o g_m} \quad (4)$$

$$r_F = r_o^2 (r_L g_m - 1) \quad (5)$$

Thus the effect of any amount of inductive peaking (maximally flat or overcompensated) can be simulated by the feedback.

When the feedback is taken around two stages, as would usually be done, one has

$$G = \frac{\left(\frac{g_m r_L}{1 + C_s r_L p} \right)^2}{1 - \left(\frac{g_m r_L}{1 + C_s r_L p} \right) \left(\frac{C_F r_o p}{1 + C_F (r_F + r_o) p} \right)}$$

$$= \frac{(\text{Linear Function of } p)}{(\text{Cubic Function of } p)} \quad (6)$$

On the other hand, the gain for two stages with inductive peaking is given by the square of Eq. 2. Since the denominator of Eq. 6 is a cubic in p , while that of the square of Eq. 2 is a quartic, it will not, in general, be possible to simulate exactly the effect of inductive peaking. However, it is possible to

BIRTCHEr TUBE CLAMPS

Hold Tubes in Sockets
under all Vibration,
Impact and
Climatic
Conditions

83
VARIATIONS
FOR
STANDARD
TUBES

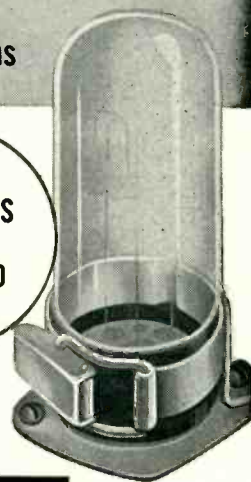

NEW
CLAMP
FOR
MINIATURE
TUBES

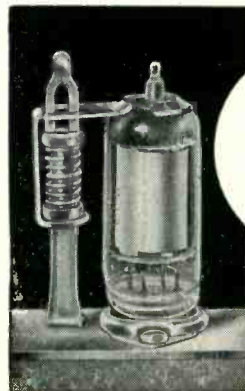

You can't shake, pull or rotate a tube out of place when it's secured by a Birtcher Tube Clamp. The tube is there to stay. Made of Stainless Steel, the Birtcher Tube Clamp is impervious to wear and weather.

BIRTCHEr TUBE CLAMPS can be used in the most confined spaces of any compact electronic device. Added stray capacity is kept at a minimum. Weight of tube clamp is negligible.

Millions of Birtcher Tube Clamps are in use in all parts of the world. They're recommended for all types of tubes: glass or metal—chassis or sub-chassis mounted.

THERE'S A BIRTCHEr TUBE CLAMP FOR EVERY STANDARD AND MINIATURE TUBE!

Write for samples, catalogue and price lists.

THE BIRTCHEr CORPORATION
4371 Valley Blvd.
Los Angeles 32, Calif.

choose the constants of Eq. 6 to obtain a desired behavior of G with frequency (maximally flat, or equal ripple). It is impossible, however, to deal with the selection of optimum gain vs frequency characteristics in this letter, the purpose of which is merely to point out the relation of the technique of extending the pass band by feedback to other techniques for accomplishing that purpose.

*This is, of course, the expression $A/(1 - A\beta)$, A being given by Eq. 1 and β by $r_o C_r p / [1 + (r_o + r_p) C_r p]$

H. L. ARMSTRONG
National Research Council
Ottawa, Canada

Omitted

DEAR SIRs:

WITH RESPECT to our article "Bridge Oscillator has Linear Tuning", which appears on page 134 in the August 1952 issue of ELECTRONICS, an error crept in during the editorial process.

The (1) in column 2 of page 134 should refer to two equations which were deleted, i.e.:

$$\omega_o = R/L; R_o/R_1 = 1/2$$

and should not appear after the equation with which it is now connected.

Unfortunately this change may make the derivation somewhat more difficult to follow.

BENSON CARLIN
ABE HERSHLER
Electro-Marine Mfg. Corp.,
New York, N. Y.

Math Available

DEAR SIRs:

I AM writing in reference to the article entitled "Improving Amplifier Response" by L. E. Garner, Jr., which appeared in the *Electrons at Work* department of ELECTRONICS on page 213 of the September 1952 issue.

Mr. Garner stated that he had made no mathematical investigation of why greater bandwidth is afforded by the capacitive coupling feature described in his article. I should like to refer your readers to my article in the *DuMont Oscillographer* where the math ap-



THE NEW
SYNCRONPLEX

MODEL—G-101

A MULTIWAVE FORM
GENERATOR AND
GENERAL PURPOSE
UTILITY PULSE
SYNCHRONIZATION
UNIT

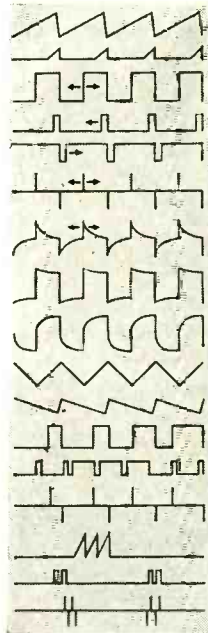

The G-101 provides, at repetition rates of 1 cycle per second to 100 kilocycles per second: 1. Sawtooth Waves, 2. Square Waves or Square Pulses, one microsecond to one second duration with rise time of 0.15 microseconds, 3. Integrated or Differentiated versions of the square waves and pulses. All outputs are simultaneously available and independently variable in amplitude. All outputs may be synchronized, triggered or gated by sine waves, pulses or other complex wave forms.

Additional applications of the SYNCROPLEX include: oscilloscope sweep phaser, delayed pulse generator, oscilloscope trace expander, frequency divider, and pulse time or pulse width modulator. The SYNCROPLEX is an excellent educational demonstrator and useful electronics laboratory accessory. \$175 Net FOB N.Y.C.



TELEVISION EQUIPMENT CORP.
238 WILLIAM ST., NEW YORK 38, N. Y.
IN CANADA: THE AHEARN & SOPER CO. LTD., OTTAWA

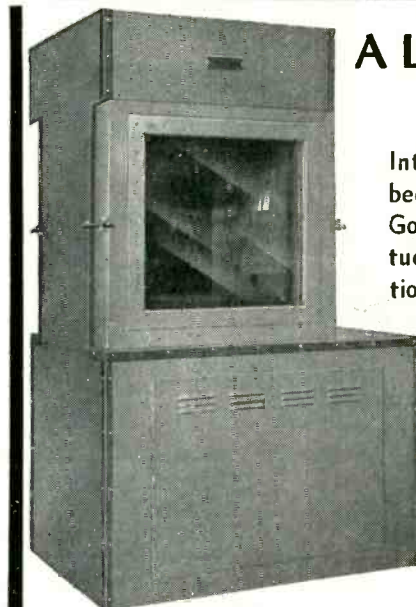

**ALTITUDE
CHAMBER**

International's Altitude Chambers have been designed to meet and conform to Government specifications governing altitude simulation tests. Any or all conditions can be had in one unit.

- **RELATIVE HUMIDITY 10 to 95%**
 - a) Wet Bulb Control of Humidity range 35°F to 200°F
 - b) Dew Point Control of Humidity to -20°F
- **TEMPERATURES**
From -150°F to +300°F (or any segment)
- **VACUUM**
Maximum limit — 5 microns.
Altitude from 3000 to 10,000 feet/min. to 100,000 ft.
- **SEALED EQUIPMENT**
Sealed shafts, hand tuning shafts and electrical connections. Utility Ports can be installed at nominal cost.

International will redesign and rebuild your old equipment to up-to-the-minute requirements. Estimates and consultation at no obligation. We welcome your inquiries.

Manufacturers of: Low and High Temperature Chambers • Altitude, Humidity, Explosion and Walk-in Chambers with Vibration test facilities

INTERNATIONAL RADIANT CORP.
40 MATINECOCK AVE. • PORT WASHINGTON, N. Y.

"Made by Engineers for Engineers"

CORNISH

custom CORD SETS

Available in rubber, neoprene and plastic

Tailored to your needs... quality controlled from start to finish... deadly enemies of CORDelirium! You make the electronic products and we will supply the dependable connecting parts.

Also
"NOFLAME-COR"
 The Television Hookup Wire

CORNISH WIRE CO., INC.
 50 Church Street. New York 7, N. Y.

pears in connection with the description of a new instrument. The article is somewhat commercial, but I believe that the portion concerning circuit investigation may be of interest.

WILLIAM J. O'MEARA
 Technical Sales Engineer
 Allen B. DuMont Labs. Inc.
 Clifton, New Jersey

Another 'Tron

DEAR SIRs:

MR. BOCCIARELLI'S low-deflection-power cathode-ray tube (ELECTRONICS, Sept. 1952) brings back memories of an experimental tube produced at General Electric Company in 1940. We were even then conscious of a future demand for big-picture, inexpensive picture tubes short enough for table-model television sets.

An experimental tube was built having a 3/4-inch diameter stem attached to a standard 12-inch bulb. By use of a simple triode gun and miniaturized focusing and deflection coils, a stem length of only about 3 inches was required. Simplified manufacture, reduced deflection power and short overall length were achieved at some cost in spot fineness.

The tube was nicknamed the Tittron and was not produced commercially to my knowledge.

FRANK G. WILLEY
 Head, Electronics Engr. Dept.
 Servo Corp. of America
 New Hyde Park, N. Y.

LOOK WHAT'S NEW!

MADE TO YOUR SPECIFICATIONS

TECHNITROL Type TE PULSE TRANSFORMERS

SEALED IN CASTING RESIN

Currently available in one physical size—3/4" diam. x 9/16" deep, with 2" leads of No. 20 wire—made to your order within the following range of specifications.

Pulse Width: 0.1 to 2.0 microseconds
 Maximum Pulse Repetition Rate: 2.0 mc.
 Operating Range: -55° to +105°C.

One or two secondaries may be provided, either inverting or non-inverting.

WRITE US YOUR SPECIAL REQUIREMENTS including a brief outline of the contemplated circuit, or ask for our blank specification sheets.

NOW YOU CAN SIMPLIFY AND MINIATURIZE YOUR SHORT-PULSE CIRCUITS

LOOK AT THESE PRICES!	
1 to 3	\$7.50 each
4 to 10	6.35 each
11 to 100	5.85 each

Write us for quotations for quantities over 100

TECHNITROL
 ENGINEERING COMPANY
 2751 North 4th Street, Philadelphia 33, Pa.

Touche'

DEAR SIRs:

I AM SURPRISED at your being taken in on so simple a thing as appeared in the item "Rosin-Fume Fan" on page 256 of the August issue of ELECTRONICS.

You can no more reverse the action of a fan "by putting the fan on the motor shaft backward" than you can make a left-hand threaded bolt out of one with a right-hand thread by putting the slot at the other end. The change can, of course, be made by bending the blades as you suggest. Wouldn't it be simpler, though, to simply face a standard fan away from the operator

J. CREIGHTON DOUGLAS
 Town of Mount Royal, Quebec

PROFESSIONAL SERVICES

CROSBY LABORATORIES, INC.

Murray G. Crosby & Staff
Radio - Electronic
Research Development & Manufacturing
Communications, FM & TV
Robbins Lane, Hicksville, N. Y.
Hicksville 3-3191

R. W. HODGSON

RESEARCH & DEVELOPMENT ENGINEERS SPECIALIZING IN ELECTRONICS, NUCLEONICS, INSTRUMENTATION, SERVOMECHANISMS & CYBERNETICS
Office—6600 Lexington Ave., Hollywood 38, Calif.
All Mail to Box 874, Sherman Oaks, Calif.
Gladstone 9680

ALBERT PREISMAN

Consulting Engineer
Television, Pulse Techniques, Video Amplifiers, Phasing Networks, Industrial Appliances
Affiliated with
MANAGEMENT-TRAINING ASSOCIATES
3308-14th St., N. W. Washington 10, D. C.

DATA ENGINEERS, INC.

Engineering that "Counts"
Designers & Manufacturers of
Data Recording Instruments
4608 Ravenswood Ave. Chicago 40, Ill.

R. W. HODGSON

PATENT AGENT SPECIALIZING IN ELECTRONICS
Registered to Practice Before the U. S. & Foreign Patent Offices
Office—6600 Lexington Ave., Hollywood 38, Calif.
All Mail to Box 874, Sherman Oaks, Calif.
Gladstone 9680

JOSEPH RACKER COMPANY

Radar Consultants & Editors
Technical Manuals
Research and Development
140 Nassau Street, New York 38, N. Y.
Worth 4-1463

DUBROW DEVELOPMENT CO.

Design — Development — M
Quality Electronic Equipment
347 High St. Burlington, N. J.
Burlington 3-0446

HOGAN LABORATORIES, INC.

John V. L. Hogan, Pres.
Applied Research, Development, Engineering
Est. 1929. Electronics, Optics, Mechanisms, Facsimile Communication, Digital Computers, Electro-sensitive recording media, Instrumentation.
155 Perry Street, New York 14. CHelsea 2-7855

W. C. ROBINETTE CO.

MOTRON DEADBEAT HIGH GAIN SERVOS
Speed control of any Prime Mover 1/2% to .001% average. Electric Transmissions 1/2 to 50 HP plus controls—Zero droop—No load to full load.
802 Fair Oaks Ave. South Pasadena, Calif.
Py 11594

EDGERTON, GERMESHAUSEN & GRIER, INC.

Consulting Engineers
Research, Development and Manufacture of Electronic and Stroboscopic Equipment
Specialists in High-Speed Photography
140 Brookline Avenue, Boston 15, Mass.

THE KULJIAN CORPORATION

Consultants • Engineers • Constructors
Electronic Control Specialists
Utility • Industrial • Chemical
1200 N. Broad St. Phila. 21, Pa.

SKINNER, HARLAN AND IRELAND, INC.

Consulting Engineers
Specializing in Magnetic Materials and Their Application
Office and Laboratory Indianapolis 7, Indiana

Eldico of New York Inc.

Pioneers of Television Interference Elimination from Transmitters, Induction Heaters, Diathermy and etc.
Donald J. S. Merten & Engineering Staff
44-31 Douglaston Pkwy Douglaston, N. Y.
Bayside 9-8686

MEASUREMENTS CORPORATION

Research & Manufacturing Engineers
Harry W. Houck Jerry B. Minter
John M. van Beuren
Specialists in the Design and Development of Electronic Test Instruments
Boonton, N. J.

THE TECHNICAL MATERIEL CORPORATION

Communications Consultants
Systems Engineering
General Offices and Laboratory
121 Spencer Place, Mamaroneck, N. Y.

ERCO RADIO LABORATORIES, INC.

Radio Communications Equipment
Engineering - Design - Development - Production
Pioneers in Frequency Shift Telegraph
Garden City • Long Island • New York

Eugene Mittelman, E.E., Ph.D.

Consulting Engineer & Physicist
High Frequency Heating—Industrial Electronics
Applied Physics and Mathematics
549 W. Washington Blvd. Chicago 6, Ill.
State 2-8021

TELECHROME, INC.

Electronic Design Specialist
COLOR TELEVISION EQUIPMENT
Flying Spot Scanners, Color Synthesizers, Keyers, Monitors, Oscilloscopes and Related Apparatus
J. R. Popkin-Curman, Pres. & Ch. Engr.
88 Merrick Rd. Amityville, L. I., N. Y.

HARRIS GALLAY

Consultant
MICROWAVE AND PULSE TECHNIQUES
BB 11eville 2-4237 60 Perry St., Belleville 9, N. J.

NIAGARA ELECTRON LABORATORIES

CONSULTATION - DESIGN - CONSTRUCTION
MFG. THE THERMOCAP RELAY
Specializing in solution of problems of electronic and electro-physical instrumentation for the research of analytical laboratory. Industrial plant problems also invited.
Andover, New York Cable Address: NIATRONLAB

HARRIS A. THOMPSON

Microwave Electronic Radar
Electro-Mechanical Consulting
MFG. & DEVELOPMENT PROBLEMS
2525 Penn., Boulder, Colorado Phone 1202W

HANSON-GORRILL-BRIAN INC.

Products & Mfg. Development
ELECTRICAL - ELECTRONIC
HYDRAULIC - MECHANICAL
One Continental Hill Glen Cove, N. Y.
Glen Cove 4-1922

PHYSICS RESEARCH LABORATORIES, INC.

Applied Mechanics, Thermodynamics, Heat Transfer, Optics, Magnetic and Electrical Devices, Electronics, Nuclear Physics.
507 Hempstead Turnpike,
West Hempstead, L. I., N. Y.

WHEELER LABORATORIES, INC.

Radio and Electronics
Consulting—Research—Development
R-F Circuits—Lines—Antennas
Microwave Components—Test Equipment
Harold A. Wheeler and Engineering Staff
Great Neck, N. Y. Great Neck 2-7806

HIGHLAND ENGINEERING CO.

William R. Spittal & Staff
DESIGN, DEVELOPMENT AND MANUFACTURE OF TRANSFORMERS, CHOKES, ETC.
FOR THE
ELECTRONIC, INDUSTRIAL & ALLIED FIELDS
Main & Urban, Westbury, L.I., N.Y.
WE-7-2933

PICKARD AND BURNS, INC.

Consulting Electronic Engineers
Analysis and Evaluation of Radio Systems
Research, Development and Design of Special Electronic Equipment
240 Highland Ave. Needham 94, Mass.

YARDNEY LABORATORIES, INC.

Research - Design - Development
Electro-Chemical Generators of Energy
105 Chambers Street WORTH 2-3534, 35, 36
New York 7, N. Y.

CONTACTS

FOR THE FIELD OF ELECTRONICS

We are set up to do all types of SUBCONTRACTING

Our modern plant is equipped to do complete testing and development work on civilian and military electronic equipment.

Our Shop is set up to wind Bobbin, spool, form, layer, interwoven, Universal and Pile RF and IF chokes and coils.

Our New Etched Circuit Department can handle all types of work. Contact us for details on your subcontracting needs.

MICHEL MANUFACTURING CO.
227 North Water Milwaukee, Wis.

ELECTRICAL COILS

Bobbin, spool, form, layer, interleaved, interwoven types. Made of any material, any finish, for any application.

Send blue-prints and specifications for prompt quotation.



THE FIVE STAR COMPANY

West Main Street
Plantsville, Conn.

FLUXES
SODERING
BRAZING & WELDING
L. B. ALLEN CO. INC. Chicago 31, Ill.
6751 BRYN MAWR AVE.

Shorted Turn Indicator

for unmounted coils
MODEL 101C BULLETIN 42
HUNTINGTON BEACH, CALIF.

KARTRON

ELECTRO PLATING

SPECIALISTS IN
Silver, Cadmium & Zinc
Barrel Plating

Iridite and Cronak
Processes

To Government Specifications
Government Certified

EVEREADY PLATING CO.
1790 FIRST AV. N.Y.C.
EN 9-1222

GRC WING NUTS TOP QUALITY PRICED LOWER

Rust-proof zinc alloy with GRC's recessed-wing finger-grip. All commercial finishes, all popular thread sizes. Special threads or untapped wing nuts; special designs to order.



Write today for samples and prices — and compare!

GRIES REPRODUCER CORP.

100 Willow Ave., N. Y. 54 • Phone: MO 5-7400

SUB-CONTRACTING MILITARY and COMMERCIAL

receivers—test equipment
transmitters—controls
sub-assemblies

TELETRONICS LABORATORY, INC.
Westbury, L. I., N. Y. Westbury 7-1028

PRECIOUS METAL PLATING

(Government Certified)
★ GOLD ★ SILVER ★ PALLADIUM
★ RHODIUM ★ ALBALOY

ELECTRO-COATINGS INC.
1662 W. Fullerton Ave. Chicago 14, Ill.
EAsgate 7-9770

WALKIE-RECORDALL

8 1/2" miniature BATTERY RECORDER-PLAYBACK
Continuous, permanent, indexed recording, up to 4 hrs., only 3c hr. Instantaneous, permanent playback. Picks up sound up to 80 ft. Records conferences, lectures, dictation, 2-way phone & sales talks; while walking, riding or flying. Records in closed briefcase with "hidden mike"! Write for Detailed Literature.

MILES REPRODUCER CO., INC.

812 BROADWAY Dept E-11 NEW YORK 3, N. Y.

MICA

Gauge Glass Gasket Mica in any size also any other large size for electrical use buy direct from mine owners known for quality, honesty and reasonableness. Airmail your requirements to

ARUNA BROTHERS
3 Keeling Road, New Delhi (India)
Cables: "MUKTI"

JUST OUT

RADIO SPECTRUM CONSERVATION

A Program of Conservation Based on Present Uses and Future Needs

A realistic review of the properties of radio transmission, and discussion of the course to be pursued to assure maximum benefits in its use. Shows how much can be gained by taking a long-range view of the radio spectrum, after the past fifty years of sporadic development. Gives propagation characteristics of the spectrum, covers the history of allocations and gives an ideal approach to them; gives a critique of the present allocations, and suggests a dynamic program of conservation. A report of the Joint Technical Advisory Committee of the Institute of Radio Engineers and The Radio-Television Manufacturers Association. 218 pp., illus., \$5.00



CHECK LIST

of other recent McGRAW-HILL books

ELECTRON TUBES IN INDUSTRY

Third Edition

Tells how the electron tube makes industrial processes simpler, cheaper, safer. Explains operating principles of components, tubes, and circuits applied to industrial problems of control, measurement, electronic heating, motor speed control—counting, sorting, and grading. Describes amplifiers, thyratrons, phototubes, and cathode-ray tubes and applications. By Keith Henney, Editorial Director, and James D. Fahnestock, Assoc. Editor, *Electronics*. 3rd ed., 347 pp., 234 illus., \$6.00

ELECTRONICS FOR COMMUNICATION ENGINEERS

Saves research time and effort on electronic problems in communications. Its 252 articles from *Electronics* contain a wealth of design equations, charts, monographs, tables, etc. Covers amplifiers—antennas—audio—cathode-ray tubes—components—electronic music—filters—measurements—microwaves—oscillators—power supplies—propagation—pulses—receivers—transmission lines—transmitters. Edited by John Markus and Vin Zeluff, Assoc. Editors, *Electronics*. 624 pp., hundreds of illus., \$10.00

TELEVISION ENGINEERING

Second Edition

Covers the whole television process—from studio to receiver—clearly, and in detail. Treats TV technology, operating principles of TV systems, use of equipment. Provides practical working diagrams, complete with values of parts, tube types, etc. Explains color TV, intercarrier sound reception, distributed amplification, and many other phases. By Donald G. Fink, Editor, *Electronics*. 2nd ed., 721 pp., 512 illus., \$8.50

SEE THESE BOOKS 10 DAYS FREE

McGraw-Hill Book Co., 330 W. 42 St., NYC (36)

Send me book(s) checked below for 10 days' examination on approval. In 10 days I will remit for book(s) I keep, plus few cents delivery, and return unwanted book(s) postpaid. (We pay delivery if you remit with this coupon—same return privilege.)

- JTAC—Radio Spectrum Conservation—\$5.00
 Henney & Fahnestock—Electron Tubes—\$6.00
 Markus & Zeluff—Electronics for Com. Eng.—\$10.00
 Fink—Television Engineering—\$8.50

(Print)
Name.....
Address.....
City..... Zone..... State.....
Company.....
Position..... L-11
This offer applies to U. S. only

EISLER MANUFACTURES COMPLETE EQUIPMENT

WELDERS FOR SPOT & WIRE BUTT
RADIO, TV TUBE EQUIPMENT & REPAIR UNITS
INCANDESCENT, FLUORESCENT MFG EQUIPMENT
NEON SIGN MAKERS EQUIPMENT, GLASS LATHES
ELECTRONIC EQUIPMENT, VACUUM PUMPS, Etc.
Wet Glass SLICING & CUTTING MACHINES for Lab Use
TRANSFORMERS, SPECIAL & STANDARD TYPES

EISLER ENGINEERING CO., INC.
751 So. 13th St. Newark 3, N. J.



SALES ENGINEER

with Aeronautical
and
Electronic Experience

Here is a real opportunity for a good personality—a man with electrical engineering know-how plus a desire to make sales contacts among the large aircraft companies. You would live in and work out of Dallas, Texas. Earnings can go far beyond the normal E.E. levels. Tell us of your qualifications and your interest. Our personnel knows of this ad and your correspondence will be held in strict confidence. Direct inquiries to Ben Boldt, American Phenolic Corporation, 1830 S. 54th Avenue, Chicago 50, Illinois.

REPLIES (Box No.): Address to office nearest you
NEW YORK: 530 W. 42nd St. (36)
CHICAGO: 520 N. Michigan Ave. (11)
SAN FRANCISCO: 68 Post St. (4)

POSITION VACANT

ELECTRONICS EXPERT needed now or later for perfecting and developing instrumentation for combustion research in the field of turbulence and spectroscopy, carried out in Chemical Engineering Department of University of Delaware, Newark, Del. Participation in the research program welcomed but not required. Part-time teaching position in the Physics Department possible if desired. Reply to Prof. K. Wohl, above address.

SELLING OPPORTUNITIES OFFERED

WE ARE seeking a representative on the West Coast who calls on Electronic Equipment Manufacturers exclusively. We produce a complete line of Drawn Cans and Shields also Stampings for the Electronic Industry. Give full details and advise present lines. Worcester Pressed Aluminum Corp., P. O. Box 1250, Worcester 1, Massachusetts.

WANTED—SALES Engineers for large industrial instrument manufacturer. Prefer men with special training in electronics and graduates of recognized engineering colleges. Will consider Mechanical and Chemical Engineers. Fine opportunity for young engineers with sales aptitude to connect with one of the fastest growing industrial instrument companies in the United States. Locations: Cleveland, New York, Chicago, and Philadelphia. SW-5508, Electronics.

POSITIONS WANTED

CONSULTANTS WITH 12 years electronics experience, well-equipped large laboratory, desire development and production work. Will demonstrate our efficiency, inventiveness, and economy. Write PW-5673, Electronics.

DUTCH COMMUNICATIONS Engineer, graduate 1938 mechanical, aeronautical and radio Engineering, single, desires responsible work overseas. Highly experienced in large communication systems and broadcast in Europe, Middle East and South East Asia, thorough knowledge of five languages, adaptable to any situation, no objections against much traveling. PW-5501, Electronics.

Electrical Engineer; 1½ yr. public utility co-op; ¼ yr. G.E. test; 2 yr. servomechanism and electronic development, Signal Corps. Desire control development and application work. PW-5541, Electronics.

ENGINEERING PHYSICIST, two years experience in Magnetic Amplifiers, Quality Control, and Instrument Development. Can I fit into your organization? PW-5676, Electronics.

SENIOR B.S., M.S.; has had 12 years of all around experience in instrumentation, servo's, electronics, instrument design & production. Had supervisory operation. Eastern location preferred. PW-5254, Electronics.

WANTED

Surplus Telegraphic Equipment wanted. Keys, Sounders, Relays, Switches, etc. W-5423, Electronics.

Are you looking for a good job with an excellent future?

Positions are open where your ability and initiative will soon be recognized . . . fine opportunities for qualified men:

- Project Engineers
Electronic
Mechanical
- Model Makers
- Sales Engineers

Engineering background essential. Fine opportunities to grow with a young, progressive organization; long-range development work; pleasant suburban surroundings; congenial and cooperative co-workers.

Send complete resume to Personnel Manager,

A. W. Haydon Company

Waterbury, Conn.

TRANSISTOR ENGINEER

Transistor engineer, electrical or chemical, experienced design and production, to direct germanium device production. Excellent opportunity. Replies in strict confidence.

P-5646, Electronics
330 W. 42 St., New York 36, N. Y.

CANADIAN FIRM

well established in Electronic field wishes to affiliate with U. S. company to manufacture electronic components (or complete equipments) in Canada.

Excellent manufacturing facilities, machine shop and plant with fully trained personnel.

CW-5496, Electronics
330 W. 42 St., New York 36, N. Y.

ELECTRONIC PRODUCT WANTED

A small progressive company is interested in manufacturing an electronic item with good market possibilities.

Item may be in any stage of development from idea to production model.

Company facilities include engineering department with laboratory, electrical and mechanical assembly department and machine shop.

BO-5602, Electronics
330 W. 42nd St., New York 36, N. Y.

ENGINEERS

ELECTRONIC
and
Electro-Mechanical



MAKE
YOUR MOVE
IN THE
RIGHT
DIRECTION

POSITIONS THAT POINT TO
A SUCCESSFUL FUTURE!

Minimum Requirements

Four years' experience in advanced research and development on Radar Systems, Computers, Wave Guide and Antennas, Servo-mechanisms, Pulse Techniques Gyroscopic Equipment and Related Fields.

If your skills are now being fully utilized in a vital defense industry, please do not apply.

Kindly send resume and salary requirements to

**The W. L. MAXSON
CORPORATION**

460 W. 34th St. New York 1, N. Y.

**MR. MANUFACTURER:
LOOKING FOR A NEW PRODUCT?
ADDITIONAL ITEMS FOR
YOUR PRESENT LINE?**

IDEAS FOR SALE!!

Patented; Pat. Pend; Unpatented;
Basic Designs

Models Available in Some Cases
OUTLINE YOUR REQUIREMENTS:

M-5424, ELECTRONICS
330 W. 42 STREET
NEW YORK 36, N. Y.

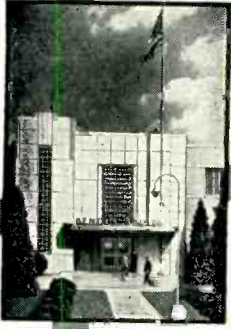

**MAKE THIS YOUR HOME
FOR IMPORTANT WORK
UNDER IDEAL CONDITIONS**

- TV RECEIVER DESIGN ENGINEERS
- ELECTRONICS ENGINEERS
- FIELD ENGINEERS
- TEST & INSPECTION ENGINEERS
- LAB. TECHNICIANS

NEEDED TO WORK ON: Radar, G.C.A., Mobile Radio, Auto Radio, Airborne Communication & Navigation Equipment, Television, Antennas, Microwave Equipment, Servo Mechanisms, Guided Missiles and Test Equipment Design.

YOU BENEFIT AT BENDIX RADIO: from high wages, a modern, air-conditioned plant, paid vacations and holidays, group insurance and a good chance for advancement.

Housing immediately available in the beautiful suburban and country areas that surround the Bendix Radio plant.

Write, Wire or phone

MR. E. O. COLE, DEPT. J.

Bendix Radio

DIVISION OF BENDIX AVIATION CORPORATION

BALTIMORE-4, MD. Phone: TOWSON 2200

*Makers of the World's Finest
Electronic Equipment*

P.S.

The advertisement at left tells of attractive opportunities for engineers and technical personnel at The Bendix Radio Division of the Bendix Aviation Corporation in Baltimore.

Bendix Aviation also needs engineers and technical personnel for assignments at its new plant in York, Pennsylvania.

There are openings for electronic engineers, lab technicians, mechanical engineers, draftsmen, technical writers and tool & die designers.

So, here's the chance to get in at the start of a new operation of the Bendix Aviation Corporation . . . and benefit from good pay, interesting work and the chance for rapid advancement.

If interested in employment at York, Pennsylvania, write giving brief resume of your experience to:

Bendix Aviation Corp.

Dept. Y-1

P.O. Box No. 1202

YORK, PENNSYLVANIA

ELECTRONIC DESIGNERS

For design and layout of UHF equipment, microwave components and systems.

RADIO ENGINEERS

Minimum 5 years' experience. For research and development in radio and radar systems and components.

**WHAT MAKES KOLLSMAN
A FINE PLACE TO WORK?**

Partly, it's the pride of belonging to the organization which designs and manufactures America's finest aircraft instruments . . . a progressive, growing organization in which there's every opportunity to advance.

And a big part of it is in the spirit of cooperation and friendliness which prevails among Kollsman men.

Not to be overlooked is the convenient location in a quiet residential section of Queens . . . and the many liberal benefits such as completely paid life, hospitalization, surgical, accident and health insurance.

KOLLSMAN INSTRUMENT CORP.

80-08 45th Avenue, Elmhurst, Long Island, New York

ENGINEERS

AND

PHYSICISTS

BS—MS—Ph.D:

Responsible positions in mechanical, electrical or electronic engineering, physics or engineering physics for advanced development and design of special equipment and instruments. Prefer men with minimum of two years' experience in experimental research design and development of equipment, instruments, intricate mechanisms, electronic apparatus, optical equipment, servomechanisms, control devices and allied subjects. Positions are of immediate and permanent importance to our operations. Southwestern location in medium sized community. Excellent employee benefits. Reply by letter giving age, experience and other qualifications. All applications carefully considered and kept strictly confidential.

Ind. Rel. Manager
Research & Development Dept.

**PHILLIPS
PETROLEUM COMPANY**

Bartlesville

Oklahoma

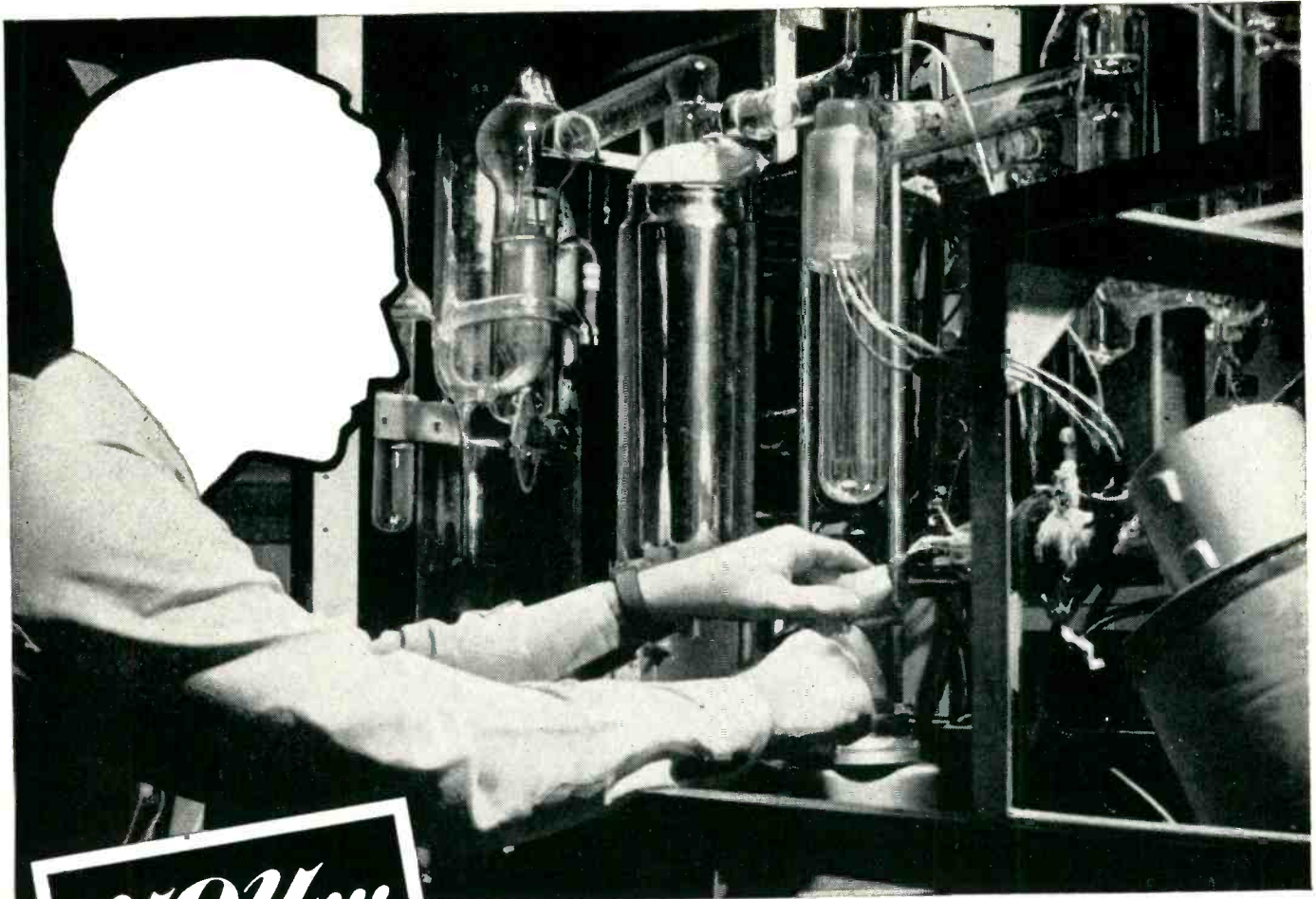

you...

... are headed for a better future —when you come to RCA

If you want to work where you enjoy the highest professional recognition among your colleagues, come to RCA. Here your accomplishments are recognized and rewarded. Here your future is brighter, through challenging assignments that lead to better opportunities, better positions. Here you set goals for future attainment at advanced levels.

If your talent and skill are not being used in a way for which your education and experience has equipped you, come to RCA. Here you will find unusual opportunities to work in close association with distinguished scientists and engineers in research . . . development . . .

design . . . and application of specialized electronic equipment for military projects as well as for an ever-increasing line of diversified commercial products.

Positions open are lifelong *career* opportunities. They are not "temporary" jobs. Unlike "feast or famine" industries,

RCA has forged ahead regardless of war or depression. You can continue advanced study at recognized universities under RCA's modern tuition refund plan. You and your family enjoy outstanding Company benefits. Yes, your future is better at RCA.

LIFETIME OPPORTUNITIES FOR

ENGINEERS—Electronic . . . Electrical . . . Communication . . . Mechanical . . . Computer . . . METALLURGISTS and PHYSICISTS

In Research—Development—Design—Application: in the following fields:

RADAR • MISSILE GUIDANCE • SERVO MECHANISMS • COMPUTERS • TRANSFORMERS AND COILS • NAVIGATION AIDS • TELEVISION • ELECTRON TUBES • COMMUNICATIONS TECHNICAL SALES • ELECTRONIC EQUIPMENT FIELD SERVICE

Send a complete résumé of your education and experience.

Personal interviews arranged in your city.



RADIO CORPORATION of AMERICA

Send résumé to:
Mr. ROBERT E. McQUISTON, Manager
Specialized Employment Division,
Dept. 46K
Radio Corporation of America
30 Rockefeller Plaza, New York 20, N. Y.

ELECTRONIC ENGINEERS & PHYSICISTS

OUR STEADILY EXPANDING LABORATORY OPERATIONS
ASSURE PERMANENT POSITIONS AND UNEXCELLED
OPPORTUNITY FOR PROFESSIONAL GROWTH IN

RESEARCH & DEVELOPMENT

GUIDED MISSILES

TELEVISION

ELECTRONIC NAVIGATION

SOLID STATE PHYSICS

VACUUM TUBES

RADAR

ADDRESS

THE EMPLOYMENT DEPT.

INQUIRIES TO **CAPEHART FARNSWORTH CORP.**

FORT WAYNE, IND.



We, The Telegraph
Condenser Co. Ltd., London,
England, the largest specialist
manufacturers in the United
Kingdom of all types of fixed
capacitors, seek representatives
in the United States.

Primarily, we are not inter-
ested in the jobbing market, but
desire to extend our present
business with leading American
Manufacturers of radio and
electronic equipment.

Only firms of the highest
integrity and with the necessary
technical background will be
considered.

One of our Executives will
shortly visit the United States
again. If you are interested to
see him on this matter, please
submit full particulars to:—

**THE
TELEGRAPH CONDENSER
COMPANY LIMITED**

**NORTH ACTON
LONDON, W.3 · ENGLAND**

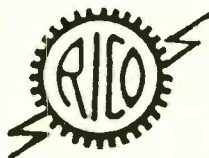

ATTENTION!

Former Field Engineers

We urgently need men with elec-
tronic background, and preferably
radar or computer experience, to
supervise, instruct and assist in
installation—maintenance of elec-
tronic equipment.

Excellent starting salary during
factory training, plus overtime
premium in field. Substantial in-
surance program. Domestic &
overseas assignments available.
Salary will be commensurate with
experience.

Please forward your personal
experience record to:

Personnel Supervisor
Field Eng. Div.

Reeves Instrument Corp.
215 East 91st St.
New York, 28, N. Y.

WANTED

Electro-Acoustical Engineer

An engineer experienced in design
and development of electro-acoustical
or electro-mechanical transducers is
wanted by an established, progressive
manufacturer of microphones, televi-
sion boosters and electronic equipment.
Must be capable of carrying responsi-
bility for development of new products
from initial plans to finished product
in transducer field. Position is chal-
lenging and desirable. Salary com-
mensurate with experience and ability.

Contact

Paul Thompson, Chief Engineer

The TURNER Company

917 17th Street N.E.,
CEDAR RAPIDS IOWA

RESEARCH AND DEVELOPMENT

*forge the KEY to America's future in the AIR
take YOUR place . . . with GOODYEAR AIRCRAFT*

The continued and steady growth of established research and development projects presents a number of unusual opportunities for outstanding and experienced men.

SCIENTISTS

- Electrical Systems
- Circuit Analysis
- Analog Computers
- Servomechanisms
- Test Equipment

ENGINEERS

- Structures
- Aerodynamics
- Applied Mathematics
- Electronics
- Physics

DESIGNERS

- Stress Analysis
- Flight Test
- Missile Design
- Dynamics
- Microwaves

Positions are available in our organization for qualified personnel in the following fields:

Openings also exist for welding engineers, civil engineers, and mechanical engineers with experience in metals fabrication; and for personnel with ability and experience in technical editing, art, and motion pictures.

Positions are available at several levels, and inquiries are also invited from recent graduates. Salaries are based on education, ability, and experience. Liberal salary, vacation, insurance, and retirement plans are yours if you qualify.

If YOU are interested in a secure future, write, giving full details, to
Mr. C. G. Jones, Salary Personnel Department.



GOODYEAR AIRCRAFT CORPORATION, 1210 Massillon Road, Akron 15, Ohio

ENGINEERS

WHY NOT INVEST YOUR ABILITY

With the Finest Electronic Engineering Team in the West. Excellent Opportunities for Permanent Employment With Hoffman Exist For All Grades of Electronic Engineers, Mechanical Engineers and Engineering Technicians Experienced in Electro-Mechanical Engineering or Any of the Following:

- Radio Systems MF to UHF
- Receiver Design MF to UHF
- Pulse Techniques
- Selsyn Control and Servo Systems
- Electronic Type Test
- CRT Display Circuits
- Mechanical Design
- Antenna Design

LIVE IN
CALIFORNIA

Enjoy Advancement and Further Training; Paid Holidays and Vacations; Good Salaries. Applicants Requested to Forward Resume of Education and Experience with Letter of Application To:

ENGINEERING EMPLOYMENT OFFICE.

Hoffman

LABORATORIES, INC.

3761 SOUTH HILL STREET, LOS ANGELES 7, CALIFORNIA .

A SUBSIDIARY OF HOFFMAN RADIO CORPORATION

ELECTRONIC

ENGINEERS
DESIGNERS
DRAFTSMEN

INTERESTING DEVELOPMENT WORK IN—

Television

Color TV

AM-FM Radio

Direction Finder

Ultra-High Freq.

WITH ADVANTAGES OF—

Permanent Positions

Many Employee Benefits

Top Wages

WRITE OR APPLY TO

Personnel Dept.

1300 N. Kostner Ave., Chicago, Ill.

Call Albany 2-1000, Ext. 145

For Interview

STEWART-WARNER

ELECTRIC

ELECTRONICS

Research & Development

POSITIONS OPEN

Cornell Aeronautical Laboratory, Inc. has several professionally challenging and rewarding positions open in the field of Electronic Engineering.

The laboratory was acquired in January, 1946, by Cornell University in response to a widespread need for a stable, highly competent research organization in the aeronautical sciences. Since its acquisition the laboratory has grown steadily to a multi-million dollar annual contract level with a staff of over 850.

The laboratory's projects deal largely with applied science. Typical electronics projects include computer design, radar and microwave applications, precision instrumentation, missile guidance, telemetering, and complex control systems.

Professional growth of staff members is encouraged through regular seminars, attendance at meetings of scientific societies, a graduate study tuition refund program, and constant interchange of ideas and discussions with senior level scientists. Salary level and employee benefit programs are on a par with industry. While the pace of projects is high, the informal organization of the laboratory tends more toward a friendly, thought-stimulating, academic atmosphere. Practical scientists and engineers work closely together in making important contributions to America's scientific progress.

A booklet describing the activities and interests of the laboratory has recently been made available for distribution. If you would like to learn more about this unique organization or its personnel needs, please feel free to write. No obligation, of course.

CORNELL AERONAUTICAL LABORATORY, INC.

P.O. BOX 235

BUFFALO 21, NEW YORK

ELECTRONIC ENGINEERS

Mechanical Designers for Research
and Engineering

To work in the design and development of new electronic equipment. Excellent working and living conditions, good salaries and exceptional employee benefits. Write, giving full details including education and experience. Personal interviews will be arranged.

THE NATIONAL CASH REGISTER COMPANY

Main & K Sts., Dayton 9, Ohio

ELECTRONIC ENGINEERS MECHANICAL ENGINEERS

*You GROW
at Melpar!*

Our Engineering Department is organized on a PROJECT basis

(not by functional sections, with their tendency to narrowness of specialization and limitation of professional growth). Here the member of a project group is in close touch with all phases of the project—responsible for his own share in his particular field but able to see the whole. The engineer in charge of the group, instead of being limited to expertness in producing one kind of unit to be assembled by others, is an executive responsible for ALL phases of the successful completion of the project.

- FLIGHT SIMULATORS
- Computers
- Telemetering
- Guided Missiles
- Airborne Radar
- Microwave Receivers



452 Swann Ave.

Send resumes
to:
PERSONNEL
DIRECTOR
MELPAR,
INC.

Alexandria, Va.

ENGINEERS

LOCATE IN THE

Healthful Southwest

WITH ATOMIC WEAPONS
INSTALLATION

Mechanical Engineers, Electronics and Electrical Engineers, Physicists, Mathematicians, Specifications Engineers, and Technical Writers. A variety of positions in research, development and production open for men with Bachelors or advanced degrees with or without applicable experience.

These are permanent positions with Sandia Corporation a subsidiary of the Western Electric Company, which operates the laboratory under contract with the Atomic Energy Commission. The Laboratory offers excellent working conditions and liberal employee benefits, including paid vacations, sickness benefits, group life insurance and a contributory retirement plan.

Albuquerque, center of a metropolitan area of 150,000, is located in the Rio Grande Valley, one mile above sea level. Albuquerque lies at the foot of the Sandia Mountains which rise to 11,000 feet. Cosmopolitan shopping centers, scenic beauty, historic interest, year 'round sports, and sunny, mild, dry climate make Albuquerque an ideal home. New residents experience little difficulty in obtaining adequate housing in the Albuquerque area.

Make application to the
PROFESSIONAL EMPLOYMENT DIVISION

SANDIA
Corporation

SANDIA BASE
ALBUQUERQUE, N. M.

We desire personnel of the highest caliber—experienced in the field of airborne automatic electro-mechanical control equipment.

ENGINEERS

MECHANICAL DESIGN
ELECTRONIC
SERVO

This work deals with the manufacture and development of highly complex equipment of the most advanced type in a new and expanding division of an established firm with 20 years of successful experience in the precision instrument field.

We cite a few of the good reasons why you might like to join our organization . . .

SALARY increases are based on merit and initiative—two weeks VACATION, HOSPITALIZATION BENEFITS, GM's own INSURANCE PLAN—POSITIONS ARE PERMANENT due to long range manufacturing and developing programs—EXPENSES incident to interviews and moving all absorbed by company—HOUSING and LIVING CONDITIONS among the best and finest of any along Lake Michigan.

• We have a Junior Engineering Training Program of one year for inexperienced engineering graduates. Opportunity to become acquainted with all phases of industry.

• For the convenience and direct use of engineers in our Engineering Department, we have our own model shop where highest skilled mechanics are employed.

• Educational opportunities for advanced degrees available at U. of W., Marquette. Technical engineering offered at Milwaukee Vocational School.

. . . all inquiries answered—write or apply . . .

★ AC SPARK PLUG DIVISION

GENERAL MOTORS CORPORATION

1925 E. KENILWORTH PL.

MILWAUKEE 2, WIS.

CIRCUIT DESIGNER

Principally DC amplifiers and closed loop systems. Minimum requirement B.S. Degree with major in Electronics. Preference given advance degrees or graduate work. 3 to 4 years experience. Salary open, commensurate with qualifications. Send complete resume, including salary desired. Medium size electronic equipment manufacturer; location Middle West.

P-5603, Electronics
520 N. Michigan Ave., Chicago 11, Ill.

TWO ENGINEERS

. . . Two engineers, mathematicians or physicists are needed to plan and execute theoretical studies in two general problems of communications and control systems.

Exceptional ability and a Ph. D. or equivalent experience are essential. Training in mathematics and statistics, noise and communication theory, and systems analysis necessary.

Problems involve the synthesis of reliable mechanisms from unreliable components by parallelism or other means, and the application of information and noise theory to radar and communications systems, both as applied to guided missiles.

Send resume including education, scholastic record, experience and references to

California Institute of Technology

Jet Propulsion Laboratory

4800 Oak Grove Drive
Pasadena 3, California

Transformer and Filter Engineers

Experience with toroidal coils, design of wave filters and carrier telephone equipment desired, but not essential.

Company is engineer-owned and operated. Well established, financially sound. Five years of continuous expansion. Future prospects most promising. Suburban Kansas City, Missouri. Salary open. Contact, stating qualifications, Edward J. King, Jr., President,

COMMUNICATION ACCESSORIES CO.

Hickman Mills, Missouri
Phone DWight 5410

UHF ENGINEERS UNUSUAL SALARY OPPORTUNITIES

Excellent Opportunities for Advancement in our New Research Laboratory Furnished with Finest Equipment.

Write Giving Full Details to:
Personnel Director, Dept. A.

GIBBS MANUFACTURING AND RESEARCH CORPORATION

Janesville, Wisconsin

ENGINEER WANTED—BOSTON AREA

We are seeking an engineer who has shown ingenuity in the development of small electro-mechanical devices, switches, relays and the like. A knowledge of relay design principles would be preferable, but not absolutely necessary.

The man who has this ability has a position and a future awaiting him with a 40 year old company that is large enough to offer a secure position, yet small enough for personal contact and recognition. We are expanding our field of operations and are seeking to supplement our present engineering force. Without resorting to extravagant verbiage, we offer a good position with a good future, for a good man. This position is not dependent upon the defense program.

If you think you qualify for this position, please send a short resume of past history, experience and salary expected. All information will be kept in strict confidence and letters will be acknowledged.

P-5647, Electronics
330 W. 42 St., New York 36, N. Y.

TELREX, INC.
OF ASBURY PARK, N. J.

wishes to engage a

**SENIOR
ELECTRONIC SPECIALIST**

to conduct antenna, filter, converter, research and development particularly at television frequencies. Applicant must possess scientific qualifications together with considerable manufacturing and field experience and a proven record of accomplishments. Must be imaginative, capable of original thinking and able to work with minimum supervision. Frankly, we are looking for an unusually good man and an attractive salary will be offered the right applicant. Write stating qualifications and record.

**PHYSICISTS . . .
NEW FRONTIERS TO CONQUER**

Enjoy great opportunities for personal satisfaction and advancement . . . help keep our nation strong and free . . . investigate the following openings with TRACERLAB, the foremost commercial firm in the field of NUCLEONICS.

Positions are available for PHYSICISTS with training in . . . ELECTRONICS . . . CLASSICAL PHYSICS . . . SOLID STATE PHYSICS . . . NUCLEAR PHYSICS.

Openings exist at several levels and require Bachelor's or Advanced Degree with or without industrial experience. If you feel that you are qualified, we'll be glad to hear from you. Please write:

Industrial Relations Department

TRACERLAB, INC.

130 HIGH STREET
BOSTON 10, MASS.

**ELECTRONIC ENGINEERS
5 OR MORE YEARS EXPERIENCE**

Small electronic research and development laboratory, located 8 miles outside of Washington, D. C., has several openings for senior electronic engineers. Degree essential. Varied projects, including considerable Defense work. Liberal salaries dependent upon experience. Excellent personnel policies.

THE DAVIES LABORATORIES

Incorporated

4705 Queensbury Road, Riverdale, Maryland

ELECTRONIC ENGINEERS

FOR DESIGN & DEVELOPMENT WORK IN
RADAR

COMPUTERS

DIGITAL TECHNIQUES

with a young progressive company,
send resumé of experience and
education, with salary requirements,

to



Electronic Engineering Company

of California

140 SOUTH ALVARADO STREET LOS ANGELES 14, CALIFORNIA
DUNKIRK 2-7253

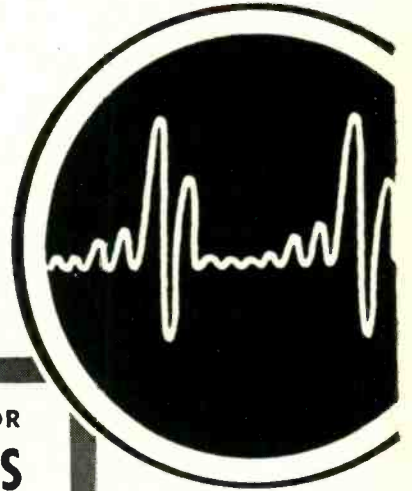
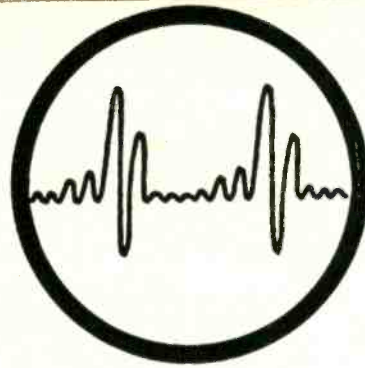

**SPECIAL OPPORTUNITIES FOR
SENIOR ENGINEERS**

Convair in cool, clean, beautiful San Diego invites you to join an "engineers" engineering department. Interesting, challenging, essential long-range projects in commercial aircraft, military aircraft, missiles, engineering research and electronics development. Positions open in these specialized fields:

Radar Systems Missile Guidance Systems
Servo-mechanisms
Electronic Circuits
Microwave Components and Systems

Generous travel allowances to those accepted.
For free brochure, write Mr. H. T. Brooks,
Engineering Dept. 900

CONVAIR
IN BEAUTIFUL
SAN DIEGO

3302 PACIFIC HIWAY
SAN DIEGO 12, CALIFORNIA

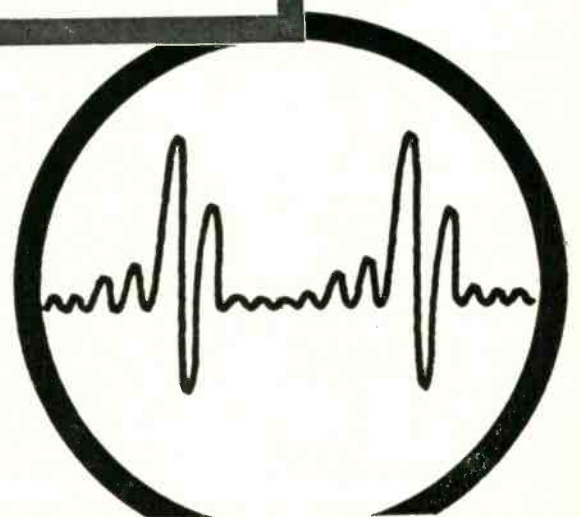

ELECTRONIC ENGINEERS

At least 2 years' experience in design of marine communication systems.

ELECTRONIC DRAFTSMEN

5 years' experience in communication and control systems.

WHAT NUCLEAR POWERED SHIPS CAN MEAN TO YOUR FUTURE

STABILITY—Electric Boat, builders of the world's first atomic-powered submarines, offers you a permanent position on its technical staff, where there have been no layoffs for over 20 years!

OPPORTUNITY—The potential of the great new field of nuclear power is unlimited. At Electric Boat, you will join the top ranking ship designers and builders . . . forge ahead in this expanding industry and pioneer many of its peacetime developments.

HIGH EARNINGS—Good salary provides an added basis for a secure and rewarding future.

BETTER LIVING—You will enjoy a relaxing, leisurely life in the attractive community of Groton, Connecticut (near New London), on Long Island Sound . . . minutes away from every recreational facility. Electric Boat's Housing Bureau will help you relocate.

NOW—Start your future in nuclear powered ships at Electric Boat! Send Complete resume to Mr. Peter Carpenter.

ELECTRIC BOAT

Division of General Dynamics Corp.
GROTON CONNECTICUT

EXPORT FIELD ENGINEER

To call on Latin-American distributors to solve specialized engineering problems, help in setting up service facilities, train servicemen, etc.

Must have electronic experience. Fluent Spanish essential. Extensive traveling, one month trips. Midwestern headquarters. Permanent position. Excellent opportunity with rapidly expanding organization.

Send full description of all experience, including electronic and non-electronic work, also describe education, past earnings, etc. All replies kept confidential.

ADMIRAL CORPORATION

SERVICE DIVISION

201 E. NORTH WATER ST. CHICAGO 11, ILLINOIS

POSITIONS OPEN

Location
KANSAS CITY, MO.

Electronic & Mechanical Engineers

ELECTRONIC ENGINEERS: Must have considerable development experience in radio transmitting and receiving equipment. Ability to fill position of Senior Project Engineer a requisite.

MECHANICAL ENGINEER: Must have development experience in mechanical design of electronic or similar precise equipment. Practical and theoretical knowledge of materials, finishes, sheet metal, and machine shop design are basic requirements. Position is one of considerable responsibility.

SALARY: Open.
These positions are permanent.
Write stating educational and professional history direct to:

Jay V. Wilcox, President
WILCOX ELECTRIC COMPANY, INC.
1400 Chestnut St. Kansas City 1, Mo.
Dependable communications since 1931

ELECTRICAL ENGINEERS

Unusually attractive research opportunities continue to develop in Battelle's expanding research program. Electronic components, servo-mechanisms, digital and analog computers, ultrasonics, x-rays—these immediate openings illustrate the variety of opportunities in our laboratories. Regardless of the field of specialization, electrical engineers interested in research in any area of electrical engineering are urged to apply. Please reply directly for prompt, confidential consideration, to

BATTELLE MEMORIAL INSTITUTE
505 KING AVENUE
COLUMBUS 1, OHIO

APPLICATIONS ENGINEERS

Electrical or electronic engineers with degree, to act as liaison between tube and set manufacturers and or supervise related laboratory problems. Experience not necessary, excellent opportunity, many employee benefits, good pay. Apply or send resume to:

TUNG-SOL ELECTRIC, INC.
200 Bloomfield Ave. Bloomfield, N. J.

ELECTRONIC TECHNICIANS

Our Physics Research Laboratories need technicians to assist in the design, construction and operation of electronic and associated equipment. Training in electronics is essential; a knowledge of machinework practice, vacuum technology or glassblowing would be an asset. Salary range \$2400 - \$3720, depending upon qualifications. State particulars as to age, marital status, education and experience in detail, in first letter. Address inquiries to File 9A,

Atomic Energy of Canada Limited
Chalk River, Ontario

STAVID ENGINEERING, INC.

has openings for
Graduate

ELECTRONIC ENGINEERS MECHANICAL ENGINEERS

Experience in Design and Development of Radar and Sonar necessary.

Broad knowledge of Search and Fire Control Systems; Servo Mechanisms, Special Weapons, Microwave, Antenna and Antenna Mounts, etc.

Mechanical Engineer should have experience in packaging of Electronic Equipment to Gov't specifications including design of complex cabinets, shock mount and sway brace structures, Servo Mechanisms.

Positions are available in Field Service and Technical Writing.

Liberal personnel benefits including life, sickness and accident insurance, and a worthwhile pension system. Paid holidays and vacations.

Personnel Office
200 W. Seventh St.
Plainfield, N. J.
Telephone Plainfield 6-4806

ELECTRONIC ENGINEER

**A Graduate E.E.—or
equivalent experience**

... we are a well-established precision manufacturing company . . . Our small Product Engineering group is responsible for the introduction and technical supervision of a wide range of commercial and government products, such as: Professional Motion Picture Projection and Sound Equipment, Automatic Dry Cleaning Equipment, Gyros, Servo Systems, etc. Our Product Engineers guide a new project from prototype to production . . . this work involves liaison with the research and production department as well as development of the production design.

*This is a PERMANENT job
with an excellent opportunity
for a young man with initiative
and ability*

INTERNATIONAL PROJECTOR CORP.

55 LA FRANCE AVE.
BLOOMFIELD, NEW JERSEY
BLOOMFIELD 2-8052

INVITATION TO *Engineers*

Openings are available for qualified Electronic or Electrical Engineers in the rapidly growing Electronics Design Section of Chance Vought Aircraft. This section is responsible for designing, testing and supervising the manufacture of new and improved electronic and electro-mechanical equipment which will meet the high performance and reliability standards required for operation in modern military aircraft and guided missiles. In addition, it is responsible for surveying the Electronic industry to select the finest electronic parts and equipment for incorporation into Chance Vought designs.

Chance Vought Aircraft, one of the oldest and most progressive aircraft manufacturers in this country, has an outstanding record of producing first line Naval fighter aircraft for over thirty-five years. The company recently entered the guided missile field and is now flight testing its missiles with excellent results.

The Chance Vought plant is located in the Dallas-Fort Worth area which has a metropolitan population of approximately one million and offers the finest cultural and recreational facilities in the Southwest.

Both the experienced and recently graduated engineer with a creative and imaginative interest in the solution of complex problems in the field of Aviation Electronics will find excellent opportunities available in this progressive organization. Positions open at the present time include vacancies of Electronic Test and Development Engineers, Electronic Quality Control Engineers, Circuit Designers, Guidance Engineers, and Servo-Engineers. For further information regarding these opportunities submit resume to Engineering Personnel Section, Chance Vought Aircraft, P. O. Box 5907, Dallas, Texas.

CHANCE VOUGHT AIRCRAFT



DALLAS, TEXAS

DIVISION OF UNITED AIRCRAFT CORPORATION

OIL FILLED CONDENSERS

Table with columns for MFD, VDC, Price, MFD, VDC, Price, MFD, VDC, Price, MFD, VDC, Price. Lists various capacitor models and their specifications.

OILMITES

Table with columns for MFD, VDC, TYPE, Price. Lists oil-filled capacitor models like OM-6002, OM-6005, etc.

COAXIAL CONNECTORS



FULL LINE OF JAN APPROVED COAXIAL CONNECTORS IN STOCK

Table listing various coaxial connector models (e.g., UG-7/AP, UG-12/U) and their prices.

QUOTATIONS UPON REQUEST ON ANY CONNECTORS NOT LISTED HERE

Small table listing connector models (M-358, MC-277, etc.) and their prices.

Small table listing connector models (93-C, 93-M, 49120, etc.) and their prices.

COAXIAL CABLE

Table listing coaxial cable models (e.g., RG-5/U, RG-8/U) and their prices per foot.

ADD 25% TO PRICES SHOWN FOR QUANTITIES UNDER 500 FT.

2 φ LOW INERTIA SERVO MOTORS

Text describing servo motor models like KOLLSMAN-45, PIONEER-10047-2-A, and PIONEER-CK-14.

HIGH VOLTAGE TRANSFORMERS

Text describing high voltage transformer models like G.E.-Pri. 115V 60 cy. Sec. 6250V 80 MA.

ANTENNAS

Text describing antenna models like AT-4/ARN-1, AT-38A/APT, etc.

RELAYS

Text describing relay models like Sigma type 4AH-2000Q, Stevens Arnold type 171, etc.

METERS

Text describing meter models like I MA DC 3 1/2" R DeJur Mod 310, etc.

CRYSTAL DIODES

Table listing crystal diode models (e.g., 1N21, 1N21A) and their prices.

TYPE "J" POTENTIOMETERS

Table listing potentiometer models (e.g., 60 SS, 100 SS) and their prices.

DUAL "JJ" POTS.—\$2.95 ea.

Small table listing dual potentiometer models and prices.

TRIPLE "JJJ" POTS.—\$3.95 ea.

Small table listing triple potentiometer models and prices.

SOUND POWERED TELEPHONES

Text describing sound powered telephone models like U. S. NAVY TYPE M HEAD AND CHEST SETS.

GENERATORS AND INVERTERS

Text describing generator and inverter models like Eclipse-Pioneer type 716-3A, etc.

TEST EQUIPMENT

Text describing test equipment models like Gen. Radio 475B Frequency Monitor, etc.

MISCELLANEOUS EQUIPMENT

Text describing miscellaneous equipment models like I-2F Selsyn Indicator, SCR-515 compl. w/dynamotor, etc.

PULSE TRANSFORMERS

Text describing pulse transformer models like G.E. K54J318, etc.

Text describing pulse transformer models like Westinghouse 1R7AW2F, etc.

AN/APA-23 RECORDER

Text describing AN/APA-23 recorder model and its features.

SPRAGUE PULSE NETWORKS

Text describing Sprague pulse network models like 7.5 E3-1-200-67P, etc.

ELECTRONIC RESEARCH LABORATORIES

715-19 ARCH ST. PHILA. 6, PA. Telephones - MARKET 7-6771-2-3

"CABLE ADDRESS—ELECTRONIC PHILADELPHIA"

GUARANTEED
BRAND
NEW

TUBE SPECIALS

STANDARD
BRANDS
ONLY

Receiving Tubes	6AG7	1.59	6SK7	89	14A7	97	3GP1	4.95	2051	1.15	FL-5B	8.95	WE-254A	5.90	805	4.50
OOA	\$1.50	6AH6	1.39	6SK7GT	89	14H6	93	3HP7	4.91	5545	32.50	4B24	WE-257A	5.75	806	24.50
OIA	.67	6AJ5	2.50	6SK7GT	96	14H8	1.09	4AP10	4.75	Transmitting	4B25/	EL-6CF	8.95	274B	2.85	807
OIA	.74	6AK5	1.35	6SN7GT	89	14C5	1.29	5AP1	5.95	Purpose Tubes	4E27	17.25	WE-275A	6.95	808	2.40
OZ4A	.90	6AK5W	3.05	6S07	75	14E6	1.09	5BP1	5.75	OAA	4J36	150.00	WE-283A	4.25	810	10.95
IA3	.71	6AK6	.99	6S07GT	75	14E7	1.29	5BP4	5.75	OAA2	4J38	120.00	WE-285A	5.55	811	9.50
IA5GT	.72	6A15	.69	6SR7	81	14F7	.93	5CP1	4.95	OBB	4J52	400.00	WE-294A	5.75	814	3.95
IA6	.72	6A15W	2.90	6SR7	81	14H7	.93	5CP7	4.95	OC3	5D21	26.50	304TH	9.75	815	2.75
IAH5	.91	6A05	.89	6ST7	1.25	14J7	.93	5HP1	5.75	OIB3	5J23	52.50	304TH	9.75	816	1.45
IB3GT	.89	6A06	.79	6T7G	1.09	14K7	.93	5HP4	5.75	OIB2A	5J29	18.50	307A	5.50	826	1.45
IB4P	1.17	6A05	.99	6U5	1.19	14W7	.93	5J1P	26.50	OIB2	6AN5	.85	WE-309A	6.45	828	13.48
IC5GT	.85	6A06	3.30	6U7G	89	14X7	.93	5J2P	26.50	OIB3	6AN5	5.95	WE-310A	7.50	829	9.95
IC6	.69	6A07G	4.53	6V6	1.60	19	.89	5J4P	26.50	IB24	6AR6	3.35	WE-313C	4.15	829A	14.50
IC7G	.69	6A16	.63	6V6G	.89	19T8	1.16	5L1P	19.75	(West)	6C21	29.50	316A	.89	829B	14.50
ID5GP	.69	6A16	1.21	6V6GT	.79	22	1.16	5L5P	19.75	IB24 Sylv	6C24	52.50	327A	4.25	830B	7.95
ID7G	.69	6A16	.69	6W4GT	.72	24A	.79	5MP1	10.65	IB24A	6J4	7.95	WE-331A	9.75	832	9.95
ID8GT	.71	6A16	.63	6W6GT	.99	25A6	1.16	7BP1	8.75	IB26	7-7-11	1.49	WE-343A	185.00	832A	9.95
IE5GP	.71	6B4G	1.60	6X4	.59	25L6GT	.89	7BP2	7.95	IB27	19.50	10T1	5E-346A	2.75	833A	45.00
IF4	.69	6B5	1.20	6X5GT	.59	25Z5	.99	7BP4	14.95	IB32	3.95	10Y	WE-350A	6.95	836	3.50
IF5G	.69	6B7	.97	6Y6G	.99	26	.79	7BP14	14.95	IB35	12.50	15E	80	350H	4.95	837
IF6	.71	6B8	.99	6ZV5G	.89	27	.69	7CP1	14.95	IB36	12.50	15R	WE-356B	5.45	838	3.25
IG4GT	.69	6B8G	.85	7A4	.79	28D7	1.75	9CP7	12.85	IB38	32.50	REL-21	.95	361A	4.75	841
IG5G	.69	6B8G	.72	7A5	.88	30	.72	9L7	9.95	IB40	18.50	24C	2.25	368A	6.95	842
IG6GT	.69	6B8G	1.20	7A6	.83	30 Spec.	.48	10BP4	18.50	IB42	4.95	HR-24	3.95	371B	.95	845W
IH4G	.89	6B85	.88	7A7	.83	31	.62	10BP7	24.50	IB44	9.80	RG-25	3.82	388A	2.95	849
IH5GT	.79	6B85	1.10	7A8	.83	32	.87	12DP7	16.50	IB45	32.50	FG-32/	WE-399A	4.79	851	67.00
IH6GT	1.01	6B16	1.60	7AD7	1.44	32L7GT	.87	12HP7	16.50	IB20	.88	5558	6.75	417A	16.95	852
IJ5G	.74	6B16	.72	7B4	1.08	33	.99	12HP1	16.50	IS21	9.50	RK-34	.49	434A	17.50	860
IJ6G	.95	6B16	1.10	7B5	.83	33 51	.79	905	4.45	I22	3.75	35T Ion	4.95	446A	1.95	864
IL4	.69	6B16	.83	7B6	.83	35A5	.89	IP23	\$4.10	IC21	2.20	gauge	5.95	446B	2.25	865
IL4A	.83	6B16G	.83	7B7	.83	35B5	.89	IP24	1.27	IC22	.75	35TG	4.95	450TH	42.50	866A
IL4B	1.10	6B16	.99	7B8	.89	35L6GT	.85	918	.49	IC26	.49	REL-36	7.95	450TH	42.50	869B
ILB4	1.01	6B16	.99	7C4	.89	35W4	.81	919	1.85	IC26A	.49	RK-47	4.92	451	1.39	872A
ILC5	.81	6B17	1.60	7C5	.83	35Y4	.81	919	1.85	IC34	.49	VT-52	.65	1B21A	2.75	874
ILC6	.93	6B17GT	1.45	7C7	.83	35Z4GT	.69	923	1.95	IC34	22.00	VT-52	.65	53A	5.60	878
ILD5	.93	6B16	1.59	7E5	1.20	35Z5GT	.59	927	1.85	IC40	16.25	53A	5.60	503AX	1.65	886
ILD5GT	.79	6B16GT	1.36	7E6	.83	37	.69	93A	6.95	IC42	26.50	RK-59	2.44	506AX	1.47	954
ILH4	.82	6C	.65	7E7	.83	37	.69	1643	1.95	IC43	21.50	RK-60	1.95	507AX	1.47	956
ILN5	.91	6C5	.75	7F7	.99	38	.69	Thyratrons & Ignitrons	IC44	1.50	VT-62 Br	1.15	507AX	1.47	956	.49
IN5GT	.85	6C6B	.89	7F8	1.50	39 44	.59	OA4G	\$1.32	IC46	29.50	RK-63	22.50	507AX	1.47	956
IN6G	.97	6C6	.88	7G7	1.32	41	.71	EL-41A	4.75	IC51	1.25	IC53	12.00	507AX	1.47	956
IP5GT	.69	6C8G	.96	7H7	1.32	42	.89	2A4G	1.25	IC53	12.00	RK-69	2.25	531	17.29	957
IO5GT	2.40	6D16G	2.40	7J7	1.32	45	.89	2B4	2.10	IC53	12.00	RK-69	2.25	531	17.29	957
IR4	.69	6D18	.88	7K7	1.32	45	.89	2C33	4.95	IC53	12.00	RK-69	2.25	531	17.29	957
IR5	.89	6D18G	.83	7L7	.97	46	.81	2D21	1.55	IC53	12.00	RK-69	2.25	531	17.29	957
IS4	.71	6E5	1.10	7N7	.97	46	.81	3C23	1.85	IC53	12.00	RK-69	2.25	531	17.29	957
IS5	.81	6F5GT	.83	7O7	.83	47	.99	3C31	1.55	IC53	12.00	RK-69	2.25	531	17.29	957
IT4	.81	6F6	.99	7R7	.94	48	.94	3C31B	3.95	IC53	12.00	RK-69	2.25	531	17.29	957
IT5GT	.71	6F6G	.85	7V7	1.11	50	1.41	3C45	17.50	IC53	12.00	RK-69	2.25	531	17.29	957
IU4	.86	6E7	.85	7V7	1.11	50	1.41	4C35	28.75	IC53	12.00	RK-69	2.25	531	17.29	957
IU5	.81	6F8G	.91	7W7	1.11	50A5	.91	4C35	28.75	IC53	12.00	RK-69	2.25	531	17.29	957
IV	.69	6G6G	1.06	7Y4	.73	50B5	.88	EL-C5B	9.95	IC53	12.00	RK-69	2.25	531	17.29	957
IX2	1.09	6H6	.83	7Z4	.89	50C5	.88	5C22	53.45	IC53	12.00	RK-69	2.25	531	17.29	957
2A3	1.28	6H6GT	.83	10	.45	50L6GT	.92	C6J	9.95	IC53	12.00	RK-69	2.25	531	17.29	957
2A5	.89	6J5G	.64	12A	.65	50V6GT	.92	C6J	9.95	IC53	12.00	RK-69	2.25	531	17.29	957
2A7	.89	6J5G	.64	12A6	.71	53	.95	FG-17/55575	25.38	IC53	12.00	RK-69	2.25	531	17.29	957
2B7	.79	6J5GT	.64	12A6GT	.69	55	.99	FG-33	17.50	IC53	12.00	RK-69	2.25	531	17.29	957
2E5	.94	6J6	1.09	12A7	1.16	55B	.40	FG-41	122.50	IC53	12.00	RK-69	2.25	531	17.29	957
2X2	.89	6J7	.99	12ARGT	.77	1.55B	.32	FG-67	14.40	IC53	12.00	RK-69	2.25	531	17.29	957
2X2A	1.85	6J7GT	.79	12AH7GT	1.32	56	.69	FG-81A	4.95	IC53	12.00	RK-69	2.25	531	17.29	957
3A4	.85	6J8G	1.28	12A15	.89	57	.89	91	7.85	IC53	12.00	RK-69	2.25	531	17.29	957
3A5	1.89	6K5GT	.99	12A16	.59	58	.89	FG-95/	25.00	IC53	12.00	RK-69	2.25	531	17.29	957
3A8GT	2.25	6K6GT	.69	12A17	1.15	59	1.24	5550	39.50	IC53	12.00	RK-69	2.25	531	17.29	957
3B7	.57	6K7	.83	12A16	.79	70L7GT	.79	5610/	24.60	IC53	12.00	RK-69	2.25	531	17.29	957
3C6	1.15	6K7G	.88	12A17	.95	71A	.79	5610/	24.60	IC53	12.00	RK-69	2.25	531	17.29	957
3D6	.53	6K8	1.22	12A18	.63	75	.69	FG-105	19.50	IC53	12.00	RK-69	2.25	531	17.29	957
3LP4	.91	6K8GT	.96	12AW6	1.20	76	.89	FG-166	95.00	IC53	12.00	RK-69	2.25	531	17.29	957
3O4	.77	6L5G	1.06	12AX7	1.08	77	.79	FG-172	39.50	IC53	12.00	RK-69	2.25	531	17.29	957
3O5GT	.83	6L6	1.87	12B6A	.72	78	.79	FG-178	14.50	IC53	12.00	RK-69	2.25	531	17.29	957
3S4	.77	6L6G	1.79	12B7A	.95	79	.89	FX-233A	4.95	IC53	12.00	RK-69	2.25	531	17.29	957
3V4	.87	6L6GA	1.89	12BD6	.99	80	.65	FX-235A	94.50	IC53	12.00	RK-69	2.25	531	17.29	957
5A24	.64	6M7	1.08	12B6GT	.70	81	1.41	2K28	34.50	IC53	12.00	RK-69	2.25	531	17.29	957
5R4GY	1.59	6L7G	.95	12C5	.77	82	1.19	FG-271/	62.50	IC53						

Reliance Specials

GEAR ASSORTMENT

100 small assorted gears. Most are stainless steel or brass. Experimenter's dream! Only \$6.50



HAYDON TIMING MOTOR
1 R.P.M., 115 V., 60 Cycle.....\$1.95



SOUND POWER HANDSET BRAND NEW

Includes 5 ft. cord.—Uses no batteries or external power source. \$18.50 pr

AC LINE CORDS 6 ft. long with molded plug.....16c

BALL BEARINGS

Mfg. No.	ID	OD	Thick.	Price
MRC5028-1	5 1/2	6 1/2	1	\$3.75
MRC7026-1	5 5/64	6 15/64	9/16	3.50
MRC7021-200	4 1/8	5 9/32	23/64	2.95
MRC106M2	1 17/64	2 7/16	25/64	1.75
MRC106M1	1 13/64	2 7/16	25/64	1.60
Federal LS11	1 1/8	2 1/2	5/8	1.75
Norma S11R	1 1/8	2 1/2	5/8	1.50
Federal AS41	1 1/16	1 1/2	9/32	1.00
Schatz	3/4	1 3/4	9/16	1.00
Norma 203S	5/8	1 9/16	7/16	.90
ND5202-C13M	1/2	1 3/8	1 3/8	1.00
ND 3200	25/64	15/32	11/32	.60
ND R6	3/8	7/8	7/32	.40
MRC39R1	11/32	1 1/32	5/16	.45
MRC38R3	8/16	55/64	13/32	.45

NEEDLE BEARINGS

TORRINGTON B108 1/2" wide 3/4" 13/6".....30c

Brand New Meters—Guaranteed

0-10 ma. D.C. 3 1/2".....\$3.95 0-80 Amp. D.C. 2 1/2".....\$2.50
0-1 Ma. D.C. 3 1/2" DeJur. (Scale Reads 0-4 KV).....\$5.75

SELENIUM RECTIFIERS

Full Wave 200 MA 115V.....\$1.79
Half Wave 100 MA 115V......91

TIMING MOTOR

8 RPM 115V 60 cyc  **\$1.79**
E. Inghram Co.

400 CYCLE INVERTERS

Leeland Electric Co.
#10890 in: 20-28 V.D.C., 92 A., 8000 R.P.M. Out: 115V, 400 Cyc., 1 phase, 1500 V.A., 90 PP.....\$24.95

3 AG FUSES

Amp.	Per 100	Amp.	Per 100	Amp.	Per 100
1/8	\$4.00	3/4	\$4.00	8	\$3.00
3/8	4.00	4	3.00	10	3.00
1/2	4.00	5	3.00	15	3.00

3 AG FUSE HOLDERS (Finger) 25c

DELAY NETWORK—ALL 1400Ω

T 114—Approx. 2.2 micro sec. delay......95c
T 115 Similar to T 114 with tap brought out......7 each

Sound Powered Chest Set RCA—With 24 Ft. Cord

Per Pair  **USED \$17.60**
NEW \$26.40

POSTAGE STAMP MICAS

mmf	mmf	mmf	mmf	mmf	mmf	mmf	mmf	mfd	mfd
40	70	125	240	400	680			.0016	.004
20	47	75	135	250	430	800		.002	.0044
22	50	82	150	270	470	820		.0027	.005
23	51	82	160	300	500	910		.0033	.006
24	56	90	175	330	510	001		.0036	.0065
25	60	100	180	360	580	.0012		.0068	
33	62	110	200	370	600	.0013		.0082	
39	63	120	220	390	650	.0015		.01	

Price Schedules

10 mmf to 820 mmf..... 5c
.001 mfd to .0016..... 8c
.002 mfd to .0082 mfd..... 15c
.01 mfd..... 28c

SILVER MICAS

mmf	mmf	mmf	mmf	mmf	mmf	mmf	mmf	mfd	mfd
10	50	100	170	360	510	001		.0024	.0047
18	51	110	180	370	525	.0011		.0025	.005
22	56	115	208	390	560	.0013		.0027	.0051
23	60	120	225	400	570	.0015		.0028	.0056
24	62	125	240	410	680	.0016		.003	.006
25	66	130	250	430	700	.0018		.0033	.0068
27	68	135	255	470	800	.0022		.0039	.004
30	75	150	260	488	900	.0023		.004	
40	82	155	270	500					

Price Schedule

10 mmf to 700 mfd..... 10c
.0011 mfd to .002 mfd..... 20c
.0022 mfd to .0082 mfd..... 50c

PULSE TRANSFORMERS

UTAH—9282 9278 9280 9340
WESTERN ELECTRIC—D166173 D161310
KS8996, KS9565, KS9800, KS9862, KS13161
GENERAL ELECTRIC—80-G-5
JEFFERSON ELECTRIC—C-12A-131S
DINION COIL—TR 1048 TR1049
also 352-7250-2A; 352-7251-2A; T-1229621-60

COAXIAL CABLE CONNECTORS



15c	\$1.20	30c	75c	40c	12c
UG175/U	\$3.1F	83-1AP	83-LJ	SO-239	HOOD
83-1AC	\$.42	UG-23/U	1.20	UG-175/U	.15
83-1AP	.30	UG-23B/U	1.90	UG-176/U	.15
83-1F	1.20	UG-23C/U	1.90	UG-185/U	1.20
83-1H	.12	UG-24/U	1.30	UG-224/U	1.35
83-1HP	.25	UG-25/U	1.35	UG-255/U	2.45
83-1J	.75	UG-27/U	1.30	UG-259/U	1.20
83-1R	.40	UG-27B/U	3.45	UG-261/U	1.20
83-1RTY	.65	UG-28A/U	3.75	UG-262/U	1.20
83-1ST	.50	UG-30/U	2.30	UG-274/U	2.75
83-1SPN	.65	UG-31/U	2.30	UG-290/U	1.20
83-1T	1.30	UG-38/U	.80	UG-291/U	1.25
83-2AP	1.95	UG-58A/U	1.15	UG-306/U	2.95
83-2J	2.10	UG-59A/U	2.25	UG-499/U	1.25
83-2R	1.70	UG-83/U	1.95	UG-625/U	1.35
83-22AP	1.40	UG-85/U	1.75	CW-123A/U	1.30
83-22R	.68	UG-87/U	1.60	M-358	1.30
83-22SP	.90	UG-88/U	1.10	M-359	.30
83-168	.15	UG-89/U	1.35	PL-258	.75
83-185	.15	UG-102/U	.90	PL-259	.50
UG-13/U	1.70	UG-103/U	.68	PL-259A	.55
UG-21/U	.95	UG-104/U	1.40	PL-274	1.20
UG-21B/U	1.35	UG-106/U	1.12	SO-239	.40
UG-22/U	1.30	UG-146/U	2.55		
UG-22A/U	1.60	UG-167/U	5.70		

NEW COAXIAL CABLES

Price per 1000 Ft.	Price per 1000 Ft.
RG 5/U*.....\$140.00	RG 22/U*.....150.00
RG 6/U.....180.00	RG 22A/U.....\$285.00
RG 7*.....85.00	RG 24.....675.00
RG 8*/U.....100.00	RG 26/U.....475.00
RG 9*/U.....250.00	RG 29*.....50.00
RG 9A/U.....275.00	RG 34/U.....300.00
RG 10.....240.00	RG 35.....900.00
RG 11*/U.....100.00	RG 41*/U.....295.00
RG 11A/U*.....150.00	RG 54A/U.....97.00
RG 12*.....240.00	RG 55*.....110.00
RG 13*/U.....216.00	RG 59*.....325.00
RG 17.....650.00	RG 58*.....60.00
RG 18/U.....900.00	RG 58A/U*.....65.00
RG 19.....1250.00	RG 59*.....55.00
RG 20/U.....1450.00	RG 62*.....75.00
RG 21.....220.00	RG 77*.....100.00

Add 25% for orders less than 500 feet.
* No minimum order—others 250' minimum.



UNIVERSAL JOINT ALUMINUM
1/4" hole x 1/2" O.D.
1 1/8" long **85c**

SPAGHETTI SLEEVING—assortment—90 feet.....\$1.00

TYPE "J" POTENTIOMETERS

100 S.S.*	1,500 1/4S.S.	15K 1/4	200K S.S.*
150 S.S.	2,000 1/4	25K S.S.	250K 5/8
300 S.S.*	2,500 S.S.	70K S.S.	250K S.S.*
400 S.S.	3,000 3/8	80K S.S.	500K S.S.*
500 S.S.	4,000 3/8	100K 7/16	1Meg S.S.
1,000 3/8	5,000 3/4*	100K S.S.*	
1,000 S.S.	10K 5/8	200K 5/8	

*Split Locking Bushing **\$1.50 EACH**

TYPE "JJ" POTENTIOMETERS

Ohms	Shaft	Ohms	Shaft	Ohms	Shaft
1000	S.S.	30K-10K	3/8"†	1 Meg.	1/2"
10K	3/16"	3K-90K	1/4"	1 Meg.	S.S.
15K	S.S.			1 Meg.	S.S.

SD—Screw Driver *Split Locking Bushing †With Switch

PRICE—\$2.00 EACH

JONES BARRIER STRIPS

2-140Y	\$.17	3-141W	.27	9-141Y	.71
3-140W	.21	4-141W	.33	12-141	.64
6-140W	.28	5-141W	.29	3-142	.24
10-140W	.59	5-141 1/2W	.41	2-150	.43
10-140 1/2W	.59	7-141 1/2W	.56	3-150	.60
3-141 1/2W	.27	8-141 1/2W	.64		

TIME DELAY RELAY

Raytheon CPX 24166
1 Min. Delay. 115 V., 60 Cycle
2 1/2 second recycling time spring return •
Microswitch contact, 10A • Holds ON as
long as power is applied • Fully Cased •
ONLY \$6.50

AN CONNECTORS
IMMEDIATE SERVICE
PHONE! WIRE! WRITE! YOUR NEEDS

OIL FILLED CONDENSERS

MFD	V.D.C.	Price	MFD	V.D.C.	Price
5.2	50	\$0.35	.25	3,000	2.25
6	400	.85	1	3,600	3.95
3 x 3	400	1.00	3 x 2	4,000	2.50
4-4	500	.85	2	4,000	6.95
8	500	1.35	.01	4,000	7.95
1	600	.45	.01-.03	5,000	.95
5-5	600	.40	.03-.03	6,000	1.40
2	600	.80		6,000	1.50
8	600	1.63	.02-.02	7,000	1.55
10	600	2.95	.02-.03	7,000	1.60
4 x 3	600	1.75	-1-1	7,000	2.25
8-8	600	1.79		7,500	2.25
1	800	.60	3-3	7,500	4.50
2	1,000	.75	.075-.075	8,000	1.85
3	1,000	1.70	.15-.15	8,000	2.95
6	1,000	2.75	.25	20,000	19.95
8	1,000	3.25			
1	1,500	1.45			
.02	2,000	.65			
.1-1	2,000	1.30			
.1-5	2,000	1.65			
3	2,000	3.75			
8	2,000	7.95			



\$9.95

PRECISION RESISTORS—1/4 WATT—30c

2	10.48	12.32	14.98	62.54	147.5	705
2.5	10.84	13.02	15.8	79.81	220.4	2,193
3.5	11.25	13.52	16.37	105.8	301.8	3,500
5	11.74	13.89		123.8	366.6	
6.68				125	414.3	59,148

PRECISION RESISTORS—1/2 WATT—35c

.25	11.1	75	400	6,500	16,000	36,000
.334	13.15	87	723	17,000	16,700	37,000
.444						

MOTOR GENERATORS

2.5 KVA Diehl Elec. Co. 120DC to 120AC, 60 cy., 1 Ph., Complete with Magnetic Controller, 2 Field Rheos and full set spare parts including spare armatures for generator and motor. New. \$295.00
 2 KVA O'Keefe and Merritt, 115DC to 120AC, 50 cy., 1 Ph. Export Crated. New. \$195.00
MOTOR GENERATOR, TYPE CGU-2
 Unit of U. S. Navy TCK-7 Transmitter
 Motor: 2 H.P., 230 V.D.C., 10 amps.
 Generator: 1800V. D.C., 0.4 A, 500V. D.C., 0.35A, 115 V. D.C., 1.5A, 12 V. D.C., 2A, 3480 R.P.M. Self excited. Brand new including spare armature. \$365.00

INVERTERS

Onan M.G.-215H. Navy type PU/13. Input 115/230, 60 cy., 1 Ph. Output: 115, 480 cy., 1 Ph., 1.2KW and 26V DC at 4 amps. New. \$295.00
 Leland Elec. Co. PE206A. Input: 28DC at 38 Amps. Output: 80V, 800 cy. 1 Ph., 485VA. New. \$22.50
 G.E. J8169172. Input: 28DC. Output: 115, 400 cy., 1 Ph., 1.5KVA. New. \$32.50
 G.E. 5A81315511A. Model 218J. Input: 28DC. Output: 115, 400 cy., 1 Ph., 1.5KVA. Regulated. New. \$89.50
 Holtzer-Cabot M.G. 164. Input: 440, 3 Ph., 60 cy. Output: 70V, 146 cy. 3 Ph., 0.140KVA. New \$67.50
 Eicor. 32DC to 110AC, 60 cy., 1 Ph. at 2.4 Amps. New. \$39.50

DYNAMOTORS

Navy type CA10-211444. Input: 105 to 130DC. Output: either 26DC at 20 amps, or 13DC at 40 amps. Radio filtered and complete with line switch. New. \$89.50
 Type PE94CM. For SCR-522. Brand new in overseas cases. \$19.50

AMPLIDYNES

G.E. 5AM211J7. Input: 27VDC. Output: 60VDC, 150 Watts, 4600 RPM. Type MG-27-B. New \$34.50
 Edison 5AM31N18A. Input: 27VDC, 44 Amps, 8300RPM. Output: 60VDC at 8.8 Amps., 530 Watts. New. \$22.50

SMALL D.C. MOTORS

G.E. 5BA50L12A. Armature 27VDC at 8.3 Amps. Field 60VDC at 2.3A. RPM 4000, H.P. 0.5. New. \$27.50
 Oster E-7-5. 27.5DC. 1/20HP, 3600RPM. Shunt Wound. New. \$9.50
 Dumore Co. type ELBG. 24VDC, 40-1 gear ratio. For type B-4 Intervalometer. New. \$8.50

BLOWERS

Westinghouse. Type FL 115V, 400 cy., 6,700 RPM. Airflow 17CFM. New. \$9.50
 E.A.D. Type J50-CW-60 cycle-NEW. \$15.50

SYNCHROS

Ford Inst. Co. Synchro Differential Generator. Mod. 3 Type 58DG, 90/90V, 400 cy., Ord. Dr. 173020. New. \$22.50
 Armor. Synchro Differential Generator. Type 6DG. New. \$60.00
 Hobart Mfg. Co. Synchro Differential Synchro Type XIX 115V, 60 cy. New. \$9.50

PARABOLOIDS

Spun Magnesium dishes 1 7/8" dia. 4" deep. Mounting brackets for elevation and azimuth control on rear, 1 1/2 x 1 1/2" opening in center for dipole. Brand new, per pair. \$12.50

SOUND POWERED CHEST SETS

U. S. Instrument Co. No. A-260 Combination headset and chest microphone. Brand new, including 20 ft. of rubber covered cable. \$17.50 each
 W. E. Laboratory Headsets—Type 316 B, 600 ohms at 1000 C.P.S. Brand new—Price per set. \$6.50

RELAYS

Struthers-Dunn 1BXX129, 110 A.C. \$2.60
 Advance type 455C, SPDT, 115 A.C. \$1.95
 Leach type 1154A, SPDT, 115 A.C. \$2.35
 Leach type 1054, BSN 20-28V D.C. \$2.35
 Clare Plug-in base No. 30FMX 115 A.C. \$3.50
 G.E. Plug-in base Sensitive K271853. \$4.50
 Western Electric D-163781 Plug-in. \$10.00
 Guardian Time Delay type B-9-SPDT. \$2.95
 Haydon Time Delay 17717 110V/60. \$4.75

HI-VOLT CAPACITORS

25 Mfd., 20KV. \$26.50
 25 Mfd., 15KV. \$22.50
 1 Mfd., 15KV. \$44.50
 1 Mfd., 7.5KV. \$12.50
 2 Mfd., 6.0KVA. \$14.50
 50 KV Capacitors also available various sizes. Write for list.

MODEL AN/APA-10 PANORAMIC ADAPTER

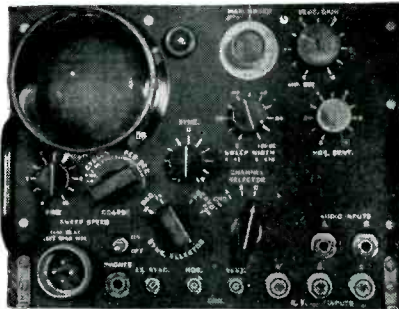

Provides 4 Types of Presentation:

- (1) Panoramic (2) Aural
 - (3) Oscillographic (4) Oscilloscopic
- Designed for use with receiving equipment AN/ARR-7, AN/ARR-5, AN/APR-4, SCR-587 or any receiver with I.P. of 455 kc, 5.2mc or 30mc. With 21 tubes including 3" scope tube. Converted for operation on 115 V. 60 cycle source. \$245.00
 Gov't Cost \$1800.00
 AN/APA-10 80 Page Tech Manual. \$2.75

TEST EQUIPMENT

TS-127/U Lavoie Freq. Meter—375 to 725 MC.
 TS-47APR Test Osc. 40-500MC.
 TS-487/U Peak to Peak VTVM.
 AN/APR-1 Receiving sets.
 R11A/APR-5A Receiver—1000 to 6000 MC.
 AN/APR-4 Tuning Units TN-17 (76-300 MC).
 AN/APR-4 Tuning Units TN-18 (300-1000 MC).
 AN/APR-4 Tuning Units TN-19 (950-2200 MC).
 TU-58 Range "A" Tuning Units (110-370 MC).
 AN/APA-10 Panoramic Adapters 115V/60 cycles.

Repair Parts for BC-348 (H, K, L, R only)
 Also BC 224 Models F, K. Coils for ant., r.f., det., osc., I.F., c.w. osc., xtal filters, 4 gang cond., front panels, dial assemblies, vol. controls, etc. Write for complete list and free diagram.

HIGH QUALITY CRYSTAL UNITS

Western Electric—type CR-1A/AR in holders. 1/2" pin spacing. Ideal for net frequency operation. Available in quantities, 5910-6350-6370-6470-6510-6610-6670-6690-6940-7270-7350-7380-7390-7480-7580-9720. All fundamentals in KC. Good multipliers to higher frequencies. \$1.25 each

RADAR

Antenna-Trans-Rec. Unit ASG-1.
 Radar Set S9 complete with spares.
 Modulator type SO-11.
 Pulse Timers CUZ-50AGD (SD-5 Radar).
 Radar Crystal Units 98.35kc, Raytheon.
 1N21B Sylvania Diodes.
 Repeater Adapters C1M-50 AFO.
 SO Series Accessory Control Panels.
 SO Series Transmitter-Receiver unit.
 CARD 23AEK Bearing Control Units for SO Series. Auxiliary Rectifier.

RADAR ANTENNAS

Type SO-1 (10CM) assembly with reflector, waveguide nozzle, drive motor, etc. New. \$279.50
 Type SO-3 (3 CM.) Surface Search type with reflector, drive motor, etc., but less plumbing. New in original cases. \$189.50
 Type SO-12 (10CM.) Complete assembly with 21" dish, dipole, drive motor, gearing, etc. New \$149.50
 Also in stock — spare reflectors, nozzles, probes, right angle bends for SO-1 antennas.

RECTIFIERS

G.E. No. 6 RC89F16 for 54 cells 10 amps.
 Mallory APS-20—In: 115/230/60/3. Out: 12/42V-65-13A.
 Furret Trainer Supply. In: 220/60/3. Out: 28V-130A.
 Complete specs. on request.

TERMS: Rated Concerns Net 30, FOB Bronxville, New York. All Merchandise Guaranteed. Prices Subject to Change

400 CYCLE TRANSFORMERS

AUTO. 400 cy. G.E. Cat. No. 80G184.
 KVA 945S-520P Volts 460/345/200/115. New. \$6.95
FILAMENT—400/2600 CPS. Input—0/75/80/85/105/115/125V. Output—5V3A/6V3A/6V6A/6.3V 0.5A. No. 7249010—New. \$3.95
PLATE WECO KS 9560 800 cy. Pri: 115V. Sec: 1350-0-1350 at .057A (2700 V. Total). Elestat shlded. Wt. 2.3 lbs. New. \$2.95
Plate Thordarson #T46889. 1650 VA. Pri: 105-120V. 500 cy. 1 PH. Sec: 5600V. Center tapped. 1.5KV. insulation. Brand new. \$49.50
PLATE & FIL. WECO KS9555, 400 cy. Pri: 115V. Sec. #1: 930-0-930. Sec. #2: Three 6.3V windings. \$4.95
FILAMENT 400/2400 cps. WECO KS9553. Pri: 115V. Sec: 8.2V1.25A/6.35V1.5A Elestat shlded. Wt. 0.5 lbs. New. \$2.95
PLATE & FIL. 400/2600 cy Pri: 0/80/115V. Sec: #1=1200VDC at 1.5MA. Sec. #2=400 VDC at 130MA. Fil. Secs: 6.4V4.3A/6.35V0.8A (1ns) 1500MV/6V2A/6V2A. \$4.95
RETARD. 400 cy. WECO KS9598. 4 Henry 100MA. \$2.75

HIGH POT TRANSFORMERS

High Voltage Trans. Westinghouse Pri: 115. 60 cy. Sec: 15,000 C.T., 60 MA. Good for Hi-Pot test set up. C. T. ungrounded. \$39.50

PULSE TRANSFORMERS

PULSE WECO KS-9563 Supplies voltage peaks of 3500 from 807 tube. Tested at 2000 Pulses/sec and 5000 peak. Wdg. 1-2=18 ohms. Wdg. 1.3=72 ohms. L of Wdg. 1.3=082H at 100 cps. \$7.50
PULSE. WECO KS-161310. 50 KC to 4MC, 1 1/2" Dia. x 1 1/2" high. 120 to 2300 ohms. New. \$6.75
 High Reactance Trans. G.E. type Y-3502A. 60 cy. Voltage 11200-135. Inductance H.V. Winding 135 Henries. Output: Peak Voltage 22.8KV. Cat. 8318065GL New. \$89.50

RAYTHEON VOLTAGE REGULATORS

Adj. input taps 95-130V, 60 cy. 1 Ph. Output: 115V, 60 Watts, 1/2 of 1% Reg. Wt. 20 lbs. 6 1/2" H x 8 1/4" L x 4 1/2" W. Overload protected. Sturdily constructed. Tropicalized. Special. \$16.75

AMPLIFIERS

GE Serro type 2CV1C1, 400 cycle
 Constant Output Line RC-730C
 Synchro Amplifiers for Radar
 Intercommunication type BC-605

ANTENNAS

MR-162 Coast Guard 23 1/2 ft. wtlps
 AS-32 APT-2, AT-38A/APT, AS-62/APB-13
 AS-125/APR for APR-5A
 TDY Radar JAMMER HORNS
 PARABOLOIDS, MAGNESIUM DISHES 17 1/2" dia.
 SCR-623-A (part of RC-153-B Antenna)
 CU 64/APT Antenna matching unit 50 ohm unbal. to 100 bal.

POTENTIOMETERS

W.E. KS-15138 Linear Sawtooth
 W.E. KS-8732 for SCR547 Radar
 W.E. KS-8801 Motor Drive

LINEAR SAWTOOTH POTENTIOMETER

W.E. KS-15138
 Has continuous resistance winding to which 24 volts D.C. is fed to two fixed taps 180° apart. Two rotating brushes 180° apart take off linear sawtooth wave voltage at output. Brand New. \$5.50

MISCELLANEOUS

Cathode Ray Shields for 3" tube. \$3.75
 Variac type Motor Controls 600 watt. \$13.50
 10 CM Waveguide 90° elbow. \$20.00
 Adel Clamps assorted types—write for samples
 Shock Mounts Lord #20. \$4.40
 Shock Mounts U. S. Rubber #5150C. \$3.30
 Commando Pole Jacks (Elec. Co.). \$1.00
 Switchboard Lamp Receptacles & Covers. \$4.40
 SCR522 Transmitter Receivers. Brand New
 Fire Detector Wilcolator
 No. A-4242. Ord. No. B 257736. \$1.00
 Dial Drive Assembly for Bendix, MN-28-Y. \$4.50
 Instruction Manual for SCR-193A, B, C, D, E \$1.50
 Solenoid Cannon 24 V.D.C.—New. \$2.00
 Attenuators Tech-Lab 500/500 type 700. \$4.75
 Volume control Dual for BC-433G. \$2.85
 Switch 600V., 60A. Bendix CI19078. \$2.50
 Switch Arkless 0 sec. Rotary. \$4.50
 Switch Arkless 16 sec. Rotary. \$7.50
 Switch Panels SA-2/F1C. \$12.50
 Switch Micro R-RL2T. \$1.65
 Switch Navy Rotary #647491. \$17.50
 Contactor CRP-23AG for SC-1 radar. \$24.75
 Band-Switch assembly for AR-88 receiver. \$9.50
 RTV AN/APN-1 Receivers
 BC-423B Modulators
 BC-1366M Jack Boxes—Large quantity
 Sweep Generator Capacitors 5/10 mfd. \$2.50

INDICATORS

ID-24/ARN-9. \$12.50
 ID-14/APN-1. \$7.95
 ID-60/APA-10 Panoramic Adapter converted for 60 cycle operation—complete with tubes and 80 page Tech. Manual. \$245.00

ELECTRONICRAFT INC.

27- MILBURN ST. BRONXVILLE 8, N. Y.
 PHONE: BRONXVILLE 2-0044

NEW YORK'S RADIO TUBE EXCHANGE



TYPE	PRICE	TYPE	PRICE	TYPE	PRICE
0A3	\$1.40	2J32	69.95	4J41	199.00
0A8	1.75	2J31	105.00	6B8	3.95
0B2	1.75	2J38	37.95	6BP1	6.95
0C8	1.25	2J40	35.00	6BP4	6.95
0D8	1.25	2J44	189.00	6CP1	6.95
C1B	6.95	2J49	108.00	6D21	27.50
1B21A	2.75	2J50	195.50	5JF1	27.50
1B22	3.95	2J55	95.00	4P2	19.50
1B23	9.95	2J61	75.00	1P4	27.80
1B24	17.95	2J62	75.00	WE8AK6	2.50
1B26	2.95	2K25	37.56	6C21	29.50
1B27	13.50	2K28	37.50	6VA	12.50
1B28	4.10	2K29	37.50	6B1	10.95
1B28	33.00	2K41	158.00	7BP7	7.95
1B42	18.95	2K48	149.50	7DP4	10.00
1B41	9.95	2V30	2.10	12A4	55.00
1B46	49.95	3BP1	7.50	15E	1.95
1B60	69.95	3B24	5.50	15R	1.95
1N21	1.35	3B24W	7.50	NE19	.68
1N21A	1.75	EL3C	6.95	FG17	6.95
1N21B	4.25	2C22	120.00	RX21	3.95
1N22	1.75	3C24	1.95	FC23	12.95
1N23	2.00	3C31	5.95	86T	4.95
1N23A	2.00	3DP1A	10.95	45 Special	.35
1N23B	3.75	3DP1B2	12.00	RK39	2.95
1N23B	6.80	3E29	15.50	HF50	1.75
1N27	5.00	3EP1	5.50	V752	.25
1N48	2.50	8N4	5.50	RK72	1.95
2B21	1.95	4A1	1.75	RK73	1.95
2B26	3.75	4A21	2.75	100TH	9.95
2C4	.35	4B26	10.95	FG105	19.00
2C40	26.00	4C27	25.00	203A	8.95
2C48	27.08	4C28	35.00	211	.95
2C4	.90	4E27	17.50	217C	18.00
2D21	1.75	4J26	199.00	242C	10.00
2E22	1.75	4J28	199.00	244A	12.95
2E30	2.75	4J27	199.00	249C	4.95
2J21	17.95	4J31	199.00	260T	19.95
2J26	17.95	4J32	199.00	274A	3.00
2J26	27.75	4J33	199.00	274B	3.00
2J27	29.95	4J37	199.00	304TH	15.00
2J81	29.95	4J38	95.00	304TL	14.50
		4J39	199.00	307A	4.95



TYPE	PRICE	TYPE	PRICE	TYPE	PRICE
310A	7.95	724A	4.95	885	1.75
311A	7.95	724B	6.95	888H	199.50
312A	3.95	725A	9.95	914	75.00
323A	25.00	726A	18.00	914A	6.95
327A	3.95	726B	56.00	954	.38
328A	9.45	726C	69.00	955	.55
354A	7.95	726V	27.00	956A	.69
260H	5.95	801A	1.00	957	.29
257A	20.00	802	4.75	958A	.69
268A8	6.95	803	7.95	961	.65
271H	2.95	804	13.50	1114	.35
285A	4.95	805	5.95	1200	1.95
288A	2.95	806	25.00	1011	1.95
294A	7.95	807	1.69	1013	1.38
M2408U	.75	808	3.50	1016	2.95
434A	27.95	810	11.00	1018	.89
448A	1.95	811A	3.15	1022	2.75
446H	5.40	813	9.95	1024	2.00
450TH	45.00	814	3.95	1025A	1.95
450TL	48.00	815	3.50	851	1.85
464A	9.95	816	1.45	1050	1.85
471A	2.75	817	12.95	8025	6.95
627	15.00	818A	13.95	8012	4.75
W1530	3.50	819H	15.95	8013	2.95
W1531	22.50	820	3.50	8015A	1.90
W1533	17.50	822	7.95	8019	1.78
700A/D	25.00	823A	9.95	8020	3.58
701A	7.50	824	49.95	8025	6.95
702A	6.95	825	7.95	118366	89.00
705A	3.95	826	4.95	9001	1.78
707A	17.95	827	2.95	9002	1.50
707B	27.00	828	6.95	9003	1.78
714A	17.95	829	5.95	9004	1.78
715A	7.95	830	52.50	9005	1.90
716A	18.00	831	80.50	9008	.38
716B	25.00	832	4.95		
716C	1.95	833	39.50		
717A	1.95	834	1.79		
718A/YEY	48.50	835A	57.50		
721A	29.80	836X	35.00		
722A	3.95	837A	3.95		
722A/B	17.95	838	1.95		
		844	1.94		

Minimum Order \$25.00

ATTENTION OIL COMPANY ENGINEERS SHIP SUPPLIERS USERS OF SHORAN WE HAVE FOR IMMEDIATE DELIVERY TESTED AND GUARANTEED PERFECT, NEW **4C28 SPECIAL PRICE \$35.00**



MICROWAVE TEST EQUIPMENT TS148/UP SPECTRUM ANALYZER

Field type X Band Spectrum Analyzer, Band 8430-9580 Megacycles.

Will check Frequency and Operation of various X Band equipment such as Radar Magnetrons, Klystrons, TR Boxes. It will also measure pulse width, c-w spectrum width and Q of resonant cavities. Will also check frequency of signal generators in the X band. Can also be used as frequency modulated Signal Generator etc. Available new complete with all accessories, in carrying case.

Also available of new production TS239A Synchroscope and TS147/UP X Band Signal Generator.

Other test equipment, used hecked out, surplus.

- TSK1/SE K Band Spectrum Analyzer
- TS3A/AP Frequency and power meter S Band
- RF4A/AP Phantom Target S Band
- TS10/APN Altimeter Test Set
- TS12/AP VSWR Test Set for X Band
- TS13/AP X Band Signal Generator
- TS15/AP Flux Meter
- TS16/AP Altimeter Test Set
- TS33/AP X Band Power and Frequency Meter
- TS34/AP Western El. Synchroscope
- TS34A/AP Western El. Synchroscope
- TS35/AP X Band Signal Generator

- TS36/AP X Band Power Meter
- TS47/APR 40-400 MC Signal Generator
- TS69/AP Frequency Meter 400-1000 MC
- TS100 Scope
- TS102A/AP Range Calibrator
- TS108 Power Load
- TS110/AP S Band Echo Box
- TS125/AP X Band Power Meter
- TS126/AP Synchroscope
- TS174/AP Signal Generator
- TS175 Signal Generator
- TS226 Power Meter

- TS251 Range Calibrator APN9
- TS270 S Band Echo Box
- TS147 X Band Signal Generator
- TS239A Synchroscope

SURPLUS EQUIPMENT

- APA10 Oscilloscope and panoramic receiver
- APA38 Panoramic Receiver
- APS 3 and APS 4 Radar
- APR5A Microwave Receiver
- APT2 Radar Jamming Transmitter
- APT5 Radar Jamming Transmitter

MINIMUM ORDER 25 Dollars

YOU CAN REACH US ON TWX NY1-3235

Cables: TELSUP

SPECIAL
Wide Band S Band Signal Generator 2700/3400MC Using 2K41 or PD 8365 Klystron, Internal Cavity Attenuator, Precision individually calibrated Frequency measuring Cavity. CW or Pulse Modulated, externally or internally.

Large quantities of quartz crystals mounted and unmounted.
Crystal Holders: FT243, FT171B others.
Quartz Crystal Comparators.
North American Phillips Fluoroscopes Type 80.
Large quantity of Polystyrene beaded coaxial Cable.



LIBERTY ELECTRONICS, INC.
135 LIBERTY STREET NEW YORK 6, N. Y.
PHONE WORTH 4-8262

PE 218 LELAND ELECTRIC

Output: 115 VAC; Single Phase; PF 90; 380/500 cycle 1500 VA. Input: 25-28 VDC; 92 amps; 8000 RPM; Exc. Volts 27.5. **BRAND NEW**\$39.95 ea.

MG 153 HOLTZER-CABOT

Input: 24 V, DC, 52 amps; Output: 115 volts—400 cycles, 3-phase, 750 VA, and 26 Volt—400 cycle, 250 VA. Voltage and frequency regulated\$95.00 ea.

PIONEER 12130-3-B

Output: 122.5 VAC; 1.15 amps, 400 cycle single phase, 141 VA. Input: 20-30 VDC, 18-12 amps. Voltage and frequency regulated\$89.50 ea.

INVERTERS

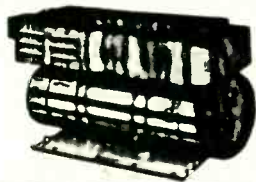

10563 LELAND ELECTRIC

Output: 115 VAC; 400 cycle; 3-phase; 115 VA; 75 PF. Input: 28.5 VDC; 12 amp.\$80.00 ea.

5 RPM GEAR HEAD MOTOR



Mfg. RAE., Type 7619, 115 Volts AD, DC. Fractional HP, Overall dimension: 5 1/2"\$12.95 ea. Lots of 10.....\$11.95 ea.

METERS

AMMETER: DC; 2" 100-100, complete with external shunt\$5.95 ea. **AC Volt,** Westinghouse, Type NA-35—3-inch round. F.S.-10 MA.....\$6.95 ea.

ELAPSED TIME METER, Aero Instrument Co.—Model 1001. Records operating time of AC electrical and electronic equipment. Registers up to 9,999.9 hours in 1/10th hour increment then automatically resets. Diameter 3 1/2" with glass covered face. 120 VAC; 60 cycle. NEW.\$14.95

MICROPOSITIONER

Barber Colman AYLZ 2133-I Polarized D.C. Relay: Double Coil Differential sensitive; Alnico P. M. Polarized field. 24V contacts; .5 amps; 28 V. Used for remote positioning, synchronizing, control, etc.....\$12.50 ea.



BLACK & DECKER MOTOR AN 94-32159-A; Volts 24; 1 amp; series wound; 12,000 RPM; 1/75 H.P.; Cont. duty; overall size 5-3/8" x 3" dia...\$9.95 ea.

SYNCHROS

- IF Special Repeater (115V-400 Cycle)**\$15.00 ea.
- 2JIF3 Generator (115V-400 cyc.)**\$10.00 ea.
- 5CT Control Transformer; 90-50 Volt; 60 Cyc.**\$50.00 ea.
- 5F Motor (115/90 volt—60 cyc.)**\$60.00 ea.
- 5G Generator (115/90 volt—60 cyc.)**\$50.00 ea.
- 5SDG Differential Generator (90/90 volts—400 cyc.)**\$30.00 ea.
- TRANSMITTER, BENDIX C-78248; 115 Volt, 60 Cycle**\$25.00 ea.
- REPEATER, BENDIX C-78410; 115 Volt, 60 Cycle**\$37.50 ea.
- REPEATER, AC synchronous 115 V., 60 cycle, C-78863**\$15.00 ea.
- 7G Synchro Generator (115/90 volt; 60 cycle)**\$75.00
- 6G Synchro Generator (115/90 volt; 60 cycle)**\$60.00
- 6DG Synchro Differential Generator (90/90 volt; 60 cycle)**\$60.00
- 1DG Synchro Differential Generator (90/90 volt; 60 cycles)**\$50.00
- 1CT Control Transformer (90/65 volt; 60 cycle)**\$50.00
- 1F Synchro Motor (115 volt; 60 cycle)**\$50.00

SYNCHRONOUS SELSYNS

110 volt, 60 cycle, brass cased, approx. 4" dia. x 6" long. Mfg. by Diehl and Bendix. Quantities Available. **REPEATERS**\$20.00 **TRANSMITTERS**\$20.00



Immediate Delivery
ALL EQUIPMENT FULLY GUARANTEED
All prices net FOB Pasadena, Calif.

MG 165 HOLTZER-CABOT

2000 VA; 27.5 Volt; 100 amps. OUTPUT: 115 volt; 400 cycle; 3 phase; 90% PF\$249.50

12116-2-A PIONEER

Output: 115 VAC; 400 cycle; single phase; 45 amp. Input: 24 VDC 5 amp.\$90.00 ea.

10285 LELAND ELECTRIC

Output: 115 Volts AC, 750 V.A., 3 phase, 400 cycle, .90 PF, and 26 volts, 50 amps, single phase, 400 cycle, .40 PF. Input: 27.5 VDC, 60 amps, cont. duty. 6000 RPM. Voltage and Frequency regulated.\$195.00

94-32270-A LELAND ELECTRIC

OUTPUT: 115 Volts, 190 V.A., Single Phase: 400 cyc.; .90 PF, and 26 Volts, 60 V.A., 400 cyc.; .40 PF. INPUT: 27.5 Volts DC, 18 amps; Cont. Duty. Voltage and frequency regulated\$95.00

G. E. ALTERNATOR

208 Volts, 400 Cycle, 3 Phase Mod. 2CM9781, \$5.5 Amps., PF .75, Speed 8000 KW 15, Cont. Duty, Limited Quantity...\$320.00

SERVO MOTOR 10047-2-A; 2 Phase; 400 Cycle; with 40-1 Reduction Gear\$10.00 ea.

PIONEER TORQUE UNITS

TYPE 12604-3-A: Contain CK5 Motor coupled to output shaft through 125:1 gear reduction train. Output shaft coupled to auto-syn. follow-up (AY43). Ratio of output shaft to follow-up Autosyn is 15:1 \$70.00 ea. **TYPE 12606-1-A:** Same as 12604-3-A except it has a 30:1 ratio between output shaft and follow-up Autosyn\$70.00 ea. **TYPE 12602-1-A:** Same as 12606-1-A except it has base mounting type cover for motor and gear train.\$70.00 ea.

400 CYCLE MOTORS

AIRESEARCH: 115V; 40 CPS; Single phase; 6500 RPM; 1.4 amp; Torque 4.6 in. oz.; HP .03\$10.00 ea. **EASTERN AIR DEVICES TYPE JM6B:** 200 VAC; 1 amp; 3 phase; 400 cycles, 6000 RPM\$12.50 ea. **EASTERN AIR DEVICES, TYPE J31B:** 115 V, 400-1200 Cycle, Single Phase\$12.50 ea. **AIRESEARCH:** AC Induction, 200 V; 3 Phase, 400 Cycle, 2 H.P.; 11,000 RPM; 8 amps\$79.50 ea. **AIRESEARCH:** AC Induction, 200 V; 3 Phase, 400 Cycle, 12 H.P., 6500 RPM; 1.5 amps\$25.00 **Electric Motor: PNT-1400-A1-1A** Serial No. 207, 208 V., 400 cycles, 3 phase, Kearfott Co., Inc.\$17.50 ea.

BLOWER ASSEMBLY

115 Volt, 400 Cycle. Westinghouse Type FL 17CFM, complete with capacitor. New\$12.50 ea

BLOWER



Eastern Air Devices, Type J31B; 115 volt; 400-1200 cycle; single phase; variable frequency; continuous duty; L & R = 2 blower; approx. 22 cu. ft./min.\$15.00

PIONEER AUTOSYNS

AY-1.....26 Volt—400 Cycle.....\$6.95
AY-5.....26 Volt—400 Cycle.....\$7.95
AY27D.....\$25.50
AY6—26 Volt—400 cyc\$4.95 ea.
AY30D—26 Volt—400 cyc\$25.00 ea.
AY14D\$14.00
AY34\$20.00
AY20—26 Volt—400-cyc.\$12.50 ea.

MOTOR GENERATORS

G.E. Model 5LY77AB1, Input: 115 volts D.C.; 1 1/2 H.P. motor; 13 amp; 3600 RPM; shunt contact regulated. Output: 115 Volts A.C. 60 cycles; KVA .06; shunt self excited\$129.00 ea. **MG-183,** Input: 70 Volts DC, 5.4 amps., 1/3 H.P., 3500 RPM. Output: 50 Volts AC, 2.6 amps., 175 cycles, 3 phase, .225 KVA.\$79.00 ea.

POWER RHEOSTATS



Standard Brands: 5 Ohms; 100 Watt; 4.48 amps 100 Ohms; 100 Watt; 1.0 amp.

Boxed, Brand New with Knob \$2.50 each—or—\$25.00 per Doz.

SMALL DC MOTORS

(Approx. size...4" long x 1 1/4" dial.) **General Electric Type 5BA10AJ37;** 27 volts, DC; .5 amps, 8 oz inches torque; 250 RPM; shunt wound; 4 leads; reversible.\$12.50 ea. **General Electric, Mod. 5BA10FJ33;** 12 oz. inches torque, 12 V DC, 56 RPM, 1.02 amp.\$15.00 ea. **General Electric-Type 5BA10AJ52C;** 27 volts, DC; .5 amps, 8 oz. inches torque; 145 RPM; shunt wound; 4 leads; reversible.\$12.50 ea. **General Electric Type 5BA10AJ18D;** (27 volts DC; 1 oz. foot 110 r.p.m.; .07 amp.\$19.95

ALNICO FIELD MOTORS

(Approx. size overall) . . . 3 3/4" x 1 1/4" diameter) **Delco-Type 5069230;** 27.5 volts; DC; 145RPM\$19.95 ea. **PM Motor, Delco Type #5069370;** 27.5 volt; DC Alnico Field; 10,000 r.p.m.; dimensions 1" x 1" x 2" long; shaft extension 1/2" diameter 0.125"\$12.50 **PM Motor, Diehl Mfg. SS, FD6-21;** 27.5 volt; DC Alnico Field; 10,000 r.p.m.; dimensions 1" x 1" x 2" long; shaft extension 1/2", diameter 0.125"\$12.50

AC CONTROL MOTOR

Diehl Mfg. Co., FPE-25-7, 20 Volts, 2 ph 1600 RPM, .85 amps\$15.00 **Diehl Mfg. Co., FPE-25-11;** 75 to 115 volts; 11 amps, 60 cycle, 2 phase 2 pole. Low inertia motor, 5 watts output.\$25.00

SENSITIVE ALTIMETERS



Pioneer Sensitive altimeters, 0-35,000 ft. range . . . calibrated in 100's of feet. Barometric setting adjustment. No hook-up required . . .\$12.95 ea.

PIONEER GYRO FLUX GATE AMPLIFIER

Type 12076-1-A, complete with tubes\$27.50 ea.

SINE-COSINE GENERATORS

(Resolvers)

Diehl Type FJE43-9 (Single Phase Rotor). Two stator windings 90° apart, provides two outputs equal to the sine and cosine of the angular rotor displacement. Input voltage 115 volts, 400 cycle.\$25.00 ea. **Diehl Type FPE-43-1** same as FJE-43-9 except it supplies maximum stator voltage of 220 volts with 115 volts applied to rotor.\$25.00 ea. **Arma Resolver Type 213044;** equal in size to size 5 synchro; 55-60 cycle; single phase primary, 2 phase secondary.\$79.50

SYNCHRONOUS MOTOR

Reuland Electric; 3 phase; 220/440 volt; 1/3rd HP; 60 cycle; 1800 r.p.m.; frame #203; cont. duty; 40° C rise. Star connected; ball bearing; mounted in 1 HP frame\$49.50

C and H Sales Company
BOX 356-X EAST PASADENA STATION • PASADENA 8, CALIFORNIA

A LEADING SUPPLIER OF ELECTRONIC & AIRCRAFT EQUIPMENT**A. C.
SYNCHRONOUS
MOTORS**

110 Vt. 60 Cycle

HAYDON TYPE 1600, 1/240 RPM
 HAYDON TYPE 1600, 1/60 RPM
 HAYDON TYPE 1600, 4/5 RPM
 HAYDON TYPE 1600, 1 RPM
 HAYDON TYPE 1600, 1 1/5 RPM
 TELECHRON TYPE B3, 2 RPM
 TELECHRON TYPE BC, 60 RPM
 HOLTZER CABOT, TYPE RBC 2505, 2 RPM,
 60 oz. 1 in. torque.

SERVO MOTORS

PIONEER TYPE CK1, 2 ϕ 400 CYCLE
 PIONEER TYPE 10047-2-A, 2 ϕ , 400 CYCLE,
 with 40:1 reduction gear.

D. C. MOTORS

BODINE NFHG-12, 27 VTS., governor controlled, constant speed 3600 RPM, 1/30 H.P.
 DELCO TYP 5068750, 27 VTS., 160 RPM, built in brake.
 DUMORE, TYPE EIY2PB, 24 VTS., 5 AMP., .05 H.P., 200 RPM.
 GENERAL ELECTRIC, TYPE 5BA10AJ18D, 27 VTS., 110 RPM, 1 oz. 1 ft. torque.
 GENERAL ELECTRIC, TYPE 5BA10AJ37C, 27 VTS., 250 RPM, 8 oz., 1 in. torque.
 BARBER COLMAN ACTUATOR TYPE AYL 5091, 27 VTS., .7 amp., 1 RPM, 500 in. lbs. torque.
 WHITE ROGER ACTUATOR TYPE 6905, 12 VT., 1.3 amp., 1 1/2 RPM, 75 in. lbs. torque.

AMPLIDYNE AND MOTOR

AMPLIDYNE, GEN. ELEC. 5AM31NJ18A input 27 vts., at 44 amp. output 60 vts. at 8.8 amp., 530 watts.
 MOTOR, GEN. ELEC. 5BA50LJ22, armature 60 vts. at 8.3 amp., field 27 vts. at 2.9 amp. 1/2 H.P., 4000 RPM.

**PIONEER AUTOSYNS
400 CYCLE**

TYPE AY1, AY5, AY14G, AY14D, AY20, AY27D, AY38D, AY54D.
 PIONEER AUTOSYN POSITION INDICATORS & TRANSMITTERS.
 TYPE 5907-17, single, Ind. dial graduated 0 to 360°, 26 vts., 400 cycle.
 TYPE 6007-39, dual Ind., dial graduated 0 to 360°, 26 vts., 400 cycle.
 TYPE 4550-2-A, Transmitter, 2:1 gear ratio 26 vts., 400 cycle.

INVERTERS

WINCHARGER CORP. PU 16/AP, MG750, input 24 vts. 60 amps. outputs 115 vts., 400 cycle, 6.5 amp., 1 phase.
 HOLTZER CABOT, TYPE 149F, input 24 vts. at 36 amps., output 26 vts. at 250 V.A. and 115 vts. at 500 V.A., both 400 cycle, 1 phase.
 PIONEER TYPE 12117, input 12 vts., output 26 vts. at 6 V.A., 400 cycle.
 PIONEER TYPE 12117, input 24 vts., output 26 vts. at 6 V.A., 400 cycle.
 WINCHARGER CORP., PU/7, MG2500 input 24 vts. at 160 amp., output 115 vts. at 21.6 amp., 400 cycle, 1 phase.
 GENERAL ELECTRIC, TYPE 5D21NJ3A, input 24 vts. at 35 amps., output 115 vts. at 485 V.A., 400 cycle, 1 phase.
 LELAND, PE 218, input 24 vts. at 90 amps. output 115 vts. at 1.5 K.V.A., 400 cycle, 1 phase.
 LELAND, TYPE D.A. input 28 vts., at 12 amp. output 115 vts. at 115 V.A., 400 cycle, 3 phase.

ENGINE HOUR METER

JOHN W. HOBBS, MODEL MI-277 records time up to 1000 hours, and repeats, operates from 20 to 30 volts.

VOLTAGE REGULATOR

LELAND ELEC. CO. TYPE B, CARBON PILE. Input 21 to 30 volts D.C. regulated output 18.25 vts. at 5 amp.
 WESTERN ELEC. TYPE BC937B, input 110 to 120 volts 400 cycle. Output variation 0 to 7.2 ohms at 5 to 2.75 amps.
 WESTERN ELEC. TRANSTAT, input 115 vts., 400 cycle output adjustable from 92 to 115 vts., rating .5 K.V.A.
 AMERICAN TRANS. CO., Transtat input 115 vts., 400 cycle output 75 to 120 vts. or 0 to 45 volts, rating .72 K.V.A.

SYNCHROS

1 F SPECIAL REPEATER 115 vt. 400 cycle.
 2J1F1 GENERATOR, 115 vt. 400 cycle.
 2J1F3 GENERATOR, 115 vt. 400 cycle.
 2J1G1 CONTROL TRANSFORMER 57.5 vt. 400 cycle.
 2J1H1 DIFFERENTIAL GEN. 57.5/57.5 vt. 400 cycle.
 5G GENERATOR, 115 vt. 60 cycle.
 5DG DIFFERENTIAL GEN. 90/90 vts. 60 cycle.
 5HCT CONTROL TRAN. 90/55 vts. 60 cycle.
 5CT CONTROL TRAN. 90/55 vts. 60 cycle.
 5SDG DIFFERENTIAL GEN. 90/90 vts. 400 cycle.

ALL PRICES
 F. O. B.
 GREAT NECK
 N. Y.

**IMMEDIATE
 DELIVERY -- FULLY
 GUARANTEED**

**TACHOMETER GENERATOR
& INDICATOR**

GENERAL ELECTRIC, GEN. TYPE AN5531-1, Pad mounting 3 phase variable frequency output.
 GENERAL ELECTRIC, GEN. TYPE AN5531-2, Screw mounting 3 phase variable frequency output.
 GENERAL ELECTRIC, IND. 8DJ13AAA, works in conjunction with above generators, range 0 to 3500 RPM.

D. C. ALNICO FIELD MOTOR

DIEHL TYPE FD6-23, 27 vts. 10,000 RPM.
 DELCO TYPE 5072400, 27 vts. 10,000 RPM.

**GENERAL ELECTRIC
D. C. SELSYNS**

8TJ9-PAB TRANSMITTER 24 VTS.
 8TJ11- INDICATOR, dial 0 to 360°, 24 vts.

RECTIFIER POWER SUPPLY

HAMMETT ELECTRIC MFG. CO. MODEL SPS-130. Input voltage 208 or 230 volts, 60 cycle, 3 phase, 21 amps. Output 28 volts at 130 amps. continuous duty, 8 point tap switch, voltmeter ammeter, thermo reset all on front panel.

MISCELLANEOUS

PIONEER MAGNETIC AMPLIFIER ASSEMBLY Saturable reactor type, designed to supply variable voltage to a servo motor such as CK1, CK2, CK5 or 10047.
 SPERRY A5 CONTROL UNIT, part No. 644836.
 SPERRY A5 AZIMUTH FOLLOW-UP AMPLIFIER, part No. 656030.
 SPERRY A5 DIRECTIONAL GYRO, part No. 656029, 115 vt. 400 cycle, 3 phase.
 SPERRY A5 PILOT DIRECTION INDICATOR, part No. 645262 contains AY 20.
 ALLEN CALCULATOR, TYPE C1, TURN & BANK IND., part No. 21500, 28 vts. D. C.
 TYPE C1, AUTO-PILOT FORMATION STICK, part No. G1080A3.
 PIONEER GYRO FLUX GATE AMPLIFIER, type 12076-1-A, 115 vt. 400 cycle.

**INSTRUMENT
 ASSOCIATES**

**363 GREAT NECK ROAD, GREAT NECK, N. Y.
 Telephone GReat Neck 4-1147**

Write for Catalog NE100

U. S. Export License-2140

Western Union address:
 WUX Great Neck, N. Y.

IMMEDIATE DELIVERY

LOW PRICES

FULLY GUARANTEED



Aircraft Generator Eclipse NEA-3
Output 115 VAC; 10.4 amps 800 cycles at 2400 rpm. Also 30 VDC at 6 amps. Stock #SA-306. Price \$39.50 each.



Radio Compass Indicator I-82F, Compass Indicator. 0-360°-5 in. dial, 26 v. 400 cy. 8-12 v. 60 cy. Ideal position indicator. Stock #SA-284. Price \$6.50 each



JAI MOTOR (D-C)
Electric Specialty, ¼ hp. 24 v. D-C. (Wing flap motor.) Stock #SA-325. Price \$19.50 ea.



OSTER PM MOTOR
Alineo Field
27.5 v. d-c. Can also be used as rate generator. #SA-281. Price \$8.75 each



DIEHL PM MOTOR
Type FD6-31-1. 27.5 V. D.C. 10,000 rpm. Dual Shaft. Shaft ext. ½" ea. end. Diam. 0.120. Motor 1" Sq. x 2" Lg. Stock #SA-355. Price \$13.25 each.

400 CYCLE 2 HP. ACTUATORS

AIRESEARCH—Linear Actuator—Dwg. 29178. Frame 26-39. 200 volt 3 phase 400 cycle motor with thermal protection. 2 hp. 8 amps. 11,000 rpm. Duty 1-20. Stat. 3100; Tens. 1600; Comp. 1600. Stock #SA-508.

Torque Actuator
Dwg. 29180. Driven by same motor as above. Stock #SA-509.

PRICES ON REQUEST



OSTER MOTOR
John Oster Type B-9-1 motor with dual output shaft gear reduction. Cam operated linear motion translation. Motor 27.5 v. DC at 0.7 Amps. 5600 rpm. Stock #SA-335. Price \$9.75 each.



DELCO CONSTANT SPEED MOTOR A-7155
1/30 hp. 27.5v d-c 3600 rpm. Cont. duty, 2 ½" diam. x 5 ½" lg. ¾" shaft extension. 5/32" diam. 4 hole base mounting. Stock #SA-34. Price \$19.50 each.



BLOWER ASSEMBLY
Delco 27 v. DC motor, 5400 rpm. 3" Sirroco impeller. Shunt motor. 4 in./oz. torque. Base Mtg. Stock #SA-352. Price \$9.75 each.



PRECISION AUTOSYN
Pioneer Type AY-150 Control Autosyn. Precision type. 26 v. 400 cycle. Stock #SA-297. Special low price \$14.50 each.

WRITE FOR LISTING
Prices F.O.B. Paterson
Phone ARmory 4-3366
Teletype PAT. 199

HOLTZER CABOT MG SETS

TYPE MG-221. Input 32 volts DC at 8.5 amps. 3430 rpm. Output 110 volts at 1.0 amps. 400 cy. Single phase. 100 watts. Stock #SA-506. Price \$99.50 each.
TYPE MG-218. Input 115 volts DC at 2.3 amps. Output 110 volts 400 cy. Single phase. 100 watts. Stock #SA-507. Price \$119.50 ea.

BLOWER ASSEMBLY

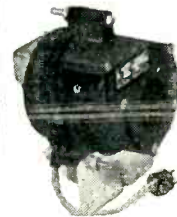

WESTINGHOUSE

FL BLOWER

115 v. 400 cy. 17 c.f.m. Includes capacitor. Stock #SA-144. Price \$14.50 ea.

KOLLSMAN SERVO MOTOR

Type 776-06. 115 v. 400 cy. 2 phase. 5600 rpm. Drag Cup type. 10 Tooth 96 P.D. shaft. Stall torque 0.5 in/oz. Stock #SA-358. Price \$29.50 each.

SELSYN SPECIALS



General Electric 2J1F1 & 2J1F3
115 v. 400 cycle Selsyn Generator. Large quantity. Prices on request

INVERTERS



Wincharger PU-7/AP
Input 28 VDC at 160 amps. Output 115 v. 400 cy 1 φ at 2500 VA. Voltage and frequency v. regulated. Cont. duty. Stock #SA-164. Price \$119.50 each.



G.E. 5AS131N3 (PE-118)
Input 26 VDC at 100 amps. Output 115 v. 400 cy. 1 φ at 1500 VA. PF 0.8 W.E. Spec. Ks-5601L1 Stock #SA-286. Price \$39.50 each



PE-218E Inverters
Russell Electric and Leland. Input 28 VDC at 92 amp. Output 115 v. 400 cycles at 1500 VA. PF 0.9. Stock #SA-112A. Price \$69.50 each.



Pioneer 12130-1-B
Input 28 VDC at 14 amps. Output 120 v. 400 cy. single phase at 1.15 amps. (140 VA.) Voltage and frequency regulated. Made 1949. Stock #SA-304. Price \$99.50 each.

DC SERVO MOTORS

Elineo B-64 DC Servo Unit — armature voltage, 80 v d-c max. 27.5 v. field 1/165 hp 3100 rpm. Field current 200 ma. Armature current 200 ma. at normal torque. Stock #SA-211. Price \$16.50 each.



DIEHL DC MOTOR
Type FDE-83-2. 24v @ 9.5 Amps. 1/6 hp. 6350 rpm. Cont. duty. Motor 4 ¼" diam. x 5" Lg. with 1" shaft ext. x ¾" dia. front mtg. flange 4 ¼" Sq. Stock #SA-354. Price \$19.50 ea.

Aircraft Turret Motor—G.E. 51A501 J22. ½ hp. Amplidyne controlled motor. Armature voltage 60 max. Field 27 v. Max. arm. current 8.3 amps. Field 2.9 amps. 10 minute rating. Stock #SA-345.

Quantity prices on request.



AUTOSYN MOTOR

Bendix-Marine 851
32 v. 60 cycle excitation. Use as either generator or repeater. Stock #SA-158. Price \$24.50 each.



KOLLSMAN TELETRIQUE

Kollsman Type 403 self synchronous units. (Synchrol 115 Volt 60 cycle excitation. Use as either generator or repeater. Stock #SA-79. Prices on request.



115 VOLT D-C MOTOR

G.E. Type SD. 1/20 hp. 4 lead shunt. Reversible. Double shaft extensions. Speed 1725 rpm. Large Quantity.

Special \$19.50 each.



LEAR POSITIONING MOTOR

Model 156A. 115 watt 24 v. DC motor. 10,000 rpm. Int. duty. Reversible. Dual rt. angle output shaft. Release clutch. 7:1 reduction to output. 250:1 reduction to limit switches. Stock #SA-343. Prices on request



AC Motor Special Eastern Air Devices J-33
115 V. 400 cy. 3 phase synchronous. 8000 RPM. Stock #SA-59.

Price \$19.50 each



SYNCHROS AND SELSYNS

Navy Types

A; M; 1SF; 6G; 5F; 6SDG; 6SG; 6SF; 6HSF; 6DG; 7G; etc.

Army Types

II; IV; V; VII; IX; XXI; XV; etc.

G.E. Types

2J6F2; 2JD5J2; 2J5A2; 2J6HA1; 2J1H1; 2J1F1; 2J1G1; 2J1F3; 2JD5HB1; 2J5LA1; 2JD5C2, etc.

SERIES MOTOR

John Oster Type A-21D-7A

24 v. DC. 0.006 hp. .6 Amps. 11,000 rpm. Cont. duty. 1-½" diam. x 2-½" lg. Front flange mtg. Shaft 3/16 dia. x ¾" ext. Stock #SA-353. Price \$8.75 each.

Servo-Tek

products co.

4 Godwin Ave. Paterson, N. J.

SPECIALISTS IN FRACTIONAL HORSE POWER MOTOR SPEED CONTROL

COMMUNICATIONS EQUIPMENT CO.



24 VOLT TRANSFORMERS

For operating surplus gear, toy trains, gadgets, etc. Operates from 115V, 60 cy. supplies 24 VAC at 1.2 Amp., herm. sealed and cased. A Great Buy at Only **\$1.49**

UNIVERSAL SUPPLY KIT

Delivers 230V @ 40MA DC. From 110/220VAC 60 Cy. Kit Consists of 1-PWR Transformer, 5 HY @ 40MA Choke, 2-8MFD @ 450V Filter Cond. 3.95 1-6x5 Tube. A great buy at only.

Interphone Transformer Set

Rig your own interphone. Kit consists of 1-Input Transformer (Matches 4 or 6 OHM SPKR to Grid) and 1-Output Transformer (Matches 50L6, 35L6, etc. to 4 or 6 OHM Speaker Set) **1.00**

12-14V SUPPLY KIT

Delivers 12-14VDC at 3.5A from 115V, 60 cy. Kit contains 1-Transformer Rated 18.5V, 4A, 1-Selenium Rectifier, F. W. Bridge. **\$6.95**

OSCILLOSCOPE SUPPLY KIT

Ideal for 3" Scope or Panadaptor. Delivers 850V Negative, 300 VDC @ 65MA, 6.3V @ 4A, 6.3V @ 0.6A, 2.5V @ 1.7A. You get 1-Herm. Sealed Transformer 1-25H Choke, 1-2x2 Tube, 3-3x5 Rect, 3-Filter Cond. 1-Filter Resistor, 1-Bleeder For **\$12.95** Only

POWER TRANSFORMERS

Comb. Transformers—115V/50-60 cps Input			
CT75B	600-0-600V/.6A, 2X5VCT/6.2A, 6.3VCT/3A, 6.3V/3A		\$12.95
CTJ5-2	600VCT/2A, 5V 6A		5.95
CT-15A	550VCT/.085A 6.3V/.6A, 6.3V/1.8A		2.85
CT-16A	420V.002A/12KV Test, 5VCT/3A/12KV Test, 6.3V/0.6A/5400V Test		12.95
CT-341	1050 10 MA.—625V @ 5 MA, 26V @ 4.5A 2x2.5V/3A, 6.3V @ 3A		16.95
CR-825	360VCT .340A 6.3VCT/3.6 6.3VCT/3A		3.95
CT-626	1500V .160A 2.5/12.30/100		9.95
CT-071	110V .200A 33, 200, 5V/10, 2.5/10		4.95
CT-367	580VCT .050 A 5VCT/3A		2.25
CT-99A	2x115VCT .010 A 6.3/1A, 2.5VCT/7A		3.25
CT-403	350VCT .026 A 5V/3A		2.75
CT-931	585VCT .086 A 5V/3A, 6.3V/6A		4.25
CT-610	1250 .002 A 2.5V/2.1A, 2.5V/1.75A		4.95
CT-456	390VCT 30 MA 6.3V/3A, 5V/3A		3.45
CT-36V	800VCT 100 MA 6.3V/1.2A, 5V/3A		4.95
CT-931	585VCT 86 MA 5V/3A, 6.3V/6A		4.95
CT-442	525VCT 75 MA 5V/2A, 10VCT/2A, 5V/200 MA		3.85
CT-720	550-0-550V/250 MA, 6.3V/1.8A		8.95
CT-43A	600-0-600V/.08A, 2.5VCT/6A, 6.3VCT/1A		6.49
CT-501	650VCT/200 MA, 6.3V/8A, 6.3V/5A		6.49
CT-444	230-0-230V/.085A, 5V/3A, 6V/2.5A		3.49

Filament Transformers—115V/50-60 cps Input			
Item	Rating	Each	
FT-674	8.1V/1.5A		\$1.10
FT-357	4V/16A, 2.5V/1.75A		2.95
FT-101	6V/.25A		.79
FT-924	5.25V/21A, 2x7.75V/6.5A		14.95
FT-824	2x26V/2.5A, 16V/13A, 7.2V/7A, 6.4V/10A, 6.4V/2A		8.95
FT-463	6.3VCT/1A, 5VCT/3A, 5VCT/3A		5.49
FT-55-2	7.2V/21.5A, 6.5V/6.85A, 5V/6A, 5V/3A		8.95
FT-986	16V @ 4.5A or 12V @ 4.5A		3.75
FT-38A	6.3/2.5A, 2x2.5V/7A		4.19
FT-A27	2.5V/2.5A, 7V/7A, TAP 2.5V/2.5A, 16KV TEST		18.95
FT-608	6.3V/3A/750V Test		1.79
FT-873	4.5V/5A, 7V/7A		2.19
FT-899	2x5V @ 5A, 29KV Test		24.50

Plate Trans.—115V, 60 cps			
Item	Rating	Price	
PT-699	300/150V/.05A, 300/150V/.05A		\$2.79
PT-302	120-0-120V/350 MA		4.69
PT-108	17,600V/144 MA		120.00
PT-671	62V/3.5A		7.95

Special Fil. Transformers—60 cps			
Item	Pri. Volts	Secondaries	Price
STF-370	220/440	3x2.5V/5A, 3KV Test 2.5V/15A	\$6.95
STF-11A	220V	2x40V/.05A, 2x5V/6A	4.49
STF-608	220V	24V/0.6A, 5V/3A, 6.3V/1A, 6.3V/1A	3.45
STF-968	230V	2.5V/6.5A	3.50
STF-631	230V	2x5V/27A, 2x5V/9A	17.59

Special Plate Transformers—60 cps			
Item	Pri. Volts	Secondaries	Price
STP-613	230V	230/.05A, 230V/.05A	\$1.79
STP-409	220/440V	136VCT/3.5A	5.69
STP-815	240/440, 3ph	1330V/.67A, 6KV Test.	27.50
STP-129	230V	3850V/3.12KVA	42.59
STP-823	137V	22VCT/3A	2.35
STP-088	50V	2x750V/.001A	1.79
STP-622	210/220/230	5000V/1A	59.75
STP-945	210/220/230	550-0-550V/.3A	5.95

Special Comb. Transformers—60 cps			
Item	Pri. Volts	Secondaries	Price
STC-16A	220V	260V/.03A, 100V/1A, 6.3V/4.2A	\$4.69
STC-609	220V	220V/3A	6.95

TWO-WAY COMMUNICATION EQUIPMENT

SONAR MOBILE MB-26 Xmrtr



Like SR-9 Rcvr, this crystal-controlled 8-tube Xmrtr goes everywhere. Fits anywhere, employs latest v.h.f. techniques! Lets you send clear signal, no matter how grueling the going. Output: 6 watts. Power consumption: equivalent to car bright lights. Just 6 1/2" high, 7" wide, 5 3/4" deep. Built-in antenna relay system, power filter network. Low maintenance — standard tubes. Power and antenna coax connectors on front panel.

FOR
● 2 MTRS
● 6 MTRS
● 10-11 MTRS
\$72.45

SONAR MOBILE SR-9 Rcvr



MODEL SR-9

2 MTRS
● 6 MTRS
● 10-11 MTRS
\$72.45

Indispensable when you must hear what's coming through, in mobile or fixed operation, CD, CAP or emergency activity. More than a monitor, more than a converter—it's a 9-tube superhet receiver with overall sensitivity better than 1.0 micro-volt. Tiny, only 4-9/16" high, 5-3/16" wide, and 5-11/16" deep. Yet SR-9 gives you built-in automatic noise limiter, voltage regulated oscillator, precision slide rule dial.

Model MR-3 5 Bands • 8 Tubes

Ideally suited for mobile with its compact size, lightweight, the MR-3 is excellent for CD, CAP, or any emergency operations. The MR-3 is a COMPLETE 5 BAND RECEIVER—NOT a converter—for 80-75, 20, 10-11 mtr bands, with less than 1 micro-volt of sensitivity—comes complete with 8 tubes, one of the best automatic noise limiters yet designed, voltage regulated oscillator, accurate slide-rule, dial and mounting brackets **\$89.95**

FOR MORE DETAILED INFORMATION ON THE MODELS SHOWN, AND THE NEW MODEL AC-109 AIRCRAFT RECEIVER, SEND FOR BULLETIN "S".



DYNAMOTORS

Type	Input Volts	Input Amps	Output Volts	Output Amps	Radio Set
PE28	24	1.25	300	.050	RC 36
DM416	24	4.2	330	.170	RU 19
DM33A	28	7	540	.250	BC 456
PE101C	13/26	12.6	400	.135	SCR 515
RD AR 93	28	3.25	375	.150	
23250	27	1.75	280	.075	APN-1
ZA0515	12/24	1.75	500	.050	
B-19 pack	12	9.4	275	.110	MARK 11
D-104	12		225	.100	
			400	.200	
DA-3A	28	10	300	.060	SCR 522
			150	.010	
			14.5	.5	
S053	28	1.4	250	.060	APN-1
PE73CM	28	19	1000	.350	BC 375
CW21AAX	13	12.6	400	.135	
	26	6.3	800	.020	
			9	1.12	
PE94	28	10	300	.200	SCR 522
			150	.101	
			14.5	.5	

INVERTERS

PE-218-H₁ Input: 25 2dc, 92 amp. Output: 115 v. 350 500 cy 1500 volt-amperes. New \$44.50
PE-206: Input: 28 vdc, 38 amp. Output: 80 v 800-cy, 500 volt-amp. Dim: 13" x 5 1/2" x 10 1/2" New \$22.50
LELAND No. 10536: In: 28 VDC. Out: 115V, 115VA, 400 CY 3 PHASE. EXC. COND \$70.00

THERMISTORS VARISTORS

D167018	\$1.50	D171812	\$1.50
D167332	1.50	D172155	1.50
D167613	1.50	D167176	1.50
D166228	1.50	D168887	1.50
D164699	2.50	D167208E, D171858	1.50
D166792	2.15	308A, 3A, 27-B	1.50
		D168403	2.15

INTERPHONE AMPLIFIER

Easily converted to an Ideal Inter-Communications set for office, home or factory. Original. New **\$4.75** w/conversion diagram.



*SELENIUM RECTIFIERS

F. W. BRIDGE

UP TO 18 VAC IN—	13-15	220-	\$1.20
UP TO 14 VDC OUT	20-24	110-	1.00
2A	26-30	220-	1.35
4A	43-65	110-	1.25
6A	43-65	110-	1.25
10A	47-81	110-	1.25
12A	50-75	110-	1.50
24A	53-60	220-	1.25
UP TO 36 VAC IN—	61-69	320-	1.60
UP TO 28 VDC OUT	64-72	110-	1.25
1A	72-87	110-	1.25
2A	75-84	110-	1.50
5A	88-106	110-	1.65
10A	107-129	110-	1.75
12A	130-150	70-	1.50
24A	130-180	110-	1.85
UP TO 54 VAC IN—	158-191	110-	2.35
UP TO 42 VDC OUT	161-180	110-	1.75
2A	189-210	110-	1.95
4A	200-220	110-	1.95
UP TO 120 VAC IN—	270-300	110-	2.10
UP TO 100 VDC OUT	324-360	110-	2.40
2A	378-429	110-	3.00
10A	432-480	110-	2.70
12A	485-540	110-	2.85

NON-POLAR CAPACITORS

A.C. ELECTROLYTICS

CAP.	VAC.	PRICE
13-15	220-	\$1.20
20-24	110-	1.00
26-30	220-	1.35
43-65	110-	1.25
43-65	110-	1.25
47-81	110-	1.25
50-75	110-	1.50
53-60	220-	1.25
61-69	320-	1.60
64-72	110-	1.25
72-87	110-	1.25
75-84	110-	1.50
88-106	110-	1.65
107-129	110-	1.75
130-150	70-	1.50
130-180	110-	1.85
158-191	110-	2.35
161-180	110-	1.75
189-210	110-	1.95
200-220	110-	1.95
270-300	110-	2.10
324-360	110-	2.40
378-429	110-	3.00
432-480	110-	2.70
485-540	110-	2.85

FILTER CHOKES

Stock	Description	Price
CH-366	20H/.3A	6.95
CH-322	.35H/350 MA—10 Ohms DCR	2.75
CH-141	Dual 17/75 MA, 11H/60 MA 5KV D.C. Test	4.69
CH-119	8.5H/125 MA	2.79
CH-69-1	Dual: 120H/17 MA	2.35
CH-8-28	2 x 5H/380 MA/25 Ohms	1.79
CH-776	1.28H/130 MA/75 ohms	2.25
CH-344	1.5H/145MA/1200V Test	2.35
CH-43A	10H V/15MA—850 ohms DCR	1.75
CH-91	10H, 450MA, 10KV TEST	12.95
CH-366	200/300MA	6.95
CH-999	15H/15MA—400 ohms DCR	1.95
CH-511	6H/80MA—310 ohms DCR	2.45
CH-501	2x5H/400MA	1.79
CH-366	5H/200MA	2.79
CH 303	300H/.02A, 2500V Test	1.69
CH 932	SWING 9-60H/4-.05A, 10KV	7.95

This Month's Special

OSCILLOGRAPH RECORDING, PHOTO PAPER, 35 MM, 250 FT. Roll	\$1.00
SA44/APA-1 Motor Driven Coaxial Ant. Switch DPDT, Continuous Operation from 24VDC. Completely Enclosed	\$24.50
MP-22 MAST BASE Mobile Antenna Mount	4.95
SA1A/APN-1 Altitude Limit Switch for APN-1 Altimeter	7.95
ALTITUDE INDICATOR for APN-1	12.50
C-387-D Final P.A. Coil for BC610 2-3.5 MC, Variable Link	4.89
RA-74 Power Supply for Super Pro	69.50
J-17/ARC-5 Junction Box for ARC-5	7.95
J-22/ARC-5 Junction Box	3.49
SUPERSONIC CRYSTALS, Rochelle salt	9.50 ea.
MOTO-24 vdc, 2 HP 3500 rpm, New	\$75.00
TV LEAD-IN WIRE, 300 ohms HI-O	
Lo-Loss 1/2" x 8 1/2" Rolls	23¢ ea. 5/
Tel. Tape, 4" Rolls	12¢ ea. 10/
BC366 Interphone Jack Box	.79 ea.
AN/109	

COMMUNICATIONS EQUIPMENT CO.

MICROWAVE COMPONENTS

S BAND—3" x 1 1/2" W.G. 10 CM.



DIRECTIONAL COUPLER, Broadband, 20 db. Coupling, Type "N" Takeoff. Complete with all Hardware. Navy # CARV-47AAN-2. As shown \$37.50
WAVEMETER, 2700-3400 MC. Reaction Type with counter Dial-Mfg. W.E. \$92.50

REACTION WAVEMETER, Mfg. G.E. 3000-3700 MC. Mic. Head. \$125.00
LHTR LIGHTHOUSE ASSEMBLY, Part of RT39 APG 5 & APG 15. Receiver and Trans. Cavities w/assoc. Tr. Cavity and Type N CPLG To 2700 MCS. Silver Plated. \$49.50

BEACON LIGHTHOUSE cavity 10 cm. Mfg. Bernard Rice, each \$47.50
MAGNETRON TO WAVEGUIDE Coupler with 721A Duplexer Cavity, gold plated. \$45.00
RT-39/APG-5 10 cm. lighthouse RF head c/o Xmt-r. Recvr.-TR cavity, compl. recvr. & 30 MC 1F strip using 6AK5 (2040, 2C43 1B27 lineup) w/Tubes. 721A TR BDX complete with tube and tuning plungers. \$12.50
McNALLY KLYSTRON CAVITIES for 707B or 2K28 \$4.00
F 29/SPR-2 FILTERS, type "N" input and output Hi-Pass Over 1000 MC \$12.50
WAVEGUIDE 2 1/2" RIGID COAX "DOORKNOB" ADAPTER CHOKE FLANGE, SILVER PLATED BROAD BAND \$32.50
ASHA/AP-10 CM Pick up Dipole with "N" Cables \$1.50
OAJ ECHO BOX, 10 CM TUNABLE \$22.50
HOMEDELL-TO-TYPE "N" Male Adapters, W.E. D162349 \$2.75
I, F AMP STRIP, 30 MC, 120 db gain, 2 MC Band width, uses 6AC7's with video detector. Less tubes \$24.50
POLYROD ANTENNA, AS81/APN-7 in Lucite Ball. Type "N" feed \$22.50
ANTENNA, AT49A/APR Broadband Conical, 300-3300 MC Type "N" Feed \$12.50
"E" or "H" PLANE BENDS, 90 Deg. less flanges \$7.50

7/8" RIGID COAX—3/8" I. C.

RIGHT ANGLE BEND, with flexible coax output pick-up loop \$8.00
SHORT RIGHT ANGLE BEND, with pressurizing nipple \$3.00
RIGID COAX to flex coax connector \$3.50
STUB-SUPPORTED RIGID COAX, gold plated 5' lengths. Per length \$5.00
RT. ANGLES for above \$2.50
RT. ANGLE BEND 15° L. OA \$3.50
FLEXIBLE SECTION, 15° L. Male to female \$4.25
7/8" RIGID COAX, BULKHEAD FEED-THRU \$14.00

X BAND—1" x 1/2" W.G. 3 CM.

1" x 1/2" waveguide in 5' lengths, UG 39 flange to UG40 cover per length \$7.50
Rotating joints supplied either with or without deck mounting. With UG40 flanges each, \$17.50
Bulkhead Feed-thru Assembly \$45.00
Pressure Gauge Section 15 lb. gauge and press nipple \$10.00
Pressure Gauge, 15 lbs. \$2.50
Dual Oscillator, Mount. (Back to back) with crystal mount, tunable termination attenuating slugs \$18.50
Directional Coupler, UG-40/U Take off 20 db. \$17.50
TR-ATR Duplex section for above \$8.50
723AB Mixer—Beacon dual Osc. Mnt. w/xtal holder \$12.00
Waveguide Section 12" long choke to cover 45 deg. twist & 2 1/2" radius, 90 deg. bend. \$4.50
Twist 90 deg. 5" choke to cover w/press nipple. \$6.50
Waveguide Sections 2 1/2 ft. long silver plated with choke flange \$5.75
Rotary joint choke to choke with deck mounting \$17.50
3 cm. mitered elbow "E" plane \$12.00
UG 39 Flanges \$.85
90 degree elbows, "E" or "H" plane 2 1/2" radius \$12.50
45 degree twist \$8.00
APS-4 Under Bolt Assembly, less tubes \$375.00

1 1/4" x 5/8" WAVEGUIDE

CG 98B/APQ 13 1/2" Flex. Sect. 1.4" x 5/8" OD. \$10.00
X Band Wave GD. 1 1/4" x 5/8" O.D. 1/16" wall alum-inum per ft. 75¢
Slug Tuner Attenuator W.E. guide, Gold plated. \$6.50
B1-Directional Coupler, Type "N" Takeoff 25 db. coupling \$27.95
B1-Directional Coupler, UG-52. Takeoff 25 db. coupling \$24.95
Waveguide-to-Type "N" Adaptor, Broadband \$22.50

K BAND—1/2" x 1/4" W.G. 1.25 CM.

APS-34 Rotating Joint \$49.50
Right Angle Bend E or H Plane, specify combination of couplings desired \$12.00
45° Bend E or H Plane, choke to cover \$12.00
Mitered Elbow, cover to cover \$4.00
TR-ATR-Section, Choke to cover \$4.00
Flexible Section 1" choke to choke \$4.00
"S" Curve Choke to cover \$4.50
Adaptor, round to square cover \$5.00
Feedback to Parabola Horn with pressurized window \$27.50
90° Twist \$10.00

WANTED

RADAR SETS AND PARTS
 ... ANY AND ALL TYPES.
Also SURPLUS ELECTRONIC PARTS
 ... WHAT HAVE YOU TO SELL

400 CYCLE TRANSFORMERS

(All Primaries 115V, 400 Cycles) $\frac{1}{4}$ Pk Price

Stock #	Rating	Price
352-7039	640VCT @ 250MA, 6.3V/.9A, 6.3V/6A, 5V/6A	\$5.49
702724	9800/8600V @ 32MA	8.95
12033	4540V/250MA	17.50
KS9584	5000V/290MA, 5V/10A	22.50
521652	13,500V/3.5MA	14.65
KS9607	734VCT/.177A, 1710VCT/.177A	6.79
352-7273	700VCT/350MA, 6.3V/.9A, 6.3V/2.5A, 6.3V/.06A, 5V/6A	6.95
352-7070	2X2.5V/2.5A (2KV TEST) 6.3V/2.25A, 1.20V/100V/750V @ .005A	7.45
352-7196	1140V/1.25MA, 2.5V/1.75A, 2.5V/1.75A—5KV Test	3.95
352-7176	320VCT/50MA, 4.5V/3A, 6.3VCT/20A, 2X6.3VCT/6A	4.75
RA6400-1	2.5V/1.75A, 6.3V/2A—5KV Test	2.39
901692	13V/9A	2.49
901699-501	2.7V @ 4.25A	3.45
901698-501	900V/75MA, 100V/.04A	4.29
UX8855C	900VCT/.067A, 5V/3A	3.79
RA6405-1	800VCT/65MA, 5VCT/3A	3.69
T-48852	700VCT/80MA, 5V3A, 6V/1.75A	4.25
352-7098	2500V/6MA, 300VCT/435MA	5.95
KS 9336	1100V/50MA TAPPED 625V 2.5V/5A	3.95
M-7474319	6.3V/2.7A, 6.3V/66A, 6.3VCT/21A	4.25
KS 8984	27V/4.3A, 6.3V/2.9A, 1.25V/0.2A	2.95
52C080	526VCT/50MA, 6.3VCT/2A, 5VCT/1.2A	3.75
32332	400VCT/35MA, 6.4V/2.5A, 6.4V/.15A	3.85
68G631	1150-0-1150V	2.75
80G198	6VCT/00006 KVA	1.75
302433A	6.3V/.9A, 6.3VCT/6.5A, 2.5V/3.5A, 2.5V/3.5A	4.85
KS 9445	592VCT/118MA, 6.3V/8.1A, 5V/2A	5.39
KS 9685	6.4/7.5A, 6.4V/3.8A, 6.4V/2.5A	4.79
	ALL CT	
70G30G1	600VCT/36MA	2.65
M-7474318	2100V/.027A	4.95
95-G-45	2000V/.002A, 465V/.6A, 44V/10A, 6.3V/23.5A, 6.3V/1.8A, 5V/9A, 2X2.5V/1.75A	17.95
TRANSTAT IN 115V, 400 CY	OUT: 75-120V, 6.0 Amps	12.95



LHTR LIGHTHOUSE ASSEMBLY, Part of RT39 APG 5 & APG 15. Receiver and Trans. Cavities w/assoc. Tr. Cavity and Type N CPLG. To Recvr. Uses 2C40, 2C43, 1B27. Tunable APX 2400-2700 MCS. Silver Plated. \$49.50

TS-13/AP TEST SET

SIGNAL GENERATOR (PULSE AND CW) COMPLETE WITH BUILT-IN WAVEMETER AND POWER MONITOR. FOR CHECKING RECEIVER SENSITIVITY AND BANDWIDTH. ALSO POWER OUTPUT FROM RADAR TRANSMITTER. FREQ. RANGE: 9305-9445 MC/SEC. OUTPUT: 0-50 MICHOWATT. POWER REQUIREMENTS: 105-120 VAC, 60-800 CY, 150W. COMPLETE WITH ALL PROBES AND ACCESSORIES. WRITE FOR PRICE.

TS 34/AP SYNCHROSCOPE

PORTABLE UNIT FOR OBSERVING VIDEO PULSES AND TRIGGER MEASURES PULSES FROM 0.25 USEC TO 30.000 USEC. FREQ. RESPONSE: 30 CPS-1,000,000 CPS. TRIGGER SWEEP: 5, 50, 250 USEC. SAWTOOTH: 10-50,000 CPS. POWER INPUT: 105-125 VAC, 50-1200 CPS, 90W. INQUIRIES INVITED.

● Signal Gen.	RCA 710A, 370-560 MC	350.00
● Signal Gen.	20A Microvibrator	175.00
● TS 10A	Altim ter Test Set	32.50
● TS 16/AP	Altimeter Test Set	
● TS 36	Power Meter, 3 CM	
● TS 47/APR	Test Osc. 50-3000 MC	325.00
● TS 56/AP	Slotted Line, 500 MC	325.00
● TS 127/UP	Wavemeter, 300-700 MC	72.50
● TS 69/AP	Wavemeter, 340-1000 MC	72.50
● TS-70/AP	Pwr. Meter, 200-800 MC	
● TS 110/AP	Echo Box, 2400-2700 MC	

1 PER CENT PRECISION W. W. RESISTORS

ALL VALUES IN OHMS

	5	82	150	800	7.500	20,000	
5.0%±1	120	250	920	10,000		30,000	
10.1%±1	125	430	1100	12,000		35,000	
13	128	468	4300	17,000		84,000	
30c EACH					10 FOR	\$2.50	
100K		120K		150K		220K	
40c EACH					10 FOR	\$3.50	
1 MEGOHM						EACH	75c

STEP-DOWN TRANSFORMERS



Watts	Price
300	7.49
500	10.95
1000	19.95
1500	24.95

210-250V PRI—110/120V SEC

PULSE NETWORKS

15A-1-400-50: 15 KV, "A" CKT. 1 microsec. 400 PPS. 50 ohms imp. \$37.50
G.E. #1633-5-2000 501P2T 6KV "E" circuit, 3 sections 5 microsecond, 2000 PPS 50 ohms impedance (as shown) \$6.50
G.E. #3E (3-84-810) (3-224-405) 501P1P: 3 KV "E" CKT Dual Unit; Unit 1, 3 sections. 0.84 Microsec. 810 PPS, 50 ohms imp; Unit 2, 8 sections, 2.24 microsec. 405 PPS, 50 ohms imp. \$5.50
7.5E3-1-200-67P. 7.5 KV, "E" Circuit, 1 microsec 200 PPS, 67 ohms impedance 3 sections. \$7.50
7.5E4-16-60-67P. 7.5 KV, "E" Circuit, 4 sections 16 Microsec. 60 PPS, 67 ohms impedance. \$15.00
7.5E3-3-200-6FT. 7.5 KV, "E" Circuit, 3 microsec. 200 PPS, 6 ohms imp. 3 sections. \$12.50
#755: 10KV, 2.2usec., 375 PPS, 50 ohms imp. \$27.50
#754: 10KV, 0.85usec., 750 PPS, 50 ohms imp. \$27.50

PULSE TRANSFORMERS

U-10198 Pri: 4-5KV, 97A Pk Sec: 18KV, 26A, PRI: 350-500 Cy. Duration 1.3 usec. \$42.50
D-166173: Video, Ratio 50:900 Ohms 10KC 2AIC \$12.50
G.E.K.-2745 \$39.00
G.E.K.-2744-A, 11.5 KV High voltage, 3.2 KV Low voltage @ 200 KW oper. (270 KW max.) 1 microsec. or 1/10microsec. @ 600 PPS. \$39.50
W.E. D169271 Hi Volt input pulse Transformer. \$27.50
G.E. K2450A. Will receive 13KV, 4 micro-second pulse on pri, secondary delivers 14KV. Peak power out 100 KW G.E. \$34.00
G.E. K2748A. Pulse Input line to magnetron. \$36.00
Ray UX 7896—Pulse Output Pri. 5v, sec. 41v. \$7.50
Ray UX 8442—Pulse Inversion +40v + 40v. \$7.50
Ray UX 7361 \$5.00
PHILOCO 352-7250, 352-7251, 352-7287 \$5.60
UTAH 9322, 9278, 9341
RAYTHEON: UX8693, UX5986 \$5 ea.
W.E. D-166310, D-166238, KS 9800, KS9948

PULSE EQUIPMENT



H/1-Volt Pulse Bulkhead. Feed thru. Fits UG-36 Connector—as shown \$15.00
APQ-13 PULSE MODULATOR. Pulse Width: .5 to 1.1 Microsec. Rep. rate 624 to 1348 PPS. Pk. Pwr out 35 KW Energy 0.018 Joules. \$49.00
TPS-3 PULSE MODULATOR. Pk. power 50 amp. 24 KW (1200 KW pk); pulse rate 200 PPS. 1.5 microsec. pulse line impedance 50 ohms. Circuit series charging version of DC Resonance type. Uses two 705-A's as rectifiers. 115 v. 400 cycle input. New with all tubes \$49.50

DELAY LINES

D-168184: 5 microsec. up to 2000 PPS 1800 ohm term. \$4.00
D-170499: 25/50/75 microsec. 8 KV 50 ohms imp. \$16.50
D-65897: 1 1/2 microsec. \$7.00
RCA 2J5686-502, 2.2u sec. 1400 ohms \$2.00

MAGNETRONS

Tube	Tube	Tube
D2J7	D149	720BY
D1J1	D161	725-A
D2J1	700	730-A
D2J2	706	OK 62
D2J6	D262	OK 61
D2J2	3J31	OK 60
D2J7	5J30	D156
D2J8	718DY	D132
D2J9		



MICROWAVE ANTENNA EQUIPMENT

AS-31/APN-7: 10 cm Polvrod in Lucite Ball. Type N Fitting Coax Feed. \$22.50
Relay System Parabolic reflectors approx. range 2000 to 6000 Mc. Dimensions 4 1/2" x 3". New. \$100.00
Dipole for above \$12.00
TDY "JAM" Radar rotating antenna, 10 cm, 30 deg. beam, 115 V AC drive. New. \$150.00
Cone Antenna, AS 125 APR, 1000-3200 mc. Stub supported with type "N" connector. \$14.75
AT49A/APR—Broadband Conical, 300-3300 MC. Type N Feed \$22.50

10 CM GUN-SIGHT ANTENNA

SPHERICAL RADOME HOUSES DRIVE MOTOR, DISH, FEED AND GUNMOUNT. TOTAL DIAMETER APPROX: 15 INCHES. DISH: 13" DIAM. FEED: DIPOLE AND DISK VERTX. SCAN: CONICAL AT 2400 RPM. BEAMWIDTH: 25°-30°. ENTIRE UNIT MAY BE PRESSURIZED UP TO 15 LBS./IN. AND ENERGY MAY BE FED BY ANY FLEXIBLE COAX CABLE. COMPLETE UNIT WITH DRIVE MOTOR AND RADOME \$325.00

MAIL ORDERS PROMPTLY FILLED. ALL PRICES F.O.B. NEW YORK CITY. SEND M.O. OR CHECK. ONLY SHIPPING SENT C.O.D. RATED CONCERNS SEND P.O. ALL MDSE. SUBJECT TO PRIOR SALE, AND PRICES SUBJECT TO CHANGE WITHOUT NOTICE. PARCELS IN EXCESS OF 20 POUNDS WILL BE SHIPPED VIA CHEAPEST TRUCK OR RAILEX.

131 Liberty St., New York 7, N. Y. Dept E-11 Chas. Rosen Phone: Digby 9-4124

Buy TOP Radio-Electronic Values!

RCA and KENRAD
Individually Boxed
JAN 826's
75¢ Each 100 Lots 85¢ ea

RAYTHEON
Individually Boxed
JAN VT-127's
25¢ Each 100 Lots 35¢ each 3 for \$1.00

BUTTERFLY CONDENSERS

FIG. 1

9-62 mmfd per section. 6-34 mmfd sections in series. Double ceramic end plates and bearings. 1/4" diam. shaft, 5/16" long. .065 Plate spacing end plates 1-3/8" square.
Stock No. 5076-A FIG. 1 Price Each **90¢**

FIG. 2

4-22 mmfd per section. 3-12 mmfd sections in series. Single ceramic end plate 1-3/8" square, 1/4" diam. x 1/4" long shaft.
Stock No. 5077-A FIG. 2 Price Each **60¢**

AUDIO PASS FILTERS

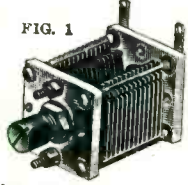
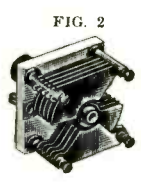
Band pass 800 to 1200 cycles input 10000 ohms — Output 25000 ohms Level 10DB
Stock No. T48500 Price to: \$5.50 ea.

SMALL MOTORS

OSTER B9-2. 5600 RPM. 12 VDC @ 1.2 Amps. \$7.00 Ea.
OSTER C-2H-1A 7000 RPM. 27.5 VDC 1/100 HP. \$7.50 Ea.
KOLLSMAN Type 775-01 Mo-26 \$2.50 Ea.
WESTINGHOUSE 115 volt 400 C. Blower. Type Fl. 6700 RPM. \$6.95 Ea.

OIL FILLED CONDENSERS

Stock No.	Capacity MFD.	D. C. WKG. Voltage	Dimensions	Price Each
6057A	2	600	1" x 1-3/4" x 2 3/4"	\$0.59
5994A	4	600	1-1/4" x 2-1/2" x 3-1/4"	1.75
5865A	4	1000	1-1/4" x 2 1/2" x 4 3/4"	1.95
6102A	8	1000	1-1/4" x 3 3/4" x 4 3/4"	2.50
6101A	4	1500	1-1/4" x 3-3/4" x 4-1/2"	2.75
6103A	0.5	5000	2-1/4" x 4" x 4 1/8"	2.95
6104A	1	5000	3-5/8" x 4 1/2" x 4 1/8"	4.25
5399A	0.045	16000	1-3/4" x 3-1/2" x 4 3/4"	4.95
6052A	2 X .15	8000	1-3/4" x 3-1/2" x 4 3/4"	4.95

All have ceramic insulated terminals except No. 5865A which has bakelite insulated terminals. All are NEW, standard name brands.

SIGNAL CORPS TRANSFORMERS—CHOKES & FILTERS

2C6191/K1	2Z9619-00	2Z9638-44	3C317-43
2C6191/T3	2Z9621-43	2Z9643-42	3C317-44
2C6191A/3	9Z9621-112	2Z9647-11	3C323-4C
2C619F/T2	2Z9625-1	2Z9655	3C323-14A
2C6230/123	2Z9625-8	2Z9662	3C323-54B
2C6230.3/124	2Z9626	2Z9702-2	3C323-129B
2C6307/AK1	2Z9627-35	2Z9760	3C323-145B
2C6386A/T14	2Z9628-2	2Z9805	3C324-4
2C6494A/C11	2Z9631.7	2Z9808	3C324-40
2C6530-653A/C10	2Z9631.187	2Z9828	3C343-2
2C6530-653A/T5	2Z9632.8	2Z9851	3C344
2Z3625-66	2Z9632.14	2Z9853	3C344-9
2Z5731-337	2Z9632.39	2Z9854	3C362-8
2Z9600.3	2Z9632.170	2Z9855	3C375-15
2Z9604.16	2Z9632.171	2Z9876-2	3C549
2Z9608.36	2Z9632.248	2Z9878-11	3C573
2Z9611.115	2Z9632.362	2Z9878-13	3C575G-1
2Z9611-289	2Z9632.365	2Z9879-2	3C362-23
2Z9612.52	2Z9632.366	2Z9879-3	3C362-24
2Z9613.14	2Z9634.4	2Z9879-3	3C1987.20
2Z9613.304	2Z9634.35	2Z9900-5	3C1987-29
2Z9614-94	2Z9634.39	2Z9944	3C4075
2Z9617-92	2Z9634.46	2Z9984	3F4061B/C1
2Z9618-9	2Z9634.49	3C106B	6C8/F1
2Z9618-42	2Z9636.16	3C307-1	
2Z9619.42	2Z9638.14	3C307-46	
2Z9619.63	2Z9638.16	3C317-33	

MORE INFORMATION AND PRICES UPON REQUEST

6.3 VOLT FILAMENT TRANSFORMERS
Primary 115 Volt 60 Cycle 1600 Insulation Three 6.4 Volt Secondaries

6.3 Volts @ 4.9 Amps. Horizontal Half Shell Mounting. 2 1/4" x 2 13/16"
6.3 Volts @ 4.5 Amps. Mounting Centers. 2 13/16" x 3 3/8" Core Size. 2 1/2"
6.3 Volts @ 1.1 Amps. above Chassis. Solder Lug Terminals—All Terminals Maked.

Stock No. 5254A

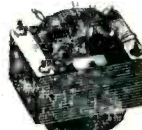
Price **\$2.65** EACH

MICROPHONE CONNECTORS

Single Contact Female Cable Connector. Same as Amphenol 75-MCIF. \$15.00 per 100
Stock No. 6131 Price Each **18¢**

Single Contact Male Cable Connector. Same as Amphenol 75-MCIM. \$12.50 per 100
Stock No. 6132 Price Each **15¢**

H & H ROTARY SWITCH

S.P.S.T. Rotary Switch. Screw Terminals. 1/4" Shaft x 1/2" Long. 3 Amp. @ 250 Volts. Hardware included. \$15.00 per 100
Stock No. 6105 Price Each **18¢**

MISCELLANEOUS ITEMS

HEAVY DUTY 10 ft. SJ-7/16 Dia. BUNA CORD, 2 ins. #14 strd Conductors w/heavy duty plug. \$.60 each
J-5 Flameproof keys. \$.95
J-38 Keys. \$.95
Fenwal #S1080 Therman Switches. \$.95
Guardian BK-17A Relay. \$2.95
MS-52-53 Mast Sections. \$.95
TS-13 Handset. \$7.95
TS-9 Handset. \$7.95
T-46 Chestset. \$1.95

2 VOLT BATTERY

Signal Corps Type BB-54A 2 Volt 27 Ampere Hour Storage Battery. Non-Spillable Transparent Acid Proof Plastic Case has Built-in Ball Type Hydrometer. 3" x 4" x 5" High. Shipped Dry with Acid in Separate Container. Made by Willard.
Carton of 12 @ \$1.60 Each
Stock No. 5458A Price Each **\$1.95**

10 MFD.—600 VDC

Sprague No. R2-157, 10 Mfd. 220 VAC 600 VDC Capacitor with Universal Mounting Ring. 2-7/16" Diameter, 3 3/4" high. Bakelite insulated terminals.
Stock No. 5958A Price Each **95¢**

TRANSMITTING MICAS

Stock No.	Cap.	Test Volts	Type No.	Price Each
5493A	.01	1000	1445	.35¢
5494A	.02	1000	144T	.40¢
5495A	.006	1200	A2	.40¢
5496A	.0001	1500	BE 15	.20¢
5493A	.004	2500	4	.30¢
5499A	.001	5000	F	.60¢
5600A	.0036	5000	A2	1.90
5601A	.15	1000V	X5	.98¢
5602A	.00007	2500V	3	.98¢
5603A	.00005	3000V	15L	1.00
5604A	.0001	5000V	F2L	1.00
5605A	.0008	5000V	F21	1.00
5606A	.00025	10,000	PL-34L	1.95
5607A**	.00015	10,000	PL-315	7.95

*Supplied with Meter Bracket
**D.C. Working Voltage
OTHER TYPES AND SIZES AVAILABLE

TERMS:

Open Account to rated or Acceptable reference accounts. Others Pre-payment of 25% deposit with order, balance C.O.D. Price F.O.B. Chicago and subject to change without notice. Merchandise subject to prior sale.

ORDER TODAY!

Radio Surplus Corp.

732 South Sherman Street
Chicago 5, Illinois
Phone: HARRISON 7-5923

SEE OUR PREVIOUS ELECTRONICS ADS FOR LISTINGS OR WRITE FOR CIRCULARS

SHORT TELEPHONE RELAYS

A11996 CLARE (H77519-1) 24VDC, 3PST n.o. (3As), 2000 ohm, #R94.....	\$ 1.75
6385 ARC 12VDC, SPST n.o. (1A), 10A contact, 200 ohm, Part of ARC5 or SCR 274N, #R13.....	1.50
C58180 BENDIX 12VDC, DPDT & SPST n.c. (2C, 1B) 150 ohm, Part of SCR522, #R58.....	2.00
A22268 CLARE, 12VDC, SPST n.o. (1A), 200 ohm, #R411.....	1.50
5586 W.E., 12-24VDC, SPST n.o. (1A), 425 ohm, #R414.....	1.25
D170788 W.E., 4850 ohm, 8maDC, SPDT, #R92.....	2.50
CLARE 24V DC, SPDT(1C), 500 ohm #R278.....	2.75
CLARE K102, 6ma DC, 3500 ohm #R30.....	3.49
CLARE 110V, 50-60 cyc, 3PST n.c. (3Bs) Quick acting, Octal Plug Base, #1279.....	3.25
AUTOMATIC, 1.5V DC, DPST n.c. (2Bs), 5 ohm, #R280.....	3.00

TELEPHONE TYPE RELAYS

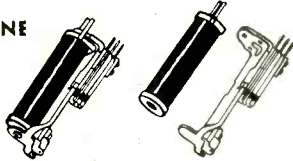

These relays have been standardized so that coils and frames of most manufacturers can be interchanged without affecting adjustments. A wide variety of applicable combinations are thus possible from a comparatively small number of relays.

Listed below are frames and coils from our stock. They may be purchased separately. However, a complete relay consists of coil and frame.

Representative completed relays are also listed with voltage and current ratings. Values are indicative of sensitivity that may be expected from similar combinations.

107 COOK, 3-6VDC, 6 make, 1 break (5As, 1C), 12 ohm, Part of BC654, #R407.....	\$ 3.95
CLARE, 6500 ohm, 8maDC, 3 makes (3As), R276.....	4.25
5035A7 AUTOMATIC, 1300 ohm, 8maDC, SPST n.o. (1A), #R103.....	1.75
A18258 BENDIX (Cook 102) 8-12 VDC, Copper Slug, Slow Release, SPDT, 200 ohm, Part of SCR 522, #R365.....	2.49
R5229A1 AUTOMATIC 6VDC, 3PST n.o. (3As), 75 ohms, Slow Release, #R412.....	2.50
R5021A1 AUTOMATIC 1300 ohm, 20maDC, SPST n.c. (1B), #R413.....	2.95

FRAMES

(For Cost of Relay Add Price of Frame to Price of Coil)



Stock No.	Contacts	Price each	F106 1B, 1A	F106 1B, 2A	F106 1B, 3A	F106 1B, 4A	F106 1B, 5A	F106 1B, 6A	F106 1B, 7A	F106 1B, 8A	F106 1B, 9A	F106 1B, 10A	F106 1B, 11A	F106 1B, 12A	F106 1B, 13A	F106 1B, 14A	F106 1B, 15A	F106 1B, 16A	F106 1B, 17A	F106 1B, 18A	F106 1B, 19A	F106 1B, 20A	F106 1B, 21A	F106 1B, 22A	F106 1B, 23A	F106 1B, 24A	F106 1B, 25A	F106 1B, 26A	F106 1B, 27A	F106 1B, 28A	F106 1B, 29A	F106 1B, 30A																														
F101	1A	1.25	F108	1B, 1A, 1C	F108	1B, 2A, 2C	F108	1B, 3A, 3C	F108	1B, 4A, 4C	F108	1B, 5A, 5C	F108	1B, 6A, 6C	F108	1B, 7A, 7C	F108	1B, 8A, 8C	F108	1B, 9A, 9C	F108	1B, 10A, 10C	F108	1B, 11A, 11C	F108	1B, 12A, 12C	F108	1B, 13A, 13C	F108	1B, 14A, 14C	F108	1B, 15A, 15C	F108	1B, 16A, 16C	F108	1B, 17A, 17C	F108	1B, 18A, 18C	F108	1B, 19A, 19C	F108	1B, 20A, 20C	F108	1B, 21A, 21C	F108	1B, 22A, 22C	F108	1B, 23A, 23C	F108	1B, 24A, 24C	F108	1B, 25A, 25C	F108	1B, 26A, 26C	F108	1B, 27A, 27C	F108	1B, 28A, 28C	F108	1B, 29A, 29C	F108	1B, 30A, 30C

FRAMES WITH MICROSWITCH

F125	1A, 1C (Microsw.)	1.75
F126	1A, 1A (Microsw.)	1.75

COILS

(For Cost of Relay Add Price of Coil to Price of Frame)



Stock No.	Ohms	Price each	Stock No.	Ohms	Price each
K101	0.75	1.25	K106	1100/500 Dual	2.00
K102	12	1.25	K111	1300	1.75
K103	250	1.25	K112	2000	2.25
K104	450	1.50	K113	3000	2.50
K105	500	1.50	K114	3600	2.50
K106	500/1100 Dual	2.00	K115	4600	2.75
K107	750	1.50	K116	6500	2.75
K108	900	1.75	K117	10,000	3.00
K109	1000	1.75	K118	10,000	3.25
K110	1100	1.75			

A-C COILS

Stock No.	Voltage	Price each
K119	6V AC	1.75
K120	24V AC	1.75
K121	110V AC	2.50

SLOW ACTION COILS

Stock No.	Ohms	Slow Action	Price each
K122	33	Make	1.50
K123	75	Release	1.50
K124	200	Release	1.50
K125	300	Make	2.00
K126	2000	Make	2.00
K127	2500	Release	2.00

No. 0150734
S.C. stock No. 2C6996-1053A/C2

Western Electric

PHASE SHIFT CAPACITOR

As Used in BC1053A, SCR545 and other Radar Equipment. New, in original boxes. 10 for 150.00, 100 for 1250.00.

17.50 each

ULTRA SENSITIVE RELAY

Nominal Operating Characteristics, 11,000 ohms, 0.4 Ma, 4V DC SPDT Kurman BK35 Adjustable Contacts & Armature, #R277, 10 for 55.00, 100 for 475.00.

5.95 each

110V 60 CYC TIMING MOTORS

INGRAHAM 8 RPM Fully Enclosed..... \$1.95

TELECHRON 3.6 RPM..... 2.50

GILBERT With Gear Train for 6 RPD/Day..... 1.95

GILBERT 60 RPM (1 RPM)..... 1.75

HAYDON 1600A; 1 RPM..... 2.25

HAYDON: 1 RPM, 24V AC..... 1.95

WE ALSO HAVE PRODUCTION QUANTITIES IN STOCK OF

APC Air Trimmers	Coils	Knobs	Spaghetti
Binding Posts	Controls	Sine-Cosine	Micro Switches
Cable	Crystals	Potentiometers	Toggle Switches
Capacitors	Filters	Pulse Transformers	Transformers
Ceramics	Fuses	Relays	Tubes
Adel & Tinnerman	Kovar Glass Seals	Resistors	And Other Radio & Electronics Parts
Clamps	Rubber Grommets	Servo Transformers	
Chokes	Hardware	Shockmounts	
	Iron Core Slugs	Sockets	

TERMS:—All Prices F.O.B. Our Plant. Rated Firms Net 10 Days; All Others Remittance with Order. Orders Under \$10 Remittance With Order, Plus Approximate Shipping Charges (overage will be returned.)

SHOCKMOUNTS

Large Quantities of Lord, Barry, U. S. Rubber and Other Makes of Shockmounts in Stock. Most Sizes Available. Prices Below Manufacturer's Cost. Send Us Your Requirements.

APC TRIMMERS

We Have Production Quantities of 13, 15, 25, 35, 50, 75, 100 and 140 Mmf Air Trimmers Available at Low Prices.

MU-METAL LAMINATIONS

Es, Fs, Is, Ls. Ten Sizes. Quantities Available. Sample Kit, 6 lbs, Sufficient Quantity of Each Size for One Unit—Postpaid in U. S. A. **\$19.75**

H-F TIE POST

Low-Loss Melamine Insulation, pictured actual size (4-40 Thread) ..\$7.50/C \$67.50/M



SEALED RELAYS

Clare 5001: 24vdc; DPDT; 300 ohm; Octal Plug Base; #R678.....	\$5.95
Struthers-Dunn 181CXC100: 12 vdc; 3As, 3Bs; #R679.....	\$5.95
Sigma 73351: 16vdc; SPDT; 2000 ohm; 8 ma; #R682.....	\$6.95
Allied SKHX, 24VDC; 3A, 3B; 425 ohm; #R913.....	\$6.95
SIGMA Type 4AH: 2000 ohm; SPDT, 4 ma, pull in, 2.5 ma, hold, 5 prong plug-in.....	\$3.95
SIGMA 71257: 6 voc. SPDT, 500 ohms.....	\$4.95
SIGMA 949: 115V AC, SPST N.C.....	\$4.95

KOVAR GLASS TO METAL SEALS HIGH-VOLTAGE FEED THRU



Many types and sizes. Send us your blueprint or sample for our quote. Our prices are a fraction of original factory costs.

SAMPLE KIT 96 Seals (8 ea. 12 types) **500** postpaid in USA
LAB KIT 300 Seals (20 types) **1500** postpaid in USA



STEPPING RELAYS GUARDIAN SERIES R

Three basic types for 24V AC operation:

1. Continuous rotation: In this type the contact finger advances one step each time the circuit is made and broken.
2. Electrical reset. Resets when a second coil is energized.
3. Add and subtract. Steps back one or more contacts at a time instead of resetting completely. 10 Pulses per second. Contacts are rated at 1 ampere at 110 volts, 60 cycles, non-inductive AC. The electrical reset type has up to 36 active contacts while the continuous rotation types each have 40 contacts. SEND US YOUR REQUIREMENTS.

* A=Normally Open; B=Normally Closed; C=Double Throw.

324 CANAL ST., N.Y.C., 13, N.Y. WALKER 5-9642

Universal general corp.

WE SPECIALIZE IN

RELAYS

TREMENDOUS QUANTITIES IN STOCK!

CONDENSERS

MICRO & TOG. SWS. - RELAYS - "J" POTS

GUARANTEED-OIL CONDENSER SPECIALS-GUARANTEED

1 mfd.—1500	\$1.05
GE #26F537-G2	
3.75 mfd.—1000 V	\$1.25
C-D KGR 6037-1	
6 mfd.—330 VAC	\$1.15
Dims. 4 1/2" x 3 1/2" x 1 1/4"	
2 mfd.—600 V	\$0.69
C-D 2 3/4" x 1 3/4" x 1"	
.5 mfd.—400 V	\$0.21
CP#3 BIAE504 KK	
Avox 416 MCT. Disc.	
100 10%, 500 25%	

10 mfd.—600 V \$0.98

Three term, bal. mtg. channel type. Dims. 3 3/4" x 3 1/2" x 2". Two 5 mfd. sections rated 400 V at 72 deg. "C". 1500 V test. Meets commercial specs. for 600 V. operation up to 40 degs. "C". Ideal for filter or power factor application. Repeat sales prove this rugged high quality condenser to be of outstanding value. Carton of 24, weight 42 lbs. Large qua. available. . \$89

4 mfd.—600 V \$1.15

Tobe TRS-604

5 mfd.—300 VAC \$1.05

3 7/8" x 2 1/2" x 1-3/16"

8 mfd.—600 V \$1.69

4 1/2" H. x 2" Dia. Bkt.

1—1 mfd.—600 V \$0.85

3 ST. Bathub. Lots of 100 10% Disc. Same Type but with 2 Terms. Case common. \$70 Lots of 100 10% Disc.

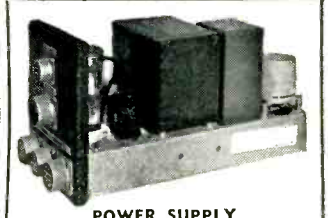

POWER SUPPLY
#CJP-20AIR for ASB 7/7A/7B equip. 800 cy. 115V. imp. 2.5/56.5/880/2000V. out. Contains 6A/7, 5T4 & 2X2, plus oil conds; chokes, resistors, connectors & switches. Brand new and individually boxed. Measures 7 1/2" x 5 3/4" x 13" L. Cover not shown. \$6.75 Lots of 10, 10% disc.; 25, 15%; 50 & over, 25%.

— TRANSTAT —
115V. 1 phase, 100 amps., Kva. 11.5. Range 0-115 V. Amertran #29145. Specially priced.

JAN APPROVED

10mfd—1000V 4.55	8mfd—600V 2.25
8mfd—1500V 4.25	6mfd—600V 1.55
8mfd—1000V 3.25	4mfd—600V 1.75

Mfd	Volts	Price	Mfd	Volts	Price
.005	10K	3.75	2	2000V	2.80
.005-.01	10K	4.25	2	2500V	3.39
.01	10K	4.25	2	3000V	4.69
.012	25KV	15.90	2	4000V	5.69
.02	20KV	15.90	2	5000V	10.95
.03	18KV	Quote	2	12.5KV	Quote
.075	7.5KV	3.95	2	800V	1.25
.075	7.5KV	4.24	2	800V	1.48
.08	12.5KV	15.95	2	800V	1.25
.1	1500V	.59	2	1000V	1.95
.1	2000V	1.59	2	1000V	2.79
.1	2500V	1.49	2	1000V	4.23
.1	7500V	1.29	2	1000V	7.95
.1	300V	1.75	2	1000V	1.45
.1	7500V	1.75	2	1000V	1.83
.1	7500V	4.24	2	1000V	1.83
.1	7500V	6.25	2	1000V	1.25
.1	10KV	8.95	2	1000V	1.95
.1	15KV	15.95	2	1000V	2.79
.1	20KV	19.50	2	1000V	4.23
.15-1	8000V	1.95	2	1000V	7.95
.15-1	10KV	10.95	2	1000V	2.40
.25	2000V	1.25	2	330VAC	1.75
.25	3000V	2.25	2	600V	1.35
.25	6000V	1.75	2	600V	2.45
.25	18KV	15.95	2	1500V	2.89
.25	20KV	19.95	2	1500V	3.89
.25	10KV	12.95	2	330VAC	2.49
.4	1500V	1.02	2	1000V	2.49
.4	2000V	1.99	2	1000V	3.25
.4	3000V	2.69	2	2000V	3.95
.4	25KV	Quote	2	800V	1.45
.4	25KV	1.89	2	1000V	1.90
.4	25KV	1.89	2	1000V	2.49
.4	600V	.69	2	1000V	1.45
.4	600V	.69	2	1000V	1.90
.4	600V	.69	2	1000V	2.49
.4	600V	.69	2	1000V	1.45
.4	600V	.69	2	1000V	1.90
.4	600V	.69	2	1000V	2.49
.4	600V	.69	2	1000V	1.45
.4	600V	.69	2	1000V	1.90
.4	600V	.69	2	1000V	2.49
.4	600V	.69	2	1000V	1.45
.4	600V	.69	2	1000V	1.90
.4	600V	.69	2	1000V	2.49
.4	600V	.69	2	1000V	1.45
.4	600V	.69	2	1000V	1.90
.4	600V	.69	2	1000V	2.49
.4	600V	.69	2	1000V	1.45
.4	600V	.69	2	1000V	1.90
.4	600V	.69	2	1000V	2.49
.4	600V	.69	2	1000V	1.45
.4	600V	.69	2	1000V	1.90
.4	600V	.69	2	1000V	2.49
.4	600V	.69	2	1000V	1.45
.4	600V	.69	2	1000V	1.90
.4	600V	.69	2	1000V	2.49
.4	600V	.69	2	1000V	1.45
.4	600V	.69	2	1000V	1.90
.4	600V	.69	2	1000V	2.49
.4	600V	.69	2	1000V	1.45
.4	600V	.69	2	1000V	1.90
.4	600V	.69	2	1000V	2.49
.4	600V	.69	2	1000V	1.45
.4	600V	.69	2	1000V	1.90
.4	600V	.69	2	1000V	2.49
.4	600V	.69	2	1000V	1.45
.4	600V	.69	2	1000V	1.90
.4	600V	.69	2	1000V	2.49
.4	600V	.69	2	1000V	1.45
.4	600V	.69	2	1000V	1.90
.4	600V	.69	2	1000V	2.49
.4	600V	.69	2	1000V	1.45
.4	600V	.69	2	1000V	1.90
.4	600V	.69	2	1000V	2.49
.4	600V	.69	2	1000V	1.45
.4	600V	.69	2	1000V	1.90
.4	600V	.69	2	1000V	2.49
.4	600V	.69	2	1000V	1.45
.4	600V	.69	2	1000V	1.90
.4	600V	.69	2	1000V	2.49
.4	600V	.69	2	1000V	1.45
.4	600V	.69	2	1000V	1.90
.4	600V	.69	2	1000V	2.49
.4	600V	.69	2	1000V	1.45
.4	600V	.69	2	1000V	1.90
.4	600V	.69	2	1000V	2.49
.4	600V	.69	2	1000V	1.45
.4	600V	.69	2	1000V	1.90
.4	600V	.69	2	1000V	2.49
.4	600V	.69	2	1000V	1.45
.4	600V	.69	2	1000V	1.90
.4	600V	.69	2	1000V	2.49
.4	600V	.69	2	1000V	1.45
.4	600V	.69	2	1000V	1.90
.4	600V	.69	2	1000V	2.49
.4	600V	.69	2	1000V	1.45
.4	600V	.69	2	1000V	1.90
.4	600V	.69	2	1000V	2.49
.4	600V	.69	2	1000V	1.45
.4	600V	.69	2	1000V	1.90
.4	600V	.69	2	1000V	2.49
.4	600V	.69	2	1000V	1.45
.4	600V	.69	2	1000V	1.90
.4	600V	.69	2	1000V	2.49
.4	600V	.69	2	1000V	1.45
.4	600V	.69	2	1000V	1.90
.4	600V	.69	2	1000V	2.49
.4	600V	.69	2	1000V	1.45
.4	600V	.69	2	1000V	1.90
.4	600V	.69	2	1000V	2.49
.4	600V	.69	2	1000V	1.45
.4	600V	.69	2	1000V	1.90
.4	600V	.69	2	1000V	2.49
.4	600V	.69	2	1000V	1.45
.4	600V	.69	2	1000V	1.90
.4	600V	.69	2	1000V	2.49
.4	600V	.69	2	1000V	1.45
.4	600V	.69	2	1000V	1.90
.4	600V	.69	2	1000V	2.49
.4	600V	.69	2	1000V	1.45
.4	600V	.69	2	1000V	1.90
.4	600V	.69	2	1000V	2.49
.4	600V	.69	2	1000V	1.45
.4	600V	.69	2	1000V	1.90
.4	600V	.69	2	1000V	2.49
.4	600V	.69	2	1000V	1.45
.4	600V	.69	2	1000V	1.90
.4	600V	.69	2	1000V	2.49
.4	600V	.69	2	1000V	1.45
.4	600V	.69	2	1000V	1.90
.4	600V	.69	2	1000V	2.49
.4	600V	.69	2	1000V	1.45
.4	600V	.69	2	1000V	1.90
.4	600V	.69	2	1000V	2.49
.4	600V	.69	2	1000V	1.45
.4	600V	.69	2	1000V	1.90
.4	600V	.69	2	1000V	2.49
.4	600V	.69	2	1000V	1.45
.4	600V	.69	2	1000V	1.90
.4	600V	.69	2	1000V	2.49
.4	600V	.69	2	1000V	1.45
.4	600V	.69	2	1000V	1.90
.4	600V	.69	2	1000V	2.49
.4	600V	.69	2	1000V	1.45
.4	600V	.69	2	1000V	1.90
.4	600V	.69	2	1000V	2.49
.4	600V	.69	2	1000V	1.45
.4	600V	.69	2	1000V	1.90
.4	600V	.69	2	1000V	2.49
.4	600V	.69	2	1000V	1.45
.4	600V	.69	2	1000V	1.90
.4	600V	.69	2	1000V	2.49
.4	600V	.69	2	1000V	1.45
.4	600V	.69	2	1000V	1.90
.4	600V	.69	2	1000V	2.49
.4	600V	.69	2	1000V	1.45
.4	600V	.69	2	1000V	1.90
.4	600V	.69	2	1000V	2.49
.4	600V	.69	2	1000V	1.45
.4	600V	.69	2	1000V	1.90
.4	600V	.69	2	1000V	2.49
.4	600V	.69	2	1000V	1.45
.4	600V	.69	2	1000V	1.90
.4	600V	.69	2	1000V	2.49
.4	600V	.69	2	1000V	1.45
.4	600V	.69	2	1000V	1.90
.4	600V	.69	2	1000V	2.49
.4	600V	.69	2	1000V	1.45
.4	600V	.69	2	1000V	1.90
.4	600V	.69	2	1000V	2.49

YOUR MOST COMPLETE SOURCE OF UHF • UG • AN CONNECTORS



NO.	JAN NO.	DESCRIPTION	1-99	100 TO 999	1000 AND OVER
83-IR	SO 239	RECEPTACLE	\$.50	\$.45	\$.40
83-ISP	PL 259	PLUG	.55	.55	.50
83-168	UG 176/U	ADAPTER	.15	.12	.11
83-185	UG 175/U	ADAPTER	.15	.12	.11
83-ISPN	PL 259A	PLUG	.65	.60	.55
83-776	UG 203/U	PLUG	.65	.60	.55
83-IRTY	RECEPTACLE	.75	.65	.65
83-IH	UG 106/U	HOOD	.15	.14	.13
83-IHP	HOOD	.27	.24	.22
83-765	UG 177/U	HOOD	.24	.24	.24
83-IAC	CAP & CHAIN	.55	.50	.45
83-IBC	CAP & CHAIN	.35	.31	.30
83-IT	M 358	T CONNECTOR	1.50	1.40	1.40
83-IAP	M 359	ADAPTER	.35	.30	.28
83-IAP	M 359A	ADAPTER	.80	.75	.70
83-IJ	PL 258	JUNCTION	.75	.70	.65
83-IF	PL 274	FEED THRU	1.25	1.20	1.10
83-22SP	UG 102/U	TWIN PLUG	.90	.80	.75
83-22R	UG 103/U	RECEPTACLE	.90	.80	.75
83-22AP	UG 104/U	ADAPTER	1.40	1.25	1.10
83-22J	UG 105/U	JUNCTION	1.50	1.40	1.40
83-22T	UG 196/U	T CONNECTOR	1.65	1.50	1.50
83-22F	PL 275	FEED THRU	2.00	1.80	1.75
83-2SP	PL 295	PLUG	2.25	2.15	2.00
83-2R	SO 265	RECEPTACLE	1.65	1.55	1.50

From stock

Type	Price	Type	Price	Type	Price	Type	Price	Type	Price
UG 9/U	\$ 1.95	UG 57 U	\$ 2.30	CW 155/U	\$.63	UG 254 A/U	\$ 3.50	UG 496/U	\$ 3.50
UG 10/U	2.75	UG 57 B/U	1.85	UG 155/U	9.50	UG 255/U	2.85	UG 499/U	1.50
UG 11/U	2.25	UG 58 U	.80	UG 156/U	8.50	UG 256/U	15.50	UG 503/U	50.00
UG 12/U	1.55	UG 58 A/U	1.25	UG 157/U	8.50	UG 257/U	15.50	MX 504	.45
UG 13/U	2.25	UG 59 U	2.45	UG 158/U	47.50	UG 259/U	6.50	UG 505/U	50.00
UG 14/U	1.80	UG 59 A/U	2.15	CW 159 U	1.95	UG 260/U	1.20	UG 506/U	50.00
UG 15/U	1.25	UG 59B/U	2.75	UG 159 A/U	2.20	UG 260 A/U	1.40	UG 507/U	50.00
UG 16/U	2.75	UG 60 U	2.40	UG 160 A/U	2.20	UG 261 U	1.20	UG 526/U	3.75
UG 17/U	2.75	UG 60 A/U	2.25	UG 160 B/U	2.50	UG 262/U	1.20	UG 530/U	4.50
UG 18/U	1.75	UG 61 U	2.55	UG 166/U	47.50	UG 266 U	4.50	UG 531/U	5.15
UG 18 A/U	1.75	UG 61 A/U	2.40	UG 167/U	5.75	UG 269 U	3.75	UG 532-U	6.95
UG 18 B/U	1.75	UG 83 U	1.95	UG 167 A/U	5.75	UG 270/U	10.00	UG 533/U	10.00
UG 19 U	2.25	UG 85 U	2.00	UG 173 U	.38	UG 271 U	10.00	UG 535/U	4.95
UG 19 A/U	2.25	UG 86 U	2.80	UG 174 U	20.00	UG 272 U	25.00	UG 536/U	2.45
UG 19 B/U	1.95	UG 87 U	1.60	UG 180 A/U	10.00	UG 273 U	2.55	UG 541/U	3.95
UG 20 U	1.95	UG 88 U	1.10	UG 181 A/U	10.00	UG 274 U	3.95	MX 554/U	2.25
UG 20 A/U	1.90	UG 88 B/U	1.95	UG 182 A/U	10.00	UG 275 U	7.50	UG 557/U	5.50
UG 20 B/U	1.90	UG 89 U	1.35	UG 185 U	1.35	UG 276 U	7.50	MX 564/U	.55
UG 21 U	1.25	UG 90 U	1.60	UG 188 U	1.30	UG 279 U	3.95	UG 564 U	3.95
UG 21 A/U	1.95	UG 91 U	1.95	MX 195/U	1.00	UG 286/U	4.95	UG 565/U	3.95
UG 21 B/U	1.45	UG 91 A/U	1.70	UG 197 U	4.95	UG 287 U	7.75	UG 566/U	7.95
UG 21 C/U	1.75	UG 92 U	1.80	UG 201 U	2.75	UG 290 U	1.20	UG 567/U	6.95
UG 21 D/U	1.95	UG 92 A/U	2.25	UG 202 U	3.95	UG 291 U	1.25	UG 568 U	4.95
UG 22 U	1.65	UG 93 U	1.95	UG 204 A/U	3.50	UG 294 U	2.20	UG 569 U	2.95
UG 22 A/U	1.60	UG 93 A/U	2.25	UG 206 U	2.00	UG 299 U	7.75	UG 570 U	2.95
UG 22 B/U	1.50	UG 94 A/U	2.25	UG 207 U	25.00	UG 306 U	2.95	UG 571 U	6.95
UG 22 C/U	1.95	UG 94 A/U	1.60	UG 208 U	22.50	UG 309 U	3.75	UG 572 U	5.95
UG 23 U	1.65	UG 95 U	1.95	UG 212 A/U	3.50	UG 332 U	3.50	UG 573 U	7.25
UG 23 A/U	1.95	UG 95 A/U	2.00	UG 213 A/U	4.10	UG 333 U	5.50	UG 602 U	3.00
UG 23 B/U	1.75	UG 96 U	2.10	UG 215 U	5.50	UG 334 U	6.50	UG 603 U	3.00
UG 23 C/U	1.95	UG 96 A/U	1.95	UG 216 U	14.00	UG 335 U	3.75	UG 625 U	1.70
UG 27 A/U	3.75	UG 97 U	4.25	UG 217 U	7.50	UG 347 U	2.50	UG 627 U	7.25
UG 27 B/U	3.75	UG 97 A/U	3.95	UG 218 U	10.00	UG 348 U	1.50	UG 628 U	7.25
UG 27 C/U	4.50	UG 98 U	2.50	UG 219 U	7.50	UG 349 U	3.50	UG 634 U	4.95
UG 28 U	3.95	UG 98 A/U	2.70	UG 220 U	10.00	UG 352 U	7.50	MX 913/U	.65
UG 28 A/U	3.95	UG 100 U	2.95	UG 222 U	43.75	UG 352A/U	9.00	UG 931 U	3.00
UG 28 B/U	4.50	UG 100 A/U	3.75	UG 223 U	6.50	MT 412	.95	UG 932/U	3.00
UG 29 U	1.00	UG 101 U	4.45	UG 224 U	1.20	UG 414 U	2.95		
UG 29 A/U	1.90	UG 101 A/U	4.55	UG 231 U	2.70	UG 419 U	1.95		
UG 29 B/U	1.90	UG 107 A/U	4.50	UG 233 U	18.50	UG 421 U	3.25		
UG 30 U	2.50	UG 107 B/U	4.50	UG 234 U	18.50	UG 422 U	3.25		
UG 32 U	19.00	UG 108 U	2.90	UG 235 U	35.50	UG 423 U	5.80		
UG 33 U	19.00	UG 108 A/U	3.25	UG 236 U	12.00	UG 447 U	1.50	MC 10	.36
UG 34 U	19.00	UG 109 U	2.30	UG 237 U	25.00	UG 478 U	50.00	MC 20	.46
UG 35 A/U	19.00	UG 109 A/U	2.90	UG 241 U	3.45	UG 479 U	33.80	MC 30	.82
UG 36 U	19.00	UG 110 U	15.00	UG 242 U	3.95	UG 482 U	33.80	MC 40	.86
UG 37 U	19.00	UG 114 U	2.15	UG 243 U	4.50	UG 483 U	4.65	MC 50	.36
UG 37 A/U	19.00	UG 115 U	2.25	UG 244 U	4.00	UG 484 U	5.80	MC 60	.46
UG 38 A/U	22.00	UG 119 U.P	7.50	UG 245 U	2.50	UG 486 U	2.30	MC 70	.82
UG 39 U	1.75	CW 123 A/U	.55	UG 246 U	3.10	UG 487 U	6.50	MC 80	.86
UG 40 U	1.95	UG 131 U	10.00	UG 249 U	18.50	UG 491 U	2.25	MC 100	1.20
UG 45 U	5.00	UG 146 U	2.95	UG 250 U	18.50	UG 492 U	5.00	MC 110	1.12
UG 46 U	5.00	UG 148 A/U	7.85	UG 251 U	18.50	UG 493 U	7.25	MC 120	.36
UG 49 U	20.00	UG 149 A/U	5.25	UG 252 U	7.50	UG 494 U	4.75	MC 150	.75
UG 50 U	20.00	UG 154 U	9.50	UG 253 U	5.50	UG 495 U	7.50	MC 250	1.50



IPC Miniature Connector

It's Free! A request on your letterhead will bring you a copy of our new AN and Associated Hardware and Fittings Catalog just off the press. Request catalog No. AN 9.

LIFE ELECTRONIC SALES

345 Broadway, New York 13, N. Y.
Digby 9-4154

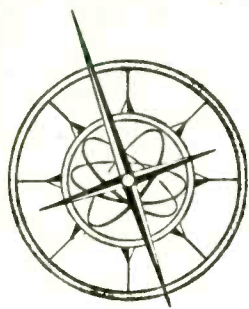

COMPASS

COMMUNICATIONS COMPANY

393 GREENWICH STREET
NEW YORK 13, N. Y.

CABLE ADDRESS: COMPRADIO, N. Y.
ALL PHONES: BEEKMAN 3-6509

WE MAINTAIN
OUR OWN FULLY
EQUIPPED TESTING
LABORATORY TO
TEST AND GUARANTEE
ANYTHING WE SELL

Suppliers of

MARINE, GROUND & AIRBORNE

TRANSMITTERS

FROM 25 WATTS TO 5 KILOWATTS

RADAR

SONAR

TEST SETS

TELEPHONE EQP'T.

CONVERSION EQP'T.

- MOTOR GENERATORS
- CONVERTORS
- DYNAMOTORS
- INVERTERS
- POWER SUPPLIES
- RECTIFIERS

AND

TUBES— SPECIAL PURPOSE and TRANSMITTING TYPES

TCS—Collins mfd. Navy radiotelephones for shipboard and mobile use, complete with all accessories for operation from 12, 24, 110, 230 volts d.c. and 110 or 220 volts a.c.

TDE—Navy or commercial marine transmitters, complete 110 & 220 volts d.c. and a.c.

TBK—Navy high frequency transmitter, 2-20 mcs; 500 watts output. Supplied complete with m/g and starter for d.c. or a.c. operation.

TBM—same transmitter but with speech input equipment to give 350 watts phone.

TBL—Navy all-wave transmitter; 350 watts output; CW and phone. Supplied complete with m/g and starter for d.c. or a.c. operation.

TAJ—Navy intermediate freq. transmitter, 175-550 kcs; 500 watts output. Supplied complete with m/g and starter for a.c. or d.c. operation.

SCR-284—the famous mobile and ground station for field use. Large quantity of complete sets available.

MAG—10 cm. portable link radar transmitter receivers, 6-volt operation.

TBN—200-500 kcs, complete with 220/440 volt, 3 ph. 50-60c. power supply—conservatively rated at 1 kw. output.

SCR-510 and 610 in quantity.



• BEACONS

- AN/CPN-8 10 cm.
- AN/CPN-6 3 cm.
- YJ and YG . . . for shipboard use

JAN TUBES

0A290	3B24 7.50	6J6W 5.50	12SK775	707A 7.50	2050 1.25	FG57 17.50
0B2 1.00	3B26 3.50	6K765	12SL775	708A 4.50	2051 1.00	FG97 22.50
0C3 1.00	3B27 3.75	6L6 2.00	12SN775	715B 8.50	5654 2.75	FG105 17.50
0D390	3B28 7.50	6L6G 1.50	12SR775	717A 1.25	5670 4.50	HY31Z 2.50
1AE4 1.25	3E29 14.50	6L7 1.00	24G 1.25	718CY 35.00	5686 3.75	HY114B50
1E150	3Q475	6N7 1.10	2526GT 1.25	728AY-GY 35.00	5687 5.25	HY61525
1B22 2.00	3S475	6SC785	28D7 1.25	801A35	5704 2.50	KC4 47.50
1B24 9.50	4A1 1.00	6SF575	35T I.G. 3.00	807W 3.50	5726 2.10	KC4-3 37.50
1B42 8.50	4B24 5.75	6SG7W 3.75	8150	82675	5783 1.50	KV21A 8.75
1P23 2.75	4B25 8.00	6SJ775	101L WE 1.00	827R 125.00	6101 35.00	LVR 3.50
1Z2 3.75	4E27 15.00	6SJT85	203Z 4.50	829B 12.00	6099 3.50	Write QK117 50.00
2C2225	4X-150A 35.00	6SL775	252A 5.50	835 17.50	801375	Write QK117A 65.00
2C2625	5J29 11.50	6SN775	286A 7.50	837 3.00	8020 1.25	RM3475
2C26A40	5R4GY 1.50	6SQT85	204TH 6.75	872AS 3.00	8025 8.50	RM47 4.50
2C3460	6-450	6X5GT75	304TL 7.50	874 1.10	900435	RM60 1.75
2C40 12.50	6AG575	6Y6 1.25	307A 4.50	95425	900635	RM72 1.00
2C51 (W.E.) 5.75	6AJ5 1.35	7C24 110.00	313C 1.75	95635	CE1C/838 3.00	RM73 1.25
2D21 1.35	6AK565	10Y35	329A 4.50	95745	CE2 1.50	RM77 1.50
2E25 5.00	6AKS WE 2.25	12A675	371A75	958A60	CE2A 3.50	SD82875
2J21A 6.50	6AKSW 1.00	12A7 1.00	412A WE 1.25	95935	CE2B 3.50	VS1 12.50
2J26 15.00	6AK660	12A7U7 1.00	417A 15.00	95935	CE2C 2.50	VT31 50.00
2J27 15.00	6AL550	12AX7 1.00	450TL 35.00	95935	CE2T 1.50	VU508 1.50
2J31 22.50	6AR6 2.75	12J5GT60	471A 2.25	95945	CE25/927 1.25	WL481 1.00
2J40 35.00	6AS6 4.25	12K8Y60	700-A/B/C 25.00	95965	CE25C 2.50	WL532A 3.00
2J61 35.00	6AS775	12SG775	702A 3.00	95965	ELC1A 8.75	WL670A 7.50
2J61A 45.00	6B850	12SG7Y85	704A75	95965	ELC1B 3.25	ZB120 10.00
2K22 Write	6C450			95965	ELC5B 2.50	45X874 10.00
2K23 Write	6HG75			95965	ELC6A 3.50	SAP1 3.75
2K25 35.00	6J550			95965	ELC6J 7.50	SBP4 3.75
2K28 27.50	6J6 1.00			95965	ELC6C 7.50	SBP1 4.75
3A4 1.50				95965	F123A 6.75	SSP1 Write
3A5 8.50						7BP7 7.50
3B4 2.25						7HP4 7.50
3B24 4.75						9LP7 4.50

ROSE PRODUCTS COMPANY

102 WARREN STREET

REctor 2-8078-9

NEW YORK 7, N. Y.

Headquarters for Microwave Test Equipment

TO AMERICAN INDUSTRY:

WESTERN LABORATORIES

announces

A New and Unique Electronic Service

Because of the unusual demand for military electronic test equipment, we will re-create pieces with military nomenclature of acknowledged superior design in small or moderate quantities.

Moreover, we will do this at a speed unheard of in electronic circles. Our vast library of technical information, together with unexcelled laboratory facilities under the control of the finest technicians, frequently permit procurement of critically needed test gear otherwise unavailable.

We often are able to produce and deliver before similar material can be supplied as GFE or government bailment.

Complete satisfaction assured, and best of all, our prices reflect a considerable savings to you. Write, wire, or telephone.

TEST EQUIPMENT HEADQUARTERS

Western Laboratories
Weston 93, Mass.

IMMEDIATE DELIVERY

PL-112	U-16-U
PL-118	UG-34/U
PL-147-A	UG-88/U
PL-151-A	UG-260/U
PL-259-A	UG-306/U

NOW IN STOCK

P. J. SALES - WO - 4-2490

99 Murray St.

New York City 7, N. Y.

POWER RHEOSTATS



r	W	Ea.	r	W	Ea.	r	W	Ea.
.5	25	1.98	75	25	1.98	500	300	9.49
.5	50	2.81	75	75	3.90	585	150	6.59
.5	150	5.93	80	50	2.53	750	25	2.23
1	50	2.81	80	500	12.46	750	150	5.46
2	50	2.81	100	25	1.98	1000	25	2.53
2	100	4.68	100	50	2.53	1000	50	2.66
2	300	8.42	100	100	4.39	1200	225	7.20
3	100	4.67	125	25	2.23	1200	300	8.40
3	225	6.58	150	50	2.53	1250	50	2.66
4	225	6.60	175	25	2.23	1250	150	6.10
5	25	1.97	185	25	2.23	1500	25	2.53
5	50	2.53	200	25	2.23	1500	50	2.66
5	100	4.68	200	100	4.40	1600	50	2.66
6	25	2.23	200	150	5.04	1800	150	6.19
6	50	2.53	225	50	2.53	2000	55	2.53
6	75	3.90	250	25	2.23	2000	50	2.66
7	25	1.98	250	50	2.53	2250	150	6.24
7.5	75	3.95	300	50	2.53	2500	50	2.66
8	50	2.53	300	75	3.90	2500	100	4.68
10	25	2.23	300	100	4.40	2500	150	6.24
10	50	2.53	300	150	5.04	3000	25	2.66
10	100	4.37	350	25	2.23	3000	100	4.95
12	25	2.23	350	100	4.40	5000	25	2.66
12	50	2.53	370	25	2.23	5000	50	2.90
15	25	1.98	378	150	6.59	7500	50	2.90
15	75	3.90	400	25	2.23	7500	100	5.32
15	100	4.38	400	75	3.90	10000	50	2.90
20	50	2.53	500	25	2.23	10000	100	5.32
22	50	2.53	500	50	2.53	10000	100	5.51
25	25	2.23	500	75	3.95	15000	25	3.25
50	25	1.98	500	100	4.50	20000	150	8.75
50	50	2.53	500	150	5.15			

Specify Type Shaft Required "S" or "Knob"
Special Prices to Quantity Users.

LARGEST VARIETIES OF NEW SURPLUS AT LOWEST PRICES

- OIL CAPACITORS
LARGE RECTANGULARS
SMALL RECTANGULARS
BATHTUBS; TUBULAR
- MICA SILVER TRANSM. G-1-2-3-4
- ELECTROLYTIC FP CANS
- AMPHENOL-CANNON
- AN-UG-UHF CONNECTORS
- LORD SHOCK MOUNTS
- BIRTCHEr Tube CLAMPS
- JONES PLUGS—SOCKETS
BARRIER STRIPS
- POWER RHEOSTATS
- SWITCHES TOGGLE, ROTARY
MICRO, PUSH-MOM.
- POTENTIOMETERS J.
JJ.
JJJ.
- OTHER CARBON WIRE-WOUND POTS
- MOSSMAN LEVER SWITCHES
- AIRCRAFT NOISE FILTERS
- RESISTORS GLASS FERRULE PRECISION
- FUSEHOLDERS-MOUNTS
- INSTRUMENT KNOBS
- MANY OTHER ITEMS

HIGH POWER TRANS. MICA



G-1 Type	G-2 Type	G-3 Type	G-4 Type
.0001 6kv	.0001 10kv	.001 20kv	.0025 30kv
.00015 5kv	.00015 10kv	.00015 20kv	.0005 35kv
.0002 6kv	.0002 10kv	.0004 20kv	.0025 25kv
.0008 6kv	.00025 12kv	.00015 15kv	.003 20kv
.01 4kv	.0003 10kv	.00047 20kv	.0039 20kv
.032 2kv	.000375 10kv	.0005 20kv	.0075 15kv
.04 1kv	.0004 5kv	.00095 5kv	.01 12kv
.051 1.5kv	.0005 10kv	.001 20kv	.03 18kv
.08 1.5kv	.00057 10kv	.0011 20kv	.056 15kv
.09 1.5kv	.00065 10kv	.00124 15kv	
	.001 10kv	.01 5kv	
		.015 3kv	
		.25 1.6kv	

C-D Type #56

.000155 30kv	.001 30kv
.0004 30kv	.03356 2.5kv
.000533 30kv	.007/15kv—70A/300kc

Full ratings and prices upon request.
Specify your needs.

A. MOGULL CO.

50 West Broadway N. Y. 7, N. Y.
Phone: WORTH 4-0865



ATR-13 TRANSCEIVER

Dynamotor powered, either 14 or 28 V. Shock mounted, remotely controlled transceiver. Tunable receiver, range 108-160 M.C., 4-channel crystal controlled VHF transmitter, built-in provisions for omni. Weight, complete with plugs, less cable, 19 lbs. Less crystal, **\$245.00**

PORTABLE RADAR

Model SQ. 12 cm. Used on small ships. Has PPI indicator. Maximum range 20 miles. 1 Kw. output. Operates from 110 VAC, 60 cps. Price On Request.

NEW HEADSETS & HANDSETS

HS-23	HN-28	T-26	HS-18
HS-33	TS-10-G	TS-13-C	EE-8

RADAR

APS-4	Mark 16	RC-214
APS-6	MD4/APS2	RC-224
APT-1	MD5/APS3	RC-266
APT-2	MD22/UPN2	RT34/APS13
APT-3	MD38/APQ13	SCR-517
APT-4	RC-1841FF	T-85/APT-5

TEST EQUIPMENT Complete Line!

DuMont 224-A Oscilloscope	TS-118/AP
1-77 Hickok Tube Checker	TS126
1-208 FM Signal Generator	TS127/U
RPC Model 644 Multimeter	TS131
Ferris Microvoter Mod. 18-C	TS159
Hewlett Packard 200-C	TS170/ARN
I-198	TS19/APQ
BC-638	TS-23/APN
RC-1255	TS24/A/ARR-2
IE-36	TS27/TSM
I-95	TS-33
I-96	TS34/AP
I-122	TS-35/AP
I-130A	TS36/AP
I-139	TS-45A/APM-3
I-145	TS61/AP
I-212	TS62/AP
I-222	TS89
TS-3A/AP	TS92
TS10A/APN	TS100/AP
TS12/AP	TS-102
TS16/APN	TS111/CP
	TS175/UR
	TS175/UP
	TS182/UP
	TS184A/AP
	TS204/AP
	TS251
	TS311A/UP
	TS323/UP
	1-146
	TS-268/U
	Boonton Mod.
	733 Sig. Gen.
	Boonton Type
	102F Sig. Gen.

COMBINATION SIGNAL GENERATOR AND FREQUENCY METER. Freq. range: 150-200 MC., crystal calibrated. Has separate 30 MC signal output, crystal cal; 3-stage, AF amplifier. Power measurements by built-in VTVM circuit. 0-1 MA. meter as 2-range voltmeter. Built-in 400 cps. voltage regulated power supply. Now...\$69.95

POWER SUPPLY

110 V. 60 cps., 4 tubes voltage regulated. Power output 200 VDC @ 50 MA. and 6.3 VAC @ 7 amps. Used to supply necessary power for radar transmitter G-29200. Now...\$39.95

RADAR TRANSMITTER

Model G-23200. 15 tubes. Has 4 independent oscillators, each adjustable in frequency between 509-521MC, by means of knobs on front panel. Has 4 independent variable pulse shaping modulators, complete with tubes. Requires above separate POWER SUPPLY. Now...\$89.95

AN/ART-13 PARTS

Part #	Item
564918	Barometric Switch
565927	4-1/2" Pie Ceramic, Variable Cap.
K7800443	6-1/2" Pie Ceramic, Variable Cap.
564605	4 Centralab-Type 843-003 Cap Assembly

GAS ENGINE POWER SUPPLY

1 1/2 Kw. 110 V. 60 cps. Complete gas engine power supply. Now...\$59.50 P. U. R.

FLUX METER

For measuring flux density between magnet poles. Has two meters in series with a potentiometer and battery for power supply. Range: 500-4000 Gauss in 3 scales. Requires 1 battery which mounts in case. NEW...\$37.50

RECEIVERS—TRANSMITTERS

APR-4	MI-10G	RTA/1B
APR-5	PE-125AX	SCR-522
ARC-1	R-9/APN-4	TA21-24
ARC-3	RC-733-D	IR-89/ARN
IR-4/ARR-2	R-57/ARN	R-1/ARR-1
ID-6/APN-4		

RA-52 RECTIFIER

Transat controlled to produce high voltage DC from 110 VAC 60 cycle source. Up to 11,500 VDC @ 50 W. Metered high voltage (0-15 KV) and current (0-20 MA). NEW...\$74.50

MISCELLANEOUS

MINE DETECTOR: SCR-625 for prospecting, mining, etc. NEW...\$59.50
LP-21 LOOPS: Mod. LM, AM, A. Excel. cond.

- NOTE: WE HAVE ONE OF THE LARGEST MOST COMPLETE INVENTORIES OF MILLIARY ELECTRONICS IN THE U. S. CALL OR WRITE TODAY. SEND FOR FREE CATALOGUE.

ARROW SALES, INC.

7460 VARNA AVE. Dept. E.
 N. HOLLYWOOD, CALIF.
 Poplar 5-1810 Stanley 7-6005
 Cable address: ARROWSALES
 (See Arrow Sales Inc. ad Page 478)

*Headquarters for
 Microwave Test Equipment*

THE WIDEST ASSORTMENT, THE STRONGEST DEPTH AND THE MOST IMMEDIATE AVAILABILITY OF ANY SOURCE ON TEST EQUIPMENT.

We are currently producing and delivering the TS-117, TS-125, TS-108, TS-102A, TS-89, TS-268, TAA-16EA and the TSX-4SE. A more complete list follows:

TS-1ARR	TS-62/AP	TS-175/U	TS-323	I-167A	BC-1255/A
TS-3A/AP	TS-63/AP	TS-184/AP	TS-324/U	I-177	BC-1287/A
TS-8A/U	TS-75/APM-3	TS-189/U	TS-328	I-178	BE-67
TS-10A/APN-1	TS-87/AP	TS-192/CPM-4	TS-338	I-196A	LAD
TS-11/AP	TS-89/AP	TS-194/CPM-4	TS-359A/U	I-198A	LAF
*TS-12	TS-96/TPS-1	TS-197/CPM-4	TS-363/U	I-208/A	LAE-2
TS-13	TS-98/AP	TS-198/CPM-4	TS-375	I-212	LM-()
TS-14	TS-100/AP	TS-203/AP	TS-377/U	I-222/A	LU-2
TS-15B/AP	TS-101/AP	TS-204/AP	TS-389/U	I-225	LZ
TS-16/APN	TS-102/AP	TS-205/AP	TS-421/U	I-233	ME-11
TS-18	TS-108/AP	TS-210/MPM	TS-437	IE-21/A	OAA-2
TS-19	TS-110/AP	TS-218/UP	I-56	IF-12/C	OAW
TS-23/AP	TS-111/CP	TS-220/TSM	I-61B	IS-189	SG/8U
TS-24/APM-3	*TS-117/GP	TS-226A	I-83A	AN-PNS-1	TAA-16EA
TS-26/TSM	TS-118/AP	TS-230/B	I-95/A	BC-221(*)	TSS-4SE
TS-27/TSM	*TS-125/AP	TS-233/TPN-2	I-98/A	BC-376	TSX-3SE
TS-32A/TRC-1	TS-127/U	TS-239A	I-106/A	BC-438	TSX-4SE
TS-33/AP	TS-131/AP	TS-251	I-114	BC-439	TTX-10RH
TS-34A	TS-142/PG	TS-263	I-115	BC-906/D	UNP-9HU
TS-34A/AP	TS-143/CPM-1	TS-268	I-122	BC-949/A	TUM-13
TS-35/AP	TS-144/TRC-6	TS-270A/UP	I-122-B	BC-1060/A	
TS-36/AP	TS-146	TS-281/TRC-7	I-126	BC-1066/A	
TS-46/AP	*TS-147/UP	TS-285/GP	I-130A	BC-1201/A	
TS-47/APR	*TS-148/UP	TS-293	I-134B	BC-1203	
TS-18	TS-153	TS-294/U	I-137A	BC-1236/A	
TS-51/PG-4	*TS-155	TS-297/U	I-139A		
TS-55/AP	TS-170/APN-5	TS-301/U	I-145		
TS-60/U	TS-173/UR	TS-303A/G	I-147		
TS-61/AP	TS-174/U	TS-311/F5M-1	I-153A		

(*Of new manufacture.)

Before selling your idle test equipment, please get our offer

Cable: WESLAB

Tel: Boston: WE 5-4500

Weston Laboratories
 Weston 93, Mass.

PULSE TRANSFORMERS

Tube base plug in type

Here are precision made, high quality compact pulse transformers wound on hypersil cores. They are built in octal bakelite tube bases and can be adapted to many uses. They are completely impregnated and sealed.

SUGGESTED USES

- ★ Blocking Oscillator, Multivibrator and Scope Circuits.
- ★ Wherever Accurate Timing and Triggering are necessary.
- ★ Unexcelled in circuit applications for generating low power and low voltage pulses.
- ★ Can be used in circuits utilizing repetition rates from 0 to well over 1 MC and pulse widths ranging from .05 Microsecond up.

PRICE \$4.50 EACH IMMEDIATE DELIVERY

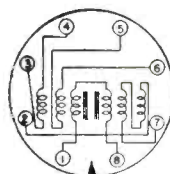

TYPE UX 7350
 1 ACW COIL - 50-T-364
 MAX DC RES OHMS
 1 8 8 • 4.02A
 1 8 7 • 4.542A
 1 8 4 • 2.357A
 1 8 6 • 2.185A

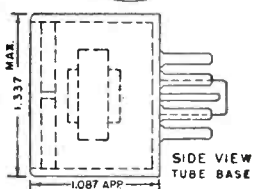
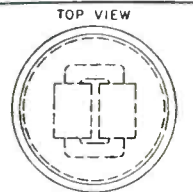

HATRY and YOUNG

The Elect IN ELECTRONICS

811 Boyston St., Boston 16, Mass. CO 7-4700

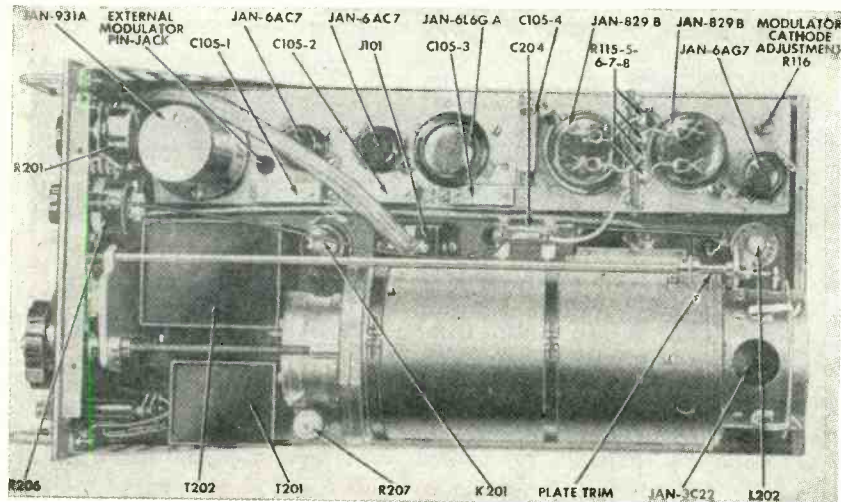

300-1600 MC Noise Modulated Transmitter T-85/APT-5, 40 watts C.W. Complete with 3C22 light house tube operates on 110 volts, 60 cycles supplied, requires external supply 1000 volts 100 milliamps, new in original crate\$300.00

TUNING UNITS FOR APR-4 RECEIVER

These tuning units are incomplete, new, in operating condition but lack the front panel, tuning motor and tuning shaft and side panels.\$100.00

TN 18 300-1000 MC TN 19 1000-2200 MC TN 54 2200-4000 MC

BUTTERFLY TUNERS

110-330 megacycles oscillator butterfly \$25.00
 80-300 megacycles mixer butterfly with socket for 955 (used as diode mixer) \$25.00
 400-800 megacycles oscillator butterfly with 703 tube mounted on it \$30.00

X Band Spectrum Analyzer 8500-9600 MC. Calibrated frequency meter, tuned mixer, 4 i.f. stages. 3 Video stages over-all gain 125 db., reg. Power Supply.
 S Band Spectrum Analyzer 2700-3900 megacycles—Similar to above.

HIGH POWER DUMMY LOADS

DC-2000 MC, 100 watts dissipation, VSWR less than 1.1, no cooling necessary.
 X Band, 1 1/4" x 5/8" guide, choke or plain flange, dissipates 350 watts average power continuously in still air, VSWR less than 1.15 between 7 and 10 KFC, weight 5 1/4 pounds.
 X Band, 1 1/2" x 1" guide, choke flange, dissipates 250 Watts average power continuously in still air, VSWR less than 1.15 between 8.2 x 12.4 KMC, weight 3 1/4 pounds.
 X Band, 1 1/4" x 5/8" guide, plain flange, dissipates 200 watts average power continuously in still air, VSWR less than 1.15 between 7-10 KMC, weight 3 1/4 pounds.
 X Band, 1 1/4" x 3/8" guide, plain flange, dissipates 150 watts average power continuously in still air, weight 2 pounds 4 ounces.
 S Band 1 1/2" x 3" guide dissipates 1000 watts average power in still air, VSWR less

than 1.15 between 2.5 to 3.7 KMC, choke flange, weight 13 pounds.

S Band Mixer, tunable by means of slider; type N connector for the R.F. and local oscillator input, U.H.F. connector for the I.F. output, variable oscillator injection \$30.00

33 MC I.F. STRIP, VIDEO, and AUDIO AMPLIFIER and 110 Volt 60-2600 cps POWER SUPPLY. Bandwidth 10 mc new, part of SPR-2 Receiver. AMPLIFIER STRIP AM-SSA/SPR-2 contains I.F. amplifier, detector, video amplifier, pulse stretcher and audio amplifier and Rectifier Power Unit PP-155A/SPR-2 bandwidth 10 mc, center frequency 30 mc. sensitivity 50 microvolts for 10 milliwatts output. Power supply 80/115 V ac 50-2600 cps 1.3 amps. Send for schematic. \$65.00 less tubes

S Band Signal Generator Cavity With Cut-Off Attenuator, 2300-2950 mc., 2C40 tube, with modulator chassis \$30.00
 High Pass Filter F-29/SPR-2, cuts off at 1000 mc and below; used for receivers above 1000 mc. \$12.00

TS-89 Voltage Divider for measuring high video pulses, ratios 1:10 and 1:100 transmission flat within 2 db 150 c.p.s. to 5 mc., with cable for attaching to syndroscope \$30.00

Variable Waveguide Below Cut-Off Attenuator L 101-A U.H.F. Connectors at each end calibration 30-100 db. \$15.00
 S Band Standard Frequency Cavity, adjustable, with crystal holder and 1N27 crystal \$50.00

S Band Test Load TPS-55P/BT. 50 ohms \$12.00

NIBUR SALES CORP

62-A WHITE ST.

RED BANK, N. J.



RELAYS ... WORLD'S LARGEST STOCK!

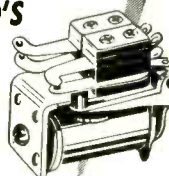

Your requirements of large or small quantities of relays can be quickly supplied from our huge stock.

Wide variety of types, all made by leading manufacturers. Each relay is brand new, inspected and fully guaranteed by Relay Sales.

- ✓STANDARD TELEPHONE RELAYS
- ✓SHORT TELEPHONE RELAYS
- ✓DUAL TELEPHONE RELAYS
- ✓SLOW ACTING RELAYS
- ✓SEALED RELAYS
- ✓ROTARY RELAYS
- ✓MIDGET RELAYS
- ✓KEYING RELAYS
- ✓DIFFERENTIAL RELAYS
- ✓PLATE CURRENT RELAYS
- ✓ANTENNA SWITCHING RELAYS
- ✓"BK" SERIES
- ✓STEPPERS & RATCHET RELAYS
- ✓LATCHING & INTERLOCKING RELAYS
- ✓MECHANICAL ACTION RELAYS
- ✓VOLTAGE REGULATORS
- ✓OVERLOAD & CIRCUIT BREAKERS
- ✓REVERSE CURRENT RELAYS
- ✓AIRCRAFT CONTACTORS
- ✓MOTOR & CONTROL DEVICES
- ✓TIMERS
- ✓SOLENOIDS
- ✓RELAY ASSEMBLIES



New
RELAY SALES CATALOG NOW READY

WRITE FOR YOUR COPY TODAY



833 W. CHICAGO AVE.
 DEPT. 4, CHICAGO 22, ILL.

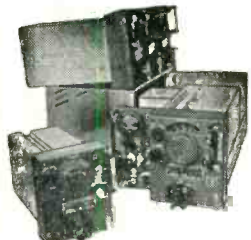

AN/APR-4 LABORATORY RECEIVERS

Complete with all five Tuning Units, covering the range 38 to 4,000 Mc.; wideband discone and other antennas, wavetraps, mobile accessories, 100 page technical manual, etc. Versatile, accurate, compact—the aristocrat of lab receivers in this range. Write for data sheet and quotations.

We have a large variety of other hard-to-get equipment, including microwave, aircraft, communications, radar; and laboratory electronics of all kinds. Quality standards maintained. Get our quotations!

We will buy any Electronic Material at top prices. SCHOOLS—unload your dusty surplus for cash or credit.

ENGINEERING ASSOCIATES

434 PATTERSON ROAD

DAYTON 9, OHIO

WAREHOUSE CLEARANCE TUBE SALE

NEW, STANDARD MANUFACTURERS, IMMEDIATE DELIVERY

OB3/VR90	\$1.20	5JP2	\$19.50	464A	\$ 9.50	8020	\$ 2.50
OC3/VR105	1.20	5T4	1.50	531	14.50	9001	1.75
OD3/VR150	.85	6AC7	.95	532A/1B32	3.95	9002	1.50
1A3	.85	6AG7	1.20	705A	3.75	9003	1.75
1A5GT	.78	6AJ5	2.25	706AB	22.50	9004	1.75
1B22	3.75	6B6G	2.10	706AY-GY	32.50	9006	.75
1B24	14.95	6B6G	.75	707A	14.50	CE22/918	1.50
1B27	17.50	6C6	.79	721A	2.45	CK5011X	1.50
1B32/532A	3.95	6C8G	.79	723AB	22.50	CK1089	1.50
1N21	1.25	6H6	.69	724A	2.95	EL5B/4B22	9.75
1N22	1.25	6K7	.74	724B	5.95	ELC5B	9.75
1N23	1.50	6SA7	.97	726A	14.95	ELC6A	7.50
1N27	2.95	6SC7	.79	750TL	79.50	EL6CF	8.95
1P23/CE-1	3.50	6SH7GT	.79	801	.85	EL302.5/3B21	4.50
1R4/1294	.85	6SH7	.79	803	5.95	FG27A	\$ 8.95
1T4	.59	7C4/1203A	.75	804	10.50	FG-90	6.50
2A3	.95	7E5/1201	.95	805	4.95	GL-316A	3.40
2AP1	8.95	7E6	.55	807	1.79	GL-434A	22.50
2B22	4.25	10Y	1.50	E10	10.95	GL446A	2.50
2C33/RX233A	3.45	12A6	.85	E11	2.85	GL605	49.95
2C40	17.50	12C8	.89	E14	8.95	ML-531	14.40
2E22	3.49	12H6	.69	E14	3.40	QK-59	85.00
2J21	9.95	12J5GT	.57	E16	1.45	QK-60	85.00
2J21A	12.95	12SF7	.75	E26	1.39	QK-61	85.00
2J22	14.95	12SJ7GT	.65	E30B	2.95	QK-72	85.00
2J27	22.50	14H7	.97	E32A	3.69	RK-25	26.50
2J34	38.45	14J7	1.10	E32A	9.50	RK-65	26.50
2J50	69.50	15R	1.00	E32A	1.95	RK-72/CRP72	1.95
2J55	95.00	23D4	.65	E36	4.50	RX21	3.85
2X2	.89	30	.48	E38	3.50	RX233A/2C33	3.45
2X2A	2.15	45	.35	E38W	6.50	VR-90	1.20
3A4	.85	53A	3.95	E45	3.95	VR-105	.85
3B7/1291	.62	71A	.69	E45W	6.95	VR-150	2.95
3B24	5.50	76	.58	E66A	1.25	VT-127A	2.95
3C23	10.50	77	.65	E72A	3.65	WL-417A	22.50
3C24/24G	1.95	78	.80	E84	1.79	WL-653B	75.00
3DP1	3.95	100TH	10.50	902P1	7.50	ZP-653	65.00
3D6/1299	.62	112A	.49	957	.45		
3EP1	4.95	211	1.25	958	.60		
3FP7	4.50	227A	4.50	959	1.50		
3GP1	4.75	274B	2.95	991/NE16	.25		
3JP12	14.50	304TH	13.95	1616	2.95		
4B22/EL5B	9.75	304TL	19.50	1619	.89		
4B25/EL6CF	8.95	350A	6.95	1621	1.95		
4J36	175.00	359A	2.50	1625	2.00		
4J37	175.00	371B	2.95	1629	2.00		
5BP1	5.95	388A	2.95	1655/6SC7	.97		
5D21	23.95	394A	4.25	1846	115.00		
5FP7	2.50	450TH	44.50	2051	.95		
5JP1	23.50	450TL	44.50	8005	5.85		

SPECIAL PURCHASE SALE!

1 mfd @ 15,000
OIL CONDENSER
REG. \$195

\$38.75

Type 14F63. Originally p/o RA-38 rectifier. Size 16x12x4" Brand NEW! ORIGINAL CARTONS!
Order No. RE-370 \$38.75



THIRTEEN "HOT" RADIO SHACK SPECIALS!

Amertran Transtat 103-126/1/60 to 115/1/60 @ 2.17a (BN)	\$ 9.95
BC-221 Frequency Meter (LN)	89.50
Delco Dual Blower 120 CFM 115/1/60 (BN)	14.85
Eilnco B-68 Tach. Gen. 120 V AC 60 cy. (BN)	27.50
Haydon #1600 115/1/60; 1/3 or 1/2 rpm (BN)	1.95
Heineman Circuit Breaker #AM1515 115 V AC, 5P, 10a (BN)	2.95
Heineman Circuit Breaker #0322 220 V AC, 2P, 8-25a (BN)	3.95
HS-33 Headphone, 5' cord w/PL55, HB-7 headband (BN)	4.95
Sola 30864 Constant V Reg. 190-260 V; 115/1/60 @ 1.7a (BN)	19.95
TS-11 Handset; same as H-23/U but w/PL-106 plug (BN)	6.95
TS-51/4PG-4 Tachometer Speed Indicator (BN)	95.00
TS-100AP Test Scope (BN)	295.00
Westinghouse FL Blower 115/1/400; 17CFM (BN)	6.95

(BN) Brand New. (LN) Like New

RADIO SHACK CORPORATION

167 Washington St., Boston 8, Mass.

WRITE TODAY FOR FREE 8-PAGE FLYER. HUGE LISTING OF OFF-PRICE VALUES!

SAVE ON

TUBES

BRAND NEW

TUBES

GUARANTEED

TUBES

OA2	\$1.00	2J22	6.95	4J26	129.50	450TH	35.00	809	2.95	1629	.39
OA3/VR75	1.10	2J26	14.95	4J27	129.50	451	3.95	810	10.95	1630	.95
OB2	.95	2J27	14.95	4J28	129.50	464A	10.95	811	3.50	1631	1.50
OB3/VR90	1.00	2J31	39.50	4J29	149.50	469	13.95	812	2.75	1632	.69
OC3/VR105	1.00	2J32	49.50	4J30	28.50	479	2.25	813	11.95	1635	1.50
OD3/VR150	1.00	2J33	39.50	4J31	99.50	520	12.95	814	2.95	1636	2.75
1A3	1.00	2J34	39.50	4J32	129.50	530	16.95	815	2.90	1644	3.95
1B22	2.25	2J36	110.00	4J41	129.50	531	5.75	826	1.95	1787	Write
1B23	8.95	2J37	110.00	4J42	Write	532	2.95	828	9.95	2050	1.40
1B24	16.50	2J40	27.50	4J50	200.00	536	2.95	829	9.95	2051	1.40
1B26	2.35	2J48	27.50	4X500A	100.00	537	Write	829B	2.75	5514	Write
1B27	17.50	2K23	49.50	5A1	7.50	538	1.49	830R	11.95	5523	Write
1B32	3.10	2K25	85.00	5B1	4.95	539	3.75	832A	8.95	1560/FG95	22.50
1B37	14.95	2K26	149.50	5B2	4.95	587	Write	833A	34.95	5886	249.50
1B40	4.95	2K27	39.50	5B3	4.50	605CX	Write	836	3.45	5611	115.00
1B41	47.50	2K28	39.50	5B4	4.50		Write	837	1.45	5635	8.95
1B42	17.50	2K29	49.50	5B5	4.50	12HP7	13.50	841	.45	5637	Write
1B47	12.50	2K32	49.50	5B6	4.50	15E	1.25	842	.45	5638	8.95
1N21B	2.75	2K35	29.50	5B7	4.50	15R	6.9	843	2.90	5645	8.95
1N21C	14.95	2K38	32.00	5B8	4.50	FG-17/5557	Write	844	16.50	5646	8.95
1N22	1.25	2K39	32.00	5B9	4.50	T-20	1.95	845	16.50	5651	2.95
1N23	1.25	2K43	Write	5B10	4.50	2G-21	4.95	846	16.50	5654	3.95
1N23A	2.25	2K44	110.00	5B11	4.95	2G-24	1.50	847	16.50	5670	4.30
1N23B	3.50	2K45	110.00	5B12	4.95	2G-27A	4.95	848	4.50	5672	2.00
1N26	7.50	2K48	Write	5B13	19.95	FG-27A	4.95	849	2.75	5685	3.95
1N28	Write	2K54	Write	5B14	19.95			850A	4.95	5686	2.25
1N34	1.50	2K55	Write	5B15	19.95			850B	1.50	5687	4.25
1N38	1.50	2X2	.59	5B16	19.95			850C	29.50	5694	2.60
1N40	8.50	3A5	.85	5B17	19.95			850D	29.50	5702	6.50
1N47	4.50	3A5	.85	5B18	29.50			850E	29.50	5704	4.50
1N54	.89	3AP1	8.95	5B19	11.95	FG-32	12.95	850F	29.50	5718	Write
1N55	2.75	3B7/1291	8.95	5B20	11.95	45 Spec.	3.32	850G	29.50	5726	2.25
1N56	1.25	3B25	4.95	5B21	39.50	RK47	4.95	850H	17.50	5726	5.95
1N58A	1.25	3B24	4.95	5B22	1.98	FG-57	13.95	850I	17.50	5749	3.95
1N60	.60	3B24W	7.50	5B23	12.50	RK60/1643	2.25	850J	3.95	5751	3.25
1N63	2.35	3B26	3.50	5B24	2.75	HY69	4.50	850K	8.95	5754	1.50
1N64	.80	3B28	6.50	5B25	1.95	CRP-72	.75	850L	6.50	5783	6.00
1T5GT	1.95	3BP1	80.00	5B26	1.10	CRP-73	.75	850M	6.25	5784	5.50
1Z2	9.50	3C23	9.95	5B27	2.00	CRP-75	.75	850N	8.95	5787	6.00
	.89	3C24/24G	1.50	5B28	3.65	RRK-73	.75	850O	22.75	583D	3.25
	.29	3C27	2.75	5B29	2.75	75T	6.95	850P	.98	583E	Write
	.39	3C31	3.15	5B30	2.25	75T	6.95	850Q	24.50	583F	5.50
	25.00	3C33	9.95	5B31	2.30	FG-95/5560	22.50	850R	12.95	583G	3.95
	29.95	3C35	16.95	5B32	Write	FG-95/5560	22.50	850S	19.95	583H	1.95
	9.95	3D6	.59	5B33	Write	FG-95/5560	22.50	850T	10.95	583I	3.95
	19.95	3DP1	13.95	5B34	4.50	100-L	Write	850U	8.50	583J	4.95
	1.13	3FP7	1.95	5B35	1.10	100H	1.10	850V	8.50	583K	Write
	4.95	4B24	6.95	5B36	3.50	100H	1.10	850W	8.50	583L	4.95
	2.49	3GP1	3.95	5B37	2.00	FG-105	19.00	850X	3.95	583M	1.25
	1.95	465A	17.50	5B38	1.19	VU-111	2.00	850Y	3.95	583N	4.95
	4.45	4125	25.00	5B39	6.95	VF-100	Write	850Z	3.95	583O	1.95
	4.50	4E27/CV92	17.50	5B40	6.95	VF-100	Write	850A	3.95	583P	1.50
	2.95	4E28	25.00	5B41	4.95	VF-110	Write	850B	3.95	583Q	.69
	7.50	4J22	129.50	5B42	4.95	VF-120	Write	850C	3.95	583R	1.50
	1.10	4E27	14.95	5B43	4.95	VF-127A	Write	850D	3.95	583S	.69
	1.10	4J21	129.50	5B44	4.95	FG-172	25.50	850E	10.95	583T	1.50
	7.95	4J23	129.50	5B45	4.95	HF200	14.50	850F	19.95	583U	1.50
				5B46	16.95	201A	98.00</				

QUARTZ CRYSTALS

NEW LISTING

Made from the finest Brazilian Quartz. Will provide a high degree of activity and frequency stability. All tested and marked by the manufacturer to a very close tolerance. In the frequencies outlined below the crystals itemized under the heading "From & To" are mostly in progressive frequencies between the limits shown (as for example: "From 3300 to 3377," are as follows: 3300KC, 3301KC, 3302KC—, 3377KC.) are of limited quantities in each frequency. Those listed singly are in quantities of 50 or more.

FT243
Prong centers 1/2", Prong dia. 3/32"
Price \$1.15 ea. (25 for \$25.00)

FROM	TO	FROM	TO	FROM	TO
1915	1995	6100	6173.3	7906	7968
2030	2065	6225		8000	
2125	2155	6250		8025	
2300		6275		8050	
2320	2390	6300	6292	8100	8175
2420	2450	6400	6498	8206	8275
2604		6500		8300	8375
2605		6500		8385	
3195		6506.6	6675	8400	8475
3652		6700	6775	8500	8575
3729		6800	6875	8600	8650
3905		6815		8786.25	
4100		6830		8808.75	
4104	4150	6900	6975	8876.25	
4244	4290	6978.75		8921.25	
4305	4397	7228	7281	9151.0	
4400	4480	7325	7375	9342	9399
4690	4690	7458.75		9405	9499
4800	4898	7440	7475	9500	
4913	4941	7500	7597	9516	9589
5190	5195	7606	7673.3	9609	9638
5300		7625		10043	
5320	5397.5	7650		12698	
5500		7675		12700	
5630		7700		12783	
5633.3		7725		12800	
5655.5		7728.8		12998	
5677.7		7750		13004	
5700		7751.25		13100	
5706.6		7773.75		13199	
5722.2	5775	7775	7790	13213	
5744.4		7800		13302	
5800	5892	7825		13361	
5900	5975	7850		13496	
5955		7875		13554	
6000		7900		13837	
6000.6	6075	7925		13903	
6150		7950		14038	
6175		7925		14110	

CR 1A/AR or FT241
Prong spacing 1/2", Prong dia. 1/8"
Price 79¢ ea. 12 for \$9.00

FROM (Frequencies In KC)	TO	FROM (Frequencies In KC)	TO
2853		7620	
3988		7625	
4188		7650	
4285		7738	
4300	4374	7740	
4788		7750	
5020	5090	7760	
5100		7770	
5120	5180	7775	
5200	5295	7780	
5250		7790	
5300	5396	7800	
5410		7810	
5470		7825	
5500		7830	
5468	5780	7850	7880
6470		7851	
5810		7900	
5891		7910	
5910		7925	
5923	5960	7930	
6011	6011	7940	
6130	6195	7950	
6203	6275	7970	
6270		7975	
6300	6375	7990	
6370		8002	
6400	6499	8007	8010
6490		8012	
6500	6590	8022	
6600	6685	8082	
6744		8298	
6815	6877	8308	
6905	6980	8300	8370
7270		8407	
7300		8412	
7460		8405	8490
7500		8506	8561
7540		8645	
7542.6		8630	8650
7560		8985	
7600		11677	

XL5 Dual
3 prongs 1/2" x 1 19/32" prong dia.

Price \$1.95 ea.

2520 & 2698
2731 & 2891
2436 & 2276
3128 & 3153
2605 & 3153

XL5 Single
3 prongs 1/2" x 1 19/32" prong dia.

Price \$1.35 ea.

FROM	TO
2200	2210
2300	2384
2410	2450
2561	2600
2600	2698
2787	2802
2802	2891
2916	2916
3117	3171
3154	3154
3325	7640
7650	7650
3435	3371
3857	

FT241A

SPECIAL TYPE WE.
Prong spacing 1" CTS.
Prong Size 3/32" dia.

These are in successive steps of .1 MC variation from 20.0 MC to 27.9 MC
Suitable for low frequency purposes (1/54 of Stated Value)

Price \$1.15 ea.

UNASSEMBLED CRYSTALS
consists of quartz crystal plates made for FT243 holders. Furnished complete with holders, electrodes, springs and all hardware.

Price .29 ea.

Crystal plates available in the following frequencies:—

7533	7750	7873	8475
7541	7775	7950	8750
7550	7775	8275	
7640	7800	8325	
7650	7825	8450	
7700	7850		

154 Greenwich Street,
New York, N. Y.
Telephone DIgby 9-3143

EDLIE ELECTRONICS, Inc.

AVIATION ELECTRONIC EQUIPMENT

New or used, all equipment tested and guaranteed ready for installation in aircraft. Equipment, if used, completely reconditioned.

"Specializing in Installations of the Highest Quality"

Transmitters	Receivers	Dynamotors
ART-13	BC-348	DY-17
BC-640	AKB	DY-21
T67/ARC-3	R77/ARC-3	DY-9
TA2J	BC-342	PE-94
Transceivers	Mounts	Control Boxes
ARC-1	MT/230	C45/ARC-1
SCR-522	FT-488	C87/ART-13
RTA1B	FT-498	BC-602B

Inquiries given prompt attention—Early deliveries

SPECIALS!!

2500—MC215 Tuning Shafts, Used Good	25¢ ea.
Large Quantity 274N and ARC-5 Mounts, Used	50¢ ea.
300—DM32 Dynamotors—Some New—All Good	1.95 ea.
350—SA1A Altitude Limit Switch, Used	1.00 ea.
120—C115/ARC1 Control Boxes, New	6.00 ea.

JAMES S. SPIVEY COMPANY

1406 G. ST. N.W. - Tel. STerling 2215 - WASHINGTON, D. C.

"Buyers of Surplus Aviation Electronic Materials"

Triplet Meters All Brand New In Boxes

Model	Description	Price
341	0-500 ma. RF 3" rd.	\$6.50
337A	0-1 amp. A.C. 3" sq.	5.50
232	0-10 volts A.C. 2" rd.	6.50
334	0-15 volts A.C. 3" rd.	6.50
221	400 micro amp. volt-ohm scale 3" rd.	5.00
327A	0-1 ma. D.C. 0-100 bad-good scale 3" sq.	6.50
321T	1-0-1 ma. D.C. zero center scale 3" rd.	8.50
327A	0-60 micro amp. D.C. 0-1000 ohm scale 3" sq.	6.50
327A	0-400 micro amp. D.C. 0-25-50-100 A.C.V. scale 3" sq.	6.50
671	0-5 ma. A.C. 0-5-10-25 A.C. ma. scale 3" sq.	6.50
327A	0-35 ma. D.C. 3" sq.	6.50
327A	6.5 ma. (300 M.V.) 0-5-10-25 D.C. amp. scale 3" sq.	6.50
327A	0-1 ma. 0-10 volts D.C. good-bad scale 3" sq.	6.50
327A	150-0-150 volts D.C. 125 ohms/volt 3" sq.	6.50
327A	0-1 ma. D.C. 0-25-50-100 D.C. volt scale 3" sq.	6.50
242T	0-1 ma. D.C. 0-100 scale 2" rd.	4.50
221	0-8 ma. D.C. 0-100 scale 2" rd.	4.50
242T	1.2 ma. D.C. 0-100 scale 2" rd.	4.50
421A	20 ma. D.C. (50 MV.) 0-1 scale 4" sq.	5.00
431	0-300-500 A.C. volts 4" sq.	5.00
1200	Dual 3" meter—50 MV. D.C. 0-100 D.C. amps. and suppressed 3 to 9 volts D.C.	6.50

Our warehouses contain large quantities of Aircraft Instruments, Dynapacitors, Switches, Relays, Hys, Potentiometers, etc.

SEND FOR A FREE CATALOG
OR CALL ARMORY 4-581

Electro Device
INCORPORATED
247 BROADWAY PATERSON, N.J.

WIRE-CABLE TUBES PARTS

CORDAGE

CO-122 3 conductor each #22 AWG neoprene jacket 550' lengths
CO-127 single #14 AWG braided and tinned copper braid shield

MULTI-CONDUCTOR

2 conductor AWG 12 7 conductor AWG 16
7 conductor AWG 14 19 conductor AWG 16
14 conductor AWG 16 6 conductor AWG 20
11 conductor shielded 10 conductor AWG 16
AWG 70 22 conductor AWG 16
2 conductor AWG 18
2 conductor shielded AWG 10

AMOUR

DR1A-23 DHFA-100 FRIA-4

SINGLE CONDUCTOR AWG 10

shielded cable with terminal lug each end 100' and 150' lengths

WIRE

AWG 18 copperweld
AWG 29 tinned copper
Resistance wire AWG 32
AWG 22 with nylon core plastic insulation

OIL FILLED CONDENSERS

MFD	VDC	Each	Ten	MFD	VDC	Each	Ten
1	600	.85	.80	5	2000	2.00	1.90
2	600	.95	.95	.25	3000	2.85	2.80
4	600	1.40	1.40	.5	3000	2.95	2.90
5	600	1.65	1.60	.2	5000	4.50	4.25
1-8	600	2.50	2.35	.1	7500	3.95	3.95
.01	1000	.85	.80	1	12000	7.95	7.95
.5	1000	.95	.90	.1	7500	12.50	12.00
2	1000	1.65	1.60	.0008	15000	12.50	11.75
1	1200	1.65	1.60	.2	15000	14.95	14.80
1	1500	1.75	1.65	.045	16000	12.95	12.50

SPECIALS

80-86 Crystal in Holder \$2.50
Balloon with Hydrogen Generator \$2.50
300 Feet Aerial Wire \$2.00

SWITCHES—BATHTUB—OIL FILLED—MICA CONDENSERS—POTENTIOMETERS. SEND FOR CATALOG

COMET ELECTRONIC SALES CO.

22 Washington St.

Tel. BEacon 2-7863

Brighton 35, Mass.

TERMS: Minimum order \$5.00 — Mail orders promptly filled—All prices F.O.B. Boston, Mass. Send M.O. or check. Shipping charges sent C.O.D. 25% deposit required with all C.O.D. orders.

MICROWAVE TEST EQUIPMENT

10 CM echo box CABV 14ABA-1 of OBU-3, frequency range 2890 MC — 3170 MCS. Direct reading micrometer head. Ring prediction scale plus 9% to minus 9%. Type "N" input. Resonance indicator meter. With accessories, spares and 10 CM directional coupler. Brand New.

TUBES

2C34	5.45	803	3.60	CEQ 72	.85
2X2/879	.55	826	.65	CK 70	4.15
3B2A	4.95	864	.25	CRP 72	.85
3C24	1.60	931A	4.45	E 1148	.30
7C4 1203A	.70	955	.30	HY 615	.20
19Y	.35	957	.35	RKR 72	.85
15R	.65	CK 1005	.45	RK 73	.45
30 Spec.	.40	CK 1007	.90	5BP4	4.25
39/44	.25	1626	.35	5FP7	1.75
45 Spec.	.35	1629	.25	1J6 G	.70
WE 203A	6.75	2051	1.10	1B3 GT	.80
316A	.60	7193	.50	3A4	.60
WL 531	4.95	8011	1.50	SU4G	.60
713A	.90	8008	.30	6K6GT	.57
801A	.25	C5	8.00		

HI VOLTAGE FILTER CHOKES

4 HY 4.5 Amp DC 3 ohms 1230 RMS to ground. New.
1 HY 3.2 Amp DC 3.5 ohm GE69G459. New.
1.7-3 HY 2 AMP DC 34,000 VDC GE Y346A. New.

NAVY ENTERING TYPE INSULATOR

Porcelain flanged bowl with brass rod, fittings and aluminum shield. Dimensions 4 3/8" high, 6-5/16" OD at base. Brand new \$4.50.

10 CM ROTATING ANTENNA

24" Parabola in turret 360° span at 12 RPM DC, motor control and reversing switch New.

FOR THE EXACTING . . . THE PRECISE!

. . . the discriminating . . . For men who measure the invisible, listen to silence; who mark on paper—on glass—the passage of stars and atoms, who tap and cut and feel and clutch—at the very heart of nature; for men who count—on whom we count—these test instruments are humbly offered:

106-M IH. Indicator
616A UHF. Signal Generator
300A Harmonic Wave Analyzer (Hewlett-Packard)
B-41451 Shield SC# P/OTS-34/APS
I-82-F Indicator, P/O SCR-269F
EE-65-F Test Set
188X Signal Generator (Hickok)
A-27 Antenna Phantom P/O SCR-506
BC-1016 Recorder
BC-1255-A Delco Het. Monitor
BC-906-D Frequency Meter
CW-60-ABM Wavemeter
CZH-50152 Audio Amplifier
EE-65-E Test Set
EE-85 Time Interval Apparatus
EE-99-T3 Telephone Repeater Equipment

Type 1 Officers' Intercept Kit
Type 7 Oscilloscope
TVFM Electronic Sweep Generator
TS-16/APN Test Set
TG-10-B Automatic Keyer Vidio Sweep Oscillator
US-253 G.E. Square Wave Generator
155 R.C.A. Scopes
620A G.R. Test Set
720A G.R. Het. Freq. Meter
BC-221-J Frequency Meter (Mercury)
E-400 Sweep Signal Generator (Precision)
I-56-E Test Set, Weston Model 714, Type 4
I-95-A Field Strength Meter
I-102-A Indicator
I-135-E Galvin Test Set
I-198-A Signal Generator

(Details and Prices on application)

I-222A Signal Generator
ID-6A/APN-4 Oscilloscope Indicator
ME-21A Maintenance Equipment
OAN (Fada) Test Oscillator
PRC Analyzer Test Set Recorder, by Leeds & Northrup
S-6 Browning Lab. Freq. Meter
SR-90A Het. Freq. Meter
TS-59/APN-1 Test Set
TS-323UR Freq. Meter
TG-10 Keyer
VM-27 Vac. Tube Voltmeter, (Barber)
19X Hickok Microvolt Generator
546B G.R. Microvolter
715 RCA Scope Console
726A G.R. Vac. Tube Voltmeter
BC-221J Freq. Meter (Howard)

WANTED

RADCOM pays top prices for surplus equipment, parts & tubes. Always needed:—TCS-7 and up; SCR-274-N; SCR-399 Equipment; SCR-508 Equipment; BC-312, 342 and 348 Receivers; SCR-522 Equipment; SCR-211 Frequency meters and RA-34 Rectifiers.

RADCOM

ENG.
CO.

8 LIVINGSTON ST., NEWARK 3, N. J.
Blgelow 2-6666 Telegraph: WUX Newark, N. J.

PREMIER

Special Purpose and Transmitting TUBES

3E29	12.95	8090	2.95
5BP1	3.95	813	7.75
5BP4	3.95	911	.59
5CP1	3.95	6C91	21.95
7BP7	5.95	3DP1	3.95
872	2.75	807	1.55
9006	.25	304TL	9.95
826	.60	2E22	2.95
10BP4	10.95	2J31	25.00
12LP4	12.95	2J32	25.00
100TH	6.95	2J33	25.00
250TH	19.95	2J34	25.00
250TL	16.95	17BP4A	16.95
450TH	37.50	20CP4A	19.95
450TL	62.00		

866 A, Standard gas rectifier... \$1.49
 866 A, Special noise-free vacuum type
 —6000V @ 800 MA... \$1.75

DIRECTLY INTERCHANGEABLE,
 IMPROVED PERFORMANCE

SPECIAL TUBE BUYS!

1B3GT	.57	654	.41
1L4	.50	6S8GT	.63
1R5	.48	6SD7GT	.77
1S5	.39	6SL7GT	.53
1T4	.49	6SN7GT	.47
1U4	.48	6T8	.70
1U5	.39	6V6GT	.40
3A4	.54	6W4GT	.40
3Q4	.54	6X4	.29
3S4	.51	12A7	.32
3V4	.52	12A7	.61
5U4G	.36	12AU6	.37
5Y3GT	.25	12AU7	.47
6AG5	.46	12AV7	.47
6AK5	.86	12AX4GT	.54
6AL5	.36	12AX7	.53
6AO5	.41	12BA6	.38
6AU6	.32	12BE6	.40
6AV6	.37	12SN7GT	.47
6AX4GT	.54	19T8	.70
6BA6	.38	25B06GT	.77
6BC5	.46	25L6GT	.43
6BD6	.41	35B5	.41
6BE6	.40	35C5	.41
6BG6G	1.21	35L6GT	.45
6BH6	.50	35W4	.26
6BJ6	.41	35Z5GT	.31
6BQ6GT	.77	50B5	.41
6C4	.32	50C5	.41
6CB6	.46	50L6GT	.43
6CD6G	1.58	117Z3	.34

Critical tubes are always on hand
 and at the right prices
 ... in quantity

We Will Be Pleased to Quote Special Prices
 for Large Quantity Purchases.

OVER 1,000,000 TUBES IN STOCK

Since 1926 Prime Source for TUBES

Receiving Special Purpose and Picture Tubes

PARTS All Types - All Brands - Special Lots

Manufacturers Exporters Jobbers and

We invite your inquiries on electronic components of all descriptions!

Write - Wire - Phone TODAY!

PREMIER

Radio Tube Division

CONTINENTAL CORPORATION

547 W. Randolph St. Chicago 6, Ill.
 ANdover 3-1590



FOREIGN BUYERS AND AIRLINES

Check Our Complete Stock—
 Prompt Replies to All Inquiries.

NOW AVAILABLE!

SCR-718C
 AS-27-A/ARN-5
 RA-20 Power Supplies
 RA-51 RECT. Radio Compass, 12V Installation
 R-89-B/ARN-5
 HI ALTITUDE SWITCH P/O DY-17
 Circuit Breakers P/O DY-17
 MG-149F Inverters
 IE-17 Test Sets for SCR-536
 SA-22/ART-13
 TS-251 Loran Test Set, complete
 1D-6B/APN-4

TEST EQUIPMENT

A-58	I-210	Esey 105	TS-56
APA-6	I-224	Tube Tester	TS-67
APA-11	I-130	Aircraft	TS-69
AN/UPM-1	I-203	Thermometer	TS-143
APA-23	I-106	Tester	TS-178
BC-1016	I-155		TS-226
BC-1236	LM	TS-3	TS-323
Microvoluter	LS-1	TS-10	TS-418
BC-381-TT	GB-583A	TS-11	TN-1
BC-906	output	TS-12	2, 3
BC-221	meter	TS-13	TN-16
BC-438	Ferris 20A-L	TS-16	TN-17
I-95	Microvoluter	TS-19	TN-18
I-83	Lavoie	TS-45	TN-19
I-148	105SM	TS-51	TN-54

NAVIGATION EQUIPMENT

AN/APN-4
 AN/APN-9
 SCR-718-A, B, C
 AN/ARN-7
 ILS System (ARN-5, RC-103)
 AN/APN-1
 SCR-269

RACKS

MT-14A/APN-1
 MT-283/ART-13
 MT-284/ART-13
 MT-163/ART-13
 MT-164/ART-13
 MT-161/ART-13
 FT-446/APN-4
 FT-447/APN-4

TRAINING EQUIPMENT

0-6/APN-T1
 IE-52 LORAN

RADAR EQUIPMENT

APS-2
 APS-4
 APS-6 (Parts)
 APS-15
 APG-13A
 AN/APN-2
 SCR-729
 SCR-717 and Spares
 AN/APS-13
 ABK

JAMMING EQUIPT.

APT-1
 APQ-2
 APT-4
 SCR-596

EXPORT INQUIRIES INVITED

We carry an unusually large stock of Airline Equipment, Test Equipment, Radar Sets, etc. Write for our low prices and complete information. We furnish immediate answers to all inquiries. Write today!

RECEIVERS

APR-1 BC-314
 APR-4 BC-348
 APR-5 RA-10
 ARR-5 MN-26
 BC-312 BC-342

MG SETS

MG-153 PE-218
 MG-153F PE-115
 MG SET CONVERTED
 DC to AC, 230 V. AC
 input 7.5A 110 V. AC,
 6A, 60-cycle output

25 KW DIESEL PLANT

3-phase, 110 v., 60 cps with spares

COMMUNICATIONS EQUIPMENT

ARC-1	34 Meg. FM	BC-721A
ARC-3	Set 6 V.	Handle
ARC-4	25 Watt FM	Talkie
ARC-5	SET 30-40	CU-32/APN
SCR-274N	Megs. 6V.	ART-13 LFO
SCR-522 AM	BC-640	Relay K-104
ID-5B/APN-4	BC-610	ART-13
T-47/ART-13	AN/TRC	Keying
or	O-16/ART-13	Relay K-102
T-47A/ART-13	CU-25/ART-13	IS-21 Vacuum
TCS	SA-22/ART-13	Switch for
GO-9	RTA-1B	ART-13
SCR-509	TAJ2-24	DY-17 Hi-
BC-684FM	TBS-4,5	Altitude
BC-924FM		Switch

V & H ELECTRONIC INDUSTRIES INC.

2033 West Venice Blvd.—Dept. E-17
 Los Angeles 6, California
 Phone: RPublic 3-1127

R.G.A. Model MI-8167 TRANSMITTERS

Point-to-point communications

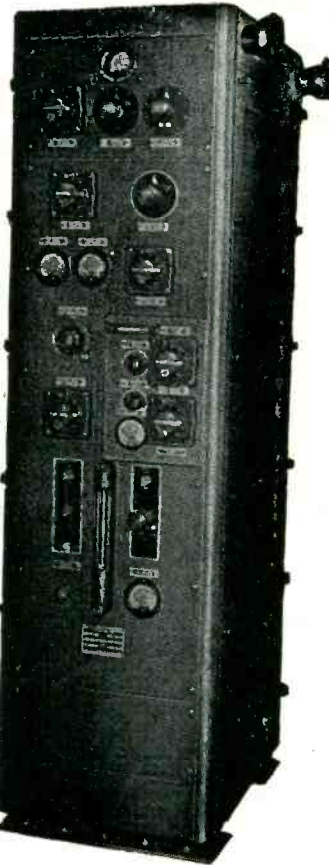

Freq. Range: 2000 to 20,000 Kcs.
 Output: 350 Watts C.W. 250 Watts Radio
 telephone
 Input: 190 to 250 Volts AC 50/60 cps.
 Size: 60" high, 17" wide, 27" deep.
 Tubes: 807s, 813s, 805s, 866s.
 Crystal Oscillator unit built-in, fully shielded
 and stable. All self contained including an-
 tenna network. Master Oscillator unit (avail-
 able) fits in place of Xtal unit. Speech ampli-
 fier is only external unit and has 110/220 v.
 AC input, four stagus, high gain. Total net
 weight, 625 lbs.

Complete! New! From Stock! Quantities!
 Prices on Request.

COMMUNICATION DEVICES CO.
 INCORPORATED
 2331 Twelfth Ave. N. Y. 27, N. Y.

CARRIER EQUIPMENT

Western Electric CF-1A 4-channel carrier telephone
 terminals.
 EE-101-A 2-channel 1000/20 cycle carrier ringers.
 CFD-B 4-channel carrier pilot regulated telephone
 terminals complete with four channels 1000/20
 cycle ringing.
 CFD-B 4-channel pilot regulated telephone re-
 peaters.
 C-42-A V. F. telegraph in from 2- to 12-channel
 terminals.
 FMC 1 or 2 channels carrier telephone terminals,
 automatic regulation, duplex signaling each
 channel. Carrier frequencies above 35 KC. Ideal
 for adding channels above type "C".
 Complete engineering and installation services
 offered.

RAILWAY COMMUNICATIONS, INC.
 Raytown, Missouri
 Telephone: FLOring 2121

"Opportunity" Advertising:
 Think
 "SEARCHLIGHT"
 First

WAREHOUSE CLEARANCE TUBE SALE

NEW, STANDARD MANUFACTURERS, IMMEDIATE DELIVERY

OB3/VR90	\$1.20	5JP2	\$19.50	464A	\$ 9.50	8020	\$ 2.50
OC3/VR105	1.20	5T4	1.50	531	14.50	9001	1.75
OD3/VR150	.85	6AC7	.95	532A/1B32	3.95	9002	1.50
1A3	.85	6AG7	1.20	705A	3.75	9003	1.75
1A5GT	.78	6AJ6	2.25	706AB	22.50	9004	1.75
1B22	3.75	6AJ6	2.10	706AY-GY	32.50	9006	.75
1B24	14.95	6B6G	.75	707A	14.50	CE22/918	1.50
1B27	17.50	6C6	.79	721A	2.45	CK501LX	1.50
1B32/532A	3.95	6C8G	.69	723AB	22.50	CK1089	1.50
1N21	1.25	6H6	.79	724A	2.95	EL5B/4B22	9.75
1N22	1.25	6K7	.75	724B	5.95	ELC5B	9.75
1N23	1.50	6SA7	.74	726A	14.95	ELC6A	7.50
1N27	2.95	6SC7	.97	750TL	79.50	EL6CF	8.95
1P23/CE-1	3.50	6SH7GT	.79	801	.85	EL302.5/3B21	4.50
1R4/1294	.85	6SH7	.75	803	5.95	FG27A	\$ 8.95
1T4	.59	7C4/1203A	.95	804	10.50	FG-90	6.50
2A3	.95	7E5/1201	.95	805	4.95	GL-316A	3.40
2AP1	8.95	7E6	.55	807	1.79	GL-434A	22.50
2B22	4.25	10Y	1.50	810	10.95	GL446A	2.50
2C33/RX233A	3.45	12A6	.85	811	2.85	GL605	49.95
2C40	17.50	12C8	.89	813	8.95	ML-531	14.50
2E22	3.49	12H6	.69	814	3.35	QK-59	85.00
2J21	9.95	12J5GT	.57	815	3.40	QK-60	85.00
2J21A	12.95	12SF7	.75	816	1.45	QK-61	85.00
2J22	14.95	12SJ7GT	.65	826	1.39	QK-72	85.00
2J27	22.50	14H7	.97	830B	2.95	RK-25	3.69
2J34	38.45	14J7	1.10	832	7.95	RK-65	26.50
2J50	69.50	15R	1.00	832A	9.50	RK-72/CRP72	1.95
2J55	95.00	23D4	.65	836	4.50	RX21	3.85
2X2	.89	30	.35	838	3.50	RX233A/2C33	3.45
2X2A	2.15	45	.35	838W	6.50	VR-90	1.20
3A4	.85	53A	3.95	845	3.95	VR-105	1.20
3B7/1291	.62	71A	.69	845W	6.95	VR-150	.85
3B24	5.50	76	.58	866A	1.25	VT-127A	2.95
3C23	10.50	77	.65	872A	3.65	WL-417A	22.50
3C24/24G	1.95	78	.80	884	1.79	WL-653B	75.00
3DP1	3.95	100TH	10.50	902P1	7.50	ZP-653	65.00
3D6/1299	.62	112A	.49	957	.45		
3EP1	4.95	211	1.25	958	.60		
3FP7	4.50	227A	4.50	959	1.50		
3GP1	4.75	274B	2.95	991/NE16	.25		
3JP12	14.50	304TH	13.95	1616	2.95		
4B22/EL5B	9.75	304TL	19.50	1619	.89		
4B25/EL6CF	8.95	350A	6.50	1624	1.95		
4J36	175.00	359A	2.50	1625	2.00		
4J37	175.00	371B	2.95	1629	2.00		
5BP1	5.95	388A	2.95	1655/65C7	.97		
5D21	23.95	394A	4.25	2051	.95		
5FP7	2.50	450TH	44.50	8005	5.85		
5JP1	23.50	450TL	44.50				

SPECIAL PURCHASE SALE!

1 mfd @ 15,000
OIL CONDENSER
REG. \$195

\$38.75

Type 14P63. Originally p/o RA-38 rectifier. Size 16x12x4" Brand NEW! ORIGINAL CARTONS!
Order No. RE-370 \$38.75



THIRTEEN "HOT" RADIO SHACK SPECIALS!

Amertran Transtat 103-126/1/60 to 115/1/60 @ 2.17a (BN)	\$ 9.95
BC-221 Frequency Meter (LN)	89.50
Delco Dual Blower 120 CFM 115/1/60 (BN)	14.85
Elenco B-68 Tach. Gen. 120 V AC 60 cy. (BN)	27.50
Maydon #1600 115/1/60; 1/3 or 1/2 rpm (BN)	1.95
Heineman Circuit Breaker #AM1515 115 V AC, 5P, 10a (BN)	2.95
Heineman Circuit Breaker #0322 220 V AC, 2P, 8-25a (BN)	3.95
M5-33 Headphone, 5' cord w/PL55, MB-7 headband (BN)	4.95
Sola 30864 Constant V Reg. 190-260 V; 115/1/60 @ 1.7a (BN)	19.95
TS-11 Mandset; same as M-23/U but w/PL-106 plug (BN)	6.95
TS-51/APG-4 Tachometer Speed Indicator (BN)	95.00
TS-100AP Test Scope (BN)	295.00
Westinghouse FL Blower 115/1/400; 17CFM (BN)	6.95

(BN) Brand New. (LN) Like New

RADIO SHACK CORPORATION
167 Washington St., Boston 8, Mass.

WRITE TODAY FOR FREE 8-PAGE FLYER. HUGE LISTING OF OFF-PRICE VALUES!

SAVE ON TUBES BRAND NEW TUBES GUARANTEED TUBES

OA2	\$1.00	2J22	6.95	4J26	129.50
OA3/VR75	1.10	2J26	14.95	4J28	129.50
OB2	1.20	2J27	14.95	4J29	149.50
OB3/VR90	.95	2J31	39.50	4J30	22.50
OC3/VR105	1.00	2J32	39.50	4J31	99.50
OD3/VR150	.85	2J33	39.50	4J32	129.50
1A3	1.00	2J34	39.50	4J33	129.50
1B22	2.25	2J36	110.00	4J34	Write
1B23	8.95	2J37	12.70	4J35	Write
1B24	16.50	2J40	27.50	4J36	200.00
1B26	2.35	2J48	27.50	4X500A	100.00
1B27	17.50	2J50	27.50	C5B	7.50
1B32	3.10	2J55	85.00	C5B	4.95
1B37	14.95	2J56	149.50	5BP1	4.95
1B40	4.95	2J61	39.50	5BP4	4.50
1B41	47.50	2J62	39.50	5BP4	4.50
1B42	17.50	2M22	49.50	5C21	35.00
1B47	12.50	2M23	49.50	5C22	35.00
1N21B	2.75	2M25	29.50	5D21	19.95
1N21C	14.95	2M28	32.00	5FP7	1.95
1N22	1.25	2M29	23.95	5FP14	16.50
1N23	1.25	2M33	Write	5GP1	4.50
1N23A	2.25	2M41	110.00	5HP1	6.95
1N23B	3.50	2M45	110.00	5HP4	4.95
1N26	7.50	2K48	Write	5JP1	19.95
1N28	Write	2K54	Write	5JP2	19.95
1N34	1.50	2X2	.59	5JP5	19.95
1N38	1.50	2X2	.59	5J23	19.50
1N40	8.50	3A4	.85	5J26	259.50
1N47	4.50	3A5	.85	5J29	11.95
1N54	.89	3AP1	8.95	5J30	39.50
1N55	2.75	3B7/1291	4.95	5R4G V	1.50
1N56	1.25	3B24	4.95	5T4	1.98
1N58A	1.25	3B24W	7.50	6CL/5528	12.50
1N60	.60	3B24W	1.50	6AC7W	2.75
1N63	2.39	3B28	6.50	6AJ5	1.95
1N64	.80	3B28	6.50	6AK5WE	1.50
1T5GT	1.95	3BP1	80.00	6AK5W	2.00
1Z2	2.95	3C22	4.95	6AN5	3.65
VS-2	9.50	3C23	2.75	6AN6	5.95
ZAP1	8.95	3C24/24G	3.15	6AR6	2.25
ZC21/1642	.68	3C27	16.95	6B16	Write
ZC22/7193	.29	3C31	16.95	6B16	Write
ZC26	.49	3C33	16.95	6B16	Write
ZC39	25.00	3C45	16.95	6B16	Write
ZC39A	9.95	3DP6	.59	6B16	Write
ZC40	1.95	3DP1	13.95	6F4	4.95
ZC43	1.95	3E25	1.95	6G6G	1.10
ZC44	1.13	3FP7	1.95	6H6	6.95
ZC45	5.95	4B24	6.95	6K4	3.50
ZC52	4.95	3CP1	3.95	6N7	2.00
ZD21W	2.45	3HP7	25.00	6S7WGT	1.13
ZE22	1.49	4-65A	3.95	6S7WGT	1.13
ZE24	4.65	4-125A	3.95	6S7WGT	1.13
ZE25A	4.50	4E27/CV92	17.50	7C23	69.50
ZE26	2.95	4C28	25.00	7V7	1.13
ZE30	1.98	4C35	24.50	9LP7	4.95
ZE32	1.10	4E27	14.95	10Y	.49
ZE41	1.10	4E27	14.95	12A V7	4.50
ZF21	7.50	4I22	129.50	12DP7	16.95
ZJ21A	7.95	4I23	129.50	12GP7	25.00

5 FIGURE adds or subtracts 10 only for each revolution of shaft

95¢

Veeder-Root Counters Model S-1

Size 3/4" wide x 1-5/16" long. Dove-tail mounting—removable lever.

YOUR SURPLUS WANTED
We Pay Highest Prices!

450TH	35.00	809	2.95	1629	.39
464A	4.51	811	10.95	1630	1.50
469	13.95	812	2.75	1631	.35
471	2.25	813	11.95	1636	1.50
527	12.95	814	2.95	1636	2.75
531	5.75	826	1.95	1787	Write
532	2.95	828	9.95	2050	1.40
533	14.40	829	9.95	2051	1.10
551	Write	829B	11.95	5514	Write
559	1.49	830B	2.75	5520	Write
569	16.50	832A	2.75	5520 FG95	22.50
587	Write	833A	34.95	5586	249.50
605CX	Write	836	3.45	5611	115.00
609	Write	837A	1.45	5615	8.95
615	Write	841	.45	5637	Write
632	19.95	843	.45	5638	8.95
632	39.50	845	8.50	5645	8.95
632	16.50	852	19.95	5646	8.95
632	16.50	860	3.75	5651	2.75
632	16.50	861	19.95	5652	3.95
632	16.50	861A	.45	5670	4.30
632	4.50	864	.39	5672	2.00
632	2.75	865	.98	5676	3.95
632	4.95	866A	1.35	5678	2.25
632	Write	866JR	1.25	5686	4.25
632	1.50	869	59.00	5687	4.25
632	29.50	872A	2.75	5694	2.60
632	29.50	874	1.10	5702	6.50
632	29.50	876	.59	5704	4.50
632	29.50	881	1.50	5718	Write
632	29.50	884	1.60	5726	5.95
632	7.95	885	Write	5744/619CX	3.95
632	17.50	889R	139.50	5749	3.95
632	3.95	905	3.25	5751	3.25
632	95	923	1.29	5763	1.50
632	5.50	927A	1.25	5783	6.00
632	6.25	931A	6.50	5784	6.00
632	4.95	931B	Write	5787	6.00
632	22.75	933D	Write	5814	3.25
632	.98	953E	Write	5823	3.95
632	24.50	954	.33	5844	5.50
632	Write	955	.49	5915	1.00
632	2.95	957	4.95	5916	4.95
632	Write	956	.49	6026	Write
632	1.95	958	.69	6553	3.95
632	16.95	959	2.95	6554	4.95
632	3.95	959	Write	8012	1.95
632	6.95	979	Write	8013	4.95

QUARTZ CRYSTALS

NEW LISTING

Made from the finest Brazilian Quartz. Will provide a high degree of activity and frequency stability. All tested and marked by the manufacturer to a very close tolerance. In the frequencies outlined below the crystals itemized under the heading "From & To" are mostly in progressive frequencies between the limits shown (as for example: "From 3300 to 3377," are as follows: 3300KC, 3301KC, 3302KC—, 3377KC.) are of limited quantities in each frequency. Those listed singly are in quantities of 50 or more.

FT243				CR 1A/AR or FT241				XL5 Dual		FT241A	
Prong centers 1/2", Prong dia. 3/32"				Prong spacing 1/2", Prong dia. 1/8"				3 prongs 1/2" x 1 19/32" prong dia.		SPECIAL TYPE WE. Prong spacing 1" CTS. Prong Size 3/32" dia.	
Price \$1.15 ea. (25 for \$25.00)				Price 79¢ ea. 12 for \$9.00						These are in successive steps of .1 MC variation from 20.0 MC to 27.9 MC	
				FROM TO FROM TO FROM TO						Suitable for low frequency purposes (1/54 of Stated Values)	
				(Frequencies In KC)						Price \$1.15 ea.	
1915	1995	6100	6173.3	2853	7620	7620	7625	5250	5180	2711 & 2891	
2030	2065	6225		4188	3988	7650	7650	5020	5090	2436 & 2276	
2125	2155	6250		4285	4374	7738	7740	5120	5180	3128 & 3153	
2300		6275		8025	4300	7750	7750	5200	5295	2605 & 3153	
2320	2390	6300	6292	8100	8175	7760	7760	5300	5396		
2420	2490	6400	6375	8206	8275	7770	7770	5410	5470		
2604		6400	6400	8300	8375	7780	7780	5460	5500		
2605		6500	6292	8385	8400	7780	7780	5500	5500		
3105		6500	6292	8400	8475	7790	7790	5500	5500		
3652	3689	6700	6675	8500	8575	7800	7800	5500	5500		
3729	3799	6800	6875	8600	8650	7810	7810	5500	5500		
3805		6800	6875	8786.25	8800	7820	7820	5500	5500		
		6900		8806.75	8876.25	7830	7830	5500	5500		
4104	4150	6900	6975	8921.25	8935.0	7840	7840	5500	5500		
4244	4290	6978.75		9150	9399	7850	7850	5500	5500		
4305	4397	7228	7281	9405	9499	7850	7850	5500	5500		
4400	4480	7325	7375	9516	9589	7860	7860	5500	5500		
4600	4690	7458.75		9608	9638	7870	7870	5500	5500		
4800	4898	7440	7475	9608	9638	7880	7880	5500	5500		
4913	4941	7500	7597	9608	9638	7890	7890	5500	5500		
5100	5195	7625	7673.3	9608	9638	7900	7900	5500	5500		
5300		7625		9608	9638	7910	7910	5500	5500		
5320	5390	7650		9608	9638	7920	7920	5500	5500		
5500		7650		9608	9638	7930	7930	5500	5500		
5630		7700		9608	9638	7940	7940	5500	5500		
5633.3		7725		9608	9638	7950	7950	5500	5500		
5655.5		7728.8		9608	9638	7960	7960	5500	5500		
5677.7		7750		9608	9638	7970	7970	5500	5500		
5700		7751.25		9608	9638	7980	7980	5500	5500		
5706.6		7773.75		9608	9638	7990	7990	5500	5500		
5722.2		7775		9608	9638	8000	8002	5500	5500		
5744.4		7800	7790	9608	9638	8007	8007	5500	5500		
5800	5892	7825		9608	9638	8012	8012	5500	5500		
5900	5975	7850		9608	9638	8022	8022	5500	5500		
5955		7875		9608	9638	8032	8032	5500	5500		
6000		7900		9608	9638	8040	8040	5500	5500		
6000.6	6075	7925		9608	9638	8050	8050	5500	5500		
6150		7950		9608	9638	8060	8060	5500	5500		
6175		7925		9608	9638	8070	8070	5500	5500		

EDLIE ELECTRONICS, Inc.

154 Greenwich Street,
New York, N. Y.
Telephone DIgby 9-3143

AVIATION ELECTRONIC EQUIPMENT

New or used, all equipment tested and guaranteed ready for installation in aircraft. Equipment, if used, completely reconditioned.

"Specializing in Installations of the Highest Quality"

Transmitters	Receivers	Dynamotors
ART-13	BC-348	DY-17
BC-640	AKB	DY-21
T67/ARC-3	R77/ARC-3	DY-9
TA2J	BC-342	PE-94
Transceivers	Mounts	Control Boxes
ARC-1	MT/230	C45/ARC-1
SCR-522	FT-488	C87/ART-13
RTA1B	FT-498	BC-602B

Inquiries given prompt attention—Early deliveries

SPECIALS!!

2500—MC215 Tuning Shafts, Used Good	25¢ ea.
Large Quantity 274N and ARC-5 Mounts, Used	50¢ ea.
300—DM32 Dynamotors—Some New—All Good	1.95 ea.
350—SATA Altitude Limit Switch, Used	1.00 ea.
120—C115/ARC1 Control Boxes, New	6.00 ea.

JAMES S. SPIVEY COMPANY

1406 G. ST. N.W. - Tel. STerling 2215 - WASHINGTON, D. C.

"Buyers of Surplus Aviation Electronic Materials"

Triplet Meters All Brand New In Boxes

Model	Description	Price
341	0-500 ma. RF 3" rd.	\$6.50
337A	0-1 amp. A.C. 3" sq.	6.50
232	0-10 volts A.C. 2" rd.	6.50
334	0-15 volts A.C. 3" rd.	6.50
221	400 micro amp. volt-ohm scale 3" rd.	5.00
327A	0-1 ma. D.C. 0-100 bad-good scale 3" sq.	6.50
321T	1-0-1 ma. D.C. zero center scale 3" rd.	8.50
327A	0-60 micro amp. D.C. 0-1000 ohm scale 3" sq.	6.50
327A	0-400 micro amp. D.C. 0-25-50-100 A.C.V. scale 3" sq.	6.50
671	0-5 ma. A.C. 0-5-10-25 A.C. ma. scale 3" sq.	6.50
327A	0-35 ma. D.C. 3" sq.	6.50
327A	6.5 ma. (100 M.V.) 0-5-10-25 D.C. amp. scale 3" sq.	6.50
327A	0-1 ma. 0-10 volts D.C. good-bad scale 3" sq.	6.50
327A	150-0-150 volts D.C. 125 ohms/volt 3" sq.	6.50
327A	0-1 ma. D.C. 0-25-50-100 D.C. volt scale 3" sq.	6.50
242T	0-1 ma. D.C. 0-100 scale 2" rd.	5.00
221	0-8 ma. D.C. 0-100 scale 2" rd.	4.50
242T	1.2 ma. D.C. 0-100 scale 2" rd.	4.50
421A	20 ma. D.C. (50 MV.) 0-1 scale 4" sq.	5.00
431	0-300-600 A.C. volts 4" sq.	6.50
1200	Dual 3" meter—50 MV. D.C. 0-100 D.C. amps. and suppressed 3 to 9 volts D.C.	10.50

Our warehouses contain large quantities of Aircraft Instruments, Dynamotors, Capacitors, Switches, Relays, Hydraulic Parts, Potentiometers, etc.

SEND FOR A FREE CATALOGUE
OR CALL ARMORY 4-5857

Electro Devices
INCORPORATED
247 BROADWAY PATERSON, N.J.

TRY WELLS



FOR ELECTRONIC COMPONENTS

We offer immediate delivery from our vast stock of more than 25,000 items—all standard make, carefully inspected and fully guaranteed. Our prices are below market.

Always Check Wells' Stock First!

Quotations and quantities available will be given immediately upon request.

- ADEL CLAMPS
- ANTENNAS
- Insulators, Mast Sections
- BINDING POSTS
- BLOWERS
- CABLE ASSEMBLIES
- CHOKES
- COILS
- CONDENSERS
- Oil Filled, Bath tub, Hearing Aid, Transmitting Micas, Silver Micas, Ceramic, Variable, Trimmer
- CRYSTALS
- DYNAMOTORS & BRUSHES
- FILTERS
- FUSES & MOUNTINGS
- GENERATORS
- GROUND RODS
- HEADSETS
- IF COILS
- JACKS
- JACK BOXES
- KEYS, Telegraph
- KNOBES
- LAMPS
- LORD MOUNTS
- LUGS
- MOTORS & BRUSHES
- PLUGS
- RECTIFIERS
- Selenium, Copper Oxide, Meter, Diode
- RESISTORS—All Types
- SELSYNS
- SOCKETS
- SWITCHES
- Aircraft, Micro, Switchettes, Toggle
- TIMERS
- TUBING—Flexible
- TUNING SHAFTS
- TRANSFORMERS—All Types
- VIBRATORS
- WALKIE TALKIES

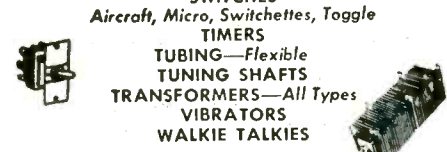

Available Now!

A complete signal corps stock number listing of items in our stock. Write for listing No. SG-200. (For government agencies and contractors only.)

Manufacturers and distributors—write for Radio-Electronics Catalog No. H 501.

Write, Wire, Phone Your Requirements

all phones: **SEeley 8-4143**



833 W. CHICAGO AVE., DEPT. 5L, CHICAGO 22, ILL.

BLOWERS:

115 Volt 60 cycle BLOWER (pictured), approx. 100 CFM Dis. 2 1/2" Intake; 2" outlet. Quiet running. Motor size: 2 1/2"x3 1/4". NEW — not Gov't surplus. **\$7.99**
Order No. E-520



DUAL BLOWER—Same as RN-520 above, except has blower assembly on each side of motor. Order No. E-800 \$12.95

COMPACT TYPE—108 CFM, motor built inside squirrel cage, 4-1/2" Intake; 3-3/8" x 3" Dis. Complete size: 4-1/4" W x 9-3/8" H x 8-1/8" D. Order No. E-860 \$13.50

FLANGE TYPE—140 CFM, 3-3/4" Intake; 2-1/2" Dis. Complete size: 7-1/2" W x 7-1/4" H x 6-3/4" D. Order No. E-865 \$12.95

FLANGE TWIN—275 CFM, 4-1/2" Intake; 3-1/4" x 3" Dis. Complete size: 11-3/4" W x 8-3/8" H x 8-1/16" D. No. E-134 \$20.95

CORDS—CABLES

- C-501 Cord—f/GN-45 Generator \$2.50
- CD-318 Cord w/PL-68 & SVV-141 & JK-48F89
- CD-307 Cord—6.5 Ft. w/PL-55 & JK-2689
- CD-604 Cord w/C-410 Trans. & PL-54 Plug89
- CD-365 Cord for LP-21-Loop 1.75
- MC-215 Tuning Shaft for 274N 2.00

JUST WHAT YOU NEED

- Standard Test Leads, 4" x 1-1/2" Prods. Pair: 39¢ — 3 for \$1.00
- Phone Plug—Nickel Plated, Screw Terminals. Ea.: 39¢ — 3 for \$1.00
- Instrument Knobs—Bar, Octagon, Set Screw, Skirts, Ass't. 10 for \$1.00
- Line Cord—Bro. Rubber 7 ft., Molded Rubber Plug. Ea.: 29¢ — 4 for \$1.00
- Line Cord—Black Rubber 8 ft., Angle Molded Plug. Ea.: 39¢ — 3 for \$1.00

PLUGS AND CONNECTORS

- PL-112 Plug for LP-21 Loop \$1.25
- PL-P-103 Plug for BC-348 1.50
- MC-211 Rightangle Adapter for Comm. Sets50
- M-359 Rightangle Coaxial Connector25

CONTROL BOXES:

- | | | |
|----------------------------|---------|--------|
| | NEW: | USED: |
| C-87/ART-13—f/ART-13 Trans | \$ 6.95 | \$4.95 |
| BC-434 for ADF | 5.95 | 3.95 |
| RC-732 for Localizer | 2.95 | 1.95 |

MOUNTINGS AND CLAMPS:

- FT-134 for BC-348 Receiver \$2.50
- FT-470 Mounting & Clamp 1.00
- MC-476 Maple Ball for above—f/Fairlead 1.00
- MC-898 Wood Clamp for Fairlead75
- M-235 Bobbin & 250 Ft. W-106 Antenna Wire 3.50
- WT-7 Weight for Trailing Antenna 1.50

AIRCRAFT CONTROL CABLE—3/32" 7 x 14 Strand, Weatherproofed, Galvanized, 920 lb. Test. Ideal for Television Guying and many other uses. Prices: 3-1/2¢ per Ft. 1000 Ft. or more @ 3¢ per Ft.

FAIR RADIO SALES

DYNAMOTORS:

DYNAMOTOR and BLOWER: 9 Volts DC input; output 450 Volts 60 MA. 4500 RPM. At 6 Volts DC input; output 260 Volts 65 MA. 3000 RPM. \$4.95

Input	Output	Stock No.	Price
14 V. DC	600 V. 300 MA.	BD-86	\$9.95
12 V. DC	220 V. 70 MA.	DM-24	6.95
12 V. DC	220 V. 100 MA.	DM-18	4.95
12 or 24 V. DC	440 V. 200 MA. & 220 V. 100 MA.	D-104	14.95
14 V. DC	375 V. 150 MA.	DM-375	2.95
14 V. DC	330 V. 135 MA.	DM-330	7.95
14 V. DC	500 V. 500 MA.	PE-59	14.95
12 or 24 V. DC	275 V. 110 MA.	USA/0516	3.95
12 or 24 V. DC	500 V. 50 MA.	USA/0515	3.95

ALSO—PE-73; PE-86; DM-53; DM-33-5055; DM-416; PE-101, etc.

ANTENNA EQUIPMENT

MAST BASES—INSULATED:

- MP-132 BASE—(As illustrated at left) 1" heavy coil spring, 2" insulator. Overall length: 11-3/4". Weight: 2-3/4 lbs. Price \$3.95
- MP-48 BASE—Insulated type with heavy coil spring. Requires 1-3/8" mounting hole. Weight: 11 lbs. \$4.9
- MP-57 BASE—Insulated type with heavy coil spring and 5" dia. insulator. Requires 1-3/8" hole for mtg. Weight: 9 lbs. \$5.95

MAST SECTIONS For ABOVE BASES:

- Tubular steel, copper coated, painted, in 3 ft. sections, screw-in type. MS-53 can be used to make any length with MS-52-51-50-49 for taper. Any section .50¢ Each
- Larger Diameter Sections: MS-55-54 \$1.25 Each
- AN-104B Antenna—100-156 MC.—Copper \$5.95
 - AN-104A Antenna—100-156 MC.—Steel 3.95
 - AN-104A Antenna—100-156 MC.—Steel 3.00
 - AN-104A Antenna—100-156 MC.—Steel 2.00
 - AN-117 Whip Steel—6 Ft. length 1.50
 - AN-109A Whip Steel, 5 Ft. w-Base 1.50
 - AS-27/ARN-5 Ram's Horn, 10 MC.—USED 5.95
 - LP-20A Loop for ADF equip.—Used, tested 9.95
 - AT-37/APT Stub—113-150 MC.—Copper 6.95
 - AT-42/APT-3 or APT-1 Stub—113-150 MC. 6.95
 - AS-61/ARN-5 Spike with coaxial lead in base. 4.9"
 - AS-61/ARN-5 Half-Wave Dipole—335 MC. 3.95
 - AT-2/APN-2 4.9

SELENIUM RECTIFIER UNITS

- HEAVY DUTY—30 VOLT DC OUTPUT:**
- 115/200 V. Three Phase 400 Cycle Input:
 - TYPE 143 w/Transformer & VRT 100 Amp \$69.50
 - TYPE 3FS-5 w/Trans., VRT, & Blower—200 Amp \$69.50
 - TYPE 52A-11 Rectifier Only, Cased, 200 Amp \$39.50
 - TYPE A-1 Rectifier Only, Cased, 300 Amp \$49.50

- AERIAL WIRE**—Phosphorus Bronze #18 Stranded, 200 lb. test. Weatherproof. 150 ft. on Reel. TEL-3 with Clips \$1.50
- TELEPHONE WIRE**—3 Cond. copper & steel, 525 ft. \$4.75

TRANSFORMERS—110 V. 60 Cycle Pri.

- Sec. Two 12 V. 4 A. windings—gives 12 V. 8 A. or 24 V. 4 A. \$5.95
- Sec. 24 Volt 1/2 Amp. 1.50
- Sec. 24 Volt 1 Amp. 1.95
- Sec. 24 Volt 6 Amp. 5.9
- Sec. 6-24 or 30 Volts 8 Amp. 5.95

Address Dept. E • All Prices Are F.O.B., Lima, Ohio • 25% Deposit on C.O.D. Orders

132 S. MAIN ST. LIMA, OHIO

• CORRECTION •

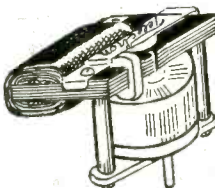

Due to Typographical error in Sept. ELECTRONICS the **TELECHRON 2 RPM MOTOR** was priced at \$2.00. The Correct price is \$2.90. For our other Listings see pg. 465

BLAN

64 Dey St. New York 7, N. Y.

LARGE INVENTORY

- OIL FILLED CAPACITORS
- BATH TUB CONDENSERS
- TYPE "J" AND "JJ" POTENTIOMETERS
- CONNECTORS
- SWITCHES
- IMMEDIATE DELIVERY
- LEMAR ELECTRONICS CO.
- 135 LIBERTY ST. N. Y. 6, N. Y.
- PHONE: BARCLAY 7-8675

ERIE CERAMICONS

Large quantities in stock; immediate delivery. All values and tolerances.

N.P.O. & TEMPERATURE COEFFICIENT FEED-THRU, STANDOFF, DISC, CERAMICONS. LITTLE FUSE—ALL VALUES.

BELOW FACTORY PRICE

CAP ELECTRONICS INC.

102 Warren Street
New York 7, N Y

Worth 2-4363

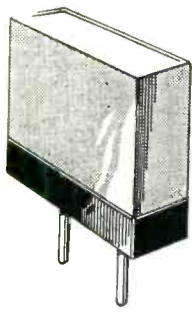

SAVE! SAVE! SAVE!

SURPLUS RADIO CRYSTALS

PRICED TO SELL . . . AT A FRACTION OF THEIR ORIGINAL COST
MFG. BY WESTERN ELECTRIC AND FEDERAL TEL. & RADIO
ALL FT-241-A HOLDERS

Available As Follows For:

SCR 608-A and SCR 628-A SCR 528 and SCR 538
BC 684 120 per set BC 604 80 per set

200 KC Crystals	\$2.95 ea.
500 KC Crystals	\$1.95 ea.
1000 KC Crystals	\$3.95 ea.

QUANTITIES AVAILABLE

Write For Price Quotation On Your Requirements.

C and H Sales Company

BOX 356-Z EAST PASADENA STATION • PASADENA 8, CALIFORNIA



ELECTRONIC EXPEDITERS

SUPPLYING

THE NEEDS OF INDUSTRY —
GOVERNMENT — FOREIGN
PURCHASING COMMISSIONS

WITH

COMMUNICATIONS
EQUIPMENT, RECEIVING
AND TRANSMITTING
TUBES, ELECTRIC WIRE
AND CABLE

AIRCRAFT ELECTRONICS—
INSTRUMENTS—
HYDRAULICS

PROMPT ATTENTION
GIVEN TO ALL INQUIRIES

Rated—Dun & Bradstreet

Electronic Expeditors

Dept. WW, 225 N. Wabash Avenue

Chicago 1, Illinois • ANdover 3-0841

Cable Address: "ELEXPEDITE" • TWXCG1510

TELEPHONE RELAYS



Large Stock of
CLARE, TYPES C, D & E
COOKE, AUTOMATIC—ELECTRIC
ALL TYPES OF COILS and PILE-UPS

Send Us Your Specs. for Our Quote
Clare Type G Half Size
Sensitive Telephone Relays

Coil	Contacts	Will Close at	Price
1) 6500 ohms	2A	5 MA	\$2.50 ea.
2) 5800 ohms	3A	4 MA	2.50 ea.
3) 5800 ohms	2B-1C	5 MA	2.50 ea.
4) 4850 ohms	1C	4 MA	2.50 ea.
5) 3600 ohms	1C	6 MA	2.00 ea.
6) 4850 ohms	1A	5 MA	2.00 ea.
7) 3300 ohms (None)	ACTUATOR		1.50 ea.

All above Relays may be used for continuous duty operation on 110V. D.C.

Other Type G Telephone Relays			
1) 1300 ohms	1A-1C	24 or 48V.	2.50 ea.
2) 700 ohms	2A-1C	24V.	2.50 ea.
3) 400 ohms	1A	12 or 24V	1.65 ea.

Clare Type C Standard Size Telephone Relays			
Coil	Contacts	Voltage	Price
1) 2500 ohms	1A	24 or 48V	\$2.25 ea.
2) 2500 ohms	1B-1C	24 or 48V	2.50 ea.
3) 2500 ohms	2A-1B	24 or 48V	2.50 ea.
4) 2500 ohms	3A-1B	24 or 48V	2.75 ea.
5) 2500 ohms	5A	48V	3.00 ea.
6) 2500 ohms	5A-1C	48V	3.00 ea.

CONTACT SYMBOLS
A=Norm. Oper. B=Norm. Closed C=S.P.D.T.
G.E. Relays #CR 2791-B109136 Coil—10,000 ohms
Contacts 1A, 1B Operates on 8 MA. Price \$1.65
Signal Wheelock Relays #KS9665 Coil—2,000 ohms
Contacts—1A, 1B, 1C Operates at 9 MA.
Price—\$2.75 ea.
Leach Relays Type 1025-SN-BF. Coil—24V. 425
ohms. Contacts—D.P.S.T. Norm. closed. Rated
at 10 Amps. Price—\$1.50 ea.
Five Prong CR-2791 G.E. Plug In Relays.
1) C-103C25 2200 ohms SPDT 4.5 MA. \$4.00 ea.
2) C-104B28 700 ohms SPDT 6 MA. \$3.00 ea.
Slow Release (For SCR-522-A) Telephone Relays.
Part No. A18258. Price—\$2.00 ea.
Patch Cords—2 1/2 Ft. long with a Phone Plug
(Like PL-55) on each end. Price—95c

Chase

Electronic Supply Co.
222 Fulton St.
New York 7, N. Y.
Dlgy 4-3088
Hollis 4-5033



State Labs Inc.

Nation's Largest
Wholesale Supplier
Specializing ONLY in
Buying and Selling

ELECTRONIC TUBES AND CRYSTALS

OVER 4000 TYPES AVAILABLE
TOP STANDARD BRANDS
IMMEDIATE QUOTATIONS

WRITE FOR
FREE
WEEKLY
MARKET
GUIDE



State Labs Inc.

37 EAST 28 STREET, NEW YORK 16, N. Y.
PHONE: MURRAY HILL 3-9802
WIRE: STATE LABS, WUX, N. Y.
TELETYPE: N. Y. 1-1807 CABLE: STATELABS

Telephone Equipment & Parts

TS 15 handsets with cord & PL68 and PL55 plug	Each \$ 8.50
TS 13 handsets with cord & PL68 and PL55 plugs	8.50
New W.E. F1W handsets with cord & PL47 plug	6.95
New TS9 handsets with butterfly flip switch in handle	6.50
EE8 field telephones reconditioned	Each 18.50
Like new Magneto Wall telephones (Like EE8)	Each 13.00
Reconditioned like new W.E. solid handsets	Each 4.95
Reconditioned like new TS9 handsets	Each 4.95
Upright desk telephones reconditioned (for extensions, etc.)	Each 2.95
Operators head & Chest sets HS19 reconditioned Double receiver	Each 6.50
Single receiver	Each 5.75
EE2C units less cord used. For BD7k & BD72 switchboards	Each 1.00
New 4 1/2 foot rubber cords with PL47 plug	Each 0.75
Sound power field telephones like new	Each 25.00

Terms:

Check with Order—F.O.B. Brooklyn, N. Y.

EASTERN TELEPHONE CO.

Dept. E 323 Vanderbilt Ave.
Brooklyn 5, N. Y. MA 2-3753

VOLUME DISCOUNTS

PORTER SALES FEATURE

Famous 2" Sq. Weston Sangamo
PANEL METERS

0-20v DC 0-5 R.F. MA
0-40v DC 0-5 MA

0-100 MA (0-300 SCALE)

LARGE QUANTITIES AVAILABLE

\$ 269

Any Type were \$3.95

WRITE TUBE REQUIREMENTS

MONEY BACK GUARANTEE!

PORTER RADIO SALES CO.
132 Nassau Street, New York 38, N. Y.

Columbia

GEM OF THE SURPLUS

RA-38 RECTIFIER
Hi voltage, heavy duty power supply. Many uses such as radar, and commercial heat induction. Like new \$595.00

BC-625 MINE DETECTOR
New Special \$59.95

DYNAMOTORS AND INVERTERS
PE-103: Brand new, SPECIAL \$35.00
PE-73: 28 V. supply for BC-375. Used \$5.95
BD-77: 12 V. power supply for BC-191. Excel. cond. \$14.95
PU-7 PE-218 PE-206

110 V. VARIACS
18 amp. \$42.50
22.5 amp. \$59.50
30 amp. Dual \$75.00

METERS
2" rd. Westinghouse 0-9 amp. RF \$2.99
2" rd. Westinghouse 0-15 VAC 600-800 cycles \$3.25
2" rd. Weston 0-25 MA. \$2.99
1" rd. 0-1 MA. \$3.95

TEST EQUIPMENT Price On Request
BC-221 TS-170 TS-47 TS-34
TS-10 TS-16 TS-127 LM

CONDENSERS—All New! Guaranteed!
2 mfd. @ 4000 V. \$7.95 .045 mfd. @ 16,000 VDC \$19.95
2 mfd. @ 5000 V. 9.95 .5 mfd. @ 25,000 VDC \$39.50
Standard Brand .05 MUF @ 25,000 V. P.U.R.
RESISTOR PROTECTED CAP. 120 mfd. @ 3000 VDC. Res. 0.5 ohm P.U.R.

TUBES! BIG VARIETY! BOXED!
250TL \$14.95 813 \$10.95 CRT-TUBES
804TL 9.95 899B 9.95 2-3 API P.U.R.
1B24 8.95 830B 1.95 3BP1 P.U.R.
V8 Tubes, Ea. .99 2A1 9.95 3DP1 P.U.R.
72A/B 15.95 MANY OTHERS 5BP4 P.U.R.

RADAR EQUIPMENT
RT-30/APQ-5 TRANSMITTER-RECEIVER P.U.R.
APR-1, APR-4, APR-5 P.U.R.
APS-4, RC-184 IFF, Complete P.U.R.

HEADSETS & HANDSETS—Checked Out
HS-30, Used \$1.95 TS-13, New \$9.95
HS-32, New 4.95 HS-30, New 3.50
HS-33, Used 3.95 HS-33, New 5.95
T-17, Used 5.00 TS-9, New 9.95
TS-9, Used 7.95 T-17B, New 7.50
T-17D, New 9.95

AIRCRAFT EQUIPMENT
ARN-7 RADIO COMPASS, Complete \$200.00
MN-26C RADIO COMPASS, Complete \$9.50
SCR-322 VHF TRANSMITTER-RECEIVER, 24 V. Complete \$150.00
SCR-274N or ACR-5 (Medium or VHF frequency), Complete installation available P.U.R.
LORAN APN-4B Complete \$150.00
APN-1 ALTIMETER, Complete \$49.50
ARC-4 VHF TRANSMITTER, 12 or 24 V. P.U.R.
ARC-1 SCR-269-G TA-2124 P.U.R.
ARC-3 BC-348 TA-5
RTA-18 BC-733-D TA-12
ARR-13 RR-85/ARR-3 ARR-5
SCR-284 BC-375 ARR-7

IF YOU NEED IT—WE GOT IT!
Write for Quantity Discounts.

REMEMBER: WE ALSO BUY NEW AND USED RADIO GEAR. WE PAY TOP DOLLAR AND WILL BEAT ANY COMPETITIVE PRICE! WRITE US TO SELL ANYTHING IN ELECTRONICS. SWIFT REPLY GUARANTEED!

COLUMBIA ELECTRONICS SALES
522 South San Pedro St., Los Angeles 13, Calif.

OIL CONDENSERS
6 MFD 600VDC CP70B1FF605K with brackets \$1.37 each.
12 MFD 600V DC in-terteen Type FP \$12.75
1 mfd. 600 V DC Type T J 85c ea.
1 mfd. 600VDC Type TQ 6040 with brackets \$1.67 ea.
1 mfd. 600 VDC round can 1 Lug size 23/4H 50c each.
3.75 mfd. 330 V A C Pyranol Type 21F403 \$1.05 ea.

BATHTUB CONDENSERS
.5 MFD CP53 B1FF 504K, 600 VDC \$.64 each; (\$5.52 each by lot of 100)
.05 MFD Side terminal, 600 VDC \$.35 each.

RHEOSTAT
TYPE J150 ohm 50 Watt #5381 \$1.89 each
TYPE K 100 Watt 25 Ohm \$2.96
TYPE H 25 Watt 15 Ohm \$1.67

SPRAGUE PULSE NETWORKS
1. 7E-3-5 1000-50P \$10.25
2. 15-E3-5 935-32P 22.50
3. 10-5-E6-4, 5-200-16P 32.50
Klixon Circuit breakers

"AN" connectors PL-UG

Discounts 30 to 70%

immediate delivery

TEFLON — MELAMINE — BLUE

"AN" CONNECTORS, Partial Listing

8S1P	16-15P	20-19P	22-25S	24-28P	36-1S
8S1S	16-15S	20-19S	22-27P	24-28S	36-2P
10S-2P	16-16P	20-20P	22-27S	28-1P	36-2S
10S-2S	16-16S	20-20S	22-28P	28-1S	36-3P
10SL-3P	16S-17P	20-21P	22-28S	28-6P	36-3S
10SL-3S	16S-17S	20-21S	22-35P	28-6S	36-12P
10SL-4P	18-1P	20-22P	22-35S	28-7P	36-12S
10SL-4S	18-1S	20-22S	22-36P	28-7S	36-13P
12S-1P	18-5P	20-23P	22-36S	28-13P	36-13S
12S-1S	18-5S	20-23S	22-37P	28-13S	36-14P
12S-6P	18-6P	20-24P	22-37S	28-14P	36-14S
12S-6S	18-6S	20-31P	24-1S	28-14S	36-21P
14S-1P	18-7P	20-31S	24-2P	28-15P	36-21S
14S-1S	18-7S	20-32P	24-2S	28-15S	40-1P
14S-2P	18-8P	20-32S	24-3P	28-21P	40-1S
14S-2S	18-8S	20-33P	24-3S	28-21S	40-8P
14-3P	18-9P	20-33S	24-4P	28-22P	40-8S
14-3S	18-9S	22-1P	24-4S	28-22S	40-11P
14S-4P	18-10P	22-1S	24-5P	32-1P	40-11S
14S-4S	18-10S	22-2P	24-5S	32-1S	40-14P
14S-14P	18-29P	22-2S	24-6P	32-2P	40-14S
14S-14S	18-29S	22-6P	24-6S	32-2S	44-1P
16S-1P	18-30P	22-6S	24-15P	32-9P	44-1S
16S-1S	18-30S	22-8P	24-15S	32-9S	44-2P
16-2P	18-31P	22-8S	24-16P	32-10P	44-2S
16-2S	18-31S	22-15P	24-16S	32-10S	48-4P
16S-3P	20-1P	22-15S	24-17P	32-14S	48-4S
16S-3S	20-1S	22-16P	24-17S	32-15P	48-5P
16S-4P	20-8P	22-16S	24-25P	32-15S	48-5S
16S-4S	20-8S	22-17P	24-25S	32-19P	
16S-5P	20-9P	22-17S	24-26P	32-19S	
16S-5S	20-9S	22-24P	24-26S	32-20P	
16S-6P	20-10P	22-24S	24-27P	32-20S	
16S-6S	20-10S	22-25P	24-27S	36-1P	

Complete stock of all sizes, from 8 to 48, in all combinations and shell types. Also complete stock of "UG" and "PL" Connectors.

WRITE, WIRE, PHONE YOUR REQUIREMENTS TODAY!

ROSE Electronics Co.

100 Park Place, New York 7, N. Y. COrtlandt 7-6196

OIL CONDENSERS
6 MFD 600VDC CP70B1FF605K with brackets \$1.37 each.
12 MFD 600V DC in-terteen Type FP \$12.75
1 mfd. 600 V DC Type T J 85c ea.
1 mfd. 600VDC Type TQ 6040 with brackets \$1.67 ea.
1 mfd. 600 VDC round can 1 Lug size 23/4H 50c each.
3.75 mfd. 330 V A C Pyranol Type 21F403 \$1.05 ea.

BATHTUB CONDENSERS
.5 MFD CP53 B1FF 504K, 600 VDC \$.64 each; (\$5.52 each by lot of 100)
.05 MFD Side terminal, 600 VDC \$.35 each.

RHEOSTAT
TYPE J150 ohm 50 Watt #5381 \$1.89 each
TYPE K 100 Watt 25 Ohm \$2.96
TYPE H 25 Watt 15 Ohm \$1.67

SPRAGUE PULSE NETWORKS
1. 7E-3-5 1000-50P \$10.25
2. 15-E3-5 935-32P 22.50
3. 10-5-E6-4, 5-200-16P 32.50
Klixon Circuit breakers

Clare Telephone RELAYS

- Plug in, Type C 3000 Ohm 48 VDC SPDT (INC-2N0) \$4.37
- Plug in, Type A 24 V AC SPST \$3.26
- Type C 1500 Ohm 24V DC 4PST (INC-3N0) \$2.78
- Type C 30 Ohm I, 5 VDC DPST \$1.95
- Automatic Electric 14V DC 1000 Ohm N.O. DPST \$2.34

Struthers Dunn Type 8BXX110VDC DPST 4 amp. \$7.59
Struthers Dunn Type 8BXX32VDC DPST 4 amp. \$7.51
Struthers Dunn Type 1BXX 110V AC 6 amp. DPST N.O. \$2.57
Struthers Dunn Type 1XBXX105 V AC DPDT \$3.73
Guardian Type 100 AC 12 V SPST \$1.12
Porter Blumfield Type PR3 SPST, 115V A.C. \$1.68
Porter Blumfield Type PR5 D SPDT, 48V DC \$1.90
Sigma 12 VDC SPDT size 2 1/4" x 1 1/2" \$.77
GE type CR 2791—B109P36 SPDT, 10,000 ohm Coil \$1.45
GE type CR2791—B109V39 150 ohm Coil \$1.15

ALL the material in STOCK
LEONARD GREENE
381 Tremont St.—HA 6-4794
BOSTON, MASS.

HAYDON MOTOR SYNCHRONOUS

110 V.A.C.
1/2 R.P.M.
3.6 Watts
\$2.75 each

Haydon 2.2 watt 1-120 RPM complete with coin arrangement for 25c pc. \$2.95 minimum order 5 pcs. on synchronous motor.
Haydon, 3-6 watt, 1.5 RPM #5901-4, adjustable reset timer \$7.10
MICA TRANSMITTING CAPACITORS Type G3 .0001 Mfd 25 KV \$35.00 ea.
Type G2-50, .0001 mfd., .0002 mfd., .0005 mfd. 10 KV \$10.00
Type H, .01 mfd., 2500 V test, #CM50A103M \$65.00/hundred
Type H, .01 mfd., 2500 V test, #CM45B103K \$30.00/hundred
ATTENUATOR DAVEN TYPE H-994-2 7500/3900-2BSten \$4.25
Type TA-1000-2 7500/3900 Ohm \$5.25 ea.

Manufacturers! Attention!

WE OWN & OFFER, QUANTITY LOTS OF BRAND NEW PANEL METERS!

Wholesale quantities only at special reduced lot prices. Some of these lots can be modified to your requirements. Write for complete details and special low prices.

Quan.	Type	Range	Make	Model
57	DC Milliammeter	0-30	Weston	301
59	DC Milliammeter	0-50	Gruen	622
130	DC Ammeter	0-100	Hoyt	
49	AC Ammeter	0-35	Roller Smith	
28	Microammeter	special	Weston 368	
77	DC Milliammeter	0-3	Gruen	5-87
124	DC Milliammeter	0-15	Simpson	26
23	DC Milliammeter	0-150	Gen. Elec.	DO-53
60	DC Milliammeter	0-200	Marion	
32	DC Milliammeter	0-200	Simpson	25
281	DC Milliammeter	0-400	Thiplett	321-T
147	DC Milliammeter	0-500	Druet	812
77	DC Voltmeter	0-5/125	Weston	606
57	DC Voltmeter	0-150	Hoyt	17-L
61	DC Voltmeter	0-300	Sun	2A/346
35	DC Voltmeter	0-300	Sun	3A/P380
50	AC Ammeter	0-150(5)	Westinghouse	NA-35
210	RF Ammeter	0-2.5	Weston	425
40	RF Ammeter	0-2.5	Simpson	35
193	RF Ammeter	0-2.5	Westinghouse	NT-35
740	RF Ammeter	0-2.5	McClintock	
34	RF Ammeter	0-3	Weston	425
220	RF Ammeter	0-5	Westinghouse	NT-35
98	RF Ammeter	0-5	Gen. Elec.	DO-44
122	RF Ammeter	0-5	Gen. Elec.	DO-44
1200	RF Ammeter	0-6	Gen. Elec.	DW-44
1360	AC Voltmeter	0-15	Gen. Elec.	AW-41
288	AC Voltmeter	0-15	Westinghouse	NA-35
57	AC Voltmeter	0-75	Westinghouse	NA-33
53	AC Voltmeter	0-75	Weston	617
24	DC Ammeter	0-1	Gen. Elec.	DO-41
360	AC Milliammeter	0-1.3	Weston	545

The following items are NAF type 1091 series and miscellaneous aircraft style instruments. All are made by Weston, Westinghouse, or General Electric. External shunts are available where required.

Quan.	Type	Range	Notes
330	DC Amp	0-30	self-contained
660	DC Amp	30-0-30	self-contained
3500	DC Amp	0-60	50 M.V.
490	DC Amp	60-0-60	50 M.V.
240	DC Amp	0-120	50 M.V.
270	DC Amp	120-0-120	50 M.V.
1340	DC Amp	0-240	50 M.V.
230	DC Amp	240-0-240	50 M.V.
2800	DC Volt-Amp	0-30v/30a	50 M.V.
330	DC Volt-Amp	0-30v/60a	50 M.V.
80	DC Amp	0-50	50 M.V.
60	DC Amp	50-0-50	self-contained
140	DC Amp	20-0-100	50 M.V.
300	DC Amp	0-150	50 M.V.
250	DC Amp	0-300	50 M.V.
180	DC Volt	0-30	50 M.V.
280	AC Volt	0-40	50 M.V.

ONLY A PARTIAL LISTING!
We have in stock a large variety of panel, switchboard, laboratory and recording instruments, too numerous to itemize.
We also stock a full line of shunts, current transformers and multipliers, as well as miscellaneous items, such as voltage regulators, meggers, voltage relays, tachometers, etc.
Let us know your requirements!
Send for our latest listing!

Switchboard BD-72 and BD-71

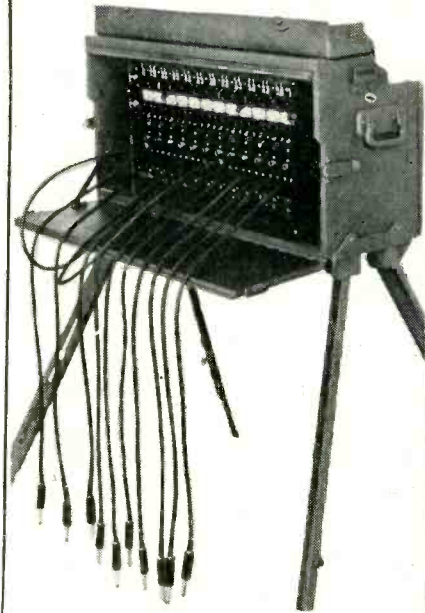

These Switchboards are portable, monocord, magneto-telephone switchboards for use primarily in field wire systems.

The capacity of the Switchboard BD-72 is 12 lines and of the BD-71 is 6 lines. Each switchboard contains all the equipment necessary for terminating and switching field telephone circuits, including a line terminal strip to which incoming lines may be connected directly.

These units are reconditioned and ready to set-up and operate. They are tested and in excellent operating condition.

Write for Literature and Price

DEALERS IN ELECTRONIC AND RADAR EQUIPMENT

FRENCH-VAN BREEMS, INC.

375 Fairfield Avenue
Stamford, Connecticut
Tel: 48-9231

MARITIME SWITCHBOARD INSTRUMENTS—ACCESSORIES

336 Canal Street Wo 4-8217 New York 13, New York

PHOTOCON SALES

417 N. Foothill Blvd. SY camore 2-4131
Pasadena 8, Calif. RY an 1-6751

FREE 24 PAGE SURPLUS SALES CATALOG

WANTED new or clean used electronic surplus. Please state exact description of the condition and details of modification. Include lowest price in first letter.

APS-3	Exc.	PUR*
SCR-284 Field Sets	Exc.	PUR*
APNA or B	Exc.	PUR*
APR-5A	Exc.	PUR*
SCR-645 Radar Trailer	Exc.	PUR*
Type 120A Test Set 130-210mc.		
Boonton Radio Corp.	PUR*	
Antenna AT-104/APNS	New	20.00
Automatic Pilot Inverter		
Type DA Input 28VDC @ 12 amps.		
Output 115V, 3 phase, 400 c.p.s.	Exc.	80.00
Audio Oscillator Hewlett-Packard 200		
BR 20-20,000 c.p.s.	Exc.	\$110.00
LM & BC-221 Frequency Meter with cal. book, crystal, and tubes	Exc.	99.50
TS-352/U Weston Test Set	Exc.	150.00
TS-173/UR Frequency Meter 90-450 mc. complete with crystal, cal. book, & 115 VAC. Power Supply. Like New		600.00
TS-146/UP X-Band Signal Generator	Exc.	PUR*
TS-13/AP X-Band Signal Generator	Exc.	PUR*
TS-84/AP Portable Oscilloscope	Exc.	350.00
TS-12 Test Set for X-Band Box 1 & 2 complete	Exc.	PUR*
Measurements Corp. Model 82 Standard Signal-Generator 20cy.-50mc. Exc.		PUR*
Hewlett-Packard Model 410A High Frequency V.T.V.M.	Like New	PUR*
APR-4 Search Receiver	Like New	PUR*
Tuning Units for APR-4 Receiver		PUR*
BC-348, BC-312, BC-342 Receivers		PUR*
T-17 Hand Microphone with cord and PL-88	Exc.	4.50
TS-146/UP New Mfg.		PUR*
Impedance Bridge 650A General Radio	Like New	225.00
Signal Generator 196A	Like New	PUR*
Million Signalizer Radio & TV. Like New		PUR*
Dumont 208 Scope	Exc.	PUR*
HS-23 800 ohm. Used \$2.95	New	5.95
HS-18 800 ohm. Used 1.75	New	2.25
HS-33 600 ohm. Used 3.50	New	6.95
HS-38 600 ohm. Used 1.75	New	2.25
RG-58/U Coaxial Cable		.06 ft.

*PUR—PRICE upon request.
NOTE: One of the largest and most complete electronic surplus stocks in the country. We have thousands of tubes, capacitors, plugs, accessories, transmitters-receivers, test equipment, etc. Send us your requirements.
TERMS: Prices F.O.B. Pasadena, California, 25% on all C.O.D. orders. Californians add 3% Sales Tax. Prices subject to change without notice.

SEARCH RECEIVER — ARD-2

Frequency range 80 to 3000 Mcs.

Measures RF signals from 80 to 3000 Mcs and pulse rates from 50 to 8000 cycles.

The ARD-2 can be used as a Direction Finder to locate signals, or as a frequency meter, by VISUAL and AURAL indicators, provide Originally designed and used by USN aircraft. Ideally suited for military, laboratory and general purpose use.

Equipment consists of the following:
Antenna Detector-CMD-66AFH—Has variable length antennas, diode detector and silver plated tuning stub with calibrated scale.

AMPLIFIER CMD-50ADC—has three stage pulse amplifier, a trigger circuit, a pulse rate counter circuit and audio amplifier, visual signal indicator, rectifier power supply which is operative on 115 Volts AC 60 to 2400 cycles current, regulated.

Test OSCILLATOR-CMD-60ABG—Has cavity frequency of 400 cycles with selection of four pulse repetition rates.

ALL CABLES AND FITTINGS, ACCESSORIES AND SHOCK MOUNTED RACK for immediate installation, plus two Technical Manuals.

SPARE PARTS—Steel chest includes spares for components and two extra sets spare tubes. Guaranteed NEW

All the above in original export packed cases. Wt.: 113-lbs

Price each \$27500

Other selected equipment for Radio Communications in our stocks

COMMUNICATION DEVICES CO.
2331 Twelfth Ave. NYC 27, N. Y.
Cable: Communidev Tel: Ad 4-6174

WE BUY AND SELL GOVERNMENT SURPLUS electronic components, units, wire, etc.

Your Inquiries Invited
LAPIROW BROS.
1649 Hoffman St. Cincinnati 23, Ohio
Kirby 1285

BUY AND SELL

We do both!—Electronic Equipment of every description. No lot too large. TOP PRICES. Ask us to help you. RAPID ACTION ALWAYS.

ELECTRONIC SURPLUS BROKERS

148 CHAMBERS ST., NEW YORK RECTOR 2-1591

TIME DELAY

RELAY 115v 60cy adjustable 6 sec. to 2 minutes
Cramer TD-120S. Also TD60S 6 to 60 sec. \$12.95
RELAY 3PDT 24vdc 250 ohm Clare Type K... \$1.95
RELAY 4 PDT 12 vdc 70 ohm Mini tel type... \$1.75
SELSYN-1F Special 115/90 v 400 cy... \$11.95
FIL XFRMR 6.3 @ 1.3A (other sizes avail)... \$3.99
ANS106-10S-25, PL-68, PL-250A, 83-1H, 88, JK38A
CONDENSERS: BATHUB, MICA AIR, OIL, HV, CER.
IPOTS, RELAYS, MIKES, 3AG&MDL fuses, SWITCHES
SPARES for: BC-1296A, MK11 Radar, AN/TPN-2
2% .002 Silver Mica CM30; many other items.

EMPIRE ELECTRONICS COMPANY

409 Avenue L Brooklyn 30, N. Y.
CLoverdale 2-2411 BRyant 9-1220

FOR THE BEST IN ELECTRONIC SURPLUS!

SEE NEW LOCATION OF

TELEMARINE COMMUNICATIONS CO.

3040 WEST 21st STREET, BROOKLYN 24, N. Y.

(1/2 BLOCK FROM FAMOUS BOARDWALK OF CONEY ISLAND)

TREMENDOUS STOCKS OF: RADIOTELEPHONES, X'MTRS, BROADCAST EQPT., RECEIVERS, RADAR, AMPLIFIERS and MISCELLANEOUS ELECTRONICS.

MOVED

TO A BIGGER & BETTER WAREHOUSE
PILED HIGH WITH
HARD-TO-FIND PARTS & EQUIPT.

Just a partial list of our present stock:

- BC-348 • BC-342 • ART-13
- ARC-3 • APN-9 • LM
- BC-221 • BC-611
- VARIOUS TEST EQUIPMENT

NEW EXPORT DIVISION FOR ALL FOREIGN ORDERS

Prompt attention to all inquiries—all languages!

Attn: Schools, Labs, Hams!

WE PAY MORE

FOR RADIO PARTS & EQUIPMENT

Cash in on your surplus equipment—or we'll trade for something you really need. Write today!

NEW ADDRESS:

CANDEE-AIRCO

Dept. E-7

P. O. Box 1187

Magnolia Park Station
BURBANK, CALIFORNIA

CHarleston 0-1486 • RÖckwell 9-1070

DYNAMOTORS

From our inventory. New, original containers, BD-77; DM-21; DM-32; DM-36; DY-22; PE-86 and others. Substantial quantities. Also John Oster Co. fractional horsepower motors.

LINE HARDWARE CO.

1515 N. 26th St. Phila. 21, Pa.

IF there is anything you want that other readers can supply—
OR . . . something you don't want—that other readers can use—
Advertise it in the SEARCHLIGHT SECTION

CAPACITOR HEADQUARTERS

MFD	BATHTUB COND.			CHANNEL TYPES		
	400V	600V	1000V	400V	600V	1000V
.05	\$.30	\$.35	\$.40	\$.35	\$.40	\$.50
.10	.35	.40	.45	.40	.45	.50
.25	.40	.45	.50	.50	.60	.65
.50	.45	.50	.60	.60	.65	.70
1.0	.50	.65	.75	.75	.85	—
2.0	.85	1.15	—	—	—	—
2 x .05	.35	.40	.45	.40	.45	.60
2 x .10	.40	.45	.50	.45	.50	.65
2 x .25	.45	.55	.65	.50	.65	.75
2 x .50	.55	.65	.85	.60	.75	—
2 x 1.0	.85	.95	—	—	—	—
3 x .05	.40	.45	.50	.45	.50	.65
3 x .10	.40	.45	.65	.45	.50	—
3 x .25	.50	.65	—	.60	.75	—
3 x .50	.60	.65	—	—	—	—

YAB/T WAB/T
SPECIFY TERMINAL LAYOUT WHEN ORDERING
OTHER VALUES—VOLTAGES AVAILABLE
JAN-C-25 TYPES AVAILABLE IN QUANTITY

ATTENTION

New Manufacture Hi-Capacity Oil Cond.
For Servo-Control-Network Applications
20-30-40-50-60 MFD/600 VDC, also AC rated

FOR FAST INTELLIGENT FRIENDLY SERVICE
"CALL ON ESSCO"

ELECTRONIC SPECIALTY SUPPLY CO.

58 Walker St. WA 5-8187 NYC. 13 N. Y.



OILS-MICAS-MOLDED PAPER TYPES

QUALITY—SERVICE

SENSIBLE PRICES

400 CYCLE TRANSFORMERS

352-7061	352-7091	352-7106	352-7245
352-7066	352-7096	352-7167	352-7295
352-7068	352-7098	352-7194	352-1402
352-7070	352-7099	352-7198	
352-7086	352-7102	352-7222	

YOUR INQUIRIES INVITED

G.E. THYRITE, a non-linear resistance material in which L varies as En. Excellent HV regulator 1/4 dia. x 1/8 thk. W/1/2" hole, Current 5-40 ma at 21 to 33 volts. Pkg of 5 \$2.85 ea. \$6.65
HAYDON SYNCHRONOUS MOTOR, operates 115 Vac 60 cy W/capacitor, high torque geared shaft, 5RPHR \$1.25

COMPACT UNITS

10-20-40-80-100 MFD/100 VDC (Oils)
Fast Delivery—Let Us Quote on Your Needs

WHIP ANT. SECTIONS, MS-49 to MS-56 . . . ea. \$4.5
A.E. type #13 STEPPER RELAY, 8-12 VDC, 3 deck 25 position, 360 degree rotation \$8.95
MU-METAL & #750 GRADE LAMINATIONS
EE-26-27, F-11, F-12, large quantities, available.

TUBE REBUILDING

Large Transmitting and Power types

Economical • Guaranteed

FREELAND PRODUCTS CO.

700 DRYADES ST., N. O., LA.

RELAY SPECIALISTS

AUTHORIZED FACTORY DISTRIBUTORS
STRUTHERS-DUNN POTTER & BRUMFIELD

100,000 RELAYS ALL TYPES

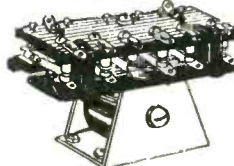

SIX-POLE DOUBLE THROW ALLIED #BN-18D-39 has 10 AMPERE CON-TACTS 2800 ohm coil operates on 30 MILLS DC OR 110 V. DC. \$6.95

RADIO DEVELOPMENT & SALES CO.

323 Atlantic Ave. Brooklyn 2, N. Y. ULster 5-0488

STANDARD BRAND TUBES

Jan Types Fully Guaranteed

1B29	\$2.75	715A	\$5.95
2C40	9.75	813	9.75
2C46	27.50	814	2.50
2C51	6.75	815	1.50
2K22	37.50	872A	3.25
2K23	37.50	931A	3.95
2K25	22.50	954	.39
3C31/C1B	2.51	955	.39
4C27	22.00	957	.45
6AK5	.85	958A	.59
6AS6	2.75	1005	.59
9GP7	12.50	1007	.85
15E	2.35	HV1269	2.25
T21	1.50	1613	1.15
120A	7.50	1616	.65
121A	2.95	1619	.35
F127A	17.00	1632	.59
304TH	6.75	1614	.85
507AX	1.45	2050/1665	1.40
705A	1.75	2051	1.00

CRYSTAL DIODES

1N21	.75	1N23B	3.50
1N21A	1.50	1N26	7.75
1N21B	3.25	1N34	.65
1N23A	2.25	1N34A	.89

Relay Coaxial 24v DC5 K-101 \$3.95

Please note our new address and telephone number:

ALLIED ELECTRONIC SALES

74 CORTLANDT STREET, NEW YORK 7, N. Y.

Barclay 7-5839

SEARCHLIGHT SECTION

Radar

SCR-545A Search and Track. Complete trailer, power supply and spare parts. Nearly New. Write for description and price.

Transformers & Chokes

- * New 10 K.W. Amertran oil cooled plate transformers 115v./230v. 60 cy. single phase primary, 17,500 volts, .5 amp. secondary. Can be furnished center tapped or two wire 2800 volts, 1.0 amp. State primary and secondary voltage desired. Priced \$75.00 each f.o.b. Los Angeles.
- * Filament, American Transformer Co. Spec. 29106. Type WS. .050 KVA. 50/60 cy. S.P., 35 KVA test, 12 KV d-c operating. Pri. 115 v., Sec. 5 v., 10 amps w/integral stand-off insulator and socket for #371,872, etc., rectifier tubes. \$15.00 each. Transstat. line voltage regulator, 115 v. 60 cy. Range 103-126 v. 2.17 amp. Amertran Spec. #29144. \$9.50 each.
- * Battery Charger, G.E. Cat. #WS-99316. Pri. 105-115-125 V. 60 C. Sec. 105-90-75-60-45-30 v. @ 6 amps. each side of center tap. Voltage reduced 10% and 20% thru tapped primary; two x 5 v. 18 amp. C.T. (Tungar filaments) and two x 7 v. 10 amp. 7/8" h. x 8-3/4" w. x 5 1/2" d. Wt. 56 lbs. New, orig. packing. G. E. Price \$52.00. \$17.50, 2 for \$30.00.
- * Choke, swinging 15,000 v. d-c line, ripple frequency 120, 149 ohms. .02 amp. @ 900 henrys; .52 amp. @ 25 henrys; 48% ripple. Amertran Spec. #29107. \$12.00.

Capacitors

9.12 mfd., 1265 v. 60 c. a-c or 4000 v. d-c power factor correction 5.0 K.V.A.R. Cat. #2528908. \$17.50
 .25-.25. 6000 v. d-c or .125 @ 12,000 v. d-c., Fast Cat. #A7548 oil. \$3.75.
 1.25/1.25 mfd., 7500 v. Pyranol Cat. #26F360. \$17.50

* Quantities available—subject to special discounts.

EPCO

1527 E. Seventh Street

Los Angeles 21, Calif.

***Resistors**

Fixed w.w. 160,000 ohm, 200 w. ferrule ends. \$1.00
 Fixed, w.w. 5,000 ohm, 200 w. ferrule ends. 1.00

***Meters & Multipliers**

Westinghouse Type R-5. 1 meg. precision meter multiplier resistors, wire wound, non inductive, 1/2% tolerance. Can be screwed together for any desired total. New. \$4.00 each.
 Ammeter, a-c, 3" Westinghouse NA-35 or Weston Model 476. 3 amps, f.s. deflection; scale calibrated 0-120. includes doughnut type current transformer w/200-5 ratio at 25-133 cy. \$8.50.

***Relays**

Allen-Bradley overload relay, 110 v. 60 cy. Cat. #810. Adjustable 6.3 to 18.1 amps. \$7.95 each.
 Westinghouse, 110 v. 60 cy. D.P.S.T. 15 amp. contacts with interlock. \$4.95 each.

***Rectifiers, Dry Disc**

Cu. S. FWB 1.8 v. d-c @ 1 amp. \$75 4 for 2.50
 Selenium, FWCT 2.2 v. d-c @ 3 amp. .75 4 for 2.50
 Selenium, HW, 36 v. d-c @ .2 amp. .75 4 for 2.50
 Selenium, FWB, 54 v. a-c @ 1.6 amp. 3.60
 Selenium, FWB, 154 v. a-c .6 amp. 5.50
 Selenium, FWB, 180 v. a-c .4 amp. 5.50

***Stand Off Insulators, Ceramic**

1 1/4" dia. x 5" \$.90 ea.
 1 1/2" dia. x 6" 1.00 ea.
 1 1/2" dia. x 8" 1.25 ea.
 All sizes with metal caps and bases.

High Voltage Rectifier Power Supply

Variable output 0-15,000 v. d-c @ 500 mills. Input 115 v. 60 cy. single phase. Army type RA-38. Size 6 1/2" x 5 3/4" x 5 7/8". Wt. 2040 lbs. Units are new, complete with spare tubes and remote control. Write for detailed information.

WESTINGHOUSE HIPERSIL CORES

Quantity	Gauge	Strip Width	Build Up	Window Width	Window Height
11,365	.003	1 1/8	1/2	7/16	3
3,741	.003	7/8	3/8	7/16	3

Available for immediate delivery

RAYTHEON MFG. CO.

Surplus Sales Dept. Waltham, Mass.
 Tel. Waltham 5-5860—Ext. 2

WHOLESALE ONLY

**ELECTRONIC COMPONENTS
 AIRCRAFT EQUIPMENT
 HYDRAULICS**

RADIO & ELECTRONIC SURPLUS
 13933-9 Brush St. Detroit 3, Mich.
 Phone Townsend 9-3403

WANTED

WANTED

TDE TBS TCS RBG Radio parts
 SA, SF, SG, SL, SO RADAR parts
 Submit lists

W-5431, ELECTRONICS
 330 W. 42 St., New York 36, N. Y.

WE BUY

All kinds of surplus electronic equipment and components.

ELECTRONICRAFT, Inc.

27 Milburn St. Bronxville 7, N. Y.
 Bronxville 2-0044

An Investment !

Productive advertising is an INVESTMENT rather than an EXPENDITURE.

"Searchlight" advertisers almost invariably report prompt and satisfactory results.

BE CONVINCED — send us your advertisement TODAY.

Address

Classified Advertising Division

ELECTRONICS
 330 W. 42nd St., N. Y. 18, N. Y.

ELECTRONIC EQUIPMENT WANTED!

Sell to



We want to buy all types of new and used surplus electronics equipment. Highest prices paid. We are the largest purchasers of such equipment.

ARROW SALES, INC. 7460 VARNA AVE., N. HOLLYWOOD, CALIF.

We Pay Highest \$\$\$\$ Prices for
RADIO & AIRCRAFT

ELECTRONICS EQUIPMENT
 You'll be pleasantly and profitably surprised at the prices we pay for needed parts and equipment. Simply send us a description of what you have—tell us your top dollar asking price—and we'll shoot back a prompt reply! Convert that equipment to ready cash now! Write:
ALVARADIO SUPPLY CO.—Division E-1
 4665 Melrose Av. Los Angeles 29, Cal. OLympia 2155

WANTED

RADIOSONDE

Number AMQ-1C, or 1D, or the later 208 MC. Type. Must be new in original sealed waterproof overseas export packaging. Any quantity accepted. Please write

K & L RADIO PARTS CO.
 1406 Venice Blvd. Los Angeles 6, Calif.

WANTED

- AN/TRC-1 Equipments.
- T14 Transmitters.
- R19 Receivers.
- TS32 Test Oscillators.

Any condition or quantity
 W-3858, Electronics
 330 W. 42nd St. New York 36, N. Y.

WANTED

BD110 Telephone Switchboards, BD100 Telegraph Switchboards, BD90 Power Boards, EE101 V-F Ringers, BE72 Cabinets, FM19 Frames, RA43, REC30, KS5988, RA87, RA37, RA91 Rectifiers, BD101 Test Boards, SB6 Switchboards, Type CF1A, CF3A, CF2B Carrier Equipments. Any condition and quantity.

W-4212, Electronics
 330 W. 42 St., New York 36, N. Y.

WANTED

Western Electric gray-finished EQUIPMENT CABINETS

For 19" panels. Heights of 2' 6", 3' 6", 7' 0" and 7' 6".

W-4852, Electronics
 330 W. 42 St., New York 36, N. Y.

WANTED

Federal type

**101B Voice-frequency Ringers
 Signal Corps type TA-3/FT.**

W-4814, Electronics
 330 W. 42 St., New York 36, N. Y.

ELECTRONIC TUBES

Electro is rapidly becoming the prime source for manufacturers, jobbers and exporters. Your requirements of large or small quantities of tube, all types, can be quickly supplied from our huge stock. Each and every tube is brand new, inspected and fully guaranteed by Electro. We carry Standard Brands Only. Critical tubes are almost always on hand at the right price. Write, Phone or Wire your needs at once.

RECEIVING		TRANSMITTING		RECEIVING		TRANSMITTING		
6Y4	.45	6J8G	1.30 28Z5	.65 2E24	4.50 FG271	57.50	CK1006	3.45
OYA	.55	6K6GT	1.00 25Z6GT	.65 2E26	3.75 FG280	59.50	CK1089	1.25
O1A	.65	6K7GT	.75 27A	.30 2E30	2.00 FG285	22.50	CK1090	.75
1A8	.70	6L8	.79 28D7	2.35 2E31	2.35 G1393A	13.25	R1111	3.50
1A8GT	.58	6L8GT	.79 30	.30 2E32	1.60 304TH	13.5	R1131C	7.50
1A7GT	.45	6L9	.85 32	.45 2E33	1.25 304TL	13.35	R1131E	4.8
1B1	.55	6L9GT	.75 36A5	.47 2E41	3.35 307A	4.95	I201	1.20
1B3GT	.82	6L9GT	.75 36A5	.64 2E42	2.75 308A	55.00	I203A	.79
1C6	.69	6L9GT	1.45 35L6GT	.67 2Q21	2.45 CE309	5.75	I203B	.85
1D5GT	.69	6L7G	.85 38Z3	.67 2Q22	2.45 310A	7.50	I612	2.25
1E4	.65	6N5	.95 38Z4	.67 2H21	125.00 313C	4.15	I613	1.60
1E4GT	.69	6N5GT	.85 38Z5	.49 312A	4.75 315A	4.15	I614	1.20
1E6GT	.69	6N7GT	.85 38	.69 3122	10.50 327A	4.75	I616	1.25
1E8GT	.69	6N7GT	.79 37	.60 3126	17.50 331A	3.50	I619	1.25
1J6GT	.75	6R7GT	.85 38/44	.59 3137	17.50 384B	2.25	I620	2.25
1L4	.85	6R7G	.85 40	.64 2130	69.50 349A	1.35	I621	2.00
1L4A	.85	68A	.62 41	.59 2131	27.50 360A	7.95	I622	2.15
1L4A	.98	68A7	.65 43	.75 2132	27.50 368A3	5.25	I623	4.00
1L4A	.98	68A7GT	.65 45	.69 2134	27.50 371B	3.75	I624	4.00
1L4A	.98	68A7GT	.65 45	.69 2137A	32.50 393A	8.95	I625	.49
1L4A	.98	68A7GT	.65 45	.69 2138	27.50 394A	8.95	I626	.49
1L4A	.98	68A7GT	.65 45	.65 2RA3	1.95 417A	17.50	I629	.95
1L4A	.98	68A7GT	.65 45	.75 2X2A	1.95 GL441	4.50	I630	.95
1L4A	.98	68A7GT	.65 45	.75 2X2A	1.95 GL441	4.50	I631	.95
1L4A	.98	68A7GT	.65 45	.75 2X2A	1.95 GL441	4.50	I632	.95
1L4A	.98	68A7GT	.65 45	.75 2X2A	1.95 GL441	4.50	I633	.95
1L4A	.98	68A7GT	.65 45	.75 2X2A	1.95 GL441	4.50	I634	.95
1L4A	.98	68A7GT	.65 45	.75 2X2A	1.95 GL441	4.50	I635	.95
1L4A	.98	68A7GT	.65 45	.75 2X2A	1.95 GL441	4.50	I636	.95
1L4A	.98	68A7GT	.65 45	.75 2X2A	1.95 GL441	4.50	I637	.95
1L4A	.98	68A7GT	.65 45	.75 2X2A	1.95 GL441	4.50	I638	.95
1L4A	.98	68A7GT	.65 45	.75 2X2A	1.95 GL441	4.50	I639	.95
1L4A	.98	68A7GT	.65 45	.75 2X2A	1.95 GL441	4.50	I640	.95
1L4A	.98	68A7GT	.65 45	.75 2X2A	1.95 GL441	4.50	I641	.95
1L4A	.98	68A7GT	.65 45	.75 2X2A	1.95 GL441	4.50	I642	.95
1L4A	.98	68A7GT	.65 45	.75 2X2A	1.95 GL441	4.50	I643	.95
1L4A	.98	68A7GT	.65 45	.75 2X2A	1.95 GL441	4.50	I644	.95
1L4A	.98	68A7GT	.65 45	.75 2X2A	1.95 GL441	4.50	I645	.95
1L4A	.98	68A7GT	.65 45	.75 2X2A	1.95 GL441	4.50	I646	.95
1L4A	.98	68A7GT	.65 45	.75 2X2A	1.95 GL441	4.50	I647	.95
1L4A	.98	68A7GT	.65 45	.75 2X2A	1.95 GL441	4.50	I648	.95
1L4A	.98	68A7GT	.65 45	.75 2X2A	1.95 GL441	4.50	I649	.95
1L4A	.98	68A7GT	.65 45	.75 2X2A	1.95 GL441	4.50	I650	.95
1L4A	.98	68A7GT	.65 45	.75 2X2A	1.95 GL441	4.50	I651	.95
1L4A	.98	68A7GT	.65 45	.75 2X2A	1.95 GL441	4.50	I652	.95
1L4A	.98	68A7GT	.65 45	.75 2X2A	1.95 GL441	4.50	I653	.95
1L4A	.98	68A7GT	.65 45	.75 2X2A	1.95 GL441	4.50	I654	.95
1L4A	.98	68A7GT	.65 45	.75 2X2A	1.95 GL441	4.50	I655	.95
1L4A	.98	68A7GT	.65 45	.75 2X2A	1.95 GL441	4.50	I656	.95
1L4A	.98	68A7GT	.65 45	.75 2X2A	1.95 GL441	4.50	I657	.95
1L4A	.98	68A7GT	.65 45	.75 2X2A	1.95 GL441	4.50	I658	.95
1L4A	.98	68A7GT	.65 45	.75 2X2A	1.95 GL441	4.50	I659	.95
1L4A	.98	68A7GT	.65 45	.75 2X2A	1.95 GL441	4.50	I660	.95
1L4A	.98	68A7GT	.65 45	.75 2X2A	1.95 GL441	4.50	I661	.95
1L4A	.98	68A7GT	.65 45	.75 2X2A	1.95 GL441	4.50	I662	.95
1L4A	.98	68A7GT	.65 45	.75 2X2A	1.95 GL441	4.50	I663	.95
1L4A	.98	68A7GT	.65 45	.75 2X2A	1.95 GL441	4.50	I664	.95
1L4A	.98	68A7GT	.65 45	.75 2X2A	1.95 GL441	4.50	I665	.95
1L4A	.98	68A7GT	.65 45	.75 2X2A	1.95 GL441	4.50	I666	.95
1L4A	.98	68A7GT	.65 45	.75 2X2A	1.95 GL441	4.50	I667	.95
1L4A	.98	68A7GT	.65 45	.75 2X2A	1.95 GL441	4.50	I668	.95
1L4A	.98	68A7GT	.65 45	.75 2X2A	1.95 GL441	4.50	I669	.95
1L4A	.98	68A7GT	.65 45	.75 2X2A	1.95 GL441	4.50	I670	.95
1L4A	.98	68A7GT	.65 45	.75 2X2A	1.95 GL441	4.50	I671	.95
1L4A	.98	68A7GT	.65 45	.75 2X2A	1.95 GL441	4.50	I672	.95
1L4A	.98	68A7GT	.65 45	.75 2X2A	1.95 GL441	4.50	I673	.95
1L4A	.98	68A7GT	.65 45	.75 2X2A	1.95 GL441	4.50	I674	.95
1L4A	.98	68A7GT	.65 45	.75 2X2A	1.95 GL441	4.50	I675	.95
1L4A	.98	68A7GT	.65 45	.75 2X2A	1.95 GL441	4.50	I676	.95
1L4A	.98	68A7GT	.65 45	.75 2X2A	1.95 GL441	4.50	I677	.95
1L4A	.98	68A7GT	.65 45	.75 2X2A	1.95 GL441	4.50	I678	.95
1L4A	.98	68A7GT	.65 45	.75 2X2A	1.95 GL441	4.50	I679	.95
1L4A	.98	68A7GT	.65 45	.75 2X2A	1.95 GL441	4.50	I680	.95
1L4A	.98	68A7GT	.65 45	.75 2X2A	1.95 GL441	4.50	I681	.95
1L4A	.98	68A7GT	.65 45	.75 2X2A	1.95 GL441	4.50	I682	.95
1L4A	.98	68A7GT	.65 45	.75 2X2A	1.95 GL441	4.50	I683	.95
1L4A	.98	68A7GT	.65 45	.75 2X2A	1.95 GL441	4.50	I684	.95
1L4A	.98	68A7GT	.65 45	.75 2X2A	1.95 GL441	4.50	I685	.95
1L4A	.98	68A7GT	.65 45	.75 2X2A	1.95 GL441	4.50	I686	.95
1L4A	.98	68A7GT	.65 45	.75 2X2A	1.95 GL441	4.50	I687	.95
1L4A	.98	68A7GT	.65 45	.75 2X2A	1.95 GL441	4.50	I688	.95
1L4A	.98	68A7GT	.65 45	.75 2X2A	1.95 GL441	4.50	I689	.95
1L4A	.98	68A7GT	.65 45	.75 2X2A	1.95 GL441	4.50	I690	.95
1L4A	.98	68A7GT	.65 45	.75 2X2A	1.95 GL441	4.50	I691	.95
1L4A	.98	68A7GT	.65 45	.75 2X2A	1.95 GL441	4.50	I692	.95
1L4A	.98	68A7GT	.65 45	.75 2X2A	1.95 GL441	4.50	I693	.95
1L4A	.98	68A7GT	.65 45	.75 2X2A	1.95 GL441	4.50	I694	.95
1L4A	.98	68A7GT	.65 45	.75 2X2A	1.95 GL441	4.50	I695	.95
1L4A	.98	68A7GT	.65 45	.75 2X2A	1.95 GL441	4.50	I696	.95
1L4A	.98	68A7GT	.65 45	.75 2X2A	1.95 GL441	4.50	I697	.95
1L4A	.98	68A7GT	.65 45	.75 2X2A	1.95 GL441	4.50	I698	.95
1L4A	.98	68A7GT	.65 45	.75 2X2A	1.95 GL441	4.50	I699	.95
1L4A	.98	68A7GT	.65 45	.75 2X2A	1.95 GL441	4.50	I700	.95
1L4A	.98	68A7GT	.65 45	.75 2X2A	1.95 GL441	4.50	I701	.95
1L4A	.98	68A7GT	.65 45	.75 2X2A	1.95 GL441	4.50	I702	.95
1L4A	.98	68A7GT	.65 45	.75 2X2A	1.95 GL441	4.50	I703	.95
1L4A	.98	68A7GT	.65 45	.75 2X2A	1.95 GL441	4.50	I704	.95
1L4A	.98	68A7GT	.65 45	.75 2X2A	1.95 GL441	4.50	I705	.95
1L4A	.98	68A7GT	.65 45	.75 2X2A	1.95 GL441	4.50	I706	.95
1L4A	.98	68A7GT	.65 45	.75 2X2A	1.95 GL441	4.50	I707	.95
1L4A	.98	68A7GT	.65 45	.75 2X2A	1.95 GL441	4.50	I708	.95
1L4A	.98	68A7GT	.65 45	.75 2X2A	1.95 GL441	4.50	I709	.95
1L4A	.98	68A7GT	.65 45	.75 2X2A	1.95 GL441	4.50	I710	.95
1L4A	.98	68A7GT	.65 45	.75 2X2A	1.95 GL441	4.50	I711	.95
1L4A	.98	68A7GT	.65 45	.75 2X2A	1.95 GL441	4.50	I712	.95
1L4A	.98	68A7GT	.65 45	.75 2X2A	1.95 GL441	4.50	I713	.95
1L4A	.98	68A7GT	.65 45	.75 2X2A	1.95 GL441	4.50	I714	.95
1L4A	.98	68A7GT	.65 45	.75 2X2A	1.95 GL441	4.50	I715	.95
1L4A	.98	68A7GT	.65 45	.75 2X2A	1.95 GL441	4.50	I716	.95
1L4A	.98	68A7GT	.65 45	.75 2X2A	1.95 GL441	4.50	I717	.95
1L4A	.98	68A7GT	.65 45	.75 2X2A	1.95 GL441	4.50	I718	.95
1L4A	.98	68A7GT	.65 45	.75 2X2A	1.95 GL441	4.50	I719	.95
1L4A	.98	68A7GT	.65 45	.75 2X2A	1.95 GL441	4.50	I720	.95
1L4A	.98	68A7GT	.65 45	.75 2X2A	1.95 GL441	4.50	I721	.95
1L4A	.98	68A7GT	.65 45	.75 2X2A	1.95 GL441	4.50	I722	.95
1L4A	.98	68A7GT	.65 45	.75 2X2A	1.95 GL441	4.50	I723	.95
1L4A	.98	68A7GT	.65 45	.75 2X2A	1.95 GL441	4.50	I724	.95
1L4A	.98	68A7GT	.65 45	.75 2X2A	1.95 GL441	4.50	I725	.95
1L4A	.98	68A7GT	.65 45	.75 2X2A	1.95 GL441	4.50	I726	.95
1L4A	.98	68A7GT	.65 45	.75 2X2A	1.95 GL441	4.50	I727	.95
1L4A	.98	68A7GT	.65 45	.75 2X2A	1.95 GL441	4.50	I728	.95
1L4A	.98	68A7GT	.65 45	.75 2X2A	1.95 GL441	4.50	I729	.95
1L4A	.98	68A7GT	.65 45	.75 2X2A	1.95 GL441	4.50	I730	.95
1L4A	.98	68A7GT	.65 45	.75 2X2A	1.95 GL441	4.50	I731	.95
1L4A	.98	68A7GT	.65 45	.75 2X2A	1.95 GL441	4.50	I732	.95
1L4A	.98	68A7GT	.65 45	.75 2X2A	1.95 GL441	4.50	I733	.95
1L4A	.98	68A7GT	.65 45	.75 2X2A	1.95 GL441	4.50	I734	.95
1L4A	.98	68A7GT	.65 45	.75 2X2A	1.95 GL441	4.5		

TO THE ADVERTISERS

November, 1952

SEARCHLIGHT SECTION

(Classified Advertising)

H. E. Hilty, Mgr.

Goodyear Aircraft Corp.	443
Green, Leonard	475
Hatry & Young	467
Hoffman Laboratories, Inc.	444
Houde Supply Co.	465
Instrument Associates	456
International Projector	449
J. S. H. Sales Co.	469
K & L Radio Parts Co.	478
Kollsman Instrument Corp.	440
Laprow Bros.	476
Leotron Research Laboratories	450, 451
Lemar Electronics Co.	473
Liberty Electronics Inc.	454
Life Electronic Sales	463
Line Hardware Co.	477
Maritime Switchboard	476
Maxson, W. L.	439
Melpar, Inc.	445
Mogull Co., Inc., Alexander	466
Monmouth Radio Laboratories	462
National Cash Register Co.	444
Nibur Sales Corp.	468
Norman Radio Distributors Inc.	462
P & J Sales	466
Phillips Petroleum Co.	440
Photocon Sales	476
Porter Radio Sales Co.	474
Precision Electrical Instrument Corp.	462
Premier Continental Corp.	472
Radcom Engineering	471
Radio Corp of America	441
Radio Development & Sales Co.	477
Radio & Electronic Surplus	478
Radio Ham Shack, Inc.	482
Radio Shack Corp.	469
Radio Surplus Corp.	460
Railway Communications, Inc.	472
Raytheon Manufacturing Co.	478
Reeves Instrument Corp.	442
Relay Sales	468
Reliance Merchandizing Co.	452
Rose Electronics Co.	475
Rose Products Co.	464
Sandia Corp.	445
Servo-Tek Products, Inc.	457
Spivey Co., James S.	470
Stavid Engineering Inc.	449
State Labs	474
Stewart-Warner Electric	444
"TAB"	483, 484
Telegraph Condenser Co., Ltd.	442
Telemarine Communications Co.	477
Telorex, Inc.	447
Tracerlab, Inc.	447
Tung-Sol Electric Inc.	448
Turner Co.	442
Universal General Corp.	461
V & H Electronic Industries Inc.	472
Wells Sales Inc.	473
Weston Laboratories	466, 467
Wilcox Electric Co.	448

ELECTRO—FOR ELECTRONIC SURPLUS

OIL FILLED CONDENSERS

MFD.	VOLT.	TYPE	PRICE	MFD.	VOLT.	TYPE	PRICE	MFD.	VOLT.	TYPE	PRICE
.01	1000 DC	24F174	.49	.5	600 DC	65B144504K	.95	2.0	3000 DC	Ldg. Mfr.	7.95
.02	400 DC	26F789	1.95	.5	1000 DC	23F331	.89	2.0	400 DC	Ldg. Mfr.	14.95
.02	1000 DC	26F789	1.95	.5	1000 DC	10059C	.89	2.0	5000 DC	23F50	15.95
.02	400 DC	23F274	.39	.5	1500 DC	481294	.95	2.0	6000 DC	60020	27.50
.02	15 KVDC	24F14	3.50	.5	1500 DC	21F628	1.50	2.0	6000 DC	Ldg. Mfr.	27.50
.045	15 KVDC	D-4495	9.50	.5	2000 DC	26F598	1.95	2.2	750 AC	21F563	1.75
.05	600 DC	S. T.	.29	.5	3000 DC	30003	3.95	2.25	330 AC	21F479	1.85
.05	1000 DC	23F328	.49	.5	4000 DC	28F128	9.95	2.25	600 DC	Ldg. Mfr.	1.85
.05-.05	600 DC	S. T.	.29	.5	5000 DC	30005	7.95	2.25	1600 AC	21F667	4.50
.05-.05	600 DC	22F797	.69	.5-1	400 DC	481769	.70	2.5	330 AC	Ldg. Mfr.	2.35
.06	25 KVDC	26F595	17.50	.5-3	400 DC	23F280	.85	2.5	430 AC	21F744	2.35
.1	400 DC	26F595	17.50	.5-3	400 DC	Top Term.	.75	2.6-0.4	440 AC	21F676	1.75
.1	500 DC	M7876543	.49	.5-3	600 DC	23F498	.92	2.7	230 AC	Ldg. Mfr.	2.45
.1	600 DC	22F425	.59	.5-3	600 DC	21F487	.95	2.5	330 AC	21F583	2.45
.1	1000 DC	27F287	.59	.5-3	3000 DC	25F526	4.95	2.75	385 AC	49F16	2.60
.1	1500 DC	W70B1EH104K	.59	.5-5.5	600 DC	22F437	1.25	3.0	330 AC	Ldg. Mfr.	2.75
.1	3500 DC	K5204513	.69	.58	100 AC	21F476	1.65	3.0	1000 DC	Ldg. Mfr.	2.75
.1	7500 DC	25F405	3.95	.6-6.6	100 AC	22F7142	1.25	3.0-.05	600 DC	22F632	1.65
.1	10 KVDC	23F430	9.95	.635	130 AC	21F386	1.30	3.0	600 DC	21F702	1.65
.1	10 KVDC	23F430	9.95	.635	900 AC	21F386	1.30	3.26	230 AC	21F696	2.75
.1-1	230 AC	Z13860	.49	.666	800 AC	21F333	1.35	3.5	330 AC	21F587	3.45
.1-1	600 DC	22F805	.85	.67	120 AC	26F663	1.95	3.5	600 DC	21F718	3.45
.1-1	600 DC	21F291	.85	.7	1300 AC	21F485	1.50	3.7	230 AC	49F5	3.45
.1-1-1	400 DC	NCP9183	.79	.7-7	800 AC	21F381	1.95	3.7	230 AC	21F705	3.45
.1-1-1	400 DC	CA-255	.79	.75	700 AC	21F718	1.95	3.75	1000 DC	6037	3.75
.1-1-1	600 DC	61115	.85	.75	800 AC	9CEA148	1.95	3.75	330 AC	Ldg. Mfr.	3.50
.1-1-1	600 DC	37J425	.85	.75	400 DC	28F168	.89	3.9	230 DC	Ldg. Mfr.	3.50
.15	440 AC	52J3288	.70	.8	120 AC	21F601	.89	3.9	400 DC	Oil Filled	2.50
.15	4000 DC	400015	2.95	.8	650 DC	21F716	1.95	4.0	400 DC	481249	2.75
.15-15	6000 DC	26F435	5.25	1.0	100 DC	54B1EB105K	1.25	4.0	400 DC	Oil Filled	2.50
.15	8000 DC	Ldg. Mfr.	6.95	1.0	500 DC	23F303	1.95	4.0	600 DC	26F106	2.75
.15	200 DC	28F201	2.35	1.0	500 DC	9CD6A4	.95	4.0	600 DC	70B1F40V3545	4.50
.2	440 AC	Ldg. Mfr.	.69	1.0	500 DC	9CEA320	1.05	4.0	600 DC	21F702	2.75
.2	1000 DC	23F316	.72	1.0	440 AC	21F601	1.05	4.0	660 AC	21F665	3.95
.2	10 KVDC	26F433	10.95	1.0	600 DC	21F714	1.95	4.0	1000 DC	Oil Filled	3.75
.2-2.2	4000 DC	10345	4.95	1.0	600 DC	Bathtub	1.15	4.0	1000 DC	Oil Filled	3.75
.25	250 AC	26F922	.69	1.0	600 DC	21F714	1.95	4.0	4000 DC	70E1EM405K	2.25
.25	250 AC	TJF200447	.72	1.0	600 AC	Ldg. Mfr.	1.15	4.0-4.0	1000 DC	4223	27.50
.25	400 DC	DA4025	.49	1.0	1000 DC	Ldg. Mfr.	1.15	4.0-4.0	230 AC	21F703	3.95
.25	460 AC	26F876	.79	1.0	1150 AC	21F641	1.15	4.0-4.0	330 AC	21F693	4.25
.25	400 DC	22F311	.95	1.0	1150 AC	21F641	1.15	4.0-4.0	330 AC	21F693	4.25
.25	1000 DC	62B1F6254K	.85	1.0	2000 DC	23F70	2.95	4.5	330 AC	21F134	4.35
.25	1800 DC	27F255	.85	1.0-1.0	4000 DC	40010	8.95	5.0	220 AC	21F134	4.35
.25	1800 DC	26F467	.85	1.0-1.0	600 DC	23F569	1.65	5.0	330 AC	9CEA306	4.35
.25	1800 AC	481129	1.45	1.1-1.5	150 DC	Ldg. Mfr.	.95	5.0	330 AC	9CEA306	4.35
.25	2000 DC	TJF200025	.72	1.1	200 AC	21F717	1.65	3.75	330 AC	26F108	4.50
.25	3000 DC	5511P	3.45	1.1	200 AC	25F450	1.25	5.0	440 AC	21F420	4.75
.25	3500 DC	25F637	4.95	1.1	240 AC	25F853	1.30	6.0	600 DC	5060	4.85
.25	4000 DC	25F637	4.95	1.1	240 AC	25F853	1.30	6.0	600 DC	5060	4.85
.25	6000 DC	25F659	7.95	1.25	125 AC	26F594	1.45	6.5	330 AC	Ldg. Mfr.	4.95
.25-25	400 DC	22F640	.79	1.25	125 AC	28F392	1.45	6.5	330 AC	Ldg. Mfr.	4.95
.25-25	400 DC	22F640	.79	1.25	125 AC	28F392	1.45	6.5	330 AC	9CEA309	4.95
.25-25	600 DC	51B4F254L	.79	1.26	440 AC	21F338	1.45	6.6	600 DC	6080	5.25
.25-25	600 DC	K7102019P1	.95	1.26-25	1000 AC	21F380	1.45	6.6	600 DC	Oil Filled	5.95
.3	2000 DC	25F332	1.45	1.35	125 AC	28F238	1.49	10.0	330 AC	26F273	4.95
.3-3	1000 AC	21F860	1.95	1.45	750 AC	Ldg. Mfr.	1.55	10.0	50 AC	26F412	2.75
.36	800 AC	25F888	1.65	1.5	330 AC	25F483	1.55	10.0	440 AC	25F501	5.95
.36-127	330 AC	25F888	1.65	1.5	330 AC	25F483	1.55	10.0	440 AC	Ldg. Mfr.	5.95
.375	250 AC	26F337	.79	1.58-0.3	600 AC	21F651	1.75	10.0	1800 DC	23F152	8.95
.38-38	800 AC	21F707	1.65	1.58-0.3	600 AC	21F651	1.75	10.0	1500 DC	70B1F4106K	8.95
.4	400 AC	21F588	1.70	1.75	660 AC	21F631	1.95	12.0	750 AC	25F268	8.95
.4-4	800 AC	21F588	1.70	1.75	660 AC	21F631	1.95	12.0	1000 AC	25F234	8.95
.4	1400 AC	25F334	1.70	2.0	120 AC	1A9369	1.65	15.0	330 AC	Ldg. Mfr.	9.50
.4	800 AC	21F588	1.70	2.0	120 AC	1A9369	1.65	15.0	330 AC	Ldg. Mfr.	9.50
.44-44	880 AC	21F484	1.70	2.0	330 AC	Ldg. Mfr.	1.70	20.0	220 AC	21F299	9.50
.44-44	120 DC	Ldg. Mfr.	.65	2.0	400 DC	Bathtub	1.70	20.0	50 DC	Bathtub	1.45
.45-45	800 AC	21F588	1.70	2.0	600 DC	25F330	1.68	30.0	90 AC	Ldg. Mfr.	2.65
.46	1750 AC	21F573	1.95	2.0	600 DC	25F330	1.68	30.0	90 AC	Ldg. Mfr.	2.65
.5	200 DC	Ldg. Mfr.	.62	2.0	250 AC	25F330	1.68	30.0	90 AC	Ldg. Mfr.	2.65
.5	330 AC	21F588	1.70	2.0	650 AC	25F330	1.68	30.0	90 AC	Ldg. Mfr.	2.65
.5	400 DC	C59589	.69	2.0	800 AC	21F835	1.90	46.2	330 AC	26F413	24.50
.5	400 DC	Ldg. Mfr.	.69	2.0	1000 DC	Ldg. Mfr.	1.95	50.0	300 AC	26F413	24.50
.5	600 DC	Ldg. Mfr.	.79	2.0	1300 DC	Ldg. Mfr.	3.95	50.0-50.0	90 AC	MK4	29.95
.5	600 DC	Ldg. Mfr.	.79	2.0	2000 DC	20020	5.00	50.0	600 DC	Leadline Mfr	22.50
.5	600 DC	Ldg. Mfr.	.79	2.0	2500 DC	Ldg. Mfr.	6.45	50.0	600 DC	Leadline Mfr	22.50

HIGH VOLTAGE CAPACITORS

#18F269 rated dual 60 Mfd @ 3000 VDC	\$65.00
#19F740-4244G Paper rated 7.0 Mfd @ 4000 VDC	\$42.80
14 F Rated 4.0 Mfd at 5000 VDC	\$42.50
14 F2 Rated 7.0 Mfd at 5000 VDC	\$52.50
#19P10 rated 0.1 Mfd @ 8000 VDC max amps 204	\$37.50
#7520 Oil, rated Dual 1.0 Mfd 7500 VDC	\$79.50
#14F38 rated 4.5 Mfd @ 7500 VDC	\$29.50
#2C21B1 Paper rated Dual 0.5 Mfd @ 9000 VDC	\$32.50
Inerteen type FL, rated 1.0 Mfd @ 10,000 VDC	\$37.50
#26F68 rated 0.1 Mfd @ 12,000 VDC	\$9.95
#A7548 oil filled, rated Dual 0.25 Mfd @ 6000 VDC	\$14.50
#TK120065-1 Paper rated 0.65 Mfd @ 12,500 VDC	\$19.95
#15020 rated 0.25 Mfd @ 15,000 VDC	\$19.50
20020 rated 0.25 Mfd @ 20,000 VDC	\$27.50
#TK20002-2 Paper rated 0.25 Mfd @ 20,000 VDC	\$27.50
#TK20005 Paper rated 0.5 Mfd @ 20,000 VDC	\$48.00
#14F22 rated 1.0 Mfd @ 20,000 VDC	\$120.50
#20A00 rated 2.0 Mfd @ 20,000 VDC	\$120.50
#14F103 rated 0.5 Mfd @ 25,000 VDC	\$37.50
#TK25050 Paper rated 0.5 Mfd @ 25,000 VDC	\$87.50
Inerteen type FP rated 0.5 Mfd @ 25,000 VDC	\$37.50
#14F88 rated 0.75 Mfd @ 25,000 VDC	\$72.50
#A9734 rated 1.0 Mfd @ 25,000 VDC	\$82.50
#14F112 rated 0.001 Mfd @ 50,000 VDC	\$42.50
#14F96 rated 0.025/0.025 Mfd @ 50,000 VDC	\$89.50
#14F127 rated 0.025 Mfd @ 50,000 VDC	\$49.50
#14F97 rated 0.25 Mfd @ 50,000 VDC	\$79.50

Amertran "TRANSTATS" Voltage Regulator

11.5 KVA 50/60 cy. Commutator range 0-115V. Max. Amps. 100. Reconnection diagram available for 250 V. 50.00
 Transtat 25 KVA. Fixed winding 115/1/60. Commutator range 103-120V. Max. AMPS. 2.17 \$9.45

SUPERIOR POWERSTAT

Type 112B-3V. Pri.: 230V. 3 ph. 60 cy. Output: 0-270 Volts 7 KVA. May be separated and used as three 0-115V, 1 ph. 60 cy. 2.0 KVA units. Brand New \$300.00

GP-7 Radio Xmtr. Complete w/6 Tuning Units & all accessories. Freq. Range: 350-9050 Kcs. Tube Complement: (1) 803. (1) 801. (1) 843. (1) 5Z3. (2) 1618 and a full set of spares. 100W output. Brand New export boxed. Gross Wt. 450 Lbs. \$149.50

MOTORS INVERTERS & GENERATORS

PU

WANTED! WANTED!

Needed for Government Defense Projects—all types of military electronic gear with the prefix TS, BC, SCR, APR, APS, etc. Highest prices paid or will exchange for your needs. No offer too small or too large.

WRITE! WIRE! CALL!

TEST EQUIPMENT



TS-34/AP SYNCHROSCOPE AND OSCILLOSCOPE.

Used to test and service airborne and ground radars. Complete in portable carrying case with all probes, cables and accessories. Input 110v 60-2600 cyc.

- TS-3/AP—S-Band Power Frequency Meter
- TS-10/AP—APN-1 Test Set
- TS-12/AP—X-Band V.S.W.R. Test Set
- TS-13/AP—X-Band Signal Generator
- TS-14/AP—S-Band Signal Generator
- TS-15/AP—Flux Meter
- TS-16/AP—APN-1 Test Set
- TS-18/AP—Capacity Divider
- TS-23/APN—SCR-718 Test Set
- TS-33/AP—X-Band Frequency Meter
- TS-35/AP—X-Band Test Set
- TS-36/AP—X-Band Power Meter
- TS-45/APM-3—X-Band Signal Generator
- TS-59/APN—APN-1 Test Set
- TS-61/AP—S-Band Echo Box
- TS-62/AP—X-Band Echo Box
- TS-68/AP—300-1000 MC Frequency Meter
- TS-89/AP—Pulse Voltage Divider
- TS-98/AP—Pulse Voltage Divider
- TS-102/AP—Range Calibrator
- TS-111/AP—S-Band Wavemeter
- TS-118/AP—Power Meter
- TS-125/AP—S-Band Power Meter
- TS-155/UP—S-Band Signal Generator
- TS-164/AP—Frequency Meter
- TS-170/ARN-5—I.L.S. Test Set
- TS-184/AP—Test Set
- TS-226/AP—300-1000 MC Power Meter
- TS-268/UP—Crystal Test Set
- TS-278/AP—AFS-13 Test Set
- IE-19—SCR-522 Test Set
- IE-36—SCR-522 Test Set
- BC-221—Frequency Meter
- BC-1277—S-Band Signal Generator
- TBN/3EV—Thermistor Bridge
- CW/60/ABM—S-Band Frequency Meter

FLUXMETER

Portable Gauss Meter with range of 500-4000 Gauss. Used to test Magnatron and other magnets. Probe has a gap of 1/4". Complete. Brand New \$32.50

RECEIVING TUBES

0A2	50.95	6AK5	50.88	6E7	50.9
0A4G	1.05	6AK6	1.09	6SU7GT	2.7
0B2	1.05	6AL5	.52	6V7	1.8
0Z4	.70	6A06	.85	6V6GT	1.35
1A7GT	.80	6AR5	1.25	6WA	.6
1B3/8016	.75	6AU5	1.19	6X5GT	.6
1C5GT	.65	6AU6	.59	6V6G	.9
1D8GT	.65	6AV6	.55	6Y7G	.7
1G6GT	.65	6B4C	1.25	7A6	.7
1L4	.85	6B7	.75	7B7	.7
1L4A	.85	6B8G	.75	7C5	.7
1L6A	.98	6BA6	.65	7C7	.7
1L8A	.75	6BC5	.75	7F7	.7
1L8B	.91	6BE6	.65	7N7	.8
1L8C	.75	6BF6	.72	7Y7	.8
1L8D	.91	6BF6	.65	7N7	.8
1LN5	.75	6BF6	.72	7Y7	.8
1N5GT	.65	6BG6G	1.89	12A6	.9
1P5GT	.65	6BH6	.9	12A7	.6
1R4	.69	6BJ6	.95	12AH7GT	1.1
1R5	.65	6BQ6	1.25	12AT6	.5
1S4	.67	6CS6	.85	12BA6	.6
1S5	.65	6CS6	.85	12BE6	.6
1V	.65	6D6	.72	12C8	.6
1X2	1.10	6E8	.85	12H6	.6
2A3	.96	6F6	.85	12S47GT	.7
2X2	1.50	6F6	.85	12S7GT	.8
2X2A	1.50	6F7	.85	12S7GT	.8
3A4	.65	6H6	.85	12S7GT	.8
3A5	.85	6H6GT	.85	12S7GT	.8
3B7/1291	4.2	6J5	.75	12S7GT	.8
3D6/1293	4.2	6J5GT	.75	12S7GT	.8
3Q4	.63	6J6	.65	12S7GT	.8
3Q5GT	.79	6J7	.69	12S7GT	.8
3S4	.74	6K6	.65	12S7GT	.8
3V4	.74	6K6GT	.65	12S7GT	.8
5H4GV	1.65	6K7	.79	14M7	.85
5T4	1.32	6K8GT	1.15	25L6GT	.65
5U4G	.69	6L6	1.25	25Z6	.65
5V4G	.98	6L6G	1.50	25G6T	.65
5W4	.98	6L6GA	1.50	45	.69
5Y3GT	.45	6L7	.85	45	.69
5Y4G	.67	6N7GT	.85	45A5	.75
5Z3	.95	6G5	.75	50A5	.89
5Z4G	.95	6G7GT	.85	50B5	.75
6A3	.95	6SC7	.75	50C5	.67
6A6	.89	6SG7	.75	50L6GT	.65
6A7	.89	6SG7	.75	50Y6	.72
6A8GT	.95	6SH7	.65	53	.65
6A8T	.95	6SH7	.65	53	.65
6AC5GT	1.05	6SK7GT	.72	80	.82
6AC7	.95	6SL7GT	.75	83V	.95
6AG5	.95	6STGT	.75	83V	.95
6AG7	1.45	6SQ7	.65	84/GZ4	.92
6AH6	1.29	6SR7GT	.68		
6AJ5	1.35	6SS7	.80		



RELIABILITY! HONESTY! SERVICE!

RADAR

- APA-10—Panoramic Adaptor
- APA-17—Automatic Direction Finder 250-1000 MC
- APB-5—Low Altitude Tracking & Bombing Equip.
- APR-1—Radar Search Receiver 40-5400 MC
- APR-2—Radar Search Receiver 85-1000 MC
- APR-4—Radar Search Receiver 38-4000 MC
- APR-5—Radar Search Receiver 1000-3100 MC
- APR-6—Radar Search Receiver 3000-6000 MC
- APS-2—S-Band Search Radar
- APS-3—X-Band Search Radar
- APS-4—X-Band Search & Homing Radar
- APS-6—X-Band Search & Gun Laying Radar
- APS-15A—X-Band Blind Bombing Radar
- APR-4—Radar Jamming Xmitter 165-780 MC
- APT-5—Radar Jamming Xmitter 350-1400 MC
- SO-13—S-Band Marine Radar, Lightweight
- SO-10—CM Portable Radar
- TPS-1—Portable Search Radar
- TPS-3—L-Band Search Radar
- UPN-1 & 2—S-Band Portable Beacon Battery or 110v AC

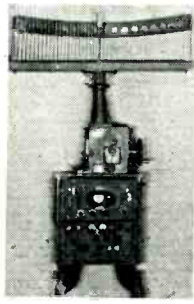

SQ 10 CM PORTABLE RADAR

This set is a very compact search radar. Complete installation available. Now in carrying cases. Tech. data as follows:
power input: 90-130v
cyc. eye: pulse rate: 800
cyc. range: 3, 15, 45
miles; pulse width: 1
microsec.; 300 yds.
min. range, all ranges:
I.F.F. synch. output
available; accuracy ±
5%; power output 1 KW;

beam width: 8° horiz. 15° vert.; presentation: A, B, P, P, I.

MOBILE POWER PLANT

(GAS DRIVEN)

Output: 220v — 3KW — 60 cyc. One phase. Excellent condition, checked out.

- RA-34—Power Supply for BC-375E
- RA-62—Power Supply for SCR-522
- BC-1016—Ink Tape Recorder
- PE-103—Dynamotor Power Supply
- PE-104—Vibrator Power Supply
- GN-58—Hand Cranked Generator W/Legs & Seat
- SCR-578—Gibson Girl (Emergency Xmitter)
- CRT-3—Victory Girl Dual Freq. Emergency Xmitter
- Special Powered Chest & Headsets MI-2454-B; Type O, Mfg. RCA.
- AS-32/APX-1—Antenna
- AN/RCR-7—V.H.F. Handi-Talkies 112MC Xtal Control
- MN/26 Y—Compass Receiver
- BC-733D—Receiver with Tubes
- C-3—Navy Sniperscope in Carrying Case
- BC-1284—Lighthouse Tube Preamp
- BC-996—Interphone Amplifier
- RL-42—Motor Antenna Reel
- 30 MC I.F. Strips Using 6AK5
- RD-7/APA-23—Recorder for APR
- AS-27/ARN-5—Antenna
- ARA—Receiver—500-1500 KC
- ID/80-APA-17—Indicator
- RA-300/ARC-5—Receiver—100-156 MC
- RM-29—Remote Control
- BC-455—Receiver—6-9 MC
- BC-454—Receiver—3-6 MC
- BC-800—Transmitter/Receiver
- BC-9-0—Transmitter—100-156 MC
- RA-300—FM Exciter (Mfg. Tempco)
- FL-8—Filter
- FL-5—Filter, Less Cables
- 3C-16-D GSAP—Gun Camera Computers with All Accessories; in Carrying Case
- AT-2A/APN-2—Antenna

SPARE PARTS AND COMPONENTS AVAILABLE FOR MANY EQUIPMENTS

ALL EQUIPMENT SOLD IS CAREFULLY RECONDITIONED AND CHECKED OUT TO ORIGINAL SPECIFICATIONS IN OUR OWN SHOPS USING FINEST LAB TYPE TEST EQUIPMENT

THESE COMPLETELY EQUIPPED SHOPS AND OUR EXPERIENCED TECHNICAL STAFF ARE AVAILABLE FOR GOVERNMENT PRIME OR SUB-CONTRACT WORK OR PRIVATE COMMERCIAL ORDERS ON ANY TYPE OF COMMUNICATIONS OR RADAR APPARATUS.

PANEL METERS

2" SQUARE WESTON—SANGAMO

0-20 Volts D.C.	\$2.95	0-5 Ma	\$2.95
0-40 Volts D.C.	2.95	0-500 Microamp	4.95
0.5 Amp. R.F.	2.95	0-100 Ma (0-300 scale)	2.95

COMMUNICATIONS

AN/ARC-1 TRANS/REC.

Provides Radio-Telephone Communication between Aircraft or Aircraft and Ground. Complete with Shock Mount and Control Box. Input: 28V DC. Excellent condition. Available in either 10 or 20 Crystal Controlled Channels 100-156 MCS.



- APA-11—Pulse Analyzer
- APN-1—Airborne Radio Altimeter
- ARC-4—VHF Transceiver 140-156 MC
- ARN-5—Glide Path Receiver
- ARN-7—Airborne Directional Finder
- ARR-2—Homing & Receiving Equipment
- ART-13—Collins Autotone Transmitter
- BC-223—30-Watt Transmitter 2-5.2 MC
- BC-342—Receiver—1.5 to 18 MC 110v AC
- BC-348—Receiver—1.5 to 18 MC 28v DC
- BC-375E—Radio Transmitter
- BC-639—VHF Receiver 100-156 MC
- BC-640—VHF Transmitter 100-156 MC
- BC-1206—Beacon Receiver 200-400 KC
- RC-103—Airborne Localizer Receiver
- SCR-269—Radio Compass
- SCR-274N—Command Equipment
- SCR-284—Field Radio Station
- SCR-291—Semi-Portable Direction Finder
- SCR-300—Field Transmitter and Receiver
- SCR-522—VHF Transmitter and Receiver
- SCR-536—Handi-Talkie
- SCR-555—Semi-Portable Direction Finder
- SCR-694—Portable Field Transceiver
- SCR-625—Mine Detector
- SCR-718A-AM-C—High Altitude Altimeter
- T-50—Radio Telegraph Transmitter
- TCS—Marine Telephone Transceiver

XMITTING TUBES

0A3/XR75	51.04	15R	50.69	866A	51.39
0B3/VR105	1.19	30 Spec	11.07	868B	65.07
0D3/VR150	.95	35T	3.25	872A	2.97
1B24	9.75	45 Spec	8.32	872B	3.17
1B27	14.95	21T	6.65	878	1.57
1B29	9.75	100TH	19.95	885	1.37
1N21B	3.25	250TL	17.95	918	1.17
1N23	1.25	262B	3.95	922	1.27
1N23A	2.95	274B	2.95	925	3.97
1N23B	3.69	304TH	8.95	927	1.07
1N34	.76	304T	8.95	930	4.47
1N34A	10.95	307A/RK75	3.95	931A	4.47
2AP1	10.95	316A	.65	954	.23
2C40	4.75	328A	8.95	955	.33
2C43	17.50	350A	6.45	956	6.83
2C44	1.19	350A	3.95	957	.43
2C46	7.95	368AS	7.50	959	3.75
2C47	2.95	371B	.95	959	3.75
2D21	1.35	371B	.69	991/NE16	.75
2E22	1.75	393A	7.95	1603	7.75
2E24	4.45	394A	3.95	1631	.75
2E26	3.15	417A	6.75	1616	.67
2K25/723AB	28.75	434A	27.50	1619	.75
2K28	32.50	446B	3.75	1624	2.45
2K33A	310.00	575A	15.75	1625	1.45
3B24	9.95	703A	5.75	1626	.75
3B24W	5.25	703A	5.25	1629	.75
3B26	7.95	705A	1.65	1630	.75
3BP1	5.95	714AY	7.95	1638	.72
3C22	115.00	715A	6.39	1651	1.45
3C24/24G	1.75	724A	8.75	715	1.18
3C45	15.95	715C	19.95	5670	6.95
3CP1	1.95	717A	.98	8088	6.95
3CP151	3.95	721A	2.45	8011	.90
3DP1	4.45	723A	9.50	8012	2.65
3DP1A	6.95	724A/B	19.95	8013	.98
3DP2A	3.25	725A	6.75	8020	1.50
3F29	13.95	726A	18.00	8022	1.50
3FF7	4.39	730A	29.50	9003	1.65
3GP1	4.39	810	1.75	9004	.35
4-125A	27.50	850A	3.95	9005	1.45
4-250A	37.50	803	3.25	9006	.27
4AP10	4.45	804	11.75	C11A	9.95
4C35	27.50	808	3.75	C6A	7.00
4E27	14.95	808	24.95	C6J	6.39
5AP1	3.45	807	1.59	CK1005	.48
5AP4	3.45	808	2.69	F123A	7.75
5BP1	4.45	810	9.50	F127A	27.50
5BP4	4.45	811	2.85	F128A	89.50
5CP1	4.45	812	2.75	FG17	4.89
5CP7	11.75	813	11.75	FG27A	4.95
5D21	19.95	814	2.69	FG32A	8.95
5FP7	1.85	815	2.35	FG57	14.95
5GP1	24.45	826	.69	FG105	17.95
5H2	2.95	828	3.25	GL102	3.50
5LP1	22.50	829	10.95	GL434A	29.95
5NP1	5.50	829B	12.95	GL502A	1.79
6A5	7.25	830B	6.75	GL10	8.95
6A56	2.50	832	6.75	HF300	22.45
6A57	4.45	832A	8.50	HY114R	.69
6C21	21.00	836	3.49	IL10	2.25
6J4	6.75	837	1.45	ML101	47.50
7BP7	6.55	838W	2.25	REL23	1.95
7DP4	14.50	845W	3.25	SK60/164L	2.25
9LP7	4.95	849C	27.50	RM65	26.50
10BP4	17.45	851	47.50	RK72	2.49
11P7	4.95	860	3.95	VT127A	8.45
12DP7	14.75	861	22.50	WL616	34.50
15E	1.35	865	.98		

PHONE: DIGBY 9-0347

WRITE FOR CATALOG

CABLE: HAMSHACK, N. Y.

WRITE FOR QUANTITY PRICES

Prices subject to change without notice. F.O.B. N. Y. C minimum order \$10.00 20% deposit required. All merchandise guaranteed.

RADIO HAM SHACK inc.
191 GREENWICH STREET . NEW YORK, N. Y.

SEARCHLIGHT SECTION

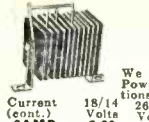

SELENIUM RECTIFIERS

We specialize in Rectifiers and Power supplies to your specifications. Immediate delivery.

Current (cont.)	18/14	20/18	30/28	54/40	100/70
2AMP	1.75	2.00	3.50	4.50	10.50
4AMP	3.75	4.50	7.75	10.00	27.00
5AMP	4.50	5.25	9.00	11.50	30.00
10AMP	6.75	9.98	12.00	20.00	40.00
12AMP	8.50	16.20	16.00	25.00	50.00
15AMP	10.00	16.20	24.00	36.00	60.00
24AMP	16.00	30.00	31.00	39.50	90.00
30AMP	18.50	24.30	36.00		
35AMP	25.50		45.00		

Full Wave Selen Rect. & Trans. in Kit Form.
All 115V/60cy inputs. V
up to 14VDC at 12 amperes..... 23.98
up to 28VDC at 8 amperes..... 31.98
up to 28VDC at 48 amperes..... 149.50
up to 220VDC at 8 amperes..... 12.98

RECTIFIER XFMRs

18.8-19.2-20.4-21.4 Volts/12 Amp	\$14.98
31-32-34-36 Volts/12 Amp 2 Kvsins.	16.98
18-12-9-12-18V/12 Amp	16.75
18-12-9-12-9-12-18V/12 Amp	16.75
36VCT-24V-18V/24 Amp	35.75

BATTERY CHARGER RECTIFIER
10-10 Volt Ct. 120 Amp (Fan Cooled) Selenium Rectifier. Recharge Efficient. Output 30 Amps. Types: "TAB" Special. \$33.75
WRITE FOR QUALITY PRICES

SELENIUM POWER SUPPLY

0 to 12VDC/2 Amp. Variable DC supply, unceasing and completely built-in. 115V/60 cy. DC supply filament. D.C. plating, battery charging, model railroad, includes voltage and speed control and center off reversing sw. Ideal for two "HO" locomotives. 2 for \$10.90

0A2	.95	2E24	4.69	6A4	1.89
0A3/VR75	1.04	2E25/HY65	5.15	6AS5	2.39
0B2	1.37	2E30	1.95	6AT7	1.32
0B3/VR60	1.09	2E31	1.49	6AR7	1.09
0C3/VR105	2.9	2E32	2.39	6AT6	1.32
0D3/VR150	3.00	2E41	2.39	6AB5/6N5	1.33
0Y4	2.53	2E43	1.89	6AR7/1853	1.39
1A0	6.20	2G21	2.79	6A5	1.32
1A2	2.53	2J21	1.39	6A5	1.32
1A3	1.10	2J21A	8.90	6A7	1.99
1A4	1.10	2J30	8.75	6AD7G	1.99
1A4F	.79	2J31	7.25	6AF6G	1.33
1A5	1.10	2J32	7.95	6AF7	1.99
1A6	1.49	2J35	27.45	6AG7	1.99
1A7G	1.32	2J36	27.25	6AH5G	1.49
1A8	1.32	2J37	27.45	6AG7	1.99
1A9	1.32	2J38	27.45	6AG7	1.99
1A9A	1.32	2J39	27.45	6AG7	1.99
1A9B	1.32	2J40	27.45	6AG7	1.99
1A9C	1.32	2J41	27.45	6AG7	1.99
1A9D	1.32	2J42	27.45	6AG7	1.99
1A9E	1.32	2J43	27.45	6AG7	1.99
1A9F	1.32	2J44	27.45	6AG7	1.99
1A9G	1.32	2J45	27.45	6AG7	1.99
1A9H	1.32	2J46	27.45	6AG7	1.99
1A9I	1.32	2J47	27.45	6AG7	1.99
1A9J	1.32	2J48	27.45	6AG7	1.99
1A9K	1.32	2J49	27.45	6AG7	1.99
1A9L	1.32	2J50	27.45	6AG7	1.99
1A9M	1.32	2J51	27.45	6AG7	1.99
1A9N	1.32	2J52	27.45	6AG7	1.99
1A9O	1.32	2J53	27.45	6AG7	1.99
1A9P	1.32	2J54	27.45	6AG7	1.99
1A9Q	1.32	2J55	27.45	6AG7	1.99
1A9R	1.32	2J56	27.45	6AG7	1.99
1A9S	1.32	2J57	27.45	6AG7	1.99
1A9T	1.32	2J58	27.45	6AG7	1.99
1A9U	1.32	2J59	27.45	6AG7	1.99
1A9V	1.32	2J60	27.45	6AG7	1.99
1A9W	1.32	2J61	27.45	6AG7	1.99
1A9X	1.32	2J62	27.45	6AG7	1.99
1A9Y	1.32	2J63	27.45	6AG7	1.99
1A9Z	1.32	2J64	27.45	6AG7	1.99
1B0	1.32	2J65	27.45	6AG7	1.99
1B1	1.32	2J66	27.45	6AG7	1.99
1B2	1.32	2J67	27.45	6AG7	1.99
1B3	1.32	2J68	27.45	6AG7	1.99
1B4	1.32	2J69	27.45	6AG7	1.99
1B5	1.32	2J70	27.45	6AG7	1.99
1B6	1.32	2J71	27.45	6AG7	1.99
1B7	1.32	2J72	27.45	6AG7	1.99
1B8	1.32	2J73	27.45	6AG7	1.99
1B9	1.32	2J74	27.45	6AG7	1.99
1C0	1.32	2J75	27.45	6AG7	1.99
1C1	1.32	2J76	27.45	6AG7	1.99
1C2	1.32	2J77	27.45	6AG7	1.99
1C3	1.32	2J78	27.45	6AG7	1.99
1C4	1.32	2J79	27.45	6AG7	1.99
1C5	1.32	2J80	27.45	6AG7	1.99
1C6	1.32	2J81	27.45	6AG7	1.99
1C7	1.32	2J82	27.45	6AG7	1.99
1C8	1.32	2J83	27.45	6AG7	1.99
1C9	1.32	2J84	27.45	6AG7	1.99
1D0	1.32	2J85	27.45	6AG7	1.99
1D1	1.32	2J86	27.45	6AG7	1.99
1D2	1.32	2J87	27.45	6AG7	1.99
1D3	1.32	2J88	27.45	6AG7	1.99
1D4	1.32	2J89	27.45	6AG7	1.99
1D5	1.32	2J90	27.45	6AG7	1.99
1D6	1.32	2J91	27.45	6AG7	1.99
1D7	1.32	2J92	27.45	6AG7	1.99
1D8	1.32	2J93	27.45	6AG7	1.99
1D9	1.32	2J94	27.45	6AG7	1.99
1E0	1.32	2J95	27.45	6AG7	1.99
1E1	1.32	2J96	27.45	6AG7	1.99
1E2	1.32	2J97	27.45	6AG7	1.99
1E3	1.32	2J98	27.45	6AG7	1.99
1E4	1.32	2J99	27.45	6AG7	1.99
1E5	1.32	2J00	27.45	6AG7	1.99
1E6	1.32	2J01	27.45	6AG7	1.99
1E7	1.32	2J02	27.45	6AG7	1.99
1E8	1.32	2J03	27.45	6AG7	1.99
1E9	1.32	2J04	27.45	6AG7	1.99
1F0	1.32	2J05	27.45	6AG7	1.99
1F1	1.32	2J06	27.45	6AG7	1.99
1F2	1.32	2J07	27.45	6AG7	1.99
1F3	1.32	2J08	27.45	6AG7	1.99
1F4	1.32	2J09	27.45	6AG7	1.99
1F5	1.32	2J10	27.45	6AG7	1.99
1F6	1.32	2J11	27.45	6AG7	1.99
1F7	1.32	2J12	27.45	6AG7	1.99
1F8	1.32	2J13	27.45	6AG7	1.99
1F9	1.32	2J14	27.45	6AG7	1.99
1G0	1.32	2J15	27.45	6AG7	1.99
1G1	1.32	2J16	27.45	6AG7	1.99
1G2	1.32	2J17	27.45	6AG7	1.99
1G3	1.32	2J18	27.45	6AG7	1.99
1G4	1.32	2J19	27.45	6AG7	1.99
1G5	1.32	2J20	27.45	6AG7	1.99
1G6	1.32	2J21	27.45	6AG7	1.99
1G7	1.32	2J22	27.45	6AG7	1.99
1G8	1.32	2J23	27.45	6AG7	1.99
1G9	1.32	2J24	27.45	6AG7	1.99
1H0	1.32	2J25	27.45	6AG7	1.99
1H1	1.32	2J26	27.45	6AG7	1.99
1H2	1.32	2J27	27.45	6AG7	1.99
1H3	1.32	2J28	27.45	6AG7	1.99
1H4	1.32	2J29	27.45	6AG7	1.99
1H5	1.32	2J30	27.45	6AG7	1.99
1H6	1.32	2J31	27.45	6AG7	1.99
1H7	1.32	2J32	27.45	6AG7	1.99
1H8	1.32	2J33	27.45	6AG7	1.99
1H9	1.32	2J34	27.45	6AG7	1.99
1I0	1.32	2J35	27.45	6AG7	1.99
1I1	1.32	2J36	27.45	6AG7	1.99
1I2	1.32	2J37	27.45	6AG7	1.99
1I3	1.32	2J38	27.45	6AG7	1.99
1I4	1.32	2J39	27.45	6AG7	1.99
1I5	1.32	2J40	27.45	6AG7	1.99
1I6	1.32	2J41	27.45	6AG7	1.99
1I7	1.32	2J42	27.45	6AG7	1.99
1I8	1.32	2J43	27.45	6AG7	1.99
1I9	1.32	2J44	27.45	6AG7	1.99
1J0	1.32	2J45	27.45	6AG7	1.99
1J1	1.32	2J46	27.45	6AG7	1.99
1J2	1.32	2J47	27.45	6AG7	1.99
1J3	1.32	2J48	27.45	6AG7	1.99
1J4	1.32	2J49	27.45	6AG7	1.99
1J5	1.32	2J50	27.45	6AG7	1.99
1J6	1.32	2J51	27.45	6AG7	1.99
1J7	1.32	2J52	27.45	6AG7	1.99
1J8	1.32	2J53	27.45	6AG7	1.99
1J9	1.32	2J54	27.45	6AG7	1.99
1K0	1.32	2J55	27.45	6AG7	1.99
1K1	1.32	2J56	27.45	6AG7	1.99
1K2	1.32	2J57	27.45	6AG7	1.99
1K3	1.32	2J58	27.45	6AG7	1.99
1K4	1.32	2J59	27.45	6AG7	1.99
1K5	1.32	2J60	27.45	6AG7	1.99
1K6	1.32	2J61	27.45	6AG7	1.99
1K7	1.32	2J62	27.45	6AG7	1.99
1K8	1.32	2J63	27.45	6AG7	1.99
1K9	1.32	2J64	27.45	6AG7	1.99
1L0	1.32	2J65	27.45	6AG7	1.99
1L1	1.32	2J66	27.45	6AG7	1.99
1L2	1.32	2J67	27.45	6AG7	1.99
1L3	1.32	2J68	27.45	6AG7	1.99
1L4	1.32	2J69	27.45	6AG7	1.99
1L5	1.32	2J70	27.45	6AG7	1.99
1L6	1.32	2J71	27.45	6AG7	1.99
1L7	1.32	2J72	27.45	6AG7	1.99
1L8	1.32	2J73	27.45	6AG7	1.99
1L9	1.32	2J74	27.45	6AG7	1.99
1M0	1.32	2J75	27.45	6AG7	1.99
1M1	1.32	2J76	27.45	6AG7	1.99
1M2	1.32	2J77	27.45	6AG7	1.99
1M3	1.32	2J78	27.45	6AG7	1.99
1M4	1.32	2J79	27.45	6AG7	1.99
1M5	1.32	2J80	27.45	6AG7	1.99
1M6	1.32	2J81	27.45	6AG7	1.99
1M7	1.32	2J82	27.45	6AG7	1.99
1M8	1.32	2J83	27.45	6AG7	1.99
1M9	1.32	2J84	27.45	6AG7	1.99

5 MILLIAMPERES at 30 KV

REGULATED-REVERSIBLE RF HIGH VOLTAGE POWER SUPPLY

Model 33HRR

OUTPUT:

From below 1 KV to 30 KV in three ranges, at currents up to 5 Milliamperes. (Up to 400 VA regulated AC may be drawn simultaneously from convenience outlets on panel.)

REGULATION:

0.1% of full scale on all ranges.

LINE VOLTAGE STABILIZATION:

.01% per volt variation.

RIPPLE VOLTAGE:

Less than .05% of DC output voltage.

OUTPUT POLARITY:

Reversible — Either positive or negative.

METERING:

Output Kilovoltmeter, three ranges, 0-5, 0-15 and 0-30 KV. Current Meter, three ranges, 0-.5, 0-1 and 0-5 MA. Final stage plate voltage meter. Final stage plate milliammeter.

SAFETY FEATURES:

Adjustable load cut-out. Double push-buttons requiring both hands to energize high voltage. Safety interlock on door. Latching circuit keeps HV off after line voltage failure.



A TOOL FOR RESEARCH BEYOND USUAL CURRENT LIMITATIONS

Bench Type NEUTRONIC HIGH VOLTAGE Supplies

RF Type

The following NEUTRONIC models are now available. Your specific modifications can be incorporated. All units are housed in standard 19" rack panel cabinets.

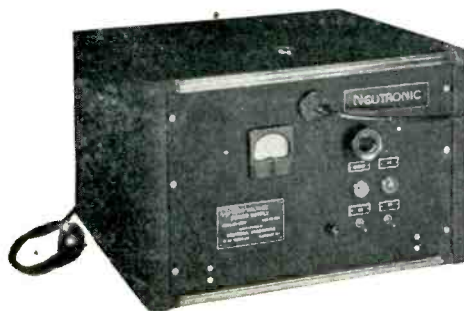

Model No.	Voltage Range	Current Range	Regulation
21 M	1-15 KV	6 MA. at 10 KV	...
21 MR*	1-15 KV	6 MA. at 10 KV	.5%
22 C	3-26 KV	2 MA. at 18 KV	...
22 CR*	3-26 KV	2 MA. at 18 KV	.5%
22 M	3-26 KV	3 MA. at 20 KV	...
22 MR*	3-26 KV	3 MA. at 20 KV	.5%
23 C	5-40 KV	1.3 MA. at 25 KV	...
23 CR*	5-40 KV	1.3 MA. at 25 KV	.5%
23 M	5-45 KV	1.5 MA. at 30 KV	...

Model No.	Voltage Range	Current Range	Regulation
23 MR*	5-45 KV	1.5 MA. at 30 KV	.5%
24 C	5-50 KV	1 MA. at 35 KV	...
24 CR*	5-50 KV	1 MA. at 35 KV	.5%
24 M	5-55 KV	2 MA. at 30 KV	...
24 MR*	5-55 KV	2 MA. at 30 KV	.5%
33 S	1-30 KV	4 1/2 MA. entire range	...

*Regulated models will maintain Regulation to 80% of the MAXIMUM STATED CURRENT.

NEUTRONIC ASSOCIATES

CONTROL DEVICES

8356 VIETOR AVENUE • ELMHURST, L. I., N. Y.

Federated Metals Division.	
American Smelting & Refining Co.	315
Federation Francaise Des Syndicate Nationaux De L'Industrie Radioelectrique	197
Ferroxcube Corp. of America	45
Fidelity Chemical Products Corp.	419
Filtron Co., Inc.	49
Five Star Company, The	438
Franklin, A. W.	91
Franklin Institute, The	408
Frequency Standards	378
Fugle-Miller Laboratories	420
Furst Electronics	429

Gamewell Company	389
General Electric Company	
Apparatus Dept.	46, 47, 82, 88, 89, 179, 397
Electronics Dept.	60, 61, 273
General Precision Laboratory, Inc.	243
General Radio Company	17
General Transformer Company	296
Gertsch Products, Inc.	421
GM Laboratories, Inc.	407, 428
Goat Co., Inc., Fred.	246
Grant Pulley & H'dw'e Co.	373
Graphite Metallizing Corporation	430
Green Instrument Co.	226
Gudebrod Bros. Silk Co., Inc.	393

Hammarlund Mfg. Co., Inc.	84
Harper Company, H. M.	375
Hathaway Instrument Company	326
Haydon Company, A. W.	374
Haydon Manufacturing Co., Inc.	284
Heath Company	246
Heiland Research Corp.	407
Heinemann Electric Company	376
Heldor Manufacturing Co.	307
Helipot Corporation	171
Hemiway & Bartlett Mfg. Co.	429
Hermetic Seal Products Co.	37
Hetherington, Inc.	348
Hewlett-Packard Company	35
Hexacon Electric Co.	405
Hickok Electrical Instrument Co.	317
Hudson Radio & Television Corp.	379
Hudson Tool & Die Company, Inc.	51
Hudson Wire Company	215
Hughes Research & Development Laboratories	360, 425
Hycor Company, Inc.	242
Hytron Radio & Electronics Co.	52

Improved Seamless Wire Company	234
Indiana Steel Products Co.	178
Industrial Condenser Corp.	225
Instrument Resistors Co.	376
Instrument Wire Company, The	413
International Nickel Company, Inc.	317
International Radiant Corp.	435
International Rectifier Corp.	255
International Resistance Company	56, 57
Insuline Corporation of America	257
Ippolito & Co., Inc., James	419
Irvington Varnish & Insulator Co.	33
I-T-E Circuit Breaker Company	323

James Vibrapower Co.	368
Jeffers Electronics	
Division Speer Carbon Co.	259
Jelliff Manufacturing Corp.	425
Jennings Radio Manufacturing Co.	388
JFD Mfg. Co.	363
Johanson Manufacturing Corp.	418
Johns-Manville	86
Johnson Co., E. F.	209
Jones Div., Howard B. Cinch Mfg. Corp.	425
Joy Manufacturing Company	223

Kahle Engineering Co.	258
Karp Metal Products Co., Inc.	55
Kartron	438
Kay Electric Company	285
Kellogg Company, M. W.	309
Kenyon Transformer Co., Inc.	64
Kester Solder Company	267
Keystone Products Company	194

Kirk & Blum Mfg. Co.	264
Klein & Sons, Mathias	290
Kollsman Instrument Corporation	331
Krohn-Hite Instrument Company	53
Kupfrian Manufacturing Co.	428

Laboratoire Industriel de Physique Appliquee	199
Laboratories R. Deveaux	83
Laboratory for Electronics, Inc.	19
Lambda Electronics Corp.	431
Lampkin Laboratories, Inc.	238
LaPointe-Plascomold Corp. (Vee-D-X)	234
Lapp Insulator Co.	233
Le Condensateur Cramique	202
Lenkurt Electric Sales Company	334, 401
Lewis Engineering Co.	370
Lewis Spring & Mfg. Co.	301
Lion Fasteners, Inc.	412
Little Inc., Arthur D.	324
Logistics Research Company	252
Lord Manufacturing Co.	350
Louthan Manufacturing Company	382

MacDonald Co., Inc., W. S.	385
Magnatran, Inc.	337
Malayan Tin Bureau	222
Mallory & Co., Inc., P. R.	96, 167
Marconi's Wireless Telegraph Co., Ltd.	408
Marion Electrical Instrument Co.	2
Markem Machine Company	308
Maryland Electronic Mfg. Corp.	295
MB Manufacturing Company, Inc.	181
McGraw-Hill Book Co.	438
Measurements Corporation	426
Mepeco, Inc.	196
Mercury Electronic Company	230
Merritt & Zaleski, Inc.	207
Metal Textile Corp.	358
Metals & Controls Corp., General Plate Div.	48
Mica Insulator Company	293
Michel Manufacturing Co.	438
Mico Instrument Company	254
Micro Switch, Div. of Minneapolis-Honeywell Regulator Co.	27
Miles Reproducer Co., Inc.	438
Milford Rivet & Machine Co.	406
Millen Mfg. Co., Inc., James	319
Milo Radto & Electronics Corp.	354
Milwaukee Transformer Company	390
Miniature Precision Bearings, Inc.	173
Minneapolis-Honeywell Regulator Co., Industrial Div.	237
Aero Div.	342
Minnesota Mining & Mfg. Co.	78
Missouri Research Laboratories	391
Mitchell-Rand Insulation Company, Inc.	92
Moloney Electric Company	215
Mosinee Paper Mills Company	300
Multhead & Co., Ltd.	3
Mycalex Corporation of America	211

National Company, Inc.	346
National Moldite Company	356
National Plastic Products Co.	272
National Research Corporation	80, 81
National Vulcanized Fibre Co.	253
Neo-Sil Corporation	391
Neutronic Associates	486
New Hermes, Inc.	427
New York Transformer Co., Inc.	322
Ney Company, J. M.	423
North American Aviation, Inc.	250
Northeastern Engineering, Inc.	370
Nothelfer Winding Laboratories	426

Ohmite Mfg. Co.	32A, 32B
Olympic Metal Products Co., Inc.	238
Owens-Corning Fiberglas Corp.	40, 41

Panoramic Radio Products, Inc.	424
Par-Metal Products Corporation	368
Penn Engineering & Manufacturing Corp.	395
Penta Laboratories, Inc.	413
Phalo Plasties Corporation	202
Phaotron Co.	433
Phelps Dodge Copper Products Corp., Inca Manufacturing Division	28, 29
Phillips & Hiss Co., Inc.	384
Pix Manufacturing Co., Inc.	378
Plastic Capacitors, Inc.	289

ENGINEERED FLUOROCARBONS

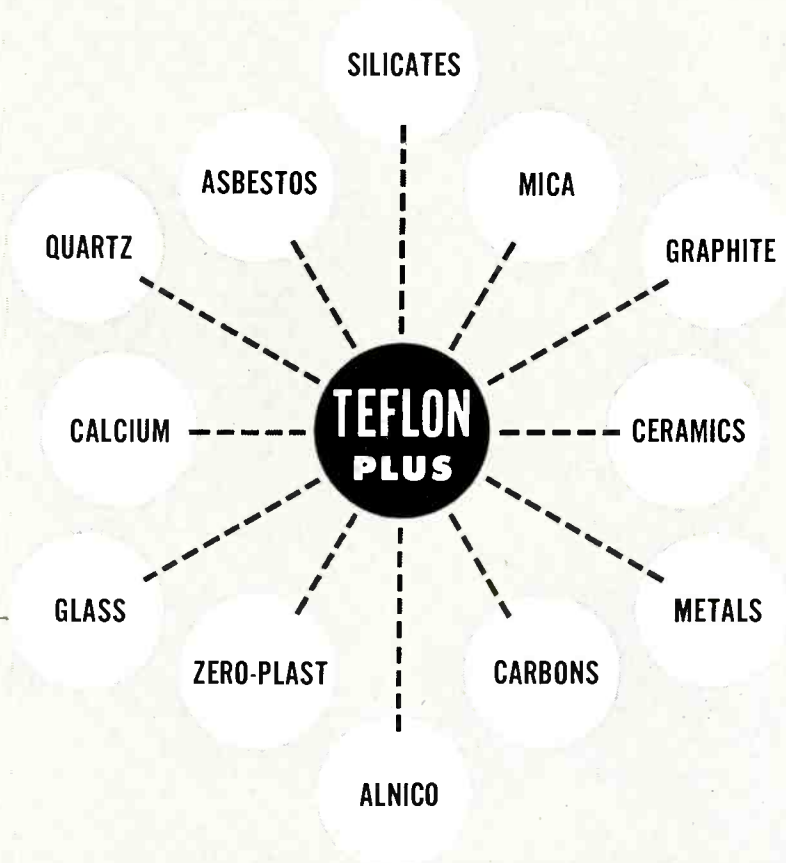

Offer Engineers a Whole New Family of Materials

Starting with TEFLON*, United States Gasket Company engineers have developed a series of "Filled" Fluorocarbon materials, greatly broadening the scope of usefulness of this wonder-plastic. For example, United States Gasket Company "Application Engineering" has already helped solve such material problems as long-wearing chemical resistant bearings and pump impellers; valve and pump packings, expansion joints and chambers, gaskets; the metal plating of Teflon; the hermetic sealing of electronic components; soldering and cementing to Teflon; etc., etc.

If you have a special materials problem, that one of these Teflon "alloys" might solve, tell us about it. Our engineering department will work with yours to determine the Chemelec Mixture best suited to your requirements.

UNITED STATES GASKET COMPANY

FLUOROCARBON PRODUCTS DIVISION
FABRICATORS OF "TEFLON" "KEL-F" AND OTHER FLUOROCARBON PLASTICS
CAMDEN 1, NEW JERSEY

*duPont's trademark for its tetrafluoroethylene resin.

THESE ARE THE

REASONS

WHY **DAVEN** IS THE
LEADER IN THE
AUDIO ATTENUATOR
FIELD

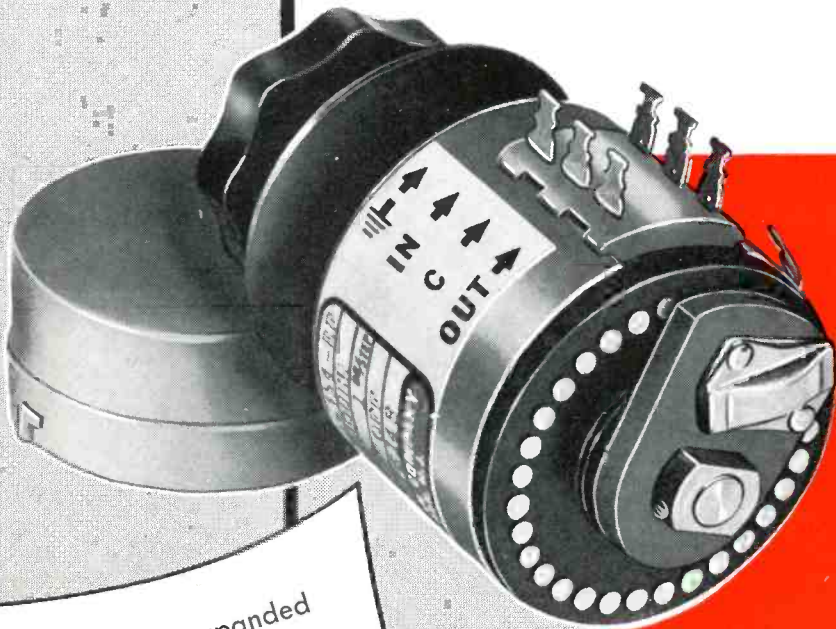

Greatly expanded production facilities enable Daven to make delivery from stock on a large number of standard attenuator types.

LA-130 Series,
Ladder Network
30 Steps, 1 3/4" Diameter



- 1 "KNEE-ACTION" ROTOR . . . gives positive contact and low contact resistance under all conditions.
- 2 BRASS CASE OF 2-PIECE CONSTRUCTION . . . gives excellent shielding and allows more compact equipment design.
- 3 "LOCK-TITE" DUST COVER . . . designed to withstand severe vibration and at the same time allow easy accessibility.
- 4 ENCLOSED ROLLER-TYPE DETENT MECHANISM . . . gives positive indexing, but does not increase depth of unit.
- 5 LOW-LOSS MOLDED TERMINAL BOARD . . . has high resistance to leakage.

Write for complete catalog data.

THE **DAVEN** co.

WORLD'S LARGEST MANUFACTURER OF ATTENUATORS

191 Central Ave., Newark 4, N. J.



An RCA progress report ...on Transistors



MORE THAN FOUR YEARS AGO, RCA embarked on a research and development program to determine the practicability of transistors in the field of electronics. The early work was concerned with the principles, designs, and applications of point-contact transistors; and later was expanded to include junction transistors and other similar semi-conductive devices.

As an important recent result of the studies on point-contact transistors, RCA Tube Department engineers have made in the laboratory experimental point-contact transistors which oscillate at frequencies above 200 megacycles, one of which exceeded 300 megacycles. This achievement opens the way to the use of transistors in FM radio and in VHF television, in addition to their previous potentialities for low-frequency applications including audio and switching uses.

This work has also led to considerable success in developing junction transistors for audio and radio amplifier applications. A point of particular significance is that much progress has been made in the development of practical assembly techniques.

Point-contact types are now being sampled to equipment manufacturers and government agencies as a part of our development program. It is anticipated that junction transistors will be available for similar sampling in the near future.

Although much remains to be done, promising results have been attained in controlling the characteristics of both types of transistors; pilot production runs are being made.

Meanwhile RCA is pushing forward its development program to assure its customers that the commercial transistors of the future will be made to the same high standards of quality and dependability as the RCA electron tubes of today.



RADIO CORPORATION of AMERICA
ELECTRON TUBES

HARRISON, N. J.