

OCTOBER • 1952

PRICE 75 CENTS

electronics

A MCGRAW-HILL PUBLICATION



Printed Circuit Techniques





MINIATURE COMPONENTS FROM STOCK...

SUBOUNCER UNITS

FOR HEARING AIDS...VEST POCKET RADIOS...MIDGET DEVICES

UTC Sub-Ouncer units fulfill an essential requirement for miniaturized components having relatively high efficiency and wide frequency response. Through the use of special nickel iron core materials and winding methods, these miniature units have performance and dependability characteristics far superior to any other comparable items. They are ideal for hearing aids, miniature radios, and other types of miniature electronic equipment. The coils employ automatic layer windings of double Formex wire...in a molded Nylon bobbin. All insulation is of cellulose acetate. Four inch color coded flexible leads are employed, securely anchored mechanically. No mounting facilities are provided, since this would preclude maximum flexibility in location. Units are vacuum impregnated and double (water proof) sealed. The curves below indicate the excellent frequency response available. Alternate curves are shown to indicate operating characteristics in various typical applications.

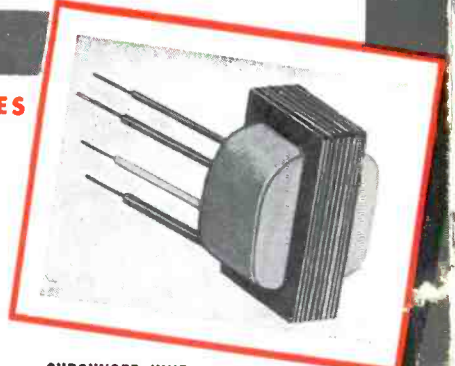

SUBOUNCER UNIT
Dimensions...9/16" x 5/8" x 7/8"
Weight......03 lb.

Type	Application	Level	Pri. Imp.	D.C. in Pri.	Sec. Imp.	Pri. Res.	Sec. Res.	List Price
*SO-1	Input	+ 4 V.U	200 50	0	250,000 62,500	16	2650	\$6.50
SO-2	Interstage/3:1	+ 4 V.U	10,000	0	90,000	225	1850	6.50
*SO-3	Plate to Line	+ 20 V.U	10,000 25,000	3 mil 1.5 mil.	200 500	1300	30	6.50
SO-4	Output	+ 20 V.U	30,000	1.0 mil	50	1800	4.3	6.50
SO-5	Reactor 50 HY at 1 mil	D.C. 3000 ohms D.C. Res						5.50
SO-6	Output	+ 20 V.U	100,000	.5 mil.	60	3250	3.8	6.50

*Impedance ratio is fixed, 1250:1 for SO-1, 1:50 for SO-3 Any impedance between the values shown may be employed

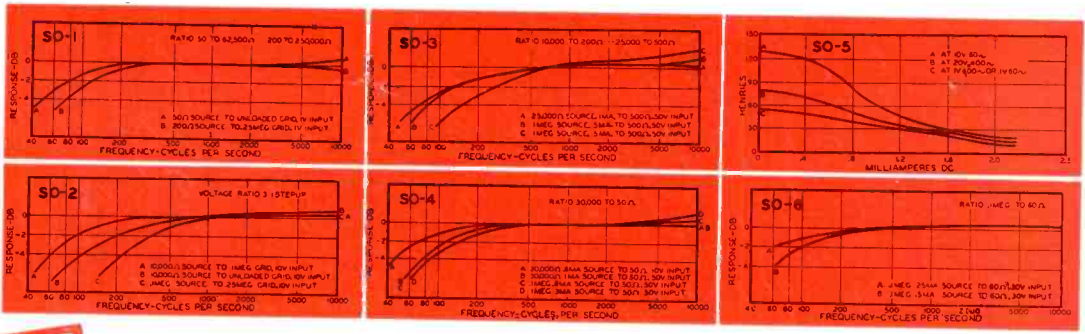

SUB-SUBOUNCER UNITS

FOR HEARING AIDS AND ULTRA-MINIATURE EQUIPMENT

UTC Sub-SubOuncer units have exceptionally high efficiency and frequency range in their ultra-miniature size. This has been effected through the use of specially selected Hiperm-Alloy core material and special winding methods. The constructional details are identical to those of the Sub-Ouncer units described above. The curves below show actual characteristics under typical conditions of application.

Type	Application	Level	Pri. Imp.	D.C. in Pri.	Sec. Imp.	Pri. Res.	Sec. Res.	List Price
*SSO-1	Input	+ 4 V.U	200 50	0	250,000 62,500	13.5	3700	\$6.50
SSO-2	Interstage/3:1	+ 4 V.U	10,000	0	90,000	750	3250	6.50
*SSO-3	Plate to Line	+ 20 V.U	10,000 25,000	3 mil 1.5 mil.	200 500	2600	35	6.50
SSO-4	Output	+ 20 V.U	30,000	1.0 mil.	50	2875	4.6	6.50
SSO-5	Reactor 50 HY at 1 mil	D.C. 4400 ohms D.C. Res.						5.50
SSO-6	Output	+ 20 V.U	100,000	.5 mil.	60	4700	3.3	6.50

*Impedance ratio is fixed, 1250:1 for SSO-1, 1:50 for SSO-3. Any impedance between the values shown may be employed.

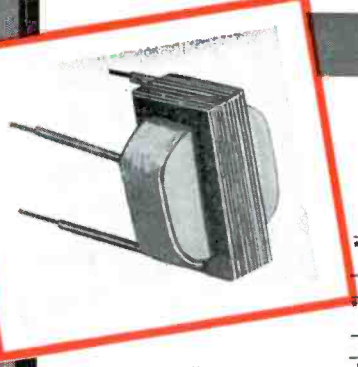
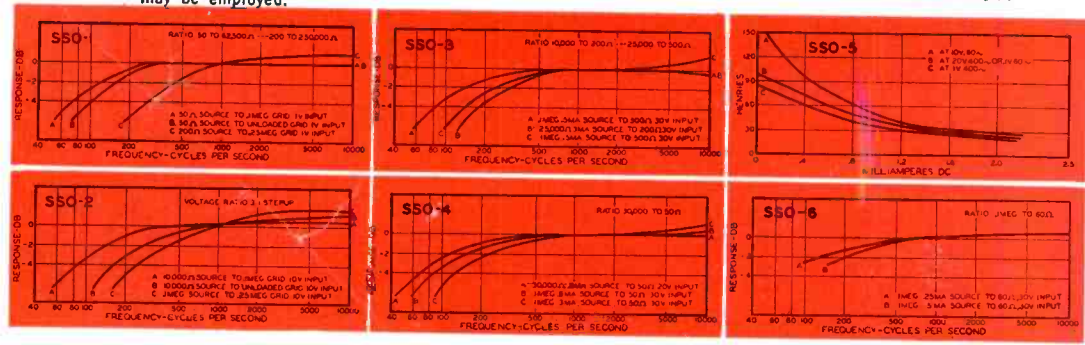

SUB-SUBOUNCER UNIT
Dimensions...7/16" x 3/4" x 5/8"
Weight......02 lb.

United Transformer Co.
150 VARICK STREET NEW YORK 13, N. Y.
EXPORT DIVISION: 13 EAST 40th STREET, NEW YORK 16, N. Y. CABLES: "ARLAB"

PRINTED CIRCUIT TECHNIQUES—Solder-dipping operation in Auto-Semby system of Photo Circuits Corp. and steps in prefabricating circuit by Signal Corps engineers at Squier Signal Laboratory, Fort Monmouth, N. J. COVER (See page 172)

FIGURES OF THE MONTH, Electronics Output Index	4
INDUSTRY REPORT, Top-level news, trends and market interpretations	5
ACOUSTIC FIRING ERROR INDICATOR, by Marcus C. Eliason and W. G. Hornbostel	98
USING C-R TUBES WITH INTERNAL POLE PIECES, by C. V. Fogelberg, E. W. Morse, S. L. Reiches and D. P. Ingle	102
PRODUCTION CONTROL OF PRINTED RESISTORS, by W. H. Hannahs and J. W. Eng	106
CONELRAD ALERT RECEIVER, by Martin M. Mitchum	110
A PHASE INDICATOR FOR COLOR TELEVISION, by Kurt Schlesinger and Leroy W. Nero	112
POWER CONTROL WITH MAGNETIC AMPLIFIERS, by E. L. Harder	115
HIGH-SPEED COUNTER USES TERNARY NOTATION, by Richard Weissman	118
FIELD PLOTTING IN DEFLECTION YOKE DESIGN, by E. Sieminski	122
DIGITAL TO ANALOG CONVERTER, by M. Miller, B. L. Waddell and J. Patmore	127
SKEWED ANTENNA AT WJZ-TV, by M. W. Scheldorf	130
CLOSED LOOP CONTROLS HUMAN CENTRIFUGE, by Thomas F. Peirce	132
HOW TO DESIGN VR TUBE CIRCUITS, by Raymond C. Miles	135
BANDWIDTH OF QUARTER-WAVE SECTIONS, by E. G. Fubini and F. H. Rockett, Jr.	138
SERVICING MOBILE RADIO EQUIPMENT, by Maurice E. Kennedy	140
HIGH-POWER SQUARE-PULSE GENERATOR, by W. E. Williams, Jr.	144
FRAME SYNCHRONIZATION FOR COLOR TELEVISION, by Donald Richman	146
CATHODE-RAY-TUBE BEAM INTENSIFIER, by Robert W. Rochelle	151
STABLE-OUTPUT OSCILLATOR, by Sherwin Rubin	154
UNITIZED PULSE CIRCUITS SPEED COMPUTER DESIGN, by Harry Kenosian	156
LINEAR-SCALE VELOCITY METER, by R. Stuart Mackay	158
ISOLATION CIRCUITS FOR ANALOG COMPUTERS, by Rawley McCoy and Frank R. Bradley	162
R-F COUPLING NOMOGRAPH, by Raymond E. Lafferty	166
CROSSTALK.....97 ELECTRONS AT WORK.....168 PRODUCTION TECHNIQUES.....256 NEW PRODUCTS.....312	
PLANTS AND PEOPLE.....394 NEW BOOKS.....404 BACKTALK.....420 INDEX TO ADVERTISERS (Last Page)	

W. W. MacDONALD, Executive Editor; VIN ZELUFF, Managing Editor; John Markus, A. A. McKenzie, James D. Fahnestock, Associate Editors; William P. O'Brien, Ronald K. Jurgen, John M. Carroll, William G. Arnold, Assistant Editors; Ann Mastropolo, Marilyn Wood, Mary J. Johnson, Editorial Assistants; Gladys T. Montgomery, Washington Editor; Harry Phillips, Art Director; Eleanor Luke, Art Assistant

KEITH HENNEY, Editorial Director

H. W. MATEER, Publisher; WALLACE B. BLOOD, Manager; R. S. Quint, Buyers' Guide Manager; N. F. Cullinan, Promotion & Research Assistant; H. E. Hilty, Classified Manager; D. H. Miller, James Girdwood, New York; Wm. S. Hodgkinson, New England; Warren W. Shew, Philadelphia; C. D. Wardner, Chicago; J. L. Phillips, Cleveland; T. H. Carmody, R. C. Alcorn, San Francisco; Carl W. Dysinger, Los Angeles; Ralph C. Maultsby, Atlanta



October, 1952

ELECTRONICS
Member ABC and ABP

Vol. 25, No. 10



Published monthly with an additional issue in June by McGraw-Hill Publishing Company, Inc., James H. McGraw (1860-1948), Founder. Publication Office, 99-129 North Broadway, Albany 1, N. Y.

Executive, Editorial and Advertising Offices: McGraw-Hill Building, 330 W. 42nd St., New York 36, N. Y. Curtis W. McGraw, President; Willard Chevallier, Executive Vice-President; Joseph A. Gerardi, Vice-President and Treasurer; John J. Cooke, Secretary; Paul Montgomery, Senior Vice-President, Publication Division; Ralph B. Smith, Vice-President and Editorial Director; Nelson Bond, Vice-President and Director of Advertising; J. E. Blackburn, Jr., Vice-President and Director of Circulation.

Subscriptions: Address correspondence to Electronics—Subscription Service, 99-129 N. Broadway, Albany 1, N. Y., or 330 W. 42nd St., New York 36, N. Y. Allow one month for change of address. Subscriptions are solicited only from persons engaged in theory, research, design, production, maintenance and use of electronic and industrial control components, parts and end products. Position and company connection must be indicated on subscription orders.

Single copies 75¢ for United States and possessions, and Canada; \$1.50 for Latin America; \$2.00 for all other foreign countries. Buyers' Guide \$2.00. Subscription rates—United States and possessions, \$6.00 a year; \$9.00 for two years. Canada, \$10.00 a year; \$16.00 for two years. Other western hemisphere countries, \$15.00 a year; \$25.00 for two years. All other countries \$20.00 a year; \$30.00 for two years. Entered as second class matter August 29, 1936, at the Post Office at Albany, N. Y., under act of Mar. 3, 1879. Printed in U. S. A. Copyright 1952 by McGraw-Hill Publishing Co., Inc.—All Rights Reserved. BRANCH OFFICES: 520 North Michigan Avenue, Chicago 11, Ill.; 68 Post Street, San Francisco 4; McGraw-Hill House, London, E. C. 4; Washington, D. C. 4; Philadelphia 3; Cleveland 15; Detroit 26; St. Louis 8; Boston 16; 1321 Rhodes-Haverty Bldg., Atlanta 3, Ga.; 1111 Wilshire Blvd., Los Angeles 17; 738-9 Oliver Building, Pittsburgh 22. ELECTRONICS is indexed regularly in The Engineering Index.



CHASE® WIRE gets a “physical” to make your products better

Chase wire is carefully inspected and tested to catch any defect.

In addition to the usual tensile strength tests, it is tested for slivers or any other physical or surface defect not possible to detect by visual inspection.

Because of the high ductility and malleability of Chase wire, it is superior for cold-heading, drawing, forming, shearing and many other operations. Chase brass wire is available in a wide range of color from copper red to golden color.

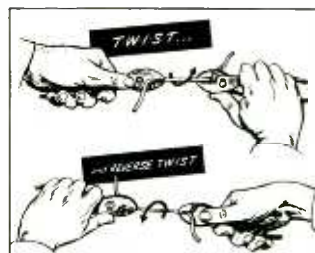

TEST NO. 1. Chase wire is twisted ten times in each direction to reveal seams, slivers, as well as other irregularities.

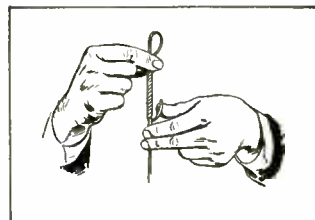

TEST NO. 2. Only wire of the very highest quality can pass this exacting 360 degree wrap-around test for forming.

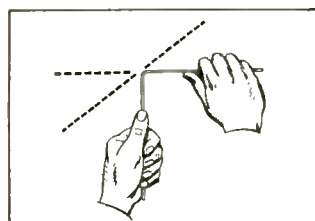

TEST NO. 3. Chase wire is bent sharply at right angles in four different directions to reveal possible brittle condition.

Chase BRASS & COPPER

WATERBURY 20, CONNECTICUT • SUBSIDIARY OF KENNECOTT COPPER CORPORATION

• The Nation's Headquarters for Brass & Copper

Albany†	Cleveland	Kansas City, Mo.	New York	San Francisco
Atlanta	Dallas	Los Angeles	Philadelphia	Seattle
Baltimore	Denver†	Milwaukee	Pittsburgh	Waterbury
Boston	Detroit	Minneapolis	Providence	(†sales
Chicago	Houston†	Newark	Rochester†	office only)
Cincinnati	Indianapolis	New Orleans	St. Louis	

THIS INTERESTING QUARTERLY WILL BE MAILED FREE TO ANY PART OF THE WORLD

AUSTRALIA

Messrs. Watson Victor Limited,
9-13, Bligh Street,
Sydney, N.S.W.

BELGIUM

Paul Groeninckx,
4-6, Avenue Hansen-Soulie,
Brussels.

CANADA

The J. W. Ellis Industries,
42, Lombard Street,
Toronto.

DENMARK

Ditz Schweitzer,
Norre Voldgade, 48,
Copenhagen, K.

FRANCE

Jacques Pérès Fils,
4, Avenue de l'Opéra,
Paris 1.

HOLLAND

Geo. C. F. Kauderer,
Muiden.

INDIA

Adair, Dutt & Co. (India) Ltd.,
5, Dalhousie Square,
Calcutta.

ITALY

Ing. Silvio Garrone,
Piazza Della Marina, 1,
Rome.

NEW ZEALAND

Richardson, McCabe & Co. Ltd.,
P.O. Box 792,
Wellington.

NORWAY

J. L. Nerlien A/S,
Nedre Slottsgt. 13,
Oslo.

SOUTH AFRICA

Johnson & Phillips South Africa
(Pty.) Limited,
P.O. Box 552,
Germiston.

SWEDEN

Ingeniorsfirma Hugo Tillquist,
Nybrokajen 7, Postbox 7026,
Stockholm 7.

SWITZERLAND

Camille Bauer,
Dornacherstrasse 18,
Basel.

U.S.A.

Muirhead & Co. Ltd.,
Elmers End, Beckenham,
Kent, England.

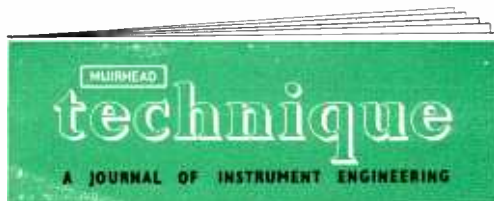

TECHNIQUE IS ALSO PUBLISHED IN FRENCH. IF THIS EDITION
IS REQUIRED, MARK YOUR COUPON "EDITION FRANÇAISE"

FILL IN THIS COUPON AND MAIL TO US OR OUR AGENTS

(SEE LIST ABOVE)

*Please mail me, free of charge,
the quarterly journal
of instrument engineering
"technique"
published by
Muirhead & Co., Limited.*

NAME _____
POSITION _____
COMPANY _____
ADDRESS _____

ELECTRONICS 74

MUIRHEAD & Co. LTD.
PRECISION ELECTRICAL INSTRUMENT MAKERS
BECKENHAM · KENT · ENGLAND

Telegrams and Cables: MUIRHEADS ELMERS-END

PRECISION
MUIRHEAD
ELECTRICAL INSTRUMENTS

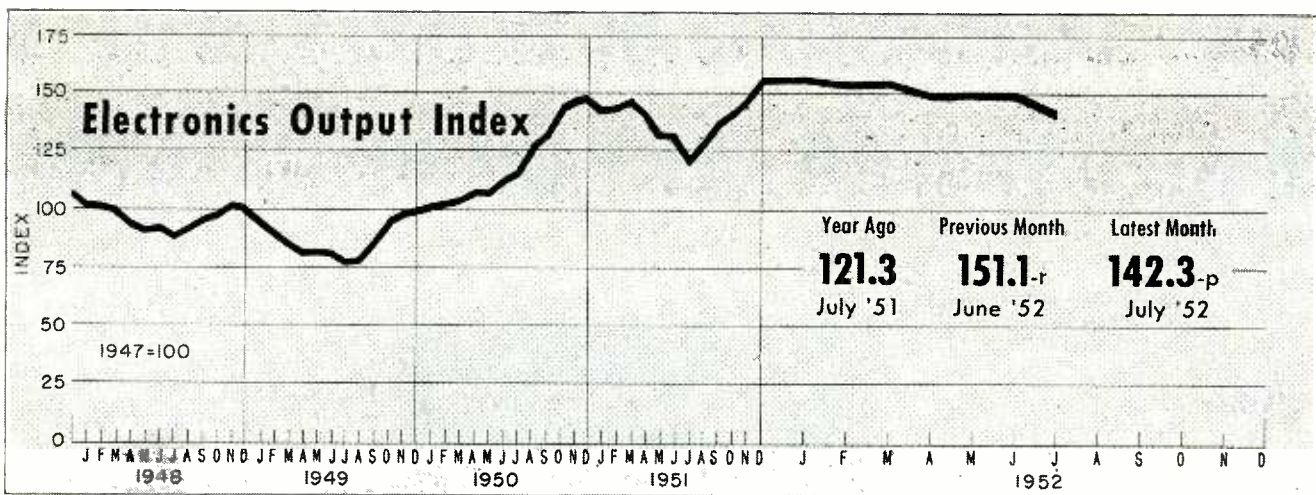

FIGURES OF THE MONTH

RECEIVER PRODUCTION	Year Ago	Previous Month	Latest Month
(Source: RTMA)	July '51	June '52	July '52
Television sets	152,306	361,152	198,921-p
Home Radio sets	184,002	422,158	265,163-p
Portable sets	70,538	205,186	81,353-p
Auto sets	293,955	246,909	95,220-p

RECEIVER SALES	Year Ago	Previous Month	Latest Month
(Source: Licensee figures)	Apr. '51	Mar. '52	Apr. '52
Television sets, units	285,498	370,905	349,015
Electric radio sets, units	485,970	380,846	354,518
Battery sets, units	136,981	68,339	82,873
Auto sets, units	1,057,484	204,990	235,651
Television sets, value	\$49,061,450	\$62,988,663	\$58,872,294
Electric radio sets, value	\$11,222,433	\$7,963,825	\$8,594,861
Battery sets, value	\$2,592,267	\$1,332,640	\$1,495,919
Auto sets, value	\$26,076,566	\$5,912,217	\$6,700,718

RECEIVING TUBE SALES	Year Ago	Previous Month	Latest Month
(Source: RTMA)	July '51	June '52	July '52
Receiv. tubes, total units	13,185,567	24,365,462	20,944,831
Receiving tubes, new sets	7,117,435	15,770,335	11,504,503
Rec. tubes, replacement	4,625,314	5,187,557	6,795,252
Receiving tubes, gov't.	220,083	2,477,569	1,956,905
Receiving tubes, export.	1,222,735	930,001	688,171
Picture tubes, to mfrs.	89,144	285,975	239,625

BROADCAST STATIONS	Year Ago	Previous Month	Latest Month
(Source: FCC)	Aug. '51	July '52	Aug. '52
TV Stations on Air	107	109	109
TV Stns CPs—not on air	1	21	34
TV Stns—Applications	440	838	855
AM Stations on Air	2,292	2,356	2,356
AM Stns CPs—not on air	105	95	112
AM Stns—Applications	278	300	291
FM Stations on Air	645	627	622
FM Stns CPs—not on air	11	18	21
FM Stns—Applications	8	12	12

NETWORK BILLINGS	Year Ago	Previous Month	Latest Month
(Source: Pub. Info. Bureau)	July '51	June '52	July '52
AM/FM—ABC	\$2,267,674	\$3,001,314	\$2,082,666
AM/FM—CBS	\$4,387,193	\$4,590,536	\$3,238,256
AM/FM—MBS	\$1,347,841	\$1,632,977	\$1,339,276
AM/FM—NBC	\$3,728,687	\$3,708,014	\$2,878,196
TV—ABC	\$1,351,168	\$1,276,250	\$943,387
TV—CBS	\$3,434,659	\$5,385,820	\$4,163,245
TV—DuMont	\$645,359	\$758,356	\$653,415
TV—NBC	\$3,477,952	\$5,904,546	\$4,591,130

TV AUDIENCE	Year Ago	Previous Month	Latest Month
(Source: NBC Research Dept.)	Aug. '51	July '52	Aug. '52
Sets in Use—total	13,271,700	17,983,200	18,354,300
Sets in Use—netw'k conn.	11,205,500	17,955,000	18,325,700
Sets in Use—New York	2,455,000	3,040,000	3,070,000
Sets in Use—Los Angeles	1,003,000	1,215,000	1,230,000
Sets in Use—Chicago	942,000	1,185,000	1,210,000

COMMUNICATION AUTHORIZATIONS	Year Ago	Previous Month	Latest Month
(Source: FCC)	June '51	May '52	June '52
Aeronautical	34,061	32,852	32,603
Marine	29,544	35,476	35,500
Police, fire, etc.	9,129	10,965	11,143
Industrial	9,551	13,056	13,680
Land Transportation	4,253	4,966	5,027
Amateur	90,585	110,931	113,092
Citizens Radio	560	1,175	1,401
Disaster	2	65	71
Experimental	475	357	488
Common carrier	815	970	985

EMPLOYMENT AND PAYROLLS	Year Ago	Previous Month	Latest Month
(Source: Bur. Labor Statistics)	June '51	May '52	June '52
Prod. workers, electronic	241,200	267,000-r	266,800-p
Prod. wkrs., radio, etc.	149,000	167,200	166,100-p
Av. wkly. earnings, elect.	\$62.05	\$64.80-r	\$64.48-p
Av. wkly. earnings, radio	\$58.42	\$60.83-r	\$60.77-p
Av. weekly hours, elect.	41.2	40.6	40.3-p
Av. weekly hours, radio	40.4	40.1	39.8-p

STOCK PRICE AVERAGES	Year Ago	Previous Month	Latest Month
(Source: Standard and Poor's)	Aug. '51	July '52	Aug. '52
Radio—TV & Electronics	242.9	295.7	291.1
Radio Broadcasters	230.6	232.4	279.6

INDUSTRIAL EQUIPMENT ORDERS	Quarterly Figures		
	Year Ago	Previous Quarter	Latest Quarter
(Source: NEMA)	2nd '51	1st '52	2nd '52
Dielectric Heating	\$600,000	\$150,000	\$510,000
Induction Heating	\$3,140,000	\$2,400,000	\$2,410,000

INDUSTRIAL TUBE SALES	Quarterly Figures		
	Year Ago	Previous Quarter	Latest Quarter
(Source: NEMA)	2nd '51	1st '52	2nd '52
Vacuum (non-receiving)	\$7,750,000	\$11,320,000	\$12,110,000
Gas or vapor	\$2,700,000	\$3,100,000	\$3,150,000
Phototubes	\$360,000	\$500,000	\$480,000
Magnetrons and velocity modulation tubes	\$4,130,000	\$8,460,000	\$9,830,000

p—provisional; r—revised; e—estimated

INDUSTRY REPORT

electronics—OCTOBER • 1952

Army Spurs Transistor Production

Four recent contract awards totaling \$5,377,960 are aimed at machinery development

WITH the awarding of four large contracts (Raytheon \$1,180,053, General Electric \$1,364,674, Sylvania \$1,599,200 and RCA \$1,234,033), the Signal Corps has started the ball rolling on increased production of point-contact and junction transistors and germanium diodes.

These contracts have not been awarded for large quantities of transistors but rather for setting up operations, developing automatic production machinery and for running off sample lots.

Pilot production runs with the machinery developed will be used to prove out and perfect designs, machines and techniques leading to final approval of the transistors. Standardization for size and test procedures will also result.

► **Machinery Requirements**—Automatic machinery is to be designed to perform the following basic operations or functions: purify germanium, grow crystals, cut and prepare pellets, mount and clean pellets, etch pellets, form junctions, form cat whiskers, assemble and test point contacts, package and test electrically.

The machinery is to be capable of producing 5,000 units each of point-contact transistors, junction transistors and diodes per week and will remain Signal Corps property once developed.

► **Transistor Types**—Point-contact transistors involved in these contracts are for general purpose and switching applications. Junction transistors are for low-power gen-

eral-purpose use and for high-power applications ($\frac{1}{2}$ watt to 100 watts) at audio frequencies. Junction-type phototransistors are also included. Diodes are to be of the point-contact type and junction type for power rectification at low and high currents.

New ASDE Radar At Idlewild Airport

High-resolution set guides ground traffic in instrument weather

ON THE 16th of September a new eleven-story CAA control tower at New York's Idlewild International Airport went into operation, using something new in the way of elec-

tronic control equipment.

In the control room a prominent position has been given to the new ASDE (Airport Surface Detection Equipment) radar. This equipment has received the popular name "taxi" radar, since it is used in guiding aircraft after landing and before takeoff during weather when planes cannot be seen visually by the tower operators.

The new high-resolution radar was developed for the USAF Rome Air Development Center and has been installed at Idlewild for CAA evaluation under high-traffic-density conditions. Through its use, experienced operators can follow an aircraft from touchdown and guide it safely by radio to appropriate taxi strips and to unloading platforms.

► **Grass**—In dealing with the high-resolution ground surveillance equipment, engineers have found it

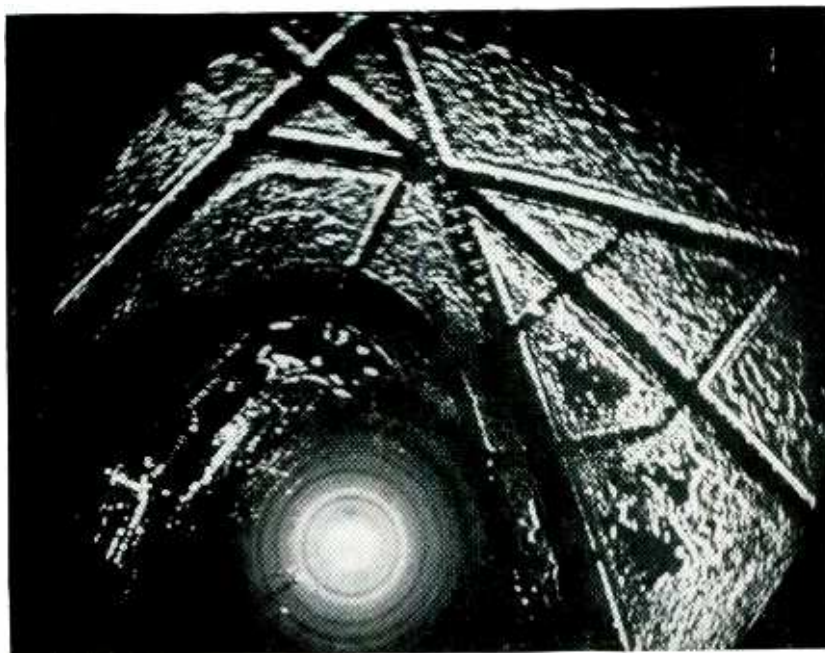

Airport surface radar clearly shows outline of planes, buildings, runways and taxi strips. Note multiple image of plane made during landing by time exposure of successive 60 per minute sweeps

necessary to use qualifying words in speaking of grass. When referring to radar grass (noise), one uses the two words "radar grass" to avoid confusion with "green grass" (that which grows on the ground) which shows up clearly on the 16-inch radar scope.

An experienced operator can distinguish between 2 and 4-engine airplanes by their returns.

Research on the project was begun at Gilfillan and final development work was carried on at Airborne Instruments Laboratories. It is believed that the new type radar will speed up traffic in large air terminals during instrument weather by providing airport operators with a positive means for controlling ground traffic.

UHF Egg Is Waiting for UHF Chicken

Receiver manufacturers working fast to ready sets for coming markets

"I DO NOT WISH to seem bureaucratic," said Federal Communications Commissioner Rosel H. Hyde recently, "but I feel strongly that every purchaser of a new tv set is entitled to a set providing complete tv service. And a set which is not designed for uhf reception does not offer complete tv service." What his West Coast audience of radio engineers and electronic manufacturers thought in reply is not recorded.

► **Three Questions**—Engineers and set manufacturers face three general technical problems—what basic circuits to put in a uhf set; whether to use strip or continuous tuning; how much of the whole uhf-vhf receiving package they should consider.

Engineers know how to build uhf receivers or adapters. But to market a receiver that appeals to the general public requires compromise with optimum engineering design. As a result, production men to whom ELECTRONICS has talked think

that the initial large production can be expected to comprise converter-type circuits, either built into the console or in separate boxes with a uhf oscillator beating the signal down to vhf around channel 5 or 6. Suitable oscillator tubes seem to be available, but it is a safe bet that germanium or silicon crystal mixers will be used for some time. Many designers think radio-frequency amplifiers either have discouraging noise figures or cost too much. Intermediate frequencies will be 40 mc and noise figures may run between 15 and 22 db. (Good vhf sets may be as low as 10 db.)

Will most people buy sets having switches for quick tuning? Or will they prefer continuous tuners that may be slightly less convenient to use, but insure complete coverage of all uhf television channels? The answer may well reside in the attitude of dealers out of whose time, and perhaps profits, will come the changing of strips. Manufacturers haven't made up their minds just how this problem will finally work out but they tell us that they will not be caught napping.

Some set manufacturers, like the

people who make tubes, transmission lines and antennas, feel that their own problems are a big enough worry. They are content to turn out their respective products and let the serviceman put the pieces together. Others take a lively interest in the whole receiving package from the roof down. While they may not manufacture the various critical components they are in active co-operation with those who do.

► **Outside the House**—Antennas (p 5, Sept. 1952) seem to present no great problem, although installers may quickly find that no one design is the answer for every location at every frequency. Inexpensive low-loss transmission line to connect antenna and set just ain't! Line available now has losses ranging upwards from 5 db per 100 feet at 1,000 mc when dry. Tested under water the losses rise fantastically. Fortunately, there will be few uhf-tv installations as damp as this. It is known that new lines have been developed and ordered in quantity. Other, better, lines are in development. But the developers won't let their names be mentioned.

New York's Ch. 9 Gets Power Boost

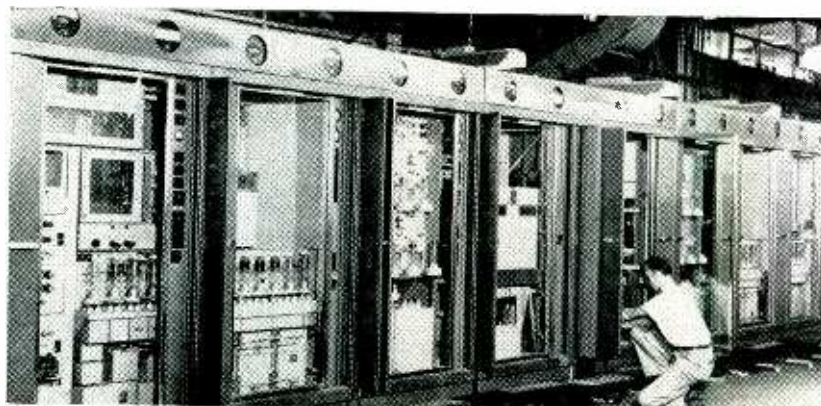

New vhf 20-kw television transmitter on test. Final amplifier for WOR-TV comprises four-units of this lineup

NEW YORK CITY'S lone standout tv station, located across the river in Jersey rather than on the Empire State tower, is due to jump its erp (effective radiated power) from 22,000 to 90,000 watts in late September. At this time, fringe-area regions will start getting better

signals and Grade A coverage will increase from a present radius of 30 miles to about 39.5 miles. The Grade B region will expand its present 50-mile radius to approximately 57 miles.

While this leaves some margin

(Continued on page 8)

STILL ANOTHER SYLVANIA EXCLUSIVE

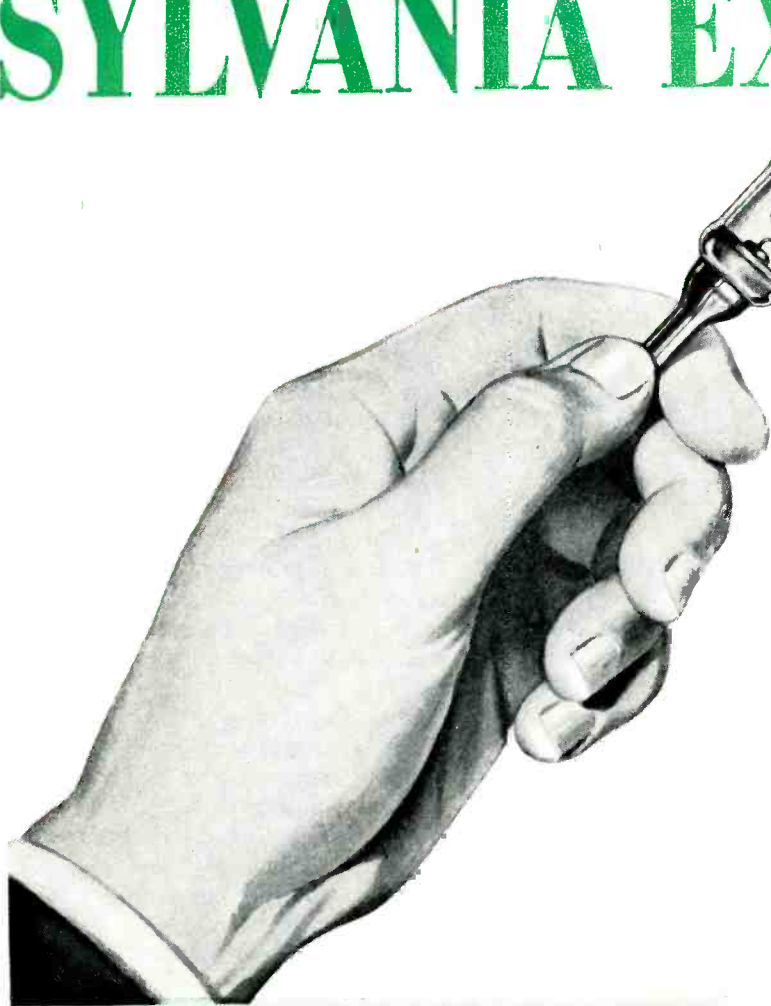

**SYLVANIA NOW OFFERS
THE ONLY IN34A CRYSTAL
DIODE WHICH IS...**

- JAN approved
- Sealed in glass
- Guaranteed to meet JAN moisture-resistance standards

**SYLVANIA'S COMPLETE LINE OF
SEALED-IN-GLASS CRYSTAL DIODES
NOW INCLUDES THE FOLLOWING TYPES:**

**1N38A
1N54A
1N55A**



**1N56A
1N58A
1N82**



The above illustrated folder gives full descriptions and electrical ratings of all Sylvania's Sealed-in-glass Crystal Diodes. Mail the coupon for your copy NOW!

SYLVANIA

ELECTRONIC DEVICES; RADIO TUBES; TELEVISION PICTURE TUBES; ELECTRONIC TEST EQUIPMENT;
FLUORESCENT TUBES; FIXTURES, SIGN TUBING, WIRING DEVICES; LIGHT BULBS; PHOTOLAMPS; TELEVISION SETS

Sylvania Electric Products Inc.
Dept. E-2610, 1740 Broadway, N. Y. 19, N. Y.

Please send me new folder describing the complete line of Sylvania Sealed-in-glass Crystal Diodes.

Name _____

Street _____

City _____ Zone _____ State _____

below the FCC legal maximum, WOR-TV engineers are satisfied to take a long look at what now passes for real high power at vhf before they reach for the ceiling.

► **First of a Line**—WOR-TV's Decision to use Standard Electronics Corp. equipment is a minor triumph for this Claude Neon, Inc. subsidiary. The company inherited the Western Electric line of a-m and

f-m transmitters some time ago. The tv transmitter line, however, is pure Standard, whose engineers have been working hard over its development for more than two years.

Nub of the high-power amplifier is the Amperex type AX9904R/5924 forced-air-cooled triode. With a manufacturer's upper limit of 220 mc, this tube should be good even at channel 13 (210-216 mc).

TV Station CP Holders Look Ahead

Estimates of first year's revenue, construction and operating costs vary widely

INTRIGUING picture of the tv broadcasting business is revealed in an analysis of the first-year cost and profit estimates made by tv station applicants who now hold construction permits.

The first 49 cp grantees expect to spend a total of \$15,717,624 on station construction. Thus new cp holders expect to spend an average of \$350,000.

This is considerably higher than recent FCC estimates of the average investments of present tv stations in markets of comparable size.

The range in construction cost estimates swings from a low of \$138,800 expected by the Appalachian Company of Scranton, Pa. using channel 73, to a high of \$972,000 (nearly \$300,000 higher than that of any other grantee) for the Vindicator Printing Company in Youngstown, Ohio, also granted channel 73.

► **Profit and Loss**—First-year operating cost and revenue estimates of 41 commercial cp holders show that more than half of them expect to go in the red.

Vindicator Printing Company sees the greatest loss. They estimate first-year operating costs at \$446,104 and revenue at \$315,000 for a first-year loss of over \$131,000.

On the other side of the ledger, Empire coil expects its station in Portland, Oregon, due in November, to show a profit. They estimate operating costs at \$450,000, but expect revenue to total \$525,000 for a net of \$75,000.

KFEL-TV, pioneer on-the-air station of the new cp holders, estimates its first year in Denver at \$520,000 for operating costs, but revenue is only expected to total \$500,000 for a loss of \$20,000. However, it is possible that KFEL's early estimates will need revision

(Continued on page 10)

Broadcast Phase of CONELRAD Approved by Co-op Agencies

CD officials urge production of \$8 battery-or-line receiver and repair campaign

OPERATION CONELRAD (control of electromagnetic radiation) is essentially a broad-gage plan to furnish limited broadcast radio service to the general public while denying navigation information to enemy aircraft (ELECTRONICS, p 94, Aug. 1952).

Implementation of the broadcast (a-m, f-m, tv) phase involves more than 1,200 a-m stations grouped in 200 clusters throughout the country. Most of the technical bugs have been ironed out and the plan approved by FCDA, FCC, Air Force, Air Defense Command, Secretary of Defense and National Securities Resources Board.

► **Who Pays**—Air Force has agreed to foot the \$400,000 bill for control

telephone lines that will be installed by the Bell System. Program lines to carry identical material to all stations of a cluster will cost \$80,200, to be paid by FCDA. Broadcasters have already sunk a million and a half dollars of their own into emergency-operation equipment. They still have to buy more new crystal-control and power-varying equipment.

► **Listener's Job**—During an emergency, all the listener has to do is tune to 640 or 1,240 kc and follow directions.

Federal Civil Defense officials are talking up a program of keeping receivers in good condition, especially battery-operated types that can be carried into shelters. Manufacturers are considering a suggestion that they develop a "cheap, portable a-m set that could sell for seven to eight dollars, operating with power or battery."

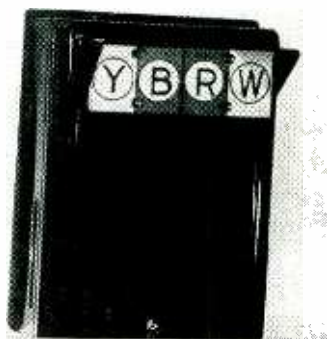

Bell System wire alerting network proposed for hospitals, factories and other large centers. Alerts and clear signals are sent from defense control point by special dial impulse to light appropriate indicator. Dial shown is under glass cover locked with key to prevent unauthorized tampering

PUT YOUR FINGER ON THE RIGHT PULSE NETWORK

**Hundreds of combinations
for the right size...voltage...
pulse shape**

Whatever your needs in pulse-forming networks—whatever your requirements for size, voltage, number of meshes, pulse lengths, or pulse repetition rates—Sprague has the right answer for that need.

Providing the right network for each application has been a Sprague specialty since Sprague made the very first networks for radar during World War II. Literally hundreds of pulse-forming networks have been designed and built by Sprague since then. Among these standard types can usually be found the solution to a specific requirement. If not, you'll find Sprague ready, willing, and able to manufacture networks to your exact order.

For details, write for our special bulletin "Pulse-Forming Networks."

SPRAGUE ELECTRIC COMPANY
35 Marshall Street • North Adams, Mass.

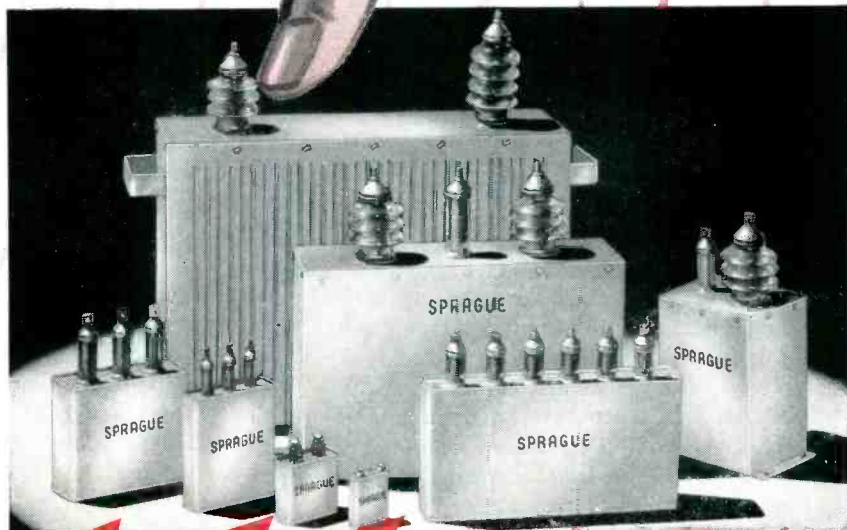

**WORLD'S LARGEST
CAPACITOR MANUFACTURER**

after the tv set sales boom that Denver experienced. Already the tv audience is larger than expected,

so that rates can be raised to increase total revenue and reduce loss.

Cobalt	629	218	66
Copper*	40,487	12,951	69
Lead	1,154	1,790	..
Nickel	1,278	450	65
Iron, Steel	224,115	118,915	47
Tin	1,064	534	50
Zinc**	15,631	5,745	51

* Includes copper used in brass
** Includes zinc used in brass

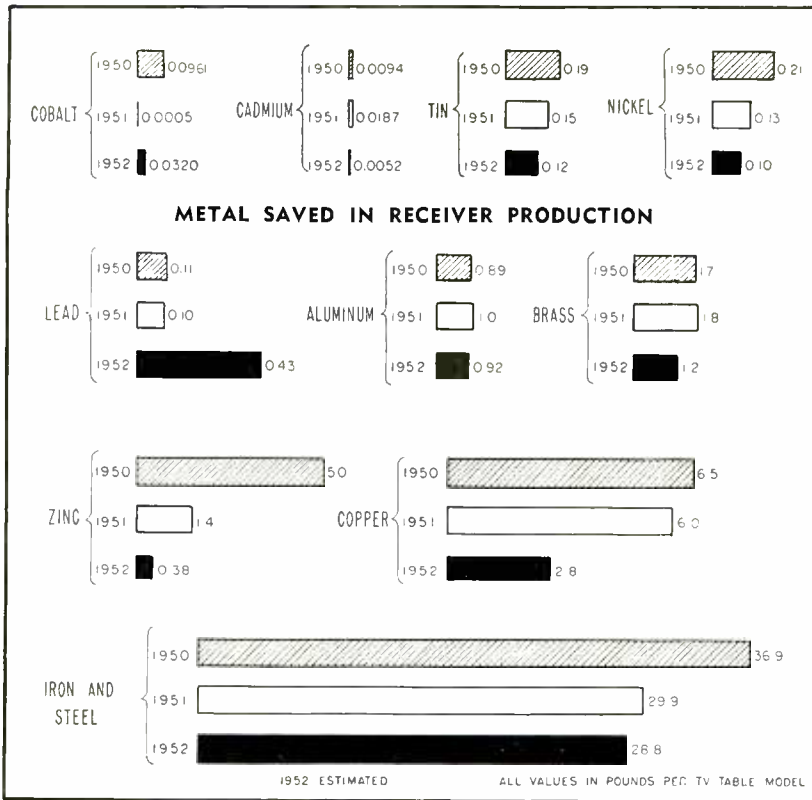

METAL USAGE in table model and console sets declines as . . .

Manufacturers Conserve Materials

Early estimates of savings may have to be revised but gains will still be substantial

IF the 1952 radio and television production estimate made by the RTMA Material Bureau Advisory Council earlier this year holds true, the industry will effect a 50 percent saving in the use of critical metals. (In its final report on materials used by radio and television manufacturers, the council estimates that total radio-tv production for 1952 will be 14,267,000 units compared to 18,012,160 for last year and 22,053,700 units in 1950.)

► **Outlook**—With new television markets already becoming a reality, it is probable that early 1952 production estimates, especially for tv sets, will have to be revised upwards and that total critical metal

savings will not be quite as substantial as indicated. But manufacturers do not expect that the current sales upswing will drastically affect conservation.

The supply of many critical metals has improved steadily, so that some are no longer listed as critical. Copper and aluminum were recently dropped from the list and are now classified by the DPA as "supplies in approximate balance with demand."

► **Total Savings**—The following table gives a comparison of the total amounts of metals used in 1950 and likely to be used in 1952 in radio-tv production if early production estimates hold:

	1950 (tons)	1952 (tons)	% Saved
Aluminum	6,229	3,139	50
Brass	13,361	4,844	64
Cadmium	284	119	59

Savings of over 47 percent are expected for every critical metal this year except lead, which has increased in use since 1950 as a result of greater use in solder.

Microwave Sharpens Europe's Air Defenses

Relay network carries radar intercept data and top-level orders

FREE EUROPE'S air defenses are now being sharpened and toughened by a million-dollar microwave radio-relay network providing highly-mobile multichannel communications, free from jamming and interference, for top-priority operational voice and telegraph circuits.

Ordered by Allied Air Forces, Central Europe, from RCA International, the system will consist of 6 terminals and 17 repeater stations plus complete standby equipment and spares. Two terminals and one repeater were in operation this month during Operation Blue Alliance as 1,500 aircraft of seven NATO countries mock-clashed in Western Europe's skies and flew close cover for British and French armies maneuvering on the Rhine.

► **Mobility**—Initially installed to link major allied air installations with NATO headquarters, the equipment is readily transportable and will be moved around in the AAFCE area as required. The 58-ft, three-section telescoping masts can be collapsed to a mere 23 feet.

Each station is installed in five trucks carrying tower and antenna, cables and accessories, receiving and transmitting equipment, power generating equipment and personnel. The six-foot paraboloidal antennas, used both for transmitting and receiving, are fed with flexible RG-17/U coaxial cable.

► **System Layout**—The 15-centimeter carrier is modulated by a Lenkurt

(Continued on page 14)

Put this Ceramic Button-type Capacitor in your electronic picture...

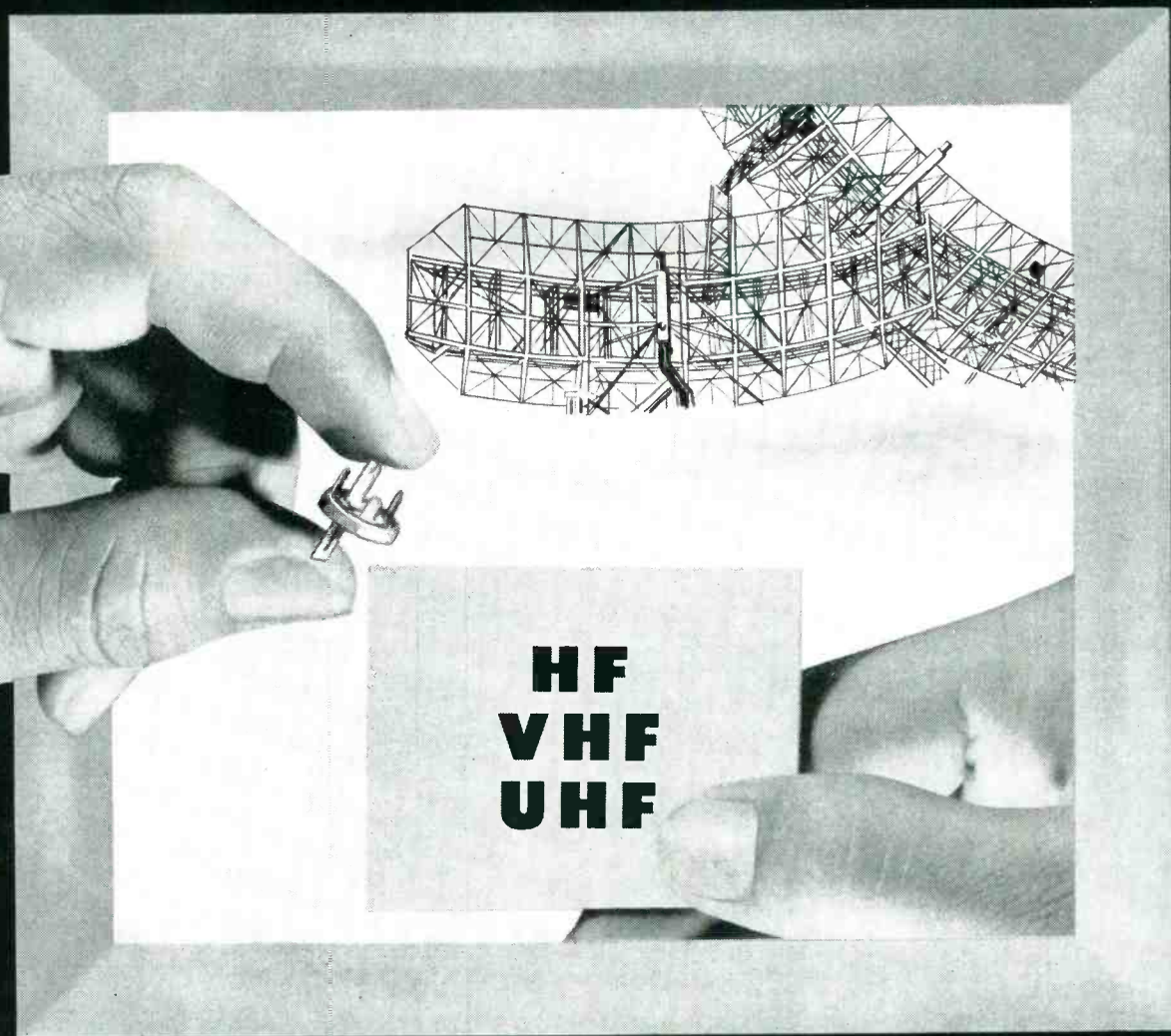

and get 4 big
exclusive advantages

for proof...see next two pages

CRL Ceramic Button-type Capacitors you get small size... longer life...

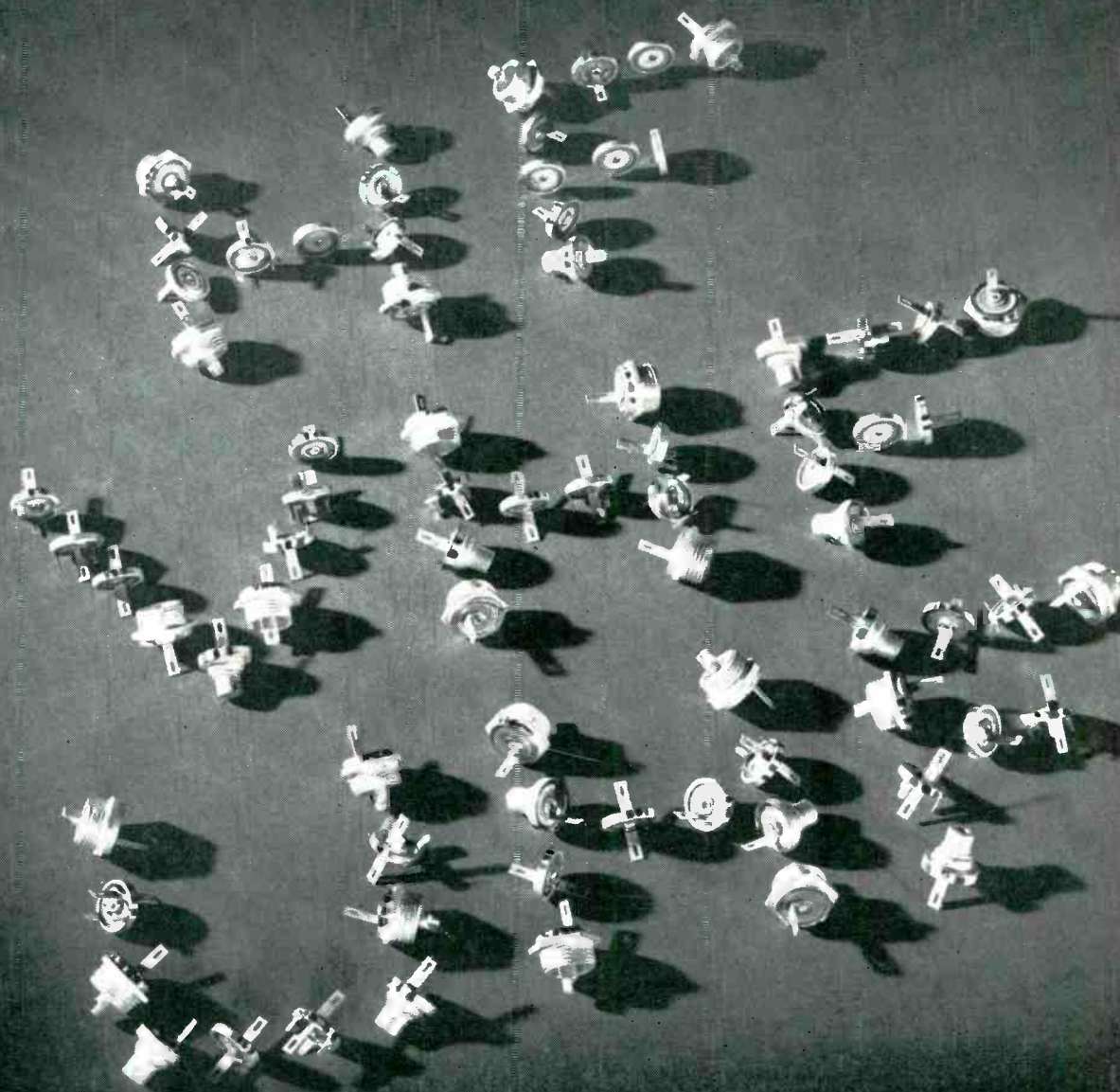

TYPE 902
FEED-THRU —
with threaded shell



TYPE 903
STAND-OFF with
single soldering lug



TYPE 904
STAND-OFF with
tapped base—single lug



TYPE 905 and TYPE 906
FEED-THRU (LEFT) with mounting lugs
(RIGHT) plain with two soldering lugs



BUTTON STYLE CERAMIC CAPACITORS are available in five different types, including feed-through with threaded shell, stand-off with soldering lug and ground terminal, and stand-off with tapped ground terminal. Used on HF, VHF, and UHF,

they are especially suited for feed-through and by-pass. The shell is effectively at ground potential in all styles. Capacities range from 5 to 1000 mmf. Voltage ratings, 500 vdcw and 1000 vdc. For complete details, write for Bulletin 42-122R.

replace old-fashioned "micas"...

lower inductance...lower cost!

YES, only Centralab offers these four big reasons for specifying Ceramic Button-type Capacitors for use in low power, high frequency electronic equipment. Their ceramic construction provides: (1) Small size and light weight, (2) lower cost, (3) lower inductance—a real advantage in high frequency work, (4) longer life — *there's no deterioration with age.*

These capacitors are adaptable for transmitter exciter units and communication receivers and for aircraft, marine and government equipment.

Ceramic X, the exclusive CRL dielectric, is used for the

ceramic body. It's non-hygroscopic, providing the ultimate in humidity resistance. All units withstand moisture conditions as specified in Jan C-20-A.

In addition, CRL Button-type Capacitors are solder-bonded to provide maximum sealing between shell and disc. Pressure contacts are eliminated, removing the possibility of intermittance and mechanical flutter.

Compare these dependable Centralab Ceramic Button-type Capacitors with old-fashioned micas. You'll find their exclusive features are your assurance of highest quality performance and true permanence at lower cost.

CENTRALAB OFFERS THE WIDEST LINE OF CERAMIC CAPACITORS AVAILABLE

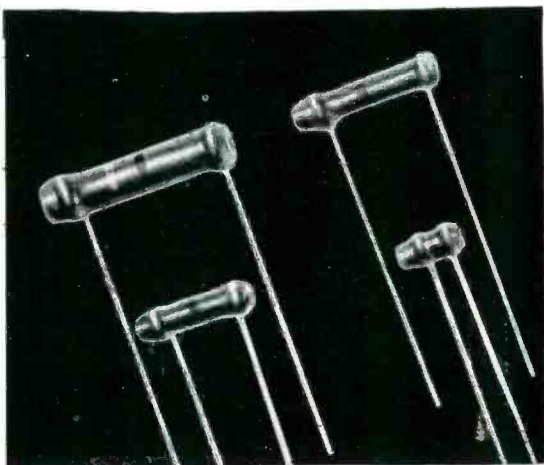

BC HI-KAP TUBULAR CERAMIC CAPACITORS available from 1 mmf to 10,000 mmf. Ideal for use in r.f. by-pass and audio-coupling applications. For details, write for Bulletin 42-3R.

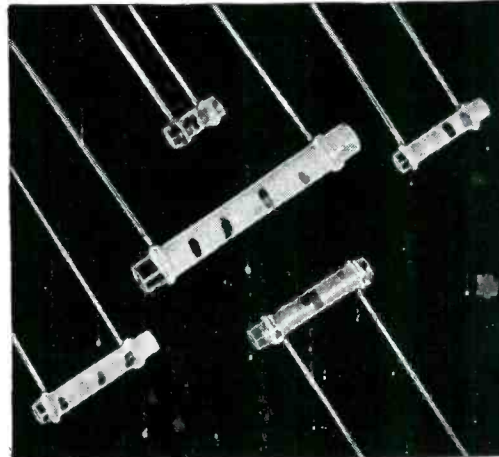

TUBULAR CERAMIC CAPACITORS — Type TCZ show no capacitance change over wide temperature range. Type TCN special ceramic body varies capacitance with temperature. Write for Bulletin 42-18.

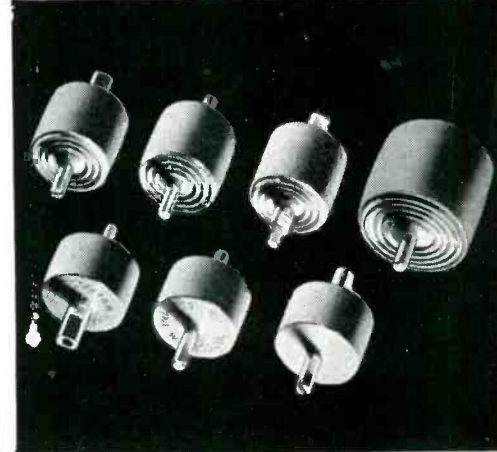

TV HI-VO-KAPS are the standard high-voltage capacitors for the TV industry. Capacitance: 500 mmf, 10 KV, 20 KV and 30 KV D. C. working. Write for 42-10R.

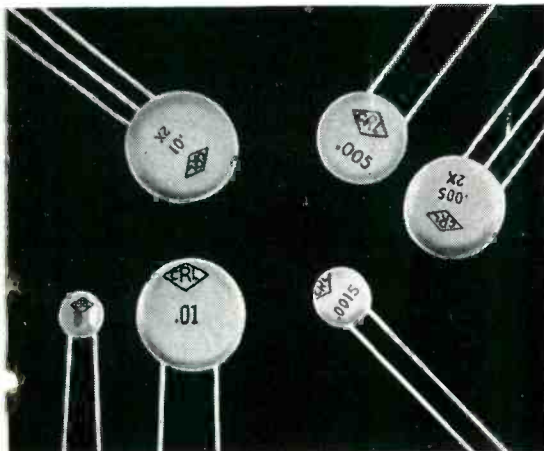

CERAMIC DISC HI-KAP CAPACITORS hold thickness to a minimum. Make possible very high capacity in extremely small size. Used in HF by-pass and coupling. For details, write for Bulletin 42-4R.

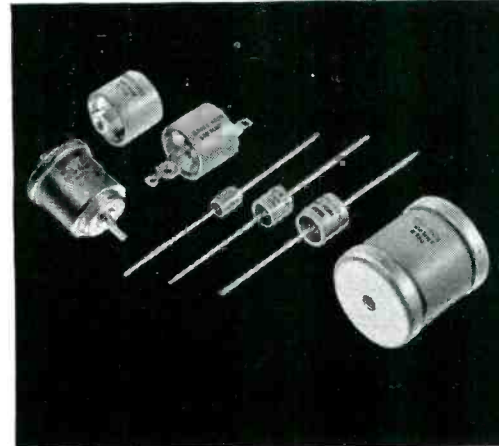

HIGH VOLTAGE CERAMIC CAPACITORS. Capacitance: 5 to 500 mmf, 5KV to 40 KV D.C. working. Ideal for portable or mobile equipment and high-voltage, high-frequency gear. Bulletin 42-102R.

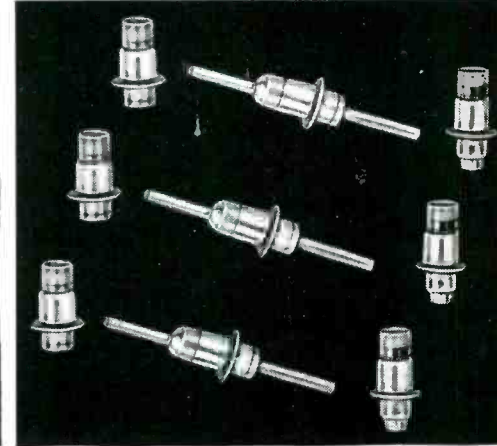

EYELET-MOUNTED FEED-THROUGH CERAMIC CAPACITORS—smallest made... widest range obtainable with general temperature-compensating characteristics. 10 to 3000 mmf, 500 vdw. Bulletin EP-15.



Centralab

A Division of Globe-Union Inc.
900 E. Keefe Ave. • Milwaukee 1, Wisconsin
In Canada, 635 Queen Street East, Toronto, Ontario

www.americanradiohistory.com

CENTRALAB, A Division of Globe-Union Inc.

914 East Keefe Avenue, Milwaukee 1, Wisconsin

Please send me the Technical Bulletins on Ceramic Capacitors as checked:

- 42-122R 42-18 42-4R
 42-3R 42-10R 42-102R
 EP-15

Name.....

Address.....

Company..... Title.....

frequency-division system to obtain 24, 5-kc voice channels in the 10 to 135-kc modulation spectrum. Each voice channel transmits frequencies from 300 to 3,400 cps. Twenty-three channels are used for telephone circuits while the remaining voice channel is subdivided to give 16 channels of on-off keyed tone telegraph.

Encompassing about 660 route miles, the microwave network is laid out in several legs converging on Allied Air Headquarters at Fontainebleau and connecting to their major subordinate commands on the Western European continent.

The primary network includes the 6 terminals and 17 repeaters. All 24 voice channels are available at each terminal and five voice channels are brought out for drop and insert at each repeater station. The voice channel carrying the telegraph circuits is available for drop and insert at every repeater. There is also a voice channel available below 10 kc on a party-line basis for order wire service.

A 40-mc carrier shift between transmit and receive frequencies is introduced at each relay station and terminal. Crosstalk, in addition to being reduced by a high front-to-back antenna ratio, is further reduced by changing the plane of antenna polarization 90 degrees at each terminal and relay point. Basic equipment supplied is commercial RCA CW-20 microwave radio relay.

Civil Defense Doubles Communications Budget

FCDA will spend \$6 million on communication equipment and \$3 million on noise devices during the 1953 fiscal year. The Federal Civil Defense Administration budget, made up of equal contributions by states and the federal government, represents a complete reversal of the 1952 budget which earmarked \$3 million for communications and \$6 million for warning devices.

Communications equipment to be purchased includes such items as radio receivers, television receivers, loud-speakers, and portable transmitter-receivers.

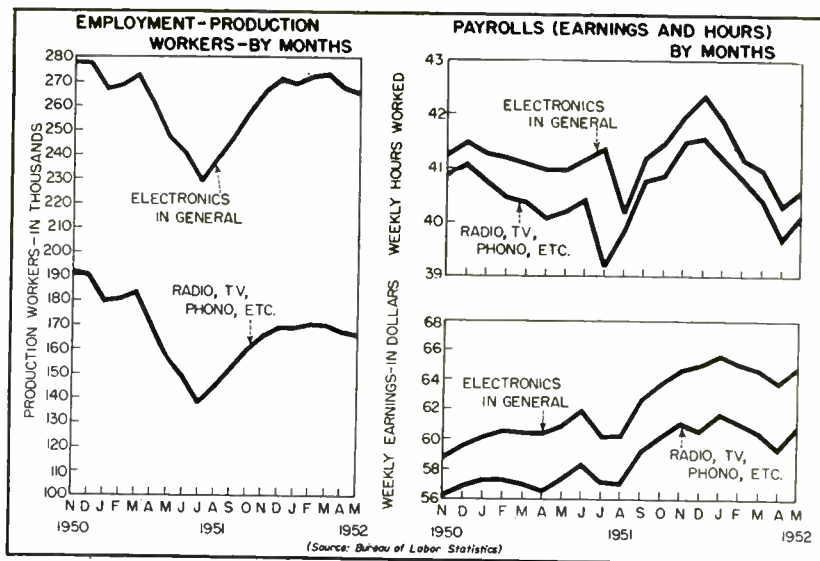

1952 Employment Peak Falls Short

Electronics industry production employment figures level off below predicted high

FALLING SHORT of the expected high, the 1951-1952 electronics production-worker peak reflects material shortages and slow-downs in military spending. Weekly salaries for production workers in radio and electronics continue their steady increase, despite seasonal dip in average number of hours worked. These trends are revealed in the accompanying plot of "Employment and Payrolls" statistics that appear on the "Figures of the Month" page in each issue of ELECTRONICS (p 4).

► **Breakdown**—Figures showing the number of workers engaged in electronics production were obtained from the Bureau of Labor Statistics publication, "Employment and Payrolls". They include personnel involved in such activities as fabricating, processing, inspecting, handling, maintenance and repair of electronic equipment, but exclude those primarily engaged in purchasing, finance, accounting, legal and executive phases of the business.

Earnings and hours statistics are taken from the BLS publication "Hours and Earnings". The salary

figures are before deductions and include pay for sick leave, holidays and vacations. Pay for vacations not taken and retroactive pay and bonuses are excluded unless earned and paid regularly each pay period.

Transistors Operate at High Temperatures

SUCCESSFUL operation of junction transistors at temperatures in the neighborhood of 120 degrees Centigrade has been reported by the General Electric Company in Syracuse, N. Y. This is in contrast to previous reports that operation above 75 degrees Centigrade was inherently unstable.

According to John S. Saby of GE, the alloy-diffusion process used in making the junction transistor results in the collector of the transistor having low resistivity. The low resistivity of the collector keeps the current control factor of the transistor constant within a fraction of one percent up to about 120 degrees Centigrade. Formerly, the current control factor would increase above unity with increasing temperature (above 75 degrees Centigrade) and cause instability.

Failure of transistors under high-

(Continued on page 16)

an ounce
(and 1/4) →

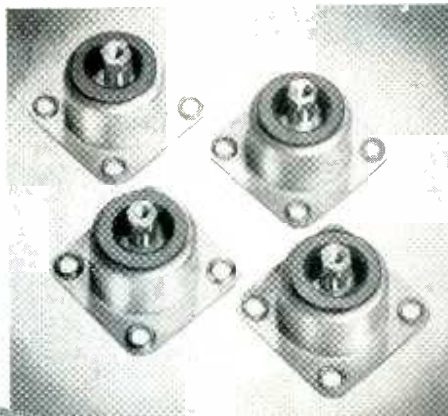
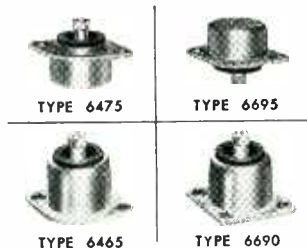

Photo courtesy Vapor Heating Corp.

insures the reliability of your equipment.

Miniature air-damped Barrymounts were developed specifically to help you with your miniaturization projects. They give you these advantages:

1. Less space — reduced height cuts cubage of mounted equipment.
2. Less weight — only 5/16 ounce per unit isolator.
3. Wide load range — 0.1 to 3.0 pounds per isolator.
4. Satisfy temperature (−67 to +170F), vibration, and other performance requirements of JAN-C-172A — special models available for extreme high or low temperatures.
5. Ruggedized models — available for equipment that must meet shock-test requirements of AN-E-19, MIL-E-5272, and MIL-T-5422.
6. Four styles — available as unit isolators or assembled with mounting bases built to your needs.



For complete information, ask for Barry Catalog 523-A; it's free on request. And for greatest benefits with miniature Barrymounts, let our Field Engineering Service share our experience with you in the early stages of your designs.

THE **BARRY** CORP.

707 PLEASANT ST., WATERTOWN 72, MASSACHUSETTS

SALES REPRESENTATIVES IN

Atlanta Chicago Cleveland Dallas Dayton Detroit Los Angeles Minneapolis New York Philadelphia
Phoenix Rochester St. Louis San Francisco Seattle Toronto Washington

temperature conditions has been a major obstacle. With this problem at least experimentally licked and high-frequency operation possible (ELECTRONICS, Aug. 1952, page 10), the chief obstacle remaining seems to be quantity production.

Tell-Tale Cars Speed Subway Travel

Train equipped with "electronic describer" signals destination before entering station

NEW YORK CITY'S subway system, one of the safest railroads in the world, is ever on the alert to increase safety and speed traffic. Latest device undergoing test will undoubtedly be called AETID by some newsman because it is officially described as "automatic electronic train identification device". Originator of the idea, Cameron A. Reed, Engineer of Line Equipment for the Board of Transportation, is emphatic that he does not consider it a safety device. Other engineers think it does contribute to safety.

► **How It Works**—A coil tuned to some frequency between 50 and 220 kc and requiring no energy sticks out from the first car of a train. Alongside the track is another coil, tuned to the same frequency and connected into a Wheatstone-bridge circuit. As the train passes, the bridge is unbalanced and a relay rings an alarm or lights a lamp. Other coils have no effect.

► **How It is Used**—A train on the Independent line coming into 59th St. station is identified by the towerman from the pattern of colored lights displayed on the front car. He throws switches to send this train onto either the 6th or 8th Ave. tracks. If he makes an error, there is no danger to the passengers but there is considerable inconvenience and the towerman gets the next day off—without pay. The electronic describer will help avoid such infrequent errors.

Boxed Orthicon Is Lightest Camera



Designed for closeups during fight telecasts, this new portable tv camera developed by Robert Sammon of CBS contains only an image orthicon tube and controls. It is connected by cable to sweep and video circuits in a standard studio camera some 15 feet away. Equipped with a bullseye view finder, it weighs 22 pounds

Technical Book Prices Rise

Labor, constituting 80 percent of cost, is chief reason for trend to 2¢-a-page books

PUBLISHERS of engineering books today have a double worry—about costs and prices of the books they do put out, and about the books they can't afford to publish.

In the early '40's it took only about 5,000 copies to reach a satisfactory profit position (regain production, editorial, promotion and overhead costs) on a new technical book. Today, however, around 8,000 copies must be sold in order to get back the original investment, even with the book priced at the new 2¢-a-page level. This means that many meritorious specialized manuscripts without such high sales prospects will go unpublished, unless some publisher has the nerve to price them at the required break-even figure of 3¢ or even 4¢ a page.

Success of such a gamble hinges on willingness of engineers to pay upwards of \$10 even for the books they need badly.

► **Cost Breakdown**—The raw materials of books are paper, ink and binding; their cost, added to prorated amortization of plant, equipment, engraving metal and printing metal, amounts to 20 percent of the cost of manufacturing a new scientific book. The balance is labor—for editing, type-setting, making drawings, making engravings, operating the presses, proof-reading, and binding.

The labor portion of this cost has almost doubled in the past ten years, paper has gone up 54 percent, binder's cloth 75 percent, binder's board 58 percent, and even the gold leaf for stamping covers has gone up 56 percent. As a consequence, the book that cost \$1 a

(Continued on page 18)

Close

DOESN'T COUNT

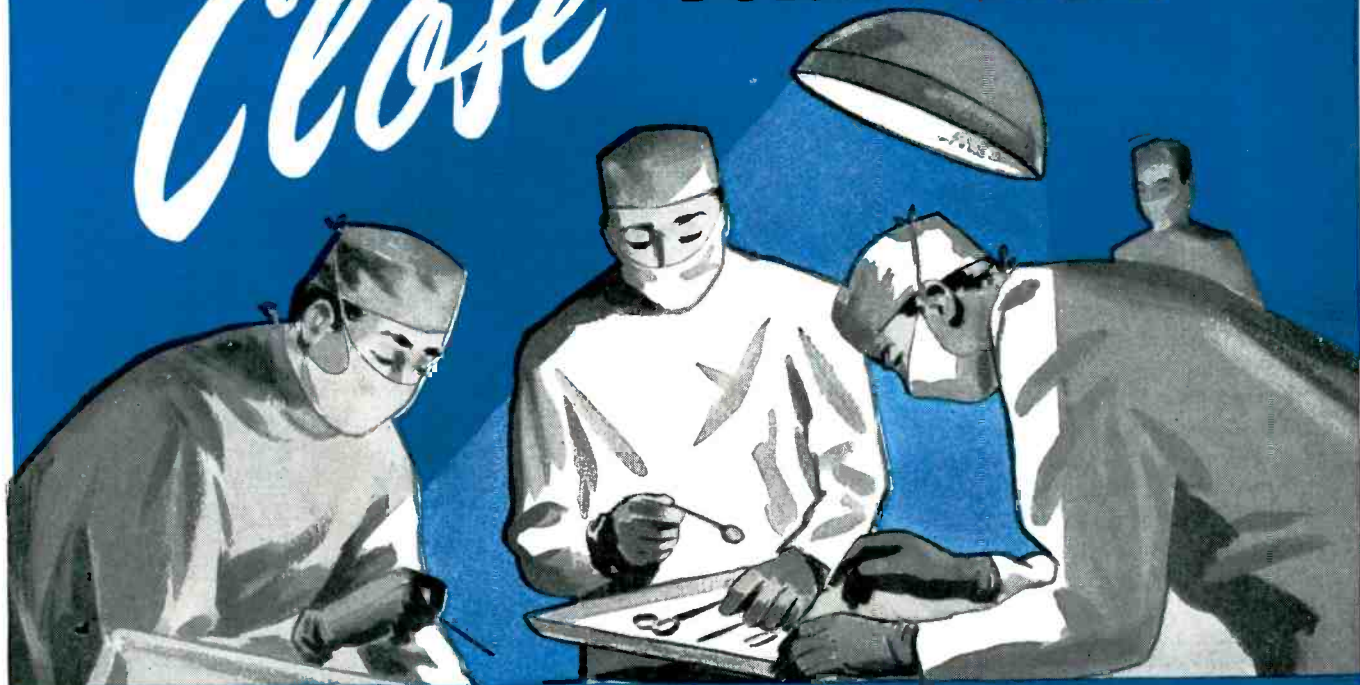

In the hushed white of the operating room, precision and dependability mean life to the quiet patient. Almost is the same as failure. In electronics the identical holds true . . . close just isn't good enough.

This is why El-Menco Capacitors are designed for the ultimate in reliability and are built with razor-edge accuracy.

Lessons have been learned from surgery . . . today a doctor always allows a large margin of safety in standard operations. For long life and freedom from failure in your electronic applications every El-Menco Silvered-Mica Capacitor is factory-tested at more than double its working voltage.

For peak performance in compact form . . . for higher capacity values, which require extreme temperature and time stabilization . . . there are no substitutes for El-Menco Capacitors. Available for every specified military capacity and voltage.

WRITE ON YOUR
BUSINESS LETTERHEAD
FOR CATALOG AND
SAMPLES

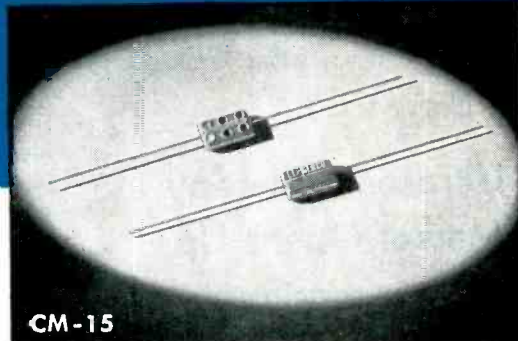

CM-15

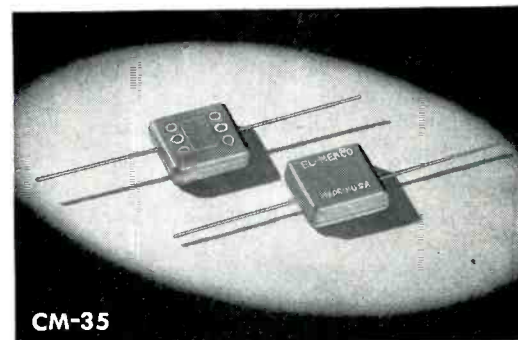

CM-35

JOBBER AND DISTRIBUTORS: For information write to Arco Electronics, Inc., 103 Lafayette St., New York, N. Y.—Sole Agent for Jobbers and Distributors in U. S. and Canada.

MOLDED MICA **EL-MENCO** MICA TRIMMER
CAPACITORS

Radio and Television Manufacturers, Domestic and Foreign, Communicate Direct With Factory—

THE ELECTRO MOTIVE MFG. CO., INC.

WILLIMANTIC, CONNECTICUT

copy to produce in 1942 is today costing close to \$1.75 a copy.

Author royalties, generally 10 percent of retail selling price, go up whenever a book price is boosted. Promotion, advertising, mailing and other incidental costs likewise go up. Selling prices have not risen at the same rate, because publishers kept hoping that costs would stop rising and because they were afraid of market resistance to higher prices.

Net profit on books has dropped steadily downward in the last four years. Whereas traditionally publishing contracts have been so calculated that overall profit on the average book was divided about equally between author and publisher, today the author is making about twice as much as the publisher. The only shining light in the picture for publishers, albeit very dim, is that federal income taxes go down when income goes down.

Ultrasonic Therapy Market Opens Up

One company already has units in production for treating organic disease

INTEREST in ultrasonic therapy among American medical men has been negligible until recently, although units have been manufactured and used in Europe for ten years.

Experiments of physicians here



Ultrasonic vibrations being applied to the spinal column of a patient

are now reported to show that ultrasonic energy can be used in alleviating some organic diseases.

►**How It Works**—One technique is to apply ultrasonic vibrations to the spinal cord of a patient. The human nervous system is said to conduct high-frequency vibrations to other parts of the body and so stimulate hormone production to combat disease. Some danger lies in the fact that too much energy could injure the nervous system.

An ultrasonic therapy unit is being manufactured by the Birtcher Corporation of Los Angeles, California.

Emerson Electric Explains Contract Loss

ALTHOUGH a \$105-million Emerson Electric Mfg. Co. contract for the intricate A-2 remote fire control system for B-47 tail armament was cancelled by the Air Force last year (Oct. 26, 1951), the action only recently received widespread newspaper publicity. Stories were considered so misleading by the St. Louis firm that it sent a special letter of explanation to its stockholders:

►**History of Contract**—In January 1945 Emerson Electric started research and development on an advanced type of fire control system comprising over 20,000 parts, to be used in the Boeing six-jet B-47 bomber for controlling the tail-turret guns automatically from an up-forward radar-aiming location. The next six years were a story of one difficulty after another, with the Air Force continuing to pour in money because success always seemed just around the corner. Critical stability problems in a highly advanced system design were the chief trouble.

By January 1951, engineering time was running out and the company was given a "must" schedule of deliveries to meet requirements of the B-47 program. The engineering changes still needed were scheduled to be made as production progressed. Systems al-

ready delivered were to be modified at the installation point.

►**Interim System**—The modification program did not work out. On May 7, 1951 production was stopped, and the Air Force ordered Emerson Electric to concentrate on making the system "reliable." Bomber production continued, however, and tail-turret controls were badly needed. In September, the company was requested to provide an interim armament system using certain major components of the original system, with plans for swinging back to the original design as soon as it proved satisfactory.

In October 1951 the Air Materiel Command cancelled the original Emerson A-2 contract; plane manufacturer requirements far exceeded production capacity of Emerson's government-owned armament plant at that time, forcing the decision to use the simpler alternate system.

Engineering work is continuing on the original system, with a recent prototype undergoing extensive tests on a bomber. The basic design is considered fundamentally sound. The troubles encountered with it are considered typical of those encountered when taking the calculated risk of developing extremely complex equipment for military aircraft concurrently with design and production of the aircraft itself.

American Airlines Buys New A-12's for DC-7's

Company reaffirms faith in aviation electronics after mishap with automatic pilot

AVIATION ELECTRONICS took what seemed to be a hard knock last month when American Airlines discontinued use of automatic pilots in certain of their commercial airliners following a malfunction during operation that caused one of these planes to assume an irregular attitude in flight.

That this action was not a

(Continued on page 20)



MODEL M-2

**marion's
NEW
metertester**

**MEASURES
SENSITIVITY AND RESISTANCE**

for testing and calibration of D. C. instruments in the laboratory and on production lines

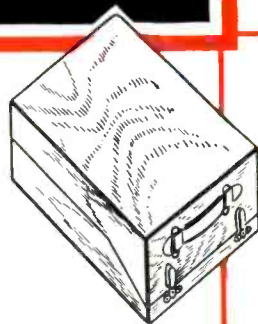

Marion's New Metertester (Model M-2) retains proven Marion features but increases application flexibility. In addition to improved circuitry for sensitivity measurement it also measures internal resistance of sensitive instruments without exceeding full scale rating of the instrument under test.

FEATURES

- Regulated Power Supply
- Stepless Vacuum Tube Voltage Control
- Illuminated 8½" Mirror-Scale Standard Instrument, Hand Calibrated
- Marion Ruggedized Null Indicator movement for bridge balance indication
- Decade of .1% accurate Manganin Wire Wound Resistors
- Direct Reading Bridge Circuit using Helipot
- Complete. No accessories required

SPECIFICATIONS

ACCURACY: Overall better than ¼ of 1%
 RESISTANCE RANGE: 0-5000 ohms
 POWER SOURCE: 115V A C 60 cycles
 CASE SIZE: 15½" x 10½" x 5½"
 WEIGHT: 15 lbs.

SENSITIVITY RANGES

0-25UA 0-200UA 0-800UA 0-10 MA
 0-50UA 0-400UA 0-1 MA 0-100 Volts
 0-100UA 0-500UA 0-5 MA

The New M-2 Model can also be used for additional purposes, such as a precise source of DC current and voltage and as a precision Wheatstone bridge in the 0-5000 ohm range.

For further information write Marion Electrical Instrument Co., 401 Canal Street, Manchester, N. H., U. S. A.



marion meters

Reg. U. S. Pat. Off.

MANUFACTURERS OF RUGGEDIZED, HERMETICALLY SEALED AND STANDARD PANEL INSTRUMENTS

blanket rejection by that company of all electronic flight equipment was vividly illustrated when American later announced that a complete complement of new automatic control equipment will be installed in its new fleet of Douglas DC-7 Flagships.

► **Improved Model**—The 25 new ships now on order will be equipped with Sperry autopilots complete with automatic approach couplers and a newly-developed automatic cut-off device to prevent such vio-

lent maneuvers as might be caused by autopilot misbehavior.

The new automatic cutoff consists of a pair of accelerometers, one in the nose and one in the tail of each ship. These measure vertical acceleration and are thus able to measure angular acceleration about the pitch axis of the aircraft. Improper relationship between autopilot signals and the airplane's angular motion causes the detectors to signal the human pilot to take over manually.

tions up to the seventh order and incorporates 12 amplifiers. Another boasts 24 amplifiers and handles twelfth order equations. With an improved cooling system, this machine uses regular-sized tubes.

► **New Products**—A novel temperature and strain-gage recorder was introduced that permits a-c amplification of low-level d-c voltages. An electronic chopper inverts the signal at a 50 kc rate.

A unique capacitor-follower recorder minimizes indicator loading. A vane, acting as one plate of a variable capacitor, is mounted on the indicating galvanometer pointer. The other plate is mechanically coupled to a servo motor controlled by an electronic capacitance relay. The servo drives the recording pen.

Other instruments included a surface-roughness gage operating on the principle of a phonograph pick-up and a viscosity meter deriving its information from the damping rate of an ultrasonic pulse.

Industrial control devices were largely of the temperature, pressure, rate-of-flow and liquid level regulating type applicable mainly in chemical plants and other process industries. Midget electronic components for process control have recently met with wide acceptance by larger chemical and petroleum manufacturers.

The navy exhibited a halogen-filled Geiger-Mueller tube using no critical materials and a vector airborne magnetometer using three saturable inductors as sensing elements.

► **Foreign Competition**—Rumblings that may portend the return of Western Europe's master instrument makers to the American market were heard at the show. One Dutch firm and three Swiss concerns displayed their wares and an American manufacturer exhibited a line of Danish instruments.

Further evidence of increased productivity in Europe was found in announcement of the first International Instrument Congress and Exposition, scheduled for Philadelphia.

(Continued on page 22)

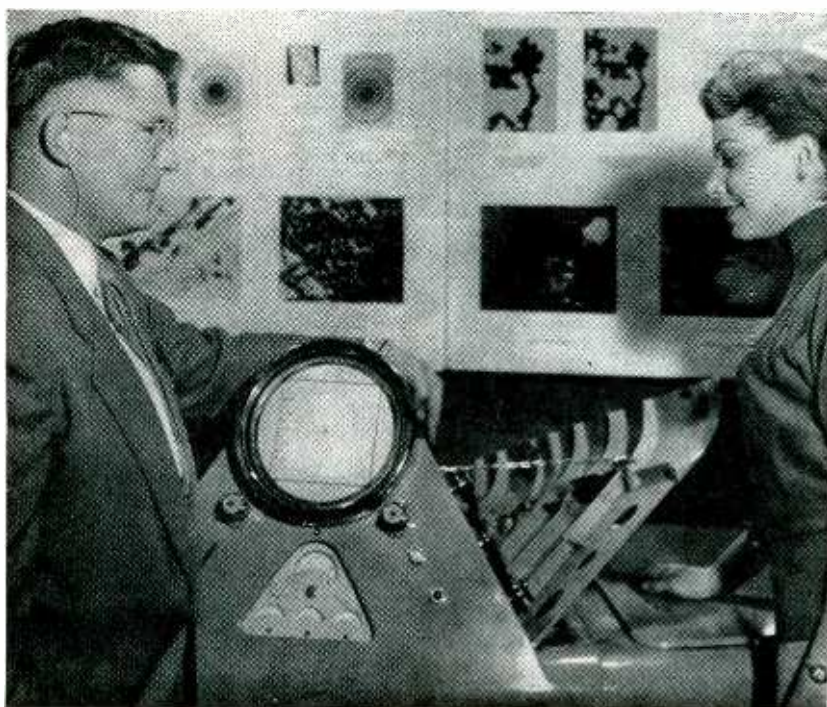

PER CLEVELAND LASS gets pointers on an electron microscope at the National Instrument Show where

Instrument Makers Stabilize Lines

New offerings scarce, manufacturers exploit last year's strides

COMMERCIAL exploitation of instruments designed within the last two years rather than introduction of brand-new models characterized displays of 198 manufacturers exhibiting at the seventh National Instrument Conference and Exhibit held September 8-12 in Cleveland's public auditorium.

The show belonged predominantly to smaller manufacturers,

some larger instrument makers having decided that progress in the field warrants exhibition only every other year.

► **Computers**—Electronically, the most significant development was emergence of the computer from the laboratory into the field of instrumentation. This has been hailed as a long step towards fully-automatic control of industrial operations.

One electronic analog computer on display handles differential equa-

“ZERO” PHASE SHIFT

TRANSFORMERS FOR COMPUTER REFERENCE VOLTAGE

LESS THAN 0.1 MILLIRADIAN PHASE SHIFT
 $\pm .02\%$ ACCURACY OF VOLTAGE RATIOS

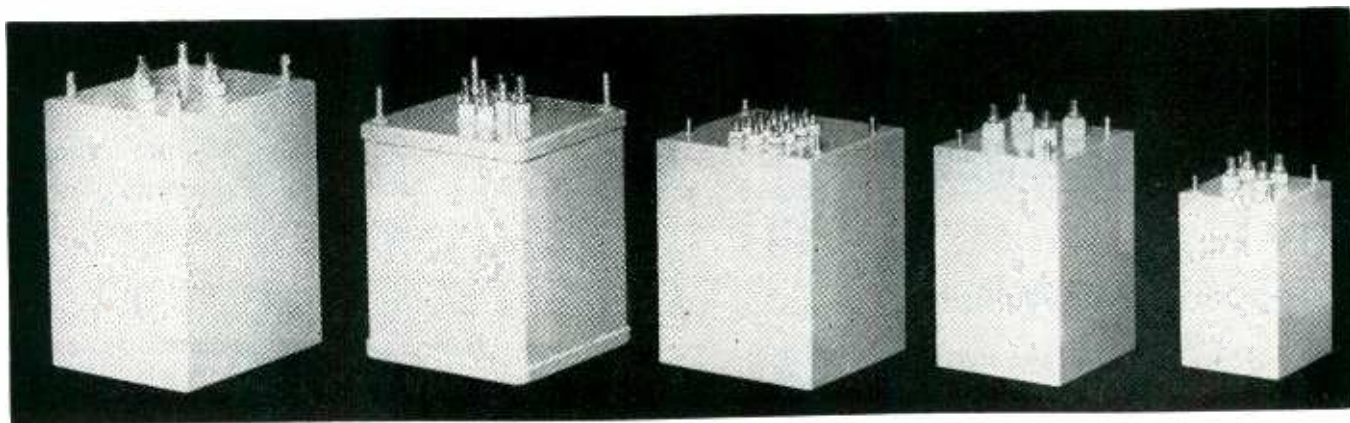

The Design of Computer Reference Voltage Transformers Presents Distinct Problems

The solution of these problems requires elaborate test equipment and a different design and manufacturing technique. Our laboratory equipment permits the measurement of phase angles as small as .02 milliradians and minimum ratio errors of .01%. Our manufacturing equipment enables us to produce ANY type of transformer, and our raw material inventory includes all core alloys in all common sizes, in addition to toroidal cores.

MAGNETIC AMPLIFIERS

TOROIDAL TRANSFORMERS
INSTRUMENT TRANSFORMERS
PULSE TRANSFORMERS

VIDEO TRANSFORMERS
INPUT-INTERSTAGE-OUTPUT
POWER TRANSFORMERS

MIL-T-27 TRANSFORMERS



TRANSFORMERS INC.

532 NORTH STREET

Telephone ENDICOTT 8-1801

ENDICOTT, NEW YORK

STATIC ELECTROMAGNETIC DEVICES

phia's museum and convention hall, September 13-25, 1954. The next national instrument show will be held in Chicago, Sept. 21-25, 1953.

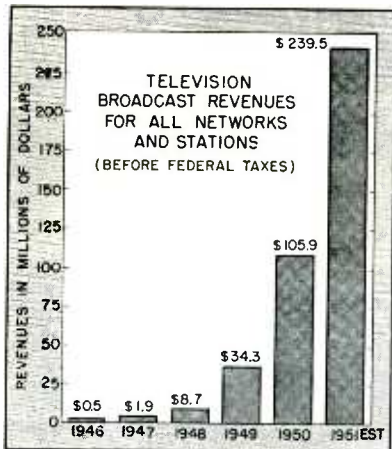

TV Income Topped \$239 Million

TELEVISION network and independent station revenues (time, talent and program sales) for 1951 totalled \$239.5 million, more than twice the 1950 figure.

Networks, including owned and operated stations, grossed \$132.2 million, with expenses of \$119.8. (For the first time, the networks received more from tv than from a-m with its \$100.4 million gross and \$90 million expenses.) Income from combined a-m and tv networks came to \$22.8 million, more than double the 1950 income of \$8.7.

Ninety-three independent tv stations reported totals of \$107.3 million compared with 1950's \$50.4. With station expenses increasing at a slower rate, the 1951 station income was \$31.2 million as compared with \$0.8 million in 1950.

► **Individual Income**—Of the 106 stations reporting preliminary figures to the FCC, 93 showed a profit in 1951. Median income was \$350,000 as compared with a median for 53 stations in 1950 of \$129,000.

Seven of the 13 losing tv stations reported losses of \$200,000 or less, while two reported losses in excess of \$800,000. Eight of the thirteen losing tv stations were located in the two seven-station markets—New York and Los Angeles.

TV Component Delivery Near Normal

Receiver manufacturers report delivery time at 4 to 6 weeks for most parts

TELEVISION RECEIVER manufacturers are reasonably happy about the component supply. Deliveries of most parts are only 2 to 3 weeks behind normal and are being made in quantities ordered, a survey of leading set producers reveals.

A few set makers are feeling a pinch in the supply of 21-inch picture tubes which now are used in the lion's share of tv set production, but they expect the shortage to be quickly overcome. One manufacturer notes that electrolytic capacitors are taking as long as 8 weeks to deliver and another reports a 16-week lag in chassis delivery.

► **Early Pickup**—The earlier-than-usual upswing in tv sales this year caught some component manufacturers with their inventories down. The rise came in July, about a month and a half ahead of the usual time.

Set producers see three main reasons for the early tv sales increase. The defreeze started the ball rolling; early opening of the Denver market helped bring inventories down to the present level of about 240,000 sets. Then the political convention telecasts promoted sales for all tv manufacturers during the traditional summer slump.

The fact that the majority of leading set producers brought out new lines ahead of time to tie in with the political convention promotions also contributed heavily to the tv sales upswing. In July, tv production was 34 percent higher than it was for the same month in 1951. During August, each weeks production topped the preceding week by a good margin.

► **Outlook**—Some component manufacturers do not share the present optimistic attitude of tv set manufacturers concerning the supply situation. Selenium rectifier manufacturers, for example, recently ad-

vised NPA that fewer of their products may be available for tv sets in 1953 because of military requirements. Loudspeaker manufacturers also expect shortages in production because of lack of steel. They predict that set manufacturers may feel the pinch in the next few months.

Russian Periodicals Available in U.S.

Some technical information on radio and electronics flows freely from east to west

RUSSIAN equivalents to ELECTRONICS and other western technical journals are available in this country in certain libraries. Through these publications, with a little effort in translating, the western engineer can keep fairly well abreast of advances made by his eastern counterpart.

For example, an article in one Russian magazine describes a new ultrasonic microscope with complete details of theory, construction and operation. Another describes Russian progress in transistors and presents experimental results obtained by subjecting various semiconductor materials to a wide variety of operating conditions. The article credits O. V. Losev with having developed a semiconductor device capable of producing oscillations in the early 1920's.

Much information is dispersed in report form. One such report tells of successful use of ultrasonic energy in processing steel. Others describe progress at virtually all levels from pure theoretical dissertations to experiments and projects for hobbyists.

► **Sources**—According to Gilbert B. Devey, whose search of the Library of Congress Slavic Room and the MIT Science Library inspired this article, Russian technical language is relatively easy to

(Continued on page 24)

Saving time and money...

throughout the World!



ERSIN
Multicore
3-CORE SOLDER

**THE ONLY SOLDER MADE WITH
EXTRA-ACTIVE, NON-CORROSIVE
ERSIN FLUX**

**WORLD'S
FINEST
CORED SOLDER**

- Thin wall 3-core construction assures flux continuity . . . prevents "dry" joints.
- Contains only virgin tin and lead. Tin - 99.75% pure, Lead - 99.97% pure.
- Non-corrosive even after long exposure to humidity.
- Wets metal rapidly due to reduced surface tension.
- Leaves only pure resin after soldering.
- Perfect joints on difficult metals and alloys even if oxidized.
- Conforms with QQ-S-571-b and all other pertinent Federal specifications.



New Edition! FREE—
Valuable booklet "Modern Solders" and testing samples available on request.

Address U. S. A. and Canadian inquiries to
MULTICORE SALES CORP.
164 Duane Street • New York 13, N. Y.

Inquiries regarding other territories to
MULTICORE SOLDERS LTD.
Maylands Ave. • Hemel Hempstead, Herts., England

read by the "hunt and peck" method, with a Russian-English dictionary.

Lists of Russian publications are available as follows: "Serial Publications of the Soviet Union", published by the Library of Congress, Washington 25, D. C., "Guides to Russian Scientific Periodical Literature", Brookhaven National Laboratory, Upton, New York (Available through Office of Technical Services, Department of Commerce, Washington 25, D. C.) "Monthly List of Russian Accessions", Library of Congress, Washington 25, D. C.

Automatic ILS System Released

Lear F-5 demonstrates ability to guide planes smoothly to point of touch-down

BY ADDING 79 pounds and \$13,750 worth of electronic components, commercial aircraft can now be flown to within five feet of an ILS-equipped runway with only air-speed control by the pilot. This advance in flying was demonstrated to **ELECTRONICS** by inventor-engineer Bill Lear in New York on June 12 as his company made the hitherto military F-5 autopilot available for civilian use.

The 27-tube (all 12AY7's) autopilot has many features that make it unique. Most noticeable of these is the smooth control afforded by circuits that average error signals and thus avoid violent maneuvers due to momentary signal discontinuities. In fact, if the plane is on the glide slope for one minute or more, it will continue steadily toward the point of touch-down even if the ILS transmitter fails.

Military airplanes of the F86D, F89 and F84G types already incorporate the F-5. This same 8 x 10 x 13-inch package can be used to fly automatically any plane from a B36 intercontinental bomber to a single-engine lightplane such as the Beechcraft Bonanza.

Printed Circuits Cut Home Radio Costs

PRODUCTION of home radios with printed circuits, and using dip soldering, will begin in mid-October at Hallicrafters. Using a recently-developed "power print" process, in which unwanted copper is photographically etched away from a plastic base, over 100 hand operations will be eliminated, according to Bill Halligan, president of the company.

In rough figures, a particular radio that now requires 100 girls to produce 1,000 sets a day will in the future require 20 girls, because the new technique permits use of single-dip soldering. Eventually, the process may reduce the cost of tv and radio sets by as much as 25 percent.

Sightless TV Keeps Up With the Joneses

Sound-channel receiver provides all vhf bands and f-m broadcasting

KEEPING up with the Joneses is as important to sightless persons as to the rest of us, and sometimes more so.

Just as children of a televisionless family feel socially outcast, so blind children and adults both feel left out of the main stream of life when they lack knowledge of tv personalities. Workers with the blind say this frame of mind tends to make the sightless person withdraw further from contact with the world.

To supply this lack, Herbert Abrams, president of Pyramid Television Service Co., New York City, put together a simple table radio receiver that tunes in the sound on tv channels 2 through 13 and all f-m channels.

A standard tuning unit is modified so that a detent device emits clicks as the dial is moved from one tv channel to the next.

Engraved numbers also serve

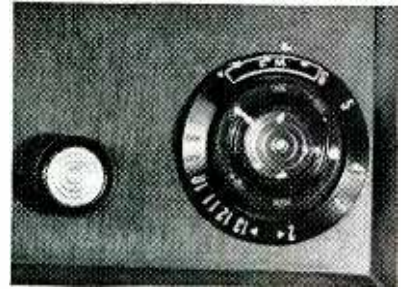

Screenless tv controls in one corner of front panel include on-off volume control (left) and tuning dial (right). As each channel is tuned in, the dial clicks. Raised dots over the f-m range where there are no clicks give Braille-like channel identification

to identify channels through the sense of touch. Across the f-m band, where the clicks are missing, raised dots on both the outer dial and the inner vernier show a pattern that can be interpreted by fingertips as broadcast channels. The only other knob operates a combination volume control and on-off switch.

► **Soon Available**—Although the set is expected to sell for \$50 to \$65, it is simpler, less bulky and more easily moved about than even the smallest, most inexpensive television receiver. Its simplicity is expected to result in lower maintenance costs and greater reliability.

The New York Guild for the Jewish Blind, a nonsectarian agency for the blind and visually handicapped, will distribute the screenless tv set as soon as demand has been established and a manufacturing program is set up.

Radar Heads U.S. List Of Electronics Orders

REPORTS from RTMA members show \$538,794,477 in electronics orders from the U. S. Government in the first six months of the current year.

Radar heads the list at \$263,131,886. Communications equipment ran second at \$160,693,327 and radio navigation aids accounted for \$45,423,158. Sonar orders amounted to \$10,783,-

(Continued on page 26)

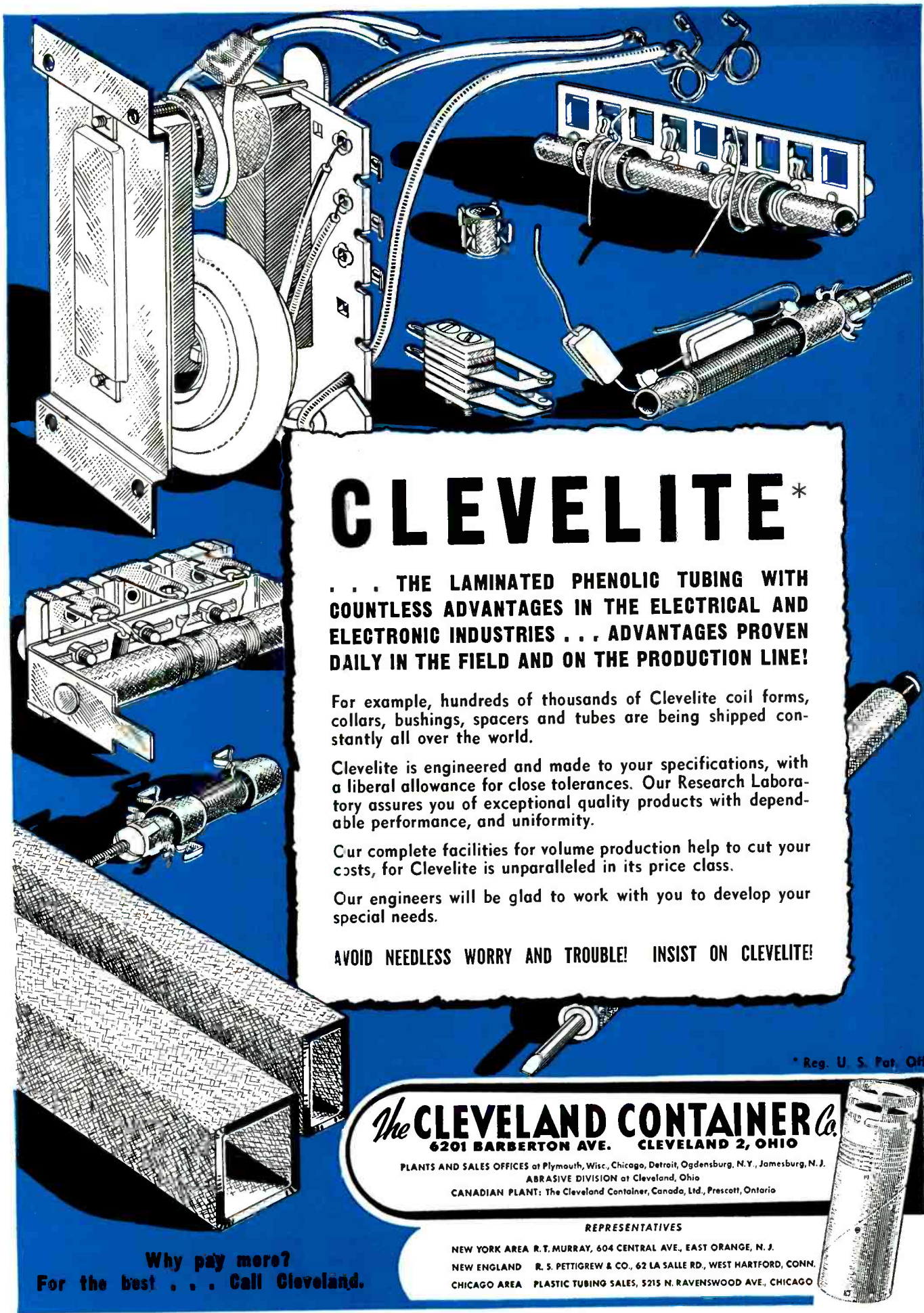

CLEVELITE*

... THE LAMINATED PHENOLIC TUBING WITH
 COUNTLESS ADVANTAGES IN THE ELECTRICAL AND
 ELECTRONIC INDUSTRIES . . . ADVANTAGES PROVEN
 DAILY IN THE FIELD AND ON THE PRODUCTION LINE!

For example, hundreds of thousands of Clevelite coil forms,
 collars, bushings, spacers and tubes are being shipped constantly
 all over the world.

Clevelite is engineered and made to your specifications, with
 a liberal allowance for close tolerances. Our Research Laboratory
 assures you of exceptional quality products with dependable
 performance, and uniformity.

Our complete facilities for volume production help to cut your
 costs, for Clevelite is unparalleled in its price class.

Our engineers will be glad to work with you to develop your
 special needs.

AVOID NEEDLESS WORRY AND TROUBLE! INSIST ON CLEVELITE!

* Reg. U. S. Pat. Off.

The **CLEVELAND CONTAINER Co.**
 6201 BARBERTON AVE. CLEVELAND 2, OHIO

PLANTS AND SALES OFFICES at Plymouth, Wis., Chicago, Detroit, Ogdensburg, N.Y., Jamesburg, N.J.
 ABRASIVE DIVISION at Cleveland, Ohio
 CANADIAN PLANT: The Cleveland Container, Canada, Ltd., Prescott, Ontario

REPRESENTATIVES

- NEW YORK AREA R.T. MURRAY, 604 CENTRAL AVE., EAST ORANGE, N. J.
- NEW ENGLAND R. S. PETTIGREW & CO., 62 LA SALLE RD., WEST HARTFORD, CONN.
- CHICAGO AREA PLASTIC TUBING SALES, 5215 N. RAVENSWOOD AVE., CHICAGO

**Why pay more?
 For the best . . . Call Cleveland.**

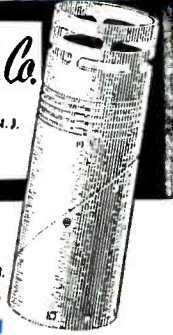

479, laboratory and test equipment \$13,459,401, and miscellaneous, \$45,296,101.

Billings to the government by RTMA members for the same period jumped from \$76 million in 1951 to \$243 million this year.

Experimental UHF TV Goes Commercial

RCA'S PIONEER experimental uhf tv transmitter at Bridgeport, Connecticut may soon become the pioneer commercial uhf tv station in the country.

Operating experimentally since 1949, it was recently sold to Empire Coil for use in Portland, Oregon.

The equipment is being modified to operate on the Portland channel and should be in service by Thanksgiving, possibly by election day.

► **20 Left**—Shift of KC2XAK to commercial service brings the number of experimental tv stations in the U. S. down to 20. Following is the current list of experimental stations now in operation or with CP grants.

Stations

Call Letters and Licensee	Frequency in mc	Power a—aural n—visual
KG2XAZ—Assoc. Broadcasters, main transmitter, Bethlehem, Pa. booster, Easton, Pa.	511-519	5 kw 500 w v 250 w a 50 w v 25 w a
KQ2XBB—Radio Electronic TV School, Detroit, Mich.	500-520	400 w v 50 w a
KE2XIA—CBS, New York, N. Y.	470-476	1 kw v 1 kw a
KQ2XBH—Crosley Broadcasting Corp., Cincinnati, O.	529-535	100 w v 50 w a
KE2XDN—DuMont Labs, New York, N. Y.	600-620	1 kw v 1 kw a
KE2XDR—DuMont Labs, New York, N. Y.	700-720	1 kw v 1 kw a
KE2XHZ—Federal Tel. Labs, Nutley, N. J.	ch 2-13 (incl)	5 kw v 5.5 kw v 3 kw a
KE2XHX—General Electric Co., Syracuse, N. Y.	ch 2-13 and 480-890	50 kw v 25 kw a 400 w v
KA2XBD—Kansas State, Manhattan, Kan. (L)		200 w a 100 w v
KM2XBB—Paramount TV, Los Angeles, Calif.		50 w a 1 kw v
KM2XCW—Television Calif., San Francisco, Calif.	580-630	1 kw v
KG2XCV—Phileo, Phila., Pa.	6,875-6,900	0.1 w v
KM2XAD—Pacific Video Pioneers, Mt. Wilson, Calif.	520-540 780-800	200 w v 100 w a
KS2XBR—Zenith, Chicago, Ill.	512-528	1 kw v 1 kw a
KS2XBS—Zenith, Chicago, Ill.	ch 2	1 kw v 500 w a
KG2XDI—Conestoga TV Lancaster, Pa.	590-610	5 kw v 2.5 kw a
KG2XDU—Sylvania, Emporium, Pa.	509-529	300 w v 100 w a
KG2XEL—Sylvania, Emporium, Pa.	878-884	30 w v 10 w a
KG2XEJ—Sylvania, Emporium, Pa.	1,990-2,008	0.2 w v
KG2XEV—Sylvania, Emporium, Pa.	2,042-2,059	0.2 w v

MEETINGS

- OCT. 1-3: Canadian Electrical Manufacturers Association, General Brock Hotel, Niagara Falls, Ont.
- OCT. 3-4: American Society for Quality Control, Sheraton Hotel, Worcester, Mass.
- OCT. 6-8: NAED, Fall Meeting of the Pacific Zone, Hotel del Coronado, Coronado, Calif.
- OCT. 13-17: AIEE Fall General Meeting, New Orleans, La.
- OCT. 20-22: Radio Fall Meeting, RTMA Engineering Department, Hotel Syracuse, Syracuse, N. Y.
- OCT. 20-24: National Metals Show, Philadelphia Auditorium, Philadelphia, Pa.
- OCT. 21-23: Twenty Ninth Annual Session, Communications Section, Association of American Railroads, Edgewater Gulf Hotel, Edgewater Park, Miss.
- OCT. 26-29: NAED, Meeting of Board of Governors, Grove Park Inn, Asheville, N. C.
- OCT. 28-30: AIEE Middle Eastern District Meeting, Commodore Perry Hotel, Toledo, Ohio.
- OCT. 29-Nov. 1: Audio Fair, Hotel New Yorker, New York, N. Y.
- Nov. 5-7: Sixteenth Annual Time and Motion Study and Management Clinic, Sheraton Hotel, Chicago, Ill.
- Nov. 7: IRE Microwave Professional Group, Symposium On Microwave Circuits, Western Union Telegraph Co. Auditorium, New York, N. Y.
- Nov. 10-13: NEMA, Haddon Hall, Atlantic City, N. J.
- Nov. 10-30: International Radio and Electronics Exhibition, Bombay, India.
- Nov. 17-18: AIEE, Technical Conference on Recording and Controlling Instruments, Benjamin Franklin Hotel, Philadelphia, Pa.
- Nov. 19: American Standards Association, 34th Annual Meeting, Waldorf Astoria, N. Y.
- Nov. 21-22: Fourth Annual IRE Regional Papers Technical Conference, President Hotel, Kansas City, Mo.
- DEC. 10-12: IRE-AIEE Computer Conference, Park Sheraton Hotel, New York, N. Y.
- JAN. 14-16, 1953: Joint AIEE-IRE Conference on High Frequency Measurement, Washington, D. C.
- FEB. 4-6: Western Computer Conference, Hotel Statler, Los Angeles, Calif.
- FEB. 5-7: IRE Southwestern Conference and Electronics Show, Plaza Hotel, San Antonio, Texas.
- MARCH 9-12: NEMA, Edgewater Beach Hotel, Chicago, Ill.
- MARCH 23-26: IRE National Convention, Waldorf-Astoria Hotel and Grand Central Palace, New York, N. Y.
- MAY 11-13: National Conference on Airborne Electronics, Dayton, Ohio.
- MAY 24-28: NAED, 45th Annual Convention, Conrad Hilton Hotel, Chicago, Ill.

Business Briefs

► **Magnetic Recorder** plugged into toll telephone lines to announce delays when circuits are busy is expected to release operators for active duty during rush times, like Christmas.

► **Pinholes** in telephone cables formerly detected by leaking gas and application of soap that blew bubbles will be pinpointed in future by an electronic sniffer. The GE device (ELECTRONICS, p 100 Mar. 48) pulled along a cable filled with Freon 12 (CCl₂F₂); rings a bell at the leak.

► **Telecommunications** Planning Committee appointed by Haraden Pratt, advisor to the President, includes representatives of Office of Transportation and Communications Policy (State Department);

Communications-Electronic Director of the Joint Chiefs of Staff (Department of Defense); Administrator of the Civil Aeronautics Administration (Department of Commerce), Federal Communications Commission and Central Intelligence Agency. New committee will plan and advise, not operate or procure.

► **Reduction** in sales taxes on wireless sets and tubes has been ordered by the Australian government to help the electronics industry. On an average wireless set, drop will amount to an estimated \$15.

► **Popocatepetl**, the 17-thousand foot volcano in Mexico, is the site on which a tv signal repeater station may be constructed to send Mexico City tv signals to the Gulf seacoast city of Vera Cruz.

READ THIS!

To Find Out
Why More &
More Companies

Specify Only

**SUPER
DAVOHM**
Precision
Wire Wound
RESISTORS

SUPER DAVOHM
Precision Wire Wound
RESISTORS

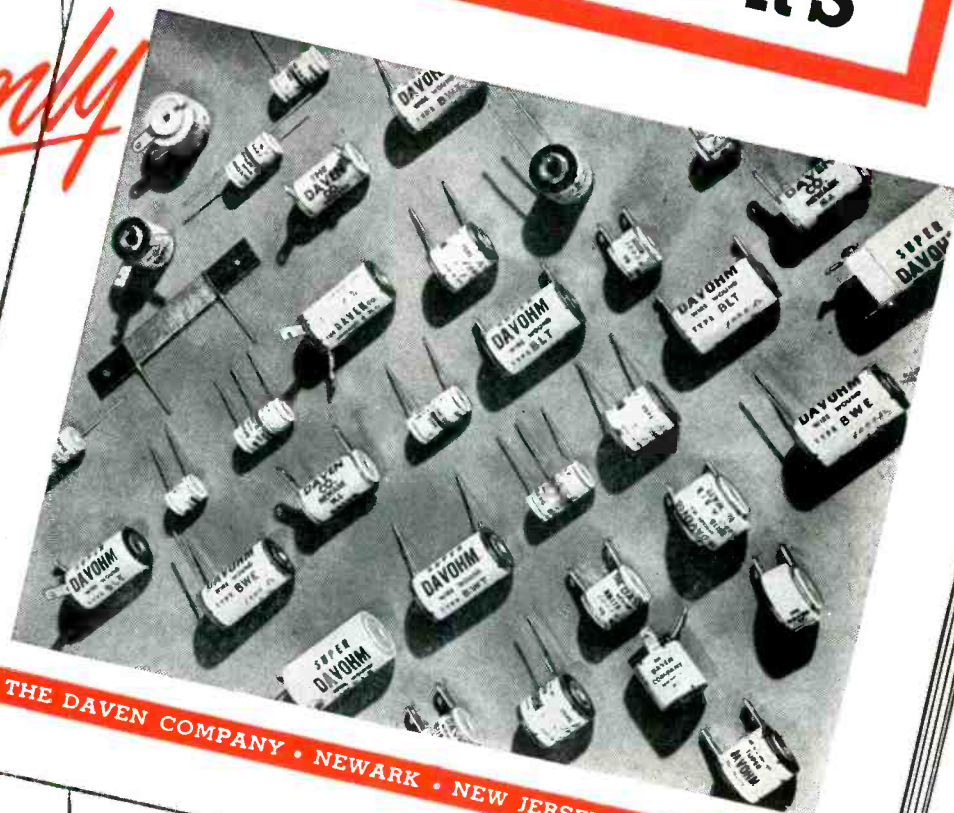

THE DAVEN COMPANY • NEWARK • NEW JERSEY

Section R

It's FREE

Write for
Bulletin R Now!



THE **DAVEN** CO.

191 CENTRAL AVENUE
NEWARK 4, NEW JERSEY

Phelps Dodge Rectangular **SAVE SPACE—IMPROVE**



The application of thin film insulation to rectangular or square wire—pioneered by Phelps Dodge—permits . . .

- ✓ BETTER SPACE FACTOR
- ✓ SMALLER COILS—LESS IRON
- ✓ BETTER FORMING AND WINDING
- ✓ OVER-ALL SAVINGS IN COST



"It takes the best

PHELPS DODGE COPPER PRODUCTS
CORPORATION

or Square Formvar Helps You **DESIGN AND EFFICIENCY**

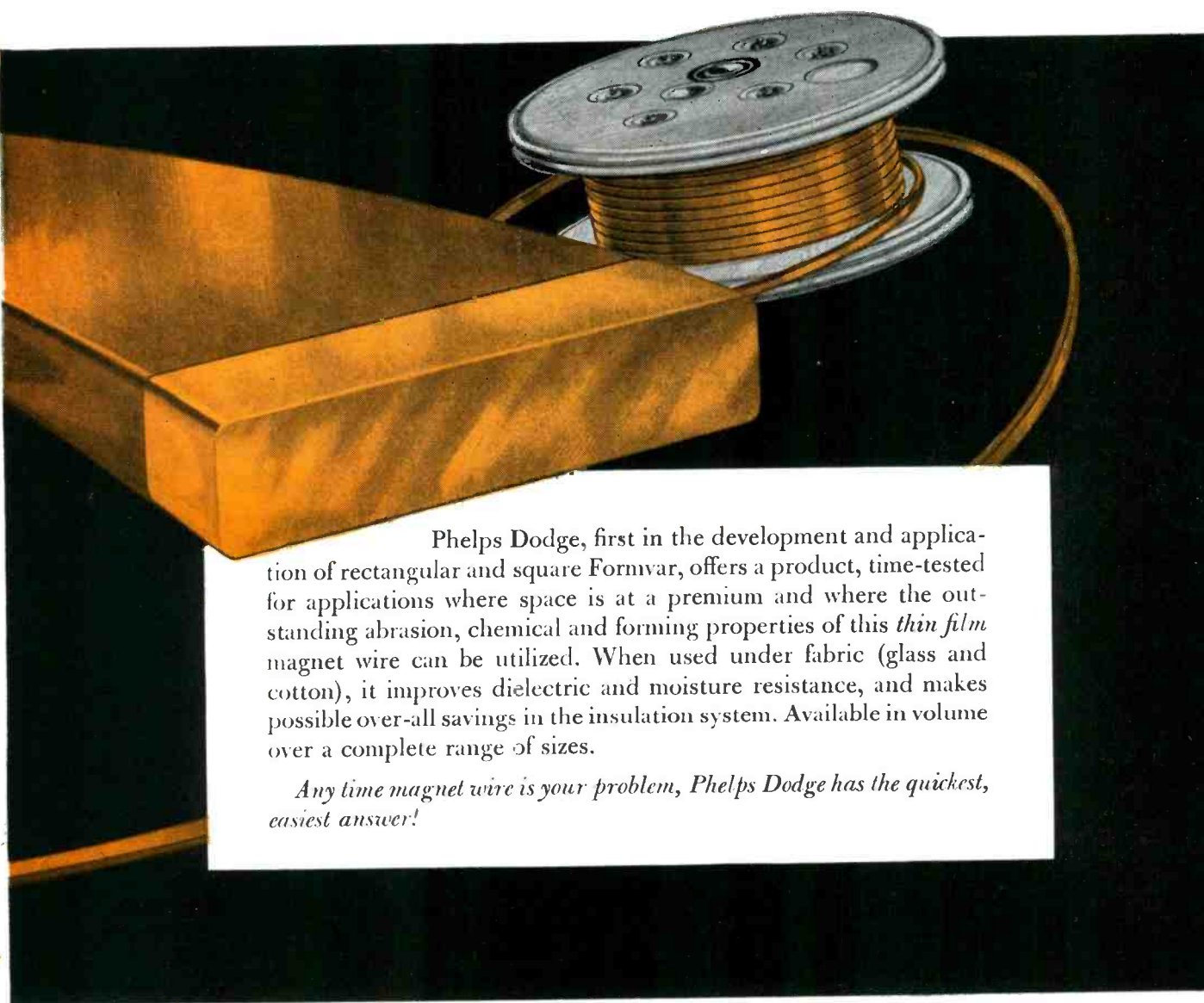

Phelps Dodge, first in the development and application of rectangular and square Formvar, offers a product, time-tested for applications where space is at a premium and where the outstanding abrasion, chemical and forming properties of this *thin film* magnet wire can be utilized. When used under fabric (glass and cotton), it improves dielectric and moisture resistance, and makes possible over-all savings in the insulation system. Available in volume over a complete range of sizes.

Any time magnet wire is your problem, Phelps Dodge has the quickest, easiest answer!

to make the best!"



INCA MANUFACTURING DIVISION

FORT WAYNE, INDIANA

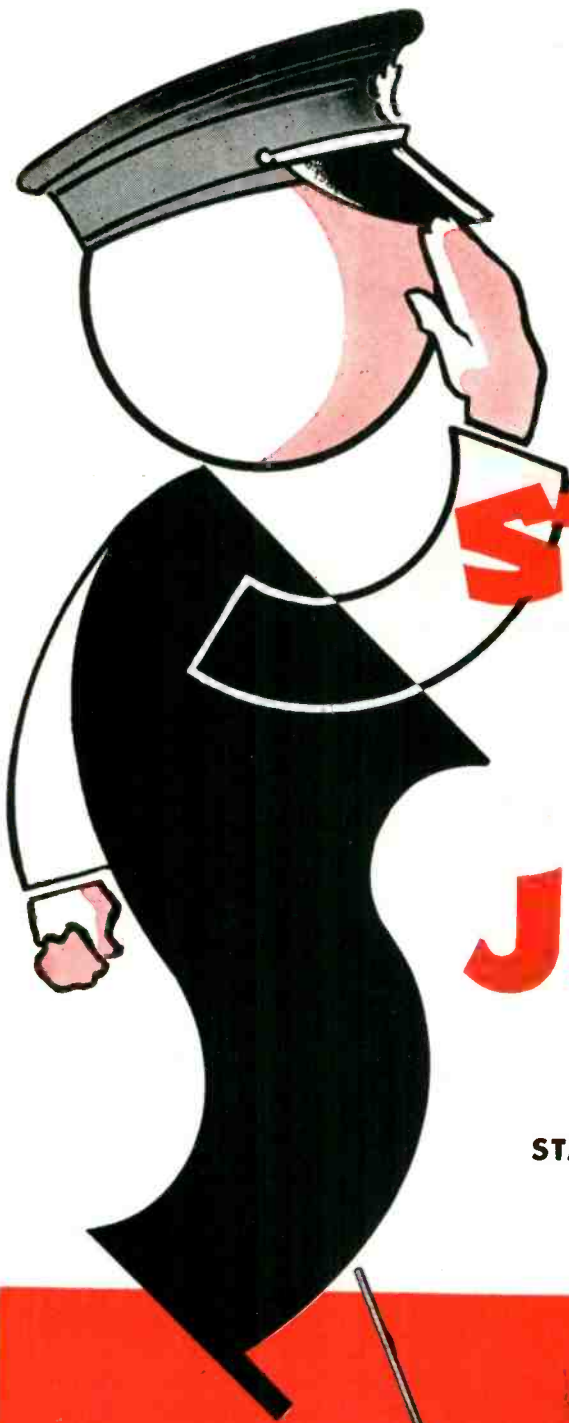

STACKPOLE

Fixed Composition Resistors

in accordance with

JAN-R-11

specifications

Electronic Components Division
STACKPOLE CARBON COMPANY, St. Marys, Pa.

**RC10
RC20
RC21**

**RC30
RC31**

**RC41
RC42**

Insulated types.
Write for Bulletin
for complete details.

A DEPENDABLE SOURCE OF RESISTOR SUPPLY *for over 20 YEARS*

The Reader



His Mark

THE ABC SYMBOL which is printed at the head of this page is, in a very real sense, *your* brand on this magazine. Those letters stand for Audit Bureau of Circulations. The symbol indicates that the magazine is a member and supporter of that Bureau.

To the advertiser who contemplates using the magazine as an advertising medium, this symbol has a well-recognized significance. It tells him that the circulation records and practices of the magazine are wide open to the auditors of the Bureau, who check the publisher's claims and make public the precise terms and conditions under which subscriptions are obtained. And it assures him that the magazine stays in business by virtue of a demonstrated demand from its readers as shown by their paid subscriptions or newsstand purchases.

BUT HERE we are concerned only with the significance of ABC to you as a reader. For when the advertisers, the advertising agencies, and the publishers founded the Bureau nearly forty years ago to help establish honest circulation figures, they unwittingly set up a cooperative institution that has become a major safeguard for the interests of the reading public.

That is because membership in ABC constitutes one of the strongest guarantees that any publication can offer of its primary devotion to the interests of its readers. And by making that guarantee possible, ABC becomes a major safeguard of the freedom of the press, an objective of exceptional importance in these days when the public is flooded with propaganda from so many sources.

THE SUREST MEANS by which to preserve a free press is to keep it directly answerable to the reading public it would serve. It follows, then, that the survival of a truly free press must depend on its acceptance by that public; and that means in turn that the people must have in their hands some adequate means for holding the publishers responsible to them.

No one has yet devised any means to that end more simple, more direct or more practical than the paid subscription or newsstand purchase price. The right to purchase or refrain from purchasing a publication gives to the readers and to no one else the power to pass judgment on whether that publication should continue to serve the reading public.

TO SUPERVISE this vital process, to check and certify the integrity of the publication's circulation methods and claims, requires a strict and continuing audit of each publication's success in meeting this test of its public acceptance. To that essential function the ABC has contributed mightily by the conscientious performance of its mission. And that is why we are able to have a press supported, for the most part, by advertising revenues, but not controlled as to its circulation or content by any influence other than its readers.

When an advertiser consults the ABC statement of a publication to ascertain the amount, the quality and the trend of its circulation, he does so in the legitimate pursuit of his own interest. But at the same time, inevitably, he is helping the ABC to keep the press responsible and responsive to the reading public. For, in effect, he is asking the publication to demonstrate through its circulation figures that it owes its standing to a voluntary demand by its readers.

SO THE Audit Bureau of Circulations, by auditing and certifying paid circulations, has come to perform a vital service to the readers of this magazine and of every other member publication. And in performing that service, it helps to maintain in our country a press that is answerable to the reading public and to it alone. So long as the practices and principles for which ABC stands continue to prevail in American publishing, we shall find in it a sure support for a truly free press, responsible only to the public it serves.

McGraw-Hill Publishing Company

ALLIED'S NEW 50 G Sub-Miniature Relays



Approved by U.S.A.F.
Spec. MIL-R-5757A



Type MH-6



Type MH-12



Type MH-18

2# 6-32 STUDS
FOR MOUNTING

RED WHT

Developed specifically to meet the rigid requirements of U.S.A.F. Spec. MIL-R-5757A, the new Allied line of sub-miniature double throw relays includes the MH-18 (6-Pole), the MH-12 (4-pole), and MH-6 (2-pole). • Contacts are rated at 2 amps resistive or 1 amp inductive at 28 volts D.C. • The high performance of these relays has been achieved in an extremely compact, unitized construction and parallels the most recent advances in airborne equipment design.

*For detailed specifications
and drawings of these new relays,
write for Bulletin 1002*



ALLIED CONTROL COMPANY, INC. 2 EAST END AVE., NEW YORK 21, N. Y.

AL 140



How to select a carbon resistor

Need a carbon resistor?
Before you choose ask yourself
these **5** questions:

- 1. Does the resistor meet specifications?**
Speer fixed carbon resistors fully meet both JAN and MIL specifications.
- 2. Is there a wide range available?**
Speer resistors come in $\frac{1}{2}$, 1 and 2 watts in all standard values up to 20 megohms.
- 3. What is the ambient temperature?**
Speer resistors operate up to 40° C ambient.
- 4. Is the resistor well made?**
Speer resistors are carefully controlled at each manufacturing step. They have a carbon core sealed with an outer cover of phenolic resin to give maximum protection.
- 5. Is the resistor thoroughly tested?**
All orders of Speer resistors are given numerous tests for resistance rating, and are backed by an accelerated ten day test for humidity.

*Write today for
information on specifications.*



SPEER *Resistor Corp.*

St. Marys, Pennsylvania
A Subsidiary of Speer Carbon Co.

Other subsidiaries: Jeffers Electronics, Inc.
International Graphite & Electrode Corp.

Other Speer Products for the Electronics Industry

anodes · contacts · molded notched* coil forms
iron cores · discs · brushes · battery carbon
graphite plates and rods
also

R. F. Coils · ceramic capacitors · capristors · high
voltage condensers · disc capacitors · chokes
made by

Jeffers Electronics, Inc.

*Patented

IRVINGTON INSULATING VARNISH DIGEST



Comparative Tests Show Superiority Of Internal Curing

That heat-induced chemical polymerization results in more thorough drying of insulating varnishes and does away with soft, tacky interiors is indicated by studies performed on test lids with various types of varnishes. These studies show that varnishes which dry chiefly by oxidation may remain soft and tacky in the interior, even after prolonged baking, while the internal curing type of varnish, which dries by polymerization, sets throughout after only a few hours of baking.

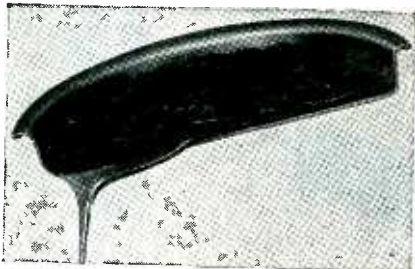

Varnish on this test lid—one of a type drying by oxidation—baked two weeks at 220° F., remained soft and tacky in the interior

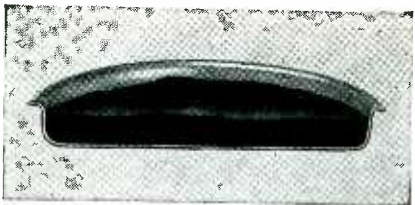

Internal curing varnish on this test lid set completely after only 8 hours baking at 212° F.

Air Drying Varnishes Have Many Applications

Air drying varnishes produced by Irvington Varnish & Insulator Company find wide use both as a final coat on windings already impregnated with other types of Irvington varnish and as a means of protecting other types of electrical apparatus and improving appearance.

These varnishes are also used as coatings on switch boxes, battery trays, conduit boxes, signal boxes and metallic surfaces in general. Varnishes are supplied in both black and clear types. A list of the major types is available on request.

[For further information, write the Sales Manager, Varnish Div., Irvington Varnish & Insulator Co., 11 Argyle Terrace, Irvington, N. J.]

"Deep-Cure" Insulating Varnishes Give Outstanding Performance

Finished Windings Combine High Dielectric, Mechanical Strength with Exceptional Resistance to Chemicals

Insulating varnishes that cure throughout by heat-induced chemical polymerization offer unusual service advantages, because this method of curing does away with wet, sticky interiors even in very deep windings. The exceptional degree of penetration of these varnishes and their complete solidification on curing combine to assure a thoroughly insulated, firmly bonded winding. These features prevent shorts caused by chafing of insulation resulting from the movement of adjacent turns.

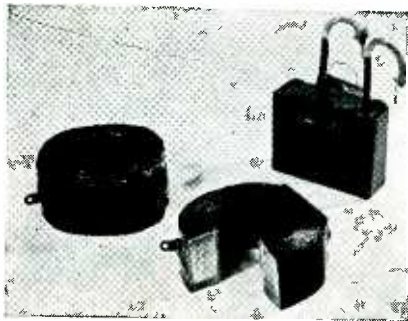

Thorough impregnation and complete curing result from use of internal curing type varnish on these and many other types of windings

Finishing Enamels Protect Windings Against Oil, Dust

Insulated windings can be protected from the harmful effects of oil, moisture, chemicals, water and grease by means of a quick-drying coat of a finishing enamel. Formulated specifically for use as a finishing coat, Irvington Enamels are easily applied by brush and dry rapidly to a tough adherent film.

Two major types are: No. 32 red, designed to give the fastest drying time consistent with good protection under most service conditions; and No. 30 red, for especially severe service conditions.



Easy to brush on, Irvington Red Enamels protect windings from corrosive action and also improve dielectric properties

In addition, these varnishes offer high dielectric strength, ranging from 1,700 to 2,200 volts per mil, depending on the particular type of varnish used. Specific formulations are adaptable to a wide range of operating conditions, from stationary coils to high-speed rotating equipment.

Chemical Stability

All Irvington internal curing varnishes have good-to-excellent resistance to oil, moisture, acids and heat, and the majority of them have good resistance to alkalis as well. Because of this high degree of chemical stability, they are adaptable to a wide range of service conditions. Typical applications include high-voltage coils; radio and TV transformers; low, medium and high speed armatures; field coils; oil-cooled transformers; relay coils.

Production Procedures

These varnishes are adaptable to a wide variety of application processes. The vacuum and pressure method is commonly used to assure the fullest degree of impregnation of deep windings. The varnishes may also be successfully applied by dipping. Brush application is used between layers as coils are being wound. All of these varnishes are adaptable to a variety of baking schedules. Their internal curing properties permit application of multiple coatings with only short, partial curing bakes between coats.

Internal curing varnishes are available in both black and clear types, and in formulations that provide either considerable flexibility or high rigidity in the finished windings. In addition, Irvington's Research Department is prepared to assist varnish users in evaluating the properties of varnishes for specific requirements of service performance, methods of application and baking schedules.

triple duty

WITH THE DUMONT UNIVERSAL CAMERA CHAIN

More of everything you want — and need
in a camera chain . . . greater versatility,
dependability and finer performance —
the DuMont Universal Camera Chain.

The DuMont Camera Chain is designed
for triple duty and is equally qualified for use
in the field, studio, or for film pickup.
This is the proven equipment, now
finer than ever.

For the full story write for your copy of
the new DuMont Camera Booklet.
Learn how you can utilize this equipment
in doing more work, in cutting maintenance
costs, in reducing obsolescence to the
minimum and in effecting a drastic saving
on spare parts. Read about the
revolutionary new DuMont development in
film pickup. Find out how you can get
triple-duty from the DuMont Camera Chain.

DUMONT

TELEVISION TRANSMITTER DIVISION
ALLEN E. DUMONT LABORATORIES, INC.
CHELTON, N. J.

Dept.-EC

write for your copy today . . .



However you compute

IRC BT RESISTORS ARE FIRST



By whatever factor you consider most important, IRC filament type BT resistors lead the industry. The next time you specify insulated composition resistors remember—it pays to do business with the leader. Most people do.

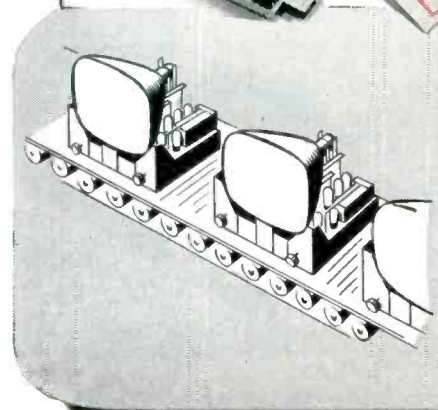

IF QUANTITY PRODUCTION INDICATES LEADERSHIP—
remember more IRC BT resistors are used in radio and TV sets than any other brand. During the last five years IRC supplied 40% of the resistors used in radio and TV set production.

IF QUALITY STANDARDS DENOTE LEADERSHIP—
remember IRC Advanced Type BT resistors meet and beat rigid JAN-R-11 specifications. Nearly all producers of government equipment have tested and approved IRC's advanced BT resistor.

leadership



IF GLOBAL ACCEPTANCE REFLECTS LEADERSHIP—

remember IRC filament type BT resistors are favored in every major market of the world. Licensee plants in Canada, England, Denmark, Belgium, Italy and Australia produce IRC BT's for international electronics.

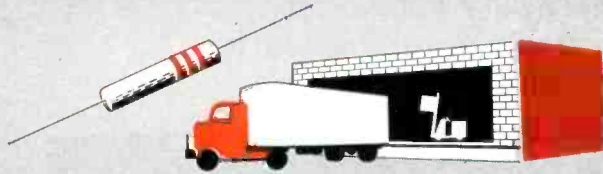

IF DEPENDABLE DELIVERY REPRESENTS LEADERSHIP—

remember IRC's long record of strike-free labor relations protects your assembly lines. Dependable delivery of Advanced Type BT resistors is further assured by IRC's financial ability to maintain large stocks of wanted ranges and to draw from foreign licensees when demand warrants it.

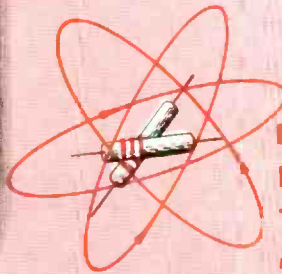

IF RESEARCH AND ENGINEERING TESTIFY TO LEADERSHIP—

remember IRC BT resistors are produced by the largest resistor manufacturer in the world. The finest accumulation of resistance know-how has been pooled in the perfection of these filament type resistors.

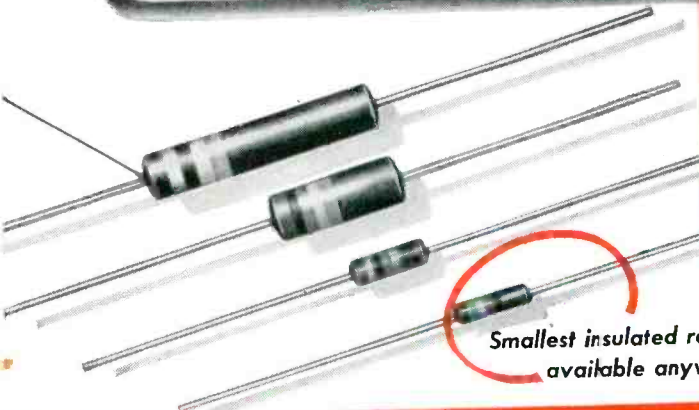

Smallest insulated resistor available anywhere

This coupon brings you full data on IRC BT Resistors



Boron-Carbon Precistors • Power Resistors • Voltmeter Multipliers • Low Wattage Wire Wounds • Insulated Composition Resistors • Volume Controls • Voltage Dividers • Precision Wire Wounds • Deposited Carbon Precistors • Ultra HF and High Voltage Resistors • Insulated Chokes • Selenium Rectifiers

Wherever the Circuit Says 
INTERNATIONAL RESISTANCE COMPANY
 Philadelphia 8, Pennsylvania

In Canada: International Resistance Co., Ltd., Toronto, Ontario

INTERNATIONAL RESISTANCE COMPANY
 403 N. Broad Street, Philadelphia 8, Pa.

Please send me full data on IRC Advanced Type BT Resistors:—

Also name and address of nearest IRC Distributor who can furnish speedy delivery of BT resistors in small quantities.

NAME _____
 TITLE _____
 COMPANY _____
 ADDRESS _____
 CITY _____ ZONE _____ STATE _____

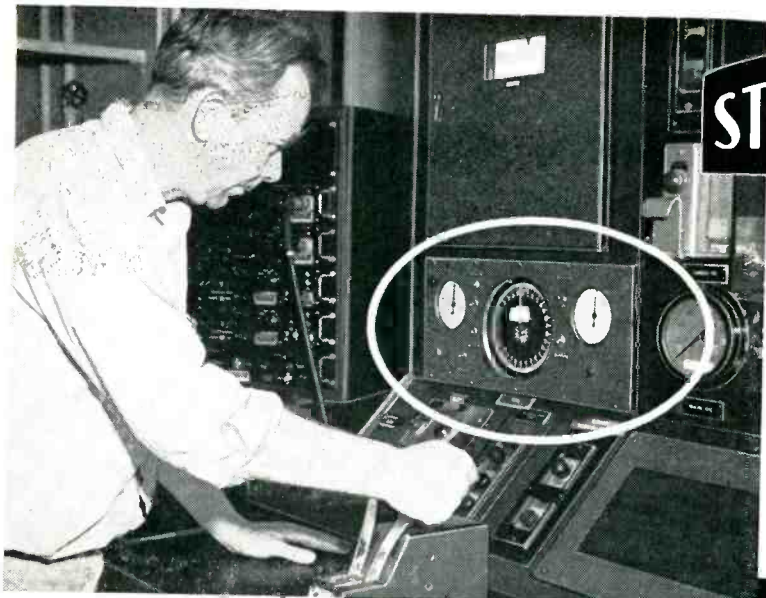

STANDARD

SINCE 1884

WRIGHT AERONAUTICAL DIVISION
CURTISS-WRIGHT CORPORATION

This photograph, taken in one of the experimental cells of the Wright Aeronautical plant at Woodridge, N. J., shows a STANDARD Chronotachometer installed in their test panel.

Not Only Chronotachometers . . .

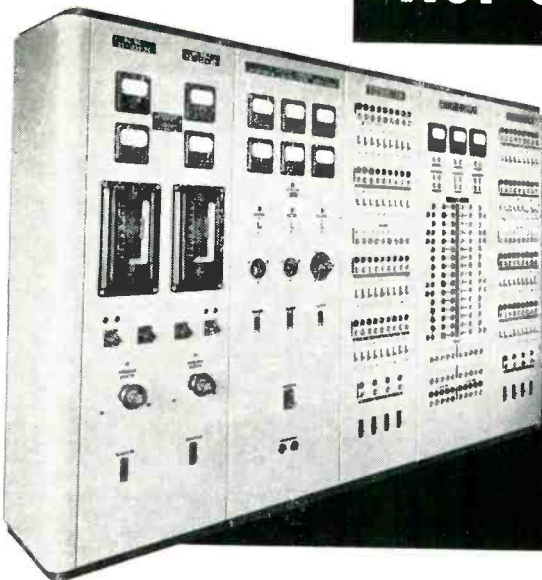

WILSON DAM (T. V. A.)

This experimental control and distribution switchboard handles various power supplies for their Chemical Laboratory Building.

plus "flexlab" Control and Distribution Switchboards

WESTINGHOUSE ELECTRIC COMPANY

This specially designed unit is for the control and test of aircraft timers, series relays, contactors, servo motors, and booster coils. It is typical of the wide range of custom-built equipment by STANDARD.

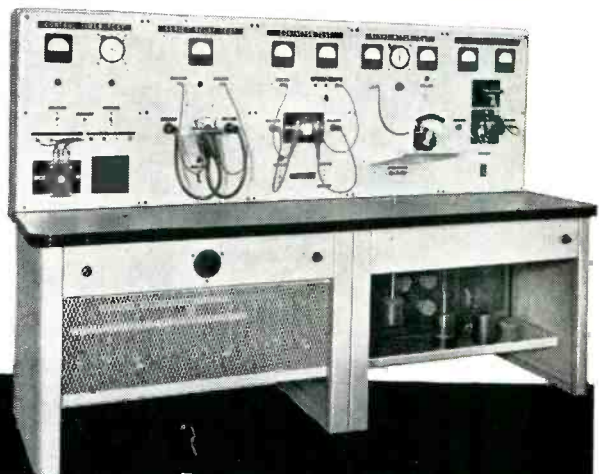

. . . but all kinds of Custom-built Electrical Test Panels

THE STANDARD ELECTRIC TIME COMPANY

97 LOGAN STREET • SPRINGFIELD 2, MASSACHUSETTS

Now

for ultra-high TV ... 200 KW E.R.P. from G.E.'s new **15-KW KLYSTRON!**

- ★ **Highest-power u-h-f transmitting tube!**
- ★ **Linear in operation** up to 12 kw sync output! This is ample power to assure superior transmission at 200 kw signal strength, figuring a 20-to-1 antenna increase.
- ★ **High tube gain!** As little as 60 w will drive the G-E klystron at 12 kw output! You save . . . when designing and building your transmitter . . . the tubes and circuitry for one, two, or more intermediate stages needed to drive conventional power tubes.
- ★ **Built-in r-f**—integral with the klystron. You eliminate r-f problems from your transmitter circuit.
- ★ **Will outlast other power tubes!** The bombarded-type cathode of heavy pure tantalum (1) withstands metal loss during operation, (2) eliminates stripping and "poisoning". The heater of pure tungsten operates at relatively low temperatures. Those parts of the klystron which may be affected by long, continuous service, such as the cathode and collector assemblies, are removable and can be replaced.

⊗ The G-E 15-kw klystron for u-h-f television was developed by Varian Associates, Inc., to General Electric specifications. Six types, including Type GL-6241 illustrated here, serve to cover the entire u-h-f TV band from 470 to 890 megacycles.

Wire, phone, or write for further information! If you wish, a G-E tube application engineer will be glad to call on you. *General Electric Company, Tube Department, Schenectady 5, N. Y.*



GL-6241

GENERAL



ELECTRIC

163-182



TYPE 252, JAN-R-19, Type RA20

2 watt, 1 17/64" diameter variable wirewound resistor. Also available with other special military features not covered by JAN-R-19. Attached Switch can be supplied.

Resistance	RA20, JAN Shaft Type SD		RA20 High Torque, JAN Shaft Type SD	
	CTS Part	JAN-R-19 TYPE	CTS Part	JAN-R-19 TYPE
50 ±10%	B8079	RA20A1SD500AK	X3496	RA20A2SD500AK
100 ±10%	W6929	RA20A1SD101AK	L9388	RA20A2SD101AK
250 ±10%	X3497	RA20A1SD251AK	M9879	RA20A2SD251AK
500 ±10%	W6931	RA20A1SD501AK	X3498	RA20A2SD501AK
1000 ±10%	W6932	RA20A1SD102AK	X3499	RA20A2SD102AK
1500 ±10%	W6933	RA20A1SD152AK	M9809	RA20A2SD152AK
2500 ±10%	W6934	RA20A1SD252AK	L9103	RA20A2SD252AK
5000 ±10%	W6935	RA20A1SD502AK	L9104	RA20A2SD502AK
10,000 ±10%	W6936	RA20A1SD103AK	H8979	RA20A2SD103AK



TYPE 25, JAN-R-19, Type RA30 (May also be used as Type RA25)

4 watt, 1 17/32" diameter variable wirewound resistor. Also available with other special military features not covered by JAN-R-19. Attached Switch can be supplied.

Resistance	RA30, JAN Shaft Type SD		RA30 High Torque, JAN Shaft Type SD	
	CTS Part	JAN-R-19 TYPE	CTS Part	JAN-R-19 TYPE
50 ±10%	X3502	RA30A1SD500AK	W2837	RA30A2SD500AK
100 ±10%	X3503	RA30A1SD101AK	X3504	RA30A2SD101AK
250 ±10%	X3505	RA30A1SD251AK	X3506	RA30A2SD251AK
500 ±10%	X3507	RA30A1SD501AK	M7566	RA30A2SD501AK
1000 ±10%	X3508	RA30A1SD102AK	S2444	RA30A2SD102AK
1500 ±10%	X3509	RA30A1SD152AK	X3510	RA30A2SD152AK
2500 ±10%	X3511	RA30A1SD252AK	S2736	RA30A2SD252AK
5000 ±10%	Q1409	RA30A1SD502AK	X3512	RA30A2SD502AK
10,000 ±10%	X3513	RA30A1SD103AK	R1561	RA30A2SD103AK
15,000 ±10%	X3514	RA30A1SD153AK	L9107	RA30A2SD153AK

Immediate delivery from stock

JAN-R-94 AND JAN-R-19 TYPE MILITARY VARIABLE RESISTORS

167 types

Preference given to orders carrying military contract number and DO rating. Other JAN items or special items with or without associated switches can be fabricated to your specifications. Please give complete details on your requirements including electrical and mechanical specifications.

UNPRECEDENTED PERFORMANCE CHARACTERISTICS
Designed for use in military equipment subject to extreme temperature and humidity ranges including jet and other planes, guided missiles, tanks, ships and submarines, telemetering, microwave, portable or mobile equipment and all other military communications.

For further information, write for Stock Sheet No. 162



NEW 38-PAGE ILLUSTRATED CATALOG—Describes Electrical and Mechanical characteristics, Special Features and Constructions of a complete line of variable resistors for military and civilian use. Includes dimensional drawings of each resistor. Write today for your copy.

REPRESENTATIVES

Henry E. Sanders
John B. McClatchy Bldg.
69th & Market St.
Upper Darby, Penna.
Phone: Flanders 2-4420

W. S. Harmon Company
1638 So. La Cienega Blvd.
Los Angeles 35, Calif.
Phone: Bradshaw 2-3321

John A. Green Co.
6815 Oriole Drive
Dallas 9, Texas

IN CANADA

C. C. Meredith & Co.
Streetsville, Ontario

SOUTH AMERICA

Jose Luis Pontet
Buenos Aires, Argentina
Montevideo, Uruguay
Rio de Janeiro, Brazil
Sao Paulo, Brazil

OTHER EXPORT

Sylvan Ginsbury
8 West 40th Street
New York 18, N. Y.



CHICAGO TELEPHONE SUPPLY
Corporation

specialists in precision mass production of variable resistors

FOUNDED 1896 • ELKHART, INDIANA

SHAFT TYPES
AVAILABLE
ON STOCK CONTROLS

CTS SHAFT TYPE LT-2 LOCKING BUSHING

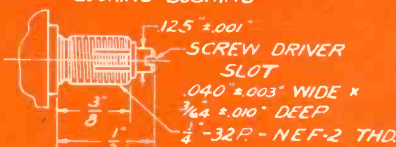

MOUNTING HARDWARE ASSEMBLED
MOUNTING NUT 3/8 HEX × 1/2
LOCK NUT 3/8 HEX × 1/2
LOCK WASHER #1914A

CTS SHAFT TYPE RE

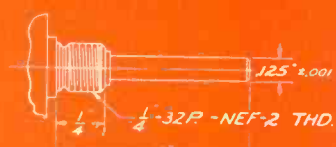

MOUNTING HARDWARE ASSEMBLED
MOUNTING NUT 3/8 HEX × 3/2
LOCK WASHER #1914A

TYPE 65

½ watt 70°C, ¼" diameter miniaturized variable composition resistor.

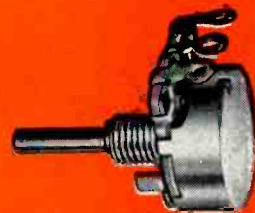

Resistance
250±10%
500±10%
1000±10%
2500±10%
5000±10%
10,000±10%
25,000±10%
50,000±10%
100,000±10%
250,000±10%
500,000±10%
1 Meg±20%
2.5 Meg±25%

CTS Part	CTS Shaft Type RE
X3516	
X3517	
X3518	
X3519	
X3520	
X3521	
X3522	
X3523	
X3524	
X3525	
X3526	
X3527	
X3528	

CTS Part	Locking Bushing	CTS Shaft Type LT-2
X3530		
X3531		
X3532		
X3533		
X3534		
X3535		
X3536		
X3537		
X3538		
X3539		
X3540		
X3541		
X3542		

TYPE 95, JAN-R-94, Type RV4

2 watt 70°C, 1¼" diameter variable composition resistor. Also available with other special military features not covered by JAN-R-94. Attached Switch can be supplied.

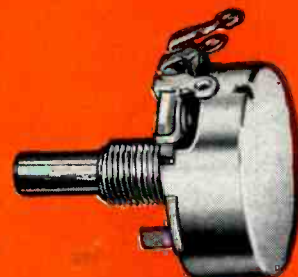

Resistance	JAN-R-94 TYPE RV4 JAN Shaft Type SD
100±10%	RV4ATSD101A
250±10%	RV4ATSD251A
500±10%	RV4ATSD501A
1000±10%	RV4ATSD102A
2500±10%	RV4ATSD252A
5000±10%	RV4ATSD502A
10,000±10%	RV4ATSD103A
25,000±10%	RV4ATSD253A
50,000±10%	RV4ATSD503A
100,000±10%	RV4ATSD104A
250,000±10%	RV4ATSD254A
500,000±10%	RV4ATSD504A
1 Meg±20%	RV4ATSD105B
2.5 Meg±20%	RV4ATSD255B
5 Meg±20%	RV4ATSD505B

JAN-R-94 TYPE RV4 JAN Shaft Type RJ
RV4ATRJ101A
RV4ATRJ251A
RV4ATRJ501A
RV4ATRJ102A
RV4ATRJ252A
RV4ATRJ502A
RV4ATRJ103A
RV4ATRJ253A
RV4ATRJ503A
RV4ATRJ104A
RV4ATRJ254A
RV4ATRJ504A
RV4ATRJ105B
RV4ATRJ255B
RV4ATRJ505B

CTS Part	Non-JAN Locking Bushing	CTS Shaft Type LT-1
W3160		
W3161		
W3162		
W3166		
W3163		
W3164		
W3167		
W3168		
W3169		
W3170		
W3171		
W3172		
W3173		
W3165		
W3159		

TYPE 45, JAN-R-94, Type RV2

¼ watt, 15/16" diameter variable composition resistor. Also available with other special military features not covered by JAN-R-94. Attached Switch can be supplied.



Resistance
100±10%
250±10%
500±10%
1000±10%
2500±10%
5000±10%
10,000±10%
25,000±10%
50,000±10%
100,000±10%
250,000±10%
500,000±10%
1 Meg±20%
2.5 Meg±20%

RV2, JAN Shaft Type SD	CTS Part	JAN-R-94 TYPE
A5876	RV2ATSD101A	
A5877	RV2ATSD251A	
A5878	RV2ATSD501A	
A5879	RV2ATSD102A	
A5880	RV2ATSD252A	
A5881	RV2ATSD502A	
A5882	RV2ATSD103A	
A5883	RV2ATSD253A	
A5884	RV2ATSD503A	
A5885	RV2ATSD104A	
A5886	RV2ATSD254A	
A5887	RV2ATSD504A	
A5888	RV2ATSD105B	
A5889	RV2ATSD255B	

CTS Part	Non-JAN Locking Bushing	CTS Shaft Type LT-1
A5922		
A5923		
A5924		
A5925		
A5926		
A5927		
A5928		
A5929		
A5930		
A5931		
A5932		
A5933		
A5934		
A5935		

TYPE 35, JAN-R-94, Type RV3

½ watt, 1¼" diameter variable composition resistor. Also available with other special military features not covered by JAN-R-94. Attached Switch can be supplied.



Resistance
100±10%
250±10%
500±10%
1000±10%
2500±10%
5000±10%
10,000±10%
25,000±10%
50,000±10%
100,000±10%
250,000±10%
500,000±10%
1 Meg±20%
2.5 Meg±20%
5 Meg±20%

RV3, JAN Shaft Type SD	CTS Part	JAN-R-94 TYPE
A5861	RV3ATSD101A	
A5862	RV3ATSD251A	
A5863	RV3ATSD501A	
A5864	RV3ATSD102A	
A5865	RV3ATSD252A	
A5866	RV3ATSD502A	
A5867	RV3ATSD103A	
A5868	RV3ATSD253A	
A5869	RV3ATSD503A	
A5870	RV3ATSD104A	
A5871	RV3ATSD254A	
A5872	RV3ATSD504A	
A5873	RV3ATSD105B	
A5874	RV3ATSD255B	
A5875	RV3ATSD505B	

CTS Part	Non-JAN Locking Bushing	CTS Shaft Type LT-1
A5907		
A5908		
A5909		
A5910		
A5911		
A5912		
A5913		
A5914		
A5915		
A5916		
A5917		
A5918		
A5919		
A5920		
A5921		

JAN SHAFT TYPE SD

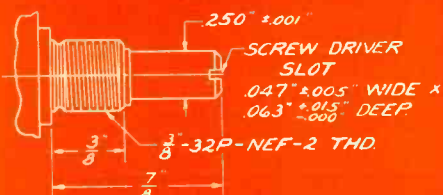

MOUNTING HARDWARE ASSEMBLED
MOUNTING NUT 5/16" HEX. × 3/32"
LOCK WASHER #1920A

JAN SHAFT TYPE RJ

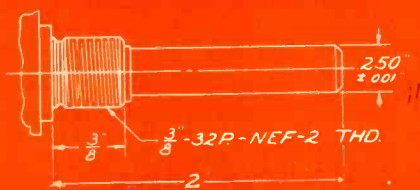

MOUNTING HARDWARE ASSEMBLED
MOUNTING NUT 5/16" HEX. × 3/32"
LOCK WASHER #1920A

CTS SHAFT TYPE LT-1 LOCKING BUSHING

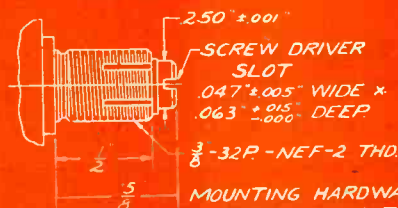

MOUNTING HARDWARE ASSEMBLED
MOUNTING NUT 5/16" HEX. × 3/32"
LOCK NUT 3/8" HEX. × 3/32"
LOCK WASHER #1920A

*Quality Controlled**

TO THE HIGHEST STANDARDS OF THE INDUSTRY

CHESTER

plasticord-plasticote

WIRES and CABLES

***Quality Control works
2 ways at CHESTER**

It's a fact and here's why! First, Chester quality control engineers certify every phase of manufacture from raw material to finished product packed for shipment. No detail is too small or unimportant to merit their full attention. Second, quality in turn governs production — not a single foot of Chester wire or cable is ever "hurried through" to meet a shipping date or heavy schedule. Extra shifts, not faster production is the method used to break bottlenecks at Chester.

This two way quality control is just one of many important reasons why electrical and electronic men, in increasing number, specify Chester wire and cable for an extra measure of reliability. Why not check your requirements with Chester today.

FOR EVERY APPLICATION —

JAN-C-76 • 80°-90°-105°C

Hook-Up Wire • Shielded Wire and Cable
Flexible Cords • Coaxial Cable • Television
Lead-In Cable • Gas Tube High Tension
Cable • Oil Burner Ignition Cable • Blast-
ing Wire • Thermostat Cable • Bell and
Office Wire • TW Building and Fixture Wire



JAN-C-76 SRIR



UL
APPROVED 105°C



JAN-C-76 SRRF



UL
APPROVED 90°C



JAN-C-76 SRHV



UL
APPROVED 80°C



JAN-C-76 WL



SHIELDED
WIRES & CABLES



FLEXIBLE CORD



INSTRUMENT WIRES



TV LEAD-IN WIRES



COAXIAL CABLE



COMMUNICATION
WIRES & CABLES

SPECIAL WIRES
& CABLES TO
SPECIFICATION



"Chester" says —
Rely on Plasticord and
Plasticote — write for
the new Catalog today

CHESTER CABLE CORP.
C H E S T E R , N E W Y O R K

MANUFACTURERS OF QUALITY WIRE AND CABLE FOR EVERY ELECTRICAL AND ELECTRONIC REQUIREMENT



Speed up analysis with these Brush instruments



Direct-coupled Amplifier
Model BL-932

← **AMPLIFIES VERY LOW VOLTAGES.** The Brush Direct-coupled Amplifier features high sensitivity and low drift. When used in conjunction with the Brush Magnetic Oscillograph, it gives one chart millimeter deflection per millivolt input. Design features reduce effects of power line fluctuation. Zero signal drift not more than one chart millimeter per hour. Frequency response essentially uniform from d-c to 100 cycles.

When used with the Brush Magnetic Oscillograph, the Amplifier can be used to record phenomena previously requiring the use of complicated intermediate equipment. Analysis of static or dynamic conditions involving either high or low signal strength is simplified and speeded with this equipment. Below, it is shown recording time constants of a reactor to provide a saturation curve.



PROVIDES IMMEDIATE RECORDING. The Brush Magnetic Oscillograph, used with the proper Brush Amplifier, makes a direct chart recording of physical phenomena which is immediately available. Either direct inking or electric stylus models available. Gear shift provides chart speeds of 5, 25, and 125 mm per second. An auxiliary chart drive is available for speeds of 50, 250, and 1250 mm per hour. Accessory equipment provides event markers where an accurate time base is required, or where it is desirable to correlate events. Photo shows two-channel model for recording of two phenomena simultaneously.



Direct-writing Two-Channel
Magnetic Oscillograph Model BL-202

CHECKS FREQUENCY RESPONSE QUICKLY. The Frequency Response Tracer permits visual examination of frequency response characteristics of radio receivers, amplifiers, transmission lines, filters. Electro-acoustic investigation of loudspeakers, microphones, and telephones can be made. Frequency range is 20 to 20,000 cycles, logarithmic scale. Continuous motor drive scans entire frequency range in 8 seconds.

Write for free copy of Bulletin 618 giving details on these Brush instruments. The Brush Development Company, Dept. K-24, 3405 Perkins Ave., Cleveland 14, Ohio. In Canada: A. C. Wickman Limited, Box 9, Station N, Toronto.

PUT IT IN WRITING WITH A BRUSH RECORDING ANALYZER

THE **Brush** DEVELOPMENT CO.

PIEZOELECTRIC CRYSTALS AND CERAMICS • MAGNETIC RECORDING
ACOUSTIC DEVICES • ULTRASONICS • INDUSTRIAL & RESEARCH INSTRUMENTS

Frequency Response
Tracer Model
BL-4703

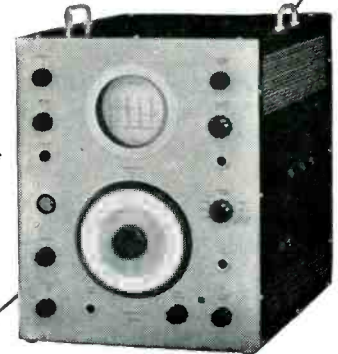

improve your product with -

MYCALEX

THE OUTSTANDING
LOW LOSS
HIGH FREQUENCY
INSULATION
FOR OVER
A QUARTER OF
A CENTURY

MYCALEX is a highly developed glass-bonded mica insulation backed by a quarter-century of continued research and successful performance. Both pioneer and leader in low-loss, high frequency insulation, MYCALEX offers designers and manufacturers an economical means of attain-

ing new efficiencies, improved performance. The unique combination of characteristics that have made MYCALEX the choice of leading electronic manufacturers are typified in the table for MYCALEX grade 410 shown below. Complete data on all grades will be sent promptly on request.

MYCALEX is efficient, adaptable, mechanically and electrically superior to more costly insulating materials

- PRECISION MOLDS TO
EXTREMELY CLOSE TOLERANCE
- READILY MACHINEABLE
TO CLOSE TOLERANCE
- CAN BE TAPPED THREADED,
GROUND, SLOTTED
- ELECTRODES, METAL INSERTS
CAN BE MOLDED-IN
- ADAPTABLE TO PRACTICALLY
ANY SIZE OR SHAPE

MYCALEX is available in many grades to exactly meet specific requirements

CHARACTERISTICS OF MYCALEX GRADE 410

Meets all the requirements for Grade L-4A, and is fully approved as Grade L-4B under Joint Army-Navy Specification JAN-1-10

Power factor, 1 megacycle	0.0015
Dielectric constant, 1 megacycle	9.2
Loss factor, 1 megacycle	0.014
Dielectric strength, volts/mil	400
Volume resistivity, ohm-cm	1×10^{15}
Arc resistance, seconds	250
Impact strength, Izod, ft.-lb/in. of notch	0.7
Maximum safe operating temperature, °C	350
Maximum safe operating temperature, °F	650
Water absorption % in 24 hours	nil
Coefficient of linear expansion, °C	11×10^{-6}
Tensile strength, psi	6000

MYCALEX is specified by the leading manufacturers in almost every electronic category



Mycalex 410
Tuning Coil Form



Mycalex 410
Tuning Switch Plate



Mycalex 410 Terminal Base
and Cap Assembly for
Fire Detection Equipment



Mycalex 410
Rotary Switch Stator



Mycalex 410
Solenoid Type Coil Form



Mycalex 410
Tuning Stator Plate



MYCALEX CORPORATION OF AMERICA

Owners of 'MYCALEX' Patents and Trade-Marks

Executive Offices: 30 ROCKEFELLER PLAZA, NEW YORK 20 — Plant & General Offices: CLIFTON, N.J.

SORENSEN

electronically

**REGULATES
AND CONTROLS**

**HIGH-VOLTAGE
DC
LOW-CURRENT**

**SORENSEN'S EXPANDED LINE OF B-SUPPLIES
NOW INCLUDES THIS NEW MULTI-RANGE DUAL SUPPLY.**

Many users of Sorensen Nobatrons* and AC Regulators are unaware that the standard Sorensen line includes a wide range of "B-Nobatrons" — high voltage, low-current DC sources.

Are you familiar with the number of units in the line? Two of them — models 360BB and 520BB — are low-cost units for those not requiring outputs adjustable down to zero, but which can be paralleled for higher current requirements. The other models are highly flexible, all-purpose laboratory instruments. All of them provide voltage and current well in excess of the specifications given below (these "plus values" are shown graphically in the new Sorensen DC catalog).

You owe it to yourself to get acquainted with these Sorensen B-NOBATRONS. You'll find they are reasonably priced — surprisingly so — yet in all ways live up to the Sorensen reputation for sound engineering, quality construction, dependable operation. Write for information.

*Reg. U.S. Pat. Off. by Sorensen & Co., Inc.



MODEL 350-B SPECIFICATIONS

INPUT	105 - 125 VAC, 50 - 60 ~, 1Ø.
OUTPUT	<ol style="list-style-type: none"> 1. 175-350 VDC @ 0-60 Ma simultaneously from two independently adjustable outlets. 2. 175-350 VDC @ 0-120 Ma from one outlet. 3. 0-175 VDC @ 0-60 Ma from one outlet. 4. 6.3 VAC @ 3.5 amps., C.T., unregulated.
OUTPUT REGULATION	± 1.0%
RIPPLE	10 mv
SIZE	13" x 7½" x 8"



520BB



560BB



500BB

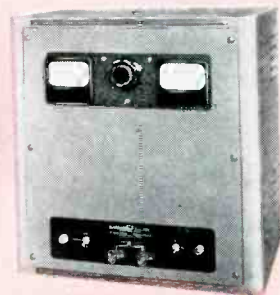

1000BB



325BB



360BB

MODEL NO.	325BB	360BB	520BB	560BB	500BB	1000BB
Output voltage	0-325	175-360	200-500	0-500	0-500	200-1000
Output current	0-125 Ma	0-120 Ma	0-200 Ma	0-200 Ma	0-300 Ma	0-500 Ma
Output voltage, bias	0-150			0-150	0-150	
Output current, bias	0-5 Ma			0-5 Ma	0-5 Ma	
Ripple	10 mv	10 mv	10 mv	10 mv	10 mv	20 mv
Low AC voltage (center tapped, unregulated)	6.3 at 10 amp.	6.3 at 10 amp.	6.3 at 10 amp.	6.3 at 10 amp.	6.3 at 10 amp.	

Regulation accuracy: ±0.5% (±1% in 360BB and 520BB)
 Input: 105-125 volts AC, 50-60 cycles, single phase.
 Models 325BB, 560BB, 500BB and 1000BB are metered.
 Units are normally self-contained. All can be provided with a front panel for rack mounting.



SPECIFY SORENSEN

For Complete Information Write
SORENSEN & COMPANY, INC.

375 Fairfield Avenue

Stamford, 1 Conn.

AMAZING *NEW* IMPREGNANT

***makes good capacitors better
by permitting higher
operating voltages***

E-therm impregnated capacitors are now available in production quantities. E-therm is a unique new impregnating material developed and compounded by Sangamo. E-therm impregnated capacitors far exceed the requirements of JAN Specifications. E-therm possesses exceptionally high thermal stability and superior electrical characteristics. E-therm impregnated capacitors mean—higher operating temperatures—lower power factor—higher resistance—longer life.



E-therm

DEVELOPED BY SANGAMO

Operating temperature 125°C

E-therm is another example of advanced Sangamo engineering. Continued research and development of new products enables Sangamo to meet the

existing and future needs of the electronic industry. For additional information about E-therm, write for Engineering Bulletin No. 104.

Those who know

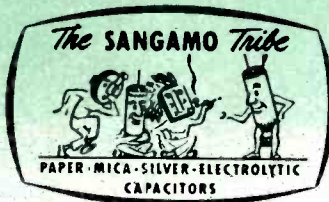

...choose Sangamo

SANGAMO ELECTRIC COMPANY

MARION, ILLINOIS

5C52-V

FOR
LOW-COST WIDE RANGE
FREQUENCY COVERAGE
5 cps to 500 kc

DISTORTION
1%

CALIBRATION
± 2%

AMPLITUDE
± 1 db

HUM
0.1%

FIXED
SYNC. OUTPUT



KROHN-HITE—Model 430-A—Audio Oscillator
only \$145⁰⁰ For Immediate Delivery

Specifications

FREQUENCY RANGE: 4.5 to 520,000 cps., continuously variable in five decade bands.

FREQUENCY DIAL: Single scale, direct reading, calibrated logarithmically from 45 to 520 on a 6" scale.

FREQUENCY ACCURACY: Calibration ±2%, drift including initial warm-up is less than 2%, drift with ±10% change in line-voltage is less than ±0.2%.

OUTPUT:
VOLTAGE: 10 volts rms. maximum, adjustable continuously by a logarithmic output level control with a scale calibrated from .01 to 10 volts. Additional fixed output 10 volts rms.

LOAD: Minimum 1000 ohms.

AMPLITUDE: Varies less than ±1 db over the entire frequency range from 4.5 to 520,000 cps. and less than ±0.5 db for ±10% change in line voltage.

DISTORTION: Less than 1% at any output level setting.

HUM: Less than 0.1% at any output level setting.

INPUT POWER: 105-125 volts, 50-60 cps., 45 watts.

TUBE COMPLEMENT: Furnished with instrument: 2-6AC7, 2-6V6-GT, 1-6AX5-GT.

FORM: Aluminum cabinet, overall dimensions 12" wide, 7" high, 8" deep. Weight 15 lbs.

Write for free catalog.



KROHN-HITE INSTRUMENT COMPANY
580 MASSACHUSETTS AVENUE
DEPT. E, CAMBRIDGE 39, MASS., U.S.A.

FILTERS

OTHER INSTRUMENTS

OSCILLATORS

Model	Type	Frequency Range	Noise & Hum	Price
310-A	Band-Pass	20 cps to 200 kc	3 mv	\$275.00
330-A	Band-Pass	.02 cps to 2 kc	0.1 mv	\$450.00
	Band-Pass	0.2 cps to 20 kc	0.1 mv	\$450.00
340-A	Servo	.01 cps to 100 cps	10 mv	\$350.00
350-A	Rejection	.02 cps to 2 kc	0.1 mv	\$450.00
360-A	Rejection	20 cps to 200 kc	5 mv	\$275.00

Model	Frequency Range	Distortion	Output	Price
400-A	.009 cps to 1.1 kc	1%	25 mw/10 v	\$350.00
410-A	.02 cps to 20 kc	1/4%	10 mw/5 v	\$950.00
420-A	.35 cps to 52 kc	1%	25 mw/10 v	\$290.00
400-C	.009 cps to 1.1 kc	1%	100 mw/10 v	\$375.00
420-C	.35 cps to 52 kc	1%	100 mw/10 v	\$325.00
440-A	.01 cps to 100 kc	1/10%	100 mw/10 v	\$450.00



CAST-PERMAFIL TRANSFORMERS

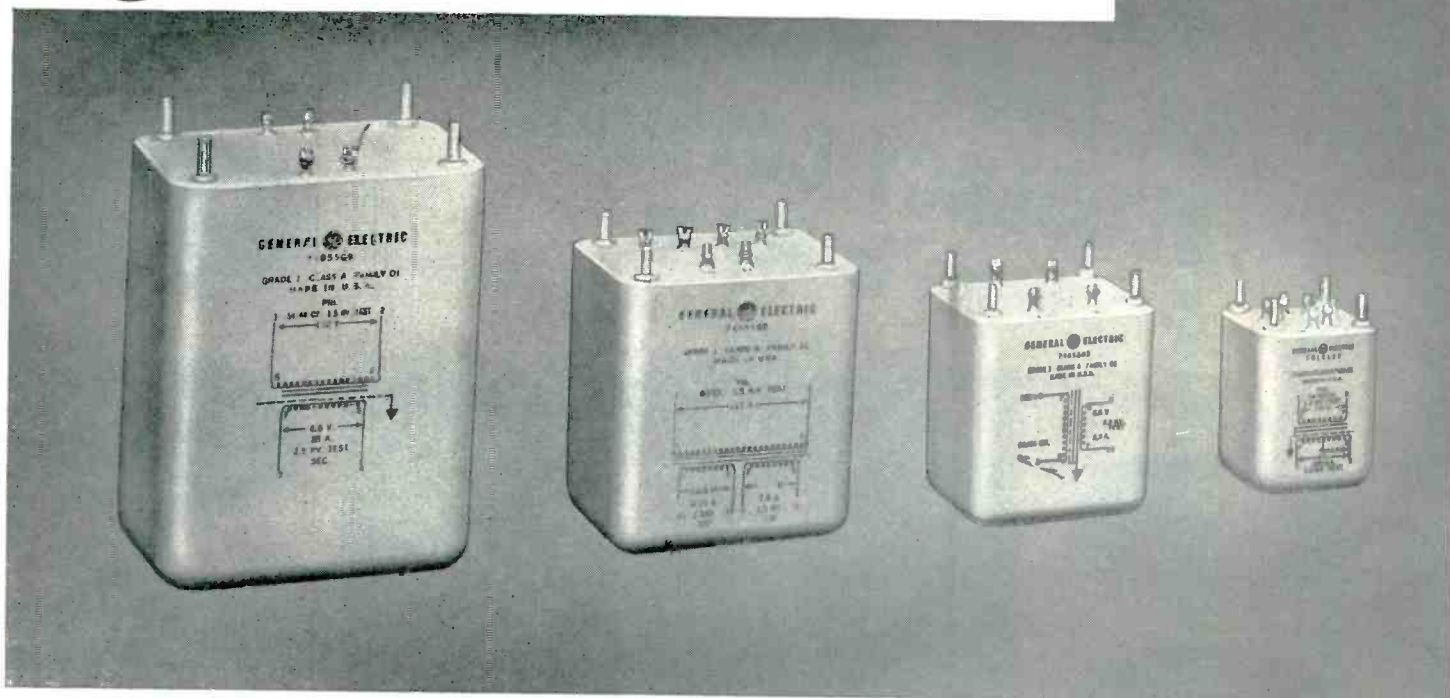

NEW LINE of G-E cast-permafil electronic transformers does away with the need for hermetically sealed metal enclosures.

Cast construction, lighter weight and smaller size offer the designer greater flexibility in many types of electronic designs.

New G-E designs available

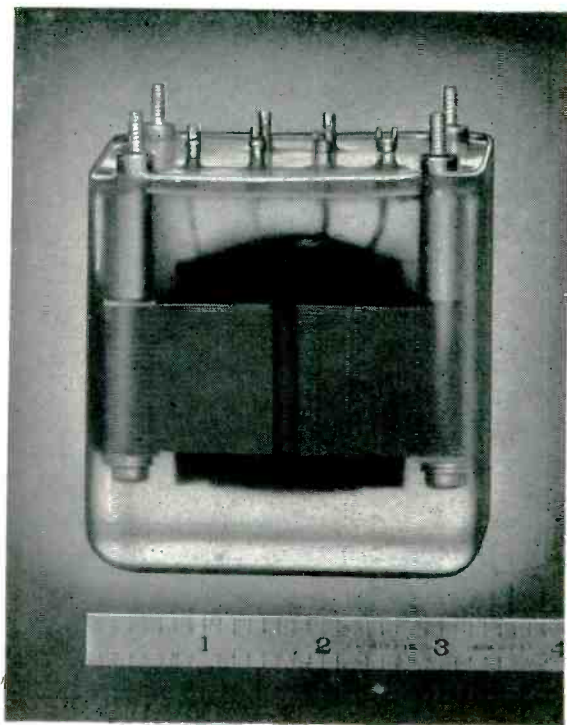

SIMPLER CONSTRUCTION of G-E cast-permafil transformers shows up dramatically in this model cast in clear resin. Note how the resin anchors the terminals, eliminating need for a steel enclosure.

Smaller, Lighter Cast-Permafil Transformers Designed to MIL-T-27 "Specs"—Need No Fungus-Proof Coatings

Interchangeable with existing hermetic designs, General Electric's new line of cast-permafil transformers—solventless resin type—offer many design advantages.

MOISTURE PROOF—"Cast-in" construction seals transformer permanently against moisture as required in MIL-T-27 Grade 1 Performance Specifications. Permafil forms a tough, shatter-resistant, solid casing.

AVERAGE 20% SMALLER because they eliminate metal enclosures, and because their terminals can be anchored directly in permafil mixture, the new G-E cast-permafil transformers are smaller and lighter weight. The complete line—which includes 11 sizes, 9 of them in two heights—averages about 20% smaller than previous models.

MORE FLEXIBLE with fewer machined and punched parts, greater flexibility in design and construction is possible. Terminal arrangements can be varied. Color can be "built in" by adding pigment to the permafil mixture. Permafil makes fungus-proof coatings unnecessary.

ACCELERATED LIFE TESTS indicate that G-E cast-permafil transformers will stand up as long as Class A hermetics at 105 C. And at 130 C. ultimate, they have an expected life of 1000 hours or more.

For complete information on the application, ratings and availability of G-E cast-permafil transformers, write to **Section 411-102, General Electric Company, Schenectady 5, N. Y.**



AUTOMATIC VOLTAGE STABILIZERS

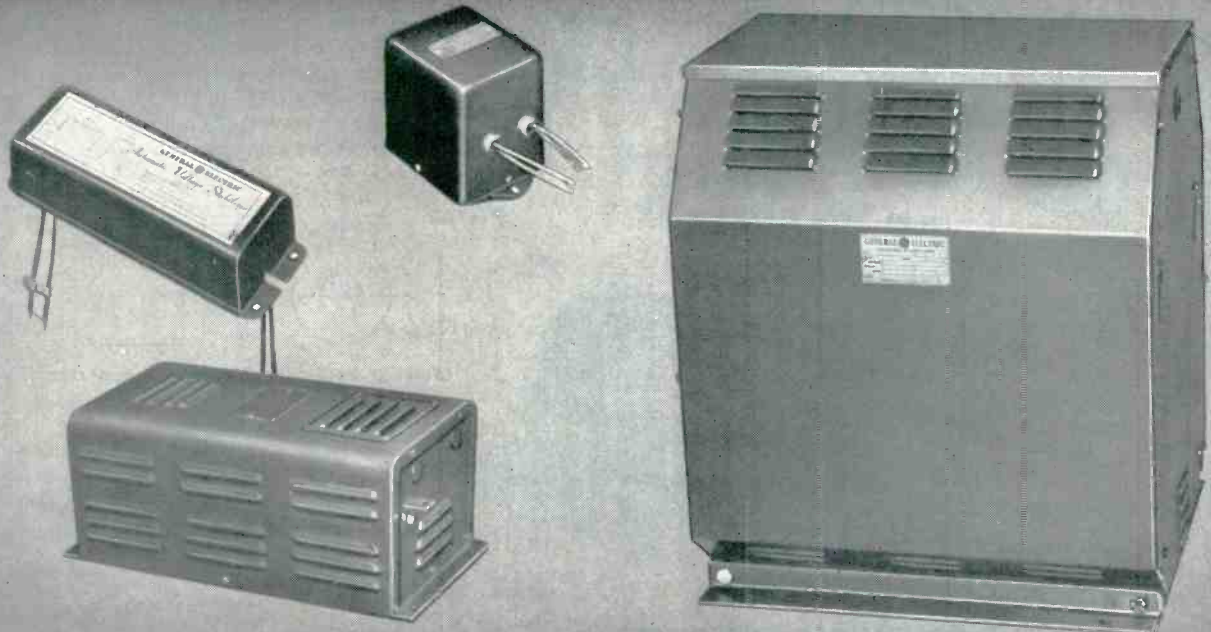

NEW LINE rated from 15 VA to 5000 VA. Stabilizers feature greater flexibility for designs involving voltage ratios other than 1:1. A wide range of voltage correction is offered.

for electronics use

Lighter G-E Automatic Voltage Stabilizers Feature Inherent Input-Output Isolation—More Voltage Ratios

SINGLE-CORE CONSTRUCTION in General Electric's new standard line of 60-cycle automatic voltage stabilizers provides inherent input-output isolation—eliminates the need for an additional isolating transformer. You get substantial weight reduction over previous units in the 1000 to 5000 VA ratings.

TOTALLY ENCLOSED construction of the new design cuts down stray magnetic fields—allowing use near sensitive electronic devices like oscilloscopes.

VOLTAGE RATIO FLEXIBILITY has also been increased in the new line. Standard stabilizers—with ratings from 1000 VA through 5000 VA—are provided with series multiple input and series multiple output.

IN ADDITION, these new units offer a wide-range of voltage correction, plus rapid stabilization, ease of installation and maintenance-free operation.

For further information on this new line of standard automatic voltage stabilizers call your local G-E distributor. Or write for bulletin GEA-5754 G-E Automatic Voltage Stabilizers. Section 411-102, General Electric Co., Schenectady 5, N. Y.

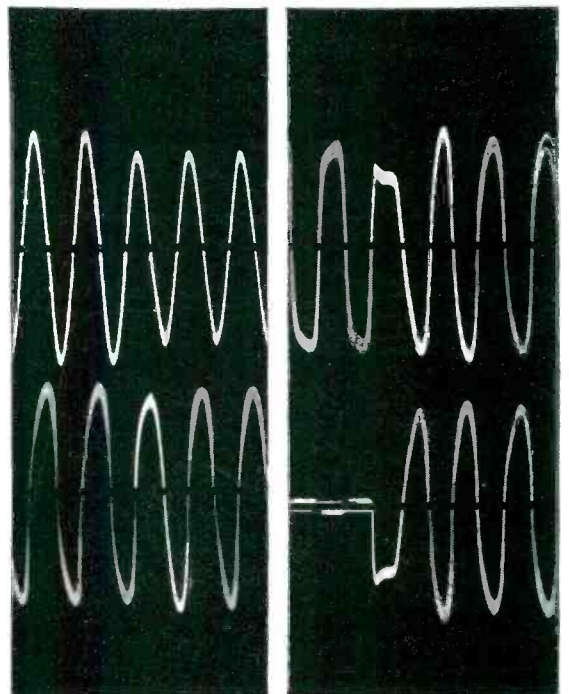

RAPID RESPONSE of G-E Automatic Voltage Stabilizers. *Left:* Stabilization within 1½ cycles as input drops from 130 to 95 volts. *Right:* Stabilization in 2 cycles as load current jumps from 0 to full load.

GENERAL ELECTRIC

INSTALLED IN 1941 AND STILL GOING STRONG...

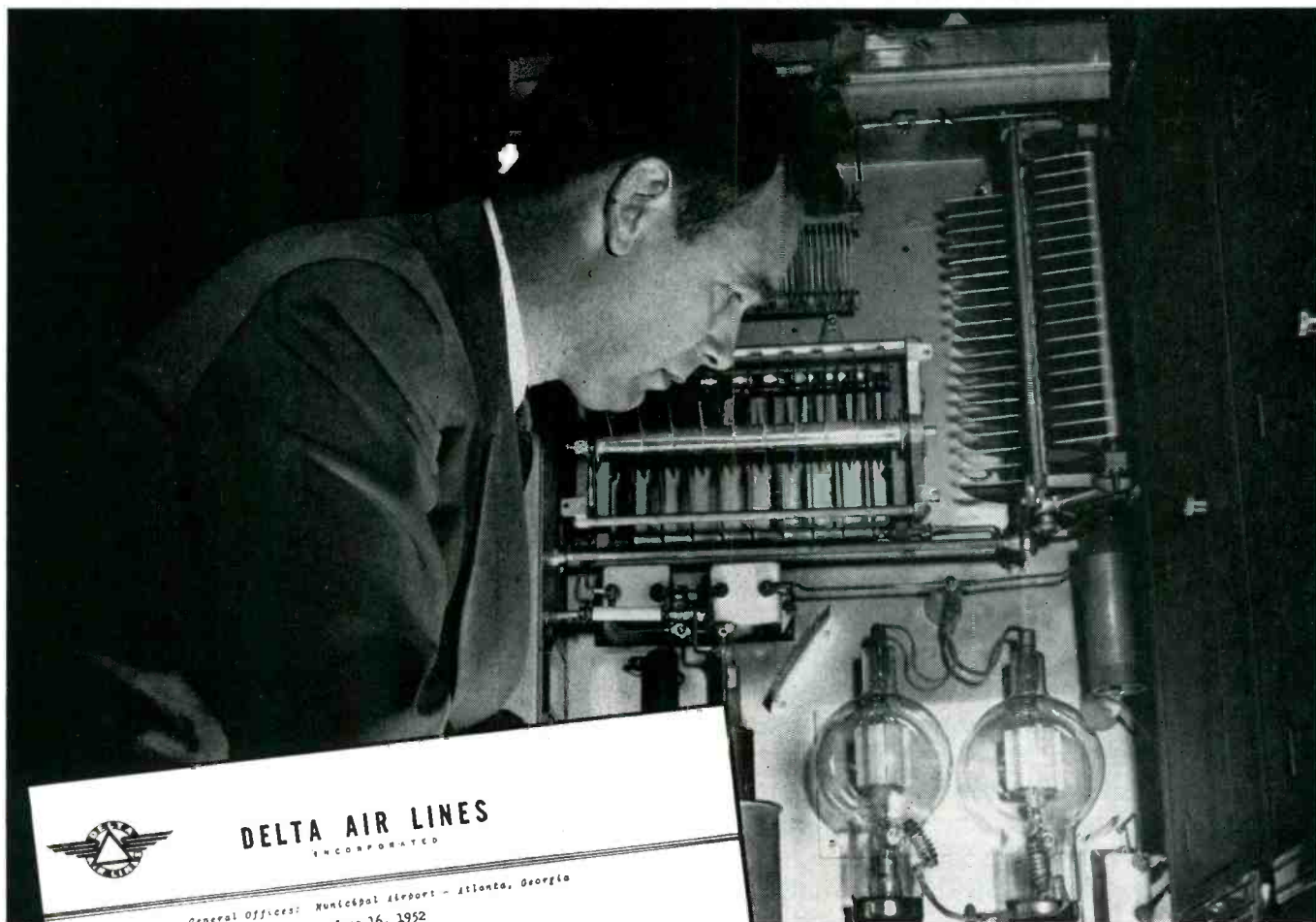

DELTA AIR LINES INCORPORATED

General Offices: Municipal Airport - Atlanta, Georgia
June 16, 1952

Eitel-McCullough, Inc.
San Bruno, California

Gentlemen:

From time to time in your advertisements, I have noticed reports of Eimac tubes that have served an exceptionally long life. You may be interested in the 450TL statistics at our Atlanta, Georgia, station.

The transmitter in this station uses eight 450TL's in RF service. Of the eight, seven have been in operation since the transmitter was installed in October, 1941. Our Dallas, Texas, transmitter installed about the same time still has five of its original 450TL tubes.

The most important factor in the operation of an airline is safety. This is determined largely by the dependability of the equipment it uses. Delta Air Lines, like any business operating on a sound financial basis, must obtain the most value for every dollar spent. It would appear, in the case of our radio tubes as well as many other products, that the two factors, safety and economy, go hand in hand.

Very truly yours,

DELTA AIR LINES, INC.

J. B. Kramer
J. B. Kramer
Supervisor of Ground Radio

JBK:dg

... reports

DELTA AIR LINES of EIMAC Tubes

This story of dependability through more than a decade of day in, day out operation is typical of what leading users of electronic equipment are finding whenever Eimac tubes are employed. Write our application engineering department for information about the complete line of Eimac transmitting power tubes.

EITEL-McCULLOUGH, INC.
SAN BRUNO, CALIFORNIA

Export Agents: Frazer & Hansen, 301 Clay St., San Francisco, California

Eimac
REG. U. S. PAT. OFF.
TUBES

Extra Protection FOR LEADS AND WIRE CONNECTIONS at No Extra Cost

with **DIEFLEX**®

"Vinylglas" Tubings and Sleeveings

You can knot it, twist it, heat or cool it . . . and it won't lose its extreme flexibility or exceptional dielectric strength. Yes, you get all these extra protective qualities just by specifying Dieflex "Vinylglas" vinyl-coated glass tubing or sleeving. Yet it is as inexpensive as ordinary cotton and glass base materials!

Think of it! Really tough assembly and operating conditions don't harm this rugged insulation. It remains as flexible and sound as ever, even after creasing, rubbing, or heating. Dieflex "Vinylglas" tubing or sleeving is available in sizes No. 24 through 1¼" in a complete range of heat resistant colors. Grades A-1, B-1, C-1, and C-2 can be supplied.

Test Dieflex "Vinylglas" vinyl-coated glass tubing or sleeving yourself. You'll be amazed at this combination of high protective characteristics and low prices. Ask your nearest IMC office for samples, literature, and more information, today.

OTHER DIEFLEX PRODUCTS

Grades A-1, B-1, C-1, C-2, and C-3 varnished cotton or rayon tubings or saturated cotton or rayon sleeveings

Heavy Wall saturated cotton sleeveings

Grades A-1, B-1, C-1, C-2, and C-3 varnished glass tubings or saturated glass sleeveings

Grades A-1, C-1, C-2, and C-3 silicone varnished glass tubings or silicone saturated glass sleeveings

Dieflex Products Are Guaranteed to Meet Or Surpass All Applicable NEMA and ASTM Standards

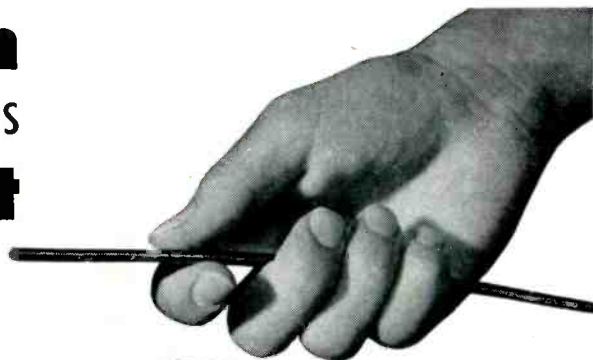

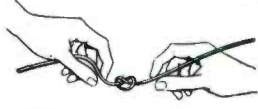

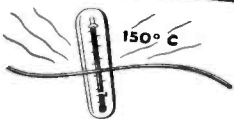

Knot it...
no cracking or loss
of dielectric



Heat it...
retained top flexibility and
dielectric after being tested
for 100 hours at 150°C



Cool it...
excellent low tempera-
ture flexibility



Push it Back...
pushes back on wire easily
—even in higher grades

INSULATION MANUFACTURERS CORPORATION

*CHICAGO 6
565 W. Washington Blvd.
Phone
CEntral 6-7320

*CLEVELAND 14
1231 Superior Ave., N. E.
Phone
SUperior 1-2310

*Local Stocks Available

DAYTON 2
120 W. Second St.
Phone Michigan 1391

DETROIT 2
Harry R. Brethen
15 Lawrence Ave.
Phone TOwnsend 8-2577

*MINNEAPOLIS 3
H. A. Holden, Inc.
1208 Harmon Place
Phone Geneva 5353

MILWAUKEE 2
312 E. Wisconsin Ave.
Phone DAly 8-5359

PITTSBURGH 22
535 Smithfield Street
Phone GRant 1-7100

PEORIA
W. C. Johnson
101 Heinz Court
Phone 2-7786



ERIE

DISC CERAMICONS®

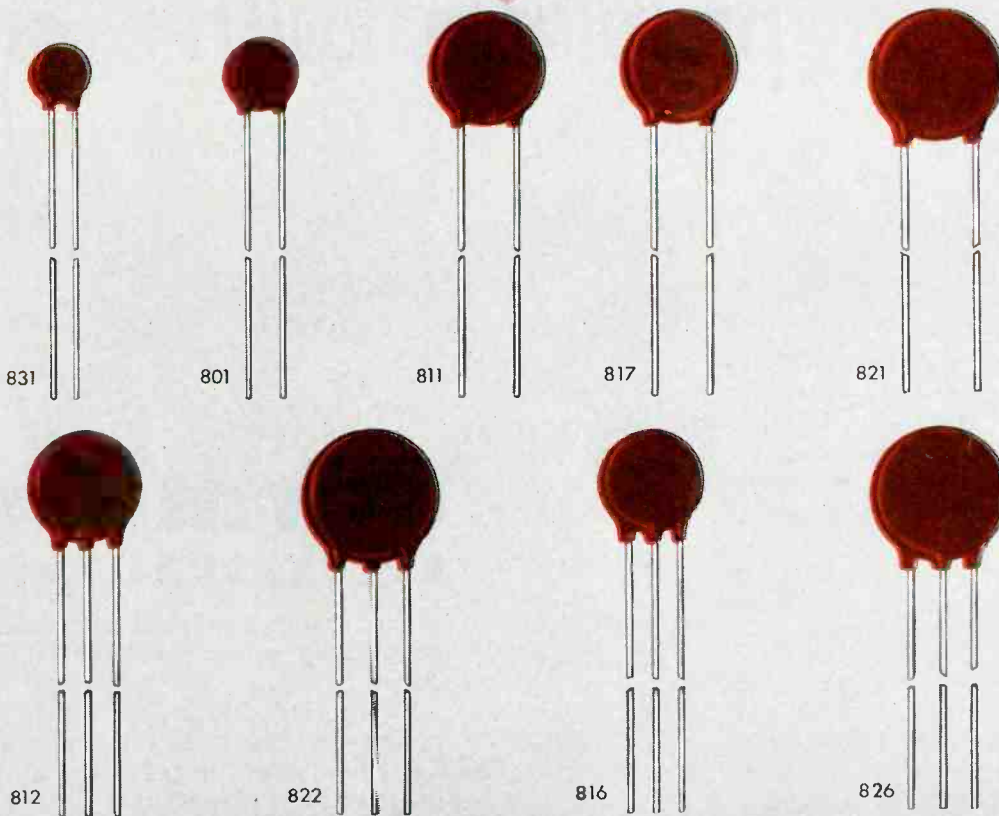

ERIE offers a complete line of Disc Ceramicons in By-Passing, Temperature Compensating, and High Voltage types. A distinguishing feature of ERIE Disc Ceramicons is high capacity—up to .02 mfd—in extremely compact size. Also, High Voltage Disc Ceramicons are available in ratings up to 8000 volts D. C. working. Basic diameter sizes are 5/16", 3/8", 19/32", and 3/4" maximum.

They are amazingly easy to install in small spaces . . . they simplify soldering and wiring operations, and speed up the

assembly line. ERIE Disc Ceramicons consist of round flat dielectrics with fired on silver plates, and leads of tinned copper wire firmly soldered to silver electrodes. The units are given a protective coating of phenolic and vacuum wax impregnation. Dual discs are available in both shielded and non-shielded construction.

Such simplicity of construction results in low series inductance and unusual efficiency in high frequency by-passing.

Write for complete information regarding your specific needs, and samples.



ERIE RESISTOR CORPORATION . . . ELECTRONICS DIVISION

Main Offices: ERIE, PA.

Sales Offices: Cliffside, N. J. • Philadelphia, Pa. • Buffalo, N. Y. • Chicago, Ill.
Detroit, Mich. • Cincinnati, Ohio • Los Angeles, Calif.

Factories: **ERIE, PA. • LONDON, ENGLAND • TORONTO, CANADA**

solve your
"Hot Potato"
problems with

® **Permacel**
ELECTRICAL TAPES

What happens to a baked potato skin cannot possibly happen to **PERMACEL** Electrical Tapes.

The potato skin becomes brittle and peels away. But **PERMACEL**, under intense heat, holds fast, because the adhesive doesn't flow or give way.

This heat stability gives you a wide safety factor in "bakes"...cuts down "pop-ups"...reduces rejections and rework.

PERMACEL Electrical Tapes lower production costs.

There's a **PERMACEL** tape for every job. High-voltage Insulation, Noncorrosiveness, Heavy-duty Holding, Quick Anchoring, Snug Conformance, High-heat Resistance—or what have you? Pass your "hot potatoes" to us. We have the products to handle them.

INDUSTRIAL TAPE CORPORATION
NEW BRUNSWICK, N. J.

Makers of **TEXCEL**® Cellophane Tape, and a complete line of pressure-sensitive tapes for industry.





MICROTRAN[®]

hermetically sealed
transformer
available as stock items

These ruggedized military type units were developed to meet demands of a growing miniaturization program.

All units are available from stock in hermetically sealed cans, although open frame units may be ordered. Open frame units are Epoxy Resin impregnated to provide thorough protection from adverse climatic conditions and are supplied with flexible 3" color coated leads.

Also available on special order for MIL applications are standard MIL type cases.



Open Frame Construction

MINIATURE TRANSFORMERS

PART NO.	MIL TYPE	APPLICATION	PRIMARY IMPED.	SECONDARY IMPED. Ω	RESPONSE ± 2 db. (C.P.S.) MAX. LEVEL 10 db.	LIST PRICE
M1	TFIA10YY	Mike pickup or line to 1 grid	50, 200, 500	50,000	20-20,000	\$15.40
M2	TFIA10YY	Mike pickup or line to 2 grids	50, 200, 500	50,000	20-10,000	15.40
M3	TFIA10YY	Dynamic mike to 1 grid	7.5, 30	50,000	20-20,000	14.30
M4	TFIA15YY	Single plate to 1 grid	15,000	60,000	20-15,000	12.10
M5	TFIA15YY	Single Plate to 1 grid	15,000 4MA.D.C.	60,000	200-20,000	12.10
M6	TFIA15YY	Single plate to 2 grids	15,000	95,000	20-15,000	14.30
M7	TFIA15YY	Single plate to 2 grids	15,000 4MA.C.C.	95,000	200-20,000	14.30
M8	TFIA13YY	Single plate to line	15,000	50, 200, 500	20-20,000	15.40
M9	TFIA13YY	Single plate to line	15,000 4MA.D.C.	50, 200, 500	150-20,000	15.40
M10	TFIA13YY	Push pull plates to line	30,000 ohms P.-P.	50, 200, 500	30-50,000	15.40
M11	TFIA10YY	Crystal mike to line	50,000	50, 200, 500	20-20,000	15.40
M12	TFIA16YY	Mixing and matching	50, 200	50, 200, 500	30-40,000	14.30
M13	TFIA20YY	Reactor 300 HYS. - No D.C.: 50 HYS - 3MA. D.C.		6,000 ohms D.C. res		11.00
M14	TFIA10YY	50: 1 mike or line to 1 grid	200	1/2 Megohm	80- 3,000	15.40
M15	TFIA15YY	10: 1 single plate to 1 grid	15,000	1 Megohm	100-2,500	15.40

SUB MINIATURE TRANSFORMERS

PART NO.	MIL TYPE	APPLICATION	PRIMARY IMPED. Ω	SECONDARY IMPED. Ω	RESPONSE ± 2 db. (C.P.S.) MAX. LEVEL 6 db.	LIST PRICE
SM1	TFIA10YY	Input	200, 50	250,000, 62,500	80-10,000	\$12.90
SM2	TFIA15YY	Interstage 3:1	10,000	90,000	100-10,000	12.90
SM3	TFIA13YY	Plate to line	10,000(3MA.)-25,000(1.5MA.)	200, 500	150-10,000	12.90
SM4	TFIA13YY	Output	30,000 1MA.D.C.	50	70-10,000	12.90
SM5	TFIA20YY	Reactor 50 HY at 1 mil D.C.	4,000 ohms.D.C. res.			10.90
SM6	TFIA13YY	Output	100,000 .5MA.D.C.	60	100-10,000	12.90

MICRO MINIATURE TRANSFORMERS

PART NO.	MIL TYPE	APPLICATION	PRIMARY IMPED. Ω	SECONDARY IMPED. Ω	RESPONSE ± 2 db (C.P.S.) MAX. LEVEL 0 db.	LIST PRICE
MM1	TFIA10YY	Input	200, 50	250,000, 62,500	200-10,000	\$12.90
MM2	TFIA15YY	Interstage 3:1	10,000	90,000	150-10,000	12.90
MM3	TFIA13YY	Plate to line	10,000(3MA.)-25,000(1.5MA.)	200, 500	150-10,000	12.90
MM4	TFIA13YY	Output	30,000 1MA.D.C.	50	150-10,000	12.90
MM5	TFIA20YY	Reactor 50 HY at 1 mil D.C.	3,500 ohms.D.C. res.			10.90
MM6	TFIA13YY	Output	100,000 .5MA.D.C.	60	200-10,000	12.90

TRANSISTOR TRANSFORMERS

PART NO.	MIL TYPE	APPLICATION	PRIMARY IMPED.	SECONDARY IMPED.	M	SM & MM	LIST PRICE
*T1	TFIA10YY	Input-Line to emitter	500	500			\$14.50
*T2	TFIA10YY	Input-Hi impedance mike to emitter	50,000	500			15.70
*T3	TFIA15YY	Interstage-collector to emitter	50,000	500			15.70
*T4	TFIA13YY	Output-collector to line	50,000	500			15.70
*T5	TFIA13YY	Output-collector to speaker	50,000	6			14.50

* Add M Prefix to indicate miniature size, SM for sub-miniature size, MM for micro-miniature size. Size to be used depends on D.C. current, frequency response and power output requirements. Write for full details.

Immediate delivery of stock items!

Our circuit design department can assist you in your miniaturization problems. Our recent developments of HI "Q" audio transformers for single frequency applications have permitted substantial reduction in equipment complexity.

Write for Catalogue M and name of nearest representative.

LABORATORIES, INC.

Whitehall Building, Far Rockaway 91, N. Y.

CREST

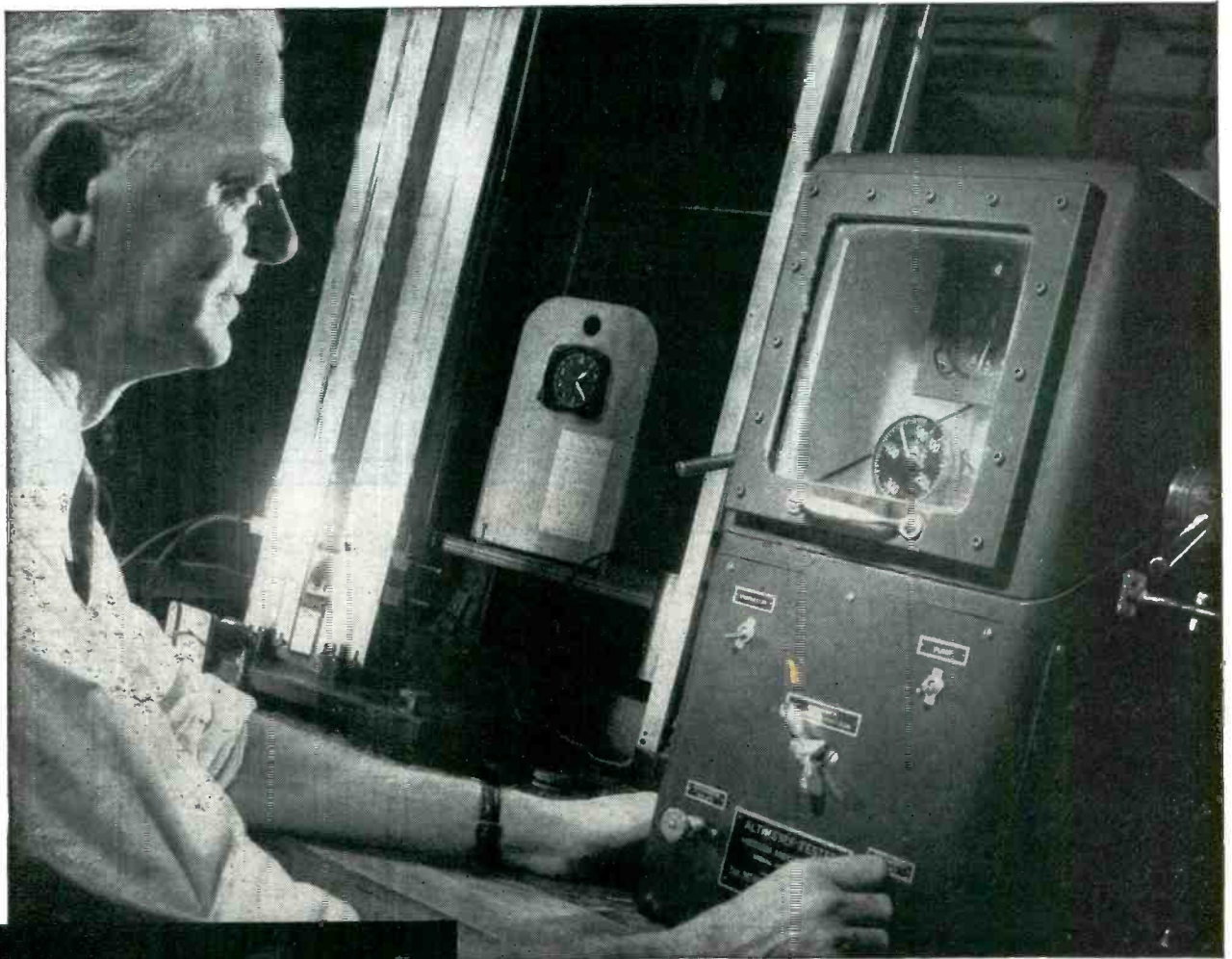

KOLLSMAN *for products of precision and dependability*

Aircraft Instruments and Controls • • • Miniature
AC Motors for Indicating and Remote Control
Applications • • • Optical Parts and Optical Devices
Radio Communications and Navigation Equipment

Today, Kollsman works without pause toward the fulfillment of America's defense needs. And to our nation's research scientists, the skill, ingenuity and creative drive of Kollsman Research Laboratories are available for the solution of instrumentation and control problems.



KOLLSMAN INSTRUMENT CORPORATION
ELMHURST, NEW YORK GLENDALE, CALIFORNIA

SUBSIDIARY OF
Standard COIL PRODUCTS CO. INC.

TAKES UP TO 10,000 VOLTS TEST

New

HIGH VOLTAGE TERMINAL

**RUGGED
FOOLPROOF**

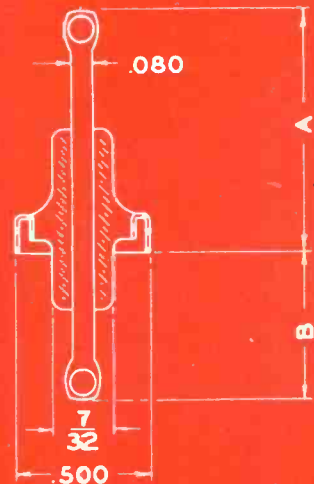
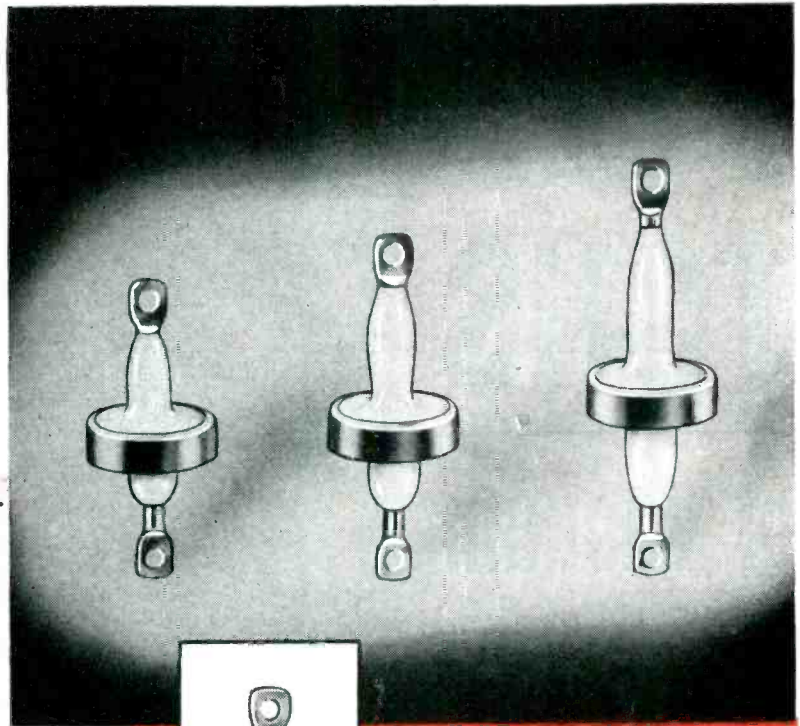

HERMETIC's new high voltage terminal is a glass-metal header that can take up to 10,000 volts and yet occupies only 1/2" diameter on the mounting surface. It is amazingly rugged and will insure foolproof operation because of the diaphragm construction of the mounting. It is available with solid or tubular center conductors. Applications are many, among which are its use in transformers, choke coils, capacitors and pulsed circuits.

What are your requirements in hermetic sealing? Contact HERMETIC, the one and only dependable source of supply, and be sure that your problems, too, will be solved to your complete satisfaction.

Write for your FREE copy of HERMETIC's informative new 32-page brochure, the most complete presentation ever offered on hermetic seals.

PART NO.	A	B	TEST VOLT *
1533-50	11/16	17/32	5000
1533-75	7/8	23/32	7500
1533-100	1.0	29/32	10000



HERMETIC SEAL PRODUCTS CO. 31 So. Sixth St., Newark 7, N. J.

FIRST & FOREMOST IN MINIATURIZATION

Serving up TONS of Vacuum Melted Metals

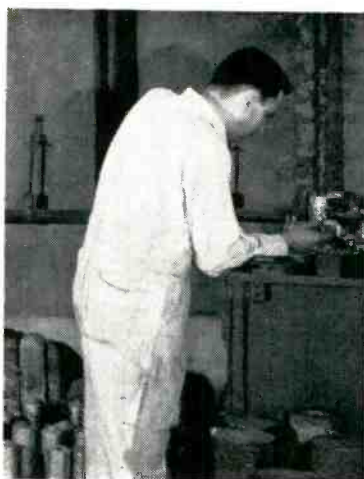
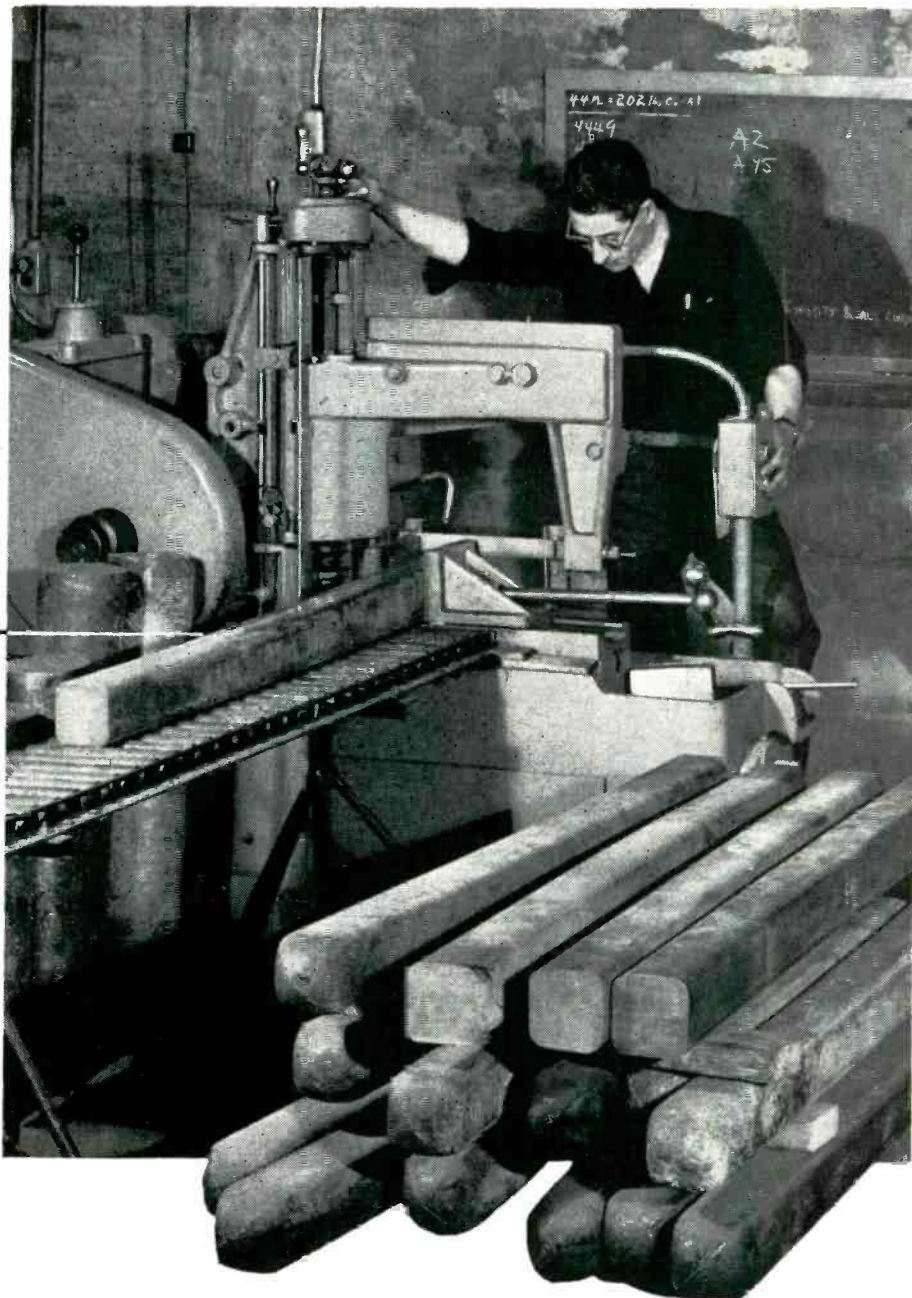

Preparing samples of vacuum melted metals for analysis.

PRODUCTION on vacuum melted metals that was formerly measured in pounds can now be measured in tons. Vacuum Metals' new expanded facilities are capable of producing 5 tons per day of Gas Free High Purity metals and alloys.

Vacuum melting techniques provide metals of higher purity . . . and alloys held to closer composition tolerances than ever before achieved commercially.

The unusual physical, chemical and electrical properties of these metals have proved of particular value for applications such as electronic and electrical parts, magnetic materials, bearing materials, diaphragms, instrument components, and Atomic Energy projects.

Metals now being vacuum melted include copper, nickel, iron, and molybdenum. Further information will be furnished gladly on request.

HIGH PURITY METALS
HIGH VACUUM CASTING
SPECIAL ALLOYS
GF (Gas Free) METALS

VACUUM METALS CORPORATION

Subsidiary of National Research Corporation

70 MEMORIAL DRIVE, CAMBRIDGE 42, MASSACHUSETTS

The Modern Way to Build Rotary Exhaust Equipment for Miniature Tubes

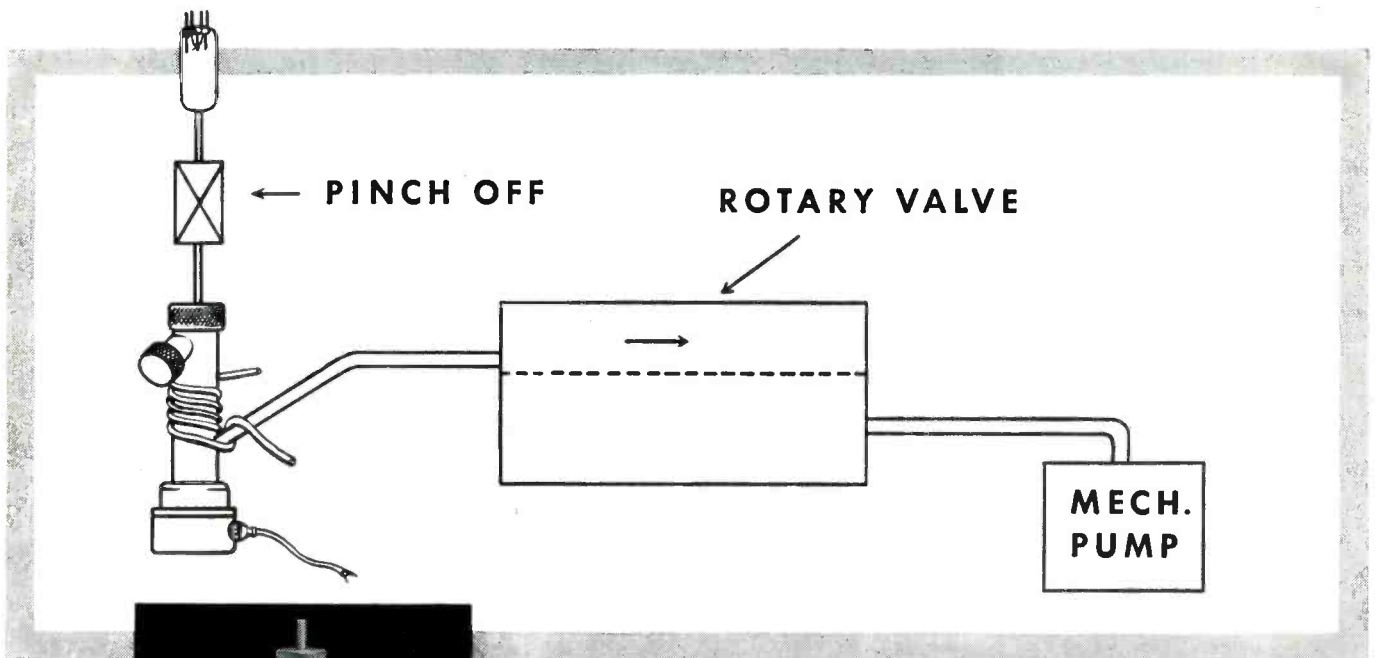

NRC's TYPE B-1 BOOSTER PUMP

- *Provides Higher Vacuum*
- *Reduces Exhaust Cycle*
- *Eliminates Troublesome Oil Vapors*

HYTRON-DESIGNED GLASS TRAP Ends Important Maintenance Problem

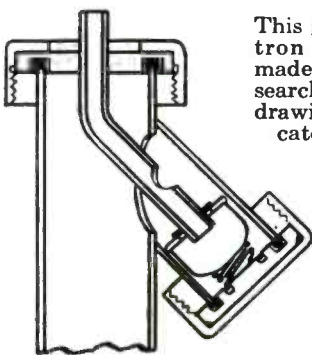

This glass trap, designed by Hytron production engineers, is made and sold by National Research. As you can see by the drawing at the left, the trap catches and holds broken glass particles. It works on the principle of a cyclone separator. The trap can be easily cleaned. Write for full details.

Our Type B-1 Booster Pump was built to meet ideal production methods as outlined by Hytron production engineers. On the production line it exactly meets their specifications in every detail — step by step. This Booster Pump lowers production costs. Its high speed reduces the exhaust cycle. Write for details.

INDUSTRIAL RESEARCH
PROCESS DEVELOPMENT
HIGH VACUUM ENGINEERING
AND EQUIPMENT



METALLURGY
DEHYDRATION
DISTILLATION COATING
APPLIED PHYSICS

National Research Corporation

"Equipment Division"

Seventy Memorial Drive, Cambridge, Massachusetts



with **ASTRON**
Subminiature
RF INTERFERENCE SUPPRESSION FILTERS

In filters, size and weight reduction need not mean *performance reduction*. Astron *Subminiature* RF Interference Suppression Filters provide for noise attenuation from 14 kc to 1000 mc with the desired characteristics of high impedance, low voltage drop, and minimum heating, in a package to fit your military or commercial needs. Through skillful use of metallized paper, new techniques, and specialized components—together with the engineering imagination that pioneered high temperature and high altitude filters—Astron is best equipped to solve your miniaturization problems.

Write us today, without obligation, outlining your filter requirements. Our engineers will forward recommendations promptly.

Astron also makes conventional filters, utilizing regular paper and foil capacitor designs. Write for Catalog AC-3.

Depend On—Insist On



255 Grant Avenue, E. Newark, N. J.

Export Division: Rocke International Corp., 13 E. 40th St., N. Y. C.

In Canada: Charles W. Pointon, 1926 Gerrard St. East, Toronto

FIRST CHOICE ON EQUIPMENT of FINE QUALITY

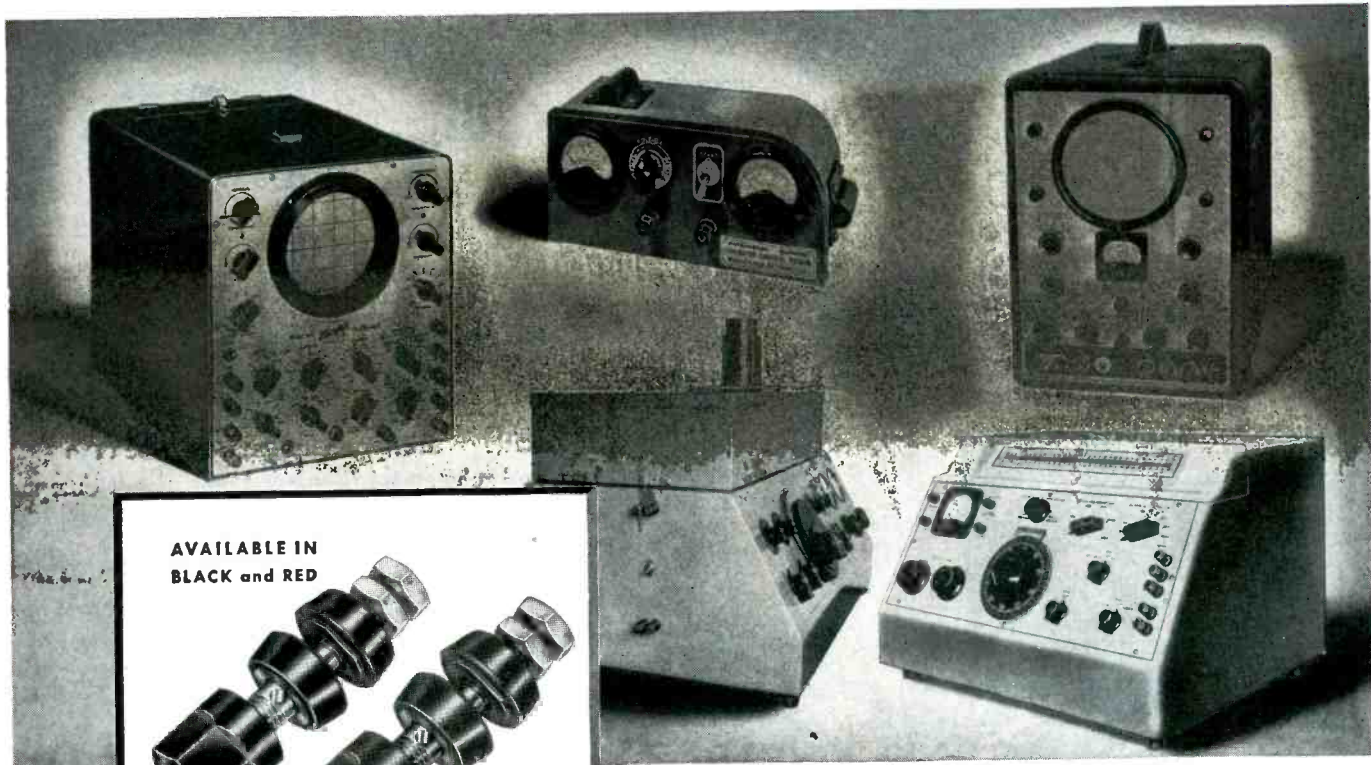

AVAILABLE IN
BLACK and RED



ACTUAL
SIZE

More and more leading manufacturers are using 5-WAY Binding Posts to provide increased flexibility and improved performance of their electrical and electronic equipment.

SUPERIOR 5-WAY BINDING POSTS

- 1 Plug-in for standard 3/4" banana plug
- 2 Clip-lead to shaft
- 3 Wire looped around shaft and clamped
- 4 Wire (up to #12) permanently clamped through center hole
- 5 Clamped spade lug connection

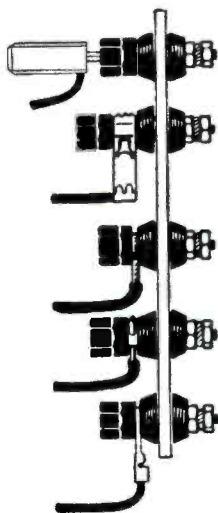

Better electrically *and* mechanically, the rugged SUPERIOR 5-WAY Binding Post affords quick, safe and positive connections for practically every application. Mounting in any panel from 1/16" to 1/4" is easily accomplished by means of a single keyed or unkeyed hole. It provides complete insulation from the panel. Construction is extra strong. Only the most durable of phenolic plastics is used. The hexagonal shaped head can be tightened with a 1/2" socket wrench without damage. Current capacity is 30 amperes; working voltage is 1000 volts. The color choice of RED or BLACK permits ready circuit or polarity identification.

A FREE SAMPLE IS AVAILABLE IF
REQUESTED ON YOUR LETTERHEAD.
210 THURE AVENUE, BRISTOL, CONNECTICUT

THE SUPERIOR ELECTRIC CO.
BRISTOL, CONNECTICUT



POWERSTAT Variable Transformers • STABLINE Automatic Voltage Transformers • VOLTBOX A-C Power Supplies • VARICELL D-C Power Supplies • POWERSTAT Light Dimming Equipment

We've been solving automatic control problems for 37 years



Knowing your whereabouts
under all circumstances

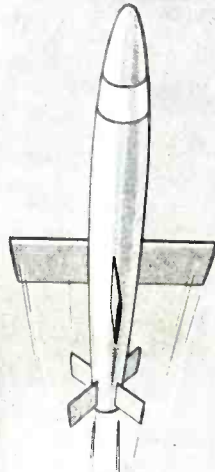

Controlling guided
missiles in flight

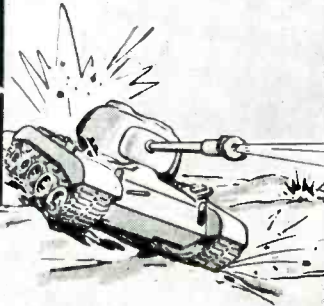

Stabilizing the guns
on bouncing tanks

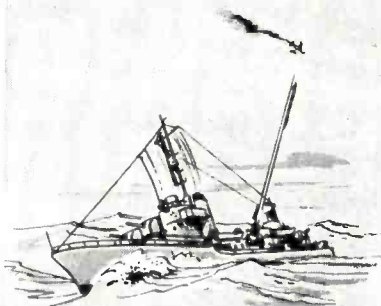

Shooting down jet planes
from the unstable decks of ships

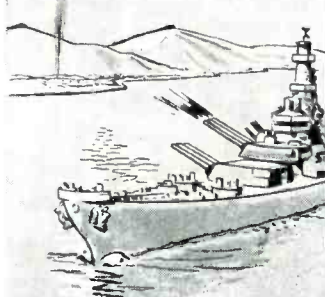

Hitting inland targets
from battleships

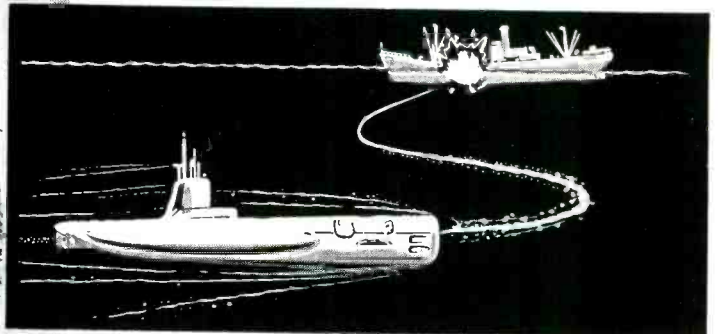

Directing torpedoes against surface craft.



FORD INSTRUMENT COMPANY

DIVISION OF THE SPERRY CORPORATION

31-10 Thomson Avenue, Long Island City 1, N. Y.

Take one part of the fantastic, mix thoroughly with Ford's engineering and production ability, and you've got the answer to another "impossible" automatic control problem. That has been the sum and substance of the Ford Instrument Company since 1915.

Stabilizing a gun on a bouncing tank or a ship's plunging deck; governing the unique movement of a torpedo; keeping a pilot informed of his whereabouts at all times and in all weather — Ford found the answer!

From the more than 16 acres of floor space that make up the engineering and production facilities of the Ford Instrument Company, come the mechanical, hydraulic, electro-mechanical and electronic instruments that bring us our "tomorrows" today! Research, development, design and production are being applied to control problems of both Industry and the Military.

An opportunity for able engineers

Build a future for yourself as an engineer at Ford. If you qualify there's a lifetime opportunity on automatic equipment design with the top name in automatic control. Write for our informative, illustrated brochure.

for electronic advancement

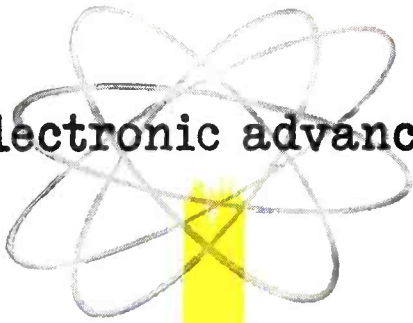

28 Volt D.C. Motor
Actuated Coaxial Switch
Model CA-71



Lobing Switch
Model CA-31



Manual Coaxial Switch
Model CA-36



Motor Actuated Coaxial Switch
Model CA-26



1P-2T Coaxial Switch
Model CA-20

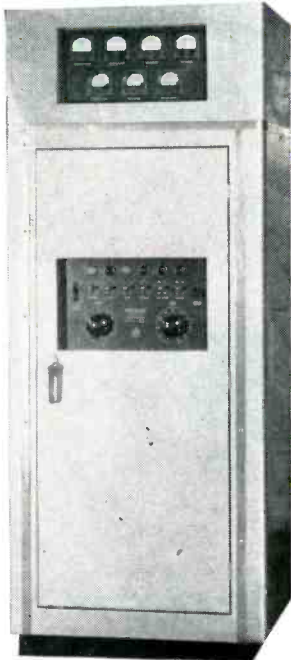

High Voltage Power Supply Unit
Model BP-01

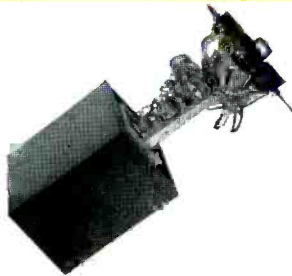

RF & Power Switch
Model CA-60



Antenna Switch
Model CA-57

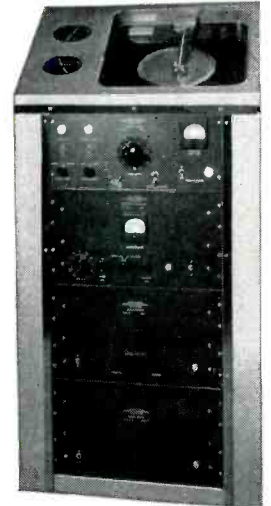

Polar Recorder
Model BU-02



Transfer Switch
Model CA-19



Logarithmic Amplifier
Model BA-01

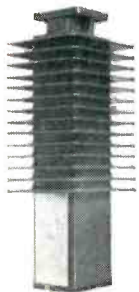

Dummy Load
Model BL-07

The research facilities of Thompson Products are helping in the development of the electronic industry. In fact, many electronic developments owe part of their creation to Thompson research or Thompson-made equipment.

We are proud of our contributions—and, we think, justfully so. On the other hand—we *should* do a top job! We are equipped to solve tough problems. Thompson has two plants—one in Cleveland, another in Columbus, Ohio—devoted exclusively to research engineering and manufacturing of electronic equipment. And our facilities stand ready, willing and able to help you solve your every problem—whether today's production or tomorrow's design—in coaxial switches, antennae, specialized test equipment or wave guide and coaxial components and accessories.

For complete information, we invite you to write, wire or telephone!

YOU CAN COUNT ON THOMPSON



Thompson Products, Inc.
ELECTRONICS DIVISION

2196 Clarkwood Road

Cleveland 3, Ohio



GLASSMIKES*



the capacitors with the exclusive glass housing and plastic dielectric film

*Preferred where
High Temperatures,
High Resistance, and
Low Loss are Essential!*



Glassmike capacitors are wound with the plastic film which accentuates the electrical characteristics you require, and results in capacitor design of minimum size. The metal ferrules, soldered to silver bands at each end of the hermetically-sealed glass tubes, eliminate mounting problems.

Applications:

**audio and RF coupling
pulse forming and de-spiking networks
radio frequency bypass
low and high pass filter networks
audio frequency coupling
electronic computers
electrometer and oscillator circuits
etc.**

Send us your requirements and we will recommend the proper capacitor.

MANUFACTURERS
Glassmike Capacitors
Plasticon Capacitors
Hi-Volt Power Supplies
Pulse Forming Networks

Condenser Products Company
Division of New Haven Clock & Watch Co.



7517 North Clark Street • Chicago 26, Illinois

* Glassmikes . . . an exclusive capacitor line originally designed by our engineers

SANTA CLAUS

Could Die of Old Age

No one shoots Santa Claus. This remark about a government which spends and spends and spends may well be true. But it is also true that Santa Claus is an old man. At his age overwork might well kill him.

It is with the possibility of working Santa Claus to death that this editorial is concerned. No position is taken as between the contending political parties in the present campaign. Our concern is with the problem of protecting Santa Claus.

It is true that as a nation we now enjoy great prosperity. The prosperity is not nearly so general as the political advertisements of it would suggest. Millions of individuals, notably those living on pensions, annuities and other fixed incomes, have been robbed of half their purchasing power by inflation during recent years, and whole industries know little or nothing of boom times.

However, measured by so basic a gauge as unemployment, we do have great prosperity. Less than two million of our total working force of over 64 million are unemployed,

and many of them are unemployed only while moving from one job to another. The real income, i.e., what their dollars will buy, of those with jobs is somewhere near its all-time peak.

Our Prosperity is Precarious

The prosperity we enjoy, however, is precarious. This is primarily because it is dependent upon a rising volume of expenditures by the federal government. At present almost a quarter of our entire national income is ladled out through Washington, and in an ever increasing amount.

If, as matters now stand, federal expenditures were to be suddenly and sharply cut, our government-financed prosperity would be severely upset. But if the federal government were to try to keep right on providing prosperity by steadily increasing its expenditures, the end result would be more certainly disastrous. It would be a crash caused primarily by having continuing inflation of prices destroy the value of the dollar.

Higher government expenditures of worthless dollars then could accomplish nothing. Santa Claus would be dead from overwork.

To Provide Firm Foundations

The general route to be followed in putting firm foundations under our prosperity is quite clear. It involves two steps which must be taken closely together. The first is to stop the continuous increase in federal expenditures. The second step is to substitute expanding private business for government-financed business as the principal foundation of expanding prosperity.

The increase in federal expenditures can be stopped without sacrificing any effective measures now directed toward meeting our top priority requirement—protection from armed Communist aggression. The most competent authorities of both major parties agree it can be done by (1) better planning of and the elimination of outright waste in defense arrangements, and (2) cutting those civilian expenditures which cannot be justified at the same time we are undertaking a great new load of defense expenditure.

It is also possible to substitute expanding private business for government-financed business. The problem is primarily that of relieving private business of the staggering load of federal taxation it now is carrying. Federal taxation now takes 52 per cent of all corporate profits and 82 per cent of all so-called excess profits. If it were not for the forced draft placed under our economy by rapidly mounting defense expenditures, this burden would surely lay a disastrous blight on private business expansion. If expanding private business is to have a chance to play its critical role as a substitute for government-financed business, its taxes must be cut, and soon.

It Won't be Easy

It would be naive to contend that it will be easy to check the expansion of federal expenditures. They have been running wild too long, and in the process contributing to a feverish, inflationary prosperity. Likewise, there is no reason to believe that the easing of the load of business taxes is going to be easy. The basic blight it puts on business expansion has been too long obscured by having our economy dosed with artificial stimulants, most notably enormous injections of federal expenditures.

The Key Question—How Long?

It is obvious that prosperity is going to be a major topic of discussion in the present political campaign. There is nothing the matter with that. Prosperity is a key concern of the voters in choosing a national administration.

To make the discussion of prosperity really useful, however, it is important to ask and get answers to the right questions about it. The key question is not whether or not we have prosperity. That we have it in large measure is generally conceded.

The key question is, "How long can we continue to have prosperity?" The answer—not very long if we continue to rely primarily on new injections of inflationary federal expenditures. Santa Claus, be it remembered, is no youngster. If we continue our present improvident course, he will be worked to death. Those politicians, regardless of party, who see this clear danger and who have plans to escape it are facing up to the crucial question about our prosperity.

McGraw-Hill Publishing Company, Inc.

Our most eloquent salesman

can't talk



BUT HE CAN SELL. In fact, every prospect who meets him becomes a customer. Every one.

For "he" is the Karp plant itself. And if you saw him, you'd know why he's a successful salesman.

It begins with our engineering department where your designs are detailed for sheet metal production. It continues through tooling where our vast assortment of available dies often eliminates the need for new tooling... where our toolmakers create special tooling when needed.

Then to actual fabrication, where skilled craftsmen process every job, whether large or small, with equal care — and use the finest of metal-working equipment to do it.

You'd see all of these things and much, much more as you travel through our plant ranging three city blocks.

At the risk of becoming dissatisfied with your present sheet metal fabrications, you're invited to tour the Karp plant — any time. Meanwhile, write for a copy of our data book.

KARP METAL PRODUCTS CO., INC. • 215 63RD ST., BROOKLYN 20, N. Y.

MOST COMPLETE FACILITIES FOR LARGE AND SMALL RUNS OF
ENGINEERED SHEET METAL FABRICATION

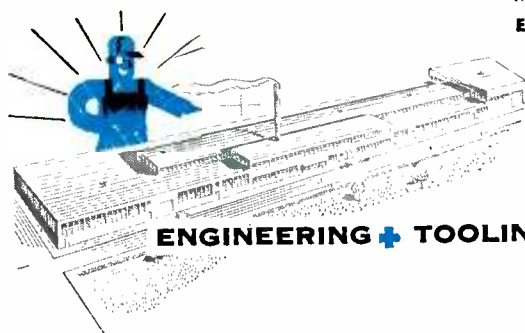

ENGINEERING + TOOLING + PRODUCTION + FINISHING =

KARP



ROLLING ELECTROLYTIC CAPACITORS with "Scotch" Electrical Tape No. 42 at The Magnavox Company, Fort Wayne, Indiana.

WHAT'S NEW IN TV TAPES?

High-purity, stick-at-a-touch tape cuts condenser breakdowns at The Magnavox Co.

At last—a tape that won't corrode electrolytic condensers! It's "Scotch" Electrical Tape No. 42—a tape with extremely low chloride content, and it's now proving its worth at The Magnavox Company, Fort Wayne, Indiana. Condenser breakdowns caused by usual wrapping methods have been sharply reduced.

This "Scotch" Electrical Tape is only one of many "Scotch" Electrical Tapes designed to give you lower costs, faster production and more dependable results.

Over 30 of these stick-at-a-touch tapes are described in a new booklet we'd like you to have as a reference. The booklet is titled "Tapes for Television," and it gives you *facts* like dielectric strength, caliper, type of backing and mechanical strength of tapes that can save you real money.

Write for your copy of this handy booklet today! Use coupon below for immediate attention.

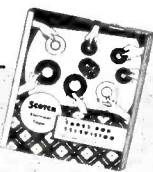

Minnesota Mining & Mfg. Co.
Dept. E102, St. Paul 6, Minnesota

Please send a copy of "Tapes for Television."

Name.....

Firm.....

Address.....

City..... Zone..... State.....

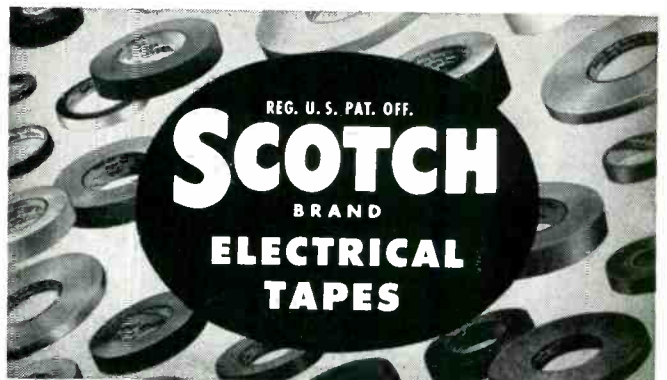

The term "SCOTCH" and the plaid design are registered trade marks for the more than 100 pressure-sensitive adhesive tapes made in U.S.A. by Minnesota Mining & Mfg. Co., St. Paul 6, Minn.—also makers of "SCOTCH" Sound Recording Tape, "UNDERSEAL" Rubberized Coating, "SCOTCHLITE" Reflective Sheeting, "SAFETY-WALK" Non-slip Surfacing, "3M" Abrasives, "3M" Adhesives. General Export: Minn. Mining & Mfg. Co., International Division, 270 Park Avenue, New York 17, N. Y. In Canada: Minnesota Mining & Mfg. of Canada, Ltd., London, Canada.

3 Waldes Truarc Rings Replace 19 Parts ... Save \$6.75 Per Unit ... Cut Weight by Nearly 16%

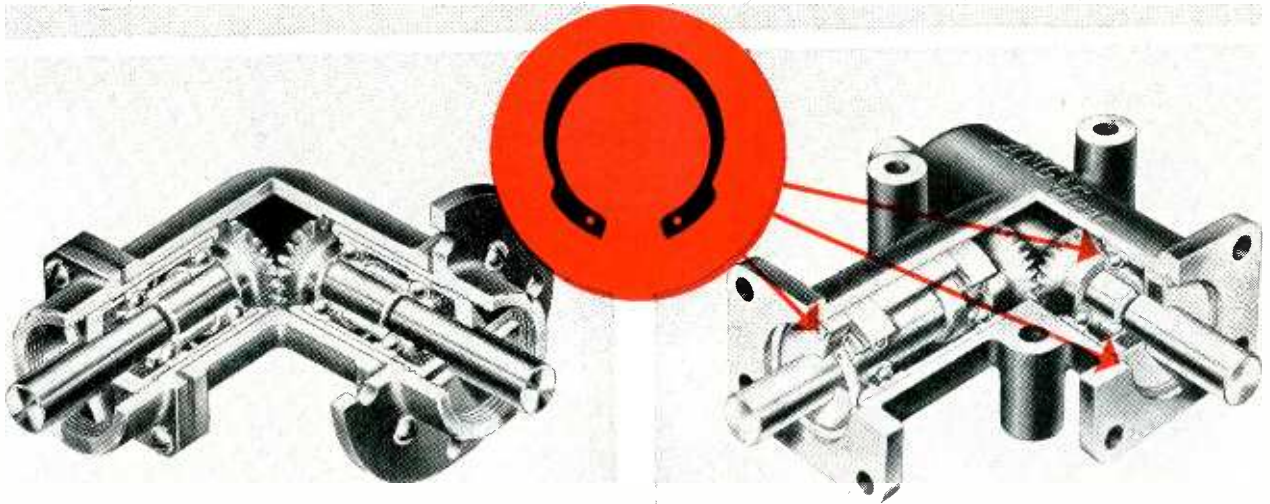

OLD WAY 2 Threaded nuts locked bearings in place. 8 screws and washers positioned bearing and shaft assemblies. This fastening method required expensive tapping and threading. Assembly was slow and costly.

TRUARC WAY Two Truarc inverted rings (Series 5008) provide uniform shoulder to lock bearings in place, position bearing and shaft assemblies. Additional Truarc Ring (Series 5100) locates ball bearing ... eliminates 1 sleeve type spacer.

Airborne Accessories Corporation, Hillside, New Jersey, uses Waldes Truarc Retaining Rings to take all thrust load from right angle bevel gears in their ANGLgear*. Truarc Rings make ANGLgear* more compact—save approximately 1/4" at each end of housing. By providing a choice of 3 mounting possibilities — instead of 1 — Truarc Rings make ANGLgear* adaptable to many different assemblies. New design increases load capacity ... eliminates machining of threads.

Redesign with Truarc Rings and you, too, will

* Trade Mark of Airborne Accessories Corp.

cut costs. Wherever you use machined shoulders, bolts, snap rings, cotter pins, there's a Waldes Truarc Retaining Ring designed to do a better job of holding parts together.

Waldes Truarc Rings are precision-engineered ... quick and easy to assemble and disassemble. Always circular to give a never-failing grip. They can be used over and over again.

Find out what Truarc Rings can do for you. Send your blueprints to Waldes Truarc engineers for individual attention, without obligation.

SEND FOR NEW CATALOG 

WALDES
TRUARC
REG. U. S. PAT. OFF.
RETAINING RINGS



WALDES KOHINOOR, INC., LONG ISLAND CITY 1, NEW YORK
WALDES TRUARC RETAINING RINGS AND PLIERS ARE PROTECTED BY ONE OR MORE OF THE FOLLOWING
U. S. PATENTS: 2,382,947; 2,382,948; 2,414,852; 2,420,921; 2,428,341; 2,439,785; 2,441,848; 2,455,165;
2,483,380; 2,483,383; 2,487,802; 2,487,803; 2,491,306; 2,509,081 AND OTHER PATENTS PENDING.

Waldes Kohinoor, Inc., 47-16 Austel Place, L. I. C. 1, N. Y.

Please send me the new Waldes Truarc Retaining Ring catalog.

(Please print)

E-104

Name.....

Title.....

Company.....

Business Address.....

City..... Zone..... State.....

*NOT Catalogued!

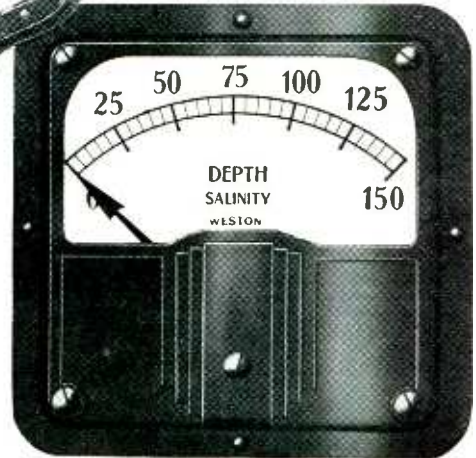
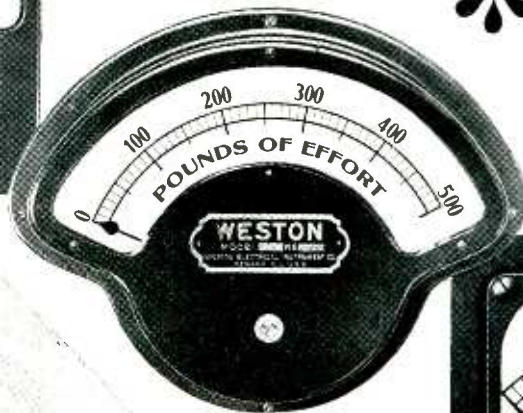

Standard WESTON Switchboard

Instruments are all catalogued, of course. But these are *special* switchboard instruments... a few of the many hundreds of different types being constantly engineered and produced to meet specific requirements. Requirements such as... *special sensitivities—scale markings—pointer styles and response—mirror scales—adjustment to give maximum accuracy at critical points, etc.* Whatever your instrument requirement... *standard or special*... the answer is available here at *instrument headquarters.*

WESTON Electrical Instrument Corporation, 617 Frelinghuysen Avenue, Newark 5, New Jersey... manufacturers of Weston and TAG instruments.

WESTON

798

SWITCHBOARD

Instruments

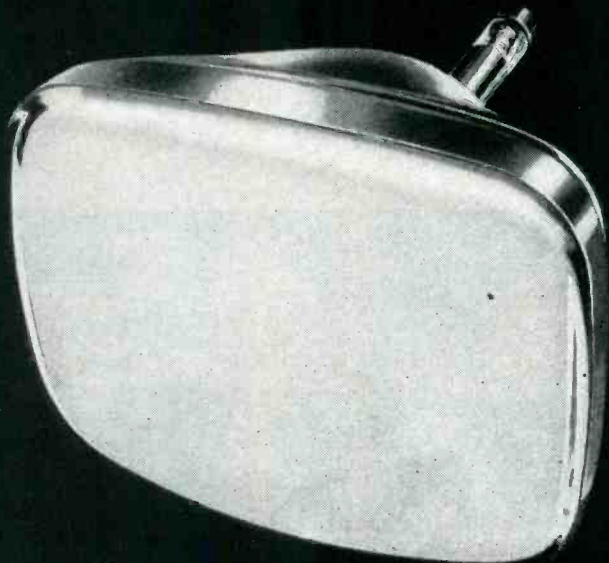

THERE'S ALWAYS ONE LEADER...

DU MONT

*Fine receivers can be
made finer through the use of Du Mont Teletrons.*

Available in all popular screen sizes.

Cathode-ray Tube Division, Allen B. Du Mont Laboratories, Inc., Clifton, N. J.

*trade mark

What Rauland means by "Perfection Through Research"

Rauland is one of the few companies devoting so much top engineering talent full time to picture tube improvement and perfection.

The result has been to give you more picture tube advancements since the war than any other manufacturer . . . first chance at the latest developments

for companies using Rauland tubes as original equipment . . . and a real selling edge at the retail level because of the extra satisfaction which Rauland advantages offer.

That's why so many alert manufacturers look to Rauland for the best in picture tubes.

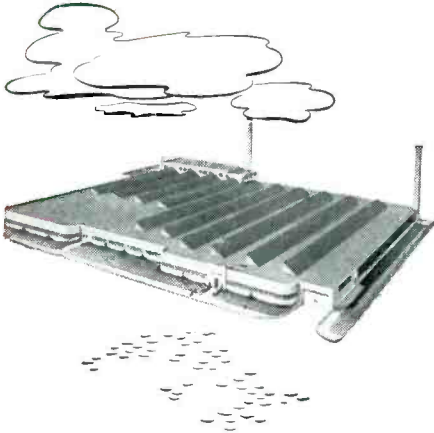

Rubber model for studying electron optical designing—basis for Rauland's exclusive Indicator Ion Trap.

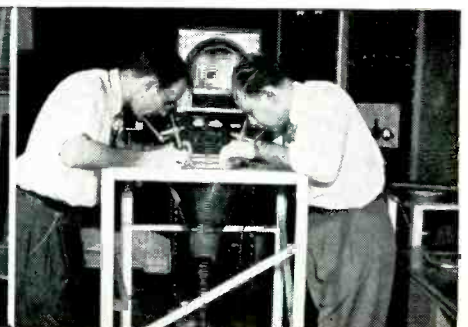

Alignment of the screen and parallax mask of tri-color tube containing approximately a million fluorescent dots.

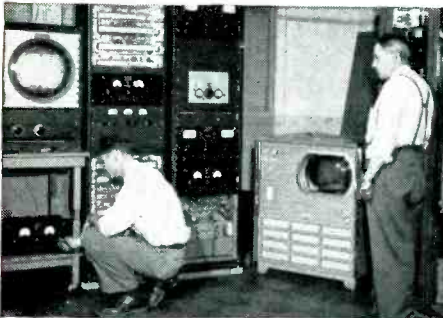

All-electronic tri-color tube in electronic receiver system (left) in comparison with mechanical system (right).



Inspection and checking of perforations .0075" in diameter in masks of tri-color picture tubes.

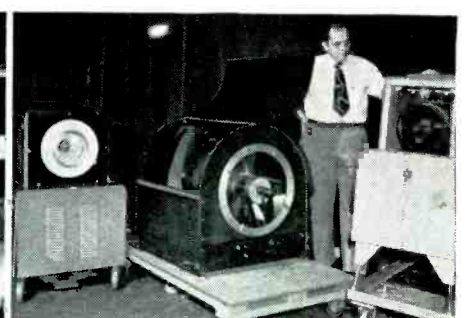

Rauland large-screen projectors using three different optical systems, all of which give theater-size pictures.

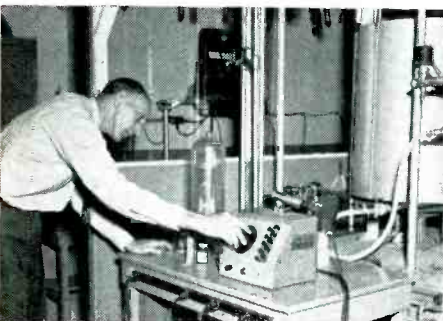

Careful study of the formation of thin metallic films in a vacuum . . . basis for the aluminizing of tubes.



Examination with polarimeter permits careful control of strains for superior glass-to-metal sealing.



A physicist using a Rauland-developed radiation meter in checking X-ray radiations from cathode ray apparatus.

THE RAULAND CORPORATION



Perfection Through Research

2425 N. KNOX AVENUE • CHICAGO 41, ILLINOIS



Only the G-E Dual Regulated Power Supply ST-9A gives you...



1. ELECTRONIC OVERLOAD PROTECTION
2. BUILT-IN MODULATOR

TYPE ST-9A (500 VOLT) Electrical Specifications

Power Requirements	105-125 volts (210-250 volts), 50/60 cycle, 320 watts maximum
Output Voltages #1 Regulated	Continuously variable, 0-500 volts, maximum current 100 ma
#2 Regulated	Same as #1
Parallel #1 and #2	Continuously variable, 0-500 volts, maximum current 150 ma
Unregulated	Approximately 650 volts no load, maximum current 200 ma
-75 Volts	VR tube regulation, 0-2 ma
-150 Volts	VR tube regulation, 0-4 ma
Filament Supply	6.3 volts a-c at 10 amps
Regulation	Better than $\frac{1}{2}\%$ + $\frac{1}{2}$ volt within the cross-hatched area of the graph (below)
Ripple and Noise	Less than 3.5 mv (10 mv peak-to-peak) on all regulated outputs
Instruments	Milliammeter 0-300 ma d-c; voltmeter 0-500 volts d-c; voltage and current can be metered at #1 and #2 Regulated and Unregulated outputs; total current drawn from all outputs can be metered and it should not exceed 200 ma
Overload Protection	3 amp fuse in the a-c line; $\frac{3}{8}$ amp fuse in the d-c line; overload of any degree on the regulated outputs will harm neither the supply itself nor the instruments.
Ambient Temperature	0 to 40°C

FOR general laboratory purposes, no power supply on the market today can match this new General Electric unit. Routine bench casualties are no problem for the ST-9A: the instruments cannot be harmed by short circuits on the regulated outputs. And—for the first time you can observe hum and noise tolerances by actually duplicating them on the equipment. This saves you time by establishing final power supply design specifications quickly.

- Outputs readily available on insulated binding posts
- Output terminal on rear for rack mounting
- Outputs are individually metered and a fourth position is added for metering total current
- *Even when* the unit is cabinet or rack-mounted, drop front panel permits easy accessibility to components (without removing panel lock)
- Regulation specification holds over the full range of 0-500 volts.

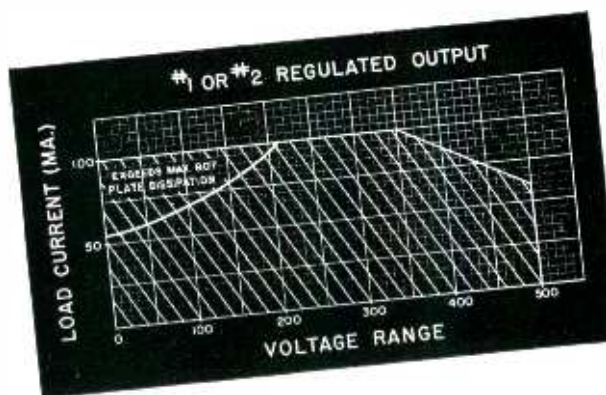

General Electric Company, Section 4102,
Electronics Park, Syracuse, N. Y.

Please send my copy of your new G-E Power Supply Catalog.

NAME _____
 COMPANY _____ TITLE _____
 ADDRESS _____
 CITY _____ STATE _____

GENERAL ELECTRIC

NEW



AUDIO



New convenience for laboratory, field or production measurements in sub-audio, audio, telephony, carrier current, super-sonic, telemetering and rf applications.

**New! Completely redesigned!
Highest quality throughout
Lighter weight, smaller size
New wider frequency range
Time-tested RC circuits
No zero set. High stability
Constant output, low distortion**

COMPACT, EASY TO USE BASIC INSTRUMENTS FOR LABORATORY OR PRODUCTION TESTS

Hewlett-Packard RC oscillators have long been basic tools for making electrical and electronic measurements of precise accuracy. Now these world-famous test instruments are redesigned to give you the most compact, dependable, accurate and easy-to-use commercial oscillators available.

New *hp*-200 series oscillators have highest stability and precisely accurate, easily resettable tuning circuits. Low impedance operating levels together with superior insulation guarantee peak performance throughout years of trouble-free service. New models have wider frequency range. Operation is simplified—just three front panel controls. Size is different, too—the instruments are more compact, lighter in weight and enclosed in an easy-to-handle aluminum case with carrying strap. Minimum bench space is required. (Rack mounting available on request.)

Complete Coverage! HEWLETT-PACKARD

OSCILLATORS

The total coverage of just two of the new *-hp-* oscillators is materially greater than that offered by four previous *-hp-* instruments. For example, new Model 200AB, for general audio tests, offers a wider frequency range of 20 cps to 40 kc and a full watt output. New *-hp-* 200CD, for wide-range measurements at lower power, provides constant voltage output from 5 cps to 600 kc.

In addition to these new instruments, *-hp-* continues to offer Model 200H for carrier current work up to 600 kc, and Model 202D for low frequency and vibration studies down to 2 cps. These instruments retain their time-tested design.

Components, insulation and other electrical and mechanical features are of the highest possible quality. The instruments are carefully adjusted and calibrated to meet exact frequency and performance specifications. An output amplifier provides complete isolation of the load, and changes in the output load cannot change the performance of the oscillator. Frequency stability is better than $\pm 2\%$ including warmup, and hum voltage is less than 0.1% of rated output.

-hp- 202A Low Frequency Function Generator

This instrument is a compact, convenient and versatile source of transient-free test voltages between 1,000 and 0.01 cps. It provides virtually distortion-free signals for vibration studies, servo application, medical and geophysical work and other subsonic and audio problems. The equipment generates 3 wave forms — sine, square and triangular. Output is 30 volts peak-to-peak for all wave forms. The output system is fully floating with respect to ground and may be used balanced or single-ended. The instrument will deliver 10 volts RMS to a 2,500 ohm load; internal impedance, however, is only 40 ohms. There are no coupling capacitors in the output system, and a high degree of dc balance is achieved by a special circuit. Price, \$450.



BRIEF SPECIFICATIONS—200 SERIES OSCILLATORS

<i>-hp-</i> MODEL	FREQUENCY RANGE	BANDS	FREQUENCY RESPONSE	POWER OUTPUT	LOAD IMPEDANCE	DISTORTION	POWER CONSUMPTION	PRINCIPAL APPLICATIONS	PRICE
200AB	20 cps to 40 kc	4 ranges	± 1 db Ref. 1 kc	1 watt or 24.5 v	600 ohms	1%	60 watts	Audio Tests	\$120.00
200CD	5 cps to 600 kc	5 ranges	± 1 db Ref. 1 kc	160 mw — 600 ohms or 20 volts open circuit*		1%	75 watts	Audio, Ultra-sonic, tests	\$150.00
200H	60 cps to 600 kc	4 decades	± 1 db Ref. 1 kc	10 mw or 1 v	100 ohms	1%, 100-100,000 cps 3%, 60-600,000 cps	115 watts	Carrier Current & Telephone Tests	\$350.00
202D	2 cps to 70 kc	5 ranges	± 1 db Ref. 1 kc	100 mw or 10 v	1,000 ohms	1%	80 watts	Low Frequency Measurement	\$275.00
200I	6 cps to 6 kc	6 ranges	± 1 db Ref. 400 cps	100 mw or 10 v	1,000 ohms	1% 10-6,000 cps	115 watts	Interpolation and Frequency Measurement	\$225.00

(*Internal impedance 600 ohms.)

Data subject to change without notice.

Prices f.o.b. factory.

HEWLETT-PACKARD COMPANY

Field Engineers in Principal Cities

2523A PAGE MILL ROAD • PALO ALTO, CALIFORNIA



INSTRUMENTS — Complete Coverage!

edwin i. guthman & co., inc.

15 s. throop st. chicago 7, CH 3-1600 . also attica, indiana

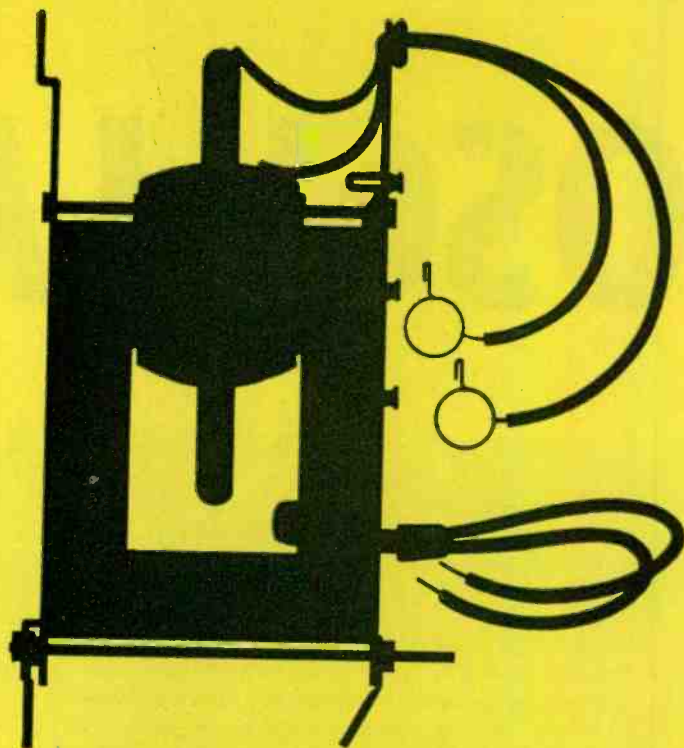

flyback transformers

For reliability in high voltage specify Guthman Flybacks—they won't break down even under the most severe voltage requirements. Wire used in Guthman Flybacks is fabricated in our own plant and is quality controlled from raw material to finished product guaranteeing a superior uniformity of performance. The excellent linearity and voltage regulation characteristics of Guthman Flybacks aids in preserving picture quality.

Coils used in Guthman Yokes are form wound. Complete isolation between vertical and horizontal coils achieved by a molded nylon piece permits a yoke rating of 5,000 volts pulse maximum. Anti-magnetic core retainer band and brass mounting nut assures no magnetism in Guthman Yokes.

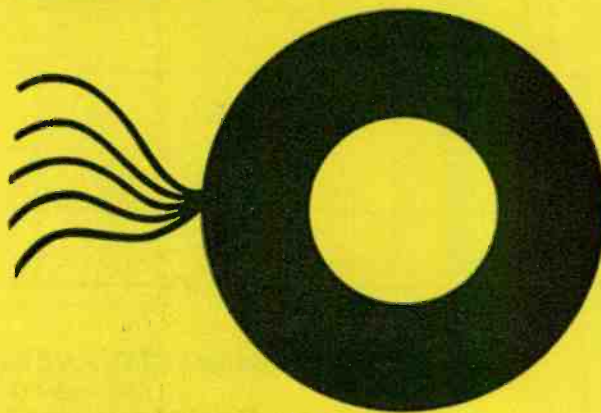

DELAY LINES
SHIELD CANS
ANTENNA COILS
OSCILLATOR COILS
COMPRESSION TYPE
MICA TRIMMERS
I.F. TRANSFORMERS
LOOP ANTENNAS
R.F. TUNERS

yokes

BURTON BROWNE ADVERTISING



THIS IS NOT
 a **TAFT-HARTLEY**
 CIRCUIT BREAKER

Unique in the field of circuit protection equipment, **HEINEMANN** Circuit Breakers do not require a "cooling-off period." Immediately after correction of a fault, either short circuit or overload, **HEINEMANN** Circuit Breakers can be turned ON. There is no waiting for a thermal element to cool . . . no wasted production time . . . no reset procedure . . . just restore service by throwing the switch to the ON position.

NO WAITING TO RESET . . . YET NEVER NUISANCE TRIPPING

While there is no waiting to reset after tripping, **HEINEMANN** Circuit Breakers do provide time delay before tripping to allow for **temporary, harmless** overloads, thus avoid nuisance tripping. This allows for the initial inrush of starting motors and other equipment.

TIME DELAY FOR OVERLOADS . . . YET INSTANTANEOUS SHORT CIRCUIT PROTECTION

Beyond providing time delay for overloads, the hydraulic-magnetic operating principle of **HEINEMANN** Circuit

Breakers differentiates between overloads and short circuits. **HEINEMANN** Circuit Breakers always trip instantly at ten times the rated current . . . providing the fast protection you must have for your wiring and equipment even at the low short circuit values.

KNOW THE FACTS . . .

Send for this new informative booklet entitled, "WHAT YOU SHOULD KNOW ABOUT CIRCUIT BREAKERS." Ask for Manual 101 . . . no obligation, of course.

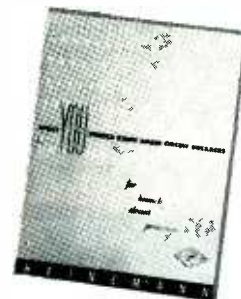

HEINEMANN ELECTRIC COMPANY
 97 Plum Street • Trenton 2, N. J.

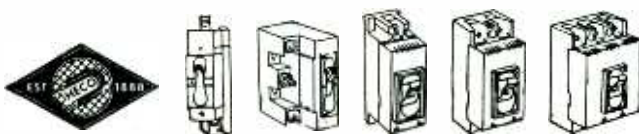

Heinemann Circuit Breakers. One, two and three pole. 10 milliamps to 100 amperes.



Simplify your
production procedure
with High-precision

Stupakoff

**CERAMIC
to Metal
ASSEMBLIES**



for Electrical
and Electronic Applications

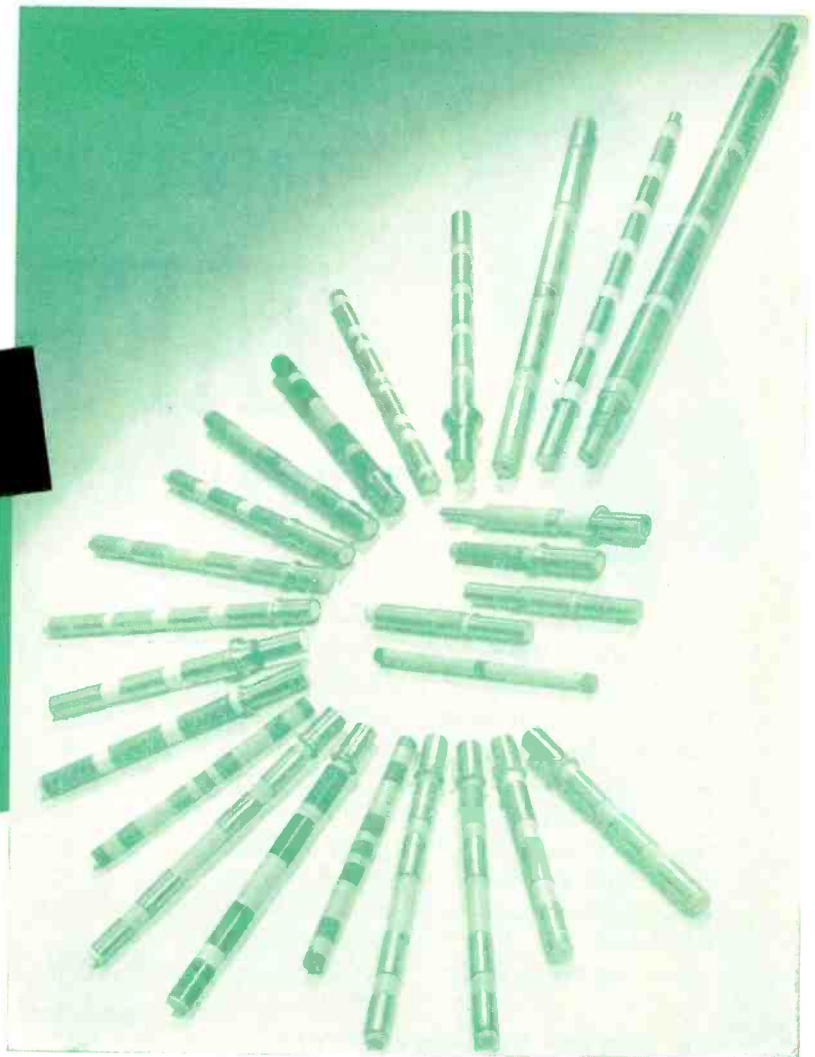

To combine ceramic and metal parts into one permanent unit, Stupakoff draws upon extensive experience with both materials. Methods of assembly employed by Stupakoff include: metallizing, soldering, pressing, spinning and others. Among the metals assembled to ceramics are silver, copper, brass, stainless steel and monel.

The rotor shafts shown above consist of metal bands attached securely to ceramic rods, and exemplify Stupakoff precision manufacture. On a mass production

basis, concentricity of components, for example, are held to less than ± 0.001 in. Likewise, the strainers and spreaders, stand-offs and trimmers shown below meet the exacting requirements of the service for which they are made.

Stupakoff high-precision ceramic assemblies offer many opportunities to reduce costs, increase production and improve electrical and electronic equipment.

We will be glad to discuss your requirements with you and to submit samples for your inspection.



**STUPAKOFF
CERAMIC & MANUFACTURING CO.**

LATROBE, PENNSYLVANIA

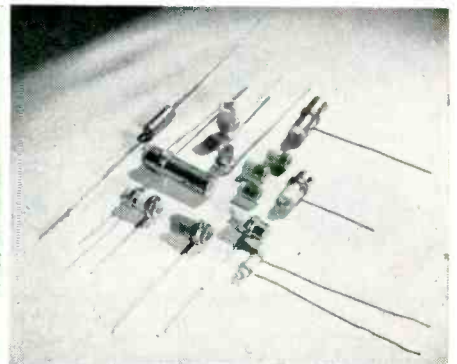
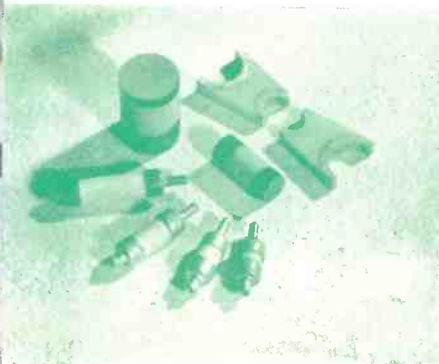

Ready for Your Circuit

Basic Foundation Components, Plug in, Connecting, Fastening Devices for the
ELECTRONIC CONTROL INDUSTRY

Making it possible to build quickly any electronic circuit into practical production design (you supply the circuit — we supply the components).

- by giving you basic components of tremendous flexibility which simplify layout time in production of your equipment.
- by providing you a technique to solve mechanical, space, connecting, interconnecting, fastening, sensing and indicating problems for you.

Giving you equipment that is easy to operate and maintain

- so that — with spares — your equipment never needs to be out of operation more than 30 seconds.
- so that non-technical personnel can set up, operate and maintain your equipment.



WORKING WITH "ALDEN'S HANDBOOK", THE DESIGN ENGINEER
AUTOMATICALLY CREATES PRACTICAL PRODUCTION DESIGN, as follows —

1. Anything electrical or electronic usually operates with an outside source of power and may be connected to outside circuits. So Alden provides for this with the efficient Detachable Line Cord for bringing in 110V AC power. Available in lengths to your specs for making a neat connection. Sure grip plug is self-piloting for quick mating.

SEE "ALDEN HANDBOOK" PAGES 4A & B FOR COMPLETE DETAILS

2. A great deal of equipment will have a front panel with such things as sensing controls, jacks for testing and fuseholders. For this Alden provides a basic slide-in chassis with a detachable front and back panel so that rheostats, indicator lights, test jacks, interwiring, etc. are all easy-to-work subassembly operations.

SEE "ALDEN HANDBOOK" PAGES PI-1E thru G FOR COMPLETE DETAILS

3. Sensing Units — telltales that all is well or not — in simple indicator light — fuse holders that sense — or command — or keep on repeating so that units or elements almost assume brain functions.

SEE "ALDEN HANDBOOK" PAGES ES-5A & B; DL-5A & B; TE-3A & B; CG — all pages

4. The telephone, telegraph, electric light companies have always brought the incoming circuits to a bus bar or terminal board so that the incoming circuits could always be checked at one point — and equipment connected not being condemned because of imperfect outside circuits. So Alden provides in its Back Connectors and supporting Back Plates the one area in which all incoming circuits can be checked.

SEE "ALDEN HANDBOOK" PAGES PI-2A & B; 4D FOR COMPLETE DETAILS

5. The next problem is to house the components and have them do the electrical or electronic work required. Any such circuitry will have certain main functions and branching from it other functions. Many of these functions can be layered — so circuits go direct from back connector to front panel. Alden provides: simple component mounting panels for putting any circuit in layers. (And incidentally such component panel simplify the thinking, should the circuits give sufficient volume to be printed.) So Alden has the Terminal Panel Boards to make equipment easy to lay out by putting any function in one plane — plus the unit cables of correct lengths with stripped ends ready for interconnecting the Terminal Panels.

SEE "ALDEN HANDBOOK" PAGES PI-1B thru D FOR COMPLETE DETAILS

6. Not all circuits can be a simple, straight circuit from back connector to front panel because there are auxiliary functions and branches that have to be in the main functions. The usual chassis carries tubes, transformers and components that rise vertically from the chassis, often leaving vacant spaces. In these spaces can be placed the plug-in units which have these secondary circuits; using the plug-in technique usually removes the congestion of the wiring below the chassis, provides automatically for shielding and heat dispersion and yet gives you largest amount possible circuitry per cubic space, the circuits free from interaction.

SEE "ALDEN HANDBOOK" PAGES PI-1A thru H FOR COMPLETE DETAILS

7. Again these techniques often lead to putting one function such as a power supply and amplifier on separate chassis and so the back connectors or the chassis itself may need interconnecting unit cables to either chassis or racks. Alden provides sufficient variety of connectors to choose from — and designed so that any cable, no matter how involved, cannot be wrongly plugged in.

SEE "ALDEN HANDBOOK" Sec. PC - Sec. MP5 FOR COMPLETE DETAILS

8. To design so that no equipment — whether plug-in unit or slide-in chassis — needs to be out of operation for more than 30 seconds (having adequate spares on hand), Alden provides quick detaching and quick fastening devices for chassis. The Serve-a-Unit locks that will move chassis against weight or the resistance of gaskets. There is the Target Screw (coin operated), a Tool-less screw — the Captive Screw which becomes part of the equipment.

SEE "ALDEN HANDBOOK" PAGE PI-11 FOR COMPLETE DETAILS

9. Government designers and those in the electronic control industry want elements of equipment so that they can be portably operated or tested, can be carried by one man with spares, parts easily sent by mail or airborne and also prefer that the same design equipment can be used in conventional racks. Those designing for field operation use, at sea, prefer to have the equipment so it can be unloaded by two people, set up and immediately interconnected. This is provided by the Alden Basic Chassis using Back Connectors, Unit Cables and for the last purpose, the Uni-Rack which can be set on top of one another and immediately interconnected with each other.

SEE "ALDEN HANDBOOK" PAGE PI-11 FOR COMPLETE DETAILS



CORD LENGTH TO YOUR SPECS.

Avoid floorful of over-length cords.

Avoid midget cords that compel added extension cords.

Front panel (various sizes) carries controls, indicators, sensing elements, with their interwiring.

Detachable front panel hinged giving accessibility for ease of assembly and servicing.

Indicator lamps always easily replaced so always functioning.

Insulated test point jacks for plate voltages up to 6,000V.

Plug-in Memory or Pulse Circuits.

Alden Back Connectors, color coded, with accessible unconnected solder terminals — permit easy servicing and rapid circuit checks at central point.

Back Connectors permit direct efficient wiring — avoid conventional rat's nest wiring.

Back Connectors mount on Back Plate to give one point to check all chassis connections.

Terminal Panel Board with all components mounted in one plane, and Alden Unit Cable for interconnecting all panel elements with leads.

Layering of circuits using Alden Terminal Panels to segregate each main function and associate elements in one plane — for ease of assembly and check.

Masking of essential electronic elements yet with excellent heat dispersion and freedom from interaction, in a Basic Chassis.

How Alden Terminal Panel groups main functions and how plug-in units have parallel functions for largest amount circuitry per cubic space.

Alden "20" Packages house plug-in Units give independent shielding and heat dispersion.

Separate chassis may be stacked in Alden Uni-rack Cabinet. Cabinet can be interconnected within by Alden unit plug-in cables.

Alden Unit Cable — with variety of plug-in connectors. Carries wiring from chassis to chassis or rack to rack.

A turn of the Serve-a-Unit Lock handle — located in front panel — draws in unit against pressure — reverse turn ejects.

Alden Target Screw The Toolless Screw

The Captive Screw, never lost.

Chassis in carrying or serviceman's case or case to house spare.

Same chassis fits in Uni-Rack Cabinet for field or permanent use. In field all elements can be connected as fast as you can unload them.

SEND FOR the Alden Handbook — your key to practical production design — with components already tooled — yet can be modified — ready for volume production without delays or procurement headaches.



ALDEN PRODUCTS COMPANY 127 North Main Street, Brockton, Massachusetts



BURNELL AUDIO FILTERS
clock the speed of the
S. S. UNITED STATES



WE ARE PROUD TO ANNOUNCE THAT *ONLY* BURNELL & COMPANY AUDIO FILTERS WERE EMPLOYED IN THE HASTINGS INSTRUMENT COMPANY RAYDIST EQUIPMENT ABOARD THE S. S. UNITED STATES ON ITS RECORD SHATTERING RUN.

“Although the forces of nature combined to make the speed run AND the speed measurement extremely difficult, our raydist equipment using BURNELL filters surmounted all handicaps and exceeded specified accuracy”, said Mr. Hastings.

WE ARE HAPPY TO ADD THIS TO OUR EVER INCREASING LIST OF TESTIMONIALS ON THE QUALITY OF BURNELL'S TOROIDS AND AUDIO FILTERS.

Exclusive Manufacturers of Communications Network Components



Burnell & Company
YONKERS 2, NEW YORK
CABLE ADDRESS "BURNELL"



thinking in circles?

When you're about to order recording discs, do you begin to think in circles? Are you confused by claims of low cost, best lacquer, top quality? Then, consider PRESTO.

As America's pioneer producer of recording equipment and discs, PRESTO has brought its manufacturing process to the point where the PRESTO label is synonymous with perfection. Every step of disc production . . . the selection of the finest aluminum base . . . the exclusive lacquer flowing process, where the disc is untouched by human hands . . . the rigid inspection of each disc and the long curing process have set new standards in the disc industry.

It pays to think in circles before you order your next recording disc . . . if those circles contain the PRESTO label . . . your assurance of the finest disc that money can buy.

PRESTO
RECORDING CORPORATION
PARAMUS, NEW JERSEY

EXPORT DIVISION:

25 Warren Street,
New York 7, N. Y.

CANADIAN DIVISION:

Walter P. Downs, Ltd.
Dominion Square Bldg., Montreal

WORLD'S LARGEST MANUFACTURER

OF PRECISION

RECORDING EQUIPMENT

AND DISCS

PRECISION-BUILT *for*



WIRE-WOUND COMPONENTS

Now you can get a full line of high quality wire-wound components—all from one reliable source. Specially designed to meet the exacting and changing requirements of the electronics industry, every I-T-E wire-wound product is precision-built by quality-controlled methods.

Whatever your wire-wound needs, it will pay you to investigate I-T-E quality products. They're made to give you long, accurate, dependable performance—in every critical electronic application.

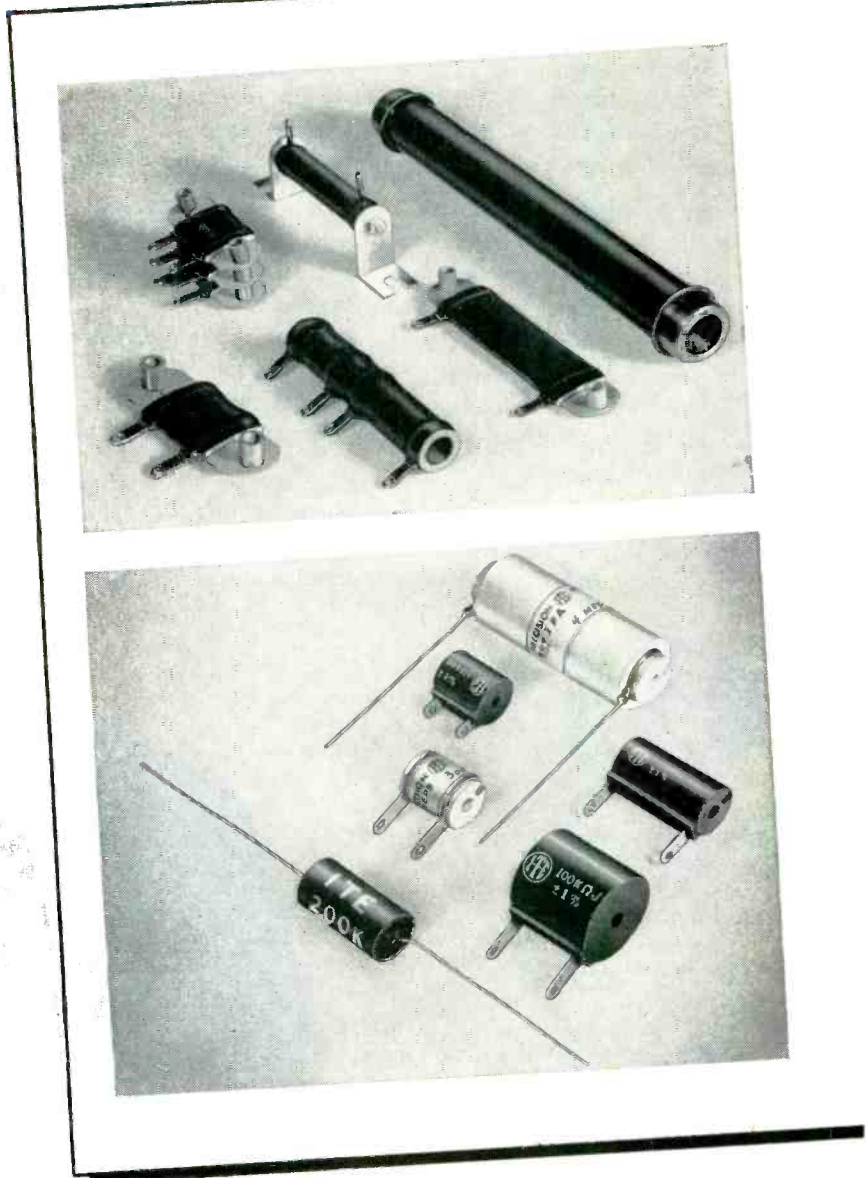

specify



WIRE-WOUND

I-T-E RESISTOR

1924 HAMILTON STREET • PHILADELPHIA 30, PA.

dependable performance

I-T-E POWER RESISTORS

- Non-hygroscopic ceramic foundations are in accordance with JAN specifications.
- Purest resistance wires are uniformly wound to prevent shorted turns and excessive hot spots. All connections silver-soldered.
- Vitreous enamel coating (organic if required) provides a glazed moisture-repellent surface with fast heat-dissipation qualities.
- Advanced production methods assure high stability, long life.

Standard tolerance: $\pm 10\%$, $\pm 5\%$ and less made to order.

I-T-E PRECISION RESISTORS

- High quality wire alloys are used—free from internal stresses and strains.
- Automatic precision winding assures even tension—eliminates hot spots.
- Hermetic or vacuum-impregnated sealing protects against destructive effects of salts, moisture, and atmospheric conditions.
- Accelerated aging process prior to calibration assures accuracy.
- Critical quality control eliminates all resistors which do not come up to high I-T-E standards.

Standard tolerance: $\pm 1\%$. Available in specified tolerances down to $\pm 0.05\%$.

Standard fixed resistors:
5-200 watts

Adjustable resistors:
10-200 watts

Oval resistors:
30-75 watts

Ferrule resistors:
12-200 watts

Special resistors:
built to specifications

TYPE A:

lightweight, hermetically sealed—for precision operation up to 125 C. Surpass JAN R-93 A, Characteristic A, and MIL R-93 A specifications.

TYPE B:

Vacuum-impregnated, moisture-resistant. For JAN R-93, Characteristic B, specifications.

Ratings from 0.01 ohm—10 megohms, 0.125—5 watts.



I-T-E DEFLECTION YOKES

I-T-E offers you high quality deflection yokes—all built with uniform characteristics. Wire size and quality are constantly checked. Coils are impregnated in special moisture-resistant thermoplastic—properly cured to insure a firm coil with minimum losses. Deflection yokes can be obtained complete with wire leads, resistors, and capacitors—to your specifications.



PRODUCTS

DIVISION

A DIVISION OF THE I-T-E CIRCUIT BREAKER CO.

FOR DETAILS—

get in touch with your nearest I-T-E representative. Or, send for your copies of the I-T-E Power Resistor Catalog and the new Precision Resistor Bulletin 100A today.

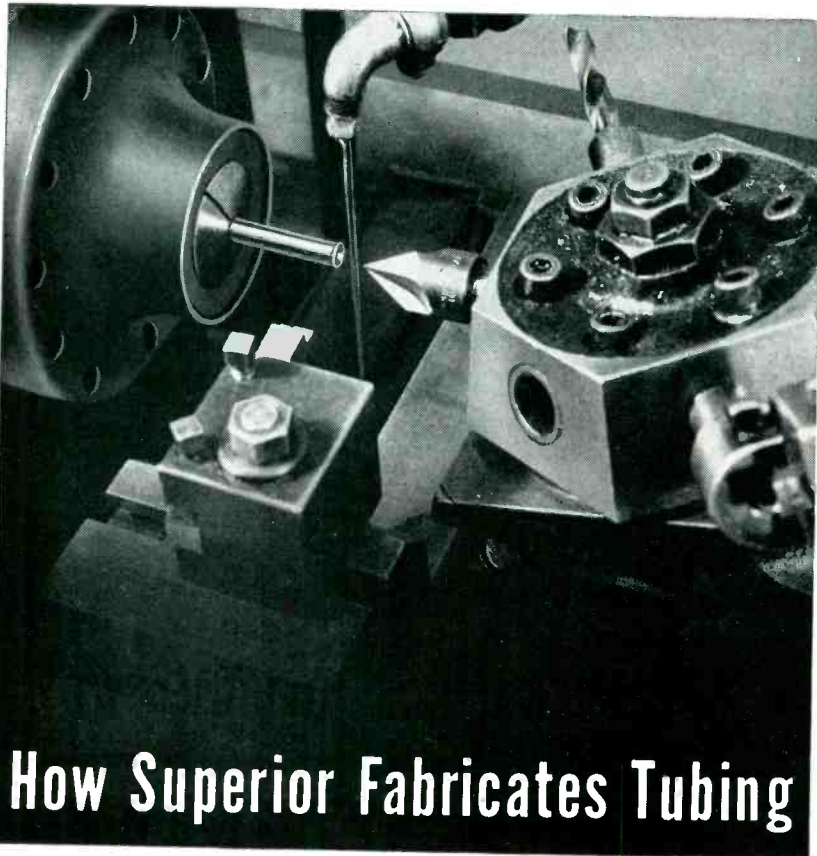

How Superior Fabricates Tubing

to give you the parts you need

Need a tubular part machined, inside or out, at one or both ends?

Like to have it drilled transversely at one or several points?

Want it to meet rigid dimensional and metallurgical specifications?

You're reading the right advertisement for all of these are Superior Specialties.

Superior has the experienced men, the specialized, highly developed equipment, the floor space, and the research facilities to produce quantities of drilled and machined tubular parts rapidly and economically.

It's a job we like to do and know how to do. But there's more to the story than simple production of fabricated or semi-finished parts, or even top-quality tubing in any analysis and many sizes.

The rest of the story is our willingness, desire and ability to work closely with customers' development engineers and product designers. Frequently we are able to materially assist in design of parts, selection of analysis, and development of processes. Many times we have been able to suggest minor changes in shape or method to effect major economies in assembly time and product cost.

If you are a manufacturer or an experimenter in electronics and have a need for a tubular part of any kind, check with us. We can probably help by giving you quantity production of the parts you need. Write Superior Tube Company, 2500 Germantown Ave., Norristown, Pennsylvania.

This Belongs in Your Reference File

... Send for It Today.

NICKEL ALLOYS FOR OXIDE-COATED CATHODES: This reprint describes the manufacturing of the cathode sleeve from the refining of the base metal. Includes the action of the small percentage impurities upon the vapor pressure, sublimation rate of the nickel base; also future trends of cathode materials are evaluated.

SUPERIOR TUBE COMPANY • Electronic products for export through Driver-Harris Company, Harrison, New Jersey • Harrison 6-4800

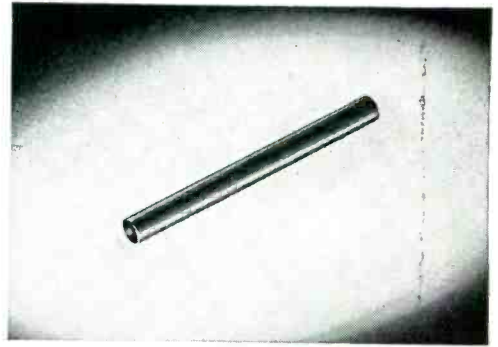

Cut and Annealed. Extensive cutting equipment, hand cutting jigs, electronically controlled annealers and other equipment, much of it developed within our own organization results in high speed, precision production of parts.

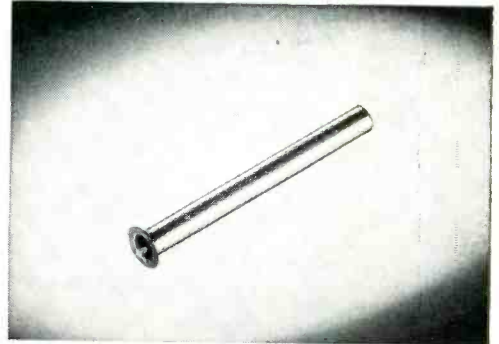

Flanging. Automatic flaring and flanging machines are combined in Superior's Electronics Division with carefully trained production and inspection personnel who know how to do a job right and take the time to be sure.



Expanded. Here is a part almost ready for delivery. Simple as it looks, it may well have been the subject of a score of operations and at every stage the prime consideration has been the *quality* of the finished part.



THE BIG NAME IN SMALL TUBING

All analyses .010" to 1/4" O.D.
Certain analyses (.035" max. wall) Up to 1 1/4" O.D.

VACUUM

FACTS

It's a **FACT** ...



... Kinney originated the rotating plunger vacuum pump ... universally acclaimed for fast pump down and quick recovery.

It's a **FACT** ...



... Kinney pioneered the oil-sealed pumping system.

It's a **FACT** ...



... Kinney is the **BIG LINE** of mechanical vacuum pumps ... more models, more sizes, more capacities to choose from.

It's a **FACT** ...



... Only Kinney offers in such a wide range both single stage and compound vacuum pumps — for creating and maintaining low absolute pressures alone or with diffusion pumps.

It's a **FACT** ...



... More vacuum processes depend on Kinney Vacuum Pumps than on any other make or type of pump.

Find out for yourself how Kinney Vacuum Pumps can help in your low pressure processes — in laboratory, pilot plant, or production.

Send coupon or write for details.



Kinney Manufacturing Co., Boston 30, Mass. Representatives in New York, Chicago, Detroit, Cleveland, Atlanta, Philadelphia, Pittsburgh, Johnstown (Pa.), Los Angeles, Charleston (W. Va.), Houston, New Orleans, San Francisco, Seattle and foreign countries.



SUBSIDIARY OF THE NEW YORK AIR BRAKE CO.

KINNEY MANUFACTURING CO.

3565 Washington St., Boston 30, Mass.

Please send new Bulletin V-51B. Our vacuum problem involves:

- | | | |
|--|--|--|
| <input type="checkbox"/> Vacuum drying | <input type="checkbox"/> Vacuum coating | <input type="checkbox"/> Vacuum metallurgy |
| <input type="checkbox"/> Vacuum impregnating | <input type="checkbox"/> Vacuum distillation | <input type="checkbox"/> Vacuum research |

Name

Company

Address

City State

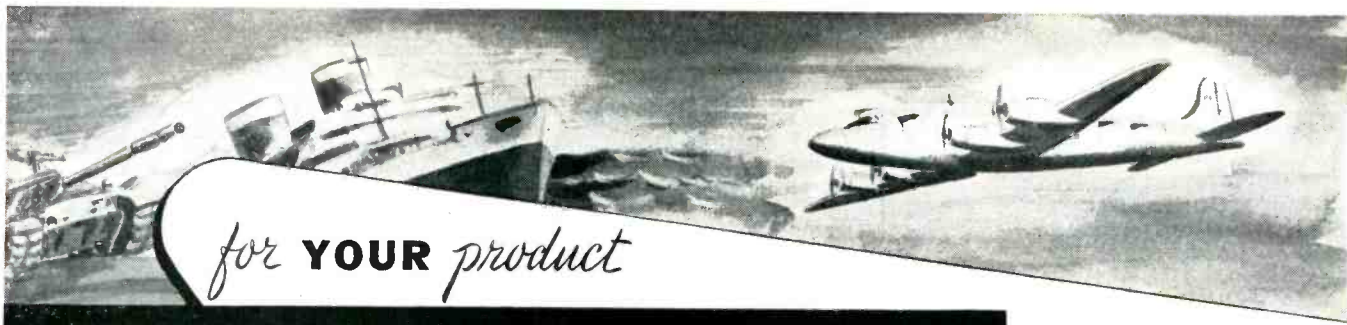

for **YOUR** product

WHICH PILOT LIGHT DO YOU NEED?



THE BIG ONE

This Pilot Light Assembly was first made to accommodate the *S-11 lamp* and was intended for use in the cabs of great diesel locomotives.

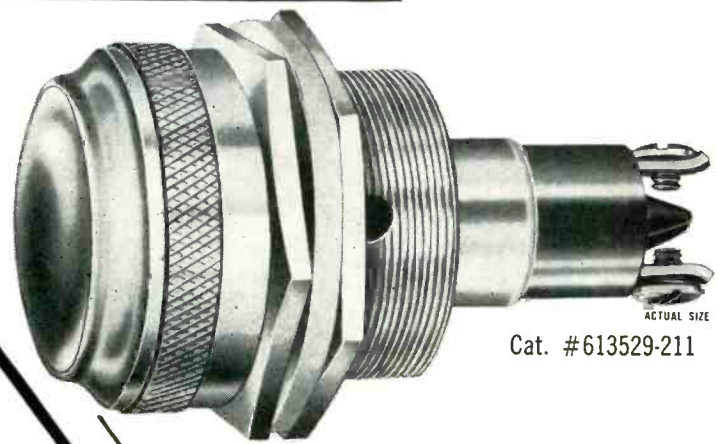

ACTUAL SIZE
Cat. #613529-211

Dialco HAS THE COMPLETE LINE OF INDICATOR and PANEL LIGHTS

This BIG one

or

THE LITTLE ONE

this LITTLE one

The miniaturization program on defense products required the development of this *sub-miniature* light. It is used on communication equipment and aircraft. Midget flanged base bulbs to fit are rated 1.3, 6, 12, and 28 volts.



ACTUAL SIZE
Cat. #8-1930-621

Samples

to suit your own special conditions and requirements will be sent promptly and *without cost*. Just outline your needs. Let our engineering department assist in selecting the *right lamp* and the *best pilot light* for YOU.



Write for the Dialco HANDBOOK of PILOT LIGHTS
Foremost Manufacturer of Pilot Lights

The DIAL LIGHT COMPANY of AMERICA

60 STEWART AVE., BROOKLYN 37, N. Y. HYACINTH 7-7600

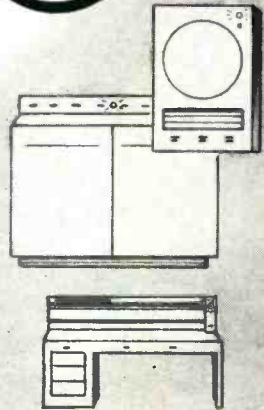

© 1952

IT PAYS TO Bring your relay problems to CLARE

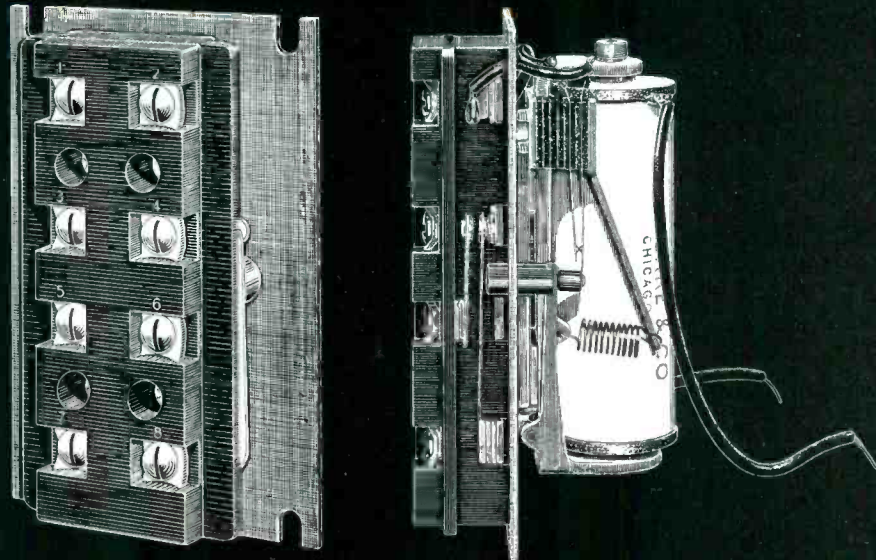

Front View

Side View

CLARE Type "CP" POWER RELAY

• Some of the most important relay developments of the past decade have been the result of CLARE cooperation with engineering staffs of acknowledged leaders in the electrical and electronic industries.

Development of the CLARE Type CP Power Relay, for instance, came about from a consultation with a large electrical manufacturer who uses power relays extensively in the manufacture of various electronic control units. This CLARE customer objected to the use of ordinary power relays in plate circuit applications because one watt or more was required to operate them. Also, this necessitated the use of a high-current thyatron tube, or the interposition of another, more sensitive relay. He wanted a power relay sensitive enough to operate in the plate circuit of any triode, including miniatures.

Years of satisfactory service from CLARE tele-

phone-type relays had convinced the customer's engineers that the best way to achieve this would be to adapt these sensitive, dependable, durable relays to suit the special requirements of their use as power relays. Valuable contributions to the design of the CLARE Type CP Power Relay were made by the customer's engineers.

The result of this cooperation between these engineers and the CLARE engineering staff is a relay which simplified control equipment, saves money and space, and will outwear several ordinary power relays.

CLARE engineers, both in the field and in the plant, are anxious and willing to cooperate with you and your engineers to solve perplexing relay problems. Call the nearest CLARE office or write: C. P. Clare & Co., 4719 West Sunnyside Avenue, Chicago 30, Illinois. In Canada: Canadian Line Materials Ltd., Toronto 13. Cable Address: CLARELAY.

CLARE RELAYS

First in the Industrial Field

VOLTAGE REGULATED POWER SUPPLY

MODEL 700

The Kepco Model 700 features one regulated voltage supply with excellent regulation, low ripple content and low output impedance.

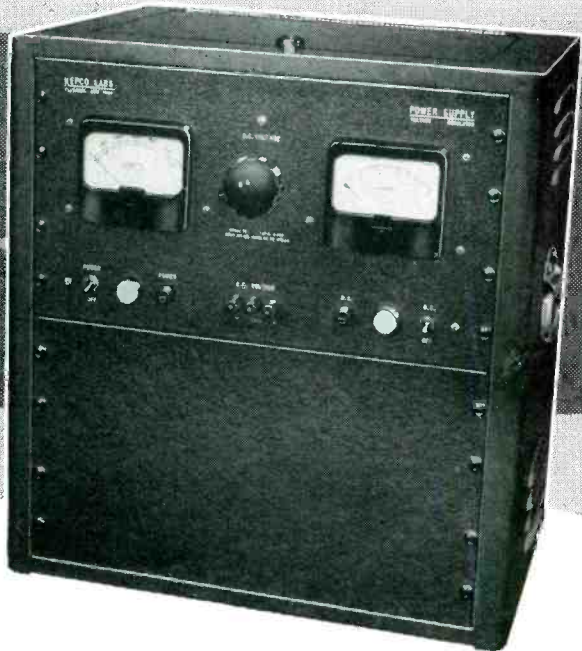

SPECIFICATIONS

OUTPUT VOLTAGE DC: 0-350 volts continuously variable.

OUTPUT CURRENT DC: 0-750 milliamperes continuous duty.

REGULATION: In the range 30-350 volts the output voltage variation is less than 1/2% for both line fluctuations from 105-125 volts and load variation from minimum to maximum current.

RIPPLE VOLTAGE: Less than 10 millivolts.

FUSE PROTECTION: Input and output fuses on front panel. Time delay relay is included to protect rectifier tubes.

POWER REQUIREMENTS: 105-125 volts, 50-60 cycles.

OUTPUT TERMINATIONS: DC terminals are clearly marked on the front panel. Either positive or negative terminal of the supply may be grounded. DC terminals are isolated from the chassis. A binding post mounted on the front of the panel is available for

connecting to the chassis. All terminals are also brought out at the back of the chassis.

METERS:

Ammeter: 0-1 ampere, 4" rectangular.

Voltmeter: 0-500 volts, 4" rectangular.

PHYSICAL SPECIFICATIONS: Cabinet height 22 3/4", width 21 3/4", depth 15 1/4". Rack panel height 21", width 19", color gray, panel engraved.

CONTROLS: Power on-off switch, H.V. on-off switch, H.V. control.

ADDITIONAL MODELS AVAILABLE IN THE 700 SERIES VOLTAGE REGULATED POWER SUPPLIES

Volts	Current	Model
0-350	0-0.75 Amp.	700
0-350	0-1.50 Amp.	710
0-350	0-2.25 Amp.	720
0-350	0-3.00 Amp.	730
0-600	0-0.75 Amp.	750
0-600	0-1.50 Amp.	760
0-600	0-2.25 Amp.	770
0-600	0-3.00 Amp.	780

FOR NEW POWER SUPPLY CATALOG — WRITE DEPT. #1



KEPCO LABORATORIES, Inc.

131-38 SANFORD AVENUE

FLUSHING 55, NEW YORK



If it uses gas, it can use **SYNTHANE**

"I like to stand at the corner of Market and Main in my home town," one Synthane representative tells us, "and watch the traffic on a Saturday afternoon."

"There are our customers on parade... anything that uses gas—passenger cars, trucks, fire engines, motorcycles... Joe Zink's tractor... even the gas pumps at Eddie's service station use parts made from Synthane laminated plastics."

The reason is plain. When America turns on the ignition key it expects to go places. Back of this confidence are components.

Reliable components have to be made from dependable materials. Synthane is such a material. So you find it in water pumps because it makes a good seal washer, in differential thrust washers because of its wear resistance, in power steering for its light weight and rigidity, in starting and lighting equipment because it is an excellent electrical insulator and machines like a breeze.

Synthane might be a material you can use. The Synthane Catalog will help you decide. Send for your copy. Synthane Corporation, 6 River Road, Daks Penna.

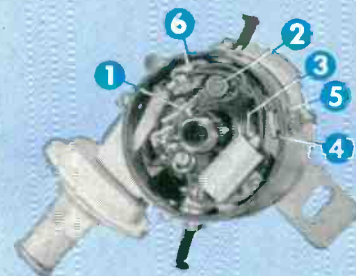

Avolite distributor uses laminated plastics in 6 places. (1) and (2) insulating angle and bushing on breaker arm (3) condenser seal washer, (4), (5), (6) insulating washers.

Synthane—one of industry's unseen essentials

SYNTHANE

LAMINATED PLASTICS

Bomac

FOR GAS SWITCHING TUBES TR, ATR, PRE-TR, HYDROGEN THYRATRONS CRYSTALS AND MICROWAVE COMPONENTS



BAND	FREQ.	DESCRIPTION	TYPE
K BAND	23630-24580	TR, Integral Cavity, Tunable	1B26
	23500-24500	ATR, Fixed-Tuned, Low Q	1B36
	23350-24950	TR, Band Pass	BL-11
X BAND	9300-9450	Cross Guide Duplexer	BL-3
	9050-9600	ATR, Fixed-Tuned, Low Q	1B35
	9050-9600	ATR, Fixed-Tuned, Low Q Fast Recovery Time	6038
	8750-9300	ATR, Fixed-Tuned, Low Q	ATR388
	8600-9650	TR, Glass Envelope, Fixed-Tuned	724B
	8600-9050	ATR, Fixed-Tuned, Low Q	1B37
	8490-9600	TR, Integral Cavity, Tunable	1B24A
	8490-9600	TR, Integral Cavity, Tunable	1B60
	8490-9578	TR, Band Pass	1B63A
	8490-9600	TR, Integral Cavity, Tunable Reservoirless	BL-22
Xb BAND	6200-6700	ATR, Fixed-Tuned, Low Q	1B51
	6000-7100	TR, Integral Cavity, Tunable	1B50
S BAND	3550-3700	ATR, Fixed-Tuned, Low Q	1B52
	3400-3550	ATR, Fixed-Tuned, Low Q	1B53
	3300-3700	Pre-TR	1B54
	3250-3400	ATR, Fixed-Tuned, Low Q	1B57
	3100-3650	TR, Band Pass	1B55
	3000-3100	ATR, Fixed-Tuned, Low Q	5793
	2900-3000	ATR, Fixed-Tuned, Low Q	5792
	2870-3230	TR, Band Pass	5853
	2800-2900	ATR, Fixed-Tuned, Low Q	1B56
	2750-2850	ATR, Fixed-Tuned, Low Q	ATR387
	2700-3400	TR, Glass Envelope, Tunable	1B27
	2700-3300	TR, Glass Envelope, Fixed-Tuned	1B62
	2700-3300	TR, Glass Envelope, Fixed-Tuned	721B
	2700-2800	ATR, Fixed-Tuned, Low Q	1B44
	2650-2950	Pre-TR	1B38
	2600-3000	TR, Band Pass	1B58
2600-3000	TR, Band Pass Pressurized System	6117	
L BAND	1215-1355	TR, Glass Envelope, Tunable	BL-25
	900-1200	TR, Glass Envelope, Fixed-Tuned	1B23
	1075-1095	TR, Fixed-Tuned, Electrodeless Discharge	1B40
Ku BAND	16,200-16,800	ATR, Fixed-Tuned, Low Q	BL-15
	16,200-16,800	TR, Integral Cavity, Tunable	BL-16

SPARK GAP MODULATORS



1B41
1B45

Simplify Your Procurement Problems . . .

Bomac, leading producer of gas switching tubes, offers you a single source for TR, ATR, Pre-TR and Attenuator Tubes, Pressurizing Windows, Hydrogen Thyratrons, and Crystals. Why not simplify your procurement problems? Make *Bomac* your ONE source for all of your special requirements.

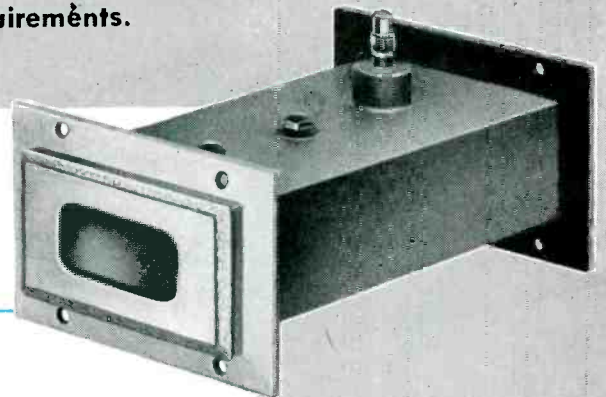

HYDROGEN THYRATRONS

Type	Peak Anode Voltage	Peak Anode Current	Average Anode Current	Peak Trigger Voltage
	kv max.	amps max.	ma max.	volts min
3C45	3.0	35	45	175
4C35	8.0	90	100	175
5C22	16.0	325	200	200

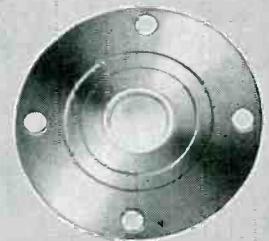

PRESSURIZING WINDOWS

TYPE	FREQUENCY	DESCRIPTION
BL105	9375	Pressurizing Window RG 51/u Guide
BL106	9245	Pressurizing Window RG 52/u Guide
BL107	9310	Rectangular Window RG 51/u Guide
BL114	9310	Pressurizing Window RG 52/u Guide
BL112	9080	Pressurizing Window RG 52/u Guide

CRYSTALS — Silicon Detectors & Germanium Diodes

To meet the growing demand for Germanium and Silicon crystals, Bomac now is in limited quantity production. Availability to industry will be announced at a later date. . . .

We invite your inquiries regarding

- ENGINEERING
- DEVELOPMENT
- PRODUCTION



Illustrated catalog available upon request. Write today on your company letterhead.

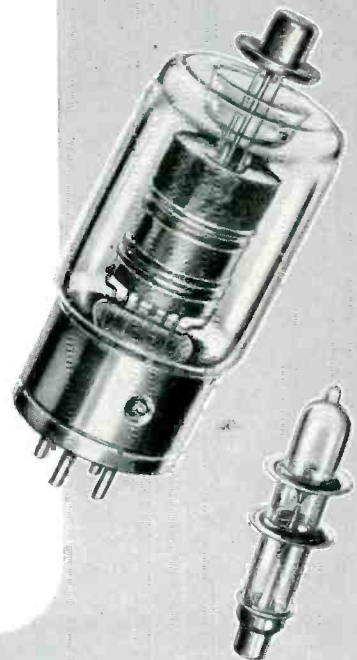

Bomac

LABORATORIES, INC.

DEPARTMENT E-1
BEVERLY, MASSACHUSETTS

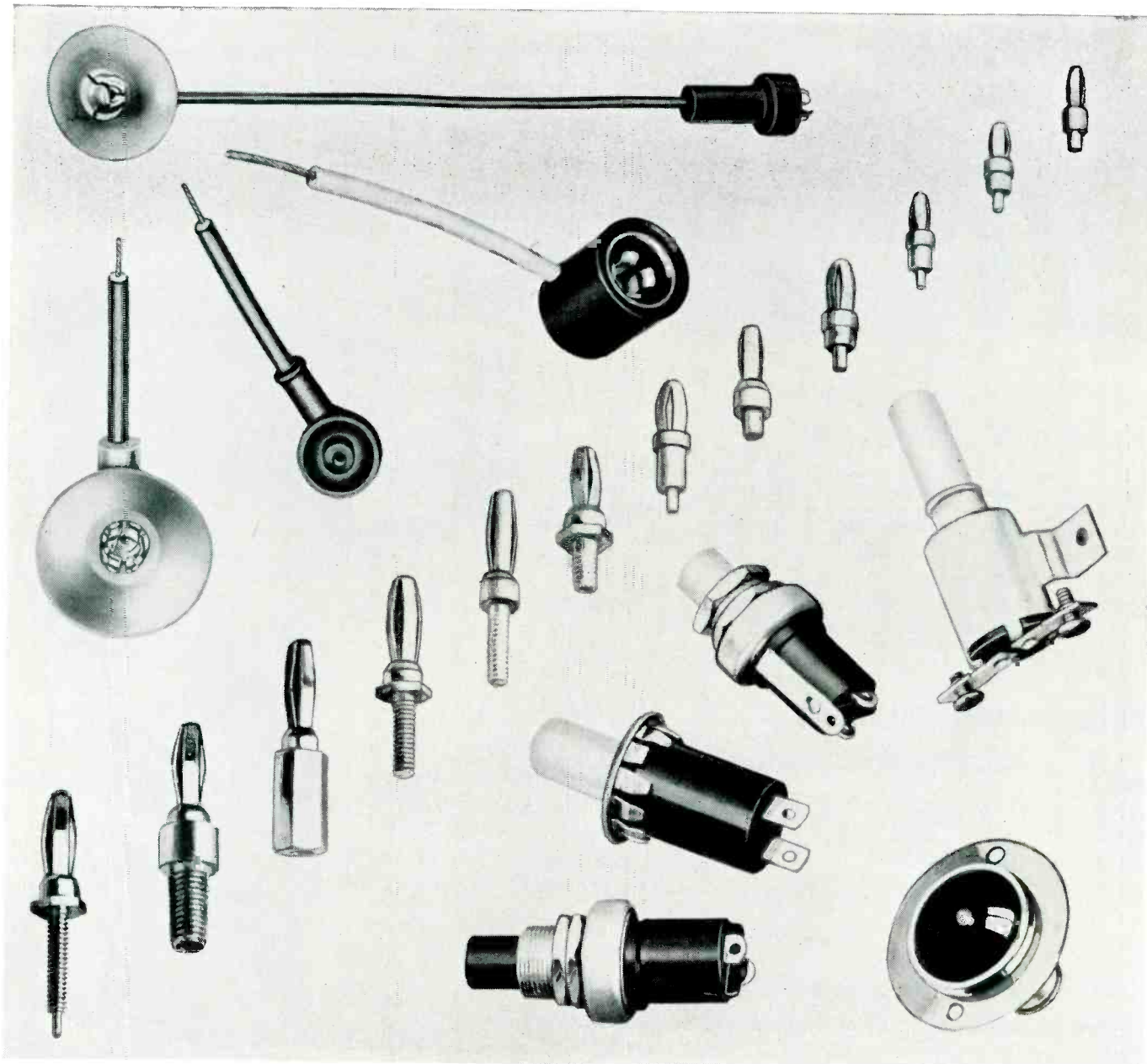

Precision Pays

Precision has always been a watchword at Ucinite . . . precision in design and precision in manufacture. It pays off in the high quality and dependable performance of Ucinite-designed, Ucinite-made electrical components.

Connectors, switches, sockets . . . shock mounts, tube caps, stampings and moldings of many kinds can be manufactured in volume, assembled and wired to your specifications.

Our design staff has had wide experience in catering to the special needs, both civilian and military, of the electronics industry. Our plant is equipped both for large scale production of metal parts and for the assembly of metal to plastic and ceramic components.

Call your nearest Ucinite or United-Carr representative for full information, or write directly to us.



The
UCINITE CO.
Newtonville 60, Mass.
Division of United-Carr Fastener Corp.

}

Specialists in
ELECTRICAL ASSEMBLIES,
RADIO AND AUTOMOTIVE

11,000 gallons through "single-point fueling" in 18 minutes . . .

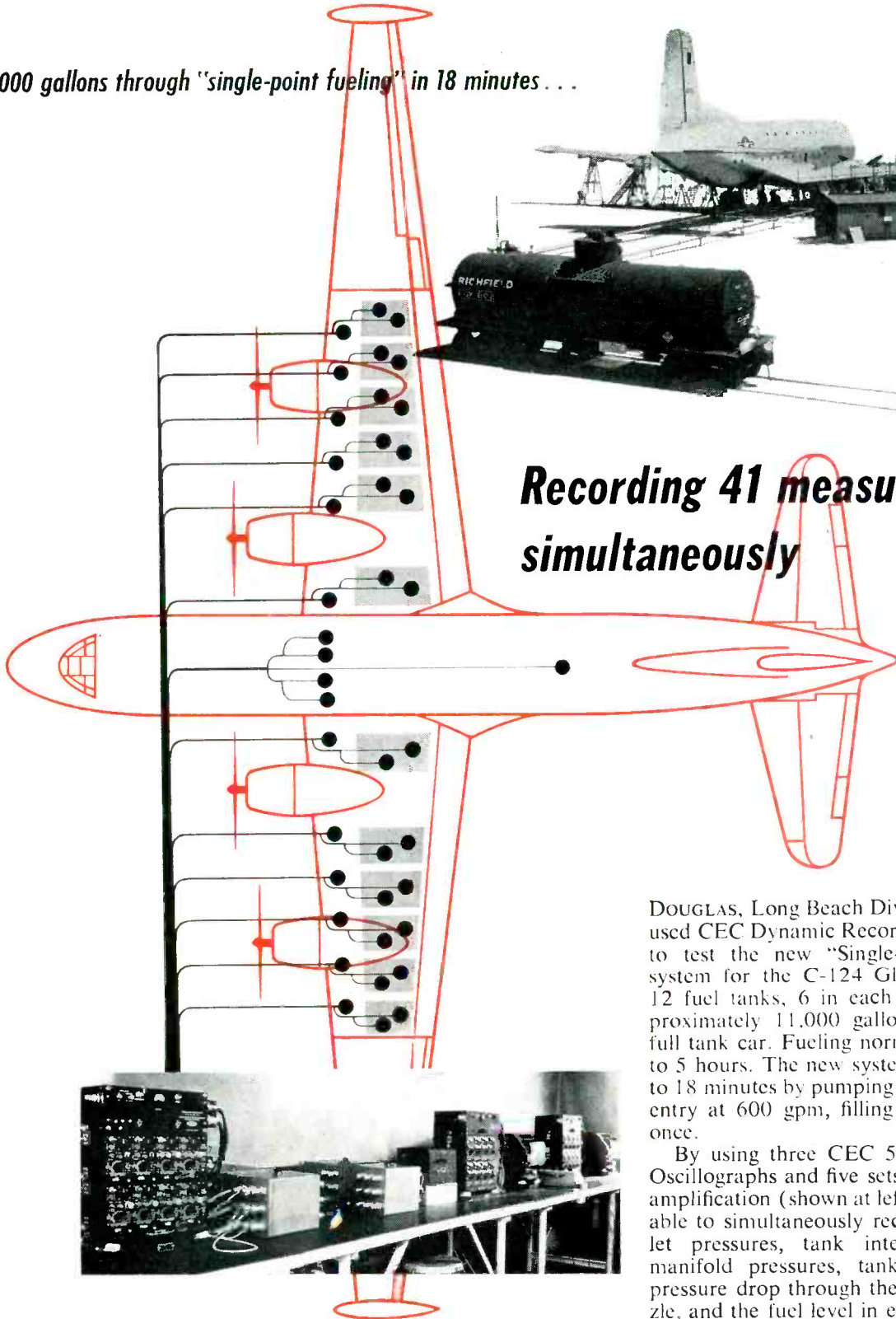
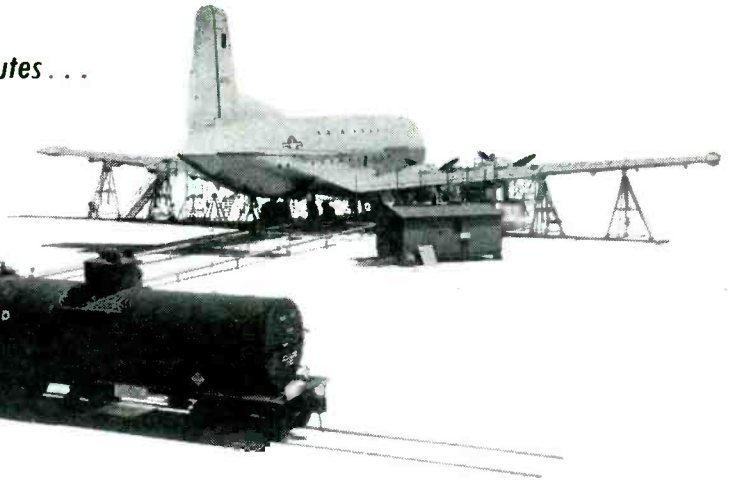

Recording 41 measurements simultaneously

DOUGLAS, Long Beach Division, engineers used CEC Dynamic Recording Equipment to test the new "Single-Point Fueling" system for the C-124 Globemaster. The 12 fuel tanks, 6 in each wing, hold approximately 11,000 gallons—equal to a full tank car. Fueling normally requires 4 to 5 hours. The new system cuts this time to 18 minutes by pumping through a single entry at 600 gpm, filling all 12 tanks at once.

By using three CEC 5-114 Recording Oscillographs and five sets of System "D" amplification (shown at left), Douglas was able to simultaneously record all tank inlet pressures, tank internal pressures, manifold pressures, tank shut-off time, pressure drop through the main inlet nozzle, and the fuel level in each tank. In all, the findings of 29 pressure pickups and 12 capacitance fuel gages were recorded.

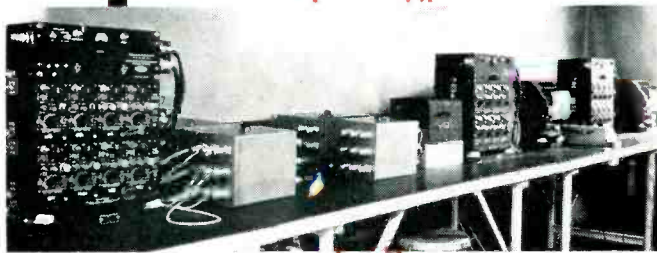

Consolidated Engineering

CORPORATION

300 North Sierra Madre Villa, Pasadena 15, California

Sales and Service through **CEC INSTRUMENTS, INC.**
a subsidiary with offices in: Pasadena, New York, Chicago,
Washington, D. C., Philadelphia, Dayton.

*analytical
instruments
for science
and industry*

Dynamic Recording Systems

such as the one shown here are designed and manufactured by Consolidated. Variations in the arrangement of the equipment are infinite. Applications are widely varied throughout industry and the sciences. A typical recording system includes pickups, amplifiers or bridge balances, and a recording oscillograph. Write for Bulletin CEC 1500B.

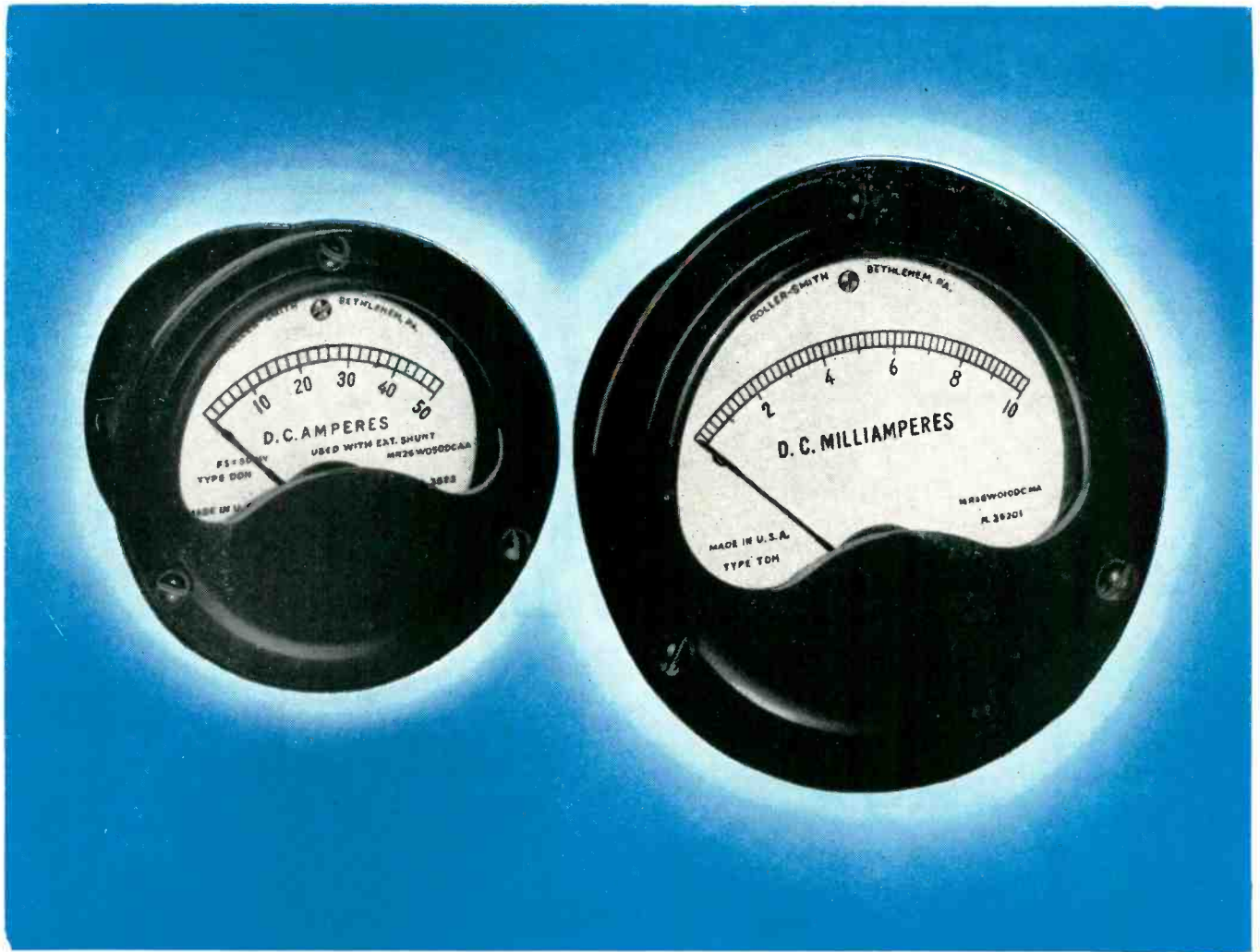

Roller-Smith Ruggedized Instruments

Shock-Proof • Vibration-Proof • Weather-Proof

Roller-Smith announces production of hermetically sealed *Ruggedized* 2½" and 3½" instruments conforming to MIL-M-10304.

In addition to *Ruggedized* instruments, a complete line of hermetically sealed and unsealed types in conformance with Government specifications are available.



ROLLER-SMITH CORPORATION
BETHLEHEM, PENNSYLVANIA

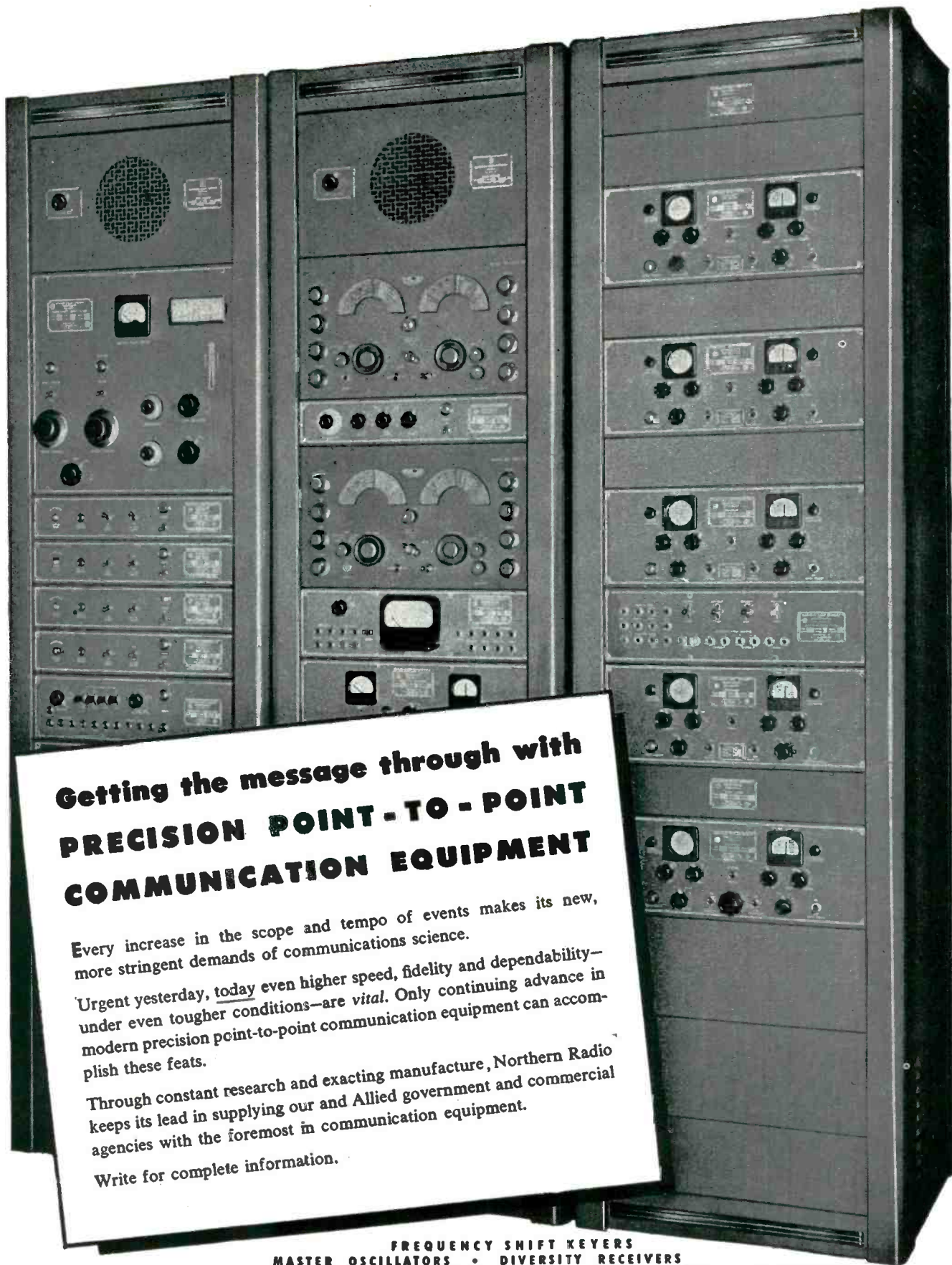

**Getting the message through with
PRECISION POINT - TO - POINT
COMMUNICATION EQUIPMENT**

Every increase in the scope and tempo of events makes its new, more stringent demands of communications science.

Urgent yesterday, today even higher speed, fidelity and dependability—under even tougher conditions—are vital. Only continuing advance in modern precision point-to-point communication equipment can accomplish these feats.

Through constant research and exacting manufacture, Northern Radio keeps its lead in supplying our and Allied government and commercial agencies with the foremost in communication equipment.

Write for complete information.

- FREQUENCY SHIFT KEYS
- MASTER OSCILLATORS • DIVERSITY RECEIVERS
- FREQUENCY SHIFT CONVERTERS • MULTI-CHANNEL TONE SYSTEMS
- TONE KEYS • DEMODULATORS • RADIO MULTIPLEX SYSTEMS
- MONITORS • TONE FILTERS • LINE AMPLIFIERS

*Pace-Setters in Quality
Communication Equipment*

NORTHERN RADIO COMPANY, inc.



147 WEST 22ND STREET, NEW YORK 11, NEW YORK

The Electric Candy Floss Machine Co.

"A pink cotton candy machine rheostat must provide exact temperature control"

says John G. Pettyjohn, John G. Pettyjohn Company, Knoxville, Tennessee, representative for Ward Leonard Electric Company.



Spinning sugar into fine, fluffy floss for pink cotton candy requires precise heat control. Unless a high degree of heat is closely controlled, candy becomes too thick or too thin. Since these machines are used at circuses, traveling carnivals, resorts, and similar places, machines must be ruggedly built. They must also be able to compensate for variance in voltage and surrounding temperature, depending upon the location.

The Electric Candy Floss Machine Company, Nashville, Tenn., uses Ward Leonard VITROHM plate rheostats in the heater circuits on the spinner heads of their new

super deluxe candy floss machines for two reasons:

- (1) VITROHM rheostats are the only rheostats they have found that would stand up and give good service,
- (2) they are able to get a much better grade of candy.

Ward Leonard rheostats are available in several multiples of resistance values to meet various operating conditions. Special purpose rheostats requiring non-standard values and tapers can also be supplied.

Our engineering department is always ready to work with you to design the most economical rheostat for your particular application. Write for Rheostat Bulletin 60A.



WARD LEONARD ELECTRIC COMPANY

MOUNT VERNON, NEW YORK

Result-Engineered Controls Since 1892



ERICK SCHNEIDER, a company employee for over 23 years, operates a hydraulic press for securing the bushing assembly to the rheostat base plate.

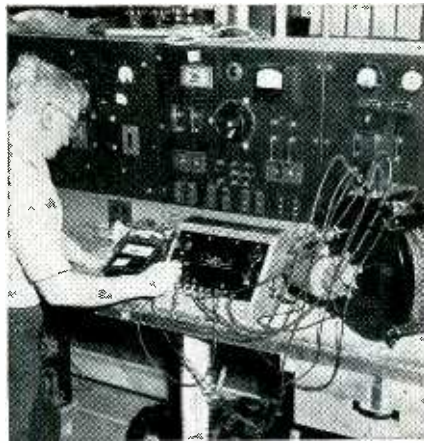

MOTOR-DRIVEN RHEOSTAT undergoes a thorough electrical test prior to final inspection. Ian Scott, a company employee for 17 years, is the electrical tester.

VITROHM

rheostat construction assures smooth, precise control and long life

Five features of VITROHM rheostat construction important to efficient operation are:

(1) Pressed steel plate forms a rigid, durable, but lightweight base.

(2) Resistance element of special alloy wire, of low temperature coefficient of resistance assures permanent resistance values.

(3) Stationary contacts are solidly anchored to the resistance element by a patented Ward Leonard process assuring a perfect junction.

(4) Movable contact is made of solid metal graphite having self-lubricating properties for smooth operation.

(5) VITROHM insulation applied over the resistance wire holds the wire and contacts in place and protects them against corrosion, mechanical damage.

Consult Ward Leonard on the adaptability of standard or modified electric controls to meet your particular needs.



HEAT-RESISTANT FINISH is automatically applied and infrared baked. Arthur Vasold removes finished plates and loads sand-blasted plates on continuous conveyor.



REVOLVING BALL MILLS grind the frit to the exact fineness needed to produce the perfect vitreous enamel used in the manufacture of the VITROHM rheostat.

DISTRICT OFFICES AND REPRESENTATIVES

Atlanta 5, Georgia	C. B. Rogers and Associates
Baltimore 18, Md.	Durling Electric Co.
Charlotte 1, N. C.	James L. Highsmith & Co.
Chicago 4, Illinois	Ward Leonard Electric Co.
Cincinnati 2, Ohio	Sheldon Storer and Assoc.
Cleveland 14, Ohio	The Ambos-Jones Co.
Corpus Christi, Texas	Branche-Krachy Co., Inc.
Denver 2, Colorado	Mark G. Mueller
Detroit 21, Michigan	Jesse W. Eakins Co.
Hartford 6, Conn.	Ward Leonard Electric Co.
Houston 1, Texas	Branche-Krachy Co., Inc.
Kansas City 2, Mo.	Maury E. Bettis Co.
Knoxville, Tennessee	John G. Pettyjohn
Los Angeles 13, Calif.	Ward Leonard Electric Co.
Memphis 3, Tenn.	E. E. Torkell
Minneapolis 5, Minn.	Marvin H. Kirkeby
Newark 2, N. J.	Ward Leonard Electric Co.
New Orleans 13, La.	Electron Engineering Co.
Philadelphia 17, Pa.	Ward Leonard Electric Co.
Pittsburgh 16, Pa.	W. A. Bittner
Roanoke, Virginia	Lynn H. Morris
Rochester 7, N. Y.	Ward Leonard Electric Co.
St. Louis 10, Mo.	Ward Leonard Electric Co.
Salt Lake City 1, Utah	Leonard M. Slusser
San Antonio, Texas	Branche-Krachy Co., Inc.
San Francisco 3, Calif.	L. F. Church Co.
Seattle 4, Wash.	Northwestern Agencies, Inc.
Tucson, Arizona	Central Station Equipment Co.
Washington 5, D. C.	Federal Engineering Co., Inc.

CANADA

Edmonton, Alta.	D. M. Fraser, Ltd.
Halifax, N. S.	D. M. Fraser, Ltd.
Montreal 25, P. Q.	D. M. Fraser, Ltd.
Toronto 1, Ont.	D. M. Fraser, Ltd.
Vancouver, B. C.	D. M. Fraser, Ltd.
Winnipeg, Man.	D. M. Fraser, Ltd.

EXPORT

New York 4, N. Y. | Ad. Auriema, Inc.



RHEOSTATS



RELAYS



MOTOR CONTROLS



CHROMASTER

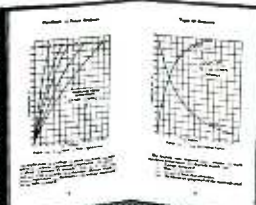

Ward Leonard's complete engineering textbook, "Handbook of Power Resistors," \$3 per copy.

MALLORY
paper
dielectric
capacitors
JAN-C-25 types

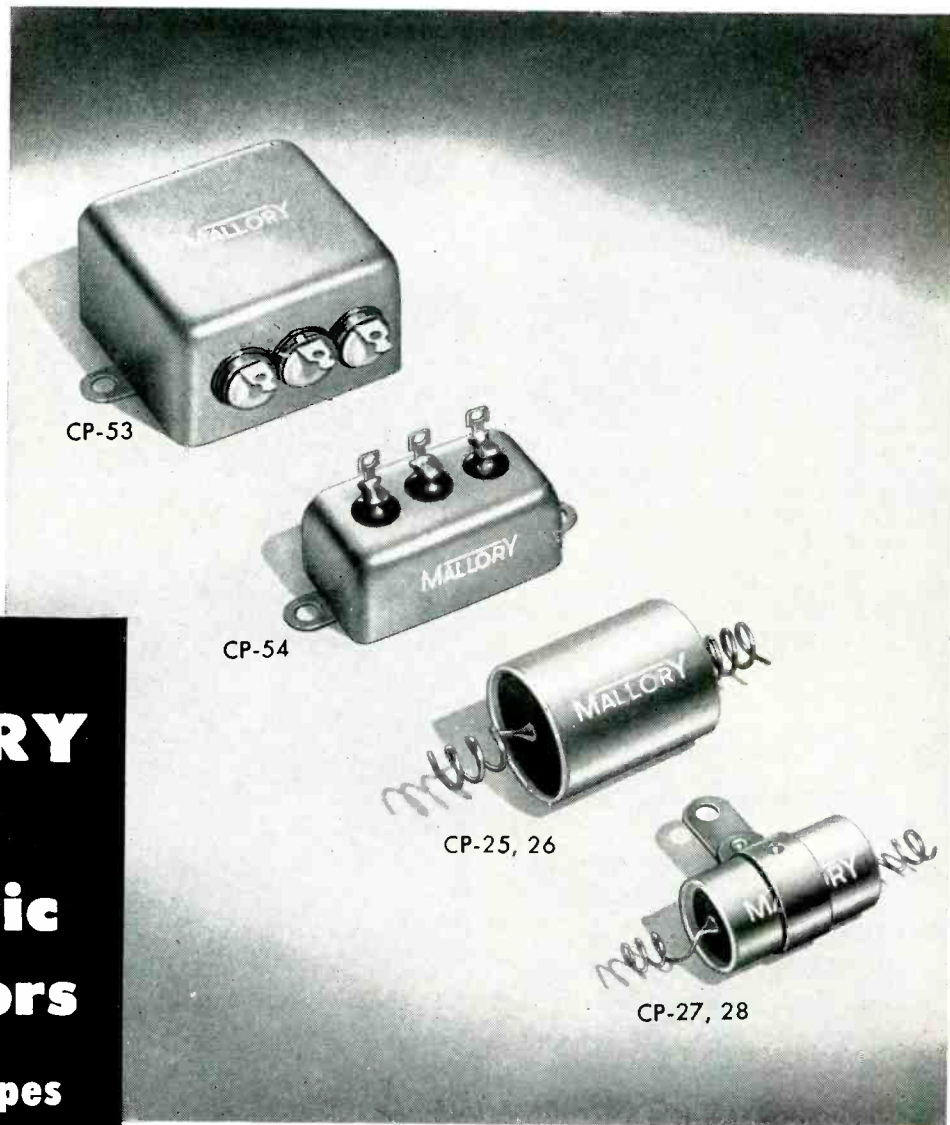

For use in military electronic equipment, Mallory manufactures a line of paper dielectric capacitors which will conform to Characteristic E of Specification JAN-C-25. Included in the Mallory line are the following types:

CP-25, CP-26, CP-27, CP-28
 CP-29, CP-53, CP-54, CP-55

Into these military-type capacitors go the same engineering know-how and production craftsmanship which have made Mallory capacitors the standard of quality in the industrial and electronic fields. They are now in quantity production and your inquiry will receive prompt attention.

Look to Mallory for all your capacitor needs . . . whether for military or civilian applications.

**New Folder Describes
 JAN-C-62 Capacitor Types**

In addition to paper dielectric capacitors Mallory produces a full line of electrolytic capacitors conforming to JAN-C-62. Write for your copy of the new Technical Information Bulletin. It is an ideal reference for everyone who uses or specifies electrolytic capacitors.

P. R. MALLORY & CO., Inc.
MALLORY

SERVING INDUSTRY WITH THESE PRODUCTS:

Electromechanical—Resistors • Switches • Television Tuners • Vibrators
Electrochemical—Capacitors • Rectifiers • Mercury Dry Batteries
Metallurgical—Contacts • Special Metals and Ceramics • Welding Materials

P. R. MALLORY & CO., INC., INDIANAPOLIS 6, INDIANA



CROSS TALK

► **COLOR** . . . Lifting of the freeze gave the television industry a shot in the arm that will keep it very much alive and kicking for many years. And when the rejuvenated body again begins to slow down along will come more adrenalin in the form of color; there may even be a modest injection before the arteries show serious signs of hardening.

It now seems certain that when color comes again it will be compatible. People who have monochrome sets will be able to watch programs transmitted in color without buying accessories. They will, of course, see these programs in monochrome. If they want to see color programs in color they will probably buy a new set. And there is no reason to suppose that this necessity will be widely resented. People always have been willing to spend more money for more service, in this and every other business.

Already several companies operating tv stations are quietly air-testing compatible color on their own hook. There are still some bugs but these appear to be minor. Next step will be coordination of test results and proposal of just about universally approved standards to the FCC.

The second coming of color should please the public, the government and the industry, in timing as well as in result.

► **TURNABOUT** . . . Sooner or later, export business will once again become as important to American manufacturers of electronic equipment as it was before the war and subsequent domestic shortages. When this time comes, much of our ability to sell merchandise abroad will depend upon how many dollars foreign customers can scrape up. And this, in turn, will depend largely upon what they can sell us to get the necessary exchange.

Exports are inevitably tied to imports. Countries that facilitate one kind of business are very likely to get the other.

► **HANDICAP** . . . Speaking of imports, several firms selling European-made electronic equipment in the U. S. tell us it is not the easiest job in the world to secure Underwriters' approval. Checking, we find that this is true. Foreign equipment is gone over with a particularly critical eye, and this process takes time and costs money.

We can think of several reasons why charity, if any, might begin at home when equipment is examined for possible fire hazards. But there is one aspect of the inspection routine which seems almost too pat. Equipment hooked up with European-made wire is generally disapproved; foreign manufacturers apparently have to buy

our insulated wire if their gear is to receive the seal of approval.

It seems very curious indeed that insulated wire made in Europe should seemingly have at least two strikes against it before coming to bat. Surely all of the wire made overseas is not as bad as that.

► **NAMES** . . . "Reliable" tubes have now become "military" reliable tubes, "commercial" reliable tubes and "electronic industry" reliable tubes. There are also "reliable-rugged" tubes.

A reliable tube may or may not be ruggedized, depending upon whether it has been engineered to withstand extreme shock or vibration. A ruggedized tube may or may not be reliable other than with respect to its ability to withstand shock or vibration.

All this trick terminology is very confusing. In the end it is the same old story of picking the right tube for the right job and then using it in the right way.

► **UP** . . . Business is good with **ELECTRONICS**. So we are ploughing more and more material into the book for the reader.

This issue contains 22 (count 'em) feature articles, plus expanded departments. We think it really covers the waterfront in our fast-moving field and hope you do too.

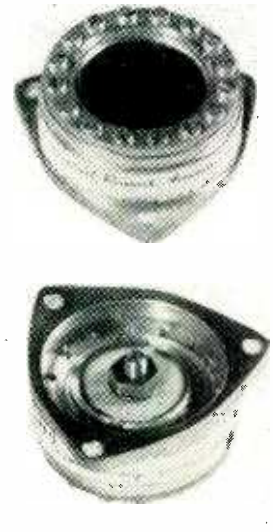
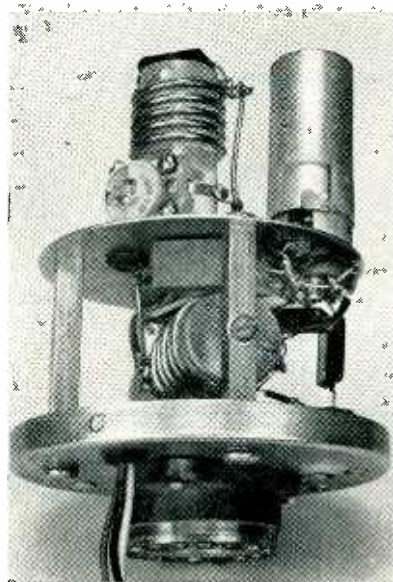
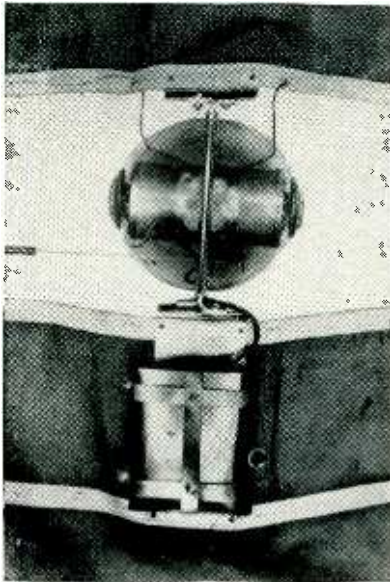

Construction details of transmitters and microphones used in target to detect misses. At left is complete two-microphone transmitter unit mounted in plastic ball set into window of airborne flag target. Battery case is below sphere, and the two antenna wires are woven through the flag. Center—closeup of one transmitter, with microphone mounted under its base. Right—details of rugged capacitor microphone used, having extremely close spacing of diaphragm from case to get high sensitivity

Acoustic Firing Error Indicator

AIRBORNE TARGETS used to simulate a plane have been chiefly flags, sleeves or gliders towed at the end of several thousand feet of cable by a special towing plane.

The number of actual target hits which can be made in training on such targets is an extremely small fraction of total rounds fired.

The firing error indicator described gets training value from misses by indicating errors of aim directly to the marksmen both in ground-to-plane and plane-to-plane shooting at airborne targets. It came as the result of certain ideas originating with members of the staff of the California Institute of Technology who had witnessed Army target practice in connection with other war research work, so that their attention was forcibly called to the existence of the problem. The idea was carried through development and production stages at Caltech during World War II under NDRC contract OEM sr 600.

* Formerly with Air Associates Inc., Teterboro, N. J.

By **MARCUS G. ELIASON***

*Hughes Aircraft Co.
Culver City, Calif.*

and **W. G. HORNBOSTEL***

*International Research Associates
Santa Monica, Calif.*

As long as their speed relative to the air mass substantially exceeds the speed of sound, projectiles send out from their trajectories acoustic waves known as ballistic shock waves. The intensity of the ballistic shock waves existing at a given point in the air is a characteristically diminishing function of the distance from the trajectory. In the firing error indicator, two microphone-and-transmitter units are mounted in the airborne target and linked by radio with a radio receiving station near the gun. The target-borne units send quantitative signals to that station indicative of the intensity of the shock waves from the bullets as they pass in the vicinity of the target. These signals are inter-

preted at the receiving station by automatic means as projectile distance and direction from the target for each miss or hit.

Two f-m receivers placed near the gun detect the radio signals and convert the frequency modulation into brief audio voltage pulses proportional to the response of the microphones to the shock wave. These pulses are suitably amplified and pulse-lengthened to give visual indications and permanent records. Since the radio-frequency excursion from the carrier value corresponds to shock wave amplitude, the telemetered measurement is independent of transmission conditions so long as the input signal level is sufficient for limiter saturation.

The two pulse-lengthened audio signals, proportional to the responses of the two microphones, are electrically added to form the sum response, which is taken as a measure of the miss distance. The difference in time between the two microphone signals is taken as an indication of the side of the trans-

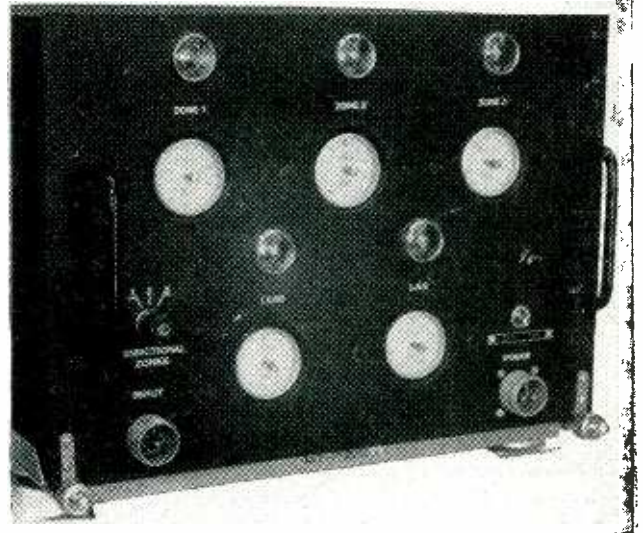
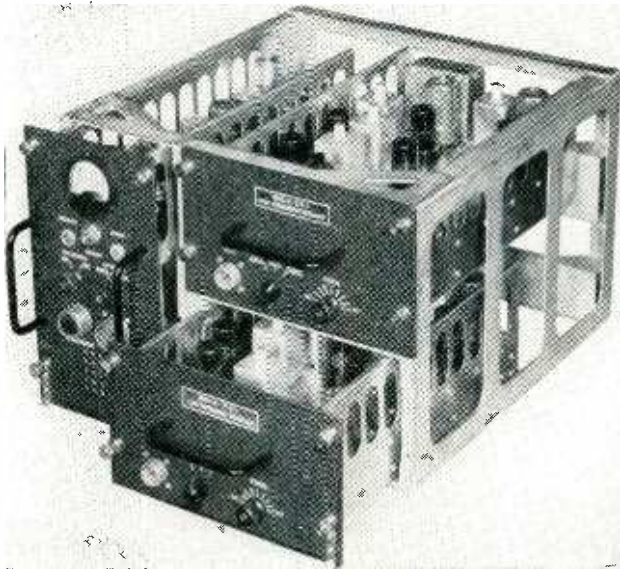

Receiving and indicating equipment used either at ground location or in accompanying observation plane. Three-chassis unit contains the two receivers one above the other, with the computer chassis at their left. Indicator is separate unit, shown at right. Computer adds the two audio output signals to get miss distance in three zones on upper three counter dials, and subtracts for direction of miss, shown on lower two counter dials as count of lead and lag shots

Microphones at opposite ends of plastic sphere in towing-sleeve target respond to ballistic shock waves and modulate tiny f-m transmitters. Two receivers near gunner actuate indicators that show miss distance and tell if gunner is leading or lagging

mitter on which the bullet passed. In the receiver unit, circuits provide two directionality-indicating channels corresponding to the two microphones in the transmitter. The coupling is such that a signal appears at the output only in that channel which received the earlier of the two microphone signals, the signal in the other channel being completely blocked.

Adjustable thresholds are pro-

vided in the receiver in such a manner that the sum signal is, according to its intensity, routed into one or more of three different sum channels. Choice of these thresholds establishes in the target area substantially circular concentric sum response zones.

Each transmitter is a master oscillator-power amplifier using a 3A5 double triode. The microphone is mounted on top of a cylindrical

box which shields the oscillator components. Carrier frequencies used are 56.75 mc and 55.5 mc.

Receiving Station

The block diagram of the receiver unit is shown in Fig. 1. The antenna cable feeds a tee connector from which quarter-wave 100-ohm cables lead to the antenna coils of the two receiver channels. Each antenna coil is matched to

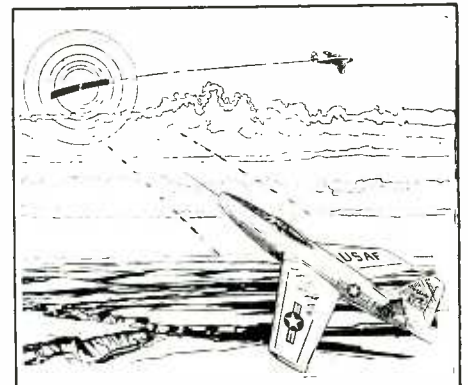

Two examples of firing error indicator installations. When used in 16-foot target glider, antenna wires run from plastic sphere back to outriggers on wing tips. Antennas for towing-sleeve installation are woven into cloth. In both uses, the receiving station is located in the tow plane, and error information is relayed on a command set to each fighter pilot in turn as he makes passes at the target

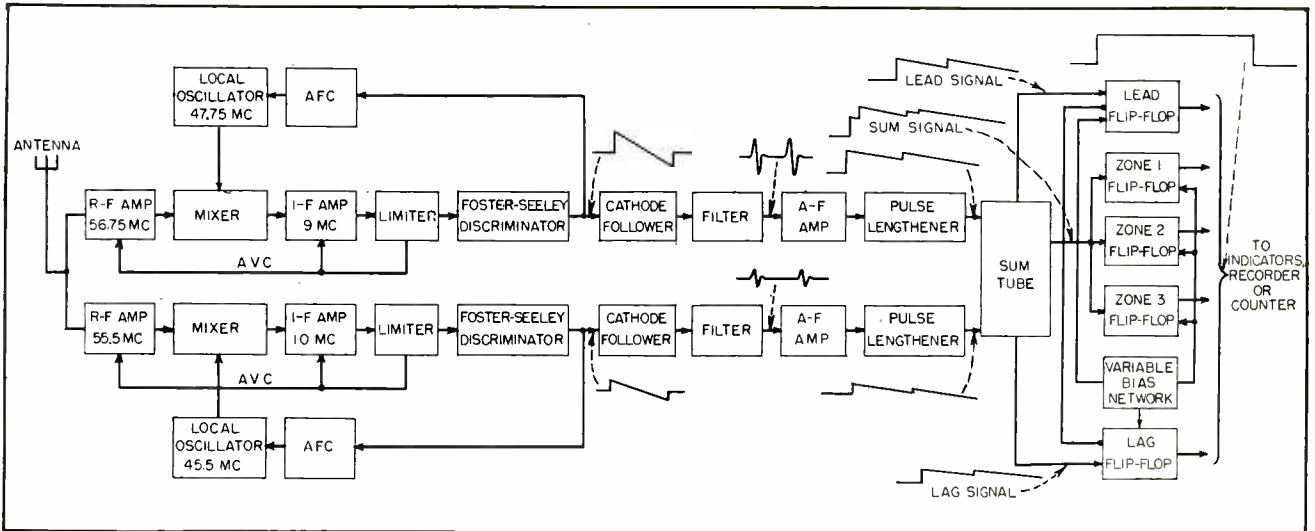

FIG. 1—Block diagram of receiver unit. Two separate f-m receivers feed the sum tube in the computing section in such a way that the five outputs indicate the number of bullets passing through each of three miss zones, the number of leading misses and the number of lagging misses

this same impedance for its own signal frequency. For the signal frequency of the other channel, however, the antenna coil presents a terminal impedance of only about 15 ohms and hence rejects signals of that channel.

Two separate local oscillators and two different i-f values are used to permit individual automatic frequency control of the two channels.

The gain of the i-f amplifier is maintained over a wide range of input amplitude fluctuations by the use of avc fed back from the first limiter and by the operation of the two-stage limiter itself.

The discriminator output voltage is also used to furnish automatic frequency control to the local oscillator. Moderately slow drifts of transmitter frequency are automatically followed so as to maintain the i-f signal in the receiver at the correct value.

After suitable impedance transformation in the cathode follower stages, the a-f signals pass through audio bandpass filter networks which are 3 db down from mid-band value at 4,000 and 10,000 cps respectively. The filters eliminate low-frequency noise and disturbances but retain the two discontinuities of the shock wave¹ in the

form of two transient pulses, as indicated on the block diagram. These pulses do not usually coincide in time in the two channels because the two microphones on opposite sides of the spherical case in the transmitter unit seldom receive the shock wave simultaneously. This time displacement, which may be in the order of one millisecond, would prevent addition of the two microphone signals to form the sum response unless pulse lengthening is used.

Computer and Indicators

Figure 2 shows one channel of the audio amplifier and the sum-

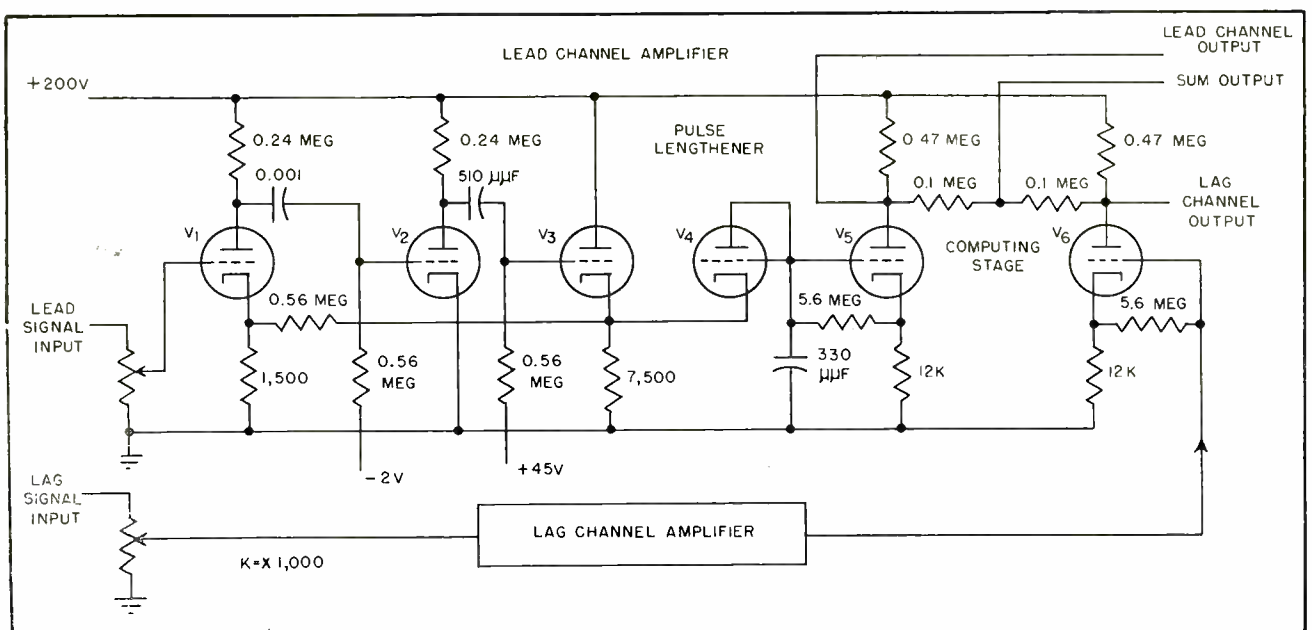

FIG. 2—One channel of audio amplifier in a receiver, and sum-difference computing stage serving both receiver channels

difference computing stage. The audio amplifier uses negative feedback with a certain amount of direct coupling and small time constants to flatten the response, give stable amplification and provide a very low impedance output to drive the pulse-lengthening diode which connects to the sum tube. The lengthened pulse exhibits a delay to half its initial peak value in approximately six milliseconds. Since the tops of lengthened pulses are nearly constant for a few milliseconds, the signals from the two channels may now be combined in a sum tube or computing stage. The sum of the two pulse-lengthened signals is a superimposed exponential pulse, as indicated in Fig. 1.

For purposes of scoring, it is desirable to classify the shock-wave signals as having fallen in three concentric miss distance zones of predetermined radii. This function is performed by the zoning flip-flops.

Whenever the sum signal exceeds a certain amount, one of the zoning flip-flops will trip and furnish, for a standardized length of time, a plate signal which can be used for recording equipment or for use with a mechanical counter. The peak value of input pulse at which flipping occurs is adjustable by means of bias potentiometers; with these, the sizes of the miss-distance zones of a target can be set for a given calibre of ammunition.

Two more flip-flops are so interconnected that one or the other trips according to which microphone channel receives its signal first. The receiver output thus contains five channels, one or more of which are activated as the bullet passes through the three miss distance zones and two directionality zones. These five channels may be connected to indicating devices such as a tape recorder or a counter.

The Microphone

The heart of the system is a specially designed and carefully built capacitor microphone having a response characteristic flat to within plus or minus 1 db from 0 to over 10,000 cps. The construction is such that it will withstand repeated application of 200-G

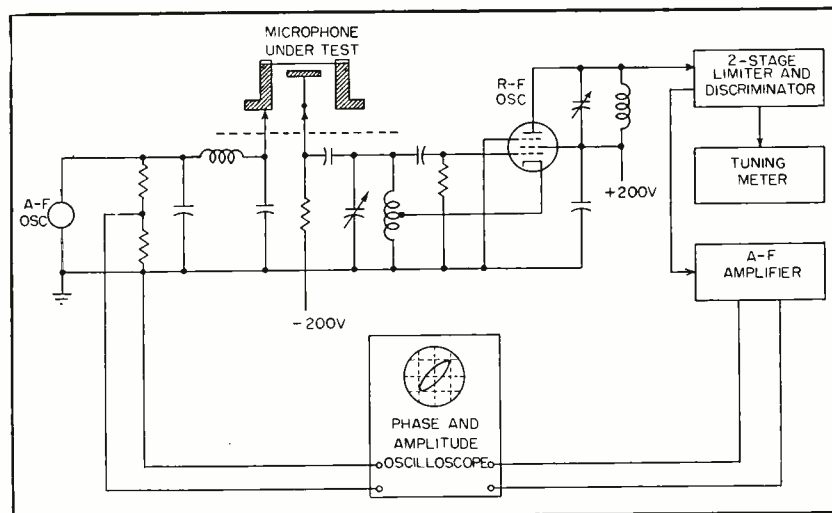

FIG. 3—Simplified diagram of electrostatic microphone tester used in production-testing the special flat-response microphones required

shocks without damage or change of characteristics. Response is linear to within 5 percent up to an applied pressure of 30,000 bars, which is 0.44 lb per square inch. A relief vent in the microphone permits use at any air pressure from sea level up to 10,000 feet of altitude with no serious change in its characteristic.

The microphone diaphragm is made of 0.0016-inch beryllium copper. The diaphragm-supporting casting is a special bronze selected to have essentially the same coefficient of expansion as the diaphragm material, so that the temperature coefficient of the sensitivity of the microphone is negligible.

Microphone Testing

The electrostatic microphone tester circuit shown in Fig. 3 uses the microphone as part of a tuned r-f oscillator circuit. By applying an a-f voltage from a low-impedance source to the microphone and simultaneously applying a d-c polarizing voltage to the insulated electrode button of the microphone, it is possible to make the diaphragm move at the a-f rate by electrostatic attraction. This correspondingly varies the capacitance that the microphone introduces in the r-f oscillator grid circuit.

The a-f oscillator voltage is simultaneously fed to the horizontal plates of an oscilloscope. The r-f oscillator voltage, which becomes frequency-modulated by the a-f voltage, is fed through a two stage-limiter, discriminator and a-f

amplifier. The resulting a-f output is fed to the vertical plates of the same oscilloscope. The voltage between the horizontal and vertical plates is compared for phase angle. When the microphone is critically damped, the only way in which the resonance point of the diaphragm can be determined is by using the criterion that when it is at resonance, the diaphragm movement is 90 degrees out of phase with the applied voltage. This makes it possible to duplicate microphones under production conditions. The response of the microphone to the electrostatic deflection is essentially identical to that which will occur if the microphone were acoustically excited.

Since the original development of the acoustic firing error indicator equipment, this device has been produced in large quantity by electronic equipment manufacturers for use by the Armed Services.

The successful development of the equipment described was to a very large extent due to the able direction and efforts of J. W. M. DuMond of California Institute of Technology, who was project coordinator, and W. K. H. Panofsky, now at Stanford University, who was project director.

REFERENCE

- (1) J. W. M. DuMond, E. R. Cohen, W. K. H. Panofsky and E. Deeds, A Determination of the Wave Forms and Laws of Propagation and Dissipation of Ballistic Shock Waves, *Jour. Acoustical Soc. America*, p 97, July 1946. This paper was the result of field studies of ballistic shock waves in conjunction with development of firing error indicator equipment.

Using C-R Tubes With

Use of pole-piece extensions built into neck of cathode-ray tube reduces magnetic energy required to achieve focus and minimizes astigmatism due to nonsymmetrical fields from the external focus unit. Different types of internal pole pieces and their use in e-m and p-m picture tubes are discussed

By **C. V. FOGELBERG** and **E. W. MORSE** and By **S. L. REICHES** and **D. P. INGLE**

*National Video Corp.
Chicago, Illinois*

*All Star Products Inc.
Defiance, Ohio*

IN ATTEMPTS to reduce the consumption of critical materials in television receivers, much attention has been paid to the focus system of the picture tube. The electrostatically focused tubes represent one means of saving copper and Alnico. However, it has become apparent that other material-saving focus systems would be desirable.

Design

Work on this problem has led to the development of the magnetically focused picture tube that uses internal magnetic pole pieces to form the focus lens. The use of these poles has reduced the external focus energy requirements by 36 to 65 percent, depending upon the particular pole-piece design and upon the type external-focus device used. Further, due to control of aberrations in the focus lens, picture quality has been improved beyond that of the conventional magnetic and electrostatic-focus tubes.

It has long been clear that the conventional magnetic focus system is inefficient owing to the fact that much of the magnetic circuit is in air or vacuum unnecessarily since the region in which the electron beam must enter the field is relatively small. By providing a comparatively low reluctance path for the magnetic flux inside the tube, it is possible to produce a sufficiently strong magnetic field near the beam with greatly reduced amounts of magnetomotive force.

The magnetic circuit that has been developed has one unavoidable

high-reluctance gap due to the glass neck thickness, and one other gap near the beam where the magnetic lens is formed. In the focus-lens gap, the diameter of the apertures in the pole pieces was made as small as possible to give the greatest reduction in magnetomotive force necessary to focus, but large enough to prevent beam masking. The length of the lens gap was determined by other considerations, which will be discussed below. The aperture diameter and the gap length chosen determine the reluctance of the lens gap. The separation of the poles of the external source of magnetomotive force determines the length of the pole-piece assembly, since these must be coupled to the external poles with minimum air gap to give minimum gap reluctance. For the same reason, the inner diameter of the external poles should be held to a minimum to reduce the reluctance of the gap between them and the

inner pole pieces.

A simplified consideration of the effect of the length of the focus lens gap on the required amount of magnetomotive force shows that the change ought to be directly proportional; increasing the gap length increases the magnetomotive force necessary. This would be expected since the effect of increasing any gap would be to increase the reluctance of that gap.

A series of pole pieces was constructed in which the length of the gap was varied in 1/16-inch steps, and all other parameters were held constant. A graph of the focus current required for these various gaps, all at the position of best coupling between outside and inside poles, is shown in Fig. 1.

The results shown confirm the conclusions drawn above. Since reluctances vary as the inverse of the area of the gap, it might be expected that energy requirements would also vary as the inverse of



Early design of internal pole piece for mounting atop anode barrel

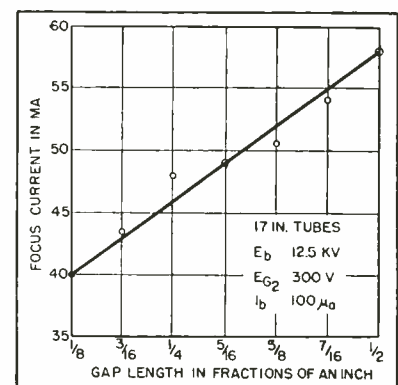
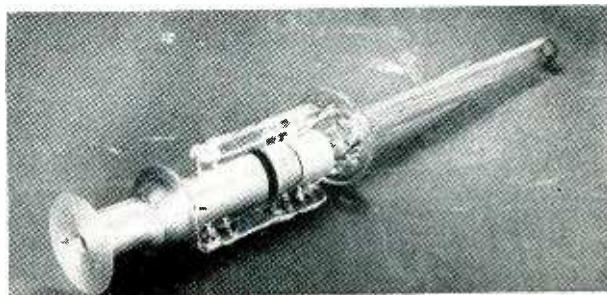

FIG. 1—Focus current for different gap lengths

Internal Pole Pieces



Later internal pole piece uses flat-plate front pole to reduce shielding of focus lens and allow shifting of field for centering



Photograph shows flat-plate pole piece mounted on crt gun before insertion in cathode-ray tube

the gap area. This was found not to be true. The explanation of this lies in the fact that the flux effective in focusing the beam is essentially leakage flux between the two poles. Removing the two poles from this region by increasing the aperture diameter increases the energy required to produce a given lens.

Positioning

Since outside support of the magnetic source might be necessary, it was deemed desirable to locate the lens at the same general region in which the present focus devices are located. This further avoids insulation problems since this is a region essentially free from electric fields.

In previous magnetic-focusing systems that located the focusing device near the deflection system, an interaction between the focusing field and the deflection fields was unavoidable. The fact that the focus field in the pole piece tube is largely confined to the low-reluctance pole-piece region reduces this problem to a minimum. A shortening of the anode barrel further reduces field interaction.

In addition to energy requirements, consideration of the relative centering motion available with different pole pieces is important. Centering of the beam is often obtained by shifting the axis of the magnetic field with an outside slide pole piece. When this sort of device is used with a pole-piece lens, the shielding effect of the pole pieces tends to smooth out the effect of

shifting the outside pole to the point where insufficient centering motion is available. The longer gap lengths tend to increase centering motion but increase the energy requirements as noted above. This difficulty is avoided by displacing the outside focus device toward the face of the tube. This produces sufficient flux for centering without greatly increasing the energy requirements. A displacement of about one-eighth inch to the front of the front pole piece was found to give good results.

The shorter gap lengths require extremely careful alignment of the outside pole pieces of the focusing device with the internal pole pieces, and were, therefore, deemed impractical despite the lowered reluctance of the lens gap. Various types of internal pole pieces are shown in the accompanying photographs.

The photograph shows a pole piece designed to be mounted on top of the anode barrel. With this early design it was noted that insufficient centering motion was possible with the slide-pole device used. This is to be expected since the change in field produced by the slide pole is largely smoothed out near the lens, and little stray field exists on the screen side of the gun. An independent centering device is commercially undesirable.

The more recent flat-plate front pole design (see above) reduces the shielding of the focus lens, and allows a shifting of the magnetic field to affect the beam

sufficiently to provide adequate centering. This reduced shielding works in conjunction with added stray field in front of the front pole piece.

A gratifying result of this work was the improved picture quality caused by reduced aberrations of a focus lens produced by means of pole pieces as compared to a lens produced by wholly external focus devices. Flux lines are linearly distributed. Nonuniformities of the focus magnet's field have been smoothed out by the pole pieces producing an essentially non-astigmatic field near the beam.

Focus devices for use with the pole-piece tube may be either permanent or electromagnetic in design. Both kinds have been built and give excellent results.

Production tolerances for pole-piece tubes are, in general, wide. The variations in gap length produced by common tolerances used in stamped electron gun parts are almost unnoticeable. Standard tolerances for aperture diameters hold, as is true for aperture concentricity. Alignment of the pole pieces on the axis is important, but is easily attained with proper assembly fixtures.

Attempts to redesign the focus system of magnetically-focused picture tubes have led to a focusing system that requires greatly reduced amounts of magnetomotive force. This result may be translated into greatly reduced consumption of critical materials and picture tubes giving noticeably

better performance without increased manufacturing difficulties.

Application

Internal pole-piece material is generally cold-rolled steel between 0.010 and 0.020-inch thickness. Low-carbon irons, however, have the advantage that their permeability is almost independent of the direction of rolling whereas in cold-rolled steel there may be as much as 20 percent difference between the axis of rolling and that at right angles.

Centering of a tube with internal pole pieces requires that displacement of the electron beam be done in front of the pole piece closest to the face of the tube. If the beam is displaced in the area between the pole piece closest to the face of the tube and the base of the tube, cutting of the beam by the various apertures takes place. It has been found that if an internal-pole-piece configuration such as shown in Fig. 2 is used and a slide pole arranged on the external focus unit, centering of the picture follows the conditions plotted in Fig. 3. These curves show the amount of centering as a function of the displacement of the slide pole piece on the focus unit with respect to the front internal pole piece. This data is presented for two second-anode voltages.

It is seen here that the position of the slide pole for maximum centering is not the position for the most efficient coupling. The percentage of flux carried by the slide pole as compared to the fixed pole mounting the slide pole is a factor controlling the amount of centering available. In the designs found practical the largest percentage of the flux is carried by the slide pole. This is the reverse of the general case in the conventional p-m unit.

The amount of centering motion shown is possible only if the front pole piece (the one closest to the face of the tube) is substantially a flat plate. Tubes that use two truncated cones to form the internal pole pieces are generally found to be a little more efficient magnetically but as a rule do not allow adequate centering motion.

The length of the magnets chosen for these focus units seems opti-

mum for the conditions of use, but it is possible that with further tube development, the spacing between the internal pole pieces will not be such that the back poles will be in alignment for maximum coupling. On this account, a sleeve is inserted in the back pole piece of the focus unit to allow a fairly large displacement along the neck of the tube without losing coupling between the back pole pieces. This rearward-pointing sleeve may be so arranged that part is inside the focus unit if tube design tends to place internal pole pieces very close together.

Basic Types

Practical p-m focus units for these tubes have evolved as two basic types, the pilaster-mounted and the neck-supported types shown in the photographs.

The pilaster-mounted type is rigidly supported by the same assembly holding the deflection yoke in conventional practice. The mounting is designed so that the unit has the proper relationship to the internal pole pieces for magnetic coupling and for proper centering conditions.

Focus is controlled by turning the focus control knob, (Fig. 2) which moves the annular ring forward and back to change the shunting effect on the magnets.

Centering is achieved by displacing the slide pole using the slide-

pole extension. This unit is used and handled in the same way as is the conventional p-m unit, except that care must be exercised in placement along the neck of the tube.

To facilitate this positioning, which is important in both types of units, the tube manufacturers who will position the internal poles relative to the reference line intend to also provide either a window in the Aquadag or an external mark on the tube as a quick guide for positioning.

The neck-supported type of unit was the original design approach and came about because of the economies involved, both in construction and in mounting ease.

Control of focus with this unit is achieved by moving the entire flux-producing part of the assembly along the neck of the tube. By doing this the air gap between the external and internal pole pieces can be varied and focus controlled. Centering is again controlled by the slide pole. The data shown in Fig. 2 also hold for this design. A sleeve in the back pole piece is used here also to allow displacement between the front pole pieces at all times and still allow focus control by moving the whole assembly.

It has also been found that this sleeve gives a smoother control over focus since only one air gap is changed as the unit is moved.

A unit of the neck-supported type weighs about 6 oz, depending some-

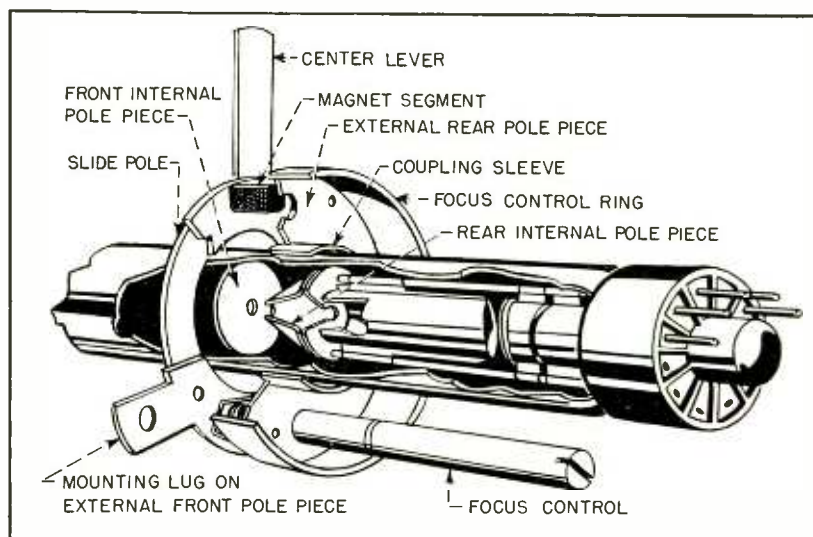

FIG. 2—Drawing shows typical positions of internal pole pieces and focus unit mounted externally on neck of tube

what on the magnet requirements. Initially, it was believed this was too much weight to put on the neck of a tube. However, one receiver manufacturer has investigated this point and is of the opinion this weight is safe.

Mechanical Problems

While the design of the pilaster-mounted type of unit was straightforward several problems had to be solved with the neck-supported design.

Even with internal pole pieces it is not desirable to bring the three magnet segments used close to the neck of the tube for reasons of stability. Close spacing aggravates the tendency of the unit to displace sideways during focusing and centering causing the entire picture to wiggle.

By means of close-fitting guides the neck supported unit shown has a stability during focusing and centering that is entirely satisfactory even with the magnets at some distance from the neck of the tube.

Possibly one large-scale use for this type of unit is in the replacement of electrostatic tubes. Most electrostatic tube sets do not have provisions for mounting a focus unit.

One unusual effect noticed, that is probably of importance only to the engineer working experimentally, results from the residual magnetism of the internal pole pieces. If work is being done with

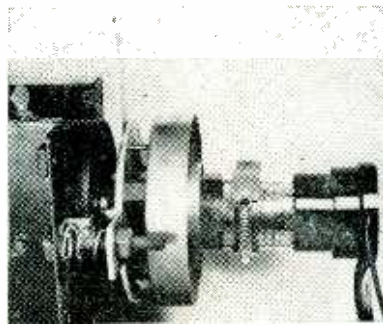

Pilaster-supported external focus unit for use with tubes containing internal pole pieces

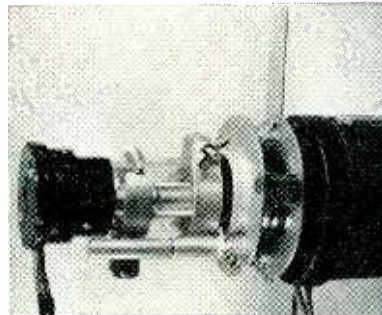

Photograph shows neck-supported focus unit

focus units of reversed magnetization it is suggested the internal pole pieces be demagnetized before each test. The use of low-carbon irons for the internal pole pieces will largely avoid this. However, since the flux in the gap at the center of the tube is of the order of 20 gauss it is seen that even 2-gauss residuals, which have been found, can cause trouble. In addition, if there are areas around the

aperture with unequal residual flux, the dot can be distorted. This effect has been seen on some tubes and easily remedied by demagnetizing the internal pole pieces.

The ion-trap setting has proved to be a little more critical than is found for the conventional magnetic focus, but not as critical as in the electrostatic tube. This condition is believed to come about for somewhat the same reasons as in the electrostatically-focused tube. Because the length of the magnetic lens is very short and because the aperture in the internal pole pieces is in the order of 0.150 inch it is evident that the beam-bundle axis should be as coaxial as possible with the magnetic lens so as to minimize astigmatism.

Industry Use

The saving in magnetic material in the p-m case is quite high and in the neighborhood of 65 to 70 percent over that required in the conventional magnetic case. This much saving has not appeared in the e-m case primarily because of the difference in the stray field conditions from the e-m compared to the p-m. Much more of the total energy in a conventional p-m unit is lost to stray fields than in the e-m unit.

Due to the more complete magnetic path of the internal-pole-piece tube much of the field normally stray is utilized. At this stage of the development of the e-m coil about 36-percent saving in ampere turns is achieved. This actually represents a bigger savings in copper because the reduction in copper takes place on the longer outside turns.

It is now believed correct to state that at this time there are three types of c-r tubes available to the industry: the conventional magnetic focus, the electrostatic focus, and internal pole piece magnetic type. The factors dictating the choice of tube are evident as being comparative performance, cost of tube and associated equipment and availability.

It seems that all three types will find a place in the industry but with the possibility that the ipp tube may in time displace the conventional magnetic type.

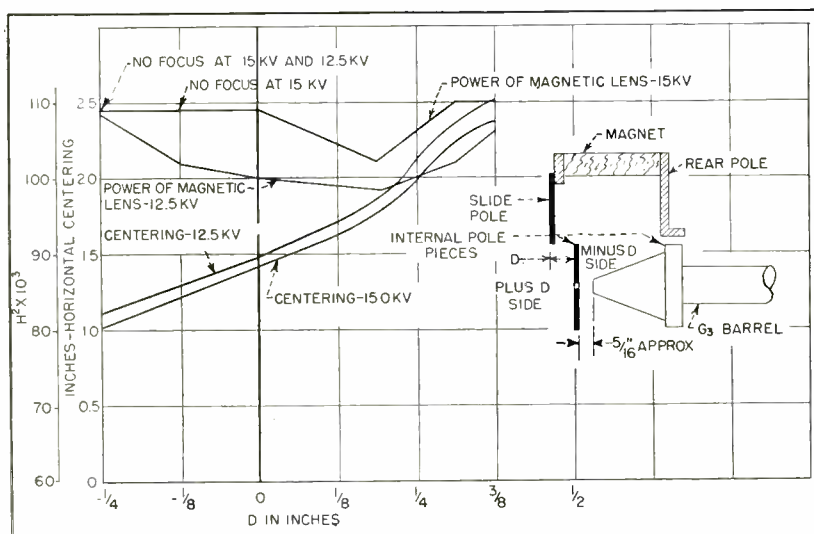
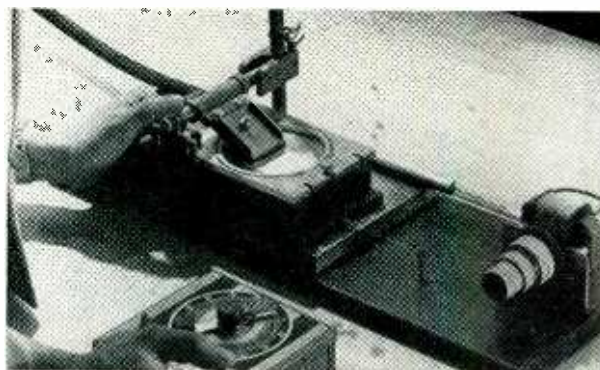

FIG. 3—Effect of alignment of internal and external poles. Minimum current point in front pole is due to rear flange of focus



Applying silver mix to screen for producing terminal areas. Techniques for resistor mixes are identical



Use of small geared-down motor to pull screen under rubber squeegee. Uniform velocity is essential for reproducibility of results

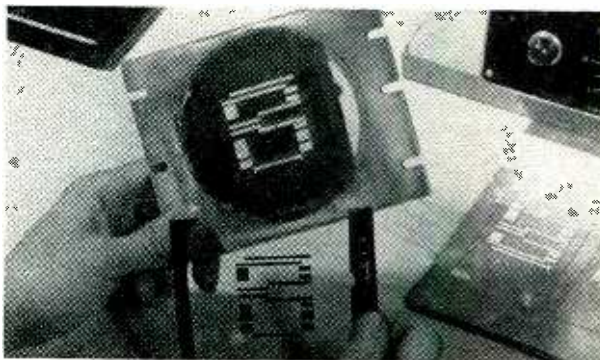

Silk screen for silver mix (left hand) and silver terminal pattern on glass plate (right hand)

Production Control

AN IMPORTANT objective to be attained in the use of a printed circuit is the reduction of production cost. This cost in any mass-production process is closely dependent on the rejection rate. A second factor is the effect of producing several circuit elements on one plate, a procedure which precludes selection and sorting of components. Relatively uncontrolled processes are rendered usable in the production of individual components by sorting 100 percent of the product into salable value groups.

The silk-screened resistor is generally intended as a replacement for fixed composition resistors and its requirements as to value, tolerance, temperature coefficient, drift, noise, life and voltage stability are at least

nominally evaluated by JAN-R-11 tests. Although these specifications are not entirely appropriate since the functioning of a printed group is a more valid criterion than a blanket tolerance applied to each resistor value, it will be assumed here that the same limits are required for printed as for individual composition resistors.

Steps in Manufacture

Theoretical and experimental effort has been directed toward isolating major cases of variability in the printing process and toward optimizing the procedures. In outline, the procedure used is:

- (1) Firing silver terminal areas on base plate
- (2) Printing resistors with silk screen

- (3) Low-temperature drying with convection
- (4) Baking at intermediate temperature
- (5) Curing
- (6) Screening with protective coating
- (7) Room-temperature drying with convection
- (8) Stabilizing in convection oven

A complete cycle of manufacture exclusive of the first step (metallizing) is about 4 hours.

For silk screening of the silver terminal areas, a common commercial ceramic decorating paint was used, with consolidation of the paint by 600 C firing.

The resistor screening mixes were formulations of graphite, carbon-black, resin and a solvent. The

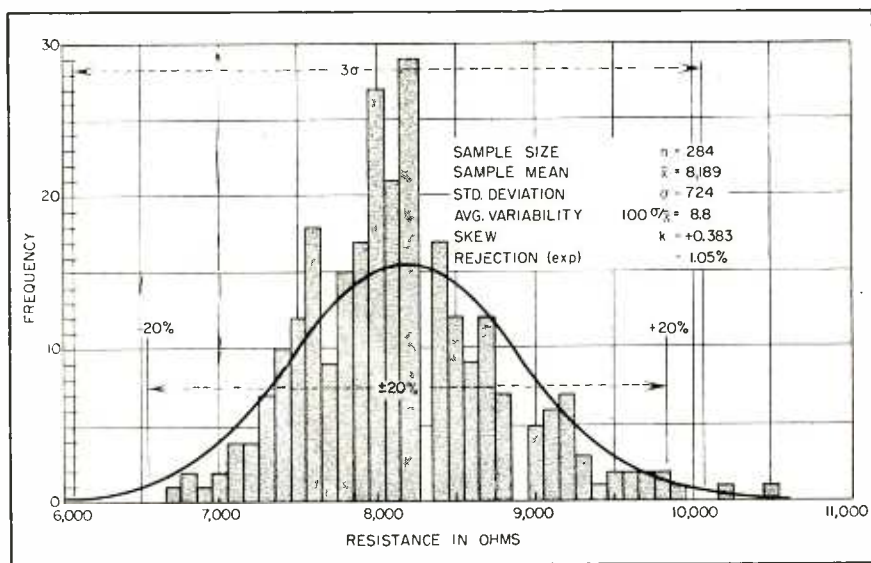

FIG. 1—Distribution of resistance values for batch of uncoated cured resistors

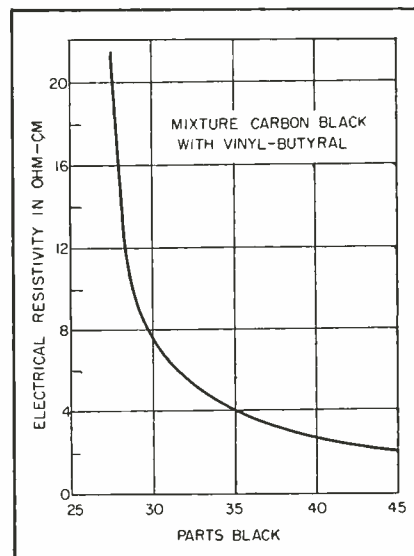

FIG. 2—Effect of carbon concentration

Analysis of factors affecting reproducibility of silk-screened resistors. To minimize final-assembly rejections, five major variables require critical control: carbon concentration, squeegee speed, screening temperature, curing temperature and overcoating

By **W. H. HANNAHS** and **J. W. ENG**

*Sylvania Electric Products Inc.
Physics Laboratories, Sylvania Center
Bayside, N. Y.*

of Printed Resistors

binder resin is a modified styrene and the solvent a high-boiling acetate, to minimize evaporation on the screen. White shellac provides a satisfactory seal coat when over-protected with slurry-applied granular phenolic resin. While not followed in these tests, commercial practice requires a third protective layer comprising impregnation with wax.

All of the data given is for resistors screened on glass. Drying and baking were done with conventional laboratory equipment refined slightly to achieve the temperature uniformity required. Screening was done in an environment controlled to prevent temperature variations greater than ± 0.5 C on the printing screen.

In Fig. 1 is shown a distribution

of values for a lot of uncoated resistors several times minimum sample size, including several runs under normally varying conditions. Control of all variables in the process up to the coating step is evidenced by the small actual rejection, 1 percent at the ± 20 percent limits.

Rejection Rates

The detection of fine differences representing the effects of low-order variables requires samples of considerable size. Samples of 48 or more resistors have been found necessary for maintaining a confidence level of 80 percent in most of the tests reported.

The influence of mixture concentration is shown in Fig. 2. Although this curve is for a mixture containing carbon black as the only conduc-

tive material, it is representative of the situation most frequently met in graphite, carbon-black, resin and solvent combinations where the carbon black is a small but critical constituent. With low concentrations of carbon black, high variations in resistivity result from small changes in composition.

The application of a protective coating is a critical step because of the large and general unpredictable increases in value produced. After considerable investigation, several types of sealant were found which give only moderate interference. As a typical example, screening a sealing coat of shellac on a sample of resistors containing 3 percent rejects broadened the distribution and shifted the values. As shown in Fig. 3, the shift was about 12

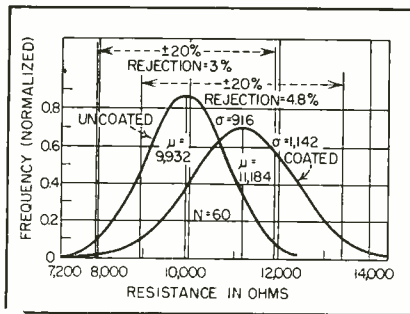

FIG. 3—Effect of overcoating on final resistance value

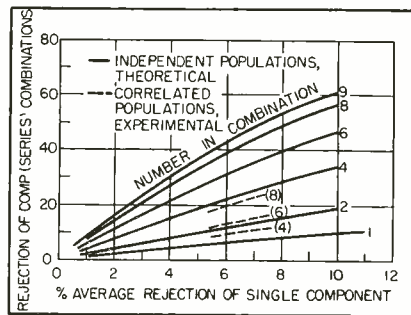

FIG. 4—How rejection rate increases with number of components

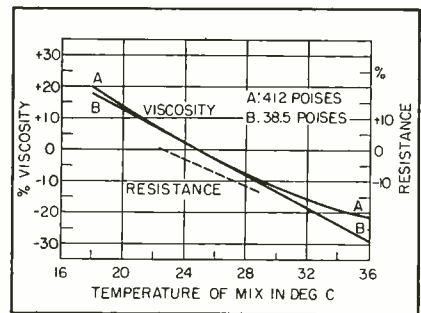

FIG. 5—Effect of temperature on viscosity of resistor mixes

percent and the rejection increased to 4.8 percent for this particular lot.

The rejection of component groups printed together, because of defects in one individual, has a significant bearing on all printed circuit applications. If the simplest series case is analyzed, the theoretical effect of combination, up to 9, is shown by the solid lines of Fig. 4. The rejections shown for combinations are based on the following assumptions: the complete assembly does not function when one member is out of specification, and the components in the group are from independent random populations which were not related during fabrication. This represents the maximum rejection, seldom met in production. Actually, in a process under control, there is considerable probability that an assembly rejected for one bad component will also contain another defective. For two or more resistors silk-screened simultaneously the correlation is sufficiently high so that rejects in aggregate amount to less than 40 percent of the above predicted

value. These experimentally derived results are shown as the dotted lines in Fig. 4.

Process Variables

The major influences on the final value of resistors were found in the carbon concentration, screen opening size, curing temperature, overcoating formulation and the screening temperature. This is only a small proportion of the total number of variables.

Some indication of the factors entering into the printing operation can be had by applying the laws of fluid mechanics to the dispensing of fluid through a square orifice per unit time is described by the relation

$$q = \frac{\pi S^4 C}{7.12\eta} \frac{dp}{dL} \quad (1)$$

If this is applied as an approximation of the flow of resistor mix through a screen opening, with consideration of the angle and pressure of the squeegee, the total volume discharged is

$$q' = \frac{\pi S^4 C T p}{7.12\eta L} \cos \theta \quad (2)$$

Relating time to squeegee travel and velocity, combining constants and multiplying for additional orifices results in

$$Q = \frac{C_1 S^5 K A p}{\eta v L} \cos \theta \quad (3)$$

The resistance of a particular uncoated resistor may be expressed in terms of its dimensions when dry (l, w, t_d) and specific resistance ρ

$$R = \rho \frac{l}{wt_d} \quad (4)$$

Another consideration is volume change upon drying, in terms of the dimensions of the freshly screened resistor and a wet-to-dry ratio γ ,

$$R = \rho \frac{l}{w\gamma t_w} \quad (5)$$

As an approximation, the wet thickness t_w may be taken as equal to the volume of mix discharged (Q) divided by the cross-section or open area A in screen and pattern. Substituting this for t_w ,

$$R = \frac{\rho \eta L v}{K w \gamma S^5 \cos \theta p} \quad (6)$$

in which

- A = area in sq cm
- R = resistance in ohms
- μ = viscosity in poises
- v = velocity of the squeegee in cm per sec
- w = width of resistor in cm
- l = length of resistor in cm
- c_1 = proportionality constant
- γ = ratio of wet to dry film thickness
- S = linear parameter of sieve opening in cm
- K = numbers of openings per sq cm of screen
- L = distance fluid travels through screen in cm
- ρ = resistivity in ohm-cm
- θ = angle of the squeegee with respect to the work
- p = vertical pressure of squeegee on the screen in dynes per sq cm
- dp/dL = differential pressure throughout the length of an orifice



Placing coated glass plates in small furnace for curing of silver. Resistor printing with silk screen is next operation

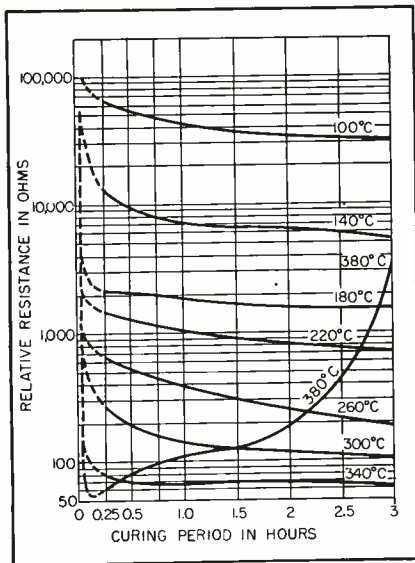

FIG. 6—Curing curves for mixture of lampblack and alkyl resin

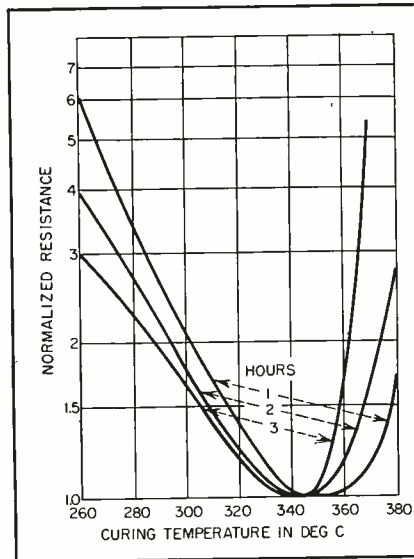

FIG. 7—Determination of optimum curing schedule for uncoated resistors

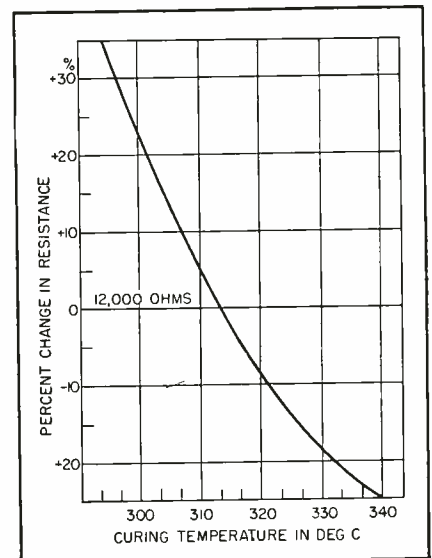

FIG. 8—Effect of curing temperature on uncoated resistors

C = nozzle coefficient
 T = time of fluid flow in seconds

The value of a given resistance is thus illustrated to be effected by eleven factors in the screening process plus the superimposed effects of time-temperature in the curing cycle, interference during overcoating and the basic formulation of the mix. Equation 6 indicates that the resistance produced is directly dependent on the resistor length, viscosity of the mix, distance through the orifice and the speed of the squeegee. The resistance is inversely proportional to resistor width, the wet-to-dry ratio, holes per unit area, the pressure drop through the orifice, the squeegee angle and to the fifth power of the hole parameter.

Critical Factors

The influence indicated for the hole size suggests that wear of the screen may be a prime importance. The weight of some of the factors in Eq. 6 has been evaluated experimentally. A velocity increase of 14.4 percent in squeegee motion was found to result in an increase of 21 percent in uncoated resistor value. A decrease of 13.7 percent in viscosity resulted in a 12.6-percent decrease in resistance. The viscosity is markedly reduced by slight increases in the temperature of the mix at the time of screening. These three related variables are shown together on Fig. 5. Sig-

nificantly, a rise of one degree centigrade in room (mix) temperature during screening translates into a 2¼-percent decrease in the mean value of resistors produced.

In the overall manufacture, the main curing step prior to coating is critical. Batches subjected to progressively higher baking temperatures decrease in resistance during curing as shown in Fig. 6, successively approaching lower and presumably more stable final values until the decomposition level is

reached, when the resistance rapidly rises during baking.

Similar data near the crossover point may be analyzed in a different manner, as in Fig. 7, to find the temperature-time schedule which represents the fastest approach to a low, stable value. With a curing schedule near the indicated optimum, resistors may be lowered 5 percent in value by an increase of only 3½ deg C, as shown in Fig. 8.

The use of a curing schedule optimized only with respect to speed and stability may result in higher noise levels; resistors processed by the fastest cure on Fig. 7 show about 3 microvolts per volt.

Screened resistors approximating the other JAN standards may be produced by the procedure outlined; an average voltage coefficient of about 0.04 percent per volt (25 C) has been noted. Drift is of about 3½ percent as shown in Fig. 9. The temperature coefficient, which is well within type E limits, is shown in Fig. 10.

In conclusion, the principle limitations in reproducibility are set by a critical carbon concentration, squeegee speed, a viscosity of screening which is sensitive to temperature, the curing temperature and the overcoating formulation. Theoretical analysis points also to squeegee pressure and to irregularities in screen openings as possible causes of large variations in printing.

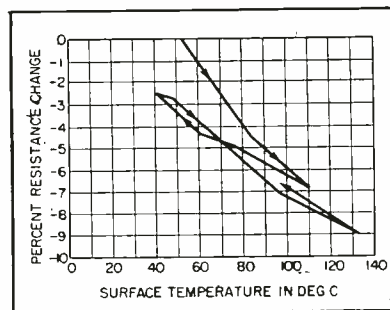

FIG. 9—Drift of protected 10,000-ohm resistor under temperature cycling

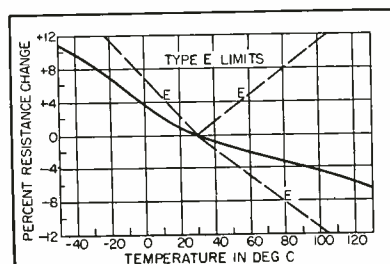

FIG. 10—Temperature coefficient for nominal 10,000-ohm silk-screened resistor

CONELRAD

Crystal-controlled broadcast receiver gives alarm when key station to which it is tuned goes off air in response to FCC technique denying navigation aid to enemy aircraft. Malfunction in receiver itself sounds alarm

IN COMPLYING with the request of the Federal Communications Commission to participate in the air-raid warning project CONELRAD (control of electromagnetic radiation)¹ many broadcast station engineers are confronted with the problem of constructing monitoring equipment that will give an indication of carrier failure of a key station.

The simplest solution to the problem is to utilize the failure of the AVC voltage of an existing receiver to trigger some warning device. This approach has several disadvantages. Most broadcast receivers are not designed for rack mounting, and therefore present a mounting problem if a neat and compact installation is to be maintained. Such receivers are often

not constructed according to broadcast equipment standards, and they may leave something to be desired in the way of dependability when operated continuously.

Single-Frequency Receiver

It is possible to purchase a communications receiver that overcomes all these objections. However, this solution raises the objection of high cost plus the rather ridiculous situation of having provided equipment capable of tuning a large portion of the spectrum to monitor one frequency. The problem is simplified by starting from scratch and building a receiver solely for an alerting device.

Since the receiver is to monitor only one frequency, crystal control can be used and all front-panel tun-

ing controls dispensed with. In addition, this design goes a long way toward achieving dependability by virtually eliminating oscillator drift problems. With such stability in the local oscillator, and since high-fidelity audio is not required, use of a rather low intermediate frequency is justified. This low i-f will permit great gain and selectivity in a minimum number of stages.

Low intermediate frequencies are usually accompanied by image interference, but for single-frequency reception it is easy to select the intermediate frequency and local oscillator frequency so that no strong images will be present. Design is further simplified in that the range of signal intensities encountered will be much less than that an ordi-

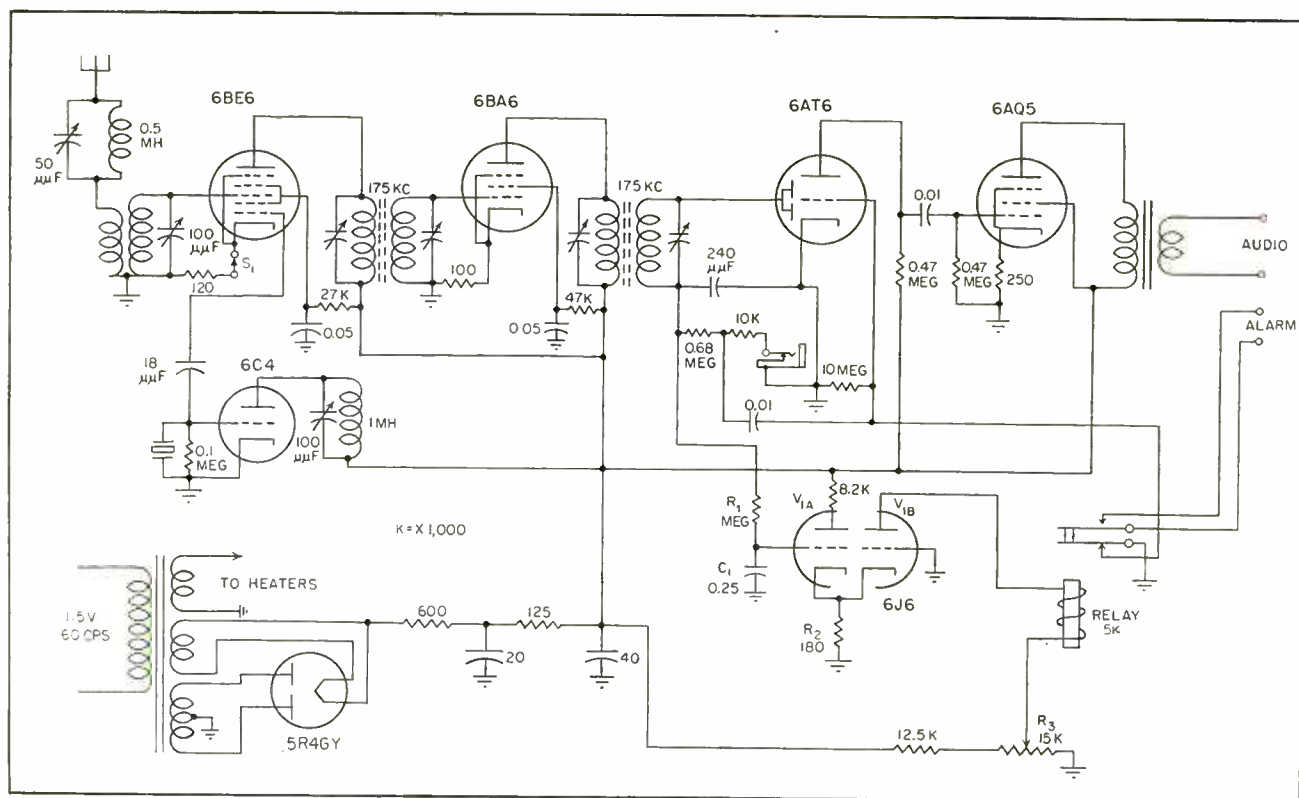

FIG. 1—Circuit diagram of the fixed-tune alert receiver

Alert Receiver

By **MARTIN M. MITCHUM**

*Radio Engineering Consultant
Rolla, Missouri*

nary receiver is designed to accommodate.

The system to be described was constructed for use at radio station KTTR in Rolla, Missouri to provide day and night monitoring of KMOX in St. Louis, Missouri, which operates on 1,120 kc with 50-kw. During the day, a signal of the order of 0.5 millivolt per meter can be expected from KMOX. At night the signal will vary considerably above and below this value.

Image Signals

With this much signal, it was decided that a converter and one stage of intermediate-frequency amplification would be sufficient. Since image interference was no problem, it was decided to dispense with any stages of radio-frequency amplification preceding the converter.

An intermediate frequency of 175 kc was decided upon and the local oscillator operates at a frequency 175 kc lower than the carrier frequency of KMOX or 945 kc. There is virtually no signal present in this area on the image frequency of 770 kc.

Reference to Fig. 1 will disclose few departures, other than those already mentioned, from normal receiver design. It was decided, in the interest of simplicity, to use no avc in this receiver. Since the signal strength is not great enough to overdrive the i-f stage, and since carrier fading is taken care of in the alerting device, avc would serve no useful purpose here.

A meter jack is placed in series with the second-detector load resistor to permit the use of a microammeter as an indicating device when it is desired to make tuning adjustments or to observe carrier fading.

The simplest and therefore most obvious method of obtaining an

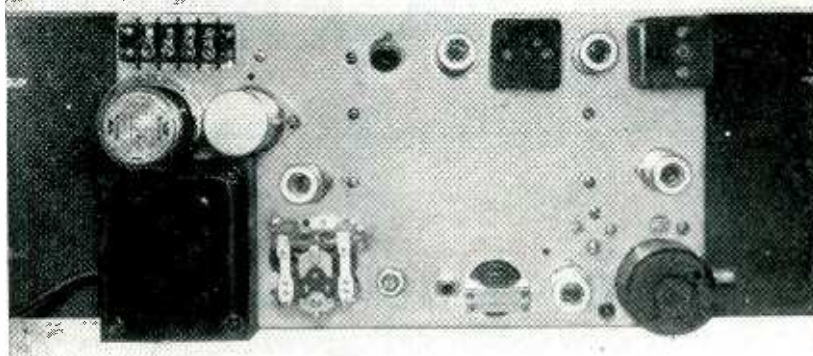

Rack mounted receiver requires no front-panel controls

alert alarm would be to use the voltage produced by carrier rectification to bias a tube to cutoff. The condition could be indicated by inserting a relay in the plate circuit of the tube. A moment's reflection, however, shows that with this system many receiver failures (for example, heater failure of the control tube) could occur that would make the system inoperative and yet would give no indication that things were not as they should be.

Receiver Failure

It is desirable, therefore, to design an alerting device that will indicate receiver failure as well as carrier failure of the key station. The rectified carrier voltage is therefore used to bias a triode but the relay is inserted in the plate circuit of a second triode and the two triodes share a common cathode resistor.

Under normal operation, V_{1A} is biased by the rectified carrier voltage and R_2 is adjusted so that V_{1B} is conducting enough to hold the relay closed. If a carrier failure occurs, V_{1A} will conduct, producing an increased voltage across R_2 . This increased voltage biases V_{1B} enough to cause the relay to drop out. Any receiver failure that causes V_{1B} to stop conducting (such as a failure of the rectifier tube) will give an alert.

An added set of contacts on the relay provides for closing a circuit to ring a bell in case the failure is of such a nature as to provide no

audio voltage to operate the speaker. The components R_1 and C_1 have a time constant that prevents relay operation until two seconds after a carrier failure. This is to prevent operation of the alerting system by momentary fading of the night-time signal of KMOX. The relay is so adjusted that it does not reclose when the carrier of the key station is restored. Resetting is done manually. Snap-action switch S_1 provides simulated carrier failure for testing.

When the receiver was installed at the KTTR transmitter, some cross modulation was encountered. This was eliminated by inserting a wave trap tuned to the KTTR frequency in the antenna lead to the receiver.

Installation

The receiver was constructed for rack mounting and occupies 7 in. of panel space. The chassis mounts vertically and all wiring is exposed by removing the front panel but without removing the receiver from the rack cabinet.

No particular claim is made for the virtues of the components used in this receiver. Some of them were selected because they were on hand or readily available. In the case of tubes, selection was made, in part, on the basis of tubes already stocked by the station for replacement in other equipment.

REFERENCE

(1) A. A. McKenzie, War-Emergency Operation of Broadcast Stations, *ELECTRONICS*, p 94, Aug. 1951.

A Phase Indicator

High-speed device is useful in development of circuits for color tv and as an aid in aligning and producing color receivers. Other applications are p-m and f-m monitoring, direction finding and delay network problems

By **KURT SCHLESINGER** and **LEROY W. NERO**

*Television Research Department
Motorola, Inc.
Chicago, Ill.*

IN THE NTSC system of band-shared color television, the chromaticity information is transmitted by a subcarrier of 3.89 mc, whose amplitude and phase are used to transmit saturation and hue of the colors, respectively.^{1, 2}

The need for an all-electronic high-speed phase indicator, capable of displaying on the screen of an oscilloscope, the instantaneous phase and amplitude of the color subcarrier became apparent. Such an instrument is described here.

Theory of Operation

The instrument requires two signal inputs: a constant carrier e_0 at $\omega/2\pi = 3.89$ mc for phase reference and a test carrier at the same frequency but with unknown phase. As Fig. 1 shows, the reference carrier is applied to a balanced modulator, where it is split into two sidebands and suppressed. Since the local oscillator has a frequency $\Omega/2\pi = 1$ mc, the two sidebands are placed at nominally, 3 mc and 5 mc. The two carriers at 1 and 4 mc are suppressed in the special modulator, Fig. 2.

If both sidebands have equal amplitudes, the modulator output reads

$$e_1 = e_0 \frac{1}{2} [\cos(\omega + \Omega)t + \cos(\omega - \Omega)t] = e_0 \cos \omega t \cos \Omega t \quad (1)$$

This sideband doublet is employed to decode both the test signal

$$e_2 = A \cos(\omega t + \varphi) \quad (2)$$

and its quadrature component

$$e_3 = A \sin(\omega t + \varphi) \quad (3)$$

To obtain the quadrature signal e_3 from the test signal, the latter is fed through a quarter-wave delay line or through a 90-deg phase shifter.

Both the test signal e_2 and the quadrature signal e_3 are then fed into separate synchronous detectors where they mix with the decoding wave e_1 . Only demodulation products at the frequency $\Omega/2\pi = 1$

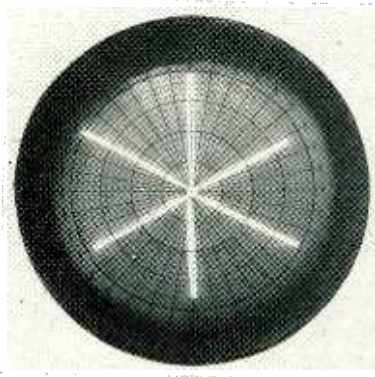

Hexagon display resulting from tying the instrument sequentially to six equidistant points along a delay line one wavelength long at 3.89 mc. Line was made up of lumped constants and contact to the instrument was made through an electronic sequencer

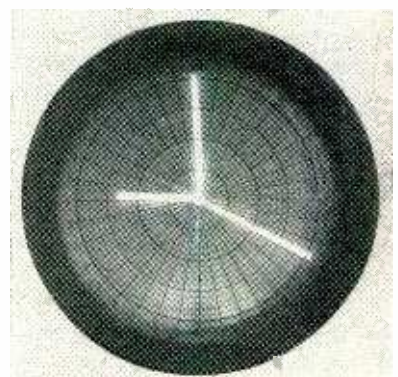

Odd-field display used to monitor an NTSC color test picture consisting of three horizontal bars per field, each in a saturated primary color. Short blue signal vector may be distinguished from a parallel but longer vector representing the cpa axis

for Color Television

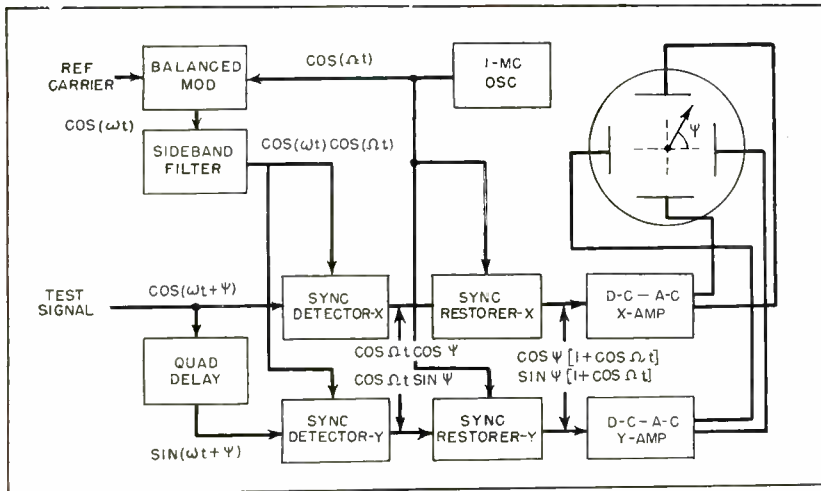

FIG. 1—Block diagram of the instrument called the Vectorscope

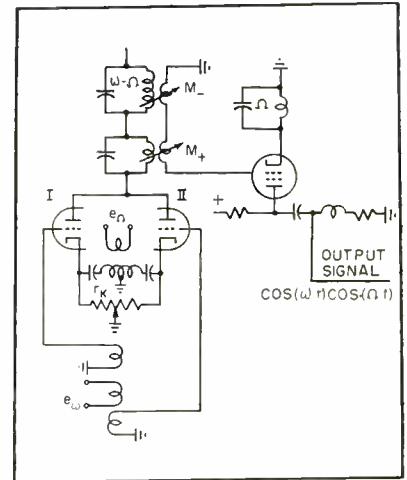

FIG. 2—Carrier-split circuit

mc are allowed to pass through the output filters of these detectors.

To find these components, expand Eq. 2

$$e_2 = A (\cos \omega t \cos \varphi - \sin \omega t \sin \varphi) \quad (4)$$

Since synchronous detection by e_1 yields no output from the sine term of Eq. 4, the detector output is

$$e_4 = \frac{1}{2} e_0 A \cos \varphi \cos \Omega t \quad (5)$$

Similarly, the result of synchronous

detection of e_2 by e_1 becomes

$$e_6 = \frac{1}{2} e_0 A \sin \varphi \cos \Omega t \quad (7)$$

If the phase signals e_4 and e_6 were used directly for deflection in the x and y direction, respectively, the result would be a phasor with the correct amplitude and inclination, swept through the center of the screen by a one-mc sine wave. This type of display is unable to differ-

entiate between phasors 180-deg apart.

To avoid this ambiguity, a radial offset is desirable, which makes each phasor start from the center on outward. Mathematically speaking, this requires the addition to the phase signals e_4 and e_6 of shift voltages of the form

$$e_8 = \frac{1}{2} A e_0 \cos \varphi \quad (7)$$

$$e_7 = \frac{1}{2} A e_0 \sin \varphi \quad (8)$$

respectively. In operation, these terms can assume either polarity.

Synchronous Restorers

Generation of the shift-signals e_6 , e_7 from the phase signal input e_4 , e_5 is done in two synchronous d-c restorers. At the restorer output, shift and phase signals are combined

$$e_y = \frac{1}{2} e_0 A \sin \varphi [1 + \cos (\Omega t)] \quad (9)$$

$$e_x = \frac{1}{2} e_0 A \cos \varphi [1 + \cos (\Omega t)] \quad (10)$$

These composite voltages require only some suitable amplification, see Fig. 5, before being applied to the deflecting plates of the instrument. The resulting vector display con-

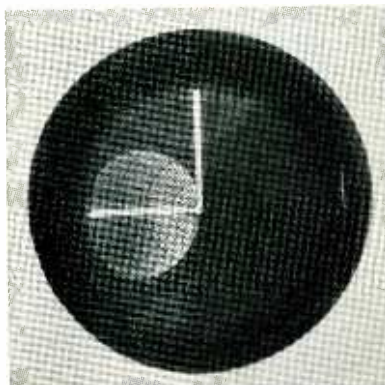

Attempts to lock a quartz crystal in with a variable frequency. Two vectors at 0 and 90 deg show resulting quadrature relationship between input and output. Vector pattern is response of the quartz. Luminescent area displays the expected circle diagram

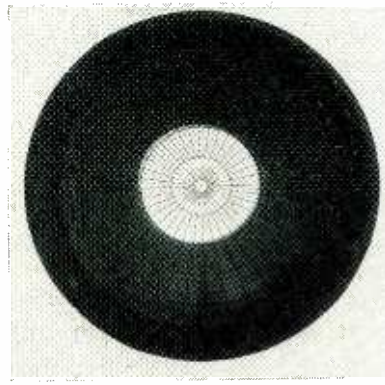

Appearance of side-locking, the locking of a resonator on sidebands of a carrier which arrives in bursts. This vector display of first-order side-locking shows a luminous circle swept by a radius vector rotating at a speed of 15,750 revolutions per second

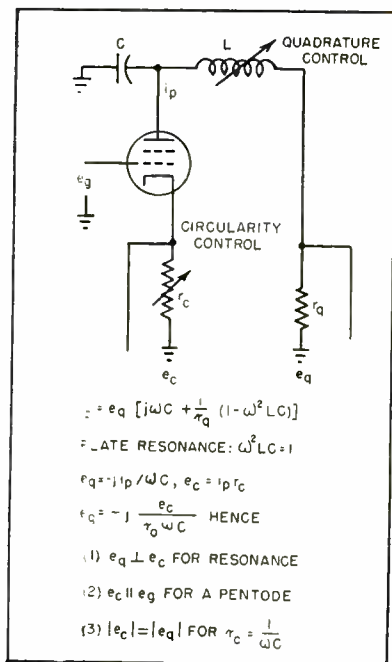

FIG. 3—Pentode delay circuit

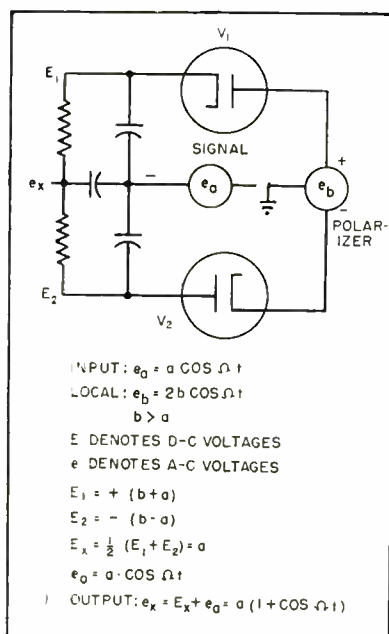

FIG. 4—Synchronous d-c restoration

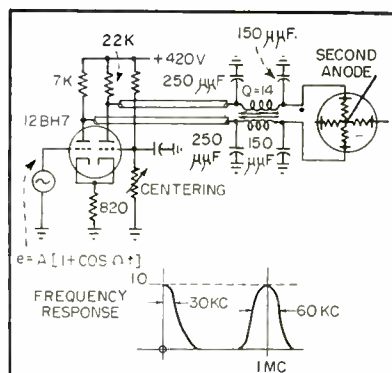

FIG. 5—Deflection amplifier for instrument display

veys not only the angular or phase information, but amplitude information as well, as long as the reference level e_0 is kept constant. The instrument is thus capable of a complete vector presentation of the test carrier in polar coordinates.

Unconventional Circuitry

Figure 2 presents the carrier split circuit used to replace the 4-mc reference by two sidebands at 3 and 4 mc. This unit employs a double triode modulator with double balance; both the signal carrier ω as well as a modulating carrier Ω are applied in push-pull fashion. The plate output is single ended with both plates in parallel.

If the triodes are balanced at the cathode bias resistor r_c as shown, both carrier frequencies ω and Ω cancel in the plate circuit, whereas the two sideband energies at $(\omega \pm \Omega)$ add.

The sideband frequencies are selected by two circuits tuned to 3 and 5 mc, respectively. By adding controlled amounts of pickup from each in a common tertiary, the sideband amplitudes are equalized and the desired decoding signal e_1 results. The output amplifier is flat beyond 5 mc and has a tuned cathode trap to remove any remnants of the 1-mc carrier.

The signal delay circuit used to obtain e_3 from e_2 is shown in Fig. 3. The circuit permits separate adjustment of amplitude ratio and phase angle between two output voltages e_p and e_c . This is shown by the set of equations indicated on Fig. 3 that quadrature between e_p and e_0 is obtained for any value of r_p by tuning the plate inductance for resonance. Circularity or equal output in both phases results if the cathode resistor r_c equals the reactance of the plate capacitor C . The values of plate inductance and plate load resistance r_p are again immaterial in this respect.

The transfer constant of this circuit is somewhat less than unity. The use of a pentode, rather than a triode, insures phase coincidence between grid voltage and cathode output regardless of the plate load impedance.

Figure 4 demonstrates the principle of synchronous d-c restoration

which is used in the instrument to add a radial shift to an on-center display of phasors. The technical problem consists in converting a waveform $A \cos \Omega t$ into the composite wave $A (1 + \cos \Omega t)$, where A can assume both positive and negative values in rapid succession. To make the restorer polarity conscious, a synchronous polarizing wave is used whose amplitude exceeds the signal.

Two diodes serve as envelope detectors for sum and difference of signal and polarizer. The difference of the two d-c outputs is then the desired shift voltage.

Figure 5 shows the deflection output amplifier used in the instrument. Since the signal consists of a constant frequency component and a d-c shift, the frequency response of the unit is designed for two separate lobes. One is around 1 mc and the other around the d-c axis. The bandwidth of each lobe is chosen such that the resulting speed of a-c and d-c response is of the same order, 5 μ sec. This prevents the vectors from overshooting the center for rapidly varying color signals.

Color Applications

The photographs illustrate some of the results obtained when the device was put to use in connection with color equipment. The instrument was first lined up by tying it sequentially to six equidistant points along a delay line one wavelength long at 3.89 mc. The line was made up of lumped constants and contact to the instrument was made through an electronic sequencer, with each contact lasting 1/360 sec.

The use of a phase indicator of this type is not limited to color television. Other applications include p-m and f-m monitoring, direction finding and problems involving delay networks. This includes the study of phase and delay distortion in the general four-terminal network.

REFERENCES

- (1) C. T. Hirsch, W. F. Bailey and B. D. Loughlin, Principles of NTSC Compatible Color Television, ELECTRONICS, p 58, Feb. 1952.
- (2) Specifications for Color Television Field Tests, ELECTRONICS, p 126, Jan. 1952.

Power Control With Magnetic Amplifiers

Recent developments in high-power industrial magnetic amplifiers, which have been overshadowed in the past few years by more glamorous advances in miniaturization, are described. New materials and circuits improve power control characteristics

By E. L. HARDER

*Consulting Transmission Engineer
Westinghouse Electric Corp.
East Pittsburgh, Pennsylvania*

THREE outstanding advances have changed the magnetic amplifier from the crude and sluggish amplifier of 20 years ago to the amazingly fast, flexible, and powerful control component of today. These are: the self-saturating circuits, which raised the ratio of power gain to response time by about 100; the development of square-loop magnetic materials such as Hipernik V and others which gave combined high gain with high output, and improved control; and improvements in dry-type rectifiers which further improved the gain, stability, and reliability.

This article is based on a paper presented at the American Power Conference, sponsored by Illinois Institute of Technology.

Operation of the self-saturated magnetic amplifier may be explained by the idealized half-wave circuit of Fig. 1A in which a large inductance blocks a-c from the control winding. During the reverse (opposite to rectifier) half cycle of voltage the flux density B has assumed a value corresponding to the control current, I_{co} , as shown in Fig. 1B. When the forward half cycle of voltage occurs, the core generates a back voltage preventing the flow of load current until the core saturates. This is repeated each cycle.

The average voltage reduction on the load, occasioned by this delay in firing (Fig. 1C) on each forward half cycle, is directly propor-

tional to the flux reduction, $\Delta\phi$, below saturation produced by the control current I_{co} . The control characteristic of Fig. 1D results. Practical full wave circuits operate in essentially the same manner but do not require the inductor in the control circuit.

The basic magnetic amplifier circuits now in use for power control represent many combinations and modifications of the circuit shown in Fig. 1. The self-saturated types have replaced the simple saturable reactor type for most applications. Most popular are the parallel-connected or doubler circuit, with a-c output; the center-tapped transformer, full-wave connection for d-c output; and the bridge connection for d-c output. The doubler output can of course be rectified for d-c output. Usually the choice of d-c or a-c output and the voltage rating will determine which circuit should be used.

The rectifiers may be divided into self-saturating, those directly in series with saturable reactor windings, and simple rectifying units. The latter act as in any rectifiers but the former have the added requirement of low and stable back current to produce high amplifier gain and low drift. In low-voltage applications, where a single disk in series is adequate, the bridge connection results in smaller size and weight, whereas if several disks are required in series, the doubler (requiring fewer self-saturating rectifiers) is advantageous. Such and



Magnetic amplifiers for controlling 1,800-kw 60-cps power supply for r-f heater on tin reflow line. Motor-generator set supplies d-c control power

other practical considerations dictate the basic circuit to be employed.

The center-tapped transformer connection and the bridge connection correspond to the connections of dry-type rectifiers except for the insertion of the saturable reactors to control the firing, giving the equivalent of a thyatron grid delay. This equivalence gives rise to

the symbolic representation used in the remainder of this article, in which the rectifiers alone are shown with the control and bias windings indicated schematically.

A few typical power applications illustrate the potentialities of this new tool.

Steel Mill Regulator

The four or five stands of a tandem cold rolling mill are regulated to follow in speed a master d-c reference bus which brings the mill from a low threading speed up to running speeds of over a mile a minute in a matter of six seconds, closely controlling the tension all the while. The stop is also six seconds (four in emergencies) and uniform tension between stands must be maintained down to standstill.

A high grade regulator is required which can maintain proper inter-stand relations throughout this difficult cycle in spite of minor load fluctuations and irregularities. High regulator speed prevents differing acceleration lags and prevents loops accumulating due to minor fluctuations of material or voltage. Reliability is a prime requisite because a shutdown means serious loss of production.

Figure 2 shows the circuit of a magnetic amplifier regulator for one stand of such a mill. The equipment replaces an earlier system with about 5 to 1 improvement in response time, greatly simplified damping requirements, simpler adjustments and consequent improved reliability. The inherent delay in a magnetic amplifier tends to be about the same number of cycles, irrespective of frequency so that the 420-cycle magnetic amplifier is inherently seven times faster than a corresponding 60-cycle unit.

Other Mill Applications

Magnetic amplifier applications have also been made to the main drives of many other types of mill, tin plating lines, and printing presses, as well as to many auxiliaries.

The reel drive is worthy of special notice since so much processed material must be reeled and re-reeled as it passes through various processes from the raw material to

the finished product. The usual requirement is a constant tension drive permitting a reduction in rotational speed as the material builds up on the reel. This is secured by current regulation, the magnetic amplifier comparing the reel motor current with a reference and controlling the motor field current accordingly. Highly successful applications have been made and it is interesting to note that the control panel, including the magnetic amplifiers, for one of these is no larger than the control panel previously used for the rotating regulators being displaced.

Magnetic amplifiers are now controlling the firing circuits of ignitron rectifiers, providing a smooth reliable control and replacing the thyratrons previously used for this purpose.

Regulated d-c power supplies are now available, entirely without vacuum tubes. These are being applied in government applications at present but will also provide an almost maintenance-free unit for industry.

Magnetic amplifiers have been used for years in certain variable speed controls to cranes and hoists. Now the new high performance units are bringing in a whole field of applications of variable speed drives, both d-c and a-c, for all kinds of industrial operations, elevators, wind tunnels, and the like.

Tin Reflow Line

High performance control is nowhere better exemplified than in the tin reflow line where high-frequency heat raises the temperature of electrolytically-plated tin to the flow point so precisely that with the plated strip moving nearly half a mile a minute, the flow line remains stationary in position. A phototube signals the position of the flow line to an amplifier. Power is amplified through an exciter and three 600-kw power magnetic amplifiers to the plates of the tubes that generate the high frequency for heating. This set-up is shown in Fig. 3.

The smooth control obtained with static high power equipment is advantageous in this case. Of interest is the use of electronic, rotating, and magnetic amplifiers, in this single control. However, the present

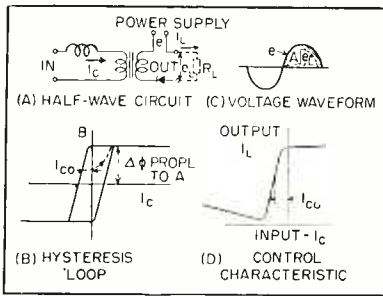

FIG. 1—Idealized magnetic amplifier circuit and characteristics

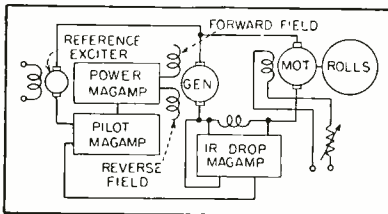
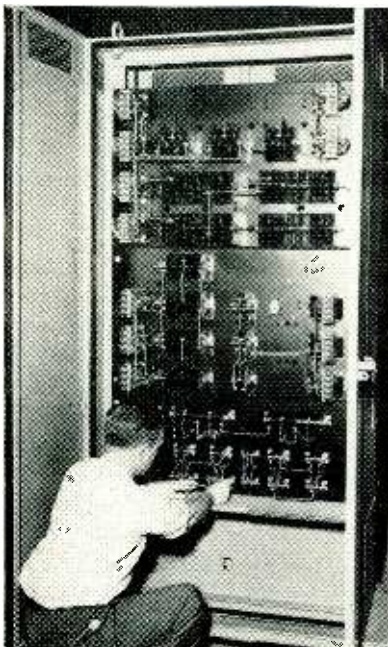

FIG. 2—Schematic of magnetic amplifier for one stand of tandem steel mill regulator



Cubicle housing 400-cps pilot, power and IR-drop magnetic amplifiers for tandem steel mill regulator (Fig. 2)

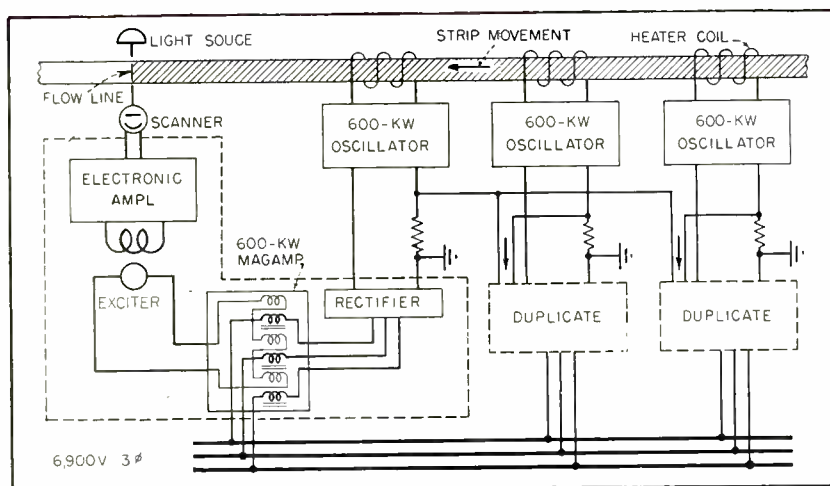

FIG. 3—Tin reflow line requires a series of 600-kw magnetic amplifiers for accurate heating control

trend is to extend the use of the magnetic amplifier.

Magnetic amplifiers are finding use in generator excitation systems from the smallest aircraft generators to the largest central station unit. The advantages offered are numerous.

Exciter Circuit

A magnetic amplifier excitation unit and regulator for machines of several hundred kilowatts is shown in Fig. 4. In this case about half of the excitation at full load is supplied directly by series compensation, resulting in extremely rapid response to sudden load changes. The balance of the excitation required for no load and to compensate for drift, aging, temperature changes and forcing is supplied through the exciter under control of the static regulating circuit.

The latter unit in effect compares the generator voltage, compensated for reactive drop, with a fixed reference and provides a corrective signal to the magnetic amplifier in event of any voltage deviation from setting. Essentially the same magnetic amplifier that serves as the exciter for this size generator would be the pilot magnetic amplifier supplying a main exciter for the largest turbine-generator units.

In addition to voltage, all manner of other quantities are being regulated. These include speed, frequency, position, temperature, charging rate, light intensity, and the like, it merely being required to reduce the regulated quantity to an

electrical signal for application to the amplifier.

Military Applications

Greatest current interest in power magnetic amplifiers is in the military field, where because of their smaller size, greater efficiency,

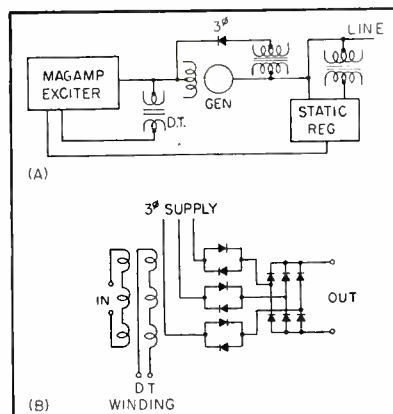

FIG. 4—Magnetic amplifier and regulator for machines of several kilowatts

rugged construction and prospective freedom from maintenance, they are replacing electron tubes in many applications. A number of autopilots and gun mounts and stabilizers are already converted, a single autopilot using over 30 separate magnetic amplifiers. The tremendous development in the military field is making technical improvements in power magnetic amplifiers available at a rapid rate for industrial applications.

D-C Transducer

The d-c current transformer like perpetual motion was long ago

crossed off the slate as impossible. However, the series-connected magnetic amplifier has an equal-ampere-turn law and provides isolation of instrumentation from d-c power circuits and so serves the role so well that it is by courtesy sometimes called a d-c current transformer. For larger direct currents of 2,000 to 75,000 amperes, the d-c is passed through the openings of the saturable reactor cores and acts as the control current. The a-c secondary current is proportional to it. For smaller currents, shunts are more economical and auxiliary current-transducers are used for the isolation function.

Similarly shunt-connected magnetic amplifiers are used to isolate the power d-c bus from potential coils of switchboard instruments. Other instrumentation uses of magnetic amplifiers are to thermocouple and photocell amplifiers, strain gages and as a d-c amplifier.

Performance

The figure of merit of small 10 to 50-watt magnetic amplifiers is of the order of 1,000 per cycle, this figure increasing with physical size. This means that a power gain of 10,000 per stage is feasible with 10-cycle time constant or 3,000 with 3-cycle time constant, and so forth. Special circuits have been developed to carry this relation down to one cycle or less.

The control characteristic of the magnetic amplifier approaches a straight line relationship between control current and output or load current.

For many industrial controls the advantage of using available 60-cycle power sources precludes 400 or 800-cycle sources for the improved speed and lower weight. Static frequency multipliers are available and afford an answer to this problem for the lower power stages.

A frequency tripler, three phase from single phase, is composed of a star-delta transformer bank operated in saturation with the triple frequency load taken from one corner of the delta.

The applications which have been cited are typical of literally hundreds of applications being made in all branches of power control.

High-Speed Counter Uses Ternary Notation

Counter based on powers of three attains high counting speeds using fewer tubes than conventional counters. Circuit described operates reliably up to 175,000 counts per second using only nine stages. Application of circuit in fast nuclear scalers is predicted

MOST ELECTRONIC COUNTERS are binary in nature. Regardless of the number system used, they are made up of binary cells. In such counters, those using binary notation are most economical, not only in cost, but also in space and power requirements for a given memory capacity.

The usual four-tube decade when employed in a scale of one thousand would have a scale of over four thousand if the same twelve stages were used in binary notation. In commercial applications, such as nuclear scalers, even with binary notation there is a severe limitation in the memory capacity of a reasonably sized unit.

To take full advantage of a high-speed counter when storing large counts, it is necessary to use more binary stages than are commonly employed in nuclear scalers. Since the usual mechanical number register has a maximum speed of about twenty counts per second, to utilize the full speed of a 200-kc counter, at least fourteen binary stages must be used ahead of the number register. This is more than twice the number of stages found in commercial units. Improvement would be achieved through use of a memory element comparable in size and cost to the binary element but having greater memory capacity. The advantage of reliably increased memory capacity in large computers needs no explanation.

This paper describes a simple ternary memory and a fast counter using this memory in ternary no-

tation. Any number of stages may be used, giving a number capacity of 3^n for n stages. In this counter, eight stages provide a scale of 6,561 as contrasted with 256 for an eight-stage binary counter.

Ternary Memory

The flip-flop circuit, which provides conventional binary memory, may be considered as a closed-loop positive-feedback circuit comprising two amplifier stages. When the

loop gain is greater than one, the circuit is unstable, and any minute change in plate current of either tube will reinforce itself and keep building up until loop gain is reduced to one, either by an approach to saturation in one tube or an approach to cutoff in the other.

The circuit will then be in a stable condition until a change in voltage in any part of the loop drives it back to the region of higher gain. The change will then continue until limited by saturation or cutoff of the opposite tube, affording a second condition of stable operation.

To obtain more than two stable states, there must be an intermediate region wherein loop gain is reduced below unity. This may be accomplished by insertion of additional nonlinear elements into the loop. A convenient way of inserting the required nonlinearity is the use of diode coupling between cathodes. The component requirement is about the same as that of a Higinbotham-type binary stage¹.

Theory

The ternary memory is illustrated in Fig. 1. With the diodes removed, each half of the circuit resembles a phase-splitting circuit wherein plate and cathode resistances are about equal. The gain of each half is approximately one at both plate and cathode. Plate currents of both halves will be equal, since the circuit is symmetrical. Total loop gain will be the product of the gains of each half (slightly less than one).

If the cathodes are tied together,

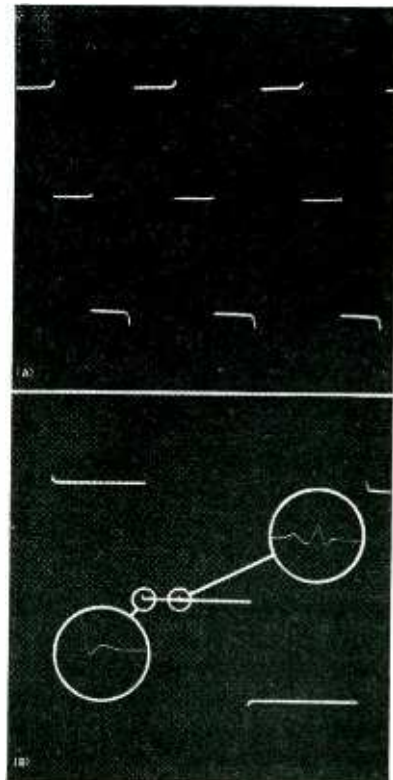

Ternary counter waveforms illustrate the three discrete operating states comprising a counting cycle. Stage 2 plate voltage (B) shows division by three of input prf. Stage 1 plate voltage is shown in (A)

Much of the work described in this article was carried on at Illinois Institute of Technology.

By RICHARD WEISSMAN

Senior Engineer
Cook Research Laboratories
Skokie, Illinois

in addition to the signal at the grid of either tube, we may consider that another signal is injected at its cathode by the cathode of the other tube. The loop gain will now be greater than one and the circuit operates as a flip-flop. Another way to visualize the effect of tying cathodes together is to consider that as long as the circuit is symmetrical, increase in plate current of one tube will be cancelled by decrease in plate current of the other tube and the cathodes will remain at a fixed potential, thereby eliminating the degenerative effect of the cathode resistor.

With diodes connected as shown in Fig. 1, as long as both plate currents are the same, the cathodes will be at the same potential and both diodes will be nonconducting since the diode anodes are at a negative potential with respect to their cathodes. A stable intermediate condition is thus provided as though the diodes were not in the circuit.

Memory Operation

If a pulse is applied at any electrode, the pulse being of sufficient amplitude to cause an amplifier

cathode to move to a voltage below that of the tap on the opposite cathode resistor, or to raise a cathode resistor tap above the potential of the opposite cathode, a diode will begin to conduct. Once a diode begins conducting, the effect is the same as that of tying the cathodes together through a small resistor. Loop gain will be increased to a value considerably greater than one, and flip-flop action will take place. Any tendency of a diode to conduct will result in a signal injected at a cathode, the signal being of the right polarity to make the diode conduct still further. Thus, using nonlinear coupling in a closed-loop positive-feedback system, it is possible to obtain three regions in the conduction characteristic wherein loop gain is less than unity, and consequently to achieve three stable conditions. The three states are well defined and widely separated. Plate potentials in a typical circuit are 135, 190 and 255 volts.

Counting, or plus-one operation necessitates driving the memory successively through its three states by a repeated pulse at the same point of the circuit. If the counter

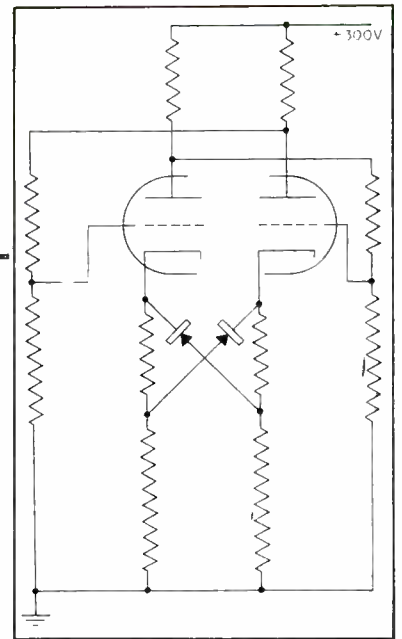

FIG. 1—Basic ternary memory has three stable operating states

is to be used in ternary notation, the operation must be cyclical. Instead of stopping at the last stable position, the circuit must revert to its initial condition on the next impulse and repeat its cycle.

Counting Operation

Derivation of the cyclical counting operation from the ternary memory requires the use of the same plate-to-grid capacitors found in binary memories. Injection of the input pulse at a cathode is used here, but plate and grid injection have been found successful as well. An advantage of additional stability is obtained by cathode injection because of relative freedom from kick-back from the driven stage since the injection point is not subject to full transition voltage.

Counting Circuit

Two stages, providing a scale of nine, and the means for interstage coupling are shown in Fig. 2. Additional stages of the same type may be added as desired. The explanation of the first stage applies also to subsequent stages.

Referring to the first stage, the three stable states are designated as follows: $0, V_{IB}$ cut off, $1, V_{IB}$ and V_{IA} both in medium conduction, and, $2, V_{IB}$ fully conducting. The sequence of states is 0-1-2-0. In state

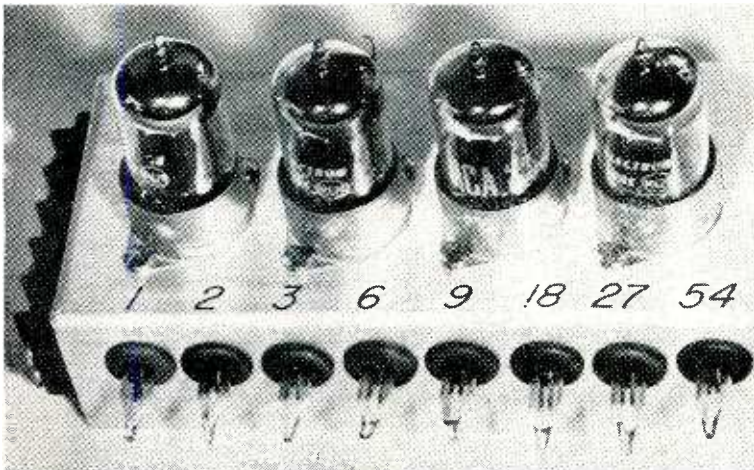

Four-stage ternary counter, with two-light-per-stage indication, having a scale of 81. Lighted neon bulbs indicate 3^n and 2×3^n

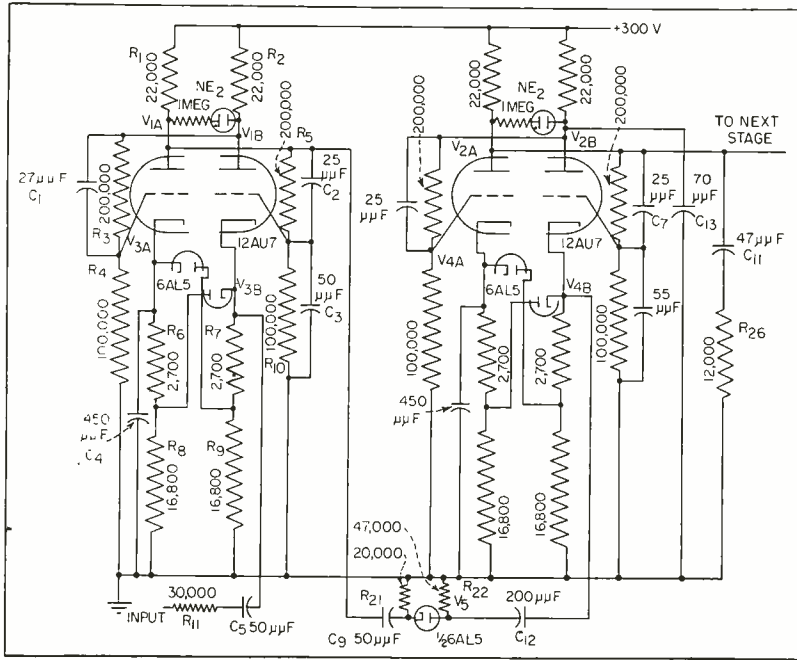

FIG. 2—Successive negative pulses to V_{1B} cathode drive the counter through its three states. With V_{1B} cut off, first pulse drives both tubes into conduction. Second pulse cuts off V_{1A} . Third pulse returns circuit to initial condition

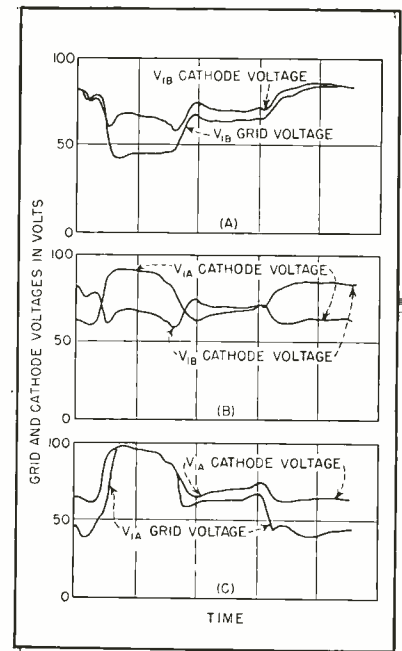

FIG. 3—Simultaneous grid and cathode voltage waveforms from both stages show step-by-step counter operation

0, V_{1B} is cut off and V_{1A} is fully conducting. A negative-going pulse of one microsecond duration is injected at the V_{1B} cathode. The momentary lowering of cathode potential drives V_{1B} out of cutoff and multivibrator action ensues, carrying the stage toward state 2. When both triodes are in the region of medium conduction, the cathodes are at the same potential and diodes V_{3A} and V_{3B} are nonconducting because of negative plate-to-cathode voltage. The input pulse has by this time disappeared. Multivibrator action ceases because cathode degeneration is permitted in the region of medium conduction and overall loop gain is reduced below unity. Thus the stage never reaches state 2 on the first pulse, but remains stably in the medium-conducting state.

Second Pulse

The next input pulse increases the conduction of V_{1B} to a point where loop action drives the cathode of V_{3A} negative with respect to its plate. Cathode degeneration is no longer permitted and multivibrator action takes place until state 2 is reached. Cutoff of V_{1A} reduces the loop gain and the circuit remains stably in state 2. V_{1B} is now fully conducting.

The next input pulse drives V_{1B}

into positive-grid-voltage region wherein C_2 takes on an additional function. Because of diode action between grid and cathode of V_{1B} during the pulse, current flows through R_1 to increase the charge of C_2 . When the input pulse has ended, V_{1B} grid is sufficiently negative with respect to its former potential for V_{1B} to start into cutoff. The new potential across C_2 is maintained for a long enough time for the stage to pass completely through stage 1 and directly to the stable 0 condition. Diode action between grid and cathode of V_{1B} acts as a pulse stretcher, permitting fast charge and slow discharge of C_2 . Thus the

secondary effect of the input pulse, which is to lower the grid potential of V_{1B} , is prolonged until some time after the pulse itself has ended. By virtue of this secondary effect V_{1B} begins to cut off.

Memory Reset

Multivibrator action takes the stage to state 1, but this time, instead of stopping in state 1, the stage passes through the middle state directly into the initial 0 condition since C_2 still retains some charge from the prolonged secondary effect. Since V_{1B} has previously been cut off and its grid is considerably lower in potential than its

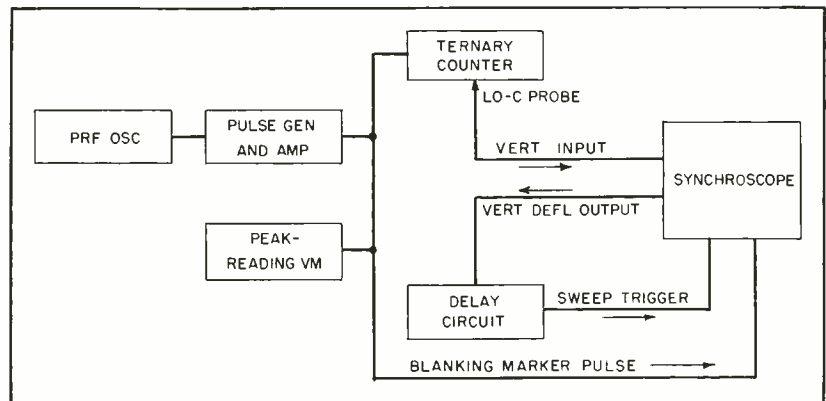

FIG. 4—Ternary counter and test equipment setup used to study circuit operations. Waveforms shown in Fig. 3 were traced from synchroscope

cathode, the secondary effect can not occur in the transition from state 0 to state 1.

Typical waveforms of the ternary counter are shown in the photograph. They were taken at the first and second stage plates. For a detailed study of the various events occurring simultaneously in different parts of the circuit during each transition, it was found convenient to make tracings directly from the oscilloscope. Intensity modulation was used to secure a fixed time reference so that waveforms taken from separate points could be shown accurately on the same time axis. Use of a variable sweep delay permits display of the three transitions in the first stage on a time base of one microsecond per centimeter. Figure 3 shows the essential voltage relationships in the grid and cathode circuits with blanking markers derived at the start of each input pulse. The test setup, which is useful in any general study of counters and similar circuits, is shown in the block diagram, Fig. 4.

Circuit Details

In Fig. 2, capacitor C_3 , not only complements the secondary effect in the 2-0 transition by a fast discharge-slow charge action similar to that of C_2 , but also serves to reduce overshoot from the 0-1 transition. This overshoot would result in V_{1B} grid being driven farther negative than its normal state 1 potential and would tend to produce an undesired 0-2 transition. Capacitor C_4 acts to reduce rise time of V_{1A} plate voltage. Relatively fast rise of V_{1A} plate voltage in the 2-0 transition is necessary to obtain a sufficiently sharp output pulse to drive the succeeding stage.

Resistor R_2 prevents overshoot in the input pulse, which would otherwise result from the $C_5-R_7-R_8$ combination when the input pulse is rectangular. With R_{11} in the input circuit, the input pulse shape is not critical. In the second and subsequent stages C_{13} is added; C_{13} permits use of the comparatively slow rising pulse derived from the previous stage by slowing up the 0-1 transition to assure the passing of the input pulse by the time transi-

tion is well under way. In the first stage, faster counting speed requires a shorter input pulse and C_{13} is not necessary.

To derive the pulse for triggering the second stage, the step waveform of the 0-2 transition in the first stage is differentiated by the $R_{21}-C_9$ combination. Diode V_6 eliminates positive pulses from 0-1 and 1-2 transitions. Resistor R_{22} establishes the diode plate reference point and C_{12} serves as a blocking capacitor. At the second stage output R_{23} and C_{11} are used as an output load to represent the succeeding stage.

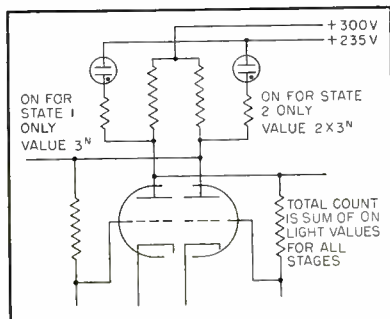

FIG. 5—Two-light-per-stage ternary indicating system

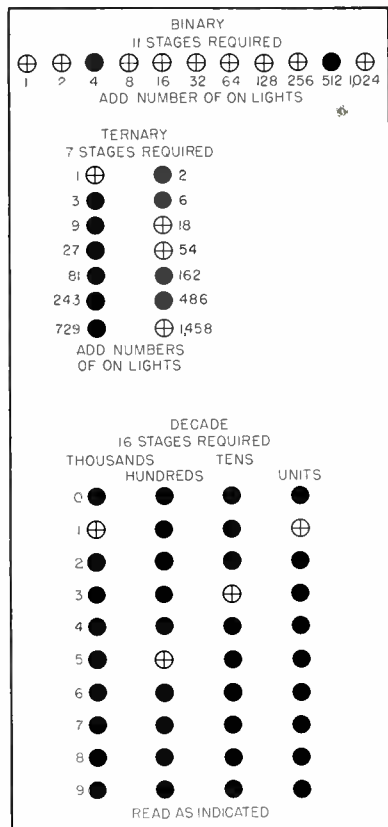

FIG. 6—Number 1,531 displayed in binary, ternary, and decade indications. Economy in number of stages characterizes ternary system

Diodes in this circuit are hard tube types, but germanium rectifiers will work equally well.

Indicating System

The indicating system shown in Fig. 2 requires only one neon light per stage. The left electrode glows in state 0, the lamp is dark in state 1, and the right-hand electrode glows to indicate state 2. In applications where ease of reading is more important than compactness, a two-light-per-stage system as shown in Fig. 5 may be used. In either case, there is no marginal operation and no resistor network is needed to obtain the read-out in ordinary ternary notation. As an example of the ternary read-out with two lights per stage compared with the conventional binary and decade indication the arbitrary number 1,531 is displayed in Fig. 6 in three different systems. The relative number of stages required is indicated for each system.

Components

The counter operates reliably at speeds up to 175,000 pulses per second. Input pulse height can vary from 85 to over 150 volts with perfect counting action throughout the range. The component tolerances are about the same as for a conventional binary counter. Symmetrically located component pairs are required to be matched within five percent with the exception of the plate load resistors, which can be within twenty percent. If the required matching of pairs is effected, the pairs may be within ten percent of the nominal value. Exceptions may be made for R_{21} , R_{22} , R_{11} , C_5 , C_9 , C_4 , C_{10} and C_{12} , which need only be held to within twenty percent of nominal value.

The counter is not critical of supply voltage variation and will operate satisfactorily with B voltages from 250 to 325. At the nominal operating voltage of 300 volts, the current drain is about eight milliamperes per stage, which is about the same as that of the conventional Higinbotham-type binary stage of equal speed.

REFERENCE

1. W. Higinbotham, J. Gallagher, M. Sands, The Model 200 Pulse Counter, *Rev Sci Instr.* 18, 10, Oct. 1947.

Field Plotting in

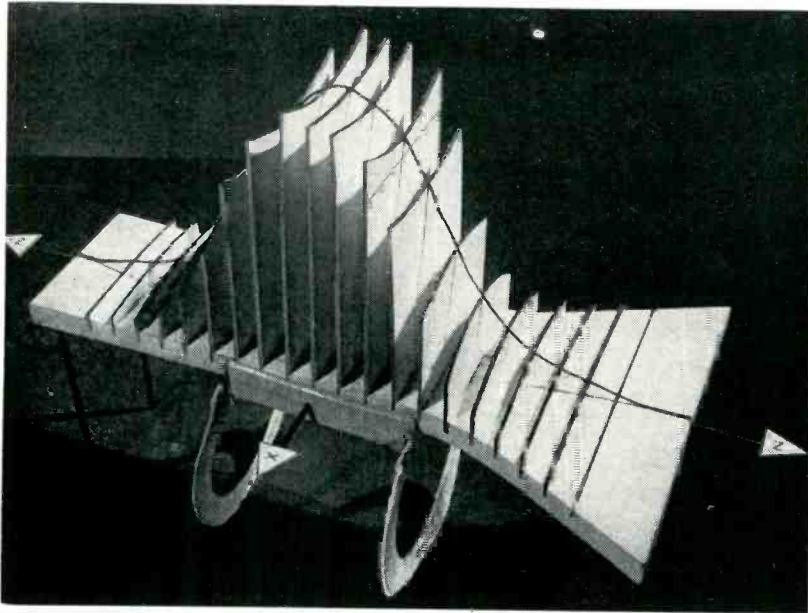

Space-model plot of the H_y component through the xz plane

By **E. SIEMINSKI**

*Physics Laboratories
Sylvania Electric Products, Inc.
Bayside, New York*

SCANNING PROBLEMS in television picture tubes challenge the ingenuity of the television engineer. This is largely because of the difficulty of analyzing the magnetic deflection yoke, the heart of the scanning system in common use. Significantly, the conventional deflection yoke was developed almost entirely by empirical techniques.^{1,2,3,4}

Competition has fostered a demand for better picture quality and picture tubes with larger faces and shorter neck and cone lengths, all of which magnify the difficulties of yoke design. The advent of tricolor picture tubes with most exacting deflection requirements has necessitated a renewed search for better design techniques. In the course of this search, deflection field configurations were studied and the utility of the field plot established in both the empirical and analytical^{5,6} approaches to the deflection problem.

The Field

An electron beam has an appreciable thickness and in the process of being focused on the phosphor screen, takes on a long, thin conical shape. The greater the deviation from the ideal (infinitely-thin) cylindrically shaped beam and the greater the angle of deflection, the more serious are the defocusing and raster distortion effects⁷. In the three-gun tricolor tube, the cluster of three beams behaves like an extra-thick composite beam having an extra-large convergence angle and aberration effects are severe. The elimination of deflection aberrations is usually the major problem in the design of deflection yokes.

In the following discussion, the horizontal and vertical magnetic

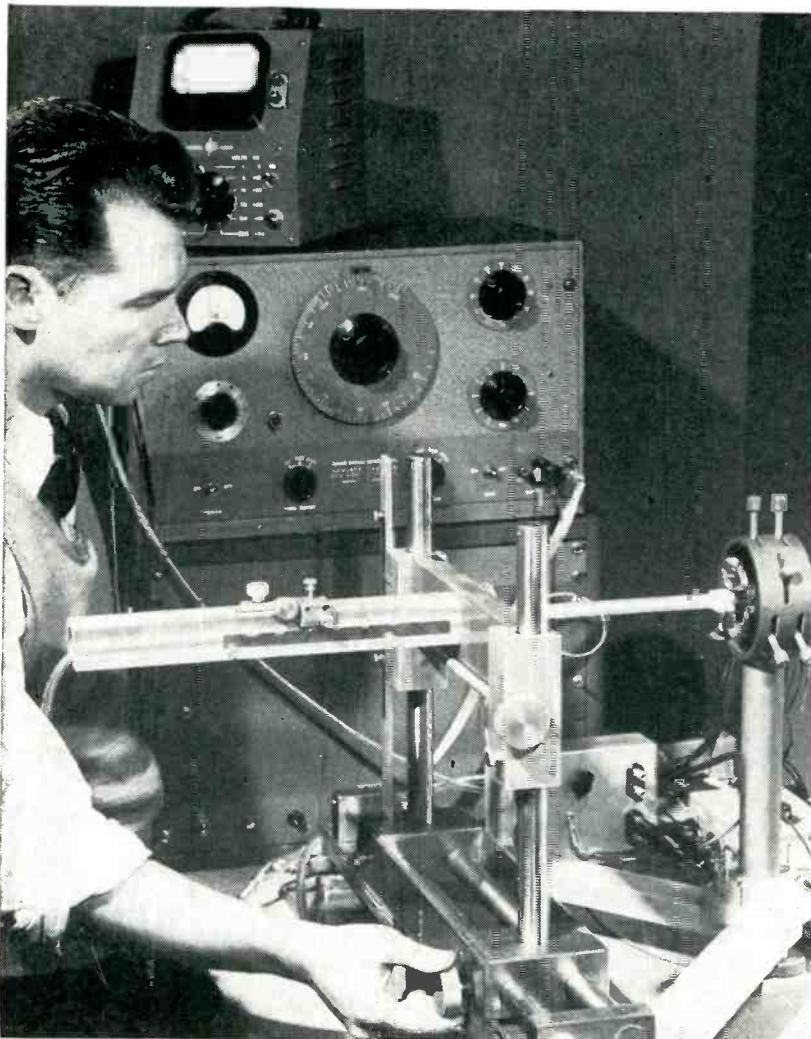

Field-plotting equipment. Probe coil may be rotated fully about the longitudinal axis of the probe rod

Deflection Yoke Design

Simple method of analysis permits accurate measurement of differences in performance caused by design changes. Specific deflection responses may be attributed to specific design changes. Need for manipulating cathode-ray tubes is minimized

fields of the television yoke will be identified by the symbols: $H =$ magnitude of the field set up by current in horizontal deflection windings and $V =$ magnitude of the field set up by current in vertical deflection windings.

Since both fields follow the same laws of physics, only one field H is to be studied and the conclusions reached applied, in principle, to the other field.

A magnetic field is a vector quantity which can be visualized as the resultant of component vectors directed along the three axes of a system of Cartesian coordinates, Fig. 1. The three components of the H field will be designated H_x , H_y , and

H_z . Since the H_y component is the one which produces horizontal deflection (x direction), it will receive the most attention.

Figure 1 depicts also the manner in which the H_y component varies in a typical television yoke. The H_y component is explored along x , y and z axes. Cross-sectional sketches of side and end views of the windings serve to locate the plotted points in space with reference to the physical windings. The points A , B , C , D and E are common on all three sets of curves.

As a further aid in visualizing field configurations it is sometimes helpful to build a space model such as that shown in the photograph.

This is a plot of the H_y component throughout the xz plane. The base of the model represents the xz plane which bisects the horizontal windings and the height of the curves above the base represents the relative magnitude of field component in the xz plane. Mathematically, the surface formed by the curves expresses H_y as a function of x and z , or $H_y(x, z)$.

The sets of line plots employed here are those most useful in practice namely: The $H_y(x)$ function expressed in a family of curves taken along lines paralleling the x axis and the $H_x(z)$ function defined as the single curve $H_y(z)$ taken along the z axis proper. In the photo-

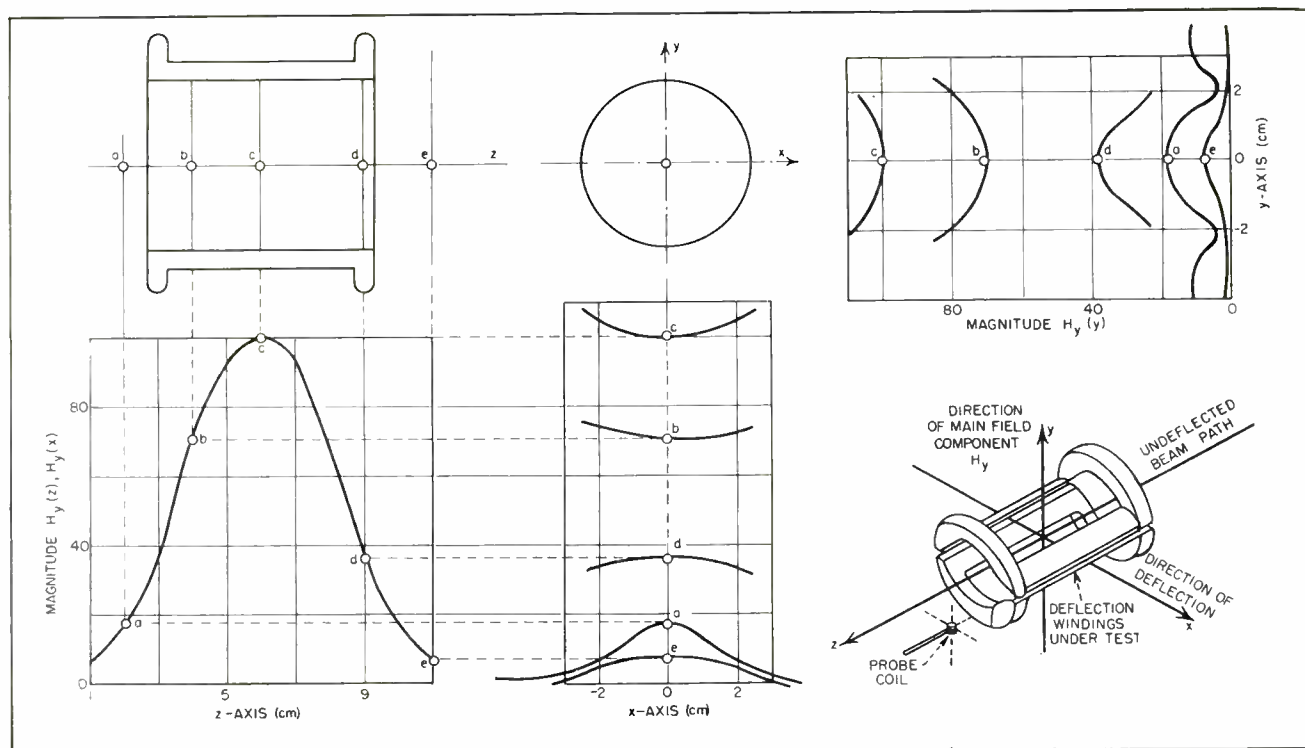

FIG. 1—The H_y field plot of a commercial yoke and a mechanical sketch showing the coordinate axes

graph, this curve is the dark line joining the midpoints of the successive $H_x(x)$ curves.

A complete picture of the field would require a discouragingly large number of plots in families of curves $H_x(x)$, $H_x(y)$, $H_x(z)$, repeating all for $H_x(x,y,z)$ and $H_x(x,y,z)$. In practice a modest number of plots suffices. A specific problem often involves restricted areas of interest, so that only those areas need be explored. Advantage may be taken of the similarities exhibited by field characteristics in different regions plotted, reducing the number of curves necessary to supply desired information. For the H field, the H_x component is the dominant one. In the region of the main field, the H_x and H_y compo-

nents are insignificantly small and need not be explored extensively.

Empirical-Design Plots

The ultimate criterion of a deflection yoke design is its performance on a picture tube, but the use of field plots provides unique advantages in analyzing and evaluating the numerous expedients used in reaching the design. It is a simple method of analysis that minimizes the need for manipulating cathode-ray tubes, always troublesome in experimental work. Whereas observations on picture tubes are subject to considerable error, the field-plotting technique permits accurate measurement of differences in performance caused by various design alterations. It

becomes practicable to attribute specific deflection responses to specific design changes.

The degree of deflection produced by a winding geometry is proportional to the field intensity set up by the winding with a given current flow. To a first approximation, the integrated area under the H_x plot is a measure of the total deflection produced in a picture tube. When comparing plots, one must keep in mind the values of current required to produce the fields, as well as the relative inductances of the windings used in the comparison.¹

Field plots reveal the amount of useful magnetic component present as compared to the remaining, usually troublesome, components. The field produced outside possible beam

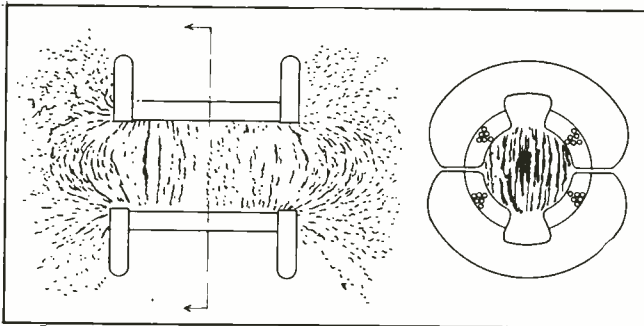

FIG. 2—Iron-filing plot of a uniformly-distributed winding and resulting barrel-shaped field

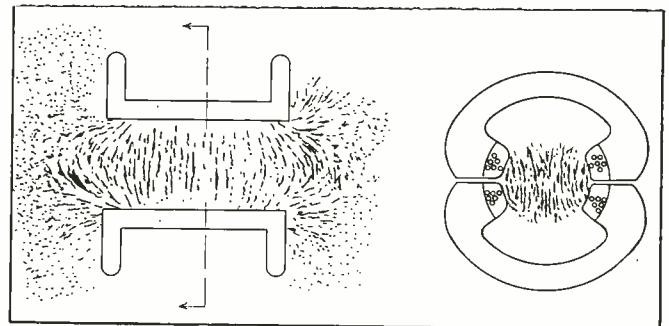

FIG. 3—Iron-filing plot of a concentrated winding and pin-cushion field

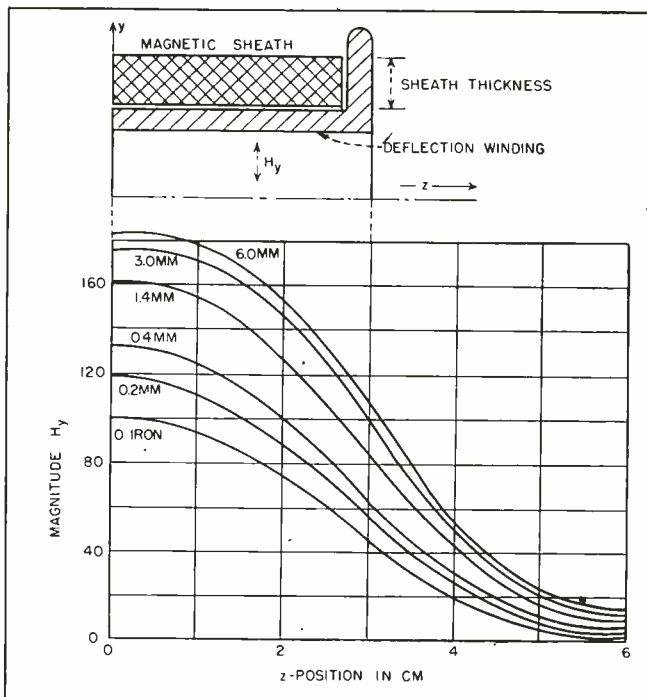

FIG. 4—Deflection field as a function of magnetic-sheath thickness

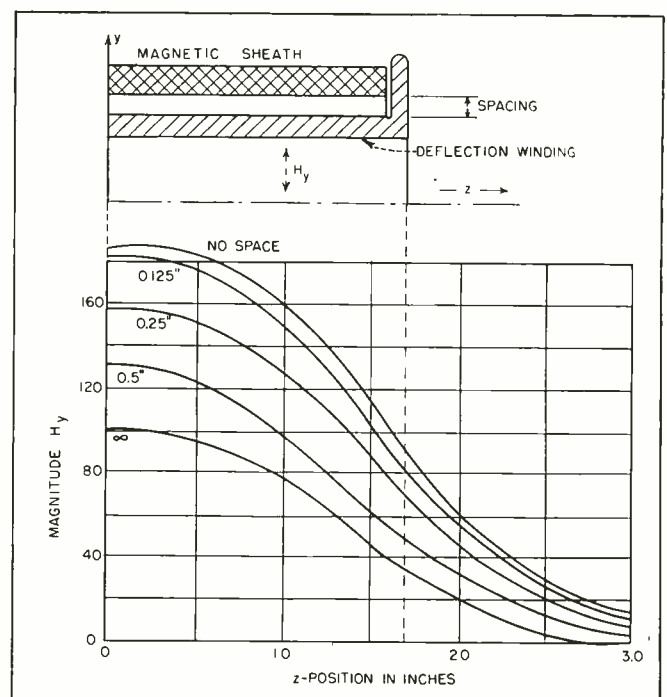

FIG. 5—Deflection field as a function of magnetic-sheath spacing

paths is wasteful of power since it has no effect on deflection. The involved fringe field may be studied effectively also by exploring all components.

With large deflection angles, avoidance of neck shadow may require a concentration of the field in the flared region of the tube neck. By contrast, in conventional yokes (Fig. 1), the build-up of area under the H_z curve indicates that the bulk of deflection occurs well before the beam enters the flared neck of the picture tube, which is the screen end of the deflection winding. With the help of field plots, a more efficient concentration of field can be obtained.

Pattern Distortion

Shaping the deflection field has a profound effect upon raster distortion.⁸ Even if the ideal uniform field could be obtained ($H_y = 0$), the flat or near-flat geometry of the conventional tube face would cause a pincushion-shaped distortion to appear on the tube screen. The perfect raster would be formed on a spherical screen surface. To eliminate the raster distortion, an equal and opposite distortion may be introduced by curving the deflection field appropriately. It may be shown⁸ that a barrel-shaped distortion in the raster is produced by a pincushion-shaped field. Conversely, a pincushion distortion is introduced by a barrel-shaped field.

Figures 2 and 3 illustrate these two field configurations obtained experimentally. In these illustrations, iron-filing pictures were made in d-c excited windings. Unlike the other field plots appearing graphically in this discussion, Fig. 2 and 3 each show combinations of two field components (H_x and H_y in the lengthwise view and H_x and H_z in the end-on view). These are isometric plots of the field, loci of points of the same intensity, in the cross-sectional planes indicated.

Winding Geometry

Winding geometry may be studied effectively with field plots. Whereas uniform distribution of conductors on the circumference of the tube neck tends toward generation of the barrel-shaped field of

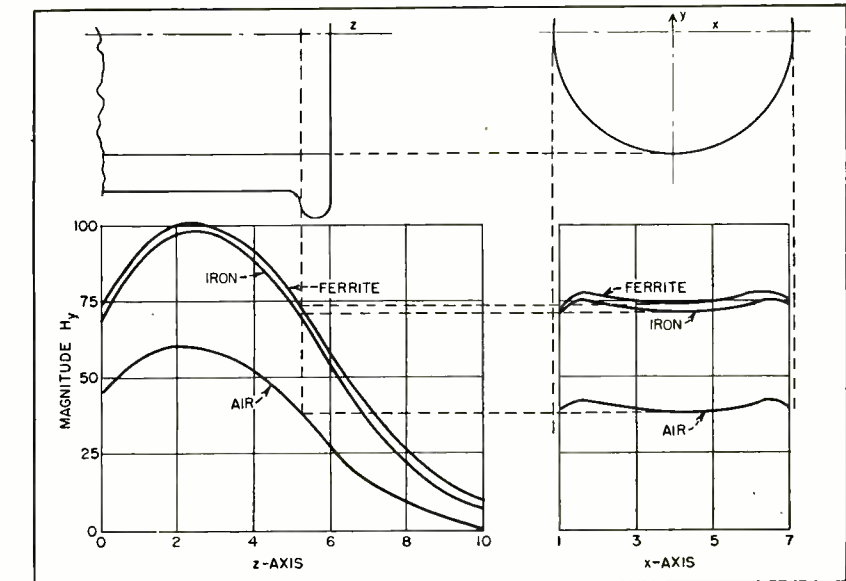

FIG. 6—Suitability of different sheath materials may readily be evaluated

Fig. 2, a relatively concentrated winding generates the pincushion-shaped field of Fig. 3. Present-day commercial yoke windings often utilize a type of conductor distribution wherein the number of conductors in a small arc on the circumference varies as the cosine of the angular location of the arc with reference to the direction of deflection. In each cosine-type winding, the main curves expressing $H_y(x)$ will tend to be straight lines.

The curvature in plots of $H_y(x)$ is related to the curvature illustrated by the iron-filing pictures. The $H_y(x)$ plot of the barrel-shaped field would show the field intensity dropping off toward the ends of the plot. The $H_y(x)$ plot of the pincushion-shaped field would show the field intensity increasing at the ends of the plot. Both curvatures can be seen in the plot of Fig. 1.

Shaping of the field is effective in minimizing spot distortion. For better focusing over the face of the usual picture tube, a deflection yoke should have a field characteristic H_y least intense at the center of the yoke and increasing slightly in intensity with distance along the x axis, the direction of deflection. This is a pincushion-shaped field. In practice, a form of conductor arrangement approaching the cosine-squared distribution has proven advantageous. The role of field plotting in such a result is obvious.

Field plots are useful in studying the effects of ferromagnetic materials in deflection windings. Figure 4 was plotted with constant current in the winding, varying the thickness of the ring or sheath of magnetic material. The curves show that with increasing thickness of sheath, the field intensity increases until a ring depth is reached above which there is a negligible increase in intensity. It is interesting to note that the relative shape of the curves remains practically the same in all cases, only the magnitude changing. The corresponding curves of $H_y(x)$ and $H_y(y)$, although not illustrated, follow the same rule.

Air Space

Figure 5 reveals a further result of investigating magnetic sheaths. The air space within the yoke, through which the beam travels, is the dominant factor in fixing the reluctance of the magnetic flux path. A ferromagnetic sheath provides a low-reluctance return path for the flux. Spacing the sheath from the windings lengthens the air gap in the magnetic path and thereby affects the field intensity.

In Fig. 6, field plots are used to compare the effectiveness of different magnetic materials having the same physical dimensions. There is little difference in the two results. Evidently the reluctance of the return path of the field flux is reduced to a negligible value in either case;

a choice between the two materials must depend upon considerations other than their relative permeabilities.

Fringe-Field Effects

The fringe field in deflection yokes has always been a source of uncertainty. From an inspection of the preceding field plots it should be evident that there is no sharp line of demarcation between main field and fringe fields. Figure 7 shows one way in which field plots may be used to study fringe fields. The same deflection yoke is used in each case.

In one of the trials the winding end is flared to fit the flared neck of the television picture tube. In another trial, the winding end is spaced off the tube neck but is not flared as in the first trial. The curves show the corresponding effects on the field. More detailed conclusions may be reached only after exploration of the other components involved in the three alternatives and an evaluation of their influence upon deflection and spot focus.

The classical treatment of deflection appears to have originated in German laboratories⁶ and has been expanded upon in this country. All such approaches pre-suppose a knowledge of field distributions. Conceivably, these may be calculated but even in the simplest cases, the calculation proves so laborious that an experimental determination of the field becomes a necessity.

Utility of the field plot may be shown by a theoretical analysis involving beam deflection.⁵ In such an analysis, two-dimensional fields (components in x and y directions only) are used and the work is restricted to field types which have mirror symmetry about the xz and yz planes. The vertically deflecting and horizontally deflecting fields exist simultaneously in the same region.

It is interesting to note that any magnetic-field nonuniformity which a field plot discloses is evidence that the flux lines of the field are curved in that region. Any curvature in the plot of a field component discloses the existence of another field component.

Studies involving the mathema-

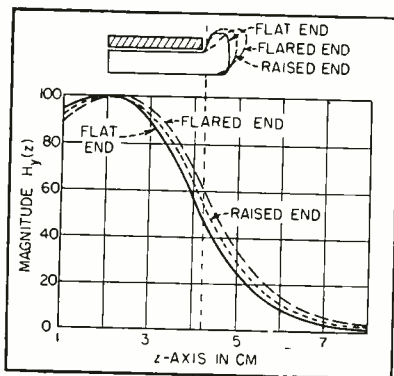

FIG. 7—Field plots show effect of forming the winding end

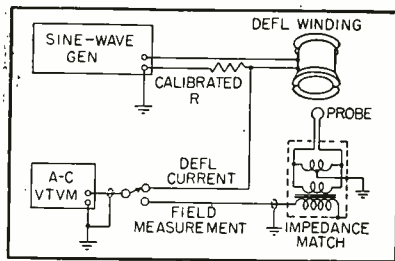

FIG. 8—Block-schematic diagram of the test equipment

tics of deflection may well lead to yoke designs having a minimum of deflection distortions.

Equipment

Figure 8 outlines the equipment used for measuring the deflection field. Sine-wave currents are used in the yoke windings and a calibrated series resistor provides a means for measuring the current flow.

Stable, sensitive and precise equipment is readily available for generating and measuring sine waves, a waveform which is easily controlled and offers a minimum of difficulty in calibrations and computations.

To approximate dynamic operating conditions, a frequency of 15 or 16 kc is used in the horizontal windings and approximately 1 kc in the vertical windings. The latter frequency is low enough to avoid deleterious effects of frequency, yet high enough to permit field exploration with the low-impedance probe coil used.

The probe coil consists of approximately 200 turns of No. 42 wire, wound on a nylon form having winding space of 0.040 in. inside

diameter, 0.120 in. outside diameter and 0.040 in. wide. The terminal wires connect to a miniature type step-up transformer feeding a sensitive vacuum-tube voltmeter which serves to indicate field strength.

A second photograph shows the field-plotting equipment, essentially a mechanism for locating the exploring coil accurately in all parts of the magnetic field of a deflection winding along each of three mutually perpendicular coordinate axes. The probe coil may be rotated fully about the longitudinal axis of the probe rod.

In the field area, construction is nonmetallic to avoid distortion of the field under test. The probe rod is of plastic material. Electrostatic pickup is minimized by using a carefully balanced bifilar winding centertapped to ground at the probe terminals. The transformer and this balancing winding, for reasons of magnetic shielding, are housed in a thick-walled iron shell located at the base of the probe rod. This shell functions as a plunger which rides in a bored casing of squared cross-section and acts as a support and guide for moving the probe along the z axis in the direction of the probe rod. Precautions must be taken to avoid operating the equipment in the presence of interfering fields. The 60-cycle pickup which is encountered in the vicinity of voltage-regulating line transformers is particularly objectionable.

Credit is due Fred Clair, John Kackauskas, William Hoenig and Daryl Shipley for contributions in this work.

REFERENCES

- (1) W. T. Cocking, Deflection Coil Characteristics, *Wireless World*, 56, March 1950, 56, April 1950, 56, May 1950.
- (2) A. W. Friend, Deflection and Convergence in Color Kinescope, *Proc. IRE*, 39, p 1,249, Oct. 1951.
- (3) B. B. Bycer, Design Considerations for Scanning Yokes, *Teletech*, 9, p 32, August 1950.
- (4) Kurt Schlesinger, Anastigmatic Yoke for Picture Tubes, *ELECTRONICS*, 22, p 103, Oct. 1949.
- (5) R. G. E. Hutter, Electron Beam Deflection, *Jour. App. Physics*, 18, August 1947 and Sept. 1947.
- (6) Georg Wendt, Über die Abbildungsfehler Magnetischer Ablenkfelder, *Die Telefunken Rohre*, 15, p 100, April 1933.
- (7) V. K. Zworykin, G. A. Morton, E. G. Ramberg, J. Hillier, A. W. Vance, "Electron Optics and the Electron Microscope", John Wiley & Sons, Inc., New York, 1945.
- (8) I. G. Maloff and D. W. Epstein, "Electron Optics in Television", McGraw-Hill Book Co., Inc., New York, 1938.

Digital to Analog Converter

By M. MILLER, B. L. WADDELL and J. PATMORE

*Electronic Associates
Long Branch, New Jersey*

Information stored in digital systems, such as business machine cards and magnetic tapes, is changed to analog form for application to industrial processes requiring d-c control voltages, or to analog-type plotting boards for rapid interpretation

INFORMATION STORAGE, whether it be data concerning the performance of a guided missile or the rise and fall of bobby pin sales, whether in analog form such as a curve plotted by two variables or in digital form such as columns of figures, pulses on magnetic tape, or holes punched in cards or tape, can be represented through the medium of numbers.

The information stored in several thousand numbers expressing, for example, the performance of a turbo jet engine under test, becomes extremely hard to evaluate. The digital information might be reduced to analog form by some plotting method for rapid interpretation, but this operation usually is accomplished manually at the cost of speed and accuracy.

The digital-to-analog converter is intended to automatize plotting of digital information without materially sacrificing the speed or affecting the accuracy of the digital system. The converter can be used in applications other than digital plotting, such as, furnishing input data to analog computers, or as an electronic control for industrial processes. However, development of the converter was initiated primarily so that digital information from IBM cards could be plotted.

The function of the converter is that of transforming digital data into d-c voltages for plotting and recording, and the equipment can be attended readily by non-

engineering operating personnel.

The basic elements of the converter, as shown by the block diagram of Fig. 1, are a basic timer, two temporary storage units, two d-c converters and a control panel.

Operation

In operation, two four-digit numbers and their signs recorded on an IBM card are read by a type 513, 517, or 523 IBM card machine. This information is stored in the temporary storage units until the card-reading cycle is completed and the two numbers assembled. While the numbers are being assembled, the two d-c converter units switch in precision resistors in a voltage-divider arrangement. The resultant voltages are summed in the d-c amplifiers and the output, which is proportional to the digital input, is applied to the plotting board servo

system to position a pen and plot a point.

Each card has eighty columns across its width, each column numbered from zero through nine from top to bottom. Two other positions arranged above the zero at the top of the card will be considered as the eleventh and twelfth numbers. During the card-reading cycle, the IBM machine emits a series of pulses which indicate the particular line the machine is reading.

The eleventh position is used to indicate the sign of the number, a hole punch in this position indicating that the whole number is negative, and no punch a positive number. In recording the number on the card, the sign may be indicated in any column of the four-digit number. Regardless in which column the sign appears, the converter will detect it and cause the

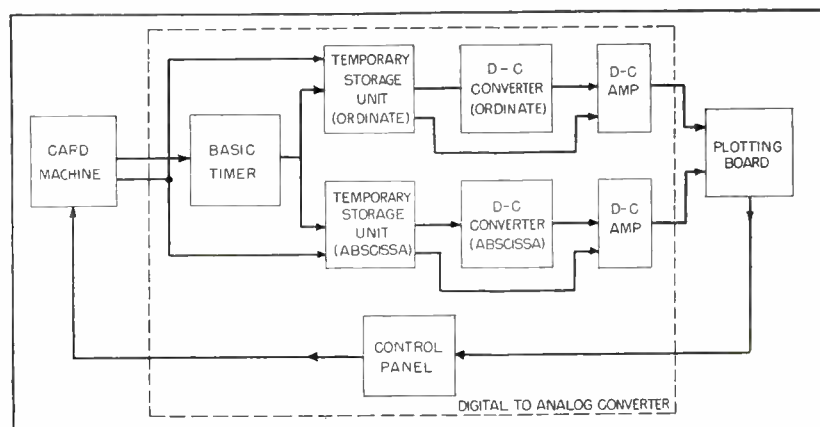

FIG. 1—Block diagram shows principle of digital to analog converter

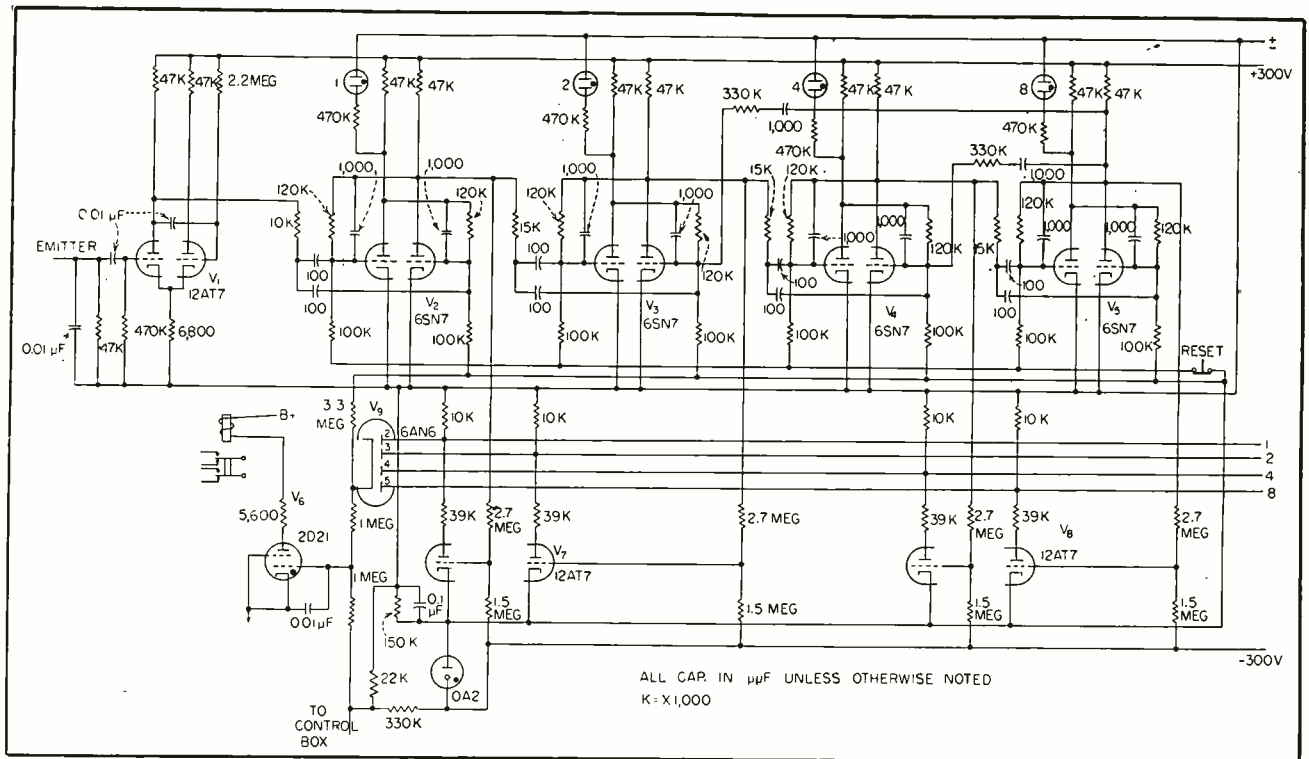

FIG. 2—Converter basic timer consists of a pulse shaper and four multivibrators and isolation amplifiers

resultant d-c voltage output to be either positive or negative.

Basic Timer

The converter basic timer (Fig. 2) consists of a pulse shaper, four Eccles-Jordan multivibrators, and four associated isolating amplifiers used to furnish control voltages to the temporary storage units. The 12AT7 pulse shaper V_1 insures that the emitter pulses are clear and well defined, for dependable and accurate operation. The timer counts from nine through zero in a coded binary form, that is, with the first emitter pulse the Eccles-Jordan circuit registers nine, indicated by the numbers one and eight. This corresponds to the nine-line being read on the IBM card.

The second pulse for the eight-line is indicated by the number eight. The third pulse is indicated by the numbers one, two, and four, representing the seven-line, and so on through zero. The eleventh pulse, indicating sign, is not handled in the basic timer but is applied to the appropriate temporary storage unit which selects a positive or negative voltage.

A self-checking circuit is included which compares the count of the

timer against the zero emitter pulse. If the basic timer is not on zero, a thyatron is fired which pulls in an error relay causing a buzzer to operate, simultaneously, the operation of the IBM machine and the converter are stopped so that the d-c output voltage for that pulse will not be plotted. Indicator lights on the front panel show which multivibrator failed, and also show the number of pulses missed during that cycle. A reset button is provided, which when operated, will reset the basic timer to zero.

Temporary Storage Units

Two temporary storage units hold the ordinate and abscissa numbers while they are being assembled and converted to d-c voltages. Each storage unit (Fig. 3) has a pulse-shaping section, an isolating amplifier, and a matrix or number assembly (storing thyatron) section.

The pulse-shaping section uses five 12AT7 dual triodes. Four of the triode sections receive pulses produced by the IBM machine brushes when a punched hole is encountered on the card in any of the four number columns. Two tubes are used as isolating amplifiers to provide half-control voltages to the

matrix. The fifth pulse shaper fed by the eleven-line emitter pulse is arranged to furnish half-control voltage to a sign-changing thyatron. The other half-control voltage is obtained when a punched hole appears on the eleventh line in any column of the IBM card. When this occurs, the appropriate IBM column brush, pulse shaper, and isolating amplifier feed a voltage to one plate of a 6AN6 diode and from there to the control grid of the sign-changing thyatron. The thyatron in turn will fire and operate a relay which selects either positive or negative voltage in the d-c converter.

D-C Converter

The two d-c converters accomplish the actual changing of digital information to d-c voltages. When a thyatron is fired in the matrix a relay is operated, connecting a precision resistor in a voltage-divider circuit. When the whole number is assembled by this resistor selection process, the resultant voltages are summed in a contact-stabilized d-c amplifier and applied to the plotter. The sign of the voltage is determined by the presence or absence of a hole on the

eleventh line of the card.

The converter unit has been provided with a control circuit to provide operate pulses to the auxiliary devices and control starting and stopping of the converter. The check circuits operate through the control circuits and provide stops to suspend operation if an error occurs. The control circuits allow different auxiliary devices to be connected without rewiring.

The control panel contains a power on-off switch, automatic-manual feed, a manual pushbutton, and a storage clear. The control circuit also provides parallax and scale factor controls previous to the d-c amplifiers to allow the summing inputs to be modified according to the requirements of the digital input.

Sequence of Operation

Let us assume that one of the two numbers punched in an IBM card is -1952. As the card-reading operation proceeds, a pulse is received from the IBM emitter which indicates that the nine-line is being read. This pulse, which is fed to the basic timer, causes the first and fourth Eccles-Jordan multivibrators to go on, representing the numbers one and eight, or the coded binary equivalent of the number nine.

When the two stages of the basic timer go on they cause a volt-

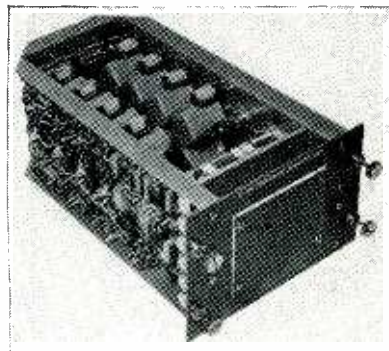
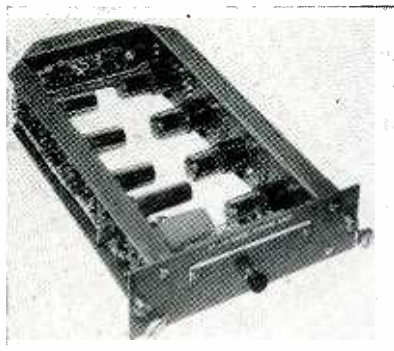

Basic timer (left) and temporary storage unit (right) form basis of converter

age, amounting to half control voltage, to be applied to thyatron rows one and eight in the matrix. At the same time that the nine-line pulse is produced, a brush riding the second column of the card makes contact through the punched hole representing the nine of the whole number 1952.

This contact produces a pulse which is fed to the temporary storage unit (Fig. 3) where one-half of the control voltage required to fire the thyatron is formed. This voltage is then applied to all of the thyatrons in the second or hundreds column. Since thyatron rows one and eight have received half their required control voltage from the basic timer, this additional voltage is then sufficient to fire thyatrons one and eight in the second column only. These thyatrons, in turn, cause relays to switch appropriate resistors into

the voltage divider of the d-c converter.

At this point we have achieved temporary storage of the number nine and partial conversion of the whole number into d-c voltage. As the card-reading cycle continues, the remaining lines of the IBM card are read in the same manner as described above until the whole number and its sign are stored and converted. The total d-c voltage produced is fed to the plotter. For this application, the plotter has been arranged to plot a point only after its servo system and associated pen have come to a complete null, thereby realizing the maximum possible accuracy.

Applications

The digital to analog converter has many applications. The d-c outputs can be used to control manufacturing processes. This application allows uniformity of information from day-to-day or hour-to-hour control. The digits or control number used at time t_1 will have the same d-c value at time t_2 . The change in controlled process can be easily effected by giving the device new numbers to operate on in the form of new IBM cards, new list for keyboard operation, or a new magnetic tape.

The data reduction flexibility of the device can be seen from the fact that d-c or analog comparator techniques can be applied between the d-c amplifier and the plotting board; that is, multiplication by a constant, or subtraction or integration previous to the plot. Thus, the engineer can try many different parameter combinations on his test data and receive a plot of the results of his changes almost simultaneously.

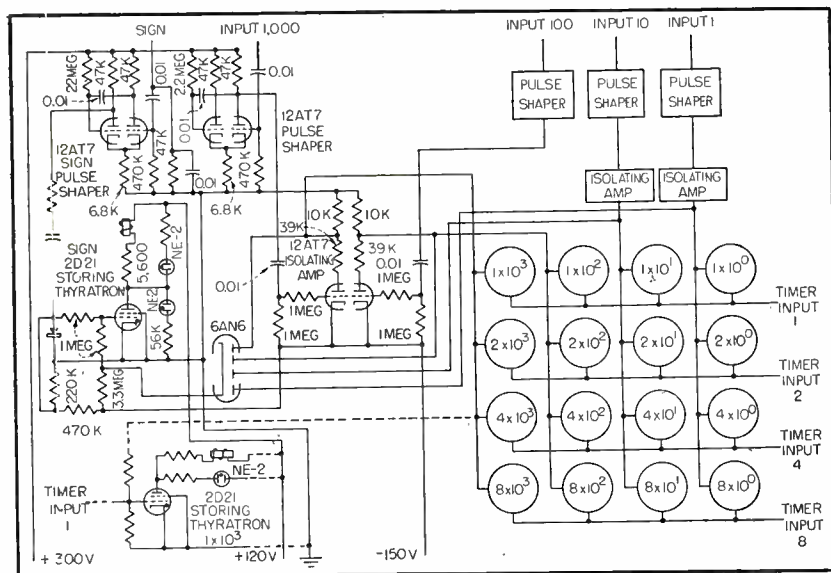

FIG. 3—Two storage units hold ordinate and abscissa numbers while they are being assembled and converted to d-c voltages

Skewed

By **M. W. SCHELDORF**

*Director of Research
Andrew Corp.
Chicago, Ill.*

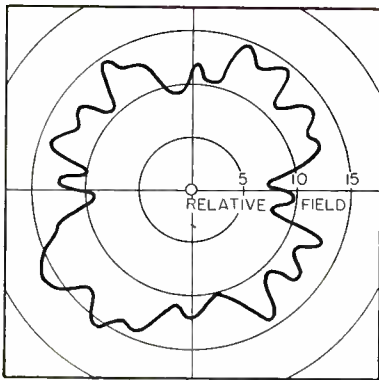

FIG. 1—Measured pattern in relative field strength of four-element skewed group mounted on circle of 4.2 wavelengths diameter

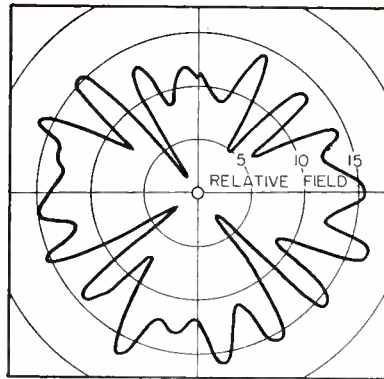

FIG. 2—Measured pattern in relative field strength of antenna group with four-element conventional orientation that causes dips

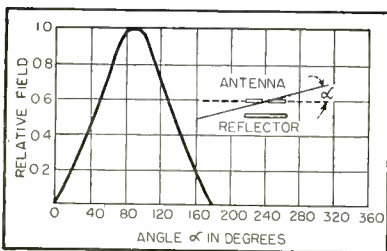

FIG. 3—Simplified calculated curve of antenna field vs angle for individual radiator. Backward radiation is not considered

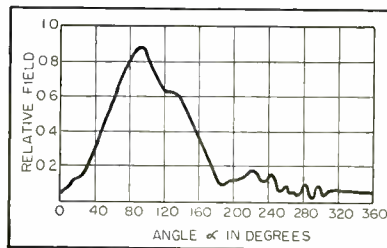

FIG. 4—Actual measured pattern of individual radiator. Undesired backward radiation deepens nulls of final array pattern

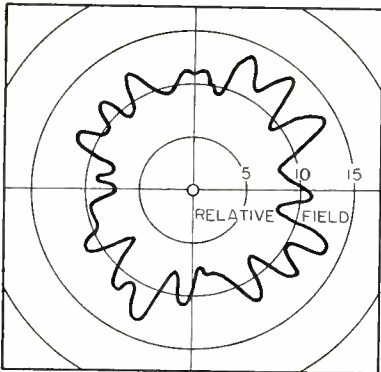

FIG. 5—Measured pattern from vertically-polarized elements. This polarization is not used for television

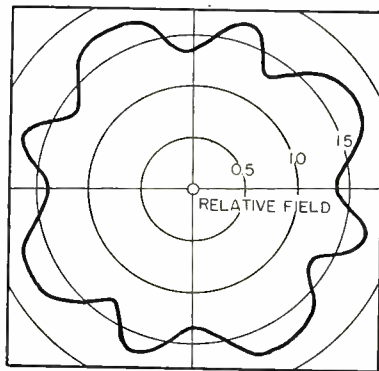

FIG. 6—Midchannel calculated pattern of the skew antenna showing the relatively uniform coverage

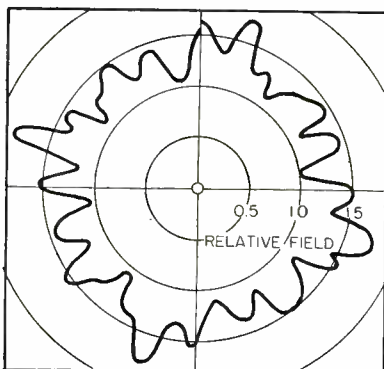

FIG. 7—Midchannel measured pattern showing effect of Fig. 4

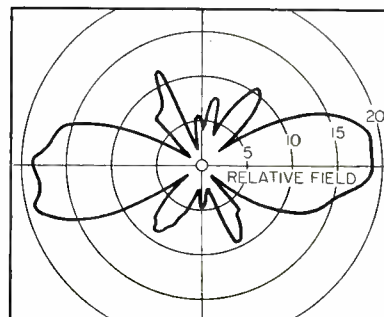

FIG. 8—Average vertical pattern of the standby array scale model

TELEVISION broadcasting stations find it highly practical from a commercial viewpoint, to have available a completely separate standby transmitting antenna system. At the Empire State Building in New York City, one of the five prominent antenna positions is occupied by WJZ-TV. The conical portion of the building directly beneath the five-antenna tower is allotted to them for a standby radiator.

Skew Method

The normal method of installing radiators employs four directive antennas beamed away from the center, each covering one-fourth of the azimuthal range. It is customary in this case, to use the supporting tower surface as a reflector and produce a directive beam with a simple half-wave radiator.

A new arrangement, in which the simulated tower faces have been extended in one direction to produce reflectors at 90 degrees with respect to radial directions, is shown in the photograph. Now the half-wave radiators, turned 90 degrees from their former positions, produce beams that are skewed 90 degrees.

Halfway between the beams, in both cases, is a crossover angle, at which the radiation is equal from two adjacent radiators. The phasing can be chosen to give the desired relative signal at this angle but at other angles near it the resultant signal depends on the several chosen fixed conditions.

When there is no skew, the rate

Antenna at WJZ-TV

Standby radiator comprises four corner-reflector units mounted on the conical tower below regular tv antennas. Elements skewed 90 degrees smooth radiation contours that would otherwise suffer dips from interference patterns resulting from mounting elements tangent to frustum of the cone

of change of the phase between the individual radiated signals varies rapidly as the angle changes and the pattern develops relatively deep null values. When there is 90-degree skew, this rate of change of phase is much slower so that the pattern nulls are less prominent.

Initial work made use of an experimental setup of four antennas mounted on a circle of 4.2 wavelengths diameter. In the particular case the antennas were skewed at 90 degrees. Because of the horizontal polarization it was important to drop the individual cables considerably below the level of the antennas for the interconnections. Each antenna was a corner-reflector type, giving good control of both planes of polarization.

The experimental curve obtained with this arrangement is given in Fig. 1. Figure 2 gives the result when the skew is reduced to zero. The improvement by the use of a skew angle is quite apparent. Calculations have been made for comparison with the experimental data. Figures 3 and 4 show the calculated and measured curves for the individual radiators. Figure 3 is based on the forward radiation obtained from a commercial corner-reflector antenna. The backward radiation was eliminated to reduce computation and the sources were assumed to be points, in order further to simplify the work.

Although the principal concern in this study was horizontal polarization because of its application

to tv, it should be noted that there is nothing about the skew technique that is restricted by polarization. To demonstrate the point the experimental curve of Fig. 5 is shown for which the corner-reflector radiators were vertically polarized.

Empire State Mockup

The WJZ-TV antenna was given a full-scale test at our laboratory site in Orland Park. The conical portion of the building and a short lower section of the antenna tower were reproduced in wire mesh. The entire arrangement was rotated for horizontal patterns. Earlier tests on a model basis were used to obtain the vertical patterns so that the antenna gain could be calculated.

Figures 6 and 7 show respec-

tively the calculated and measured patterns at midchannel. Better agreement between them is prevented by the limitations of the individual pattern, shown by Fig. 4. The presence of undesired backward radiation introduces interference and results in doubling the number of radiation lobes and deepening the nulls.

Figure 8 is the average vertical pattern obtained from the scale model. It can be shown that the gain of the antenna system as compared with a half-wave dipole antenna is unity.

We are indebted to V. J. Andrew for the origin of the skew principle and to R. E. Green and A. Wojnowski for assistance in calculating numerous patterns and for the experimental work.

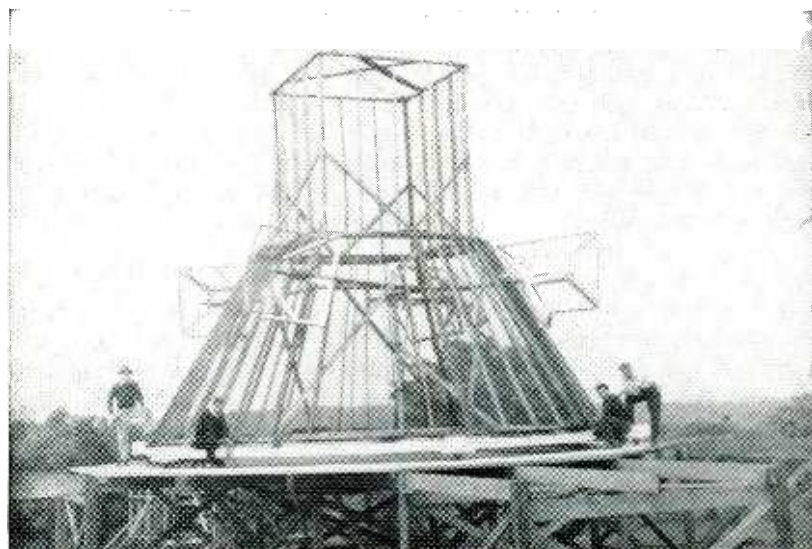

Full-scale mockup of the Empire State tower section showing three of the corner-reflector radiators mounted at 90 degrees

Closed Loop Controls Human Centrifuge

Electronically-controlled 4,000-hp motor accelerates massive human centrifuge from rest to 173 mph in 7 seconds. Gimbal-control motors produce any desired stress concentration.

Centrifuge is designed to test airborne electronic gear and pilots' G-suits

By **THOMAS F. PEIRCE**

*Aviation Medical Acceleration Lab.
Naval Air Development Center
Johnsville, Pa.*

ACCCELERATION FORCES up to 40 g are developed by the human centrifuge at NADC, Johnsville, Pa. The centrifuge simulates stresses encountered in high-speed flight and will be used to conduct research into biological effect of forces developed in aircraft, in testing airborne electronic equipment and in developing protective clothing for pilots.

As shown in the photograph, the 180-ton centrifuge consists of a 50-foot tubular-steel arm attached to the shaft of a 4,000-hp motor. At the end of the arm is an oblate spheroidal gondola. The gondola is mounted in gimbal supports and positioned by an electrohydraulic system. This permits the axis of the gondola to be positioned continuously through the resultant of the radial, tangential, and vertical components of acceleration when the centrifuge is in motion.

The centrifuge may be accelerated from a dead stop to approximately 173 mph in less than seven seconds and decelerated at the same rate. Both the main accelerating motor and the two gimbal control motors are electronically controlled using closed-loop systems.

Instrumentation

Close study of the subject in the gondola is accomplished by television, motion-picture cameras,

high-speed x-ray equipment and special physiological sensing and measuring equipment. Gimbal motor control information, television signals and output from physiological sensing devices are linked to control stations through rhodium-plated slip rings on the main rotor shaft. The entire centrifuge room is shielded with $\frac{1}{8}$ -inch copper against electrical and magnetic interference.

Braking is accomplished using a photoelectric relay. When the centrifuge in decelerating reaches a rate of three rpm, a light source on the end of the arm activates a phototube relay that reduces the speed to 0.5 rpm.

As the light source passes a second phototube, a second relay is activated that in turn sets the brakes and the centrifuge comes to a dead stop opposite the retractable platform in the chamber wall.

Acceleration Motor

The acceleration motor control circuit is shown in Fig. 1. The 4,200-hp synchronous motor is started as an induction motor. When its speed reaches a predetermined value, the motor is automatically thrown across the 4,160-volt a-c line.

The field of the 4,200-hp motor is supplied by a voltage-regulator-controlled exciter mounted on the

motor shaft. Also, on this shaft are two 1,500-kw d-c generators. These generators are connected in parallel and supply power to drive the 4,000-hp accelerator motor. Two speed ranges, 0 to 29.8 rpm and 0 to 48.5 rpm are made available by splitting the generator fields for either parallel or series connection.

The fields of the d-c generators are supplied by two electronically controlled 32.5-kw amplidyne generators. The amplidynes are driven by a 100-hp synchronous motor. Their output is a function of the difference between the actual speed of the accelerator motor and the speed called for by the operator or automatic program cam. This difference voltage is introduced to the amplidyne fields through the electronic amplifier.

Amplifier Control Panel

The operator in the overhead control-blister selects the desired type of operation, either by hand throttle, or by means of automatic program cam, or by the subject in the gondola.

The amplifier control panel, shown in Fig. 2, contains the outputs from three potentiometer controls. From the position of the potentiometer in use, a reference voltage is obtained that is balanced against the tachometer output voltage. Part of the difference voltage

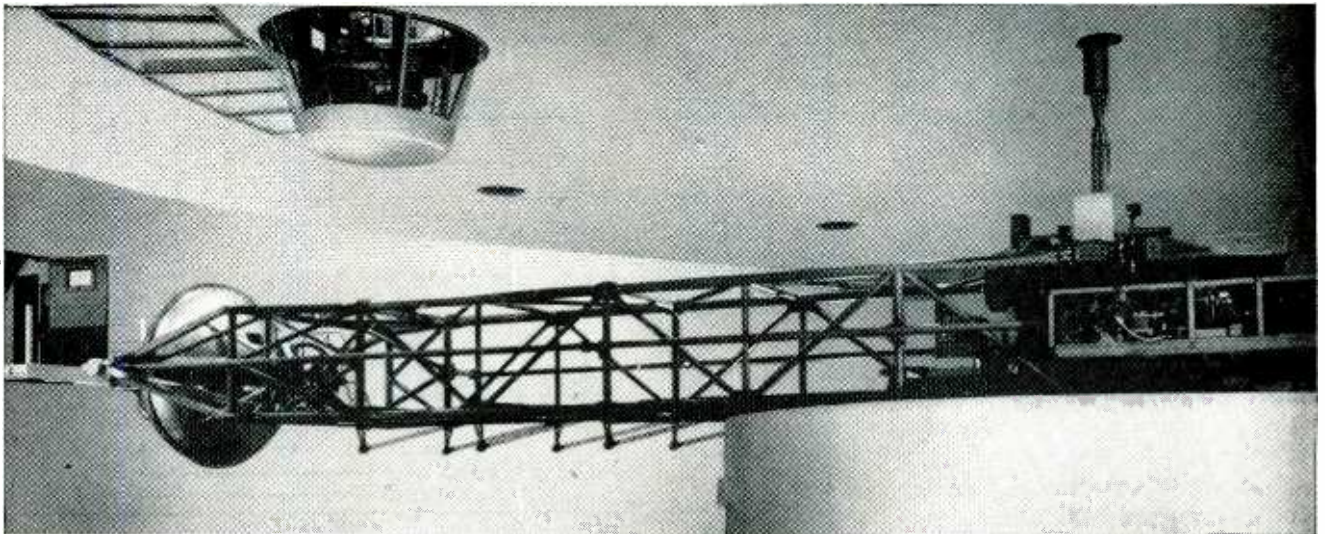

Subject rides gondola at end of 50-foot boom. Operator controls test from overhead control blister. Gimbal-mounted gondola is brought to positive stop opposite retractable access port by phototube-controlled braking system

is applied to the grid of the control amplifier. Calling for increased speed raises the output voltage from the amplifier and will keep it raised until the tachometer generator output and the voltage being called for are equalized.

Limit-Balance Panel

The output from the amplifier-control panel is trimmed in the limit-balance control panel. Here also are introduced, two voltages, proportional to the portions of the accelerator motor field supplied by generators *A* and *B*, respectively. When the load is equally divided

between the two generators, the voltages cancel. However, should one generator supply more current than the other, current will pass through the control coil of a kenotron (a high vacuum diode whose plate current is controlled by a magnetic field). The unbalanced load drives the tube beyond cutoff raising the signal level of the generator not bearing its share of the load and lowering the signal of the other until balance is restored.

Current-Limit Panel

In the current-limit control panel, a voltage is introduced pro-

portional to each generator's armature current. Two magnetically-controlled kenotrons are used for each generator, one for forward current and one for reverse current. As limiting current is reached, the appropriate kenotron is cut off. In this manner, the increased signal potential is dissipated in fixed resistors thus limiting the current.

Part of the output voltage from the generators is used as a bias source providing negative, adjustable feedback to aid in system stabilization.

Rectifier Panel

The control signal is applied to the rectifier panel that consists of two banks of four push-pull 807's each. The first bank has the amplidyne buck field in its plate circuit; while the second bank has the boost field in its plate circuit. Both banks have a common cathode potentiometer set for maximum amplidyne field current. Current through the buck and boost fields is held equal at zero signal input. Calling for increased speed lowers the input signal to the first group of 807's, decreasing current in the buck field. Because of the common cathode resistor, current flow is increased in the boost field. The main generator field is strengthened resulting in higher generator output and increased motor torque

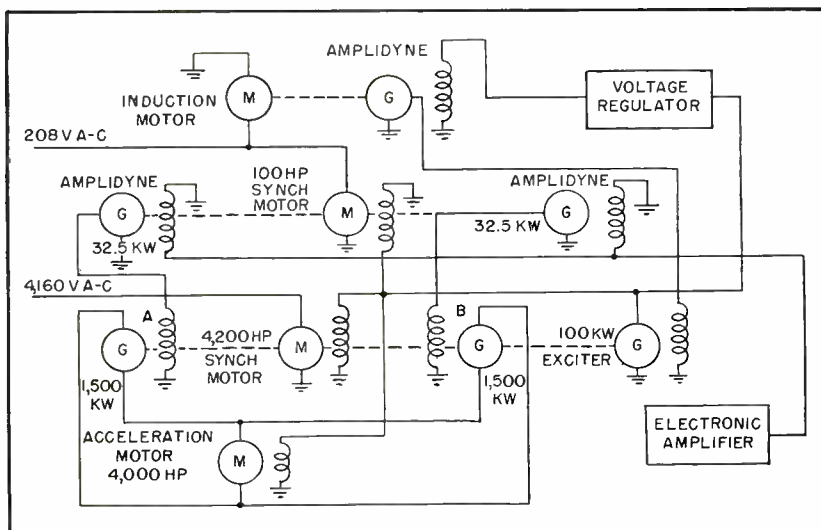

FIG. 1—Accelerator-motor control system. Electronic amplifier controls amplidyne's supplying fields to dual d-c generators driving motor

to accelerate the centrifuge.

The gimbal control motors, 75 hp for the outer gimbal, 40 hp for the inner gimbal, drive the gimbal rings through shafts running the length of the arm.

Gimbal Control

The gimbal control system, shown in Fig. 3, is designed to control accurately the movement of a gimbal ring using two parallel closed loops. One is responsive to input angular position and the other to input angular velocity. The angular-position loop uses a pair of selsyns to generate an angular-position error signal.

The angular velocity-loop employs a tachometer generator and linear potentiometer to obtain a differentiated voltage proportional to the rate of change or angular velocity of the input.

The selsyn error signal is fed to a phase-sensitive detector. The d-c voltage appearing across the output varies in magnitude with the magnitude of the error signal.

The error signal is also applied to a second amplifier and detector combination. When the d-c voltage exceeds a predetermined value (error signal for approximately 4 degrees), an emergency circuit is actuated that stops the centrifuge since the gimbal rings are not following the operator's commands within specified limits. This arrangement also prevents starting if control and gimbal positions are not synchronized with those being called for by the operator or program cam.

In the derivative amplifier, variation of the linear potentiometer changes bias of the input tube. From an R-C network in the plate circuit of the input tube, a voltage is obtained proportional to the time derivative of angular movement of the potentiometer. This voltage is fed to a push-pull d-c amplifier and cathode follower. The output of this circuit varies in proportion to the desired angular velocity set up on the linear control potentiometer.

Mixing and Stabilizing

Output from the phase-sensitive detector, derivative amplifier,

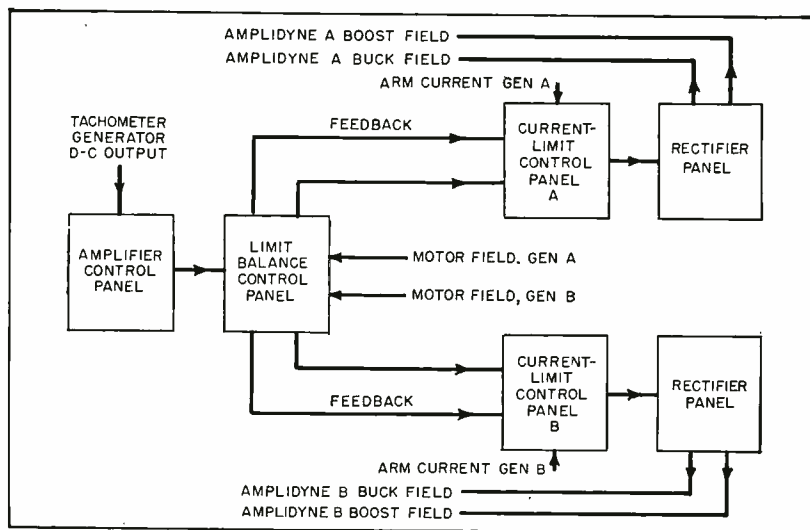

FIG. 2—Closed-loop motor control system uses difference voltage between tachometer d-c output and voltage picked off control potentiometer

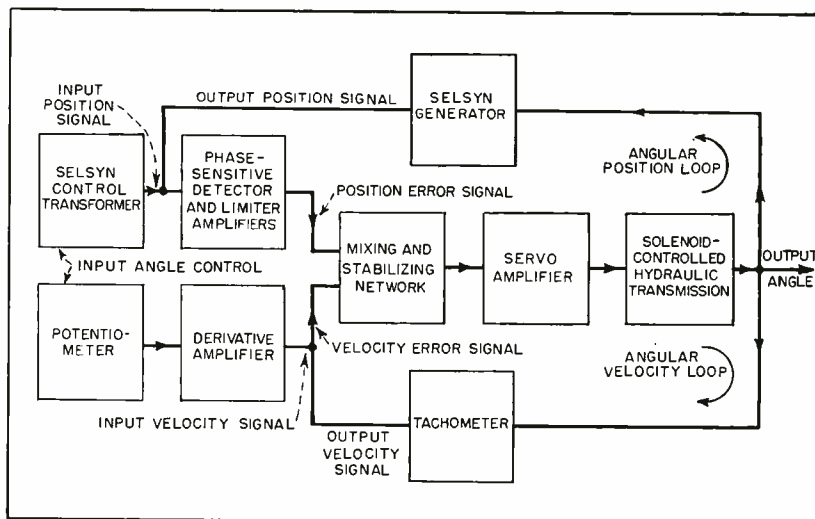

FIG. 3—Gimbal-control system employs parallel closed loops responsive to both angular position and velocity

and tachometer generator are algebraically summed and inserted into the mixing and stabilizing panel. The resultant is fed to a push-pull d-c amplifier that excites the gimbal solenoid coils in accordance with angular and velocity error signals. The solenoid controls the hydraulic amplifier and transmission.

Rotation of the outer gimbal ring through 90 deg. results in approximately 5 deg. rotation of the inner gimbal ring with the inner gimbal ring not powered. A selsyn differential driven by the outer gimbal shaft is connected in the selsyn circuit and compensates for differential gearing.

With this control system, the inner gimbal ring may be rotated and the gondola tumbled at a rate variable from 0 to 30 rpm in either direction.

The outer gimbal ring permits tilting the gondola through a 90 deg. about a horizontal axis at right angles to the longitudinal axis of the centrifuge arm. This 90-deg. movement may be accomplished in approximately one second.

The cooperation of the General Electric Company and the McKiernan-Terry Corporation in the preparation of this article is sincerely appreciated by the author.

How To Design VR Tube Circuits

By **RAYMOND G. MILES**

*Airborne Instruments Laboratory, Inc.
Mineola, New York*

Direct approach for determining optimum design on the basis of a stated set of requirements saves time and paper work. Family of curves for various tube types is the key to a quick solution of VR tube circuit-design problems

VOLTAGE-REGULATOR tubes of the gaseous glow-discharge type find many applications in d-c voltage supplies required to deliver fixed output voltages with moderately good regulation.

For the circuit designer, the problem frequently becomes one of design by successive approximations. A more satisfactory design procedure would be to employ a direct approach to the synthesis of an optimum design on the basis of a stated set of requirements. Such a procedure may be based on the accompanying charts, which have been developed as described below.

Table I lists the most significant electrical characteristics of six popular types of gaseous voltage-regulator tubes. These characteristics include the nominal d-c voltage at which the tube operates, E_T , the supply voltage which must be available to the tube in its unfired condition to insure that firing will occur, E_F , and the maxi-

imum and minimum values of current drawn by the tube itself to insure satisfactory operation of the tube, I_{Tmax} and I_{Tmin} , respectively.

Figure 1 shows a simplified schematic of a typical power supply employing a VR tube. Battery E_s represents the open-circuit voltage of the supply to the VR tube, essentially the no-load output voltage of the transformer-rectifier-filter combination used in most applications. Resistor R_s is equivalent to the internal resistance of the supply to the VR tube. It includes the effective resistance of the transformer-rectifier combination and the d-c resistance of any filter chokes in addition to the lumped series resistance deliberately inserted in the VR tube supply.

Although the total series resistance R_s is ordinarily not constant as a function of current because of the nonlinear characteristics of the

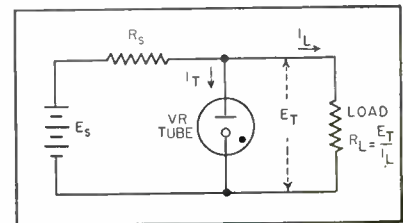

FIG. 1—Simplified schematic diagram of a typical power supply using a V-R tube

rectifier-filter, it may be considered so for most practical purposes. This is so because the nonlinear components of the resistance are ordinarily a small portion of the total. The voltage developed across the load in Fig. 1 is equal to E_T for the VR tube employed when the tube has fired and is operating normally.

The current drawn by the VR tube itself is represented as I_T , and that drawn by the load at voltage E_T as I_L . The analysis which follows assumes a load of linear characteristics, so that load resistance

$$R_L = \frac{E_T}{I_L}$$

In order for the VR tube to operate within its rated limitations, three relations must be satisfied by the circuit values shown in Fig. 1.

First, the voltage applied to the VR tube in its unfired condition must equal or exceed the minimum supply voltage E_F for the particular tube type. Since the tube itself

Table I—Electrical Characteristics of VR Tubes

Tube Type	OA2	OA3 VR75	OB2	OB3	OC3 VR105	OD3 VR150
D-C Operating Volts..... E_T	150	75	108	90	105	150
Min D-C Supply Volts..... E_F	185	105	133	130	133	185
Max Tube Current (amps)..... I_{Tmax}	0.030	0.040	0.030	0.030	0.040	0.040
Min Tube Current (amps)..... I_{Tmin}	0.005	0.005	0.005	0.005	0.005	0.005

represents essentially an infinite resistance before it fires, the minimum supply voltage requirement may be expressed as

$$E_s \frac{R_L}{R_L + R_s} \geq E_F$$

Load resistance may be expressed in terms of the load voltage E_T and maximum load current I_{Lmax} which exist when the VR tube is fired. The expression may then be solved for required supply voltage E_s , for example, yielding

$$E_s \geq E_F + \frac{E_F}{E_T} R_s I_{Lmax} \quad (1)$$

Once the tube has fired, the minimum VR tube current must equal or exceed I_{Tmin} for the tube type employed. The tube will draw its lowest value of current when the load current is maximum. At maximum load current, the circuit relations for Fig. 1 are

$$E_s = E_T + R_s (I_T + I_{Lmax})$$

Since the VR tube current must equal or exceed the minimum value I_{Tmin} , the required supply voltage is

then limited by the equation

$$E_s \geq E_T + R_s (I_{Tmin} + I_{Lmax}) \quad (2)$$

Equations 1 and 2 both relate to the maximum load current and both must be satisfied in order for the VR tube to operate within the proper limits.

The third condition of VR tube operation which must be satisfied is that the tube current must not exceed I_{Tmax} . For this condition, it is possible to write another expression similar to Eq. 2 but for minimum load current and maximum tube current. This expression is

$$E_s \leq E_T + R_s (I_{Tmax} + I_{Lmin}) \quad (3)$$

Once a VR tube type has been selected, the circuit values chosen must be such as to satisfy Eq. 1, 2 and 3 simultaneously.

The charts of Fig. 2 through 4 present Eq. 1, 2 and 3 in a form which is convenient for the design of VR tube circuits. Once a tube type has been selected, known or assumed values of any two of the

quantities supply voltage, supply series resistance, and load current permit determination of the third quantity.

Each of the figures shows supply voltage as the ordinate, supply series resistance as the abscissa and load current as a parameter. The maximum load current which may be drawn without exceeding the VR tube ratings is indicated by a family of solid lines, while minimum load current is presented by dashed lines. The charts may be entered at the ordinate, abscissa or parameter and followed to a point which represents a suitable combination of all three variables (four considering both maximum and minimum load currents).

Use of the charts in designing VR-tube regulated supplies is best illustrated by the following examples:

Example 1. Using an OA2 with a supply voltage of 300 volts and a supply series resistance of 5,000 ohms, what is the maximum load current which may be drawn?

Solution: Find the point on the OA2 chart, Fig. 2, corresponding to 300 volts and 5,000 ohms and interpolate between the solid lines. The maximum load current is found to be approximately 19 ma.

Example 2. In example 1, what is the minimum permissible load current?

Solution: The zero-ma minimum load-current line passes through the point representing 300 volts and 5,000 ohms. Hence the load current may be allowed to fall to zero.

Example 3. What is the lowest value of supply voltage which may be used with an OA3 voltage regulator to supply an output of 75 volts at any load current between 5 and 20 ma? What value of series resistance is required?

Solution: Using the chart for the OA3, Fig. 3, the minimum permissible value of supply voltage will be found at the point where the line representing a maximum load current of 20 ma intersects the line representing a minimum load of 5 ma. This point is found to be at 152 volts and the required series resistance is 1,700 ohms.

Example 4. In example 3, what

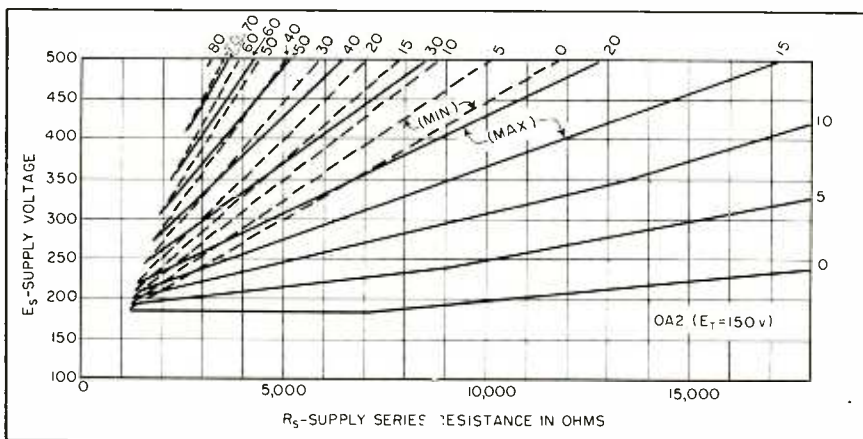

FIG. 2—Family of curves for the OA2

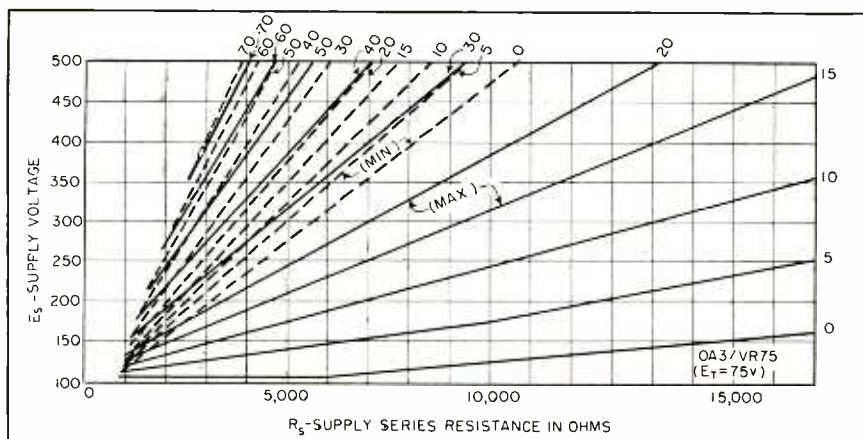

FIG. 3—Family of curves for the OA3

is the lowest nominal value of supply voltage which may be used if this voltage is subject to a ± 5 -percent variation? What is the new value of required series resistance?

Solution: This problem may be solved readily by a trial and error method as follows. The variation in supply voltage necessitates a nominal supply voltage higher than that found in example 3. From example 3, one may first assume a minimum supply voltage of 152 volts together with a series resistance of 1,700 ohms. The corresponding nominal supply voltage is $152/0.95 = 160$ volts. At minimum supply voltage, concern is with maximum load current. From example 3, the maximum load current is known to be 20 ma for 152 volts and 1,700 ohms. The value of maximum supply voltage is $160 \times 1.05 = 168$ volts. From Fig. 3, however, it will be seen that this voltage and a series resistance of 1,700 ohms correspond to a minimum load current of 15 ma instead of the desired 5 ma. Consequently, these values may not be used.

As a second assumption, one may choose a higher value of supply series resistance, 3,000 ohms. With this value, a maximum load current of 20 ma can be delivered with a minimum supply voltage of 188 volts. The corresponding nominal supply voltage is $188/0.95 = 198$ volts and the maximum supply voltage is then $198 \times 1.05 = 208$ volts. With 208 volts and 3,000 ohms, minimum load current is slightly less than 5 ma. Thus a nominal supply voltage of 198 volts and a series resistance of 3,000 ohms will be adequate.

Example 5. In examples 3 and 4, what supply voltage and series resistance will be required if the supply-voltage variation is ± 10 percent from nominal?

Solution: By the same method used in example 4, the required nominal supply voltage is found to be 268 volts (241 volts minimum to 295 volts maximum). The required series resistance is 4,900 ohms. Examples 3, 4 and 5 illustrate the severe penalty in terms of supply-voltage requirements and power loss imposed by a varying supply voltage.

Example 6. Using an OB2 tube in a circuit with a fixed supply voltage of 350 volts, what range of adjustment must be provided in the series resistance in order that any load current from 0 to 50 ma may be supplied?

Solution: The maximum series

not available. As a second set of assumptions, choose a minimum supply voltage of 220 volts and a minimum series resistance of 2,900 ohms. Corresponding maximum values are 244 volts and 3,540 ohms. Examination of Fig. 4 discloses that, with any combination of these

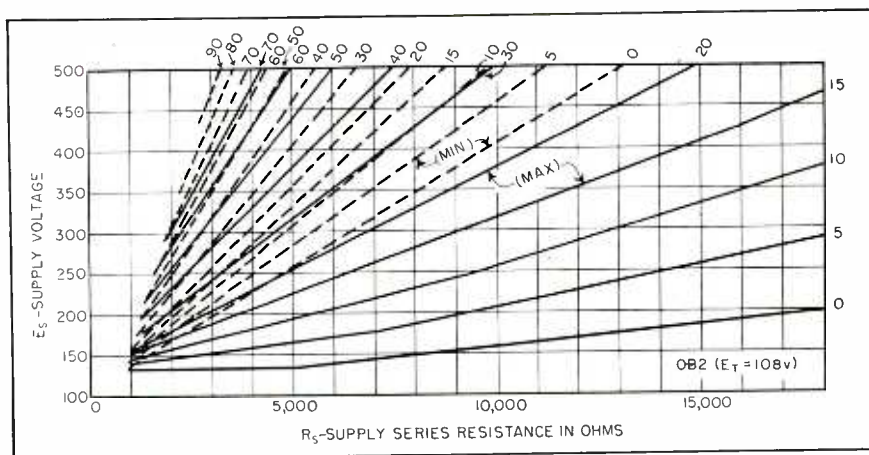

FIG. 4—Family of curves for the OB2

resistance required is determined by the zero-ma minimum load current and is found from Fig. 4 to be 8,100 ohms. The minimum series resistance is determined by the 50-ma maximum load current and is 3,550 ohms.

Example 7. What nominal supply voltage and series resistance should be used to deliver 108 volts at a constant load current of 20 ma from a supply using an OB2 if supply voltage is subject to a ± 5 -percent variation and if a ± 10 -percent tolerance resistor is to be used as the series resistance?

Solution: This problem is solved by a process of trial and error. First assume a minimum supply voltage of 157 volts and a minimum series resistance of 1,000 ohms (values at the intersection of the two 20-ma load-current lines on the OB2 chart, Fig. 4). Maximum supply voltage is then $\frac{157 \times 1.05}{0.95} = 173.5$ volts and maximum series resistance is $\frac{1,000 \times 1.1}{0.9} = 1,220$ ohms.

At 157 volts and 1,220 ohms, maximum load current is only 15 ma. Also, at 173.5 volts and 1,220 ohms the required load current is

values of maximum and minimum voltages and resistances, minimum load current is less than or equal to 20 ma and maximum load current is greater than or equal to 20 ma. Therefore, the corresponding nominal values of voltage and resistance, 232 volts and 3,220 ohms, will be satisfactory.

Example 8. Two type OA2 tubes in series are to be used to supply 300 volts regulated at 10 to 15 ma load current. What supply voltage and series resistance should be used?

Solution: Using the OA2 chart, Fig. 2, find the supply voltage and resistance required to deliver the specified load current at 150 volts from a single tube. These values are 213 volts and 1,600 ohms as determined from the intersection of the 15-ma maximum and 10-ma minimum load current lines. These values may be doubled to find the required values for 300 volts from two tubes. Required voltage and resistance are then 426 volts and 3,200 ohms, respectively.

Similar sets of curves may be drawn for other VR tube types and the curves of Fig. 2, 3 and 4 may be extended to include higher supply voltages.

Bandwidth of Quarter-Wave Sections

Charts show relative bandwidth obtained for specified impedance ratio and reflection coefficient when a load is matched to a transmission line by a single or double quarter-wave matching section. Band for the double section is half again as wide as that for a single section

By E. G. FUBINI and F. H. ROCKETT, Jr.

*Airborne Instruments Laboratory
Mineola, N. Y.*

A WIDELY used method for matching the impedance of a load to a transmission line is to interpose a short line between the two. The characteristic impedance of this matching section is made the geometric mean of the impedance of the load and the transmission line; its length is made a quarter wave at the frequency for which the impedances are to be matched.

In general, however, the load is required to be matched over a band of frequencies. If the load need not be perfectly matched, the bandwidth over which the load is matched within a specified reflection coefficient can then be computed from transmission-line equations. It is more useful, however, to normalize the equations and to plot their solutions as design curves¹. This has been done in the charts whose uses are described.

The first chart is for a single quarter-wave section; the second chart is for a double quarter-wave section. The double section matches the impedances—for a specified maximum reflection coefficient—over a wider band than the single section. By comparing the bandwidths on the two charts for a specified problem, it can be determined quickly whether a single or a double matching section is required.

Consider first the commonest type of matching section—a line that is a quarter-wavelength long

at the matching frequency f_1 . For maximum bandwidth (and perfect matching at f_1), the load must be a pure resistance at f_1 .

If the load is a pure resistance R , constant with frequency, the reflection coefficient $|K|$ can be calculated and plotted as a function of the relative frequency f/f_1 , for various values of relative load R/R_0 where R_0 is the characteristic (resistive)

impedance of the transmission line. This was done in Fig. 1, giving the frequency characteristic for a series of values of R/R_0 . Because the chart is symmetrical about $f/f_1 = 1$, it has been folded back on itself about this axis. Then, if $|K|$ is required to be less than a certain value, the maximum and minimum values of f/f_1 are given at that ordinate. The following is a ty-

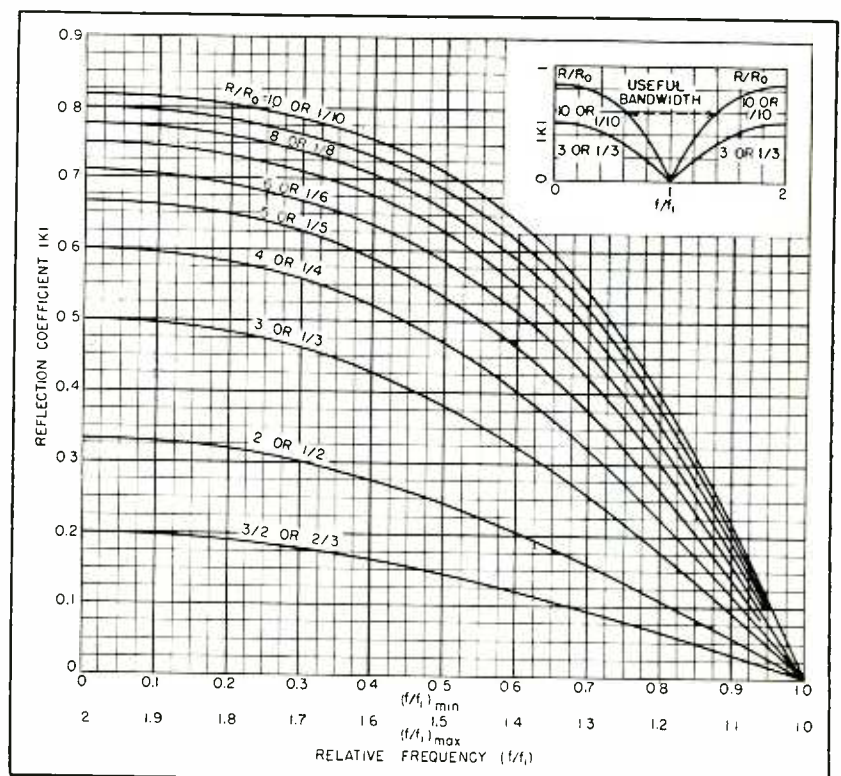

FIG. 1—Frequency characteristic of a quarter-wave matching section

pical example: Given a resistance of 140 ohms to be matched to a 70-ohm line, $R/R_0 = 2$, and the frequency characteristic is given by this curve in Fig. 1. If $|K|$ is required to be less than 0.2, the limiting values of f/f_1 are about 0.61 and 1.39; the frequency band is 1.39/0.61 or 2.28 to 1.

Folding the chart about $f/f_1 = 1$ results in the relative frequencies being spaced as in an arithmetic series. Because the edge and center frequencies used in specifying bandwidth are usually in geometric ratio, $f/f_1 = 1$ is not the center frequency as usually given. Rather, in the foregoing example, the relative center frequency (the geometric mean between the edge frequencies) is $f/f_1 = 0.92$.

Double Quarter-Wave Section

The simplest multiple-matching section is a pair of lines of equal length, each a quarter-wavelength long at the matching frequency f_1 . At this frequency the load must be a pure resistance R for perfect matching. For this case and by proper choice of the impedances of the matching sections, a purely resistive load can be transformed at

f_1 to an impedance that not only has the correct resistance (with zero reactance) but also has a zero derivative of resistance (and of reactance). Thus the whole frequency characteristic can be improved, giving a considerably wider frequency band than that obtained by the single, conventional quarter-wave section.

For the case of a constant resistive load, Fig. 2 gives the relative bandwidth. The reflection coefficient $|K|$ was calculated and plotted as a function of relative frequency f/f_1 for various values of the relative load R/R_0 . The curves of this chart are very similar to those of Fig. 1, except that the frequency band for a specified $|K|$ is wider.

For example, using the values of the previous problem (140-ohm load matched to a 70-ohm line with $|K|$ less than 0.2), from the curve in Fig. 2 for $R/R_0 = 2$, the limiting values of f/f_1 are found to be about 0.45 and 1.55; the frequency band is 3.44 to 1. Thus, the band for the double section is half again as wide as that for a single section.

It will be noted, of course, that the curves for single and double-matching sections come to the same

values of $|K|$ at $f/f_1 = 0, 2, 4$ and so on.

Impedance Computations

In using the information obtained from the two charts, one computes the required characteristic impedance for the matching sections. For a single matching section of impedance Z , the impedance is given by $Z = (RR_0)^{1/2}$. For a double-matching section where the section nearer the load has an impedance Z_1 and the section nearer the line has an impedance Z_2 , the impedances of the sections are given by

$$Z_1 = \sqrt{R(R_0R)^{1/2}}$$

$$Z_2 = \sqrt{R_0(R_0R)^{1/2}}$$

The charts are plotted in terms of reflection coefficient $|K|$. Impedance ratios are often measured in terms of standing-wave ratios S . The relation between the two is

$$|K| = (S - 1)/(S + 1)$$

Figures 1 and 2 are plots of $|K|$ as functions of transformation ratio $A^2 = R/R_0$ and the relative angular frequency $\theta = 0.5\pi f/f_1$. The equation for Fig. 1 is

$$|K|^2 = \frac{|A^2 - 1|^2}{(A^2 - 1)^2 + 4A^2 \sec^2 \theta}$$

The equation for Fig. 2 is

$$|K|^2 = \frac{|A^2 - 1|^2}{(A^2 - 1)^2 + 4A^2 \sec^4 \theta}$$

If the load impedance is a resistance that varies with frequency, the charts are no longer valid.

The charts given here can be used in several ways other than that illustrated in the examples. If the maximum tolerable reflection coefficient and impedance ratio are specified, the charts show whether a single or a double matching section can produce a match, and, if so, what bandwidths can be obtained.

If the relative bandwidth and either the reflection coefficient or the relative impedance are specified, the unspecified quantity can be determined. Thus, these charts provide useful design data for many common transmission-line problems.

REFERENCE

- (1) E. G. Fubini, P. J. Sutro and R. F. Lewis, Frequency Characteristics of Wide-Band Matching Sections, Report 41123, Radio Research Laboratory, Harvard University, April 19, 1943.

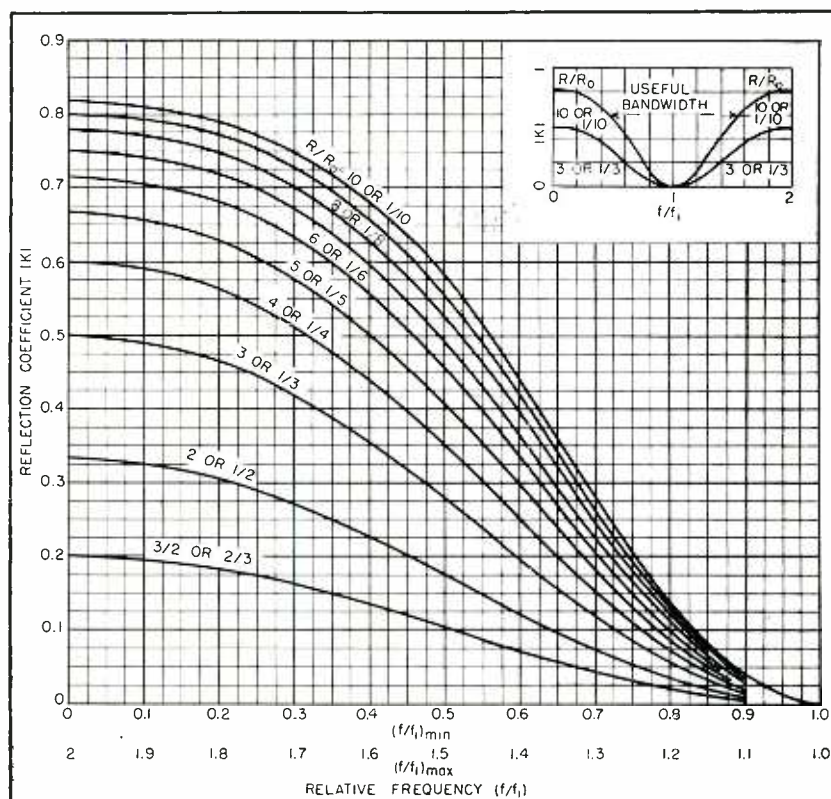
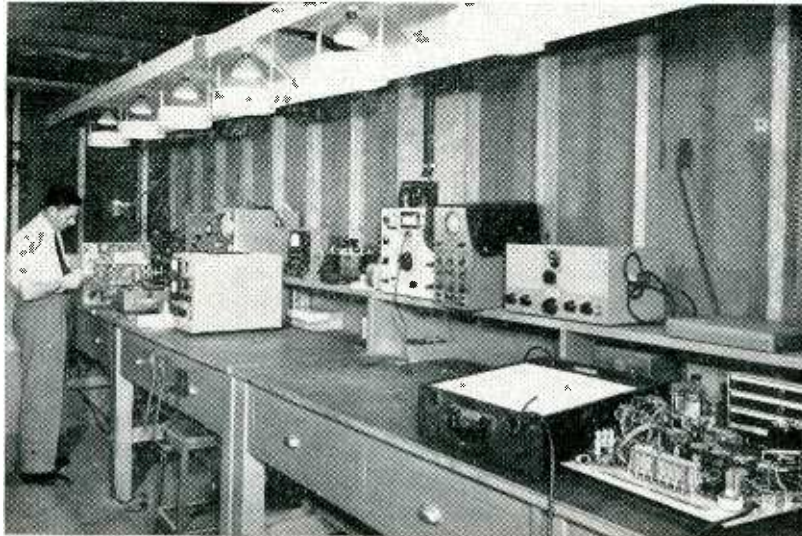

FIG. 2—Frequency characteristic of a double quarter-wave section



"A shielded or screened inner room is desirable for noise-free receiver alignment and transmitter testing"

Servicing Mobile Radio Equipment

New business opportunity combining some attributes of the engineering consultant with those of the radio serviceman exists in the rapidly growing two-way radio field. At the present rate of expansion, more qualified technicians and inexpensive test equipment will be needed to keep communications systems running at top efficiency

By **MAURICE E. KENNEDY**

*Chief, Communications Division
Los Angeles County Flood Control District
Los Angeles, Calif*

SKILLED radio technicians throughout the United States and Canada are finding new opportunities to expand existing servicing business by adding facilities for mobile communications equipment.

Up to May 1949, two-way mobile radio communications facilities for police and other emergency services, developed over the past 20 years, were generally serviced in shops maintained by municipalities or companies operating large fleets of mobile units.

In the past three years, since the

Federal Communications Commission has released its stabilized mobile communications plan, thousands of new radio systems have been established by progressive taxi operators, oil companies, lumbering interests, trucking and transportation concerns, ambulance services, common carriers with their fleets of private subscribers, small municipalities, industrial services and numerous others.

This rapidly expanding use of electronic equipment is beginning to present many maintenance problems for owners and operators. In

many cases, the equipment was originally installed by the manufacturer's sales engineering organization. Because the federal law requires that a licensed technician be responsible for the equipment, some inexperienced person in the company with a license or a local radio repairman, has often been assigned the task of keeping the system operating.

In many instances a local broadcast station technician with limited test equipment is attempting to assist several small radio communication systems in his area.

For economic reasons the small operator of a dozen taxis, or three ambulances, a utility with 15 mobile units, or a small community with a dozen police cars and two fire engines, must seek outside technical assistance from a skilled technician holding at least a second-class radiotelephone license.

A number of qualified technical men have seen the opportunity of establishing a profitable business in this growing field. A review of their operations will indicate that most of them start out with their own back-yard service shop or small radio repair shop. In many cases these men are licensed amateur radio operators with transmitter experience or a good technical knowledge of f-m radio equipment and circuits.

They put themselves through a training program on the various types of communications equipment which they will have to maintain. These servicemen have found the equipment manufacturers interested in helping them do a good job. Most manufacturers will gladly furnish service manuals, circuits and a wealth of technical data to qualified servicemen. A number of the larger equipment manufacturers will send a representative to inspect the shop, make recommendations for proper test procedures on their equipment, suggestions for test equipment needed, or even establish the shop as an authorized

Opportunity Knocks

A manufacturer writes, "There are excellent servicing opportunities in the mobile communications field for qualified technicians. It is a growing field with little competition offered to the man who has above-average technical know-how. Because of the inherent complexity of communications equipment, the qualifications are in excess of those required for routine service of home sets."

Such a serviceman is ultimately responsible to the Federal Communications Commission both for the accuracy of required tests and for subsequent operational performance. Moreover, the usefulness of mobile equipment may often depend in large part upon the availability of qualified service personnel.

The design of simple, inexpensive electronic test equipment, some of it to solve problems unique to this field, offers still another opportunity

service station for specific sets.

The service technician desiring to enter this equipment maintenance field must possess a second-class radiotelephone license, or better yet, a first-class license.

Test Equipment

Most of the test equipment found in a modern radio shop can also be used for servicing mobile f-m radio equipment. This would include a modern tube tester, oscilloscope, vacuum-tube voltmeter, a good all-purpose volt-ohm-milliammeter, and possibly a sweep generator.

Special test equipment that is not usually found in radio and television service shops but should be included in the f-m communication equipment service shop would include:

Some form of grid-dip meter for circuit alignment, and r-f output wattmeter (also used as a dummy antenna load), a precision all-band oscillator with controlled output (crystals with reference points on

all intermediate frequencies), and a number of small test items that the technician can build.

These items should include a single-tube Pierce oscillator with plate current and output indicators for testing quartz crystals, a small amplifier with impedance multi-matching input transformer for testing microphones, and a field-strength meter to cover all of the communication frequencies.

The FCC requires that operators of mobile and base stations in the communication services must have each licensed transmitter checked for frequency deviation, modulation, and power input at least every six months. This service should also be offered by the progressive communications service shop.

Many service technicians have purchased secondary frequency standards (such as BC-221 and LM) from war surplus sources, altered the equipment to cover the frequency ranges of interest to their clients and built or purchased interpolation oscillators for expanded applications. The surplus type TS-323 covers the 20 to 200-mc range. Commercial frequency standards are also available.

Radio station WWV is the primary source of calibration check and its service is available to anyone merely by tuning in the standard frequency transmissions on 2.5, 5, 10, 15, 20, 25, 30 and 35 mc. By utilizing the heterodyne principle and beating the WWV signal against a local secondary standard, continuous accurate calibration can be maintained. Local broadcast stations (required to maintain frequency within ± 20 cycles) and their harmonics offer additional check points.

The modulation meter for a-m systems may be an oscilloscope or

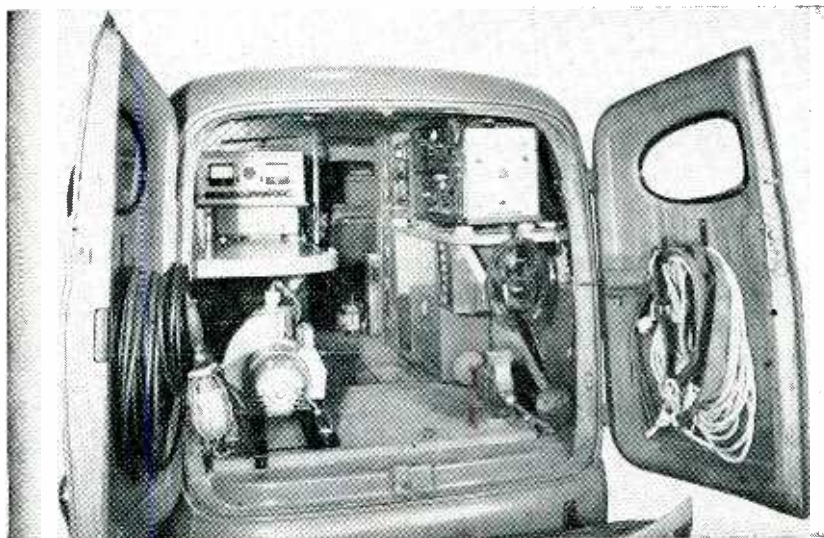

"Many of the servicemen in the Southern California area maintain a portable service shop in a panel delivery truck . . ."

inexpensive modulation indicator meter. For frequency modulation checks the deviation instrument is not so simple. It is possible to build and calibrate an instrument using accurate crystal-controlled receivers with the addition of calibrated deviation indicators in the discriminator circuits. This equipment would have to be checked for frequency and placed exactly on the transmitter frequency before each measurement.

Commercial modulation measuring equipment is available and would probably be less expensive than a composite modulation-deviation indicating instrument. Some of the mobile equipment manufacturers make an all-purpose test kit for their equipment which is very satisfactory for tuning purposes.

Charges

Simple mobile equipment installations can be done in a day's time by one man with some additional assistance on larger installations. Trucks, fire engines, and special vehicles usually take more time, owing to the need for waterproof housing boxes and other special construction. No standard exists for installation or service charges, but new mobile installations usually run about \$25.00 and up.

Main-station installations, antenna erections and control-desk wiring should generally be done on a labor plus materials basis.

Some fleet operators are paying from \$3 to \$10 per month per mobile unit for maintenance labor plus parts. This charge includes routine repairs and service checks, six months complete frequency, modulation and power-input measurements, and technical supervision of the system. Main station equipment maintenance contracts run slightly higher.

Most small operations prefer to pay a straight labor-plus-parts cost when the equipment fails, or at the six-months service period.

Preventive maintenance is hard to sell the small operator. The large operator has found that it reduces the possibility of equipment failure with resulting increased in-service time.

The well-organized service shop should include some provision for

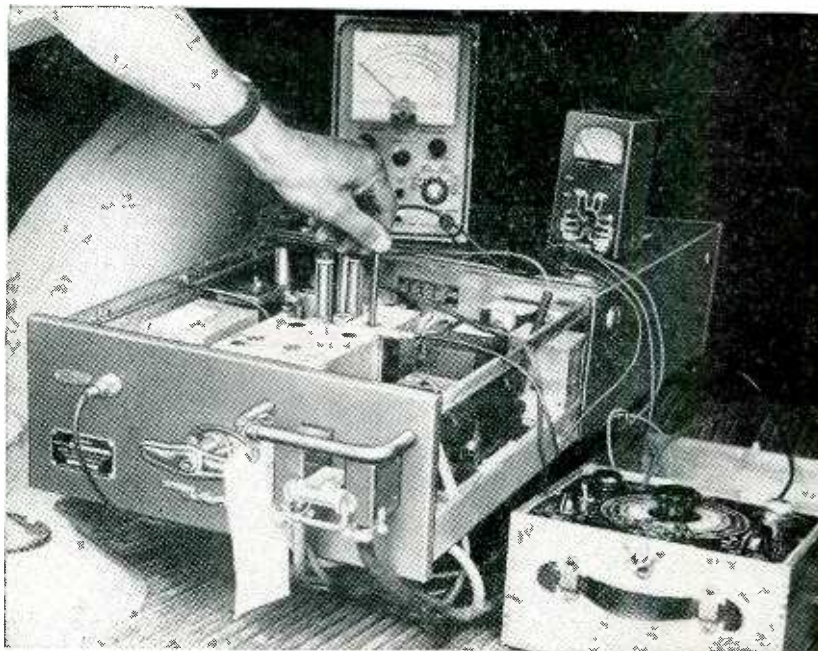

"Most manufacturers will furnish service manuals, circuits and a wealth of technical data to qualified servicemen"

working on cars within a building, preferably over a pit, hoist, jacks, or ramp. The necessity for working under the cars to install cables makes some form of car-elevating device desirable.

The service bench should have a 7.1-volt 60-ampere direct current source available from busbars extending to all service positions. Storage batteries with a floating charger will supply this current, but a high-current transformer, dry-disk rectifier and large filter make for a cleaner operation. A high-current ammeter and an accurate 0-to-8 volt d-c voltmeter are useful features in this bus supply system.

Screen Room

A shielded or screened inner room is desirable for noise-free receiver alignment and transmitter testing.

Soldering irons of the instant-heat type or with very small tips are necessary to work within the limited clearances of most modern mobile equipment.

Other tools required should include rubber and forceps-type tube-pullers, soldering-aid tools, tube-pin straighteners, long-nose pliers, diagonals with sharp oblique points, miscellaneous pliers, wrenches, socket sets and screwdrivers. A good stock of spare parts including

tubes, vibrators, all values of resistors and capacitors, filters, generator brushes and wire should be maintained.

Portable Shop

Many of the servicemen in the Southern California area maintain a portable service shop in a panel delivery truck or station wagon. This practice permits them to make the rounds of their many customers, working a day or two at each location.

One of the most useful service procedures in the larger systems is the maintenance of one or more spare units for instant exchange in the field or when the car driver comes to the main shop with a defective unit. This provision permits repair work on the service bench under ideal conditions and it does not hold up a busy customer while the serviceman looks for a defective component.

Automobile Electrical System

Prior to tuning up a new installation in a radio car the battery voltage should be checked. Most radio equipment manufacturers recommend a battery voltage of not over 7.2 volts and not under 6.3 volts measured at the battery terminals. There is a voltage drop in the long battery cables to the larger

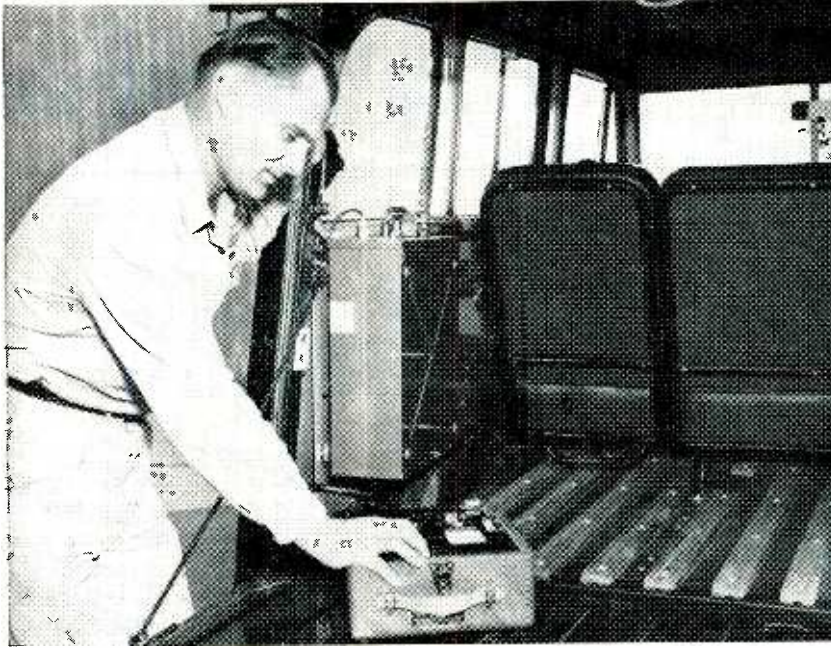

"Preventive maintenance . . . reduces equipment failure with resulting increased in-service time"

mobile equipment particularly during the time the transmitter is in operation. Special high-current generators or alternators with dry-disk rectifiers are recommended for cars with mobile radio equipment of the 30 and 60-watt sizes.

Care in adjusting the car's voltage regulator will usually permit continued use of the standard (35 amp) car generator for mobile units up to and including 30 watts if the battery is not required to furnish power for too many other loads such as red lights, sirens, heaters, fan and full lights for considerable night driving.

Standard automobile voltage regulators are seldom set for optimum adjustment at the factory and considerable trouble from too-low or too-high battery voltage is common. This fact necessitates drilling off enclosure rivets, and with accurate d-c meters, adjusting the charging rate to maintain a 7.2-volt value under normal driving conditions.

The battery's specific gravity should be approximately 1.280 when a regulator is adjusted. Drivers should be cautioned to inspect battery water level at least once a week. Battery voltage should be checked as part of the routine equipment service.

Ignition noise reduction should be accomplished on all initial in-

stallations. Resistor-type spark plugs may be necessary. Capacitors, suppressors, and full instructions are usually furnished with the installation kit that comes with a new mobile unit.

Ignition noise in some cars presents problems that can best be solved by reading all the known data on the subject and then overcoming individual cases by trial and error. Experience will be the best guide on noise elimination as each car is different with respect to ignition-noise problems.

Legal Tips

One of the most important goodwill building services that a mobile service station can render its customers is to help educate the owners and operators of the radio equipment.

Field engineers of the FCC indicate that a large number of law violations by mobile fleet operators result from not understanding the simple rules and regulations about keeping an operating log, posting licenses, announcement of call letters, and dozens of other simple requirements that most engineers and all licensed operators must know.

The best sources of legal information are the following government bulletins:

Part 6—Rules Governing Public Radio Communication Services, 10¢.

Part 10—Rules Governing Public Safety Radio Services, 10¢.

Part 11—Rules Governing Industrial Radio Services, 10¢.

Part 13—Rules Governing Commercial Radio Operators, 5¢.

Part 16—Rules Governing Land Transportation Radio Services, 10¢.

These publications may be obtained from the Superintendent of Documents, Government Printing Office, Washington 25, D. C.

By studying the legal requirements and passing the information along, the serviceman helps the customers operate within the law. Six-month service checks should also include a check of operating practices to be sure the customer is operating in such a manner that embarrassing violation citations will not be received each time his system is inspected by a field representative of the Federal Communications Commission.

A good shop file system is indispensable. Accurate technical logs are required on each piece of equipment serviced. Copies of this information should also be on file at the customer's headquarters for reference at inspection time. Service file records should also show expiration dates of customers' construction permits and station licenses. At least two months notice should be given them prior to expiration or better yet, they should be assisted with their license problems.

Identification tags issued by the Federal Communications Commission must be attached to each mobile transmitter.

By offering this type of courtesy to customers, assuming a few routine responsibilities for them, and doing a good workmanlike technical maintenance job, it will soon be found either that the shop will have to turn new business away or expand to accommodate a rapidly growing, profitable organization.

Some of the photos used in this article were furnished through the courtesy of the Southern Counties Gas Co. of California and the Los Angeles County Flood Control District.

High-Power

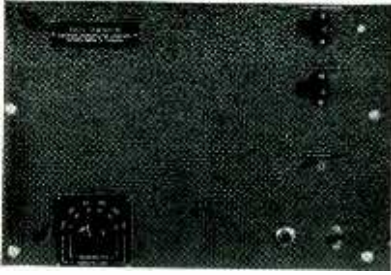

Front panel has six-position frequency-duration switch

By **W. E. WILLIAMS, JR.**
*Electronics Instrumentation Section
 Electronics Division
 National Bureau of Standards
 Washington, D. C.*

IN THE STUDY of vacuum-tube cathodes¹, a pulse generator supplying square-top high-voltage and high-current output pulses was desired.

Previous experiments with vacuum-tube cathodes had shown correlation between the emission of a cathode when operating with direct current and with short duration pulses.

Pulse Technique

If pulses of relatively long duration were used, it was hoped that the correlation between direct current and pulsed emission data might be improved to a point that would permit the pulse technique to be used. This would allow the measurement of temperature-limited emission without excessive heating of tube parts.

For this work a pulse generator was required capable of supplying pulses with a maximum amplitude of 1,200 volts at two amperes of current drain with approximately a one-percent duty cycle. Both pulse amplitude and repetition rate were required to be adjustable. A survey of existing commercially available pulse generators revealed none capable of supplying pulses with the required peak power and voltage amplitude. To satisfy these requirements, the pulse-generating circuit shown in Fig. 1 was developed. Although specifically designed for a study of vacuum-tube cathodes, this instrument may find other applications where nearly square-top, high-voltage and high-current pulses are desired.

It was essential for this application that overshoot of pulse ampli-

tude, at the beginning and end of the pulse, be minimized. The need for multiple power supplies and transformers with high-voltage insulation was to be eliminated if possible.

The use of standard components or easily constructed special components was a primary aim in the instrument design.

Circuit Description

The complete circuit diagram of the instrument is given in Fig. 1. An unbalanced multivibrator, V_1 , is controlled to give repetition rates of 10, 20, 30, 40, 50 and 60 pulses per second, with a constant one-percent duty cycle. The six-position selector switch S_1 provides the selection of pulse repetition rate and at the same time adjusts the pulse duration so that the one-percent

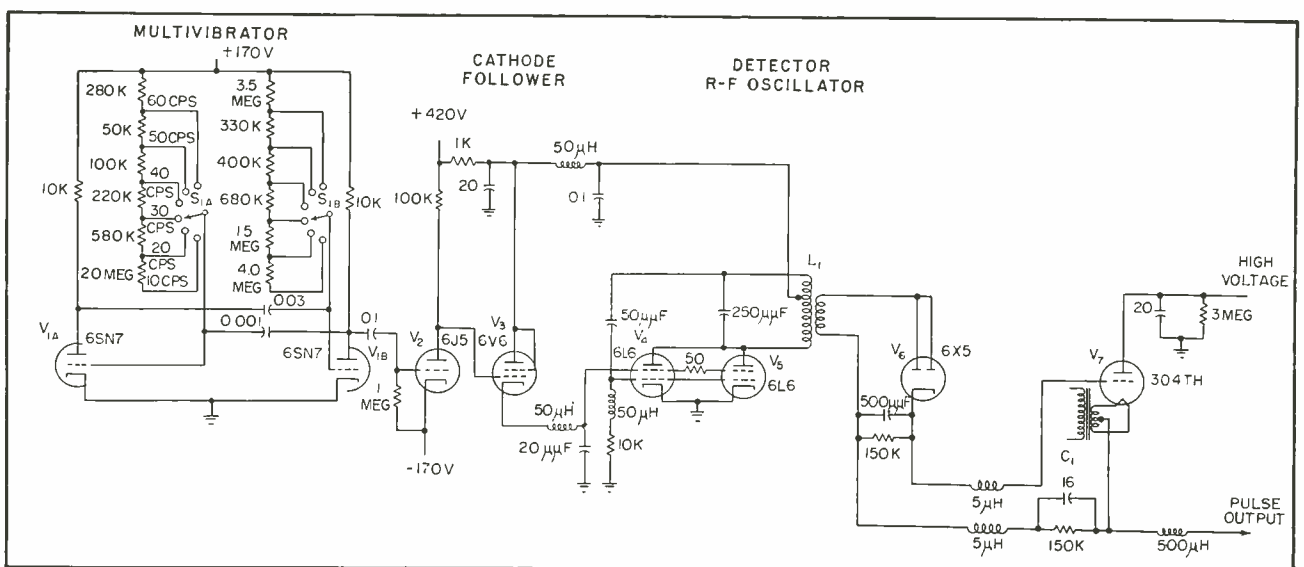

FIG. 1—Schematic diagram of the pulse generator

Square-Pulse Generator

Repetition frequency is variable in steps from 10 to 60 pulses per second with fixed duty cycle of one percent. Output is square-top pulses at several amperes with adjustable amplitude up to 1,200 volts

duty cycle is maintained. The multivibrator output pulses are amplified by a single triode stage V_2 and coupled by the cathode follower V_3 to the r-f oscillator V_4 and V_5 which is then keyed-on for the duration of the pulse.

The cathode follower controls the screen voltage of the class-C 4.2-mc oscillator, holding it biased at cutoff until a positive pulse is received. The oscillator output is a 4.2-mc carrier with 100 percent 10 to 60-cycle modulation. This triggered oscillator and rectifier combination is substituted for a pulse transformer with high-voltage insulation, which otherwise would be required for such applications.

Diode Detector

The signal is applied to a diode detector from the secondary winding of the oscillator coil L_1 . This secondary is used in place of a transformer and high-voltage insulation between the two windings of L_1 provides the necessary isolation from the high d-c output voltages.

The modulated signal is passed through a diode detector V_6 resulting in a square-top pulse of the same repetition rate and duty cycle as that of the multivibrator. This pulse is then used to trigger the 304TH power triode V_7 , supplying the desired output pulse.

Grid current in V_7 provides bias fairly independent of plate-supply voltage, thus the tube is self-biased to cutoff with the -130 v charge on C_1 . The plate voltage of the 304TH is supplied from an adjustable external source not exceeding 2,000

volts, control of which determines the output pulse amplitude. Both the r-f oscillator and detector are enclosed in a shielded box to keep the radiated energy to a minimum. All circuit components are com-

mercially available with the excep-

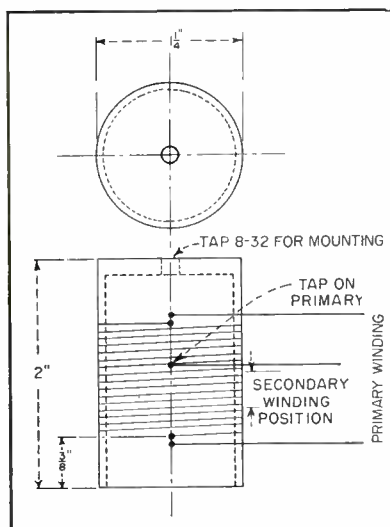

FIG. 2—Construction details of the oscillator coil

mercially available with the exception of the oscillator coil L_1 the construction details of which are given in Fig. 2.

Performance

The instrument produces square-wave pulses at a repetition rate of 10, 20, 30, 40, 50 and 60 pulses per second with a duty cycle of one percent, equivalent to pulse durations from 165 to 1,000 microseconds.

The pulse amplitude is determined by the plate voltage of the 304TH triode V_7 . In the service for which the instrument was designed,

pulses at voltages up to 1,200 volts with 2-ampere current drain were obtained.

With the use of other external power supplies, to supply the high plate voltage of the 304TH, pulses at higher voltages and considerable higher currents may be obtained.

The output pulse has an amplitude which was found to fall off linearly at the rate of 0.01 percent per microsecond of pulse duration. The drop, for example, is two percent for 200-microsecond pulses. This die-away is due primarily to the decrease in the plate supply voltage for the 304TH, resulting from discharge of the final capacitor in the supply. The circuit is capable of supplying pulses having sufficiently flat tops to meet the requirements of many applications calling for square-top, high-voltage and high-current pulses.

Coil Construction

A drawing showing the construction details of the coil form for oscillator coil L_1 is given in Fig. 2. The primary consists of 16 turns of No. 20 copper wire with Formex insulation, with a tap six turns from one end, wound 12 turns per inch. The secondary is composed of 10 turns of No. 20 copper wire closewound over the primary as shown. Insulation between primary and secondary must be capable of withstanding 2,000 volts.

The author is indebted to M. L. Greenough for many helpful discussions and suggestions.

REFERENCE

- (1) Ralph Forman and G. F. Rouse, Oxide Cathode Base Metal Studies, *NBS Journal Research*, 46, p 30, Jan. 1951.

Frame Synchronization

Analysis shows present FCC monochrome sync waveform contains adequate timing information for reliable frame synchronization on simple triggered basis for use with NTSC color-television system. Simple circuit is developed and discussed

By **DONALD RICHMAN**

Senior Development Engineer
Hazeltine Corporation
Little Neck, N. Y.

PROPOSED NTSC Standards for compatible color television are based on the principle of adding color to a monochrome picture by means of a color subcarrier. The standards include the technique of color phase alternation wherein the phase sequence of colors in the color subcarrier is reversed on alternate fields. The red color difference signal leads the blue color difference signal by 90 deg during one field and lags by 90 deg in the succeeding field in each frame, and results in improved color fidelity.

An arrangement for automatically synchronizing the direction of reversal at the receiver and at the transmitter is essential. This necessity has created the problem of determining whether or not adequate timing information exists in the present monochrome FCC synchronizing waveform to provide reliable frame synchronization for color television.

Apparently there is enough timing information in the present signal for this purpose.

Frame synchronization, as described in this paper, depends on a beatnote process and requires the combination of two pieces of timing or synchronizing information, one at field rate and one at line rate.

Timing information at any single frequency may exist within a composite sync waveform in three basic forms; it may exist as a single component at the fundamental sync frequency, it may be carried by harmonics of the fundamental frequency, or it may exist in the beatnote between two signal components which are not harmonics of the fundamental sync frequency. The problem of using all of the timing information at any frequency involves using all of the frequency components which may help carry

the desired timing information and decoding it so that it is converted to the desired frequency in the most efficient manner with regard to signal-to-noise ratio.

Figure 1 shows ideally how the line and field timing information can be combined for frame synchronization. The line rate information derived from the composite sync signal is used in the form of very narrow pulses which are shown at the correct normal phase during each field retrace period. The field rate information derived from the composite sync signal is used in the form of a single broad pulse during each field retrace period, having, ideally, a duration of just a little less than one line. In field 1 the field pulse normally occurs halfway between two line pulses. In field 2 the field pulse is coincident with one line pulse and provides a means for positive means of identification of this field.

In actual practice the waveforms used may differ from these ideal waveforms. More important, the presence of random noise causes fluctuations in the relative timing between the line and field rate pulses. It is possible to obtain substantially perfect performance down to some level of signal-to-noise ratio at which the random fluctuations become large enough so that occasional observable errors in identification of the fields occur. In order to evaluate the level at which this begins to take place in (color phase alternation) frame synchronization, for bandwidth-limited white thermal noise, it is necessary to under-

stand the physical nature of sync timing information.

Basic Timing

For any sync signal $S(t)$ such as that shown in Fig. 2, there is an upper limit to the sync accuracy, which can be computed for any specified signal-to-noise ratio. Since the signal is repetitive, it can be expressed in terms of a Fourier series. The signal is characterized by its peak-to-peak amplitude S_0 , by phase coefficient ϕ_k and by the relative amplitude coefficients Z_k . The relative phases of the frequency components do not affect the sync accuracy which can be obtained, provided these phases are

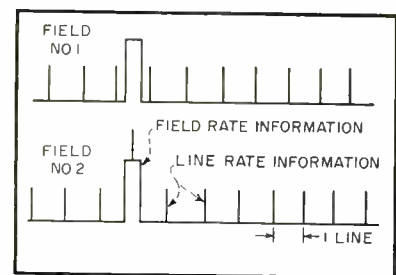

FIG. 1—Idealized drawing shows how line and field timing information can be combined for frame synchronization

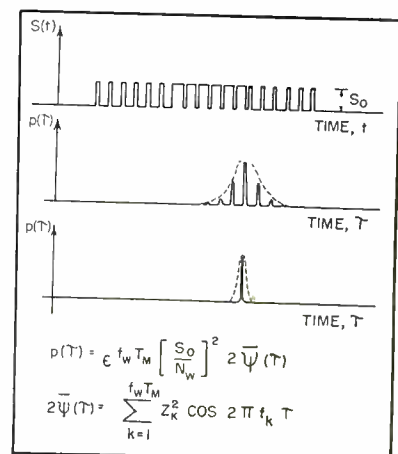

FIG. 2—Typical sync signal analysis used to study basic timing information

for Color Television

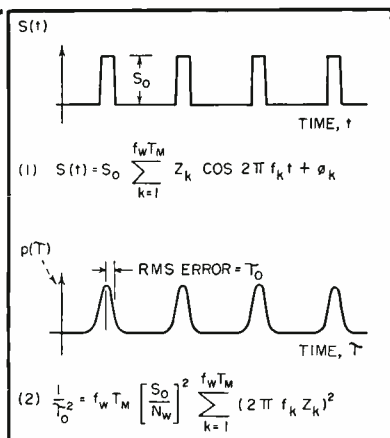

FIG. 3—Field timing signal which is applicable for frame synchronization

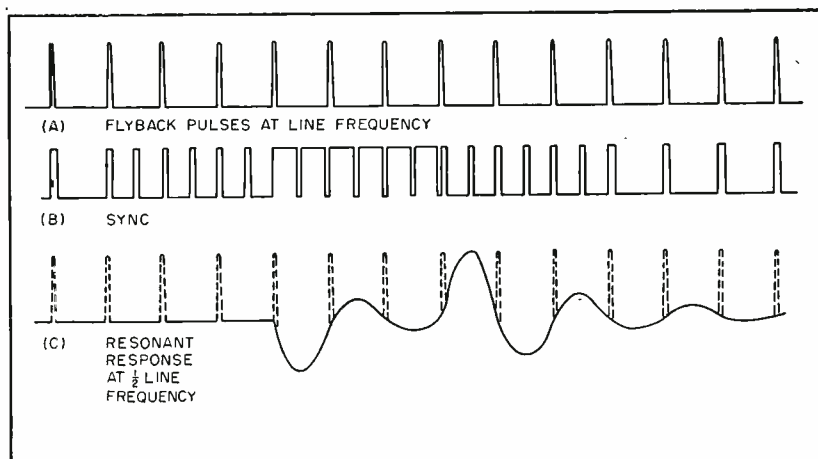

FIG. 4—Waveforms showing one mode of time-selection relating to field 1, as explained in text

known in advance.

The measuring device may be considered to examine a section of the signal, T_M in duration, for each composite measurement of the sync signal. Each such measurement defines the phase during a cycle. If the video signal bandwidth is f_w there are $f_w T_M$ possible harmonic components associated with each time measurement of the signal. If the noise is uniform throughout the band f_w it may be represented by its rms value N_w .

The timing accuracy obtainable for a given signal-to-noise ratio may be expressed in terms of a relative probability density function $p(\tau)$ such as appears in Fig. 2. The curve $p(\tau)$ permits the determination of the probability that the sync timing answer which results from a single complete measurement of the sync signal will occur within a specified time interval. This probability is proportional to the area under the curve $p(\tau)$ within the specified interval.

The curve $p(\tau)$ defines the probability laws for the noise in the output of the synchronizing system. The probability curve which describes the timing accuracy is repetitive at the fundamental frequency of sync because the sync signal is repetitive. In other words, the output noise from the sync measuring device has the same character from cycle to cycle.

For many energy distributions, $p(\tau)$ has very nearly the shape of a normal or gaussian probability curve, and in such cases it may be completely specified by the rms time error of measurements τ_0 for any specified signal-to-noise ratio. When the normal law applies, as it may for line or for subcarrier phase synchronization, the formula shown in Fig. 2 may be used to compute the rms time error. The formula shows that the mean squared error is inversely proportional to the product of several quantities. These are the number of independent Fourier component phase measurements applicable to each time measurement $f_w T_M$, the power ratio of signal-to-noise during a sync pulse $(S_0/N_w)^2$, and a function which depends on the distribution of signal energy throughout the frequency spectrum. This formula is based on taking the best possible weighted average of the timing measurements on all of the frequency components of the signal. This formula applies accurately when there is enough timing information in the low frequency components to identify cycles of the highs. For example, it is found that line-frequency flyback pulses in a receiver having an efficient afc system with a reasonable time constant of integration may be considered essentially noise free for purposes of frame sync performance, at all

noise levels for which the video content of the picture is likely to be visually acceptable.

Timing Threshold

The field timing signal which is applicable for frame synchronization is indicated as $S(t)$ in Fig. 3 for one field sync interval of a frame. When the signal-to-noise ratio is very poor, the relative probability density function for time measurements, $p(\tau)$, has the serrated shape shown by the upper curve of Fig. 3. This occurs because there is not enough low-frequency timing information, indicated by the dotted curve, to identify completely one of the multiple peaks. At some higher signal-to-noise ratio, as indicated in the lower curves for $p(\tau)$, the main lobe is effectively the only one that exists and the formula presented earlier for the rms error may apply.

Whenever the probability density curve is multi-peaked, the rms error based on the characteristics of the main lobe is not adequate to describe the threshold accuracy and it is desirable to know the shape of the probability density curve. The equation for $p(\tau)$ which is shown in Fig. 3 has been used to estimate the threshold of substantially perfect performance for frame sync. It includes as exponential parameters the number of independent phases or harmonic components $f_w T_M$, the

power ratio of signal-to-noise during a pulse peak, and a function which is represented by a series including all of the Fourier components of the signal, weighted according to the squares of the relative amplitudes.

The function $\psi(\tau)$, is a form of normalized auto-correlation function. In many cases its value for a specific value of τ may be computed by convolution methods. The threshold level has been computed from this formula for the case where the first pair of side lobes of the multip peaked probability density curve is 10 napiers or 87 db smaller than the main lobe. It corresponds to slightly more than one erroneously phased field in a 15-minute program. For this case the rms noise is approximately five times the peak-to-peak amplitude of the sync pulses.

This value obtained for the complete composite field sync signal including the notches and equalizing pulses is only two db better than would be obtained for a single broad pulse three lines in duration, using the same formula. This occurs as a result of the nonuniform energy distribution of the signal, which causes the high-frequency components introduced by the equalizing pulses and notches to be chiefly effective to quantize $p(\tau)$ as shown, but not to narrow its envelope substantially.

This suggests that if a beatnote type of frame sync system is built in which horizontal flyback timing information is compared with the basic field synchronizing information of the broad pulse group, and the information added by the equalizing pulses and notches is ignored, that it should be possible to obtain substantially perfect performance up to the point where the rms noise is about four times as large as the peak-to-peak amplitude of sync pulses.

Waveforms, Field 1

One method which has been used to accomplish nearly this level of performance is as follows. The field selection is made by comparing the phase of vertical field synchronizing information with the phase of horizontal flyback information. The

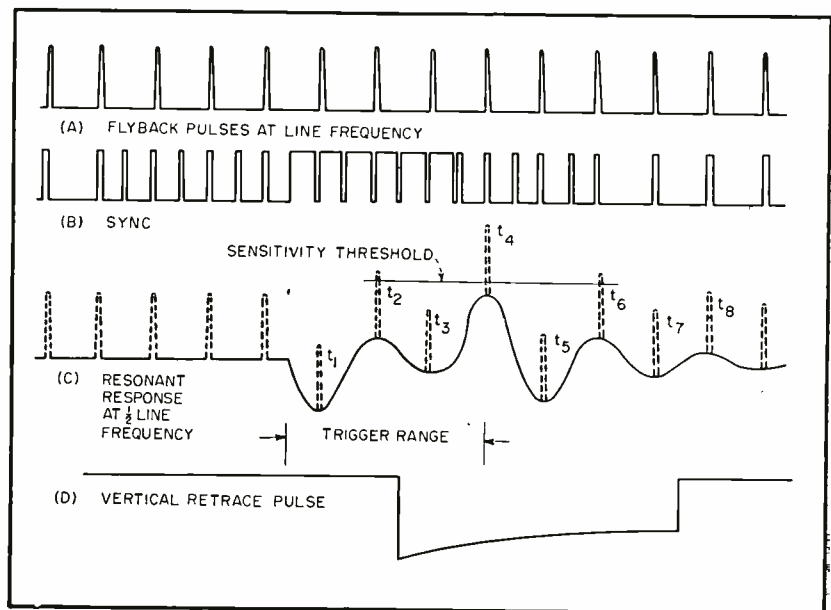

FIG. 5—Field 2 waveforms show coincidence of flyback pulses and peaks of ringing waveform

composite sync waveform is used to shock-excite a damped tuned circuit resonant at one-half line-frequency. The resulting waveform exists predominantly in response to the field synchronizing broad pulses. When keyed during horizontal flyback intervals, this oscillation permits selection of the desired field as on alternate fields the line rate keying pulses occur alternately (1) at the intervals of zero amplitude or (2) the intervals of peak amplitude of the damped oscillation at one-half line-frequency.

Figure 4 presents some waveforms illustrative of this mode of time selection relating to field 1. Curve A represents flyback pulses at line frequency. Curve B represents the sync signal near the field sync interval. Curve C represents the resonant response at one-half line frequency, the peaks of which may be seen to be interleaved in time between the line flyback pulses.

Waveforms, Field 2

Figure 5 represents relevant waveforms occurring in field 2. Curve A represents flyback pulses at line frequency and curve B represents the sync signal near the field sync region. Curve C represents the resonant response at one-half line frequency. In this case the flyback pulses are coincident with the peaks of the ringing waveform. A peak detector will nomin-

ally select the pulse at t_4 . If the sensitivity threshold is adjusted as indicated, any one of the pulses at t_2 , t_4 and t_6 may be used to identify the start of the selected field in the frame. The unit which derives an output pulse from the combined timing information, so that the desired field in each frame may be identified, is called a field recognizer.

Although the line rate pulses are present at all times the resonant ringing of the one-half line-frequency resonator normally occurs only at the field sync intervals. This self-keying action is adequate for reliable field recognition in the presence of weak signals with substantial thermal noise interference. In the presence of strong impulse noise interference it is desirable to provide additional noise immunity. This immunity may be obtained by time-gating so that the field recognizer is operative only during a short interval in each field in the vicinity of the vertical sync interval.

Curve D represents a pulse indicative of the occurrence of vertical retrace relative to the synchronizing waveform of curve B. Such a pulse normally appears in television receivers across the spike resistor of the interstage network between the vertical scanning oscillator and the vertical output amplifier. The indicated variation in front edge or

trigger range is believed representative. The retrace pulse provides a convenient source of a narrow time gate for impulse noise immunity. A pulse duration of the order of five lines is reasonable. This means that the system can be made to ignore noise impulses 98 percent of the time.

Circuitry

The connections of a typical cpa frame synchronizing system in a color television receiver are shown in the block diagram of Fig. 6. The frame sync system receives as input signals composite stripped sync from the sync separator of the receiver, horizontal flyback pulses from the horizontal scanning system and vertical retrace pulses from the vertical scanning system. It provides a square-wave control voltage as an output to the color decoder of the receiver.

A detailed block diagram showing the units in the frame sync circuit is shown in Fig. 7. The cpa frame sync system includes a field recognizer unit and a square-wave generator or flip-flop. The field recognizer unit is shown within a dashed line box. It includes a sync amplifier and limiter and associated circuitry, a shock-excited resonant circuit tuned to one-half line frequency, an amplitude limiter for the 60-pps field keying pulses which gate on the recognizer and the recognizer phase detector which is a biased peak detector.

Output of the recognizer phase detector is normally a train of pulses at a 30-cycle rate occurring, for example, at the normal trigger time t_s . Occasionally, ringing of the one-half line-frequency resonator by impulse noise will cause an output pulse from the recognizer phase detector on the undesired field. Less often a desired sync pulse may be missing. The 30-cps output pulses from the recognizer are fed to the flip-flop for providing triggering in one direction. A 60-cps train of pulses derived from the leading edge of the vertical keying pulse by differentiation is fed to the flip-flop for triggering in the other direction.

The circuit arrangement is such that after the flip-flop has been triggered it cannot be triggered again during the keying interval. In this mode of operation, called latch-on, once the flip-flop has begun operating in the proper phase sequence, occasional noise output pulses from the recognizer on undesired fields are not able to interfere with the proper functioning and the phase sequence of the flip-flop or of the cpa switching system. This reduces the time interval in each frame during which the noise impulses can cause interference from two to one percent. Since noise causes extra output pulses from the recognizer more often than it causes the desired pulse to be missing, the reduction in the number of of erroneous phases due to severe

impulse noise is greater than two or one.

A schematic diagram for the frame sync circuit is shown in Fig. 8. An input signal of about 15 volts of positive composite sync is supplied as indicated to the sync amplifier through a wave-shaping network which is designed to emphasize the trailing edge of the vertical broad pulse group. For best performance, it is desirable that the sync be double limited prior to this point. The resonant waveform is developed across the tuned transformer. Horizontal flyback pulses derived from the horizontal scanning system are added in series with it, by virtue of L_s . The resultant waveform as it appears on alternate fields at the grid of the recognizer phase detector is sketched in the figure. The 60-cycle vertical retrace pulses are applied through the pulse limiter tube, and a biasing network, to the cathode of the recognizer phase detector, to render it sensitive during the pulses. The plate current of the phase detector is a series of pulses at a 30-cycle rate and is fed to a suitable point in one voltage divider of the flip-flop. The 60-cycle pulses derived from the leading edges of these field retrace pulses are fed capacitively to the other voltage divider of the flip-flop which then generates a synchronized 30-cycle square wave as indicated in the figure.

Waveforms relating to the mode

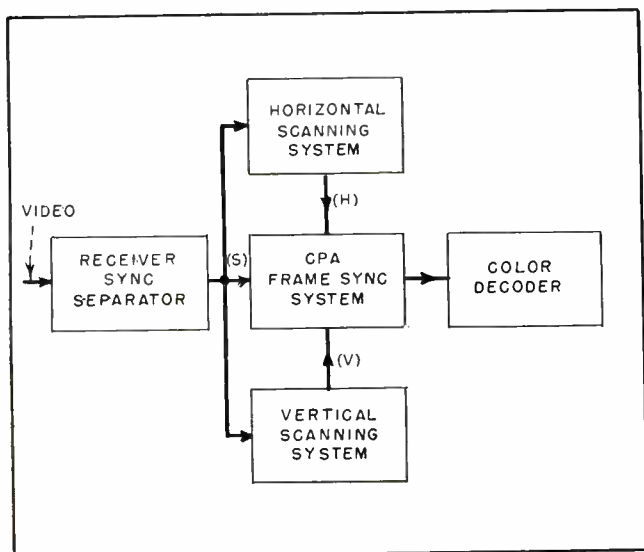

FIG. 6—Block diagram shows connections of frame sync system in tv receiver

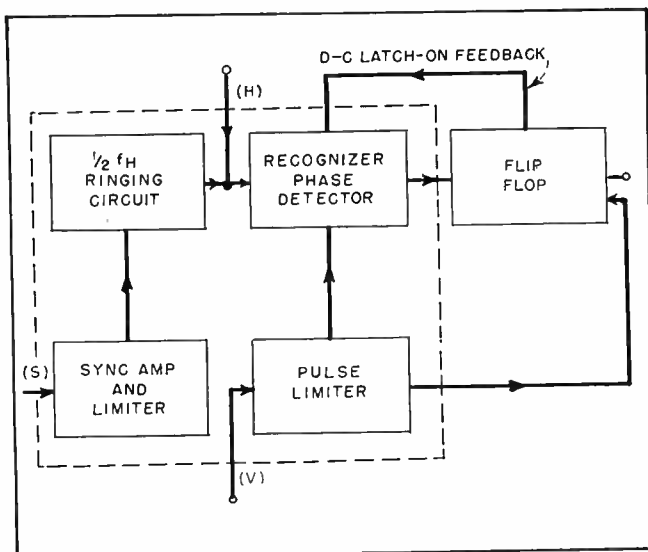

FIG. 7—Frame sync circuit consists of field recognizer (inside dashed line) and flip-flop circuit

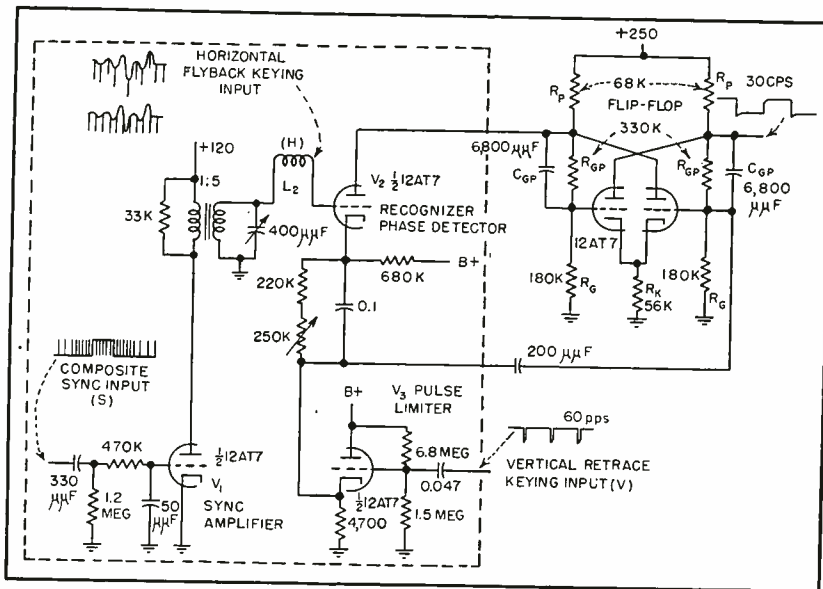

FIG. 8—Schematic for frame synchronization system

of triggering are shown in Fig. 9. Figure 9A represents (to an exaggerated time scale) the negative keying pulses at field rate, as they appear at the cathode of the recognizer phase detector V_2 . Figure 9B represents the differentiated pulses derived therefrom for triggering the flip-flop in one direction. Figure 9C represents the output current pulses of the recognizer phase detector V_2 . Pulses P_1 and P_2 represent normal output pulses in the desired fields. Pulse N_1 represents a spurious pulse due to noise in an undesired field. Figure 9D represents the desensitized period for the system following field trigger pulse F_1 , whereby N_1 is ignored. Figure 9E shows the grid waveform of the flip-flop showing the existence of a finite recovery time after triggering, thereby causing the desensitized periods.

Experimental tests were run to investigate the performance of the field recognizer for normal signals, and under the adverse conditions of weak, noisy signals and impulse interference.

An important factor relating to impulse noise immunity of the frame sync system is the ability of the receiver to maintain horizontal and vertical synchronization in the presence of impulse interference, as well as the ability of the receiver to maintain a good signal-to-noise ratio at the output of the sync channel in the presence of noise.

The circuit was tested in several different receivers, having different sync systems. All of these receivers provided double-limited full amplitude sync at the output of the sync channel for all signal levels of interest.

For thermal noise, the threshold level with this circuit appears to be within a few db of the theoretical optimum value for a triggered system. In most cases when misfirings occurred, the cpa phase was in error for one sixtieth of a second. This disturbance has low visibility due to its short duration, and it was masked by the high amplitudes of the low-frequency components of thermal noise in the video signal at the levels for which occasional misfirings would occur. Visibility of the short time (1/60 second) misphasing of cpa sync was higher in some present models of color receivers than it will be in true constant luminance receivers.

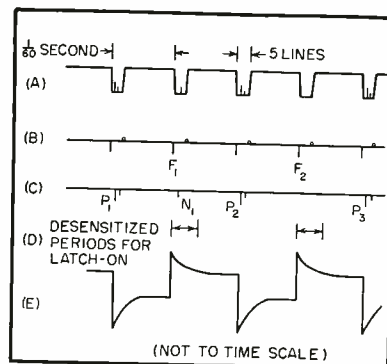

FIG. 9—Waveforms relative to mode of triggering flip-flop

One difficult problem in the evaluation of thermal noise performance is the determination of the noise level at which the picture becomes visually unacceptable. This level may vary by a considerable amount, depending on a number of factors. Tests thus far, as viewed by one group of observers, have indicated that the video signal may become visually unacceptable due to noise in the picture before occasional misphasing of the cpa frame sync occurs.

In the presence of high-amplitude impulse noise the frame sync appeared to hold together to within a few db of the level at which vertical sync failed, in all receivers. The differential performance of field versus frame sync did not appear to vary significantly between receivers.

The tests indicated that the time-gate for impulse noise immunity provides the difference between satisfactory and unsatisfactory performance with impulse interference.

Field tests now in progress should provide more data on how well triggered frame sync meets the requirements. While it is recognized that the effective signal-to-noise ratio can be further improved by integration, using an afc system, data obtained thus far does not indicate this as being necessary.

Preliminary field tests for adjacent and cochannel interference using color receivers designed for the NTSC signal shows that pictures usually become intolerable in video content before cpa sync fails.

The circuit presented above is economical and thus far has given satisfactory performance.

Conclusion

It has been shown that the present monochrome FCC synchronizing waveform appears to contain adequate timing information for reliable frame synchronization on a simple triggered basis, and that simple circuits can be built which achieve close to the theoretical optimum performance.

The author is indebted to J. R. White, R. J. Keogh, C. E. Page and C. J. Hirsch for encouragement in the preparation of this paper.

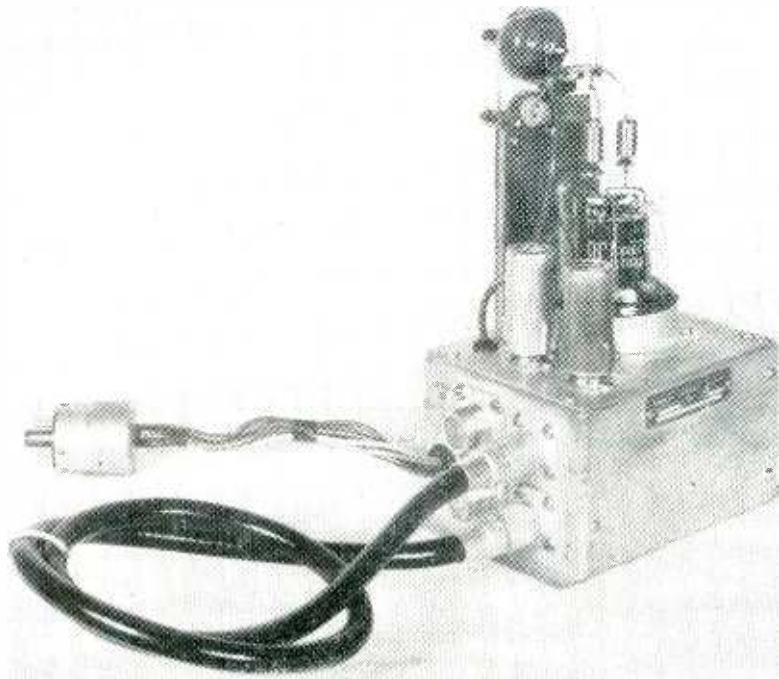

Chassis of cathode-ray-tube beam intensifier showing delay cable used to control duration of beam-on time

Cathode-Ray-Tube Beam Intensifier

Three-tube circuit provides positive spot intensification for millimicrosecond oscillography of random transients. Composite photographs of high-voltage pulses may be made using intensifier to select various portions of pulse

By **ROBERT W. ROCHELLE**

*Naval Research Laboratory
Washington, D. C.*

SPECIAL TECHNIQUES are employed in the design of intensifiers for use with multiband post-acceleration cathode-ray tubes. These tubes are noted for their extremely high writing speed and spot brilliancy. The duration of the signal presented to them is small, so that advantage can be taken of their fast writing rate. Intensification of the beam becomes harder to accomplish as the period of observation grows smaller. To offset this, a cathode-ray-tube intensifier has been developed to provide positive

intensification for time durations in the millimicrosecond range. This intensifier originally was designed to intensify the beam from nonrecurrent transients. The prime requisite is that the transient signal be delayed as little as possible while the tube beam is being turned on.

There are various methods of intensifying the beam of a cathode-ray tube. Multivibrators often are used to gate long-time-base oscillogscopes. As observation time is shortened, the multivibrator cannot be depended upon to produce the

desired rise-time gating pulse; consequently, some systems use thyratrons. Thyratrons have fast ignition time; however, with low triggering voltages, ignition time may be well over one microsecond. This time is too long for observation of fast rise-time pulses. Further, ignition time of a thyatron varies with trigger-signal waveform and amplitude. The intensifier described uses a hard tube as the gating tube and thyratrons to shut off the beam.

This system is novel in that the

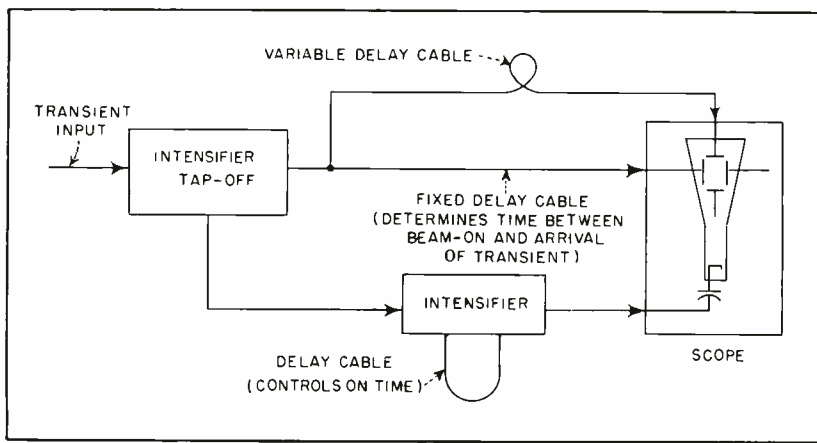

FIG. 1—Block diagram shows how intensifier is connected with oscilloscope

gating signal is the trigger signal amplified and clipped. The hard tube assumes two functions: it amplifies a portion of the leading edge of the trigger signal and clips the remainder to provide a constant level of intensification. Clipping occurs in the grid circuit as the grid goes positive. The output is a negative signal and must be capacitively-coupled to the cathode of the cathode-ray tube.

Since multiband high-voltage cathode-ray tubes have deflection factors in the range of 100 to 250 volts per inch, the signal applied to the plates can be applied directly to the intensifier through a tap-off. This results in extremely accurate time coordination between gating pulse and observed signal.

With negative or zero trigger signals the intensifier is turned off. It is on only for positive signals

that carry the hard tube to zero grid bias. This is not a disadvantage since the purpose of this type of intensifier is to examine a small portion of a pulse, such as the leading or trailing edge. Various portions of the pulse may be displayed by changing the length of delay cable between the intensifier tap-off and the cathode-ray tube. A series of pictures of the pulse taken with decreasing length of delay line will effectively expand the sweep length many times when the pictures are joined to make one composite photograph.

Linear Sweep

The generation of a linear sweep for a short duration presents a difficult problem. A convenient method of generating a linear sweep, when observing such phenomena as rise times of phototubes

and pulse generators, is to bias the cathode-ray-tube horizontal plates so that the linear portion of the fast rise from the signal appears across the center of the tube. The vertical signal may then be delayed in successive steps by inserting lengths of delay line to complete the composite photograph. Figure 1 is a block diagram of the setup.

The intensifier delays are adjusted so that intensification is obtained only in the linear portion of the horizontal trace. When this method is used, there will be no time jitter between the signal and the sweep. An advantage in the case of periodic signals is that a sweep generator is not required for the oscilloscope. Periodic signals are handled in the intensifier by removing the thyratrons. Biasing the grid of the hard tube controls the duration of intensification, and the delay line from tap-off to intensifier controls the phase.

The circuit of the intensifier is given in Fig. 2. A 3E29 or 829-B is used as the hard tube. The ability of these tubes to deliver a large current at zero grid voltage helps to charge the cathode-ray-tube cathode capacitance quickly, resulting in a faster rise time. The series grid resistor allows clipping to occur after the trigger signal has reached zero grid bias and, consequently, has been amplified in the plate circuit.

Two 2D21 thyratrons turn off the intensifier. One is across the screen grid of the 3E29 and the

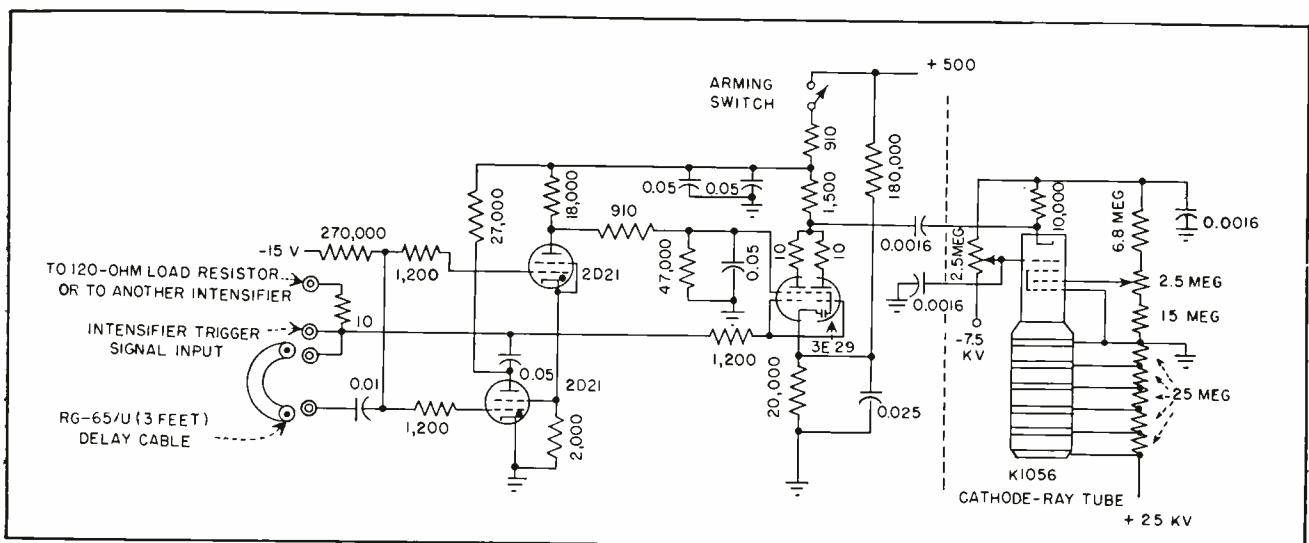

FIG. 2—Complete circuit of intensifier attached to multiband postacceleration cathode-ray tube

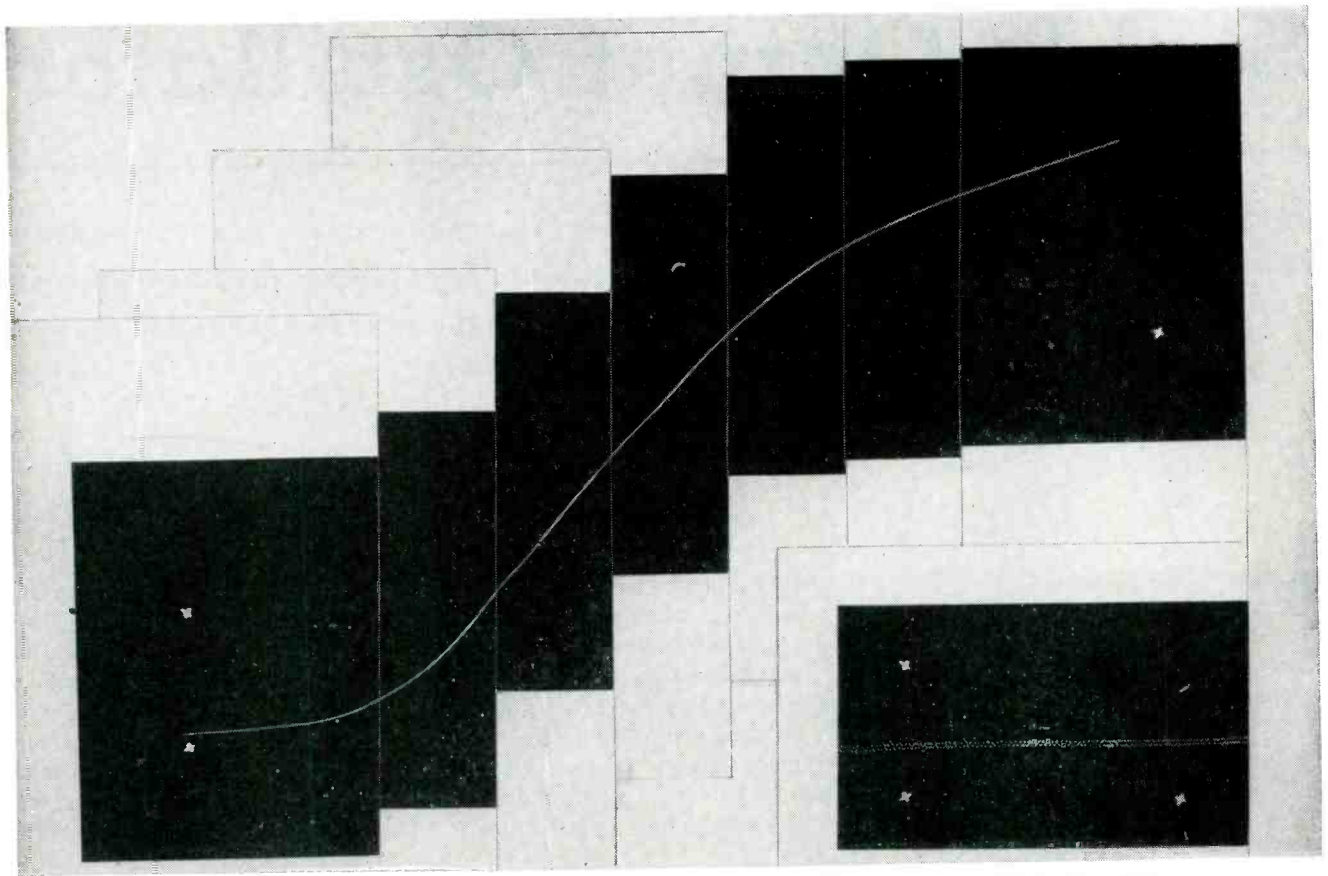

FIG. 3—Composite photograph of pulse rise made with intensifier. Time scale is a 6,500-mc sine wave

other is across the control grid.

For the particular application for which the intensifier was designed, it was necessary to lock out all signals after the main signal. The thyratrons are triggered from the main trigger signal but delayed for the presentation time by means of a small section of high-delay RG-65/U cable. This cable has a characteristic impedance of 950 ohms and a velocity of propagation of approximately 20 feet per microsecond. The screen-grid thyatron provides positive lockout, but its action is not fast enough. The screen-grid capacitor is slow in discharging; therefore, a thyatron has been added on the control grid to provide immediate cutoff. However, this thyatron will not lock out for all time owing to the possibility that a negative trigger signal could extinguish the tube by carrying its plate below ground potential. Another positive signal would then intensify the hard tube before the trigger signal reached the thyatron grid through the high-delay cable, thus causing a spurious intensification. This cannot occur

since the screen-grid thyatron has cut off the hard tube.

The intensifier has been used to intensify a DuMont type-K1056 multiband, high-writing-speed cathode-ray tube. The time of signal observation can be changed by connecting different lengths of RG-65/U delay cable on the side of the intensifier. A 2-ft length gives approximately 100 millimicroseconds of presentation.

Transient Photography

Figure 3 shows a composite photograph taken of the leading edge of the output from a pulse generator. The linear-rise portion of the pulse comprises the horizontal sweep as explained above. The pulse was connected to the vertical plates through a delay cable. A delay of four millimicroseconds was added in this variable delay cable after each picture was taken, until the entire leading edge had been photographed. Fiducial markers from small masked lights near the cathode-ray-tube screen aided in positioning the individual photographs.

A timing trace for obtaining a

time base was made by photographing a 6,500-mc magnetron output on the vertical plate against this same horizontal sweep. A distance equivalent to four millimicroseconds, the time delay between successive photographs, was laid off in the center of the negative. This distance was transferred to the pulse photographs, and the right edge of each was clipped at the end of the 4-millimicrosecond period. The traces were then joined and photographed, as shown in Fig. 3. The resulting trace covers a total time of 30 millimicroseconds.

By using the method just described, the resolution will effectively be increased when large signals are to be observed. Another advantage is that the recording is obtained with a minimum of required equipment; for example, it is not necessary to employ a pulse attenuator or to provide a horizontal sweep source.

The author wishes to acknowledge the helpful suggestions rendered by H. J. Peake and N. W. Matthews in the design and development of this intensifier.

Stable-Output Oscillator

Oscillator amplitude is reduced only 3 percent for 30-percent decrease in either heater or plate-to-cathode potential. Output stabilizing circuit can be applied to existing equipment when provided with 2-ma source of regulated d-c reference potential

By **SHERWIN RUBIN**

*National Bureau of Standards
Washington, D. C.*

MODERN INSTRUMENTATION has increased the demand for stable radio-frequency potentials. For widest application, generators supplying such voltage should satisfy certain requirements. First, r-f output amplitude should be maintained within reasonable limits over an anticipated range of long and short-term variations. Second, means for varying the magnitude of the regulated potential should be included, and third, circuits should remain simple and noncritical from the standpoints of maintenance, adjustment, and economics.

Regulated amplitude oscillators satisfying one or more of the above requirements, either in full or in part, have been constructed.^{1,2,3} The main advantage of the unit to be described here is its ability to operate with any positive d-c reference potential available, whether within or external to the equipment of which it is a part. To the author's knowledge, the particular circuitry shown has not been previously used in this manner. From the standpoints of economics, simplicity, and ease of adaptability to existing equipment, the above feature should prove valuable for laboratory use.

The input stage of the d-c amplifier, upon which control depends, and the voltage divider that supplies the reference potential comprise V_s , R_1 , R_2 , and R_3 in the circuit diagram. It is this circuit feature that makes the unit so readily adaptable in practice. The fact that the plate resistor of the input stage of the d-c amplifier V_s is 15 megohms limits the maximum cathode

current variation to less than 20 microamperes, when using a supply potential of 300 volts or less. With the voltage-divider resistors R_2 and R_3 chosen to allow a current flow of two milliamperes from the d-c reference source, the maximum change in reference voltage due to cathode current flow is less than 1 percent.

The output of oscillator V_1 is rectified by a CK-707 germanium diode, and the positive d-c potential thus obtained is applied to the grid of V_2 . The d-c amplifier output stage V_2 is a cathode follower that supplies the plate and screen power to the oscillator. An increase in potential at the grid of V_2 causes a decrease in potential at the cathode of V_2 , thereby reducing the amplitude of the r-f output of V_1 . The stabilizer thus attempts to keep the r-f output amplitude constant.

Circuit Analysis

Voltage-divider network R_2 and R_3 allows adjustment of output amplitude. For many purposes a particular output voltage is desired. In these cases R_3 can be fixed and minor adjustments for a constant-output voltage made by detuning the oscillator tank capacitor, C_1 . It might be preferable to obtain the reference potential from a gaseous regulator tube or a stabilized low-voltage supply using a mercury cell battery as reference.⁴ For this reason, the values of R_2 and R_3 are not specified.

The rectifier circuit is a series, peak-reading arrangement. A 2-mh iron-core choke L_1 provides a low-

resistance d-c return necessary for capacitively coupled peak-reading rectifiers. The choke in question must have sufficient reactance at the lowest oscillator frequency to minimize oscillator loading, and hence must not become series resonant at the highest oscillator frequency. In the circuit shown, rectification efficiency was found to be constant within 2 percent in the range from 1.8 to 19.5 megacycles.

In the V_s -to- V_2 coupling network, C_2 (a plate bypass capacitor) prevents the unit from oscillating as a low-frequency phase-shift oscillator. The plate of V_s is directly coupled to the grid of V_2 . Resistor R_2 , connected from the grid to cathode, provides the grid return for V_2 . The impedance looking into the grid of V_2 is

$$Z = R_2 \left(1 + \frac{\mu R_1'}{r_p + R_1'} \right) + \frac{r_p R_1'}{r_p + R_1'}$$

For this equation, only the low-frequency case has been considered; R_1' is the parallel impedance of R_1 (the cathode-follower cathode resistor) and the plate and screen-loading of V_1 ; μ is the amplification factor of V_2 . When R_2 is large compared to the parallel combination of R_1' and r_p , the second term on the right may be neglected.

Under the operating conditions for the circuit shown, the plate resistance of V_2 is approximately 4,000 ohms and the minimum value of R_1' is about 4,000 ohms. The μ of V_2 is about 20. Under these conditions, the load presented to the plate of V_s by the input of V_2 will be approximately 36 megohms. It

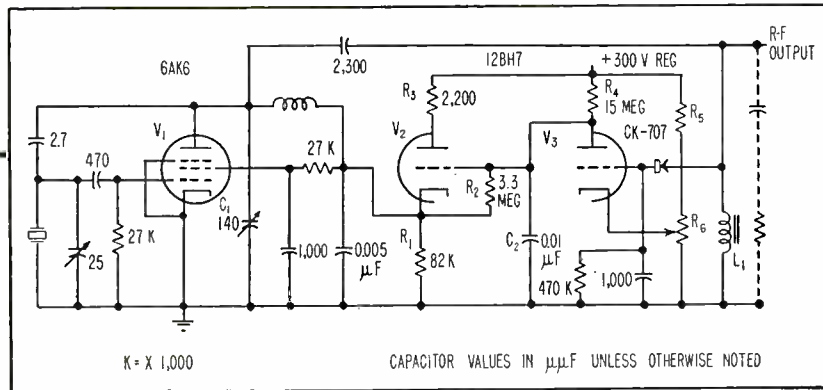

Circuit diagram of the stabilized oscillator. Control section can be used with existing oscillator circuits to insure constant-amplitude output

should be noted that with this circuit arrangement, some of the current drawn by V_3 will come from the cathode of V_2 . This restricts the value of R_2 to a magnitude large enough to prevent the maximum current through V_3 from exceeding 20 microamperes. A higher value of cathode current will adversely affect the stability of the reference potential at the cathode of V_3 . The cathode resistor R_1 is chosen small enough to keep the cathode-heater potential within rated value if oscillator current discontinues for any reason, but large enough to prevent excess current drain with high output voltages.

Under normal conditions the largest current drawn by this resistor will be less than 2.5 milliamperes. Keeping down the current drawn by the cathode resistor allows the d-c amplifier portion to operate with essentially full gain when the cathode emission falls off (as approximated in tests by reduced heater temperature). Stability with respect to heater potential changes is thereby improved. The plate resistor R_3 of V_2 , is inserted for decoupling and overload protection.

The plate and screen of the oscillator are fed from the cathode of V_2 . A d-c blocking capacitor is often connected in series with the tank capacitor of series-fed circuits to prevent temporary shorts in the tank capacitor, during adjustment or operation, from blowing the plate supply fuse. The connection shown eliminates the need for such a capacitor and, in addition, provides

a single oscillator d-c power lead.

Amplitude-stabilized devices used in a laboratory should be stable with respect both to short and long-time intervals. The prime factors usually affecting amplitude in the short term (fifteen minutes or so) are changes in load and changes in line voltage. Factors affecting long-term stability are usually associated with tube transconductance changes. Stability with respect to short-time changes was approximated by changing heater potential on V_1 , V_2 , and V_3 , and oscillator load. A change of $2\frac{1}{2}$ percent in output amplitude resulted from a 30-percent decrease in heater potential.

Stability

A maximum change of 3 percent in output amplitude resulted from either doubling or halving the oscillator load. Stability with respect to

long-time changes may be approximated by changing plate potential on all tubes (keeping the reference potential constant by use of a second stabilized supply) and filament potential.

The tube mutual conductance is a function of plate-cathode potential. The effects of decreased emission from an aging cathode can be approximated by reduced heater potential. Here a 30-percent decrease in heater potential and plate-to-cathode potential (each taken separately) resulted in an output amplitude reduction of 3 percent. Since the accuracy of the average laboratory r-f voltmeter is 3 percent, this stability may be considered good.

The stabilized oscillator described may be used as a separate source of r-f potential, or the d-c amplifier stabilizer may be adapted to existing generators. In cases requiring much greater d-c power for the oscillator, a separate power stage and pentode input tube may be used, or the oscillator plate may be supplied separately and the screen alone fed from the regulator. The unit is simple and easy to install. It shows good long and short term stability, and provides a ready means of amplitude adjustment.

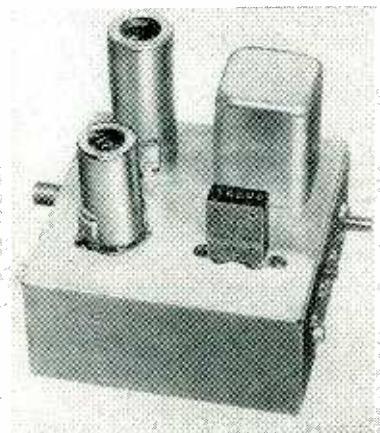

Laboratory model of the stabilized-output oscillator

REFERENCES

- (1) Maurice L. Greenough, and William E. Williams, An Electronic Circuit for Measuring the Displacement of Pressure Sensitive Diaphragms, *Jour. of Research*, NBS, 46, No. 1, p 5, Jan. 1951.
- (2) Maurice L. Greenough, Electronic Micrometer, *Radio-Electronic Engineering*, 9, p 11, Aug. 1947.
- (3) Norris C. Hekimian, Constant Amplitude Oscillator, *ELECTRONICS*, July 1951.
- (4) Sherwin Rubin, Low Voltage Regulator, *TV Engineering*, p 8, Mar. 1952.

Unitized Pulse Circuits

Rack-mounted pulse-control circuits perform basic gating, mixing and delay functions to save time and money in design of pulse equipment. Any type of pulse equipment can be set up quickly by interconnecting basic units with coaxial cable

By **HARRY KENOSIAN**

*Research Engineer
Burroughs Adding Machine Company
Philadelphia, Pa.*

PULSE CIRCUIT DESIGN is accomplished with a minimum of time, effort and material by use of basic pulse circuit units to generate, control and distribute 0.1- μ sec pulses.

Building block units, like the coincidence detector shown in the photograph, perform elementary pulse manipulations such as gating, mixing and delay. These units are mounted in standard 19-inch racks and may be interconnected by coax to set up any desired type of pulse equipment.

The large photograph shows an experimental digital computer using about 500 pulse-control units. This computer has been in operation for over a year.

Basic pulse-control units are listed in the table. Figure 1 is a functional block diagram illustrating

how several basic units may be interconnected. The system shown is a four-way pulse distributor wherein pulses applied to the input appear successively at outputs one, two, three and four. Two flip-flop circuits and six coincidence detectors are employed.

Voltage Waveforms

All operations are performed almost entirely by two kinds of voltage waveforms, a half-sine wave having a 0.1- μ sec duration, and a two-valued voltage waveform that can be switched in 0.2 μ sec, and which can remain at either value for an indefinite period the higher value being ground potential and the lower value between -14 and -30 volts.

Pulse durations other than 0.1 μ sec are used mainly in terminal

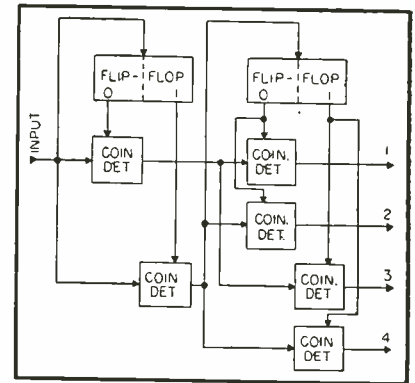

FIG. 1—Four-way pulse distributor requires two flip-flop circuits and six coincidence detectors

circuits linking a system of pulse-control units with other equipment types.

Each unit is designed so that pulse distortion is corrected before the pulse is delivered to the output jack. This correction permits cascading units without pulse deterioration.

Output Characteristics

The pulse-control units deliver 0.1- μ sec half-sine pulses into RG-62/U, 93-ohm, terminated coaxial cable. The zero-signal output and baseline voltage level is ground potential.

The output transformer is connected to the line through two parallel crystal diodes and a three-position switch. The diodes connect the outputs of several parallel units without impedance mismatch and disconnect the low impedance of the terminated output cable during the time the transformer output tends to go negative. This cuts off negative overshoot and ringing following the output pulse.

The switch permits reversal of output pulse polarity. In neutral position, the transformer is discon-

Building Block Units for Pulse Circuit Research

Unit	Function
Pulse Generator 1001B	Generates 0.1- μ sec pulses over continuous frequency range 15 to 650,000 cps
Pulse Generator 1002A	Generates 0.1- μ sec pulses over continuous frequency range 0.2 to 4.5 mc
Pulse Generator 1003A	Generates single pulse by push-button control
Flip-Flop 1101B	Bistable E-J circuit can be switched by 0.1- μ sec pulses. Two outputs are d-c levels for gating pulses
Coincidence Detector 1201A	Senses coincidence between 0.1- μ sec pulse and flip-flop output
Coincidence Detector 1202A	Senses coincidence between outputs of up to five flip-flop circuits
Pulse Delay 1301B	Delays 0.1- μ sec pulses from one to 70,000 μ sec
Pulse Delay 1302A	Delays 0.1- μ sec pulses from 0.1 to 1.9 μ sec in 0.05- μ sec steps
Channel Selector 1401A	Feeds input 0.1- μ sec pulses to four output jacks
Mixer 1601	Mixes up to five inputs for a common output

Speed Computer Design

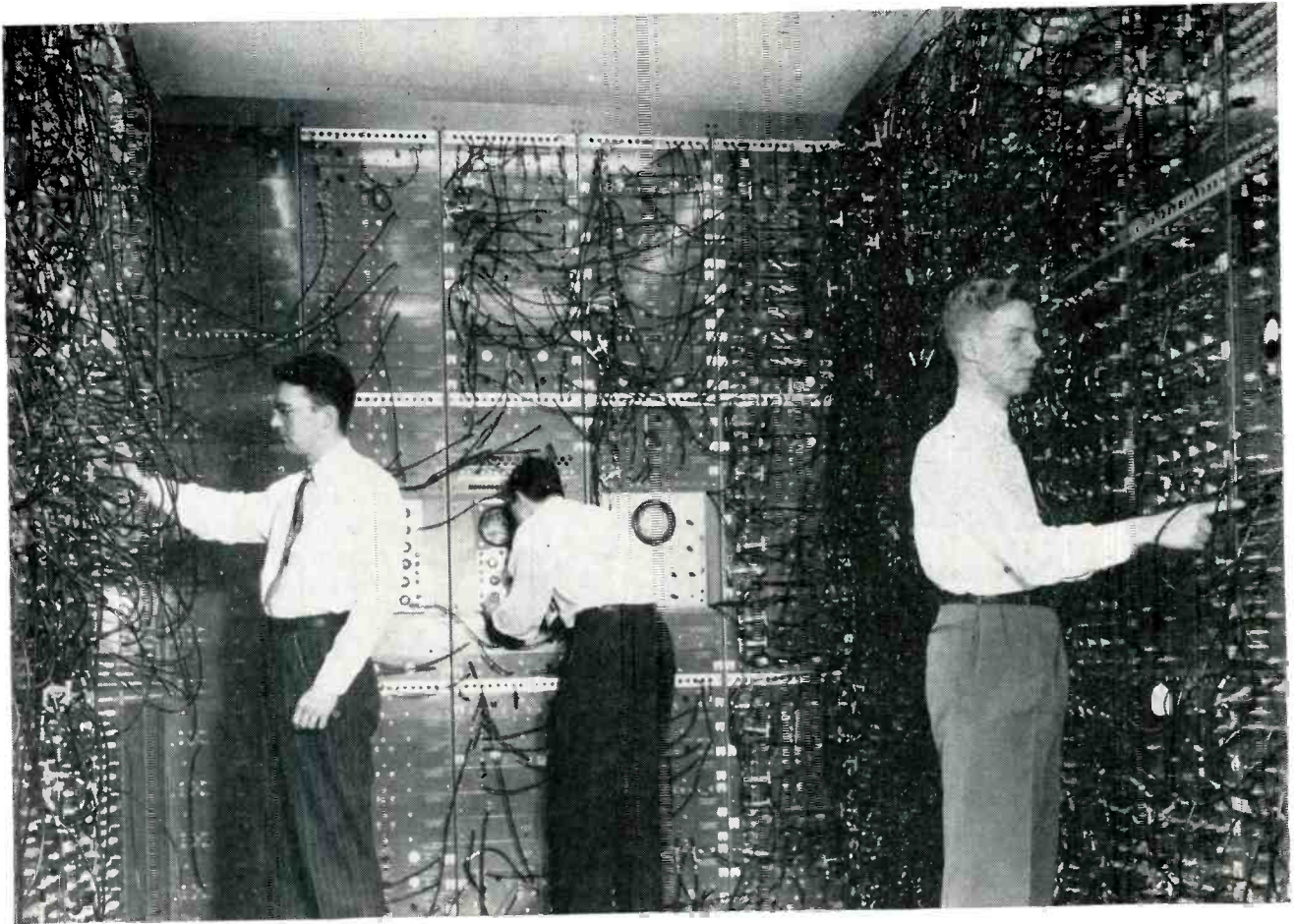

This experimental digital computer incorporates nearly 500 basic pulse-control units

nected from the output jack.

The output circuits can be paralleled only when the desired pulses have the same polarity.

The amplitude of the output pulse can be varied between 10 and 32 volts by a potentiometer. Output impedance level is not affected by amplitude. The output pulse is slightly distorted at maximum amplitude setting but the distortion will not affect operation of succeeding units.

Input Characteristics

The input circuits utilize positive 0.1- μ sec pulses or d-c voltage level. Minimum amplitude required to trigger the units varies from 9 to 15 volts. The units are designed for uniform operation over a wide range of input pulse amplitude.

Since the input impedance of most units is high compared to the

characteristic impedance of the terminated cable, it is possible to feed several units with one cable.

When using the pulse-control units with other equipment, it may be necessary to convert the 0.1- μ sec pulses into pulses having different shapes and impedance levels. It may also be necessary to convert pulses from an external source into 0.1- μ sec pulses.

For these applications, special adapter units must be made to obtain signals with the proper amplitude, shape, impedance and voltage level.

The pulses can be lengthened with single-shot multivibrators, blocking oscillators, smearing circuits, and so on. Pulses from external equipment can be shortened with peaking circuits operated by current pulses easily obtained from single-shot multivibrators, flip-flops,

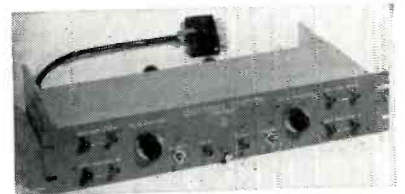

Coincidence detector is typical of rack-mounted pulse circuit building blocks

Schmitt circuits, or gas tubes. Gas-tube peaking circuits are simplest, but are limited to lower frequencies.

Acknowledgment

The author wishes to acknowledge the efforts of Jay W. Forrester, head of Project Whirlwind, MIT, who first proposed the idea of constructing unitized components and whose encouragement led to the development and construction of the original equipment.



Phototube timer is located unattended on ski slope. Servomechanism operates meter farther down slope, where skier may stop and read her speed

Linear Scale

By R. STUART MACKAY

Division of Electrical Engineering
University of California
Berkeley, Calif.

SKIERS can determine their speeds using a phototube-operated timer that displays speed directly in miles per hour on a linear-scale meter. The timer may be located unattended on the slope with the servocontrolled meter installed at the foot of the hill.

The timer may also be used to clock vehicle and animal speed

trials. With some circuit modification, it can measure other events per unit time or events per unit event. Such applications could include measuring cycles per second, watch ticks per hour, revolutions per minute or miles per gallon. If desired, the timer can be modified to display elapsed time as well as speed.

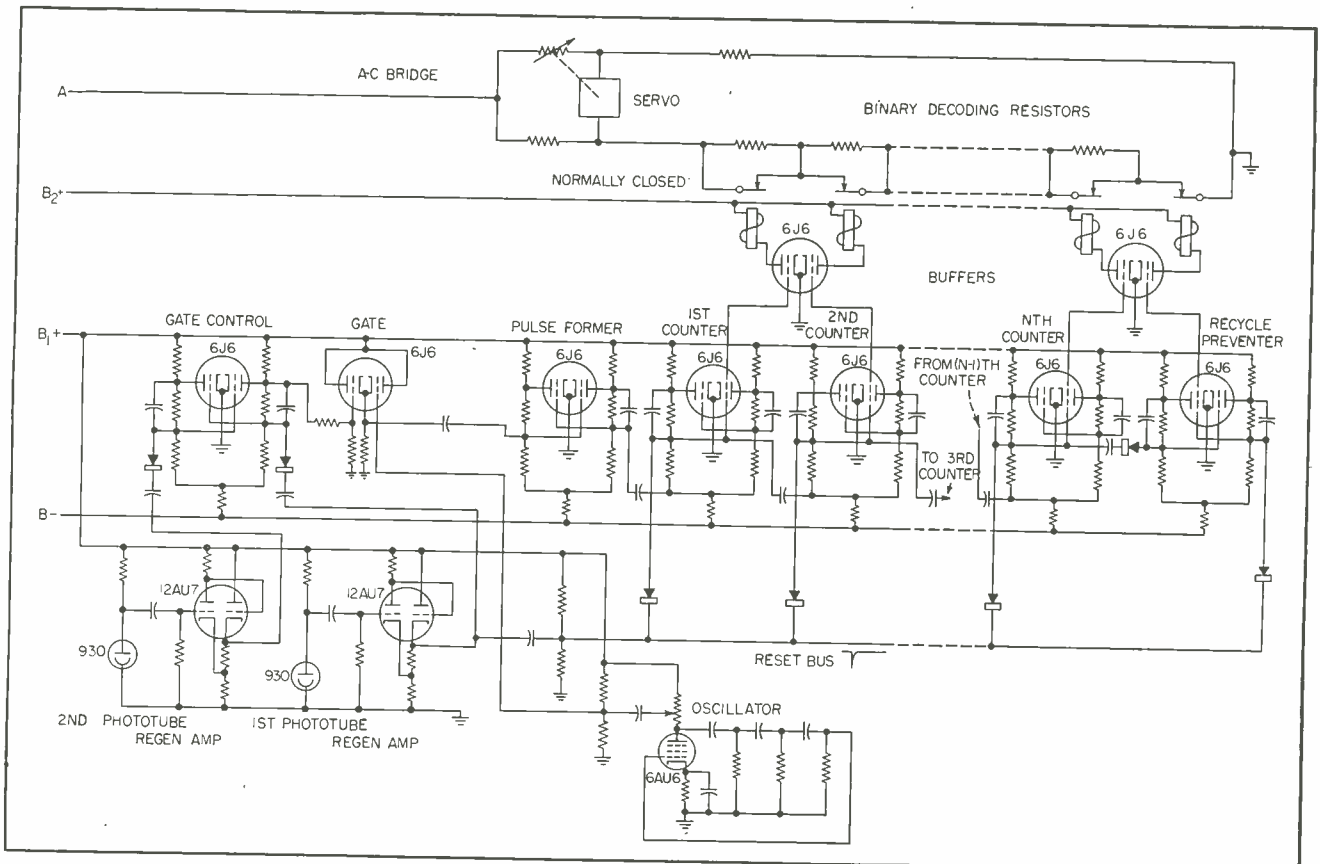

FIG. 1—Phototubes gate pulse input to binary counter. Binary decoding resistors, switched by counter-output relays, form one arm of Wheatstone bridge

Velocity Meter

Versatile timer clocks speed trials, or it can also measure auto miles per gallon. Phototube pair gates constant-rate pulse train fed to binary counter. Counter output selects resistors proportional to elapsed time. Current through resistor chain then varies directly with speed

The device consists of two phototubes separated by a short distance and used to gate a standard oscillator on and off as the skier passes. A binary counter registers the number of cycles passed from the standard oscillator as a measure of elapsed time. Relays operate to connect in series a resistor chain proportional to time and a bridge-

balancing servomechanism converts this information into speed.

Circuit Details

Figure 1 is the circuit of the linear, direct-reading velocity meter. The signal from the first phototube is amplified by a regenerative amplifier that accepts the slowly-varying waveform and sup-

plies a pulse to activate the trigger pair that opens the cathode-follower gate. The gate-tube grid receiving the oscillator signal is then at the higher potential and the cathode voltage follows it.

This signal is converted into pulses by a modified trigger pair and the pulses fed to the binary counter until a signal from the second phototube gates off the oscillator signal. The counter stages (bistable multivibrators) activate, with the help of buffer tubes, relays that connect resistors in series. Each successive resistor is twice the previous one. The total resistance is proportional to the number of cycles and thus, to the elapsed time.

If a fixed voltage is applied to this resistance, the current will be inversely proportional to time and an ammeter will give a linear indication of speed. In Fig. 1, the binary resistors constitute one arm of a Wheatstone bridge whose opposite arm is a potentiometer driven to balance the bridge. The setting of the potentiometer is inversely proportional to time and its attached dial can be calibrated in speed.

If a skier feels he has made good time at the measuring point, he can stop farther down the slope and activate the bridge servomechanism to display his speed.

Counter Reset

The trigger pairs act as a short memory, storing information about each skier's speed until the next one comes along. When the next skier passes the first phototube, the binary counters are instantly reset and

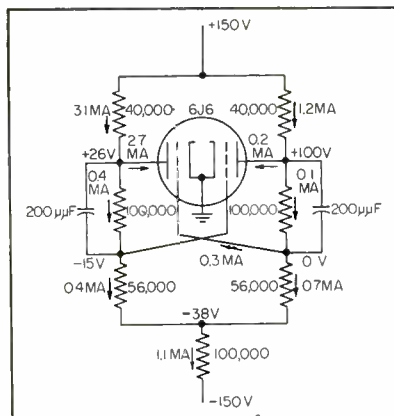

FIG. 2—Binary counter cell capable of counting about 75,000 pulses per second

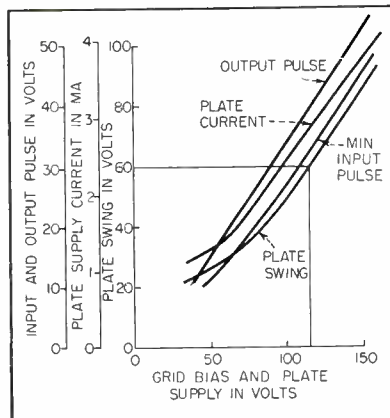

FIG. 3—Characteristics of binary counter cell shown in Fig. 3



Electronic timer using binary counters. Input phototubes are at extreme ends of chassis

immediately start counting.

Reset action is not impaired if, due to a fall, a skier crosses only the first phototube. Since only a limited range of speed is of interest the last trigger pair is diode coupled so it will not switch back. After a maximum count, it opens the resistor string and the reading, if displayed, will correspond to zero velocity.

The cathode-follower gate is especially poor for gating fast, negative-going signals; thus the sinusoidal wave is gated and then shaped into pulses. The reset bus must be biased a few volts positive or the counters will interact and normal counting will be impossible. Circuit constants in Fig. 1 depend upon the order of magnitude of the speeds. A medium-speed trigger pair is shown in Fig. 2. Its characteristics are given in Fig. 3.

These circuits are stable and do not require regulated power supplies. As line voltage increases, output pulse height increases at the same rate that sensitivity of the next stage decreases, and they readily cascade. A convenient operating point is with plate supply and grid bias both approximately equal to 125 v as delivered by half-wave, selenium-rectifier circuits. A switch-operated, monostable multivibrator is used to activate the indicator circuits.

Accuracy

Since the accuracy of indication varies with magnitude, the designer is primarily concerned with maximum error. A maximum error of one percent requires a count of at least 100 cycles during the shortest interval of interest. If a speed range of ten-to-one is to be covered, ten counters are required.

Binary resistors should be accurate to about one percent, though each successive resistor smaller than the seventh need be only half as accurate as the previous one.

If the phototube separation is known, the oscillator frequency (which must be accurate to one percent) is also specified. In practice, however, the oscillator can be adjusted to make all readings perfect once a single known velocity is properly indicated. Although the

effective position of a phototube depends upon the gain of the associated amplifier and the speed of passing, both tubes are similarly affected and their separation remains accurately fixed. Parallax introduces little error since the cosine of an angle varies slowly near zero degrees.

Uncertainty in the count can be reduced by using a pulsed oscillator, which can start instantly because its inductive energy is continuously stored, rather than using a gated continuous oscillator.

Light Sources

The device can usually be used with ambient illumination, changes in which have no effect because of the capacitor-coupled input. The heat dissipated by the tubes keeps the windows clear.

In some circumstances, separate light sources are desirable. They can be aimed from inside the phototube housing and the light returned from suitably placed auto-collimators. One can avoid possible blocking by using a U-shaped beam of ultraviolet light falling on a single phototube.

The servomechanism display device is usually preferred to the simpler ammeter. The bridge circuit provides readings independent of line voltage, permits partial cancellation of temperature effects on precision resistors and minimizes possible damage due to accident off-scale operation.

Bridge-Balancing Servo

The servo indicator provides a large, rugged, weatherproof, 360-degree scale and a permanence of display between indications; an expanded scale or suppressed zero may be incorporated.

A simple, bridge-balancing servomechanism is shown in Fig. 4. It employs a differential amplifier to analyze the bridge signal and activate the relays. If there is bridge unbalance, only one relay will be activated. Fitted with trailing-tube rectifiers to stop chattering, the relays operate the motor, which turns to restore bridge balance. If both relays are either activated or not activated, no power is applied to the motor. At such a balance point, no power is drawn and the load is shorted. This not only supplies

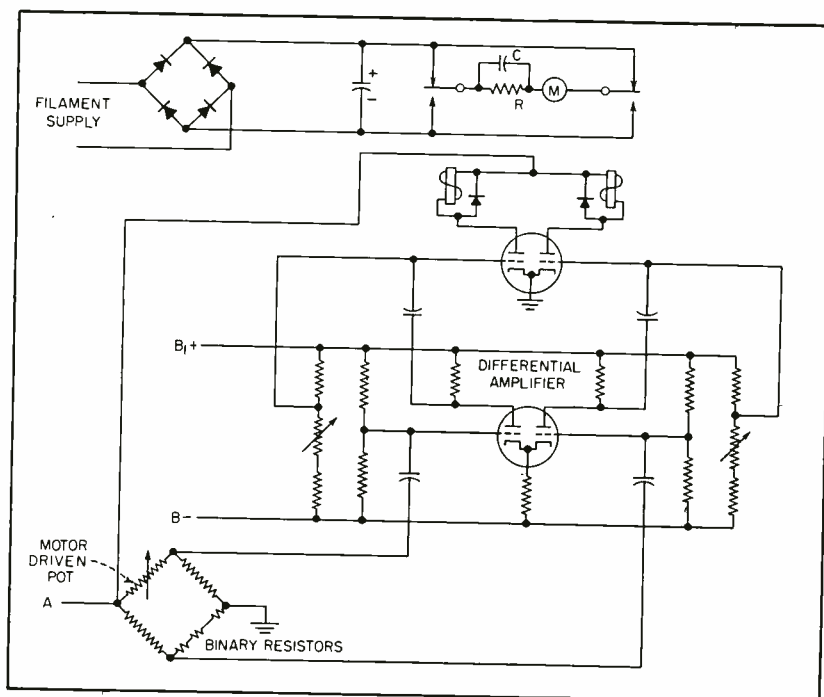

FIG. 4—Bridge-balancing servomechanism employs differential amplifier to control potentiometer motor drive

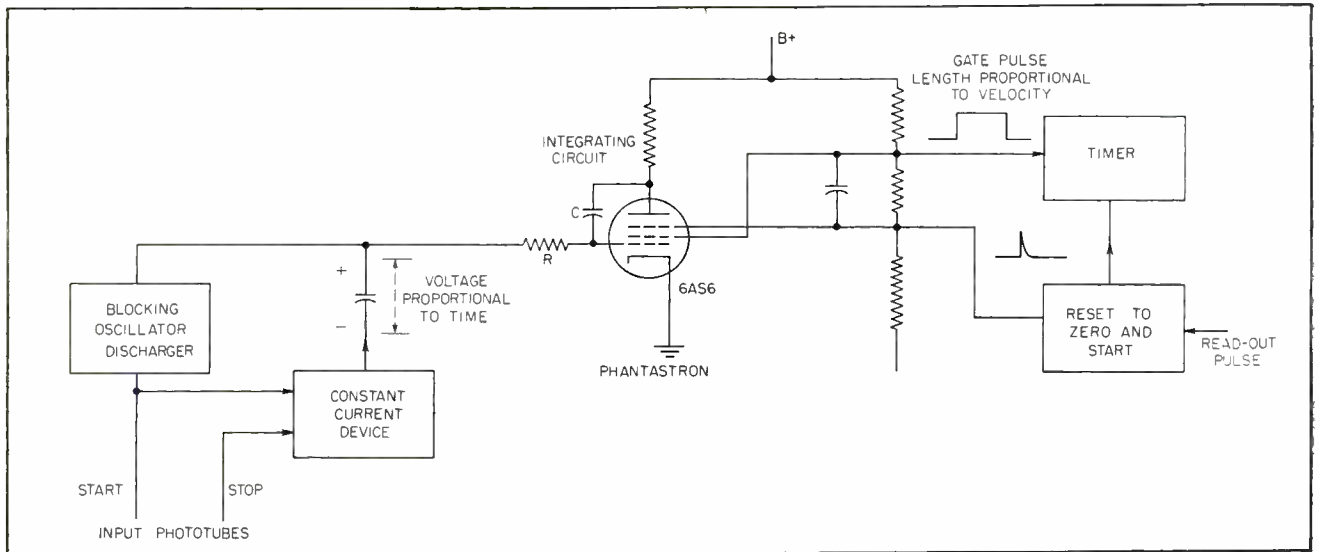

FIG. 5—Integrating a fixed voltage proportional to elapsed time until a preset voltage is reached requires a time interval proportional to velocity. Length of timer gating pulse from phantastron measures integration time

dynamic breaking at the null, but also permits insertion of a lead network. This network applies, through the capacitor, a larger-than-normal voltage change of suitable polarity during any transition between the three states of motion and thus provides extra fast response. This is true whether the discharged capacitor allows a larger-than-normal current surge to start the motor, or the charged capacitor discharges in the reverse direction to stop the motor. If R and C are matched to the motor one can apparently cancel armature mass and tolerate a smaller dead zone.

In the bridge circuit, one need only interchange two adjacent arms to display elapsed time rather than speed. With meter indication one would have to pass a constant current through the resistor chain and place a voltmeter across it.

If an event consumes appreciable time, a motor-driven potentiometer will furnish a resistance increasing linearly with time. The input devices can activate a small magnetic clutch to provide instant starting.

Capacitor-Charge Timer

Instead of counting cycles arriving at a uniform rate, it is possible to charge a capacitor from a constant-current source. This then

provides a linearly-increasing voltage and a final voltage proportional to time. Constant current can be supplied by pentodes, beam power tubes, saturated diodes, phototubes with constant illumination and cascode amplifiers or other feedback systems.

The voltage proportional to time, can be converted into a corresponding resistance by passing constant current through a variable resistor and adjusting it until its voltage drop equals the input voltage. A servomechanism can then be used in a bridge-balancing circuit.

Voltage proportional to time can also be impressed across a potentiometer having a constant-voltage source in series with its arm. If the arm is driven by a servomechanism until the voltage tapped off the potentiometer balances the voltage in its arm, the resistance from arm to ground will be proportional to speed.

Other Circuits

Another circuit is indicated in Fig. 5. Here the voltage proportional to time is integrated with respect to time until a preset value is reached. Integration time is inversely proportional to elapsed time. An indication proportional to this new time gives speed. The indicator can be a second capacitor charging at a constant rate during

integration and observed with a voltmeter or a standard scaler counting cycles from an oscillator.

These methods can incorporate instantaneous reset at the start of each new count if a discharging high current is delivered to the capacitor. Discharging current of the order of an ampere can be delivered by a blocking oscillator.

A constant voltage gated into one of the more precise integrating circuits will also provide a voltage increasing linearly with time. A binary-counter system can likewise be used wherein each successive stage switches a resistor half as large as the one previous; the output voltage will stair-step linearly with time.

A capacitor can be charged linearly and the voltage passed through any device with a logarithmic response. The derivative of this signal is proportional to $1/t$ and drops sharply to zero at the end of the interval. The magnitude of this drop is proportional to the reciprocal of the total time involved.

A final scheme starts with a fully-charged capacitor, and to discharge it during the interval with some device having a voltage-current characteristic of i proportional to V^2 . One can obtain such a response from a biased-diode, arbitrary-function generator. The final voltage on the capacitor is a linear measure of speed.

Isolation Circuits

Cathode followers fail to provide adequate isolation for computer circuits. Output circuits described have high input, low output impedance with nearly unity gain. Differential amplifiers and high-gain feedback amplifiers are used

By **RAWLEY D. McCOY** and **FRANK R. BRADLEY***

Reeves Instrument Corporation

New York 7, New York

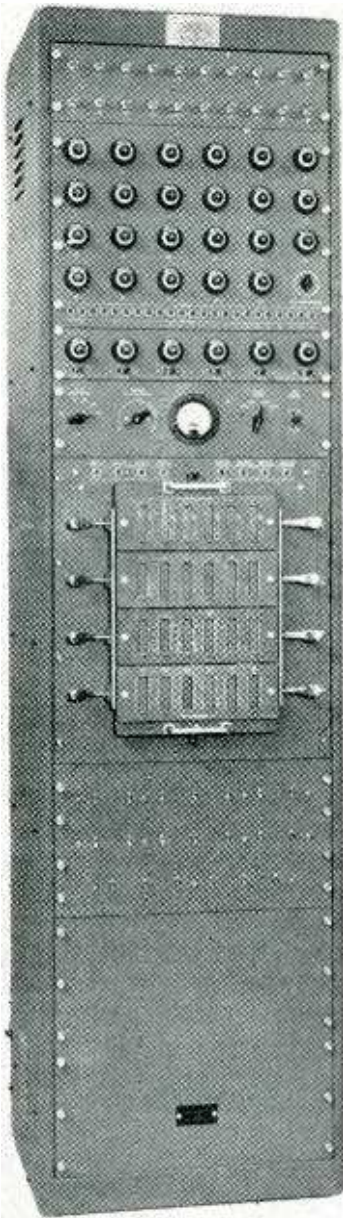

Electronic analog computers, such as REAC, require isolation circuits better than the usual cathode follower. Special isolation circuits designed for this computer are described in detail.

ELECTRONIC ANALOG computers place stringent requirements on their isolation or buffer circuits. Ideally such circuits should have infinite-impedance input, zero-impedance output circuit and exactly unity gain.

The cathode-follower circuit, the elements of which are shown in Fig. 1A, is not adequate for most computer applications. The two basic isolation circuits to be described were developed in conjunction with the REAC (Reeves Electronic Analog Computer).

Voltage gain of a cathode follower is

$$\frac{\mu}{(\mu + 1) + \frac{r_p}{R_K}}$$

By making μ large, the overall gain can be made close to unity and, the output impedance reduced. Figure 1B illustrates a method for accomplishing this. The output voltage is produced by the cathode follower, but the difference between output and input voltage is measured by a differential amplifier and amplified in two stages before being applied to the cathode follower. The effective μ of the cathode follower is then $G_1 G_2 \mu$ and the overall gain close to unity.

D-C Application

Figure 2A shows a d-c isolation amplifier. One grid of the 5691 is returned to the cathode of the 6SN7 as is the cathode of the 6SJ7. The 5691 is connected as a differential amplifier so that its output

voltage is the amplified difference of its inputs.

If both input grids swing positive at the same time, the net grid-to-cathode voltage change of the first grid remains unchanged because the cathode follows the second grid. Plate voltage is therefore unchanged. If the second grid swings negative while the first grid goes positive, the net grid-to-cathode voltage change of the first grid is the sum of the two inputs, hence the plate voltage change is proportional to the sum of the input voltages.

The differential amplifier has an appreciable gain because of its 350,000-ohm plate resistance. Its output is amplified in the 6SN7 and the total output applied between grid-and-cathode of the 6SN7 in a bootstrap arrangement.

Bootstrap Circuit

Plate voltage for the bootstrap stages is supplied by two 5651 voltage-regulator tubes, which are referred to the output voltage. No matter what the voltage swings are required of the circuit, the bootstrap-amplifier tubes operate at the same place on their characteristic curves. This makes the amplifier virtually independent of the characteristics of input tubes.

A bias potentiometer is included in the cathode of the 6SJ7 to set the stage operating point and anti-swing networks are included in the coupling between the first and second stage and from grid to plate in the second stage. These shape the open-loop amplifier response curve to attenuate amplifier gain

Now with Hillyer Instrument Company, 54 Lafayette St., New York, N. Y.

for Analog Computers

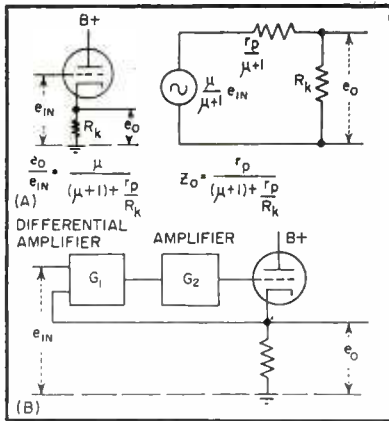

FIG. 1—Cathode follower (A) has nearly unity gain when used with a differential amplifier (B)

below unity before the phase shift approaches 180 degrees. A crystal diode is used in the second grid input circuit of the 5691 to eliminate the possibility of the circuit settling in a stable but nonoperable condition. If, on starting, the grid should go positive with respect to the plate, the stage would remain in that condition. The crystal prevents this by limiting the grid-to-cathode voltage.

A-C Application

An a-c version of this circuit, used at 60 cps as a resolver buffer amplifier is shown in Fig. 2B. This circuit, developed by P. A. Seay, was the predecessor of the d-c circuit. The circuit is a-c coupled and interstage antising networks used. Since it is necessary to shape frequency response at both the high and low ends, the networks are more complex. The input amplifier cathode is returned to the output rather than to a differential amplifier since the succeeding a-c coupling eliminates d-c level adjustment problems, which dictated the differential amplifier used in Fig. 2A.

The cathode load is a 750-ohm resistor in series with a parallel R-C network across the resolver primary. The network consists of a three-microfarad capacitor and a

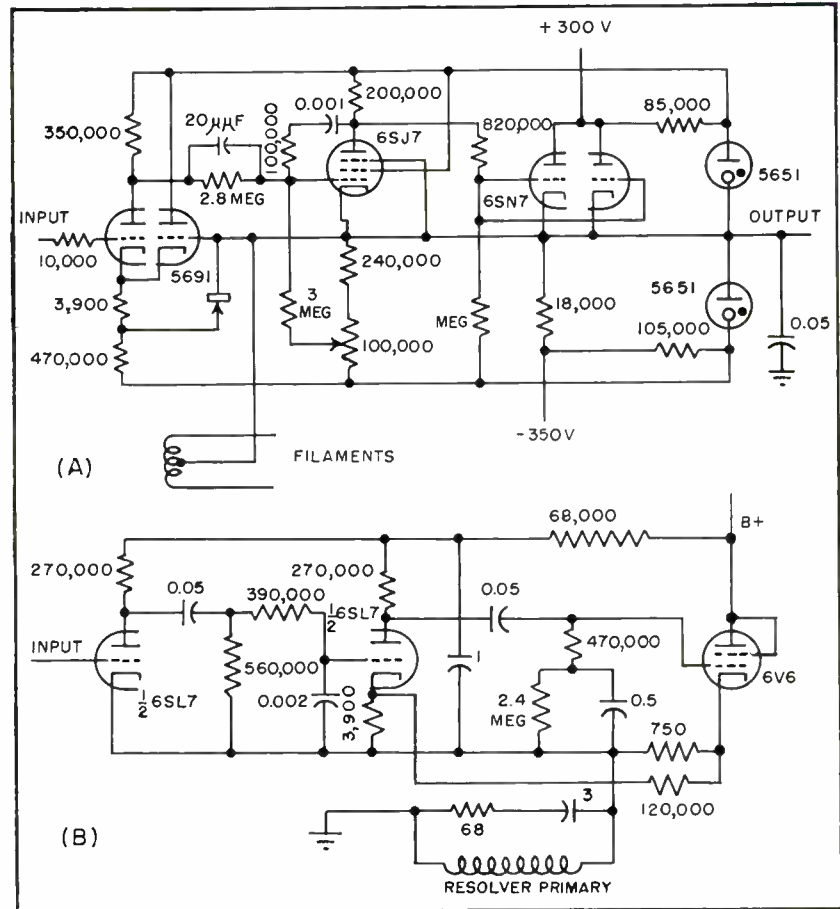

FIG. 2—Isolation amplifier using cathode follower and differential amplifier is suitable for either d-c (A) or a-c (B) application

68-ohm resistor and provides power factor correction for the inductive resolver load.

Operating point of the second amplifier stage is set by the voltage divider consisting of the 120,000 and 3,900-ohm resistors from the 6V6 cathode to the output.

The decoupling network consisting of a 68,000-ohm resistor and one-microfarad capacitor between the 6V6 and 6SL7 plate supplies replaces the two VR tubes used in the d-c version of this circuit. The capacitor refers the 6SL7 plate supply to the a-c output voltage so that the 6SL7 operates in the same portion of its characteristic curve and the circuit is relatively stable despite tube variation.

The isolation circuit shown in Fig. 3A uses high-gain feedback

amplifiers. The voltage at the potentiometer arm drives a low or varying-impedance load. Without isolation, load variations would affect the voltage at the potentiometer arm.

High-Gain Amplifiers

High-gain phase-inverting amplifiers, when connected in feedback circuits as shown, develop an output voltage that cancels the input voltage. Thus the voltage at the output of the first amplifier is $-e$ and the voltage division between e and $-e$ across R_1 and R_2 gives a null at the grid. Similarly, the voltage at the output of the second amplifier is $2e$. The junction of R_1 and R_2 is a virtual ground and the output voltage, $2e$, divides across R_1 and R_2 to give

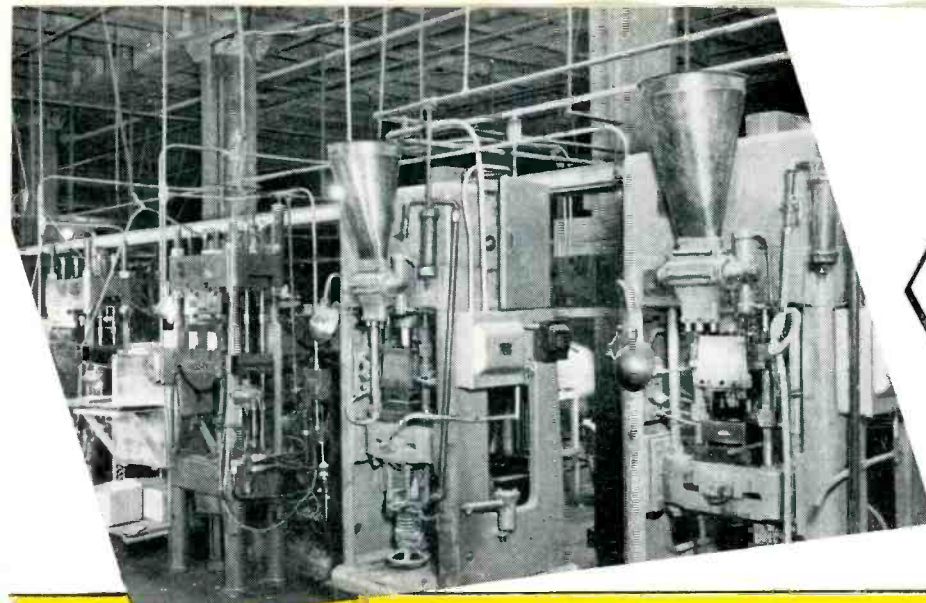

QUANTITY PRODUCTION OF LOW LOSS MICA COMPONENTS . . . exclusively a CINCH feature . . . and another contributing factor in the choice of CINCH electronic components as **STANDARD**

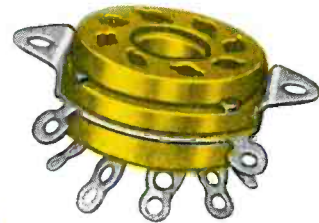

(Above) CINCH Octal molded socket, 1-5/16" Mtg. Center, 1-1/2" M.C. available.
(Left) Loktal Molded Socket, 1-5/16" mtg. Center.

MOLDED SOCKETS

The miniature, Noval, Octal and Loktal Sockets are molded from high dielectric black bakelite and Mica . . . with component parts of the best materials available; sturdy steel mounting saddle and CINCH solder coated contacts for easy soldering. Dependable and durable under the most exacting requirements.



CINCH constantly demonstrates ability to hold tolerances on Mica moldings . . . to meet the most exacting requirements in small metal plastic assemblies for components of higher quality materials held to closer tolerances.



(Above left) Cinch Noval socket — saddle type Mica filled molded with .093 mtg. hole 1-1/8" mounting center. (Left) Molded Miniature, 7/8" mounting center.



CONSULT CINCH

CINCH MANUFACTURING CORPORATION

1026 South Homan Ave., Chicago 24, Illinois

Subsidiary of United-Carr Fastener Corporation, Cambridge, Mass.



Cinch
ELECTRONIC
COMPONENTS

Available at leading electronic jobbers—everywhere.

R-F Coupling Nomograph

Gives coefficient of inductive coupling of an r-f transformer directly from Q-meter measurements. Procedure permits correcting for effects of distributed capacitance

WHEN MEASURING the coefficient of inductive coupling of an r-f transformer with a Q-meter, one winding of the transformer is connected to the inductor terminals of the Q-meter and the capacitance of the Q-meter circuit is tuned to resonance with the second winding open to give C_1 , and shorted to give C_2 . Then

$$k = \sqrt{1 - (C_1/C_2)} \quad (1)$$

Equation 1 also neglects the effect of distributed capacitance in either or both windings, and

By **RAYMOND E. LAFFERTY**

Engineering Development Group
National Broadcasting Co.

is valid only if the Q's of both windings are greater than 10. Where primary distributed capacitance C_p and secondary distributed capacitance C_s are both present to a significant degree,

$$k = \sqrt{1 - U} \quad (2)$$

where $U = \frac{1}{(1 - \gamma^2) \left(\frac{C_2 + C_p}{C_1 + C_p} \right) + \gamma^2}$

$$\gamma^2 = (f/f_0)^2$$

$f =$ Q meter frequency
 $f_0 =$ self-resonant frequency of secondary, or $1/2\pi\sqrt{L_s C_s}$

Where C_p is significant and C_s is negligible ($\gamma^2 \approx 0$);

$$k = \sqrt{1 - V} \quad (3)$$

where $V = (C_1 + C_p)/(C_2 + C_p)$

Where C_s is significant and C_p is negligible ($C_p < 5$ percent of C_1);

$$k = \sqrt{1 - W} \quad (4)$$

where $W = \frac{1}{(1 - \gamma^2) \frac{C_2}{C_1} + \gamma^2}$

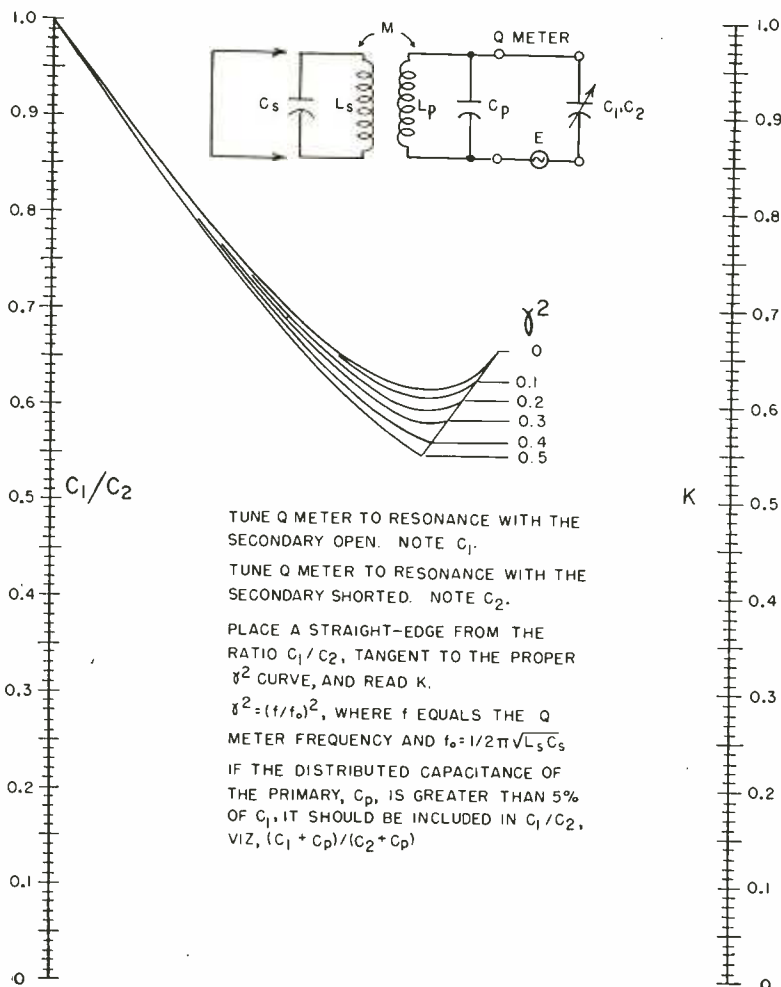

The nomograph is used by extending a straight-edge from C_1/C_2 , tangent to the correct γ^2 curve, and reading its intersection with the scale for k . If C_s is small enough to be neglected, γ^2 is approximately zero and the zero curve should be used.

If both windings of the transformer have appreciable capacitance, C_p and f_0 should be measured before the coils are inductively coupled.

Example 1. The Q-meter tunes to 460 kc with 210 $\mu\mu\text{f}$ of capacitance when one winding of an r-f transformer is connected to the inductor terminals and the other winding is left open. When the second winding is shorted the Q-meter capacitor must be increased to 375 $\mu\mu\text{f}$ to maintain resonance at 460 kc. The self-resonant frequency of the secondary is found to be 840 kc, and C_p can be considered negligible. From this, $C_1/C_2 = 0.56$ and $\gamma^2 = 0.3$. Using the nomograph, k is 0.6.

Example 2. $C_1 = 95 \mu\mu\text{f}$, $C_2 = 116 \mu\mu\text{f}$, $C_p = 15 \mu\mu\text{f}$ and C_s is negligible (hence $\gamma^2 \approx 0$). From these data, $(C_1 + C_p)/(C_2 + C_p) = 0.84$ and the nomograph shows k to be 0.4.

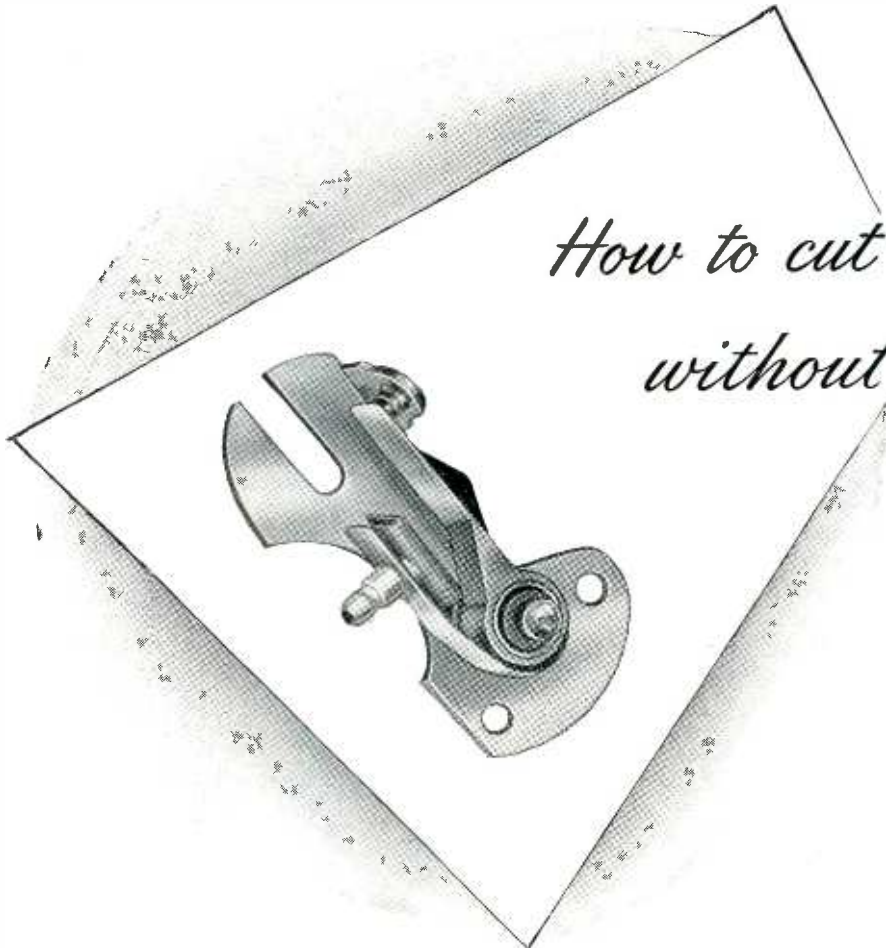

*How to cut contact costs
without cutting corners*

Consider the case of this contact assembly for a large manufacturer. The contact material is tungsten. The entire assembly consists of 16 separate parts . . . including springs, bushings, rivets and cam blocks.

Originally Mallory supplied only the contacts. Other parts were bought from various suppliers. Still others were made in the manufacturer's own plant where he also handled the complete assembly operation.

Then he discovered the economy of having Mallory do the entire job—from material procurement and inspection . . . to fabrication and finishing of parts . . . to final assembly. The burden of ordering, delivering, scheduling, warehousing and production is now in the hands of men who are thoroughly qualified by years of experience in the production of all kinds of contacts.

This manufacturer is using tens of thousands of these contacts every month. By letting Mallory make the complete assembly he has concentrated production responsibility and is getting a better assembly at a lower cost.

Call or write Mallory today. You'll find, as this manufacturer did, that it pays in many ways to depend on Mallory for your complete contact assembly needs.

EXPECT MORE . . . GET MORE FROM MALLORY

In Canada, made and sold by Johnson Matthey and Mallory, Ltd., 110 Industry St., Toronto 15, Ontario

Electrical Contacts and Contact Assemblies

P. R. MALLORY & CO. Inc.
MALLORY

SERVING INDUSTRY WITH THESE PRODUCTS:
Electromechanical—Resistors • Switches • Television Tuners • Vibrators
Electrochemical—Capacitors • Rectifiers • Mercury Dry Batteries
Metallurgical—Contacts • Special Metals and Ceramics • Welding Materials

P. R. MALLORY & CO., INC., INDIANAPOLIS 6, INDIANA

ELECTRONS AT WORK

Including INDUSTRIAL CONTROL

Edited by RONALD K. JURGEN

Automatic Communications System... 168	Impulse Modulator 206
Gated Lamp Decade Counters..... 170	Synchronous Demodulator for Color TV 214
Compound Sweep Circuit..... 172	Counter Test Circuits..... 230
Color TV Projection System For Theaters 178	Remote-Controlled Broadcast Transmitter 238
Small Wire Capacitors 184	Low-Copper Sweep Yoke..... 250
Graphical Aids to Broadcasting..... 195	

OTHER DEPARTMENTS

featured in this issue:

	Page
Production Techniques...	256
New Products	312
Plants and People.....	394
New Books	404
Backtalk	420

Automatic Communications System

BY J. D. LANE
General Engineering Development Co.
Boston, Mass.

AUTOMATIC MESSAGE and/or signal collection and repeating for communication networks is accomplished by a device known as the Robo-Communicator, which may be used as a terminal equipment for automatic answering of calls. The equipment will also record two-way communication network conversation and office conference and it will record and reproduce spoken messages and other types of signals.

When answering a call, the communicator responds to call signals so as to impress a station identification announcement on the coupled communication system for a timed interval. This broadcast may include a voice message to instruct the calling station that it is connected to a signal recording device at the called station that will make an electrical transcription of message transmission.

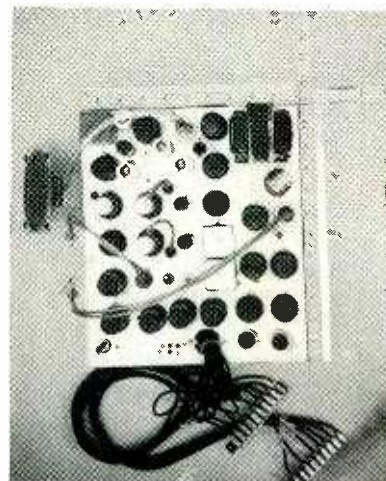

Amplifier chassis for the communicator

A further announcement may state that the message to be stored will be received by the called party at his earliest convenience. The machine then shifts automatically into condition for recording reception of the calling station's message. At the completion of the call, the machine disconnects itself from the communication network and waits to receive further calls.

The amplifier is shown in block-diagram form in Fig 1. Various circuit combinations to be mentioned are controlled by selective switching apparatus located remote from the amplifier tubes.

When using the machine with an external communication system, it is desirable to broadcast beep signals from the beep oscillator, Fig. 1, so that a caller will receive signals to distinguish recording pe-

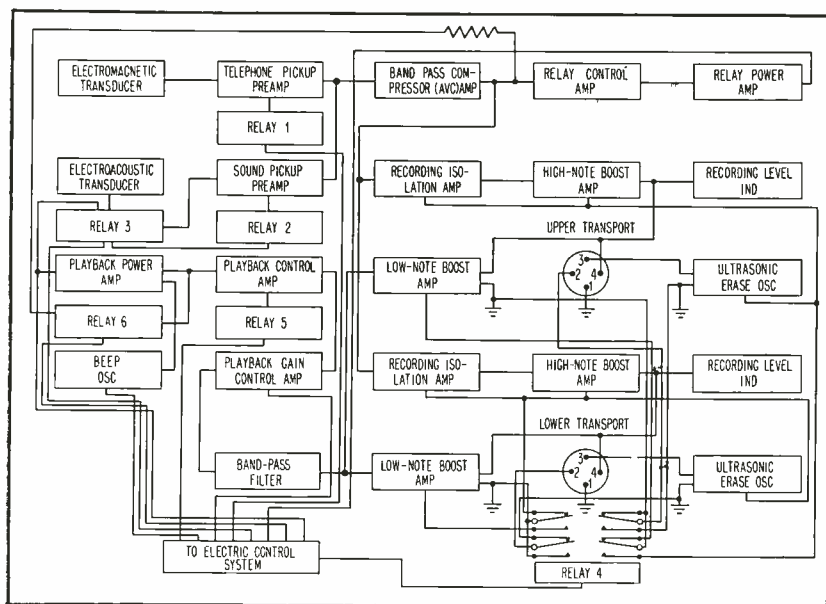

FIG. 1—Block diagram of the amplifier for the Robo-Communicator

A Conductance Measuring Instrument

G meter

Type 192-A

MEASURES:

- Conductance values of low loss dielectric materials.
- Q of small high quality capacitors.
- Capacitance of dielectric materials and capacitors.
- RF resistance of large value resistors.
- Dynamic impedance of resonant circuits.



The G Meter, 192-A, may be used to obtain values of dielectric constant and power factor of test samples to the degree of refinement required in standard testing methods such as ASTM specification D-150-47T. Test samples with very small losses and capacitances may be accurately measured. The instrument is self-contained and requires no external generator or detector for its operation.

The G Meter, 192-A, employs a crystal controlled oscillator to supply a constant amplitude voltage to a high quality reference tuned circuit. A calibrated precision loss circuit and a differential VTVM are internally connected across the resonant circuit. External means are provided for connecting test samples across the same resonant circuit. By substituting internally connected values of calibrated loss and capacitance for the test sample, to secure a reference voltage, the conductance

and capacitance of the sample may be determined. The differential VTVM provides very great sensitivity to changes from the reference voltage allowing very accurate settings of the conductance and capacitance dials.

SPECIFICATIONS

CONDUCTANCE RANGE: 0 to 35 micromhos—Direct reading in seven ranges.

CAPACITANCE RANGE: 0 to 100 micro-micro-farads—Direct reading. (Simple indirect method allows measurements to 1000 mmf.)

FREQUENCIES: 1 mc. and 30 mc. crystal controlled.

SENSITIVITY: 10% Deflection of Panel Meter results from conductance change of 0.003 micromhos at 1 mc. and 0.03 micromhos at 30 mc.

VOLTAGE ON TEST SAMPLE: 20 to 35 volts RMS.

LINE VOLTAGE: Internal regulation permits operation over range of 105-125 volts.

Write for further information



BOONTON RADIO

Corporation

BOONTON, N.J. U.S.A.

riods from dead-system condition whenever the machine is used to record messages from a remote station. The electromagnetic transducer together with the following block components constitute a receiver-amplifier system for signals to be recorded from an external communication system.

The receiver-amplifier system includes the band-pass compressor (avc) amplifier, the recording isolation amplifier and the high-note boost amplifier which supplies recording signal power to the voice coil on one of the wire transports. Calling signals are tapped from the output of the avc circuit and coupled to the line by the relay control amplifier and the relay power amplifier.

Relay 1 is energized to close a



Model of the equipment for use as terminal equipment

cathode circuit to ground when the telephone pickup preamplifier is used to complete coupling to an external communication system via the electromagnetic transducer. When acoustic signals are picked up from the vicinity of the machine's microphone, relays 2 and 3 are energized to put the sound pickup components in operation to feed signals to the receiver-amplifier.

When it is desired to broadcast signals stored on the lower transport, relay 4 is energized, its contacts are pulled down and the low-note boost amplifier is energized. The amplifier couples the voice coil on the wire transport to the band-pass filter, playback gain-control amplifier, the playback control amplifier and the playback

power amplifier unit.

Relay 4 controls the coupling of electronic components to both transports so that when one transport is coupled for playback operation, the other will be coupled for recording and vice versa. Feedback isolation of circuits to be coupled to the two transports is provided by using relay 4 to control the action of coupled amplifier units as well as the erase oscillators. Isolation amplifier circuits effectively isolate the two transducers so that one

transport may be coupled to record from any communication network that is directly energized by playback from the second transport.

When it is desired to copy a recording from the lower transport and record the lower transport signals on the upper transport, as for editing and dubbing-in operations, the playback circuits mentioned previously are energized. Relay 5 is energized also to complete connection from the playback circuit to the recording circuit.

Gated Lamp Decade Counters

By ROBERT L. ROD

Assistant Director of Research
Bogue Electric Manufacturing Company
Paterson, New Jersey

AMONG MANY electronic counter circuits devised during the past few years, the scale-of-ten decade counter is perhaps the most widely used. The particular feedback circuit devised by Grosdoff¹ utilizing neon lamp decimal read-out is finding many applications in frequency measuring and similar systems which are used to count events per unit time.

Generally, decimal indicating decades are used to count an unknown number of pulses occurring during a definite interval of time. Some time after this summation process has been completed, the decade counters are either electrically or manually reset to zero prior to the onset of another cycle of counting operation.

Whereas, the individual neon

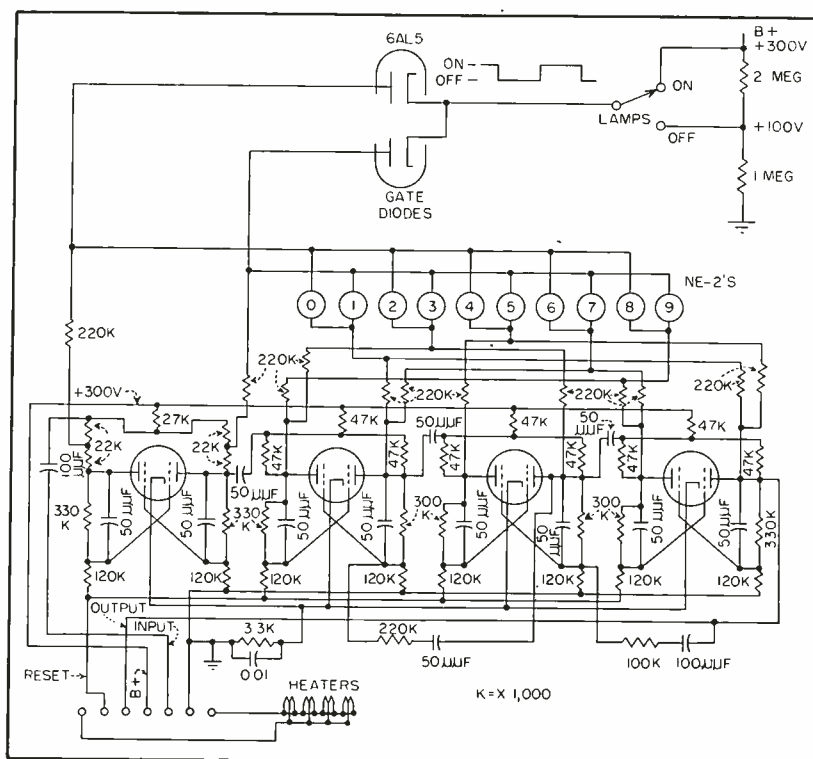

FIG. 1—Gated lamp decade modifications. Counter tubes are 12AU7's



Wrap it up ...

WITH MICABOND TAPES

Here's flexible, uniform mica tape that will work in even the toughest application! Here's why: C-D-F Micabond tapes are made from the finest mica splittings carefully placed, bonded and supported to prevent insulation "leaks". C-D-F Micabond tapes are made with many different backings including: fiberglas, silk, cellophane, cotton, and paper. There's a grade of Micabond tape for almost every application.

C-D-F makes other Mica products, too—Sheets, tubes and formed parts are used in the entire electrical industry. C-D-F is a leading manufacturer of quality mica "V" rings, washers and commutator segments.

Your C-D-F sales engineer can be very helpful to you; his experience will save your time and money. Call him today (offices in principal cities) —*he's a good man to know!*

CDF

Continental-Diamond Fibre Company

GENERAL OFFICES:

NEWARK 16 DELAWARE

THE FRONT COVER

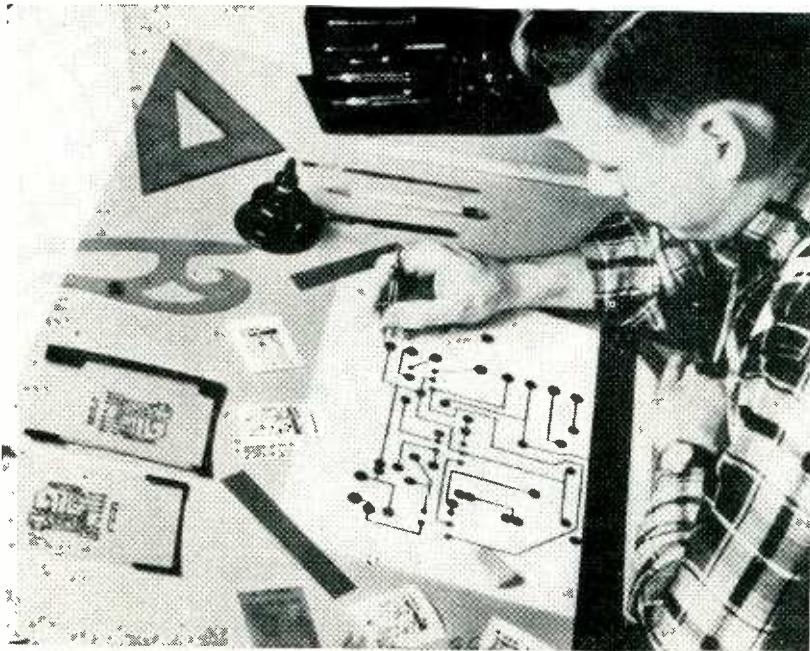

SHOWN in the cover photographs and the accompanying photograph are steps in the Auto-Semby System of circuit fabrication. The elements of this Signal Corps process are the insulating base chassis bearing the circuitry with conventional components in their proper position on the blank side and all component leads passing through perforations to the circuit side of the chassis. Application of a suitable soldering flux, solder dipping and removal of excess component leads completes the assembly.

Patterns of subminiature circuits requiring great accuracy are drawn three or four times original size and reduced to actual size photographically. Advantage of the enlarged drawing may be taken to include lettering, terminal designations or other circuit details before reduction to the required size. Precision of conductor size and spacing is a further advantage.

lamp indicators in a particular decade are continually advancing during the summation cycle, only one particular lamp remains lit after the count is terminated until the circuit is reset. In applications where the "on" or counting time is appreciably more than the subsequent "hold" time prior to reset, the observer is annoyed by a flickering effect during counting that can very well obscure the final reading. In the extreme case where the decade is reset to zero shortly after the termination of counting, the final reading is not clearly distinguishable.

Means for gating off the lamps and eliminating the flickering during the counting interval without affecting the dividing action of the

individual scale-of-two stages are useful during high-duty-cycle operations. The arrangement shown in Fig. 1 above the neon diodes is an auxiliary gating system designed to satisfy this requirement.

In this type of decade, representative of many commercially available units, the neon lamps are energized by a sufficiently great peak-to-peak voltage developed from a combination of a positive-going square wave derived from the head odd-even binary and a composite negative-going waveform obtained from combinations of the outputs of the three succeeding stages. By individually clipping the positive output pulses of both sides of the first stage by means of the auxiliary gating diodes, the neon lamps fail to light

on the remaining negative-going voltage pulses derived from the subsequent binaries because of insufficient impressed voltage.

Biasing the gate diode cathodes at the supply voltage will effectively open-circuit the diodes and permit normal operation of the lamps. Lowering the voltage to 100 volts or so will cause the diodes to slice the odd-even square waves sufficiently low in amplitude to keep the lamps out.

This gating technique may be useful in the simplest case with manual selection of the gating voltage applied to the diode cathodes. In those applications using pulsed timing oscillators whose shaped pulses are counted by decade counters, the oscillator gating waveform itself can be directly applied to the gate diode cathodes to gate the lamps on and off.

Germanium or selenium diodes can be used for this application providing that their reverse resistance is sufficiently high. However, the use of vacuum diodes results in far more stable and reliable operation of the system. Either a subminiature dual diode integral to the decade itself or an external tube such as a 6AL5 can be used as desired. In any event, with the diodes integral to the decade itself only one additional terminal is required for this modification.

REFERENCE

- (1) I. E. Grosdoff, Electronic Counters, *RC A Review*, 7, p 438, Sep. 1946.

Compound Sweep Circuit

BY JOHN H. PORTER

Office of Naval Inspector of Ordnance
Navy Ordnance Division
Rochester, New York

FREQUENTLY it is desirable to examine in its entirety a fairly long transient whose initial rate of change is considerably different than the rate during the rest of the interval. The circuit shown in Fig. 1 was developed to provide a sweep voltage to photograph a transient lasting for 100 seconds and which arrives at 75 percent of its maximum value in approximately 0.1 second and which decays to about 85 percent of its maximum

TIME-TRIED TETRODE

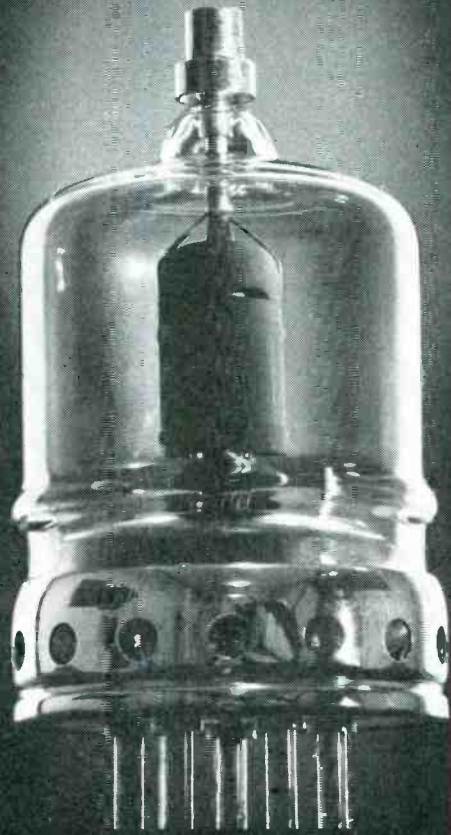

LOS GATOS 4D21/4-125A

MODERN in every respect—
with exclusive Sintercaste black-
body high-dissipation anode and
emission-free grids—the Los
Gatos 4D21/4-125A provides a
new source of supply for a widely-
applied tetrode type. Check
Los Gatos for your requirements
in other types with emphasis
on long service life.

LEWIS AND KAUFMAN, INC.

LOS GATOS 1

CALIFORNIA





AMPHENOL

Carries the Pulse OF THE Electronics INDUSTRY

... and if the cables and connectors in your equipment aren't of top quality, then the pulse will be weak and unreliable. Insist on Amphenol cables and connectors and be assured of maintained continuity and positive connection.

TEFLON CABLES developed by Amphenol are ideally suited for applications in the high temperature range. These cables operate without difficulty in temperatures from -100°F. to $+450^{\circ}\text{F.}$ They also feature extremely low loss and high voltage break down. Look to Amphenol for the entire series of RG Cables.

AUDIO CONNECTORS made by Amphenol are ruggedly built for severe usage and feature a unique watertight seal that provides full protection against water leakage. This type of connector is now standard on all Signal Corps communication equipment. Contacts are spring loaded and self-cleaning.

A-N CONNECTORS require a strict conformity to Army-Navy Specifications. Many of the now standard design features were originated and developed by Amphenol's extensive engineering staff. Amphenol's A-N Cable Assemblies provide the ideal combination of top quality components and high grade workmanship.

RF CONNECTORS are better if they are made by Amphenol—better because they are made better! Amphenol's RF Connectors have the quality and precision necessary in the most delicate and accurate of instruments, yet are rugged enough to meet the punishing demands of modern military aircraft and mechanized ground equipment.

AMERICAN PHENOLIC CORPORATION
1830 SOUTH 54TH AVENUE • CHICAGO 50, ILLINOIS

AMPHENOL

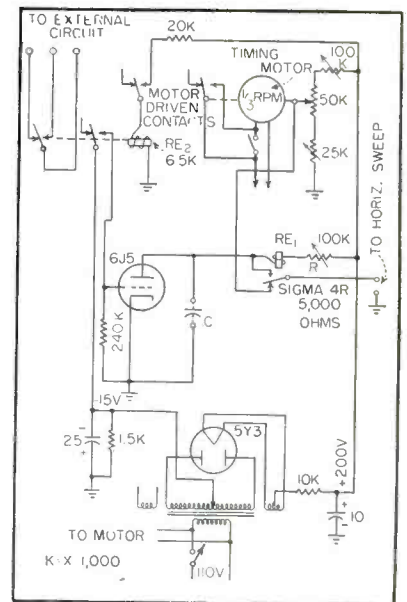

FIG. 1—Schematic diagram of the sweep circuit

value during its duration.

The time span is broken into two intervals and individual sweep voltages are provided for each interval. The initial sweep is short, lasting from 0.02 to 1 second depending on the C and R used, while the second sweep lasts up to 3 minutes.

Initially, the tube is without bias and draws sufficient current to hold R_{v1} closed and keep the output connected to the tube plate. To initiate the sweeps, the timing motor is started and upon reaching synchronous speed, puts cutoff bias on the tube via R_{v2} and with the same relay energizes an external circuit as desired.

As the energy contained in the coil of R_{v1} is dissipated in the capacitor C through the timing resistance R , the voltage across C rises and eventually R_{v1} drops out. It is this rise of voltage, limited to but a volt or two, that provides the fast sweep.

When R_{v1} opens, the output is connected to a potentiometer across the power supply and driven by the timing motor. The control used is an Ohmite AB with the stop removed to allow 360 deg rotation. The voltage gradient across the motor-driven potentiometer is adjusted to be the same as the change in voltage across C after R_{v1} opens.

This circuit has been used with a Land-Polaroid camera for single-

This eye spots

*fast-moving
trouble*

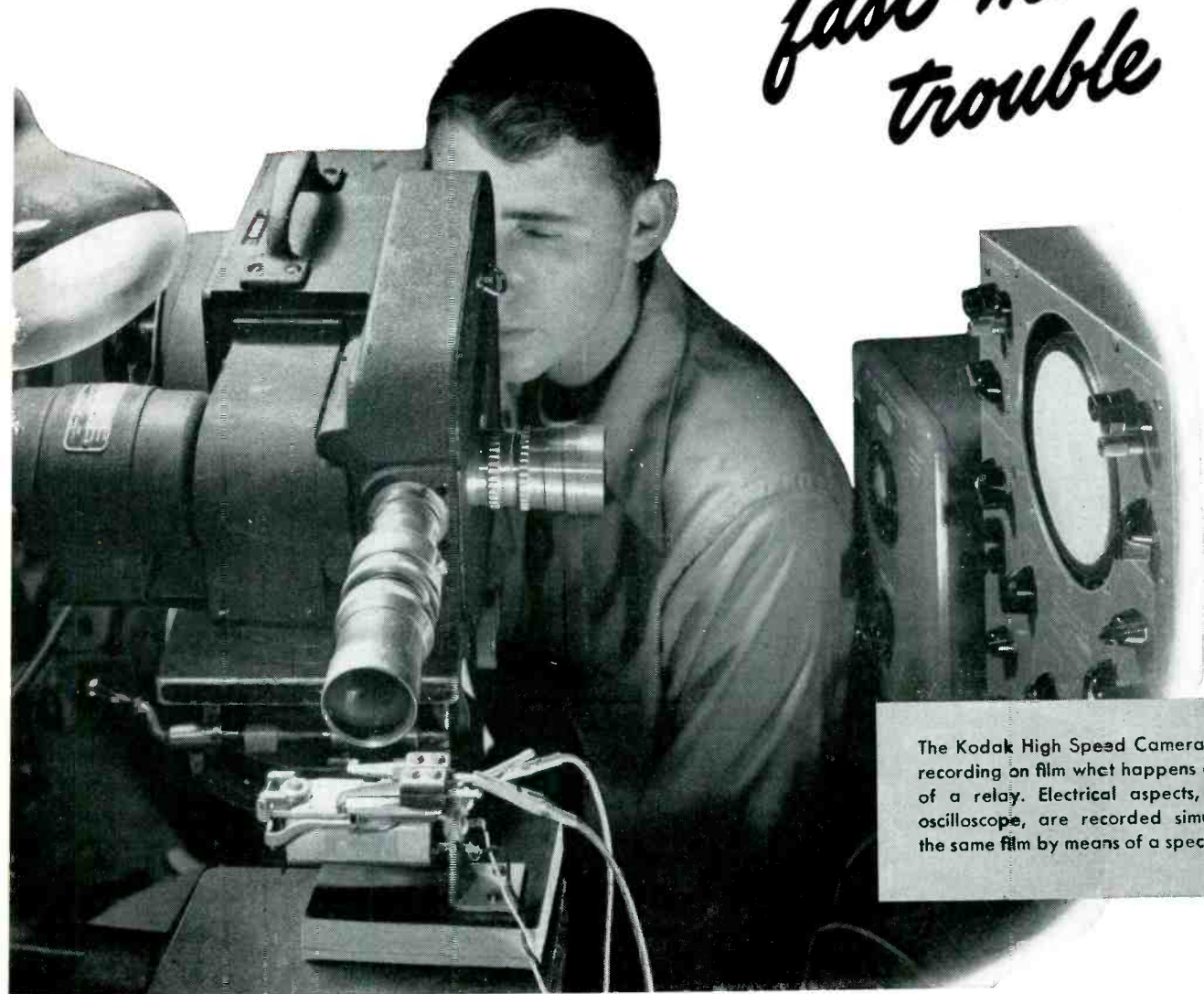

The Kodak High Speed Camera is shown here recording on film what happens at the "break" of a relay. Electrical aspects, shown on an oscilloscope, are recorded simultaneously on the same film by means of a special attachment.

When trouble is hidden in a blur of speed too fast to see, the cause is hard to find. Here's the way to get the answer in a hurry without costly, tedious cut-and-try experimentation or theoretical analysis.

With the Kodak High Speed Camera, you can take up to 3200 clear pictures a second on 16mm film. When projected at normal speed, the film shows action slowed as much as 200 times—makes visual analysis quick and easy. And the films are available for study over and over.

This high speed "eye" is daily solving

complex problems of design, production, and product performance—problems where usual methods of analysis would be slow and costly. One manufacturer projects high speed movies within two hours after they are taken—the solution to a problem is on the drawing board the same morning it is discovered. We'd be glad to send you, with our compliments, a folder showing how this company uses the Kodak High Speed Camera so effectively. Eastman Kodak Company, Industrial Photographic Division, Rochester 4, N. Y.

the Kodak **HIGH SPEED** Camera

Kodak
TRADE-MARK

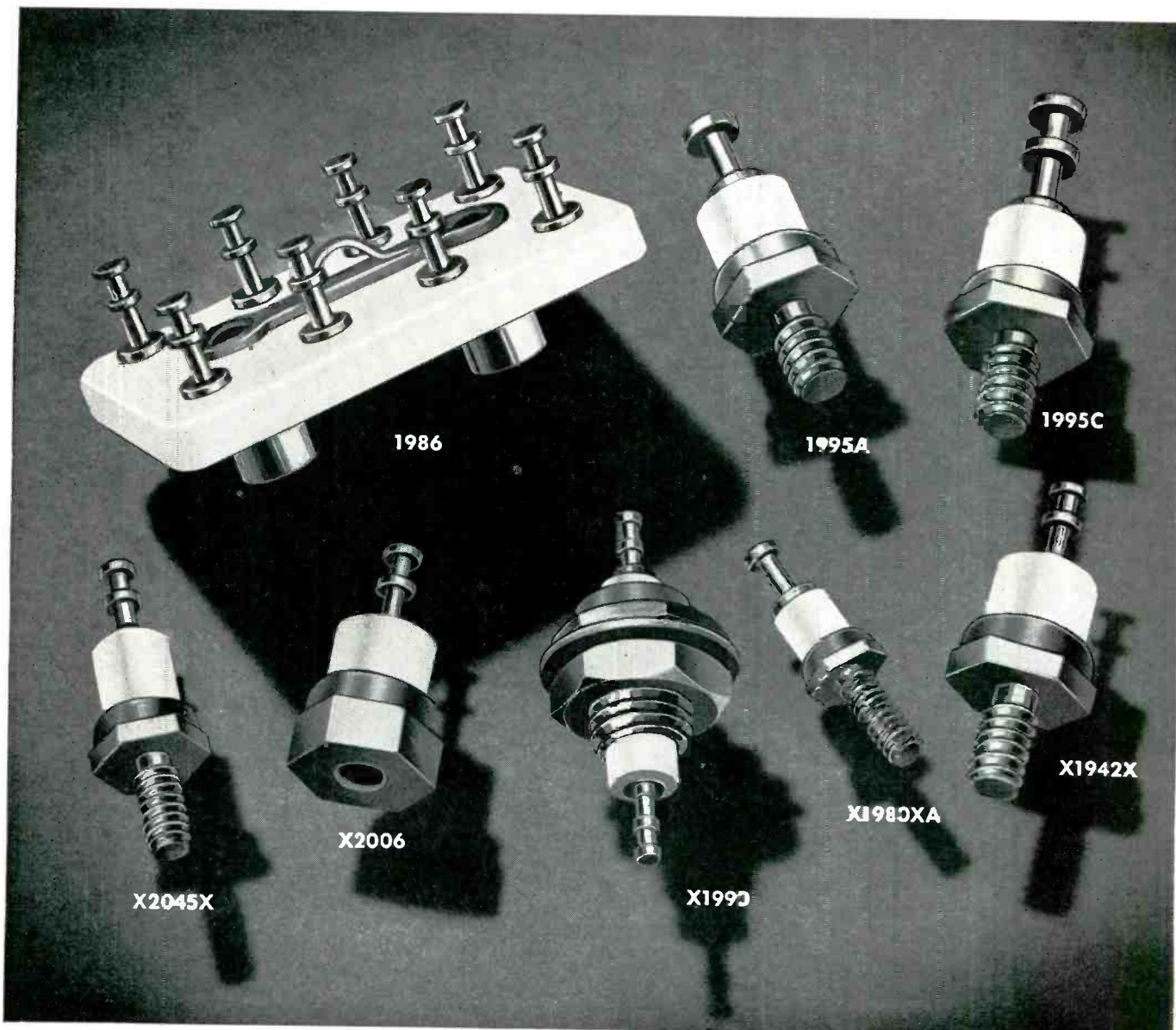

Units shown magnified approximately 2½ times

Make sure of meeting government "specs" . . . see C.T.C. for ceramic insulated components

You have to be 100% on-the-beam if your equipment is to withstand the conditions it must undergo in military service.

That's why manufacturers using electrical and electronic components turn to C.T.C. for their ceramic insulated units. Our long experience and constant dealing with government requirements have gained us a wide acceptance as an outstanding supplier to those working on U. S. contracts . . . especially for the armed forces.

Whatever your needs in ceramic insulated terminals, feed-throughs or terminal boards you can depend on C.T.C. We meet the most exacting government standards for materials, tolerances, finishes, moisture prevention and anti-fungus treatment. Fin-

ishes on metal surfaces for instance, can be hot tinned, electro-tinned, cadmium plated, silver plated or gold plated to your requirements. All ceramic units in our standard line are grade L-5, silicone impregnated.

C.T.C. offers a consulting service at no extra charge to help solve your spe-

cial problems. For all specifications and prices, write to Cambridge Thermionic Corporation, 437 Concord Avenue, Cambridge 38, Mass. West Coast Manufacturers contact: E. V. Roberts, 5068 West Washington Boulevard, Los Angeles 16 and 988 Market Street, San Francisco, California.

C A M B R I D G E T H E R M I O N I C C O R P O R A T I O N

custom or standard . . . the guaranteed components

For our complete listing of C.T.C. electronic and electrical components, see Electronics Buyers Guide.

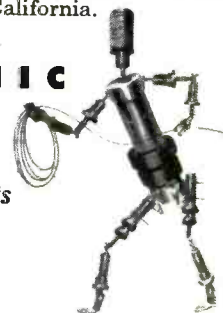

**MITCHELL-RAND
features
electrical
insulating
tapes**





BI-SEAL

self-bonding Polyethylene, for resistance to corrosion and chemicals.

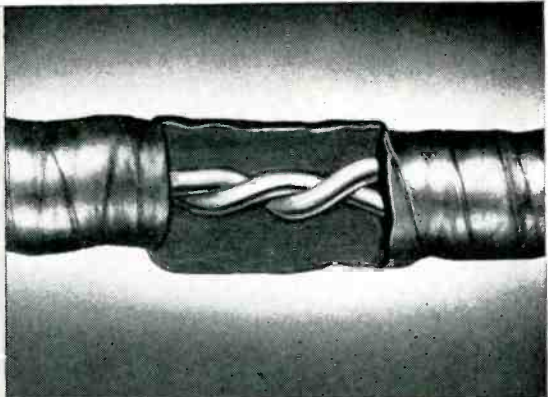

BI-PRENE

self-affixing Neoprene, for resistance to oils and chemicals.

BI-SEAL INSULATION CHARACTERISTICS	SELF-BONDING	
<p>Electrical Properties Dielectric strength 1000 volts/mil avg. Power factor 60 cycles... 0.0006 1000 cycles... 0.0006 106 cycles... 0.0004 Dielectric constant 60 cycles... 2.32 1000 cycles... 2.34 106 cycles... 2.13</p>	MOISTURE RESISTANT	
<p>Physical and Chemical Properties Resistance to: Ozone Excellent Oxygen Excellent Acids Excellent Alkalies Excellent Moisture vapor transmission Negligible Castor Oil Good Commercial Hydraulic Fluids Excellent Aging qualities Excellent Operating temperature 197°F to -67°F Application temperatures 150°F to -67°F</p>	UNAFFECTED BY LOW TEMPERATURES	
	HI-DIELECTRIC STRENGTH	
	SUPERIOR AGING	
	EXCELLENT CONFORMABILITY	
	CORROSION-CHEMICAL OIL RESISTANT	
BI-PRENE INSULATION CHARACTERISTICS		
<p>Physical Tests on Press Cured Slabs 10°/310°F Tensile 1980 p.s.i. Elongation 400% 200% Modulus 1030 p.s.i. Ozone 6 hours to cut</p>		
<p>Physical Properties on Aging 80°C Oxygen Bomb for 14 days 67.4% of original elongation 62.6% of original Tensile</p>		
<p>Air Bomb at 26°F for 30 Days at 80 p.s.i. 160% of original elongation 66% of original Tensile</p>		
<p>Oil Resistance A.S.T.M. Reference fluid number one—11.7% maximum swell in 24 hrs. A.S.T.M. Reference fluid number two—69.7% maximum swell in 24 hrs. 18 hr. exposure in oil at 121°C —Tensile decreased 4.5%. Elongation increased 70%.</p>		

Here are two multi-purpose electrical insulating tapes for wire or cable splicing . . . the self-bonding BI-SEAL and the self-affixing (air-curing) BI-PRENE . . . to meet the strictest requirements for unusual as well as ordinary cable splice applications for the smallest wire or the largest cable . . . wherever tape can be used for splicing.

The outstanding characteristics and excellent electrical insulation properties, plus the feature that once applied BI-SEAL and BI-PRENE tapes fuse into a solid mass, impossible to unwrap or delaminate, enables these products to offer complete and lasting protection against moisture, acids, alkalies, oils, chemicals, sunlight, corrosion, fungus, ozone, etc.



Write for samples and detailed data

MITCHELL-RAND INSULATION COMPANY, INC.

31 MURRAY STREET CORP. Bldg. 7-9264 NEW YORK 7, N. Y.

A PARTIAL LIST OF M-R PRODUCTS: FIBERGLAS VARNISHED TUBING, TAPE AND CLOTH • INSULATING PAPERS AND TWINES • CABLE FILLING AND POTHEAD COMPOUNDS • FRICTION TAPE AND SPLICE • TRANSFORMER COMPOUNDS • FIBERGLAS SATURATED SLEEVING • ASBESTOS SLEEVING AND TAPE • VARNISHED CAMBRIC CLOTH AND TAPE • MICA PLATE, TAPE, PAPER, CLOTH, TUBING • FIBERGLAS BRAIDED SLEEVING • COTTON TAPES, WEBBINGS AND SLEEVINGS • IMPREGNATED VARNISH TUBING • INSULATING VARNISHES OF ALL TYPES • EXTRUDED PLASTIC TUBING

RADIO SHACK

IS THE EXCLUSIVE DISTRIBUTOR
IN NEW ENGLAND AND UPPER
NEW YORK STATE
(see map) FOR
AMPEX DATA
RECORDERS



OUR ENGINEERING SERVICES ARE FREE!

Let Radio Shack's AMPEX-FACTORY-TRAINED personnel help you in the planning and design of the Ampex recording equipment you need for industrial and scientific use. In addition, broadcast and sound engineers are invited to discuss their Ampex needs with our technical staff — regarded by manufacturers and users alike as one of the most competent in this country. Write, wire, or telephone LA 3-3700 in Boston for information and service entirely without obligation.



**IMMEDIATE
DELIVERY**
from stock on all Ampex
"300" and "400" series
broadcast recorders.

AMPEX

LOW-FLUTTER MODEL 500

MAGNETIC TAPE RECORDER

... for the ultimate in data recording

- **FLUTTER and WOW:** less than 0.1% peak-to-peak. Error on final data less than 0.7% using $\pm 7.5\%$ deviation.
- **FREQUENCY RESPONSE:** within 3 db. from 200 to 80,000 cycles at 60 ips, or 200 to 40,000 cycles at 30 ips.
- **SIGNAL-TO-NOISE RATIO:** well above 40 db. at the 1% harmonic distortion level, measured in 15% bandwidths.
- **FOUR CHANNELS:** three for data recording, one for timing reference. All chassis of plug-in construction.
- Meets all relevant JAN specifications and Navy Department Specification 16-E-4.

Write TODAY for your FREE copy of the new 1953 Radio Shack industrial electronics parts catalog, with more than 200 pages listing over 23,000 JAN and standard components with pictures and reference data.

NAME

ADDRESS

CITY STATE.....

RADIO SHACK
CORPORATION

167 Washington St., Boston 8, Mass.

shot photography of a transient initiated by R_{y2} . The relay selected for R_{y1} is a Sigma 4R with coil resistance of 5,000 ohms. The drop-out current for the particular relay used is approximately 1.5 ma and is obviously independent of the initial rate of sweep. Since it is desirable to reduce the beam intensity for the long sweep, a relay with additional contacts might be chosen for R_{y1} , to control the crt bias.

Color TV Projection System for Theaters

LARGE-SCREEN color television in the Eidophor system works from a signal of 150 fields a second and 75 frames per second, 25 for each of the three colors red, green and blue. This gives 25 complete colored pictures or frames per second since a frame of each color is required to give one complete frame in color.

Actually, there is first a red picture, then a green one and then a blue but they seemingly overlap, because of the properties of the human eye, and give the impression of a colored picture. Sound movies use 24 frames per second.

Interlaced scanning is used in the Eidophor system. The entire picture is scanned over half of its lines and then over the intervening lines, first the odd-numbered lines and then the even ones. The entire field (half the lines) is scanned 150 times per second. Since two fields are equal to one frame, this gives 75 frames, in the three different colors, each second.

The system uses overlapping lines. The scanning beam is wider than necessary to cover the picture. A mirror system comprises a film of specially developed oily liquid on a continuously moving spherical mirror. The picture is formed on the surface of the oil film as a result of surface deformation caused by the discharge of the electron beam on the surface of the oil. The liquid consists principally of a special petroleum oil containing a salt as the electrically conductive material. A stationary knife blade maintains the oil film at the right thickness.

Since the liquid changes rapidly in viscosity and flow characteristics

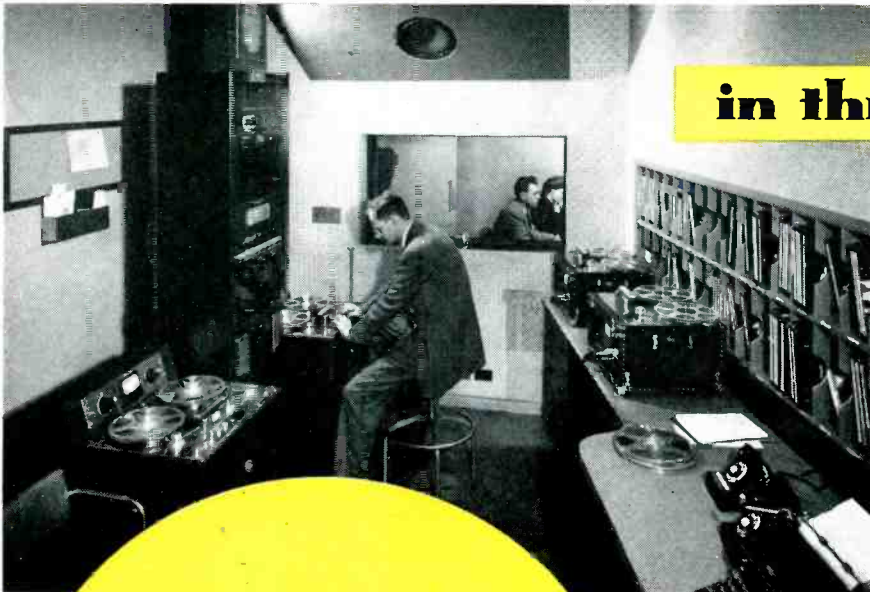

in this room...

there's no room for doubt

There can be no room for doubt in the continuity and fidelity of your broadcast. Precisely the reason you demand—and get—the best in transmitting and studio equipment.

Nor should you compromise with quality in the tape recorder you select.

In AMPEX Recorders you will find the same matchless reliability and performance you expect of your transmission equipment... and for the same reason—they are engineered to the highest *professional* standards.



AMPEX

brings you these cost-saving operating advantages:

- **UNINTERRUPTED SERVICE**

Under the demand of heavy-duty programming, AMPEX Recorders deliver thousands of hours of unbroken service. Recently a set of AMPEX heads was returned from Honolulu for routine replacement after 11,000 hours continuous use, 17 hours a day. The heads were still within AMPEX specifications for new heads and had several thousand more hours of use remaining.

- **MINIMUM "DOWN TIME"**

AMPEX Recorders are designed for thousands of hours of continuous operation with minimum "down time," resulting in low maintenance costs and protection from sudden broadcast failures.

- **ACCURATE TIMING**

AMPEX split-second timing accuracy protects your programs and commercials from embarrassing time overlaps.

- **HIGHEST FIDELITY**

Even when programs are repeatedly transcribed from one tape to another, there is no noticeable build-up of noise level, "wow" or distortion.

- **LONG LIFE**

AMPEX Recorders are designed and built for years of service dependability. Its recordings match established NARTB standards. When you have an AMPEX, you have a machine built for years-ahead performance.

IF YOU PLAN FOR TOMORROW, BUY AN AMPEX TODAY

AMPEX

MAGNETIC RECORDERS

AMPEX ELECTRIC CORP.
934 CHARTER STREET • REDWOOD CITY, CALIF.

**SILECTRON
"C" CORES**
*for quick
delivery*
**IN
PRODUCTION
QUANTITIES**

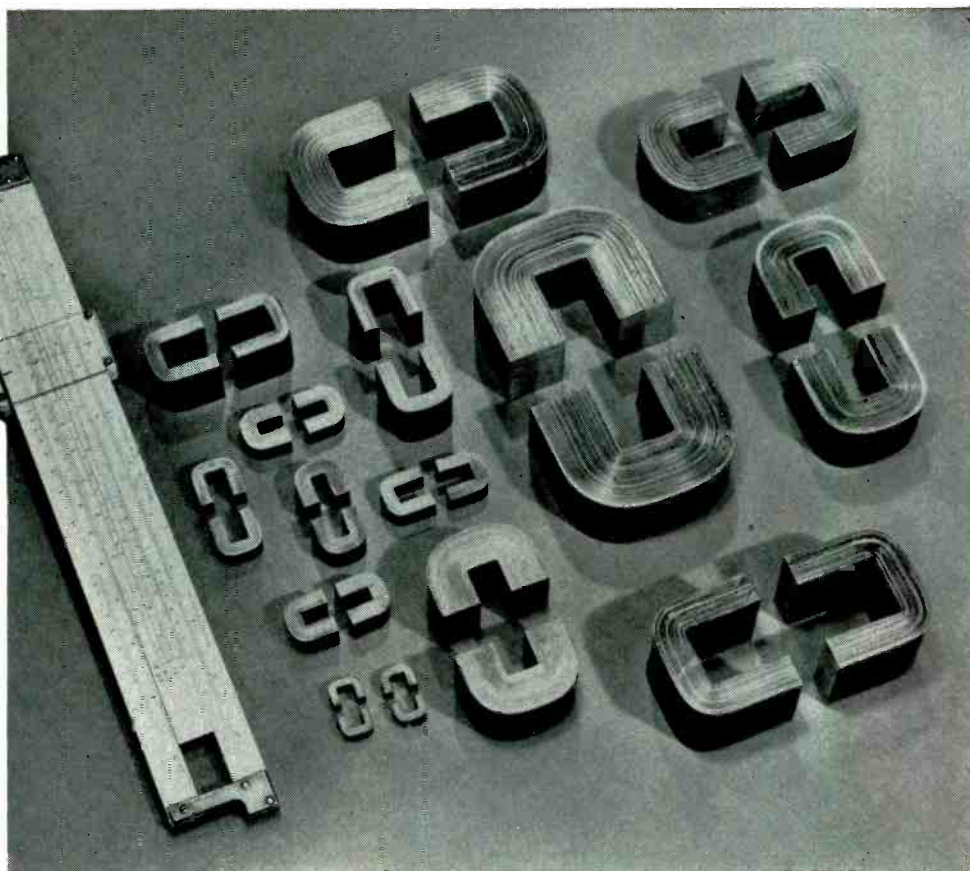

... wound from strip as thin as 0.00025"

*Quality-Tested
and Proved*

- ★ Arnold "C" Cores are made to highly exacting standards of quality and uniformity. Physical dimensions are held to close tolerances, and each core is tested as follows:
- ★ 29-gauge Silectron cut cores are tested for watt loss and excitation volt-amperes at 60 cycles, at a peak flux density of 15 kg.
- ★ 4-mil cores are tested for watt loss and excitation volt-amperes at 400 cycles, at a peak flux density of 15 kg.
- ★ 2-mil cores are tested for pulse permeability at 2 microseconds, 400 pulses per second, at a peak flux density of 10 kg.
- ★ 1-mil cores are tested for pulse permeability at 0.25 microseconds, 1000 pulses per second, at a peak flux density of 2500 gauss.
- ★ 1/2 and 1/4-mil core tests by special arrangement with the customer.

Now available—"C" Cores made from Silectron (oriented silicon steel) thin-gauge strip to the highest standards of quality.

Arnold is now producing these cores in a full range of sizes wound from 1/4, 1/2, 1, 2 and 4-mil strip, also 29-gauge strip, with the entire output scheduled for end use by the U. S. Government. The oriented silicon steel strip from which they are wound is made to a tolerance of plus nothing and minus mill tolerance, to assure designers and users of the lowest core losses and the highest quality in the respective gauges. Butt joints are accurately made to a high standard of preci-

sion, and careful processing of these joints eliminates short-circuiting of the laminations.

Cores with "RIBBED CONSTRUCTION"* can be supplied where desirable.

Ultra thin-gauge oriented silicon steel strip for Arnold "C" Cores is rolled in our own plant on our new micro-gauge 20-high Sendzimir cold-rolling mill. For the cores in current production, standard tests are conducted as noted in the box at left—and special electrical tests may be made to meet specific operating conditions.

● We invite your inquiries.

*Manufactured under license arrangements with Westinghouse Electric Corp.

W&D 4211

THE ARNOLD ENGINEERING COMPANY

SUBSIDIARY OF ALLEGHENY LUDLUM STEEL CORPORATION

General Office & Plant: Marengo, Illinois



THE SOLA FAMILY OF

5 Voltage Regulator Types

MEETS MOST
MILITARY and INDUSTRIAL
REQUIREMENTS

SOLA adjustable, harmonic filtered type CVL:

Regulation $\pm 1\%$
Harmonic Distortion less than 3%
Output adjustable from
0-130 volts



SOLA DISCIPLINES VOLTAGE

SOLA standard type CV:

Regulation
 $\pm 1\%$



SOLA television receiver type CVA:

Regulation $\pm 3\%$
Plug-in accessory unit



SOLA plate and filament type CVE:

Regulation $\pm 3\%$



SOLA harmonic filtered type CVH:

Regulation $\pm 1\%$
Harmonic Distortion
less than 3%



CHARACTERISTICS OF SOLA CONSTANT VOLTAGE TRANSFORMERS

- Static-magnetic regulation
- Ultra-fast response (1.5 cycles)
- No moving or renewable parts
- No manual adjustments
- Complete automatic, continuous regulation
- Self-protecting against short circuits
- Automatic current limiting action
- Choice of transformation ratios

We invite you to write regarding your voltage regulating problems, or for inclusion of your name on our technical mailing list.

SOLA

Constant Voltage
TRANSFORMERS

Made under one or more of
the following patents: 2,143,745;
2,212,198; 2,346,621; 2,552,111;
2,489,245 and patents pending.

Transformers for: Constant Voltage • Fluorescent Lighting • Cold Cathode Lighting • Airport Lighting • Series Lighting • Luminous Tube Signs
Oil Burner Ignition • X-Ray • Power • Controls • Signal Systems • etc. • SOLA ELECTRIC CO., 4633 W. 16th Street, Chicago 50, Illinois
Manufactured under license by: ADVANCE COMPONENTS LTD., Walthamstow, E., England • M. C. B. & VERITABLE ALTER, Courbevoie (Seine), France
ENDURANCE ELECTRIC CO., Concord West, N. S. W., Australia • UCOA RADIO S.A., Buenos Aires, Argentina

where

dependable timing

is essential

to product performance

... consult

Cramer

As specialists in TIME as a factor of CONTROL, we have developed a wide range of timing devices, extensively used on electrically-operated commercial and industrial equipment where accurate, dependable timing is essential to insure efficient product performance . . . to add convenience of operation . . . to prevent work spoilage and protect equipment itself.

Although the majority of timing problems can be effectively solved by devices considered "standard" in our line, we have had a great deal of experience in the design of special devices to meet specific requirements . . . and will welcome the opportunity to help solve your timing problem. Write us for complete information.

THE R. W. CRAMER CO., INC.

BOX 3, CENTERBROOK, CONN.

INTERVAL TIMERS

TIME DELAY RELAYS

PERCENTAGE TIMERS

RUNNING TIME METERS

PULSE TIMERS

SYNCHRONOUS MOTORS (A-50 CLUTCH, REVERSIBLE AND CHART DRIVE TYPES)

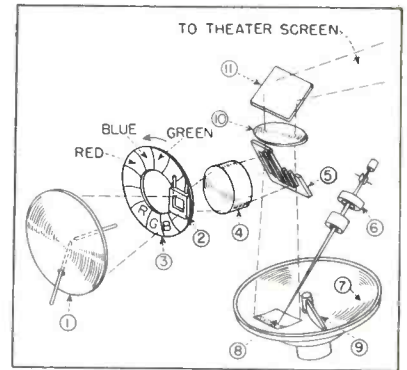

FIG. 1—Mechanical drawing of the projection system. Arc light source (1), aperture plate (2), color wheel (3), condenser lens (4), mirror bar system (5), electron gun and deflection system (6), spherical mirror with thin layer of liquid (7), electron bombarded liquid area that modulates light beam (8), knife edge determining thickness of liquid layer (9), projection lens (10) and directing mirror (11)

with temperature, changes in temperature cause a difference in the rate of the disappearance of the picture or any given portion of it. The correct temperature is maintained by a cooling machine which circulates water on the under side of the mirror. The water temperature is adjusted automatically by a thermostat.

The entire mirror system is maintained continuously under high vacuum. The mirror is driven by a motor outside the vacuum system operating through a specially packed shaft. A large vacuum line leads from the mirror system to a high vacuum pump. The pressure in the mirror system is kept at 10^{-5} millimeters of mercury.

Arc Light

The system utilizes a special arc light which gives a completely symmetrical arc. Air is blown continuously around the positive carbon to stabilize the arc. Magnetic stabilization is also provided. These two types of stabilization give a constant arc of constant brightness. It is essential with color to have a uniform arc light. The lighting density required by the Eidophor system is much higher than with the ordinary movie projection systems. About twice as much current is fed to the arc.

The positive carbon is fed by a photoelectrically-controlled device which keeps the crater exactly in

There's a DPi high vacuum measuring instrument for every laboratory and industrial requirement

HERE ARE EXAMPLES . . .

For the range from 10^{-3} to 10^{-5} mm Hg, DPi's Knudsen Gauge, Type BL-1, is a radiometer gauge with a constant response that is essentially independent of the nature of most gases. Readings are absolute, giving total gas and vapor pressure. With no incandescent filament, better accuracy is assured in measuring vacuums in systems where gases are subject to decomposition. A magnetic damper provides stable readings without loss of sensitivity. And it can be attached to any system by standard glass or metal joints.



For the range from 1 micron to 1×10^{-8} mm Hg, DPi's Type VG-1A Ionization Gauge Tube, sealed in your vacuum system, provides the sensitivity required for measuring pressures as low as 10^{-8} mm Hg, yet is reliable at pressures of 1 micron. Its design reduces electrical leakage and outgassing to a minimum.

The DPi DPA-38 Ionization Gauge Control Circuit affords a completely self-contained power and amplifying unit for an ionization gauge tube—saves you the time and trouble of building your own. Designed for use with the VG-1A tube, but adaptable to others, it provides a tube degassing circuit. An automatic relay turns off gauge tube and turns on power for an alarm system when pressures exceed safe limits. Its very large range and continuous direct readings widen the DPA-38's application and make your work easier.

Both the Knudsen Gauge and the DPA-38 will hold calibration indefinitely and operate from any 115-v a-c outlet. And both are the result of nearly 20 years of experience in making high vacuum easy and economical to produce, measure and use. For more detailed information and prices, or engineering help on any problem involving high vacuum, write to *Distillation Products Industries*, Vacuum Equipment Department, 727 Ridge Road West, Rochester 3, N. Y. (Division of Eastman Kodak Company).

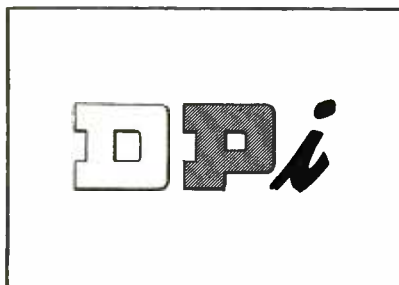

high vacuum research and engineering

Also . . . vitamins A and E . . . distilled monoglycerides . . . more than 3500 Eastman Organic Chemicals for science and industry

just off the press!

WRITE FOR YOUR COPY NOW...

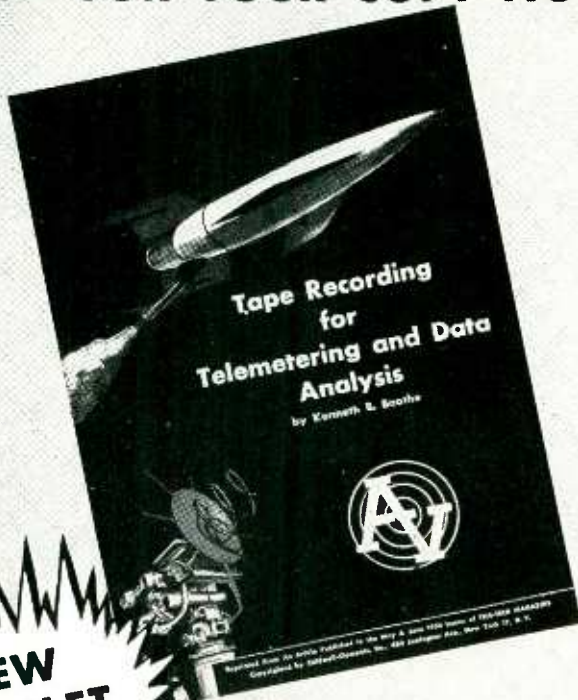

A NEW BOOKLET

AMPEX

SPECIAL PURPOSE MAGNETIC TAPE RECORDERS

...described in detail in this new booklet published by the...

Instrumentation Division

of the

Audio & Video

PRODUCTS CORPORATION

730 Fifth Avenue

New York 19, N. Y.

Plaza 7-3091



.....(use this coupon for convenience).....

AUDIO & VIDEO PRODUCTS CORPORATION Dept. E-10

Instrumentation Division

730 Fifth Avenue

New York 19, New York

Please send me a copy of your booklet

"Tape Recording for Telemetry and Data Analysis"

Name Title

Company

Address

the focus of the mirror behind the arc, the best position for the most light. The negative carbon is fed in the conventional manner using the negative characteristic of the arc to control its feeding. As is conventional, the positive carbon is consumed about twice as fast as the negative.

Light from the arc is directed through a gate, see Fig. 1, then through a rotating color wheel, into a condenser in the wall of the vacuum system in which the mirror is located. After the light goes through this condenser, it strikes a mirror bar system made of a group of spaced reflective bars with the space between the bars approximately equal to the width of the bars.

Half of the light from the arc goes straight through the openings between the bars and strikes a water-cooled black surface in the vacuum housing and is lost. The other half of the light from the arc is reflected down by the bars onto the mirror with the film on it, striking the film over the area where the image is found on the oil film. If there is no picture on the film and consequently no deformation of the surface of the liquid, the mirror reflects the light back to the bars and then back to the arc lamp. If there is a picture on the film because of an incoming television signal, the light hits the picture and is reflected back between the bars, through a normal objective lens with its axis vertical, to a mirror inclined at 45 deg and then to the screen on which the picture is projected.

The picture is formed on the surface of the film by an electron beam generated by an electron gun of conventional type activated by the incoming television signal and located in the vacuum system.

Small Wire Capacitors

THE WIRE CAPACITOR developed by N. V. Philips, Eindhoven, Netherlands, has a capacitance of about 100 pF and, in its most common form, consists of a small metal tube less than 1 mm in diameter and about 5-cm long. The tube contains a metal core about 1/2-mm thick while

From the world's largest manufacturer
of precision potentiometers . . .



come to **Helipot**
for the largest
selection of
multi-turn
precision
potentiometers

advanced engineering! volume production!

HELIPOT is the organization that originated the helical potentiometer—the device that brought to electronic engineering new horizons of precise control by its greater resolution, higher linearity, mechanical precision, and broad range of resistance values. HELIPOT's policy of constantly working to anticipate the needs of the industry has led to steady advancement in the basic multi-turn principle—and today, HELIPOTS are available in the industry's widest selection of ranges and designs to meet varying requirements.

HELIPOT offers you . . .

▶ **Advanced Engineering.** Through its years of leadership HELIPOT has built an organization unequalled in the industry—with trained engineers, specially-designed equipment, overall facilities to solve *tough* potentiometer problems!

▶ **Volume Production of Special Designs.** HELIPOT not only welcomes tough potentiometer problems, but also has expanded facilities to mass-produce special designs to rigid specifications—at economical cost!

▶ **Versatile Basic Designs.** Most of the basic units shown below can be readily adapted to special requirements—ganged assemblies, servo mountings, single or double shaft extensions, taps spot-welded to a *single* turn of winding at virtually any desired point, and many other individualized features to meet *your particular needs!*

See the next pages for complete electrical and mechanical data on the following Multi-Turn Helipots . . .

MODEL A:



A 10-turn unit, approximately 1 $\frac{3}{4}$ " diameter with 12 to 14 times the resolution of single-turn units of same diameter. Very versatile—low in price—wide range of applications.*

MODEL C:



Similar to Model A, but 3 turns of resistance winding instead of 10.*

MODELS B, D, & E:



Larger-diameter (3 $\frac{5}{16}$ "") designs. B has 15 turns—C, 25 turns—E, 40 turns, for applications requiring extreme ranges of adjustment and highest possible resolution.*

ultra-precision



MODELS AN, BS, BSP, & CN:

Similar to Models A, B & C in size and performance but feature precision ball-bearings and extra-close tolerances throughout. Have approximately twice the linearity accuracy of equivalent standard Helipots—are ideal servo units.*

miniature



MODELS AJ, AJS, AJSP:

Tiny multi-turn Helipots the diameter of a penny, weight 1 oz. All have 18.5" slide wire for high resolution (1/6550—50 K unit). AJ has threaded bushings, sleeve bearings . . . AJS, servo mountings, sleeve bearings . . . AJSP, servo mountings, ball bearings. Many other features.*

THE **Helipot** CORPORATION
SOUTH PASADENA, CALIFORNIA

(Turn page for list of representatives)



See next two pages
for complete mechanical and
electrical details

ELECTRICAL CHARACTERISTICS

MODEL	A	AJ
HELICAL TURNS	10	10
RESISTANCE RANGE (OHMS)	10 TO 300,000	100 TO 50,000
RESISTANCE TOLERANCE (ST'D)	±5%	±5%
LINEARITY TOLERANCE (ST'D)	±0.5%	±0.5%
BEST LINEARITY TOLERANCE	±.05% (above 2K1)	±.1% (above 5K1)
ELECTRICAL ROTATION	3600° ±4° -0°	3600° ±12° -0°
MECHANICAL ROTATION	3600° ±4° -0°	3600° ±12° -0°
POWER RATING (WATTS) (40° Ambient)	5	2
COIL LENGTH (INCHES)	46.5	18.5
NET WEIGHT (OUNCES)	4	1

Technical Data for Helipot Potentiometers

PHYSICAL DIMENSIONS (In Inches)

K BODY DIAMETER	1.812	.750
L Body Length (To Front Mtg. Surface)	2	1.375
M Shaft Diameter	.2500 ±.0005 -.0002	.1250 ±.0005 -.0002
N Shaft Extension (Beyond Bushing) Front	.5	.375
O Shaft Extension (Beyond Bushing) Rear	.5	.375
P Shaft Extension (Beyond Mtg. Surf.) Front	.812	.687
Q Shaft Extension (Beyond Mtg. Surf.) Rear	.812	.375
R Mounting Shoulder Diameter	.4062 ±.0005 -.0010	.281 ±.0005 -.002
S Mounting Shoulder Length	.125	.062
U Bushing Extension (Beyond Mtg. Surface)	.312	.312
V Height of Terminals (Above Body)	.312	.203
W Mounting Shoulder Diameter	—	—
X Lid Outer Diameter	—	—
THREADS	3/8-32	1/4-32
Number of Sections (Max.)	3	1
Add to "L" Dimension for each additional Section	—	0
Type Bearing	Sleeve	Sleeve
Starting Torque (Oz. In.)	2	.75

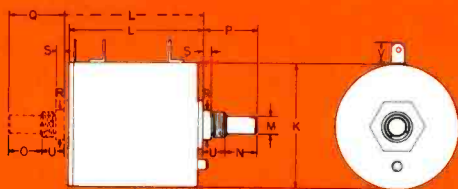

A-AJ-B-BP-C-D-E-L

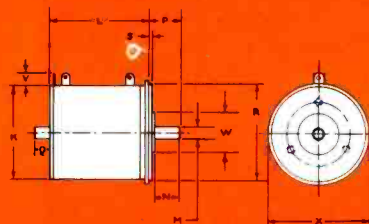

AJ5-AN-B5-BSP-CN

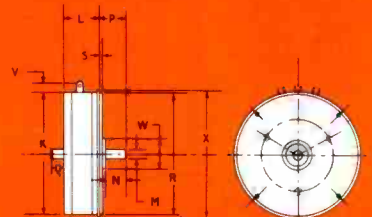

J-LS-LSP-T

NOTES:

1. All locating lugs extend 1/16" beyond mounting surface.
2. Locating lugs on Models A, C and G are placed on a radius 9/16" from shaft centerline.
3. Locating holes on Models B, D, E and L are placed on a radius 17/32" from shaft centerline.
4. Three threaded 8-32 NC-2 x 5/32" deep equally spaced holes are provided on a 1.250 B.C. on Model AN, CN and J.
5. Terminals are marked as follows: C.C.W.—#1 ... C.W.—#2 ... Slider—S.
6. Tolerances on all decimal dimensions are ±.015".
7. Tolerances on all fractional dimensions are ±1/64".

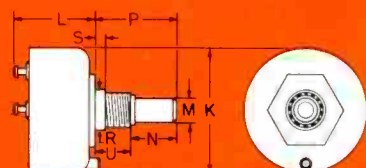

G

	AJS AJSP	AN	B BP	BS BSP	C	CN	D	E	G	J	L	LS	LSP	T
	10	10	15	15	3	3	25	40	1	1	1	1	1	1
	100 TO 50,000	100 TO 250,000	50 TO 500,000	50 TO 500,000	5 TO 50,000	30 TO 75,000	100 TO 750,000	200 TO 1,000,000	5 TO 20,000	50 TO 50,000	10 TO 100,000	10 TO 100,000	10 TO 100,000	1000 TO 100,000
	±5%	±5%	±5%	±5%	±5%	±5%	±5%	±5%	±5%	±5%	±5%	±5%	±5%	±5%
	±0.5%	—	±0.5%	—	±0.5%	—	±0.5%	±0.5%	±0.5%	±0.5%	±0.5%	±0.5%	±0.5%	±0.5%
	±.1% (above SKI)	±.025% (above SKI)	±.025% (above 10K)	±.025% (above 10K)	±.1% (above SKI)	±.05% (above 1K)	±.025% (above 1K)	±.02% (above 1K)	±.25% (above SKI)	±.15% (above 10K)	±.1% (above SKI)	±.1% (above SKI)	±.1% (above SKI)	±.25% (above SKI)
	3600° ±12° ±0°	3600° ±12° ±0°	5400° ±4° ±0°	5400° ±4° ±0°	1080° ±4° ±0°	1080° ±1° ±0°	9000° ±4° ±0°	14,400° ±4° ±0°	356° ±2°	357° ±1°	358° ±1°	358° ±1°	358° ±1°	355° ±3° ±3°
	3600° ±12° ±0°	3400° ±12° ±0°	5400° ±4° ±0°	5400° ±4° ±0°	1080° ±4° ±0°	1080° ±1° ±0°	9000° ±4° ±0°	14,400° ±1° ±0°	360°	360°	360°	360°	360°	360°
	2	5	10	10	3	3	15	20	2	5	5	5	5	2
	18.5	46.5	140	135	14	14	234	374	3.1	5.0	8.5	8.5	8.5	2
	1	4	13	13	2	2.5	17	21	2	4	8	8	8	.56

.750	1.820	3.312	3.328	1.812	1.820	3.312	3.312	1.312	2	3.000	3.000	3.000	.875
1.516	1.969	2.828	2.938	1.141	1.094	4.140	6.015	.891	1.032	.9375	.875	.875	.781
.1247 + .000 - .003	.2500 + .000 - .005	.2500 + .000 - .005	.2500 + .000 - .005	.2500 + .000 - .005	.2500 + .000 - .005	.2500 + .000 - .005	.2500 + .000 - .005	.2500 + .000 - .003	.2500 + .000 - .003	.2497 + .000 - .003	.2497 + .000 - .003	.2497 + .000 - .003	.0780 + .000 - .003
.313	.5	1	.875	.5	.5	1	1	.5	.5	1	.5	.5	.25
.375	—	.5	—	.5	—	.5	5	None	.5	.5	.5	.5	.25
.375	.625	1.5	1	.812	.625	1.5	1.5	.875	.625	1.5	.625	.625	.312
.375	—	1	—	.812	—	1	1	None	.5	.5	.5	.5	.25
.625 + .000 - .001	1.875 + .000 - .001	.5437 + .000 - .010	.750 + .000 - .001	.4062 + .000 - .010	1.875 + .000 - .001	.5937 + .000 - .010	.5937 + .000 - .010	.4062 + .000 - .010	1.875 + .000 - .001	.5937 + .000 - .010	3.000 + .000 - .001	3.000 + .000 - .001	7.500 + .000 - .003
.062	.062	.125	.125	.125	.062	.125	.125	.125	.062	.125	.062	.062	.062
0	0	.5	0	.312	0	.5	.5	.375	0	.5	0	0	0
.203	.281	.265	.281	.312	.281	.265	.265	0	.250	.203	.203	.203	.156
—	.750 + .000 - .001	—	—	—	.750 + .000 - .001	—	—	—	.750 + .000 - .001	—	.750 + .000 - .001	.750 + .000 - .001	—
.750	2	—	3.5	—	2	—	—	—	2	—	3.125	3.125	.875
Flange	Flange	1/2-32	Flange	3/8-32	Flange	1/2-32	1/2-32	3/8-32	Flange	1/2-32	Flange	Flange	Flange
1	2	3	3	3	2	1	1	1	8	8	8	8	4
0	1 3/8	—	2 1/2	—	1	0	0	0	11/16	1/2	1/2	1/2	1/2
AJS—Sleeve AJSP—Ball	Ball Bearings	B—Sleeve BP—Ball	BS—Sleeve BSP—Ball	Sleeve	Ball Bearings	Sleeve	Sleeve	Sleeve	Ball Bearings	Sleeve	Sleeve	Sleeve	Ball Bearings
.75	1.0	B—2.75 BP—.75	BS—2.75 BSP—.75	1.75	1.0	3.5	4.5	.75	1.0	1.75	1.75	1.50	.005 Min. .015 Std.

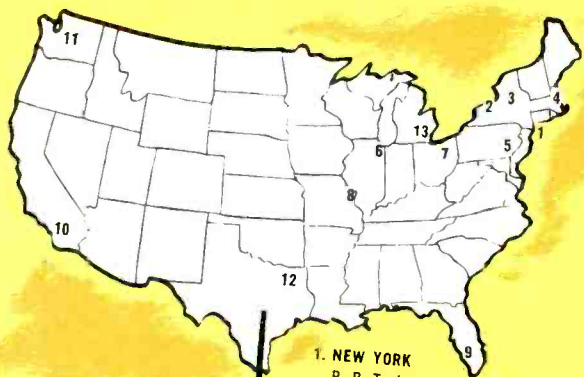

**COAST TO COAST
THERE'S A HELIPOT
REPRESENTATIVE
NEAR YOU!**

- NEW YORK**
B. B. Taylor
241 Sunrise Highway
Rockville Centre, New York
ROckville Centre 6-1014-6-1015
- ROCHESTER**
E. A. Ossmann & Associates, Inc.
3 Juniper Street
Rochester 10, New York
CUlver 7640
- SCHENECTADY, N. Y.**
E. A. Ossman & Associates, Inc.
DElanson 2319
- BOSTON**
Harold Gerber
25 Huntington Avenue
Boston 16, Massachusetts
COpley 7-1961

- PHILADELPHIA**
James C. Muggleworth
506 Richey Avenue
Collingswood 6, New Jersey
COllingswood 5-3515
 - CHICAGO**
Roy J. Magnuson
4258 West Irving Park Road
Chicago 41, Illinois
PALisade 5-1170
 - CLEVELAND**
Howard N. Heasley
1940 East Sixth Street
Cleveland, Ohio
PRespect 1552
 - ST. LOUIS**
Harris-Hanson Company
5506 South Kingshighway
St. Louis 9, Missouri
SWEetbriar 5584
 - FORT MYERS**
Arthur H. Lynch & Associates
P. O. Box 466
Fort Myers, Florida
FORT MYERS 1269-M
 - LOS ANGELES**
G. S. Marshall Company
40 South Los Robles
Pasadena 1, California
RYan 1-8345; SYcamore 5-2022
 - SEATTLE**
Samuel N. Stroum
1612 Broadway
Seattle 22, Washington
FRanklin 7515-7516
 - DALLAS**
J. Y. Schoonmaker Company
2011 Cedar Springs
Dallas 1, Texas
STERling 3335
 - DETROIT**
S. Sterling Company
15310 West McNichols Rd.
Detroit 35, Michigan
BROADway 3-2900
- EXPORT AGENT**
Frathom Company
33 West 42nd Street
New York 18, New York
BRyant 9-1296
- CANADA**
Cossor (Canada) Ltd.
Mr. J. S. Root
301-303 Windsor St.
Halifax, Nova Scotia
4-6488
- Cossor (Canada) Ltd.
Mr. Fred Bates
648 Yonge St.
Toronto, Ontario, Canada
PRincess 1226



ADVANCED ENGINEERING! VOLUME PRODUCTION!

come to Helipot for the largest selection of single turn precision potentiometers

The same engineering know-how and precision manufacturing facilities that have made HELIPOT the world's largest manufacturer of multi-turn potentiometers, have also established its leadership in the design and production of high precision *single-turn* potentiometers. These single-turn units are built with the same infinite care . . . on the same types of specially-designed equipment . . . by the same highly trained personnel that have made Helipot multi-turn potentiometers the world's standard. *Result*—a wide selection of single-turn potentiometers, available in volume, built to the highest-possible standards—at *mass-production economies!*

Most of the units shown at right are readily adaptable to special requirements—servo mountings, ball or sleeve bearings, ganged assemblies, single or double shaft extensions, taps spot-welded to a *single* turn of winding at virtually any desired point, and many other optional features to meet the needs of *your* applications.

So, no matter what your requirement in precision potentiometers, bring it to Helipot!



MODEL L SERIES (3" DIA.):

A high-precision single-turn unit with continuous mechanical rotation and minimum electrical dead space. Model L has bushing mounting, sleeve bearings . . . LS, servo mounting, sleeve bearings . . . LSP servo mounting, ball bearings. All are gangable to 8 sections, sections phaseable after assembly to within $\pm 1^\circ$. Many other features.*



MODEL J (2" DIA.):

The first production designed potentiometer with ball bearings as a standard feature—also versatile three-way servo mounting. Individual sections can be easily ganged and independently phased by the user after installation without external brackets or clamps. Many other unique features.*



MODEL G (1 5/16" DIA.):

A compact, single-turn precision potentiometer—low in price, extra rugged. Developed initially for remote positioning and indicating in aircraft applications—now also used for general instrumentation and servo mechanisms. Continuous 360° rotation. In certain resistance values is excellent for high temperature applications—at ambient temperatures as high as 165°C. under certain conditions.*

miniature



MODEL T "TINYTORQUE" (7/8" DIA.):

A miniature ultra-low-torque unit for guided missiles and aviation electronics. Features shielded ball bearings, highest possible precision and quality, long life, rugged dependability. Length only 25/32"—weight only 0.56 oz.—starting torque only 0.005 oz. in., when specified—negligible running torque. Sliders phaseable to within 3°. On vibration tests units have successfully withstood frequencies 0 to 2000 c.p.s. in 3 planes, accelerations up to 20 G's for periods to 1 hr.*

*See preceding pages for complete electrical and mechanical data.

Duodials for every application

Duodial turns-indicating knob-dials are ideal for Helipots and other multi-turn applications. Available in a wide range of sizes and turns ratios . . .



MODEL RA:

The beautiful new 10 turn Precision Duodial (1-13/16" dia.) with a "feel" and appearance that add distinction to the finest instrument panels. Features excellent readability, positive locking lever, easy assembly. Available in 10:1 ratio only.



MODEL R:

Standard 2" Duodial in 10:1, 15:1, 25:1, 40:1 turns ratios for various Helipot ranges. Locking device, if desired.



MODEL W:

Large 4 3/4" Duodial for primary control applications. Easy to adjust and read. Finger hole for rapid rotation. Available in turns ratios of 10:1, 15:1, 25:1, 40:1.

THE LABORATORY HELIPOT (MODEL T-10A):

A 10 turn Helipot, "RA" Duodial and 3-way binding posts combined in a handsome walnut-cased unit ideal for laboratory and instruction purposes. Simplifies making and changing experimental circuits. More compact and 5 times faster to set than decade boxes. Linearity 0.1%, Power Rating 5 watts, Standard Resistance Ranges 100 to 100,000 ohms—others on order.



See preceding page
for nearest representative

THE Helipot CORPORATION
SOUTH PASADENA, CALIFORNIA

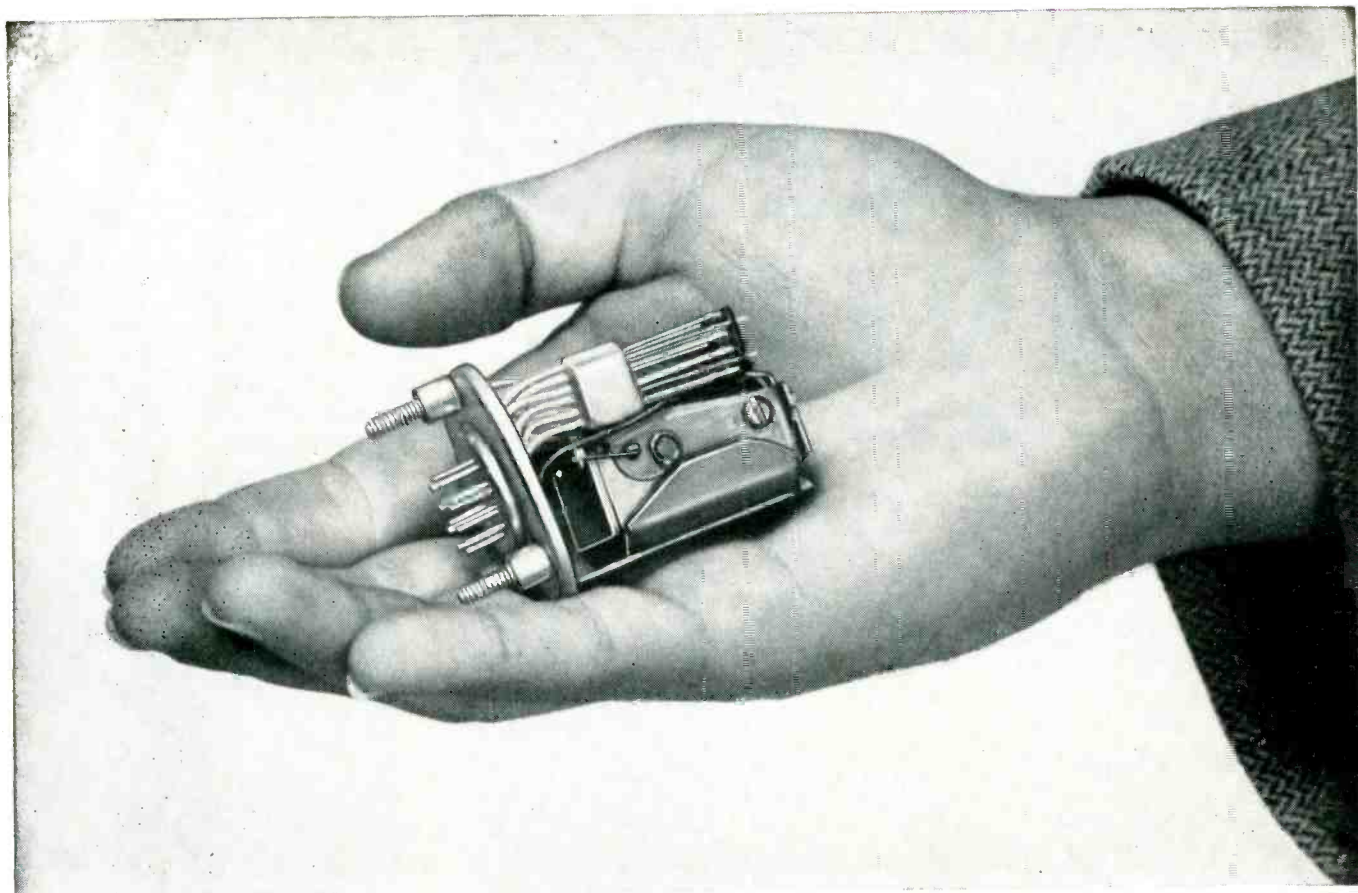

New G-E Relay Doubles Tip Pressure

Hermetically-sealed unit has larger magnet, no extra weight

Double the average tip pressure, 40-55 grams, is delivered by the larger magnet structure of the new G-E relay without exceeding Air Force-Navy specifications for size and weight.

The new relay, the first specifically designed for hermetic sealing, will withstand 50g operational shocks and instantaneous voltage surges up to 1500 volts rms *without failure*.

LONGER RELAY LIFE

The large magnet, polyester stack insulation, and silver-tipped contacts assure reliable, long-lived operation in aircraft, shipboard, portable land-based equipment and other systems which must meet Air Force-Navy specifications.

In every way, this new G-E relay is in a world of its own—sealed in a standard size enclosure against dirt, salt spray, high humidity, and widely varying air pressures.

RELIABLE SHIPMENT

This new device is now in full production and shipment can be made to meet your schedules.

Ask your nearest G-E office for more information, and send the attached coupon today. *General Electric Company, Schenectady 5, New York.*

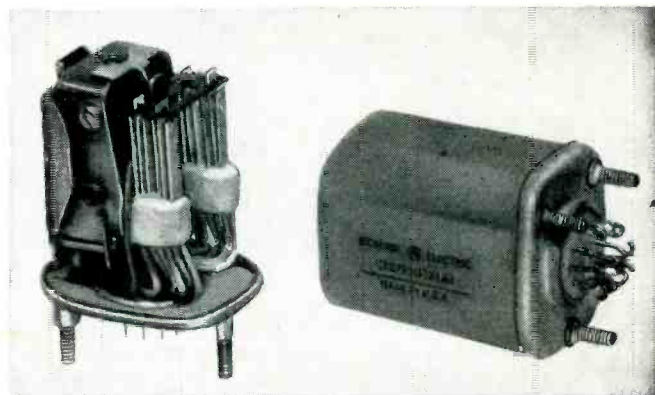

THE LARGER MAGNET is made possible by an exclusive G-E design which utilizes the relay housing for structural support, thus eliminating much of the weight of internal bracing.

GENERAL  **ELECTRIC**

General Electric Company
Section B730-41
Schenectady 5, New York

Gentlemen:

I would like copies of Bulletin GEA-5729 on hermetically-sealed relays for:

reference only

an immediate project

Name Title

Company

Address

City State

Top Performers
...in air...or oil

TAYLOR

8020 and 8013-A

HIGH VOLTAGE RECTIFIERS

Taylor 8020 Ratings

The 8020 is rated at 40 KVP inverse or forward in air, 60 KVP in oil. Average current: 100 MA, with instantaneous peak current capacity of 2 Amp.

Taylor 8013-A Ratings

The 8013-A is rated at 40 KVP inverse or forward in air, 55 KVP in oil. Average current: 20 MA continuous in air -30 MA continuous in oil; with instantaneous peak current capacity of 450 MA.

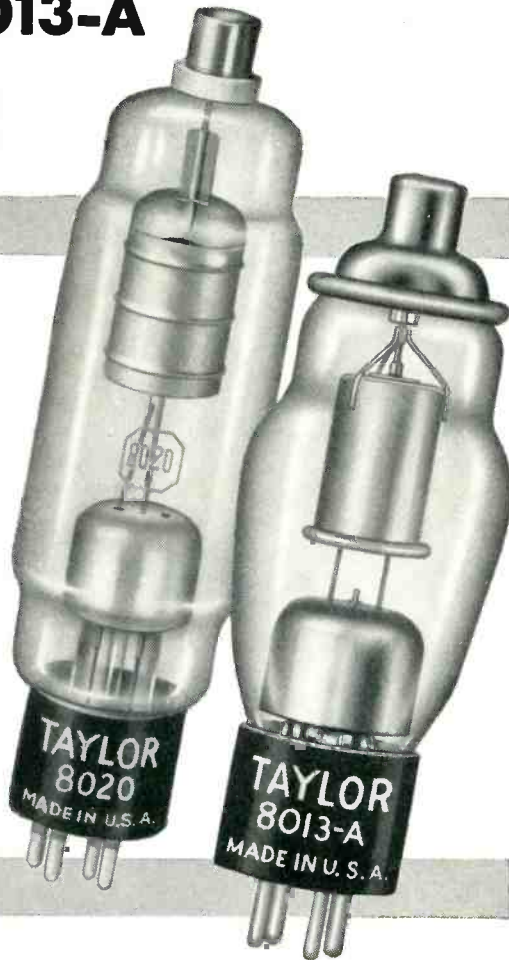

The extra measure of care and consideration afforded every Taylor Tube is a plus value that means greater operating efficiency and longer tube life. It's worth looking into.

★ TRANSMITTING
★ RECTIFIER

★ INDUSTRIAL
★ ELECTRONIC

As always, Taylor is producing tubes of superior quality and outstanding performance. The Taylor Representative nearest you is ready and willing to discuss your particular requirements. Call on him for information any time.

Taylor HEAVY CUSTOM BUILT DUTY *Tubes*

TAYLOR TUBES INC., 2312-18 WABANSIA AVE., CHICAGO 47, ILL.

Canada: Atlas Radio Corp., Ltd.
560 King St., W., Toronto 2-B
Cable: ATRADCO

Export: Royal National Company
75 West St., New York 6, N. Y.
Cable: NATVARNCO

the space between the core and the jacket is filled with a compressed insulating material with high dielectric constant. Total volume of the wire capacitor is about 30 cubic mm.

The narrow space between the core and the jacket is filled with the insulating material in such a way as to make it highly uniform throughout. The basic material for the production of drawn capacitors is a copper tube 20-cm long, with outer diameter of 20 mm and a wall thickness of 2 mm.

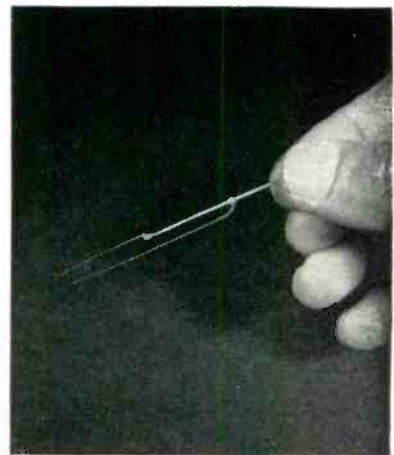

Photograph illustrating the small size of the wire capacitor

A wire core about 8 mm thick is inserted in the tube and centered with the aid of two rings acting as jigs. The annular space is filled with insulating material in powder form which is stamped in. The whole piece is then hammered and drawn out to a wire of about 40 meters and of a diameter slightly less than 1 mm.

The drawn wire is divided into pieces of the desired length and at one end of each piece, the jacket and insulation are removed to leave the core bare. Connecting wires are soldered onto the bare end of the core and onto the jacket.

Manufacturing Details

When dividing the 40-meter wire there must not be any short-circuiting between the inner and outer conductors. Since the jacket always bends somewhat outward when being broken, there is not much danger of a short circuit developing. The insulating material is packed so firmly between the core and the

Why "dag" Colloidal Graphite is Best for CRT Exterior Walls

"Dag" Exterior Wall Coating has better adhesion . . . requires no baking . . . resists scratching . . . and is economical.

The smooth, uniform, conductive black film obtained with "dag" Exterior Wall Coating adheres tenaciously to all types of glass. Its adherent properties are so good that it resists scratching and readily withstands water immersion.

This specially processed electric-furnace graphite coating is dispersed in a lacquer-base vehicle and is easily applied to CRT surfaces by spraying. It dries so rapidly that tubes can be handled in 2 or 3 minutes after coating. Maximum adherence is obtained by red drying at 100° C. for ½ hour.

More information on the advantages of "dag" Exterior Wall Coating . . . as well as data on other "dag" dispersions for the electronics and electrical industries . . . is contained in a recent bulletin. Write today for your free copy of Bulletin No. 433-5K.



Acheson Colloids Company, Port Huron, Mich.

... also **ACHESON COLLOIDS LIMITED, LONDON, ENGLAND**
Units of Acheson Industries, Inc.



DESIGNER'S

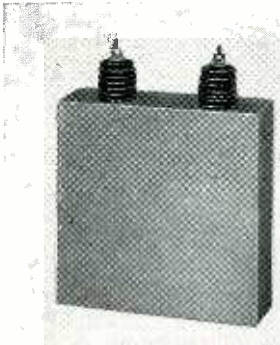

CAPACITORS



METERS AND INSTRUMENTS



TRANSFORMERS



POWER SUPPLIES



VOLTAGE REGULATORS



RECTIFIERS



CONTROL



AMPLISTATS

Ready to serve expanding tv industry— G-E components for transmitter builders

Recent lifting of the freeze on new television stations has created many design and production problems for transmitter manufacturers. General Electric is ready to help designers solve one of these problems by providing a dependable supply of reliable, long-life electrical components.

To avoid costly delays, G.E. will plan output of its ample manufacturing facilities to match your production schedules. And recent design improvements and important new products resulting from continuing

G-E research and development activities will add to the performance of your equipment.

If you are engaged in supplying the huge demand for new tv station equipment, you'll find it worthwhile time-wise, cost-wise, and quality-wise to investigate the full line of applicable General Electric products. Your G-E Apparatus Sales Engineer has the story. Get in touch with him today, or write, giving full details and quantities involved, to General Electric Co., Sect. 667-22, Schenectady 5, N. Y.

GENERAL ELECTRIC

DIGEST

TIMELY HIGHLIGHTS ON G-E COMPONENTS

New drawn-oval capacitors are 10 to 20% lower priced

Here's a new line of General Electric capacitors for electronic applications, housed in drawn-oval containers, that features size reductions up to 30 per cent and cost reduction up to 20 percent! These fixed paper-dielectric capacitors also weigh less and are mechanically stronger than conventional types because of the drawn-steel container's single seam, hermetically sealed by double rolling. What's more, shipments are shorter. Designed to replace case styles CP70 and CP53, the new units are available in ratings from 2.0 muf to 10.0 muf, 600 to 1500 volts d-c and 330 to 660 volts a-c. See Bulletin GEA-5777.



New G-E reactor makes d-c voltage measurement safer



G.E.'s new d-c voltage measuring reactor minimizes hazard to personnel and equipment by isolating the instrument circuit from the d-c power source when making d-c voltage measurements. Since special safety precautions are not necessary, instrumentation costs are reduced. Available in six models for measurements up to 1200 volts. For complete application information, check Bulletin GEC-898.

New analog field plotter simplifies field studies



Electronics equipment engineers will find the General Electric analog field plotter a valuable aid in design work. Comprising plotting board and associated electric equipment, it speeds solution to problems such as electrode shapes in electronic tube design, field patterns in wave guides and electron lenses. Accompanying 50-page manual explains operation. See Bulletin GEC-851.

New G-E program boosts electronics in industry

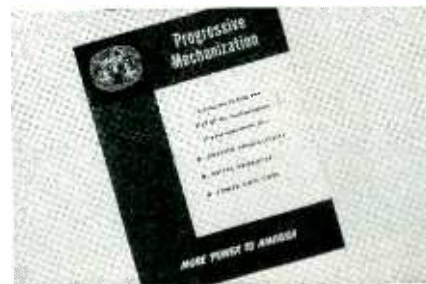

"Progressive Mechanization," a new G-E More Power to America program, has just been launched. Consisting of a color movie and an authoritative manual, its aim is to help step up industry's mechanization. One expected result is an expansion of the market for electronic controls. For details on this program which may mean added business for you, check Bulletin GEA-5789.



EQUIPMENT FOR ELECTRONICS MANUFACTURERS

Components

Meters, Instruments
Dynamotors
Capacitors
Transformers
Pulse-forming networks
Delay lines
Reactors
Thyrite*
Motor-generator sets
Inductrols
Resistors
Voltage stabilizers

Fractional-hp motors
Rectifiers
Timers
Indicating lights
Control switches
Generators
Selsyns
Relays
Amplidyne
Amplistats
Terminal boards
Push buttons
Photovoltaic cells
Glass bushings

Development and Production Equipment

Soldering irons
Resistance-welding control
Current-limited high-potential tester
Insulation testers
Vacuum-tube voltmeter
Photoelectric recorder
Demagnetizers

*Reg. Trade-mark of General Electric Co.

General Electric Company, Section A667-22
Schenectady 5, New York

Please send me the following bulletins:

Indicate: for reference only
 X for planning an immediate project

- GEA-5777 Drawn-Oval Capacitors
 GEA-5789 Progressive Mechanization
 GEC-851 Analog Field Plotter
 GEC-898 DC Voltage-Measuring Reactor

Name.....

Company.....

City..... State.....

Maybe you've noticed
how much of today's
best equipment
uses

SHALLCROSS

precision

WIRE-WOUND RESISTORS

Accuracy from $\pm 1.0\%$ to 0.01% as required

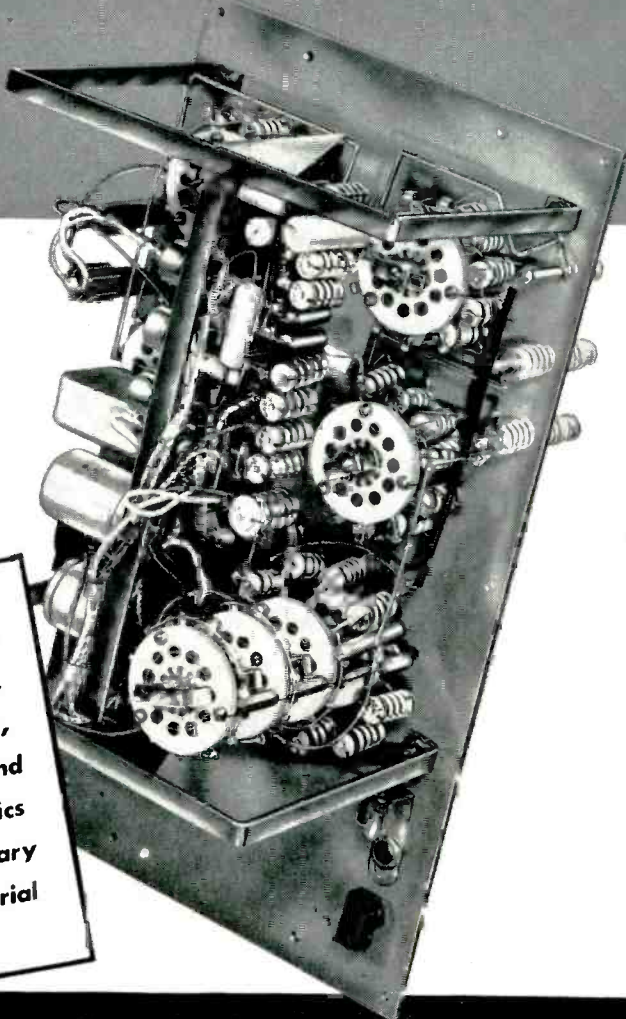

The largest,
most complete
line of types,
shapes, sizes,
mountings and
characteristics
for all military
and industrial
uses.

SHALLCROSS MANUFACTURING COMPANY

Collingdale, Pa.

jacket that there is no possibility of any of it falling out of the capacitor along the plane of rupture.

To bring about electrical contact with the inner conductor, the jacket and the insulation have to be removed over part of the length of the capacitor. This affords an opportunity to give the capacitor exactly the desired value by removing just as much of the jacket as necessary to reach the particular value of capacitance.

In practice, the jacket is removed by electrolytic etching with the jacket serving as anode. One hundred of the capacitors at a time are immersed in the etching bath to a depth corresponding to the length of jacket to be removed. A voltage is then applied between all the jackets and an electrode placed in the bath.

The current passing through the bath is continuously controlled. By the time the metal of the jacket has dissolved, the current has dropped practically to zero. The inner conductor of the capacitor cannot act as an electrode because it is insulated from the outer conductor. The insulating material is so firmly compressed during the drawing process that after the outer jacket has been etched off, it does not of itself break away from the inner conductor but has to be removed separately. After the etching proc-

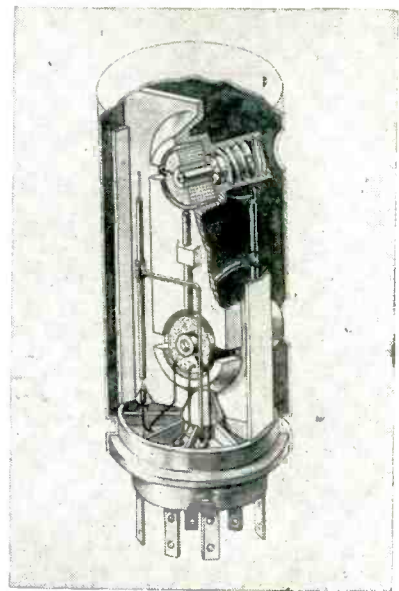

Wire capacitor as used in an i-f transformer. The capacitor may be seen on the left and right sides

TYPE "SNAPPER" THERMAL TIME DELAY RELAY

FEATURES . . .

Snap action. Small size.
Light weight. Low operating temperature. Operates in any position. High contact rating. Gas filled. Consistent timing. Mechanical structure insures durability and long life.

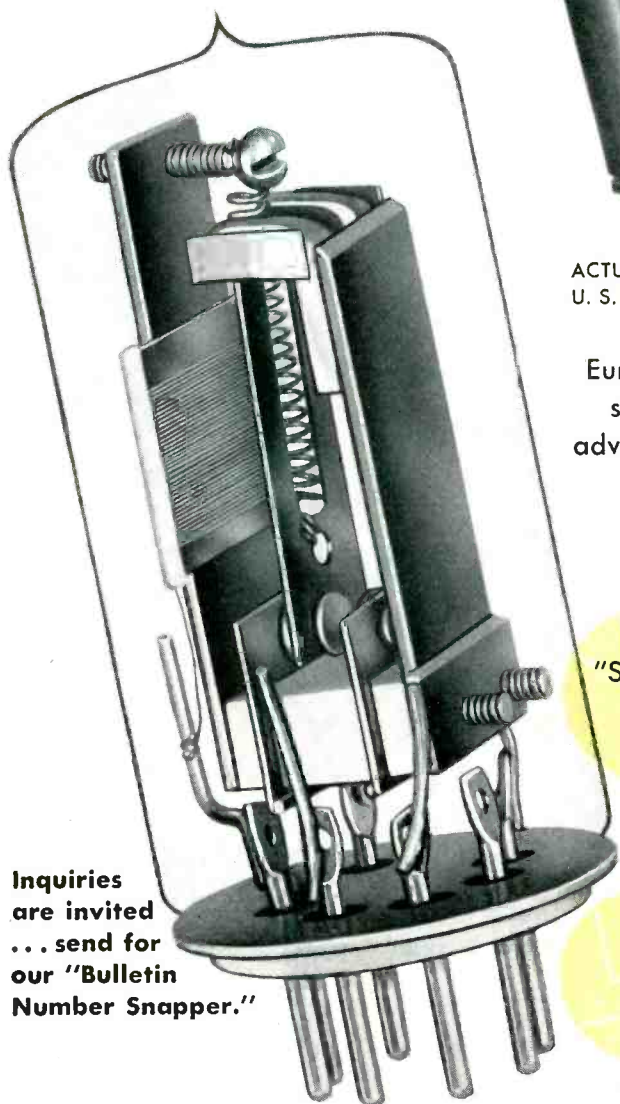

Inquiries are invited . . . send for our "Bulletin Number Snapper."



"TEST AFTER TEST IT'S THE BEST"
EUREKA PRESENTS
POSITIVE
SNAP ACTION

ACTUAL SIZE
U. S. PATENTS APPLIED FOR

Eureka's "SNAPPER" incorporates the most radical forward step in the history of THERMAL TIME DELAY RELAYS with the advent of "POSITIVE SNAP ACTION". . . With this action the ELIMINATION OF CHATTERING is accomplished . . .

The various uses for a THERMAL TIME DELAY RELAY have been increased manifold with the incorporation of a "SINGLE POLE DOUBLE THROW" feature. Due to its versatility, the "SNAPPER" relay can be manufactured to suit required needs.

VOLTAGE: 6.3, 26.5 and 115 volts (A.C. or D.C.) or as required. AMBIENT TEMPERATURE RANGE: - 60°C. to + 80°C. ENVELOPE: Miniature, or octal metal; glass upon request. All have identical operating characteristics.

TIME DELAY PERIODS: Preset from 2½ seconds and up.
VACUUM: Evacuated, inert gas filled producing an arc quenching atmosphere.
HEIGHT: 1¾" max. seated.

EUREKA TELEVISION AND TUBE CORPORATION

Manufacturers of Cathode-Ray Tubes and Electronic Products

69 Fifth Avenue, Hawthorne, New Jersey • Telephone Hawthorne 7-3907

BRASS
for "Bridgeport" Service
CO.



BRIDGEPORT WAREHOUSE SERVICE

The Bridgeport warehouses are designed to supply from stock limited quantities of sheet, rod, wire or tubing. It is the policy of the company to maintain adequate warehouse stocks at all times so that small orders can be filled without delay.

The fabricator is in a position to obtain promptly metal to fill orders for experimental work or to start production runs, while waiting for mill shipments.

Bridgeport warehouses make every effort to carry the variety of alloys, sizes and gages which fulfill the requirements of the locality they serve.

To take care of the maximum range of widths of strip metal, slitting service is available—not only to serve warehouse stocks, but also to make customers' stocks of non-ferrous strip metal more flexible.

Bridgeport's Warehouse Stocklist carries weight tables and a technical digest giving the properties of the most popular copper-base alloys. If you do not have a copy, ask your nearest Bridgeport office.

**Mills in Bridgeport, Conn. and Indianapolis, Ind.
In Canada: Noranda Copper and Brass Limited, Montreal**

BRIDGEPORT BRASS COMPANY



30 GRAND STREET, BRIDGEPORT 2, CONNECTICUT



HERMETICALLY SEALED

Diameter.....3/16" to 1-1/4"
 Length.....9/16" to 10"
 Current: half-wave...1.5 ma to 60 ma
 Voltage: DC output.....20 volts to 4,000 volts

PHENOLIC CARTRIDGE

Diameter.....1/8" to 1"
 Length.....1/2" to 12"
 Current: half-wave...1.5 ma to 60 ma
 Voltage: DC output.....20 volts to 10,000 volts



SELENIUM DIODES

Diameter.....0.100" to 0.300"
 Length.....0.210" to 0.250"
 Output Voltage.....20V to 80V
 Output Current...200 ua to 1.5 ma
 Temperature Range...-50°C to 100°C



Selenium

Rectifiers



A recent month's production included Rectifiers to supply 40 microamperes, 1,000 volts, and Rectifiers with a capacity of 140,000 amperes, 14 volts.

POWER STACK

60 Kw DC Power

Considered to be the largest single selenium rectifier stack produced.

Owned and managed by Engineers who are specialists in the design and manufacture of Selenium Rectifiers. Submit your problems for analysis and we will be glad to offer our recommendations.

INTERNATIONAL RECTIFIER

C O R P O R A T I O N

General Offices: 1521 E. Grand Ave., El Segundo, Calif. • Phone: El Segundo 1890
 Chicago Branch Office: 205 West Wacker Drive • Phone: Franklin 2-3889

40.109
240.65
1174.6
20000.
-OR ANY OTHER

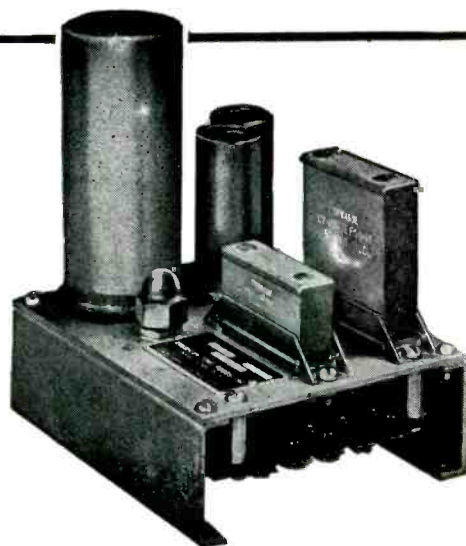

precision

FREQUENCY

FROM 40 TO 20,000 CYCLES

CONSERVATIVE ACCURACY UNDER USUAL CONDITIONS
1 PART IN 100,000—(.001%)

CALIBRATED AGAINST A STANDARD
ACCURATE TO 1 PART IN 10-MILLION

The basic unit of this frequency standard is an electronically driven fork,—temperature compensated and hermetically sealed against changes of humidity and barometric pressure. Through its use, any frequency or multi-frequencies between 40 and 20,000, fractional or otherwise, are obtainable.

Have you a need for any specific number of cycles in precision frequencies?

Can a source of such frequency solve your design problem or increase its factor of safety?

Have you a system that requires great accuracy, stability and dependability?

The frequencies shown at the top of the page are but a few among hundreds furnished for precision application in industries, laboratories and Government departments.

**OUR ENGINEERS
ARE AVAILABLE
TO COOPERATE
ON ANY PROBLEM**

American Time Products, Inc.

580 Fifth Avenue

New York 19, N. Y.

MANUFACTURING UNDER PATENTS OF WESTERN ELECTRIC CO.

ess, the capacitors are washed in water to remove any traces of the etching medium.

An entirely different method of removing the jacket is to shave it off with a lathe. For this purpose, a special lathe has been designed which is characterized by the fact that the cutter rotates while the capacitor is clamped close up against the cutter. The capacitor is centered in the lathe by means of a diamond cutting die, while a diamond cutter shaves off the jacket over the length necessary.

The capacitance is measured while the jacket is being shaved off and as soon as it reaches a value within the required tolerances, the rotating cutter is stopped automatically. By this shaving process, it is possible to reach a tolerance of 0.2 percent in capacitance. By the etching method the degree of accuracy is not as high.

Applications

The wire capacitor has been developed for use in i-f transformers consisting of two mutually magnetically coupled L-C circuits. The two coils are wound directly on a core of Ferroxcube, a ceramic material with high permeability. In these transformers, the small wire capacitors have replaced the large mica capacitors.

Simple high-frequency tuning circuits also are applicable for wire capacitors. These consist of a small coil with a movable Ferroxcube core and a wire capacitor. By screwing the core in or out of the coil, it is possible to vary the resonant frequency of the circuit. This device replaces the conventional tuning circuits built up from one or more coils and one or more variable capacitors.

Graphical Aids to Broadcasting

By A. E. RICHMOND

Consulting Engineer
Portland, Oregon

ALTHOUGH MUCH graphical and tabular data have been published relative to the design of electronic equipment, the use of graphical information in the operation of equipment is not too common. Graphical operating devices have several advantages over the more

THE SIMPSON MODEL 260 VOLT-OHM-MILLIAMMETER

*outsells all others combined
because . . .*

- A covers all ranges necessary for Radio and TV set testing
- B includes the Simpson 50 Microampere Meter Movement known the world over for its ruggedness
- C no bulky harness wiring, thus eliminating all intercircuit leakage at this high sensitivity
- D molded recesses for resistors, batteries, etc.
- E easy battery replacement
- all components — including case and panels — are specially designed and completely tooled for maximum utility . . . not merely assembled from stock parts

ranges 20,000 Ohms per Volt DC,
1,000 Ohms per Volt AC
Volts, AC and DC: 2.5, 10, 50,
250, 1000, 5000
Output: 2.5, 10, 50, 250, 1000
Milliamperes, DC: 10, 100, 500
Microamperes, DC: 100
Amperes, DC: 10
Decibels (5 ranges):
- 12 to +55 DB
Ohms: 0-2000 (12 ohms
center), 0-200,000 (1200 ohms
center), 0-20 megohms
(120,000 ohms center)

SIMPSON ELECTRIC COMPANY

5200 W. Kinzie St., Chicago 44 Phone COlumbus 1-1221

In Canada: Bach-Simpson, Ltd., London, Ont.

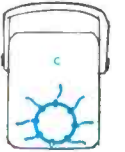

BURTON BROWNE ADVERTISING

prices

Model 260 \$38.95;
With Roll Top \$46.90.
Complete with test
leads and operator's
manual. 25,000 volt
DC Probe for use with
Model 260, \$9.95.



**Get the whole
story about**

Typical group of Sylvania
electronic components.
What do you need?

SYLVANIA ELECTRONIC COMPONENTS

Sylvania provides highest quality electronic components for radio, television and other electronic equipment . . . at lowest prices.

New plant facilities and improved methods now enable Sylvania to provide you with highest quality electronic components for every need . . . when you need them.

Typical examples of Sylvania components in-

clude hundreds of diversified items such as: *Terminal Strips and Boards; JAN Sockets; Radio Tube, Cathode Ray Tube and Power Tube Sockets; Fuse Holders; Plugs and Connectors.*

To be sure of the finest possible quality . . . put your component problems up to Sylvania. We welcome your inquiries addressed to: Sylvania Electric Products Inc., Dept. A-1010. Warren, Pa.



SYLVANIA



RADIO TUBES; TELEVISION PICTURE TUBES; ELECTRONIC PRODUCTS; ELECTRONIC TEST EQUIPMENT; FLUORESCENT TUBES, FIXTURES, SIGN TUBING, WIRING DEVICES; LIGHT BULBS; PHOTOLAMPS; TELEVISION SETS



One World ...

ONE

Nichrome

"One World." All over the globe, men have come to acknowledge this unique concept as the most effective basis for solving innumerable problems related to human progress.

"One Nichrome." All over the globe, men have come to acknowledge this unique alloy as the most effective means for solving a host of problems also related to human progress—in the fields of engineering and production.

This being so, we take particular pride in our trademark: NICHROME—granted solely and wholly to us by the United States Patent Office forty-three years ago. Representing a series of superb electrical heating and resistance alloys, developed and produced *only* by Driver-Harris, it symbolizes top quality and utmost dependability to manufacturers everywhere.

**T. M. Registered
in United States
Patent Office by
Driver-Harris Company
August, 1908*



World-Famous **Nichrome** is produced only by

Driver-Harris Company

HARRISON, NEW JERSEY

BRANCHES: Chicago, Detroit, Cleveland, Los Angeles, San Francisco

Manufactured and sold in Canada by The B. GREENING WIRE COMPANY, LTD., Hamilton, Ontario, Canada
Factories: U. S. A., CANADA, ENGLAND, IRELAND, FRANCE, ITALY, SPAIN Representatives in 38 COUNTRIES

MAKERS OF THE MOST COMPLETE LINE OF ELECTRIC HEATING, RESISTANCE, AND ELECTRONIC ALLOYS IN THE WORLD

NEW MOTOROLA 460 Mc. with A.F.C.

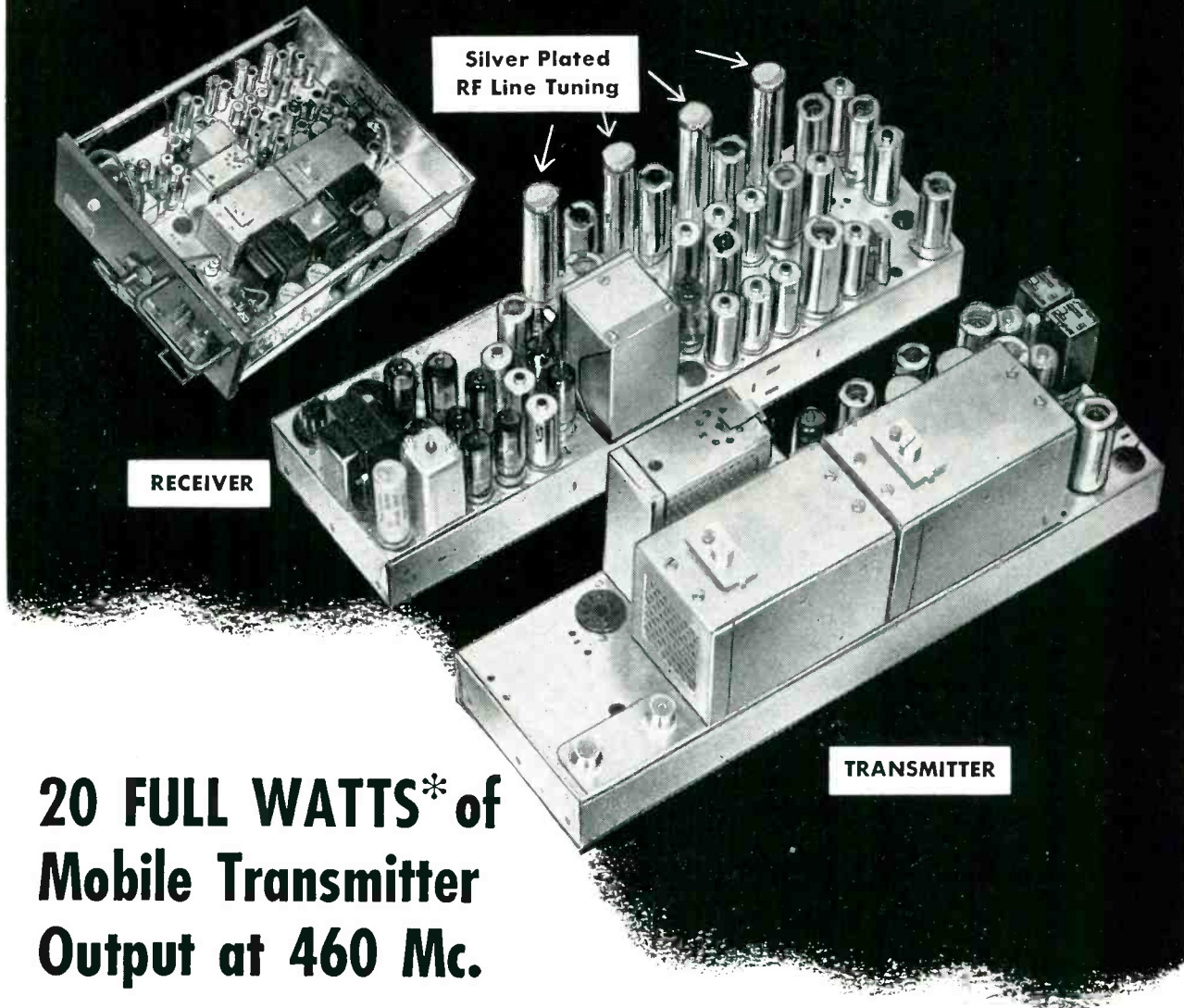

20 FULL WATTS* of Mobile Transmitter Output at 460 Mc.

AUTOMATIC FREQUENCY CONTROL

Motorola's new crystal controlled A.F.C. system provides positive barriers so that the receiver cannot jump to a strong adjacent channel signal.

This new Motorola A.F.C. technique is fortified with extraordinary system stability. The A.F.C. crystal controlled oscillator provides a full 10 to 1 correction ratio and keeps the receiver tuned on the nose to the distant transmitted carrier.

The new U. H. F. tuned circuits and research design cavities for ground grid amplifier operation provide phenomenal circuit stability, spurious rejection and extraordinary efficiency.

TRANSMITTER

The Motorola 460 Mc. system with 9 tuned circuits provides 18* to 20* Watts with *Efficiencies of more than 65%!*

SILVER PLATED SEALED TUNED CAVITIES

By use of silver plated line sections, high standards of selectivity protect the receiver from high power U.H.F., TV intermodulation.

Motorola

Communications & Electronics Division
4545 Augusta Blvd., Chicago 51, Illinois
Rogers Majestic Electronics Ltd., Toronto, Canada

Table 1—Operating Currents for Array of Fig. 1

Tower Number	Normal Current (amp)	Normal Ratio to Tower 1 Current
1	2.1	1
2	1.5	0.714
3	2.8	1.333

customary slide-rule or pencil-and-paper methods. In particular, the graphs are made especially for the job and can be made more accurate and convenient than other rapid methods.

As examples, this article presents two easily prepared aids to the broadcast-transmitter operator. The graphs are to be prepared individually for the particular values anticipated in each case.

Figure 1 shows a method of determining almost instantly whether or not the ratios of currents within a directional array are within their required five-percent tolerance. This sort of graph is especially useful where several towers are used, although to avoid confusion not more than about two other currents should be compared with the reference current on any one sheet. Figure 1 applies to an array having the normal operating currents given in Table I.

It is a simple matter to determine

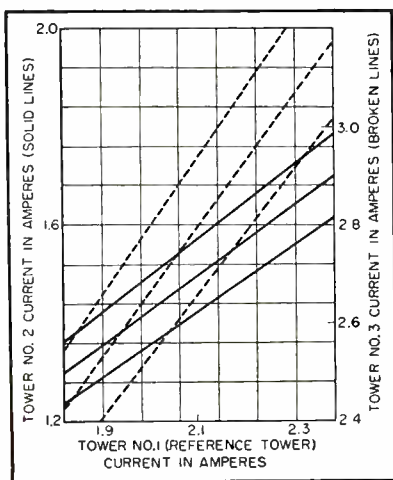
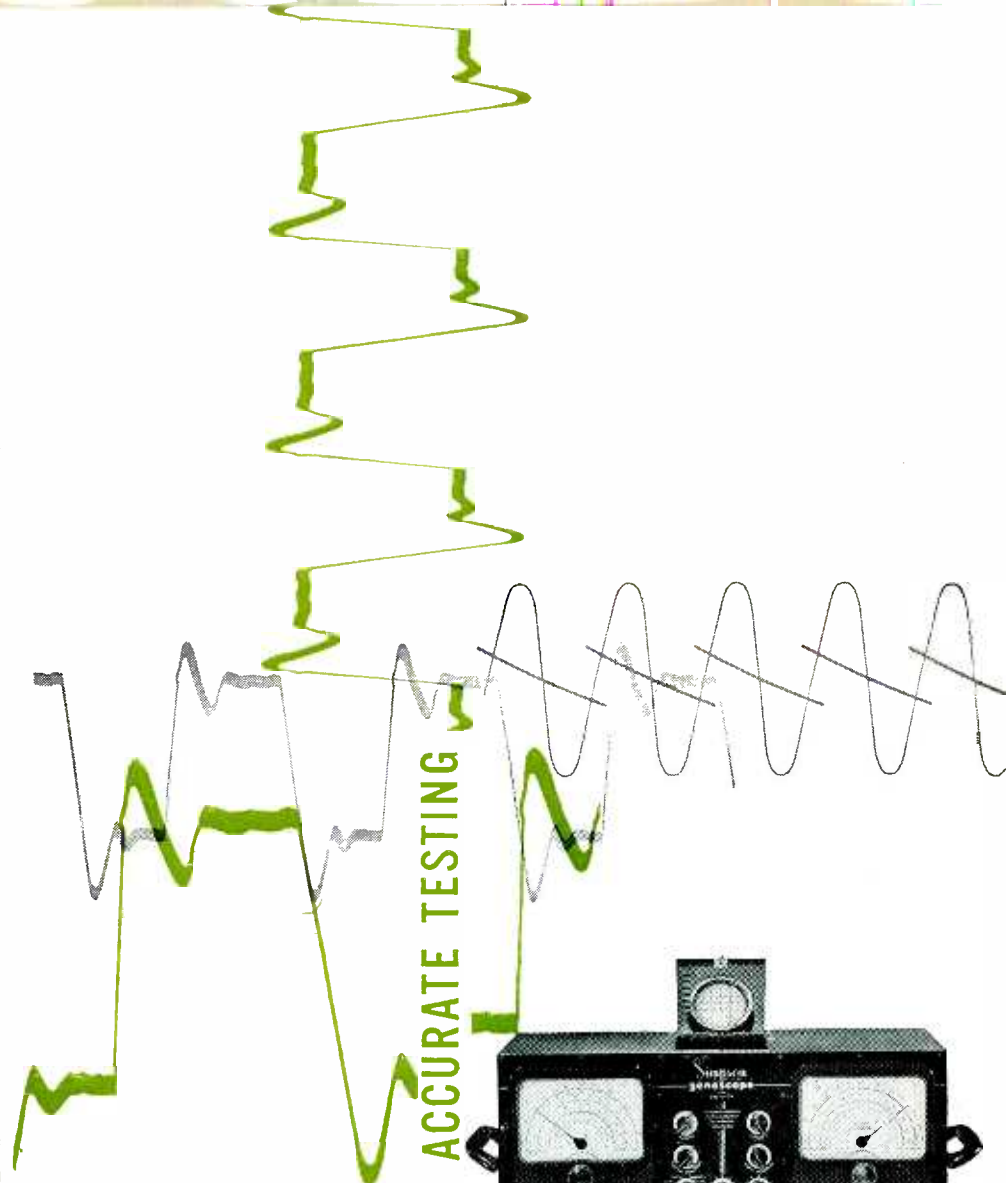

FIG. 1—Sample graph for checking ratios of currents in different towers of broadcast directional antenna



SIMPSON MODEL 480 GENESCOPE FOR ACCURATE TESTING

approved by
service managers of:

- admiral*
- zenith*
- motorola*
- emerson*
- hoffman*
- hallicrafters*

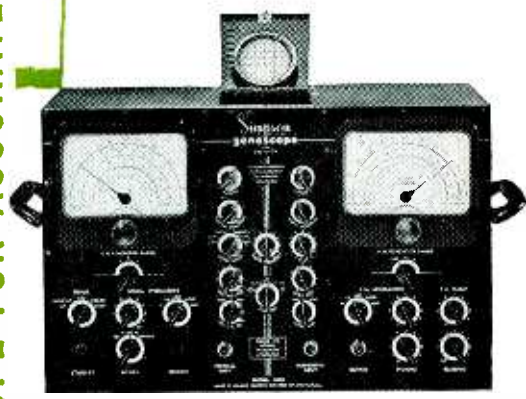

- All the necessary signal sources for alignment of FM and TV receivers • Includes the Simpson High Sensitivity Oscilloscope and high frequency crystal probe for signal tracing • Independent, continuously variable attenuators and step attenuators for both AM and FM units offer complete control of output at all times • 0.15 megacycle sweep is provided by a noiseless specially designed sweep motor based on D'Arsonval meter movement principles • The exclusive Simpson output cable (illustrated) includes a variable termination network, quickly adapted to provide open, 75 or 300 ohm terminations — the addition of a pad provides attenuation and isolation Use of appropriate resistors across certain terminals will provide any other termination required. A .002 MFD blocking condenser can be added on any termination for use on circuits containing a DC component • The FM generator output voltage is constant within .2 DB per MC of sweep.

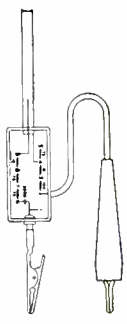

dealer's net \$395.00

SIMPSON ELECTRIC COMPANY

5200 W. Kinzie St., Chicago 44, Illinois • Phone: COLUMBUS 1-1221 • In Canada: Bach-Simpson, Ltd., London, Ont.

BETTER CONTROL OF COPPER OR ALLOY BRAZING WITH LITTON HYDROGEN FURNACE

Litton Model 4400 Vertical Hydrogen Furnace is designed for easily observed, accurately controlled production-line brazing of assemblies up to 6½" in diameter and 12" in length. Brazing is performed in a hydrogen atmosphere and work can be inserted into the open bottom either mechanically or hydraulically. Operating temperature range permits copper brazing as well as all types of gold-copper and silver alloy brazing.

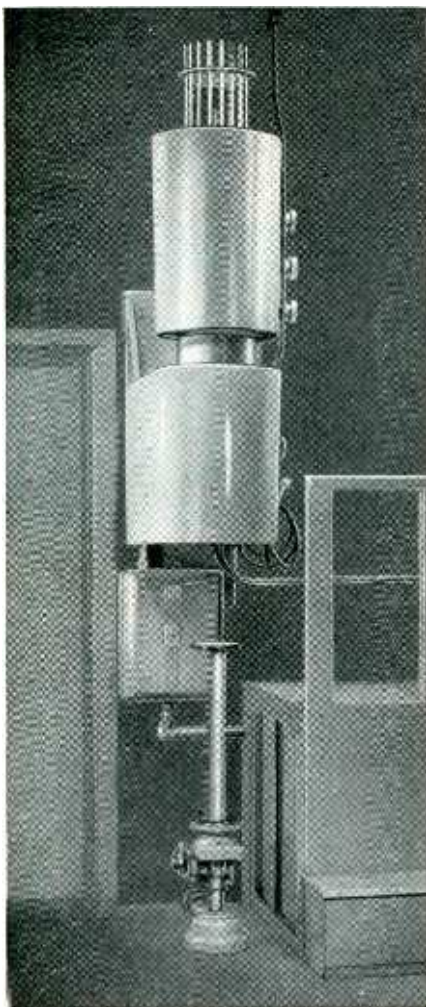

Model 4400 Furnace is divided into two chambers. The upper or brazing chamber is equipped with radiant heating for maximum flexibility. The lower or cooling chamber permits rapid cooling to the freezing point of the metal or alloy. The heating chamber has an inconel inner wall surrounded by 3" of thermal insulation. Two replaceable pyrex windows permit a clear view of the work during the heating cycle. Tungsten heating rods are spring-loaded to preserve tautness, and may be easily replaced. The cooling chamber is a double-walled cylinder of stainless steel within which water is circulated.

In operation, work is raised into the upper chamber, heated at the desired rate or rates, and immediately lowered into the cooling chamber. Since power is applied only during the heating cycle (normally less than one-third of loading, heating and cooling time), power consumption is minimized.

SPECIFICATIONS—MODEL 4400 VERTICAL HYDROGEN FURNACE

Work diameter, max.	6½"
Work length, max.	12"
Temperature, max.	1250°C
Voltage to maintain 1250°C . . .	Approx. 22v
Kva to maintain 1250°C . . .	Approx. 23 kva
Overall height	75"
Overall diameter, heater . . .	17"
Overall diameter, cooler . . .	12"
Heater elements: 15 Tungsten rods, .050" dia. x 40" long, connected in parallel.	
Time to raise furnace and work to 1000°C:	Approx. 17 minutes.

GLASS BAKING OVENS

Litton Glass Baking Ovens are circular and easily mount in any exhaust position. Heating is by Calrod units and



ovens are designed for continuous operation at 500°C. Oven models 2, 3 and 4 can be operated in either series or parallel. Ovens range from 5" to 12¾" in diameter, and 12" to 18" in length. Complete details and prices for all models will be supplied on request.

MODEL 5301 BELL JAR

For smaller brazing problems, Litton table-top Bell Jars offer maximum convenience and speed. Visibility through the all-glass jar simplifies alignment and positioning of the work. Vertical movement of the bell is lightened by a counterweight inside the supporting column. Work stand height is variable, and the heater rod can be adjusted and locked in position.



SPECIFICATIONS—MODEL 5301 BELL JAR

Base	11½" x 16½"
Column height	56¾"
Heater stand, height	23½"
Heater stand arm (extended length)	10¾"
Heater stand, vertical travel	12"
Work stand extensions	2", 4", 6", 8" and 12"
Jar diameter	12"
Height	24"
Travel of jar	28½"

Prices, delivery information on request.

LITTON INDUSTRIES

2538 SAN CARLOS, CALIFORNIA, U. S. A.



DESIGNERS AND MANUFACTURERS of:

Glassworking Lathes and Accessories, Vertical Sealing Machines, Burner Equipment, Precision Spotwelders, Oil Vapor Vacuum Pumps, Glass Baking Ovens, Vacuum Tubes and Tube Components, Magnetrons, High Vacuum Molube Oil, Microwave Equipment.

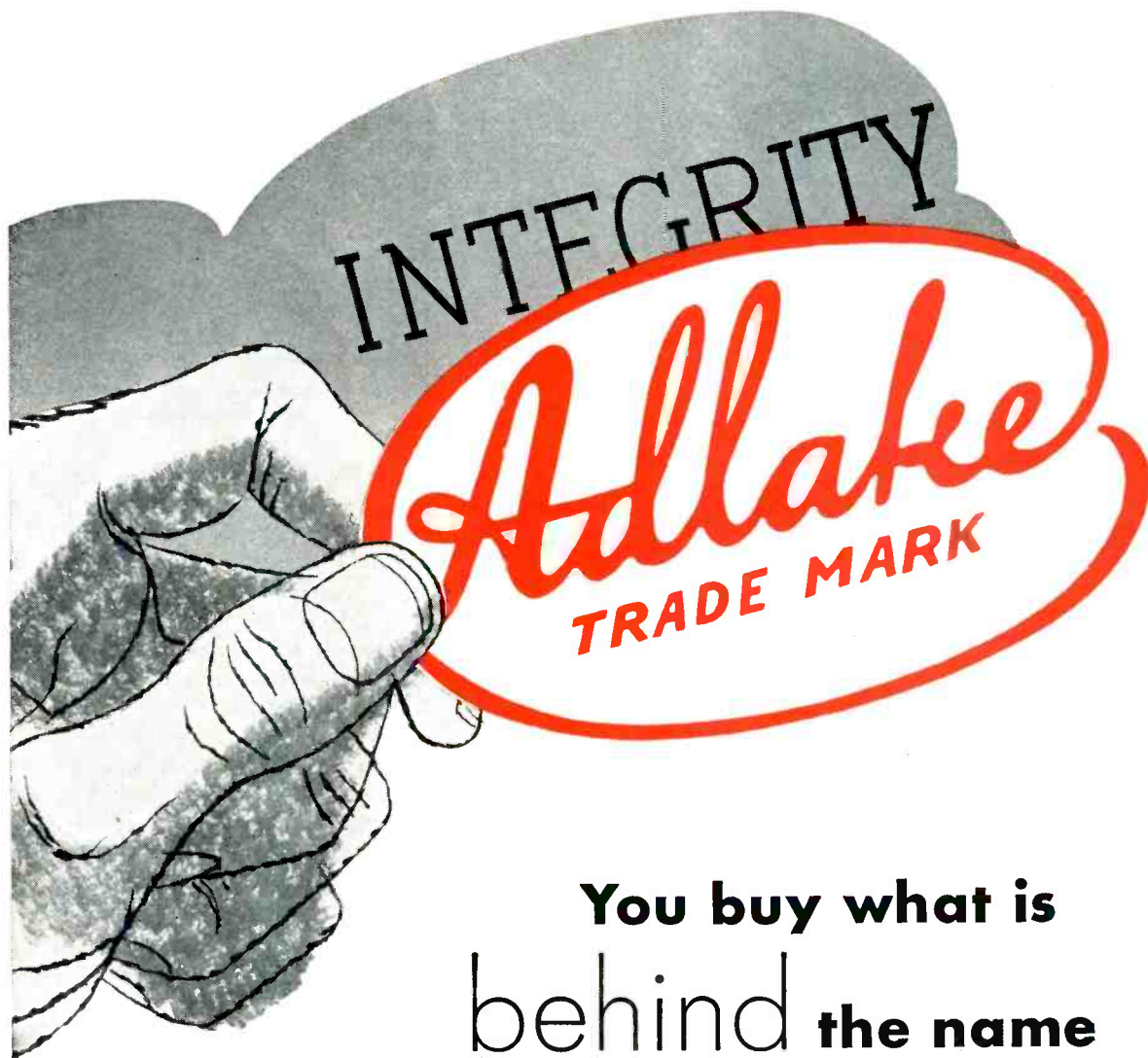

You buy what is behind the name

When you buy an ADLAKE product, you receive something with it that never shows up on an invoice . . . the integrity of the manufacturer.

Integrity is made up of many things. In the case of The Adams & Westlake Company, it's a combination of

- **Experience** Almost a century of manufacturing know-how is behind each ADLAKE product.

- **Facilities** A modern manufacturing plant covering 10 acres with an unequalled staff

of specialists to maintain the high level of ADLAKE workmanship.

- **Good Faith** ADLAKE's policy has always been to keep faith with its customers. For that reason, no effort is spared to make sure that every purchaser gets precisely what he bargained for and that he is always satisfied.

This integrity is an integral part of every ADLAKE Mercury Relay . . . as thousands of dependable, economical installations in an amazing variety of industries will testify!

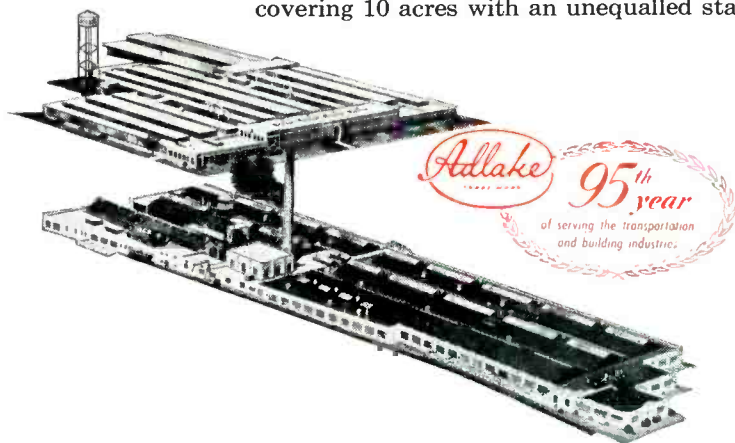

THE Adams & Westlake COMPANY

Established 1857 • ELKHART, INDIANA • New York • Chicago

Manufacturers of
Hermetically Sealed ADLAKE Relays



you don't have to keep a cow!

Your local market has fresh milk. Meat and vegetables, too. You don't have to send to the fruit groves for oranges, the packers for steaks, the farm for potatoes.

MILO is your supermarket for electronic components and test equipment. Why send separate purchase orders to a dozen factories? If you use the dependable lines, the standards of the industry, get them from MILO. Everything you need. In stock! Else our purchasing expeditors get the goods faster than an electronic milker.

Specify **AEROVOX, C-D, MALLORY, SANGAMO; GE, HYTRON, RAYTHEON, RCA, SYLVANIA, TUNG-SOL, WESTINGHOUSE**—and get what you ordered.

Consider your hidden costs. Of processing the purchase orders, writing or phoning a dozen places, of handling a dozen shipments, the possibility of a half dozen headaches.

You can do better at MILO. One call, one order, one shipment, one bill. And let us have the half a headache.

CHECK LIST (E-O) of LEADING BRANDS IN STOCK

SPECIFY:

Eitel-McCullough
Erie
General Cement
General Electric
Guardian Electric
Hallicrafter

Hammarlund
Hickok
Hytron
ICA
IRC
E. F. Johnson
Kester

Kings Electronics
Littelfuse
Mallory
Meissner
James Millen
National Company
Ohmite

JAN-APPROVED COMPONENTS

FREE CATALOG!

Chief Engineers, Purchasing Agents, Qualified Executives! Write now on your company letterhead for MILO's edition of the 1953 Master. Please address Dept. E-10.

the **ONE** source for **ALL** your electronic needs

MILO RADIO & ELECTRONICS CORP.
200 GREENWICH STREET, NEW YORK 7, N. Y. • Phone BEekman 3-2980
Teletype NY1-1839 • Wire MILO-WUX-N.Y. • Cable MILOELECTRO-N.Y.

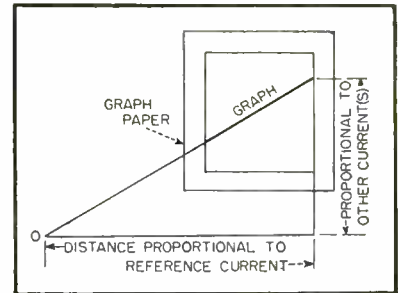

FIG. 2—Method of preparing graphs of type shown in Fig. 1

whether or not the currents have ratios within their tolerances if the reference current remains constant. With a graph of this kind, however, the operator is prepared to meet quickly the more probable situation wherein the reference current changes simultaneously with the other currents.

Figure 1 depends for its design upon the proportional relationships between the sides of similar triangles. Each graph is a segment of the hypotenuse of a right triangle, the base and altitude of which are proportional, respec-

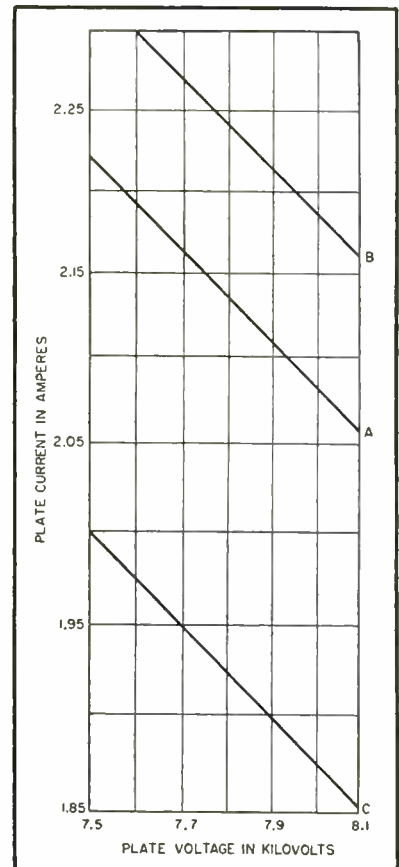
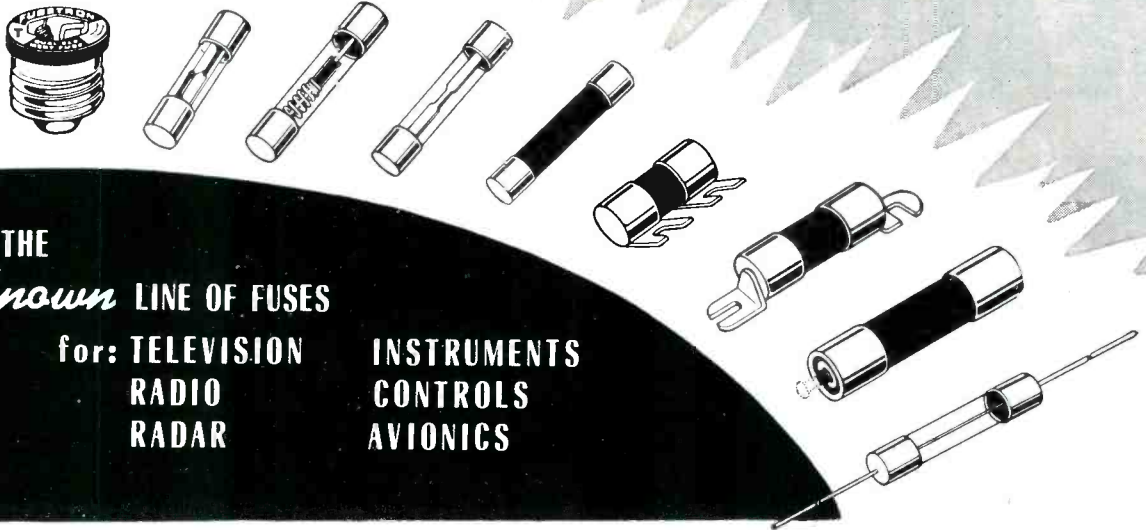

FIG. 3—Rapid determination of input power to transmitter final amplifier

BUSS FUSES

**Help Protect Your Product . . .
Your Profit . . . Your Reputation**



THE
Known LINE OF FUSES

for: TELEVISION
RADIO
RADAR

INSTRUMENTS
CONTROLS
AVIONICS

38 year's service to American homes, farms and industry is behind every fuse that bears the BUSS trademark. Your customers have confidence in BUSS . . . they know the BUSS name represents fuses of unquestioned high quality.

To maintain this high standard each and every BUSS fuse is tested in a highly sensitive electronic device that rejects any fuse that is not correctly calibrated — properly constructed and right in physical dimensions.

It's easy to select a BUSS fuse that's right for your fuse application. The complete BUSS line includes: Dual Element (Fusetron slow blowing type fuses), Renewable and One-Time types — available in all standard sizes, and many special sizes and designs.

IF YOU HAVE A PROTECTION PROBLEM
— We welcome requests for help in selecting the fuse or fuse mounting best suited to your conditions. Submit sketch or description showing type of fuse contemplated, number of circuits, type of terminals, and the like. Our staff of fuse engineers is at your service.

For More Information
CLIP THIS HANDY COUPON NOW . . .

BUSSMANN MFG. CO., Division McGraw Electric Company
University at Jefferson St. Louis 7, Mo.

. . . Plus
**A COMPLETE LINE OF FUSE CLIPS,
BLOCKS AND HOLDERS**

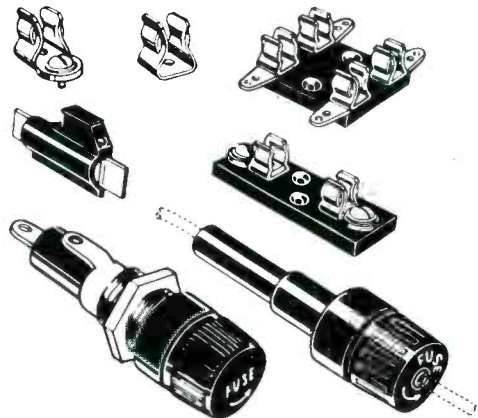

BUSSMANN Mfg. Co. (Division of McGraw Electric Co.)
University at Jefferson, St. Louis 7, Mo.

Please send me bulletin SFB containing complete facts on BUSS small dimension fuses and fuse holders.

Name.....

Title.....

Company.....

Address.....

City & Zone..... State..... ELRC-1052

TOPS IN HERMETIC SEALING

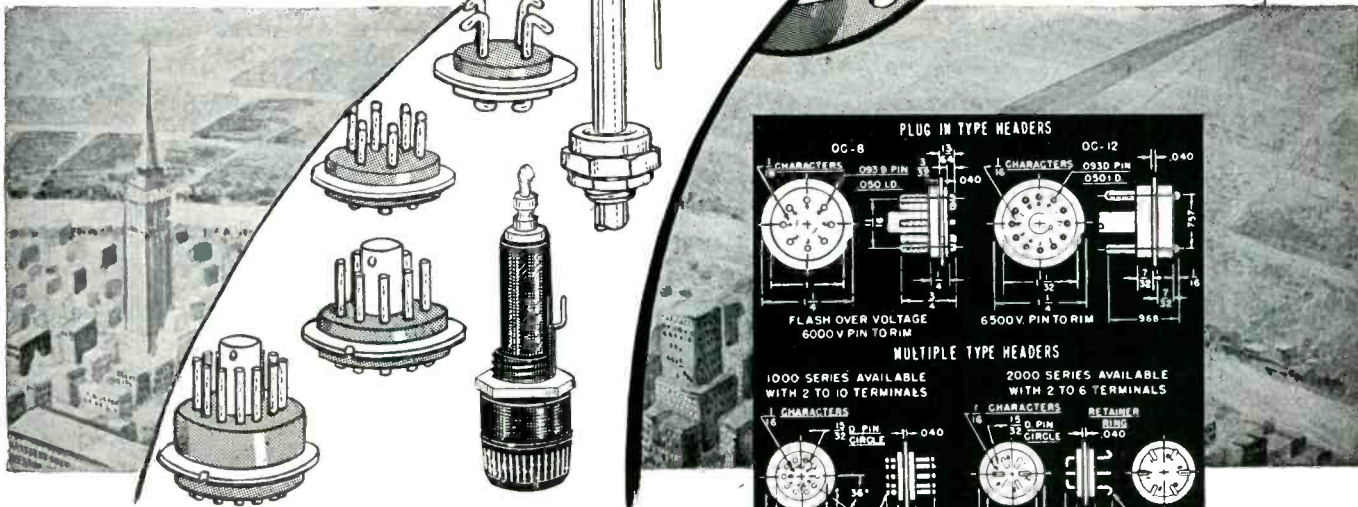

NEO-SIL HERMETIC SEAL TERMINALS — Applicable on MIL requirements. Will withstand thermal shock, vibrations, mechanical strains, and excessive pressures with no impairment of the seal or other functional characteristics. E-3LW terminals are now being used at 1000 psi static oil pressure and undergo 5000 psi tests for two minutes.

NEO-SIL OCTAL TYPE PLUG IN HEADERS — Applicable for MIL requirements. These units can undergo sustained vibrations, large temperature changes, and other strains without impairment to the seal or other functional characteristics. Available with eight and twelve pins.

NEO-SIL MULTIPLE PIN HEADERS — Applicable for MIL requirements. Presently being used on MIL-T-27 transformers. These units are available with 2 to 10 pins. These units can undergo conditions mentioned above with no impairment to the seal or other characteristics.

NEO-SIL FUSE HOLDERS, HERMETICALLY SEALED — Available for 3-AG and 4-AG fuses. These units are completely sealed from moisture with or without the cap or fuse inserted. They are applicable on pressurized and gas filled components.

NEO-SIL CABLES, HERMETICALLY SEALED — The cables are hermetically sealed at the plug on thru to the panel.

NEO-SIL ROTARY WATERSEAL PANEL ASSEMBLIES — These units have an excellent seven year customer history on gas filled pressurized components. They are available for 1/4" shafts and for potentiometers and switch bushings.

NEO-SIL LINE CORDS WITH PLUGS FOR EUROPEAN USE, HERMETICALLY SEALED — These units are completely sealed at the plug and are being used on pressurized units.

NEO-SIL GASKETS, METER, PANEL, COVER, ETC. — Molded from Neoprene for complete sealing.

NEO-SIL ADAPTERS, U. S. TO EUROPEAN, AFRICAN, SOUTH AMERICAN SOCKETS — Our 200A and 300A together will adapt virtually all standard plugs, sockets, and lamp sockets of the above mentioned areas.

NEO-SIL COIL FORMS, CRYSTAL CONTACTS, and other molded bakelite and Neo-Sil rubber units.

We welcome your inquires on any phase of design, development or production.

PLUG IN TYPE HEADERS

OC-8 1 CHARACTER 0.080 PIN 0.050 I.D. 0.040

OC-12 1 CHARACTER 0.050 PIN 0.050 I.D. 0.040

FLASH OVER VOLTAGE 6000V PIN TO RIM

6500V PIN TO RIM

MULTIPLE TYPE HEADERS

1000 SERIES AVAILABLE WITH 2 TO 10 TERMINALS

2000 SERIES AVAILABLE WITH 2 TO 6 TERMINALS

1 CHARACTER 0.080 PIN 0.040

1 CHARACTER 0.050 PIN 0.040

FLASH OVER VOLTAGE 6500V PIN TO RIM

6500V PIN TO RIM

NEO-SIL HERMETIC SEALS INDIVIDUAL TYPE TERMINALS

E-1 2500V

E-3 5500V

E-4 5500V

FLASH OVER VOLTAGE 2500V 5500V 5500V

TEST DATA

The result of the Electrical Testing Laboratories Inc., Report #330655, dated March 18, 1949, on this material shows the following:

Volume Resistivity at 800 Volts d-c
Room Temperature 25°C R.H. 30 percent
Megohm-inches ohm-centimeters
1.4 x 10⁶ 3.5 x 10¹²

Dielectric Constant and Dissipation Factor

Dielectric Constant	Dissipation Factor	Loss Factor
9.22	@ 60 cycles per second .058	5.32
6.17	@ 1 megacycle per second .0455	.28
5.35	@ 50 megacycles per second 0.20	1.1

Dielectric Strength at 60 cycles
Volts per mil — 370

Durometer Average — 80 ± 5
Temperature — Rated as a Class A material conservatively + 175° to -70° centigrade.

The Flashover Voltage indicated were taken at a temperature of 68° Fahrenheit, and 47% Relative Humidity.



26 CORNELISON AVE., JERSEY CITY 4, N. J.

BALLANTINE

STILL THE FINEST

in

ELECTRONIC VOLTMETERS

Ballantine pioneered circuitry and manufacturing integrity assure the maximum in
SENSITIVITY • ACCURACY • STABILITY

- All models have a single easy-to-read logarithmic voltage scale and a uniform DB scale.
- The logarithmic scale assures the same accuracy at all points on the scale.
- Multipliers, decade amplifiers and shunts also available to extend range and usefulness of voltmeters.
- Each model may also be used as a wide-band amplifier.



MODEL 310A

MODEL	FREQUENCY RANGE	VOLTAGE RANGE	INPUT IMPEDANCE	ACCURACY	PRICE
300	10 to 150,000 cycles	1 millivolt to 100 volts	1/2 meg. shunted by 30 mmfds.	2% up to 100 KC 3% above 100 KC	\$200.
302B Battery Operated	2 to 150,000 cycles	100 microvolts to 100 volts	2 megs. shunted by 8 mmfds. on high ranges and 15 mmfds. on low ranges	3% from 5 to 100,000 cycles; 5% elsewhere	\$225.
305	Measures peak values of pulses as short as 3 microseconds with a repetition rate as low as 20 per sec. Also measures peak values for sine waves from 10 to 150,000 cps.	1 millivolt to 1000 volts Peak to Peak	Same as Model 302B	3% on sine waves 5% on pulses	\$280.
310A	10 cycles to 2 megacycles	100 microvolts to 100 volts	Same as Model 302B	3% below 1 MC 5% above 1 MC	\$235.
314	15 cycles to 6 megacycles	With probe, 1 millivolt to 1000 volts. Without probe, 100 microvolts to 1 millivolt	With probe, 11 megs. shunted by 6 mmfds. Without probe, 1 meg. shunted by 25 mmfds.	3% except 5% above 3 megacycles	\$265

For further information, write for catalog.

BALLANTINE LABORATORIES, INC.

100 FANNY ROAD, BOONTON, NEW JERSEY



tively, to the reference current and to the current being compared with it.

Figure 2 shows one way of preparing such graphs. The intermediate graph of each set indicates currents of precisely the proper ratio and the ± 5 percent tolerances are indicated on the upper and lower graphs of the set.

Figure 3 is helpful in checking the operating power of transmitters, such as f-m or tv transmitters, using the indirect method of power measurement. The example shown would be suitable for use with a 10-kw f-m transmitter using an arbitrary efficiency figure of 60 percent. The normal plate voltage is about 7.8 kilovolts for the particular example chosen, and the current about 2.12 amperes. Current and voltage products falling upon graph A provide the specified power input, while those between the limits of graphs B and C are within the f-m transmitter temporary tolerances of 5-percent above and 10-percent below rated power.

The voltage and current scales of Fig. 3 are not linear but have intervals proportional to the logarithms of the quantities represented. In graphs for actual use, additional divisions of the scales will be convenient in both types shown.

Impulse Modulator

By HILARY MOSS
Chief Engineer
Electronic Tube Corp.
Philadelphia, Penn.

GENERATING amplitude-modulated waves which are substantially free from distortion at high modulation depths is far from easy. The classical plate-modulated class-C circuit is quite good but involves critical adjustments. This article describes a simple feedback method which gives excellent results and requires little adjustment.

Development of the method may be seen from Fig. 1. This shows the essentials of a perfect modulator. The switch S operates at the carrier frequency to which the secondary of T_1 is tuned. Assume that transformer T_2 has a perfect core material, then the whole network is linear and it follows that the am-

From miniature to giant.... insuline METAL GOODS for every requirement!



INSULINE manufactures one of the most diversified lines of metal goods . . . built-up in the past 32 years by supplying every type needed by manufacturers, servicemen, engineers and hams. Huge stocks are maintained from the smallest cabinet to massive transmitter racks . . . for immediate shipment.

If your requirements are special, INSULINE can produce anything in metal . . . steel, aluminum, brass, copper, etc. . . to your specifications. Our facilities are adequate to manufacture your complete job from beginning to end . . . in fast time. Send prints and specifications for estimate.

Guide to Illustrations

- 1 Channel-Lock Aluminum Boxes.
- 2 Slip Cover Aluminum Boxes.
- 3 Flexi-Mount Aluminum Cases.
- 4 Utility Cabinets with built-in chassis.
- 5 Portable Steel Cabinets.
- 6 Open End Aluminum Chassis.
- 7 Speaker Cabinets.
- 8 Sloping Panel Cabinets.
- 9 Transmitter Racks.

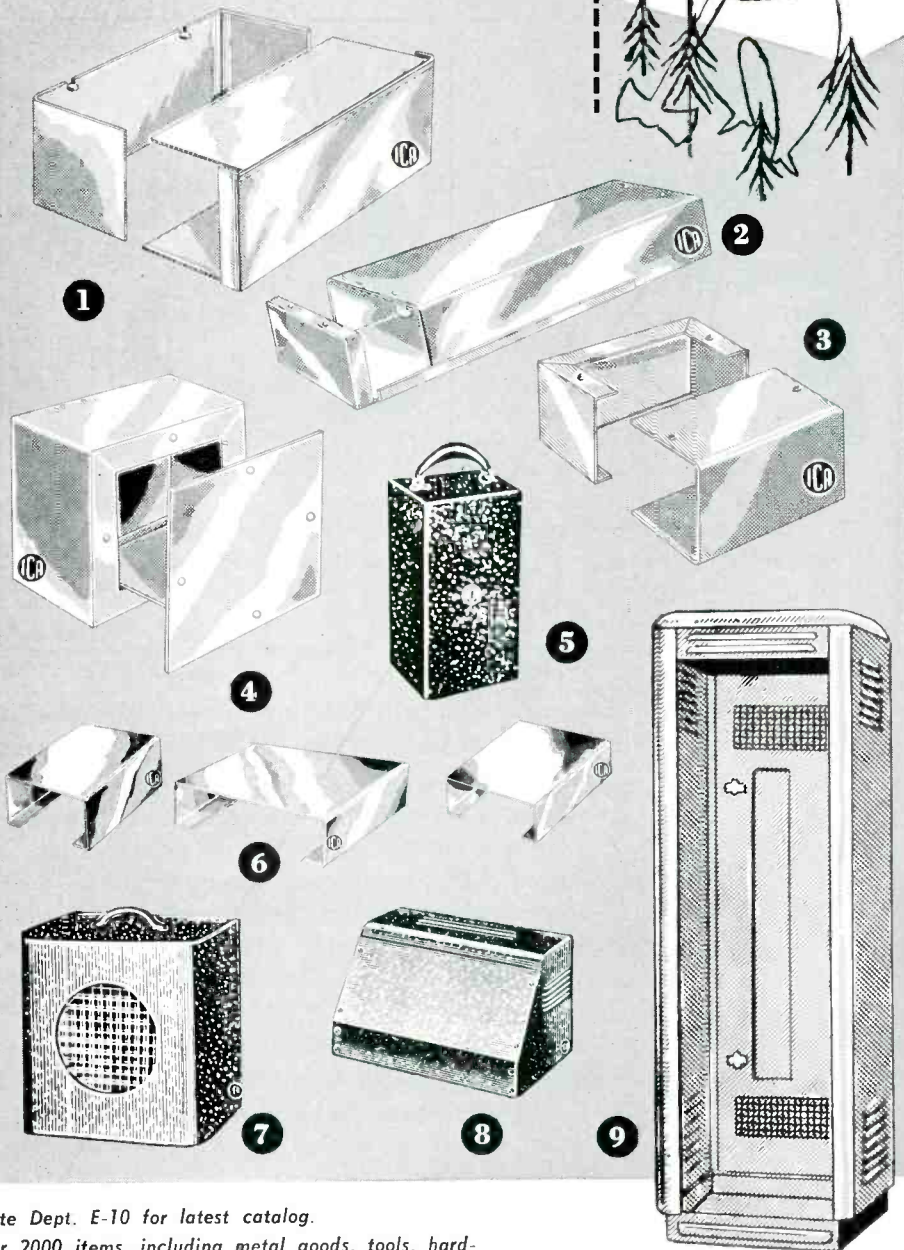

Write Dept. E-10 for latest catalog.
Over 2000 items, including metal goods, tools, hardware, components, television and accessories.



insuline CORPORATION OF AMERICA

INSULINE BUILDING • 36-02 35th AVENUE • LONG ISLAND CITY, N. Y.
West Coast Branch and Warehouse: 1335 South Flower Street, Los Angeles, Calif.
Exclusive Canadian Sales Agents: CANADIAN MARCONI COMPANY, Toronto

it's a magic world for homemakers!

—thanks to the accuracy, dependability and

long life of *Telechron*[®] motors

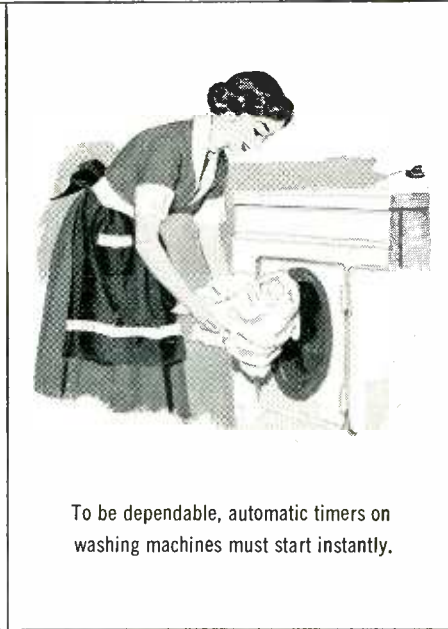

Accurate timing by Telechron motors has helped take much of the drudgery out of household chores.

Telechron timing motors are true synchronous motors. Rotors make one complete rotation for each cycle of the alternating current source— and are instantly self-starting (reach full speed in 1/20th of a second). This is especially advantageous for such uses as home appliances where many applications require intermittent operation of the timing motor, and demand instant, dependable starting.

Similarly, because Telechron synchronous motors do not need close clearances between rotor and stator, they will remain quiet throughout their long life.

Get complete facts on the broad line of Telechron synchronous timing motors. Application engineering service assures proper selection. Write for catalog IS-120. Telechron Department, General Electric Company, 410 Homer Ave., Ashland, Mass.

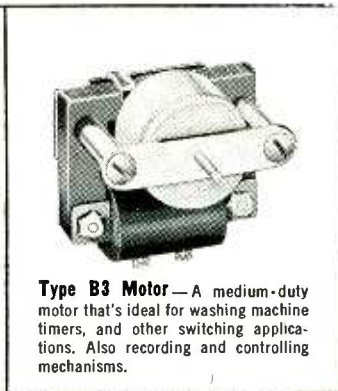
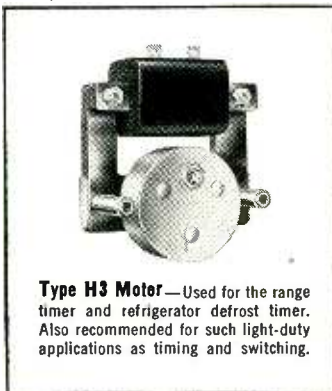

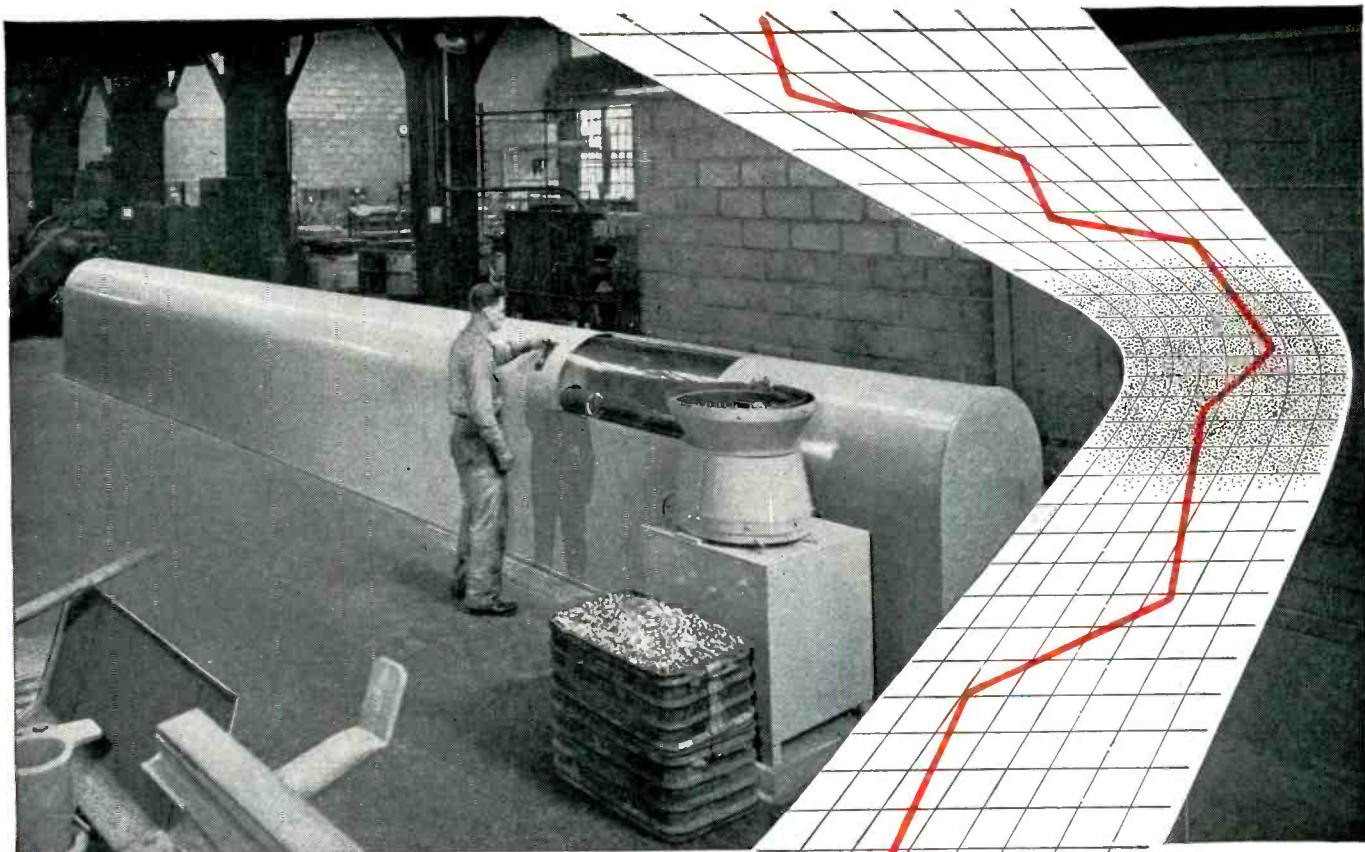

An automatic heat treat machine. Production is about 3 times that possible with manual methods while quality is held within very close limits.

CRUCIBLE ALNICO MAGNETS

KEEP COSTS DOWN ... through
automatic production that gives quality control

Alnico magnets have been getting smaller and lighter, thanks to production techniques in use at Crucible. Automatic machinery cuts the possibility of human error to a minimum, so rejections are low. This helps to maintain stable price levels in the face of rising material and labor costs. At the same time, Crucible's rigid inspection standards and attention to quality have developed a magnet with the *highest gap flux per unit weight of any on the market.*

Today, Crucible can offer lighter, magnetically stronger Alnico magnets because of these automatic production techniques developed over the sixteen years that we have been producing the Alnico alloys. And behind our familiarity with permanent magnets lies more than 52 years' experience with specialty steelmaking. Let us advise you on your magnet problem.

CRUCIBLE

first name in special purpose steels

52 years of *Fine* steelmaking

PERMANENT ALNICO MAGNETS

CRUCIBLE STEEL COMPANY OF AMERICA, GENERAL SALES OFFICES, OLIVER BUILDING, PITTSBURGH 30, PA.
STAINLESS • REX HIGH SPEED • TOOL • ALLOY • MACHINERY • SPECIAL PURPOSE STEELS

WHEELER

GRADE 1 CLASS A



MIL-T 27

TRANSFORMER COMPONENTS

● Whether your requirements fall within standard military and civilian classifications or you need experienced help in developing special units, you can profit by Wheeler's background and facilities.

● If your program calls for transformers featuring precision construction, optimum performance, minimum size and weight, standard MIL case design, hermetically sealed or Fosterited* units... we invite your inquiries. Our facilities are geared for large production without sacrifice of quality.

*The WESTINGHOUSE encapsulating insulation that gives a high degree of protection to small transformers. Applied by Wheeler under license.



WHEELER

MAGNET WIRE
COILS
COMMUNICATIONS
EQUIPMENT
TRANSFORMERS

MAKES THESE PRODUCTS A *Specialty*

THE WHEELER INSULATED WIRE COMPANY, INC.
Division of The Sperry Corp. • 1101 EAST AURORA ST., WATERBURY 20, CONN.

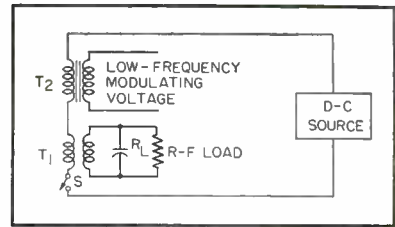

FIG. 1—Essential circuitry for a perfect modulator

plitude of the r-f voltage across the load R_L is an exact reproduction of the modulating voltage waveform. The mark/space ratio of the switch S is immaterial, provided it is constant.

It would seem profitable to try to simulate the network of Fig. 1 in the search for a perfect linear modulator. The problems of doing this are wholly associated with the switch S . The only form of switch having suitable frequency characteristics must be a thermionic tube. Since this is inherently a nonlinear device, the simplicity and perfection of Fig. 1 can not be entirely achieved.

Figure 2 shows a practical network to simulate that of Fig. 1. Tube V_1 is the off-on keyed tube replacing S . Its resistance when conducting is made low by connection of a low-valued resistor R_1 between the anode and control grid. Non-linearities in the tube's conductance-voltage curve become relatively unimportant in comparison with the cathode resistor R_c . The capacitor C_1 , which shunts R_c , acts as a bypass only for the carrier frequency.

The turns ratio on T_1 is kept high so that the variation in back voltage across its primary is small and does not appreciably vary the resistance of V_1 during the conducting portion of its cycle. These details of operation will be quantitatively discussed elsewhere.

Tube V_2 is the keying tube which

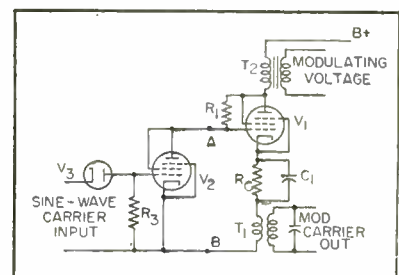
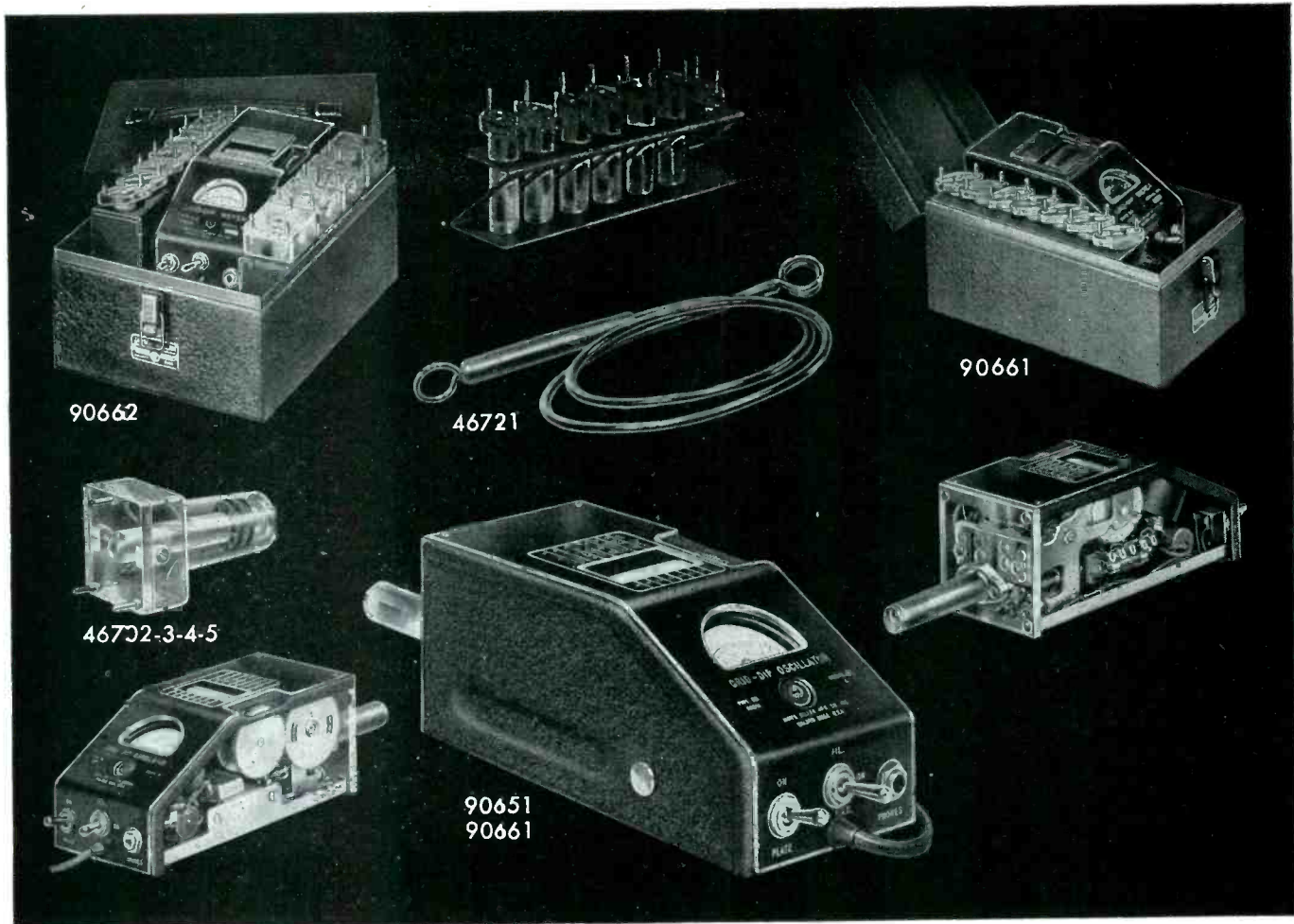

FIG. 2—Practical network simulating circuit of Fig. 1



Designed for Application

Grid Dip Meters

Millen Grid Dip Meters are available to meet all various laboratory and servicing requirements.

The 90662 Industrial Grid Dip Meter completely calibrated for laboratory use with a range from 225 kc. to 300 mc. incorporates features desired for both industrial and laboratory application, including three wire grounding type power cord and suitable carrying case.

The 90661 Industrial Grid Dip Meter is similar to the 90662 except for a reduced range of 1.7 to 300 mc. It likewise incorporates the three wire grounding type cord and metal carrying case.

The 90651 Standard Grid Dip Meter is a somewhat less expensive version of the grid dip meter. The calibration while adequate for general usage is not as complete as in the case of the industrial model. It is supplied without grounding lead and without carrying case. The range is 1.7 to 300 mc. Extra inductors available extends range to 220 kc.

The Millen Grid Dip Meter is a calibrated stable RF oscillator unit with a meter to read grid current. The frequency determining coil is plugged into the unit so that it may be used as a probe.

These instruments are complete with a built-in transformer type A.C. power supply and interterminal terminal board to provide connections for battery operation where it is desirable to use the unit on antenna measurements and other usages where A.C. power is not available. Compactness

has been achieved without loss of performance or convenience of usage. The incorporation of the power supply, oscillator and probe into a single unit provides a convenient device for checking all types of circuits. The indicating instrument is a standard 2 inch General Electric instrument with an easy to read scale. The calibrated dial is a large 270° drum dial which provides seven direct reading scales, plus an additional universal scale, all with the same length and readability. Each range has its individual plug-in probe completely enclosed in a contour fitting polystyrene case for assurance of permanence of calibration as well as to prevent any possibility of mechanical damage or of unintentional contact with the components of the circuit being tested.

The Grid Dip Meters may be used as:

1. A Grid Dip Oscillator
2. An Oscillating Detector
3. A Signal Generator
4. An Indicating Absorption Wavemeter

The most common usage of the Grid Dip Meter is as an oscillating frequency meter to determine the resonant frequencies of de-energized tuned circuits.

Size of Grid Dip Meter only (less probe): 7 in. x 3 $\frac{3}{8}$ in. x 3 $\frac{3}{8}$ in.

JAMES MILLEN

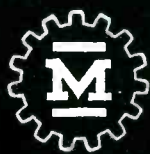

MFG. CO., INC.

MAIN OFFICE

AND FACTORY

MALDEN, MASSACHUSETTS, U.S.A.

MODERN ELECTRONIC ACHIEVEMENT!

THE LA POINTE-PLASCOMOLD
CORPORATION RELIES ON
"PRINTED CIRCUIT" FILTERS.

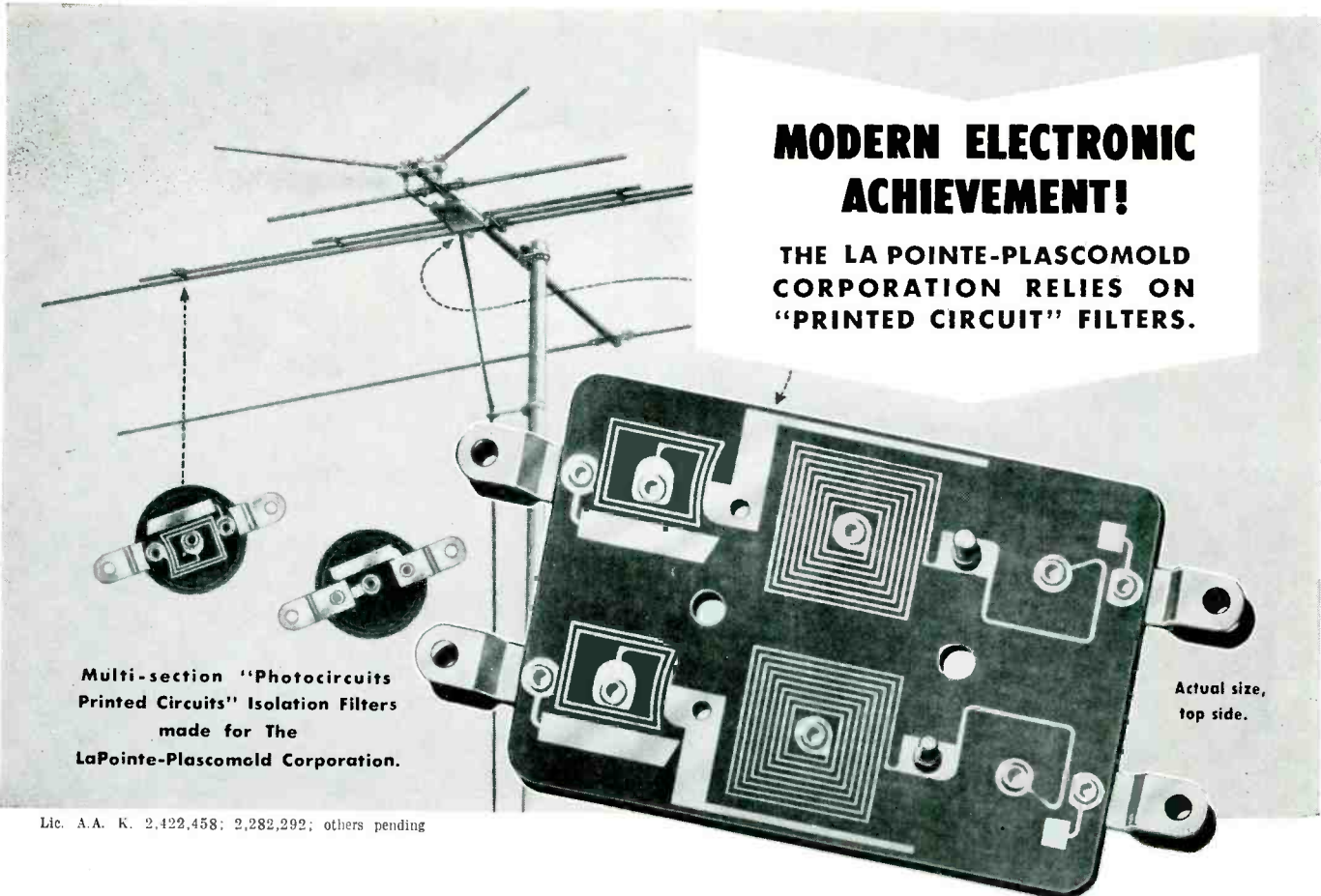

Multi-section "Photocircuits
Printed Circuits" Isolation Filters
made for The
LaPointe-Plascomold Corporation.

Actual size,
top side.

Lic. A.A. K. 2,422,458; 2,282,292; others pending

"PHOTOCIRCUITS PRINTED CIRCUITS"* CUT COSTS

of the **MASS PRODUCED** VEE-D-X All Channel 2-83 VHF-UHF ANTENNA

Application of
"Photocircuits Printed Circuits"
extend to...

**MICRO-WAVE PLUMBING,
RADIO and TV CHASSIS, I.F.
STRIPS, ANTENNA FILTERS,
TERMINAL BOARDS, WIPING
SWITCHES, FLUSH COMMU-
TATORS etc.**

This new antenna employs EIGHT "Photocircuits Printed Circuits" channel separators to enable all-channel reception of TV signals with a single antenna and a single transmission line. It is a great boon to TV sales in this period of changeover to UHF! *Completely assembled filters cost only a fraction of previously used unassembled component coils and capacitors.*

YOU TOO can *simplify and save* with "Photocircuits Printed Circuits." *Lower wiring costs, reduced assembly time, circuit reproducibility, improved reliability and miniaturization* will make your product better and more profitable. *Let our engineering facilities and experience help solve your design and application problems.*

*T.M. Reg. U.S. Pat. Off.



For our new ENGINEERING BROCHURE write

PHOTOCIRCUITS *Corporation*
Dept. E-10, GLEN COVE, NEW YORK

Why Do Leading TV Makers Specify **RMC DISCAPS?**

Manufacturers specify DISCAPS because they provide faster assembly line production and lower over-all costs.

Why Do Engineers Specify **RMC DISCAPS?**

Engineers specify DISCAPS for their uniform quality, low inherent inductance, high working voltage and greater mechanical strength.

Why Do Purchasing Agents Specify **RMC DISCAPS?**

Purchasing agents specify DISCAPS because they can depend on RMC to make delivery when scheduled.

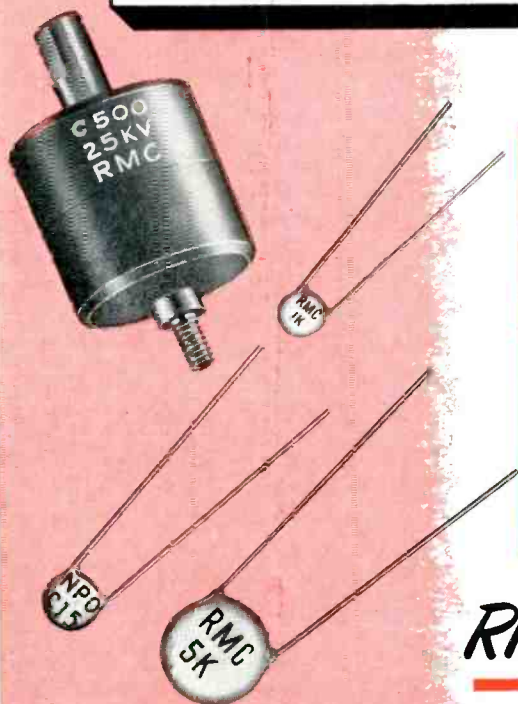

RMC offers a full line of by-pass and temperature compensating DISCAPS. Proved in use as a money-saving replacement for mica and ceramic tubular capacitors, DISCAPS are widely used by leading manufacturers of TV sets and tuners, radio receivers and high frequency electronic equipment. If you are interested in improving the quality and uniformity of your product, you will be interested in RMC DISCAPS.

RMC[®] DISCAPS[®] THE RIGHT WAY TO SAY
CERAMIC CAPACITORS

DISCAP
CERAMIC
CONDENSERS



RADIO MATERIALS CORPORATION
GENERAL OFFICE: 3325 N. California Ave., Chicago 18, Ill.

FACTORIES AT CHICAGO, ILL. AND ATTICA, IND.

Two RMC Plants Devoted Exclusively to Ceramic Condensers

dependable instruments

Heiland
DENVER

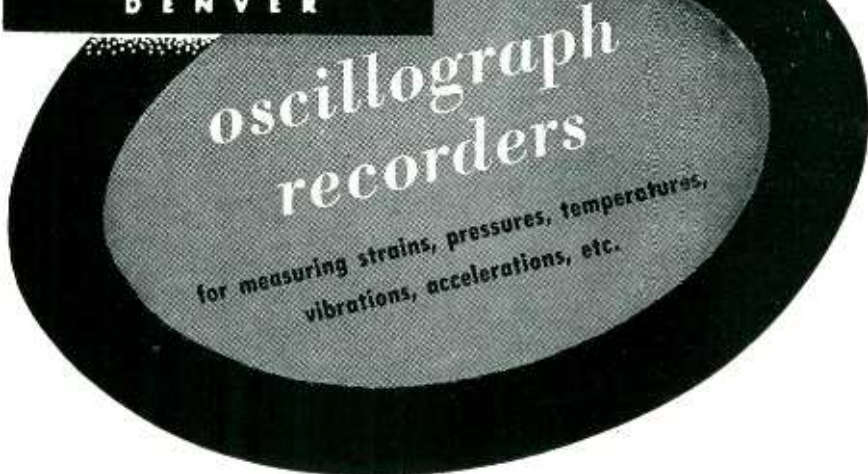

The Heiland A-500 recorder embodies many features found only in much larger instruments... easy loading; four quick change paper speeds; precision time lines; trace identification; paper movement indicator; direct monitoring of galvanometer light spots. Case dimensions 6 $\frac{3}{4}$ " x 9 $\frac{7}{8}$ " x 12 $\frac{3}{4}$ ". Weight 33 lbs. Paper width 4"-100' long. Available for either 12 volt or 24 volt D.C. operation.



A-500 12 channels

An 8 volt battery pack provides self contained power source affording complete portability and flexibility to the Heiland A-401 Recorder. Other features are similar to the A-500. Case dimensions with battery pack 7" x 9 $\frac{1}{2}$ " x 12 $\frac{1}{4}$ ", without 4 $\frac{1}{4}$ " x 9 $\frac{1}{2}$ " x 12 $\frac{1}{4}$ "; Weight with pack, 39 lbs., without, 22 lbs. Single speed. Paper width 2"-100' long. Available for 12 volt or 24 volt D.C. operation without battery pack.



A-401 6 channels

Accurate oscillograph records provide data for better product design and performance. Heiland recorders are being widely used for numerous aircraft, laboratory and industrial applications. Write today for Heiland catalog of recorders, galvanometers and associate equipment.



HEILAND RESEARCH CORPORATION • 130 E. Fifth Avenue, Denver, Colorado

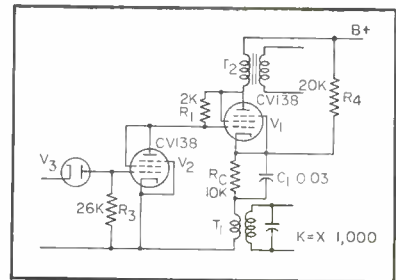

FIG. 3—Final circuit of the impulse modulator

is periodically made conducting by driving it from a large amplitude carrier source via diode V_3 and load R_3 . This operation cyclically cuts off V_1 by joining A and B through an equivalent low resistor. The bias developed across C_1 cuts off V_1 .

The network of Fig. 2 has one obvious weakness. At those portions of the modulation cycle when the anode potential on V_1 is low, V_2 operates over very nonlinear portions of its characteristic and one should expect nonlinearity in the output modulated wave. The circuit however, is quite good for modulation depths up to about 80 percent.

In the circuit of Fig. 3, a resistor R_4 has been added between the cathode of V_1 and the high-voltage supply. Thus, V_1 becomes cut off and the modulation reaches 100 percent before the potential of V_2 reaches zero. By making R_4 sufficiently small, the keying tube V_2 is made to operate almost linearly.

Synchronous Demodulator for Color TV

BY ROBERT B. MCGREGOR

Senior Design Engineer
Arvin Industries, Inc.
Chicago, Ill.

MUCH SIMILARITY exists between a black-and-white tv receiver and the NTSC color receiver. The front end, the i-f amplifier and the sweeps are the same. However, the video which is extracted by the second detector contains a subcarrier of 3.89 mc which carries the color information. Besides the standard video amplifiers, which may be called the monochrome channel, there is a channel which extracts the color information and then uses video amplification to put the color into the picture. This is called the chro-



Self-Locking Fasteners

ELASTIC STOP NUTS

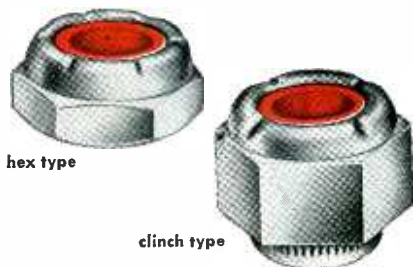

...with the famous red elastic collar of nylon or fiber

For heavy duty applications where precise adjustments must be maintained against severe vibration



...the slotted tubular steel pin with chamfered ends

Vibration-proof spring pins replacing rivets, set screws, straight, serrated or cotter pins, dowels



ELASTIC STOP NUT CORPORATION OF AMERICA

Mail Coupon for Design information

Elastic Stop Nut Corporation of America
Dept. N21-1021, 2330 Vauxhall Road, Union, N. J.

Please send me the following free fastening information:

- Elastic Stop Nut Bulletin
- Rollpin Bulletin
- AN-ESNA Conversion Chart

Here is a drawing of our product. What fastener would you suggest?

Name _____ Title _____
 Firm _____
 Street _____
 City _____ Zone _____ State _____

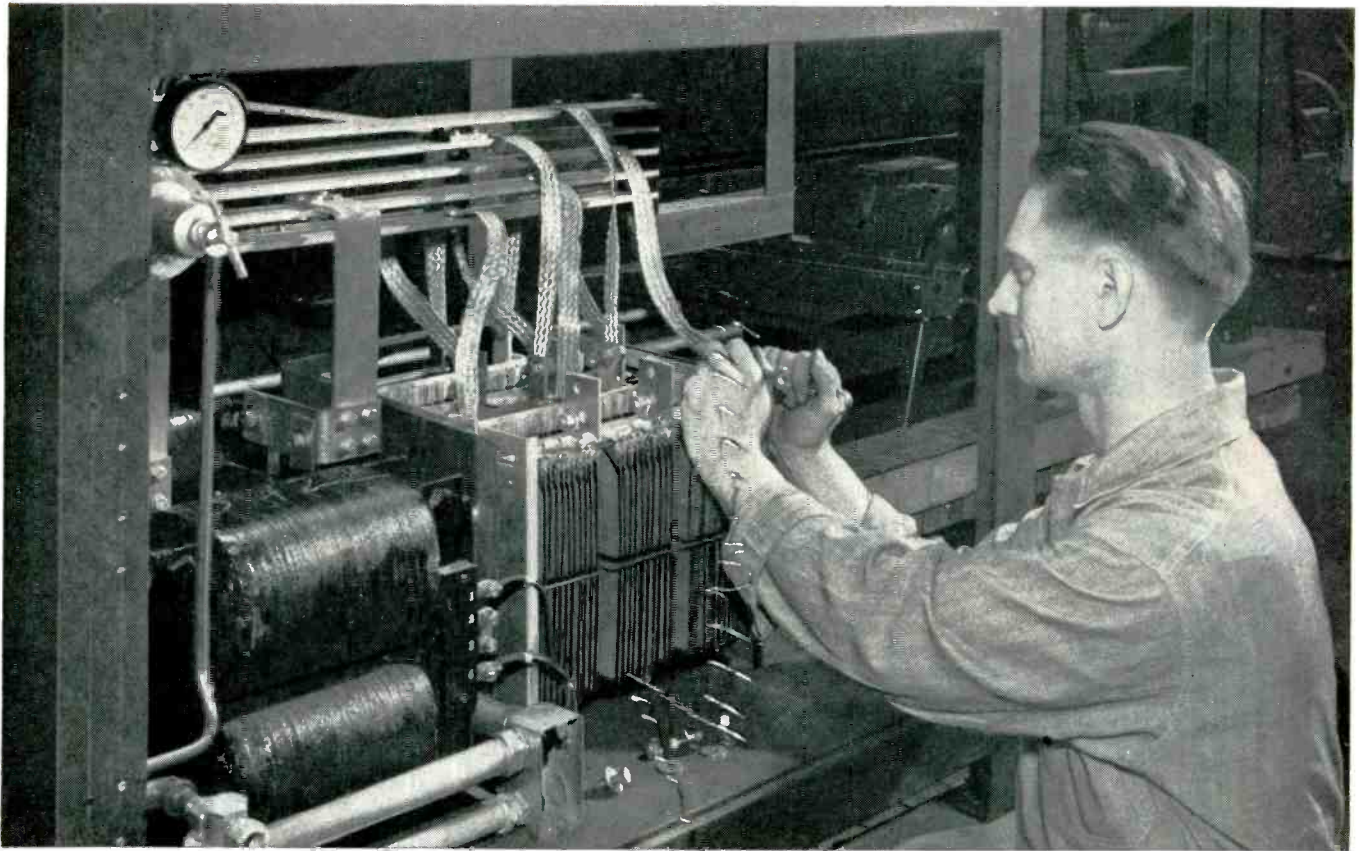

G-E COPPER-OXIDE RECTIFIER STACKS, BEING INSTALLED BY MAGNAFLUX' H. E. SCHREIBER, PROVIDE HIGH CONVERSION EFFICIENCY.

Magnaflux Corp. Relies on G-E Rectifiers

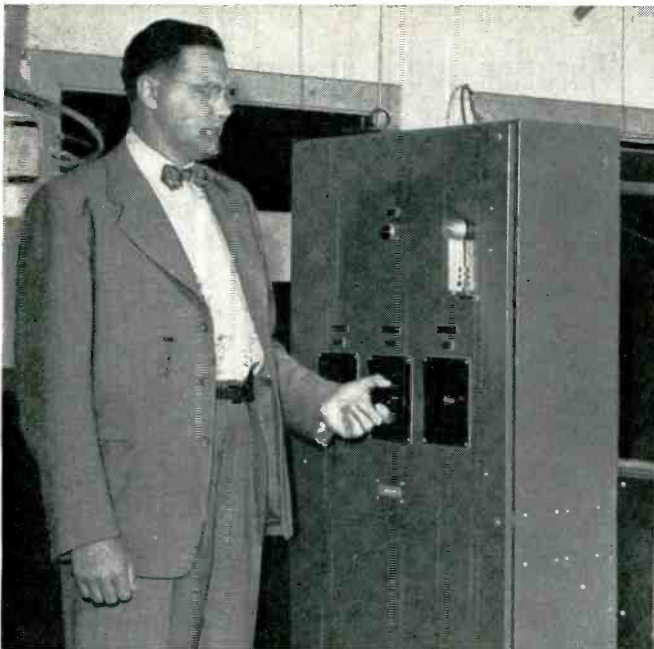

STABLE ELECTRICAL CHARACTERISTICS of General Electric copper-oxide rectifier stacks help maintain customer good will, says W. D. Reid, Magnaflux second vice-president and plant manager.

COPPER-OXIDE STACKS MEET SEVERE SERVICE REQUIRED BY MAGNAFLUX TESTING EQUIPMENT

As pioneer developer and world leader in the manufacture of non-destructive testing equipment, the Magnaflux Corporation insists on dependable rectifiers.

These rectifiers supply the d-c current that sets up the magnetic field for detecting sub-surface defects. G-E copper-oxide rectifier stacks were selected because tests proved that they can take heavy current overloads for short periods without over-heating or deteriorating.

Mr. W. D. Reid, second vice-president and plant manager at Magnaflux, enthusiastically reports, "In our application, rectifiers are subjected to extremely severe service because of the high currents drawn from them for the magnetization of parts to be inspected. They must have the highest conversion efficiency to assure maximum voltage output with lowest losses in operation. G-E copper-oxide rectifiers meet all these requirements."

"We have several thousand copper-oxide rectifiers in service. Failures have been almost unknown."

YOUR PRODUCT, too, will benefit from the many operating advantages and extremely long life of G-E copper-oxide rectifiers. For information on how to apply them, contact your nearest G-E Apparatus Sales Office, or write Section 461-23, General Electric Co., Schenectady, N. Y.

GENERAL  **ELECTRIC**

AVAILABLE NOW
in a wide range
of sizes!

GOVERNMENT APPROVED
MIL-W-5086

AIRCRAFT WIRE

AWG SIZES

24-22-20-18-16-14

12-10-8-6

ALSO

MIL-C-7078 (MIL-W-5086)

WITH SHIELD

**COMPLETELY EXTRUDED
INSULATIONS**

Primary Insulation: Polyvinylchloride
Overall Insulation: Nylon Jacket

Write for samples
and complete test data.



RHODE ISLAND INSULATED WIRE CO., Inc.

50 BURNHAM AVENUE

CRANSTON, RHODE ISLAND

National Sales Offices: 624 S. Michigan Blvd., Chicago, Ill.

JOHNSON variable inductors

for **RF** power applications

To meet the needs of RF power equipment manufacturers, JOHNSON builds a most diverse line of variable inductors. These range from 3 to 50 amperes current capacity, inductance to 300 microhenries in standard types. Characteristics of all models are: high frequency insulation grade L4 or better, low contact resistance, rigid construction. Two typical examples of JOHNSON variable inductors are:

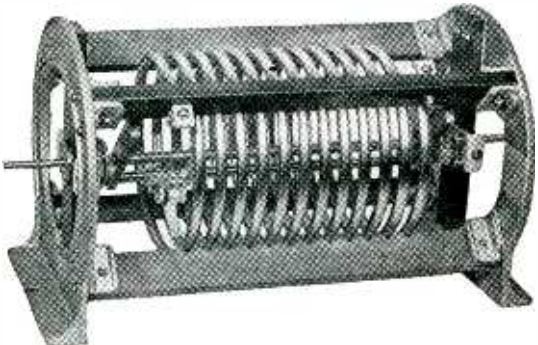
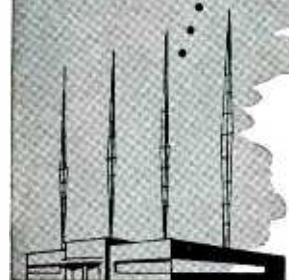

224-2-1

Variable inductor for high power applications. Winding is $\frac{1}{2}$ " copper tubing rated to 50 amperes current. Inductance continuously variable to 16.5 microhenries. Spring loaded silver plated roller contact permits adjustment with full power applied. Insulators are glass bonded mica; cast aluminum end frames are slotted to minimize Eddy current losses. Overall dimensions: length $21\frac{1}{8}$ ", width 9", height 9". Available in eight standard models, maximum inductances 10 thru 110 microhenries. Variations from standard units such as special inductances, dual inductors for push-pull applications can be readily furnished in production quantities.

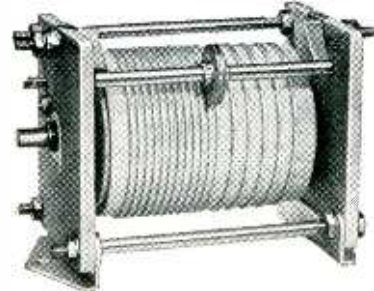

229-201

10 microhenry rotary inductor for 100 watt applications. Winding is #14 tinned copper wire with variable pitch for efficient extended frequency range. Beryllium copper tension springs maintain rolling contact. Overall size: length $4\frac{1}{2}$ ", width $2\frac{1}{2}$ ", height 3". Other inductors in the same series utilizing #12 and #16 tinned copper windings, maximum inductance 37 to 300 microhenries.

In addition to these illustrated types, the JOHNSON line includes many other variable and fixed inductors for low, medium and high power applications. Fixed inductors are available with single or multiple windings, fixed or variable coupling windings and with electrostatic shields.

At your request, we will be pleased to furnish additional information regarding JOHNSON inductors.



E. F. JOHNSON COMPANY
WASECA, MINNESOTA

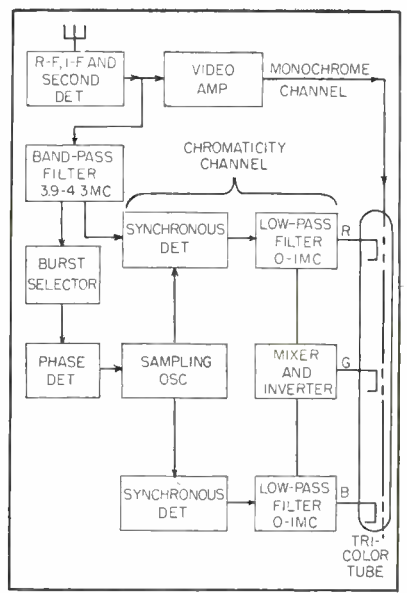

FIG. 1—Block diagram of color-TV receiver

chromaticity channel,¹ see Fig. 1. To recover the color information from the subcarrier, it becomes necessary to employ a process of synchronous demodulation or detection. The subcarrier contains two different sets of data provided by modulating the carrier both in amplitude and phase. The amplitude determines the color saturation and the phase modulation conveys the hue.

A more informative representation is to consider the subcarrier as composed of two sine waves in quadrature, each amplitude modulated. The problem is to recover the modulation information from each sine wave separately without crosstalk from the other.

Consider the circuit in Fig. 2, with the two sine-wave voltages applied to the control grid *G*₁ in quadrature as shown. The wave to be detected or demodulated is *ACE*. The sine wave which must contribute nothing is *BDF*. When switch *S*₁ is closed to the negative position, negative voltage on the screen grid *G*₂ of the tube, there can be no plate current. When the switch is thrown to the alternate position so that there is normal screen grid voltage, the tube functions in a normal manner.

Consider that there is negative voltage on the screen grid of the tube at all times except for an instant at time *B*. For each cycle of wave *ACE*, the tube functions in a

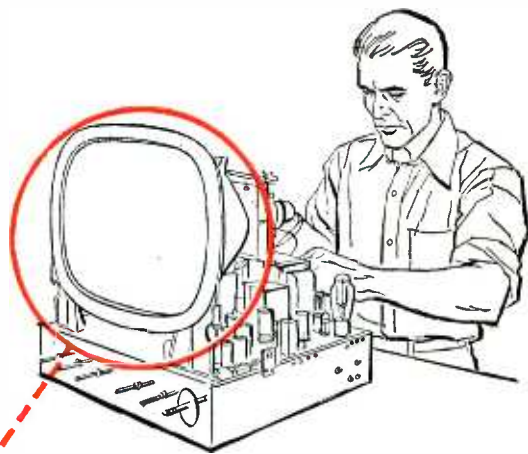

Du Pont "Alathon"* insulates TV tube carrying 20,000 volts

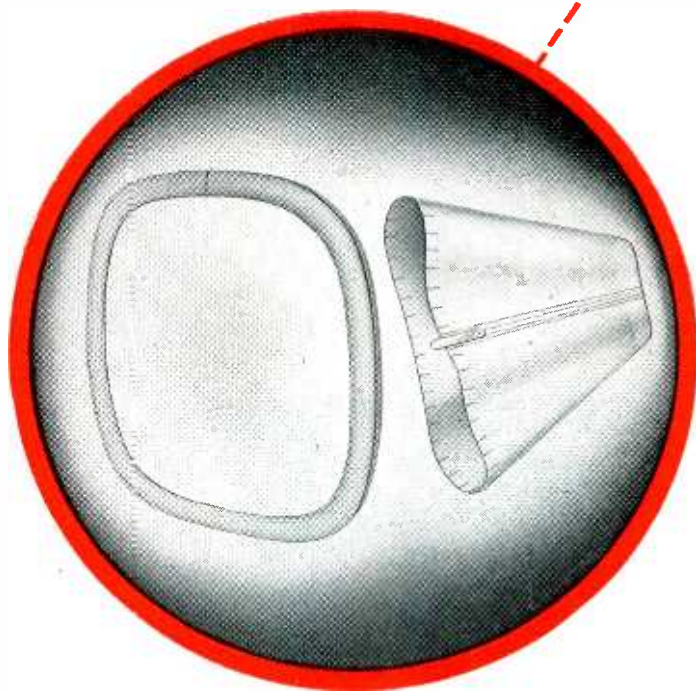

Ring and sleeve of "Alathon" retain dielectric properties . . . pass humidity tests . . . lower shipping costs

When television-set manufacturers started using metal picture tubes, they were faced with the problem of insulating the outer portion of the tubes that carry up to 20,000 volts. A material was needed that could withstand the voltage, while resisting humidity that would ruin its insulating value.

The solution was this ring and sleeve extruded of Du Pont "Alathon" polythene resin. Of all the materials tested, only "Alathon" retains its electrical properties in service. "Alathon" has excellent dielectric strength, low dielectric constant (2.3), and low power factor (0.0005). Because of its very low moisture-absorption rate (0.01% by A.S.T.M. test), "Alathon" easily passes exacting humidity tests.

Du Pont "Alathon" offers other important advantages. Its flexibility simplifies installation. Shipping costs are reduced because "Alathon" absorbs shock . . . makes possible packing of sets as units . . . eliminates shipping the delicate tubes separately. And reassembly time and labor at outlets are eliminated. Many TV manufacturers now use these rings and sleeves.

Du Pont "Alathon" is widely used for such insulating applications as TV lead-in wire, high-voltage TV lead wire, and police and fire-alarm cable. We will gladly suggest suppliers who can meet your specific needs for electrical or other uses of "Alathon." For further information, write:

Rings and sleeves extruded by
Anchor Plastics Co., Inc.
New York, N. Y.

*REG. U.S. PAT. OFF.



REG. U.S. PAT. OFF.

150th Anniversary

Better Things for Better Living
... through Chemistry

Polychemicals

DEPARTMENT

PLASTICS • CHEMICALS

E. I. du Pont de Nemours & Co. (Inc.)
Polychemicals Department, District Offices:
350 Fifth Avenue, New York 1, New York
7 S. Dearborn St., Chicago 3, Illinois
845 E. 60th St., Los Angeles 1, California

AIRCRAFT TRANSFORMER ASSEMBLIES

This sounds trite but it's true . . . the Keystone imprint on a transformer is as good as the word "Sterling" on silver! The unit in the background consists of a power transformer and an input transformer. Also inter-stage transformer and output transformer. We build them open or hermetically sealed. Dependable deliveries by Keystone prevent production tie-ups. Get our estimate *now*. Prints and specifications should be sent to us via *registered mail* for safety.

We also produce high quality Magnetic Amplifiers!

RIGHT—Open view of a Keystone Aircraft Transformer Assembly to show workmanship. This unit is being delivered hermetically sealed in ever increasing quantities each month.

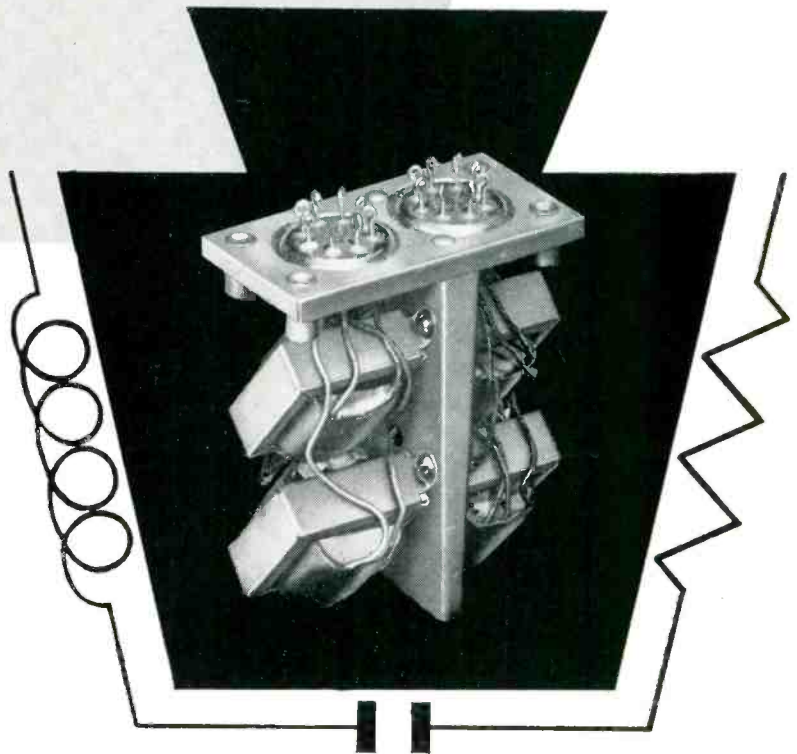

KEYSTONE PRODUCTS COMPANY

UNION CITY 2, N. J.

UNION 6-5400

IDEAS

in the making

Araldite Bonding and Casting Resins developed by Ciba Research are simplifying manufacturing methods, improving product efficiency, and opening new fields of product development. You will want to know more about them.*

ARALDITE® BONDING RESINS

ARALDITE® TYPE	CURING CONDITIONS	PHYSICAL APPEARANCE	BOND STRENGTH* ALUMINUM-ALUMINUM (LB./SQ. IN.)	SUGGESTED USE
AN-101	Room temperature	High viscosity liquid	2000-2500	Bonds or seals glass-metal.
AN-102	Room temperature	Low viscosity liquid contains solvents	1400-1600	Bonds metal-metal and metal-wood.
AN-111	Heat cure	Low viscosity liquid contains solvents	2000-2500	Impregnating (vacuum method), laminating and bonding.
AN-115	Heat cure	Low viscosity liquid contains solvents	2500-3000	Impregnating, laminating and bonding.
AN-106	Heat cure	Heavy paste silver color	3000-3200	Bonds socket-type joint.
AN-107	Heat cure	Heavy paste tan color	3000-3200	Bonds socket-type joint.
AN-112	Heat cure	Heavy paste tan color	2500-3000	Laminating, bonding. Rapid cure.
AN-100	Heat cure	Powder tan color	4000-4500	Bonds { Heat-resistant, smooth, non-porous materials . . . metal-metal, metal-glass, metal-ceramic, glass-glass
AN-110	Heat cure	Powder silver color	4000-4500	
AN-120	Heat cure	Stick tan color	4000-4500	
AN-130	Heat cure	Stick silver color	4000-4500	
AN-104	Room temperature	Non-flowing paste tan color	1000-1500	Bonds loose-fitting joints.
AN-103	Heat cure	Non-flowing paste tan color	1200-1400	Bonds loose-fitting joints.

*ASTM D1002-49T

ARALDITE® CASTING RESINS

ARALDITE® TYPE	CURE	PHYSICAL APPEARANCE	SUGGESTED USE	SHRINKAGE	ELECTRICAL PROPERTIES
CN-501	Heat cure	Amber solid	Casting, potting, encapsulating. Good adhesion.	Very low (½ to 2%)	Excellent
CN-502	Room temperature or heat cure	Thin liquid	Casting, potting, encapsulating. Good adhesion.	Very low (½ to 2%)	Good
CN-503	Room temperature or heat cure	Liquid	Similar to Araldite CN-501. Low temperature. Pour.	Very low (½ to 2%)	Excellent
CN-504	Heat cure	Very thin liquid	Impregnating, casting, potting, encapsulating. Good adhesion.	Low (< 2%)	Good

SEND THIS COUPON . . . or write us on your company letterhead . . . for complete technical data on the physical properties and recommended procedures for the successful use of Araldite Resins for your own fabricating needs.

*Reg. U.S. Pat. Off.

Ciba

Plastics

★ BONDING ★ CASTING ★ COATING RESINS

CIBA COMPANY INC., PLASTICS DIVISION

627 Greenwich St., New York 14, N. Y.

(In Canada: Ciba Co. Ltd., Ciba Bldg., Montreal)

Please send me Ciba Plastics Technical Bulletins for

BONDING CASTING COATING

Name _____

Company _____ Title _____

Address _____



Western Auto



Philco



Regal

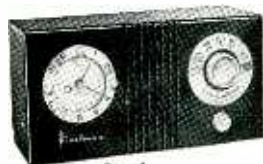

Steelman

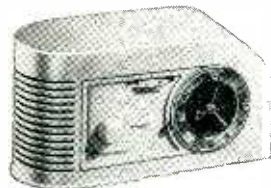

Continental



Admiral

The value leaders in Clock-Radios continue to be the brands equipped with



SESSIONS TIMERS



Esquire



Sparton



Philco



Sears Roebuck

Because Sessions Timers are lower-priced than other dependable makes, more and more clock-radio manufacturers are offering buyers a better value for their money.

Make any comparison. Take this initial price advantage and add Sessions-quieter operation, unbeatable accuracy, and attractive styling, and you have a total number of important features unmatched by any other clock-radio timer. For details write the Sessions Clock Company, Timer Division, Dept. 48, Forestville, Connecticut.



Jewel

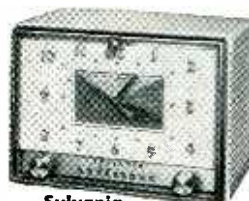

Sylvania

normal manner at point *B* which corresponds to the time of maximum amplitude of this sine wave. If the amplitude of this sine wave varies, as with amplitude modulation, the pulses of plate current will vary in a like manner as shown. If the low-frequency component of these pulses is extracted as with a low-pass filter, the envelope of the wave will be reproduced as shown by the dotted line.

When examining the effect of sine wave *BDF* on this synchronous detector, remember that the plate current in the tube flows only at point *B* of each cycle, but sine wave *BDF* is zero at point *B*. Even though the amplitude of this wave increases or decreases, it will always be zero at the time of the sampling pulse. Therefore, the information contained in the modulation of wave *ACE* is recovered without crosstalk from the other sine wave *BDF*.

If the modulated subcarrier is fed to another synchronous detector which is pulsed on at time *C*, the information contained in wave *BDF* will be recovered. This type of synchronous detection was one of the first types used. Later methods of recovering the information use a synchronous sine wave in precisely the same manner as the synchronous pulse sampling.

Figure 3 shows a synchronous detector with desirable characteristics. The input signal is applied to the control grid *G₁* while the sampling oscillator is applied to the suppressor grid *G_s*. Since the plate current of the tube is cut off when the suppressor is more negative

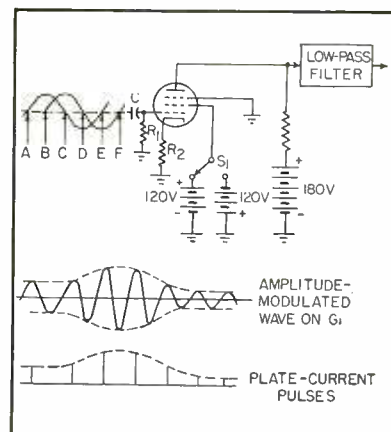

FIG. 2—Synchronous detector used in early work



silicone rubber coated glass cloth

class H
insulation

... for extreme temperatures

Do you have an application where rubber-like properties must be retained for long periods of time under extremes in temperature? Silicone Rubber Coated Glass meets these rigid requirements.

This tough, flexible material is suitable for use over a temperature range of -70° F to 400° F and is resistant to thermal shock. It will not crack, become brittle or deteriorate in service at high or low temperatures. It offers good resistance to hot lubricating oils and most chemicals.

Silicone Rubber Coated Glass Cloth is ideally suited

for seals, diaphragms and gaskets. One of its unique properties is the fact that it does not stick to metal parts when used for gaskets. It requires no scraping or peeling during disassembly.

In addition, this Class H insulation possesses good dielectric strength and low power factor. It can be used over a wide frequency range in many electrical applications.

Write today for complete information about Silicone Rubber Coated Glass Cloth and other electrical insulating materials.



MICA *Insulator* **COMPANY**

Schenectady 1, New York

Offices in Principal Cities

LAMICOID® (Laminated Plastic) • MICANITE® (Built-up Mica) • EMPIRE® (Varnished Fabrics and Paper) • FABRICATED MICA

PROBLEM:

How to Reduce the High Cost of Platinum in an Electrode?

GENERAL PLATE

Provided the Solution with Platinum Clad to Copper . . . A Composite Metal

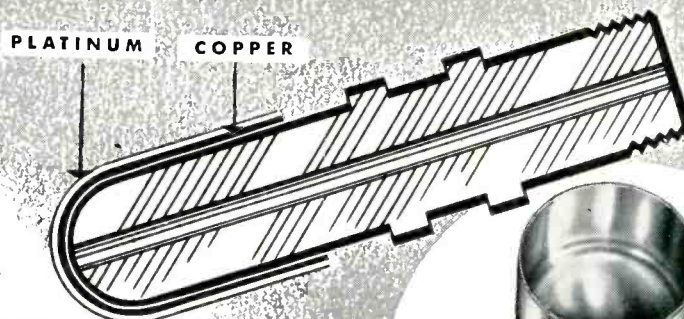
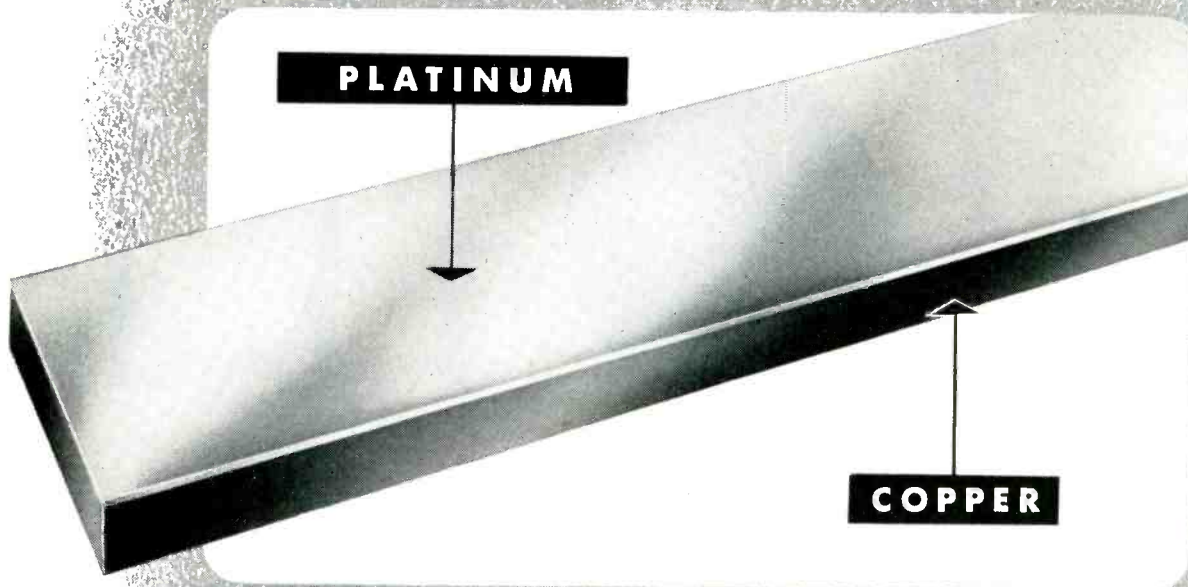

A well-known manufacturer was faced with the problem of how to cut the cost of a platinum electrode. Pure platinum was ideal but was expensive and the supply short.

The problem was presented to General Plate whose engineers quickly found a solution by bonding a thin layer of platinum to a thicker, less costly layer of copper.

The result was a General Plate composite material that gave the performance of pure platinum, and reduced costs considerably.

In addition, General Plate was able to fabricate the complete assembly providing the manufacturer with further savings.

No matter what your problem, it will pay you to consult with General Plate. Their vast experience in cladding precious to base metals, or base to base metals can overcome your problems . . . often reduce costs.

General Plate products include . . . precious metals clad to base metals, base metals clad to base metals, silver solders, composite contacts, buttons and rivets, Truflex® thermostat metals, Alcuplate®, platinum fabrication and refining, #720 manganese age-hardenable-alloy. Write for information.



*Have You a Composite Metal Problem?
General Plate can solve it for you.*

GENERAL PLATE
Division of Metals & Controls Corporation
FOREST STREET, ATTLEBORO, MASS.



Do you need a switch to work on a "desert island"?

THAT'S JUST ONE OF THE REQUIREMENTS FOR SWITCHES IN GATES RADIO'S NAVY BROADCAST TRANSMITTER

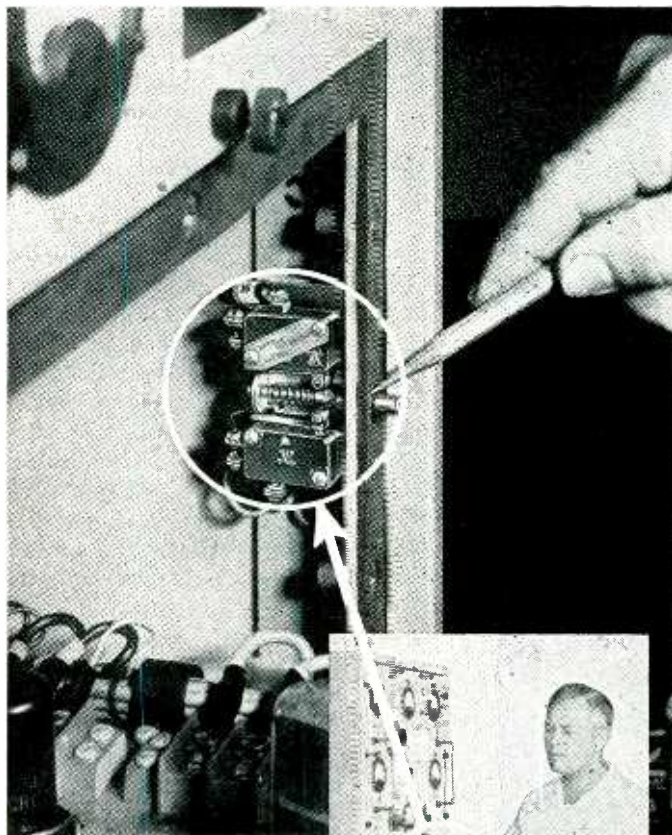

One of these two MICRO switch assemblies turns off the current when the cabinet is opened. If current is then turned on manually for checking equipment, the other switch flashes a warning light on the front of cabinet. Reclosing the door automatically resets switches.

Tom G. Banks, Jr., Gates engineer, pulls out drawer of Navy 400-watt transmitter cabinet to show location of two MICRO door interlock switches which protect operating personnel from high voltages.

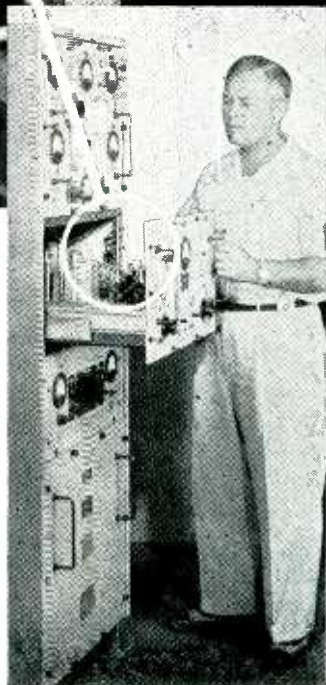

Radio transmission in the Navy recognizes no climate. Equipment must be ready to "send" instantly after a splash through the surf to a humid, south sea "desert island" or a trek over the ice to an Aleutian hut.

These high voltage transmitters must be safe, too. There must be no danger to personnel from the 2500 volts if the door is opened accidentally.

These were just a few of the exacting requirements which faced engineers of the Gates Radio Company when they designed their AN/URN-5 Radio Beam Transmitter for the U. S. Navy. For a door interlock switch that would always work, under all conditions, they turned to MICRO. This switch, they told us—

- 1 Must be made of materials which would be unaffected by fungus or corrosion.
- 2 Must operate perfectly in temperatures ranging from -55° to $+65^{\circ}$ C.
- 3 Must withstand high humidities up to 95%.
- 4 Must withstand Class B military shock and vibration tests.
- 5 Must meet rigid "JAN" specifications.

These requirements were met in every particular by the MICRO double door interlock switch; now three of these units guard each door of this Navy transmitter.

This recognition on the part of Gates engineers of MICRO precision and dependability as components of equipment which must not fail is typical of confidence industrial designers everywhere place in MICRO engineering. MICRO has, or can develop, a switch to meet YOUR most exacting problem. Field engineers are located near you to cooperate in the solution of YOUR switch problem. We invite you to call the nearest MICRO branch.

Let a MICRO Engineer show you how you can "Use MICRO Precision Switches as a principle of good design"

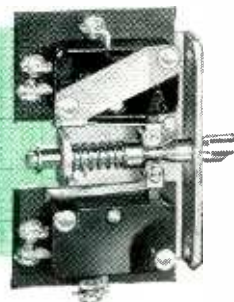

MICRO
MAKERS OF PRECISION SWITCHES
FREEPORT, ILLINOIS

A DIVISION OF
MINNEAPOLIS-HONEYWELL REGULATOR COMPANY



YOUR PRODUCT

largely determines the success, profits and future of your company. Its marketability and acceptance may well be increased by modern, precision fastening. You are invited to enlist Milford Rivet's Design Engineering Service without obligation.

MILFORD . . .

4 modern plants on Industry's doorstep to expedite service of your needs for QUALITY Tubular and Split Rivets, Rivet-Setting Machines and Special Cold-Headed Fasteners.

Est. 1919

the **MILFORD RIVET & MACHINE CO.**

855 Bridgeport Ave., MILFORD CONN. 806 Illinois Ave., AURORA, ILL.
1106 W. River St., ELYRIA, O. 26 Platt St., HATBORO, PA.

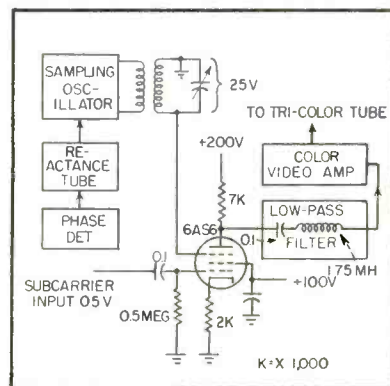

FIG. 3—Synchronous demodulator with desirable characteristics

than -10 v, every negative peak is limited.

If the input signal to G_1 is in phase with the sampling oscillator voltage on G_s , G_1 will go positive when G_s goes positive. The transconductance of the tube increases greatly and there is heavy plate current on the positive peaks. These plate-current pulses will follow the modulation which is impressed on the wave on G_1 . The response of the tube is linear to the G_1 voltage.

The detector will again ignore the quadrature component of the frequency on G_1 although this component will again produce phase shift of the plate-current pulses. This component can be recovered by applying the same signal to another synchronous detector on whose suppressor there is a frequency which is in phase with the desired signal on G_1 .

If the frequency on the suppressor is not the same as the frequency of the modulated wave on the control grid, there will be a beat frequency and the usual superheterodyne mixer circuit emerges. The difference frequency will be modulated in accordance with the combined amplitudes on G_1 . There will be other products of the mixing process just as in any mixer.

The difference frequency may readily pass through the low-pass filter. This suggests a method of adjusting the frequency of the sampling oscillator in a synchronous demodulator circuit. With an oscilloscope on the output of the low-pass filter and a pure unmodulated sine wave on G_1 and G_s , the frequency of one is varied. The scope will show the beat frequency. As the frequency on G_1 approaches G_s ,

C

onsistently

D

ependable

DYKANOL*

CAPACITORS

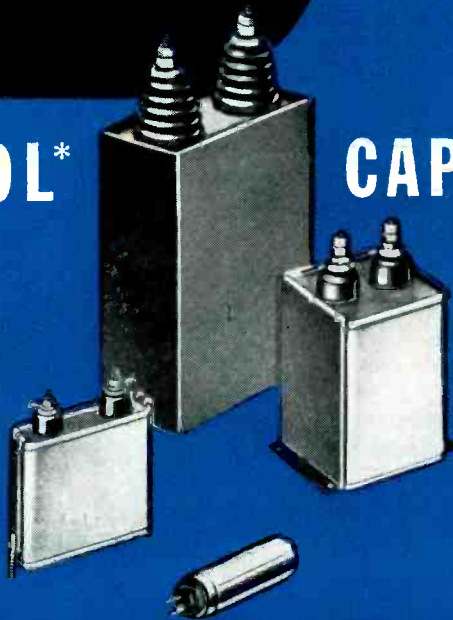

* COPYRIGHTED TRADE MARK OF C-D M'PREGNATES



Nobody knows oil capacitors like C-D. It's generally acknowledged that "nobody can duplicate C-D's Dykanol capacitor." You can count on the ruggedness and durability that have made C-D capacitors famous for 42 years and that is all too rare these days. Catalog No. 400 will show you how broad the line is. Write for it to: Dept. K102 Cornell-Dubilier Electric Corp., South Plainfield, N. J.

CORNELL-DUBILIER

world's largest manufacturers of capacitors



ANTENNAS



ROTATORS



CAPACITORS



VIBRATORS



CONVERTERS

SOUTH PLAINFIELD, N. J. • NEW BEDFORD, WORCESTER AND CAMBRIDGE, MASS. • PROVIDENCE, R. I. • INDIANAPOLIS, IND. • FUQUAY SPRINGS, N. C. • SUBSIDIARY, THE RADIART CORP., CLEVELAND, O.



Heat-Stable, Moisture-Proof SILICONE DIELECTRIC MATERIALS

are available in the following forms:

LIQUID DIELECTRICS

DOW CORNING 200 FLUIDS are a series of clear, inert liquids, notable for their thermal stability and for their remarkably flat viscosity-temperature slopes. Available in viscosities from 0.65 to 1,000,000 centistokes. Pour points range from -123° to -47°F . and flash points range from 30° to 600°F . Low dissipation factors at elevated temperatures or at high frequencies, inertness to moisture, oxidation resistance and heat stability make Dow Corning 200 Fluids unique among liquid dielectrics.

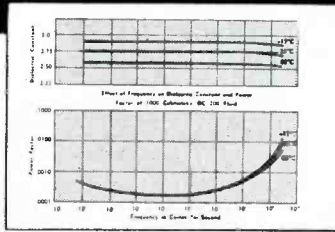

As indicated by these curves, neither frequency nor temperature changes have any pronounced effect on the power factors or dielectric constants of Dow Corning 200 Fluids. Power factor and dielectric constant of 1000 cs. fluid at -17° , 23° , and 83°C . are plotted against frequencies ranging from 10 to 10^{10} cycles per second.

DIELECTRIC COMPOUND

DOW CORNING 4 COMPOUND is a nonmelting water-repellent dielectric paste which retains its grease-like consistency at temperatures from -70° to 400°F . It is highly resistant to oxidation and to deterioration caused by corona discharge. Power factor is less than 0.003 at frequencies up to 10,000 megacycles; volume resistivity is more than 10^{12} ohm centimeters at temperatures up to 400°F .; dielectric strength is more than 500 volts per mil at a 10 mil gap. Dow Corning 4 meets all requirements of Specification AN-C-128a.

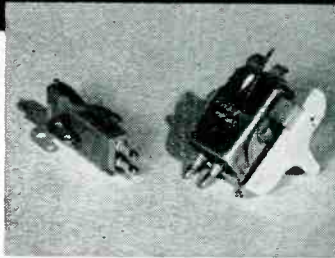

Dow Corning 4 packed in phonograph pick-up head cartridges increased crystal service life 20 times. The silicone compound prevents Rochelle Crystals from deteriorating due to absorbed moisture. It also acts as a viscous damping medium, thereby reducing excess vibration and enabling the head to handle a much higher frequency.

ELECTRICAL INSULATING VARNISHES

DOW CORNING 996 VARNISH dries tack-free in not more than 3 hours at 150°C . Dielectric strength measured with 2 inch electrodes on 2 mil films baked for 16 hours at 150°C . is 1000-2000 volts/mil, dry, and 500-1500 volts/mil, wet. Heat flexibility is more than 100 hours at 250°C . Cured films have good resistance to dilute acids, concentrated hydrochloric acid, and dilute or concentrated alkalis.

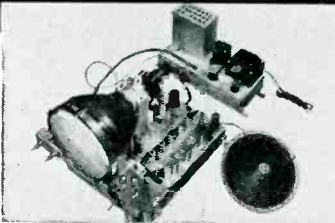

Flashover in high voltage television power supply coils can set ordinary organic varnish aflame. To eliminate this fire hazard, coils are impregnated with Dow Corning 996. Highly resistant to arcing, 996 provides positive protection against carbon tracking for the life of the entire set.

SILASTIC*, THE DOW CORNING SILICONE RUBBER

Silastic combines the remarkable heat stability and moisture resistance of resinous silicones with the physical properties of rubber, including resilience, shock and abrasion resistance, and resistance to both mechanical and electrical fatigue. Its dielectric properties show little change over a wide range of frequencies, even after aging at high temperatures. The surface resistivity of Silastic is high, and its thermal conductivity is about twice as great as that of either organic rubber or resinous insulating materials.

*T.M. REG. U.S. PAT. OFF.

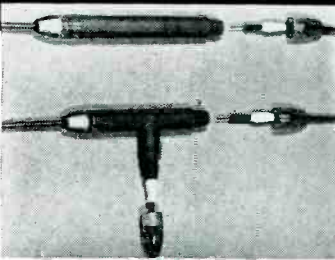

Completely eliminating taped connections on aircraft antennae, white Silastic seals reduce static and corona discharge by as much as 90%. They retain their resilience as well as their dielectric properties, excluding moisture and foreign matter after long exposure to the full range of ground and stratospheric temperatures.

SILICONE-GLASS LAMINATES

DOW CORNING THERMOSETTING RESINS are used to bond inorganic fabrics and finely divided particles such as powdered metals or mica. Typical $\frac{1}{8}$ " silicone-glass laminates have a flexural strength of 22,000 to 45,000 psi; water absorption after 24 hours of 0.25 %; dielectric strength with continuous filament cloth of 250 volts/mil or more; power factor of 0.002 at 1 mc; loss factor of 0.007 at 1 mc; arc insulation resistance of more than 10^{12} ohms; arc resistance of 300 seconds and a heat distortion value above 250°C .

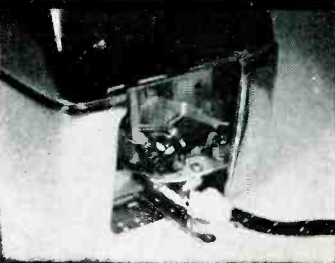

For maximum dependability and long service life, silicone-glass terminal blocks and contactor bases are being used in late model automatic toasters. Tests prove that Dow Corning silicone resin bonded glass laminates are more rigid, more heat-stable, more resistant to moisture and easier to fabricate and assemble than conventional materials.

MAIL THIS COUPON TODAY!

DOW CORNING CORPORATION, DEPARTMENT BE-22, MIDLAND, MICHIGAN
Please send me full information on the subjects checked:
 Dow Corning 200 Fluids Dow Corning 4 Compound Dow Corning Electrical Insulating Varnishes Silastic Dow Corning Silicone-Glass Laminates Reference Guide to Dow Corning Silicones

NAME _____
COMPANY _____
STREET _____
CITY _____ ZONE _____ STATE _____

ATLANTA • CHICAGO
CLEVELAND • DALLAS
LOS ANGELES • NEW YORK
WASHINGTON, D.C.

In Canada: Fiberglas Canada Ltd., Toronto • In Great Britain: Midland Silicones Ltd., London



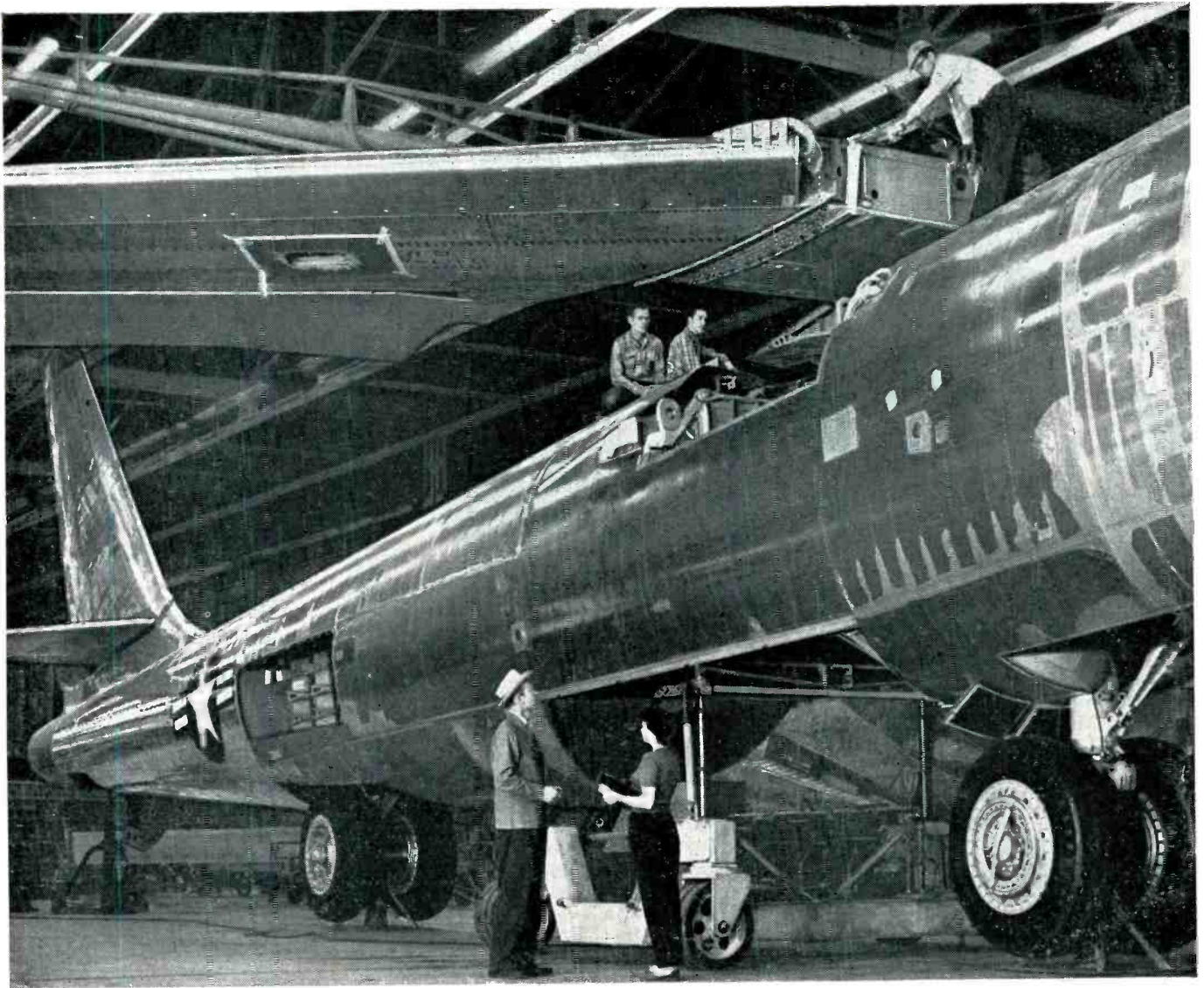

Top production teams back up Boeing engineers

When Boeing engineers developed the revolutionary, flexible-wing B-47, their designs called for aluminum forgings larger than any ever before made, and for a completely new kind of wing "skin" ranging in thickness from 5/8" at the body joint to 3/16" at the tip.

New techniques, machines and procedures had to be worked out. Production is so precise that the eight-ton wing slips in place with less than a hairsbreadth of clearance. Many of these new procedures were thought "impossible" a few years ago. Today they are routine in Boeing plants. That's the kind of production teamwork Boeing engineers expect—and get.

Boeing engineers also enjoy the advantages of the finest research facilities in

the industry. Their work, over the past 35 years, has given them tremendous prestige. You can share that prestige by becoming a Boeing engineer. You'll work on such long-range projects as guided missiles, nuclear-powered aircraft and the exploration of supersonic flight.

There are openings at Boeing right now for experienced and junior engineers in all fields, for aircraft

- DESIGN • DEVELOPMENT
- RESEARCH • PRODUCTION
- TOOLING

also for servo-mechanism and electronics designers and analysts, and for physicists and mathematicians with advanced degrees.

You can choose our Midwest plant at Wichita, or work in the Pacific Northwest at Seattle. Boeing provides a gen-

erous moving and travel allowance, offers you special training, a salary that grows with you—and a future of almost limitless range.

You'll be proud when you say, "I'm a Boeing engineer!"

Write today to the address below, or use the convenient coupon

JOHN C. SANDERS, Staff Engineer—Personnel
Dept. No. H-10
Boeing Airplane Company, Seattle 14, Wash.

Engineering opportunities at Boeing interest me. Please send me further information.

Name _____

Address _____

City and State _____

BOEING

Berkeley
PRINTED
READOUT

13273
25182
25173*

2 5 7 1 3

FOR
ELECTRONIC
COUNTERS!

• DIRECT READING • RAPID CYCLING • LOW COST

P RINTED READOUT for high speed electronic counters is now available at low cost as a standard BERKELEY product! This Digital Recorder provides a direct means of permanently recording sequential count information in arabic numeral form on a standard adding machine tape. It is designed to operate from electronic counters, Time Interval Meters, Events-per-Unit-Time Meters, nuclear scalars, and other electronic totalizing devices. Most standard BERKELEY instruments now in use can be readily adapted for operation with the BERKELEY Series 1550 Digital Recorder, thus eliminating the need for purchase of new counting equipment.

DIGITAL RECORDER . . . Series 1550 is composed of a Readout unit and a Printing Recorder. The first unit consists of a bank of readout decimal counting units essentially paralleling the totalizing function of the basic counting instrument from which they operate, and a selecting relay matrix to channel information from the counting circuit to the Printing Recorder. This second unit presents a sequence of total counts in direct reading digital form on a standard adding machine tape.

A COMPLETE SYSTEM . . . of Electronic Counter and Digital Recorder then consists of three elements: a suitable electronic counting device, Readout unit, and Printing Recorder. The latter two elements comprise the complete Digital Recorder. Under certain conditions a special modification of the system will permit original count information to be channeled directly into the Readout unit, thus eliminating the need for a separate electronic counter.

SPECIFICATIONS . . . Minimum counting period determined by the characteristics of the basic counting instrument. Maximum cycling rate: 1 printout every $\frac{3}{4}$ second. Indicating capacities 3, 4, 5 or 6 columns. Readout Unit— $20\frac{3}{4}$ " x $10\frac{1}{2}$ " x 15" cabinet, wt. 60 lbs., standard 19" relay rack panel. Printing Recorder— $7\frac{1}{2}$ " x $8\frac{1}{4}$ " x $14\frac{1}{2}$ " cabinet, wt. 20 lbs. Price, Digital Recorder, Model 1553 (3-column), \$1050; Model 1554 (4-column), \$1125; Model 1555 (5-column), \$1200; Model 1556 (6-column), \$1275, f.o.b. factory.

M-2

Please request Bulletin 110

Berkeley Scientific

division of BECKMAN INSTRUMENTS INC.
2200 WRIGHT AVENUE • RICHMOND, CALIFORNIA

"DIRECT READING DIGITAL PRESENTATION OF INFORMATION"

the number of cycles on the scope will become fewer and fewer until the two frequencies are the same. If the sampling oscillator has the proper lock-in circuit, the frequencies will then lock in synchronism. The scope display is then a straight line. Assuming G_1 and G_2 are in phase, if modulation is applied to the wave on G_1 , the modulating wave will appear on the scope.

This type of synchronous detector functions similarly to the mathematical process of trigonometric multiplication. After the electrons in the detector tube leave the cathode and receive modulation at G_1 , they pass to the neighborhood controlled by G_2 and are again acted upon. Another viewpoint is to consider that the instantaneous voltage on G_1 determines the amount of current and the instantaneous voltage on G_2 determines the proportion of that current that goes to the plate of the tube. The first function G_1 is multiplied by the second G_2 .

REFERENCES

- (1) D. G. Fink, Plans For Compatible Color Television, *ELECTRONICS*, 24, p 90, Aug. 1951.
- (2) C. J. Hirsch, W. F. Bailey and B. D. Laughlin, Principles of NTSC Compatible Color Television, *ELECTRONICS*, p 88, Feb. 1952.

Counter Test Circuits

BY RICHARD WEISSMAN

Senior Engineer
Cook Research Laboratories
Skokie, Illinois

To STUDY the behavior of a ternary counter, it was found helpful to use certain auxiliary equipment. A monopulse generator proves convenient in locating faults in any complex counting operation. To obtain a single keyed pulse directly from a switch closure is extremely difficult when an identical waveform, free from raggedness and spurious transients, is desired.

Another small unit which has proved invaluable in the study of waveform transitions is the variable delayed trigger circuit for initiating the oscilloscope sweep. When it is desired to view a small detail of a recurrent waveform on a greatly expanded time scale, it is usually impossible to select the particular detail for display from the entire pattern with the regular oscilloscope controls without at least

Sensational Advancements In Science & Industry

Created the Need for

THE NEW

Stabelex "D" CAPACITORS

YOUR FREE INDUSTRIAL CONDENSER CORPORATION Stabelex "D" Capacitor Catalog may prove to be the most important new single piece of literature for you this year!



The unusually high insulation resistance at 20° C. in turn insures unusually high resistance at temperatures up to 75° C. The insulation resistance of these capacitors at 75° C. is approximately ten times that of commercial oil capacitors at 20° C. This is well illustrated in Curve #1109.

Performance curves illustrating various characteristics of the Stabelex "D" Capacitor will appear in this magazine each month.

OUTSTANDING FEATURES

INSULATION RESISTANCE AT 20° C. AFTER THREE MINUTES CHARGE—900,000 megohm microfarads

INSULATION RESISTANCE AT 75° C.—78,000 megohm microfarads

INSULATION RESISTANCE AT -75° C.—In excess of 5 million megohm microfarads

CHANGE IN CAPACITANCE FROM 25° C. TO -80° C; +0.76%

SELF TIME CONSTANT OF 10 MFD CAPACITOR—4800 hours

Q AT 50 KILOCYCLES—10,000

POWER FACTOR AT 1 KC—0.00025

SEND FOR CATALOG 1117 TODAY

After a long period of research, Industrial Condenser Corporation now offers to industry for the first time the first of their family of Stabelex capacitors, stabelex "D", which has been produced for special applications for some time.

Complete information performance curves, characteristics, and suggested applications of the various types now available will be found in this catalog.

Mfrs. of OIL, WAX, ELECTROLYTIC, PLASTIC

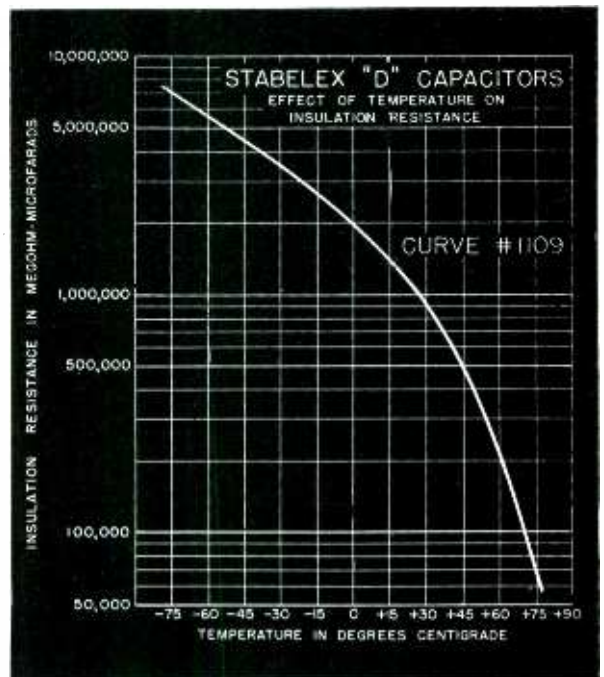

INDUSTRIAL CONDENSER CORPORATION

3244 N. California Avenue
Chicago 18, Illinois, U.S.A.

Please send me my FREE copy of your new Catalog 1117 on Stabelex "D" Capacitors.

Name

Company Position

Street

City..... Zone State

CAPACITORS and RADIO INTERFERENCE FILTERS

13[♣] is your lucky number...

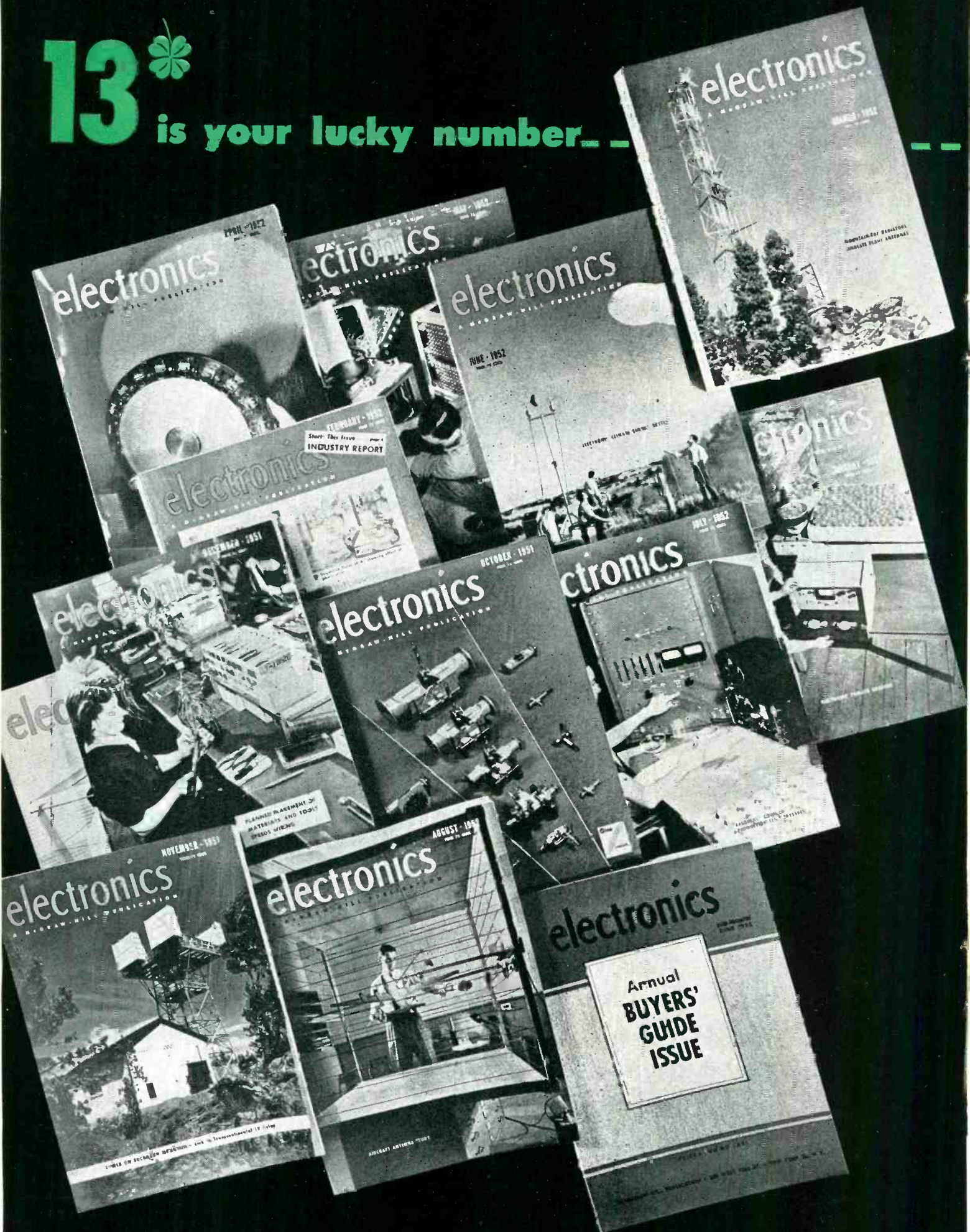

--- when it adds up to the

12 regular monthly issues of
electronics
and . . . THE ANNUAL MID-JUNE
electronics BUYERS' GUIDE

 **Plan NOW for these 13 issues in your Ad-Budget for '53**

There is a big year ahead in electronics — big in dollar volume — big in unit volume and — big in competition. Now is the time to make sales plans for the increased business expected in '53.

One important part of those plans should be a consistent advertising campaign in **ELECTRONICS** — the 12 regular monthly issues and the Annual Mid-June Buyers' Guide. In these 13 issues you can tell your sales story most effectively to 31,126 buyer-readers — by far the largest, most interested, buying audience you can get. You can put your product up for sale in every nook and cranny of the market, in places where it counts and where, more often than not, your salesman cannot reach. Every important company, large or small, has done it year after year, and their continued use is proof of the statement so often heard, "ELECTRONICS is a must in our sales plans".

 **To completely cover ALL your markets**

As electronics explores further into communications and as its use increases in industry, the problem of marketing its countless products becomes more complex. A company sales force, no matter how hard hitting, cannot cover all the bases. But the 13 issues of **ELECTRONICS** can. It will bring out all the prospects, and as a market research medium, it will uncover new applications and brand new markets, sending a sales force on its way to profitable calls. You can't know all your markets nor all your sales potentials — let **ELECTRONICS** bring them out in the open.

 **For EVERY month throughout '53**

Don't plan a big splurge for January, then "slide on your side" till June. Electronics as a science industry just doesn't operate that way. It is a day and night business — working all the time developing new products, new techniques, new equipment. Tell your story consistently month after month so that as each new need arises, your product story will be there to fill that need. And, of course, tell it in **ELECTRONICS**

Be sure . . . it's 13 for '53 in

 **electronics** 

12 REGULAR MONTHLY ISSUES *and the* BUYERS' GUIDE
A MCGRAW-HILL PUBLICATION
330 West 42nd Street • New York 36, N. Y.

ANDREW

antenna research,
development
facilities

The 420-acre ANDREW research Center, including a mile-long testing range, is devoted entirely to antenna research and development. In addition to the many Andrew standard models which have been developed here, several research and design problems have been undertaken on both prime and sub-contracts. The use of these facilities can be of material assistance in the design and manufacture of systems, associated equipment or in the development of custom antenna equipment.



◀ The testing range utilizes this platform and various towers for antenna field testing. Recently, a full-scale model of the Empire State Building's conical upper section was built on the platform for testing television transmitting antennas. The ANDREW "Skew" antenna developed from the tests is now in use on the Empire State Building.

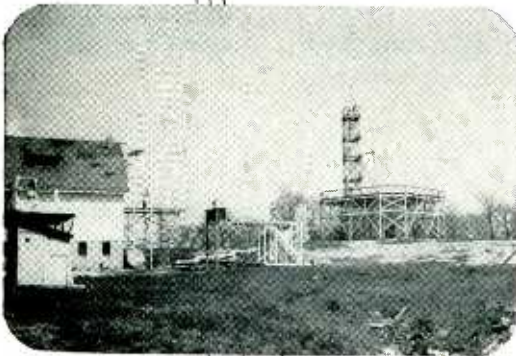

◀ At this large, well equipped Center, a wide range of equipment and set-ups are available, both indoors and out. Antenna problems are solved by antenna specialists—equipment and experience cover 50 KCS to 20,000 MCS—these enable ANDREW to accept a wide range of antenna development and engineering responsibilities.



◀ The large indoor laboratory has provisions for handling large equipment and is equipped with complete machine shop and metal working facilities. Testing is done in the upper portion of the building where the all-wood construction and elimination of metallic surfaces permit undistorted operation of the test set-up.

Andrew

ANTENNA SPECIALISTS

CORPORATION • 363 EAST 75TH STREET, CHICAGO 19

TRANSMISSION LINES FOR AM-FM-TV-MICROWAVE • ANTENNAS • DIRECTIONAL ANTENNA EQUIPMENT • ANTENNA TUNING UNITS • TOWER LIGHTING EQUIPMENT

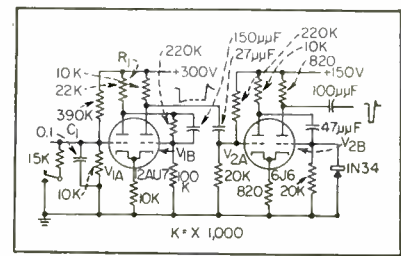

FIG. 1—Schematic diagram of the monopulse generator

destroying the sweep-speed calibration.

By initiating the sweep from an external variably delayed trigger it is easy to magnify any desired part of a waveform, such as a fast transition in a slowly recurring pattern, using any sweep speed up to the maximum capabilities of the scope without changing the calibration or linearity of the sweep.

Figure 1 shows the circuit for the monopulse generator. Triode V_{1A} is normally conducting but when the key is depressed, the grid voltage drops exponentially until the multivibrator action flips the V_{1B} plate into conduction. The differentiated negative step triggers V_2 which is a monostable trigger circuit delivering a single one-microsecond negative pulse each time it is triggered.

Resistor R_1 prevents free running in the V_1 multivibrator so that the key must be released before the circuit can flip back to normal. Relaxation time, controlled by C_1 , is sufficient to prevent double pulsing from switching transients.

The variable sweep delay is shown in Fig. 2. A cathode-coupled monostable multivibrator is triggered by the signal at some fixed time in each cycle. When the circuit flips back to the stable condition, a positive output pulse is derived by the C_1R_1 differentiating circuit. The crystal diode prevents the initial negative multivibrator pulse from appearing at the output. The time required for the right-hand grid to relax and flip the circuit back is determined by the setting of the switch and the fine-delay potentiometer.

The sweep, triggered by the multivibrator output pulse is delayed until the occurrence of the desired portion of the signal. The multivibrator may be triggered conveniently from one of the vertical de-

**NEW EXPANDED
LINE -**



TYPE:
RR-60W-PP



TYPE:
CCS-80W-XP



TYPE:
CCS-80W-HP



TYPE:
C-80W-2/56P



TYPE:
C-75T-SS



TYPE:
B-60W-SS



TYPE:
ABS-40W-XP



TYPE:
AAA-30W-HS



TYPE:
AAA-30W-HP



TYPE:
AAA-30W-SX



TYPE:
AA-40W-SP



TYPE:
AB-60T-SX



TYPE:
AB-60W-SS



TYPE:
AB-60T-LX



TYPE:
ABS-40W-HH



TYPE:
ABS-40W-HP

**OF E-I STANDARD
terminals**

48 STANDARD TYPES NOW AVAILABLE
TO SIMPLIFY YOUR DESIGN PROBLEMS,
SPEED DELIVERIES, REDUCE COSTS!

16 ADDITIONAL TYPES!

The increasingly popular E-I STANDARD LINE of SEALED TERMINALS now includes 16 additional types making a total of 48 items that can be ordered direct from stock with prompt delivery pressured. Our application engineers believe that this new expanded group of standard items could readily solve the majority of sealed terminal problems thereby eliminating much of the time and expense involved in custom design and production.

All 48 types are currently being specified in great numbers for an extremely wide range of applications, thus users of these types benefit by the additional economy of large scale production. For complete information covering all 48 types write today for Bulletin 949-A.

E-I... YOUR HEADQUARTERS
FOR HERMETICALLY-SEALED
MULTIPLE HEADERS, OCTAL
PLUG-INS, TERMINALS, COLOR
CODED TERMINALS, END
SEALS, etc. WRITE FOR CATALOGS.

DIVISION OF
AMPEREX ELECTRONIC
CORPORATION



ELECTRICAL INDUSTRIES

MANUFACTURERS OF SPECIALIZED ELECTRONIC EQUIPMENT
44 SUMMER AVENUE, NEWARK 4, NEW JERSEY



keeping communications **ON THE BEAM**

FREQUENCY & MODULATION MONITOR



*the JK
FD-12*

Monitors key for frequencies anywhere between 25 mc and 175 mc. Checks both frequency deviation and amount of modulation. Keeps the "beam" on direction; guarantees more solid coverage, too!

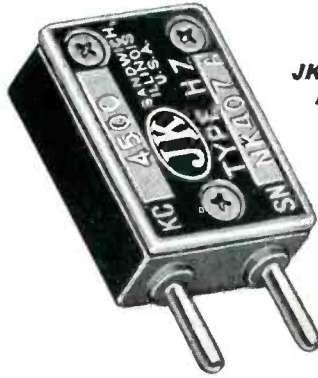

**JK STABILIZED
H-7 CRYSTAL**

CRYSTALS FOR THE CRITICAL

The H-7 crystal is in common use with two-way police radio systems. Frequency range: 3 to 20 mc. Water and dust-proof, it is pressure mounted, has stainless steel electrodes. Just one of many JK crystals made to serve EVERY crystal need!

Time-Saver to Prowl Cars, Life-Savers to Thousands!

In a split second your police station and the farthest cruising prowl car can respond as one man! Such "safety at your doorstep" is possible only through compactly efficient two-way radio. JK crystals and transmitters are in constant use to keep police radio frequencies reliably "on the beam."



THE JAMES KNIGHTS COMPANY
SANDWICH 3, ILLINOIS

Announcing Radio Receptor's new range of



Germanium Diodes

FEATURING POLARITY AT A GLANCE!

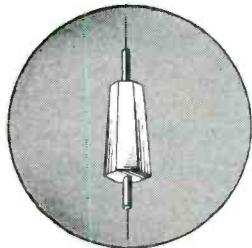

ACTUAL SIZE



Keynoting sound design features and simplicity in construction, the new Radio Receptor Germanium Diodes will give a maximum of trouble-free operation even under the most adverse conditions.

Normally in diodes such as these, one side of the germanium wafer is plated so that it may be soldered to the base . . . but Radio Receptor's improved production methods make it possible to *omit* plating, thus eliminating possible flaking and improving quality.

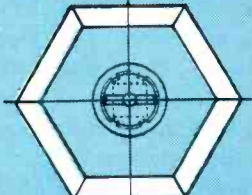
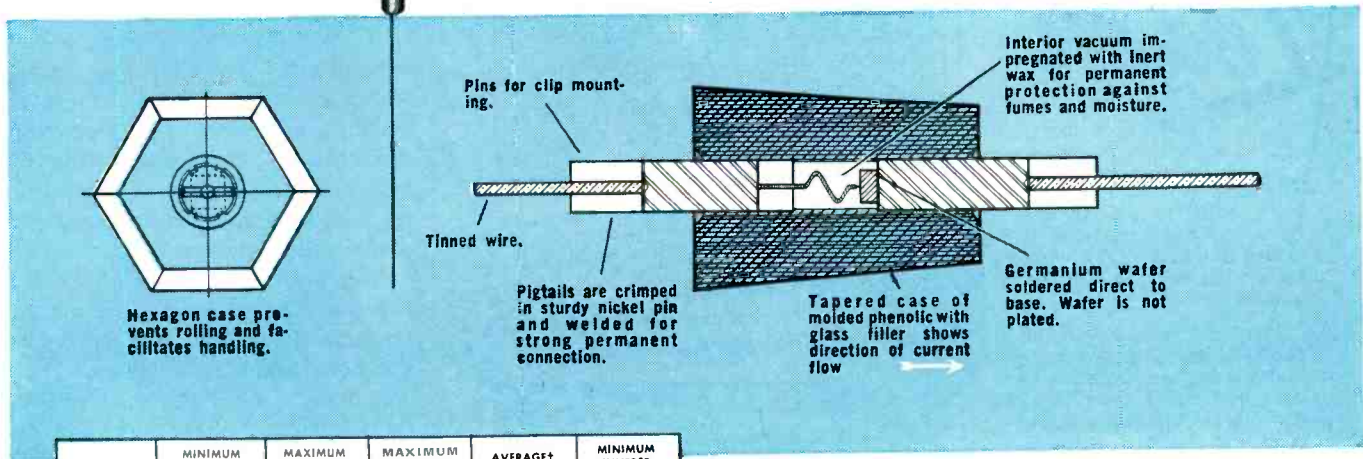

Hexagon case prevents rolling and facilitates handling.

CODE NO.	MINIMUM CURRENT AT 1 VOLT FORWARD MA	MAXIMUM CURRENT AT 10 VOLTS REVERSE MA	MAXIMUM CURRENT AT 50 VOLTS REVERSE MA	AVERAGE† RECTIFIED CURRENT MA	MINIMUM INVERSE PEAK VOLTS
1N48	4.0	—	0.833	50	85
1N51	2.5	—	1.667	25	50
1N52	4.0	—	0.150	50	85
1N63	4.0	—	0.050	50	125
1N64	Minimum of 0.100 MA in 44 MC Test Circuit				20
1N65	2.5	—	0.200	50	85
*1N69	5.0	0.050	0.850	40	75
*1N70	3.0	0.025	0.300	30	125
1N75	2.0	—	0.050	50	125
*1N81	3.0	0.010	—	30	50

The distinctive tapered shape of the glass-filled phenolic cartridge body indicates the direction of current flow, while the hexagon form assures ease of handling — Prevents rolling, especially when the leads are cut off to permit mounting the diode in clips.

Submit your germanium diode application problems to us . . . We'll be glad to make recommendations without obligation!

*JAN type

†Average half wave rectified current at 60 CPS and 25° C. Consult us for ratings at other conditions.

Germanium Transistors are coming!

. . . WATCH FOR OUR ANNOUNCEMENT SOON

SELETRON & GERMANIUM DIVISION

RADIO RECEPTOR COMPANY, INC.



Since 1922 in Radio and Electronics



Sales Dept.: 251 W. 19th St., New York 11, N. Y. • Factory: 84 N. 9th St., Brooklyn 11, N. Y.

For better
controls
through better
Hermetically
Sealed Relays

SPECIFY

Leach

The most advanced hermetically sealed relays can best be designed and produced by a firm like *Leach* which pioneered this field from the beginning.

Here at *Leach* you will find complete engineering, testing and production facilities to help you solve your relay problems in the electrical and electronic fields.

The unsurpassed dependability of *Leach Relays* has been proved by nearly four decades of leadership in providing all types of relays for maximum performance under competitive operating conditions.

FOR BETTER CONTROLS
THROUGH BETTER RELAYS
—Specify Leach



No. 637SS, AN3307-1
2PDT Hermetically Sealed,
Solder Terminal Type

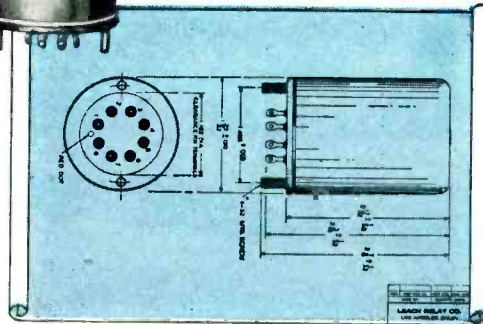

No. 637PS
2PDT Hermetically Sealed,
Plug-In Type in Octal Plug

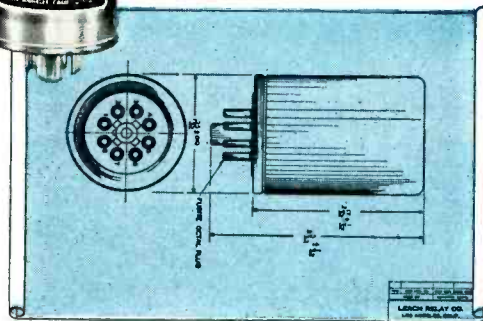

No. 9031SS
3PDT Hermetically Sealed,
Solder Terminal Type

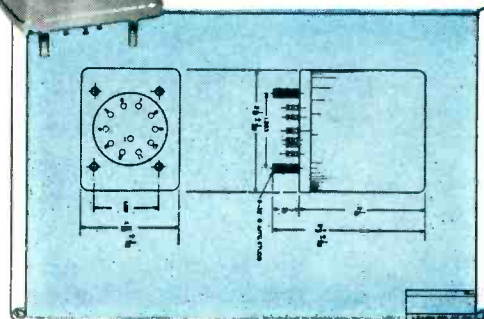

Performance characteristics for the
Relays illustrated above are as follows:

- Contacts rated: 10 Amps.
Resistive and inductive at 29 VDC.
- 6 Amps. Motor load at 29 VDC.
- 10 Amps. Resistive at 115 VAC, 400 cycles.
Coil 24-28 VDC.



LEACH RELAY CO.

5915 AVALON BOULEVARD • LOS ANGELES 3, CALIFORNIA
Representatives in Principal Cities of the U.S. and Canada

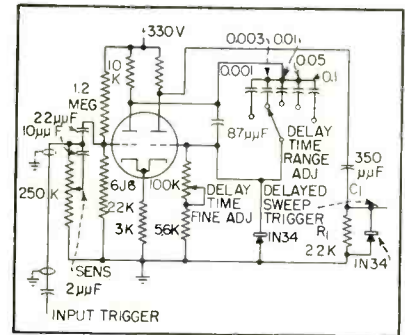

FIG. 2—Variable sweep delay circuit

flection plates of the oscilloscope through a 2- μ f capacitor to avoid loading either the scope or the circuit under test.

Remote-Controlled Broadcast Transmitter

By V. E. HUGHES

*Marconi's Wireless Telegraph Company
Chelmsford, England*

UNATTENDED remotely-controlled radio transmitters offer numerous advantages, outstanding among which are the major points of releasing personnel for important work other than at the station site and the feasibility of installing transmitters in remote places, to cover a limited area.

One pair of lines is all that is necessary to remotely control the station. Programs are sent over a pair of high-quality lines.

Compactness of the equipment is an additional advantage and the self-contained monitoring circuits automatically close down a faulty section of the installation while good sections carry on the program.

Installations of $\frac{1}{4}$ to 2 kw can be made up of the units which comprise the robot transmitters shown in the photograph. Units are of 500 to 660 watts output, each unit being a complete transmitter. The units are operated singly, at reduced power, or in parallel. Each has monitor circuits which check phase difference between r-f drive input and r-f output, amplitude of the r-f drive and output, as well as the a-f input and output.

Each transmitter is enclosed in an aluminum alloy cabinet, and access is required only at the front, thus allowing the units to be placed close to a wall.

Heavy components are mounted

Phaotron

presents a new concept in meters

**LABORATORY TYPE INSTRUMENTS
RUGGEDIZED for FIELD SERVICE**

at a realistically low price

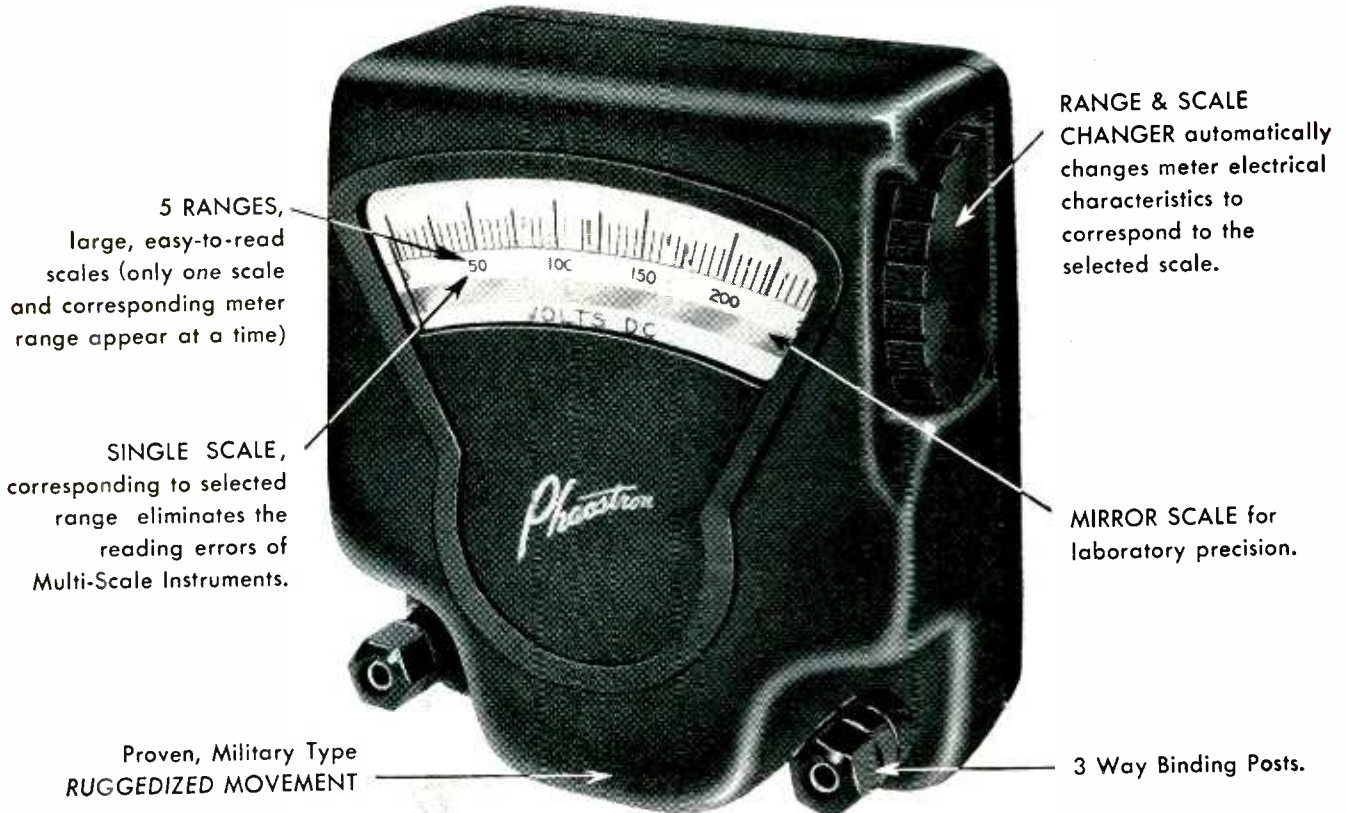

5 RANGES,
large, easy-to-read
scales (only one scale
and corresponding meter
range appear at a time)

SINGLE SCALE,
corresponding to selected
range eliminates the
reading errors of
Multi-Scale Instruments.

RANGE & SCALE
CHANGER automatically
changes meter electrical
characteristics to
correspond to the
selected scale.

MIRROR SCALE for
laboratory precision.

Proven, Military Type
RUGGEDIZED MOVEMENT

3 Way Binding Posts.

ILLUSTRATION APPROXIMATELY 3/4 SIZE

AVAILABLE IN FOUR MODELS

1000 OHMS PER VOLT DC VOLTMETER WITH 5 RANGES

0-2.5, 0-10, 0-50, 0-250, 0-1000

20,000 OHMS PER VOLT DC VOLTMETER WITH 5 RANGES

0-2.5, 0-10, 0-50, 0-250, 0-1000

AC VOLTMETER WITH 5 RANGES

0-10, 0-50, 0-150, 0-500, 0-2500

DC MICRO-MILLIAMETER WITH 5 RANGES

0-250 μ a, 0-1 MIL, 0-10, 0-100, 0-500

LITERATURE AVAILABLE ON REQUEST
JOBBER INQUIRIES INVITED

— REPRESENTED BY —

BLAIR-STEINBERG CO., New York, N.Y.
WALTER BERGGREN & ASSOCIATES, Chicago, Ill.
MARSHANK SALES CO., Los Angeles, Calif.

ENVIRONMENT FREE
ELECTRICAL EQUIPMENT by



PHAOSTRON COMPANY, 151 PASADENA AVENUE, SOUTH PASADENA, CALIFORNIA

For *Critical* Applications
Triplett 630-A Has No Counterpart

Accuracy
 to 1½%

Readability
 with a Mirror-Scale

Adaptability
 with ½% resistors

Try it at your distributor's

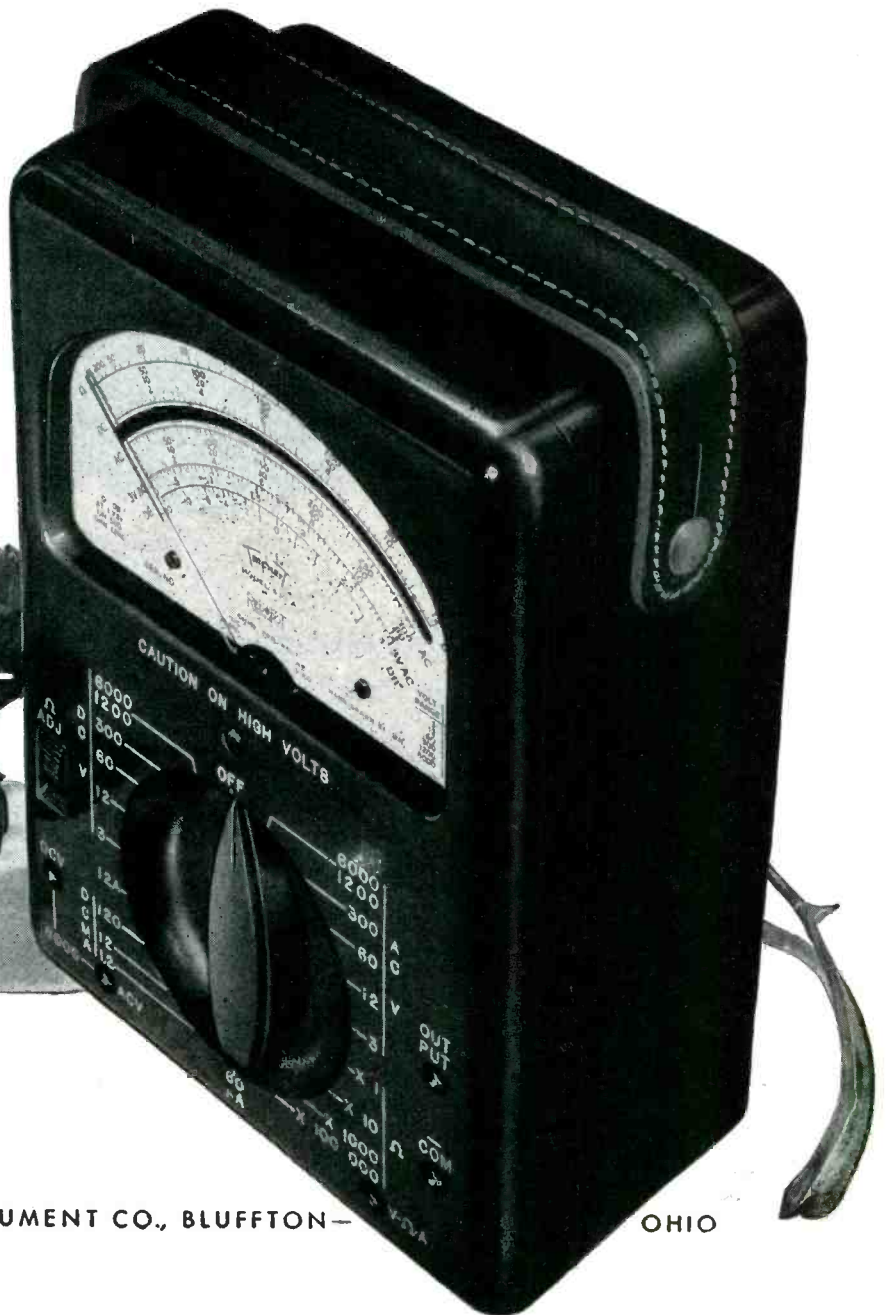

TRIPLETT ELECTRICAL INSTRUMENT CO., BLUFFTON—

OHIO

**A MIDGET HELPER
FOR A
GIANT IN FLIGHT**

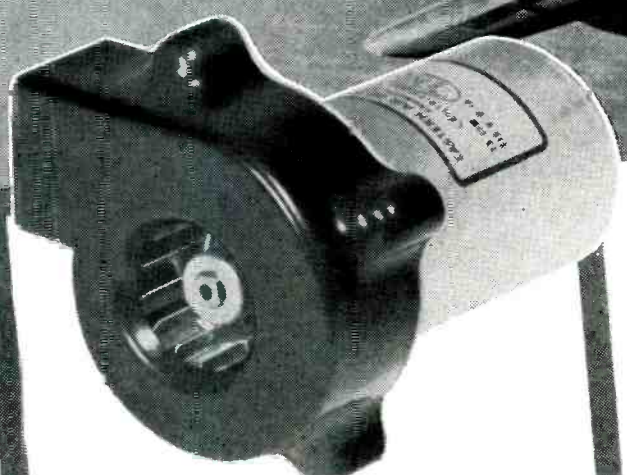

J 55-C CENTRIFUGAL BLOWER
Overall Dimensions
(3-11/16" x 2-29/32" x 2-15/16")

SPECIFICATIONS:

- 115 Volts
- 400 Cycles
- 7000 RPM
- 13 CFM 0" Static Pressure
- Single Phase
- 1 Amperes
- 1.12 lbs. wgt.

Meets all military specifications for corrosion resistance, fungus-proof, humidity, shock and vibration.

APPLICATIONS

- VENTILATING EQUIPMENT
- RADAR EQUIPMENT
- AMPLIFIER UNITS
- TRANSMITTERS
- OSCILLATORS

Solving Special Problems is Routine at EAD

If your problem involves rotating electrical equipment, bring it to EAD. Our completely staffed organization will modify one of our standard units or design and produce a special unit to meet your most exacting requirements.

EAD

Eastern Air Devices
INC.

585 DEAN STREET
BROOKLYN 17, NEW YORK

TWA
specifies EAD

Centrifugal Blowers
for their new
Super Constellations

This new 60 ton giant is scheduled for TWA coast-to-coast service this fall. It is 113½ feet long . . . has a wingspread of 123 feet . . . and can carry 64 passengers at more than 300 miles per hour. It's the world's largest commercial airliner . . . utilizing the finest safety and comfort features conceivable.

Right in the heart of this giant's main electrical system TWA specified EAD's J 55-C Centrifugal Blowers, to cool the vital voltage regulators. These amazing midgets weighing only approximately 18 ounces met every rigid specification. Another outstanding example of EAD's ability to produce the finest in rotating electrical equipment.

"Choose EAD for reliability"

PATENT ATTORNEYS

An unusual situation has developed at Hughes. In the last few years, our Laboratories have grown to a population of more than three thousand men and women, who cover a wide range of research and development. New electronics products we have developed support a manufacturing organization of thousands of additional people.

And yet today our patent attorneys can be numbered on the fingers of two hands!

The explanation is, of course, that our growth has been very rapid and we have gotten a late start in trying to build an appropriately large patent department. The situation has not been made any easier for us by a current rapid expansion of our commercial, nonmilitary interests. As a result, however, we believe that the opportunities for patent attorneys are now unusually attractive at Hughes.

To keep abreast with the work being done in our Laboratories, our patent department must be greatly enlarged; this means that today's openings carry unusual potentialities for rapid advancement. On the other hand, the fact that the Research and Development organization to be served has already established itself as one of the largest and most productive electronics laboratories in the country provides a degree of security not usually associated with opportunities for rapid individual growth.

*Inquiries should be addressed to:
Engineering Personnel Department*

HUGHES

**RESEARCH and
DEVELOPMENT
LABORATORIES**

Culver City, Los Angeles County, California

Assurance is required that re-location of the applicant will not cause disruption of an urgent military project.

in the base of the cabinets and, to facilitate removal and replacement, the location of heavy components is by spigots.

Individual chassis do not exceed 50 lbs in weight.

The drives supplied with these transmitters fulfill the requirements of the Copenhagen Plan and have a day-to-day stability of one in one million.

Two drives are supplied. These are mounted in a separate cabinet, which is smaller than the transmitter cabinet. This cabinet houses also the transmitter control circuits.

Should high precisions drives be required for common wave or synchronous working, these can also be supplied and used without alterations to the transmitter. Such drives have a day-to-day stability of one in 100,000,000.

The r-f amplifier consists of two beam tetrodes in parallel and the anode circuit of this stage is tuned by an L-C circuit. The output is then R-C coupled to the grids of the modulated amplifiers.

The anode circuit of the penultimate stage of the transmitters is used for effecting phase adjustment. In this stage the anode voltage is provided by a 500-v auxiliary rectifier.

The modulated amplifier, consisting of two transmitting triodes



One of the 660-watt unattended transmitters. Top shelf, modulator and modulated amplifier; second shelf (left to right) submodulator, monitor unit, r-f amplifier; third shelf (top) contactor panel, (bottom) bias rectifier chassis. The lower three shelves contain the high-voltage rectifiers and auxiliary rectifiers

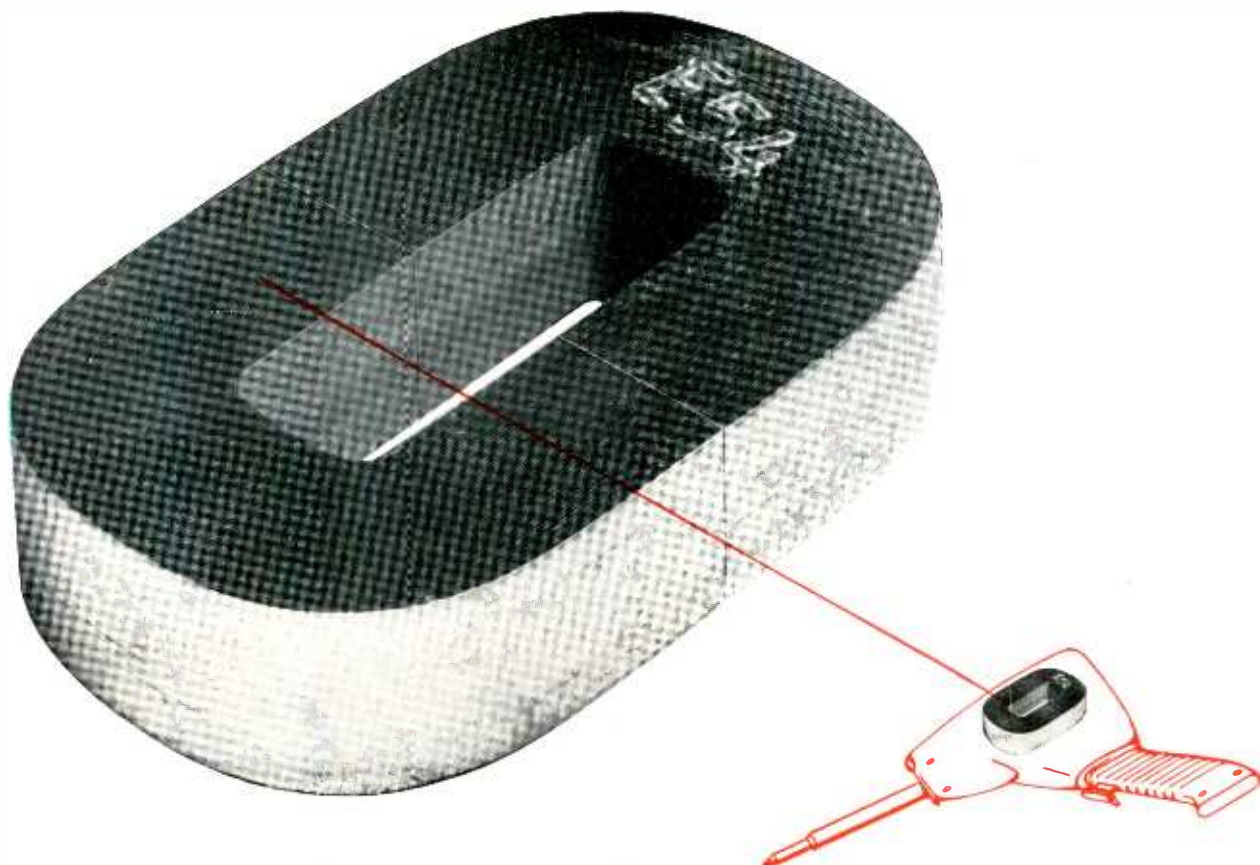

HIPERSIL CORES

help revolutionize this soldering gun!

In designing their new Versa-Tool soldering gun, Phillips Manufacturing Company wanted a power unit that would provide instantaneous heat for off-on operation, yet operate on household voltage. A transformer was needed to build adequate amperage. But it had to be small, to fit into the handle . . . lightweight, for balance . . . reasonable in cost, to insure competitive pricing of the assembled unit.

Westinghouse Type RC Hipersil Cores provided the complete answer.

Because Hipersil Cores have greater flux-carrying capacity, Phillips engineers were able to cut size and weight of the transformer, effecting considerable savings in coil as well as core costs. But, better still, because the two-piece cores simplified assembly, manufacturing costs were slashed.

Hipersil Cores can cut cost, size and weight in all types of electrical and electronic transformers. Available in a wide range of sizes and shapes for low or high-frequency applications. Greater flux-carrying capacity, compact construction, plus the savings they effect in your manufacturing costs make them the best transformer cores on the market today. For more technical information on applying Hipersil Cores to your product, write to Westinghouse Electric Corporation, P. O. Box 868, Pittsburgh 30, Pennsylvania.

J-70628

YOU CAN BE **SURE** ...IF IT'S
Westinghouse

HIPERSIL CORES

APPEARING ON THE HORIZON...

a great NEW COLLINS development

The Collins Navigation Computer automatically . . .

- ★ Displays course and distance from aircraft to destination which may be an off set point where . . . *no radio facilities exist!*
- ★ Gives continuous right-left steering information with regard to the desired course.
- ★ Supplies continuous readings of distance to touchdown during an ILS approach.
- ★ Greatly simplifies all in-flight navigation computations.

Soon to be available is the Collins Navigation Computer, a punched card operated electronic device which automatically furnishes all essential in-flight navigation computations. This development presents, for the first time, a foolproof automatic navigation aid to give the pilot a continuous position fix measured in miles from his destination along his chosen course.

VOR, ILS, DME, or ADF information is fed to the Navigation Computer on a pre-computed punch card provided with the equipment. Simple interpretation of the readings from only two instruments gives the pilot his position at all times.

Whether the flight plan calls for Chicago to Des Moines, or Dallas to Schenectady, the navigation for the complete flight can be pre-calculated. Armed with the appropriate punched card to activate the Navigation Computer, the pilot is confident of knowing his exact position at any point along the entire route . . . and of flying an accurate course to his final destination.

We have prepared a descriptive booklet on the Collins Navigation Computer and will be glad to mail you a copy on request. Also available are 16-mm demonstration films of the Collins Flight System.

For Electronic Advancement in Aviation, It's . . .



COLLINS RADIO COMPANY, Cedar Rapids, Iowa

11 W. 42nd St., NEW YORK 36

1930 Hi-Line Drive, DALLAS

2700 W. Olive Ave., BURBANK

**LET ME
BRING YOU UP-TO-DATE
ON
"Lavite" FERRITE
COMPONENTS**

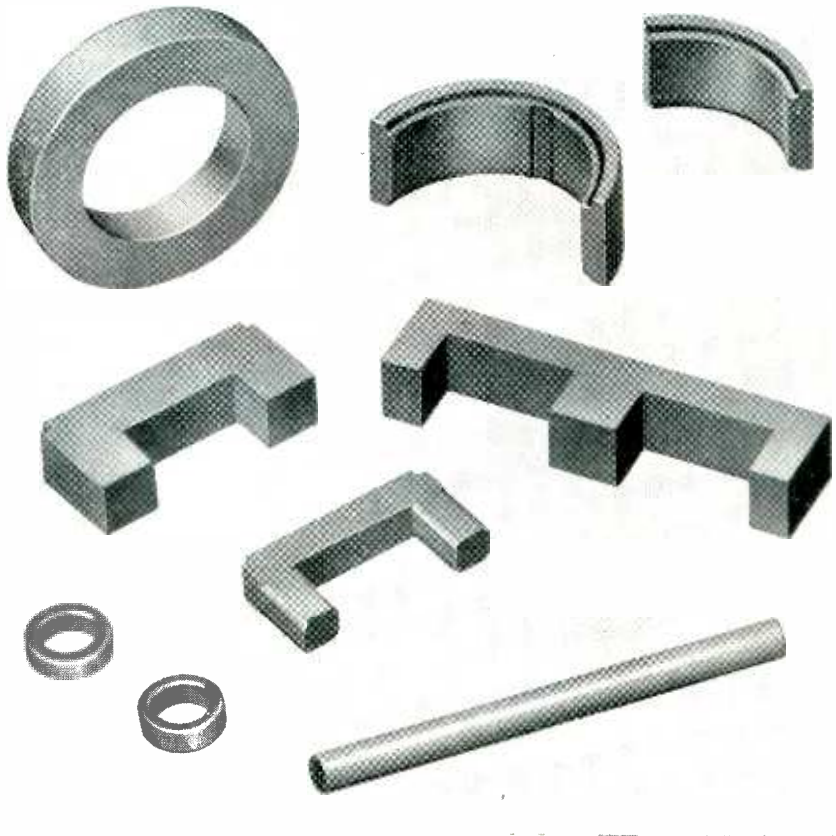

Let me first emphasize the essential difference between "Lavite" Ferrites and general Ferrites. When you use "Lavite" Ferrites, you first have all of the desirable basic advantages of this type of material. These advantages are many varieties in composition to better meet specific electrical properties that may be required as to high saturation, higher permeabilities, high Q and FM frequencies, low temperature coefficient, etc.

Ask for general characteristic data on all "Lavite" Technical Ceramics — ("Lavite" Steatite, "Lavite" Titanates, "Lavite" Ferrites, and others).



To this is added the plus value of:

1. Steward's private research and development,
2. Steward's modern and highly efficient facilities to produce your "Lavite" Ferrite components to greater accuracy in both material and size,
3. Interestingly low production costs of these parts, and
4. Prompt delivery.

And in addition to all this, you are invited to consult Steward engineers, without obligation, for scientific answers to your specific problems. Send me your specifications.

**D. M. STEWARD
MANUFACTURING CO.**

3604 Jerome Ave, Chattanooga, Tennessee.
Sales Offices in Principal Cities

operated at an anode voltage of 1,600 v, is modulated by two tubes of the same type operated as Class-B modulators.

A-F Stages

The line input is transformer-coupled to the low-frequency amplifier which is a preamplifier employing high slope pentodes in push-pull. Output from the preamplifier feeds two tetrodes which act as a push-pull amplifier driving the cathode followers. The a-f amplifiers and cathode-follower stages are all fed from the auxiliary rectifier.

When two or three transmitters are used to give higher power, three transmitters for 2 kw, they are mounted side by side. The output feeders of each transmitter unit are paralleled and connected to a transducer, the elements of which are switched by contactors. This allows the correct matching of one, two or all transmitters. The transducer consists of an inductance, capacitors and contactors, all of which are liberally rated and carefully designed thus eliminating the need for an automatically switched spare unit.

A change-over contactor is provided in the output feeder of each transmitter and is arranged to switch the transmitter output to either the transducer or a test load. Separate test loads are provided for each transmitter and this arrangement enables the transmitters to be tested independently. Facilities for automatic checking are also included.

As stated previously, each transmitter is provided with two monitoring circuits, one for the r-f chain and one for the modulator. The r-f amplitude and phase monitoring is achieved by comparing vectors derived by direct capacitive coupling from the antenna output and the r-f drive input to the transmitter. These vectors, when all is well, are applied in antiphase to the monitor and adjusted to give equal amplitude.

The resultant voltage is rectified and applied to the grid of a tube, in the anode circuit of which is a relay. The tube under normal conditions carries current and holds the relay energized. A fault con-

You change ranges
this simple way

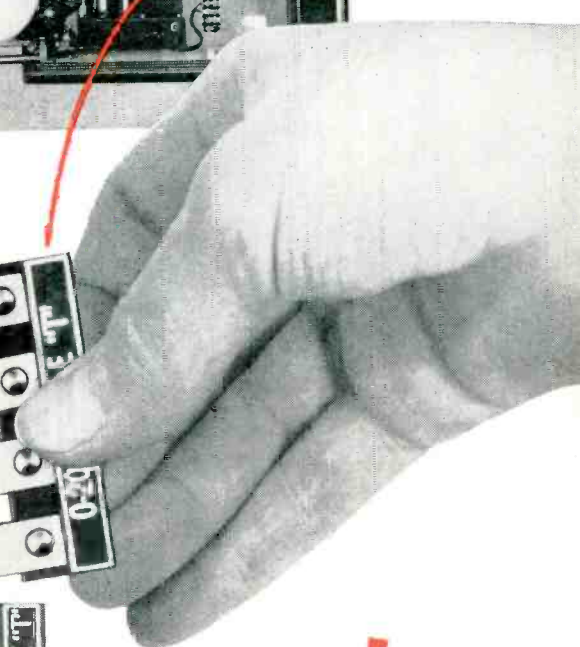
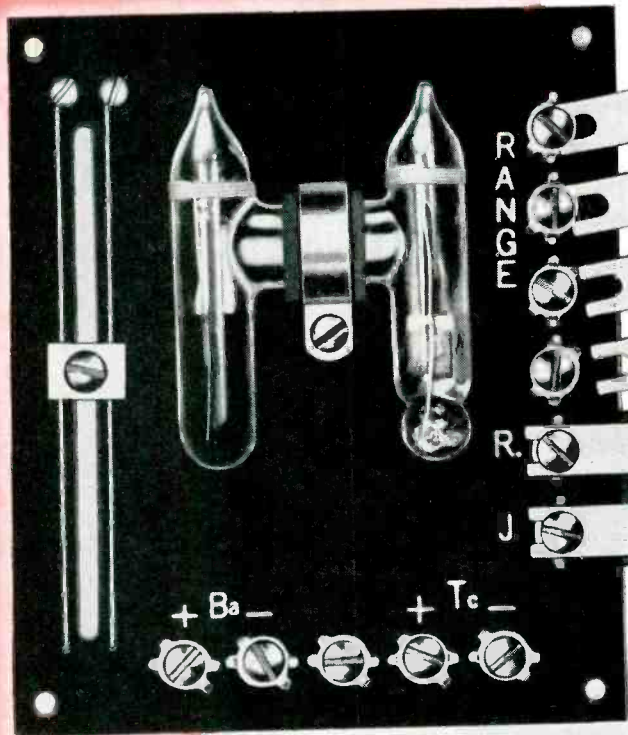
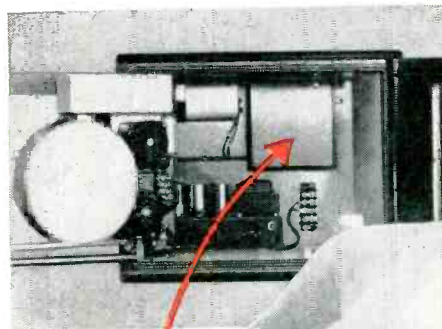

New!

simplified...

Recording Potentiometer by WESTON

The question probably occurs to you, as it has to many other instrument users who have examined the new WESTON Recording Potentiometer, "Why haven't such improvements been offered before?"

Take range changing, just as an example. *You* make the change, simply by inserting the desired range standard, as illustrated above. Not even a soldered connection to break. No change in the universal slide-wire necessary. And reference junction compensation is changed in like manner, when changing type of sensing element.

And there are many more features, electrical and mechanical, that remove the complexities from instrument operations and maintenance. They're all found in this new WESTON Recorder. Ask us to send you all the facts . . . WESTON Electrical Instrument Corporation, 617 Frelinghuysen Avenue, Newark 5, New Jersey . . . *manufacturers of Weston and Tag Instruments.*

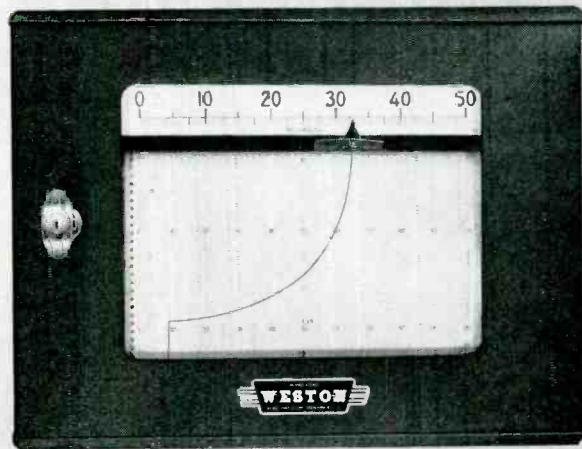

WESTON *Instruments*

... INDICATE — RECORD — CONTROL



versatile

Multi-channel --
telegraph A1 or
telephone A3.

FROM GROUND TO AIR OR POINT TO POINT

STABLE

High stability (.003%) under
normal operating
conditions.

RUGGED

**Components
conservatively
rated. Completely
tropicalized.**

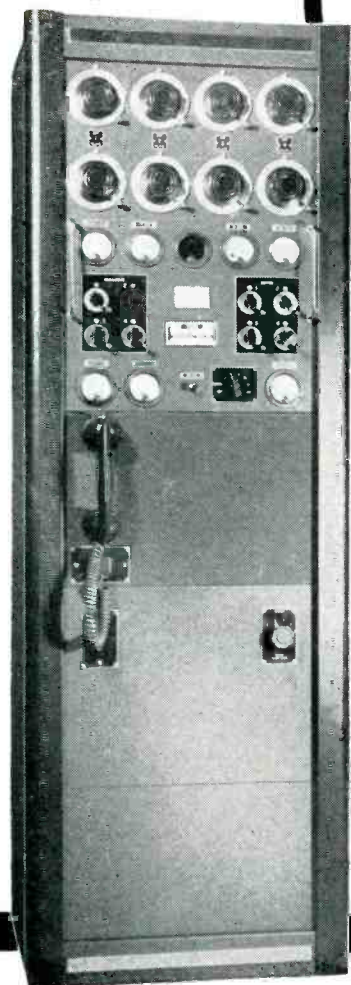

Model 446 transmitter operates on 4 crystal-controlled frequencies (plus 2 closely spaced frequencies) in the band 2.5-13.5 Mcs (1.6-2.5 Mcs available). Operates on one frequency at a time; channeling time 2 seconds. Carrier power 350 watts, A1 or A3 AM. Stability .003% using CR-7 (or HC-6U) crystals. Operates in ambient 0° to + 45° C using mercury rectifiers; -35° to + 45° C using gas filled rectifiers. Power supply, 200-250 volts, 50/60 cycles, single phase. Conservatively rated, sturdily constructed. Complete technical data on request.

Here's the ideal general-purpose high-frequency transmitter! Model 446... 4-channel, 6-frequency, medium power, high stability. Suitable for point-to-point or ground-to-air communication. Can be remotely located from operating position. Co-axial fitting to accept frequency shift signals.



3090 DOUGLAS ROAD

MIAMI 33, FLA.

Reg. U.S.

Pat. Off.

Consultants, designers and manufacturers of standard or special electronic, meteorological and communications equipment.

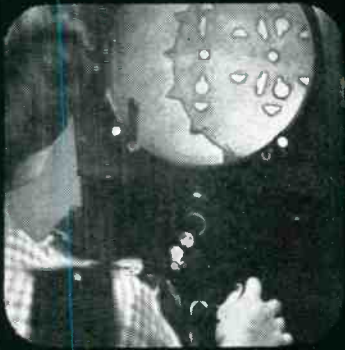

Mica specifications checked to thousandth-inch accuracy.



Completed mounts are inspected for visual defects.

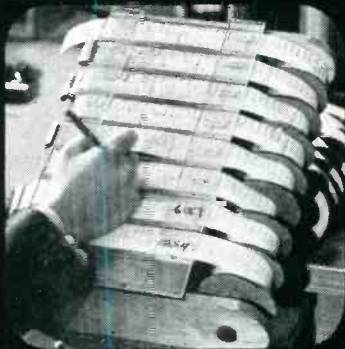

Statistical control assures uniformity of quality and performance.

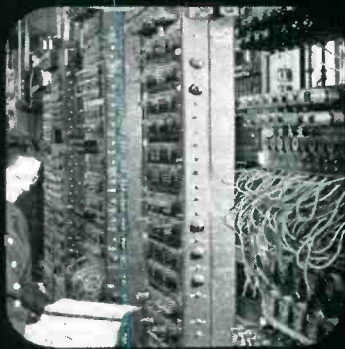

Life tests prove Tung-Sol Tubes can take it.

Complete control of materials and manufacturing procedures makes Tung-Sol Tubes dependable!

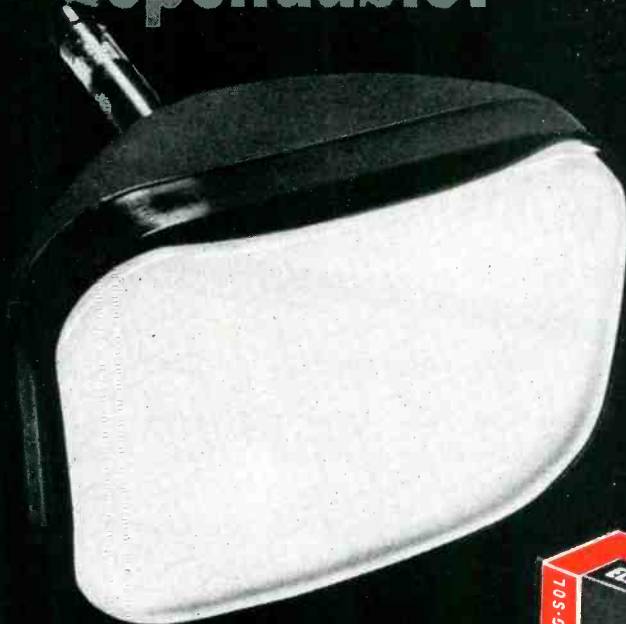

You can build a reputation on Tung-Sol Quality



TUNG-SOL ELECTRIC INC., Newark 4, N. J.

Sales Offices: Atlanta, Chicago, Culver City, Dallas, Denver, Detroit, Newark

TUNG-SOL MAKES All-Glass Sealed Beam Lamps, Miniature Lamps, Signal Flashers, Picture Tubes, Radio, TV and Special Purpose Electron Tubes.

"PARTS
not pounds!"

...we let

Fansteel
FABRICATE OUR
**TUNGSTEN &
MOLYBDENUM**
COMPONENTS



EWING GALLOWAY

no scrap... no rejects... no time waste

Whether you want semi-fabricated blanks or completely finished parts, you will save by letting Fansteel fabricate your tungsten and molybdenum components for you. Fansteel maintains complete facilities for fabricating, including forming, stamping, bending, deep drawing, forging, machining, brazing, welding, assembly and finishing. You'll find Fansteel engineering assistance valuable, too. Fansteel engineers are long experienced in the fabricating techniques peculiar to tungsten and molybdenum, and are well prepared to design parts with the minimum amount of metal and lowest fabricating costs.

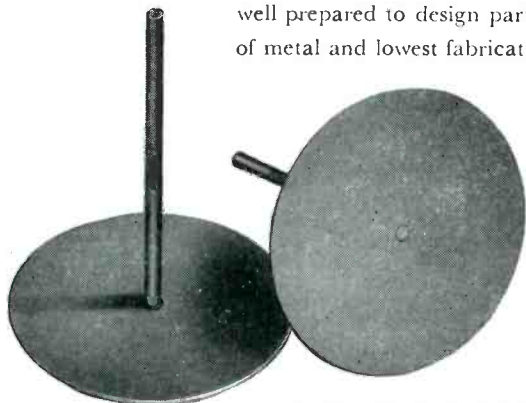

Anodes for hydrogen thyratron electronic tubes. The disks are heavy molybdenum sheet. The shafts are made of tungsten rod.

If you are a user of tungsten and molybdenum, consult Fansteel (without obligation) for assistance in design and most economical fabrication.

Write for the informative booklet: "FANSTEEL TUNGSTEN AND MOLYBDENUM"

TUNGSTEN & MOLYBDENUM

22501C

Fansteel Metallurgical Corporation NORTH CHICAGO, ILLINOIS, U.S.A.

ELECTRONS AT WORK (continued)

dition backs the tube off and de-energizes the relay. A stage of amplification follows the drive to provide isolation and sufficient amplitude for the monitor.

To overcome the effect of modulation on the vector from the antenna output terminal, a rectified signal proportional to the incoming audio frequency is used as a variable bias on the relay tube.

The a-f monitor compares the input audio signal with the output, taken from the modulation transformer. The two signals are made equal under normal conditions and the difference is made to operate a relay when a fault condition occurs. The transmitters will then be checked by their monitors. The defective transmitter will be switched off but the good transmitters are returned to the output bus bar.

The time taken for the transmitters to switch to test load, check, and switch back to the output feeder is of the order of 5 to 10 seconds. A reasonable time delay on the operation of the monitors is in any case essential in order to avoid the transmitters switching out due to momentary over-modulation peaks.

These monitors obviate the need for overload protection on individual tubes because a fault on any tube in the transmitter will operate either of the monitors.

Low-Copper Sweep Yoke

BY C. E. TORSCH

Receiver Department
General Electric Company
Syracuse, New York

UNORTHODOX COIL utilization provides improved sensitivity, balance and focus uniformity. An improved high-frequency coil design minimizes a common defect in yoke performance—sweep velocity modulation.

Novel manufacturing methods were developed to yield precise coil, insulator and coil form shapes to gain performance through compactness.

Conventional yoke connections use the slightly shorter pair of yoke coils for vertical sweep. The longer coils are used for horizontal sweep, favoring the more difficult task with the more sensitive, long coils. Shape interlock of the coil ends

Miniature MULTIPLE HERMETIC Terminal Panels

The Fusite line of glass-to-steel hermetic terminals has kept pace with the trend toward miniature sizes. As interest in these small sizes continues to increase, we present herewith a complete line of both regular and plug-in types now available from Fusite. These terminals are available in several flange variations in addition to those shown. Write to Dept. (B) for engineering drawings and complete dimensions.

4-900 SERIES

1000 V (RMS)

Available in 2 to 9 turret head straight wire or looped electrodes.



4-909 THSW-2E illustrated

4-1100 SERIES

1000 V (RMS)

Available in 2 to 11 turret head straight wire electrodes.

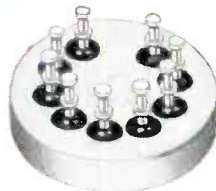

4-1109 THSW-2F illustrated

4-1400 SERIES

1000 V (RMS)

Available in 2 to 14 turret head straight wire electrodes. Also available with longer center electrodes as -1.



4-1414 THSW-2-2F illustrated

4.5-1400 SERIES

1250 V (RMS)

Available in 2 to 14 turret head straight wire electrodes. Also available with short center electrodes as -2.



4.5-1414 THSW-1-2H illustrated

5-900 SERIES

1500 V (RMS)

Available in 2 to 9 flattened and pierced or looped electrodes.

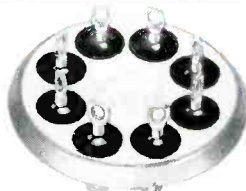

5-908 FP-1B illustrated



FOR PLUG-IN APPLICATIONS

4-907 PISW

1000 V (RMS)

For top side plug-in to standard 7 pin miniature socket.



2E Flange illustrated

4-907 THPI

1000 V (RMS)

For bottom side plug-in to standard 7 pin miniature socket.

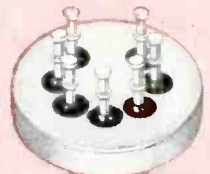

2E Flange illustrated

4-1109 PISW

1000 V (RMS)

For top side plug-in to standard 9 pin miniature socket.



2F Flange illustrated

4-1109 THPI

1000 V (RMS)

For bottom side plug-in to standard 9 pin miniature socket.

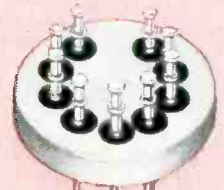

2F Flange illustrated

4-1414 PISW

1000 V (RMS)

For top side plug-in to standard 14 pin miniature socket.

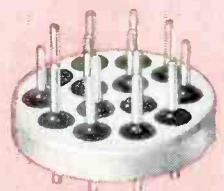

2F Flange illustrated

THE **FUSITE** CORPORATION

6028 FERNVIEW AVENUE - CINCINNATI 13, OHIO

Same wires— many more voices

Connecting new multi-voice system to open-wire lines, near Albany, Georgia. With new system, 150,000 miles of short open-wire telephone lines can be made to carry up to 16 simultaneous messages economically.

MUCH of your Long Distance telephone system works through cable but open-wire lines are still the most economical in many places. Thousands of these circuits are so short that little would be saved by using elaborate carrier telephone systems which are better suited for long-haul routes. But a new carrier system . . . the Type O designed especially for short hauls . . . is changing the picture. It is economical on lines as short as 15 miles. With Type O thousands of lines will carry as many as 16 conversations apiece.

Type O is a happy combination of many elements, some new, some used in new ways. As a result, terminal equipment takes up one-eighth as much space as before. Little service work is required on location; entire apparatus units can be removed and replaced as easily as vacuum tubes.

Moreover, the new carrier system saves copper by multiplying the usefulness of existing lines. For telephone users it means more service . . . while the cost stays low.

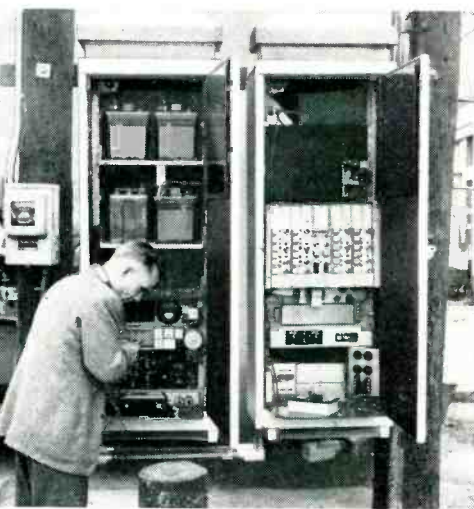

Repeater equipment is mounted at base of pole in cabinet at right, in easy-to-service position. Left-hand cabinet houses emergency power supply. System employs twin-channel technique, transmitting two channels on a single carrier by using upper and lower sidebands. A single oscillator serves two channels.

BELL TELEPHONE LABORATORIES

Improving telephone service for America provides careers for creative men in scientific and technical fields



Stokes is FIRST in vacuum

For many manufacturers in the high vacuum field the gap between the laboratory and the successful process has been a costly step . . . wasteful of time and money.

To vacuum engineering problems Stokes brings a wealth of experience in the design and manufacture, the installation and operation, of practical high vacuum equipment.

Stokes is the only manufacturer to design and make every element of its high vacuum equipment. Integrated design, centralized manufacturing responsibility and unparalleled experience are the unique extra value in Stokes High Vacuum equipment.

Stokes Vacuum Engineering steers a practical course through such design considerations as fluid flow, the effect of temperature and vacuum on structural elements, the selection of condensing surfaces, the introduction of mechanical motions to the vacuum chamber, and the operation of electrical equipment under high vacuum. The skilled application of these and other design factors is necessary for the successful use of high vacuum in metal coating and emission equipment, and in the production of zirconium, hafnium, titanium, magnesium and many other products.

Send for new Vacuum Calculator for rapid slide-rule calculations. Includes standard ABCD log scale. Also send for catalog 700, "Stokes Microvac Pumps for High Vacuum" with copious reference material.

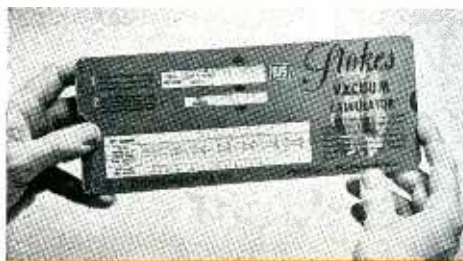

Stokes vacuum equipment

includes Microvac pumps, diffusion pumps, booster pumps, vacuum gages, vacuum furnaces, and equipment for vacuum drying, vacuum freeze-drying, vacuum impregnation, vacuum evaporation and vacuum distillation.

STOKES

F. J. STOKES MACHINE COMPANY, 5547 TABOR ROAD, PHILADELPHIA 20, PA.

minute
or

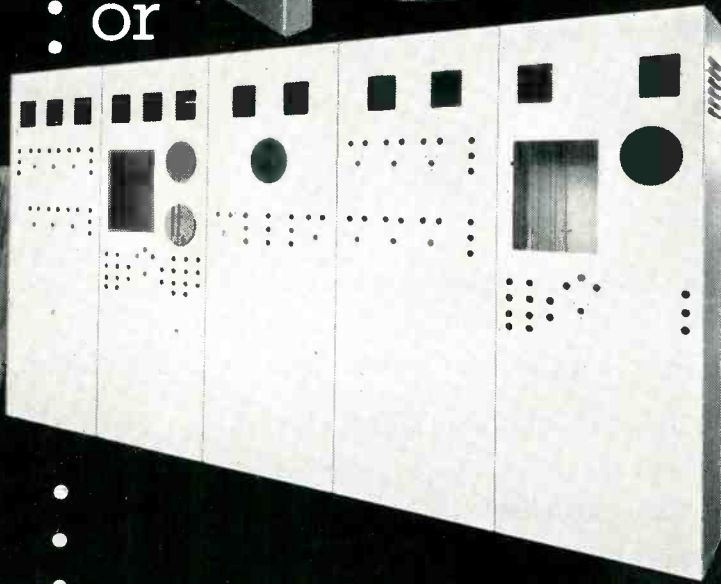

MASSIVE

KIRK AND BLUM

Electrical Enclosures

Any size . . . any shape . . . any number . . . for whatever requirement . . . KIRK & BLUM fabricating experience and facilities are at your service. Built to exacting specifications . . . we custom fabricate sheet steel, light plate, stainless, aluminum, monel and other alloys to 1/2" in thickness.

Write for your copy of the latest KIRK & BLUM Electrical Enclosures Booklet . . . for prompt quotation on any job send prints to The KIRK & BLUM MFG. CO., 3211 Forrer Street, Cincinnati 9, Ohio

Control Desks • Instrument Panels
Electrical Enclosures • Cubicles
Control Panels • Transformer Tanks
Outdoor Electrical Enclosures
Switch Gear Housings • Test Stands

KIRK AND BLUM

METAL FABRICATION

considerably lengthened the short coils relative to popular 70-deg yoke designs. The long nylon coil form developed for a 52-deg yoke was adequate for 70-deg coils with nested ends allowing the effective deflection center to move forward on the picture tube neck.

Benefits of reduction in core-enclosed air-path reluctance (relative to conventional yokes) were not appreciated until excessive horizontal sweep sensitivity, relative to the byproduct of anode supply voltage with a single diode rectifier was noted. Reconnection of the yoke coils to reduce horizontal sweep sensitivity by using the shorter coils for horizontal produced three benefits: favorable energy storage to balance high voltage derivation with sweep for single diode rectifier systems, increased vertical sweep sensitivity and substantial improvement in focus uniformity due to field astigmatism compensation by 90-deg rotation of the yoke assembly.

Yoke Field Analysis

Yoke field analysis with a small probe-coil disclosed that the edge fields of conventionally wound coils were not fully in phase with the field at that instant at the yoke axis, following the retrace transient. This led to modulation of beam sweep and to objectional vertical bands of brightness modulation in most commercial television equipment.

Since this discovery, a fundamental cure has been evolved and successfully manufactured. The transient response of both units of each high-frequency coil pair has been equalized to minimize circulating harmonic currents superimposed on the desired sawtooth wave. This eliminates field-intensity modulation at the coil edges and avoids velocity modulation of the cathode-ray sweep.

Elimination of the usual balancing capacitor is now practical by winding such self-balanced coils to high impedance, of relatively fine wire (No. 35 or 36) and connecting such coils in parallel. Less than half of the copper usually needed for 70-deg yokes is shown to produce even improved performance and fully comparable focus in the reproduced picture.

HAVE YOU AN
"impossible" requirement
FOR TECHNICAL CERAMICS?

TRY ALSIMAG[®]

These parts are enlarged approximately one and one half times ▶

Many people are kind enough to say we're the first to try for any "impossible" technical ceramic. It's probably true that we've made more different sizes, types and shapes than anybody.

Through cooperation, and a little give and take on both sides, we've been able to make a lot of "impossible"

ceramics. If you have an "impossible" requirement, let us know. We might be able to work it out with you. Anyway, we'd be caught trying.

We don't make a thing but technical ceramics. We've been doing it for over fifty years. It might pay you to give us first crack at anything in technical ceramics.

P. S. A couple of new plants in production now! On most things we can give you pretty fast deliveries.

51ST YEAR OF CERAMIC LEADERSHIP

AMERICAN LAVA CORPORATION

CHATTANOOGA 5, TENNESSEE

OFFICES: METROPOLITAN AREA: 671 Broad St., Newark, N. J., Mitchell 2-8159 • PHILADELPHIA, 1649 North Broad St., Stevensen 4-2823
SOUTHWEST: John A. Green Co., 6815 Oriole Drive, Dallas 9, Dixon 9918 • NEW ENGLAND, 1374 Massachusetts Ave., Cambridge, Mass., Kirtland 7-4498
LOS ANGELES, 5603 North Huntington Drive, Capitol 1-9114 • CHICAGO, 228 North LaSalle St., Central 6-1721 • ST. LOUIS, 1123 Washington Ave., Garfield 4959

Production Techniques

Edited by JOHN MARKUS

Connection-Checking Card	256	Solder Holder	276
Coil-Winding Setup	256	Dual Air Guns Speed Subassembly Work	280
Continuity Tests	258	Cabling-Board Pegs	284
Low Stools on Casters for On-Floor Assembly Work	258	Drafting Board is Low-Cost Wiring Bench	288
Candle Flame Singes Whiskers On Wire	260	Capacitor Breakdown Tester.....	292
Oil Can Applies Cement to Voice Coil.....	260	Chassis-Tilting Cradle	300
Overhead Coat Hangers.....	261	TV Alignment Island.....	304
Magnet Holds Pointer on Riveting Machine	268	Soldering Plastic Wires to Connectors.....	304
Wire-Plugging Tools.....	272	Clips Hold Leads.....	308

OTHER DEPARTMENTS

featured in this issue:

	Page
Electrons At Work.....	168
New Products	312
Plants and People.....	394
New Books	404
Backtalk	420

Connection-Checking Card

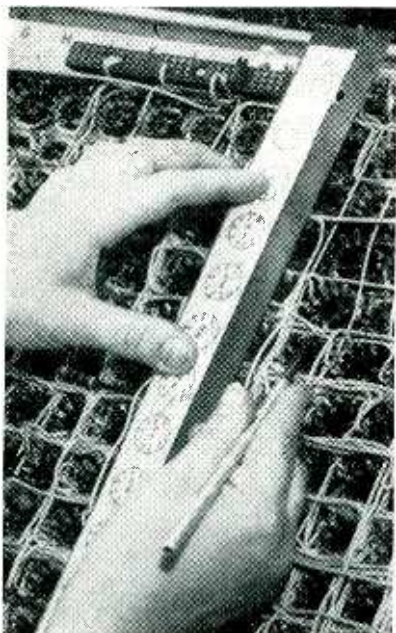

Use of checking card and probe for inspection of socket wiring

TO SPEED the checking of socket connections on an electronic calculator having over 200 tubes, a separate checking card is used for each vertical row of eleven sockets. Each card is made of heavy fiber on which is cemented a paper strip with checking data. The wires that should go to each terminal are drawn in their correct colors on the card, so that the operator can compare colors for an entire socket almost at a glance.

The checking card is held in position with the left hand, and a probing tool in the right hand is used for wiggling suspicious joints or

dressings wires. The probing tool also has psychological value in improving the accuracy of inspection.

Checking cards are identified by letters corresponding to those imprinted on the chassis of the calculator. The technique has greatly improved the efficiency of a tedious inspection operation in the Poughkeepsie, N. Y. plant of International Business Machines Corp.

Coil-Winding Setup

THE low-cost improvised winder for r-f grid coils, shown here, was developed by production engineers of

DuMont's East Paterson, N. J. plant. A belt-and-pulley drive is used in combination with rheostat control of a fractional-horsepower electric motor to provide the desired headstock speed for the winding lathe. The spring-loaded tailstock slides and turns freely in a ball-bearing mount. Starting and stopping is by means of a foot-pedal switch. A counter on top of the headstock indicates total turns at a glance, and is crank-reset to zero after completion of each coil.

Ends of coils are fastened securely in place by applying beeswax with a pencil-type soldering iron.

Except for the reel of wire, the

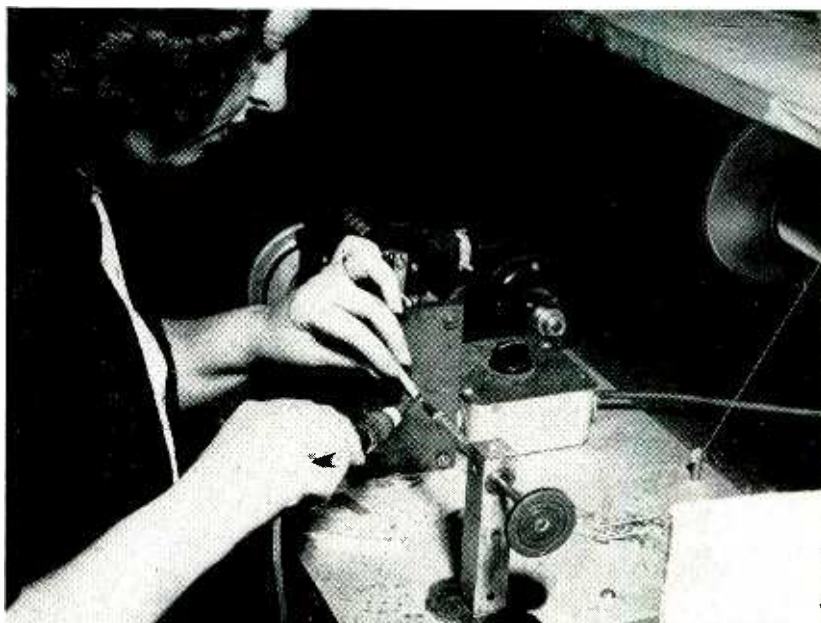

Improvised setup for winding r-f grid coils, showing how wax is melted over end of coil with small soldering iron to anchor the lead

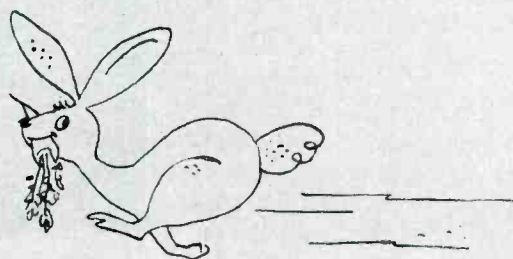

FAST



KESTER FLUX-CORE SOLDER

FAST . . . FASTER . . . FASTEST

FAST . . . Kester Plastic Rosin-Core, the old reliable, always does a fast job.

FASTER . . . Step up the tempo with Kester "Resin-Five" and still retain flux stability.

FASTEST . . . For high-speed soldering, unbelievable flux mobility. You'll want Kester "44" Resin-Core the newest of all Core Solders.

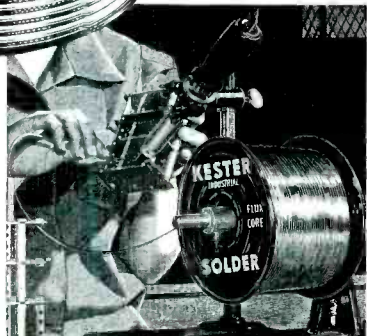

Over 100,000 types
Kester Flux-Core Solder
available

Free Technical Manual—write for your copy of
"SOLDER and Soldering Technique."

KESTER SOLDER COMPANY
4204 Wrightwood Ave., Chicago 39
Newark 5, New Jersey • Brantford, Canada



entire assembly is mounted on a heavy steel plate, to maintain alignment of parts while retaining portability. A small aluminum dial-cord pulley mounted on a metal stud guides the wire from the reel to the coil.

Continuity Tests

A POWER supply chassis with indicator lamps is used to check the continuity of all four coils in a television receiver deflection yoke in one simple operation in the Television Receiver Division of Allen B. DuMont Labs., Inc., East Paterson, N. J. A different chassis-mounted test set is provided for each type of yoke.

Units ready for test are slid down a metal trough that rests on top



Plugging deflection yoke unit into test set socket, cable for which runs under metal pass-along trough on bench

of the bench. Units which pass the test are given another push down the trough to the next position.

Testing merely involves plugging the deflection yoke cable into a

socket that comes out of the test set and making one alligator-clip connection to the metal yoke frame.

Pliofilm Bags Protect Finished Subassemblies

IN THE military electronic production department of IBM's Poughkeepsie, N. Y. plant, completed subassemblies for electronic equipment are placed in pliofilm bags to keep out dirt and prevent scratching of finished surfaces. A large assortment of bag sizes is maintained in stock for this purpose.

Larger covers made to particular shapes are used to protect finished commercial products during actual shipping. These are so designed that they can be used by the customer later as a dust cover.

Low Stools on Casters For On-Floor Assembly Work

INEXPENSIVE shop-made stools eliminate the need for kneeling or crouching on the floor during final assembly and testing of the large racks of electronic equipment used in the type 604 IBM electronic calculator.

One type of stool is essentially a wood box with four casters on the bottom and a leatherette cushion on top. A small drawer fitted into the box provides convenient storage for pliers, screwdrivers and other needed hand tools.

Another type has a back rest, supported by bent pipe attached to the base of the stool. The back rest may be removed when not wanted. Projecting parts of the pipe are taped to prevent them from scratching the finished cabinet of the

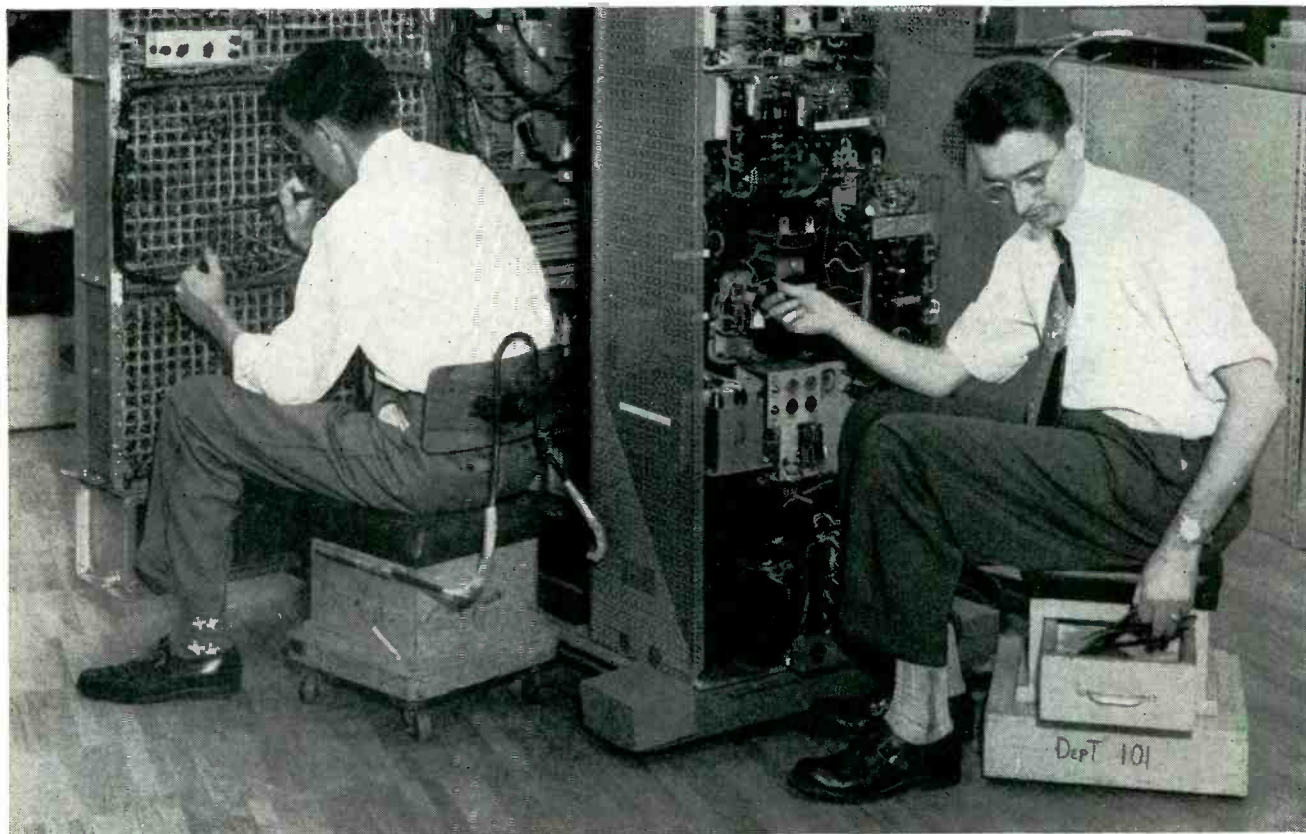

Rolling stools developed for work on rack-mounted equipment

The FIRST and still the only all-band direct reading SPECTRUM ANALYZER

10 MCS TO 21,000 MCS
Polarad's Model LSA Spectrum Analyzer is the result of years of research and development. It provides a simple and direct means of rapid and accurate measurement and spectral display of an r.f. signal.

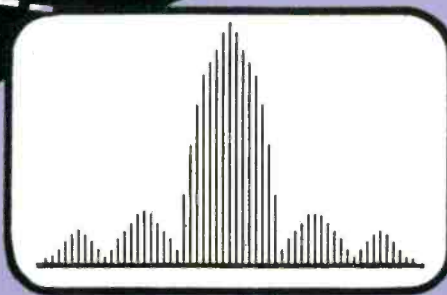

Outstanding Features:

- Continuous tuning.
- One tuning control.
- 5 KC bandwidth on final i. f.
- 250 KC to 25 MCS display at all frequencies.
- Tuning dial frequency accuracy 1%.
- No Klystron modes to set.
- Broadband attenuators supplied with equipment from 1 to 12 KMC.
- Frequency marker for measuring frequency differences 0-25 MCS.
- Only four tuning units required to cover entire range.
- Microwave components used latest design non-contacting shorts for long mechanical life.
- Maximum frequency coverage per dollar invested.
- 5 inch CRT display.

Where Used:

Polarad's Model LSA Spectrum Analyzer is a laboratory instrument used to provide a visual indication of the frequency of distribution of energy in an r.f. signal in the range 10 to 21,000 MCS.

Other uses are:

1. Observe and measure sidebands associated with amplitude and frequency modulated signals.
2. Determine the presence and accurately measure the frequency of radio and/or radar signals.
3. Check the spectrum of magnetron oscillators.
4. Measures noise spectra.
5. Check and observe tracking of r.f. components of a radar system.
6. Check two r.f. signals differing by a small frequency separation.

The instrument consists of the following units:

Model LTU — 1 R.F. Tuning Unit — 10 to 1000 MCS.
 Model LTU — 2 R.F. Tuning Unit — 940 to 4500 MCS.
 Model LTU — 3 R.F. Tuning Unit — 4460 to 14,520 MCS.
 Model LTU — 4 R.F. Tuning Unit — 15,000 to 21,000 MCS.
 Model LDU — 1 Spectrum Display Unit.
 Model LPU — 1 Power Unit.
 Model LKU — 1 Klystron Power Unit.

Write for Complete Details

Polarad
Electronics Corporation

100 METROPOLITAN AVE.
BROOKLYN 11, N. Y.

Manufacturers of broadband microwave laboratory instruments.

Continuous Radioactivity

Measurements

for NUCLEAR RESEARCH
CHEMISTRY
MEDICINE & BIOLOGY
GEOLOGY
METALLURGY
AGRICULTURE
MINERALOGY

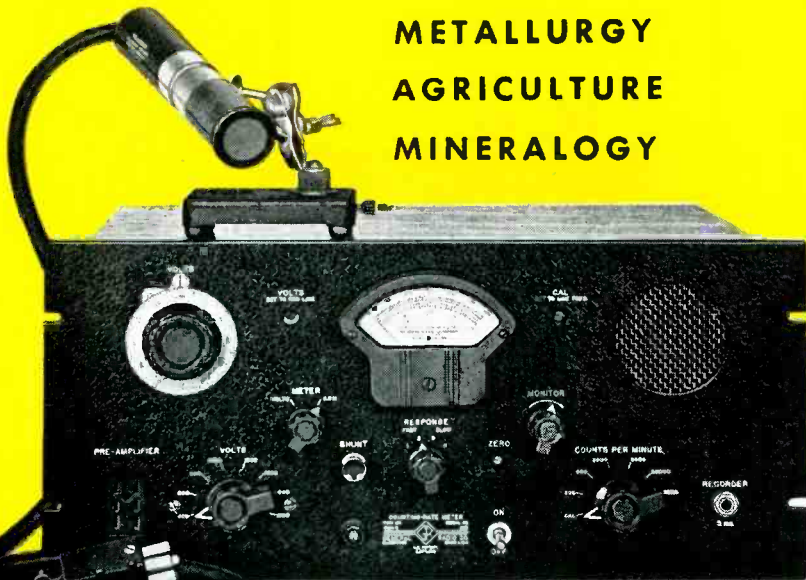

 **Type 1500-B
Counting-Rate Meter.....\$540**

Range: full-scale values of 200, 600, 2000, 6000 and 20,000 counts per minute — minimum rate readable on meter scale is 5 counts per minute

Accuracy: $\pm 3\%$ of full scale

Pre-amplifier: built into hand probe at end of 6-foot cable — adapter permits use of either self-quenched or internally quenched counter tubes of any design

Response: Four response speeds for wider range of meter damping

Counter Circuit Voltage: continuously variable from 400 to 2,000 volts, and available at

rear of instrument — can be read from 8-position switch and calibrated dial — means provided for standardizing voltage

Output: trigger circuit output — recorder jack on front panel

Accessories Supplied: plug for connecting recorder, counter tube adapter, line cord and spare fuses (counter tubes extra)

Type 1500-P4 Beta-Gamma-Ray Counter Tube \$40

Type 1500-P5 Beta-Gamma-Ray Counter Tube \$50

Type 1500-P11 Probe Mounting Stand . . . \$12.50



equipment. All other parts that might bump a cabinet are wood or leatherette, and hence are not likely to scratch. These stools were developed at International Business Machines Corp.

Candle Flame Singes Whiskers on Wire

WHEN hard, tough fibres of woven insulation on wires are not completely cut by automatic stripping machines, workers at the Poughkeepsie electronic plant of International Business Machines Corp. use



Flame of candle burns off dangling strands of insulation

an ordinary candle to burn off the whiskers of cotton that remain. This prevents the insulating strands from impairing continuity of soldered joints. Burning proved much faster than the former practice of cutting with scissors.

Oil Can Applies Cement to Voice Coil

A SMALL oil can mounted upside down on a cement-applying fixture is used in Crosley's Cincinnati plant to apply a band of loudspeaker cement around a voice coil during the operation of assembling the voice coil and spider.

The voice coil is pushed on an arbor to a turned stop, then rotated under the spout of the oil can. Dur-

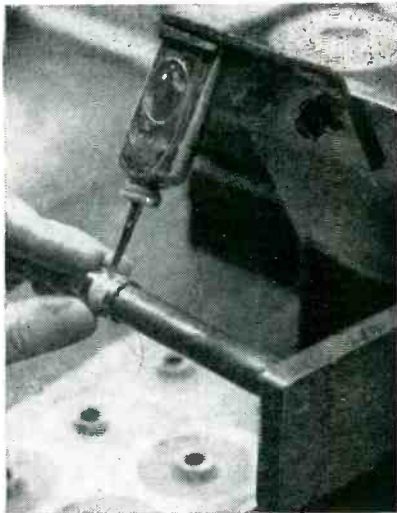

Method of mounting small oil can to apply cement in uniform-width band as voice coil is rotated on arbor of fixture

ing normal steady production the cement flows freely without being started. When starting up after lunch, a few squeezes on the side of the can clear the clogged spout.

Overhead Coat Hangers

DEAD space near the ceiling in production areas is used for hanging coats in the Cincinnati plant of the Crosley Division, Avco Mfg. Corp. This unique practice eliminates the



Crosley employee demonstrates how a coat is brought down from the ceiling



The Type 1500-B Counting-Rate Meter, with Geiger-Mueller Counter, is a complete precision instrument for the continuous visual, aural and graphic measurement of the rate of random radiation. It is basically a laboratory instrument rather than a field survey device.

Four response speeds control meter fluctuations for varying conditions — change in rate of count occurring in a fraction of a second can be recorded or measured accurately — high input sensitivity permits use of long cable to counter tube — calibration adjustment on panel — accuracy unaffected by $\pm 10\%$ changes in line voltage.

WITH THIS INSTRUMENT the geologist has observed the disintegration of mineral deposits to learn the age of the earth . . . the metallurgist has compiled valuable data on case hardening, welding and alloying . . . chemists have studied photosynthesis by tracer techniques . . . biologists have determined the effects of dosage of food or of medicine on a specific organ, and have applied irradiation selectively . . . the mineralogist has tabulated the relative abundance of natural radioactive isotopes.

Crystallography, oil surveying, glass and plastic manufacturing, combustion engineering design, ore assaying and turbulence research are but few of the many fields where measurement of radioactivity is proving very valuable.

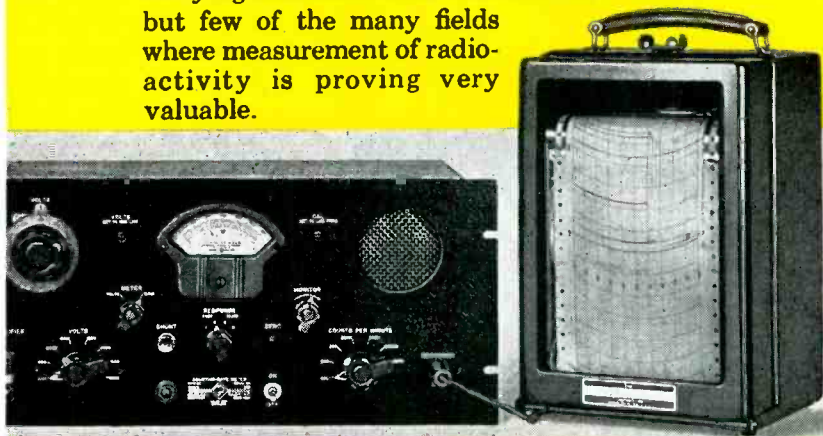

The Type 1500-B Counting-Rate Meter is being used to drive the Esterline-Angus 5 ma model pen recorder . . . particularly useful for obtaining a permanent graphical record of changes in rate. Visual and aural indication of radiation intensity are provided by panel meter and loud speaker.

GENERAL RADIO Company

275 Massachusetts Avenue, Cambridge 39, Massachusetts
 90 West St. NEW YORK 6 920 S. Michigan Ave. CHICAGO 5
 1000 N. Seward St. LOS ANGELES 38

Since 1915 — Designers and Manufacturers

of Electronic Test Equipment

ALPHA

PREFERRED BY CRAFTSMEN FOREMOST IN QUALITY

SOLDER

for everything electronic

CEN-TRI-CORE ENERGIZED ROSIN-FILLED SOLDER



Guaranteed non-corrosive for radio, television, electronic and other electrical applications. No other solder works faster or easier... It provides greater fluxing uniformity and stronger smoother joints.

No activating chlorides or other chemical agents tending to produce acid conditions, toxic or sticky vapors, or latent corrosion.

Ideal where plated and/or oxidized parts must be soldered. Designed for use where faster fluxing is desirable.

CEN-TRI-CORE's exclusive design guarantees rosin throughout the complete length of the wire. Eliminates rejects commonly encountered in the use of ordinary rosin core solders. CEN-TRI-CORE is faster fluxing: thinner walls between solder and rosin assure faster penetration of heat to the flux - requires less heat and guarantees maximum fluxing action of the rosin.

**CEN-TRI-CORE
PLASTIC
ROSIN-FILLED
SOLDER**

For those applications where a conventional rosin flux is required. For telephone and other critical soldering operations.

ALPHA

write for generous samples

ALPHA METALS, INC.

58 Water Street, Jersey City 4, N. J.



Aerophysicists, Designers, Engineers

YOUR IDEAS WILL COUNT AT NORTH AMERICAN

North American encourages advanced thinking, because they know looking ahead is the only way to maintain leadership in the aviation industry. That's why North American needs men of vision. If you like hard thinking and would like to work for a company that will make the most of your ideas, you'll find real career opportunities at North American. North American offers you many extra benefits, too.

North American Extras —

Salaries commensurate with ability and experience • Paid vacations • A growing organization • Complete employee service program • Cost of living bonuses • Six paid holidays a year • Finest facilities and equipment • Excellent opportunities for advancement • Group insurance including family plan • Paid sick leave • Transportation and moving allowances • Educational refund program • Low-cost group health (including family) and accident and life insurance • A company 24 years young.

Write Today

Please write us for complete information on career opportunities at North American. Include a summary of your education, background and experience.

IS YOUR FIELD LISTED HERE?

Airborne Electronic Equipment
Equipment Flight Tests
Precision Instruments
Automatic Controls
Propulsion Systems
Servo-Mechanisms
Airframe Studies
Radar Devices
Instrumentation
Micro Wave Techniques
Metallurgical
Electroplating
Engineering Planning

NORTH AMERICAN AVIATION, INC.

Aerophysics, Electro-Mechanical Research
Division

Dept. 3, Personnel Section,
12214 Lakewood Blvd., Downey, California
North American Has Built More Airplanes
Than Any Other Company In The World

Introducing the BOGUE Criterion...

When requirements call for practically pure direct current or high cycle power for laboratory or production, inquiries invariably pin point in the Bogue direction. And, Bogue engineering-production ability has long been known for fine control equipment.

As we look forward to our 61st year of service to American Industry we pledge an ever increasing quality of power equipment to meet your varying needs for high precision products.

It's part of the Bogue service to plan with you for future requirements. Our technical staff is always ready to help you solve tough problems.

And the Bogue Criterion, the symbol of quality, is your assurance of continued high standards throughout the Bogue organization.

Bogue Electric Manufacturing Company
Paterson 3, New Jersey.

**BOGUE DC GENERATORS PROVIDE
LOW RIPPLE PRACTICALLY PURE DC CURRENT**

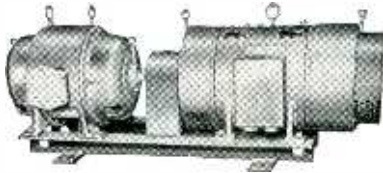

**BOGUE MAGNETIC AMPLIFIERS FOR PRECISE
CURRENT CONTROL WITHOUT MOVING PARTS**

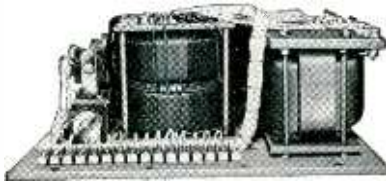

**BOGUE 400 CYCLE POWER FOR
LABORATORY OR PRODUCTION TESTING**

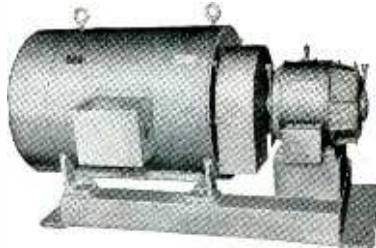

PANELS FOR AUTOMATIC PROCESS CONTROL

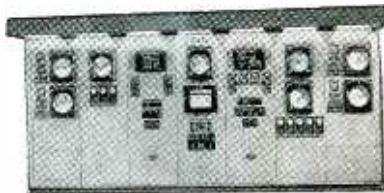

AND . . . Precision Selenium Rectifiers, AC and DC Motors and Generators, Alternators, Power Supplies for Controlled Current and Voltage with output regulated to 1%—less than 1% ripple, Magnetic Controllers, Marine Equipment, Railway Equipment, Aircraft Equipment, Petroleum Equipment, Communication Equipment.

Our 60th Year
BOGUE PRECISION POWER

SINCE 1892 SPECIALISTS • GENERATOR •
Bogue
IN FINE MOTORS & GENERATORS



BRUSH and the future of communications...

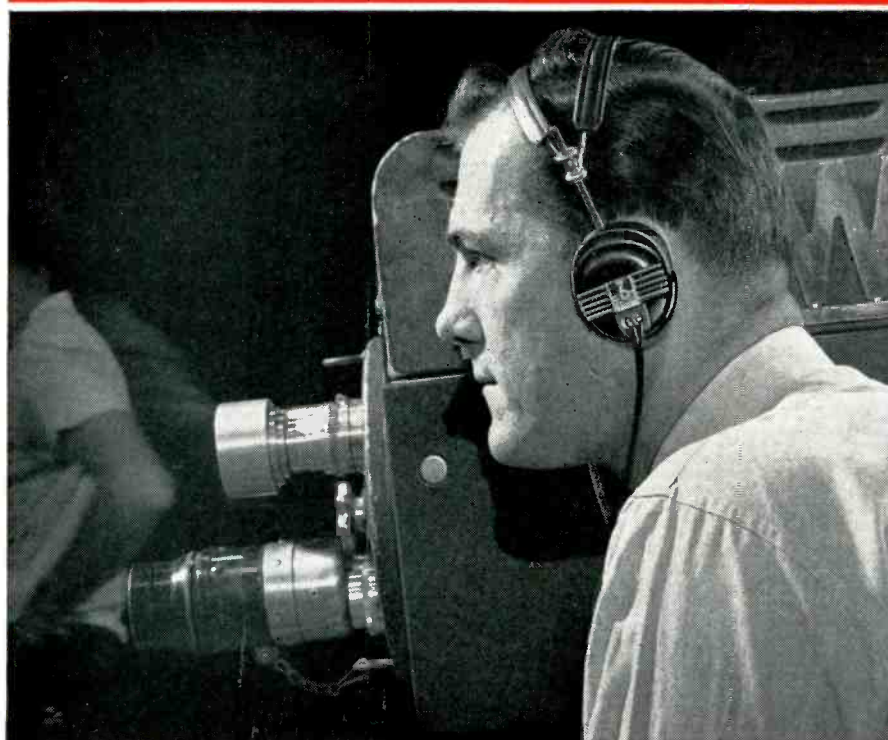

Brush headphones using the exclusive BIMORPH CRYSTAL drive element provide flat response, high sensitivity, and low distortion . . . are also engineered for comfort.

THE news flash "HARDING IS ELECTED" was spoken into an unwieldy microphone . . . picked up by crude radios . . . but the era of commercial broadcasting had begun.

The very next year, Brush began research on piezoelectric crystals, the nerve centers of many modern high quality acoustical instruments and equipment.

Brush pioneering has produced light, powerful headphones, replacing the heavyweights of yesterday. Smaller, more sensitive microphones have been developed. The original cumbersome hearing aids have become feather light and almost invisible.

Tomorrow is UHF television—new refinements in electrical circuits—new endeavors in electronics. Keeping pace with tomorrow is Brush, designing new dimensions in the quality of sound reproduction and transmission, working with research staffs everywhere to develop new products to meet the changing needs of America. Brush's business is the future!

THE *Brush*
DEVELOPMENT COMPANY
3405 Perkins Avenue • Cleveland 14, Ohio



Piezoelectric Crystals and Ceramics
Magnetic Recording Equipment
Acoustic Devices
Ultrasonics
Industrial & Research Instruments

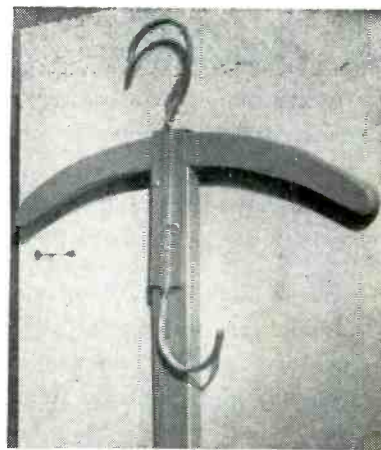

Closeup of overhead coat hanger, showing construction details. The double-hook piece is spot-welded to the U-shaped sheet metal brace

need for space-consuming locker rooms and in no way hinders use of floor space under the coats.

Overhead storage is made possible by a Crosley-designed long-handled hanger that hooks over a two-inch pipe suspended from the ceiling. The handle and the conventional curved crosspiece are of wood, fastened together by stove bolts and a U-shaped piece of sheet metal. The hook, made from $\frac{1}{8}$ by $\frac{3}{8}$ -inch soft iron, is spot-welded to the sheet metal. An additional hook



New chair for assembly-line workers, showing compartment for storage of personal property

Bradley

will do
the engineering for you
on rectifier specifications

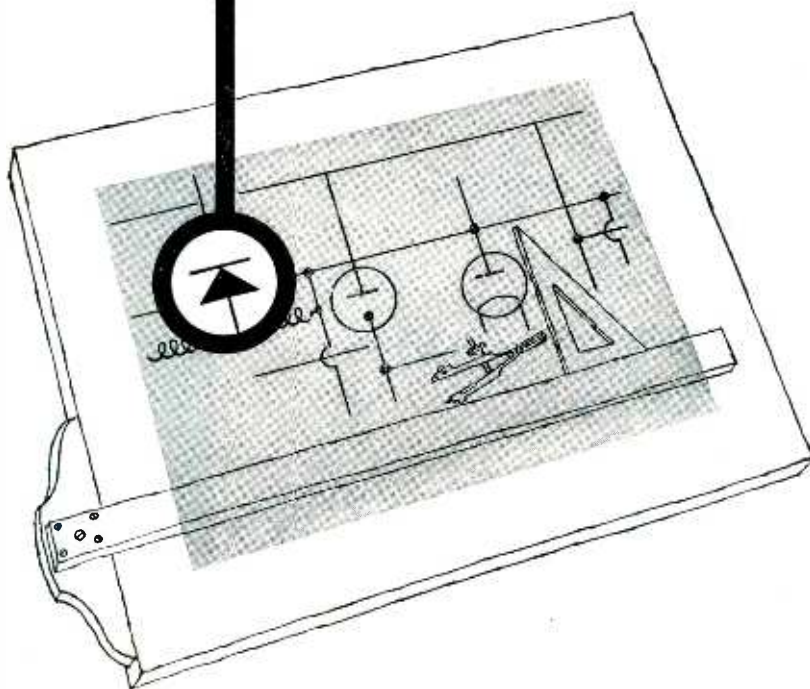

We have selfish reasons for making this offer. Experience has shown that we save time in our own engineering, give the customers a better rectifier and more often than not deliver the production item at a lower cost than expected. We know that customers so served come back again and again.

Why not make sure that your rectifier specifications are the stiffest you can set for the intended application and for the price per unit you wish to pay. You can be sure by letting

Bradley handle your rectifier requirements — the tough ones especially — from the very start. Simply tell us what your application needs are and we will draw up the specifications.

You will not only save valuable engineering time, but you will get the right rectifier more promptly and in all probability at less cost. In addition, our exclusive vacuum manufacturing process assures production rectifiers that are true to rating, built precisely to specifications.

SELENIUM AND COPPER
OXIDE RECTIFIERS

SELF-GENERATING
PHOTOELECTRIC CELLS

ELECTRONICS — October, 1952

BRADLEY RECTIFIERS for PERFORMANCE AS RATED
BRADLEY LABORATORIES, INC.
168 COLUMBUS AVENUE • NEW HAVEN 11, CONNECTICUT



VEXED... with VARIATIONS?

Thomas & Skinner can now give you intricate shapes in **PERMANENT MAGNETS** with tolerances often as close as $\pm .005''$ without grinding or finishing

The costly headaches and limitations of loose tolerances—which have vexed the engineer with variations of $1/32''$ in permanent magnet design—have been virtually eliminated by Thomas & Skinner, specialists in magnetics for more than half a century.

Now your engineers can specify the intricate casting shapes—with sharply defined relief—which in the past have been too difficult or too expensive to produce. Through radically new techniques, Thomas &

Skinner permanent magnets are cast with such close precision that little or no grinding and finishing is required for dimensional accuracy.

Call in a Thomas & Skinner engineer—let him work with your own development specialists—learn how your permanent magnet problems of close tolerances and intricate designs may be solved by the new Thomas & Skinner technique—now! Write today—ask for the new Thomas & Skinner Permanent Magnet Bulletin, No. 151.



THOMAS & SKINNER Steel Products Company
1120 East 23rd Street • Indianapolis, Indiana

DC - AC CHOPPERS

A model for every use.

10 — 500 cycles

Single pole

60 cycles

Single pole and double pole

Make-before-break contacts

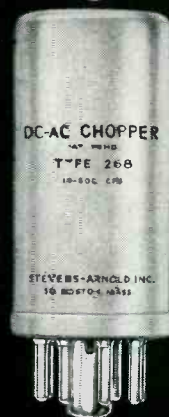

These Choppers convert low level DC into pulsating DC or AC so that servo-mechanism error voltages and the output of thermocouples and strain gauges, may be amplified by means of an AC rather than a DC amplifier.

They are hermetically sealed, precision vibrators having special features which contribute to long life and low noise level.



WRITE FOR THESE CATALOGS ...

#230A

10-500 cycles

#246C

60 cycles

**STEVENS
ARNOLD
INCORPORATED**

22 ELKINS STREET
SOUTH BOSTON 27, MASS.

SA-5

RCA WO-88A...

**A new 5-inch scope
with "picture-perfect"
square-wave response**

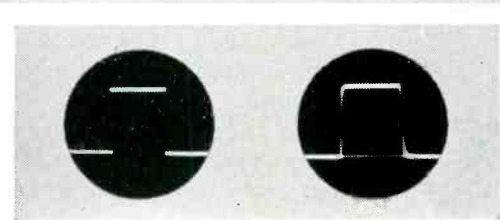

Unretouched photographs of 60-cycle and 50 Kc square waves reproduced on screen of WO-88A. Note fast retrace.

FEATURES —

- Direct-coupled, push-pull, two-stage vertical amplifier; push-pull horizontal amplifier.
- Frequency-compensated and voltage-calibrated attenuators.
- Front-panel source of 1-volt peak-to-peak calibrating voltage.
- Graph screen scaled directly in peak-to-peak voltage.
- Metal shield enclosing CRT gun to minimize hum-pickup from stray fields.
- Extra fast sweep-oscillator retrace.
- Built-in 60-cycle sweep with phasing control.

SPECIFICATIONS —

- Deflection Sensitivity: (vertical amplifier) 25 rms millivolts or better per inch.
- Vertical Amplifier Frequency Response: Flat from dc to 100 Kc; within -3 db at 500 Kc; within -10 db at 1 Mc.
- Input Resistance and Capacitance: 10 megohms and 9.5 uuf with WG-216B Low-Capacitance Probe.
- Sweep-Circuit Frequency (four ranges): 15 cps to 30 Kc.
- Square-Wave Response: Negligible tilt and overshoot.
- Power Supply: 105/125 volts, 50/60 cycles.
- Size 13 1/2" high, 9" wide, 16 1/2" deep. Weight only 25 lbs (approx.).

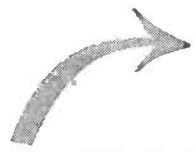

New WG-216B Low-Capacitance Probe gives the WO-88A an overall input resistance of 10 megohms shunted by less than 10 uuf.

The WO-88A combines the features required for TV receiver servicing, and the high stability and ruggedness essential for continuous production-line duty.

The outstanding feature of the WO-88A is its remarkably true square-wave response, obtained by adequate band-width, negligible phase shift, and a complete absence of peaking circuits. Vertical and horizontal sync pulses, as well as other complex wave forms, are reproduced with fidelity characteristic of expensive laboratory instruments. Furthermore, uniform frequency response is maintained over the entire range of the attenuators.

The two-stage dc vertical amplifier has more than enough gain for all usual applications. Moreover, all of the gain is useable because the input circuits are shielded against extraneous noise and hum right out to the probe tips. Push-pull circuitry in both stages of the vertical amplifier minimizes "line bounce"; and direct coupling

provides instantaneous "recovery" time.

For operating convenience, the controls for push-pull balance, astigmatism adjustment, and interstage dc coupling are accessible from outside the cabinet.

Voltage measurements and waveshape observations can be made simultaneously with the WO-88A. A front-panel terminal provides a 1-volt peak-to-peak reference voltage; the green graph screen is scaled in peak-to-peak voltage divisions, which are multiplied by the settings of the step attenuator to determine the voltage.

The WO-88A incorporates other quality 'scope features such as "plus" and "minus" sync, 60-cycle sweep and phasing, and a shield around the CRT gun.

For complete details on the WO-88A, see your RCA Test Equipment Distributor, or write RCA, Commercial Engineering, Section JX-42, Harrison, New Jersey. TMK. ®



RADIO CORPORATION of AMERICA
TEST EQUIPMENT
HARRISON, N. J.

Famous Guns



Deringer Percussion Pistol, Model 1843, product of Henry Deringer of Philadelphia. Deringer's large caliber, short barreled pocket pistols were so popular that others imitated them—calling them "derringers". John Wilkes Booth used a Deringer to assassinate Lincoln.



Trap or Doorjamb Pistol, Caliber .31, made by North & Couch, Middletown, Conn. This lethal little device protected householders against burglars. Fixed to the doorjamb, with a cord running from muzzle rod to door, the pistol fired all its barrels into any intruder.

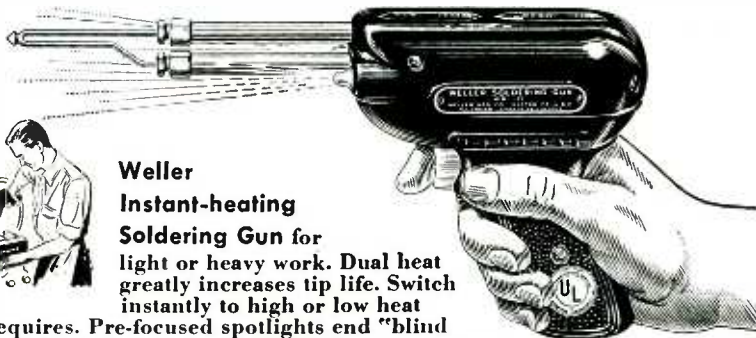

Weller Instant-heating Soldering Gun for light or heavy work. Dual heat greatly increases tip life. Switch instantly to high or low heat as job requires. Pre-focused spotlights end "blind soldering". Exclusive tip-fastening arrangement assures full, constant heat. High-impact plastic housing. Perfect balance. Low-cost replaceable tips. Pays for itself in a few months. See at your Distributor or write for Bulletin direct.

Get **SOLDERING TIPS**, new Weller Handy Guide to faster, easier soldering. 20 pages fully illustrated. Price 10c at your Distributor or order direct.

Weller BETTER FROM GRIP TO TIP!

SOLDERING GUNS 806 Packer Street, Easton, Pa.
The Finest Soldering Tool for the Finest Craftsmen

is formed at the lower end, on which umbrellas and other personal belongings can be hung.

With this arrangement, each assembly-line workers' coat is only a few steps back of her bench. This reduces considerably the time otherwise spent in going to locker rooms to get things from coat pockets. Overhead storage also reduces the possibility of theft, as pockets are well out of reach and a person lifting down somebody else's coat to get into the pockets would be in plain sight of assembly-line workers.

The rods are painted grey, with a few inches of the lower end a bright red. The red serves to warn the cleaning crew against bumping their heads on empty hangers at night.

A new Crosley-designed chair for assembly-line positions contributes further to the needs of workers by providing a compartment underneath for storage of purse, lunch, working shoes and other small personal belongings. Again theft is minimized, and bench appearance is greatly improved by keeping personal belongings out of sight.

Magnet Holds Pointer on Riveting Machine

IN THE operation of flaring a bushing after insertion in a radio dial pointer, many rejects formerly occurred because the operator could

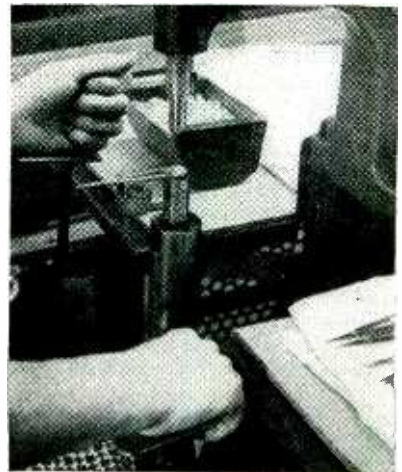

Alnico permanent magnet holds dial pointer in correct position on mandrel of riveting machine, leaving both hands of operator free to actuate the two safety controls that start the machine

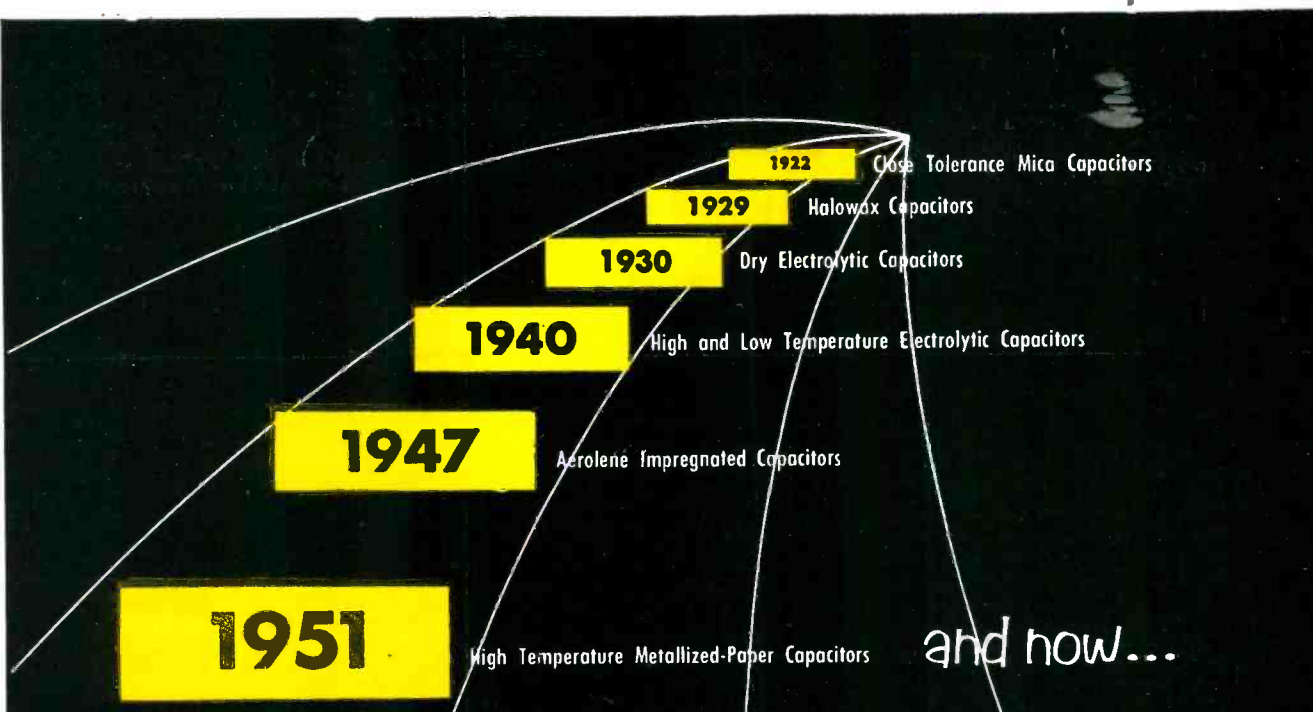

and now...

**ANOTHER MAJOR ACHIEVEMENT
IN CAPACITOR DEVELOPMENT...**

in 1952
AEROFILM*
Capacitors

The development of Mylar** polyester film by Du Pont chemists and its adaptation as a capacitor dielectric by Aerovox engineers, presents challenging potentialities in the field of electronic capacitors.

Known as Aerofilm Capacitors, these latest components permit higher operating temperatures without corresponding increase in size, as well as unusually high insulation resistance.

Both gains mean much to the designers of tomorrow's fantastic weapons and again to peaceful electronic applications.

Thus in 1952 Aerovox auspiciously embarks upon its fourth decade of capacitor craftsmanship.

*Aerovox Trade Mark

**Du Pont Trade Mark for polyester film



AEROVOX CORPORATION

NEW BEDFORD, MASS.

Hi-Q® DIVISION
CLEAN, N. Y.

WILKOR DIVISION
CLEVELAND, OHIO

Export: 41 E. 42nd St., New York 17, N. Y. • Cable: AEROCAP, N. Y. • In Canada: AEROVOX CANADA LTD., Hamilton, Ont. • JOBBER ADDRESS: 740 Belleville Ave., New Bedford, Mass.

Tips on Cutting Costs in Ordering Fasteners

You can avoid unnecessary delays and costly misunderstandings by checking the following points when inquiring about or ordering fasteners.

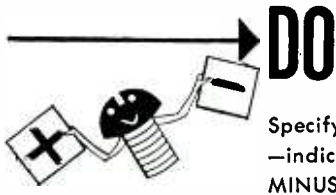

DO
Specify all allowable tolerances—indicate whether all PLUS, all MINUS, or PLUS and MINUS.



Submit sketch if possible (may be rough as long as dimensions are clearly shown).



Submit samples if possible.

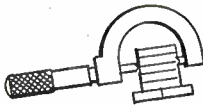

Specify as liberal tolerances as intended use will permit. (Close tolerances increase costs.)

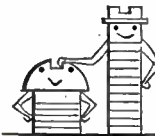

If any special allowance is to be made for subsequent plating the thickness of plate should be specified.

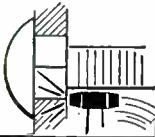

Where square shoulders are to be subsequently staked over, this fact should be so stated.



DON'T
Don't specify dimensions in decimals when fractional dimensions are sufficient.

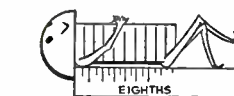

Don't specify lengths in units finer than necessary.

REPRINTS

of this chart are available on request for use in drafting and purchasing departments.



MACHINE SCREWS, NUTS AND SPECIAL FASTENERS ARE OUR BUSINESS



WRITE FOR OUR CATALOG

THE PROGRESSIVE MANUFACTURING COMPANY
50 NORWOOD ST., TORRINGTON, CONN.

Save research time and effort on

ELECTRONIC PROBLEMS IN COMMUNICATIONS

This new Markus and Zeluff book helps you do it. It gives you easy access to essential information on many important recent developments in radio communication, radio broadcasting, television, and radar.

In the same convenient style as their other books, the authors have selected 252 outstanding articles from recent issues of *Electronics*—then condensed, classified, and indexed them for your easy reference.

The result is a reference book that will save you hours of duplicative research—giving you circuits, equations, charts, nomographs, and other job data on 15 major electronics fields.



Just Published

ELECTRONICS FOR COMMUNICATION ENGINEERS

Edited by JOHN MARKUS and VIN ZELUFF
Associate Editors, *Electronics*
624 pages, hundreds of illustrations, \$10.00

This compact volume presents important work of other engineers, making it practical and economical to begin a new problem where others have left off—rather than starting from scratch. Its 252 articles contain a wealth of design equations, charts, nomographs, tables, etc. Because of its authoritative and detailed coverage, every article has permanent reference value—each contributes to a book that will more than pay its own way in your reference library.

16 CHAPTERS COVER

- amplifiers
- antennas
- audio
- cathode-ray tubes
- components
- electronic music
- filters
- measurements
- microwaves
- oscillators
- power supplies
- propagation
- pulses
- receivers
- transmission lines
- transmitters

Full coverage of electronic music

A helpful feature is the chapter on Electronic Music, a relatively new branch of electronics that is growing rapidly more important today. Compiled here are 10 articles giving information on both commercial and custom-built electronic organs.

Much of the material in the audio section supplements the basic articles on electronic music, since the audio amplifier is an essential part of every electronic organ.

Radar and television circuit developments are treated and explained in each appropriate chapter, rather than being grouped in a separate chapter.

SEE THIS BOOK 10 DAYS FREE

McGraw-Hill Book Co., 330 W. 42nd St., NYC 36
Send me Markus and Zeluff's **ELECTRONICS FOR COMMUNICATION ENGINEERS** for 10 days' examination on approval. In 10 days I will remit \$10.00, plus few cents for delivery, or return book postpaid. (We pay for delivery if you remit with coupon; same return privilege.)

(PRINT)

Name

Address

City

Company

Position

FL-10 52

This offer applies to U. S. only

Another New Phil-trol Relay!

• WITHSTANDS VIBRATION AND SHOCK

• LONG OPERATING LIFE

• COMPACT, LIGHTWEIGHT, RUGGED

• 10 TO 20 AMPERE CAPACITY

• RESPONDS TO 1/2 CYCLE

• 1 TO 5 POLE, DOUBLE THROW

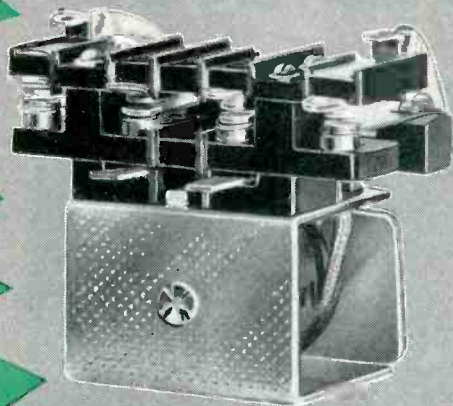

Sets a New High in Performance, Efficiency and Economy!

The new Phil-trol Type 33 Relay is another triumph of Phillips designing and engineering. It is an important addition to the complete line of Phil-trol Relays that enables you to select the type practically tailor-made for your particular needs.

The Type 33 Phil-trol Relay is of single coil design and box shape construction. Armature and frame construction of a type that affords fast action in both operation and release. Contacts are quickly and easily pressure adjusted by means of screws. The Type 33 is available for either a.c. or d.c. operation (33 AC or 33 QA). The constant of operate and release times has qualified this relay for many applications such as are found in timing circuits.

Write for detailed Data Sheet and copy of latest Phil-trol Relay Catalog

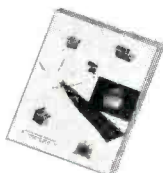

Phil-trol PRODUCTS

PHILLIPS CONTROL CORPORATION

84 W. JEFFERSON ST. • JOLIET, ILL.
OFFICES IN PRINCIPAL CITIES

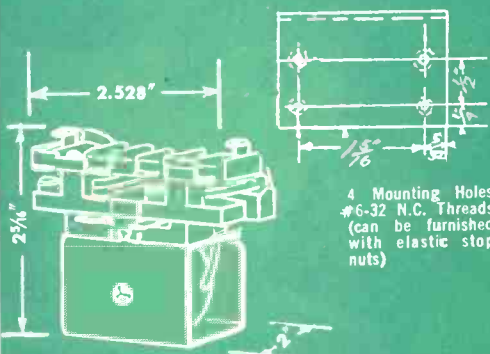

OTHER PHIL-TROL RELAYS:



Power Relay
Type 27QA



Miniature Telephone
Type 4QA



Telephone
Type 2QA



Hermetically Sealed
Type 20366-1



Hermetically Sealed
Type 40015

There's More to a Good Filter Than Meets the Eye!

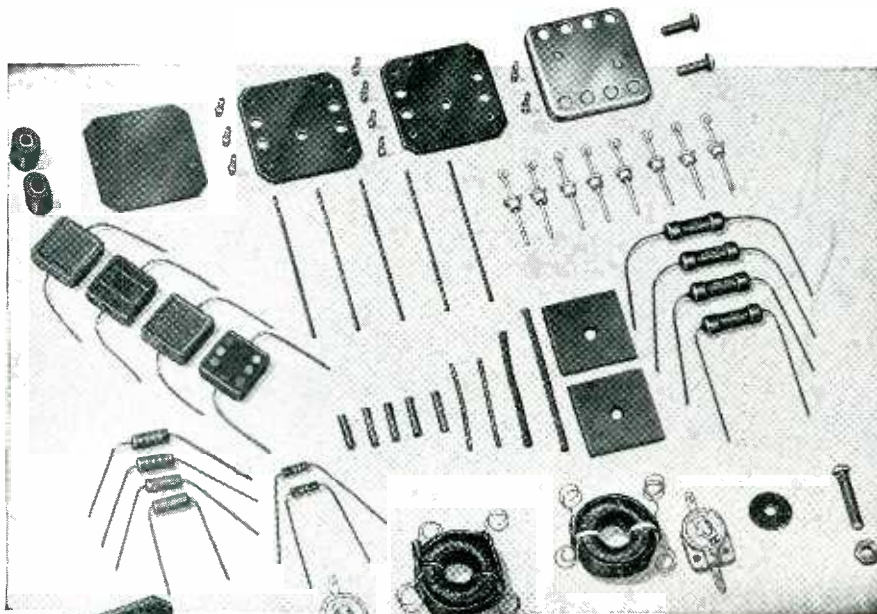

All of these 66 parts are from a single B&W Toroidal-coil type discriminator only 1 $\frac{3}{4}$ " square by 3 $\frac{1}{2}$ " long exclusive of terminals!

Throughout, the job is one calling for precision components plus a wealth of engineering "know how" in producing and assembling them for maximum performance and effectiveness.

Like all other B & W Special Components, the one illustrated here was designed and produced for a specific application—in this instance a critical military use.

FILTERS

In addition to "tailor-made" discriminators, B & W offers a complete line of performance-proved filters including high-pass, low-pass, band-pass and band suppression types.

TOROIDS

B & W Toroidal Coils of various styles and sizes are available in a wide range of inductance values in open, shielded, potted and hermetically sealed types.

not hold the pointer precisely at right angles to the bushing and at the same time safely actuate the two starting controls for the press.

The problem was solved in the Cincinnati plant of Crosley Division by mounting a small permanent magnet on the mandrel of the machine, and taping onto this a V-shaped piece of iron which positioned the pointer at exactly the correct angle. The magnetic attraction is sufficient to hold the plated iron pointer rigid despite the jar as the press first hits the bushing.

Wire-Plugging Tools

WIRES with AMP insulation-piercing plugs are pushed into mating pin jacks with two types of tools during assembly of electronic business machines in the Poughkeepsie, N. Y. plant of International Business Machines Corp., to give secure joints without use of solder.

At working positions where a large number of such connections are made, a pneumatic plugging tool



Using air-operated tool to push plug-tipped wires into tiny jacks

B&W **Barker & Williamson, Inc.**
237 Fairfield Ave., Upper Darby, Pa.

A lot of engineering for a Component!



Converter's job in Speedomax instruments is to receive the (often very small) direct current signal which is related to the temperature, stress pH or other condition being measured, and produce an alternating voltage. This output is amplified, and then directs the balancing system to measure, record, and if desired control.



Good engineering shows in this Amplifier's thorough filtering, high impedance, and plug-in connection to the rest of the Speedomax.

Good engineering shows in this Slide-wire's non-inductive winding and in absence of any flexible leads which might form inductive loops.



Good engineering shows in this balancing motor's small size, and in its torque ample to operate accessory control and signalling fitments.

and every Speedomax user benefits by it!



• The operating precision of the thousands of Speedomax Recorders and Controllers which serve industry and science begins with the engineering of components like this Converter. Our specifications apply at all stages—all the way back to the plants which make metals, insulation materials, etc., for us. These specs represent also the best thinking of our

suppliers' engineers. The resulting materials are thus quality-controlled for us—and us alone.

From these materials our engineers tell our factory how to make converter parts to truly tight specifications. Some parts require principally flatness, or elasticity, or dimensional stability. Reeds need correct natural frequency. Many parts of course combine various needs; each gets its requirements.

Life tests show Fidelity and Stamina. Ingenious and often original design creates from these parts a converter with noise level equivalent to only 0.2 microvolt in an emf potentiometer circuit. And this fidelity promotes accurate measurement and control.

Running on life tests since 1948, present-model converters are today still well inside performance tolerances. Such a run equals 21.9 years of 8-hours-a-day, 200-days-a-year-service—or 1.9 years more than the present age of the first Speedomax.

This kind of engineered performance is also built into the amplifier, slidewire, motor and scores of other exclusively Speedomax parts. It's at your service whether you want to control a laboratory furnace, plot an X-Y function, or record the facts about atoms or molecules. Call on L&N application engineers in selecting the range (from among thousands) and measuring circuit (from among over 2300) to meet your needs. Write our nearest office, or 4979 Stenton Avenue, Philadelphia 44, Pa.

CAREER OPPORTUNITIES AT L&N

Expansion program of this long-established firm has many features to attract outstanding recent graduates in engineering and science. Opportunities are in sales field engineering, product and application engineering, research, advertising, market development. Widely-respected policies assure recognition of progress and achievement. Address Personnel Manager for preliminary interview at nearest of 17 L&N offices.



LEEDS NORTHROP

instruments • automatic controls • furnaces

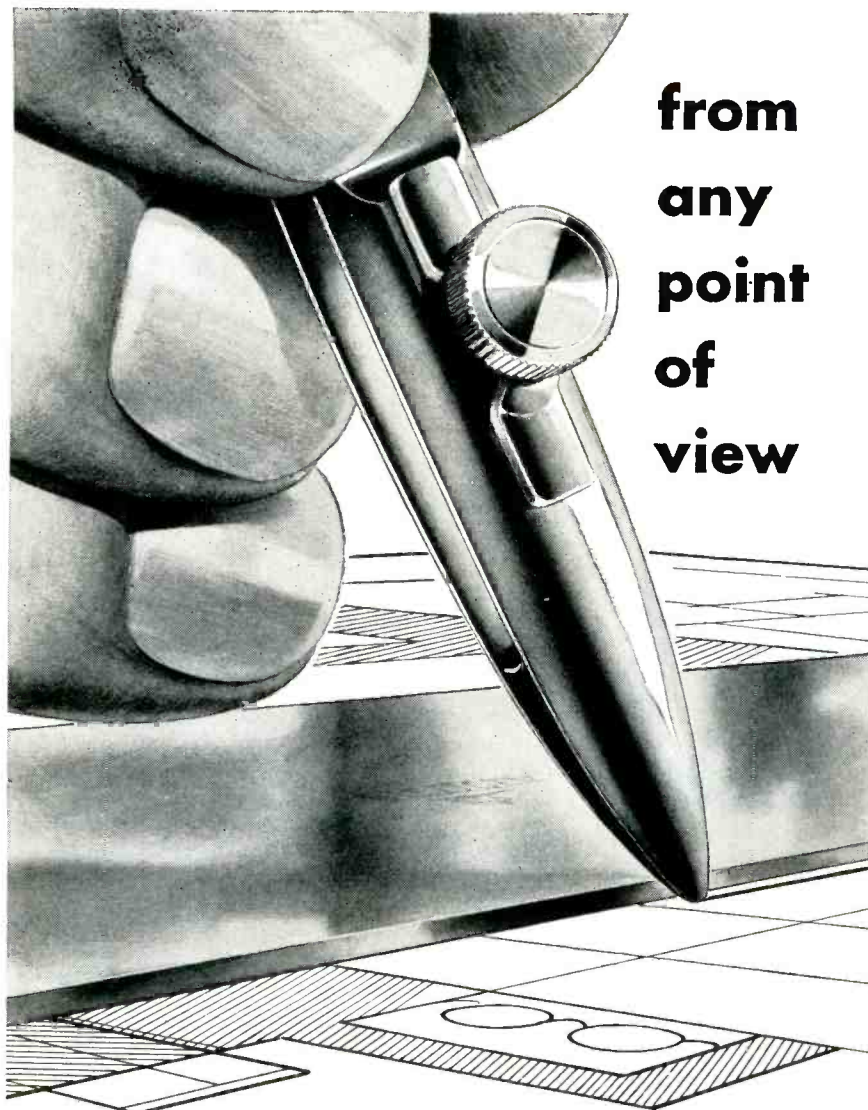

from
any
point
of
view

You'll save with **ARKWRIGHT**

Arkwright Tracing Cloths are made to help you do your best work more easily.

Arkwright cloth saves time. There's never a pinhole, uneven yarn or other imperfection to slow you down.

Arkwright cloth saves trouble. You can draw over erasures time and again and not have an ink line "feather".

Arkwright cloth saves money. If needed, you can get clean, ghost-free reproduction from a drawing years after you make it—years after paper or inferior cloth would have turned brittle and opaque with age.

Wouldn't you like to see for yourself why Arkwright Tracing Cloth is best? Write for samples to Arkwright Finishing Co., Industrial Trust Bldg., Providence, R. I

ARKWRIGHT

Tracing Cloths

AMERICA'S STANDARD FOR OVER 30 YEARS



Available
NOW!

RUGGEDIZED METERS

... TO MEET
SIG. C. SPEC.
MIL-M-10304

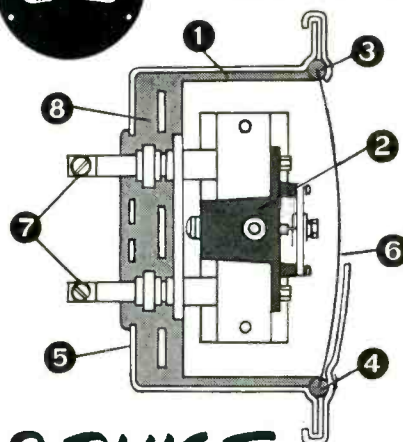

8 PLUS Features

EXTRA "RUGGEDIZED" FEATURES

- 1 Meter movement shock-mounted and housed in rubber-lined case.
- 2 Meter movement supported by die-cast frame for greater strength and increased accuracy.
- 3 Observation window rubber grommetted and sealed to rubber lining of case—providing hermetical seal of high dielectric materials.
- 4 Non-rigid mounting of observation window with rubber grommet increases resistance to shock.
- 5 Each meter designed and built by SUN to highest

quality and precision standards.

EXTRA INSTALLATION ADVANTAGES

- 6 Slight convexity of observation window reduces chance of accidental breakage during installation or shipment.
- 7 Terminals side-tapped and provided with tinned binding screws to facilitate wiring with or without wire lugs or by pressure, soldering or both.
- 8 Breakage or damage in wiring is reduced through non-rigid mounting of terminals and use of flexible interior conductors.

Building rugged electric meters is not new to SUN... For over 20 years, the automotive industry has depended on SUN as one of the largest "D'Arsonval-type" meter manufacturers—to produce rugged, tough meters that will stand up under the abuse and rough handling of portable field instruments used in automotive repair work. SUN "Ruggedized" Meters not only meet Specification MIL-M-10304 (Sig. C)—but also embody many *plus* features that make installation easier, faster and help prevent assembly or shipping damage. Complete data bulletin on SUN "Ruggedized" Meters available on request.

SUN "Ruggedized" Meters are available as D-C Volt Meters, Ammeters, Milli-ammeters and Micro-ammeters and also may be ordered as rectifier type A-C instruments.

6060-0

SUN ELECTRIC CORPORATION

383 Avondale Avenue, Chicago 31, Illinois

HI-Q SERVES NATIONAL DEFENSE

Wherever Electronics
Play Tag with
a Plane

Guided missiles that can chase an enemy plane for miles... and eventually catch and destroy it... are just one of the many "fantastic weapons" which electronics have contributed to the defense of our nation. And here, as in all other phases of this great new science, you'll find **HI-Q** components valued for their dependable performance, long life and rigid adherence to specifications. Whether it be disk capacitors... tubulars, plates or plate assemblies... high voltage slug types... trimmers, wire wound resistors or choke coils... you can count on the **HI-Q** trade mark as a guarantee of quality in ceramic units. And you can likewise count on **HI-Q** engineers for skilled cooperation in the design and production of new components to meet specialized or unusual needs.

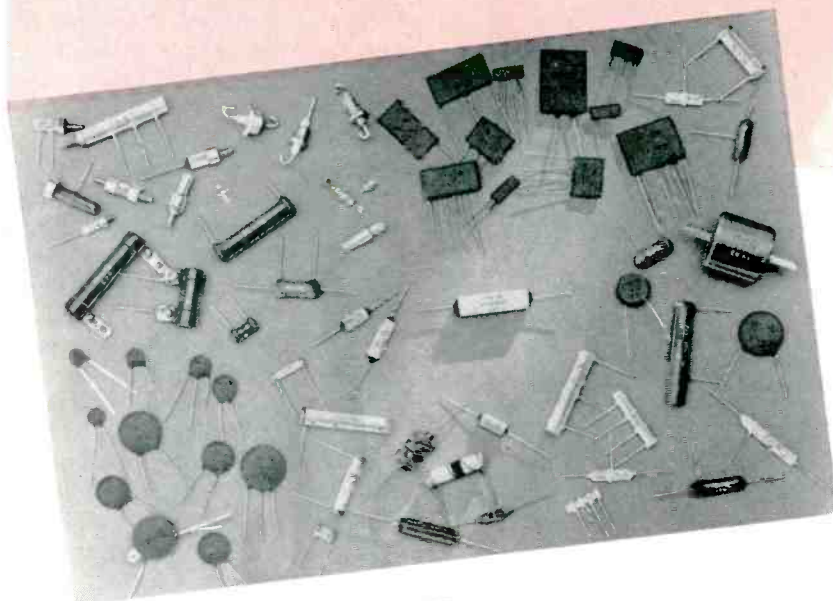
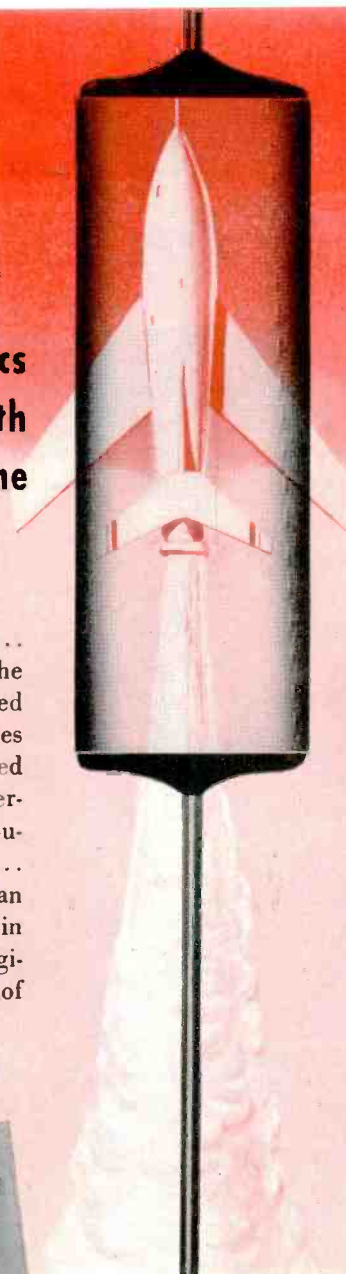

HI-Q TUBULAR CAPACITORS

... may be had with axial leads and a specially developed endseal as shown above, or with conventional leads. **HI-Q** tubulars are available in a complete range of by-pass, coupling and temperature compensating types as well as in an HVT line developed specifically for use on the relatively high pulse voltages encountered in the horizontal sweep and deflection sections of television circuits. Whatever your needs for tubular capacitors or other ceramic components, you are invited to consult **HI-Q**.

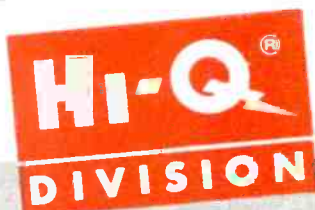

AEROVOX CORPORATION

OLEAN, N. Y.

AEROVOX CORPORATION
NEW BEDFORD MASS.

WILKOR DIVISION
CLEVELAND, OHIO

Export: 41 E. 42nd St., New York 17, N. Y. • Cable: AEROCAP, N. Y. • In Canada: AEROVEX CANADA LTD., Hamilton, Ont. JOBBER ADDRESS: 740 Belleville Ave., New Bedford, Mass.

7 good reasons for specifying MEPCO *Precision Resistors*

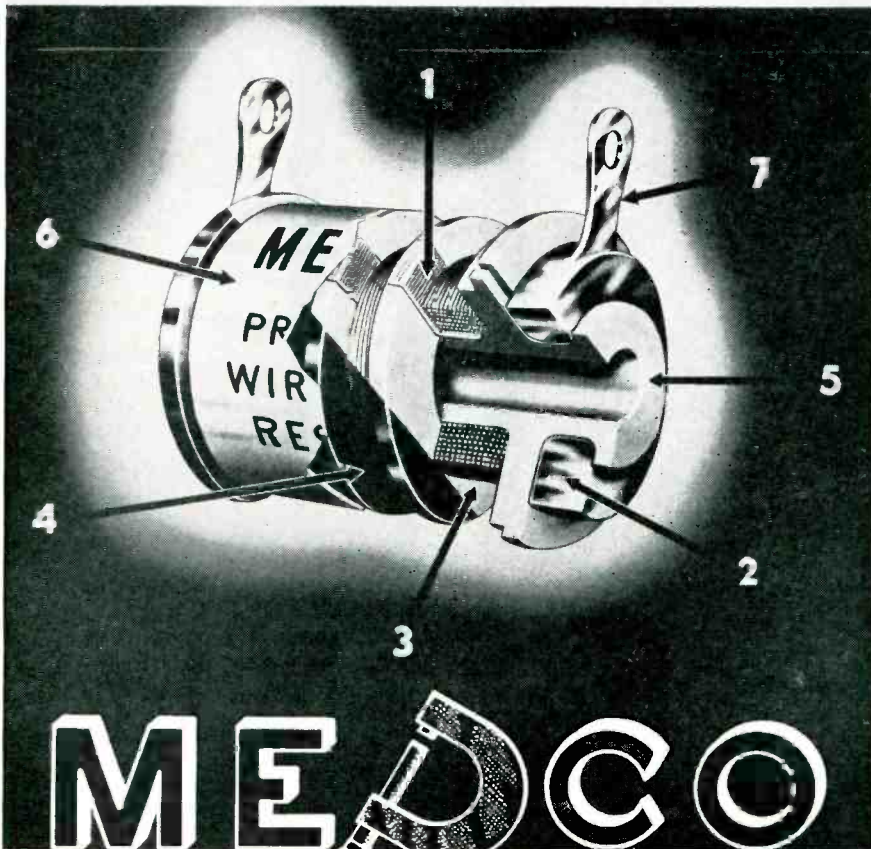

- ① Crossover wire insulated from each winding by 2000v. insulation (patented).
- ② Special metal molded connecting feature, which bonds end of winding and terminal in a non-corrosive and mechanically secure manner—no solder or flux used.
- ③ Reversed and balanced PI-windings for low inductance, with use of only the finest resistance alloys.
- ④ Impregnated with approved fungus, moisture and salt water-proofing compounds.
- ⑤ JAN approved non-hygroscopic steatite bobbin, specially treated prior to winding in order to provide additional protection for fine enameled wire.
- ⑥ Protective fungi resistant acetate label.
- ⑦ Rigid hot solder coated brass terminals for easier soldering.

MEPCO, INC.,
MORRISTOWN, NEW JERSEY



Hand tool for plugging wires into jacks

is used. The tool in this is a rod having a hole drilled in its end to the diameter and depth of the thick part of the plug. A milled slot runs lengthwise into this hole. In use, the tool fits over the plug, with the wire coming out of the slot. After inserting a plug-tipped wire in its correct jack loosely by hand, the operator holds the tube over the jack and operates the thumb valve. The resulting vibratory action forces the plug into the jack smoothly in a few seconds.

At working positions requiring only occasional plugging in of wires, a hand plugging tool having a plain screwdriver-type handle is used. Here the operator must have sufficient strength to push in the plug, since force is required. The plugs are made by Aircraft Marine Products Co., Harrisburg, Pa.

Solder Holder

SIMPLE metal holders attached to the undersides of benches keep rosin-core solder within reach of assembly-line operators at all times

Important to Engineering, Research & Testing

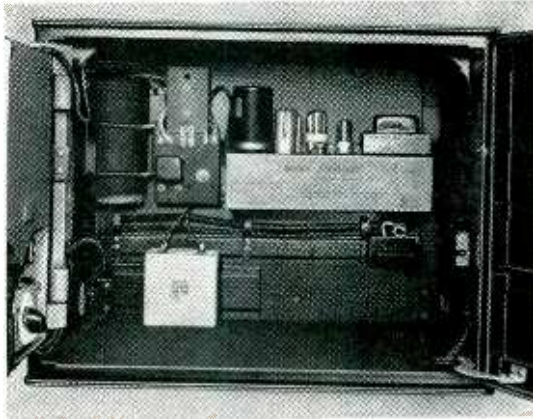

Internal view showing amplifier and damping circuit components.

● NEW HIGH SPEED *Elektronik* RECORDER

For accurate records of rapidly changing variables

● Now you can accurately record, on a wide chart and on a *null-balance instrument*, full scale signals which vary as rapidly as 20 cycles per minute. Signals with a peak to peak amplitude of 10% of scale can be reproduced at variations up to 3 cycles per second.

The instrument develops a pen speed that traverses its eleven inch graduated chart in *one second!* It has chart speeds up to 4 inches per second—20 feet per minute. It incorporates an adjustable damping circuit . . . has a motor driven reroll mechanism to maintain constant tension on the chart . . . and is adaptable to the measurement of practically any d-c signal.

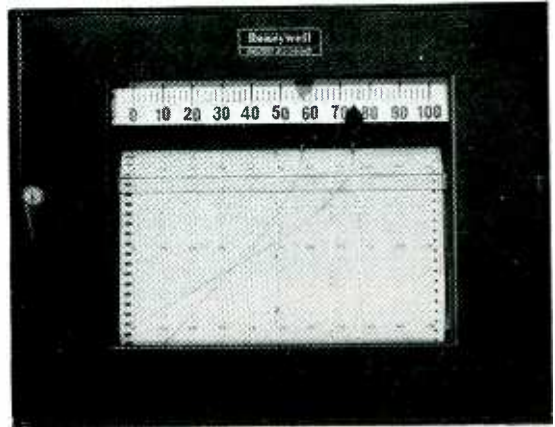

● THE *Elektronik* DUPLEX RECORDER

Simultaneously records two independent variables ON ONE CHART

● On a single chart, the *Elektronik* Duplex Recorder provides a clear, easily read record of the measurement of practically any combination of two independent variables. A "natural" for such applications as atomic energy, stress analysis and acoustics . . . this instrument is particularly useful in before and after comparisons made by recording a measurable characteristic of a substance as it enters and emerges from a processing stage or reaction.

Auxiliary switches can be supplied on one pen for control or signalling . . . a solenoid-actuated third pen can be provided to register in time conformance with one of the standard pens.

MINNEAPOLIS-HONEYWELL REGULATOR CO., *Industrial Division*, 4428 Wayne Avenue, Philadelphia 44, Pa.

MINNEAPOLIS
Honeywell
BROWN INSTRUMENTS

First in Controls



● *Important Reference Data*

WRITE FOR A COPY OF DATA SHEET NO. 10.0-7 ON THE HIGH SPEED RECORDER . . . DATA SHEET NO. 10.0-6 ON THE DUPLEX RECORDER.

Century MODEL 1809 BRIDGE CONTROL UNIT FOR VIBRATION AND STRESS ANALYSIS



Designed as a companion unit to Century's famous Model 409 Oscillograph, the Model 1809 Bridge Control Unit is the latest addition to Century's line of industry-standard vibration and stress analyzing equipment. Packaged in a small, compact space, the unit contains all of the facilities necessary for use with 12 channels of resistance strain gages or bridge-type transducers. Where used with the Model 409 Oscillograph, it is necessary only to connect strain gages and power source to have a complete stress-strain measuring and recording system, small and rugged enough to be placed in an aircraft wing tip or guided missile warhead.

FEATURES:

Size: 4½" x 7" x 11".

Weight: 10½ pounds.

Aluminum case.

Up to 12 channels.

For any resistance strain gage or bridge-type transducer.

May be used with direct indicating instrument.

Power: Control unit, 22-28 Volt D.C.

Strain gage, 6-28 Volt D.C.

Write for Bulletin CGC—307

MODEL 409 OSCILLOGRAPH



The Century Model 409 Oscillograph has been designed for recording data where space and weight requirements are limited. The Oscillograph has been tested to record faithfully while subjected to accelerations up to 20 G's.

FEATURES:

Size: 5" x 6½" x 11½".

Weight: 13 pounds.

Cast aluminum case.

Paper speeds variable ½" to 6" and 2" to 24" per second.

Detachable daylight loading magazine with a capacity of 3½" x 100' paper.

2 to 14 individual channels.

Trace identification.

Trace viewing.

Write for Bulletin CGC—303

REGISTER and VOTE—it's YOUR country

Century GEOPHYSICAL CORPORATION
TULSA, OKLAHOMA

1505 Race St. Philadelphia, Pa. 3406 W. Washington Blvd. Los Angeles 18, Calif. 238 Lafayette St. Dayton 2, Ohio 309 Browder St. Dallas, Texas EXPORT OFFICE 149 Broadway, N. Y. City



KENYON TRANSFORMERS for standard and special applications

Designed by specialists of 25 years standing • Engineered to exact specifications • Tested for peak performance • Constructed to outlast their guarantee • Kenyon transformers meet all Army-Navy specifications.



KENYON TRANSFORMERS FOR

- MIL Applications
- Radar
- Broadcast
- Atomic Energy Equipment
- Special Machinery
- Automatic Controls
- Experimental Laboratories

Write for details

KENYON TRANSFORMER CO., Inc.
840 Barry Street, New York 59, N. Y.

National Engineering Research finds the *economical* solution

The problem:

to insulate a 5 kilovolt, 1500 ampere bus bar installation

Recently I-T-E Circuit Breaker Company of Philadelphia had the problem of *completely* insulating 5 kilovolt, 1500 ampere 3 phase bus bar units for an Atomic Energy Commission installation. It was simple enough to insulate the bus bars with oval Phenolite tubing. But, to completely insulate the bus supports and expansion joints was a real problem. I-T-E's engineers showed us what they wanted . . . postformed Phenolite insulating covers . . . drawn deeper than anything we had ever attempted. Our engineers tackled the problem.

The solution:

Phenolite Grade X-114A postforming material and National's technical "know how" in the design of forming dies

Perhaps *your* problem doesn't involve the insulation of 5 KV, 1500 ampere bus bars. But maybe you have an insulating problem where National can give you some real help in solving how to do your certain job economically. Write us, our engineering service is immediately available.

National Laminated Plastics
nationally known—nationally accepted

PHENOLITE
Laminated PLASTIC

The perfect insulation material for high and low voltage applications, Phenolite possesses an unusual combination of properties. It has great mechanical strength and high resistance to moisture; ready machinability; is about one-half the weight of aluminum. Standard colors are natural, black, chocolate; mirror, semi-gloss and dull finishes. Sheets, Rods, Tubes, Special Shapes.

National Vulcanized Fibre Company

Wilmington



Delaware

Offices in

Principal Cities

Since 1873



Phenolite postformed expansion joint cover.

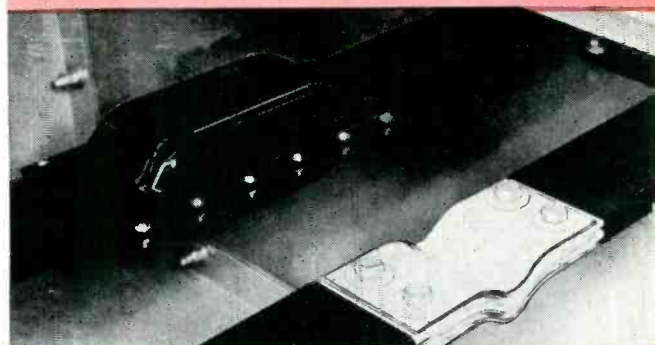

Expansion joint with and without Phenolite insulating covers.

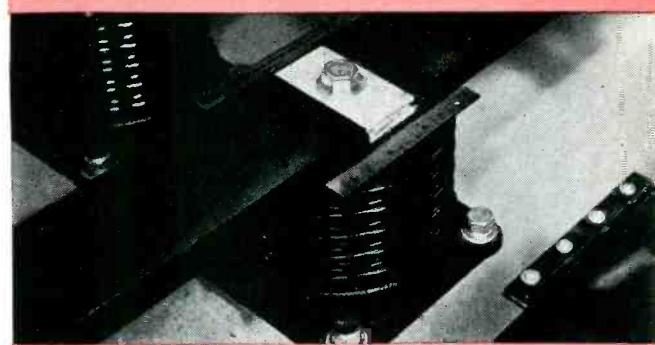

Bus support with and without Phenolite insulating covers.

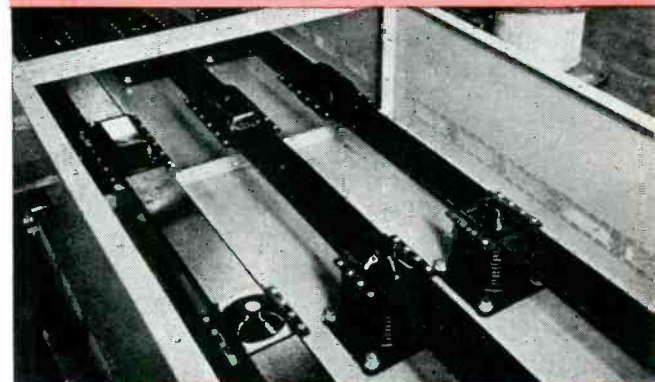

Completed installation, showing Phenolite insulation for bus bars, supports and expansion joints.

for best marking results use

MARKEM



METHODS

MARKEM MACHINES • MARKEM TYPE • MARKEM INKS

FOR MARKING PRODUCTS, PARTS, PACKAGES, TAPES, TAGS, LABELS

Markem Methods are engineered to solve *specific* marking problems. The proper combination of a Markem marking machine, Markem type and Markem ink is matched to the individual requirements. Not only are the properties of the surface itself considered, but also local conditions of temperature and humidity together with your own handling techniques during production, storage and packaging. That is why it is so important that the Markem Method be followed completely.

When you have a marking problem, ask Markem about it. Send a sample of the item to be marked and details of your needs. Markem engineers have worked out practical solutions for many manufacturers. Markem Machine Company, Keene 5, N. H.

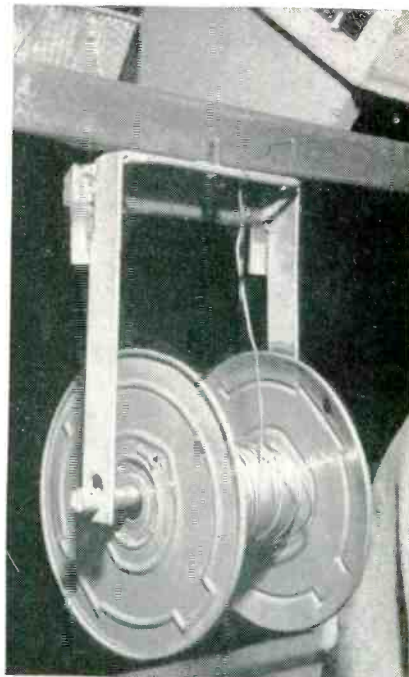
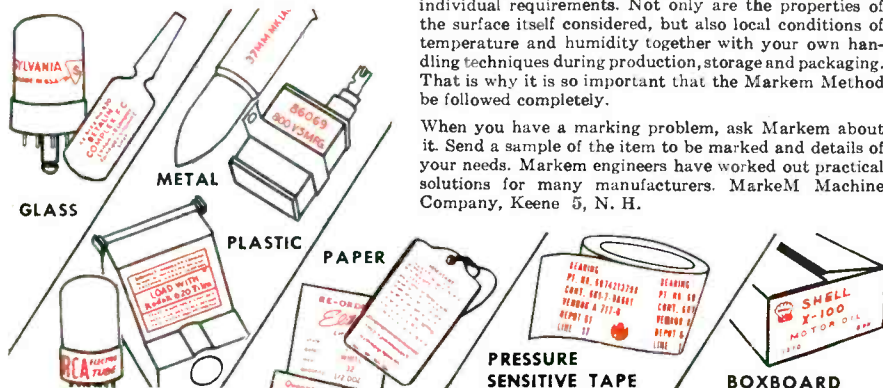

Metal holder for solder reel

in Emerson's Jersey City television plant. The metal shaft for the reel of solder has a deep turned groove in one end to prevent it from sliding out of the U-shaped frame. To change reels, the grooved end of the shaft is lifted slightly, so it can be slid out of the hole in the frame.

The end of the solder is brought up through a hole in the top of the holder. This prevents the end from dropping to the floor out of reach.

Dual Air Guns Speed Subassembly Work

ASSEMBLY of two television controls on a small subpanel is speeded in Crosley's Cincinnati plant by mounting two air-operated socket



Dual air gun setup for driving nuts on vertical linearity control and height control for tv set



MAGNET, RESISTANCE and ALLOY WIRE

- Small space factor
- Unaffected by chemicals or corrosive atmosphere
- Capable of withstanding 250° centigrade
- High dielectric
- Excellent flexibility and abrasion resistance
- Sizes: 10 through 50 A.W.G.

Send for NEW Warren Wire Specification 1001



WARREN WIRE CO.
POWNAI VERMONT

Producers of Nylon, Plain Enamel and Served Magnet Wire, Tinned and Bare Copper Wire.

*Du Pont trademark for Polytetrafluoroethylene Enamel

MOLONEY *HiperCore* ELECTRONIC CORES



Over 200 manufacturers of electronic products for ultimate use by the U. S. Government are now using Moloney HiperCore Cores for Electronic Transformers.

More than 1000 standard sizes are available in quantity to such manufacturers in thicknesses from 1 mil to 12 mil and in widths from 1/4". HiperCore Electronic Cores are of wound core construction using oriented-grain, cold-rolled silicon steel which results in greater flux carrying capacity and lower losses than other type cores of comparable sizes. These smaller, lighter cores perform better and permit increased production by savings in assembly time.

Rigid control of core production permits these cores to test well within industry tolerances. Table at right shows typical test requirements. Special tests for specific operating conditions are made when desired.

Write today for further information.

ME-52-27

MOLONEY ELECTRIC COMPANY

Manufacturers of Power Transformers • Distribution Transformers • Load Ratio Control Transformers Step Voltage Regulators • Unit Substations

SALES OFFICES IN ALL PRINCIPAL CITIES • FACTORIES AT ST. LOUIS, MO. AND TORONTO, ONT., CANADA

ELECTRONICS — October, 1952

STANDARD TESTS

All 12 mil cores are tested for core loss (true watts) and exciting volt-amperes (apparent watts) at 60 cycles. 4 mil cores are tested at 400 cycles. Following table gives maximum test values. Average values are approximately 20% less than maximum.

	12 Mil—60 Cycle @ 15000 gauss	4 Mil—400 Cycle @ 10000 gauss
Core Loss (TW)	0.95 x lbs.	4.4 x lbs.
Exciting Volt-Amps (AW)	1.75 x lbs. + 6.25A*	5.0 x lbs. + 16.6A*

* A = Gross Area of core face in Sq. In.

All 2 mil cores are tested for pulse permeability by using a 2 microsecond pulse width at 400 P. P. S. and maximum flux density of 10000 gauss. The minimum permeability will be 500.

All 1 mil cores are tested for pulse permeability by using a 0.25 microsecond pulse width at 4000 P. P. S. and maximum flux density of 3000 gauss. The minimum permeability will be 175.



WIRE *and* CABLE

for every application



The sensitive and dependable performance so important in electronic equipment demands wire and cable that conform to rigid specifications.

You can depend on Carol wires, cables, and wiring assemblies made to your specifications to *surpass* every test requirement!

Carol engineering and manufacturing facilities are complete—for we draw copper, copperweld, and aluminum; formulate our insulating materials from natural rubber or synthetic rubber or plastics. Carol is a complete wire mill with all the necessary adjuncts to be completely independent and without intermediate profits.

Constant Laboratory control over raw materials, work in process, and finished product assures dependable performance.

Check the advantages of Carol quality and service in solving your wiring problems. Write us about those problems today!

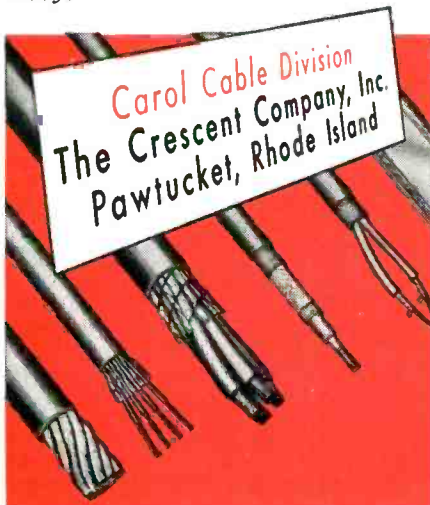

SERVOSCOPE®



Test analyzer for use in development and PRODUCTION of SERVOMECHANISMS and PROCESS CONTROLS. Measures FREQUENCY RESPONSE, PHASE SHIFT 0.1 to 20 CYCLES SINE WAVE, SQUARE WAVE, MODULATED CARRIER, 50 to 800 CYCLES.

SERVOBOARD

A FLEXIBLE SET of PRECISION mechanical parts for quickly coupling motors, synchros, potentiometers to form assemblies of Servo systems, regulators, computers.

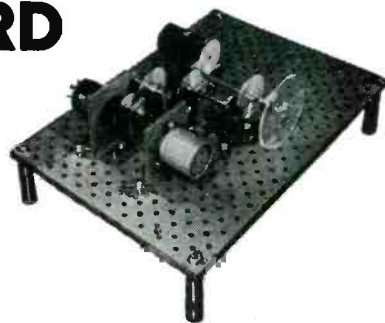

SERVO CORPORATION
OF AMERICA

DEPT. E-10

NEW HYDE PARK, N.Y.

**CONTROLLED
QUALITY...**

**CUSTOM BUILT
FOR GOVERNMENT
AND INDUSTRY**

**TRANSFORMERS
REACTORS
RESONANT FILTERS**

Top Engineering and Workmanship

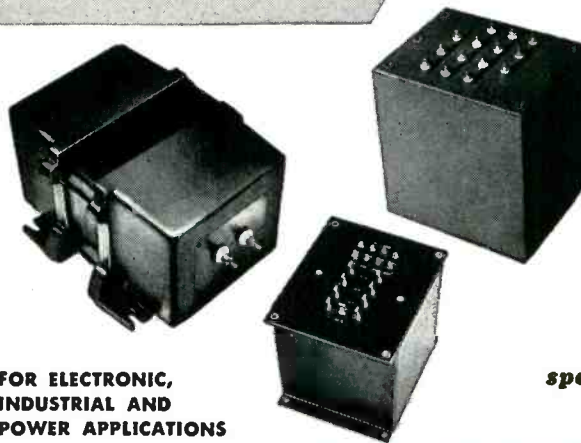

FOR ELECTRONIC,
INDUSTRIAL AND
POWER APPLICATIONS

We have been solving the transformer engineering problems of government and industry since 1938!

Write or phone us regarding your special requirements.

ELECTRONIC TRANSFORMER COMPANY, INC.
209 West 25th Street • WAtkins 4-0880 • New York 1, N. Y.

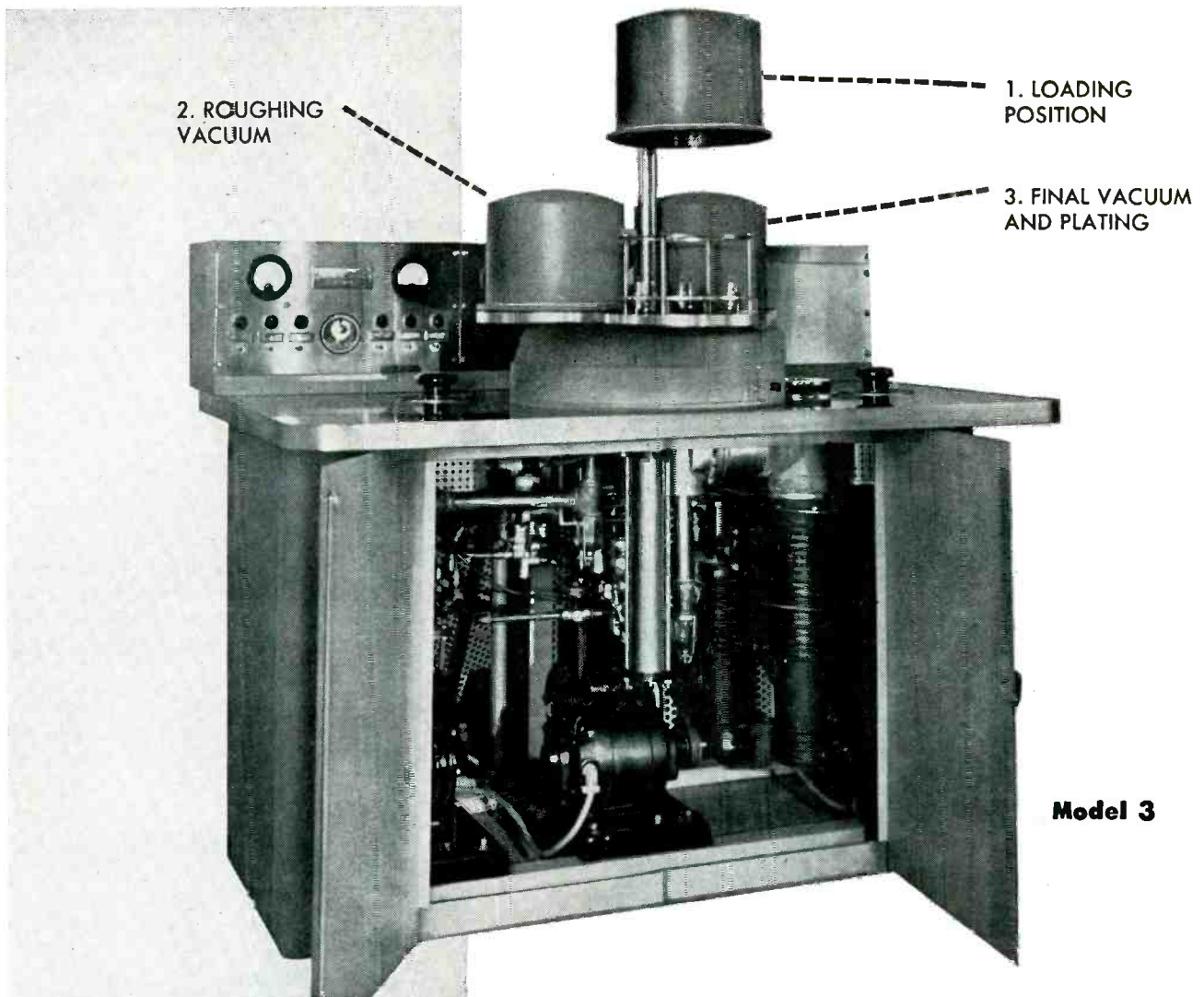

Model 3

here's how to calibrate crystals accurately, quickly...

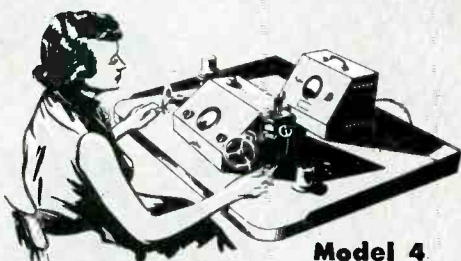

Model 4

Manifold type final frequency calibration unit, type FFO. This unit is engineered to calibrate one crystal every 15 seconds with vacuum of less than $\frac{1}{2}$ micron. Designed for bench mounting in multiple units, this model is available for immediate delivery designed for either manual or electric valve operation. Although possible to base plate with this machine, it was primarily designed for final frequency calibration only. This equipment does not include frequency measuring instruments.

MANUFACTURING
ENGINEERS

Production quantities of quartz crystal oscillator plates can be brought to precise frequencies efficiently and accurately with the equipment shown above. This unit, Model 3, deposits thin, uniform films of metal (gold, silver, aluminum, etc.) on crystal blanks, glass, metal or ceramics . . . in both base plating and final frequency operations for crystal manufacture.

An important feature of Model 3 is the triple turret design. This turret, indexing to 3 positions, permits the simultaneous operations of 1. loading-unloading, 2. initial evacuation 3. final evacuation and plating. Completion of exhaust cycle in less than 2 minutes is accomplished by use of two mechanical pumps and two oil diffusion pumps. These exclusive features are but a few reasons why nine out of ten crystal manufacturers today use CONSTANTIN equipment.

*For complete information and specifications,
write now to Constantin — pioneers in vacuum coating equipment.*

L. L. Constantin & Co.

ROUTE 6 AT FRANKLIN AVE. • P. O. BOX 283, LODI, NEW JERSEY

LEADING PRODUCERS OF EVERY TYPE HERMETIC SEAL INCLUDING CRYSTAL HOLDERS



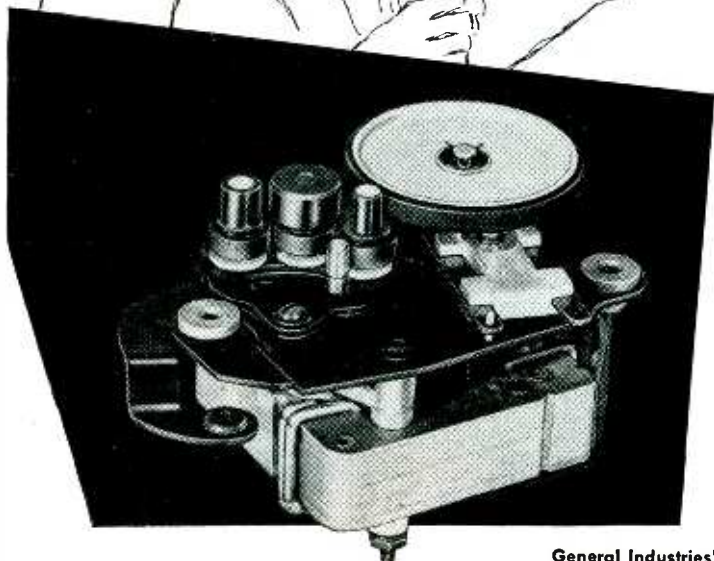

General Industries' 3-Speed Turret-type Phonomotor for record-changer applications.

Smoothness...

another reason why leading manufacturers prefer General Industries' 3-Speed Phonomotors

Complementing the rich, unwavering tones of a recorded masterpiece, is the uniformly smooth, quiet operation of the General Industries *Smooth Power* Phonomotor. Unique drive mechanism assures accurate turntable speed at 33 $\frac{1}{3}$, 45 and 78 R.P.M.

Write *today* for detailed information about General Industries' *complete* line of phonomotors for every phonograph application.

THE GENERAL INDUSTRIES CO.

Department MA • Elyria, Ohio



wrenches side by side rigidly on the bench. The operator merely places the controls in their panel holes, places Pal nuts in the wrenches, then pushes the shafts of the controls into the hollow shafts of the wrenches, to spin both nuts tight simultaneously. The wrenches are of the clutch type, hence they start as soon as the threaded bushings of the controls are pushed against the nuts.

Cabling-Board Pegs

METAL rods are used in place of nails for positioning wires on cabling boards, to improve accuracy and quality in the military radio section of Federal Telephone and Radio Corporation's Clifton, N. J. plant.

Three different techniques are used for anchoring the ends of wires. The most used and most

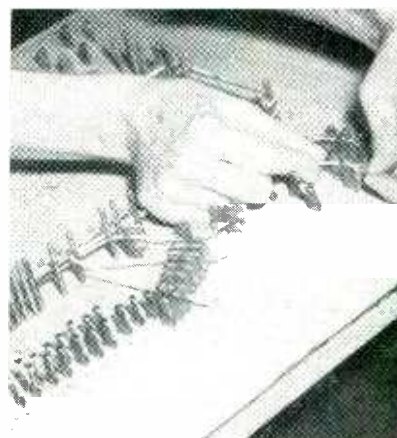

Use of metal wire-positioning rods and steel clips on cabling board

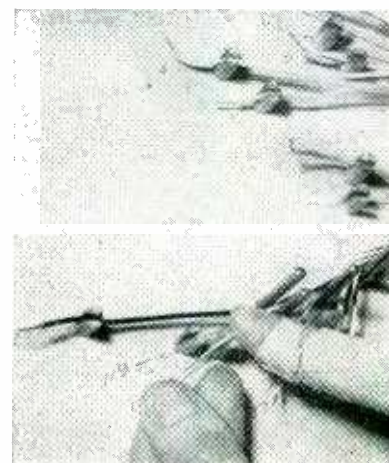

Pushing wire into slot of wood dowel rod

Requirement:— *A wide-band klystron in Ku band which operates at low voltage (less than 350 v.)*

Choice #1:— *Type SRU-55 reflex klystron*

Data:— *Cover range from 14000 mc. to 17500 mc. (3500 mc., 22% band) 15-60 mw. output. Max. beam voltage = 350 v.*

Tuned by means of Waveguide
0.702" x 0.391" w.

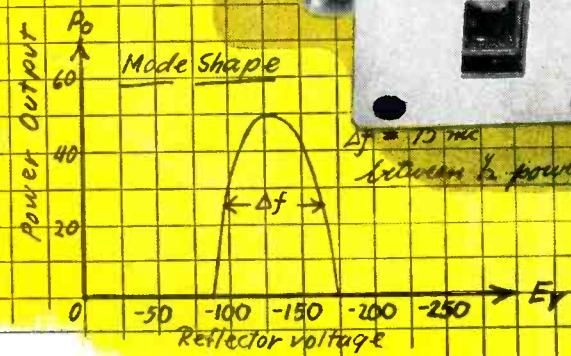
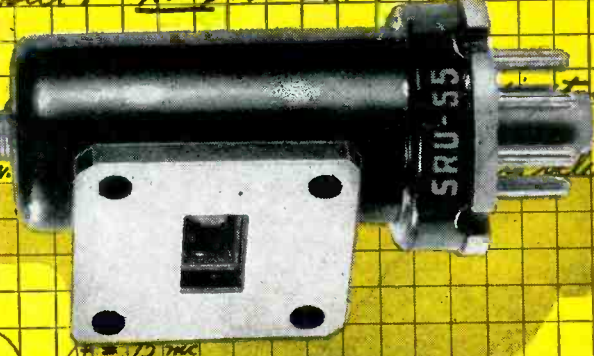

- Octal Base
1. Shell B+ (Gnd)
 2. Heater
 - 5 Refl. *(all other pins are Int. Comps.)*
 - 7 Heater
 - 8 Cath.

... WIDE TUNING RANGE with LOW-VOLTAGE KLYSTRON

14,000 to 17,500 MC at 300 VOLTS

Type SRU-55 is a low-voltage, reflex klystron oscillator with radio frequency output of 15 to 60 milliwatts, operating over the frequency range of 14,000 to 17,500 mc. This Sperry tube can be used as a local oscillator for microwave receivers or as a bench oscillator in the measurements laboratory.

Operating at a frequency of 16,000 mc with a beam voltage of 300 volts, this tube provides 25 milliwatts of output power. Under these conditions the modulation sensitivity is approximately 1.3 megacycles

per volt. The electronic tuning range measured between 3 db points is 75 megacycles per second.

Physical characteristics of Sperry Type SRU-55 are: weight, 3¼ oz. — height, 3 1/16" — mounting, standard octal 8-pin socket (in any position). The r-f connection is a standard UG-419/U fitting for 0.702" x 0.391" waveguide. Its cathode is of the oxide coated, unipotential type. For ambient temperatures below 70°C, only free convection cooling is required. The tuning adjustment on this tube is

driven by a ¼" shaft containing a screwdriver slot.

For additional information on Type SRU-55 and other Sperry Klystrons, write our Special Electronics Department.

MODEL SRU-55	
GENERAL CHARACTERISTICS	
Freq. Range	14,000-17,500 mc.
(mech. tuning)	
Heater Voltage (ac or dc)	6.3 v.
Heater Current	0.6 amp.
MAXIMUM RATINGS	
Beam Voltage	350 v.
Beam Current	35 ma.
Reflector Voltage	0 to -350 v.
Heater-Cathode Voltage (peak)	45 v.



GYROSCOPE COMPANY
DIVISION OF THE SPERRY CORPORATION

GREAT NECK, NEW YORK · CLEVELAND · NEW ORLEANS · BROOKLYN · LOS ANGELES · SAN FRANCISCO · SEATTLE
IN CANADA — SPERRY GYROSCOPE COMPANY OF CANADA, LTD., INTERNATIONAL AVIATION BUILDING, MONTREAL

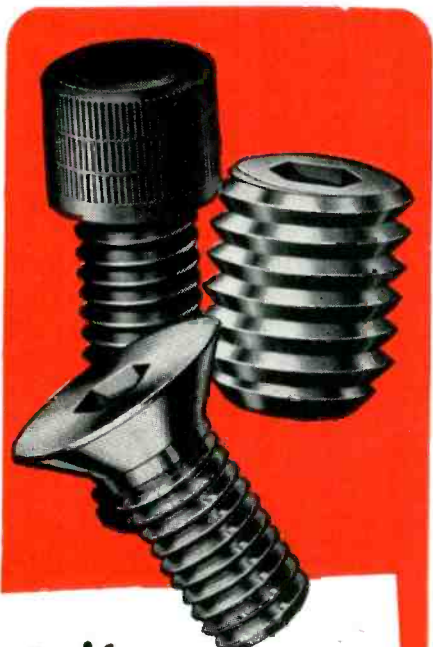

Wherever you use fasteners

- ✓ under vibration
- ✓ under strain
- ✓ in limited space
- ✓ for fine adjustment
- ✓ in inaccessible places
- ✓ needing strength in small sizes
- ✓ in compact design
- ✓ for maximum holding power
- ✓ for fastening thin pieces

... use genuine **ALLEN HEAD** socket screws and keys

Class 3rd fit, quality controlled uniformity and strength, wide range of standard sizes.



WARNING
Allen-Type screws aren't necessarily Allen-Made. Get genuine "Pressur-form" Allen Head screws in this black and silver box.

Sold only thru leading INDUSTRIAL DISTRIBUTORS

ALLEN **ALLEN HEAD**
MANUFACTURING COMPANY
Hartford 2, Connecticut, U. S. A.

PRODUCTIMETER "SPECIALS"

for Radar and Electronic Applications



Companion shutter counters used as dual direction indicators. One counter adds while the other subtracts. Shutter blanks out counter which is on negative side of 000.



"Y" 2-figure Rotary Counter used in navigating instruments.



High-speed, non-reset "Y" type counter for building into radar instruments.



Special Model "Y" with window at rear designed for use in radar equipment.

These are a few of the "specials" developed by Durant for Radar and Electronic applications. When one of the many standard Productimeters is not the exact answer to a problem, Durant engineers modify, combine, or develop entirely new counters to meet the particular requirements of the job.

Write for Bulletin

DURANT MFG. COMPANY
1912 N. Buffum St. 112 Orange St.
Milwaukee 1, Wis. Providence 3, R. I.
Representatives in Principal Cities

PRODUCTIMETERS
SINCE 1879 *Count Everything*

MIL-B-233A
JOINT ARMY-NAVY
SPECIFICATIONS

SPARE AND REPAIR PARTS BOXES



Manufactured to meet material, workmanship and finish requirements of Army-Navy specifications.

Accessories: Internal framing, partitions, trays and wood chucks as required.

Complete Facilities under one roof for quality mass production, including Heliarc welding, baking and finishing. Whistler and Wiedermann equipment for short runs. Tool and die engineering and designing. Completely conveyerized finishing facilities. Large assortment of stock and special dies for radio and television and electronic field.

Write for Catalog and Price List.

ART-LLOYD
Metal Products Corp.

2973 Cropsy Ave., Brooklyn 14, N. Y. • CO 6-5100
PRECISION SHEET METAL PRODUCTS, MASS PRODUCTION SPECIALISTS.

FREED

Instruments & Transformers

Famous For

QUALITY • DEPENDABILITY • ACCURACY

FREED 1020-B MEGOHMMETER

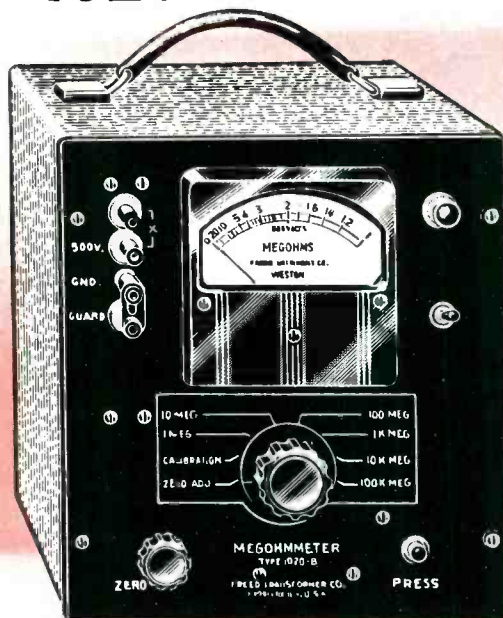

A precision electronic megohmmeter which for years has given satisfactory service in hundreds of laboratories and on production lines.

● **EASY TO READ**

Direct reading on a 4" scale.
Protected against overload.

● **RAPID & SAFE TO USE**

Test voltage removed from terminals and capacitive components discharged to ground in all positions of multiplier switch.

● **ACCURATE**

Within 3% up to 100,000 megohms, 5% from 100,000 to 2,000,000 megohms.

SPECIFICATIONS

Range: 1 megohm to 2,000,000 megohms in six overlapping ranges selected by a multiplier switch.

Voltages on Unknown: The voltage applied to the unknown terminals is 500 volts d-c and is independent (less than 1% of the value of the unknown).

Stability: Line voltage variations from 105-125 volts will cause less than 2% variation in the meter reading.

Power Supply: 105-125 volts A.C.
50-60 cycles 30 watts.

Dimensions: 9½ x 10½ x 8 inches.
Net Weight: 18 pounds.

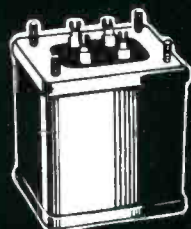

High Fidelity Transformers



Slug Tuned Components

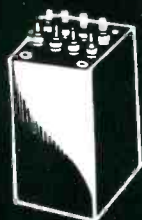

Hermetically Sealed Components to meet MIL-T-27 Specs

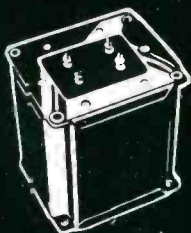

Commercial Components



Sub-miniature hermetically sealed Toroidal Inductors

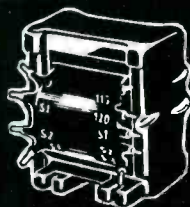

Freedseal Treatment ANE-19 Specs



Miniature Inductors

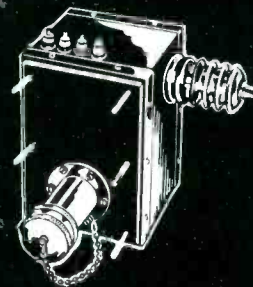

Pulse Modulators

FREED TRANSFORMER CO., INC.

1722B WEIRFIELD ST. (RIDGWOOD) BROOKLYN 27, N. Y.

Here's how the **BECKMAN EASE COMPUTER** helped simplify F-86 Sabre jet design

$e_1 \propto \delta a$ **AILERON**

at North American Aviation

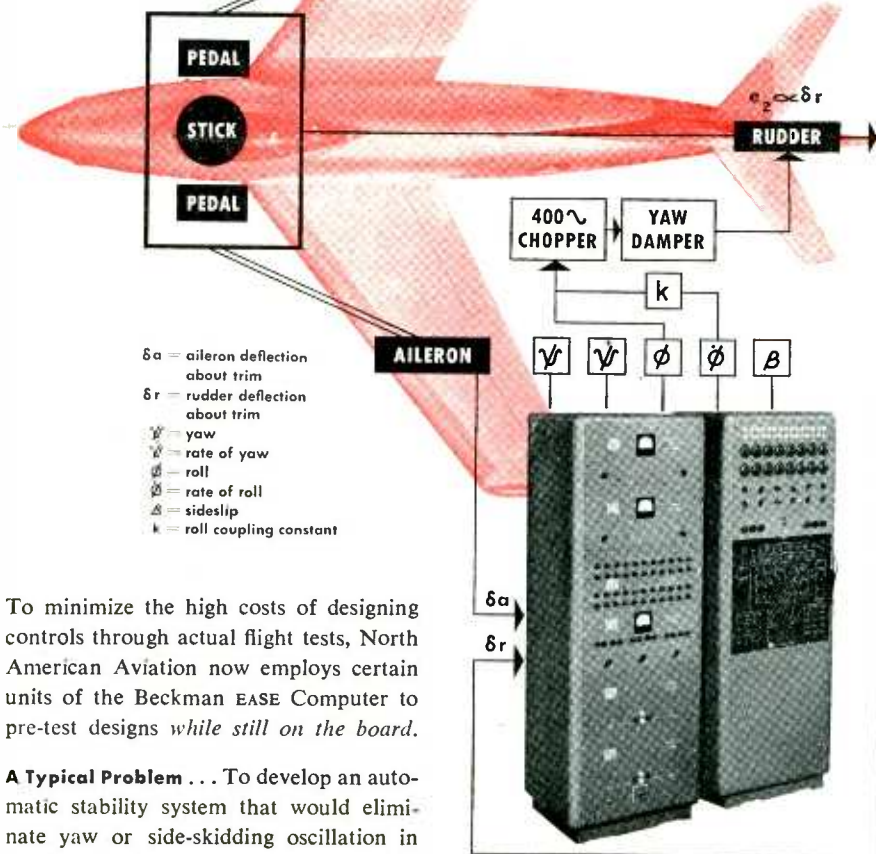

δa = aileron deflection about trim
 δr = rudder deflection about trim
 ψ = yaw
 $\dot{\psi}$ = rate of yaw
 ϕ = roll
 $\dot{\phi}$ = rate of roll
 Δ = sideslip
 k = roll coupling constant

To minimize the high costs of designing controls through actual flight tests, North American Aviation now employs certain units of the Beckman EASE Computer to pre-test designs while still on the board.

A Typical Problem . . . To develop an automatic stability system that would eliminate yaw or side-skidding oscillation in piloting the F86-D Sabre Jet over a wide range of speeds and at altitudes from sea level to the stratosphere.

How North American Solved It . . . The diagram above shows how North American used certain units of the Beckman EASE Computer to quickly solve the problem by flight simulation. A control-system mockup was designed by engineers at North American which generated voltages proportional to aileron and rudder deflections made by movement of mockup stick and pedals. These voltages were fed into the computer so that its electrical response was analogous to the response of the F86-D in flight. Flight conditions—speed and altitude—were varied on the computer by merely turning knobs.

Airborne performance confirmed the results as developed by flight simulation!

WHAT ABOUT YOUR DESIGN PROBLEMS?

The Beckman EASE Computer is currently being used to solve design problems on such products as guided missiles, submarines, railroad cars, automobiles, military vehicles—and has many other time and money-saving applications in industry and research. It is not only, by far, the lowest priced quality instrument in the field . . . but its unitized design, employing compact rack-mounted components, permits the user to select a custom computer which meets his exact requirements—whether as equation solver, simulator, or tester. Let us study your design problems and make helpful suggestions on applying the EASE to your operations!

Get complete details on this new Beckman advancement by writing for Data File 18-59

Special Products Division

BECKMAN INSTRUMENTS, INC.
 SOUTH PASADENA, CALIFORNIA
 Factory Service Branches: New York—Chicago—Los Angeles



Beckman Instruments include: pH Meters and Electrodes — Spectrophotometers — Radioactivity Meters — Special Instruments



Use of springs to anchor ends of wires

satisfactory is a spring steel clip that is pushed into holes drilled in the board to make a force fit. Each clip holds a single wire in practice, even though it could grip two or more. Individual clips permit checking for completeness of the harness at a glance by noting whether all clips are filled.

During a shortage of the steel clips, substitutes made from hardwood dowel rods were used instead. The rods were driven into slightly undersize holes in the board after slotting one end of each rod. Slot width was slightly less than insulation thickness, to give a gripping action.

Where a large number of wires terminated in a small area on the board, a coil spring was fastened to the board with two wood screws and wires were pushed between adjacent turns of the spring. Here one turn of spring was used for each wire, hence the entire spring had to be filled to complete the harness.

When a particular cabling board is no longer needed, pegs and clips are pulled out for reuse on new boards.

Drafting Board is Low-Cost Wiring Bench

ADJUSTABLE-HEIGHT, adjustable-angle drafting boards costing approximately fifteen dollars each provide an ideal working position for wiring and assembly of magnetic drum storage unit panels used in IBM electronic data processing machines. A simple angle-iron framework added to the rear of the bench near the floor provides sup-

These "Firsts" Helped Westinghouse Customers

USERS OF WESTINGHOUSE TUBES GET FIRST BENEFITS FROM MANY NEW TUBE DEVELOPMENTS

These are only a few of the "firsts" that Westinghouse created in the electronic tube industry. In each case, designers using Westinghouse Tubes gained advantages by having first chance to use these innovations.

Today, Westinghouse still pioneers in electronic tubes and tube making. For instance, Westinghouse 40 KV and 20 KV rectifying tubes are under 9 ounces, only 2¾" high. Designers seeking the ultimate in space and weight savings will find them in these new WL-6102 and WL-6103 tubes.

Radical new developments in other power tubes and receiving and tele-

vision picture tubes are now being engineered at the *NEW* Westinghouse Electronic Tube Division at Elmira and Bath, New York.

NEW SERVICE, NEW DISTRIBUTION

Westinghouse plans for Electronic Tube Division expansion are in operation. New service facilities, new warehousing policies, and new distributors are opening rapidly.

New merchandising methods will aid distributors in serving industrial users—many of these business-building programs are totally new in the tube industry. Here, as elsewhere, Westinghouse plans to provide industry leadership in service.

It pays in profits to deal with Westinghouse and with Westinghouse distributors. For full information on how Westinghouse can help you with problems of design, service, or supply, call your nearest Westinghouse representative, or write to Department A-110.

RELIATRON™

YOU CAN BE SURE...IF IT'S
Westinghouse

ET-95003

1920

Westinghouse Makes
First Dry Battery
WD-11 Tube

1921

Westinghouse Testing
New Indirectly-Heated
Tube

1926

WESTINGHOUSE INVENTS
NEW KU-610 THYRATRON

1928

Announce New Photo-
Tube and Long-Life
Cathode Ray Tube

1929

Westinghouse Patents
KOVAR for Metal-to-
Glass Tube Sealing

1931

Westinghouse Unveils
First High Power
UHF Tube

1932

Westinghouse Tells of
New Ignitron Tube

1941

WL-530 in Radar
at Pearl Harbor

TUBES

ELECTRONIC
TUBE DIVISION

Westinghouse Electric Corporation
Box 284, Elmira, N. Y.



Tube Sockets for PRINTED CIRCUITS

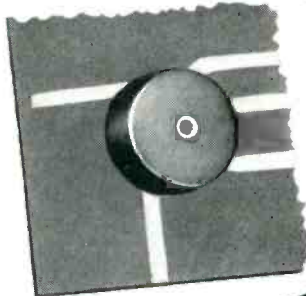
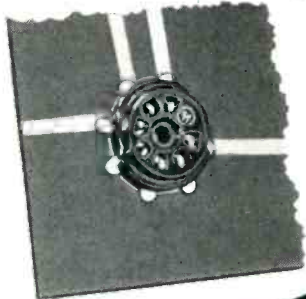

**ready for
mass production**

METHODE, now ready with volume production capacity on seven pin miniature tube sockets for printed circuit application . . . offers units with simple, time-proven design features providing reinforced mechanical spring contact with printed conductors, easily supplemented by solder dip operations. Insulators and retainer caps are heat resistant black phenolic and hardware is cadmium plated copper base alloy.

Recommended Usage: 1) sockets are snapped into keyed holes of $\frac{3}{64}$ " diameter; 2) insulating panel is solder dipped on under side to fuse socket terminals to printed conductors; 3) supplementary con-

nections for top panel connections, if necessary, are spot soldered; 4) retainer cap is eyeletted or screwed to socket, locking assembly to board and assuring pressure contact.

We invite your inquiries

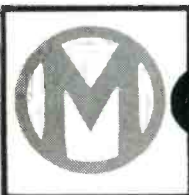

METHODE Manufacturing Corp.

2021 West Churchill Street
Chicago 47, Illinois

Geared to produce
Plastic and Metal Electronic Components

smaller than a suitcase



**. . . and almost
as portable!**

AMERICAN ELECTRIC

400 Cycle
**MOTOR
ALTERNATOR**

WEIGHT: Approx 125 lbs.

SIZE: 22" x 12" x 12"

Designed for production and laboratory high frequency power supply requirements. **STRONG—SIMPLE—INDESTRUCTIBLE CONSTRUCTION**—No delicate moving parts, brushes or springs to wear out or maintain. Replaces single large, hard-to-get H-F power supply serving multiple purposes . . . *A bank of these compact, flexible units costs far less, provides individual portable power sources for each project, avoids downtime hazards of single unit!*

Meets power supply requirements for AN-E-19 equipment.

OUTPUT: Up to 1000 Watts single phase 115V or up to 1800 Watts three phase 115/200V. Input: 60 cycle AC.

Total harmonic content under 5%; $\pm 1\%$ voltage regulation.

WRITE FOR DETAILS!

Larger capacities available.



TWO IMPROVED TYPES
of Synchronous Motor Driven
TIME DELAY
TIMERS
for Industrial Applications



TDAF



TDAB

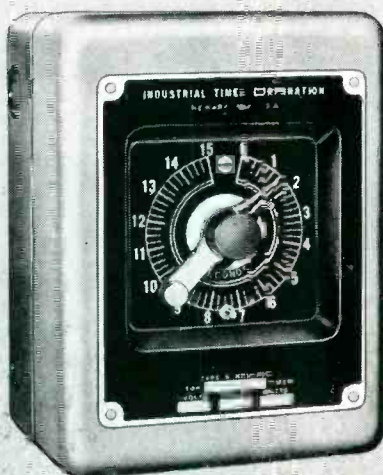

TDAB (in case)

Time Delay Timers are designed for application on circuit controls where a time delay is required between the closing of one circuit and the predetermined closing or opening of another.

Series TDAF and Series TDAB Time Delay Timers are built to stand abuse, and afford the dependable, consistent operation which modern industrial applications demand.

These timers are designed to handle time cycles up to 3 hours. They employ an external, magnetically-operated clutch that not only assures exceptional accuracy but permits *instantaneous*, automatic reset. Thus these timers are ideal for use where rapid recycling is necessary.

OUTSTANDING FEATURES

Automatic, Instant Reset—As soon as the clutch is disengaged, an internal spring brings the actuating arm back to its reset position in a fraction of a second.

Time Setting Adjustment—Adjustment is accomplished by simply moving the black-button pointer to the time cycle required. Quick, easy, accurate.

Dial—Dials of both series have large, easily read numerals.

SERIES TDAF TIMERS

for panel mounting. Terminal strip for electrical connections located at back. 115 volt and 220 volt, A.C.—25, 50, and 60 cycles. (For time ranges, see chart.)

SERIES TDAB TIMERS

for surface mounting. Terminal strip for electrical connections located at front, below dial. If required, can be supplied in steel housing, as illustrated—eight knockouts for easy hook-up. 115 volt and 220 volt, A.C.—25, 50 and 60 cycles. (For time ranges, see chart.)

TIME RANGES—Series TDAF and Series TDAB Timers

DIAL CALIBRATION	MAXIMUM TIME CYCLE
1/10 Second	5 Seconds
1/4 Second	15 Seconds
1/2 Second	30 Seconds
1 Second	60 Seconds
2 Seconds	3 Minutes
5 Seconds	5 Minutes
15 Seconds	15 Minutes
30 Seconds	30 Minutes
60 Seconds	60 Minutes
2 Minutes	3 Hours

For complete technical data request bulletin 39

MANUFACTURERS OF THESE AND OTHER TIMERS AND CONTROLS FOR INDUSTRY—Cam Timers • Manual Set Timers • Tandem Automatic Recycling Timers • Instantaneous Reset Timers • Running Time Meters

Timers that Control
the Pulse Beat of Industry



INDUSTRIAL TIMER CORPORATION

115 EDISON PLACE, NEWARK 5, N. J.

HAMMARLUND DUPLEX SIGNALING UNIT

PRODUCTION TECHNIQUES

(continued)

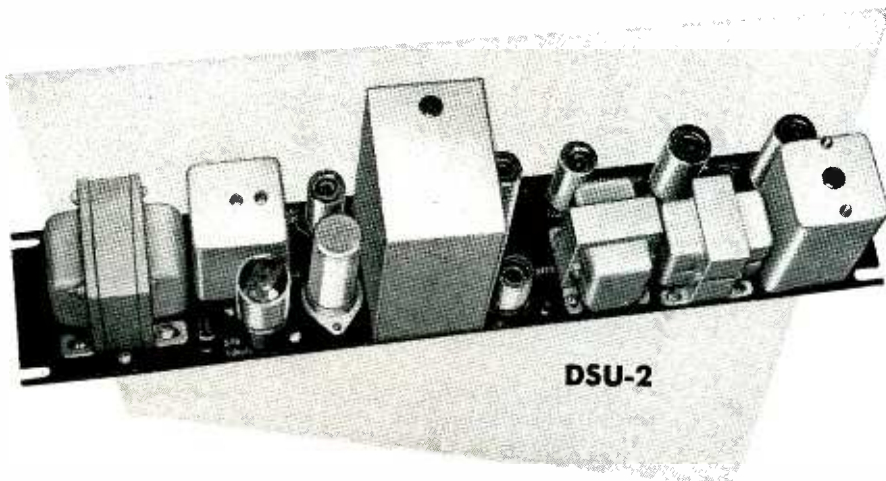

DSU-2

- **Watchdog of Indispensable Circuits**
- **Controller of Remote Operations**

The Hammarlund Standard Duplex Signaling Unit consists of a tone generator and frequency selective receiver designed to operate over wire lines, telephone or power line carrier, and radio or microwave communications circuits for signaling, dialing, slow speed telemetering, supervisory controls or other information. Transmitters and receivers are available for 33 frequency channels between 2000 and 6025 cps.

This equipment is ideally suited to requirements of emergency services, broadcasters, military and governmental agencies, pipeline and power companies, airlines, railroads and other groups requiring remote on-off switching, continuous indication of operating conditions, and automatic detection of wire line or power source failures along their systems.

Make Hammarlund Duplex Signaling Units your electronic watchdogs and supervisors.

◆ Write Today For Detailed Information ◆

HAMMARLUND
MORE THAN 40 YEARS EXPERIENCE COUNTS!
THE HAMMARLUND MANUFACTURING CO., INC.
460 WEST 34th STREET • NEW YORK 1, N. Y.



Use of inexpensive drafting table for assembly work

port for the reels of wire used in the operation.

To hold the work in position on a slanting board, four studs are set into the board and the panel is fastened to them with thumb screws. These boards proved much cheaper and yet more satisfactory than conventional benches in the Poughkeepsie, N. Y. plant of International Business Machines Corp.

Capacitor Breakdown Tester

By CURTISS R. SCHAFER
The Liquidometer Corp.
Long Island City, N. Y.

IN THE capacitor breakdown test unit shown, a d-c voltage, usually equal to twice the rated voltage of the capacitor, is applied for one minute. The on time is controlled



Capacitor tester; hinged box for ten capacitor units, in foreground, is connected to cut off high voltage automatically when cover is raised, to protect operator

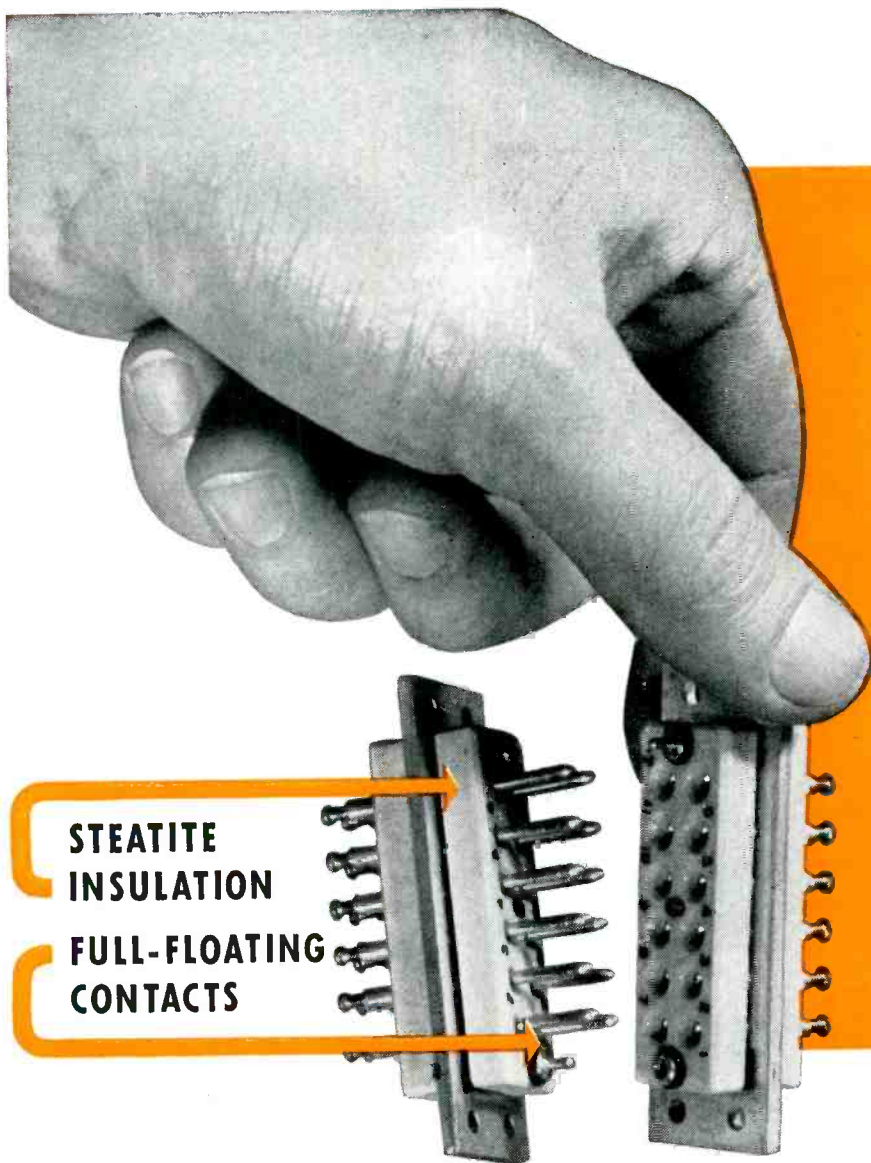

Lapp

PLUG-AND-RECEPTACLE

for

Sectionalizing Circuits

SIMULTANEOUS contact of any number of leads can be made or broken by use of Lapp Plug-and-Receptacle units, for panel-rack assembly or other sectionalized circuits. Insulation is Steatite, the low-loss ceramic which is non-carbonizing, even when humidity, moisture or contamination sets up a leakage path. The unit shown above provides twelve contacts, rated for operation at 2.5Kv peak terminal-to-terminal, 1.5Kv peak terminal-to-ground, 25 amps at 60 cps. All contacts are silver-plated; terminals are tinned for soldering. Polarizing guide pins assure positive alignment. Write for specifications of this and other available units, or engineering recommendations for special units for your product.
Lapp Insulator Company, Inc., LeRoy, New York

Lapp

*American Beauty
makes perfect Soldered Connections
for Lear, Inc.*



American Beauty Electric Soldering Irons are Service Proven... Since 1894

These features make American Beauty the Standard-of-Perfection on the world's production lines . . . where dependability, long life and efficiency are demanded.

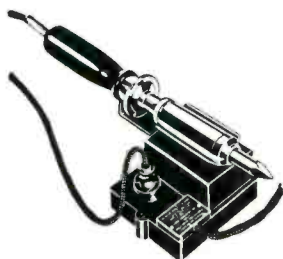

TEMPERATURE REGULATING
STAND

Thermostatically controlled to maintain heat of Iron at any desired temperature while at rest.

A-102

- Nickel-coated, corrosion-resistant tips, easily and quickly replaced
- Super-flexible cord, American Beauty made, resists wear due to flexing
- Heating element of chrome-nickel ribbon resistance wire
- Insulated with pure mica
- Built-in adapter for ground wire

WRITE FOR FREE LITERATURE

AMERICAN ELECTRICAL HEATER COMPANY
DETROIT 2, MICHIGAN

DOUBLE BARREL Advertising

Advertising men agree—to do a complete advertising job you need the double effect of both Display Advertising and Direct Mail.

Display Advertising keeps your name before the public and builds prestige.

Direct Mail supplements your Display Advertising. It pin-points your message right to the executive you want to reach—the person who buys or influences the purchases.

More and more companies are constantly increasing their use of Direct Mail because it does a job that no other form of advertising will do.

McGraw-Hill has a special Direct Mail Service that permits the use of McGraw-Hill lists for mailings. Our names give complete coverage in all the industries served by McGraw-Hill publications—gives your message the undivided personal attention of the top-notch executives in the industrial firms. They put you in direct touch with the men who make policy decisions..

In view of present day difficulties in maintaining your own mailing lists, our efficient personalized service is particularly important in securing the comprehensive market coverage you need and want.

Ask for more detailed information today. You'll be surprised at the low over-all cost and the tested effectiveness of these hand-picked selections.

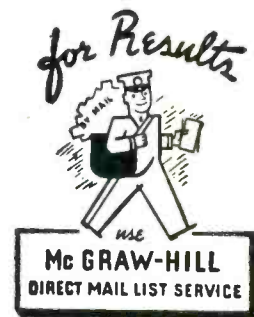

Dept. A

**McGRAW-HILL
PUBLISHING CO., INC.**

330 West 42nd Street
NEW YORK 18, N. Y.

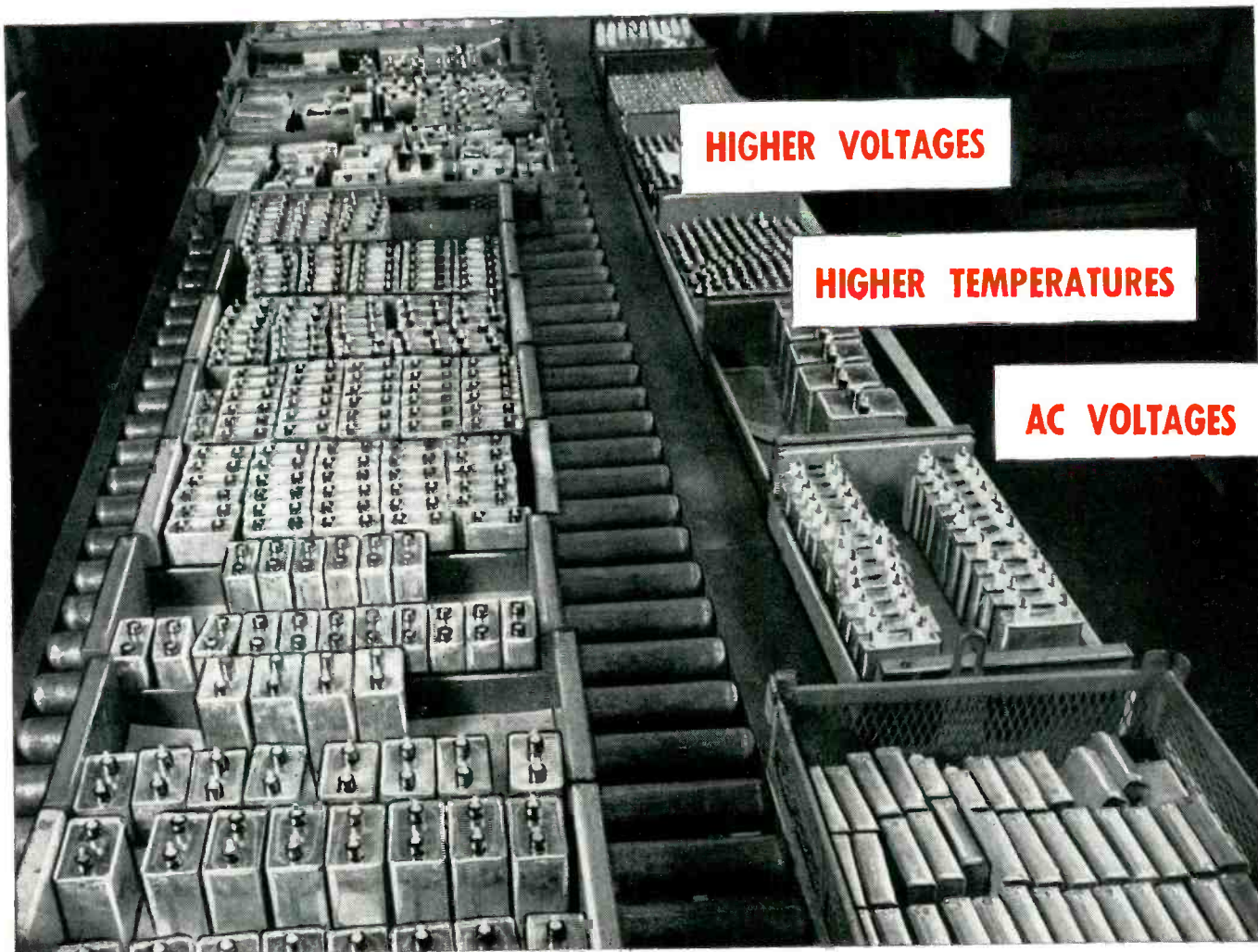

General Electric can show you how to make wider use of **JAN-C-25 capacitors**

From years of experience in manufacturing paper-dielectric capacitors, General Electric can show you how to make wider use of your JAN capacitors.

These capacitors are used in thousands of applications—primarily d-c at rated voltages and temperatures. However, most JAN units can be operated at other voltages and under widely varying conditions.

For example, actual life tests have shown that a General Electric 1 muf. CP 70 unit rated for a minimum life of 10,000 hours at 1000 v. d-c and 40 C or 700 v. d-c and 85 C, can also be used at:

Higher voltages—1380 v. d-c at 85 C for 500 hours.
1300 v. d-c at 85 C for 1000 hours.

Higher temperatures—105 at 525 v. d-c for 500 hours.

AC voltages—440 volts, 60 or 400 cycles
with normal JAN-C-25 derating.

General Electric has similar data for most of its JAN units, showing how each may be operated under a variety of conditions. For information on how these standard G-E capacitors may be applied in your circuits, consult your Apparatus Sales Office, or write to Specialty Capacitor Sales, General Electric Company, Hudson Falls, N. Y.

GENERAL  **ELECTRIC** 407-507

Metron MINIATURE SPEED CHANGERS

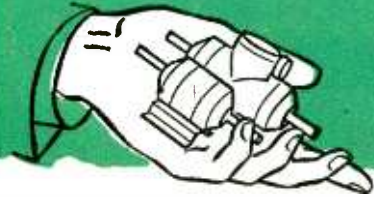

VARIABLE SPEED DRIVES

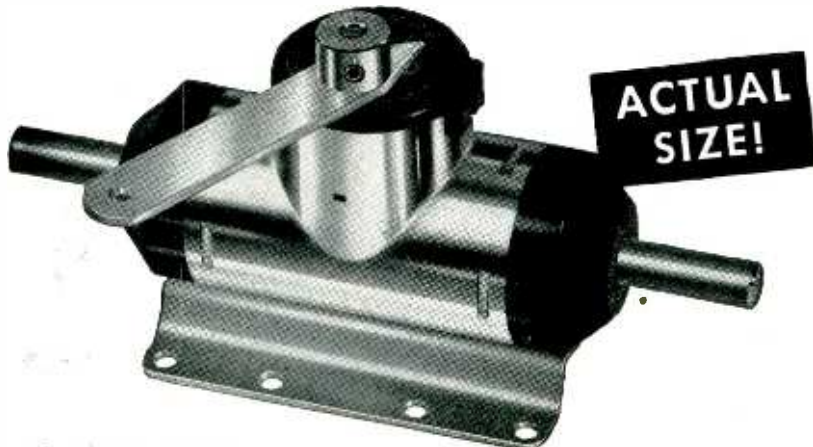

- Compact! Only 4 $\frac{3}{16}$ " overall
- Light! Weigh only 5 $\frac{1}{2}$ oz.
- Continuously variable speeds over a wide range
- Knob, lever, push-rad or gear control (Lever control illustrated)
- Rotation in either direction
- Coaxial shafts for in-line construction
- Ball-bearings throughout
- Completely sealed
- Permanently lubricated for trouble-free high/low temperature service

• Operate in any position
Write for Bulletin 99

FIXED RATIO SPEED CHANGERS (Gear Type)

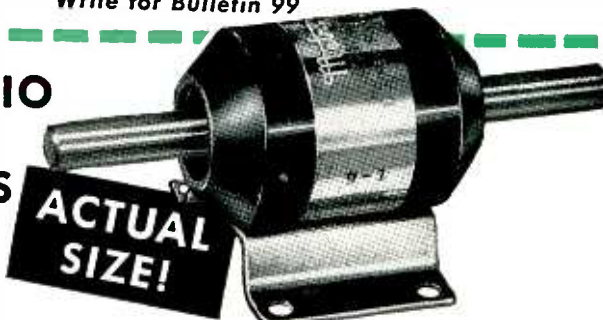

- Only 1.050" diameter!
- Single section weighs only 3 oz.
- STANDARD ratios from 10:9 to 531,441:1!
- Hobbled gears for smooth, precision running
- Anti-backlash units . . . virtually zero backlash in either direction
- Completely sealed
- Permanently lubricated
- Mount in any position

Write for Bulletin 100

MINIATURE COMBINATION FIXED AND VARIABLE SPEED CHANGERS

For applications requiring variable speed at a reduced nominal output speed, combinations of Metron Variable Speed Drives and Fixed Ratio Speed Changers are available in compact, integral units. Ask for Technical Data, or write giving your requirements for prompt engineering recommendations and prices.

METRON INSTRUMENT COMPANY
440 Lincoln Street • Denver 9, Colorado

BUILT BY **Metron** MAKERS OF INSTRUMENTS FOR PRECISION MEASUREMENT

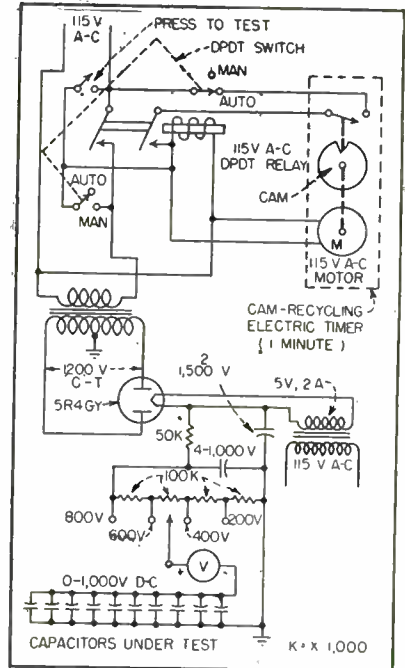

Circuit gives choice of automatic 1-minute high-voltage test or manually timed application of high voltage to capacitors

by a built-in timer of the synchronous motor type.

Ten capacitors are tested at a time. The capacitor tray has a hinged cover; when this cover is raised, the high voltage is automatically cut off, to preclude the possibility of shock to the operator. A shorted capacitor causes the meter to indicate the total applied voltage; a capacitor with excessive leakage causes a partial deflection of the pointer. A good capacitor causes only a momentary deflection, depending upon the capacitance value, after which the pointer returns to zero. A meter having a resistance of 5,000 ohms per volt is used. The applied voltage is selected by a switch. If the timer is not wanted, it is switched out and application of the test voltage is controlled by a press-to-test pushbutton switch.

If a shorted or leaky capacitor is indicated in the group under test, the operator must open the tray and remove capacitors one at a time until the faulty unit is eliminated.

In addition to the breakdown test, each capacitor is checked for actual capacitance value and dissipation factor on a General Radio 740-B bridge. A small percentage from each shipment is checked by the

when *production*
COUNTS!

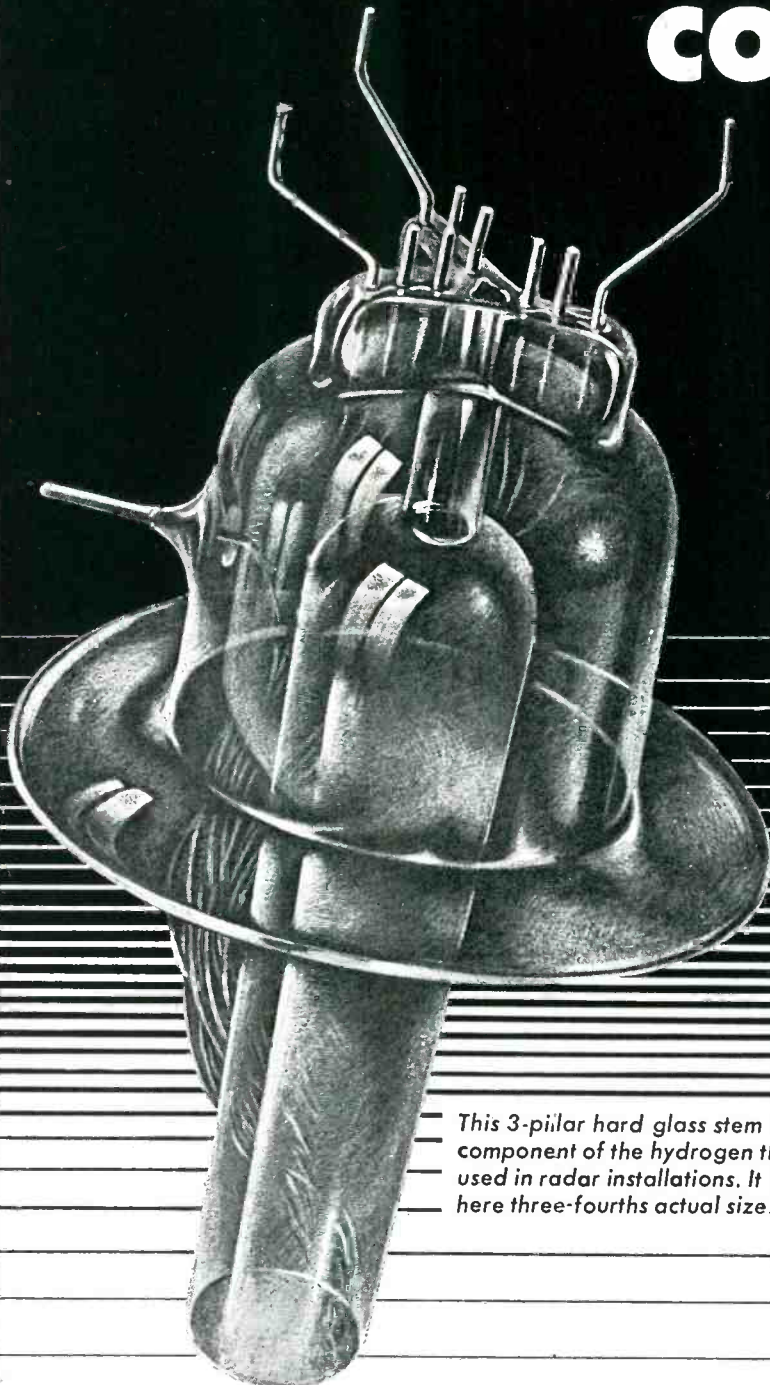

**MACHINE-PRODUCED 3-PILLAR
HARD GLASS STEMS . . . AN-
OTHER KAHLE SOLUTION TO
DIFFICULT PROBLEMS OF ELEC-
TRONIC TUBE PRODUCTION.**

Hand-blown hard glass stems proved too costly for a recent Kahle client. The problem was to find a machine capable of mass-producing uniform 3-pillar hard glass stems. Kahle's solution was to design and build the special purpose machine, Model 1958, shown below. This unique, hydrogen-fired machine permits semi-skilled operators to produce the hard glass stems in quantity . . . maintaining rigid quality control.

This is but one of hundreds of problems solved by Kahle. In every case, Kahle's experience and ability have resulted in the design, development and production of a machine engineered to produce results as specified. Working closely with your organization, Kahle's experienced staff of electronic and equipment engineers will, at your request, recommend a solution to your own specialized production problems. Learn how Kahle's more than 40 years of practical experience can benefit you . . . write Kahle now.

This 3-pillar hard glass stem is a vital component of the hydrogen thyratron used in radar installations. It is shown here three-fourths actual size.

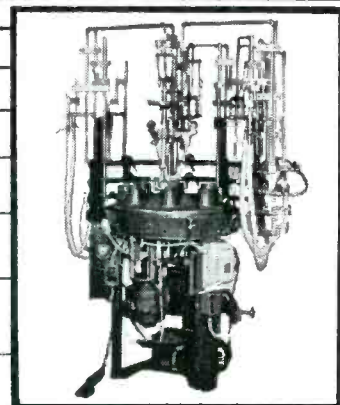

Kahle ENGINEERING COMPANY
1310 SEVENTH STREET NORTH BERGEN N. J.

STANDARD
*Radio Interference
 and Field Intensity*
MEASURING EQUIPMENT
 Complete Frequency Coverage -- 14kc to 1000mc!



NM - 10A VLF

14kc to 250kc
 Commercial Equivalent of
 AN/URM-6.
 Very low frequencies.

HF NM - 20A

150kc to 25mc
 Commercial Equivalent of AN/PRM-1.
 Self-contained batteries. A.C. supply
 optional. Includes standard broadcast
 band, radio range, WWV, and commun-
 ications frequencies.



NMA - 5A VHF

15mc to 400mc
 Commercial Equivalent of
 TS-587/U.
 Frequency range includes
 FM and TV Bands.



UHF NM - 50A

375mc to 1000mc
 Commercial Equivalent of
 AN/URM-17.
 Frequency range includes Citizens
 Band and UHF color TV Band.



These instruments comply with test equipment requirements of
 such radio interference specifications as JAN-I-225a, ASA C63.2,
 16E4(SHIPS), AN-I-24a, AN-I-42, AN-I-27a MIL-I-6722 and others.

STODDART AIRCRAFT RADIO CO.

6644 SANTA MONICA BLVD., HOLLYWOOD 38, CALIFORNIA

Hillside 9294



Now
**BERYLLIUM
 COPPER STRIP**

...rolled to precision tolerances
 and to ultra-thin gauges

WE CAN MEET your requirements for one
 pound—or for thousands. We can meet them
 in a hurry, too—because we keep a working
 inventory of beryllium copper that insures de-
 livery within two to four weeks.

WE REGULARLY custom-roll beryllium strip
 up to 6" wide and down to .0005" thin—to
 tolerances as close as $\pm .0001$ "—solution an-
 nealed or rolled to temper.

WE'RE SPECIALISTS in cold-rolling a wide
 variety of metals—to your specifications...
 in any quantity. It's everyday work for us
 to roll strip to exacting specifications—the
 "tough ones" that commercial mills ordinarily
 refuse to produce.

We also custom-roll Invar • Phosphor Bronze
 • Copper • Brass • Nickel-Silver • Stainless
 Steels • Nickel • Monel • Haynes Stellite Alloys
 • Magnetic Alloys • Chrome Iron Alloys...
 and many others.

WE CARRY a working inventory of some
 metals... and also re-roll **your** metals on a
 toll basis. Our up-to-the-minute equipment
 includes precision 2-High, 4-High, and Send-
 zimir rolling mills... precision gang slitters
 ... and continuous atmosphere annealers.

OUR ENGINEERING DEPARTMENT will
 be happy to assist you with your custom-
 rolling problems. Just write or call—and ask
 for our catalog.

INDUSTRIAL DIVISION

AMERICAN SILVER COMPANY, Inc.
 36-03 PRINCE STREET, FLUSHING 54, N. Y.





"We would pay a premium for these 50,000 Air Shipments yet we actually saved thousands of dollars!"

Robert S. Woolf, Mgr., Teletranscription Dept., Dumont Television Network

"When we ship TV film, we're interested in *service*. We can't afford to take any other attitude. We've bought program time all over the country, and those programs *must* be filled.

"We at Dumont use Air Express. It's the fastest. It has all-point coverage. Above all, it is **DEPENDABLE**.

"As to cost — Air Express costs Dumont *less* than other air services would, by thousands of dollars per year! For instance, on our regular shipments

to Detroit, other services cost 37% to 337% *more* than Air Express. And we can't duplicate the service at any price!

"The Air Express people have carried upwards of 50,000 shipments for Dumont in the last four years. Their ability to trace shipments — especially when being shuttled between stations — is almost uncanny! It has helped us out in many an emergency.

"It pays to specify Air Express — in more ways than one!"



AIR EXPRESS

GETS THERE FIRST

*Division of Railway Express Agency
1952 — our 251st year of service*

KLEINS

*the widest
selection
of quality
pliers*

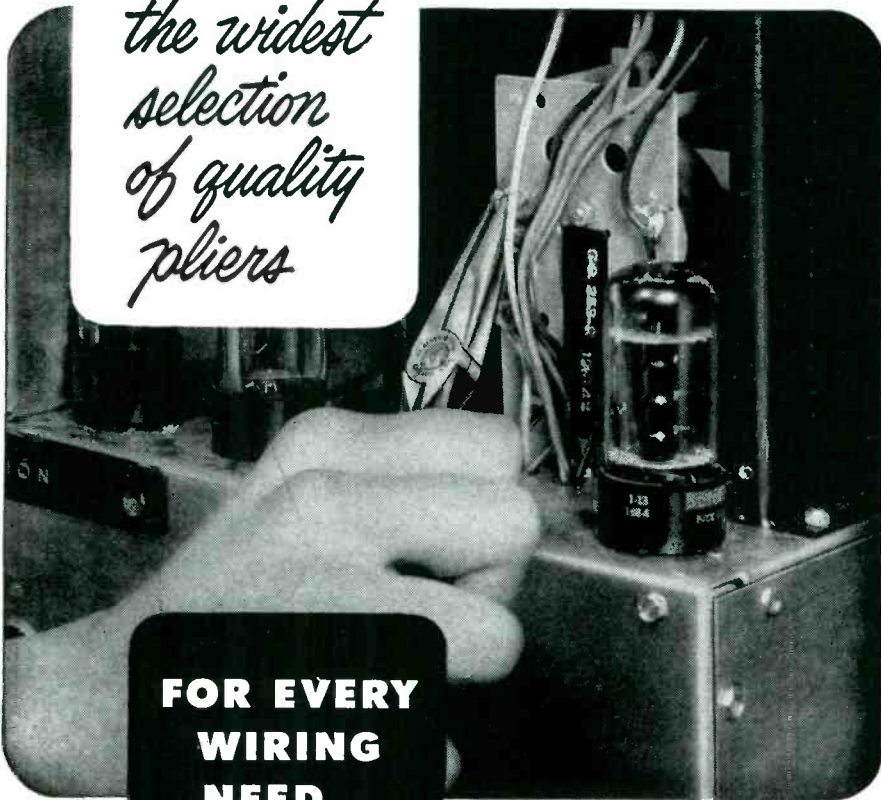

**FOR EVERY
WIRING
NEED...**

● Why put up with pliers that aren't *exactly* right —pliers that may be costing you valuable production minutes? In the complete Klein line there is a pair of pliers for *every* job in radio, TV or amplifier wiring. You'll find long nose pliers that assure a tight grip even in confined space, keen edged cutters, flat nose, duck bill—whatever you need, and in a wide variety of sizes.

Klein Pliers are better pliers, too, each pair individually tested for proper balance and hand-fit. Made by plier specialists with a reputation for quality "Since 1857."



ASK YOUR SUPPLIER

Foreign Distributor: International Standard Electric Corp., New York

This Klein Pocket Tool Guide gives full information on all types and sizes of Klein Pliers. A copy will be sent without obligation.



"Since 1857"



Mathias KLEIN & Sons
Established 1857 **Chicago, Ill., U.S.A.**

3200 BELMONT AVENUE, CHICAGO 18, ILLINOIS

engineering department for hermetic sealing, and for variations in capacitance and dissipation factor over the temperature range from -65 C to $+125\text{ C}$.

These test units have been designed, for the most part, to check components for a production line producing between 200 and 5,000 electronic fuel gage amplifier or indicator units per month. These quantities would not be considered high in the radio or television receiver industry, but they are relatively high for the production of precision aircraft fuel gauges at this time.

The author acknowledges the skillful work of Arthur Hull in the mechanical layout of these units and their actual construction and wiring.

Chassis-Tilting Cradle

A SINGLE cradle serves for assembly, machining and testing operations on the base unit for an electronically controlled IBM key punch. A Powrarm Junior holding fixture is mounted on a sheet metal pedestal at one end of the plywood pallet, and a plain pivot support for the chassis is bolted to the other end. For drilling operations, a guide fixture is clamped over the chassis and a welded steel frame work is slipped under it to take

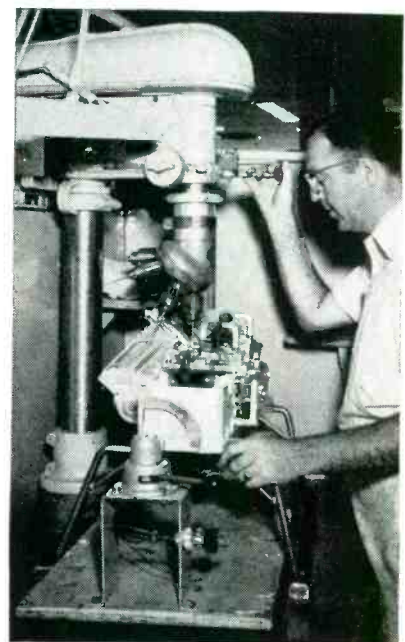

Use of multiple-spindle drill press on chassis while mounted in special cradle

Announcing

A COMPLETE LINE OF

Plastic Film Dielectric CAPACITORS

Plastic Capacitors, Inc., offers you a complete line of plastic film capacitors in a wide range of electrical characteristics, values, impregnant and containers. Because the solid film is chemically stable, has great dielectric strength and is non-porous, these capacitors are smaller in size and lighter in weight than capacitors of equivalent values using conventional dielectrics. By making a proper choice of the solid dielectric film and impregnant, the important electrical characteristics are accentuated, thereby

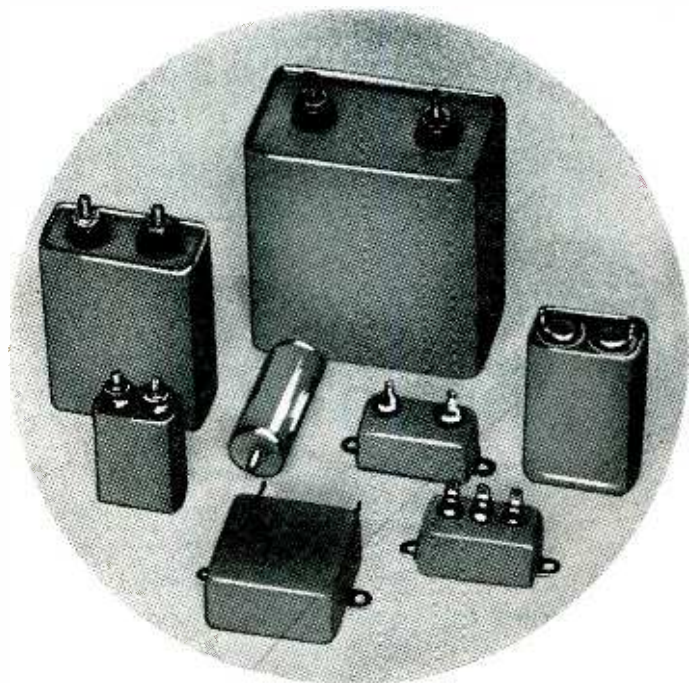

increasing the effectiveness of the circuit in which the capacitors are used. Containers include glass tubular, bath-tub, drawn and fabricated rectangular, and drawn oval—all hermetically sealed.

THESE CAPACITORS OFFER YOU

- ✓ Operation up to 150° C and more without voltage derating.
- ✓ Series resistance exceeding 10^{12} megohms/mfd and as high as 10^{14} for small values of capacitance.
- ✓ Dielectric absorption as low as 0.02%.
- ✓ Power factor at 60 cycles as low as 0.01%.
- ✓ Q values exceeding 500 at 100 KC.
- ✓ Capacitance stability to within 0.5% for a period of one year.
- ✓ Voltage range 100 volts to 60 KV.
- ✓ High current (continuous or intermittent) service for r. f. or pulse circuits.

Get your copy of this **FREE** Catalog

CATALOG CONTENTS

Temperature range • Capacitance tolerances
• Capacitance stability • Temperature coefficient
• Power and Q factors • Dielectric absorption •
Permissible ripple • Life • Containers • Impregnant
• Insulators and terminals • Mounting brackets •
Vibration and shock • Salt spray and immersion
plus
*High-voltage low-current power supplies and pulse
forming networks.*

Plastic Capacitors, Inc.

PLASTIC FILM CAPACITORS • HIGH VOLTAGE POWER SUPPLIES
PULSE FORMING NETWORKS

2511 West Moffat Street • Chicago 47, Illinois

RVC-2* PRECISION POTENTIOMETERS



featuring UNITIZED CONSTRUCTION

- Each potentiometer a complete unit
- Individual units may be stacked in any desired combination
- No common shaft — Shaft coupling by means of drive pin and spring loaded crank arm assembly†
- Units held together with cast aluminum two-section clamp ring†
- Universal mounting plate unit machined to servo precision

Quantity production, prompt deliveries, Standardization and economy — achieved through Unitized Design — no sacrifice of quality, accuracy or reliability.

Write for Bulletin A10 today.

§ PAT. NO. 2,543,226 † PAT. NO. 2,543,673

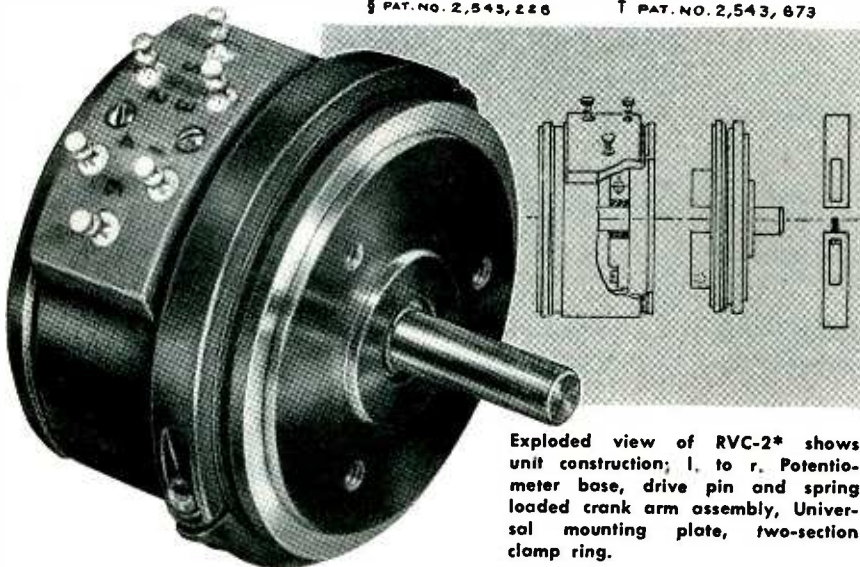

Exploded view of RVC-2* shows unit construction; 1. to r. Potentiometer base, drive pin and spring loaded crank arm assembly, Universal mounting plate, two-section clamp ring.

DESIGN FEATURES:

Dual Paliney spring contacts to winding, precious metal take-off contacts; Bases—precision machined aluminum, black Alumilite finish; Oilite bushings, stainless steel shaft.

Servotrol manufactures under license agreement with Technology Instrument Corp.

SPECIFICATIONS:

Independent linearity $\pm 0.5\%$ std., available to $\pm 0.3\%$; Taps to $\pm .6^\circ$; Electrical rotation 320° std., tol. $\pm .3^\circ$; Std. Resistance values 100-100,000 Ω ; Rotational Life app. 1,000,000.

See us at Booth 91 National Electronics Conference

ENGINEERING REPRESENTATIVES

Cleveland, Ohio — Prospect 1-6171
Chicago, Ill. — Uptown 8-1141
Rochester, N. Y. — Monroe 3143
Canaan, Conn. — Canaan 649
Dayton, Ohio — Michigan 8721

Amrrior, Ontario, Can. — Amrrior 400
New York, N. Y. — Murray Hill 8-5858
Cambridge, Mass. — Eliot 4-1751
Hollywood, Cal. — HOLlywood 9-6305
Dallas, Texas — Dixon 9918



SERVOTROL COMPANY

114 WEST ILLINOIS STREET, CHICAGO 10, ILLINOIS • TEL. SUPERIOR 7-3082
EASTERN BRANCH OFFICE—FRAMINGHAM CENTRE, MASS. • TEL. FRAMINGHAM 4421

NOW AVAILABLE ON EASY TERMS

Save trouble, time,
and money with the
aid of this practical
RADIO ENGINEERING
help . . .

HERE is a handy volume embracing a great deal of constantly needed reference material covering all fields and aspects of radio engineering — concise, dependable, arranged in easy-to-get-at form.

What the Standard Handbook, Marks Handbook, and others are in their respective fields, Henney's Handbook is in the radio field. And now this new Fourth Edition is available:

with new data on the physical, mathematical, psychological, and acoustical bases on which all electrical communication exists — on the means of transmitting and utilizing energy in the very high frequency portions of the radio spectrum, with completely rewritten sections on radio communication, inductance, radio-frequency amplifiers, modulation and detection, electron tubes, receiving systems, radio aids to aviation, and many other subjects. With revision throughout to make the book as useful as possible in modern practice.



Presents RADIO PRINCIPLES, STANDARDS, and PRACTICES for the designer, engineer, and radio technician

New 4th Edition

RADIO ENGINEERING HANDBOOK

Keith Henney, Editor-in-Chief
Consulting Editor of Electronics
1197 pages, 6 x 9, 1038 illustrations, \$10

IN scope, this book ranges from fundamentals to discussion of newest circuits, amplifiers, power supply systems, short-wave systems, etc. Frequency modulation, developments in television and aircraft radio, and other applications are covered. The book abounds in circuit diagrams, tables, charts, formulas, design equations and data. The circuits described quantitatively are those in use today, or soon to be widely used.

In RADIO ENGINEERING HANDBOOK you get—

SPECIAL OFFER

When you receive a copy of Henney's RADIO ENGINEERING HANDBOOK you can look over the book for 10 days before deciding whether or not to buy it. Then, if you decide to keep the book, you can pay for it in easy monthly terms—\$4.00 at the end of 10 days, and \$3.00 per month until balance is paid.

- 1,197 pages of carefully selected, accurate data—charts, tables, circuits, diagrams, formulas.
 - 23 sections covering all the most needed subjects for engineers and radio technicians, from fundamentals to specialized applications.
 - Every section prepared by one or more specialists, to assure you dependable, expert answers to your problems in design and practice.
- Not only the radio technician, but every man interested in the design or manufacture of radio or television transmitters and receivers, and apparatus utilizing vacuum tubes and photocells, will find this improved handbook a helpful, day-to-day guide.

SEE THIS BOOK 10 DAYS FREE



McGraw-Hill Book Co., Inc.
330 W. 42nd St., New York 18
Send me Henney's RADIO ENGINEERING HANDBOOK for 10 days' examination on approval.

If I find the book satisfactory, I will send you \$4.00 in 10 days, plus a few cents for delivery, and \$3.00 a month until \$10.00 has been paid. Otherwise I will return the book postpaid.

Name
Address
City Zone State
Company
Position (F.L. 10-52)

This offer applies to U. S. only.

bend it . . . knot it . . . twist it . . . it won't crack . . .

BH "1151"

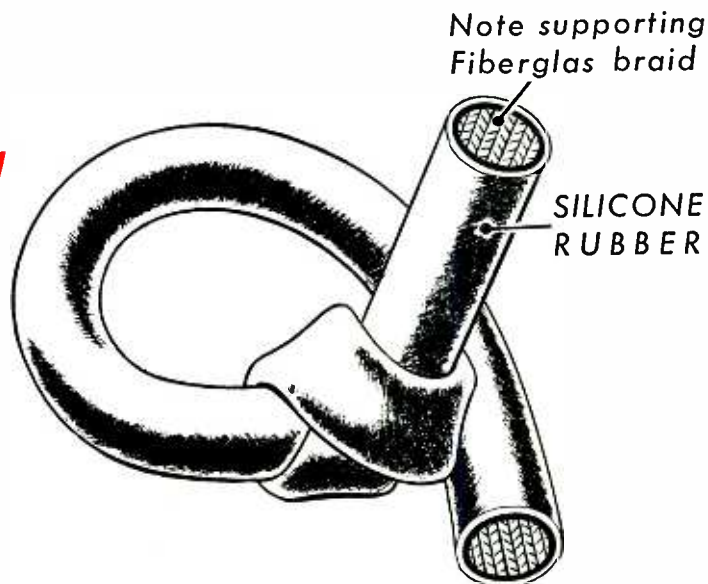

. . . stays flexible to protect electrical equipment

BH "1151" is a new tubing and sleeving which provides flexibility in Class H insulations. It can be knotted, twisted or bent without cracking, crazing or loss of dielectric strength.

BH "1151" withstands the stresses and strains of assembly, remains unchanged through continuous equipment operation in a temperature range of -90°F . to 400°F . Even after 15 minutes at 600°F . its dielectric and physical properties are constant.

BH "1151" is a long-lasting union of two great inorganic materials – Silicone Rubber and Fibreglas. It is extremely flexible when manufactured and keeps that flexibility for the life of the tubing.

Electrical resistance is unusually high. It will resist inorganic acids, alkalis and most organic solvents. It will not support fungus growth.

BH "1151" meets all applicable Class H NEMA specifications.

BH "1151" may be ordered in economical continuous lengths, or in 36 inch lengths. Short pieces, cut without wastage to individual specifications, may be had on special order. It is available in colors for circuit tracing and coding. Get all the facts – write for samples and data sheets today.

Address Dept. E-10

Bentley, Harris Manufacturing Co.
Conshohocken, Pa.

BH *Fibreglas**
SLEEVINGS

*BH Non-Fraying Fibreglas Sleeveings are made by an exclusive Bentley, Harris process (U. S. Pat. No. 2393530). "Fibreglas" is Reg. TM of Owens-Corning Fibreglas Corp.



P & B
CUSTOM
MANUFACTURING
FACILITIES

mean

service

3 large plants to serve you

Over 50,000 square feet of floor space . . . fully equipped with modern, up-to-date production equipment including complete tooling, coil winding, plastic molding, heat treating, glass metalizing, welding, hermetic sealing and machine tools for every operation.

quality

20 years specialized experience

Widely diversified technical knowledge acquired in the design, development and custom manufacture of more than 15,000 versions of relays, switches, controls and small electro-mechanical assemblies enables P & B to meet critical standards at lowest cost.

REMEMBER, if your problem concerns the development or production of electro-mechanical components for any electronic or electrical apparatus, Potter & Brumfield offers you the quickest, most practical and most economic solution. Send specifications for samples, recommendations and quotations. (Catalog available on request.)

Potter & Brumfield

PRINCETON, INDIANA Export: 13 E. 40th St., N. Y., N. Y.
 SALES OFFICES IN PRINCIPAL U. S. AND CANADIAN CITIES

P & B CATALOGUED RELAYS AVAILABLE AT YOUR ELECTRONICS PARTS DISTRIBUTOR

10,000 relays per day

Orderly, efficient plant layout plus competent, well-trained personnel assure speedy, precise assembly line production . . . single shift capacity 10,000 relays per day!

unequaled engineering facilities

Extensive research, laboratory, development, type test and model shop facilities at your service *any time*. Test samples and pilot runs completed quickly at reasonable cost.

industry's leading supplier

For many years, the leading supplier of electrical and electronic relays to America's foremost industrial organizations.

specialists in relays for military equipment

Complete file of latest MIL specifications. All necessary laboratory and testing instruments available. Certified test reports on request.

drilling pressure off the cradle.

For testing, power is applied to a plug mounted on the pedestal. Leads from the plug are connected to the a-c input terminals on the chassis throughout the sequence of test operations in the Poughkeepsie, N. Y. plant of International Business Machines Corp.

TV Alignment Island

IN THE test and alignment section of Emerson's Jersey City television plant, good sets go to the right and bad ones to the left past openings or islands in a wide metal-covered bench. At each island are test facilities, large mirrors and small stocks of spare parts. Access is



Two-man island for testing and aligning television sets. Section of bench in foreground is hinged to provide access

provided by a hinged section of the metal covered bench, the bottom of which often serves for pin-up pictures. A wood fence around the island provides a resting place for the caster-mounted pallets, so that the chassis does not move around during alignment adjustments.

Soldering Plastic Wires to Connectors

TO PREVENT runback of plastic insulation when soldering wires to the terminals of large cable connectors, the terminals are each filled with solder first. Next, the correct stripped wire for a particular terminal is held over the end of the terminal and a soldering iron is applied to the side of the terminal. When the solder inside melts, the stripped end of the wire is quickly inserted without over-heating adja-

TOP PERFORMANCE 7000 MCS and every other microwave frequency

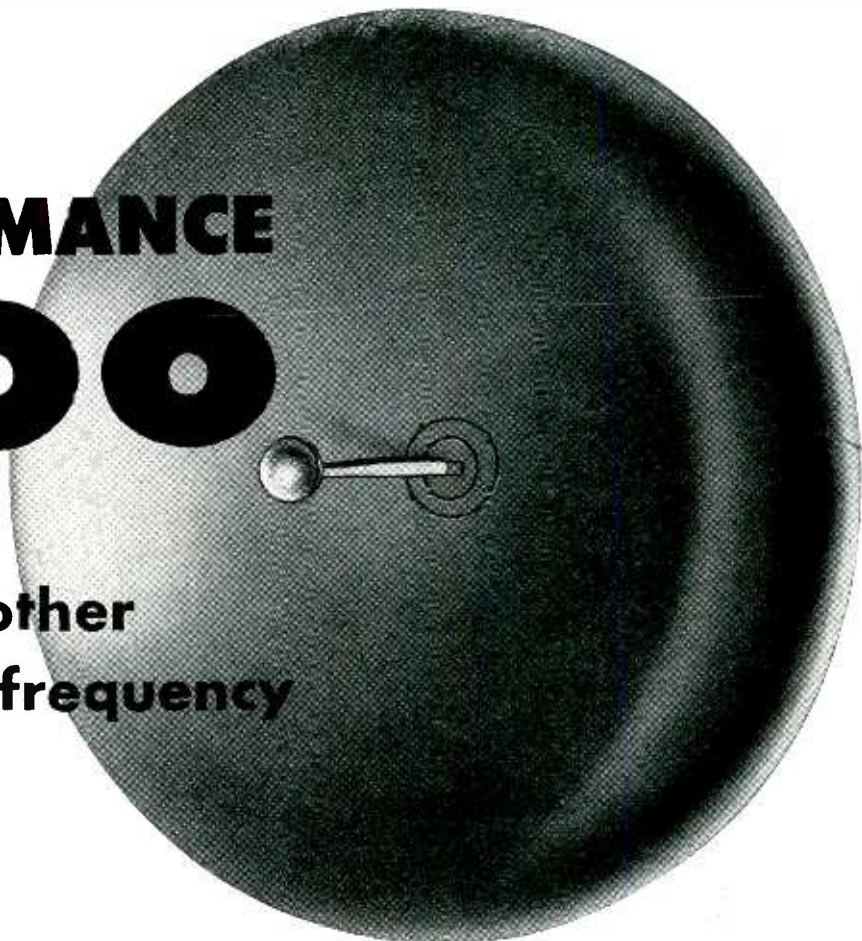

The WORKSHOP was the first manufacturer to bring out a complete line of parabolic antennas. Today these antennas are recognized as the top performers for all microwave frequencies. This is the result of years of specialization on all types of high-

frequency antennas in laboratories with the finest research and test equipment. Normally, we can meet your requirements with our standard equipment but for special applications, reflectors can be supplied in a wide range of sizes and focal lengths.

Series 7000 Includes Models 6075, 6725 and 7275

	Model 6075			Model 6725			Model 7275		
Frequency Range	5925 to 6175 Mcs.			6525 to 6875 Mcs.			7125 to 7425 Mcs.		
Reflector Size	48"	72"	96"	48"	72"	96"	48"	72"	96"
Gain (db, approx., over isotropic radiator)	34.4	37.5	40.4	35.0	38.5	40.8	36.0	39.4	42.0
Half Power Angles (H plane)	2.86°	1.92°	1.32°	2.50°	1.74°	1.32°	2.42°	1.61°	1.21°
(E plane)	3.24°	2.04°	1.47°	2.79°	1.94°	1.47°	2.70°	1.81°	1.36°

Input Impedance	52 ohms nominal
VSWR	1.3 to 1 or better
Power Rating	1 kw. continuous
Polarization	Either vertical or horizontal available at time of installation.
Side Lobes	25 db down or better
Input Connection	UG-343/U choke flange fitting for RG-50/U (3/4" x 1 1/2") pressurized waveguide. Standard fitting. Special feeds and fittings on special orders only.
Dish and Feed Heaters	Available for all models. The dish heater capacities range from 400 to 4000 watts. The feed heater draws 20 watts.

OTHER STANDARD MODELS

MODEL NO.	FREQUENCY (MCS.)	GAIN* (DB.)	HALF POWER ANGLE	
			E Plane*	H Plane*
940	920-940	19.0-28.0	19.75°-7.8°	17.75°-6.9°
2000	1700-2300	27.0-34.5	10.28°-3.65°	9.2° -3.25°

*Gain and Half Power Angles are dependent on size and frequency of parabolas, — 4, 6, 8 or 10 foot diameter.



FREE SLIDE RULE—This pocket size slide rule quickly computes diameter, wavelength, angle and gain for parabolic antennas. Reverse side carries FCC frequency allocations, conversion tables and other data. Write for your copy.



Write for Parabolic Antenna Catalog
THE WORKSHOP ASSOCIATES

DIVISION OF THE GABRIEL COMPANY

Specialists in High-Frequency Antennas

135 Crescent Road, Needham Heights 94, Massachusetts



GOSLIN Transformers

*Guaranteed
Terminal Performance
for AIRCRAFT*

**IMMEDIATE
DELIVERY!**



**CUSTOM-MADE TRANSFORMERS
FOR RADAR, ELECTRONIC AND
MANY OTHER ELECTRICAL
EQUIPMENT APPLICATIONS:**
POWER • PULSE • CHOKE
BIAS • AUDIO • FILAMENT
MODULATION • PHASE SHIFT
ISOLATION • INDUCTOR
STEPDOWN, ETC.

Hermetically sealed or
open framed airborne
units meet or surpass all
Military and Civilian
specifications. Complete
facilities for all JAN-tests.

Specialists in transformer
miniaturization for
aircraft application.
Designed for lightweight,
high altitude, vibration,
humidity, temperature,
etc. Competent
engineering, controlled
quality and skilled
workmanship.

Greatly expanded
facilities make possible
**IMMEDIATE
DELIVERY!**

Write for new, descriptive
Brochure containing detailed
information on GOSLIN
Transformers and facilities.

GOSLIN
ELECTRIC & MANUFACTURING CO.
A DIVISION OF THE GOSLIN CORPORATION

Designers and Manufacturers
of Electro-Magnetic Components

2921 WEST OLIVE ST., BURBANK, CALIFORNIA



when timing gives you a hard time

Turn your problem over to the
A. W. HAYDON COMPANY — past masters at
solving the tough ones.

The know-how of A. W. Haydon

Engineers is your assurance of prompt,
accurate service regardless of the
intricacies of the problem.

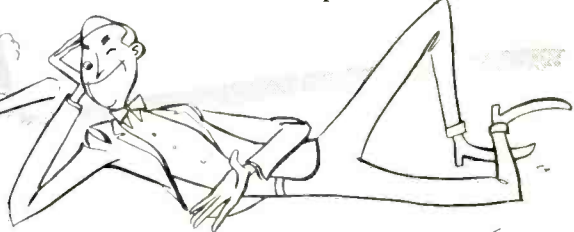

Send for catalog.

Would you like to work with
us? We need qualified engi-
neers and skilled model
makers *now*. Excellent op-
portunities for men who are
looking to the future.



The
A. W. HAYDON
COMPANY

235 NORTH ELM STREET
WATERBURY 20, CONNECTICUT
Design and Manufacture of Electrical Timing Devices

**Independent
Research Proves:**

2 out of 3 Engineers Prefer BURGESS BATTERIES!

NO WONDER Burgess is *the*
first source for industrial
dry batteries. Burgess long-life
dependability and uniform,
high-level performance are
backed by more years of engi-
neering "know-how" than any
other batteries. The mainte-
nance of highest quality always
is the reason why 2 out of 3 en-
gineers prefer Burgess... by independent survey.
Check for your local source of supply or write now!



No. 4FH

No. Z30NX

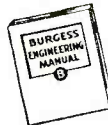

**WRITE FOR ENGINEERING MANUAL AND CHECK
SHEET**—No obligation. By return mail you will re-
ceive the **FREE** Engineering Manual listing the com-
plete line of Burgess Batteries together with detailed
specifications; also the Burgess "Check Sheet" on
which you may outline your battery requirements in
the event that the battery you need has not already
been developed. Address:

BURGESS BATTERY COMPANY
(DEPT. E-8) FREEPORT, ILLINOIS

UNIFORMITY!

Plus lowest installed
cost of any *insulated*
wire termination!

Combination of AMP Automatic Wire Terminators and AMP PRE-INSULATED* strip terminals gives an all time high in precision and uniformity at lowest possible unit cost. All the advantages of solderless methods plus SPEED. No heat, no solder, no irons or flux, no cold joints; no separate insulation tubing. Yet tests prove AMP terminals superior in all respects: conductivity, tensile strength, resistance to corrosion, vibration and bending, heat, etc. Human error in terminal application is all but eliminated! Connections are free from R.F. Noise; safe for most critical applications.

SEND FOR SPECIAL AUTOMATIC
MACHINE CATALOG!



THE ONLY AUTOMATIC WIRE
TERMINATOR PROVEN BY
YEARS OF CONTINUOUS SER-
VICE! WRITE FOR A DEMON-
STRATION IN YOUR PLANT!

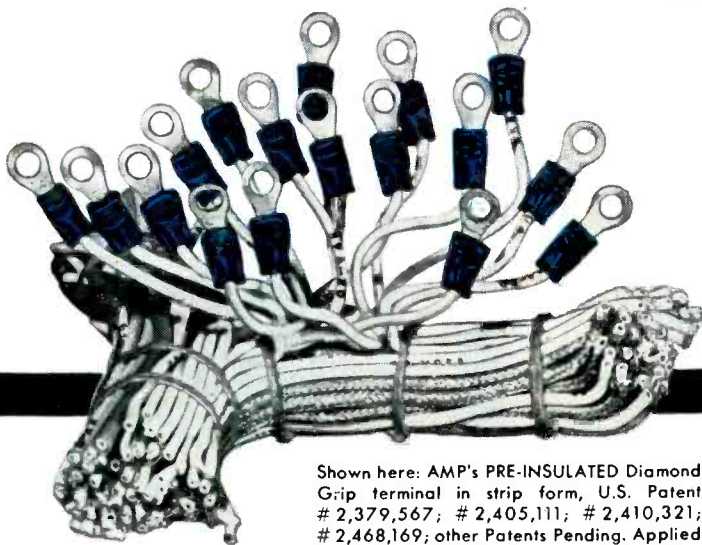

Shown here: AMP's PRE-INSULATED Diamond Grip terminal in strip form, U.S. Patent # 2,379,567; # 2,405,111; # 2,410,321; # 2,468,169; other Patents Pending. Applied by AMP-O-LECTRIC Machine, U.S. Patent # 2,396,913; other Patents Pending.

*Trade-Mark
AMP Trade-Mark Reg. U. S. Pat. Off.

NON-INSULATED AMP terminals and connectors can be applied at rates up to 4,000 terminations per hour!



AIRCRAFT-MARINE PRODUCTS INC.
2100 PAXTON STREET • HARRISBURG, PA.

In Canada: ONTARIO, R. M. HUTCHESON, 10 Nordale Crescent, Hardington, P.O. Toronto 15, Ont., Canada

QUEBEC, BRUCE C. WALLACE, 3275 Linton Boulevard, Apt. 9 Montreal, Quebec, Canada

**You can
REDUCE
equipment
failure**



● Use Electro Custom Processed Varnished Insulation to INCREASE LIFE EXPECTANCY and to insure the safe, successful operation of electrical equipment.

Selecting dependable insulation need not present any problem to design, insulation and maintenance engineers if they specify ELECTRO. Our method of processing produces varnished insulation with the ESSENTIAL SAFETY FACTORS.

*You may buy with confidence
when you buy these*

ELECTRO



TECHNICAL PRODUCTS

Silicone Varnished
Fiberglas*
Quin-Glas Hi-Tem-
perature Insulation
Varnished Fiberglas*
Cloth
Electro "300"
Combination Slot
Insulation

Treated Asbestos
Cloth & Paper
Flexible Varnished
Cambric Tape
Varnished Condenser
Paper
Varnished Silk
and Rayon
Cable Wrapping Tapes

We invite you to use our Special Service facilities if you need varnished insulation to meet specific requirements. Write or phone Department E-1 for technical data and samples.

ELECTRO-TECHNICAL PRODUCTS

DIVISION OF SUN CHEMICAL CORPORATION

NUTLEY 10, NEW JERSEY

*T. M. Reg. U. S. Pat. Off. by Owens Corning Fiberglas Corp.



Method of soldering wire to cable connector without softening plastic insulation. Wood block serves as fixture for holding connector outside of transmitter housing during assembly

cent plastic insulation. This technique is used in the military radio section of Federal Telephone and Radio Corporation's Clifton, N. J. plant.

Clips Hold Leads

DURING wiring of a 275-socket electronic calculator panel, alligator clips are used freely to hold longer leads in position temporarily. After shorter wires have been put in, the long leads become automatically locked in position and the clips can be removed. This technique has proved highly satisfactory in IBM's Poughkeepsie, N. Y. plant.



Alligator clips hold long leads in position temporarily until enough additional wires have been added to give effect of weaving that locks all wires in position



**designed for jobs
where one failure
is one too many!**

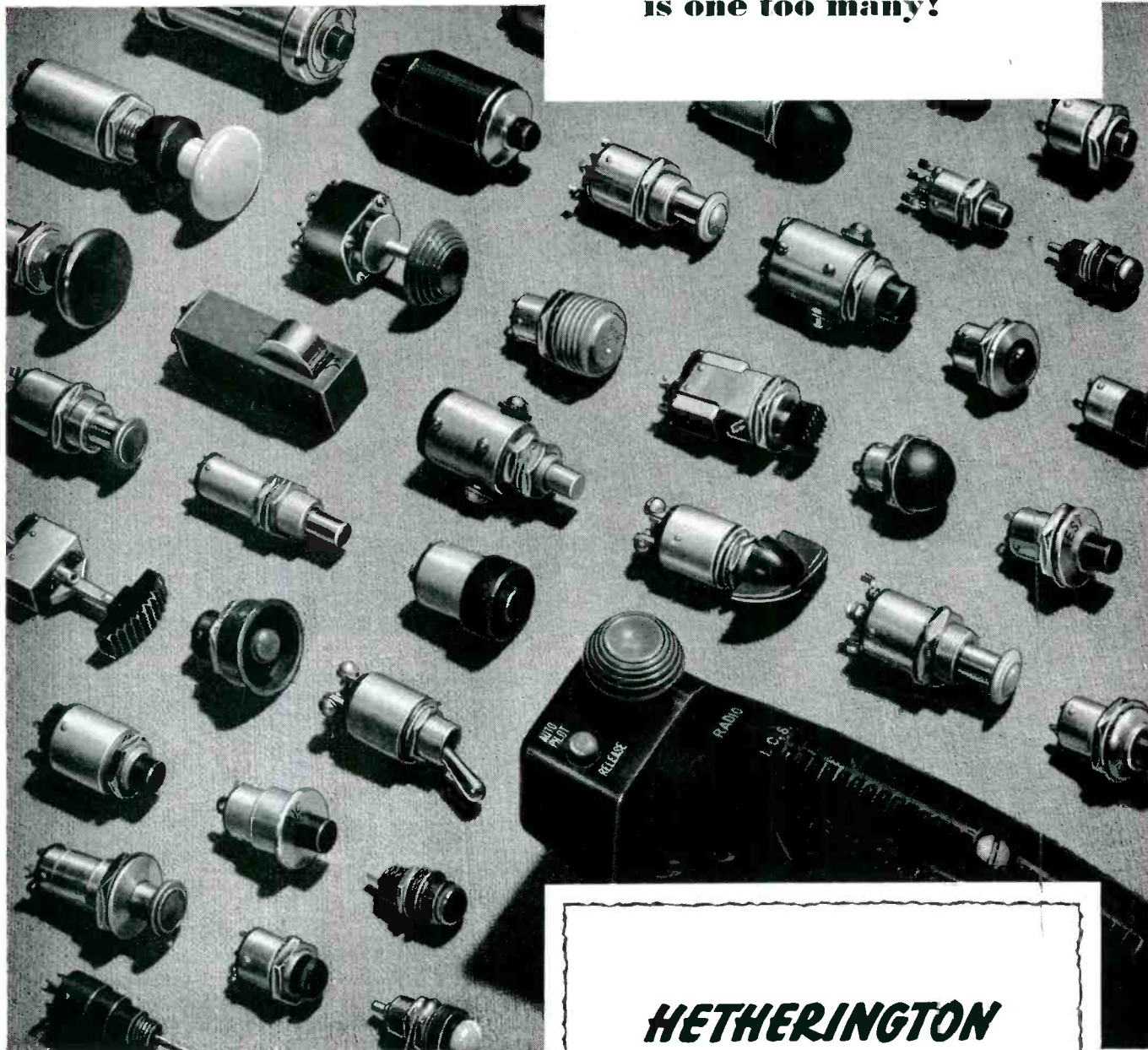

HETHERINGTON SWITCHES

Built to exacting aircraft standards, Hetherington switches are readily adaptable to any application where compactness and unfailing dependability are required. Standard switches include many push-button and snap-action types in the 15 to 50 ampere range with operating pressures of approximately 4 pounds.

Special types and switching assemblies are regularly supplied for an even broader range of exacting requirements. Write for catalog.

HETHERINGTON, INC., Sharon Hill, Pa.
(West Coast Division: 8568 W. Washington Blvd.,
Culver City, Calif.)

In the aircraft field, Hetherington special switch types are available for:

**FIRE DETECTION INDICATORS • TRIM TAB CONTROL
SEAT POSITIONING • AUTO PILOT RELEASE • TANK
JETTISON • MICROPHONE CIRCUITS • AUDIBLE
SIGNAL SILENCERS • EQUIPMENT TESTING • FIRE
DETECTOR TEST • CANOPY RELEASE • SEAT EJECTORS
AUTO PILOTS • BOMB OR ROCKET FIRING
MECHANISMS and many other uses.**

POWER

in a
Miniature Package

DALOHM

Miniature Power Resistors

WIRE WOUND—SILICONE COATED RESISTORS

Complete welded construction from terminal to terminal. Temperature coefficient 0.00002 deg. C. Ranges from 0.1 Ohm to 55,000 Ohms, depending on Type. Tolerance 0.05%, 0.1%, 0.25%, 0.5%, 1%, 3%, 5%.

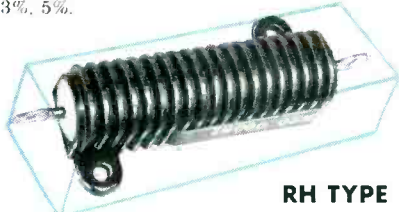

RH TYPE

Available in 25, 50 and 250 watt sizes. Silicone sealed in die-cast, black anodized radiator finned housing for maximum heat dissipation.

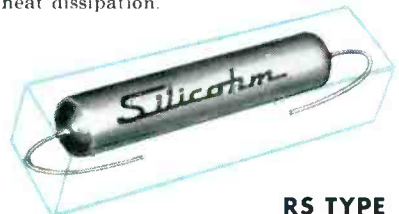

RS TYPE

Available in 2 watt, 5 watt, and 10 watt sizes. Silicone sealed offering maximum resistance to abrasion, high thermal conductivity and high dielectric strength.

DEPOSITED CARBON RESISTORS

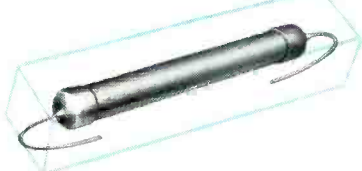

Dalohm precision deposited carbon resistors offer the best in accuracy, stability, dependable performance and economy. Available in 1/2 watt, 1 watt and 2 watt sizes.

Carefully crafted in every respect, Dalohm resistors are true power in miniature—provide the answer to those space problems.

Write, wire or phone
George Risk
For price and delivery
Telephone 2139

DALE PRODUCTS, INC.

1300 28th Ave., COLUMBUS, NEBR.

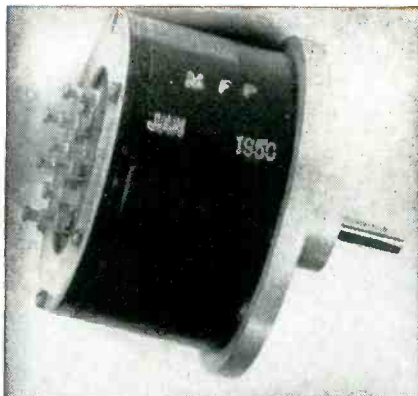

PRECISION POTENTIOMETERS

SINUSOIDAL TYPE

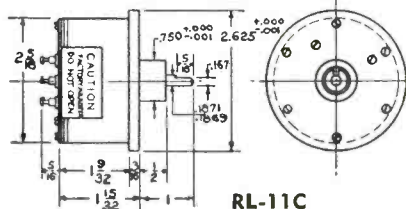

RL-11C

CONDENSED SPECIFICATIONS

	RL 11-C	RL 14-MS
Total resistance	16,000 ± 10%	35,400 ± 1%
Percent resistance within brush circle	Approx. 85%	99 ± 1/4%
Angle of rotation	360°	360°
Weight	4.75 oz.	1.8 lbs.
Torque (Approximate)	1/4 oz. in.	2 oz. in.
Wire	80 Ni 20 Cr	80 Ni 20 Cr
Resolution	.4°	.2°
Angular accuracy	±.6°	±.5°
Amplitude accuracy	±.8%	±.6%
Maximum volts across winding	150	350
Maximum speed	60 rpm	60 rpm
Expected Life	350,000 cycles	200,000 cycles

Illustration shows RL-11C unit, RL-14MS unit is approximately twice as large. Minor variations of these standard designs, available on special order, permit operation at high rotational speeds with some loss of accuracy but, with a substantial increase in expected life. Sine and cosine voltages are produced simultaneously. Resistances other than those shown above are available within certain limits.

FOR COMPLETE DETAILS SEND FOR BULLETIN F-68-A



THE GAMEWELL COMPANY
NEWTON UPPER FALLS 64, MASSACHUSETTS

SHOCKPROOF VACUUM TUBE RETAINERS

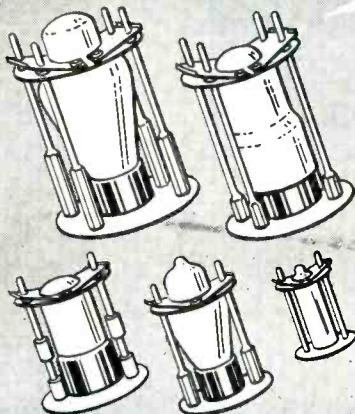

These retainers are used to secure Vacuum Tubes and to resist side motion of Vacuum Tubes used in radio equipment which is subject to shock and vibrations. These retainers meet the requirement of all JAN specifications. The insulated portion is made of a melamine base Fibre Glass Phenol which provides 300 volts insulation to ground and withstands a temperature of 350 F. The insulated plate can readily be fastened or released by hand.

Available for envelope types T7, T8, MT8, T9, T12, ST12, T12ZDL, ST14, S14, ST16, T5 1/2, T6 1/2, MT-IC, ST19, T14, ST128CT-9.

Manufacturers of
Electronic Components

JAMES IPPOLITO & CO., INC.
401 CONCORD AVENUE, BRONX 54, N. Y.

"A monumental set of books . . .

on the theory and practice
of pulses and microwaves—
with particular emphasis
on radar techniques."

—ELECTRONICS

All 27 volumes
of this outstanding

M. I. T.

RADIATION
LABORATORY
SERIES

are available for
FREE EXAMINATION!

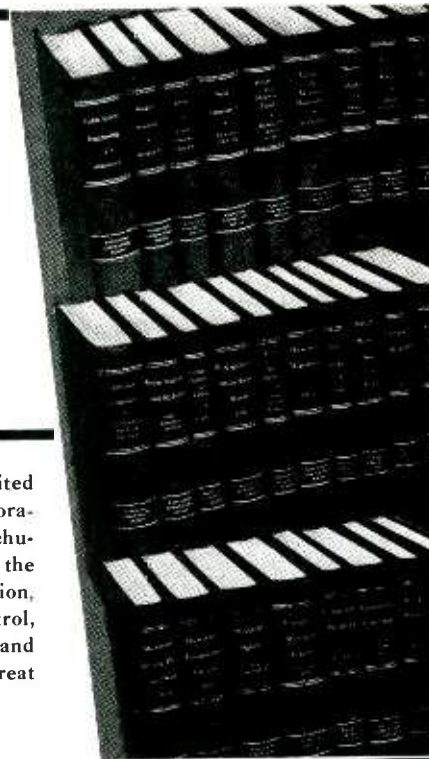

This series of 27 titles was written and edited principally by members of the Radiation Laboratory, maintained during the war at the Massachusetts Institute of Technology. The usefulness of the Series extends over all the fields—communication, television, industrial instrumentation and control, research in biological and physical sciences, and radar—in which electronic techniques are of great applicability and importance.

Vol. 1. RADAR SYSTEM ENGINEERING. Outlines general principles of radar systems, and discusses basic design considerations. Edited by L. N. Ridenour, U. of Penn. 408 pages, \$8.50

Vol. 2. RADAR AIDS TO NAVIGATION. Describes the advantages and limitations of the use of radar in navigation and pilotage. Edited by J. S. Hall, Amherst Coll. 389 pages, \$5.00

Vol. 3. RADAR BEACONS. Survey of the design of radar responder beacons and their use in navigation and identification. Edited by A. Roberts, State U. of Iowa. 409 pages, \$6.50

Vol. 4. LORAN. Complete account of the design and use of the long-range pulse navigation system known as Loran. By J. A. Pierce, Harvard U., A. A. McKenzie, Electronics, and R. H. Woodward, Harvard U. 468 pages, \$6.00

Vol. 5. PULSE GENERATORS. Covers the theoretical and practical aspects of the generation of power pulses. By G. N. Glascoe, Rensselaer Polytechnic Inst., and J. V. Levacqz, Johns Hopkins U. 737 pages, \$9.00

Vol. 6. MICROWAVE MAGNETRONS. Theoretical and practical aspects of multicavity magnetrons in the frequency range from 1000 to 24,000 Mc/sec and in the power output range from 10 watts to 3,000,000 watts. Edited by G. B. Collins, U. of Rochester. 769 pages, \$9.00

Vol. 7. KLYSTRONS AND MICROWAVE TRIODES. Discusses low power microwave triodes and klystrons. Edited by D. R. Hamilton, Princeton U., J. K. Knipp, Iowa State Coll., and J. B. H. Kuper, Brookhaven Nat'l. Lab. 534 pages, \$8.00

Vol. 8. PRINCIPLES OF MICROWAVE CIRCUITS. Describes guided electromagnetic waves. Edited by C. C. Montgomery, Yale U., R. H. Dicke, Princeton U., and E. M. Purcell, Harvard U. 479 pages, \$6.50

Vol. 9. MICROWAVE TRANSMISSION CIRCUITS. Problems of transmission of power from one place to another at microwave frequencies. Edited by G. L. Ragan, General Electric Research Lab. 716 pages, \$8.50

Vol. 10. WAVEGUIDE HANDBOOK. Data on the properties of microwave transmission lines, microwave circuit elements, etc. Edited by N. Marcuvitz, Polytechnic Inst. of Brooklyn. 500 pages, \$7.50

Vol. 11. TECHNIQUE OF MICROWAVE MEASUREMENTS. Procedures for measuring the properties of microwaves. Edited by C. G. Montgomery, Yale U. 937 pages, \$10.00

Vol. 12. MICROWAVE ANTENNA THEORY AND DESIGN. Surveys theory and design techniques for microwave antennas, and discusses antenna measurement methods. Edited by S. Silver, U. of Calif. 623 pages, \$8.00

Vol. 13. PROPAGATION OF SHORT RADIO WAVES. Investigates the propagation characteristics of radiation at frequencies too high to be affected by the ionosphere. Edited by D. E. Kerr, Johns Hopkins U. 728 pages, \$10.00

Vol. 14. MICROWAVE DUPLEXERS. Analyzes the problems of using a single antenna for receiving and transmitting pulsed signals. Edited by L. D. Smullen and C. G. Montgomery, Yale U. 437 pages, \$6.50

Vol. 15. CRYSTAL RECTIFIERS. Characteristics and use of the silicon and germanium point-contact rectifiers. Edited by H. C. Torrey and C. A. Whitmer, Rutgers U. 440 pages, \$6.50

Vol. 16. MICROWAVE MIXERS. Discusses various high-frequency receiving systems and their relative merit. By R. V. Pound, Harvard U. 381 pages, \$5.50

Vol. 17. COMPONENTS HANDBOOK. Covers the properties and characteristics of electronic components. Edited by J. F. Blackburn, M.I.T. 626 pages, \$8.00

Vol. 18. VACUUM TUBE AMPLIFIERS. The special constructional techniques pertaining to many important types of amplifiers. Edited by G. E. Valley, Jr., M. I. T., and H. Wallman, M. I. T. 733 pages, \$10.00

Vol. 19. WAVEFORMS. Describes the generation and use of precisely controlled voltages and currents having various time dependence and duration. Edited by Britton Chance, U. of Penna., F. C. Williams, Manchester U., V. Hughes, Columbia U., D. Sayre, Alabama Polytechnic Inst., and E. P. Mac Nichol, Jr., U. of Penn. 783 pages, \$10.00

Vol. 20. ELECTRONIC TIME MEASUREMENTS. Several precision methods for data transmission employing pulse timing techniques. Edited by B. Chance, U. of Penna., E. P. Mac Nichol, Jr., U. of Penna., and R. I. Hulsizer, M. I. T. 528 pages, \$7.50

Vol. 21. ELECTRONIC INSTRUMENTS. Design of simple electronic computing systems. Edited by I. A. Greenwood, Jr., General Precision Lab., J. V. Holdam, Jr., Laboratory for Electronics, Inc., and D. MacIae, Jr., Harvard U. 708 pages, \$9.50

SPECIAL PRICE
for Entire Set
AVAILABLE ON TERMS

The books in this series total \$206.50 in price. If all 27 volumes are purchased at once, a library price of \$186.00 applies, affording a savings of about 10%. In addition, the amount may be paid in installments, first payment \$36.00, ten days after receipt of books, and the balance \$30.00 monthly.

Vol. 22. CATHODE RAY TUBE DISPLAYS. Basic characteristics, principles of operation, and methods of application of cathode ray tubes. By J. T. Soiler, Amherst College, M. A. Starr, U. of Portland, and G. E. Valley, Jr., M. I. T. 736 pages, \$10.00

Vol. 23. MICROWAVE RECEIVERS. Treats all the elements making up a wide-band receiver. Edited by S. N. Van Vorhis, U. of Rochester. 611 pages, \$8.50

Vol. 24. THRESHOLD SIGNALS. Analyzes factors affecting perception of desired signals in the presence of various kinds of interference. Edited by J. L. Lawson, General Electric Co., and G. E. Uhlenbeck, U. of Michigan. 388 pages, \$5.00

Vol. 25. THEORY OF SERVOMECHANISMS. Standard theory of servomechanism design. Edited by H. M. James, Purdue U., N. B. Nichols, Taylor Instrument Co., and R. S. Phillips, U. of So. Calif. 375 pages, \$5.00

Vol. 26. RADAR SCANNERS AND RADOMES. Discusses design, problems, and properties of scanners and radomes. Edited by W. M. Cady, U. S. Naval Ordnance, M. B. Karoltz, General Precision Lab., and L. A. Turner, State U. of Iowa. 482 pages, \$7.00

Vol. 27. COMPUTING MECHANISMS AND LINKAGES. A detailed study of bar linkages in computers. Edited by A. Svoboda. 379 pages, \$5.00

If you wish individual volumes at list price encircle numbers below:

1	2	3	4	5	6
7	8	9	10	11	12
13	14	15	16	17	18
19	20	21	22	23	24
25	26	27			

---FREE EXAMINATION COUPON---

McGraw-Hill Book Company, Inc., Dept. L-8-52, 327 W. 41st St., New York 36

Send me the M.I.T. RADIATION LABORATORY SERIES, 27 volumes, for 10 days' examination on approval. If the books prove satisfactory, I will remit \$36.00 in 10 days, and \$30.00 monthly until \$186.00 is paid. Otherwise I will return books postpaid.

(Print)
Name

Address

City Zone State

Company

Position

L-8-52

This offer applies to U. S. only

NEW PRODUCTS

Edited by WILLIAM P. O'BRIEN

Testing Devices For Laboratory and Industry Are Described . . .
 Variety of New Components Included . . . Thirty-Six Recent
 Manufacturers' Catalogs Reviewed (p 374)



Intermodulation Meter

D&R, LTD., 402 E. Gutierrez St., Santa Barbara, Calif. Model IM-3B intermodulation meter features compactness, simplified operation, high stability and reduced weight. The instrument is provided with high impedance input terminals for bridging at any point within an amplifier. In this manner the contribution of any stage to the total intermodulation factor may be readily determined. A vtm is provided, having a flat frequency response throughout the range of the instrument, and a sensitivity of 10 mv full scale. The lowest full-scale intermodulation reading is 1.0 percent, and the inherent intermodulation of the instrument is less than 0.1 percent.



Pressure Transmitter

WRIGHT ENGINEERING CO., 180 E. California St., Pasadena 1, Calif. A new pressure transmitter, the

Digitran, is available for ranges from 0 to 3 psi absolute to 5,000 psi absolute. It was designed to satisfy the requirements for digital computers, automatic process control and digital recording systems. By using the magnetic field vibrating wire principle, the instrument generates a frequency output variable with pressure, or other physical variables. The use of the stable frequency output can be counted for a specified period of time and a digital number is provided in the electronic counter equal to the pressure experienced. This new technique realizes increased accuracy, resolution, readability and recording without the need for additional conversion equipment to digital numbers.



TV Booster

TURNER CO., Cedar Rapids, Iowa, is producing a new model of its television booster. The model TV-2 employs the cascode circuit, which is noted for its low noise factor, in combination with the Inductuner. The unit tunes continuously over tv channels 2 to 13 with single-knob tuning. A three-way control switch turns on set only, set and booster, or turns off both set and booster simultaneously. The unit is sup-

OTHER DEPARTMENTS

featured in this issue:

	Page
Electrons At Work	168
Production Techniques	256
Plants and People	394
New Books	404
Backtalk	420

plied complete with twin-lead lines for quick connection to the receiver.

A simple terminal strip accommodates either 75-ohm coaxial or 300-ohm twin-lead transmission lines.

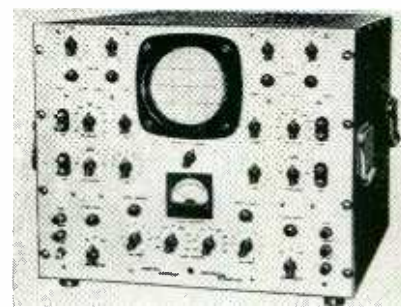

Dual-Channel Oscilloscope

ELECTRONIC TUBE CORP., 1200 E. Mermaid Lane, Philadelphia 18, Pa., announces model H-21A general-purpose twin-channel oscilloscope that displays two independent signals on the face of a single 5-in. crt. Each of the two channels has individual controls for intensity, focus and positioning of the X and Y axes. Both input signals can be observed either on a common or on separate time bases. Sweep circuits with a range from 2 to 50,000 cps can be triggered externally with a delay of less than 1 sec. Either internal or external sync may be selected. A built-in, direct-reading calibrator supplies a 60-cycle square wave to either vertical amplifier. A panel voltmeter indicates continuous calibration voltage from 0 to 1.5 v peak-to-peak. Range is governed by a built-in attenuator per-

Big News
FOR YOU
in a whisper

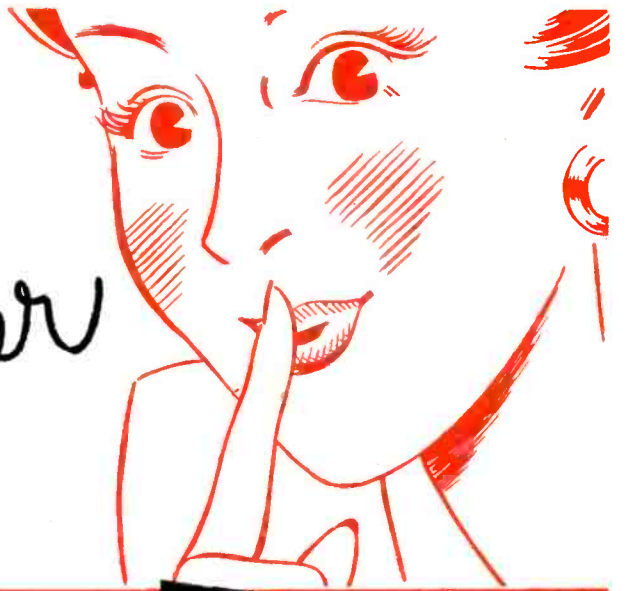

THE NEW

RAYTHEON

TYPE CK628

**LOW MICROPHONIC
SUBMINIATURE TRIODE**

OF A UNIQUE DESIGN*

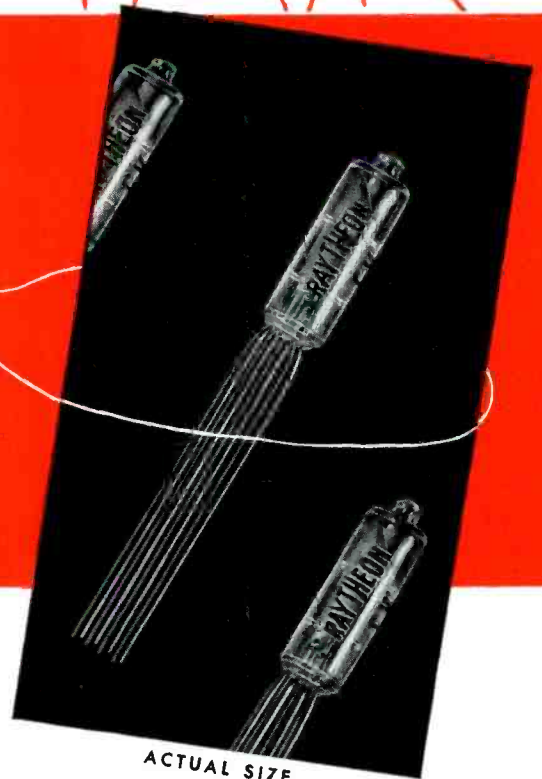

FOR guided missiles
telemetering
recorder amplifiers
and all audio frequency amplifiers
critical for microphonics

MICROPHONIC NOISE OUTPUT — NOT MORE THAN 2.5 MILLIVOLTS across plate resistor of 10,000 ohms with applied vibrational acceleration of 15 G at 40 cycles per second.

- AMPLIFICATION FACTOR 60
- MUTUAL CONDUCTANCE 2500 umhos
- HEATER 6.3 volts, 200 ma.

*The low microphonics result from Raytheon's advanced design — not from tube selection.



RAYTHEON MANUFACTURING COMPANY

Receiving Tube Division — for application information call

Newton, Mass. Bigelow 4-7500 • Chicago, Ill. National 2-2770 • New York, N.Y. Whitehall 3-4980 • Los Angeles, Calif. Richmond 7-5524

RAYTHEON MAKES ALL THESE:

RELIABLE SUBMINIATURE AND MINIATURE TUBES • GERMANIUM DIODES AND TRANSISTORS • NUCLEONIC TUBES • MICROWAVE TUBES • RECEIVING AND PICTURE TUBES

Excellence in Electronics

mitting measurement up to 150 v peak-to-peak.

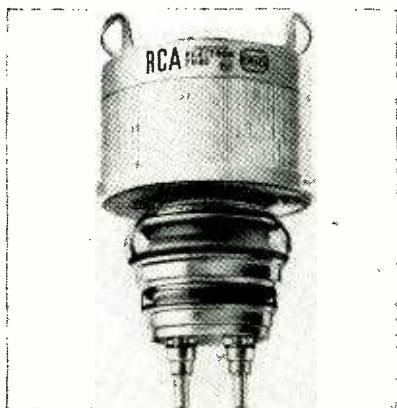

Power Tetrode

RADIO CORP. OF AMERICA, Harrison, N. J. The forced-air-cooled power tetrode type 6166 is designed for vhf service in tv and c-w applications. It has a maximum plate dissipation of 10 kw, is rated for operation up to 220 mc, and utilizes an economical thoriated-tungsten filament. The tube can deliver a synchronizing-level power output of 12 kw in broad-band tv service at 216 mc; and a power output of 9 kw in class C f-m telephony service in circuits operating at 216 mc. The coaxial electrode structure of the 6166 is designed especially for use with high-power circuits of the coaxial-cylinder type. The design provides low-inductance, large-area, r-f electrode terminals for insertion into the cylinders, and facilitates multiple use of the 6166 in cavity circuits.

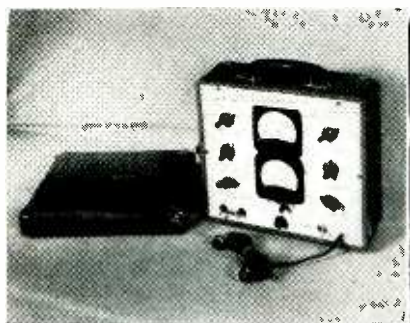

Germanium Diode Checker

GENERAL ELECTRIC Co., Syracuse, N. Y., has announced a germanium diode checker for use in laborator-

ies, quality control groups, service shops and wherever a need exists for checking static characteristics of diodes. Among the device's other uses are general resistance checking, an accurately metered power supply, and forming electrolytic capacitors and checking d-c leakage current. The type ST-12-A has test clips for diodes having leads, and for those with pins on each end. Diode resistance is checked by placing a variable accurately-metered d-c voltage across the diode. A three-inch voltmeter and three-inch current meter permit voltage and current to be metered simultaneously. A chart of manufacturer's limits for about 40 of the most commonly used diodes is secured in the cover of the new unit.

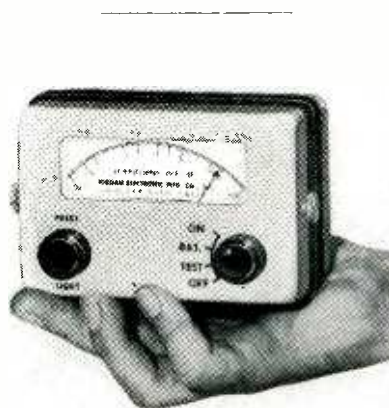

Radiation Detector

JORDAN ELECTRONIC MFG. Co., INC., 9042 Culver Blvd., Culver City, Calif. The Radector, a radiological monitoring field unit for civil defense, military or industrial use, utilizes the Neher-White ionization chamber. The unit is designed to measure from 0.02 roentgens per hr to 500 roentgens per hr on a large, easy-to-read, logarithmic scale. Powered by only 4½ v, without the need of amplification, it has eliminated such troublesome components as vibrators, rectifiers, voltage regulators, capacitors, high megohm resistors and transformers. It measures 5 in. × 3 in. × 3 in. and weighs only 2 lb. It has a performance record of 168 hours of continuous use with no drop in meter reading. Demonstrable accuracy is within less than ±10 percent of radiation intensity shown anywhere on the scale.

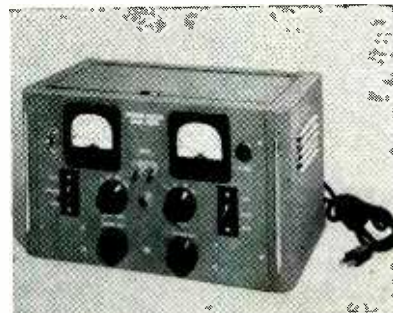

Diode Tester

COMPUTER RESEARCH CORP., 3348 W. El Segundo Blvd., Hawthorne, Calif., has developed an instrument for testing the dynamic as well as static characteristics of crystal diodes. Where large numbers of diodes are used in plug-in form, the diode tester can also be used for periodic circuit checks to detect potential diode failures before they occur. The unit occupies a space less than ½ cu ft, and will accommodate diodes with forward currents of 0 to 100 ma and back currents of 0 to 1,000 µa. Forward voltage is measured to an accuracy of 2 percent and back current to 3 percent. The tester is adaptable to high speed, volume testing and operates on 115 v, 60-cycle current, using 100 watts or less.



Pulse Transformer

ENGINEERING RESEARCH ASSOCIATES, INC., 1902 W. Minnehahah Ave., St. Paul W4, Minn., has developed a new multipurpose miniature pulse transformer designed especially for use in low-power applications. Type 130A1 transformer has several features: Its three isolated windings provide versatility of application; compact transformer design permits mounting on a tube strip or chassis in approximately the same space required for a standard miniature tube; short

New! 

DIRECTIONAL COUPLERS

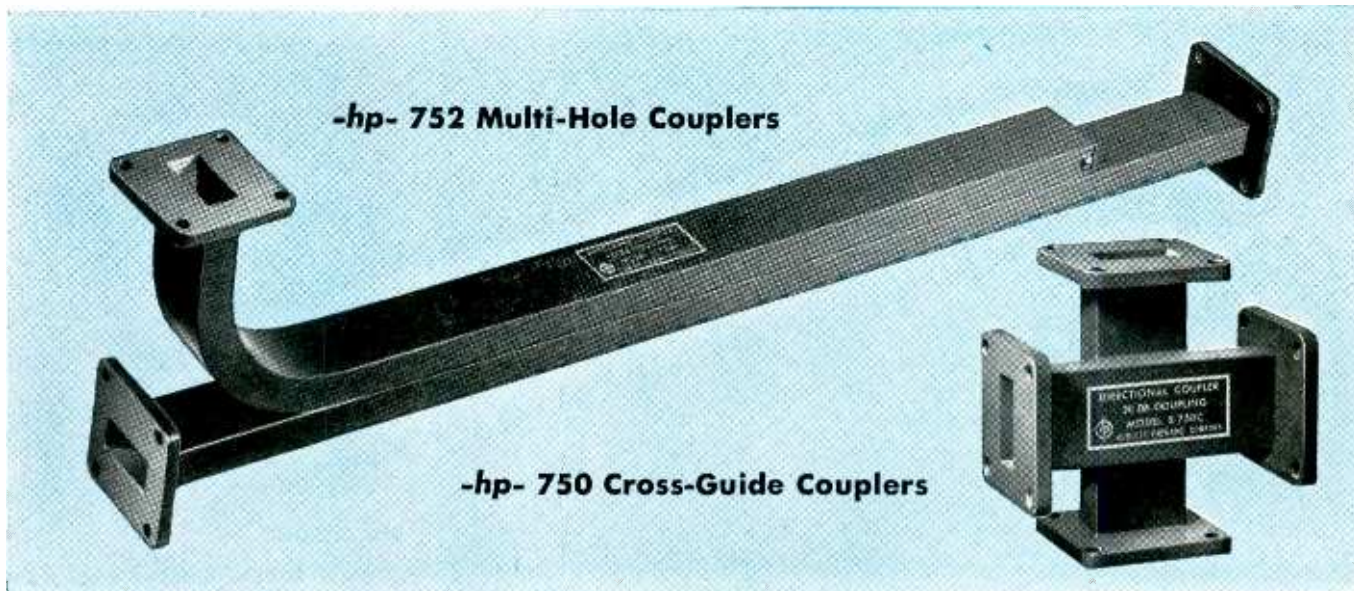

- ▶ New additions to complete, integrated **-hp-** waveguide line
- ▶ Broad band coverage

- ▶ High directivity, high accuracy; low VSWR
- ▶ Simple design, low cost

Like other units of the **-hp-** waveguide instrument line, Models 752 and 750 Directional Couplers incorporate a design approach new to commercial waveguide equipment. All elements cover the complete range of their waveguide frequency band, and all are mechanically and electrically integrated. New, simpler design insures high accuracy, stability and quality—yet permits quantity production and low cost. The complete line includes adaptors, attenuators, detector mounts, frequency meters, slotted sections, tees, transformers, terminations, loads, shorts and probes in standard waveguide sizes. Select the exact instruments you need; and be assured of maximum flexibility, convenience and economy.

-hp- 752 Multi-Hole Couplers

In this coupler the broad faces of two waveguides are joined together, with coupling obtained from a series of graduated holes. Power is detected by connecting a crystal detector or bolometer mount to the open end of the auxiliary arm. Directivity is better than

40 db entire range. Coupling factors are 10 and 20 db, accuracy of coupling level is ± 0.4 db across entire frequency range, and frequency sensitivity is ± 0.5 db full range. 5 models for each coupling factor cover waveguide frequencies from 2.6 to 12.4 kmc. The instruments form a 3-terminal network ideal for monitoring power, measuring reflections, mixing or isolating signals.

\$100.00 to \$210.00 f.o.b. factory.

-hp- 750 Cross-Guide Couplers

These instruments answer most monitoring, isolating or mixing needs where more precise multi-hole couplers are not needed. They consist of two waveguide sections mounted at right angles across their broad faces. Directivity is approximately 20 db, and accuracy of coupling level is ± 0.4 db across full range of waveguide. Frequency sensitivity is ± 1.3 db. Coupling factors offered are 20 or 30 db, and connections may be made to all four terminals. 5 models for each coupling factor cover frequencies from 2.6 to 12.4 kmc.

\$50.00 to \$100.00 f.o.b. factory.

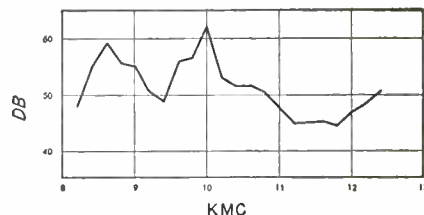

Typical over-all directivity, **-hp- 752**, 10 db model

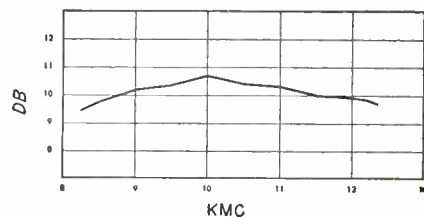

Typical coupling, **-hp- 752**, 10 db model

Data subject to change without notice

HEWLETT-PACKARD COMPANY

2526A PAGE MILL ROAD • PALO ALTO, CALIF., U.S.A.
Sales representatives in all principal areas



INSTRUMENTS – Complete Coverage!

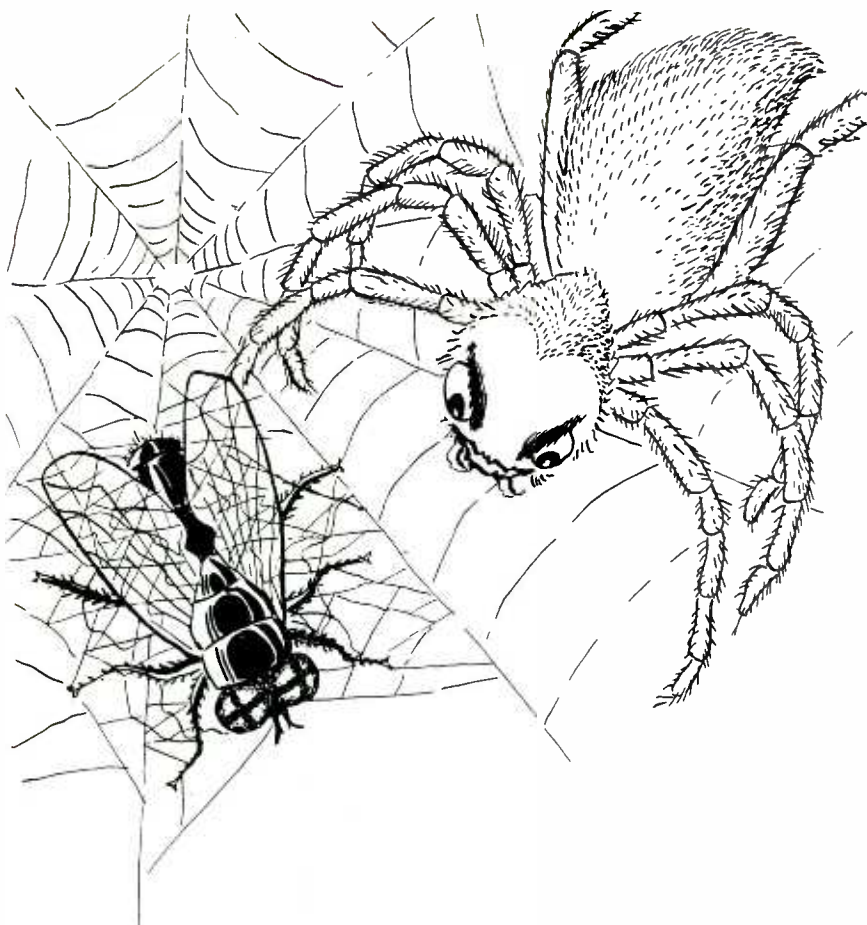

IS THIS YOUR PROBLEM*

This is an example of how one bug can put another bug out of action. However, when you're dealing with complicated electronic equipment, you can't depend upon the bugs to exterminate each other — besides, even if you could, you'd always have the problem of what to do with the last bug.

One thing you can do is to use components whose bug content is at an absolute minimum. We at Sigma have spent years removing bugs of all sizes and species from Sigma Sensitive Relays. As a result, we can boast that many of our relays are practically bug-free. Like everybody else, we have a few dogs with parasites we won't even mention. Even in such cases, however, it is possible that our experience with the little fellows would be of value to you.

*-?

We won't let our advertising agency use question marks in headlines.

SIGMA

SIGMA INSTRUMENTS, INC.

62 PEARL ST., SO. BRAintree, BOSTON 85, MASS.

rise time and small droop minimize critical associated circuit design problems. Typical applications include triggering and counting circuits, blocking oscillators, d-c isolation, inversion, pulse-shaping and pulse-transmission circuits.



UHF Tuner

GENERAL INSTRUMENT CORP., 829 Newark Ave., Elizabeth 3, N. J. A new and unique approach to uhf tuners is characterized in the model 60 (illustrated) that features very low noise factor, better sensitivity, no sliding contacts, straight-line-frequency dial calibration and full uhf channel coverage. It can be fitted and mounted in any position around a vhf tuner. A typical application is shown above, where the model 60 is used in conjunction with model 48, 13 position vhf turret tuner, 3-shaft design, with built-in reduction drive for fine tuning.



Selenium Rectifier Tester

GALVANIC PRODUCTS CORP., 110 E. Hawthorne Ave., Valley Stream, N. Y. Model 100A Seletester, for

Stearns MAGNETIC, INC.

Road Sweeping Magnet Coils

Are Insulated with

NATVAR

Silicone Coated Fiberglas

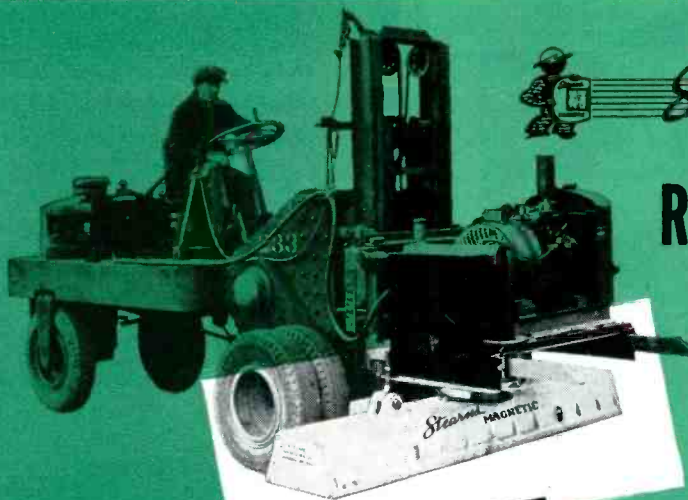

Stearns road magnets are saving airlines, bus operators and motorists from inconvenience and expense of tire repairs by removing tons of nails, spikes, screws, wire, and other scrap metal from runways and highways. In many cases, the metal recovered more than pays for the operation of the magnets. Coils of these highly specialized, heavy-duty magnets are built to last. They are insulated and protected with Natvar Silicone Coated Fiberglas because of its excellent electrical and mechanical characteristics, particularly its ability to withstand heat and moisture.

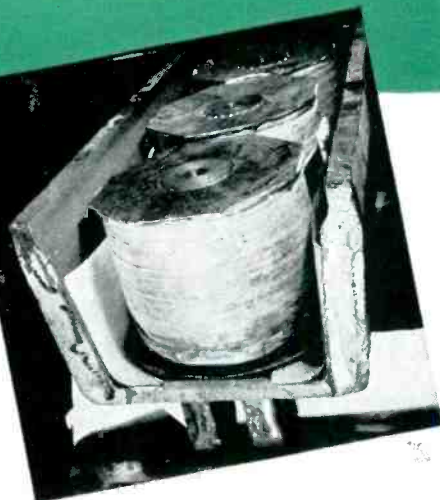

Natvar Products

- Varnished cambric—straight cut and bias
- Varnished cable tape
- Varnished canvas
- Varnished duck
- Varnished silk
- Varnished special rayon
- Varnished Fiberglas cloth
- Silicone coated Fiberglas
- Varnished papers
- Slot insulation
- Varnished tubing and sleeving
- Varnished identification markers
- Lacquered tubing and sleeving
- Extruded plastic tubing and tape
- Extruded plastic identification markers

Ask for Catalog No. 22

Stearns Magnetic, Inc., Milwaukee, manufactures magnetic clutches, brakes, separators, pulleys, drums, and other magnetic devices and equipment for industrial uses, where reliability of performance is essential.

This calls for a highly specialized engineering knowledge of magnetism, its practical application to specific problems, and a thorough familiarity with the characteristics of materials under actual operating conditions. Natvar Silicone Coated Fiberglas was selected for their road magnet because of its proven resistance to heat and moisture.

Natvar flexible electrical insulating materials have good electrical and mechanical properties and are consistently uniform, no matter when or where purchased. They are available either from your wholesaler's stock or direct from our own.

NATVAR CORPORATION

FORMERLY THE NATIONAL VARNISHED PRODUCTS CORPORATION

TELEPHONE
RAHWAY 7-8800

CABLE ADDRESS
NATVAR: RAHWAY, N. J.

201 RANDOLPH AVENUE • WOODBRIDGE, NEW JERSEY

testing selenium rectifiers as used in radio and tv receivers, provides means for testing for (1) forward resistance, (2) reverse leakage currents, (3) "opens" and (4) "shorts". It provides positive, fast and accurate tests for all stacks rated at 10 to 1,000 ma. The Selester will also test any new miniature selenium rectifiers which may be introduced, without any adaptors or other equipment. Input is 117 v, 60 cycle a-c.

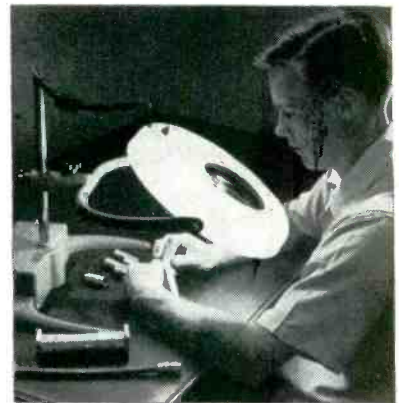

Inspection Instruments

ENGINEERING DEVELOPMENTS, INC., 32 West Pelham St., Newport, R. I., has introduced its latest types of Magnivision inspection devices and assembly aids. The units are essential for accurate viewing of fine detail for all classes of inspection and assembly of machined parts, wire, tubing, radio parts, crystals, electric relays, meter assembly and many other uses around the shop. Magnivision gives strain free vision, stereoscopic vision, shadowless vision and cool intense light with no discomfort due to heat ordinarily present from filament lamps.

Maintenance Instrument

ANCO INSTRUMENT DIVISION, 4254 West Arthington St., Chicago 24, Ill., has announced the Elec-Detec, a portable electronic maintenance instrument for locating trouble in machinery and other moving mechanisms. This electronic stethoscope helps maintenance men locate friction noises in engines, gears, shafts, transmissions, traps, valves and

LEDEX ROTARY SOLENOIDS

... for remote controlled power in TOMORROW'S PRODUCTS

LeSabre . . . General Motors' low, sleek car of tomorrow with dramatic sweeping lines of a jet aircraft, is a "laboratory on wheels" for testing futuristic styling and mechanical ideas. It is designed with advanced mechanical innovations including the dependable rotary snap action of Ledex Rotary Solenoids for the electrical push-button control of door releases, convertible top operation, and hood and trunk latch releases.

Let Ledex Engineers assist you, in choosing rotary solenoids best suited for your products of tomorrow. Six basic models range in diameters from 1 1/2" to 3 3/4", with torque values from 1/4 to 50 pound-inches. Various power linkages and types of mountings are available. Write for descriptive literature today!

G. H. Leland INC.

12 WEBSTER STREET, DAYTON 2, OHIO

There are hundreds of jobs open to engineers today! *but few opportunities like these*

Westinghouse is in nuclear power to stay. We believe in the development of atomic energy as man's next great source of power. If you want to get in on a new era in industry, we want to talk to you.

Atomic power opportunities are waiting for electronic engineers with 4 to 10 years of this kind of experience...

ELECTRONIC COMPUTERS, employing pulse amplifying wide range linear amplifying and rate circuits.

NULL BALANCE DEVICES, employing both vacuum tube and magnetic amplifiers, **SERVOMECHANISMS**, **PLANT CONTROL SYSTEMS**.

LIAISON with customers, contractors, designers of component equipment.

SUPERVISION of drafting work.

REMEMBER! We are primarily interested in good experienced application and development engineers—lack of previous reactor development experience is no handicap in this type of work.

HOW TO APPLY! What Westinghouse wants to know is: Where and when you obtained your degree . . . how you did in school . . . where you have worked at your profession . . . what kind of work you have done.

In other words, right now we're more interested in your ability to fill current openings and to develop in the Westinghouse Atomic Power Division than we are in your vital statistics. Write your letter of application accordingly.

You will be in communication with men who are experienced in keeping secrets. All negotiations will be discreet, and your reply will be kept strictly confidential.

Address your application letter to: **Manager, Industrial Relations Department, Westinghouse Electric Corporation, P. O. Box 1468, Pittsburgh 30, Pennsylvania.**

What do you want?

MONEY? Good jobs are open here now—waiting for good men who want to make a permanent connection.

A PERMANENT JOB? Many of the engineers who joined Westinghouse 20 and 25 years ago are still with Westinghouse—and in key positions—and engineers who join us now will have the opportunity to make this work their lifetime careers. When many other industries may be going through slack times, atomic energy will still be in a stage of expansion.

SUBURBAN LIVING? It's here—within easy driving distance of your work. Within a few minutes of shopping centers . . . schools . . . metropolitan centers.

JOB EXTRAS? Westinghouse offers: Low cost life, sickness and accident insurance with hospital and surgical benefits. A modern pension plan. Westinghouse stock at favorable prices. Westinghouse appliances for your home at discount.

YOUR KIND OF ASSOCIATES? Every fourth person in the Division is an engineer or scientist. More than half the top Westinghouse executives are engineers.

FASCINATING WORK? What other branch of science offers such exciting challenges? So many opportunities for discovery? So many chances to benefit mankind? So many opportunities for original work?

GROWTH OPPORTUNITIES? Never again in your lifetime will you be able to get into such a sure-to-expand industry so early in its development.

YOU CAN BE SURE.. IF IT'S **Westinghouse**

CANNON PLUGS

for
laboratory
and
switchboard



CSR Tandem Receptacle
CSP Plug

Here are a few examples of Cannon's Experimental Laboratory and Switchboard Connectors. They are used extensively throughout industry, public utilities, sound studios, broadcasting stations, college and university physics and chemistry laboratories, in AC network analyzers and electronic analog computers. They may be applied wherever quick disconnect switching

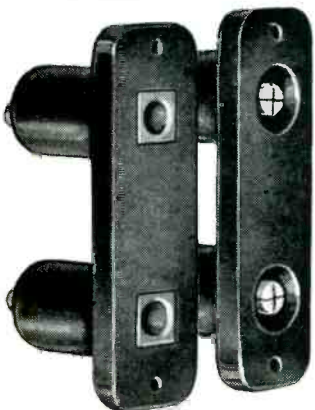

SDR Receptacle

SDP Receptacle

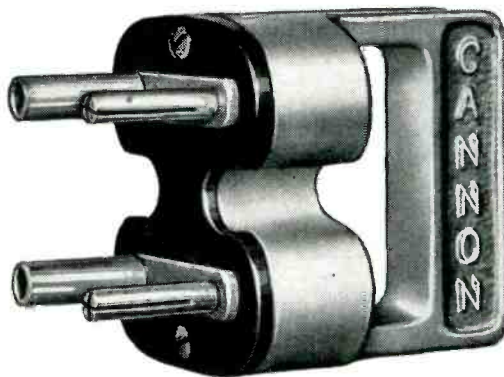

SWPR-4 Switching Plug having both
pin and socket contacts

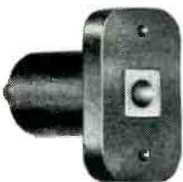

SR Receptacle

and patch cord plugs are required. High grade materials are used throughout. Molded phenolic of high dielectric strength is used for insulation. Both pin and socket contacts are machined from solid brass. Some are silver plated. All are rated at 75 amps. Pin contacts are split for low loss seating in tapered bore sockets. Single contact fittings are supplied in either red or black phenolic to designate direct or alternating current circuits respectively. Two-contact and larger plugs have sand-blasted cast aluminum shells and handles with clear lacquer finish. Various combinations of pin and socket contacts are used as a polarizing guide. For further information write for Bulletin LS5-1951.



SCR Plug



SCP Plug



SRB Receptacle

CANNON ELECTRIC

Since 1915



Factories in Los Angeles, Toronto, New Haven, Benton Harbor. Representatives in principal cities. Address inquiries to Cannon Electric Company, Dept. J-120, P. O. Box 75, Lincoln Heights Station, Los Angeles 31, Calif.

REXOLITE

1422

(FORMERLY G. E. TEXTOLITE 1422)

THE **Better** PLASTIC
U. H. F. INSULATION
BECAUSE OF:—

- outstanding electrical properties
- superior machinability
- high heat resistance
- dimensional stability and extremely low initial cost

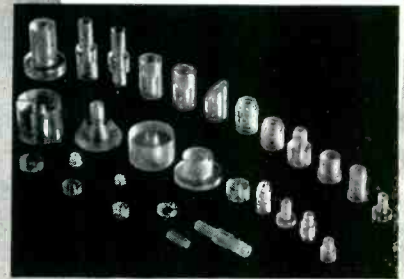

Rexolite 1422 has been specifically designed and developed to meet the growing need for a lightweight — low cost U. H. F. insulating material.

Rexolite 1422 is available for immediate delivery as centerless ground rod in any diameter up to 1". Also cast in larger diameter rods and sheets.

Meets JAN-P-77 and MIL-P-77A specifications.

The unusual chemical inertness and physical properties of Rexolite 1422 allow its use where other materials fail.

For use in: connectors, coaxial connectors, waveguide, antennas, leads and spacers, spreaders and air wound coil supports, coil forms.



Write today
for technical
bulletins and
samples. Our en-
gineering staff is al-
ways at your dis-
posal.

Manufacturers of Non-strip wire, High Temperature Electrical Tubing and other extruded plastic products.

THE REX CORPORATION

63 LANDSDOWNE STREET
CAMBRIDGE 39, MASS.

ASCOP

PRECISION ENGINEERING IN ELECTRONICS

**Telemetry and Data Handling Equipment
Special Components**

GROUND STATION EQUIPMENT



Installations for reception and all forms of handling and reduction of data from pulse width and FM/FM radio telemetry systems • Custom-engineered and custom-built to hold equipment to a minimum consistent with accuracy, operation ease, reliability • Functional mounting of components assures servicing ease — and flexibility for ready unit expansion with any of the following:

- Specialized receiving equipment
- Magnetic tape field storage and playback
- Regenerative integrator for PM signals
- Channel selector for PW systems with automatic zero and channel sensitivity adjustments, and
- automatic missing pulse insertion.
- Oscillographic film reader, with line center finder
- Tabulated numerical output
- Punched card output
- Graphical output

DATA HANDLING EQUIPMENT



Automatic or semi-automatic devices for marked reduction of time, expense, man-power usually required to place volumes of recorded data in final usable form • Input data — film records, varying DC voltages, magnetic tape recordings, etc.— processed point by point, at high rates, with automatic correction for zero drift, scale factor, and measuring system non-linearities • Outputs available as continuous plots on film or paper, with scale and time coordinates, as DC voltages, as pulse coded signals for remote transmission, or as electrical indications for existing tabulating and card punching devices • All systems custom-designed for accuracy and economy; custom-assembled from special purpose components devised in continuous engineering of data handling systems.



Your Inquiries Are Invited • Write or Telephone

Applied Science Corp. of Princeton

P. O. Box 44, Princeton, N. J. PLainsboro 3-4141

PULSE WIDTH RADIO TELEMETERING

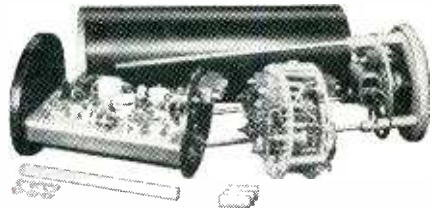

PW/PM Small, rugged units particularly suited to vehicular use where many different variables must be continuously transmitted.

- 30 data channels
- 215-235 mc Carrier-crystal controlled
- Based on RDB telemetry standards
- 4 watt RF power output
- 30 cps sampling rate
- 1% system accuracy
- 1/2% linearity
- 0.5 volt DC inputs
- 60 g sustained acceleration
- -40° to +60°C
- Vibration — 1/8 in. at 60 cps
- Single or two package form
- 3 1/4 in. diam.; 17 in. length; 7 lbs. weight
- Primary power 28 volts, 3.5 amps

Note: Also available without dynamotor. Transmitters available separately. Integral subcommutator if more channels are desired

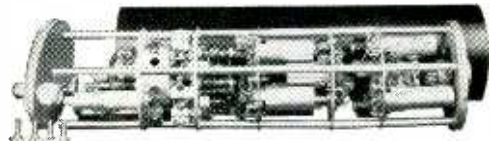

PW/FM For higher power output, with space no factor. Stable, highly reliable over long distances. Components readily accessible for replacement to extend unit life.

- Based on RDB telemetry standards
- 215-235 mc Carrier
- Max. drift — .04%
- 10 watt RF power output
- 30 data channels
- 30 cps sampling rate
- 1% system accuracy
- 1/2% linearity
- 0.5 volt DC inputs
- 60 g sustained acceleration
- Vibration: 1/8 in. at 60 cps
- 10 kc oscillator supply for AC pickups included
- 4 1/4 in. diam.; 30 in. combined length; 17 lbs. combined weight
- Primary power 28 volts at 5.7 amps.

Note: Model PAD-1 Power Amplifier-Dynamotor unit may be added to increase transmitter power to 40-50 watts. Transmitter of Transmitter-Dynamotor packages available separately.

HIGH-SPEED ROTARY SAMPLING SWITCHES

ASCOP designs and manufactures switches to your most difficult and exacting requirements. Here are a few typical examples



TYPE T Built to withstand vibration, shock, temperature and altitude extremes. Switching designed for airborne radio telemetry systems. DC motors for 27, 12, and 6 volts. Up to 4 poles, each with 30 contacts. Sampling speeds from 0.1 to 20 rps.



TYPE U Custom-designed for limited space applications. Complete with DC drive motor, yet only 1 in. in diameter. A single pole samples 32 fixed contacts at the rate of 100 rps.



TYPE L For high performance with space secondary. Single pole samples 120 fixed contacts at rates up to 30 rps. Connection to external drive through 1/4 in. steel shaft running in sealed ball bearings. Special contact material for long service-free life.



TYPE V For precision in sampling speed plus long life. Synchronous drive motor permits selection of single pole sampling of 60 fixed contacts at many rates from 1 rps. to 1 rev. per day. Adaptable, through variety of mountings and terminals, for use as a component of industrial instrumentation systems.

HIGH SPEED



ELECTRONIC

COUNTING

TIMING

CONTROL

INSTRUMENTS

FOR APPLICATIONS INVOLVING THESE BASIC MEASUREMENTS

CALCULATION $+ - \div \times$

For business, industrial and scientific applications requiring computation, data handling, memory and high speed printing, the Potter Instrument Company can supply complete systems. Some of the newly developed equipments include simplified electronic arithmetic units, multipurpose shift registers, storage devices, photoelectric readers, tape handlers and high speed line-at-a-time printer.

QUANTITY



Pills, buttons, bottle caps, hardware, etc., can be counted and batched in precise predetermined quantities at speeds up to 60,000 per minute. Important savings in labor and overages are assured by the speed and accuracy of the Potter Electronic Counter. Count Detectors for any product are available.

LENGTH



Wire or strip material can be automatically sheared or marked in precise predetermined lengths at high rates of speed, and if required, automatically stacked in predetermined quantities. Practically any definition of measurement can be obtained.

TIME



Time intervals can be easily measured or generated with extremely high accuracy through the use of Potter Counter Chronograph Interval Timers. Registration of measurement is retained until reset. Accuracy of one part in 8,000,000 can be provided.

SEQUENCE



Since the electronic counters can be arranged to predetermine any sequence of selected counts, they can be readily and advantageously substituted for cams, gears, patterns, chains and other systems of timing control. Control by absolute count assures high accuracy, faster operating speeds, since there are no moving parts to wear.

FREQUENCY

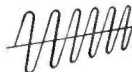

Potter Electronic Counters provide an exact ratio of division which is maintained even though the input frequency is varied. If the input frequency is stopped the output also stops. Frequencies can be measured or generated with high precision. Square waves of variable frequency, pulse-width and number can be easily generated.

REVOLUTION



Through electromagnetic or photoelectric pickup, shaft rotation can be accurately counted or timed without physical contact. Fractional parts of a revolution can be measured or used to control automatic machine processes as a function of predetermined counts.

PROBLEMS ?

Your specific counting, timing or control problem, explained on our data sheet, will result in a prompt and efficient solution by our engineers.

pipe lines. The instrument uses a metal probe which serves as a microphone to locate the exact source of tell-tale noise. Noise impulses are transmitted through an amplifier to headphones.



Mobile Transmitter

E. F. JOHNSON Co., Waseca, Minn. Designed primarily for under-dash mounting in autos, the Viking mobile transmitter is capable of 60 w input, 100-percent a-m modulated, on the 75, 20 and 10 meter amateur bands. The unit is completely bandswitched and has provisions for one additional band. Additional features include: receiver muting, front panel audio gain control, gang tuning and provision for push-to-talk operation.

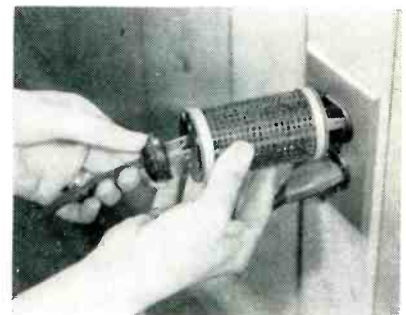

TV Ballast

CLAROSTAT MFG. Co., INC., Dover, N. H. The tv ballast is designed primarily to be plugged in between tv set and electric receptacle, for use in areas where line voltage tends to increase up to 140 v. The unit operates on the ballast principle, whereby, as voltage increases, the resistance increases, giving an increased drop across the resistance, thus allowing a lower poten-

WRITE FOR DESCRIPTIVE CATALOG NO. 38

POTTER INSTRUMENT COMPANY

INCORPORATED
113 CUTTER MILL ROAD, GREAT NECK, NEW YORK

STANDARD BOXES *for* SPECIAL JOBS!

No matter what business you are in—or what problems you have in handling small parts, there is a standard NesTier custom-made to fit your requirements. A production line product, the NesTier effects savings in initial cost as well as on the job—from stock room to loading dock.

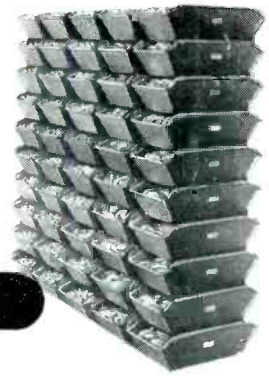

STOCK ROOM OR STORAGE

Nowhere else will you find a box that will serve alone as a permanent stock room fixture. No racks are necessary as tiered units lock themselves together to form rigid stacks. Parts in all units are visible and accessible.

PRODUCTION

NesTiers were designed primarily for production line work. Empty, they nest to save space. Filled and tiered, they lock together with contents of all units visible and accessible. Filled or empty, they are easily transported by truck, roller or overhead conveyor—even by hand.

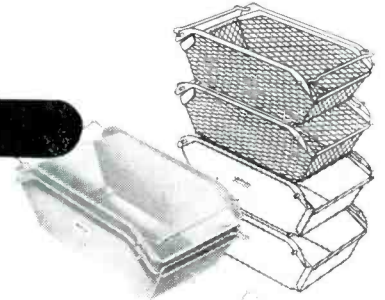

DRAINAGE

Here is the standard one-piece sheet steel NesTier with a lanced bottom that permits rapid drainage of contents without allowing even the smallest parts to slip through. No need to transfer parts requiring drainage when this box is used.

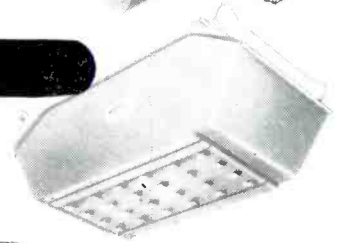

DEGREASING

The necessity to change boxes for any cleaning, dipping or degreasing operation has been eliminated with this NesTier expanded metal basket. Formed in the distinctive NesTier shape, this unit is as rugged as the solid sheet steel box and retains all of the outstanding NesTier features.

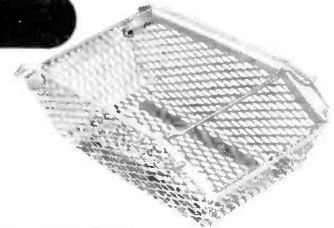

PROTECTION

NesTier fibre inserts actually perform two functions. Parts are protected against damage from metal box and a variety of parts may be placed in one box without becoming mixed. Furnished with or without dividers.



SHIPPING

The NesTier one-piece "snap on" lid keeps parts from jouncing out while being transported through the plant or from plant to plant. Filled units with lids attached can be tiered, allowing parts to be stored or transported and yet keep clean.



NesTiers are formed of one-piece sheet steel, with or without lanced bottom; zinc plated expanded metal, galvanized, stainless steel or aluminum. All units and accessories interchangeable. Two standard sizes.



THE CHAS. Wm. DOEPKE MANUFACTURING CO., INC.
METAL SPECIALTIES DIVISION

ROSSMOYNE, OHIO

GTC Transformers

demanded for

Unusual Applications



The illustrated new automatic pin-spotter is a product of the American Machine & Foundry Company. An exceptionally high degree of precision is necessary for proper performance.



"GTC" Transformers are used in the AUTOMATIC PIN-SPOTTER because of their accepted ability to meet the most rigid specifications. If your application is most unusual or standard, we suggest you consider "GTC" — proven transformers where maximum performance is essential.

We welcome your inquiries.

GENERAL TRANSFORMER COMPANY

serving industry since 1928

18240 Harwood Avenue, Homewood, Illinois
(Suburb of Chicago)



Understand TV Technology fundamentals

• circuits • equipment

Here is the volume that gives you working knowledge of the complete television system—prepares you fully for technical work in designing television systems—operating television equipment—or understanding the details of receiving equipment. Much has been done in advancing television technology in the past few years—much more is to come. This book gives you the essential grounding and the knowledge of today's practice that will equip you to take advantage of the opportunities ahead in this great field.

Just Published! 2nd Edition

TELEVISION ENGINEERING

By Donald G. Fink

Editor, *Electronics*; Vice Chairman,
National Television System Committee

721 pages, 512 illustrations, \$8.50

This outstanding book meets the need for grounding in the engineering and technical fundamentals of television. The whole television process, from studio to receiver, is covered. Aspects peculiar to television technology, such as scanning and wave-form analysis, illumination and colorimetry, camera tubes and picture tubes, are treated in detail, starting from first principles. The principles of operation of television systems, in black-and-white and color, are covered, and the book describes in detail the design, operation, and use of television equipment.

Brings you these new features:

COLOR TV:

Two chapters devoted to color television fundamentals and description of six color systems.

Explains many NEW DEVELOPMENTS:

- stagger tuning of i-f amplifiers
- intercarrier sound reception
- distributed amplification
- the keyed clamp circuit
- offset carrier reduction of co-channel interference
- tonal gradation correction amplifiers
- reaction type power supplies
- batwing and superturnstile transmitting radiators

CIRCUIT DIAGRAMS: Contains complete circuit diagrams, with tube types and component values of nearly every item of equipment in the television system, including sync-signal generator, cameras and camera controls for live pickup and film, and microwave relay transmitter and receiver.

10 DAYS' FREE EXAMINATION

McGraw-Hill Book Co., Inc.,
330 W. 42 St., NYC 36

Send me Fink's TELEVISION ENGINEERING for 10 days' examination on approval. In 10 days I will remit \$8.50, plus few cents for delivery or return book. (We pay for delivery if you remit with this coupon; same return privilege.)

(Print)

Name

Address

City Zone.... State.....

Company

Position FL-10-52

This offer applies to U. S. only.

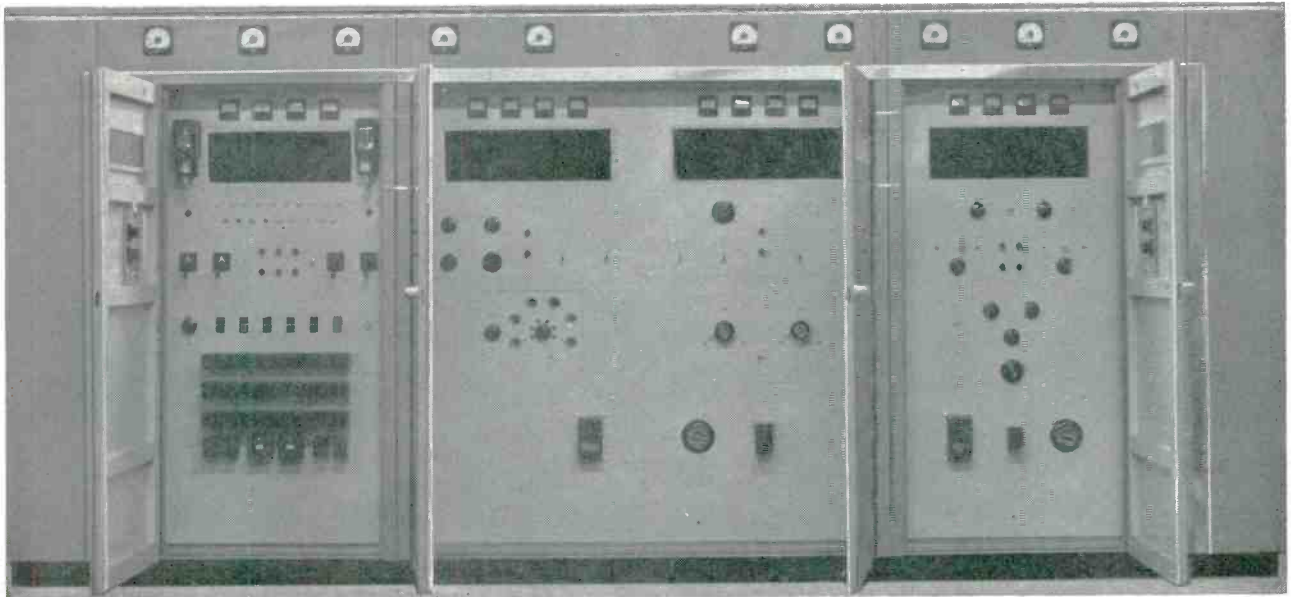

Model XT-2-A

25 / 40 KW Short Wave Broadcast and Communication Transmitter

All assembling done with parts, manufacturing drawings and specifications supplied by the General Electric Co.

- 40 KW A-1 Transmission (Telegraph and Frequency Shift Keying)
- 25 KW A-3 Transmission (Broadcast Quality)
- Carrier Frequency: 3.5 to 22 Mcs.

Fully guaranteed performance, in accordance with Federal Communications Commission's Standards of Good Engineering Practice Methods.

**PROMPT
DELIVERIES
GUARANTEED
on
Model XT-2-A**

20 KW

**Single Side Band
H F TRANSMITTER**

Complete Line of
**SINGLE SIDE BAND
TRANSMITTER AND
RECEIVER EQUIPMENT**

Inquiries invited . . .

Our engineering department is prepared to submit proposals upon receipt of inquiry.

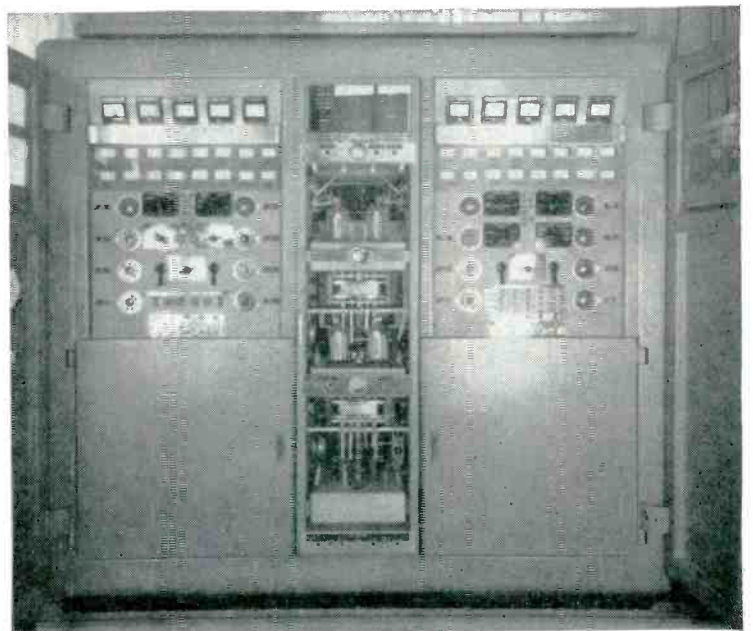

MAURICE I. PARISIER & CO.

1475 BROADWAY • NEW YORK 36, N. Y.

Cable Address MIPARISIER, New York

Pyroferric

IRON CORES

PYROFERRIC IRON CORES are scientifically manufactured, under strictest quality controls and rigid maintenance of close electrical and mechanical tolerances.

PYROFERRIC services are available for the engineering of your core production requirements . . . write for catalog 22, which gives complete powdered iron core information such as the manufacture of iron cores, their electrical properties, materials, design considerations, standardization data, uses, and contains other useful information.

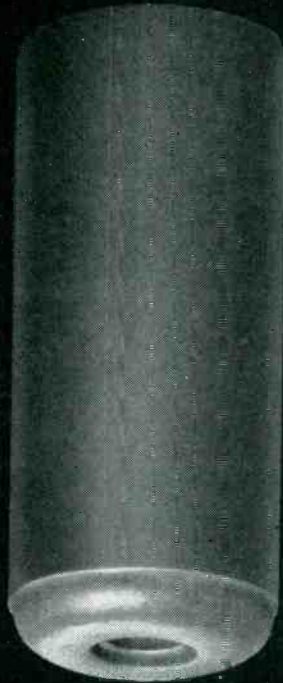

PYROFERRIC

621 EAST 26 ST.,

NEW YORK 67, N. Y.

NEW PRODUCTS

(continued)

tial to be applied to the tv set. At 110 v and under, the voltage drop is negligible; but with increases up to 140 v, the voltage applied to the tv set will not normally increase much above 115 v, depending on the load applied. They are available in type TVA, 200 to 300 w; and type TVB, 300 to 375 w.



Monitor Kinescope

RADIO CORP. OF AMERICA, Harrison, N. J. The 10SP4 directly-viewed, 10-in. c-r tube was designed for monitor service in connection with theater-tv systems, industrial tv equipment and studio broadcast equipment. Utilizing electrostatic focusing the 10SP4 features an electron gun designed with an acceleration type of electron lens to provide high resolution and good uniformity of focus over the entire picture area. Focus can be maintained automatically with variation in line voltage and with adjustment of picture brightness.

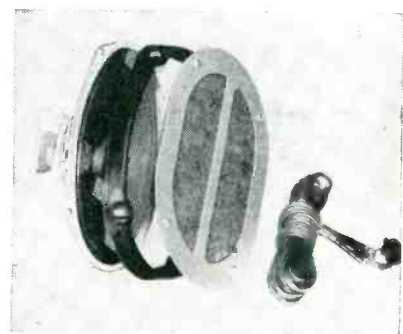

Auto Speakers

QUAM-NICHOLS Co., Chicago, Ill., has announced two new rear seat auto speakers. Model AS-1 kit includes a 6½-in. p-m. Adjust-A-Cone

Another new instrument by

DU MONT

Type 303-A Performance PLUS HIGH VOLTAGE

the new
Du Mont type
303-AH



- Up to 10,000 volts accelerating potential.
- Pulse response, 0.033 μ sec.
- 10-megacycle bandwidth.
- Maximum linear sweep speed, 10" per μ sec.
- Time calibration.
- Amplitude calibration.
- Vertical sensitivity, 0.1 p-p v in.

Now, in addition to all the features that won for the Type 303-A such wide acceptance as *the* wide-band, quantitative oscillograph in the medium-price range, *high accelerating potential* has been added. Thus the range of this versatile laboratory instrument is now extended to include the analysis of high-speed single transients, pulses of low-duty cycle, or other phenomena where high spot intensity is required. The high accelerating potential of the Type 303-AH not only makes possible the observation of extremely rapid phenomena by providing higher light output, but also produces finer spot size and hence increased resolution for more precise observation and measurement.

Intensifier potentials of 3000, 7000 or 10,000 volts may be selected in the Type 303-AH, enabling the operator to make the most satisfactory compromise between pattern brilliance and deflection sensitivity for a given signal.

In the new Type 303-AH, Du Mont presents the first high-gain, wide-band, high-voltage oscillograph in a single, small cabinet at a low cost.

SPECIFICATIONS . . .

- Type 5XP- cathode-ray tube; accelerating potentials, 3000, 7000, or 10,000 volts.
- Y-Sensitivity: 0.1 p-p v/in. (0.04 p-p v/cm.) at 3000 volts' acceleration. Sensitivity lower at higher accelerating potentials.
- Y-Frequency Response: Down less than 30% at 10 cps and 10MC at any setting of attenuator or gain control.
- Pulse Response: 0.033 μ sec.
- X-Frequency Response: d-c to 700 KC (30% down).
- Sweep Speed: 0.1 sec. to 2 μ sec; expansion on all ranges to six times full screen; max. linear sweep speed better than 10"/ μ sec (25.4 cm./ μ sec.) at 3000 volts' acceleration.
- Amplitude Calibration: 0.1, 1.0, 10, 100 volts, better than $\pm 5\%$ accuracy.
- Time Calibration: 0.1, 1.0, 10, 100 μ sec.; better than $\pm 3\%$ accuracy.
- Illuminated scale with front-panel dimmer control.
- Du Mont Type 2592-B52 shielded coaxial adapter with 52 ohm termination, included.

INSTRUMENT DIVISION, ALLEN B. DU MONT LABORATORIES, INC.
1500 Main Avenue • Clifton, N. J.

PRICE **\$990⁰⁰**

MARCONI



TELEVISION

VENEZUELA INSTALLS MARCONI



Dr. Rodriguez Jimenez, Venezuelan Consul-General in London, at the signing of a contract in the London consulate on 5th July, 1952, to provide British equipment for a television service at Caracas.

Equipment for the Caracas Television Station, sponsored by "Televisa," includes

- 5 kW vision transmitter
- 3kW sound transmitter
- Associated aerial system
- Complete studio installation
- Complete mobile O/B television unit, with two camera channels and micro-wave links

MARCONI of England

television transmitting equipment

MARCONI'S WIRELESS TELEGRAPH CO LTD · CHELMSFORD · ESSEX · ENGLAND



he's working for you

THIS FELLOW IS TRAINED IN YOUR BUSINESS. His main duty is to travel the country — and world — penetrating the plants, laboratories and management councils . . . reporting back to you every significant innovation in technology, selling tactics, management strategy. He functions as your all-seeing, all-hearing, all-reporting business communications system.

THE MAN WE MEAN IS A COMPOSITE of the editorial staff of this magazine. For, obviously, no one individual could ever accomplish such a vast business news job. It's the result of many qualified men of diversified and specialized talents.

AND, THERE'S ANOTHER SIDE TO THIS "COMPOSITE MAN," another complete news service which complements the editorial section of this magazine — the advertising pages. It's been said that in a business publication the editorial pages tell "how they do it" — "they" being all the industry's front line of innovators and improvers—and the advertising pages tell "with what." Each issue unfolds an industrial exposition before you — giving a ready panorama of up-to-date tools, materials, equipment.

SUCH A "MAN" IS ON YOUR PAYROLL. Be sure to "listen" regularly and carefully to the practical business information he gathers.



McGraw-Hill PUBLICATIONS

October, 1952 — ELECTRONICS

Sample Precision Potentiometers now available in 4 to 6 weeks



Better delivery than ever before of Fairchild Precision Potentiometers is the result of recently improved facilities and additions to personnel. Now you can expect delivery of sample standard units with windings to meet your requirements in 4 to 6 weeks after your final approved specifications are received. The same reasonable prices prevail, too.

Enlargement and realignment of facilities

and personnel also enable us to start delivery of production orders in 3 to 4 months after receipt of your order.

Thus, when you look to Fairchild for your precision - potentiometer requirements you get products built to the highest standards of quality coupled with sound engineering help that starts with your idea and carries through to final delivery.

HOW PRECISION IS DESIGNED AND BUILT INTO FAIRCHILD POTENTIOMETERS

1. Shaft is centerless-ground from stainless steel to a tolerance of $+0.0000$, -0.0002 in. which, together with precision-bored bearings, results in radial shaft play of less than 0.0009 in.

2. Mounting plate has all critical surfaces accurately machined at one setting to insure shaft-to-mounting squareness of 0.001 in./in. and concentricity of shaft to pilot bushing within 0.001 in. FIR.

3. Housing is precision-machined from



aluminum bar stock. Close tolerance of this construction permits ganging up to 20 units on a single shaft with no eccentricity of the center cups, even though only two bearings are used.

4. Windings are custom-made by an exclusive technique. This, together with precious metal alloy contacts results in guaranteed accuracies of $\pm 0.5\%$ linear and $\pm 1.0\%$ non-linear in standard type potentiometers. Higher accuracies (to 0.05%) are available in other types.

DO YOU HAVE CONTROL PROBLEMS?

Fairchild Sample Laboratory engineers are available to help you with potentiometer problems. To get the benefit of their knowledge and experience write today, giving complete details, to Potentiometer Division, Fairchild Camera and Instrument Corporation, Park Avenue, Hicksville, L. I., New York, Department 140-29A1.

FAIRCHILD
PRECISION POTENTIOMETERS

where the world's toughest transformers
are a "must" for the toughest installations...

you'll find

CHICAGO

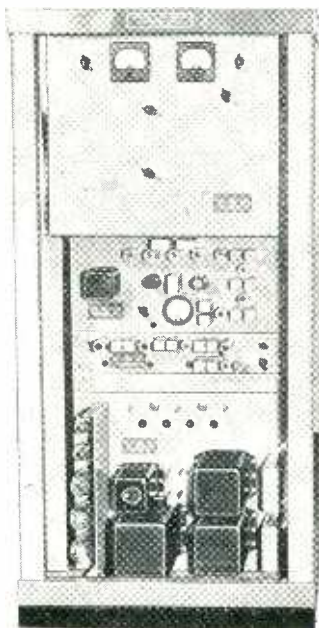

REL specifies and uses CHICAGO

You'll find CHICAGO "Sealed-in-Steel" transformers used throughout REL's FM Transmitting and Relay Equipment. Absolute dependability is a prime requirement in all REL equipment—and CHICAGO transformers contribute significantly to quality, superior performance and long time stability.



COLLINS specifies CHICAGO

This COLLINS MHF Single Frequency Communications Receiver utilizes CHICAGO "Sealed-in-Steel" transformers for trouble-free, continuous service under the most rugged operating conditions.

where the going's tough—specify CHICAGO "Sealed-in-Steel"
NEW EQUIPMENT TRANSFORMERS

CHICAGO "New Equipment" transformers (available in 3 mountings) feature one-piece drawn-steel cases—the strongest, toughest, best-looking units you can buy. The one-piece seamless design, enclosing an electronically perfect construction, provides the best possible electrostatic and magnetic shielding, with complete protection against adverse atmospheric conditions. For every application: Power, Bias, Filament, Filter Reactor, Audio, MIL-T-27, Stepdown—ask your electronic parts distributor for CHICAGO "Sealed-in-Steel" transformers.

Free "New Equipment" Catalog



Get the details on CHICAGO's full *New Equipment Line*—covering "Sealed-in-Steel" transformers for every modern circuit application. Write for your Free copy of this valuable catalog today, or get it from your distributor.

H-TYPE

Hermetic sealing meets all MIL-T-27 specs. Steel base cover is deep-seal soldered into case. Terminals hermetically sealed. Ceramic bushings. Stud-mounted unit.



S-TYPE

Steel base cover fitted with phenolic terminal board. Convenient numbered solder lug terminals. Flange-mounted unit.



C-TYPE

With 10" color-coded leads brought out through fibre board base cover. Lead ends are stripped and tinned for easy soldering. Flange-mounted unit.



speaker with capacity to handle the full output of any single-ended auto set. It has a 1.47-oz Alnico V magnet. Model AS-2 kit includes a heavy-duty 6 × 9-in. p-m Adjust-A-Cone speaker with capacity to handle the most powerful auto set made. It has a 2.15-oz Alnico V magnet. Both types feature rugged 3-position switch for dash mounting and ample cable, flocked grill screen, baffle plate, miscellaneous hardware and installation instructions.

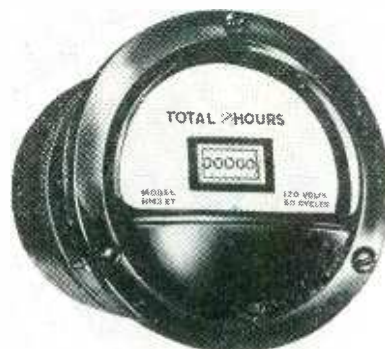

Running Time Meter

MARION ELECTRICAL INSTRUMENT Co., 401 Canal St., Manchester, N. H., has introduced a new hermetically sealed running time meter for registering the operating time of machine tools, electronic, electrical or general industrial equipment. It is designed to perform perfectly in a wide range of temperatures and in hazardous atmospheres. The unit is powered by a self-starting synchronous motor, available for 110 to 125, 220 to 250 v, 50 or 60 cycles a-c.



Crosshatch Generator

SIMPSON ELECTRIC Co., 5200 W. Kinzie St., Chicago 44, Ill. With the model 485 cross hatch pattern

CHICAGO TRANSFORMER
DIVISION OF ESSEX WIRE CORPORATION
3501 ADDISON STREET • CHICAGO 18, ILLINOIS

REFLEX

KLYSTRONS

for

RUGGED

SERVICE

8.5 to 10.0 kmc

Meet MIL-T-5422

and AN-E-19

specifications

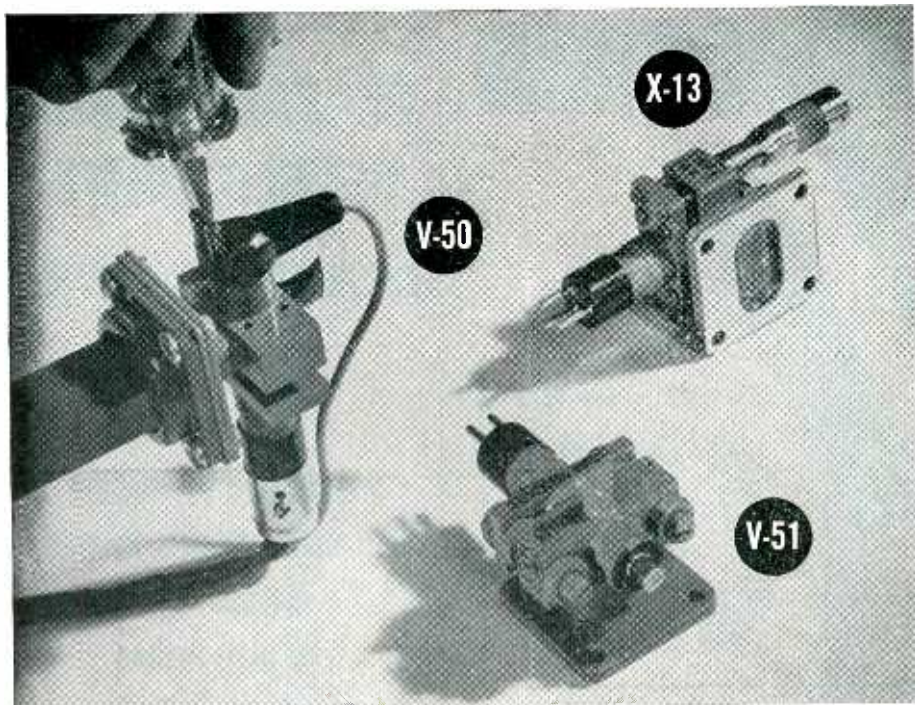

Development based on the widely-used Varian X-13 klystron has produced two new Varian tubes with unusual possibilities for X-band applications involving extreme shock and vibration.

V-50 RUGGED, TUNABLE RADAR LOCAL OSCILLATOR. Here is a tube capable of withstanding severe vibration and shocks well beyond 30 times gravity. It is tunable with extreme smoothness over the band from 8.5 to 10.0 kmc, and can be used with conventional afc circuits. Power output is 25 milliwatts, minimum, with a resonator voltage of 300 volts. The output connector mates with UG39/U flange (1 x 1/2" waveguide).

V-51 RUGGED RADAR L. O. OR LOW-POWER TRANSMITTER. Lock-nut tuning enables the Varian V-51 klystron to withstand even rougher treatment than the V-50. Frequency range, application, and construction are otherwise similar. Tuning is easily done in the field with a standard open-end wrench. This tube is capable of 75 milliwatts, minimum, at 350 volts on the resonator. The output connection also mates with a UG39/U flange.

X-13 GENERAL-PURPOSE X-BAND SIGNAL SOURCE. A versatile, stable, reliable, laboratory-type signal source, the familiar Varian X-13 klystron tunes readily with a built-in micrometer device over a wide frequency range of 8.2 to 12.4 kmc. The X-13 is not intended for rugged service. It delivers well over 100 milliwatts at a resonator voltage of 500 volts. Output connection is a UG39/U flange.

Send for your copies of data sheets giving full information about this group of X-band Varian klystrons. There is a Varian Associates field representative nearby to assist on any application problems you may have.



VARIAN associates

990 VARIAN STREET - SAN CARLOS, CALIFORNIA

Representatives in Principal Cities

Winchester Electronics

**SPECIAL
DESIGNS**

for your special
CONNECTOR
requirements

ILLUSTRATED
2/3 ACTUAL SIZE

F9S-9P-G F9P-9S-G

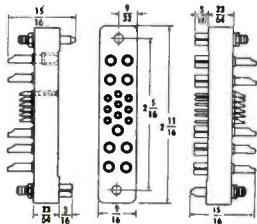

F5P-G F5S-G

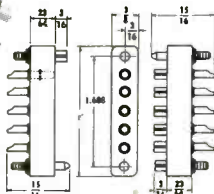

F2S-8P-G F2P-8S-G

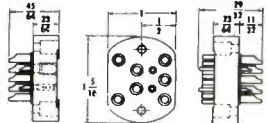

NEW DESIGNS for electronic equipment in aircraft and guided missiles have required circuit connectors with special contact sizes and arrangements. The above connectors are typical of several recent designs we have supplied to meet this need. Winchester's staff of experienced engineers is prepared to help you with your "special" connector problem.

PHYSICAL AND ELECTRICAL DATA

Plug Code No.	Receptacle Code No.	Small Contacts		Large Contacts		Weight—Oz.		D. C. Volts Breakdown Between Contacts	
		Number of Contacts	Solder Cup Dia. In.	Number of Contacts	Solder Cup Dia. In.	Plug	Rec.	Sea Level	60,000 Feet
								Normal Humidity	Altitude
F5P-G	F5S-G	—	—	5	.081	.5	.6	4500	1100
F2P-8S-G	F2S-8P-G	2	.043	8	.081	.8	.7	4500	1100
F9P-9S-G	F9S-9P-G	9	.043	9	.081	1.0	.9	4500	1100

IF GUIDE PINS ARE NOT DESIRED, OMIT "G" FROM CODE NOS.

MONOBLOC* CONSTRUCTION eliminates unnecessary creepage paths, moisture and dust pockets and provides stronger molded parts.

MOLDED MELAMINE BODIES (in accordance with MIL-P-14) mineral filled — are fungus-proof and provide

mechanical strength as well as high arc and dielectric resistance.

PRECISION MACHINED CONTACTS: Pins from brass bar (QQ-B611) and sockets from spring temper phosphor bar (QQ-B746a). They are gold plated over silver for consistent low

contact resistance, reduction of corrosion and ease of soldering.

POLARIZATION: Guide pins and guide sockets assure positive engagement.

RACK AND PANEL MOUNTING: Either plug or receptacle may be mounted on a panel or chassis.

Wire or write for catalog on other types or advise your special requirements.

**WINCHESTER
ELECTRONICS
INCORPORATED**

West Coast Branch: 1729 Wilshire Blvd.,
Santa Monica, California

GLENBROOK, CONN., U.S.A.

* Trademark

RESEARCH AND DEVELOPMENT

ENGINEERS — TECHNICIANS
— PHYSICISTS

Specialists in

Vacuum Tube Development
Micro wave - Power - Receiving
Cathode Ray
Solid State Devices
Electronic Circuitry

WESTINGHOUSE
offers you
OPPORTUNITY
FOR ADVANCEMENT

in a new expanding Electronic
Division producing for defense and
the commercial market.

Check These Outstanding Benefits:

Attractive Wages
Ideal Working Conditions
Advancement on Merit
Graduate Study Opportunities
Employee Scholarships
Beautiful Finger Lakes Section

Send resume of experience and
education to

Manager of Industrial Relations

**WESTINGHOUSE
ELECTRIC CORPORATION**

P. O. Box 284

ELMIRA, NEW YORK

Federal announces the first successful

ENCAPSULATION

of SELENIUM RECTIFIER STACKS — PLUS OTHER COMPONENTS

APPLICATIONS
RANGE FROM
TINY RECTIFIERS TO
SUB-ASSEMBLIES
AND COMPLETE
POWER SUPPLIES

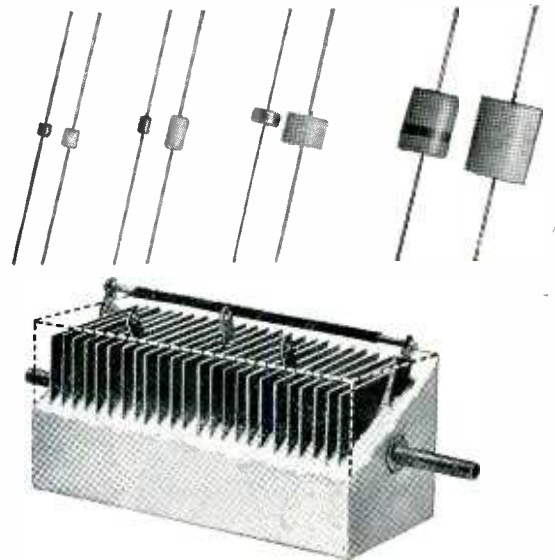

ENCAPSULATION OFFERS THESE MAJOR ADVANTAGES:

- Expands the application range of rectifiers
- Replaces oil-filled and special applications
- Ideal for sub-assemblies of various components
- Assists heat dissipation at high altitudes
- Better protection from fungus, corrosion, etc.
- Adaptable to complicated printed circuits
- Increases the over-all efficiency of equipments
- Provides ruggedness of a single, solid block

A unique development in component-sealing — opening to industry a new concept in MILITARY EQUIPMENT DESIGN

FEDERAL—America's *pioneer* in selenium rectifiers—now enables manufacturers for the first time to obtain these versatile AC-to-DC power conversion units in encapsulated form . . . to use them where special conditions formerly made their application impossible!

Encapsulation gives *new flexibility* to military equipment designers . . . offers a new means of greater protection against vibration, mechanical abuse, moisture, fungus, salt air corrosion and other hazards . . . plus faster heat dissipation in rarified atmosphere.

Sub-assemblies comprising transformers, capacitors, resistors and other components —*inter-connected with selenium rectifiers*— may now be assembled in equipments as single expendable blocks. Broad opportunities are offered to printed circuits involving numerous components. Encapsulated rectifiers also provide an improved replacement for oil-filled and other special applications.

For full information on Federal encapsulation of selenium rectifiers, power supplies and complete sub-assemblies of various components, write to Selenium-Intelin Division, Dept. F-213.

America's oldest and largest manufacturer of selenium rectifiers



Federal Telephone and Radio Corporation

SELENIUM-INTELIN DIVISION

100 KINGSLAND ROAD, CLIFTON, NEW JERSEY

In Canada: Federal Electric Manufacturing Company, Ltd., Montreal, P. Q.
Export Distributors: International Standard Electric Corp., 67 Broad St., N. Y.



generator, horizontal and vertical linearity, hold, height, width and drive adjustments may be made easily and quickly when transmitter test patterns are not available. It provides a synchronized signal, modulated on the carrier frequencies of channels 2 through 6, which can be tuned and sent through the receiver under test. When the receiver has been properly adjusted, the signal will show equally spaced lines in vertical, horizontal or cross-hatch patterns on the picture tube. All patterns are locked in place with synchronizing pulses, exactly the same as the sync pulses in transmitted waveforms, making it unnecessary to double check against actual transmitted test pattern. The output cable includes a variable termination network which is quickly adapted to provide 75 or 300-ohm terminations.

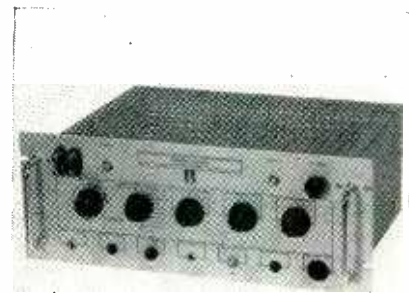

Universal Amplifier

THE BRUSH DEVELOPMENT Co., 3405 Perkins Ave., Cleveland 14, Ohio. Model BL-360 universal amplifier for rack mounting was designed for use with magnetic direct-writing oscillographs in studies of static or dynamic strains up to 100 cps when measured by the use of resistance-sensitive strain gages. The instrument was designed for use with the SR-4 120-ohm strain gage but may be used with any gage type with ohmic resistance of 50 to 1,000 ohms. Measurable range of the unit is 10 to 40,000 μ in. per in. with one active gage. Sensitivity is increased 4 times by use of 4 active gages. The control panel contains a 10-step attenuator, terminals for connection of strain gages, calibration resistor holder, resistance and capacitance bridge balance controls,

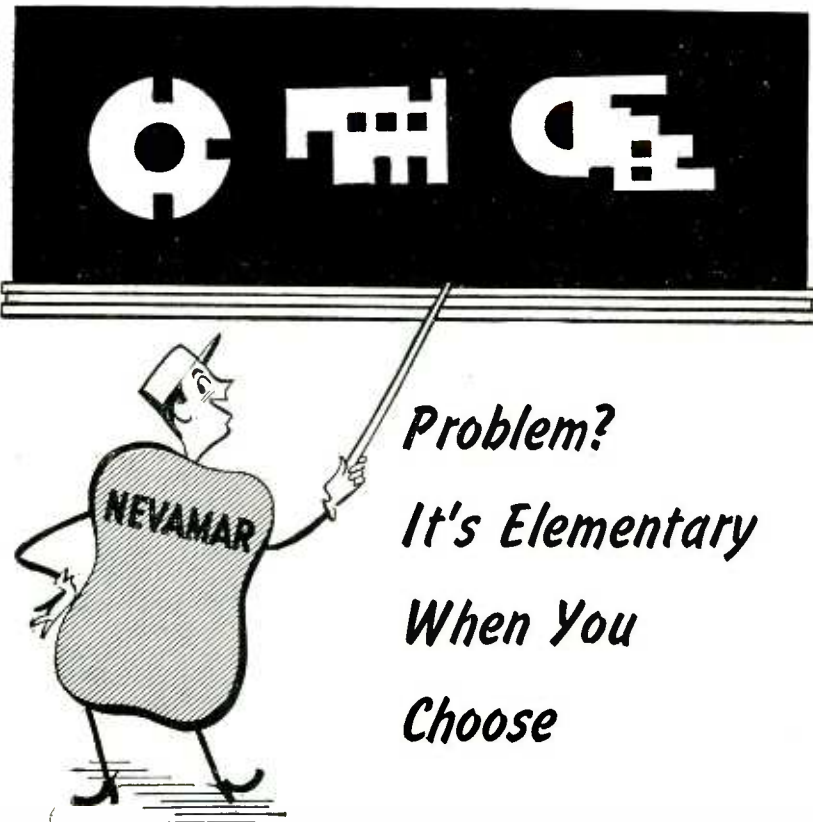

*Problem?
It's Elementary
When You
Choose*

NEVAMAR[®]

INDUSTRIAL GRADE LAMINATES

NEVAMAR industrial grade laminates simplify problems for designers and fabricators of parts and products. Produced in a number of different grades to meet varying requirements, NEVAMAR meets or exceeds the exacting standards established by the National Electrical Manufacturers' Association. Its superior properties make NEVAMAR suitable for numerous mechanical and electrical applications. Learn for yourself how NEVAMAR measures up to your requirements. We'll gladly send you samples and complete information.



 **The NATIONAL Plastic Products Company**

Manufacturers of Nevamar Decorative and Industrial Laminates • SARAN FILAMENTS • Wynene Molded Products
ODENTON, MARYLAND • NEW YORK: EMPIRE STATE BUILDING • LOS ANGELES: 5025 HAMPTON STREET

Heldor's "PACKAGE"

will save you plenty

not
this

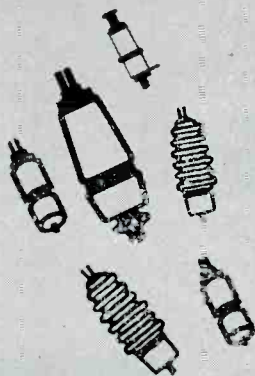

and
this

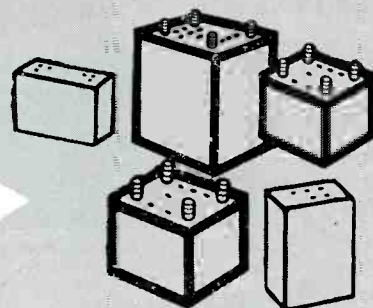

but
this!

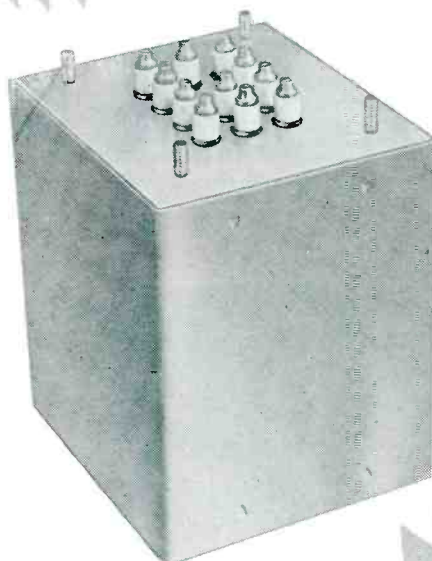

- SAVE TIME
- SAVE MONEY
- SAVE INVENTORY LOSSES
- SAVE PRODUCTION HEADACHES
- INCREASE PRODUCTION CAPACITY

Let Heldor supply you its "PACKAGE"—transformer cans with compression-type, hermetic-seal bushings ASSEMBLED in can covers, made to meet MIL-T-27 or commercial specifications—all ready for your final assembly operations.

Don't buy just cans . . . don't buy just terminals . . . buy the Heldor complete "PACKAGE" . . . and SAVE!

Send specifications of your present can and terminal assemblies. LET HELDOR'S QUOTATION ON THE "PACKAGE" PROVE HOW IT CAN SAVE YOU PLENTY!

MAIL COUPON TODAY

Enclosed are specifications.
 Quote on (Quantity) Heldor "PACKAGES"
 Send new Heldor Bushing Catalog.
 Name Title
 Company
 Street
 City Zone State



HELDOR MANUFACTURING COMPANY
 Division of HELDOR BUSHING & TERMINAL CO., INC.
 225 Belleville Avenue, Bloomfield, New Jersey

**FOR DOWNRIGHT
RECORDING
VERSATILITY**

Current
Voltage
Pressure
Temperature

*You can't beat the
system* **WHEN IT'S A
SANBORN**

Stress
Strain
RPM
Displacement

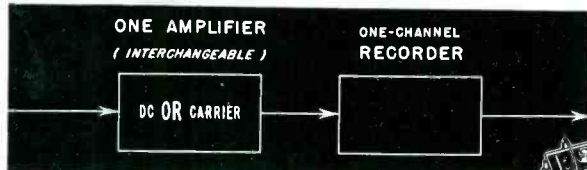

**ONE
channel**

Paper speed 25 mm/sec (slower speeds available). All systems record without ink in true rectangular coordinates.

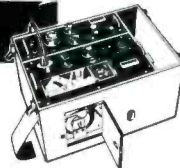

Torque
Force
Flow
Shock
Radiant Energy

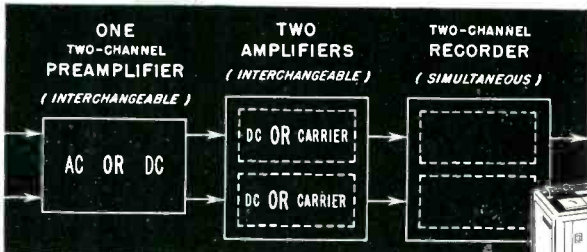

**TWO
channel**

Five dual sets of speeds, from 0.5 to 100 mm/sec. Channels on 2 and 4 channel systems operate independently of each other, register simultaneously on one record.



Light
Tension
Load
Velocity
Vacuum

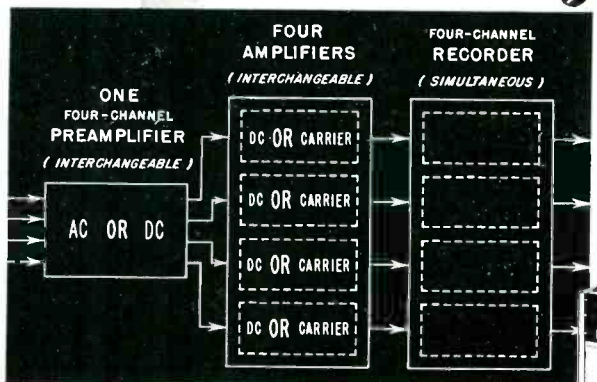

**FOUR
channel**

Eight speeds, 0.25 to 50 mm/sec. On 2 and 4 channel systems, user may record in number of channels he chooses, on corresponding widths record paper.



Gas Analysis
Humidity
Acceleration
Thickness
Sound Pressure

For complete catalog
address Industrial Division.

**SANBORN
COMPANY**

CAMBRIDGE 39, MASS.



**BIRTCHEER
TUBE CLAMPS**

Hold Tubes in Sockets
under all Vibration,
Impact and
Climatic
Conditions

**83
VARIATIONS
FOR
STANDARD
TUBES**



**NEW
CLAMP
FOR
MINIATURE
TUBES**

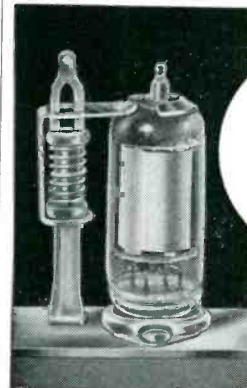

You can't shake, pull or rotate a tube out of place when it's secured by a Birtcher Tube Clamp. The tube is there to stay. Made of Stainless Steel, the Birtcher Tube Clamp is impervious to wear and weather.

BIRTCHEER TUBE CLAMPS can be used in the most confined spaces of any compact electronic device. Added stray capacity is kept at a minimum. Weight of tube clamp is negligible.

Millions of Birtcher Tube Clamps are in use in all parts of the world. They're recommended for all types of tubes: glass or metal—chassis or sub-chassis mounted.

**THERE'S A BIRTCHEER TUBE CLAMP
FOR EVERY STANDARD AND
MINIATURE TUBE!**

Write for samples, catalogue and price lists.

THE BIRTCHEER CORPORATION
4371 Valley Blvd.
Los Angeles 32, Calif.

gain controls and pen centering control. The amplifier contains a 2,000-cycle bridge energizing oscillator, high-gain a-c amplifier, phase-sensitive discriminator and d-c output amplifier.

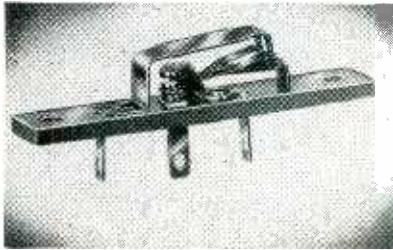

Snap-Acting Switch

THE W. L. MAXSON CORP., 460 W. 34th St., New York 1, N. Y. Wherever electrically operated apparatus has limited space for switch installation, the new Unimax type E switch offers an answer to the control problem. Requiring only $1\frac{1}{2} \times \frac{1}{8} \times \frac{3}{8}$ in., exclusive of terminals and terminal strip, the miniature switch will handle a resistive load of 10 amperes at 125 v a-c and 5 amperes at 250 v a-c. Its contacts have positive wiping action that makes the switch adaptable to use with tungsten-filament lamp loads.



Static Detector

KEITHLEY INSTRUMENTS, 3868 Carnegie Ave., Cleveland 15, Ohio, has announced the model 2005 static detector, a device that clips onto a v-t electrometer providing a convenient combination for detecting and locating static charges. The new electrometer accessory consists primarily of two concentric tubes and an aluminum rod. When clipped over the high terminal electrode of



PECO Regulated Rectifiers
PEC 615 Series

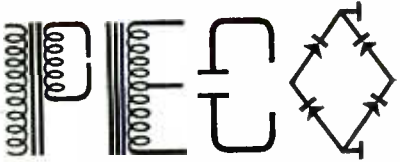

POWER for ELECTRONIC COMPUTERS

For a reliable, accurate, regulated rectifier type power supply for powering the various sections of electronic computers, the Power Equipment Company has developed the PEC 615 series of units. Already installed and powering some of the larger computer installations in the country, these units have an extremely low maintenance program for equipment of this size.

For complete specifications, write for Bulletin No. 109 today.

SPECIAL FEATURES

- Each power supply is insulated from ground so that either polarity may be grounded as required.
- Each power supply is equipped with a "high-low" protective system.
- All tubes used are operated at conservative ratings to provide long-life, with a minimum of maintenance.
- At the time of starting, the voltage is automatically applied and slowly raised to the operating condition to protect the tubes and condensers.
- Fuses are provided in each thyatron tube plate lead for maximum protection.

PECO *Custom Built* REGULATED RECTIFIERS

To meet the requirements of closely regulated and filtered rectifier type power supplies, where the total amount of power is too great to be assembled into a single cabinet, Power Equipment Company is prepared to build equipments arranged for mounting on racks, and designed to generally conform with the customer's existing or proposed apparatus. For complete specifications, write for Bulletin No. 108.

POWER EQUIPMENT

Battery Chargers • Battery Eliminators •
D.C. Power Supply Units • Regulated Exciters
• and other Special Communications Equipment

55 ANTOINETTE STREET DETROIT 2, MICHIGAN



MOSINEE

"More than Paper"



If you have a fabricating or processing problem involving paper . . . if you require definite technical characteristics and, above all, *dependable uniformity*, it may be worthwhile for you and MOSINEE technicians to get together. MOSINEE is not interested so much in terms of volume production as in our ability to render helpful service to manufacturers in the field of electronics and in the electrical goods industry. Our "paperologists" are at your service for consultation. Please write Dept. E.



MOSINEE PAPER MILLS COMPANY • MOSINEE, WIS.
Essential Paper Manufacturers

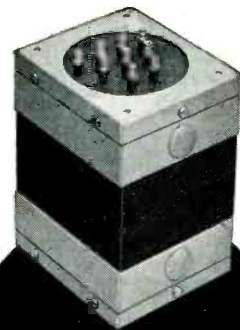

where precision matters...

THERMADOR



*Transformers for Television
... Radar... Aircraft...
Geophysics... Radio*

You will find Thermador ready, willing and fully qualified to handle your transformer requirements. Engineering experience and manufacturing know-how, developed over a period of 35 years, form the hard core that makes Thermador today's largest West Coast manufacturer of electrical appliances and transformers. We would like to work with you on your next project involving the design and production of transformers for specific requirements...including joint Army-Navy specifications.

transformers:

- Audio Auto Geophysical
- Driver Filament High-Fidelity Audio
- Input-Output Midget Plug-In
- Plate Power Television
- Tube to Line

...also Chokes and Reactors



**THERMADOR ELECTRICAL
MANUFACTURING CO.**

5110 District Boulevard • Los Angeles 22, Calif.

the electrometer, the tubes provide shielding which gives charges along the cylinder axis the most effect. Results are qualitative and observed by noting the deflection of the meter pointer. Many uses are cited for the instrument, such as locating charged bobbins in textile mills, detecting charges on moving paper in printing plants, and for sensing dangerous charges in explosives plants.

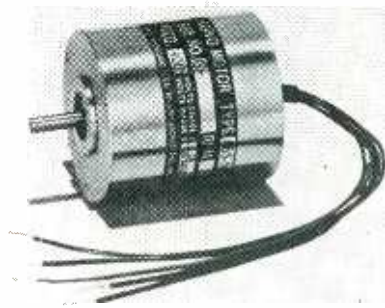

Precision Servo Motors

G-M LABORATORIES INC., 4300 N. Knox Ave., Chicago 41, Ill., has introduced a small precision servo motor measuring 1.7 in. in diameter and 1 1/4 in. long, for frequencies varying from 60 to 400 cycles, and in 2, 4 or 8-pole construction. Stall torque is approximately 2 in. oz. The extreme precision required in these motors involves tolerances as small as ±0.0001. The motors can be supplied to meet rigid military specifications with regard to humidity, temperature, range, vibration and altitude.



Liquid Level Control and Indicator

INDUSTRIAL ELECTRONICS Co., INC., Hanover, Mass. The Acrafloat is a ruggedly built, industrial type in-



Electronic equipment manufactured by the Electronics Division of Westinghouse Electric in Baltimore must meet rigid performance specifications. To evaluate this equipment under controlled atmospheric conditions, Westinghouse uses a Bowser Walk-In Room which will simulate temperatures from -85° F. to +176° F., and relative humidity from 20% to 95%. In addition, pressures found at altitudes up to 80,000 feet can be created. The entire test facility is operated and controlled from a remote control station.

The complete room was designed, built and installed by Bowser. This unit is an example of what Bowser can do to help anyone whose products require testing, processing, or stabilized storage. Environmental simulation units, as well as other Bowser equipment, can be engineered to meet individual requirements with unlimited specifications for size, temperature and humidity ranges and peak altitude.

PROGRESS REPORT
To meet the increasing demand for Bowser test equipment, a new building containing 5,000 sq. ft. of floor space has just been added to our facilities . . . and to carry on our policy of independent research, we have doubled our engineering staff.

Why not take advantage of Bowser's long continuous experience, the first and best in the field. Our trained engineers are available for consultation at your plant without obligation.

✓ CHECK AND MAIL TODAY

BOWSER
TECHNICAL REFRIGERATION
DIVISION BOWSER INC.
TERRYVILLE • CONN.

BOWSER TECHNICAL REFRIGERATION, Terryville, Conn.

Send information on test equipment checked:

- High Temperature
- Low Temperature
- Temperature Shock
- Humidity
- Altitude
- Walk-In Rooms
- Fungus Resistance
- Rain and Sunshine
- Sand and Dust
- Immersion
- Explosion Proof
- Vapor Tight
- Special Engineering

Name _____ Pos. _____

Company _____

Street _____

City _____ Zone _____ State _____ 8-5

Autosyn* SYNCHROS

Precision-Built by
ECLIPSE-PIONEER



For more than 18 years, Eclipse-Pioneer has been a leader in the development and production of high precision synchros for use in automatic control circuits of aircraft, marine and other industrial applications. Today, thanks to this long experience and specialization, Eclipse-Pioneer has available a complete line of standard (1.431" dia. X 1.631" lg.) and Pygmy (0.937" dia. X 1.278" lg.) Autosyn synchros of unmatched precision. Furthermore, current production quantities and techniques have reduced cost to a new low. For either present or future requirements, it will pay you to investigate Eclipse-Pioneer high precision at the new low cost.

*REG. TRADE MARK BENDIX AVIATION CORPORATION

AVERAGE ELECTRICAL CHARACTERISTICS—AY-200 SERIES**

	Type Number	Input Voltage Nominal Excitation	Input Current Milliamperes	Input Power Watts	Input Impedance Ohms	Stator Output Voltages Line to Line	Rotor Resistance (DC) Ohms	Stator Resistance (DC) Ohms	Maximum Error Spread Minutes
Transmitters	AY201-1	26V, 400~, 1 ph.	225	1.25	25+j115	11.8	9.5	3.5	15
	AY201-4	26V, 400~, 1 ph.	100	0.45	45+j225	11.8	16.0	6.7	20
Receivers	AY201-2	26V, 400~, 1 ph.	100	0.45	45+j225	11.8	16.0	6.7	45
Control Transformers	AY201-3	From Trans. Autosyn	Dependent Upon Circuit Design				42.0	10.8	15
	AY201-5	From Trans. Autosyn	Dependent Upon Circuit Design				250.0	63.0	15
Resolvers	AY221-3	26V, 400~, 1 ph.	60	0.35	108+j425	11.8	53.0	12.5	20
	AY241-5	1V, 30~, 1 ph.	3.7	--	240+j130	0.34	239.0	180.0	40
Differentials	AY231-3	From Trans. Autosyn	Dependent Upon Circuit Design				14.0	10.8	20
**Also includes High Frequency Resolvers designed for use up to 100KC (AY251-24)									
AY-500 (PYGMY) SERIES									
Transmitters	AY503-4	26V, 400~, 1 ph.	235	2.2	45+j100	11.8	25.0	10.5	24
Receivers	AY503-2	26V, 400~, 1 ph.	235	2.2	45+j100	11.8	23.0	10.5	90
Control Transformers	AY503-3	From Trans. Autosyn	Dependent Upon Circuit Design				170.0	45.0	24
	AY503-5	From Trans. Autosyn	Dependent Upon Circuit Design				550.0	188.0	30
Resolvers	AY523-3	26V, 400~, 1 ph.	45	0.5	290+j490	11.8	210.0	42.0	30
	AY543-5	26V, 400~, 1 ph.	9	0.1	900+j2200	11.8	560.0	165.0	30
Differentials	AY533-3	From Trans. Autosyn	Dependent Upon Circuit Design				45.0	93.0	30

For detailed information, write to Dept. C.

ECLIPSE-PIONEER DIVISION of
TETERBORO, NEW JERSEY



Export Sales: Bendix International Division, 72 Fifth Avenue, New York 11, N. Y.

*Sapphire...
Glass...*

**PRECISION
Jewel Bearings**

by
Bird



At your service, for all small bearing problems, the Bird Company engineering staff designs accurate sapphire and glass jewel bearings used in the world's most famous aircraft, electrical and timing instruments; weather and all types of recorders; and fine indicating apparatus.

Close tolerances, accuracy, and long life qualify Bird Jewel Bearings to insure quality in your finest instruments.

Quotations on request for jewels made to specifications for your individual requirements.

The engineering staff of the Bird Company is at your service for all small-bearing problems.

Serving industry with fine jewels since 1913

Richard A. Bird & Co., Inc.
Sapphire and glass jewels • Precision glass grinding
Ferrite precision products • Sapphire styli
7 Spruce Street, Waltham 54, Mass.

Let WILLIAMS
help you apply
ferric oxides to
the manufacture
of your

ferrites

You'll be well repaid by getting the facts on a special group of Pure Ferric Oxides, developed by Williams especially for use in the manufacture of ferrites.

Williams Ferric Oxides analyze better than 99% Fe₂O₃. They contain a minimum of impurities. They are available in a broad range of particle sizes and shapes. Among them, we're certain you'll find one that's "just right" for your requirements. The proper application of Ferric Oxides to the manufacture of Ferrites is our specialty.

Tell us your requirements... we'll gladly send samples for test. Chances are good that our Ferric Oxide "Know How" can save you considerable time and money. Address Dept. 25, C. K. Williams & Co., Easton, Pa.

WILLIAMS
COLORS & PIGMENTS

C. K. WILLIAMS & CO.
Easton, Pa. • East St. Louis, Ill.
Emeryville, Cal.

P. S. We also produce IRN
Magnetic Iron powders for the
Electronic Core Industry, the
Magnetic Tape Recording Industry
and others. Write for complete
technical information.

ENGINEERING SERVICE

...in the field

to help you get the most from your TEKTRONIX instruments

EASTERN DIVISION OFFICE

TEKTRONIX, INC., 49 PONDFIELD ROAD, BRONXVILLE 8, NEW YORK
BRonxville 2-3266

J. J. Cassidy Jack Day George Edens

BRANCH OFFICES

TEKTRONIX, INC., BALTIMORE 14, MD.
8118 Harford Road
Boulevard 2600
G. E. Bauder F. K. Frost

TEKTRONIX, INC., SYRACUSE 10, N. Y.
313 Nottingham Road
Phone: 72-3339
Byron Broms

TEKTRONIX ENGINEERING REPRESENTATIVES

Arizona, PHOENIX

Neely Enterprises
32 West Jefferson St.
Phone: 4-7311
Bill Saxon

Colorado, DENVER, 10

Ronald G. Bowen Co.
852 Broadway
Acoma 5211
R. G. Bowen

Missouri, KANSAS CITY, 3

Everett Associates
1629 East 31st Street
Armour 9539
Eugene Shapiro

Oklahoma, TULSA

M. F. Klicpera Company
P.O. Box 1012
A. R. Loomis

Oregon, PORTLAND, 14

Hawthorne Electronics
700 S. E. Hawthorne Blvd.
VERmont 5585
Glenn McDowell
Jack Stevenson

California, HOLLYWOOD, 46

Neely Enterprises
7422 Melrose Avenue
Whitney 1147
N. B. Neely
R. L. Morgan
John O'Halloran

Florida, FORT MYERS

Arthur Lynch & Associates
P.O. Box 466
Fort Myers 5-6762
Arthur H. Lynch

New Mexico, ALBUQUERQUE

Neely Enterprises
107 So. Washington St.
Phone: 5-8731
L. E. French
Hoyt Westcott

California, SACRAMENTO, 14

Neely Enterprises
1317 15th St.
GIlbert 2-8901
Rudy Poucher

Illinois, CHICAGO, 45

Everett Associates
6744 N. California Ave.
AMBassador 2-3702
Jim Everett
Geo. Knackstedt
Dave Pivan

North Carolina, HIGH POINT

Bivins & Caldwell
Security Bank Bldg.
Phone: 3672
John Bivins
Dave Caldwell
C. M. Smith, Jr.

California, SAN FRANCISCO, 3

Neely Enterprises
2830 Geary Blvd.
WAlnut 1-2361
Jack Ingersoll
Don Kestell

Michigan, DETROIT, 14

The Satullo Company
7635 E. Jefferson
Lorain 8-1508
Anthony R. Satullo

Ohio, CLEVELAND

The Satullo Company
1125 Fidelity Bldg.
Prospect 1552
Howard Heasley

Texas, DALLAS, 8

M. F. Klicpera Company
P.O. Box 4117, Station A
FEderal 0992
Jay T. Jones, Jr.

Texas, HOUSTON, 1

M. F. Klicpera Company
P.O. Box 3113
JACKson 2-8459
Mil Klicpera

Utah, SALT LAKE CITY

Ronald G. Bowen Co.
P.O. Box 2215
A. W. Bradford

TEKTRONIX OVERSEAS DISTRIBUTORS

Belgium, BRUSSELS

Etudes et Recherches
Industrielles
13 Rue D'Egmont
Phone: 12. 31. 90.
A. C. Schoepp
L. Woygnet

Brazil, RIO DE JANEIRO

Empresa Comercial
Importadora Limitada
Rua Araujo
Porto Alegre, 70-8°
Phone: 42-9460 and
42-9649
J. M. Toureng

France, PARIS 16e

Relations Techniques
Intercontinentales
4 bis, rue de l'Assomption
Miron Kaplan
A. Antoine

South Africa, JOHANNESBURG

Protea Holdings, Ltd.
7 Newton St., Wemmer
Phone: 33-2211
Eric Mance

Israel, TEL AVIV

Joseph Giveon
92 Allenby Road
Joseph Giveon

Norway, OSLO

Eugen Nilsson
Møllergaten 8
Phone: 331428
Jens A. Stavnes

Sweden, STOCKHOLM, 32

Erik Ferner
Postfack
Phone: 198949
Erik Ferner

(TEKTRONIX Field Engineers are equipped for ordinary field maintenance problems. If modernization or complete reconditioning is desired, the instrument must be returned to the factory. Whenever available, a substitute instrument will be provided on a loan basis. Please ask your TEKTRONIX Field Engineer for complete details.)



TEKTRONIX, Inc.

P. O. BOX 831A, PORTLAND 7, OREGON

Phone: CYpress 2-2611

Cable: TEKTRONIX

SIGNAL ENGINEERING HERMETICALLY SEALED RELAYS

Meet AN Standards or Armed Services Applications

Compact, multiple contact... vibration and shock proof. Built to meet rigid specifications and severe operating conditions.

Unique pile up arrangement reduces over-all space compared with conventional relays.



Octal base, snap-on dust cover or hermetically sealed. Also AN connector.

**SERIES 80
MIDGET
TELEPHONE
TYPE
RELAYS**

**NEW
CONTAINER
SAVES SPACE**



Hermetically sealed header type: 2" h. above mounting surface, x 1 5/8" w. x 1" d.

Write for Bulletin MTR-6

Engineering Representatives in Principal Cities

Wheelock RELAYS

SIGNAL
ENGINEERING & MFG. CO.
154 WEST 14TH ST. NEW YORK 11, N.Y.

DETACH AND MAIL COUPON BELOW

Gentlemen:
Without obligation, please give us information regarding your HERMETICALLY SEALED RELAYS for following application:

.....

Company.....

Name..... Title.....

Address.....

City..... State.....

NEW! AVAILABLE NOW

**KELLOGG CODE 101-A
20 cycle
INVERTER**



Reliable - Fast Starting - Efficient

This new 20 Cycle Inverter was designed and developed in Kellogg Laboratories for military use. Now, in addition to military application, it is available for commercial purposes. Check your requirements against the features, exclusive with Kellogg, that are listed below.

- A miniaturized, hermetically sealed inverter designed to provide a 20 cps output from a DC source.
- Suitable for a variety of applications where a source of 20 cps ringing signals is required.
- Incorporates a special noise suppression filter.
- Operates over a wide range of DC input voltages from 80 to 140 volts.
- Reaches full output in less than 0.25 sec.

Output voltage (p. to p.)... = DC input voltage
Output frequency..... 20 cps \pm 1.5 cps
Contact rating..... 30 VA. .25 amps. max.
Contact dwell..... 74% min.
Operating Temp..... -40°C to 85°C
Overall size (approx.)..... 3-11/32 L x 2-1/32 W x 2-7/8 H
Mounts..... 4 No. 4-40 x 1/4 studs
Mtg. Dimensions..... 1-23/32 x 2-29/32
Dielectric strength..... 200 V. DC each terminal to case

KELLOGG



SWITCHBOARD AND SUPPLY CO.

For more information write Dept. 26-J

..... Sales Offices: 79 W. Monroe St., Chicago 3, Ill.
An Associate of International Telephone and Telegraph Corporation

"PERFECT.."



That's What Production Engineers Say about DANCO COILS

And, it's no accident, of course. The Danco rigid policy of attentive testing and inspecting every coil in all vital stages of production guarantee perfect performance.

Send us samples or specifications with quantity requirements for our recommendation. No obligation!

- Form Wound
 - Paper Section
 - Acetate Bobbin
 - Molded Coils
 - Bakelite Bobbin
 - Cotton Interweave
 - Coils for High Temperature Application.
- Also, Transformers Made To Order



THE DANCO ELECTRIC CO.
93 MAIN ST., WINSTED, CONN.

TYPE "M"

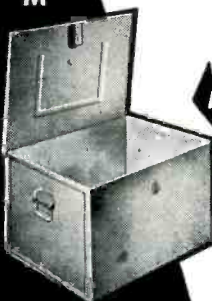

19 STOCK SIZES AT PUBLISHED PRICES!

NOW available to you... without costly sub-contracting problems

MIL-B-233A SPARE-PARTS BOXES...

FOR THE PROTECTION OF ON-BOARD REPAIR PARTS

Stock standard TYPE M STEEL SPARE OR REPAIR PARTS BOXES, made in strict accordance with Military Specifications. To better service your need for Specification Spare-Parts Boxes we have put them on a mass production line.

Write for Size and Price Chart
DOLIN METAL PRODUCTS INC.
319 LEXINGTON AVE., BROOKLYN 16, N. Y.

strument designed for controlling and indicating liquid levels, especially in those applications beyond the scope of the conventional liquid level controls. The unit has no electrodes, thereby eliminating danger of shock or explosion. It operates equally as well on nonconductive liquids as it does on conductive liquids. Parts exposed to the liquid are normally made of stainless steel and can be made of other corrosion resisting materials such as glass or ceramic. If the proper size wire is provided between the float and the control to avoid voltage drop, the control can be located at a considerable distance from the float.



Home Music Amplifier

NEWCOMB AUDIO PRODUCTS Co., 6824 Lexington Ave., Hollywood 38, Calif., has introduced the Classic 25 amplifier with complete remote control unit. Frequency response extends from below 10 to over 100,000 cycles. A newly developed Audibalance permits one to achieve perfect balance of output tubes in seconds. Six inputs are provided for radio, tv, tape recorder, crystal and 2 magnetic pickups. A cross-over selector simplifies attainment of correct playback response, includes foreign and domestic frequencies and the new AES standard.

Resonant Amplifier

KALBFELL LABORATORIES, INC., P.O. Box 1578, 1090 Morena Blvd., San Diego 10, Calif., has available a new type of resonant amplifier giving high-Q performance at very low frequencies, as well as at audio frequencies. The compact plug-in unit measures $2 \times 2 \times 4\frac{1}{2}$ in. The well known method of incorporating a twin-T filter in the feedback loop of an amplifier is employed, but

New Flasher Light R-F Noise Filter

Weight cut 50%; volume reduced to 29% of original on radio interference filter for flashing navigation lights

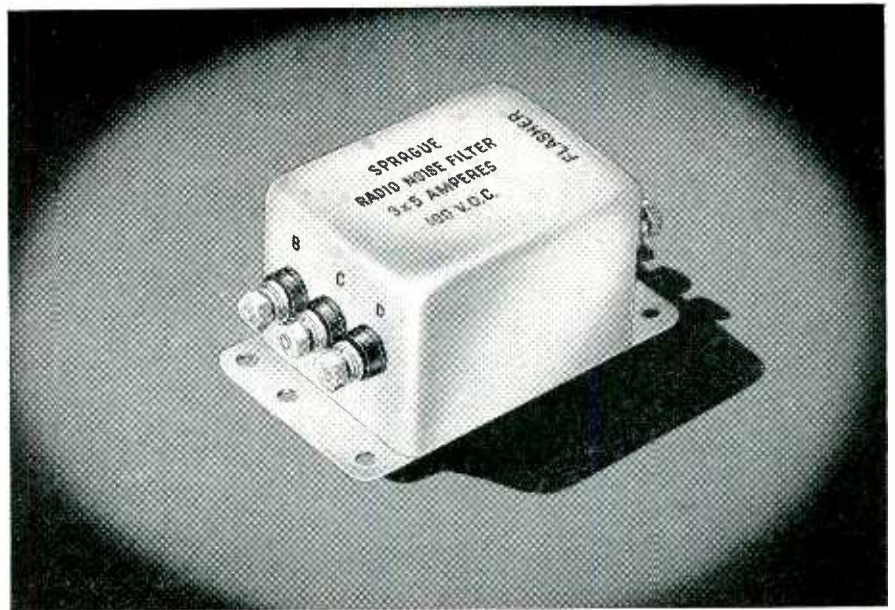

One of the first tasks before the recently opened Western radio noise suppression laboratory of the Sprague Electric Company, at 11325 Washington Boulevard, Culver City, Calif., was a difficult radio interference problem concerning flashing navigation lights on a new plane design.

Working with another supplier, the aircraft manufacturer's engineers had developed a filter assembly made of three general purpose filters, assembled in a special housing. The completed filter assembly was 41 cubic inches in volume and weighed 30 ounces. It involved not only procurement of all component parts, but costly engineering drawing, production and assembly operations on the part of the airplane manufacturer.

► The size and weight of this three-circuit filter were a disappointment, and one of the aircraft engineers mentioned this casually to a Sprague field engineer. Only three weeks remained before the plane design was to be frozen but the Sprague engineer volunteered to see what could be done. Well within the allotted time, the Sprague laboratory

came up with the answer, shown in the photograph. The new Sprague filter, designed specifically for the application, is only 12 cubic inches in volume and weighs only 15 ounces, yet has superior attenuation characteristics to the unit it replaces. And it is furnished complete and ready for installation!

► Today, from the production facilities of the world's largest capacitor factory in North Adams, Mass., Sprague filters are regularly meeting West Coast plane manufacturers' production schedules.

Since the design of this filter, Sprague's West Coast Laboratory has proven equally as helpful on crash programs in more than a dozen other critical situations. Sprague engineers both at Culver City and at the Central Research and Development laboratories in North Adams are fully acquainted with the critical problems that call for "tailoring" filters to meet specific mounting, vibration, and shock requirements, as well as the severe minimum insertion loss limits of today's newest military electrical and electronic gear.

► Sprague engineers will recommend one of several thousand existing designs if these fill the bill, but they do not hesitate to roll up their sleeves on those "specials" which are fast becoming standard as the aircraft industry forges ahead.

A telephone call to Sprague's Culver City office—TEXAS 0-7491, or to the executive offices in North Adams—North Adams 423, will enlist the services of a Sprague filter engineer without obligation on your part.

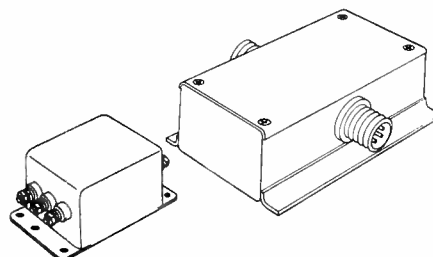

Size comparison. Original filter assembly right; new Sprague 3-circuit filter unit at left.

(Advertisement)

TRANSFORMERS

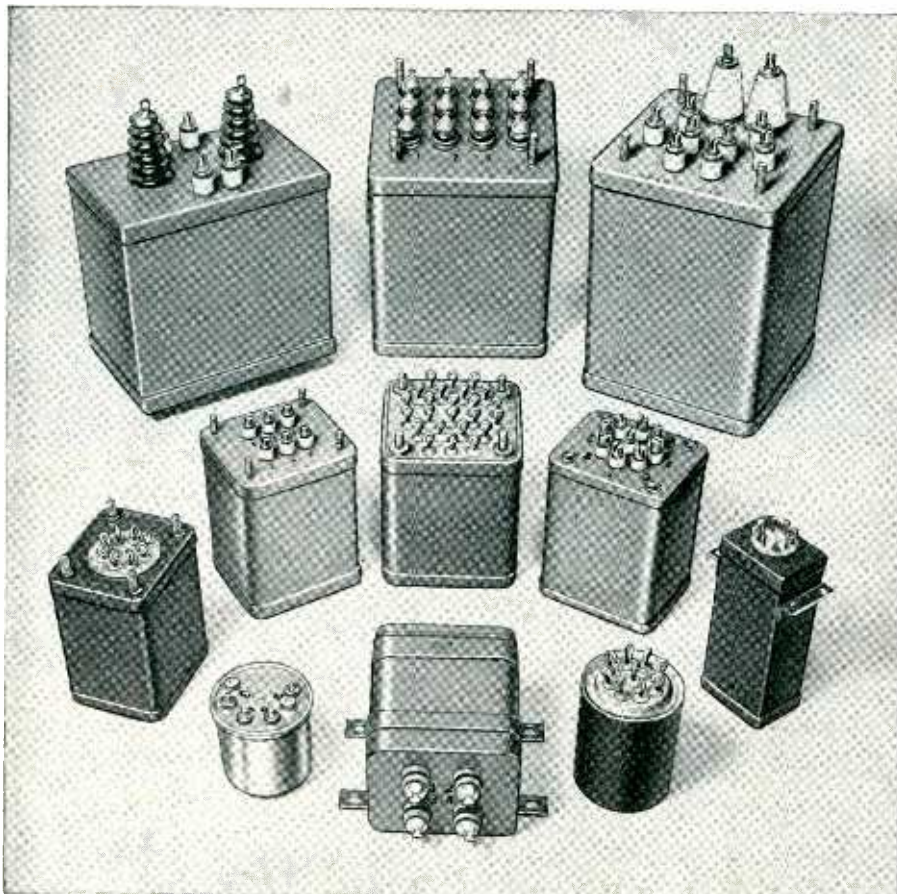

HERMETICALLY SEALED TO MIL-T-27 SPECIFICATIONS

NYT offers a wide variety of transformer types to meet military and civilian specifications, designed and manufactured by specialists in transformer development.

Latest NYT service for customers is a complete test laboratory equipped and approved for on-the-spot MIL-T-27 testing and faster approvals.

**NEW YORK
TRANSFORMER CO., INC.**
ALPHA, NEW JERSEY

If...

YOU CHANGE YOUR ADDRESS

Be sure to notify us at once, so future copies of **ELECTRONICS** will be delivered promptly.

Also make certain you have advised your local Post Master of your new address so other important mail doesn't go astray.

Both the Post Office and we will thank you for your thoughtfulness. Mail the information below to: Subscription Dept., **ELECTRONICS**, 330 W. 42nd St., New York 36, N. Y.

New

Name

Address

City..... Zone.... State.....

Company Title.....

Old

Name

Address

City..... Zone.... State.....

ELECTRONICS

330 W. 42nd St.
New York 36, N. Y.

A PRACTICAL SOLUTION TO THE

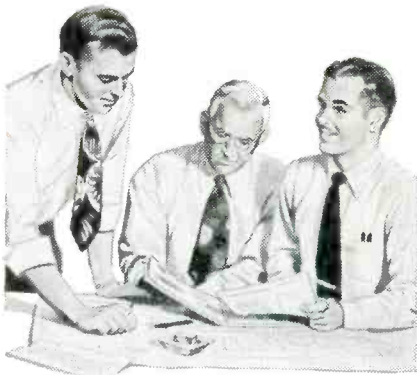

TECHNICAL MANPOWER SHORTAGE PROBLEM

Are you interested in the possibility of getting some of your testing and trouble shooting work done without hiring another man?

Our solution is very direct. No doubt many of your trained engineers and chemists are tied down by routine but essential testing tasks. You can release these men for more demanding, more responsible duties by entrusting our laboratories with your routine testing schedules.

Why is this possible? Because Testing is our Business. Your tests will be handled by men who live, breathe, and think testing. They will receive the care and attention that only a specialized laboratory can give them. That means speed, accuracy, and real economy.

We would like to get together and discuss your manpower problems and possibly point the way to a solution.

Write for booklet describing our services.

UNITED STATES TESTING COMPANY, Inc.

ESTABLISHED 1880

1550 Park Avenue, Hoboken, N. J.

PHILADELPHIA • BOSTON • PROVIDENCE
CHICAGO • NEW YORK • LOS ANGELES
MEMPHIS • DENVER • DALLAS

Member of American Council of Commercial Laboratories

ANNOUNCING IMPROVED SHIELDING ROOMS FOR R-F INTERFERENCE SUPPRESSION

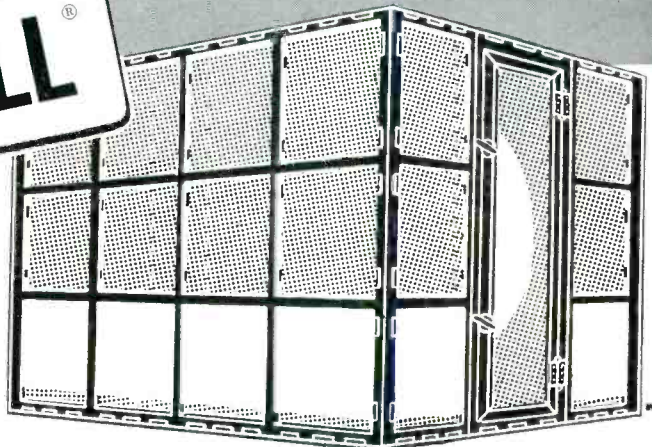
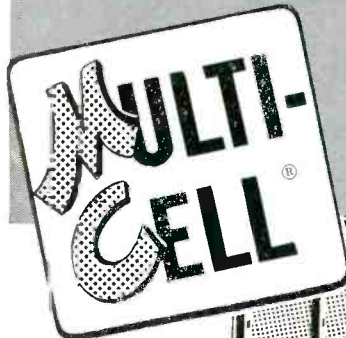

Double shield, multiple cell type screen room

Better 9 Ways

1. HIGHER ATTENUATION
min. 100db from .15 to 10,000 MC
2. SILVER PLATED CONTACT BETWEEN ALL SEAMS
3. DOOR CONTACT STRIPS HEAVILY SILVER PLATED
4. AIR INLET FOR CHOICE OF VENTILATION
5. IMPROVED HANDLES FOR LEAK-PROOF DOORS
6. BUFFER PANELS FOR PROTECTION OF OUTSIDE SCREENS
7. PANELS UNDER CONSTANT PRESSURE WITH EXCLUSIVE BOLTING SYSTEM
8. COPPER FILTER PANEL SUPPLIED WITH LINE FILTER
9. ALL PANEL SECTIONS INTERCHANGEABLE

Designed and built by
AMERICA'S MOST EXPERIENCED SHIELDING ENGINEERS

Backed by years of experience in hundreds of major installations. MULTI-CELL® Screen Rooms meet Jan-1-225, 16E4 (Ships), MIL-I-6181 and all other specifications for electrical and electronic equipment performance in research, development and production.

Let us show you how to **SAVE MONEY!**

Not only is our service exceptionally fast but our price will cut your expenses. We construct every type of enclosure: Solid or screen. Double shield, multiple cell. Double shield, isolated cell. Single shield. No obligation for engineering consultation.

Write for Bulletin No. 10



SHIELDING, INC.

R-F SHIELDING ROOMS

RIVERSIDE PARK, N. J. "The Talent to Create — The Skill to Produce"

Phone: Riverside, N. J. 4-1202

NEW MINIATURE

5-ampere Radio Interference Filter

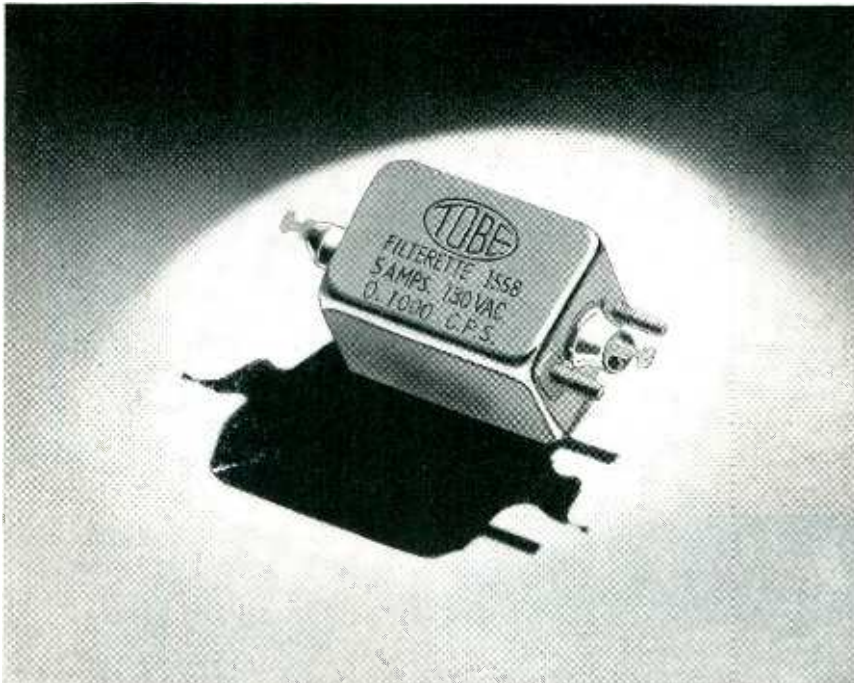

In a space only $1\frac{1}{4} \times 1\frac{1}{8} \times 1\frac{3}{4}$ inches, this new, miniature, radio interference filter provides more than 86 db attenuation from 0.6 to 30 megacycles and handles five amperes at 130 volts, 0-1000 cycles per second, with a voltage drop of only 0.25 volt at full load. This unit is designed for bulkhead mounting, with input and output terminals on opposite sides of the bulkhead. The Type 1558 Miniature Radio Interference Filter is hermetically sealed in a drawn, metal case with glass terminals. It is built to withstand the shock and vibration of aircraft service. Attenuation characteristics are shown on the curve below.

For help with any interference problem, call on Tobe — specialist in filtering since 1929, originator of modern filtering methods.

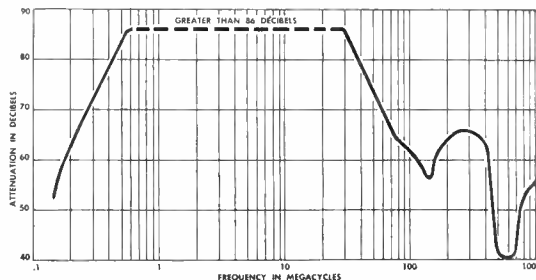

TOBE DEUTSCHMANN
CORPORATION
NORWOOD, MASSACHUSETTS

some novel direct-coupled features give stable values of Q up to 100 plus feedback stabilization of gain even at the peak of the frequency response curve. Ask for peaked amplifier bulletin 504.



Mercury Switches

MICRO SWITCH, Freeport, Ill., has announced newly designed Honeywell mercury switches embedded in plastic potting compounds for added protection. The first of these new switch assemblies is the 1MP1 switch whose overall size is $2\frac{1}{2}$ in. long, $3\frac{1}{4}$ in. wide and $1\frac{1}{2}$ in. high. This unit provides less than 1 deg differential angle, with an electrical rating of 2 amperes 115 volts a-c, or 1 ampere 115 volts d-c. Contact arrangement is single-pole, normally open.



Relay Racks

PREMIER METAL PRODUCTS Co., 3160 Webster Ave., Bronx 7, N. Y., announces the manufacture of a line

of enclosed relay racks rigidly constructed of 16 gage cold rolled sheet steel. The panel mounting angles of 12 gage steel are tapped for 10/32 machine screws on Western Electric spacings. Panels fit into a recess so that edges are not exposed. Rear doors are hung on sturdy loose-jointed hinges and closed by a flush snap catch. A complete catalog of precision-built metal housings is available on request.

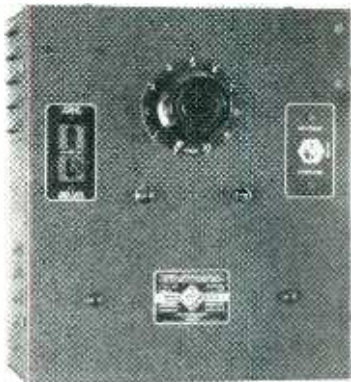

Motor Speed Control

GENERAL RADIO Co., 275 Massachusetts Ave., Cambridge 39, Mass. Designed for light production work where a 1/2 h-p motor is used, the type 1702-A Variac speed control uses no electronic tubes and so takes no warm-up time. Instant starting and reversing are provided together with strong dynamic braking. It saves production time. Typical applications are on lathes, for instance, where several operations are done on the same piece at different optimum speeds; or for operations such as blind tapping where gradual starting and stopping is desired.

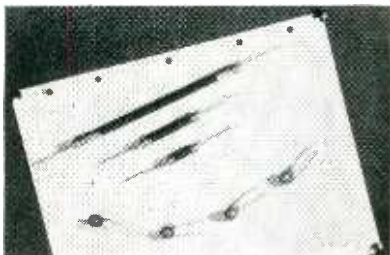

Miniature Resistors

GENERAL ELECTRIC Co., Schenectady 5, N. Y., has expanded its line

PULSE FORMING NETWORKS



- Any pulse width from 0.1 to 40 microseconds
- Any impedance from 5 to 500 ohms
- Any voltage rating from 1000 to 25000 volts*

Tobe pulse forming networks have an excellent record of performance, both in radar sets and in seasoning equipment for magnets and hydrogen thyratrons. Our design experience and production facilities assure deliveries to your schedule requirements. Widely used networks are tabulated below. Many others are available — write for data sheet.

TOBE TYPE	CODED IDENTIFICATION	DIMENSIONS (exclusive of terminals)
DPN-1	3 - 0.75 - 800	50P6T 2 1/2 x 3 3/4 x 3 1/2
	9 - 2.25 - 300	
	14 - 3.50 - 200	
	20 - 5.00 - 200	
GEPN-2	2.64E2 - 0.4 - 800-50P2T	1 13/16 x 1 1/16 x 2 5/8
GEPN-4 14E	2 - 0.5 - 2000	50P4T 8 x 4 x 4 1/4
	7 - 0.185 - 380	
	9 - 2.35 - 380	
RCPN-2	17E3 - 2.0 - 600 - 50P2T	3 x 6 x 7
RCPN-4	24E2 - 1.0 - 630 - 25PY2T	10 x 4 1/2 x 7 9/16
RPN-5	11.5E4 - 2.0 - 400 - 16P2T	5 1/4 x 10 x 10
SPN-8	6E4 - 0.45 - 2000 - 50T2T	3 3/4 x 2 1/4 x 4 3/4
SPN-14	2 - 0.25 - 4000	55P8T 4 x 8 x 2
	4 - 0.50 - 2000	
	7 - 1.0 - 1000	
	12 - 2.0 - 500	
SYPN-6	2E3 - 1.0 - 50 - 50P2T	1 1/16 x 1 13/16 x 3 3/4

*Over 25KV, pulse-type capacitors with external coils are usually recommended; write for data sheet.



TOBE DEUTSCHMANN CORPORATION
NORWOOD, MASSACHUSETTS

Thyratrons



RCA-2050. Most widely used thyratron... rated for max. peak cathode current of 1.0 amp. and a max. peak inverse anode voltage of 1300 v.

... your choice, up to 15,000 volts!*

RCA is headquarters for a wide line of thyratrons—gas, hydrogen, and mercury-vapor types, triodes and tetrodes, miniatures and jumbo sizes. Peak cathode current ratings range from 0.1 to 77 amperes, maximum. Anode voltage ratings range from 350 to 15,000 volts, maximum peak inverse!



For prompt, on-the-spot service, call your local RCA Tube Distributor. He can supply you with RCA thyratrons—and all types of RCA tubes for industrial applications.

*Maximum peak inverse rating



TMK.®

RADIO CORPORATION of AMERICA
ELECTRON TUBES
HARRISON, N. J.

Advertisers:

How about the NUCLEAR field?

There are a good many advertisers using **ELECTRONICS**, who should also be advertising in **NUCLEONICS**.

Particularly in instrumentation and laboratory equipment, there is a cross-over of use in the electronic and in the nuclear field.

But, there is very little cross-over in the subscriber lists of the two publications—a matter of a few percentage points.

It is quite possible that you are doing an effective presentation of your products and abilities in this excellent issue, but are missing such presentation before one of the fastest growing fields in the country's history—the field of atomic energy.

The sales representatives of **ELECTRONICS** are also the sales representatives of **NUCLEONICS**. They have much evidence pointing to the opportunities in this great **NEW** field. Ask them to show you what your potentials can be.

NUCLEONICS

ABC

ABP

A McGraw-Hill Publication
330 West 42nd St.
New York 36, N. Y.

- ELECTRONIC DESIGN ENGINEERS
- TECHNICAL WRITERS
- DESIGN DRAFTSMEN
- PHYSICISTS

Westinghouse
offers you
SECURITY AND OPPORTUNITY

EE's and ME's with over 3 years experience . . . a number of excellent positions are now available in our Electronic & X-ray and Air-Arm Divisions for work on:

- Broadcast Transmitters
- Power Line Carrier Communication Equipment
- Railroad Radio
- Radio Frequency Heating
- Medical and Industrial X-ray
- Commercial Radar
- Balancing Equipment
- Military Radar (ship, ground, airborne)
- Military Transmitters
- Specialized Electronic Equipment
- Fire Control Systems
- Automatic Pilots
- Guided Missiles

Check These Outstanding Benefits: Top pay, ideal working conditions, advancement on merit, graduate study opportunities, employee scholarships, paid relocation expenses, Baltimore location.

Send resume of experience and education to: Manager of Industrial Relations, Westinghouse Electric Corp., 2519 Wilkens Ave., Baltimore 3, Md.

If you are using your greatest skill in a defense industry, do not apply.

YOU CAN BE SURE... IF IT'S
Westinghouse

How to tell Quality in **TEFLON***



You'll have all these properties
with **FLUOROFLEX-T**®

■ "Teflon" powder is converted into Fluoroflex-T rod, sheet and tube under rigid control, on specially designed equipment, to develop optimum inertness and stability in this material. Fluoroflex-T assures the ideal, low loss insulation for uhf and microwave applications . . . components which are impervious to virtually every known chemical . . . and serviceability through temperatures from -90° F to +500° F.

Produced in *uniform* diameters, Fluoroflex-T rods feed properly in automatic screw machines without the costly time and material waste of centerless grinding. Tubes are concentric - permitting easier boring and reaming. Parts are free from internal strain, cracks, or porosity.

For maximum *quality* in Teflon, be sure to specify Fluoroflex-T.

*DuPont trade mark for its tetrafluoroethylene resin.
© Resistoflex trade mark for products from fluorocarbon resins.

"Fluoroflex" means the best in Fluorocarbons

RESISTOFLEX
CORPORATION



RESISTOFLEX CORPORATION, Belleville 9, N. J. E10
SEND NEW BULLETIN containing technical data and information on Fluoroflex-T.

NAME.....TITLE.....
COMPANY.....
ADDRESS.....

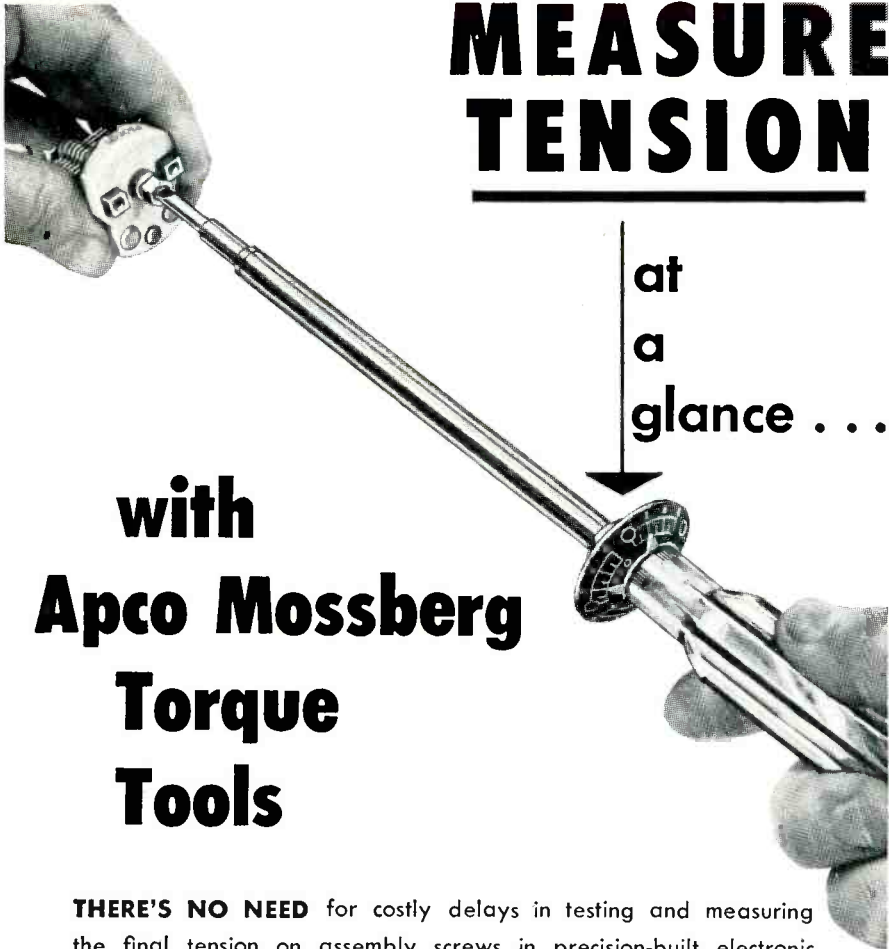

MEASURE TENSION

at
a
glance . . .

with Apco Mossberg Torque Tools

THERE'S NO NEED for costly delays in testing and measuring the final tension on assembly screws in precision-built electronic equipment. Today, you can do the job quickly, accurately and at a minimum cost . . . with Apco Mossberg Torque Screw Drivers.

ESPECIALLY DESIGNED for greater convenience, Apco Torque Screw Drivers feature easy-to-read dials for accurate, instantaneous measurements. Every Apco screw driver is easy to handle . . . simple to operate . . . completely dependable. There are no springs or intricate parts to get out of kilter. Each driver is equipped with a standard Stanley tool holder to accommodate interchangeable bits for tightening and testing torque on all types of screws — including light plastic screws where precision tightening is an absolute necessity.

YOU'LL FIND that Apco Torque Screw Drivers are available in a complete range of sizes — from the 0 to 6 inch ounce size for light bench work to the 0 to 24 inch ounce models with large positive and positive-negative dials for every job in the shop. Get the complete details on these and other Apco Mossberg Torque Tools for Industry from your distributor or write direct. Apco Mossberg Co., 189 Lamb Street, Attleboro, Mass., U. S. A.

APCO MOSSBERG CO.

ATTLEBORO, MASS.

EXTRA!

GOOD
Transformer
NEWS!

New 20-20 plus
transformers

New miniature
transformers

New—super
standard audio

New
400 cycle power

All with...
extra quality
extra flexibility
extra performance

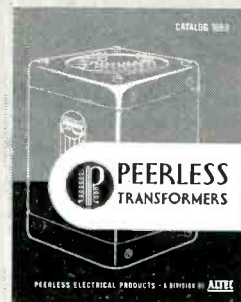

Write
today
for the
new
1953
Peerless
Catalog

It's the best transformer
news in years

PEERLESS
Electrical Products

A DIVISION OF



9356 Santa Monica Blvd., Beverly Hills, Calif.
161 Sixth Avenue, New York 13, New York

of miniature resistors. The resistors, whose electrical resistance decreases with increases in applied voltage, are designed for use as a stabilizing influence on circuits supplied by rectifiers, for control of voltage-selective circuits and for protection against voltage surges. They are composed of a silicon carbide ceramic resistance material called Thyrite, whose nonlinear resistance characteristic is stable and substantially independent of polarity and frequency. The line now includes small $\frac{1}{2}$ in. diameter units, with or without wire leads, having a maximum continuous rating in free air of 0.1 watt. Small $\frac{1}{4}$ in., rod-type units, rated from 0.25 to 1.0 w, are available from 1 in. up to 6 in. in length. For one watt ratings, rod-type resistors capable of continuous operation at 10 kv are available.

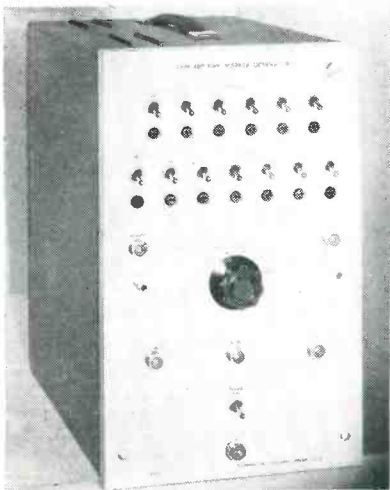

Time Mark Generator

TEKTRONIX, INC., Sunset Highway and Barnes Road, Portland 7, Oregon. Type 180 time mark generator has time markers of 1, 5, 10, 50, 100 and 500 μ sec; 1, 5, 10, 50, 100 and 500 milliseconds; and 1 second, all available separately and simultaneously through pin jacks or mixed in any combination through uhf connector. It also features: sine wave outputs of 5, 10 and 50 mc; trigger impulses of 1, 10 and 100 cycles, and 1, 10 and 100 kc through uhf connector; all outputs controlled by a 1-mc crystal accurate within 0.02 percent. The unit was developed for the purpose of

now in full production!

the AIRPAX MIDGET CHOPPER

THE

NEWEST

MOST

REVOLUTIONARY

DEVELOPMENT

IN MINIATURE

CHOPPERS!

CONTACTS

SPDT only, break before make. Rated at 100 volts, 2 ma.

HERMETIC SEALING

May be operated at full rating at any altitude or humidity. Won't be damaged by prolonged exposure to humidity or salt spray.

PHASE ANGLE Contacts lag 65° behind driving sine wave. Dwell time 135°

RESIDUAL NOISE At 1 megohm impedance, residual noise is less than 400 microvolts peak, measured from any contact to ground.

ACCELERATION Operates under greater than 50G, any plane. Will take over 500G, in certain planes.

DRIVE Now available only at 400 cycles, 6.3 volts, max. coil voltage. Usual frequency range is 380 to 420 cycles.

TEMPERATURE Operates successfully between 70°C to 120°C , not damaged by temperatures varying over those limits.

VIBRATION Operates well under vibration of 10G, 10 to 55 cycles.

LIFE. Repeated life tests by some of nation's major electronic and aircraft concerns show a life expectancy in excess of 1,000 hours.



Wgt.—1.2 oz.
Size—Fits 7 pin miniature socket.
Length 1.812.
Max. dia. .765.



DIGITAL COMPUTER RESEARCH

Your inquiry is invited concerning a position on our staff if you are experienced in the design and development of automatic data processing systems for military, industrial and commercial applications.

Logical Design
Component Development
Programming
Magnetic Recording
Circuit Design
Input & Output Devices

HUGHES

Research and Development Laboratories

Engineering Personnel Department

Culver City, Los Angeles County, California

Assurance is required that the relocation of the applicant will not cause the disruption of an urgent military project.

JUST PUBLISHED

ELECTRONIC ANALOG COMPUTERS

1. Gives aid in the design and operation of electronic computers of the d-c analogy type used as differential analyzers and equation solvers. Shows procedure for setting up problems that lessens chief error of faulty assignment of scale factors. Gives samples of practical applications. Covers design of computer circuits, auxiliary components, and complete installations to meet specific needs. By Granino A. Korn, Staff Engr., Lockheed Aircraft Corp., and Theresa M. Korn, formerly Engr. Boeing Aircraft Co. 378 pp., 70 illus., \$7.00



ELECTRONIC MEASUREMENTS

2. Covers measurement fundamentals in many fields beyond conventional radio, including television, radar, and other pulsed systems, microwave techniques, and techniques of value to engineers in other areas who use electronics in their instrumentation. Treats circuit constants and lumped circuits; waveform, phase, and time interval measurements; receiver and antenna measurements; generators of special waveforms; attenuators and signal generators, etc. By F. E. Terman, Dean, School of Engr., Stanford U., and J. M. Pettit, Assoc. Prof. of Elec. Engr., Stanford U. Second Ed., 683 pp., 450 illus., \$10.00

RADIO ANTENNA ENGINEERING

3. Provides guidance in the design and construction of receiving and transmitting antennas used in point to point, ground-to-air, and military communications, as well as broadcasting. Deals with wires, masts, and towers, with frequencies up to 30 mega. Treats radiation, circuit, and mechanical engineering, operational requirements, bandwidth, propagation, and system engineering for each type of antenna. Includes advanced designs suggested by very-high frequency and ultra-high-frequency techniques, emphasizing their growing importance. By Edmund A. Laport, Chief Engr., RCA Int. Div. 363 pp., 366 illus., \$9.00



MUSICAL ENGINEERING

4. Explains the theory and practice of interrelated phases of musical engineering—including speech, music, musical instruments, acoustics, and hearing. Treats the construction, range, characteristics, vibrating and resonating systems of musical instruments. Analyzes each aspect of sound reproducing and pickup systems. Gives help toward better production of vocal and instrumental music, in acoustic design of studios, and problems in recording, transmission, and broadcasting of music and speech. By Harry F. Olson, Dir. Acoustical Laboratory, RCA Laboratories, Princeton, N. J. 309 pp., 303 illus., 28 tables, \$6.50

SEE THESE BOOKS 10 DAYS FREE

McGraw-Hill Book Co.,
330 W. 42nd St., NYC 36

Send me book(s) checked below for 10 days' examination on approval. In 10 days I will remit for book(s) I keep, plus few cents for delivery, and return unwanted book(s) postpaid. (We pay for delivery if you remit with this coupon; same return privilege.)

- 1. Korn & Korn—ELECTRONIC ANALOG COMPUTERS \$7.00
- 2. Terman & Pettit—ELECTRONIC MEASUREMENTS \$10.00
- 3. Laport—RADIO ANTENNA ENGINEERING \$9.00
- 4. Olson—MUSICAL ENGINEERING \$6.50

(Print)
Name

Address

City Zone State

Company

Position FL-10-52

This offer applies to U. S. only.

oscilloscope time base calibration and is useful for calibrating counters and computers.



Aircraft Test Instrument

MIDWESTERN GEOPHYSICAL LABORATORY, Tulsa, Oklahoma. Model 310 dynamic meter is a miniature oscillograph used to present flight test data for either visual or photographic observation. The galvanometers used in the meter produce appreciable deflections from conventional strain-gage signals without amplification. The light intensity of the edge-lighted Lucite screen may be varied (external potentiometer) to produce optimum contrast between signal spots and screen graduations. Specifications include: weight—2.3 lb; optical arm distance—4.8 in.; and power required—24 v at 1.5 amperes.



Demodulators

AUTOMATIC TEMPERATURE CONTROL Co., INC., 5200 Pulaski Ave., Philadelphia 44, Pa. Three new demodulators have been designed for rectifying an a-c signal, generated by an Atcotran transmitter for

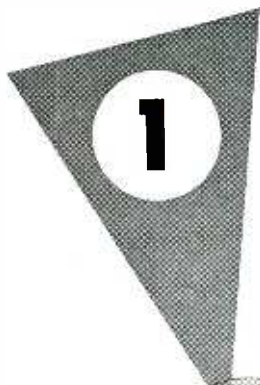

*how
one manufacturer
pin-points*
quality control...*

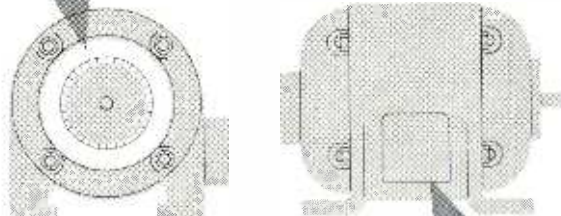

with **Kum-Kleen**

pressure-sensitive

laid on labels

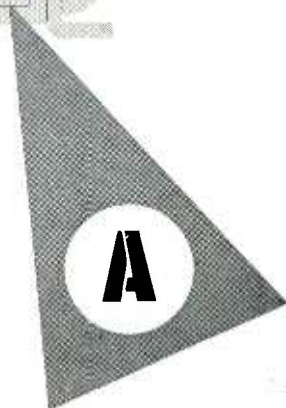

A PROMINENT MAKER of electric motors *pin-points* quality control by identifying every production and inspection operation with Avery Kum-Kleen self-adhesive labels. It's a simple, easy way to quickly trace and correct any variations from their high standards of quality. Prior to the use of Kum-Kleen labels, which are just LAID ON with a finger-touch, no other method had proved satisfactory. * Each stator winding operator's work is identified by a small, round Avery Kum-Kleen label bearing a numeral. It STAYS STUCK on the laminated surface...is not damaged by varnish dip and bake. Similar Kum-Kleen labels, which are die-cut letters to preserve identification even though spray-painted, are used by each final tester-inspector.

Write for sample labels and complete details on this effective way to improve quality. You may be able to apply it to *your* business!

AVERY Producers of Pressure-Sensitive products since 1935

AVERY ADHESIVE LABEL CORPORATION

117 Liberty St., New York 6 608 S. Dearborn St., Chicago 5
1616 So. California Ave., Monrovia Offices in Other Principal Cities

Please send case histories, free samples and prices.

Have the Avery label man call.

NAME _____

TITLE _____

COMPANY _____

ADDRESS _____

**Easy way
to control
inaccessible
parts...**

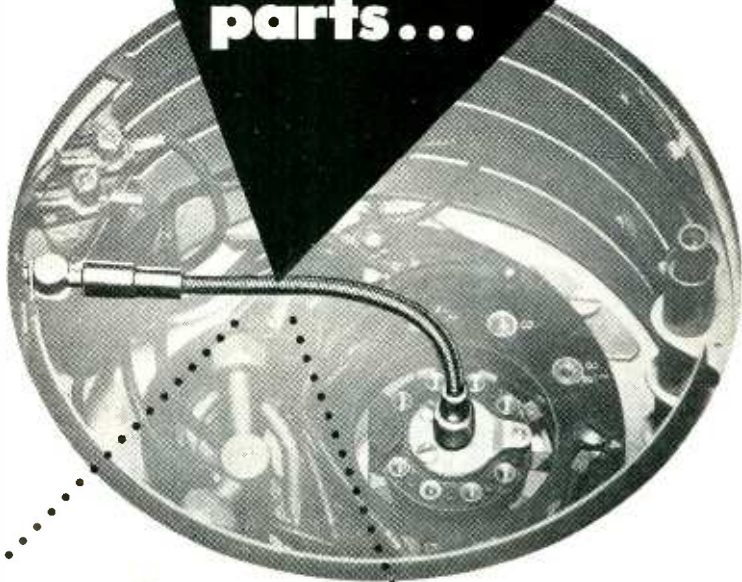

S.S. WHITE FLEXIBLE SHAFTS

Providing a means of controlling inaccessible parts *could be* a tough problem — especially if the parts had to be mounted some distance away from the point of control. We say *could be*, because S.S.White remote control flexible shafts are a simple, time-saving way to do the job.

These shafts have been built just for this purpose. They have all the flexibility needed to run them around turns or to install them over or under obstacles. What's more, S.S.White flexible shafts have the necessary physical properties to provide a quality of control that satisfies practically every requirement. It's simply a matter of proper selection and application.

SEND FOR THE FLEXIBLE SHAFT HANDBOOK

256 pages of factual data and information on how to select and apply flexible shafts. Sent free — if you request it on your business letterhead.

Use them to —

Meet exacting space and dimensional requirements

Eliminate alignment problems

Bring control around turns

Gain extra design freedom

Control variable elements

Simplify servicing

Reduce costs



THE S.S. White INDUSTRIAL DIVISION
DENTAL MFG. CO.

Dept. E, 10 East 40th St.

NEW YORK 16, N. Y.



Western District Office • Times Building, Long Beach, California

Accurate • Portable • AVAILABLE



the Type H-12 **UHF** **SIGNAL** **GENERATOR**

900-2100 Megacycles

This compact, self-contained unit, weighing only 43 lbs., provides an accurate source of CW or pulse amplitude-modulated RF. A well-established design, the Type 12 has been in production since 1948. The power level is 0 to -120 dbm, continuously adjustable by a directly calibrated control accurate to ± 2 dbm. The frequency range is controlled by a single dial directly calibrated to $\pm 1\%$. Pulse modulation is provided by a self-contained pulse generator with controls for width, delay, and rate; or by synchronization with an external sine wave or pulse generator; or by direct amplification of externally supplied pulses.

Gold Plating of the oscillator cavity and tuning plunger assures smooth action and reliable performance over long periods. Generous use of silicone-treated ceramic insulation, including resistor and capacitor terminal boards, and the use of sealed capacitors, transformers, and chokes, insures operation under conditions of high humidity for long periods.

Built to Navy specifications for research and production testing, the unit is equal to military TS-419/U. It is in production and available for delivery.

Price: \$1,950 net, f.o.b. Boonton, N. J.

Type H-14 Signal Generator

(108 to 132 megacycles) for testing OMNI receivers on bench or ramp. Checks on: 24 OMNI courses, left-center-right on 90/150 cps localizer, left-center-right on phase localizer, Omni course sensitivity, operation of TO-FROM meter, operation of flag alarms.

Price: \$942.00 net, f.o.b. Boonton, N. J.

WRITE TODAY for descriptive literature on A.R.C. Signal Generators or airborne LF and VHF communication and navigation equipments, CAA Type Certificated for transport or private use. Dept. 5



Dependable
Electronic Equipment
Since 1928

Aircraft Radio Corporation
Boonton, New Jersey

pressure, flow, thickness, weight and displacement, into a d-c signal that may be fed into a d'Arsonval type d-c meter or potentiometer type instrument of the indicating or recording variety. Operation features include a single electronic tube rectifying circuit designed for continuous trouble-free service. One type 6101C will operate into any existing potentiometer type recording instrument and incorporates a chopper circuit for changing the a-c input signal to the d-c output signal.

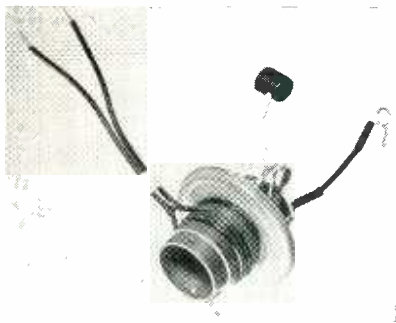

Autotransformer

RAM ELECTRONICS SALES Co., Irvington-on-Hudson, N. Y. Latest horizontal output transformer just off the company's production line is the model X068 air-core autotransformer. Featuring high efficiency and excellent voltage regulation, as well as improved anticorona construction, it delivers 11 to 13 kv output for 14 to 20-in. tv picture tubes. Since the unit is designed for direct drive circuits, the model Y70F30/3 direct-drive deflection yoke is recommended as its associated component.

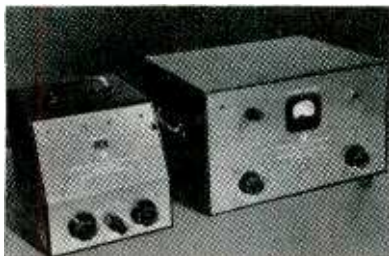

Magnetometer

LABORATORY FOR ELECTRONICS, INC., 75 Pitts St., Boston 14, Mass. Model 101 magnetometer accurately measures magnetic field strength by



If you use parts like these (up to 1/4" dia. and to 1 1/2" length) in large quantities, it is almost certain that we can show you a big saving. And assure on-time deliveries to meet your pressing defense work schedules. We have something unique back of that claim . . .

OUR QUOTE IS LOWER BECAUSE NOBODY HAS WHAT WE HAVE To be able to produce our famous Bead Chain to sell for pennies per yard, we had to develop our own equipment and method . . . our MULTI-SWAGE Method.

Instead of turning and drilling small parts from solid rod, or stamping and forming them, this advanced method automatically swages them from flat stock into precision tubular forms, with tight seams. By increasing the production rate many times, and eliminating

scrap, this saves a large part of the cost by other methods.

FAMOUS USERS PROVE IT For years leading manufacturers in the radio and electronics field have depended on us to cut costs of millions of contact pins, terminals, jacks and sleeves. And, for pinlike parts and variations of bushings needed for mechanical purposes, we are the money-saving supplier to scores of prominent makers of toys, business machines, appliances, ventilators etc.

WHAT WE CAN MAKE Our Bead Chain MULTI-SWAGE Method permits parts to be beaded, grooved, shouldered, and of almost any metal. Generally, they should not exceed 1/4" dia. or 1 1/2" length. Catalog shows many *Standard Items* available in small quantity. *Special Designs* must usually be ordered in lots of a half-million or more, unless they are frequently re-ordered.

GET COST COMPARISON! Send blueprint or sample and quantity requirements. Our engineers will return an eye-opener on economy.

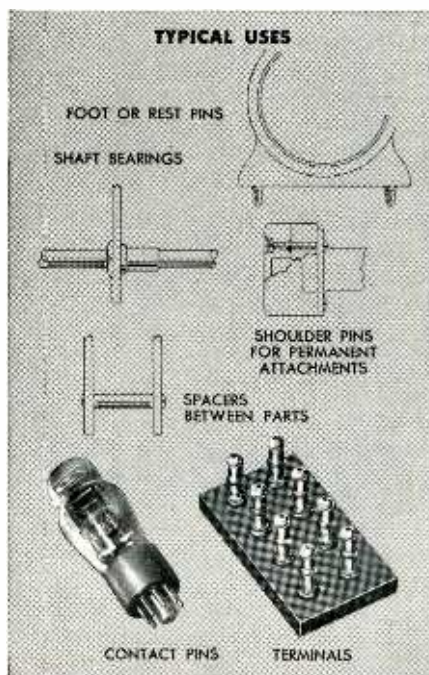

Let **BEAD CHAIN** make it by the **MULTI-SWAGE METHOD**



I want this Catalog-Data Folder
The Bead Chain Manufacturing Co.
88 Mountain Grove St., Bridgeport, Conn.

Name, title.....
Company.....
Address.....

Production "Problem-Children" LICKED!



Rely on Clippard specialization to save you headaches, heartaches, time and money. We take "problem" R.F. coil and sub-assembly children off your hands, replacing "snafu" operations with smooth-sailing production and profits.

In many instances the creative thinking of Clippard design, production and control engineers also results in significant mechanical and electrical improvement. We produce windings and sub-assemblies that save size, weight, critical materials, money, assembly problems and production delays for some of the foremost names in electronics, and can do the same for you.

A manufacturers' manufacturer, Clippard specializes in production runs of 1,000, 10,000, 10,000,000 or more units of laboratory accuracy. High speed coil winding and control equipment of our own design plus a staff of skilled technicians assure you the quality coils and sub-assemblies you want, when you want them, with a minimum of rejects, fuss or bother.

Call on Clippard to free your production facilities for more profitable work...to get precision coils and sub-assemblies quickly and economically. Send us a sample, specifications or other details for a prompt solution or quotation, NOW!

Want to save TIME and MONEY Testing Resistors and Condensers?

Send for catalog sheets describing our P.R. 5 Resistance Comparitor or P.C. 4 Capacitance Comparitor. Both quickly pay for themselves by allowing unskilled operators to check 30 or more components per minute with laboratory accuracy!

Clippard

INSTRUMENT LABORATORY INC.
7350-90 Colerain Road • Cincinnati 24, Ohio
**MANUFACTURERS OF R. F. COILS
AND ELECTRONIC EQUIPMENT**

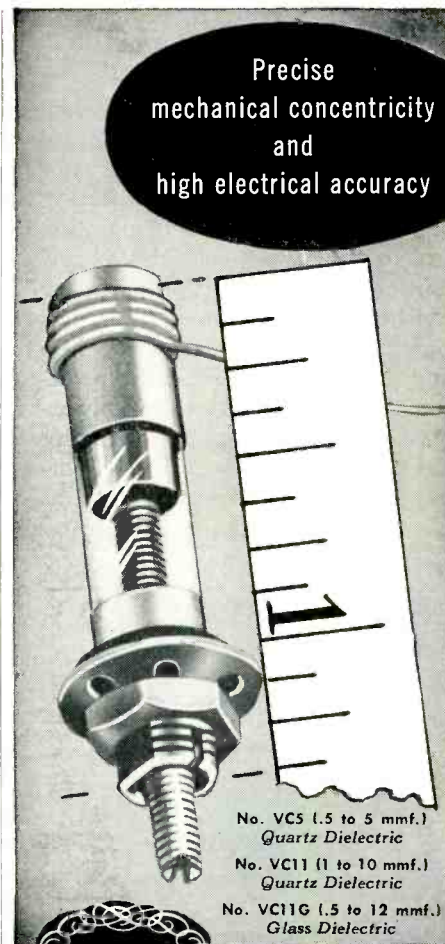

Piston type variable trimmer capacitors

Compare these Outstanding Features

- One-piece spring loaded piston and screw made of special invar alloy having extremely low temperature coefficient of expansion.
- Silver band fused to exterior of precision drawn quartz or glass tube serves as stationary electrode.
- Piston dimensional accuracy is held to close tolerance maintaining minimum air gap between piston and cylinder wall.
- Approximately zero temperature coefficient for quartz and ± 50 P.P.M. per degree C. for glass units.
- "Q" rating of over 1000 at 1 mc.
- Dielectric strength equals 1000 volts DC at sea level pressure and 500 volts at 3.4 inches of mercury.
- 10,000 megohms insulation resistance minimum.
- Operating temperatures, -55 C. to $+125$ C. with glass dielectric. And -55 C. to $+200$ C. with quartz dielectric.
- Over 100 megohms moisture resistance after 24 hours exposure to 95% humidity at room temperature.

Write for Form No. 199



JFD Mfg. Co.
Brooklyn 4
BEnsonhurst 6-9200

world's largest manufacturer of TV antennas & accessories

using the principle of nuclear resonance. An oscillatory magnetic field is provided by means of a coil surrounding a sample which permits measurement of proton resonance and the nuclear resonance of lithium. The coil is part of an oscillator which is so designed that its level of oscillation drops with an increase in circuit losses, such as may be introduced by nuclear resonance in the sample material. Means have been provided to make this resonance easily viewed on an oscilloscope. Range of field strength measurements is from 300 gauss to 25,000 gauss, covered by proton and lithium resonances. This range is covered by a frequency spectrum of 1.18 to 34 mc. Means are provided for varying the width of modulation sweep from 1.6 to 16 gauss.

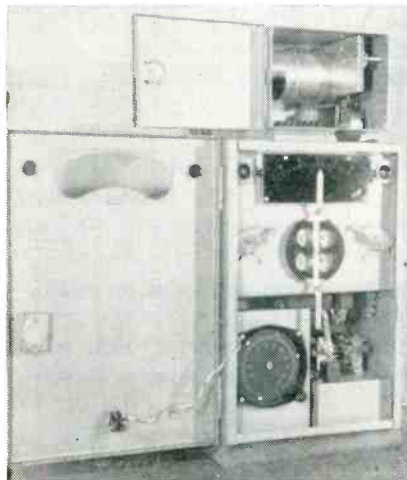

Remote Indicating Contact Gage & Alarm

INDUSTRIAL ELECTRONICS CO., INC., Hanover, Mass., now has a device for measuring thickness on the fly and indicating at a convenient remote location. Any material which can tolerate a moderate pressure, such as rubber or asphalt tile, metals of all kinds, sheet asbestos and rubber impregnated cloth can be measured. The device consists of two sections: (1) a housing containing a precision ground roller mounted with and coupled to a selsyn motor; (2) a main cabinet containing a scale graduated in thousandths of an inch, as well as an electronic relay connected to a selsyn motor in such a way that a pilot light is lit when the material

THREADED I. F. CORE

SLEEVE CORE

"E" CORE

TOROID

CUP CORE

DUMBELL CORE

IRON CORE COIL FORM

PLAIN CORE

INSERT CORE

TUNING CORE

special shallow thread

Threaded Core Advantages

THREADED CORES COST LESS THAN ANY OTHER TYPE OF ADJUSTABLE CORES

1. Reduced cost per core
2. Smaller assemblies (less space necessary)
3. Simplest IF transformer core design
4. Higher "Q" by elimination of metal inserts
5. Hexagonal hole design permits top tuning
6. Saving of critical material

Television, Electronic and Radio set designers are considering the advantages of the Threaded Core. Where Threaded Core substitutions for Insert Cores are indicated as more practicable design, greater economy, stability and better performance have been the result. Part and labor cost reductions can easily be visualized through the elimination of brass screw inserts and simplified assembly.

Threaded Iron Cores are blank-formed with screwdriver slots or hex holes. The blank is then externally threaded on a centerless thread grinder. Your threaded core self-taps itself through the serrated paper coil form.

Threaded core permeability is effected by the type of threads selected. The table illustrates the advantages of selecting finer and shallower threads.

Thread Form	Per Cent Change	Diameter Tolerance vs. Permeability
20 pitch	-22	The permeability of a threaded core is controlled by varying the outside diameter. O. D. Permeability tolerance ±0.001 in. ±4% ±0.002 ±2%
28 pitch	-14	
32 pitch	-13	
28 shallow pitch	-7	
32 shallow pitch	-6.5	

The "Q" potential: Threaded Cores having the least permeability drop during threading usually provide the highest "Q" as smaller coils (less copper) are required to achieve the given inductance.

Threaded Core Size and Strength

Greater physical strength is attained in the Threaded Core with the use of finer threads because of the effective larger diameter. The ratio of length to diameter shall not be less than 1 1/2 to 1, nor more than 4 to 1, for economical core design. (Standard Diameters: 0.159; 0.181; 0.238; 0.249; 0.304.)

Radio Core Quality Control

All Radio Cores manufactured, are produced with special attention to both mechanical and electrical tolerances resulting in lower incoming inspection and assembly costs on the part of the customer.

For more detailed Threaded Core information—Write for: Samples, designs and Specific Costs. Dept. E10525. Technical Data Booklet "Engineered Radio Cores" No. E1052.

Radio Cores, Inc.

9540-50 Tulley Avenue Oak Lawn, Illinois

This STANCOR TRANSFORMER filled the BILL!

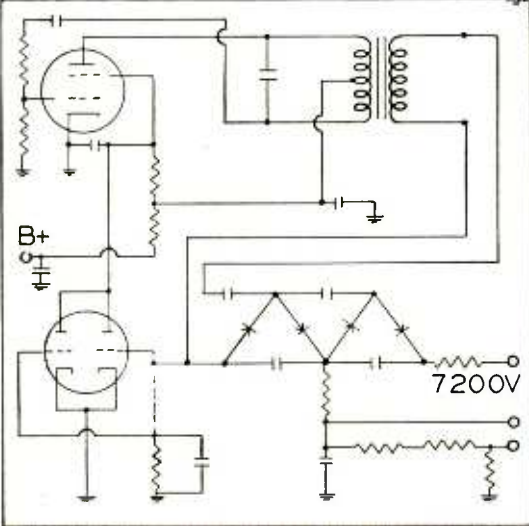
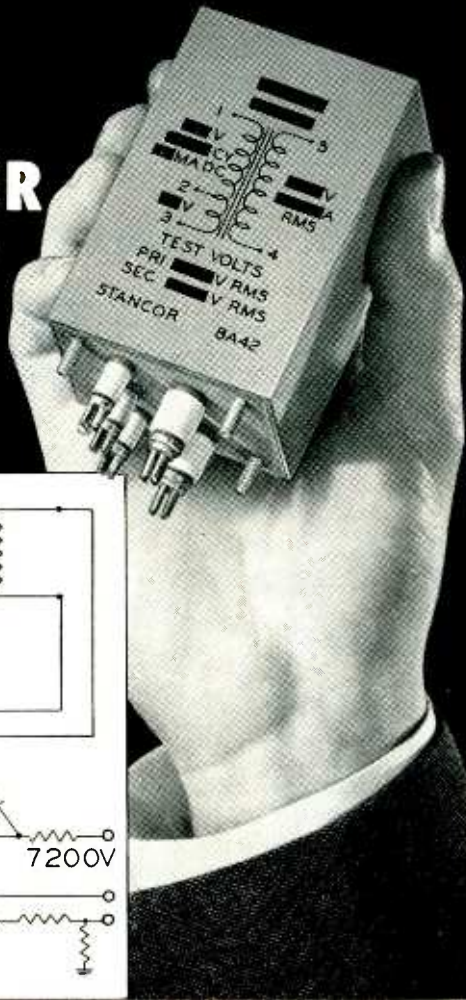

- Problem:**
- ✓ To design and build a transformer to operate in an oscillating circuit at 1500 CPS.
 - ✓ Output voltage through a voltage quadrupler is to be $7200V \pm 5\%$ at 20 microamperes load.
 - ✓ Oscillating frequency and output voltage must remain stable from $-40^{\circ}C$ to $65^{\circ}C$ and the unit must meet the requirements of MIL-T-27, grade 1, Class A, specifications for hermetically sealed transformers.

Solution: STANCOR TRANSFORMER 8A42

*For the Answer to Your Toughest Problems
of Transformer Design, Consult Stancor Engineers!*

Stancor welcomes troublesome problems of transformer design, like the one illustrated, as a responsibility of leadership. We have the necessary engineering skill and resources, backed

by in-plant facilities for qualification testing of MIL-T-27 transformers. Next time you're faced with a transformer design problem, let our engineers offer you a quick, practical solution.



STANDARD TRANSFORMER CORPORATION

3578 NORTH ELSTON AVENUE, CHICAGO 18, ILLINOIS

being measured exceeds the pre-selected tolerance.

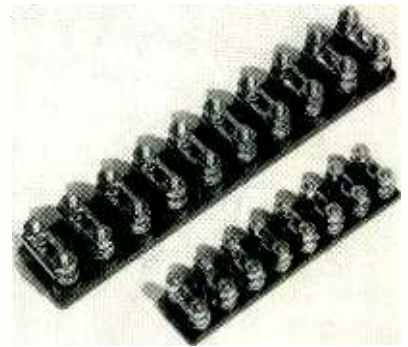

Terminal Strips

THE BRACH MFG. CORP., 200 Central Ave., Newark, N. J., has developed the type 2500 universal terminal strips (shown above, rear). Each is made of 10 units molded in one piece. It is so constructed that circuits can be opened and closed for testing by means of a sliding link without disturbing any connected wire. The strips are made of Bakelite with heavy screws molded rigidly into place to prevent their turning. Type 1500 terminal strip, also illustrated, is smaller and more compact, and uses silicon bronze screws with heavy specially designed nuts for strength.



Railroad & Mobile Equipment

BENDIX RADIO DIV. OF BENDIX AVIATION CORP., Baltimore 4, Md., has announced production of a line of railroad and mobile equipment designed for operation in the 152 to 174-mc band. The new vhf equipment can be packaged either in a three unit housing or a single compact case. The equipment is provided with a choice of transmitter

VICKERS educational magnetic amplifier

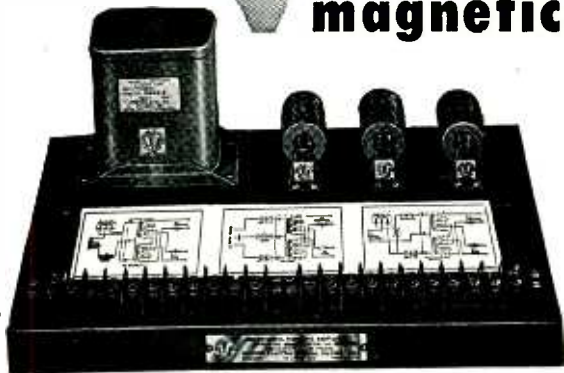

Permits study of all three basic single phase self-saturating circuits

- For Industrial Laboratories — Schools.
- Can actually be used in operating controls circuits.
- Gives d-c or a-c output... uses d-c or a-c control power.

Designed by Vickers Electric Division to help industrial personnel and students obtain a wider knowledge of the characteristics and applications of high-performance self-saturating magnetic amplifiers.

Complete with Magnetic Amplifier Laboratory Manuals and Magnetic Amplifier Design Handbooks.

Write for literature and price.

VICKERS ELECTRIC DIVISION

1801 LOCUST STREET • ST. LOUIS 3, MISSOURI

where **LESS**
is **MORE**
international
instruments



1" and 1 1/2" SUB-MINIATURE AND MINIATURE ELECTRICAL METERS

FOR AIRCRAFT, GUIDED MISSILES,
ELECTRONIC and ATOMIC DEVELOPMENTS,
COMMUNICATIONS and INDUSTRY

Wherever less weight and smaller size are vital, these sub-miniature and miniature meters allow more savings. They not only provide accuracy and dependability equal to that of larger models, but, in addition, the inherently strong construction withstands shock and vibration far better than conventional sized instruments. A D'Arsonval type movement of excellent design, precision workmanship and materials of selected quality permit miniaturization while retaining high performance standards.

Meters, testing devices and allied equipment are available for a wide variety of requirements and can be adapted for use wherever it is desired to measure quantities electrically. Instruments are engineered for unusual applications by our staff of skilled technicians. Efficient production insures good delivery and low cost on both regular and special jobs.

If smaller size and lighter weight can help solve your instrument problems, fill in and mail the attached coupon today.



**international
instruments**
INCORPORATED

P. O. BOX 2954, NEW HAVEN 15, CONN.
LIAISON ENGINEERS IN PRINCIPAL CITIES

Please send me engineering data sheets covering the International line of instruments.

NAME _____
POSITION _____
CO. NAME _____
ADDRESS _____
CITY _____
ZONE _____ STATE _____

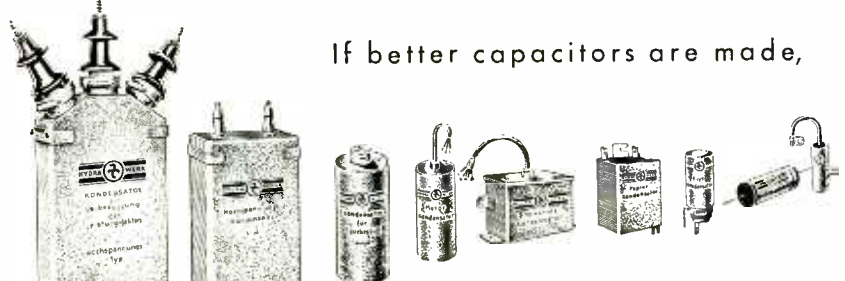

If better capacitors are made,

HYDRA will make them.

**HYDRAWERK AKTIENGESELLSCHAFT
BERLIN N 20 (WEST), GERMANY**

DIGITAL COMPUTER SALES ENGINEERS ELECTRICAL ENGINEERS

needed for customer contacts, sales, service, and contract administration concerning large commercial installations of electronic digital computers, inventory and accounting systems.

Minimum 2 years experience required

- Replies Strictly confidential
- Interviews arranged at our expense

Engineering Research Associates, Inc. 

Leaders in the Development of Digital Computers

1902 W. Minnehaha, St. Paul 4, Minn.

● "You Will Enjoy Living in Minnesota"

CINEMA

TYPE B-13

PRECISION WIRE-WOUND RESISTORS



NON-INDUCTIVE: Accuracies 1% to 1/20%. 1/4 to 10 Watt power ratings. Several impregnation treatments to fit your specific requirements. 42 different styles. Sub-miniature and laboratory instrument types. Characteristics to best commercial tolerances; temperature coefficients; and wire alloys. Orders accepted for special controlled, calibrated resistors, and ratio sets. Cinema resistors are finding nation-wide acceptance from proto-type to production. For complete technical data, write for Catalogue 14-R.

TYPE 992-A

PRECISION VARIABLE ATTENUATORS



ROTARY TAP CONTROLS: Precision and general purpose types. Resistance accuracies 5% to 1/20%. Nickel silver contacts and brushes. Low, constant contact resistance with stutter-free performance. "Multi-brush" design assures positive wiping action and quiet operation. Fine decibel accuracy and accurate voltage ratios. Mixer and detented action. Special ratio and resistance steps. (Specials are our largest business.) Write for Catalogue 18-A.

TYPE CES

INSTRUMENT SWITCHES

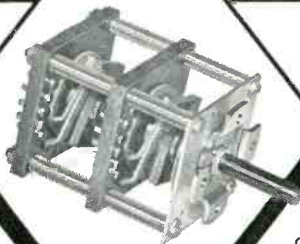

ROTARY TAP TYPE: Low contact resistance and long life are features of the CES design. Complete with integral detent action with stops or 360 degree rotation. Nickel silver contacts and brushes. Phenolic insulation. Especially designed for dc and audio instrument applications. Custom built in jig-time from basic production parts. Speedy service is the key-note of this design. Catalogue provides formula by which literally hundreds of switch circuit possibilities may be selected to fit your specific needs. Request Catalogue 17-S.

CINEMA ENGINEERING COMPANY

1510 WEST VERDUGO AVENUE, BURBANK, CALIFORNIA

Export Agents: Frazar & Hansen, Ltd. • 301 Clay St. • San Francisco, Calif., U.S.A.

NEW PRODUCTS

(continued)

power—2½, 12, 25 or 35 watts. In addition, fixed stations can transmit up to 60 watts. The transmitter consists of basic exciter chassis with interchangeable power amplifier decks which, when operated with appropriate power supply, can be replaced at any time to increase power as desired. Dual channel operation can be provided by insertion of sealed plug-in relay and crystal. Frequency stability is 0.0006 percent with crystal type oven and 0.0025 percent without oven.



Low-Voltage High-Current D-C Sources

SORENSEN & Co., INC., 375 Fairfield Ave., Stamford, Conn., has available an addition to its line of Nobatrons. Designated as models E-6-5A, E-6-15A, E-6-40A and E-6-100A Nobatrons, the instruments convert nominal 115 v ac line to 6 v d-c adjustable ± 10 percent, at currents of 5, 15, 40 and 100 amperes respectively, and with a regulation accuracy of ± 0.2 percent. The important new feature is a front panel switch that instantly changes output from 6 v d-c to 7 v d-c, adjustable ± 10 percent.



Servo Amplifier

AUTOMATIC TEMPERATURE CONTROL Co., INC., 5200 Pulaski Ave., Phil-

Check...



**THESE
4
IMPORTANT
FEATURES**

- ✓ LONG LIFE
- ✓ SMALL SIZE
- ✓ LIGHT WEIGHT
- ✓ HIGH EFFICIENCY

Production capacity has recently been expanded to supply your increasing demand for vibrators and vibrator power supplies. Engineering facilities are available for designing vibrators and power supplies to your specifications.

Victoreen has two standard vibrator power supplies for use with battery-operated portable equipment such as Geiger counters, photo-multipliers, and electronic equipment requiring a high voltage supply. These compact units have been potted and hermetically sealed to make them reliable and rugged. They contain regulator circuits to stabilize their outputs. Net weight is only one pound.

● THE MODEL 517 VIBRATOR POWER SUPPLY operates from 4.5 volts dc and supplies +900 volts at 5 microamperes and +58 volts at 0.25 milliamperes.

● THE MODEL 532 VIBRATOR POWER SUPPLY operates from 3.0 volts dc and supplies -900 volts at 15 microamperes and +58 volts at 0.25 milliamperes.

The precision vibrators which are used in these power supplies are available separately. They have been mounted in sponge rubber and hermetically sealed, and are invaluable for such applications as high voltage power supplies, portable Geiger counters, scintillation counters, and portable radios. These plug-in units weigh only 2½ ounces.

● THE MODEL 531 VIBRATOR is designed to operate from a 1.5 or 1.3 volt battery and requires as little as 18 milliwatts driving power.

● THE MODEL 532 VIBRATOR is also an 18 milliwatt unit, but designed for operation in series with the primary of a transformer and from a 1.5 to 6 volt battery.



BETTER COMPONENTS
MAKE
BETTER INSTRUMENTS

**Victoreen
Instrument Co.**

5806 HOUGH AVE.
CLEVELAND 3, OHIO

TANDEM TERMINALS

Attached and Soldered

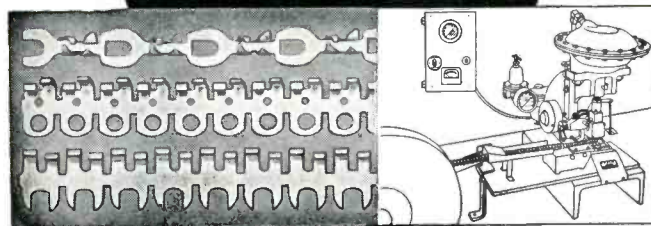

*at rates up to
1200 Per Hour*

Costs are reduced, production increased and more efficient terminations consistently result when P-M Pre-Soldered Tandem Terminals are machine attached and soldered! Produced in continuous form, and supplied on reels, P-M Tandem Terminals are applied in our machine that cuts off, clinches and solders terminals to wires in one instantaneous operation. This method has replaced slow, costly hand attachment in many leading plants. Handling of loose terminals, solder and flux are eliminated to cut costs and boost production on long runs. Standard types available. Send for detailed information, and enclose sample of terminal and wire now used. Address Dept. E.

For ordinary runs in moderate quantities we continue to produce

SEPARATE TERMINALS for ELECTRIC WIRES

We are also large producers of SMALL METAL STAMPINGS. Modern plant with complete equipment for large volume production of stamped metal parts in accordance with customers' prints. Moderate die charges. Precision work. Prompt service.

PATTON-MacGUYER COMPANY

201 CHAPMAN ST., PROVIDENCE 5, R. I.

IT'S ALLIED FOR RCA

AUTHORIZED



DISTRIBUTOR

ELECTRON TUBES FOR INDUSTRY

Quick, Expert Service on RCA Tubes

ALLIED maintains in stock for quick shipment, the world's largest distributor inventory of RCA special-purpose tubes. We specialize in supplying the needs of industrial, broadcast, governmental and other users. To save time, effort and money—phone, wire or write to ALLIED. Fill all your electronic needs from one complete reliable supply source.



ALL TYPES IN STOCK

- Vacuum Power
- Thyratrons
- Vacuum & Gas Rect.
- Ignitrons
- Cold-Cathode
- Phototubes
- Oscillograph Tubes
- Camera Tubes
- Monoscopes
- Special Types

FREE Interchangeability Directory

Valuable guide to selection of proper RCA tube type replacements. Lists 1600 tube types. Write today for this FREE RCA Guide No. 37-046.

1953 ALLIED CATALOG

Refer to your ALLIED Catalog for all electronic supplies—parts, tubes, test instruments, audio amplifiers, accessories—available from the world's largest stocks. Write today for FREE 1953 ALLIED Catalog.



Everything in Electronics
FROM ONE RELIABLE SOURCE

ALLIED RADIO

833 W. Jackson Blvd., Dept. 11-K-2
Chicago 7, Ill.

FREE CATALOG!—Send for it now!

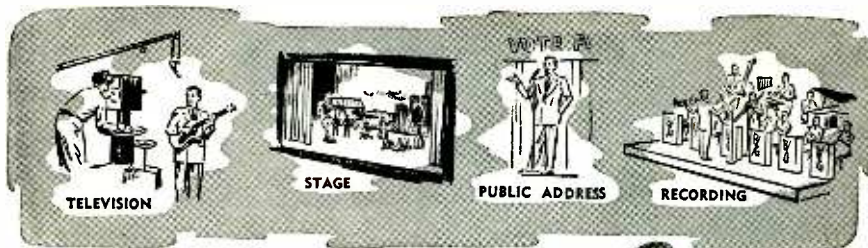

It's New!

The TURNER 51D



The new Turner Model 51D (similar to the Model 50 Aristocrat) offers exceptionally high quality performance at a new low cost. The Model 51D is essentially non-directional in operation — equally effective for individual or group pickups. A unique ball swivel coupler permits fast change from stand to hand or vice versa.

Use the Model 51D anywhere, indoors or out — it's blast-proof, and not affected by variations in humidity or temperature. Advanced circuit design with high output dynamic generator requires no closely associated auxiliary equipment for outstanding results.

For TV, FM, AM, recording and public address specify the Turner Model 51D — the outstanding dynamic microphone in its field.

SPECIFICATIONS

Frequency Response: 60 to 13,000 c.p.s. substantially flat.

Output Level: 58 db below 1 volt/dyne/sq. cm. at high impedance.

Impedance: Choice of 50, 200 or 500 ohms connected for balanced line output; high impedance (25,000 ohms) connected for single ended output.

Polar Pattern: Essentially non-directional in any position.

Transformer: Magnetically shielded for minimum hum pickup.

Diaphragm: Special aluminum alloy.

Case: All metal rich umber grey finish.

Mounting: Ball and swivel type, tilts in any direction. Standard $\frac{5}{8}$ " — 27 thread.

Dimensions: $1\frac{5}{8}$ " maximum diameter, $6\frac{1}{2}$ " long (less cable connector).

Weight: 16 oz. (less cable).

Cable: 12 foot high quality two conductor shielded cable with Cannon quick-disconnect plug.

List Price: \$85.00.

THE TURNER COMPANY

905 17th St. N. E. • Cedar Rapids, Iowa

IN CANADA:
Canadian Marconi Co., Ltd.
Toronto, Ont., & Branches

EXPORT
Ad. Auriema, Inc.
89 Broad Street, New York 4

Philadelphia 44, Pa., has introduced a high-gain, class A amplifier that is designed for driving servo-mechanisms from very small a-c input potentials such as those generated by differential transformers, a-c potentiometer circuits and resistive and inductive bridge circuits. The amplifier consists of a low-impedance transformer input to a dual triode, two-stage voltage amplifier tube which drives a pentode power amplifier tube having one motor winding in its anode circuit. The d-c voltage for the amplifier is obtained from a transformer and a full-wave rectifier tube. A potentiometer in the grid of the pentode provides control of the amplifier gain. Power input to the unit is isolated from ground allowing the input circuit to be adequately grounded and decrease the possibility of stray pickup.

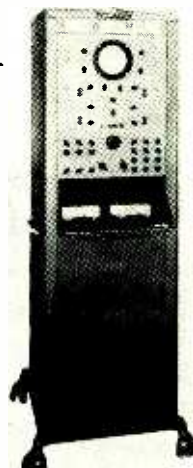

Memoscope

MILLIVAC INSTRUMENT CORP., 444 Second St., Schenectady 6, N. Y. Type MS-10A Memoscope records magnetically wave shapes and signal traces for instantaneous reproduction on the screen of its c-r tube. A new frequency converter makes it possible to record magnetically frequencies as high as 10 mc without harmonic distortion. The instrument can be used as a production testing tool where instantaneous comparison of wave shapes is needed, also as an auxiliary device in development and research where wave shapes change too frequently for photographic reproduction and



GAIR

FOLDING CARTONS

Sell on Sight!

Smartly designed and brilliant multicolor Folding Cartons by GAIR are solving packaging problems for many manufacturers who are as meticulous about their packaging as they are about their famous products.

Sales, profits and prestige are increased with the SELL-ON-SIGHT magic of GAIR MULTICOLOR CARTONS.

WRITE TODAY for samples and technical information.



ROBERT GAIR COMPANY, INC.

155 EAST 44TH STREET, NEW YORK • TORONTO
PAPERBOARD • FOLDING CARTONS • SHIPPING CONTAINERS

— There is Always One Leader in Every Field —

BODNAR INDUSTRIES, INC.

Leads in the Field of

TRANSILLUMINATED PLASTIC LIGHTING PLATES

because of

QUALITY • UNIFORMITY • PERFORMANCE • QUANTITY PRODUCTION PROMPTLY
DESIGN AND LAYOUT "KNOW-HOW SERVICE"

NEW YORK — 19 Railroad Ave., New Rochelle (Home Office)
TEXAS — Box 4116 Station A, Dallas CALIFORNIA — 11055 Cumpston St., N. Hollywood
OHIO — 2001 Maiden Lane, Springfield CANADA — 313 Montreal Trust Bldg., 67 Yonge St., Toronto
DEMONSTRATION PANEL MIL-P-7788 (AN-P-89) Sent on Letterhead Request

Specify SERVO MOTORS PRECISION ENGINEERED

RELIABLE PERFORMANCE • RUGGED CONSTRUCTION

In the operation of • GUNFIRE CONTROLS • ROCKET CONTROLS
GUIDED MISSILES • AIRCRAFT CONTROLS • INDUSTRIAL CONTROLS

G-M Servo Motors can be supplied to meet rigid military specifications with regard to humidity, temperature range, vibration and altitude. Available in 2, 4 or 8 pole construction and for frequencies from 60 to 400 cycles.

Write today for complete information.



Another product of  LABORATORIES INC. 4336 NORTH KNOX AVENUE
CHICAGO 41, ILLINOIS

SIEMENS

SUPERSONIC SOLDERING DEVICE

for aluminium and aluminium alloys



The Siemens Supersonic Soldering Device solders quickly, neatly and easily aluminium parts of all kinds such as aluminium sheet, casings, wires and small fittings. The supersonic vibrations destroy the aluminium oxide coating on the surface of the part to be soldered so that the bare aluminium is brought into direct contact with the molten tin. The soldered joint should be given a coat of lacquer to protect it from the effect of moisture.

Frequency approx. 20 kilocycles

Electrical requirements:
110/127/220 volts a. c.

Power consumption: 45 wa

SIEMENS-SCHUCKERTWERKE
AKTIENGESELLSCHAFT
BERLIN-SIEMENSSTADT · ERLANGEN

When
you think of
**STAINLESS STEEL
FASTENINGS**
think first
of
ANTI-CORROSIVE

Anti-Corrosive has millions of stainless fastenings *in stock* (probably the largest selection of varieties and sizes in the world) for *immediate delivery*. Anti-Corrosive has the exceptional production capacity that can fill your requirements beyond stock items faster, *better!*



FREE—A-N Stainless Fastening Selector

This handy slide-chart instantly identifies A-N Nos. pertaining to stainless steel nuts, screws, bolts, rivets, cotter pins, washers; gives sizes and other data. Write for "Chart 52H" TODAY!

Anti-Corrosive
Metal Products Co., Inc.
Manufacturers of STAINLESS STEEL FASTENINGS
CASTLETON-ON-HUDSON, NEW YORK

**25 YEARS OF
LEADERSHIP
IN FASTENINGS OF
STAINLESS STEEL**

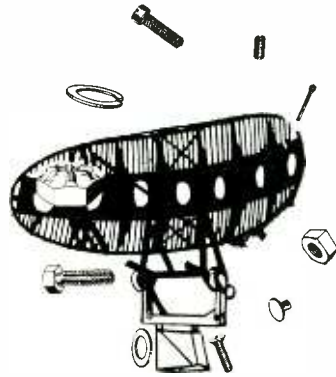

where instantaneous comparison of two traces is essential.



Utility Picture Monitor

FEDERAL TELECOMMUNICATION LABORATORIES, INC., Nutley, N. J., has announced a new low-cost utility picture monitor for tv station applications. The FTL-P-91B monitor is available either rack or cabinet mounted. A high-quality, high-resolution 9 × 12-in. presentation is made on a 16GP4 kinescope. Duplicate coax input connectors with a switch to select composite video, or separate video and composite sync, are provided at the rear of the chassis. A self-contained, fused power supply is included.



Power Amplifier and Speaker

TAPEMASTER, INC., 13 West Hubbard St., Chicago 10, Ill. Model SA-13 portable power amplifier and speaker combines in one unit a new 7½-in. accordion-type floating cone speaker, new advanced amplifier design, and a more effective principle of baffling. Amplifier response is within 1 db from 30 to 15,000 cps. Total distortion at 5-w output

ACME

ELECTRONICS

offers

COMPLETE FACILITIES EXTENSIVE EXPERIENCE

For several years Acme Electronics, Inc., has been prominent in designing and producing magnetic amplifiers and adapting magnetic amplifier design to a variety of complete electronic and servo systems.

Acme has expanded its engineering staff and is now offering complete research and development facilities for new projects in this field.

If your program presents a need for development and engineering in magnetic amplifier design, your inquiry is invited.



300 North Lake Ave., Pasadena 4, Calif.

ELECTRONICS — October, 1952

NEW

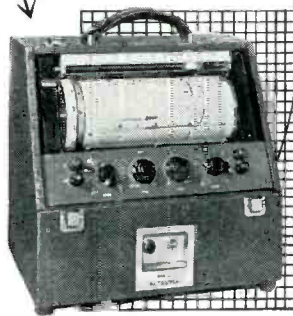

TYPICAL PLOTTING APPLICATIONS:

- Current/Voltage
 - Lift/Drag
 - Speed/Torque
 - Magnetization
 - Frequency response
 - Analog computer output curves
 - Temperature/Pressure
 - Stress/Strain
 - Transistor and Diode characteristics
 - Magnetic amplifier, input/output
 - Temperature/Activity
- X=(f)Y

the AUTOGRAF

a general purpose, wide range, portable, universal X-(f)Y graphic recorder

Now you can expedite your research, development, and test programs with the AUTOGRAF—a precision recorder that automatically plots curves showing relationship between a dependent and an independent variable. Through two re-balancing, servo-actuated recording axes, the AUTOGRAF draws cartesian coordinate graphs from any data that can be reduced to electrical form. You save the time it would ordinarily take to read meters, collate data, transfer data to grid, draw in curves... The AUTOGRAF does all this work for you, plotting the data simultaneously with occurrence of the phenomenon being studied. Too, the AUTOGRAF draws related curves in families as fast as input information can be altered. Without any additional steps, once a test is run, you have in hand a complete, accurate, pen-and-ink graph, drawn on a standard 8½" x 11" sheet of paper, ready for study, file, notebook, or reproduction.

SPECIFICATIONS: — Two independent servo-actuated recording axes; input free of ground. • Recording speed, both axes, 1 second for full scale travel. • Scales: from 0.5 millivolts up to 0-100 volts, both axes. • Full-range zero set on either axis—plots data in any desired quadrant. • Sensitivity—200,000 ohms per volt, 5 microamperes drain for full scale. • Size and weight: 13" x 13" x 10"; 35 lbs. • Self-contained; operates from 115 volt 60 cycle line, 85 watts.

WRITE for complete details

—MOSELEY—

FRANCIS L. MOSELEY
1136 N. LAS PALMAS AVENUE
LOS ANGELES 38, CALIFORNIA

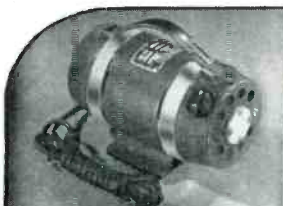



DC to AC Converters
Dynamotors
Genemotors

DEPENDABLE . . . COMPACT . . . EFFICIENT

Carter Rotary Power

Carter DC to AC Converters, Dynamotors, Genemotors, Magmotors, and Inductor Alternators (inverters) are made in a wide variety of types and capacities adaptable to communications, laboratory, and industrial applications, of many kinds. Widely used in aircraft, marine, and mobile radio, geophysical instruments, laboratory work, ignition, timing and many other uses.

Carter Motor Co.

2646 N. Maplewood Ave., Chicago 47
Sales Offices in Principal Cities

Recorder Converters
Inductor Alternators
Magma 0-5

MAIL COUPON FOR CATALOGS

Please send catalogs containing complete information on Carter Rotary Power Supplies.

Name _____

Address _____

City _____ State _____



*Trade Mark Registered

NEW NB-X- TYPE FILTERS by VECTRON

Narrow Band pass X-tal Filters
to your Specifications

Available at frequencies from
45 kc to 600 kc

*Hermetically Sealed · Compact Design
Materials to Government Specifications*

NEW exclusive mathematical techniques produce:

- Fewer Elements
- Narrower Bands
- Improved reliability
- Closer tolerances



Is your filter problem
one of
these?

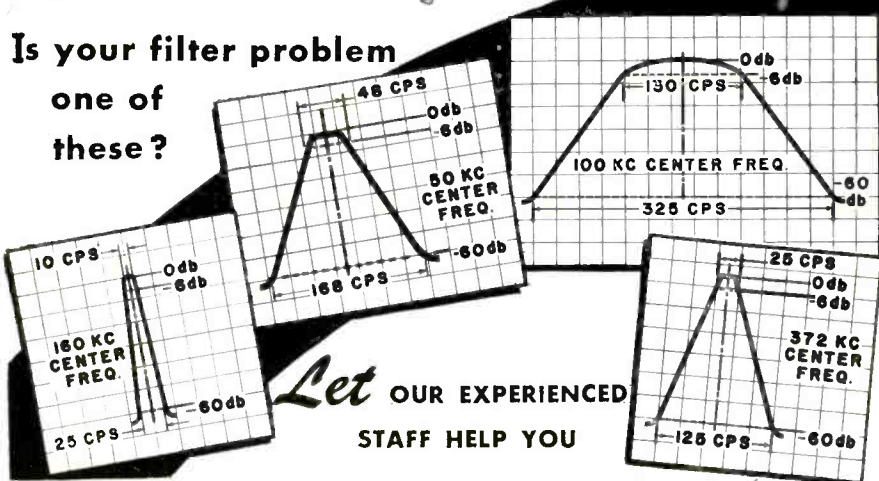

Let OUR EXPERIENCED
STAFF HELP YOU

A complete engineering and manufacturing service in the design and production of electro-mechanical apparatus is available. Your needs in development of instrumentation, gyro-mechanisms, communication networks, filters, servomechanisms, and electronic systems can be met by our plant, equipment, personnel and experience.

**VECTRON
SERVICES**

Electro-Mechanical Equipment
VECTRON, inc.
235 HIGH STREET, WALTHAM, MASSACHUSETTS



NEW PRODUCTS

(continued)

is less than 1.0 percent. Peak output is 8 watts. Power characteristics at 5-w are within 3 db from 30 to 15,000 cps. Other features are: regulation, within 1 db; damping factor of 10; and internal impedance at 8-ohm output, less than 1 ohm.

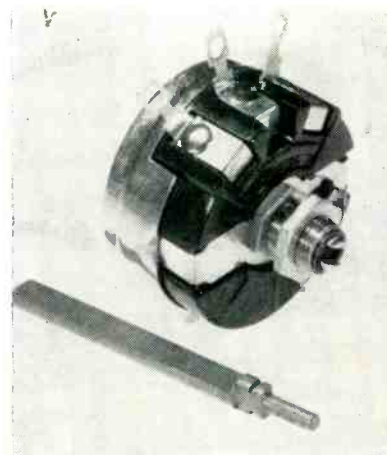

Wire-Wound Controls

CLAROSTAT MFG. CO., INC., Dover, N. H., announces availability of wire-wound controls with field-attached shafts. The new controls may be used with any one of the company's 11 different Pick-A-Shafts. They come in three series: the A43 is rated at 2 watts; the A58 is rated at 3 watts; and the A10 is rated at 4 watts. A wide range of resistance values is available in each series.



Function Generator

COMPUTER CORP. OF AMERICA, 149 Church St., New York 7, N. Y. Computations involving backlash, dead-zone and limit-stops now may

CUSTOM *Molded* POWDERS

FOR HERMETIC SEALS

IRON SEALING and
KOVAR SEALING GLASS

Close tolerance maintained . . . the
highest precision to satisfy your speci-
fications.



NAME YOUR REQUIREMENTS



We'll be glad to meet your
specifications. Our laborator-
ies welcome working with
you on new powders and de-
signs for pressing. Let us
quote on your requirements.

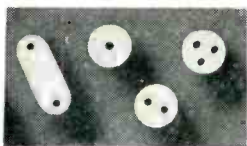

(Quick
Delivery)

- Sintered powders
- Ceramic bodies
- Cold mold plastics



MANSOL
CERAMICS

13 VALLEY STREET
BELLEVILLE, NEW JERSEY

SPECIALISTS FOR THE TRADE

THE GRAYHILL SERIES 5000
MINIATURE TAP SWITCH IS DESIGNED
TO MEET SPACE FACTORS INVOLVED IN
THE MINIATURIZATION TREND. THE
POSSIBLE CONTACT ARRANGEMENTS RUN
FROM A SINGLE DECK UP TO 10, WITH
FROM 2 TO 10 TAPS PER DECK. EITHER
SHORTING OR NON-SHORTING CONTACTS.
RATED TO BREAK 1 AMP., 115 V. A C,
NON-INDUCTIVE.

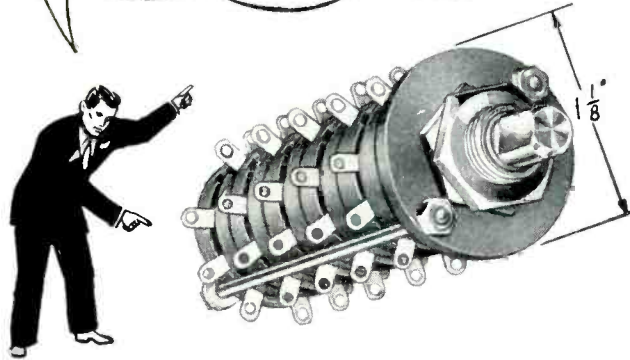

Grayhill

GET DETAILS — Write
for the Grayhill
Catalog now

4522 West Madison Street, Chicago 24, Illinois

Boost Your Quality Standards with **DX** ELECTRONIC COMPONENTS



TOROID COILS

SPECIAL
ASSEMBLIES

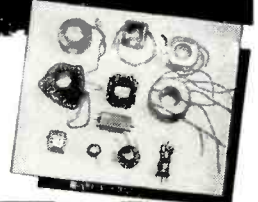

DEFLECTION
YOKES

CRYSTALS



TOROID FILTERS . . . I. F. TRANSFORMERS . . . R. F. COILS . . . DISCRIMINATORS
TRANSFORMERS . . . TV TUNERS . . . ION TRAPS . . . SPEAKERS

If you require exacting quality and dependable performance, let
DX engineers figure with you on your next production run. Users
of DX components enjoy exceptional freedom from field failures.
This advantage can be yours at no extra cost. Write today.



DX RADIO PRODUCTS CO.

GENERAL OFFICES: 2300 W. ARMITAGE AVE., CHICAGO 47, ILL.

*Hook-up
with the Best*

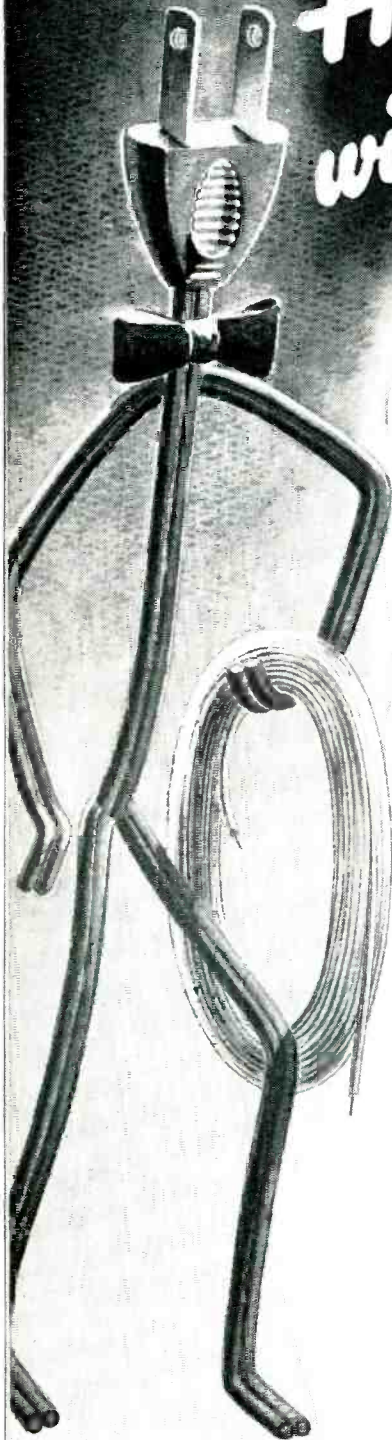

PHALON
TRADE MARK

ELECTRONIC THERMOPLASTIC HOOK-UP WIRE

Got a particularly difficult electronic insulation problem? We've got the answer! Call on PHALON . . . you'll discover that one of the PHALON line of electronic hook-up, lead wires or fixture wires will do the job — and do it well.

PHALON electronic hook-up wire is strong and tough, yet strips easily, leaving clean conductors.

Get the complete PHALON story now!

A FEW TYPES OF PHALON ELECTRONIC HOOK-UP WIRE

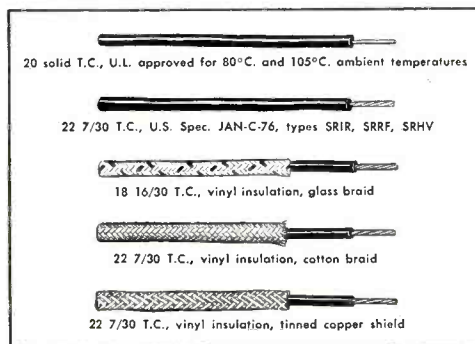

PHALO PLASTICS CORPORATION
CORNER OF COMMERCIAL ST. • WORCESTER • MASS.
Manufacturers of Thermoplastic Insulated Wire, Cables, Cord Sets and Tubing

PHALO
TRADE MARK

be easily and accurately accomplished on any real-time analog computer such as IDA, REAC or GEDA. Generation of these three nonlinear functions is made possible by a new, compact unit, designated model NLU-2. It has two completely independent channels, each of which may be set for any of the three modes of operation. All-electronic in design, the unit may be used at higher frequencies than a servo-operated function generator. The NLU-2 has a self-contained power supply operating from a 115-v, 60-cycle line and drawing $\frac{1}{2}$ ampere.

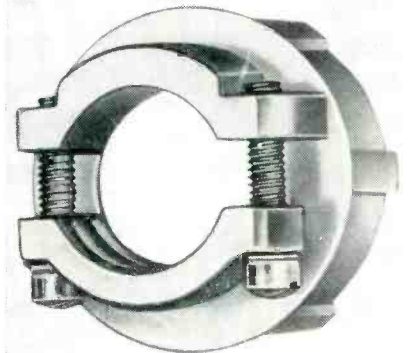

Cable Clamps

TLG ELECTRIC CORP., 31 W. 27th St., New York 1, N. Y., are producing AN3057 cable clamps in 7 popular sizes. These clamps are time-proved standards for communication application in the electronics, aviation, marine, railroad and transportation industries. Precision-manufactured and guaranteed to meet every requirement of rigid Army-Navy specifications, these clamps support cable or wire at the plug or receptacle with excellent security, and prevent twisting or pulling at vulnerable soldered connections. The sizes of type AN3057 now in production are: 3, 4, 6, 8, 10, 12 and 16. Further information is available on request.

Phono Accessories

GENERAL ELECTRIC Co., Syracuse, N. Y., has added a new variable reluctance cartridge and a new wide-

IT'S NEW!



**10-POUND PORTABLE
BATTERY-OPERATED
TAPE RECORDER**

**THE MAGNEMITE*
NEW DRY BATTERIES**

Inexpensive flashlight-type cells that last 100 operating hours.

NEW SPRING MOTOR

Governor-controlled constant speed motor runs 15 minutes per winding.

NEW PLAYBACK & MONITORING

Feeds directly into headphones or external amplifier and speaker.

NEW SENSITIVITY

Crystal-clear recordings up to 100 feet from the microphone.



Field recording is now as easy as studio recording, with the Magnemite* Portable series. There's a midget battery-powered spring-motor Magnemite* model for every recording need — speech, music and sound effects. Write today for descriptive literature and direct factory prices.

*Trade Mark Reg.

AMPLIFIER CORP. of AMERICA
398 Broadway New York 13, N. Y.

*Ideal for
ANTENNA CONNECTIONS
PHOTO-CELL WORK
MICROPHONE CONNECTIONS*

**JONES
SHIELDED TYPE
PLUGS & SOCKETS**

**LOW LOSS PLUGS AND
SOCKETS FOR HIGH
FREQUENCY CONNECTIONS.
SUPPLIED IN 1 AND 2
CONTACT TYPES:**



P-101-1/4
S-101

101 Series can be furnished with 1/4", .290", 5/16", 3/8" or 1/2" ferrule for cable entrance. Knurled nut securely fastens unit together. Plugs have ceramic insulation and sockets have bakelite. Quality construction. Fine finish. Assembly meets Navy specifications.

For full details and engineering data ask for Jones Catalog No. CS-18.

**JONES MEANS
Proven QUALITY**

Jones **HOWARD B. JONES DIVISION**
CINCH MANUFACTURING CORPORATION
CHICAGO 24, ILLINOIS
SUBSIDIARY OF UNITED CARB FASTENER CORP.

EDWARD E. ROBINSON

**METERING PUMP
for HOT WAXES
and CEMENTS**

- Filling
- Sealing
- Potting
- Insulating
- Cementing
- Impregnating
- Weather Proofing

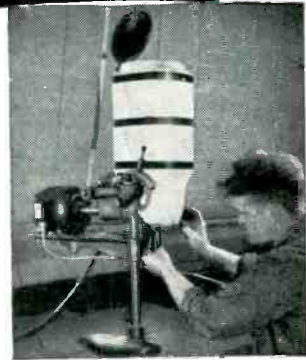

Robinson Metering Pump being used to forcibly eject metered amounts of cement into wire brush handle. Reservoir temperature 350° F.

- | | |
|--------------|----------------|
| Transformers | Sockets |
| Condensers | Switches |
| Rectifiers | Wiring Devices |

Not a gravity dispenser — Forcibly ejects hot waxes and cements. Thermostatically controlled heat — Variable with a maximum reservoir temperature of 450° F.

Motor driven, clutch actuated — 2/3 second per ejection. Variable discharge — Ejections changed in 2 seconds, without tools. Reduces unit costs — No skilled operator required. Saves material — reduces rejects.

Easily installed — Adaptable to any production set-up.

For complete information on this modern production tool and its possible application to your requirements, write for Bulletin No. 1A-R.

EDWARD E. ROBINSON
INCORPORATED

95 PARK AVENUE • NUTLEY 10, N. J.

Build YOUR OWN TEST EQUIPMENT

Heathkit AUDIO GEN. KIT \$34.50

Heathkit TUBE CHECKER KIT \$29.50

Heathkit TELEVISION GENERATOR KIT \$39.50

Heathkit SIGNAL TRACER KIT \$19.50

Heathkit CONDENSER CHECKER KIT \$19.50

Heathkit IMPEDANCE BRIDGE KIT \$69.50

Heathkit HANDITESTER KIT \$13.50

Heathkit PUSH PULL OSCILLOSCOPE KIT \$43.50

Heathkit ELECTRONIC SWITCH KIT \$19.50

Heathkit BATTERY ELIMINATOR KIT \$24.50

Heathkit VACUUM TUBE VOLTMETER KIT \$24.50

Heathkit R.F. SIGNAL GEN. KIT \$19.50

Heathkits are completely engineered instruments supplied unassembled. Every kit goes together smoothly and easily. All drilling, punching, and painting has already been done for you.

It's easy and fun to build a Heathkit. All parts are furnished and are of highest quality for years of trouble-free, dependable operation.

Save money by constructing your own. All expensive wiring and assembly costs are completely eliminated.

Detailed construction manual shows clearly where each wire and part goes and tells exactly how to build the kit. Write for free catalog.

HEATH COMPANY
BENTON HARBOR 14, MICHIGAN

EXPORT AGENT
BOCKE INTERNATIONAL CORP.
13 E. 40th St.
NEW YORK CITY (16)

introductory offer

ARROW

PRINTED CIRCUIT KITS

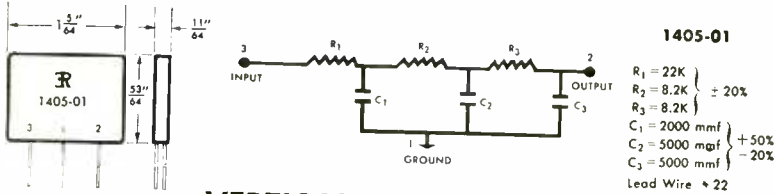

VERTICAL INTEGRATOR

Printed Electronic Circuits offer so many advantages and savings in space, time and cost that the electronics industry finds new uses for them daily. They are important components in computers, control circuits, military equipment requiring sub-miniaturization, radio and TV sets, hearing aids, remote control model equipment, etc.

Find out for yourself how these Erie Printed Circuits can be valuable to you. Take advantage of Arrow's special introductory offer. Get one, or several, of these special money-saving kits of the entire series for all purposes. Circuit diagram and suggested uses with each unit. Complete technical data supplied on request.

EXPERIMENTER'S KIT

Contains one each of the listing shown below. Ideal for the experimenter, technician, serviceman or hobbyist. Sizes range from 37/64" x 21/64" to 1 11/32" x 57/64". All 11/64" thick with 2 1/2" tinned leads. In handsome plastic case useful for small hardware, etc.

KIT #1
List \$11.50

ARROW SPECIAL

5⁹⁵

INTERMEDIATE KIT

Contains six 1405-01, four 1403-01, three each of 1406-01, 1404-01, 1404-02, 1408-01, two each of 1403-02, 1403-03, 1406-02, 1407-01, 1407-02, 1407-03, 1408-02. In Plastic Case.

KIT #2. List \$28.50

ARROW SPECIAL

15⁹⁵

NUMBER	DESCRIPTION	LIST PRICE
1403-01	Diode Filter	\$.60
1403-02	Diode Filter	.60
1403-03	Diode Filter	.60
1406-01	Triode Plate Coupler	.70
1406-02	Triode Plate Coupler	.70
1404-01	Triode Plate Coupler	.75
1404-02	Triode Plate Coupler	.75
1407-01	Pentode Plate Coupler	.90
1407-02	Pentode Plate Coupler	1.00
1407-03	Pentode Plate Coupler	.90
1405-01	Vertical Integrator	1.10
1408-01	Audio Output Coupler	1.00
1408-02	Audio Output Coupler	1.15

KIT #3
List \$57.00

ARROW SPECIAL

29⁹⁵

LABORATORY KIT

Offers an extra saving for industry, laboratory, school, research use. Contains DOUBLE the amount of all units listed in Intermediate Kit at left. In Plastic Case.

For your copy of ARROW'S new 1952-53 1100-page Master Catalog please write Dept. E-10 on your company letterhead.

ARROW ELECTRONICS INC.

82 CORTLANDT STREET • NEW YORK 7, N. Y. • Phone Dlgby 9-4714
Teletype NY1-472 • Western Union ARROW ELECTRONICS-WUX-N. Y.
Cable AROLECTRO-N. Y.

range stylus to its line of phono accessories. The new wide cartridge, model RPX-052 is equipped with a dual wide-range sapphire and diamond Baton stylus. It is designed to perform with uniform velocity response up to 15,000 kc. Minimum record wear is assured by designing the stylus in such a way that only six to eight grams of pressure results for all types of records.

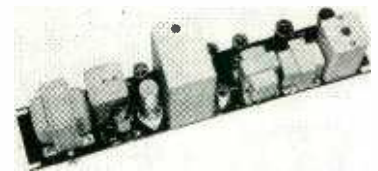

Duplex Signaling Unit

HAMMARLUND MFG. CO., INC., 460 W. 34th St., New York 1, N. Y., has introduced a new duplex signaling unit consisting of a tone transmitter and frequency selective receiver designed to operate over wire lines, telephone or power line carrier, and radio or microwave communications circuits. The units may be used to transmit and receive signaling, dialing, telemetering, teleprinting, supervisory controls or other information. Transmitters and receivers are available on the same or different frequencies between 2,000 and 6,025 cps. Up to 33 channels can be used over a single circuit.

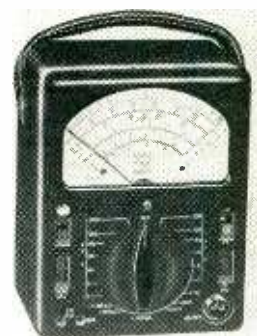

VTVM

TRIPLETT ELECTRICAL INSTRUMENT Co., Bluffton, Ohio. Peak-to-peak a-c voltage and r-f measurements by the model 650 vtm are made



NO BURN OUTS in thin sheets. Engineered projections prevent.

NO RETAPPING. Shank protects threads from weld spatter.

NO PILOTS or costly special electrodes.

NO INDEXING. Round, compact shape eliminates orientation. Permits use on narrower flanges. Self Locating.

YES. PEM WELD FASTENERS will do a better fastening job at lower cost, wherever load carrying threads are required in thin metals that may be welded. Write for literature and samples for trial. Penn Engineering & Manufacturing Corp., Doylestown, Pa.



other uses
Measure acceleration and velocity. Trigger or synchronize cathode ray oscillograph sweep circuits, angular position indicator (shaft or fly-wheel), reference marker (degrees, position or dead center). Indicate RPM, operations, cycles or motion at rates in excess of 20,000 per second when used with electronic counters.

ACCURATELY MEASURES Rate of Acceleration or Motion

UP TO 20,000 PER SECOND WITHOUT CONTACT



Model 3010 U. S. Pat. 2396703

NEW **Electro** IMPULSE GENERATOR

Small low cost electromagnetic pick-up amplifies electrical impulses for counting recurring operations, revolutions, sequences, cycles or motions. It produces a voltage output proportional to the object's rate of speed. And may be actuated by the displacement or vibration of any magnetic material in the field of the pick-up. Such as a slot or key-way in the rim of a wheel or shaft, the teeth in a gear or any magnetic part on a moving body. Consult Our Engineers on Your Particular Problem.

Write for Bulletin MP 552 Today!

ELECTRO PRODUCTS LABORATORIES

4501-Eu North Ravenswood Ave., Chicago 40, Ill. In Canada: ATLAS RADIO CORP. LTD., Toronto

AGASTAT

TRADE MARK

TIME DELAY RELAY

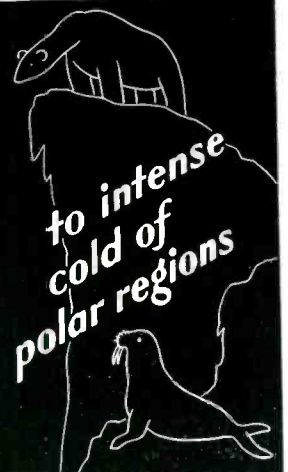
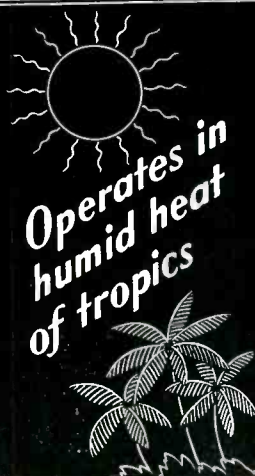

Small ~ Compact ~ Few moving parts ~ Easily mounted
Operates in any position
Time delay range, 1 second to 5 or more minutes

A'GA® DIVISION OF ELASTIC STOP NUT CORPORATION OF AMERICA
1027 NEWARK AVENUE • ELIZABETH 3 • NEW JERSEY

Molded Coil Forms

BY MOLDITE

Another Moldite component, made with uncompromising adherence to quality and complete assurance of punctual delivery! Moldite molded coil forms are available in sizes from .125 to .375 OD.

- Magnetic Iron Cores
- Filter Cores
- Molded Coil Forms
- Threaded Cores
- Sleeve Cores • Cup Cores

NATIONAL

MOLDITE

COMPANY

1410 Chestnut Ave., Hillside 5, N. J.

Samples promptly submitted upon request for design, pre-production, and test purposes.

SEND FOR CATALOG 112

Robert T. Murray 614 Central Ave. East Orange, N. J.	Jerry Golten Co. 2750 W. North Ave. Chicago 22, Ill.	Martin P. Andrews Mott Road Fayetteville, N. Y.	Perimuth-Colman & Assoc. 1335 South Flower Los Angeles, Cal.	Jose Luis Pontet Cardoba 1472 Buenos Aires
--	--	---	--	--

NEW PRODUCTS

(continued)

with one probe. Complete frequency coverage is from 20 cps to over 110 mc. One main selector switch controls all ranges. An especially designed, insulated, shielded r-f probe with short leads provides for h-f measurements and the tester has zero center mark for f-m discriminator alignment plus any other galvanometer measurements. A high input impedance of 11 megohms on d-c allows for accurate measurements without loading the circuit under test.

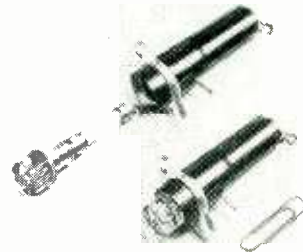

Indicating Fuseholder

ALDEN PRODUCTS Co., 117 N. Main St., Brockton 64, Mass., has announced a new neon indicating fuseholder, the Fuselite 44-5FH, that takes a standard 3AG or 3AB fuse. A unique feature is the integrally molded neon bulb in a crystal clear plastic lens that lights up instantly when the fuse blows. Because of its standard design and compact construction, the 44-5FH has practically universal application in 110 v circuits. With slight modifications it can be used for 220 v.

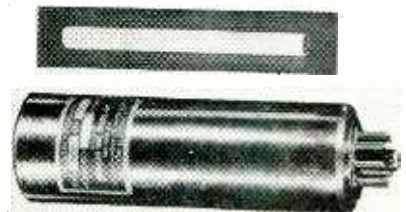

Frequency Standard

AMERICAN TIME PRODUCTS, INC., 580 Fifth Ave., New York 36, N. Y. Type 2003 frequency standard, a hermetically-sealed, plug-in unit, contains a miniature, high-Q tuning

A NEW HIGH



IN AUDIO WAVE FORM ANALYSIS

PANORAMIC SONIC ANALYZER LP-1

Specifically designed for applications demanding maximum resolution, the LP-1 offers many new possibilities and high speed analysis of sounds, vibrations and electrical wave forms.

4 Selectable Scanning Ranges

Log Scan	40 cps to 20,000 cps
3 Linear Scanning Ranges	Resolution
100 cps	26 cps
500 cps	53 cps
1500 cps	105 cps

- Graphic presentation of frequency vs voltage
- Selection and magnification of any spectrum segment for sharp, detailed analysis
- Automatic maximum resolution on all scanning ranges
- Continuously variable tuning control from 40cps to 20 KC
- One cycle per second scanning rate
- Wide input voltage range of 500M.V to 500V
- Sweep oscillator output connection for operation with Panoramic Sonic Response Indicator G-2

SPECIAL APPLICATIONS

- Investigations of closely spaced sound and vibration frequencies
- Harmonic analysis of waveforms having low frequency fundamentals
- Spectrum analysis requiring constant band width

Write Today For Complete Specifications



10 South Second Ave., Mount Vernon, N. Y.
Phone: Mount Vernon 4-3970

SEE US AT N-E-C, BOOTH 84

IF THE WIRING FAILS



SO DOES YOUR PRODUCT'S REPUTATION

FOR DEPENDABLE PRODUCT WIRING USE

UNILECTRIC Wiring Systems

Year after year — for over ten years — UNILECTRIC has produced millions of wiring systems, for more than 150 leading manufacturers of electric and electronic products. From controls to complex armed forces equipment, these wiring systems have consistently met the most exacting requirements and provided substantial savings to each customer.

To assure utmost dependability plus cost saving engineering assistance, low cost production and "on-schedule delivery" investigate UNILECTRIC today.

UNILECTRIC Wiring Systems

Manufactured by
UNITED MANUFACTURING & SERVICE COMPANY
409 SOUTH 6th STREET • MILWAUKEE 4, WISCONSIN

IN-RES-CO TYPES SM-15 & SM-30 WIRE WOUND RESISTORS

SUB-MINIATURE weather-tested midgets

Type SM-15 and SM-30 Resistors offer three vital advantages — sub-miniature size, weather resistant construction and high resistance. The elimination of center hole mounting and the inclusion of axial leads increases winding area and results in 25% greater resistance value than resistors of standard design. Special coating is moisture and fungus proof and designed to meet JAN-R-93 specifications. Sealed in Bakelite construction affords additional climatic protection. As ratings are conservative, types SM-15 and SM-30 can be specified with confidence for service under rigorous conditions.



TYPE SM-15
5/16" DIA. x 3/8" LG.



TYPE SM-30
5/16" DIA. x 3/4" LG.

ASK FOR THE NEW RESISTOR HANDBOOK —

Contains complete data on resistors for every purpose and their recommended applications. Please make request on company letterhead.



INSTRUMENT RESISTORS CO.

COMMERCE AVENUE UNION NEW JERSEY

APPLICATION-DESIGNED RESISTORS FOR ELECTRONICS AND INSTRUMENTATION

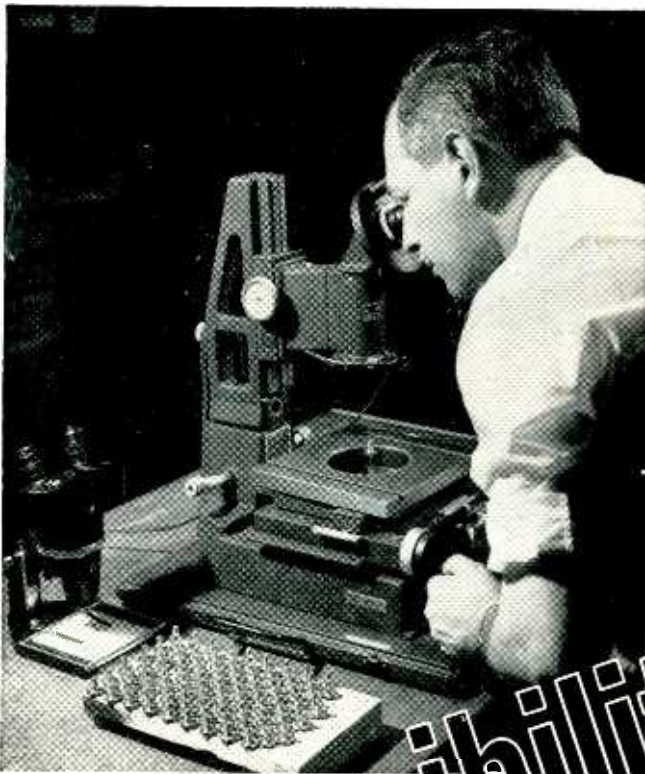

Responsibility

The centering of responsibility in one reliable source of supply is no small matter in the procurement of ultra-precision components.

To specify Transicoil control motors combined with Transicoil precision gear trains, complete Transicoil motor-gear train, or motor-driven induction generator-gear train assemblies offers best possible assurance of getting control jobs done the way you want them done.

Control Motors
Induction Generators
Miniature Gear Trains
Servo Amplifiers

... new catalog sent on request

TRANSICOIL

CORPORATION

107 GRAND ST.

NEW YORK 13, N. Y.

fork and all critical circuit components. External circuit consists of one 12AT7, (choice of 5 other types) and 6 small components. Input is 75 to 300 v at 1 to 5 ma, 6 v a-c or d-c at 0.3 ampere. Output frequency is 400 or 500 cycles. Accuracy is ± 1 part in 50,000 at room range, ± 1 part in 5,000 from -65 to $+85$ C. The unit will withstand 125 C ambient temperature. Output voltage is approximately 5 v into 200,000 or more ohms. It has internal silicone shock mounting, and weight is 10 oz maximum. Size is $4\frac{1}{2}$ in. long by $1\frac{1}{2}$ in. diameter.



Transcription Player

AUDIO-MASTER CORP., 341 Madison Ave., New York 17, N. Y., has developed a more elaborate version of its transcription player combined with p-a system. Model AM53-PA has a 12-in. detachable loudspeaker with 10-ft extension cord and plays all sizes and types of records and transcriptions from 7 to $17\frac{1}{2}$ in. It has a 5-tube high-gain amplifier, twist crystal cartridge fitted with 2 permanent needles, a 3-speed motor for $33\frac{1}{3}$, 45 and 78 rpm, variable volume and tone control, and special mixer that permits simultaneous use of record and microphone.

Literature

Electronic Components. Sylvania Electric Products Inc., Second Ave., Warren, Pa., has issued an 8-page folder illustrating and describing a line of electronic components. Items covered include radio and c-r tube sockets, terminal

**2 KW
VACUUM TUBE
BOMBARDER
OR
INDUCTION
HEATING UNIT**



For only \$650.

Never before a value like this new 2-KW bench model "Bombarder" or high frequency induction heater . . . for saving time and money in surface hardening, brazing, soldering, annealing and many other heat treating operations.

Simple . . . Easy to Operate . . . Economical Standardization of Unit Makes This New Low Price Possible.

This compact induction heater saves space, yet performs with high efficiency. Operates from 220-volt line. Complete with foot switch and one heating coil made to customer's requirements. Send samples of work wanted. We will advise time cycle required for your particular job. Cost, complete, only \$650. Immediate delivery from stock.

Scientific Electric Electronic Heaters are made in the following ranges of Power: 1-2-3½-5-7½-10-12½-15 - 18 - 25-40-60-80-100-250KW.

*Scientific
Electric*

Division of
"S" CORRUGATED QUENCHED GAP CO.
107 Monroe St., Garfield, N. J.



**PRECISION
MACHINES**

for Die-less Duplicating

See the
Complete line









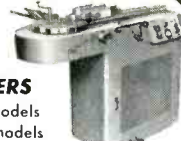

BOOTH 630



National Metals
Exposition
October 20-24
Philadelphia

Or send for New
32 page Catalog

O'NEIL-IRWIN MANUFACTURING CO.
321 8th Ave., Lake City, Minnesota

	BENDERS 5 hand models 2 power models	
	SHEARS 4 hand models .4 power models	
	ROD PARTERS 2 hand models 1 power model	
	PUNCH PRESSES 2 hand models 2 power models	
	NOTCHERS 1 hand model 1 power model	
	BRAKES 10 hand models	
	ROLLERS 2 hand models	

**PRIMARY BATTERIES
for your Specialized Needs**

DRY TYPES

78 Standard Industrial,
Laboratory and Gov-
ernment Types.



**LAB-BILT
BATTERIES**

Our engineers will design
and create to your re-
quirements. Send us your
specifications.

**HI-DRIVE
MINIATURE
MOTOR**



Precision-built, low-cost,
battery-operated—
available for delivery
now.

RESERVE TYPES

Water activated
"One Shot" Batteries.



Send for **FREE** Catalog

SPECIALTY BATTERY COMPANY

A Subsidiary of the **RAYOVAC** Ray-O-Vac Company

MADISON 10, WISCONSIN



AN



AVD

VELVET VERNIER MECHANISMS

National's famous line of velvet vernier mechanisms has been accepted by well-known commercial users as well as individual builders. Having a standard 5 to 1 ratio, they are available to fit either $\frac{3}{16}$ " or $\frac{1}{4}$ " shafts. Types are also available with insulated or non-insulated output hubs for connecting to $\frac{1}{4}$ " output shafts. Write for drawings and specifications.

POPULAR TERMINAL ASSEMBLIES

National terminal assemblies have proved extremely popular because of extremely low-loss characteristics, their rugged construction and practical design.

Type FWG is a Victron terminal strip for high frequency use. Binding posts take banana plugs at top, grip wires through a hole at bottom.

Type FWH — the insulators of this terminal assembly are moulded bakelite. Binding posts same as FWG.

Type FWJ utilizes same insulators as FWH, but has jacks.

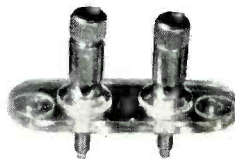

FWG



FWH



FWJ

boards, terminal strips, plugs and connectors and loop antennas.

Ultrasonic Soldering Equipment. Mullard Ltd., Century House, Shaftesbury Ave., London, WC2, England. An 8-page publication describes the principles and methods of use of the company's ultrasonic soldering equipment, which consists of a soldering iron and tinning bath. Applications suggested for the equipment include the tinning of electronic chassis assemblies, the soldering of connections to aluminum foil capacitors, and the joining of aluminum lugs to stranded aluminum cables.

Self-Locking Fastener. Elastic Stop Nut Corp., 2330 Vauxhall Road, Union, N. J. Interesting case histories and latest engineering data for the Rollpin self-locking fastener are important features of catalog No. 800. Photographs illustrate the versatility of the device as a practical substitute for rivets, cotter pins, set screws, stop pins, hinge pins, positioning dowels, lock pins and shaft keys.

Precision Indicating Potentiometers. Minneapolis-Honeywell Regulator Co., Wayne and Windrim Aves., Philadelphia 44, Pa. Specification sheet 177 describes and illustrates both the new console type operator's desk and the Brown ElectroniK precision indicator. It describes the precision indicator for both single and multipoint indication of variables as well as the extended range indicator and shows how this indicator, when combined with the operators desk and banks of switches, permits the operator to review and log many variable readings while sitting at the desk.

Potentiometers and Resistors. Cornell Electronics Corp., 40-33 Main Ave., Douglaston, N. Y. A recent 4-page folder gives a technical description and illustration of the F-101 series potentiometers designed for military airborne instrumentation and similar applications. Also included is information on the company's standard

Write for drawings



You'll SAVE MONEY in Your SHOP With

PALMGREN

The Only Table Having Rotary Feed Combined with DUAL CROSS FEEDS!

This PALMGREN TABLE is sensational in price, construction and performance. Just what shops need for accurate, precision work. You can rout straight or curved, rabbet, drill, sand or mortise. Do hundreds of jobs as milling slots, grooves, keyways, squares, hexagons, curves, flats, dovetails, indexing and laying out work.

Designed for use on Drill Press or Milling Machine. It handles all types of metal and woodworking operations and makes your drill press a vertical milling machine. Precision built, it permits close tolerances. Rotary Feed is calibrated in degrees. Cross Feeds in thousandths. Cross slides and feeds are $2\frac{1}{2}$ " each side of center— $4\frac{1}{2}$ " overall. Adjustable gibbs on cross slides—4 to 1 worm and gear ratio in rotary feed. 4 Bolt slots—2 lock screws.

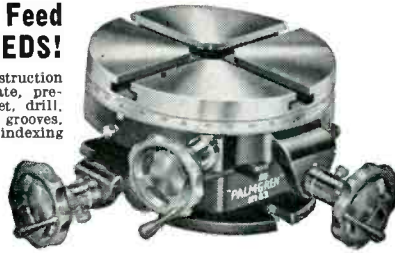

No. 83 ROTARY TABLE Only \$54.50

No.	BASE KEYWAY	T-Slots	TABLE DIA.	BASE DIA.	HEIGHT	WEIGHT	PRICE
83	$5/8$ "	$5/8$ "	8"	$6\frac{1}{4}$ "	5"	28 lb.	\$54.50
82	Same as above without Rotary Feed					26 $1/2$ lbs.	\$43.75

QUICK, ACCURATE Setups — End Delays — Spoilage



only \$8.75 with this Angle Vise

"M" Base \$3.00

Solve all your difficult angle jobs! End make shift methods, delays and spoilage with this famous PALMGREN ANGLE VISE. Ideal for Drilling, Milling, Grinding, Filing, Fitting, Marking and hundreds of jobs requiring speed and accuracy of angles on machine or bench. Set at any angle up to 90 degrees and lock—it's ready for use. Accurately graduated, every part of vise is accurately machined. Jaws of steel $2\frac{1}{2}$ " wide. 1 Plain, 1 Grooved for holding round pieces. Auxiliary Bases for machine or bench use. Swivel "M" Base shown \$3.00 Extra. Order NOW! Today!

Write for Circular No. 302

CHICAGO TOOL and ENGINEERING CO.

No. 000 Vise Mounted on SWIVEL "M" BASE

Mfrs. of PALMGREN PRODUCTS Since 1918
8380 South Chicago Avenue Chicago 17, Ill.

PIX

WIRE FORMING SPECIALISTS

Precision Parts to meet your Production and Engineering needs. From .002" dia. to .125" dia. Radio tube parts—Stampings—Drawings Modern facilities, high-production equipment.

Metal Crystal Holder Parts

Send sketch or print for quotation.

PIX MANUFACTURING CO., Inc.

24A Bedford St., Newark 3, N. J.

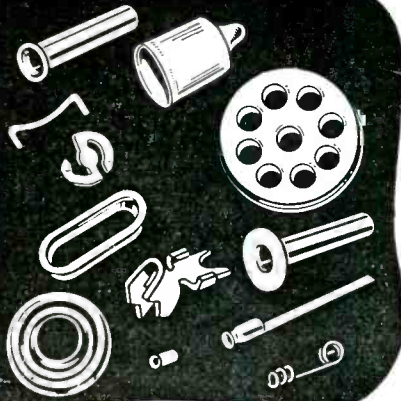

FOR QUALITY • QUANTITY — QUICKLY

SPECIFY

DAGE

RADIO FREQUENCY CONNECTORS

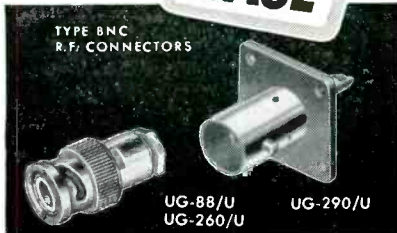

TYPE BNC R.F. CONNECTORS

UG-88/U
UG-260/U

UG-290/U

Dage specializes in the manufacture of the finest in Type BNC, Type N and special radio frequency connectors. Your requirements for radio frequency connectors will be met quickly and efficiently by Dage. All Dage connectors are manufactured in strict accordance with military specifications. Write Dage today.



QUALITY QUANTITY QUICKLY

DAGE

DAGE ELECTRIC COMPANY, INC.

62 North Second Street • Beech Grove, Indiana

ATR

AUTO RADIO VIBRATORS

have Ceramic Stack Spacers



A COMPLETE LINE OF VIBRATORS . . .

Designed for Use in Standard Vibrator-Operated Auto Radio Receivers. Built with Precision Construction, featuring Ceramic Stack Spacers for Longer Lasting Life. Backed by more than 20 years of experience in Vibrator Design, Development, and Manufacturing.

ATR
NEW MODELS
NEW DESIGNS
NEW LITERATURE

"A" Battery Eliminators, DC-AC Inverters, Auto Radio Vibrators

See your folder or write factory

AMERICAN TELEVISION & RADIO CO.

Quality Products Since 1931

SAINT PAUL 1, MINNESOTA-U. S. A.

and noninductive fixed wire-wound resistors.

Rotary Accelerator. Statham Development Corp., 12411 West Olympic Blvd., Los Angeles 64, Calif., has available a 4-page brochure on its rotary accelerator, an instrument that provides a controlled variable centrifugal acceleration for calibrating or testing instruments, electronic subassemblies, small mechanisms and other similar equipment. Acceleration range of the unit described is from 0.1 g to 100 g.

Carbon Film Resistors. Chase Resistor Co., 9 River St., Morristown, N. J., has issued a 4-page folder dealing with a line of 1-percent precision microcrystalline carbon film resistors. Dimensions of the various types, construction information and characteristics are given. Temperature coefficient curves are shown. A price list is included.

Oscillator. Southwestern Industrial Electronics Co., 2831 Post Oak Road, Houston 19, Texas. A 4-page folder describes the model L oscillator that has been designed as a source of power covering the frequency range of 0.01 to 100 cps. An illustration, technical specifications, a page of information on output circuits and prices are given. Also included is a circuit diagram showing a simplified version of the two-amplifier-bridge-stabilized oscillator which is used in the model L oscillator.

Electronic Flow Meter. Minneapolis-Honeywell Regulator Co., Wayne and Windrim Aves., Philadelphia 44, Pa. Instrumentation Data Sheet 10.3-5 describes the Potter-Brown Flowmeter for measurement of fluids over an extremely wide range of temperatures and pressures with an accuracy of 0.5 percent. The system described is easily installed, has linear characteristics and can be used to measure, record and control flow at one or more points.

Hermetic Seal Bushings. Helder Terminal and Bushing Co., Inc., 225 Belleville Ave., Bloomfield,



*The
finest
reproduction
comes from*

FAIRCHILD

MODEL 126 TAPE RECORDERS



Whatever you put on tape, you can count on the finest reproduction from the Fairchild Model 126 Magnetic Tape Recorder. It is quality designed for a long, useful life . . . for year-in, year-out accuracy and minimum maintenance. That means its final cost is substantially less than other professional recorders. These exclusive Fairchild features explain why.

EXCLUSIVE Highest signal-to-noise ratio of any tape recorder—permits recording with lowest possible distortion and dubbing or transfer without degradation of quality.

EXCLUSIVE Syncroll Drive insures exactly synchronous tape speed from start to finish. Comes up to stable speed faster. Gives you accurate timing of program and on-pitch reproduction. Splice tape from remote sections of roll when required—no change in pitch.

EXCLUSIVE Oversize Capstan, 1 1/4" diameter with 180° tape wrap, eliminates tape slippage, giving better timing accuracy.

EXCLUSIVE Dynamic Reel Braking insures smooth stops. No friction brakes to wear out.

EXCLUSIVE Pic-Sync Attachment—optional feature. Corrects for tape stretch and shrinkage. Provides absolute timing required for lip synchronous sound on tape with motion pictures and TV programs.

EXCLUSIVE Automatic Framing Control—available with Pic-Sync—brings the recorder into "frame" with movie projector or second tape machine when both are started from standstill, regardless of differences in starting times. Also ideal for editing.

Remember, invest in a Fairchild and you have tomorrow's recorder today . . . at lowest overall cost. Send for bulletin T11, giving complete data.



FR 132

FAIRCHILD RECORDING EQUIPMENT

154th STREET & 7th AVENUE • WHITESTONE, NEW YORK

drawn cases

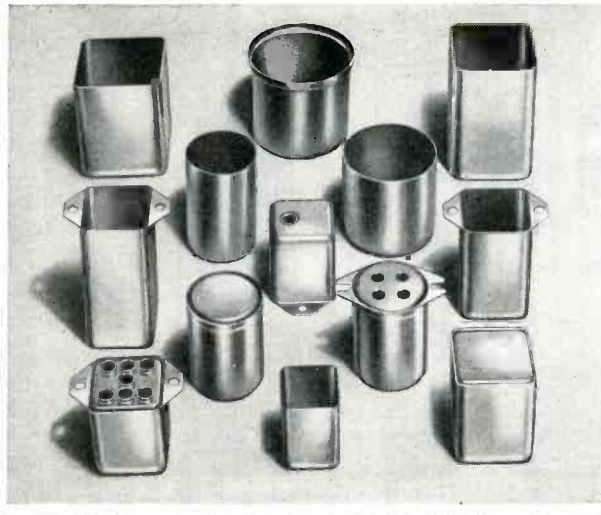

hot tin dipped . . . fabricated terminal and vent holes . . . smooth, one-piece construction using cold rolled steel . . . draw depths up to 2½" . . . inside fit covers for easy hermetic sealing in all sizes . . . available as stock sizes and as special fabrications.

OLYMPIC METAL PRODUCTS COMPANY, INC.
P. O. BOX 71A PHILLIPSBURG, N. J.

Precision in Miniature!



Extended Range AUDIO OSCILLATOR

- Only 6" x 4¼" x 5".
- 18 cycles to 1.2 megacycles.
- Distortion less than 0.2%.
- Constant output ±0.5 db.

\$150 Literature on request

Waveforms, inc.

333 Sixth Avenue
New York 14, N. Y.

**PALLADIUM • GOLD
SILVER • RHODIUM
LEAD • other metals
PLATED ON**

- Contact Pins
- Wave Guides
- Conductors
- Cavities
- Terminals

**ALUMINUM • STAINLESS STEEL
MU-METAL • BERYLLIUM COPPER
MONEL • PHOSPHOR BRONZE
POWDERED METALS ETC.**

ELECTRONIC ELECTROPLATING TO EXACTING SPECIFICATIONS

During the growth of the Electronic Industry, MERIT PLATING CO., has been in the forefront in solving Electroplating problems arising from the highly specified requirements for plating Electronic Components and Equipment.

MERIT PLATING COMPANY

218 East 141st Street

New York 51, N. Y.

CYpress 2-7251

filtered by
FILTRON

CHANCE VOUGHT
CUTLASS

*Like a
Bat out
of Hades!*

**RF NOISE SUPPRESSION
FILTERS DESIGNED FOR
YOUR SPECIFIC PROBLEM
DELIVERED WHEN YOU
NEED THEM . . .**

FILTRON

has positive quality control!

FILTRON coil structures represent the finest engineering in wire wound inductors.

FILTRON core structures are the result of years of research to develop the best materials suited for your filter.

FILTRON capacitors' sections are designed and manufactured specifically for your RF Interference Filter.

FILTRON'S filter design assures economy of size and weight. Our metal fabrication department will construct a filter housing to fit the available space.

FILTRON'S modern shielded laboratories are available for the RF Interference testing and filter design for your equipment, to the required specifications.

RF INTERFERENCE SUPPRESSION FILTERS FOR:

- | | |
|------------|--------------|
| Motors | Dynamotors |
| Generators | Power Plants |
| Inverters | Actuators |
| Electronic | Gasoline |
| Controls | Engines |
- And other RF Interference producing equipment

Send for our LATEST CATALOG
on your company letterhead

THE **FILTRON** CO., INC.
FLUSHING, LONG ISLAND, N. Y.

**LARGEST EXCLUSIVE MANUFACTURERS
OF RF INTERFERENCE FILTERS**

3 WAYS TO MAKE PANELS, LIDS and DOORS RF TIGHT

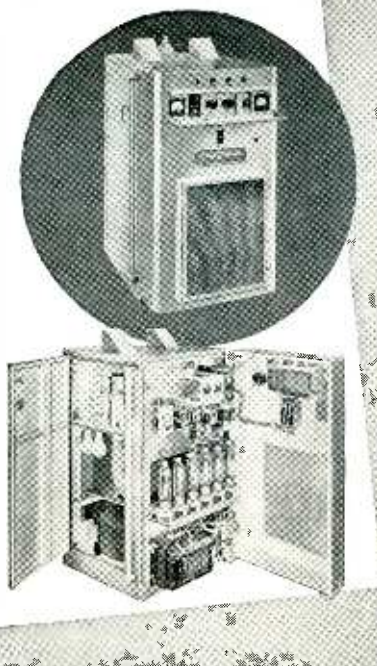

Thermatron built by Radio Receptor Co., Inc.

1

Machine mating surfaces to closest tolerances.

Costly and difficult! And the close fit is often destroyed by warping, corrosion and normal use.

2

Install numerous latches, screws, bolts or other fastenings.

Also costly! And makes maintenance more difficult, more time-consuming.

3

USE METEX ELECTRONIC WEATHERSTRIPPING.

The simple, sure, economical way!

Made of resilient, compressible *knitted* metal wire mesh, METEX strips and gaskets "close" these openings just as a weatherstrip "closes" windows and doors.

Because they are metallic, METEX strips and gaskets are conductive. Because they are knitted, they are flexible and resilient. They will conform to surface irregularities with no loss in shielding efficiency.

Close manufacturing control assures uniformity in the resiliency and dimensions best adapted to specific applications.

METEX electronic strips and gaskets are easy to install. They are not expensive—in fact, they may well save more than their cost by eliminating the need for many operations formerly thought necessary.

It will pay you to investigate the production and performance advantages of METEX Electronic Weatherstripping. A bulletin giving detailed information is yours for the asking—just write on your company letterhead.

METAL TEXTILE CORPORATION

KNITTERS OF WIRE MESH FOR MORE THAN A QUARTER CENTURY

641 East First Avenue • Roselle, New Jersey



N. J. A new, comprehensive catalog gives full technical descriptions and dimensional diagrams of a complete line of hermetic seal bushings. The 40-page presentation features in addition to bushings and terminal assemblies, technical data on studs, washers, steatite, convoluted steatite and glands. Special sections are devoted to the company's MIL-T-27 cans and covers, and attention is focused on a new cover assembly service.

Precision Test Equipment. Polytechnic Research & Development Co., Inc., 202 Tillary St., Brooklyn 1, N. Y. Eighty-eight pages of loose-leaf perforated bulletins are presented in the latest edition of the test equipment catalog. Subjects covered include attenuators and terminations, impedance measurement and transformation, transmission line components, frequency measuring devices, detection and power measurement, signal sources and receivers and vhf-uhf test equipment.

Tube Booklet. Mullard Ltd., Century House, Shaftesbury Ave., WC2, London, England, recently issued a revised and enlarged edition of a booklet entitled "Valves and Tubes for Industry and Communications." Purpose of the booklet is to provide electronic equipment designers with a convenient guide to the wide range of tubes recommended for communication and industrial applications. Besides abridged data on all available types, the publication includes general operational recommendations and a guide to American (RTMA) types replaceable by Mullard types.

Production Facilities. Sylvania Electric Products Inc., Second Ave., Warren, Pa., has announced a new bulletin describing production facilities available at its Parts Division. The 20-page 2-color publication describes the company's manufacturing and engineering services in the following industries: plastics, formed metal parts, wire, welds, mica and electronic components. The 8 × 10 bulletin contains more than 60

SILVER GRAPHALLOY

BRUSHES

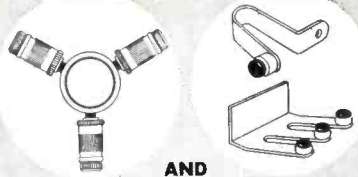

AND

CONTACTS

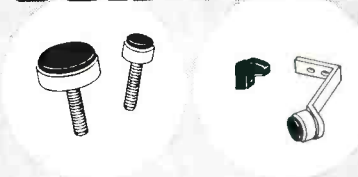

... for applications requiring low electrical noise, low and constant contact drop, high current density and minimum wear.



EXTENSIVELY USED IN

**SELSYNS
ROTATING THERMOCOUPLE and
STRAIN-GAGE CIRCUITS
ROTATING JOINTS
GUN-FIRE CONTROLS
DYNAMOTORS etc.**

Wide range of grades available for standard and special applications.

Brush holders and coinsilver slip rings available for use with Silver Graphalloy Brushes.

OTHER GRAPHALLOY PRODUCTS:

Oil-free self-lubricating Bushings and Bearings, Oil-free Piston Rings, Seal Rings, Thrust and Friction Washers, Pump Vanes.



Write us for Data Sheets and further information. Outline your problem and we will apply our years of accumulated experience toward its solution.

GRAPHITE METALLIZING CORPORATION

1055 NEPPERHAN AVENUE • YONKERS, N. Y.

PANEL METERS

by **SUPREME**

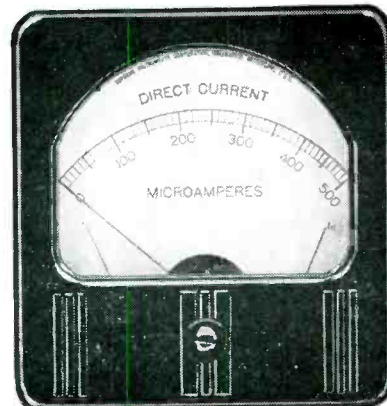
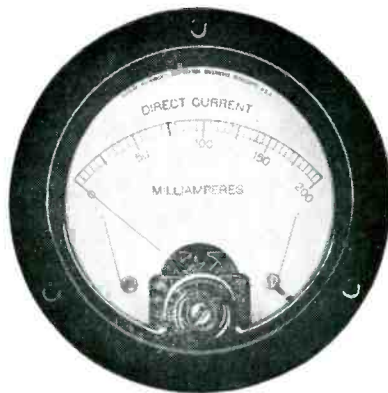

Every year more and more manufacturers are using Supreme meters as initial equipment in hundreds of electrical and electronic devices. Quality built in every respect with many outstanding features such as EFFICIENT ALNICO BAR MAGNET—SELECTED PIVOTS AND JEWELS—DOUBLE BRIDGE CONSTRUCTION—HIGH TORQUE MOVEMENT—STRONG TOUGH POINTER—RUGGED MOVING ELEMENT. Available in a variety of sizes and types with or without special dials. Write Supreme today about your meter needs. Requests for prices and delivery given prompt attention.

Our 25th Year

SUPREME, INC.

GREENWOOD 18,
MISSISSIPPI

Cut Your Costs, Too, With **POWRARM** WORK POSITIONERS

HERE'S HOW OTHERS DO IT

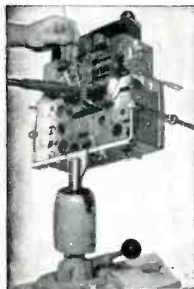

POWRARM cuts costs by increasing every worker's productivity. It gives the worker a powerful *third hand* to hold work while two hands produce. That's why POWRARM works on the most efficient assembly lines in America today, and *belongs on yours*. Write us about your production "headache" . . . we'll show you how POWRARM can cure it.

Write For Catalog 101E
32 informative pages, FREE

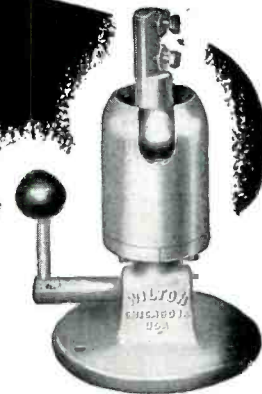

Holds work at any angle in Horizontal, Vertical or Co-axial Plane.

Three sizes of Powrarm—24 to 150 lbs. capacity.



WILTON TOOL MFG. CO.

Precision Built Bench Vises, "C" Clamps and Work Positioners

925-T Wrightwood Avenue • Chicago 14, Illinois



This new Bendix-Pacific development is an extremely compact and very light-weight S-band beacon. It is designed for use in aircraft and guided missiles, to increase the operating range of the tracking radar by reinforcing the normal echo with a retransmitted signal.

Despite its minimum size, the beacon has been fully engineered to withstand the shock, vibration, and temperature conditions encountered in missile installations.

S P E C I F I C A T I O N S :

Sensitivity:
—40 dbm signal for steady triggering

Output:
Power: 50 peak watts nominal
Frequency: 2700-2900 mc.

Pulse Width:
.6 microseconds to 3 db points
Repetition Rate of
Interrogator: 200-2500 pps.

Power Requirements:
6.3 volts AC or DC $\pm 10\%$ at 4.0 amps.
300 volts DC nominal at approx. 120 ma.

Controls:
Accessible through end of case. Cavity frequency control. Sensitivity control.

Stability:
Frequency drift less than 3 mc.

In addition to the S-band beacon Bendix-Pacific can supply similar equipment to cover the X-band, or to answer only a definite coded interrogation.

Complete engineering assistance is also available for other types of beacons to meet any specific requirement. Complete information will be sent to qualified companies.

Delay Time:
Delay between received and transmitted pulses approximately 1.5 microseconds.

Environmental Conditions:
Acceleration of 55 G's on longitudinal axis for 5 seconds.
Vibration of .06 in. total amplitude at 50 cps for 3 minutes.
Shock of 30 G's for 11 milliseconds in any plane.
Pressure sealed for high altitude operation. Requires no forced air cooling for continuous operation between -55°C (-67°F) and 38°C (100°F).

Size:
 $3\frac{1}{2}$ dia. x 12 in. long exclusive of connectors.
Weight: 5.5 lbs.

illustrations describing plants and services in 10 locations.

Broadband Ferrite-Core Transformers. Sierra Electronic Corp., 810 Brittan Ave., San Carlos, Calif. Several examples of new transformer-engineering techniques are presented in a new folder, Form SA14. Transformers utilize ferrite cores to achieve extremely high permeabilities and efficiencies at the higher radio frequencies as well as new insulation techniques which minimize leakage inductance and distributed capacitance. Examples of four typical units are shown by illustration, circuit application and response curves. Also included in the folder is an application chart revealing the areas of frequency and power-handling capacity most advantageously served by transformers of this design. Data are also included on a plug-in adjustable inductor for aircraft radio use at 200 to 400 kc.

Antenna Catalog. The LaPointe Plascomold Corp., Windsor Locks, Conn., has released the 1952 Vee-D-X catalog containing the complete line of antennas and accessories. Containing 24 pages and printed in two colors, the catalog features not only standard Vee-D-X products, but also includes such new developments as the Q-Tee, the Long John, 3 new models of the RW series lightning arresters, the new Mighty Match, and many others.

Atomic-Hydrogen Arc Welding. General Electric Co., Schenectady 5, N. Y., has available a new two-color, two-page bulletin on single-phase, 60-cycle atomic hydrogen arc welding equipment. In addition to explaining the process of atomic-hydrogen welding, bulletin GEC-598A describes the recently redesigned power generating equipment and lists its specifications, applications and advantages. It also covers the features of the company's atomic-hydrogen torch.

High-Vacuum Rectifier. Lewis & Kaufman, Inc., 50 El Rancho Ave., Los Gatos, Calif. A two-page loose-leaf-perforated data sheet de-





**INFORMATION
on positions at
NORTHROP**

Northrop Aircraft, Inc. is engaged in vitally important projects in scientific and engineering development, in addition to aircraft production. The program is diversified, interesting and long-range. Exceptional opportunities await qualified individuals.

The most responsible positions will go to top-caliber engineers and scientists. However, a number of excellent positions exist for capable, but less experienced, engineers. Some examples of the types of positions now open are:

ELECTRONIC PROJECT ENGINEERS...

ELECTRONIC INSTRUMENTATION

ENGINEERS... RADAR ENGINEERS...

FLIGHT-TEST ENGINEERS...

STRESS ENGINEERS...

AERO- AND THERMODYNAMICISTS...

SERVO-MECHANISTS... POWER-PLANT

INSTALLATION DESIGNERS...

STRUCTURAL DESIGNERS...

ELECTRO-MECHANICAL DESIGNERS...

ELECTRICAL INSTALLATION DESIGNERS.

ENGINEERING DRAWING CHECKERS...

Qualified engineers and scientists who wish to locate permanently in Southern California are invited to write for further information regarding these interesting, long-range positions. Please include an outline of your experience and training.

Allowance for travel expenses.

Address correspondence to
Director of Engineering,

**NORTHROP
AIRCRAFT, INC.**

1009 E. BROADWAY
HAWTHORNE, CALIFORNIA

FOR MARKING...



**PLASTIC • METAL
GLASS • PAPER
RUBBER • CERAMIC
CARDBOARD**

in such products as Resistors, capacitors, valves, tubes, labels, sleeves, spark plugs, cartons, etc., etc.

**THESE PRODUCTS
AND MANY OTHERS
OF ALMOST ANY
MATERIAL AND SHAPE
CAN BE IMPRINTED**

ON THE

**REJAFIX
MARKING MACHINE**

Why not send us samples of your products? They will be test-printed and returned to you for your examination!

- REJAFIX HAND-OPERATED MODELS FOR SMALL RUNS. FULLY AUTOMATIC MODELS FOR MASS PRODUCTION.

EST. 1922

POPPER & SONS INC. 300 FOURTH AVENUE
NEW YORK 10, N. Y.

THE DISTINCTIVE NEW
ER-225
SERIES

RACKS by PAR-METAL
18" Deep, 22" Wide

offer you the greatest dollar-for-dollar value in the industry today!

Because only in the ER-225 will you find these unique features:

- ✓ Standard 43 1/4", 67 3/4", and 83 1/2" heights.
- ✓ New ribbed design corner trims, with new quick FRONT detachable fastenings.
- ✓ The door is stamped from one piece of steel and reinforced—with formed, clean, smooth, double thick edges.
- ✓ "Multitracks" available with closed or open intermediate sides for rack-to-rack wiring.
- ✓ Streamlined modern design; beautiful finish.

Planning an electronic product? Consult Par-Metal for

**RACKS • CABINETS
CHASSIS • PANELS**

Remember, Par-Metal equipment is made by electronic specialists, not just a sheet metal shop.

Made by
Electronic
Specialists!

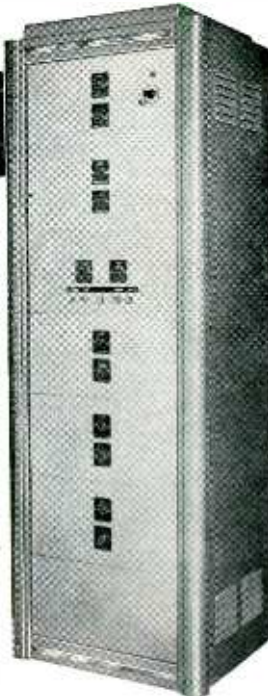

"MULTIRACKS"

These Racks may be assembled in multiple units as shown above.

SHELVES available. Also ROLLER TRUCKS available for single racks or "Multitracks".

NO INCREASE IN COST!

The ER-225 is priced to compete with racks not having the equivalent features. Beyond doubt—it's the industry's greatest value.

The ER-225 Rack as used by the American Communications Corp., N. Y. C. 13.

PAR-METAL
PRODUCTS CORPORATION

32-62 — 49th ST., LONG ISLAND CITY 3, N. Y.

Tel.: ASTORIA 8-8905

Export Dept.: Rocke International Corp.

13 East 40 Street, New York 16, N. Y.

WRITE FOR CATALOG!

TIC-TALKS FEATURE

Technology Instrument Corporation potentiometers are designed for application in computing devices, instrumentation, electronic control and servo mechanisms — wherever extreme electrical and mechanical precision is an essential requirement.

As a result of years of custom manufacturing a complete line of standard sizes is available ranging from 7 inches in diameter to the sub-miniature $\frac{1}{8}$ " in diameter.

Custom design both mechanical and electrical is a featured TIC service. Precision non-linear pots may be designed to meet customer's requirements from either empirical data or implicit functions. Taps and special winding angles anywhere up to 360° continuous winding can be incorporated into both linear and non-linear precision potentiometers. Greatly expanded facilities plus mass production techniques meet customer volume needs yet maintain precision tolerances in both linear and non-linear potentiometers.



Type RVP3 tapped hole and precision pilot mounting

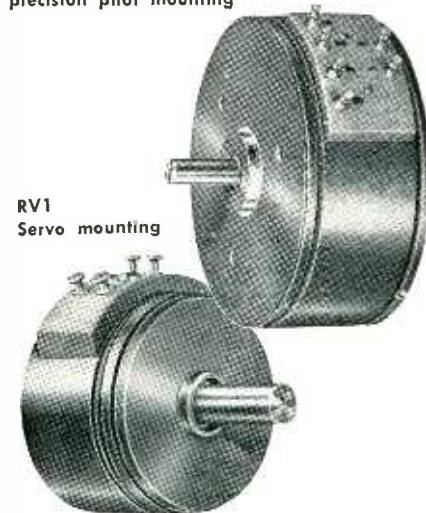

describes the type 8020 high-vacuum rectifier. It gives operating characteristics for both rectifier and surge-limiting diode operation. The tube is illustrated and outline dimensions are given.

Patch Cords and Jack Panels. Trimm, Inc., 400 Lake St., Libertyville, Ill., has published bulletins R-15a and R-23 describing complete lines of patch cords and jack panels used in broadcast stations and recording studios. Included in the bulletins are descriptions of sub-parts of jack panels frequently useful to laboratories in construction of specialized test equipment.

Vibration Meter. Consolidated Engineering Corp., 300 N. Sierra Madre Villa, Pasadena 8, Calif., has issued a 4-page bulletin describing the 1-110B vibration meter, an extremely simple and compact instrument that gives direct readings of both linear and torsional velocity and displacement, allowing rapid, easy calculation of the vibrational characteristics of machines and structures. The instrument described incorporates a four-stage, single-channel amplifier, highly stabilized by negative feedback to insure extreme reliability over long periods of time.

Industrial X-Ray Folder. Westinghouse Electric Corp., 401 Liberty Ave., Pittsburgh 30, Pa. In a 4-page folder entitled "Seven Industrial Eyes", seven types of x-ray equipment for industrial application are pictured and described. The units described are: a single-column tubestand unit; an industrial jib crane unit; an ultra-high-speed radiograph unit; a mobile unit; equipment for mass inspection of parts; a wall-mounted industrial x-ray unit; and a thickness gage.

Recording Potentiometer. Weston Electrical Instrument Corp., 614 Frelinghuysen Ave., Newark 5, N. J. A recent pamphlet introduces the single point recorder of the null-balancing (potentiometer) type, which employs a line-driven synchronous converter and ampli-

TYPE	DIAM.	RESISTANCE	ELECTRICAL ANGLE	LINEARITY	POWER RATING	MOUNTING	EXAMPLE OF NON-LINEAR FUNCTION AVAILABLE AS STANDARD
RVP-7	7"	1-500,000 Ω tol. to $\pm 1\%$	320° tol. to $\pm 5^\circ$	As low as $\pm .05\%$	6 watts at 25° C.	Servo	Type RVP7-52 function: $E_{out} = \sin \Theta / 2 \pm 0.1\%$ peak amplitude
RVP-3	3"	Std. values to 200,000 Ω tol. to $\pm 1\%$	320° tol. to $\pm .5^\circ$	As low as $\pm .1\%$	6 watts at 25° C.	Servo-tapped hole and precision pilot or threaded bushing	Type RVP3-54 function: 50 db logarithmic; conformity: $\pm 2\%$ constant fractional accuracy
RV-3	3"	Std. values to 200,000 Ω tol. to $\pm 1\%$	315° tol. to $\pm 1^\circ$	As low as $\pm .25\%$	8 or 12 watts	3 tapped hole	Available for non-linear functions Note: Phenolic base precision potentiometer, stainless steel or bakelite shaft
RV2	2"	Std. values to 100,000 Ω tol. to $\pm 1\%$	320° tol. to $\pm .5^\circ$	As low as $\pm .2\%$	4 watts at 25° C.	Servo-tapped hole and precision pilot or threaded bushing	Type RV2-5112 function: $R = K\Theta$ conformity: $\pm .5\%$ over 64° to 320°
RV1-1/2	1- 1/2"	Std. values to 100,000 Ω tol. to $\pm 1\%$	320° tol. to $\pm 1^\circ$	As low as $\pm .25\%$	3 watts at 25° C.	Servo-tapped hole and precision pilot or threaded bushing	Type RV1-5104 function: $E_{out} = \sin \Theta \pm 4\%$ peak amplitude per quadrant
RV1	1- 1/16"	Std. values to 50,000 Ω tol. to $\pm 1\%$	320° tol. to $\pm 2^\circ$	As low as $\pm .3\%$	2 watts at 25° C.	Servo or threaded bushing	Type RV1-57 function: $E_{out} = \sin \Theta / 1.78 \pm 4\%$ of peak amplitude
LINEAR TYPES ONLY:							
RV-3/8	3/8"	Std. values to 40,000 Ω tol. to $\pm 1\%$	320° tol. to $\pm 3^\circ$	As low as $\pm .5\%$	1 watt	Servo or threaded bushing	
RVT	Translatory 3/32" x 1 1/2"	10,000 Ω $\pm 15\%$	Stroke* 2 1/2"	$\pm 1\%$ total resistance	1 watt	Provides output proportional to a linear displacement rather than a rotary motion of a shaft	

* Special resistance values and stroke lengths from .6 inches to 15 inches can be provided on a custom basis.

Engineering Representatives

- Cleveland, Ohio — PProspect 1-6171
- Chicago, Ill. — UPTown 8-1141
- Rochester, N. Y. — Monroe 3143
- Canaan, Conn. — Canaan 649
- Dayton, Ohio — Michigan 8721
- Arnprior, Ont., Can. — Arnprior 400
- New York, N. Y. — MURray Hill 8-5858
- Cambridge, Mass. — ELiot 4-1751
- Hollywood, Cal. — HOLLYwood 9-6305
- Dallas, Texas — DIXon 9918

TECHNOLOGY INSTRUMENT CORP.

533 Main Street, Acton, Massachusetts, Telephone: Acton 600

the annual
electronics
**BUYERS'
GUIDE**

is the electronic engineer's

**BREADBOARD
WHO'S WHO**

for

quick, accurate
answers to any
questions about
**COMPONENTS
EQUIPMENT
MATERIALS**

used in electronics

*Get in the habit
of looking it up in...*

the **electronics
BUYERS' GUIDE**

"The Book that has all the answers"

A MCGRAW-HILL PUBLICATION
330 West 42nd Street
NEW YORK 36, N. Y.

ZOPHAR

WAXES

COMPOUNDS

Zophar Waxes, resins and compounds to impregnate, dip, seal, embed, or pot electronic and electrical equipment or components of all types; radio, television, etc.

Cold flows from 100°F. to 285 F.

Special waxes non-cracking at -76°F.

Compounds meeting Government specifications plain or fungus resistant.

Let us help you with your engineering problems.



ZOPHAR MILLS, INC.
112-130 26th Street,
Brooklyn 32, N. Y.

GOLD PLATED TUNGSTEN & MOLYBDENUM

Grid Wire

Gold Plated Nickel Alloy
and Molybdenum Alloy
Grid Wire

- Made to meet your specifications... for gold content, diameter and other requirements.

Write for details and
list of products

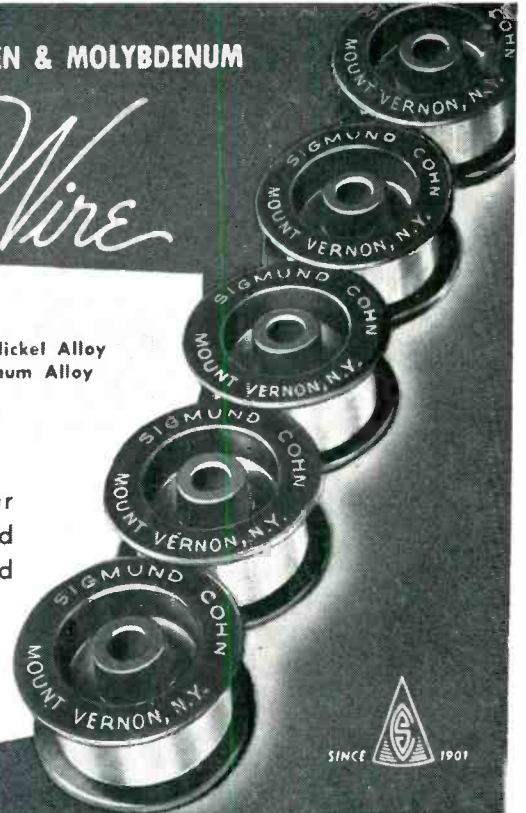

SIGMUND COHN MFG. CO., INC.

121 SOUTH COLUMBUS AVENUE • MOUNT VERNON, NEW YORK

choose your TOROIDAL INDUCTORS

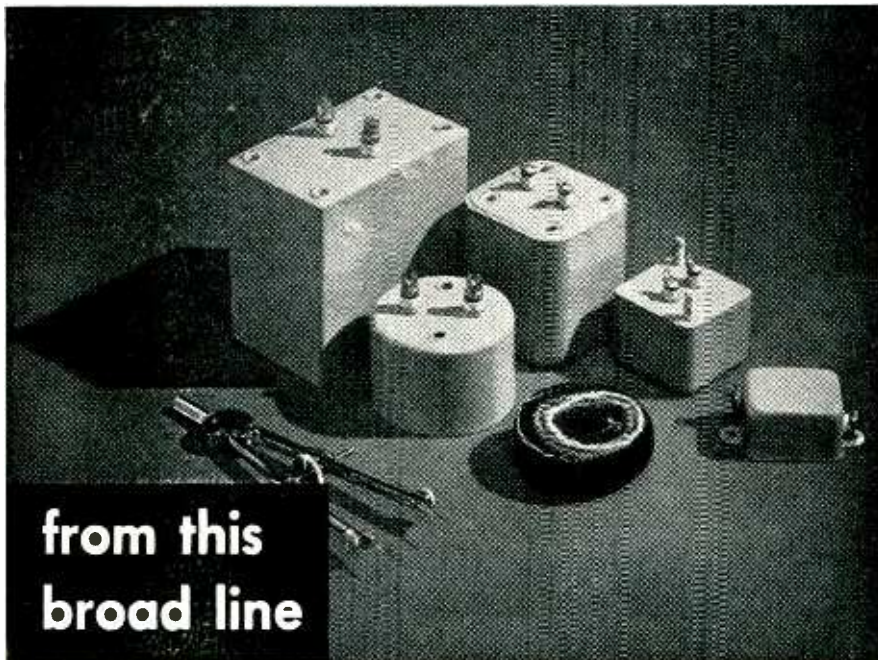

from this
broad line

PRECISION ENGINEERED and manufactured in a modern high-capacity plant, Lenkurt Toroidal Inductors are supplied in the five hermetically-sealed case styles illustrated. These meet the large majority of application requirements. Un-cased toroidal coils are available in the same range of inductance values—all being wound on high-Q molybdenum-Permalloy cores and guaranteed within one per cent of nominal inductance value.

RANGING in value from 1 millihenry to 80 henrys, the complete line offers a combination of 42 individual standard values distributed over five case styles. These are available for rapid delivery in quantities to meet your most demanding production schedules. Intermediate values can be supplied on special order. For full details, ask for your copy of the descriptive folder, Form TL-P4.

LENKURT INDUCTORS are made by Lenkurt Electric Company—*largest independent manufacturer of telephone toll-transmission equipment*—also producers of variable inductors, quality filters, decade inductors, and molded iron-powder parts.

**LENKURT ELECTRIC
SALES COMPANY**
San Carlos 1 California

Lenkurt

fier to control a two-phase motor and rebalance the measuring circuit. The instrument illustrated and described in the brochure can be used to measure and record temperature, d-c current, d-c voltage, resistance, a-c voltage, a-c current, speed, speed ratio, power, frequency, hydrogen ion (pH), light intensity or any other quantity that can be converted into electrical values.

H-V Ceramic Capacitors. Sprague Electric Co., 35 Marshall St., North Adams, Mass. Bulletin No. 606 gives complete details on type 700C high-voltage ceramic capacitors that are molded in moisture-resistant, nonflammable thermosetting plastic, rated at 20,000 v d-c and designed for 85C operation. The capacitors described find broad use as h-v supply filters in tv receivers and c-r instruments and have a standard rated capacitance of 500 μf .

Industrial Fasteners. Southeo Division, South Chester Corp., Lester, Pa., has available a handbook of fastening specialties containing 22 pages of information on industrial fasteners for metal-to-metal and metal-to-wood applications. Blind rivets and a variety of door latching and fastening devices are illustrated in this two-color, spiral-bound book which also includes several pages of frequently used engineering data. Installation procedure, sample applications and complete dimensional information are given for all fasteners.

Flexible Waveguides. Technicraft Laboratories, Inc., Thomaston, Conn. A recent 6-page folder gives an illustrated description of the type V (vertebra), type S (seamless-corrugated) and type L (interlocked) flexible waveguides. Charts are included showing standard lengths available, nominal attenuation in db, angular bend and axial twist. Information on combination assemblies is also given.

Decadal Frequency Generator. Arthur Schomandl, Troger Strasse 32, Munich 8, Germany, has published a 4-page bulletin illustrat-

WHEN you need a quick answer to **WHO MAKES IT...**

Just look it up in the **electronics BUYERS' GUIDE**

There are ...

23,367 ANSWERS
to
1,445 PROBLEMS

covering every ...

COMPONENT EQUIPMENT and MATERIAL
used in every phase of electronics

GET IN THE HABIT OF LOOKING IT UP IN

the

electronics BUYERS' GUIDE

A McGRAW-HILL PUBLICATION

330 West 42nd Street
NEW YORK 36, N. Y.

ENGRAVING and MARKING

The Green Engraver



ENGRAVES,
ROUTS,
PROFILES and MODELS

A real money saver for industry. Proven by the experience of tool and die, electronic machine, radio, electrical and instrument manufacturers.

The Green Engraver zips out precision work on metal, plastics, wood, glass, hard rubber etc. . . . engraves panels, name plates, scales, dials, molds, lenses, instruments, instruction plates, directional signs . . . by simple tracing. *Routing, profiling and three dimensional modeling indicate its versatility.* Electric etching attachment available.

Specify the Green Engraver for the best in low cost performance. Special attachments and engineering service available for production work.

FREE — Fact-packed folder yours upon request.



363 PUTNAM AVENUE • CAMBRIDGE, MASS.



MONITOR RF POWER & VSWR

SMALL, LIGHTWEIGHT COUPLER CAN BE BUILT DIRECTLY INTO TRANSMITTERS

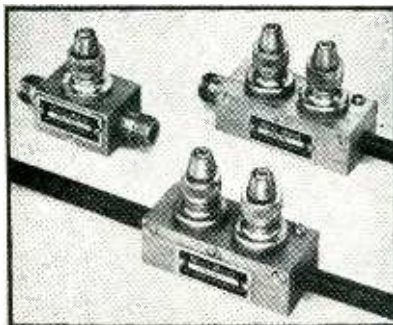

MicroMatch

MM 570 SERIES

4—1200 Watts 20—2000 MCS

This light, compact coupler unit, built into an RF transmission line, continually monitors RF power output, VSWR, and side tone. Monitoring these most important characteristics enables detection of trouble before it can become serious. Converts RF power into DC voltage which is read on indicator circuit meter.

SPECIFICATIONS

FREQUENCY RANGE—20 to 2000 MCS.
IMPEDANCE—51 ohms.
CONNECTORS—Supplied with RG-9A/U cable, N, BNC, C, or UHF Type connectors either or both ends. Also available for RG-17/U cable.
POWER RANGES—May be set to provide full scale reading on the indicator for any power level from 4 watts to 1200 watts.
VSWR RANGES—Meter scale reads 0 to infinity.
VSWR of 3.0 corresponds to approximately 1/2 full scale deflection.
INDICATOR CIRCUIT—Circuit diagram furnished.
METER CALIBRATION—All meter calibration data for both power and VSWR are supplied. Meter scales or meters will be supplied if desired.
ACCURACY—Plus or minus 5% of full scale for RF power. Plus or minus 10% for VSWR.
SIZE—Single coupler 1 3/4" l. x 1 1/4" w. x 2 5/8" h. Double coupler 2-15/16" l. x 1 1/4" w. x 2 5/8" h.
WEIGHT—Single coupler unit 6 ounces. Double coupler unit 8 ounces.
SIDE TONE MONITOR OUTPUT—AF output avail. also for monitoring when used with an AM type transmitter.



M. C. JONES
ELECTRONICS COMPANY
BRISTOL, CONNECTICUT

Distributed outside of Continental U.S.A. by RCA International Div., N.Y., N.Y., U.S.A.

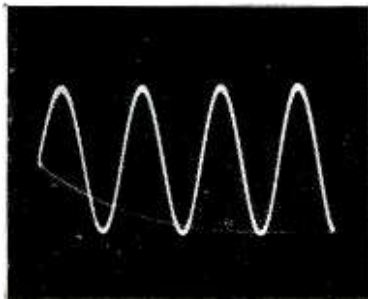

15 kc Unmodulated Carrier

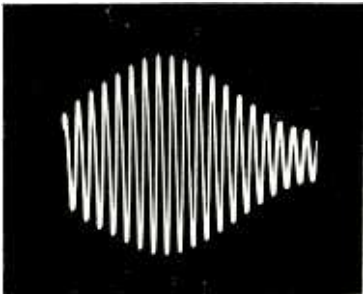

24 kc Carrier modulated at 1000 cps

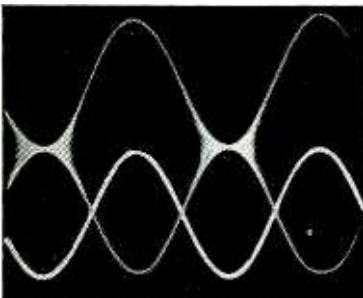
320 kc Carrier modulated at 400 cps —
audio source on lower trace shows fidelity

Excellent amplitude modulation is an outstanding feature — a.m. accompanied by unmeasurable f.m. Other features include:

Wide range — 15 kc (or less) to 30 mc on 15 ft. high-discrimination full-vision scale. **Crystal Accuracy** — 0.01% with built-in 1 mc harmonic source. **High Output** — 4 volts down to 0.4 microvolts. **Flexible Modulation** — internal 400 and 1,000 cps, external 50-10,000 cps within a db. **Also incorporated**: automatic level control, negative feed-back, modulation monitoring by dual-rectification and variable impedance termination with animated diagram.

A signal generator also ideal as a video oscillator for wide-band television systems.

STANDARD SIGNAL GENERATOR

TYPE TF 867

AM WITHOUT FM

100% MODULATION

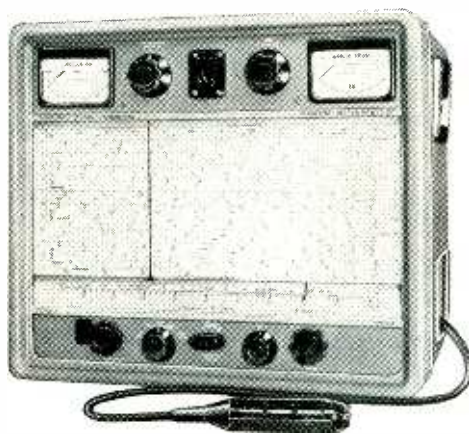

MARCONI instruments

Specialists in Communication Test Equipment

23-25 BEAVER STREET • NEW YORK 4

CANADA: CANADIAN MARCONI CO., MARCONI BUILDING, 2442 TRENTON AVENUE, MONTREAL
ENGLAND: Head Office: MARCONI INSTRUMENTS LIMITED • ST. ALBANS • HERTS.

Managing Agents in Export: MARCONI'S WIRELESS TELEGRAPH COMPANY LIMITED
MARCONI HOUSE, STRAND • LONDON • W.C.2

ing and describing the type ND5 decadal frequency generator for generation of any desired frequency with crystal accuracy within a range from 1 kc to 30 mc. Output frequency of the instrument described is controlled in a fixed-phase relationship by an input frequency of 100 kc, for which either an available 100 kc standard frequency or the output frequency of any 100 kc crystal-oscillator may be employed.

Tape Recorder. Magnecord, Inc., 360 N. Michigan Ave., Chicago 1, Ill. A recent issue of the company's house organ describes and illustrates the Magnecordette, a tape recorder for use with radio or amplifier systems. The mechanical part of the unit described has separate erase and record-reproduce heads and includes 7½ and 15 in. per second tape speed capstans for either speed with a frequency response of 15,000 cycles ±2 db.

Heavy-Duty Connectors. Cannon Electric Co., 3209 Humboldt St., Los Angeles 31, Calif. An 8-page bulletin covers a rugged heavy-duty connector series having resilient material insulators and grommets made to Army Ordnance specifications. The series described, available in AN shell styles with various accessories, is moisture proof and pressurized.

Solderless Terminals. Aircraft-Marine Products, Inc., 2100 Paxton St., Harrisburg, Pa., has available a booklet dealing with quality control of the entire solderless wire termination process. Of special interest to engineers, designers and manufacturers in the electrical and allied fields, it provides technical information concerning 3-way control of the process from the raw metal, through manufacture, to the finished installation.

Transformers. Milwaukee Transformer Co., 5231 North Hopkins St., Milwaukee 9, Wis., has issued a booklet on its transformers, reactors, filter networks and similar components that are custom-engineered for commercial, industrial, laboratory and government applications. It gives a well illustrated

INSTRUMENT HOUSINGS PANELS • CHASSIS

*Manufactured to
your Requirements*

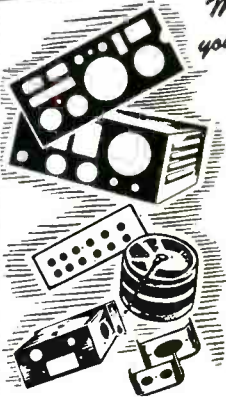

**MECHANICAL
& ELECTRICAL
ASSEMBLIES**

**STAMPINGS,
ALL METALS**

A complete manufacturing service:
Fabricating, Stamping, Screw Machine Work, Assembling.

Precision work, experienced fabrication,
dependable service.

SEND DRAWINGS FOR ESTIMATES!

**STAMFORD METAL
SPECIALTY COMPANY**

Metal Work of Every Description

429 West Broadway, New York 12, N. Y.



Style 18 (Medium),
500 yd. spools,
black or natural.



for lacings that stay put!

GUDELACE

BRAIDED NYLON LACING TAPE*

A New and Revolutionary Type of Lacing

- Saves time, saves money, greatly reduces the number of rejects
- Won't "bite through" insulation
- Won't cut wiremen's fingers or cause dermatitis
- Ties easier, ties tighter and cuts down on slipping of knots

Let GUDELACE answer your lacing problems.

*Write for FREE
samples and prices.*

GUDEBROD BROS. SILK CO., INC.

Electronics Division

Main Office: 12 South 12th Street, Philadelphia 7, Pa.

225 West 34th Street, New York 1, N.Y.

*Patent Pending.

Linde
Trade-Mark

M. S. C.

(Mass Spectrometer Checked)

RARE GASES

HELIUM • NEON

ARGON • KRYPTON • XENON

LINDE Rare Gases are mass spectrometer checked to assure you gases of known purity and uniformly high quality. Available in commercial-size cylinders and glass bulbs.

LINDE, the world's largest producer of gases derived from the atmosphere, can meet your individual needs of purity...volume...mixture...containers...

LINDE AIR PRODUCTS COMPANY

A DIVISION OF UNION CARBIDE
AND CARBON CORPORATION

30 East 42nd Street **UCC** New York 17, N. Y.

In Canada:
Dominion Oxygen Company, Limited, Toronto

The term "Linde" is a registered trade-mark
of Union Carbide and Carbon Corporation

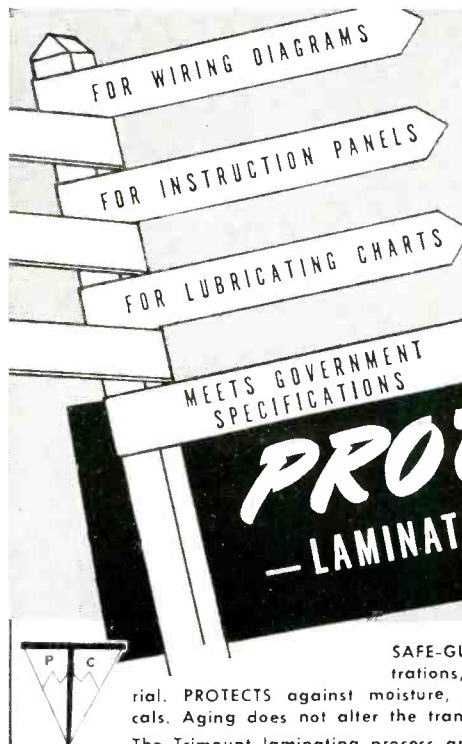

a practical
low cost
means of

PROTECTION
—LAMINATING BY TRIMOUNT

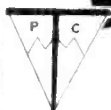

SAFE-GUARDS charts, diagrams, technical illustrations, and any other type of printed materials. PROTECTS against moisture, oils and greases, resists many chemicals. Aging does not alter the transparency. Withstands tough handling. The Trimount laminating process applies a tough, lustrous, transparent film of plastic to the surface of paper, fabric, or just about any material. Engineered to the most exacting specifications. Write, Phone or Send Samples for Specific Recommendations. For technical data or consultation — consult

TRIMOUNT PLASTIC CO., INC. 71 DUDLEY ST., ARLINGTON 74,
MASS., TEL. ARLINGTON 5-9023

A NEW DEGREE OF FREEDOM IN CIRCUIT DESIGN

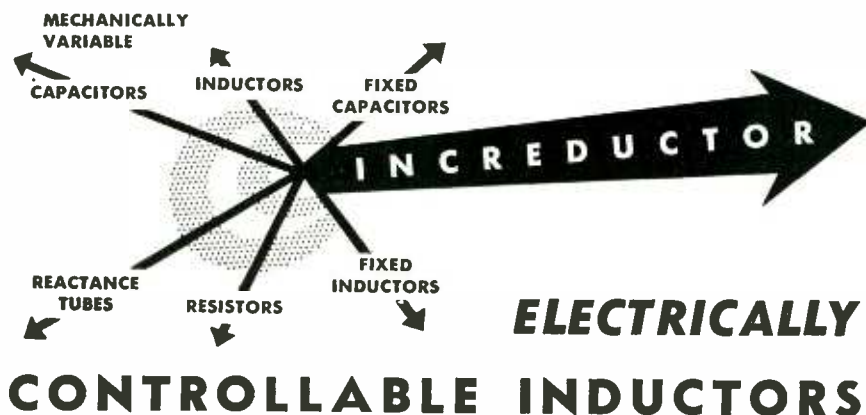

description of the company's facilities and production techniques. Ordering information is included.

Subminiature Capacitors. Astron Corp., 255 Grant Ave., E. Newark, N. J., has announced new catalog sheets, complete with engineering performance and test specifications, on its new type AQ subminiature paper capacitors. As a result of the newly developed X-250 high temperature impregnant, the capacitors described will operate at temperatures up to 125 C without derating.

Hermetically Sealed Components. T. C. Wheaton Co., Millville, N. J., announces catalog W52. In addition to the specifications covering the regular line of hermetic lead-thru terminals and suggestions on how to use them, the company's new glass trimmer capacitors are introduced. An insert covering the specifications on the new WR-8 relay is also included with the catalog.

Transformers and Related Components. Standard Transformers Corp., 3580 Elston Ave., Chicago 18, Ill. A completely revised 24-page catalog and replacement guide contains over 500 separate listings of transformers and related components. A numerical index and price list; classified index, and separate sections for high fidelity, input and interstage, output, driver modulation, power, filter chokes, filament, plate, isolation and autoformers and a separate tv component section are contained in the book. Seventy classifications are indexed in the catalog. Also included are an output transformer chart, matched power supply chart and data on the Stancor-Williamson amplifier.

Ground Plane Antennas. Ward Products Corp., 1523 E. 45th St., Cleveland 3, Ohio, has available a descriptive sheet dealing with three new ground plane antennas. It covers the SPPA-94 that is designed for the amateur two-meter band, 144 to 152 mc; the SPPC-94 that covers many of the aircraft frequencies, operating between

This new wide-range, low-loss, electrically controllable inductor is applicable from sub-audio frequencies to over 100 Mc. Of particular interest at the lower end of this spectrum is the H3M series. These types make available an inductance change of at least 400:1 and may be operated at starting frequencies as high as 80 kc. One of the popular models in this series has a nominal signal winding inductance of 30 millihenries and a control winding inductance of 90 henries. Size is 2-5/16" x 1-15/16" x 1-7/16", hermetically sealed. Typical frequency change versus control current and Q curves are shown in the chart below. A detailed brochure of this unit is available on-request and the units themselves are available from stock.

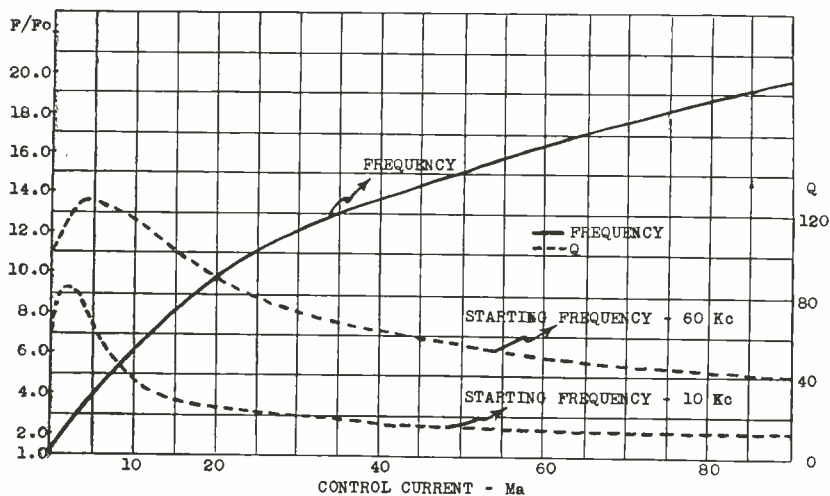

Typical Control Curves of Low Frequency INCREDUCTOR Types #H3M Series
Later advertisements in this series will describe other available units.

Write on your company letterhead for engineering data and technical information on standard types. We will be glad to give you our recommendations regarding your specific problems.



C. G. S. LABORATORIES, INC.
391 LUDLOW STREET, STAMFORD, CONN.

ELECTRONIC GLASS WORKING EQUIPMENT for RADIO, TELEVISION TUBES, INCANDESCENT LAMPS, GLASS LATHES for TELEVISION TUBE REPAIR

We make Transformers, Spot and Wire Butt Welders, Wire Cutting Machines and 500 other items, indispensable in your production. Eisler Engineers are constantly developing New Equipment. If you prefer your own designs, let us build them for you. Write to Charles Eisler who has served The Industry over 32 years.

Machines for small Radio Tubes of all kinds; 24-Head Stem, 24-Head Sealing and 24-Head Exhaust Machines, Spot Welders, etc.

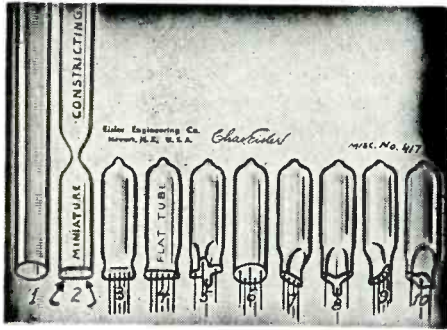

• WE MAKE MANY TYPES OF TRANSFORMERS FOR THE ELECTRONIC INDUSTRY

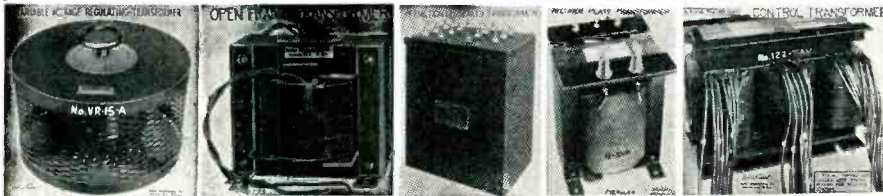
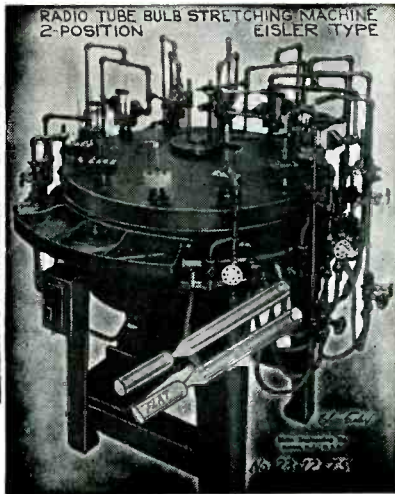

EISLER ENGINEERING CO., Inc.

751 So. 13th St.
Newark 3, N. J.

You Are Invited to Attend the Fourth Annual
Fourth Annual AUDIO FAIR

OCTOBER 29TH, 30TH, 31ST AND NOVEMBER 1ST
HOTEL NEW YORKER—NEW YORK CITY



The most important annual event in the field of Audio. Of utmost interest to Government and Military Agencies, Broadcast Engineers, Recordists, Sound-On-Film Men, Public Address Men, Hobbyists, High Fidelity Enthusiasts, and Distributors and Dealers of quality audio and high fidelity equipment.

The *Audio Fair* is the largest and most concentrated exhibition of Audio Equipment held under one roof. Every up-to-the-minute development will be represented, shown and heard.

The General Public Invited to Attend. No Admission Charge.

Sponsored by the **AUDIO** engineering society
(FOURTH ANNUAL CONVENTION)

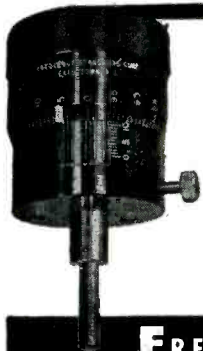

FS MICROMETER HEAD
for the Electronics Industry

ELECTRONIC ENGINEERS PRAISE FS MICROMETER HEADS FOR THEIR PRECISE ACCURACY EVEN AFTER LONG HARD USAGE. THIS ACCURACY IS MADE POSSIBLE BY A PATENTED THREAD-FORM WITH RADIALLY-LOADED NUT FOR ELIMINATION OF BACK-LASH, AND AUTOMATIC WEAR COMPENSATION . . . OTHER FEATURES AND SPECIFICATIONS ARE DESCRIBED IN OUR NEW BULLETIN, OBTAINABLE ON REQUEST.

FREQUENCY STANDARDS

P. O. BOX 66, EATONTOWN, N. J. • TELEPHONE ASBURY PARK 1-1018

INSTRUMENT BALL BEARING

with a
NON-RUBBING SEAL!

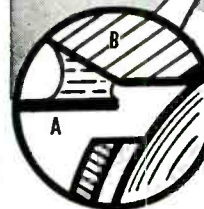
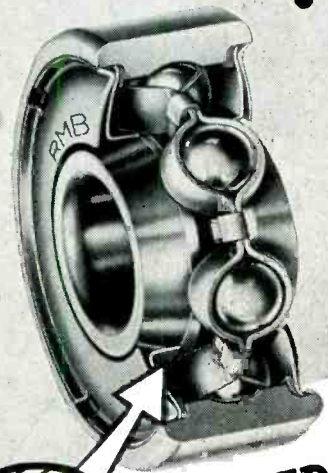

SEALED
by a
Film of Oil

In the new RMB FILMOSEAL bearing, a capillary film of oil forms between cylindrical washer (A) and the tapered O.D. of inner race (B). This strong film of oil seals the bearing — keeps the lubricant in, keeps dirt out — yet there is no rubbing contact between the sealing elements.

The FILMOSEAL bearing thus has all the advantages of a sealed bearing, plus the freedom of rotation of an open bearing:

- Permits the use of oil instead of grease as a lubricant.
- Low starting and running torque.
- Torque constant over long periods.
- Adjusts for pressure variations.
- No heating or scoring at high speed.
- Remains sealed in any position.
- Maintenance is greatly reduced.

FILMOSEAL precision bearings are available in 10 bore sizes from 2 mm. (.0787") to 8 mm. (.3150") and corresponding O.D. from 6 mm. (.2362") to 22 mm. (.8661").



WRITE FOR
COMPLETE
DESCRIPTIVE
LITERATURE

LANDIS & GYR, INC.
45 W. 45th St., New York 36

MICROWAVE RESISTORS TELEWAVE TYPE R

**SMALLEST
RESISTOR
AVAILABLE**

(Ideal for Miniaturization)

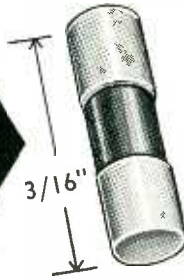

TYPICAL APPLICATIONS

- Power measurement at any frequency
- Matched terminations for waveguides or coaxial lines
- Resistive power pickup loops
- RF pads or attenuators
- Dummy loads
- Temperature measurements
- Impedance matching

SPECIFICATIONS

Resistance: 50 ohms standard, other values on request.
Tolerance: 5% or 10%
Wattage: 1/4 watt continuous duty at 25°C
Size: 1/16 inch diam. x 3/16 inch long
Terminals: Tinned sections 1/16 inch long
Film Length: Type R-063 — 1/16 inch
Type R-093 — 3/32 inch
Temperature Coefficient:
approx. 0.0019 ohms/ohm/°C.
Power Sensitivity: Approx. 10 ohms/watt

TYPE R RESISTORS employ noble metal film deposits on specially selected heat resistant glass.

FILM THICKNESS offers negligible skin effect, at microwave frequencies.

POWER CAPACITY of 1/4 watt provides high power handling ability.

PHYSICAL STRUCTURE is ideally suited to impedance matching in standard coaxial line and waveguides.

FINISH. Coated with a special silicone varnish to protect the film.

TELEWAVE LABORATORIES, INC.

100 Metropolitan Ave. • Brooklyn 11, New York

AVAILABLE
FOR
IMMEDIATE
DELIVERY

ALWAYS . . . "on the beam"
with *Standard Piezo* CRYSTALS



If it is important for your transmitting and receiving equipment to stay "on the beam"—always, regardless of atmospheric extremes and rough handling—be sure to specify Standard

Piezo Crystals. They're built to take it. Send for our completely illustrated catalog or submit your problems to our engineers for recommendations.

Standard Piezo Co.
CARLISLE, PENNA.

Silicone Rubber. General Electric Co., Pittsfield, Mass. Designers, purchasing agents and engineers will be interested in a recently published booklet entitled "Imagining With Silicone Rubber." The 24-page bulletin CDS-3 includes comprehensive information on properties, applications, classes and design specifications of the company's silicone rubber.

The applications illustrated show how the unique properties of this silicone rubber are helping to make for better products, improve production processes and develop entirely new products. The silicone rubber parts described feature resistance to temperature extremes, release from sticking, inertness and unusual surface properties.

108 and 120 mc; and the SPPD-94 that covers 120 to 132 mc.

Ridged Waveguide. Polytechnic Research & Development Co., Inc. Volume 1, No. 2 of the PRD Reports covers a transmission system that operates over a wider frequency range than conventional rectangular waveguide. It gives a fully illustrated technical description of the ridged waveguide, a rectangular waveguide with a rectangular metal ridge protruding from the center of one broad face. Compared with a rectangular guide of the same fundamental mode cutoff frequency, the ridged waveguide described has five times the attenuation for a bandwidth of four and nine times for a bandwidth of five.

Carrier Amplifier. Consolidated Engineering Corp., 300 N. Sierra Madre Villa, Pasadena 8, Calif. Bulletin 1522A describes the type 1-118 carrier amplifier which is designed primarily for the smaller engineering and development laboratory not having a full-time staff devoted exclusively to testing. The instrument discussed is of special interest to engineers engaged in development of high-speed industrial equipment as it greatly simplifies analysis and evaluation of all the h-f and transient physical factors affecting product performance.

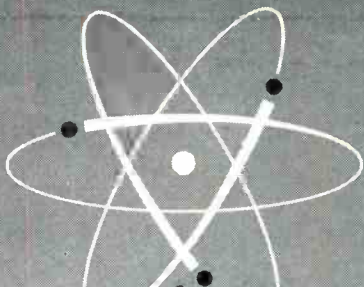

REFRASIL

for electronics

In electronics — for insulation against heat, flame, moisture and grounding — use REFRASIL. A refined fibrous silica product, REFRASIL applications are virtually unlimited: An ideal insulation for power equipment ... electric muffle furnaces ... soldering iron heating elements ... electric heating mantles, rheostats ... and for thermocouple lead wire covering. If insulation is your problem — specify REFRASIL—the most versatile product of its kind in use today in many industries.

IMPORTANT FEATURES

- ★ Chemical resistance of pure silica
- ★ Resists temperatures up to 1800° F.
- ★ Low thermal conductivity
- ★ Fiber diameter .00020-.00040 in.
- ★ Specific heat .19
- ★ Thickness .14-.15 in.
- ★ Surface density .05 lb./sq. ft.



Light and versatile, REFRASIL is supplied in many forms, as illustrated, to meet virtually any insulation need.

CONSULTATION SERVICE

Mail this ad with your letterhead to nearest Refrasil Representative for consultation service — at no charge.

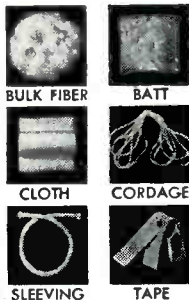

BULK FIBER **BATT**
CLOTH **CORDAGE**
SLEEVING **TAPE**

WRITE OR CALL YOUR NEAREST REPRESENTATIVE:

EASTERN: Fred W. Muhlentfeld
6659 Loch Hill Rd.
Baltimore 12, Md.
Valley 3135

TEXAS, OKLA. & KANSAS: Thomson Engineering Service
708 Hemphill St.
Fort Worth 4, Texas
Fortuna 5240

MIDWEST: Burnie L. Weddle
3219 West 29th St.
Indianapolis 22, Ind.
Hickory 6685



THE H. I. THOMPSON COMPANY
1729 CORDOVA STREET
LOS ANGELES 7, CALIF.

TOROIDS

SELF-RESONANT FREQUENCY AND DISTRIBUTED CAPACITANCE OF TYPICAL D&R TOROIDS

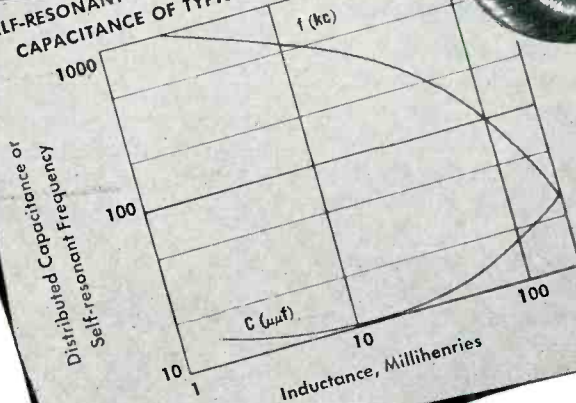

DISTRIBUTED BY

Giannini

BROCHURES AVAILABLE • G. M. GIANNINI & CO. INC. • PASADENA 1, CALIFORNIA

NEED A GOOD SOURCE FOR TERMINALS? WE MAKE ALL SIZES, ALL KINDS!



SMALLEST TO LARGEST — Hermaseal manufactures Sealed Terminals in an extremely wide range of sizes, for very low or very high voltage, with tubular electrodes for high current-carrying capacity — and with solid electrodes for moderate current requirements.

COMPLETE ASSEMBLIES — We have facilities for soldering terminals to your transformer covers — evacuating and pressure filling enclosures.

NEW CATALOG Just off the press, a new catalog with descriptions and specifications for most of Hermaseal's stock sizes and designs. Write for your copy today!



THE HERMASEAL CO, Inc. Elkhart 10, Indiana

PLANTS AND PEOPLE

Edited by WILLIAM P. O'BRIEN

Marchant Gets New Division

MARCHANT CALCULATORS, INC., has acquired a controlling interest in Physical Research Laboratories, Inc. of Pasadena, Calif., developers and makers of electronic computers and components. The laboratories will be re-named Marchant Research, Inc., and will be moved to company headquarters at Oakland.

Research activities of the new division will be directed toward developing simplified electronic computers with broad applications in science and business. Electronic components—such as magnetic recording heads for electronic computers, pulse transformer and delay lines for radar and loran equipment—developed by Marchant Research, will be manufactured and sold by Marchant Calculators.

Edgar B. Jessup, president of the parent company, will be chair-

man of the board of directors of Marchant Research, Inc., and George Greene, who was founder and president of Physical Research Labs, will be president and director. Donald White, co-founder of Physical Research Labs, will be chief engineer and a director.

Battelle Expands

GROUND was recently broken in Columbus, Ohio, for a new million-dollar special-purpose laboratory building for Battelle Institute. Construction was authorized by the NPA because of the important defense research being conducted at Battelle.

Some 300 industrial firms, in addition to the Air Force, Army, Navy and Atomic Energy Commission, are sponsoring important research studies at Battelle. Director

OTHER DEPARTMENTS

featured in this issue:

	Page
Electrons At Work.....	168
Production Techniques ..	256
New Products	312
New Books	404
Backtalk	420

Clyde Williams estimates that in the space provided by the new building, Battelle will be in a position to conduct an additional \$2,000,000 worth of research for defense agencies and defense industry.

Beckman Buys Berkeley

BERKELEY SCIENTIFIC CORP., Richmond, Calif., manufacturer of electronic equipment, has been purchased by Beckman Instruments, Inc., of South Pasadena, Calif. The Berkeley Corp. has been dissolved and its operations will continue as a division of the parent company.

W. K. Rosenberry, founder and president of Berkeley Scientific, becomes vice-president of Beckman Instruments in charge of operations at the Richmond plant.

The Beckman organization now has 18 plants or plant sites in the country, and employs 1,400 people. Biggest source of sales is a precision potentiometer made by subsidiary Helipot Corp. The company also makes pH meters, spectrophotometers, computers, radioactivity meters and other devices.

Engineering Changes at Bendix

EDWARD K. FOSTER, vice-president and general manager of the Bendix Radio Division of Bendix Aviation Corp., has announced the appointment of Arthur C. Omberg as director of engineering and research for the division. Adam E. Abel has been named as his assistant. Om-

SERVICE AWARD PRESENTATION

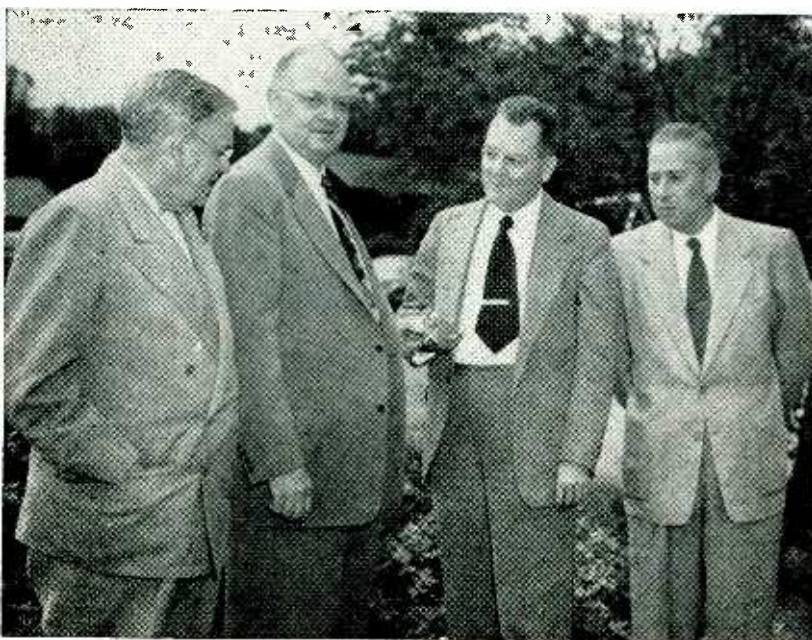

Albert C. Gable, second from left, manager of engineering for General Electric's Industrial and Transmitting Tube operations, receives the first Service Award of the Joint Electron Tube Engineering Council at the council's last meeting in Big Moose Lake, N. Y. Presentation of the award plaque was made by Virgil M. Graham, council chairman. At left is Frank J. Martin, council secretary, and at right is Henry J. Hoffman, NEMA director of JETEC. Mr. Gable recently resigned from the council after two years' service, during which he served as chairman of the council's critical materials committee



**TO-DAY'S GREATEST SUCCESS . . .
THE AUTO-CHANGER OF TO-MORROW**

The "Monarch" auto changer

A masterpiece in design and technical excellence—a three-speed automatic record changer designed to play 12", 10" and the increasingly popular 7" records *intermixed in any order*. The "Monarch" combines ease and simplicity of operation with the high standard of reproduction and performance demanded by the most discriminating listener.

Note these 7 star features.

- * Automatically selects and plays 7", 10" and 12" records, intermixed, at 33 $\frac{1}{3}$, 45 or 78 r.p.m. Capacity 10 records.
- * Pick-up automatically returned to rest position and motor switched off after last record.
- * New reversible dual stylus crystal pick-up has extended frequency range to 10,000 c.p.s. Self compensated for the L.P. lower frequencies with the Turnover frequency at the correct point.
- * Remarkably compact design makes it an ideal unit for the radiogram/TV combination console.
- * Simplicity of design guarantees long life and trouble-free operation.
- * Beautiful styling and finish that will harmonize with any cabinet design.
- * Operates on 100/125-200/250 volts, 50 cycles A.C. Models also available for 60 cycles A.C.



The "Regent"

. . . a beautifully styled three-speed gramophone. Complete with ingenious automatic stop and light-weight high-fidelity turnover type crystal pick-up fitted with two permanent sapphire styli.

U.S. Offices

149 Broadway, New York 6, N.Y.
Telephone Worth 4-4847



Birmingham Sound Reproducers Ltd., Old Hill, Staffs. England. Grams: 'Electronic Old Hill, Cradley Heath.'

berg succeeds W. L. Webb who was recently promoted to the central engineering staff of the Bendix Aviation Corp. in Detroit.

Mr. Omberg, who has been associated with Bendix since 1944, has been assistant director of engineering and research for the past two years.

Adam E. Abel, who becomes assistant director of engineering and research, has been chief radar engineer for the radio division, responsible for the design of both the military and civilian radar which is now being produced by Bendix in large quantity.

New West Coast Manufacturer

LLOYD M. JONES, with KFI A-M—F-M—TV for over 19 years and with KTTV for 1½ years as operations engineer, has left KTTV to embark upon his own manufacturing business. The business will be known as Lloyd's Enterprises, Box 313, Altadena, Calif.

During the war he was with the Radiation Lab at MIT as a staff member. Projects included APG-1, APG-5, APG-8 and APG-15.

The new organization will make new types of test equipment for TV and electronic research.

Co-Design President Named

DONALD E. WILLIAMSON has been named president of the Co-Design Corp., located at 751 Main St., Winchester, Mass. He is former associate director of research of Baird Associates, Inc. The new corporation will engage in engineering and manufacture of special instruments and devices.

Sylvania Promotes Moncton

THE APPOINTMENT of Howard S. Moncton as administrative engineer of the Radio and Television Division of Sylvania Electric Products Inc. was recently announced. He joined Sylvania in 1939 and has been assistant to the manager of the Physics Laboratories since 1943.

Mr. Moncton assumes his new



H. S. Moncton

duties at headquarters of the Radio and Television Division in Buffalo, N. Y. He will be responsible for the coordination of the administrative functions of the division's engineering department.

Audio & Video Names New Board Member

SIDNEY K. WOLF has been appointed to the board of directors of the Audio & Video Products Corp., 730 Fifth Ave., New York City. He was at one time deputy director of the radio and Radar Division of the War Production Board and director of the Communication Division of the Munitions Board.

Kahle Announces Engineering Rep

THE KAHLE ENGINEERING CO. of North Bergen, N. J., has announced the appointment of James B. Lindsay as a special engineering repre-



J. B. Lindsay

sentative for the company.

Mr. Lindsay, former vice-president of Thomas Electronics, has devoted the past 25 years to the electronics industry. His association with RCA for more than 12 years resulted in many important contributions to the design and development of tube equipment and techniques.

Instrument Labs Acquires Stewart Bros.

STEWART BROTHERS, INC. of Chicago, Ill., manufacturers of telephone and telegraph test equipment for the independent telephone systems in this country and abroad, has been acquired by Instrument Laboratories, also of Chicago, and will be operated as Stewart Brothers, Division of Instrument Laboratories. The acquisition will result in a program of modernization and improvement to make the line of even greater use and value to the telephone industry.

Westinghouse Establishes Fellowship Fund

A FELLOWSHIP fund to help promising young engineers and scientists of the Westinghouse Electric Corp. continue their studies at a graduate level has been established in honor of the late Leon R. Ludwig, inventor (he collaborated in the development of the ignitron rectifier) and company engineering executive. The fund will be administered initially by five company officers.

To be eligible for a fellowship, a candidate must have shown marked ability in engineering or scientific fields and must be a Westinghouse employe of at least two years' service.

Goss Joins RCL

C. GILBERT GOSS, development engineer in electronic circuitry at Oak Ridge National Laboratory for the past four and one-half years, has joined Radiation Counter Laboratories, Inc., as director of electronic research. He has had wide experi-



HERE'S THE FASTEST, EASIEST WAY TO GET ELECTRONIC COMPONENTS IN AN EMERGENCY

When you need resistors in a hurry—for maintenance, experimental work, or pilot runs . . .

*Pick up your phone and call your
nearest IRC Distributor!*

You'll save yourself worry and trouble—red tape and long delivery cycles. For your IRC Distributor *has* the standard resistors you need *right on his shelf!* IRC's Industrial Service Plan keeps him amply stocked for prompt delivery of emergency quantities.

There are other advantages, too . . . Your IRC Distributor can often act as counsellor on problems of parts with which you may not be familiar. And he's often able to get parts which you can't obtain elsewhere.

All in all, your IRC Distributor is a handy man to know. If you haven't met him, just let us know. We'll be glad to send you his name and address.



**INTERNATIONAL
RESISTANCE COMPANY**

403 N. Broad Street—Philadelphia 8, Pa.

In Canada: International Resistance Co., Ltd., Toronto, Licensee

Wherever the Circuit Says ~~~~~

CONTINENTAL

MINIATURE
Precision
CONNECTORS

RACK TO PANEL TYPE

4 to 100 contacts



POSITIVE POLARIZATION • FLOATING CONTACTS • PRECISION MACHINED CONTACTS • VIBRATION PROOF • MINERAL FILLED MELAMINE BODY • FLAME RESISTANT • HI-DIELECTRIC AND MECHANICAL STRENGTH

CABLE TO PANEL TYPE

4 to 100 contacts



VOLTAGE BREAKDOWN (Sea level normal humidity) 3600 V. RMS
CURRENT RATING 5 AMPS
CONTACT SIZE 20 AWG wire
EFFECTIVE CREEPAGE 1/8 in.
MECHANICAL SPACING 5/64 in.

CABLE TO PANEL TYPE



Hexagonal type is provided with positive polarization and a Vibration Ring and Spring with detent locking action. Voltage breakdown at Sea level normal humidity. — 1600 V. RMS.

CATALOG WITH COMPLETE DETAILS — AVAILABLE ON REQUEST. TO DEPT. E-10



DeJUR AMSCO CORPORATION

45-01 NORTHERN BOULEVARD, L. I. C. I., N. Y.

PLANTS AND PEOPLE

(continued)

ence with linear amplifiers, scalars, differential discriminators, special voltage supplies and other electronic equipment used in nuclear detection work.

Prior to becoming a member of the staff at ORNL, he was an instructor in electrical engineering at Louisiana Polytechnic Institute.

AIEE Appoints New Committee Chairman

L. F. HICKERNELL, chief engineer of the Anaconda Wire & Cable Co., Hastings-on-Hudson, N. Y., has been named chairman of the newly formed Committee on Technical Operations of the AIEE. The new



L. F. Hickernell

committee will be coordinating agency for the AIEE's five technical divisions, which represent 38 technical committees, and will supervise all technical affairs of the Institute.

Philips Plans Java Plant

CONSTRUCTION of an electronic and communications equipment manufacturing plant at Bandoeng, Java, is being planned by the Indonesian Philips Co. In addition to locally recruited manpower, at least 2,000 workers will be brought from Sourabaya, Java.

New Audio & Video V-P

KENNETH B. BOOTHE has been elected a vice-president and director of the instrumentation division of Audio & Video Products Corp., New York, N. Y. This advances him from the position of manager of

DeJUR

EXTERNAL PHASING
C-200
Potentiometers



- MULTIPLE GANGING
- INDIVIDUAL EXTERNAL PHASING
- POSITIVE INTERLOCK
- PRECISION MACHINED ANODIZED ALUMINUM CASE
- ADJUSTABLE TAPS WITHIN $\pm 1/2^\circ$

Designers are invited to submit their applications to DeJUR engineers for recommendations and suggestions.

- 2" Diameter
- 4 Watts Fully Enclosed
- 10 to 200,000 Ohms Accuracy up to 1%
- Linearity up to 0.3%
- Non Linear Windings
- 360° (Continuous) Mechanical Rotation
- 320° Electrical Rotation
- Taps as Required
- High Resolution 1,000,000 Cycles Operational Life
- Precious Metal Contacts
- Low Torque 1 oz. inch
- Centerless Ground Stainless Steel Shafts
- Ball Bearings to Special Order
- Single or Ganged Units
- Servo Type Mounting or Single Hole Threaded Bushing
- Numerous Shaft Designs

WRITE FOR BULLETIN E-10



DeJUR AMSCO CORPORATION

45-01 NORTHERN BOULEVARD, L. I. C. I., N. Y.

THE SAR PULSESCOPE

BY WATERMAN

MODEL S-4-A

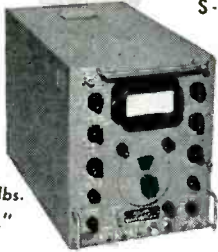

Weight 31.5 lbs.
9 1/8" x 11 1/4"
x 17 1/4"

Another example of WATERMAN pioneering, a compact, portable instrument for precision pulse measurements adaptable for all electronic work, including radar and TV. S-4-A SAR PULSESCOPE will portray all attributes of the pulse; such as shape, amplitude, duration and time displacement. In S mode of operation, the unit functions as a wide band oscilloscope, with optional video delay, in either repetitive or triggered sweep conditions. In A mode of operation the unit functions as a precision time measuring device, with internal crystal controlled markers available for self calibration. In R mode of operation a desired small segment of A Sweep is expanded to fill the face of the tube for detailed observation.

Video Amplifier band pass up to 11 mc... optional Video delay 0.55 μ s... Pulse rise and fall time better than 0.07 μ s... Video sensitivity of 0.5 p to p/inch... S Sweep 80 cycles to 400 KC either triggered or repetitive... A Sweep 1.2 μ s to 12,000 μ s, R Delay 3 μ s to 10,000 μ s... Directly calibrated on a precision dial... R Pedestal (or sweep) 2.4 μ s to 24 μ s... A & R Sweep Triggers available externally... Internal crystal markers of 10 μ s \pm 50 μ s... Built in precision amplitude calibration... Operates on 50 to 1000 cycles at 115V AC.

WATERMAN PRODUCTS CO., INC.

PHILADELPHIA 25, PA.
CABLE ADDRESS: POKETSCOPE

WATERMAN PRODUCTS INCLUDE:

S-5-A LAB	PULSESCOPE
S-10-B GENERAL	POCKETSCOPE
S-11-A INDUSTRIAL	POCKETSCOPE
S-14-A HIGH GAIN	POCKETSCOPE
S-14-B WIDE BAND	POCKETSCOPE
S-15-A TWIN TUBE	POCKETSCOPE

Also RAYONIC Cathode Ray Tubes
RAKSCOPES and other equipment



SQUARE WAVES - 6 cy. to 1 mc.

.01 microseconds rise time into 100-ohm load

Negligible overshoot or ringing.

Self contained oscillator may be externally synchronized.

Both frequency control and output attenuator continuously variable.

Outputs include synchronizing pulse.



MODEL 43A

SQUARE WAVE GENERATOR

\$230.00 F.O.B. Ridgefield, Conn.

MANUFACTURERS OF

DIRECT COUPLED AMPLIFIERS • EXTREMELY HIGH

GAIN 10 CY. AMPLIFIERS • FM/FM TELEMETERING EQUIPMENT

Electro-Mechanical Research, Inc.

RIDGEFIELD, CONNECTICUT

AMPERITE

THERMOSTATIC METAL TYPE

Delay Relays



PROVIDE DELAYS RANGING FROM 1 TO 120 SECONDS

FEATURES: — Compensated for ambient temperature changes from -40° to 110° F... Hermetically sealed; not affected by altitude, moisture or other climate changes... Explosion-proof... Octal radio base... Compact, light, rugged, inexpensive... Circuits available: SPST Normally Open; SPST Normally Closed.

PROBLEM? Send for "Special Problem Sheet"

Regulators

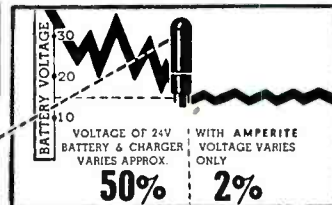

Amperite REGULATORS are the simplest, lightest, cheapest, and most compact method of obtaining current or voltage regulation... For currents of .060 to 6 Amps... Hermetically sealed; not affected by altitude, ambient temperature, humidity.

Write for 4-page Illustrated Bulletin.

AMPERITE CO., Inc., 561 Broadway, New York 12, N. Y.

In Canada: Atlas Radio Corp., Ltd., 560 King St., W. Toronto

COAXWITCH

COAXIAL SELECTOR SWITCH

50 Ohms—

Type N Connectors—Manually Controlled
Low VSWR—4 Models

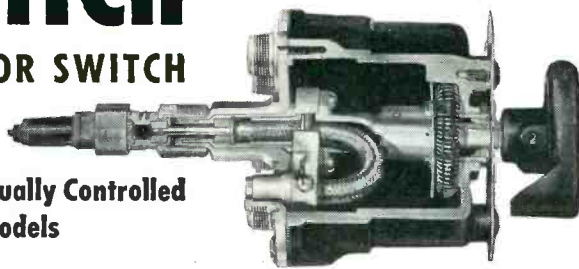

CUT-A-WAY VIEW, MODEL 74

The COAXWITCH is an RF switch for use in coaxial circuits where it is important that the 50 OHM impedance of the cables be maintained. In a circuit sense, this switch consists of two pairs of "N" connectors spaced 4½" apart using RG-8/U as the connecting link. The COAXWITCH itself introduces no VSWR other than that of connectors. Characteristic impedance is maintained thru all switch details. Cut-a-

way view shows that shield as well as center conductor is switched. Beryllium copper contacts, on the gooseneck, mate directly with male "N" (Type UG-21B/U) connectors, which connect directly to back plate of switch. Since all connectors come out in line with axis of switch, right angle connectors are usually unnecessary.

Literature Gladly Sent

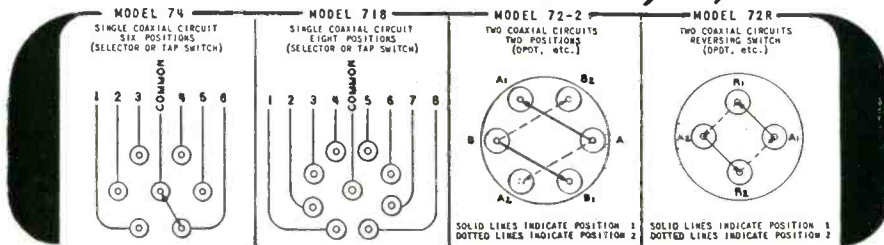

BIRD
ELECTRONIC CORP.
TERMALINE COAXIAL LINE INSTRUMENTS

1800 EAST 38TH ST.
CLEVELAND 14,
OHIO
West Coast:
NEELY ENTERPRISES
HOLLYWOOD 46, CAL.

How to Fabricate SHEET PLASTIC Rapidly... at LOW COST

Write for this booklet showing latest Taber machines and methods of fabricating sheet material .005"-.030" thickness.

PLASTIC MACHINE DIVISION

Taber INSTRUMENT CORPORATION
111 EL Goundry St., North Tonawanda, N. Y.

ALSO WRITE FOR FREE LITERATURE ON
★ V-5 Stiffness Gauge ★ Scratch and Toughness Testers For Plastics

the instrumentation division.

Before joining Audio & Video in 1949, Mr. Boothe was chief engineer and technical supervisor for the United Nations Sound and Recording Department. He organized and directed the engineering for the Paris General Assembly and supervised the simultaneous interpretation and recording installations for the U. N. in Geneva and Havana.

New Chief Engineer

CONDENSER PRODUCTS Co. of Chicago, manufacturer of Glassmikes, capacitors, high-voltage power supplies, pulse-forming networks and plasticon capacitors, has announced the promotion of Tom Murphy to chief engineer.

Mr. Murphy, with the firm for



T. Murphy

four years, will head the engineering department, which is presently composed of eleven engineers.

Sylvania Occupies New Site

THE ELECTRONICS DIVISION of Sylvania Electric Products Inc. recently moved its headquarters from Boston to 100 Sylvan Road, Woburn, Mass. Products manufactured in Woburn will be used in such fields as radar, navigation, communication and flight, and will include electron tubes, microwave tubes, semiconductor devices (including transistors) and special-purpose tubes.

Opening of the multi-million dollar Woburn plant brings to six the

from

Accelerometers

to

Yokes

you'll find the correct answer to who makes everything in the entire field of electronics including... components equipment and materials

in the...

electronics BUYERS' GUIDE

Get in the habit of looking it up in...

the electronics BUYERS' GUIDE

"The Book that has all the answers"

A MCGRAW-HILL PUBLICATION
330 West 42nd Street
NEW YORK 36, N. Y.

New! SELENIUM RECTIFIER POWER SUPPLIES



These General Purpose Power Supplies provide a modern and convenient means of obtaining unfiltered direct current from 115 or 230 volt A.C. power lines. This new series includes 15 models, compactly designed for portability and ideally suited for installations where bench space is at a premium.

Request Bulletin No. 147 for additional information on standard units.

Special Selenium Rectifier power supplies available to specifications. Write for Rectifier Equipment Questionnaire. Proposals and recommendations forwarded promptly.

Opad-Green
COMPANY

71-2 Warren St., New York 7, N. Y.

Phone: BEekman 3-7385-6

ELECTRAN

TRANSFORMERS

- ★ TRANSFORMERS
- ★ SATURABLE REACTORS
- ★ ELECTRONIC DEVICES

Specialists in SMALL quantities of custom built transformers from milliwatts to 50 KVA, single or polyphase—designed and manufactured to best meet your exact requirements.

Each Electrnan Transformer is built to the highest standards of quality and precision. There is no "second" grade of Electrnan.

ELECTRAN MFG. CO.

1901 CLYBOURN AVENUE • CHICAGO 14, ILLINOIS

number of communities in Massachusetts in which Sylvania has manufacturing operations. The Electronics Division last spring opened a new plant in Newton for the production of magnetrons for radar, and the company will retain the Boston plant for production of electronic equipment, such as radar systems and electronic computers.

Hoffman Plants Enlarged

ADDITIONS to the company's Los Angeles plants have been made by Hoffman Radio Corp., making a total factory area of nearly a half million sq ft. The new buildings, with an aggregate of 122,000 sq ft of space, are located at 3764 South Broadway Place and 2034 East 48th St.

Construction has just begun on an annex to the main plant in Los Angeles (3761 So. Hill St.). Cost will be \$550,000.

The two buildings already occupied plus the new one will increase the production area by 31 percent.

D&R Staff Addition

LEO JOHNSON, formerly with the Naval Research Laboratory and General Electric Co., has joined the staff of the Magnetics Division of D&R Ltd., Santa Barbara, Calif.

At both GE and NRL his work was in connection with servo projects, computers and the development of high-performance magnetic amplifiers. He will continue his research work on magnetic amplifiers in his present position with D&R.

AiResearch Expands

THE ENGINEERING department of AiResearch Mfg. Co. has been moved to enlarged quarters in a new building at 9225 Aviation Blvd., Los Angeles, Calif. The new engineering building is a single-story structure embracing 37,500 sq ft of floor space.

In addition to engineering personnel, the new quarters are providing space for the handbook department, preliminary design and engineering records.

Precision

AIRBORNE ELECTRONICS

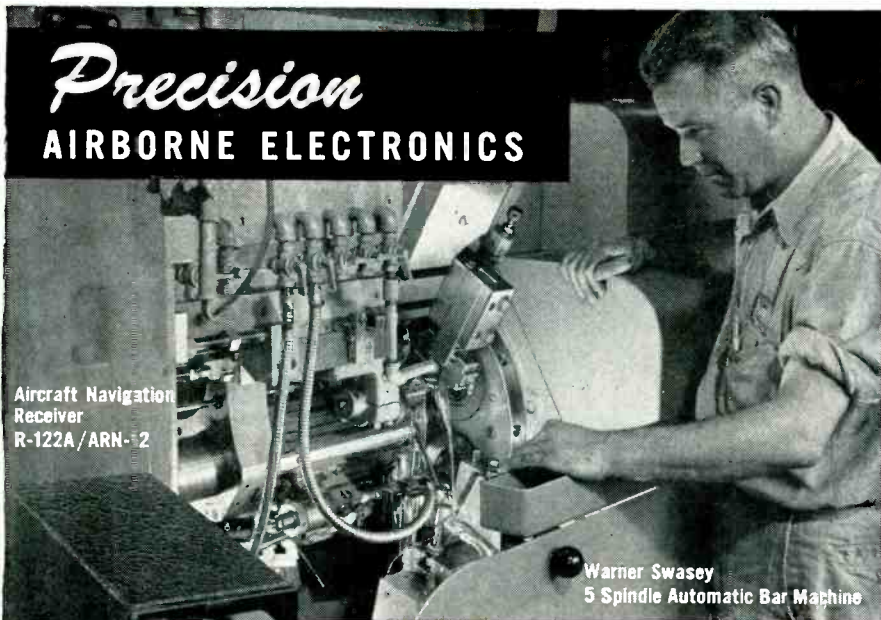

Aircraft Navigation Receiver
R-122A/ARN-2

Warner Swasey
5 Spindle Automatic Bar Machine

Behind the production of this precise aircraft receiver stand engineering and manufacturing facilities geared to the exacting demands of electronics today.

Remler Company Ltd., 2101 Bryant St., San Francisco 10



Since 1918 PIONEERS IN ELECTRONICS, AND PLASTICS

Only with

CO-A-X

AIR SPACED ARTICULATED R.F. CABLES



4 mm²/ft.

Patent Regd. Trade Mark.

THE LOWEST EVER CAPACITANCE OR ATTENUATION

We are specially organized to handle direct enquiries from overseas and give IMMEDIATE DELIVERIES FOR U.S.A. Billed in dollars Settlement by your check.

LOW ATTEN. Types	IMPED. Ohms	ATTEN. db/100ft. of 100 Mcs.	LOADG. Kw.	OD"
A.1.	74	1.7	0.11	0.36
A 2	74	1.3	0.24	0.44
A34	73	0.6	1.5	0.88

LOW CAPAC. Types	CAPAC. mm ² /ft.	IMPED. Ohms	ATTEN. db/100ft. of 100 Mcs.	OD"
C 1	7.3	150	2.5	0.36
PC 1	10.2	132	3.1	0.36
C 11	6.3	173	3.2	0.36
C 2	6.3	171	2.15	0.44
C 22	5.5	184	2.8	0.44
C 3	5.4	197	1.9	0.64
C33	4.8	220	2.4	0.64
C44	4.1	252	2.1	1.03

TRANSRADIO LTD
CONTRACTORS TO H.M. GOVERNMENT.
138A CROMWELL ROAD, LONDON SW.7 ENGLAND
CABLES: TRANSRAD LONDON.

HIGH POWER FLEXIBLE

PHOTOCELL CABLE

VERY LOW CAPACITANCE



ERA MAGNETIC DRUM STORAGE SYSTEMS

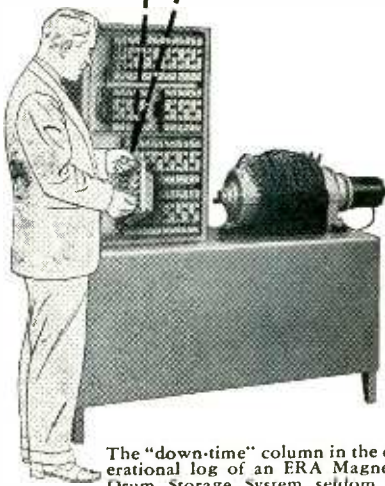

The "down-time" column in the operational log of an ERA Magnetic Drum Storage System seldom receives an entry. Every component of these systems has been designed or specially selected to assure day-in day-out operational reliability.

Simple test routines have been developed to detect marginal electronic components *before* they fail. The pluggable chassis construction utilized in the electronic sections of ERA Magnetic Drum Storage Systems permit the easy replacement of any unit incorporating a faulty component. Result—the system continues to operate while the pulled chassis is serviced. This practical design philosophy is one of the important reasons behind the ERA Magnetic Drum Storage System reputation for reliability.

Write today for descriptive brochure.



Engineering Research Associates, Inc.

A Subsidiary of **Remington Rand**
Department E-4, 1902 West Minnehaha Avenue
St. Paul 4, Minnesota

Digital Computers...Data-Handling Systems...Magnetic Storage Systems...Instruments...Analog Magnetic Recording Systems...Communications Equipment

An Improved Orientation Head for the Precision Processing of Quartz Crystals



MASTERCRAFT MODEL 600 B-2

This model is fitted with compound dovetail slides and with an all angle table top capable of being inclined 3½ degrees on two planes, which adapts itself to laboratory, production or research work or where a particular technique requires orientation of the X axis in two directions from horizontal. The Z axis may be rotated throughout 360 degrees with orientation within one minute precision.

Lead screw operated micrometer dials permit accuracy of sawing to one thousandths of an inch. Heavy rigid construction has been designed into these heads to insure maximum stability during the sawing operations.

Write for Complete Catalogue of Other Quartz Tables and for Other Mastercraft Tools.

F & M SALES, INC. Mfgs.
1054 Cahuenga Blvd. Hollywood 38, Calif.

Opportunities in CANADA

FOR ELECTRONICS AND MECHANICAL ENGINEERS

Canada is today's "land of opportunity" . . . offering unusual incentives for the technical and professional skill required to man its expanding development. Canadian Westinghouse Company has a number of attractive positions in its fast-growing Electronics Division at Hamilton, Ontario:

- Electronics Engineers—3 to 10 years' experience in Design and Development of Radio and TV, Telecommunications for Commercial and Defence Projects.
- Mechanical Engineers—3 to 10 years' experience in Manufacturing, Tooling and Design for Manufacturing for work on Defence Projects and Home Appliances.
- Electrical Engineers—Experienced on small Transformers for Research and Development Department.

These are permanent positions, combining security with excellent opportunities to get ahead in a Company and a Country with an unequalled future! Salary fully commensurate with qualifications. Location, Hamilton. Special assistance given in securing living accommodation. Please give full details as to qualifications in first letter. Replies strictly confidential. Address replies to:

Manager of Engineering, Electronics Division,

CANADIAN WESTINGHOUSE CO. Limited,
HAMILTON, ONTARIO, CANADA.

MICROPOT

PRECISION TEN-TURN POTENTIOMETER

1. You get permanent accuracy because the resistance wire is locked in place. It is precision positioned and moulded integrally with the housing.
2. You get permanently accurate settings, smooth action and low uniform torque provided by the stainless steel, precision ground, double thread lead screw guiding the moving contact.
3. You get precise positioning of the moving contact because of the two bearings supporting the rotor assembly.
4. You get good rigid terminals because they are moulded integrally with the housing.
5. Terminals soldered to ends of resistance element before moulding. Entire resistance circuit is an integral part of the housing.
6. You get accurate setting and re-setting due to anti-backlash spring in contact guide.
7. You get a fine resolution because of the $43\frac{1}{2}$ " length of resistance wire in the spiral element.
8. You get a resistance output directly proportional to shaft rotation within $\pm 0.1\%$ of the total resistance. Every potentiometer is automatically machine tested for linearity at 101 points.

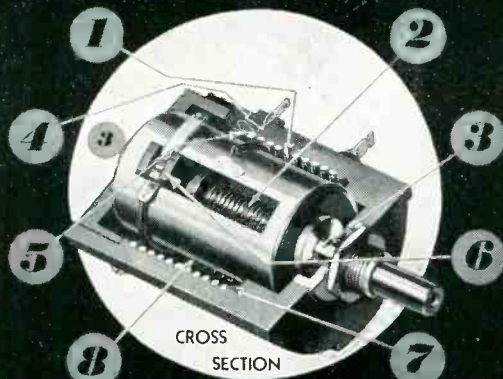

**LINEARITY
ACCURACY $\pm 0.1\%$**

Units for immediate shipment:
1,000 to 30,000 ohm range.
Special resistance values made to order.

WRITE TODAY FOR
ENGINEERING INFORMATION



BORG EQUIPMENT DIVISION
THE GEORGE W. BORG CORPORATION
JANESVILLE • WISCONSIN

NEW BOOKS

Principles of Radio

BY KEITH HENNEY AND GLEN A. RICHARDSON. *John Wiley & Sons, Inc., New York, 6th ed., 1952, 655 pages, \$5.50.*

THE Sixth Edition of "Principles of Radio" keeps this text in the lead in the field of basic radio knowledge. In the same manner that a certain gift is required to teach the fundamentals of a subject to beginners, it is also difficult to write a text for that purpose, particularly so if the material is to be rigorous.

To make certain that the reader has the proper background to understand and follow the radio material, the first nine chapters cover the electrical knowledge essential to radio, and in a manner that invites the student to keep on going and see what is coming up next. A variety of problems are included so that the material will not be the "descriptive" type only.

Then proceeding through several chapters on the vacuum tube and its basic operation, the particular applications of radio are treated to give a well rounded study so that the reader will cover a-m receivers, a-m transmitters, antennas, frequency modulation, ultrahigh frequency phenomena, television and radar. Or if the reader is interested in audio systems there is a chapter on that subject.

A book of this type without a mention of electronic instruments would be incomplete. A very interesting chapter is included on that subject. Also the non-sinusoidal wave and its circuits has been treated. Even the recent developments in color television are described.

The price of the book, based on the number of pages and their contents, is very moderate at present day book prices.—HOLLIS BAIRD, *Northeastern University, Boston, Mass.*

Electronic Measurements

By F. E. TERMAN & J. M. PETTIT. *McGraw-Hill Book Co., Inc., New York, 1952, 2nd Edition, 890 pages, \$10.00.*

THE AUTHORS claim that they have extensively revised the senior

THIS IS IT!

World-wide recognition for this outstanding line of electric soldering irons —

HEXA CON

— specified by the big names for the **TOUGH JOBS!**

- ★ MINNEAPOLIS HONEYWELL
- ★ RADIO CORP. OF AMERICA
- ★ STROMBERG-CARLSON
- ★ WESTERN ELECTRIC
- ★ WESTINGHOUSE
- ★ EMERSON
- ★ KAISER
- ★ BENDIX
- ★ SPERRY,
- etc.

HEXA CON ELECTRIC CO.

130 W. CLAY AVE., ROSELLE PARK, NEW JERSEY



PLUG OR SCREW TIPS
40 to 700 Watts
 $\frac{1}{8}$ " to $1\frac{3}{4}$ " Tip Dia.

Follow the leaders and you'll specify HEXA CON! They'll efficiently solve your soldering problems too! Write for literature.

Here's the famous
HEXA CON HATCHET TYPE

These irons feature better balance for reduced operator fatigue. Efficiency is stepped up, and quality of work is improved. The ideal iron for inaccessible and intricate jobs.



LOOKING AHEAD?

If you're a top performer in the field of physics, electronic engineering or design, and you're looking for a career as well as a well-paid position, it will pay you to investigate the excellent opportunity we offer.

BASIC QUALIFICATIONS:

Minimum of four year's experience in advanced research or development related to:

- PULSE CIRCUITS
- COMPUTERS
- NUCLEAR INSTRUMENTS
- MINIATURIZATION

• • •

ILLUSTRATED BROCHURE on request. Please write (giving summary of your education and experience, plus salary requirements) to:

BERKELEY SCIENTIFIC

division of
Beckman Instruments Inc.
2200 Wright Avenue
RICHMOND, CALIFORNIA

MICRODIAL

TEN TURN-COUNTING DIAL

Microdial is composed of two concentrically mounted dials . . . one for counting increments of each turn and the other for counting turns. The incremental dial has 100 equal divisions and is attached rigidly to the shaft so there is no backlash. Thus the contact position is indicated to an indexed accuracy of 1 part in 1000. Rotation is continuous in either direction. There are no stops on the Microdial assembly.

COMPACT . . . Microdial has same O.D. as Micropot . . . requires no more panel space.

CLEAR READING . . . Forced fast-reading tests showed only 1/20th as many errors with Microdial open window as with next most legible dial. Turn counter distinguishes between 0 and 10 turn readings, and accelerates to avoid confusion on readings near integral turns. Precise readings are made from larger dial with maximum separation of graduations and wide angle visibility.

CONVENIENT . . . delivered completely assembled with dials synchronized. Easily mounted in a few seconds. All dials may be locked.

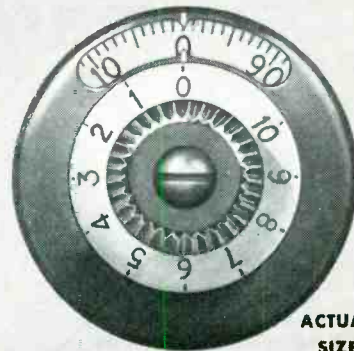

ACTUAL
SIZE

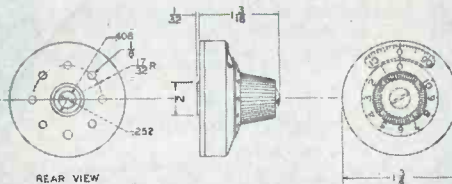

REAR VIEW

Microdial . . . turn-counting dial, primarily designed for use on Micropot ten turn linear potentiometers . . . use it on any multiturn device having ten turns or less.



BORG EQUIPMENT DIVISION
THE GEORGE W. BORG CORPORATION
JANESVILLE • WISCONSIN

Roanwell



Style
No. 2906

CLOTHES CLIP

Sturdily constructed for maximum life. Finished in semi-gloss black enamel. Ribbed, firm-gripping clamping pads made of hard neoprene. Mounting plate enables clip to be attached to hard surface, such as a switch case. Hard drawn steel spring wire insures optimum spring action.

WITH MOUNTING
HOOK FOR USE ON
CORDSETS

This model utilizes a steel mounting hook which can be hooked directly on a cordset molded for this purpose.

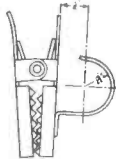

DATA SHEETS
ON REQUEST.

ROANWELL CORPORATION

27 SIXTH AVENUE, BROOKLYN 17, NEW YORK

leading users of
STEATITE
bobbins
SPECIFY

Thor

Steatite Bobbins are only one of the scores of standard and custom-made steatite products we manufacture to Jan-1-10 or Commercial Specifications.

Write Dept. E
for Details
& Catalogs.

Thor Ceramics, Inc.
225 Belleville Avenue, Bloomfield, New Jersey

Assure power for **MICROWAVE** systems

with **ONAN** *Standby* **ELECTRIC PLANTS**



WHEN STORMS, floods or break-downs cut off central station power, dependable Onan Standby Units keep repeater stations functioning.

Automatic line transfer controls start and stop plant. Units require a minimum of attention; will run continuously if necessary. Proved dependable in hundreds of installations serving utilities, pipelines, railroads, TV networks, and police.

A size and model for every standby use

Air-cooled: 1,000 to 3,500 watts. One and two-cylinder models. Water-cooled: 5,000 to 35,000 watts. Powered by four and six-cylinder industrial engines.

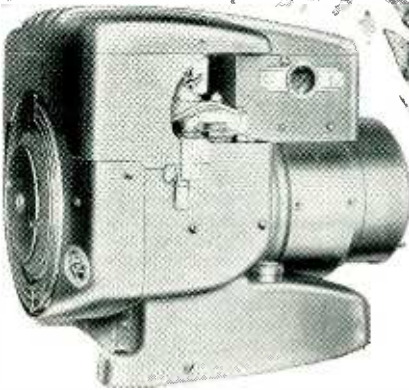

WRITE our sales engineering department for complete specifications.

D. W. ONAN & SONS INC.

7030 University Ave., S. E.

Minneapolis 14, Minn.



STANDARD SIGNAL GENERATOR

2 Mc. - 400 Mc.

Model 80

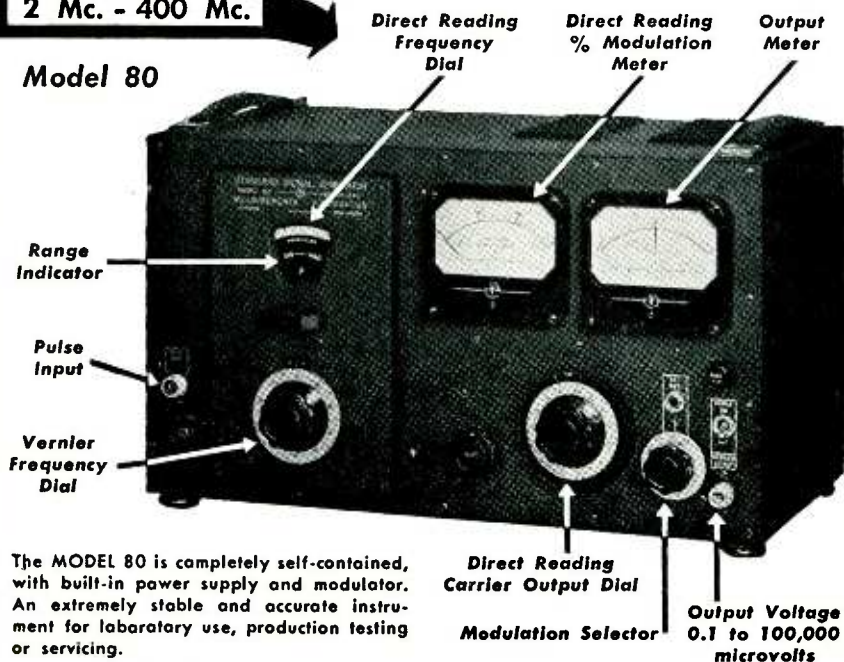

The MODEL 80 is completely self-contained, with built-in power supply and modulator. An extremely stable and accurate instrument for laboratory use, production testing or servicing.

Complete data on request

MEASUREMENTS CORPORATION
BOONTON NEW JERSEY



NEW BOOKS

(continued)

author's book, "Measurements in Radio Engineering." This is an understatement. The book is essentially a new one—not just a "second edition,"—and the authors' claim that the "change in title is indicative of the increased scope of the new book" is modest, indeed. It is a pleasure to read a book which has obviously been so carefully planned and executed. The intent, as defined in the preface, is carefully followed throughout, and the typography and illustrations are excellent.

The book "has as its aim the providing of a comprehensive engineering discussion of the measuring problems commonly encountered by radio or electronic engineers." The fundamental measurements of voltage, current, and power are first covered, followed by chapters on measurements of circuit constants in both lumped and distributed constant systems. Frequency, waveform, phase and time-interval measurements are discussed. A short chapter on tube characteristics is followed by chapters on amplifier, receiver, antenna and radio wave measurements. Descriptions of various types of laboratory oscillators, reactance and resistance standards, and attenuators and signal generators are given. A chapter on generators of special waveforms contains a wealth of information not readily available in such practical form elsewhere. This latter chapter is unusual to find in this type of book, but it has obviously been included because of its importance as an aid to laboratory measurement techniques.

The specialist in any single field will undoubtedly find his own particular interest too sketchily covered in this text—this is as it should be, for the aim of the text is to present to the student the "experimental aspects of radio in the same comprehensive way that the general principles are ordinarily studied." On the other hand, it will be a very finicky specialist who will not admit that the footnote references will lead the reader, if he so desires, to the latest and best literature in practically every field covered. The references are amazingly complete and up-to-date; a quick glance gives the impression

MICO

Precision Apparatus

TOROID COIL

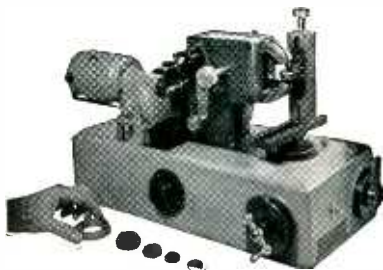

WINDERS

Flexible machines for your laboratory prototype development work.

Production machines built for volume manufacturing of specific coils.

MICO INSTRUMENT CO.

76E Trowbridge St. Cambridge, Mass.

Reduce Maintenance of Soldering Iron Tips

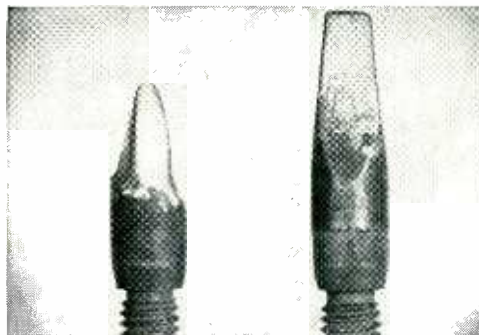

Save money on soldering iron maintenance! No filing of tips needed—G-E Ironclad copper tips have a layer of iron on the working surface which *retards* pitting and corrosion. Both tips above were used 363.5 hours at 250 C. Plain copper tip (left) pitted but Ironclad tip retained its original form, ready for many more hours of use—and still no filing will be needed.

Write For Free New Bulletin GEA-4519C to Section 720-95, General Electric Company, Schenectady 5, N. Y.

GENERAL ELECTRIC

Check the performance of this
HERMETICALLY SEALED

TERMINAL*

Kel-F molded by
BRILHART

See why over 1,000,000 are now in use by the biggest names in industry!

- 2000 volts, RMS-Corona Free
- Flashover . . . 7500 volts RMS Min.
- Insulation Resistance . . . 1,000,000 Megohms
- 60 Cycle test . . . 5000 volts (RMS)
- Current rating . . . 15 Amperes
- Air, helium, oil pressure tests . . . 20 lbs per sq. inch
- Temp. . . -100°C. to +150° C. cont.

Custom problem? Write today!

*PAT. PENDING.

BRILHART RESEARCH CORPORATION

MINEOLA, L. I., N. Y.

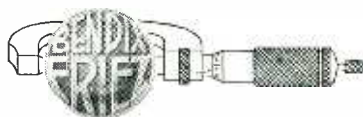

precision-made to your needs . . .

BENDIX-FRIEZ thermistors

Maybe your need for these temperature responsive resistors can be satisfied by a type we carry in stock. Maybe you require a specially-developed type. In either case you can depend on Bendix-Friez to provide precision-made thermistors to serve you with maximum efficiency. High standards of quality control in manufacture make Bendix-Friez Thermistors pre-eminent in their field . . . assure you of utmost satisfaction.

STANDARD TYPES FOR IMMEDIATE DELIVERY

Size (inches)	@ +30°C.	@ 0°C.	@ -30°C.
.140 x .75	45.0 ohms	86 ohms	194 ohms
.040 x 1.5	12,250 ohms	26,200 ohms	65,340 ohms
.018 x 1.5	35,000 ohms	82,290 ohms	229,600 ohms

Write for details.

FRIEZ INSTRUMENT DIVISION of . . .

1454 Taylor Avenue, BALTIMORE 4, MARYLAND

Export Sales: Bendix International Division
72 Fifth Avenue, New York 11, N. Y.

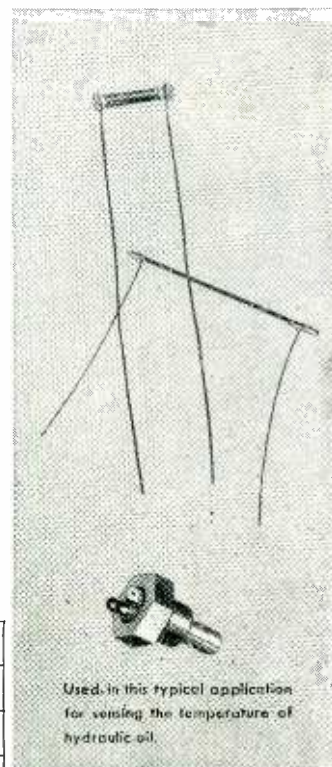

Used in this typical application for sensing the temperature of hydraulic oil.



For Faster Chassis Wiring

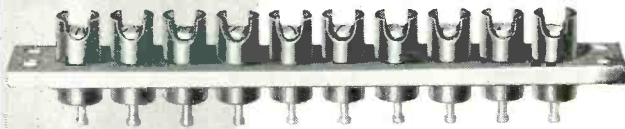

CURTIS Type "FTS" BLOCKS

Write for Bulletin DS-115. For quick reference consult our condensed catalog in the McGraw-Hill Electrical Catalog for Production Engineers.

TYPE:

Feed-thru, factory assembled in any number of terminals from 1 to 16.

TERMINALS:

Combination screw and solder type separately insulated, held permanently in metal strip.

RATED:

300 Volts between terminals of opposite polarity and to ground. 20 Amps. (Conservative).

CURTIS DEVELOPMENT & MFG. CO.

3203 NORTH 33rd STREET • MILWAUKEE 16, WISCONSIN

WESGO

CRACK- PROOF CERAMIC SHAPES for Furnace Brazing



BOAT AT 2000° F. PLUNGED INTO
ICE WATER DOES NOT CRACK

**WRITE
for
DETAILS**

Available in stock forms of boats or slabs. Special shapes made to your individual specifications.

WESTERN GOLD & PLATINUM WORKS
589 BRYANT ST. • SAN FRANCISCO, CALIF.

- withstand any amount of thermal shock without cracking
- have proven superior to carbon or metal brazing fixtures in positioning vacuum tube components for furnace brazing
- are non-reactive with most metals
- will retain shape at high temperatures
- are clean . . . will not rub off on hands or workpiece
- are permanent . . . will not react with air or reducing gases

that over 50 percent are dated subsequent to 1945 and many are dated 1951. The authors are to be commended for the help they have given to the man they term "the practicing engineer." This man will find "Electronic Measurements" in the same category as Terman's "Radio Engineer's Handbook."

It is unfortunate that the criticisms which must be mentioned cannot be printed as footnotes or in very small print, so that their relative importance could be made clear. In lieu of this, they will be short. The section on measurement of feedback amplifier characteristics is very condensed considering the extensive use of such amplifiers and the importance of accurate knowledge of their characteristics. No mention is made of measurements of servo systems, in which a large measure of control of the overall characteristics of the electro-mechanical system rests in the electronic portion of the circuit. The section on noise figure, both in the amplifier and receiver chapters, is rather loosely written and contains several technical errors and misconceptions. (Here the authors may criticize the reviewer for being the "finicky specialist" mentioned above. The accusation is admitted, but the criticism stands.)

On the whole, this book is one which will find its way into the libraries of most engineers in the electronics field. It is an excellent book in an area which has been devoid of one for many years —
MATTHEW T. LEBENBAUM, *Assistant Supervising Engineer, Radar Section, Airborne Instruments Laboratory, Mineola, New York.*

Radio and Television Receiver Troubleshooting and Repair

By A. A. GHIRARDI AND J. R. JOHNSON. *Rinehart Brooks, Inc., New York, 1952, 822 pages, \$6.75.*

ASSUMING a basic knowledge of how television and radio receiver circuits work, this vocational text gives major emphasis to techniques for finding and fixing trouble. The first chapter is both orientation and review, stressing the importance of individual components in circuits



he's working for you

THIS FELLOW IS TRAINED IN YOUR BUSINESS. His main duty is to travel the country — and world — penetrating the plants, laboratories and management councils . . . reporting back to you every significant innovation in technology, selling tactics, management strategy. He functions as your all-seeing, all-hearing, all-reporting business communications system.

THE MAN WE MEAN IS A COMPOSITE of the editorial staff of this magazine. For, obviously, no one individual could ever accomplish such a vast business news job. It's the result of many qualified men of diversified and specialized talents.

AND, THERE'S ANOTHER SIDE TO THIS "COMPOSITE MAN," another complete news service which complements the editorial section of this magazine — the advertising pages. It's been said that in a business publication the editorial pages tell "how they do it" — "they" being all the industry's front line of innovators and improvers — and the advertising pages tell "with what." Each issue unfolds an industrial exposition before you — giving a ready panorama of up-to-date tools, materials, equipment.

SUCH A "MAN" IS ON YOUR PAYROLL. Be sure to "listen" regularly and carefully to the practical business information he gathers.



McGraw-Hill PUBLICATIONS

You Get **TOPS** In Transformer Performance when built by **NOTHELFER**

The large transformer in the picture is 300 KVA, 3 phase, 550V/42V, 60 cycle. The small one is .01 KVA, 1 phase, 440V/6V.

Over 28 years experience in the manufacture of specials at cost that compares favorably with standard types. Built-in quality proved by years of actual use.

From 10 VA to 300 KVA Dry-Type only. Both open and encased. 1, 2 and 3 phase. 15 to 400 cycles.

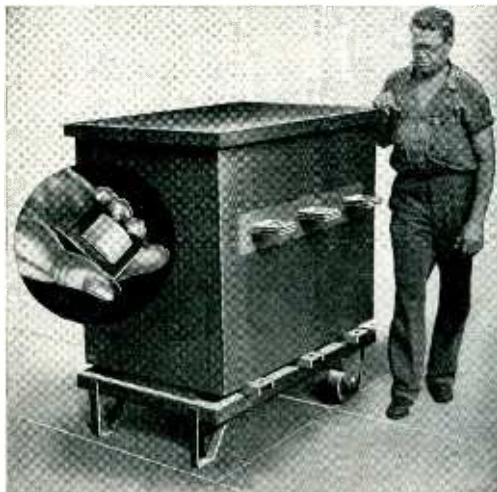

SEND FOR 8 PAGE BULLETIN, AND PRICE LIST



NOTHELFER

WINDING LABORATORIES

9 ALBEMARLE AVE., TRENTON 3, N. J.



and discussing briefly the commonest troubles associated with each type of component. The next nine chapters cover the different types of troubleshooting techniques used by practical servicemen on the various types of receivers. Three chapters cover alignment of a-m, f-m and tv receivers respectively; one tells how to take performance data; six chapters cover in detail the repair and replacement of defective components; the last two chapters deal with record players and recorders.

Chapter summaries and review questions greatly improve the effectiveness of the book both for classroom use and home study. Answers to odd-numbered questions are given at the end of the book, presumably to enable home-study readers to grade their own work.

This book merits the same high praise as its predecessor, "Modern Radio Servicing", and can be recommended to anyone desiring to learn how to fix receivers of all types. Though not specifically covering electronic control circuits, it can also serve for training service technicians in that field because many of the circuits and components are the same in the two fields.—J.M.

Handbook of Engineering Fundamentals

IVID W. ESHBACH, editor. *John Wiley & Sons Inc., New York, Second edition, 1952, 1,000 pages plus, \$10.00.*

FIRST edition of the popular handbook, published in 1936, had for its purpose the embodiment in a single volume of those fundamental laws and theories of science which are basic to engineering practice. Although much of the present volume is identical with material in the first edition, all of the older material has been reviewed, much has been revised, and much new matter appears. Here and there are changes in emphasis as necessitated by newer knowledge and the greater use of MKS units. While the volume has grown, it is not unwieldy or overly expensive.

There are 14 sections divided roughly into tables, mathematics, units and standards, mechanics, aerodynamics, thermodynamics,

"IMPROVED" GOLD CLAD NICKEL SUPPORT WIRE FOR VACUUM TUBES

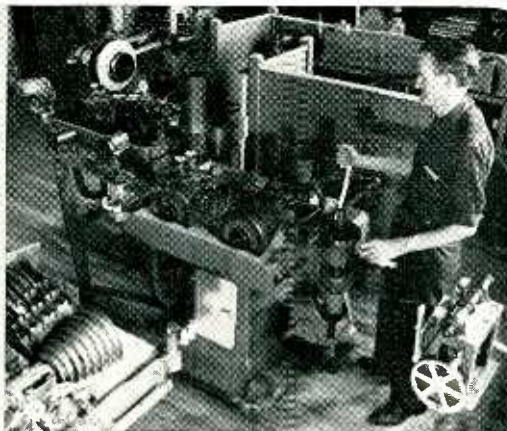

One of "IMPROVED'S" expert craftsmen is shown drawing gold clad nickel support wire for the vacuum tube industry.

This is just another example of the innumerable industrial applications of "IMPROVED'S" versatile service. Profit by the experience, the devotion to research and the prompt attention of this 54 year old owner-managed company. Write today regarding your particular problem with any kind of composite material for any industrial application. Your inquiries will be appreciated.



The Home of IMPROVED Service
Rhode Island's largest manufacturer
of Laminated Metals.

The IMPROVED SEAMLESS WIRE COMPANY
INCORPORATED 1898
775 Eddy Street, Providence 5, Rhode Island

TEST CHAMBERS

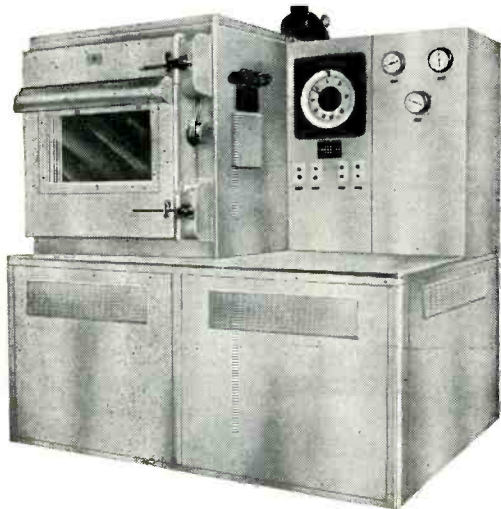

HIGH & LOW
TEMPERATURES

CONTROLLED
HUMIDITY

- -150°F. to +200°F.
- 20% to 95% R.H.
- 1 cu. ft. to 75 cu. ft. cabinets

Walk-in Rooms
Temperature Baths

Electronic or pneumatic
recording or indicating
control systems

CUSTOM CHAMBERS
built to specifications.

Years of satisfactory service!



56 Washington Avenue
Carlstadt, New Jersey

We serve you with your electronic parts needs. We stock all leading lines direct for the industrial market exclusively.

ELECTRONICS CENTER, Inc.
118 Duane Street
New York 7, New York
BRarclay 7-2241



Advance Electric & Relay	General Electric
Acro Switch	Greenlee
Aerovox	JCA
Alpha Solder	E. F. Johnson
Alpha Wire	JBT
American Radio Hardware	Kester
Amphenol	Kraeuter
Arrow Hart & Hegeman	Littelfuse
Astron	IRC
ATR	Mallory
Belden	Merit
Birnbach	Mueller
Burgess	National
Bussman	Ohmite
Centralab	Potter Brumfield
Cinch Jones	Shure
Clarostat	Simpson
Cornell Dubilier	Smith
Eby	Standard Electric
Fi-mac	Stancor
Erie	Sprague
Eveready	Triplet
	UTC
	Ward Leonard
	Walsco

WASHERS—ALL KINDS

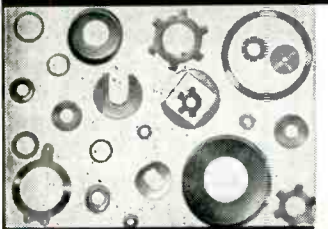

WASHER SPECIALISTS for nearly half-a-century. Dies in stock will produce most sizes. Big runs made with automatic presses. An economical, accurate, and highly reliable source for washers, also all kinds of metal stampings. HAVE WHITEHEAD'S CATALOG ON FILE; write for it.

BEVELED CUP
D-HOLE RETAINER
LOCK SPACERS
SPRING TENSION SQUARE HOLE
STAR LOCK THRUST TONGUE



EST. 1903

WHITEHEAD STAMPING COMPANY

1691 W. LAFAYETTE

DETROIT 16, MICH.

NEW 2 new D. C. REGULATED POWER SUPPLIES By mercury

Featuring — Continuously Variable output voltage (without switching)

MODEL 304-B

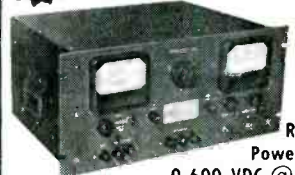

Regulated Power Supply
0-600 VDC @ 300 MA

OUTPUT VOLTAGES: #1 0-600 VDC @ 300 MA Regulated. #2 0-150 VDC @ 5 MA Regulated. #3 6.3 VAC @ 10 Amps Unregulated.

REGULATION: Within .5% from 20-600 VDC. From no load to full load. At 10 volts. Regulation 1%.

HUM VOLTAGE: Less than 8 millivolts.

METERS: High Voltage and Bias Voltage readable on voltmeter. Milliammeter included.

OUTPUT TERMINATIONS: Positive or Negative ground.

OUTPUT IMPEDANCE: Less than 2 ohms at 20 cycles or more for all output voltages.

DIMENSIONS: Length 19" x Height 10 1/2" x Depth 13". Panel size 19" x 10 1/2". WE Notching.

MODEL 308-A

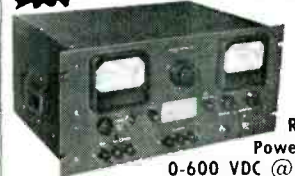

Regulated Power Supply
0-600 VDC @ 200 MA

OUTPUT VOLTAGES: #1 0-600 VDC @ 200 MA, Regulated. #2 0-150 VDC @ 5 MA Regulated. #3 6.3 VAC @ 10, Amps Unregulated.

REGULATION: Within .5% from 20-600 VDC from no load to full load. At 10 volts Regulation 1%.

HUM VOLTAGE: Less than 5 millivolts.

METERS: High Voltage and Bias Voltage readable on voltmeter. Milliammeter included.

OUTPUT TERMINATIONS: Positive or Negative ground.

OUTPUT IMPEDANCE: Less than 2 ohms at 20 cycles or more for all output voltages.

DIMENSIONS: Length 19" x Height 8 3/4" x Depth 13". Panel size 19" x 8 3/4". WE Notching.

WRITE FOR COMPLETE DETAILS ON THESE TWO NEW UNITS AND A COPY OF OUR LATEST CATALOG

Designers, Developers, Producers
of Fine Electronic Equipment

mercury electronic company

RED BANK

NEW JERSEY

A NEW COMPLETE SERVICE ON

ALL TYPES OF CONSTRUCTION NOW AVAILABLE AT LOW COST

SLIP RINGS and COMMUTATORS

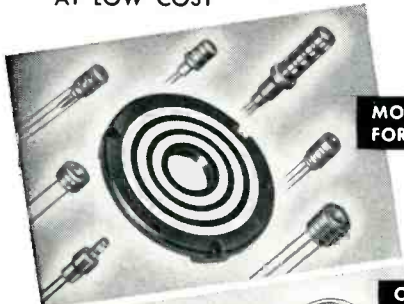

MOLDED OR FABRICATED TYPES FOR LOWEST POSSIBLE COST

Assemblies of these types can be supplied at low cost. Quality is the highest in the industry. Dimensional accuracy and other characteristics are excellent and these units are highly recommended for instruments such as synchros.

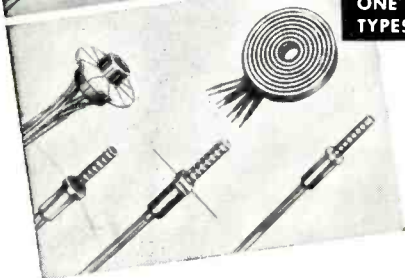

ONE PIECE ELECTRO-PLATED TYPES FOR EXTREME ACCURACY

Wherever extreme dimensional precision, accurate concentricity, and high dielectric qualities are required the electro-deposition method is recommended... the production of which is licensed under an exclusive arrangement with the Electro Tec Corporation. This well-known process is most satisfactory for miniatures and sub-miniatures down to .035" diameters.

ULTRA-MODERN, COST REDUCING, NEW PRODUCTION FACILITIES—The last word in plant, equipment and skilled personnel are grouped here to provide fast delivery at lowest unit cost.

CALL, WRITE OR WIRE TODAY FOR QUOTATIONS ON YOUR REQUIREMENTS



INSTRUMENT CORP. OF AMERICA BLACKSBURG, VIRGINIA

electricity and magnetism (completely revised), radiation, light and acoustics, chemistry, metallic and nonmetallic materials and engineering law.

Merely glancing through this large book of fine print and looking over the index of some 7,500 entries convinces one that this is a standard work valuable to all engineers.

—K. H.

Electronic Analog Computers

BY G. A. KORN AND T. M. KORN. *McGraw-Hill Book Co.*, 1952, 378 pages, \$7.

THIS text, the first of its kind, should be especially welcome to the newcomer in this field. It represents an integration of the current techniques of application, operation, and design of analog computers, which has heretofore been available only in widely scattered form in periodicals and reports of limited circulation. The authors have succeeded in keeping the treatment mathematically simple so that the qualified electronic engineer should have little difficulty in grasping the essential principles involved while at the same time getting an introduction to the more difficult analytical aspects of the field. Not the least important group who will be benefited by this text, particularly in these days of critical personnel shortages in the computer and associated fields, are the service personnel who form such an essential part of a computer facility. The service personnel, be they maintenance personnel or machine operators, can profitably, with a limited technical training, study this text to increase their effectiveness by a better overall understanding of computer techniques.

In the introductory chapter, the functional characteristics of basic computer components are described. Chapters 2 and 3 deal with the detailed steps in the application or setup of these components into a machine configuration to solve problems. Step-by-step procedures are described and the details are carried out of some specific typical problems. In Chapters 4, 5, and 6 a detailed study of the theory and design of computing elements is

SPECIAL ATTENTION!

Learn what **TURBO INSULATION MATERIALS** are doing today—and can do tomorrow

Send For Your Copy of This Insulation Materials, Wire and Wire Markers Characteristics Manual

If the harmful effects of oil, grease and sunlight, alkali fluids and acids are handicapping your wiring work, be sure to investigate Turbo products. They are designed and constructed on an unusually different principle and offer many advantages not found in other types of wire and cable insulation materials.

This booklet on Turbonics includes installation drawings, photographs, blueprints and descriptive suggestions for future planning incorporating new basic principles. You will benefit from the improved "as rated" characteristics of modern electrical and electronics insulating materials. Write for your free copy... Engineering Dept. A

For The Most Reliable Performance Be Sure The **BRAND Name IS ON All Your Electrical & Electronic Insulating Materials, Wire, and Wire Markers.**

INSULATING MATERIAL

TURBO

DESIGN AND DEVELOPMENT ENGINEERS

Electrical and Electronics Insulating Materials Mica and Wire



Here's how... **TURBONICS** will assist you in solving your complicated wiring system and insulation problems



THE WILLIAM BRAND & COMPANY, INC. Willimantic, Connecticut

SEND FOR YOUR COPY TODAY

SPECIALISTS SINCE 1920

THE WILLIAM BRAND AND CO., INC.

Dept. E-10, Willimantic, Connecticut, U.S.A., Telephone 3-1661

TURBO Insulated Wires - Wire Markers - Extruded Tubing - Glass Sleeving and Tubing Varnished Saturated Sleeving and Tubing - Cambric Cloths, Tapes, Papers - Mica

SALES REPRESENTATIVES IN PRINCIPAL CITIES

VULCAN

ELECTRIC HEATING UNITS

On Airplanes



in high altitudes and sub-zero temperatures, Vulcan Electric Heating Units hold lubricants in a liquid state.

They're used also as anti-ice protectors in thermostat control: in guided missiles and in speed indicators.

Vulcan electric heat is helping out in many new inventions for both war and peace. To assist in the further development of your ideas, Vulcan heating designers will be glad to join their know-how to yours.

VULCAN

ELECTRIC COMPANY

DANVERS 10, MASS

HOW TO GET 0.05% Accuracy! -FOR CALIBRATION



The U.S. Navy Electronics Laboratory, San Diego, Calif., uses the STROBOCORR to calibrate within 0.05% accuracy the oscillators used to reproduce sound samples recorded at sea. (Official Photo, U.S. Navy)

NEW 6T-4 Strobocorr

The 6T-4 measures all types of repetitive frequencies, both constant and variable—no waiting or computation. Frequencies become continuous, visual patterns for the duration of the signal, from which precise analysis and measurement can be made at any instant. Whether your problem is determining frequency drift under varying conditions, measuring natural or line frequencies, calibrating precision oscillators or tachometers, or measuring rotational speeds, you can always be sure of accuracy to 0.05%.



Free FOLDER
Informative folder on request. Explains and illustrates operation, specifications and applications.

Write C. G. CONN Ltd., Electronics Div., Dept. 1012, Elkhart, Ind.

for the ELECTRONIC INDUSTRIES

Quality

Ribbons STRIPS

**MOLYBDENUM
TUNGSTEN
TANTALUM
FORMED PIECES**

Your Special Metals Rolled to Thin Sizes & Close Tolerances

YOUR INQUIRIES WILL RECEIVE PROMPT ATTENTION

H. CROSS CO.

15 BEEKMAN ST., N. Y. 38, N. Y.
Worth 2-2044 and CORlandt 7-0470

ELECTRIC INSTRUMENT & CONTROL HEADQUARTERS

YES, OFF-THE-SHELF SERVICE



Electro-Tech maintains one of the largest and most complete stocks in the country of electrical meters, instruments and industrial control equipment—representing over 250 top lines.

Yes, our warehouse is bulging with standard stocks of

Counters	Solenoids	Toggle Switches
Panel Meters	Tachometers	Shunts (Electrical)
Transformers	Thermometers	Meggers
Switchboard Meters	Thermostats	Solenoid Valves
Micro Switches	Rectifiers	Pyrometers
Photo Electric Equipment	Rheostats	Multimeters
Relays	Timers	Oscilloscopes

and Laboratory Standard Instruments

In addition, we manufacture and stock *Special Test Equipment* • Electric Heating Units • Current Transformers • Pyrometers • Thermocouples • Rectifiers.

Our laboratory is available for repair work, rescaling, recalibration and special calibration of your electrical and industrial instruments. Often months are saved by rescaling and calibrating stock instruments to your specifications.

FOR SPEED
Wire — Code RDL
Teletype — NY 1-2906
Phone — BArlay 7-4209

"The Industries Buying Guide"
our
GENERAL CATALOG E-10
FREE

CONSULT US ABOUT YOUR REQUIREMENTS

ELECTRO-TECH EQUIPMENT CO.

55 LISPENARD ST., NEW YORK 13, N. Y.



**Rigid
Laboratory
Tests assure**

PRECISION paper TUBES

**"MATERIAL
CONTROL"**

With all materials thoroughly tested by up-to-date laboratory equipment, you can be sure every Precision Paper Tube meets or exceeds the highest standards. This means you get better heat-dissipation, greater resistance to moisture and better insulation. Also, spiral winding and die-forming under pressure provide up to 20% more strength with lighter weight—greater coil winding space, as well!

Made to your specifications of finest dielectric Kraft, Fish Paper, Cellulose Acetate or combinations—in round, square, oval, rectangular, or any shape, length, ID or OD.

Also Mfrs. of **PRECISION BOBBINS**

Write today for free sample and New Mandrel List of over 1000 sizes.

PRECISION PAPER TUBE CO.

2041 W. Charleston St.,
Chicago 47, Ill.

Plant No. Two, 79 Chapel St., Hartford, Conn.

200 MC BAND WIDTH AMPLIFIERS

Model 202P Wide-Band Chain Amplifier with Regulated Power Supply.

Band Width: 100 KC to 200 MC. Gain: 20 db.

Impedance: 200 ohms. Rise Time: Less than .0026 usec.

With the Model 202P: very fast pulses, transients and other high frequency voltages can now be amplified.

With the Model 202P: vacuum tube voltmeters and oscilloscopes are ten times more sensitive.

With the Model 202P: the output voltage of signal, sweep and pulse generators is ten times greater.

Other Wide-Band Chain Amplifiers available:

Model 214 **CHAIN PULSE** Amplifier — 30db gain

Manufacturers of the finest
in electronic equipment

Write for Bulletin 202P-1-R

SKL SPENCER-KENNEDY LABORATORIES, INC.
186 MASSACHUSETTS AVE., CAMBRIDGE 39, MASS.

presented: circuit configurations of feedback amplifiers which add, integrate, and differentiate, and error analyses of such configurations; multiplying and dividing devices employing voltage sensitive elements, and the recently developed step type multipliers; a variety of functional generators which can generate functions of a single variable.

The final two chapters are devoted to such items as power supplies, recorders for plotting results, control circuits, operating procedures, and some of the overall requirements involved in the design and layout of a complete computer installation. The overall design features of several modern analog computer installations are described.

The book should prove popular as an introductory treatment. As a textbook, it has unfortunately the shortcoming that no problems have been included.—DR. W. H. BOGHOSIAN, Associate Professor, University of Pennsylvania, Philadelphia 4, Pennsylvania.

Automatic and Manual Control

By A. TUSTIN. U. S. edition published by Academic Press Inc., New York, 584 pages, \$10.00.

THIS volume is, in effect, the proceedings of a Conference on Automatic Control. The conference, under the auspices of the Department of Scientific and Industrial Research with the support of the Institution of Electrical Engineers and the Institution of Mechanical Engineers, took place at the College of Aeronautics, Cranfield, England, July 1951.

Usefulness

Author and subject indices, in addition to a table of contents, facilitate locating information in the volume. This is especially important because of the breadth of subjects. Each of the three dozen papers deals at the specialist level with a particular aspect of control; for the most part, the authors have assumed that readers are conversant with the current state of the art. In bringing together these related but varied papers that might otherwise appear in several



Brand New!

GRC SMALL DIE CAST
TUBULAR RIVETS
BY THE MAKERS OF POPULAR GRC WING NUTS



PROMPT DELIVERY
on standard sizes:
1/16" to 9/64" dia.;
up to 5/16" lgth.
Specials to order.



GRIES REPRODUCER CORP.

100 WILLOW AVE., NEW YORK 54 • Phone: MOtt Haven 5-7400

- non-ferrous zinc alloy • rustproof and corrosion resistant • die cast (not headed!) to closer tolerances with more uniform heads for greater riveting efficiency • recommended where shear and tensile strength of steel is not required
- in all commercial finishes at substantial savings
- usable unfinished for greater economies.

Write for bulletin, samples, prices.

NEW BOOKS

(continued)

different journals, the conference committees have provided a volume of widening influence and at the same time relieved society journals of the great pressure from papers awaiting publication. Other conference committees might well study the economics of a book such as this. It takes longer to produce such a book but the result is more legible, although with pages as wide as those of this book, a two-column makeup might have been preferable. Distributing the book through commercial channels brings the conference before as wide an audience as possible.

Organization

The papers are grouped under sections dealing with educational problems, general theory, process control, nonlinear problems, systems working on intermittent data and step-by-step servos, the human operator, descriptions of particular devices and a symposium on analog computers.

The content of the volume is too specialized and varied to discuss adequately in a short review. Engineers dealing with automatic and assisted control will find it an authoritative reference on advanced aspects of servo design.

Examples

The two papers on the human operator illustrate the nature of the conference and of this volume. One paper presents the results of psychological tests comparing free-moving and fixed control levers in manual tracking.

Beyond the specific subject of this paper is the problem of how to evaluate operator error; if the operator is treated as a filter (predictor), by what measure of error shall his performance be judged? This problem is considered in the second paper in which the human transfer function in servo systems is developed for several environmental conditions. The theoretical development, which is based on servo and modern information concepts, provides statistical design criteria such as stability boundaries. The results point the way for obtaining further and much needed experimental data such as that presented in the first paper.

It is in this manner that papers

Type 2A TAP SWITCHES

HAVE A CONSTANT CONTACT RESISTANCE OF **ONLY 1 or 2 MILLIOHMS!**

These high quality switches with up to 24 contacts were specifically developed to meet the need for rugged precision instrument switches that have longer operating life and are economical components in competitively priced electronic instruments and military equipment.



Write for Technical Bulletin No. 28.
Exclusive Canadian Dist.
RCA Victor Ltd.

TECH LABORATORIES

PALISADES PARK
BOX 148, N. J.

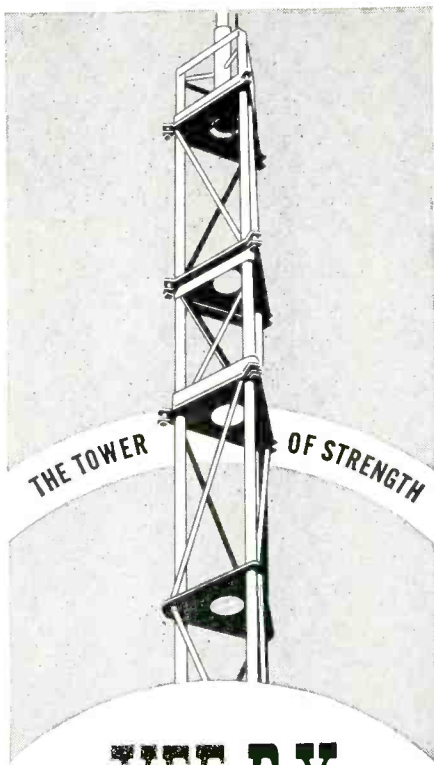

VEE-D-X

Sectional Tower

*MOST ECONOMICAL FOR
MICROWAVE • FM • TV
COMMUNICATIONS • RADAR*

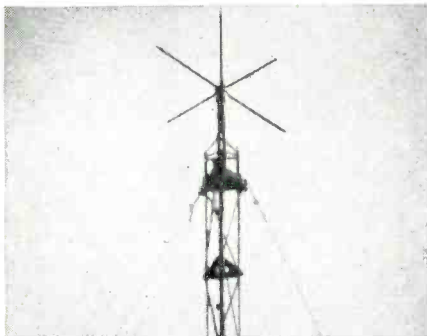

Actual photograph of VEE-D-X Sectional Tower installation showing 152 MC ground-plane antenna suited for ground-to-plane, ship-to-shore, and mobile communications.

THE LaPOINTE-PLASCOMOLD CORP.
ROCKVILLE, CONNECTICUT



ELECTRONICS — October, 1952

For the First Time Anywhere

POWER SUPPLIES WITH REGULATION AND STABILITY MEASURED IN **PPM***

* PARTS PER MILLION

- Regulation within 20 PPM* for line voltages of 105 to 130V.
- Load regulation better than 40 PPM* from zero to 500 ma.
- Stability within 100 PPM* per day under average conditions.
- MORE STABLE THAN BATTERIES.
- Short warmup period of 20 minutes.

MODEL 301A. — Voltage: 7.5 to 750 volts. Current: 0 to 500 ma. Ripple: less than 10 millivolts. Auxiliary voltages of —350 and —700 vdc. at 10 ma. —1/2% regulation, less than 4 millivolts ripple; and 6.3 volts center-tapped at 10 amperes.

MODEL 300N. — Performance same as 301A but voltage range 750 to 3000 vdc. at 0 to 30 ma. No auxiliary outputs.

MODEL 300E. — Performance same as 301A but voltage range —1000 to —1500 vdc. at 0 to 100 ma. Auxiliary output of 6.3 vac. at 1.5 amp.

SPECIAL MODELS. — Special models are available with output voltages from millivolts to kilovolts either positively or negatively grounded and at currents from milliamperes to amperes.

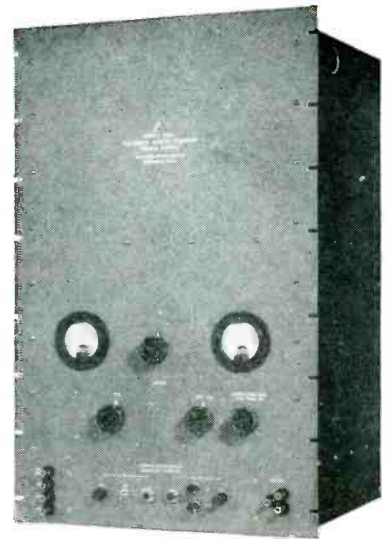

ALSO

SERIES 400 PRECISION POWER SUPPLIES

- For nuclear work.
 - High stability — close regulation.
 - Electronically regulated.
 - High voltage — low current.
- MODEL 400B. — Output: 1000 to 5000 vdc. Current: 0 to 1 ma. Regulation against line voltage 105 to 130 v. is within .01%. Regulation against load is .01%. Short term stability is .01% — long term stability is .1%. Ripple less than .01%.
- MODEL 400C. — Same as 400B except output: 500 to 1500 vdc.
- These models available with positive side grounded.



JOHN FLUKE ENGINEERING COMPANY

P. O. BOX 755 — SPRINGDALE, CONN.



SCALE:
FULL SIZE

**TWO ADJUSTABLE
MINIATURE
THERMOSTATS**
from the extensive line of

**ULANET THERMAL
CONTROLS**

Whether you need miniature or standard built-in units... call us for the Thermostat that will exactly meet your requirement.
GEORGE ULANET COMPANY, 417 Market St., Newark 5, N. J.

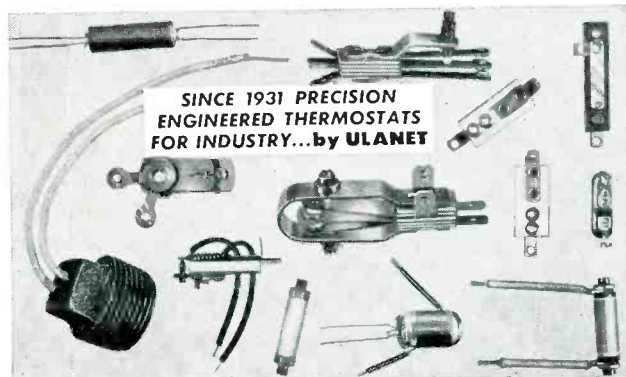

SINCE 1931 PRECISION
ENGINEERED THERMOSTATS
FOR INDUSTRY...by **ULANET**



THE ULANET ORGANIZATION SPECIALIZES IN THE DESIGN AND MANUFACTURE OF

**THERMAL
UNITS**

FOR ALL TYPES OF
**TIMING &
THERMOSTATIC
CONTROLS**

It will pay you to compare our units — contact us and you'll save time & money by using engineered Ulanet Controls.

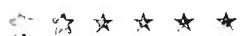



Here at Coto-Coil . . .

PARTIALLY WOUND
COTTON INTERWEAVE
COIL

. . . each of these interweave winding machines can produce up to four precision-engineered coils simultaneously—coils able to meet the most exacting electrical and physical specifications. A cotton, acetate or nylon yarn, interwoven with the wire throughout the coil, insures maximum uniformity, firmness and protection under all kinds of operating conditions. These modern production facilities, plus 35 years of experience, combine to make Coto Coils the first choice for engineered coils. Coto-Coil Company, 67 Pavilion Avenue, Providence 5, R. I.

Coto

 PRECISION

 WOUND

Coils

quality
**hand-wound
COILS**
of Tungsten
and Molybdenum

quality
"precision"
LEADS
of
TUNGSTEN
MOLYBDENUM
NICKEL
NICKEL-CLAD
COPPER
and ALLOYS

quality
**MACHINED
TUBE
COMPONENTS**
to customers'
specifications

Your products can
only be as good as
the parts you put
into them!

**SEND US YOUR BLUEPRINTS or
SPECIFICATIONS FOR QUOTATIONS!**

ELECTRONIC PARTS MANUFACTURING CO.
508 25th St., Union City, N. J.

throughout the book present complementary viewpoints and collateral information.—F. H. ROCKETT, *Airborne Instruments Laboratory, Mineola, N. Y.*

THUMBNAIL REVIEWS

RADIOLOGICAL MONITORING METHODS AND INSTRUMENTS. Handbook 51, National Bureau of Standards, 1952, 33 pages, 15¢. Indicates types of measurements and instruments necessary to determine adequacy of radiation shielding. Valuable to anyone dealing with x-rays, beta and gamma radiation and neutrons.

WORLD LIST OF SCIENTIFIC PUBLICATIONS, 1900-1950. Edited by William Allan Smith, Francis Lawrence Kent and George Burden Stratton. Butterworth's Scientific Publications, London, and Academic Press Inc., New York, N. Y., 1952, \$37.00. A revised and reset third edition listing more than 50,000 volumes. A standard reference work for libraries, editors and research people.

TV TROUBLESHOOTING AND REPAIR GUIDE BOOK. By Robert G. Middleton. John F. Rider, Publisher, Inc., New York, N. Y., 1952, 204 8½ x 11 pages, \$3.90. An obviously valuable book for radio service technicians faced with keeping modern complex tv receivers in operation.

ANALYSIS OF ALTERNATING CURRENT CIRCUITS. By W. R. LePage. Syracuse University. McGraw-Hill Book Co., 1952, 444 pages, \$6.50. An introductory course devoted to the steady-state in lumped linear networks. Presupposes a knowledge of the elements of a-c and d-c circuits.

EXTENSION AND DISSEMINATION OF ELECTRICAL AND MAGNETIC UNITS BY THE NATIONAL BUREAU OF STANDARDS. By Francis B. Silsbee. NBS. Circular 531, 33 pages, 25¢, 1952. Historical report of the work of NBS in the field of electrical measurements during its first 50 years. Describes processes whereby from the ohm and volt the other units (farad, henry, ampere, watt, joule, gauss and oersted) are derived.

ELECTRONIC RAYS AND SIGHT EQUIPMENT IN TECHNIQUE AND MEDICINE, Vol. 11, by Paul E. Klein. Weldmannsche Verlags buchhandlung, Berlin, Germany, 1952, 356 pages, DM 35.00. Applications of the cathode-ray oscilloscope to numerous fields of science, medicine and engineering. In German. Also by the same author and publisher, *Electronic Ray Oscillographs*, 212 pages, DM 9.50; and *Time and Period Measuring by Cathode-Ray Oscillographs*, 60 pages, DM 3.90.

CHARTING STATISTICS. By Mary Eleanor Spear. McGraw-Hill Book Co., 1952, 253 pages, \$4.50. Methods of designing and the proper use of basic charts for portrayal of economic and statistical data. Useful to those who lecture or write on economic matters, as well as the drafting room or artist who makes the illustrations for such lectures or articles.

MEASUREMENT OF THICKNESS OF CAPACITOR PAPER. By Wilmer Souder and S. B. Newman. Circular 532, National Bureau of Standards, 1952, 10 pages, 15¢. Discusses methods used at the Bureau, gives statistical analysis of measurements made there, and offers suggestion to laboratory workers dealing with the problem of maintaining capacitor uniformity.

MOLECULAR MICROWAVE SPECTRA TABLES. By Paul Kisliuk and Charles H. Townes. Circular 518, National Bureau of Standards, 1952, 127 pages, 65¢. Gives frequencies, assignment of quantum numbers and intensities of about 1,800 microwave absorption lines of frequency higher than 1,000 mc. Also includes considerable other pertinent molecular data.

NOISE: Causes, Effects, Measurement, Costs, Control. University of Michigan School of Public Health and Institute of Industrial Health, Ann Arbor. 192 pages, \$5.00. A valuable series of papers on the problem of noise and its effects on people.

New!
RAWSON-LUSH
 Rotating Coil
GAUSSMETER

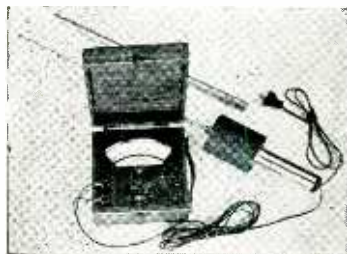

Tiny coil (approx. 3 mm diameter) rotates in the field to be measured. The voltage generated is rectified in a synchronous rectifier and used to deflect a Rawson high sensitivity voltmeter with scale calibrated in kilogausses.

Features

- (1) Simple operating principles, simple to use and maintain.
- (2) Compact and portable, just one meter and the long probe unit.
- (3) Ranges 0.4—1.2—4—12—40—120 kilogausses, all in one instrument.
- (4) Practically point measurement of magnetic field.
- (5) Can be inserted in any gap larger than 1/4" and will reach center of 37" diameter gap. Coil protected by stationary outer tubing.
- (6) Measures direction of field as well as intensity.
- (7) Guaranteed accuracy 1 per cent or better.
- (8) Low Price \$350.00 complete with meter.

**RAWSON ELECTRICAL
 INSTRUMENT COMPANY**

111 Potter St. Cambridge, Mass.

U. G. CONNECTORS

*Our Coaxial Cable
 Connectors Meet All
 Government Specifications*

★ ALL ORDERS DELIVERED PROMPTLY ★

*Manufacturers of
 Highest Quality Connectors*

ALLIED INDUSTRIES, INC.

**1023 S. 21st STREET
 LOUISVILLE 10, KY.**

Phone Arlington 4640

when you need a

QUALITY OSCILLATOR

SIE

**MODEL M-2
 IS YOUR ANSWER**

The unique SIE oscillator circuit which has no lower limit to its possible frequency of oscillation is responsible for the excellent low frequency performance of the Model M-2 and other SIE oscillators. Write today for complete specifications.

**SOUTHWESTERN
 INDUSTRIAL
 ELECTRONICS CO.**

2831 Post Oak Rd. Houston 19, Texas
 434 Seventh Ave. East—Calgary,
 Alberta, Canada

MINIATURE SLIP RING ASSEMBLIES

Commutators and other Electro-Mechanical Components

PRECISION MADE TO YOUR OWN SPECIFICATIONS

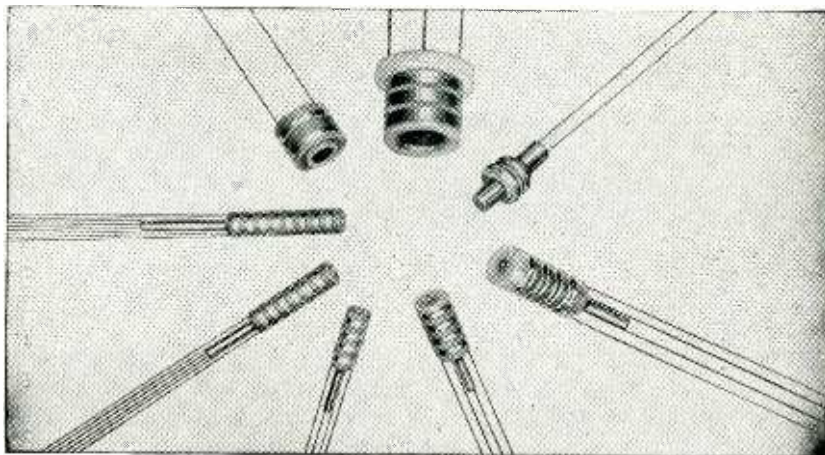

Our Swiss methods and techniques are geared to meet exacting requirements. We invite your inquiries.

COLLECTRON CORPORATION

216 EAST 45th STREET • NEW YORK 17, N. Y.

MURRAY HILL 2-8473



Indispensable
Reference
For
Communi-
cation,
Electronics
Engineers

Pender's ELECTRICAL ENGINEERS' HANDBOOK

Communication—Electronics

Edited by HAROLD PENDER and
KNOX McILWAIN,
with 78 contributors

Compact, concise and convenient, this effectively illustrated handbook of electronics has proven of immeasurable value to engineers and designers. This fully revised and enlarged Fourth Edition represents the growth of knowledge and the greater degree of specialization in the various phases of the field. Here you'll find the answers to thousands of daily questions on radio receivers and transmitters, FM systems, photographic sound recording, microwave plumbing, TV broadcasting, radio telephone and telegraph equipment, loudspeakers, wave guides, antennas, scanning systems, pulse techniques in communication and radar, coaxial cables, and countless other topics. To insure accuracy and reliability, every section was written by an outstanding specialist.

CONTENTS: Mathematics, Units, and Symbols • Properties of Materials • Resistors, Inductors, and Capacitors • Electron Tubes • Electric Circuits, Lines, and Fields • Passive Circuit Elements • Vacuum Tube Circuit Elements • Frequency Modulation • Pulse Techniques • Transmission Circuits • Electrical Measurements • Acoustics • Electromechanical-Acoustic Devices • Optics • Electro-Optical Devices • Sound Reproduction Systems • Telephony • Telegraphy • Facsimile • Television • Electronic Control Equipment • Aids to Navigation • Medical Applications of Electricity.

1950 1618 pages, 1497 illustrations \$8.50

Companion Volume

ELECTRIC POWER

Edited by HAROLD PENDER and
WILLIAM A. Del MAR,
with 71 contributors

Practical, up-to-the-minute coverage of rheostats, capacitors, batteries, servomechanisms, direct-current machines, rotary energy converters, transformers, power rectifiers, lighting and heating, switchgear and control equipment, power stations, rural electrification, transportation, electrochemical processes and many others.

1949 1716 pages, 977 illustrations \$8.50

Mail Coupon Today For Copies On 10-Day Trial

APPROVAL COUPON

JOHN WILEY & SONS, INC.
440 Fourth Ave., New York 16, N. Y.

On 10 days' approval, send book(s) checked. I will remit purchase price plus postage, or return book(s) postpaid. (Offer valid only in U. S.) ... *Communication-Electronics*, \$8.50 ... *Electric Power*, \$8.50

Name
Firm
Address
City Zone... State.....

SAVE POSTAGE! We pay postage if payment is enclosed. Same money-back return privilege.

BACKTALK

Insanitary

DEAR SIRs:

THE DESIGNERS of the amplifier described in the March 1952 issue of *ELECTRONICS* (40-DB Feedback Amplifier, p 130) make no mention of the fundamental disadvantage of the type of feedback used, a disadvantage which to my mind makes it unfit for use in a high-quality amplifier with a large amount of negative feedback.

The primary of a push-pull output transformer is, in effect, a center-tapped autotransformer with its center tap grounded (for a-c). Consequently, no matter how much out-of-balance there may be in the output valves, approximately equal voltage swings will appear at the two anodes. Therefore the voltages fed back to the cathodes of the driver valves will also be equal, $\pm x$ percent, where x depends mainly on the tolerances in the six resistances in the feedback chains. Now if there is 40 db of feedback the input voltage to the driver valves should be 1 percent greater than the voltage fed back to the cathodes.

If the net input voltages to the driver valves are to be equal to ± 10 percent the voltages from the phase splitter and the voltages fed to the cathodes from the feedback chains should be matched to about 0.1 percent (i.e. 10 percent of 1 percent). This involves selecting resistors to better than 0.05 percent, which is an absurd requirement for an audio amplifier.

In practice it appears that the designers have not attempted such careful matching but have tried to ensure reasonable balance in the output stage by the very dubious method of unbypassed common screen and cathode resistors, dubious because common screen droppers and bias resistors tend to increase any inherent d-c unbalance, while the omission of cathode and screen bypass capacitors from the output valves reduces the maximum undistorted output even for a per-

VACUUM FILLED
OIL IMPREGNATED

CHICAGO

APPROVED

CAPACITORS



Approved SILICONE BUSHING capacitor, oil impregnated, hermetically sealed. Featuring SILICONE BUSHINGS for peak performance at high temperature operation.



Approved SILICONE BUSHING RECTANGULAR TYPE capacitor, oil impregnated, hermetically sealed and tested at twice rated voltage to meet all specs.



Approved GLASS SEALED TUBULAR TYPE capacitor, oil impregnated, hermetically sealed to meet all specs.

CHICAGO
CONDENSER
CORPORATION

3255 WEST ARMITAGE AVE.
CHICAGO 47, ILLINOIS



development
and production

METALLURGISTS

BASE, RARE AND PRECIOUS
METALS AND ALLOYS

SMALL UNITS

SMALL SIZES

CLOSE TOLERANCES

Nickel alloy, filament wire and
ribbon: flat, grooved, crowned.

Grid wire electroplated.

Alloys for highly engineered ap-
plications, bare or enamelled.

•

Further details upon request



METALS CORPORATION

228 East 45th Street, New York 17, N. Y.
MUrray Hill 7-1594

SOLID

ultra-sonic
DELAY LINES

Spurious signals -40 db or
better . . . Completely cased
with BNC connectors or to
customer's specs . . . Maximum
precision and stability
. . . Complete facilities for
ultrasonic research and
development.

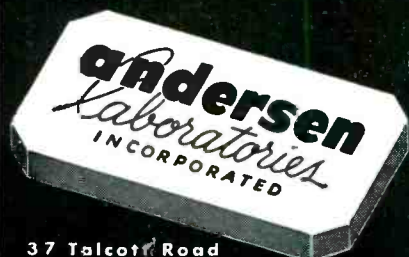

37 Talcot Road
West Hartford 10, Conn.

Research • Development • Engineering • Manufacturing

CUSTOM BUILT ELECTRONICS!

CDC are designers and engineers of Electronic Devices
to fit your requirements.

- Digital and Analogue Computers
- Test and Measuring Equipment
- Servo Systems
- Instrumentation
- Engineering Consulting Service
- Product Engineering and Design
- Parts Machining and Assembly
- Instrument and Electronic Equipment Overhaul
- Field Maintenance of Electronic Computers
- Developments for Armed Forces

YOUR ENQUIRIES WILL RECEIVE
PROMPT AND EFFICIENT ATTENTION

COMPUTING DEVICES of CANADA LIMITED

General Offices—338 Queen Street Laboratories—475 Cambridge Street,
Ottawa, Ontario, Canada

DANIEL KONDAKJIAN TUNGSTEN LEADS

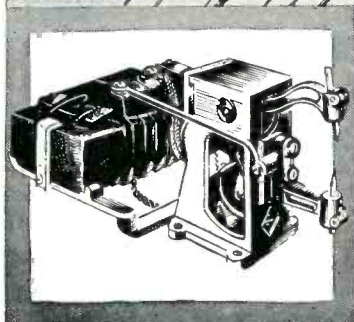

DKE SPOT WELDER . . . The DANIEL KONDAKJIAN high efficiency spot welder offers high speed production advantages worthy of immediate consideration. Write today.

Quality Leads Make Quality Tubes

The Engineering Co. under personal supervision of Daniel Kondakjian has been making "Quality Precision Leads" for the Electronic Industry for the past 30 years. Specializing in "Leads of Tungsten, Moly, Nickel, Nickel Clad Copper and Copper Alloys."

The Engineering Co. makes the finest leads. No Leakage or Breakage when you use our leads.

Parts are made to customers blue prints or specification. Send us your prints for quotations.

Our engineers are ready to serve you.

THE ENGINEERING CO.
27 WRIGHT STREET, NEWARK 5, NEW JERSEY

PLASTIC "BELL JAR" ALTITUDE CHAMBER

Environmental testing under complete observation—visually and operationally—is now a simple reality with this first plastic chamber. The first in the manufacture and design of Bell-Jar Altitude Chambers, International's Engineers will tailor units to your needs to simulate altitudes of 100,000 feet—in any size you require.

This unit specifications—

- 36" Dia., vertical sides up to 30".
- Electric Hoist to raise & lower dome.
- Manual or automatic control of vacuum.
- 85,000 feet altitude in 20 minutes.
- Maximum—to 5 microns.
- 8 AN 3100-C36-8 Pressurized.
- 2 AN 3100-C36-9 Pressurized.
- 2 1/4" Syncrodrive shafts.
- 8 Flexible cable shafts.
- 1 Manometer-calibrated in thousands of ft. and inches of mercury.

International Engineers will discuss your problem with you at no obligation — also we will redesign and rebuild your old equipment to new up-to-the-minute requirements. We welcome your inquiries.

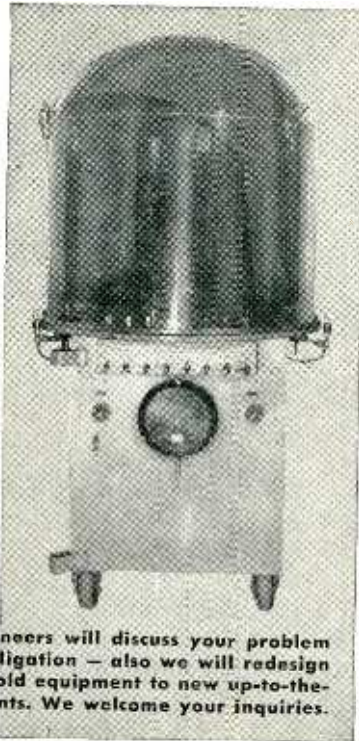

Manufacturers of: Low and High Temperature Chambers • Altitude, Humidity, Explosion and Walk-in Chambers with Vibration test facilities

INTERNATIONAL RADIANT CORP.

40 MATINECOCK AVE. • PORT WASHINGTON, N. Y.

SWITCHCRAFT[®] "LITTEL-JAX"



To Meet JAN Specifications

C-11 Open Circuit—2 Conductor
JAN Type JJ-034 (old JK-34A)

C-12B Open Circuit—3 Conductor
JAN Type JJ-033 (old JK-33A)

A COMPLETE LINE OF ENGINEERED "LITTEL-JAX"

Improved design eliminates probability of shifting—firmly holds mating plug—long life springs — requires minimum panel space and depth.

FLEXIBLE TOOLS MAKE MODIFICATIONS PRACTICAL

Our flexible tools make modifications, to meet special requirements, economical. Please furnish complete information, applicable specifications, etc., for prompt handling of your inquiry.

This NEW CATALOG

Should Be In Your File!



SWITCHCRAFT

1336 N. Halsted St., Chicago 22, Ill.

Canadian Representative: Atlas Radio Corp. Ltd., 560 King St. W., Toronto 2B, Canada. Phone Waverly 4761.

* The name "Switchcraft" is a registered trade mark and is the property of Switchcraft, Inc.

AVAILABLE AT ALL LEADING RADIO PARTS JOBBERS •

fectly balanced pair.

Please forgive me for troubling you with purely destructive criticism. I sincerely believe, however, that it is wrong that any of your readers, some of whom may have little experience of audio-frequency techniques, should be encouraged to copy an "insanitary" design when much better designs exist.

E. F. GOOD

Malvern,
Worcs.,
England

Grads and Post-grads

DEAR SIRs:

I SHOULD like to register a protest against an impression given in an item appearing on page 8 of the June 1952 issue of *ELECTRONICS*. This item concerned the shortage of electrical engineering graduates.

First, may I compliment you on gathering the data and presenting it in attractive graphical form. My only point of protest lies in your analysis of the percentage of graduates available to industry. You show a "loss" of 19 percent of the graduates, including 8 percent going into graduate study. The implication seems to be that men disappearing into this status of graduate students do not ever appear again! The fact of the matter is, of course, that in addition to those men graduating this year at the Bachelor's level, there are a substantial number of M.S. and Ph.D. men who undoubtedly compensate in numbers for the 8 percent entering graduate study this year.

To ignore the men emerging from the colleges with advanced degrees is to commit an error not only in numbers, but more importantly in quality. As you well know, there is a very heavy demand from industry at present for men with advanced degrees, and it would be folly indeed if someone should magically change the situation so that the 8 percent of the graduates which you show as "lost" would go with the 81 percent into industry immediately upon graduation.

While the situation at Stanford is perhaps not typical, it might interest you to see how far in error you would be as to our production

Polarad
Electronics Corporation

THE LEADING
NAME IN

TELEVISION
MONITORS



**WAVE FORM
MONITOR**

Model
T0-1

Designed for precise waveform analysis and amplitude measurement of video signal in television circuits. Ideal as a general purpose instrument because of its wide frequency response, high sensitivity, and excellent synchronizing capability.

Specifications:

- Maximum Vertical Deflection Sensitivity: 0.1 volts per inch
- Input Signal Level: 0.1 to 500 volts peak to peak
- Frequency Response: (V. Amp.) flat to -3db at 4 mc; flat to -3db at 35 kc
- Large Symmetrical Horizontal Expansion — 20 Diam.
- High Impedance Probe

**12" STUDIO
PICTURE
MONITOR**

Model
M-105



Model M-105 is a 12" picture monitor of size sufficient for ease of observation under studio conditions. It is a high impedance device and may be connected across a video transmission line without affecting the terminal impedance of the line. All adjustments are accessible from front panel.

Features:

- High resolution, in excess of 450 lines
- Excellent vertical and horizontal linearity
- Light weight
- Complete with internal power supply
- Provision for black and white or color presentation

Specifications:

- Input Video Signal 0.25 to 2.0 volts negative
- Input Impedance 470,000 ohms
- Input Power 105-125 volts, 2 amps, 50/60 cps
- Resolution Greater than 450 lines
- Video Amplifier Flat to 5.0 mc \pm 1/2db

**POLARAD
ELECTRONICS CORP.**

100 Metropolitan Ave. Brooklyn 11, N. Y.

ENGRAVING • PROFILING

for heavy production

with the **Engravo**
graphTM



TRACER
GUIDED FOR
UNSKILLED
LABOR

NEW HERMES, Inc.

13-19 University Place, New York 3, N.Y.

Engravo
graphTM

Write for literature describing:

1. Heavy Duty model (as illustrated) — Catalog H 29
2. Portable models — Catalog IM 29

NEW HERMES, Inc. 13-19 University Place, N.Y. 3, N.Y.

In Canada: 359 St. James St., Montreal

World's Largest Manufacturer of Portable Engraving Machines

MODEL B-2

PULSE GENERATOR

- 10 cycles to 1 00 kc repetition rate
- .2 μ s to 1,000 μ s pulse widths at 100 ohms impedance—100 volts open circuit ● 0 to 10,000 μ s delays
- 6 output pulses for synchronizing at various intervals during single repetition period



Write for complete data: our bulletin E-B-2

Rutherford **ELECTRONICS CO.** 3707 S. ROBERTSON BLVD.
CULVER CITY, CALIFORNIA

MEGOHMS
MEGOHMS
MEG
MEG
MEGOHMS
MEGOHMS
MEGOHMS
MEGOHMS
MEGOHMS
MEGOHMS

Cheaper by the dozen with JELLIFF ALLOY 1000 RESISTANCE WIRE

This new material packs 1000 ohms/cm—48% more than the widely-used nickel-chromium alloys.

And what's more, there's no loss of other important physical and electrical properties. High tensile strength—excellent solderability—TC of Resistance is 20—EFM vs Copper + 7 micro-volts—Coefficient of Expansion 13.9—remarkable Surface-Corrosion Resistance—and many more vital characteristics make ALLOY 1000 a money-making, prestige-building component of compact, precision resistors. For complete data get Bulletin 17.



HYCOR

the **NEW**
700 series



Decade-Inductor units

- HYCOR DECADE — INDUCTOR units are indispensable for design and experimentation work on audio filters.
- The units are available in four ranges up to 10 henries. Units may be used individually or all four may be connected in series to obtain 11.11 henries in 1 milli-henry steps.
- Toroid coils are used to obtain high "Q", stability and low pickup from external fields. Inductance accuracy is 2%.

Send for bulletin D-2

HYCOR COMPANY, INC.

11423 VANOWEN STREET, NORTH HOLLYWOOD, CALIFORNIA • SUNset 3-3860

Manufacturers of Toroid Inductors, Decade Inductor Instruments, Wave Filters, Resistive Networks, and Precision Resistors

of engineers for industry if you counted only men with Bachelor degrees. We had 25 such graduates in Electrical Engineering in the 1952 class. For this same year we had 41 graduating with the M.S. degree, 14 with the Engineer's Degree and 19 with the Ph.D. degree, all in Electrical Engineering.

I will not labor you further with this issue, as I am sure you are well aware of the importance to industry of men going on for graduate work. Unfortunately, it seems not to be well known among engineering seniors with whom I have talked at other universities, and even with faculty members. Accordingly, may I urge you in future editorial presentations to lean more in the direction of encouraging graduate work for our best graduates in order that they may make a maximum contribution in later years.

JOSEPH M. PETTIT
*Stanford University
Stanford, California*

(Editor's Note: Actually, our figures for total electrical engineering graduates included those entering industry at a graduate level. We agree completely with Prof. Pettit's views on the importance of advanced work. Any impression given otherwise is unintentional.)

Three A's

DEAR SIRs:

I READ Doctor Kantor's article in the June 1952 issue of *ELECTRONICS*, and have been following the back talk in "Backtalk" ever since. My reactions have been somewhat of a mixture of approval, amazement and amusement.

I have felt approval because I like to see informative articles such as Dr. Kantor's appear in magazines like *ELECTRONICS*. As you have seen, interest is always stirred up and productive developments are always forthcoming.

I have felt amazement because I have been active and reasonably productive in the field of electronic instrumentation for application to biological problems for over a decade, and realize the extent which this art has reached. Visit any laboratory or facility devoted to biological research and look about. I venture to predict that you will be unable to find any laboratory in

TRANSFORMERS

MIL-T-27

& COMMERCIAL

- Pulse
- Audio
- Power
- Filter Choke
- Filament
- RF Coils

Custom Built to Your Specifications

**WE SOLICIT ONLY
SAMPLES and SHORT
RUN PRODUCTION**

Present Delivery Schedule:
2-4 weeks

STERLING TRANSFORMER CORP.

297 North 7th St., Brooklyn 11, N. Y.

ELECTRONICALLY REGULATED LABORATORY POWER SUPPLIES



● STABLE
● DEPENDABLE
● MODERATELY
● PRICED

MODEL 28
STANDARD
RACK
MOUNTING
PANEL SIZE
5 1/4" x 19"
WEIGHT 16 LBS.

- **INPUT:** 105 to 125 VAC, 50-60 cy
- **OUTPUT #1:** 200 to 325 Volts DC at 100 ma regulated
- **OUTPUT #2:** 6.3 Volts AC CT at 3A unregulated
- **RIPPLE OUTPUT:** Less than 10 millivolts rms

For complete information write for Bulletin E



LAMBDA ELECTRONICS
CORPORATION
CORONA NEW YORK



The All-Weather Resistors

TYPE 65X
(Actual Size)

The resistors that give you . . .

- Inherent low noise level
- Good stability in all climates

STANDARD RANGE
1,000 OHMS TO 9 MEGOHMS

These resistors are used extensively in commercial equipment, including radio, telephone, telegraph, sound pictures, television, etc. They are also used in a variety of U. S. Navy equipment.

HIGH VALUE RANGE
10 TO 10,000,000 MEGOHMS

This unusual range of high value resistors has been developed to meet the needs of scientific and industrial control, measuring and laboratory devices — and of high voltage applications.

SEND FOR BULLETIN 4906

It gives details of Standard and High Value Resistors, including construction, characteristics, dimensions, etc. Also described are S.S. White 80X Resistors, designed for extremely high voltage equipment. Copy with Price List sent on request.



THE S.S. White INDUSTRIAL DIVISION
DIGITAL MFG. CO.



Dept. R, 10 East 40th St.
NEW YORK 16, N. Y.

WESTERN DISTRICT OFFICE: Times Building, Long Beach, Calif.

WIRE & CABLE

for ALL your
ELECTRONIC
wiring needs!

Specify BIRNBACH

GOVT. SPEC. HOOKUP WIRE

- JAN-C-76 SRIR-SRHV PLASTIC
Solid Colors or Spiral Markings
- AIRCRAFT WIRE, NYLON JACKET
MIL-W-5086 (Supersedes AN-J-C-48a)
- JAN-C-76 WL GLASS BRAID
Solid or Tracer Colors
- 105° C. UL APPROVED THERMOPLASTIC Hookup Wire

COMPLETE WAREHOUSE STOCKS

- Multiconductor Rubber covered Cables
- Tinned & Bare Wire
- Magnet Wire, Formvar
- Vinyl Extruded Tubing
- Shielded Wires
- Insulated Hardware
- Plugs, Jacks, Sockets
- Test Leads, Switches
- Insulators, Steatite—Ceramic
- Terminal Strips
- Insulated Hardware

- JAN-C-76 Wires SRIR-SRHV Plastic Solid or Spiral Markings
- JAN-C-76 Wires WL—Glass Braid Solid & Tracer Colors
- 105° C. UL Approved Wires
- Multi-Conductor & Shielded Cables to meet Govt. Spec. #71-4945

Write for Catalog 52-E

BIRNBACH

Quality Products for the Electronics Industries Since 1923

BIRNBACH RADIO CO. Inc.

145 HUDSON STREET
NEW YORK 13, N. Y.

KLYSTRON POWER SUPPLY

Model 2310

Custom Built for Precise
Microwave Measurements

OUTPUTS

Beam Supply

175 to 1500 V.D.C., @
0 to 330 ma. continu-
ously variable.
5 mv. ripple.
Regulation better than
0.02% with 5% change
of line voltage.

Reflector Supply

-150 to -1500 V.D.C.,
@ 0 to 5 ma. continu-
ously variable.
5 mv. ripple.
Regulation better than
0.01% with 5% change
of line voltage.

Reflector Section Available with Vernier Dial as
Output Indicator.

Control Electrode Supply

0 to -50 V.D.C., @ 0
to 1 ma. continuously
variable.

and
0 to 50 V.D.C., @ 0 to
25 ma. continuously vari-
able.

5 mv. ripple.
Regulation better than
0.05% with 5% change
of line voltage.

Filament Supply

6.3 V.A.C., 60 c/s @
2 A., not regulated.



BACKTALK

(continued)

this country which is not simply filled with a variety of electronic instruments without which the techniques being employed would be impossible.

I find it hard to realize that people in both the biologic and electronic fields can have remained unaware of the impact of electronics upon biologic research. Are they also unaware that every research activity with which I am personally familiar, and that includes a large number, has a full-time electronic engineer as an important and indispensable member of its staff? I suspect that one reason might be that most of our instruments are "one-shot" affairs and with a few exceptions, such as the electroencephalograph and electrocardiograph, have not had much in the way of commercial applications after they have helped supply the answers to the problems for which they were designed and fabricated.

I am also amazed at the general lack of knowledge concerning the existence of the American Instrument Society, and the fine annual meetings held since 1948 on "Electronics in Medicine and Biology" which a joint AIEE-IRE committee has sponsored in New York. The attendance has always numbered several hundred about equally divided between medical and electronics personnel. Maybe next year we should have a subcommittee for missionary work!

I am amused because I have a visit almost everyday from some eager electronics engineer who wants to know what sort of instrument he could make which would be useful to a biologist. I rattle off a number of requirements and he is pleased. He then asks questions concerning the probable market for such things, and I must tell him it is not large. I am forced by honesty to disabuse him of the likelihood of his devising an Idiopathometer, and thus having a market for his device comparable to that of the tv industry. When confronted with this unhappy news the eager engineer invariably loses much of his enthusiasm for shoving back the frontiers of biologic knowledge.

Be assured there is a healthy development of the electronic art within the sancta of medicine and

WRITE FOR DETAILS

FURST ELECTRONICS

3324 W. Lawrence Avenue,

Chicago 25, Illinois



VERSATILITY IN BLOWER MOTORS

TYPE A15CF-X-13

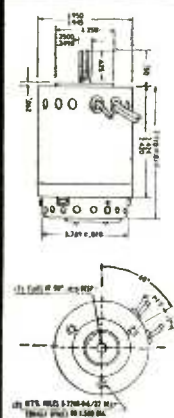

PRECISION SATISFACTION

This blower motor is dual wound to operate on 50/60 cycles and 360 to 1600 cycles and will drive a 3½ inch fan. Similar types of multiple frequency motors can be supplied to meet many air delivery problems.

This blower can also be supplied complete with mountings to include 1 piece motors and condenser mount.

SPECIFICATIONS

Conform to NEMA Standards and other Gov't specifications.

Continuous duty

WEIGHT	16 oz.
C F M	22 Average
R P M	6250 Average
VOLTS	115
CYCLES	360-1600

can be supplied CW and CCW suitable for 50 to 60 CPS

AIR MARINE MOTORS INC.

2183 JACKSON AVENUE,

SEAFORD, L. I., N. Y.

WAntagh 2-7309

Double Barrel Advertising

Advertising men agree — to do a complete advertising job you need the double effect of both Display Advertising and Direct Mail.

Display Advertising keeps your name before the public and builds prestige.

Direct Mail supplements your display advertising. It pin-points your message right to the executive you want to reach — the person who buys or influences the purchases.

More and more companies are constantly increasing their use of Direct Mail because

it does a job that no other form of advertising will do.

McGraw-Hill has a special Direct Mail Service that permits the use of McGraw-Hill lists for mailings. Our names give complete coverage in all the industries served by McGraw-Hill publications — gives your message the undivided personal attention of the topnotch executives in the industrial firms. They put you in direct touch with the men who make policy decisions.

Some people have a wrong conception of Direct Mail. There's no hocus-pocus to it — there's no secret formula — nor is there need for an extensive department to plan and execute your mailing program. You don't even need your own mailing lists.

Probably no other organization is as well equipped as McGraw-Hill to solve the complicated problem of list maintenance in industrial personnel. Our lists are compiled from exclusive sources, based on hundreds of thousands of mail questionnaires and the reports of a nationwide field staff, and are maintained on a twenty-four hour basis.

In view of present day difficulties in maintaining your own mailing lists, this efficient personalized service is particularly important in securing the comprehensive market coverage you need and want.

Ask for more detailed information today. You'll be surprised at the low over-all cost and the tested effectiveness of these hand-picked selections.



McGRAW-HILL
PUBLISHING COMPANY, INC.

330 WEST 42nd STREET, NEW YORK 18, N. Y.

LET



Engineer and Supply
your SLIP-RING and
BRUSHHOLDER assemblies

ONE PIECE — SOLID RINGS — MOLDED CONSTRUCTION

.023 to 18" Diameter—High Voltage
Concentric within .0005 T.I.R.
Finished To Four Micro Inch

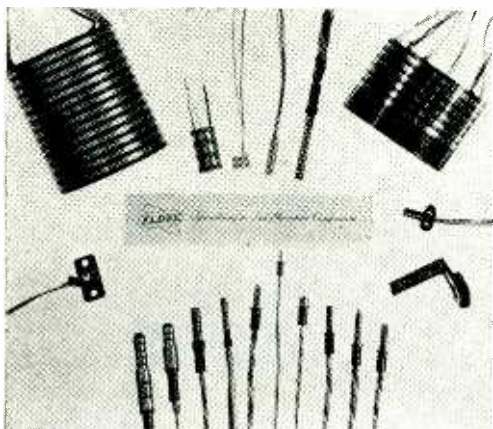

Eldec "Companion" Brushholders match all high standards incorporated in our molded slip rings—Low Brush Pressure—One-piece Construction—Designed to specification.

Literature upon request—"Write or Wire"

ELECTRO DEVELOPMENT CORPORATION

Culver City, California

New York • Boston • Milwaukee • Detroit • Dallas • Rochester

biology. Let those who doubt that this is so base their conclusion, not on an inspection of their family physician's suite of offices, but rather on a visit to a research organization such as the Lovelace Foundation.

As a clincher, my subscriptions to professional journals have always included **ELECTRONICS** as well as those devoted to biology and medicine, and it is regarded to be as indispensable as any of the latter. By actual count, fifty percent of the volumes in my working library are reference texts on electronics and electromagnetic physics. I am not regarded as particularly unique—crazy perhaps—but all agree that I have plenty of company!

F. G. HIRSCH, M. D.

The Lovelace Foundation
Albuquerque, New Mexico

¹ Idiopathic—self-caused disease, or disease of unknown cause. We in the business refer to the ultimate apparatus which will diagnose all and treat all as an idiopathometer.

Noise

DEAR SIRs:

A METHOD of measuring uhf-tv receiver noise figures is described in the March issue of **ELECTRONICS** (p 128). I have been using a simpler procedure of measuring uhf converter noise figures based on a method developed by Goldman in his book, "Frequency Analysis, Modulation and Noise" in the paragraph on noise figures with networks in cascade. He develops the formula

$$F_a = \frac{F_b (Y-1) + 1}{G_a}$$

where $Y = N_{ab}/N_b$, and all values are in terms of power.

A suitable tv receiver of known noise figure is set up with the antenna properly terminated. The detector is linearized in the usual manner and the noise output voltage recorded. The uhf converter is then connected to the receiver (keeping the detector linearized) and the noise output again recorded. Knowing the gain of the converter, its noise figure is easily calculated. It is assumed that the converter output impedance and the receiver input impedance are substantially resistive and equal.

E. M. TINGLEY
Glen Ellyn, Illinois



LOOK WHAT'S NEW!

MADE TO YOUR SPECIFICATIONS

TECHNITROL Type TE

PULSE TRANSFORMERS

SEALED IN CASTING RESIN

Currently available in one physical size—3/4" diam. x 9/16" deep, with 2" leads of No. 20 wire—made to your order within the following range of specifications.

Pulse Width: 0.1 to 2.0 microseconds
Maximum Pulse Repetition Rate: 2.0 mc.
Operating Range: -55° to +105°C.

One or two secondaries may be provided, either inverting or non-inverting.

NOW YOU CAN SIMPLIFY AND MINIATURIZE YOUR SHORT-PULSE CIRCUITS

WRITE US YOUR SPECIAL REQUIREMENTS

including a brief outline of the contemplated circuit, or ask for our blank specification sheets.

LOOK AT THESE PRICES!

1 to 3	\$7.50 each
4 to 10	6.35 each
11 to 100	5.85 each

Write us for quotations for quantities over 100



TECHNITROL

ENGINEERING COMPANY

2751 North 4th Street, Philadelphia 33, Pa.

Runzel WIRE CORD and CABLE



"Products of Science"

The Runzel Laboratory insures that every inch of Runzel wire, cord and cable is thoroughly tested before shipping. Your wiring needs in hook-up, lead-in, shielded wire and cords, speaker cords and all types of insulated wire products, in almost endless variety of colors, sizes and specifications, are available from this centrally located plant.



WRITE FOR SAMPLES

RUNZEL

CORD & WIRE CO.
4723 Montrose Avenue
Chicago 41, Illinois

High Sensitivity . . . Logarithmic AC VOLTMETER 50 MICROVOLTS TO 500 VOLTS

MODEL 47 VOLTMETER

SELF-CONTAINED
ALL AC OPERATED UNIT

An extremely sensitive amplifier type instrument that serves simultaneously as a voltmeter and high gain amplifier.

- Accuracy $\pm 2\%$ from 15 cycles to 30 kc.
- Input impedance 1 meg-ohm plus 15 uuf. shunt capacity.
- Amplifier Gain 25000

Also MODEL 45
WIDE BAND
VOLTMETER
.0005 to 500 Volts!
5 Cycles 1600 kc

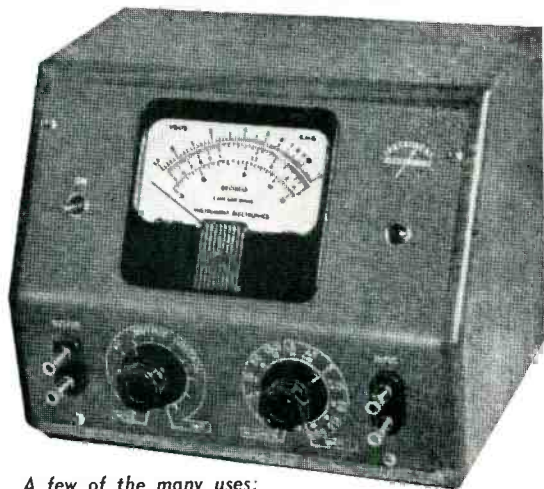

A few of the many uses:

- Output indicator for microphones of all types.
- Low level phonograph pickups.
- Acceleration and other vibration measuring pickups.
- Sound level measurements.
- Gain and frequency measurements for all types of audio equipment.
- Densitometric measurements in photography and film production.
- Light flux measurements in conjunction with photo cells.

Write for Complete Information

Instrument Electronics Corp. 90 MAIN STREET
PORT WASHINGTON, N. Y.

ARMY and NAVY SPECIFICATIONS PHONE PLUGS



Types:

PJ-068

NAVY NO. 49007A
and

PJ-055B

NAVY NO. 49109

in exact accordance
with Government
Specifications
JAN P-642

AGROD CORP.

National Exclusive Sales Agents For
ALGREN MFG. CO., Inc.

Write for literature to
AGROD CORP.

45 West 45th St., New York 36, N. Y.

more LISTENING COMFORT with lightweight TELEX headsets!!

THE ONLY
PERSONAL PART
OF ANY
COMMUNICATION
SYSTEM



*MONOSET

The modern styling and dependability and superior performance of the TELEX Mono-set have made old fashioned head-phones obsolete. Magnetic.



*DYNASET

New dynamic under-chin TELEX Dynaset, with more highs and lows of both music and speech, is the delight of radio and TV monitors. Weighs only 1.25 oz.



Modern, light-weight, durable . . . Easily adjustable and built for hard usage, TELEX Headsets give top quality reception without the punishment of extra weight and pressure.



*TWINSET

This lightweight 1.6 oz. TELEX Twinset pipes signal directly into the ear, blocking out background noises and banishing listening fatigue. Magnetic.

*EARSET

Sensitive TELEX Earset slips onto ear and is preferred by all who use single-phone headsets. Weighs only 1/2 oz. and leaves other ear free for phone calls or conversation.



STANDARD OF THE
WORLD FOR
QUALITY HEADSETS

*Trade Mark

Commercial Communications - Electronic Laboratories
Office Transcribing Machines - Radio Monitoring
Telecasting - Amateur Radio - Record Stores - Theaters
Phone-Order Boards - Wired Music Installations
For complete information on any of the above headsets, write
TELEX, ELECTRO-ACOUSTIC DIV.
Department 9-B • St. Paul 1, Minnesota
In Canada, ATLAS RADIO CORP., Toronto

Telex produces
headsets to
manufacturers'
specification
TELEX
HEARING AT
ITS BEST

"SEE YOU AT THE POLLS!"



"SEE YOU AT THE POLLS!"



"SEE YOU AT THE POLLS!"

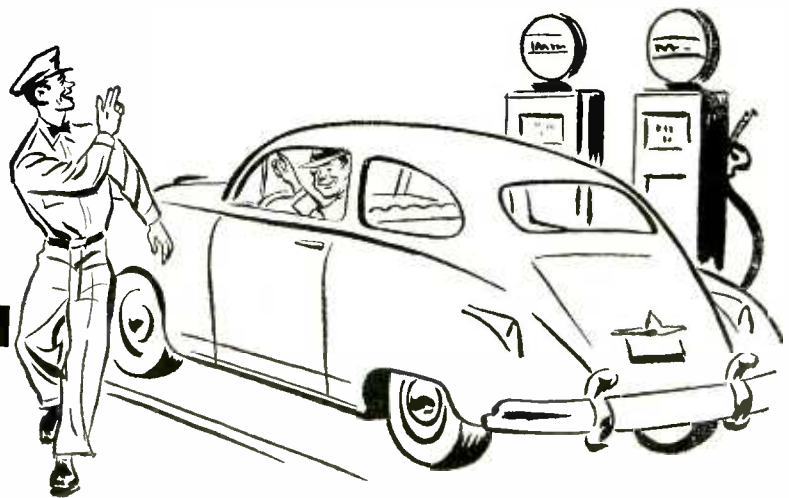

Nobody knows for sure how it started—this line about "See you at the Polls!" we're hearing all over these days.

Best explanation seems to be that it came from that state candidate out west. . . . His opponent in a debate got all riled up and challenged him to fight it out in the alley.

But he said—"I'll settle this the AMERICAN way—I'll see you at the polls!" And the audience picked up the chant.

Now everybody's saying it—and on Nov. 4 everybody will be *doing* it!

"SEE YOU AT THE POLLS!"



"SEE YOU AT THE POLLS!"



ELECTRONICS

PROFESSIONAL SERVICES

CROSBY LABORATORIES, INC.

Murray G. Crosby & Staff
Radio - Electronic
Research Development & Manufacturing
Communications, FM & TV
Robbins Lane, Hicksville, N. Y.
Hicksville 3-3191

WHEN TIME IS

SHORT

put the solution of your problems up to a specialized Consultant whose professional card appears on this page. His broad experience may save you months of costly experimentation.

ELECTRONICS

330 West 42nd St., New York 36, N. Y.

ALBERT PREISMAN

Consulting Engineer
Television, Pulse Techniques, Video
Amplifiers, Phasing Networks,
Industrial Appliances
Affiliated with
MANAGEMENT-TRAINING ASSOCIATES
3308-14th St., N. W. Washington 19, D. C.

DATA ENGINEERS, INC.

Engineering that "Counts"
Designers & Manufacturers of
Data Recording Instruments

4608 Ravenswood Ave., Chicago 40, Ill.

JOSEPH RACKER COMPANY

Radar Consultants & Editors
Technical Manuals
Research and Development
140 Nassau Street, New York 38, N. Y.
Worth 4-1463

DUBROW DEVELOPMENT CO.

Design — Development — M
Quality Electronic Equipment
347 High St. Burlington, N. J.
Burlington 3-0446

R. W. HODGSON

RESEARCH & DEVELOPMENT ENGINEERS SPECIALIZING IN ELECTRONICS, NUCLEONICS, INSTRUMENTATION, SERVOMECHANISMS & CYBERNETICS
Office—6600 Lexington Ave., Hollywood 38, Calif.
All Mail to Box 874, Sherman Oaks, Calif.
Gladstone 9680

W. C. ROBINETTE CO.

MOTRON DEADBEAT HIGH GAIN SERVOS
Speed control of any Prime Mover 1/2% to .001% average. Electric Transmissions 1/2 to 50 HP plus controls—Zero droop—No load to full load.
802 Fair Oaks Ave. South Pasadena, Calif.
Py 11594

EDGERTON, GERMESHAUSEN & GRIER, INC.

Consulting Engineers
Research, Development and Manufacture of Electronic and Stroboscopic Equipment
Specialists in High-Speed Photography
160 Brookline Avenue, Boston 15, Mass.

R. W. HODGSON

PATENT AGENT SPECIALIZING IN ELECTRONICS
Registered to Practice Before the U. S. & Foreign Patent Offices
Office—6600 Lexington Ave., Hollywood 38, Calif.
All Mail to Box 874, Sherman Oaks, Calif.
Gladstone 9680

SKINNER, HARLAN AND IRELAND, INC.

Consulting Engineers
Specializing in Magnetic Materials and Their Application
Office and Laboratory Indianapolis 7, Indiana

Eldico of New York Inc.

Pioneers of Television Interference Elimination from Transmitters, Induction Heaters, Diathermy and etc.
Donald J. S. Merten & Engineering Staff
44-31 Douglaston Pkwy Douglaston, N. Y.
Bayside 9-8686

HOGAN LABORATORIES, INC.

John V. L. Hogan, Pres.
Applied Research, Development, Engineering
Est. 1929. Electronics, Optics, Mechanisms, Facsimile Communication, Digital Computers, Electro-sensitive recording media, Instrumentation.
155 Perry Street, New York 14. CHelsea 2-7855

THE TECHNICAL MATERIEL CORPORATION

Communications Consultants
Systems Engineering
General Offices and Laboratory
121 Spencer Place, Mamaroneck, N. Y.

ERCO RADIO LABORATORIES, INC.

Radio Communications Equipment
Engineering - Design - Development - Production
Pioneers in Frequency Shift Telegraph
Garden City • Long Island • New York

THE KULJIAN CORPORATION

Consultants • Engineers • Constructors
Electronic Control
Specialists
Utility • Industrial • Chemical
1200 N. Broad St., Phila. 21, Pa.

TELECHROME, INC.

Electronic Design Specialist
COLOR TELEVISION EQUIPMENT
Flying Spot Scanners, Color Synthesizers, Keyers, Monitors, Oscilloscopes and Related Apparatus
J. R. Pophin-Curman, Pres. & Ch. Engr.
88 Merrick Rd. Amityville, L. I., N. Y.

HARRIS GALLAY

Consultant
MICROWAVE AND PULSE TECHNIQUES
BE 11eville 2-4287 60 Perry St., Belleville 9, N. J.

MEASUREMENTS CORPORATION

Research & Manufacturing Engineers
Harry W. Houck Jerry B. Minter
John M. van Beuren
Specialists in the Design and Development of Electronic Test Instruments
Boonton, N. J.

HARRIS A. THOMPSON

Microwave Electronic Radar
Electro-Mechanical Consulting
MFG. & DEVELOPMENT PROBLEMS
2525 Penn., Boulder, Colorado, Phone 1202W

HANSON-GORRILL-BRIAN INC.

Products & Mfg. Development
ELECTRICAL - ELECTRONIC
HYDRAULIC - MECHANICAL
One Continental Hill Glen Cove, N. Y.
Glen Cove 4-1922

Eugene Mittelman, E.E., Ph.D.

Consulting Engineer & Physicist
High Frequency Heating—Industrial Electronics
Applied Physics and Mathematics
549 W. Washington Blvd. Chicago 6, Ill.
State 2-8021

WHEELER LABORATORIES, INC.

Radio and Electronics
Consulting—Research—Development
R-F Circuits—Lines—Antennas
Microwave Components—Test Equipment
Harold A. Wheeler and Engineering Staff
Great Neck, N. Y. Great Neck 2-7806

HIGHLAND ENGINEERING CO.

William R. Spittal & Staff
DESIGN, DEVELOPMENT AND MANUFACTURE OF TRANSFORMERS, CHOKES, ETC.
FOR THE ELECTRONIC, INDUSTRIAL & ALLIED FIELDS
Main & Urban, Westbury, L.I., N.Y.
WE-7-2933

NIAGARA ELECTRON LABORATORIES

CONSULTATION - DESIGN - CONSTRUCTION
MFG. THE THERMOCAP RELAY
Specializing in solution of problems of electronic and electro-physical instrumentation for the research of analytical laboratory. Industrial plant problems also invited.
Andover, New York Cable Address: NIATRONLAB

YARDNEY LABORATORIES, INC.

Research - Design - Development
Electro-Chemical Generators of Energy
105 Chambers Street Worth 2-3534, 35, 36
New York 7, N. Y.

• CONTACTS •

FOR THE FIELD OF ELECTRONICS

We are set up to do
all types of

SUBCONTRACTING

Our modern plant is equipped to do complete testing and development work on civilian and military electronic equipment.

Our Shop is set up to wind Bobbin, spool, form, layer, interwoven, Universal and Pile RF and IF chokes and coils.

Our New Etched Circuit Department can handle all types of work. Contact us for details on your subcontracting needs.

MICHEL MANUFACTURING CO.
227 North Water Milwaukee, Wis.

MICO "SOLDERUX" INSTRUMENT SOLDERING FLUXES

Non-Corrosive. Especially recommended for soft soldering fine wires and small parts of many metals including steel, brass, chromel, constantan, nickel, silver and copper. Mico Solderux Liquid for vigorous action—Mico Solderux Cream for strong action—Mico Solderux Paste for milder action. These fluxes are unique in that chemical action, so necessary in cleaning metals of oxides, grease, and dirt, does not begin until soldering temperatures are reached. When the work cools, any remaining flux subsides into a chemically inert material of low conductivity having non-hygroscopic properties. 1 oz. trial jar—50¢.

MICO INSTRUMENT CO.
76E Trowbridge St. Cambridge 38, Mass.

Screw Machine Products

from • Brass, • Aluminum,
• Stainless Steel



New, modern machinery. Forward our specs and prints for prompt estimates.

Maryland Precision Instrument Co.
12 E. Lanvale St. • Mulberry 4789 • Balto. 2, Md.
Complete Manufacturing Facilities
20 Years Production Knowhow

ELECTRO PLATING

SPECIALISTS IN
Silver, Cadmium & Zinc
Barrel Plating

Iridite and Cronak
Processes

To Government Specifications
Government Certified

EVEREADY PLATING CO.
1790 FIRST AV. N.Y.C.
EN 9-1222

Shorted Turn Indicator for unmounted coils

MODEL 101C BULLETIN 42
HUNTINGTON BEACH, CALIF.
KARTRON

WALKIE-RECORDALL & 16 miniature BATTERY RECORDER-PLAYBACK

Continuous, permanent, indexed recording, up to 4 hrs., only 3¢ hr. Instantaneous, permanent playback. Picks up sound up to 60 ft. Records conferences, lectures, dictation, 2-way phone & sales talks; while walking, riding or flying. Records in closed briefcase with "hidden mike"! Write for Detailed Literature.

MILES REPRODUCER CO., INC.
812 BROADWAY Dept E-10 NEW YORK 3, N. Y.

PRECIOUS METAL PLATING (Government Certified)

★ GOLD ★ SILVER ★ PALLADIUM
★ RHODIUM ★ ALBALOY
ELECTRO-COATINGS INC.

1662 W. Fullerton Ave. Chicago 14, Ill.
EAstgate 7-9770

SUB-CONTRACTING MILITARY and COMMERCIAL

receivers—test equipment
transmitters—controls
sub-assemblies

TELETRONICS LABORATORY, INC.
Westbury, L. I., N. Y. Westbury 7-1028

This CONTACTS Section

supplements other advertising in this issue with these additional announcements of products essential to efficient and economical production and maintenance. Make a habit of checking this page, each issue.

from

Accelerometers

to

Yokes

you'll find the

correct answer to

who makes

everything in the

entire field

of electronics

including... components

equipment

and

materials

in the...

electronics BUYERS' GUIDE

Get in the habit of looking it up in...

the electronics BUYERS' GUIDE

"The Book that has all the answers"

A MCGRAW-HILL PUBLICATION

330 West 42nd Street
NEW YORK 36, N. Y.

October, 1952 — ELECTRONICS

EISLER Manufactures Complete Equipment for:

SPOT WELDERS, Electric, for 1/4 to 250 KVA.
TELEVISION - TUBE GLASS WORKING EQUIPMENT.
TRANSFORMERS, Special and Standard Types.
INCANDESCENT LAMP Manufacturing Equipment.
FLUORESCENT TUBE Manufacturing Equipment.
NEON SIGN MAKERS EQUIPMENT.
ELECTRONIC EQUIPMENT, Vacuum Pumps, etc.
WET GLASS SLICING and Cutting machines for Laboratory Use.
EISLER ENGINEERING CO., Inc. 751 So. 13th St., Newark 3, N. J.

WINTER IN SOUTH FLORIDA

Transmitter Engineer/Technician. Degree not required; ham experience preferred; 1st phone necessary. Marine installations and repairs. Guarantee of \$1,850 for 5 months; \$2,750 not improvable. Reasonable quarters available. Send resume, photos and references.

P5162 ELECTRONICS
330 W. 42 St. New York 36, N. Y.

REPLIES (Box No.): Address to office nearest you
NEW YORK: 330 W. 42nd St. (36)
CHICAGO: 520 N. Michigan Ave. (11)
SAN FRANCISCO: 68 Post St. (4)

SELLING OPPORTUNITY OFFERED

REPRESENTATIVES WANTED by manufacturer for sale of first grade varnished tubings and sleeving. Good connections with the Television and Radio industries are essential. RW-5300, Electronics.

WANTED—SALESMAN or sales engineer covering Southern California to represent Eastern mfr of specialty condensers with high potential among scientific and military customers. Molded paper condensers also available in line. SW-5366, Electronics.

POSITIONS WANTED

ELECTRONICS PATENT Attorney, approximately four years patent law plus over five years engineering experience, presently handling all electronic patent matters for large corporation, outstanding scholastic record, desires to relocate. PW-4881, Electronics.

ELECTRONIC TECHNICIAN seeks challenging position with responsibility. 12 years aggregate experience in radio, radar and currently in industrial electronics. CREI-TV Engineering graduate. Excellent record. PW-5304, Electronics.

EXECUTIVE ELECTRONICS Engineer proven ability, experience engineering sales, government contracts overall project administration, employed, desires responsible position in California, setting up branch office or formation new enterprise. PW-5119, Electronics.

SENIOR B.S., M.S.; has had 12 years of all around experience in instrumentation, servo's, electronics, instrument design & production. Had supervisory operation. Eastern location preferred. PW-5254, Electronics.

FOR SALE

For Sale—1936-1941 issues A.I.E.E., 1935-1943 issues Q.S.T., 1938-1947 issues Electronics. Robert H. Worrell, Route 1, Box 265A, Rogue River, Oregon.

CONFIDENTIAL COUNSELLING

In All Employment Categories
\$5,200-\$50,000

To EMPLOYER and EMPLOYEE
NATIONAL COVERAGE

Please write briefly outlining your specific experience or personnel needs.

EMPLOYMENT COUNSEL

Suite 500 7 W. Madison St.
Chicago 2, Ill. Financial 6-2107

NO SHORTAGE OF ENGINEERS

(for somebody)

AVAILABLE: Group of engineers, for advanced development work and production in a wide range of electronics fields — a complete operating staff including technicians, headed by an executive specialist in direction of engineering, who has a nationally recognized 25-year research-development background.

All, or any suitable part, available to form: 1) West Coast division of Eastern firm, 2) New unit of Los Angeles area firm, or 3) New organization, in association with financial interests.

BO-5306, Electronics
1111 Wilshire Blvd., Los Angeles 17, Calif.

ATTENTION—ELECTRONICS INDUSTRY

AVAILABLE in Quincy, Mass. 26,000 sq. feet or desirable space in new, modern building now occupied by prominent electronics manufacturer. 12,000 sq. feet can be obtained at once. Plenty of specialized trained electronics help available. Located near transportation. Favorable lease and terms to desirable tenant.

INDUSTRIAL PROPERTIES
67 PARKINGWAY QUINCY, MASS.
Tel. MAyflower 9-3100

ELECTRONIC ENGINEERS & PHYSICISTS

OUR STEADILY EXPANDING LABORATORY OPERATIONS
ASSURE PERMANENT POSITIONS AND UNEXCELLED
OPPORTUNITY FOR PROFESSIONAL GROWTH IN

RESEARCH & DEVELOPMENT

GUIDED MISSILES

TELEVISION

ELECTRONIC NAVIGATION

SOLID STATE PHYSICS

VACUUM TUBES

RADAR

ADDRESS
INQUIRIES TO

CAPEHART FARNSWORTH CORP.
FORT WAYNE, IND.

**ENGINEER WANTED
BOSTON AREA**

We are seeking an engineer who has shown ingenuity in the field of small electro-mechanical devices, appliance and automotive switches, communication type relays and the like. The man who can satisfactorily demonstrate his ability to us, has a job and a future awaiting him with a 40 year old company that is large enough to offer a secure position, yet small enough for personal contact and recognition. We are expanding our field of operations and are seeking to supplement our present engineering force. Without resorting to extravagant verbiage, we offer a good position with a good future, for a good man. If you think you qualify for this position, please send a short resume of past history, experience and salary expected to Box No. All information will be kept in strict confidence and all letters will be acknowledged.

P-5337, Electronics
330 W. 42 St., New York 36, N. Y.

STANDARDS ENGINEER

To establish and direct engineering and manufacturing standards program for the manufacture of military and commercial electronic equipment. Education required: BS in ME or EE or equivalent. Experience: 6 years minimum in electrical engineering or manufacturing including at least 2 years as standards engineer.

P-4866, Electronics
1111 Wilshire Blvd., Los Angeles 17, Calif.

Are you looking for a good job with an excellent future?

Positions are open where your ability and initiative will soon be recognized . . . fine opportunities for qualified men:

- Project Engineers
Electronic
Mechanical
- Model Makers
- Sales Engineers

Engineering background essential. Fine opportunities to grow with a young, progressive organization; long-range development work; pleasant suburban surroundings; congenial and cooperative co-workers.

Send complete resume to Personnel Manager,

A. W. Haydon Company
Waterbury, Conn.

ENGINEERS

LOCATE IN THE

Healthful Southwest

WITH ATOMIC WEAPONS
INSTALLATION

Mechanical Engineers, Electronics and Electrical Engineers, Physicists, Mathematicians, Specifications Engineers, and Technical Writers. A variety of positions in research, development and production open for men with Bachelors or advanced degrees with or without applicable experience.

These are permanent positions with Sandia Corporation a subsidiary of the Western Electric Company, which operates the laboratory under contract with the Atomic Energy Commission. The Laboratory offers excellent working conditions and liberal employee benefits, including paid vacations, sickness benefits, group life insurance and a contributory retirement plan.

Albuquerque, center of a metropolitan area of 150,000, is located in the Rio Grande Valley, one mile above sea level. Albuquerque lies at the foot of the Sandia Mountains which rise to 11,000 feet. Cosmopolitan shopping centers, scenic beauty, historic interest, year 'round sports, and sunny, mild, dry climate make Albuquerque an ideal home. New residents experience little difficulty in obtaining adequate housing in the Albuquerque area.

Make application to the
PROFESSIONAL EMPLOYMENT DIVISION

SANDIA
Corporation

SANDIA BASE
ALBUQUERQUE, N. M.

ELECTRONIC ENGINEERS MECHANICAL ENGINEERS

*You GROW
at Melpar!*

Our Engineering Department is organized on a PROJECT basis

(not by functional sections, with their tendency to narrowness of specialization and limitation of professional growth). Here the member of a project group is in close touch with all phases of the project—responsible for his own share in his particular field but able to see the whole. The engineer in charge of the group, instead of being limited to expertness in producing one kind of unit to be assembled by others, is an executive responsible for ALL phases of the successful completion of the project.

- FLIGHT SIMULATORS
- Computers
- Telemetering
- Guided Missiles
- Airborne Radar
- Microwave Receivers



Send resumes

to:

PERSONNEL
DIRECTOR

MELPAR,
INC.

452 Swann Ave.

Alexandria, Va.

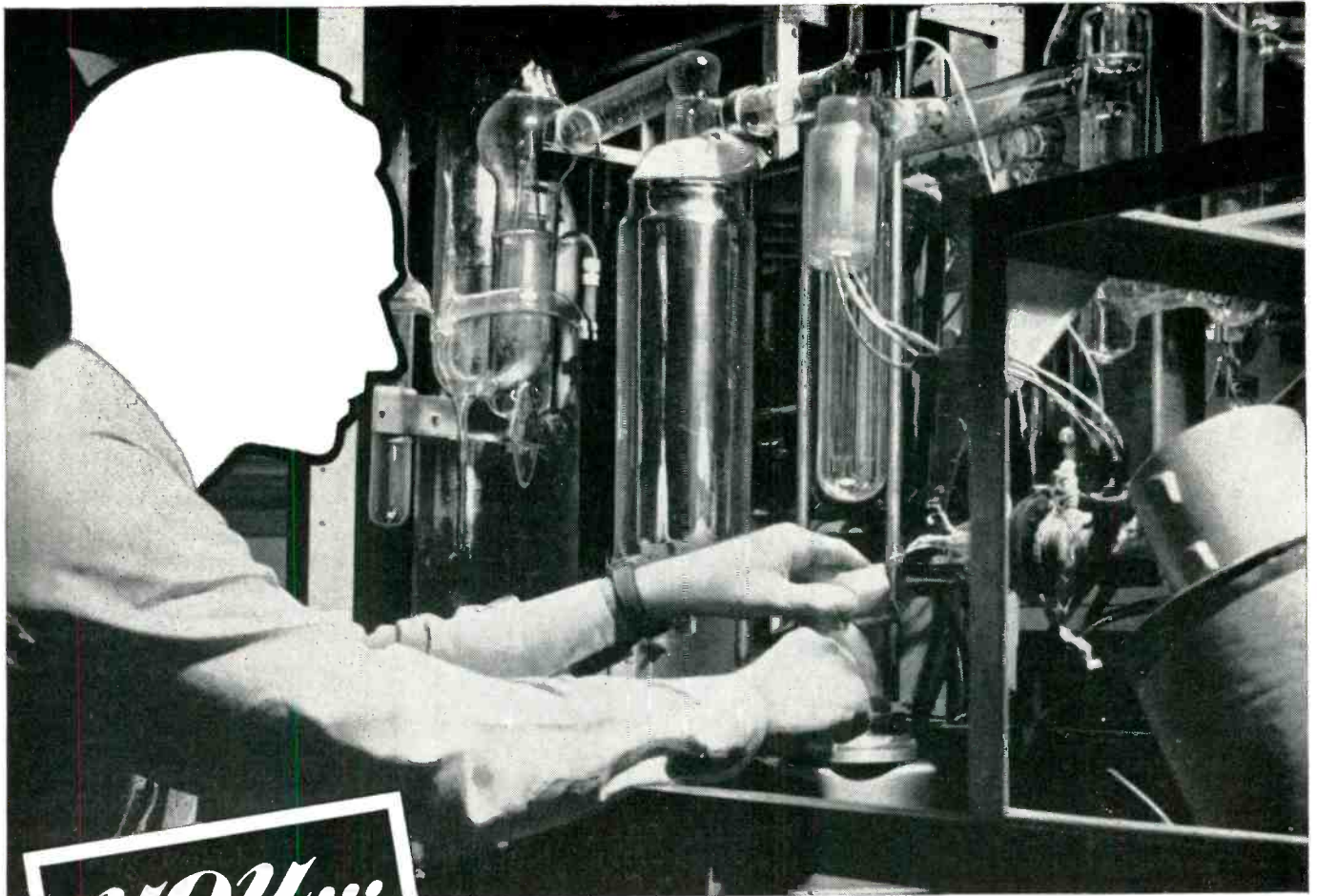

you...

... are headed for a better future —when you come to RCA

If you want to work where you enjoy the highest professional recognition among your colleagues, come to RCA. Here your accomplishments are recognized and rewarded. Here your future is brighter, through challenging assignments that lead to better opportunities, better positions. Here you set goals for future attainment at advanced levels.

If your talent and skill are not being used in a way for which your education and experience has equipped you, come to RCA. Here you will find unusual opportunities to work in close association with distinguished scientists and engineers in research . . . development . . .

design . . . and application of specialized electronic equipment for military projects as well as for an ever-increasing line of diversified commercial products.

Positions open are lifelong *career* opportunities. They are not "temporary" jobs. Unlike "feast or famine" industries,

RCA has forged ahead regardless of war or depression. You can continue advanced study at recognized universities under RCA's modern tuition refund plan. You and your family enjoy outstanding Company benefits. Yes, your future is better at RCA.

LIFETIME OPPORTUNITIES FOR

**ENGINEERS—Electronic . . . Electrical . . . Communication . . .
Mechanical . . . Computer . . . METALLURGISTS and PHYSICISTS**

In Research—Development—Design—Application: in the following fields:

**RADAR • MISSILE GUIDANCE • SERVO MECHANISMS • COMPUTERS • TRANSFORMERS AND
COILS • NAVIGATION AIDS • TELEVISION • ELECTRON TUBES • COMMUNICATIONS
TECHNICAL SALES • ELECTRONIC EQUIPMENT FIELD SERVICE**



Send a complete résumé of
your education and experience.

Personal interviews
arranged in your city.

Send résumé to:
Mr. ROBERT E. McQUISTON, Manager
Specialized Employment Division,
Dept. 46J
Radio Corporation of America
30 Rockefeller Plaza, New York 20, N. Y.

RADIO CORPORATION of AMERICA

RESEARCH AND DEVELOPMENT

*forge the KEY to America's future in the AIR
take YOUR place . . . with GOODYEAR AIRCRAFT*

The continued and steady growth of established research and development projects presents a number of unusual opportunities for outstanding and experienced men.

SCIENTISTS

ENGINEERS

DESIGNERS

Positions are available in our organization for qualified personnel in the following fields:

- | | | |
|----------------------|-----------------------|-------------------|
| • Electrical Systems | • Structures | • Stress Analysis |
| • Circuit Analysis | • Aerodynamics | • Flight Test |
| • Analog Computers | • Applied Mathematics | • Missile Design |
| • Servomechanisms | • Electronics | • Dynamics |
| • Test Equipment | • Physics | • Microwaves |

Openings also exist for welding engineers, civil engineers, and mechanical engineers with experience in metals fabrication; and for personnel with ability and experience in technical editing, art, and motion pictures.

Positions are available at several levels, and inquiries are also invited from recent graduates. Salaries are based on education, ability, and experience. Liberal salary, vacation, insurance, and retirement plans are yours if you qualify.

If YOU are interested in a secure future, write, giving full details, to
Mr. C. G. Jones, Salary Personnel Department.



GOODYEAR AIRCRAFT CORPORATION, 1210 Massillon Road, Akron 15, Ohio

**MAKE THIS YOUR HOME
FOR IMPORTANT WORK
UNDER IDEAL CONDITIONS**



- TV RECEIVER DESIGN ENGINEERS
- ELECTRONICS ENGINEERS
- FIELD ENGINEERS
- TEST & INSPECTION ENGINEERS
- LAB. TECHNICIANS

NEEDED TO WORK ON: Radar, G.C.A., Mobile Radio, Auto Radio, Airborne Communication & Navigation Equipment, Television, Antennas, Microwave Equipment, Servo Mechanisms, Guided Missiles and Test Equipment Design.

YOU BENEFIT AT BENDIX RADIO: from high wages, a modern, air-conditioned plant, paid vacations and holidays, group insurance and a good chance for advancement.

Housing immediately available in the beautiful suburban and country areas that surround the Bendix Radio plant.

Write, Wire or phone
MR. E. O. COLE, DEPT. J.

Bendix Radio

DIVISION OF BENDIX AVIATION CORPORATION
BALTIMORE-4, MD. Phone: TOWSON 2200

*Makers of the World's Finest
Electronic Equipment*

P.S.

The advertisement at left tells of attractive opportunities for engineers and technical personnel at The Bendix Radio Division of the Bendix Aviation Corporation in Baltimore.

Bendix Aviation also needs engineers and technical personnel for assignments at its new plant in York, Pennsylvania.

There are openings for electronic engineers, lab technicians, mechanical engineers, draftsmen, technical writers and tool & die designers.

So, here's the chance to get in at the start of a new operation of the Bendix Aviation Corporation . . . and benefit from good pay, interesting work and the chance for rapid advancement.

If interested in employment at York, Pennsylvania, write giving brief resume of your experience to:

Bendix Aviation Corp.

Dept. Y-1 P.O. Box No. 1202
YORK, PENNSYLVANIA

ENGINEERS

WHY NOT INVEST YOUR ABILITY

With the Finest Electronic Engineering Team in the West. Excellent Opportunities for Permanent Employment With Hoffman Exist For All Grades of Electronic Engineers, Mechanical Engineers and Engineering Technicians Experienced in Electro-Mechanical Engineering or Any of the Following:

- Radio Systems MF to UHF
- Receiver Design MF to UHF
- Pulse Techniques
- Selsyn Control and Servo Systems
- Electronic Type Test
- CRT Display Circuits
- Mechanical Design
- Antenna Design

Benefits include opportunity for advancement and further training, holidays and vacation with pay, good salaries. Applicants requested to forward resume of education and experience with letter of application to

ENGINEERING EMPLOYMENT OFFICE.

Hoffman

LABORATORIES, INC.

3761 SOUTH HILL STREET, LOS ANGELES 7, CALIFORNIA .

A SUBSIDIARY OF HOFFMAN RADIO CORPORATION

RESEARCH ENGINEERS

AND

SENIOR SCIENTISTS

Needed to work on the University of Chicago campus in the field of Electronics. Various projects include such topics as servo systems, magnetic amplifiers, computers, and electronic and transistor circuitry.

Complete facilities and excellent associations are available in this academic atmosphere. Various research projects deal with long-range problems of the Tactical Air Command.

We offer salaries generally prevailing in industry as well as the security of a continuing position with this military laboratory. Applicants must be U. S. citizens.

For information write to:

**Director of Scientific Personnel
Chicago Midway Laboratories**

6040 South Greenwood Avenue
Chicago 37, Illinois

STAVID ENGINEERING, INC.

has openings for
Graduate

**ELECTRONIC
ENGINEERS**

**MECHANICAL
ENGINEERS**

Experience in Design and Development of Radar and Sonar necessary.

Broad knowledge of Search and Fire Control Systems; Servo Mechanisms, Special Weapons, Microwave, Antenna and Antenna Mounts, etc.

Mechanical Engineer should have experience in packaging of Electronic Equipment to Gov't specifications including design of complex cabinets, shock mount and sway brace structures, Servo Mechanisms.

Positions are available in Field Service and Technical Writing.

Liberal personnel benefits including life, sickness and accident insurance, and a worthwhile pension system. Paid holidays and vacations.

Personnel Office
200 W. Seventh St.
Plainfield, N. J.
Telephone Plainfield 6-4806

ENGINEER!

- IS YOUR WORK STIMULATING?
- ARE YOU CHALLENGED BY YOUR JOB?
- ARE YOU RECEIVING PROFESSIONAL RECOGNITION?

SYLVANIA

believes in building men

The company now in its 51st year is expanding rapidly. Net sales this year exceed 1938 by 16 times. Additional high caliber men are needed with training and experience in all phases of electronics, physics and mechanics.

Write us about yourself, if your experience and future plans fit into this picture.

William B. Seiniger

Department F

SYLVANIA ELECTRIC PRODUCTS, Inc.

Radio & Television Division

254 Rano Street, Buffalo 7, New York

ENGINEERS

PHYSICISTS

CHEMISTS

METALLURGISTS

Choose a Future of Achievement

with

GENERAL ELECTRIC

Through the opportunity to work with leading scientists on important advanced projects ... through continued advancement possibilities ... and the stability of association with a company whose products are vital to American defense, industrial and consumer needs, you can be more certain of a future of satisfaction and achievement.

Positions are now open in Advanced Development, Design, Field Service, and Technical Writing in connection with:

**MILITARY RADIO & RADAR
MOBILE COMMUNICATION
MULTIPLEX MICROWAVE
COMMUNICATIONS
ELECTRONIC COMPONENTS
TELEVISION, TUBES & ANTENNAS**

Bachelor's or advanced degrees in Electrical or Mechanical Engineering, Physics, Metallurgy, or Physical Chemistry and/or experience in electronics industry necessary.

Do not apply, please, if your best skills are being used for vital defense work.

Please send resume to:
Dept. 10-2E, Technical Personnel
ELECTRONICS PARK

GENERAL  ELECTRIC
SYRACUSE, N. Y.

ELECTRONIC ENGINEERS

**Mechanical Designers for Research
and Engineering**

To work in the design and development of new electronic equipment. Excellent working and living conditions, good salaries and exceptional employee benefits. Write, giving full details including education and experience. Personal interviews will be arranged.

THE NATIONAL CASH REGISTER COMPANY

Main & K Sts., Dayton 9, Ohio

electronic designers

Duties involve design and layout responsibilities on the board in research and development of UHF equipment, microwave components, and subminiaturization techniques.

radio engineers

Minimum 3 years' experience
Mathematics & Physic background desirable

1. Development of pulse, sweep, multivibrator, magnetic amplifier, and transistor circuits.
2. Development of receivers, radio frequency amplifiers, mixers, and oscillators.
3. Design and test of microwave antennas and components.
4. Analysis of operating radio system parameters. Determination of transmitter power, band width, noise factor and other characteristics of practical radio systems.

to men who want the best

Kollsman provides excellent facilities for the design and development of America's finest aircraft instruments. In our modern radio communications group you'll find a congenial atmosphere in which you can do your best work. You'll be encouraged to advance as our progressive organization continues to grow. And you'll receive liberal benefits including completely paid life, hospitalization, surgical, accident and health insurance.

KOLLSMAN INSTRUMENT CORP.

80-08 45th Ave., Elmhurst, Long Island, N. Y.
NEWTOWN 9-2900

TELREX, INC. OF ASBURY PARK, N. J.

wishes to engage a

SENIOR ELECTRONIC SPECIALIST

to conduct antenna, filter, converter, research and development particularly at television frequencies. Applicant must possess scientific qualifications together with considerable manufacturing and field experience and a proven record of accomplishments. Must be imaginative, capable of original thinking and able to work with minimum supervision. Frankly, we are looking for an unusually good man and an attractive salary will be offered the right applicant. Write stating qualifications and record.

PHYSICISTS . . . NEW FRONTIERS TO CONQUER

Enjoy great opportunities for personal satisfaction and advancement . . . help keep our nation strong and free . . . investigate the following openings with TRACERLAB, the foremost commercial firm in the field of NUCLEONICS.

Positions are available for PHYSICISTS with training in . . . ELECTRONICS . . . CLASSICAL PHYSICS . . . SOLID STATE PHYSICS . . . NUCLEAR PHYSICS.

Openings exist at several levels and require Bachelor's or Advanced Degree with or without industrial experience. If you feel that you are qualified, we'll be glad to hear from you. Please write:

Industrial Relations Department

TRACERLAB, INC.
130 HIGH STREET
BOSTON 10, MASS.

ELECTRONIC ENGINEER

. . . having good theoretical knowledge and thorough practical experience, to do work on *piezo-electrical crystals and associated circuits*. Skill in laboratory work desirable.

We will test your ability. If you are good we will hire you.

If interested contact Personnel Department giving full details concerning your education and experience.

Standard Piezo Company

Carlisle

Pennsylvania

QUARTZ DEVELOPMENT

Engineer or physicist experienced in preparation and testing of quartz oscillator plates wanted for investigation of electrical and some chemical properties of quartz crystals. Position offers opportunity to participate in established program for introduction of synthetic quartz crystals. Knowledge of crystallography helpful. Good salary. Submit photograph and details of education and experience.

The Brush Development Co.

3405 Perkins Ave.

CLEVELAND 14

OHIO

POSITIONS OPEN

Location
KANSAS CITY, MO.

Electronic & Mechanical Engineers

ELECTRONIC ENGINEERS: Must have considerable development experience in radio transmitting and receiving equipment. Ability to fill position of Senior Project Engineer a requisite.

MECHANICAL ENGINEER: Must have development experience in mechanical design of electronic or similar precise equipment. Practical and theoretical knowledge of materials, finishes, sheet metal, and machine shop design are basic requirements. Position is one of considerable responsibility.

SALARY: Open.

These positions are permanent. Write stating educational and professional history direct to:

Jay V. Wilcox, President
WILCOX ELECTRIC COMPANY, INC.
1400 Chestnut St. Kansas City 1, Mo.
Dependable communications since 1931

Challenging Opportunity

RECENT ENGINEERING GRADUATE for management position

Sylvania offers recent engineering graduate a challenging opportunity in production management.

If you are interested in working with people. If you have production management potentials, and want to use your engineering background to advance yourself, this may be your chance to start right in on the management level.

Sylvania's expansion and its policies offer you a very promising long range future. Training and experience in radar electronics preferred although not absolutely necessary.

SYLVANIA Believes in BUILDING MEN.

For further information send a personal resume to:

William B. Seiniger
Supervisor of Employment

SYLVANIA ELECTRIC PRODUCTS, Inc.

Radio and Television Division
254 Rano Street
Buffalo 7, New York

CAREERS IN RESEARCH

The National Union Research Division offers opportunities to men interested in Permanent Positions with excellent future prospects.

There are several openings on our research staff in the fields of Specialized Vacuum Tube Development and Electronic Circuit Design.

ENGINEERS
PHYSICISTS
TECHNICIANS

..... Are invited to inquire regarding these positions.

..... Benefits include:

- Free Hospitalization
- Medical Surgical Plan
- Free Life Insurance
- Profit Sharing Plan
- Paid Vacations
- Paid Holidays
- Merit Salary Reviews
- Excellent Working Conditions

NATIONAL UNION
RESEARCH DIVISION

350 Scotland Road Orange, N. J.

ELECTRONIC ENGINEERS

FOR DESIGN & DEVELOPMENT WORK IN
RADAR

COMPUTERS

DIGITAL TECHNIQUES

with a young progressive company,
send resumé of experience and
education, with salary requirements,
to

 Electronic Engineering Company
of California

180 SOUTH ALVARADO STREET LOS ANGELES 4, CALIFORNIA
DUNKIRK 2-7353

WANTED:

Sales Engineers

For Aircraft Equipment Division of well-known manufacturer of precision instruments and automatic controllers. Our company was one of very few companies which were successful in developing automatic engine temperature controllers for certain difficult applications on combat planes. We have now completed outstanding development work on other much needed devices which have wide use on all types of planes. We need one Sales Engineer for Los Angeles and another for Fort Worth or Dallas.

If you are interested in making a connection with a company which is geared to war or peace conditions and which has plans for a long range program we will be glad to hear from you. Prefer engineering graduates with strong aptitude for selling. Graduate Aeronautical Engineers with aircraft accessory experience also preferred.

We will start you on a moderate straight salary basis which will be interesting to men who are looking for opportunity for steady advancement in a long range program of development and sales.

P-5235, Electronics
330 W. 42 St., New York 36, N. Y.

We desire personnel of the highest caliber—experienced in the field of airborne automatic electro-mechanical control equipment.

★
ENGINEERS
MECHANICAL DESIGN
ELECTRONIC
SERVO

★
DESIGNERS-LAYOUT MEN
ELECTRONIC
MECHANICAL

This work deals with the manufacture and development of highly complex equipment of the most advanced type in a new and expanding division of an established firm with 20 years of successful experience in the precision instrument field.

We cite a few of the good reasons why you might like to join our organization . . .

SALARY increases are based on merit and initiative—two weeks VACATION, HOSPITALIZATION BENEFITS, GM's own INSURANCE PLAN—POSITIONS ARE PERMANENT due to long range manufacturing and developing programs—EXPENSES incident to interviews and moving all absorbed by company—HOUSING and LIVING CONDITIONS among the best and finest of any along Lake Michigan.

● We have a Junior Engineering Training Program of one year for inexperienced engineering graduates. Opportunity to become acquainted with all phases of industry.

● For the convenience and direct use of engineers in our Engineering Department, we have our own model shop where highest skilled mechanics are employed.

● Educational opportunities for advanced degrees available at U. of W., Marquette. Technical engineering offered at Milwaukee Vocational School.

... all inquiries answered—write or apply . . .

★ AC SPARK PLUG DIVISION

GENERAL MOTORS CORPORATION

1925 E. KENILWORTH PL.

MILWAUKEE 2, WIS.

SYSTEMS ENGINEERS

For design and installation of radio communication systems of all types in HF, VHF and Microwave bands for use in foreign countries.

Applicants should have experience in either radio propagation studies and antenna design or in the application of telephone and telegraph terminal equipment.

These positions are not dependent on government contracts and would be based in New York with occasional overseas duty.

Send full details to
Personnel Dept.

Radio Corporation of
America

RCA International Div.
30 Rockefeller Plaza
New York 20 New York



ATTENTION!

Former Field Engineers

We urgently need men with electronic background, and preferably radar or computer experience, to supervise, instruct and assist in installation—maintenance of electronic equipment.

Excellent starting salary during factory training, plus overtime premium in field. Substantial insurance program. Domestic & overseas assignments available. Salary will be commensurate with experience.

Please forward your personal experience record to:

Personnel Supervisor
Field Eng. Div.

Reeves Instrument Corp.
215 East 91st St.
New York, 28, N. Y.

OIL FILLED CONDENSERS

MFD	VDC	Price	MFD	VDC	Price	MFD	VDC	Price	MFD	VDC	Price
1-5	400	\$.55	1	1500	.59	1	6000	9.95	1	25KV	85.00
1	600	1.65	.5	1500	1.25	1	7000'd	1.75	.001	50KV	24.50
2	600	.55	3	1500	2.50	1-.1	7000	5.95	0.25	50KV	42.50
2	600	.69	4	1500	2.95	1	7500	2.85	.2	50KV	85.00
2-2	600 R'd	.69	1.5	2000	.95	1-1	7500	22.50	.25	50KV	95.00
2	600 R'd	1.65	2.5	2000	1.50	.075-.075	8KV	6.50	7.5	220VAC	1.95
4	600	.95	3	2000	1.30	.5	10	16.50	1-3	330VAC	1.95
4	600	1.65	3	2000	1.95	1	10KV	29.50	10	330VAC	3.95
4	600R'd	1.65	3	2000	3.75	1	12KV	8.95	12.75	330VAC	4.10
5	600	1.75	12	2000	8.95	1	15KV	37.50	15	330VAC	4.50
6	600	1.85	1	2500	2.75	.045	16KV	4.70	5	440VAC	3.10
6	600R'd	1.85	1-1	2500	3.85	.05	16KV	4.95	2.9	660VAC	3.50
8	600	1.95	32	2500	15.80	.075	16KV	8.95	7	660VAC	4.25
4-4-4	600	2.50	15	3000	2.40	.25	20KV	19.95	8	660VAC	4.50
4 x 3	600	3.25	1	3000	4.50		20KV	54.00			
10	600	3.25	2	3000	4.50						
1	1000	.65	.03	4000	1.25						
2	1000	.90	3 x .2	4000	2.95						
2	1000R'd	.95	2	4000	6.95	MFD	VDC <td>TYPE <td>Price</td> <td></td> <td></td> </td>	TYPE <td>Price</td> <td></td> <td></td>	Price		
3.5-.5	1000	1.95	2	5000	1.60	.02	600	OM-6002	\$.45		
4	1000	2.50	1	5000	2.50	.05	600	OM-6005	.48		
6	1000	2.50	1	5000	4.88	1	600	OM-610	.51		
8	1000	3.25	2	5000	18.50	.25	600	OM-625	.55		
1	1200	1.85	.5	5000	29.50	.5	600	OM-650	.60		
1-1-1	1200	1.85	.01-.03	6000	1.65	1.0	600	OM-601	.85		

POWERED TELEPHONES

U. S. NAVY TYPE M HEAD AND CHEST SETS
 U.S.I. A-260 W.E. D-173013
 A.E. GL832BAO
 ANY TYPE—\$14.88 EACH
 TS-10 Type Handsets.....\$9.25

GENERATORS AND INVERTERS

Ecl/Insa-Plioneer type 716-3A (Navy Model NEA-3A)
 Output-AC 115V 10.4A 800 to 1400cy. 1φ: DC 30
 Volts 60 Amps. Brand new.....\$38.50
 Eclipse-Plioneer type 1235-1A. Output-30 Volts DC
 15 Amps. Brand New-Original Packing.....\$15.50
 PE-218 Inverters-28 VDC to 115 VAC 400 cy 1500
 VA. (New).....\$49.50
 Pioneer Type 800-1B Inverter-28VDC to 120V 800
 cy 7 amp AC (used).....\$22.65
 G. E. Inverter-28 VDC to 120 VAC 800 cy 750 VA
 1φ.....\$39.50
 ATR Inverter 6VDC to 110 VAC 60 cy 75W.....\$22.95
 PU-7/AP Inverter-28 VDC to 115 VAC 400 cy 2500
 VA (used).....\$75.00
 Eclipse-Plioneer type 12121-1A Inverter-Voltage and
 frequency regulated—24VDC 18 Amp Input—AC
 output 115V 3φ 400 cy 250VA 0.7 PF —(New).....\$225.00

OILMITES

MFD	VDC	Price	MFD	VDC	Price
1	600	\$.45	1	600	\$.45
1	600	.48	1	600	.48
1	600	.51	1	600	.51
1	600	.55	1	600	.55
1	600	.60	1	600	.60
1	600	.85	1	600	.85

COAXIAL CONNECTORS



FULL LINE OF JAN APPROVED COAXIAL CONNECTORS
 IN STOCK
 UHF—N—PULSE—BN—BNC

UG-7/AP	UG-22C/US	UG-37/U	UG-102/U	UG-176/U	UG-255/U
\$6.30	\$1.65	\$17.50	\$9.00	\$1.15	\$2.45
UG-12/U .95	UG-23 U .20	UG-57/U .20	UG-103 U .68	UG-177/U .24	UG-280/U 1.20
UG-15/U 1.50	UG-23B/U 1.90	UG-58/U .80	UG-104/U 1.40	UG-185/U 1.35	UG-281/U 1.20
UG-18/U 1.25	UG-23C/U 1.90	UG-58A U 1.15	UG-106 U .15	UG-181/AP .80	UG-282/U 1.20
UG-18B/U 1.60	UG-24/U 1.30	UG-59A U 2.25	UG-108 U 2.60	MX-195 U .75	UG-273/U 2.25
UG-19/U 1.80	UG-25/U 1.35	UG-83 U 2.25	UG-109/U 2.60	UG-197/U 2.80	UG-274/U 2.75
UG-20/U 1.80	UG-27 U 2.95	UG-85 U .75	UG-146/U 2.55	UG-201 U 2.25	UG-275/U 5.50
UG-21 U .95	UG-27A U 2.95	UG-86 U .75	CW-159/U .80	UG-203 U 1.80	UG-276/U 2.75
UG-21A/U 1.50	UG-28A U 3.75	UG-87/U 1.80	UG-166 U 32.50	UG-208 U 1.80	UG-200/U 1.20
UG-21B/U 1.35	UG-29 U 1.55	UG-88/U 1.10	UG-167/U 5.85	UG-224 U 1.20	UG-291/U 1.35
UG-21C/U 1.45	UG-30 U 2.30	UG-89 U 1.35	UG-171 U 2.80	UG-236/U 3.85	UG-306/U 2.95
UG-22/U 1.35	UG-34/U 16.50	UG-90 U 1.80	UG-173 U .40	UG-245/U 2.30	UG-414/U 3.25
UG-22B/U 1.65	UG-38/U 50	UG-98/U 1.85	UG-175 U .15	UG-254/U 2.75	UG-625/U 1.35

QUOTATIONS UPON REQUEST ON ANY CONNECTORS NOT LISTED HERE

M-358	MC-277	PL-259A	PL-325
M-359	MC-320	PL-274	SO-239
M-369A	PL-258	PL-284	SO-264
M-380	PL-259	PL-293	TM-201

93-C	49120	D-163950	ES-685696-5
93-M	49121A	D-166132	ES-689172-1

COAXIAL CABLE

Type	Price Per M Ft.	Type	Price Per M Ft.	Type	Price Per M Ft.
RG-5/U.....	\$140.00	RG-13/U.....	\$216.00	RG-57/U.....	\$325.00
RG-6/U.....	180.00	RG-17/U.....	650.00	RG-58/U.....	60.00
RG-7/U.....	85.00	RG-18 U.....	900.00	RG-34/U.....	300.00
RG-8/U.....	100.00	RG-19/U.....	1250.00	RG-35/U.....	900.00
RG-9/U.....	250.00	RG-20/U.....	1450.00	RG-36/U.....	110.00
RG-9A/U.....	275.00	RG-21/U.....	220.00	RG-55/U.....	110.00
RG-10/U.....	240.00	RG-22/U.....	150.00		
RG-11/U.....	100.00	RG-22A/U.....	285.00		
RG-12/U.....	240.00	RG-24/U.....	675.00		

ADD 25% TO PRICES SHOWN FOR QUANTITIES UNDER 500 FT.

2 φ LOW INERTIA SERVO MOTORS

KOLLSMAN—45 Volt 60 cycle 4 watts 1500 RPM—
 new.....\$22.50
 PIONEER—10047-2-A 26 volt 400 cycle with 40:1 re-
 duction gear.....\$10.50
 PIONEER—CK-14 115 volt 400 cycle—includes damp-
 ing signal generator (antonyu).....\$47.50

HIGH VOLTAGE TRANSFORMERS

G.E.—Pri. 115V 60 cy. Sec. 6250V 80 MA—12.5 KV
 insulation.....\$18.50
 G.E.—Pri. 115V 60 cy. Sec. 6250/3550/2600V 50 MA
 12.5 KV Insulation.....\$18.50

ANTENNAS

AT-4/ARN-1.....\$8.25
 AT-38A/APT (70 to 400MC).....\$3.70
 AT-49/APR-4 (300 to 3300MC).....\$3.70
 AN-65A (P/O SCR-521).....1.50
 AN-66A (P/O SCR-521).....1.75
 A1A-3CM conical scan.....125.00
 ASB Yagi—5 element 450 to 560MC.....9.00
 ASB Yagi—Double stacked 6 element.....14.70
 ASA Yagi—Double stacked 370 to 430MC.....29.40

RELAYS

Sigma type 4AH—2000Q 4 ma DC coil—SPDT con-
 tacts—hermetically sealed 5 pin plug-in base.....\$3.30
 Sigma type 4R—3000Q 1 ma DC coil—SPDT con-
 tacts—enclosed type 5 pin plug-in base.....\$4.25
 Stevens Arnold type 171 Millisec relay—900 ohm coil
 SPST NO contacts.....\$5.50
 Cutler-Hammer and Square D type B-7A contactor—
 24 VDC coil—SPST NO 200 Amp contactor.....\$4.75
 Price Bros type 161 M—220 VAC contactor—SPST
 NO double bk 30A contacts.....\$3.25
 G.E. CR5181-1A6—115 V 60 cy. AC contactor—4PST
 30 Amp contacts plus two auxiliary SPDT con-
 tacts.....\$14.50
 REM—115 V 60 cy. AC coil—DPDT 3 amp Con-
 tacts.....\$3.20

METERS

1 MA DC 3 1/2° R DeJur Mod 310 (0-4KV scale).....\$5.75
 500 Microamps. DC 2 1/2° round—Sun.....4.30
 1 ma. DC Fan type—4 scale (rem. from eqpt).....3.95
 500 ma. DC 2 1/2° R.—General Electric.....2.95
 2 amp. RF 2 1/2° Sq.—Simpson.....3.15
 5 amp. AC 4 1/2° R.—JBT.....4.11
 30 V DC 2 1/2° R.—General Electric.....3.95
 3 amp. RF 3 1/2° R.—Weston.....6.00

CRYSTAL DIODES

IN21	IN27	IN41	IN25
\$1.19	\$1.79	\$1.25	\$1.25
IN21A 1.69	IN31 8.10	IN42 18.75	
IN21B 3.50	IN34 .66	IN43 1.55	
IN22 1.09	IN34A .95	IN45 .94	
IN23 1.95	IN38 1.70	IN52 1.05	
IN23A 3.25	IN39 6.25	IN55 3.15	
IN23B 4.25	IN40 10.60	IN60 5.55	

TYPE "JJ" POTENTIOMETERS

Resis.	Shaft	Resis.	Shaft	Resis.	Shaft
60	SS	5K	1/4"	50K	3/8"
60	9/16"	5K	3/8"	50K	1/2"
100	SS	5K	1/2"	100K	SS
200	SS	10K	SS	150K	1/2"
250	1/8"	10K	3/8"	200K	3/8"
500	SS	10K	1/2"	250K	SS
500	5/16"	15K	SS	250K	3/4"
500	1/2"	15K	1/2"	250K	3/8"
500	5/8"	20K	SS	500K	SS
650	1/2"	25K	SS	500K	1/4"
1K	SS	25K	1/4"	500K	1/16"
2K	3/8"	30K	1 1/8"	1Meg	SS
2500	SS	40K	SS	2.5 Meg	SS
4K	SS	50K	SS	5 Meg	SS
5K	SS	50K	1/4"		

DUAL "JJ" POTS.—\$2.95 ea.

50 SS 330 SS 2500 SS 2.5 meg SS
 100 SS 500 SS 10K SS 5 meg SS
 250 SS 1K SS 1 meg SS 1K/25K 3/8"

TRIPLE "JJJ" POTS.—\$3.95 EA.

100K/100K/100K 3/8" 20K/150K/15K 3/8"

PULSE TRANSFORMERS

UTAH	UTAH
G.E. K541318	Westinghouse 187AW2F
G.E. 68G-627	Westinghouse 232-AW2
G.E. 68G828	Westinghouse 232-BW-2
G.E. 68G929G1	AN/APN-4 Block Osc.
G.E. 80G13	Philco 352-7149
G.E. K-2468B	Philco 352-7071
G.E. K-2468A	Philco 352-7178
G.E. K-2744B	Philco 352-7178
AN/APN-9 (901756-501)	Raytheon UX-7350
AN/APN-9 (901756-502)	Raytheon UX-10066
AN/APN-9 (352-7250)	W.E. D-161310
AN/APN-9 (352-7251)	W.E. D-163247
Westinghouse 132-AW	W.E. D-163235
Westinghouse 139DW2F	W.E. D-164661
Westinghouse 166AW2F	W.E. KS-9563
Westinghouse 176AW2F	

AN/APA-23 RECORDER

Sweeps any receiver through its tuning range and permanently records frequency and time of received signals on paper chart. Power input—(motor) 27V DC 1.5A, and (recorder) 80/115V AC 60-2600 cy 135W.
 Originally designed to record pulse or sinewave modulated signals received by AN/AP-1, AN/APR-2, AN/APR-4, AN/APR-5, BC-348, S-27, SC-28, BRAND NEW.....\$147.50

PRAGUE PULSE NETWORKS

7.5 E3-1-200-67P, 7.5 KV, "E" Circuit 1 Microsec.
 200 PPS 67 ohms Imped, 3 sections.....\$4.50
 7.5 E3-3-200-67P, 7.5 KV, "E" Circuit 3 Microsec.
 200 PPS, 67 ohms Imped, 3 sections.....\$6.75
 7.5 E4-16-60-67P, 7.5 KV, "E" Circuit 4 sections.
 16 microsec, 60 PPS, 67 ohms Imped.....\$8.25
 15 E4-1-400-50P, 15 KV, "E" Circuit .91 microsec.
 400 PPS, 50 ohms Imped, 4 sections.....\$16.50
 15-A-1-400-50P, 15 KV, "A" Circuit, 1 microsec.
 400 PPS, 50 ohms Imped.....\$37.50

ELECTRONIC RESEARCH LABORATORIES
 715-19 ARCH ST. PHILA. 6, PA.
 Telephones - MARKET 7-6771 - 2 - 3

GUARANTEED BRAND NEW

TUBE SPECIALS

STANDARD BRANDS ONLY

Receiving Tubes	6AG7	1.59	6SK7	.89	14A7	.97	3GP1	4.95	2051	1.15	EL-5B	8.95	WE-254A	5.90	805	4.50		
OOA	\$1.50	6AH6	1.39	6SK7GT	.89	14B6	.93	3HP7	4.75	5545	32.50	4B24	5.75	WE-257A	3.77	806	24.50	
OIA	.67	6AJ5	2.50	6SL7GT	.96	14B8	1.09	4AP10	4.95	Transmitting		4B25	8.95	WE-274A	5.50	807	1.70	
OZA	.74	WE-6AK5	1.35	6SN7GT	.89	14C3	1.29	5A11	5.95	& Special		4E27	12.25	WE-283A	2.85	808	2.65	
OZAA	.90	6AK5W	3.05	6SN7WGT	2.30	14C7	1.15	5AP4	4.75	Purpose Tubes		4J36	150.00	WE-275A	6.95	809	2.40	
IA3	.71	6AK6	.69	6SO7GT	.75	14E6	1.09	5BP1	4.75	OA2	1.51	4J38	120.00	WE-285A	5.57	811	2.60	
IA5GT	.72	6AI5	.69	6SR7	.81	14F7	1.29	5BP4	5.75	OB3	1.50	4J50	375.00	WE-286A	7.90	813	9.50	
IA6	.72	6AI5W	2.90	6SS7	.99	14H7	.93	5CP1	4.95	OB2	1.29	4J52	400.00	WE-294A	5.75	814	3.95	
IA7GT	.91	6AO5	.89	6ST7	1.25	14J7	.93	5CP7	9.50	OC3	1.20	5J21	26.50	304TH	8.99	815	2.75	
IA85	.89	6AO6	.79	6T7G	1.09	14K7	1.09	5HP1	5.75	OD3	1.15	5J23	52.50	304TL	9.75	816	1.45	
IB3GT	.99	6AR5	.79	6T8	1.11	14R7	.93	5HP4	5.75	IB21A	2.85	5J29	18.50	307A	5.50	826	1.45	
IB4P	1.17	6AS5	.99	6U5	1.19	14W7	.93	5J1P1	26.50	IB22	3.25	6-8B	.85	WE-309A	6.45	828	13.48	
IC5GT	.85	6AS6	3.30	6U7G	.88	14X7	.89	5J2P2	26.50	IB23	9.95	6AN5	5.95	WE-310A	7.50	829	9.95	
IC6	.69	6AS7G	4.53	6V6	1.60	19T8	1.16	5J2P4	26.50	IB24	12.95	6AR6	3.35	WE-313C	4.15	829B	14.50	
IC7G	.69	6AT6	.69	6V6GT	.79	22	1.16	5L1P5	19.75	(West)		6C21	29.50	316A	6.95	830	3.50	
ID5GP	.69	6AT8	1.21	6V6GT	.79	22	1.16	5L1P5	19.75	IB24(Sylv)	18.95	6C24	52.50	327A	4.25	830B	3.95	
ID7G	.69	6A16	.69	6W4GT	.72	24A	.79	5MP1	10.65	IB26	3.73	7-7-11	1.19	WE-331A	9.75	832	7.95	
ID8GT	.71	6AV6	.63	6W6GT	.99	25A6	1.16	7BP1	8.75	IB26	3.73	7-7-11	1.19	WE-343A	185.00	832A	9.95	
IE5GP	.71	6BA4	1.60	6X4	.59	25L6GT	.89	7BP7	7.95	IB27	19.50	10T1	.88	WE-346A	2.75	833A	45.00	
IF4	.69	6B5	1.20	6X5GT	.59	25Z5	.69	7BP12	14.95	IB29	2.90	10Y	.45	WE-350A	6.95	837	3.50	
IF5G	.69	6B7	.99	6Y6G	.89	26	.79	7BP14	14.95	IB32	3.95	13-4	.80	350B	4.95	837	1.85	
IF8	.71	6B8	.99	6Z5G	.89	27	.79	7CP1	14.95	IB35	12.50	15E	2.35	WE-356B	5.45	838	3.25	
IG4GT	.69	6BR8	.85	7A4	.79	28D7	1.75	9GP7	12.85	IB36	12.50	15R	.95	361A	4.75	841	.49	
IG5G	.69	6BA6	.82	7A5	.88	30	.72	9LP7	9.95	IB38	32.50	REL-21	2.25	368A	6.95	843	.59	
IG6GT	.69	6BA7	1.20	7A6	.83	30 Spec.	.48	10BP4	18.50	IB40	4.95	24G	1.85	371A	.95	845	5.75	
IH4G	.89	6BC5	.88	7A7	.83	31	.62	10FP4	24.50	IB41	47.50	HK-24	3.95	371B	6.95	849	29.50	
IH5GT	.74	6BC7	1.10	7A8	.83	32	.69	12FP7	16.50	IB42	9.80	FG-32	3.82	388A	2.95	849	67.00	
IH6GT	1.01	6BD6	1.69	7AD7	1.44	32L7GT	.87	12GP7	16.50	IB45	11H20	.88	5558	6.75	417A	16.95	852	22.60
IJ5G	.74	6BE6	.72	7B4	.83	34	.99	902P1	9.95	IS21	9.50	RK-34	.49	434A	17.50	860	4.95	
IJ6G	.95	6BF5	1.10	7B5	.83	35 51	.79	905	4.45	IS22	3.75	35T	4.95	446	1.95	861	24.50	
IL4	.69	6BF6	.83	7B6	.83	35A5	.89	Photo Cells		2B22	2.20	35T Ion		446	1.95	862	6.75	
IL4A	.89	6BF6G	1.92	7B7	.83	35B5	.89	1P23	\$4.10	2C21	7.75	1A5E	5.95	446B	2.25	865	1.28	
IL5	1.10	6BI6	.99	7B8	.89	35L6GT	.81	1P24	1.27	2C22	.75	35TC	4.95	450TH	42.50	866A	1.48	
ILB4	1.01	6BI6	.99	7C4	.69	35W4	.55	918	1.65	2C26	.49	REL-36	.78	450TL	42.50	869B	45.00	
ILC5	.81	6BK7	1.60	7C5	.83	35Y4	.81	919	1.95	2C26A	.49	RK-47	4.92	451	1.39	872A	3.95	
ILD6	.93	6BI7GT	1.45	7C7	.83	35Z4GT	.69	923	1.35	2C34	.49	EF-50	.79	471A	.75	874	1.45	
ILD5	.93	6BN6	1.59	7E5	1.20	35Z5GT	.59	927	1.85	2C39	22.00	VT-52	.65	482A	1.95	876	6.00	
ILE2	.82	6BO6GT	1.26	7E6	.58	36	.69	2ACG	6.95	2C40	16.25	SS-501	12.50	503AX	1.65	886	3.50	
ILH4	.82	6B7G	1.32	7E7	.87	37	.69	1645	1.95	2C42	26.50	RK-59	2.44	506AX	1.47	954	.39	
ILN5	.91	6C5	.75	7F7	.99	38	.69	Thyratrons & Ignitrons		2C43	21.50	RK-60	1.95	506AX	1.47	955	.70	
IN5GT	.85	6CB6	.89	7F8	1.59	39 44	.59	OA4G	\$1.32	2C46	29.50	VT-62(Br)	1.15	507AX	1.47	955	.70	
IN6G	.97	6C6	.88	7G7	1.32	41	.79	OA4G	\$1.32	2C46	29.50	RK-63	22.50	527	12.25	956	.49	
IP5GT	.69	6CG	.96	7H7	.83	42	.89	EL-C1A	4.75	2C51	5.75	VT-67	.48	530	17.20	958	.69	
IO5GT	.69	6CD6G	2.40	7J7	1.32	43	.89	2ACG	6.95	2E22	1.85	72	1.32	532A	3.95	959	1.50	
IR5	.89	6D8G	.83	7L7	.97	45Z5GT	.79	2C33	4.95	2E24	4.10	73	1.32	WL-533	65.00	991	.45	
IS4	.71	6E5	1.10	7N7	.97	46	.81	2D21	1.55	2J21A	9.95	RK-75	3.50	559	2.20	1003	.79	
IS5	.81	6F5GT	.83	7O7	.83	47	.99	3C23	9.95	2J22	9.95	VR-75	5.95	561	3.50	CK-1005	.79	
IT4	.81	6P6	.99	7R7	.94	48	1.60	3C31 EL	1.60	2J26	26.50	OA3	1.51	HY615	4.95	1011	1.20	
IT5GT	.71	6P6G	.99	7S7	1.11	49	1.19	C1B	3.95	2J27	26.50	75T	5.80	WL670A	8.70	1201	3.25	
IU5	.81	6P8G	.85	7S7	1.11	50A5	1.41	3C45	17.50	2J31	39.50	VR-78	.64	700A	24.50	1203	.69	
IV	.69	6GGG	1.06	7Y4	.73	50B5	.88	3C45	28.75	2J32	42.50	VR-90	42.50	700B	24.50	1291	.69	
IX2	1.09	6H6	1.06	7Z4	.73	50B5	.88	EL-C5B	9.95	2J33	39.50	OB3	1.29	700C	24.50	1299	.69	
2A3	1.28	6H6GT	.83	10	.45	50L6GT	.79	5C22	53.45	2J34	39.50	VT-98	65.00	700D	24.50	1299	2.25	
2A5	.67	6J5	.75	12A	.65	53	.99	C6A	6.75	2J36	85.00	C100E	2.30	701A	4.95	1613	1.20	
2A7	.69	6J6	.69	12B	.75	53	.99	FG-17	55.75	2J38	17.50	100R	2.90	702B	4.25	1614	2.00	
2B7	.79	6J5GT	.64	12A6GT	.69	55	.99	FG-33	17.50	2J39	49.50	100TH	10.25	703A	6.95	1616	1.07	
2E5	.94	6K6	1.09	12A7	1.16	55B5	.99	FG-41	122.50	2J40	39.50	WE-101D	1.65	704A	.95	1619	.39	
2X2	.89	6J7	.79	12A8GT	.77	155B	.62	FG-67	14.80	2J41	175.00	WE-101F	3.62	705A	2.75	1620	6.25	
2X2A	1.85	6J7GT	.99	12AH7GT	1.32	56	.39	FG-81A	4.95	2J48	49.50	WL102F	2.85	706B	45.00	1622	2.30	
3A4	.65	6K8G	1.28	12AL5	.89	57	.89	91	7.85	2J50	39.50	VR-105	65.00	706BY	45.00	1624	1.95	
3A5	1.89	6K8GT	.69	12AT6	.59	58	1.29	FG-95/		2J50	39.50	OC3	1.20	706CY	45.00	1625	.45	
3A8GT	2.25	6K6GT	.99	12AT7	1.15	59	.89	5560	25.00	2JB51	2.50	WE-113A	1.32	706FY	45.00	1626	3.99	
3B7	.57	6K7	.83	12AU6	.79	70L7GT	.91	FG-104/		2J54	47.50	HY-114	.75	706GY	45.00	1629	.39	
3C6	1.15	6K7G	.88	12K7	.95	71A	.79	5561	24.60	2J55	87.50	WE-117A	.95	707A	9.95	1630	.95	
3D6	.57	6K8	1.22	12AV6	.63	75	.89	FG-106	95.00	2J56	150.00	F-123A	8.95	707B	4.95	1631	1.38	
3L74	.91	6K8GT	.96	12W6	1.20	76	.69	FG-106	95.00	2J61	45.20	WE-124A	3.80	708A	4.85	1632	.75	
3Q4	.77	6L5G	1.06	12AX7	1.08	77	.69	FG-172	39.50	2K23	37.50	F-127A	22.50	709A	4.87	1636	3.10	
3Q5GT	.83	6L6	1.82	12BA6	.72	78	.79	FG-178	14.50	2K25	33.50	VT-127A	3.60	710A	1.70	1638	.75	
3S4	.77	6L6G	1.79	12BA7	.95	79	.89	RX-233A	4.95	2K26	107.15	AB-150	12.50	713				

SEARCHLIGHT SECTION

**Sound Powered
Chest Set RCA—
With 24 Ft. Cord
Per Pair
USED \$17.60
NEW \$26.40**



**SOUND POWER HANDSET
BRAND NEW**
Includes 6 ft. cord.—No batteries
external power source—used.
\$18.50 pr.

POSTAGE STAMP MICAS

mmf	mmf	mmf	mmf	mmf	mmf	mmf	mmf	mfd	mfd
10	39	62	120	240	400	800	.001625	.0044	
20	49	75	150	250	430	820	.002	.006	
22	47	75	160	270	470	910	.0027	.0065	
23	50	80	175	300	500	.001	.0033	.0068	
24	51	82	180	330	510	.0012	.004	.0082	
25	56	90	200	360	580	.0013			
33	60	100	220	370	600	.00136			
		110	390	650		.0015			

Price Schedule

7 mmf to 910 mmf 5¢
 .001 mfd to .001625 8¢
 .002 mfd to .0032 mfd 15¢
 .01 mfd 28¢

SILVER MICAS

mmf	mmf	mmf	mmf	mmf	mmf	mfd	mfd
10	40	82	155	270	470	.0011	.0024
18	50	100	170	360	500	.0013	.0025
22	51	110	180	370	510	.0015	.0027
23	56	115	208	390	525	.0016	.00282
24	60	120	225	400	560	.0018	.003
27	62	125	240	410	570	.002	.0033
30	66	130	250	430	650	.0022	.0038
39	68	135	255	700		.0023	.0042
	75	150	280				

Price Schedule

8 mmf to 800 mfd 10¢
 .0011 mfd to .002 mfd 20¢
 .002 mfd to .0032 mfd 50¢

GEAR ASSORTMENT
 100 small assorted gears. Most are stainless steel or brass. Experimenters' dream! Only \$6.50

TYPE "J" POTENTIOMETERS

100 S.S.*	1,500 1/4S.S.	15K 1/4	200K S.S.*
150 S.S.*	2,000 1/4S.S.	25K S.S.	250K 5/8
300 S.S.*	2,500 S.S.	70K S.S.	250K 1/2S.S.*
400 S.S.*	3,000 3/8	80K S.S.	500K 1/2S.S.*
500 1/4	4,000 3/8	100K 7/16	1Meg S.S.
1,000 3/8	5,000 3/4*	100K S.S.*	
1,000 1/4	10K 5/8	200K 5/8	

* Split Locking Bushing **\$1.50 EACH**
 For Standard Brand Resistors—Check Us First
 Phone Write Wire Your Needs

COAXIAL CABLE CONNECTORS



15¢ UG175/U	\$1.20 83-1F	30¢ 83-1AP	75¢ 83-1J	40¢ SG-239	12¢ HOOD
83-1AC	\$.42	UG-22/U	1.30	UG-106/U	.12
83-1AP	.30	UG-22A/U	1.65	UG-167/U	5.70
83-1F	1.20	UG-22B/U	1.50	UG-175/U	.15
83-1H	.12	UG-23/U	1.20	UG-176/U	.15
83-1HP	.22	UG-23B/U	1.75	UG-185/U	1.35
83-1J	.75	UG-23C/U	1.90	UG-201	2.25
83-1R	.40	UG-24/U	1.30	UG-224/U	1.20
83-1RTY	.65	UG-25/U	1.35	UG-255/U	2.45
83-1SP	.50	UG-27/U	1.30	UG-260/U	1.20
83-1SPN	.55	UG-27B/U	3.45	UG-261/U	1.20
83-1T	1.30	UG-30/U	2.30	UG-290/U	1.20
83-2AP	1.95	UG-37/U	2.30	UG-306/U	2.95
83-2J	2.10	UG-37B/U	1.85	UG-499/U	1.25
83-2R	1.70	UG-38/U	.80	UG-625/U	1.35
83-22AP	1.40	UG-68A/U	1.15	CW-123A/U	.50
83-22R	.68	UG-69A/U	2.15	M-358	1.30
83-22SP	.80	UG-85/U	1.75	M-359	.30
83-16S	.15	UG-87/U	1.60	PL-258	.75
83-18S	.15	UG-88/U	1.10	PL-259	.50
83-1F	1.20	UG-89/U	1.35	PL-259A	.55
UG-13/U	1.70	UG-102/U	.80	PL274	1.20
UG-1R	.95	UG-103/U	.68	SO-239	.40
UG-21B/U	1.35	UG-104/U	1.40		

NEW COAXIAL CABLES

Price per 1,000 Ft.	Price per 1,000 Ft.
RG 5/U* \$140.00	RG 22A/U \$285.50
RG 6/U 180.00	RG 24/U 675.00
RG 7/U* 85.00	RG 26/U 475.00
RG 8/U 100.00	RG 29/U* 50.00
RG 9/U* 250.00	RG 34/U 300.00
RG 9A/U 275.00	RG 35/U 900.00
RG 10/U 240.00	RG 41/U* 295.00
RG 11/U* 100.00	RG 54A/U 97.00
RG 12/U 240.00	RG 55/U* 110.00
RG 13/U 216.00	RG 57/U* 325.00
RG 17/U* 650.00	RG 58/U* 60.00
RG 18/U 950.00	RG 58A/U 65.00
RG 19/U 1250.00	RG 59/U* 55.00
RG 20/U 1450.00	RG 62/U* 75.00
RG 21/U 220.00	RG 77/U* 100.00
RG 22/U* 150.00	RG11A/U* 150.00

Add 25% for orders less than 500 feet.
 * * No minimum order—others 250' minimum.

GET ON OUR MAILING LIST

RELIANCE MERCHANDIZING CO.
 Arch St. Cor. Croskey Phila. 3, Pa. Telephone RIttenhouse 6-4927

UNIVERSAL JOINT ALUMINUM
 1/4" hole x 1/2" O.D.
 1 1/8" long **85¢**

PRECISION RESISTORS—1/4 WATT—30¢

2	10.48	12.32	14.98	69.54	147.5	705
2.5	10.84	13.02	15.8	79.1	220.4	2,193
3.5	11.25	13.52	16.37	105.8	301.8	3,500
5	11.74	13.89		123.8	366.6	
6.68				125	414.3	59,148

PRECISION RESISTORS—1/2 WATT—35¢

.25	11.1	75	400	6,500	16,000	36,000
.334	13.15	87	723.1	7,000	16,700	37,000
.444	13.3	97.8	855	7,300	17,000	45,000
.502	15	125	970	7,500	21,500	47,000
.557	25	178	1,500	8,000	21,300	50,000
.627	44.73	179.5	2,500	8,500	25,000	56,000
.76	45	180	2,850	8,800	30,000	59,000
1.00	46	200	3,995	10,000	32,700	59,905
1.01	52	210	4,000	12,000	32,888	68,000
1.53	55.1	235	4,295	14,325	33,000	79,312
2.04	60	260	4,451	15,000	33,300	100,000
3.25	61	270	5,714	15,750	35,888	180,000
5.26	65	290	5,900	15,755		
5.89	66.6	298.3		15,810		

PRECISION RESISTORS—1 WATT—45¢

.1	2.58	15	60	425	7,000	55,000
.11	2.6	15	60	1,500	34,000	56,000
.2	2.66	28	250	2,250	9,000	65,000
.861	3.1	30	270	3,300	10,000	68,000
1.01	3.39	38	312	5,221	12,000	70,000
1.166	4.29	45.5	420		12,420	84,000
2.55	5.21	54.25			80,000	

PRECISION RESISTORS—1 WATT—60¢

100,000	149,500	270,000	348,000	560,000
105,000	150,000	290,000	399,000	600,000
120,000	166,100	310,000	413,000	645,000
128,000	240,000	320,000	520,000	650,000
130,000	260,000		522,000	700,000
132,000				

MEGOHM 1 WATT—1%—\$1.50—5%—60¢
PRECISION RESISTORS—2 WATT—75¢
 4,385 5,000 6,000 10,000 19,917
 Minimum Orders \$3 All orders f.o.b. PHILA. PA.

SAVE! SAVE! SAVE!

SURPLUS RADIO CRYSTALS

PRICED TO SELL . . . AT A FRACTION OF THEIR ORIGINAL COST
ALL FT-241-A HOLDERS • MFG. BY WESTERN ELECTRIC

AVAILABLE FOR THE FOLLOWING SETS

SCR 608-A (BC 684)	and	SCR 628-A	120 per set
SCR 528 (BC 604)	and	SCR 538	80 per set
AN/TRC		200 KC CRYSTALS	

(in FT-241-A Holders
 For ART-13 and BC 654

QUANTITIES AVAILABLE
 WRITE FOR PRICE QUOTATION ON YOUR REQUIREMENTS

C and H Sales Company
 BOX 356-Z EAST PASADENA STATION • PASADENA 8, CALIFORNIA

SEARCH RECEIVER—ARD-2

Frequency range 80 to 3000 Mcs.

Measures RF signals from 80 to 3000 Mcs and pulse rates from 50 to 8000 cycles.

The ARD-2 can be used as a Direction Finder to locate signals, or as a frequency meter, by VISUAL and AURAL indicators, provide Originally designed and used by USN aircraft. Ideally suited for military, laboratory and general purpose use.

Equipment consists of the following:
 Antenna Detector-CMD-66ARF—Has variable length antennas, diode detector and silver plated tuning stub with calibrated scale.
 AMPLIFIER CMD-50ADC—has three stage pulse amplifier, a trigger circuit, a pulse rate counter circuit and audio amplifier, visual signal indicator, rectifier power supply which is operative on 115 Volts AC 60 to 2400 cycles current, regulated.
 Test OSCILLATOR-CMD-60ABG — Has cavity frequency of 400 cycles with selection of four pulse repetition rates.

ALL CABLES AND FITTINGS, ACCESSORIES AND SHOCK MOUNTED RACK for immediate installation, plus two Technical Manuals.
 SPARE PARTS—Steel chest includes spares for components and two extra sets spare tubes.
 Guaranteed NEW

All the above in original export packed cases.
 Wt.: 113-lbs

Price each \$27500

Other selected equipment for Radio Communications in our stocks

Communication Devices Co.
 2331 Twelfth Ave. NYC 27, N. Y.
 Cable: Communidev Tel: Ad 4-6174

WHOLESALE ONLY

**ELECTRONIC COMPONENTS
 AIRCRAFT EQUIPMENT
 HYDRAULICS
 RADIO & ELECTRONIC SURPLUS**
 13933-9 Brush St. Detroit 3, Mich.
 Phone Townsend 9-3403

AN CONNECTORS

BLACK INSERTS MELAMINE INSERTS

50% OFF LIST 40% OFF LIST

IMMEDIATE SERVICE

Insert	3100	3101	3102	3106	3108	Shell	List Price	Shell	3100	3101	3102	3106	3108
8S-1S	\$1.59	1.63	1.19	1.59	2.61	18-25S	\$3.21	2.87	1.73	3.65	3.65	3.65	3.65
8S-1P	1.53	1.59	1.19	1.59	2.61	18-26P	2.72	2.76	1.68	2.96	4.00	4.00	4.00
10S-2S	1.48	1.53	1.08	1.39	2.47	18-26S	3.21	2.87	1.73	3.65	4.00	4.00	4.00
10S-2P	1.43	1.48	1.08	1.48	2.52	18-26P	2.72	2.76	1.68	2.96	4.00	4.00	4.00
10S-3S						18-27S	3.25	2.92	1.83	3.80	4.44	4.44	4.44
10S-3P	1.73	1.77	1.43			18-27P	2.96	3.07	2.03	3.21	4.44	4.44	4.44
10S-4S	1.59	1.63	1.19	1.53	2.76	18-28S	3.25	2.92	1.83	3.80	4.44	4.44	4.44
10S-4P	1.63	1.73	1.19	1.97	2.72	18-28P	2.96	3.07	2.03	3.21	4.44	4.44	4.44
12S-1S	1.68	1.68	1.24	1.97	2.87	18-29S	3.60	3.25	2.17	4.40	4.99	4.99	4.99
12S-1P	1.63	1.73	1.19	1.97	2.72	18-29P	3.80	3.45	2.37	4.59	4.99	4.99	4.99
12S-2S	1.68	1.68	1.24	1.97	2.87	18-30S	2.96	3.11	2.08	3.21	4.49	4.49	4.49
12S-2P	1.63	1.73	1.19	1.97	2.72	18-30P	3.31	2.92	1.12	3.76	4.99	4.99	4.99
12S-3S	1.68	1.68	1.24	1.97	2.87	18-31S	2.96	3.11	2.08	3.21	4.49	4.49	4.49
12S-3P	1.39	1.53	1.04	1.59	2.72	18-31P	3.44	4.69	3.60	4.75	4.99	4.99	4.99
12S-4S	1.39	1.53	1.04	1.59	2.72	20-1P	5.63	6.32	3.91	5.92	5.97	5.97	5.97
12S-4P	1.59	1.92	1.39	1.97	3.01	20-2S	3.11	3.31	1.83	3.45	4.25	4.25	4.25
12S-5P	1.53	1.73	1.24	1.92	2.81	20-2P	3.11	3.31	1.83	3.45	4.25	4.25	4.25
12S-6S	2.37	2.37	1.84	2.67	3.73	20-3S	3.71	3.76	2.23	3.50	4.84	4.84	4.84
12S-6P	3.14	3.49	2.61	3.79	4.56	20-3P	3.41	3.56	1.97	3.80	4.84	4.84	4.84
14S-1S	1.77	2.03	1.33	2.37	3.16	20-4S	3.36	3.36	2.08	3.76	4.93	4.93	4.93
14S-1P	1.77	2.03	1.33	2.32	3.16	20-4P	3.16	3.20	1.92	3.71	4.84	4.84	4.84
14S-2S	1.88	1.97	1.43	2.41	3.25	20-5S	3.07	3.16	1.68	3.45	4.40	4.40	4.40
14S-2P	2.08	2.17	1.63	2.37	3.50	20-5P	2.87	2.92	1.43	3.56	4.40	4.40	4.40
14S-3S	2.03	2.08	1.43	2.17	4.15	20-6S	3.25	3.45	2.03	3.60	4.40	4.40	4.40
14S-3P	2.08	2.12	1.43	2.57	3.95	20-6P	3.25	3.33	1.83	3.80	4.40	4.40	4.40
14S-4S	1.70	1.70	1.43	2.37	3.16	20-7S	3.51	4.15	2.87	3.80	5.09	5.09	5.09
14S-4P	1.39	1.48	1.08	1.97	2.81	20-7P	4.35	4.69	3.25	4.64	5.59	5.59	5.59
14S-5S	2.12	2.32	1.57	2.47	3.71	20-8S	4.40	4.44	3.01	5.33	5.33	5.33	5.33
14S-5P	2.12	2.37	1.59	2.81	3.71	20-8P	4.20	4.29	2.81	4.89	5.09	5.09	5.09
14S-6S	2.57	2.47	1.73	3.07	4.20	20-9S	4.29	4.40	2.92	4.79	5.09	5.09	5.09
14S-6P	2.61	2.61	1.83	3.47	4.09	20-9P	4.15	4.20	2.76	4.64	5.09	5.09	5.09
14S-7S	2.23	2.23	1.63	2.76	3.76	20-10S	3.36	3.36	2.08	3.76	4.93	4.93	4.93
14S-7P	1.97	1.97	1.43	2.37	3.16	20-10P	3.16	3.20	1.92	3.71	4.84	4.84	4.84
14S-8S	2.08	2.08	1.53	2.37	3.56	20-11S	4.44	5.04	3.60	4.75	6.92	6.92	6.92
14S-8P	1.97	1.92	1.43	2.23	3.36	20-11P	5.63	6.03	4.59	5.92	6.92	6.92	6.92
14S-10S	2.17	2.17	1.63	2.52	3.65	20-12S	3.56	3.60	2.12	4.44	4.35	4.35	4.35
14S-10P	2.12	2.17	1.63	2.52	3.65	20-12P	3.36	3.45	2.03	3.80	4.35	4.35	4.35
14S-11S	2.37	2.37	1.83	2.72	3.85	20-13S	3.65	3.65	2.27	4.84	5.59	5.59	5.59
14S-11P	2.08	2.08	1.53	2.37	3.56	20-13P	3.11	3.76	2.27	3.45	4.59	4.59	4.59
14S-12S	2.08	2.08	1.53	2.37	3.56	20-14S	4.40	4.44	3.11	5.59	5.59	5.59	5.59
14S-12P	2.08	2.08	1.53	2.37	3.56	20-14P	3.91	4.44	2.92	4.15	5.28	5.28	5.28
14S-13S	2.08	2.08	1.53	2.37	3.56	20-15S	4.55	4.69	3.21	5.15	4.93	4.93	4.93
14S-13P	2.08	2.08	1.53	2.37	3.56	20-15P	4.55	4.79	3.31	4.89	5.63	5.63	5.63
14S-14S	2.17	2.17	1.63	2.52	3.65	20-16S	4.44	4.49	3.11	4.89	5.43	5.43	5.43
14S-14P	2.37	2.37	1.83	2.72	3.85	20-16P	4.44	4.55	3.11	5.63	5.43	5.43	5.43
16S-1S	2.61	2.87	2.23	3.21	3.85	20-17S	4.44	4.55	3.11	5.63	5.43	5.43	5.43
16S-1P	2.87	2.87	1.88	3.21	4.40	20-17P	4.20	4.29	2.81	4.59	5.19	5.19	5.19
16S-2S	2.27	2.32	1.68	2.72	3.56	20-18S	4.84	4.93	3.41	5.83	6.40	6.40	6.40
16S-2P	2.17	2.17	1.63	2.52	3.65	20-18P	4.75	4.79	3.31	5.83	6.40	6.40	6.40
16S-3S	1.83	1.92	1.24	2.23	3.41	20-19S	4.20	4.25	2.81	5.39	5.19	5.19	5.19
16S-3P	1.83	1.92	1.24	2.23	3.41	20-19P	3.91	4.15	2.72	4.21	5.04	5.04	5.04
16S-4S	1.92	2.03	1.39	2.37	3.21	20-20S	4.25	4.29	2.81	4.40	5.24	5.24	5.24
16S-4P	1.92	2.03	1.39	2.32	3.56	20-20P	3.80	3.91	2.41	4.40	4.79	4.79	4.79
16S-5S	2.17	2.17	1.63	2.76	3.56	20-21S	4.59	4.75	3.25	4.93	5.63	5.63	5.63
16S-5P	2.17	2.17	1.63	2.76	3.56	20-21P	4.44	4.44	3.11	5.43	5.43	5.43	5.43
16S-6S	2.17	2.17	1.63	2.76	3.91	20-22S	4.44	4.55	3.11	5.43	5.43	5.43	5.43
16S-6P	2.12	2.17	1.53	2.52	3.71	20-22P	4.25	4.35	2.87	4.55	5.24	5.24	5.24
16S-7S	2.67	2.72	2.08	2.61	4.15	20-23S	3.71	3.80	2.32	4.64	6.49	6.49	6.49
16S-7P	2.37	2.52	2.08	2.81	3.91	20-23P	3.36	3.45	2.03	3.80	4.35	4.35	4.35
16S-8S	2.37	2.72	2.08	3.07	3.65	20-24S	3.91	4.00	2.57	5.04	4.89	4.89	4.89

List Prices Shown—Deduct 50% on Black Inserts—40% on Melamine Inserts

16S-8P	2.61	2.47	1.92	2.87	3.71	18-24P	4.59	4.75	3.65	4.84	6.13	6.13	6.13
16S-9S	2.72	2.87	2.12	3.25	4.29	20-24P	3.71	3.80	2.32	4.35	4.69	4.69	4.69
16S-9P	2.57	2.67	2.03	3.01	4.05	20-25S	4.44	5.04	3.60	4.75	5.92	5.92	5.92
16S-10S	2.61	2.76	2.12	3.11	4.09	20-25P	5.63	6.03	4.59	5.92	6.92	6.92	6.92
16S-10P	2.27	2.52	1.83	2.47	3.91	20-26S	3.80	3.91	2.23	3.80	4.55	4.55	4.55
16S-11S	2.27	2.37	1.59	2.72	3.80	20-26P	3.45	3.71	2.23	3.80	4.55	4.55	4.55
16S-11P	2.27	2.37	1.59	2.72	3.80	20-27S	4.44	5.04	3.60	4.75	5.92	5.92	5.92
16S-12S	2.67	2.72	2.08	3.07	4.15	20-27P	5.63	6.03	4.59	5.92	6.92	6.92	6.92
16S-12P	2.37	2.47	1.77	2.76	3.85	20-28S	4.44	5.04	3.60	4.75	5.92	5.92	5.92
16S-13S	2.96	3.02	2.19	3.92	4.74	20-28P	5.63	5.97	4.44	5.92	6.57	6.57	6.57
16S-13P	2.50	2.50	1.92	3.07	4.09	20-29S	4.20	4.25	2.81	4.40	5.24	5.24	5.24
16S-15S	2.03	2.08	1.43	2.37	3.60	20-29P	6.13	6.53	5.09	6.42	7.42	7.42	7.42
16S-15P	1.97	2.08	1.39	2.37	3.60	20-30S	4.44	5.04	3.60	4.75	5.92	5.92	5.92
16S-16S	2.03	2.08	1.53	2.37	3.60	20-30P	5.63	6.03	4.59	5.92	6.92	6.92	6.92
16S-16P	1.97	2.08	1.39	2.37	3.60	21-1S	3.71	3.71	2.03	4.25	5.04	5.04	5.04
16S-17S	3.57	4.47	2.77	2.81	3.71	21-1P	3.41	3.45	1.88	4.00	4.53	4.53	4.53
16S-17P	3.12	3.28	1.83	3.11	3.71	21-2S	3.44	3.45	2.07	5.24	5.63	5.63	5.63
18-1S	3.65	3.80	2.87	3.91	5.19	21-2P	3.95	4.00	2.57	4.40	5.33	5.33	5.33
18-1P	4.00	4.15	3.16	4.49	5.72	21-3S	3.71	3.76	2.32	4.79	5.04	5.04	5.04
18-2S	3.51	3.16	2.08	3.71	4.69	21-3P	3.36	3.36	1.97	3.95	4.75	4.75	4.75
18-2P	2.61	2.72	1.63	3.80	4.25	22-4S	4.00	4.09	2.52	4.55	4.89	4.89	4.89
18-3S	2.76	2.76	1.63	3.31	4.44	22-4P	3.41	3.41	2.03	4.60	4.49	4.49	4.49
18-3P	2.76	2.76	1.63	3.31	4.44	22-5S	3.95	3.95	2.57	4.15	5.33	5.33	5.33
18-4S	2.87	2.92	1.83	3.11	3.95	22-5P	3.71	3.71	2.27	3.91	5.19	5.19	5.19
18-4P	3.07	2.96	2.03	3.16	4.55	22-6S	3.80	3.85	2.37	5.04	5.09	5.09	5.09
18-5S	2.76	2.76	1.63	3.16	4.44	22-6P	3.56	3.56	2.12	4.29	3.56	3.56	3.56
18-5P	2.96	2.67	1.88	2.96	4.44	22-7S	3.85	3.85	2.47	4.75	5.24	5.24	5.24
18-6S	2.87	2.92	1.83	3.11	4.28	22-7P	3.41	3.41	2.03	4.60	4.49	4.49	4.49
18-6P	2.72	2.81	1.73	2.96	4.25	22-8S	3.71	3.91	2.52	4.15	5.24	5.24	5.24
18-7S	3.36	3.11	2.03	3.60	4.64</								

SURPLUS EQUIPMENT

PE 218 Leland Electric

Output: 115 VAC; Single Phase; PF 90; 880/500 cycle 1500 VA. Input: 25-28 VDC; 93 amps; 8000 RPM; Exc. Volts 27.5. **BRAND NEW**\$39.95 ea.

16086 Leland Electric

Output: 115 VAC; 400 Cycle; 3-Phase; 175 VA; 80 PF. Input: 27.5 DC 12.5 amp; Cont. Duty\$90.00 ea.

PIONEER 12130-3-B

Output: 122.5 VAC; 1.15 amps, 400 cycle single phase, 141 VA. Input: 20-30 VDC, 18-12 amps. Voltage and frequency regulated\$89.50 ea.

INVERTERS



10563 LELAND ELECTRIC

Output: 115 VAC; 400 cycle; 3-phase; 115 VA; 75 PF. Input: 28.5 VDC; 12 amp.\$80.00 ea.

12116-2-A PIONEER

Output: 115 VAC; 400 cyc; single phase; 45 amp. Input: 24 VDC 5 amp.\$90.00 ea.

10285 LELAND ELECTRIC

Output: 115 Volts AC; 750 V.A., 3 phase, 400 cycle, .90 PF, and 26 volts, 50 amps, single phase, 400 cycle, .40 PF. Input: 27.5 VDC, 60 amps, cont. duty, 6000 RPM, Voltage and Frequency regulated.\$195.00

94-32270-A LELAND ELECTRIC

OUTPUT: 115 Volts, 190 V.A., Single Phase; 400 cyc.; .90 PF, and 26 Volts, 60 V.A., 400 cyc., .40 PF. INPUT: 27.5 Volts DC, 18 amps; Cont. Duty, Voltage and frequency regulated\$95.00

5 RPM GEAR HEAD MOTOR



Mfg. RAE., Type 7519, 115 Volts AD, DC. Fractional HP, Overall dimension: 5 1/2"\$12.95 ea. Lots of 10\$11.95 ea.

METERS

AMMETER: DC; 2" 100-100, complete with external shunt\$5.95 ea. **AC Volt:** Westinghouse, Type NA-35-3 inch round, F.S.-10 MA\$6.95 ea.

MICROPOSITIONER

Barber Colman AYLZ 2133-1 Polarized D.C. Relay: Double Coil Differential sensitive; Alnico P.M. Polarized field, 24V contacts; .5 amps; 28 V. Used for remote positioning, synchronizing, control, etc.\$12.50 ea.

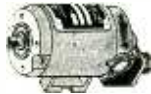

BLACK & DECKER MOTOR AN 94-32159-A; Volts 24; 1 amp; series wound; 12,000 RPM; 1/75 H.P.; Cont. duty; overall size 5-3/8" x 3" dia.\$9.95 ea.

6 RPM GEAR BOX MOTOR

110 Volt, 60 cyc., Single Phase; Ratio—544:1; Mfg. by Merkle-Korff Gear Co., Overall dimensions approx. 3 1/2" x 3 1/2"\$9.95 ea. Lots of 10\$9.50 ea.



Merkle-Korff 20 RPM motors, 60 cycle, 110 V. AC.Like New, \$6.95 ea.

Merkle-Korff motor, 24 Volt AC, 60 cycle, CCW Rotation, 110-1 Ratio, 30 RPM \$7.95 ea.

Victor Adding Machine Motors geared down to 56 RPM. Have built-in over running clutch; 60 cycle, 110 V. AC, Universal type. Net cost new \$35.00.Like New, \$12.95 ea.

DELCO FAN—TYPE S.S.P.



115 Volts AC, 50/60 cycle, 6-inch blades, rubber shock mounted. Noiseless, ideal for exhaust and cooling. Complete with mounting as pictured. New, original cartons\$6.95 ea.

BLOWER ASSEMBLY

115 Volt, 400 Cycle, Westinghouse Type PL, 17CFM, complete with capacitor. New\$12.50 ea.

ALL EQUIPMENT FULLY GUARANTEED

Please enclose full amount with order
All prices net FOB Pasadena, Calif.
Prices subject to change without notice

G. E. ALTERNATOR

208 Volts, 400 Cycle, 3 Phase Mod. 2CM97B1
55.5 Amps., PF .75, Speed 8000 KW 15, Cont. Duty, Limited Quantity\$320.00

SERVO MOTOR 10047-2-A; 2 Phase; 400 Cycle; with 40-1 Reduction Gear\$10.00 ea.

PIONEER TORQUE UNITS

TYPE 12604-3-A: Contain CK5 Motor coupled to output shaft through 125:1 gear reduction train. Output shaft coupled to autosyn. follow-up (AY43). Ratio of output shaft to follow-up Autosyn is 15:1 \$70.00 ea.
TYPE 12606-1-A: Same as 12604-3-A except it has a 30:1 ratio between output shaft and follow-up Autosyn\$70.00 ea.
TYPE 12602-1-A: Same as 12606-1-A except it has base mounting type cover for motor and gear train\$70.00 ea.

400 CYCLE MOTORS

AIRESEARCH: 115V; 40 CPS; Single phase; 6500 RPM; 1.4 amp; Torque 4.6 in. oz.; HP .03\$10.00 ea.
EASTERN AIR DEVICES TYPE JM6B: 200 VAC; 1 amp; 3 phase; 400 cycles; 6000 RPM\$12.50 ea.
EASTERN AIR DEVICES, TYPE J31B: 115 V, 400-1200 Cycle, Single Phase\$12.50 ea.
AIRESEARCH: AC Induction, 200 V; 3 Phase, 400 Cycle, 2 H.P.; 11,000 RPM; 8 amps\$79.50 ea.
AIRESEARCH: AC Induction, 200 V; 3 Phase, 400 Cycle, .12 H.P., 6500 RPM; 1.5 amps\$25.00 ea.
Electric Motor: PNT-1400-A1-1A Serial No. 207, 208 V., 400 cycles, 3 phase, Kearfott Co., Inc.\$17.50 ea.

SYNCHRONOUS SELSYNS

110 volt, 60 cycle, brass cased, approx. 4" dia. x 6" long. Mfg. by Diehl and Bendix.



Quantities Available

REPEATERS\$15.00 ea.
TRANSMITTERS\$15.00 ea.

SYNCHROS

IF Special Repeater (115V-400 Cycle)\$15.00 ea.
2J1F3 Generator (115V-400 cyc.)\$10.00 ea.
5CT Control Transformer; 90-50 Volt; 50 Cyc.\$50.00 ea.
5F Motor (115/90 volt—60 cyc.)\$60.00 ea.
5G Generator (115/90 volt—60 cyc.)\$50.00 ea.
5SDG Differential Generator (90/90 volts—400 cyc.)\$30.00 ea.
TRANSMITTER, BENDIX C-78248; 115 Volt, 60 Cycle.\$25.00 ea.
REPEATER, BENDIX C-78410; 115 Volt, 60 Cycle.\$37.50 ea.
REPEATER, AC synchronous 115 V., 40 cycle, C-78863\$15.00 ea.

ALNICO FIELD MOTORS

(Approx. size overall) 3 3/8" x 1 1/2" diameter)
Delco-Type 5069230; 27.5 volts, DC, 145RPM \$19.95 ea.

POWER RHEOSTATS

Standard Brands: 5 Ohms; 100 Watt; 4.48 amps 100 Ohms; 100 Watt; 1.0 amp.

Boxed, Brand New with Knob \$2.50 each—or—\$25.00 per Doz.

SMALL DC MOTORS

(Approx. size....4" long x 1 1/4" dial.)
General Electric Type 5A10AJ37; 27 volts, DC; .5 amps, 8 oz inches torque; 250 RPM; shunt wound; 4 leads; reversible.\$12.50 ea.
General Electric, Mod. 5BA10FJ33; 12 oz. inches torque, 12 V DC, 56 RPM, 1.02 amp.\$15.00 ea.
General Electric-Type 5BA10AJ52C; 27 volts, DC; .5 amps, 8 oz. inches torque; 145 RPM; shunt wound; 4 leads; reversible\$12.50 ea.

SENSITIVE ALTIMETERS

Pioneer Sensitive altimeters, 0-35,000 ft. range, calibrated in 100's of feet. Barometric setting adjustment. No hook-up required.\$12.95 ea.

PIONEER GYRO FLUX GATE AMPLIFIER Type 12076-1-A, complete with tubes\$27.50 ea.

MOTOR GENERATORS

G.E. Model 5LY77A11; Input 115 volts D.C.; 1 1/2 H.P. motor; 13 amp; 3600 RPM; shunt contact regulated. Output: 115 Volts A.C. 60 cycles; KVA .06; shunt self excited.\$120.00 ea.
MG-183; Input: 70 Volts DC, 5.4 amps, 1/3 H.P., 3500 RPM. Output: 50 Volts AC, 2.5 amps., 175 cycles, 3 phase, .225 KVA.\$79.00 ea.

PIONEER AUTOSYNS

AY-1 26 Volt—400 Cycle\$6.95
AY-5 26 Volt—400 Cycle\$7.95
AY27D\$25.50
AY6—26 Volt—400 cyc.\$4.95 ea.
AY30D—26 Volt—400 cyc.\$25.00 ea.
AY14D\$14.00
AY34\$20.00
AY20—26 Volt—400-cyc.\$12.50 ea.

AC CONTROL MOTOR

Diehl Mfg. Co., FPE-25-7, 20 Volts, 2 phase, 1600 RPM, .85 amps\$15.00 ea.

SINE-COSINE GENERATORS

(Resolvers)
Diehl Type FJE-43-9 (Single Phase Rotor). Two stator windings 90° apart, provides two outputs equal to the sine and cosine of the angular rotor displacement. Input voltage 115 volts, 400 cycle.\$25.00 ea.
Diehl Type FPE-43-1 same as FJE-43-9 except it supplies maximum stator voltage of 220 volts with 115 volts applied to rotor\$35.00 ea.



BOX 356-X EAST PASADENA STATION • PASADENA 8, CALIFORNIA

NEW YORK'S RADIO TUBE EXCHANGE



TYPE	PRICE	TYPE	PRICE	TYPE	PRICE
0A2	51.40	2J32	63.95	4J41	199.00
0A3	1.75	2J38	105.00	6B5	3.95
0B2	1.75	2J38	17.95	6BP1	6.95
0C3	1.25	2J40	35.00	6BP4	6.95
0D3	1.25	2J42	189.00	6CP1	6.95
C1B	6.95	2J49	109.00	6D21	27.50
1B21A	2.75	2J50	195.50	8J1P1	27.50
1B22	3.95	2I85	95.00	8J2P1	27.50
1B23	9.95	2J61	75.00	JP4	19.50
1B24	17.95	2J62	75.00	WE8AK6	2.50
1B26	2.95	2K26	37.50	6C21	25.50
1B27	15.50	2K28	37.50	6C3	10.95
1B28	4.10	2K29	37.50	7BP7	7.95
1B28	33.00	2E41	150.00	7DP4	10.00
1B42	19.95	2K46	149.50	7DP4	10.00
1B51	9.95	2V2G	2.10	12AF4	65.00
1B64	49.95	3BP1	7.80	16E	1.95
1B60	69.95	3B2A	5.90	16R	1.95
1N21	1.35	3B24W	7.50	NE16	.68
1N21A	1.75	EL30	5.95	FG17	6.95
1N21B	4.25	4C22	120.00	RX21	3.95
1N22	1.75	3C24	1.95	FG33	12.95
1N23	2.00	3C31	5.95	86T	4.95
1N28	2.00	3DP1A	10.95	4K Special	3.95
1N28A	3.75	3DP182	12.00	RF30	2.95
1N28B	6.00	3E20	15.50	H F50	1.75
1N37	6.00	3GFP1	2.25	VT62	2.5
1N48	2.50	8N4	5.50	RK39	1.95
1B22	1.95	4A1	1.75	RK72	1.95
2B26	3.75	4A21	2.75	RK73	1.95
2C24	.38	4B26	10.95	100TH	9.95
2C40	26.00	4C27	25.00	FG105	19.00
2C49	27.00	4C28	35.00	203A	8.95
2C44	.90	4E27	17.50	217C	18.00
2D21	1.75	4J26	199.00	242C	10.00
2E22	3.75	4J26	199.00	244A	12.95
1E30	2.75	4J27	199.00	249C	4.95
2J21	17.95	4J31	199.00	250TL	19.95
2J22	17.95	4J32	199.00	274A	3.00
2J26	27.75	4J33	199.00	274B	3.00
2J27	29.95	4J37	199.00	304TH	15.00
2J31	29.95	4J39	199.00	304TL	14.50
				307A	4.95

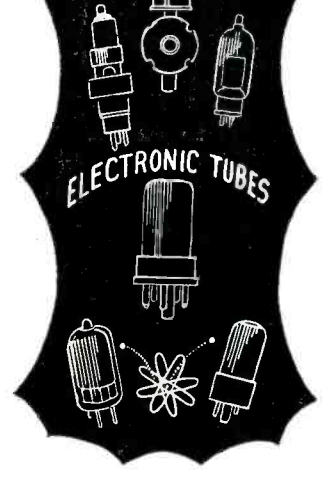

TYPE	PRICE	TYPE	PRICE	TYPE	PRICE
310A	7.95	724A	4.95	885	1.75
311A	7.95	724B	6.95	889R	199.50
312A	3.95	725A	9.95	914	75.00
323A	25.00	726A	18.00	931A	6.95
327A	3.95	726B	56.00	954	.35
328A	9.95	726C	69.00	955	.58
350A	7.95	728AY	27.00	966	.59
360B	5.95	801A	1.00	967	.29
367A	20.00	802	4.25	958A	.69
368AS	6.95	803	7.95	991	.65
371B	2.95	804	13.50	E114B	.35
385A	4.95	805	5.95	1280	1.99
388A	2.95	806	25.00	1611	1.95
394A	7.95	807	1.69	1613	1.38
MX408U	.75	808	3.50	1616	2.95
417A	27.95	810	11.00	1619A	.89
431A	29.95	811A	3.15	1622	2.75
448A	1.95	813	9.95	1624	2.00
448B	6.40	814	3.95	1925	.45
460TH	45.00	815	3.50	1851	1.88
460TL	45.00	816	1.45	2050	1.88
464A	8.95	829	12.95	8013	1.60
471A	2.75	829A	13.95	8012	4.28
527	15.00	829B	15.95	8013	2.95
WL630	3.50	830H	3.50	8019A	5.95
WL631	22.50	832	7.95	8018	1.75
WL633	17.50	832A	9.95	8020	3.50
700A/D	25.00	833A	49.95	8025	6.95
701A	7.50	834	7.95	PD8366	89.00
703A	6.95	836	4.95	9001	1.78
706A	3.95	837	2.95	9002	1.50
707A	17.95	838	6.95	9003	1.75
707B	27.00	845	5.99	9004	1.75
714A	17.95	849	52.50	9005	1.98
716A	7.95	851	80.50	9006	.35
716B	18.00	880	4.95		
717C	25.00	881	39.50		
717A	1.95	886A	1.79		
718AY/EY	48.50	899B	57.50		
719A	29.50	899B X	35.00		
721A	3.95	873A	1.95		
722A	3.95	878	1.95		
723A/R	17.95	884	1.95		

Minimum Order \$25.00

ATTENTION OIL COMPANY ENGINEERS SHIP SUPPLIERS USERS OF SHORAN WE HAVE FOR IMMEDIATE DELIVERY TESTED AND GUARANTEED PERFECT, NEW **4C28 SPECIAL PRICE \$35.00**



MICROWAVE TEST EQUIPMENT TS148/UP SPECTRUM ANALYZER

Field type X Band Spectrum Analyzer, Band 8430-9580 Megacycles.

Will check Frequency and Operation of various X Band equipment such as Radar Magnetrons, Klystrons, TR Boxes. It will also measure pulse width, c-w spectrum width and Q of resonant cavities. Will also check frequency of signal generators in the X band. Can also be used as frequency modulated Signal Generator etc. Available new complete with all accessories, in carrying case.

Also available of new production TS239A Synchroscope and TS147/UP X Band Signal Generator.

Other test equipment, used checked out, surplus.

- | | | |
|--|-------------------------------------|---|
| TSK1/SE K Band Spectrum Analyzer | TS36/AP X Band Power Meter | TS251 Range Calibrator APN9 |
| TS3A/AP Frequency and power meter S Band | TS47/APR 40-400 MC Signal Generator | TS270 S Band Echo Box |
| RF4A/AP Phantom Target S Band | TS69/AP Frequency Meter 400-1000 MC | TS147 X Band Signal Generator |
| TS10/APN Altimeter Test Set | TS100 Scope | TS239A Synchroscope |
| TS12/AP VSWR Test Set for X Band | TS102A/AP Range Calibrator | |
| TS13/AP X Band Signal Generator | TS108 Power Load | SURPLUS EQUIPMENT |
| TS15/AP Flux Meter | TS110/AP S Band Echo Box | APA10 Oscilloscope and panoramic receiver |
| TS16/AP Altimeter Test Set | TS125/AP X Band Power Meter | APA38 Panoramic Receiver |
| TS33/AP X Band Power and Frequency Meter | TS126/AP Synchroscope | APS 3 and APS 4 Radar |
| TS34/AP Western El. Synchroscope | TS174/AP Signal Generator | APR5A Microwave Receiver |
| TS34A/AP Western El. Synchroscope | TS175 Signal Generator | APT2 Radar Jamming Transmitter |
| TS35/AP X Band Signal Generator | TS226 Power Meter | APT5 Radar Jamming Transmitter |

MINIMUM ORDER 25 Dollars

YOU CAN REACH US ON TWX NY1-3235

Cables: TELSERSUP

SPECIAL
Wide Band S Band Signal Generator 2700/3400MC Using 2K41 or PD 8365 Klystron, Internal Cavity Attenuator, Precision individually calibrated Frequency measuring Cavity. CW or Pulse Modulated, externally or internally.

Large quantities of quartz crystals mounted and unmounted.
Crystal Holders: FT243, FT171B others.
Quartz Crystal Comparators.
North American Phillips Fluoroscopes Type 80.
Large quantity of Polystyrene beaded coaxial Cable.

LIBERTY ELECTRONICS, INC.
135 LIBERTY STREET NEW YORK 6, N. Y.
PHONE WORTH 4-8262

IMMEDIATE DELIVERY *Servo-Tek* **FULLY GUARANTEED**

BLOWER ASSEMBLY



Lear frame CO10, 5500 rpm motor with 3" Sirroco impeller. Motor 28 v. DC @ 1.2 Amps. Output 10 watts. Cont. duty. Stock #SA-347 Price \$9.75 each.

Radio Compass Indicator



I-82F. Compass Indicator. 0-360°-5 in. dial, 26 v. 400 cy. 8-12 v. 60 cy. Ideal position indicator. Stock #SA-284.

Price \$6.50 each

JA1 MOTOR (D-C)



Electric Specialty. 1/4 hp. 24 v. D-C. (Wing flap motor.) Stock #SA-325. Price \$19.50 ea.

OSTER PM MOTOR



Alineo Field

27.5 v. d-c. Can also be used as rate generator. #SA-281. Price \$8.75 each

DIEHL PM MOTOR



Type FD6-31-1. 27.5 V. D.C. 10,000 rpm. Dual Shaft. Shaft ext. 5/8" ea. end. Diam. 0.120, Motor 1" Sq. x 2" Lg. Stock #SA-355. Price \$13.25 each.

800 CYCLE INVERTERS

ECLIPSE Type 800—Model 1, Style D. 24-28 v. DC input @ 62 Amps. 8000 rpm. Output 115 volts 800 cycles single phase. 7.0 Amps. Stock #SA-502. Price \$69.50 each.

G. E. Type 5AS1211J2. Navy Type CRV-21AAR. 27 v. DC input @ 62 Amps. Output 120 volts 800 cycles single phase at 750 VA. VOLTAGE and FREQUENCY REGULATED. Stock #SA-192. Price \$59.50 each.

60 CYCLE AMPLIDYNES

G.E. Types 5AM45DB15 and 5AM73AB95. Type 45DB15 input 115 v. 60 cy. at 5 amps. Output 250 volts DC at 0.6 amp. Stock #SA-147.

Type 73AB95 input 115 volts 60 cy. at 9 amps. Output 250 volts DC at 1.5 amps. Stock #SA-257.

PRICES ON REQUEST

DELCO CONSTANT SPEED MOTOR A-7155



1/30 hp. 27.5v d-c 3600 rpm. Cont. duty. 2 1/2" diam. x 5 1/2" lg. 3/8" shaft extension. 5/32" diam. 4 hole base mounting. Stock #SA-34. Price \$19.50 each.

BLOWER ASSEMBLY



Delco 27 v. DC motor, 5400 rpm. 3" Sirroco impeller. Shunt motor, 4 in./oz. torque. Base Mtg. Stock #SA-352. Price \$9.75 each.

27.5 VOLT DC MOTOR



John Oster Type E-7-5 4 lead shunt. 1/20th hp. Internal fan cooled 4 3/4" lg. 3 3/4" diam. 7/8" shaft extension. 5/16" diam. 3650 rpm. Stock #SA-31. Price \$19.50 each.

HOLTZER CABOT MG SETS

Type MG-221. Input 32 volts DC at 8.5 amps. 3430 rpm. Output 110 volts at 1.0 amps. 400 cy. Single phase. 100 watts. Stock #SA-506. Price \$99.50 ea. Type MG-218. Input 115 volts DC at 2.3 Amps. Output 110 volts 400 cy. Single phase. 100 watts. Stock #SA-507. Price \$119.50 ea.

BLOWER ASSEMBLY



WESTINGHOUSE FL BLOWER

115 v. 400 cy. 17 c.f.m. Includes capacitor. Stock #SA-144. Price \$14.50 ea.

Pioneer Servo Motor



Type 10047-2A, 2 φ 400 cycle low inertia. 26 v fixed phase. 45 v. max. variable phase. Stock #SA-90. Price \$12.50 each.

SELSYN SPECIALS



General Electric 2J1F1 & 2J1F3

115 v. 400 cycle Selsyn Generator. Large quantity.

Prices on request

INVERTERS



Wincharger PU-7/AP Input 28 VDC at 160 amps. Output 115 v. 400 cy. 1 φ at 2500 VA. Voltage and frequency regulated. Cont. duty. Stock #SA-164. Price \$119.50 each.

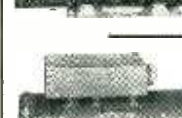

G.E. 5AS181NJ3 (PE-118) Input 26 VDC at 100 amps. Output 115 v. 400 cy. 1 φ at 1500 VA. PF 0.8 W.E. Spec. KS-5601L1 Stock #SA-286. Price \$39.50 each.



PE-218E Inverters Russell Electric and Leland. Input 28 VDC at 92 amp. Output 115 v. 400 cycles at 1500 VA. PF 0.9. Stock #SA-112A. Price \$69.50 each.



Pioneer 12130-4-B Input 28 VDC at 14 amps. Output 120 v. 400 cy. single phase at 1.15 amps. (140 VA.) Voltage and frequency regulated. Made 1949. Stock #SA-304. Price \$99.50 each.

AUTOSYN POWER SUPPLY (CONVERTER)

PIONEER Dwg. 12108-2B. Designed to supply 26 v. 400 cycle excitation to from 20-50 Pioneer Autosyn units. Input voltage 24 v. DC at 3.0 Amps. 4000 rpm. Stock #SA-504. Price \$59.50 each.

DIEHL DC MOTOR



Type FDE-83-2. 24v @ 9.5 Amps. 1/6 hp. 6350 rpm. Cont. duty. Motor 4 1/4" diam. x 5" Lg. with 1" shaft ext. x 3/8" dia. front mtg. flange 4 1/4" Sq. Stock #SA-354. Price \$19.50 ea.

DC MOTOR



John Oster Type A-161-A-2B. 28 v. DC Shunt wound. 8000 rpm. 0.09 oz./in. torque. Large Qty. Prices on request.

AUTOSYN MOTOR



Bendix-Marine 851

32 v. 60 cycle excitation. Use as either generator or repeater. Stock #SA-158. Price \$24.50 each.

KOLLSMAN TELETORQUE



Kollman Type 403 self synchronous units. (Synchro) 115 volt 60 cycle excitation. Use as either generator or repeater. Stock #SA-79. Prices on request.

115 VOLT D-C MOTOR



G.E. Type SD. 1/20 hp. 4 lead shunt. Reversible. Double shaft extensions. Speed 1725 rpm. Large Quantity. Special \$19.50 each.

LEAR POSITIONING MOTOR



Model 156A. 115 watt 24 v. DC motor. 10,000 rpm. Int. duty. Reversible. Dual rt. angle output shaft. Release clutch. 7:1 reduction to output. 250:1 reduction to limit switches. Stock #SA-343. Prices on request

MAGNETIC AMPLIFIER

Pioneer Type 12077

115 v. 400 cy. One Tube Servo Amplifier using saturable reactor type outlet transformer. Limited Quantity

SYNCHROS AND SELSYNS

Navy Types

A; M; 1SF; 5G; 5F; 5SDG; 6SG; 5SF; 5HSF 6DG; 7G; etc.

Army Types

II; IV; V; VII; IX; XXI; XV; etc.

G.E. Types

2J6F2; 2JD5J2; 2J5A2; 2J5HA1; 2J1H1; 2J1F1; 2J1G1; 2J1F3; 2JD5HB1; 2J5LA1; 2JD5C2. etc.

SERIES MOTOR

John Oster Type A-21D-7A



24 v. DC. 0.005 hp. .6 Amps. 11,000 rpm. Cont. duty. 1-1/2" diam. x 2-1/2" lg. Front flange mtg. Shaft 3/16 dia. x 5/8" ext. Stock #SA-353. Price \$8.75 each.

WRITE FOR LISTING

Prices F.O.B. Paterson
Phone ARMory 4-3366
Teletype PAT. 199

Servo-Tek

products co.

4 Godwin Ave. Paterson, N. J.

SPECIALISTS IN FRACTIONAL HORSE POWER MOTOR SPEED CONTROL

IMMEDIATE DELIVERY - - FULLY GUARANTEED

A. C. SYNCHRONOUS MOTORS

110 Vt. 60 Cycle
 HAYDON TYPE 1600, 1/240 RPM
 HAYDON TYPE 1600, 1/60 RPM
 HAYDON TYPE 1600, 4/5 RPM
 HAYDON TYPE 1600, 1 RPM
 HAYDON TYPE 1600, 1 1/5 RPM
 TELECHRON TYPE B3, 2 RPM
 TELECHRON TYPE BC, 60 RPM
 HOLTZER CABOT, TYPE RBC 2505, 2 RPM, 60 oz. 1 in. torque.

SERVO MOTORS

PIONEER TYPE CK1, 2 ϕ , 400 CYCLE
 PIONEER TYPE 10047-2-A, 2 ϕ , 400 CYCLE, with 40:1 reduction gear.

D. C. MOTORS

BODINE NFHG-12, 27 VTS., governor controlled, constant speed 3600 RPM, 1/30 H.P.
 DELCO TYPE 5068750, 27 VTS., 160 RPM, built in brake.
 DUMORE, TYPE E1Y2PB, 24 VTS., 5 AMP., .05 H.P., 200 RPM.
 GENERAL ELECTRIC, TYPE 5BA10AJ18D 27 VTS., 110 RPM, 1 oz. 1 ft. torque.
 GENERAL ELECTRIC, TYPE 5BA10AJ37C 27 VTS., 250 RPM, 8 oz., 1 in. torque.
 BARBER COLMAN ACTUATOR TYPE AYLC 5091, 27 VTS., .7amp., 1 RPM, 500 in. lbs. torque.
 WHITE ROGER ACTUATOR TYPE 6905, 12 VT., 1.3 amp. 1 1/2 RPM, 75 in. lbs. torque.

ENGINE HOUR METER

JOHN W. HOBBS, MODEL MI-277 records time up to 1000 hours, and repeats, operates from 20 to 30 volts.

AMPLIDYNE AND MOTOR

AMPLIDYNE, GEN. ELEC. 5AM31NJ18A, input 27 VTS., at 44 amp. output 60 vts. at 8.8 amp., 530 watts.
 MOTOR, GEN. ELEC. 5BA50LJ22, armature 60 vts. at 8.3 amp., field 27 vts. at 2.9 amp. 1/2 H.P., 4000 RPM.

INVERTERS

WINCHARGER CORP. PU 16/AP, MG750, input 24 vts., 60 amps. output 115 vts., 400 cycle, 6.5 amp., 1 phase.
 HOLTZER CABOT, TYPE 149F, input 24 vts. at 36 amps., output 26 vts. at 250 V.A. and 115 vts. at 500 V.A., both 400 cycle, 1 phase.
 PIONEER TYPE 12117, input 12 vts., output 26 vts. at 6 V.A., 400 cycle.
 PIONEER TYPE 12117, input 24 vts., output 26 vts. at 6 V.A., 400 cycle.
 WINCHARGER CORP. PU/7, MG2500 input 24 vts. at 160 amp., output 115 vts. at 21.6 amp., 400 cycle, 1 phase.
 GENERAL ELECTRIC, TYPE 5D21NJ3A, input 24 vts. at 35 amps., output 115 vts. at 485 V.A., 400 cycle, 1 phase.
 LELAND, PE 218, input 24 vts. at 90 amps. output 115 vts. at 1.5 K.V.A., 400 cycle, 1 phase.
 LELAND, TYPE D.A. input 28 vts., at 12 amp. output 115 vts. at 115 V.A., 400 cycle, 3 phase.

PIONEER AUTOSYNS 400 CYCLE

TYPE AY1, AY5, AY14G, AY14D, AY20, AY27D, AY38D, AY54D.
 PIONEER AUTOSYN POSITION INDICATORS & TRANSMITTERS.
 TYPE 5907-17, single, ind. dial graduated 0 to 360°, 26 vts., 400 cycle.
 TYPE 6007-39, dual ind., dial graduated 0 to 360°, 26 vts., 400 cycle.
 TYPE 4550-2-A, Transmitter, 2:1 gear ratio 26 vts., 400 cycle.

VOLTAGE REGULATOR

LELAND ELEC. CO. TYPE B, CARBON PILE. Input 21 to 30 volts D.C. regulated output 18.25 vts. at 5 amp.

WESTERN ELEC. TYPE BC937B, input 110 to 120 volts 400 cycle. Output variation 0 to 7.2 ohms at 5 to 2.75 amps.

WESTERN ELEC. TRANSTAT, input 115 vts., 400 cycle output adjustable from 92 to 115 vts., rating .5 K.V.A.

AMERICAN TRANS. CO., Transtat input 115 vts., 400 cycle output 75 to 120 vts. or 0 to 45 volts, rating .72 K.V.A.

TACHOMETER GENERATOR & INDICATOR

GENERAL ELECTRIC, GEN. TYPE AN5531-1, Pad mounting 3 phase variable frequency output.

GENERAL ELECTRIC, GEN. TYPE AN5531-2, Screw mounting 3 phase variable frequency output.

GENERAL ELECTRIC, IND. 8DJ13AAA, works in conjunction with above generators, range 0 to 3500 RPM.

SYNCHROS

I F SPECIAL REPEATER 115 vt. 400 cycle.

2J1F1 GENERATOR, 115 vt. 400 cycle.

2J1F3 GENERATOR, 115 vt. 400 cycle.

2J1G1 CONTROL TRANSFORMER 57.5 vt. 400 cycle.

2J1H1 DIFFERENTIAL GEN. 57.5/57.5 vt. 400 cycle.

5G GENERATOR, 115 vt. 60 cycle.

5DG DIFFERENTIAL GEN. 90/90 vts. 60 cycle.

5HT CONTROL TRAN. 90/55 vts. 60 cycle.

5CT CONTROL TRAN. 90/55 vts. 60 cycle.

55DG DIFFERENTIAL GEN. 90/90 vts. 400 cycle.

D. C. ALNICO FIELD MOTOR

DIEHL TYPE FD6-23, 27 vts. 10,000 RPM.

DELCO TYPE 5072400, 27 vts. 10,000 RPM.

GENERAL ELECTRIC D. C. SELSYNS

8TJ9-PAB TRANSMITTER 24 VTS.

8TJ11- INDICATOR, dial 0 to 360°, 24 vts.

RECTIFIER POWER SUPPLY

HAMMETT ELECTRIC MFG. CO. MODEL SPS-130

Input voltage 208 or 230 volts, 60 cycle, 3 phase, 21 amps. Output 28 volts at 130 amps. continuous duty, 8 point tap switch, voltmeter ammeter, thermo reset all on front panel.

MISCELLANEOUS

PIONEER MAGNETIC AMPLIFIER ASSEMBLY
 Saturable reactor type, designed to supply variable voltage to a servo motor such as CK1, CK2, CK5 or 10047.

SPERRY A5 CONTROL UNIT, part No. 644836.

SPERRY A5 AZIMUTH FOLLOW-UP AMPLIFIER part No. 656030.

SPERRY A5 DIRECTIONAL GYRO, part No. 656029, 115 vt. 400 cycle, 3 phase.

SPERRY A5 PILOT DIRECTION INDICATOR, part No. 645262 contains AY 20.

ALLEN CALCULATOR, TYPE CI, TURN & BANK IND., part No. 21500, 28 vts. D. C.

TYPE CI, AUTO-PILOT FORMATION STICK, part No. G1080A3.

PIONEER GYRO FLUX GATE AMPLIFIER, type 12076-1-A, 115 vt. 400 cycle.

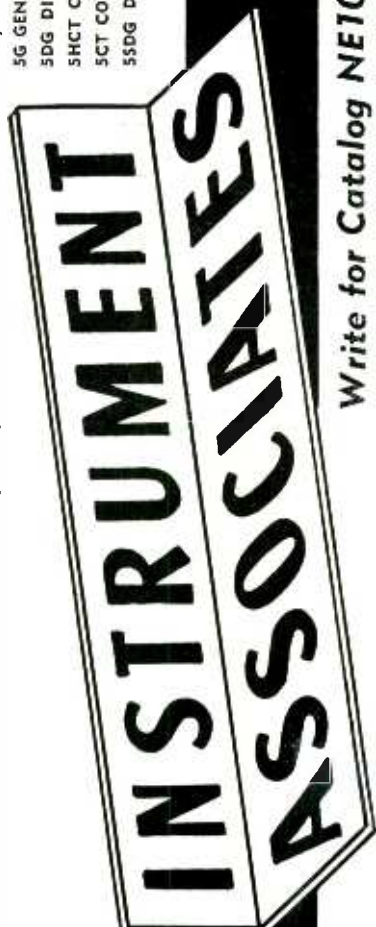

Write for Catalog NE100

U. S. Export License-2140

Western Union address:
WUX Great Neck, N. Y.

351 GREAT NECK ROAD, GREAT NECK, N. Y.
Telephone Great Neck 4-1147

Buy TOP Radio-Electronic Values!

SIGNAL CORPS TRANSFORMERS— CHOKES & FILTERS

2C6191/K1	2Z9619-99	2Z9638-44	3C317-43
2C6191/T3	2Z9621-43	2Z9643-42	3C317-44
2C6191A/3	2Z9621-112	2Z9647-11	3C323-6C
2C619F/T2	2Z9625-1	2Z9655	3C323-14A
2C6230/123	2Z9625-8	2Z9662	3C323-54B
2C6230-3/124	2Z9626	2Z9702-2	3C323-122B
2C6307/AK1	2Z9627-35	2Z9760	3C323-145B
2C6386A/T14	2Z9628-2	2Z9805	3C324-4
2C6494A/C11	2Z9631-7	2Z9808	3C324-40
2C6530-653A/C10	2Z9631-187	2Z9828	3C343-2
2C6530-653A/T5	2Z9632-8	2Z9851	3C344
2Z3625-66	2Z9632-14	2Z9853	3C344-9
2Z5731-337	2Z9632-39	2Z9854	3C362-8
2Z9600-1	2Z9632-170	2Z9855	3C375-15
2Z9604-16	2Z9632-171	2Z9876-2	3C549
2Z9608-36	2Z9632-248	2Z9878-11	3C573
2Z9611-115	2Z9632-362	2Z9878-13	3C575G-1
2Z9611-289	2Z9632-365	2Z9879-2	3C62-23
2Z9612-52	2Z9632-366	2Z9879-3	3C62-24
2Z9613-14	2Z9634-4	2Z9879-3	3C1987-20
2Z9613-304	2Z9634-5	2Z9900-5	3C1987-29
2Z9614-94	2Z9634-39	2Z9944	3C4075
2Z9617-22	2Z9634-46	2Z9984	3F4061B/C1
2Z9618-9	2Z9634-49	3C106B	6C8/F1
2Z9618-42	2Z9636-16	3C307-1	
2Z9619-42	2Z9638-14	3C307-46	
2Z9619-63	2Z9638-16	3C317-33	

MORE INFORMATION AND PRICES UPON REQUEST

OIL FILLED CONDENSERS

Stock No.	Capacity MFD.	D. C. WKG. Voltage	Dimensions	Price Each
6057A	2	600	1" x 1-3/4" x 2-3/4"	\$0.59
5994A	4	600	1-1/4" x 2-1/2" x 3-1/4"	1.75
5865A	4	1000	1-1/4" x 2-1/2" x 4-3/4"	1.95
6102A	4	1000	1-1/4" x 3-3/4" x 4-3/4"	2.50
6101A	4	1500	1-1/4" x 3-3/4" x 4-1/2"	2.75
6103A	0.5	5000	2-1/4" x 4" x 4-1/8"	2.95
6104A	1	5000	3-5/8" x 4-1/2" x 4-1/8"	4.25
5399A	0.045	16000	1-3/4" x 3-1/2" x 4-3/4"	4.95
6052A	2 X .15	8000	1-3/4" x 3-1/2" x 4-3/4"	4.95

All have ceramic insulated terminals except No. 5865A which has bakelite insulated terminals. All are NEW, standard name brands.

10 MFD. — 600 VDC

Sprague No. R2-157, 10 Mfd. 220 VAC 600 VDC Capacitor with Universal Mounting Ring, 2-7/16" Diameter, 3 3/4" high. Bakelite insulated terminals.

Stock No. 5658A Price Each **95¢**

SPECIAL PURPOSE TUBES

1B23	7.95	860	2.00
304TL	6.95	872A	3.00
368AS	5.00	874	.79
3E29	9.95	1616	.75
718BY	25.00	1619	.50
724B	2.50	1626	.75
725A	5.95	1629	.75
803	2.95	8020	1.00
811	2.00	8025	3.50
826	.50	3BP1	2.75
837	1.00	5BP1	3.75
838	1.95	5BP4	3.75

2 VOLT BATTERY

Signal Corps Type BB-54A 2 Volt 27 Ampere Hour Storage Battery. Non-Spillable Transparent Acid Proof Plastic Case has Built-in Bail Type Hydrometers. 3" x 4" x 5" High. Shipped Dry with acid in Separate container. Made by Willard.

Carton of 12 @ \$1.60 Each

Stock No. 5458A Price Each **\$1.95**

INVERTERS

Wincharger PU-7/AP Input 28VDC at 160 Amps. Output 115V, 400cy, 1 ϕ at 2500VA. Voltage and frequency regulated Cont. duty.

PRICE EACH **\$95.00**

PE-125AX Vibrator power Supply. Input 12 or 24 VDC. Output 500VDC. @ 160MA.

PRICE EACH **\$25.00**

TRANSMITTING MICAS

Stock No.	Cap.	Test Volts	Type No.	Price Each
5493A*	.01	1000	1445	.35¢
5494A	.02	1000	144T	.40¢
5495A	.006	1200	A2	.40¢
5496A	.001	1500	BE 15	.20¢
5493A	.04	2500	F	.30¢
5495A	.001	5000	F	.60¢
5600A	.0036	5000	A2	\$1.00
5601A	.15	1000V	XS	1.90
5602A	.00007	2500V	3	.90¢
5603A	.00005	3000V	15L	1.00
5604A	.0001	5000V	F2L	1.00
5605A	.0008	5000V	F2L	1.00
5606A	.000025	10,000	PL-34L	1.95
5607A**	.00015	10,000	PL-315	7.95

* Supplied with Meter Bracket
** D.C. Working Voltage
OTHER TYPES AND SIZES AVAILABLE

MISCELLANEOUS ITEMS

AIRCRAFT CAMERA K-25 with carrying case \$125.00

SCR-522 w/Control Box, Dynamotor PE-94C and Antennas, new & with all tubes, \$95.00 each

BC 659 A&K Receiver and Transmitter, good used \$19.95

HEAVY DUTY 10 ft. SJ-7/16 Dia. BUNA CORD, 2 ins. #14 strd Conductors w/heavy duty plug \$.60 each

W.E. D163119-A. plug in type Relay \$9.95 each

500 ohm AB type J POT, Indiv. Boxed w/set screw knob, used on Control Box C-76/APS-13 \$.49 each

SMALL MOTORS

OSTER B9-2. 5600 RPM. 12 VDC @ 1.2 Amps. \$7.00 Ea.

OSTER C-2H-1A 7000 RPM. 27.5 VDC 1/100 HP. \$7.50 Ea.

KOLLSMAN Type 775-01 Mo-26. \$2.50 Ea.

WESTINGHOUSE 115 volt 400 C. Blower. Type FL. 6700 RPM. \$6.95 Ea.

MISCELLANEOUS ITEMS

TS-13 Handset \$7.95

TS-9 Handset \$7.95

T-46 Chestset \$1.95

AN-104A Antenna \$1.50

BD.57A Switchboards \$20.00

J-5 Flameproof keys \$.95

J-38 Keys \$.95

Fenwal #S1080 Therman Switches. \$3.95

Guardian BK-17A Relay \$2.95

MS-52-53 Mast Sections \$.95

MP-48A Mast Bases. \$5.95

2Z 9635-25 ARC/3 Transformer ... \$5.00

6.3 VOLT FILAMENT TRANSFORMERS

Primary 115 Volt 60 Cycle 1600 Insulation Three 6.4 Volt Secondaries

6.3 Volts @ 4.9 Amps.
6.3 Volts @ 4.5 Amps.
6.3 Volts @ 1.1 Amps.

Stock No. 5254A
Horizontal Half Shell Mounting. 2 1/4" x 2 13/16" Mounting Centers. 2 13/16" x 3 3/8" Core Size. 2 1/2" above Chassis. Solder Lug Terminals—All Terminals Marked.



Price **\$2.65** EACH

TERMS:

Open Account to rated or acceptable reference accounts. Others Pre-payment of 25% deposit with order, balance C.O.D. Price F.O.B. Chicago and subject to change without notice. Merchandise subject to prior sale.

ORDER TODAY!

Radio Surplus Corp.

732 South Sherman Street
Chicago 5, Illinois
Phone: HARRISON 7-5923

MOTOR GENERATORS

2.5 KVA Diehl Elec. Co. 120DC to 120AC, 60 cy., 1 Ph., Complete with Magnetic Controller, 2 Field Rheos and full set spare parts including spare armatures for generator and motor. New. \$295.00
 2 KVA O'Keefe and Merritt. 115DC to 120AC, 50 cy., 1 Ph. Export Crated. New. \$195.00
MOTOR GENERATOR, TYPE CGU-2
 Unit of U. S. Navy TCK-7 Transmitter
 Motor: 2 H.P., 230 V.D.C., 10 amps.
 Generator: 1800V. D.C., 0.4 A, 500V. D.C., 0.35A.
 115 V. D.C., 1.5A, 12 V. D.C., 2A. 3480 R.P.M.
 Self excited. Brand new including spare armature. \$365.00

INVERTERS

Onan M-G-.215H. Navy type PU/13. Input 115/230, 60 cy., 1 Ph. Output: 115, 480 cy., 1 Ph., 1.2KW and 24V DC at 4 amps. New. \$295.00
 Leland Elec. Co. PE208A. Input: 28DC at 38 Amps. Output: 80V, 800 cy, 1 Ph., 485VA. New. \$22.50
 G.E. J8169172. Input: 28DC. Output: 115, 400 cy., 1 Ph. 1.5KVA. New. \$32.50
 G.E. 5AS1315511A. Model 218J. Input: 28DC. Output: 115, 400 cy., 1 Ph., 1.5KVA. Regulated. New. \$89.50
 Holtzer-Cabot M.G. 164. Input: 440, 3 Ph., 60 cy., Output: 70V, 148 cy, 3 Ph., 0.140KVA. New \$67.50
 Eicor. 32DC to 110AC, 60 cy., 1 Ph. at 2.4 Amps. New. \$39.50

DYNAMOTORS

Navy type CAJO-211444. Input: 105 to 130DC. Output: either 28DC at 20 amps, or 13DC at 40 amps. Radio filtered and complete with line switch. New. \$89.50
 Type 54CM. For SCR-522. Brand new in overseas cases. \$19.50

AMPLIDYNES

G.E. 5AM211J7. Input: 27VDC. Output: 60VDC. 150 Watts, 4800 RPM. Type MG-27-B. New \$34.50
 Edison 5A W31N18A. Input: 27VDC, 44 Amps. 8300RPM. Output: 60VDC at 8.8 Amps. 530 Watts. New. \$22.50

SMALL D.C. MOTORS

G.E. 5BA50LJ2A. Armature 27VDC at 8.3 Amps. Field 60VDC at 2.3A. RPM 4000, H.P. 0.5. New. \$27.50
 Oster E-7-5. 27.5DC. 1/20HP, 3600RPM. Shunt Wound. New. \$9.50
 Dumore Co. type ELBG. 24VDC. 40-1 gear ratio. For type B-4 Intervalometer. New. \$8.50

BLOWERS

Westinghouse. Type FL. 115V. 400 cy., 6,700 RPM. Airflow 17CFM. New. \$3.50
 E.A.D. Type J50-CW-60 cycle-NEW. \$15.50

SYNCHROS

Ford Inst. Co. Synchro Differential Generator. Mod. 3 Type 5SDG. 90/90V. 400 cy., Ord. Dr. 173020. New. \$22.50
 Armor. Synchro Differential Generator. Type 6DG. New. \$60.00
 Hobart Mfg. Co. Synchro Differential Synchro Type XIX 115V. 60 cy. New. \$9.50

PARABOLOIDS

Spun Manganese dishes 17 1/2" dia. 4" deep. Mounting brackets for elevation and azimuth control on rear. 1 1/2 x 1 1/2" opening in center for dipole. Brand new. per pair. \$12.50

SOUND POWERED CHEST SETS

U. S. Instrument Co. No. A-260 Combination headset and chest microphone. Brand new, including 20 ft. of rubber covered cable. \$17.50 each
 W.E. Laboratory Headsets—Type 316 B, 600 ohms at 1000 C.P.S.
 Brand new—Price per set. \$6.50

RELAYS

Struthers-Dunn 1BX129, 110 A.C. \$2.60
 Advance type 455C, SPDT, 115 A.C. \$1.95
 Leach type 1154A, SPDT, 115 A.C. \$2.35
 Leach type 1054, BSN 20-28V D.C. \$2.35
 Clare Plug-in base No. 30FMY 115 A.C. \$3.50
 G.E. Plug-in base Sensitive K271853. \$4.50
 Western Electric D-163781 Plug-in. \$10.00
 Guardian Time Delay type B-9-SPDT. \$2.95
 Hayden Time Delay 17717 110V/60. \$4.75

HI-VOLT CAPACITORS

.25 Mfd., 20KV. \$26.50
 .25 Mfd., 15KV. \$22.50
 1 Mfd., 15KV. \$44.50
 1 Mfd., 7.5KV. \$12.50
 2 Mfd., 6.0KV. \$14.50
 50 KV Capacitors also available various sizes. Write for list.

MODEL AN/APA-10 PANORAMIC ADAPTER



Provides 4 Types of Presentation:
 (1) Panoramic (2) Aural
 (3) Oscillographic (4) Oscilloscopic

Designed for use with receiving equipment AN/AIR-7, AN/AIR-5, AN/APR-4, SCR-537 or any receiver with I.F. of 455 kc. 5.2mc or 30mc. With 21 tubes including 3" scope tube. Converted for operation on 115 V. 60 cycle source.
 Price \$245.00
 Gov't Cost \$1800.00.
 AN/APA-10 80 Page Tech Manual. \$2.75

TEST EQUIPMENT

TS-127/U Lavole Freq. Meter—375 to 725 MC.
 TS-47APR Test Osc. 40-500MC.
 TS-487/U Peak to Peak VTVM.
 AN/APR-1 Receiving sets.
 R111A/APR-5A Receiver—1000 to 6000 MC.
 AN/APR-4 Tuning Units TN-17 (76-300 MC).
 AN/APR-4 Tuning Units TN-18 (300-1000 MC).
 AN/APR-4 Tuning Units TN-19 (950-2200 MC).
 TU-58 Range "A" Tuning Units (110-370 MC).
 AN/APA-10 Panoramic Adapters 115V/60 cycles.

Repair Parts for BC-348 (H, K, L, R only)

Also BC 224 Models P, K. Coils for ant., r.f., det., osc., I.F., c.w. osc., xtal filters, 4 gang cond., front panels, dial assemblies, vol. conds., etc. Write for complete list and free diagram.
HIGH QUALITY CRYSTAL UNITS
 Western Electric—type CR-1A/AIR in holders. 1/2" pin spacing. Ideal for net frequency operation. Available in quantities, 5910-6350-6370-6470-6510-3610-6670-6690-6940-7270-7350-7380-7390-7480-7580-9720. All fundamentals in KC. Good multipliers to higher frequencies. \$1.25 each

RADAR

Antenna-Trans-Rec. Unit ASG-1.
 Radar Set SQ complete with spares.
 Modulator type SO-11.
 Pulse Timers CUZ-50AGD (SD-5 Radar).
 Radar Crystal Units 98.35kc, Raytheon.
 IN21B Sylvania Diodes.
 Repeater Adapters CRM-50 AFO.
 SO Series Accessory Control Panels.
 SO Series Transmitter-Receiver unit.
 CARD 23AEK Bearing Control Units for SO Series. Auxiliary Rectifier.

RADAR ANTENNAS

Type SO-1 (10CM) assembly with reflector, waveguide nozzle, drive motor, etc. New. \$279.50
 Type SO-3 (3 CM.) Surface Search type with reflector, drive motor, etc., but less plumbing. New in original cases. \$189.50
 Type SO-13 (10CM.) Complete assembly with 2 1/2" dish, dipole, drive motor, gearing, etc. New \$149.50
 Also in stock — spare reflectors, nozzles, probes, right angle bends for SO-1 antennas.

RECTIFIERS

G.E. No. 6 RC89F16 for 54 cells 10 amps.
 Mallory APS-20—In: 115/230/60/3. Out: 12/42V-65-130V.
 Turret Trainer Supply. In: 220/60/3. Out: 28V-130A.
 Complete specs. on request.

TERMS: Rated Concerns Net 30, FOB Bronxville, New York. All Merchandise Guaranteed. Prices Subject to Change

400 CYCLE TRANSFORMERS

AUTO. 400 cy. G.E. Cat. No. 80G184.
 KVA .9455-.520P Volts 400/345/200/115.
 New. \$69.95
FILAMENT—400/2600 CPS. Input—0.75/80/85/105/115/125V. Output—5V3A/5V3A/5V6A/6.3V 0.5A. No. 7249010—New. \$3.95
PLATE WECO KS 9560 800 cy. Pri: 115V. Sec: 1350-0-1350 at .057A (2700 V. Total). Elestat shielded. Wt. 2.3 lbs. New. \$2.95
 Plate. Thordarson #T46889. 1650 VA. Pri: 105-120V. 500 cy. 1 PH. Sec: 5600V. Center tapped. 1.5KV. insulation. Brand new. \$49.50
PLATE & FIL. WECO KS9555, 400 cy. Pri: 115V. Sec. #1: 930-0-930. Sec. #2: Three 6.3V windings. \$4.95
FILAMENT. 8.2V/2100 cps. WECO KS9553. Pri: 115V. Sec: 8.2V/1.25A/6.35V/1.5A Elestat shielded. Wt. 0.5 lbs. New. \$2.95
PLATE & FIL. 400/2600 cy Pri: 0/80/115V. Sec: #1=1200VDC at 1.5MA. Sec. #2=400 VDC at 130MA. Fil Secs: 6.4V/3A/6.35V/0.8A (ins. 1500V)/5V2A/5V2A. \$5.98. 4 Henry 100MA. \$2.75

HIGH POT TRANSFORMERS

High Voltage Trans. Westinghouse Pri: 115. 60 cy. Sec: 15,000 C.T., 60 MA. Good for HI-Pot test set up. C. T. ungrounded. \$39.50

PULSE TRANSFORMERS

PULSE WECO KS-9563 Supplies voltage peaks of 3500 from 807 tube. Tested at 2000 Pulses/sec and 5000 peak. Wdg. 1-2=18 ohms. Wdg. 1.3=22 ohms. L of Wdg. 1.3=082H at 100 cps. \$7.50
PULSE. WECO KS-161310. 50 KC to 4MC. 1 1/2" Dia. x 1 1/2" high, 120 to 2350 ohms. New. \$6.75
 High Reactance Trans. G.P. type Y-362A.—60 cy. Voltage 11200-135. Inductance H.V. Winding 135 Henries. Output: Peak Voltage 22.8KV. Cat. 8318065G1. New. \$89.50

RAYTHEON VOLTAGE REGULATORS

Adj. input taps 95-130V., 60 cy. 1 Ph. Output: 115V. 60 Watts, 1/2 of 10% Rd. Wt. 20 lbs. 6 1/2" H x 8 1/2" L x 4 1/2" W. Overload protected. Sturdily constructed. Tropicalized. Special. \$16.75

AMPLIFIERS

GE Servo type 2CV1C1 400 cycle
 Constant Output Line RC-730C
 Synchro Amplifiers for Radar
 Intercommunication type BC-605

ANTENNAS

MR-162 Coast Guard 23 1/2 ft. whips
 AS-33 APT-2, AT-35A/APT, AS-62/APS-13
 AS-125/APT for APT-5A
 TDY RADAR JAMMER HORNS
 PARABOLOIDS, MAGNESIUM DISHES 17 1/2" dia.
 SCR-623-A (part of RC-153-B Antenna)
 CU 64/APT Antenna matching unit 50 ohm unbal. to 100 bal.

POTENTIOMETERS

W.E. KS-15138 Linear Sawtooth
 W.E. KS-8732 for SCR1547 Radar
 W.E. KS-8801 Motor Driven

LINEAR SAWTOOTH POTENTIOMETER

W.E. KS-15138
 Has continuous resistance winding to which 24 volts D.C. is fed to two fixed taps 180° apart. Two rotating brushes 180° apart take off linear sawtooth wave voltage at output. Brand New. \$5.50

MISCELLANEOUS

Cathode Ray Shields for 3" tube. \$3.75
 Variac type Motor Controls 600 watt. \$13.50
 10 CM Waveguide 90° elbow. \$20.00
 Adel Clamps assorted types—write for samples
 Shock Mounts Lord #20. \$4.40
 Shock Mounts U. S. Rubber #5150C. \$3.30
 Commando Pole Jacks (Cook Elec. Co.) \$1.00
 Switchboard Lamp Receptacles & Jewels. \$4.40
 SCR522 Transmitter Receivers. Brand New
 Fire Detector Wileolator
 No. A-4242. Ord. No. B 257736. \$1.00
 Dial Drive Assembly for Bendix, MN-28-Y. \$4.50
 Instruction Manual for SCR-195A, B, C, D, E \$1.50
 Solenoid Cannon 24 V.D.C.—New. \$2.60
 Attenuators Tech-Lab 500/500 type 700. \$4.75
 Volume control Dual for BC-433G. \$2.85
 Switch 600V., 60A. Bendix CB19078. \$9.50
 Switch Arkless 9 sec. Rotary. \$4.50
 Switch Arkless 16 sec. Rotary. \$7.50
 Switch Panels SA-2/ERC. \$12.50
 Switch Micro R-RL2T. \$6.65
 Switch Navy Rotary #647491. \$17.50
 Connector CRP-23AGO for SG-1 radar. \$24.75
 Band-Switch assembly for AR-88 receiver. \$9.50
 RTT-AN/APN-1 Receivers
 RC-4231B Modulators
 RC-1366M Jack Boxes—Large quantity
 Sweep Generator Capacitors 5/10 mfd. \$2.50

ELECTRONICRAFT
 INC.
 27 MILBURN ST. BRONXVILLE 8, N. Y.
 PHONE: BRONXVILLE 2-0044

INDICATORS
 ID-24/ARN-9. \$12.50
 IO-14/APN-1. \$7.95
 ID-60/APA-1 Panoramic Adapter converted for 60 cycle operation—complete with tubes and 80 page Tech. Manual. \$245.00

COMMUNICATIONS EQUIPMENT CO.

WANTED

RADAR SETS AND PARTS
 ANY AND ALL TYPES.
 Also SURPLUS ELECTRONIC PARTS
 WHAT HAVE YOU TO SELL

RADARS

- AN/AP5-2 Airborne S Band Radar
- AN/AP5-3 Airborne 3CM Radar
- AN/AP5-4 3CM Airborne Radar
- RU/GF Complete Airborne Xmttr-Rev'r \$99.50
- SO-1 ICCM SEA Radar, 115VDC
- SN 1CCM Portable Radar, 115V, 60Cy.
- PP-4/APQ-2 DC Power Supply from 400 Cy. 65.00
- MK 10 10CM Gun Laying Radar
- MK IV 800MC Gun Laying Radar
- SO-8 10CM Radar 115V DC
- CPN-8 10CM NAV. Beacon, Ground Sta.
- SG 10CM Heavy Duty Ship Radar
- AN/APN-4 Lorain Set, Airborne
- AN/APN-3 Shore, Xmttr. only
- SE 10 cm Surface Search Radar
- RA-30 H.V.P. Power Supply
- AN/APN-7 Airborne Beacon, 10CM.
- BM or BG IFF Sets, 115VAC

MICROWAVE ANTENNA EQUIPMENT



- AT49A/APR—Broadband Conical, 300-3300 MC. Type N Feed. (AS SHOWN) \$12.50
- AS-31/APN-7: 10 cm Polyrad in Lucite Ball, Type N Fitting Coax Feed. \$22.50
- Relay System Parabolic reflectors approx. range 2000 to 6000 Mc. Dimensions 4 1/2" x 3". New. \$100.00
- Dipole for above \$12.00
- Radar rotating antenna, 10 cm. 30 deg. beam, 115 V AC drive. New. \$150.00
- Parabolic Peel. Radiation pattern approx. 25 deg. in horizontal, 33 deg. in vertical planes. \$35.00
- Cone Antenna. AS 125 A.P.H. 1000-3200 mc. Stub supported with type "N" connector. \$14.50

140-600 mc Directional Antenna

140-310 mc cone and 300-600 mc cone, each consisting of 2 end feed half wave conical sections with enclosed matching stub for reactance changes with changing frequency.
 New: complete with mast, guys, cables, carrying chest \$49.50

30' SIGNAL CORPS RADIO MASTS

Complete set for erection of a full flat top antenna. Of rugged plywood construction telescoping into 3 ten-foot sections for easy storage and transportation. A perfect set-up for getting out. Supplied complete: 2 complete masts, hardware, shipping crate. Shipping wt. approx. 300 lbs. Sig. Corps No. 2A289-223-A. New. \$39.50 per set

AS14A/AP, 10 CM pick up dipole assy. complete w/length of coax and "N" connectors. \$3.50

AS46A/APG-4 Yagi Antenna, 5 element array. \$22.50

30' Parabolic Reflector Spun Aluminum dish. \$4.85

THERMISTORS VARISTORS

D167018	1.50	D171812	1.50
D167332	1.50	D172155	1.50
D167613	1.50	D167176	1.50
D166228	1.50	D168387	1.50
D164699	2.50	D167208E	D171858
D166792	2.15	308A, 3A, 27-B	1.50
		D168403	2.15

RADAR TRAINER

Bench set designed for training personnel in use of ASB radars, or any sets using "B" presentation. Simulates convoy, ship, land, sea return with adjustable amplitude, range and azimuth. Brand new, in original cases, complete with all cables and instruction book. Prices and additional info on request.

T-4 CHRONOGRAPH HEAD

Consists of RF head, using 723A/B oscillator, 1 trans. antenna, and 1 receiving antenna. All cables used for field testing of projectile velocity. Entire equipment is enclosed in 2 carrying chests. Write for Price.

MAGNETRONS

Tube	Tube	Tube
2J197	2J49	790BY
9J131	2J61	735-A
9J101	700	720-A
0192	706	OK 62
0196	2J62	OK 61
0192	3J31	OK 60
0197	5J30	2J56
0198	718DY	2J32
2J39		



MAIL ORDERS PROMPTLY FILLED. ALL PRICES F.O.B. NEW YORK CITY. SEND M.O. OR CHECK. ONLY SHIPPING SENT C.O.D. RATED CONCERNS SEND P.O. ALL MDSE. SUBJECT TO PRIOR SALE, AND PRICES SUBJECT TO CHANGE WITHOUT NOTICE. PARCELS IN EXCESS OF 20 POUNDS WILL BE SHIPPED VIA CHEAPEST TRUCK OR RAILCAR.

MICROWAVE COMPONENTS

S BAND—3" x 1 1/2" W.G. 10 CM.



- DIRECTIONAL COUPLER**, Broadband, 20 db. Coupling, Type "N" Takeoff. Complete with all Hardware, Navy # CABV-47AAN-2. As Shown. \$37.50
- WAVEMETER**, IES 700-3400 "MC." Readout Type, with counter Dial—Mig. W.E. \$92.50
- REACTION WAVEMETER**, Mig. G.E. 3000-1700 MC. Mic. Head. \$125.00
- LMTR. LIGHTHOUSE ASSEMBLY**, Part of RT39 APG 5 & APG 16. Receiver and Trans. Cavities w/assoc. Tr. Cavity and Type 51 CPLG. To Revr. Uses 2C40, 2C43, 1B27. Tunable APX 2400-2700 MCH. Silver Plated. \$49.50
- BEACON LIGHTHOUSE cavity** 10 cm. Mig. Bernard Rice, each. \$47.50
- MAGNETRON TO WAVEGUIDE Coupler** with 721A Diplexer Cavity, gold plated. \$45.00
- RT-39/APG-5** 10 cm. Lighthouse RF head c/o Xmttr-Rev'r. YK cavity, compl. covr. & 30 MC IC strip using 6A55 (2C40, 2C43 1B27 lineup) w/Tubes. \$42.50
- MCNALLY KLYSTRON CAVITIES** for 707B or 2K28. \$44.00
- F 29/SPR-2 FILTERS**, type "N" input and output Hi-Pass Over 1000 MC. \$12.50
- WAVEGUIDE TO "N" RIGID COAX "DOORKNOB" ADAPTER CHOKE FLANGE, SILVER PLATED BROAD BAND**. \$32.50
- AS14A/AP-10 CM Pick up Dipole** with "N" Cable. \$24.50
- OAJ ECHO BOX, 10 CM TUNABLE**. \$22.50
- HOMDELL-TO-TYPE "N" Male Adapters**, W.E. # D107294 \$2.75
- I. F. AMP. STRIP**, 30 MC. 120 db. gain, 2 MC Bandwidth, uses 6A07A—with video detector. Less tubes. \$24.50
- POLYRAD ANTENNA**, AS31/APN-7 in Lucite. \$11.25
- "N" feed**. \$22.50
- ANTENNA**, AT49A/APR: Broadband Conical, 300-3300 MC. Type "N" Feed. (AS SHOWN) \$12.50
- "E" or "H" PLANE BENDS**, 90 Deg. less flanges. \$7.50

7/8" RIGID COAX—3/8" I. C.

- RIGHT ANGLE BEND**, with flexible coax output pickup w/loop. \$8.00
- SHORT RIGHT ANGLE BEND**, with pressurizing nipple. \$8.00
- RIGID COAX to flex coax connector**. \$3.50
- STUB-SUPPORTED RIGID COAX**, gold plated 6' lengths. Per length. \$2.50
- RT. ANGLE BEND 15' L O.A.** \$3.50
- FLEXIBLE SECTION**, with 1/2" I.C. female. \$3.50
- 7/8" RIGID COAX, BULKHEAD FEED-THRU**. \$14.00

IMMEDIATE DELIVERY -- FULLY GUARANTEED

X BAND—1" x 1/2" W.G. 3 CM.

- 1" x 3/4" waveguide in 5' lengths, UG739 flange to UG40 cover per length \$7.50
- Rotating joints supplied either with or without deck mounting. With UG40 flanges. each, \$17.50
- Bulkhead Feed-Thru Assembly**, Pressure Gauge Section 1 1/2 lb. gauge and press nipple. \$10.00
- Pressure Gauge**, 15 lbs. \$2.50
- Dual Oscillator, Mount.** (Back to back) with crystal mount, tunable termination attenuating plugs. \$18.50
- Directional Coupler, UG-40/U Takeoff** 20 db. \$17.50
- TR-ATR Duplexer section** for above. \$12.50
- 723A/B Mixer**—Bacon Dual Osc. Mix. wrist holder. \$12.00
- Waveguide Section 12" long** choke to cover 45 deg. twist & 2 1/4" radius, 90 deg. bend. \$6.50
- Twist 90 deg. 6" choke** to cover with wire nipple. \$6.50
- Waveguide Sections 2 1/4" ft. long** silver plated with choke. \$7.50
- Rotary joint** choke to choke with deck mounting. \$17.50
- 3 cm. mitered elbow "E" plane**. \$12.00
- UG 39 Flange**. \$7.25
- 50 degree elbows "E" or "H" plane** 2 1/4" radius. \$12.50
- 45 degree twist**. \$8.00
- APS-4 Under Belly Assembly**, less tubes. \$375.00

1 1/4" x 5/8" WAVEGUIDE

- CG758B/APQ1312" Flex. Sect. 1 1/4" x 5/8" OD. \$10.00
- X Band Wave GD. 1 1/4" x 5/8" O.D. 1/16" wall aluminum. \$12.50 per ft. 75c
- Slug Tuner Attenuator** W.E. guide, Gold plated. \$6.50
- BI-Directional Coupler**, Type "N" Takeoff 25 db. coupling. \$27.95
- BI-Directional Coupler**, UG-52. Takeoff 25 db. \$24.95
- Waveguide-to-Type "N" Adaptor**, Broadband. \$22.50

K BAND—1/2" x 1/4" W.G. 1.25 CM.

- APS-34 Rotating Joint. \$49.50
- Right Angle Bend** E or H Plane, specify combination of coum. plings desired. \$12.00
- 45° Bend E or H Plane, choke to cover. \$12.00
- Mitered Elbow, cover to cover. \$4.00
- TR-ATR Section. Choke to cover. \$4.00
- Flexible Section 1" choke to choke. \$5.00
- "S" Curve Choke to cover. \$4.50
- Adaptor, round to square cover. \$5.00
- Feedback to Parabola Horn with pressurized window. \$27.50
- 50° Twist. \$10.00

400 CYCLE TRANSFORMERS

(All Primaries 115V, 400 Cycles)

Stock	Specifications	Price
352-7039	640VCT @ 250MA, 6.3V/9A, 6.3V/6A, 5V/6A	\$5.49
702724	9800/8600 @ 32MA	8.95
12033	4540V/250MA	17.50
KS9584	5000V/290MA, 5V/10A	22.50
521652	13,500V/3.5MA	14.65
KS9607	734VCT/177A, 1710VCT/177A	6.79
352-7273	700VCT/350MA, 6.3V/0.9A, 6.3V/2.5A, 6.3V/0.6A, 5V/CA	6.95
352-7070	2X2.5V/2.5A (2KV TEST) 6.3V/2.25A, 1200/1000/75 DV @ .005A	7.45
352-7196	1140V/1.25MA, 2.5V/1.75A, 2.5V/1.75A -5KV Test	3.95
352-7176	320VCT/50MA, 4.5V/3A, 6.3VCT/20A, 2X6.3VCT/6A	4.75
RA6100-1	2.5V/1.75A, 6.3V/2A-5KV Test	2.35
901692	13V 9A	2.49
901699-501	2.77V @ 4.25A	3.45
901698-501	900V/75MA, 100V/0.04A	4.29
UX8855C	900VCT/0.67A, 5V/3A	3.79
HA6401-1	800VCT/65MA, 5VCT/3A	3.69
T-48852	700VCT/80MA, 5V/3A, 6V/1.75A	4.25
352-7098	2500V/6MA, 300 VCT, 135MA	5.95
KS-9336	1100V/50MA TAPPED 625V 2.5V/5A	3.95
M-7474319	6.3V/2.7A, 6.3V/6.6A, 6.3VCT/21A, 4.25	4.25
KS 9844	27V/4.3A, 6.3/2.9A, 1.25V/.02A	2.95
52C080	526VCT/50MA, 6.3VCT/2A, 5VCT/2A, 400VCT/35MA, 6.4V/2.5A, 6.4V/.15A	3.85
32332	1150-0-1150V	2.75
68G631	6VCT/00006 KVA	1.75
80G198	6.3V/9.1A, 6.3VCT/6.5A, 2.5V/3.5A, 2.5V/3.5A	4.85
302433A	592VCT/118MA, 6.3V/8.1A, 5V/2A, 6.4/7.5A, 6.4V/3.8A, 6.4V/2.5A	5.39
KS 9445	ALL CT	4.79
KS 9685		
70G30G1	600VCT/36MA	2.65
M-7474318	2100V/0.27A	4.95
95-G-15	2000V/0.022A, 465V/6A, 44V/10A, 6.3V/23.5A, 6.3V/1.8A, 5V/9A, 2X2.5V/1.75A	17.95

TRANSTAT IN: 115V, 400 CY.
 OUT: 75-120V, 6.0 Amps. 12.95

PULSE NETWORKS

- 15A-1-400-50: 15 KV, "A" CKT. 1 microsec. 400 PPS, 50 ohms imp. \$37.50
- G.E. #32-5-2000-501P: 6KV "F" circuit, 3 sections, .5 microsec, 2000 PPS 50 ohms impedance. \$8.50
- G.E. #3E (3-84-810) (8-224-405) 50P4P: 3KV "E" CKT Dual Unit; Unit 1, 3 sections, 0.84 Microsec. 810 PPS, 50 ohms imp; Unit 2, 8 sections, 2.24 microsec. 405 PPS, 50 ohms imp. \$6.50
- 7.5E3-1-200-67P: 7.5 KV, "F" Circuit, 1 microsec. 200 PPS, 67 ohms impedance 3 sections. \$7.50
- 7.5E4-16-60, 67P: 7.5 KV, "E" Circuit, 4 sections, 16 Microsec. 60 PPS, 67 ohms impedance. \$15.00
- 7.5E3-3-200-67T: 7.5 KV, "E" Circuit, 3 microsec. 200 PPS, 6 ohms imp. 3 sections. \$12.50
- #755: 10KV, 2.2usec., 375 PPS, 50 ohms imp. \$27.50
- #754: 10KV, 0.85usec., 750 PPS, 50 ohms imp. \$27.50

PULSE TRANSFORMERS

- U-10198 Pri: 4-5KV, 97A Pk Sec; 18KV, 26A. PRR-350/500 Cy. Duration 1.5 usec. \$42.50
- D-166173: Vdr, Ratio = 50:900 Ohms 10KVA, 2MC. \$12.50
- G.E.K.-2745: \$39.50
- G.E.K.-2744-A, 11.5 KV High voltage, 3.2 KV Low voltage @ 200 KW oper. (270 KW max.) 1 microsec. or 1/microsec. @ 600 PPS. \$39.50
- W.E. D169274: Hi Volt input pulse Transformer, \$27.50
- Ray UX 8442—Pulse inverter—40v + 40v. \$7.50
- Ray UX 7361 \$5.00
- PHILCO 352-7250, 352-7251, 352-7287
- UTAH 9332, 9278, 9341.
- RAYTHEON: UX8693, UX9586 \$5 ea.
- W.E.: D-166310, D-16638, KS 9800, KS9948

PULSE EQUIPMENT

- H/1-Volt Pulse Bulkhead. Feed-thru. Fits UG-36 Connector—as shown. \$15.00
- APQ-13 PULSE MODULATOR. Pulse Width .5 to 1.1 Micro Sec. Rep. rate 624 to 1348 PPS. Pk. \$49.00
- TPS-3 PULSE MODULATOR. Pk. power 50 amp. 24 KW (1200 KW pk); pulse rate 200 PPS, 1.5 microsec. pulse line impedance 50 ohms. Circuit series charging version of DC Resonance type. Uses two 705-A's as rectifiers. 115 v. 400 cycle input. New with all tubes. \$49.50

DELAY LINES

- D-168184: 5 microsec. up to 2000 PPS 1800 ohm term. \$4.00
- D-170499: 25/50/75 microsec. 8 KV 50 ohms imp. \$16.50
- D-165997: 1 1/4 microsec. \$7.50
- RCA 255686-502, 2.2u sec. 1400 ohms. \$2.00

COMMUNICATIONS EQUIPMENT CO.

AIR TRIMMERS



Capacity		Fig.	Shaft Length	Post Length
Min. $\mu\mu\text{f}$	Max. $\mu\mu\text{f}$			
3	12	D	5/16"	3/32"
3	27	A	1/2"	3/32"
2	10	D	5/16"	3/32"
4	18	D	5/16"	1/4"
4	25	A	17/32"	3/32"
5	50	A	1/2"	3/32"
5	55	A	1/2"	3/32"
7	28	C	5/16"	3/32"
7	35	D	5/16"	3/32"
8	45	A	17/32"	3/32"

PRICE, EACH .47¢

Fig. A: Round Shaft, Screwdriver Adj. W/Locknut. Fig. C: Ild. Shaft, Screwdriver Adj. Fig. D: Hexnut screwdriver Adj.

AUDIO TRANSFORMERS

- AT201 50L6 output (4000 ohms) to V.C. (3 ohms) \$5.44
- AT SUB Subouncer, Multimatch, 200 ohms to 15 K ohm C.T. and 100 K ohm Grids. \$5.69
- AT731 H.F. Plate (1500 ohm C.T.) to V.C. (16/4 ohms) 20-16KC \$3.29
- AT501 HI-FI Special; PRI: 3000 ohms P-P/Sec: 4/16/12/50/200 ohms 60-10,000 CY.—1 db 50V. \$3.49
- AT152 HI-FI Driver Pri: 10,000 ohms Sec: 40,000 ohms PP Grids 50-15 KC/1 db \$1.45
- AT062 Output to H.S. or line PRI: 14,200 ohms Sec: 8000/6000 ohms. \$1.10
- AT444 HI-FI Driver (5000 ohms) to P.P. output grids (4,000 ohms) 100-10,000 CY. 10W 6V to PP 805A. \$2.39
- AT666 Interon Input: Spkr (4-8 ohms) to grid (250-500 ohms) \$5.69
- AT416 Plate (18,000 ohms C.T.) to line (125 ohms) 175 w. 500-600 CY. \$3.95
- AT558 Plate (10,000 ohms C.T.) to line (125 ohms) 135/130 ohms HI-FI 50W. \$6.95
- AT070 Mike-or-Line (250 ohms) to grid (250,000 ohms C.T.) \$1.20
- AT705 Mike-or-Line (600 ohms) to grid (50,000 ohms C.T.). \$5.69
- AT-694 HI-FI Output: 3 Watts. 8500 Ohms P-P to V.C. (15 Ohms) 15-15KC P.M. 1 db. \$1.49
- AT4-A: Mike (85 ohms Carbon) to Line 600 ohm/200 ohm \$1.19
- AT649: Line (500 ohms) to Grid (75K ohms) \$5.89
- AT448: Line (600 ohms) to V.C. (8 ohms) 17 db. Level. \$1.19
- AT631: Mike-or-Line (200 ohms) to Single or P-P Grids (50K Ohms) \$5.59
- AT719 Line (300 ohms) to Line 600/30 Ohm Response 50-20KC P.M. 1 db. \$4.49

RU/GF GEAR



RU/GF XMTR COIL SETS
 2000-2500 KC \$1.79
 3000-3075 KC \$1.79
 3075-4525 KC \$1.79
 4000-7300 KC \$1.79
 7350-9050 KC \$1.79

RU/GF COIL SETS SINGLE BAND RCVR UNITS

BAND	FREQUENCY
L	400-800 KC
C	545-850 KC
D	850-1330 KC
E	1330-2040 KC
F	2040-3000 KC
G	3000-4525 KC
H	4000-6000 KC
I	4000-7700 KC
N	6000-9050 KC
K	9050-13,375 KC

PRICE \$1.50 EACH
 RCVR. DUAL BAND COILS

ACCESSORIES
 REMOTE TUNING BOX TYPE \$1.75
 CW-23012 \$1.75
 XMTR. CONTROL BOX, CW-23097 1.69
 RCVR. SWITCH BOX, CW-23098A 1.75
 28V DYNAMOTOR & FILTER BOX FOR RU 8.95
 COMPLETE RU/GF SET WITH ALL PLUGS, MOUNTINGS, XMTR, RCVR, TUNING UNITS, DYNAMOTOR, INSTRUCTION BOOK—READY TO GO—ALL BRAND SPACKING NEW \$97.5

400-600 KC 6000-9050 KC
 540-830 KC 5200-7700 KC
 195-280 KC 290-435 KC
 640-830 KC 840-830 KC
 PRICE \$2.25 EACH
 Schematic of RU/GF Set. 35¢

UNIVERSAL SUPPLY KIT

Delivers 230V @ 40MA DC. From 110/220VAC. 60 CY. Kit consists of 1 Transformer, 1-5 HY @ 40MA Choke, 2-8MFD @ 450V Filter Cond, 1-6X5 Tube. A Great Buy at Only **\$3.95**

MFRST MFRST MFRST NEW, FINISHED JAN MATERIAL FOR YOUR WAR CONTRACTS
 Write! Phone! Wire!

ID-24 ARN-9 Dual @ 200 Microamp Movement in 3" Case. ILS Equipment \$6.95

932 PHOTO TUBE
 Gas Phototube having SI Response, particularly sensitive to Red and Near Infrared Radiation. Can be used with incandescent light source. Send for data. Price **75¢**



INTERPHONE AMPLIFIER

Easily converted to an ideal inter-communications set for office, home, or factory. Original. New **\$4.75** w/conversion. Diagram

This Month's Special

- SUPERSONIC CRYSTALS, Rochelle salt. \$5.00 ea.
- MOTOR, 24 vdc. 3 HP 3800 rpm. New. \$75.00
- TV LEAD-IN WIRE, 300 ohms. HI-Q. Lo-Loss \$17.50/M FT Roll
- BC 306 ANTENNA TUNING UNIT. New. 6.95
- R9/APN-4, New, With Tubes. 75.00
- ID6/APN-4, New, With Tubes and Crystal. 75.00
- A-62 Phantom Antenna 8.50
- 2 Meter Choke, 1000 MA, 20-144 1.00
- Supersonic Crystal Head, M-1, 22-27KC HI-2 27.45
- Underwater Microphone, Model JR, Z=50, Dynamic Mike & Headset Combo, B-19, New. 3.75
- HS-30 Inserts, M-300 per M 3.50
- AN/ARC-4 VHF Trans-Rev 75.00
- PE 36 Test Set, New 37.50
- SCR 274 Test Set, I-104. 12.25
- ART-13 Driver Trans, 6V6 to P-P 811's. 1.29
- DM 34 Dynamotor, 14V, 10, 220V, 80 MA out Sens. Relay: 3.5MA, 13K ohms, 2PST, 2A. 1.29
- Klixon Breaker; Thermal, 35A.69
- T-30 Carbon Mikes, New.89
- Tel. Tape, 3/8"x8 1/2" Rolls. 23c ea. 5/ 1.00
- Tel. Tape, 4" Rolls. 12c ea. 10/ 1.00
- BC366 Interphone Jack Box.79 ea.
- AN 109-A Antenna, 150mc. 1.92 ea.
- C-30/ARC-5 Control Box. 2.35 ea.
- EE-89A Telephone Repeater. 12.50 ea.
- EE-65A Telephone Test Set. 50.00 ea.
- ID24/ARN-9 Cross Point Indicator. 6.95 ea.
- TU-8 Tuning Unit 6.2-7.7mc. 4.95 ea.
- BC-496-A Dual Revr. Con't box, 3-6 & 6-24 mc. 1.75 ea.
- AN 104-A Antenna, 150mc. 1.49 ea.
- BC704 Indicator, 5" CR Tube, New. 22.50 ea.
- BC929 Indicator, 3BP1. All tubes, New. 29.50 ea.
- Noise Filters, 100 AMP, G.E. 1.39 ea.
- MC211 Right Angle Drives.19 ea.
- IF Transformers, 112 KC Double Slug Tune.69 ea.
- IF Transformers, 1600 KC Double Slug Tune.75 ea.
- MD/7 Modulator for ARC/5, All tubes. 7.95 ea.
- ARC-5 Xmtr. Tuning Cond. #5032. 1.49 ea.
- ARC-5 Xmtr. M.O. Trimmer #4990. 1.29 ea.
- Buffer or Osc. Coil, 160 meters, 50W End-Link, 5 pr. STD. Socket, OEL-160.79 ea.
- MC 22 MASTER BASE \$4.95
- OSCILLOGRAPH RECORDING, PHOTO PAPER: 35 MM, 250 FT. Roll. \$1.00

UNIVERSAL POWER XFMR

Pri: Vibrator Input @ 6/12/24/110 VDC. AC Input: 110/220-V @ 60 CY. Sec: 230-0-230 V—40 MA 6.3V—1.8A **\$1.49**

POWER TRANSFORMERS

- Comb. Transformers—115V/50-60 cps input
- CTJ5-2 600VCT/2A, 5V/6A \$5.95
- CT-15A 550VCT, .085A 6.3V/5A, 6.3V/1.8A 2.85
- CT-164 4200V.002A/12KV Test, 5VCT/3A/12KV Test, 6.3V/0.6A/5400V Test. 12.95
- CT-341 1050V/10 MA.—625V @ 5 MA, 26V @ 4.5A 2x2.5V/3A, 6.3V @ 3A 16.95
- CR-825 360VCT-340A 6.3VCT/3.6, 6.3VCT/3A 3.95
- CT-626 1500V .160A 2.5/12, 30/100 9.95
- CT-071 110V .200A 33/200, 5V/10, 2.5/10 4.95
- CT-367 580VCT .050A 5VCT/3A 2.25
- CT-99A 2X110VCT .016A 6.3/1A, 2.5VCT/7A 3.25
- CT-403 350VCT .026A 5V/3A 2.75
- CT-991 585VCT .086A 5V/3A, 6.3V/6A 4.25
- CT-610 1250 .002A 2.5V/2.1A, 2.5V/1.75A 4.95
- CT-866 330V .065A 6.3V/1.2, 6.3V/600 MA 1.75
- CT-456 390VCT 30MA 6.3V/1.3A, 5V/3A 3.45
- CT-180 800VCT 100MA 6.3V/1.2A, 5V/3A 4.95
- CT-931 585VCT 85MA 5V/3A, 6.3V/6A 4.95
- CT-442 525VCT 75MA 5V/2A, 10VCT/2A, 50V/200MA 3.85
- CT-720 550-0-550V/250MA, 6.3V/1.8A 8.95
- CT-43A 600-0-600V/.08A, 2.5VCT/6A, 6.3VCT/1A 6.49
- CT-7501 650VCT/200MA, 6.3V/5A 6.49
- CT-444 230-0-230V/.085A, 5V/3A, 6V/2.5A 3.49

- Filament Transformers—115V/50-60 cps input
- Item Rating Each
- FT-674 8.1V/1.5A \$1.10
- FT-157 4V/16A, 2.5V/1.75A 2.95
- FT-101 6V/.25A 1.79
- FT-924 5.25V/21A, 2x7.75V/6.5A 4.95
- FT-824 2x26V/2.5A, 16V/1A, 7.2V/7A, 6.4V/10A, 6.4V/2A 8.95
- FT-463 6.3VCT/1A, 5VCT/3A, 5VCT/3A 5.49
- FT-55-2 7.2V/21.5A, 6.5V/6.85A, 5V/6A, 5V 3A 8.95
- FT-986 16V @ 4.5A or 12V @ 4.5A 3.75
- FT-38A 6.3/2.5A, 2x2.5V/7A 4.19
- FT-A27 2.5V/2.5A, 7V/7A, TAP 2.5V/2.5A, 16KV TEST 18.95
- FT-608 6.3V/3A/750V Test 1.79
- FT-873 4.5V/5A, 7V/7A 2.19
- FT-899 2x5V @ 5A, 29KV Test 24.50

POWER RESISTORS

120W-WW-5% Tol.
 1 1/2" Ferrule, 9 1/2" Long

Res.-Ohms	Price	Res.-Ohms	Price
2.5*	55c	198*	35c
25*	35c	225	30c
30	45c	250	45c
32.5	35c	300*	35c
40	7c	450	65c
50*	45c	500*	40c
70*	45c	630*	55c
100	7c	4,500	50c
125	45c	8,000	90c
125*	45c	160,000	65c

* Tapped to give 10 equal sections with 9 tabs.

ELECTROLYTIC CAPACITORS

TWIST PRONG

Cap. Mfd	WVDC	Price
8	450	50.16
30	300	.18
40	450	.38
50	400	.36
60	300	.21
80	150	.29
8/8	450	.24
30-20	25	.16
20-20	150	.23
80-80	300	.21
90-10	350	.49
80-10	150	.49
150-50-25	450	.21
80-10-10-10	300	.21
40-40-20-20	150	.28
30-15-15-15	300	.32
80-10-10-10	350	.32
40/10	450/350	.55
40/20	150/25	.21
40/50	400/300	.28
80/50	450/50	.65
250/1000	10/6	.30
8-8-10	450/25	.26
40-10-10	150/25	.23
30-10-20	450/25	.26
10-15-20	350/25	.18
15-15-10	450/350	.23
80-40/150	400/50	.45
120-60/20	150/25	.45
30-30-15/30	300/50	.39
40-40-20/20	350/25	.28
60-40-20/50	300/25	.28
60-40-20/200	150/10	.39
80-40-30/20	150/25	.36
80-40-30/100	150/25	.36
8/8/8	475/100/100	.23
10/50/100	350/100/50	.23
10/50/100	450/100/50	.27
20/20/10/20	350/300/300/25/35	1.5

MFD Each
 220VAC/600VDC 51.29
 6.2 3.49
 330VAC/1000VDC 3.79
 15 1000VDC69
 5 1.59
 5 1.19
 1 1.49
 4-1.5 2.19
 1 1.39
 1500 WVDC 1.79
 1 2.500 WVDC 1.79
 1 2500 WVDC 2.98
 1 4000 WVDC 6.95
 1 4800 WVDC 4.79
 1 6000 WVDC 3.69
 1 15.15 3.89
 1.5 10.98
 7000 WVDC 3.79
 1 9.95
 1 8000 WVDC 3.79
 .075-.075 8.95
 10K VDC 7.95
 1 15K VDC 7.95
 1 16K VDC 9.50
 .015 20K VDC 17.50
 .25 25K VDC 33.50
 1 35.00
 1 85.00
 1 65.00

UPRIGHT OIL CAP.

MFD Each

220VAC/600VDC	Price
6.2	51.29
15	3.49
330VAC/1000VDC	3.79
15	1000VDC69
5	1.59
5	1.19
1	1.49
4-1.5	2.19
1	1.39
1500 WVDC	1.79
1	2500 WVDC 1.79
1	2500 WVDC 2.98
1	4000 WVDC 6.95
1	4800 WVDC 4.79
1	6000 WVDC 3.69
1	15.15 3.89
1.5	10.98
7000 WVDC	3.79
1	9.95
1	8000 WVDC 3.79
.075-.075	8.95
10K VDC	7.95
1	15K VDC 7.95
1	16K VDC 9.50
.015	20K VDC 17.50
.25	25K VDC 33.50
1	35.00
1	85.00
1	65.00

1 PER CENT PRECISION RESISTORS

ALL VALUES IN OHMS

5	82	150	800	7,500	20,000
5.05	120	250	920	10,000	30,000
10.1	125	430	1100	12,000	35,000
18	128	468	1300	17,000	84,000

30c EACH 10 FOR \$2.50
 100K EACH 120K 150K 220K 250K 330K 350K 470K 510K 560K 680K 750K 820K 910K 10K FOR \$3.50
 1 MEGOHM 10 FOR \$7.50

DYNAMOTORS

F Type	Input Volts	Input Amps	Output Volts	Output Amps	Radio Set
PE86	28	1.25	250	.060	RC 36
DM416	14	6.2	330	.170	RU 19
DM33A	28	7	540	.250	BC 456
PE101C	13/26	12.6	400	.135	SCR 515
		6.3	800	.020	
BD AR 93	28	3.25	375	.150	
23350	27	1.75	285	.075	APN-1
ZA0515	12/24	4/2	500	.160	
B-19 pack	12	9.4	275	.110	MARK 11
			500	.050	
D-104	12		225	.100	
			440	.200	
DA-3A	28	10	300	.060	SCR 522
			14.5	.010	
5053	28	1.4	250	.060	APN-1
PE73CM	28	19	1000	.350	BC 375
PE94	28	10	300	.200	SCR 522
			150	.101	
			14.5	.5	

INVERTERS
 PE-218-H: Input: 25 28 vdc, 92 amp. Output: 115 v. 350-500 cy 1500 volt-amperes. New
 PE-206: Input: 28 vdc, 38 amps. Output: 80 v 800-cy. 500 volt-amperes. Dim: 13"x5 1/2"x10 1/2". New. \$22.50
 LELAND #10336: IN: 28 VDC, 12A. OUT: 115V, 115VA, 400 CY 3 PHASE. EXC. COND. **\$70.00**

MAIL ORDERS PROMPTLY FILLED. ALL PRICES F.O.B. NEW YORK CITY. SEND M.O. OR CHECK. ONLY SHIPPING SENT C.O.D. RATED CONCERNS SEND P.O. ALL MDSE. SUBJECT TO PRIOR SALE, AND PRICES SUBJECT TO CHANGE WITHOUT NOTICE. PARCELS IN EXCESS OF 20 POUNDS WILL BE SHIPPED VIA CHEAPEST TRUCK & RAILEX.

131 Liberty St., New York 7, N. Y. Dept E-10 Chas. Rosen Phone: Dlgby 9-4124

324 CANAL ST., N.Y.C., 13, N.Y. Walker 5-9642

Universal general corp.

RELAYS

WE SPECIALIZE IN

TREMENDOUS QUANTITIES IN STOCK!

SEE OUR PREVIOUS ELECTRONICS ADS FOR LISTINGS OR WRITE FOR CIRCULARS

WE ALSO HAVE PRODUCTION QUANTITIES IN STOCK OF

- APC AIR TRIMMERS
- BINDING POSTS
- CABLE
- CAPACITORS
- CERAMICONS
- CERAMICS
- ADEL & TINNEMAN
- CLAMPS
- CHOKES

- COILS
- CONTROLS
- FILTERS
- FUSES
- KOVAR GLASS SEALS
- RUBBER GROMMETS
- HARDWARE
- IRON CORE SLUGS
- KNOB

- SINE-COSINE
- POTENTIOMETERS
- PULSE TRANSFORMERS
- RELAYS
- RESISTORS
- SERVO TRANSFORMERS
- SHOCKMOUNTS
- SOCKETS
- SPAGHETTI

- MICRO SWITCHES
- TOGGLE SWITCHES
- TRANSFORMERS
- TUBES
- AND OTHER RADIO & ELECTRONIC PARTS

SENSITIVE SWITCHES

MICROSWITCHES

Type	Contacts	Actuator	Ea
WZRS9	Clsd	Plunger	.69
M2	Actuator		.49
WZ7RTC	Clsd	Pin	.69
WZRO41	Clsd	Plunger	.89
WZ7RQ1T	Clsd	Plunger	.97
WZ3RTC	Clsd	Pin	.79
WZ3RDI	Clsd	Button	.69
WZ7RST1	Clsd	Plunger	.79
WP37	Clsd	Plunger	.79
YZRO41	Open	Plunger	.89
YZR31	Open	Pin	.69
APR201	SPDT	P unger	.89
B15 (Magnet)	Open	P unger	1.94
BZRWS42	SPDT	Leaf	1.79
BZRS	SPDT	Pin	.79

MU SWITCHES

Type	Contacts	Actuator	Ea
DGBP-32	Open	Plunger	1.19
CUM24211	2 ckt	Pin	.79
MGS	2 ckt	Plunger	.89
2A2R	SPDT	Pin	.79

CUTLER HAMMER

A2	Normally Closed	Plunger	.79 ea
----	-----------------	---------	--------

CR1070 G.E. SWITCHETTES

No.	Contacts	Ea	No.	Contacts	Ea
C103E3	Open	.63	C130B3	Open	.69
C122A3	Closed	.69	C130D3	Closed	.59
C103F3	2 ckt	.63	C103R3	SPDT	.69
Enclosed Type CR1070D107B3			Open		1.19

ACRO SWITCHES

Type	Contacts	Actuator	Ea
TD48LSP1L	SPDT	Leaf	1.39
HRC71A2T	Closed	Pin	.69
SI276	Open	Pins (Set of 3)	per set 1.50
XC72L	Closed	Leaf	.69
RD1A	SPDT	Pin	.79

MINIATURE ACRO SWITCHES

Type	Contacts	Actuator	Ea
2MC31A	Closed	Pin	.59
2MD31A	SPDT	Pin	.79
2MD21A	SPDT	Pin	.69

TOGGLE & PUSH SWITCHES

Contacts	Mfgr. & No.	Description	Amps	Each
SPST	Carling	Small Toggle	3A, 110V	.15
SPST	C-H	Toggle	6A, 110V	.29
SPST	A, H&H	Toggle	3A, 250V	.29
SPST	C-H B5A	Aircraft	35A, 24V	.23
SPDT	C-H B9A	Aircraft	35A, 24V	.29
SPDT	A, H&H	Toggle	3A, 125V	.29
1 B*	A, H&H	Momentary	5A, 125V	.23
1 B*	T&M Co.	Push	3A, 125V	.23
1 A*	Square D	Push	15A, 24V	.49
SPST	Circle F	Molded Toggle	6A, 125V	.25
DPDT	A, H&H	Molded Toggle	6A, 115V	.69
2Ps	C-H	C6B Aircraft	20A, 125V	.89
3DPT	C-H	8744K7	10A, 250V	1.95
3FST	C-H	8740-K4	10A, 250V	1.29

*1A = SPST n.o. 1B = SPST n.c.

20% off in lots of 100 or more

OIL FILLED CAPACITORS

Many other sizes available at comparative prices. Send us your requirements

BATHTUBS

Mfd.	WVDC	Term	Ea	Mfd.	WVDC	Term	Ea
3x0.1	200	Side	.35	0.5	400	Side	.45
2x0.1	600	Top	.35	2x0.64	400	Side	.45
2x0.1	600	(2) Bot.	.35	1.0	600	Side	.55
2x0.1	600	Bot.	.35	2x1.0	600	(2) Side	.65
3x0.1	600	Bot.	.40	2.0	600	Bot.	.65
0.2	440AC	Side	.40	4.0	50	(1) Side	.65
0.25	600	Top	.40	100	25	(2) Side	.65
0.5	600	Bot.	.45	50	25	(1) Side	.30
0.5	600	Top	.42				

CHANNEL

Mfd.	WVDC	Term	Ea	Mfd.	WVDC	Term	Ea
0.015	600	Top	.28	2x0.5	200	(2) Bot.	.35
0.05	1000	Bot.	.35	2x0.5	400	Bot.	.45
2x0.1	600	Bot.	.35	0.5	400	Bot.	.40
3x0.1	400	Bot.	.40	0.5	600	Bot.	.48
3x0.1	600	Bot.	.45	1.0	400	Bot.	.48
0.25	1000	Bot.	.40	1.0	400	Top	.48
2x0.25	600	(2) Bot.	.48	1	500	Top	.48

RECTANGULAR

Mfd.	WVDC	Ea	Mfd.	WVDC	Ea
2x0.1	7000	1.69	1.0	2000	1.85
3x0.2	4000	1.95	1.5	330AC	.89
0.2	5000	2.25	2	600	.95
0.25	4000	1.95	5	25	.49
2x0.5	1500	1.49	7	600	1.45
0.75	1000	.69	3x8	5	1.95
1.0	400	.30	17.5	330AC	3.25
1.0	600	.65	Filterette	50V3A	.59
1.0	1500	1.49			

ROUND CANS (Single Terminal)

Mfd.	WVDC	Ea	Mfd.	WVDC	Ea
0.1	3000	2.25	2.0	600	.95
0.25	2500	1.75			

SHOCKMOUNTS

Large Quantities of Lord, Barry, U. S. Rubber and Other Makes of Shockmounts in Stock. Most Sizes Available. Prices Below Manufacturer's Cost. Send Us Your Requirements.

APC TRIMMERS

We Have Production Quantities of 13, 15, 25, 35, 50, 75, 100 and 140 Mmf Air Trimmers Available at Low Prices.

Mu-Metal Laminations

Es, Fs, Is, Ls. Ten Sizes. Quantities Available.

Sample Kit, 6 lbs, Sufficient Quantity of Each Size for One Unit—Post-Paid in U. S. A. \$19.75

TERMS:—All Prices F.O.B. Our Plant. Rated Firmers Net 10 Days: All Others Remittance with Order. Orders Under \$10 Remittance With Order. Plus Approximate Shipping Charges (overage will be returned.)

115V AC RELAYS

SIGMA 41F57: SPDT, 10,000 ohms #R909...\$2.95
WARD LEONARD 104-662: DPDT, #998...\$3.50
PRICE ELECTRIC Type 1620: DPST N.O. 10 Amp. Contacts...\$2.95
RBM #42600: DPST N.O. 10 amp. Contacts...\$3.25

H-F TIE POST

Low-Loss Melamine Insulation, pictured actual size (4-40 Thread) ...\$7.50/C \$67.50/M



SEALED RELAYS

Clare 5001: 24vdc; DPDT; 300 ohm; Octal Plug Base; #R678...\$5.95
Struthers-Dunn 181CX100: 12 vdc; 3A, 3B; #R679...\$5.95
Sigma 73351: 16vdc; SPDT; 2000 ohm; 8 ma; #R682...\$6.95
Allied SKHX, 24VDC; 3A, 3B; 425 ohm; #R913...\$5.95
SIGMA Type 4AH: 2000 ohm; SPDT; 4 ma. pull in; 2.5 ma. hold; 5 prong plug-in...\$3.95
SIGMA 71257: 6 vdc. SPDT, 500 ohms...\$4.95
SIGMA 949: 115V AC, SPST N.C...\$4.95



Kovar Glass to Metal Seals High-Voltage Feed Thru

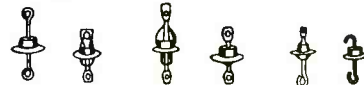

Many types and sizes. Send us your blueprint or sample for our quote. Our prices are a fraction of original factory costs.

SAMPLE KIT 96 Seals (8 ea. 12 types) 500 postpaid in USA
LAB KIT 300 Seals (20 types) 1500 postpaid in USA

D.C. SENSITIVE RELAYS



SIGMA Type 4AH: 2000 ohms; SPDT 4 ma. pull in. 2.5 ma. hold; 5 prong plug-in...\$3.95
Sigma 41F57: 2 ma; SPDT; 10,000 ohm; @ #R914...\$2.95
Allied FID: 8 ma; 1A; 3000 ohm; &R916...1.50
RBM 23024: 6 ma.; 41SP n.o. (4As); 6500 ohm; #R802...2.95
RBM 23025 6 ma. SPDT, 8000 ohm, #R428...1.50
W.E. (Whelock) KS9665 9 ma., 1A, 1B, 1C, 2000 ohm, #R429...4.95
Kurman Midget 12 ma., SPDT, 1500 ohm, #R427...98
Clare Type J (K102) 6 ma., SPDT, 8500 ohm, #R30...3.50
Cooke Type C 4 ma., 1A, 6500 ohm, #R596...3.50
B11613 (K101) 2 ma., SPDT, 6500 ohm, #R588...4.95
Clare A8053 8 ma., 3A, 6500 ohm, #R108...3.95
RBM 452-1041: 4 ma., 12,000 ohm; DPDT; Telephone Type; #R685...4.95
POTTER-BROMFIELD Type LC: 5000 ohms, 5 ma. SPST N.O. #R230...1.50
POTTER-BROMFIELD Type LC: 2500 ohms, 9 ma. SPDT #684...1.50

324 CANAL ST., N.Y.C., 13, N.Y. Walker 5-9642

Universal general corp.

Discounts 25-40-60%

24 to
72 hour
DELIVERY

"AN" Connectors "AN"

8S1P	14S-14P	18-7S	18-404P	20-24S	22-17P	24-4S	24-710P	28-22S	32-14S	36-13S	40-12P
8S1S	14S-14S	18-8P	18-404S	20-25P	22-17S	24-5P	24-710S	28-410P	32-15P	36-14P	40-12S
10S-2P	16S-1P	18-8S	20-1P	20-25S	22-18P	24-5S	24-835P	28-410S	32-15S	36-14S	40-13P
10S-2S	16S-1S	18-9P	20-1S	20-26P	22-18S	24-6P	24-835S	28-684P	32-16P	36-15P	40-13S
10SL-3P	16-2P	18-9S	20-2P	20-26S	22-19P	24-6S	24-865P	28-684S	32-16S	36-15S	40-14P
10SL-3S	16-2S	18-10P	20-2S	20-27P	22-19S	24-7P	24-865S	28-693P	32-17P	36-16P	40-14S
10SL-4P	16S-3P	10-10S	20-3P	20-27S	22-20P	24-7S	28-1P	28-693S	32-17S	36-16S	44-1P
10SL-4S	16S-3S	18-11P	20-3S	20-28S	22-20S	24-9P	28-1S	28-695P	32-18P	36-17P	44-1S
10SL-	16S-4P	18-11S	20-4P	20-28P	22-21P	24-9S	28-2P	28-695S	32-18S	36-17S	44-2P
656P	16S-4S	18-12P	20-4S	20-29P	22-21S	24-10P	28-2S	28-702P	32-19P	36-18P	44-2S
10SL-	16S-5P	18-12S	20-5P	20-29S	22-22P	24-10S	28-3P	28-702S	32-19S	36-18S	44-3P
656S	16S-5S	18-13P	20-5S	20-30P	22-22S	24-11P	28-3S	28-745P	32-20P	36-19P	44-3S
12S-1P	16S-6P	18-13S	20-6P	20-30S	22-23P	24-11S	28-4P	28-745S	32-20S	36-19S	44-4P
12S-1S	16S-6S	18-14P	20-6S	20-31P	22-23S	24-12P	28-4S	28-766P	32-101P	36-20P	44-4S
12S-2P	16-7P	18-14S	20-7P	20-31S	22-24P	24-12S	28-5P	28-766S	32-101S	36-20S	44-5P
12S-2S	16-7S	18-15P	20-7S	20-32P	22-24S	24-14P	28-5S	28-833P	32-102P	36-21P	44-5S
12S-3P	16S-8P	18-15S	20-8P	20-32S	22-25P	24-14S	28-6P	28-833S	32-102S	36-21S	44-6P
12S-3S	16S-8S	18-16P	20-8S	20-33P	22-25S	24-15P	28-6S	28-840P	32-722P	36-646P	44-6S
12S-4P	16-9P	18-16S	20-9P	20-33S	22-27P	24-15S	28-7P	28-840S	32-722S	36-646S	48-1P
12S-4S	16-9S	18-17P	20-9S	22-1P	22-27S	24-16P	28-7S	28-852P	32-810P	36-697P	48-1S
12-5P	16-10P	18-17S	20-10P	22-1S	22-28P	24-16S	28-8P	28-852S	32-810S	36-697S	48-2P
12-5S	16-10S	18-18P	20-10S	22-2P	22-28S	24-17P	28-8S	28-880P	32-811P	36-795P	48-2S
12S-6P	16-11P	18-18S	20-11P	22-2S	22-29P	24-17S	28-9P	28-880S	32-811S	36-795S	48-3P
12S-6S	16-11S	18-19P	20-11S	22-3P	22-29S	24-18P	28-9S			36-799P	48-3S
14S-1P	16-12P	18-19S	20-12P	22-3S	22-30P	24-18S	28-10P	32-1P	36-1P	36-799S	48-4P
14S-1S	16-12S	18-20P	20-12S	22-4P	22-30S	24-19P	28-10S	32-1S	36-1S	36-853P	48-4S
14S-2P	16-13P	18-20S	20-13P	22-4S	22-31P	24-19S	28-11P	32-2P	36-2P	36-853S	48-5P
14S-2S	16-13S	18-21P	20-13S	22-5P	22-31S	24-20P	28-11S	32-2S	36-2S	40-1P	48-5S
14-3P	16S-14P	18-21S	20-14P	22-5S	22-32P	24-20S	28-12P	32-3P	36-3P	40-1S	3057-3
14-3S	16S-14S	18-22P	20-14S	22-6P	22-32S	24-21P	28-12S	32-3S	36-3S	40-2P	3057-4
14S-4P	16-15P	18-22S	20-15P	22-6S	22-33P	24-21S	28-13P	32-4P	36-4P	40-2S	3057-6
14S-4S	16-15S	18-23P	20-15S	22-8P	22-33S	24-22P	28-13S	32-4S	36-4S	40-3P	3057-8
14S-5P	16-16P	18-23S	20-16P	22-8S	22-34P	24-22S	28-14P	32-5P	36-5P	40-3S	3057-10
14S-5S	16-16S	18-24P	20-16S	22-9P	22-34S	24-23P	28-14S	32-5S	36-5S	40-4P	3057-10-6
14S-6P	16S-17P	18-24S	20-17P	22-9S	22-35P	24-23S	28-15P	32-6P	36-6P	40-4S	3057-12
14S-6S	16S-17S	18-25P	20-17S	22-10P	22-35S	24-24P	28-15S	32-6S	36-6S	40-5P	3057-12-6
14S-7P	18-1P	18-25S	20-18P	22-10S	22-36P	24-24S	28-16P	32-7P	36-7P	40-5S	3057-16
14S-7S	18-1S	18-26P	20-18S	22-11P	22-36S	24-25P	28-16S	32-7S	36-7S	40-6P	3057-20
14S-9P	18-2P	18-26S	20-19P	22-11S	22-37P	24-25S	28-17P	32-8P	36-8P	40-6S	3057-24
14S-9S	18-2S	18-27P	20-19S	22-12P	22-37S	24-26P	28-17S	32-8S	36-8S	40-7P	3057-28
14S-10P	18-3P	18-27S	20-20P	22-12S	22-404P	24-26S	28-18P	32-9P	36-9P	40-7S	3057-32
14S-10S	18-3S	18-28P	20-20S	22-13P	22-404S	24-27P	28-18S	32-9S	36-9S	40-8P	3057-40
14S-11P	18-4P	18-28S	20-21P	22-13S	24-1P	24-27S	28-19P	32-10P	36-10P	40-8S	
14S-11S	18-4S	18-29P	20-21S	22-14P	24-1S	24-28P	28-19S	32-10S	36-10S	40-9P	
14S-12P	18-5P	18-29S	20-22P	22-14S	24-2P	24-28S	28-20P	32-12P	36-11P	40-9S	
14S-12S	18-5S	18-30P	20-22S	22-15P	24-2S	24-684P	28-20S	32-12S	36-11S	40-10P	
14S-13P	18-6P	18-30S	20-23P	22-15S	24-3P	24-684S	28-21P	32-13P	36-12P	40-10S	
14S-13S	18-6S	18-31P	20-23S	22-16P	24-3S	24-691P	28-21S	32-13S	36-12S	40-11P	
	18-7P	18-31S	20-24P	22-16S	24-4P	24-691S	28-22P	32-14P	36-13P	40-11S	

THE ABOVE INSERTS ARE AVAILABLE IN ALL TYPE SHELLS

"AN-3055" — adapters "9760" — cap & chains

Wilgreen Industries

99 MURRAY STREET NEW YORK 7, N. Y. Worth 4-2490-1-2

CONDENSERS

MICRO & TOG. SWS. - RELAYS - "J" POTS



POWER SUPPLY
 #CJP-20ABX for ASB 7/7A/7B equip.
 800 cy. 115V. inp. 2.5/5.5/8.80/2000V.
 out. Contains 6AC7, 5T4 & 2X2, plus
 oil coils; chokes, resistors, connectors
 & switches. Brand new and individual-
 ually boxed. Measures 7H x 5 1/2" W x
 13" L. Cover not shown. \$6.75
 Lots of 10, 10% disc.; 25, 15%; 50
 & over, 25%.

8 mfd.—1000 V. \$3.20
 CP70E1EGR05K—New Stock. Lots of 10
 5% disc., 25 or more 10%.

.1 mfd.—7500 V. \$1.75
 Standard Brand #25F475, plus bracket
 Carton of 10 10% disc. Quantity disc.

7 mfd.—600 V. \$1.15
 Brand new—Dims. 4 1/2" x 3 1/2" x 3/4"
 Bracket. \$1.15

.2 mfd.—1000 V. \$2.21
 Standard 2 side term. bathtub cond.
 Same dims. as .25 mfd-600 V type.
 Exceptional value. Qua. disc.

OIL CONDENSER SPECIALS

10 mfd.—600 V. \$98
 Three term. bal. mtg. channel type.
 Dims. 3 3/4" x 3 1/2" x 2". Two 5 mfd.
 sections rated 400 V at 72 deg. "C".
 1800 V test. Meets commercial specs.
 for 600 V operation up to 40 degs. "C".
 Ideal for filter or power factor applica-
 tion. Repeat sales prove this rugged
 high quality condenser to be of out-
 standing value. Carton of 24, weight
 42 lbs. Large qua. available. \$89

2 mfd.—1000 V. \$85
 4" x 1 1/4" x 1" Standard Brand

1 mfd.—600 V. \$59
 Top term. bathtub cond. Type DYR
 10% disc. Lots of 100

7 mfd.—800 V. \$1.90
 Windings insulated for 1000 V operation.
 Individually boxed. Case of 20 10% disc.
 2 x 1 mfd.—230 VAC (600 DC) 2 ST
 Bathtub cond. Individually boxed (Qua.
 disc.)

JAN APPROVED

10mfd—1000V 4.55 8mfd—600V 2.25
 8mfd—1500V 4.25 6mfd—600V 1.55
 8mfd—1000V 3.25 4mfd—600V 1.75

TRANS. MICA COND.

Mfd	Wdgc	Price	Mfd	Wdgc	Price
.0001	3000	\$0.80	.01	600	.40
.00015	5000	1.75	.01	1200	.55
.0002	15KV	Quote			
.00025	1200	.35	.01	15KV	Quote
.0005	5000	2.25	.0125	6000	5.50
.00025	5000	1.95			
.0004	2500	.23	.02	600	.27
.001	2500	.48	.02	2000	1.15
.001	8000	3.65			
.002	6000	3.50	.03	600	.49
.0024	5000	1.95			
.003	6000	5.95			
.005	2000	.43			

AIRCRAFT TOG. SWS.

Aircraft type—20A @ 24VDC-10A @ 125VAC-C-II
 CH# Govt. Spec. Circuit

8201K4 B-5A SPST On-Off
 8211K6 B-6B 3PST Off-Mom. On
 8208K4 B-7A SPST On-Off-Mom. On
 8210K5 B-1B SPST On-Off
 8200K8 A1022-1B SPDT On-Off-On
 Push Mounted-Luminous Tip—Bat. Handle—
 Price—\$2.22 ea; \$20/100; \$170/1000.
 To get 1000 qua. disc. you may combine types.

TYPE "AB" POTS

OHMS Shaft	OHMS Shaft
50 1/8 S	2000 1 1/4 & /8 L.S
60 1/8 L.S	2500 3/8 & 1/8 S
150 1/4 S	3000 1/8 S
300 3/8 S	4000 1/8 L.S
500 3/8 & 1/8 S	5000 1/4 & 1/8 S
1000 1/8 S	5000 1/8 L.S
1500 1/4 S	10000 1/2"
2000 1/8 L.S & 3/8 S	15000 1/4 & 1/8 S
2500 1/8 S	20000 1/8 L.S
3000 1/8 L.S	25000 1/8 L.S 9/16
5000 1/4 L.S & 3/8	30000 1/8 S & 1/8 S
10000 3/8 & 1 1/7	12 terms.)
10000 5/16	5 Mex. 1/8 L.S
15000 1/8 S	1 Mex. 1/8 S & 7/16 L.S

Mfd	Volts	Price	Mfd	Volts	Price	
.005	10KV	3.75	1500V	1.65		
.01	10KV	4.25	2000V	2.80		
.012	25KV	15.50	3000V	3.25		
.02	20KV	15.90	4000V	4.69		
.03	16KV	15.90	5000V	5.69		
.075	7.5KV	3.95	6000V	6.25		
.08	12.5KV	15.95	8000V	7.95		
.1	1500V	.59	1000V	1.59		
.1	2000V	.49	1500V	2.80		
.1	2500V	1.20	3000V	3.25		
.1	3000V	1.75	400V	.75		
.1	7500V	1.75	1000V	1.59		
.1	7500V	4.25	1500V	2.80		
.1	7500V	6.25	600V	1.25		
.1	10KV	8.95	1000V	1.95		
.1	15KV	15.95	1500V	2.79		
.15-16	8000V	1.95	2000V	4.25		
.2	10KV	10.95	3000V	7.95		
.2	2000V	1.25	400V	2.40		
.25	3000V	2.15	330VAC	1.75		
.25	3000V	1.75	600V	1.35		
.25	18KV	15.95	800V	2.48		
.25	20KV	19.95	1500V	2.89		
.25	10KV	12.95	400V	1.89		
.5	1500V	1.02	600V	1.45		
.5	2000V	1.39	330VAC	2.49		
.5	3000V	2.69	1000V	2.49		
.5	25KV	15.95	1500V	3.25		
.5-1	2000V	.89	2000V	3.95		
.5-5	400V	.69	600V	1.45		
1	500V	.59	800V	2.49		
1	1000V	1.35	1000V	2.35		
1	1500V	1.95	600V	1.75		
1	2000V	2.25	1000V	3.20		
1	2500V	3.50	1500V	4.25		
1	3000V	4.99	2000V	4.95		
1	6KV	7.50	800V	1.75		
1	10KV	14.99	1000V	2.50		
1	15KV	24.99	1000V	4.55		
1	15KV	Quote	10	Quote		
1	25KV	Quote	12	Quote		
1-1	7500V	Quote	12	Quote		
2	600V	.59	14	1000V	5.25	
2	TLAD	800V	15	1000V	5.25	
2	TLA	1000V	17	25V	.69	
2	TLA	1000V	1.29	24	1500V	8.50

MICA CONDENSERS

5, 6, 8, 10, 15, 25, 30, 34, 30, 50, 70, 75, 100,
 140, 150, 180, 200, 230, 240, 250, 300, 350,
 390, 400, 470, 500, 510, 600, 650, 700, 750,
 1000, 1200, 1250, 1400, 1500, 2000, 2200,
 2400, 3000, 3300, 3700, 3900, 4000, 4700,
 5000, 5100, 6000, 6200, 6500, 7900, 7950,
 7960, 8000, & 9100 mmfd.

OTHER AIRCRAFT TYPES

On SPST 15A Push but.—
 8871K-1 Type A2—On-Mom. OF \$59 P.T.
 8905K-514 SP-4Pos. 35A @ 24VDC On-Off-Mom. .79 L.T.
 8905K-526 SPST 5A B-5A-1/4" Bat. .32 L.T.
 8905K-722 3PST 10A Off-Mom. On .79 L.T.
 8911K-924 DPST 10A Push But.—
 Mom. On .59 P.T.
 8202K-7 SPST 10A 2 Gang B-5A .32 L.T.
 10% Dis. in quan. of 100 or more net type.

DUAL "AB" POTS

OHMS SHAFT	OHMS SHAFT
1500	20K 7/16"
1-5 meg	1 meg 1/2"
	2 meg 1/8 S

PRICE SCHEDULE

5 to 750 mmfd. 5¢
 2000 to 5100 mmfd. 11¢
 1000 to 1500 mmfd. 7¢
 6000 to 8000 mmfd. 12¢

TOGGLE SWITCHES

CH# Circuit Price AH & H Circuit Price
 8800K4 SPDT \$.60 6A. 125V DPST \$.42
 8824K4 DPDT .75 6A. 125V DPDT .50

BATHTUB COND.

Mfd	Volts	Price	Mfd	Volts	Price
.01-01	600	5.25	.25-.26	600	.49
.02-.02	600	.25	.25	1000	.45
.04-.04	600	.25	.3	400	.45
.05	600	.20	.5	400	.37
.05-.05	600	.25	.5	600	.47
.08-.08	600	.25	5	1000	.52
.1	1000	.39	2x.5	600	.59
.1	1000	.42	1	200	.25
.1	1200	.45	1	300	.39
.1-1	400	.29	1	400	.45
.1-1	600	.39	1	600	.59
.1-1	1000	.51	1-1	600	.75
3x.1	600	.40	2	400	.60
			4	600	.80
			2	100	.40
.2	1000	.21			
.25	800	.19			
.25	400	.30			
.25	600	.41			

SPECIAL MICA KIT—100 @ \$3.50

RELAYS & CONTACTS

Type	Volts	Ohms	Current	Action	Price
1027	12	Leach	87	8 DPST	1.25
1027-BE-W	24	Leach	160	1/2 Cont. DPDT	1.50
1220-BE	24	Leach	95	20 SPST	1.25
				Double Break	1.25
1222-BF	24	Leach	180	10 SPST	1.25
				Double Break	1.25
1227-B2A	24	Leach	140	25 SPST	1.25
1264M	24	Leach	160	10 2-SPST	1.25

SILVER MICA CONDENSERS

7, 24, 25, 33, 50, 60, 75, 95, 100, 120, 150,
 170, 200, 270, 300, 330, 390, 400, 450, 500,
 750, 800, 1000, 1400, 1450, 1700, & 2500
 mmfd.

7 to 95 mmfd. 8¢
 1000 to 1700 mmfd. 14¢
 100 to 800 mmfd. 9¢
 2500 mmfd. 16¢

MICRO SWITCHES

Number	Actuator	Circuit	Ferm. Price
WZR-31	Pin	SPST-N.C.	.45
WZR-31-M	MC2711		
M-WZ-RS13	Plunger	SPST-N.C.	.69
WZR-31	HO3-RE11	SPST-N.C.	1.95
WZR-31	Plunger	SPST-N.O.	.89
WZRQ-41	Plunger	SPST-N.C.	.89
WZR-31	T-Actuator-LH	SPST-N.O.	.79
Y23RDT	Plunger	SPST-N.O.	.99
Y23YBT	Plunger	SPST-N.O.	.69
Y23RDT	Plunger	SPST-N.O.	.99
Y23YBT	Plunger	SPST-N.O.	.69
Y23RDT	Plunger	SPST-N.O.	.99
Y23YBT	Plunger	SPST-N.O.	.69
BZRL2	Roller	SPDT	Solder .95
BZ3HW2T	Roller	SPDT	Solder 1.05
MC-SW(15A 125V)	Lever	DPST N.O.	Solder 1.05

CHANNEL COND.

Mfd	Volts	Price	Mfd	Volts	Price
2x.05	600	.30	.5	400	.21
1	500	.28			
1	800	.32			
1	2500	1.20			
2x.1	400	.34	.5	600	.43
2x.1	600	.40	.5-1	600	.39
3x.1	400	.40	.5-5	400	.39
3x.1	1000	.52	.5	600	.49
2x.25	600	.43	.5	600	.50
2x.25	1000	.48	1	500	.58
.4	600	.30	1	600	.63

SPECIAL 5.MICA KIT—100 @ \$6.50

CERAMICON COND.

10, 56 & 100 mmfd @05
 1000 to 5000 mmfd @06
 .01 400 V01

SUPER SPECIALS

Trans. Jefferson #240-151, 230 to 115V
 .5KV Waterproof. \$10.00
 S. Mica Cond. 400 mmfd. Per Cap 7.00.
 Par M. \$5.00
 Mica Cond. 150 mmfd. Per Cap 4.00.
 Ser M. \$5.00
 Res. 10W 100 ohm WL. \$1.15
 Res. 20W 500 ohm WL. \$1.22
 25 mfd-75V Electro. \$1.15
 500 mfd-6V Electro. \$1.29
 Car filter cond. .01 mfd-200V \$0.07
 Socket 7 pin (2Z8-09-4). \$0.03

MOLDED PAPER COND.

.01 400 V type CN 35 15¢ ea. \$10.50per"CM"
 .01 .05 .06 400V. 4¢ ea. \$ 3.50per"CM"
 .004, .01, .03 600V. 5¢ ea. \$ 4.50per"CM"
 .1 1000V. 8¢ ea. \$ 7.50per"CM"
 .01 1000V. 15¢ ea. \$13.50per"CM"

YOUR INQUIRIES INVITED

G.E. THYRISTE, K8396832-1, 5-40 ma/21-33
 volts. \$6.65
 A.F. TYPE #13 STEPPER RELAY, B-12VDC
 3 deck 25 position, 360 degree rotation. \$8.95
 SCR-274N OUTPUT TRANSFORMER, ES-
 690127. \$1.65

WANTED
 Condensers of all types in any
 quantity. Also other standard
 components. Top prices.

Write: ART HANKINS, Owner

MONMOUTH RADIO LABORATORIES

BOX 159 Long Branch 6-5192 OAKHURST, N. J.

Quality • Reliability • Service PAYS OFF

WE ARE MOVING TO LARGER QUARTERS

OUR NEW FACILITIES WILL ENABLE US TO DO EVEN BETTER

BATHUB COND. YAB/T CHANNELS WAB/T

MFD	400V	600V	1000V	400V	600V	1000V
.05	5.30	5.35	5.40	5.35	5.40	5.50
.10	.35	.40	.45	.40	.45	.50
.25	.40	.45	.50	.50	.60	.65
.50	.45	.50	.60	.60	.65	.70
2 1.0	.50	.65	.75	.75	.85	
2.0	.90	1.25				

YOUR MOST COMPLETE SOURCE OF UHF • UG • AN CONNECTORS



NO.	JAN NO.	DESCRIPTION	1-99	100 TO 999	1000 AND OVER
83-IR	SO 239	RECEPTACLE	\$.50	\$.45	\$.40
83-ISP	PL 259	PLUG	.55	.55	.50
83-168	UG 176/U	ADAPTER	.15	.12	.11
83-185	UG 175/U	ADAPTER	.15	.12	.11
83-ISPN	PL 259A	PLUG	.65	.60	.55
83-776	UG 203/U	PLUG	.65	.60	.55
83-IRTY	RECEPTACLE	.75	.65	.65
83-IH	UG 106/U	HOOD	.15	.14	.13
83-IHP	HOOD	.27	.24	.22
83-765	UG 177/U	HOOD	.24	.24	.24
83-IAC	CAP & CHAIN	.55	.50	.45
83-IBC	CAP & CHAIN	.35	.31	.30
83-IT	M 358	T CONNECTOR	1.50	1.40	1.40
83-IAP	M 359	ADAPTER	.35	.30	.28
83-IAP	M 359A	ADAPTER	.80	.75	.70
83-IJ	PL 258	JUNCTION	.75	.70	.65
83-IF	PL 274	FEED THRU	1.25	1.20	1.10
83-22SP	UG 102/U	TWIN PLUG	.90	.80	.75
83-22R	UG 103/U	RECEPTACLE	.90	.80	.75
83-22AP	UG 104/U	ADAPTER	1.40	1.25	1.10
83-22J	UG 105/U	JUNCTION	1.50	1.40	1.40
83-22T	UG 196/U	T CONNECTOR	1.65	1.50	1.50
83-22F	PL 275	FEED THRU	2.00	1.80	1.75
83-2SP	PL 295	PLUG	2.25	2.15	2.00
83-2R	SO 265	RECEPTACLE	1.65	1.55	1.50

From stock

Type	Price	Type	Price	Type	Price	Type	Price	Type	Price
UG 9/U	\$ 1.95	UG 57/U	\$ 2.30	CW 155/U	\$.63	UG 254 A/U	\$ 3.50	UG 496/U	\$ 3.50
UG 10/U	2.75	UG 57 B/U	1.85	UG 155/U	9.50	UG 255/U	2.85	UG 499/U	1.50
UG 11/U	3.25	UG 58/U	1.80	UG 156/U	8.50	UG 256/U	15.50	UG 503/U	50.00
UG 12/U	1.55	UG 58 A/U	1.25	UG 157/U	8.50	UG 257/U	15.50	MX 504	.45
UG 13/U	2.25	UG 59/U	2.45	UG 158/U	47.50	UG 259/U	6.50	UG 505/U	50.00
UG 14/U	1.80	UG 59 A/U	2.15	CW 159/U	1.95	UG 260/U	1.20	UG 506/U	50.00
UG 15/U	1.85	UG 59B/U	2.75	UG 159 A/U	2.20	UG 260 A/U	1.40	UG 507/U	50.00
UG 16/U	2.75	UG 60/U	2.40	UG 160 A/U	2.20	UG 262/U	1.20	UG 526/U	3.75
UG 17/U	2.75	UG 60 A/U	2.25	UG 160 B/U	2.50	UG 262 U	1.20	UG 530/U	4.50
UG 18/U	1.75	UG 61/U	2.55	UG 166/U	47.50	UG 266/U	4.50	UG 531/U	5.15
UG 18 A/U	1.75	UG 61 A/U	2.40	UG 167/U	5.75	UG 269/U	3.75	UG 532/U	6.95
UG 18 B/U	1.75	UG 83/U	1.95	UG 167 A/U	5.75	UG 270/U	10.00	UG 533/U	10.00
UG 19/U	2.25	UG 85/U	2.00	UG 173/U	.38	UG 271/U	10.00	UG 535/U	4.95
UG 19 A/U	2.25	UG 86/U	2.80	UG 174/U	20.00	UG 272/U	25.00	UG 536/U	2.45
UG 19 B/U	1.95	UG 87/U	1.60	UG 180 A/U	10.00	UG 273/U	2.55	UG 541/U	3.95
UG 20/U	1.95	UG 88/U	1.10	UG 181 A/U	10.00	UG 274/U	3.95	MX 554/U	2.25
UG 20 A/U	1.90	UG 88 B/U	1.95	UG 182 A/U	10.00	UG 275/U	7.50	UG 557/U	5.50
UG 20 B/U	1.90	UG 89/U	1.35	UG 185/U	1.35	UG 276/U	7.50	MX 564/U	.55
UG 21/U	1.25	UG 90/U	1.60	UG 188/U	1.30	UG 279/U	3.95	UG 564/U	3.95
UG 21 A/U	1.95	UG 91/U	1.95	MX 195/U	1.00	UG 286/U	4.95	UG 565/U	3.95
UG 21 B/U	1.45	UG 91 A/U	1.70	UG 197/U	4.95	UG 287/U	7.75	UG 566/U	7.95
UG 21 C/U	1.75	UG 92/U	1.80	UG 201/U	2.75	UG 290/U	1.20	UG 567/U	6.95
UG 21 D/U	1.95	UG 92 A/U	2.25	UG 202/U	3.95	UG 291/U	1.25	UG 568/U	4.95
UG 22/U	1.65	UG 93/U	1.95	UG 204 A/U	3.50	UG 294/U	2.20	UG 569/U	2.95
UG 22 A/U	1.60	UG 93 A/U	2.25	UG 206/U	9.00	UG 299/U	7.75	UG 570/U	2.95
UG 22 B/U	1.50	UG 94/U	2.25	UG 207/U	25.00	UG 306/U	2.95	UG 571/U	6.95
UG 22 C/U	1.95	UG 94 A/U	1.60	UG 208/U	22.50	UG 309/U	3.75	UG 572/U	5.95
UG 23/U	1.65	UG 95/U	1.95	UG 212 A/U	3.50	UG 332/U	3.50	UG 573/U	7.25
UG 23 A/U	1.95	UG 95 A/U	2.00	UG 213 A/U	4.10	UG 333/U	5.50	UG 602/U	3.00
UG 23 B/U	1.75	UG 96/U	2.10	UG 215/U	5.50	UG 334/U	6.50	UG 603/U	3.00
UG 23 C/U	1.95	UG 96 A/U	1.95	UG 216/U	14.00	UG 335/U	3.75	UG 625/U	1.70
UG 27 A/U	3.75	UG 97/U	4.25	UG 217/U	7.50	UG 347/U	2.50	UG 627/U	7.25
UG 27 B/U	3.75	UG 97 A/U	3.95	UG 218/U	10.00	UG 348/U	1.50	UG 628/U	7.25
UG 27C/U	4.50	UG 98/U	2.50	UG 219/U	7.50	UG 349/U	3.50	UG 634/U	4.95
UG 28/U	3.95	UG 98 A/U	2.70	UG 220/U	10.00	UG 352/U	7.50	MX 913/U	.65
UG 28 A/U	3.95	UG 100/U	2.95	UG 222/U	43.75	UG 352A/U	9.00	UG 931/U	3.00
UG 28 B/U	4.50	UG 100 A/U	3.75	UG 223/U	6.50	MT 412	.95	UG 932/U	3.00
UG 29/U	1.00	UG 101/U	4.45	UG 224/U	1.20	UG 414/U	2.95		
UG 29 A/U	1.90	UG 101 A/U	4.55	UG 231/U	2.70	UG 419/U	1.95		
UG 29 B/U	1.90	UG 107 A/U	4.50	UG 233/U	18.50	UG 421/U	3.25		
UG 30/U	2.50	UG 107 B/U	4.50	UG 234/U	18.50	UG 422/U	3.25		
UG 32/U	19.00	UG 108/U	2.90	UG 235/U	35.50	UG 423/U	5.80		
UG 33/U	19.00	UG 108 A/U	3.25	UG 236/U	12.00	UG 447/U	1.50	MC 10	.36
UG 34/U	19.00	UG 109/U	2.30	UG 237/U	25.00	UG 478/U	50.00	MC 20	.46
UG 35 A/U	19.00	UG 109 A/U	2.90	UG 241/U	3.45	UG 479/U	33.80	MC 30	.82
UG 36/U	19.00	UG 110/U	15.00	UG 242/U	3.95	UG 482/U	33.80	MC 40	.86
UG 37/U	19.00	UG 114/U	2.15	UG 243/U	4.50	UG 483/U	4.65	MC 50	.36
UG 37 A/U	19.00	UG 115/U	2.25	UG 244/U	4.00	UG 484/U	5.80	MC 60	.46
UG 38 A/U	22.00	UG 119 U/P	7.50	UG 245/U	2.50	UG 486/U	2.30	MC 70	.82
UG 39/U	1.75	CW 123 A/U	.55	UG 246/U	3.10	UG 487/U	6.50	MC 80	.86
UG 40/U	1.95	UG 131/U	10.00	UG 249/U	18.50	UG 491/U	2.25	MC 100	1.20
UG 45/U	5.00	UG 146/U	2.95	UG 250/U	18.50	UG 492/U	5.00	MC 110	1.12
UG 46/U	5.00	UG 148 A/U	7.85	UG 251/U	18.50	UG 493/U	7.25	MC 120	.36
UG 49/U	20.00	UG 149 A/U	5.25	UG 252/U	7.50	UG 494/U	4.75	MC 150	.75
UG 50/U	20.00	UG 154/U	9.50	UG 253/U	5.50	UG 495/U	7.50	MC 250	1.50

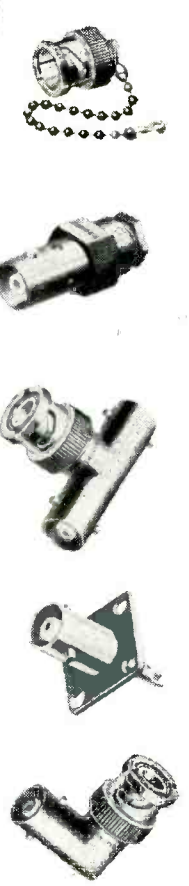

It's Free! A request on your letterhead will bring you a copy of our new AN and Associated Hardware and Fittings Catalog just off the press. Request catalog No. AN 9.

LIFE ELECTRONIC SALES

**345 Broadway, New York 13, N. Y.
Dlgy 9-4154**



COMPASS

COMMUNICATIONS COMPANY

393 GREENWICH STREET
NEW YORK 13, N. Y.

CABLE ADDRESS: COMPRADIO, N. Y.
ALL PHONES: BEEKMAN 3-6509

WE MAINTAIN
OUR OWN FULLY
EQUIPPED TESTING
LABORATORY TO
TEST AND GUARANTEE
ANYTHING WE SELL

Suppliers of
MARINE, GROUND & AIRBORNE
TRANSMITTERS
FROM 25 WATTS TO 5 KILOWATTS
RADAR
SONAR
TEST SETS
TELEPHONE EQP'T.
CONVERSION EQP'T.

- MOTOR GENERATORS
- CONVERTORS
- DYNAMOTORS
- INVERTERS
- POWER SUPPLIES
- RECTIFIERS

AND

TUBES— SPECIAL PURPOSE and TRANSMITTING TYPES

TCS—Collins mfd. Navy radiotelephones for shipboard and mobile use, complete with all accessories for operation from 12, 24, 110, 230 volts d.c. and 110 or 220 volts a.c.

TDE—Navy or commercial marine transmitters, complete 110 & 220 volts d.c. and a.c.

TBK—Navy high frequency transmitter, 2-20 mcs; 500 watts output. Supplied complete with m/g and starter for d.c. or a.c. operation.

TBM—same transmitter but with speech input equipment to give 350 watts phone.

TBL—Navy all-wave transmitter; 350 watts output: CW and phone. Supplied complete with m/g and starter for d.c. or a.c. operation.

TAJ—Navy intermediate freq. transmitter, 175-550 kcs; 500 watts output. Supplied complete with m/g and starter for a.c. or d.c. operation.

SCR-284—the famous mobile and ground station for field use. Large quantity of complete sets available.

MAG—10 cm. portable link radar transmitter receivers, 6-volt operation.

TBN—200-500 kcs, complete with 220/440 volt, 3 ph. 50-60c. power supply—conservatively rated at 1 kw. output.

SCR-510 and 610 in quantity.



• BEACONS

AN/CPN-8 10 cm.

AN/CPN-6 3 cm.

YJ and YG . . . for shipboard use

SURPLUS G. E. AMPLIDYNES
6A. 250v. Output, 440v.—3 ϕ —60N—3600 RPM
Input—3A. 250v. Output, 440v.—3 ϕ —60N—1800 RPM Input.
INQUIRE:
Industrial Instrument & Central Co.
103 Pond Street Natick, Mass.

DYNAMOTORS
From our inventory. New, original containers, BD-77; DM-21; DM-32; DM-36; DY-22; PE-86 and others. Substantial quantities. Also John Oster Co. fractional horsepower motors.
LINE HARDWARE CO.
1515 N. 26th St. Phila. 21, Pa.

For television micro-wave relay use—One 200 foot "Skyline" double-guyed TOWER Complete with required obstruction lighting. Also, four reflecting screens which permit the mounting of micro-wave dishes on ground.
Call, wire or write J. M. McDonald, CROSLY BROADCASTING CORP., Cincinnati 2, Ohio Cherry 1822



AN/APR-4 LABORATORY RECEIVERS
Complete with all five Tuning Units, covering the range 38 to 4,000 Mc.; wideband discone and other antennas, wavetraps, mobile accessories, 100 page technical manual, etc. Versatile, accurate, compact—the aristocrat of lab receivers in this range. Write for data sheet and quotations.
We have a large variety of other hard-to-get equipment, including microwave, aircraft, communications, radar; and laboratory electronics of all kinds. Quality standards maintained. Get our quotations!
We will buy any Electronic Material at top prices. SCHOOLS—unload your dusty surplus for cash or credit.

ENGINEERING ASSOCIATES
434 PATTERSON ROAD DAYTON 9, OHIO

RELAY SPECIALISTS
AUTHORIZED FACTORY DISTRIBUTORS
STRUTHERS-DUNN POTTER & BUMFIELD

100,000 RELAYS ALL TYPES



MINIATURE AIRCRAFT TYPE—4 Pole D.T. contacts. 1 1/2" overall, 280 ohm coil. \$2.95 24 V. D.C.
RADIO DEVELOPMENT & SALES CO.
323 Atlantic Ave. Brooklyn 2, N. Y. ULster 5-0488

THE BEST IN ELECTRONIC SURPLUS

TRANSMITTERS

3 KW GE FM BROADCAST STATION (Formerly WGIN), COMPLETE. 38-108 mc. Includes FM Exciter-Driver in one cabinet, 3 KW Amplifier with Power Supply in second cabinet, 2 RCA type 70-C1 Transcription turntables 33 1/2 and 78 rpm include Gray Recorder arms and heads, 1—RCA MI-11301A Console, Supply. 1 RCA Type 76-B2 Studio Amplifier, plus Freq. & Mod. Monitor, Station Monitor, Monitor Amplifier, etc., and all tubes for all equipment. All in good operating condition.

PRICE (not crated).....\$5,000.00
2 KW Radio Ranging or Homing Transmitter, 125 to 525 KC; A1, A2 & A3 emission. Consists of Wilcox 96-200A with VFO or Crystal-Controlled Oscillator in one cabinet, Wilcox 36A Rectifier in 2nd cabinet, and Wilcox 50A Modulator in 3rd cabinet. All NEW, unused equipment, export packed. Operation from 220 V., 50-60 cycles, 3-phase A.C. **Write for Price.**

LINK FM TRANSMITTER-RECEIVER, 70-100 mc, 50 watts output. Model 1498. Wall style cabinet containing transmitter, receiver and 14 V. D.C. or 110V. A.C. power supply, hand-set. Dim.: 34" x 21" x 11". NEW condition. Complete with tubes, crystals, special telescopic antenna, instruction book. **PRICE \$500.00**

MODEL ATD AIRCRAFT RADIO TRANSMITTER EQUIPMENT. This is a Navy Model, 4-channel (motor driven band switching), covering the range of 540 KC to 9050 KC. Output 50 watts phone, but operates A-1, A-2 as well as A-3. Operates from 24-28 volt DC dynamotor. Each set includes: Dynamotor, Remote Control, Channel Selector Control, Plug Connectors, Operating Tubes, Spare Chest with Spare Tubes and Parts, and Instruction Books. All BRAND NEW, in Original Cases; each with 4 Tuning Units to cover the aforementioned range of frequency.

PRICE EACH.....\$160.00
TDQ TRANSMITTERS, VHF, 45 watts output AM, 110 to 156 mc; 115/230 V. AC, 60 cycles, with tubes, cables, EXCELLENT condition. **PRICE EACH.....\$650.00**
BC-797-A TRANSMITTERS, 110-126 mc, 50 watts output phone, AM, for 110 V. 60 cycle operation. **PRICE, EACH.....\$600.00**
SCR-522 VHF AIRBORNE TRANSMITTER, RECEIVERS, With Tubes, LIKE NEW condition.

PRICE, EACH, less accessories.....\$85.00
MODEL GP-7 AIRCRAFT TRANSMITTING EQPT., 40 watts output A1, A2, and A3. Range 350 to 9050 Kcs covered by 6 plug-in tuning coil units. Ept. includes: External Loading (Ant.) Coil, Operator's Control Box, Pilot's Control Box, Cable Connectors. All NEW material, export packed.
Price, Per Set.....\$75.00

AUDIO SOUND

Beachmaster 250 W.; Western Elec. Model HLAS-500W.

RECEIVERS

RBM, RBS, BC-1088 VHF, SCR-206 Direction Finders, **BC-224, BC-969-T1 & 974-T2, CRV-46136, 100 to 1500 KC**, part of DP-13 Radio Eqpnt.
RT-3/ARN-1 Radio Altimeters, New, Model **ZB-3, Aircraft Homing Adapters**, with plugs and accessories, New Eqpnt.

Immediate Delivery from Stock

**Cable: Telemarine, N. Y.
 Tel. LOngacre 4-4490-1**

NEW GE 1 KW, 3 KW, and 10 KW-RF AMPLIFIERS!

G.E. Transmitting Equipment of recent design, NOT WAR SURPLUS, all NEW and export cased—at tremendous reduction from original price! Available, in quantity: Type BF-1-A, 1 KW Power Amplifier and Power Supply; BF-2-A, 3 KW Power Amplifier with separate matching Rectifier-Power Supply; BF-3-A, 10 KW Power Amplifier with separate matching Rectifier-Power Supply. This equipment is designed for 88-108 MC FM broadcasting application, beautifully engineered and constructed. (250 Watt FM Exciter or Driver NOT AVAILABLE). Conversion to lower frequencies (2 to 24 mc, or other frequencies) can be accomplished at very low cost. Our factory will be glad to quote on conversion to specified frequencies. All units designed for 208/230 volts, 50/60 cycles operation; 3 KW and 10 KW units require 3-phase. All incorporate internal blower systems for forced air-cooling, and use latest G.E. hi-efficiency tubes. Quantities sufficient to interest manufacturers—to convert for other applications. Ideal for FM Broadcasters, communication companies, Schools, Labs! Available as separate units, or complete. Write for more complete specifications and prices.

Model ZA Instrument Landing Equipment Eqpnt., Complete, with Glide-Path Receiver, Localizer, Antenna, 2 Sensitive Landing Indicators, tubes, accessories, etc. All NEW Eqpnt. **PRICE, PER SET.....\$85.00**
Model DZ-2, Direction Finder Eqpnt. Complete, NEW EQPT., mfd. by RCA. Covers from 15 KC to 1750 KC in 6 bands, with super-sensitive superhet circuit, with sharp selectivity below 200 KC where mostly required. Ideal for superomnes monitoring or testing. Direction finding on boats or aircraft, or as low-frequency communications receiver. With Loop, Pedestal ad Drive, 24/28 V. DC Dynamotor and Filter, Cable, etc. Export Packed. **PRICE, Per Set.....\$110.00**

MISCELLANEOUS

GENERAL ELECTRIC VOLTAGE REGULATOR (POWER SUPPLY), Model 3GVD-14B-3, delivers up to 750 volts at 10 MA, with voltage divider network to provide lower voltages all regulated. Incorporates switch for "regulating", "non-regulating", and "stand-by". Uses following tubes (not supplied): 1—807, 1—6X4, 2—6H6, 1—VR-105, 1—VR-150, 1—6AG7, and 1—5R4GY. Chassis dimensions 12" x 16" x 3" with chassis cover 9" high. Ideal for laboratories, Frequency Shift Equipment, Stable Oscillator construction, etc. ALL NEW Units.

PRICE, EACH.....\$24.50
RADIOSONDE AN/AMQ-1, Meteorological Balloon transmitter with self-contained instruments. New Units, with slide-rule temperature evaluators and spare (sealed) humidity elements. Large quantity available. Receiving and Recording supplementary eqpt. also available. Type AN/FMQ-1. **WRITE FOR PRICE.**

All Prices F.O.B. N.Y.C.

TRANS-RECEIVERS

TCS COLLINS SHIP TRANSMITTER-RECEIVERS. Each with cables, remote control box and loading coil, radio-telephone and radio-telegraph at 20 and 40 Watts, 1.5 to 12.0 mc. Following power supplies available. 12 V. DC, 24 V. DC, 230 V. DC, 110 V. AC. Complete with all accessories EXCELLENT, like NEW condition. **WRITE FOR PRICE.**

SCR-284 EQUIPMENT, consisting of BC-654 Transmitter-Receiver, PE-103 Generator Power Supply, GN-45 Hand Generator with cranks and legs, and PE-104 Receiver-Vibrator Power Supply, plus other minor accessories. All equipment in EXCELLENT Condition, with complete tubes. **WRITE FOR PRICE.**

SCR-511 POGO STICK WALKIE-TALKIE. This is a low-powered portable AM Radio Telephone Transmitter-Receiver, covering a frequency range of from 3 to 6 mc. Pre-Tuned Plug-in Tuning Units (BC-740) which contain appropriate Transmitter and Receiver Crystals and matching coils are employed to provide quick changeover to any frequency in the 3 to 6 mc. band. The Transmitter-Receiver (BC-745) is mounted on a 30" metal stake, which can be driven into the ground to support the unit. A telescopic antenna is provided at the top, along with a convenient "press to transmit" switch. Each set consists of: BC-745 Transmitter-Receiver, complete with Tubes; 5 Plug-in Tuning Units BC-746, with crystals and coils to provide coverage over the 3 to 6 mc. range; PE-157 Vibrator Power Supply, which incorporates the dynamic Loudspeaker (for reception), Vibrator, Dry Disc Rectifier, and space for a 2 volt non-spillable acid type storage battery (not supplied). Equipment is NEW and UN-USED. A T-17 Microphone and 2-Volt Storage Battery (Plastic case type readily available) are all that are required for each set to put into operation. **PRICE, EACH.....\$139.50**
WESTERN ELECTRIC MODEL 233A VHF Radiotelephone, 4 Channels, crystal control both txvr and xmtrr, 140 to 145 mc, Amp. Mod., up to 10 watts output, Dynamotor for 12 or 24 V. DC operation. Supplied complete with 4 WE Dual Crystals, dynamotor, channel selector control unit, all tubes, operating manual. **NEW EQPT.** Ideal for Planes, Marine, Mobile, or other 2-way applications. Can be modified easily for other frequencies. Quantities available immediate delivery. **WRITE FOR PRICES.**

20-40 MC RADIO BEACON EQUIPMENT

For SCR-508, 528, 608, 628, 509, 510, 609, 610, etc.

MODEL RC-163 is designed for ready connection to RADIO SET SCR-508, 528, etc., and 608, 628, etc.—or similar transmitting and receiving equipment. It permits directional transmission and reception for beacon, homing, etc., applications. Eqpnt. consists essentially of a rotating directional antenna (Adcock type) synchronized to an automatic code keyer (which can be removed). Four sets of plug-in inductors are supplied to cover the 20 to 40 mc range. Designed to operate from a 12-volt storage battery, power consumed approximately 54 watts (4.5 amps). **PRICE EACH SET.....\$169.50**

All Material Offered Subject to Prior Sale

TELEMARINE COMMUNICATIONS CO.

**540 W. 27th St.
 N. Y. 1, N. Y.**

BIG SAVING! FERRULE TYPE RESISTORS

Immediate Delivery from Our Stock of Over 250,000

Wide assortment from 0.2 to 300,000 ohms

ENAMEL—GLASS
 FIXED—ADJUSTABLE

NEW AND IN PERFECT CONDITION

Nearly All Made to JAN Specification

Write for Catalog E-10

ELECTRONIC DIVISION
UNIVERSAL YONKERS CORP.
 137 Alexander St., Yonkers 2, N. Y.

REMEMBER

Any Kind of Electronic Equipment
 Bought or Sold

ELECTRONIC SURPLUS BROKERS

148 CHAMBERS ST., NEW YORK

RECTOR 2-1591

DEPENDABILITY IN ELECTRONICS

Attn: Industrial Purchasing Agents . . .

Our new Radio Master Catalogue is available to you at no charge upon receipt of your request on your letterhead. We are National Distributors of General Electric, Sylvania, Ohmite, Amphenol, Sprague, Aerovox, Sangamo, Stancor, Merit A. H. & H., Simpson and many others. All telegrams, cablegrams, and inquiries acknowledged and promptly answered.

NORMAN RADIO DISTRIBUTORS INC.
 94-29 MERRICK BOULEVARD JAMACIA, N.Y. - REpublic 9-4651

WIRE-CABLE TUBES PARTS

CORDAGE

CO-122 3 conductor each #22 AWG neoprene jacket 550' lengths
 CO-127 single #14 AWG braided and tinned copper braid shield

MULTI-CONDUCTOR

2 conductor AWG 12 7 conductor AWG 16
 7 conductor AWG 14 19 conductor AWG 16
 14 conductor AWG 16 6 conductor AWG 20
 11 conductor shielded 10 conductor AWG 16
 AWG 20 22 conductor AWG 16
 2 conductor AWG 18
 2 conductor shielded AWG 10

AMOUR

DRIA-23 DHFA-100 FRIA-4

SINGLE CONDUCTOR AWG 10

shielded cable with terminal lug each end 100' and 150' lengths

WIRE

AWG 18 copperweld
 AWG 29 tinned copper
 Resistance wire AWG 32
 AWG 22 with nylon core plastic insulation

LINEAR WIRE WOUND POTENTIOMETERS

10 Ohm	25 Watt	5.90	15000 Ohm	25 Watt	\$1.70
15	25	.95	20000	25	2.00
20	25	.95	50	50	1.60
25	25	.95	150 /switch	50	2.15
50	25	.95	200 w/switch	50	2.15
100	25	.95	10000	50	2.95
200	25	1.20	15	75	2.95
350	25	1.20	.5 Meg 1" shaft	AB	1.45
500	25	1.20	200,000 1/8 SD	AB	1.40
1000	25	1.30	200 1/8 SD	AB	1.40

SPECIALS

80-86 Crystal in Holder \$2.50
 Balloon with Hydrogen Generator \$2.50
 300 Feet Aerial Wire \$2.00
 Box Kite 17" x 17" x 36" \$2.25

MICROWAVE TEST EQUIPMENT

10 CM echo box CABV 14ABA-1 of OBU-3, frequency range 2890 MC — 3170 MCS. Direct reading micrometer head. Ring prediction scale plus 9% to minus 9% Type "N" input. Resonance indicator meter. With accessories, spares and 10 CM directional coupler. Brand New.

TUBES

2C34	50.55	803	53.75	CEO-72	\$1.15
2X2/879	.60	826	.95	CK-70	4.25
3B24	5.00	864	.40	CRP-72	1.15
3C24	1.75	931A	4.45	E1148	.35
7C4/1203A	.75	955	.40	HY-615	.20
10Y	.45	957	.40	RR-R-72	1.15
15R	.70	CK1005	.50	RA-73	.60
30 Special	.45	CK1007	.90	5B14	4.95
39/44	.30	1626	.40	5F7	1.95
45 Special	.35	1629	.35	116G	.70
WE 203A	8.00	2051	1.15	1B3GT	.89
316A	.65	7193	.50	3A1	.65
WL-531	5.50	8011	1.50	5U4G	.57
713A	.95	9006	.40	6K6GT	.65
801A	.40	C5B	8.50	12A6	.65

HI VOLTAGE FILTER CHOKES

.4 HY 4.5 Amp DC 3 ohms 1230 RMS to ground. New.
 .25 HY 4 Amp .5 ohm 20,000 Test. New.
 1 HY 3.2 Amp DC 3.5 ohm GE69G459. New.
 1.7-3 HY 2 Amp DC 34,000 VDC GE Y346A. New.

NAVY ENTERING TYPE INSULATOR

Porcelain flanged bowl with brass rod, fittings and aluminum shield. Dimensions 4 7/8" high, 6-5/16" OD at base. Brand new \$4.50

10 CM ROTATING ANTENNA

24" Parabola in turret 360° span at 12 RPM DC, motor control and reversing switch New

TIME DELAY SWITCHES

1 Minute 115 VAC 60 cycle Enc. in Waterproof Metal Case New \$5.25
 3 Micro Switches Contact at 40-41-42 Second Time Delay 110 VAC Motor New \$4.50
 Thermo Switch 50° to 300° F 115 VAC @ 6A 230 VAC @ 5A
 Breaks Contact with Increase in Temperature New \$1.35

CONTACTORS

DPST 115 VAC 60 cycle 15 Amp De-Ion Line Starter Westinghouse \$6.95
 DPST 115 VAC "AB" #700 \$5.95

RELAYS

12 VDC DPST Allied Control Box \$2.25
 24 VDC DPST Allied Control BJD36... \$1.45
 24 VDC 3PDT 8 Amp... \$1.50
 110 VAC DPST 1 Amp Contacts Struthers Dunn CKA 1970... \$3.65
 115 VAC DPST Struthers Dunn CXA 2997 \$3.65
 220 VDC DPST Struthers Dunn CK 2122... \$4.50
 230 V 50 cycle DPDT G.E. 12HGA11A2... \$4.00

ROLLER INDUCTANCE COIL 0-15 MH WITH VERNIER ADJUSTMENT

Coil is wound on ceramic form 3 1/8" long. Right angle drive gear with 5/8" shaft. Three position switch for vernier operation New—Meissner—C-625

METERS

Portable 0-25 Amps AC Weston #433 Brand New \$37.50
 Switch Board Panel 0-100 Amps DC Weston #269 with 100 Amp Shunt Brand New \$24.95

EQUIPMENT

Walkie-Talkies 2.3-4.6 MC
 MN-26Y Bendix Compass Receiver
 BC-733 Glide Path Receiver
 DAB-3—Direction Finder
 RDF Receiver Equipment 200-550 KC Fixed Tuned

SWITCHES—BATHTUB—OIL FILLED—MICA CONDENSERS—POTENTIOMETERS. SEND FOR CATALOG

COMET ELECTRONIC SALES CO.

22 Washington St.

Tel. BEacon 2-7863

Brighton 35, Mass.

TERMS: Minimum order \$5.00 — Mail orders promptly filled—All prices F.O.B. Boston, Mass. Send M.O. or check. Shipping charges sent C.O.D. 25% deposit required with all C.O.D. orders.

MOVED

TO A BIGGER & BETTER WAREHOUSE
 PILED HIGH WITH
HARD-TO-FIND PARTS & EQUIP.

Just a partial list of our present stock:

- BC-348 • BC-342 • ART-13
- ARC-3 • APN-9 • LM
- BC-221 • BC-611
- VARIOUS TEST EQUIPMENT

NEW EXPORT DIVISION FOR ALL FOREIGN ORDERS

Prompt attention to all inquiries—all languages!

Attn: Schools, Labs, Hams!

WE PAY MORE

FOR RADIO PARTS & EQUIPMENT

Cash in on your surplus equipment—or we'll trade for something you really need. Write today!

NEW ADDRESS:

CANDEE-AIRCO

Dept. E-6

4109 BURBANK BLVD.
 BURBANK, CALIFORNIA
 Charleston 0-1486 • Rockwell 9-1070



ATTENTION BUYERS OF ELECTRONIC EQUIPMENT

Here is Your One Complete Dependable Source for All of Your Electronics Needs

RECEIVING TUBES

OZ4	6AU6	6SC7	7F7	12SK7GT
1U4	6BA6	6SN7GT	7Y4	12SQ7GT
3S4	6BE6	6T8	12AT7	25L6GT
5V4G	6CB6	6W4GT	12AV7	35W4
6AB4	6BK7	7A4/XXL	12BA7	35Z5GT
6AC7	6F6	7A6	12BF6	50B5
6AH6	6J6	7B6	12H6	50L6GT
6AS7G	6L6G	7C6	12SH7	75

TRANSMITTING AND SPECIAL PURPOSE TUBES

3C45	304TH	832A	2051
5R4GY	723A/B	845	5829
6AN5	807	954	8020
100TH	813	957	9002
211	829B	658	9003

BRAND NEW COAXIAL CABLE

Meeting Jan-C-17A Specifications
 RG-8/U \$110.00 per M Feet
 RG-11/U 107.90 per M Feet
 RG-59/U 59.60 per M Feet

300 OHM Lead Wire 70 Mil Webbing \$19.00 per M Feet
 JK26 Jacks—39¢ ea. 500 MMFD Volt DCW TV High Voltage Condensers .36¢ ea.
 Centralab TV1-501—One end threaded, other end plain stud .32¢
 Centralab TV3-501—One end threaded, other end screw terminal. .32¢

LET US KNOW ALL YOUR ELECTRONIC NEEDS

Write - Wire - Phone For Prices

Electronic Expeditors

Dept. EE, 225 N. Wabash Avenue
 Chicago 1, Illinois
 Cable Address "ELEXPEDITE" • TWX CG1510

Hershel Special

Bk 22K Relay	\$3.95
Butterfly Condenser	
Type A-76 to 300 MC	4.95
Type B-300 to 1000 MC	4.95
Mallory FL-17A Filter Unit 25 AMP 35 Volt	.95
Ideal for mobile generator interference)	
Modulation Transformer P.P.P.	
6L6 to 3000 ohm	2.95
6SN7 P to 815 Grids	1.95
815 Class AB2	3.95
Low Pass Filter 500 ohm Line 3000 CPS—cut off	1.95
Swinging Choke	
2 to 7 H 550 MA	6.95
.01 Mfd 8000 V Mica Cond	4.95
.1 Mfd 7000 V Can type paper	1.95
.002 Mfd 3000 V. Mica	.69
R. L. Drake Filter F 15 U	3.95

(Stop your TVI with this high pass filter)

Tubes:	
814 New	2.95
8020 New	2.95
T-17 Mike	4.95
Scope Transformer	
PRI—110 v Sec. 4000 v at 10 MA	3.95
A-5 Automatic Pilot directional Gyro—New	19.95

20% Deposit with Order. Balance C.O.D. Michigan Residents Add 3% Sales Tax.

HERSHEL RADIO CO.

5245 Grand River Avenue
 DETROIT 8 MICHIGAN

WAREHOUSE CLEARANCE TUBE SALE

NEW, STANDARD MANUFACTURERS, IMMEDIATE DELIVERY

0B3/VR90	\$1.20	5JP2	\$19.50	464A	\$ 9.50	8020	\$ 2.50
0C3/VR105	1.20	5T4	1.50	531	14.50	9001	1.75
0D3/VR150	.85	GAC7	.95	532A/1B32	3.95	9002	1.50
1A3	.85	GAG7	1.20	705A	3.75	9003	1.75
1A5GT	.78	GAJ5	2.25	706AB	22.50	9004	1.75
1B22	3.75	GAJ6	2.10	706AY-GY	32.50	9006	.75
1B24	14.95	6B6G	.75	707A	14.50	CE22/918	1.50
1B27	17.50	6C6	.79	721A	2.45	CK5011X	1.50
1B32/532A	3.95	6C8G	.79	723AB	22.50	CK1089	1.50
1N21	1.25	6H6	.69	724A	2.95	EL5B/4B22	9.75
1N22	1.25	6K7	.75	724B	5.95	ELCSB	9.75
1N23	1.50	6SA7	.74	726A	14.95	ELC6A	7.50
1N27	2.95	6SC7	.97	750TL	79.50	EL6CF	8.95
1P23/CE-1	3.50	6SH7GT	.79	801	.85	EL302.5/3B21	4.50
1R4/1294	.85	6SH7	.79	803	5.95		
1T4	.59	7C4/1203A	.75	804	10.50		
2A3	.95	7E5/1201	.95	805	4.95		
2AP1	8.95	7E6	.55	807	1.79		
2B22	4.25	10Y	1.50	810	10.95		
2C33/RX233A	3.45	12A6	.85	811	2.85		
2C40	17.50	12C8	.89	813	8.95		
2E22	3.49	12H6	.69	814	3.35		
2J21	9.95	12J5GT	.57	815	3.40		
2J21A	12.95	12J5F7	.75	816	1.45		
2J27	14.95	12J5JGT	.65	826	1.39		
2J27	22.50	14H7	.97	830B	2.95		
2J34	38.45	14J7	1.10	832	7.95		
2J50	69.50	15R	1.00	832A	9.50		
2J55	95.00	23D4	.65	836	4.50		
2X2	.89	30	.48	838	3.50		
2X2A	2.15	45	.35	838W	6.50		
3A4	.85	53A	3.95	845	3.95		
3B7/1291	.62	71A	.69	845W	6.95		
3B24	5.50	76	.58	866A	1.25		
3C23	10.50	77	.65	872A	3.65		
3C24/24G	1.95	78	.80	884	1.79		
3DP1	3.95	100TH	10.50	902P1	7.50		
3D6/1299	.62	112A	.49	957	.45		
3EP1	4.95	211	1.25	958	.60		
3FP7	4.50	227A	4.50	959	1.50		
3GP1	4.75	274B	2.95	991/NE16	.25		
3JP12	14.50	304TH	13.95	1616	2.95		
4B22/EL5B	9.75	304TL	19.50	1619	.89		
4B25/EL6CF	8.95	350A	6.95	1624	1.95		
4J36	175.00	359A	2.50	1625	2.00		
4J37	175.00	371B	2.95	1629	2.00		
5B1P	5.95	388A	2.95	1655/65C7	.97		
5D21	23.95	394A	4.25	1846	115.00		
5FP7	2.50	450TH	44.50	2051	.95		
5JP1	23.50	450TL	44.50	8005	5.85		

BRAND NEW! EXCLUSIVE 3600V @ 520 Ma. PLATE TRANSFORMER

REG. \$125 **\$49.50**



Thordarson plate transformer in gray steel potted case. Supplies 3600V @ 520 ma. with three 866A rectifiers. Pri. 208/230V Delta conn. to 1890V, 1/2 phase, Sec. 3280V AC. Input: VA 2270. 19 1/2 x 15 x 8". Wt. 150 lbs. Order No. T-254

RADIO SHACK

CORPORATION

167 Washington St., Boston 8, Mass.



BRAND NEW! 8 WATT PRECISION RHEOSTAT

REG. \$5.00 **ONLY \$1.50**

10 for \$12.50 100 for \$100
Save \$3.50! New, boxed model 260. 20K ohms. Linearity accuracy 1%; tot. resistance accuracy 5%. Max. current 20 ma, 8W rating. Angle of rot. 294° Inside contact arm, 4 separate wiping fingers. 3 x 1 1/2", 3/4 x 3/8" shaft. Can be ganged. Order No. R-5262

QUARTZ CRYSTALS

NEW LISTING

Made from the finest Brazilian Quartz. Will provide a high degree of activity and frequency stability. All tested and marked by the manufacturer to a very close tolerance. In the frequencies outlined below the crystals itemized under the heading "From & To" are mostly in progressive frequencies between the limits shown (as for example: "From 3300 to 3377," are as follows: 3300KC, 3301KC, 3302KC—, 3377KC.) are of limited quantities in each frequency. Those listed singly are in quantities of 50 or more.

FT243				CR 1A/AR or FT241				XL5 Dual		FT241A	
Prong centers 1/2", Prong dia. 3/32"				Prong spacing 1/2", Prong dia 1/8"				3 prongs 1/2" X 1 19/32" prong dia.		SPECIAL TYPE WE.	
Price \$1.15 ea. (25 for \$25.00)				Price 79¢ ea. 12 for \$9.00						Prong spacing 1" CTS.	
				(Frequencies in KC)						Prong Size 3/32" dia.	
FROM	TO	FROM	TO	FROM	TO	FROM	TO	FROM	TO	FROM	TO
1915	1995	6225	8800	2853	7620	7625	7625	2520 & 2698			
2030	2065	6250	8025	3988	7650	7650	7650	2731 & 2891			
2125	2155	6275	8050	4188	7738	7738	7738	2436 & 2276			
2300			8100	4285	7740	7740	7740	3128 & 3153			
2320	2390	6300	8100	4300	7750	7750	7750	2605 & 3153			
2420	2490	6400	8200	4788	7760	7760	7760				
2804		6500	8285	5020	7770	7770	7770				
2805		6506.6	8400	5100	7778	7778	7778				
3652	3689	6700	8500	5120	7780	7780	7780				
3729	3799	6800	8600	5200	7790	7790	7790				
3805		6823	8786.25	5300	7800	7800	7800				
		6830	8876.25	5410	7810	7810	7810				
4104	4100	6830	8876.25	5470	7825	7825	7825				
4244	4290	6978.75	8921.25	5500	7830	7830	7830				
4305	4397	7228	9135.0	5668	7850	7850	7850				
4400	4480	7325	9342	5780	7880	7880	7880				
4600	4630	7458.75	9405	5810	7900	7900	7900				
4800	4898	7440	9405	5851	7910	7910	7910				
4911	4911	7500	9589	5910	7925	7925	7925				
5100	5195	7606	9608	5923	7930	7930	7930				
5300		7625	10075	6011	7940	7940	7940				
5320	5397.5	7750	12698	6130	7950	7950	7950				
5500		7675	12783	6203	7970	7970	7970				
5630		7700	12880	6275	7975	7975	7975				
5633.3		7725	12902	6270	7980	7980	7980				
5655.5		7728.8	13004	6370	7990	7990	7990				
5677.7		7750	13010	6400	8002	8002	8002				
5700		7751.25	13010	6490	8007	8007	8007				
5706.6	5775	7773.75	13213	6500	8012	8012	8012				
5722.4		7775	13302	6590	8020	8020	8020				
5744.4		7800	13400	6685	8092	8092	8092				
5800	5892	7825	13500	6744	8298	8298	8298				
5900	5975	7850	13587	6815	8308	8308	8308				
5955		7875	13903	6877	8300	8300	8300				
6000	6075	7900	13897	6905	8370	8370	8370				
6000.6		7925	14038	7270	8407	8407	8407				
6150		7950	14110	7330	8412	8412	8412				
6175		7925	14198	7400	8405	8405	8405				
6100	6173.3	7906	7968	7500	8566	8566	8566				
				7540	8650	8650	8650				
				7541.6	8650	8650	8650				
				7560	8985	8985	8985				
				7600	11677	11677	11677				

EDLIE ELECTRONICS, Inc.

154 Greenwich Street,
New York, N. Y.
Telephone DIgby 9-3143

TUBES

We guarantee all tubes. We endeavor to give you low, low prices, consistent with quality merchandise and service. Stock Up Now.

OB2	\$.98 6AG7	1.45	373-A (WE)	5.00
QA2	1.10 6AJ5	1.90	374-A (WE)	4.00
OZ4	.59 6AK5	.75	387-A (WE)	2.50
1AE4	1.10 6AK6	.90	400-A (WE)	2.50
1B22	2.00 6AN5	1.75	401-A (WE)	3.50
1B23	8.00 6B8	.65	403-B (WE)	7.50
1L4	.59 6C4	.45	407-A (WE)	5.00
1L21	4.00 6FC-M	.88	408-A (WE)	2.75
1N21-B	3.45 6F8-G	.88	GL-559	1.00
1N23-A	2.45 6G6-G	.95	KU-676	25.00
1N23-B	3.70 6J5	.49	700-D	55.00
1N31	5.50 6J6	.59	715-C	20.00
1N34	.64 6J7	.75	717-A	.98
1N34-A	.85 6K7	.70	803	3.59
1N44-400-B	1.21 6L5-G	.49	805	2.50
1N45-400-C	1.39 6L6-G	1.19	807	1.59
1N54	.89 6L7	.98	811-A	3.50
2C39	29.95 6E7	.98	837	1.45
2C43 (G.E.)	15.35 6E8-7	.79	838	2.25
2C52	5.00 6G7	.80	850	3.95
2D21	1.35 6SK7-GT	.60	861	22.50
2E24	2.75 6SL7-GT	.60	866-A	1.55
2E30	2.15 6SN7-GT	.65	872-A (G.E.)	3.50
2J30	65.00 6V6-M	1.10	CK-1005	.48
2J34	27.50 6V6-G	.95	1616	.74
2J49	34.50 7C30	85.00	1619	1.95
2K45	85.00 7H7	.80	1622 (GL6M)	1.95
3B28	7.50 12A6	.65	1625	.40
3B29	12.00 12C8	.79	1629	.30
3BP1	5.75 12AH7-GT	1.10	1631	1.50
3BP11	10.00 12AU7	.69	1632	.70
3C27	7.50 12SF5	.70	2059	1.45
3C33	9.95 12SG7	.87	2051	1.19
3C29	10.95 12SH7	.65	5516	5.95
3Q5	.99 12SJ7	.65	5508-A	3.95
4C35	26.50 12SR7	.70	5554	2.00
4X150A	3.50 FG-105	19.50	5314	4.50
5BP1	3.50 211	.70	5310	.75
5BP4	4.00 274-A (WE)	3.50	8020	.98
5CP1	3.00 274-B (WE)	2.25	9001	1.35
5FP7	1.95 276-F and G15.00	9003	9003	1.10
3A4GY	1.40 304-TH	7.00	9004	.39
5U4-G	.59 304-TL	8.00	9006	.39
5Y4-G	.85 310-A (WE)	6.95	C6-5528	15.00
5Y3-GT	.45 311-A (WE)	5.50	FK-123-A	6.95
5Z3	.85 350-B (WE)	4.95	RK-72	.75
6AB7	.95 359-A (WE)	4.00	RK-73	.75
6AC7	.98 371-B	.85		

WRITE ON TYPES NOT LISTED

Top Dollar Paid for SURPLUS TUBES & EQUIPMENT — Send List With Details

SELENIUM RECTIFIERS

Full-Wave Bridge Types

Current (Continuous)	18/14 Volts	36/28 Volts	54/42 Volts	130/100 Volts
1 Amp.	\$1.25	\$2.20	\$3.60	\$7.50
2 Amps.	2.20	3.60	6.50	10.50
2 1/2 Amps.				13.00
4 Amps.	3.75	6.75	8.75	15.00
5 Amps.	4.95	7.95	12.95	27.00
6 Amps.	5.50	9.00	14.00	33.00
10 Amps.	6.75	12.00	20.00	40.00
12 Amps.	8.50	16.00	25.00	50.00
20 Amps.	13.50	24.00	38.00	90.00
24 Amps.	16.00	31.00	39.50	98.00
30 Amps.	18.50	36.00		
36 Amps.	25.50	45.00		

New Selenium Rectifier Transformers

PRI: 115 V., 60 cycles in. } 4 Amps. \$ 8.75
 SEC: 9, 12, 18, 24, and 36 } 12 Amps. 16.75
 volts } 24 Amps. 35.75

Made to our specs. for continuous, heavy-duty use

• 115V. PRI—36V. 50 amp second XFMR. \$39.95
 • 115V. PRI—5V. @ 190 AMP. SEC. \$59.95
 • 115/230 V. 60 cy. PRI. SEC.: 1.5. 30.5. 33.5. and 36.5V @ 4 AMPS. Herm. Sealed. @ \$6.50

• New Selenium Rectifier Chokes
 4 Amps.—.07 hy.—6 ohm \$7.95
 12 Amps.—.01 hy.—1 ohm \$14.95
 24 Amps.—.004 hy.—.025 ohm \$29.95

We manufacture standard as well as special types of selenium rectifiers, rect. supplies and XFMRs. Low prices. Write. You will like our quick service, low prices, and good workmanship.

32 KV. VACUUM CAPACITORS. EIMAC BOXED
 6MMF. \$8.50 — 12 MMF. \$10.95
 50 MMF. \$13.50

- Bliley-Type SMC100—Crystal Standards. New—100 KC. and 1,000 KC Bar. \$8.50
- ART-1—DeLuxe 75 Meter AM Mobile XMTR—New—Complete. Only \$19.95
- AR-11—Complete Station for 20, 40, 80, Superhet Rev.—50 Watts CW w/ built in AC Pwr Supply. New—in compact suitcase (orig. cost over \$500). Special. Only \$99.50
- Weston Meters. 0-100 micro amps. 2 1/4" Diam. (Blank Scale) New Boxed. VERY Special. \$5.95

Terms: FOB-NYC—25% Deposit with order—or send full remittance to save COD charges—Rated Firms (D.&B.) Net 10 days — All merchandise guaranteed.



136 LIBERTY STREET • NEW YORK 6, N. Y.
 Phone: REctor 2-2562
 Cable: Barrylect, N. Y.



ATR-13 TRANSCEIVER

Dynamotor powered, either 14 or 28 V. Shock mounted, remotely controlled transceiver. Tunable receiver, range 108-160 M.C., 4-channel crystal controlled VHF transmitter, built-in provisions for omni. Weight, complete with plugs, less cable, 19 lbs. Less crystal. **\$245.00**

PORTABLE RADAR

Model SQ. 12 cm. Used on small ships. Has PPI indicator. Maximum range 20 miles. 1 Kw. output. Operates from 110 VAC, 60 cps. Price On Request.

NEW HEADSETS & HANDSETS

HS-23 HS-38 TS-10-G TS-13-C AS-83
 HS-33 HS-18 T-26 RS-38

RADAR

AP5-4 Complete Radar RC-184IFF
 AP5-6 Complete Mark 16 RC-214
 APT-1 MD4/AP52 RC-224
 APT-2 M5/AP53 RC-208
 APT-3 MD32/UP28 RT34/AP513
 AIT-4 MD38/APQ13 T-85/AIT-5

TEST EQUIPMENT Complete Line!

DuMont 224-A Oscilloscope TS-118/AP
 I-7 Hickok Tube Checker TS126
 I-208 FM Signal Generator TS127/U
 R/C Model 644 Multimeter TS131
 Ferris Microvoltage Mod. 18-C TS159
 Hewlett Packard 200-C TS170/ARN
 I-198 TS10/APQ TS-173/UR
 BC-638 TS-23/APN TS175/UP
 RC-1255 TS24A/AR-2 TS182/UP
 IE-364 TS27/TSM TS284/AP
 I-95 TS-33 TS294/AP
 I-96 TS34/AP TS251
 I-122 TS-35/AP TS311A/UP
 I-130A TS36/AP TS323/UP
 I-139 TS-45A/APM-3 I-146
 I-145 TS61/AP TS-288/U
 I-212 TS62/AP Boonton Mod.
 I-222 TS99 75B Sig. Gen.
 TS-3A/AP TS92 Boonton Type
 TS10A/APN TS100/AP 102F Sig. Gen.
 TS12/AP TS-102
 TS16/APN TS111/CP

TS-159/TPX

COMBINATION SIGNAL GENERATOR AND FREQUENCY METER. Freq. range: 150-200 MC., crystal calibrated. Has separate 30 MC signal output, crystal cal.; 3-stage AF amplifier. Power measurements by built-in VTVM circuit. 0-1 MA. meter as 2-range voltmeter. Built-in 400 cps. voltage regulated power supply. New. \$69.95

POWER SUPPLY

110 V. 60 cps. 4 tubes voltage regulated. Power output 200 VDC @ 50 MA. and 6.3 VAC @ 7 amps. Used to supply necessary power for radar transmitter G-23200. New. \$39.95

RADAR TRANSMITTER

Model G-23200-15 tubes. Has 4 independent oscillators, each adjustable in frequency between 509-521 MC. by means of knobs on front panel. Has 4 independent variable pulse shaping modulators, complete with tubes. Requires above separate POWER SUPPLY. New. \$89.95

AN/ART-13 PARTS

Part # Item
 564916 Barometric Switch
 565027 4-Pile Ceramic, Variable Cap.
 K7890443 6-Pile Ceramic, Variable Cap.
 564605 4 Centralab-Type 843-003 Cap Assembly

RA-38 RECTIFIER

High voltage power supply. Used with ground radar set. New. Price on request.

FLUX METER

For measuring flux density between magnet poles. Has two meters in series with a potentiometer and battery for power supply. Range: 500-4000 Gauss in 3 scales. Requires 1 battery which mounts in case. NEW. \$37.00

RECEIVERS—TRANSMITERS

APR-4 MP-10G RTA-1B
 APR-5 PE-125AX SCR-522
 ARC-1 R-9/APN-4 TA2T-24
 ARC-3 340-580 MC. New 733-D
 R-4/ARR-2 complete
 ID-6/APN-4 R89

RA-52 RECTIFIER

Transtat controlled to produce high voltage DC from 110 VAC 60 cycle source. Up to 11,500 VDC @ 50 V. Metered high voltage (0-15 KV) and current (0-20 MA). NEW. \$74.50

MISCELLANEOUS

MINE DETECTOR: SCR-625 for prospecting, mining, etc. NEW. \$59.50
 LP-21 LOOPS: Mod. LMI, AM, A. Excel. cond.

- NOTE: WE HAVE ONE OF THE LARGEST.
- MOST COMPLETE INVENTORIES OF MILITARY ELECTRONICS IN THE U. S. CALL OR WRITE TODAY. SEND FOR FREE CATALOGUE.

ARROW SALES, INC.

7460 VARNA AVE. DEPT E.
 N. HOLLYWOOD, CALIF.
 PO Box 5-1810 Stanley 7-6005
 Cable address: ARROWSALES
 (See Arrow Sales Inc. ad Page 471)

POWER RHEOSTATS



F	W	Eq.	r	W	Eq.	r	W	Eq.
.5	25	1.98	75	25	1.98	500	300	9.49
.5	50	2.81	75	75	3.90	585	150	6.59
1	150	5.93	80	50	2.53	750	25	2.23
1	50	2.81	80	500	12.46	750	150	5.46
2	50	2.81	100	25	1.98	1000	25	2.53
2	100	4.68	100	50	2.53	1000	50	2.66
2	300	8.42	100	100	4.39	1200	225	7.20
3	100	4.67	125	25	2.32	1200	300	8.40
3	225	6.58	150	50	2.53	1250	50	2.66
4	225	6.60	175	25	2.23	1250	150	6.10
5	25	1.97	185	25	2.23	1500	25	2.66
5	50	2.53	200	25	2.23	1500	50	2.53
5	100	4.68	200	100	4.40	1600	50	2.66
6	25	2.23	200	150	5.04	1800	150	2.90
6	50	2.53	225	50	2.53	2000	25	2.53
6	75	3.90	250	25	2.23	2000	50	2.66
7.5	25	1.98	250	50	2.53	2250	150	6.24
7.5	75	3.95	300	50	2.53	2500	50	2.66
8	50	2.53	300	75	3.94	2500	100	4.68
10	25	2.23	300	100	4.40	2500	150	6.24
10	50	2.53	300	150	5.04	3000	25	2.66
10	100	4.37	350	25	2.23	3000	100	4.95
12	25	2.23	350	100	4.40	5000	25	2.66
12	50	2.53	370	25	2.23	5000	50	2.90
15	25	1.98	378	150	6.59	5000	50	2.90
15	75	3.90	400	25	2.23	7500	100	5.32
15	100	4.38	400	75	3.90	10000	50	2.99
20	50	2.53	500	25	2.23	10000	100	5.32
22	50	2.53	500	50	2.53	10000	100	5.31
25	25	2.23	500	75	3.95	15000	25	3.25
50	50	2.53	500	100	4.50	20000	150	8.75

Specify Type Shaft Required "S" or "Knob"
 Special Prices to Quantity Users.

LARGEST VARIETIES OF NEW SURPLUS AT LOWEST PRICES

- OIL CAPACITORS
 LARGE RECTANGULARS
 SMALL RECTANGULARS
 BATHTUBS; TUBULAR
- MICA SILVER G-1-2-3-4
 TRANSM.
- ELECTROLYTIC FP CANS
- AMPHENOL-CANNON
- AN-UG-UHF CONNECTORS
- LORD SHOCK MOUNTS
- BIRTCHEER Tube CLAMPS
- JONES PLUGS—SOCKETS
 BARRIER STRIPS
- POWER RHEOSTATS
- SWITCHES TOGGLE, ROTARY
 MICRO, PUSH-MOM.
- POTENTIOMETERS I.
 J.J.
- OTHER CARBON WIRE-WOUND POTS
- MOSSMAN LEVER SWITCHES
- AIRCRAFT NOISE FILTERS
- RESISTORS GLASS FERRULE
 PRECISION
- FUSEHOLDERS-MOUNTS
- INSTRUMENT KNOBS
- MANY OTHER ITEMS

HIGH POWER TRANS. MICA



G-1 Type	G-2 Type	G-3 Type	G-4 Type
.0001 6kv .0001	10kv .0001	20kv .0001	.00025 30kv
.00015 5kv .00015	10kv .00015	20kv .00015	.0006 35kv
.0002 6kv .0002	10kv .0002	20kv .0002	.0025 25kv
.0008 6kv .00025	12kv .00045	15kv .003	20kv
.01 4kv .0003	10kv .00047	20kv .0039	20kv
.032 2kv .000375	10kv .0005	20kv .0075	15kv
.04 1kv .0004	5kv .00095	5kv .01	12kv
.051 1.5kv .0005	10kv .001	20kv .03	8kv
.08 1.5kv .00057	10kv .0011	20kv .056	5kv
.09 1.5kv .00065	10kv .00124	15kv .001	5kv
	.01	.01	5kv
	.015	.015	5kv
	.25	1.6kv	

C-D Type #56
 .000155 30kv .001 30kv
 .0004 30kv .0356 2.5kv
 .000533 30kv .

Switchboard BD-72 and BD-71

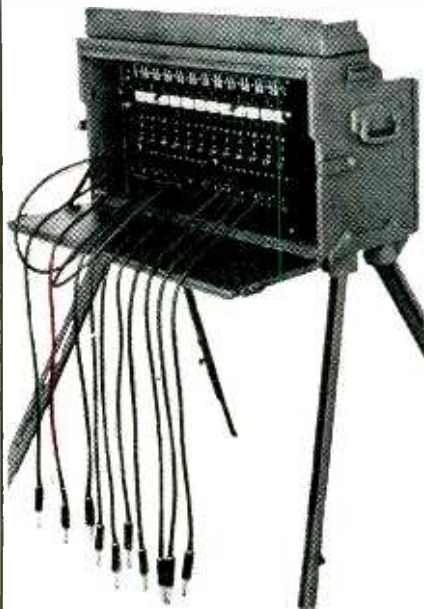

These Switchboards are portable, moncord, magneto-telephone switchboards for use primarily in field wire systems.

The capacity of the Switchboard BD-72 is 12 lines and of the BD-71 is 6 lines. Each switchboard contains all the equipment necessary for terminating and switching field telephone circuits, including a line terminal strip to which incoming lines may be connected directly.

These units are reconditioned and ready to set-up and operate. They are tested and in excellent operating condition.

Write for Literature and Price

DEALERS IN
ELECTRONIC AND RADAR
EQUIPMENT

FRENCH-VAN BREEMS, INC.

375 Fairfield Avenue
Stamford, Connecticut
Tel: 48-9231

JUST WHAT YOU NEED . . .

- Standard Test Leads, 4" x 1-1/2" Prods. Pair: 39¢ — 3 for \$1.00
- Phone Plug—Nickel Plated, Screw Terminals. Ea.: 39¢ — 3 for \$1.00
- Instrument Knobs—Bar, Octagon, Set Screw, Skirts, Asst. 10 for \$1.00
- Line Cord—Bro. Rubber 7 ft., Molded Rubber Plug Ea.: 29¢ — 4 for \$1.00
- Line Cord—Black Rubber 6 ft., Angle Molded Plug Ea.: 39¢ — 3 for \$1.00

PLUGS AND CONNECTORS

- PL-112 Plug for LP-21 Loop. \$1.25
- PL-P-103 Plug for RC-348. 1.50
- MC-211 Rightangle Adapter for Comm. Sets.50
- MC-359 Rightangle Coaxial Connector.25

CONTROL BOXES:

- | | | |
|---------------------------------------|---------|---------|
| | NEW: | USED: |
| C-87, ART-13—f/ART-13 Trans | \$ 6.95 | \$ 4.95 |
| MR-9C/Control Box f/RA-10 Rec. 12.95 | | |
| BC-434 for ADF | 5.95 | 3.95 |
| RC-732 for Localizer | 3.95 | 1.95 |

MOUNTINGS AND CLAMPS:

- FT-154 for BC-348 Receiver \$2.50
- FT-470 Mounting & Clamp. 1.00
- MC-476 Maple Ball for above—f/Fairlead. 1.00
- MC-396 Wood Clamp for Fairlead.75
- M-235 Bobbin & 250 Ft. W-106 Antenna Wire. 3.50
- WT-7 Weight for Trailing Antenna. 1.50

AIRCRAFT CONTROL CABLE—3/32" 7 x 14 Strand, Weatherproofed, Galvanized, 920 lb. Test. Ideal for Television Guying and many other uses. Prices: 3-1/2¢ per Ft. 1000 Ft. or more @ 3¢ per Ft.

BLOWERS:

- 115 Volt 60 cycle BLOWER (pictured), approx. 100 CFM Dis. 2-1/2" intake; 2" outlet. Quiet running. Motor size: 2-1/2"x3-1/4". NEW — not Gov't surplus. Order No. E-520 **\$7.99**
- DUAL BLOWER—Same as RN-520 above, except has blower assembly on each side of motor. Order No. E-800 \$12.9



- COMPACT TYPE—108 CFM, motor built inside squirrel cage, 4-1/2" Intake; 3-3/8" x 3" Dis. Complete size: 4-1/2" W x 9-3/8" H x 8-1/2" D. Order No. E-860 \$13.50
- FLANGE TYPE—140 CFM, 3-1/2" Intake; 2-1/2" Dis. Complete size: 7-1/2" W x 7-1/4" H x 6-3/4" D. Order No. E-865 \$12.95
- FLANGE TWIN—275 CFM, 4-1/2" Intake; 3-1/2" x 3" Dis. Complete size: 11-3/4" W x 8-3/8" H x 8-1/16" D. No. E-134 \$20.95

CORDS—CABLES

- C-501 Cord—f/GN-45 Generator \$2.50
- CD-318 Cord w/PL-68 & SW-141 & JK-48F.89
- CD-307 Cord—6.5 Ft. w/PL-55 & JK-26.89
- CD-604 Cord w/C-410 Trans. & PL-54 Plug.89
- CD-365 Cord for LP-21-Loop 1.75
- MC-215 Tuning Shaft for 274N. 2.00

ANTENNA EQUIPMENT

MAST BASES—INSULATED:



- MP-132 BASE—(As illustrated at left) 1" heavy coil spring, 2" insulator. Overall length: 11-1/2". Weight: 2-3/4 lbs. Price \$3.95
- MP-48 BASE—Insulated type with heavy coil spring. Requires 1-3/8" mounting hole. Weight: 11 lbs. \$4.95
- MP-57 BASE—Insulated type with heavy coil spring and 5" dia. insulator. Requires 1-3/8" hole for mtg. Weight: 9 lbs. \$5.95

MAST SECTIONS For ABOVE BASES:

- Tubular steel, copper coated, painted, in 3 ft. sections, screw-in type. MS-53 can be used to make any length with MS-52-51-50-49 for taper. Any section 50¢ Each
- Larger Diameter Sections: MS-55-54. \$1.25 Each
- AN-104B Antenna—100-156 MC.—Copper \$9.95
- AN-104A Antenna—100-156 MC.—Steel 3.95
- AN-104A Antenna—100-156 MC.—Copper 2.00
- AN-117 Whip Antenna—100-156 MC.—Steel 2.00
- AN-109A Whip Steel—6 Ft. length 1.50
- AN-109A Whip Steel, 5 Ft. w-Base. 1.50
- AS-27/ARN-5 Ram's Horn, 110 MC.—USED. 5.95
- LP-20A Loop for ADF equip.—Used, tested. 9.95
- AT-37/APT Stub—113-150 MC. 6.95
- AT-42/APT-3 or APT-1 Stub—113-150 MC. 6.95
- AS-97/ARQ-8 Spike with coaxial lead in base. 4.95
- AS-61/ARN-5 Half-Wave Dipole—335 MC. 3.95
- AT-2/APN-2 4.95

DYNAMOTORS:

DYNAMOTOR and BLOWER: 9 Volts DC input; output 450 Volts 60 MA. 4500 RPM. At 6 Volts DC input; output 260 Volts 65 MA. 3000 RPM. \$4.95

Input	Output	Stock No.	Price
14 V. DC	600 V. 300 MA.	BD-86	\$9.95
12 V. DC	220 V. 70 MA.	DM-24	6.95
12 V. DC	220 V. 100 MA.	DM-18	4.95
12 or 24 V. DC	440 V. 200 MA. &		
	220 V. 100 MA.	D-104	14.95
14 V. DC	375 V. 150 MA.	DM-375	8.95
14 V. DC	330 V. 135 MA.	DM-330	7.95
14 V. DC	500 V. 500 MA.	PE-59	14.95
12 or 24 V. DC	275 V. 110 MA.	USA/0516	3.95
12 or 24 V. DC	500 V. 50 MA.	USA/0515	3.95

ALSO—PE-73; PE-86; DM-53; DM-33; 5055; DM-416; PE-101, etc.

GEAR MOTOR—110 V. 60 cycle for slow motion light displays or production work. Machine cut brass gears. Size: 5" H. x 2-1/2" W. x 1-1/2" D. Shaft: 3/16" x 1". Choice of 3, 8, or 24 RPM. Specify RPM desired \$8.75

AERIAL WIRE WIRE—HEAVY DUTY RUBBER COVERED

- Phosphorus Bronze #16 Stranded 1/14" Shielded, Rubber Covered, 50 Ft. Length. \$2.75
- 200 lb. test. Or—Per Foot—at06
- Weatherproof 150 feet on Reel. 1/8" Cotton Covered—Ft.06
- RL-3 with Clips 12 Conductor—Shielded—Ft.15
- 6 Conductor—Shielded—Ft.09
- TELEPHONE WIRE: 3 Cond. copper & steel, 525 Ft. \$4.75

TRANSFORMERS—110V. 60 Cycle Pri.

- Sec. Two 12 V. 4 A. windings—gives 12 V. 8 A. or 24 V. 4 A. \$5.95
- Sec. 24 Volt 4 Amp. 1.50
- Sec. 24 Volt 1 Amp. 1.95
- Sec. 24 Volt 8 Amp. 5.95
- Sec. 6-24 or 30 Volts 8 Amp. 5.95

Address Dept. E • All Prices Are F.O.B. Lima, Ohio • 25% Deposit on C.O.D. Orders

FAIR RADIO SALES 132 S. MAIN ST. LIMA, OHIO

- ART-13, ATC Transmitters
- DY-12 Dynamotors
- LM & BC-221 Frequency meters
- SCR-284-A & SCR-694
- ARROW APPLIANCE COMPANY
429 Broad St., Lynn, Mass.
Lynn-8-3100. Richmond 2-0916
P. O. Box 19 Boston 1, Mass.

**WE BUY AND SELL
GOVERNMENT SURPLUS**
electronic components, units, wire, etc.
Your Inquiries Invited
LAPIROW BROS.
1649 Hoffner St. Kirby 1285 Cincinnati 23, Ohio

Your First Choice of JAN TYPE TUBES at Lowest Prices COMPARISON PROVES

Crystal Diodes	Tubes	Type	Price	Type	Price	Type	Price	Type	Price	Type	Price	Type	Price
IN21	2C40	3A4	.85	6AS6	2.75	120A	7.50	738DY	45.00	955	.39	1619	.35
IN21A	2C46	3B2	1.95	6SU6GT	2.25	121A	2.95	721A	2.25	957	.45	1625	.45
IN21B	2C51	3C22	120.00	9GP7	12.50	F127A	17.00	723AB	17.50	958A	.59	1641	1.95
IN23A	2J31	3C31/C1B	2.50	10Y-G.E.	.49	211 G.E.	1.25	726A	8.25	1005	.59	1644	.85
IN23B	2J32	3C45	15.00	15E	2.35	507AX	1.45	814	2.50	1006	2.95	2050/1665	1.40
IN26	2J48	3E31	12.50	T21	1.50	532A	3.75	815	1.50	1007	.85	2051	1.00
IN34	2K25	4C27	22.00	RK72	1.45	705A	1.75	872A	3.25	HW1269	2.25	5670	4.50
1B29	2X2	6AK5	.85	VR105	1.25	706CY	45.00	931A	3.95	1613	1.15	5702	.50
		6AL5	.39	VU111	1.20	715A	5.95	954	.39	1616	.65	7193	.45

ALLIED ELECTRONIC SALES 136 Liberty St. New York 6, N. Y. Cortlandt 7-4320

PHONE or WRITE for quantity prices. F.O.B. New York. Rated Firms send purchase order.



FOR ELECTRONIC COMPONENTS

We offer immediate delivery from our vast stock of more than 25,000 items—all standard make, carefully inspected and fully guaranteed. Our prices are below market.

Always Check Wells' Stock First!

Quotations and quantities available will be given immediately upon request.

ADEL CLAMPS
ANTENNAS

Insulators, Mast Sections

BINDING POSTS

BLOWERS

CABLE ASSEMBLIES

CHOKES

COILS

CONDENSERS

Oil Filled, Bathub, Hearing Aid, Transmitting

Micas, Silver Micas, Ceramic, Variable, Trimmer

CRYSTALS

DYNAMOTORS & BRUSHES

FILTERS

FUSES & MOUNTINGS

GENERATORS

GROUND RODS

HEADSETS

IF COILS

JACKS

JACK BOXES

KEYS, Telegraph

KNOBS

LAMPS

LORD MOUNTS

LUGS

MOTORS & BRUSHES

PLUGS

RECTIFIERS

Selenium, Copper Oxide, Meter, Diode

RESISTORS—All Types

SELSYNS

SOCKETS

SWITCHES

Aircraft, Micro, Switchettes, Toggle

TIMERS

TUBING—Flexible

TUNING SHAFTS

TRANSFORMERS—All Types

VIBRATORS

WALKIE TALKIES

Available Now!

A complete signal corps stock number listing of items in our stock. Write for listing No. SG-200. (For government agencies and contractors only.)

Manufacturers and distributors—write for Radio-Electronics Catalog No. H 501.

Write, Wire, Phone Your Requirements

all phones: **SEeley 8-4143**



833 W. CHICAGO AVE., DEPT. SL, CHICAGO 22, ILL.



Attention all FOREIGN BUYERS & AIRLINES, check this complete stock and write for full information. Prompt replies to all inquires.

RECEIVERS		MG SETS	
APR-1	BC-314	MG-152	PE-218
APR-4	BC-348	MG-149F	PE-115
APR-5	RC-10	MG SET CONVERTED	
ARR-5	MN-26	DC to AC, 230 V. AC,	
BC-312	BC-342	Input 7.5A 110 V. AC,	
		6A, 60-cycle output	

25 KW DIESEL PLANT

3-phase, 110 v., 60 cy. with spares

COMMUNICATIONS EQUIPMENT

ARC-1	34 Meg. FM	BC-721A
ARC-3	Set 6 V.	Handle
ARC-4	25 Watt FM	Talkie
ARC-5	SET 30-40	CU-92/APN
SCR-27AN	Megs. 6V.	ART-13 LFO
SCR-522 AM	BC-640	Relay K-104
ID-6B/APN-4	BC-610	ART-13
T-47/ART-13	AN/TRC-1	Keying
or	0-16/ART-13	Relay K-102
T-47A/ART-13	CU-25/ART-13	IS-21 Vacuum
GO-9	SA-22/ART-13	Switch for
SCR-509	RTA-1B	ART-13
BC-684FM	TA2J-24	DY-17 HI-
BC-924FM	TBS-4.5	Altitude
		Switch

NOW AVAILABLE!

SCR-718C	AS-27-A/ARN-5	RA-20 Power Supplies	RA-51 RECT. Radio Compass, 12V Installation
R-89-B/ARN-5	HI ALTITUDE SWITCH P/O DY-17	Circuit Breakers P/O DY-17	MG-149F Inverters
IE-17 Test Sets for SCR-536	SA-22/ART-13	TS-251 Loran Test Set, complete	ID-6B/APN-4

TEST EQUIPMENT

A-58	I-210	Espay 105	TS-56
APA-6	I-224	Tube Tester	TS-67
APA-11	I-130	Aircraft	TS-69
AN/UPM-1	I-203	Thermometer	TS-143
APA-23	I-106	Fester	TS-170
BC-1016	I-155	TS-3	TS-226
BC-1236	LM	TS-3	TS-323
Microvoltage	MS-1	TS-10	TS-419
BC-391-TI	GR-583A	TS-11	TN-1
BC-906	output	TS-12	2, 3
BC-221	meter	TS-13	TN-16
BC-438	Ferris 20A-1	TS-16	TN-17
I-95	Microvoltage	TS-19	TN-18
I-83	Lavie	TS-45	TN-19
I-148	1055M	TS-51	TN-54

NAVIGATION EQUIPMENT

AN/APN-4	AN/APN-9	SCR-718-A, B, C	AN/ARN-7	ILS System (ARN-5, RC-103)	AN/APN-1	SCR-269
----------	----------	-----------------	----------	----------------------------	----------	---------

RACKS

MT-14A/APN-1	MT-283/ART-13	MT-284/ART-13	MT-163/ART-13	MT-164/ART-13	MT-161/ART-13	FT-446/APN-4	FT-447/APN-4
--------------	---------------	---------------	---------------	---------------	---------------	--------------	--------------

TRAINING EQUIPMENT

0-6/APN-TI	IE-52 LORAN
------------	-------------

RADAR EQUIPMENT

APS-2	APS-4	APS-6 (Parts)	APS-15	APG-13A	AN/APN-2	SCR-729	SCR-717 and Spares	AN/APS-13	ABK
-------	-------	---------------	--------	---------	----------	---------	--------------------	-----------	-----

JAMMING EQUIPT.

APT-1	APQ-2	APT-4	SCR-596
-------	-------	-------	---------

EXPORT INQUIRIES INVITED

We carry an unusually large stock of Airline Equipment, Test Equipment, Radar Sets, etc. Write for our low prices and complete information. We furnish immediate answers to all inquiries. Write today!

Prompt Replies To All Inquiries

V & H ELECTRONIC INDUSTRIES INC.

2033 West Venice Blvd.—Dept. E-16
Los Angeles 6, California
Phone: REpublic 3-1127



Since 1926

Prime Source for TUBES

Receiving, Special Purpose and Picture Tubes

PARTS

All Types - All Brands - Special Lots

- MANUFACTURERS
- JOBBERS and
- EXPORTERS

We invite your inquiries on electronic components of all descriptions!

Critical tubes are always on hand and at the right prices in quantity

SPECIAL

TUBE BUYS!

1B3GT	57	6W4GT	40
1L4	50	6X4	29
1R5	48	12AT6	32
1S5	39	12AT7	61
1T4	49	12AU6	37
1U4	48	12AU7	47
1U5	39	12AV7	47
3A4	54	12AX4GT	54
3Q4	54	12AX7	53
354	51	12BA6	38
3V4	52	12BE6	40
5U4G	36	12SN7GT	47
5Y3GT	25	19T8	70
6AG5	46	25BQ6GT	77
6AK5	86	25L6GT	43
6AL5	36	35B5	41
6AQ5	41	35C5	41
6AT6	32	35L6GT	45
6AU6	37	35W4	26
6AV6	37	35Z5GT	31
6AX4GT	54	50B5	41
6BA6	38	50C5	41
6BC5	46	50L6GT	43
6BD6	41	117Z3	34
6BE6	40	8020	2.95
6BG6G	1.21	813	8.95
6BH6	50	211	75
6BJ6	41	6C21	25.00
6BQ6GT	77	3DP1	9.95
6C4	32	807	1.55
6CB6	46	304TL	9.95
6CD6G	1.58	2E22	2.95
654	41	2J31	25.00
658GT	63	2J32	45.00
65D7GT	77	2J33	25.00
65L7GT	53	2J34	25.00
65N7GT	47	17BP4A	16.95
6T8	70	20CP4A	19.95
6V6GT	40		

We Will Be Pleased to Quote Special prices for Large Quantity Purchases.

OVER 1,000,000 TUBES IN STOCK

Write—Wire—Phone TODAY!
PREMIER
Radio Tube Division
CONTINENTAL CORPORATION
547 W. Randolph St. Chicago 6, Ill.
ANDover 3-1590

SAVE ON

TUBES

BRAND NEW

TUBES

GUARANTEED

TUBES

OA3/VR75...	\$1.00	2E25A	4.50	3C33	9.95	5T4	1.98	201A	98.00	KU676	39.50	836	3.45	1632	.69
OB3/VR90...	1.00	2E26	2.95	3C45	16.95	6AL5W	2.00	304A	49.50	700A/B/C	16.50	837	1.25	1644	.89
OC3/VR105...	1.20	2E30	1.98	3DP1	3.95	6AN5	3.65	212A	4.95	701A	4.50	838	2.25	5528 CGL	8.95
OD3/VR150...	2.25	2J21A	7.95	3E29	13.95	6AS6	2.75	221A	1.95	702A	2.75	845	4.25	5611	Write
1B22	2.25	2J22	6.95	3FP7	1.95	6BM6	Write	RX233A	3.50	703A	4.95	851	39.95	5635	8.95
1B23	8.95	2J26	14.95	3GP1	3.95	6C21	19.50	250R	8.95	705A	1.50	852	19.95	5638	8.95
1B24	9.50	2J27	14.95	3HP7	3.95	6F4	5.50	250TH	20.00	706A/BY/FY	3.25	860	3.75	5645	8.95
1B26	2.25	2J31	27.50	4-125A	25.00	6J4	6.95	274B	3.25	GY	35.00	861	19.95	5646	8.95
1B27	12.95	2J32	27.50	4B24	6.95	6K4	4.50	279A	Write	707A	7.95	864	53.00	5654	19.95
1B32	3.10	2J33	27.50	4C27 CV92	17.50	6SN7WGT.	1.98	304TH	8.95	707B	14.95	869B	3.95	5672	2.00
1B37	1.95	2J34	27.50	4C28	25.00	6J23	59.50	304TL	8.95	708A	4.50	874	4.9	5676	3.35
1B38	24.50	2J36	110.00	4C35	25.00	12A7	4.50	307A/RK75	4.25	714AY	6.25	876	1.50	5694	2.60
1B41	47.50	2J37	12.70	4E27	129.50	12DP7	16.95	327A	4.50	715A	8.95	881	1.50	5702	6.50
1B47	12.50	2J40	27.50	4J21	129.50	12GP7	25.00	331A	10.95	715B	22.75	884	1.50	5703	1.90
1N21B	2.75	2J48	27.50	4J22	129.50					715C	.98	889RA	139.50	5704	4.50
1N21C	19.95	2J55	85.00	4J23	129.50					717A	24.50	905	3.25	5718	Write
1N22C	1.25	2J56	149.50	4J26	129.50					720AY	Write	927	1.25	5726	2.95
1N23	1.25	2J61	39.50	4J27	129.50					720BY	Write	930	1.25	5744/619CX	5.95
1N23A	2.25	2J62	39.50	4J28	129.50					721A	1.95	931A	6.50	5749	3.95
1N23B	3.65	2K22	Write	4J29	149.50	15E	1.98	349A	8.50	722A	1.95	934A	Write	5783	6.00
1N26	7.50	2K23	29.50	4J30	249.50	15R	.69	350A	5.95	723A/B	3.95	935B	Write	5784	5.95
1N28	Write	2K28	32.00	4J31	99.50	FG-17	3.98	350A	3.95	724B	3.95	936	Write	5787	6.00
1N34	.69	2K29	23.95	4J32	129.50	T-20/1623	3.75	374B	3.95	725A	2.75	936E	15.00	5787	6.00
1N38	1.50	2K39	99.50	4J35	99.50	RX21	3.95	393A	9.95	725C	6.95	954	.33	5814	4.50
1N40	8.50	2K45	90.00	4J41	99.50	24G/3C24	1.50	394A	3.95	726C	69.00	955	.49	5823	3.95
1N54	.89	2K48	Write	4J52	Write	FG-27A	6.95	417A	8.50	730A	25.50	956	.49	5844	3.95
1N55	2.75	2K54	Write	4K150A	35.00	FG-32	12.95	GL434A	19.95	802	3.95	957	.49	5915	1.00
1N56	1.95	2K55	Write	5CP1	4.50	RK-47	4.95	446A	1.19	803	3.75	958	.69	6005	4.25
1N58A	1.25	2X2	.59	5CP1	4.50	RK-60/1641	2.25	446B	3.50	805	3.25	959	2.95	6653	3.95
1N60	.60	2X2A	1.59	5C22	35.00	HY69	4.50	450TH	35.00	807	1.59	977CX	Write	8005	4.95
1N63	2.39	3A4	.65	5D21	19.95	75TL	5.95	GL451	3.95	808	2.95	979P	Write	8012	1.95
1Z2	Write	3A5	.85	5FP7	1.95	FG-81A	3.49	GL464	8.50	809	2.95	980D	Write	8013	4.95
2A1	8.95	3AP1	8.95	5FP4	16.50	FG-95/5560	22.50	469	2.25	811	2.90	1005	.69	8020	1.25
2C21/1642	.69	3B2	4.24	5J1	4.50	83V	1.10	471A	2.25	811	2.75	1006	2.75	8025	4.95
2C22/7193	.29	3B24W	7.50	5J1P	17.50	VT98British	19.95	527	9.95	812	2.95	1007	.89	8001	1.25
2C26A	.39	3B26	1.50	5J2	17.50	98R	5.95	WE423A	Write	814	2.90	1016	.90	8002	.98
2C40	8.50	3B28	6.50	5J25	17.50	100TH	8.50	WL530	16.95	815	5.75	829	9.95	9024	1.90
2C43	24.50	3B21	4.95	5J23	149.50	VT127A	3.75	551	Write	829B	11.95	1025	3.9	9004	.69
2C44	1.19	3C22	80.00	5J28	11.95	FG104	24.95	559	Write	830B	2.75	1026	.39	9005	1.50
2C52	2.49	3C23	4.95	5J30	39.50	FG105	19.00	575A	13.95	832A	9.95	1030	.95		
2D21W	2.49	3C24/24G	1.90	5J30	1.50	FG-172	29.50	WL632	19.95	833A	34.95	1031	1.50		
2E24	4.65	3C27	2.75	5R4G	1.50										

Special: VACUUM CAPACITORS
12 mmfd., 20,000 V. \$7.50

YOUR SURPLUS WANTED
We Pay Highest Prices!

J. S. H. SALES CO.

Dept. E-17, 7552 Melrose Ave.
Los Angeles 46, California

Special: VACUUM CAPACITORS
50 mmfd., 32,000 V. \$12.50

1000 mmfd., 20,000 V. \$15.00
1000's of other types in stock. Send us your requirements.

All Prices F.O.B. Los Angeles, subject to change without notice. Minimum order \$3.00.

PHOTOCON SALES

417 N. Foothill Blvd. SY camore 2-4131
Pasadena 8, Calif. RY an 1-6751

FREE 24 PAGE SURPLUS SALES CATALOG

WANTED new or clean used electronic surplus. Please state exact description of the condition and details of modification. Include lowest price in first letter.

APS-3	Exc.	PUR*
SCR-284 Field Sets	Exc.	PUR*
APN4A or B	Exc.	PUR*
APR-5A	Exc.	PUR*
SCR-545 Radar Trailer		PUR*
Type 120A Test Set 130-210mc.		
Boonton Radio Corp.		PUR*
Antenna AT-104/APN9	New	20.00
Automatic Pilot Inverter		
Type DA Input 28VDC. @ 12 amps.		
Output 115V., 3 phase, 400 cps.	Exc.	80.00
Audio Oscillator Hewlett-Packard 200		
BR 20-20,000 c.p.s.	Exc.	\$110.00
LM & HC-221 Frequency Meter with cal. book, crystal, and tubes	Exc.	99.50
TS-352/U Weston Test Set	Exc.	150.00
TS-173/UR Frequency Meter 90-450 mc. complete with crystal, cal. book, & 115 VAC. Power Supply. Like New		600.00
TS-146/UP X-Band Signal Genera- tor	Exc.	PUR*
TS-13/AP X-Band Signal Generator	Exc.	PUR*
TS-34/AP Portable Oscilloscope	Exc.	350.00
TS-12 Test Set for X-Band Box 1 & 2 complete	Exc.	PUR*
Measurements Corp. Model 92 Stand- and Signal-Generator 20cy.-50mc. Exc.		PUR*
Hewlett-Packard Model 410A High Frequency V.T.V.M.	Like New	PUR*
APR-4 Search Receiver		PUR*
Tuning Units for APR-4 Receiver		PUR*
BC-348, BC-312, BC-342 Receivers		PUR*
T-17 Head and Microphone with cord and PL-68	Exc.	4.50
TS-148/UP New Mfg.		PUR*
Impedance Bridge 650A General Radio	Like New	225.00
Signal Generator 196A	Like New	PUR*
Million Signalizer Radio & TV	Like New	PUR*
Dumont 208 Scope	Exc.	PUR*
HS-23 8000 ohm. Used \$2.95	New	5.95
HS-18 8000 ohm. Used 1.75	New	2.25
HS-33 800 ohm. Used 3.50	New	6.95
HS-38 600 ohm. Used 1.75	New	2.25
RG-58/U Coaxial Cab		.06 ft.

*PUR-PRICE upon request.
NOTE: One of the largest and most complete electronic surplus stocks in the country. We have thousands of tubes, capacitors, plugs, accessories, transmitters-receivers, test equipment, etc. Send us your requirements.
TERMS: Prices F.O.B. Pasadena, California. 25% on all C.O.D. orders. Californians add 3% Sales Tax. Prices subject to change without notice.

LARGE INVENTORY

OIL FILLED CAPACITORS CONNECTORS
BATHTUB CONDENSERS SWITCHES
TYPE "J" AND "JJ" POTENTIOMETERS
IMMEDIATE DELIVERY
LEMAR ELECTRONICS CO.
135 LIBERTY ST. N. Y. 6, N. Y.
PHONE: BARCLAY 7-8675

"NEW" TRANSMITTER-RECEIVER AN/FRC-1



An extremely versatile transmitter-receiver with a very desirable frequency range from 1.5 mc to 12.5 mc (200-24 meters) Ideal for Airport Traffic Control.

Power Output.....150-250 watts
Transmission.....Phone, CW, MCW
Power Input.....90-120, 200-230v 50/60

COMPONENTS

1. TRANSMITTER
2. RECEIVER
3. MODULATOR
4. POWER SUPPLY
5. DELUXE CABINET
6. REMOTE CONTROL
7. CABLES
8. KEY AND MICROPHONE

Export Packed for Immediate Shipment.
Write for Specs. and Price.

Dealers in Electronic and Radar Supplies

FRENCH-VAN BREEMS, INC.

375 Fairfield Avenue Tel. 48-9231 Stamford, Connecticut

CARRIER EQUIPMENT

Western Electric CF-1A 4-channel carrier telephone terminals.
EE-101-A 2-channel 1000/20 cycle carrier ringers.
CFD-B 4-channel carrier pilot regulated telephone terminals complete with four channels 1000/20 cycle ringing.
CFD-B 4-channel pilot regulated telephone repeaters.
C-42-A V. F. telegraph in from 2- to 12-channel terminals.
FMC 1 or 2 channels carrier telephone terminals, automatic regulation, duplex signaling each channel. Carrier frequencies above 35 KC. Ideal for adding channels above type "C".
Complete engineering and installation services offered.

RAILWAY COMMUNICATIONS, INC.
Raytown, Missouri
Telephone: FLEMING 2121

Portable Instruments

Molded Bakelite case 7" x 4 1/2" x 3"
D.C. MICROAMMETERS 5 .10 .50 microamperes
THERMOCOUPLE MILLIAMMETERS 1, 5, 5 .10 milliamperes
THERMOCOUPLE VOLTMETERS 5 to 500 volts
Available in multiple range combinations

Precision Electrical Instrument Co.
146 Grand Street New York 13, N. Y.

FOR SALE!

39 UNITS BC957A RADAR INDICATOR UNUSED

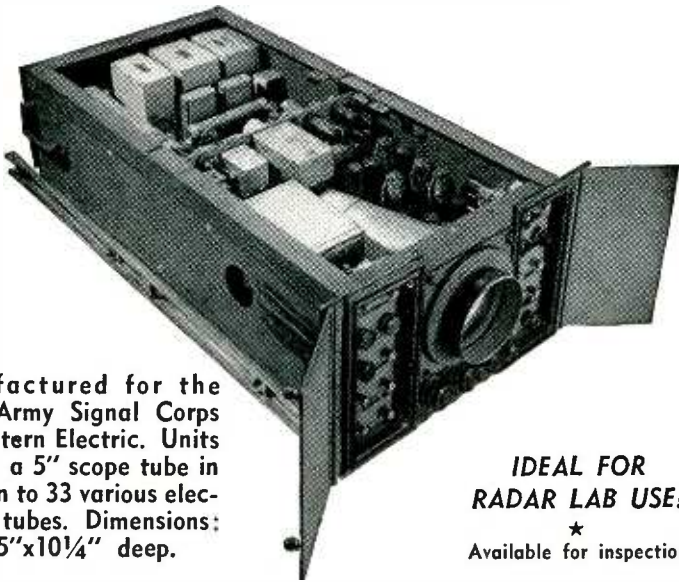

Manufactured for the U. S. Army Signal Corps by Western Electric. Units contain a 5" scope tube in addition to 33 various electronics tubes. Dimensions: 17 1/4 x 35" x 10 1/4" deep.

IDEAL FOR
RADAR LAB USE!

★ Available for inspection

WRITE—WIRE—PHONE

COMMERCIAL SURPLUS SALES CO.

4101 Curtis Avenue, Baltimore 26, Maryland
Telephone Curtis 3300

GUARANTEED TEST EQUIPMENT

RECORDING INSTRUMENTS (limited quantities)

- A.C. Voltmeter, suppressed zero, records from 360 to 520 volts, Westinghouse type U Graphic, electric chart drive, 60 cycle, BRAND NEW @ \$65.00
- A.C. Voltmeter, suppressed zero, double range, records from 180 to 260, and 360 to 520 volts, Westinghouse type U Graphic, electric chart drive, 60 cycle, BRAND NEW @ \$75.00
- A.C. Ammeter, records from 0 to 5 amps, Westinghouse type U Graphic, electric chart drive, 60 cycle @ \$65.00
- A.C. Voltmeter, double range, records from 0 to 150 volts, and 0 to 300 Volts, Westinghouse type GY-40, electric chart drive, 60 cycle, BRAND NEW @ \$150.00
- A.C. Voltmeter, records from 0 to 500 volts, Westinghouse type GY-40 electric chart drive, 60 cycle, BRAND NEW @ \$125.00
- Polyphase Wattmeter, records from 0 to 1 K.W. and 0 to 2 K.W., * 250/460 volt, 5 Amp coils, Westinghouse type GY-40, electric chart drive, 60 cycle, BRAND NEW @ \$175.00
- Polyphase Wattmeter, records from 0-1, 0-2 and 0-5 K.W., * 100/200/500 volts, 5 Amp coils, 1000/2000/5000 Watts full scale. Esterline Angus Model AW, 60 cycle, clock chart drive, complete with carrying case (like new) @ \$200.00
- D.C. Millivoltmeter, records from 0 to 100 M.V., Full scale equals 100 M.V. and .273 amps, D.C. Esterline-Angus, type L-3, clock chart drive, complete with external shunts for 100 and 500 amperes. USED-EXCELLENT CONDITION, (other shunts available) @ \$125.00

INSTRUMENT STANDARDS

- FREQUENCY METER, 50 to 70 cycle, 115 volt, General Electric type P-3 electro-dynamometer of resonant circuit type, mirror scale, 0.33% accuracy, in hardwood case BRAND NEW @ \$175.00
- POTENTIAL TRANSFORMER, 1150/575 to 115 volt, normal (1500/750 to 150 V max.) Weston Model 311, 15 VA capacity, 25 to 125 cycle, BRAND NEW @ \$115.00
- ROTATING STANDARD WATTHOUR METER, 1 and 5 amps, 120 to 240 volts normal; Westinghouse type CP, with switch and lead, 50 cycles BRAND NEW @ \$65.00
- ROTATING STANDARD WATTHOUR METER, 1, 10 and 25 amps, 120 and 240 volts normal; Westinghouse type CP, with switch and leads, 50 cycles. BRAND NEW @ \$75.00

MISCELLANEOUS

- FREQUENCY METER, 58-62 cycle, Switchboard type, Westinghouse type UY-25, 6" square surface mounted case, 120 volt, complete with external reactor, Signal Stock # 3F2731-1. @ \$50.00
- MEGGER, 0-10,000 ohms and 0-100 Megohms, James Biddle Co., 500 volt test potential, hand crank type, (100 ohms and 3 megohms center scale) in metal case, complete with canvas carrying case and leads. @ \$150.00
- D.C. VOLTAGE REGULATORS, Carbon Pile Type, 20 Amps, 110 load volts max. 140 line volts max. Safety Car H. & L. Co. # 29540 type S700E @ \$85.00

All items are fully guaranteed. *Indicates can be used with current transformer to extend range.

MARITIME SWITCHBOARD

338 Canal St. New York 13, N. Y.
Worth 4-8217

This is only a partial listing. We also stock a wide variety of shunts, transformers, multipliers, and panel meters. All prices are net F.O.B., New York.

TUBE REBUILDING

Large Transmitting and Power types

Economical • Guaranteed
FREELAND PRODUCTS CO.
700 DRYADES ST., N. O., LA.

TUBES

BOUGHT AND SOLD
Special Purpose & Receiving
GEM ELECTRONICS CO.
995 Eastern Parkway Brooklyn 13, N. Y.
Tel. President 4-3300
WRITE FOR OUR FREE FLYER

10 Sec. to 24 Min. Timer

A hand wound electric TIMING SWITCH Pointer moves back to ZERO and shuts off RADIO—TV—Electric Mixer—Photographic Devices—Time Delay etc. Furnished with Calibration Chart and Pointer \$1.25 Knob. Biggest bargain we ever had.



HAYDON SYNCHRONOUS TIMING MOTOR

- 110 v. 60 cycle 30RPM..... \$2.60
- 110 v. 60 cycle 1/10 RPM... \$2.35
- 110 v. 60 cycle 1RPM..... \$2.85

ISOLATION TRANSFORMER

- Step-Up or Step-Down 230 volts to 115 volts
- 115 volts to 230 volts
- 4 1/2 lbs. . . \$2.85 115 volts to 57 volts

ALNICO 17% COBALT

PURCHASE ENABLES US TO OFFER YOU THESE

MAGNETS!

39¢ EACH 3 FOR \$1.00



REDMOND Powerful 5" Blower or Ventilator 115 volts AC 60 cycles 18 watts. For Kitchen—Laboratory. Heat or Cold or Chemicals....\$7.50

Genuine TELECHRON Motors



- 2 RPM \$2.90
- 3 RPM 3.90
- 3.6 RPM ... 3.15
- 1 RPM 3.95
- 60 RPM ... 4.30
- One of each \$15.00

Westinghouse

ELAPSED TIME METERS

\$15.50



General Electric

Round Case Smaller Numerals

\$14.50

ALL BRAND NEW

1800 RPM SYNCHRONOUS Motor; 115 volts AC, 18 watts 1 1/4 lbs.; 2"x3"x2"..... \$4.50

DID YOU EVER WISH FOR A 3RD HAND?

A FOOT SWITCH MADE OF NEW SURPLUS MATERIAL

\$4.95 KIT \$5.75 COMPLETE

USING A 15 AMP. MICRO SWITCH

ALL PRICES F.O.B. N. Y.

EST. 1923 **BLAN** EST. 1923

64 Dey St. New York 7, N. Y.

TIME DELAY

- RELAY 115v 60cy adjustable 6 sec. to 2 minutes Cramer TD2-120S. Also TD60S 6 to 60 sec. \$12.95
- RELAY SPDT 24vdc 250 ohm Clare Type K. \$1.95
- RELAY 4 PDT 12 vdc 70 ohm Mini let type. \$1.75
- SELSYN-1F Special 115/90 v 400 cy. \$11.95
- FIL XFMRM 6.3 @ 1.3A (other sizes avail). \$5.99
- CHOKE 4H 70ma. 69c; 2H 70ma 110 ohm. \$3.49
- BLOWER MOTOR 400-1800cy 115v FAD J31C. \$9.95
- BIRCHER CLAMPS 925A, 926B, 926C. \$5.25
- 3-15MMF variable No. HF. .49c; MC-100S. \$5.99
- ISOLATION XFMRM 35 watts prim 115v sec. 115 or 135v & 6.3 tap 2 1/4 x 2 1/8". \$2.45
- SUBMINIATURE tube socket 5 pin, 100 for. \$10.00
- POWER XFMRM 700VCT @ 170ma5 @ 3.8.3 @ 4.54.25
- SILV TRMR TS2A, 1.5-7.7.45 @ 35c; MICA 3-30 5.04
- AN3106-10S-25, PL-68, PL-259A, 8S-1H, 8S, JK33A
- CONDENSERS; BATHTUB, MICA, AIR, OIL, HV. CER. IPTOS. RELAYS, MIKES, 3AG&MDL fuses, SWITCHES SPARES for: BC-1296A, MK11 Radar, AN/TPN-2 2% .002 Silver Mica CM30; many other items.

EMPIRE ELECTRONICS COMPANY

409 Avenue L Brooklyn 30, N. Y.
Cloverdale 2-2411 Bryant-9-1220



RELAYS ... WORLD'S LARGEST STOCK!

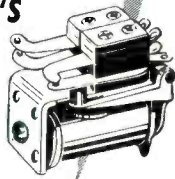

Your requirements of large or small quantities of relays can be quickly supplied from our huge stock. Wide variety of types, all made by leading manufacturers. Each relay is brand new, inspected and fully guaranteed by Relay Sales.

- ✓ STANDARD TELEPHONE RELAYS
- ✓ SHORT TELEPHONE RELAYS
- ✓ DUAL TELEPHONE RELAYS
- ✓ SLOW ACTING RELAYS
- ✓ SEALED RELAYS
- ✓ ROTARY RELAYS
- ✓ MIDGET RELAYS
- ✓ KEYING RELAYS
- ✓ DIFFERENTIAL RELAYS
- ✓ PLATE CURRENT RELAYS
- ✓ ANTENNA SWITCHING RELAYS
- ✓ "BK" SERIES
- ✓ STEPPERS & RATCHET RELAYS
- ✓ LATCHING & INTERLOCKING RELAYS
- ✓ MECHANICAL ACTION RELAYS
- ✓ VOLTAGE REGULATORS
- ✓ OVERLOAD & CIRCUIT BREAKERS
- ✓ REVERSE CURRENT RELAYS
- ✓ AIRCRAFT CONTACTORS
- ✓ MOTOR & CONTROL DEVICES
- ✓ TIMERS
- ✓ SOLENOIDS
- ✓ RELAY ASSEMBLIES

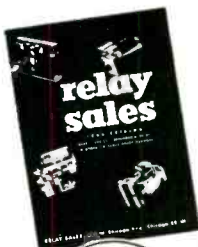

New
RELAY SALES
CATALOG
NOW READY

WRITE FOR YOUR
COPY TODAY



833 W. CHICAGO AVE.
DEPT. 4, CHICAGO 22, ILL.

*Headquarters for
Microwave Test Equipment*

THE WIDEST ASSORTMENT, THE STRONGEST DEPTH AND THE MOST IMMEDIATE AVAILABILITY OF ANY SOURCE ON TEST EQUIPMENT.

We are currently producing and delivering the TS-117, TS-125, TS-108, TS-102A, TS-89, TS-268, TAA-16EA and the TSX-4SE. A more complete list follows:

TS-1ARR	TS-51/AP	TS-173/UR	TS-303A/G	I-145	BC-1066/A
TS-3A/AP	TS-62/AP	TS-174/U	TS-311/FSM-1	I-147	BC-1201/A
TS-8A/U	TS-63/AP	TS-175/U	TS-323	I-153A	BC-1203
TS-10A/APN-1	TS-76/APM-3	TS-184/AP	TS-324/U	I-167A	BC-1235/A
TS-11/AP	TS-87/AP	TS-189/U	TS-328	I-177	BC-1287/A
*TS-12	TS-89/AP	TS-192/CPM-4	TS-338	I-178	BC-1277
*TS-13	TS-96/TPS-1	TS-194/CPM-4	TS-359A/U	I-196A	BE-57
TS-14	TS-98/AP	TS-197/CPM-4	TS-353/U	I-198A	LAD
TS-15B/AP	TS-101/AP	TS-198/CPM-4	TS-375	I-208/A	LAF
TS-16/APN	TS-102/AP	TS-203/AP	TS-377/U	I-212	LAE-2
TS-18	TS-108/AP	TS-204/AP	TS-389/U	I-222/A	LM-*
TS-19	TS-110/AP	TS-205/AP	TS-421/U	I-223A	LU-2
TS-23/AP	TS-111/CP	TS-210/MPM	TS-437	I-225	LU-3
TS-24/APM-3	*TS-117/GP	TS-213/UP	I-56	I-233	LZ
TS-26/TSM	TS-118/AP	TS-220/TSM	I-81B	IE-21/A	ME-11
TS-27/TSM	*TS-125/AP	TS-226A	I-83A	IE-36	OAA-2
TS-32A/TRC-1	TS-127/U	TS-230/B	I-95/A	IF-12/C	OAW
TS-33/AP	TS-131/AP	TS-233/TPN-2	I-98/A	IS-185	PAE
TS-34AP	TS-142/APG	TS-239A	I-106/A	IS-189	SG/8U
TS-35/AP	TS-143/CPM-1	TS-251	I-114	AN-PNS-1	TAA-16EA
TS-36/AP	TS-144/TRC-6	TS-263	I-115	BC-221(*)	T55-4SE
TS-46/AP	TS-146	TS-268	I-122	BC-376	TSX-3SE
TS-47/APR	*TS-147/UP	TS-270A/UP	I-122-B	BC-438	TSX-4SE
TS-18	*TS-148/UP	TS-281/TRC-7	I-126	BC-439	TTS-4BR
TS-51/APG.4	TS-153	TS-285/GP	I-130A	BC-838	TTX-10RH
TS-55/AP	*TS-155	TS-294/U	I-134B	BC-906/D	TUN-9HU
TS-60/U	TS-170/APN-5	TS-297/U	I-137A	BC-949/A	UPM-13
		TS-301/U	I-139A	BC-1060/A	

*Of new manufacture.

Before selling your idle test equipment, please get our offer

Cable: WESLAB

Tel: Boston: WE 5-4500

*Weston Laboratories
Weston 93, Mass.*

IMMEDIATE DELIVERY

PL-112

U-16-U

PL-118

UG-34/U

PL-147-A

UG-88/U

PL-151-A

UG-260/U

PL-259-A

UG-306/U

NOW IN STOCK

P. J. SALES - WO - 4-2490

99 Murray St.

New York City 7, N. Y.



★ NOTE!!! ALL PURCHASING AGENTS for export, industrial or military electronics! We have A-to-Z inventory of EVERYTHING IN RADIO. Write or contact us—especially for hard-to-get items. Remember: WE WILL NOT BE UNDERSOLD!

RECTIFIERS

RA-62: 110 V. supply for SCR-522. New. \$139.50
RA-34: 110 V. supply for BC-191. Excel. cond. \$175.00

DYNAMOTORS

PE-103: Brand new, SPECIAL. \$35.00
PE-101-C: See Aug/52 CQ for conversion to 6 V. NEW. \$4.95
PE-73: 28 V. supply for BC-375. Used excel. \$5.95

CONDENSERS—All New! Guaranteed!

2 mfd. @ 4000 V. \$7.95 8x8 mfd. @ 600 V. \$1.95
2 mfd. @ 5000 V. 9.95 Plus Many Other Types

TEST EQUIPMENT

We have tremendous stock. Write us for YOUR requirements.

TUBES! BIG VARIETY! NEW! BOXED!

1B-24. 813. \$10.95 CRT-TUBES
304TL. 9.95 829B. 9.95 2-3 AP1. P.U.R.
GL-5030. 39.95 715. 22.00 3DP1. P.U.R.
706AX. 29.50 832A. 9.95 3DP1. P.U.R.
MANY OTHERS 5BP4. P.U.R.

VICTORY BLUEPRINT MACHINE. Make own blueprints. New. Reg. price, \$125.00. REDUCED TO ONLY \$49.50
EE-8 FIELD TELEPHONE. Excellent condition & guar. Per pair. \$39.95

RADAR EQUIPMENT

RT-30/APQ-5 TRANSMITTER-RECEIVER. P.U.R.
APR-1, APR-4, APR-5. P.U.R.
ID-98/APQ-13. P.U.R.
APS-4, APS-18, RC-184 IFF. Complete. P.U.R.

HEADSETS & HANDSETS—Checked Out

HS-30. Used. \$1.95 TS-13. New. \$9.95
HS-22. New. 4.95 HS-30. New. 3.50
HS-32. Used. 2.95 HS-53. New. 5.95
T-17. Used. 5.00 TS-9. New. 9.95
TS-9. Used. 7.95

AIRCRAFT EQUIPMENT

ARN-7 RADIO COMPASS. Complete. \$150.00
MN-26C RADIO COMPASS. Complete. 89.50
SCR-522 VHF TRANSMITTER-RECEIVER. 24 V. Complete. 150.00
SCR-274N or ACR-5 (Medium or VHF frequency) Complete installation available. P.U.R.
LORAN APN-4 Complete. 150.00
APN-1 ALTIMETER. Complete. 49.50
ARC-1 SCR-269-G TA-2124
ARC-3 BC-348 TA-6
RTA-18 BC-745-D TA-12
ART-13 R-89/ARN-5 ARR-5
APN-9 BC-375 ARR-7

IF YOU NEED IT—WE GOT IT!

WE STOCK COMPLETE LINE: Inverters, Motors, Meters, Dynamotors, Power Supplies. Also SCR-193, BC-812, BC-342, Haliastrator BC-810 Transmitter, 400 Watts, BD-71 & BD-72 Switchboard. Prices upon Request.

REMEMBER: WE ALSO BUY NEW AND USED RADIO GEAR. WE PAY TOP DOLLAR AND WILL BEAT ANY COMPETITIVE PRICE! WRITE US TO SELL ANYTHING IN RADIO. DO IT NOW!

COLUMBIA ELECTRONICS SALES

522 South San Pedro St., Los Angeles 13, Calif.

R.C.A. Model MI-8167 TRANSMITTERS

Paint-to-point communications



Freq. Range: 2000 to 20,000 Kcs.

Output: 350 Watts C.W. 250 Watts Radio telephone

Input: 190 to 250 Volts AC 50/60 cps.

Size: 60" high, 17" wide, 27" deep.

Tubes: 807s, 813s, 805s, 866s.

Crystal Oscillator unit built-in, fully shielded and stable. All self contained including antenna network. Master Oscillator unit (available) fits in place of Xtal unit. Speech amplifier is only external unit and has 11G/220 v. AC input, four stages, high gain. Total net weight, 625 lbs.

Complete! New! From Stock! Quantities! Prices on Request.

COMMUNICATION DEVICES CO.

INCORPORATED
2331 Twelfth Ave. N. Y. 27, N. Y.

CHASSIS-RELAY RACKS

Mtg. Brackets—Panels—Utility Cases
Amplifier Cases—Desk Top Cabinets
ALL STANDARD TYPES—TOP DISCOUNTS

Bl. Chassis & Bot. Plates—Zinc Pl. or Blk. Wrinkle

SIZE	EA.	B.PL.	SIZE	EA.	B.PL.
5x10x3"	5.90	5.33	10x14x3"	51.33	5.58
6x14x3"	1.05	.45	10x17x2"	1.33	.73
7x7x2"	.75	.33	10x17x3"	1.38	.73
7x9x2"	.90	.35	10x17x4"	1.70	.73
7x11x2"	.93	.43	11x17x2"	1.73	.75
7x13x2"	.99	.48	11x17x3"	2.05	.75
7x15x3"	1.20	.53	12x17x2"	1.43	.80
4x17x5"	1.08	.43	12x17x3"	1.70	.80
7x17x3"	1.30	.55	12x17x4"	1.88	.80
8x17x2"	1.20	.55	13x17x2"	2.05	.88
8x17x3"	1.30	.55	13x17x3"	2.38	.88
10x12x3"	1.25	.55	13x17x4"	2.70	.88

OIL CONDENSERS

Bathtubs, Uprights, Channels, etc. Lowest Prices
Centralab Hi-Volt Caps: TV1-501, 10,000 VDCW—
.39e TV1-502 and TV2-502, 20,000 VDCW—75c.
TV1-503, 30,000, VDCW—\$1.98

BRAND NEW TUBES

RCA—GE—SYLV. ONLY—LATE STOCK

1R5.....	\$7.79	6AT6.....	5.62	6SJ7.....	5.69
1B3.....	.95	6AU6.....	.72	6SN7.....	.85
1x2A.....	.95	6AV6.....	.62	6W4GT.....	.69
5U4G.....	.59	6BC5.....	.71	12AU7.....	.85
5V4G.....	.98	6BG6.....	1.93	12BA6.....	.69
5Y3GT.....	.45	6BQ6.....	1.29	12BE6.....	.69
6AC7.....	1.10	6CB6.....	.69	12SA7.....	.75
6AG5.....	.86	6C5.....	.59	35W4.....	.50
6AK5.....	1.69	6C6.....	.95	5015.....	.75
6AL5.....	.65	6K6.....	.59	5016.....	.69
6AQ5.....	.76	6L6G.....	1.18	16AP4A.....	25.00

SPECIALS: Amphenol 8 Prong Octal Sockets #CP8 with retainer rings—7c, #3-13 Plug Caps—7c, ICA Type Brass N.P. Binding Post, 8/32 Male Threaded Shank, No Markings—9c, Plexiglas-New Masked, 3/64" Clear 1/30 Sq. Ft. 1/2" \$1.95 Sq. Ft. Machining, Drilling, Forming, etc. Done as Special Service for Schools, Labs, Experimenters.

PHONE CYPRESS 8-6940

WHOLESALE ELECTRONICS

224 E. 204 St. N. Y. C. 68, N. Y.

this Searchlight
Section of
ELECTRONICS

is an index of reliable sources for Surplus or Used Equipment now available. Consult the Searchlight Section in following issues for later offerings.

If you don't see what you want—ask for it. Ask the advertisers. They are constantly adding to their stocks and may have acquired just what you need. Or, shall we ask them for you?

And, when you have special items to dispose of, use the Searchlight Section of Electronics to help you locate buyers . . . Send a list of your equipment and we will gladly give full information as to space and rates.

Classified Advertising Division

ELECTRONICS

330 West 42nd St. • New York 18, N. Y.

HIGH FREQUENCY EQUIPMENT

GE-Leland MG set. 5 HP, 220V, 3 ph. 60 cy. motor & 24/32V DC, 78 amp. generator, on common shaft, direct-driving Leland 3KVA, self-excited, 3450 RPM, 400-cy., 3-ph., 120/208V, 4-wire alternator. Alternator has excellent wave form. 400-cy. alternator is electrically independent of low voltage generator. \$995.00
Voltage regulator for above to regulate plus or minus 2 volts. \$125.00
Newton Bros. MG set. 2 1/2 KW, 1-ph., 400-cy., 2400 RPM alternator, belt-driven by Fairbanks-Morse, 7 1/2 HP, 220V, 3-ph., 60-cy., 3450 RPM motor. \$500.00
Ballantine MG set. NEW. 1KVA, 1-phase, 400-cy. alternator, 115V, self-excited; belt-driven by NEW 2HP motor, 220V, 3-ph., 60-cy. With voltage regulator & variable speed sheave. \$300.00
belt-driven by NEW 2HP Motor, 115/230V, 1-phase, 60 cy. With voltage regulator & variable speed sheave. \$400.00
Onan Electric Plant. BRAND NEW. Gasoline-driven. AC output 120V, 10 amps, 1200W, 800 cy. DC output 28V, 18 amps, 500W. \$250.00
Batteries for self-starting Onan Plant. \$45.00

EDWARD WOLF COMPANY

P. O. Box 82 Mattapan 26, Mass.
Bluehills 8-1254

WILL SELL BRAND-NEW

- 1 Ferris Model 22-D Signal Generator \$1195.00
- 1 Model 80 Signal Generator \$1055.00
- 1 80-ZH3 Pad \$ 29.25
- 1 80-ZH4 Cable \$ 29.25

No waiting for defense orders on this equipment. Address inquiries:

SERVICIOS AERONAUTICOS DE MEXICO, S.A.
AEROPUERTO CENTRAL
Mexico, D. F., Mexico
Attention: Sales Manager

Somebody—Somenbere,

needs your idle equipment! Reach that buyer quickly and economically thru the
"SEARCHLIGHT SECTION"
The meeting place of Used Equipment Buyers and Sellers

OIL CONDENSERS



2 MFD. 5000 VDC with brackets \$11.95
 6 MFD. 600 VDC CP
 70 BIFF. 605K with
 Brackets, \$2.75 each;
 by 100 lot each. \$1.37
 1 MFD. 2500 VDC Type
 TJ \$2.75
 4 MFD. 1500 \$2.98
 10 MFD. 2500 V. \$7.98
 1 MFD. 6000 VDC In-
 terneen Type FP. \$12.75

BATHTUB CONDENSERS CP53BIF504K
 5MFD-600V. \$ 6.1
 Round 1 MFD. 1000 VDC screw Type I Lug 2 3/4"
 High 50c ea.
 .05 MFD-600 V. 35c ea.

RHEOSTAT

TYPE J150 ohm 50 Watt #5381 \$1.89 each
 TYPE K 100 Watt 25 Ohm \$2.96
 TYPE H 25 Watt 15 Ohm \$1.67

PACKET SWITCHES made by A&H&H Type
 80989 25 amp. size 2PDT and 3DP. \$7.95 ea.
SELECTOR SWITCHES CENTRALAB Non
 shorting Type 1401 1 Pole 2-6 position. 49c ea.

EQUIPMENT

1—SCR 522 (BC 624A-BC 625A) New in original
 crate with following accessories:
 Antenna AN 188, 3 control boxes BC (312-13-14,
 1 cord 809-A, 1 cord Cd 133 RG 8U, coax.cable
 w/ all plugs. \$125.00
 2—(same as above without accessories—slightly
 scratched cabinet, \$65.00 each.
 2—New (in original boxes) type CH 172-B
 Power Supply for above equipment, contains 500
 ft. cable, 7 conductors and 1 rectifier RA 62 B
 \$100.00 each.
 1—Oscilloscope TS-198/CPM-4 for observation
 of elec't. wave shapes and radar A—scope. \$125.00

TUBES

721A	53.00	9001	51.35
835	2.80	9002	1.35
829B	14.50	9003	1.50
830B	3.00	9006	0.40
832	6.95	ELIC	2.75
832A	9.00	6L6G	1.35
1B245YL	13.95	2J49	105.00
3B24	5.50	2J50	65.00
4J37	125.00	2J38	15.00

Weston **WATTMETER** Model 641 0-4 KW 250 V.
 20 amo. \$32.75
 Voltmeter Westinghouse Type NX35 0-500 V DC
 3 1/2" rd. FS-1MA \$12.35
 0-150V AC Type NA-50 FS-1MA \$7.85
 0-150VAC Hurlinton 2" \$4.75
 Meter 0-15 MA-DC Westinghouse RX-37 4"
 square \$11.85
COUNTER Veeder Root Ratchet 5 Number Type
 1144 \$1.19

UG CONNECTORS

UG 352U \$6.00 EACH
 UG 9/U95 EACH
 UG 483 2.60 EACH
 MX 564-U, Chassis type. 5.75 EACH
 83-22 R75 EACH
 Selenium Rectifier, C. E. 4 1/2 V input, 24 V output,
 D. C. 4 amps \$12.95
 Selenium Rectifier, Rectox 62 V input, 24 V out-
 put, D. C. 4.88 amps. \$12.85

ALL the material in STOCK

LEONARD GREENE

381 Tremont St.—HA 6-4794

BOSTON, MASS.

HAYDON SYNCHRONOUS MOTOR



110 V.A.C.
 1/2 H.P.M.
 3.6 Watts
 \$2.75 each

Haydon, 2.2 watt 1-120 RPM. \$2.75
 complete with coin arrangement for 25c pc. \$2.95
 minimum order 5 pcs. on synchronous motor.

Haydon, 3-6 watt, 1.5 RPM #5901-4, adjustable
 reset timer \$7.50

MICA TRANSMITTING CAPACITORS Type G3
 .0001 Mfd 25KV \$35.00 ea.
 Type G2-50, .0001 mfd, .0002 mfd, .0005 mfd,
 10KV \$10.00

Type H, .01 mfd, 2500 V test, #CM50A103M
 \$66.00/hundred
 Type 1445.01, 1200 V test, #CM45B103K
 \$30.00/hundred

ATTENUATOR DAVEN TYPE T-994-2 7500/
 3900-2DBStep \$4.25
 Type TA-1000-2 7500/3900 Ohm \$5.25 ea.

RELAYS

SIGMA 12 Volts DC S.P.D.T. size 2 1/4" x 1 5/8"
 \$7.77 each
G E TYPE CR2791-B109P36 S.P.D.T. 10,000
 Ohm Coil \$1.05
G E TYPE CR2791-B109U39 150 Ohm Coil. \$1.15

TELEPHONE RELAYS



Large Stock of
CLARE, TYPES C, D & E
COOKE, AUTOMATIC-ELECTRIC
 ALL TYPES OF COILS and PILE-UPS
 Send Us Your Specs. for Our Quote

Clare Type G Half Size Sensitive Telephone Relays

Coil	Contacts	Will Close At	Price
1) 6500 ohms	2A	5 MA	\$2.50 ea.
2) 5800 ohms	3A	5 MA	2.50 ea.
3) 5800 ohms	2B-1C	5 MA	2.50 ea.
4) 4850 ohms	1C	4 MA	2.50 ea.
5) 3600 ohms	1C	6 MA	2.00 ea.
6) 4850 ohms	1A	5 MA	2.00 ea.
7) 3300 ohms	(None)	ACTUATOR	1.50 ea.

All above Relays may be used for continuous duty operation on 110V, D.C.

Other Type G Telephone Relays

1) 1300 ohms 1A-1C 24 or 48V. 2.50 ea.
 2) 700 ohms 2A-1C 24V. 2.50 ea.

CONTACT SYMBOLS

A-Norm. Open B-Norm. Closed C-S.P.D.T.

G. E. Relays #CR 2791-B109P36 Coil—10,000 ohms
 Contacts 1A, 1B Operates on 8 MA. Price \$1.65

Signal Wheelock Relays #KS9665 Coil—2,000 ohms
 Contacts-1A, 1B, 1C Operates at 9 MA. Price—\$2.75 ea.

Leach Relays Type 1025-SN-BF. Coil—24V. 425
 ohms. Contacts—D.P.S.T. Norm. closed. Rated
 at 10 Amps. Price—\$1.50 ea.

Five Prong CR-2791 G.E. Plug In Relays.
 1) C-103C25 2200 ohms SPDT 4.5 MA. \$4.00 ea.
 2) C-104B28 700 ohms SPDT 6 MA. \$3.00 ea.

Slow Release (For SCR-522-A) Telephone Relays
 Part No. A18258. Price—\$2.00 ea.

Patch Cords—2 1/2 Ft. long with a Phone Plug
 (Like PL-55) on each end. Price—95c

Chase

Electronic Supply Co.
 222 Fulton St.
 New York 7, N. Y.
 Digby 4-3088
 HOllis 4-5033

“AN” CONNECTORS



AN-3100 AN-3101 AN-3102 AN-3106 AN-3108

Any of the shells pictured here
 may be used with any of the
 inserts listed. For example: If
 a right angle cable connector
 is desired with a 20-29 pin insert



SOCKET INSERT (Female)



PIN INSERT (Male)

Shell	Size	Socket Insert	PIN INSERT
3108	20	29P	(Male)
85-1	16S-1	18-9	20-4
105-2	16S-2	18-10	20-5
105-656	16S-3	18-11	20-6
105L-3	16S-4	18-12	20-7
105L-4	16S-5	18-13	20-8
125-3	16S-6	18-14	20-9
125-1	16S-7	18-15	20-10
125-2	16S-8	18-16	20-11
125-4	16S-9	18-17	20-12
125-4	16S-10	18-18	20-13
125-5	16S-11	18-19	20-14
145-1	16S-12	18-20	20-15
145-2	16S-13	18-21	20-16
145-4	16S-14	18-22	20-17
145-6	16S-15	18-23	20-18
145-8	16S-16	18-24	20-19
145-9	16S-17	18-25	20-20
145-10	16S-18	18-26	20-21
145-11	16S-19	18-27	20-22
145-12	16S-20	18-28	20-23
145-13	16S-21	18-29	20-24
145-14	16S-22	18-30	20-25
14-3	16S-23	18-31	20-26
	16S-24	18-32	20-27
	16S-25	18-33	20-28
	16S-26	18-34	20-29
	16S-27	18-35	20-30
	16S-28	18-36	20-31
	16S-29	18-37	20-32
	16S-30	18-38	20-33
	16S-31	18-39	20-34
	16S-32	18-40	20-35
	16S-33	18-41	20-36
	16S-34	18-42	20-37
	16S-35	18-43	20-38
	16S-36	18-44	20-39
	16S-37	18-45	20-40
	16S-38	18-46	20-41
	16S-39	18-47	20-42
	16S-40	18-48	20-43
	16S-41	18-49	20-44
	16S-42	18-50	20-45
	16S-43	18-51	20-46
	16S-44	18-52	20-47
	16S-45	18-53	20-48
	16S-46	18-54	20-49
	16S-47	18-55	20-50
	16S-48	18-56	20-51
	16S-49	18-57	20-52
	16S-50	18-58	20-53
	16S-51	18-59	20-54
	16S-52	18-60	20-55
	16S-53	18-61	20-56
	16S-54	18-62	20-57
	16S-55	18-63	20-58
	16S-56	18-64	20-59
	16S-57	18-65	20-60
	16S-58	18-66	20-61
	16S-59	18-67	20-62
	16S-60	18-68	20-63
	16S-61	18-69	20-64
	16S-62	18-70	20-65
	16S-63	18-71	20-66
	16S-64	18-72	20-67
	16S-65	18-73	20-68
	16S-66	18-74	20-69
	16S-67	18-75	20-70
	16S-68	18-76	20-71
	16S-69	18-77	20-72
	16S-70	18-78	20-73
	16S-71	18-79	20-74
	16S-72	18-80	20-75
	16S-73	18-81	20-76
	16S-74	18-82	20-77
	16S-75	18-83	20-78
	16S-76	18-84	20-79
	16S-77	18-85	20-80
	16S-78	18-86	20-81
	16S-79	18-87	20-82
	16S-80	18-88	20-83
	16S-81	18-89	20-84
	16S-82	18-90	20-85
	16S-83	18-91	20-86
	16S-84	18-92	20-87
	16S-85	18-93	20-88
	16S-86	18-94	20-89
	16S-87	18-95	20-90
	16S-88	18-96	20-91
	16S-89	18-97	20-92
	16S-90	18-98	20-93
	16S-91	18-99	20-94
	16S-92	18-100	20-95
	16S-93	18-101	20-96
	16S-94	18-102	20-97
	16S-95	18-103	20-98
	16S-96	18-104	20-99
	16S-97	18-105	20-100
	16S-98	18-106	20-101
	16S-99	18-107	20-102
	16S-100	18-108	20-103
	16S-101	18-109	20-104
	16S-102	18-110	20-105
	16S-103	18-111	20-106
	16S-104	18-112	20-107
	16S-105	18-113	20-108
	16S-106	18-114	20-109
	16S-107	18-115	20-110
	16S-108	18-116	20-111
	16S-109	18-117	20-112
	16S-110	18-118	20-113
	16S-111	18-119	20-114
	16S-112	18-120	20-115
	16S-113	18-121	20-116
	16S-114	18-122	20-117
	16S-115	18-123	20-118
	16S-116	18-124	20-119
	16S-117	18-125	20-120
	16S-118	18-126	20-121
	16S-119	18-127	20-122
	16S-120	18-128	20-123
	16S-121	18-129	20-124
	16S-122	18-130	20-125
	16S-123	18-131	20-126
	16S-124	18-132	20-127
	16S-125	18-133	20-128
	16S-126	18-134	20-129
	16S-127	18-135	20-130
	16S-128	18-136	20-131
	16S-129	18-137	20-132
	16S-130	18-138	20-133
	16S-131	18-139	20-134
	16S-132	18-140	20-135
	16S-133	18-141	20-136
	16S-134	18-142	20-137
	16S-135	18-143	20-138
	16S-136	18-144	20-139
	16S-137	18-145	20-140
	16S-138	18-146	20-141
	16S-139	18-147	20-142
	16S-140	18-148	20-143
	16S-141	18-149	20-144
	16S-142	18-150	20-145
	16S-143	18-151	20-146
	16S-144	18-152	20-147
	16S-145	18-153	20-148

Standard Brands

Electronics, INCORPORATED

All Items Fully Guaranteed

ATTENTION - First Listing of a New and Exciting Condenser Inventory!

CP 70 STYLE CONDENSERS	MFD	Voltage DC	Type	MFD	Voltage DC	Type
0091	15 KVDC	14F113	1	500 VDC	9CE6A4	.05
01	16 KVDC	572	1	1000 V	CP70B1EH105V	.14
07	600 VDC	OM66001	1	1200 V	TI10010-2	.6
02	600 VDC	P13356	1	1500 V	7810691	1
05	1000 V	OM66005	1	1750 V	CP70B1EH105V	1
05	1000 V	23F93G2	1	2000 V	CS48396	1
05	3000 V	23F636	1	3000 V	RS29001	2
05-.05	5000 V	P720555-69	1	5000 V	CP70EFL105V	3-3-3
05-.05-.05	500 V	B34584	1	6000 V	23F49-G2	3-75
1	600 V	28E28	1	10 K V	TI60010A	3.5
1	1750 V	CS48596-AP	1	15 K V	14F59	4
1	2000 V	23F378	1	25 K V	14F59	5
1	3500 V	130001G	1.5	1000 V	K7106149A	6
1	5000 V	XLMW351	2	1500 V	TRS202	6
1	7500 V	25F475	2	2000 V	CP70B1-	6
1	10 K V	14F267	2	1500 V	CP70B1EFG205K	8
1	12 K V	26F628-10	2	2000 V	TRS1502	10
1	13 K V	2F3138	2	3000 V	23F161	10
1	15 K V	26F359	2	5000 V	2509R01	10
1-1-1	600 V	SPG62108	2	4000 V	TQ30020	10-10-10
1-1-1	7 K V	25F774	2	5000 V	23F47-G2	12
1-1-1	7500 V	7520	4	400 V	23F188	12
1-1-1	600 V	CP70EAF405K	4	600 V	25F66G2	15
25	1000 V	CP658	4	1000 V	CP70EAF405K	15
25	3000 V	23F942	4	1500 V	CP70D1DG6405K	16
25	6000 V	3009	4	2000 V	XLMW15-4	500
25	7500 V	25F659	4	3000 V	TRS2504	
25	10 K V	25F431	4	4000 V	TJ30040-7	
25	10 K V	D9181	4	5000 V	25F66-4G2	
25	25 K V	TK20002	4	600 V	TI50040	
25-.25-.25	600 V	CP6985EF-254	5	1000 V	KLMRW6-5	
.49	10 K V	408936	5	1000 V	XLMW10-5	
5	600 V	CP70B1EF504V	6	10 K V	TK10050G	
5	1000 V	TJU10005	6	600 V	TRS606	
5	2000 V	26F698	6	1500 V	CAY48731-10	
5	2500 V	PO192509	6	2000 V	CAY48730	
5	3000 V	CP70E1E504N	8	2000 V	TRS208	
5	4000 V	23F409	8	600 V	TRS608	
5	5000 V	TIH50005	8	1500 V	TJ15080	
5	10 K V	408936	8	3 K V	P15988	
5	25 K V	14F103	10	600 VDC	25F339	
5-5	400 V	RAL300	10	1000 VDC	TIH10100	
5-5	600 V	77088R	10	2500 VDC	23F397	
5-5	1000 V	9107	12	4000 VDC	0115	
5-5	2000 V	26F864	12	1000 VDC	35-83P1	
5-5	3000 V	25F595	15	4000 VDC	TJ10150	
5-5	5000 V	PC9151	15	1500 VDC	TJ15150	
5-5-5	900 V	B34584	15	1000 VDC	Photo flash	
875-.875	400 VDC	93F979	25	3000 VDC	Photo flash	
1	400 VDC	CP6982BE1105MK	25			

VACUUM CONDENSERS	MFD	Voltage DC	Type	MFD	Voltage DC	Terminal
300 VAC	.05	300 VAC	PCI344-3	.25-.25	400 VDC	Side
115 VAC	.14	115 VAC	26F988	.25-.25	600 VDC	Side, Top, Bottom
90 VAC	.6	90 VAC	Type 1C Model 2	.25-.25-.25	600 VDC	Side
150 VAC	1	150 VAC	25F757	3	600 VDC	Top
220 VAC	1	220 VAC	21F319	3	600 VDC	Top
330 VAC	1	330 VAC	677X1	5	400 VDC	Side
330 VAC	2	330 VAC	26F406	5	400 VDC	Side, Bottom
90 VAC	3-3-3	90 VAC	26F536	.67	120 VAC	Side
330 VAC	3.5	330 VAC	Type 9C Model 2	.75	600 VDC	Bottom
440 VAC	3.75	440 VAC	KG3037	1	200 VDC	Side
440 VAC	4	440 VAC	21F319	1	300 VDC	Side
330 VAC	5	330 VAC	67X23	1	400 VDC	Side
440 VAC	6	440 VAC	21F120-G2	1	400 VDC	Bottom
660 VAC	6	660 VAC	KGM3060	1	600 VDC	Side
660 VAC	6	660 VAC	Vit. O	1-1	400 VDC	Side
1500 VAC	8	1500 VAC	21F5063	1-1	600 VDC	Bottom
920 VAC	10	920 VAC	22F57	2	25 VDC	Side
330 VAC	10	330 VAC	ALMUW22-10	2	400 VDC	Side
660 VAC	10	660 VAC	PRE3310	2	50 VDC	Side
660 VAC	10	660 VAC	25F698	4	50 VDC	Side
90 VAC	12	90 VAC	26F57163	4	100 VDC	Side
220 VAC	12	220 VAC	MC787	4	450 VDC	Side
330 VAC	12	330 VAC	21F130	4	150 VDC	Side
330 VAC	15	330 VAC	25F801-G2	10	150 VDC	Side
660 VAC	15	660 VAC	PC1330	20	25 VDC	Side
100 VAC	16	100 VAC	KLHRAW1-50	25	25 VDC	Side
330 VAC	500	330 VAC	KGH3500-3	40	25 VDC	Side
				50	50 VDC	Side

STANDARD BATH TUB CONDENSERS	MFD	Voltage	Terminal	WESTINGHOUSE	PULSE TRANSFORMERS
600 VDC	.01	600 VDC	Side	1P1	132 BW2
1000 VDC	.05	1000 VDC	Side	1P6	145 EW
1000 VDC	.05-.05	1000 VDC	Side	1P29	133 DW
600 VDC	.08	600 VDC	Side	134 BW	176 AW
1500 VDC		1500 VDC	Top	134 BW2	301445-1
600 VDC	1	600 VDC	Side		
1000 VDC	1	1000 VDC	Side, Top, Bottom		
400 VDC	1-1	400 VDC	Side		
600 VDC	1-1	600 VDC	Side		
400 VDC	1-1-1	400 VDC	Side		
600 VDC	1-1-1	600 VDC	Side		
1000 VDC	2	1000 VDC	Side		
400 VDC	.25	400 VDC	Side		
600 VDC	.25	600 VDC	Side		

GENERAL ELECTRIC	RAYTHEON
68G813	UX 7307
68G894	UX 7350
68G979	
80G13	
80G58	
80G59	
K2435D	
K2478	
K2449	
K2728	
K2740-A2	

OUR PRICES ARE COMPETITIVE WITH THE LOWEST EXISTING MARKET
 • TREMENDOUS STOCK OF TUBES, TRANSFORMERS, AND CONDENSERS •

(For Partial Tube Listing See Our Ad in September Electronics, pg. 454)

Write - Phone -
 Telegraph

Electronics, INCORPORATED

92 Broad Street, Babson Park, Mass.
 Wellesley 5-5210-1

AUCTION SALE

Radio Receiving Tubes

A. J. WILNER AUCTIONEER, WILL SELL ON WEDNESDAY, NOVEMBER 12, 1952 at 11 A.M. on PREMISES 472 BROAD ST., NEWARK, N. J., 2nd FLOOR. ENTIRE STOCK OF RADIO RECEIVING TUBES, SPECIAL PURPOSE TUBES, EQUIPMENT, OFFICE FURNITURE, ETC. REMOVED FOR CONVENIENCE OF SALE FROM STANDARD ARCTURUS CORPORATION

Approximately 500,000 Tubes

Most Tubes are Cartoned—75% are JANS

All Brands—RCA, GE,

Sylvania, Arcturus, Tungsol, Hytron, Etc.

Type	Quantity	Type	Quantity
OA2	1878	6SK7GT	2943
OB2	2753	6M8GT	427
OZ4	1101	6S07GT	61
OZ4G	7754	6U4GT	1875
O1A	360	6U7G	1252
1A5GT	1000	6V6GT	1000
1A6	338	6W4GT	2486
1B5	213	6W7G	187
1C6	381	6X4	2982
1D5GP	524	6X5G	324
1C7G	384	7C4	10727
1E7G	327	7E5	3716
1E7GT	148	12A5	190
1F4	517	12A6	27000
1F5G	251	12BA7	6216
1G4GT	244	12AV6	209
1G6GT	900	12C8	7989
1H5GT	1000	12F5GT	1052
1H4G	1812	12H6	3789
1H6G	209	12J5GT	4272
1H6GT	190	12K8	9238
1G6G	1300	12Q7GT	1039
1J6GT	301	12SR7	386
1L4	12608	12Z3	332
1L5G	351	14A4	291
1LA4	124	18	339
1LC5	249	19	759
1N5GT	1000	19BG6G	4672
1U4	791	22	373
2E5	560	27	190
3B7	221	30 Spec.	65
3D6	1900	31	227
3Q4	4333	32	741
6A6	775	33	998
6AJ6	2730	34	483
6AL5	415	35	1391
6AS5	234	36	1083
6B5	282	37	958
6B8G	1422	38	3866
6B8	4178	39/44	50,000
6BQ6GT	913	46	347
6CB6	2698	49	151
6G8G	241	50	188
6J7G	305	50C5	480
6J8G	181	55	180
6L5G	284	56	316
6P5GT	947	57	67
6R7	200	58	445
6R7G	221	70L7GT	1345
6R7GT	394	71A	649
6S4	256	77	3889
6S7	337	79	113
6SD7GT	7958	81	359
6SN7GT	1000	82	288

Tens of Thousands Other Tubes Not Listed

50,000 Special Purpose Tubes Including:

100-T-H	705A	866A	395A	394A
869B	814	872A	359A	25Z6WGT
2J32	211	FG17	2050W	OD3W
5CP1	3C29	3B25	6AL5W	OR3W
5BP1	719A	3B28	6H6WGT	
2AP1	2050	2D21	5R4WGY	
3GP1	2051	122	BS101	
3C31	884	1Y2	2D21W	
C1B	885	5594	4B32	

200,000 Assorted Cartons and fillers. Up-To-Date Customer Mailing List with Plates and Machine.

Equipment Used by Standard Arcturus Corporation Tube Testers, Branding Equipment, etc.

INSPECTION—10 A.M. to 4 P.M.—Tuesday, November 11, 1952

WANTED

WANTED

Western Electric gray-finished EQUIPMENT CABINETS

For 19" panels. Heights of 2' 6", 3' 6", 7' 0" and 7' 6".

W-4852, Electronics
330 W. 42 St., New York 36, N. Y.

We Pay Highest \$\$\$\$ Prices for **RADIO & AIRCRAFT ELECTRONICS EQUIPMENT**
You'll be pleasantly and profitably surprised at the prices we pay for needed parts and equipment. Simply send us a description of what you have—tell us your top dollar asking price—and we'll shoot back a prompt reply! Convert that equipment to ready cash now! Write:
ALVARADIO SUPPLY CO.—Division E
4665 Melrose Av. Los Angeles 29, Cal. OLYMPIA 2155

GLASS TUBING

PYREX - NONEX - URANIUM BULBS & CYLINDERS

WRITE FOR FREE MONTHLY LIST

HOUE SUPPLY COMPANY

PHONE KEYPORT 7-1286

M. R. # 1 Box 86X Keyport, N. J.

WE BUY

All kinds of surplus electronic equipment and components.

ELECTRONICRAFT, Inc.

27 Milburn St. Bronxville 8, N.Y.
Bronxville 2-0044

IF there is anything you want that other readers can supply—
OR . . . something you don't want—that other readers can use—
Advertise it in the SEARCHLIGHT SECTION

WANTED TO BUY Test Equipment

GR 650A Impedance Bridge

GR 667 Inductance Bridge

Boonton Q. Meter

Boonton XX Checker

1000 cycle inductance limit bridge

Give Full Details, including Price, Condition, Age.

Box 445, WESTBURY, L. I.

WANTED

- AN/TRC-1 Equipments.
- T14 Transmitters.
- R19 Receivers.
- TS32 Test Oscillators.

Any condition or quantity

W-3858, Electronics
330 W. 42nd St. New York 36, N. Y.

WANTED

BD110 Telephone Switchboards, BD100 Telegraph Switchboards, BD90 Power Boards, EE101 V-F Ringers, BE72 Cabinets, FM19 Frames, RA43, REC30, KS3988, RA87, RA37, RA91 Rectifiers, BD101 Test Boards, SB6 Switchboards, Type CF1A, CF3A, CF2B Carrier Equipments. Any condition and quantity.

W-4212, Electronics
330 W. 42 St., New York 36, N. Y.

WANTED Federal type

101B Voice-frequency Ringers
Signal Corps type TA-3/FT.

W-4814, Electronics
330 W. 42 St., New York 36, N. Y.

ELECTRONIC EQUIPMENT WANTED!

Sell to



We want to buy all types of new and used surplus electronics equipment. Use coupon to tell us what you have. We are the largest purchasers of such equipment.
WRITE TODAY!

Use following numbers to indicate conditions: N-1, brand new; N-2, used, like new; N-3, used.

ITEM	CONDITION	PRICE WANTED

To: ARROW SALES, INC., 7460 Varna Ave., N. Hollywood, Calif.

Name

Address

SEE ARROW SALES, INC. AD ON PAGE 462

ELECTRONIC TUBES

Electro is rapidly becoming the prime source for manufacturers, jobbers and exporters. Your requirements of large or small quantities of tube, all types, can be quickly supplied from our huge stock. Each and every tube is brand new, inspected and fully guaranteed by Electro. We carry Standard Brands Only. Critical tubes are almost always on hand at the right price. Write, Phone or Wire your needs at once.

Receiving		Transmitting	
8J8G	1.30	2E24	4.50
8K6GT	1.00	2E26	3.75
8K6GT	.65	2E30	2.00
8K7	.65	2E31	2.35
8K7GT	.75	2E32	1.60
8K8	.85	2E36	4.25
8K8GT	.85	2E41	3.35
8L6	.75	2E42	2.75
8L6GT	2.25	2G21	2.45
8L7	1.45	2G22	2.45
8L7GT	1.45	2G22	2.45
8L8	1.45	2G22	2.45
8L8GT	1.45	2G22	2.45
8L9	.85	2J21A	7.50
8L9GT	.85	2J22	10.50
8M6	.60	2J26	17.50
8M6GT	.60	2J27	17.50
8N7	.95	2J31	69.50
8N7GT	.95	2J31	69.50
8N7	.85	2J32	27.50
8N7GT	.85	2J32	27.50
8P7	.85	2K24	27.50
8P7GT	.85	2K24	27.50
8Q7	.85	2K26	27.50
8Q7GT	.85	2K26	27.50
8R7	.85	2K26	27.50
8R7GT	.85	2K26	27.50
8S7	.85	2K26	27.50
8S7GT	.85	2K26	27.50
8T7	.85	2K26	27.50
8T7GT	.85	2K26	27.50
8U7	.85	2K26	27.50
8U7GT	.85	2K26	27.50
8V7	.85	2K26	27.50
8V7GT	.85	2K26	27.50
8W7	.85	2K26	27.50
8W7GT	.85	2K26	27.50
8X7	.85	2K26	27.50
8X7GT	.85	2K26	27.50
8Y7	.85	2K26	27.50
8Y7GT	.85	2K26	27.50
8Z7	.85	2K26	27.50
8Z7GT	.85	2K26	27.50
9A7	.85	2K26	27.50
9A7GT	.85	2K26	27.50
9B7	.85	2K26	27.50
9B7GT	.85	2K26	27.50
9C7	.85	2K26	27.50
9C7GT	.85	2K26	27.50
9D7	.85	2K26	27.50
9D7GT	.85	2K26	27.50
9E7	.85	2K26	27.50
9E7GT	.85	2K26	27.50
9F7	.85	2K26	27.50
9F7GT	.85	2K26	27.50
9G7	.85	2K26	27.50
9G7GT	.85	2K26	27.50
9H7	.85	2K26	27.50
9H7GT	.85	2K26	27.50
9I7	.85	2K26	27.50
9I7GT	.85	2K26	27.50
9J7	.85	2K26	27.50
9J7GT	.85	2K26	27.50
9K7	.85	2K26	27.50
9K7GT	.85	2K26	27.50
9L7	.85	2K26	27.50
9L7GT	.85	2K26	27.50
9M7	.85	2K26	27.50
9M7GT	.85	2K26	27.50
9N7	.85	2K26	27.50
9N7GT	.85	2K26	27.50
9O7	.85	2K26	27.50
9O7GT	.85	2K26	27.50
9P7	.85	2K26	27.50
9P7GT	.85	2K26	27.50
9Q7	.85	2K26	27.50
9Q7GT	.85	2K26	27.50
9R7	.85	2K26	27.50
9R7GT	.85	2K26	27.50
9S7	.85	2K26	27.50
9S7GT	.85	2K26	27.50
9T7	.85	2K26	27.50
9T7GT	.85	2K26	27.50
9U7	.85	2K26	27.50
9U7GT	.85	2K26	27.50
9V7	.85	2K26	27.50
9V7GT	.85	2K26	27.50
9W7	.85	2K26	27.50
9W7GT	.85	2K26	27.50
9X7	.85	2K26	27.50
9X7GT	.85	2K26	27.50
9Y7	.85	2K26	27.50
9Y7GT	.85	2K26	27.50
9Z7	.85	2K26	27.50
9Z7GT	.85	2K26	27.50
0A7	.85	2K26	27.50
0A7GT	.85	2K26	27.50
0B7	.85	2K26	27.50
0B7GT	.85	2K26	27.50
0C7	.85	2K26	27.50
0C7GT	.85	2K26	27.50
0D7	.85	2K26	27.50
0D7GT	.85	2K26	27.50
0E7	.85	2K26	27.50
0E7GT	.85	2K26	27.50
0F7	.85	2K26	27.50
0F7GT	.85	2K26	27.50
0G7	.85	2K26	27.50
0G7GT	.85	2K26	27.50
0H7	.85	2K26	27.50
0H7GT	.85	2K26	27.50
0I7	.85	2K26	27.50
0I7GT	.85	2K26	27.50
0J7	.85	2K26	27.50
0J7GT	.85	2K26	27.50
0K7	.85	2K26	27.50
0K7GT	.85	2K26	27.50
0L7	.85	2K26	27.50
0L7GT	.85	2K26	27.50
0M7	.85	2K26	27.50
0M7GT	.85	2K26	27.50
0N7	.85	2K26	27.50
0N7GT	.85	2K26	27.50
0O7	.85	2K26	27.50
0O7GT	.85	2K26	27.50
0P7	.85	2K26	27.50
0P7GT	.85	2K26	27.50
0Q7	.85	2K26	27.50
0Q7GT	.85	2K26	27.50
0R7	.85	2K26	27.50
0R7GT	.85	2K26	27.50
0S7	.85	2K26	27.50
0S7GT	.85	2K26	27.50
0T7	.85	2K26	27.50
0T7GT	.85	2K26	27.50
0U7	.85	2K26	27.50
0U7GT	.85	2K26	27.50
0V7	.85	2K26	27.50
0V7GT	.85	2K26	27.50
0W7	.85	2K26	27.50
0W7GT	.85	2K26	27.50
0X7	.85	2K26	27.50
0X7GT	.85	2K26	27.50
0Y7	.85	2K26	27.50
0Y7GT	.85	2K26	27.50
0Z7	.85	2K26	27.50
0Z7GT	.85	2K26	27.50

Prices subject to change without notice. TERMS: Rated firms net 10 days, Non-rated 25% with order balance COD. Prices FOB Boston.

ELECTRO Sales Company Inc. 

110 PEARL ST. BOSTON 10, MASS. Phone: LIBERTY 2-7890

INDEX

SEARCHLIGHT

October, 1952

This index is published as a convenience to the readers. Care is taken to make it accurate but ELECTRONICS assumes no responsibility for errors or omissions.

EMPLOYMENT

- Positions Vacant..... 433
- Selling Opportunities Offered..... 433, 441
- Positions Wanted..... 433
- Employment Services..... 433

BUSINESS OPPORTUNITIES

- Offered..... 433

NOTICES

- Auction..... 471

PROPERTY

- For Sale..... 433

EQUIPMENT

- (Used or Surplus New)

WANTED

- Equipment..... 471

ADVERTISERS INDEX

- Acorn Electronics Corp..... 469
- Agrod Corp..... 468
- Allied Electronic Sales..... 463
- Alvarado Supply Co..... 471
- Arrow Appliance Co..... 463
- Arrow Sales Inc..... 462, 471
- Barry Electronics Corp..... 462
- Bendix Aviation Corp..... 438
- Blan..... 466
- Brush Development Co., The..... 440
- Candee-Airco..... 460
- Capehardt-Farnsworth Corp..... 433
- C & H Sales Co..... 444, 446
- Chase Electronic Supply Co..... 466
- Chicago Midway Laboratories..... 438
- Columbia Electronics Sales..... 468
- Comet Electronic Sales Co..... 460
- Commercial Surplus Sales Co..... 466
- Communications Devices Co..... 444, 468
- Communication Equipment Co..... 452, 453
- Compass Communications Co..... 458
- Conair..... 436
- Cornell-Aeronautical Laboratory Inc..... 436
- Crosley Broadcasting Corp..... 458
- Edlie Electronics Inc..... 461
- Electro Sales Co Inc..... 472, 473
- Electronic Engineering Co. of Calif..... 441
- Electronic Expeditors..... 460
- Electronics Inc..... 470
- Electronic Specialty Supply Co..... 456
- Electronic Surplus Brokers..... 459
- Electroncraft Inc..... 451, 471
- Empire Electronics Co..... 466
- Employment Counsel..... 433
- Engineering Associates..... 458
- E P C O..... 456
- Fair Radio Sales..... 463
- Freeland Products Co..... 466
- French-Van Breems Inc..... 463, 465
- Gem Electronics Co..... 466
- General Electric Co..... 439
- General Motor Corp., AC Spark Plug Div. 441
- Goodyear Aircraft Corp..... 437
- Green, Leonard..... 469

TO THE ADVERTISERS

October, 1952

SEARCHLIGHT SECTION
(Classified Advertising)
H. E. Hilty, Mgr.

Haydon Co., A. W.	433
Hershel Radio Co.	460
Hoffman Laboratories Inc.	438
Houde Supply Co.	471
Industrial Instrument & Control Co.	458
Industrial Properties	433
Instrument Associates	449
J S H Sales Co.	465
Kollsman Instrument Corp.	440
Lapiro Bros.	463
Electronic Research Laboratories	442, 443
Lemar Electronics Co.	465
Liberty Electronics Inc.	447
Life Electronic Sales	457
Line Hardware Co.	458
Maritime Switchboard	466
Maxson W L	436
Melpar Inc.	434
Mogull Co., Inc., Alexander	462
Monmouth Radio Laboratories	456
National Cash Register Co.	439
National Union Research Div.	441
Norman Radio Distributors Inc.	459
P. J. Sales	467
Photocon Sales	465
Precision Electrical Instrument Co.	465
Premier Radio Tube Co.	464
Radio Corp of America	435, 441
Radio Development & Sales Co.	458
Radio & Electronic Surplus	444
Radio Ham Shack	474
Radio Shack Corp.	461
Radio Surplus Corp.	450
Railway Communications, Inc.	465
Reeves Instrument Corp.	441
Relay Sales	467
Reliance Merchandizing Co.	444, 445
Sandia Corp.	434
Servicio Aeronautico de Mexico S A.	468
Servo-Tek Products, Inc.	448
Standard Piezo Co.	440
Stavid Engineering Inc.	439
Sylvania Electric Products Inc.	439, 440
Tab	475, 476
Telemarine Communications Co.	459
Telerex, Inc.	440
Tracerlab Inc.	440
Universal General Corp.	454
Universal Yonkers Corp.	459
V & H Electronic Industries Inc.	464
Wells Sales Inc.	464
Weston Laboratories	467
Wilcox Electric Co.	440
Wilgreen	455
Witner, A. J.	471
Wholesale Electronics	468
Wolf Co., Edward	468

ELECTRO—FOR ELECTRONIC SURPLUS

OIL FILLED CONDENSERS

MFD.	VOLT.	TYPE	PRICE	MFD.	VOLT.	TYPE	PRICE	MFD.	VOLT.	TYPE	PRICE
.01	1000 DC	24F174	.49	5	1000 DC	65B144504	.95	2.0	5000 DC	Ldg. Mfg.	7.95
.02	1000 DC	26F789	2.95	5	1000 DC	23F331	.89	2.0	4000 DC	22F985	14.95
.02	1000 DC	27F285	1.25	5	1000 DC	10050G	.89	2.0	5000 DC	21F563	9.95
.02	1000 DC	27F276	.39	5	1500 DC	481294	.95	2.0	8000 DC	60020	27.50
.02	10 KVDC	24714	9.50	5	1500 DC	21F628	.95	2.0-5-3	200 DC	355	.95
.045	16 KVDC	D-4495	9.95	5	2000 DC	26F698	1.95	2.2	750 DC	21F563	1.85
.05	500 DC	S T	.20	5	3000 DC	3000C	.95	2.25	3000 AC	11F479	1.85
.05	1000 DC	23F328	.49	5	4000 DC	28F128	6.95	2.25	600 DC	Ldg. Mfg.	1.85
.05-.05	800 DC	517	.49	5	5000 DC	5000S	7.95	2.25	1600 AC	21F667	4.50
.06	25 KVDC	26F585	17.50	5-5	300 DC	481765	.70	2.5	440 AC	21F705	2.35
.1	400 DC	481379	.45	5-5	400 DC	Top Term.	.79	2.6-0.4	440 AC	21F744	2.35
.1-1	400 DC	K757453	.49	5-5	500 DC	23F458	.95	2.7	440 AC	21F677	2.45
.1	600 DC	22F415	.59	5-5	600 DC	23F487	.92	2.75	330 AC	25F983	2.50
.1	1000 DC	27F287	.65	5-5	3000 DC	25F526	4.95	2.75	385 AC	49F16	2.50
.1	1500 DC	P70B5EH104K	5-35-5	5	500 DC	22F427	1.25	3.0	330 AC	Ldg. Mfg.	2.75
.1	3500 DC	K5204513	2.95	6	1000 AC	21F476	1.65	3.0	600 DC	F6030	2.25
.1	7500 DC	21F425	3.95	5-5-6	200 AC	28F120	.95	3.0	1000 DC	Ldg. Mfg.	2.75
.1	10 KVDC	23F430	9.95	635	10 AC	27F712	1.25	3.0-05	600 DC	27F632	1.55
.1	12 KVDC	26F668	9.95	656	1300 AC	21F386	1.65	3.25	330 AC	25F378	3.15
.1	23 AC	21F860	9.95	800	900 AC	25F891	1.65	3.25	230 AC	21F696	2.45
.1-1	600 DC	22F805	.85	67	120 AC	21F333	1.35	3.5	660 AC	25F971	3.95
.1-1	600 DC	27F291	.85	77	1300 AC	21F485	1.50	3.7	230 AC	49F9	3.45
.1-1-1	400 DC	KCF9183	.79	7-7	800 AC	21F320	1.45	3.7	230 AC	21F705	3.45
.1-1-1	400 DC	CA-255	.79	7-7	800 AC	21F718	1.35	3.75	330 AC	Ldg. Mfg.	3.50
.1-1-1	600 DC	G111C	.85	75	330 AC	9CE1A148	.95	3.75	1000 DC	6037	3.75
.1-1-1	600 DC	27F427	.49	866	800 AC	21F450	1.35	3.7	230 AC	21F705	3.75
.15	440 AC	5213288	.70	8	120 AC	21F603	.89	4.0	300 AC	23F548	1.95
.15	400 DC	400015	2.95	86	660 AC	21F336	.95	4.0	330 AC	Ldg. Mfg.	3.65
.15-15	6000 DC	25F435	5.25	1.0	100 DC	54B1EB105K	1.25	4.0	400 AC	21F705	3.65
.15	8000 DC	Ldg. Mfg.	6.95	1.0	500 DC	23F303	.95	4.0	600 DC	Oil Filled	2.65
.15	2500 DC	28F201	2.35	1.0	500 DC	23F303	.95	4.0	500 DC	26F106	2.75
.2	440 AC	Ldg. Mfg.	.72	1.0	440 AC	9CE1A320	1.05	4.0	600 DC	70B1F405V	3.45
.2	1000 DC	23F316	.72	1.0	600 DC	62B1BF105K	1.15	4.0	600 DC	481249	2.75
.2	10 KVDC	26F433	10.95	1.0	600 DC	Bath tub	.89	4.0	1000 DC	Oil Filled	3.75
.25	400 DC	10345	4.95	1.0	600 DC	Ldg. Mfg.	1.95	4.0	2000 DC	22F195	15.95
.25	250 AC	26F822	.69	1.0	600 DC	Ldg. Mfg.	1.15	4.0	4000 DC	70E1EW4	27.50
.25	330 AC	9CE1A147	.72	1.0	600 DC	15010	1.85	4.0-4.0	1000 DC	4223	4.50
.25	400 DC	DA4025	.45	1.0	600 DC	15010	1.85	4.0	230 AC	21F705	4.50
.25	460 DC	22F676	.79	1.0	1150 AC	40010	8.95	4.5	330 AC	21F691	4.25
.25	600 DC	22F611	.69	1.0	200 DC	Bath tub	1.25	4.5	330 AC	21F365	3.95
.25	1000 DC	62B1FG254K		1.0	4000 DC	23F569	1.65	5.0	330 AC	21F365	4.35
.25	1000 DC	27F255	.85	1.0-1.0	600 DC	21F592	1.25	5.5	330 AC	9CE1A306	4.35
.25	1000 DC	26F467	.85	1.0-1.0	600 DC	25F450	1.25	5.5	330 AC	21F702	4.40
.25	1000 DC	18F139	1.45	1.05	800 AC	21F592	1.25	5.5	330 AC	21F702	4.40
.25	2000 DC	TJU200025	1.45	1.05	800 AC	25F450	1.25	5.5	330 AC	21F702	4.40
.25	3000 DC	5511P	3.45	1.1	240 AC	25F450	1.25	5.5	330 AC	21F702	4.40
.25	3500 DC	26F857	.79	1.1	440 AC	21F592	1.25	5.5	330 AC	21F702	4.40
.25	4000 DC	26F767	.595	1.1	440 AC	21F592	1.25	5.5	330 AC	21F702	4.40
.25	4000 DC	26F767	.595	1.1	440 AC	21F592	1.25	5.5	330 AC	21F702	4.40
.25	6000 DC	25F659	7.95	1.25	125 AC	26F594	1.65	6.0	330 AC	3060	4.75
.25	600 DC	26F610	.79	1.25	125 AC	26F594	1.65	6.0	330 AC	3060	4.75
.25-25	600 DC	G022C	.79	1.25	125 AC	21F713	1.65	7.0	330 AC	21F300	4.95
.25-25	600 DC	5184FF254L	.99	1.25-25	1000 AC	21F338	1.45	7.0	330 AC	21F300	4.95
.25-25	600 DC	K7102019P1	.79	1.25-30	1000 AC	21F338	1.45	7.0	330 AC	21F300	4.95
.3	2000 DC	25F822	1.45	1.35	125 AC	21F338	1.45	7.0	330 AC	21F300	4.95
.3	1000 AC	21F480	2.50	1.45-2.8	850 AC	21F338	1.45	7.0	330 AC	21F300	4.95
.31	2000 AC	21F480	2.50	1.45-2.8	850 AC	21F338	1.45	7.0	330 AC	21F300	4.95
.36-36	800 AC	25F888	1.65	1.5	660 AC	25F483	1.75	10.0	600 DC	Ldg. Mfg.	5.95
.36-127	330 AC	25F888	1.65	1.5	660 AC	21F671	.95	10.0	1000 DC	10109G	7.95
.375	250 AC	26F937	.79	1.65	850 AC	21F671	.95	10.0	1000 DC	10109G	7.95
.38-38	800 AC	18F139	1.45	1.50	750 AC	21F671	.95	10.0	1000 DC	10109G	7.95
.4	500 AC	21F720	.79	1.75	330 AC	21F671	.95	10.0	1000 DC	10109G	7.95
.4	800 AC	21F588	1.70	1.75	120 AC	21F671	.95	10.0	1000 DC	10109G	7.95
.4	1400 AC	21F588	1.70	1.75	120 AC	21F671	.95	10.0	1000 DC	10109G	7.95
.42	800 AC	21F331	.85	2.0	220 AC	21F671	.95	10.0	1000 DC	10109G	7.95
.44	800 AC	21F484	1.70	2.0	400 DC	21F671	.95	10.0	1000 DC	10109G	7.95
.44-44	120 DC	Ldg. Mfg.	.65	2.0	400 DC	21F671	.95	10.0	1000 DC	10109G	7.95
.45-45	800 AC	21F569	1.35	2.0	600 DC	21F671	.95	10.0	1000 DC	10109G	7.95
.46	1750 AC	21F573	1.35	2.0	600 DC	21F671	.95	10.0	1000 DC	10109G	7.95
.5	200 DC	Ldg. Mfg.	.65	2.0	750 AC	21F671	.95	10.0	1000 DC	10109G	7.95
.5	330 AC	25F572	.79	2.0	660 AC	21F671	.95	10.0	1000 DC	10109G	7.95
.5	400 DC	C59589	.69	2.0	800 DC	21F671	.95	10.0	1000 DC	10109G	7.95
.5	400 DC	21F572	.79	2.0	800 DC	21F671	.95	10.0	1000 DC	10109G	7.95
.5	600 DC	22F612	.79	2.0	1000 DC	21F671	.95	10.0	1000 DC	10109G	7.95
.5	600 DC	Ldg. Mfg.	.79	2.0	2000 DC	21F671	.95	10.0	1000 DC	10109G	7.95
.5	600 DC	Ldg. Mfg.	.79	2.0	2500 DC	21F671	.95	10.0	1000 DC	10109G	7.95

HIGH VOLTAGE CAPACITORS

#18F269 rated dual 60 Mfd @ 3000 VDC	\$65.00
#PF2-40244C Paper rated 7.0 Mfd @ 4000 VDC	\$42.50
14 F Rated 4.0 Mfd @ 5000 VDC	\$42.50
14 F2 Rated 7.0 Mfd @ 5000 VDC	\$52.50
#19F210 rated 0.1 Mfd @ 6000 VDC	\$37.50
max amp 204	
#7520 Oil rated Dual 1.0 Mfd 7500 VDC	\$27.50
#14F338 rated 4.5 Mfd @ 7500 VDC	\$79.50
#22C181 Paper rated Dual 0.5 Mfd @ 8000 VDC	\$32.50
Inerteen type EL rated 1.0 Mfd @ 10,000 VDC	\$37.50
#22E68 rated 0.1 Mfd @ 12,000 VDC	\$9.95
#A7548, oil filled, rated Dual 0.25 Mfd @ 6000 VDC	\$14.50
#TR1200G-1 Paper rated 0.65 Mfd @ 12,500 VDC	\$19.95
#15020 rated 0.25 Mfd @ 15,000 VDC	\$27.50
20020 rated 0.25 Mfd @ 20,000 VDC	\$27.50

#TK20002-2 Paper rated 0.25 Mfd @ 20,000 VDC	\$27.95
#TK20005 Paper rated 0.5 Mfd @ 20,000 VDC	\$45.00
#14F22 rated 1.0 Mfd @ 20000 VDC	\$72.50
#20020 rated 2.0 Mfd @ 20000 VDC	\$129.50
#14F103 rated 0.5 Mfd @ 25,000 VDC	\$57.50
#TK25050 Paper rated 0.5 Mfd @ 25,000 VDC	\$57.50
Inerteen type FP rated 0.5 Mfd @ 25,000 VDC	\$72.50
#14F98 rated 0.75 Mfd @ 25,000 VDC	\$57.50
#14F59 rated 1.0 Mfd @ 25,000 VDC	\$82.50
#A6734 rated 1.0 Mfd @ 25,000 VDC	\$82.50
#14F12 rated 0.001 Mfd @ 172,000 VDC	\$42.00
#14F98 rated 0.025/0.025 Mfd @ 50,000 VDC	\$59.50
#14F27 rated 0.025 Mfd @ 50,000 VDC	\$45.00
#14F97 rated 0.25 Mfd @ 50,000 VDC	\$79.50

Amertran "TRANSTATS"

Voltage Regulator

 11.5 KVA 50/60 cy. Commutator range 0-115V. Max. Amps. 100. Reconnection diagram available for 220 V. 50 A operation. \$225.00
V. Trans. 25 KW. Fixed winding 115/1/60. Commutator range 103-126 V. Max. AMPS. 2.17. \$9.45

SUPERIOR POWERSTAT

Type 1126-3V. Pri.: 230V, 3 ph, 60 cy. Output: 0-270 Volts 7 KVA. May be separated and used as three 0-115V, 1 ph, 80 cy, 2.0 KVA units. Brand New \$100.00

GP-7 Radio Xmtr. Complete w/8 Tuning Units & all accessories. Freq. Range: 350-9050 Kcs. Tube Complement: (1) 803, (1) 801, (1) 843, (1) 5Z3, (2) 1616 and a full set of spares. 100W output. Brand New export boxed. Gross Wt. 450 Lbs. \$149.50

</

WANTED! WANTED!

Needed for Government Defense Projects—all types of military electronic gear with the prefix TS, BC, SCR, APR, APS, etc. Highest prices paid or will exchange for your needs. No offer too small or too large.

WRITE! WIRE! CALL!

TEST EQUIPMENT



TS-34/AP SYNCHROSCOPE AND OSCILLOSCOPE.

Used to test and service airborne and ground radar. Complete in portable carrying case with all probes, cables and accessories. Input 110v 60-2600 cyc.

- TS-3/AP—S-Band Power Frequency Meter
- TS-10/AP—APN-1 Test Set
- TS-12/AP—X-Band V.S.W.R. Test Set
- TS-13/AP—X-Band Signal Generator
- TS-14/AP—S-Band Signal Generator
- TS-15/AP—Flux Meter
- TS-16/AP—APN-1 Test Set
- TS-18/AP—Capacity Divider
- TS-23/APN—SCR-718 Test Set
- TS-33/AP—X-Band Frequency Meter
- TS-35/AP—X-Band Test Set
- TS-39/AP—X-Band Power Meter
- TS-45/APM-3—X-Band Signal Generator
- TS-59/APN—APN-1 Test Set
- TS-61/AP—S-Band Echo Box
- TS-62/AP—X-Band Echo Box
- TS-69/AP—300-1000 MC Frequency Meter
- TS-69/AP—Pulse Voltage Divider
- TS-98/AP—Pulse Voltage Divider
- TS-102/AP—Range Calibrator
- TS-111/AP—S-Band Wavemeter
- TS-118/AP—Power Meter
- TS-125/AP—S-Band Power Meter
- TS-135/AP—S-Band Signal Generator
- TS-164/AP—Frequency Meter
- TS-170/APN-5—L.S. Test Set
- TS-184/AP—Test Set
- TS-226/AP—300-1000 MC Power Meter
- TS-268/AP—Crystal Test Set
- TS-278/AP—APS-13 Test Set
- IE-19—SCR-522 Test Set
- IE-36—SCR-522 Test Set
- BC-221—Frequency Meter
- BC-1277—S-Band Signal Generator
- TBN/3EV—Thermistor Bridge
- CW/60/ABM—S-Band Frequency Meter

FLUXMETER

Portable Gauss Meter with range of 500-4000 Gauss. Used to test Magnetron and other magnets. Probe has a gap of 1/4". Complete. Brand New. \$32.50

RECEIVING TUBES

0A2	50.95	6AK5	50.88	6S7	50.98
0A4G	1.05	6AK6	1.09	6SU7GY	2.75
0B2	1.05	6AL5	.52	6SW7	.98
0Z4	.69	6AO5	.57	6X4	1.55
1A3	.70	6AQ6	.85	6V6GT	.65
1A7GT	.82	6AT6	1.25	6W4	.65
1B3/8016	.75	6AU5	1.19	6X5GT	.65
1C5GT	.82	6AU5	.59	6V6G	.65
1D8GT	.79	6B5	.59	6YF	.75
1G6GT	.65	6BA6	1.25	7A5	.95
1L4A	.85	6BT7	.95	7B7	.75
1L4B	.95	6BS9	.75	7C5	.75
1L8A	.95	6BA6	.65	7C7	.75
1L8B	.95	6B5	.75	7F7	.75
1L8C	.95	6B5	.65	7Y4	.85
1L8E	.95	6BE6	.65	7N7	.59
1L8G	.95	6BF6	.72	7Y4	.59
1L8H	.95	6BF6	1.19	12A6	.65
1P5GT	.69	6GH6	.95	12A7	.90
1R4	.69	6B16	.95	12AH7GT	1.19
1R5	.69	6B6	1.25	12AT5	.65
1S4	.69	6C4	.60	12AT6	1.10
1S5	.65	6C5	.60	12AU6	.75
1T4	.65	6C5	.59	12AU7	.88
1U4	.67	6C8G	.85	12BA6	.69
1V	.65	6D6	.72	12C8	.69
1X2	.95	6E7	.85	12CA6	.72
2A3	1.10	6E5	.79	12K8	.72
2X2	.50	6F6	.85	12SA7GT	.79
2X2A	1.15	6F7	.85	12S7	.65
3A4	.65	6H6	.65	12SG7	.65
3A5	.65	6HG7	.65	12SJ7GT	.65
3B7/1291	.42	6J5	.75	12SK7GT	.65
3D6/1299	.43	6J5GT	.55	12SL7GT	.65
3Q4	.65	6K6	.95	12SN7GT	.85
3Q5GT	.79	6K7	.95	12SQ7GT	.72
3S4	.74	6J7C	.60	12SR7	.72
3V4	.74	6K6GT	.65	14B6	.75
5R4GY	1.65	7F7	.79	14H7	.85
5T4	1.32	6K8GT	1.15	25L6GT	.65
5U4G	.69	6L6	2.25	25T5	.65
5V4G	.98	6L6G	1.50	25SGT	.68
5W4	.79	6L6GA	1.50	41	.69
5Y3GT	.45	6L7	.85	43	.65
5Y4G	.95	6N7GT	.85	45	.65
5Z3	.85	6R7	.79	50A5	.89
5Z4G	.95	6SA7GT	.65	50B5	.75
6A3	.85	6C7	.95	50C5	.67
6A6	.82	6SF7	.75	50Y6	.67
6A7	.89	6SG7	.75	50G5	.67
6A8GT	.95	6SH7	.65	50G6T	.72
6A8T	.98	6S17	.75	53	.68
6A8SGT	1.05	6SK7GT	.72	75	.82
6A8T	.95	6S7GT	.85	85	.95
6A8S	.75	6SN7GT	.75	80	.95
6AG7	1.45	6S07	.65	83V	.95
6AH6	.65	6S7GT	.65	83V	.95
6AJ5	1.95	6S5S7	.80	84/6Z4	.75

PHONE: DIGBY 9-0347

WRITE FOR CATALOG

CABLE: HAMSHACK, N. Y.

WRITE FOR QUANTITY PRICES

Prices subject to change without notice. F.O.B. N.Y.C. minimum order \$10.00. 20% deposit required. All merchandise guaranteed.

RADIO HAM SHACK inc.
189 GREENWICH STREET, NEW YORK, N. Y.



**RELIABILITY! HONESTY! SERVICE!
RADAR**

- APA-10—Panoramic Adaptor
- APA-17—Automatic Direction Finder 250-1000 MC
- APQ-5—Low Altitude Tracking & Bombing Equip.
- APR-1—Radar Search Receiver 40-3400 MC
- APR-2—Radar Search Receiver 85-1000 MC
- APR-4—Radar Search Receiver 88-4000 MC
- APR-5—Radar Search Receiver 1000-3100 MC
- APR-6—Radar Search Receiver 3000-6000 MC
- APS-2—S-Band Search Radar
- APS-3—X-Band Search Radar
- APS-4—X-Band Search & Homing Radar
- APS-6—X-Band Search & Gun Laying Radar
- APS-15A—X-Band Blind Bombing Radar
- APR-4—Radar Jamming Xmitter 165-780 MC
- APT-5—Radar Jamming Xmitter 350-1400 MC
- SO-13—S-Band Marine Radar, Lightweight
- SQ-10 CM Portable Radar
- TPS-1—Portable Search Radar
- TPS-3—L-Band Search Radar
- UPN-1 & 2—S-Band Portable Beacon Battery of 110v AC

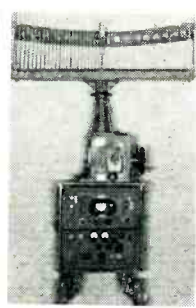

SQ 10 CM PORTABLE RADAR

This set is a very compact search radar. Complete installation available. New in carrying cases. Tech. data as follows: power input: 90-130v cy. pulse rate: 800 cpm; range: 3, 15, 45 miles; pulse width: 1 microsec.; 300 yds. min. range, all ranges; I.F.P. synch. output available; accuracy ± 5%; power output 1 KW, V.T.

beam width: 8° horiz. 15° vert.; presentation: A, B, P.P.I.

MOBILE POWER PLANT

(GAS DRIVEN)

Output: 220v—3KW—60 cyc. One phase. Excellent condition, checked out.

- RA-34—Power Supply for BC-375E
- RA-62—Power Supply for SCR-522
- BC-1016—Ink Tape Recorder
- PE-103—Dynamotor Power Supply
- PE-104—Vibrator Power Supply
- GN-58—Hand Cranked Generator W/Legs & Seat
- SCR-578—Gibson Girl (Emergency Xmitter)
- CRT-3—Victory Girl Dual Freq. Emergency Xmitter
- Sound Frequency Chest & Headsets MI-2454-B; Type O, Mfg. RCA.
- AS-32/APX-1—Antenna
- ANIGRC-7—V.H.F. Handi-Talkies 112MC Xtal Controlled
- MN/26-Y—Compass Receiver
- BC-733D—Receiver with Tubes
- C-3—Navy Snooperscope in Carrying Case
- BC-1284—Lighthouse Tube Preampifier
- BC-996—Interphone Amplifier
- FL-42—Motor Antenna Reel
- 30 MC—J.P. Straps Using 6AK5
- RD-27/APA-23—Recorder for APR
- AS-27/ARN-5—Antenna
- ARA—Receiver—500-1500 KC
- ID/80-APA-17—Indicator
- R-28/ARC-5—Receiver—100-156 MC
- RM-29—Remote Control
- BC-455—Receiver—6-8 MC
- BC-454—Receiver—3-6 MC
- BC-800—Transmitter/Receiver
- BC-950—Transmitter—100-156 MC
- RA-300—FM Exciter (Mfg. Tempo)
- FL-8—Filter
- FL-5—Filter, Less Cables
- 3C-16-D GSAP—Gun Camera Computers with All Accessories; in Carrying Case
- AT-2A/APN-2—Antenna

SPARE PARTS AND COMPONENTS AVAILABLE FOR MANY EQUIPMENTS

ALL EQUIPMENT SOLD IS CAREFULLY RECONDITIONED AND CHECKED OUT TO ORIGINAL SPECIFICATIONS IN OUR OWN SHOPS USING FINEST LAB TYPE TEST EQUIPMENT.

THESE COMPLETELY EQUIPPED SHOPS AND OUR EXPERIENCED TECHNICAL STAFF ARE AVAILABLE FOR GOVERNMENT PRIME OR SUB-CONTRACT WORK OR PRIVATE COMMERCIAL ORDERS ON ANY TYPE OF COMMUNICATIONS OR RADAR APPARATUS.

**PANEL METERS
2" SQUARE WESTON—SANGAMO**

0-20 Volts D.C.	\$2.95	0-5 Ma	\$2.95
0-40 Volts D.C.	2.95	0-500 Microamp.	4.95
0-5 Amp. R.F.	2.95	0-100 Ma (0-300 scale)	2.95

COMMUNICATIONS

AN/ARC-1 TRANS/REC.

Provides Radio-Telephone Communication between Aircraft or Aircraft and Ground. Complete with Shock Mount and Control Box. Input: 28V DC. Excellent condition. Available in either 0 or 20 Crystal Controlled Channels 100-156 MCS.



- APA-11—Pulse Analyzer
- APN-1—Airborne Radio Altimeter
- ARC-4 VHF Transceiver 140-150 MC
- ARN-5—Glide Path Receiver
- ARN-7—Airborne Directional Finder
- ARR-2—Flaming & Receiving Equipment
- ART-13—Collins Autotune Transmitter
- BC-223—30-Watt Transmitter 2-5.2 MC
- BC-342—Receiver—1.5 to 18 MC 110v AC
- BC-348—Receiver—1.5 to 18 MC 28v DC
- BC-375E—Radio Transmitter
- BC-639—VHF Receiver 100-156 MC
- BC-640—VHF Transmitter 100-156 MC
- BC-1206—Beacon Receiver 200-400 KC
- RC-103—Airborne Localizer Receiver
- SCR-269—Radio Compass
- SCR-274N—Command Equipment
- SCR-284—Field Radio Station
- SCR-291—Semi-Portable Direction Finder
- SCR-300—Field Transmitter and Receiver
- SCR-522—VHF Transmitter and Receiver
- SCR-536—Handi-Talkie
- SCR-555—Semi-Portable Direction Finder
- SCR-694—Portable Field Transceiver
- SCR-625—Mine Detector
- SCR-718A-AM-C—High Altitude Altimeter
- T-50—Radio Telegraph Transmitter
- TCS—Marine Telephone Transceiver

XMITTING TUBES

0A3/XR75	\$1.04	15R	50.69	866A	\$1.35
0B3/VR90	1.19	28D7	1.95	866R	1.29
0C3/VR105	1.35	30 Spec.	3.00	867	65.00
0D3/VR150	.95	35	3.25	872A	2.95
1B23	9.75	45 Spec.	.32	874	1.19
1B24	1.25	100TH	7.95	878	1.59
1B27	14.95	211	1.05	885	1.19
1B29	2.45	250TH	19.95	902A	9.95
1N21B	3.25	250TL	37.95	922	1.10
1N23	1.25	262B	3.95	922	1.25
1N23A	2.39	274B	2.95	923	.95
1N24	3.35	304TH	8.95	924	1.05
1N34	.76	304TL	8.95	930	.95
1N34A	.97	307A/RK75	3.95	931A	4.45
2A4	10	316A	6.65	954	.85
2C40	7.50	328A	8.95	955	.35
2C43	14.95	350A	6.45	956	.35
2C44	3.25	350TL	8.75	958	1.45
2C46	7.95	368A	7.50	958	.49
2C51	6.25	371A	.95	959	3.95
2E21	1.35	371B	3.95	NE16	1.69
2E22	1.75	393A	7.95	1603	7.95
2E24	4.65	394A	3.95	1613	.39
2E25	4.35	417A	3.95	1616	.69
2K25/723AB	3.25	434A	27.50	1619	.24
2K28	28.75	446A	1.15	1622	2.45
2K33A	32.50	446B	3.75	1624	1.45
3AP1	9.95	701A	5.75	1626	.25
3B24	5.25	702A	6.25	1629	.45
3B24W	7.95	705A	1.65	1630	.75
3B26	3.59	707B	13.95	1632	.72
3B27	5.95	714A Y	7.95	1638	.45
3C22	115.00	715A	6.39	1851	1.55
3C24/24G	1.75	715B	8.75	2051	1.18
3C45	1.95	715C	19.95	5670	1.95
3CP1	1.95	717A	8.95	8008	5.95
3CP151	1.95	721A	2.45	8011	.90
3DP1	4.45	723A	9.50	8012	2.65
3DP1A	6.95	723A B	19.95	8013	2.59
3DP1-52A	8.95	724B	3.25	8020	.98
3E21A	5.25	725A	12.50	8021	1.79
3E29	13.95	726A	18.95	9002	.98
3F7	1.65	730A	29.50	9003	1.65
3G1	4.39	800	1.75	9004	.35
4-125A	27.50	802	3.95	9005	1.45
4-250A	37.50	803	3.25	9006	.27
4AP10	4.45	804	11.75	C1A	9.95
4C35	27.50	805	3.75	C6A	7.95
4E27	14.95	806	24.95	C63	6.39
5AP1	3.45	807	1.59	CK1005	4.8
5AP4	4.45	808	2.69	F123A	7.75
5BP1	4.45	810	9.50	F127A	27.50
5BP4	4.45	811	2.95	F128A	89.50
5CP1	4.59	812	2.75	F637	4.89
5CP7	11.75	813	11.75	F627A	4.95
5D21	19.95	814	2.69	F632	8.95
5FP7	1.85	815	2.35	FG57	14.95
5GP1	4.85	816	1.05	FG81A	3.49
5GP2	8.25	817	1.75	FG125	17.95
5JP2	22.50	828	9.95	FG172	33.50
5LP1	22.50	829	10.95	GL434A	29.95
5M2	5.25	829B	12.50	GL502A	1.79
6AN5	3.30	830B	2.75	HF100	8.95
6A56	2.50	832	6.75	HF300	22.45
6A57	4.45	832A	8.50	HY148	6.69
6C21	21.00	836A	3.49	HY115	.69
6J4	6.75	837	1.45	HY101	47.50
7B7	6.25	838	2.25	FL122	1.95
7DP4	14.50	845W	4.25	RK60/1641	2.25
9LP7	4.95	849C	27.50	RK65	26.50
10SP4	17.45	851	47.50	RK72	.48
10Y	.39	860	3.95	RT17A	2.45
12DP7	14.75	861	22.50	VL127A	2.45
15E	1.35	865	.98	WL616	34.50



Infrared Snooperscope

Image-Converter Tube HJ5Sensitivity simplified design 2 dia. Williams Retron Reaction up to 350 line/in. Complete data & tube, ea. \$4.98; 2 for \$9.49

SNOOPERSCOPE PWR SUPPLY 1800V/25MA. Using 600V/100mA Transformer, Rectifier, Sockets, Resistors, Capacitors and Diagram 115V/60cy Oper. \$6.98

UHF ANTENNA

UHF ANTENNA 12"/30CM AT/ARRI Usable Citiz & Ham Band Jans. Coax Term. Silver Pl. Coax & H-wave. Mobile Mtg. .39c; 4 for \$1.00 PL259 for above. .65 TV CONICAL ANTENNA Sturdy Prefab Incl. 8 elements & 100 ft. Copper Twine Coax. & Hardware. Brand New. \$5.25 MICROWAVE ANT. AS125/APR. 1000 to 2400Mc. w/IGW. In-Built HiPass. Flip Flange Mtg. Incl. H-wave. \$5.98

MERCURY THERMO REGULATOR DUAL CKT. 105°F & 32°F. Extremely sensitive & accurate. No exacting requirements. Research, Fire Prev., Freeze, Pt. Control or Max-Min Temp. Control. Brand New. Individ. Boxed. w/data. \$1.00 SPECIAL EA. 98c. \$12 for \$10.00

ONE YEAR GTD TV PICTURE TUBES

10 inch Round \$14.95 12 inch Round 19.95 14 inch Rectangular 20.95 18 inch Round 22.95 18 inch Rectangular 27.25 17 inch Rectangular 24.85 19 inch Round 28.50 20 inch Rectangular 30.45 21 inch Rectangular 30.45 24 inch Metal 67.00 Your old picture tube worth money, write for trade-in allowance toward RMA coded and graded tubes with one year guarantee. Ship your defective picture tubes prepaid only. When ordering metal tube, defective metal tube is required.

"TAB" THAT'S A BUY

STORAGE BATTERIES 36 Volt WILLARD Mini-Brand New 6" dia. Den. Portable Equip. Models... 98c; 4 for \$3.36V. 4 Batteries W/acid. \$5.35 2V/20AH Willard PLUS 2V. Vibrator... \$2.98 6V/10AH Willard NTG/B/N/214U... 1.98 6 Volt 6AH Batteries W/acid... 2.45 6V/40AH Willard... 6.98 6V/125AH Willard... 12.98 Battery Acid, (R-Exp) 1 pt. 59c; 2 pts. .98 Hydrometer 1.0B to 1.24 Sp. Grav... 1.98 Spec Grav. and Merc. Thermom... 3.59 2V/20AH, w/Vib & Acid. \$5.98 We Ship R'Exp Only

TUBE KLEANS 928B-5 928B-10 928B 928-1 930-19 928B-19 928A-10 5 for \$1.00 TABS TUBE SPECIALS BROKEN KEYS ELECTRICALLY PERFECT 1BSGT 6H6 6K6GT 6SN7GT 12N7GT Each 50c; 5 for \$2.00 6B6G 6B6GT 12S7G 19B6B 6L6G 6L6GT Each 79c; 3 for \$1.00

CONNECTOR AND CABLES

831R/SO230 Receptacle \$0.50 10 for \$5.90 831SP/PL259A Plug \$0.65 10 for \$5.90 831SP/PL259 Plug \$0.50 10 for 4.75 6 Pin 125B Junction .109 CORDC0307A W/JK26 & PL55 5 ft. long 1.09 CORDC same as above 8 ft. \$1.29; 12 ft. long 1.49 CORC RPT COAXIAL CABLE per ft. .08 CORC RG11 5 ft. length per ft. .08 CORC D277 6 C/NDR P/O BC312 1.89 RG11 Cable per ft. \$0.08; 100 ft. \$8.98 300 Ohm Copper Twine per ft. 2c; 10 ft. \$1.98

CIRCUIT BREAKER FUSES

PUSH TO RESET Amps 3-5-7-10-15-20 Ea. 20c 4 for \$1.; 25 for \$5.; 100 for \$18. Circuit Breaker Type W/2 Mounting Clips 39c; 3 for \$1.; \$1.00; 20 for \$5.99; 100 for \$25. Fuse is 3AG Size. Operates up to 24 Volts

RHEOSTATS

2 ohm 50W Model J... \$2.59 2 ohm 25W Model LH... 3.74 15 ohm 75W Model G... 2.69 60 ohm 60W w/knob... 2.69 0 ohm 25W Model K... ea. 1.39; 4 for \$5.00 300 ohm 200W Model P... 2.25 350 ohm 500W 0 ohm Slotted shaft... 7.9c; 3 for 2.00 1000 ohm 25W Model P... 2.19 Write for Special Prices on 5 Pcs & Up

POTENTIOMETERS—Type J

5 ohm Type J 3/4 shaft... \$1.90 10 ohm Type J 3/4 shaft... 3.12 Slotted shaft 93c; 12 for \$10. 1000 ohm Type J 3/4 shaft... 3.12 3500 ohm Type J 3/4 shaft... 93c; 12 for \$10. 20 ohm Type J 3/4 shaft... 1.90 Slotted shaft 93c; 12 for \$10. 25K ohm Type J 3/4 shaft... 1.90 50K ohm Type J 3/4 shaft... 93c; 12 for \$10. 1 meg Type JJJ (Triple) 1 1/2 shaft... 3.69

866A KIT AND XFORMER

2 Tubes, Sekta, xfmr 115V 60cy Inpt. output 2.5vct. 10W/40V. \$6.98 DIODE PROBE TUBE Unexcelled for No-Loss VMT testing. Ultra sensitive submini-vac-envelope. New, w/data V92. \$25c; 5 for \$1.

Selenium Power Supply

0 to 12VDC/2 Amp. Variable DC supply, unoaded amp. Completely built-in. 115V/60 Hz. Usable LAB supply. filament D.C. plating, battery charging, model railroads, includes voltage or speed control and center of retuning av. Ideal for "HO" locomotives. 2 for \$20.00

SELENIUM RECTIFIERS

We specialize in Rectifiers and Power supplies to your specifications. Immediate delivery. Current 18/14 28/18 30/28 44/40 130/100 (cont.) Volts Volts Volts Volts 2AMP 2.20 3.50 6.50 10.50 12AMP 8.50 9.15 12.95 27.00 10AMP 6.75 9.98 12.00 20.00 40.00 12AMP 13.25 16.20 15.00 25.50 50.00 20AMP 13.25 16.20 15.00 25.50 50.00 24AMP 16.00 31.00 39.50 98.00 30AMP 18.50 24.30 36.00 36AMP 25.50 36.00 C. T. Rect 100 amp 10-0-10V... \$35.00 Full Wave Selenium Rect & Trans. in Kt. Form. All 115V/60cy inputs Volts Volts up to 14VDC at 12 amps... 23.98 up to 28VDC at 12 amps... 31.98 up to 28VDC at 48 amp... 34.50 up to 20VDC at 6 amps... 12.98 * This 6 amp supply has no aging taps.

RECTIFIER XFMR'S

18.8-19.2-20.4-21.4 Volts/12 Amp... \$14.98 31-32-34-36 Volts/12 Amp 14Kvlns... 16.98 18-2-2-9-1-18-18-18 Amp... 8.75 18-12-9-CT-9-2-28V/12 Amp... 14.50 36VCT-24V-18V/24 Amp... 28.75

TOGGLE SWITCHES

SPDT GE BKLT CSD 3A/260V 25c; 5 for \$1. SPDT AHH BKLT CSD 3A/260V 35c; 4 for \$1. SPDT BKLT CSD Momentary .49c; 5 for \$2. DPST BKLT CSD 16A/125V... 3.00 DPST BKLT CSD 8A/125V... 65c; 5 for \$2.95 DPST BKLT CSD 20A/260V... 1.25; 3 for \$3.25 DPDT AHH Laminated... 65c; 3 for \$1.90

Table of vacuum tube types and prices, including 0A2, 0A3, 0A4, 0B3, 0C3, 0D3, 0Y4, 0Z4, 6A1, 6AR5, 6AV6, 6BD6, 6BE6, 6BE7, 6BE8, 6BE9, 6BE9A, 6BE9B, 6BE9C, 6BE9D, 6BE9E, 6BE9F, 6BE9G, 6BE9H, 6BE9I, 6BE9J, 6BE9K, 6BE9L, 6BE9M, 6BE9N, 6BE9O, 6BE9P, 6BE9Q, 6BE9R, 6BE9S, 6BE9T, 6BE9U, 6BE9V, 6BE9W, 6BE9X, 6BE9Y, 6BE9Z, 6BE9AA, 6BE9AB, 6BE9AC, 6BE9AD, 6BE9AE, 6BE9AF, 6BE9AG, 6BE9AH, 6BE9AI, 6BE9AJ, 6BE9AK, 6BE9AL, 6BE9AM, 6BE9AN, 6BE9AO, 6BE9AP, 6BE9AQ, 6BE9AR, 6BE9AS, 6BE9AT, 6BE9AU, 6BE9AV, 6BE9AW, 6BE9AX, 6BE9AY, 6BE9AZ, 6BE9BA, 6BE9BB, 6BE9BC, 6BE9BD, 6BE9BE, 6BE9BF, 6BE9BG, 6BE9BH, 6BE9BI, 6BE9BJ, 6BE9BK, 6BE9BL, 6BE9BM, 6BE9BN, 6BE9BO, 6BE9BP, 6BE9BQ, 6BE9BR, 6BE9BS, 6BE9BT, 6BE9BU, 6BE9BV, 6BE9BW, 6BE9BX, 6BE9BY, 6BE9BZ, 6BE9CA, 6BE9CB, 6BE9CC, 6BE9CD, 6BE9CE, 6BE9CF, 6BE9CG, 6BE9CH, 6BE9CI, 6BE9CJ, 6BE9CK, 6BE9CL, 6BE9CM, 6BE9CN, 6BE9CO, 6BE9CP, 6BE9CQ, 6BE9CR, 6BE9CS, 6BE9CT, 6BE9CU, 6BE9CV, 6BE9CW, 6BE9CX, 6BE9CY, 6BE9CZ, 6BE9DA, 6BE9DB, 6BE9DC, 6BE9DD, 6BE9DE, 6BE9DF, 6BE9DG, 6BE9DH, 6BE9DI, 6BE9DJ, 6BE9DK, 6BE9DL, 6BE9DM, 6BE9DN, 6BE9DO, 6BE9DP, 6BE9DQ, 6BE9DR, 6BE9DS, 6BE9DT, 6BE9DU, 6BE9DV, 6BE9DW, 6BE9DX, 6BE9DY, 6BE9DZ, 6BE9EA, 6BE9EB, 6BE9EC, 6BE9ED, 6BE9EE, 6BE9EF, 6BE9EG, 6BE9EH, 6BE9EI, 6BE9EJ, 6BE9EK, 6BE9EL, 6BE9EM, 6BE9EN, 6BE9EO, 6BE9EP, 6BE9EQ, 6BE9ER, 6BE9ES, 6BE9ET, 6BE9EU, 6BE9EV, 6BE9EW, 6BE9EX, 6BE9EY, 6BE9EZ, 6BE9FA, 6BE9FB, 6BE9FC, 6BE9FD, 6BE9FE, 6BE9FF, 6BE9FG, 6BE9FH, 6BE9FI, 6BE9FJ, 6BE9FK, 6BE9FL, 6BE9FM, 6BE9FN, 6BE9FO, 6BE9FP, 6BE9FQ, 6BE9FR, 6BE9FS, 6BE9FT, 6BE9FU, 6BE9FV, 6BE9FW, 6BE9FX, 6BE9FY, 6BE9FZ, 6BE9GA, 6BE9GB, 6BE9GC, 6BE9GD, 6BE9GE, 6BE9GF, 6BE9GG, 6BE9GH, 6BE9GI, 6BE9GJ, 6BE9GK, 6BE9GL, 6BE9GM, 6BE9GN, 6BE9GO, 6BE9GP, 6BE9GQ, 6BE9GR, 6BE9GS, 6BE9GT, 6BE9GU, 6BE9GV, 6BE9GW, 6BE9GX, 6BE9GY, 6BE9GZ, 6BE9HA, 6BE9HB, 6BE9HC, 6BE9HD, 6BE9HE, 6BE9HF, 6BE9HG, 6BE9HH, 6BE9HI, 6BE9HJ, 6BE9HK, 6BE9HL, 6BE9HM, 6BE9HN, 6BE9HO, 6BE9HP, 6BE9HQ, 6BE9HR, 6BE9HS, 6BE9HT, 6BE9HU, 6BE9HV, 6BE9HW, 6BE9HX, 6BE9HY, 6BE9HZ, 6BE9IA, 6BE9IB, 6BE9IC, 6BE9ID, 6BE9IE, 6BE9IF, 6BE9IG, 6BE9IH, 6BE9II, 6BE9IJ, 6BE9IK, 6BE9IL, 6BE9IM, 6BE9IN, 6BE9IO, 6BE9IP, 6BE9IQ, 6BE9IR, 6BE9IS, 6BE9IT, 6BE9IU, 6BE9IV, 6BE9IW, 6BE9IX, 6BE9IY, 6BE9IZ, 6BE9JA, 6BE9JB, 6BE9JC, 6BE9JD, 6BE9JE, 6BE9JF, 6BE9JG, 6BE9JH, 6BE9JI, 6BE9JJ, 6BE9JK, 6BE9JL, 6BE9JM, 6BE9JN, 6BE9JO, 6BE9JP, 6BE9JQ, 6BE9JR, 6BE9JS, 6BE9JT, 6BE9JU, 6BE9JV, 6BE9JW, 6BE9JX, 6BE9JY, 6BE9JZ, 6BE9KA, 6BE9KB, 6BE9KC, 6BE9KD, 6BE9KE, 6BE9KF, 6BE9KG, 6BE9KH, 6BE9KI, 6BE9KJ, 6BE9KL, 6BE9KM, 6BE9KN, 6BE9KO, 6BE9KP, 6BE9KQ, 6BE9KR, 6BE9KS, 6BE9KT, 6BE9KU, 6BE9KV, 6BE9KW, 6BE9KX, 6BE9KY, 6BE9KZ, 6BE9LA, 6BE9LB, 6BE9LC, 6BE9LD, 6BE9LE, 6BE9LF, 6BE9LG, 6BE9LH, 6BE9LI, 6BE9LJ, 6BE9LK, 6BE9LL, 6BE9LM, 6BE9LN, 6BE9LO, 6BE9LP, 6BE9LQ, 6BE9LR, 6BE9LS, 6BE9LT, 6BE9LU, 6BE9LV, 6BE9LW, 6BE9LX, 6BE9LY, 6BE9LZ, 6BE9MA, 6BE9MB, 6BE9MC, 6BE9MD, 6BE9ME, 6BE9MF, 6BE9MG, 6BE9MH, 6BE9MI, 6BE9MJ, 6BE9MK, 6BE9ML, 6BE9MN, 6BE9MO, 6BE9MP, 6BE9MQ, 6BE9MR, 6BE9MS, 6BE9MT, 6BE9MU, 6BE9MV, 6BE9MW, 6BE9MX, 6BE9MY, 6BE9MZ, 6BE9NA, 6BE9NB, 6BE9NC, 6BE9ND, 6BE9NE, 6BE9NF, 6BE9NG, 6BE9NH, 6BE9NI, 6BE9NJ, 6BE9NK, 6BE9NL, 6BE9NM, 6BE9NN, 6BE9NO, 6BE9NP, 6BE9NQ, 6BE9NR, 6BE9NS, 6BE9NT, 6BE9NU, 6BE9NV, 6BE9NW, 6BE9NX, 6BE9NY, 6BE9NZ, 6BE9OA, 6BE9OB, 6BE9OC, 6BE9OD, 6BE9OE, 6BE9OF, 6BE9OG, 6BE9OH, 6BE9OI, 6BE9OJ, 6BE9OK, 6BE9OL, 6BE9OM, 6BE9ON, 6BE9OO, 6BE9OP, 6BE9OQ, 6BE9OR, 6BE9OS, 6BE9OT, 6BE9OU, 6BE9OV, 6BE9OW, 6BE9OX, 6BE9OY, 6BE9OZ, 6BE9PA, 6BE9PB, 6BE9PC, 6BE9PD, 6BE9PE, 6BE9PF, 6BE9PG, 6BE9PH, 6BE9PI, 6BE9PJ, 6BE9PK, 6BE9PL, 6BE9PM, 6BE9PN, 6BE9PO, 6BE9PP, 6BE9PQ, 6BE9PR, 6BE9PS, 6BE9PT, 6BE9PU, 6BE9PV, 6BE9PW, 6BE9PX, 6BE9PY, 6BE9PZ, 6BE9QA, 6BE9QB, 6BE9QC, 6BE9QD, 6BE9QE, 6BE9QF, 6BE9QG, 6BE9QH, 6BE9QI, 6BE9QJ, 6BE9QK, 6BE9QL, 6BE9QM, 6BE9QN, 6BE9QO, 6BE9QP, 6BE9QQ, 6BE9QR, 6BE9QS, 6BE9QT, 6BE9QU, 6BE9QV, 6BE9QW, 6BE9QX, 6BE9QY, 6BE9QZ, 6BE9RA, 6BE9RB, 6BE9RC, 6BE9RD, 6BE9RE, 6BE9RF, 6BE9RG, 6BE9RH, 6BE9RI, 6BE9RJ, 6BE9RK, 6BE9RL, 6BE9RM, 6BE9RN, 6BE9RO, 6BE9RP, 6BE9RQ, 6BE9RR, 6BE9RS, 6BE9RT, 6BE9RU, 6BE9RV, 6BE9RW, 6BE9RX, 6BE9RY, 6BE9RZ, 6BE9SA, 6BE9SB, 6BE9SC, 6BE9SD, 6BE9SE, 6BE9SF, 6BE9SG, 6BE9SH, 6BE9SI, 6BE9SJ, 6BE9SK, 6BE9SL, 6BE9SM, 6BE9SN, 6BE9SO, 6BE9SP, 6BE9SQ, 6BE9SR, 6BE9SS, 6BE9ST, 6BE9SU, 6BE9SV, 6BE9SW, 6BE9SX, 6BE9SY, 6BE9SZ, 6BE9TA, 6BE9TB, 6BE9TC, 6BE9TD, 6BE9TE, 6BE9TF, 6BE9TG, 6BE9TH, 6BE9TI, 6BE9TJ, 6BE9TK, 6BE9TL, 6BE9TM, 6BE9TN, 6BE9TO, 6BE9TP, 6BE9TQ, 6BE9TR, 6BE9TS, 6BE9TT, 6BE9TU, 6BE9TV, 6BE9TW, 6BE9TX, 6BE9TY, 6BE9TZ, 6BE9UA, 6BE9UB, 6BE9UC, 6BE9UD, 6BE9UE, 6BE9UF, 6BE9UG, 6BE9UH, 6BE9UI, 6BE9UJ, 6BE9UK, 6BE9UL, 6BE9UM, 6BE9UN, 6BE9UO, 6BE9UP, 6BE9UQ, 6BE9UR, 6BE9US, 6BE9UT, 6BE9UU, 6BE9UV, 6BE9UW, 6BE9UX, 6BE9UY, 6BE9UZ, 6BE9VA, 6BE9VB, 6BE9VC, 6BE9VD, 6BE9VE, 6BE9VF, 6BE9VG, 6BE9VH, 6BE9VI, 6BE9VJ, 6BE9VK, 6BE9VL, 6BE9VM, 6BE9VN, 6BE9VO, 6BE9VP, 6BE9VQ, 6BE9VR, 6BE9VS, 6BE9VT, 6BE9VU, 6BE9VV, 6BE9VW, 6BE9VX, 6BE9VY, 6BE9VZ, 6BE9WA, 6BE9WB, 6BE9WC, 6BE9WD, 6BE9WE, 6BE9WF, 6BE9WG, 6BE9WH, 6BE9WI, 6BE9WJ, 6BE9WK, 6BE9WL, 6BE9WM, 6BE9WN, 6BE9WO, 6BE9WP, 6BE9WQ, 6BE9WR, 6BE9WS, 6BE9WT, 6BE9WU, 6BE9WV, 6BE9WW, 6BE9WX, 6BE9WY, 6BE9WZ, 6BE9XA, 6BE9XB, 6BE9XC, 6BE9XD, 6BE9XE, 6BE9XF, 6BE9XG, 6BE9XH, 6BE9XI, 6BE9XJ, 6BE9XK, 6BE9XL, 6BE9XM, 6BE9XN, 6BE9XO, 6BE9XP, 6BE9XQ, 6BE9XR, 6BE9XS, 6BE9XT, 6BE9XU, 6BE9XV, 6BE9XW, 6BE9XX, 6BE9XY, 6BE9XZ, 6BE9YA, 6BE9YB, 6BE9YC, 6BE9YD, 6BE9YE, 6BE9YF, 6BE9YG, 6BE9YH, 6BE9YI, 6BE9YJ, 6BE9YK, 6BE9YL, 6BE9YM, 6BE9YN, 6BE9YO, 6BE9YP, 6BE9YQ, 6BE9YR, 6BE9YS, 6BE9YT, 6BE9YU, 6BE9YV, 6BE9YW, 6BE9YX, 6BE9YY, 6BE9YZ, 6BE9ZA, 6BE9ZB, 6BE9ZC, 6BE9ZD, 6BE9ZE, 6BE9ZF, 6BE9ZG, 6BE9ZH, 6BE9ZI, 6BE9ZJ, 6BE9ZK, 6BE9ZL, 6BE9ZM, 6BE9ZN, 6BE9ZO, 6BE9ZP, 6BE9ZQ, 6BE9ZR, 6BE9ZS, 6BE9ZT, 6BE9ZU, 6BE9ZV, 6BE9ZW, 6BE9ZX, 6BE9ZY, 6BE9ZZ

"TAB" TESTED & GUARANTEED

Table of vacuum tube types and prices, including 58, 59, 60, 61, 62, 63, 64, 65, 66, 67, 68, 69, 70, 71, 72, 73, 74, 75, 76, 77, 78, 79, 80, 81, 82, 83, 84, 85, 86, 87, 88, 89, 90, 91, 92, 93, 94, 95, 96, 97, 98, 99, 100, 101, 102, 103, 104, 105, 106, 107, 108, 109, 110, 111, 112, 113, 114, 115, 116, 117, 118, 119, 120, 121, 122, 123, 124, 125, 126, 127, 128, 129, 130, 131, 132, 133, 134, 135, 136, 137, 138, 139, 140, 141, 142, 143, 144, 145, 146, 147, 148, 149, 150, 151, 152, 153, 154, 155, 156, 157, 158, 159, 160, 161, 162, 163, 164, 165, 166, 167, 168, 169, 170, 171, 172, 173, 174, 175, 176, 177, 178, 179, 180, 181, 182, 183, 184, 185, 186, 187, 188, 189, 190, 191, 192, 193, 194, 195, 196, 197, 198, 199, 200, 201, 202, 203, 204, 205, 206, 207, 208, 209, 210, 211, 212, 213, 214, 215, 216, 217, 218, 219, 220, 221, 222, 223, 224, 225, 226, 227, 228, 229, 230, 231, 232, 233, 234, 235, 236, 237, 238, 239, 240, 241, 242, 243, 244, 245, 246, 247, 248, 249, 250, 251, 252, 253, 254, 255, 256, 257, 258, 259, 260, 261, 262, 263, 264, 265, 266, 267, 268, 269, 270, 271, 272, 273, 274, 275, 276, 277, 278, 279, 280, 281, 282, 283, 284, 285, 286, 287, 288, 289, 290, 291, 292, 293, 294, 295, 296, 297, 298, 299, 300, 301, 302, 303, 304, 305, 306, 307, 308, 309, 310, 311, 312, 313, 314, 315, 316, 317, 318, 319, 320, 321, 322, 323, 324, 325, 326, 327, 328, 329, 330, 331, 332, 333, 334, 335, 336, 337, 338, 339, 340, 341, 342, 343, 344, 345, 346, 347, 348, 349, 350, 351, 352, 353, 354, 355, 356, 357, 358, 359, 360, 361, 362, 363, 364, 365, 366, 367, 368, 369, 370, 371, 372, 373, 374, 375, 376, 377, 378, 379, 380, 381, 382, 383, 384, 385, 386, 387, 388, 389, 390, 391, 392, 393, 394, 395, 396, 397, 398, 399, 400, 401, 402, 403, 404, 405, 406, 407, 408, 409, 410, 411, 412, 413, 414, 415, 416, 417, 418, 419, 420, 421, 422, 423, 424, 425, 426, 427, 428, 429, 430, 431, 432, 433, 434, 435, 436, 437, 438, 439, 440, 441, 442, 443, 444, 445, 446, 447, 448, 449, 450, 451, 452, 453, 454, 455, 456, 457, 458, 459, 460, 461, 462, 463, 464, 465, 466, 467, 468, 469, 470, 471, 472, 473, 474, 475, 476, 477, 478, 479, 480, 481, 482, 483, 484, 485, 486, 487, 488, 489, 490, 491, 492, 493, 494, 495, 496, 497, 498, 499, 500, 501, 502, 503, 504, 505, 506, 507, 508, 509, 510, 511, 512, 513, 514, 515, 516, 517, 518, 519, 520, 521, 522, 523, 524, 525, 526, 527, 528, 529, 530, 531, 532, 533, 534, 535, 536, 537, 538, 539, 540, 541, 542, 543, 544, 545, 546, 547, 548, 549, 550, 551, 552, 553, 554, 555, 556, 557, 558, 559, 560, 561, 562, 563, 564, 565, 566, 567, 568, 569, 570, 571, 572, 573, 574, 575, 576, 577, 578, 579, 580, 581, 582, 583, 584, 585, 586, 587, 588, 589, 590, 591, 592, 593, 594, 595, 596, 597, 598, 599, 600, 601, 602, 603, 604, 605, 606, 607, 608, 609, 610, 611, 612, 613, 614, 615, 616, 617, 618, 619, 620, 621, 622, 623, 624, 625, 626, 627, 628, 629, 630, 631, 632, 633, 634, 635, 636, 637, 638, 639, 640, 641, 642, 643, 644, 645, 646, 647, 648, 649, 650, 651, 652, 653, 654, 655, 656, 657, 658, 659, 660, 661, 662, 663, 664, 665, 666, 667, 668, 669, 670, 671, 672, 673, 674, 675, 676, 677, 678, 679, 680, 681, 682, 683, 684, 685, 686, 687, 688, 689, 690, 691, 692, 693, 694, 695, 696, 697, 698, 699, 700, 701, 702, 703, 704, 705, 706, 707, 708, 709, 710, 711, 712, 713, 714, 715, 716, 717, 718, 719, 720, 721, 722, 723, 724, 725, 726, 727, 728, 729, 730, 731, 732, 733, 734, 735, 736, 737, 738, 739, 740, 741, 742, 743, 744, 745, 746, 747, 748, 749, 750, 751, 752, 753, 754, 755, 756, 757, 758, 759, 760, 761, 762, 763, 764, 765, 766, 767, 768, 769, 770, 771, 772, 773, 774, 775, 776, 777, 778, 779, 780, 781, 782, 783, 784, 785, 786, 787, 788, 789, 790, 791, 792, 793, 794, 795, 796, 797, 798, 799, 800, 801, 802, 803, 804, 805, 806, 807, 808, 809, 810, 811, 812, 813, 814, 815, 816, 817, 818, 819, 820, 821, 822, 823, 824, 825, 826, 827, 828, 829, 830, 831, 832, 833, 834, 835, 836, 837, 838, 839, 840, 841, 842, 843, 844, 845, 846, 847, 848, 849, 850, 851, 852, 853, 854, 855, 856, 857, 858, 859, 860, 861, 862, 863, 864, 865, 866, 867, 868, 869, 870, 871, 872, 873, 874, 875, 876, 877, 878, 879, 880, 881, 882, 883, 884, 885, 886, 887, 888, 889, 890, 891, 892, 893, 894, 895, 896, 897, 898,

INDEX TO ADVERTISERS

Acheson Colloids Company.....	187
Aeme Electronics, Inc.....	365
Adams & Westlake Co.....	201
Advertising Council.....	430
Aeronautical Communications Equip- ment, Inc.....	248
Aerovox Corporation.....	269
A'GA Div. of Elastic Stop Nut Corp. of America.....	371
Agrod Corporation.....	429
Air Marine Motors, Inc.....	426
Aircraft-Marine Products, Inc.....	307
Aircraft Radio Corporation.....	354
Airpax Products Company.....	351
Alden Products Company.....	77
Allen Co., Inc., L. B.....	432
Allen Manufacturing Company.....	286
Allied Control Company.....	32
Allied Industries, Inc.....	419
Allied Radio Corp.....	361
Alpha Metals, Inc.....	262
American Electric Motors.....	290
American Electrical Heater Company.....	294
American Lava Corporation.....	255
American Phenolic Corporation.....	174
American Silver Company, Inc.....	298
American Television & Radio Co.....	377
American Time Products, Inc.....	194
Amperex Electronic Corp..... Third Cover	
Amperite Co., Inc.....	399
Ampex Electric Corp.....	179
Amplifier Corp. of America.....	369
Andersen Laboratories, Inc.....	421
Andrew Corporation.....	234
Anti-Corrosive Metal Products Co., Inc.....	364
Apo Mossberg Co.....	350
Applied Science Corp. of Princeton.....	321
Arkwright Finishing Company.....	274
Arnold Engineering Co.....	180
Arrow Electronics, Inc.....	370
Art-Lloyd Metal Products Corp.....	286
Astron Corporation.....	60
Audio Fair.....	391
Audio & Video Products Corp.....	184
Avery Adhesive Label Corp.....	353
Ballantine Laboratories, Inc.....	206
Barker & Williamson, Inc.....	272
Barry Corp., The.....	15
Bead Chain Manufacturing Co.....	355
Beckman Instruments, Inc.....	288
Bell Telephone Laboratories.....	252
Bendix Aviation Corporation.....	
Eclipse-Pioneer Div.....	340
Eriez Instrument Div.....	407
Pacific Div.....	382
Bentley, Harris Manufacturing Co.....	303
Berkeley Scientific, Division of Beckman Instruments Inc.....	230, 405
Bird & Co., Inc., Richard H.....	340
Bird Electronic Corp.....	400
Birmingham Sound Reproducers, Ltd.....	395
Birnbach Radio Co., Inc.....	425
Birtcher Corporation.....	336
Bodnar Industries, Inc.....	363
Boeing Airplane Company.....	229
Bogue Electric Manufacturing Company.....	263
Bomac Laboratories, Inc.....	88, 89
Boonton Radio Corp.....	169
Borg Corporation, George W.....	404, 405
Bowser, Inc.....	339
Bradley Laboratories, Inc.....	265
Brand & Co., Inc., William.....	412
Bridgeport Brass Company.....	192
Brillhart Research Corporation.....	407
Brush Development Co.....	43, 264
Burgess Battery Co.....	306
Burnell & Company.....	78
Bussmann Mfg. Co.....	203
Centralab, A Div. of Globe-Union, Inc. 11, 12.....	13
Century Geophysical Corporation.....	278
Chase Brass & Copper, Sub. of Kenne- cott Copper Corp.....	2
Chester Cable Corp.....	42
Chicago Condenser Corp.....	420
Chicago Telephone Supply Corp.....	40, 41
Chicago Tool & Engineering Co.....	377
Chicago Transformer, Div. of Essex Wire Corp.....	330
Ciba Company, Inc.....	221
Cinch Manufacturing Corp.....	165
Cinema Engineering Company.....	360
Clare & Co., C. P.....	85
Cleveland Container Co.....	25
Clippard Instrument Laboratory, Inc.....	356
Cohn Mfg. Co., Inc., Sigmund.....	385
Collectron Corporation.....	419
Collins Radio Company.....	245
Computing Devices of Canada, Ltd.....	421
Condenser Products Company, Div. of New Haven Clock & Watch Co.....	64
Conn Ltd., C. G.....	413
Consolidated Engineering Corp.....	91
Constantin & Co., L. L.....	283
Continental Connectors Corp.....	398
Continental-Diamond Fibre Company.....	171
Cornell-Dubilier Electric Corp.....	227
Cornish Wire Co., Inc.....	415
Coto-Coil Company.....	418
Cramer Co., Inc., R. W.....	182
Crescent Company, Inc.....	282
Crest Laboratories, Inc.....	55
Cross Co., H.....	413
Cruible Steel Company of America.....	209
Curtis Development & Mfg. Co.....	408
Dage Electric Co., Inc.....	377
Dale Products, Inc.....	310
Dano Electric Co.....	342
Daven Co., The.....	27
DeJur AmSCO Corp.....	398
Dial Light Co. of America.....	84
Distillation Products Industries.....	183
Doepke Manufacturing Co., Inc., Chas. Wm.....	323
Dolla Metal Products, Inc.....	342
Dow Corning Corporation.....	228
Driver-Harris Company.....	197
DuMont Laboratories, Inc., Allen B.....	35
69.....	327
du Pont de Nemours & Co., (Inc.) E. I. Polychemicals Dept.....	219
Durant Mfg. Company.....	286
DX Radio Products Co.....	367
Eastern Air Devices, Inc.....	241
Eastman Kodak Company, Industrial Photographic Div.....	175
Eisler Engineering Co., Inc.....	391, 432
Etzel-McCullough, Inc.....	51
Elastic Stop Nut Corporation of America.....	215
Electran Mfg. Co.....	401
Electrical Industries Division Amperex Electronic Corp.....	235
Electro-Coatings, Inc.....	432
Electro-Development Corporation.....	428
Electro-Mechanical Research Inc.....	399
Electro Motive Mfg. Co., Inc.....	17
Electro Products Laboratories.....	371
Electro-Tech Equipment Co.....	413
Electro-Technical Products, Div. of Sun Chemical Corp.....	308
Electronic Parts Manufacturing Co.....	418
Electronic Transformer Co., Inc.....	282
Electronics Center, Inc.....	411
Engineering Co.....	421
Engineering Research Associates Inc.....	359, 403
Erie Resistor Corporation.....	53
Eureka Television & Tube Corp.....	191
Eveready Plating Co.....	432
C.G.S. Laboratories, Inc.....	390
Cambridge Thermionic Corp.....	176
Canadian Westinghouse Co., Ltd.....	403
Cannon Electric Company.....	320
Carter Motor Co.....	365

miniaturize!

with

GRAYBURNE

FERRITE-CORE RF CHOKES

Miniaturized dimensions and high efficiency are made possible by use of Ferrite cores.

Grayburne specializes in Ferrite-core inductances, which feature low DC resistance, high "Q", minimum distributed capacity and smallest possible physical dimensions.

PI-WOUND FERRI-CHOKES



Electrical comparison between Grayburne Ferrite-Chokes and conventional RF Chokes proves the superiority of the Ferrite-Chokes. Available in following stock types:

Model #	L	I
F-25	2.5 mh	125 ma
F-50	5.0 mh	125 ma
F-100	10 mh	125 ma
HD-25	2.5 mh	300 ma

Other values to specifications.

HIGH-RATIO VARI-CHOKES

Grayburne offers a series of variable inductances with a range as high as 10 to 1 within physical dimensions not considered possible until the introduction of Ferrite cores. Stock types:

Model V-6:	0.65 to 6 mh
Model V-25:	5.0 to 43 mh
Model V-60:	30 to 130 mh

Other values to specifications.



SINGLE-SECTION FERRI-CHOKES



Grayburne single-section RF coils are the most compact available. "Q" is maximum, resistance and distributed capacity are at a minimum. Stock types:

Model #	L	I
SL-25	2.5 mh	125 ma
SL-50	5.0 mh	125 ma
SL-100	10.0 mh	125 ma
SL-250	25.0 mh	100 ma
SL-500	50.0 mh	100 ma
SL-800	80.0 mh	100 ma

Other values to specifications.

ADJUSTABLE VARI-FORM RF COIL FORMS

In response to great demand for an assembled Cosmolite coil form employing an adjustable Ferrite core, Grayburne offers a series of 4 coil forms for developmental applications. Stock types:

C-1:	1/4" x 1 1/8"
C-2:	1/4" x 2"
C-3:	3/8" x 1 1/8"
C-4:	3/8" x 2"



EXPERIMENTER'S FERRITE CORE KIT

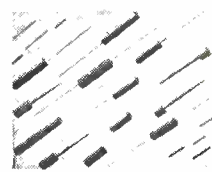

The new Grayburne Ferrite Core Kit contains an assortment of 27 various-sized Ferrite cores adapted for experiments in IF and RF coils, solenoids, linearity, width and other variable controls, and in many electro-mechanical applications.

Write for free newest Catalog E-10.

GRAYBURNE

Grayburne means Quality Electronic Components

GRAYBURNE CORP., 103 Lafayette St., N. Y. 13

For Everything in Electronics ...

it's HUDSON

RADIO & TELEVISION CORP.

One Call for All!

For the World's Toughest TRANSFORMERS .. It's

CHICAGO

there's nothing tougher than CHICAGO'S "Sealed-in-Steel" construction

HUDSON has them for today's important need. CHICAGO hermetically-sealed transformers meet all requirements of Grade 1 MIL-T-27 specifications for Class A operation. Designed expressly to fill transformer requirements for military airborne, marine, and ground communication equipment, as well as for use in tropical and arctic climates. Ideal for a wide range of application, particularly in research and development work, prototype equipment and pilot runs.

HUDSON has the complete range of CHICAGO MIL-T-27 units ready for quick shipment from stock. Representative power transformers are listed below.



H-TYPE

Hermetic sealing meets all MIL-T-27 specs. Steel base cover is deep-seal soldered into case. Terminals hermetically sealed. Ceramic bushings. Stud-mounted unit.

Mfr's Type	Plate		Rect.		Fil.		Wt. Lbs.	NET EACH
	VCT	Ma	V	A	VCT	A		
PHC-55	540	55	5	2	6.3	2	3 1/2	12.73
PHC-70	670	70	5	2	6.3	3	4 1/2	13.79
PHC-85	660	85	5	2	6.3	3	6	14.79
PHC-105	690	105	5	2	6.3	3.5	6 1/2	16.29
PHC-120	750	120	5	3	6.3	4	9 1/2	17.23
PHC-150	740	150	5	3	6.3	4	11	21.34
PHC-200	770	200	5	3	6.3	1	11 1/2	22.46
					6.3	4.5		
					6.3	1		

Complete Stocks of Chicago Transformers always on hand for prompt delivery. Order now or write for complete listings.

FREE!
New 1953
HUDSON
CATALOG

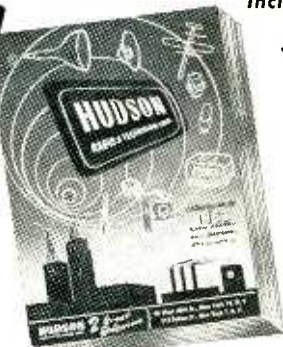

Includes The New, larger edition of JAN Cross Reference GUIDE

The most complete buying guide of its kind! INCLUDES the latest JAN CROSS-REFERENCE GUIDE and all types of fully approved JAN COMPONENTS. Over 196 pages of the latest and largest selection of Industrial Electronic Equipment, Tubes, Test Instruments, Recording and High Fidelity Audio and Sound Equipment. Complete lines. Wide selection. All Standard Makes in Stock for Prompt Delivery at LOWEST PRICES!

Send for your FREE Copy Today . . . Use Coupon or Your Letterhead

HUDSON
RADIO & TELEVISION CORP.

48 WEST 48th ST. • 212 FULTON ST.
New York 36, N. Y. New York 7, N. Y.
Circle 6-4060

Hudson Radio & TV Corp. Dept. M-10
48 West 48th St., New York 36, N. Y.

Please send FREE copy 1953 Hudson Catalog
 Full remittance enclosed On regular terms
 Ship the following:

Name Title

Firm

Address

City Zone State

Fairchild Recording & Equipment Corp. 378
 Fansteel Metallurgical Corp. 250
 Federal Telephone & Radio Corporation. 333
 Filtron Co., Inc. 379
 Finn & Company, Inc., T. R. 415
 Fluke Engineering Company 417
 Ford Instrument Company 62
 Freed Transformer Co., Inc. 287
 Frequency Standards 391
 Furst Electronics 426
 Fusite Corporation 251

GM Laboratories, Inc. 363
 Gair Company, Inc., Robert 363
 Gamewell Company 310
 General Electric Company
 Apparatus Dept. 48, 49, 185, 188, 189
 216, 295, 407
 Electronics Dept. 39, 71
 General Industries Co. 281
 General Radio Company 260, 261
 General Transformer Company 324
 Giannini & Co., Inc., G. M. 50, 393
 Goslin Electric & Mfg. Co. 306
 Graphite Metallizing Corp. 381
 Grayburne Corp. 477
 Grayhill 367
 Green Instrument Co., Inc. 387
 Gries Reproducer Corp. 416
 Gudebrod Bros. Silk Co., Inc. 389
 Guthman & Co., Inc., Edwin L. 74

Hammarlund Manufacturing Co., Inc. 292
 Haydon Co., A. W. 306
 Heath Company 369
 Heiland Research Corporation 214
 Heinemann Electric Company 75
 Helder Manufacturing Company 335
 Helipot Corporation, The. 184A, 184B
 184C, 184D
 Hermaseal Co., Inc. 393
 Hermetic Seal Products Co. 57
 Hetherington, Inc. 309
 Hewlett-Packard Company 72, 73, 315
 Hexacon Electric Co. 404
 Hi-Q Div. of Aerovox Corporation 275
 Hudson Radio & Television Corp. 478
 Hughes Research & Development Laboratories 242, 352
 Hycor Company, Inc. 424
 Hydrawerk Aktiengesellschaft 359

Improved Seamless Wire Co. 410
 Industrial Condenser Corp. 231
 Industrial Tape Corporation 54
 Industrial Timer Corporation 291
 Instrument Corp. of America 412
 Instrument Electronics Corp. 429
 Instrument Resistors Co. 373
 Insulation Manufacturers Corp. 52
 Insuline Corporation of America 207
 International Instruments, Inc. 359
 International Radiant Corp. 422
 International Rectifier Corporation 193
 International Resistance Company 36, 37, 397
 Ippolito & Co., Inc., James 310
 Irvington Varnish & Insulator Co. 34
 I-T-E Resistor Division of the I-T-E
 Circuit Breaker Co. 80, 81

JFD Mfg. Co. 356
 Jelliff Manufacturing Corp., C. O. 424
 Johnson Company, E. F. 218
 Jones Div., Howard B. Cinch Mfg. Co. 369
 Jones Electronics Company, M. C. 387

Kable Engineering Company 297
 Karp Metal Products Co., Inc. 65
 Kartron 432
 Kellogg Switchboard & Supply Co. 342
 Kenyon Transformer Co., Inc. 278
 Kepco Laboratories, Inc. 86
 Kester Solder Company 257
 Keystone Products Company 220
 Kinney Manufacturing Co. 83
 Kirk & Blum Mfg. Co. 254
 Klein & Sons, Mathias 300

Knights Company, James	236
Kollsman Instrument Corporation	56
Krohn-Hite Instrument Company	47

Laboratory for Electronics, Inc.	205
Lambda Electronics Corporation	425
Landis & Gyr, Inc.	391
LaPointe-Plascomold Corp. (Vee-D-X)	417
Lapp Insulator Company, Inc.	293
Leach Relay Co.	238
Leeds & Northrup Co.	273
Leland Inc., G. H.	318
Lenkurt Electric Sales Co.	386
Lewis & Kaufman, Inc.	173
Linde Air Products Company, A Div. of Union Carbide & Carbon Corp.	389
Litton Industries	200

Mallory & Co., Inc. P. R.	96, 167
Mansol Ceramics	367
Marconi Instrument, Ltd.	388
Marconi's Wireless Telegraph Co., Ltd.	328
Marion Electrical Instruments Co.	19
Markem Machine Company	280
Maryland Precision Instrument Co.	432
McGraw-Hill Book Co.	270, 302, 311, 324, 352
Measurements Corporation	406
Mepeo, Inc.	276
Mercury Electronic Company	411
Merit Plating Co.	379
Metal Textile Corp.	380
Metals & Controls Corp., General Plate Div.	224
Methode Manufacturing Corp.	290
Metron Instrument Company	296
Mica Insulator Company	223
Mico Instrument Co.	407, 432
Michel Manufacturing Co.	432
Micro Switch Div. of Minneapolis-Honeywell Regulator Co.	225
Miles Reproducer Co., Inc.	432
Milford Rivet & Machine Co.	226
Millen Mfg. Co., Inc., James	211
Milo Radio & Electronics Corp.	202
Minneapolis-Honeywell Regulator Co., Industrial Div.	277
Minnesota Mining & Mfg. Co.	66
Mitchell-Rand Insulation Co., Inc.	177
Moloney Electric Company	281
Moseley, Francis L.	365
Mosinee Paper Mills Company	338
Motorola	198
Muirhead & Co., Ltd.	3
Multicore Solders, Ltd.	23
Myaclex Corporation of America	44

National Company, Inc.	376
National Moldite Company	372
National Plastic Products Co.	334
National Research Corporation	59
National Vulcanized Fibre Company	279
Natvar Corporation	317
Neo-Sil Corp.	204
New Hermes, Inc.	423
New York Transformer Co., Inc.	344
North American Aviation, Inc.	262
Northern Radio Co., Inc.	93
Northrop Aircraft, Inc.	383
Nothelfer Winding Laboratories	410

Olympic Metal Products Co., Inc.	379
Onan & Sons Inc., D. W.	406
O'Neill-Irwin Manufacturing Co.	375
Opad-Green Company	401

Panoramie Radio Products, Inc.	373
Par-Metal Products Corp.	383
Parisier & Co., Maurice I.	325
Patton-McGuyer Company	361
Peerless Electrical Products, A Div. of Altec Lansing Corp.	350
Penn Engineering & Mfg. Corp.	371
Phalo Plastics Corporation	368
Phaotron Company	239
Phelps Dodge Copper Products Corp., Inca Manufacturing Division	28, 29

CHEMELEC

ELECTRONIC PARTS

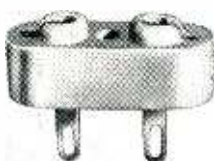

Chemelec Teflon*-insulated electronic components include a complete line of 7 and 9 pin miniature tube sockets, crystal sockets, feed-through insulators and terminals.

All provide the same high performance which this superior insulating material assures. Surface resistivity 3.5×10^{13} ohms. Loss factor less than 0.0005. Dielectric constant 2.0 (60 cycles to 30,000 megacycles). Serviceable at -110°F . to 500°F . Won't carbonize under arcing. Zero water absorption by ASTM Test. Unaffected by extreme humidity. Won't DC plate. Chemically inert, non-gassing, immune to corrosive atmospheres, fungus, oil, solvents. Non-flammable, tough, resilient, withstands and absorbs mechanical shock and vibration.

TEFLON and KEL-F STOCK and Custom-Fabricated Parts

Fabricating "Know-how", the result of years of specialized experience—and the most modern facilities for rapid, low-cost, close-tolerance production are at your command when you specify Teflon or Kel-F†, fabricated by the United States Gasket Company. Ours is the most complete line in the country—sheets, tape, rods, cylinders, tubing, bars, and custom-machined or molded parts to manufacturers' specifications.

*duPont's trademark for its tetrafluoroethylene resin.

†Trademark M. W. Kellogg Co.

UNITED STATES GASKET COMPANY

FLUOROCARBON PRODUCTS DIVISION

FABRICATORS OF "TEFLON", "KEL-F" AND OTHER FLUOROCARBON PLASTICS

CAMDEN 1, NEW JERSEY



PRECISION

CATHODE RAY TUBE TESTER

SERIES CR-30



**TESTS ALL
TV PICTURE TUBES**
(Magnetic and Electrostatic)
**'SCOPE TUBES AND
INDUSTRIAL CR TYPES**

IN FIELD, LABORATORY & WAREHOUSE
without removal from chassis or carton!

A complete and self-contained Electronic Instrument. Incorporates a TRUE BEAM CURRENT Test Circuit. Checks overall electron-gun performance for proportionate picture brightness. Additional tests for accelerating anodes and deflection plate elements.

The Precision CR-30 should not be confused with mere adapters connecting to ordinary receiving tube testers which were never designed to meet the very specialized needs of CR tube checking. Similarly, it is not to be confused with neon-lamp units or similar devices of limited technical merit and which do not check all CR tubes or all tube elements.

SPECIFICATIONS

- ★ Tests All Modern Cathode Ray Tubes. Tests All CR Tube Elements: Not just a limited few.
 - ★ Free-Point 14 Lever Element Selection System, for all Short-Check, Leakage Testing and Quality Tests.
 - ★ True Beam Current Test Circuit checks all CR Tubes with Electron-gun in operation. It is the Electron Beam (and NOT total cathode emission) which traces the pattern on the face of the CR tube. The significance of the above rests in the fact that Beam Current (and picture brightness) is primarily associated with the condition of the center of the cathode surface and not the overall cathode area.
 - ★ Voltage Regulated, Bridge Type VTVM affords super-sensitive tube quality indications and positive check of low current anodes and deflection plates..
 - ★ Micro-Line Voltage Adjustment, Meter-monitored.
 - ★ Accuracy of test circuits closely maintained by use of factory adjusted internal calibrating controls; plastic insulated, telephone type cabled wiring; highest quality, conservatively rated components.
 - ★ Built In, High Speed, Roller Tube Chart.
 - ★ Test Circuits Transformer Isolated from Power Line.
 - ★ 4% Full Vision Meter with scale-plate especially designed for CR tube testing requirements.
- SERIES CR-30 — In hardwood, tapered portable case. 17 1/4" x 13 3/4" x 6 3/4". Complete with standard duodecal cable and universal CR Tube Test Cable.
- Shipping Weight: 22 lbs.....Net Price: \$99.75

See the Series CR-30 on display at leading electronic equipment distributors.

PRECISION

APPARATUS CO. INC.

92-27 HORACE HARDING BLVD., ELMHURST, N. Y.

Export: 45E B'way, N. Y. C. U.S.A. Cables: MORHANEX
In Canada: Atlas Radio Corp. Ltd., Toronto, Ontario

Phillips Control Corporation	271
Photocircuits Corporation	212
Pix Manufacturing Co., Inc.....	377
Plastic Capacitors, Inc.....	301
Polarad Electronics Corporation.....	259, 423
Popper & Sons, Inc.....	383
Potter & Brumfield	304
Potter Instrument Company, Inc.....	322
Power Equipment Company.....	377
Precision Apparatus Co., Inc.....	480
Precision Paper Tube Co.....	414
Presto Recording Corporation.....	79
Progressive Manufacturing Company.....	2, 0
Pyroferrie Co., Inc.....	326

Radio Cores, Inc.....	357
Radio Corporation of America.....	267, 348
Fourth Cover	
Radio Materials Corporation	213
Radio Receptor Company, Inc.....	237
Radio Shack Corporation.....	178
Railway Express Agency, Air Express Div.....	299
Ranland Corporation	70
Rawson Electrical Instrument Co.....	419
Raytheon Manufacturing Company.....	313
Reuler Company, Ltd.....	402
Resistoflex Corporation	349
Rex Corporation	320
Rhode Island Insulated Wire Co., Inc.....	217
Roanwell Corporation	405
Robinson Inc., Edward E.....	369
Roller-Smith Corp.....	92
Runzel Cord & Wire Co.....	429
Rutherford Electronics Co.....	423

Sanborn Company	336
Sangamo Electric Company	46
Scientific Electric Div. of "S" Corrugated Quenched Gap Co.....	375
Secor Metals Corporation	421
Servo Corporation of America.....	282
Servotrol Company	302
Sessions Clock Company, Timer Div.....	222
Shalleross Manufacturing Co.....	190
Shielding, Inc.....	345
Siemens - Schuckertwerks Aktiengesell- schaft	363
Sigma Instruments Inc.....	316
Signal Engineering & Mfg. Co.....	342
Simpson Electric Company.....	195, 199
Sola Electric Co.....	181
Sorensen & Company, Inc.....	45
Southwestern Industrial Electronics Co.....	419
Specialty Battery Company.....	375
Speer Resistor Corp.....	33
Spencer-Kennedy Laboratories, Inc.....	414
Sperry Gyroscope Company	285
Sprague Electric Company.....	9, 343
Stackpole Carbon Co.....	30
Stamford Metal Specialty Company.....	389
Standard Cabinet Company	411
Standard Electric Time Company.....	38
Standard Piezo Co.....	392
Standard Transformer Corp.....	358
Sterling Transformer Corp.....	425
Stevens Arnold Incorporated.....	266
Steward Manufacturing Co., D. M.....	246
Stoddart Aircraft Radio Co.....	298
Stokes Machine Co., F. J.....	253
Stupakoff Ceramic & Manufacturing Co.....	76
Sun Electric Corporation.....	274
Superior Electric Co.....	61
Superior Tube Co.....	82
Supreme, Inc.....	381
Switchcraft, Inc.....	422
Sylvania Electric Products, Inc.....	7, 196
Synthane Corporation	87

Taber Instrument Corp.....	400
Taylor Tubes, Inc.....	186
Tech Laboratories	416
Techutrol Engineering Company.....	428
Technology Instrument Corp.....	384
Tektronix, Inc.....	341
Telechron Dept., General Electric Co.....	208
Teletronics Laboratory, Inc.....	432
Telewave Laboratories, Inc.....	392
Telex, Electro-Acoustic Div.....	429

Thermador Electrical Mfg. Co.....	338
Thomas & Skinner Steel Products Co.....	266
Thompson Company, H. I.....	393
Thompson Products, Inc.....	63
Thor Ceramics, Inc.....	405
Tobe Deutschmann Corporation.....	346, 347
Transformers Inc.....	21
Transicoil Corporation	374
Transradio, Ltd.....	402
Trimount Plastic Co., Inc.....	389
Triplet Electrical Instrument Co.....	240
Tung-Sol Electric, Inc.....	249
Turner Company	362

Ucinite Co., The.....	90
Ulanet Company, George.....	417
Union Carbide & Carbon Corp., Linde Air Products Div.....	389
United Manufacturing & Service Com- pany	373
United States Gasket Company.....	479
United States Testing Company Inc.....	345
United Transformer Co.....	Second Cover

Vacuum Metals Corporation, Sub. of National Research Corp.....	58
Varian Associates	331
Vectron, Inc.....	366
Veeder-Root, Inc.....	244
Vickers Electric Division.....	359
Victoreen Instrument Co.....	361
Vulcan Electric Company.....	413

Waldes Kohinoor, Inc.....	67
Ward, Leonard Electric Co.....	94, 95
Warren Wire Company.....	280
Waterman Products Co., Inc.....	399
Waveforms, Inc.....	379
Weller Electric Corp.....	268
Western Gold & Platinum Works.....	408
Westinghouse Electric Corp.....	243
289, 319, 332, 349	
Weston Electrical Instrument Corp.....	68, 247
Wheeler Insulated Wire Company Inc.....	210
White Dental Mfg. Co., S. S.....	354, 425
Whitehead Stamping Company.....	411
Wiley & Sons, Inc., John.....	420
Williams & Co., C. K.....	341
Wilton Tool & Mfg. Co.....	381
Winchester Electronics, Inc.....	332
Workshop Associates, Div. of the Gabriel Company	305

Zophar Mills, Inc.....	385
------------------------	-----

PROFESSIONAL SERVICES.....	431
----------------------------	-----

SEARCHLIGHT SECTION

(Classified Advertising)

H. E. HILTY, Mgr.

SEARCHLIGHT ADVERTISERS INDEX	472, 473
-------------------------------	----------

This index is published as a convenience to the readers. Every care is taken to make it accurate, but ELECTRONICS assumes no responsibility for errors or omissions.

AMPEREX

AIR-COOLED TUBE

AX9904-R/5924

"... Offers a maximum in kilowatts per dollar ..."

HARRY R. SMITH,
Manager, Television Engineering,
Standard Electronics Corporation

STANDARD ELECTRONICS CORPORATION uses this tube in Models TH653 High Band and TL653 Low Band Transmitters and also in their new 20 Kilowatt Transmitter, built on the exclusive S-E ADD-A-UNIT PRINCIPLE, and with special S-E features that insure dependable operation, maximum convenience, and minimum maintenance.



Re-tube with AMPEREX

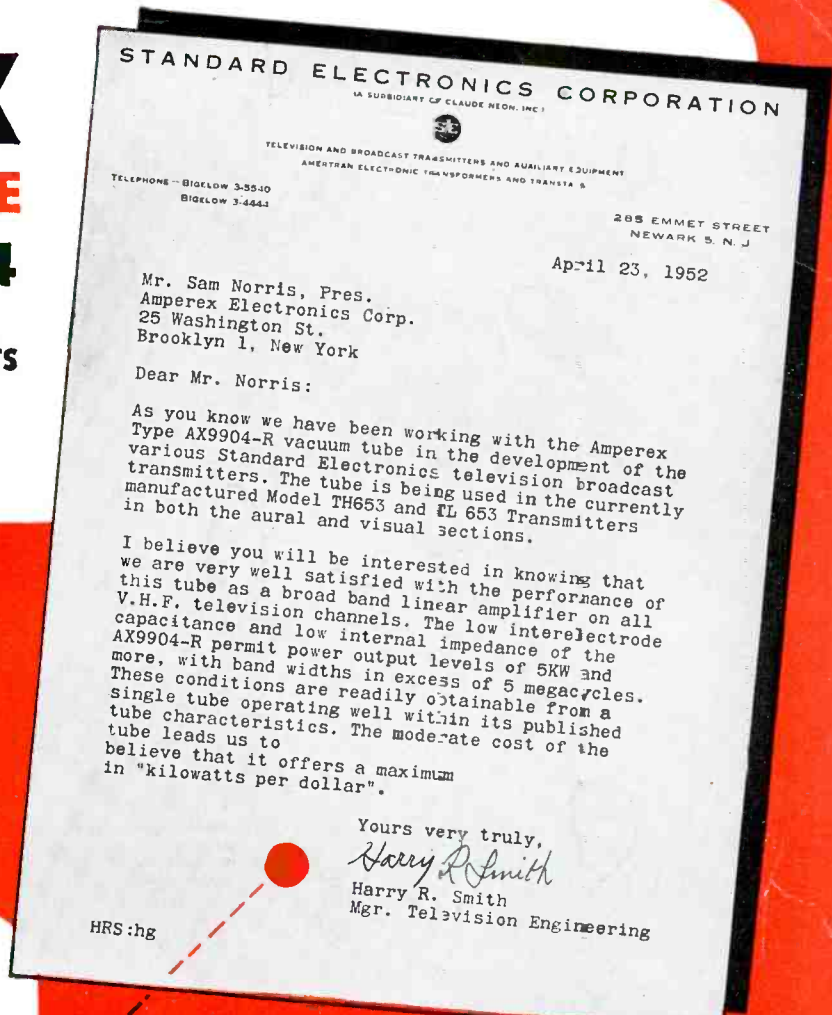

HRS:hg

Yours very truly,
Harry R. Smith
Harry R. Smith
Mgr. Television Engineering

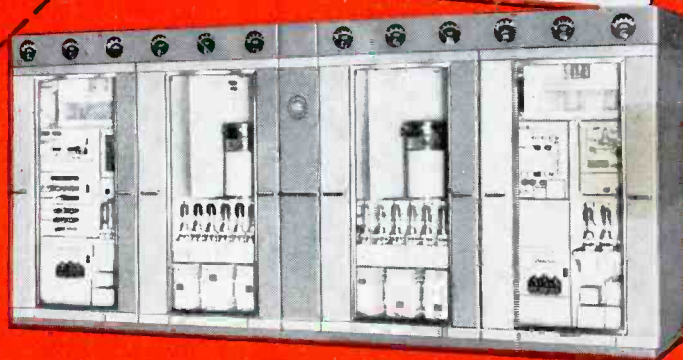

FEATURES INCLUDE . . . 14 MC band width at 220 MC . . . outputs of 5.7 KW . . . thoriated tungsten filament . . . non-emitting grid . . . disc type grid seal for minimum inductance . . . minimum capacitance . . . and PROVEN long life.

Write for complete data sheets.

This tube is also available in a Water-Cooled Version, Type AX9904-5923.



AMPEREX ELECTRONIC CORP.

230 DUFFY AVENUE, HICKSVILLE, LONG ISLAND, N. Y.

In Canada and Newfoundland: Rogers Majestic Limited

11-19 Brentcliffe Road, Leaside, Toronto, Ontario, Canada

Cable: "AMPRONICS"

RCA VIDICON

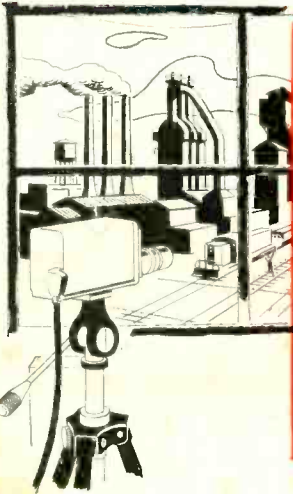

TECHNICAL FEATURES

- ✓ Only 6¼" long and 1" in diameter
- ✓ Provides 400-line resolution
- ✓ Spectral response approaching that of the eye
- ✓ Sensitivity permits televising with 100-200 foot-candles of illumination
- ✓ Designed for use with commercially available camera lenses
- ✓ Operates with low dc voltages

NEW. small-size camera tube for low-cost industrial television

Now, the RCA-developed 6198 Vidicon extends the advantages of television coverage to countless industrial users . . . opens the door to simplified television camera designs.

The small size and simplicity of operation of this television camera tube facilitates the design of compact and low-cost television camera equipment — including equipment for closed-circuit, portable, and remote-control applications.

Produced in the same plant by the same skilled hands that make the RCA Image Orthicon camera tube, the RCA-6198 offers the detail of 400-line picture quality at low unit cost. It employs magnetic focus

and deflection, and operates with relatively low dc voltages.

Utilizing a photoconductive layer as its light-sensitive element, the RCA-6198 has a sensitivity which permits televising scenes with 100 to 200 foot-candles of incident illumination. The photoconductive layer has a spectral response characteristic approaching that of the eye. The dimensions of the useful area of this layer are such that stock camera lenses can be employed. The size and location of the layer permit a wide choice of commercially available lenses.

The following components, designed for use with the RCA-6198 Vidicon, are also available:

RCA-216D1 Deflecting Yoke
RCA-217D1 Focusing Coil
RCA-218D1 Alignment Coil
RCA-233T1 Horizontal Deflection Transformer
RCA-234T1 Vertical Deflection Transformer

For complete data on the RCA-6198 Vidicon and associated components, write RCA, Commercial Engineering, Section JR42, Harrison, N. J., or contact your nearest RCA Field Office.

FIELD OFFICES: (East) Humboldt 5-3900, 415 S. 5th St., Harrison, N. J. (Midwest) Whitehall 4-2900, 589 E. Illinois St., Chicago, Ill. (West) Madison 9-3671, 420 S. San Pedro St., Los Angeles, California.

THE FOUNTAINHEAD OF MODERN TUBE DEVELOPMENT IS RCA



RADIO CORPORATION of AMERICA
ELECTRON TUBES
HARRISON, N. J.

TMK. ®