

AUGUST · 1950

electronics

A M c G R A W - H I L L P U B L I C A T I O N

MAPPING BRAIN WAVES

A black and white photograph of a man from behind, wearing a light blue button-down shirt. He is looking at a control panel for an oscilloscope. The panel features two large circular screens, several knobs, and various labels. A bundle of colorful wires (red, yellow, green, blue) is connected to the left side of the panel. Labels on the panel include "HIGH VOLTAGE SUPPLY", "POWER SWITCH", and "LOW VOLTAGE SUPPLY". The man's hair is dark and neatly combed. The overall scene suggests a technical or scientific environment from the early 1950s.



MINIATURE COMPONENTS FROM STOCK...

SUBOUNCER UNITS

FOR HEARING AIDS...VEST POCKET RADIOS...MIDGET DEVICES

UTC Sub-Ouncer units fulfill an essential requirement for miniaturized components having relatively high efficiency and wide frequency response. Through the use of special nickel iron core materials and winding methods, these miniature units have performance and dependability characteristics far superior to any other comparable items. They are ideal for hearing aids, miniature radios, and other types of miniature electronic equipment. The coils employ automatic layer windings of double Formex wire...in a molded Nylon bobbin. All insulation is of cellulose acetate. Four inch color coded flexible leads are employed, securely anchored mechanically. No mounting facilities are provided, since this would preclude maximum flexibility in location. Units are vacuum impregnated and double (water proof) sealed. The curves below indicate the excellent frequency response available. Alternate curves are shown to indicate operating characteristics in various typical applications.

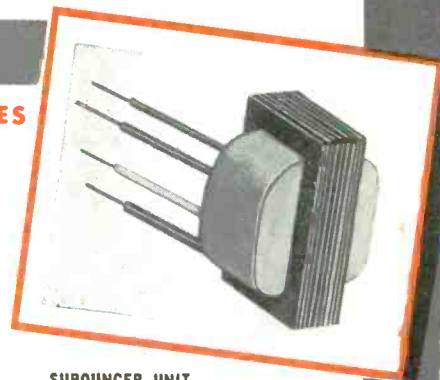

SUBOUNCER UNIT
Dimensions...9/16" x 5/8" x 7/8"
Weight......03 lb.

Type	Application	Level	Pri. Imp.	D.C. in Pri.	Sec. Imp.	Pri. Res.	Sec. Res.	List Price
*S0-1	Input	+ 4 V.U.	200 50	0	250,000 52,500	16	2650	\$5.60
S0-2	Interstage/3:1	+ 4 V.U.	10,000	0	30,000	225	1850	5.60
*S0-3	Plate to Line	+ 20 V.U.	10,000 25,000	3 mil. 1.5 mil.	200 500	1300	30	5.60
S0-4	Output	+ 20 V.U.	30,000	1.0 mil.	50	1800	4.3	5.60
S0-5	Reactor 50 HY at 1 mil	D.C. 3000 ohms D.C. Res.						5.10
S0-6	Output	+ 20 V.U.	100,000	.5 mil.	60	3250	3.8	5.60

*Impedance ratio is fixed, 1250:1 for S0-1, 1:50 for S0-3. Any impedance between the values shown may be employed.

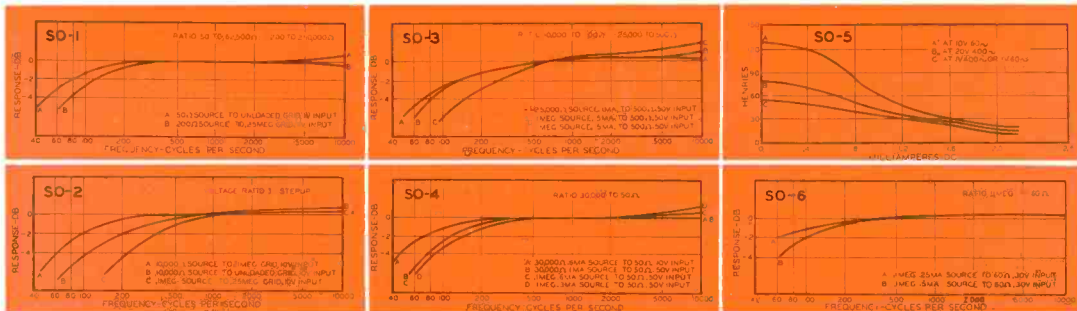

SUB-SUBOUNCER UNITS

FOR HEARING AIDS AND ULTRA-MINIATURE EQUIPMENT

UTC Sub-SubOuncer units have exceptionally high efficiency and frequency range in their ultra-miniature size. This has been effected through the use of specially selected Hiperm-Alloy core material and special winding methods. The constructional details are identical to those of the Sub-Ouncer units described above. The curves below show actual characteristics under typical conditions of application.

Type	Application	Level	Pri. Imp.	D.C. in Pri.	Sec. Imp.	Pri. Res.	Sec. Res.	List Price
*SS0-1	Input	+ 4 V.U.	200 50	0	250,000 62,500	13.5	3700	\$5.60
SS0-2	Interstage/3:1	+ 4 V.U.	10,000	0	90,000	750	3250	5.60
*SS0-3	Plate to Line	+ 20 V.U.	10,000 25,000	3 mil. 1.5 mil.	200 500	2600	35	5.60
SS0-4	Output	+ 20 V.U.	30,000	1.0 mil.	50	2875	4.6	5.60
SS0-5	Reactor 50 HY at 1 mil	D.C. 4400 ohms D.C. Res.						5.10
SS0-6	Output	+ 20 V.U.	100,000	.5 mil.	60	4700	3.3	5.60

*Impedance ratio is fixed, 1250:1 for SS0-1, 1:50 for SS0-3. Any impedance between the values shown may be employed.

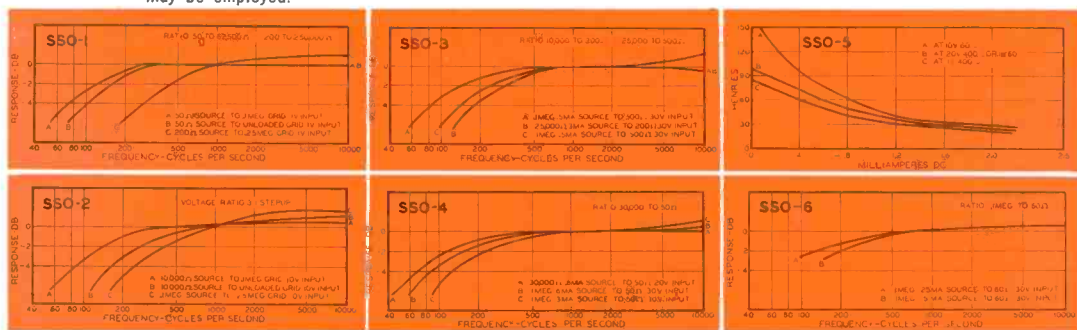

SUB-SUBOUNCER UNIT
Dimensions...7/16" x 3/4" x 5/8"
Weight......02 lb.

United Transformer Co.

150 VARICK STREET NEW YORK 13, N. Y.
EXPORT DIVISION: 13 EAST 40th STREET, NEW YORK 16, N. Y. CABLES: "ARLAB"

electronics



A McGRAW - HILL
PUBLICATION

AUGUST • 1950

MAPPING BRAIN WAVES		COVER
Traveling electrical potentials are studied at various points on the skull by means of cathode-ray apparatus and electrodes fastened to the scalp with adhesive. Part of the apparatus used by Stanford Goldman of Syracuse University's Department of Electrical Engineering is shown (see p 118)		
ELECTRON MICROSCOPY IN THE UNITED STATES , by W. MacDonald		66
A grass-roots report delineating the progress of perhaps the most unique instrument in our field		
TV—THE INTERNATIONAL SCENE , by D. G. Fink		70
CCIR Study Group makes further progress toward standards		
MOBILE F-M BROADCAST RECEPTION , by R. C. Barritt		74
Report on various f-m circuits and antennas for use in automobiles		
VOICE-SWITCHED INTERCOM , by Ralph H. Baer		79
Talk-listen switch is eliminated and users may walk around during two-way conversations		
MATRIX TELEMETERING SYSTEM , by Nolan R. Best		82
Permits transmission of 30 channels of information with overall accuracy of 1 percent		
TIMED-PULSE OSCILLATOR FOR ELECTRONIC DEPILATION , by Ralph H. Baer		86
R-F probe device permanently removes human hairs		
BLOWER SELECTION FOR FORCED-AIR-COOLED TUBES , by A. G. Nekut		88
How to determine requirements for industrial and communications applications		
IMPROVED DEFLECTION AND FOCUS , by C. V. Bocciairelli		94
Better picture quality in corners is provided by cosine-squared yoke		
CRYSTAL CONTROL FOR CITIZENS BAND , by I. Gottlieb and I. Mednick		96
Two-tube exciter for the BC-645 provides stabilized output on 460 mc		
REGULATING A-C WITH BUCK-BOOST AMPLIFIER , by C. W. Clapp		99
Stable voltage with good waveform for any load from 0 to 200 volt-amperes		
INEXPENSIVE PICTURE GENERATOR , by Ray Clurman		102
Picture tube is used as flying-spot source and sync signals are borrowed from local station		
ADMITTANCE ANALYZER , by W. B. Bernard		107
R-F measuring equipment directly indicates admittance of antennas, transmission lines and components		
PICTURE-TUBE CONTRAST IMPROVEMENT , by A. E. Martin and R. M. Bowie		110
Analysis of factors involved in evaluating optical filters		
STAGGER-TUNED I-F DESIGN (Reference Sheet) , by Matthew T. Lebenbaum		114
Chart gives 3-db bandwidth for 1 to 500 stages having up to 5 elements each		
BUSINESS BRIEFS	60	ELECTRON ART
CROSSTALK	65	NEW PRODUCTS
TUBES AT WORK	116	NEWS OF THE INDUSTRY
		120
		124
		128
		NEW BOOKS
		BACKTALK
		INDEX TO ADVERTISERS
		(Last Page)

DONALD G. FINK, Editor; **W. W. MacDONALD**, Managing Editor; John Markus, Vin Zeluff, A. A. McKenzie, Associate Editors; William P. O'Brien, James D. Fahnestock, Assistant Editors; Ann Mastropolo, Marilyn Wood, Editorial Assistants; Gladys T. Montgomery, Washington Editor; Harry Phillips, Art Director; Eleanor Luke, Art Assistant

KEITH HENNEY, Consulting Editor

H. W. MATEER, Publisher; **WALLACE B. BLOOD**, Manager; **R. S. Quint**, Buyers' Guide Manager; **D. H. Miller**, James Girdwood, New York; **Wm. S. Hodgkinson**, New England; **Warren W. Shew**, Philadelphia; **C. D. Wardner**, Chicago; **J. L. Phillips**, Cleveland; **J. W. Otterson**, San Francisco; **Carl W. Dysinger**, Los Angeles; **Ralph C. Maultsby**, Atlanta; **Bernard H. Butler**, London, England



Contents Copyright 1950, by McGraw-Hill Publishing Company, Inc. All Rights Reserved. **McGRAW-HILL PUBLISHING COMPANY, INCORPORATED**. JAMES H. McGRAW (1860-1948), Founder • PUBLICATION OFFICE, 99-129 North Broadway, Albany 1, N. Y., U. S. A. EDITORIAL AND EXECUTIVE OFFICES, 330 West 42nd St., New York 18, N. Y., U. S. A.



Curtis W. McGraw, President; Willard T. Chevalier, Executive Vice-President; Joseph A. Garardi, Vice-President and Treasurer; John J. Cooke, Secretary; Paul Montgomery, Senior Vice-President, Publications Division; Ralph B. Smith, Editorial Director; Nelson Bond, Vice-President and Director of Advertising; J. E. Blackburn, Jr., Vice-President and Director of Circulation; Dexter Keezer, Director of Economics Department; Russell F. Anderson, Editor, World News.
ELECTRONICS: August, 1950, Vol. 23; No. 8. Published monthly with an additional issue in June, price 75¢ a copy for U. S. and possessions, and Canada; \$1.50 for Latin America; \$2.00 for all other foreign countries. Buyers' Guide \$2.00. Allow at least ten days for change of address. All communications about subscriptions should be addressed to the Director of Circulation. Subscription rates—United States and possessions, \$6.00 a year, \$9.00 for two years, \$12.00 for three years, Canada (Canadian funds accepted), \$10.00 a year, \$16.00 for two years, \$20.00 for three years. Latin American countries \$15.00 for one year, \$25.00 for two years, \$30.00 for three years. All other countries \$20.00 for one year, \$30.00 for two years, \$40.00 for three years. Please indicate position and company connections on all subscription orders. Entered as Second Class matter August 29, 1936, at Post Office, Albany, New York, under the act of March 3, 1879. **BRANCH OFFICES**: 520 North Michigan Avenue, Chicago 11, Ill.; 68 Post Street, San Francisco 4; Aldwych House, Aldwych, London, W.C. 2; Washington, D. C. 4; Philadelphia 3; Cleveland 15; Detroit 26; St. Louis 8; Boston 16; Atlanta 3, Ga.; 1111 Wilshire Blvd., Los Angeles 17; 738-9 Oliver Building, Pittsburgh 22. **ELECTRONICS** is indexed regularly in The Engineering Index.

Cross it Out!

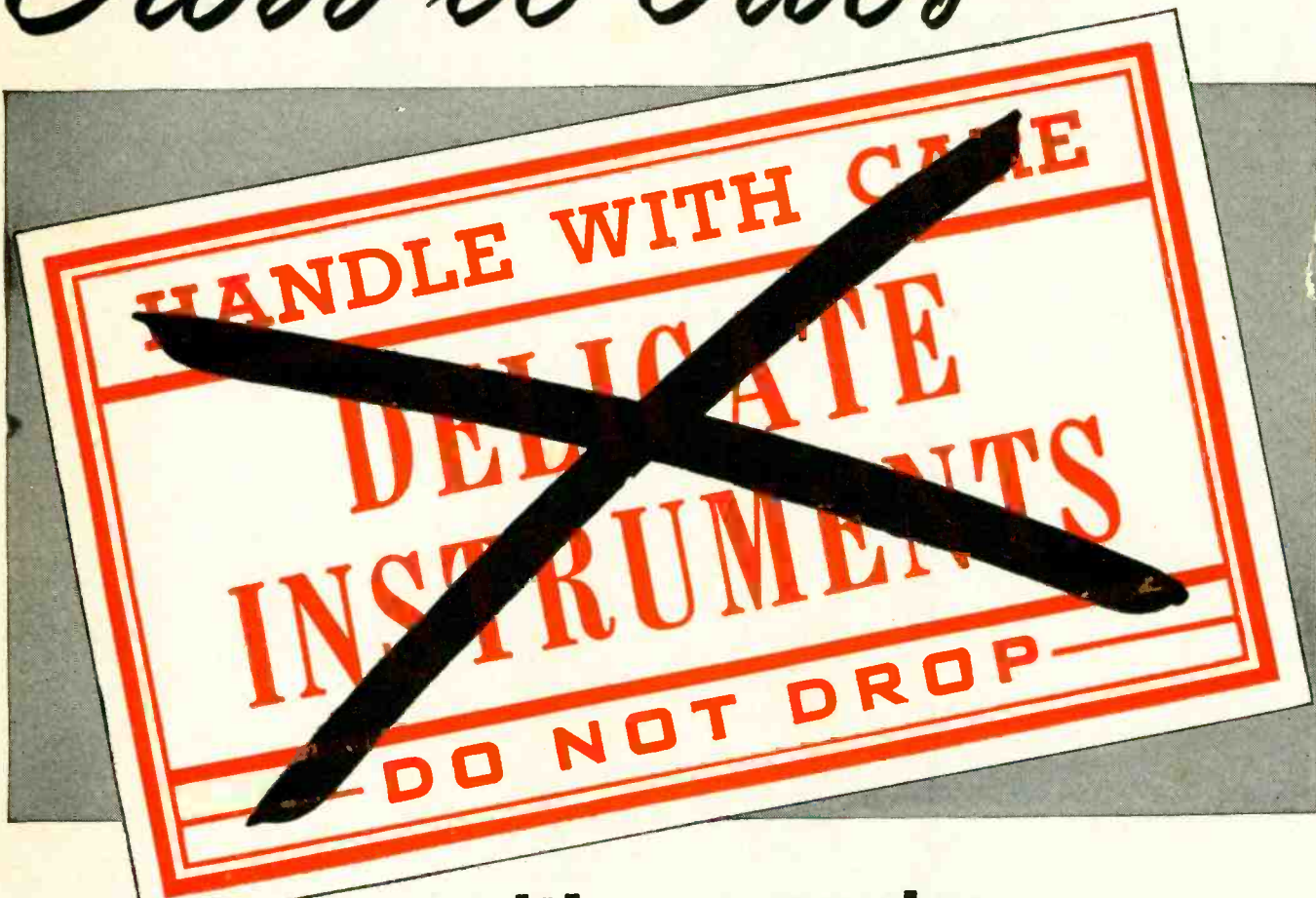

with new marion **ruggedized** instruments

The new Marion Ruggedized meters (Hermetically Sealed) now give you an exceptionally accurate and sensitive means for electrical measurement and indication — under extreme conditions of Shock, Vibration, Mechanical Stress, Strain, Weather Conditions and Climate. This whole new family of Ruggedized Panel instruments gives you new freedom of application. You can use them where you have never before dared use "delicate instruments." What's more, they meet the dimensional requirements of JAN I-6 and are completely interchangeable with existing standard JAN 2½" and 3½" types.

When you need ruggedized meters for rugged applications; when you need special meters for special applications; when you need *better* meters for *any* application . . . call on Marion — the name that means the *most* in meters.

Send for your free copy of our booklet on the New Marion Ruggedized Instruments today. Marion Electrical Instrument Company, Manchester, New Hampshire.



Manufacturers of
Hermetically Sealed
Meters Since 1944



MARION MEANS THE MOST IN METERS

Canadian Representative: Astral Electric Company, 44 Danforth Road, Toronto, Ontario, Canada
Export Division: 458 Broadway, New York 13, U.S.A., Cables MORHANEX

marion meters

THIS INFORMATIVE QUARTERLY WILL BE MAILED TO YOUR ADDRESS WITHOUT CHARGE

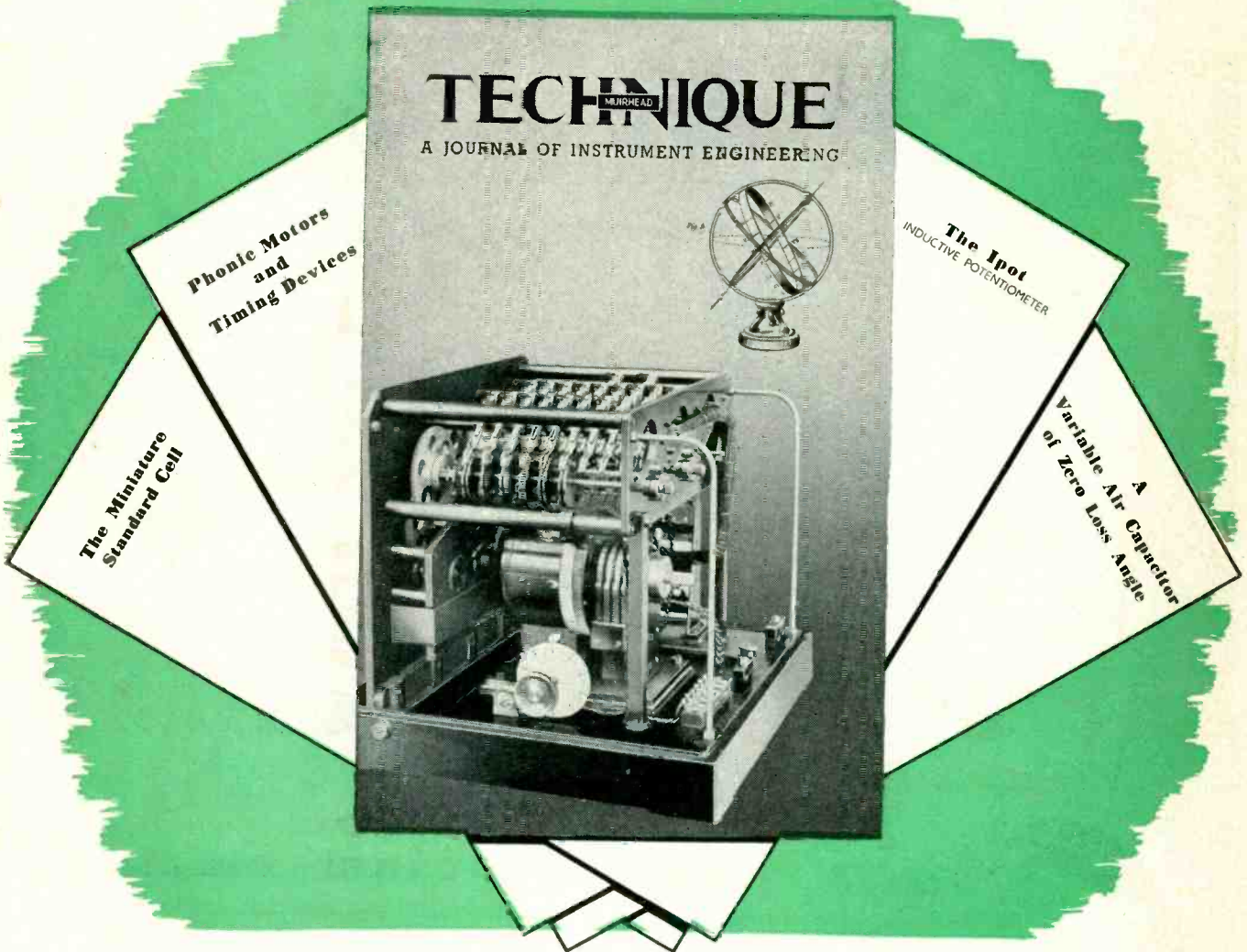

**FILL IN
THIS COUPON
NOW**

MUIRHEAD & CO. LTD • BECKENHAM • KENT • ENGLAND
Please mail me, free of charge, your quarterly journal "TECHNIQUE"

NAME _____
 POSITION _____
 COMPANY _____
 ADDRESS _____

MUIRHEAD & Co. LTD.
 PRECISION ELECTRICAL INSTRUMENT MAKERS
 BECKENHAM • KENT • ENGLAND

Telegrams and Cables: MUIRHEADS ELMERS-END

PRECISION
MUIRHEAD
 ELECTRICAL INSTRUMENTS

MU.29

Exploration

for resistors too!

Specialization in resistors lets IRC concentrate on research and quality control to a greater degree than any other supplier. *Result:*—IRC exploration anticipates future resistor needs—improves existing products—and controls quality and uniformity in every IRC unit. Largest resistor manufacturer in the world, IRC attracts the finest of engineering talent. We're using more of such talent than ever, now, to keep step with today's electronic requirements—while we plan for tomorrow's advances.

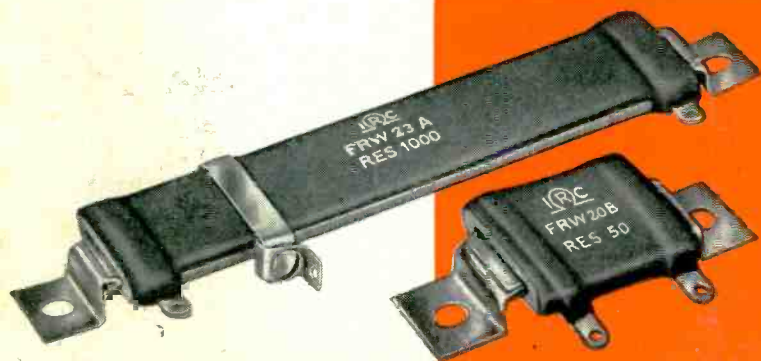

FLAT POWER WIRE WOUND RESISTORS

For high-wattage dissipation in limited-space applications, IRC Type FRW Flat Wire Wound Resistors have higher space-power ratios than standard tubular units. FRW's can be mounted vertically or horizontally—singly or in stacks. Non-magnetic mounting brackets permit easy, economical mounting, aid in heat distribution along the entire length, and transfer internal heat to the chassis. Available in 9 sizes—fixed and adjustable. Send for full details in Bulletin C-1.

is important



HIGH OHMIC RESISTORS

Engineered for high voltage applications where high resistance and power are required, IRC Type MVX Resistors are particularly suited to many types of television and electronic circuits. Unique application of IRC's proven filament resistance coating in helical turns on a ceramic tube provides a conducting path of long, effective length. Result: A unit of high resistance value with resistance materials having relatively low specific resistance. Type MVX's have 2 watt rating, are exceptionally stable—permit the use of high voltage on the resistor while keeping voltage per unit length of path comparatively low. Send coupon for complete details in Bulletin G-2.

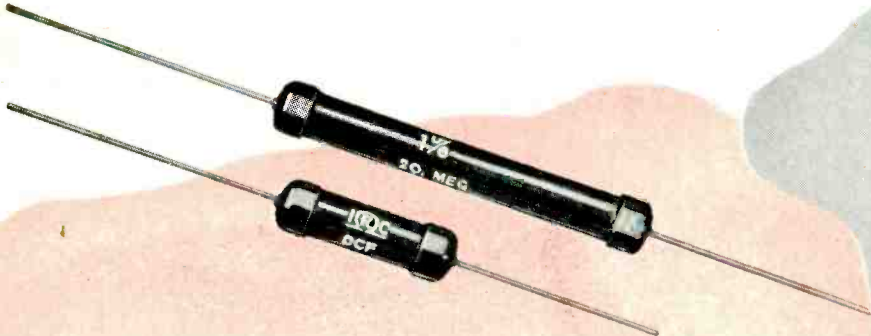

DEPOSITED CARBON PRECISTORS

A unique combination of accuracy, stability and economy makes IRC Deposited Carbon PRECISTORS ideal for applications where carbon compositions are unsuitable or wire-wound precisions too expensive. Instrumentation, advanced electronics and critical television circuits also benefit from their wide range of values, low voltage coefficient, excellent frequency characteristics, predictable temperature characteristics, high voltage rating, low noise level and small size. Coupon brings full particulars in Bulletin B-4.



VOLTMETER MULTIPLIERS Sealed-precision IRC Type MF Resistors are completely impervious to moisture—have proved themselves dependable voltmeter multipliers for use under the most severe humidity conditions. Each multiplier consists of a number of IRC Precision Resistors, mounted, interconnected, and encased in a glazed, hermetically sealed ceramic tube. MF's are compact, rugged, stable, easy to install, and may be used with very little drain on the power supply. Individual precision resistors may be either inductive or noninductive, so that they may be used on AC as well as DC. Mail coupon for full data in Bulletin D-2.



Wherever the Circuit Says

Power Resistors • Voltmeter Multipliers • Insulated Composition Resistors • Low Wattage Wire Wounds • Volume Controls • Voltage Dividers • Precision Wire Wounds • Deposited Carbon Precistors • Ultra-HF and High Voltage Resistors • Insulated Chokes

INTERNATIONAL RESISTANCE COMPANY

401 N. Broad Street, Philadelphia 8, Pa.

In Canada: International Resistance Co., Ltd., Toronto, Licensee

INTERNATIONAL RESISTANCE CO.
403 N. BROAD ST., PHILADELPHIA 8, PA.

Please send me complete information on the items checked below:—

- Flat Wire Wound Resistors (C-1) Deposited Carbon PRECISTORS (B-4)
- High Voltage Resistors (G-2) Voltmeter Multipliers (D-2)
- Name and address of local IRC Distributor

NAME

TITLE

COMPANY

ADDRESS

CITY ZONE STATE

"EVERYTHING IN CARBON BUT DIAMONDS"



The Stackpole Minute Man—your assurance of prompt, dependable service on molded carbon products.

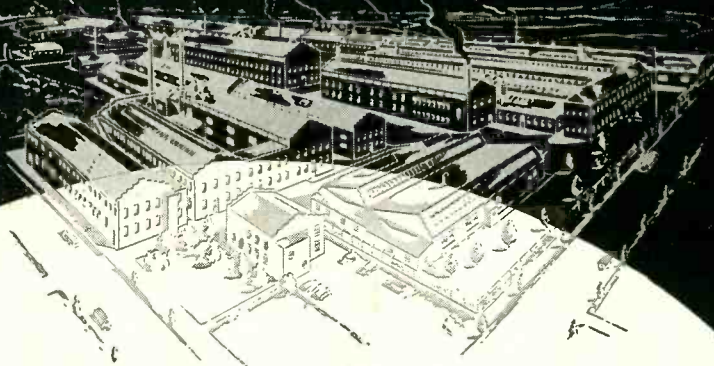

CARBON SPECIALTIES

As a long time leader in molded carbon, graphite and metal powder specialties, Stackpole offers unsurpassed facilities for designing, engineering and producing almost anything that

might be required in this line. The following list indicates something of the range of our facilities in these respects. Information on any type will gladly be sent on request:

RAIL BONDING MOLDS

... a typical example of Stackpole molded graphite. Facilitates making permanent rail bonds rapidly and without extensive equipment. A thermite mixture is ignited to melt copper which runs into the mold and forms the bond.

Electrical Contacts

Mercury Arc Rectifier Anodes

Power Tube Anodes

Carbon Pile Voltage Regulator Discs

Battery Carbons

Water Heater Electrodes

Pasteurization Electrodes

Trolley and Pantograph Shoes

Electric Furnace Elements

Resistance Brazing Tips

Welding Carbons

Seal Rings

Bearing Materials

Clutch Rings

Friction Segments

Graphite Anodes

Carbon Molds & Dies

Continuous Casting Dies

Rail Bonding Molds

Brazing Furnace Boats

Dash Pot Plungers

STACKPOLE CARBON COMPANY

St. Marys, Pennsylvania

STACKPOLE

No. 6
of a
Series

Another Engineer's Problem Solved*

SUBJECT:

Ultra High Resistance Capacitors

PROBLEM:

To supply a capacitor having the following specifications:

Capacitance: .02 mfd. $\pm 10\%$.

Size: $1\frac{7}{8}$ long by $\frac{25}{32}$ O.D.

Resistance: 10^{14} ohms, at 2200 VDC, 95% R.H., and 90°F.

Flash Test: 4000 VDC for 1 min.

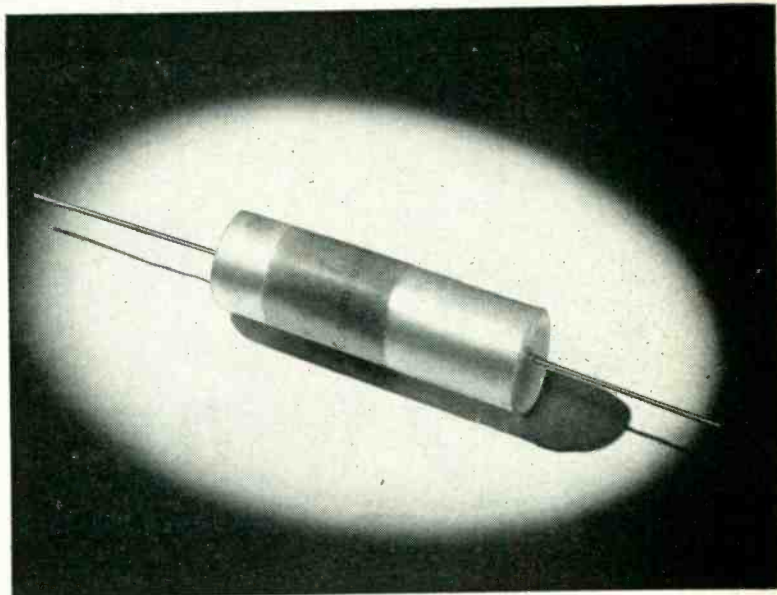

SOLUTION:

This capacitor weighs .7 oz. It replaces a 10 lb. dry battery in a portable instrument requiring an ionizing voltage of 1900-2200 VDC. The instrument load is negligible and is due mostly to leakage of the circuit insulation. The capacitor itself must have a high enough resistance so that no more than 5% of its energy is lost in 24 hours. This problem was one of the most difficult we have had.

A new plastic exhibiting very high volume resistivity was obtainable. However, this material was not available in thin, pin-hole free films. We obtained the resin for a large extruder of plastic films who produced .002 inch thick film having a K of 2.9 at 60 cycles. This film breaks down at 6000 to 10,000 VDC. It is possible to wind .02 mfd. capacitors with one layer which can be flash-tested at 4000 VDC and which have resistances from 2×10^{14} to 1×10^{15} ohms at 2200 VDC and 90° F.

Our Glassmike style was not suitable as a container because the leakage across the scrupulously-cleaned glass tube never exceeds 5×10^{13} ohms at 90% RH. It was found that the dielectric film absorbed no moisture and had a surface resistivity in excess of 10^{17} ohms/cm. The capacitor winding is wrapped in a wider strip of film and the depression formed at each end was filled with a compound which seals to the plastic film and the pigtail wires.

The Type F film as we obtain it must be carefully processed to obtain ultra-high resistance capacitors. The film must not be handled and the high-static charge must be eliminated when winding the elements.

Type FA is only one of the types of the high-resistance capacitors we make. Capacitors are available which have high resistances at 85 to 125°C. We produce others which have extremely low dielectric absorption along with high resistance.

• • •

What is YOUR engineering problem?

Your inquiries will receive immediate attention.

• • •

We Manufacture a Standard Line of Plasticon Capacitors,
Pulse Forming Networks and High Voltage Power Supplies.

Write for our catalog

Condenser Products Company

1375 NORTH BRANCH STREET • CHICAGO 22, ILLINOIS

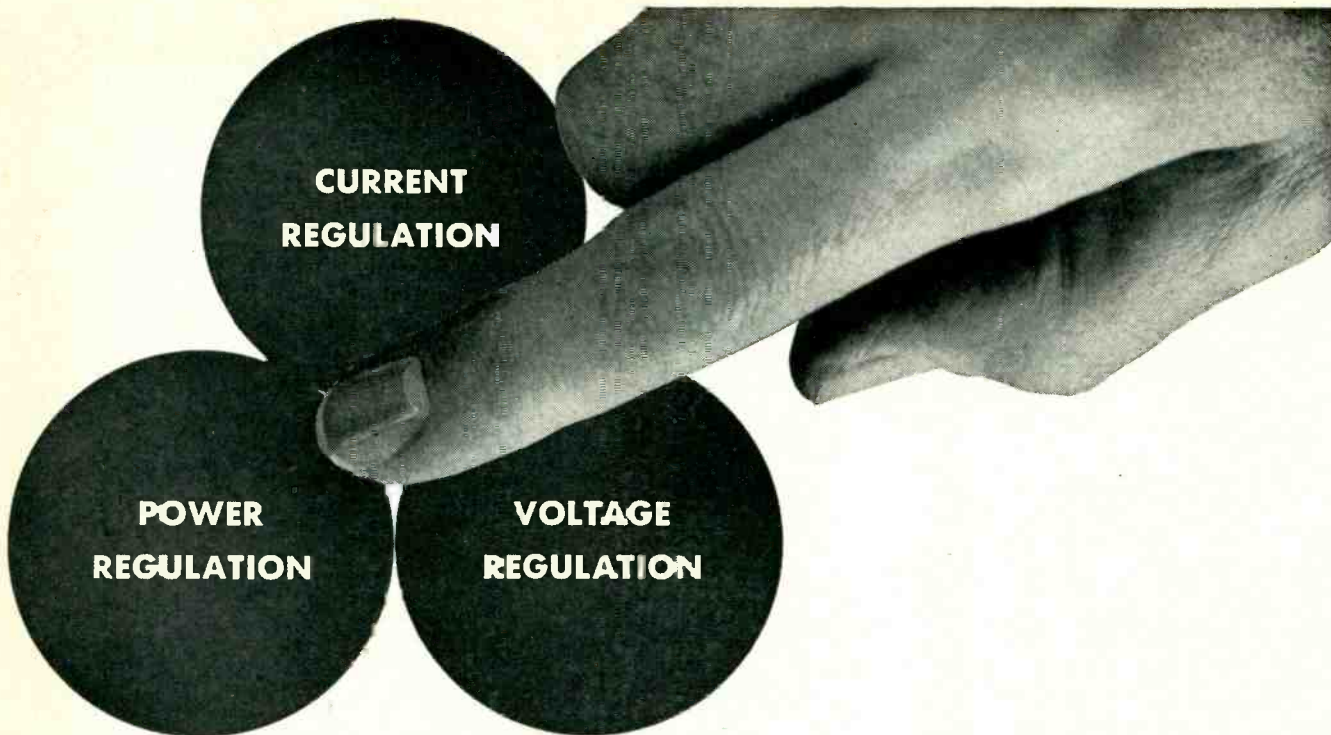

can you put your Finger on the TROUBLE?

- If you can, a SORENSEN Electronically controlled, magnetic amplifier regulating circuit can solve it!

Sorensen's new line of Electronic AC Voltage Regulators is the most accurate and most economical line of Electronic Voltage Regulators on the market today. Standard specifications offer Accuracy to within $\pm 0.1\%$ and Distortion as low as 2%. Load range from zero to full load. All models are temperature Compensated and can be supplied hermetically sealed or fosterited. And the Sorensen line uses less tubes than other electronic type regulators.

- Sorensen Engineers are always at your service to solve unusual problems and give you the benefits of years of experience. Describe your needs and let a Sorensen Engineer suggest a solution. It will save you time and money to try Sorensen first.

TYPICAL AC REGULATORS

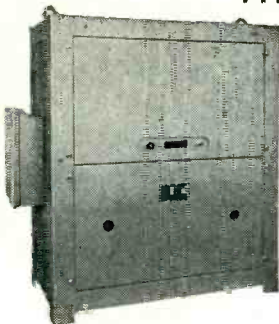

Model 5000-2S—high power
 Input 95 to 130; distortion 3%;
 load 0-5000 VA;
 Accuracy $\pm 0.1\%$ against line
 or load; 50-60 cycles

Model 3000S—medium power
 Input 95 to 130; distortion 3%;
 load 0-3000 VA
 Accuracy $\pm 0.1\%$ against line
 or load; 50-60 cycles



Model 500S—low power
 Input 95 to 130; distortion 3%;
 load 0-500 VA;
 Accuracy $\pm 0.1\%$ against line
 or load; 50-60 cycles

CATALOG A1049 DESCRIBES COMPLETE LINE

POWER
 controlled converted

Sorensen and company, inc.
 375 FAIRFIELD AVE. • STAMFORD, CONN.

MANUFACTURERS OF AC LINE REGULATORS, 60 AND 400 CYCLES; REGULATED DC POWER SOURCES; ELECTRONIC INVERTERS; VOLTAGE REFERENCE STANDARD; CUSTOM BUILT TRANSFORMERS; SATURABLE CORE REACTORS

Now... At Last!...

A PLATE CIRCUIT POWER RELAY

NEW CLARE RELAY IS TWO RELAYS IN ONE



Side view of typical CLARE Type "CP" Power Relay.

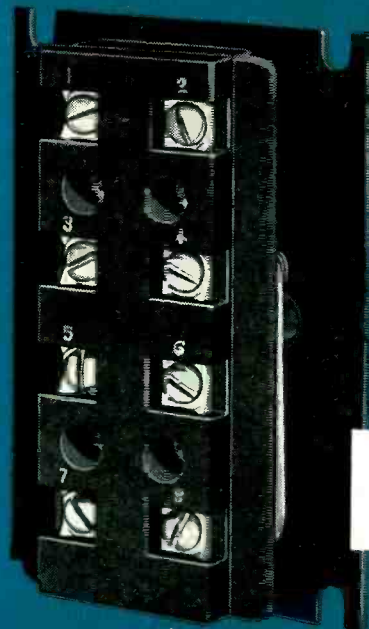

Front view showing convenient terminal arrangement.

It takes one watt or more to operate an ordinary power relay; hence, it has to be operated from a sensitive relay or a high-current tube. This new Type "CP" Power Relay, truly two relays in one, will operate on less than 200 milliwatts—with, for example, a 6,500-ohm coil. Will operate in the plate circuit of any triode, including miniatures. Simplifies equipment; saves money and space; will outwear several ordinary power relays.

SALIENT FEATURES

Sensitivity. Pickup current can be as low as 3 milliamperes—with a 12,000-ohm coil.

Marginal operation. Dropout current can be as high as 58% of pickup current.

Heavy load capacity. D. P. D. T. contacts conservatively rated at 10 amperes, 230 volts, a-c; proved by one million operations at 30 amperes inrush, 10 amperes break.

No contact bounce.

Interlock contacts. A single-pole interlock can be provided, if required.

Fast operation. Operate time can be as low as 30 milliseconds.

Heavy insulation. Minimum of one-half inch creepage over exposed areas.

Convenient terminal facilities. Screw terminals recessed in terminal block in orderly array. No separate terminal board needed.

Versatile mounting. Front, back, or surface mounting.

Long mechanical life. 25 million operations, without readjustment.

Long operational life. One million operations at rated contact load, without readjustment.

No pigtailed to break. On test, the long flexible contact springs have exceeded by 100 times the normal life expectancy of

pigtail connections, commonly used on power relays.

Wide choice of coils. Like other Clare relays, this relay is custom-built to fit the application. Our engineers can choose from hundreds of different coil specifications the one best suited for the job.

For complete information send for Clare bulletin No. 113

CLARE sales engineers are at your service to help with your individual relay problem. Located in principal cities, their expert knowledge of relay problems is readily available. Look in your classified telephone directory or address: C. P. Clare & Co., 4719 West Sunnyside Ave., Chicago 30, Ill. In Canada: Canadian Line Materials Ltd., Toronto 13. Cable address: CLARELAY.

CLARE RELAYS...

First in the Industrial Field

BH "649"

New Technical Data and Samples for Test

Get this folder on BH "649"—it's packed with technical information about the toughest insulation we have ever made. Tells how BH "649" resists severe abrasion—retains rated dielectric strength under constant vibration, excessive current load—stays supple after baking 24 hours at 302°F.

It tells how BH "649" endures high operating temperatures without impairing its physical and electrical properties and how it withstands sub-zero temperatures.

It shows some of the many applications for this outstanding insulation—products and equipment in which BH "649" is being used.

It gives important technical data on the resistance of BH "649" to vapors, oils and chemicals. It includes three 4" samples of Grade "A-1" Tubing—for production samples give us details about your requirements.

BENTLEY, HARRIS MANUFACTURING CO., CONSHOHOCKEN, PA.

BH Fiberglas* SLEEVINGS

—USE COUPON NOW—

Bentley, Harris Mfg. Co., Dept. E-8, Conshohocken, Pa.

I am interested in BH "649" Fiberglas Tubing and Sleeving. Send Technical Data Folder.

NAME _____

ADDRESS _____



KNOT IT . . . Take a length of BH "649". Knot it. Pull it as tight as you can. Twist it. Then loosen the knot. There is no cracking. No change in the dielectric strength.

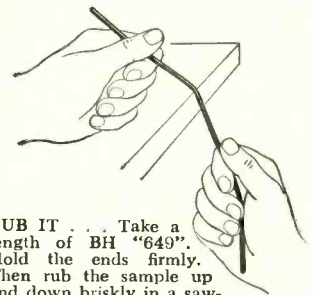

RUB IT . . . Take a length of BH "649". Hold the ends firmly. Then rub the sample up and down briskly in a sawing motion against the edge of a desk or chair. See how difficult it is to damage the coating.



HOLD A MATCH UNDER IT . . . Take a length of BH "649". Hold a lighted match under it. BH "649" will not support combustion.

Send samples, pamphlets and prices on other BH Products as follows:

- BH non-fraying Fiberglas Sleeving
- Cotton or Rayon-base Sleeving and Tubing



Jensen presents... G-610 TRIAXIAL

a NEW loudspeaker which for the first time spans the full frequency range of the ear!

A new, skillfully integrated combination of three independently-driven units . . . two compression driver and horn combinations, plus heavy-duty direct radiator . . . with 3-channel electrical crossover and control network . . . achieving the widest frequency range and finest reproduction ever attained!

Write for Data Sheets 160 and 152 which describe the G-610 and other Genuine Jensen Wide Range Speakers.

JENSEN MANUFACTURING COMPANY Division of the Muter Company
 6607 So. Laramie Ave., Chicago 38, PORTSMOUTH 7-7600 In Canada: Copper Wire Products, Ltd., 351 Carlew, Toronto.

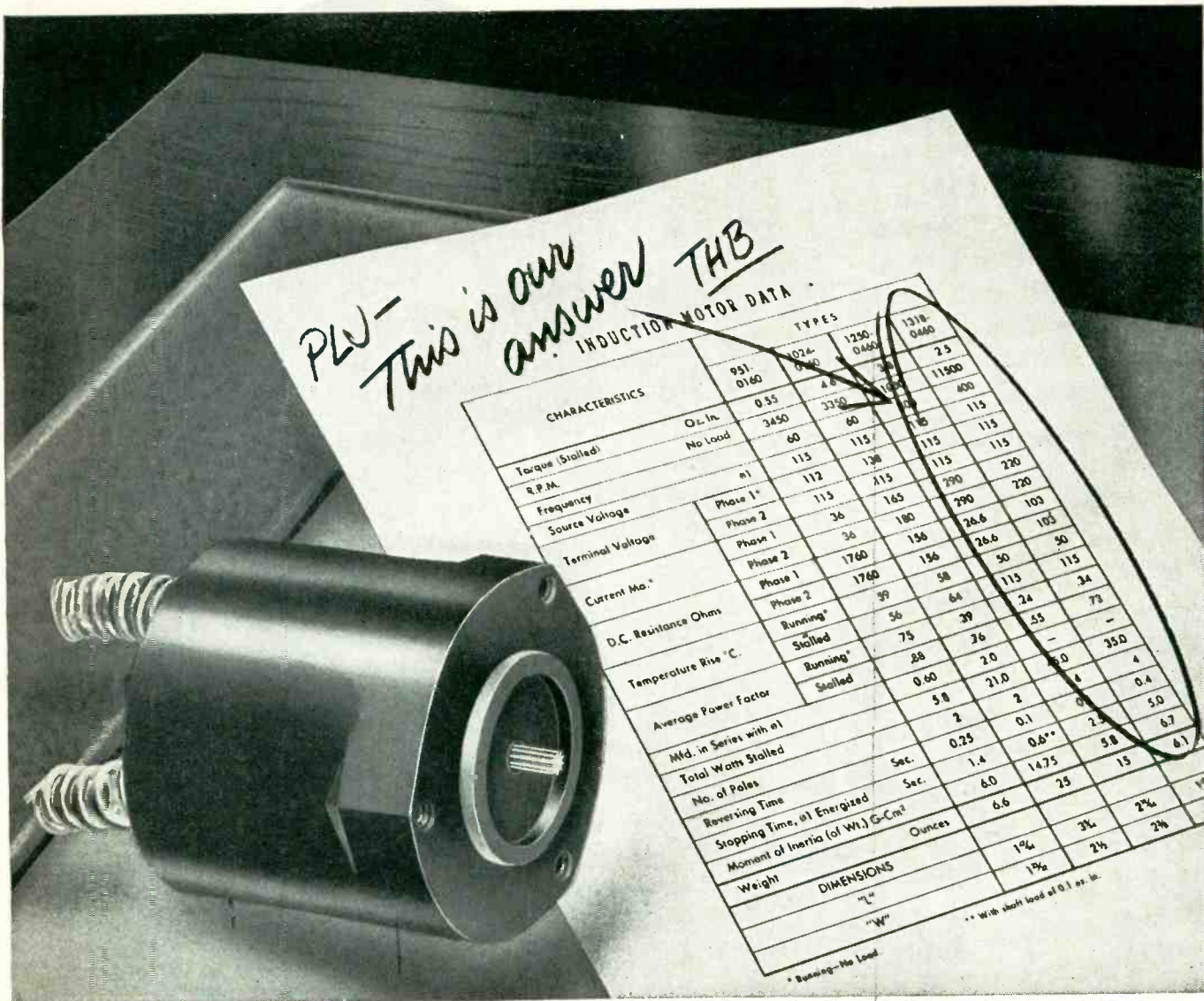

Your answer, too, for extreme precision in remote indication and control systems

Instant responsiveness, complete smoothness of operation and a high torque/rotor inertia ratio make Kollsman Induction Motors ideally suited for use as servo or follow-up motors in control mechanisms. These miniature two-phase units have fast starting, stopping and reversing characteristics and deliver maximum torque at stall. Designed with distributed wound stators and

squirrel-cage type rotors, they perform smoothly from zero to maximum r.p.m., with no "cogging" action in the low speed ranges. They may be energized by two-phase AC or by single-phase, using a phase-splitting condenser in series with one winding.

The Induction Motors constitute one series in a complete line of special purpose AC motors designed and manufactured by Kollsman, leader in the field of precision aircraft instrumentation and control. Among those available, you may find the exact answer to your control problem. If not, the skill and experience of Kollsman engineers may be relied upon to produce a unit that fulfills your particular specifications. For further information regarding these motors, address: Kollsman Instrument Division, Square D Company, 80-08 45th Avenue, Elmhurst, New York.

KOLLSMAN INSTRUMENT DIVISION

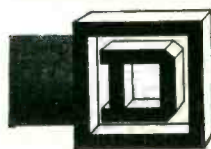

SQUARE D COMPANY

ELMHURST, NEW YORK

GLENDALE, CALIFORNIA

**Video
Monoscope
Camera
TK-1A**

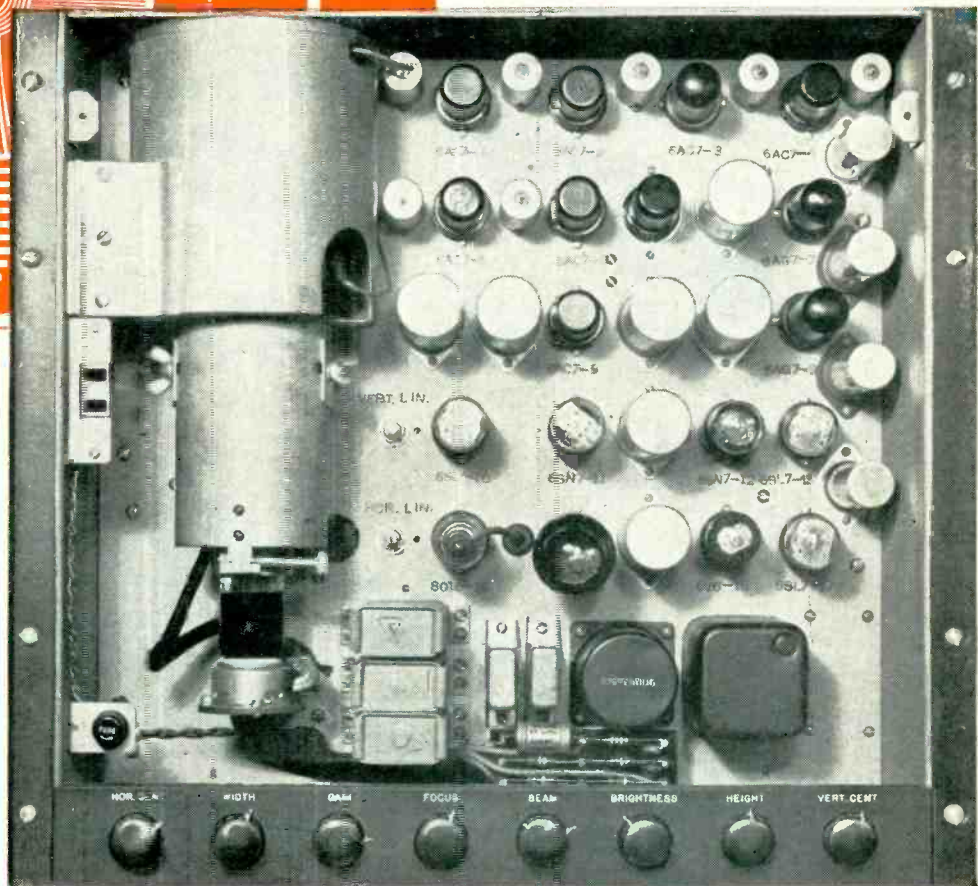

... "patternmaker" for the industry

The test pattern produced by RCA Monoscope Cameras is the standard by which picture quality has been judged since the beginning of electronic television . . . in TV stations . . . in laboratories . . . in TV receiver production.

These are the standard test-pattern cameras used by many TV receiver manufacturers. These are the standard "picture micrometers" used by TV stations to make precision measurements of video transmissions.

Deliberately designed to excel in all things, RCA Monoscope Cameras have earned the extraordinary re-

spect of television men. Evenly lighted patterns as steady as Gibraltar. Resolution as fixed as the cut of a diamond. Operation as reliable as a ship's chronometer.

Type TK-1A pictured here is RCA's newest Monoscope Camera—built to the highest standards known. It can be delivered to you with the familiar monoscope pattern (shown above)—or with a pattern of your own choice.

Ask your RCA Television Equipment Sales Engineer for prices. Mail the coupon for data.



TELEVISION BROADCAST EQUIPMENT
RADIO CORPORATION of AMERICA
ENGINEERING PRODUCTS DEPARTMENT, CAMDEN, N.J.

In Canada: RCA VICTOR Company Limited, Montreal

Radio Corporation of America
Television Broadcast Equipment Section
Dept. 36H, Camden, N. J.
Send me your technical bulletin on the RCA Type TK-1A
Monoscope Camera.

Name _____

Company or station _____

Address _____

City _____ State _____

Look at it **FOR**

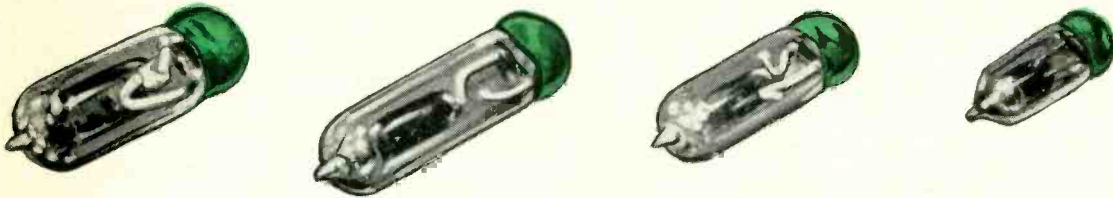

ADAPTABILITY TO PRODUCT DESIGN



... AND YOU'LL PICK THE



The cost of designing and building a product is a mighty important thing to consider when specifying the mode of electrical switching. And, that's where the Honeywell Mercury Switch comes into the picture.

Honeywell Mercury Switches are available in more than a hundred types and sizes . . . with load limits from as little as $\frac{1}{3}$ amp. up to 45 amp. . . in a wide range of tilting angles. They are tiny and compact . . . are adaptable to unusual mountings . . . and are sealed against dust, gas and corrosion.

The complete line is at your command . . . affording greater latitude in product design, with dependable performance and trouble-free operation. Write for Catalog 1343 and latest price schedule for manufacturers . . . or call in your local Honeywell engineer for a detailed discussion of a particular application.

MINNEAPOLIS-HONEYWELL REGULATOR Co., *Industrial Division*, 4428 Wayne Ave., Philadelphia 44, Pa. Offices in more than 80 principal cities of the United States, Canada and throughout the world.

FOR • POSITIVE ACTION • LOW ANGULARITY • LONGER LIFE • WIDE SELECTION

Specify



Here's a million-dollar question:



How many
**UNCOUNTED
OPPORTUNITIES
HAVE YOU...** to increase
your product's sales?



Give a product a useful new feature... give it the ability to supply to its users exact facts-in-figures on its performance or production... and you apply a powerful booster to sales.

This has been proved to manufacturers in almost every industry who have built Veeder-Root Counters into their products as integral parts, to count everything from coins inserted to parts produced. Few counter uses are alike... many were not apparent at all until a

Veeder-Root engineer was called in to see if he could figure one out. And today, it's worth anyone's time to find out if he can count his way to new sales (*perhaps even new markets*) with the competitive selling advantages gained by built-in Veeder-Root Control. How about *your* products? Write.

VEEDER-ROOT INCORPORATED, HARTFORD 2, CONNECTICUT
In Canada: Veeder-Root of Canada, Ltd., 955 St. James Street, Montreal 3. In Great Britain: Veeder-Root Ltd., Kilspeidie Road, Dundee, Scotland.

Veeder-Root

COUNTERS

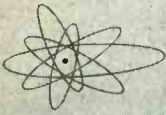

Designers



PANEL INSTRUMENTS—A COMPLETE LINE

Accurate and Reliable

FOR MEASURING D-C, A-C, RF, AF, VU

General Electric panel instruments have long been known for their reliability and accuracy. Recent design changes provide for better performance, readability, durability, and appearance. G-E voltmeters, kilovoltmeters, ammeters, milliammeters, microammeters, and vu volume-level indicators; thermocouple types and rectifier types; round or square, with conventional or long 250-degree scales—all will give your measurements the accuracy required and your panel that smooth, modern appearance. To bring you up to date on the latest improvements in cases, faces, and mechanisms, G.E. offers a comprehensive 24-page bulletin containing all information necessary for ordering. Write for Bulletin GEC-368. For vu indicators, see Bulletin GEC-369.



SOLVE DESIGN PROBLEMS WITH THE SWITCH OF 10,000 USES

A member of the well known SB-1 switch family can find a useful place on almost any large electronic control panel. The precision-built parts of this all-purpose switch permit as many as 40 stages—four banks of ten stages each—to be operated in tandem. Switches with up to 16 stages and 12 positions are commonly furnished. Over 10,000 circuit-sequence combinations are possible. Ratings go to 20 amperes at 600 volts a-c or d-c. See Bulletin GEC-270.



SB-1 switch, cover-removed

Illuminated push button



SAVE PANEL SPACE WITH ONE-UNIT PUSH-BUTTON AND INDICATING LIGHT

This space-saving pilot-circuit switch consists of a sturdy push-button unit, 2 5/8 inches high, with a hollow translucent cap and 6-volt lamp. The switch is the momentary contact type, single-pole, with one normally open and one normally closed circuit. It uses movable-disk type contacts. Buttons are supplied in clear, red, green, blue, amber, and white. For more data on this and other G-E push-button units, see Bulletin GEA-4254.

GENERAL  **ELECTRIC**

Digest

TIMELY HIGHLIGHTS ON G-E COMPONENTS



PERMAFIL CAPACITORS

NO DERATING AT 125° C OPERATION

For operation at high ambient temperatures, these standard-line G-E Permafil capacitors are naturals. They're paper dielectric units and can be used at temperatures up to 125° C without derating. All are metal encased, compression-sealed, and have long-life silicone bushings. Ratings: up to 2 muf for operation at 400 volts d-c and below. Case styles: 53, 61, 63, and 65 (JAN-C-25 specifications). For more data, write Capacitor Sales Div., General Electric Co., Pittsfield, Mass.



HIGH-VOLTAGE SELENIUM RECTIFIERS

WITH LIFE EXPECTANCY OF 60,000 HOURS!

Now available from G.E. are 26-volt RMS selenium rectifier cells with a continuous-service life expectancy of over 60,000 hours. Their initial forward resistance is very low and samples show an average increase in resistance of less than 6% after 10,000 hours of operation. General Electric knows of no other high-voltage selenium cell on the market that can even approach their performance.

The high output voltage permits the design of smaller stacks while the low resistance means cooler operation and the space saving that goes with it.

Stacks made with the new G-E cells may be obtained with rated outputs from 18 to 126 volts d-c at .15 to 3.75 amps. Write now for Bulletin GEA-5280.



INDUCTROLS

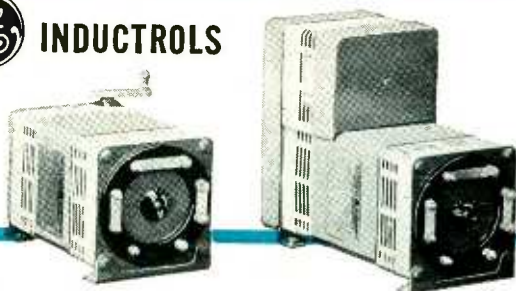

STEPLESS VOLTAGE VARIATION

Inductrols are G-E dry-type induction voltage regulators for 120 and 240-volt operation. Hand-operated models provide smooth and extremely precise voltage adjustment for such uses as instrument calibration and rectifier control. Motor-operated models are used with automatic control to maintain voltage within narrow limits, irrespective of supply variations. Sizes range from 10¼ x 6⅞ x 7⅞ inches for the smallest hand-operated unit to 14 x 6 x 10⅞ for the largest motor-operated unit. One unit provides a voltage range of 10% raise and lower on 3 and 6-kva circuits, another gives 100% raise and lower for 2.4 and 3.6 kva circuits. Complete information in Bulletin GEA-4508.

General Electric Company, Section A 667-7
Apparatus Department, Schenectady 5, N. Y.

Please send me the following bulletins:

- | | | |
|---|--------------------------|------------------------------------|
| Indicate
for
reference
only (✓)
for planning
an immediate
project (X) | <input type="checkbox"/> | GEA-4254 Push-button units |
| | <input type="checkbox"/> | GEA-4508 Inductrols |
| | <input type="checkbox"/> | GEA-5280 Selenium rectifiers |
| | <input type="checkbox"/> | GEC-270 SB-1 switch |
| | <input type="checkbox"/> | GEC-368 Panel instruments |
| | <input type="checkbox"/> | GEC-369 Vu volume-level indicators |

NAME _____

COMPANY _____

ADDRESS _____

CITY _____ STATE _____

MODERN 5kW. BROADCASTING



If you like your transmitters built big and husky, look sleek and distinguished, sound rich and full or—if you are one of those chaps that wants nothing but the best and the latest—as modern as that bobby sox daughter of yours—why, of course, you want Gates. Take the new Gates Five, for instance—

Modern Tubes. The new 3X2500 air cooled, single phase tungsten filament construction assures lower noise, lower distortion and longer life at less cost. 100% tube set is only \$695.00.

Modern Installation. No days of cabling when installing the Gates BC-5B. In fact, no cabling at all. One cubical slips into line with the next and a few simple jumpers finish the job.

Modern Design. Dead front design. Open any front door, tune any current, attend relays, even adjust crystal air gaps without disengaging a door interlock.

Modern Walk-in Construction. Open the back doors and walk in. No hodge-podge of parts here, there and yon. The smoothest construction job you ever looked at.

Modern Performance. Gates makes nothing that is second best. Gates BC-5B performance is definitely best in the 5KW field, catalog specifications are not laboratory results but expected results at your transmitter location. Lower noise, lower distortion and greater dependability.

Modern Prices. Pace setter in quality and selling price, Gates Fives are modest indeed for 1950 designs. The latest, the best, the modern in Fives costs no more than older designs—marked down, of course.

2

Leading TV Transmitters

Yes, two of the nation's leading 5KW TV transmitters now use 3X2500 tubes in their output stage, the same tube as in the Gates BC-5B Five KW. AM.

Warner Bldg., Washington, D. C.
2700 Polk Ave., Houston, Texas
Canadian Marconi Company, Montreal
Rocke International, New York City

GATES RADIO CO.

MANUFACTURING ENGINEERS SINCE 1922

QUINCY, ILLINOIS, U.S.A.

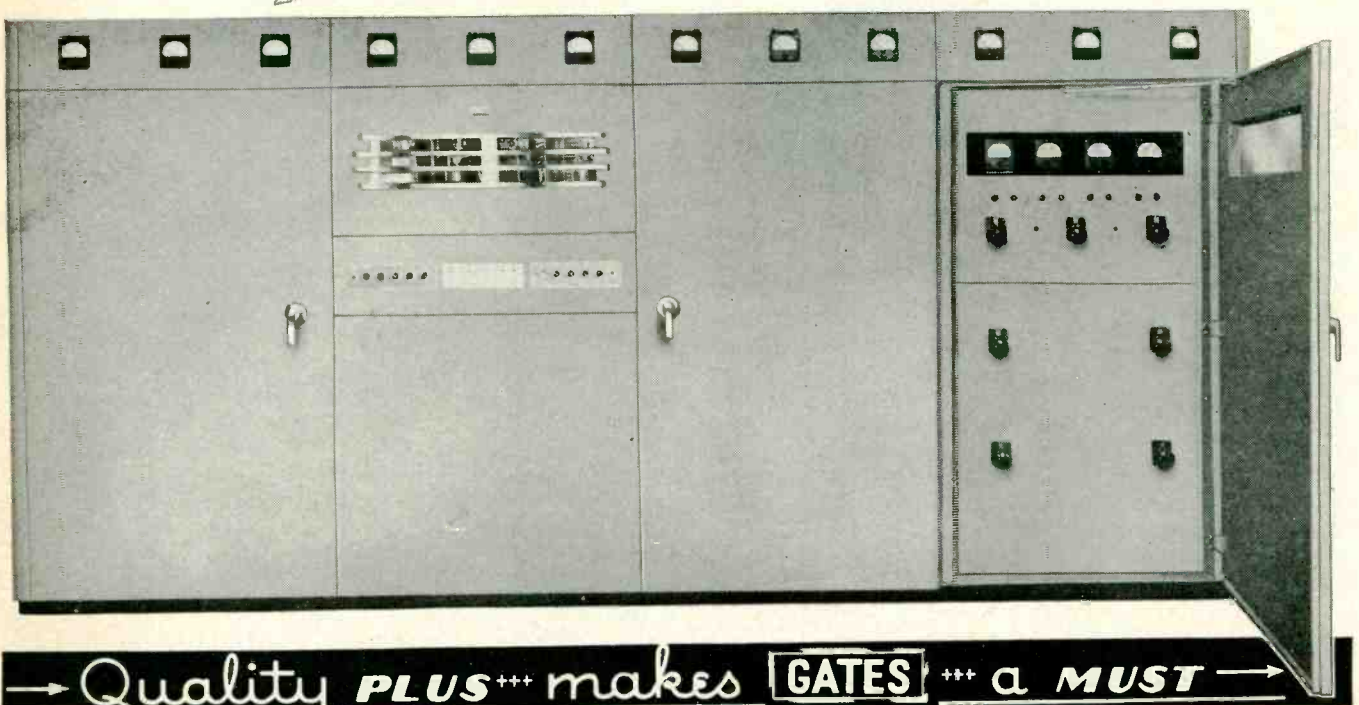

→ Quality **PLUS**+++ makes **GATES** +++ a **MUST** →

High-Accuracy Beckman pH Meter[†] relies on **D-H ALLOYS**

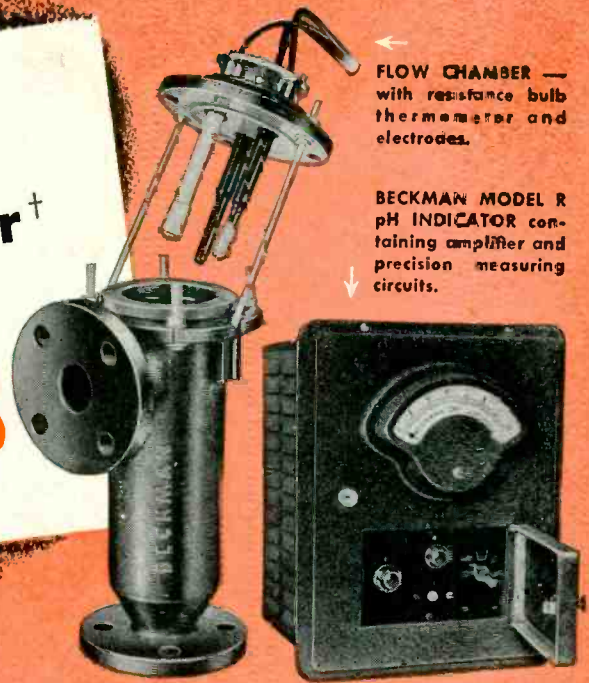

← **FLOW CHAMBER** — with resistance bulb thermometer and electrodes.

BECKMAN MODEL R pH INDICATOR containing amplifier and precision measuring circuits.

In large industrial installations, where pH control must be continuous or automatic, or both, the temperature of process solutions has to be obtained continuously, in order to compensate for effects of temperature change upon pH.

To accomplish this, the Beckman Model R Automatic pH Indicator provides a flow chamber, or immersion assembly, containing a resistance bulb thermometer in addition to the glass and calomel electrodes used in measuring pH. This resistance thermometer is an element in the feed-back circuit of a stable DC amplifier whose sensitivity is accordingly varied in proportion to the absolute temperature of the process solution.

To assure complete accuracy, the thermometer of the Beckman Model R pH Indicator is wound with D-H HYTEMCO* wire, supplemented with D-H MANGANIN. The high temperature coefficient of HYTEMCO makes it eminently suitable for this application; and the absolutely uniform behavior of this alloy, thruout a wide temperature range, helps the indicator to record pH values with utmost fidelity. The sup-

RESISTANCE BULB THERMOMETER — Sufficient Hytemco wire is used to obtain the necessary resistance value for the temperature range. A small percentage of Manganin is then added to bring total resistance of winding up to circuit requirements.

plementary winding of D-H MANGANIN is required in order to raise the resistance of the assembly to a specific circuit value without increasing the increment of resistance with temperature. This the MANGANIN does very effectively.

In addition to the desirable electrical characteristics of these D-H alloys, however, is the outstanding uniformity of the wire from spool to spool, and the quality "built into" it — as a result of exclusive Driver-Harris know-how and advanced melting, rolling and drawing techniques.

Special alloys for special uses is an important phase of our business. If you have been unable to obtain just what you are looking for, let us know your requirements. We'll gladly put our 50 years of experience at your disposal, and supply you with the alloy best suited to your needs.



[†]Product of National Technical Laboratories, S. Pasadena, Calif.

Makers of world-famous Nichrome* and over 80 alloys for the electrical, electronic and heat-treating fields

Driver-Harris Company

HARRISON, NEW JERSEY

BRANCHES: Chicago, Detroit, Cleveland, Los Angeles, San Francisco

Manufactured and sold in Canada by

The B. GREENING WIRE COMPANY, LTD., Hamilton, Ontario, Canada



*T. M. Reg. U. S. Pat. Off.

NEW DESIGN THRILLS AT YOUR FINGER TIPS...

Type SRE Bantams*—The smallest electrolytics yet. Especially suitable for personal radios, filter circuits and similar functions. Hermetically-sealed aluminum can with diameter-reducing stud terminals. Improved processing and materials combined with more efficient space utilization, means smaller sizes—but no reduction in life.

Type '87 Aerocons—Self-molded plastic tubulars with new impregnant, Aerolene*; new rock-hard Duranite* end seals. All the performance characteristics of molded-plastic capacitors at a price close to that of conventional paper tubulars. Excellent heat and humidity resisting qualities. Operating temperatures of -30°C to $+100^{\circ}\text{C}$.

Type 89ZXY Aerolites*—Aerovox-improved metallized paper capacitors were developed to meet present-day requirements for capacitors of improved reliability and reduced size. Type 89ZXY Aerolites* are metallized-paper capacitors in hermetically-sealed metal cases. Other Aerolite* capacitors are available in tubular, bathtub and other case designs.

Type P123ZG Miniatures—Metal-cased, metallized-paper capacitors featuring vitrified ceramic terminal seals for maximum immunity to climatic conditions—heat, cold, humidity. For severe-service applications and for usage in critical as well as ultra-compact radio-electronic assemblies.

Type P83Z Micro-Miniatures*—Smaller than previous "smallest"—a distinct departure from conventional foil-paper and previous metallized-paper constructions. Radically new metallized dielectric makes possible exceptionally small physical sizes. Available in two case sizes ($3/16'' \times 7/16''$ and $1/4'' \times 9/16''$); voltages of 200, 400, 600; operating temperatures range from -15°C to $+85^{\circ}\text{C}$ without derating.

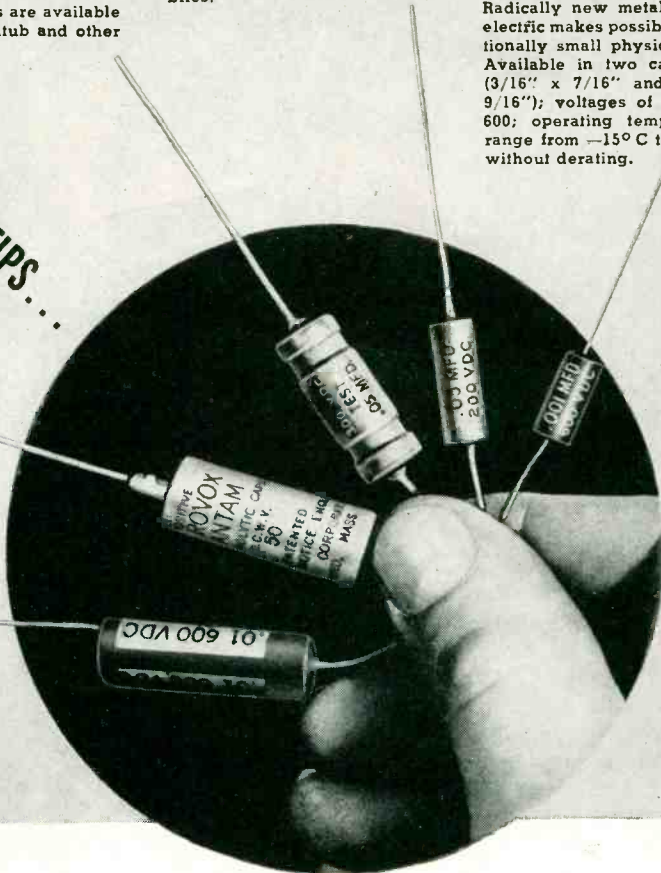

*Trade-mark

AEROVOX
"Space Miser"
CAPACITORS

There is something new in sizes!

● Never was so much capacitance packed into so little bulk. And with improved performance and life, too. Aerovox Research and Engineering have developed capacitor materials that now challenge the thinking of the progressive radio-electronic designer on several counts:

even in tiniest sizes. For *miniaturizations*: perfected metallized-paper sections. For *compact filters*: smallest electrolytics yet. For *maximum reliability*: the most conservative ratings. For *lower prices*: advanced engineering backed by highly mechanized fabrication.

● Tell us what you are designing or producing. Our engineers will gladly show you *better assembly possibilities with marked economies*. Literature on request. Write on your letterhead to Aerovox Corporation, Dept. DF-65, New Bedford, Mass.

For *elevated temperatures*: Immunity of Aerolene impregnant and Duranite end fills. For *humidity extremes*: perfected hermetically-sealed metal-can casings

New design thrills at your finger tips! That's what these latest Aerovox capacitors mean to you by way of still better radio-electronic assemblies.

CAPACITORS • VIBRATORS • TEST INSTRUMENTS



For Radio-Electronic and Industrial Applications
 AEROVOX CORPORATION, NEW BEDFORD, MASS., U. S. A. • Sales Offices In All Principal Cities
 Export: 41 E. 42nd St., New York 17, N. Y. • Cable: AERDCAP, N. Y. • In Canada: AEROVOX CANADA LTD., Hamilton, Ont.

20

Years
of
**ENGINEERING
LEADERSHIP**

in the
**SPECIALTY
TRANSFORMER
FIELD**

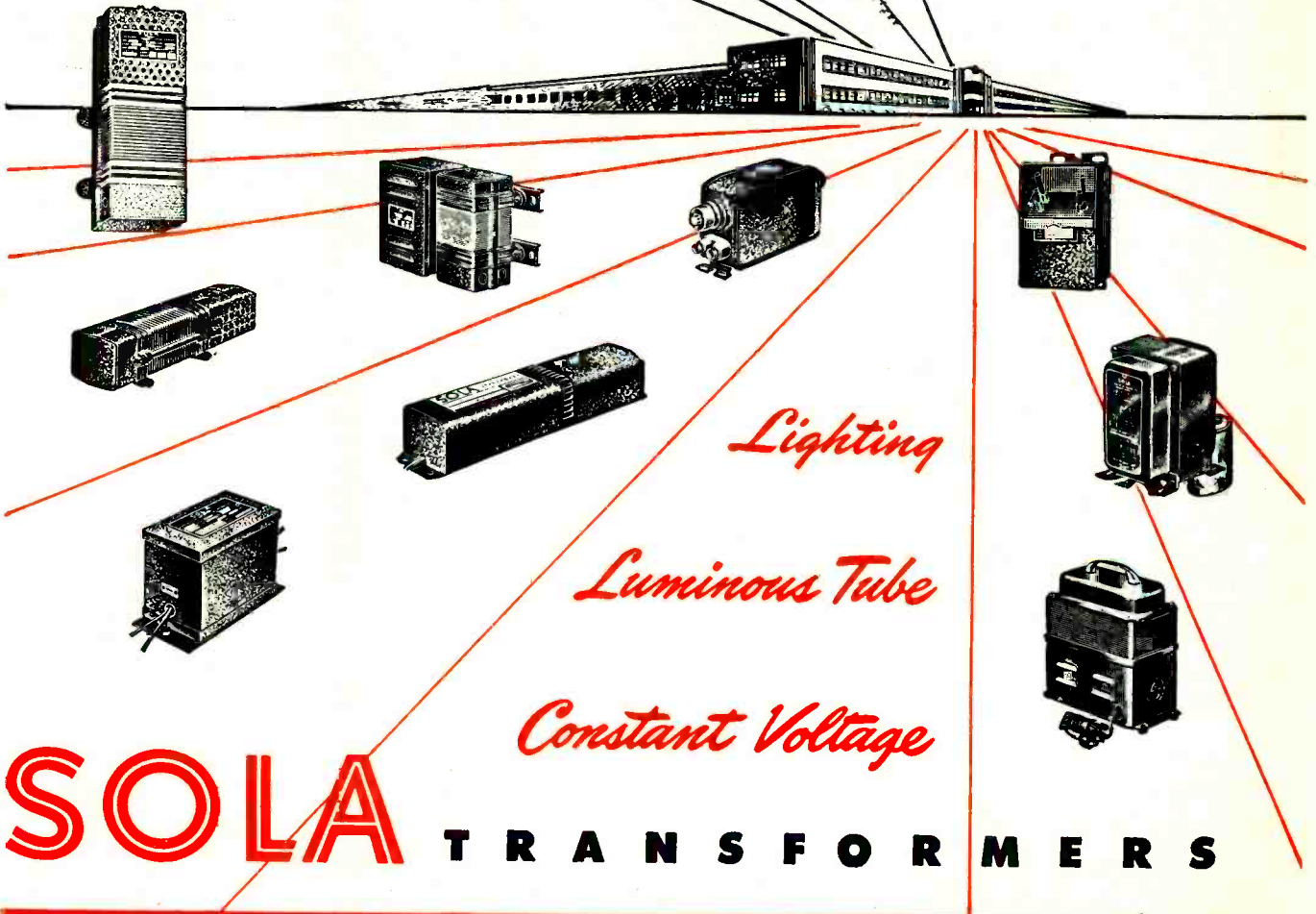

Transformers for Constant Voltage • Fluorescent Lighting • Cold Cathode Lighting • Airport Lighting • Series Lighting • Luminous Tube Signs
Oil Burner Ignition • X-Ray • Power • Controls • Signal Systems & etc. • SOLA ELECTRIC COMPANY, 4633 W. 16th Street, Chicago 50, Illinois

Where Temperature Changes affect Circuit Performance...

these Resistors provide a Solution

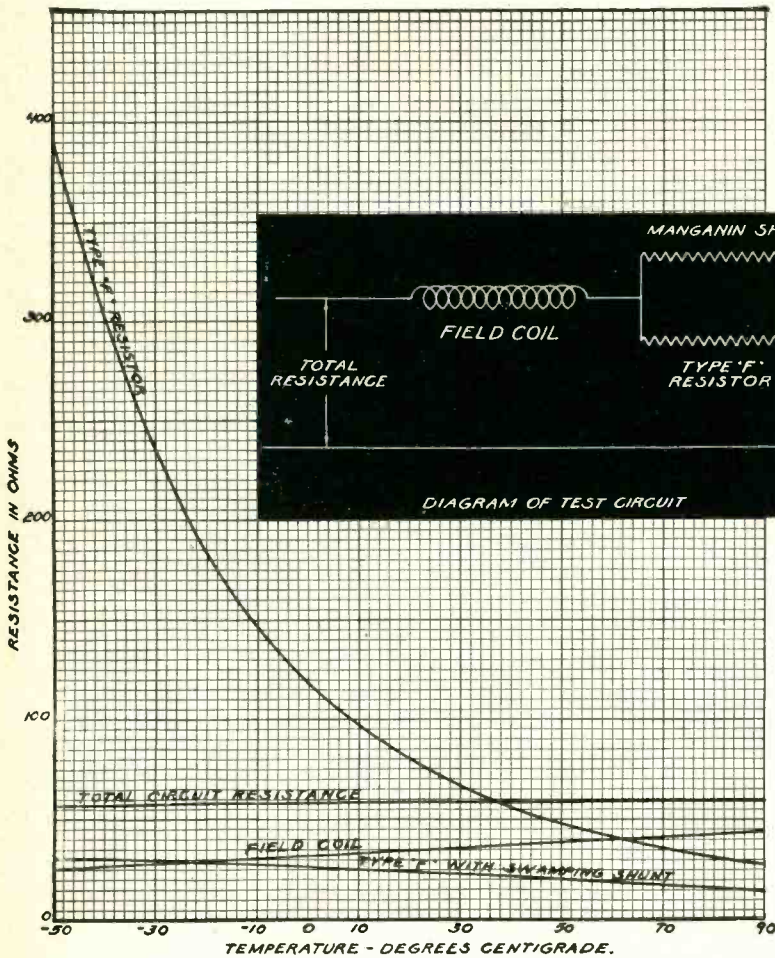
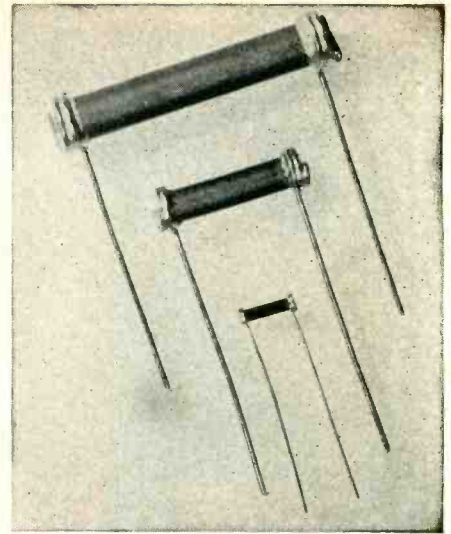

GLOBAR brand type F resistors can often provide the answer when extremes of temperature present an engineering problem. A typical example is shown by the curves plotted here. In this important control system, a GLOBAR type F resistor is used to compensate for resistance changes due to temperature variations in coils such as generator and motor fields, measuring and control circuits.

The pronounced negative resistance—temperature characteristics of GLOBAR type F resistors makes them particularly useful for stabilizing circuits having a positive temperature coefficient of resistance.

GLOBAR type F resistors have no moving parts to wear out or get out of adjustment. They have a negative temperature coefficient ranging from 1% to 2.2% per degree Centigrade at 25°C., increasing with their resistivity, and a low voltage coefficient.



● Bulletins contain useful engineering data on GLOBAR type F resistors. Copies will be supplied immediately upon request. Write Dept. V-80, The Carborundum Company, GLOBAR Division, Niagara Falls, New York.

GLOBAR Ceramic Resistors

BY CARBORUNDUM

TRADE MARK



"Carborundum" and "Globar" are registered trademarks which indicate manufacture by The Carborundum Company

Now the improved

GL-2C39-A HIGH-MU LIGHTHOUSE TRIODE!

Crowns 15 years of General Electric research and development in closely-spaced planar tubes for microwave applications.

- ★ Amplification factor 100.
- ★ Plate dissipation 100 w.

- ★ Top frequency above 2,500 mc.
- ★ Meets JAN specifications.

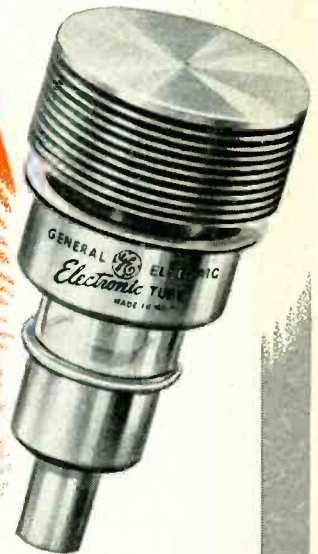

GL-2C39-A

ELECTRICAL CHARACTERISTICS

Cathode	coated unipotential
Heater voltage	6.3 v
Heater current	1.0 amp
Amplification factor, average	100
Direct interelectrode capacitances, average:	
Grid-plate	1.95 μmfd
Grid-cathode	6.50 μmfd
Plate-cathode	0.035 μmfd
Transconductance, average ($I_b = 70\text{ma}$, $E_b = 600\text{v}$)	22,000 μmhos

MAX RATINGS, R-F POWER AMPLIFIER SERVICE

Class-C FM Telephony or Telegraphy, key-down conditions, per tube.

D-c plate voltage	1,000 v
D-c cathode current	125 ma
D-c grid voltage	-150 v
Peak positive r-f grid voltage	30 v
Peak negative r-f grid voltage	-400 v
Plate dissipation	100 w
Grid dissipation	2 w

HERE is notable G-E design progress over earlier Lighthouse Types GL-2C38 and GL-2C39, which in turn originated in the laboratories of General Electric Company as the fruition of many years of tube pioneering work.

Newest, most efficient of planar types that make real the vast possibilities of the microwave regions, the GL-2C39-A combines physical compactness ($2\frac{3}{4}$ by $1\frac{3}{4}$ inches) with excellent characteristics as a power amplifier, oscillator, or frequency multiplier.

Important fields of use—where the GL-2C39-A's suitability is so marked that designers are making this fine tube their first choice—include:

- ⊕ Aircraft traffic and location controls
- ⊕ Broadcast relay equipment
- Microwave test apparatus
- Military communications
- Utility telemetering and communication systems

On these . . . and other . . . applications, General Electric tube engineers will be glad to work closely with you, and with the men at your drawing-boards who handle the details of circuit design. G-E experience with u-h-f types that goes back nearly two decades, and includes countless individual applications, is yours for the asking.

Phone, wire, or write for immediate response to your inquiry about the price of the GL-2C39-A, or for performance facts beyond those given in the right-hand column. Address *Electronics Department, General Electric Company, Schenectady 5, New York.*

GENERAL ELECTRIC

180-J5

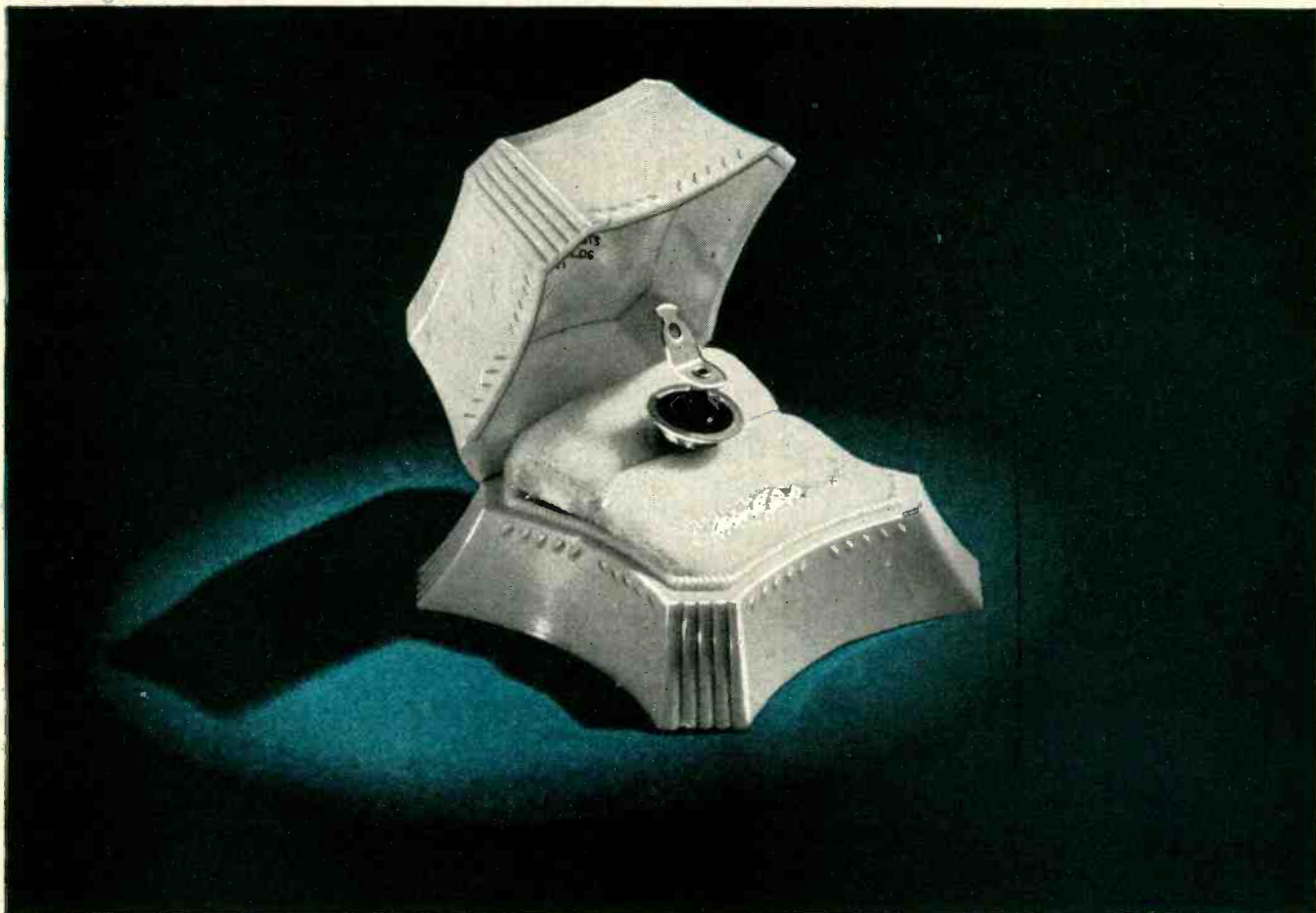

Why a Fusite Terminal Where a Diamond Ought To Be?

A Fusite Terminal would look much more natural performing its vital function in the hermetic sealing of your electrical product. But since it's every bit as valuable for 1000 other products that should be fusion sealed, we aren't playing favorites.

The smooth uniform interfusion of steel and inorganic glass that is a Fusite Terminal is as beautiful as a flawless diamond to any design engineer. In its own way, it's as rugged as the diamond used on the tip of a heavy duty drill.

It withstands the thermal shock of tortuous heat from soldering or welding and the rapid cooling that follows. It will carry up to 3000 A.C. volts (RMS) with a 10,000 megohms insulation factor after salt water immersion.

This is just one of a wide line of standard Fusite single and multiple electrode terminals.

Would you like to know more and see samples? Write to Dept. E.

TERMINAL ILLUSTRATED 112 HTL
SINGLE—HOLLOW TUBE ELECTRODE WITH LUG

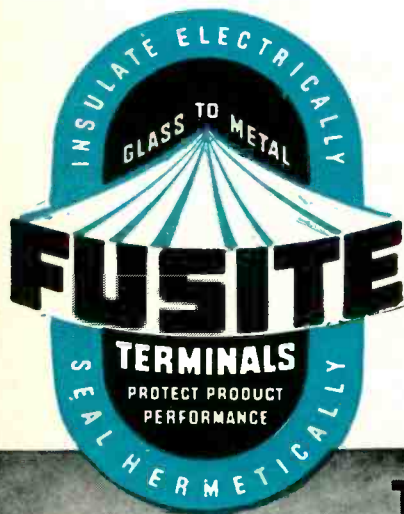

THE FUSITE CORPORATION

CARTHAGE AT HANNAFORD, NORWOOD, CINCINNATI 12, OHIO

THE
PRESTO
RC-10

**New Rack Mounting
Tape Recorder
With 10½" Reel**

These features distinguish the PRESTO RC-10 as the finest of its type available to broadcasters, recording companies, schools:

- *3-motor drive mechanism
- *Each reel driven by separate torque-type motor
- *Separate record, playback, erase heads
- *Constant tape tension to insure minimum wow or flutter
- *Two speeds: 7½ and 15"/sec
- *Fast forward and rewind speeds
- *Frequency response to 15,000 cps.
- *Takes 7" or 10½" reels
- *Instantaneous speed accuracy

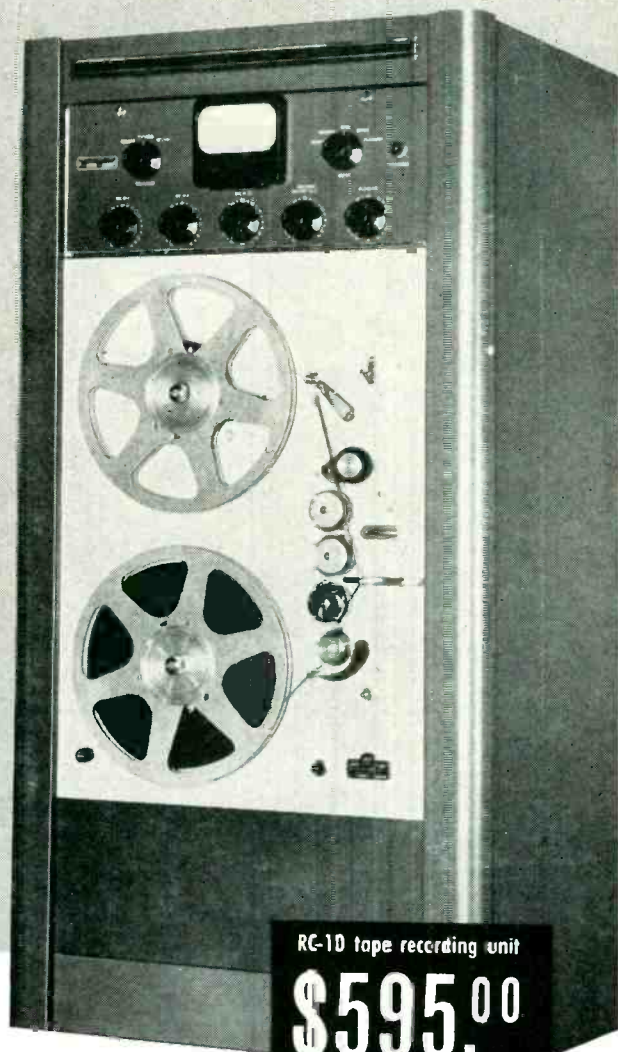

RC-10 tape recording unit

\$595.00

Ma ching 900-A1 Amplifier:
\$350.00

This new PRESTO recorder is the only machine of its type and price available today. Answering the need of broadcasters and recording studios throughout the nation, the RC-10 is another precision product of the world's largest manufacturer of instantaneous recording equipment. This is your assurance that this machine, like all other PRESTO products, is built for maximum performance and years of satisfying service.

900-A1 Amplifier is recommended for use with the RC-10 tape recorder. This is the same basic unit supplied with the PRESTO PT-900 portable tape recorder.

 **PRESTO** RECORDING CORPORATION
Paramus, New Jersey

In Canada: Walter P. Downs, Ltd., Dominion Square Bldg., Montreal, Canada
Overseas: M. Simons & Son Co., Inc., 25 Warren Street, New York, N. Y.

The *NEWEST* Development in Disc Ceramic Condensers !

RMC DISCAPS

ACTUAL SIZE

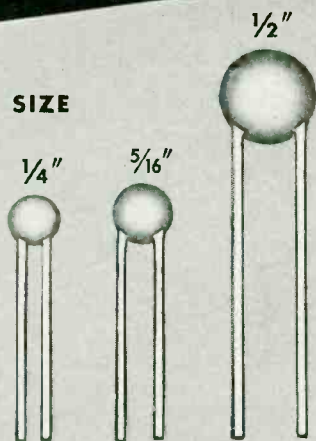

GP Series NPO and NTC General Purpose Low Capacity CONDENSERS

Type	CAP. MMF. 1/4" Body Dia.	CAP. MMF. 5/16" Body Dia.	CAP. MMF. 1/2" Body Dia.
NPO		5 TO 15	15 TO 30
N750	5 TO 20	20 TO 50	50 TO 150

Available Tolerances: $\pm 5\%$, $\pm 10\%$, $\pm 20\%$

The new GP Series DISCAPS offer for the first time a disc type general purpose zero or negative temperature coefficient disc condenser ideally suited to coupling and tuned circuit applications.

GP Series DISCAPS feature small size, low self inductance, higher working voltage (600 V.D.C.), low

power factor, greater mechanical strength and faster production line handling. Their low cost, plus their inherent quality characteristics make GP Series DISCAPS attractive to all manufacturers of high frequency equipment. Type GP Series DISCAPS are available in a variety of capacities and tolerances to suit most every requirement.

Are You Using the Now Famous Type B-GMV By-Pass Series Discaps?

Approved by leading makers of TV sets and tuners, RMC Type B-GMV DISCAPS are now available in the following capacities: .001, .0015, .002, .005, .01, 2x.001, 2x.0015, 2x.002, 2x.004, 2x.005 MFD; also Bi-element shielded section

2x.0015, 2x.005 and 2x.01 MFD. They feature small size and low self inductance and exceed GMV capacity at 85°C with 250 applied D.C.V. Capacity change between room temperature and 65°C is only + 18%, -0%.

Every DISCAP is 100% Tested for Capacity, Leakage Resistance and Breakdown

RMC production checks eliminate costly service failures. Because RMC produces the complete condenser, even to the processing of the dielectric element itself, it is possible to exercise the finest quality control. Yes, DISCAPS are definitely better!

SEND FOR SAMPLES AND TECHNICAL DATA

DISCAP
CERAMIC
CONDENSERS



RADIO MATERIALS CORPORATION
GENERAL OFFICE: 1708 Belmont Ave., Chicago 13, Ill.

FACTORIES AT CHICAGO, ILL. AND ATTICA, IND.

Two RMC Plants Devoted Exclusively to Ceramic Condensers

The
New
Adlake
"MIGHTY
MIDGET"
 (Relay 1140)



Every ADLAKE Relay gives you these "plus" features:

- **HERMETICALLY SEALED**
 (dust, dirt, moisture, oxidation and temperature changes can't interfere with operation)
- SILENT and CHATTERLESS**
- REQUIRES NO MAINTENANCE**
- ABSOLUTELY SAFE**

Now protected with metal-enclosed contact

For dependability under all operating conditions, Adlake's "Mighty Midget" Relay is now available with a metal-enclosed contact. This new improvement in the "Mighty Midget" eliminates entirely the possibility of failure due to cracked and broken switches.

Although small enough to fit into one hand, the No. 1140 Relay makes or breaks 30 amps. easily, with low operating current. Like all Adlake Relays, it requires no maintenance. Its mercury-to-mercury contact prevents burning, pitting and sticking. It is absolutely safe . . . hermetically sealed . . . and cushioned against impact and vibration.

Some of the many uses of this versatile and dependable relay are: flasher installation, power circuits, motor and heater controls and traffic signals.

Write today for full information on this new "Mighty Midget" Relay. The Adams & Westlake Company, 1107 N. Michigan, Elkhart, Indiana.



THE
Adams & Westlake
COMPANY

Established 1857 ELKHART, INDIANA New York • Chicago
 Manufacturers of Hermetically Sealed Mercury Relays for Timing, Load and Control Circuits



How to measure surface finish to less than 1/1,000,000 of an inch

● The Brush Surface Analyzer gives exact measurement of surface finishes to less than 1/1,000,000 of an inch—and provides a permanent record of each measurement as well as indicating the average finish in micro-inches. This super-sensitive measuring and recording device is rapidly becoming indispensable in more and more industrial plants where precision work is demanded.

One user, **Commercial Centerless Grinding Company**, of Cleveland, Ohio, employs the Brush Surface Analyzer to record the surface finish of instrument parts. They say, "Until just a few years ago, customers specified just 'smooth finish' when accurate finishing was wanted. Today, many of our work orders carry exact specifications, often requiring tolerances as low as one micro-inch.

"We use our Brush Surface Analyzer to make certain

that all surface specifications are being met, and to furnish the customer with a permanent record of our inspection results."

Commercial Centerless has found that this builds customer confidence and product endorsement that brings increased business.

If you manufacture or use precision parts, find out how you can benefit from the accurate measurements and proven results made possible by Brush Recording Analyzers. Write today for more information.

THE *Brush* DEVELOPMENT COMPANY

3405 Perkins Avenue, Cleveland 14, Ohio, U. S. A.

Canadian Representatives: A. C. Wickman (Canada) Ltd., P. O. Box 9
Station N, Toronto 14, Ontario



Put it in writing with a

BRUSH RECORDING ANALYZER

STRAIN ANALYZERS • SURFACE ANALYZERS • CONTOUR ANALYZERS • UNIVERSAL ANALYZERS • UNIFORMITY ANALYZERS

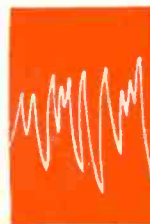

Another successful start with **DUMONT**

WHBF-TV

ROCK ISLAND, ILLINOIS

Channel 4

Another Television station with an eye to the future! WHBF-TV now goes on the air with Du Mont equipment assuring dependable, economical operation with all the advantages of the Du Mont "Grow As You Earn" system of equipment expansion. Air-cooled tubes, finest TV transmitter engineering and quality workmanship stand for low-operating expense characteristic of Du Mont TV transmitting equipment.

WHBF-TV operates on Channel 4 in Rock Island, Ill., covering the Quad Cities Area. We take this opportunity to congratulate WHBF-TV and welcome it to the ranks of the ever-increasing commercial TV stations of America.

Remember, it's smart business to investigate Du Mont first — and then compare.

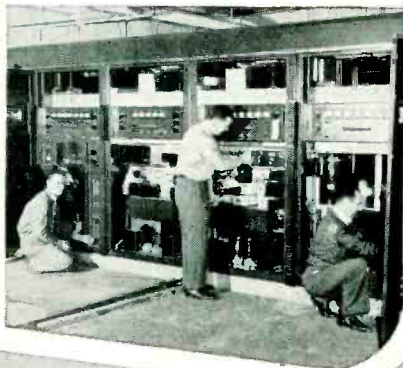
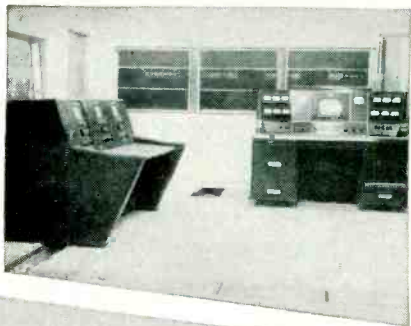

DUMONT

First with the Finest in Television

ALLEN B. DU MONT LABORATORIES, INC., TELEVISION TRANSMITTER DIVISION, CLIFTON, N. J.
ELECTRONICS — August, 1950

FOR TV RECEIVER TESTING ★ FOR BROADCAST

Get both VHF and



Electronic

Fast and Reliable TV Receiver Testing—makes this scope particularly useful in head-end position work. Unsurpassed for stability and fine trace . . . excellent definition . . . no bounce when shifting bands. Where the sweep generator does not have a baseline, measurements can be taken on the DC amplifier. Delivers maximum sensitivity without sacrifice of frequency response. Low capacity input probe is provided for trouble shooting.

In Broadcast Stations, It Pin-points Trouble—helps you stay on the air with maximum performance. Use it to check hum, noise, distortion, modulation, phase relationships; measure gain and sweep generator output; isolate defective components; determine frequency response of audio circuits.

In Laboratories, It's Versatile—Fits many applications where waveform study is essential. Built-in voltage calibrator permits calibration of the scope for voltage measurements. Gives you wide frequency response without recourse to peaked amplifier coupling circuits. Straight resistance coupling is used, and the scope can be employed on frequencies up to 3 mc. Excellent transient response within the frequency range of the instrument.

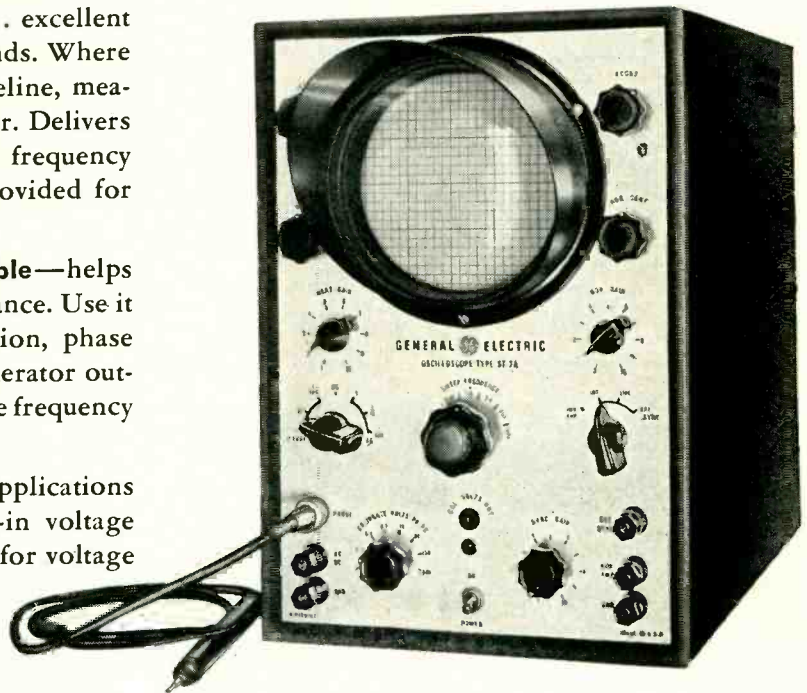

TV SCOPE ST-2A

SPECIFICATIONS

Frequency Response

Vertical Amplifier

Probe and AC—+0,—20% from 20 cycles to 500 kc (Square Wave response 60 to 40,000 cycles.)

+0,—50% from 20 cycles to 1 megacycle with gradual reduction in response beyond 1 mc.

DC—+0,—20% from 0 to 500 kc at full gain setting.

Sweep Range

10 cycles to 100 kc in six overlapping ranges.

Sensitivity

Vertical

1. AC Input—.015 volts RMS per inch
2. DC Input—2.0 volts DC per inch
3. Probe—.20 volts RMS per inch

Horizontal—.4 RMS volts per inch

Calibrating Voltages

Seven AC voltages of power line frequency—.3, 1.5, 3, 15, 30, 150 and 300 volts with $\pm 15\%$ accuracy.

STATIONS ★ FOR DEVELOPMENT LABORATORIES

UHF coverage

TEST EQUIPMENT

VARIABLE PERMEABILITY SWEEP GENERATOR—ST-4A

Completely Electronic. No Moving Parts. Using an exceptionally wide linear sweep, this instrument is ideal for television receiver maintenance, TV production and development laboratories, wide band amplifier study, and transmission line impedance measurements. The front panel is slotted, permitting the equipment to be removed and mounted in a standard 19-inch relay rack. A new Balanced Output Adaptor (Type ST-8A), also available, provides balanced 300 ohm output from the sweep generator.

SPECIFICATIONS

- Frequency Range:** Continuously variable from 4 to 110 mc and 170 to 220 mc. Can be used through 900 mc on harmonic operation.
- Sweep Width:** Linear from 500 kc to greater than 15 mc.
- Output Voltage:** Greater than 0.1 volts from 4 to 110 mc.
Greater than 0.5 volts from 170 to 220 mc.
- Output:** Single-ended or balanced 300 ohm output.



MARKER GENERATOR TYPE ST-5A

Functions as a crystal referenced calibrator from 10 mc to 300 mc. When used with the G-E sweep generator, it provides a multiple of markers spaced 1.5 or 4.5 mc apart . . . or can be used to supply a marker or markers at any frequency from 10 mc to 900 mc.

SPECIFICATIONS

- Picture Carrier Oscillator:** 15 position rotary selector switch selects 12 crystal-controlled frequencies plus 3 tuneable ranges covering intermediate frequencies.
- Channel Crystal Accuracy:** .02%
- IF Ranges:** 3 Bands—20 to 27 mc; 27 to 37 mc; 37 to 50 mc
Accuracy: dial hand calibrated, crystal calibrator $\pm .05\%$.
- Crystal Modulator:** Provides audio and intermediate frequency locations simultaneously with picture carrier.
- Crystal Accuracy:** 4.5 mcs .05% 1.5 mcs .15%.

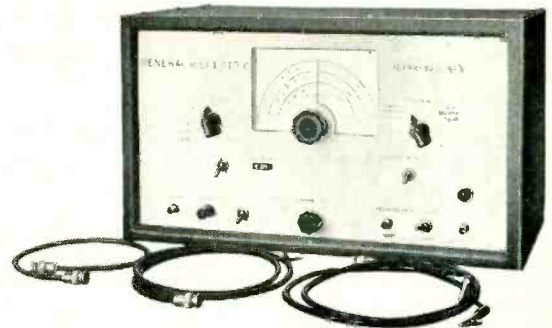

ILLUSTRATED BULLETINS

Complete information will be furnished on any of the General Electric test instruments listed here. Check those you are interested in . . . then fill in and mail the coupon today.

- | | |
|--|--|
| <input type="checkbox"/> TV Scope ST-2A | <input type="checkbox"/> Industrial Tube Analyzer YTW-3 |
| <input type="checkbox"/> Sweep Generator ST-4A | <input type="checkbox"/> Distortion and Noise Analyzer YDA-1 |
| <input type="checkbox"/> Marker Generator ST-5A | <input type="checkbox"/> Square Wave Generator |
| <input type="checkbox"/> Balanced Output Adaptor ST-8A | <input type="checkbox"/> Industrial Scope YNA-4 |
| <input type="checkbox"/> Regulated Power Supply YPD-2 | |

General Electric Company, Section 480
Electronics Park, Syracuse, New York

Please send me further information on products checked at left.

NAME.....
COMPANY.....
ADDRESS.....
CITY.....STATE.....

GENERAL ELECTRIC

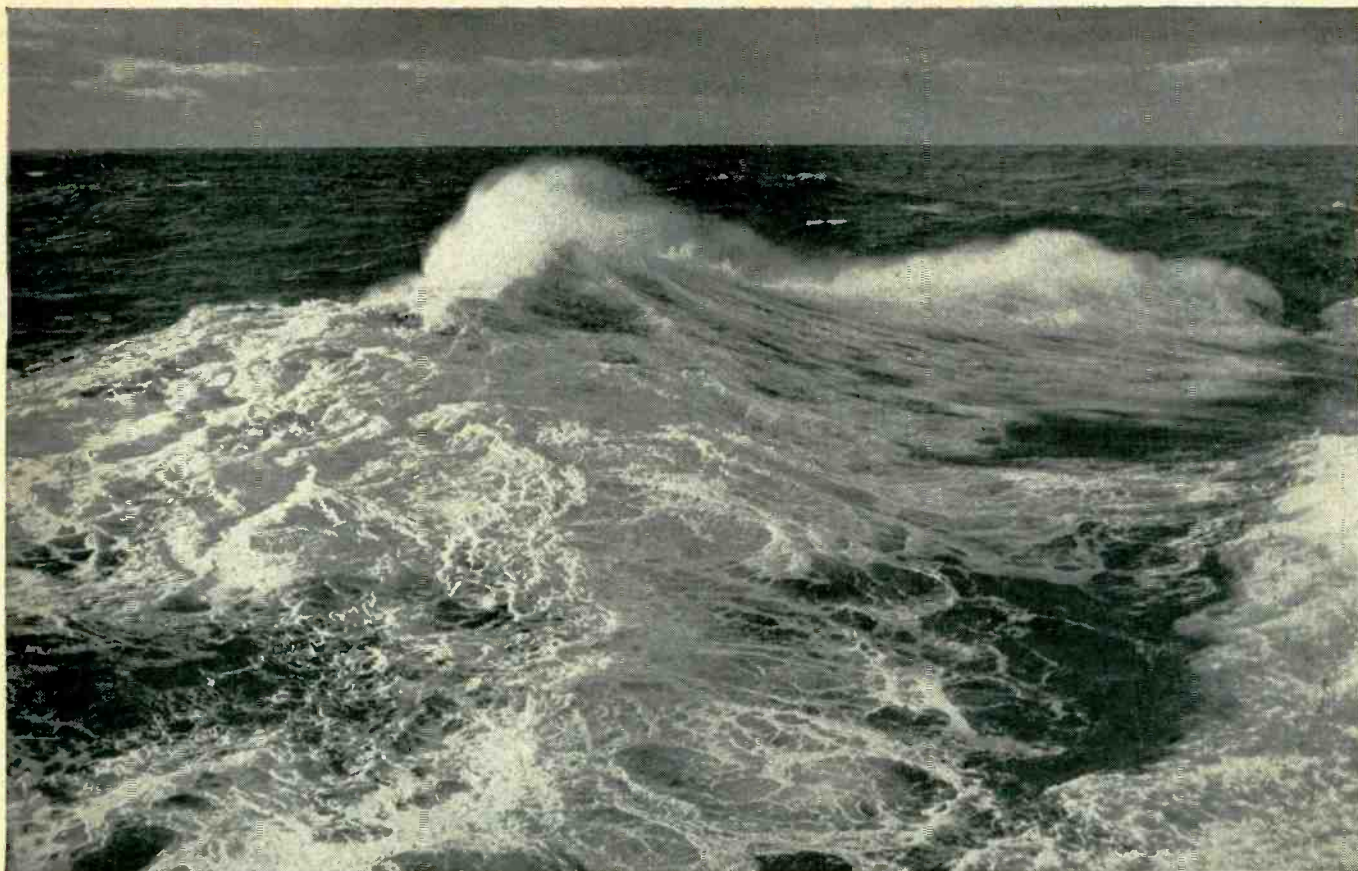

Photo by Ewing Galloway

water... *blue, green or white*

What's the color of water?

In a glass it's clear, yet Columbus sailed the "ocean blue". Sailors call it "green water" when a solid wave crashes over the rolling deck. Other times water is frothy white in the wake of a moving ship.

But whether blue, green, white or clear — water no longer holds all its old mysteries of "how deep?" or "what's below?" Thanks to the use of *sonar*, under-water detection equipment developed and manufactured by Edo for the U.S. Navy now lets the navigator see below with electronic eyes of far greater range and accuracy.

OUR TWENTY-FIFTH ANNIVERSARY

Next month we will observe our twenty-fifth anniversary — the completion of a quarter of a century of experience in research, development and manufacturing. Since 1925 the company has been closely identified with the aviation industry and the marine field having pioneered in the development of all-metal seaplane floats. With the growing importance of electronic equipment in both marine and aviation, a staff of top electronic engineering and manufacturing personnel has been developed to design and produce various types of underwater detection equipment.

If you'd like to receive our attractive, illustrated "Twenty-Fifth Anniversary" booklet, just drop a line to Dept. ES-3, Edo Corp., College Point, N. Y.



EDO CORPORATION · COLLEGE POINT, N. Y.

OHMITE RHEOSTATS

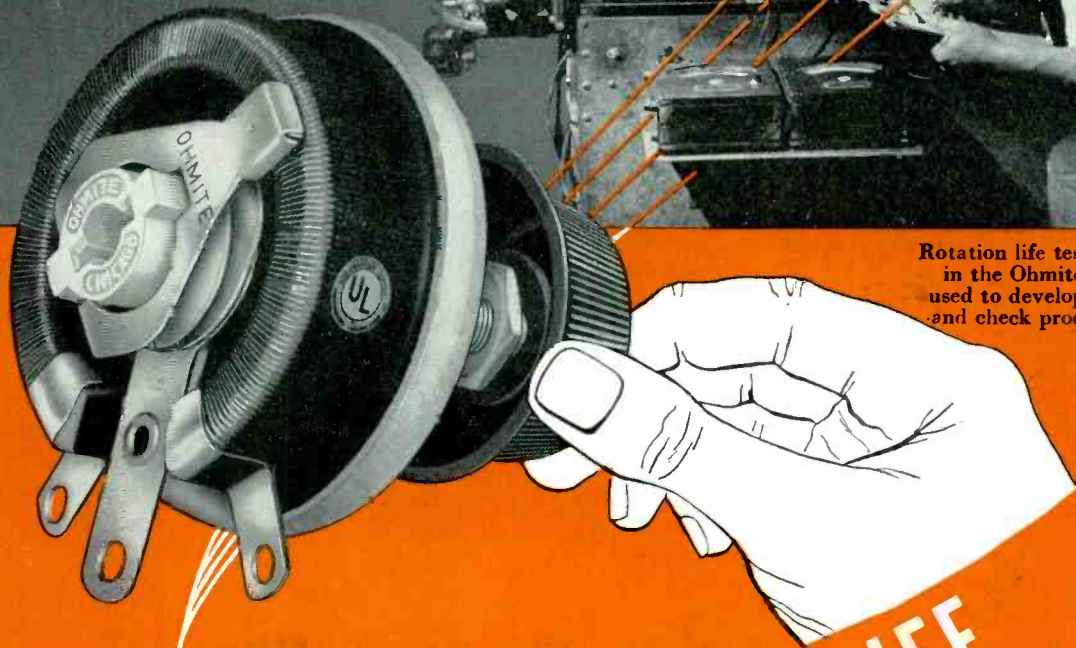

Rotation life testing machine in the Ohmite Laboratory, used to develop new designs and check production units.

BUILT FOR LONGER LIFE

The reputation of your product rests upon the unfailing dependability of every part that goes into its construction. That's why it is so important that every component part be built for lasting performance.

Ohmite rheostats have been engineered for long life . . . built to give years of trouble-free service without maintenance. Their time-proven features—outlined on the following page—provide unfailing performance, day in and day out under adverse operating conditions. That's why more manufacturers have standardized on Ohmite rheostats for their products than any other rheostat on the market. It will pay you, also, to standardize on Ohmite rheostats.

Be Right with

OHMITE

Reg. U. S. Pat. Off.

**RHEOSTATS
RESISTORS
TAP SWITCHES**

"INDUSTRY'S FIRST CHOICE"

25th Anniversary

1925-1950

OHMITE HAS THE RHEOSTAT YOU NEED!

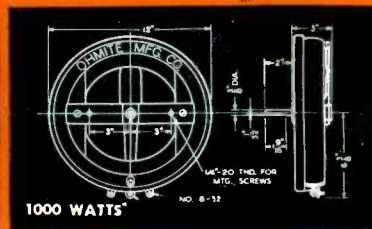
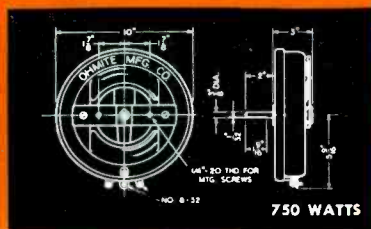
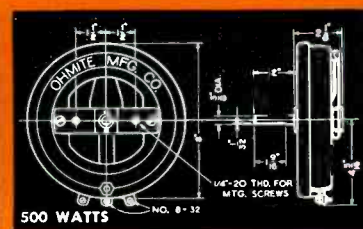
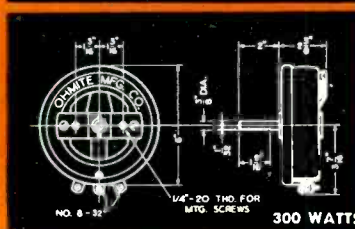
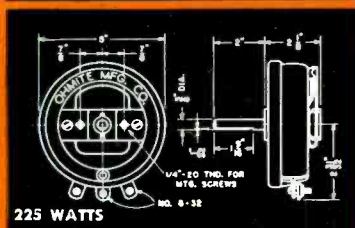
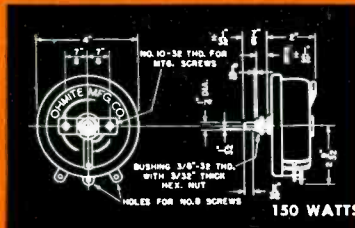
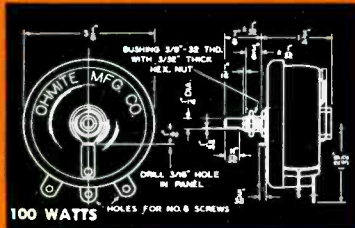
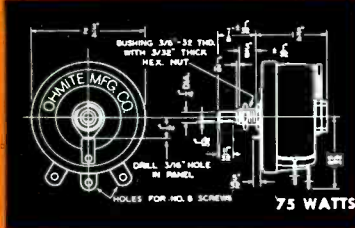
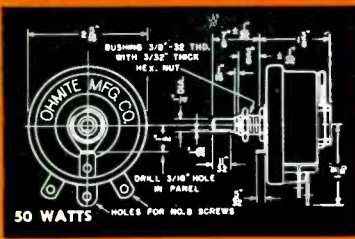
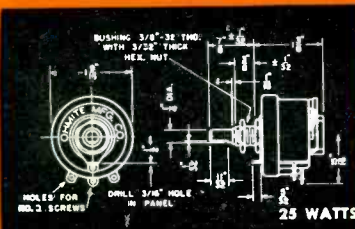

THE INDUSTRY'S MOST COMPLETE LINE—

- Ten Standard Sizes, 25 to 1000 Watts
- Special Units for Unusual Requirements

There is a *standard* Ohmite rheostat to meet practically every requirement. That's because Ohmite's line of standard rheostats is the most extensive available. Furthermore, six wattage sizes, in a wide range of resistance values, are carried in stock for immediate shipment. Special resistance values, tapered windings, tandem assemblies, and many other variations can be made to order quickly.

All rheostats have the distinctive, time-proven Ohmite design features—the all-ceramic construction, windings permanently locked in vitreous enamel, and smoothly gliding, metal-graphite brush. All are engineered to Ohmite standards for utmost dependability and long life.



Write on company letterhead for your copy of the Ohmite Catalog and Engineering Manual No. 40.

OHMITE MANUFACTURING COMPANY
4816 Flournoy St.
Chicago 44, Ill.



Be Right with

OHMITE

Reg. U. S. Pat. Off.

**RHEOSTATS • RESISTORS
TAP SWITCHES**



Pan American pioneers radiotelephone network

... equipment by COLLINS

WHEN Pan American World Airways opened a route into the Middle East in 1947, all en route plane-ground communications had to be performed by radiotelegraph—the dot-dash system. A radiotelephone network, like that used on the United States airways, did not exist overseas.

Today, through the initiative of Pan American, messages can be exchanged immediately by radiotelephone between Clipper pilots and ground radio-operators over every foot of the Clipper routes from New York to Basra, Iraq, and from New Delhi, India, eastward round the world to San Francisco.

To accomplish this extensive pioneering job, Pan American has invested three years of work and a large sum of money. This airline has negotiated permission for radio stations with foreign governments, and has installed these stations at a number of points in Europe and Asia. Pilots and ground personnel have been trained for the new operation, and the Clippers' radio installations have been modified from radiotelegraph to radiotelephone.

The major radio units chosen by Pan American World Airways for this purpose, and for the Caribbean area, are Collins high frequency ground station and airborne transmitters and receivers. In-

cluded are Collins 231D 3.5/5 kilowatt Autotune* transmitters, 16F 300/500 watt Autotune* transmitters and 51N receivers on the ground, and 18S transmitter-receivers in the air.

To complete the modernization of its ROUND THE WORLD system, Pan American has installed Collins 231D and 16F transmitters, and 51N receivers, in route stations at Santa Maria, Lisbon, London, Munich, Vienna, New Delhi, Calcutta, Bangkok, Manila, Honolulu, Los Angeles, San Francisco and Seattle; a 16F transmitter and 51N receivers at Vienna; a 16F transmitter at Damascus; and 51N receivers at Rome.

Additionally, a great improvement in ground radiotelephone service was made at Munich. There, VHF communications were relocated from the airport to the top of 10,000-foot Mount Zugspitze in the Bavarian Alps, whence a Collins 3000A very high frequency transmitting and receiving installation increases the effective operating radius from 50 to 250 miles, covering an area from Luxemburg to Milan, Italy.

This pioneering by Pan American World Airways is in the best tradition of American free enterprise. Collins is proud to have been chosen to play a part.

* REG. U.S. PAT. OFF.

IN RADIO COMMUNICATIONS, IT'S . . .



COLLINS RADIO COMPANY, Cedar Rapids, Iowa

11 W. 42nd Street, NEW YORK 18

2700 W. Olive Avenue, BURBANK

The Development of CARBONYL IRON POWDERS

Carbonyl Iron Powder is an extremely pure form of iron, the metal content being over 99.99% iron, produced in the form of almost perfect spheres only one to fifteen microns in diameter—the average diameter being 8 microns (.00032 inches). It has been produced commercially for some years, primarily for use in magnetic cores for electronic equipment. Its production is therefore now under perfect control to give absolute reliability in quality and properties.

The production of Iron Carbonyl, from which Carbonyl Iron Powders are made, depends on a unique reaction, which was discovered in 1890 by the distinguished British chemist, Sir Ludwig Mond. When iron is treated with carbon monoxide it reacts to form iron pentacarbonyl, a rare case of a liquid compound of a metal. Each atom of iron combines with five molecules of carbon monoxide to give a compound with the formula $Fe(CO)_5$. This reaction leaves behind any impurities in the original iron.

This liquid is vaporized and the vapor heated above 200°C, when it decomposes into its constituents. The carbon monoxide is driven off and the iron separates from the vapor phase, first in the form of free atoms, then as ultramicroscopic crystals, finally as microscopic, almost perfect spheres. The particle size distribution can be controlled by temperature, pressure and other operating conditions.

Controlled purity and distribution of particle size is essential for use of the powder in electronics, where minor

variations in these properties have exaggerated consequences in delicate electrical and magnetic effects.

The only other elements present are non-metals such as carbon, oxygen and nitrogen. In G A & F Carbonyl Iron

Powder, they amount to not more than 0.8% carbon, 0.9% oxygen and 0.7% nitrogen.

The first large-scale production of Iron Carbonyl was undertaken in Germany shortly after 1920. By 1928 the process had been adapted to the continuous commercial production of Carbonyl Iron Powder. Subsequently, detailed studies and meticulous laboratory-type controls in the plant permitted accurate regulation of purity and particle size for the needs of the modern electronic industry.

The first commercial Carbonyl Iron plant in the United States was opened at Grasselli, N. J., in 1941 by the General Aniline & Film Corporation, primarily to meet the large wartime demand for electronic equipment. Newer and finer grades of the powder were developed for use in high-frequency electronic equipment for radar and television. Later a second plant was put into operation at Huntsville, Alabama.

Thus the G A & F Carbonyl Iron Process is now well established and in steady operation. It is an outstanding case of the successful precision control of a sensitive chemical reaction to produce a unique material that must meet extraordinary specifications of purity, particle shape and size, and uniformity.

Write today for a free book—fully illustrated with performance charts and application data. It will help radio engineers or electronics manufacturers to step up quality, while saving real money. Kindly address your request to Dept. # 26.

The Core is the Heart of the Circuit

We are privileged to serve the
leading manufacturers of
CARBONYL IRON POWDER CORES

Aladdin Radio Industries, Inc.
Chicago, Illinois

**Henry L. Crowley
& Company, Inc.**
West Orange, New Jersey

Delco Radio Division
*General Motors Corporation
Kokomo, Indiana*

Lenkurt Electric Co., Inc.
San Carlos, California

Magnetic Core Corporation
Ossining, New York

National Moldite Company
Hillside, New Jersey

**Powdered Metal Products
Corporation of America**
Franklin Park, Illinois

Pyroferic Company
New York, New York

Radio Cores, Inc.
Oak Lawn, Illinois

RCA Victor Division
*Radio Corporation of America
Camden, New Jersey*

Speer Resistor Corporation
St. Marys, Pennsylvania

Stackpole Carbon Company
St. Marys, Pennsylvania

ANTARA® PRODUCTS

CARBONYL IRON POWDERS . . . SURFACTANTS

GENERAL

ANILINE & FILM CORPORATION

444 MADISON AVENUE • NEW YORK 22, N. Y.

G A & F® Carbonyl Iron Powders



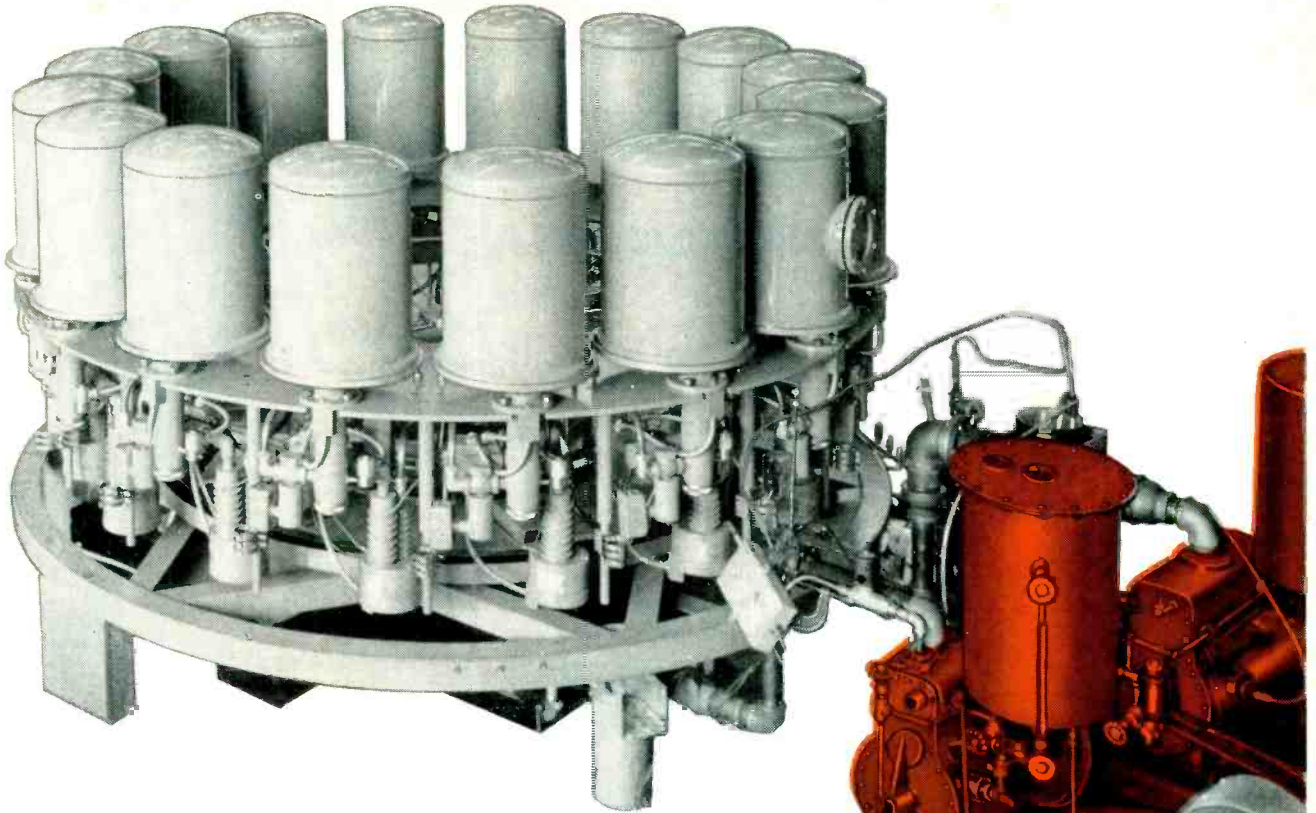

A VACUUM *Beauty Bath*

Vacuum metallizing and coating, originally developed for bomb sight lenses and aviators' goggles, is now applied to many everyday products — such as automobile ornaments, refrigerator name plates, costume jewelry, children's toys, and scores of other items. In many cases, the atom-thick coating it produces is really a beauty treatment. In others, vacuum metallizing permits important functional improvements. Metallized bomb sights, for example, permit direct sight into the sun. Again and again, the vacuum metallizing beauty bath has improved products and increased their sales potentials.

Kinney Vacuum Pumps work here, too! This continuous vacuum metallizing machine, developed by Distillation Products Industries, employs diffusion pumps and Kinney Rotary Vacuum Pumps to create the low absolute pressures required. As in many other vacuum processes, Kinney Pumps are used for roughing down from atmospheric pressure to a few microns Hg. abs., and for backing the diffusion pumps in subsequent stages of the process.

Because of their high pumping speed, their wear-free operation, and their ability to consistently create extremely low ultimate pressures, Kinney Rotary Vacuum Pumps are ideally qualified for all types of vacuum processing work — distillation, exhausting, coating, and metallurgy. If you are planning to use low absolute pressures, by all means learn more about Kinney Pumps. Write for Bulletin V45 — the complete story on Kinney Vacuum Pumps, Oil Separators, and Vacuum Pumping Accessories.

Single Stage Kinney Pumps available in eight sizes: capacities from 13 to 702 cu. ft. per min. — for pressures to 10 microns Hg. abs. Compound Pumps in three sizes: 5, 15, and 46 cu. ft. per min. — for pressures to 0.5 micron Hg. abs. or lower.

KINNEY MANUFACTURING COMPANY 3565 Washington St., Boston 30, Mass.

Representatives in New York, Chicago, Cleveland, Houston, New Orleans, Philadelphia, Los Angeles, San Francisco, Seattle.

Foreign Representatives: General Engineering Co. (Radcliffe) Ltd., Station Works, Bury Road, Radcliffe, Lancashire, England . . . Horrocks, Roxburgh Pty., Ltd., Melbourne, C. I. Australia . . . W. S. Thomas & Taylor Pty., Ltd., Johannesburg, Union of South Africa . . . Novelectric, Ltd., Zurich, Switzerland.

**Making old things better
Making new things possible**

KINNEY Vacuum Pumps

NEW Miniature Telephone Type Relay

NEW LK RELAY

MOUNTING: End mounting for back of panel or under-chassis wiring. Interchangeable with standard "Strowger" type mounting.

COIL POWER: From 40 milliwatts to 7 watts D.C.

CONTACTS: Standard 2 amperes, special up to 5 amperes. 2 amperes up to 6 P.D.T. 5 ampere contacts (low voltage) up to 4 P.D.T. Special 20 ampere power contacts S.P.S.T., normally open, paralleled.

DIMENSIONS:

1 5/8" HIGH, 2 7/32" LONG,
1 3/32" WIDE

*These are the dimensions
for the 6 pole relay.*

*Will meet Army and Navy
aircraft specifications
as a component unit.*

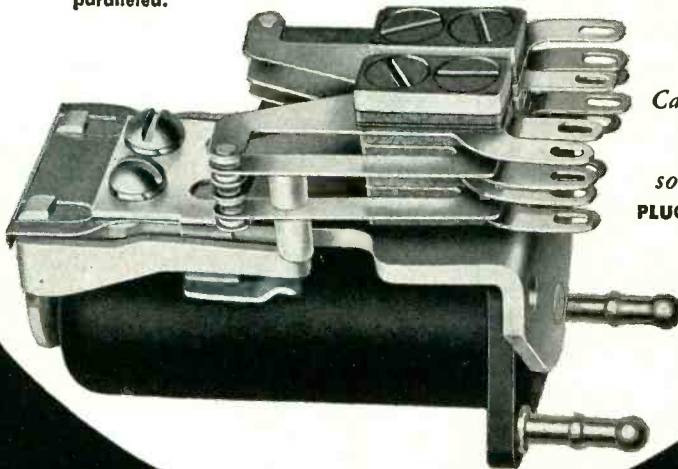

*Can be furnished
hermetically
sealed with
solder terminals.*
**PLUG-IN MOUNTING-
SPECIAL.**

SK RELAY

MOUNTING: Front of panel mounting and wiring.

COIL POWER: From 100 milliwatts to 4.5 watts D.C.

CONTACTS: Same as "LK".

DIMENSIONS: 1 1/2" HIGH, 1 9/16" LONG, 3 1/32" WIDE.

*These are the dimensions
for the 4 pole relay.*

*Will meet Army and Navy
aircraft specifications
as a component unit.*

**CAN ALSO BE FURNISHED
HERMETICALLY SEALED
WITH SOLDER TERMINALS.
PLUG-IN—SPECIAL.**

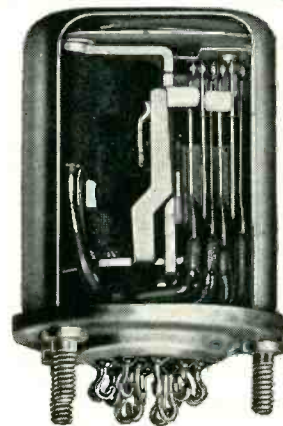

SK, HERMETICALLY SEALED

AL-132



ALLIED CONTROL CO. INC. 2 EAST END AVE., NEW YORK 21, N. Y.

ASK *Erie* RESISTOR...

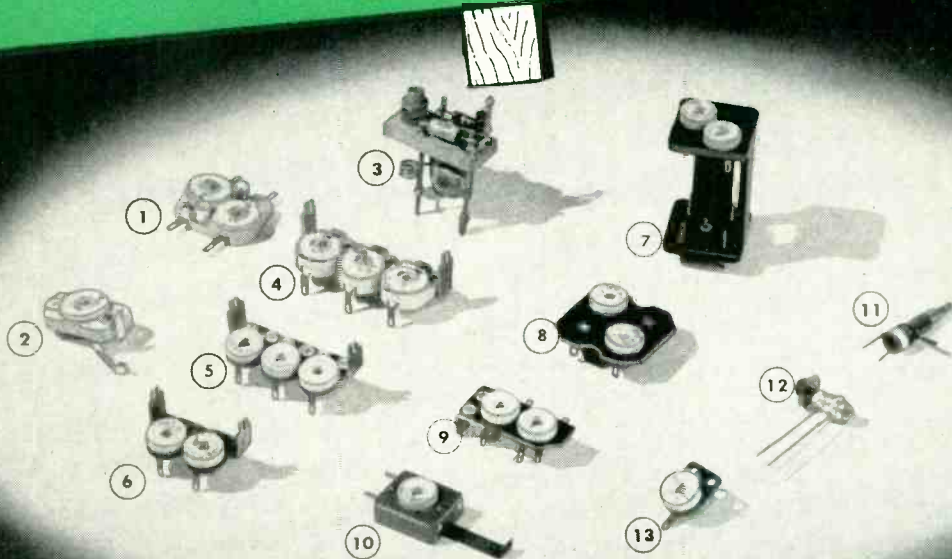

... About *Custom Designed Trimmers*

Pictured above are several custom designed trimmers that incorporate the elements of standard Erie Disc and Tubular Ceramicon Trimmers. Each has been developed for a specific purpose, and each does its job efficiently and economically. Proper design and precision manufacturing, plus our years of experience, are the keynote to Erie quality.

Look at these units carefully. They should suggest the possibility of using Erie Resistor know-how and facilities to make your equipment more compact and more efficient.

Erie has the most complete trimmer line in the industry. We want to work with you in adapting them to your requirements. Inquiries should specify complete mechanical and electrical requirements.

- ① Standard Style TD2A Dual Trimmer with mounting pillars.
- ② Special ribbon type terminals on standard Style TS2B Trimmer for direct connection to other components.
- ③ Compact Trimmer—Capacitor—Resistor—Coil Design. A complete oscillator unit.
- ④ Where special mounting is desired, standard Erie Style TS2A and Style 557 Trimmers can be supplied mounted on brackets.
- ⑤
- ⑥
- ⑦ Two trimmer elements become an integral part of this coil form and I. F. top section.
- ⑧
- ⑨ Special bracket and terminal arrangements or dual trimmer unit.
- ⑩ A compact pluggable assembly for mounting a trimmer in parallel with a plug-in crystal.
- ⑪ Special tubular ceramic trimmer and variable inductance having one common terminal.
- ⑫ Special steatite tubular dual trimmer.
- ⑬ Standard Erie Style 557 Trimmer with special bent rotor terminal.



Electronics Division

ERIE RESISTOR CORP., ERIE, PA.
LONDON, ENGLAND • • • TORONTO, CANADA

An Open Letter

TO THE RADIO & TELEVISION INDUSTRY

about Allen-Bradley Resistors

WARNING!— Allen-Bradley fixed and adjustable resistors are sold . . . under the Allen-Bradley name . . . *exclusively to manufacturers*. They are not merchandised by Allen-Bradley through dealers, jobbers, distributors, or agents.

In spite of continued expansion of plant facilities, Allen-Bradley resistor production has not been able to catch up with the demands of our customers . . . the original equipment manufacturers. We sincerely regret that this shortage so often affects our customers' production schedules.

No trade outlet for radio component parts can, therefore, legitimately represent itself as an Allen-Bradley authorized dealer, even though it may acquire an occasional inventory of surplus resistors through a roundabout course. Such supplies of Allen-Bradley fixed and adjustable resistors were never obtained direct from the Allen-Bradley Company, whose productive effort is dedicated to providing electronic equipment manufacturers with resistors of the finest quality.

Allen-Bradley Co.

J. F. [Signature] President



Bradleyunit Molded Fixed Resistors
1/2 watt . . . 1 watt . . . 2 watt ratings.



Bradleyometer Adjustable Resistors
2 watt . . . single, dual, and triple units.



ALLEN-BRADLEY

FIXED & ADJUSTABLE RADIO RESISTORS

Sold exclusively to manufacturers

QUALITY

of radio and electronic equipment



**It's
Amazing!**



TV Monitor Console



Desk Panel Cabinet Rack



Induction Heater Housing



Chassis



Marine Radio Housing



Cabinet

How Karp Makes Custom-Built Metal Cabinets and Boxes at Prices that Compete with those of Stock Items

The advantages and true economies of Karp custom-built cabinets, boxes, or housings over stock items are these:

- Your own exclusive design distinguishes and "styles" your product . . . gives it more market value.
- Flexibility of construction details speeds and simplifies your final assembly—saving you time and money.
- Our vast stock of dies can save you special die costs.
- Our 70,000 square feet of modern plant, with hundreds of craftsmen, means ample capacity for many types of work—simple or elaborate—at one time.
- Plant is fully equipped with every mechanical facility that aids economical production.
- Finishing is done in dustproof paint shop, with latest water-washed spray booths and gas-fired ovens mechanically and electronically controlled.
- We make no stock items or products of our own. Our plant, time and effort are 100% for our customers' work.
- Our engineering staff can help solve any possible design and production problems.
- It's results that count—and we give you the results you want.

Write for illustrated data book describing our facilities and showing the wide range of sheet metal fabrication we do.

CABINETS • BOXES • CHASSIS • HOUSINGS • ENCLOSURES

KARP METAL PRODUCTS CO., INC.

215 63rd STREET, BROOKLYN 20, NEW YORK

Custom Craftsmen in Sheet Metal

DELTAMAX *-now available!*

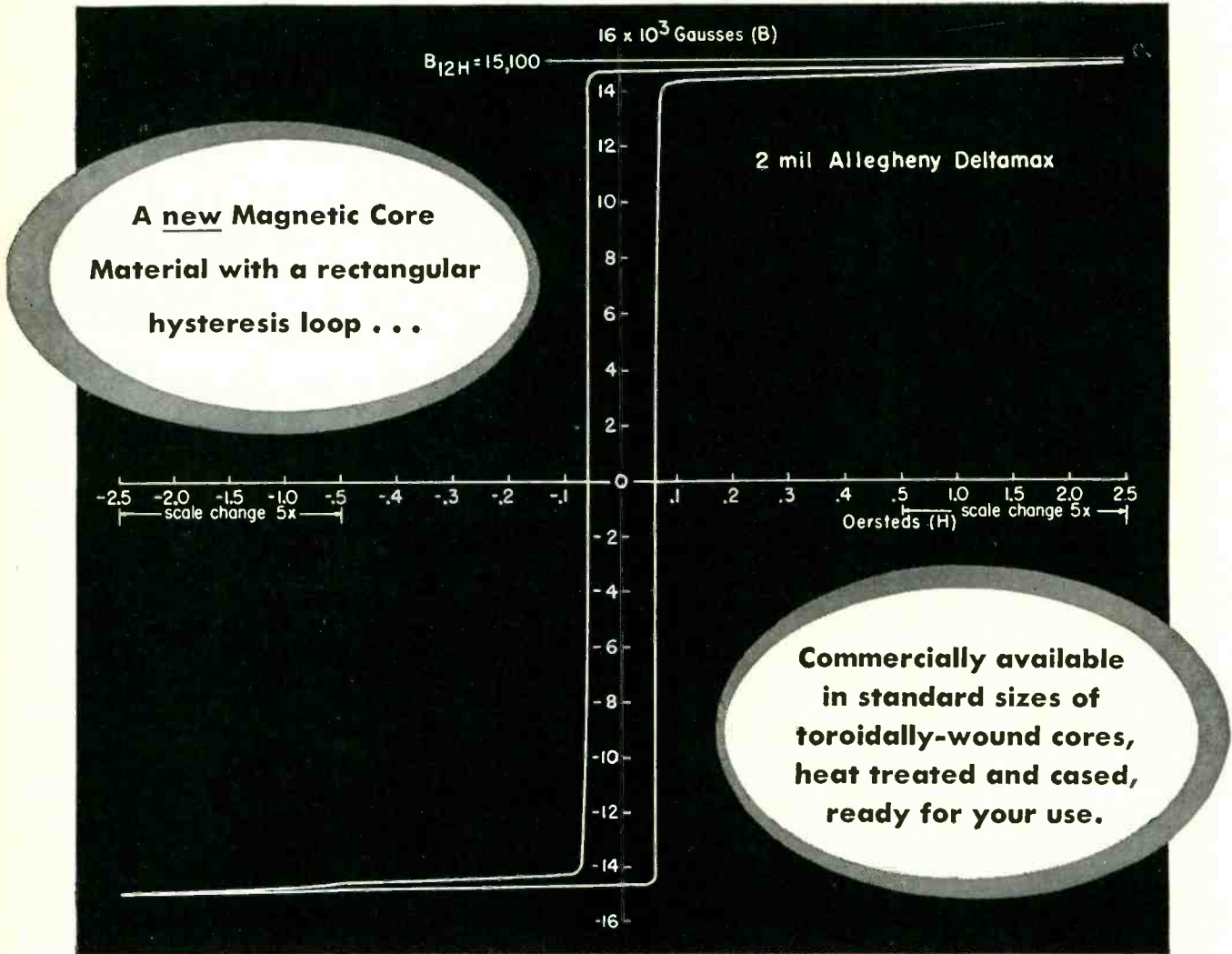

Where can YOU use a Magnetic Material with these specialized, dependable characteristics?

The properties of Deltamax are invaluable for many electronic applications, such as new and improved types of mechanical rectifiers, magnetic amplifiers, saturable reactors, peaking transformers, etc. This new magnetic material is available now as "packaged" units (cased cores ready for winding and final assembly) distributed by the Arnold organization. Every step in manufacture has been fully developed; designers can rely on

complete consistency in each standard size of core.

Deltamax is the most recent extension of the family of special, high-quality electrical materials produced by Allegheny Ludlum, steel-makers to the electrical industry. It is an orientated 50% nickel-iron alloy, characterized by a rectangular hysteresis loop with sharply defined knees, combining high saturation with low coercivity.

● Call on us for technical data.



THE ARNOLD ENGINEERING COMPANY

SUBSIDIARY OF ALLEGHENY LUDLUM STEEL CORPORATION

147 EAST ONTARIO STREET, CHICAGO 11, ILLINOIS

W&D 2379

YOU CAN BE **SURE**.. IF ITS
Westinghouse

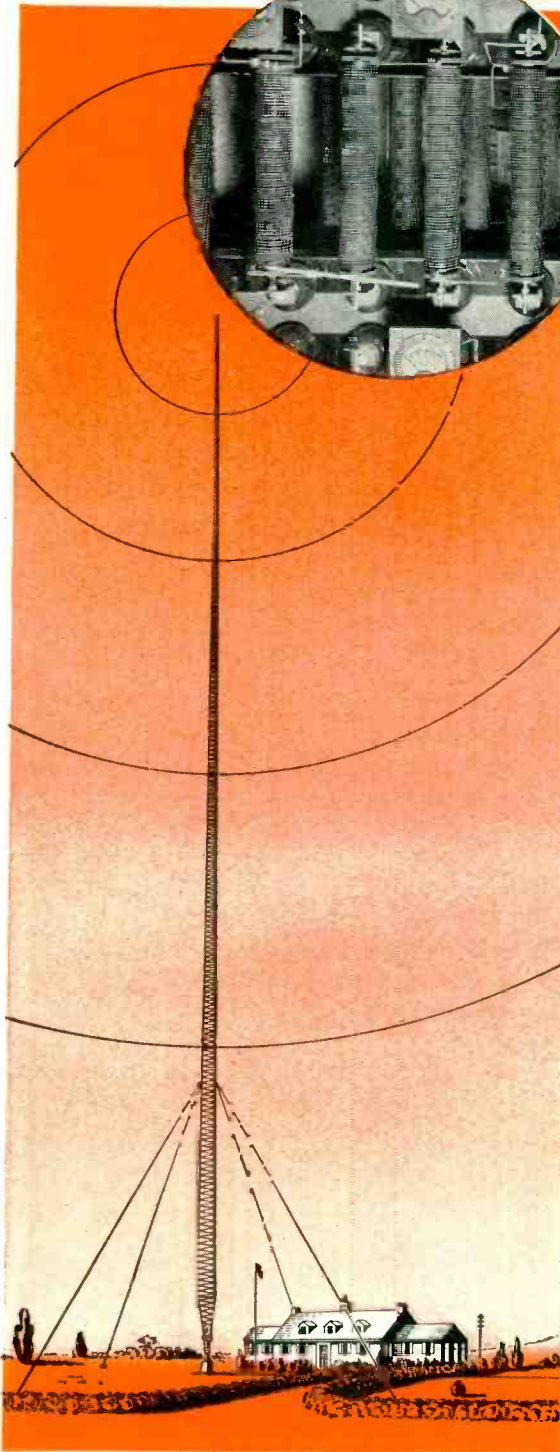
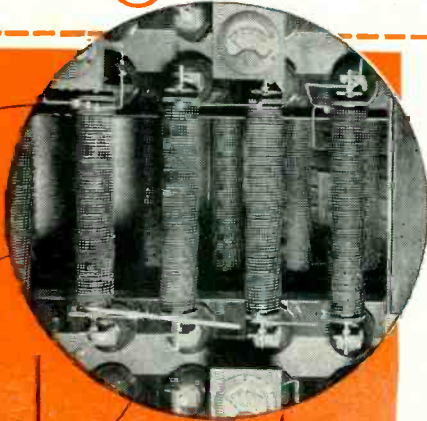

No Program Interruptions

**How KDKA MAKES SURE
with Selenium Rectifiers**

You, too, can have a power rectifier that is good for the *life* of your transmitter. Gone forever will be those costly program interruptions caused by the sudden necessity of replacing power tubes.

Since Selenium stacks were installed at KDKA, power rectifiers are no longer critical components. In addition to many years of service, these Selenium rectifiers provide other benefits. No warm-up period or filament power required . . . ability to withstand relatively high inverse surges . . . takes temporary or prolonged overloads without damage.

Why not be assured of stable operation of your power rectifier . . . of program continuity at full signal strength. Your nearby Westinghouse representative will tell you how to get the job-proved Rectox. Ask him for a copy of DB-19-025 or write Westinghouse Electric Corporation, Post Office Box 868, Pittsburgh 30, Pa. J-21568



Westinghouse
Rectox

**Rectifiers & Chargers for
ALL INDUSTRIES**

NO OTHER TESTER

does so much...so well!

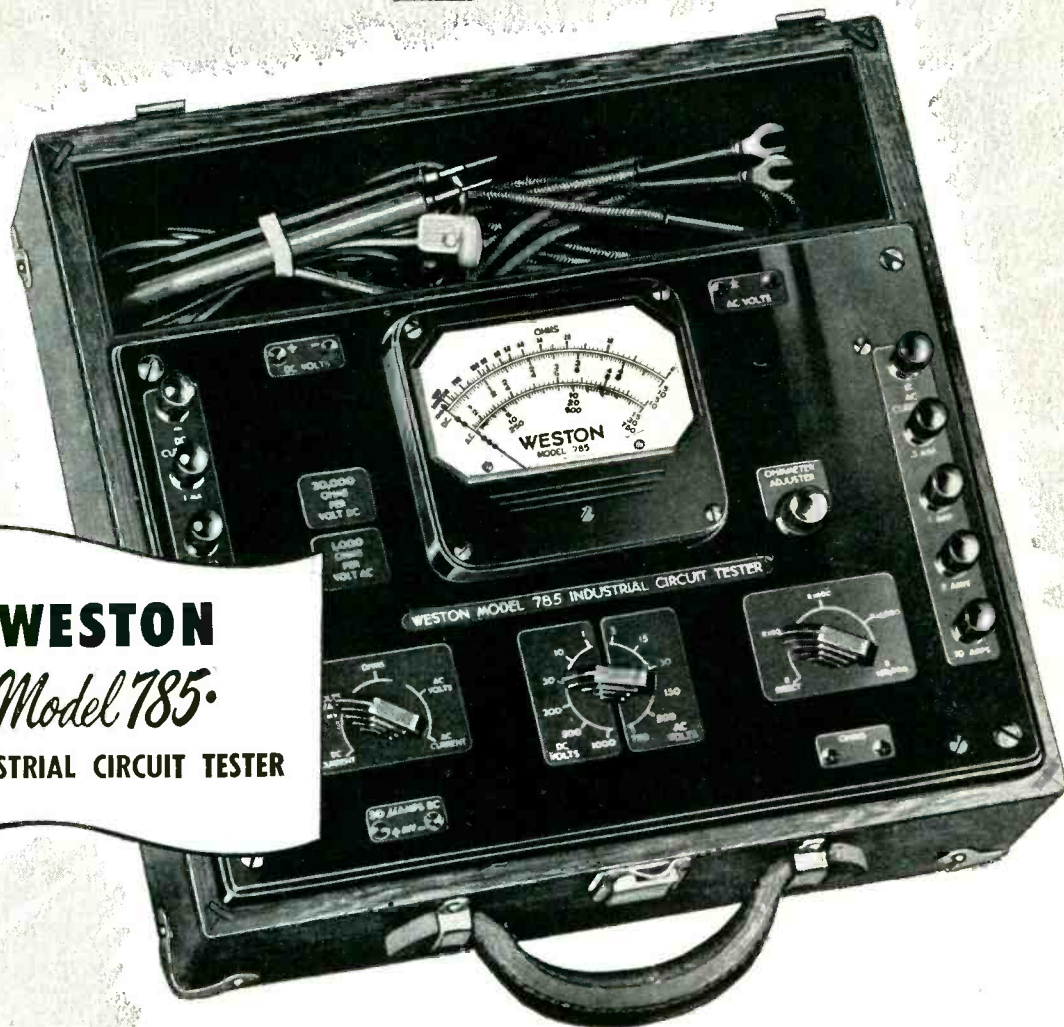

WESTON
Model 785
INDUSTRIAL CIRCUIT TESTER

*In the shop . . . 28 ranges in one case to locate circuit troubles on production equipment.
On the bench . . . 28 ranges in one case for checking electrical equipment during manufacture.
In the lab . . . 28 ranges in one case immediately available for research and development work.*

28 Instrument Ranges

D-C VOLTS: 100 mv, 1/10/50/200/500/1000 volts (20,000 ohms per volt).

A-C VOLTS: 5/15/30/150/300/750 volts.

D-C CURRENT: 50 microamps; 1/10/100 milliamps; 1/10 amps.

A-C CURRENT: .5/1/5/10 amps.

RESISTANCE: 3000/30,000/300,000 ohms; 3/30 megohms.

Stock Accessories Available for Extending Above Ranges

It does so much, so well, for so little. Check your Weston Representative for full details or see your local jobber. Weston Electrical Instrument Corporation, 618 Frelinghuysen Avenue, Newark 5, New Jersey . . . manufacturers of Weston and Tagliabue Instruments.

WESTON *Instruments*

Albany • Atlanta • Boston • Buffalo • Charlotte • Chicago • Cincinnati • Cleveland • Dallas • Denver • Detroit • Houston • Jacksonville • Knoxville • Little Rock • Los Angeles • Meriden • Minneapolis • Newark • New Orleans
New York • Orlando • Philadelphia • Phoenix • Pittsburgh • Rochester • San Francisco • Seattle • St. Louis • Syracuse • Tulsa • Washington, D. C. • In Canada, Northern Electric Company, Ltd., Powerlite Devices, Ltd.

For many uses...

ALSiMAG[®] parts may be better than metal parts
...and less expensive

A large family of technical ceramics, under the trade name ALSiMag, is custom made into parts to fit individual requirements. These are versatile ceramics. You can choose the one that combines the

physical characteristics required for your use. Characteristics of the more frequently used ALSiMag ceramics are accurately determined. They're shown on ALSiMag Property Chart 501, sent free on request.

CONSIDER THESE GENERAL CHARACTERISTICS. THEY MAY HELP YOU FIND THE ANSWER TO ONE OF YOUR DESIGN OR PERFORMANCE PROBLEMS.

CHARACTERISTIC	TYPICAL OF MOST METALS	TYPICAL OF ALSiMAG CERAMICS
Creep	Variable, but frequently excessive	Frequently can be used where metals fail
Resistance to Corrosion	Variable, but generally poor	Chemically inert
Resistance to Electrolytic Action	Generally poor	Excellent
Abrasion Resistance (Hardness)	Variable	Excellent
Resistance to Impact	Generally good	Variable, fair to poor
Compressive Strength	Excellent	Good
Magnetic Properties	Variable	Non-magnetic
Electrical Insulating Properties	Conductor	Non-conductor
Thermal Insulating Properties	Poor	Good
Dimensional Accuracy	Excellent	Can be ground to any desired tolerance

FABRICATION COST: ALSiMag parts are produced to your specifications. The material is machined in the unfired state, then converted to a very hard material by firing. Thus where parts of great hardness are required, they can generally be produced in ALSiMag at a major saving in cost. Certain small and relatively simple shapes can be produced in large quantity on automatic production machinery at costs below that of any other material or production method.

ENGINEERING COOPERATION: Send us your blue prints and an outline of your requirements. Our engineers will submit recommendations for economy in design and material. Test samples made to your specifications at reasonable cost enable you to check your design quickly and inexpensively.

AMERICAN LAVA CORPORATION

49TH YEAR OF CERAMIC LEADERSHIP
 CHATTANOOGA 5, TENNESSEE

OFFICES: METROPOLITAN AREA: 671 Broad St., Newark, N. J., Mitchell 2-8159 • CHICAGO, 9 South Clinton St., Central 6-1721
 PHILADELPHIA 1649 North Broad St., Stevenson 4-2823 • LOS ANGELES, 232 South Hill St., Mutual 9076
 NEW ENGLAND, 38-B Brattle St., Cambridge, Mass., Kirkland 7-4498 • ST. LOUIS, 1123 Washington Ave., Garfield 4959

Free NEW G-E MAGNET WIRE DATA BOOK

Now for the first time
in one complete manual

FORMEX[®] Magnet Wires
DELTABESTON[®] Magnet Wires

For jobs involving specifications and uses of magnet wire, you need this new General Electric magnet wire manual.

Packed with helpful, hard-to-get information, this 34-page book clearly and concisely covers all types of General Electric magnet wire — G-E Formex for Class A applications, temperatures up to 105 C, and G-E Deltabeston, both for Class B applications, temperatures up to 125 C; and for Class H applications, temperatures up to 180 C.

Here are just a few of the subjects covered by the G-E magnet wire manual:

- Properties of enamel- and asbestos-insulated magnet wires
- Tables of types and sizes of stock magnet wires
- Application procedures
- Information on special glass and silicone-impregnated insulations
- Tables covering electrical specifications, dimensions, weight, and other pertinent specification data

To get your copy of this fact-filled reference manual on General Electric magnet wires, just clip and mail the coupon below.

Section W13-831
Construction Materials Department, General Electric Company, Bridgeport 2, Connecticut
Please send me free copy of "General Electric Magnet Wire."
Name _____ Title _____
Company _____
Address _____
City _____ Zone _____ State _____

GENERAL  **ELECTRIC**

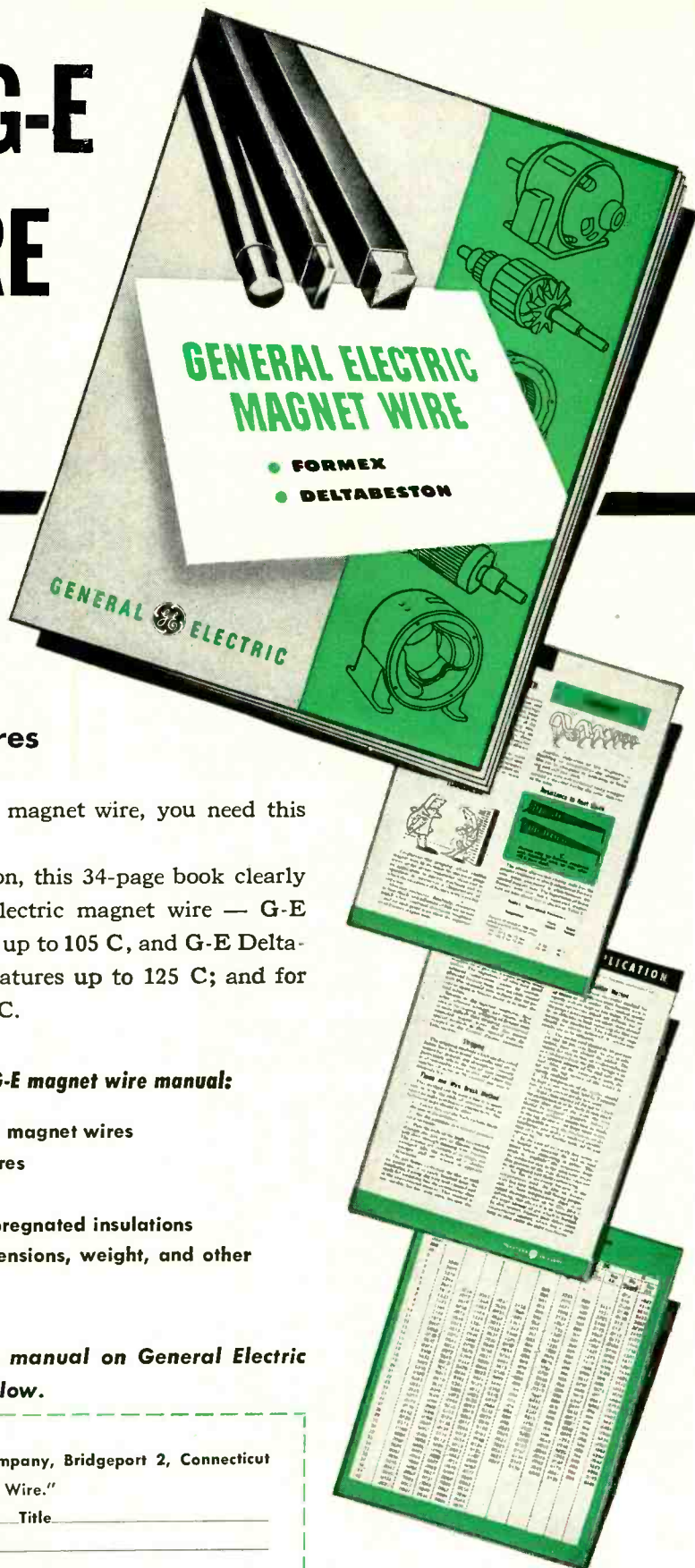



WILCOX...

First Choice of SOUTHERN AIRWAYS

Southern Airways Selects Wilcox Type 428
FACTORY PACKAGED VHF STATION
 For All Ground Stations

A WILCOX FACTORY PACKAGED STATION OFFERS YOU:

1. OPERATING CONVENIENCE

All controls are within easy reach of the operator. Conveniently grouped telephone handset, typewriter, filing cabinet, and writing desk assure efficient operation.

2. INSTALLATION ECONOMY

All wiring inside the 72-inch-high standard relay rack is completed at the factory. No costly on-the-job wiring needs to be done. Just install the antenna, plug the station into any standard electrical outlet, and it is ready for operation.

3. MAINTENANCE EFFICIENCY

Simple, conventional circuits minimize the number and types of tubes, require no special training, techniques, or test equipment. All adjustments can be made from the front of the panels. All components are easily removable by means of plug and receptacle connections. This means low-cost maintenance.

Write Today for complete information on the Wilcox Type 428 Packaged VHF Ground Station

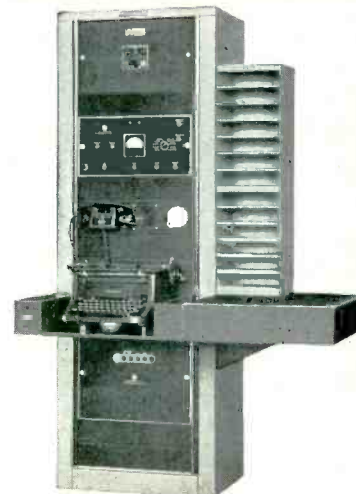

Type 428 Packaged VHF Station includes:
 —406A fixed frequency 50 watt transmitter
 —305A fixed frequency receiver
 —407A power supply
 —614A VHF antenna

WILCOX
ELECTRIC COMPANY
 KANSAS CITY 1, MISSOURI, U. S. A.



STANDARD RI-FI* METERS

14 kc to 1000 mc!

DEVELOPED BY **STODDART**
FOR THE ARMED FORCES.
AVAILABLE COMMERCIALY.



VHF!
15 MC
to
400 MC
NMA - 5

Commercial equivalent of TS-587/U.
Sensitivity as two-terminal voltmeter, (95 ohms balanced)
2 microvolts 15-125 MC; 5 microvolts 88-400 MC. Field
intensity measurements using calibrated dipole. Frequency
range includes FM and TV Bands.



VLF!
14 KC
to
250 KC
NM - 10A

Commercial equivalent of AN/URM-6.
A new achievement in sensitivity! Field intensity measure-
ments, 1 microvolt-per-meter using rod; 10 microvolts-per-
meter using shielded directive loop. As two-terminal volt-
meter, 1 microvolt.

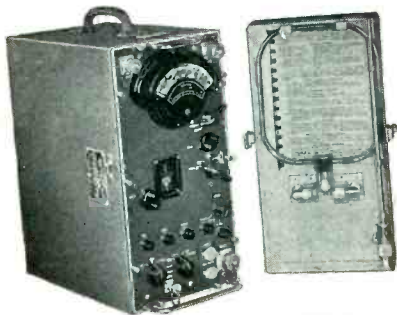

HF!
150 KC
to
25 MC
NM - 20A

Commercial equivalent of AN/PRM-1.
Self-contained batteries. A.C. supply optional. Sensitivity as
two-terminal voltmeter, 1 microvolt. Field intensity with 1/2
meter rod antenna, 2 microvolts-per-meter; rotatable loop
supplied. Includes standard broadcast band, radio range,
WWV, and communications frequencies.



UHF!
375 MC
to
1000 MC
NM - 50A

Commercial equivalent of AN/URM-17.
Sensitivity as two-terminal voltmeter, (50-ohm coaxial input)
10 microvolts. Field intensity measurements using calibrated
dipole. Frequency range includes Citizens Band and UHF
color TV Band.

Since 1944 Stoddart RI-FI* instruments have established the
standard for superior quality and unexcelled performance.
These instruments fully comply with test equipment require-
ments of such radio interference specifications as JAN-I-225,
ASA C63.2, 16E4(SHIPS), AN-I-24a, AN-I-42, AN-I-27a, AN-I-40
and others. Many of these specifications were written or re-
vised to the standards of performance demonstrated in
Stoddart equipment.

The rugged and reliable instruments illustrated above serve
equally well in field or laboratory. Individually calibrated
for consistent results using internal standard of reference.
Meter scales marked in microvolts and DB above one microvolt.
Function selector enables measurement of sinusoidal or complex
waveforms, giving average, peak or quasi-peak values.
Accessories provide means for measuring either conducted
or radiated r.f. voltages. Graphic recorder available.

*Radio Interference and Field Intensity.

Precision Attenuation for UHF!

Less than 1.2 VSWR to 3000 MC.

Turret Attenuator:

0, 10, 20, 30, 40, 50 DB.

Accuracy $\pm .5$ DB.

Patents applied for.



STODDART AIRCRAFT RADIO CO.

6644 SANTA MONICA BLVD., HOLLYWOOD 38, CALIF.
Hillside 9294

PRODUCED BY THE MILLIONS

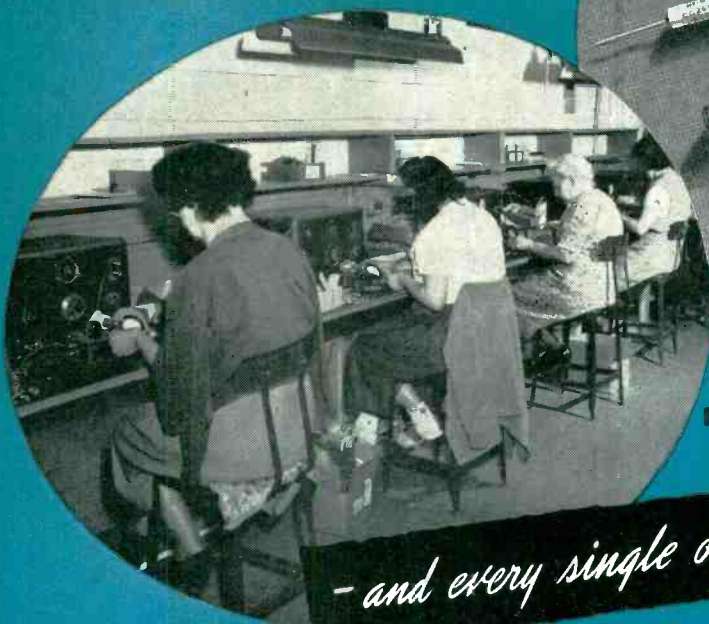

Final Inspection



Hi-Q Components

- and every single one is Individually Tested!

Hi-Q COMPONENTS

Capacitors
Trimmers • Choke Coils
Wire Wound Resistors

BETTER 4 WAYS

- ✓ PRECISION
- ✓ UNIFORMITY
- ✓ DEPENDABILITY
- ✓ MINIATURIZATION

Though **Hi-Q** Ceramic Components are produced at a rate of several million a month, each and every single one is individually tested at each stage of production and as a part of final inspection before shipment. That is one of the reasons why you can depend on all **Hi-Q** Components to precisely meet specifications, ratings and tolerances. That is one of the reasons why they are used by virtually all leading producers of television, communications and electronic equipment.

You are invited to write now for a copy of the brand new **Hi-Q** Datalog.

JOBBERS — ADDRESS: 740 Belleville Ave., New Bedford, Mass.

Hi-Q

Electrical Reactance Corp.

FRANKLINVILLE, N. Y.

SALES OFFICES: New York, Philadelphia
Detroit, Chicago, Los Angeles

PLANTS: Franklinville, N. Y., Olean, N. Y.
Jessup, Pa., Myrtle Beach, S. C.

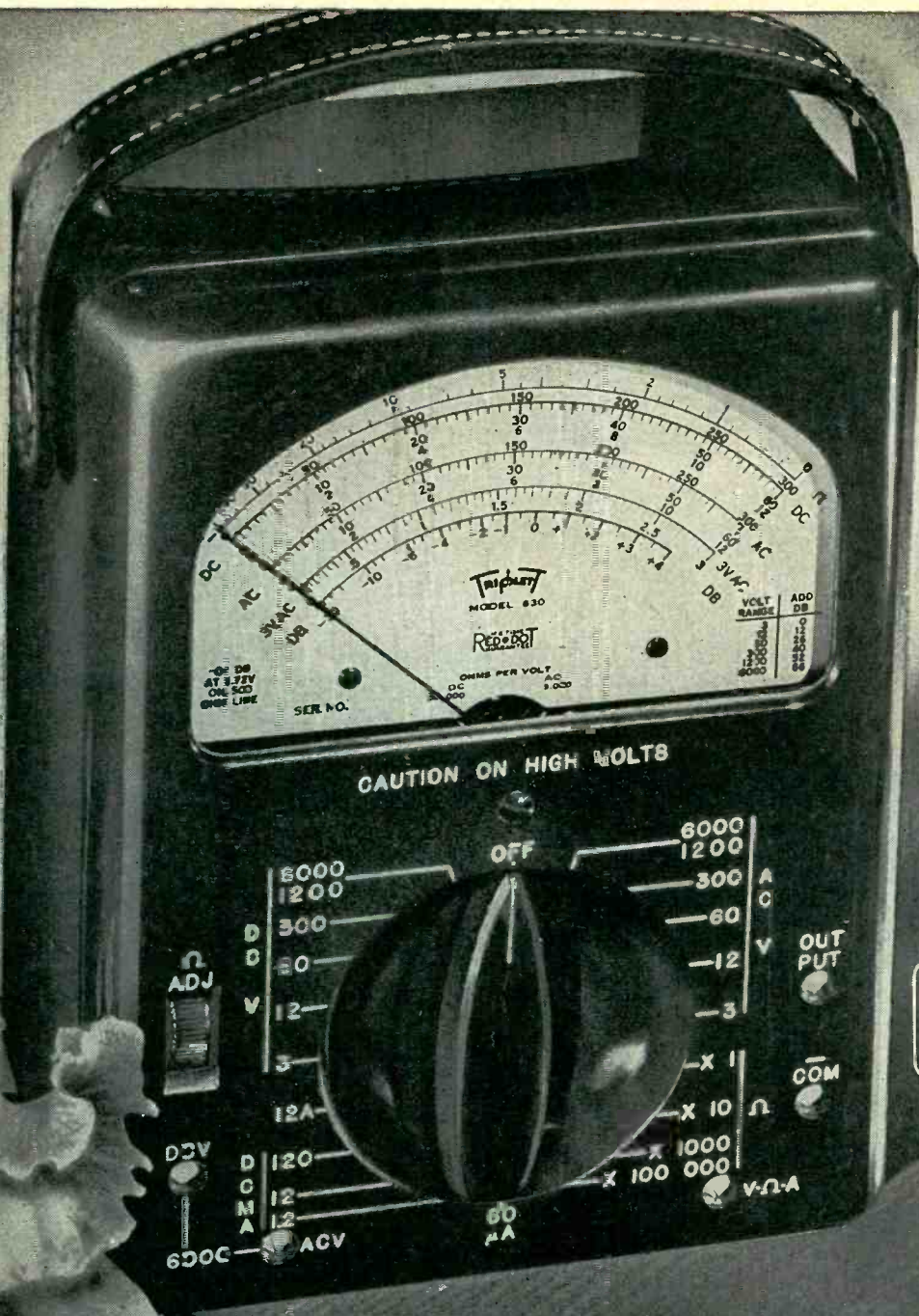

Model
630

*There is no more useful
and dependable instrument made*

FOR THE MAN WHO TAKES PRIDE IN HIS WORK

Triplet

TRIPLET ELECTRICAL INSTRUMENT COMPANY • BLUFFTON, OHIO, U.S.A.

ONLY \$37.50 AT YOUR DISTRIBUTOR

FOR ARMED SERVICES COMPONENT REQUIREMENTS—1N69 AND 1N70



Welded

GERMANIUM DIODES

MEET
JAN SPECS

SPECIFICATIONS

Max Ratings at 25°C	1N69	1N70
Peak Inverse Voltage	75	125
Max Continuous Inverse Voltage	60	100
Average Rectified Current (ma)	40	30
Peak Rectified Current (ma)	125	90
Surge Current (ma)	400	350
Temp. Range °C	-50 to +70	-50 to +70

Characteristics at 25°C

Max Inverse Current at -50v(ma)	.85	.41
Max Inverse Current at -10v(ma)	.05	.01
Min Forward Current at +1v(ma)	5.0	3.0
Average Shunt Capacitance (mmfd)	0.8	0.8

GENERAL ELECTRIC germanium diodes must meet the most rigid specifications, yet volume production continues to drive their prices steadily downward. Compare new G-E prices with all others . . . then check the following reasons for this ever-widening acceptance among electronics designers, engineers, and equipment makers:

Dual Mounting—For Convenience—Versatile G-E diodes can be mounted two ways: *clip them into place* by means of their husky, non-oxidizing nickel pin terminals . . . or use each diode's well-tinned, copper-clad steel leads to *solder* it into the circuit. These special leads are strong and flexible, conduct less heat than ordinary types, and thus prevent damage during soldering.

Platinum Whisker—For Strength—To assure stability and long life, the G-E diode's pigtail whisker is of platinum, which, unlike tungsten, can be strongly welded to germanium.

Moisture Resistant Insulating Case—For Protection—A special insulating case of molded, mineral-filled phenolic protects this unique welded contact. The case is also tapered to assure correct polarity mounting. These diodes are so easy to handle—you can install 'em in the dark!

Looking For A Long Life Diode? We've got 'em! The complete G-E line includes four general purpose diodes, two JAN types, two TV types (more than half a million of these have already been supplied to TV receiver manufacturers), one u-h-f model and the high quality quad of four balanced diodes. For product and application engineering service, inquire at the G-E electronics office near you, or write: *General Electric Company, Electronics Park, Syracuse, N. Y.*

You can put your confidence in—

GENERAL  ELECTRIC

ELECTRONICS — August, 1950

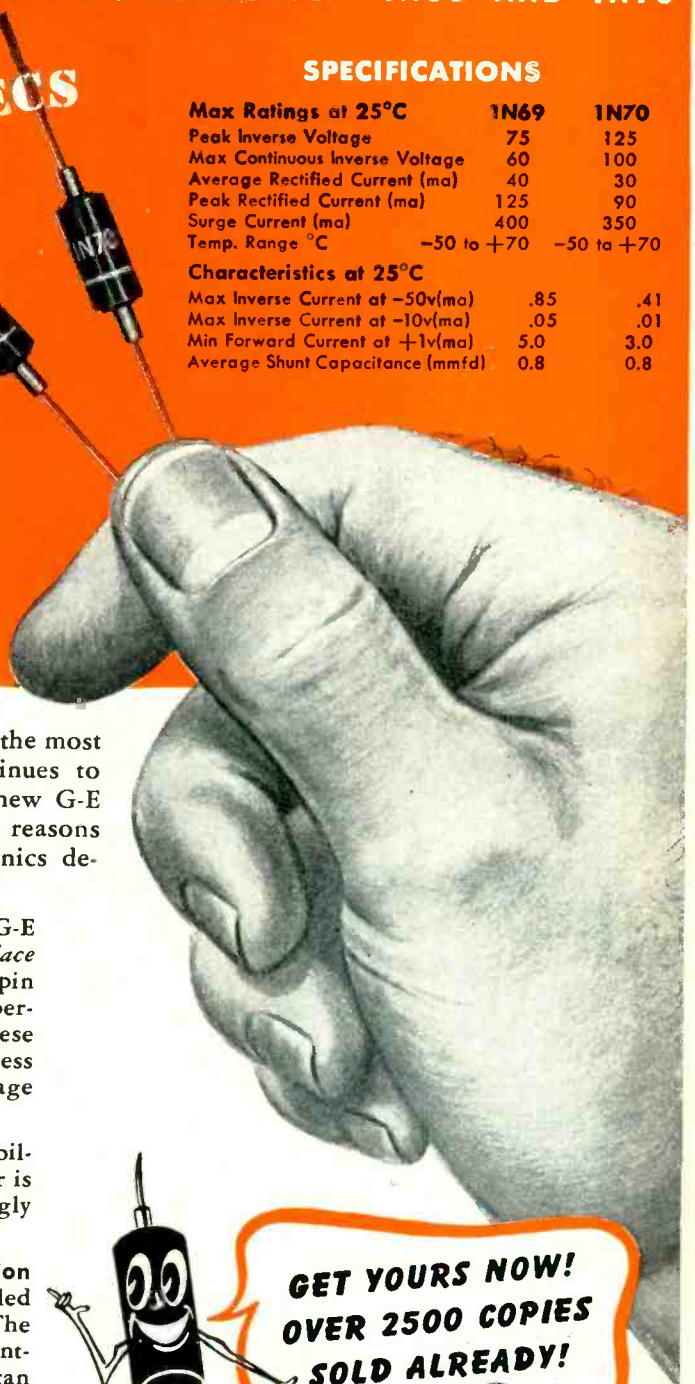

GET YOURS NOW!
OVER 2500 COPIES
SOLD ALREADY!

DANNY DIODE

NEW
DIODE
HANDBOOK



Now in 2nd Printing! Here are 68 pages of facts on characteristics, advantages, and circuitry of diodes. Charts, curves, diagrams, typical applications. Leatherette bound, loose-leaf style. Supplementary sheets furnished free as published. Worth many times its modest price of \$1.25. Send check or money order to: *General Electric Company, Section 480, Electronics Park, Syracuse, New York.*



versatile

Multi-channel --
telegraph A1 or
telephone A3.

FROM GROUND TO AIR OR POINT TO POINT

STABLE

High stability (.003%) under
normal operating
conditions.

RUGGED

**Components
conservatively
rated. Completely
tropicalized.**



Model 446 transmitter operates on 4 crystal-controlled frequencies (plus 2 closely spaced frequencies) in the band 2.5-13.5 Mcs (1.6-2.5 Mcs available). Operates on one frequency at a time; channeling time 2 seconds. Carrier power 350 watts, A1 or A3 AM. Stability .003% using CR-7 (or HC-6U) crystals. Operates in ambient 0° to +45° C using mercury rectifiers; -35° to +45° C using gas filled rectifiers. Power supply, 200-250 volts, 50/60 cycles, single phase. Conservatively rated, sturdily constructed. Complete technical data on request.

Here's the ideal general-purpose high-frequency transmitter! Model 446... 4-channel, 6-frequency, medium power, high stability. Suitable for point-to-point or ground-to-air communication. Can be remotely located from operating position. Co-axial fitting to accept frequency shift signals.

Consultants, designers and manufacturers of standard or special electronic, meteorological and communications equipment.

AER - O - COM

Reg. U. S.

Pat. Off.

AERONAUTICAL COMMUNICATIONS EQUIPMENT, INC.
3090 Douglas Road, Miami 33, Florida

DEALERS: Equipeleiro Ltda., Caixa Postal 1925, Rio de Janeiro, Brasil ★ Henry Newman Jr., Apartado Aereo 138, Barranquilla, Colombia ★ Radelec, Reconquista 46, Buenos Aires, Argentina



Redskin
Molded Paper Tubular

Chieftain
Dry Electrolytic

Sioux
6000v TV Tubular

*These three braves
scalp TV Capacitor
problems!...*



SANGAMO'S TV TRIO

Tops for original equipment — Tops for replacement needs

Sangamo offers three top television capacitors that you can use with confidence. You'll like these tested, *proved* performers for their quality, their small size and their stability.

The **REDSKIN** is a plastic molded paper tubular that is easy to work with—on production line or on the bench—because its strong, tough casing stands rough handling and the flexible leads can't pull out! It gives long life at 85° operation.

The **CHIEFTAIN** is a dry electrolytic that fits anywhere! Tiny, but durable, it is ideal for application in tight spots beneath a chassis. Bare tinned-copper wire leads make it easy to mount. Maintains uniform capacity when subjected to heat and high ripple currents.

The **SIoux** is a 6,000 volt paper television capacitor with a new standard of permanence. Designed to withstand continuous operation at 85° C, it is mineral oil impregnated to provide longer life and more stable performance over a wide range of operating temperatures.

See your Jobber... if he can't supply you, write us.



Your Assurance of



Dependable Performance

SANGAMO ELECTRIC COMPANY
SPRINGFIELD, ILLINOIS

IN CANADA: SANGAMO COMPANY LIMITED, LEASIDE, ONTARIO

8C50-7A

for **HIGH-EFFICIENCY** *Video Control*

use **LOW-CAPACITANCE**

Video Relays by

AUTOMATIC ELECTRIC

CHICAGO

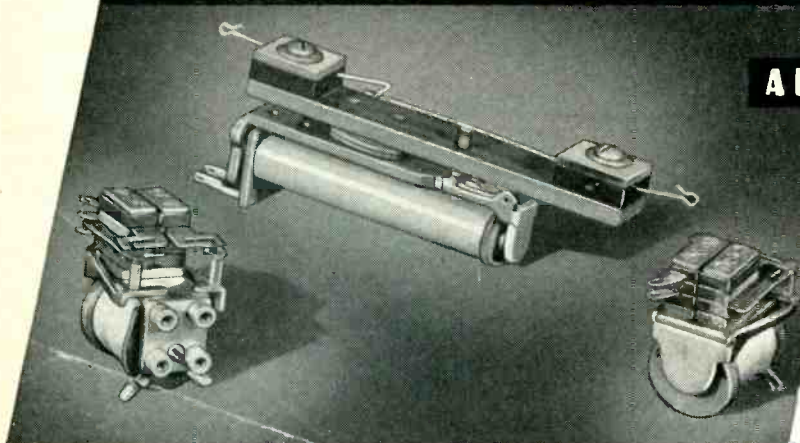

For smooth, chatter-free control, switch your video programs with Automatic Electric video relays. Automatic Electric made its first video relay more than ten years ago, and today offers two types, each providing exceptionally low capacitance between contact springs, and low capacitance between springs and ground (frame, mounting, etc.).

In addition to these low-capacitance characteristics, Automatic Electric video relays provide the dependability of "twin" contacts and the small size you need for compact mounting. The Class "C" video relay (background above) is especially suitable for strip mounting; it is only 0.687" wide and 2 $\frac{1}{8}$ " high and is 5 $\frac{15}{32}$ " in overall length. The Class "S" relay (two views in foreground) is 1" wide, 1 $\frac{3}{8}$ " high and 1 $\frac{19}{32}$ " long, overall. Operating mechanisms are basically standard Automatic Electric designs, thus assuring the high operating efficiency for which Automatic Electric controls are famous.

To receive complete information, simply let us know your specific needs. Address **AUTOMATIC ELECTRIC SALES CORPORATION**, Chicago 7, Ill. In Canada: Automatic Electric (Canada) Ltd., Toronto.

OTHER AUTOMATIC ELECTRIC TELEPHONE-TYPE CONTROLS



Stepping Switches

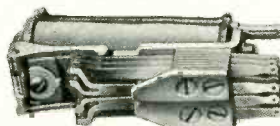

Relays



Turn Keys



Lever Keys

Efficient, dependable Automatic Electric controls are available also for many other uses in your station and studio. Lever, turn and push-type keys; telephone-type dials; stepping switches; lamp jacks and caps—as well as a complete range of telephone-type relays carrying the Automatic Electric name — are now in service in many of the largest and finest program switching installations.

RELAYS

SWITCHES

AUTOMATIC



ELECTRIC

Controlling the Nation's TV AND RADIO!

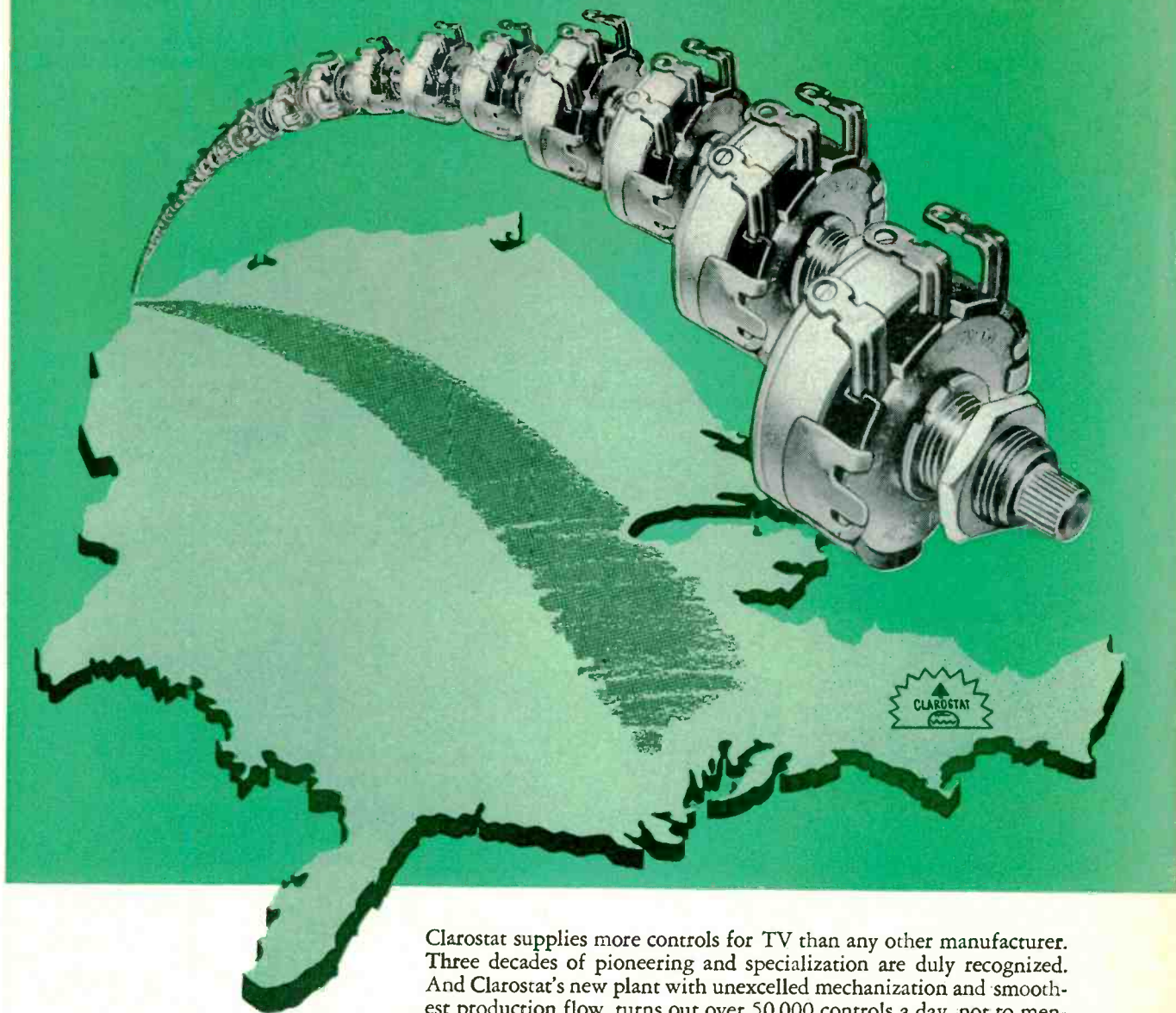

Clarostat supplies more controls for TV than any other manufacturer. Three decades of pioneering and specialization are duly recognized. And Clarostat's new plant with unexcelled mechanization and smoothest production flow, turns out over 50,000 controls a day, not to mention resistors of many different types, in meeting the major portion of today's TV and radio requirements. Obviously, for quality, uniformity, dependability, economy, it's CLAROSTAT.

Write for Engineering Bulletins on resistors, controls and resistance devices. Let us collaborate on your control and resistance problems and needs.



Controls and Resistors

CLAROSTAT MFG. CO., INC. • DOVER, NEW HAMPSHIRE
IN CANADA: CANADIAN MARCONI CO. LTD., MONTREAL, P. Q., AND BRANCHES

PRECISION FREQUENCIES

ACCURACY: 1 PART IN 100,000 (OR BETTER) .001%

FOR USE IN SUCH FIELDS AS

- AVIATION
- ASTRONOMY
- BALLISTICS
- HIGH-SPEED PHOTOGRAPHY
- VISCOSITY MEASUREMENT
- NUCLEAR PHYSICS
- TELEMETERING
- RADIATION COUNTING
- FLUID FLOW
- CHEMICAL REACTION
- NAVIGATION
- SCHOOL LABORATORIES
- INDUSTRIAL RESEARCH LABS.
- ACCURATE SPEED CONTROL

The controlling unit of these frequency standards is a bi-metallic fork, temperature-compensated and hermetically sealed against humidity and variations in barometric pressure. When combined with related equipment, accurate speed and time controls are afforded by mechanical, electrical, acoustical or optical means.

Instruments of our manufacture are used extensively by industry and government departments on such precision work as bomb sights and fire control.

Whatever your frequency problems may be, our engineers are ready to cooperate.

When requesting further details, please specify the Type Numbers on which information is desired.

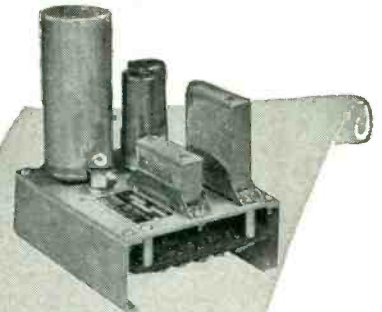

TYPE 2001-2. BASIC UNIT
Frequencies, 200 to 1500 cycles. Dividers and Multipliers available for lower and higher frequencies. Miniaturized and JAN construction. Output, 6 volts.



TYPE 2005. UTILITY UNIT
consists of Type 2001-2 and booster to provide 10 watts at 110 V at 60 cyc. Input, 50-100 cyc.



TYPE 2121A. LAB. STANDARD
Outputs, 60 cycle, 0-110 Volts.
120-240 cycle impulses.
Input, 50-400 cycles, 45 W.



TYPE 2111. POWER UNIT
50 W output, 0-110 V at 60 cyc.
Input, 50-100 cyc., 275 W.

American Time Products, Inc.
580 Fifth Avenue
New York 19, N. Y.

OPERATING UNDER PATENTS OF THE WESTERN ELECTRIC COMPANY

SWIFT, SURE FREQUENCY COMPARISON

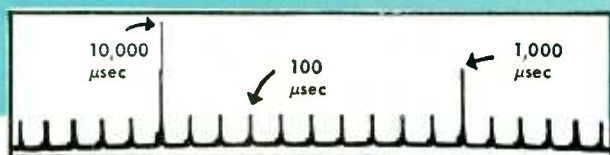

FIG. 1. Timing Comb, -hp- Model 100D

NEW **hp** SECONDARY FREQUENCY STANDARDS

MODELS 100C AND 100D

- Sine or rectangular waves
- 100 μ sec time markers
- Built-in oscilloscope
- Stability 1/1,000,000
- Low output impedance
- New, improved circuits
- Audio, supersonic, rf measurements

SPECIFICATIONS

-hp- 100D Secondary Frequency Standard

- Accuracy:** About 2 parts per million per week, normal room temperature.
- Stability:** About 1 part per million over short intervals.
- Output:** Controlled frequencies: 100 kc, 10 kc, 1 kc, 100 cps, 10 cps. Sine or rectangular waves; marker pips. Internal impedance approx. 200 ohms.
- Wave Shape:** Sine wave: less than 4% distortion into 5,000 ohms or higher load.
- Marker Pips:** 10,000, 1,000 and 100 μ sec intervals.
- Oscilloscope:** Integral with circuit. Establishes 10:1 Lissajous figures to show division ratio. May be used independently of standard.

-hp- 100C Secondary Frequency Standard

- Accuracy:** Within $\pm .001\%$ normal room temperature.
- Output:** Controlled frequencies of 100 kc, 10 kc, 1 kc, and 100 cps. Internal impedance approx. 200 ohms.
- Wave Shape:** Sinusoidal only. 4% distortion into 5,000 ohm load.
- Power Supply:** (100C and 100D) 115 v, 50/60 cps, regulated to minimize line voltage fluctuations. Power drawn approx. 150 watts.
- Mounting:** (100C and 100D) Cabinet or relay rack. Panel 19" x 10 $\frac{1}{2}$ " x 12" deep.

Data Subject to Change Without Notice

The new -hp- 100C and 100D Secondary Frequency Standards incorporate all the features of the time-tested -hp- models 100A and 100B, plus important new advantages including rectangular wave output, timing pips, and an internal oscilloscope for convenient frequency comparison. The -hp- 100D may be conveniently standardized against station WWV with a minimum of external equipment, and thus provide most of the advantages of an expensive primary standard.

Crystal Controlled Frequencies

The new -hp- Models 100D and 100C employ a crystal-controlled oscillator and divider circuits offering a new high in stability and simplicity of operation. Standard frequencies are available through a panel selector switch, and may be employed simultaneously. Internal impedance is low (about 200 ohms), so that standard frequencies can be delivered at some distance from the instrument.

The -hp- 100D Secondary Frequency Standard offers sine waves at 5

frequencies and rectangular waves at 4 frequencies, plus a built-in oscilloscope. The instrument also provides a timing comb with markers 100, 1,000 and 10,000 microsecond intervals. Rectangular wave output has a rise time of approximately 5 microseconds. Accuracy is 2 parts per million.

5 v. at all Frequencies

The more moderately priced -hp- 100C Standard offers sinusoidal frequencies at 4 crystal-controlled frequencies and, like the -hp- 100D, provides 5 volts of output at all frequencies. Accuracy .001%.

Both models operate from a 115 v. ac power supply, and power is regulated to minimize power line voltage fluctuations.

Get full details... see your
-hp- representative or write
direct... today!

HEWLETT-PACKARD CO.

1977A Page Mill Road • Palo Alto, Calif.

Export: FRAZAR & HANSEN, LTD.
301 Clay Street, San Francisco, Calif., U. S. A.
Offices: New York, N. Y.; Los Angeles, Calif.

hp laboratory instruments
FOR SPEED AND ACCURACY

a product of imagination . . .

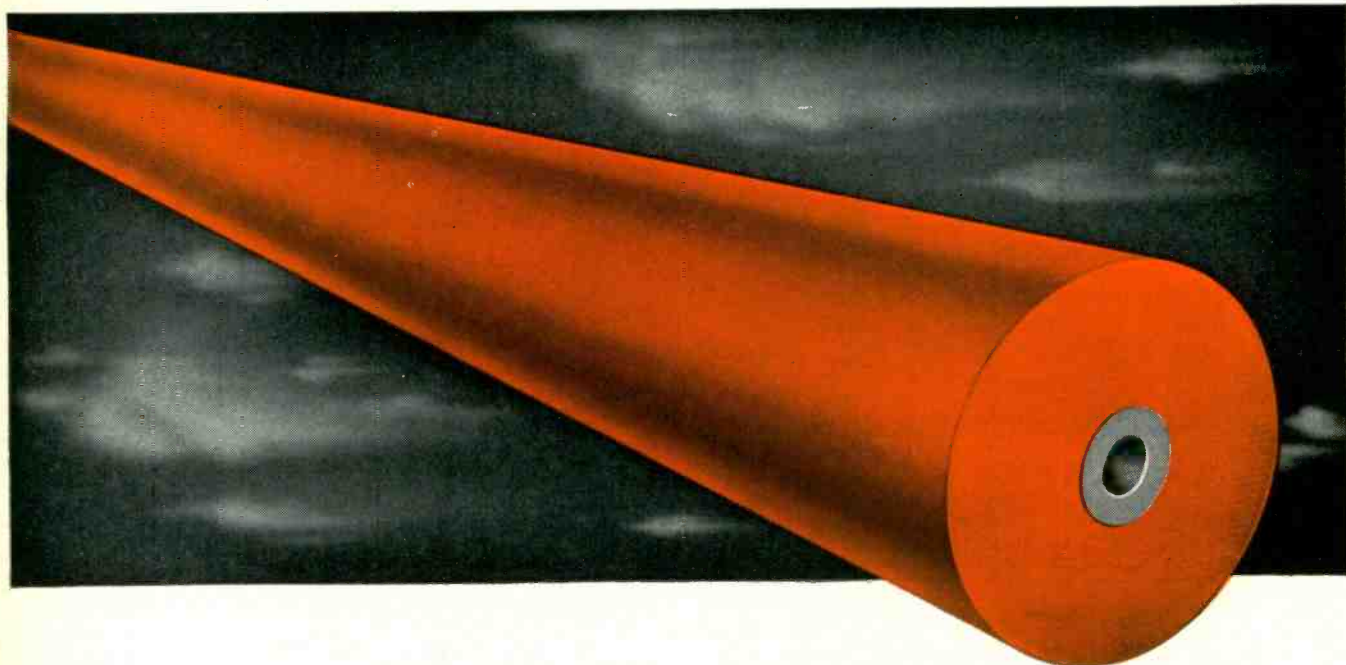

...with an ideal combination of electrical and mechanical properties

By working alongside folks like yourself—at design desks, workbenches, and in laboratories—we've acquired a good idea of the time, care, and imagination you pour into the engineering and production of your products. The thick-skinned insulation tube for an expulsion fuse shown here is a good example. The manufacturer wanted moisture resistance, high strength, weather resistance *plus* excellent arc resistance—all wrapped up in a material that was easy to machine. Working with him, and using a little imagination, C-D engineers came up with *two* different plastics: Laminated Dilecto Tubing for the wall, and Vulcanized Fibre for the core.

It's another example of how you, too, can depend upon C-D to engineer the right laminated plastic for your needs. For C-D has no "axe to grind." We can recommend from five basic plastics subdivided into a remarkably wide range of grades and combinations of grades to supply almost *any combination* of mechanical, electrical, and chemical characteristics. For *this* kind of help and imagination, call your nearest C-D office, any time.



your partner in producing better products

CELORON (Molded High-Strength Plastic)
MICABOND (Bonded Mica Splittings)
DIAMOND FIBRE (Vulcanized Fibre)
VULCOID (Resin Impregnated Fibre)
DILECTO (Laminated Thermosetting Plastic)

DE-4-50

BRANCH OFFICES: NEW YORK 17 • CLEVELAND 14 • CHICAGO 11 • SPARTANBURG, S. C. • SALES OFFICES IN PRINCIPAL CITIES.
WEST COAST REPRESENTATIVE: MARWOOD LTD., SAN FRANCISCO 3 • IN CANADA: DIAMOND STATE FIBRE CO. OF CANADA, LTD., TORONTO 8

Continental - Diamond FIBRE COMPANY

Established 1895.. Manufacturers of Laminated Plastics since 1911—NEWARK 16 • DELAWARE

Because Of **5** Outstanding Features

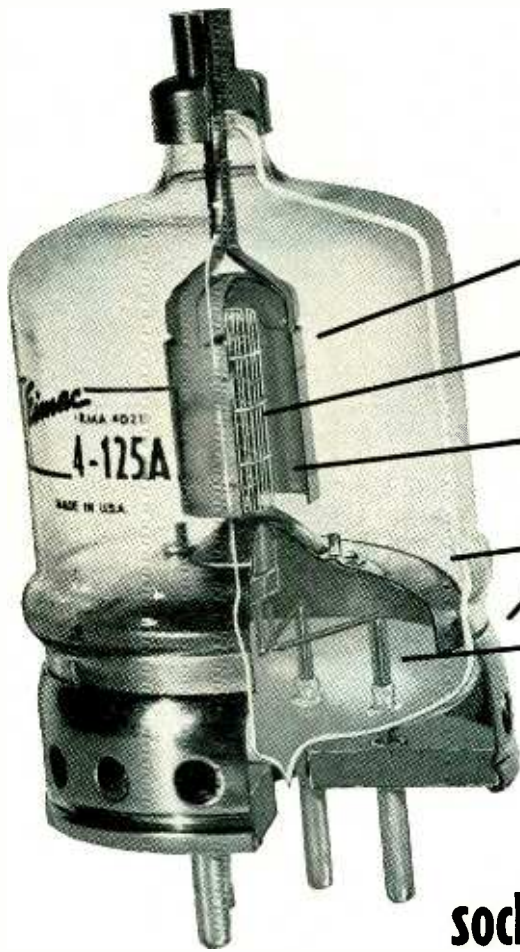

Pyrovac Plate

Long-Life Filament

Non-Emitting Grids

Input-Output Shielding

Low-Inductance Leads

Eimac 4-125A tetrodes fill more key sockets than any other 125-watt tetrode.

The Eimac 4-125A is the heart of modern radio communication systems. Its dependability-of-performance has been proved over years of service in many thousand transmitters. It will be to your advantage to consider carefully the economy and circuit simplification the Eimac 4-125A offers.

As an example of Eimac 4-125A performance, two tubes in typical class-C telegraphy or FM telephony operation with less than 5 watts of grid-driving power will handle 1000 watts input; or, two 4-125A's in high-level modulated service will handle 750 watts input.

Take advantage of the engineering experience of America's foremost tetrode manufacturer . . . Eimac. Write for complete data on the 4-125A and other equally famous Eimac tetrodes.

EITEL-McCULLOUGH, INC.
San Bruno, California

Export Agents: Frazar & Hansen, 301 Clay St., San Francisco, California

Follow the Leader, to

Eimac
TUBES

The Power for R-F

The 4-125A is another

Eimac contribution to electronic progress.



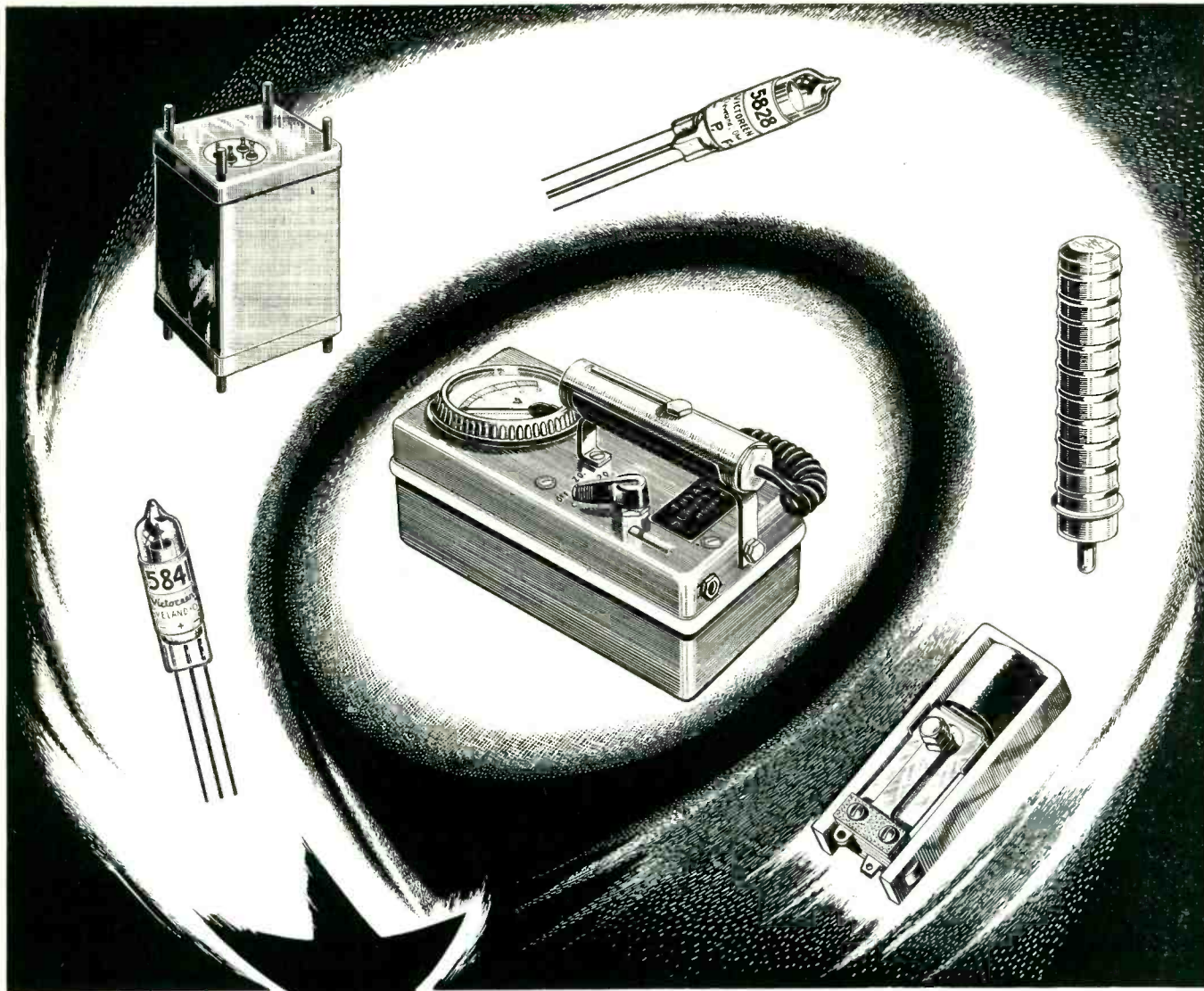

THYAC

Better Components make Better Instruments

517 Power Supply, regulated plate voltage, regulated high voltage, with low power, light weight, long life.

5841 high voltage regulator tube used in the Model 517 Power Supply protects the counter tube against overvoltage.

5828 sub-miniature vacuum tube gives reliable amplification at low power consumption.

1B85 beta gamma counter tube has a standard coax base mechanically and electrically interchangeable.

A STAR IS BORN!

The Model 389 Thyac accomplishes the transition from the past and present interim models to the ultimate future beta, gamma survey instrument.

Performance-wise, the instrument is constructed of the finest components providing regulated voltages that eliminate instrument drift, reduce calibration time, and battery replacement costs.

The design incorporates advance thinking in terms of easy and practical field operation covering three ranges of gamma radiation intensity 0.2—2.0—20 milliroentgens per hour. Its compact, rugged waterproof construction with light weight (5½ pounds) approach the exacting performance specification of a super beta gamma survey meter. The probe assembly lends itself to the use of the 1B106 mica window counter tube, 1B124 gamma ray counter tube, or the 1B125 cosmic ray tube for added versatility for many special purposes.

Economically priced—write for detailed data sheets.

The Victoreen Instrument Co.

5806 HOUGH AVENUE
CLEVELAND 3, OHIO



MODERN APPLICATION DEMANDS...

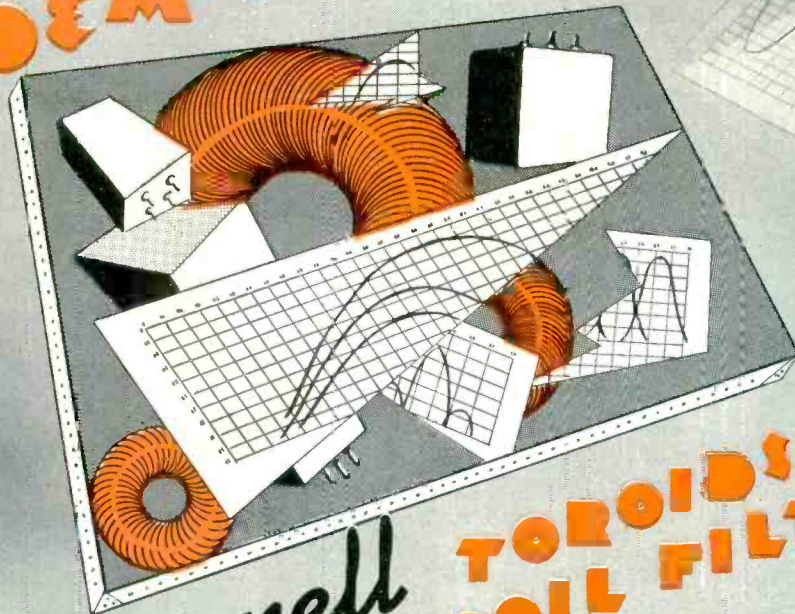
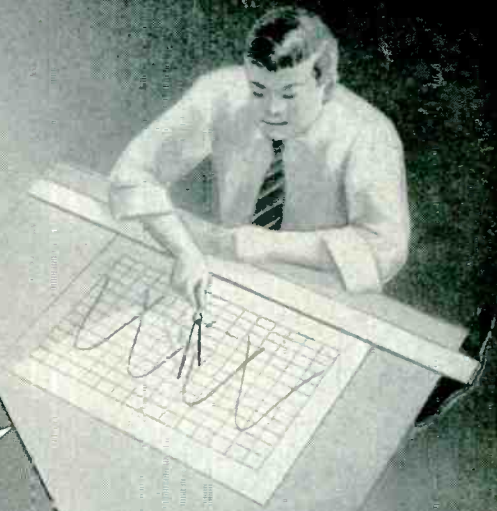

Burnell TOROIDAL COIL FILTERS & TOROIDS

We know only too well what is modern today in Electronics can be obsolete tomorrow. We can retard obsolescence by designing our products with an eye toward the future and what future applications may demand of our products.

Burnell & Company has shaped its engineering policy with this viewpoint — by striving to keep well ahead — not just abreast of developments in the Hi Q Coil and Filter business.

We search constantly for new design ideas that will permit the reduction of size and weight of Filters that "fly"; new circuits and components that will give our customers "more for their money" — and new production methods that will speed output and guarantee the reliability and life of our products.

Even our price structure has been streamlined to conform with the increasing industry-wide demand for economy, with no sacrifice in our high standard of quality.

We say that modern applications demand Burnell & Company's toroids and toroidal filter products because we are modern in every sense of the word: modern in outlook and technique as well as in price.

Exclusive Manufacturers of Communications Network Components

We particularly invite your inquiries concerning difficult filter applications

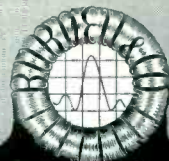

Burnell & Company
YONKERS 2, NEW YORK

CABLE ADDRESS "BURNELL"

BUSINESS BRIEFS

By W. W. MacDONALD

the New
PYRAMID
"Humidi-Seal"
(TUBULAR PAPER CAPACITOR)

Repels Moisture!

- Ruggedly built to withstand undue vibration and rough handling
- Outer tube plastic impregnated to prevent moisture-absorption
- Light outer coat of high-temp wax provides double protection
- Each end plastic sealed against moisture
- Leads anchored securely in solid plastic end

Type 85TOC "Humidi-Seal" capacitors are specially designed for 85° C. operation, even in the most humid atmospheres, and will meet the severe present-day demands of endurance in television receivers, auto radios, et .

WRITE FOR COMPLETE LITERATURE
Representatives and Distributors throughout the U. S. A. and Canada

PYRAMID

PYRAMID ELECTRIC COMPANY
155 Oxford Street
Paterson, N. J., U. S. A.
TELEGRAMS: WUX Paterson, N. J.
CABLE ADDRESS: Pyramidusa

Extension Ladders, lashed to the top of light trucks and complete with trailing red flags, were once the badge of itinerant painters. Now they more often identify a television installation man.

Philco plans to produce over 1,000,000 television receivers in 1950, and output will be stepped up to 35,000 sets a week this Fall to meet that goal. President William Balderston thinks the industry will produce 6,000,000 sets during the year and that total public investment in television will reach \$3,000,000,000 in 1951.

Five of the present ELECTRONICS editors have, over the years, written or edited 17 books on electronics, loran, radio, television, radar and photography. To anyone sending a self-addressed stamped envelope we'll be happy to send the list (advt.)

Test Equipment aboard typical vessels of the U. S. Navy includes the following items:

- Adaptor kit (tube)
- Amplifier (d-c)
- Audio oscillator
- Bridge (a-c, capacity, resistance)
- Bridge (a-f)
- Bridge (r-f)
- Bridge (wheatstone, d-c)
- Crystal rectifier test set
- Detector-amplifier assembly
- Dummy load
- Echo box
- Electronic switch
- Field-strength meter
- Fluxmeter
- Frequency meter (heterodyne)
- Frequency-power meter
- Frequency standard (radiosonde)
- Graphic milliammeter
- Loran test set
- Megger
- Multimeter (volt-ohm-milliammeter)
- Multimeter (electronic)
- Ohmmeter (electronic)
- Oscilloscope
- Radar test set
- Range calibrator
- Signal generator (r-f)
- Signal generator (wobulator)
- Sonar test set
- Spectrum analyzer
- Synchroscope
- Teletype distortion test set
- Test-tool set
- Tube tester (bulkhead type)
- Tube tester (portable)
- Voltage divider
- Wave and power meter
- Wavemeter
- Wavemeter-oscillator
- Wattmeter (r-f)

Over In Jersey a horseplayer has been picked up for defrauding bookies by means of radio.

A confederate stationed within sight of a track transmitted dope

on the winners in simple code. The dope was received in a horseparlor with slower wire service in time to get bets down on sure things.

We had this idea many years ago, as we have little doubt so also did many another amateur. Two things deterred us: (1) a dislike for bread and water and (2) the difficulty of concealing even a hearing-aid earpiece from the watchful eyes of track officials and the law.

The ingenious horseplayer in question solved the second problem by substituting a metal plate, worn underneath his shirt against the skin, for an earpiece. Every time his confederate pressed the distant key the result was literally a sharp pain in the belly.

Stanford Alumni Review says that Dean Frederick E. Terman is thinking of inventing an attachment that will prevent a television set from being turned on by a schoolboy until his homework is done.

Flight Information is now recorded by American Airlines at LaGuardia Field, New York. When you want to know if your plane will fly on schedule just dial a telephone number and a robot voice gives you the answer, much like the system used by the phone company for weather and time reports.

Electric Utilities will be operating 34,000 radio transmitters in 925 communications systems by the end of 1951, thinks J. W. Bryant of General Electric.

Each Westinghouse Worker is backed up by \$5,700 worth of tools.

Industrial X-Ray Business, down since the war because of the availability of surplus gear, is looking up. Equipment now going into the field is designed for production-line rather than laboratory use, has automatic features that permit it to be used by relatively un-

**Better TV picture resolution
... better picture gamma**

**...with this
SYLVANIA Type 1N60
Germanium Diode**



This diode is a point contact rectifier, designed for efficient and dependable service as a video detector diode for TV receivers.

In terms of set performance, the efficiency of this Sylvania Germanium Diode means better picture resolution, especially at low signal levels. The improved linearity means better picture gamma, or range of picture contrast, in the near-white regions where human vision is most critical.

Rugged Construction

The Sylvania 1N60 has construction features which assure long, trouble-free life and electrical stability. Flexible tinned leads are swaged to nickel end caps which are welded to threaded brass plugs. These plugs are screwed and firmly cemented into a strong ceramic body, thus providing a thermal reservoir, insulating the pig-tails from the active element and permitting close soldering. For further information mail the coupon today.

**Important ADVANTAGES
for set designers**

1. Low series capacitance (plate-cathode)
2. Low shunt capacitance (stray to ground)
3. Complete freedom from hum
4. Absence of contact potential
5. Compact size and ease of mounting
6. Ruggedness and permanence of ceramic
7. Built-in thermal insulation... (no soldering danger)

ELECTRONIC DEVICES;
RADIO TUBES; TELEVISION PICTURE TUBES;
ELECTRONIC TEST EQUIPMENT; FLUORESCENT LAMPS, FIXTURES, SIGN TUBING, WIRING DEVICES; LIGHT BULBS; PHOTOLAMPS; TELEVISION SETS

SYLVANIA

ELECTRIC

Sylvania Electric Products Inc.
Advertising Dept. E-1008
Emporium, Pa.

Please send me ratings and full information about Sylvania Germanium Diode, Type 1N60.

Name _____
Company _____
Street _____
City _____ Zone _____ State _____

SHOCK AND VIBRATION NEWS

BUSINESS BRIEFS

(continued)

skilled labor in making rapid tests of such things as strip-steel thickness.

Driving Strain is indicated by an electronic device with which Tufts College is experimenting. Picking up electrical impulses from electrodes strapped to the head of a man behind the wheel of a trailer-truck recently, it gave the following microvolt readings:

Turning trailer around.....	10
Heavy traffic	9.1
Sharp curves	9
Sudden stop	9
Sudden speeding up.....	8
Shifting gears	7.2
Passing	7.2
High speed	7
Rain, snow	6
Intersections	6
Open straightaways	3.5
Waiting at traffic lights.....	2
Waiting on ferry.....	1.2

Stainless Steel Production, already strained to capacity by growing demand in many industries, is being further pressed by application to metal picture tubes for television. The coefficient of expansion, it seems, is much like that of glass, so stainless simplifies sealing.

Invention Needed: William L. Kubie of Armour Research Foundation says there is no known physical measurement which can be made to describe smells, such as frequency or wavelength in sight or sound, and that at present the best thing to do is to compare an odor with other known smells.

Mexico has decreed that 10,000 television sets may be imported, and Admiral, GE, Philco, RCA, Teletone and Zenith have already applied for permits. GE, Philco and RCA may also assemble sets in the country.

Construction concessions have been granted for three stations in Mexico City, where XHGC will probably be the first to start operation, and one in Tiajuana.

Tube Manufacturers are a good source of new-product ideas for electronic equipment manufacturers. We know of two recent instances in which tube designers came up with interesting equipment ideas in the course of their work, passed them on to their man-

COLLINS new vhf radio equipment USES AIR-DAMPED BARRYMOUNTS

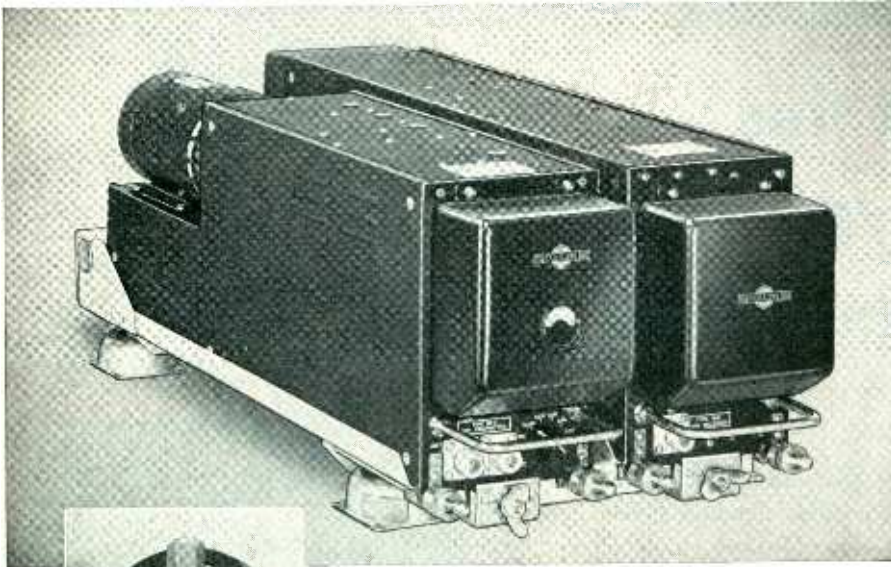

FOR ASSURED CONTROL OF SHOCK AND VIBRATION

A full line of navigation and communications equipment — developed by Collins for aircraft use in the vhf and uhf bands — makes available to the aviation industry complete integrated radio facilities that meet all requirements for navigation and communications over Federal airways.

This new Collins equipment obtains vital protection against shock and vibration with air-damped BARRYMOUNTS.

In the Collins application, the unit BARRYMOUNTS support mounting bases, of Collins design, in single- and dual-unit styles, with provision for plug-in connection of navigation and glideslope receivers, accessories, and transmitter.

Unit air-damped BARRYMOUNTS can also be furnished for direct installation to airborne instruments and in combination with Barry-built standard and special mounting bases.

Whatever your shock or vibration problem, Barry experience and consulting engineering facilities offer a sure solution. Write for free catalog listing stock BARRYMOUNTS; for special information, call our nearest office or write to

THE **BARRY** CORP.

Main Office 177 Sidney St.

Cambridge 39 Massachusetts

New York

Rochester

Philadelphia

Washington

Cleveland

Dayton

Chicago

Minneapolis

St. Louis

Los Angeles

Toronto

agement, and saw the management develop good customers for tubes by interesting outsiders in further equipment development.

Government Orders for radio transmitting and communications equipment, including radar, from members of the RMA totalled \$41,305,390 in the first quarter of 1950 as against \$37,342,885 in the same period of 1949.

Australians registered 1,982,530 radio sets at the end of 1949. This included 171,035 "second sets." There is now one set for every four people.

Wide Awake auto accessory stores are selling miniature dipoles and folded doublets that clamp on car broadcast antenna whips. The chromium plated gargets are dummies but it is conceivable that they provide some top loading and therefore a little more pickup.

Point of interest is that the weird shapes of television antennas are proving more intriguing to teen age drivers than the conventional foxtail.

Bendix gets a \$2,500,000 contract from CAA for radar units to be installed in 28 control towers at civil airports in the United States and Alaska.

Reading Our Own Ads, we note these things:

Hot after business, one manufacturer is offering a castor-equipped carrier for handling up to 28 rectangular t-v picture tubes around a plant.

Several companies are now pushing "packaged" magnetic amplifiers.

Two advertisers are offering build-it-yourself kits of test equipment.

Many component manufacturers are emphasizing the speed with which parts can be incorporated in electronic assemblies.

The only negative note this month is a purely personal objection to advertising headlines incorporating asterisks, these little jiggers referring to something buried deep down in the copy in lice type that is difficult to find.

SIGMA

Sensitive Relays

how fast is it?



Here are two test circuits. In each case, the same relay is used, the coil current is the same and the oscillogram shows the operating time.

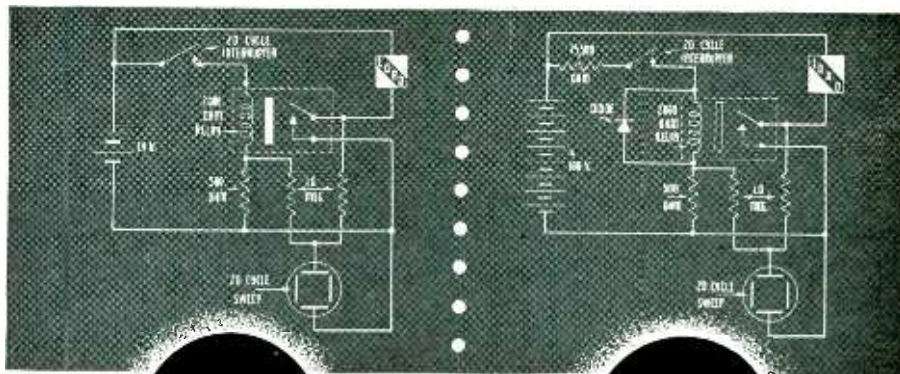

Sweep



20 cps

IN THIS CASE —

The oscillogram shows a gradual rise of coil current, based on the signal derived across the 500 ohm resistor. The first downward step is caused when the relay contact in closing grounds the load and removes some of the input voltage from the scope. Reverse curvature in the trace is due to back emf induced in the relay winding by the armature motion. The next and much larger downward step is the result of opening coil circuit by the interrupter. The small dot at its lower end indicates the delay in breaking the load circuit, after which the trace moves upward from reappearance of voltage across open contacts. The whole cycle shows a substantial operating delay, and a period of contact closure much shorter than that in which voltage is applied to the coil.

HERE HOWEVER —

Although the final relay current is identical, as is the relay, it is obvious that the electrical time constant is much shorter, the current rises faster, and the contacts close sooner. Another "wrinkle" has been introduced in the diode shown across the coil. It is polarized so as not to pass battery current; but upon interruption of the circuit, it provides a low impedance path for dissipation of the stored energy in the relay, which in the other case was dissipated in an arc at the interrupter contacts at high voltage without significant current flow. In this case, the current flow is appreciable and holds the relay on for a considerable length of time.

Not only is the relay now much faster, but the contacts are now closed for a time approximately equal to that during which the coil is energized.

Thus it is evidently difficult to state operating time of a relay unless circuit conditions are prescribed — and this is no academic qualification. (Those wishing to duplicate the above displays will recognize that the two resistors shown as 1.0 megohm should be varied to give a desirable relative magnitude to the two signals, and may in fact take the form of a potentiometer.)



Write for Catalogue

SIGMA Instruments, Inc.

SENSITIVE RELAYS

62 Ceylon St., Boston 21, Mass.

**Service
Beyond
The Sale!**

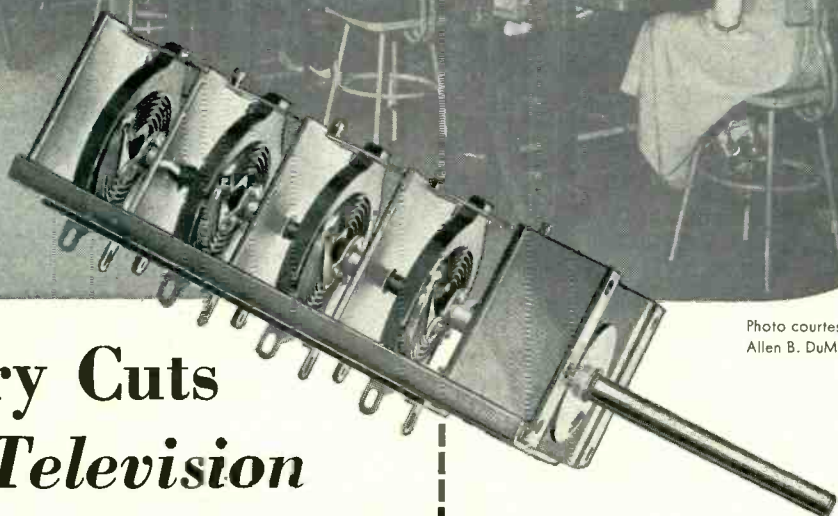

Photo courtesy
Allen B. DuMont Labs., Inc.

Mallory Cuts Factory Television Alignments by 6 to 1

Television receiver manufacturers who are employing the Mallory Inductuner* are giving their customers far more enjoyment . . . split-hair tuning accuracy, greater selectivity and stability, finger tip compensation for drift, complete FM radio coverage.

In addition, they find it possible to simplify their front end design and reduce assembly operation. For example, there are just two aligning operations on each of the three or four sections of the Inductuner, compared with six times as many on other types of tuners.

Added selling features! Reduced costs! And now, in the new Spiral Inductuner these important advantages are yours at a price no higher than other tuning devices.

If you want electronic parts of complete dependability and superior performance, from a supplier qualified to work hand in hand with you in the solution of design problems, turn to Mallory!

Outstanding Advantages of the new Mallory Spiral Inductuner:

1. A single control for easy selection and fine tuning of any television or FM channel.
2. Easily adapted to UHF converter use.
3. Excellent stability eliminates frequency drift.
4. Supplied in three- or four-section designs.
5. Far more quiet operation; permits high signal-to-noise ratio in front end designs.
6. Free from microphonics.
7. Greater selectivity on high frequency channels.
8. Eliminates "bunching" of high band channels. Covers entire range in only six turns.
9. Simplifies front end design and production.
10. Reduces assembly costs.

*Reg. trade mark of P. R. Mallory & Co., Inc. for inductance tuning devices covered by Mallory-Ware patents.

Television Tuners, Special Switches, Controls and Resistors

P. R. MALLORY & CO. Inc.
MALLORY

P. R. MALLORY & CO., Inc., INDIANAPOLIS 6, INDIANA

SERVING INDUSTRY WITH

Capacitors	Contacts
Controls	Resistors
Rectifiers	Vibrators
Special Switches	Power Supplies
Resistance Welding Materials	



CROSS TALK

► **DOTS APACE . . .** We'd like to take credit for stirring up the current interest in dot-interlace for black-and-white television (*Crosstalk*, May 1950) but honesty forbids. The subject was germinating for weeks before we mentioned it and would have blossomed without cultivation by us. That said, we can report with pleasure three happenings in this field: Firstly, at the CCIR conference on television standards in London (see p 70, this issue) it was pointed out that a 625-line black-and-white image would, with dot-interlace, provide resolution equivalent to 880 lines. Partly on this basis, the French government was asked by neighboring countries to reconsider its 819-line system in favor of adopting 625 lines along with the rest of continental Europe. Secondly, the National Television System Committee has set up an ad hoc committee to consider the advisability of establishing dot-interlace standards for black-and-white, under the chairmanship of I. J. Kaar. As we write, this committee is holding its first meeting. Thirdly, the demonstrations by Hazeltine engineers of certain improvements on the RCA dot-sequential color system (*Tubes at Work*, this issue) are so impressive that all concerned are greatly heartened over the application of dot-interlace to the color problem. The Hazeltine technique of constant-brightness sampling is not directly applicable to black-and-

white, but the half-element displacement of picture elements along adjacent scanning lines is applicable. At the moment, the principal doubts and fears about d-i for b-and-w lie in dot-crawl and other small-area flicker effects associated with the fact that a particular dot in the image is illuminated only 15 times per second when the field-scanning rate is 60 per second. Having witnessed the impressive flicker-reduction properties of a white-light silicate phosphor in Holland a few weeks ago, we suggest that such phosphors be used in dot-interlace tests at the earliest opportunity. The rewards for a successful solution to dot-interlace for black-and-white television are very substantial. So leave us leave no stone unturned!

► **NEXT DECADE . . .** The sparkle of one facet of the electronics industry, television, and its impact on other facets, notably a-m and f-m sound broadcasting and the movies, has encouraged a rash of statisticizing among the managers of these businesses. The tote for tv, all money spent for transmitters, receivers, talent and time charges is close to a billion dollars this year, certainly over a billion next year. This is a big figure, and should serve as a reminder that electronics is no longer a specialized business. It is geared to the national economy just as surely as food, clothing and autos.

All of which should make certain trends of particular interest to those managing electronic companies, be they suppliers of services, creators of components, purveyors of patents or fabricators of finished goods. The Economics Department of McGraw-Hill, in cooperation with the editors of our 30 sister publications, has just completed a survey of the growth potentials of American business and industry over the next decade. By 1960, barring war and assuming we then have full employment, the value of goods and services produced by all industry should be \$315 billion, up 18 percent over 1950. The population should be 165 million, up 9 percent, and consumer expenditures \$220 billion, up 19 percent. This is, of course, not a forecast; it is merely an index of what may easily come to pass if the national and international political climate is favorable to normal growth.

Technicians like ourselves, remote from managerial decisions, may profess disinterest in such matters. But we found the analytic basis of the trend study a matter of considerable technical interest. Accordingly we are working up an article on the long-range trends revealed in this survey, particularly as they affect our industry, for publication in an early issue. Twenty-five letters from readers, expressing extreme displeasure, will stop us cold. Any letter expressing interest will be welcome.

ELECTRON MICROSCOPY

in the United States

By **W. W. MacDONALD**

Managing Editor
ELECTRONICS

ELECTRONS can be focussed by means of electronic lenses much as light is focussed by optical lenses. Their wavelength is even less than that of ultraviolet, moreover, so electrons can illuminate in detail individual particles of matter that cannot be resolved by light. Why not, thought scientists of the early 1920's, use electrons rather than light as the basis for a new type of microscope to look at particles smaller than man had ever seen?

Early work involved examination of the enlarged patterns of materials which were themselves emitting electrons, and by 1930 a number of laboratories were using instruments of their own design to study the characteristics of such things as the filament wires of incandescent lamps and vacuum tubes. Substantial enlargement of objects intermediate between a source of electrons and a fluorescent screen was accomplished in the same decade, and in the 1940's commercialization of electron microscopes as we now know them occurred. RCA has, since that time, brought out and sold four models. North American Philips has imported several instruments. Farrand Optical is completing a design.

As of January 1950 there were 220 electron microscopes, valued at \$2,800,000, in use in the United States. Of these 41 percent were owned by schools and hospitals, 39 percent by industry including independent research laboratories, and the remaining 20 percent by city, state and federal departments and institutions. Many instruments, particularly those in colleges, are turning out research data for non-owners.

Typical Electron Microscope Applications	
<i>Schools and Hospitals</i>	
AEROSOLS, size determination	CONTROL, pilot plant and production
ATMOSPHERE, particulate matter	DIELECTRICS, surface, structure
BACTERIA, structure	DUST, particle size, structure
BIOLOGICALS, sample investigation	DYES, general study
CATALYSTS, surface studies	EMULSIONS, general study
CELLS, structure, virus	FILLERS, dispersal
CERAMICS, particle size, surface	FOODS, structure
CHEMICALS, product detection	FUMES, particle size, structure
CLAYS, physical characteristics	GREASES, soap, structure
COLLOIDS, particle size	METALS, surface, structure, films
FIBERS, structure, size	PAINT, particle size, structure
INSTRUCTION, general	PAPER, fiber studies
MARINE PARTICLES, size	PIGMENTS, dispersion
MEDICAL, general	PLASTICS, general study
METALS, surfaces, single crystals	POLYMERS, particle size, structure
MINERALS, morphology	POWDERS, particle size, structure
POLLEN, particle size	RESEARCH, general
POLYMERS, physical characteristics	RESINS, general study
PRECIPITATES, formation	RUBBER, general study
PROTEINS, fibrous structure	SLUDGES, morphology
RESEARCH, general	SMOKE, particle size, structure
SALTS, structure	VIRUS, examination
SMOKE, particle size	WAXES, general study
STARCHES, molecular weight	
TISSUES, virus infection, morphology	<i>Government</i>
VIRUS, identification	(City, State and Federal)
<i>Industry</i>	
(Including Independent Research)	
AEROSOLS, size determination	BACTERIA, direct observation
BACTERIA, identification	BIOLOGICALS, particle size, structure
BIOLOGICALS, general study	DUST, particle size
CATALYSTS, general study	MATERIALS, general identification
CLAYS, physical characteristics	MEDICAL, general
	METALS, surface, structure
	MINERALS, general study
	RESEARCH, general
	SOILS, general study
	VIRUS, direct observation

Applications for the electron microscope, present and potential, are so numerous and varied that a complete tabulation is impractical. Many current applications are classified. The accompanying table lists typical uses to orient the casual reader. The following quotes are included for those who wish to study the subject in greater detail. First, a few from schools and hospitals:

School of chemistry: "The electron microscope has been used as a primary standard method for particle size determination in synthetic rubber latices, in the investigation of pigment disper-

sion in the presence of surface active agents, for determination of the structure of surface films transparent to visible light where the resolving power or focal depth of the light microscope did not permit its use."

General research: "The instrument has been particularly useful in determining particle sizes and shape of catalysts, pigments, precipitates and cancer virus studies, and we have used the electron diffraction attachment on thin surface layers and vacuum deposited layers of metals and salts."

Research: "We have been able to detect a difference in composition between interior and surface of smoke particles."

Medical school: "We have identified characteristic virus associated with certain disease conditions in man, con-

A grass-roots report delineating the progress and penetration of perhaps the most unique instrument in our field. Typical uses are tabulated and constructive suggestions for improvement of future designs and techniques laid on the line

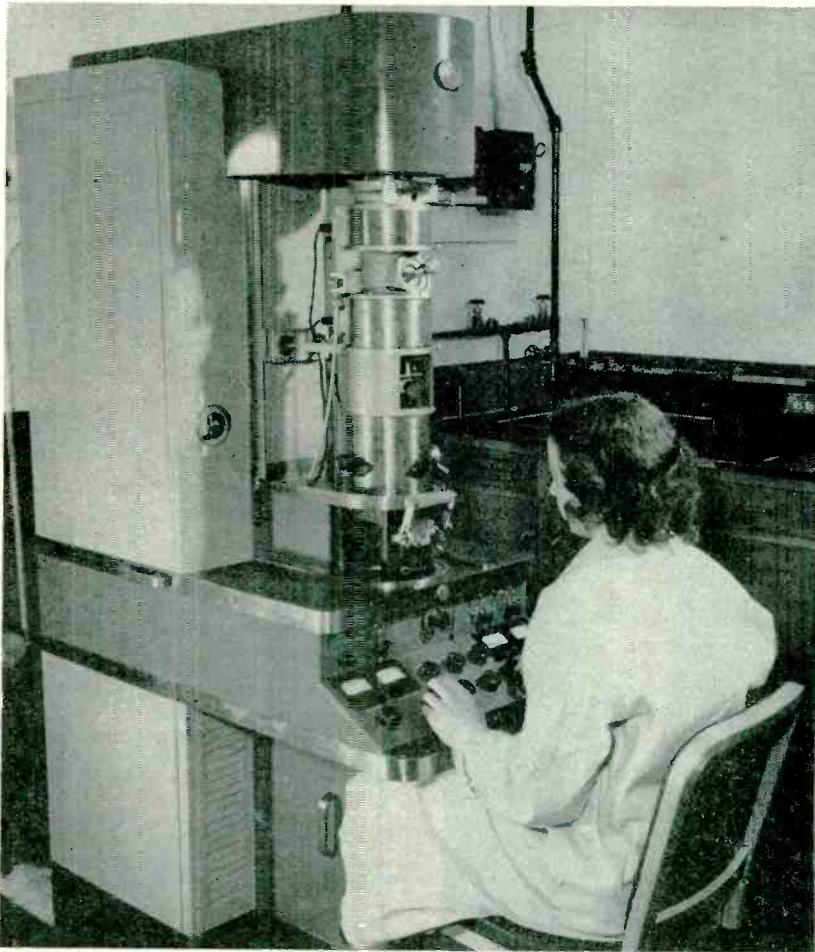

Model EMU electron microscope used in a Connecticut factory for research, development and quality control, and small dry batteries for which it helped synthesize new materials

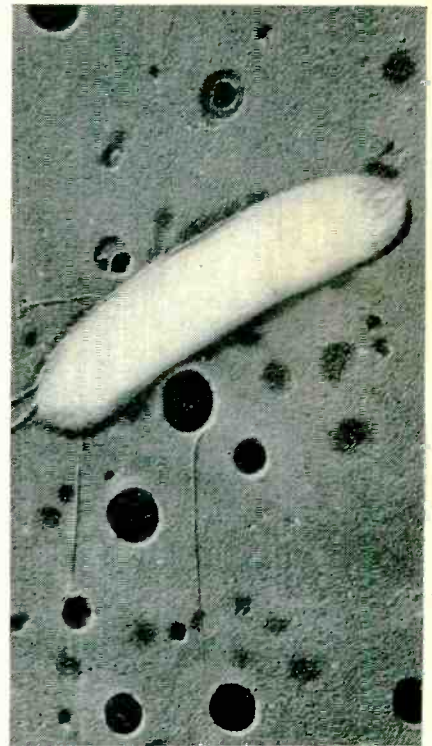

Gold-shadowed bacterium, as shown by experimental Farrand instrument

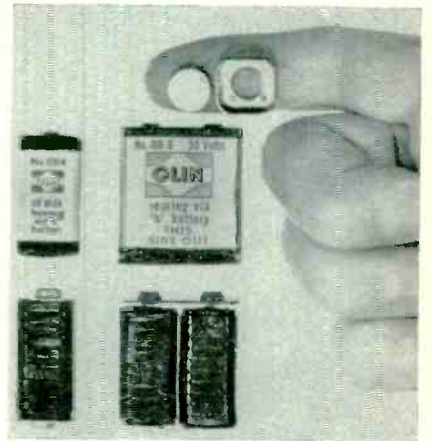

trolled physico-chemical treatments for purification of virus proteins, and studied the fine structures of fibrous proteins."

Medicine: "We have been able to see, photograph and characterize several animal virus hitherto known only by indirect evidence."

School of minerals: "We have investigated the crystalline phase in opal glass and shown that future study of this material with the electron microscope might be very significant to the industry."

Chemistry: "I feel that we have accomplished vindication by direct observation of several precipitation phenomena that were predicted by less direct methods and that we have added new knowledge concerning these phenomena."

Medical: "By using the electron microscope, I have found an otherwise unavailable source of approximate size determination in the colloidal range. The resolution was sufficient to show structure not otherwise discernible in protein fibers and in examination of sperm cell flagella."

General: "We have seen a number of new products in the field of chemistry and have observed in the field of virus and bacteriophage individuals that never could have been seen by optical means."

Bacteriology: "Our chief finding has been the discovery of the marked similarity of morphology among closely related bacteriophages active against salmonella typhosa."

Medicine: "We have been studying

the ultramicroscopic structure of myofibrils."

Medicine: "An intensive search is to be made for structures characteristic of neoplastic cells of both human and animal origin."

Medicine: "We have found globular proteins in cerebrospinal fluid, and virus-like globules in cancer extracts."

In industry, and among independent research organizations serving industry, applications for the electron microscope are still more extensive, as these examples show:

Paper company: "We have used the instrument not only as a research tool

but in plant trouble shooting. Electron microscopy has shown clearly differences in pigments which were only suspected from optical microscopic examination and thus has confirmed and placed on a sounder basis several hypotheses we had proposed. In some instances we have been surprised by the information obtained from the electron microscope in that we find unsuspected differences between similar pigments."

Battery maker: "We have been able to demonstrate relationships existing between various materials and the actual industrial utility of these materials. This has enabled us to synthesize better materials. The electron microscope is also used for routine control of incoming materials."

Electronic equipment: "We have studied the surface structure of sintered metallic oxides by means of stereoscopic pairs, and the results have considerable value in ascertaining the effects of processing changes upon the physical structure of finished products."

Electronic: "We have determined the structure of films of Al_2O_3 formed electrolytically of a thickness equal to about 0.5μ ."

Electrical: "By obtaining accurate particle size measurements compacts of different alloys of tungsten and molybdenum metal powders can be repeated."

Powder maker: "We have known for some time that cellulose from various sources behaves differently during processing. By using the electron microscope as a tool for elucidating the

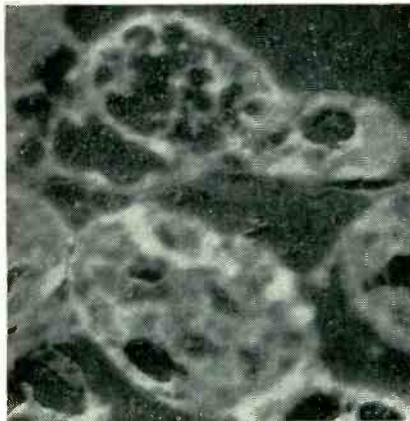

RCA's latest model, a permanent-magnet type marketed for less than \$6,000, and a micrograph of a plant section made with a 3,000X electronic lens and further enlarged photographically

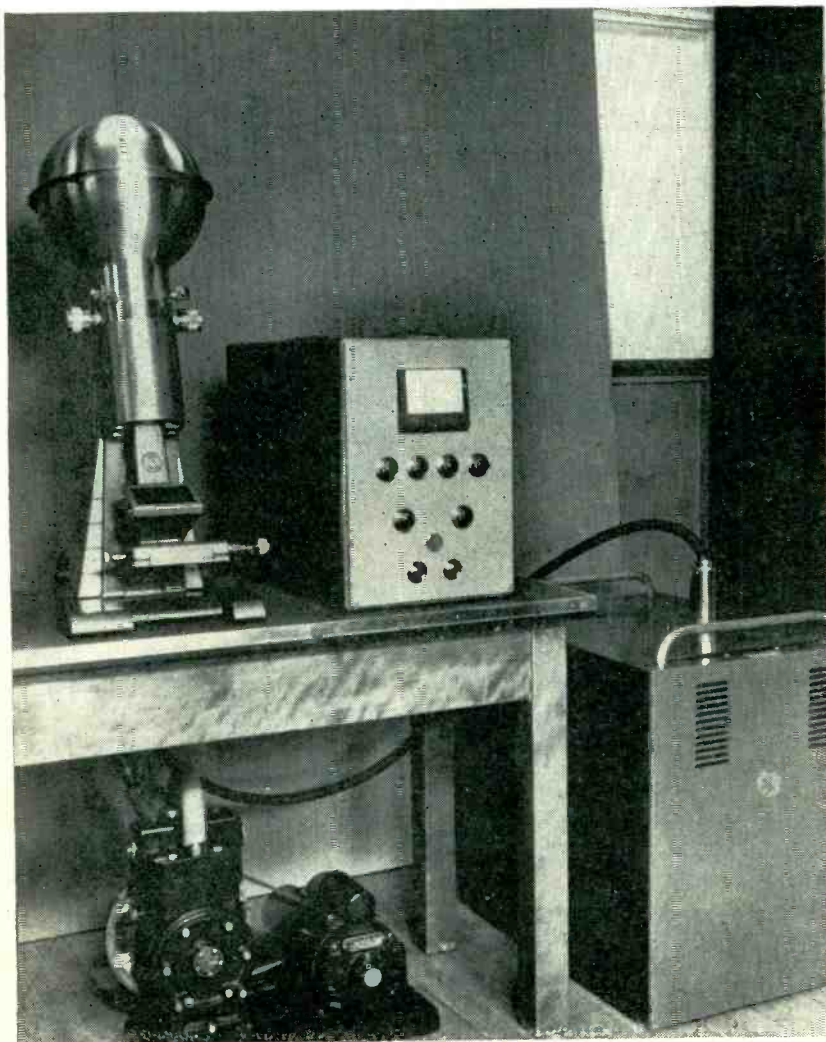

minute architecture of cellulose, dissimilarities in suomicoscopic structure have been revealed. This additional knowledge has given a new approach to the problem of reactivity, which should result in more efficient utilization of cellulose and an improvement in quality of the final product."

Pharmaceuticals: "A specific achievement has been the discovery of a new actinophage of *S. griseus*. These particles are much too small to see with the light microscope."

Oil company: "The use of reflection diffraction has made possible the identification of very thin corrosion films on metallic foils."

Oil: "Information, available only via electron microscopy, of importance in the production and evaluation of greases has been obtained."

Rubber: "We have studied and determined the relative growth rates of rubber and plastic latex particles during polymerization. By measuring the size of latex particles and determining the amount of soap on them, we have been able to calculate the size of soap molecules for a monolayer. We have determined differences in the ability of various polymers to disperse pigments."

City, state and federal government departments and institutions have been a little slower to acquire electron microscopes but a desire for the instrument is widespread:

Law-enforcement agency: "A great deal of the laboratory's work has to do with the identification of unknown materials of all types. In this regard, the diffraction adaptation has been of great aid. Electron diffraction patterns have been obtained and subsequently identified on extremely minute deposits which otherwise might have been considered too limited for adequate analysis."

Health department: "We have made, in the past, an effort to identify poliomyelitis virus with the electron microscope. Although we failed, it was possible to demonstrate that previously published photographs of what was claimed to be poliomyelitis virus were not pictures of the virus at all."

Medical: "Our microscope has been used for direct observation of bacteria and virus, sectioned tissue and SiO and AlO replicas of frozen material by means of a technique developed here."

Design Suggestions

Users of electron microscopes contacted during this study of electron microscopy in the United States expressed an almost universal hope that better methods of preparing samples for examination would soon be found. They seemed generally satisfied with the performance of their instruments but, in a spirit of helpfulness indicative of a desire to see the art progress even faster, offered some constructive suggestions regarding future design.

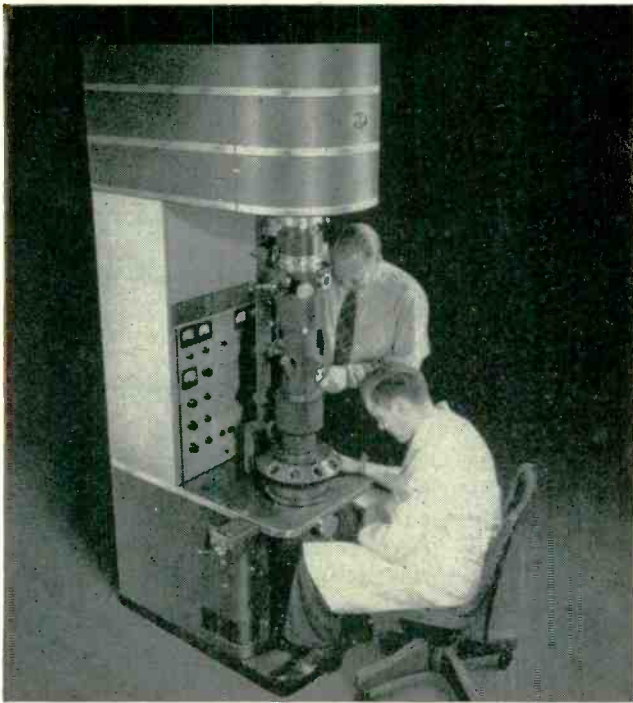

Early commercial model electron microscope type EMB, and the console type EMC that came along a little later

Design suggestions are here listed in apparent order of importance, with full knowledge that some of them are difficult or impossible to achieve at this time for either technical or economic reasons and awareness of the fact that some have already been included in most recent electron microscope models:

- (1) Greater range of magnification without complicated adjustment or dismantling.
- (2) More efficient or effective electron-diffraction accessories.
- (3) Increased resolving power to nearer the theoretical maximum.
- (4) Provision for taking more micrographs without repumping.
- (5) Improved correction of the electron lens system.
- (6) Higher voltage for greater sample penetration.
- (7) Means of reducing heating and other causes of sample instability.
- (8) Some means of obtaining more precise focussing.
- (9) Some method of determining the magnification of the specimen field by internal means.

Other suggestions, not so numerous, include: A universal stage permitting movement of samples while the instrument is in use . . . A motor-driven stage . . . Motion-

picture attachment for photographing samples . . . Adaptability to living materials . . . Larger field of view, particularly at low magnifications . . . Greater ease of adjusting new filaments after installation . . . Less susceptibility to corona and unsteadiness during humid weather . . . Elimination of effect of stray magnetic fields on ionization gage

. . . More automatic or foolproof safety controls.

In view of the accomplishments of the electron microscope since 1940, growing appreciation of what it may do that can be done by no other means, improvements in design and reduction in price, the market for the instrument should show substantial growth in the next ten years.

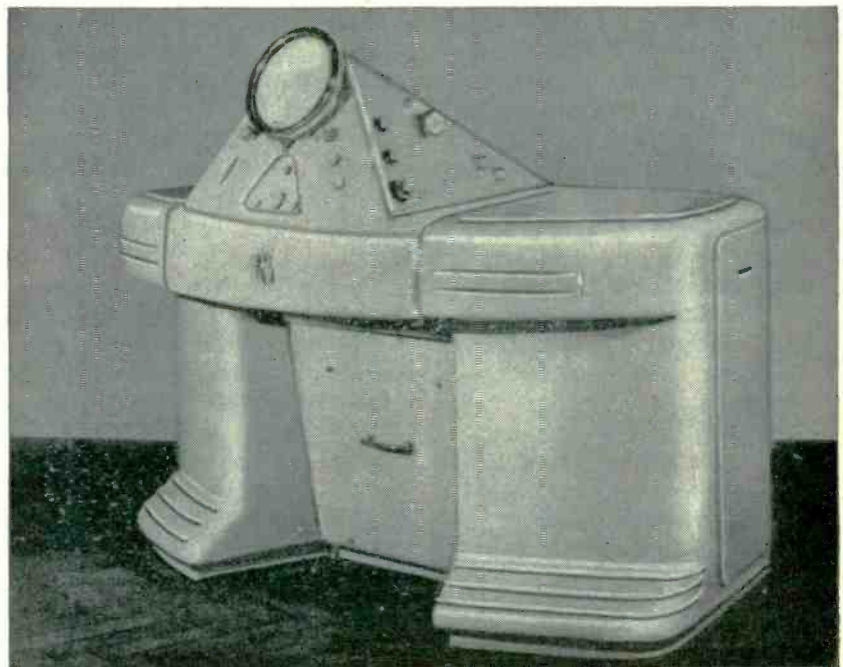

Imported Philips console model

TV—THE INTERNATIONAL

CCIR Study Group, following tour of television systems in U.S.A., France, Holland and England, makes further progress toward international agreement on standards at London conference. Standard line-scanning frequency proposed as bridge between 525-line and 625-line systems

REPRESENTATIVES of 22 nations recently participated in a tour of the television systems of the world, preparatory to the London Conference of the International Radio Consultative Committee (CCIR) study group on television standards. This group is attempting to formulate worldwide or regional standards to facilitate program interchange and to control interference. The program included inspections and demonstrations of the television systems of the United States, France, Holland, and England from March 27 to May 5, as summarized in the accompanying table, and concluded May 12.

The conference continued the study of international television begun in Zurich last year, as reported in these pages last October. The Zurich conference considered a group of questions on scanning standards, polarity of modulation, direction of polarization and sound modulation. Agreement was reached at Zurich on two-to-one interlacing, on an aspect ratio of 4-by-3, and on nonsynchronous operation (field-scanning frequency independent of the power-supply frequency). These recommendations were unanimously reaffirmed at the London conference by the 12 nations then present. In addition, vestigial sideband transmission was recommended for world-wide standardization.

Attempts to agree on the number of lines per picture and the number of fields per second proved unavailing at the London meeting, although it appeared certain that all the nations of continental Europe represented at the conference, with the exception of France, would agree on 625 lines and 50 fields. Pending a further meeting, the

French government is considering whether to go ahead with the 819-line system, or to go along with the 625-line systems of the neighboring countries.

One of the noteworthy developments of the London conference was the suggestion, advanced by the CCIR director, Dr. Balth. Van der Pol, that the line-scanning frequency be standardized as a means of bridging the difference between the 625-line European standard for line-scanning frequency and the 525-line American standard.

Technical Developments

The principal technical developments reviewed by the study group comprised seven major items: (1) the cost of operating a television system independently of the power supply frequency, (2) reduction of flicker by long-persistence phosphors, (3) the use of dot-interlace in black-and-white systems to improve resolution without increasing the bandwidth, (4) the polarity of picture modulation, (5) methods of reducing cochannel interference, (6) color television, and (7) standardizing the line-scanning frequency.

The first of these items, nonsynchronous operation, is important when transmitter and receiver operate on separate power systems, not tied together in frequency, as is likely when programs are exchanged across national borders. To avoid moving hum bars and scanning distortions, it is then necessary that stray magnetic and electric fields be removed both at transmitter and receiver.

A study of this problem, reported to the study group members by RCA at Camden, revealed that the

use of direct current on certain heater-filaments in the camera circuits and simple constructional and circuit changes in the monitors sufficed at the transmitter. Using dry-disc rectifiers for the heater supply allowed a conversion of the transmitter equipment costing less than 2 percent of the cost of the camera chain. Even lower cost was expected when the changes are introduced at the design stage.

Conversion of receivers for nonsynchronous operation was found to be equally simple. A standard 24-tube transformer-type table-model receiver was converted by substituting a larger power transformer (with less stray field), installing a magnetic shield around it, and inserting one extra multi-section electrolytic capacitor and bracket. The cost of these changes to convert from 60-cycle operation to 50-cycle nonsynchronous operation was 2 percent of the total cost of the receiver including cabinet. To convert a 50-cycle receiver for nonsynchronous operation cost only 1½ percent. Similar figures were reported by Philips engineers in Holland, who demonstrated a transformerless set converted at a cost of about 0.5 percent. As a result of these findings, the conference voted, without reservation, to adopt nonsynchronous operation as a world standard.

Studies of Flicker

Tests conducted at the RCA laboratories in Harrison, using members of the study group as observers, revealed that images scanned at 60 fields per second could be viewed at highlight brightness from 5 to 8 times greater than when scanned at 50 fields, for the

SCENE

By **DONALD G. FINK**

Editor, **ELECTRONICS**

Technical Adviser to U. S. Delegation,
CCIR Television Study Group

same visibility of flicker. This fact, which had been advanced by the U. S. delegation at Zurich in support of the 60-field American standard, impressed many of the delegates as justifying adoption of the 60-field rate. But a demonstration of flicker reduction using a long-persistence black-and-white silicate phosphor, at the Philips laboratories in Eindhoven, had the opposite effect, with the result that all the conferees except the U. S. delegation voted for the 50-field rate.

The phosphor demonstrated by Philips has two components, one producing blue light which decays to 63 percent of the initial intensity in about 0.1 millisecond, the other a yellow component decaying in about 10 milliseconds. The net effect is a bluish-white light, which decays to 6 percent of its initial intensity in one frame time, that is, in 1/25th second. Since the after-image is less than 6 percent as bright as the initial image, no smear effects are noted in objects in motion. Rapidly-moving objects may display yellow color fringes along edges at right angles to the motion, but this effect was stated not to be objectionable, since the eye is not critical of objects in rapid motion.

Using this silicate phosphor, the highlight brightness for tolerable flicker was increased about 7 times over that permissible with a short-decay sulphide white-light phosphor, when both operate at 50 fields. The increase in brightness in going from 50 to 60 fields, with short-decay phosphors, is about 6 times. Accordingly, the long-decay phosphor provides an improvement, at 50 fields, about equal to that in in-

TELEVISION TOUR — CONDENSED PROGRAM

U. S. A. (New York, Philadelphia, Washington) March 27–April 7, 1950

INSPECTIONS

DuMont, NBC, CBS and Philco studios and transmitters.
A. T. and T. microwave and coaxial terminal.
DuMont and Philco manufacturing plants.
Federal, RCA, DuMont research laboratories.
Exhibit of TV Receivers, RMA

DEMONSTRATIONS

Large-screen projection, Paramount Theatre, N. Y.
Phonevision, Zenith.
Telecine recording techniques, NBC.
525-line 60-field images vs 625-line 50-field images and flicker tests at 50, 60 and 70 fields, RCA, Harrison.
Industrial color television, DuMont.
Offset carrier operation, RCA, Princeton.
1029-line system, 20 mc, RCA, Princeton.
Nonsynchronous operation, receivers, transmitters, and film projector, RCA, NBC.
CBS field-sequential color television.
RCA dot-sequential color television, with tri-color tube.
Images on various video bandwidths, 4.25 to 20 mc, RCA.

FRANCE (Paris, Montmorency, Engien-les-Bains)—April 20–22, 1950

INSPECTIONS

Studios of French Broadcasting and Television Administration.
Exhibit, French TV Receivers.
441-line and 819-line transmitters, Eiffel Tower.

DEMONSTRATIONS

Comparison of low and high-definition images with films.
Positive vs negative modulation.
Nonsynchronous operation of receivers.
Cochannel interference reduction by sideband inversion.
Interference tests.

HOLLAND (Eindhoven) April 24–25, 1950.

INSPECTIONS

Laboratory and plants of N. V. Philips' Gloeilampenfabrieken.
Exhibit of receivers and transmitting equipment.
Visit to experimental studio and transmitter.

DEMONSTRATIONS

Images on different number of lines and bandwidths.
Nonsynchronous operation of receivers.
Flicker reduction at 50 fields by long-persistence phosphors.
High-quality projection image (60 x 80 inches).
Gradation correction of flying spot scanner (stills).

ENGLAND (London, Birmingham, Chelmsford, Hayes) April 27–May 5, 1950.

INSPECTIONS

London and Birmingham transmitters.
Studios at Alexandra Palace and Lime Grove.
GPO, BBC, EMI and Marconi research laboratories.
BBC outside broadcast facilities.
EMI and Marconi manufacturing plants.
Exhibit of receivers, Radio Industry Council.

DEMONSTRATIONS

Large-screen projection, Odeon Theater, Penge, Cintel.
Line broadening by spot-wobble method, BBC, Marconi.
Offset-carrier laboratory tests, BBC.
Comparison of 405 and 625-line transmission, BBC, EMI.
Field-sequential color tv, 405 and 625 lines, 9 mc.
Effect of scanning speed on signal/noise ratio, GPO.
Flying-spot film scanners with gradation correction, BBC.
Live pickup with cps emitron and gradation correction, EMI.
Effect of neutral filters on flicker at 50 fields, Marconi.
Simulated line and dot-sequential scanning, Marconi.
Telecine recording techniques, with spot wobble, BBC.

Nations in Attendance.

Austria, Belgium, Canada^a, Denmark, Dominican Republic^a, Ecuador^a, Egypt^a, Finland^a, France, Great Britain, Iran^a, Italy, Mexico^a, Morocco^b, The Netherlands, Norway^a, Pakistan^a, Sweden, Switzerland, Tunisia^b, Turkey^a, United States of America.

^a U. S. A. demonstrations only; ^b London conference only.

Summary of Latest Answers to Questionnaire

Country	Non-Sync. Operation	Frames/Fields Per Second	Lines Per Frame	Aspect Ratio	Modulation Polarity	Interlace Ratio	Sound Modulation	Channel Width (mc)
Austria	yes	25/50	625	4/3	negative	2/1	f-m	7
Belgium	yes	25/50	625	4/3	undecided	2/1	undecided	7-8.4
Denmark	yes	25/50	625	4/3	undecided	2/1	undecided	7
France	yes	25/50	819	4/3	positive	2/1	a-m	13.5-14
Italy	yes	25/50	625	4/3	undecided	2/1	f-m	7
Morocco-Tunisia	yes	25/50	819	4/3	positive	2/1	a-m	13.5-14
Netherlands	yes	25/50	625	4/3	negative	2/1	f-m	7
Sweden	yes	25/50	625	4/3	negative	2/1	f-m	7
Switzerland	yes	25/50	625	4/3	negative	2/1	f-m	7
United Kingdom	yes	25/50	405	4/3	positive	2/1	a-m	5
United States	yes	30/60	525	4/3	negative	2/1	f-m	6

creasing the field rate from 50 to 60 per second.

The U. S. delegation, acknowledging the importance of suitable long-decay phosphors, pointed out that such phosphors could provide even brighter pictures when used at 60 fields, and that such performance will probably be required in the future, particularly in dot-interlaced systems, in which the complete scanning cycle requires 4 fields for completion.

Dot-Interlace

Current interest in the United States in dot-interlace for color and black-and-white systems led the U.S. delegation to prepare a conference paper on this subject. This paper pointed out that dot-interlace doubles the resolution of an image relative to that of a line-interlaced image, without increasing the bandwidth. If dot interlace is to be used in a black-and-white system, without planning for a compatible color system in the future, the number of lines should be increased about 40 percent, this assuring that the increased resolution is equally distributed vertically and horizontally. If, however, it is planned to use dot-interlace in a compatible color system, the number of lines should not be increased, but the advantage of dot-interlace can nevertheless be largely realized in black-and-white, since nonuniform distribution of resolution is not subjectively harmful to image quality. Thus, using dot-interlace in a black-white sys-

tem, the 405, 525 and 625-line systems become the equivalent of 570, 740 and 880-line systems respectively, even though the line and field scanning standards are not changed. The fact that a 625-line dot-interlaced system would then be equivalent to an 880-line-interlaced system was noted by the French delegation as a possible justification for adoption of the 625-line standard by the French Government, since dot-interlace would then provide resolution somewhat superior to that of the established 819-line French standard.

Modulation Polarity

Comparative observation of the American and British systems revealed certain differences regarding polarity of modulation. The U.S. negative-modulation standard produces black spots from ignition interference, whereas the British positive polarity produces more noticeable white spots. Test reported by the Swedish delegation indicated that about twice the signal strength was needed, for equal annoyance from ignition interference, with positive modulation.

The British delegation pointed out that ignition systems produce greater interference with synchronizing pulses when negative modulation is used, and this leads to complication in receiver design to stabilize the horizontal scanning. The American delegation replied that such stabilizing circuits were also desirable to protect scanning

from thermal noise interference, which favors neither polarity of modulation, and that the higher costs of American receivers reflected a different set of conditions, including multichannel reception, brighter pictures, higher resolution, greater sensitivity, and higher quality sound reception by f-m.

The prospect of television service in the crowded centers of continental Europe entails a serious problem of interference, not unlike that currently faced along the eastern seaboard in the United States. For this reason, the European delegates were vitally interested in the American methods of reducing co-channel interference. A demonstration of the offset carrier technique was given at the RCA Laboratories at Princeton, N. J. and at the BBC Research Station at Kingswood Warren, Surrey. The measurements of the improvement afforded by offset were in close agreement on both sides of the Atlantic, the BBC figures being within 1 or 2 db of the results published by JTAC in this country.

Another means of reducing co-channel interference is the use of different directions of polarization of the radiated waves. It was unanimously agreed at Zurich and reaffirmed at London that the direction of polarization need not be specified as an international standard. This permits stations in adjacent countries to employ different directions to minimize interference. It was reported that some of the future installations in England would probably employ horizontal polarization, whereas the existing service in London and Birmingham would continue with vertical radiation.

Color Television

The conferees had a number of opportunities to view various systems of color television, intended for public consumption as well as "closed-circuit" use. Full scale demonstrations of the CBS and RCA 6-mc systems were held for the delegates in Washington, the latter with the tri-color tube. Other demonstrations included the 18-mc field-sequential industrial system of DuMont, and demonstrations in England by BBC and Pye, Ltd. of field

sequential systems using a 9-mc video band.

The conference concluded that it was too early to consider international standards for color service, but went on record as favoring a compatible system, i. e., one using the same number of lines and fields as was proposed for the black-and-white service. In this vote, the U.S. delegation abstained since the matter was currently under consideration by the FCC and no decision had been reached. The delegates were universally impressed by the ingenuity of the tri-color picture tube and understood that this type of tube could be used in any of the three color systems.

Line-Scanning Frequency

At the London conference, which was held May 8-12, it became clear that two scanning systems had most adherents throughout the world, the 525-line 60-field system of the U.S.A., Canada, Mexico, Cuba and Brazil (of which only the U.S.A. was represented) and the 625-line 50-field system favored by the continental European nations, except France. At Zurich, it had been pointed out by the U.S. delegation that these two systems have an important operating characteristic which is nearly identical, the line-scanning frequency. In the 525-line system this is 15,750 lines per second; in the 625-line system it is 15,625 lines per second. These two rates differ by 125 lines per second, or only 0.8 of a percent.

Thus, if a receiver built for 625 lines, 50 fields were operated on a 525-line 60-field system, only a minor adjustment would have to be made in the horizontal hold control to achieve line synchronization. Moreover, since the range of the vertical hold control is, in nearly all receivers, wide enough to encompass both 50 and 60 fields, field synchronization could also be achieved. If the receivers and transmitters were designed for nonsynchronous operation, so that hum bars and scanning distortion did not appear, the two systems would be compatible so far as scanning is concerned.

The demonstrated low cost of nonsynchronous operation caused this fact to assume new importance

at the London conference and the matter was the subject of much discussion. It was pointed out that nonsynchronous operation permitted tight tolerances to be maintained on the line-scanning frequency and that such tight control would permit better receiver performance at lower cost (for example, the Q of horizontal stabilizing circuits could be increased). Moreover, in anticipation of dot-interlace operation, narrow tolerances on line-scanning frequency were highly desirable, if not absolutely essential. Accordingly, it was proposed by Dr. Van der Pol that the line-scanning frequency of the 525-line and 625-line systems be made the same, at a compromise value of, say, 15,700 lines per second, and that this value be fixed within a tolerance of plus or minus one line per second, equivalent to simple crystal control of the sync generator (without temperature control of the crystal).

Since the line-scanning frequency is in fact the most critical aspect of scanning-system design, standardization would achieve important economies and make possible program interchange between nations using otherwise different scanning standards. In fact, it was noted that if the line-scanning frequency were standardized, and nonsynchronous operation were universally adopted, a continuous variation of lines and fields between the 525-60 and 625-50 limits would be possible without adverse effect and this might eventually lead to worldwide agreement on single values of these quantities.

The U.S. delegation gave immediate support to this proposal, but the other nations requested the opportunity of studying it further, placing such a standard on the agenda for the Geneva meeting, as noted below.

Conference Actions

The accompanying table shows positions taken by various delegations with respect to standards, as recorded at the London meeting.

At one stage in the conference, the British delegation proposed that four systems be recognized as world standards, those employing 405, 525, 625 and 819 lines. The

United States delegation objected that four standards would in fact be no standard at all and stated its opinion that the video bandwidth for the 405-line system (2.75 mc) was too small and that for the 819-line system (12 mc) too great, whereas the bandwidth for the other two systems (4.25 to 5 mc) was the best compromise between quality of image and quantity of television service.

Shortly thereafter, the continental European nations present (Austria, Belgium, Denmark, Italy, the Netherlands, Sweden and Switzerland) signified their desire to formulate a complete set of standards for the European region, based on 625-lines 50-fields. To make this possible, a sub-group was formed under the Chairmanship of Dr. Gerber of the Swiss delegation, to meet at the CCIR headquarters in Geneva. All member nations of the study group, including those committed to other standards, were invited to participate in this meeting, which will probably be held late this summer.

The sub-group will be charged with making definite recommendations for the continental European region regarding lines per frame, fields per second, polarity of modulation, type of sound modulation, video bandwidth and channel width, separation of sound and picture carriers, and distribution of sidebands. The matter of a standard line-scanning frequency, with a narrow tolerance, will also be taken up. Concurrently, plans were underway to hold a European television frequency allocation conference in Sweden, although this would not come under the jurisdiction of the CCIR.

An urgent plea was addressed to France by the nations named above, asking that the French 819-line standard be rescinded in favor of 625 lines, so that programs could be exchanged directly between France and her neighbors. If this action should be taken, it appears certain that there will be two regional standards recommended to the CCIR plenary session in Europe next year, the 525-line system for the North American region, and the 625-line system for continental Europe.

Mobile

By R. CAMERON BARRITT

West Pittston, Penn.

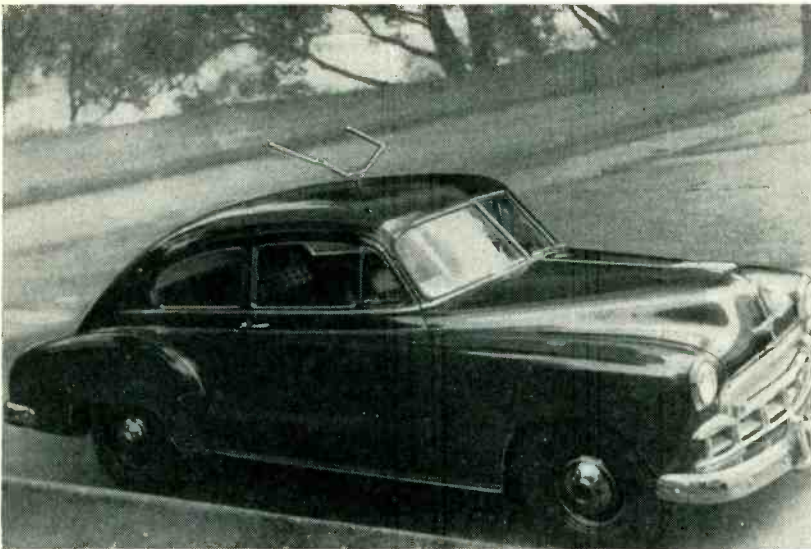

FIG. 1.—Automobile used in making tests is shown with ram's horn antenna in position

AUTOMOBILE RADIO RECEPTION is not always a dependable source of entertainment due to constantly-shifting levels of signal and interference as the receiving automobile travels. Especially in open country at night, both cochannel and adjacent-channel interference alter their intensities with each mile, and fading of the desired signal may render it impossible to keep a station coming through during an entire program.

As is well known, there is less difficulty with atmospheric noise and cochannel interference with f-m, but different problems of commensurate importance become apparent in the course of tests. Enough data has been gathered, however, to indicate that f-m broadcast reception in moving automobiles is definitely practical.

Test Equipment

The automobile used in the tests (Fig. 1) was equipped with resistor spark-plugs, a distributor suppressor, and a generator capacitor. A wide-range amplifier (30 cps to 10 kc), employing push-pull 6AQ5's with 125 volts on the plates, yielded almost 4 watts. This was sufficient to over-ride the ambient noise-level of the car at 50 mph with the windows closed, although it appears that a reserve of audio power is desirable.

A 10-inch speaker was mounted in the firewall, using the hood for a baffle, as shown in Fig. 2. This

COMMERCIAL RECEIVER REQUIREMENTS

F-M AUTOMOBILE RADIO is already practical in some areas of the country having easy topography and good program service.

A national market of sizeable proportions will develop as f-m stations in other areas increase their daytime service.

Commercial receivers designed for mobile application will have to be quite different from those now used in fixed locations. This forward-looking article tells what some of the special requirements will be

makes an almost perfect speaker enclosure and provides good bass response.

The receiver used in most of the tests was Fidelotuner with an extra r-f stage and a modified limiter, having an approximate threshold sensitivity of 2.5 microvolts (50 ohms) over some two-thirds of the band.

Major Problem

The major problem manifested itself as rapid fluctuations of the audio recovery and as fluctuation noise, which occurred only when the car was in motion but seemed to have no particular relation to the roughness of the road nor to the speed of the car. Periodicity seemed to be related to the wavelength of the signal. This condition even oc-

curred in areas of direct illumination by the transmitting antenna.

It was conjectured that out-of-phase reflections from various sources set up standing-wave patterns resulting in reinforcements and cancellations of the signal. Drops in signal strength were unnoted at first, as the average signal strength was quite high—much more than high enough to saturate the limiter when the car was not moving. Observations with an S meter verified this.

Curing Flutter

To assure saturation of the limiter while the car was in motion, an extra broad-band r-f stage was installed and the limiter was modified. Satisfactory performance was then experienced. Acceptable reception was obtained in many areas, and investigations were organized to establish what sensitivity was necessary under various conditions. It was concluded that the greatest possible sensitivity was necessary to assure the receiver's utility.

Rapid-fading proves troublesome in stationary long-distance reception. The same kind of fading often shows up in weak-field, long-distance mobile reception and is usually not accompanied by the standing-wave circumstances. The two are differentiated easily enough, as the rapid fading nearly always varies in frequency of fluctuation, probably because of a slip of phase in the paths of propagation as atmospheric refraction conditions change. When the extra path is caused by reflection from the wings of a moving airplane, the addition of the waves of changing phase is perfectly demonstrated. The trouble caused by multipath conditions can be alleviated by the wide-band treatment described in a later section.

It became apparent that amplifi-

F-M Broadcast Reception

Report on performance of various circuits and antennas for reception of frequency-modulation broadcasts in automobiles. Preliminary tests show need for increased sensitivities and improved limiting circuits in f-m broadcast receivers for moving vehicles

cation to saturate the limiter was not the whole answer to the near-field fluctuation trouble, as the speed of the ordinary limiter may not be great enough to hide serrated dips even in areas of high signal strength. These kinds of drops do not evidence themselves as vacillations of the audio recovery, but rather as fluctuation noise—sudden clicks and sputters. When the dips are not sharp, the result is a flutter of the audio.

The double cascade limiter, with its dual time constant and symmetrical limiting of both peaks, appears to be a necessity in this case. Increased numbers of cascades plus duo-diode shunt limiters can be used to advantage, but the 6BN6 gated-

beam tube seems to provide good limiting without a time constant.

A transient condition of reception in cities, similar to serration noise, is caused by phase-interference of multiple reflections from hard-surfaced buildings and streets. Abrupt phase shifts cause an audio noise. This difficulty is treated as common channel interference. Though it is possible that common channel interference may produce p-m noise, most of the effect can be eliminated by wide-band detection techniques.

The second major problem also involves limiters and is the obvious one of ignition noise. (Industrial noise is less important.) Although internal-combustion engines treated with suitable suppressors cause

little trouble in the majority of cases, a large percentage of cars and most trucks which pass cause tremendous static, often in spite of good signal strength and fair limiting. This is to be expected because of the proximity of the receiving antenna to the source of the noise. A partial solution of this problem will eventually come when laws are passed compelling all vehicles to be equipped with suitable suppressors, such as the resistor spark-plug, in order to eliminate tvi. In the meantime, improved limiters and antennas are prescribed.

Antennas

The design of a good antenna for mobile f-m reception is difficult. A

Table I—Typical Long-Distance Mobile F-M Reception Ranges
(Useful range limit estimated on basis of equivalent a-m noise performance)

Maximum range	Receiving area length	Location	Station	Receiving antenna	Remarks
105 mi	30 mi	Mount Pocono, Pa. Route 46	WHCU, Ithaca, N. Y.	Turnstile	Altitude of highway close to 2,000 feet
Up to 95	60	Skyline Drive in Virginia	All stations in Washington, most of Va. and Md. and some W. Va. stations	Ram's horn	Altitude of highway close to 4,000 feet
95	30	Routes 115 and 46 through Pocono Mts.	WQXR, New York, New York	Turnstile	
85	30		WCAU, Philadelphia, Pa		
90	No limit	Plymouth, Pa.	WSBA, York, Pa.	$\frac{1}{4}\lambda$ h-V	Received in Wyoming Valley over 1,500-foot mountains
75	Not ascertained	Dupont, Pa.	WENY, Elmira, N. Y. (5 kw ERP)	$\frac{1}{4}\lambda$ h-V	Perfect reception in mountains and good reception at foot of mountains (800-ft altitude)
70	No limit	Scranton, Pa.	WRAK, Williamsport, Pa.	$\frac{1}{4}\lambda$ h-V	
65	No limit	Scranton, Pa.	WKOK, Sunbury, Pa.	$\frac{1}{4}\lambda$ h-V	Good reception through most of variations in alt. and all towns
60	15	Wyoming, Pa.	WNBF, Binghamton, N. Y.	$\frac{1}{4}\lambda$ h-V	
50	$3\frac{1}{4}$ mi areas	Kingston, Pa.	WFMZ, Allentown, Pa.	$\frac{1}{4}\lambda$ h-V	Reception in small areas from over 2,000-foot mountain range
50	Not ascertained	Binghamton, N. Y.	WQAN, Scranton, Pa.	$\frac{1}{4}\lambda$ h-V	
45	No limit 2-50 yd areas	Scranton, Pa. 2 points inside Holland Tunnel in New York City	WPPA, Shenandoah, Pa. WQXR, New York, N. Y.	$\frac{1}{4}\lambda$ h-V	Reception possible in tunnel at points where change of slope occurs

ram's horn antenna was the first experimental antenna tried. The particular model shown in Fig. 1 has the disadvantages of extremely low gain (most pickup is concentrated skyward), a large component of vertical polarization, undesirable frequency sensitivity, and an irregular radiation pattern.

The properties of a vertically-polarized unipole were investigated, since it was thought that the loss of proper polarization might be compensated for if a good high-gain omnidirectional pattern could be acquired. Moreover, a large proportion of signals received while mobile are by reflection, and these often have much vertical polarization. However, patterns resulting were of small gain and just as irregular, due to the irregular ground-plane of the rooftop. A quarter-wave center-roof-mounted vertical whip, however, is useable for short ranges.

The gain of a horizontal antenna, $\frac{1}{4}$ wavelength above ground, was adopted as the minimum requirement. A whip type horizontal V was built using a foreshortened $\frac{1}{4}$ wavelength for a bazooka which symmetrized the pattern by balancing the potential of the two poles above ground. The gain and vertical directivity were vastly improved, and the horizontal directional characteristic obtained at center frequency was nearly perfect.

The antenna finally tested and more or less adopted as a permanent fixture is a turnstile, mounted $\frac{1}{2}$ wavelength above the roof (maximum horizontal gain is obtained in this position). An extreme mechanical problem is introduced by the large dimensions of this type.

A 75-ohm coaxial cable passes through the center of the supporting mast. A combination bazooka-balancer and $\frac{1}{4}$ -wave transformer matches the line to the parallel 75-ohm twinax leads which connect the dipoles. Good circularity and a low swr are obtained over the whole f-m band. The $\frac{1}{2}$ -wavelength mast raises the antenna above the ignition noise zone and a pickup with improved signal-to-noise ratio is obtained.

As desirable as antenna gain is, it must not be exalted at the expense of smoothness of the azi-

muthal radiation pattern. With all the variables to which the f-m signal strength is already subject, it is definitely undesirable to introduce a variation dependent on the car's maneuvering.

Present F-M Coverage

The research conducted was also intended to reveal how well typical highways are covered by f-m at the present time, which would indicate in part the practicability of commercial production of automobile f-m sets.

Highways in the East from upper New York state to Virginia are extremely well-covered by f-m stations. In fact, there are very few routes in these states that do not have large cities at least every 60 miles, and thus an f-m station always within receiving range.

The receiver used gave acceptable mountainless reception up to 40 miles from New York City with the ram's horn antenna, to 50 miles with the V antenna, and up to about 65 miles with the turnstile—when tuned to class B stations (20 kw at 500 ft). The useful distance of a set when immobile is, of course, much greater than when it is moving, because the motion of the automobile introduces the factor of fluctuating signal and noise.

It was found that the shadow problem on the highway is not so serious as feared or as academic predictions would lead one to anticipate. One can naturally expect very little reception when passing by a high mountain that lies between the route and the desired station. Also, when the road descends into a deep ravine, crosses a valley, or otherwise loses elevation rapidly, all but the nearest signals are lost until elevation is again established.

In wide valleys with steep sides there is usually good reception from stations perpendicularly behind the mountains, because reflection from the opposite side helps maintain signal strength. If the sides of the valley are gradually sloping, the fill-in may still be present, the major contribution being attributable to diffraction over a relatively sharp edge of the peak of the intercepting mountain.

It has been observed that excellent signal strength may be present

from a station 40 miles behind a 2,000-foot mountain range in an area where the peak of the diffracting mountain can clearly be viewed.

Although these two kinds of fill may be present in a trough of sufficient width-to-height ratio, it is a different story in a narrower chasm. If a highway runs through a narrow trough with steep sides, there may often be no signal from any station unless the propagation is in line with the furrow. Short range reception is best for stations which use a sufficiently high tower to minimize close range shadows.

Good homogeneity even in streets of even hilly cities has been found, probably because of the vast possibilities of reflection fill-in by buildings. Tolerable reception on highways that change elevation abruptly is often afforded because the car's motion obscures the presence of dropouts which occur in only a small area.

Regarding the aid that hills give reception, the boost observed on the side nearest the transmitting terminal is carried all the way from near the bottom to the top and a considerable distance beyond the crown. If the hill is not too steep, the only apparent effect of the lower signal on the far side is a rise in receiver hiss-level. Nearly all the quirks of propagation and reception met can be predicted by present day theory¹ on uhf propagation.

Our comparisons of f-m and a-m practicability have shown that f-m fading is no more extensive, for the most part, than a-m, and that the signal returns more often. The useful range of f-m is commensurate with that of the majority of a-m stations.

Long distance reception occurs in low swr areas with a minimum number of dropouts, that have little relation to the absolute value of signal strength and which occur not necessarily because of line-of-sight conditions, short propagation route, nor because of large transmitted power, but occur because of the characteristics of the surrounding topography.

Reception of a purely diffracted wave is reliable, but an added wave caused by atmospheric refraction produces the weak signal oscillation mentioned previously. The omni-

directional antenna necessary for mobile reception is vulnerable to out-of-phase signals and cancellations of different reception paths, as well as other interference. No antenna rejection of interference is possible in the horizontal direction.

Receivers

The ideal receiver for installation in automobiles would be quite expensive. Some shortcuts might be necessary commercially. Great sensitivity is the major requirement. Other features could be used in a greater or lesser degree, depending on how idealistic one may be.

To obtain great sensitivity means a large amount of amplification—introducing the problems of regeneration, cross modulation, and undesired responses. The double or triple superheterodyne is a likely approach as it is easier to distribute a high degree of amplification in different frequencies, thus affording isolation; but the multisuperhet design must be worked out carefully to avoid spurious responses, such as those resulting from oscillator harmonics or oscillator beat frequencies.

Another approach to high gain is in the design of the selective circuits. A transmission-line type of tuned circuit, instead of the conventional lumped constants, will furnish a higher impedance and thus a higher gain, also with accompanying greater selectivity. The transmission-line type element should be as close as possible to a full quarter-wave, however.

The importance of selectivity in the front-end for minimizing spurious responses should not be undervalued. The tuned stage should be the earliest one possible and any broad-band coupling should follow it. If the first r-f stage is broad-band, it will have to be carefully designed for linearity. The r-f stage added to the Fidelotuner was made broad-band for simplification and economy and it is, unfortunately, subject to overloads and heterodynes. The high sensitivity necessary in the mobile receiver renders it extremely vulnerable to cross-modulation.

Nominal sensitivity (50-ohm terminals) should be one microvolt and it is felt that a useful sensitiv-

ity in the tenths of microvolts can be achieved in production without extraordinary difficulty. The point should be made that supersensitivity is not of so much value unless it is accompanied by low-noise amplification in the r-f head. For a maximum range, the controlling noise of a receiver should be that due to the resistance of the antenna with a minimum added by the circuits and tubes of the r-f preamplification.²

When the receiver has enough amplification to assure saturation of the limiter, the vacillation of audio recovery previously described will not be exhibited, but in the fringe areas the trouble may still be evident in an undulation of the background noise level. This difficulty emphasizes the need for low-noise design with two triode r-f amplifiers. The cascode amplifier³ is a good arrangement, and the use of

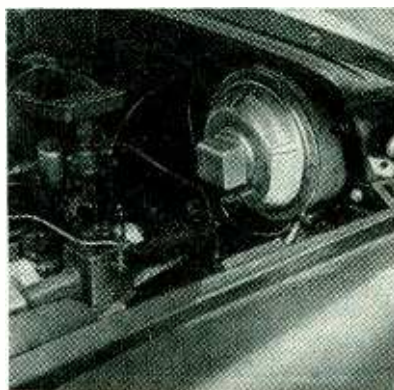

FIG. 2—Firewall speaker mounting using the hood as a baffle.

the Tung-Sol 5687 twin triode would probably yield excellent performance in gain and noise factor, although the less expensive 12AT7 may certainly be utilized in less idealistic fabrication.

The commercial receiver would have to be quite rugged and capable of holding its alignment when subjected to road shock.

Tuning indicators are of no value when in motion. Automatic-frequency-control seems to be a must for mobile receivers.⁴ It eliminates the side responses (which would occur if a conventional discriminator were used), acts as a valuable aid in tuning (the set is automatically brought into resonance when tuned near a station), obviates the necessity of crystal-controlled oscillators to eliminate drift, automatically re-

duces the distortion caused by adjacent-channel carriers⁵, and maintains the i-f in the exact center of the discriminator characteristic, meaning maximum invulnerability to any ignition noise residue passed by the limiters. The only disadvantage is the possible loss of tuning during the fluctuation of a very weak signal, or the possible switch-over to another channel.

Bandpass

It is desirable to use a somewhat wider i-f bandpass than usual. Most stations unfortunately maintain their modulation level high and speech transients slip through the compressor, resulting in the signal becoming distorted when passed through the conventional receiver—i-f—amplifier. It should be kept in mind that the bandwidth of an f-m signal deviated plus or minus 75 kc is quite a bit more than 150 kc⁶, and that it is the phase nonlinearity of the i-f, not the amplitude nonlinearity, that causes distortion⁷. Residue overmodulation of short duration is much more apparent with f-m than with a-m. Allowance for this, plus some acknowledgement of i-f drift, would seem to indicate a bandpass of well over 200 kc as the preferred specification. A steeper bandpass can be obtained by using relatively low gain per stage, which would allow for an extra stage with another bandpass network.

Wide-band detection (3 to 6 mc) used to cancel out distortion and noise products of spikes caused by multipath reception and channel interference, as described in the references 8, 9, 10, has great value in the mobile receiver. At the very extreme limit of the propagation range the fluctuation is smoothed out, since the signal is weak, while the reception is distorted by co-channel out-of-phase waves arriving by a longer path, but with almost as much strength as the direct-path wave. Elimination of the distortion, by this means, may result in a receiver of a useful range extended to over 100 miles if careful attention is paid to the noise factor of the front-end so that the signal will not be lost in a background of noise.

Skywave propagation of f-m,

represented by reception in excess of 100 miles, is related to meteorological conditions for the most part and has very little to do with ionospheric propagation. It does not fade so much, nor is it so variable as a-m skywave.

Use of wide-band limiters and discriminator should also be considered as an aid to the adjacent-channel interference problem. Channel interference has been observed in the New York City area with the receiver described having a selectivity not quite 60 db adjacent channel, considered sufficient by manufacturers at the present time.

Described in the references is a 6-mc wide-band discriminator which is conventional in utilizing tuned circuits, but is superior to the usual transformer type. Noise reduction capabilities are combined in the detector. It was conceived by Arguimbau and Granlund and is described in their latest article on Trans-Atlantic f-m¹⁰. The 6-mc bandwidth of limiters and discriminator is capable of ignoring distortion resulting from an interfering carrier with an amplitude of less than 5 percent of the desired carrier amplitude— $\frac{1}{2}$ db difference. A 3-mc discriminator is useful for a ratio of desired to interfering carrier up to 90.5 percent for 75-kc swing. Either is vastly superior to the rejection capabilities of the ordinary f-m system usually prescribed as requiring a 2-to-1 ratio of signal to interference.

In cases where this kind of wide-band detection is not warranted, it is felt that a wider discriminator than now utilized is still required. The best i-f of present-day techniques is still not good enough to ignore even a minimum of adjacent or alternate channel signal. When the peaks of the discriminator fall in the adjacent or alternate channel, the trouble is intensified and a large distortion product may result from merely an unmodulated carrier in this region. A discriminator with a bandwidth sufficiently wide so that its peaks are far out on the i-f skirt, at least farther than the alternate channel, seems to be the minimum requirement.

Though we have not yet had the opportunity to observe the mobile

performance of a receiver with wide-band detection, we certainly expect it to perform with less noise, less distortion, and greater range,—to be reliable to 100 miles in conjunction with a good antenna. The combining of a-m facilities in the mobile receiver would be desired at the present time; however, with the circuit complexities already present in the receiver due to the involved requirements of mobile f-m, it would seem inadvisable to complicate matters further and increase expense. Our visualizing such an f-m receiver commercially available is for the day when all stations furnish full-time f-m programs.

Conclusions

From experimentation it has become evident that mobile f-m broadcast reception is feasible to further limits than had been expected. Shadow fill-in by various agents renders useful the quasi-optical type of propagation, but irregularities pose an extreme problem in limiting, since the signal intensity varies to extreme limits although fill in and other phenomena have kept it at a useful value. The line-of-sight restriction having been successfully dealt with, the remaining problem is that of distortion resulting from multipath-wave interference in weak fields, which appears to be solvable with wide-band detection.

In this article we have not speculated as to the relative superiority of mobile f-m to a-m, or conversely; but in our investigation, there has been much evidence of a nature to cause a partiality toward f-m. Mobile reception of WQXR, a-m and f-m, illustrates the vast advantages of f-m, for the 10-kw a-m signals are consistently lost in a conglomeration of channel interference. (The programs of WQXR are ideal for a research of this nature.) We might add that the dead area of WQXR-FM's reception, which may occur between a distance of 65 to 80 miles from New York, is amply filled in by the retransmission of the programs through Allentown's WFMZ.

Table I lists some of the reception data obtained. It can be said that while the lower a-m frequencies

have more effectual propagation properties, the f-m band has the more pertinent value of lower noise characteristics. As the solution to the problems of mobile broadcast reception, f-m holds great promise, although all of its theoretical advantages are not yet completely utilized.

Contrary to predictions, f-m is not lost in areas where line-of-sight is impossible, even amongst the tall clusters of shadow-throwing skyscrapers on Manhattan. Also, there are no ionospheric skip effects, a minimum of erratic skywave, no serious co-channel problems, and thunder storms and other atmospheric noise have no influence whatsoever on mobile f-m reception. Also f-m is capable of penetrating most of the roadside type of barriers to a-m. Passing over a steel cantilever bridge or under a steel reinforced viaduct has almost no effect, whereas almost complete shielding of a-m signals would result.

Looking on the dark side, it appears that some time will pass before all the advantages of mobile f-m can be incorporated in a commercially available receiver of reasonable cost. The receiver improvements suggested all involve expense and difficulty of mass production. We do look to f-m however as the ultimate answer to perfected mobile broadcast reception in the future, even though the problems are of great extent. Further investigation into this application is emphatically recommended.

REFERENCES

- (1) Bullington, Radio Propagation at Frequencies Above 30 Megacycles, *Proc. IRE*, p 1,123, Oct. 1947.
- (2) Watts, Television Front-End Design, *ELECTRONICS*, p 92, Apr. 1949 and p 106, May 1949.
- (3) Wallman, Macnee and Gadsden, A Low-Noise Amplifier, *Proc. IRE*, p 700, June 1948.
- (4) Sleeper, "Standard F-M Handbook", F-M Co., Great Barrington, Mass., p 67.
- (5) Pluse, Investigation of Frequency-Modulation Signal Interference, *Proc. IRE*, p 1,054, Oct. 1947.
- (6) Corrington, Variation of Bandwidth with Modulation Index in Frequency Modulation, *Proc. IRE*, p 1,013, Oct. 1947.
- (7) Gladwin, The Distortion of Frequency-Modulated Waves by Transmission Networks, *Proc. IRE*, p 1,436, Dec. 1947.
- (8) Meyers, Nonlinearity in Frequency-Modulation Radio System Due to Multipath Propagation, *Proc. IRE*, p 256, May 1946.
- (9) Gerks, An Analysis of Distortion Resulting from Two-Path Propagation, *Proc. IRE*, p 1,272, Nov. 1949.
- (10) Arguimbau and Granlund, Sky-Wave F-M Receiver, *ELECTRONICS*, p 101, Dec. 1949.



Complete automatically switched intercommunicator. Remote stations contain only speaker and annunciator pushbutton for signaling master station to originate a call. Pushbutton switches are used to insert 14-tube voice-switched master unit between desired calling and called stations

Voice-Switched Intercom

Talk-listen switch is eliminated by using four-terminal repeater with flip-flop multivibrator that unblocks gated amplifiers alternately 30 times a second. Arriving voice signals stop flip-flop and keep desired channel open without clipping syllables

PROPER FUNCTIONING of a fully automatic system for two-way wire transmission of voice-frequency signals depends on the existence of appropriate signals which can initiate switching in the proper direction. Such a system eliminates the need for manual talk-listen switches at the master station or at all substations.

Separate microphones have been used in a number of practical intercommunicators to initiate automatic switching. In these systems the arrival of sound above a minimum threshold level at the microphone provides the control signals. Such devices have given highly satisfactory service in the past.^{1,2}

Many experimental automatic intercommunicators have been designed around voice-operated relays similar to the Vodas³ used in carrier-type telephone systems. In general, these suffer from excessive complexity and maintenance difficulties.

There exists a fundamental difference between terminal conditions

By **RALPH H. BAER**

*Chief Engineer
Wappler, Inc.
New York, N. Y.*

in Vodas systems and in intercommunicators. In the first, signal-to-noise ratios are determined by line noise and radio-link interference signals. Rapid break-in operation is highly desirable to approximate the conditions of the normal telephone conversation. A switching arrangement responsive to the syllabic content of speech is therefore indicated.

In intercommunicators, line and equipment noises are usually minimal, but the system must differentiate between ambient acoustic noise and the desired voice signal. In addition, signals at the considerable power level necessary for loud-speaker operation must be handled, increasing the difficulties resulting from circuit switching transients. Therefore, slower switching speeds than those encountered in the Vodas

and in electronically switched carrier systems⁴ appear to be necessary.

The admittedly higher first cost of a selfswitching intercommunicator is frequently justified by the conditions under which it is expected to perform. A fully automatic system like that to be described permits a much larger radius of mobility for the participants.

Gated Amplifiers

The diagram in Fig. 1 shows how automatic switching is achieved in an intercommunicator developed for office and industrial use. The two identical channels contain gated amplifiers that are unblocked alternately 30 times per second by a flip-flop multivibrator that feeds the gated tubes in opposite phase. In addition, each channel has its own control circuit that keeps the channel open if a voice signal reaches it during the 1/60th-second interval when its gated amplifier is unblocked.

In the absence of sounds above

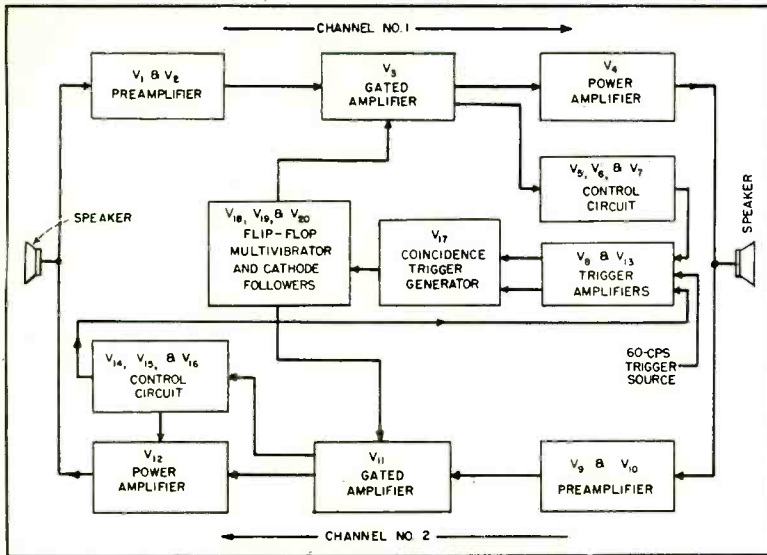

FIG. 1—Twenty stages, some using halves of dual-function tubes, keep either channel open as long as voice signals are present and permit other channel to take over quickly at end of message

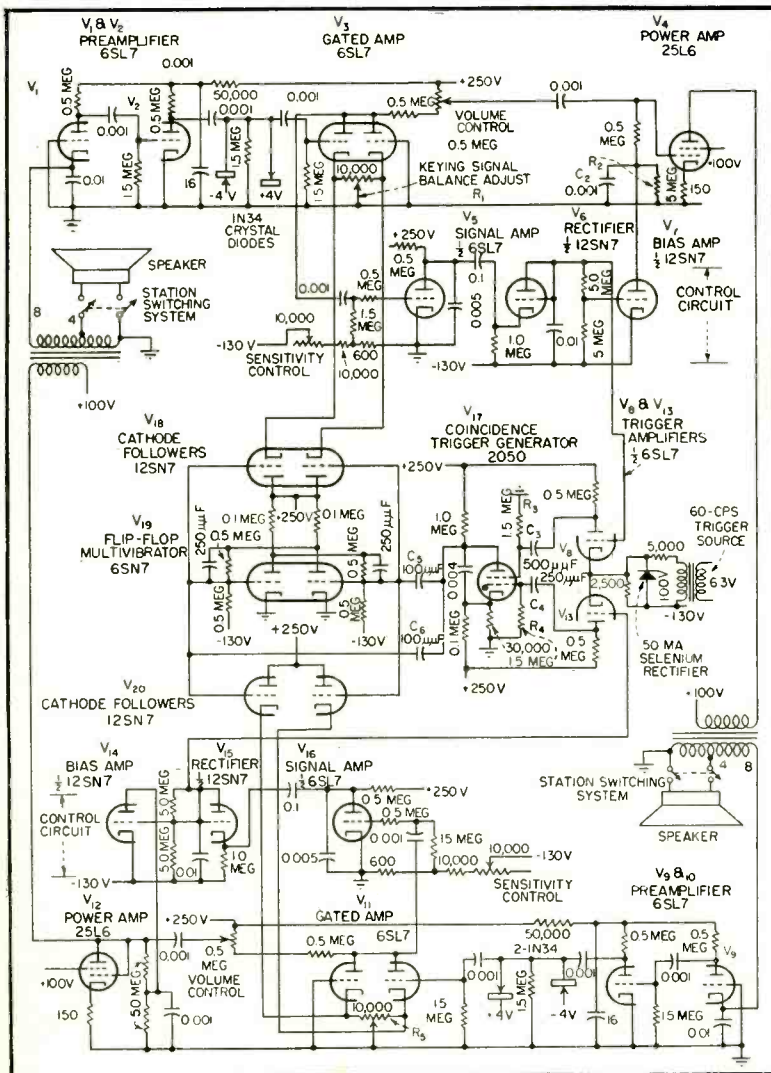

FIG. 2—Amplifiers and control circuits. Power supplies and station-switching arrangements are conventional hence not shown

ambient level at either speaker, the outputs of the gated amplifiers consist of residual hum and noise signals (approximately 1 volt peak-to-peak) keyed on and off 30 times per second. Normal voice levels at either speaker will therefore appear at the output of the corresponding gated amplifier within a maximum of 1/60th second. These gated-amplifier output signals will normally exceed 5 volts peak-to-peak, and are hence well-suited to initiate the required switching operation since they result from the presence of an adequate sound signal and are simultaneously sense-directed.

In the control circuits, these signals are amplified and rectified, yielding a d-c control voltage which removes the cutoff bias from the output tube and stops the 60-cycle triggers normally applied to the flip-flop circuit. This locks the flip-flop, holding the proper gated amplifier in the on position and permitting sound signals to keep the channel open via its own control circuits. At the same time the gated amplifier in the other channel is held in the off position by the locked flip-flop. Therefore, its control circuit obtains no signal and the power output stage of this channel remains biased beyond cutoff.

Complete plate-current cutoff is required to eliminate residual hum and circuit noise components as well as to prevent feedback through the system and resultant howling during standby conditions, since the output transformer is common to the input of the other channel. It is important that the signal-noise ratio at the output of the gated amplifier be as high as practicable, since a ratio of at least 4 to 1 is required at this point to prevent erratic operation.

A front-panel control is used to reduce the gain of the control circuit signal amplifiers so as to prevent high ambient noise levels at either terminal from locking the system in its direction. With reduced gain it is necessary to raise one's voice at that station, but this is required anyway with conventional intercommunicators to remain intelligible despite the masking effect of the ambient noise.

When voice signals cease in a channel, the d-c output in its control

circuit drops to zero, the output tube of the channel is cut off, and the 60-cycle triggers are again permitted to reach the flip-flop, which resumes its keying function.

Operating Requirements

In order to assure reliability of circuit operation the following considerations must be taken into account:

(1) The events originated by the control circuit must be in proper time sequence.

(2) The outputs of the gated amplifiers during their on periods must contain only signals fed by their respective preamplifiers. Thus, the keying signal itself must not appear in the output.

(3) The control circuits must respond rapidly enough to prevent initial syllable clipping due to retarded removal of output tube cut-off bias.

(4) To preserve naturalness of speech, intersyllable response of the control circuits must be slow enough to prevent choppy speech, but sufficiently rapid to permit quick channel reversal after termination of a message.

(5) In their off position the gated amplifiers must be capable of blocking the high-level signals arriving from the preamplifier, whose input is being driven by the output of the other channel.

(6) Despite their relative large number, individual stages should be simple and employ a minimum number of components.

Proper sequencing of events dictates mainly that the flip-flop circuit be locked before the output tube in the live channel is made operative. Also, the flip-flop must resume operation only after the output tube is completely cut off and all transients in the corresponding transformer have died out. In this connection it is important to regulate the rate at which the output tube is biased toward cutoff since this determines largely the character of the resultant transient. Similarly, the rate of response of the trigger signal circuits feeding the flip-flop must be accurately controlled. The initial response may be made nearly instantaneous while the release period must be held within 0.1 to 0.25 second. Lower

values decrease the stability of the system and higher values prolong the time taken to reverse direction of transmission after cessation of a message.

In order to prevent the square-wave keying signal from appearing in the output of the gated amplifier, the signal is caused to balance out in the plate circuit of the twin-triode by applying the square-wave keying signals out of phase to the cathodes. Thus no component of the keying signal appears across the plate load of the gated amplifier.

Circuit Details

The complete circuit of the voice-switched intercommunicator appears in Fig. 2. Here it can be seen that the gated amplifiers are driven by the flip-flop through cathode followers to isolate the channels and to make it possible to balance out individually the two gated amplifiers. Semiaadjustable controls R_1 and R_2 are provided for this purpose. The stability of the adjustment is such that it maintains balance within 0.25 volt over long periods of time and large line voltage variations. Stability depends only on the characteristics of the gated tube itself and not on those of the cathode followers or the cathode follower grid signal waveform, provided each cathode follower and its controlled amplifier section are alternately driven beyond cutoff.

The amplitude of the rectangular keying signal between cathode and ground is made approximately 10 volts peak to peak. The gain of the gated amplifier under these operating conditions is thus that of an ordinary cathode-degenerated stage. Reducing the filament voltage of the gated tubes (V_3 & V_{11}) minimizes the hum components developed across the unbypassed cathode resistance. Overall gain of the amplifiers (voice coil to plate of gated amplifier) is 95 db at 1 kc.

Rapidity of response is largely a function of the gain incorporated into the control circuit signal amplifier and of the RC time constants in the control rectifier. Components R_2 and C_2 primarily determine the bias decay and prevent a thumping noise every time plate current is restored.

To prevent gate breakdown by high signal levels, the gated amplifiers are protected by two 1N34 germanium diodes which restrict the input signal to 8 volts peak to peak. Short time constants in the coupling networks prevent the keying signal balance from being affected by the peak clippers. Grid limiting in the preamplifier keeps the signal peaks applied to the clipper diodes below 50 volts.

Trigger pulses for the flip-flop originate in V_8 and V_{12} , whose cathodes are driven by a halfwave-rectified 60-cycle pulse of large amplitude. The resultant square-waves developed across the plate load resistors are differentiated by R_3C_3 and R_4C_4 and applied to the first and second control element of a 2050 thyatron coincidence trigger generator biased beyond cutoff. The simultaneous arrival of both trigger signals will result in a plate-current pulse whose steep leading edge triggers the flip-flop through C_5 and C_6 . Appearance of rectified d-c control voltage at the grids of either V_8 or V_{12} reduces the corresponding trigger signal applied to the thyatron below the firing level. As a consequence the flip-flop maintains its instantaneous equilibrium state until all d-c voltages have disappeared and released V_8 and V_{12} .

A number of experimental models have been built for office intercommunication. They are housed in small cabinets containing the master speaker and a pushbutton arrangement for selection of outgoing lines. In the standby position the incoming amplifier input is grounded, hence plate current in the output tube is cut off and the master speaker is absolutely silent. Provision is made to permit each substation to sound an annunciator at the master to originate a call. The units are powered by selenium rectifiers and simple RC filters. Power supplies and switching arrangements are conventional.

REFERENCES

- (1) J. R. Cooney, Voice-Controlled Intercom System, *ELECTRONICS*, p 118, Sept. 1949.
- (2) H. J. McCreary, Electronic Interlocking for Intercommunicators, *ELECTRONICS*, p 30, Sept. 1941.
- (3) L. Wright, The Vodas, *Electrical Engineering*, 56, p 1012, Aug. 1937.
- (4) R. C. Fox, F. S. Beale and G. W. Symonds, Voice-Operated Switching of Carrier Systems, *ELECTRONICS*, p 12, Feb. 1950.

MATRIX TELEMETERING

System permits transmission of 30 channels of information with an overall accuracy of 1 percent. Data voltages determine position of pulses in 30 accurately-timed intervals, traversed sequentially and in synchronism at both sending and receiving stations

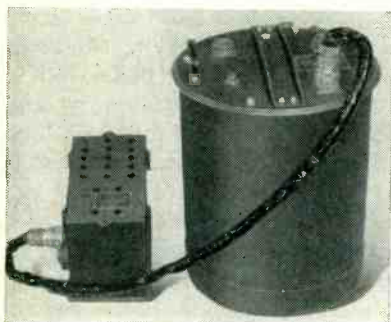

FIG. 1—Transmitting equipment weighs 130 pounds, with batteries, and produces 4 kw peak power at 1,025 mc

AS MORE AND MORE high-altitude research is conducted with unmanned rockets, there arises a need for better telemetering equipment to convey and record data obtained by the many instruments carried aloft.

Experience in the use of the sequential system originally described in March and April 1947 *ELECTRONICS* indicated several modifications in design and function for increasing the utility and reliability of that early system. These improvements have been incorporated in the matrix system: (1) An increase in power to 4 kw peak pulse, (2) an increase to 30 channels of information with increased sampling frequency, (3) reduction in crosstalk between channels, (4) overall accuracy of 1 percent with multistep calibration applied periodically at the data input and (5) direct video recording of the received signal from cathode-ray tubes, using continuous film cameras.

The resulting matrix system utilizes pulse time modulation of an r-f carrier. The data from the different sensing elements appear in the

form of d-c voltages between zero and plus 5 volts as in the sequential system. Each of the thirty data voltages modulates the position of a pulse within a given interval of time, the position of the pulse in the interval depending on the data voltage. These intervals, one for each data channel, follow one another in a fixed sequence, and the group is repeated at a 312.5-cycle rate.

Matrix Synchronization

The basis of the matrix system is a pair of oscillators in the airborne and ground stations. These oscillators are accurately synchronized in both frequency and phase to establish time reference frameworks, or matrices.

The oscillators generate a continuous series of equal intervals, each on a different circuit, by operating a 32-state electronic counter chain. The occurrence of state thirty-two in the airborne unit causes a synchronizing pulse-group to be transmitted. This is used to indicate to the counter in the ground station when to start counting its series of thirty-two. Thus, time intervals in the airborne and ground stations are made to correspond.

The time between the beginning of a channel interval (which is defined by the oscillator but not transmitted) and the corresponding data pulse is a measure of the data on that channel. The synchronization pulse is also transmitted at the end of the series and is distinguished by being made a triple pulse group.

The oscillator in the receiving station, generating its series of equal intervals, is arranged to generate pulses at the start of any chosen interval. These pulses then

initiate sweep voltages on a series of cathode-ray tubes so that the tubes are swept in sequence until the period of time between synchronizing pulses is covered. The cycle is repeated for each series of thirty-two cycles of the oscillator.

The train of time-modulated data pulses arriving from the airborne unit is displayed on the cathode-ray tubes as intensity modulation while the tubes are being swept. Since the intervals are each identified with respect to the synchronizing pulse, successive intervals of the same number fall at the same position on their respective cathode-ray tubes. The channels are, in this way, separated in the receiving station, and the pulse is free to move in its definite interval as the input voltage at the transmitter is changed over its range from 0 to plus 5 volts. Continuous-film cameras photograph the position of the spots in their intervals, resulting in the production of a graph of voltage versus time for each of the thirty data channels of the system.

The equipment used to accomplish pulse time modulation in the missile is shown in Fig. 1. The ground station equipment, as installed at the White Sands Proving Ground, where the equipment is in use, is shown in Fig. 2.

General operation of the airborne unit is best understood with reference to Fig. 3. The output of the free-running 10-kc oscillator is shaped by a multivibrator, the output of which is fed via a cathode follower to a bus in the form of a series of pulses 100 microseconds apart. A chain of thyatron tubes, arranged in such a way that only one tube conducts at a time, is driven by these pulses. Conduction

SYSTEM

By **NOLAN R. BEST**

*Naval Research Laboratory
Washington, D. C.*

shifts from one tube to the next upon the appearance of a pulse on the triggering bus. Conduction in one tube primes the succeeding tube next in the chain so that the pulse on the triggering bus can fire only it. This goes on to the end of the chain, where the last stage primes the first, causing the cycle to repeat.

Associated with each of the chain tubes is another thyratron in which the pulse time modulation is accomplished. A sawtooth, generated in the cathode circuit of the chain tube at the time that it is conducting, is added electrically to the data voltage applied to the particular input. At some time during the 100-microsecond interval so defined, the biases on the thyratron will reach the critical value and the tube will suddenly conduct. This will deliver an output pulse to a system of collecting busses.

The biases on the thyratron and the amplitude of the sawtooth are so chosen that it is sure that the critical point will be reached during the conduction interval. Thus each of the pickoff tubes, as the modulating tubes are generally called, puts out a pulse in its own interval, the posi-

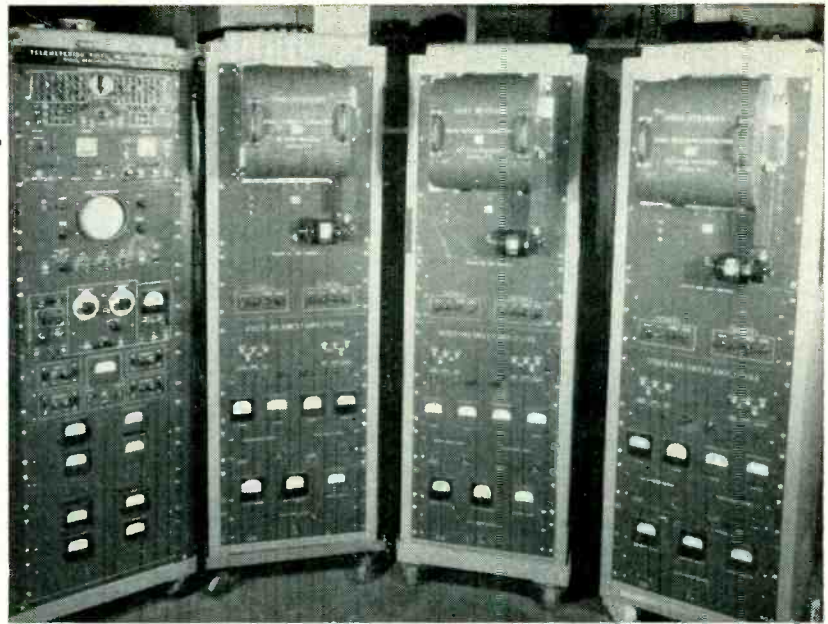

FIG. 2—Receiving station equipment employs direct video recording on continuous film strips

tion of the pulse indicating the corresponding channel's input voltage.

The thirty-second tube in the chain operates a triple-pulse generator. The triple pulse is collected along with the other data pulses and is used for ground-station synchronization. The thirty-first interval in the chain is left blank to give proper spacing for the synchronizing pulse.

Chain Circuit

All pulses on the common output video bus operate a blocking oscillator to generate pulses of uniform shape and amplitude for operation of the power modulator. The power oscillator is a reentrant cavity, operating at 1,025 mc. The antenna is a two-phase quadrupole, enclosed in a streamlined plastic radome on a tail fin of the rocket.

Figure 4 is a schematic diagram of a portion of the chain and pickoff tube circuits. Two stages are shown, both identical and typical of the thirty input channels. The upper tubes are connected as the chain. The capacitor from plate to ground is charged to B+ in the standby condition, but upon firing of the tube dumps its charge into the cathode capacitor. This gives a steep rise in potential, after which there is an exponential (nearly linear, over this portion) rise in potential, continuing during the deionization time of the tube. The thyratrons used in the circuit, Chatham type 1002A, have been especially developed to have long deionization times, to have stable firing potentials, and to have 1-watt cathodes.

The pedestal-and-slope waveform

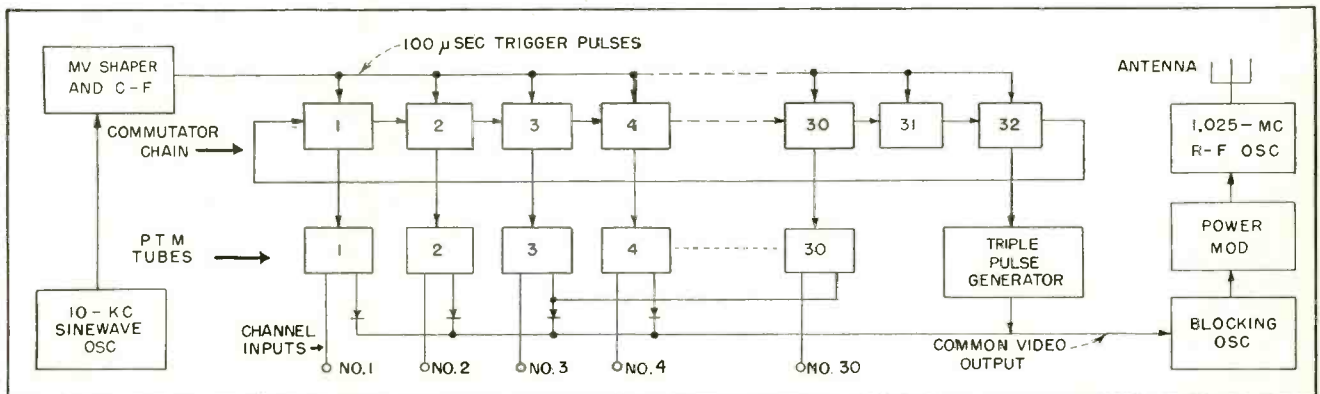

FIG. 3—At the transmitter, timing intervals are initiated by a 10-kc oscillator

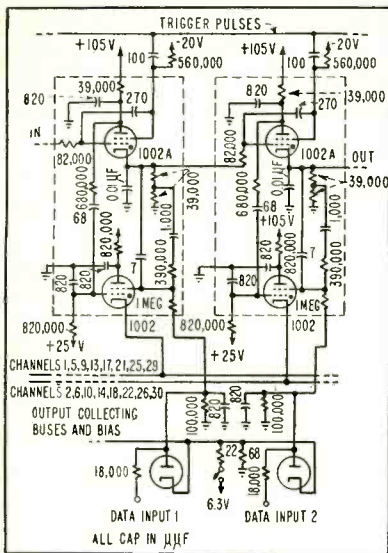

FIG. 4—Two typical stages of the 30-channel chain and pickoff circuits

is coupled by means of a resistor to the control grid of the next tube in the chain, raising its potential to a point which makes it sensitive to the next positive trigger pulse which appears at the shield grids of all of the chain tubes simultaneously. This triggering pulse causes conduction to start in the next tube.

A portion of this same cathode waveform is coupled by means of a resistor and capacitor network to the pickoff or pulse time modulating tube. It is added electrically to the data voltage which is continuously developed across the 100,000-ohm resistor to ground. The sawtooth waveform is added to this voltage, resulting in a similar waveshape which is dependent on the channel input voltage. Biases on this tube are adjusted so that with a zero data voltage the tube will fire at about 95 microseconds after the start of the sawtooth. The addition of the d-c component, however, causes conduction to occur at an earlier time. How much earlier depends on the magnitude of the input data voltage. The diode shown across the input resistor is to limit the input to a value of 5 volts. This is necessary to prevent misoperation of the circuit in case of accidental data overvoltages.

The pickoff tubes fire one after the other as the sloping pedestal waveforms are generated at the cathodes of their respective chain

tubes. The output pulses from every fourth pickoff tube are collected on separate collector lines. These four collector line outputs are combined by means of crystals onto a common line feeding the modulator.

Ground Station

The ground station comprises four racks, as shown in Fig. 2. Three of the racks are identical, containing the recording apparatus. The continuous film camera magazines are at the tops of the units, while the video and sweep amplifiers and power supplies are below. The rack on the left contains the receiver, the monitoring oscilloscope, the triple-pulse synchronizing signal discriminator, the synchronized matrix oscillator, and the counter and gate generator unit.

Figure 5 is a block diagram of the receiving station. The antenna is a four-foot parabolic dish with a circularly polarized antenna, so mounted that it can be manually pointed at the rocket during its flight. It has a beam width of 18 degrees. The receiver is conven-

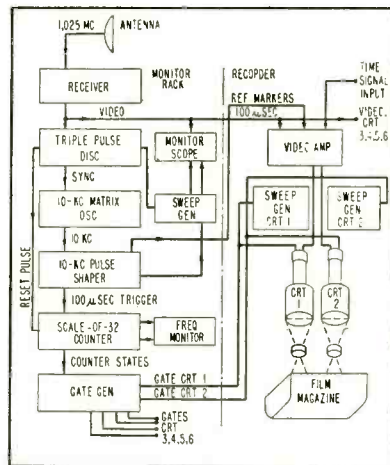

FIG. 5—Matrix receiving equipment must be kept in both frequency and phase synchronism with transmitter timing oscillator

tional in most respects, having an i-f bandwidth of 4.5 mc and provision for switching in or out of an r-f stage. It has age circuits which give a constant video output.

The detected output of the receiver is fed into two places; first, to the video amplifiers in the recording rack where it is applied to the intensity grids of the cathode-ray tubes in the recorders; second, to the triple-pulse discriminator. The output of the discriminator, the sync pulse, is applied to the matrix oscillator to control its frequency and phase.

The output of the oscillator is shaped and forms a train of pulses 100 microseconds apart which drive a scale-of-thirty-two counter. This counter is of the binary type and it is reset, when necessary, by the pulse derived from the synchronizing pulse, allowing it to be in state-to-state coincidence with the chain counter in the airborne unit.

By means of resistor networks, pulses can be obtained from the counter at any integral 100-microsecond interval to form a square wave of any desired length in the gate generator. These gates can be made to start and stop at any interval and are arranged to allow the sweep generators in the recording rack to generate sweeps successively for each of the six cathode-ray tubes in the ground station. The image on the face of each of the 5RP11 cathode-ray tubes is focused on a continuous-motion film magazine by means of a lens and prism arrangement. Two tubes and lenses are used in each of the three recording racks, recording on a single 9½-in. film in each rack. Film speed is 3.14 in. per second.

There are auxiliary circuits in the monitor rack which assist in the operation of the circuit. A frequency monitor shows if the oscil-

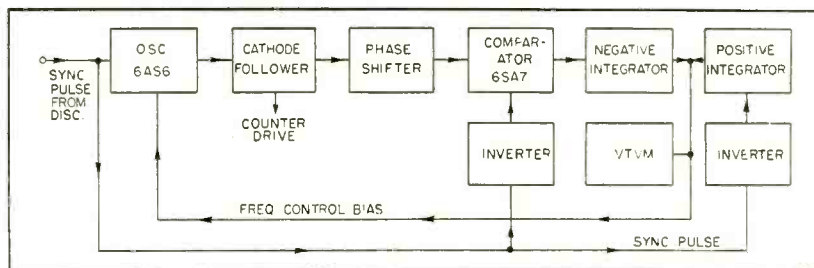

FIG. 6—Block diagram of receiving station matrix oscillator

lator is operating on the proper harmonic of the 312.5-cycle synchronizing pulse. It would be possible to set on the 31st or 33rd harmonics and to find that the synchronizing pulse arrived in exactly the proper phase while the frequency was in error. There is also a monitor oscilloscope for use of the operator in adjusting the ground station. It shows a raster of 32 lines on each of which occurs a bright dot made by the video signal. During tune-up periods the operator, by observation of this raster, can diagnose troubles occurring in the detection and synchronizing functions of the system.

Frequency Control

The matrix oscillator is the most critical circuit in the ground station. It must be kept locked in both frequency and phase with the airborne timing oscillator. Figure 6 is a block diagram of this portion of the circuit.

The matrix oscillator is a transitron-connected 6AS6 operating at 10 kc. The synchronizing pulse is injected on the control grid in such a way that the peak of the cycle is forced to occur at the time of the pulse injection. Also on the control grid is a frequency-controlling bias, supplied from correcting circuits to be described below, allowing about a 1-percent frequency range.

The oscillator output is fed to a cathode follower which feeds both the counter establishing the time reference framework and the frequency-correcting and controlling circuits. In the latter circuits, the sine wave is shifted by about 90 degrees so that the synchronizing pulse will occur at about the time the sine wave crosses its zero axis. The sine wave is then applied to one of the control grids of the 6SA7 comparator tube. On the other control grid, normally biased to cutoff, is applied the synchronization pulse which has been amplified and limited in size. The appearance of the sync pulse will cause the tube to conduct, the size of the output pulse depending upon the instantaneous value of the sine wave on the control grid.

When the frequency of operation is correct, there is no phase drift of the oscillator between synchroniz-

ing pulses and the sync pulse will occur at the zero axis of the sine wave, resulting in a given amplitude at the plate of the comparator tube. For an oscillator frequency slightly too high, the sine wave would be at a more negative value, giving the effect of biasing off the amplifier—with a smaller output of the comparator resulting. For too low a frequency, the sine wave would not yet have dropped to as low a value with the resultant output pulse being greater in amplitude.

Large errors in frequency can cause false operation because the phase error in each cycle is totaled for the 32 cycles between the synchronizing pulses. For example, if the sum of these errors approaches

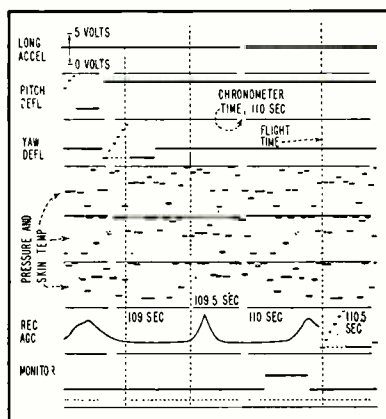

FIG. 7—Typical record of matrix telemetering system

a whole cycle, the synchronizing pulse can occur at the time the sine wave is crossing the zero axis, with the result that the correcting signal would be the same as for the correct frequency. To overcome this difficulty, an auxiliary circuit, shown in Fig. 5 as the frequency monitor, is included to indicate improper harmonic operation.

The output of the comparator, occurring once in every 32 cycles of the 10-kc oscillator, is integrated in a circuit having a negative output. The synchronization pulse is also amplified and fed into a positive integrator circuit of similar characteristics. The d-c signals from these two circuits are combined and give an error signal, which is adjusted to zero when the frequency is set correctly, but which gives the positive or negative biases as frequency errors appear. This error voltage is applied to the transitron

oscillator to correct its frequency. In addition, this voltage is measured and indicated on a vacuum-tube voltmeter on the panel of the apparatus.

The result of the telemetering operation is a record of the data versus time such as is shown in the sample record shown in Fig. 7. Eight data channels are shown, with reference lines between them. Three channels toward the center of the figure have sub-commutated data supplied to them from a large number of atmospheric pressure and skin temperature gages. On the pitch and yaw deflection channels, as well as on the receiver age channel near the bottom of the sheet can be seen calibration voltages, consisting of six one-volt steps including zero and five volts.

Time is indicated by the vertical lines which are generated by a circuit triggered from the primary time source. In the installation on which this record was made, the time source gave a pulse every half-second, eliminating the pulse occurring on the ten seconds. A secondary time source, not synchronized to the takeoff, is used to interrupt the reference marks every second. (These reference marks are obtained from the 10-kc oscillator on the ground, but are not part of the transmitted signal. They are included on the record as fiducial marks for reading data.)

On the record shown, the spot sweeps were from top to bottom, and each of the two side-by-side sweeps was 400 μ sec long. The paper was moving laterally, with later times appearing at the right.

The system of telemetering described in this article has been successfully used in numerous high-altitude rocket flights and in other applications. It is expected that a smaller version with fewer channels will be available soon. This smaller system will utilize the same ground station equipment.

The work described was done as part of the Upper Atmosphere Research Program at NRL. Besides the author, the following have had major roles in the development: J. T. Mengel, in charge; D. G. Mazur; K. M. Uglow; C. H. Smith, Jr; S. W. Lichtman; and V. L. Heeren.

Timed-Pulse Oscillator



Electronic hair-removing setup consists of equipment shown. The foot-switch initiates automatically-timed pulses and controls length of manually-timed pulses

UNDESIRE body and facial hair is a severe social and psychological problem to those afflicted with it. Early use of tweezers and wax applications for the forcible removal of superfluous growths have been generally replaced by more effective, permanent and less painful methods. Today, depilation is practiced primarily by professional electrolygists who are licensed in many parts of the country.

The employment of electrical principles in the solution of the problem dates back to the last century. It was found that application of the negative pole from a direct-current source to the hair follicle effected an electrolytic action capable of permanently destroying the small, bulbous root of the hair. The current was applied by means of a thin needle inserted into the follicle, the needle being connected to the negative terminal of a 3 to 9 volt battery, while the positive terminal led to a metallic or saturated-cloth electrode in contact with the patient's skin. One to five milliamperes flowing for 5 seconds or more was found sufficient to loosen most roots so that the hairs could be readily lifted out of the follicle.

At present electrolygists still employ this method to some extent; its simplicity and effectiveness are not sufficiently impressive to offset the slow rate at which progress is made in clearing even small skin areas.

Much more rapid hair removal became possible with the introduction of damped high-frequency current generators. Use of this equipment was an outgrowth of medical spark-gap diathermy machines developed commercially after the turn of the century. A single wire connects the needle and its holder to the output of the generator, body capacitance forming the return path for the high-frequency current.

High-Frequency Method

The depilatory action of the r-f currents on the hair root and follicle is due to the heat generated in the area immediately surrounding the needle electrode. This rapid rise in temperature results in almost instantaneous dehydration and mummification of the root, freeing the hair.

Experienced operators are able to remove several hundred hairs per hour with machines of this type; however, the high peak voltages characteristic of the waveforms produced by sparkgap circuits tend to produce occasional scarring due to uncontrolled spark discharges between the needle electrode and the tissue forming the mouth and walls of the follicle.

Since the rapid generation of local heat is the only mechanism responsible for the depilatory effects desired, an undamped r-f current is indicated. As a result sparkgap equipment has been almost universally replaced by vacuum-tube oscillators operating at frequencies between 2 and 30 megacycles and capable of developing 5 to 15 watts of r-f energy in a matched load. Actual power required at the needle is considerably below this level, between one and three watts constituting the useful range for all varieties of conditions. Power concentration in the tissue in contact

with the needle electrode is nevertheless relatively large since the average insertion is less than $\frac{1}{8}$ inch and common needle diameters are 0.003 to 0.007 inch.

The apparently excessive power margin of the oscillators given above is a necessary consequence of the peculiar power transfer problem presented by the single-cord method of operation. Figure 1 illustrates a representative physical circuit and Fig. 2 is its approximate electrical equivalent used for determining output-circuit parameters. Actually the distributed nature of the lumped impedances shown is considerably more complex; as a practical design basis the entire load to the right of line *a-b* may be represented as a resistance of the order of 150 to 300 ohms in series with a capacitor of 30 to 100 $\mu\mu\text{f}$.

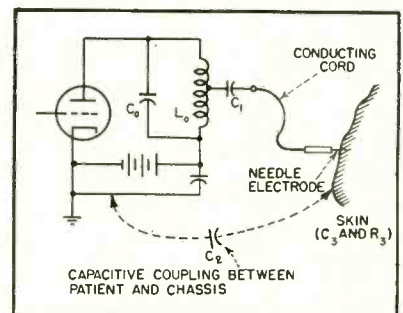

FIG. 1—The r-f pulse is conveyed by a single-conductor cord. Capacitive coupling provides the return path

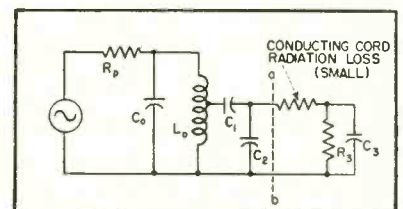

FIG. 2—Portion of equivalent circuit to right of line *a-b* represents the load on the r-f oscillator

for Electronic Depilation

Hair removal by means of electricity is not new, but constant demands for safer, more permanent and less painful methods have led to the development of electronic devices. A complete system consisting of an r-f oscillator, timer and probe is described herein

On a maximum power transfer basis, assuming the use of a high L/C tank circuit, tapping the load near the plate end of L_o is indicated. This connection will effectively add capacitance in parallel with C_o and an equivalent shunt resistance across the tank of one to several thousand ohms. However, with oscillatory peak voltages of the order normally found at the plate side of L_o , the voltage developed at the needle with respect to chassis (to which it is coupled through a capacitive reactance of fairly high value) is great enough to produce deleterious effects much like those of the sparkgap equipment. The practical situation forces a compromise between sufficient loading of the oscillator tube and short spark length. Lowering the impedance of the tank circuit by decreasing the L/C ratio and using low- r_p tubes soon reaches a limit and tapping down on L_o must be resorted to. Doing so reduces the output and accounts for the apparently oversized oscillator tube used in practice. The low absolute power level involved renders the poor overall efficiency unimportant.

Commercial Unit

Commercial depilators of the type described above are in general use by electrolygists throughout the world. The majority of these machines employ simple triode oscillators turned on and off by means of a footswitch which in turn controls the plate supply voltage to the oscillator. A number of machines incorporate timing devices adjustable over a range from 0.1 to 1.0 second which aid in administering the r-f energy in equally timed shots. Most of these devices are of the familiar

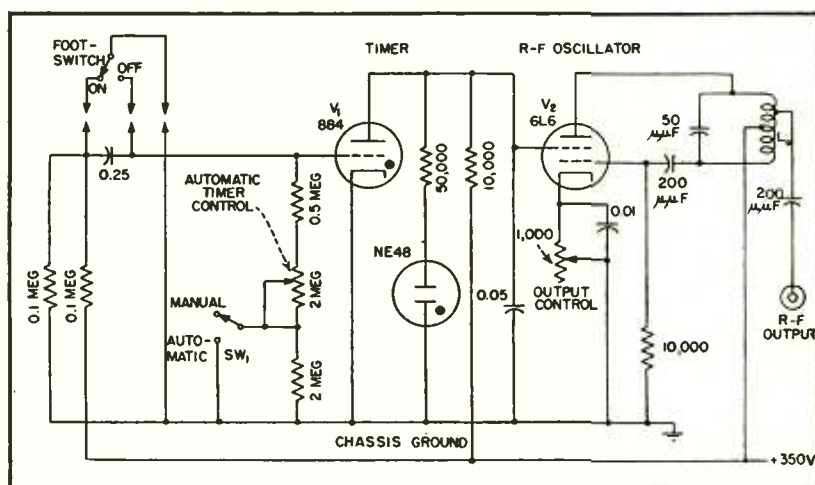

FIG. 3—Schematic of oscillator and automatic pulse timer which resembles those used in electronic exposure controls for photography

tube-relay variety in common use in phototimers.

The photograph shows a unit employing an electronic timer. The circuit diagram is shown in Fig. 3. In this instrument a 6L6 Hartley oscillator is keyed on and off by an 884 thyatron. In the stand-by condition (with the footswitch released) the thyatron fires, pulling the screen grid of the 6L6 down to 16 volts, thus preventing oscillations. Operation of the footswitch connects a charged capacitor between grid and cathode of the 884.

Since it is possible in small thyatrons of this type to interrupt the plate current by applications of control grid bias of the order of the cathode-to-anode drop, the 884 extinguishes, releasing the screen grid and permitting oscillations until the capacitor has discharged to the point where the tube fires again.

Switch SW_1 gives the operator a choice between automatic and manual timing of the r-f pulses. On automatic, the capacitor discharge

time is determined by the setting of the automatic timer control, which adjusts the resistance in the discharge circuit between 0.5 and 2.5 megohms. In the manual position, an extra 2 megohms resistance is placed in the circuit. Its presence retards the capacitor discharge so that the r-f pulses must be interrupted by the operator by taking his foot off the switch, thereby grounding the grid of the 884. The r-f output of the 6L6 oscillator is adjusted by the 1,000-ohm resistor in its cathode.

The unit operates from 110 to 220 volt a-c lines and delivers approximately 4 watts maximum into the needle electrode at 5 megacycles. This frequency makes possible an adequate output circuit compromise between efficiency, short spark length and freedom from erratic behavior due to standing waves on footswitch or a-c line cables often encountered with machines operating at frequencies above 15 megacycles.

Blower Selection for

How to determine requirements for industrial and communications applications. Charts supplied here, and examples showing how to use them, simplify the job and help to insure trouble-free performance of equipment

By **A. G. NEKUT***

Tube Department
Radio Corporation of America
Lancaster, Pa.

FORCED-AIR-COOLED power tubes have found wide acceptance in industrial and communications applications because of their convenience and economy. Although forced air is used to cool glass-to-metal seals, bulbs and metal headers of tubes the most important single use is in cooling the external anode.

When a fan or blower is selected for a particular application two factors must be known, the air-flow required by the tube and the static

pressure at the blower outlet. Although these factors apply generally to cooling any part of an electron tube, attention is directed in this article to the problem of selecting a blower for cooling the radiator or cooler of an external-anode tube, particularly when duct work is used. The results obtained are equally applicable to the problem of selecting a blower for cooling any other part of a tube.

Factors Involved in Selection

The air flow (Q) required by a tube depends upon the amount of anode dissipation and upon the maximum ambient or incoming air temperature expected in a given application. For a specified amount of anode dissipation the amount of air flow required to limit the temperature rise of the anode to a safe value may be obtained from tube

data. This value of air flow is usually based upon tests made at room temperature and normal barometric pressures, corrected for the rated maximum ambient or incoming air temperature for the tube (usually 45 C). For applications in which the blower uses air having a density appreciably different from 0.075 lb per ft³, corrections must be made.

The static pressure (P_s) at the blower outlet depends upon the pressure-versus-airflow characteristics of the system into which the blower must deliver the required volume of air. A typical system characteristic is shown in Fig. 1. The value of static pressure is determined by the following factors:

(1) The static pressure rating of the tube cooler when the required air flow is passing through it. This rating is given in tube data as a function of air flow when the cooler is operating at its maximum rated temperature. When the outlet of a blower discharges into free air, as is the case when the blower-outlet air flow is directed at a tube header, bulb or seal, the static pressure at the blower outlet is zero provided no ducts, constrictions or nozzles are used. Airflow rating of a blower for zero static pressure at the blower outlet is usually called the free-delivery rating of the blower.

(2) The friction losses in ductwork and other components such as elbows, interlock vanes and air filters. Standard tables of duct-pressure loss¹ available in most blower catalogs may be used for estimating duct friction if the effective duct length is large.

(3) The change in static pres-

* A paper sponsored by the Committee on High Vacuum Power Tubes of the Joint Electron Tube Engineering Council of the Radio Manufacturers Association and the National Electrical Manufacturers Association.

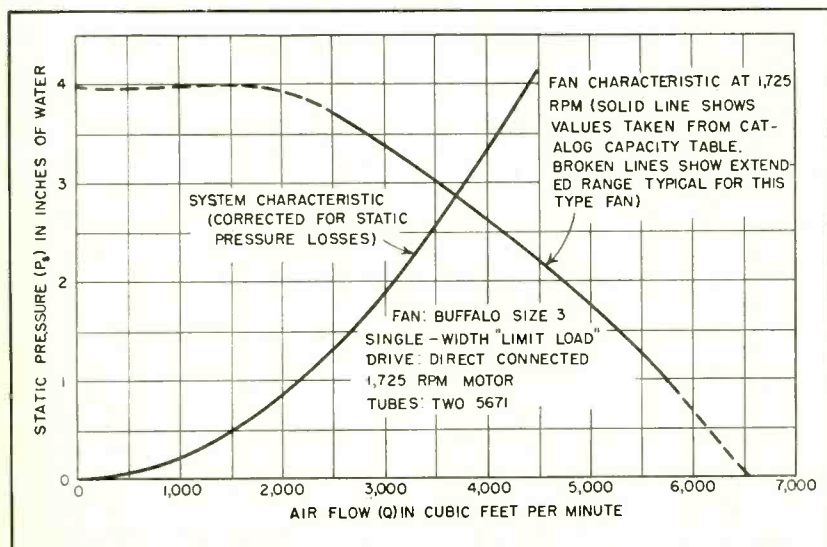
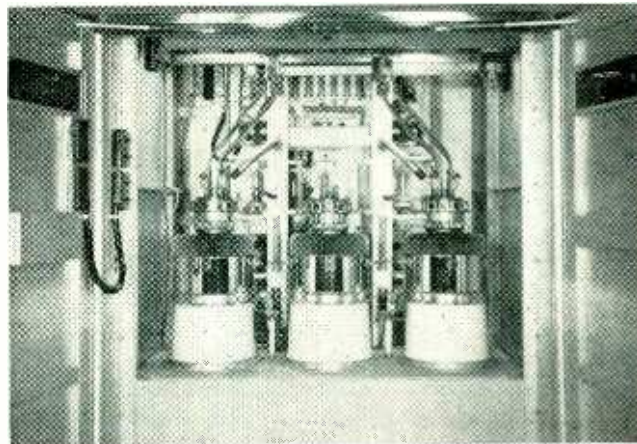

FIG. 1—Fan performance and system characteristic curves

Forced-Air Cooled Tubes



Typical blower and associated ductwork for a broadcast transmitter



Tube end of system using ducts to radiators and to filament connections

sure in a duct due to changes in cross-sectional area which increase or decrease the velocity of the air in the duct. Whenever there is any change in cross-sectional area between the blower outlet and the tube inlet a correction for velocity changes must be added algebraically to the static pressure at the blower outlet. This correction, which is positive for a contraction in area and negative for the expansion in area, is given² by the relation

$$\Delta P_s = \frac{V_2^2 - V_1^2}{(4,000)^2} \quad (1)$$

where V_1 is the velocity of the air before the change in area and V_2 is the velocity of the air after the change. These velocities in feet per minute may be found from the expression

$$V = Q/A \quad (2)$$

where A is the cross-sectional area at the place of measurement in square feet and Q is the air flow in cubic feet per minute. The factor 4,000 of Eq. 1 is the velocity constant for air of standard density of 0.075 lb per ft³. The relationship given in Eq. 1 is shown in graph form in Fig. 2.

A change in cross-sectional area also causes friction losses. Such losses are small and can be ignored when the change in cross-sectional area is gradual and occurs over a

duct length of more than six duct diameters. When, however, the change is more abrupt, a correction for friction losses must be made in addition to the correction made for velocity changes in the duct. Corrections for friction losses, whether due to either a contraction or expansion in duct area, are always positive and are added to the system static pressure.

A sudden contraction increases the static pressure at the blower outlet² according to the relation

$$\Delta P_s = \frac{K_c V_2^2}{(4,000)^2} \quad (3)$$

where K_c is a constant which depends upon the amount of contraction and is included in a plot of Eq. 3 in Fig. 3.

A sudden expansion increases the static pressure² at the blower outlet according to the relation

$$\Delta P_s = \frac{(V_1 - V_2)^2}{(4,000)^2} \quad (4)$$

The static pressure rating of the cooler and the friction losses in air filters and exit louvers produce nearly all of the static pressure at the blower outlet. The correction for changes in cross-sectional area are usually negligible unless the area changes are very large and the air velocities are high. The magnitude of the corrections in-

volved may be obtained from Fig. 3.

Another factor which should be considered in the selection of a fan or blower is the amount of noise which can be tolerated. In general, a blower operating with high blade-tip velocity and developing a value of P_s in excess of two inches of water will usually produce a noticeable amount of noise in quiet surroundings. The recommendations of the manufacturer should be obtained in applications where low noise output is important.³

When a blower is chosen for a particular application, some consideration should be given to the characteristics of the blower under varying load conditions. A satisfac-

Definitions of Terms

A	= cross-sectional area of air flow in ft ²
D	= diameter of air duct in ft
d	= density of air in lb per ft ³
P_s	= static pressure in inches of water
ΔP_s	= change in static pressure in inches of water
Q	= volume of air delivered per unit time in ft ³ per min
rpm	= speed of blower in revolutions per min
T_i	= air temperature at inlet in deg C
T_o	= air temperature at outlet in deg C
ΔT	= change in air temperature in deg C
V	= velocity of air in ft per min
W_f	= filament power in watts
W_m	= blower-shaft horsepower
W_p	= plate dissipation in watts
w	= power dissipated per unit air flow in watts per ft ³ per min

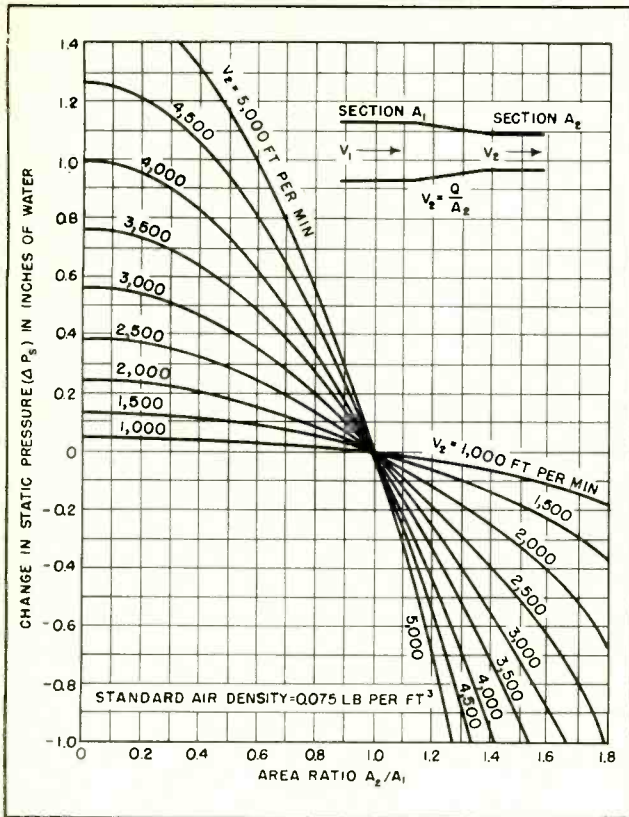

FIG. 2—Change in static pressure due to gradual change in air-flow cross-section

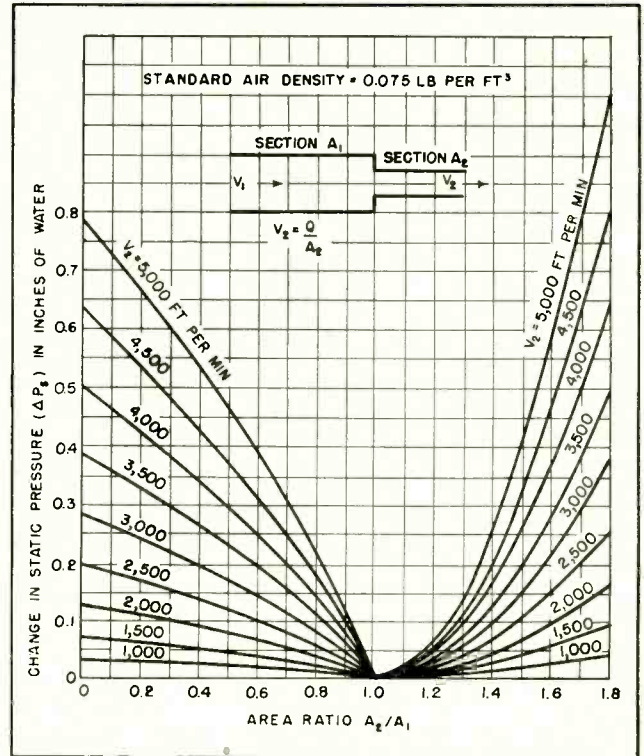

FIG. 3—Change in static pressure due to abrupt change in air-flow cross-section

tory and widely used type of centrifugal blower is one using an impeller wheel having a multitude of small vanes or blades located at the rim of the wheel and curved in the direction of rotation. Such a blower will develop a given static pressure at lower blade-tip velocity than other types of centrifugal blower, with a resultant economy in blower size. If, however, prolonged operation is contemplated with a tube removed from its socket and thus with reduced static pressure at the blower outlet, a centrifugal blower having backwardly curved blades is recommended, since such a blower has a nonoverloading characteristic. In such a blower the shaft horsepower reaches a maximum somewhere in the middle of its operating range and remains substantially constant for a constant blower speed as the static pressure at the blower outlet is reduced to zero. In the larger sizes, this type of blower often has the further advantage of permitting direct drive from a 1,750-rpm, 60-cycle a-c motor because of its inher-

ently higher speed of operation.

Axial flow fans are not used at present in any appreciable quantity for tube cooling because of the high motor speeds necessary in the sizes of fans suitable for this service. Their small size and in-line flow characteristics may recommend them for special application, however.

Outlet-Air Temperature

A matter of lesser importance but one which may require some design consideration is the effect of the temperature of the air leaving the tube cooler on some of the circuit components such as filament bypass capacitors. If some components are exposed to temperatures exceeding their normal ratings it will be necessary to reduce the temperature of the outgoing air by selecting a blower which will provide a greater air flow. The rise in temperature (ΔT) of the outgoing air in the cooler may be determined from

$$\Delta T = T_o - T_i = \frac{(T_i + 273)(W_p + W_f)}{164 Q} \quad (5)$$

where T_i is the temperature of the incoming air in degrees centigrade, W_p is the plate dissipation in watts, W_f is the filament power in watts, and Q is the airflow in cubic feet per minute. For incoming air at room temperature (25 C) this relation may be simplified to

$$\Delta T = \frac{1.82 (W_p + W_f)}{Q} \quad (6)$$

The calculated value of ΔT will usually be higher than the measured value because some of the heat produced by the plate and by the filament will be carried away by conduction in the filament leads and cooler support. A further reason is that the heated outgoing air, because of its relatively high velocity, mixes immediately with the surrounding air. Figure 4 is a plot of Eq. 5.

High-Altitude Operation

Tube operation at high altitudes or under conditions where the blower uses air having a density appreciably lower than standard density is sometimes encountered.

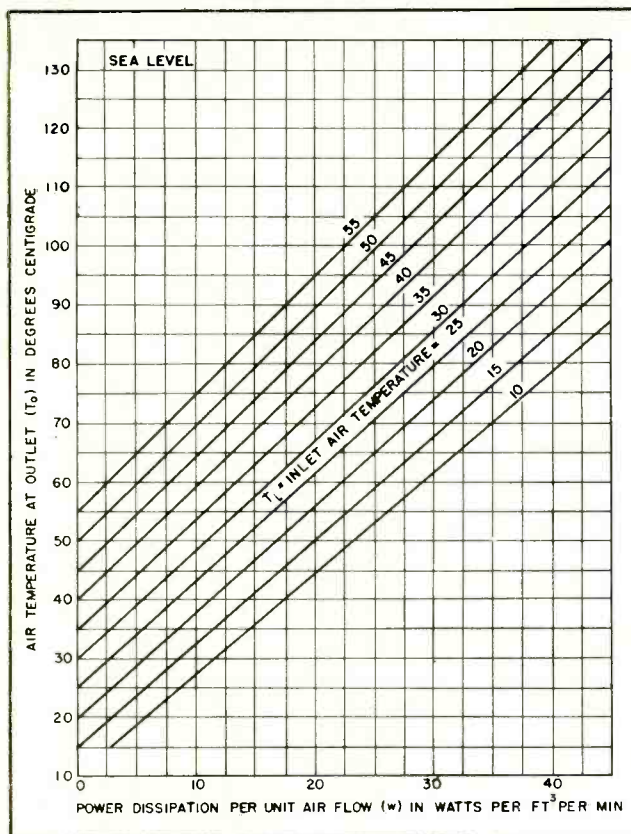

FIG. 4—Change in air temperature due to tube power dissipation

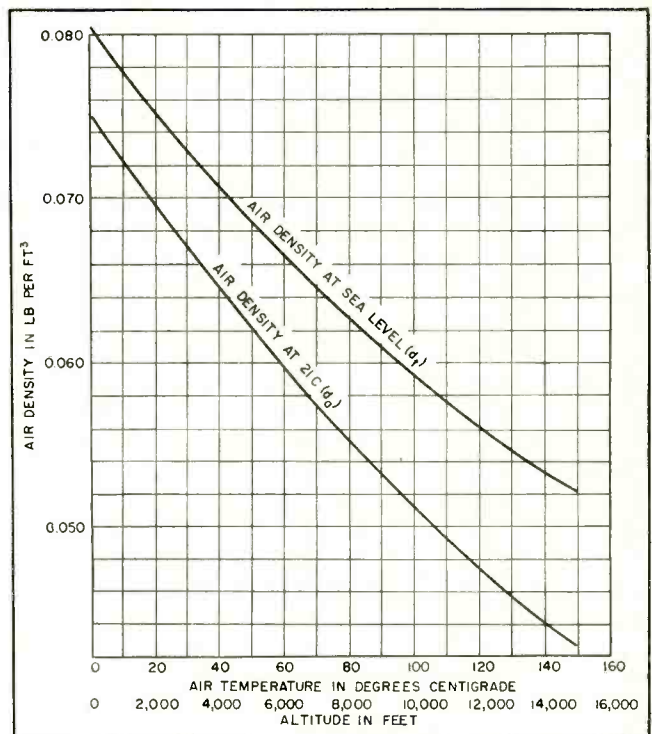

FIG. 5—Change in air density with altitude and temperature of the air

In order to maintain a constant coefficient of heat transfer between the cooler fins and the air stream, the mass rate of air flow in lb of air per minute must be held constant for all values of air density. For a blower of fixed size operating into a given system, the mass rate of air flow can be held constant by increasing the speed of the blower in inverse ratio of the air densities. In the following fan laws, subscript 1 indicates standard air-density conditions, subscript 2 indicates lower air-density conditions, and W_m is blower-shaft horsepower

$$(\text{rpm})_2 = \frac{d_1}{d_2} (\text{rpm})_1 \quad (7)$$

$$(W_m)_2 = \left(\frac{d_1}{d_2} \right)^2 (W_m)_1 \quad (8)$$

$$(P_s)_2 = \frac{d_1}{d_2} (P_s)_1 \quad (9)$$

$$Q_2 = \frac{d_1}{d_2} Q_1 \quad (10)$$

These equations may be used in selecting a blower for operation

where lower than standard air density prevails by first computing the air flow and static pressure at the blower under standard density conditions and then correcting for the different air density. The variation of air density with altitude and temperature is plotted in Fig. 5. To find the air density from this figure at any temperature and altitude, the following relation is used:

$$d = 13.3 d_a d_t \quad (11)$$

Testing the System

After the system has been installed, the static-pressure (P_s) rating for the tube may be used to determine whether sufficient air is being supplied to the cooler. A simple U-tube manometer may be constructed as shown in Fig. 6, using water as the manometer liquid. The value of P_s may be read directly as the difference in height of the liquid levels.

To make this measurement a small hole (No. 40 drill size) is drilled in the air-supply duct at some suitable place at least three inches below the cooler. Care should

be taken that the hole is free from burrs and is located in a smooth section of air duct at least three inches away from any joints, air-flow interlock vanes or other obstructions. The inlet of the manometer is connected to this hole by means of a suitable length of rubber tubing. The outlet of the manometer is connected to some point in the tube enclosure space or equipment cabinet which is maintained at the static pressure into which the tube air flow must discharge under normal service conditions. This measurement is normally made by inserting the rubber tubing connected to the manometer outlet through a louvre or other opening in the cabinet where the air velocity is negligibly small. All doors and other openings normally closed in operation must, of course, be closed. The value of P_s thus obtained should be equal to or greater than the value given in the tube data for the air flow and dissipation required.

It is desirable to make this meas-

urement with the equipment operating at full rated output, because the static pressure required for a given air flow through a tube cooler increases with cooler temperature. This increase in static pressure varies approximately from 2 to 15 percent, depending upon the tube, as the temperature rise of the cooler is increased from zero to the maximum allowable temperature rise. When many tubes are supplied from a common plenum chamber it is usually sufficiently accurate to measure the static pressure in the plenum chamber and assume that this pressure is the actual static pressure present at the tube inlet.

Standard methods of testing blowers and fans have been published.

Example

By way of illustration, let us assume that it is required to select a blower for two 5671 tubes operated at maximum ratings. The tube data indicate that an air flow (Q) of 1,800 ft³ per min per tube is required with a static pressure (P_s) at the tube inlet of 2.2 inches of water. The inlet air temperature is assumed to be 21 C and the equipment is assumed to be operated at sea level, so that no correction for air density need be made. A typical layout for the required ductwork is shown in Fig. 7.

The problem here is to find the effective static pressure required at the blower outlet. This static pressure will be made up of the tube static pressure rating, the air-filter static-pressure rating, the friction losses in the straight duct and the elbows, and the change in static pressure due to any changes in cross-sectional area of the air ducts. The static-pressure rating of the tube has already been given as 2.2 inches of water at 1,800 ft³ per min. An air filter of proper design and adequate air flow cross-section should have a static pressure rating of about 0.25 inch of water.

Before evaluating the remaining static pressure contributions of the system, it is necessary to make a tentative blower selection in order to fix its outlet area. Since the air-flow paths of the two tubes are in parallel, the blower is required to deliver cooling air at a rate of:

$$Q = 2 (1,800) = 3,600 \text{ ft}^3 \text{ per min}$$

The static pressure due to the tubes and air filter is approximately

$$P_s = 2.2 + 0.25 \cong 2.5 \text{ inches of water}$$

The cross-sectional area (A) of the tube air inlet may now be obtained from the tube dimensional outline. For the 5671, the diameter (D) of the air-inlet duct is approximately 1 foot. The tube air-inlet area is $A = \pi D^2/4 = 0.78 \text{ ft}^2$ per tube or 1.56 ft^2 for the two tubes.

An examination of blower catalogs shows that the Buffalo Forge Company size 2 $\frac{1}{2}$, single-inlet single-width Limit Load fan has an outlet area of 1.56 ft^2 and would apparently be a suitable selection. However, in order to deliver 3,600 ft³ per min against a static pressure of 2.5 inches of water the blower speed must be approximately 1,880 rpm. This speed would not permit the blower to be connected directly to a 60-cycle induction motor with a rated load speed of 1,725 rpm. A blower with a larger wheel diameter, however, will permit the use of a lower speed for the same static pressure. The Limit Load size 3 will deliver 3,600 ft³ per min against three inches of water at 1,720 rpm. Because the outlet area of this fan is 1.86 square feet, a reduction in air flow cross-sectional area is necessary in the connection between the blower and the tube. If A_1 is the blower outlet area and A_2 is the tube inlet area then the area ratio

$$\frac{A_2}{A_1} = \frac{1.56}{1.86} = 0.84$$

The air velocity V_2 at the tube inlet is

$$V_2 = \frac{Q}{A_2} = \frac{3,600}{1.56} = 2,310 \text{ ft per min}$$

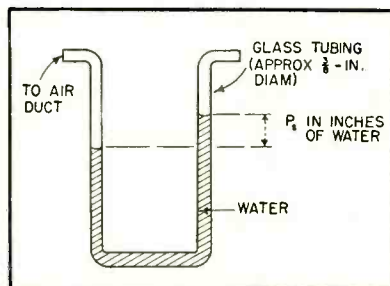

FIG. 6—Simple U-tube manometer, useful for system tests

From Fig. 2, the change in static pressure (ΔP_s) in going from section 2 to section 1 is +0.14 inch of water. Since this value is positive, it must be added to the tube static-pressure rating. This static-pressure value is based upon the assumption that the change in air-flow cross-sectional area was made gradually. In most cases, however, a gradual change is not practical. For the duct layout shown in Fig. 7 a further correction for a sudden contraction in duct area must also be made and added to the tube static-pressure rating. From Fig. 3 it is seen that this correction (ΔP_s) is 0.04 inch of water.

The remaining causes of system static-pressure losses are the elbows and the straight length of ductwork from the blower. The values of these losses may be obtained from most blower catalogs or texts on air conditioning. For a 10-foot length of rectangular duct 19 $\frac{1}{8}$ in. \times 14 $\frac{1}{2}$ in., to fit the outlet of the size 3 single-width blower, the static-pressure loss due to friction is found to be 0.02 inch of water. The static-pressure loss in the elbows can be determined from published charts in terms of an equivalent length of straight pipe having the same cross-sectional area. In this case it is equal to a length of approximately nine equivalent pipe diameters in straight pipe for the radius of curvatures of the bend scaled from Fig. 7. For the square duct 13 in. \times 13 in. the friction static-pressure loss is 0.018 inch of water. It is evident from the above that unless abnormally small duct sizes are used for a given air flow the correction for elbows, etc. are small.

When we collect and add up all the contributions of static pressure in inches of water, we obtain

5671 tubes	2.20
Air filter	0.25
Duct contraction	0.14
Correction due to sudden duct contraction	0.04
Elbow and duct friction	0.04
	2.67

The sum of all the static pressures obtained above is known as the system static pressure at the blower outlet at the rated flow of 3,600 ft³ per min. Since all of these items vary approximately as the

square of the velocity, and hence Q , at the blower outlet, the system static pressure curve may be plotted from the relation

$$(P_s)_z = P_s \left(\frac{Q_z}{Q} \right)^2 = 2.67 \left(\frac{Q_z}{3,600} \right)^2 \quad (12)$$

$$(P_s)_z = 2.06 \times 10^{-7} (Q_z)^2$$

where $(P_s)_z$ is the static pressure of the system measured at the blower outlet for any value of air flow Q_z . This equation is plotted in Fig. 1.

The intersection of the fan characteristic curve and the system characteristic curve in Fig. 1 indicates the operating point of the combination and shows that 3,700 ft³ per min will be delivered to the tubes with a static pressure at the blower outlet of 2.85 inches of water. The catalog ratings show that 2.4 horsepower is required. Since the maximum horsepower for this blower at 1,725 rpm is shown as 2.7 horsepower a three-horsepower motor would be a logical choice.

From Fig. 4, the air temperature at the tube outlet may be obtained. The power dissipated, in watts per ft³ per min, is

$$w = \frac{2(W_p + W_f)}{Q} = \frac{2(25,000 + 3,140)}{3,700} = 15 \text{ watts per ft}^3 \text{ per min.}$$

For an inlet air temperature of 21 C, the tube outlet air temperature is found from Fig. 4 to be 48 C. This value is generally of interest to the equipment designer in order to predict the maximum temperature to which various components located in the outlet air stream will be exposed.

High-Altitude Example

The preceding example considered the selection of a blower for a cooling system operating under normal conditions of temperature and atmospheric pressure. If this same system were to be operated at an altitude of 5,000 feet above sea level and with an inlet air temperature of 45 C a correction for the reduced air density would be necessary.

From Fig. 5, at an altitude of 5,000 feet and a temperature of 21 C the density $d_a = 0.062$ lb per ft³; at sea level and a temperature of

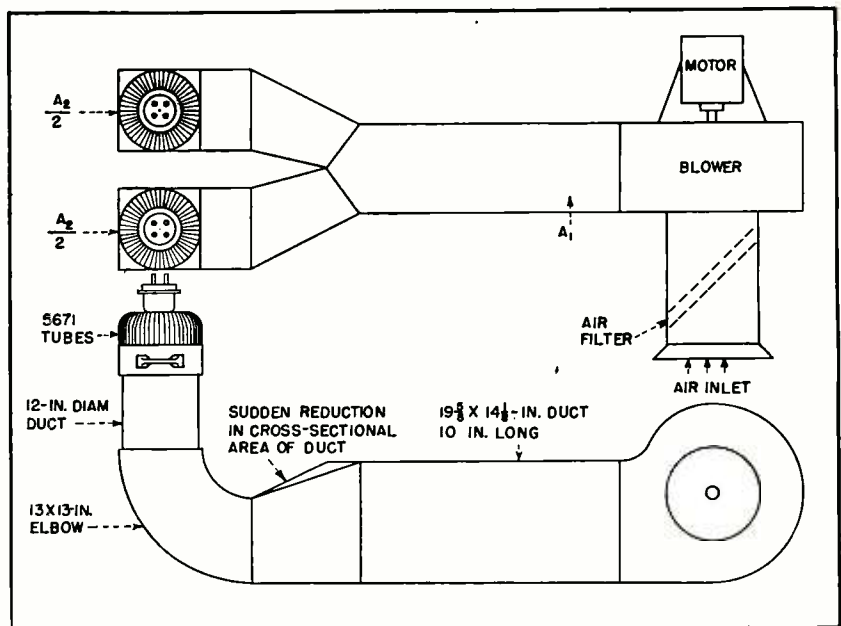

FIG. 7—Typical duct arrangement for cooling two power triodes

45 C the density $d_i = 0.069$ lb per ft³. From Eq. 11 the actual air density $d = 13.3d_a d_i = 13.3(0.062)(0.069) = 0.057$ lb per ft³. The blower selected in the previous example may be used to deliver the same mass rate of air flow when handling lower-density air by increasing its speed in accordance with Eq. 7

$$(\text{rpm})_2 = \frac{d_1}{d_2} (\text{rpm})_1 = \frac{0.075}{0.057} (1,720) = 2,260 \text{ rpm}$$

The blower-shaft horsepower rating given in the first example must be corrected in accordance with Eq. 8

$$(W_m)_2 = \left(\frac{d_1}{d_2} \right)^2 (W_m)_1 = \left(\frac{0.075}{0.057} \right)^2 (2.4) = 4.16 \text{ horsepower}$$

The static pressure measured at the blower outlet when the blower is handling the lower density air is

$$(P_s)_2 = \frac{d_1}{d_2} (P_s)_1 = \frac{0.075}{0.057} (2.9) = 3.8 \text{ inches of water}$$

The air flow under these conditions may be found from Eq. 10, although there is no particular need for the value found. The outlet air temperature is the same as found in the first example because the mass rate of air flow has been held constant.

The two examples given illustrate

the procedure to be followed in selecting blowers to supply the required air flow to the external-anode coolers of typical power tubes. The same procedure can be used to calculate the effective static pressures at the blower outlet, or inlet for suction systems, for any air system which may be used to cool the seals, bulbs or headers of vacuum tubes.

In general, unless the air system is long and has many sharp bends and large abrupt changes in air flow cross-section and unless the air velocity is abnormally high in ducts of small cross-section the corrections for duct friction and area changes are small. The largest contributors to the static pressure at the blower outlet are the tubes themselves and the air filtering systems. One major exception to this last statement, however, is the presence of inadequately designed air exit louvers or openings in the enclosing cabinet. These openings should be designed with adequate area so that the air velocity through them is kept as low as possible.

REFERENCES

- (1) "Heating, Ventilating, Air Conditioning Guide," American Society of Heating and Ventilating Engineers.
- (2) W. H. McAdams, "Heat Transmission," Second Edition, McGraw-Hill Book Co., New York, 1942.
- (3) Sound Measurements Test Code for Centrifugal and Axial Fans, National Association of Fan Manufacturers, Bulletin No. 104.
- (4) Standard Test Code for Centrifugal and Axial Fans, National Association of Fan Manufacturers, Bulletin No. 103.

Improved Deflection and

More uniform spot size over the face of the picture tube and resulting improvement in picture quality at the corners is achieved by cosine-squared distribution of turns in the deflection yoke. A permanent-magnet focusing assembly is also described

THE LUMINOUS SPOT that the electron beam excites in the phosphor of a picture tube should be round, well defined, small and uniform from portion to portion of the screen.

In current large picture tubes, the spots are often elliptical, vary in ellipticity and in slope over the picture area, and further vary from a small sharply defined spot in the center to an ill-defined, out of focus and much larger spot in the corners.

With most 1949-50 sets the reduction of information available at the face of the tube amounted to the loss of a substantial part of the definition over a large portion of the tube face. At the center, perhaps 400 lines can be separated but at the corners probably no better than 250 lines can be seen.

The problem has been to create a system of electron-optical quality which could not be easily impaired by component variation and which would be as much as possible non-critical with respect to alignment. Because of this last requirement, the components of the electron-optical system—the deflection yoke, focus coil and beam bender—must be free of any damaging interaction.

For a number of reasons, including mechanical ones such as mounting, it was desired that the new yoke be completely interchangeable with the preceding model. As a consequence of these requirements, both the deflection yoke and the focuser were completely redesigned, and only the beam bender escaped with minor changes.

Broadly speaking, the more uniform the field of a yoke, the less its aberrations. It is known that a uniform field can be produced in a completely closed volume by a winding of wire properly distributed on its surface. This fact is not directly applicable to yokes, because the beam has to enter and leave the deflection field, requiring holes in the volume with accompanying end effects.

Until recently, it was held that most of the aberrations of scanning yokes were associated with end effects, and hence that there was no particular advantage to a uniform field structure within the yokes. Recent analysis has shown, however, that the end effects by themselves need not produce much aberration, and that the interior region of the yoke has been principally responsible for the defect encountered

in picture quality. If end effects can be minimized, then the designing of a yoke having a flat field in the deflection region (exclusive of ends) requires only a distribution of turns that varies around the neck of the tube as the cosine of the angle subtended at the center of the circular cross section of the cylinder.

Form Factors

From potential theory, to produce a flat field in a cylindrical tube the number of turns along the circumference vary as $\cos \theta$. This defines, for closely packed wire whose cross-section is negligible with respect to the radius of the cylinder, a winding space whose inner circuit is a circle and whose outer circuit an ellipse whose equation is

$$\frac{X^2}{R^2(1+K)^2} + \frac{Y^2}{R^2} = 1$$

where R and K are defined as shown at the bottom of page, in the illustration of Fig. 1.

In such a structure there is the problem of arranging a suitable return for the end wires. It would be much simpler to wind the returns on the cylindrical core, obtaining a form as in Fig. 2A, the

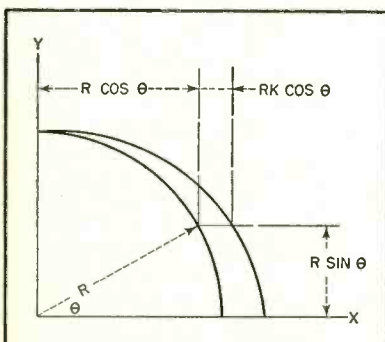

FIG. 1—Geometry of potential theory on which the yoke design is based

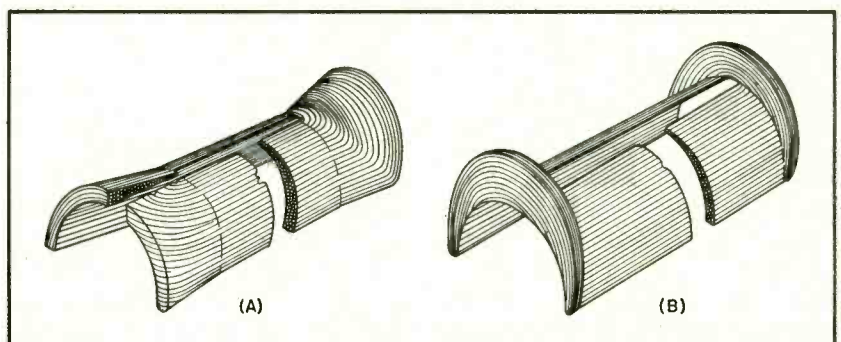

FIG. 2—Cross-section of initial experimental model of cosine deflection coil A and coil actually used in television receivers B

Focus

By **CARLO V. BOCCIARELLI**

*Project Engineer
Research Division
Philco Corporation
Philadelphia, Pa.*

cross-section of which would be everywhere about the same. Unfortunately, this form causes the inner wires to be considerably shorter than the outer ones. One would obtain a cosine yoke only for part of the structure while the two end zones define broad regions where the wire distribution changes and where our postulated flat field no longer obtains.

Notwithstanding its greater winding difficulties, the form of Fig. 2B was chosen. This form has the advantage that the end terms have a lessened influence on the beam because they are brought farther away from it; and because the field they produce tends to be parallel to the electron beam and hence its influence is largely nullified. The cosine distribution becomes so thin that for about 20 degrees no wire is needed.

In a practical yoke, one would generally favor the horizontal deflection, thus the vertical windings would be located outside the horizontal and have to be fashioned no longer on a cylindrical form but on the elliptical outer aspect of the horizontal winding. Fortunately, using potential theory, one can lay out the outside verticals with the same confidence as the inside horizontal.

Practical Design

The yokes constructed on this principle produce a flat field which unfortunately will pincushion somewhat if the tube face is flatter than a sphere concentric with the center of deflection. This is the case for most tubes and thus to provide a rectangular representation one has to depart somewhat from the ideal.

In practice, forming the yoke with a cosine-squared distribution



FIG. 3—Cross-section of finished cosine deflection coil

is adequate. This distribution starts somewhat thicker and thins out more rapidly than the cosine. In effect the amount of distortion so introduced in the field is directly proportional to the amount of pincushion produced by the cosine yoke and which the new winding corrects. This pincushion amounts to about 1 to 2 percent at the edges of the picture when the percent measures the amount by which a horizontal or vertical line fails to be straight, divided by its length.

Winding heads were designed which defined a hollow winding space where the wire would be forced to locate accurately and build up to the exact cross sections. To maintain the desired form, the wire chosen was Bondeze, whose covering will solidify in a solid mass when heated. The windings were heated in the winding jig by passing a current through the coil. This provides a solid structure, nearly impossible to bend or twist out of shape in assembly.

The finished yoke is somewhat less expensive to manufacture than the previous hand-wound yokes having aberrations. Figure 3 shows a finished section as well as a cross-section through a yoke.

Focus Improvement

The earlier all-electromagnetic focus coils developed into composite electromagnetic and permanent-magnet devices where the electromagnetic winding was mainly used to trim for focus and to compensate in part for focus variations due to high voltage changes. The flux of

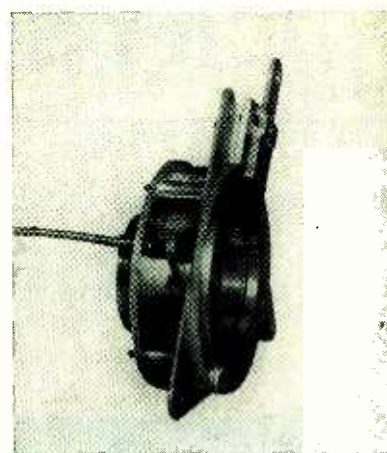

FIG. 4—Adjustable permanent-magnet focusing assembly

neither the coil nor the magnet was well used, so that considerable currents were still required and expensive potentiometers needed.

The quality of the spot of the combination is not superior to the spot that can be achieved by permanent magnets alone, and permanent-magnet focusers requiring neither current nor potentiometer are cheaper than either the electromagnetic or the combination.

The main problem of the permanent-magnet focuser is adjustment. As its field is completely independent of variations of potentials in the set, it must be capable of maintaining focus over such voltage variations as may occur in each locality due to fluctuations of supply voltage, and it must be capable of adjustment to a center value, which again depends upon local conditions.

One way to achieve this is to provide a movable shunt so that a larger or smaller portion of the total magnetic flux provided by the permanent magnets may be routed away from the focusing gap.

The problem was solved by changing the air gap instead, as shown in Fig. 4. The flexible shaft causes a magnetic ring to slide over the inner nonmagnetic ring. By so doing, the gap is opened or closed, thereby weakening or strengthening its focusing effect. The resulting structure is always symmetrical and thus free of interaction, and it focuses adequately over a 2 to 1 change in high voltage. The centering adjustment is of a new design which considerably simplifies centering.

CRYSTAL CONTROL for

Stabilized operation of the BC-645 on 460 mc is accomplished by addition of a two-tube exciter unit and use of the doorknob tube as a doubler. Frequency multiplication of 54 times is provided from crystals having fundamentals from 8.52 to 8.70 mc

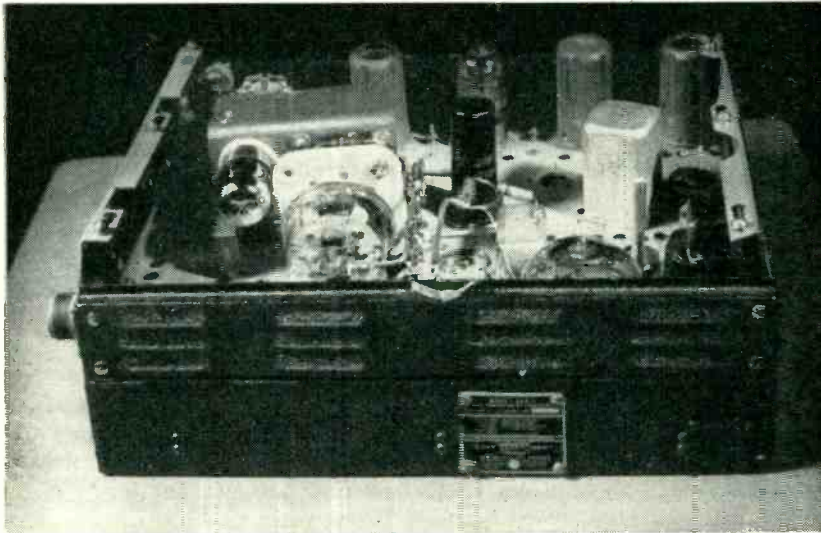

Complete transmitter-receiver for citizens band after crystal exciter has been added. Cover plates cause slight detuning of doorknob grid circuit

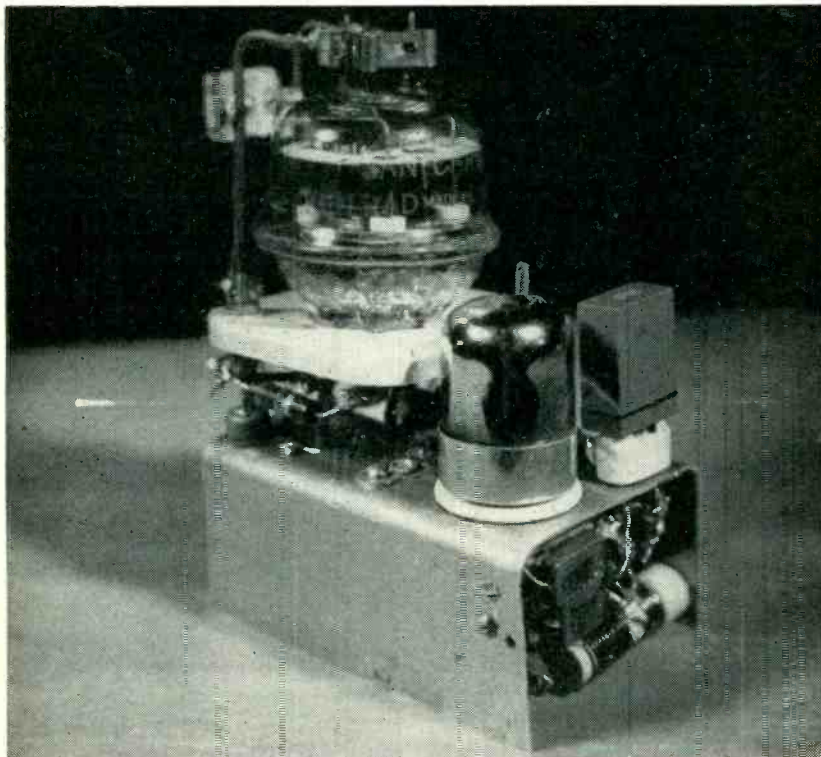

All components of the circuit shown in Fig. 1 are mounted on this small chassis that fits inside the case of the BC-645

MANY DESIGN TECHNIQUES presently utilized to provide crystal control for the 460-mc citizens band are limited to power levels of several hundred milliwatts.

The development of power outputs in excess of a watt requires large tubes such as the 316-A, the 2C43 and the 8012. However, none of these tubes possess the frequency-multiplying efficiency inherent in some of the beam-power tetrodes employed for lower frequency work. As a consequence, an abundant amount of driving power is required and the watts per dollar economy of the station suffers.

With the method to be described, four watts of crystal stabilized power may be obtained for a very nominal expenditure from a surplus BC-645 unit. Only the r-f techniques necessary to convert the transmitter to crystal control will be described.

The addition of modulation can be accomplished according to conventional practice. The conversion enables the 316-A of the BC-645 to perform as a frequency doubler fed by an exciter unit.

Exciter Unit

As a frequency doubler, the 316-A tube shows a power gain of approximately unity. Therefore, the driving power has to be supplied on a watt-for-watt basis relative to the output power. The exciter unit contains two tubes, a 7F8, and an 832-A. The latter tube is available from surplus at a price comparable to the several receiving type tubes which might be used for an alternative design. The driver unit can be mounted inside the BC-645 chassis with sufficient space left over to allow for the installation of a 6L6-6C5 modulator

CITIZENS BAND

By IRVING GOTTLIEB and IRVING ROBERT MEDNICK

Los Angeles, California

using available sockets.

The circuit of the exciter unit is shown in Fig. 1. One-half of the 7F8 dual-triode operates as a harmonic oscillator. The tank circuit L_1 - C_1 of this oscillator is tuned to the third harmonic of the fundamental frequency of a garden-variety quartz crystal.

The overall frequency multiplication factor from crystal to antenna is 54 times. To arrive at a final frequency within the 460 to 470-mc range, the crystal frequency must be within the limits of 8.52 to 8.70 mc.

The oscillator is regenerative, the amount of feedback being controlled by the number of turns of the feedback coil L_2 . Increasing the feedback results in increased third-harmonic output. However, too much feedback will result in self-oscillation.

Different constructional and wiring practices will result in slight deviations from the optimum configuration of L_2 as determined by the authors. The experimenter is urged to derive the best operating conditions peculiar to his apparatus. Once the proper amount of feedback is provided, the circuit is reliable and stable in operation with respect to different 7F8 tubes, temperature and ordinary electrode voltage fluctuations.

Do not test for self-oscillation by removing the crystal. The capacitance of the crystal holder is necessary to the circuit when the tube is incorrectly operating as a self-excited oscillator. Therefore, the removal of this capacitance will yield an erroneous indication of the performance of the circuit.

A sharp resonance at one point only over the tuning range of the tank capacitor C_1 is a reliable prac-

tical indication of piezoelectric oscillation. A calibrated frequency meter is almost indispensable when working with harmonic oscillators and frequency multipliers and is recommended.

When functioning properly, the oscillator delivers about a watt of r-f to the second half of the 7F8, which operates as a straightforward tripler.

The tripler section draws about twelve ma of plate current and develops about 1.5 watt of power at approximately 77 mc. There is no pronounced plate-current dip at resonance so it is better to tune this stage by means of an r-f indicating device.

Tripler Stage

The 832-A operates as a push-pull tripler, thereby extending the frequency to the 230-mc region. The output tank capacitor C_5 should be adjusted by means of an r-f indicating device loosely coupled to the cold end of the plate lines.

Tuning of C_5 and C_6 must be done with a screwdriver made of insulating material. The output of the 832-A should be capable of lighting

a 6-volt blue-bead lamp to a brilliant white heat when a loop containing such a bulb is momentarily held in close proximity to the plate lines.

The tank coils L_3 and L_4 should be mounted in coplanar relationship with one another. There should be a separation of $\frac{1}{2}$ inch between the two coils and their perpendicular axis should be displaced by $\frac{1}{2}$ inch.

The chassis used was $3\frac{1}{2}$ inches long, $2\frac{1}{2}$ inches high, and had a depth of $1\frac{1}{2}$ inch. These dimensions enable the exciter unit to fit snugly into the BC-645 chassis.

In arranging the components on the chassis, initial consideration should be given to the parts relative to the 832-A. All of the indicated ground connections should be as short as possible and should be made as closely to the cathode terminal of the socket as can be practically accomplished. Filament chokes and bypass capacitors may be required in some cases.

Conversion of Final

The schematic diagram of the 316-A stage converted for operation as a frequency doubler is

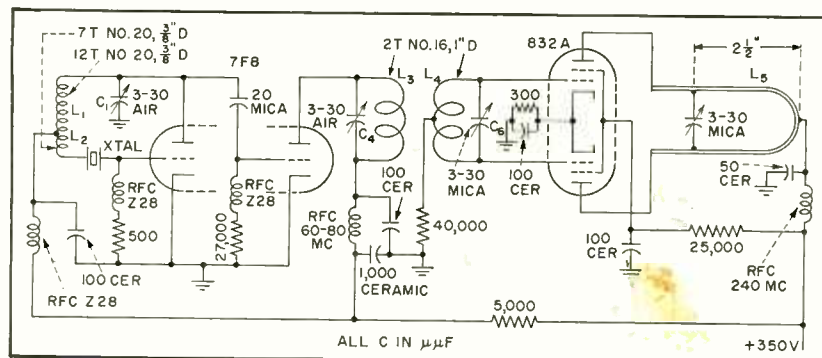

FIG. 1—Circuit of exciter unit added to BC-645. Coil L_1 is spaced the wire diameter and the others are closewound. A six-inch length of $\frac{1}{8}$ -inch copper tubing is connected to each plate of the 832-A to form L_5 .

shown in Fig. 2. Special attention is directed to the input circuit. Although the physical configuration of the arrangement has the appearance of a single transmission-line element series tuned by a capacitance, this is not the true operating condition. Rather, the chassis metal assumes the role of an opposite line and the equivalent circuit becomes an open-ended quarter-wave transmission line with a nonuniform distribution of inductance and capacitance along its length.

The procedure to be followed for the conversion is as follows:

Clear the top of the transmitter portion of the chassis of all transformers, relays, and tubes which occupy the space between the 316-A tube and the front (antenna end) of the chassis. Remove the metal partition between the transmitter and receiver.

Remove the 316-A tube. Bend the original grid line so that it will no longer contact the grid terminal of the tube. The end of this line is now connected to the proper filament terminal as depicted in Fig. 2, and it becomes L_7 . This connection can be at the right angle bend in L_7 instead of the very end if desired.

Disconnect the bias resistor at point X. This point should be grounded to the nearest spot on the chassis.

Attach a wire lead to the grid prong of the 316-A tube by winding a section of solid hookup wire around the prong, then tinning the wire wrapping with solder. This will not be a soldered joint, but will be found satisfactory both electrically and mechanically. (The tube prong is made of an alloy

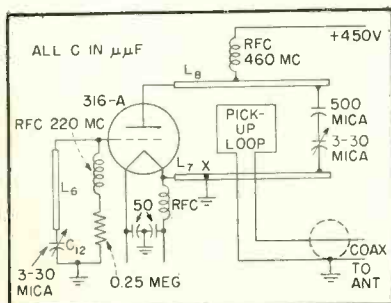

FIG. 2—Final stage of the transmitter after modification. Inductor L_6 couples to L_5 of Fig. 1



Closeup of underside of exciter chassis shows close fitting of components required. Authors advise a 12AU7 provides greater output than the 7F8

which is extremely difficult to solder.) The wire lead should be cut so that its length from the grid prong to the end is two inches. The tube should be replaced and this lead should be brought out along the glass envelope.

Connect a piece of $\frac{1}{8}$ -inch copper tubing to the wire lead coming from the grid prong. This section of the tank circuit should be between $2\frac{1}{2}$ and 3 inches in length. The free end should be soldered to one terminal of the mica trimmer capacitor C_{12} . The other terminal of this capacitor is connected to and supported by the threaded stud which projects from the chassis about a half inch from the end of the antenna coaxial assembly. Make certain that the grid prong of the 316-A does not touch L_7 . The location of the r-f choke and the bias resistor are not critical providing the proper choke is used.

It is assumed that the tuning slug and the associated relay have been removed in clearing the chassis. With a hack-saw blade, cut off the capacitor plate ends of the lines L_4 and L_5 . Connect across the severed ends the series combination of capacitors indicated in Fig. 2.

It will probably be found more

convenient to use an a-c power supply rather than the PE-101 dynamotor if fixed station operation is contemplated. To energize the entire converted unit, exciter, 316-A doubler, modulator, and receiver, the power supply should deliver a maximum of 450 volts and should be capable of furnishing a total current drain of about 160 ma.

The spacing between L_5 and L_6 is not critical; the distance of separation may be between one-half inch and two inches. The best performance usually obtains with a spacing of approximately one inch. With this spacing, a slightly over-coupled condition prevails. A spacing of two inches still allows sufficient transfer of energy, but the tuning becomes rather sharp. Too close spacing results in pronounced pulling between the tuned circuits and lowers the efficiency of energy transfer.

Tuning

With the input and plate resonant circuits properly adjusted, the 316-A tube draws approximately 25 ma. The addition of the antenna load will increase this to 35 ma. It has been found that no particular correlation exists between grid current and operating efficiency. The best indication that sufficient excitation is available from the exciter is a broad tuning characteristic displayed by C_{12} .

If the adjustment of C_{12} is critical relative to optimum output in the plate circuit, it is a pretty good indication that the r-f grid potential is inadequate. If this condition is found to exist, adjustment of the coupling between the grid line element L_6 and the output lines of the exciter should remedy the situation.

A 6-8 volt blue-bead bulb should glow brightly when touched near the center of line L_7 . Do not attempt to obtain an indication of r-f in the output lines by the conventional method of using a bulb and loop. The proximity of the loop will detune the lines to such a great extent that the detection of r-f energy by this means will be found difficult.

BIBLIOGRAPHY

Previous Citizens Band Articles, ELECTRONICS, p 80, Nov. 1947; p 80, Mar. 1948; p 96, May 1948; p 76, Aug. 1948; p 84, Dec. 1948; p 78, June 1949; p 88, Sept. 1949; p 77, Nov. 1949.

Regulating A-C With Buck-Boost Amplifier

Ten-tube electronic regulator insures good waveform with continuously variable output voltage from 110 to 120 volts. Characteristics hold true for any load within the normal capacity from 0 to 200 volt-amperes. Output voltage changes less than 0.5 percent for line variation between 105 and 125 volts

A STABLE SOURCE of 60-cycle power is required for many devices such as x-ray diffraction cameras, high-precision selsyns and microwave bridges. A new electronic regulator provides both constant voltage and wave form with a minimum of harmonic components.

After many different systems were tried, that shown in the block diagram, Fig. 1, was selected. A 60-cycle signal taken from the input line is first amplified and clipped to obtain a constant-amplitude square wave synchronized with line voltage. This wave is then filtered through a low-pass filter to yield a constant-amplitude 60-cycle signal with low harmonic content. This reference signal is compared with the voltage across the load in a mixer circuit and the difference or error signal is amplified and used to drive a buck-boost amplifier in series with the power line.

Since the output voltage of the buck-boost amplifier is phased to provide proper corrective action, the operation of the regulator is such as to make the output load voltage match the reference signal as nearly as possible under all conditions. This regulator therefore supplies corrective action to the input line voltage with a delay of only a small fraction of one cycle.

A simplified circuit diagram of the line-voltage regulator is shown in Fig. 2. The d-c power supply is designed to furnish 0.15 amp at 500 volts unregulated, and 0.05 amp at 300 volts and lower, with electronic regulation of voltage. The unregulated voltage is used to

By **C. W. CLAPP**

General Engineering and Consulting Lab.
General Electric Co.
Schenectady, N. Y.

supply the plates of the power amplifier tubes V_7, V_8, V_9, V_{10} , while the screens of these same tubes and the other tubes in the equipment are supplied with regulated voltage.

To obtain a stable reference voltage, a 60-cycle signal is first applied to the control grid of V_1 through the adjustable phasing network consisting of C_1 and R_1 . Since this signal is large enough to drive V_1 (6SH7) beyond current saturation in one direction and cutoff in the other, good limiting action is obtained. The voltage appearing at the plate of V_1 is therefore a square wave whose peak-to-peak amplitude is essentially determined by the plate voltage applied to V_1 . This voltage is fixed by the voltage regulator tube V_2 .

The output of V_1 , reduced to a suitable level in the voltage divider R_4, R_5 , is applied through the cathode-follower stage V_3 to the single-section low-pass filter con-

sisting of inductance L_1 and capacitances C_3, C_4, C_5 . The series arm of the filter is tuned to approximately 180 cycles to provide sufficient attenuation for the strong third harmonic component of the square wave. Tube V_4 , with its tuned-plate load consisting of inductance L_2 and capacitance C_7 , provides additional filtering and amplification of this signal without introducing phase shift. Because of the large plate-load impedance employed, the voltage gain of the stage consisting of V_4 is constant. The voltage across resistor R_{12} is therefore an essentially pure sine wave of constant amplitude and is synchronized with the input line. Resistor R_1 is adjusted to make this voltage exactly 180 degrees out of phase with the line voltage.

By means of the divider network consisting of resistors R_{13}, R_{14} and blocking capacitor C_{11} , the reference voltage is compared with a selected fraction of the regulator output voltage. The difference is applied to the control grid of the amplifier tube V_5 . The output of V_5 is fed through the phase-inverter tube V_6 to the control grids of the push-pull power amplifier consisting of V_7, V_8, V_9 and V_{10} . Through the step-down transformer T_2 , the amplified difference voltage is then inserted with proper polarity in series with the input line voltage. By providing sufficient gain in the regulator circuit, the output voltage is made to have essentially as good waveform and voltage stability as the reference voltage itself.

The theory of push-pull amplifiers

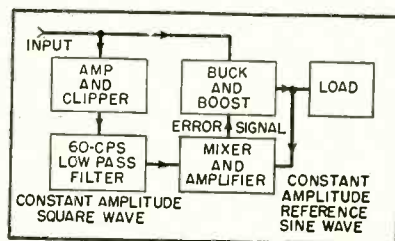

FIG. 1—Elements of the 60-cycle voltage regulator

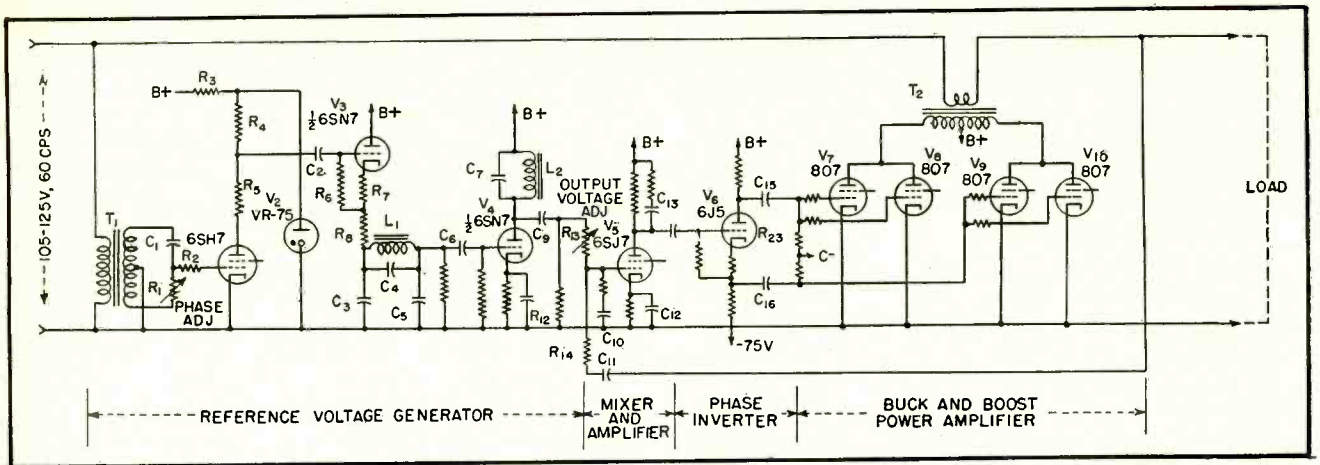

FIG. 2—Simplified schematic showing arrangement of reference generator, amplifier, inverter and buck-boost amplifier

supplying power to an external load is well developed.¹ Not so well known are the design factors that must be considered when the amplifier is required to absorb power as well as deliver it.

A simplified diagram of the load circuit of the regulator is shown in Fig. 3A. In the following discussion, we will ignore for the moment the effects of load changes and assume that the load current I_r and load voltage E_r are constant. With due regard to algebraic sign, the buck-boost amplifier voltage E_a is given by

$$E_a = E_r - E_s \quad (1)$$

where E_s , the supply line voltage, varies between some minimum value E'_s and some maximum value E''_s . The volt-ampere output of the amplifier is therefore given by

$$W_a = E_a I_r = E_r I_r - E_s I_r \quad (2)$$

The change in volt-ampere output as the supply line voltage changes from its minimum to its maximum value is therefore

$$W'_a - W''_a = (E''_s - E'_s) I_r \quad (3)$$

The change in output volt-amperes is a measure of the effectiveness of the buck-boost amplifier in this type of service, corresponding to the output rating of an amplifier in conventional service.

In Fig. 3B is shown the characteristic plate voltage-plate current curves of one of the type 807 tubes used in the push-pull output stage of the buck-boost amplifier. To avoid confusion only one curve of the family, that corresponding to zero grid voltage, is shown. In this diagram, the point Q represents the quiescent or operating

point which, in this case, has been chosen to give class-AB operation.

When considering an amplifier whose purpose is solely to deliver power to a load, it is usual to analyze its behavior with reference to a load line (or ellipse if the load is reactive) drawn on the $I_p - E_p$ characteristic of the output tube. In such service, the important variable of operation is the input or control-grid voltage. The load line portrays graphically, for any control-grid voltage, the relation between plate current and plate voltage as determined by the initial operating conditions and the impedance developed in the plate circuit of the tube by the output load.

For an amplifier used in the regulating circuit of Fig. 3A, the load voltage E_r is fixed while the load current I_r and supply voltage E_s are variables of operation. The control grids of the output stage of the amplifier must be driven in such manner as to develop the amplifier output voltage E_a required by Eq. 1 when the specified load current I_r is flowing.

Referring to Fig. 3B, the line AQM represents the load line corresponding to the condition of maximum load current and minimum line voltage E'_s . The peak voltage swing, $E''_p - E_b$, or $E_b - E'_p$, is equal to the peak value of E_a times the turns-ratio of the output transformer (one-half primary to secondary). Similarly the peak current swing I_m is equal to one-half the peak value of the load current I_r divided by the same output turns ratio. The factor of one-half is introduced by the use of two tubes

in parallel in each side of the output circuit.

If now the load current I_r is fixed, while E_s is allowed to vary, then the load line will rotate about the operating point Q to a position determined by I_r and E_s . For example, when $E_s = E_r$, then $E_a = 0$ and the load line will shift to the position BQL. If E_s is increased to its maximum value E''_s , the load line will shift to CQK. Under this condition power is being transferred from the power line to the anodes of the amplifier output tubes and power dissipation at the anodes is at its highest value.

Similarly the lines DQJ, EQH, FQG represent the load lines for the same set of line voltage conditions but with reduced load current.

We may now compute the power dissipated at the plate of one of the output tubes whose characteristic is shown in Fig. 3B. For this purpose we will consider only the 60-cycle components of a-c currents and voltages. Since the plate dissipation per tube (W_p) is given by the plate input power per tube less one-quarter the power delivered to the load

$$W_p = E_b \times I_{av} - \frac{1}{4} (E_b - E_m) \times I_m$$

where I_{av} = average or d-c component of the plate current of the tube

I_m = maximum or peak value of the a-c component of plate current

E_m = value of the plate voltage at the instant when I_p has its maximum value

$$\text{Then } W_p = E_b (I_{av} - \frac{1}{4} I_m) + \frac{1}{4} E_m I_m \quad (4)$$

In selecting the best operating conditions for the output tubes in the buck-boost amplifier, the objec-

tive is to secure the maximum volt-ampere rating as given by Eq. 3 consistent with the other conditions of the problem and with the requirement that the maximum plate dissipation given by Eq. 4 be within the safe value prescribed for the output tube in this class of service.

It is apparent that for a given volt-ampere rating of the amplifier, the plate dissipation given by Eq. 4 is reduced to its lowest value by making $E_b = 0$. Under this condition, the amplifier is used only as a variable absorber of power and delivers no power to the load under any line voltage condition. It was found however that this method of operation seriously reduces the ability of the regulator to supply a sinusoidal output voltage under adverse load and line voltage waveform conditions. For this reason the somewhat less efficient operating conditions shown in Fig. 3B were selected for this regulator.

To select the optimum plate supply voltage E_b , the point A was first fixed at the knee of the zero-grid-bias curve thus determining I_m and E'_p . Point C and E''_p were then selected by trial so that with $E_b = \frac{1}{2}(E'_p + E''_p)$ the maximum plate dissipation did not exceed a safe value for this class of service. Finally, with the amplifier operating along the load line AQM, screen dissipation was checked to ensure that it fell within the rating of the tube.

Stability of Regulator

Stability is a major problem in the design of any regulator employing negative feedback. As shown in Fig. 3C, the feedback loop in this regulator consists of the error-voltage amplifier, the power amplifier, and the circuit network comprising the output transformer, the primary power source impedance and the load impedance.

To avoid self-sustained oscillation in such a system, it is necessary to exercise some control over the vector gain around the loop.² More specifically, the vector gain when plotted as a function of frequency over the range from zero to infinite frequency must not enclose the point $(-1, 0)$, corresponding to unity gain and 180 degrees phase shift. To ensure ample safety fac-

tor, it is usual practice to design the various circuits so that, considering the loop as a whole, the phase shift will not be more than 150 degrees at any frequency at which the gain amplitude is greater than unity, and the gain amplitude will not be more than $\frac{1}{3}$ at any frequency at which the phase shift is 180 degrees or more.

The output stage of the power amplifier used in this regulator employs four type 807 tubes in a push-pull, parallel circuit. The output impedance of the amplifier as measured at the secondary of the output transformer is essentially a resistance of approximately 50 ohms in series with the small equivalent leakage reactance of the output transformer. Since this output impedance is many times the largest practicable line source impedance, the effect of the latter on the vector gain around the loop is negligible. This is fortunate, as it makes it unnecessary to consider all possible values of line impedance in determining the degree of stability obtainable with any particular load impedance.

Since a highly reactive load im-

pedance will produce a phase shift approaching 90 degrees in the output circuit of the power amplifier, extreme care must be exercised in the design of the remainder of the feedback loop to ensure stable operation. For this reason, no transformer other than the output transformer is permitted in the loop, and this transformer must be a high quality unit with low leakage reactance and distributed capacitance. Referring to Fig. 2, capacitors C_{10} , C_{12} , C_{13} , C_{15} , and C_{16} are chosen to provide a gradually increasing attenuation to frequencies outside the desired pass band, which extends from about 25 to 200 cps. All other components in the loop are designed to give as little phase shift in this frequency range as is practicable.

The regulated output voltage is continuously variable from 110 to 120 volts for any load within its normal range of 0 to 200 volt-amperes. Load power factor may have any value from zero leading to 0.3 lagging. Output voltage regulation with respect to load current is within 1 percent, indicating an equivalent output impedance for the regulator of approximately 0.6 ohm. The output voltage changes less than 0.5 percent at fixed load for changes in input line voltage from 105 to 125 volts.

Changes in supply frequency are essentially of importance only as they affect the amplitude or waveform of the standard reference voltage. Variations of ± 1 cycle at 60 cycles are readily tolerated and the effects may be further reduced by special filter design.

The waveform of the regulated output voltage will contain less than 3 percent harmonic content for any load power factor provided the input line voltage has not over 10 percent harmonic content. Nonlinear load elements such as rectifiers and saturable reactors have relatively little effect on the output waveform because of the low output impedance of the regulator at the frequencies involved.

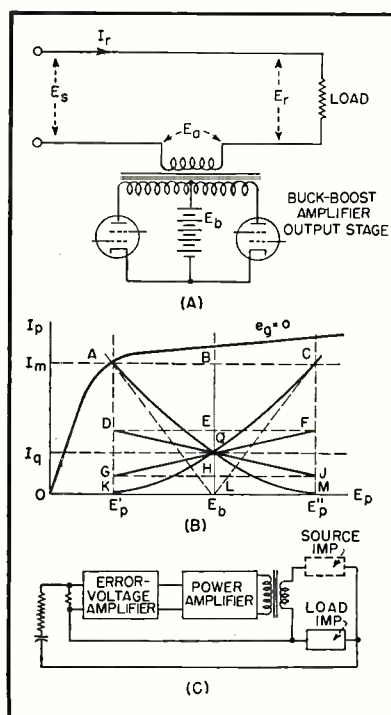
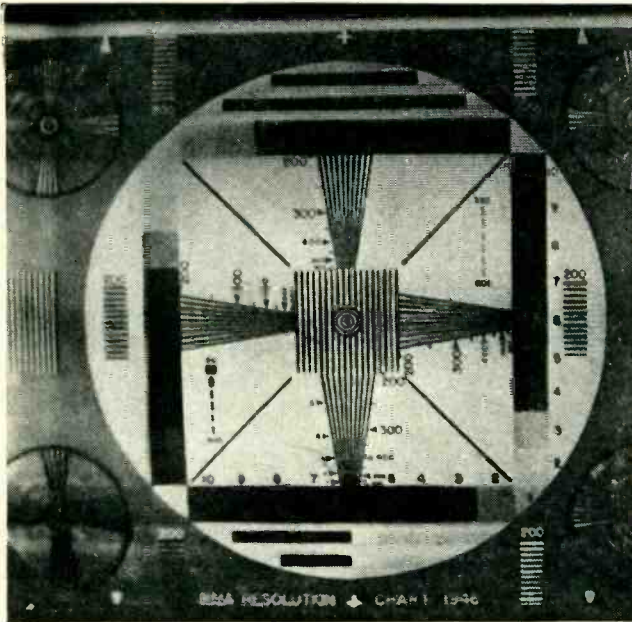

FIG. 3—(A) Load circuit of the regulator. (B) Load lines corresponding to types of operation outlined in text. (C) The feedback loop comprises error-voltage amplifier, p-a, and the circuit network, which has three elements

REFERENCES

- (1) W. G. Dow, "Fundamentals of Engineering Electronics", John Wiley & Sons, Inc., New York, 1937, Chap. 12 and 13.
- (2) H. Nyquist, *B. S. T. J.*, 11, p 126, 1932.



Example of interlaced resolution of standard test pattern. The gamma range is not representative because overexposure of film was made to emphasize wedges

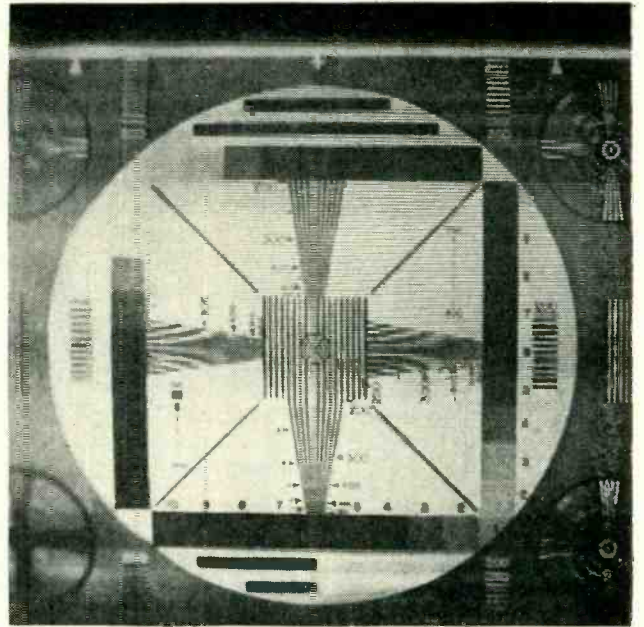

Example of resolution available from standard test pattern with no interlace. This shot is also overexposed to emphasize the reproduction of wedges

Inexpensive Picture

With interlacing, effective resolution of better than 450 lines in both directions is achieved with a conventional picture tube as the light source of a flying-spot system.

Circuit details and discussion of alternative arrangements are included

By
J. R. POPKIN-GLURMAN

*Hazeltine Electronics Corp.
Little Neck, N. Y.*

THE PICTURE GENERATOR to be described achieves economy by using the basic circuits of a television receiver and employing the flying-spot scanner principle.

The synchronizing signals for initiating the flying-spot sweeps are derived from any standard RMA generator source. These signals can be readily obtained by abstracting the composite synchronizing pulses from a broadcast television signal as received from any television station.

The generator will also operate

on a 262-line noninterlaced basis or with a simple interlacer circuit should a standard RMA signal not be available. The effective resolution of the generator is better than 450 lines in both vertical and horizontal directions if interlacing is used.

The description to follow applies equally well to the unit which can be built or for modification of an existing standard tv broadcast set. A block diagram of the picture generating system is shown in Fig. 1. The first unit contains the sweep, high-voltage and blanking circuits which are necessary to provide a raster for the cathode-ray tube used at the light source for the flying spot.

Light from the raster is sent from the crt face through the picture, which is a transparency, and is then picked up by a multiplier phototube. The signal is then amplified in a video amplifier whose frequency response is corrected for the phosphor decay characteristics of the flying-spot cathode-ray tube. The signal is then passed through a video phase splitter which allows either positive or negative transparencies to be used. Following the phase splitter is a mixer stage, which adds blanking pulses to the video and then feeds a clipping stage. These circuits are shown in Fig. 2.

The output of the clipping stage is a composite video picture suit-

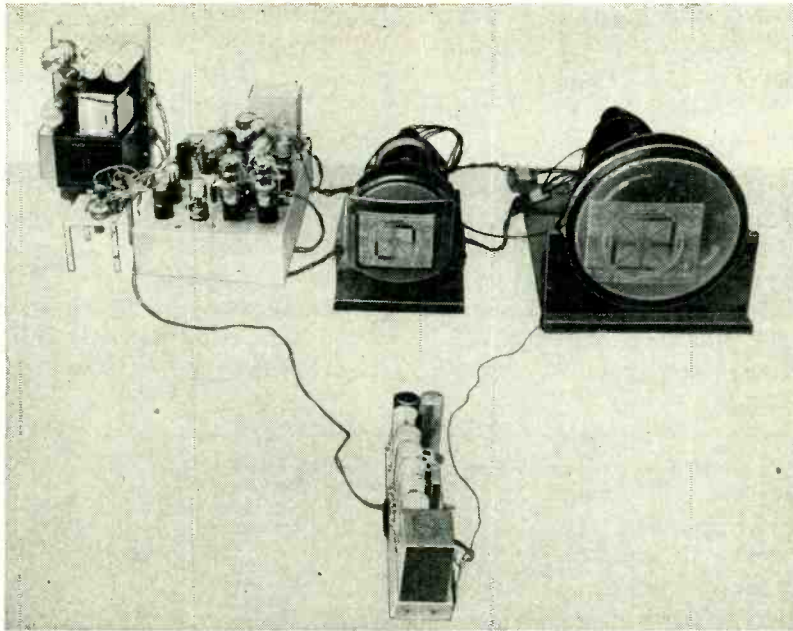

The phototube and video amplifier chassis faces test transparency on the face of the transmitting crt. For demonstration purposes the monitor picture tube at right is fed deflection currents and high voltage from the sweep chassis

Generator

able in every respect for either modulating a signal generator or feeding the video section of another television set, providing synchronizing is available. Careful adjustment of the receiver's hold controls will sometimes allow the blanking impulses to be used for sync. However, separated RMA sync pulses derived from the receiver may be added to the blanking to give an RMA composite sync video signal.

Sweep Chassis

The blanking is derived from the television receiver or the sweep chassis of Fig. 3. This chassis is conventional in most respects except for the interlace generator. Greater care than is normal for a television set is taken to preserve the linearity of the horizontal and vertical sawtooth currents generated. For those not wishing to use the exact complement of tubes shown, equivalent tube types may be readily substituted; for example, in place of the 12AU7, 6SN7 tubes may be

used. A 6W4 may be used in place of the 5V4 damper tube.

For even greater linearity in the horizontal sweep, a bootstrap 6AS7 in the circuit of Fig. 4 can be used. For the 6BG6 tube a single 6CD6 or 807 tube may be substituted. For the 6SN7 vertical deflection amplifier a 6V6, 6K6, 6F6 and similar types may be used. Instead of the blocking-oscillator circuit for the sawtooth generators, multi-vibrators or gas tubes will operate

equally well. The RCA synchro-lock horizontal oscillator and afc circuit would also provide significant improvement in performance.

The higher-than-normal voltage for the second anode is obtained by wrapping an additional filament winding (made from RG 59/U or RG 62/U cable without the shield) around the coil of the horizontal output transformer to supply the pulse-doubler rectifier tube. The horizontal output transformer is a standard RCA type 211T1 or equivalent.

The second-anode voltage to the crt is made as high as is consistent with the ability of the tube to withstand the voltage and with the available power in the sweep circuits to produce a raster of adequate size. The higher the voltage the smaller the raster spot size, the better the resolution, and the better the signal-to-noise ratio of the final derived video signal. A voltage of 18,000 to 20,000 volts has been used with the 10FP4 tube. Any of the tubes having the special P15 phosphor will give even better resolution.

Practically any cathode-ray tube will produce pictures when used for flying-spot scanner service. However, certain phosphors are very difficult to compensate for electrically. The green P1 phosphor is an example of such a type. The P2, P4, P7, P11 and P15 phosphors are all quite suitable.

Surplus P7 radar tubes make fine inexpensive flying-spot scanners; however, those types of P7 phosphors which have a heavy deposit of the long-persistence material cause a shadow or grain in the picture. The trace of the blue phosphor is the most useful one in the P7 screen. Most of the 7FP7 and 12DP7

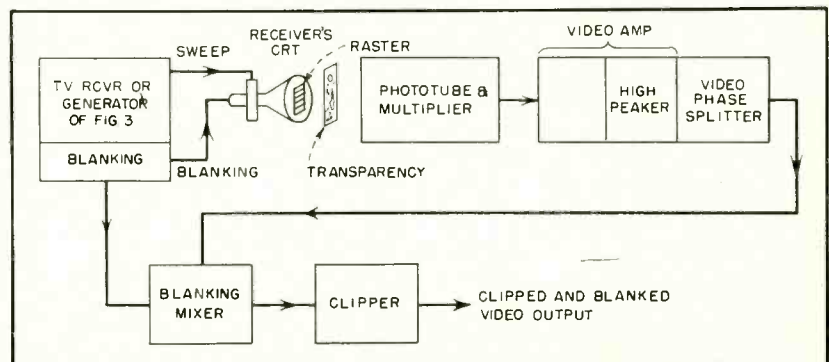

FIG. 1—Stages of the picture-generating system. The video output can feed the video stage of a conventional receiver or modulate an r-f signal generator

tubes did not show too annoying grain structure. The P4 phosphor tubes could be adequately compensated to give pictures having better than 450-line resolution. The 5WP15 tube provides beautiful 700-line definition when the video amplifier bandwidths are extended to over 10 megacycles. The P15 phosphors also produce a very good picture-signal-to-noise ratio. Because of the extra-high voltage associated with the flying-spot tube it has been

found that magnetic deflection tubes lend themselves most suitably in this application. Signal to noise for P4 screens is better than 36 db.

Blanking Circuit

The blanking is derived by differentiating the vertical and horizontal sawtooth current sweeps. A 1N34 rectifier is used across one of the horizontal output transformer are already of the proper shape and polarity for blanking.

to limit the blanking pulses fed to the grid of the flying-spot-scanner cathode-ray tube, as they are negative and any amplitude greater than beam cutoff does not affect the operation of the system. The voltage pulses present at the secondary of the horizontal output transformer are already of the proper shape and polarity for blanking.

Blanking voltages may also be obtained from other portions of the circuit than are indicated in Fig. 2.

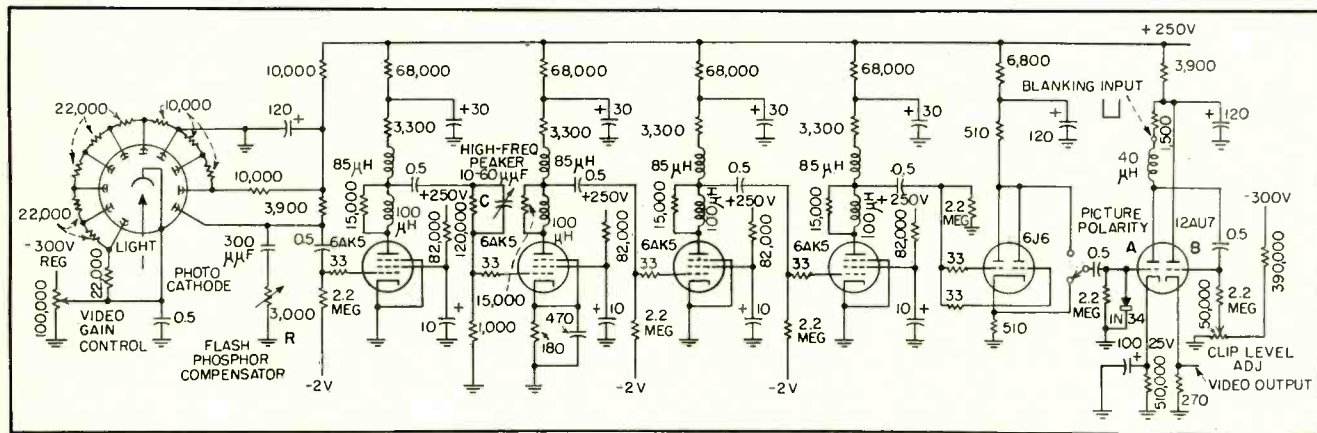

FIG. 2—Phototube and video amplifier circuits. Phase-splitter tube 6J6 permits either a positive or a negative transparency to be transmitted. Plate decoupling resistors of stages after the first can be 50,000 ohms

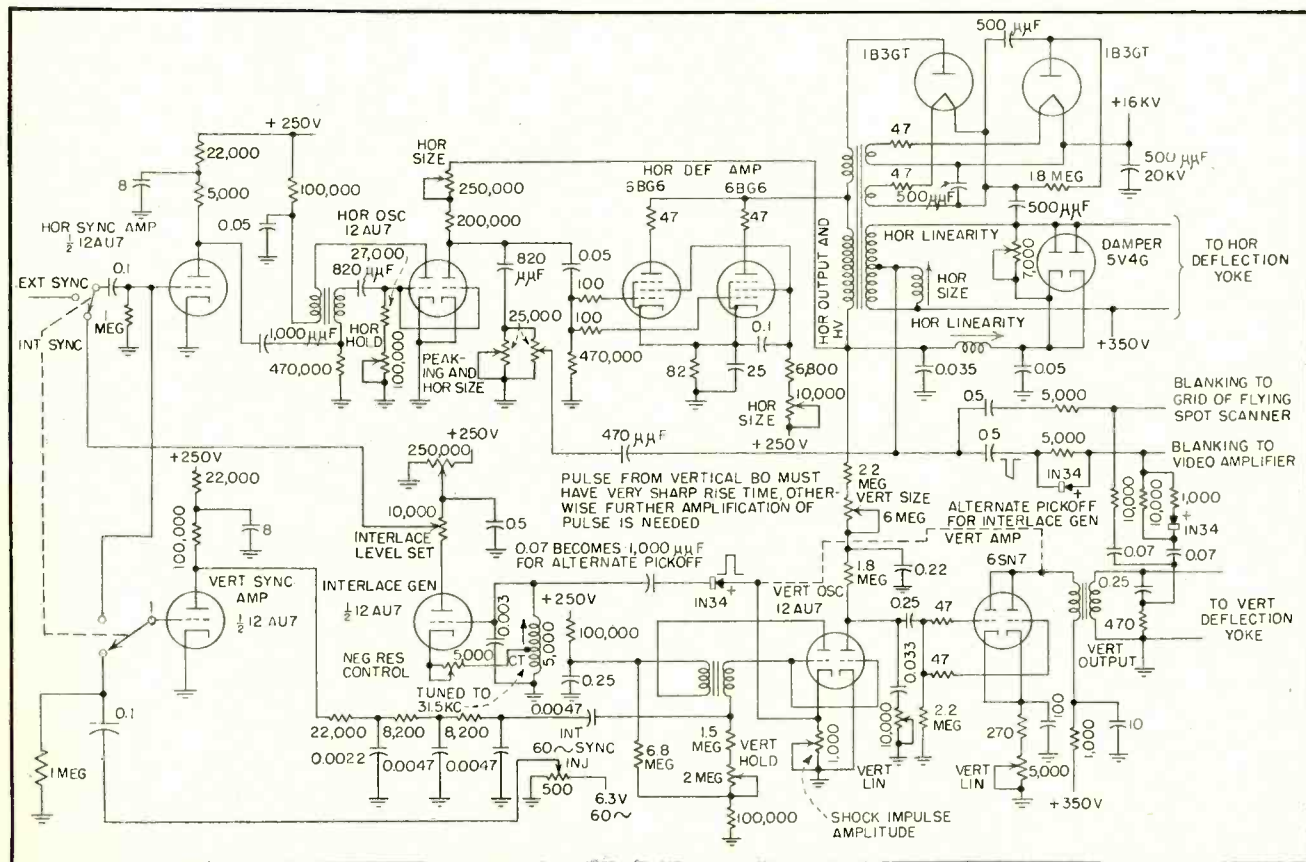

FIG. 3—Sweep chassis contains deflection circuits, interlace generator and voltage doubler for 16-kv output

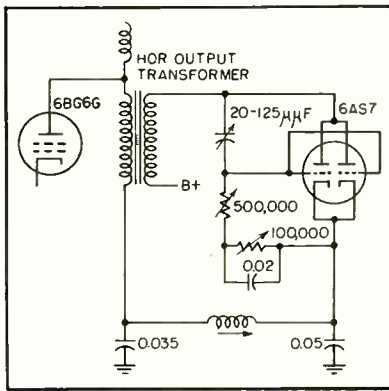

FIG. 4—All variable controls in this bootstrap circuit adjust horizontal linearity

The integrated vertical pulse present at the input to the vertical sawtooth generator may be used, or in those receivers of the RCA type 630, the vertical pulse boost in the plate circuit of the second sync amplifier may be used while the horizontal sync pulses may be used for blanking. The blanking connection to the crt grid is shown in Fig. 5, which also shows how 35-mm transparencies may be transmitted.

For initial adjustment, a video signal from a television receiver tuned to a station is fed into the grid of the picture tube instead of the mixed blanking pulses. The sync accompanying the picture is fed into the external sync input. The hold controls are adjusted until the picture is steady. The following adjustments should preferably be made using a test pattern transmitted by a station.

The horizontal and vertical size controls are set to give the proper aspect ratio of three units high to four units wide. The horizontal linearity resistor across the damper tube and the damper output circuit affects the left-hand side of the picture.

The horizontal size control in the screen grid circuit of the horizontal deflection amplifier affects the right-hand side of the picture, as do also the peaking and horizontal size controls in the plate circuit (pin 6) of the horizontal blocking oscillator and sawtooth generator.

The vertical size control in the plate circuit of the vertical sawtooth generator affects the bottom of the picture, while the vertical

linearity control in the cathode circuit of the vertical deflection amplifier affects the top of the picture.

In the event that test patterns are not available, then an r-f signal from a signal generator, suitably amplified, may be fed into the grid of the flying-spot crt and to the sync input. If the frequency is in excess of 150 kilocycles and is synchronized as a harmonic of the horizontal sawtooth generator, a series of vertical black and white bars will appear on the face of the tube. For proper linearity, these bars should have equal spacing.

Similarly, if an audio oscillator is fed into the grid of the cathode-ray tube and its frequency is between 600 to 900 cycles, horizontal bars will appear and their spacing should be adjusted to be equal for proper vertical linearity. Any of the commercial grating generators can also be used to set up the linearity of the sweeps.

If there are no sources available for interlaced sync operation, the horizontal sweep circuit may be allowed to run free and the vertical circuit synchronized to the 60-cycle line to minimize hum difficulties. This will give a 260-line noninterlaced sweep, which may be adequate for many purposes.

Figure 6 shows a simple circuit for obtaining standard 525-line interlaced sweep. Impulses of 60-cycle frequency derived from the vertical blocking oscillator are passed through the 1N34 crystal, causing a 31.5-kc tuned circuit to ring with damped oscillations. Sufficient negative resistance is added to make the 31.5-kc oscillations approximately constant in amplitude. The 15.75-kc horizontal blocking oscillator or synclock oscillator can then be synchronized

by two-to-one countdown.

By adjusting the 31.5-kc tuned circuit, interlace is readily obtained. The amount of negative resistance given this circuit is controlled by the 5,000-ohm variable resistor in the cathode of the 12AU7 interlace generator.

The amplitude of the initial ringing is set by the 1,000-ohm variable resistor in the cathode of the blocking oscillator. It is necessary that this impulse be sharp enough to cause the 31.5-kc tuned circuit to ring strongly. Too much negative resistance will cause the 31.5-kc tuned circuit to oscillate continuously and not be under the control of the vertical oscillator. If the pulse derived from the vertical oscillator is not sharp enough, further amplification and clipping may be necessary.

The proper amount of horizontal sync voltage for horizontal oscillator control is obtained by adjustment of the two potentiometers in the plate circuit of the 12AU7 interlace generator. If the amplitude of the 31.5-kc signal is too great it will cause the horizontal oscillator to tear at a 60-cycle rate. Further refinements of this circuit would consist of a differentiating and limiting amplifier following the generator to sharpen the horizontal sync pulses. This circuit is most effective when the 60-cycle line is steady; if the line frequency varies, the 31.5-kc circuit will have to be readjusted.

Construction

All of the circuits involved in the chain from the phototube through the mixer and clipper should be built with the same care normally taken for a high-gain i-f amplifier for a carrier frequency of 6 mc. The components should be well

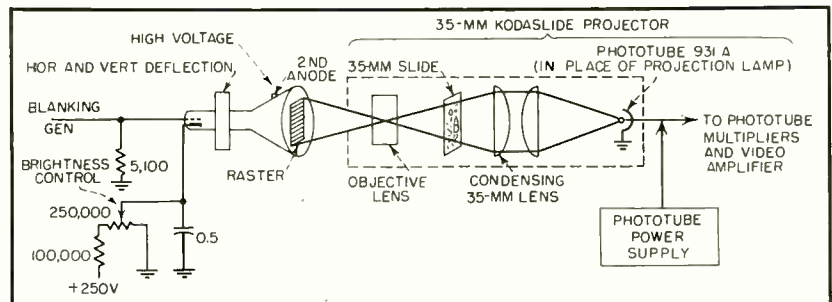

FIG. 5—Small transparencies can be accommodated by employing the optical system of a 35-mm projector backwards, with the phototube in place of the usual lamp

spaced from the chassis, and the stages isolated from each other. The first few stages operate at rather low levels and unless this portion of the unit at least is well shielded there may be considerable pickup from local broadcasting stations and others.

The phototube should be well shielded against both r-f and light pickup. Foil or thin sheet, or a proper-size can, should be placed over the phototube and grounded. A slot approximately the size of the window area of the phototube (that portion inside the tube covered by a sawtooth wire screen) should be cut in the foil or sheet in order to allow light passing through the transparency to be picked up by the phototube.

A regulated supply of 250 volts and 65 milliamperes should be used for the video circuit. A negative regulated voltage should also be used for the phototube supply. Load resistors for the dynode stages of the phototube can be wired directly to the pins of the socket.

A phase-inverter stage having equal outputs of opposite polarities is also useful should a negative instead of a positive transparency be used. Positive transparencies are preferred in this system because the noise generated in the phototube is proportional to the brightness of the light and hence any noise or snow present will be less pronounced in the lighter portions of the picture. Thus, if a positive is used to make the picture, the noise is much less visible than with a negative, where the highlights of the negative on reversal become dark areas on the resulting positive picture, showing noise in the dark areas.

The peaking coils shown will equalize the response to greater than 5.5 megacycles. Should conventional 4.5-mc video peaking coils be used, the resolution will suffer slightly. The bias for the video tubes can be derived from a small battery. Alternatively, the bias may be derived from a negative voltage source and brought down to the proper values by voltage dividers.

Adjustments

After the linearity has been properly set, the blanking is recon-

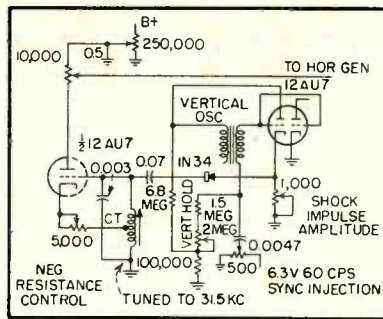

FIG. 6—Circuit of interlace generator for obtaining 525-line interlaced sweep

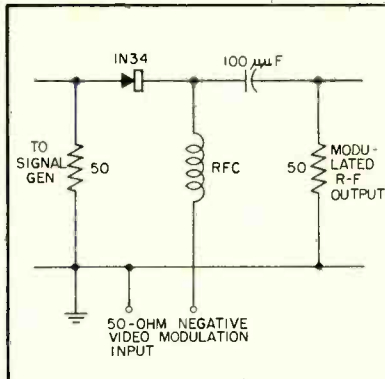

FIG. 7—Simple modulator circuit for adding video to an r-f generator

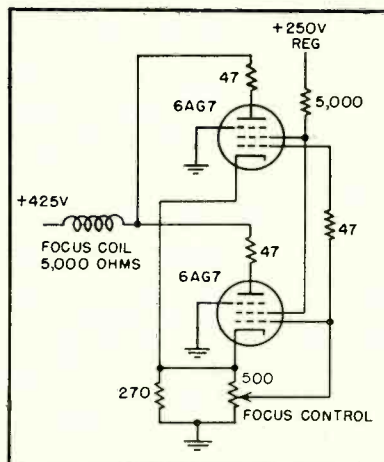

FIG. 8—Regulation of focus coil current is provided by this circuit

nected to the grid of the flying-spot scanner and to the blanking mixer in the video amplifier; a transparency is next taped on the face of the cathode-ray tube. The intensity control of the crt is then adjusted for the brightest possible raster that can still be focused.

The video gain control is advanced until a video output signal is obtained. This video signal should be examined by means of another television receiver or on a monitor screen. Should there be

streaking or long smear tails following the picture, the high-frequency peaking capacitor, *C* in Fig. 2, should be adjusted until these effects disappear. A sharp white or black outline following an object for a short distance is removed by adjusting the flash phosphor compensator, *R* in Fig 2.

The video gain control is adjusted until the proper picture contrast is obtained on the monitor. These adjustments are readily and quickly made.

A further improvement in the system may be secured by using a Kodaslide projector in reverse by focusing an image of the crt raster upon a 35-mm transparency and then picking up the light passed through the transparency with a condensing lens. The phototube is mounted where the projection lamp was formerly placed. The same precautions about shielding apply here. Figure 5 shows this setup. If it is desired to transmit opaque information, then the raster of the flying spot must be projected by a lens on to the opaque material to be transmitted, and the light from the opaque material then picked up by the phototube. This is a full application of the old flying-spot method.

Figure 7 shows a simple modulator circuit for modulating any signal generator or r-f source.

Figure 8 is a circuit for automatic regulation of focus, which might be used in more elaborate designs.

Applications

Complete picture signals for the final testing of any television receiver are available in the absence of a broadcast tv signal. Complete checks of overall low and high-frequency transient response are possible, as are tests for correct operation of the video amplifiers and sync separation.

A large part of television receiver point-by-point testing can be eliminated by using a series of simple test pictures which are specially prepared to show up television receiver faults. These special pictures would have dark and light backgrounds for showing how d-c restorers or d-c-coupled video amplifiers behave.

Admittance Analyzer

A new r-f measuring instrument that gives the quantity $G+jB$ over a range of values greater than can presently be measured by other instruments. Basically similar to a d-c ohmmeter, this apparatus is self-contained and could be battery operated

THE ADMITTANCE ANALYZER has been developed to overcome difficulties inherent in the use of other radio-frequency measurement equipment. It measures the quantity $G + jB$ over a greater range of values than can be achieved by any other available instrument. Because it is not a null instrument, it requires no well-shielded generator and detector. The apparatus is complete in one unit, portable, and could easily be powered by batteries. The first working model is housed in a case $16 \times 16 \times 8$ in., weighs about 30 pounds and is operated from the power line.

Measurements of radio-frequency components and antennas are customarily made by one of two general methods: bridge (or null) and substitution of elements. Bridge methods require a signal generator and detector besides the bridge itself. All units must be well shielded or the null will be obscured. The

By **WILLIAM B. BERNARD**

*Commander, U. S. Navy
Portsmouth Naval Shipyard
Portsmouth, N. H.*

range of resistances to be directly measured by a bridge is limited.

Element-substitution methods also require a signal generator and detector, although the latter can be a simple type, such as a thermocouple indicating instrument. The greatest disadvantage of this method is the lack of suitable variable resistors as well as difficulty in reproducing measurements.

Exact measurements by any of the present methods are particularly difficult in the field. Conditions are much less favorable than those in the laboratory and skilled personnel is seldom available. The radio-frequency properties of a component too often depend upon who has made the measurement and with what type of instruments.

The circuit of the admittance

analyzer is similar to that for a d-c ohmmeter. The basic diagram of the instrument is shown in Fig. 1A. The reference resistor is R , an r-f oscillator takes the place of the battery and a radio-frequency vtvm replaces the d-c meter movement. The output of the oscillator is not so constant as the output voltage of a dry-cell battery. It is therefore convenient to switch the vtvm to measure the oscillator output as well as voltage across the unknown.

A voltage E at the desired test frequency is impressed across points 1 and 3. The values of L and C are then resonated to the impressed frequency. It is now theoretically possible to replace the tuned circuit LC with a resistor r that represents all the losses between points 2 and 3 as in Fig. 1B. A current i then flows through the resistors R and r , producing a voltage drop e across the resistor r . We may then set up the follow-

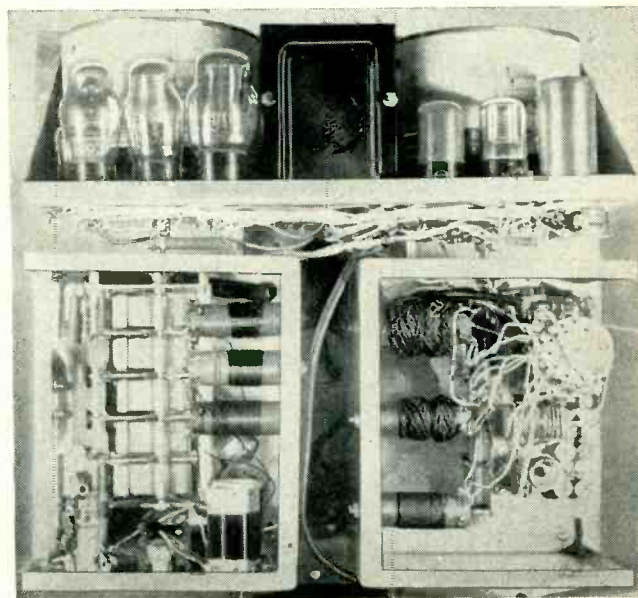
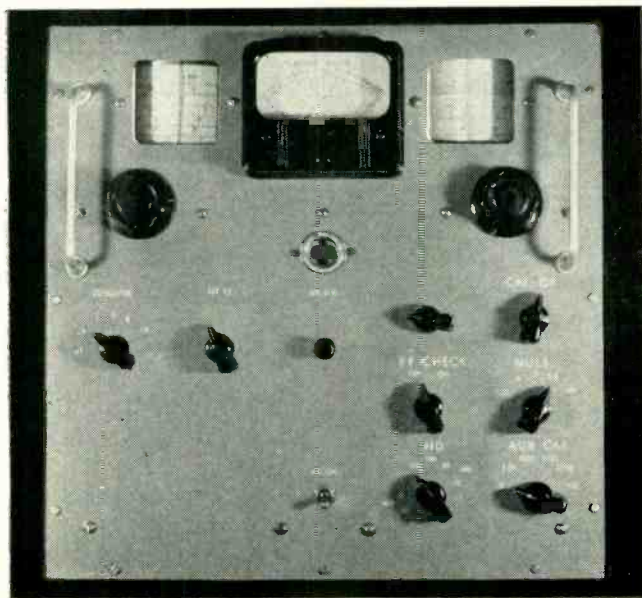

Front and rear views of the admittance analyzer with shielding removed

ing simple equations shown below:

$$E = i(R + r) \quad (1)$$

$$e = ir \quad (2)$$

Divide Eq. 1 by Eq. 2

$$\frac{E}{e} = \frac{(R/r) + 1}{R/r = (E/e) - 1}$$

Replacing $1/r$ by G and dividing both sides by R

$$G = \frac{1}{R} \left(\frac{E}{e} - 1 \right) \quad (3)$$

From Eq. 3 it is seen that if E and R are held constant, the meter that reads the voltage e can be calibrated directly in conductance. It is also true that the value of R can be changed by steps of 10 and the same meter scale can be used merely by mentally adding the proper number of zeros.

Measurement Technique

The usual method of measuring an unknown is to set the oscillator on frequency, set the oscillator output voltage to the standard value, resonate the LC circuit and record readings of the conductance G and the capacitance of the variable capacitor C . These readings are called G_1 and C_1 . The unknown is then connected to the terminals marked X and C is varied to restore resonance. The new readings are called G_2 and C_2 . The admittance of the unknown, G_x and B_x , may now be found

$$G_x = G_2 - G_1$$

$$B_x = \omega C_2 - \omega C_1$$

Since B , the susceptance of the capacitor, is equal to ωC the capacitor dial can be calibrated directly in susceptance at 1 mc. If the readings of this scale are called b_1 and b_2

$$B_x = f(b_2 - b_1) \quad (f \text{ in mc})$$

When measuring an unknown that is inductive in nature, the losses in the measuring circuit may be neglected because they are small compared to the loss in the inductance. The measurement may then be made in one step with the internal inductance omitted. The procedure in this case is to set the oscillator to the desired frequency, set the oscillator output, plug in the coil to be tested, resonate it with the variable capacitor C and then read the conductance meter and capacitor dials. The value of G_x is indicated on the conductance meter

and B_x is obtained by multiplying the reading of the b scale by the test frequency in megacycles. Since the real power dissipated in the unknown is given by $e^2 G_x$ and the reactive power is given by $e^2 B_x$, the Q of the unknown equals B_x/G_x .

One of the disadvantages of such a direct-reading circuit is that the instrument measures only amplitude and is not sensitive to phase differences. This characteristic makes the setting of the tuning capacitor rather uncertain when measuring low- Q components at low frequencies. To alleviate this difficulty the phase comparison circuit shown in Fig. 1C was added to the instrument. The phase standard is an Allen-Bradley type J potentiometer. A 1N34 crystal rectifier and a tuning-indicator tube are used to indicate a minimum voltage between the movable arm of the potentiometer and the upper end of the unknown. This circuit is usable up to a frequency of 1 mc.

Figure 2 shows the diagram of the complete instrument. The oscillator consists of a 6AQ5 tube connected in a grounded-plate Hartley circuit. The oscillator output is controlled by R_4 , which varies the oscillator screen voltage. A large amount of tuning capacitance is used in order to keep the harmonic output of the oscillator to a low amount. The output of the oscil-

lator is fed to the measuring circuit through a short length of RG-58/U cable, the shield of which is grounded only at the measuring circuit end. Any one of five resistors ranging from 100 ohms to 1 megohm may be selected for the standard resistor R by using the proper setting of S_5 . Switch S_1 is used to connect the vtvm either to measure the oscillator output or the voltage across the measuring circuit. The switch uses one spdt section on either side of the measuring circuit shield to eliminate the coupling that would exist between two adjacent switch terminals if only one section were used. The measuring capacitor C_1 is a three-gang 450- μmf -per-section variable capacitor. For low-frequency operation additional capacitance may be switched in by S_7 . The internal inductances needed to combine with C in order to make a resonant circuit are switched into the circuit by S_6 . Switch S_3 is used to connect the p-f check circuit when it is desired; as with S_1 a two-section switch is used to eliminate unwanted coupling between the oscillator output and the measuring circuit. A 9006 diode is used as the rectifier for the radio-frequency vtvm. The diode loading on the measuring circuit is held to a minimum by using a high value of diode load resistance. The output of the diode is applied to one grid of a 6SN7 balanced d-c vtvm. The d-c vtvm circuit is balanced by R_8 and the contact potential of the diode is balanced by R_9 . The sensitivity of the meter circuit is controlled by R_{10} .

When the p-f check circuit is used, the output of the 1N34 rectifier is amplified by a 6SL7 d-c amplifier and the amplifier signal is used to operate a 6AF6 eye tube.

Since the plate current of the oscillator tube varies widely when the screen voltage is varied the power supply is operated with choke input. The current to the VR tubes is further stabilized by the use of a 6-w 115-volt lamp as part of the voltage divider system. The lamp acts as a constant-current ballast.

Using The Instrument

In the amount of testing conducted since the first instrument was finished it has proved extremely useful. During this time it was not

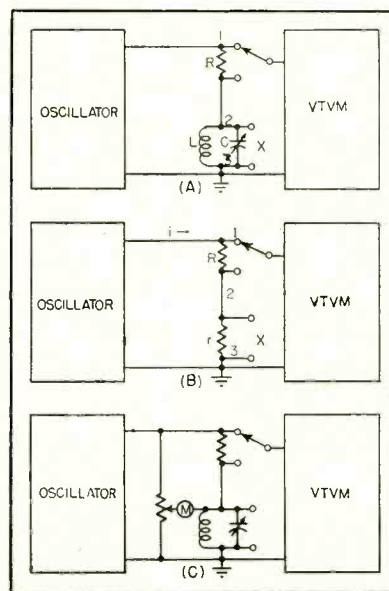

FIG. 1—Development of the admittance-measuring equipment on the basis of a d-c ohmmeter

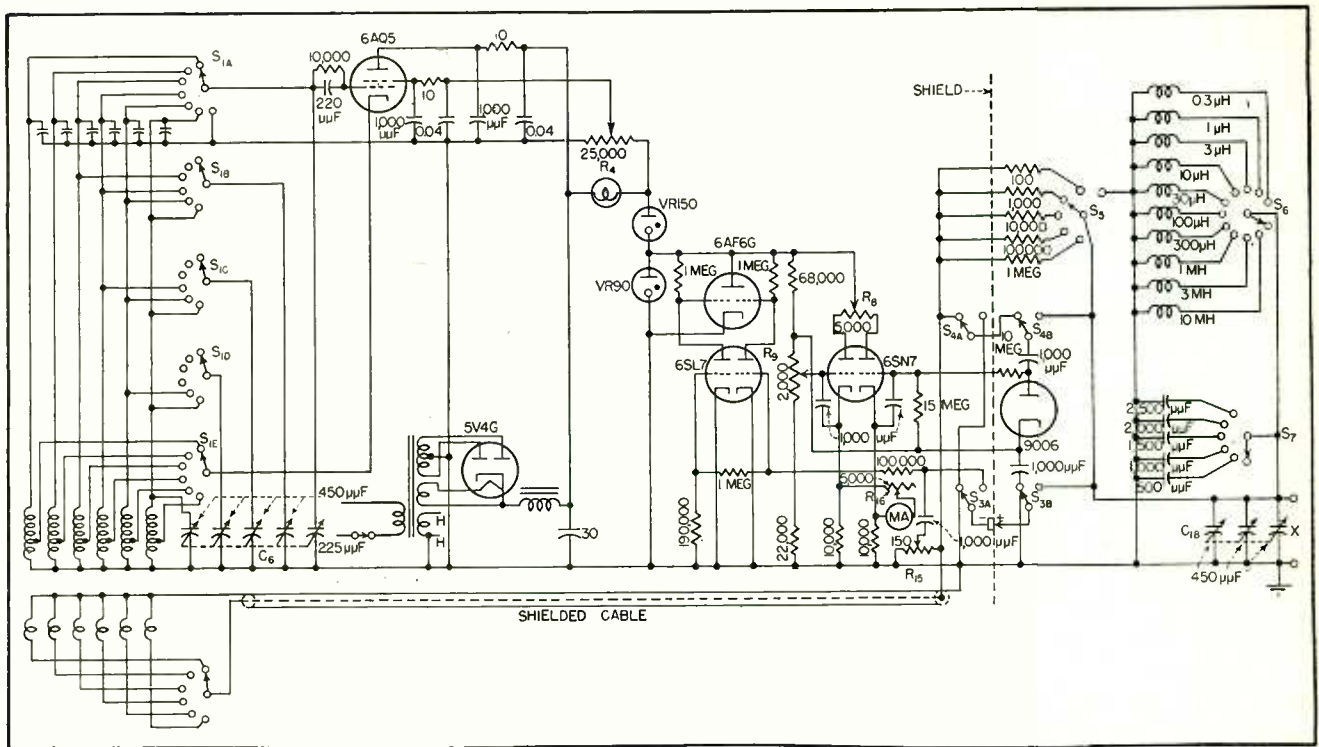

FIG. 2—Circuit diagram of the admittance meter. Oscillator portion at the left is connected to the measuring circuit by a shielded cable

necessary to add any auxiliary components to make a measurement. The accuracy of the instrument is comparable to that of any other direct-reading instrument. Absolute accuracy depends on many conditions; one thing which detracts from accuracy is that sometimes the quantities desired are small differences between large quantities. Other sources of error at high frequencies are the stray parameters present in all the circuit elements. These errors can be reduced by careful design and the development of special components for the instrument. The one model built was made entirely of standard components.

The instrument can be used for a wide range of measurements. Resistors from 10 ohms to 1 megohm may be measured up to a frequency of 1 mc. At higher frequencies the range is from 10 ohms to $1/f$ megohm (f = frequency in mc). Coils of much lower series resistance may be measured because the resistance is transformed by resonant circuit action. The admittance of antennas, transmission lines, and most commonly used r-f components lie within the direct-reading range of

this instrument. Because of its portability it is possible to take it out to the antenna tuning-house at a broadcast station and adjust the antenna network until it offers the proper termination for a transmission line. It is well suited for the measurement of antenna characteristics. On shipboard and aircraft antennas it will tell immediately whether or not the antenna will accept power from the transmitter. The routine use of a device such as this at a communication station, aboard ship or at an air field will indicate the insulation deterioration or poor connections in an antenna and transmission line system.

The use of this device requires that the user become accustomed to thinking in terms of $G + jB$ instead of $R + jX$. The main difficulty here is that a certain amount of mental inertia must be overcome. In many cases $G + jB$ measurements are advantageous since tuned circuits used with electron tubes are ordinarily parallel circuits. When damping resistors or parallel-feed elements are used the calculations become much less involved than when the parallel components are measured directly.

The antiresonant Z is simply $1/G$ if the Q of the circuit is 10 or above. The meter face could have a Z scale added for such use. For antennas the series resistance measured by any instrument is greatly affected by the base capacitance of the antenna. In order to determine the actual radiation resistance of the antenna and therefore the antenna and site efficiency, it is necessary to make a series of measurements and then a graphical determination of the actual antenna radiation resistance. If the antenna conductance were made the basis of comparison it would not involve this complication because the base capacitance has no effect on the conductance of the antenna.

The instrument described is not regarded as the ultimate since it was constructed to prove the practicability of the basic principle. The accuracy at the highest frequencies can be improved by the development of special components for use in the measuring circuit. Other special components will permit reduction in size and weight of the instrument. Patent proceedings on this instrument are being carried on by the Office of Naval Research.

Picture-Tube

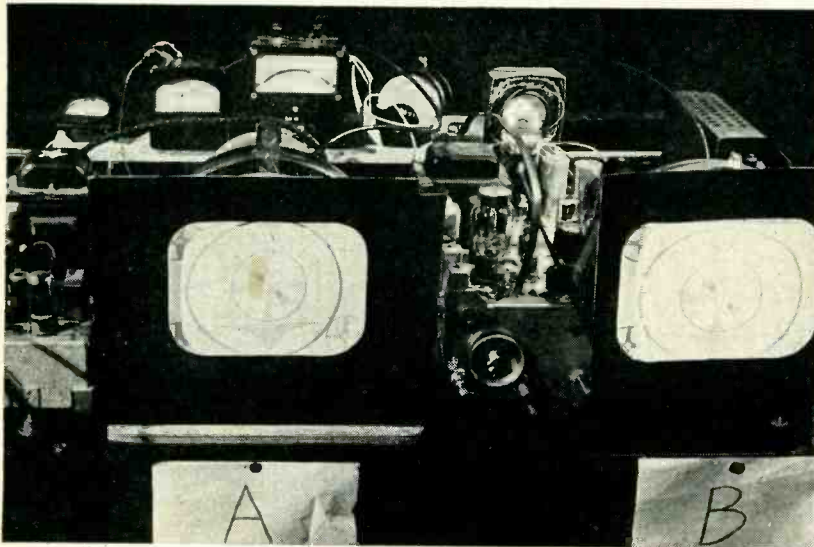

Setup for subjective comparison by disinterested observers. External illumination of 10 foot-candles was provided at the tube faces

By **ALFRED E. MARTIN** and **ROBERT M. BOWIE**

*Physics Laboratories
Sylvania Electric Products Inc.
Bayside, New York*

RECENT STUDIES have been undertaken to demonstrate the significance of contrast rendition in television images.

Contrast, for present purposes, may be defined simply as the intensity ratio between the whitest and blackest portions of a scene. Contrast deteriorates when unwanted light reaches an observer's eye from the vicinity of the screen occupied by the picture. Improvement in contrast must, accordingly, result from preferential discrimination against unwanted light.

The types of unwanted light, listed in the order of probable importance, are:

- (1) Ambient light
- (2) Halation
- (3) Reflection of back-of-picture light from air-glass interfaces such as from the safety window
- (4) Hot spots due to specular reflection of concentrated lights from the curved cathode-ray tube face
- (5) Laterally - directed picture light scattered by the phosphor itself.

Light from the back of the fluorescent screen, reflected from the inside of the bulb, also reduces contrast, but as filters have no prefer-

ential effect upon such light, further discussion of this will be omitted.

Ambient light is usually diffuse light from the room falling rather uniformly over the face of the cathode-ray tube and then diffusely scattered as shown at the right in Fig. 1. The light passes through the safety window, through the cathode-ray tube face, and is then scattered by the phosphor. Some of it goes to the observer's eyes by again traversing the tube face and the safety window.

If the face plate is a neutral gray filter of thickness D , desired light from the fluorescent spot S passing through perpendicular to the surface is transmitted in accordance with the formula $A_{\text{spot}} = T^D$, where A_{spot} is the relative transmission of desired light from the spot, and T is the transmission of a unit thickness of gray glass. Ambient light must traverse this filter twice so its transmission is at most $A_{\text{ambient}} = T^{2D}$. Thus $A_{\text{ambient}}/A_{\text{spot}} = T^D$.

Practical Transmission Value

The transmission of ambient light is usually less than T^{2D} because such light generally comes from the side

and passes through the face plate at an angle. This discussion applies equally well to filter material which might be incorporated into the safety window. Transmissions of neutral filter face plate glass center around 66 percent. It follows that the ambient light is preferentially discriminated against by at least this same percentage, or -1.8 db. The absorption could be just as effectively distributed between the face plate and the safety window.

Halation in a cathode-ray tube appears as a spurious circle of light about the scanning spot. Because the spot moves too fast to be seen on a television screen, the circle is also invisible but reduces the contrast near highlights. Its origin is due to total internal reflection at the outside surface of the cathode-ray tube face. This is shown in exaggerated form at the center of Fig. 1. The face of the cathode-ray tube has purposely been drawn disproportionately thick, making the halo larger in diameter than it is in actual practice. For a face 0.3 inch thick, the halo is about an inch in diameter.

If light starts from a point inside the glass and strikes the glass at incidence angle g , it is refracted and emerges at angle a in such a manner that

$$\frac{\sin a}{\sin g} = \text{index of refraction of glass} = \text{about } 1.5$$

Consequently, as g gets larger there comes a time when a reaches 90 degrees. Then no light can get out of the glass and it is all reflected internally.

The diffuse reflection from the screen of this internally-reflected light produces about the spot a ring having a well-defined inside edge. It is also true that if the two glass

Contrast Improvement

Analysis of the various factors involved in evaluation of the merits of several systems for improving the contrast of picture tubes with optical filters. Results of subjective tests and objective measurements favor black-faced tubes

surfaces are parallel, light originating outside the glass can never be totally internally reflected. In the case of a cathode-ray tube, some 20 to 30 percent of the light comes from fluorescent material in optical contact with the glass. The rest comes from material not in optical contact, so that this light cannot contribute to the halo.

Halo Reduction

Halation can be reduced by making the cathode-ray tube face an optical filter. In Fig. 1, the path *sbdc* is about four times the path *sa*, hence the transmission of the halo light relative to the desired light is

$$\frac{A_{\text{halo}}}{A_{\text{spot}}} = \frac{T^4 D}{T^D} = T^3 D$$

If T^D is 0.66 then $T^3 D$ is 0.3 or -5 db. Filter properties in the safety window do not reduce halation. The filter material must be in optical contact with the cathode-ray tube window. Some filters have been sprayed on the outside of the face in the form of a colored lacquer. These reduce halation. Law has suggested that filter material be placed on the inside of the face before the phosphor is settled.

Reflection of picture light back onto the screen is possible. Because a sheet of transparent glass reflects some light, the amount increasing with angle of incidence, side-directed light from a picture highlight may be reflected back on other parts of the screen. This is done chiefly by the back surface of the safety window. Such light will be discriminated against strongly by filter material in the tube face or in optical contact upon it. The transmission is about the same as for halation. Filter material in the

safety glass or in a separate sheet has negligible effect.

Other reflections, such as ambient light from the cathode-ray tube face or the front of the safety window, are usually unimportant. However, the hot spot due to a concentrated light source, such as a floor lamp

or a window, can be very annoying because of its high intensity. Such a reflection from the safety window can usually be avoided because of the specular or mirror-like nature of the reflection and the flatness of the window.

Proper placement of lamp or receiver throws the reflection out of the viewing angle. Because of the curvature of the cathode-ray tube face, however, it is almost impossible to eliminate a hot spot if there is a light source near the audience. Filter material in the safety window discriminates against this hot spot much as it discriminates against ambient light.

The filter material could be interspersed with the phosphor in the form of some colored material such as manganese dioxide. It is claimed that this reduces the reflectivity of the phosphor and decreases the spreading out laterally of the light from the spot through the phosphor itself. Tubes of this type have recently been announced.

From a purely physical standpoint, if the phosphor and the ambient light have fixed but different spectral energy distributions throughout the visible spectrum, a filter could be designed to discriminate most strongly in the regions of the ambient light. However, this would be likely to shift the color of the wanted light considerably, necessitating a new selection of phosphor blend for the cathode-ray tube. Though this might well be done for a fixed spectral energy distribution of ambient light, it is scarcely feasible for the wide variety of light sources usually encountered.

Figure 2 shows typical spectral energy distribution curves for fluo-

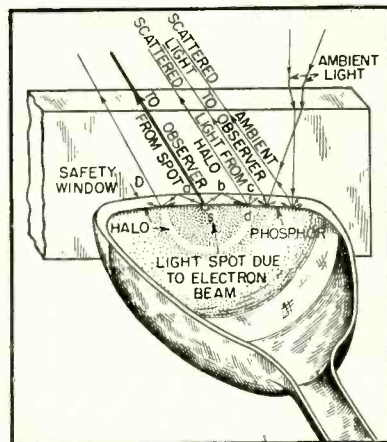

FIG. 1—Exaggerated view of picture tube and safety window shows effects of ambient light and halation

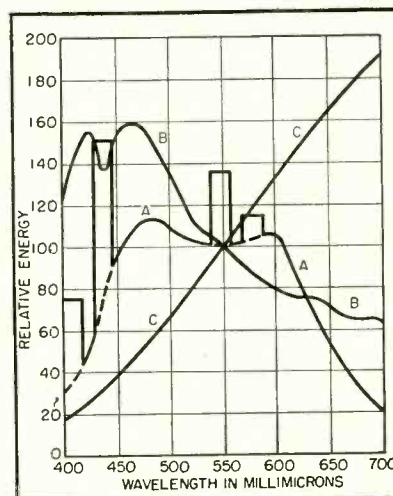

FIG. 2—Spectral energy distribution curves. A 6,500-K daylight fluorescent lamp is represented by curve A. Curve B applies to north skylight and curve C a 500-watt tungsten lamp

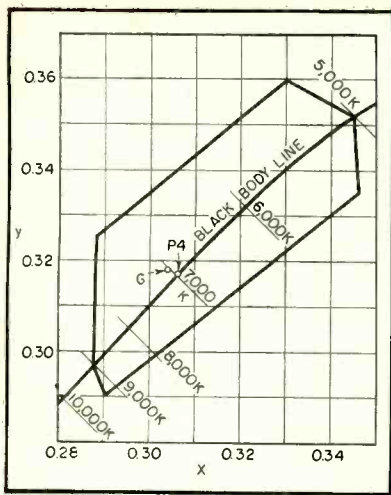

FIG. 3—JETEC color limits for P4 white phosphor

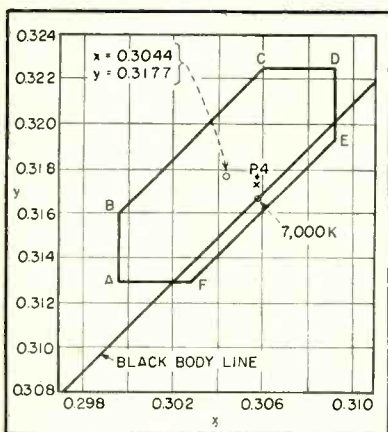

FIG. 4—JETEC specification for neutral filter face-plate glass

rescent lamp, daylight and tungsten lamp. These are, of course, appreciably modified by reflections from walls and other surfaces before reaching the cathode-ray tube face. A fair compromise appears to be the selection of a filter material absorbing as nearly uniformly across the visible spectrum as possible. This is what the glass companies have done in selecting the glass for the bulbs of dark-faced tubes on the market.

Standards

The JETEC Cathode-Ray Tube Subcommittee on Phosphors and Screen Characteristics recently adopted a typical spectral energy distribution curve for the P4 white television phosphor. The color computed from that curve gives the I.C.I. chromaticity indicated as point P4 in Fig. 3. The polygon represents the color tolerance presently set for the P4 phosphor.

If the spectral energy distribution for the P4 phosphor is modified by passing the light through a cathode-ray tube face having a neutral filter face plate, then the corresponding chromaticity shifts to point G in Fig. 3. Recently the Committee on Cathode-Ray Tubes standardized on the color and transmittance of neutral filter face plate glasses. Figure 4 shows this standard on an I.C.I. chromaticity diagram.

In preparation for standardization of neutral filter face plates, this laboratory undertook a systematic study of the factors which contribute to loss of contrast in a kinescope image. The program included both subjective testing and objective measurement. Tests involved a visual comparison, under carefully controlled lighting conditions, of a pair of 10-inch cathode-ray tubes placed side-by-side and adjusted to have the same signal input as well as identical screen luminance of 12 foot-lamberts.

Broadcast signals and standard test patterns from the laboratory video signal generator were used. A group of about 20 persons of both sexes, not trained in television work, participated in the scheduled comparisons. Observer groups ranged in size from 11 to 16 persons, the exact composition of each group varying from test to test.

Test Conditions

A group of eleven 10-inch kinescopes was used, which meant that 110 separate tests would be needed if all possible combinations of two tubes were taken. These tubes were regular production type 10BP4's and 10BP4's having experimental tinted face plates. The latter group contained gray face plates having visual transmissions ranging from 43 to 73 percent. A series of 17 elimination tests was set up, the tube deemed the better in one test being used again in the next test, and so on. Occasional checks against normal production 10BP4's were introduced into the series for control purposes.

The photograph is a view of the experimental arrangements. For illustrating the effect of ambient lighting on the picture, a 200-watt, inside-frosted incandescent lamp

was placed in a reflector so located as to produce an illumination of 10 foot-candles at each of the tube faces. Since Illuminating Engineering Society recommendations for living room illumination are 5 foot-candles and for reading are 20 to 30 foot-candles, 10 foot-candles was considered to be an ambient light level which might reasonably be encountered at the tube face if someone were reading in a living room where a television receiver was being operated.

A questionnaire was filled out by each observer during a test. The procedure followed required observing the tubes and answering each of three questions with the laboratory initially dark except for the light from the two cathode-ray tube screens. The incandescent lamp was then turned on and the observers requested to answer the same three questions once again. Finally, they were asked to answer a fourth question on the basis of what they had just seen.

At no time during any of the tests was specific information given to the observers concerning the transmissions of the face plates being used or the significance of the position designations, A and B. As a matter of fact, the winner of a given elimination would have its position changed before the next observations occurred.

General conclusions are as follows: Tinted face plate tubes seemed to be preferred over normal 10BP4's; among neutral tinted face plates, the preferred range seemed to be 50 to 60-percent transmission.

The authors acknowledge their indebtedness to the Corning Glass Works and the American Structural Products Company for cooperation in providing glass samples and pertinent optical data, and to the engineers of our own company for their execution of much necessary detail work.

BIBLIOGRAPHY

- R. R. Law, Contrast in Kinescopes, *Proc. IRE*, 27, p 511, Aug. 1939.
- C. H. Bachman, Image Contrast in Television, *Gen. Elec. Rev.*, 48, p 13, Sept. 1945.
- P. C. Goldmark, Brightness and Contrast in Television, *Elec. Eng.*, 68, p 237, Mar. 1949.
- A. E. Martin and R. M. Bowie, An Evaluation of Television Viewing Filters; Radio Fall Meeting of IRE and RMA Engineering Department; Syracuse, N. Y., Nov. 1, 1949.
- Minimizing Internal Reflections in Television Tubes, *Tele-Tech*, 8, p 39, July, 1949.

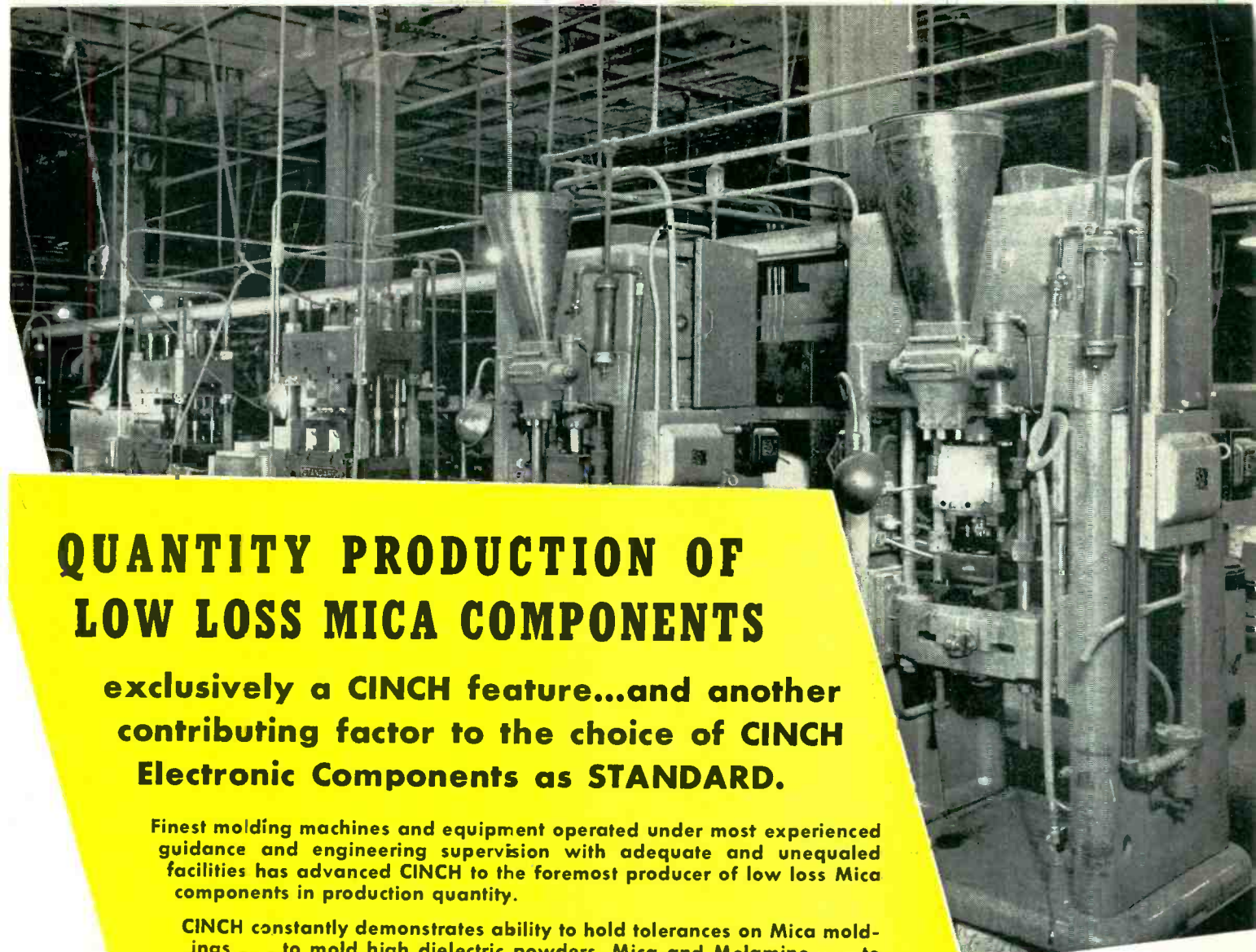

QUANTITY PRODUCTION OF LOW LOSS MICA COMPONENTS

exclusively a CINCH feature...and another
contributing factor to the choice of CINCH
Electronic Components as STANDARD.

Finest molding machines and equipment operated under most experienced
guidance and engineering supervision with adequate and unequalled
facilities has advanced CINCH to the foremost producer of low loss Mica
components in production quantity.

CINCH constantly demonstrates ability to hold tolerances on Mica mold-
ings . . . to mold high dielectric powders, Mica and Melamine . . . to
meet the most exacting requirements in small metal plastic assem-
blies for components of higher quality materials held to closer tol-
erances.

Cinch

**ELECTRONIC
COMPONENTS**

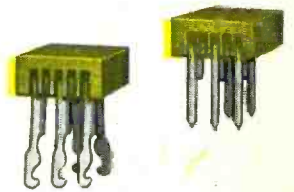

AVAILABLE AT LEADING ELECTRONIC JOBBERS . . . everywhere.



Cinch

**ELECTRONIC
COMPONENTS**

CINCH MANUFACTURING CORPORATION

CHICAGO 24, ILLINOIS

Subsidiary of United-Carr Fastener Corporation - Cambridge 42, Massachusetts

Stagger-Tuned I-F Design

Chart gives overall bandwidth for 3 db and any fraction of 3 db, for i-f amplifiers having 1 to 500 synchronous or stagger-tuned stages and up to 5 elements per stage

THE BANDWIDTH reduction factor R is here plotted as a function of the number of single or multituned stages n in the amplifier. The family parameter m represents the number of tuning elements in the interstage coupling network when all stages are synchronously tuned; thus, $m = 1$ for a simple RLC tuned interstage, and $m = 2$ for a double-tuned interstage. For a stagger-tuned amplifier, n is the number of n -uples and m is the number of elements in the general n -uple.

Example 1: Assume an amplifier is to have 8 stages using identical single-tuned interstage couplings. (a) For what 3-db bandwidth must each stage be designed if the overall bandwidth is to be 6 mc? (b) What will be the 0.5-db bandwidth?

Solution. (a) From the curves for $n = 8$ and $m = 1$, $R = 0.3$. Dividing overall bandwidth of 6 mc by this value of R gives 20 mc as the required bandwidth of each stage. (b) If n' stages cascaded give a certain 3-db bandwidth, each stage must be

By **MATTHEW T. LEBENBAUM**

Assistant Supervising Engineer
Receiver Section
Airborne Instruments Laboratory
Mineola, New York

down by $3/n'$ db and n of them will be down $(3/n') n = x$ db at that bandwidth. To determine the x -db bandwidth then, the R factor is determined for a number of stages n' where $n' = n (3/x)$; here n is the actual number of stages and $x < 3$ db. In the case at hand, $n' = 8 \times (3/0.5) = 48$, and $R = 0.12$ from the chart. The 0.5-db-down bandwidth then is 0.12×20 or 2.4 mc.

Example 2: An amplifier is to be built with an overall bandwidth of 20 mc and overall gain of 80 db; 6AK5 tubes are used with an assumed gain-bandwidth product ($g_m/2\pi C_T$) of 70 mc. (a) What is the minimum staggering required to achieve this result with 12 or less tubes? (b) If equally loaded double-tuned circuits were used (gain-bandwidth = $\sqrt{2} g_m/2\pi C_T$), how many stages would be required?

Solution. (a) Assume a value

of n , and determine R from the curve. This fixes the single-stage bandwidth required. From this, the gain per stage may be calculated from the gain-bandwidth product, and from this the overall gain. It will be found that it is impossible to achieve the desired gain with a synchronous single-tuned amplifier. Twelve stages arranged in six staggered pairs will not give the desired gain, either, but 9 stages arranged in triples or 8 in quadruples will. Possible systems are:

n/m	Tubes	db gain
6/2	12	75.5
3/3	9	80.5
4/3	12	102
2/4	8	80

(b) 12 double-tuned interstages give $R = 0.49$ ($n = 12$, $m = 2$). The overall gain then is 91.6 db for the desired bandwidth. This illustrates the superiority of multituned coupling over the corresponding order of staggering (91.6 db versus 75.5 db for the same number of staggered-pair tubes). Increasing the staggering to triples makes staggering still better, 102 db.

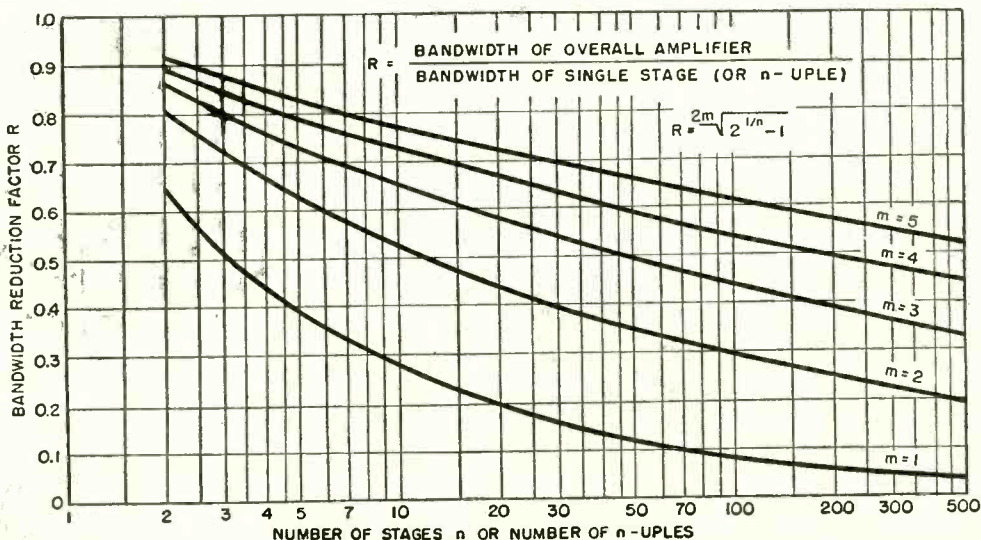

**Value
Beyond
The Purchase**

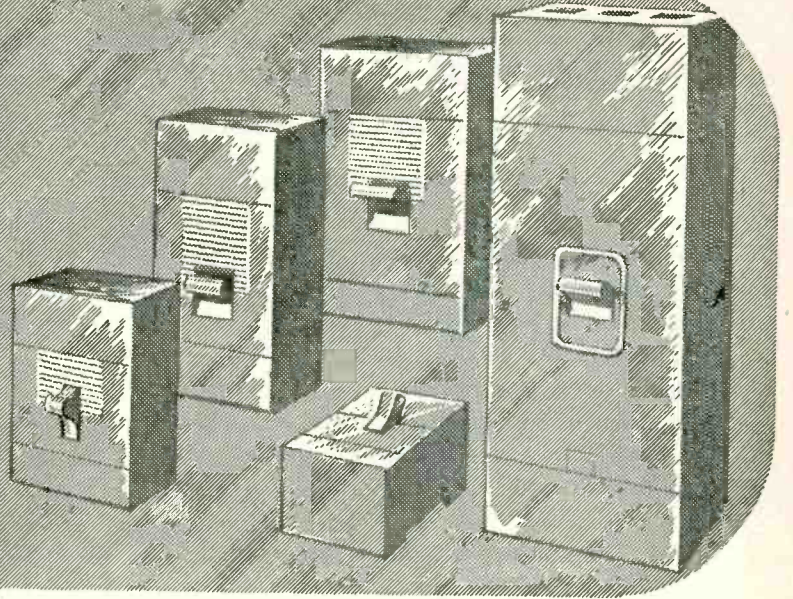
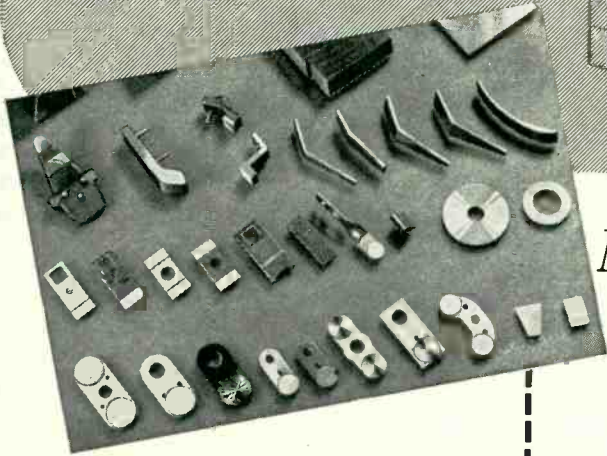

Mallory Contact Development Anticipates Customer Needs!

Elkonite* Contacts

Elkonite is the trade name for a series of contact materials developed by Mallory and manufactured from metal powders. They are best known for their hardness, resistance to mechanical wear and impact, resistance to erosion by arcing, and resistance to sticking.

Elkonite contacts are made by the only method which permits the combining of the desirable features of basic metals which cannot be alloyed. By this means, the high melting points of tungsten, molybdenum, or their carbides, can be combined with the current-carrying ability of silver and copper.

Customers' contact problems are solved rapidly and effectively due to Mallory's precise attention to every detail of design, material and production.

A manufacturer of small industrial circuit breakers recently asked Mallory to study his contact assembly . . . with an eye to reducing costs. Investigation proved that new Mallory equipment coupled with unique Mallory production techniques would eliminate certain expensive finishing operations. As a result, the problem was solved in rapid-fire order . . . and the contacts delivered at a price that is 21% less than the customer previously had been paying.

That's value beyond the purchase!

Mallory contact know-how is at your disposal. What Mallory has done for others can be done for you!

In Canada, made and sold by Johnson Matthey & Mallory, Ltd., 110 Industry St., Toronto 15, Ontario

Electrical Contacts and Contact Assemblies

*Reg. U. S. Pat. Off.

P. R. MALLORY & CO., Inc.
MALLORY

P. R. MALLORY & CO., Inc., INDIANAPOLIS 6, INDIANA

SERVING INDUSTRY WITH

Capacitors	Contacts
Controls	Resistors
Rectifiers	Vibrators
Special Switches	Power Supplies
Resistance Welding Materials	

TUBES AT WORK

Including INDUSTRIAL CONTROL

Edited by VIN ZELUFF

Television Transmission Over Coaxial Cables.....	116
The Front Cover.....	118
Hypersensitive Resonance Indicator.....	118
Improvements in Dot-Sequential Color TV.....	154
Regulated Voltage Divider.....	158
Shock-Excited High-voltage Power Supply.....	162
VHF Oscillations in Incandescent Lamps.....	166
Yarn Tensiometer.....	172

Television Transmission Over Coaxial Cables

TRANSMISSION characteristics of coaxial telephone cables require modification of the original television signal as received from the broadcast studio. At the far terminal, the telephone company must reconvert the signal before it can be used by the broadcast transmitter. Besides these problems, the system must carry the audio program and provide for supervisory signals that maintain trouble-free operation.

Factors influencing the design of the present L-1 coaxial system have been described by L. W. Morrison, Jr. of Bell Telephone Laboratories. Some of the techniques of interest

are difficult when a signal contains energy at very low frequencies. The vestigial-sideband method adopted is practically realizable with available design techniques.

Because of the difficulties in providing delay equalization at lower frequencies, 200 kc was adopted as the lower limit. The resulting sideband then becomes 2,800 kc with the vestigial sideband occupying about 100 kc. These considerations place the carrier near 300 kc and the limit of the main sideband at 3,100 kc. The sound program is handled in the band 80 to 88 kc.

Multiple modulation steps are employed in order to translate a band of frequencies by an amount small compared to the bandwidth. As shown in Fig. 2, the video signal is caused to modulate a carrier frequency of 7,944 kc. The resultant

lower sideband together with a vestige of the upper sideband selected by a band filter then modulates a carrier wave located at 8,256 kc.

The lower sideband of this second step is selected by a lowpass filter and now lies between 200 and 3,100 kc. The original video zero frequency is located at 311.27 kc. Part of the vestigial shaping is done at the transmitting terminal, the balance at the receiving end.

Preemphasis of the upper frequency components of the television signal is used at the transmitter and the receiver is equipped with a complementary restorer. This technique effectively reduces any extraneous interference including modulation effects above 400 or 500 kc on the coaxial line.

The television signal produced by scanning is composed of concentrations of energy located in frequency regions related to the line and field scanning frequencies and their harmonics. Alternate low-energy regions can be considered as related to specific forms of complex detail rarely present in television scenes. The introduction of extraneous energy into these idle regions produces complex visual effects of which the viewer is generally tolerant.

In this system, the carrier frequency has been chosen so that the pilot tones, used for automatic gain equalization and located at 556, 2064 and 3096-kc, satisfy this condition.

Simplified pilot elimination filter

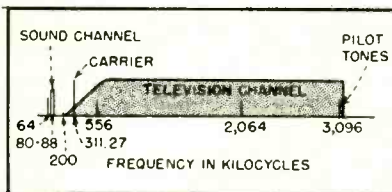

FIG. 1—Television allocation for L-1 coaxial system

to broadcasters are shown below.

The nominal transmission band of the coaxial line extends from 64 to 3,100 kc as indicated in Fig. 1. By contrast, the television video signal nominally extends from a few cycles per second to four megacycles. Frequency translation methods are used to place the original video signal into proper relation with the cable characteristic.

Because less than three megacycles is available, at best, to accommodate the 4-mc television signal, it is apparent that double-sideband transmission can not be tolerated. Single-sideband tech-

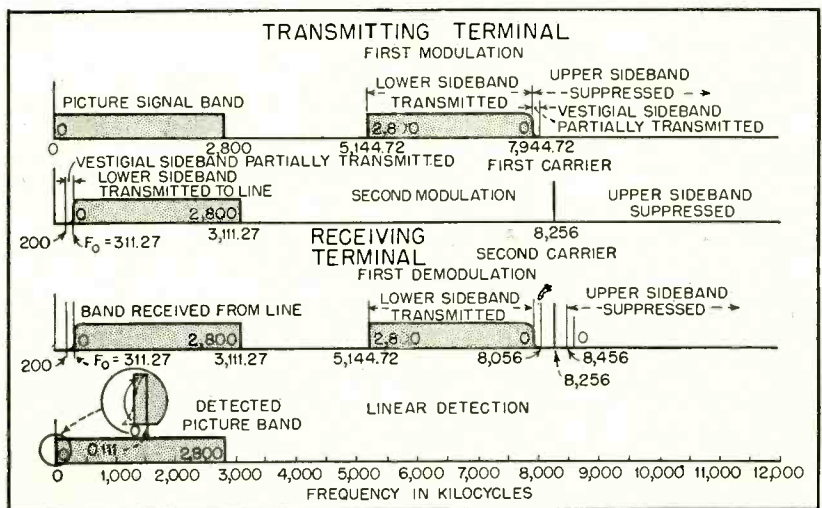
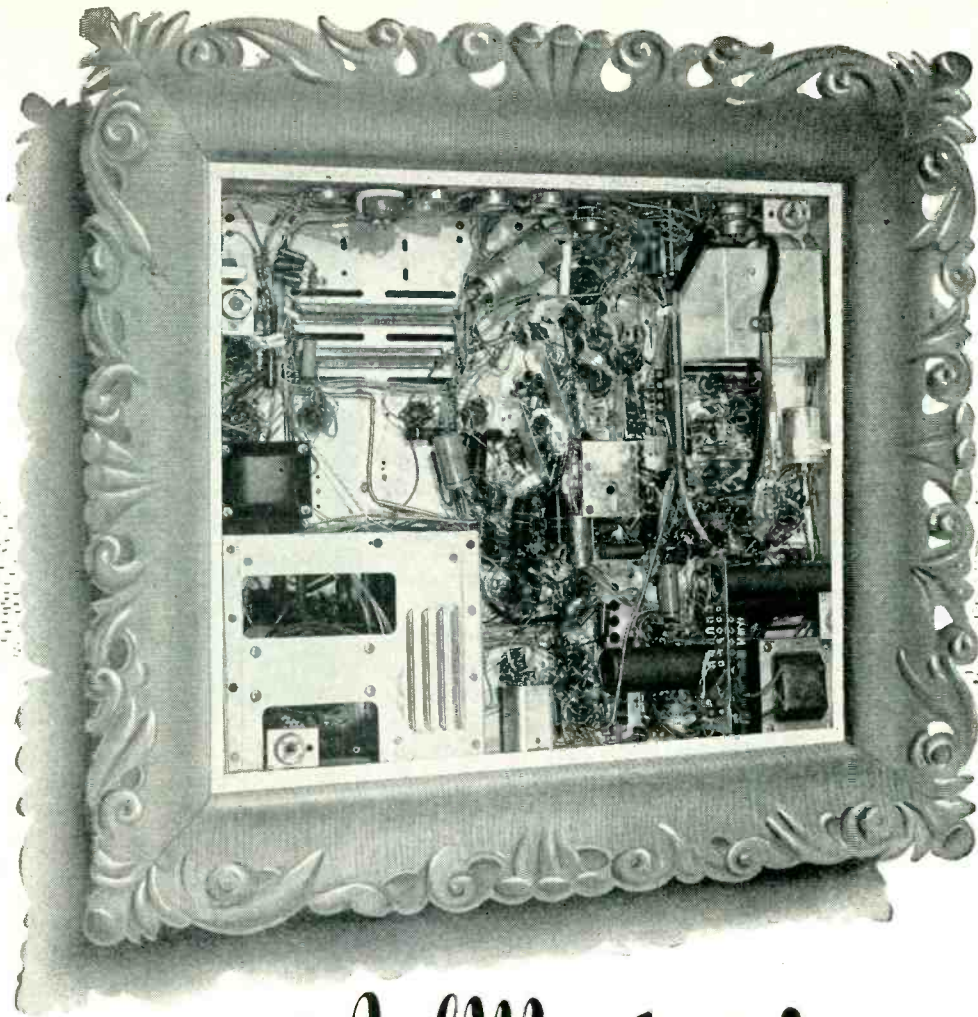

FIG. 2—Modulation diagram for television carrier terminals



A Masterpiece

COMPLEX, EFFICIENT . . . KESTER SOLDER MAKES IT POSSIBLE

Good fast work can only be done with the best materials. Kester Plastic Rosin-Core Solder and the more active Kester "Resin-Five" Core Solder, made only from newly mined grade A Tin and Virgin Lead, are formulated especially for TV, radio, and electrical work. Kester Solders flow better . . . handle easier . . . faster to use. These two Solders, which are available in the usual single-core type, can now also be had in a 3-core form.

Free Technical Manual—Send for your copy of "SOLDER and Soldering Technique."

KESTER SOLDER COMPANY

4204 Wrightwood Ave., Chicago 39, Ill.
Newark, N. J. • Brantford, Canada



SAVES TIME

DEPENDABLE

EASIER TO USE

FASTER



**KESTER
SOLDER**

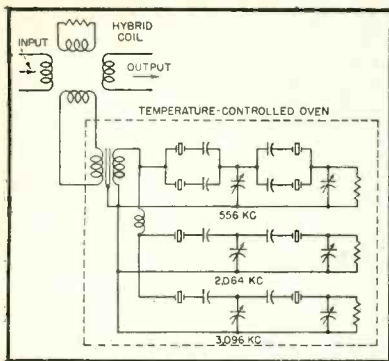

FIG. 3—Filter for elimination of pilot tones at three frequencies

is shown in Fig. 3.

New types of network elements and precise methods of construction and assembly are necessary for this exacting service. A new series of variable inductors employing adjustable metal slugs for a range from 0.22 to 220 microhenrys has been designed. Other elements include silvered-mica capacitors and resistors utilizing carbon deposited on glass. In addition, crystal filter elements are used. The whole filter is enclosed in a thermostatically controlled oven.

As an example of performance, in the pilot elimination filter the effective band-elimination width is approximately 20 cycles at 556 kc, 60 cycles at 2,064 kc and 100 cycles at 3,096 kc.

REFERENCE

(1) L. W. Morrison, Jr., Television Terminals for Coaxial Systems, *Elec. Eng.*, p. 109, Feb. 1950.

Hypersensitive Resonance Indicator

BY RONALD L. IVES
Department of Geography
Indiana University
Bloomington, Indiana

CONVENTIONAL resonance indicator circuits are adequate for steady signals above medium strength but are not very satisfactory with very weak signals or those which fade or swing badly.

The theoretically ideal method of determining resonance, by use of an oscilloscope, a standard-frequency oscillator, and a clipper, to remove the modulation from the incoming signal; functions fairly well in the realm of signals of moder-

THE FRONT COVER

THE brain-exploring equipment shown on the front cover makes use of a new system of presentation of information which provides a two-dimensional display of the distribution of potential over the surface of the skull or chest. This display appears on a cathode-ray tube as a map of the area under study and is similar in function to the ppi scope in radar presentation. The crt beam is scanned across a series of 16 grids each of which is connected to one of the pickup electrodes. The result is a square composed of 16 separate elements each of which corresponds in brightness to the potential at the corresponding test position. The equipment is being used by Stanford Goldman at Syracuse University in studying traveling waves in the brain.

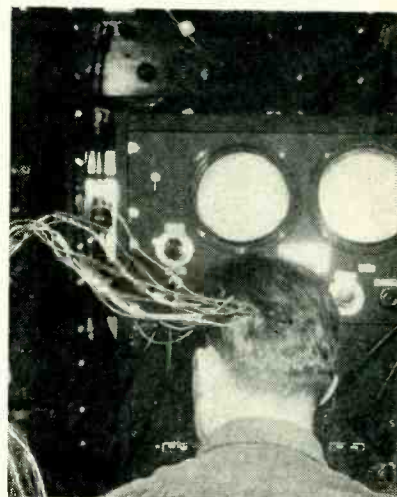

ate to great strength. However, simpler devices work just as well at one tenth the cost, and are not inordinately complicated and difficult to use, from the operator's viewpoint, with weak fading signals.

Preliminary experiments disclosed that the Foster-Seeley discriminator, in general use for f-m reception and occasionally employed for automatic frequency control, could be employed to indicate resonance, or its absence. This

circuit produces an output potential proportional (within a narrow frequency range) to the difference between the input frequency and that to which the circuits are tuned, and polarized in accord with the direction of the difference.

Amplitude of the output potential, at any given frequency difference, is a function of input signal strength, which, in most receivers of modern design, is nearly constant, due to AVC action. Regard-

(Continued on p 146)

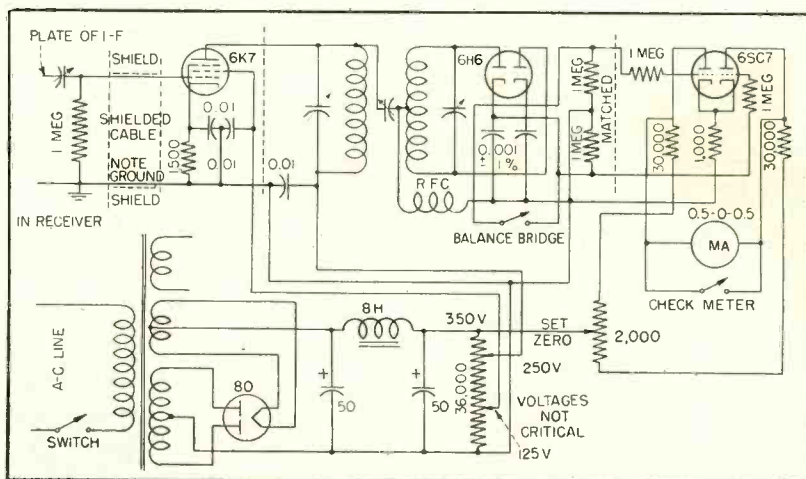

FIG. 1—Circuit of tuning indicator forms a complete unit that can be added to any standard superheterodyne receiver

THE INSIDE STORY:

WHY SPRAGUE MOLDED TUBULARS OUTPERFORM ALL OTHERS!

Molded paper tubulars may look alike from the outside. But there's a whale of a difference inside—the part that really counts in the performance of your products.

The *exclusive* difference in Sprague molded phenolic tubulars is that: *each is made by the same dry-assembly process as large metal-encased oil capacitors.* They cannot be contaminated during manufacture!

Every Sprague molded tubular from 200 to 12,500 volts is molded *dry*. After molding it is impregnated under high vacuum through an opening in the eyelet terminal. A lead is then inserted and the terminal solder sealed. Result? A capacitor that offers you superior heat and moisture protection . . . top insulation resistance . . . high capacitance stability and retrace under wide temperature variations.

Small wonder then why Sprague molded tubulars are preferred for the toughest television and auto radio applications. Take advantage of this superiority by calling in a Sprague representative today. Or, write for Engineering Bulletins 210B and 214.



Hollow eyelet terminal for impregnation after molding

Solder seal as in large metal-encased oil capacitors

Non-flammable, dense bakelite phenolic-molded housing

CUT-AWAY VIEW

Uniform windings of high purity paper and aluminum foil

SPRAGUE[®]
PIONEERS IN

SPRAGUE ELECTRIC COMPANY
North Adams, Massachusetts

ELECTRIC AND ELECTRONIC DEVELOPMENT

THE ELECTRON ART

Edited by JAMES D. FAHNESTOCK

Mapping Fields Inside Magnetrons.....	120
Beam Deflection Nonlinear Element.....	122
Series Sawtooth Oscillator.....	178
Ceramic Thickness Gage.....	182
Wideband Power Resistors.....	186
Liquid-Air Level Control.....	194
Survey of New Techniques.....	195

Mapping Fields Inside Magnetrons

THE HIGH space-charge density within a magnetron is known to have an important bearing on performance. Attempts at direct measurement of the electric-field distribution have proved unsuccessful because the very critical symmetry of the field under study was disturbed.

An accurate, sensitive technique¹ for experimentally determining the electric-field distribution and space-charge density within a magnetron has been developed at the National Bureau of Standards. The new method, which is also well suited to investigations of electron-optical lenses, gas discharge, and other space-charge problems, is a modification of the electron optical shadow technique² recently developed for the quantitative study of minute electric and magnetic fields. A magnetic lens is used to produce shadow images of two fine wire screens placed at either end of the magnetron in the path of an electron beam. Then, from the distortion in the shadow network caused by deflection of the electron rays as they pass through the magnetron field, the radial electric field is computed. These results are used to obtain the space-charge distribution.

The charge density of the probe beam is kept small compared to the space charge in the magnetron. Thus, the field under study is undisturbed. An electron gun sends the beam axially through the tube. Coaxial coils surrounding the mag-

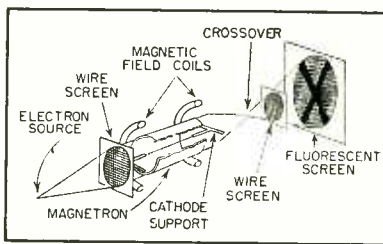

FIG. 1—Perspective drawing illustrates principle of new electron-optical technique for mapping electric-field distribution within a magnetron

netron provide a homogeneous magnetic field for the operation of the magnetron and at the same time act upon the beam as a convergent magnetic lens, bringing it to a focus beyond the tube. Two fine wire screens are placed in the path of the electrons, one just in front of the

magnetron, the other beyond the back focus of the beam. A complex shadow pattern due to the two wire screens is then formed on a fluorescent screen. When the d-c potential across the magnetron is zero, the pattern is undistorted. However, when an electric field is applied to the magnetron, the shadow network on the fluorescent screen becomes quite distorted; and theoretical analysis of this effect has related the distortion of a given part of the pattern to the intensity of the electric and space-charge fields in the corresponding region of the magnetron.

Practical Application

In practice, photographs are taken of the shadow network, both in the undistorted and distorted form. The changes in the paths of the electron rays as they pass through the magnetron are then determined from measurements of the shadow patterns and the geometrical constants of the system, such as the positions of both wire screens, the magnetron, and the electron source, and the number of meshes per unit length of the wire screens used. From the deflection of an electron ray entering the magnetron at a given radial distance from the center, the strength of the electric field in the corresponding region of the magnetron may be computed.

In comparison with previous methods using a pencil beam of

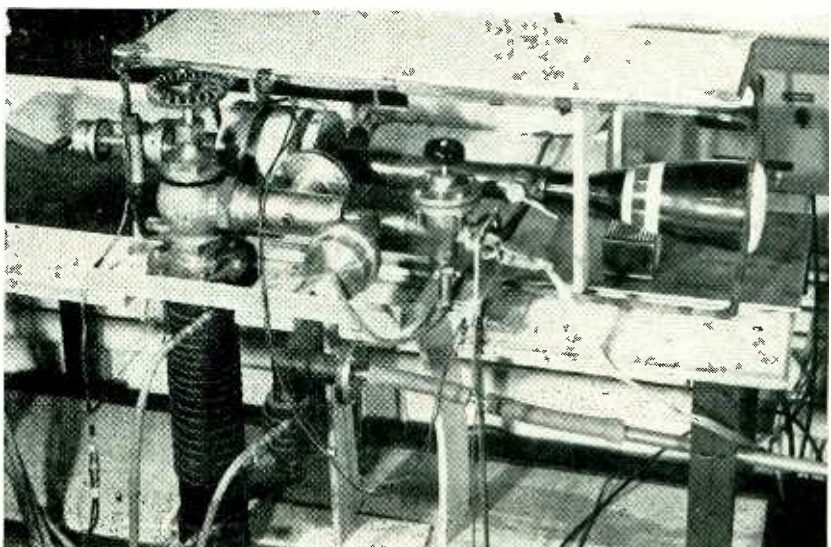
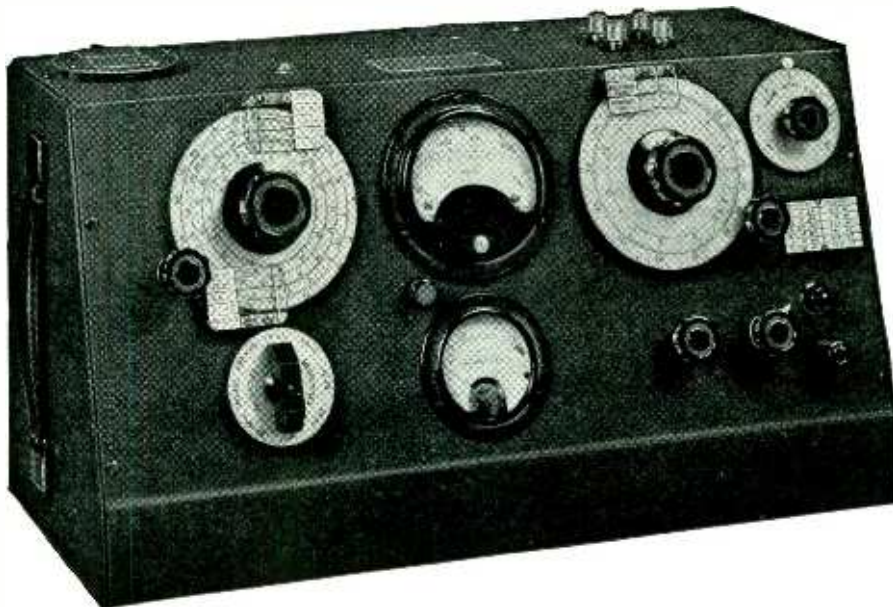

FIG. 2—Special cathode-ray tube setup for field-mapping equipment

PRECISION
FOR THE RADIO AND



INSTRUMENTS
ELECTRONIC INDUSTRY



Q-METER

TYPE 160-A

Radio frequency circuit design often requires the accurate measurement of Q, inductance, and capacitance values. For this application, the 160-A Q-Meter has become the universal choice of radio and electronic engineers throughout the country.

Each component part and assembly used in the manufacture of this instrument is designed with the utmost care and exactness. Circuit tolerances are held to values attainable only in custom built instruments.

The 160-A Q-Meter is designed specifically for the accurate and rapid measurement of Q, inductance, and capacitance. The basic method of measurement consists of measuring the voltage developed across a variable air capacitor connected as an element in a series resonant circuit. Essentially the Q-Meter is comprised of an 8 range RF oscillator, a Q measuring circuit with a main and vernier section tuning condenser, a vacuum tube voltmeter of special design which reads the voltage across the tuning condenser, and a voltage injection circuit which applies an accurately known voltage to the terminals of the series resonant circuit. In operation the Q circuit is resonated by means of the variable Q tuning capacitor and the voltage developed across this capacitor is indicated by means of the vacuum tube voltmeter which is calibrated directly in terms of Q. This method of measuring Q is simple, accurate, and requires only a single operation—resonating the circuit—to measure Q. Variations of this basic method of measurement are employed to determine effective inductance and capacitance as well as the dielectric properties of insulating materials

SPECIFICATIONS

Oscillator Frequency Range: Continuously variable from 50 kc. to 75 mc. in eight self-contained ranges. (In conjunction with an external oscillator the frequency range of the Type 160-A Q-Meter may be extended from 50 kc. to 1 kc. for coil measurements).

Oscillator Frequency Accuracy: Generally better than $\pm 1\%$, except the 50-75 mc. range which is approximately $\pm 3\%$.
Range of Q Measurements: The Q voltmeter is calibrated directly

in Q, 20-250. The "Multiply-Q-By" meter, which measures the oscillator voltage injected in the Q measuring circuit, is calibrated from $\times 1$ to $\times 2$ and also at $\times 2.5$. The reading of the Q voltmeter scale is multiplied by the setting of the "Multiply-Q-By" meter. Hence, the total range of circuit Q measurements is from 20 to 625. Condensers, dielectrics, etc., which are measured by placing these in parallel with the measuring circuit, may have Q's as high as 5,000.

Accuracy of Q Measurements: The accuracy of the direct reading measurement of circuit Q (for Q voltmeter readings between $Q=50$ and $Q=250$) is approximately 5% for all frequencies up to the region of 30 mc. and decreases with increasing frequency. Correction may be made for the error above 30 mc. as it is principally a frequency effect. The accuracy of the measurement of condensers, dielectrics, etc. is generally better than 10% for Q's below 5,000 and up to 30 mc.

Capacitance Calibration Range: Main tuning condenser 30-450 mmf. calibrated in 1 mmf. divisions from 30 to 100 mmf. and in 5 mmf. divisions from 100 to 450 mmf. Vernier condenser, plus 3 mmf., zero, minus 3 mmf., calibrated in 0.1 mmf. divisions.

Accuracy of Capacitance Calibration: Main tuning condenser, generally better than 1% or 1 mmf., whichever is the greater. Vernier tuning condenser, ± 0.1 mmf. The internal inductance of the tuning condenser at the binding posts is approximately .015 microhenry.

Voltmeter: The Q voltmeter is also calibrated in volts. A specially calibrated tube, Type BRC 105-A tube, is used. Replacements may be made without recalibration.

Power Supply: 105-120 volts, 50-60 cycles. Also 210-240 volts, 50-60 cycles. Power consumption 50 watts.

Dimensions: Height 12.5", length 20", depth 8.5".

Weight: 25 lbs.

Price: \$625.00 F.O.B. Boonton, N. J., U.S.A.

BOONTON RADIO

BOONTON · N · J · U · S · A

Corporation

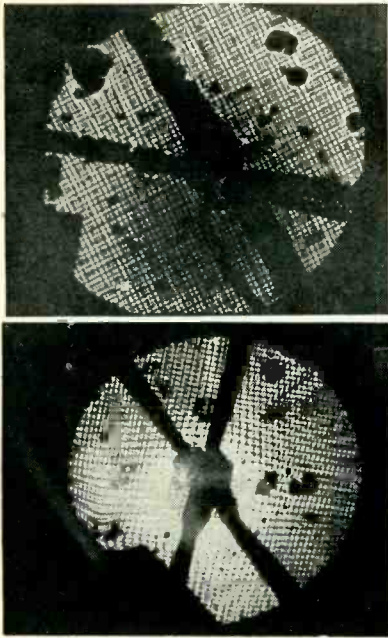

FIG. 3—Photograph at top shows no magnetic field within magnetron. Bottom view shows distortion of shadow network due to magnetic field, and a space-charge ring in central region

electrons but no optical system, this method is much more sensitive and accurate. It also has the advantage of giving a complete field map in a

Beam Deflection Nonlinear Element

BY AARON S. SOLTES
Air Force Cambridge Research
Laboratories, Cambridge, Mass.

THE APPLICATION of electronic techniques to such problems as analog computing and automatic control has brought with it the need for nonlinear circuit elements having accurate, reproducible, prescribed mathematical characteristics which are also capable of operating at the speeds afforded by conventional circuit components.

A particular application required the instantaneous squaring of radar type signals to an accuracy within 2 percent of full scale at an input frequency of 40 mc. The principle used to produce the necessary parabolic characteristic was that of deflecting an electron sheet across suitably-shaped target electrodes as shown in Fig. 1. The output current is then some function of the input voltage determined by the geometry of the electron beam

very short time. The principal source of error lies in the uncertainty regarding the configuration of the electric fringe field at either end of the magnetron under space-charge conditions.

Resulting study of the field within a steady-state magnetron indicates that the actual space-charge distribution differs considerably from that predicted by the theorists. A number of different shapes of space-charge configuration were observed which are closely related to the symmetry of the magnetron. A certain lack of sharpness noted in the patterns gave a visual indication of the noise in the tube. This suggests further extension of the method to learn more about the problem of noise in an oscillating magnetron.

REFERENCES

- (1) This work was carried out in connection with a doctoral dissertation submitted by D. L. Reverdin to George Washington University, Washington, D. C., in February 1950. Dr. Reverdin, formerly a guest worker at the National Bureau of Standards, has now returned to Switzerland.
- (2) Electron-optical shadow method, NBS Technical News Bulletin, 33, p 106, 1949.

and the shaped targets. This method is essentially inertialess and hence adaptable to a wide range of frequencies. Furthermore, a single basic tube design can be used to produce a variety of other transfer characteristics, since to alter the

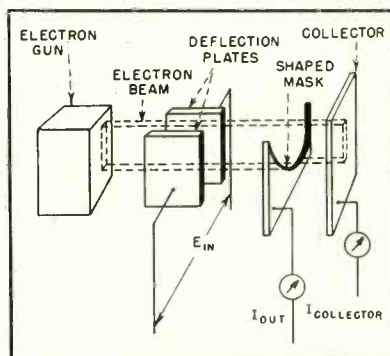

FIG. 1—Functional schematic of the beam-deflection tube

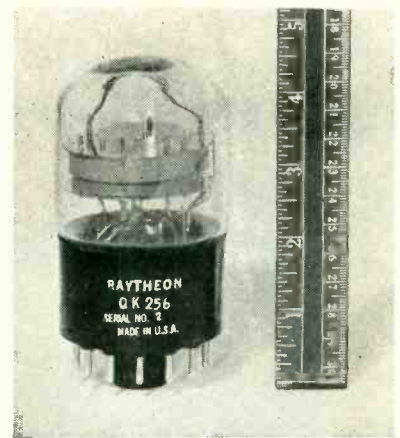

FIG. 2—Beam-deflection tube for squaring 40-mc pulses

characteristic, only the mask shape need be changed.

The mask used to produce the square-law characteristic was parabolic in shape. It can be shown that if an electron beam is uniform with height it will yield a parabolic static characteristic when deflected linearly across a parabolic mask for any beam density cross-section in its width dimension. The scale factor and the location of the vertex with respect to the origin may, however, vary from one beam cross-section to the other.

Raytheon tube engineers have worked out the physical realization of these beam deflection tubes in a convenient form. (Type QK-256). In order to obtain a large output current within space charge limitations, the tubes (Fig. 2) have cylindrical symmetry about a cathode located on the axis of the cylinder. The gun structure (in the tube shown, this is simply the cathode) thus provides a horizontal, disc shaped beam in which the electrons travel radially out from the center and are focussed on the shaped mask which is lying on its side in the form of a cylinder concentric with the cathode.

The deflection plates, located above and below the shaped mask, are washer-like in form and raise or lower the outer edge of the electron disc in accordance with the input voltage. A collector ring surrounds the shaped mask to pick up the electrons not intercepted by the mask.

If the mask were opened out flat, its shape would be a long, thin rec-

(Continued on p 174)

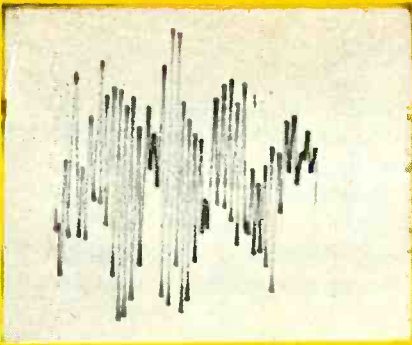

Record of vibration of an oil burner installation during $1/30$ of a second, photographed on oscillograph screen.

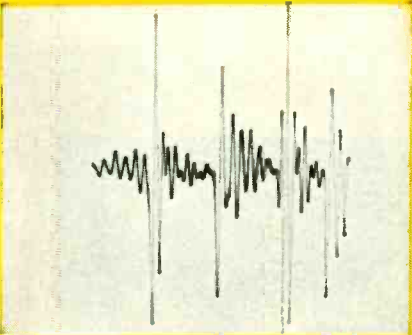

Oscillogram of vertical acceleration at the motor housing of a bench grinder, showing its vibration pattern.

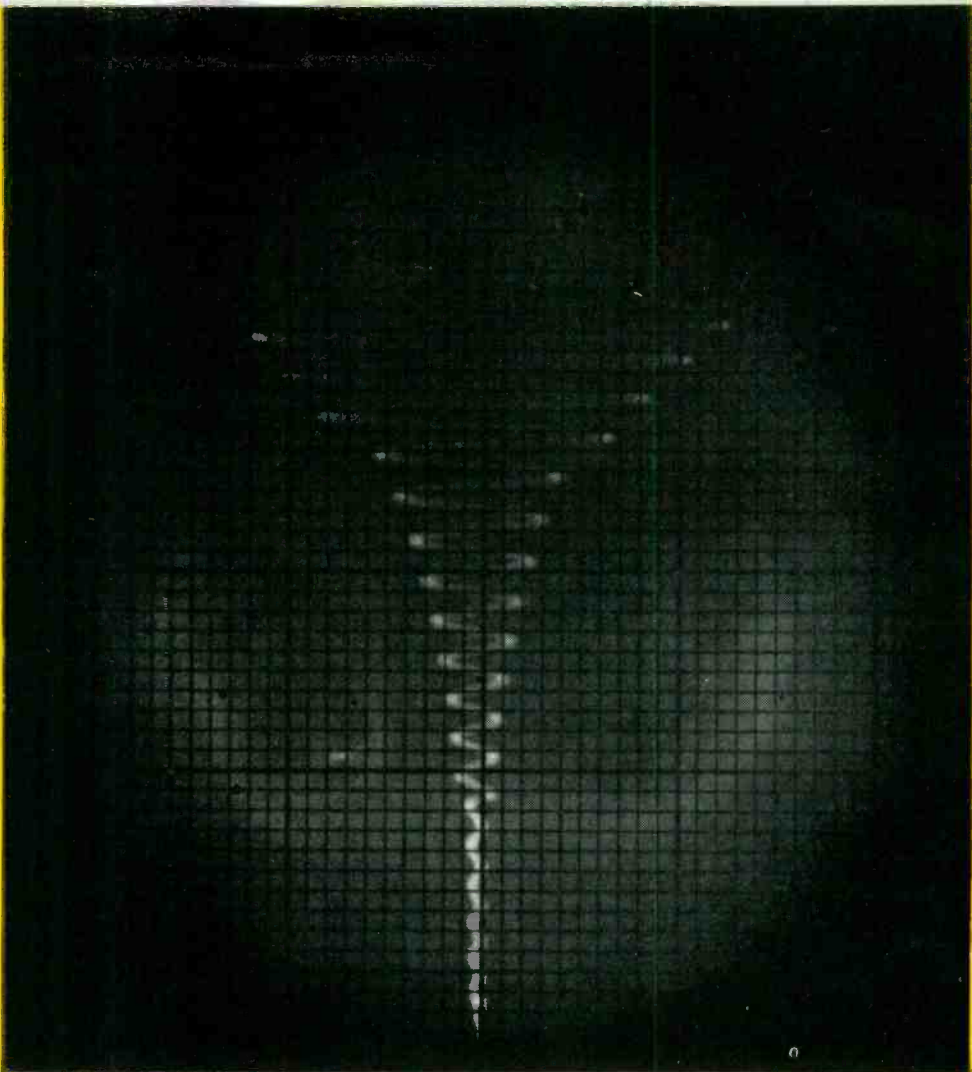

Pin down the fleeting

oscillograph trace... by PHOTOGRAPHY

You can save lots of time and settle arguments when you photograph the evidence of oscillograph traces. Even the fastest transients can be preserved... for leisurely study and for permanent records.

For most cathode-ray oscillograph work the best film is Kodak Linagraph Pan Film. With the highest practical light sensitivity, it holds its emulsion speed at writing rates of thousands of miles per second. When you're faced with spe-

cial problems requiring low red sensitivity, the recommended film is Kodak Linagraph Ortho Film.

Kodak Linagraph Films are available in 16mm. and 35mm. widths on daylight- and darkroom-loading spools. The 35mm. width is also furnished in 36-exposure cassettes. All are sold by the Kodak Industrial Dealer in your area. Eastman Kodak Company, Industrial Photographic Division, Rochester 4, N. Y.

Photorecording

... an important function of photography

Kodak
TRADE-MARK

NEW PRODUCTS

EDITED by WILLIAM P. O'BRIEN

Lab Requirements Spur Increase of Precision Measurement Instruments . . . TV Receiving Tubes, Components and Related Equipment Are Featured . . . New Devices Show Further Progress Toward Cure of TVI

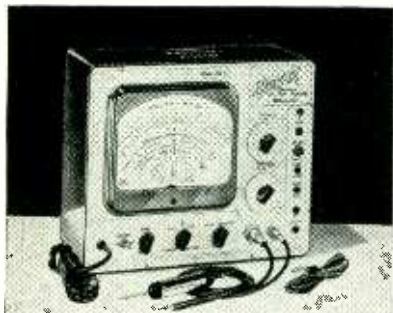

VTVM

GENERAL RADIO Co., 275 Massachusetts Ave., Cambridge 39, Mass. Type 1803-A vacuum-tube voltmeter meets most a-c voltage measurement requirements of the electronics laboratory. Voltage range is from 0.1 to 150 v, covered in 5 steps (1.5, 5, 15, 50 and 150 v, full scale). Accuracy is ± 3 percent. Frequency error is 10 percent at 120 mc, and correction curves are supplied by means of which rated accuracy can be obtained up to 200 mc.

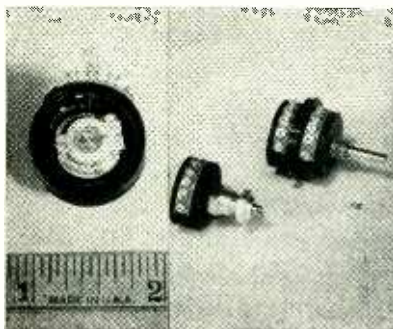

Miniature Potentiometer

TECHNOLOGY INSTRUMENT CORP., 1058 Main St., Waltham 54, Mass., offers new high-precision miniature potentiometers including all features of potentiometers of regular dimensions. Measuring $\frac{7}{8}$ in. in diameter and $\frac{3}{8}$ in. in depth, they are available in resistance ranges

of 100 to 25,000 ohms. Accuracy of total resistance may be specified as close as ± 1 percent, and linearity to ± 0.8 percent of total resistance as required.

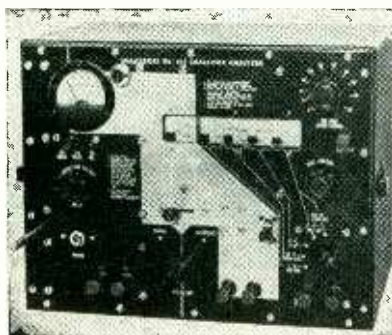

Capacitor Analyzer

SHALLCROSS MFG. Co., 10 Jackson Ave., Collingdale, Pa. A new laboratory-type capacitor analyzer will determine capacitance values between 5 μf and 12,000 μf ; insulation resistance from 1.1 to 12,000 megohms; also leakage current, dielectric strength and percentage power factor. It operates on 110-volt, 60-cycle a-c.

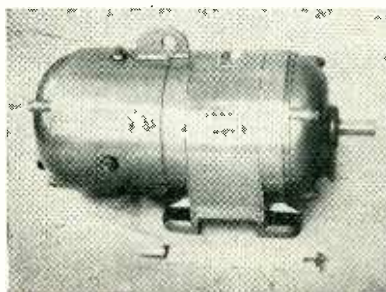

H-F Alternators

AMERICAN ELECTRIC MOTORS, INC., 4811 Telegraph Road, Los Angeles

22, Calif., has announced a new single or three-phase homopolar inductor alternator with electronic exciter regulator, providing a voltage regulation of ± 1.0 percent, equipped with a new low slip induction motor component to keep frequency within ± 0.5 percent. The alternator is available in sizes up to 10 kw, with frequencies up to 1,500 cycles, and can be supplied either as self-ventilated, or water-cooled for dusty or hazardous locations.



TV Mixer

GENERAL ELECTRIC Co., Syracuse, N. Y., recently announced type TV-19-A electronic television mixer for automatic and manual fading, lapping and dissolving of television pictures. When combined with control panels TC-21-A or TC-31-A it will provide split-second timing between channels and, because the operation of the system is largely automatic, switching errors are reduced. It is built for both portable and studio use. Power input is 117 v at 50 or 60 cycles and 275 v d-c regulated. Monitor output level is 0.2 or 0.8 v. Frequency response is flat to 6 mc and is about 1 db down at 8 mc.

Filter & Shielded Link

BARKER & WILLIAMSON, INC., 237 Fairfield Ave., Upper Darby, Pa., presents a combination shielded link and low-pass filter to help in the cure of tvi. The shielded link reduces harmonic or spurious signal radiations normally transferred by capacitance coupling. The filter,

**HERE'S USEFUL AND
IMPORTANT INFORMATION
FOR You!**

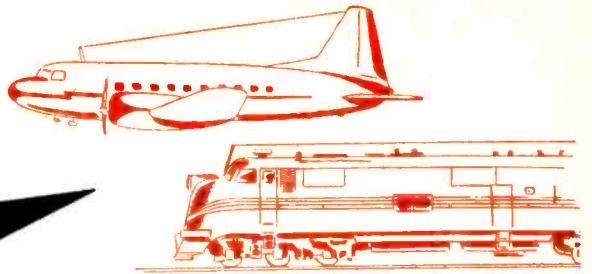

Type	Description	Typical Service	Prototype	Construction	Heater		Plate		Grid	Screen		Amp. Factor	Mut. Cond.
					Volts	Amps.	Volts	Ma.	Volts	Ma.	Volts		
2C50	Dual Power Triode	Aircraft Control Equip.	—	Bantal	12.6	0.3	300	12.5	-24	—	—	9.5	1750
2C52	Dual Amplifier Triode	Aircraft Control Equip.	—	Bantal	12.6	0.3	250	1.3	-2	—	—	90	1900
6AK5W	Pentode RF Amplifier	Military Ruggedized	6AK5	7 pin miniature	6.3	0.175	120	7.5	Rk 200	120	2.5	—	5000
6AL5W	Dual Diode	Military Ruggedized	6AL5	7 pin miniature	6.3	0.3	Max. Peak Inv. 330	Volts Max.	—	10	9 ma. dc. per plate	—	3200
6AS6W	Pentode RF Mixer	Military Ruggedized	6AS6	7 pin miniature	6.3	0.175	120	5.2	-2	—	—	17	2200
6C4W†	RF Power Triode	Military Ruggedized	6C4	7 pin miniature	6.3	0.15	250	10.5	-8.5	—	—	20	2600
6J5WGT	General Purpose Triode	Military Ruggedized	6J5GT	Standard glass	6.3	0.3	250	9	-8	—	—	38	5300
6J6W†	Dual AF-RF Triode	Military Ruggedized	6J6	7 pin miniature	6.3	0.45	100	8.5	Rk 50	—	—	—	450
6SA7WGT†	Pentagrid Converter	Military Ruggedized	6SA7GT	Standard glass	6.3	0.3	250	3.5	Rg 20000	100	8.5	—	1650
6SJ7WGT†	Pentode RF Amplifier	Military Ruggedized	6SJ7GT	Standard glass	6.3	0.3	250	3.0	-3	100	0.8	—	2600
6SN7WGT	Dual Triode	Military Ruggedized	6SN7GT	Standard glass	6.3	0.6	250	9.0	-8	—	—	20	2600
6X4W	Fullwave Rectifier	Military Ruggedized	6X4	7 pin miniature	6.3	0.6	Max. Peak Inv. 1250	Volts Max.	—	10	70 ma. dc.	—	2600
12J5WGT	General Purpose Triode	Military Ruggedized	12J5GT	Standard glass	12.6	0.15	250	9	-8	—	—	20	5000
CK5654	Pentode RF Amplifier	Commercial Aircraft Ruggedized	6AK5W	7 pin miniature	6.3	0.175	120	7.5	Rk 200	120	2.5	—	5500
CK5670	Dual Triode	Commercial Aircraft Ruggedized	2C51	9 pin miniature	6.3	0.35	150	8.2	Rk 240	—	—	35	3300*
CK5686	AF-RF Output Pentode	Commercial Aircraft Ruggedized	—	9 pin miniature	6.3	0.35	250	27	-12.5	250	5	—	3200
CK5694	Dual Power Triode	Industrial AF Amplifier	6N7G	Standard glass	6.3	0.8	294	7	-6	—	—	35	3200
CK5725	Pentode RF Mixer	Commercial Aircraft Ruggedized	6AS6W	7 pin miniature	6.3	0.175	120	5.2	-2	120	3.5	—	4400
CK5726	Dual Diode	Commercial Aircraft Ruggedized	6AL5W	7 pin miniature	6.3	0.3	Max. Peak Inv. 330	Volts Max.	—	10	9 ma. dc. per plate	—	475
CK5749†	Pentode RF Amplifier	Commercial Aircraft Ruggedized	6BA6	7 pin miniature	6.3	0.3	250	11.0	Rk 68	100	4.2	—	1200
CK5750†	Pentagrid Converter	Commercial Aircraft Ruggedized	6BE6	7 pin miniature	6.3	0.3	250	2.6	1.5	100	7.5	—	2200
CK5751†	Dual High Mu Triode	Commercial Aircraft Ruggedized	—	9 pin miniature	6.3‡	0.35	250	1.1	-3	—	—	70	—
CK5814†	Dual Medium Mu Triode	Commercial Aircraft Ruggedized	—	9 pin miniature	6.3‡	0.35	250	10.5	-8.5	—	—	17	—

†Sample quantities available late in 1950

*2.7 watts Class A output. 10 watts Class C input power to 160 mc.

Note: All dual section tube ratings are for each section.

‡Series heater rating 12.6 volts, 0.175 amps.

RAYTHEON Makes All These **Tough Service Tubes**
— and tens of thousands of them are daily
demonstrating their superior **reliability** and
stamina in commercial aircraft, industrial
and military service.

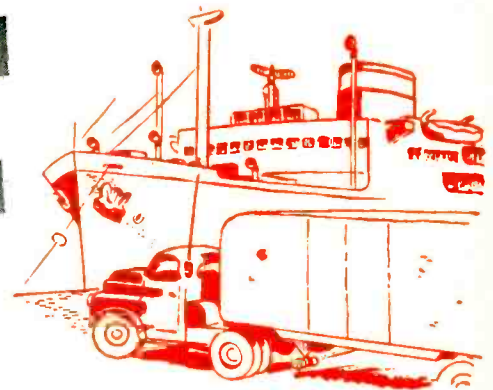

These Raytheon tubes are engineered and manufactured specifically for critical services where a single tube failure may lead to serious loss of life or dollars. We are interested in developing additional types for your tough service applications.

Over 300 Raytheon Special Purpose Tube distributors are ready to serve you on the above types. Application information on these tubes is available at Newton, Chicago and Los Angeles.

RAYTHEON

Excellence in Electronics

RAYTHEON MANUFACTURING COMPANY

SPECIAL TUBE SECTION • Newton 58, Massachusetts

SUBMINIATURE TUBES • SPECIAL PURPOSE TUBES • MICROWAVE TUBES • CATHODE RAY TUBES • RECEIVING TUBES

consisting essentially of two *m*-derived end sections and three mid-sections of constant *k* type in separate, completely-sealed, copper compartments, prevents inductive transfer of unwanted frequencies from section to section. The combination properly installed provides suppression of harmonics above 50 mc, approximately 75 db or more, throughout the entire tv band. Insertion loss is less than 0.25 db.



Miniature Receiving Tubes

GENERAL ELECTRIC Co., Syracuse, N. Y., is now producing two new miniature tubes designed primarily for television and radio receivers. The 6S4 is a high-perveance medium-mu triode designed chiefly for use as a vertical deflection amplifier in tv receivers with picture tubes having a deflection angle up to 70 deg and operating at anode voltages up to 14,000 v. The 6AH6 is a sharp-cutoff amplifier pentode. Its high transconductance and low input and output capacitances adapt it to use as a wide-band amplifier and as a reactance tube for tv and radio receivers.

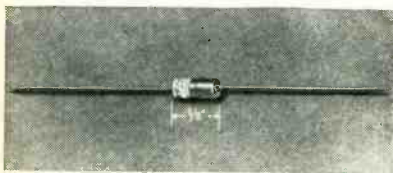

Copper-Oxide Rectifier

BRADLEY LABORATORIES, INC., 82 Meadow St., New Haven, Conn. Model CX18 copper-oxide rectifier is designed to obtain an extremely high reverse resistance of over one

megohm per plate. The unit is intended for circuits in which very low leakage and maximum stability are essential. It is rated up to 5 ma d-c.

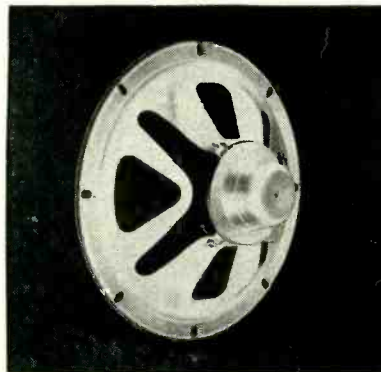

New Loudspeaker

ROLA Co., Cleveland, Ohio, has announced a loudspeaker which has a magnetically-enclosed motor structure and therefore allows for mounting close to the picture tube. The new speaker uses Alnico V in a high-efficiency magnetic structure which uses the minimum weight of Alinco V and results in overall reduction in cost of the magnet. Speakers are made in sizes ranging from 5 to 12 in.

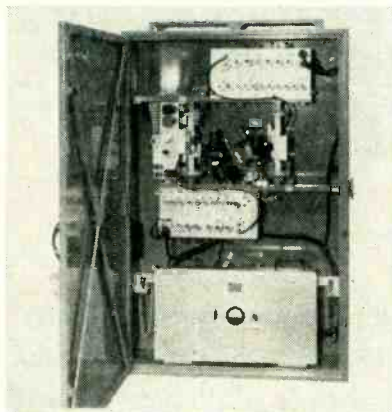

Microwave Repeater

PHILCO CORP., Tioga & C Sts., Philadelphia 34, Pa., is producing a feedback-type microwave repeater for use in communication networks. Capable of handling up to 32 two-way-voice channels or combinations of voice channels, program channels and coded intelligence, it is designed

for operation in the 5,925 to 8,000-mc band which is available to common carriers, industrial services, broadcasters and governmental agencies. The 300 to 300,000-cycle modulation acceptance bandwidth will accommodate either frequency-sharing or time-division channelizing equipment. Power consumption of the entire unit is less than 350 watts at 115 volts, 60 cycles.

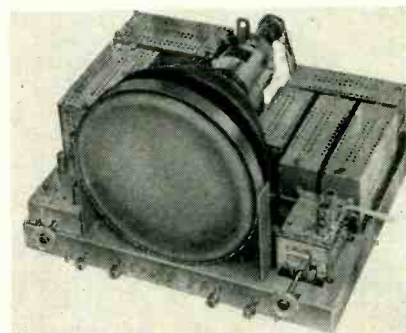

Unitized Television

SETCHELL-CARLSON, INC., New Brighton, Minn., is now producing Unitized television, featuring an entire chassis organized into eight plug-in units, each performing its separate and distinct function yet synchronized in the operation of the set. For repair or replacement each unit can be removed without interfering with the rest of the set. Unit A is a tv channel selector with vernier tuning; B, the i-f amplifier with 4 stages of i-f and germanium crystal detector; C, the sound amplifier; D, the video amplifier, agc and sync separator; E, the vertical sweep amplifier; F, the horizontal sweep amplifier with h-v supply; G, the main power supply; and H, the a-m radio tuner.

Low-Loss TV Lead-In

GONSET Co., Burbank, Calif., has announced an ultra low-loss transmission line of open wire construction for tv receiver antenna lead-in or amateur and commercial transmitting and receiving applications. It will replace ribbon-type molded lead-in to advantage especially in fringe areas. Using polystyrene

(Continued on p 198)

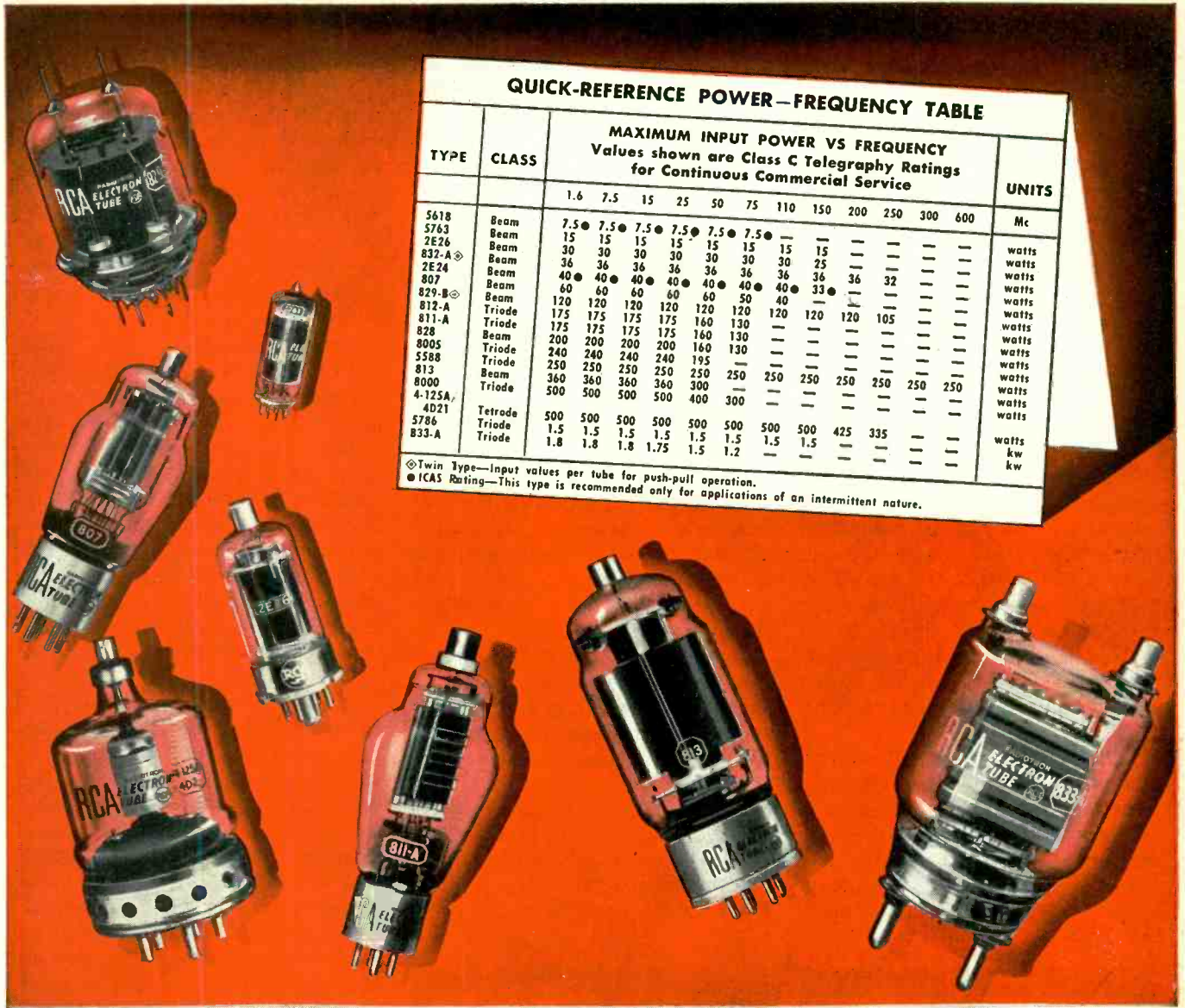

TYPE	CLASS	MAXIMUM INPUT POWER VS FREQUENCY Values shown are Class C Telegraphy Ratings for Continuous Commercial Service											UNITS			
		1.6	7.5	15	25	50	75	110	150	200	250	300		600		
5618	Beam	7.5	7.5	7.5	7.5	7.5	7.5	—	—	—	—	—	—	—	—	Mc
5763	Beam	15	15	15	15	15	15	—	—	—	—	—	—	—	—	watts
2E26	Beam	30	30	30	30	30	30	30	30	25	—	—	—	—	—	watts
832-A	Beam	36	36	36	36	36	36	36	36	36	36	32	—	—	—	watts
2E24	Beam	40	40	40	40	40	40	40	40	40	33	—	—	—	—	watts
807	Beam	60	60	60	60	60	60	60	50	40	—	—	—	—	—	watts
829-B	Beam	120	120	120	120	120	120	120	120	120	105	—	—	—	—	watts
812-A	Triode	175	175	175	175	160	130	—	—	—	—	—	—	—	—	watts
811-A	Triode	175	175	175	175	160	130	—	—	—	—	—	—	—	—	watts
828	Beam	200	200	200	200	160	130	—	—	—	—	—	—	—	—	watts
8005	Triode	240	240	240	240	195	—	—	—	—	—	—	—	—	—	watts
5588	Triode	250	250	250	250	250	—	—	—	—	—	—	—	—	—	watts
813	Beam	360	360	360	300	—	—	—	—	—	—	—	—	—	—	watts
8000	Triode	500	500	500	400	300	—	—	—	—	—	—	—	—	—	watts
4-125A, 4D21	Tetrode	500	500	500	500	500	500	500	500	425	335	—	—	—	—	watts
5786	Triode	1.5	1.5	1.5	1.5	1.5	1.5	1.5	1.5	1.5	—	—	—	—	—	kw
B33-A	Triode	1.8	1.8	1.8	1.75	1.5	1.2	—	—	—	—	—	—	—	—	kw

◆ Twin Type—Input values per tube for push-pull operation.
 ● ICAS Rating—This type is recommended only for applications of an intermittent nature.

Here today... here tomorrow Design with confidence around RCA Preferred Type Small Power Tubes

RCA Preferred Type small power tubes serve the major requirements of equipment manufacturers while providing wide design flexibility. The tubes listed are those you can depend upon *now* and for your *future* designs.

These RCA types are especially recommended because their widespread application permits production to be concentrated on fewer types . . . resulting in lower costs, improved quality, greater uniformity, and better availability.

RCA Application Engineers are ready to suggest the most suitable types for your design requirements. For further information write RCA, Commercial Engineering, Section H42R, Harrison, N. J.

The world's most modern tube plant . . .



RCA, LANCASTER, PA.

The Fountainhead of Modern Tube Development is RCA



RADIO CORPORATION of AMERICA
ELECTRON TUBES
HARRISON, N. J.

NEWS OF THE INDUSTRY

Edited by WILLIAM P. O'BRIEN

Ticket Reservations Made Electronically

A NEW combination of electronic devices which will almost completely mechanize the handling of reservations for Pullman and coach space, and in busy hours will cut to less than a third the time now consumed in these transactions, was recently announced by the Pennsylvania Railroad.

Known as the Intelix system, the new automatic reservation devices, pioneered and developed after months of research and utilization of the latest postwar techniques in communications, are being installed in Pennsylvania Station, New York City, and are already partly in operation for reservations from New York and Newark on all seven Pennsylvania daily trains to Chicago.

The Intelix system will revolutionize the whole reservation and ticket selling procedure, and as it is progressively installed over the coming months in this area and throughout the Pennsylvania Railroad, will give the public much

faster and generally improved service at the ticket window and on the telephone. It virtually eliminates the possibility of error.

The system was developed by the International Standard Trading Corp., an associate of the International Telephone and Telegraph Corp., and has been applied to railroad reservations jointly with the Pennsylvania Railroad. It utilizes some of the principles of the dial telephone, magnetic recording, printing telegraph equipment, and automatic bookkeeping in achieving a new concept of reservation procedure. It works like this:

A traveler at the ticket window asks the clerk for a roomette on the Broadway Limited to Chicago for the next day. Instead of telephoning the reservation bureau as now to determine if a roomette is available the clerk uses a special instrument, dialing in code to select the destination city and day of departure, and immediately hears through the instrument a voice recording of

accommodations available at that moment on trains to Chicago for the requested date. A roomette is available on the Broadway, so he sends the reservation bureau a short coded message, by telegraph printer, requesting the roomette and giving a ticket number for it. The message is received instantly by the operator of a new space-control unit, the heart of the new system.

This unit, a console cabinet about five feet high, holds diagrams (reservation cards for each car) for all trains to Chicago for 60 days ahead. All the diagrams for one day are in a newly-designed file on a tray, there being 60 trays. The teleprinter message from the ticket clerk actuates the unit so that the proper tray containing the diagrams for the day wanted is selected by the machine and automatically slides out on a counter before the operator.

Quickly selecting the proper diagram from the tray file, the operator assigns a roomette and transmits a confirmation back to the ticket seller as the tray automatically returns into the unit, which is then ready for the next transaction. At peak periods, messages are automatically stacked, and go to the machine in order, as each preceding reservation is made. The elapsed time from arrival of the message to dispatch of the confirmation averages less than 30 seconds. The ticket clerk, his order confirmed, completes the sale with the traveler at a substantial saving in time.

RMA Convention Results

AT THE CONCLUSION of the 26th annual convention of the RMA at the Stevens Hotel, Chicago, Robert C. Sprague, president of the Sprague Electric Co., was elected president and chairman of the RMA board of directors. Members also voted to change the name of the association to Radio-Television Manufacturers Association in recognition of the growing importance of tv to the industry. The change in name becomes effective upon the filing of necessary amendments to RMA's Illinois incorporation charter.

The reorganization plan provided



Large cabinet (left) is space-control unit, heart of Intelix system being installed by Penn. R.R. Operator receives on the teleprinter a coded message from a ticket seller for a reservation. Unit automatically selects from trays in cabinet the one containing car diagrams for trains on day requested. Operator selects proper diagram and flashes back confirmation. At right is one-sixth of the behind-the-scenes brain of the Intelix system. Gas triodes, shown at immediate left of engineer, convert incoming teleprinter characters into currents that actuate appropriate relays to bring desired tray file in front of operator at left

Tops for
TV and RADIO



CLEVELAND COSMALITE* and CLEVELITE*

LAMINATED PHENOLIC TUBES
 OUTSTANDING AS THE STANDARD FOR QUALITY!

COSMALITE known for its many years of Top Performance.
 CLEVELITE for its ability to meet unusual specifications.

Available in diameters, wall thicknesses, and lengths desired.

These CLEVELAND TUBES combine . . . High Dielectric Strength
 . . . Low Moisture Absorption . . . Great Mechanical Strength . . .
 Excellent Machining Properties . . . Low Power Factor . . . and Good
 Dimensional Stability.

For the best . . . "Call Cleveland." Samples on request.

*Trade Marks

The **CLEVELAND CONTAINER Co.**
 6201 BARBERTON AVE. CLEVELAND 2, OHIO

PLANTS AND SALES OFFICES at Plymouth, Wisc., Chicago, Detroit, Ogdensburg, N.Y., Jamesburg, N.J.
 ABRASIVE DIVISION at Cleveland, Ohio
 CANADIAN PLANT: The Cleveland Container, Canada, Ltd., Prescott, Ontario

REPRESENTATIVES

NEW YORK AREA
 NEW ENGLAND

R. T. MURRAY, 614 CENTRAL AVE., EAST ORANGE, N. J.
 R. S. PETTIGREW & CO., 968 FARMINGTON AVE.
 WEST HARTFORD, CONN.

CANADA

WM. T. BARRON, EIGHTH LINE, RR #1, OAKVILLE, ONTARIO



Ask about
CLEVELAND TUBES
 in various types and specifications
 being used in the Electrical Industry.

in the revised by-laws makes possible the election of a full-time salaried president of the association whenever the board of directors so desires. It also creates a new office of chairman of the board, re-defines the duties of various officials and readjusts the dues scale. The RMA constitution is repealed in its entirety.

Elections were as follows: L. F. Muter was reelected treasurer; W. R. G. Baker was reappointed director of the engineering department; and J. W. Van Allen was reappointed general counsel.

The new directors are: R. S. Bell of Packard-Bell Co., Los Angeles, Calif.; J. W. Craig of Avco Mfg. Co., Cincinnati, Ohio; R. C. Tait of Stromberg-Carlson Co., Rochester, N. Y.; R. G. Zender of Lenz Electric Mfg. Co., Chicago; and R. S. Perry of Federal Telephone & Radio Co., Clifton, N. J.

Nine former directors who were reelected are: E. Alschuler of Sentinel Radio Corp., Evanston, Ill.; G. M. Gardner of Wells-Gardner & Co., Chicago; H. L. Hoffman of Hoffman Radio Corp., Los Angeles; H. C. Mattes of Belmont Radio Corp., Chicago; R. E. Carlson of Tung-Sol Lamp Works, Inc., Newark, N. J.; H. J. Hoffman of Machlett Laboratories, Inc., Springdale, Conn.; R. F. Sparrow of P. R. Malloy & Co., Inc., Indianapolis; A. Liberman of Talk-A-Phone Co., Chicago; and president R. C. Sprague.

Glenn W. Thompson, of Noblitt-Sparks Industries, Inc., was elected chairman of the Set Division; R. G. Zender, of Chicago, was elected chairman of the Parts Division; H. J. Hoffman, of Springdale, Conn., was elected chairman of the Transmitter Division.

Past president Max F. Balcom was reelected chairman of the Tube Division, and A. G. Schifino of Stromberg-Carlson Company was reelected chairman of the Amplifier & Sound Equipment Division.

Chairmen Thompson and Balcom were also elected vice-presidents along with three others who were reelected, namely: W. J. Barkley, of the Collins Radio Co., for the Transmitter Division; A. D. Plamondon, Jr., for the Parts Division; and Arie Liberman, for the Ampli-

MEETINGS

MAY 15-SEPT. 27: Silver Anniversary of the Chicago Section of IRE (Sponsored by the IRE and NEC), Chicago, Ill.

JULY 24-AUG. 19: Summer Electronics Symposium (Semiconductor Electronics), U. of Michigan, Ann Arbor, Mich.

JULY 24-27: Conference on Ionospheric Physics. The Pennsylvania State College, State College, Pa.

AUG. 27-31: NEDA National Convention and Exhibition, Cleveland Public Auditorium, Cleveland, Ohio.

AUG. 28-31: APCO National Conference, Hotel Hollenden, Cleveland, Ohio.

SEPT. 11-23: URSI Ninth General Assembly, Zurich, Switzerland.

SEPT. 13-15: 1950 IRE West Coast Convention and Sixth Annual Pacific Electronic Exhibit, Municipal Auditorium, Long Beach, Calif.

SEPT. 18-22: Fifth National Instrument Conference and Exhibit, Memorial Auditorium, Buffalo, N. Y.

SEPT. 25-27: National Electronics Conference, Edgewater Beach Hotel, Chicago, Ill.

SEPT. 30-OCT. 8: Third Annual National Television & Electrical Living Show, Chicago Coliseum, Chicago, Ill.

OCT. 3-5: AIEE District No. 2 Meeting, Lord Baltimore Hotel, Baltimore, Md.

OCT. 23-27: AIEE Fall General Meeting, Skirvin Hotel, Oklahoma City, Okla.

fier & Sound Equipment Division.

Bond Geddes was reelected executive vice-president and secretary until July 31 when he will retire after 23 years of service to the association and become an RMA consultant. James D. Secrest, director of public relations and staff assistant of the RMA Parts Division, was elected secretary and general manager effective Aug. 1.

Betatron Research Program

A 50-MILLION volt betatron, designed and constructed by General Electric, has been installed in the National Bureau of Standards' new betatron laboratory, extending the Bureau's high-energy research into the region from 2 to 50 million electron volts. For work at even higher energies, a 180-million-volt synchrotron, now being completed by GE, will be installed at the Bureau next year.

The NBS research program with these machines has four main aspects: the investigation of shielding and protection against high-energy radiations, the medical applications of these radiations, their industrial applications, and their basic physical properties.

X-rays with energies between 10

and 70-million volts are now widely used in the medical treatment of deep-seated tumors. These high-energy radiations are directed to burn out a pinpoint of afflicted tissue deep within the human body without damaging the surrounding area, but proper protective precautions are of the greatest importance—both to the patient and to the radiologist administering the treatment.

Already the National Bureau of Standards has established standards for protection against low-energy x-rays, and the new betatron research program will fill the need for standards of protection in the higher regions now available to medicine. The much deeper penetration of high-energy x-rays requires entirely new scientific standards for full exploitation of these sources of radiation while maintaining adequate protection.

Standards of protection have not only a safety aspect but an economic one. Today, the exact wall thicknesses and best structural materials are not known for high-energy x-rays. In order to be on the safe side, high-energy installations are over-protected, with excessively thick walls and barriers which add greatly to the cost. In many installations the cost of pro-

(Continued on page 222)

**These famous names in
the sky...have a famous
friend in SYLVANIA**

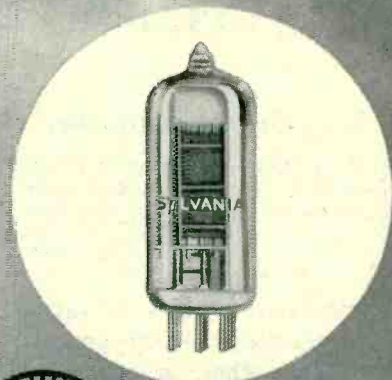

Wherever these famous airliners fly, a trusted group of friendly guides goes with them, in the form of Sylvania Radio Tubes.

For, the dependability, long life, and splendid performance of Sylvania Tubes have won them top preference with radio and electronics engineers throughout this country, as well as abroad.

Sylvania's ruggedized tubes are typical examples of the alert engineering which is responsible for the

increasing demand for all Sylvania quality products.

What is your problem?

Let Sylvania radio research and advanced engineering work for you. If you have problems—as widely varied as the designing of more compact sets, and the overcoming of shock and vibration—put them up to Sylvania. Address your letters to Radio Tube Division, Dept. R-2108, Emporium, Pa.

SYLVANIA  ELECTRIC

RADIO TUBES; TELEVISION PICTURE TUBES; ELECTRONIC PRODUCTS; ELECTRONIC TEST EQUIPMENT; FLUORESCENT LAMPS, FIXTURES, SIGN TUBING, WIRING DEVICES; LIGHT BULBS; PHOTOLAMPS; TELEVISION SETS

NEW BOOKS

The Transductor Amplifier

BY ULRIK KRABBE. *Published by Ejnar Munkesgaard, 6, Norregade, Copenhagen, Denmark 1949, 176 pages, Dan. kr. 22. Can be ordered in U. S. from Bonniers, 605 Madison Ave., New York 22 at \$5.50. In English.*

AN EXCELLENT treatise on saturable-core reactors and their applications. The author, a competent mathematician, has shown rare ability in expressing equations in words prior to resorting to formulas.

The author has used experimental observations in many places to derive factors that materially reduce the complexity of the computations and thus make possible a much less abstract treatment of the subject.

The fundamental operation of various modes of saturable reactors are broken down into their simplest forms and are treated physically and mathematically. Operation with and without self-saturation is discussed, together with analysis of the effects of various types of feedback and of various

types of loads. The connection of reactors in cascade as amplifiers is discussed. The parameters for optimum design are analyzed in respect to such factors as amplification, power gain, and speed of response.

Applications of the transductor for measurement, regulation and control are cited. The criteria for stability when operating in both

RELEASED THIS MONTH

Outline of Radio, Television and Radar; *Symposium by Eight Contributors; Chemical Pub. Co., Brooklyn; \$12.00.*

Radio Engineering Handbook; *Keith Henney; McGraw-Hill; Revised Fourth Edition; \$10.00.*

Television and F-M Receiver Servicing; *Milton S. Kiver; D. Van Nostrand Co., Inc.; 2nd Edition; \$3.25.*

Television Servicing; *S. Heller and I. Shulman; McGraw-Hill; \$5.50.*

The Principles of Television Reception; *A. W. Keen; Sir Isaac Pitman & Sons, Ltd., London; 30/.*

Wave Filters; *L. C. Jackson; John Wiley & Sons, Inc., New York; \$1.25.*

linear and nonlinear modes are analyzed.

It is this reviewer's opinion that this book will constitute an invaluable addition to the shelf of any engineering library. It should be read and studied many times to fully profit by its contents.—F. H. SHEPHARD, JR., *Summit, N. J.*

Aerials for Centimetre Wave-Lengths

BY D. W. FRY and F. K. GOWARD, *Cambridge University Press, New York, 1950, 172 pages, \$3.50.*

THIS monograph is concerned with the theory and application of micro-wave radar antennas. Both authors were engaged in the development of this type of antenna at Telecommunications Research Establishment during the war. As in the other volumes of the Modern Radio Technique Series, emphasis has been placed on physical principles and the mathematics has been kept to a minimum. Although the authors have addressed themselves to the radar design engineer and the general radio research worker, the antenna specialist also will benefit from reading the book.

The book opens with a discussion
(Continued on p 134)

BACKTALK

This Department is Operated as an Open Forum Where Readers May Discuss Problems of the Electronics Industry or Comment Upon Articles that ELECTRONICS has Published

Possible Phototube

DEAR SIRs:

INCITED and encouraged by the article by W. C. White in the September issue of ELECTRONICS I am writing you this. It might be thoroughly possible that I am several years late with my following proposal; unfortunately I am not in a position to be well posted about all events in the development of electronics nor have I the opportunity to carry out experiments.

My proposal is as follows: To build in a phototube with two cathodes of different types, with respect to color sensitivity. Uni-

form sensitivity through the whole range of the visible spectrum could be obtained, and one of these photosurfaces could be utilized simultaneously for secondary radiation. The following figure illustrates the

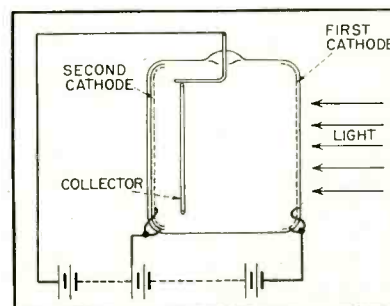

idea. The first cathode is a pervious layer of the Sb-Cs type, which lets pass the red component of the light. The second cathode is a red-sensitive cathode (Ag-Cs₂O-Cs) at a positive potential with respect to the first cathode. The electrons emitted from the first cathode and the red light strike this second cathode. If the field between the cathodes is sufficiently high, some of the electrons emitted from the first cathode will release secondary electrons.

The other portion of the electrons will be caught directly by the collector. This collector or last anode, again positive with respect to the second cathode, now collects: (1) the portion of primary electrons from the first cathode, (2) the secondary electrons from the second cathode and (3) the electrons released from the second cathode by the red light that has passed the first. Experimental in-

(Continued on p 228)

YOUR QUESTIONS...OUR ANSWERS*

May bring a solution to your

D. C. AMPLIFICATION PROBLEMS!

The Microsen D. C. Amplifier is designed for stable, accurate, and economical amplification covering an exceptionally wide range of applications. These fields of application may suggest, duplicate, or offer a solution to your particular D. C. Amplification problem.

Simple, compact and portable, the Microsen D. C. Amplifier has three different ranges in a single model. The Microsen Balance, an electro mechanical feedback amplifier, combines the advantages of high torque to current input ratio with rugged, shock-resistant construction.

Available models include Voltage, Current and Potentiometer Type Amplifiers, Direct Current Converters, Direct Current Transformers, and engineered designs to meet special requirements.

Typical applications in the field of measurement include:

THERMOMETRY in combustion research, gas turbine development, thermocouple inspection, meteorology, distillation processes.

PHOTOMETRY in fluid flow and turbulence, polar-

imetry, physiology of blood and density.

GAS ANALYSIS in mixture control, efficiency of filters and detection of explosive mixtures.

ELECTRICAL BRIDGES in resistor inspection, moisture detection, conductivity measurements, vacuum gauging, transient stresses.

ELECTRONICS in tube development, vacuum gauging and wave guide studies.

ELECTROLYSIS in electrolytic plating, electrolytic process and production control.

Input elements include thermocouples, photo cells, pirani gauges, strain gauges and others. The instrument is used generally with a recorder. The output can also be applied to a suitable milliammeter indicator or to actuate automatic control relays or signal devices. Design advantages include accuracy, sensitivity, stability and high speed response.

Inquiries for modification within the useful scope of the Microsen D. C. Amplifier are invited. If possible, such inquiries should contain complete application specifications.

MICROSEN D. C. AMPLIFIER



MICROSEN

ELECTRICAL INSTRUMENTS

A Product of

MANNING, MAXWELL & MOORE, INC.

STRATFORD • CONNECTICUT

Makers of 'Microsen' Electrical and 'American' Industrial Instruments, 'Hancock' Valves, 'Ashcroft' Gauges, 'Consolidated' Safety and Relief Valves. Builders of 'Shaw-Box' Cranes, 'Budgit' and 'Load Lifter' Hoists and other lifting specialties.



Manning, Maxwell & Moore, Inc.
250 East Main Street
Stratford, Conn.

We are interested in the Microsen D. C. Amplifier.

Application specifications and/or specific queries attached
Please send bulletin describing the instrument

Name _____

Position _____

Company _____

Street Address _____

City and State _____



sion of antenna requirements and characteristics that are important to the overall radar system. After a brief discussion of pattern theory and antenna types, there are two chapters on primary point sources and secondary radiators of the double curvature type.

The last half of the book discusses line sources and secondary radiators fed from line sources. The heavy emphasis on this type of radiator is no doubt a reflection of the author's view that "line sources and single-curvature reflectors are much to be preferred". The reviewer would like to take exception to this statement. It is quite true that for many applications, this type of radiator is certainly the most suitable. It is an elegant way of designing radar antennas since it allows the designer independent control of the vertical pattern and the horizontal pattern. However, for certain applications, the line source and single-curve reflector combination is either excessively bulky or considerably more difficult to construct than the doubly-curved shaped reflector and point source feed.

One very obvious omission from this monograph is any mention of a paraboloidal reflector with a multiple feed to obtain a shaped beam. This type of radiator has found considerable use in many American radars and is characterized by a relatively simple construction plus the highest aperture efficiency of any of the reflector systems for producing a shaped beam.

With the exception of the two comments noted above, the reviewer recommends this monograph as a very readable survey of the basic features of microwave radar antennas.—HENRY JASIK, *Airborne Instruments Laboratory, Inc., Minnola, N. Y.*

Electronic Navigation

By LEONARD M. ORMAN. Published jointly by Pan American Navigation Service, North Hollywood, Calif. and Weems System of Navigation, Annapolis, Md., 1950, 222 pages, \$4.50.

To THOSE interested in electronic aids to navigation most of the illustrations and much of the phrase-

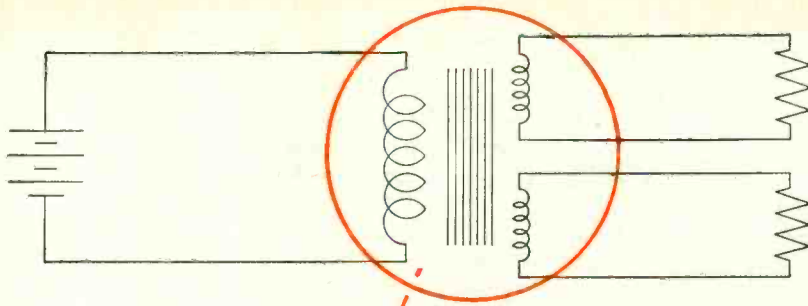

a DC transformer?

Certainly...

Bendix Specialized Dynamotors are made for the Job!

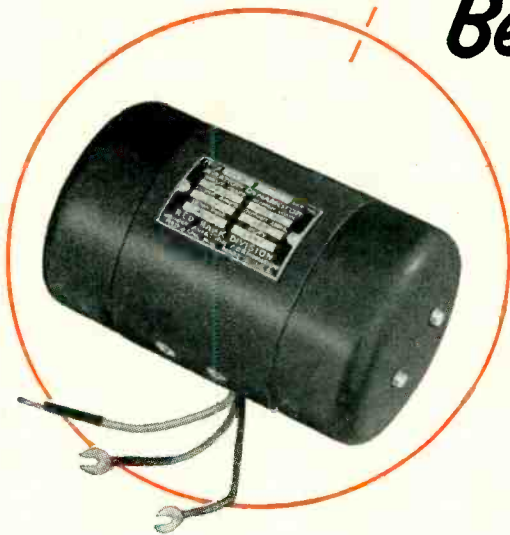

Whenever DC power is required at other than the supply voltage, Bendix* Specialized Dynamotors function as DC transformers. They can be wound for any input or output voltage between 5 and 1200 volts, and they can deliver power up to 500 watts. Multiple outputs can be supplied to correspond with several secondaries on transformers, and their output voltages can be regulated within close limits regardless of input voltage or load variations. Bendix Specialized Dynamotors are tailored to the exact requirements of each application by the design of the windings used in standardized frames. This reduces the cost, size and weight to an absolute minimum, consistent with the operational requirements. Compliance with Government specifications is assured by the choice and treatment of materials and the basic design. *A complete description of your requirements will enable our engineers to make concrete recommendations . . . All orders are filled promptly and at moderate cost.*

*REG. U. S. PAT. OFF.

**RED BANK DIVISION OF
BENDIX AVIATION CORPORATION**

RED BANK, NEW JERSEY

Expert Sales: Bendix International Division, 72 Fifth Avenue, N. Y. 11, N. Y.

Write for this colorful and informative book
—it's free. You'll find it loaded with facts
and figures about all types of dynamotors.



CANNON PLUGS

Quality in Every Part

"AN" SERIES

EXPLODED VIEW

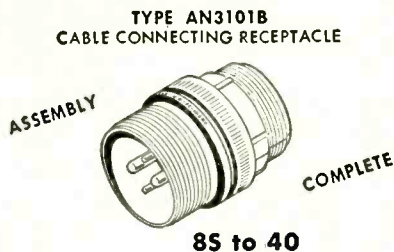
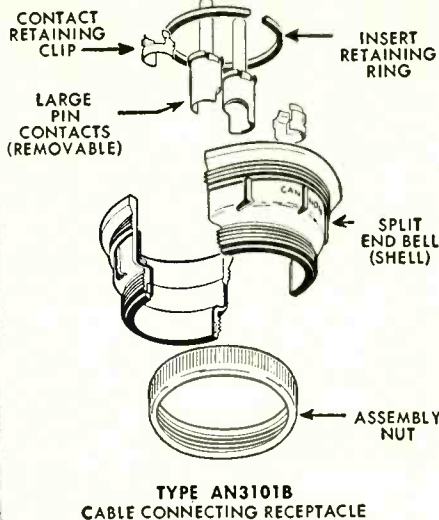
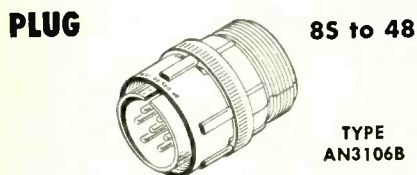
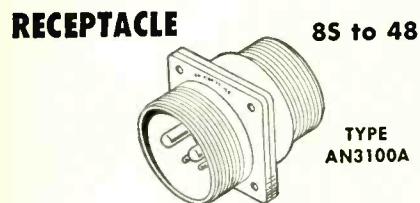
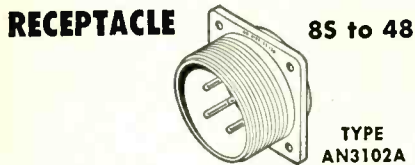
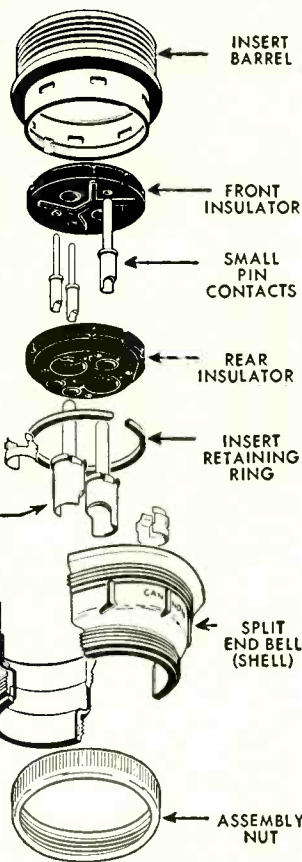

To MIL-C-5015 SPECIFICATIONS

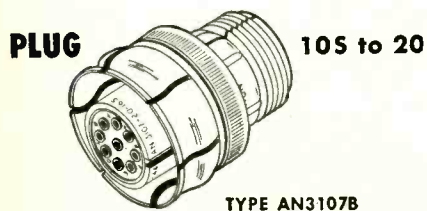
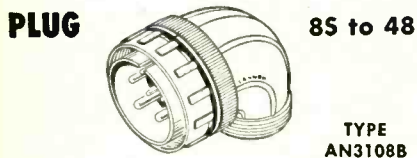

The greatest multiple circuit electric connector line in history—by the pioneers and leaders in the industry.

Cannon Electric Development Company, Division of Cannon Manufacturing Corporation, 3209 Humboldt St., Los Angeles 31, Calif. Canadian factory: Toronto. World export: Frazar & Hansen, San Francisco, New York, Los Angeles.



and Bonding Rings, Cable Clamps, Junction Shells, Dust Caps, etc.

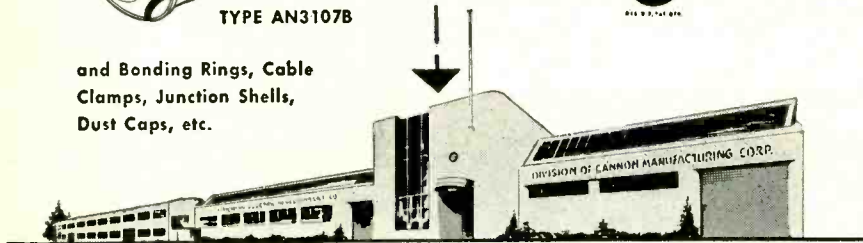

NEW BOOKS

(continued)

ology of this book will be familiar. The author has organized a great quantity of information to fit chapter categories that include: capabilities and limitations of radar, training operators, installation and maintenance, loran, other systems and auxiliary radar devices. He shows, in addition, specific operational data for currently available radar and loran equipments. The treatment concludes with a useful glossary, a bibliography and fifteen pages of questions and answers.

To the electronic engineer, the volume presents a neat summary of the overall navigational problem. The navigator will find it an invaluable condensation of thousands of pages that tell the wonders of modern navigational aids.—A. A. MCK.

Electronics, Principles and Applications

By RALPH R. WRIGHT, *Assoc. Prof. of Elec. Eng., Virginia Polytechnic Institute.* Ronald Press, New York, N. Y., 1950, 387 pages, \$5.50.

PROFESSOR WRIGHT took on the tough task of preparing a basic course in electronics for nonelectrical engineering students, a job at which he has succeeded quite well. Even electrical engineering students or physics majors can profitably use this book.

After three chapters dealing with basic electronics and tubes, he reviews d-c and a-c circuits. Then come several chapters covering the fundamental jobs that tubes do—amplification, oscillation, rectification. The remainder of the book is made up of chapters on cathode-ray tubes, x-rays, light-sensitive devices, high-frequency heating and basic control circuits.

Numerous examples of the numerical computations required in solving tube circuits are given and there are useful problems at the end of each chapter.

In writing a text for the completely uninitiated, one must overlook no opportunity to make the material clear. This involves almost superhuman devotion to the precise meanings of individual words, the avoidance of words that have more than one meaning and use of

they

may

look

alike,

but:

there

is

only

one

C-D

"VIKANE" IMPREGNATED

"GREY TIGER" Paper Tubular Capacitors

only
Cornell-Dubilier
can
offer you:



- 1 "Vikane"* impregnation — an exclusive C-D development—results in extra long life and outstanding performance over a temperature range of -35°C . to 100°C . Special high temperature and moisture end-fill seals unit.
- 2 A tubular of exceptionally high insulation resistance. At 25°C ., resistance is over 10,000 megs per unit or 2,000 megs per mfd.
- 3 A standardized line of paper tubulars that will fill both high and low temperature requirements. No duplication of stock and record keeping! No production delays! Less inventory loss! A feature of "Vikane" impregnation.
- 4 A tubular with a power-factor average of 0.35% at 1,000 cycles.
- 5 A tubular with excellent capacity stability over both the high, low temperature range.

Tinned-copper leads, standard sizes. Attractive grey case, red lettering. Available in all commercial capacity and voltage ratings.

For further details on the "Grey Tiger" line of paper tubulars, write for Bulletin No. NB116. CORNELL-DUBILIER ELECTRIC CORPORATION, Dept. K-8-0, South Plainfield, New Jersey. Other plants in New Bedford, Brookline and Worcester, Mass.; Providence, R. I., Indianapolis, Ind., and subsidiary, The Radiart Corp., Cleveland, Ohio.

SPECIFY "GREY TIGER"—A TYPICAL C-D FIRST!



CONSISTENTLY DEPENDABLE

CORNELL-DUBILIER

CAPACITORS • VIBRATORS • ANTENNAS • CONVERTERS



Announcing...

IMPROVEMENTS IN THE

BALLANTINE BATTERY OPERATED ELECTRONIC VOLTMETER

Achieving a tenfold increase in sensitivity, higher input impedance, improved low frequency response and substantial reduction in size and weight.



VOLTAGE RANGE:

100 microvolts to 100 volts in 6 decade ranges.

INPUT IMPEDANCE:

2.2 megohms shunted by 8 mmfd on high ranges and 15 mmfd on low ranges.

FREQUENCY RANGE:

2 cycles to 150,000 cycles.

ACCURACY:

3%, except 5% below 10 cycles and above 100,000 cycles.



MODEL 302B

Size: 6 $\frac{7}{8}$ " x 7 $\frac{1}{2}$ " x 12 $\frac{3}{8}$ ".

Weight: 17 lbs.

Price complete with cover and batteries: \$215.

- Available multipliers, amplifiers and shunts extend further the range and usefulness.
- Can also be used as a pre-amplifier with maximum gain of 60 DB.
- Features the well-known Ballantine logarithmic voltage and uniform DB scales.
- Battery life over 150 hours.

For further information on the Ballantine Model 302B and other Ballantine Sensitive Electronic Voltmeters and accessories measuring up to 5.5 megacycles, write for catalogue.

BALLANTINE LABORATORIES, INC.

100 FANNY ROAD, BOONTON, NEW JERSEY



clear definitions of each new concept or principle as it comes along. The author has tackled this job honestly and with considerable ability. It is inevitable that rough spots should occur, places where the student must ask a question and where the teacher will have to answer. For example, Professor Wright does not explain that Q is our symbol both for charge and for the ratio of reactance to resistance, and the student might wonder if they have any relation.—K. H.

Transformation Calculus and Electrical Transients

By STANFORD GOLDMAN, *Syracuse University*. Prentice-Hall Inc., New York, 1949, 439 pages, \$8.35.

THE primary purpose of this book is to present methods of solution of electrical transient problems in linear systems, both with lumped and with distributed parameters, including the problem of traveling waves on transmission lines. The presentation, in line with the modern trend, is based on the Laplace transformation, in contrast with the earlier methods utilizing the operational calculus of Heaviside. However, the scope is considerably broader than indicated by the title, and encompasses a range of topics in applied mathematics which form the basis of analysis of networks both in the transient and in the steady state. Thus the sections on determinants, mesh and nodal equations, and elements from complex variable theory provide a basis for the discussions of the attenuation and phase characteristics of systems as a function of frequency which are fundamental to the problems of stability in feedback systems. Chapters on gamma, error, and Bessel functions are fundamental to treatment of partial differential equations.

Written primarily as a text for senior and graduate students with a background knowledge of differential equations and of complex quantities as employed in a-c circuit analysis, the book will also serve those in research and development work with an aptitude for mathematics who need the modern concepts of network analysis, either

".. one of many
'firsts' at Rauland"...

says **Harold T. Cookson,**
manager, Hatry & Young, Lawrence, Mass.

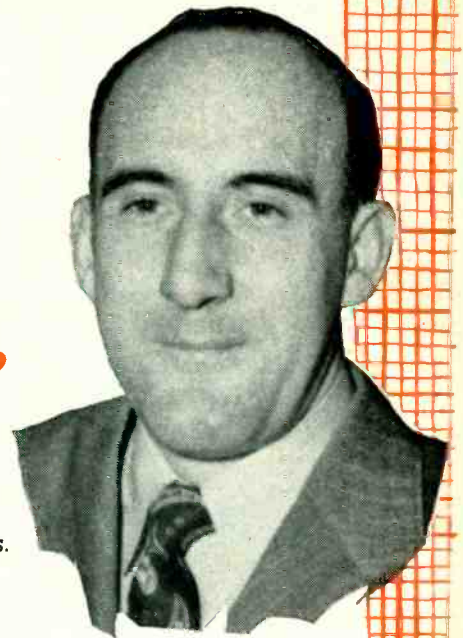

"My experience with Rauland picture tubes has shown that you have an outstanding product. Rauland research has developed feature after feature that result in easier servicing and better viewing. Your new Indicator Gun, for accurate ion trap magnet adjustment without

mirrors or guesswork, is one more of the many 'firsts' at Rauland that are contributing to television progress. And the variety of types offered, supplementing our regular tube line, enables us to give the complete picture tube service our customers expect."

From Rauland Research in the past year...

- The **FIRST** Luxide Screen ("Black" Tube)
- The **FIRST** Indicator Gun
- The **FIRST** 12" Metal Tube
- The **FIRST** Reflection-Proof Screen

THE RAULAND CORPORATION



Perfection Through Research

4245 N. KNOX AVENUE • CHICAGO 41, ILLINOIS



WEBSTER ELECTRIC

Ekotape

Network Model Tape Recorder



a complete tape recording system of the highest quality

Priced at
\$595⁰⁰

The Ekotape Network Model tape recorder has many features that make it popular with a large number of broadcasting stations. First, it is moderately priced and within range of many budgets. It is especially adapted to AM stations which want the $7\frac{1}{2}$ " per second tape speed for long playing time. It is simple to operate! A single knob controls record, playback, rewind and stop. A safety button interlock prevents accidental erasing. Fast forward (ten times normal) permits rapid cueing and selection of a desired portion of a program.

Other quality features are: overall

signal to noise ratio, including tape, is approximately 40 db . . . overall frequency response is within plus and minus 3 db from 80 to 6000 cycles per second . . . large, magnetically shielded motor is used to give $7\frac{1}{2}$ " per second tape speed . . . heavy balanced flywheel and integral capstan insure positive tape drive with a maximum "wow" of less than 0.1%. But the best way to appreciate the outstanding quality is to have the Ekotape Network Model demonstrated. Call Western Union Operator 25 for the name of your nearest dealer, or write direct.

WEBSTER ELECTRIC

Ekotape Pla-mate



Here is one of the finest lightweight portable tape recorders on the market today. It is just the unit for on-the-spot recordings or interviews where portability and outstanding tone quality are necessary. Write for full information or call your nearest dealer.

WEBSTER ELECTRIC
RACINE WISCONSIN
Established 1909

Webster Electric Company, Racine, Wisconsin
"Where Quality is a Responsibility and Fair Dealing an Obligation"

for application to strictly electrical systems or to servomechanisms. Some of the abstractions of the theory of complex variable may be difficult even for the engineer familiar with the algebra of complex numbers, but he can find a meaning for many of the principles in terms of field theory. However, this relationship is not emphasized here.

While the material presented represents an excellent collection from many sources, it can hardly be considered as a reference work for the specialist. As an engineering text many of the questions of mathematical rigor, particularly as related to the limit processes of improper integrals and infinite series, are not emphasized. It would be unfortunate if the beginner in this very extensive subject were given a false sense of security, and it is perhaps unfortunate that more opportunity has not been taken to point out some of the danger signals and to emphasize the validity conditions of the Laplace method.—
LAUREL J. LEWIS, Associate Professor of Electrical Engineering, University of Washington, Seattle, Washington.

Questions and Answers in Television Engineering

By CARTER V. RABINOFF and MAGDALENA E. WOLBRECHT. McGraw-Hill Book Co., New York, 1950, 300 pages, \$4.50.

DIFFERENT people learn by different pedagogical tricks. One technique that is particularly helpful in review is the asking of pertinent questions and, when the questioner is a book, supplying concise and informative answers. The authors cover the whole field of television in this way by using twelve chapter groupings, asking and answering in each the more important and difficult questions. Besides discussing technical circuitry, the book covers photoelectric cells, optical systems, illumination and television standards, laws and regulations. There are twelve pages devoted to two standard television broadcast receivers. Although it will be helpful to prospective broadcast operators studying for FCC license ex-

Microline

* CROSS-GUIDE
DIRECTIONAL COUPLERS

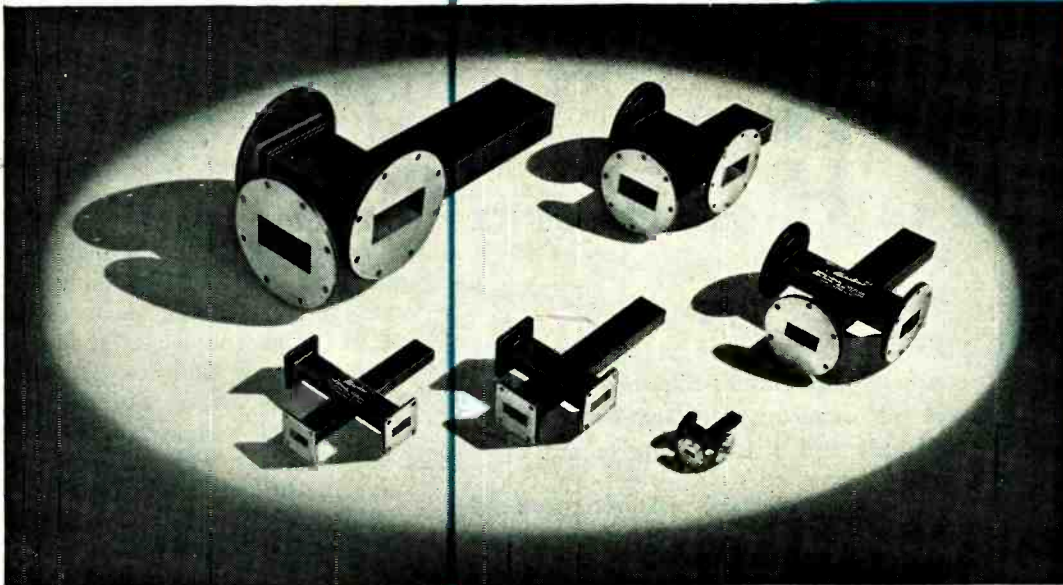

■ Sperry has a complete line of Cross-Guide Directional Couplers for all frequencies ranging from 2600 to 40,000 mc. These couplers are superior to other types of directional couplers in high directivity and unusually uniform coupling characteristics.

■ The coupling varies less than 3 db over the entire useful frequency band of the waveguide transmission line, whereas other types of couplers have attenuation which varies rapidly with frequency. Calibration accuracy on these instruments is ± 0.5 db through the quoted range. Operating temperature range is from -40° to $+55^\circ$ C and humidity effects are negligible.

■ Cross-Guide Directional Couplers, part of Sperry's MICROLINE*, are versatile, precision instruments well adapted for general laboratory and pro-

duction test work. They differ in appearance only in their external dimensions. Each consists of two rectangular waveguides, a primary and secondary guide, joined perpendicularly to each other. Coupling is provided by slots cut in the common wall between the waveguides. One end of the secondary waveguide is terminated in a matched load.

■ In addition to the superior electrical properties of the Cross-Guide Directional Couplers, they are also physically constructed for convenient assembly into a waveguide system. Our Industrial Department will be glad to give you additional information on these as well as other MICROLINE instruments.

ELECTRICAL CHARACTERISTICS			LINE AND CONNECTOR TYPES		
Model No.	Frequency Range (Kmc)	Nominal Coupling (Db)	Waveguide		Connectors Both Arms AN Type
			AN Type	Size (in.-O.D.)	
306	2.6-4.0	30	RG-58/U	3x1½x.080	UG-214/U
233	4.0-6.0	24	RG-49/U	2x1x.064	UG-149A/U
321	4.0-6.0	30			
322	4.0-6.0	40			
209	5.3-8.1	24	RG-50/U	1½x¾x.064	UG-344/U
237	5.3-8.1	30			
235	8.1-12.4	20	RG-52/U	1x½x.050	UG-39/U
236	8.1-12.4	24			
234	8.1-12.4	40			
388	12.4-17.0	20	RG-91/U	.702x.391x.040	UG-419/U
413	18.0-26.5	20	RG-53/U	½x¼x.040	UG-425/U
415	18.0-26.5	40			
405	26.5-36.0	20	RG-96/U	.360x.220x.040	UG-381/U

*TRADE MARK

SPERRY

GYROSCOPE COMPANY

DIVISION OF THE SPERRY CORPORATION, GREAT NECK, NEW YORK • NEW YORK • CLEVELAND • NEW ORLEANS • LOS ANGELES • SAN FRANCISCO • SEATTLE

H

IS FOR HORNET

CLASS H

HIGH VOLTAGE

KNOW HOW

AND THEY MAKE AN H OF A DIFFERENCE



HORNET Transformers provide minimum size, maximum efficiency and greatest life expectancy in transformers for portable and airborne equipment.

Because they are manufactured of newly developed Class H materials — silicones, fiberglas and special steels — HORNET miniature transformers can be operated at temperatures far in excess of the so-called “normal range.”

Compare These Typical Volume and Weight Figures

PLATE TRANSFORMER: Primary 115V., 380/1600cps. Secondary 860V. C.T. 70 MA-RMS, 60 V.A. (85 deg.C. ambient, 50,000 ft. alt.)					
	Max. Oper. Temp. Deg.C.	Volume Cu. Ins.	Relative Volume Percent	Weight Pounds	Relative Weight Percent
Hermetically Sealed (Class A insulation)	105	21.3	100	2.0	100
Open Construction (Class A insulation)	105	11.0	54.2	1.2	60
HORNET (Class H insulation)	200	6.5	30.5	.33	16.5

The HORNET represents a combination of ingenious design, modern materials, and radically different manufacturing techniques which opens vast new fields in transformer construction and application.



Send for your copy of Bulletin B-300, containing detailed size, weight and rating information on Hornet Transformers and Reactors.



**NEW YORK
TRANSFORMER CO., INC.**
ALPHA, NEW JERSEY

aminations, this volume should not be confused with the standard question and answer book based upon announced examination content.—
A. A. MCK.

Outline of Radio, Television and Radar

Symposium BY R. S. ELVEN, T. J. FIELDING, E. MOLLOY, H. E. PENROSE, C. A. QUARRINGTON, M. G. SAY, R. C. WALKER and G. WINDRED. *Chemical Pub. Co., Brooklyn, N. Y., 1950, 688 pages, \$12.00.*

EIGHT British engineers teamed together here to produce a husky volume that would have been a tremendous job for one alone, covering as it does the whole broad field of radio and its affiliates. The level of writing is for the student, serviceman and radio amateur, yet even engineers will find much of value in the sections dealing with new British developments in television, radar, photoelectricity and direction-finding. Extensive use of British terminology throughout, along with descriptions and illustrations of British products, may bother newcomers to the field and preclude classroom use as a study text, but does not impair the usefulness of the book to those seeking to keep in touch with British practice.—J.M.

Radio Handbook

Edited by R. L. DAWLEY. Editors and Engineers, Ltd., Santa Barbara, California, 1949, 320 pages, \$3.25.

EACH YEAR, hundreds of amateurs buy new copies of annual publications in their field, not for the basic theory and principles presented, but for up-to-date information on equipment and construction practices. The twelfth edition of the Radio Handbook is an all-constructional edition with approximately 75 different topics and projects. In addition to a large number of transmitter and receiver projects, the book includes complete discussions of mobile operation and equipment design, and corrective measures for

NEW INTERLEAVE COIL WINDER IS FULLY AUTOMATIC

Universal's new high speed automatic No. 107 winder produces accurately-wound paper-insulated or acetate-insulated coils at a very high rate of output.

Automatic feeding Single or laminated insulating sheets are fed into the machine automatically. Rate of feed, with either paper or acetate, can be as high as 25 inserts per minute.

Thus, on a coil containing 100 wire turns per layer, the machine can be operated at winding speeds up to and including 2500 rpm.

An entirely new type of delivery shelf has been designed to provide high accuracy. It imparts a uniform backward pull on the paper as it is fed into the coil, resulting in windings of highest possible density.

This delivery shelf will handle insulating papers, either "Kraft" or "Glassine," from .0006 in. to .003 in. in thickness, and where the machine is equipped with devices for removing static, acetate sheet is handled at high winding rates.

The machine utilizes a single width of insulating paper, and this can be 24 in. or up to 25 in. maximum if required.

Accurate wire control Wire sizes accommodated range between No. 19 and No. 42 (B&S). The creel stand is independently mounted, and holds up to 30 wire spools at a time,

The wire spool spindle is of the latest design, with solid construction. The braking device is mounted on the rear of the ma-

chine to give better balance between the wire spools and the higher winding speed.

Efficient winding A quick return of the wire guides is assured at the end of each wire layer, and thus there is no possibility of crossed turns due to delayed return, particularly where wear develops.

The same efficient traverse mechanism used in the Universal No. 105 Coil Winder has been adopted for the No. 107. No changes in cam are necessary for various lengths of wire layer.

Special attachments These include an auxiliary "space-wind" traverse for spacing the first and last layers of high-tension coils. A special "mid-tap" attachment permits shifting the wire guides at the end of a wire layer for "tap"

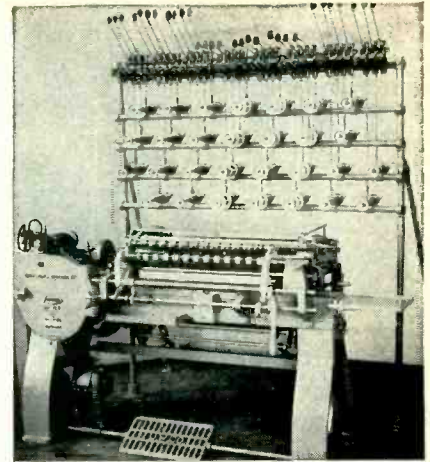

No. 107 Universal Coil Winder.

location or to arrange for starting and finishing leads.

Where required, a "dual-counter" is available so that the machine will stop automatically for the removal of a mid-tap.

The new No. 107 Coil Winder has already demonstrated, in preliminary installations in plants of several prominent electrical manufacturing plants, its ability to turn out coils of the highest quality.

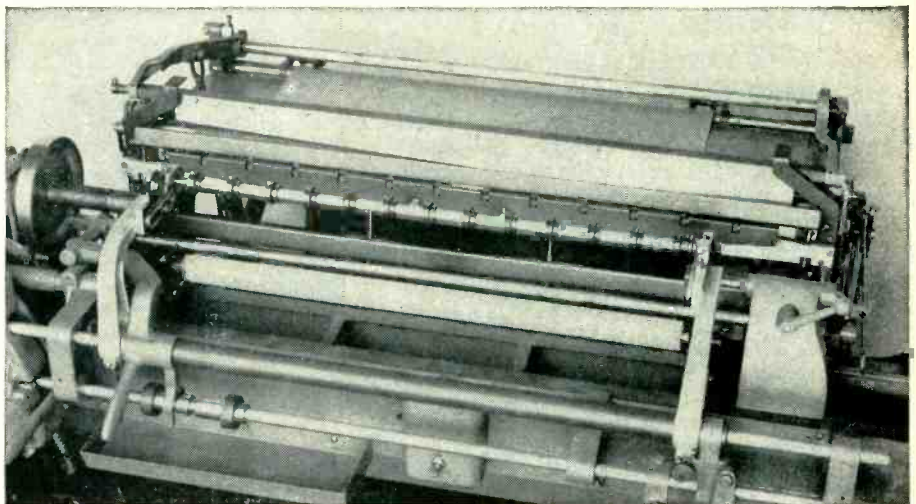

Closeup showing coil arbor in transfer position.

UNIVERSAL WINDING COMPANY

P. O. Box 1605 Providence 1, R. I.

* REG. U. S. PAT. OFF.



FOR WINDING COILS IN QUANTITY
ACCURATELY . . . AUTOMATICALLY
USE UNIVERSAL WINDING MACHINES

Don't draw it- Photograph it!

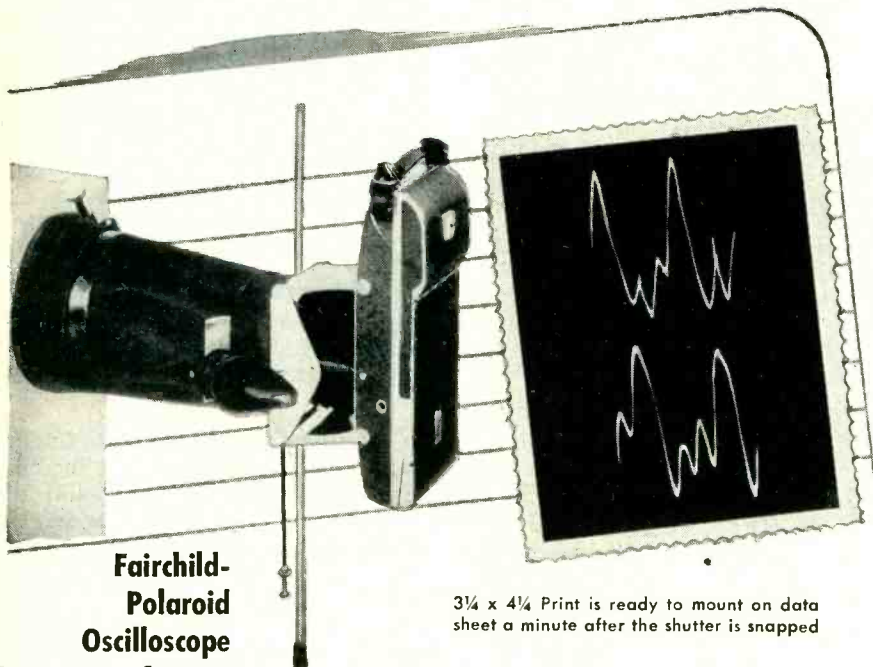

**Fairchild-
Polaroid
Oscilloscope
Camera**

3¼ x 4¼ Print is ready to mount on data sheet a minute after the shutter is snapped

Fairchild now offers an inexpensive oscilloscope camera that gives you accurate photographic records of waveshapes in almost as little time as it takes to sketch them from memory. Only one minute after the shutter is snapped, a print is ready to mount in your notebook. This permits you to evaluate oscilloscope "stills" immediately and then proceed with laboratory work.

The 3¼ x 4¼ print is small enough to mount easily in a notebook or on a data sheet, large enough for accurate evaluation. Each print records two traces to facilitate comparison runs and cut film costs in half. Operation is simple — no focusing, no darkroom processing. You just snap the shutter and remove the print from the back of the camera.

The complete Fairchild-Polaroid Oscilloscope Camera consists of a *scope adapter* to fit any five-inch oscilloscope, a *light-tight hood* with viewing port, and a *Polaroid-Land Camera body* with special lens and two-position shift device.

Write today for complete details and prices on the ready-to-use F-284 Oscilloscope Camera Kit including camera,

carrying case, and Polaroid film. *Fairchild Camera and Instrument Corp.*, 88-06 Van Wyck Blvd., Jamaica 1, N. Y. Distributors: *Tektronix Inc.*, Portland, Oregon; *Electronic Tube Corp.*, Philadelphia, Pa.

Specifications

Lens — Special 75 mm. f/2.8 Wollensak Oscillo-anastigmat.

Shutter — Wollensak Alphax; speeds 1/25 sec. to 1/100 sec., "time," and "bulb."

Focus — Fixed (approx. 8 in.).

Picture Size — 3¼ x 4¼ in. (2 images per print; 16 exposures per roll of film).

Image Size — One-half reduction of scope image.

Writing Speed — to 1 in/μsec at 3000V accelerating potential; higher speeds at higher voltages.

Dimensions — Camera, 10½ x 5¼ x 6¼ in.; hood, 11 in. length, 7½ in. dia.; adapter, 2 in. width, 6½ in. max. dia.

Weight — Complete, 7¾ lb.

television and broadcast interference.

As in the already popular eleventh edition, construction and operating instructions are given in complete and easily understood detail. This edition does not supersede the 11th edition, which contains different information and remains current. —J.D.F.

THUMBNAIL REVIEWS

PATENT PRACTICE & MANAGEMENT. By Robert Calvert. Scarsdale Press, Scarsdale, N. Y., 1950, 371 pages, \$5.00. Written for inventors and executives, presenting essentials of obtaining and using patents, plus human-interest aspects such as patent office psychology, inventor morale in organizations, secrecy aspects of inventions, advisability of infringing patents, hazards of infringing and being infringed, settlement of interferences, and similar topics going far beyond the drab legal aspects of patents.

SERVICING TV RECEIVERS. Sylvania Electric Products Inc., New York, 1950, 128 pages, \$2.00 at Sylvania distributors. Loose-leaf compilation of 53 screen patterns illustrating poor circuit operation, with cause and remedy for each, along with chapters on television receiver adjustments, servicing techniques, and oscilloscope patterns.

16-MM SOUND MOTION PICTURES. By W. H. Offenhauser, Jr. Interscience Publishers, Inc., New York, 1949, 592 pages, \$10.00. Making a 16-mm picture; characteristics of film, cameras and equipment; sound recording; editing; projection; industrial applications; television applications (about 25 percent of tv air time today comes from 16-mm film).

PULSES AND TRANSIENTS IN COMMUNICATION CIRCUITS. By Colin Cherry. Dover Publications, Inc., New York, N. Y., 1950, 317 pages, \$3.95. American edition of book first published in England and reviewed in *ELECTRONICS*, p 234, Nov. 1949.

40 USES FOR GERMANIUM DIODES. Published by Sylvania Electric Products Inc., New York, 1950, 47 pages, \$1.00. Circuits and utilization data, including crystal sets, tv and f-m receiver stages measuring instruments, d-c amplifier, audio oscillators, transmitter failure alarm, limiter, frequency doubler and tripler, and radio control circuit for models, all with crystals in place of tubes, plus tabulated characteristics of crystal diodes.

SCHEMATIC MANUAL FOR SURPLUS ELECTRONIC EQUIPMENT, VOLUME III, F-M RECEIVERS AND TRANSMITTERS. PB100043, 44 pages, \$1 from Office of Technical Services, U. S. Department of Commerce, Washington 25, D. C. Covers BC-603, BC-604, BC-605, BC-620, BC-659, BC-923, BC-924 and PE-97-A assemblies, which include BC-683, BC-684, SCR-508, SCR-509, SCR-510, SCR-528, SCR-538, SCR-608, SCR-609, SCR-610, SCR-628 and SCR-808. Volume II on A-M Receivers and Transmitters (PB 99539) and Volume I (PB 98487) are still available, at \$1 each also. Each volume provides basic circuit diagrams, part values and voltages.

SALES ENGINEERING. By Bernard Lester. John Wiley & Sons, New York, Second Edition, 1950, 226 pages, \$3.00. Rearrangement and expansion of text of first edition, with additional practical examples dealing with improved techniques of selling equipment and services that require engineering skill in their selection, application and use.



FOR BETTER TUBE PERFORMANCE

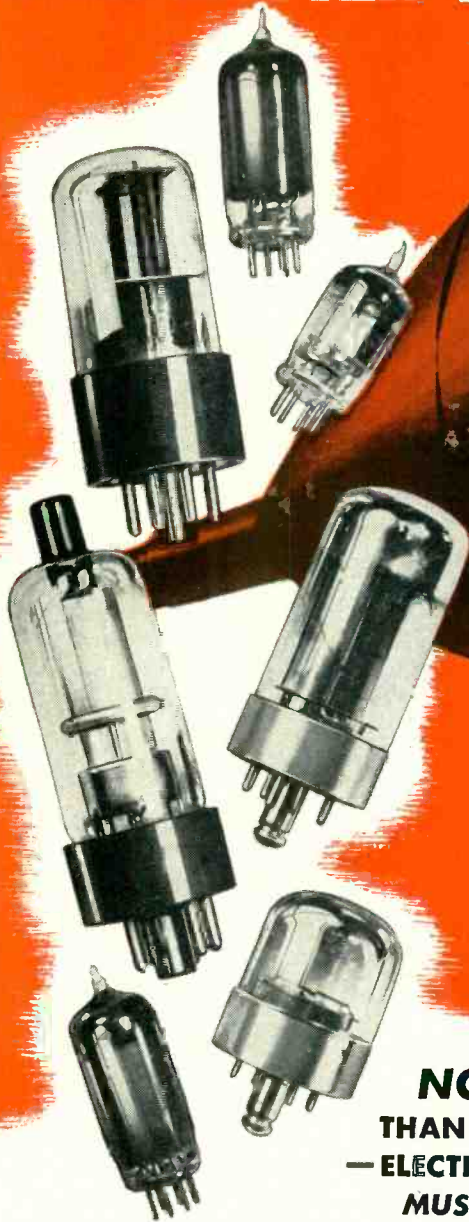

*-definitely
in the
picture!*

FILAMENT BASE METALS

SYLVALOY
MODIFIED HILO
COBANIC
TENSITE
UNIMET

CARBONIZED NICKEL

RADIOCARB
DUOCARB
POLICARB

GRID WIRE

MANGRID

**NOW—MORE
THAN EVER BEFORE
—ELECTRICAL ALLOYS
MUST BE BETTER**

The critical requirements of television circuits demand better tubes with finer electrical alloys — alloys that are superior electrically, chemically and in physical properties. A logical source for metals to meet these new standards is the Wilbur B. Driver Company, largest producer of carbonized nickel ribbon and filament alloys for more than twenty years. Inquiries concerning critical tube applications will receive prompt, capable attention. Write today, outlining your requirements — there is no obligation.

WILBUR B. DRIVER CO.

150 RIVERSIDE AVE., NEWARK 4, NEW JERSEY



Timing Ideas

WHEN TIMING COUNTS



You can always count on Haydon to provide the right motor for your timing job. Timing Headquarters offers a broad line of efficient, economical timing motors and timers produced by specialists who have no other interest than to provide the best in timing.

LOW COST VERSATILITY—1600 SERIES:

Specifically designed as a standard component for the widest possible range of timing applications with 79 speeds from 300 rpm to 1 revolution per 4 hours.

COMPACTNESS AND SLOW SPEED—4400 SERIES:

Designed for small size and low cost in applications requiring slower speeds from 6 hours to 7 days per revolution.

HEAVY DUTY DEPENDABILITY—3100 SERIES:

For control and instrument applications that require a heavy duty train and speeds from 1 hour to 14 days per revolution.

SUPERIORITY FEATURES

Slow (450 rpm) rotor speed makes for quiet operation and long life. Unusually small. All motors totally enclosed. Separate rotor and reduction gearing lubricating systems permit selection of best methods and lubricants, control circulation, insure against leakage. Operates continuously in any position. Simple to mount, entire face of motor can be supported securely against mounting surface. Standard, interchangeable design in only 2 motor series with speed range from 300 rpm to 1 revolution in 7 days.

For complete design and engineering specifications, write for catalog: Timing Motors No. 322 — Timers No. 323 — Clock Movements No. 324. Yours without obligation.



1600



4400

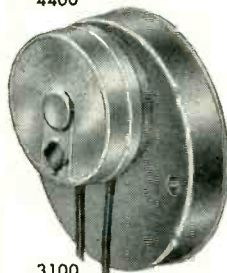

3100



TUBES AT WORK

(Continued from p 118)

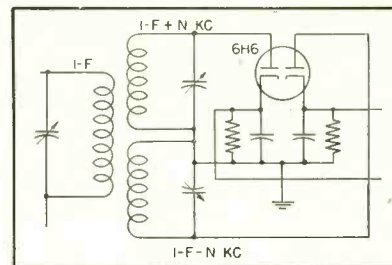

FIG. 2—For special applications, such as telemetering and telecontrol, the Doppelganger discriminator may be more useful

less of signal strength, d-c output at resonance is zero, and polarization of the output is a function of the direction of frequency deviation only. In consequence, this type of discriminator will indicate resonance, and direction off resonance, even when the signal strength varies beyond the ability of the afc to keep it constant. A Foster-Seeley discriminator is contained in the tuning indicator circuit of Fig. 1.

Doppelganger Alternative

Similar in output characteristics and tube requirements is the Doppelganger discriminator, which consists of an output circuit, tuned to the desired frequency, and two secondaries, one tuned slightly above the desired frequency, and the other the same amount below it (Fig. 2). The output characteristic can be similar to that of the Foster-Seeley discriminator. By changes in the tuning of the diode circuits, the shape of the central portion of the curve can be modified considerably. When N (Fig. 2) is quite large (more than about 5 kc), the central portion of the output curve is quite flat, indicating relative insensitivity, and difference potential increasing much faster than frequency difference on both sides of the resonant point. This type of response is useful in some types of afc as it may be used to reduce the effects of overshooting and hunting.

When N is quite small (less than about 1 kc), the central part of the curve is very steep, indicating extreme sensitivity close to the resonant point, and difference potential increasing more slowly than frequency difference as the input frequency approaches that to which either diode tank is tuned. This

HAYDON

AT TORRINGTON

HEADQUARTERS FOR

TIMING

HAYDON Manufacturing Co., Inc.

2432 ELM STREET

TORRINGTON, CONNECTICUT

SUBSIDIARY OF GENERAL TIME CORPORATION

Truarc E-Rings Improve Performance of Detachable Chain...5 ways!

COTTER PIN chain

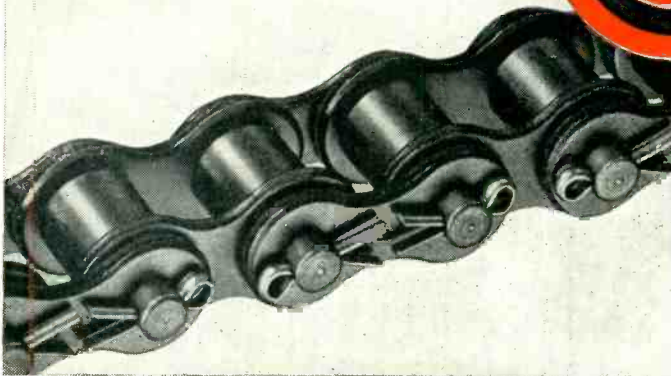

TRUARC RING chain



In every possible kind of test—tensile, impact, shock, speed—detachable chain made with Truarc Rings outperforms chain equipped with cotter pins! That's what Atlas Chain & Manufacturing Co., Philadelphia, discovered, after pioneering chain with Truarc E-Rings.

Improve your own product with Truarc Rings! Whenever you use machined shoulders, collars, cotter pins, bolts, nuts, screws, snap rings... a Truarc Ring will do the job better: improve performance, cut unit cost, save space and weight, eliminate parts, permit use of stock sizes, eliminate skilled labor operations, simplify maintenance.

Truarc Rings are precision-engineered. Quick and easy to assemble, disassemble. Give a never-failing grip. Can be used over and over again.

Find out what Truarc Rings can do for you. Send your blueprints to Waldes Truarc engineers, for individual attention, without obligation.

Waldes Truarc Retaining Rings are available for immediate delivery from leading ball bearing distributors throughout the country.

1. STRONGER. Average 30% higher *static thrust strength* than cotter pins. Resilient E-Ring reinforces links against exceptional *side stress*—resilient spring is most efficient means of damping vibration.

2. GREATER SHOCK RESISTANCE. Higher *shock strength ratios* than cotter pins, due to greater contact surface plus spring reaction for damping moment of shock. Circular movement of ring in groove relieves *shock surface loadings*—instead of resisting rigidly as with cotter pins in fixed holes.

3. HIGH SHOULDER. High effective bearing shoulder extends practically all around pin, and is geometrically perfectly proportioned to link diameter.

4. RE-USABLE. No part of E-Ring fatigues and breaks off, as with ends of re-used cotter pins. Ring removes easily with screwdriver.

5. REDUCES ACCIDENTS. Does not protrude to catch onto clothing. No sharp-pointed ends to produce electrical brush discharge and resultant fire and explosion hazard in mines and mills.

SEND FOR NEW CATALOG →

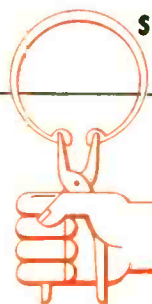

**WALDES
TRUARC**

REG. U. S. PAT. OFF.

RETAINING RINGS

WALDES KOHINOOR, INC., LONG ISLAND CITY 1, NEW YORK
WALDES TRUARC RETAINING RINGS ARE PROTECTED BY THE FOLLOWING PATENT NUMBERS: U. S. PAT. 2,382,948;
2,420,921; 2,411,761; 2,487,803; 2,487,802; 2,491,306 AND OTHER PATS. PEND.



Waldes Kohinoor, Inc., 47-16 Austel Place
Long Island City 1, N. Y.

E 082

Please send the new catalog on
Waldes Truarc Retaining Rings.

Name _____

Title _____

Company _____

Business Address _____

City _____ Zone _____ State _____ ★

MOSINEE

"More than Paper"

 In the field of electronics and the electrical goods industry, MOSINEE is known for its *dependable uniformity*, and its scientifically controlled physical and chemical properties, such as:

Good dielectric strength . . .
proper softness or stiffness . . .
high tensile or tear strength . . .
creped with controlled stretch or flexibility . . . specified pH for maximum-minimum acidity or alkalinity . . . accurate caliper, density, liquid repellency or absorbency.

If you have a fabricating or processing problem involving paper, a discussion with MOSINEE technicians might prove helpful. Please write Dept. E .



MOSINEE PAPER MILLS COMPANY, MOSINEE, WIS.

"Essential Paper Manufacturers"

TUBES AT WORK

(continued)

type of characteristic is useful in some servo-mechanism applications, where a close approach to snap action is desired when the frequency difference changes from plus to minus.

Flexibility of the Doppelganger discriminator fits it admirably for many special applications, but its additional parts requirements, and the comparative difficulty of tuning its various circuits to the requisite frequencies, limit its use to special applications.

If a zero-center microammeter is connected across the cathodes of the dual diode in either type of discriminator, it can be used to indicate whether or not an incoming signal is in resonance with the tuned circuits. To fit a particular requirement, some additional equipment to permit the use of a less sensitive indicating device was found desirable.

If the diode cathodes are connected to the grids of two triodes, each acting as a crude vacuum-tube voltmeter, and the plate circuits arranged in a bridge circuit, a relatively insensitive instrument can be used as a resonance indicator.

Coupling Methods

Experiments showed that operation from a moderately efficient buffer amplifier is desirable. A single-stage buffer may be coupled to the last i-f output in a variety of ways. The two most satisfactory methods of coupling for this special application were found to be by means of a 50- μ f capacitor from the i-f plate to the grid of the buffer amplifier; and by use of a larger capacitor from the suppressor of the last i-f tube to the grid of the buffer. The suppressor was isolated from ground, with respect to r-f, by means of a choke. Both methods of coupling required a slight re-tuning of the i-f plate circuit, but introduced no oscillation or other trouble.

The final circuit of Fig. 1 was found to be entirely adequate for resonance indication with almost any signal that could be perceived in the output of any standard super-heterodyne receiver.

The diode load capacitors and resistors are critical, not to value, but each pair must be matched

A New, MODERATELY Priced G-R A-C VACUUM TUBE VOLTMETER

- **FIVE RANGES:** four scales cover the 5 ranges from 0.1 to 150 volts, a-c (full scale 1.5, 5, 15, 50, and 150 volts)
- **ACCURATE:** $\pm 3\%$ of full-scale on all ranges; r-m-s values of sine-wave voltage
- **FREQUENCY RANGE:** without correction, up to 120 Mc with maximum error of 10%; correction curve supplied
- **INPUT IMPEDANCE:** equivalent input capacitance of probe is 11.5 μf ; with plug connectors 12 μf ; equivalent parallel input resistance 7.7 megohms at low frequencies
- **SINGLE ZERO ADJUSTMENT:** for all ranges
- **INTERNAL CALIBRATION CONTROL:** single adjustable resistor corrects calibration if amplifier tube is changed
- **AUXILIARY CONNECTORS:** G-R double plug, pair of 30-inch test leads, pair of test prods and two alligator clips supplied as convenient accessories
- **SMALL — LIGHT WEIGHT:** only $9\frac{1}{4}$ pounds

TYPE 1803-A A-C VACUUM-TUBE VOLTMETER \$145

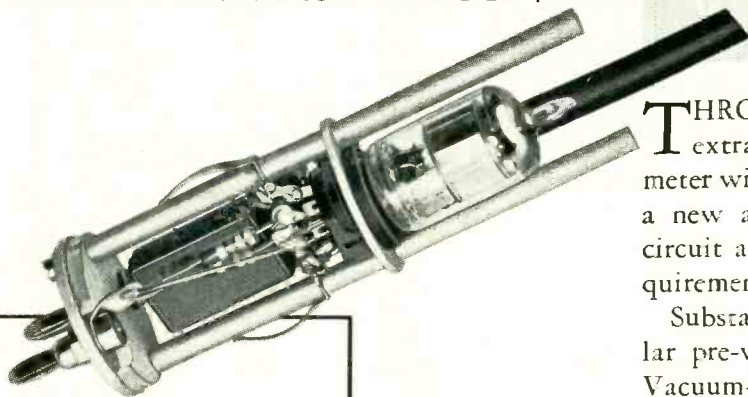
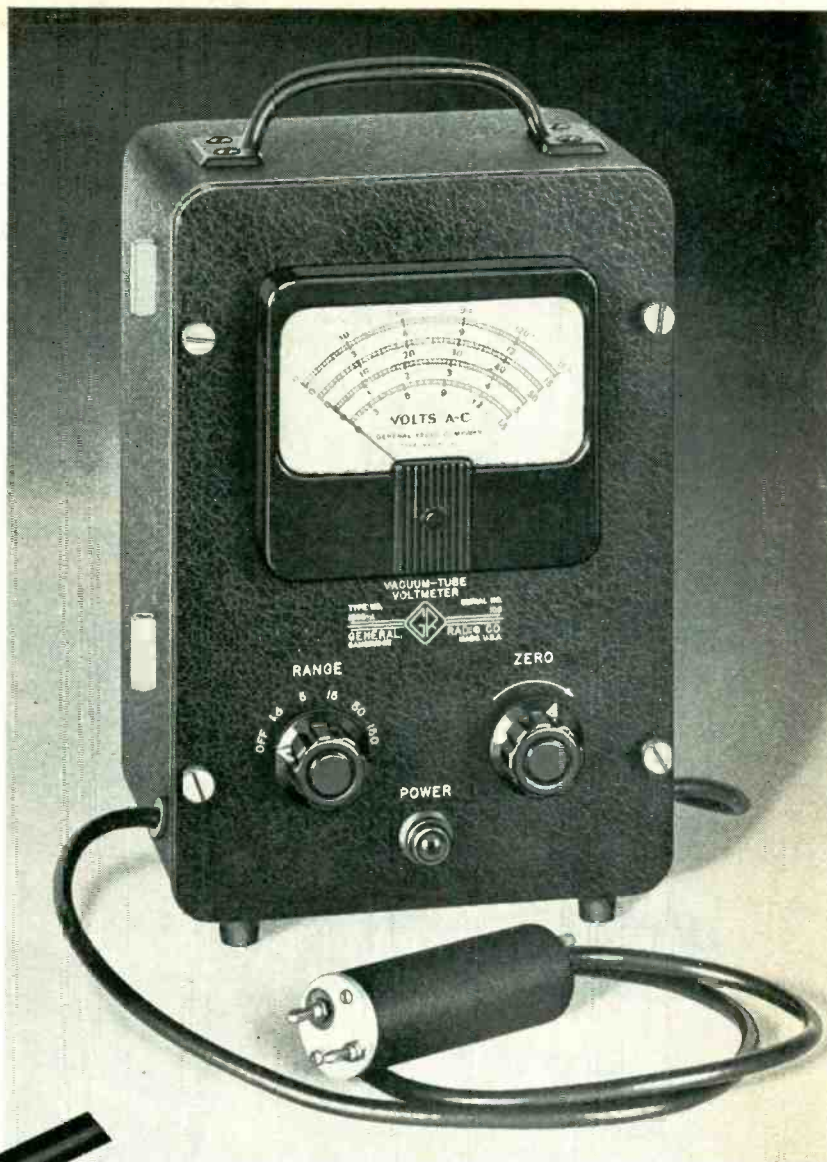

Probe with completely shielded case removed. Twin diode tube in the probe has an inactive section connected to the grid of one triode in the V-2 amplifier while the active section is connected to the grid of the other triode, both sections of the amplifier being used in a balanced circuit. The balanced amplifier insures very little zero shift when the line voltage varies.

THROUGH the elimination of many unnecessary frills and extra circuit refinements which would be necessary in a meter with ohmmeter and d-c circuits and scales, G-R announces a new a-c vacuum-tube voltmeter with a straightforward circuit and with accuracies sufficient for most laboratory requirements, at a very moderate price.

Substantially duplicating the performance of the very popular pre-war Type 726-A instrument, the new Type 1803-A Vacuum-Tube Voltmeter sells for less than its predecessor and is improved over the older model in that it is smaller, lighter, has a probe which is smaller and completely shielded, a single zero adjustment for all ranges and a power supply not limited to operation at a single frequency.

The probe plugs into the connectors on the side of the cabinet, in which position the auxiliary test leads and terminals supplied with the instrument can be attached conveniently to the input connections.

This instrument should find wide application in many laboratories operating on a modest budget. Its accuracy is sufficient for the majority of laboratory measurements.

WRITE FOR COMPLETE DATA



GENERAL RADIO COMPANY

Cambridge 39,
Massachusetts

90 West St., New York 6 920 S. Michigan Ave., Chicago 5 1000 N. Seward St., Los Angeles 38

DIRECT WRITING RECORDERS

Records are produced by a heated writing stylus in contact with heat sensitive paper. The paper is pulled over a sharp edge in the paper drive mechanism (standard speed 25 mm/sec., slower available) and the stylus wipes along this edge as it swings, thus producing records in *true rectangular coordinates*. The writing arm is driven by a D'Arsonval moving coil Galvanometer with an extremely high torque movement (200,000 dyne cms per cm deflection).

This recorder assembly may be obtained in bare chassis form, as illustrated (51-600) with or without built-in timer; or, with the addition of a stylus heating transformer, temperature controls, and control panel (127); or, with the entire assembly, controls and control panel enclosed in a mahogany carrying case (127C). Complete catalog available, see below.

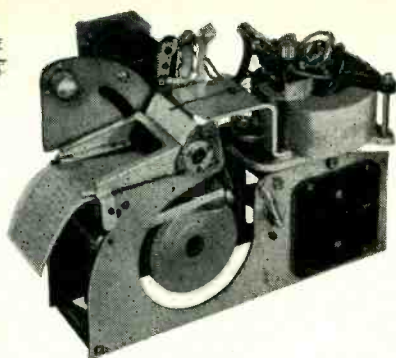

SINGLE CHANNEL
NO INK
RECTANGULAR COORDINATES
PERMANENT RECORDS

INSTRUMENT AMPLIFIERS

A general purpose, A.C. operated driver amplifier for use with model 127 Recorder, comprising three direct coupled push-pull stages. Maximum sensitivity 50 mv. per cm., minimum sensitivity 50 volts per cm., with four intermediate ranges. Balanced input terminals available with impedances of 5 megohms to ground. Complete information in catalog shown below.



AMPLIFIER-RECORDERS

Model shown at right is a single channel unit comprising above Amplifier 126 and Recorder 127, contained in one mahogany carrying case, and designed for use in the industrial field as a direct writing vacuum tube recording voltmeter capable of reproducing any electrical phenomena from the order of a few millivolts to more than 200 volts. More complete data in catalog shown below.

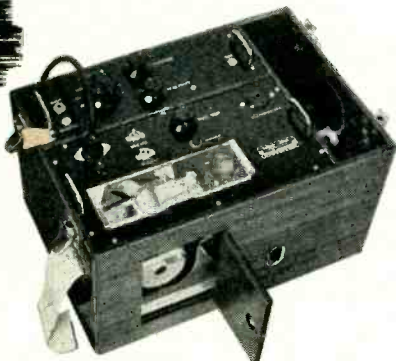

MULTI-CHANNEL
NO INK
RECTANGULAR COORDINATES
PERMANENT RECORDS

At lower right is a typical "Poly-Viso" multiple channel direct writing Recorder and Amplifier in console. Numerous combinations of this recording equipment and associated amplifiers and accessories are available. The Multi-channel Recorder (Model 165) provides for the simultaneous registration of up to four input phenomena, using the same principles and method as for the Recorder Assembly above. In addition, the "Poly-Viso" Recorder provides a selection of eight paper speeds: 50, 25, 10, 5, 2.5, 1.0, 0.5 and 0.25 mm/sec., and for the use of 4, 2, or 1 channel recording Permapaper. The Amplifier equipment is housed in a rack which has space for four individual driver amplifiers (electrically identical to model 126, above) and one 4-channel preamplifier.



For complete catalog giving tables of constants, sizes and weights, illustrations, general description, and prices, address:

SANBORN COMPANY
Industrial Division
CAMBRIDGE 39, MASS.

TUBES AT WORK

(continued)

within about 1 percent. If the resistors are not matched, the voltage output will not be balanced when input is balanced; and if the capacitances are not equal, the time constants of the two halves of the circuit will be unequal, so that the indicator will be sensitive to fading and will have an unreliable response during tuning.

The entire indicator, including the power supply, can be constructed in a 5 by 6 by 9 inch case without difficulty. The panel of the instrument is so arranged that the CHECK METER position is at the left, CHECK BALANCE at right, and operating (both check circuits, Fig. 1, open) at center. The indicator is a standard 0-1 milliammeter internally readjusted for zero center.

Without ventilation, the case has

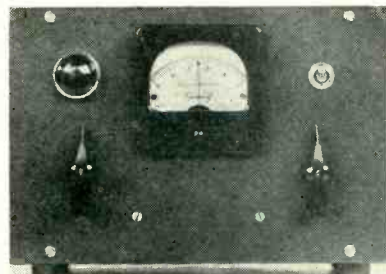

FIG. 3—Panel of the indicator contains balancing potentiometer at lower left and checking switch at lower right

an internal equilibrium temperature of about 250 F, which it attains in about 40 minutes. With a 2½-inch grille opening in the center of the back of the case, and a 1-inch grille hole in the center of the bottom, the internal equilibrium temperature of the case falls to about 130 F, and is reached in about 10 minutes. With this type of ventilation, the diode load components, which must remain equal in value at all operating temperatures, not only have substantially even ventilation, but are kept very near room temperature. Adequate ventilation is extremely important in minimizing frequency drift.

The coupling capacitor, a small trimmer, and the grid resistor of the buffer amplifier are permanently installed in the receiver. Connection from receiver to resonance indicator is made by means of a shielded cable, with a plug connector at the receiver. Flexing of a

Sanborn Recorders and Amplifiers have evolved from those originally designed by Sanborn Company for use in electrocardiographs, and have, by actual practice, proven to have wide applications in the industrial field as well.

**Longer Life
On the Shelf!**

Irv-O-Flex tubing exhibits much greater shelf life! No longer need you worry over "first in, first out" inventory control! Use up Irv-O-Flex tubing to suit your own production scheduling!



**NEW! IRV-O-FLEX® TUBING
Gives Longer Life!**

**Longer Life
On the Job!**

The longer-lasting flexibility of Irv-O-Flex tubing enhances the durability of your products. Disassembly, servicing, and re-assembly are greatly simplified with this new longer-life tubing!

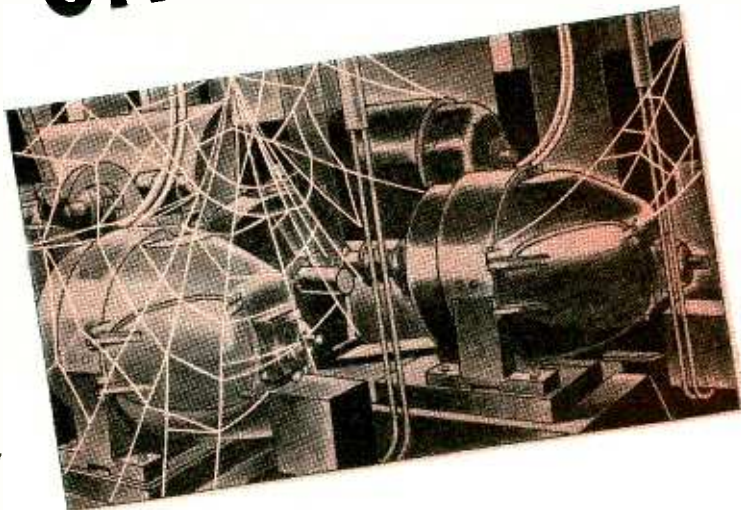

Look to Irvington
for Insulation Leadership



At last you can get tubing that *stays flexible* on the shelf, *stays flexible* on the job! Outstanding improvements in resins and processing methods—results of Irvington's unceasing research—have culminated in Irv-O-Flex—a new insulating tubing of greatly extended flexibility. So superior, in fact, are its age-resisting characteristics that you can forget shelf-life worries, forget servicing difficulties, forget replacement troubles!

Irv-O-Flex tubing incorporates a tough, sturdy braid coated with an exclusive new Irvington synthetic resin. Both physical and electrical properties are outstanding. You'll want to test this versatile new tubing yourself—be sure to write for technical data, test reports, samples!

IRVINGTON VARNISH & INSULATOR COMPANY
Irvington 11, New Jersey

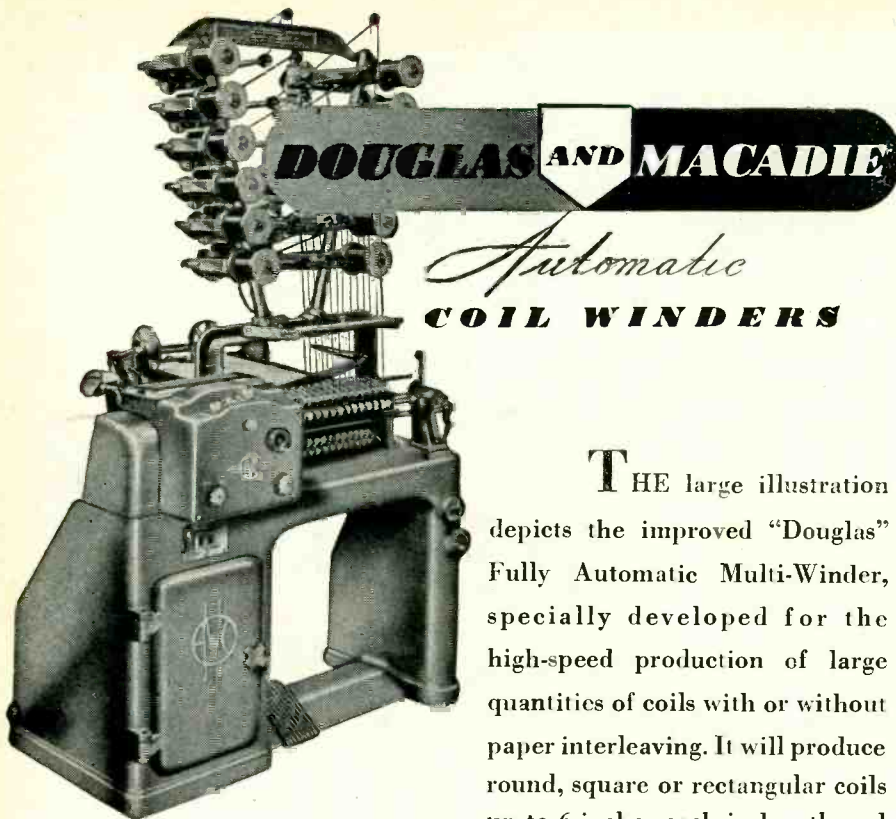

THE large illustration depicts the improved "Douglas" Fully Automatic Multi-Winder, specially developed for the high-speed production of large quantities of coils with or without paper interleaving. It will produce round, square or rectangular coils up to 6 inches each in length and up to $4\frac{1}{2}$ inches diameter. As many as twelve smaller coils can be wound simultaneously within the total available winding length of 12 inches at headstock speeds of between 600 and 2,000 revolutions per minute.

Numerous other Coil Winding and Taping Machines are illustrated in our complete Catalogue, a copy of which will be sent to interested executives on application.

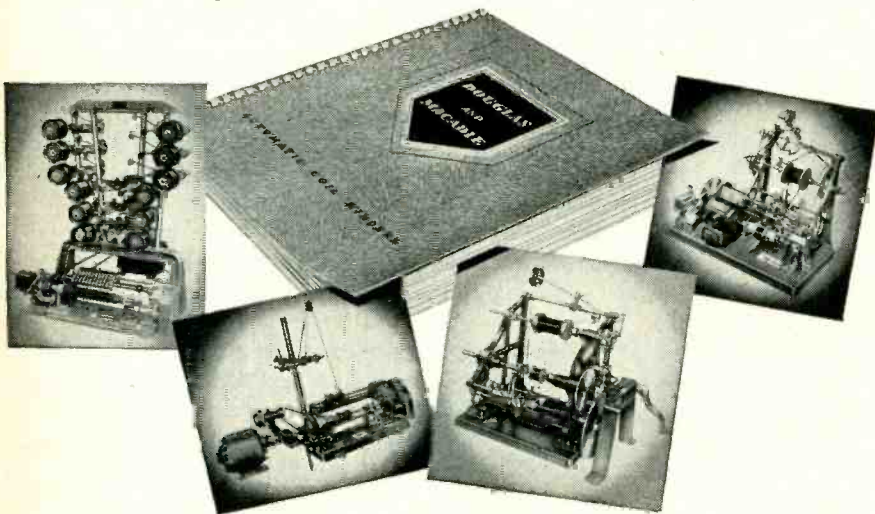

THE AUTOMATIC COIL WINDER & ELECTRICAL EQUIPMENT CO., LTD.
 WINDER HOUSE • DOUGLAS STREET • LONDON • S.W.1 • ENGLAND
 Cables: "Autowinda, Sowest, London." Code: A.B.C. 5th. Edn.

good shielded cable does not produce detectable detuning of the i-f output tank.

For adjustment, a good oscillator is desirable, but a medium-strength broadcast signal can also be used for setting. When filament and plate circuits have been in operation long enough to stabilize thermally, the indicator is ready for adjustment. With the switch in CHECK METER position, set the instrument to zero with its own zero adjuster. Then, with the switch in BALANCE position, adjust the balancing potentiometer until the instrument again reads zero. With no incoming signal, the meter should read zero when the switch is in the central position. The diode circuits and the vacuum-tube bridge are now balanced, and should require no further adjustment for several days of operation.

Tuning Adjustments

After checking the alignment of the receiver, set the coupling trimmer to about mid position (this setting is not critical), and the discriminator coupling capacitor likewise. With the receiver case closed, and the resonance indicator connected and turned on, allow the receiver to warm up to stability; then readjust the i-f output plate circuit if necessary.

Tune in a medium-strength steady signal on the receiver. Tune the plate coil of the buffer amplifier to the intermediate frequency. This can be done conveniently by connecting a low-range voltmeter across the 6SC7 cathode resistor, and tuning to maximum meter deflection. Because the plate tank of the buffer amplifier is shunted by an r-f choke in series with a capacitor, additional capacitance may be needed to bring the circuit to resonance. If more than about 20 μf is needed, a larger r-f choke is required.

When the plate tank of the buffer amplifier is tuned to the i-f, the diode tuned circuit is adjusted roughly to resonance by use of the same meter across the 6SC7 cathode resistor. With this meter disconnected, the case closed, and the indicator assembly at equilibrium temperature, the diode circuit is again tuned until the instrument

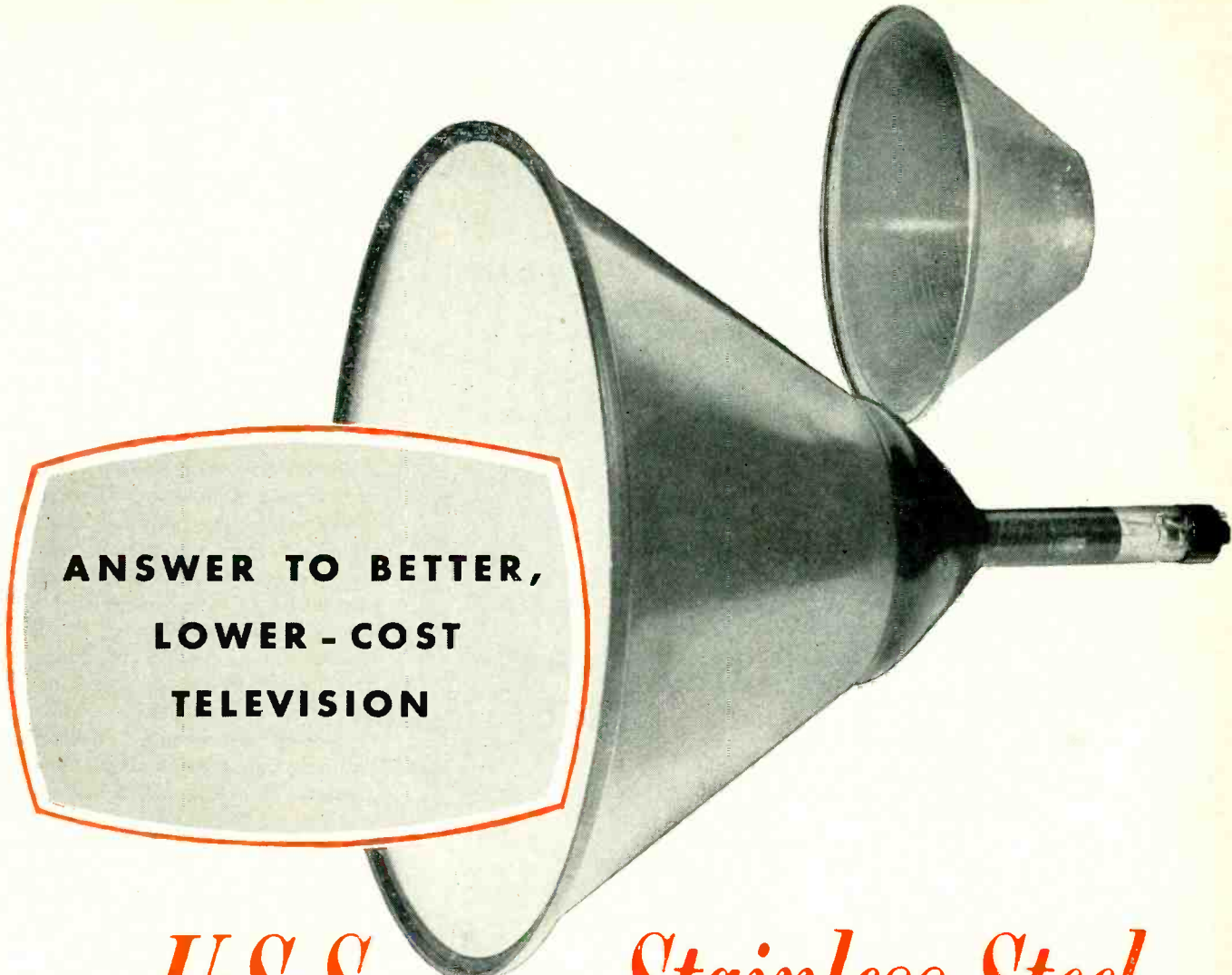

**ANSWER TO BETTER,
LOWER - COST
TELEVISION**

— U·S·S 17-TV Stainless Steel

DESIGNED ESPECIALLY for television application, U·S·S 17-TV Stainless Steel is helping many manufacturers reduce the cost of the all-important picture tube, while giving customers the large, life-like image they demand.

With progressive increase in picture tube size, all-glass tubes have been found to impose undesirable additions in weight and bulk. As a result, manufacturers have turned

to Stainless Steel for the cone portion of the picture tube.

Working in cooperation with a leading manufacturer, United States Steel developed U·S·S 17-TV. This specialized material has an appropriate coefficient of expansion, permitting fusing of the glass faceplate and neck to the Stainless cone.

U·S·S 17-TV is relatively low in cost and, in addition, permits manufacturing economies through high-

speed production. It is readily workable, allowing extreme flexibility in design. U·S·S 17-TV is very strong, reducing breakage hazards. It is light, resulting in important savings in handling, stocking and shipping costs.

If you haven't investigated U·S·S 17-TV, get the complete story now. Write United States Steel Corporation Subsidiaries, 2153 Carnegie Building, Pittsburgh 30, Pa., or contact our nearest sales office.

AMERICAN STEEL & WIRE COMPANY, CLEVELAND · CARNEGIE-ILLINOIS STEEL CORPORATION, PITTSBURGH
COLUMBIA STEEL COMPANY, SAN FRANCISCO · NATIONAL TUBE COMPANY, PITTSBURGH · TENNESSEE COAL, IRON & RAILROAD COMPANY, BIRMINGHAM
UNITED STATES STEEL SUPPLY COMPANY, WAREHOUSE DISTRIBUTORS, COAST-TO-COAST · UNITED STATES STEEL EXPORT COMPANY, NEW YORK



U·S·S STAINLESS STEEL

SHEETS · STRIP · PLATES · BARS · BILLETS · PIPE · TUBES · WIRE · SPECIAL SECTIONS

UNITED STATES STEEL

Maximum Wattage Dissipation for Size

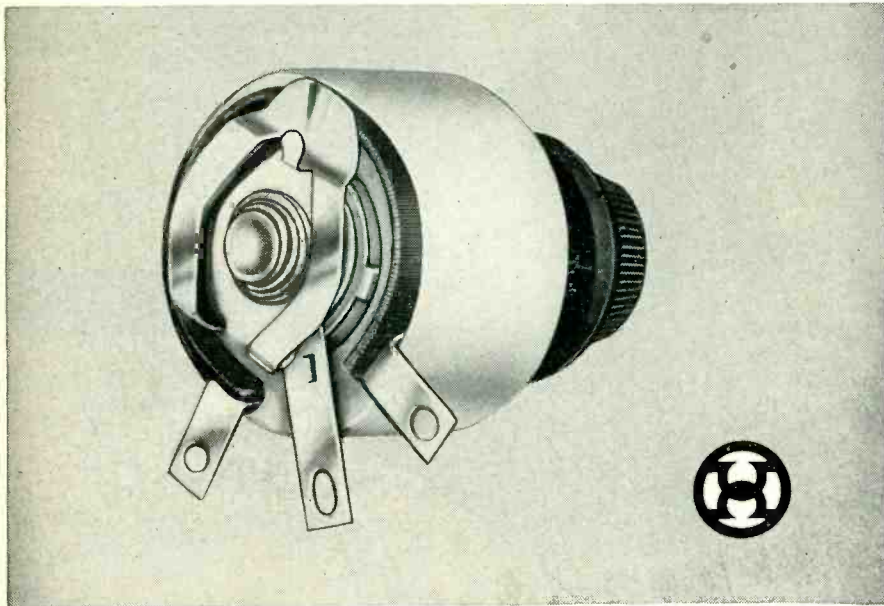

THIS COMPACT, rugged type M 25 watt rheostat offers exceptional heat dissipation. An exclusive Hardwick, Hindle feature is the lock tab which prevents deformation of the contact arm due to rough handling. Its steel stop pin will withstand over 40 inch pounds torque.

The resistance element is wound on a pure mica strip, embedded in vitreous enamel and sealed in a ceramic base—thus bonding inseparably the winding and base.

And in our type M rheostats you have a choice of 2 types of contact mechanisms, either a carbon brush or a spring metallic contact. And also a choice of 2 types of bases designed for either lug type or screw type terminals, or any combination thereof.

Other types of Hardwick, Hindle rheostats, and our many resistors offer you valuable exclusive advantages.

Write us today. Our engineers are at your service.

HARDWICK, HINDLE, INC.

Rheostats and Resistors

Subsidiary of

THE NATIONAL LOCK WASHER COMPANY

NEWARK 5, N. J. Established 1886 U. S. A.

TUBES AT WORK

(continued)

reads zero. Tuning of the trimmer is best done by means of a small hole in the top of the case, just large enough to admit an aligning tool.

Improvements in Dot-Sequential Color TV

ENGINEERS of the Hazeltine Electronics Corporation have demonstrated to the technical press and various industry groups a new method of transmitting dot-sequential color television images. Known as constant-brightness sampling, the new technique removes the dot-structure from the image, reduces the tendency of finely-detailed colored areas to shimmer, and considerably reduces the vulnerability of the image to r-f interference and thermal noise. In addition, the Hazeltine experiments confirmed that the "mixed-highs" method of transmission, previously demonstrated by RCA, is a powerful method of economizing on spectrum space. Constant-brightness-sampled, mixed-highs color images demonstrated by Hazeltine over a video band of 4 mc were virtually indistinguishable in resolution and color fidelity from simultaneous color images (three superimposed, conventionally-scanned primary images) using a 12-mc band.

The principle of the constant-brightness sampling method rests on the fact that the sensitivity of the eye to the three primary colors is in the ratio of approximately 1 for green, $\frac{1}{2}$ for red and $\frac{1}{20}$ for blue. In the RCA dot-sequential system, when a high-frequency noise disturbance is present, the sampling process produces three equal low-frequency voltage vectors which are applied in three-phase relationship to the picture tube but the corresponding vectors of visual sensation are not equal, and the vector sum of sensation, due to the added low-frequency disturbance, displays a brightness variation as well as a color variation. In the Hazeltine method the brightness variation is removed. The net effect caused by sampling noise or interference is then confined to a variation in color, and the interference is much less noticeable than when



Save space, weight in TV transformers

Armco TRAN-COR 3X is proving its mettle in weight-saving, space-saving advantages for small but powerful television transformers.

This special Armco cold-reduced electrical steel offers designers lower core loss combined with higher permeability at high inductions. Along with its superior space factor and maximum interlaminar resistivity, Armco TRAN-COR 3X permits use of a smaller core of lighter weight in TV transformers of all kinds.

Armco "3X" is known as an "Oriented" grade because its crystals have been so arranged that their axes of

easiest magnetization are nearly parallel and aligned in the direction of rolling.

You get assured results with Armco TRAN-COR 3X because it is supplied with magnetic properties fully developed at the mill by a special high-temperature heat treatment.

A low-temperature (1475° F.) stress-relieving anneal is all that is necessary to restore magnetic properties altered in fabrication through punching, shearing, or winding.

Fill in and mail the handy coupon for your copy of the new catalog on Armco TRAN-COR 3X Oriented Electrical Steel. It contains 57 curves showing various properties.

ARMCO STEEL CORPORATION

5410 Curtis Street, Middletown,
Ohio. Plants and Sales Offices from
Coast to Coast • The Armco Inter-
national Corporation, World-Wide.

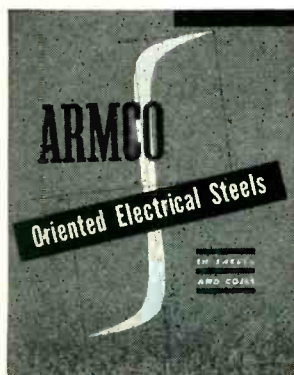

GET THIS CATALOG

ARMCO STEEL CORPORATION
5410 CURTIS STREET, MIDDLETOWN, OHIO

Send me the new catalog on Armco TRAN-COR 3X

Name Title

Company

Address

City Zone State

TOROIDAL COMPONENTS

PRECISION TUNED CIRCUITS FOR YOUR SELECTIVE AMPLIFIER



ACTUAL SIZE

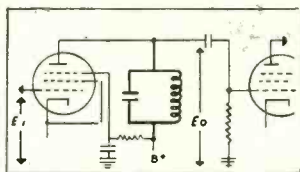

TYPICAL APPLICATION

High Q precision tuned resonant circuits, accurately adjusted to your specified frequency. Toroid coil and capacitor are permanently protected by tough thermosetting plastic. Pig-tail leads and light weight allow direct or terminal board mounting.

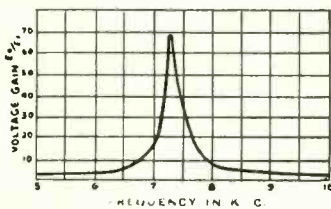

CUSTOM MADE TOROID COILS

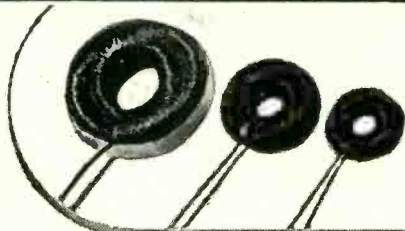

Toroid coils, transformers and discriminators in a large range of inductances, frequencies and power levels. Permalloy dust cores. Uncased, mounted in hermetically sealed cans or coated with thermosetting plastic. Close tolerances with taps at any point. Multiple windings. Up to 2 Henries on wedding ring size. Larger sizes to 50 Henries.

MINIATURE TOROID FILTERS



1 1/2" x 1 1/4" x 2" HIGH

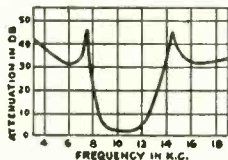

Specialized design and complete production facilities for your filter requirements. Where space is critical, miniature filters with wedding ring toroids and special capacitors. Supplied in standard units, or designed to your specification. A miniature band pass filter and curve are shown.

RAPID PRODUCTION DELIVERY. Engineering requirements given special attention. Wire, phone or write complete specifications.

COMMUNICATION ACCESSORIES

HICKMAN MILLS, MISSOURI

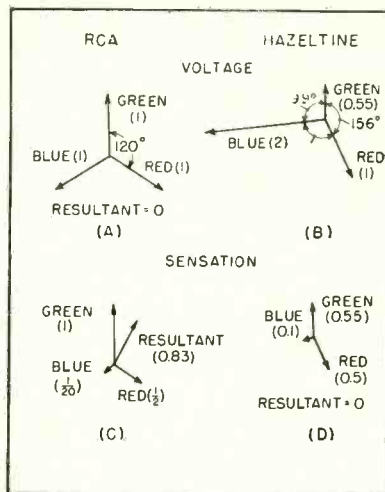

FIG. 1—Vector relations of voltage and visual sensation for the two systems. Angle blue-red is 105 degrees

the brightness variation factor is also present.

The brightness variation resulting from sampling is eliminated by changing amplitudes and phase angles of voltages applied to the picture tubes so the sum of the sensation vectors is zero. In the equipment demonstrated, the green sensation vector has a phase angle of 0 deg and an amplitude of 0.55, the red vector a phase angle of 156 deg and amplitude of 0.5, and the blue vector an angle of 261 deg and an amplitude of 0.1. As shown in Fig. 1, the sum of these vectors is zero.

The arrangement of the system is shown in Fig. 2. The composite dot-sequential signal output, like that from the final video amplifier of a typical RCA-type receiver, is fed in the first place through a 0-4-mc low-pass filter to all three picture tubes (or to all three guns of a three-gun tri-color tube). This component contains the mixed-highs component plus a sine-wave representative of the sum of the three-color signals. In the second place, the composite signal is passed through a 2-4-mc bandpass filter to the sampling switch, whose switch points are arranged in the 0-156-261 deg phase-angle relationship described above. From the switch points, the sampled signals are passed through amplifiers having 0-2-mc lowpass filters and gains in the ratio green:red:blue = 0.55:1.00:2.00. These relative gains, multiplied by the respective sensation ratio of 1:1/2:1/20, produce sen-

High dielectric strength

High moisture resistance

High stability

FIVE LAYERS OF THIN GAUGE KODAPAK SHEET, immediately next to wire strands, act as primary insulation in this cable. Results are highly satisfactory—both production- and performance-wise.—Cable made by Rockbestos Products Corporation.



It's **Kodapak Sheet**

...highly satisfactory to **WIRE AND CABLE manufacturers**

The sheet to fit the job. Kodapak Sheet is uniform... easy to use in standard equipment... exceptionally efficient. Available in several types, many gauges. Under normal conditions, all have comparable dielectric strength, dielectric constant and power factor. Kodapak II Sheet, however, is especially recommended for certain electrical applications.

To cable manufacturers... Kodapak II Sheet offers strength and toughness combined with ability to stretch more than 60% before rupturing; may be processed at higher, more economical production speeds.

To cable users... Kodapak II Sheet offers high dielectric strength assuring maximum service-life, together with high moisture-resistance and consequent protection against corrosion.

For other users—other uses. As a laminate: Kodapak Sheet is used for protecting liners in switch and transformer cases. In heavy sheet form: as layer insulation in separators and protective covers in coils and transformers. In thin sheets: as the dielectric in telephone, radio, and ballast-starter equipment.

Preparing a sample for measurement of dielectric constant and power factor. Kodapak Laboratory, Rochester, N. Y.

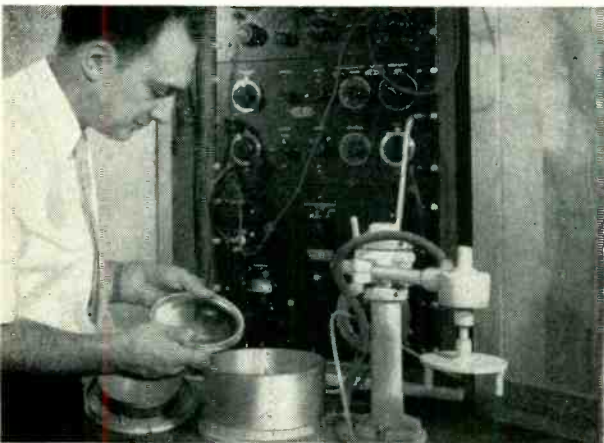

Inserting a sample preparatory to a voltage breakdown test. Kodapak Laboratory, Rochester, N. Y.



Write for free copy of the folder, "Kodapak Sheet for Electrical Uses."

Cellulose Products Division, EASTMAN KODAK COMPANY, Rochester 4, N. Y.

Sales Offices:
New York, Chicago.

District Sales Representatives:
Cleveland, Dallas,
Philadelphia, Providence.

Pacific Coast Distributor:
Wilson & Geo. Meyer & Co., San Francisco,
Los Angeles, Portland, Seattle.

Canadian Distributor:
Paper Sales, Limited, Toronto, Montreal.

Kodapak Sheet ... for efficient insulation

"Kodapak" is a trade-mark

Kodak
TRADE-MARK

specify



AVOID LOSSES FROM "NICKING"
Not being an extruded plastic, absolute uniformity of diameter can be guaranteed. Therefore:—
NO NICKING OF CONDUCTORS
NO CONSTANT RESETTING OF BLADES

"NOFLAME-COR" the TELEVISION hookup wire

APPROVED BY
UNDERWRITERS
LABORATORIES AT

90° CENTIGRADE 600 VOLTS

Proven BEST, and specified regularly, by leading manufacturers of television, F-M, quality radio and all exacting electronic equipment. For maximum output and minimum rejects. Available in all sizes, solid and stranded. Over 200 color combinations.

PRODUCTION ENGINEERS: Specify "NOFLAME-COR" for absolute uniformity of diameter, permitting clean stripping of insulation without damage to the copper conductor...

NO NICKING OF CONDUCTORS
NO CONSTANT RESETTING OF BLADES

AVOID LOSSES FROM "BLOBBING"
Not being an extruded plastic, eliminates the costly "blobbing" of insulations under soldering heat

- Flame Resistant
- High Insulation Resistance
- Heat Resistant
- Facilitates Positive Soldering
- High Dielectric
- Easy Stripping
- Also unaffected by the heat of impregnation — therefore, ideal for coil and transformer leads

COMPLETE DATA AND SAMPLES ON REQUEST

"made by engineers for engineers"

CORNISH WIRE COMPANY, Inc.

605 North Michigan Avenue,
Chicago 11

15 Park Row, New York 7, N. Y.

1237 Public Ledger Bldg.,
Philadelphia 6

MANUFACTURERS OF QUALITY WIRES AND CABLES FOR THE ELECTRICAL AND ELECTRONIC INDUSTRIES

TUBES AT WORK

(continued)

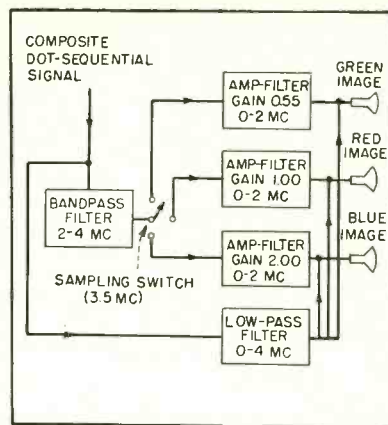

FIG. 2—Circuit arrangement for handling the three color signals

sation amplitudes in the ratio 0.55:0.5:0.1 as described above.

It will be noted that components from 2 to 4 mc feed the sampling switch. These components, beating with the 3.5-mc frequency of the switch rotation, produce beat frequencies from 0 to 1.5 mc, which are passed by the low-pass filters to the picture tubes. These signals are color-difference signals which subtract from the composite signal, also present at the grid of each picture tube, to produce the color values.

Regulated Voltage Divider

BY WILLIAM B. BERNARD
Commander, USN
Portsmouth Naval Shipyard
Portsmouth, N. H.

IN MANY electronic circuit applications it is desirable to have a voltage-divider system with good regulation. This may be needed to protect circuit components from high voltages during starting periods or it may be needed to insure proper circuit operation during steady-state operation.

When the current drain from the intermediate tap is small, VR tubes can be used to insure good regulation. When the current drain is high an electronically regulated power supply or a resistive voltage divider with a high bleeder current may be used. Both of these systems suffer from some disadvantages. The electrically regulated supply is complicated and the range over which the output voltage may be varied is small. The bleeder system

A "Brand New" SOLUTION

TO YOUR

AUDIO MEASUREMENT PROBLEMS

Daven's Moderate Priced Transmission Measuring Set

This is the instrument for which you have been waiting! For accuracy and efficiency, the Daven Type 11 A gain set, will fill your bill. Incorporating many of the features employed in more expensive models, this unit may be used to make all the precise measurements required by the FCC. This is a direct reading instrument, entirely eliminating time-consuming computations.

A new design feature, permits the servicing and inspection of all components from the front of the panel, with a maximum of ease and in a minimum of time.

It is no longer necessary to use makeshift equipment for determining the transmission characteristics of audio systems. The Type 11 A gain set has been priced low enough to put it within the reach of the most limited budget.

FEATURES

FREQUENCY RANGE: 20 cps to 20 KC.

ACCURACY: Accuracy is ± 0.1 db, from 20 cps to 20 KC.

OUTPUT LEVELS: Ranges of output level— +4 to -110 db and -10 to -124 db in steps of .1 db.

ACCESSIBILITY: All components accessible from front of rack panel— for ease of servicing.

IMPEDANCE RANGES:
(a) Source Section — 600-150 ohms internally terminated.
600-250-150-30 ohms unterminated.

(b) Load Section—600-250-150-16-8-4 ohms.

APPLICATIONS

- AUDIO GAIN MEASUREMENTS.
- AUDIO LOSS MEASUREMENTS.
- MEASUREMENTS OF MATCHING AND BRIDGING DEVICES.
- COMPLEX CIRCUIT MEASUREMENTS.
- MEASURING MISMATCH LOSS.
- FREQUENCY RESPONSE MEASUREMENTS.
- CHECKING CABLE LOSS.
- TELEPHONE REPEATER MEASUREMENTS.
- VOLUME LEVEL READINGS.

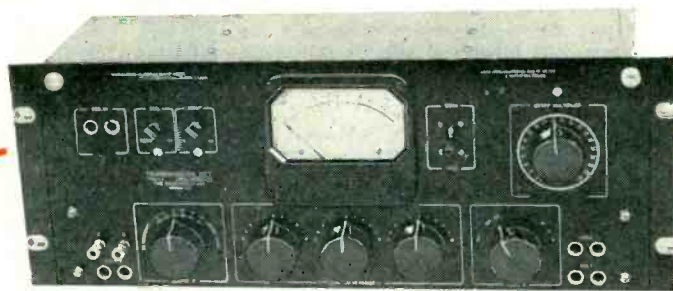

Now available for immediate delivery from stock.

Write to Dept. E-1 for additional information.

Always Specify Daven For Precision Equipment

THE **DAVEN** CO

191 CENTRAL AVENUE
NEWARK 4, NEW JERSEY

RCA TELEVISION COMPONENTS

THE STANDARDS OF THE INDUSTRY

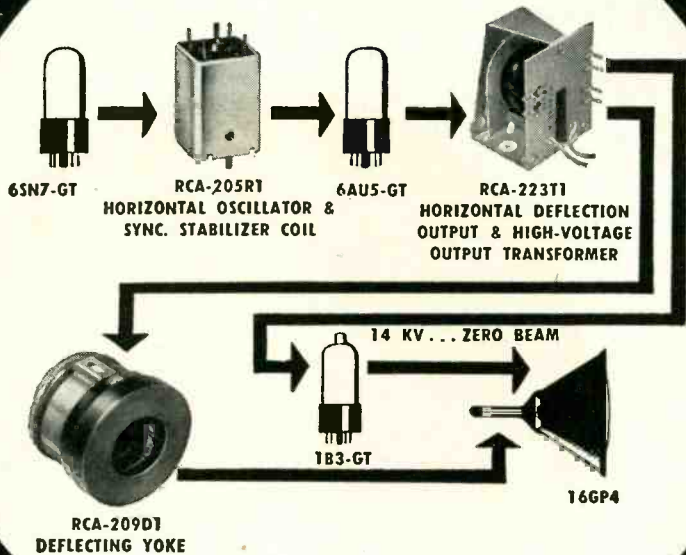

Now . . . a lower cost, high-efficiency wide-angle horizontal deflection system

Utilizing newly-designed Ferrite Core in both the High-Voltage Transformer and the Deflecting Yoke, the RCA single-tube-rectifier, Wide-Angle Deflection System provides a new high in efficiency. Developed especially for use with the 16GP4, or similar tubes having deflection angles of 70 degrees, the new system features low cost, low weight, low power consumption, low B+ supply and 14-kv output at zero beam current. In addition, this system will supply boost voltage for the vertical deflection amplifier.

All RCA television components are "originals," designed with characteristics which are correct both electrically and mechanically for the tubes and circuits. They are "performance proved" and competitively priced.

RCA Application Engineers are ready to work with you in the adaptation of RCA television components to your specific designs. For further information, write RCA, Commercial Engineering, Section H43S, Harrison, N. J. or the nearest sales office.

(EAST) Harrison 6-8000, 415 S. 5th St., Harrison, N. J.

(MIDWEST) Whitehall 4-2900, 589 E. Illinois St., Chicago, Ill.

(WEST) Madison 9-3671, 420 S. San Pedro St., Los Angeles, Calif.



RADIO CORPORATION of AMERICA

ELECTRONIC COMPONENTS HARRISON, N. J.

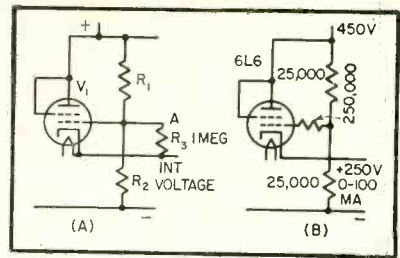

FIG. 1—The basic circuit is shown at A. Typical values of circuit B apply when the power supply bleeder resistor is used for the voltage divider

is very wasteful of power and power supply components of a higher rating are needed to support it.

If the requirements placed on regulation of the intermediate output voltage are not too stringent, most of the benefits of a regulated supply without all the complications can be obtained. If a stable high-voltage supply is available and good but not perfect regulation of the intermediate voltage is desired, the circuit of Fig. 1 is simple and satisfactory. With a triode-connected 6L6 the output impedance will be about 200 ohms. This is far lower than can be obtained from a bleeder system using a reasonable bleeder current.

Resistors R_1 and R_2 are selected to give a voltage at point A just a little below the desired intermediate voltage. The value of R_1 and R_2 should be such that the grid circuit resistance is at least 100,000 ohms to protect the grid if an extremely heavy load is placed on the intermediate supply. If R_1 and R_2 are lower in value to act as a bleeder to stabilize the high-voltage supply, a resistor in series with the grid lead should be added to make the grid circuit resistance sufficiently high, as shown in B.

If the only reason for desiring good regulation is to prevent the application of abnormally high voltages on the components fed from the intermediate circuit while the tubes are warming up and if poorer regulation during the operating can be tolerated, a resistor may be added in the plate circuit of V_1 to reduce the plate dissipation of the tube.

If R_1 and R_2 are replaced with a potentiometer of suitable rating (Fig. 2) the output of the circuit can be varied over almost the entire

SILOTEX

**withstands
hot spot
temperatures
up to 200 C!**

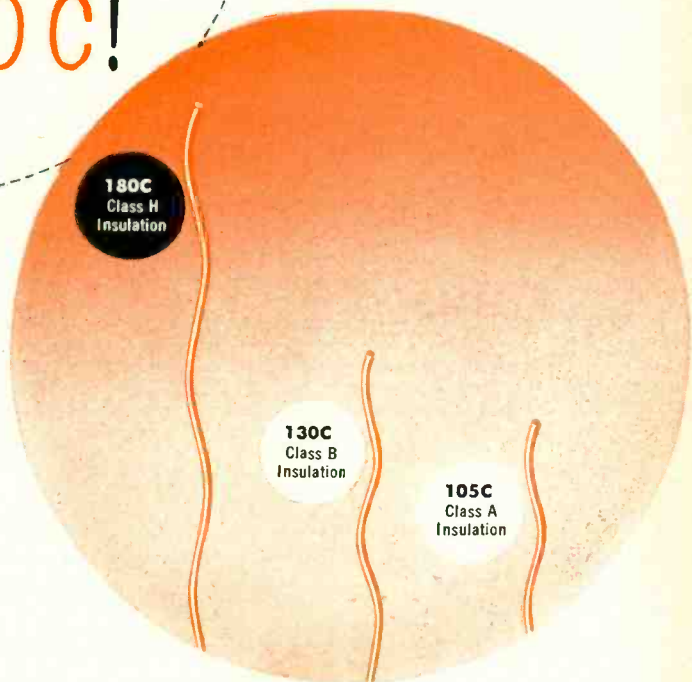

When you need magnet wire that really works for you in hotter-than-hot spots (180 to 200C)—choose Silotex*. For Silotex, Anaconda's silicone-bonded Vitrotex* (fibrous glass-insulated), has proven its ability to stand up in these danger spots . . . and for relatively long periods of time.

Here are the reasons why you will like **SILOTEX**—and continue to like it..

resists moisture at extremes in temperature . . .	withstands greater overloads . . .	has high operating temperature range over high ambients . . .	is fire resistant
---	------------------------------------	---	-------------------

Contact your nearest Anaconda Sales Office or Distributor for complete information about Silotex Magnet Wire. Anaconda Wire & Cable Company, 25 Broadway, New York 4, New York

50396

*Reg. U. S. Pat. Off.

the right wire for the job **ANACONDA[®]**
WIRE AND CABLE

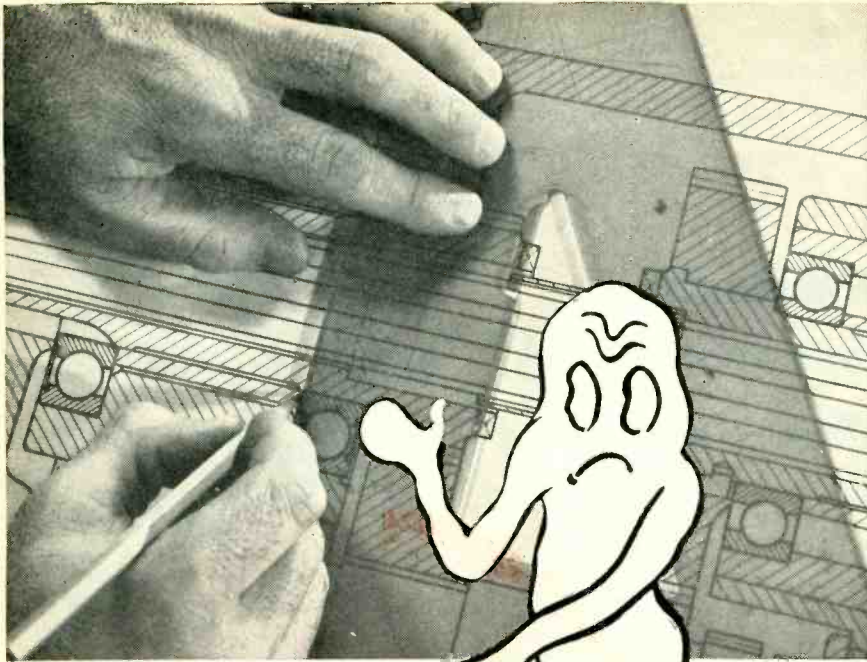

Ever been haunted by an "ERASURE GHOST"?

The beauty of Arkwright Tracing Cloth is its permanent translucency — built all the way through the cloth by a special process. Arkwright will take the heaviest erasures without "ghosting". You can count on clear, clean prints from drawings on Arkwright cloth years after you make them.

You can re-ink over erasures on Arkwright Tracing Cloth without feathering or "blobbing". You can be sure there are no pinholes, thick threads or other imperfections in the cloth to bother you. Every roll is carefully inspected before leaving the factory.

Think a moment. Isn't it an unnecessary risk to put your important drawings on inferior tracing cloth or paper? A sample will show you the difference. Write Arkwright Finishing Company, Providence, R. I.

ARKWRIGHT

Tracing Cloths

AMERICA'S STANDARD FOR OVER 25 YEARS

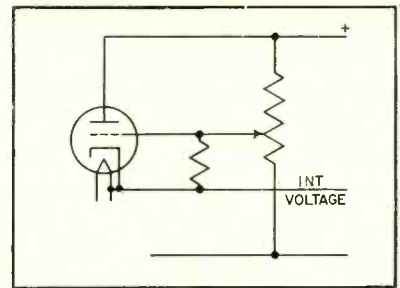

FIG. 2—Almost any desired value of intermediate voltage is obtained with this arrangement

range from zero to the value of the high voltage.

A tube for use in this circuit must of course have ratings high enough to stand the voltage current and dissipation to which it will be subjected. A high transconductance is desirable because the cathode output impedance is roughly equal to $1/g_m$. The heater supply must be furnished from a separate well-insulated secondary.

Shock-Excited High-Voltage Power Supply

AN INTERESTING CIRCUIT arrangement for obtaining 14 kv for the picture tube is contained in the Motorola chassis TS-16 and TS-30.

The high-voltage supply is of neither the r-f nor the fly-back type, but employs a shock-excited oscillator controlled by the 6BG6G high voltage pulse amplifier tube V_1 . This generates ringing voltages which are rectified in a ladder-type rectifier using two types 1B3GT tubes, V_2 and V_3 . A unique feature is the high-voltage regulation accomplished by V_4 .

The operation of the circuit is illustrated in the simplified schematic. During the trace time the unbiased high-voltage pulse amplifier tube V_1 is conducting heavily, with plate current flowing through the primary of auto-transformer T_2 . During the retrace, the grid of V_1 is driven about 125 volts negative by a pulse developed across a tertiary winding of T_1 , an isolation transformer in the filament circuit of a 35Z5 damper diode.

When the plate current of V_1 is suddenly cut off, the stored energy in the primary of T_2 starts ringing currents which induce a high-volt-

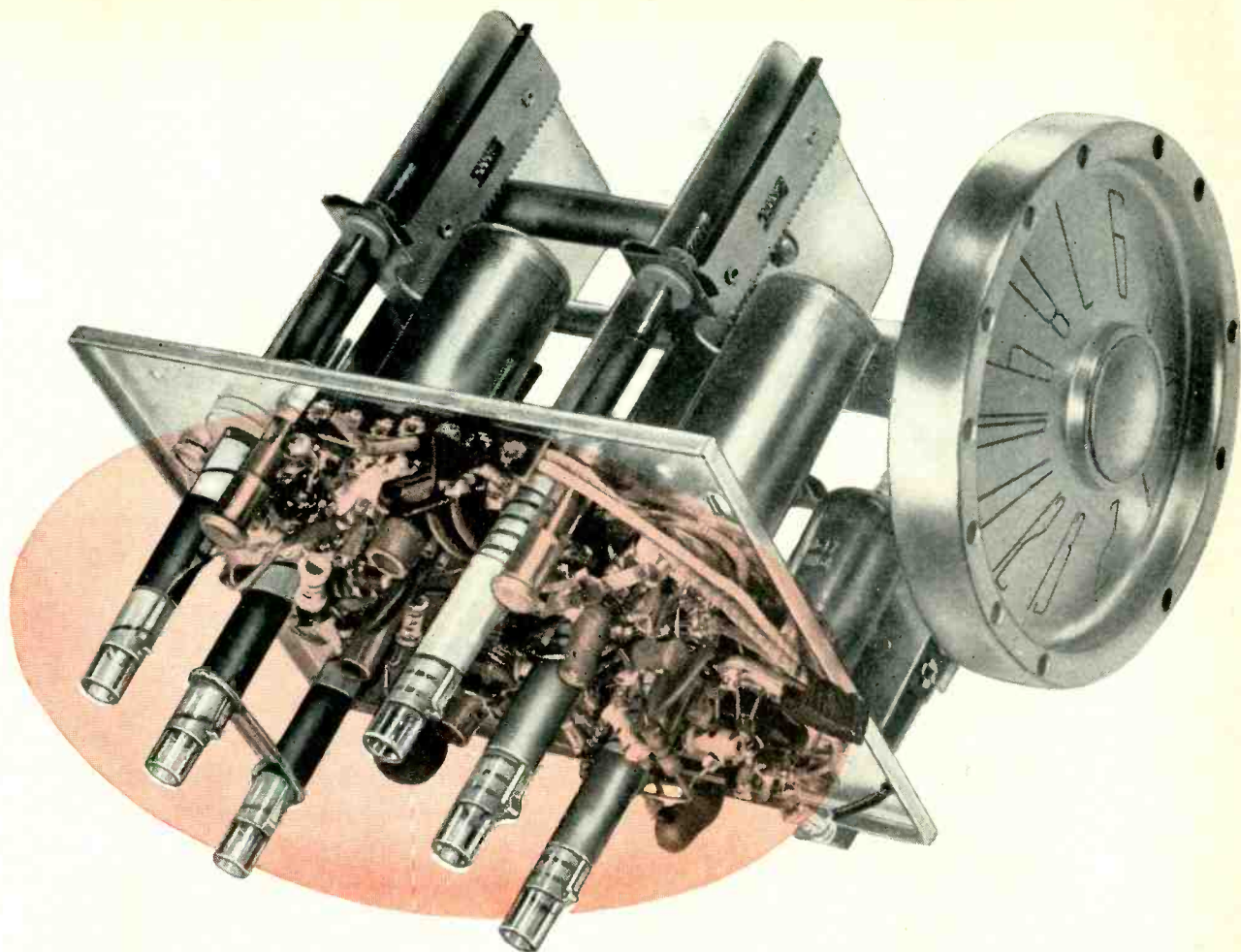

WHY A LEADING TELEVISION MANUFACTURER SPECIFIES CORNING METALLIZED GLASS INDUCTANCES

In high frequency tuning applications, stability is extremely important, both for ease of alignment and customer satisfaction. That is one of the reasons why the Stromberg-Carlson Company specifies Corning Metallized Glass Inductances. With Corning Inductances drift is negligible even under unusually variable ambient temperatures. Why? Because the integral contact of the fired-on metallizing with the dimensionally stable glass coil forms results in high temperature stability. High Q is inherent.

The inductance characteristics of the coils cannot be changed by rough handling or vibration. This is because the integral contact between the fired-on metallizing and the glass coil form eliminates voids between conductor and form. When used with powdered iron cores, the accuracy and rigidity of the

glass insures stable, noiseless tuning.

Corning Inductances of any given type can be accurately duplicated in quantity on a production basis. That means no assembly time wasted on coil adjustments. They are easily installed by conventional methods and can be supplied with terminals or solder spots as required.

Design versatility is another characteristic of Corning Inductances. They can be manufactured to the most exacting specifications in uniform, variable or double pitch windings. Fixed tuned, permeability tuned or permeability tuned inductance-trimmer combinations are available with standard cores and fittings. Let Corning help you increase performance at lower costs. Our engineers will be glad to discuss your inductance problems with you.

CORNING GLASS WORKS

ELECTRONIC SALES DEPARTMENT



CORNING, N. Y.

Corning means research in Glass

METALLIZED GLASSWARE: INDUCTANCES · CAPACITORS · BUSHINGS · ALSO A COMPLETE LINE OF TELEVISION TUBE BLANKS

Q. Why is "dag" Colloidal Graphite best for CRT Exterior Wall Coating?

A. It's cheaper ... Has better adhesion ... Requires no baking ... Resists scratching

BLEED STATIC FROM CABINETS!

Static charges built up in TV sets—particularly where metal CRT's are used—can be successfully bled off by coating the inside of cabinets with "dag" Dispersion #194. This reduces picture interference and also precludes shock. Easy to apply by spraying or brushing.

"dag" Exterior Coating is a lacquer-base dispersion of microscopically small graphite particles. It is easily applied to CRT surfaces by spraying, and dries very rapidly, enabling tubes to be handled in 2 or 3 minutes. Maximum adhesion is obtained by drying at room temperature for 24 hours, or by forced infra-red drying for ½ hour.

"dag" Exterior Coating forms a smooth, uniform, conductive black coating on any type glass. Its adhesive properties are so good that it will resist scratching by a thumb nail or soaking in water.

Prominent CRT manufacturers have found "dag" colloidal graphite dispersions satisfactory and usually cheaper for wall coatings . . . for other electronics work, too. Let Acheson Colloids engineers show YOU how these versatile dispersions can solve many and varied electronics problems. Send the coupon NOW for more information.



ACHESON COLLOIDS CORPORATION
Port Huron, Michigan

Send me more information on:

- "dag" Exterior Coating for Cathode Ray Tubes
- "dag" Dispersion # 194 for Cabinet Coating
- "dag" Colloidal Graphite in Electronics

Name.....

Company Name.....

Address.....

City.....Zone.....State.....

H-5

**ACHESON
COLLOIDS
CORPORATION**

Port Huron,
Michigan

also... Acheson Colloids Ltd.
London, England



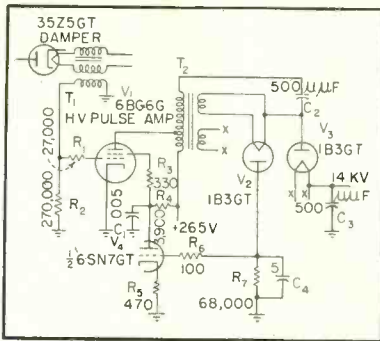

Regulated high-voltage power supply utilizes ringing current in primary of T_2 .

age damped wave across the primary. The frequency of this ringing is the self-resonant frequency of the primary, which is designed to be about 100 kc. The primary and secondary of T_2 , in series, will then develop a peak negative voltage across it of approximately 5 kv.

When the upper end of the winding is negative, tube V_2 will conduct and charge capacitor C_2 to 5 kv. On the next alternation across the transformer primary and secondary, a peak positive voltage of 9 kv will be developed and tube V_3 will conduct, but the voltage applied to it is the sum of the 9 kv transformer voltage plus the 5 kv stored in capacitor C_2 . This combined voltage results in a charge of approximately 14 kv on capacitor C_3 , which is the high voltage applied to the picture tube.

The beam current of the picture tube is about 140 microamperes, but picture content can vary this considerably, the variation resulting in changes of high voltage. To compensate for high-voltage changes and, to some extent, for line-voltage variations, a high-voltage regulator tube is used, V_4 .

The plate of V_2 is returned to ground through R_7 , which is also the grid load resistor of V_4 . Plate voltage is applied to V_4 through R_1 , which is also in the screen supply lead of the 6BG6G high-voltage pulse amplifier tube.

The action is as follows: the output of V_4 is very sensitive to screen-voltage variation; if the beam current tends to rise, which would result in a decrease of the high voltage, the current through R_7 will also rise, placing a more negative bias on the grid of the regulator

MANUFACTURERS AND DESIGNERS OF CONTINUOUSLY VARIABLE REGULATED DC SUPPLIES

SINCE 1943!



✓ MODEL A3 FEATURES

- ✓ Continuously variable, 0 to 350 volts.
- ✓ Ripple voltage less than 10 millivolts.
- ✓ Regulation better than .5%.
- ✓ Maximum current 200 milliamperes.
- ✓ Stabilized variable bias supply.
- ✓ 6.3 volts AC at 5 amperes.
- ✓ Reasonably priced.
- ✓ Request Bulletin 52 for detailed specifications.

87 leading research laboratories use daily hundreds of our "A" series power supplies.

For general laboratory use, the A 3 is worthy of adoption as STANDARD equipment.

*Described in MIT Radiation Laboratory Series Vol. 21, Electronic Instruments.

FOR HIGHER VOLTAGE AND HIGHER CURRENT OR DUAL UNITS REQUEST BULLETIN 53.

Oregon ELECTRONICS

206 S.W. WASHINGTON ST., PORTLAND 4, ORE., U.S.A.

MODERN ELECTRONIC DESIGN MEANS PLUG-IN UNIT CONSTRUCTION

With basic elements as units—that plug-in, slide-in, lock-in, break away easily—so that electronic equipment is instantly accessible—ready for rapid checks, servicing, and unit replacement.

More and more engineers are finding that plug-in unit construction is the type of design that makes many of the new complex electronic projects feasible to operate and maintain. It's also recognized that plug-in, unit principles make present electronic equipment much more practical for wider general use.

Up to now there has been no one place where components specifically designed for plug-in, unit construction were available. To get this type of construction—it has been necessary for engineers to design and have parts custom made or improvise with standard components in make shift arrangements.

Here at Alden's we are designing and manufacturing components for plug-in unit construction. We are setting up to work with manufacturers on as many of these problems as possible. Very frankly, much of our work is still in the pilot run stage—but, in every instance—proven in use. If you don't see the answer to your problems here—let us work it out with you.

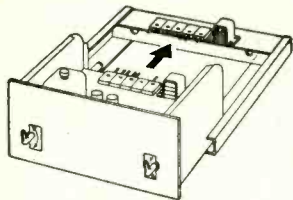

Back connected chassis—become instantly accessible. Half twist of handles brings chassis into place or ejects—no matter how heavy. Built for racks or as separate units—miniature and standard sizes.

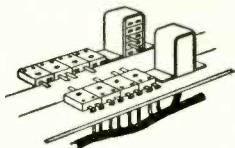

Rugged color coded back connectors—make and break circuits—provide rapid circuit checks. Wide mating tolerances compensate for any chassis misalignment. Miniature and heavy duty sizes.

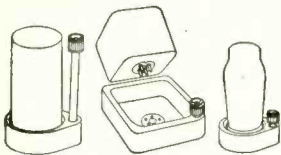

Top operated clamps for tubes and plug-in units. Take minimum of space. Can be operated in cramped locations. Free floating—orients unit to socket without straining or bending pins.

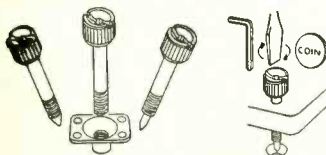

Alden Cap Captive Convenience Screws—Hold miniature chassis, heavy plug-in cans or detachable mechanical units securely. Assemble easily in production by power tools—yet any tool or coin services in field.

At last—a base specifically designed for plug-in units. No more broken bosses, bent pins, "shorted" circuits.

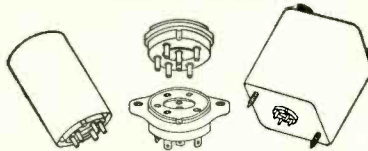

More and more engineers have been utilizing the basic elements of their circuits into compact, easily replaceable plug-in units. Since the conventional octal and tube socket bases have been the only component readily available, they have been constantly plagued by the broken bosses, bent pins, and "shorted" circuits caused by these bases.

This suggested an entirely new approach was necessary, so we went to work with some of these engineers. Out of this work the Alden-Noninterchangeable plug-in base was developed.

Pins have been made strong and stubby— for long, rugged use. The boss is eliminated entirely. Slight lead of center pins and locating rings with marker in the socket allow quick lining up of plug-in units. Further, this base is supplied with 2 to 11 contacts—in variable pin patterns— so that even where the same number of contacts are used, the pin layout may be varied so only the correct unit will mount in its proper socket. Pin patterns can even be selected to isolate critical voltages or signals.

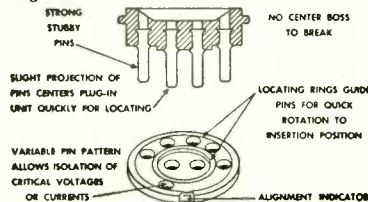

Write today for literature and samples. Let Alden work with you on your components for plug-in, unit construction.

Write for new booklet on "Components for Plug-in Unit Construction"

ALDEN PRODUCTS CO. 117 NORTH MAIN ST. BROCKTON 64, MASS.

tube V_4 , reducing its plate current and the voltage drop across resistor R_4 . Since R_4 is in the screen supply of V_4 , this results in a higher screen voltage, and more current out of the tube, thus raising the high voltage and compensating for the original increase in beam current. Resistor R_6 is used to suppress parasitic oscillation in V_4 ; capacitor C_1 keeps the grid of the regulator tube at an average d-c level during high-voltage alternation, so that it will respond only to relatively long time changes.

Because of the high voltage encountered, precautions had to be taken to prevent arc-over and breakdown. This system of rectification superimposes the a-c on the rectified d-c, and peak voltages in excess of 15 kv are produced in the secondary of the transformer. To prevent the coil arcing through the form to the laminations of the core, which are grounded, the inside of the coil form is painted with colloidal graphite, which is grounded by means of a spring. Instead of the sharp edges of the laminations, the coil now sees a rounded surface which prevents corona and breakdown. The coils themselves are first boiled in Zophar wax and dipped in bi-wax.

VHF Oscillations in Incandescent Lamps

By HANS E. HOLLMANN
Oxnard, California

VHF OSCILLATIONS of incandescent lamps causing television interference¹ apparently are a peculiar kind of Barkhausen-Kurz or "electron dance" oscillations².

Whereas the conventional electron oscillations occur, under peculiar conditions of operation, in a positive grid triode where the electrons oscillate around the grid between the cathode and the zero potential plane near the plate, they also occur in diodes consisting of either a filament surrounded by a positive grid³, a small rod surrounded by cathodes⁴, or merely two or three parallel filament-electrodes⁵. The latter type is represented by conventional incandescent bulbs having a single filament wire draped zig-zag fashion on a

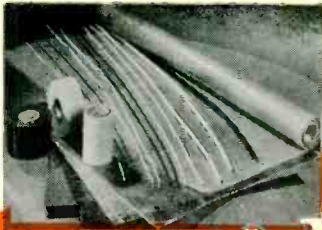

MIRAGLAS TUBINGS and SLEEVINGS

**NOW COST NO MORE
THAN COTTON TUBINGS AND SLEEVINGS**

... and PROVIDE PREMIUM PROTECTION

... at NO EXTRA COST



MIRAGLAS TUBINGS and SLEEVINGS, woven of fiberglass yarn, provide the ultimate protection against overloading, extreme high or low temperatures, moisture, corrosive acids, fumes, vapors, oils, general dust and dirt... they won't rot, have high tensile and dielectric strength and great flexibility... and they cost no more than cotton sleeveings and tubings.

MIRAGLAS VARNISHED TUBINGS are made in 4 grades:

STANDARD

for maximum flexibility and high temperature applications where dielectric strength is not a factor

TRIPLE STRENGTH

is especially flexible, resists rough handling and has a dielectric rating to 2500 volts

DOUBLE SATURATED

is similar to Standard but with a dielectric rating up to 1500 volts

IMPREGNATED

is the superior grade, has a dielectric rating beyond 7000 volts, is high gloss, non-hygroscopic, and unequalled for long life under most severe conditions

MIRAGLAS BRAIDED SLEEVINGS, of continuous filament fiberglass yarn, are available untreated or impregnated to prevent ends from fraying, in two average wall thicknesses: .008" and .006" with inside diameters from 1/16" to 1/2" in 1/16" increments (there is no 7/16" I.D. sleeving).

Take note of the name **MIRAGLAS**... it stands for the ultimate in fiberglass electrical insulations... **TAPES, TUBINGS, SLEEVINGS, CORDS, CLOTHS, ETC.** Write today for details and characteristics.

MITCHELL-RAND INSULATION CO. Inc.

51 MURRAY STREET • Cortlandt 7-9264 • NEW YORK 7, N. Y.

A PARTIAL LIST OF M-R PRODUCTS: FIBERGLAS VARNISHED TUBING, TAPE AND CLOTH • INSULATING PAPERS AND TWINES • CABLE FILLING AND POTHEAD COMPOUNDS • FRICTION TAPE AND SPLICE • TRANSFORMER COMPOUNDS • FIBERGLAS SATURATED SLEEVING • ASBESTOS SLEEVING AND TAPE • VARNISHED CAMBRIC-CLOTH AND TAPE • MICA PLATE, TAPE, PAPER, CLOTH, TUBING • FIBERGLAS BRAIDED SLEEVING • COTTON TAPES, WEBBINGS AND SLEEVINGS • IMPREGNATED VARNISH TUBING • INSULATED VARNISHES OF ALL TYPES • EXTRUDED PLASTIC TUBING

M-R THE
ELECTRICAL
INSULATION
HEADQUARTERS
FOR 61 YEARS.



Anyone
**Can build a
HEATHKIT**

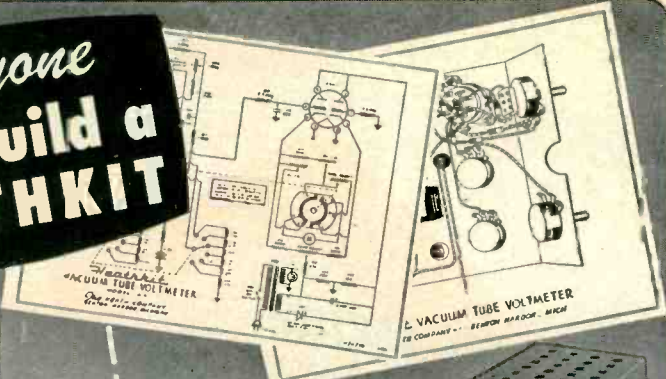

Heathkit
**SIGNAL
TRACER KIT**
\$19.50



Heathkit
**VACUUM TUBE
VOLTMEETER KIT**
\$24.50



Heathkit
TUBE CHECKER KIT
\$29.50

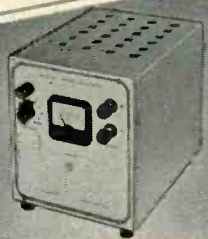

Heathkit
**BATTERY
ELIMINATOR KIT**
\$22.50



Heathkit
**CONDENSER
CHECKER KIT** \$19.50

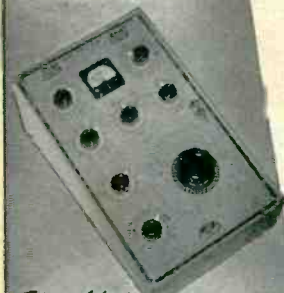

Heathkit
**IMPEDANCE
BRIDGE KIT** \$69.50



Heathkit
**R. F. SIGNAL
GEN. KIT** . . .
\$19.50



Heathkit
**HANDITESTER
KIT** . . . \$13.50

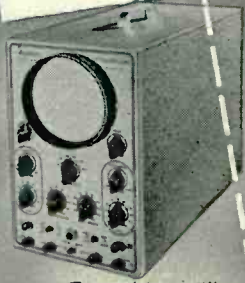

Heathkit
**5" OSCILLOSCOPE
KIT**
\$39.50



Heathkit
**TELEVISION
GEN. KIT** . . .
\$39.50

HEATH COMPANY
**BENTON HARBOR 14,
MICHIGAN**

Heathkits are beautiful factory engineered quality service instruments supplied unassembled. The builder not only saves the assembly labor cost but learns a great deal about the construction and features of the instrument. This knowledge aids materially in the use and maintenance of the equipment. Heathkits are ideal for and used by leading universities and schools throughout the United States. Each kit is complete with cabinet, 110V 60 cycle transformer (except Handitester), all tubes, coils assembled and calibrated, panel all ready printed, chassis all punched, formed and plated, every part supplied. Each kit is provided with detailed instruction manual for assembly and use. Heathkits provide the perfect solution to the problem of affording complete service equipment on a limited budget. The basic three instruments — an Oscilloscope, Vacuum Tube Voltmeter, and Signal Generator can be purchased in Heathkits for \$83.50, about the cost of a factory-built VTVM alone. Write for complete catalog.

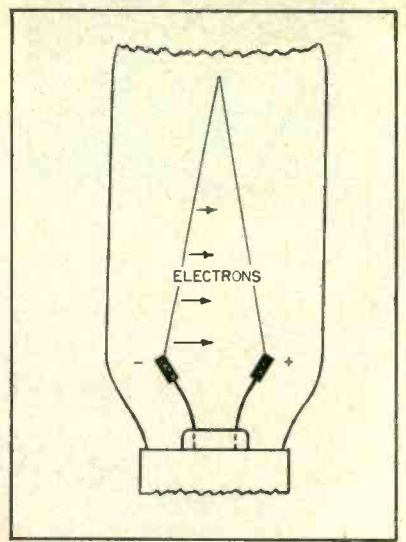

FIG. 1—Edison effect in an incandescent lamp with V-shaped filament

glass post or a coiled-coil filament. Since the problem becomes important in connection with the reported tv interferences it appears advisable to resuscitate the phenomena and explain the mechanism. The following story is taken from the oldest encyclopedia on vhf and microwaves⁶ plus some additional comments.

Consider first the simple incandescent lamp with the V-shaped filament shown in Fig. 1. It may be fed by d-c so that the left branch of the filament represents a cathode for the plate branch on the right side whereby the voltage drop along the filament gives the plate potential, starting at 110 volts near the supports and decreasing to zero at the tip.

The resulting electron discharge between opposite portions of a filament is known as the Edison effect. In addition, any cross section resembles a diode electron oscillator.

To avoid any misinterpretation, it must be well differentiated from another diode oscillator whose oscillations are purely the result of the phase-shifted displacement current owing to the electrons which pass directly from cathode to anode⁷⁻¹¹. In contrast to this, the plate of the wire diode in question plays the role of a positive grid whereby a zero potential plane results either from negatively charged glass walls or as a consequence of space charges.

Electrons leaving the cathode may easily miss the plate wire in the same way as they penetrate the grid meshes of a Barkhausen triode

Federated ROSIN CORE SOLDER

Look for the orange package . . . the universally popular solder for use in electrical applications where bonding must be secure and free from corrosion.

The flux is in the solder . . . all you need is heat! Federated Rosin Core Solder is available in 1, 5, and 20-pound sizes.



Federated makes every commercial solder . . .

Asarco Body Filler Metal, acid-core, solid wire, spray-gun, and bar . . . purity and composition guaranteed by the world's leading supplier of solder.

Federated METALS

Division of AMERICAN SMELTING AND REFINING COMPANY
120 Broadway, New York 5, N. Y.
OFFICES IN PRINCIPAL CITIES ACROSS THE NATION





Best for

ULTRA HIGH FREQUENCY NEEDS!

You can't beat the properties of Teflon when you're looking for hf and uhf insulators . . . and you'll never find more perfectly fabricated Teflon parts than those made by "John Crane".

Teflon insulators combine low dielectric constant, low loss factor, high heat resistance, toughness and resiliency.

As pioneers in the fabrication of Teflon products, we can fill your requirements. Scores of "John Crane" insulating spacers, connectors, beads, etc. are in use throughout the world on installations such as coaxial cables and radar units.

If you need Teflon insulators, let "John Crane" solve your problem. Write for full information

* John Crane products fabricated from DuPont Teflon are sold under the registered trade name "Chemlon".

JOHN CRANE **CRANE PACKING COMPANY**
 1802 CUYLER AVENUE • CHICAGO 13, ILLINOIS
 Offices in all Principal Cities in United States and Canada

Simple • Reliable • Economical
Potter decimal counter

Highest quality pretested components, conservative ratings

Four large, easy reading, bulls-eye glow lamps — replaceable socket type

All components turret-lug mounted and accessible . . . all wiring color coded

Special silver plated, self-aligning contact and rigid connectors for positive mechanical mounting

WRITE DEPT 6-U FOR COMPLETE INFORMATION AND QUANTITY DISCOUNTS

DIRECT DECIMAL READ-OUT — FOUR NEON GLOW LAMPS DESIGNATED 1-2-4-8 PROVIDE DIRECT INDICATION (0-9) AND INSTANTANEOUS LOCATION OF ANY DEFECTIVE TUBE.

STABLE OPERATION — WIDE VOLTAGE RANGE.

HIGH COUNTING RATES — UP TO 130,000 PER SECOND ABSOLUTE ACCURACY GUARANTEED.

COVERED BY BOTH I.B.M. AND POTTER PATENTS ISSUED AND PENDING

POTTER INSTRUMENT CO. INCORPORATED
 115 CUTTER MILL RD., GREAT NECK, N. Y.

A NEW LOW UNIT PRICE OF **\$45.00** IS ANNOUNCED AS A RESULT OF WIDE ACCEPTANCE AND QUANTITY PRODUCTION

and may oscillate around the plate in the closed or open orbits shown in Fig. 2. All electrons starting at favorable phases and rotating in closed orbits remain synchronous for several cycles of oscillation thus producing a vibrating or rotating space-charge cloud. The residual electrons do not contribute to the mechanism of self-excitation.

Since the incandescent lamp may be visualized as being composed of numerous wire diodes each one driven by different plate voltages, a broad band of fundamentals must be expected. Moreover the great disparity in transit times on both sides of the grid of a pure Barkhausen oscillator? makes the space-charge oscillations nonsinusoidal, so that each fundamental is accompanied by marked harmonics. A suitable resonant system, perhaps the filament itself, in connection with the leads or with an external Lecher line, may select a sharp spectral line on which the vhf energy is concentrated by the superimposed vhf fields.

A-C Filaments

Under the peculiar operating conditions that the filament is fed by a-c, the oscillations occur only during a certain interval of the half-cycle of the line frequency when the resonance between the natural

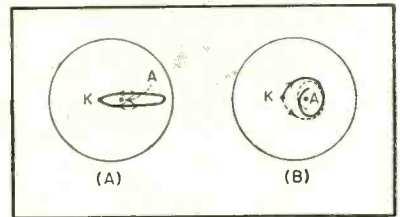

FIG. 2—Electron orbits in a wire diode (A) closed and (B) open

period of the electron dance and the period of the internal or external tank system is favorable. In addition, the lamp oscillator is driven similarly as if by a two-way rectifier because cathode and plate reverse their roles during both half-cycles of the driving frequency. This explains the tv interference in the form of pulses synchronous with 60 cycles.

This is also the general picture for explaining the electron oscillations in modern coiled-coil filament

DU PONT "TEFLON"*

**gives maximum efficiency, durability in co-ax connectors
for Sperry radar set**

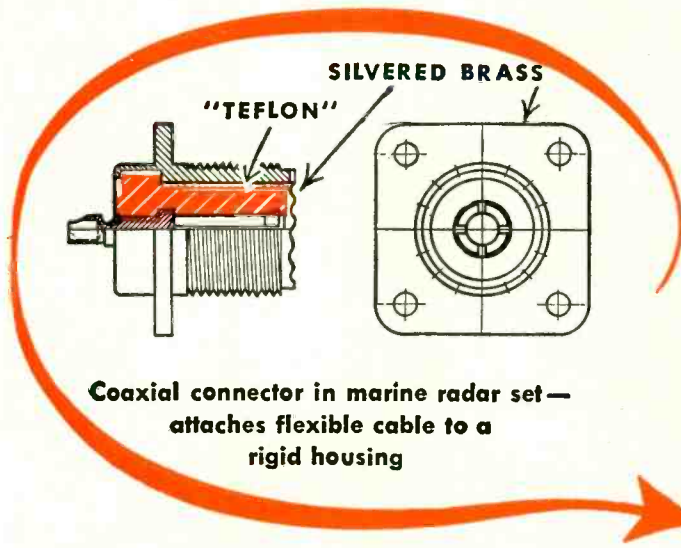

Connectors made by Industrial Products Division, Danbury-Knudsen, Inc., Danbury, Conn., for Sperry Gyroscope Co., Great Neck, L. I., N. Y.

**Tough new plastic has
low dielectric constant, low loss factor,
excellent heat-resistance**

When a material requirement calls for low dielectric constant, low loss factor, high heat-resistance, toughness, resiliency—there is *one* material that has all these properties, Du Pont "Teflon" tetrafluoroethylene resin. That's why "Teflon" is superior to all other materials for use in high-frequency connectors. That's why Sperry uses "Teflon" for the insulation in the coaxial connectors for this marine radar set. "Teflon" provides unequalled transmission efficiency plus outstanding durability.

First, "Teflon" has a low dielectric constant (2.0), constant over the entire range of frequencies measured to date. This minimizes step discontinuities that produce reflections of power. In addition, it has a low loss factor (0.0005)—so that little power is lost at the con-

ductor, and the insulation does not heat up in service.

Along with these outstanding electrical properties, "Teflon" has high heat resistance (serves up to 500°F.), eliminates danger of melting the insulation when soldering connections during assembly. It's tough, too, even at temperatures as low as -90°F., won't break or crack if connectors are dropped or banged, has just enough resiliency to give and conform when stressed during installation.

"Teflon" is supplied by Du Pont in standard shapes (rods, tubes, sheets and tape) and molding powders. Or we will recommend molders or fabricators who can supply finished parts of "Teflon." Write today for more information. Our technical staff will be glad to help you. E. I. du Pont de Nemours &

Co. (Inc.), Polychemicals Department, Plastics Sales Offices: 350 Fifth Ave., New York 1, N. Y.; 7 S. Dearborn St., Chicago 3, Ill.; 845 E. 60th St., Los Angeles, California. *REG. U. S. PAT. OFF.



you
benefit
by

THE CENTURY OF EXPERIENCE
BEHIND B&J FASTENINGS



Slotted or Phillips head machine screws, wood screws, stove bolts, tapping screws, special headed products; nuts, rivets, chaplets, wire forms, screw machine products . . . in steel, stainless steel, copper, brass, bronze, everdur, nickel, nickel silver, monel, aluminum . . .

WRITE FOR catalog of complete line of Blake & Johnson fastenings. Address Dept. E-8.



**BLAKE &
JOHNSON**
Fastenings

THE BLAKE & JOHNSON COMPANY, WATERTVILLE 48, CONN.

bulbs. Here also, one part of the helical filament forms cathodes for opposite plate portions, and vice versa, in alternate succession no matter how the filament is shaped or arranged.

REFERENCES

- (1) TV Interference From Incandescent Lamps, *ELECTRONICS*, p 132, Dec. 1949.
- (2) Lamp TVI, *ELECTRONICS*, p 65, Mar. 1950.
- (3) H. E. Hollmann, Elektronenschwingungen in Gitterdioden (Electron Oscillations in Grid Diodes), *Zeitschr. fur Techn. Physik*, 10, p 424, 1929.
- (4) J. S. McPetrie, Experiments with Inverted Diodes Having Various Filament Cathodes, *Phil. Mag.*, 19, p 501, 1935.
- (5) W. Gerber, Raumladungsschwingungen in Dioden (Space-Charge Oscillations in Diodes), *Zeitschr. fur Hochfr.* 36, p 98, 1950.
- (6) H. E. Hollmann, Physik und Technik der Ultrakurzen Wellen (Physics and Technique of VHF), 1, Ch. III, section 1. F, b, Berlin 1936.
- (7) W. E. Benham, Theory of the Internal Action of Thermionic Systems at Moderately High Frequencies, *Phil. Mag.* 5, p 641, 1928.
- (8) J. Muller, Elektronenschwingungen im Hochvakuum (Electron Oscillations in High Vacuum), *Zeitschr. fur Hochfr.* 41, p 156, 1933.
- (9) J. Muller, Experimentelle Untersuchungen uber Elektronenschwingungen (Experimental Investigations on Electron Oscillations), *Zeitschr. fur Hochfr.* 43, p 195, 1934.
- (10) F. B. Llewellyn and A. E. Bowen, The Production of UHF Oscillations by Means of Diodes, *Bell System Tech. J.* 18, p 280, 1939.
- (11) Reference 6, Ch. V, section 2.

Yarn Tensiometer

MEASUREMENT of yarn tension under true spinning conditions is provided by a new tensiometer, useful in studying the many factors affecting yarn tension, such as size and conditions of travelers, ring-rail position, diameter of yarn package, and spindle speed. The equipment is expected to become a vital instrument in textile research and development work.

The General Electric tensiometer transforms the yarn tension into an electric signal by means of two standard magnetic strain-gage coils and the usual 60-cycle 110-volt power-supply unit. Yarn guides and a restraining beam are attached to a shaft so that yarn tension causes a proportional deflection of the beam. When the beam is deflected, the air gaps between it and the coils change, causing an output signal by reason of the unbalanced strain-gage circuits. The signal is fed into a photoelectric recorder or similar instrument. Tension of one to 10 ends can be measured at once.

Don't Worry



About Fluctuating Voltage

You Can Do Something

About It



VOLTAGE STABILIZERS
...deliver a steady 115 Volts

Worried about tubes and circuits or relays and controls acting up when voltage fluctuates? One easy solution: *don't let the voltage vary!* With a General Electric Voltage Stabilizer, voltage stays right at 115 v. You can simplify circuits, save money, and get better operation too!

Stabilization is nearly instantaneous (less than 3 cycles) and within ± 1 per cent for fixed, unity-power-factor loads. All voltage fluctuations between 95 and 130 volts are *automatically* leveled out.

These stabilizers are of the transformer type. They have no moving parts and require virtually no maintenance. They will operate continuously at no load or short circuit without damage to them-

selves. They automatically limit short-circuit current to approximately 200 per cent of rated full-load current.

The stabilizer shown here is rated 1000 volt-amperes. Others are available with ratings from 15- to 5000-va. For general information, write for Bulletin GEA-3634B, Apparatus Department, General Electric Company, Schenectady 5, N. Y.

Your G-E office will be glad to evaluate your particular needs, or we can advise you by mail if you will give us data and a description of the circuit and load. Address inquiries to Specialty Transformer Sales Division, 1635 Broadway, Ft. Wayne, Indiana.

GENERAL  ELECTRIC

411-71

Atom pile by-products "fly" to help medical research

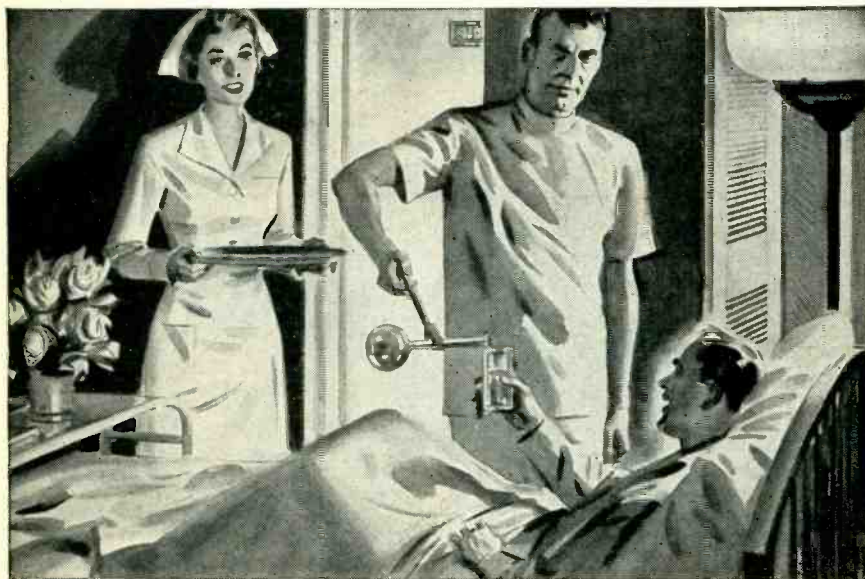

Radioisotopes were needed by a Boston hospital for patient treatment. Lead-shielded box of radioactive iodine (weight, 35 lbs.) picked up by Air Express in Knoxville, Tenn., at 11 A.M., delivered 7:15 P.M. Charge, \$8.60. Hospitals, like all business, use Air Express regularly to get supplies from anywhere in hours.

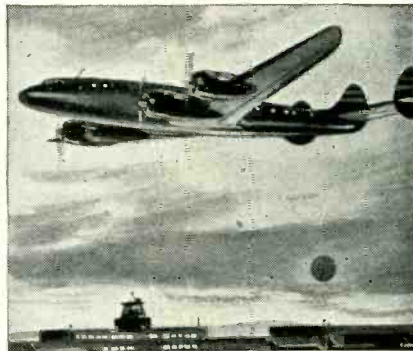

It's easier and more convenient to use the world's fastest shipping service. When shipments are ready, just phone for pick-up. Special door-to-door service included in the low rates.

Shipments keep moving. Air Express goes on every Scheduled Airline flight. Frequent schedules. Use dependable, experienced Air Express—keep your business rolling at a profitable clip.

Air Express gives you all these advantages:

- World's fastest transportation method.
- Special door-to-door service at no extra cost.
- One-carrier responsibility all the way.
- 1150 cities served direct by air; air-rail to 22,000 off-airline points.
- Experienced Air Express has handled over 25 million shipments.

Because of these advantages, regular use of Air Express pays. It's your best air shipping buy. For fastest shipping action, phone Air Express Division, Railway Express Agency. (Many low commodity rates in effect. Investigate.)

AIR EXPRESS
GETS THERE FIRST



Rates include pick-up and delivery door to door in all principal towns and cities

A service of
Railway Express Agency and the
SCHEDULED AIRLINES of the U.S.



THE ELECTRON ART

(continued from p 122)

tangle, a form within which it would be difficult accurately to shape a parabola. For mechanical convenience, the mask was actually divided into a number of identical small parabolas of convenient dimensions which are the equivalent of one long parabola as shown in Fig. 3B. It can be shown that this method of construction also results in a reduction of such distortions as arise from tilted beams and variations of current density with beam height by a factor proportional to the number of apertures into which the mask is divided.

Operation

To make the QK-256 accurately square 40-mc pulsed signals in a noncritical manner, the tube was

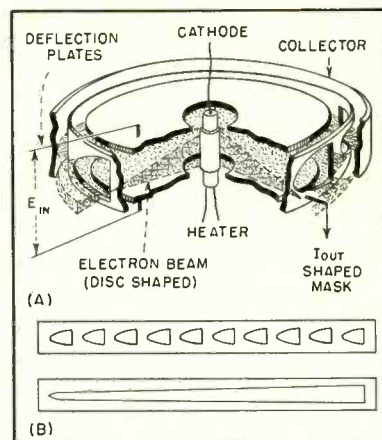

FIG. 3—Cutaway view of beam-deflection tube and equivalent mask shapes

operated with its output tuned to twice the input frequency. Advantage was thus taken of the fact that the amplitude of the second harmonic component at the output is dependent only upon the curvature of the static characteristic and is unaffected by d-c at input or output. Furthermore, by spreading the beam, its resolving power with respect to small variations in the mask contour can be reduced, if necessary, thus minimizing second harmonic contributions from sources of curvature of higher order than square. In general, there will also be average and fundamental components at the output. For an input signal $E_{IN} = E \cos \theta$ for

FREED

"PRODUCTS OF EXTENSIVE RESEARCH"

DECADE INDUCTORS BY FREED



A complete line of precision high stability decade inductors covers the range from one tenth of milli-henry to hundred henries and frequencies from 30 cycles to 300,000 cycles.

The inductors can be used either as secondary laboratory standards or as high Q components in wave filters, equalizers and tuned circuits for audio and radio frequencies. Individual inductors are wound on temperature stabilized molybdenum permalloy toroidal core. Four coils (nominal values 1, 2, 3, 4) are combined in an individual decade. A special low loss ceramic switch combined the coils in such a way as to give the eleven successive values from 0 to 10.

Special silver alloy contacts insures very low contact resistance.

OUTSTANDING FEATURES

- Very high Q at frequencies up to 300,000 cycles.
- High natural frequency.
- Astatic to external magnetic fields.
- Very low temperature coefficient.
- Electrostatic and magnetic shielding.



H-I FIDELITY
1/2 DB 20-10000 CYCLES

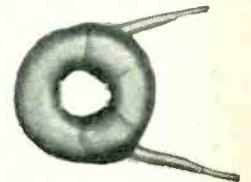

TOROIDAL INDUCTORS
60 CPS TO 1 MC.

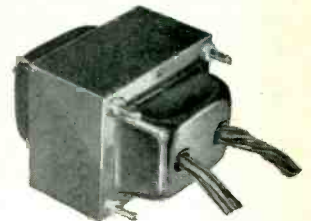

POWER TRANSFORMERS
COMMERCIAL QUALITY



HERMETICALLY SEALED
TO MEET MIL-27 SPECS.

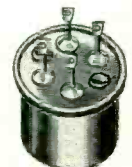

SUB MINIATURE
HERMETICALLY SEALED
TRANSFORMERS

FREQUENCY RANGE 30 TO 2000 CYCLES Q = 50 @ 200 CYCLES			Price
#1164	DECADE INDUCTOR 111	Henry total in steps of .1 Henry	195.00
FREQUENCY RANGE 100-2000 CYCLES Q = 80 @ 500 CYCLES			
#1341	DECADE INDUCTOR 100	Henry total in steps of 10 Henry	75.00
FREQUENCY RANGE 500-20,000 CYCLES Q = 60 @ 1000 CYCLES			
#1160	DECADE INDUCTOR 11.1	Henry total in steps of .01 Henry	172.00
#1163	DECADE INDUCTOR 1.11	Henry total in steps of .001 Henry	172.00
#1260	DECADE INDUCTOR 11.11	Henry total in steps of .001 Henry	215.00
FREQUENCY RANGE 500-20,000 CYCLES Q = 160 @ 1000 CYCLES			
#1220	DECADE INDUCTOR .01	Henry total in steps of .001 Henry	55.00
#1230	DECADE INDUCTOR .1	Henry total in steps of .01 Henry	51.00
#1240	DECADE INDUCTOR 1	Henry total in steps of .1 Henry	55.00
#1260	DECADE INDUCTOR 11.11	Henry total in steps of .001 Henry	215.00
#1270	DECADE INDUCTOR 10	Henry total in steps of 1 Henry	60.00
#1280	DECADE INDUCTOR 1.11	Henry total in steps of .001 Henry	195.00
#1290	DECADE INDUCTOR 11.11	Henry total in steps of .001 Henry	245.00
#1310	DECADE INDUCTOR 11.1	Henry total in steps of .01 Henry	195.00
FREQUENCY RANGE 2000-50,000 CYCLES Q = 200 @ 10,000 CYCLES			
#1161	DECADE INDUCTOR 1.11	Henry total in steps of .001 Henry	191.00
FREQUENCY RANGE 10,000-300,000 CYCLES Q = 200 @ 100,000 CYCLES			
#1162	DECADE INDUCTOR .111	Henry total in steps of .1 millihenry	197.00
*#1164 DECADE INDUCTOR is wound on a special nickel alloy core.			

SEND FOR LATEST CATALOG!

FREED TRANSFORMER CO., INC.

DEPT. AE 1718-36 WEIRFIELD ST. (BRIDGEWOOD) BROOKLYN 27, NEW YORK

Designed for



Application

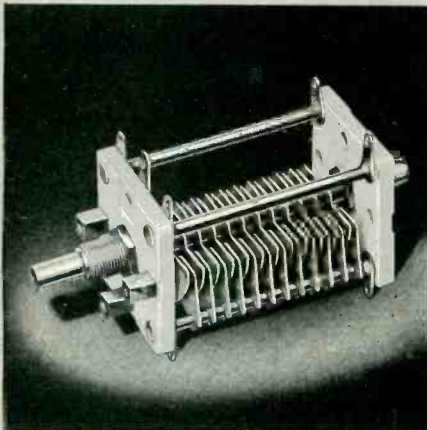

**The 23000 Series
Variable Air Capacitors**

"Designed for Application," double bearings, steatite end plates, cadmium or silver plated brass plates. Single or double section. .020" or .060" air gap. End plate size: 1 7/8" x 1 1/2". Rotor plate radius: 1 1/2". Shaft lock, rear shaft extension, special mounting brackets, etc., to meet your requirements.

**JAMES MILLEN
MFG. CO., INC.**

MAIN OFFICE AND FACTORY
MALDEN
MASSACHUSETTS

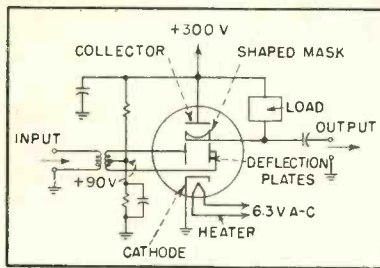

FIG. 4—Schematic of squaring amplifier circuit

example, the complete output will be

$$i_{OUT} = i_o + (V_o + E_{IN})^2$$

$$= \left(i_o + V_o^2 + \frac{E^2}{2} \right) +$$

$$\left(2V_o E \cos \theta \right) + \left(\frac{E^2}{2} \cos 2\theta \right)$$

where i_o and V_o are d-c components of the static characteristic at output and input respectively. These outputs are useful in other applications. If operation as a square-law detector is desired, for example, the average component would be selected by passing the output through a low-pass filter. The fundamental component represents the action of the square-law tube as a suppressed carrier type of linear modulator with V_o as modulation signal E the input carrier amplitude.

The relative insensitivity of a square-law characteristic to other parameters of a beam deflection tube was borne out in the experimental work. The tube was successfully operated with either single ended or push-pull input or output; double-ended output being obtainable between the shaped mask and collector electrodes. Biasing the deflection plates at a constant fraction of the B+ provided a simple, stable operating condition. The curved portions of the static characteristics are insensitive to changes in B+ over a wide range. The amplitude of the second harmonic component of the output measured as a function of input signal amplitude on an audio frequency model of the squaring amplifier circuit of Fig. 4 was parabolic within the 2 percent accuracy of the measuring equipment used. This c-w transfer characteristic was unaffected by the presence of a wide range of direct voltages introduced at the input, and remained

how can
**YOU use this
unique Edison
Thermal Relay?**

- For cathode protection
- — overload protection
- — holdovers
- — pulse integration
- — motor starting
- — or other control functions?



If you are designing circuits requiring a time delay element, or a reliable relay where a short operating interval can be tolerated, it might be to your advantage to consider the Edison 501 Thermal Relay.

Here are 7 good reasons why:

1. **Vibration and shock resistant** — Guaranteed to withstand continuous vibration of 1/16" over-all amplitude at 55 cps., and impact shock of 50 g.
2. **Chatter-proof** — Pre-loaded spring provides 50-gram pressure almost instantaneously, for sure, positive operation.
3. **Non-position sensitive** — Characteristics not affected by mounting angle — operates satisfactorily in any position. Standard intermediate octal base.
4. **Ambient compensated** — Automatically compensated for $\pm 60^\circ$ C. ambient range by extra unheated bimetal. Will operate from -60° C. to $+100^\circ$ C.
5. **Non-arcng** — Sealed-in-glass. Operates in its own arc-suppressing atmosphere. Withstands substantial currents and voltages without arc-pitting.
6. **Explosion-proof** — Hermetically sealed. You can specify it for safe use in corrosive or hazardous fumes and dusts. Tamper-proof, too.
7. **Fungus-resistant** — Available with fungus and salt-spray resistant micanol base.

GENERAL SPECIFICATIONS—STANDARD TYPES

Operating Time—5 to 300 sec., in 14 standard intervals, pre-set at factory.	Heater—5 watts, 117 v., 26.5 v., 6.3 v., dc. or ac to 2400 cps.
Contacts—Silver, SPST, normally open.	Size—1.275" max. dia., 3.250" max. seated height (standard T-9 envelope).
Contact Rating—Types 5 sec. to 75 sec., 3 amp. 150 vdc or 250 vac; Types 90 to 300 sec., 3 amp. 450 v. ac/dc.	Weight—1 1/2; to 2 1/2 ounces.
Other than standard types can be made up on special order to meet requirements for other heater voltages, higher currents, etc.	

LITERATURE AVAILABLE

Free illustrated Bulletin 3007A gives full details. Write today for a copy, 296 Lakeside Ave., West Orange, N. J.



INSTRUMENT DIVISION
THOMAS A. EDISON,
INCORPORATED

Trifles . . . that taboo Troubles—



● They're trifling things—these tiny tubes! But used as cathodes, anodes, and grids, in electronic tubes, they have to give superior performance. You can count on Superior. Electronic research and development, faster production and metallurgical control combine with close inspection, uniformity, and dependability to make Superior products the best obtainable.

Superior from the beginning pioneered in the perfection of these

vital components. Its facilities and equipment can produce the type of dependable products you have a right to expect. It's simply a matter of technology in tubing.

You may already be working with Superior. Nearly all electronic manufacturers are. If small tubing can help you, Superior can. Why not find out? Superior Tube Company, 2500 Germantown Avenue, Norristown, Pennsylvania.

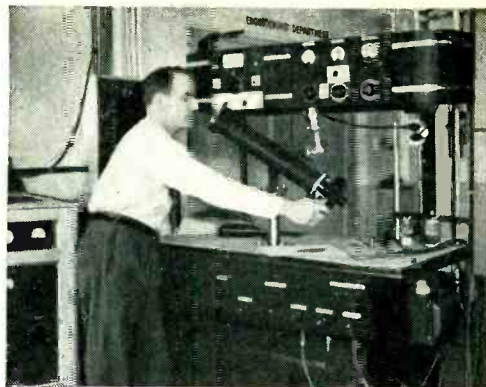

Electronic Engineering Laboratory equipment for testing emission characteristics of nickel cathode materials.

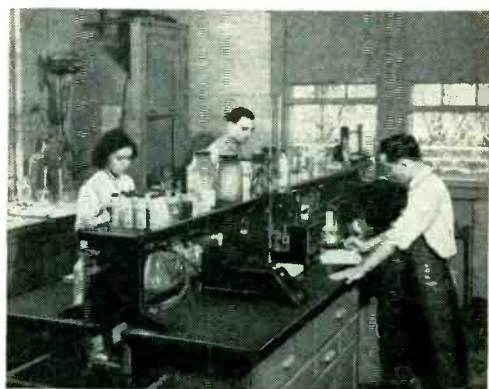

The Chemical Laboratory where nickel and nickel alloys are carefully analyzed as a part of Superior quality control.

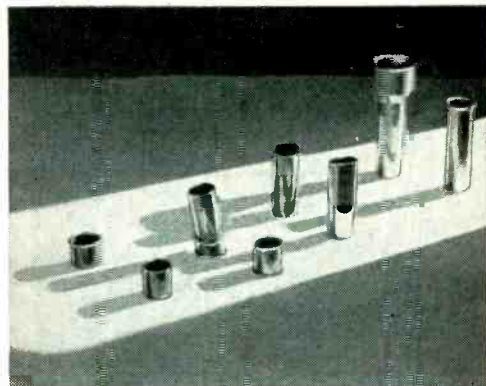

Tubular parts made to the exacting requirements of the Electronics Industry. Chemical and metallurgical engineering controls together with a penetrating production system help make Superior's electronic parts outstanding.

Which Is The Better For Your Product . . .

SEAMLESS . . .? The finest tubes that can be made. In all O.D.'s from $1\frac{3}{8}$ " and lower. Excellent for forming, bending, machining, etc. carbon, alloy, stainless, non-ferrous and glass sealing alloys.

Or LOCKSEAM* . . .? Produced directly from nickel alloy strip stock by our patented machines. Available in a wide range of nickel alloys. Round, rectangular, oval or square, cut to specified lengths, beaded or flanged.

*Mfd. under U.S. Pats. — Superior Tube Company • Electronic Products for export through Driver-Harris Company, Harrison, New Jersey • Harrison 6-4800

Superior
THE BIG NAME IN SMALL TUBING

All analyses .010" to $\frac{3}{4}$ " O.D.
Certain analyses (.035" max. wall) Up to $1\frac{1}{2}$ " O.D.

mecha

development apparatus

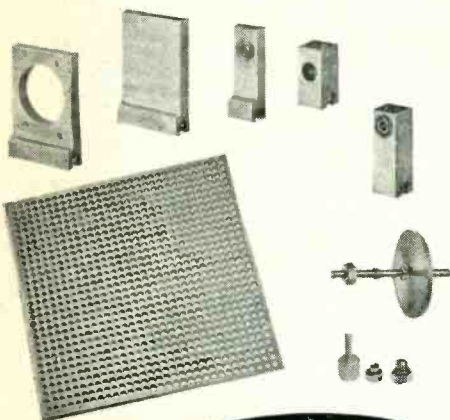

Servomechanisms, Inc.,
**Mechanical Development
 Apparatus** provides the
 designer with an extensive
 selection of precision
 components for rapid and
 economical assembly of gear
 trains and actuator devices.
 Typical applications are
 analog computers,
 signal generators,
 process programmers.

- Foundation Boards
- Bearing Blocks
- Mounting Brackets
- Gears and Shafts
- Miscellaneous
 Accessories

Write for
 Descriptive
 literature
 MDA

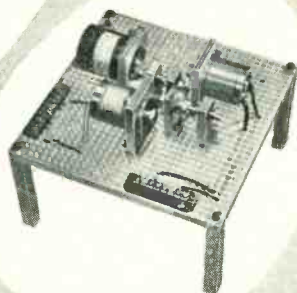

Old Country & Glen Cove Roads

MINEOLA, N. Y.

Garden City 7-0754-5-6

SERVOMECHANISMS
 inc.

unchanged, except for scale factor, under different loads. Maximum output of various models ranges from 30 volts to as high as 140 volts with more complicated gun structures.

Pulsed and c-w transfer characteristics measured with a 40-mc input and 80-mc output were linear on a db scale with a slope of 2 to an accuracy within the smallest step available in the attenuators used (1 db). The output measurements covered only the 40-db dynamic range required for the application at hand; however, there was no indication of a decrease in accuracy at the low-level end.

Further work on such nonlinear circuit elements is presently going forward. The design described is being refined. Tubes with other nonlinearities for further applications are being built and the possibilities of other tube geometrics are being explored.

Series Sawtooth Oscillator

By MAJOR CHANG SING

*Chinese Air Force
 Kangshan, Taiwan, Formosa*

MOST SAWTOOTH oscillators and multivibrators employ tubes connected in cascade. There has been no circuit of relaxation oscillators employing tubes connected in series. This is mainly due to the difficulty that the plate of one tube is not connected to B+ directly.

Figure 1A shows the schematic circuit of a new series sawtooth oscillator and Fig. 1B the different waveforms obtained. When the switch is on, C_1 is charged through V_1 . The cathode potential of V_1 , which is connected to the plate of V_2 via the resistor R_2 , increases exponentially and the plate of V_1 follows with it. As the charge on the capacitor becomes large enough, the discharging tube V_2 starts to conduct and R_2 carries the plate current of V_2 to bias V_1 off. The plate of V_1 rises to B+ and makes V_2 conduct more. In this state (V_1 cut off and V_2 conducting) C_1 discharges through V_2 . The waveform on the plate of V_2 is similar to that on the cathode of V_1 except a fall at the beginning of the discharge due

PHYSICISTS And SENIOR RESEARCH ENGINEERS

POSITIONS NOW OPEN

Senior Engineers and Physicists having outstanding academic background and experience in the fields of:

- Microwave Techniques
- Moving Target Indication
- Servomechanisms
- Applied Physics
- Gyroscopic Equipment
- Optical Equipment
- Computers
- Pulse Techniques
- Radar
- Fire Control
- Circuit Analysis
- Autopilot Design
- Applied Mathematics
- Electronic Subminiaturization
- Instrument Design
- Automatic Production Equipment
- Test Equipment
- Electronic Design
- Flight Test Instrumentation

are offered excellent working conditions and opportunities for advancement in our Aerophysics Laboratory. Salaries are commensurate with ability, experience and background. Send information as to age, education, experience and work preference to:

NORTH AMERICAN AVIATION, INC.

Aerophysics Laboratory

Box No. K-4, 12214 S. Lakewood Blvd.
 DOWNEY, CALIFORNIA

Announcing... a revolutionary new oscilloscope



Horizontal sync-pulse as displayed on WO-57A screen

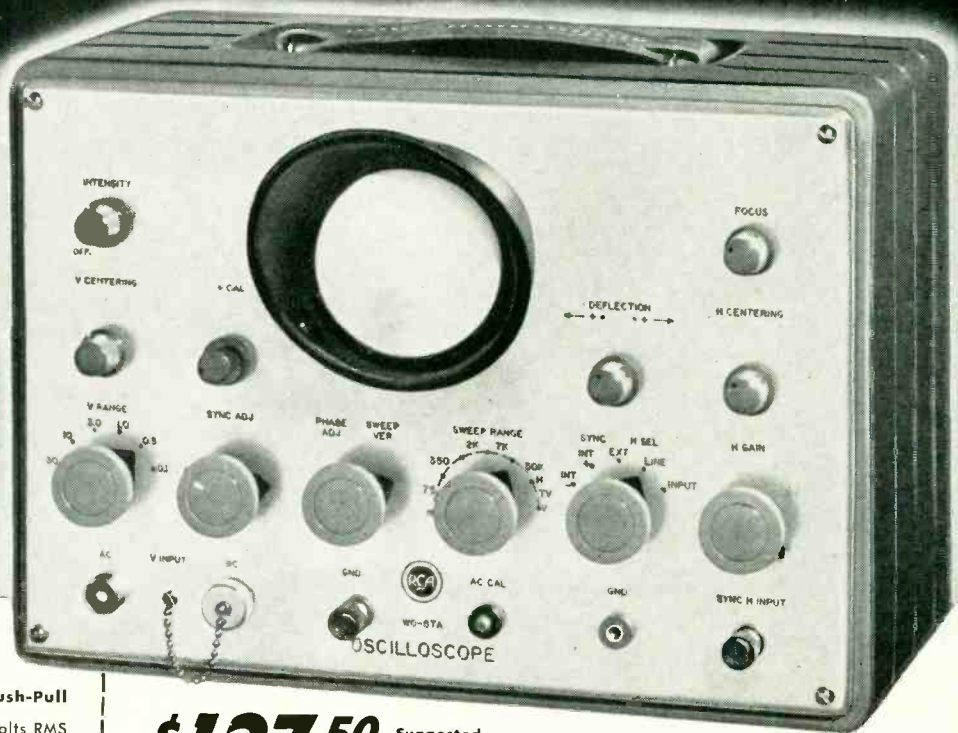

Featuring

- ✓ **A Direct-Coupled, 2-stage, Push-Pull Vertical Amplifier**
- ✓ **Deflection Sensitivity**—30 millivolts RMS per inch deflection.
- ✓ **Frequency Response**—Flat within ± 1.3 db from dc to 500 kc; within ± 3.5 db at 1 Mc; useful beyond 2 Mc.
- ✓ **Square-Wave Response**—Tilt and overshoot less than 2%.
- ✓ **Input Capacitance**—14 uuf with WG-216 accessory probe.

Special

- ✓ **Advanced Sweep Facilities**
- ✓ **Preset Fixed Sweep Positions** for viewing vertical and horizontal sync pulses and sweep oscillator waveforms.
- ✓ **Positive and Negative Synchronizing** for easy "lock-in" of upright or inverted pulse waveforms.
- ✓ **Sweep Reversal Switch** for left-to-right or right-to-left traces.
- ✓ **Linear Sweep Range**—15 to 30,000 cps.
- ✓ **60-cycle phase controlled sweep.**
- ✓ **Trace Expansion** two times screen diameter for sweep-alignment applications.

Plus These Extras

- + CR tube enclosed in nickel-iron alloy shield to minimize hum pick-up.
- + Push-pull vertical and horizontal amplifiers produce sharper trace and reduce astigmatism.
- + Frequency-compensated and voltage-calibrated step and vernier attenuators.
- + Peak-to-peak calibrating voltage source.
- + New calibrating screen for ease in making voltage measurements.
- + Slanted light shield for better visibility.
- + Portable, compact design — small size, light weight.

\$137⁵⁰ Suggested User Price

The RCA WO-57A

High Gain — Wide Band — DC and AC Input.

The WO-57A is an outstanding innovation in portable oscilloscope design. Especially suited for television, this new scope is excellent for laboratory, factory, or shop use . . . for viewing and measuring square waves, pulses, TV sync signals, and sine waves.

Unusually versatile . . . newly designed from stem to stern . . . the RCA WO-57A Oscilloscope is a triumph of engineering.

Incorporating the features of far more expensive instruments . . . and with a sensitivity and response equal to that of many laboratory units . . . the WO-57A is the first inexpensive oscilloscope wholly equipped to handle every TV and radio service job.

Direct-coupled amplifiers are used to provide low frequency response flat down to dc. Excellent low-frequency square-wave reproduction, essential for correct sweep alignment, is thus assured. High-frequency

square-wave response up to 100 kc enables the WO-57A to reproduce blanking and sync pulse wave shapes with fidelity heretofore unobtainable in moderately priced service-type oscilloscopes.

For complete technical details, ask your RCA Test Equipment Distributor for the bulletin on the new WO-57A, or write RCA, Commercial Engineering, Section H42Y, Harrison, New Jersey.

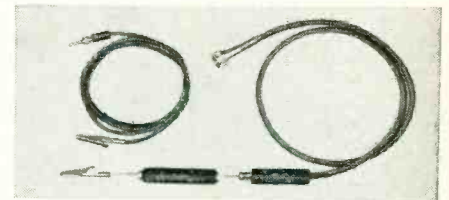

Probe Kit (WG-214)—\$7.50. Includes input cable with direct probe, slip on low-capacitance probe, and ground lead for observation of sync pulses, oscillator wave-forms and video signals without undue circuit loading.

Available from your RCA Test Equipment Distributor



RADIO CORPORATION of AMERICA
TEST EQUIPMENT
HARRISON, N. J.

400-800 CYCLE AC

From 5.5v to 230v
DC Input

New Carter* High Frequency

- **LIGHT WEIGHT**
Filter Model Shown
Weight only 22 lbs.
- **SMALL SIZE**
10" x 4 1/2" x 7 3/4"
(Filter Model as shown)
- **PRECISION BUILT**
Shaft and bore fits
held to less than .0002"
- **ARMATURE**
Triple and quad-
ruple insulated
windings static-
ally and dynamic-
ally balanced
- **BALL BEARINGS**
Require no mainte-
nance or lubrication
in normal service
*T.M. Reg. U.S. Pat. Off.

INDUCTOR ALTERNATOR

Newly developed in the Carter research and engineering departments, this new rotary power supply is ideal for aircraft, geophysical, government and laboratory research, and other applications demanding a small, mobile source of up to 100 watts high frequency AC. Primarily designed for 24-29v. DC airborne equipment, but available at any input voltage 5.5v to 230v. Inductor principle eliminates slip rings and brushes. Electrically isolated input and output units. Separate DC plate output also available in addition to the h.f. AC.



2646 N. Maplewood Ave., Chicago



WRITE for Bulletin 2530. Contains complete illustrated information on the New Carter Inductor Alternator, mechanical and electrical specifications, performance chart, etc. Yours FREE for asking!

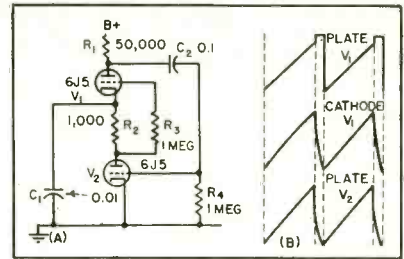
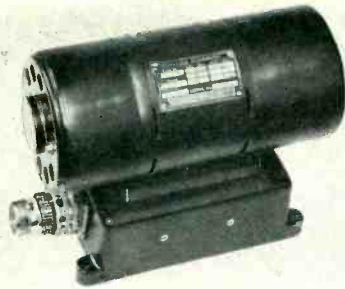

FIG. 1—Basic diagram and voltage waveforms for series sawtooth oscillator

to the drop across R_2 . When the drop across R_2 is not sufficient to cut off the plate current of V_1 , the plate potential of V_1 falls and drives the grid of V_2 to follow it. This decreases the drop of R_2 and V_1 conducts progressively. By the cumulative action V_1 conducts and V_2 is cut off. Then C_1 will charge again and the operation is repeated in the similar manner.

The waveforms produced at the cathode of V_1 and the plate of V_2 the sawtooth-shaped and that on the plate of V_1 is trapezoidal. To improve the linearity of the charging curve a pentode could be used instead of a triode for the charging tube V_1 and a positive grid return for V_2 . When the cathode of V_1 rises, its plate (or screen grid) follows it, the voltage working on the constant-current portion of its characteristic curve. The use of the positive grid of V_2 causes the tube conducting at the lower potential so that only the linear portion of the charging curve is utilized. The improved circuit is shown in Fig. 2.

In this circuit C_1 and R_1 are coarse and fine controls of frequency respectively. To improve the linearity R_2 should be small but its minimum value is limited by the plate current of V_2 so that R_2 is

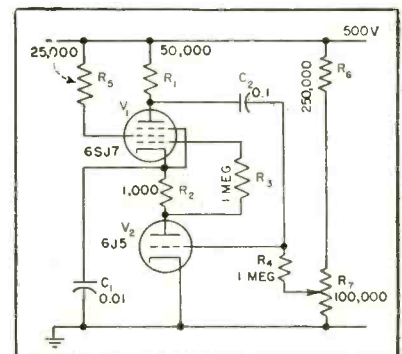

FIG. 2—Improved circuit of series sawtooth oscillator

AMPERITE

THERMOSTATIC METAL TYPE

Delay Relays

PROVIDE DELAYS RANGING FROM 1 TO 120-SECONDS



FEATURES: — Compensated for ambient temperature changes from -40° to 110° F... Hermetically sealed; not affected by altitude, moisture or other climate changes... Explosion-proof... Octal radio base... Compact, light, rugged, inexpensive... Circuits available: SPST Normally Open; SPST Normally Closed.

PROBLEM? Send for "Special Problem Sheet"

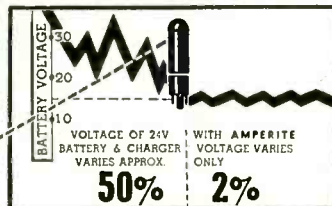

Amperite REGULATORS are the simplest, lightest,

cheapest, and most compact method of obtaining current or voltage regulation... For currents of .060 to 6 Amps... Hermetically sealed; not affected by altitude, ambient temperature, humidity.

Write for 4-page Illustrated Bulletin.

AMPERITE CO., Inc., 561 Broadway, New York 12, N. Y.

In Canada: Atlas Radio Corp., Ltd., 560 King St., W. Toronto

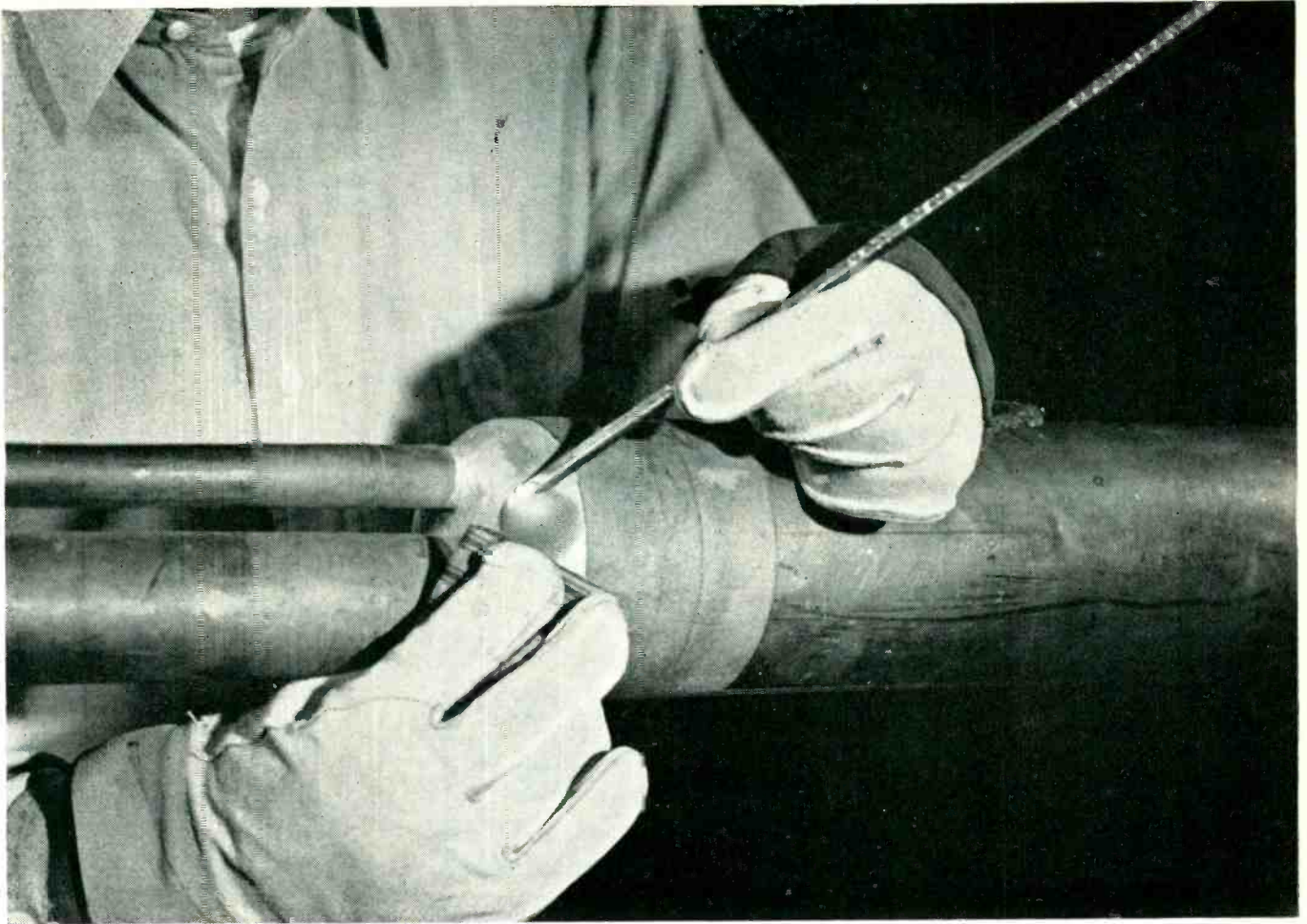

*He seals out
trouble...*

**TO KEEP THE COST
OF YOUR TELEPHONE
SERVICE DOWN**

To make cable joints tight and strong, splicers formerly used lots of solder. Then, Bell Telephone Laboratories developed a new technique for making *better* joints with much less solder. This saves one million pounds of solder a year — helps keep the price of your telephone service low.

Two kinds of solder are now used. One makes the splice strong; the other seals it. First, the splicer builds up a joint with a solder of lead and tin, which flows easily under his wiping cloth. To seal the joint, he applies a light coating of low-melting-point solder, composed of lead, tin and bismuth. On contact with the still hot joint, it flows into and seals every pore.

Cable-sealing solder is only one of 30 low-melting-point alloys which Bell metallurgists have developed for special uses — in fuse wires, for example, and in the solder connecting hair-like wires to piezoelectric crystals for electric wave filters.

Continuing research with a substance seemingly as commonplace as solder demonstrates again how Bell scientists help keep your telephone service the world's best.

BELL TELEPHONE LABORATORIES



• WORKING CONTINUALLY TO KEEP YOUR TELEPHONE
SERVICE BIG IN VALUE AND LOW IN COST

NOTHELPER Special TRANSFORMERS



Proven by
Past
Performance

Over 25 years' experience in the manufacture of special transformers to meet individual requirements. Built in quality proved by years of actual use.

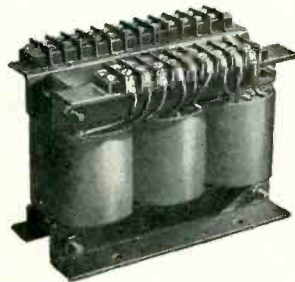

From 10 VA to 300 KVA Dry-Type only. Both Open and Encased. 1, 2, and 3 Phase. 15 to 400 cycles.

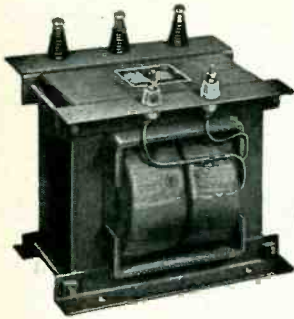

Send for NEW 8 page BULLETIN



NOTHELPER

WINDING LABORATORIES

9 ALBEMARLE AVE., TRENTON 3, N. J.



about 1,000 ohms preferably. Variable R , serves as a velocity control. The time constant of C_2 and R , should be long enough to avoid the blocking action.

Raising the high voltage is also a method of improving the linearity of the charging curve. In this case the high voltage used is from 280 v to about 500 v. The range of operating frequencies can be varied anywhere from a few cycles per second to 0.5 mc.

Ceramic Thickness Gage

THE ACCOMPANYING photograph and partial circuit diagram show an electronic thickness gage for measuring the thickness of nonconducting coatings on nonmagnetic metals. The new instrument provides a simple, direct, nondestructive measurement. These measurements have become important with the increasing use of ceramic materials as protective coatings for metals and alloys in high temperature service.

The instrument consists essentially of a small probe coil, an inductance indicating system, and a device for positioning the coil and measuring its distance from the test surface. The probe coil is housed in a cylindrical plastic test head. A small plastic rod attached to a dial indicator extends axially through the coil to serve as a feeder element. The test head provides for controlled movement of the test specimen with respect to the probe coil. The instrument employs a 500-ke oscillator and the bridge-type inductance indicating system. Measurement is based upon the change in inductance of the probe

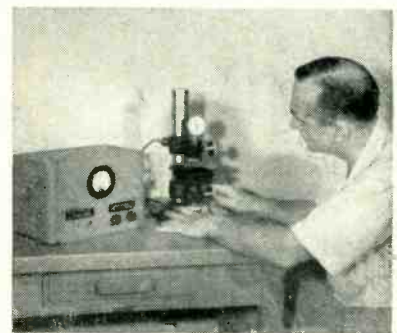

FIG. 1—Ceramic thickness gage gives direct, nondestructive measurements of thickness of nonconducting coatings on nonmagnetic metals

—high accuracy plus!

TYPE BX—
1 WATT



NON-INDUCTIVE

MAX. RES: 1.5 Megohm (331 Alloy)
1.0 Megohm (Nichrome)
30,000 Ohms (Manganin)

BODY SIZE: 1" lg. by 9/16" diam

TOLERANCE: STANDARD 1%
(TO 1/10% at Slight Extra Cost)



For Instrumentation
and other critical
applications

IN-RES-CO wire wound resistors are engineered for the manufacturer maintaining a reputation of top quality and performance in his equipment. They cover a full range from 1 watt to 10 watts and .01 ohm to 1.5 megohm. Conservative ratings assure maximum long life; trouble free service. Write for catalog today on company letterhead.

TYPE CX—
1/2 WATT



NON-INDUCTIVE

MAX. RES: 750,000 ohm (331 Alloy)
500,000 ohm (Nichrome)
15,000 ohm (Manganin)

BODY SIZE: 5/8" lg. by 9/16" diam.

TOLERANCE: STANDARD 1%
(TO 1/10% at Slight Extra Cost)

IN-RES-CO
APPLICATION-DESIGNED
RESISTORS



INSTRUMENT RESISTORS CO., 1056 COMMERCE AVE., UNION, N. J.

GENERAL ELECTRIC ANNOUNCES . . .

High-voltage Selenium Rectifiers

WITH
**LONG
LIFE!**

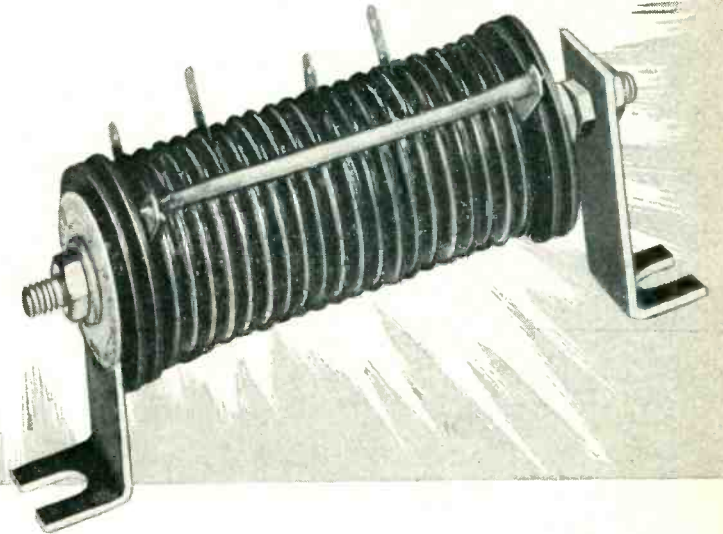

Now a 26-volt RMS selenium rectifier cell with a normal life expectancy of over 60,000 hours! By an entirely new process, our engineers have produced this new high-voltage rectifier cell with remarkably improved characteristics. We believe that these high-voltage selenium cells are far superior to any other 26-volt RMS rectifier cells now available.

EXTREMELY SLOW AGING

These high-voltage selenium cells have an extremely low initial forward resistance. Tests show that at the end of 10,000 hours this low initial forward resistance increases less than 6%. We know of no other high-voltage selenium cell on the market which can even approach this performance.

VERSATILE

These new G-E high-voltage stacks are available in a range from 18 volts DC at .25 to 8 amps—to—126 volts DC at .15 to 3.75 amps. Their small size, light weight and long life make them one of the simplest and most convenient means of obtaining d-c for electronics, control, battery-charging and general power-supply purposes.

BENEFITS

● These new cells will give you higher output voltage from a given input voltage . . . both initially and throughout their much longer life.

● You can now have the advantage of a smaller, lighter, and in many cases a less expensive stack, without sacrifice of performance.

● Because of their low resistance and power loss they are cool running.

Dollar for dollar we believe these new General Electric cells are the best selenium rectifier buy on the market today.

For additional information, fill out the coupon and mail it today. *Apparatus Dept., General Electric Company, Schenectady 5, N. Y.*

Section D 461-4
Apparatus Dept.
General Electric Co.
Schenectady 5, N. Y.

Please send me complete information on the new G-E high-voltage selenium rectifier.

Bulletin needed for:

Reference purposes

Planning immediate project

Name.....
(Please print)

Position.....

Address.....

City..... Zone..... State.....

GENERAL  **ELECTRIC**

New Miniature Insulated Terminals

to help your miniaturization program

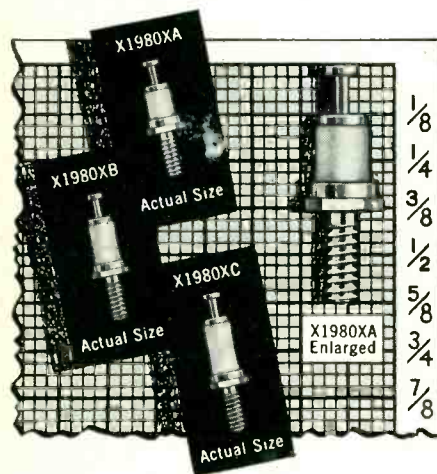

Featuring extremely small size combined with excellent dielectric properties, three new miniature insulated terminals are now available from CTC.

Designed to meet the requirements of the miniaturization programs now being carried out by manufacturers of electrical and electronic equipment, the terminals come in three lengths of dielectric and with voltage breakdown ratings up to 5800 volts. In addition, they have an extremely low capacitance to ground.

The X1980XA is the smallest terminal, having an over-all height of only three-eighths of an inch including lug. Insulators are grade L-5 ceramic, silicone impregnated for maximum resistance to moisture and fungi.

All terminals have hex-type mounting studs with 3/48 thread or .141" OD rivet style mounting. Mounting studs are cadmium plated, terminals are of bright-alloy plated brass.

Write for additional data.

custom or standard the guaranteed components

CAMBRIDGE THERMIONIC CORP.
437 Concord Ave., Cambridge 38, Mass.
West Coast Stock Maintained By: E. V. Roberts,
5014 Venice Blvd., Los Angeles, California

coil due to the proximity of the coated metal surface.

The instrument thus relies on the maintenance of a fixed distance between the probe coil and the metal surface whether the ceramic coating is present or not. The coating material has a negligible effect on the electric field at the frequency used; the metal surfaces are similar so that their electrical properties are nearly identical. Under these conditions, if the inductance of the probe coil is the same in both cases, the separation distances will be equal and the dial gage reading will give an accurate value for the coating thickness.

The instrument is first calibrated on an uncoated specimen identical in size, shape, and composition with the coated specimen to be tested.

The reference specimen is placed on the table of the gage stand and the table is raised until the feeler of the dial gage is in positive contact with the surface. The dial gage is then set at zero and the bridge rheostats are adjusted so that the galvanometer is zeroed. The inductance of the probe coil in the presence of the uncoated metal specimen is thus established as a reference value. The table is lowered and the uncoated specimen replaced by a coated specimen. The table is again raised until the galvanometer reads zero. The thickness of the coating is then given directly by the dial gage reading.

Bridge Circuit

The impedance bridge used in this instrument is particularly suitable since variations in the inductance of the probe coil are indicated without separate balancing of resistive and reactive components at the bridge voltage. This is an

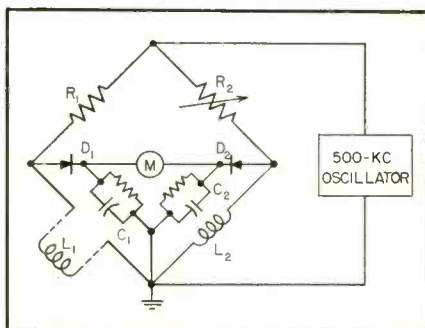

FIG. 2—Simplified schematic of inductance bridge used in ceramic thickness gage

PAPER
can be made to answer many electrical needs

ARMATURE PAPER
Strong Kraft with high dielectric strength and anti-corrosion properties.

CABLE WRAP
Flat or creped Kraft; can be water-proofed or made anti-corrosive as required.

CORE BASE PAPER
Controlled conductivity; free from harmful chemical action.

INSULATION PAPER
High physical strength, high dielectric strength.

ANTI-RUST PAPER
Treated to prevent rusting of metal with which it is in contact.

ANTI-CORROSIVE PAPER
Chemical properties carefully controlled to assure neutrality.

Centraline Engineered Electrical Papers are designed especially to solve your particular problem. They can replace more expensive materials, improve product design, increase production and reduce manufacturing costs. Uniformity and adherence to specifications is assured by laboratory control from pulp to finished Electrical Paper.

Consult a Central Paper Engineer—he will be glad to discuss your problem with you and provide samples for testing. No obligation of course.

REG. U. S. PAT. OFF.

CENTRAL PAPER COMPANY
INCORPORATED

2442 LAKESHORE DRIVE, MUSKEGON, MICH.

YOU CAN BE **SURE**.. IF IT'S
Westinghouse

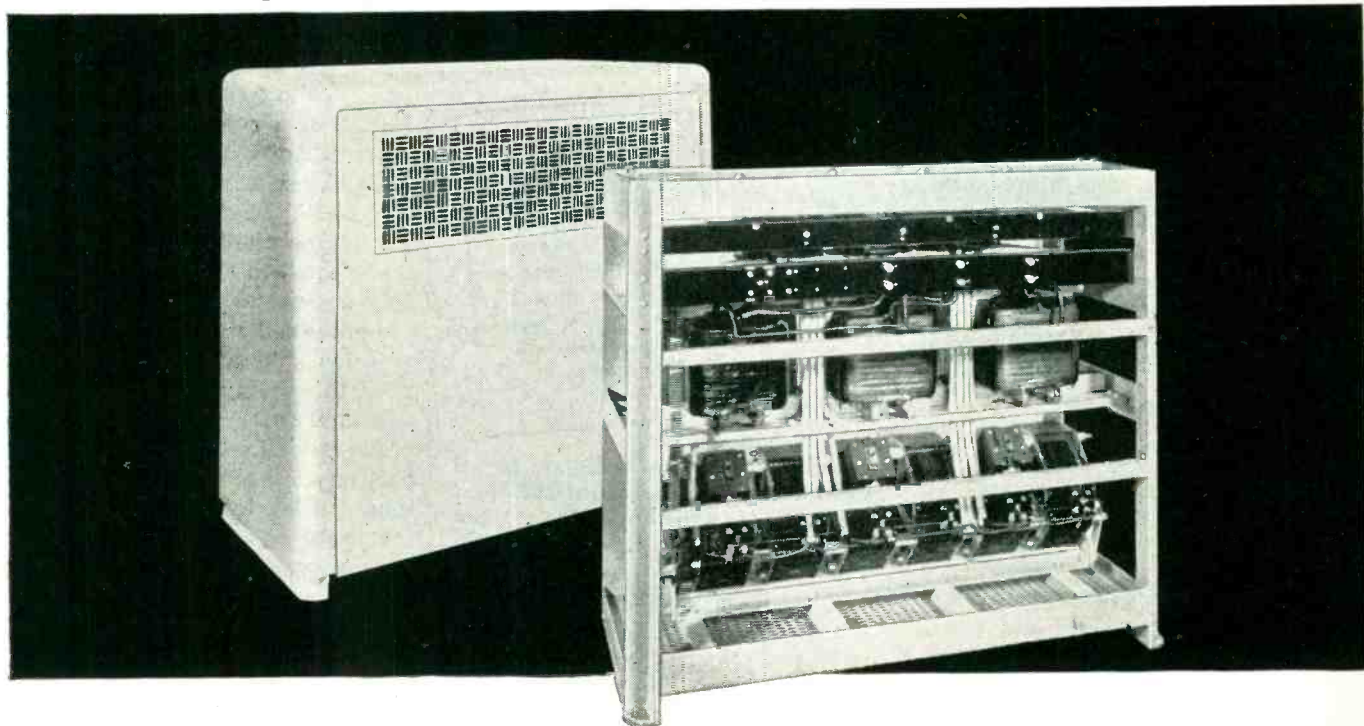

A Tough Transformer Problem Solved with **STEPLESS VOLTAGE CONTROL**

Here's a unique problem . . . but the solution illustrates the modern engineering available at Westinghouse to tackle all types of transformer problems.

The application: A transmitter required a d-c power supply of 4,000 volts, variable under full load . . . from plus 10% to minus 40%.

The Westinghouse solution: A combination of a three-phase, dry-type transformer to produce the required 4,000 volts, with a three-phase, buck-boost transformer, and a three-phase, motor-driven powerstat, serving a d-c rectifier. Quality-proven class B insulation and HIPERSIL® cores result in compact, lightweight installation that completely eliminates the need for bulky, oil-immersed, tap-changing equipment.

The main transformer is rated 73 kva, 230 volts delta on the primary, 4,240 volts wye on the secondary. The secondary of the buck-boost is in series with the output of the main transformer, and the powerstat acts to adjust the primary voltage on the buck-boost, so that stepless control of the entire assembly can be achieved under full load of the d-c rectifier. The operator stands in front of the transmitter itself, and raises or lowers the voltage by means of pushbuttons, while he watches the d-c plate voltmeter of the rectifier.

If you have a tough transformer problem, take advantage of the facilities of Westinghouse for quick, practical solutions. Transformers specially designed for all types of electrical and electronic circuits, as well as a wide selection of standardized designs . . . produced in quantity . . . with quality. Call your nearby Westinghouse representative, or write Westinghouse Electric Corp., P. O. Box 868, Pittsburgh 30, Pa. J-70565



Westinghouse

**SPECIALTY
TRANSFORMERS**

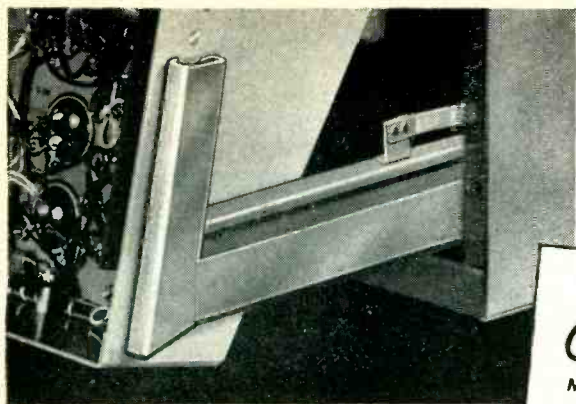

Try Remler for
Service-Tested
"Hard-to-Get"
Components

Custom Components
Metal-plastic components designed and manufactured to order. Write for quotations specifying electrical and mechanical characteristics. Describe application. No obligation.

FOR EFFICIENT MAINTENANCE

SPECIFY REMLER TILT-UP EQUIPMENT SLIDES

Remler slide rails for rack or cabinet mounting permit complete withdrawal or inspection of top and bottom of apparatus chassis. Positive . . . self-locking. Full roller type . . . handles equipment up to 50 lbs. Stainless steel for

military applications; cadmium plated cold rolled steel or bonderized cold rolled steel. Nickel plated brass rollers; roller studs in stainless or copper flashed cold rolled steel.

Remler Company Ltd. 2101 Bryant St. San Francisco 10, Calif.



Since 1918 PIONEERS IN ELECTRONICS AND PLASTICS

ALLMETAL'S First Quality STAINLESS STEEL FASTENERS



IMMEDIATE DELIVERY • ALL TYPES & SIZES

Made right . . . Priced right . . . by specialists in stainless!

See Allmetal first for stock shipments of stainless machine, set, self-tapping, wood screws, nuts, bolts, pins, washers, rivets, including Government and "AN" specs. Prompt delivery on various types of Phillips Recessed Head Screws and specials, too.

WRITE FOR CATALOG 49C



MANUFACTURERS SINCE 1929
ALLMETAL
Screw Products Co., Inc.
33 GREENE STREET, NEW YORK 13, N. Y.

advantage in thickness measurements because reactance variations are usually much larger than the accompanying resistance variations.

The bridge circuit is energized by a 500-kilocycle oscillator. A peak-reading rectifier circuit, consisting of a crystal diode in series with a capacitor and resistor in parallel, is connected across the probe coil. The d-c voltage appearing across the capacitor is essentially equal to the peak a-c voltage drop across the probe coil and, since the probe coil current is determined principally by a large series resistance, this voltage is effectively proportional to the inductance of the probe coil. In order to obtain a comparison voltage with the same sources of extraneous variation as the probe voltage, a reference coil is arranged in a similar circuit and fed from the same oscillator through a variable resistance which may be adjusted to equalize the a-c voltage drops for both coils.

Although this instrument was developed at the National Bureau of Standards primarily for the measurement of the thickness of ceramic coatings on turbine blades and other high-temperature parts of aircraft power plants, it should be generally useful for thickness determinations of paint, plastic, and other non-conducting films on aluminum, brass, copper, stainless steel, and other slightly magnetic or nonmagnetic metals.

Wideband Power Resistors

By HERBERT L. KRAUSS and PHILIP F. ORDUNG
*Yale University
New Haven, Conn.*

IN THE CONSTRUCTION of a wideband power amplifier for the transmission of short pulses, a load resistor rated at 500 ohms and 30 watts was required. The desired resistor was to have constant resistance and essentially zero reactance from 0 to 80 megacycles.

The characteristics of various types of commercially available resistors were measured up to 50 megacycles to determine their suitability for the application, and none of them met the requirements. The noninductive type of wire-wound

Compare!

Here's the Helipot Principle that is Revolutionizing Potentiometer Control in Today's Electronic Circuits

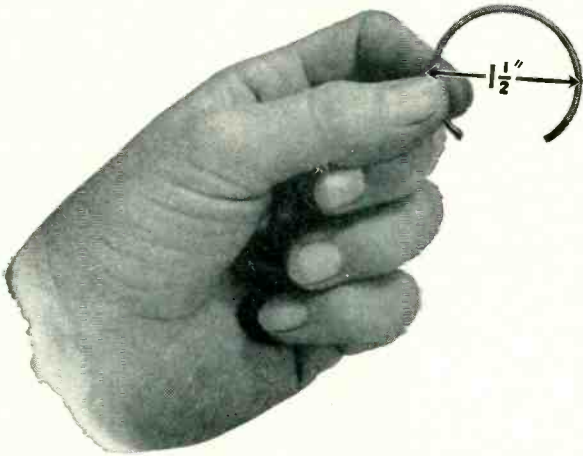

CONVENTIONAL POTENTIOMETERS have a coil diameter of approximately 1 1/2" and provide only 4" (about 300°) of potentiometer slide wire control.

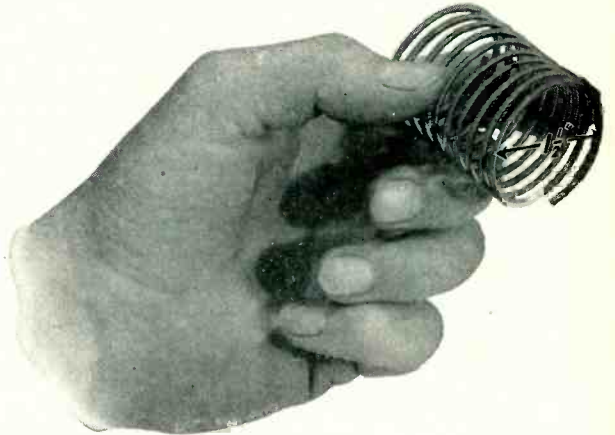

THE BECKMAN HELIPOT has the same coil diameter, yet gives up to 46" (3600°)* of potentiometer slide wire control—nearly TWELVE times as much!

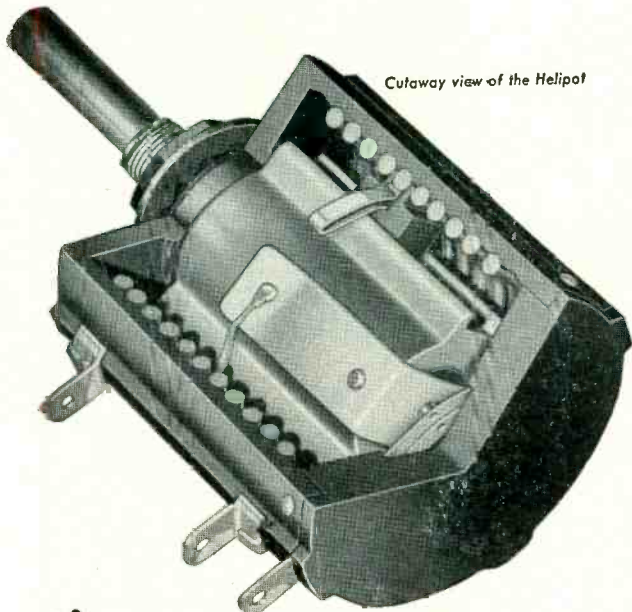

Cutaway view of the Helipot

Some of the multiple Helipot advantages

EXTENSIVELY used on precision electronic equipment during the war, the Helipot is now being widely adopted by manufacturers of quality electronic equipment to increase the accuracy, convenience and utility of their instruments. The Helipot permits much finer adjustment of circuits and greater accuracy in resistance control. It permits simplifying controls and eliminating extra knobs. Its low-torque characteristics (only one inch-ounce starting torque*, running torque even less) make the Helipot ideal for power-driven operations, Servo mechanisms, etc.

And one of the most important Helipot advantages is its unusually accurate linearity. The Helipot tolerance for deviations from true linearity is normally held to within $\pm 0.5\%$, while precision units are available with tolerances held to 0.1%, .05%, and even less—an accuracy heretofore obtainable only in costly and delicate laboratory apparatus.

The Helipot is available in a wide range of types and resistances to meet the requirements of many applications, and its versatile design permits ready adaptation of a variety of special features, as may be called for in meeting new problems of resistance control. Let us study your potentiometer-rheostat problem and make recommendations on the application of Helipot advantages to your equipment. No obligation of course. Write today.

* Data is for Model A unit



Send for the New Helipot Booklet!



HELIPOTS ARE AVAILABLE IN MANY SIZES:

MODEL A—5 watts, incorporating 10 helical turns and a slide wire length of 46 inches, case diameter 1 3/4", is available with resistance values from 10 ohms to 300,000 ohms.

MODEL B—10 watts with 15 helical turns and 140" slide wire, case diameter 3 3/4", is available with resistance values from 50 ohms to 500,000 ohms.

MODEL C—2 watts, with 3 helical turns and 13 1/2" slide wire, case diameter 1 3/4", available in resistances from 5 ohms to 50,000 ohms.

MODEL D—15 watts, with 25 helical turns and 234" slide wire, case diameter 3 3/4", available in resistances from 100 ohms to 750,000 ohms.

MODEL E—20 watts, with 40 helical turns and 373" slide wire, case diameter 3 3/4", is available with resistance values from 200 ohms to 1,000,000 ohms.

Other types and designs of Potentiometers are also available.

THE Helipot CORPORATION, SOUTH PASADENA 2, CALIFORNIA

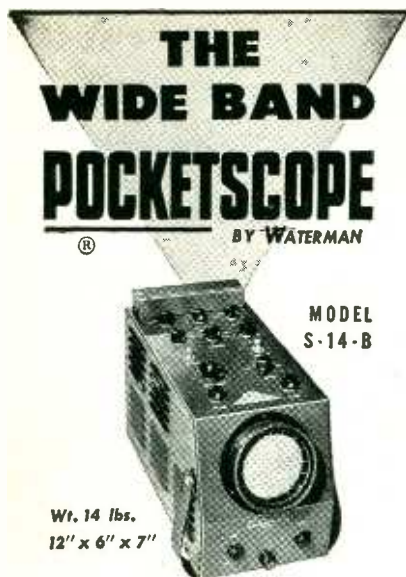

Another Waterman **POCKETSCOPE** confirming the obsolescence of conventional oscilloscopes. Characterized by wide band amplifier fidelity without peaking as well as amazing portability. **S-14-B POCKETSCOPE** is ideal for laboratory and field investigation of transient signals, aperiodic pulses, or recurrent electrical wave forms.

Vertical channel: 50mv rms/inch, with response within -2DB from DC to 700KC, and pulse rise of 0.35 μ s. Horizontal channel: 0.3v rms/inch with response within -2DB from DC to 200KC, and pulse rise of 1.8 μ s. Non-frequency discriminating attenuators and gain controls, with internal calibration of trace amplitude. Repetitive or trigger time base, with linearization, from 1/2cps to 50KC, with \pm sync. or trigger. Trace expansion. Filter graph screen. Mu metal shield. And a host of other features.

WATERMAN PRODUCTS CO., INC.
 PHILADELPHIA 25, PA.
 CABLE ADDRESS: POCKETSCOPE

WATERMAN PRODUCTS INCLUDE:

S-10-B GENERAL	POCKETSCOPE
S-11-A INDUSTRIAL	POCKETSCOPE
S-14-A HI-GAIN	POCKETSCOPE
S-15-A TWIN TUBE	POCKETSCOPE
S-21-A LINEAR TIME BASE	

Also **RAKSCOPES, LINEAR AMPLIFIERS, RAYONIC[®] TUBES** and other equipment

WATERMAN PRODUCTS

resistor was eliminated because the residual reactance was much too high. A composite resistor constructed from a number of 2-watt carbon resistors in a series-parallel arrangement was found to have very poor characteristics. Then the carbon-film type of high-frequency resistor such as the IRC type MPO was tested and was found to have superior characteristics. If such a resistor could be mounted in free space, it would behave like a resistance and a small capacitance in parallel, and would have good characteristics over a considerable range of frequencies.

Distributed Capacitance

In the practical use of such a resistor in an amplifier circuit it would inevitably be mounted in proximity to a ground plane (metal chassis) with the result that a distributed capacitance between the resistor and the ground plane would be added to the circuit. Under such conditions the characteristics of the distributed-constant device may be approximated closely by an equivalent R-C transmission line or ladder network. The principal effect of the added capacitance to ground is to make the equivalent series resistance of the device decrease more rapidly with increasing frequency than it does when the resistor is mounted in free space.

This effect is shown in the curves A, B, and C of Fig. 1, where the series resistance and reactance of an IRC type MPO-17 resistor rated at 500 ohms, 30 watts, are plotted against frequency. This resistor is approximately 10 inches long and 1 1/2 inches in diameter.

Curve A illustrates the case of minimum distributed capacitance

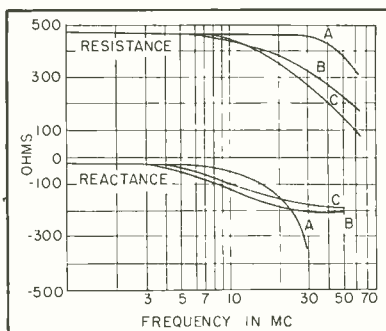

FIG.1—Resistance and reactance characteristics of MPO-17 resistor

Gold Plated
TUNGSTEN
 and
MOLYBDENUM
GRID WIRE

Made to meet your specifications... for gold content, diameter and other requirements.

Write for details and list of products

SINCE 1901

SIGMUND COHN CORP.
 44 GOLD ST. NEW YORK

COPPER ALLOY BULLETIN

REPORTING NEWS AND TECHNICAL DEVELOPMENTS OF COPPER AND COPPER-BASE ALLOYS

Prepared Each Month by BRIDGEPORT BRASS COMPANY "Bridgeport"[®] Headquarters for BRASS, BRONZE and COPPER

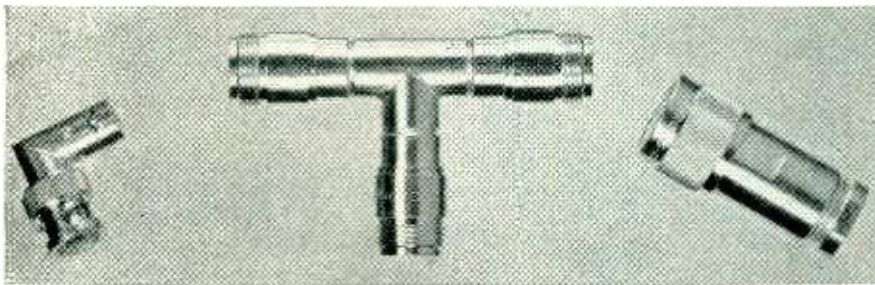

Three types of coaxial connectors for use on frequencies up to 10,000 megacycles using Teflon as the dielectric—Courtesy Industrial Products Company, Danbury, Conn.

Machined Brass Parts Assembled into High Frequency Connectors

Transmission and reception of high and ultra-high frequencies in radio, television and radar work necessitate matching the impedance of the solderless connectors, terminals and plugs accurately to the coaxial cable being used.

This has brought work on these parts into the precision class where stability must be maintained by using materials which will not change physically or electrically over long periods of time.

For this reason, as well as the ease of fabricating, joining and plating, copper and copper-base alloys are used.

Conductors Parallel

Coaxial cable is made up of two conductors. The outside, or ground side, is generally of copper mesh in the form of a sleeve. Running inside, parallel to and equi-distant from this conductor, is a copper wire. Separating these two conductors is a tubular dielectric substance.

When a sharp radius is put in a coaxial cable, the dielectric is thinned on the outside and thickened on the inside of the bend. Center conductor is therefore closer to the outside conductor at one part and further away at another, changing the electrical characteristic.

It has been found necessary to avoid such conditions by using precision fittings for right-angle, T and straight connectors. Each fitting is patterned after the coaxial cable inasmuch as there is an inside conductor which is separated from and accurately positioned to the outside conductor by a dielectric.

To insure that the center conductor is always central in connectors the parts are all turned concentrically in screw machines. Free machining brass rod is used for all parts with the exception of the center conductor which is phosphor bronze or beryllium copper because of the latter's spring properties and fatigue resistance.

Silver Plate Increases Conductivity

Since high frequency currents travel on the outside of the conductor, the lower conductivity of alloyed copper compared to the copper itself is offset by silver plating all parts. This plate not only increases electrical conductivity but, due to its close bond with the brass, withstands a 100-hour salt-spray test.

The right-angle connector in illustration shows typical fabrication steps.

The lock cap is turned, drilled and knurled in a screw machine. The two bayonet holes are drilled, then the slots are pierced. Free machining brass has the highest machinability of all the copper-

base alloys and the lead facilitates both machining and clean piercing.

Parts Silver Soldered

The right-angle piece is made up of two screw machine parts which are mitered and then joined with silver solder. Brass makes this a comparatively simple operation. The right-angle center conductor is turned, then cross slots are milled on one end to produce a pin jack to take the center conductor of the coaxial cable. After all parts have been plated with silver, the center conductor is dropped in and the two mitered pieces of Teflon dielectric are slipped over each end. These pieces are turned and drilled in a screw machine, then mitered with a milling saw.

Brass also was selected for its ability to withstand normal abuse which connectors must take. Even when the plate is chipped or wears off, it resists corrosion from the elements for exceptionally long periods of time.

If you have problems in the selection of the correct copper-base alloy for your product or in the fabrication of these alloys, Bridgeport's laboratory is ready to give you valuable technical assistance.

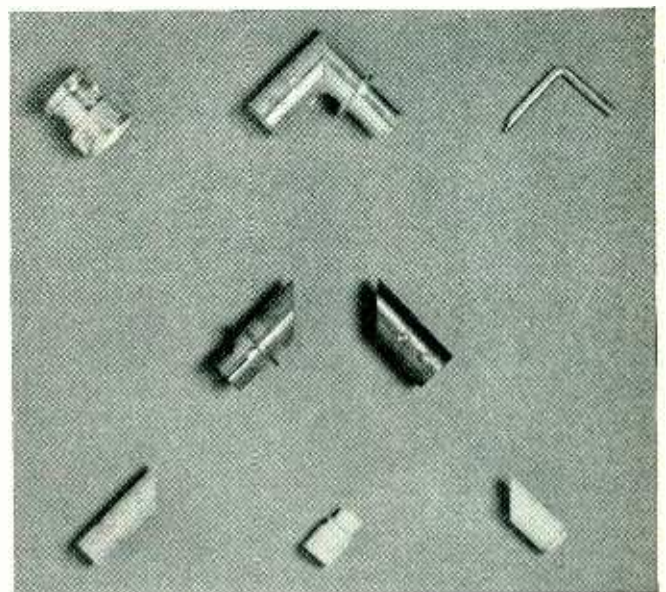

Right-angle connector showing component parts and mitered sections before silver soldering and plating. Teflon dielectric is shown at bottom—Courtesy Industrial Products Company, Danbury, Conn.

BRASS • BRONZE • COPPER • DURONZE — STRIP • ROD • WIRE • TUBING

MILLS IN
BRIDGEPORT, CONNECTICUT
INDIANAPOLIS, INDIANA

In Canada:
Noranda Copper and Brass Limited,
Montreal



BRIDGEPORT BRASS COMPANY
BRIDGEPORT 2, CONNECTICUT

Established 1865

"Bridgeport"[®] District Offices and Warehouses in Principal Cities

These "SUBS"
are first-string
PERFORMERS!



If you're looking for radio, TV or electronic sub-assemblies you can depend on for uniformly high quality, prompt delivery and reasonable price, search no further!

Clippard Instrument Laboratory facilities are at your service to produce sub-assemblies which will release your assembly departments for greater production. This service, relied upon by many of the biggest (and smallest) names in the electronic field, also eliminates endless engineering and production detail.

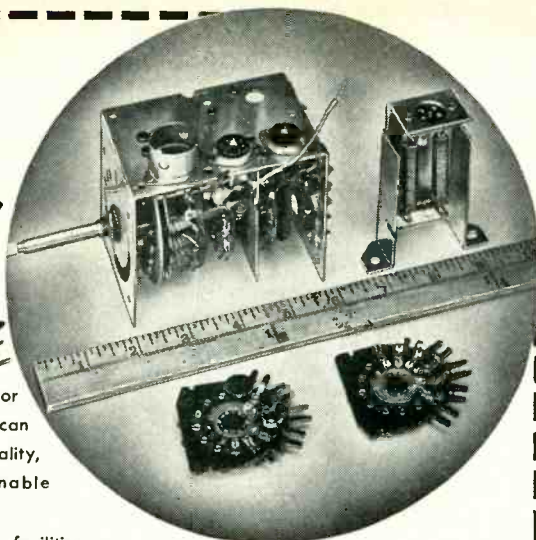

Call on Clippard, an organization of engineering and production specialists, for prompt help on any sub-assembly or R. F. coil problem. For a no-obligation quotation, mail specs and drawings, now, to Department 3.5

Clippard

INSTRUMENT LABORATORY, INC.

1125 Bank Street

Cincinnati 14, Ohio

MANUFACTURERS OF R. F. COILS AND ELECTRONIC EQUIPMENT

to ground. To obtain curve *B* the resistor was mounted 0.5-inch from a parallel ground plane; whereas for curve *C* the resistor was mounted coaxially in a 3-inch copper cylinder. The undesirable effects due to the increased capacitance to ground are clearly shown in Fig. 1.

Equalizers

From the foregoing data the conclusion may be reached that even if a resistor had ideal characteristics in free space, it could not satisfy the desired requirements because of the effect of nearby ground planes. However, if the characteristics of such a resistor were measured under actual operating conditions (physical arrangement), an equalizer network could be designed, when theoretically possible, to be connected in series with the resistor to give better overall results.

A disadvantage in the use of this procedure is that the equalizer cannot be designed until the resistor has been mounted and tested in the position where it is to be used because the effect of the capacitance to ground cannot be calculated accurately. Furthermore, if the power-dissipation rating of the overall network must be the same at all frequencies in the range, the equalizer may have to dissipate an appreciable portion of the total power at the high frequencies where the resistance of the resistor has decreased considerably below its d-c value. The equalizer would then have to contain power resistors, and the behavior would be far from the ideal. Thus it is apparent that the use of equalizers would be practical only in cases where the power dissipation requirements are reduced at the

KENYON Fits Your
Production To A "T"



KENYON "T's"—high quality, uniform transformers, are your best bet for development, production and experimental work. For over 20 years, the KENYON "K" has been a sign of skillful engineering, progressive design and sound construction.

Now—reduce inventory problems, improve deliveries, maintain your quality—specify KENYON "T's," the finest transformer line for all high quality equipment applications.

New Catalog Edition! Write Today!

KENYON new modified edition tells the complete story about specific ratings on all transformers. Our standard line saves you time and expense.

Send for your copy of our latest catalog edition now!

KENYON TRANSFORMER CO., Inc.
840 BARRY STREET · NEW YORK 59, N. Y.

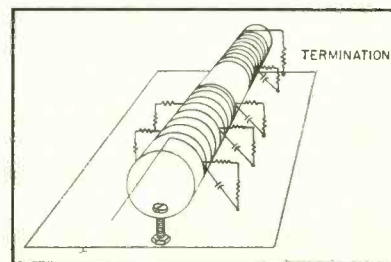

FIG. 2—Distributed-constant resistor approximate a lossy distortionless line

DUMONT *Feist*

CAPACITORS

WITH ONE OF THE LARGEST AND FINEST T.V. MAKERS

Feist WITH PLASTIC MOLDED OIL CONDENSERS (First introduced over 3 years ago)

DUMONT QUALITY *Feist* TO-DAY

HERE IS A SAMPLE REPORT OF ONE OF THE WORLD'S LARGEST T. V. MANUFACTURERS

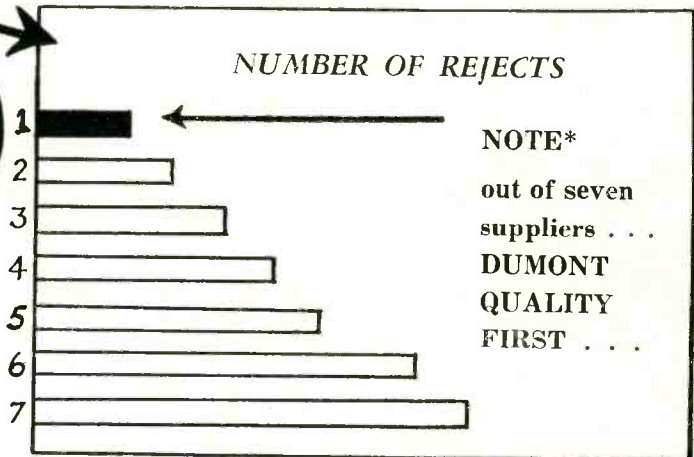

NOTE*
out of seven suppliers . . . DUMONT QUALITY FIRST . . .

* Name of company can be supplied on request.

TYPE P6M
Plastic Molded Oil Capacitors used by RCA, Admiral, Belmont, etc.

A New Feist . . .

PLAY SAFE USE

FIRST PRACTICAL AND RELIABLE HIGH VOLTAGE CAPACITOR

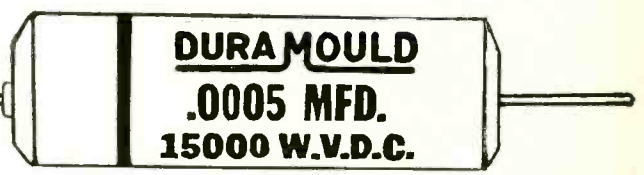

NOW STANDARD IN MANY LARGE TV SETS.
Write for Samples and Information To-Day.

DUMONT ELECTRIC CORP. 308 DYCKMAN ST. NEW YORK, N. Y.

2 KW VACUUM TUBE BOMBARDER OR INDUCTION HEATING UNIT



For Only **\$650.**

Never before a value like this new 2-KW bench model "Bombarder" or high frequency induction heater . . . for saving time and money in surface hardening, brazing, soldering, annealing and many other heat treating operations.

Simple . . . Easy to Operate . . .
Economical Standardization of
Unit Makes This New Low Price
Possible

This compact induction heater saves space, yet performs with high efficiency. Operates from 220-volt line. Complete with foot switch and one heating coil made to customer's requirements. Send samples of work wanted. We will advise time cycle required for your particular job. Cost, complete, only \$650. Immediate delivery from stock.

Scientific Electric Electronic Heaters are made in the following range of Power: 1-2-3½-5-7½-10-12½-15-18-25-40-60-80-100-250KW.

*Scientific
Electric*

Division of

"S" CORRUGATED QUENCHED GAP CO.

107 Monroe St., Garfield, N. J.

higher frequencies so that low-wattage carbon resistors can be used in the correcting network.

Distributed-Constant Resistor

The foregoing considerations led to the development of a prototype wideband resistor that would include distributed capacitance to ground as a design parameter, and require no equalization. The design was based on the theory of the distortionless transmission line. In such a line where R is the series resistance, G the shunt conductance, L the series inductance, and C is the shunt capacitance per unit length, if the relationship $R/G = L/C$ is satisfied, the characteristic impedance becomes $Z_0 = \sqrt{L/C} = \sqrt{R/G}$. The attenuation factor is $\alpha = \sqrt{RG}$, and the phase factor is $\beta = \omega\sqrt{LC}$. Thus, provided that R , L , G , and C are not frequency-dependent, the input impedance to such a line terminated in Z_0 is a pure resistance at all frequencies and equal to Z_0 . The need for terminating in Z_0 is relieved when the attenuation of the line is made high enough, because then a mismatch at the terminated end has little effect upon the value of the input impedance.

The distributed-constant resistor shown in Fig. 2 is a lumped network designed to approximate the behavior of a lossy distortionless line. The series R and L are provided by a coil of Tophet A, No. 35 resistance wire, wound 8 turns per inch on a 1-inch diameter form with a total of 88 turns. (The wire size was determined by the current rating desired and the total length was chosen to permit the dissipation of 25 watts so that a 5-watt resistor of good characteristics could be used for the termination.)

The shunt conductance was provided by carbon resistors tapped to the coil at intervals of 6.5 turns. The shunt capacitance consisted of the aggregate of the capacitance of the series coil to ground, the inherent shunt capacitances of the shunt resistors, and additional capacitances added to give the desired characteristics. The circuit was mounted above a copper ground plane to simulate actual operating conditions. The resulting series

American Beauty

ELECTRIC SOLDERING IRONS

are sturdily built for the hard usage of industrial service. Have plug type tips and are constructed on the unit system with each vital part, such as heating element, easily removable and replaceable. In 5 sizes, from 50 watts to 550 watts.



TEMPERATURE REGULATING STAND

This is a thermostatically controlled device for the regulation of the temperature of an electric soldering iron. When placed on and connected to this stand, iron may be maintained at working temperature or through adjustment on bottom of stand at low or warm temperatures.

For descriptive literature write

110-1

**AMERICAN ELECTRICAL
HEATER COMPANY
DETROIT 2, MICH., U. S. A.**



was this call necessary?

Some "Moral Insurance" here might have avoided a serious accident

Workmen's compensation is a fine thing—but it can't replace a mangled arm.

Safety laws prevent many accidents—but they can't cover every hazard of an individual plant.

Accident prevention which goes *beyond the law* is an unwritten responsibility of every employer. It is his "Moral Insurance" for his employees welfare.

The premiums for "Moral Insurance" are not high. They do not have to be paid for in fancy safety gadgets. Their cost is simply the institution of common sense safety regulations covering all local hazards—enforced by employee committees with the full support of management.

Yes—"plant safety" is a mutual job.

DON'T FORGET—THE LIFE YOU SAVE MAY BE YOUR OWN

Published in the public interest by:



McGRAW-HILL PUBLICATIONS

For AC CURRENT ANYWHERE... NO MAGIC just use **ATR** INVERTERS

STANDARD AND HEAVY DUTY INVERTERS



For Inverting D. C. to A. C.

Specially Designed for operating A. C. Radios, Television Sets, Amplifiers, Address Systems, and Radio Test Equipment from D. C. Voltages in Vehicles, Ships, Trains, Planes and in D. C. Districts.

NEW MODELS NEW DESIGNS
NEW LITERATURE

"A" Battery Eliminator, DC-AC Inverters
Auto Radio Vibrators

See your jobber or write factory

AMERICAN TELEVISION & RADIO CO.
Quality Products Since 1931
SAINT PAUL 1, MINNESOTA-U.S.A.

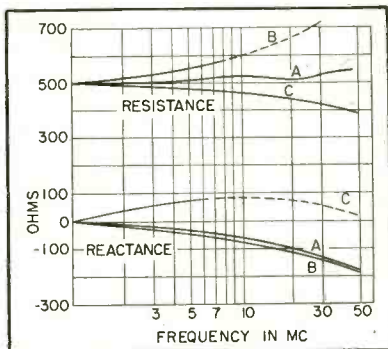

FIG. 3—Resistance and reactance characteristics

resistance and reactance characteristics for various values of shunt capacitance are shown in Fig. 3. Although the results are not perfect, they approach the ideal much more closely than the uncompensated carbon-film resistor did, and indicate that the method of design is inherently sound.

To make the device practical it should be developed in coaxial form in such a way that no lumped capacitance or conductance are required. A tapered construction may be found desirable.

Liquid-Air Level Control

A UNIQUE MEANS for controlling the level of such materials as liquid air and liquid nitrogen is illustrated in Fig. 1. The circuit employs two cold-cathode thyratrons which operate directly on a-c line voltage. The controlling elements, which are placed at the maximum and minimum limit levels within the container, are standard carbon resistors. Their negative temperature coefficients are such that when

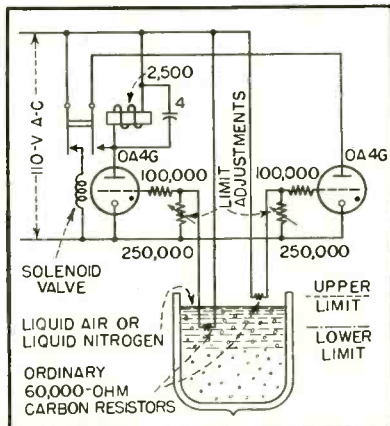
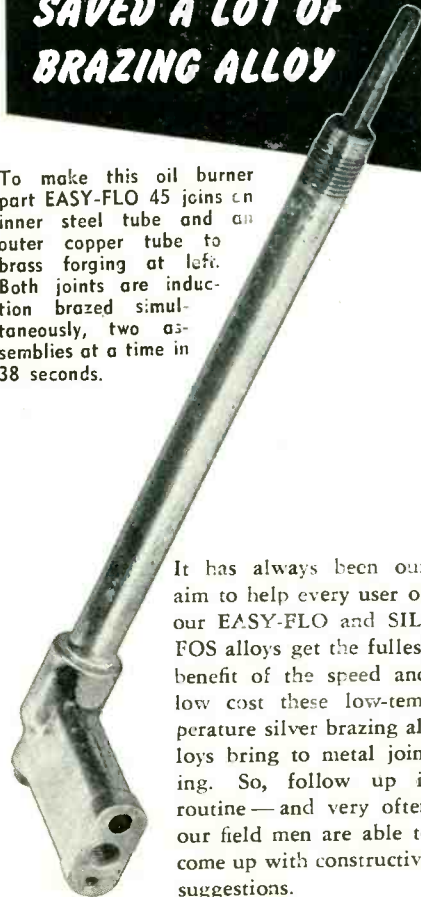

FIG. 1—Circuit diagram of low-temperature liquid level control

A LITTLE ROUTINE SERVICE SAVED A LOT OF BRAZING ALLOY

To make this oil burner part EASY-FLO 45 joins an inner steel tube and an outer copper tube to brass forging at left. Both joints are induction brazed simultaneously, two assemblies at a time in 38 seconds.



It has always been our aim to help every user of our EASY-FLO and SILFOS alloys get the fullest benefit of the speed and low cost these low-temperature silver brazing alloys bring to metal joining. So, follow up is routine—and very often our field men are able to come up with constructive suggestions.

For example—a user was doing the above job with two rings of 1/16" EASY-FLO 45 wire, one for each joint—and he was perfectly happy with results. On a routine service call our man felt that more alloy was being used than was needed. So he got some of the parts and sent them back to our research lab. There it was found that rings of 1/32" and 3/64" wire for the steel and copper tubes respectively, were ample. The saving in cost from this little reduction in the size of alloy wire has since mounted to sizable proportions.

CAN YOUR BRAZING COSTS BE CUT?

We'll be glad to send a field engineer to give you the answer—without obligating you in any way. Just write or call and say when.

For the facts about these alloys in print, write today for Bulletins 12-A and 15.

HANDY & HARMAN
82 FULTON ST., NE YORK 7, N. Y.
Bridgeport, Conn. • Chicago, Ill. • Los Angeles, Cal.
Providence, R. I. • Toronto, Canada
Agents in Principal Cities

immersed in the -180 -degree liquids their resistance changes by a factor of 1.7 from their room-temperature value. This change is sufficient to cause conduction of the thyratrons, which operate a relay to either turn the solenoid intake valve off or on.

The above circuit was described by Mark S. Fred and Everett G. Rauh, of the Argonne National Laboratories, in the March, 1950, issue of *The Review of Scientific Instruments*.

SURVEY OF NEW TECHNIQUES

PHOTOGRAPHS of the pattern of sound waves have been made recently by means of a new technique developed at Bell Telephone Laboratories.

Equipment consists of a tiny microphone and a neon lamp, mounted on a swinging beam which scans the wave field. As the beam

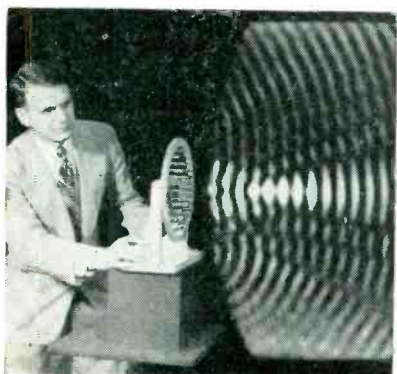

moves through the field, a clear picture of the sound radiation is built up by scanning.

WEAK RADIATION, which is present in any location, is often sufficient to cause erroneous results when determining an object's radioactivity by means of a Geiger counter. By using two such counters, one of which is shielded from the radiation of the object under test, the radioactivity of the object only can be determined by mathematical computation.

NEW MULTIPLIER PHOTOTUBE developed by RCA for use in scintillation counters can count radioactive par-

LOW FREQUENCY PULSE PHENOMENA

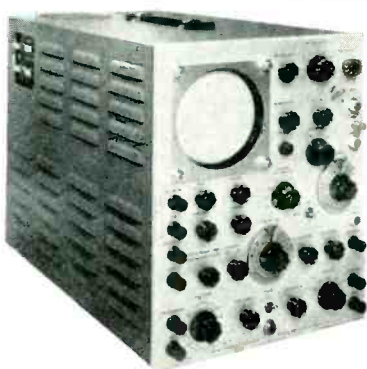

Type 512 Oscilloscope

- Band Pass—DC-2mc
- Sensitivity—5mv/cm maximum
- Sweeps—.3 sec/cm to 3 μ sec/cm

Accurate observation and measurement of slowly recurring phenomena is difficult, if not impossible, by conventional oscilloscopic techniques. The Tektronix Type 512 Cathode Ray Oscilloscope, combining as it does direct-coupled amplifiers, slow sweeps and high accuracy, is recognized by a constantly increasing number of researchers as being an indispensable laboratory tool. New and fruitful approaches to the problems encountered in research are permitted by these features. \$950.00 f.o.b. Portland, Oregon.

SUPPLEMENTARY SENSITIVITY

- Gain—1000
- Band Pass—1/6cps-40kc
- Noise Level—10 μ v peak-to-peak, max.



Type 122 Pre-Amplifier

The Tektronix Type 122 Pre-Amplifier has been designed as an accessory to the Type 512 Oscilloscope, for use in the biophysical, geophysical and other fields requiring additional sensitivity below 40 kc. At maximum gain, a 5 μ v signal will produce a 1 cm deflection on the oscilloscope. Use of the differential input gives a rejection ratio of 90 db for unwanted signals. A maximum of 20 v (peak-to-peak) is available at the cathode follower output. Multi-position switches permit separate control of both ends of the pass band. Battery operated for minimum noise level. \$85.00 f.o.b. Portland, Oregon.

Write today for detailed specification of Type 512, Type 122, and other Tektronix instruments.



TEKTRONIX, INC.

712 S. E. Hawthorne Blvd. Portland 14, Ore.

DO YOU KNOW?

— that a **PILOT LIGHT**
CAN IMPROVE YOUR PRODUCT

. . . . add attraction — safety — service?

Ask

DIALCO

- what lamp to use
- how to use it
- what it will do
- what it will cost

THIS MAY BE THE ONE
Designed for low cost NE-51 Neon

- Built-in Resistor • Patented
- U/L Listed • Rugged

Catalogue Number 521308 — 997
for 110 or 220 volts.

SAMPLES

for design purpose
NO CHARGE

NEW! Write for the
"HANDBOOK OF PILOT LIGHTS."

Write us on your design problems.



The DIAL LIGHT COMPANY of AMERICA

Foremost Manufacturer of Pilot Lights.

900 BROADWAY, NEW YORK 3, N. Y. TELEPHONE SPRING 7-1300

For Proof Beyond Compare



TRY

RUBYFLUID

Soldering Flux

Send for Ruby's \$1 Offer

For \$1 Ruby will send you 1 pint of liquid, one half pound of paste soldering flux and a new booklet on "How to Solder."

Take advantage of this offer now!

Send your \$1 today to—

RUBY CHEMICAL CO.



59 McDOWELL ST.
COLUMBUS, OHIO

Rubyfluid

**SMALL
PARTS**

Cost less when made by
MULTI-SWAGE

The economy way to get
a million small parts
similar to these —

Examine the tubular and solid metal parts shown here twice size. If you use anything similar . . . in quantities of over a million . . . important savings can be yours. Send us the part and specs. Our quotation will show why the Bead Chain Company's MULTI-SWAGE Process has long been known as the most economical method of making electronic tube contact pins, terminals, jacks and sleeves. And, why more and more users of mechanical parts (up to 1/4" dia. and to 2" length) employ our facilities. WRITE for Data Bulletin.

THE BEAD CHAIN MANUFACTURING CO.,
Tr. Mark 88 MOUNTAIN GROVE ST., BRIDGEPORT 5, CONN.

Now
**COMPLETE
TESTING**

TO **MILITARY
SPECIFICATIONS**

- ENVIRONMENTAL
- CLIMATIC
- ELECTRONIC
- PNEUMATIC
- HYDRAULIC
- METALLURGICAL
- PHYSICAL
- FATIGUE

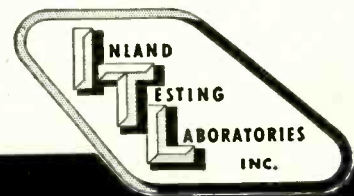

2745 N. JANSSEN AVE.
CHICAGO 14, ILLINOIS

ticles arriving less than a hundred-millionth of a second apart. The new type 5819 tube features a head-on design with a photocathode 1½ inches in diameter, giving many times the sensitive cathode area of previous tubes. Spectral sensitivity is high over a wider range, from near-ultraviolet to orange. In this range is a region in which many organic and inorganic phosphors respond efficiently to radioactive emanations.

TOY ELECTRIC TRAINS are being used to carry radioactive materials from one room to another in the Packard Radiation Laboratory at the Cleveland Clinic Hospital in Cleveland, Ohio. The train shown being loaded makes a run of 22 feet. Over a



Radioactive chemicals are carried between rooms by a toy electric train

period of time, by relieving hospital personnel from having to carry the ray-emitting materials themselves, the train reduces the day's exposure to within the maximum allowable limit.

INSTANTANEOUS observation or recording of spectral intensity as a function of both wavelength and time throughout a wide spectral range has recently been accomplished, by substituting an image orthicon for the photographic plate usually used with a spectrograph. Advantages include shorter exposure times due to higher sensitivity, sensitivity to the near-infrared region, and exhibition of a cumulative characteristic with improved linearity over the photographic plate method. Output appears on an oscilloscope after suitable video amplification.

THINK OF THE USER

... when you design TV sets



Make your sets easy to tune. Put the control knobs where the user can manipulate them without stooping, squatting or kneeling.

YOU CAN DO IT with



Use these specially developed remote control flexible shafts to couple the tuning elements to their control knobs. Then you can put the tuning elements where they should go for best circuit efficiency and easy assembly, wiring and servicing and you're free to place the control knobs for utmost user convenience.



WRITE FOR BULLETIN 4501

It contains basic facts and data on flexible shaft selection and application. Copy sent on request. Write today.



S.S. WHITE INDUSTRIAL
 THE S. S. WHITE DENTAL MFG. CO. DEPT. E 10 EAST 40th ST., NEW YORK 16, N. Y.



FLEXIBLE SHAFTS AND ACCESSORIES
 MOLDED PLASTICS PRODUCTS—MOLDED RESISTORS

One of America's AAAA Industrial Enterprises

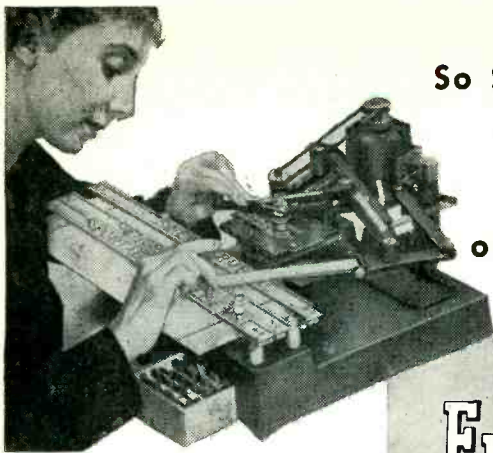

So Simple Anyone Can
ENGRAVE
on Plastic and Metal.

new hermes
Engravo
graph
TRADE MARK

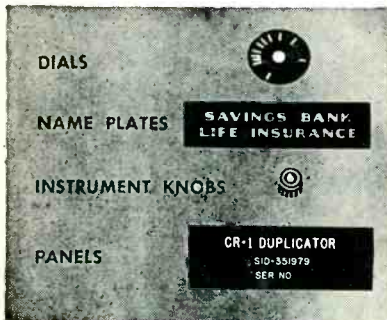

- Multiratio Tracing Arm. Engraves more than 15 sizes from ONE template.
- Covers a larger engraving area than any other portable unit of its kind.
- Ideal for any lettering.

Send for Booklet Model 1M—Dept. No. 29

World's Largest Manufacturer
of Portable Engraving Machines

NEW HERMES 13-19 University Pl.
New York 3, N. Y.

NEW PRODUCTS
(continued from p 126)

spacers to minimize line pickup and radiation losses, the line exhibits only 0.5-db loss per 100 ft at 200 mc. It is available in continuous lengths up to 500 ft.

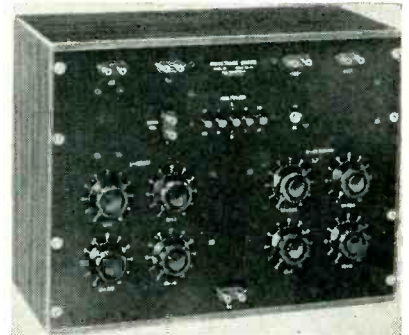

Inductance Bridge

FREED TRANSFORMER CO., INC., 1718-36 Weirfield St., Brooklyn 27, N. Y. The No. 1110 incremental inductance bridge is designed for accurate testing of communication and tv components under load conditions. Impedance range is 1 mh to 1,000 henries in five ranges. Range can be extended to 10,000 henries through the use of an external resistance. Inductance accuracy is within ± 1 percent through the 60 to 1,000-cycle range.

All you need...



for complete oscillographic recording

The 5-8 Oscillograph, long the standard of oscillographic recording, has been improved to meet the expanding demands of modern research. The NEW Type 5-8 Oscillograph has all the inherent capabilities you need to record rapidly changing phenomena such as vibration and dynamic strain.

A few of the newest features are:

- QUICK-CHANGE TRANSMISSION—16 record speeds over range of 120:1
- FULL RESILIENT MOUNTING makes possible use of super-sensitive galvanometers
- CHART TRAVEL INDICATOR provides continuous indication of chart motion
- NEW GALVANOMETER STAGE takes all Hathaway galvanometers for recording milliamperes, microamperes, and watts.
- NEW RECORD-LENGTH CONTROL and NUMBERING SYSTEM for long, trouble-free service

All the other valuable features characteristic of the 5-8 are retained. Investigate the NEW Type 5-8 and its 170 types of galvanometers.

Write for Technical Bulletin 2B1A-G



Video I-F Tube

SYLVANIA ELECTRIC PRODUCTS INC., 500 Fifth Ave., New York 18, N. Y. The new 6CB6 miniature video intermediate-frequency amplifier tube is suited for applications at approximately 40 mc or as an r-f amplifier at frequencies up to 400 mc. It features a transconductance of 6,200 μ mhos; input capacitance of

6.3 μf ; output capacitance of 1.9 μf ; and grid-to-plate capacitance of 0.020 μf maximum. Separate base pins for suppressor grid and cathode permit flexible circuit application.



Dark-Face Picture Tube

GENERAL ELECTRIC Co., Syracuse, N. Y. The 16KP4 dark-face glass rectangular picture tube provides sufficient space on the neck of the tube to mount the ion trap, focus coil and deflection yoke. Useful picture area is approximately 140 sq in. Anode voltage is 16,000 volts; grid No. 2 voltage, 410 volts; and negative bias value, 125 volts. A conventional heater supply voltage of 6.3 volts is necessary for the tube operation.



Universal Power Bridge

POLYTECHNIC RESEARCH & DEVELOPMENT Co., INC., 202 Tillary St., Brooklyn 1, N. Y. Type 650 universal direct-reading bridge permits accurate determination of r-f power levels over a wide range. It may be used with bolometers having either

MORE GEO. STEVENS COIL WINDING EQUIPMENT IS IN USE THAN ALL OTHER MAKES COMBINED!

- **MORE OUTPUT . . . LOWER COSTS . . .** from EXCLUSIVE SPEED FEATURE. Universal motors permit variable speeds without changing belts and pulleys. Coil design permitting, speeds as high as 7500 RPM are not uncommon.
- **PORTABILITY.** Conveniently carried from place to place. Machines come mounted on bases to constitute one complete unit.
- **MUCH LOWER ORIGINAL COST.** The same investment buys more GEO. STEVENS machines than any other coil winding machines.
- **LONG LIFE.** Most of the original

GEO. STEVENS machines bought 14 years ago are still operating daily at full capacity.

- **MUCH FASTER CHANGING OF SET-UPS** than any other general purpose coil winding machine. Quickly changed gears and cams save time between jobs.

- **VERY LOW MAINTENANCE.** Replacement parts are inexpensive, can be replaced in minutes, and are stocked for "same day" shipment, thus saving valuable production time.

- **EASIEST TO OPERATE.** In one hour, any girl can learn to operate a GEO. STEVENS machine.

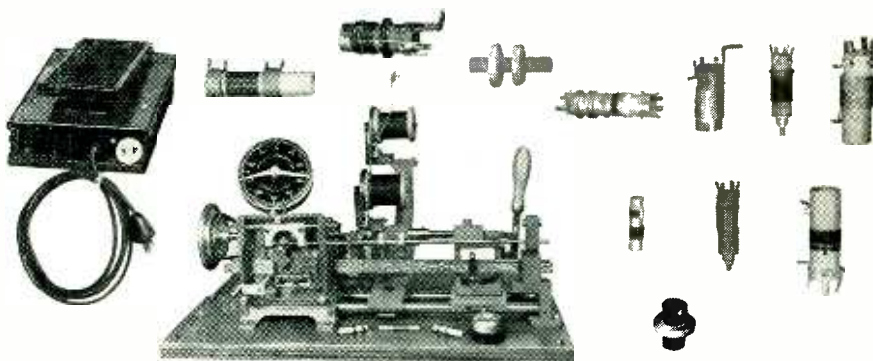

Progressive universal winding machine, Model 125, handles space wound coils and solenoids up to 8" in length, progressive universal coils up to 4" in length and 3" in diameter, universal coils up to 3/4" in width, and I.F. coils. Wire sizes are from 20x44 gauge. Cams are stocked from 1/16" to 3/4" in decrements of 1/64". Sizes larger than 3/4" or less than 1/64" decrements are made upon request. Head to tailstock is over 8"; base 22".

Change gears and idler forming the pattern are enclosed in front. Traverse rack is driven by change gears and idler enclosed in back of the head. The traverse rack has a mandrel return crank and a stop to insure return to identical starting position. Large ball bearings on head stock spindle give long life and easy running. Ball bearing tailstock with spring tension lever permits quick change of coil forms.

Motor equipment:—1/4 H.P. Universal motor, V belt driven, double spool carrier tension device with oilite bearings, and adjustable tension friction brake for changing winding tension of the wire.

Dial Counter (Model 50 or 51) with 6" full vision clock dial, accurately registers all turns.

There is a GEO. STEVENS machine for every coil winding need. Machines that wind ANY kind of coil are available for laboratory or production line. . . . Send in a sample of your coil or a print to determine which model best fits your needs. Special designs can be made for special applications. Write for further information today.

*World's Largest Manufacturer
of Coil Winding Machines*

REPRESENTATIVES

Frank Tatro
6022 No. Rogers Ave., Chicago 30, Illinois
Ralph K. Reid
1911 W. 9th St., Los Angeles 6, California
R. F. Staff & Co.
1213 W. 3rd St., Cleveland 13, Ohio

GEO. STEVENS

MFG. CO., INC.

Pulaski Road at Peterson
Chicago 30, Illinois

Why a **GROUND** bearing?

BECAUSE
a **GROUND** ball
bearing whether
miniature or
full size:

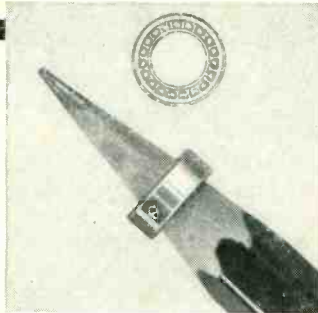

 is **ROUND**. Within .000025" (25 millionths inch) if it's a **MICRO** bearing. It does not require forcing into a housing to make it round — it's **ROUND** when you get it.

 has clean, highly-finished raceways where the load is carried. Capacity higher, friction lower. The heart of the bearing, out of sight.

 has a **STRAIGHT O.D.** Within .00001" in a **MICRO** bearing. Seats squarely in its housing.

 has **PARALLEL** sides. Within .0002" if it's a **MICRO** bearing. Essential to proper alignment.

UNGROUND bearings, satisfactory for many uses, can be bought for as low as 4¢ each. If you are paying for **GROUND** bearings, make sure you get them. Specify . . .

Micro the **GROUND** miniature bearings

New Hampshire *Micro* Ball Bearings, Inc.
5 Main Street, Peterborough, New Hampshire

MOVING?

If you are moving (or have moved), tell us about it, won't you? Your monthly copies of **ELECTRONICS** will not follow you unless we have your new address immediately. Make sure you don't miss a single important issue . . . and help us make the correction as speedily as possible by giving us your old address, too

ELECTRONICS

CIRCULATION DEPT.

330 W. 42nd St.

New York 18, N. Y.

VULCAN

ELECTRIC HEATING UNITS

CARTRIDGE



Standard sizes: brass sheath.
Maximum temperature 750° F
.373 to 1.291" diameter
110 volts 250 volts
All sizes, .622 or larger can be
had in three heat
Units .933" or larger, with any
type terminal.

**SPECIAL UNITS
TO YOUR SPECIFICATIONS!**

VULCAN

ELECTRIC COMPANY

DANVERS 10 MASS.

TRADE MARK
VULCAN
MADE

A
**TIME-TESTED
DEPENDABLE
SOURCE
FOR**

**HIGH-PRECISION FRACTIONAL H.P. INSTRUMENT-TYPE
MOTORS & GENERATORS
PRODUCED TO ORDER**

GOVERNOR CONTROLLED
SELF-SYNCHRONOUS
DRAG CUP
VELOCITY & ACCELERATION
DC & AC TACHOMETER
SHUNT
SERIES
COMPOUND
PERMANENT MAGNET
SPLIT-FIELD
SEPARATELY EXCITED
UNIVERSAL
INDUCTION
RELUCTANCE
HYSTERESIS
ONE, TWO & THREE PHASE
DC & AC SERVO
TOTALLY ENCLOSED
AC DYNAMICALLY BRAKED
REELMOTORS

ONE, TWO, THREE & FIVE SPEED
SYNCHRONOUS MOTORS

Experienced for years in meeting customers' exacting requirements for high-precision instruments designed by engineers of ability and ingenuity, and manufactured with extreme care and skill. Over 500 different basic types may be varied to meet your own unique requirements of use, either electrically or physically.

ELECTRIC INDICATOR CO.

PARKER AVENUE
STAMFORD, CONNECTICUT

positive or negative temperature coefficients and with operating resistance in the 50 to 250-ohm range. A range-selector switch provides a choice of full-scale deflection for 0.1, 1, 10 or 100 milliwatts.

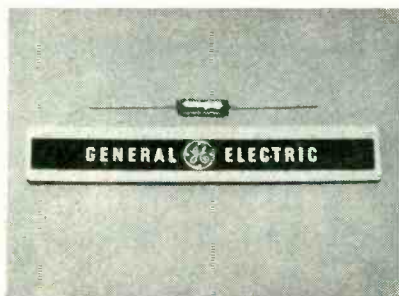

Electrolytic Capacitor

GENERAL ELECTRIC Co., Schenectady 5, N. Y Two of the advantages of the new 1- μ f, 150-volt d-c hermetically-sealed Tantalytic capacitor are a size reduction up to 90 percent of that required by paper capacitors and the promise of much longer life than aluminum electrolytic capacitors. The new capacitor uses tantalum in foil form together with a newly developed non-corrosive electrolyte.



VHF Frequency Meter

GERTSCH PRODUCTS, INC., 11, 846 Mississippi Ave., Los Angeles 25, Calif. The FM-1 vhf frequency meter for the 20 to 480-mc range is correct to 0.005 percent within the temperature range of 32 to 120 F. It is operated from dry batteries (included within the carrying case) or from regulated laboratory power supply. Provision is made to modu-

P O L A R A D

TELEVISION EQUIPMENT

for studio • laboratory • manufacturer



FIELD CAMERA CHAIN

Model CV-2

OUTSTANDING FEATURES

1. Extremely sensitive at low light levels.
2. Picture resolution greater than 500 lines.
3. Four lens turret with synchronized switching.
4. Electronic View Finder.
5. Communication Channel.
6. Portable Camera Control Unit meets all requirements of programming and monitoring.
7. Portable Power Unit adjustable for all operating conditions and completely metered.

WHERE USED

Polarad's Model CV-2, Field Television Camera Chain is used both indoors and outdoors for picking up programs. Excellent picture quality and resolution are obtained even under difficult and unpredictable lighting conditions.

DESCRIPTION

Polarad's Television Camera Chain, Model CV-2, consists of:

Field Camera Unit	Camera Cable
Camera Control Unit	Lens Component:
Power Unit	50 mm, f1.9
Electronic View Finder	90 mm, f3.5
Camera Tripod	135 mm, f3.8

This ruggedly constructed camera chain is weatherized for all possible operating conditions.

Compactness and lightweight suitcase type construction of the component parts insure portability. The camera unit is supported on a special scanning mount and tripod which provides excellent maneuverability in covering a scene over a wide angle. The electronic viewfinder plugs into the camera and is detachable from it. A removable four lens turret with interlocking switches provides means for changing scenes rapidly without circuit transients.

The Camera Unit is connected to the portable Camera Control Unit by a single special camera cable. The Camera Control Unit provides the major electrical adjustments of the camera. It monitors the picture and waveform of the output signal by means of a built-in oscilloscope and picture monitors.

The Power Unit is adjustable for varying A-C line conditions and provides metering for the system. All power requirements for the Camera Chain are provided from this unit.

Polarad's Field Camera Chain, Model CV-2, is adaptable to and can operate with existing equipment.



Television Engineers and consultants to the nation's great television stations.



100 METROPOLITAN AVE.
BROOKLYN 11, NEW YORK

VEE-D-X

SECTIONAL TOWER
engineered for
SAFETY and STRENGTH

... for all
communications
Television, AM, FM Radio
Radar, Microwave, UHF,
VHF, Floodlighting

This improved VEE-D-X Sectional Tower is ideally suited for all communication needs for heights up to 140 feet. It has the highest safety factor of any tower in its price class with rugged, all welded construction diagonally laced with angle iron for maximum rigidity. The tower is available in 10 and 20 foot sections completely assembled and galvanized.

- Safe and easy to climb
- Variable mounting methods
- Self-supported to 20 feet
- Rigid, strong—no twisting
- High wind load capacity
- Completely galvanized

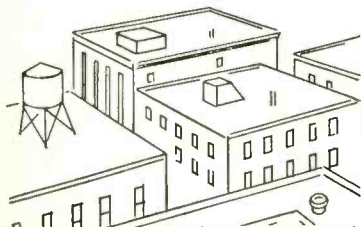

LaPOINTE-PLASCOMOLD CORP., 7
Unionville, Conn.

Please send me technical specifications on VEE-D-X sectional tower to be used for

Name _____
Address _____
City _____ Zone _____
County _____ State _____

NEW PRODUCTS

(continued)

late the carrier at approximately 30 percent at 1,000 cycles.

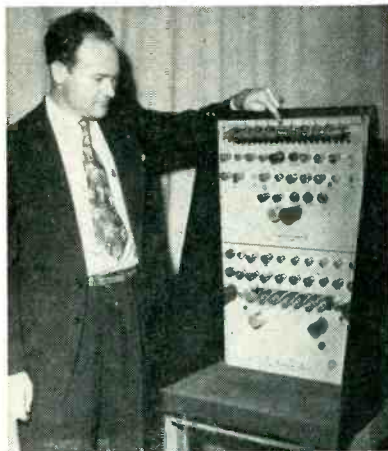

TV Sync Generator

GENERAL ELECTRIC Co., Syracuse, N. Y. Type PG-2-B tv sync generator provides the timing for all television studio equipment and sends out synchronizing signals so that receivers can also time their picture with that of the studio. The unit is built for both portable and studio applications. All timing and counting is accomplished by nonadjustable binary scalers which are provided as plug-in units. This enables the entire counting circuit to be replaced in a matter of seconds in case of a tube or component failure. A system of indicator lights provides a continuous check of the count-down operation and gives immediate indication of faulty operation.

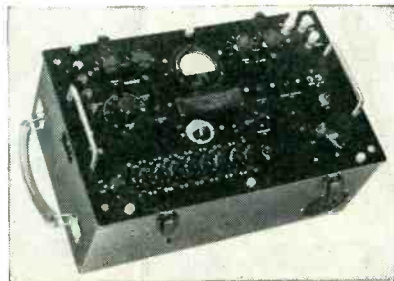

Transmission Test Set

SHALLCROSS MFG. Co., Collingdale, Pa. The model 693 portable multi-purpose transmission test set, in addition to measuring the electrical

PRECISION STAMPINGS
quickly...
economically

DIAMOND G STAMPINGS

CUT COSTS... TIME
SAVE EQUIPMENT

Let our "know-how" and modern equipment save you dollars and time in getting metal stampings. We specialize in small and medium size stampings and produce them to precise specifications at minimum cost.

COMPLETE EQUIPMENT
Garrett equipment includes not only high speed presses of all sizes, but complete equipment for finishing, heat treating, tapping, welding and plating to assure you of high quality, inexpensive precision stampings.

DIAMOND G SERVICE
...delivers them when you need them... where you need them.

OTHER GARRETT PRODUCTS
Lock washers... flat washers... spring stampings... snap and retainer rings... hose clamps.

Manufactured by
GEORGE K. GARRETT Co., Inc.
Philadelphia 34, Pa.



BIRTCHEER

STAINLESS STEEL - LOCKING TYPE

TUBE CLAMPS

Stainless Steel

Corrosion Proof



83 VARIATIONS

Where vibration is a problem, Birtcher Locking TUBE CLAMPS offer a foolproof, practical solution. Recommended for all types of tubes and similar plug-in components.

More than three million of these clamps in use.

FREE CATALOG

Send for samples of Birtcher stainless steel tube clamps and our standard catalog listing tube base types, recommended clamp designs, and price list.

THE BIRTCHEER CORPORATION
5087 HUNTINGTON DR. LOS ANGELES 32

ELECTRONICALLY REGULATED LABORATORY POWER SUPPLIES



• STABLE
• DEPENDABLE
• MODERATELY PRICED

MODEL 28
STANDARD
PACK
MOUNTING

PANEL SIZE
5 1/4" x 19"
WEIGHT 16 LBS.

- **INPUT:** 105 to 125 VAC, 50-60 cy
- **OUTPUT #1:** 200 to 325 Volts DC at 100 ma regulated
- **OUTPUT #2:** 6.3 Volts AC CT at 3A unregulated
- **RIPPLE OUTPUT:** Less than 10 millivolts rms

For complete information write for Bulletin E8



LAMBDA ELECTRONICS CORPORATION
CORONA NEW YORK

S.S. White MOLDED RESISTORS

The All-Weather Resistors

ARE USED IN THIS SUPER-SENSITIVE ULTROHMMETER

An S.S.White 100 Megohm Resistor is used as the plate load resistor for the first tube in the D.C. amplifier in this instrument which measures very small D.C. currents and voltages over an extreme range of values. The manufacturer, Beckman Instruments Division of National Technical Laboratories, says of the S.S.White Resistor "it has been very satisfactory"—which checks with the experience of many other electronic equipment manufacturers who use S.S.White Resistors.

Photo courtesy of National Technical Laboratories, So. Pasadena, Calif.

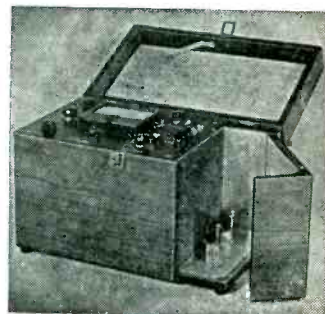

WRITE FOR BULLETIN 4906

It gives essential data about S.S.White Resistors including construction, characteristics, dimensions, etc. Copy with price list on request.



S.S. WHITE RESISTORS are of particular interest to all who need resistors that have inherent low noise level and good stability in all climates.

HIGH VALUE RANGE
10 to 10,000,000 MEGOHMS

STANDARD RANGE
1000 OHMS to 9 MEGOHMS

S.S. WHITE INDUSTRIAL DIVISION
THE S. S. WHITE DENTAL MFG. CO. DEPT. R 10 EAST 40th ST., NEW YORK 16, N. Y.



FLEXIBLE SHAFTS AND ACCESSORIES
MOLDED PLASTICS PRODUCTS—MOLDED RESISTORS

One of America's AAA Industrial Enterprises

Only with CO-AX

air-spaced articulated R.F. CABLES

4mm/ft

Patents Regd. Trade Mark

THE LOWEST EVER CAPACITANCE OR ATTENUATION

We are specially organized to handle direct enquiries from overseas and can give

IMMEDIATE DELIVERIES FOR U.S.A.

Billed in Dollars Settlement by your check. Transaction as simple as any local buy.

TRANSRADIO LTD

CONTRACTORS TO H.M. GOVERNMENT
138A CROMWELL ROAD LONDON SW7 ENGLAND
CABLES: TRANSRAD, LONDON.

LOW WATTEN TYPES	IMPED OHMS	ATTEN db/100ft at 100 Mc.	LOADING R _w	O.D."
A 1	74	1.7	0.11	0.36
A 2	74	1.3	0.24	0.44
A 34	73	0.6	1.5	0.88
LOW CAPAC TYPES	CAPAC mmf/ft	IMPED OHMS	ATTEN db/100ft 100Mc.	O.D."
C 1	7.3	150	2.5	0.36
PC 1	10.2	132	3.1	0.36
C 11	6.3	173	3.2	0.36
C 2	6.3	171	2.15	0.44
C 22	5.5	184	2.8	0.44
C 3	5.4	197	1.9	0.64
C 33	4.8	220	2.4	0.64
C 44	4.1	252	2.1	1.03

HIGH POWER FLEXIBLE

PHOTOCELL CABLE

V.L.C. ★

★ Very Low Capacitance cable.

RIGHT

NEW 100 FRAME

MOTORS AND ALTERNATORS

8th Grade

John Doe
FINAL EXAM. June 1950

1) Plu...
2) ...
3) ...
4) ...

100%

N8A — ALTERNATOR: 120 volts, 400 cycles, 1 phase, 4000 RPM, continuous duty, 400 watts rated output, overall dimensions—6⁵/₈" dia. x 5", weight 16 lbs.

D14ASM-2—HYSTERESIS SYNCHRONOUS MOTOR: 115 volts, 400 cycles, 1 phase, 12000 RPM, continuous duty, 1/3 HP output, overall dimensions — 6⁵/₈" dia. x 5⁵/₁₆", weight 17 lbs.

D14ASM-2

- ★ MORE POWER
- ★ LESS WEIGHT & VOLUME
- ★ GREATER ADAPTABILITY

EASTERN AIR DEVICES, INC. 585 DEAN STREET
BROOKLYN 17, N. Y.

characteristics of telephone lines and equipment, may be used for efficiency tests on local and common battery telephone lines and sets, carbon microphones, receivers and magnetic microphones, and to test capacitors, generators, ringers, insulation resistance, dial's and continuity.



Sensitivity Recorder

PHOTRON INSTRUMENT Co., 6516 Detroit Ave., Cleveland 2, Ohio. The new model M milliammeter recorder with a full-scale range of 0.001 ampere at 1.5 volts is available in 1, 2 and 4 channels with a wide range of fixed chart speeds. It may be used as a portable instrument and is readily adaptable to panel mounting. The single-channel instrument measures 12 in. high x 5¹/₂ in. wide x 9 in. deep.

Shatterproof Electrical Connectors

TOUGH as an elephant's trunk!

Unavoidable blows as well as careless handling quite often subject portable electrical connectors to punishment as bad as in the scene pictured above. When this happens many apparently good connectors develop cracked insulation . . . loose contacts or fail entirely.

Molded directly to cable as one-piece Neoprene units MINES plugs are Jerk-proof, Shatter-proof and Wear-resistant. Special construction and resilient rubber mounting of pins and spring loaded sockets insure a long life of positive contact under adverse conditions . . . and MINES famous Water-Seal automatically protects connections from moisture, dirt, oil, etc.

A wide variety of sizes, shapes and pin combinations are available to meet the portable power requirements of TV, FM, AM or PA Circuits. No. 3A156M Male Plug and No. 3A156F2X1 Female receptacle illustrated.

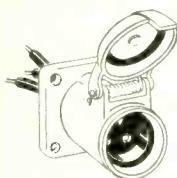

Consult a Joy Engineer



ME-1249 1

MINES EQUIPMENT — MINES — Division

JOY MANUFACTURING COMPANY

HENRY W. OLIVER BLDG., PITTSBURGH 22, PENNA.



H-V Rectifier Cartridges

INTERNATIONAL RECTIFIER CORP., 6809 S. Victoria Ave., Los Angeles 43, Calif., has developed a new line of h-v selenium rectifier cartridges with applications for radar, sonar, oscilloscope, photoflash and all types of h-v power supplies. The rectifier illustrated is rated at 440 v d-c

- Compare for results!
 - Compare for price!
- and you'll choose
the GREEN ENGRAVER



only \$215*

VISIT US AT
BOOTH 434
FIFTH
NATIONAL
INSTRUMENT
EXHIBIT

The Green Engraver offers great speed and convenience. Quickly cuts up to four lines of letters from 3/64" to 1" on curved or flat surfaces whether made of metal, plastics or wood... operates by merely tracing master copy—*anyone* can do an expert job. Special attachments and engineering service available for production work. Just the thing for radio, electronic apparatus and instrument manufacturers.

For quality engraving on

- Panels • Name Plates • Scales
- Dials • Lenses • Molds • Instruments

... also does routing, profiling and three dimensional modeling.

*Price does not include master type and special work holding fixtures.

GREEN

GREEN
INSTRUMENT CO.
363 Putnam Ave.
Cambridge, Mass.

STANCOR TRANSFORMERS

Specified as
original components
by the biggest radio
and TV set makers
in the industry.
They have to
be good!

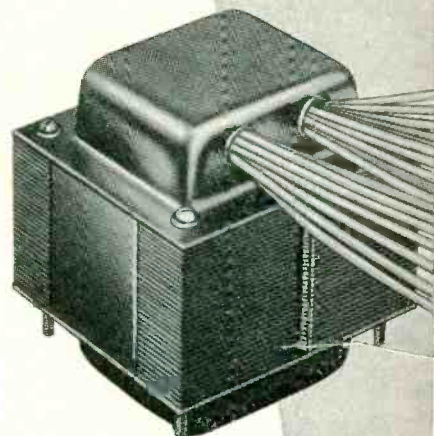

WRITE.
inquiries promptly answered



STANDARD TRANSFORMER CORPORATION
3578 ELSTON AVENUE, CHICAGO 18, ILLINOIS

INCREASED INSULATION BETTER CONNECTIONS JONES BARRIER Terminal Strips

Leakage path is increased—direct shorts from frayed terminal wires prevented by bakelite barriers placed between terminals. Binder head screws and terminals brass, nickel plated. Insulation, molded bakelite.



No. 2-142



No. 2-142-3/4 W



No. 2-142-Y

Shown: Screw Terminals—Screw and Solder Terminals—Screw Terminal above, Panel with Solder Terminal below. For every need.

Six series meet every requirement: No. 140, 5-40 screws; No. 141, 6-32 screws; No. 142, 8-32 screws; No. 150, 10-32 screws; No. 151, 12-32 screws; No. 152, 1/4-28 screws.

Catalog No. 17 lists complete line. Send for your copy.

Jones **HOWARD B. JONES DIVISION**
CINCH MANUFACTURING CORPORATION
CHICAGO 24, ILLINOIS
SUBSIDIARY OF UNITED-CARR FASTENER CORP.

ZOPHAR Waxes, Compounds and Emulsions



Materials for potting, dipping or impregnating all types of radio components or all kinds of electrical units. • Tropicalized fungus proofing waxes. • Waterproofing finishes for wire jackets. • Rubber finishes. • Inquiries and problems invited by our engineering and development laboratories.

Zophar Mills, Inc. has been known for its dependable service and uniformity of product since 1846.

ZOPHAR MILLS, Inc.

ESTABLISHED 1846

117 26th STREET, BROOKLYN 32, N. Y.

**POWER-
PACKED**

**FOR
HEAVY
DUTY**



SOLDERLITE

STREAMLINED

**5-SECOND
HEATING
RIGID-TIP
LONGER REACH**

DUAL HEAT

—single heat
200 watts,
dual heat
200/250 watts,
115 volts,
60 cycles

**New WELER
250-watt
Soldering Gun**

Heavy jobs and light jobs—the new 250-watt Weller Soldering Gun speeds them all. Chisel-shaped RIGID-TIP provides more soldering area for faster heat transfer. New “over-and-under” terminal design gives bracing action to tip. Your Weller Gun does delicate or heavy soldering with equal efficiency; compact and lightweight, it gets into the tightest spots.

Weller Guns actually pay for themselves in a few months. Fast 5 second heating means no time lost. Trigger-switch control means no current wasted—no need to unplug gun between jobs. Prefocused spotlight and longer length let you see the job and reach the job with ease. No other soldering tool offers so many time-and-money-saving features. Order your new 250-watt Weller Gun from your distributor today, or write for bulletin direct.

SOLDERING GUIDE

Get your copy of “SOLDERING TIPS”—new fully illustrated 20 page booklet of practical soldering suggestions. Price 10c at your distributor's or order direct.



**WELER
MANUFACTURING COMPANY**

806 Packer Street, Easton, Pa.

NEW PRODUCTS

(continued)

and 10 ma d-c with a peak current rating of 120 ma and a peak inverse rating of 1,500 v. Voltage drop at rated load is about 25 v and weight is 0.5 ounce. Cartridges are available in either phenolic, glass or hermetically-sealed assemblies from 0.25 in. to 1.25 in. or they can be built to specifications using either the half-wave or voltage-doubler circuit.



Vibration Measurement

ELECTRO PRODUCTS LABORATORIES, INC., 4501 N. Ravenswood Ave., Chicago 40, Ill. Dynamic or static displacement in aircraft, automotive and electrical manufacturing, in ceramics, in the railroad and marine fields and in countless industrial lines may be measured with the Electro Dynamic Micrometer. The instrument consists of a mechanical micrometer head with sensing unit and an electronic cabinet that is used with a c-r oscillograph. Calibrations in divisions of 0.0001 inch are provided. The oscillograph will show a displacement-vs-time curve on the screen, an important factor for accurate measurement of acceleration and other phenomena. Sensitivity is equal to 1 percent of total displacement.

Servo Amplifier

TRANSICOIL CORP., 107 Grand St., New York 13, N. Y. A new servo amplifier is designed to drive a control motor wound for plate-to-plate operation. It operates with a wide variety of a-c transmission elements such as autosyns and both resistive and inductive potentiom-

NATIONAL

- Proven
- Dependable
- Quality

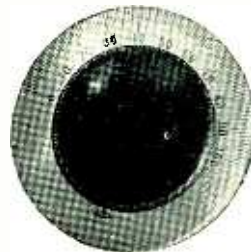

**VERNIER DIALS
AND MECHANISMS**

National's well known line of dials and mechanisms has been accepted by commercial users as well as individual builders. They are available with the popular vernier mechanisms having a 5-1 ratio. These mechanisms are also available separately. For commercial application, the dials can be supplied with special markings or with blank dial scales. Write for details.

Address export inquiries to
Export Div., Dept. E-840

NATIONAL

EST. 1914

NATIONAL COMPANY, Inc.
WALDEN, MASSACHUSETTS

eters. In carrier frequency loops it provides all the circuits needed in the error signal path. A four-page folder providing details is available upon request.

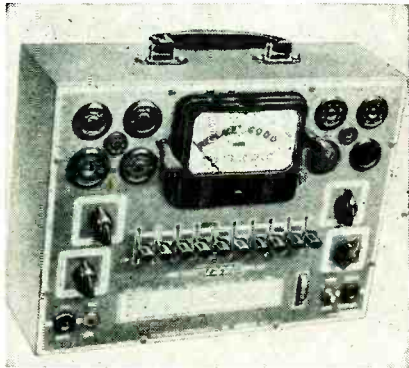

Tube Tester

ELECTRONIC INSTRUMENT CO., INC., 276 Newport St., Brooklyn 12, N. Y. Model 625K tube tester kit is a modern professional laboratory precision instrument. It tests conventional receiving and tv tubes, including: 4, 5, 6, large and small 7, octal, loctal, loval, VR and magic eye, as well as pilot bulbs. A blank spare socket and adapter for future new tubes provide protection against obsolescence.

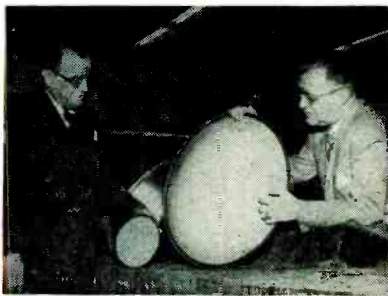

Large Picture Tube

GENERAL ELECTRIC Co., Syracuse, N. Y., has developed a 24-inch tv picture tube which will produce a direct-view picture almost as large as the daily newspaper page. Besides its giant size the tube features a dark face-plate which improves contrast and detail and an aluminum-backed fluorescent screen which increases picture brightness and permits operation at lower voltages. Illustrated above right is the new tube as compared with the 8½-

Now
PHALO HAS IT!

105° C
RATED AMBIENT TEMPERATURE

(U. L. LABELED)

**THERMOPLASTIC HOOK-UP,
CONTROL AND FIXTURE WIRE**

Sizes 16-26 AWG

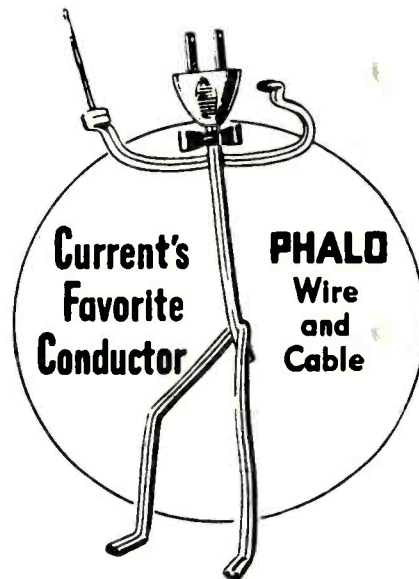

1/32" INSULATION — NO BRAID REQUIRED

1/64" INSULATION WITH LACQUERED GLASS BRAID

*Your Inquiry Will Receive
Prompt Attention!*

PHALO
Plastics Corporation

CORNER OF
COMMERCIAL STREET
WORCESTER, MASS.

Manufacturers of Thermoplastic insulated wire, cables, cord sets and tubing

TERMALINE

R.F. DIRECT READING WATTMETERS

MODEL 67
TRIPLE RANGE
0-25 WATTS
0-100 WATTS
0-500 WATTS

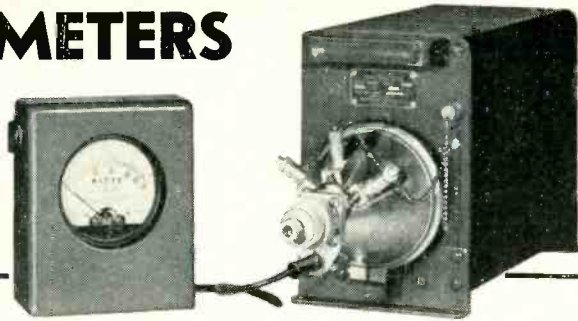

● Model 67 is widely used for laboratory work; in factories for design and production testing of transmitters, and by users of communication equipment for fixed station and field maintenance.

Fool-proof, and as simple to use as a D.C. voltmeter, with its shock-mounted 4½" indicating meter, it is ruggedly built for long trouble-free service. The power absorbing load resistor is non-radiating, thus preventing transmission of unwanted signals which interfere with message traffic in communication services.

FREQUENCY RANGE: 30 to 500 MC. (30 to 1,000 MC. By special calibration)
MAXIMUM INPUT POWER: 500 watts
IMPEDANCE: 51.5 OHMS—VSWR: Less than 1.1
ACCURACY: Within 5% of full scale

INPUT CONNECTOR: Coplanar (Bird Special, ⅜" Teflon Insulated). Mating plugs available for RG-17 and RG-19 cables, and for 1½" rigid line. Adapter CA-8 furnished. This provides a female "N" input connector, to mate with UG-21 or UG-21B plugs.

Carrying cases, ideal for field and portable shop use are now available for Model 67.

CATALOG FURNISHED ON REQUEST

BIRD ELECTRONIC CORP.
Instrumentation for Coaxial Transmission
1800 East 38th Street • Cleveland 14, Ohio
West Coast Representative • NEELY ENTERPRISES • Hollywood 46, Calif.

SPECIALTY BATTERY COMPANY OFFERS

LAB-BILT DRY BATTERIES Standard or Custom-made



Write for FREE CATALOG

This catalog gives complete specifications of 78 Lab-Bilt Batteries of industrial and hard-to-get types.

CUSTOM-MADE BATTERIES

Battery Specification Sheet illustrated in catalog enables you to get any type dry battery designed and made to your individual specifications — even in small quantities!

SUPER SERVICE

Specialty Battery Company is specially equipped to make all Lab-Bilt Batteries FRESH for each order and ship immediately. Give your customers this valuable service. Write for a new catalog today.

SPECIALTY BATTERY COMPANY

A Subsidiary of the **RAY-O-VAC** Ray-O-Vac Company

MADISON 10, WISCONSIN

in. tube, the smallest picture tube manufactured at the Park. The giant tube will be in limited production by the fall.



Isolation Testing Transformer

STANDARD TRANSFORMER CORP., 3580 Elston Ave., Chicago 18, Ill., has announced a new isolation testing transformer rated at 360 watts and large enough to handle almost any tv or radio receiver on test. It may also be used to correct a high or low line voltage. Three standard receptacles provide output voltage of 105, 115 and 125, with 117 volts a-c from the line.

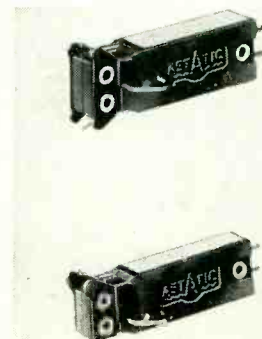

Miniature Pickup Cartridges

THE ASTATIC CORP., Conneaut, Ohio, announces a new development in miniature-sized crystal phonograph pickup cartridges. Four models in the series are: the AC-78 which has a 3-mil radius stylus tip, either precious metal or sapphire, for standard 78-rpm records; the AC (illustrated), a one-mil stylus for narrow-groove, slow-speed rec-



**... WON'T
SHAKE
LOOSE**

**ONE-PIECE
SELF-LOCKING NUTS**

FLEXLOC

The FLEXLOC is one-piece, all-metal . . . has ample tensile and long life. It is a Stop and Lock-Nut that can be reused many times. Its "chuck-like", resilient locking segments lock the FLEXLOC securely in any position on a threaded member. It positively "won't shake loose", yet can be removed easily with a wrench.

Write for Catalog 619,
it's full of Information.

STANDARD PRESSED STEEL CO.

JENKINTOWN 10, PA.

PRECISION POTENTIOMETERS

The linear Type RL-275 illustrated is one of a series ranging from 1 1/4" to 5" in diameter, with resistance ranges of 80 ohms to 500,000 ohms.

GAMEWELL Potentiometers are precision instruments in every respect. They feature extremely close limits in electrical characteristics and mechanical construction, low electrical noise, low torque, and long life—far in excess of 1,000,000 cycles of operation.

All types will operate within specified limits of performance at temperatures -55° C. to +55° C., 95% relative humidity at altitudes up to 50,000 feet. Corrosion resistant materials are used throughout and all insulating parts are fungicided. Our potentiometers meet AN-E-19 specifications.

We invite your inquiries and will gladly study and quote on special requirements.

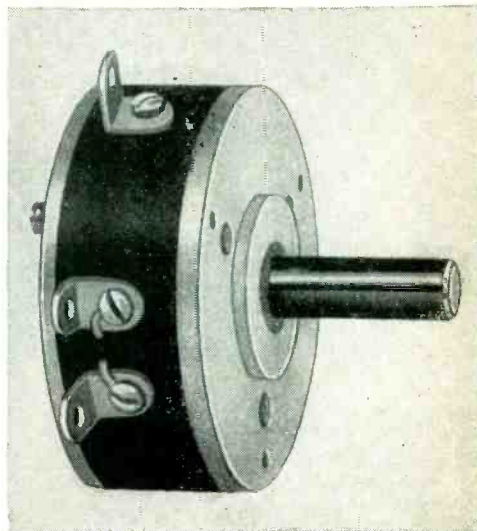

Write for Bulletin F-68.

THE GAMEWELL COMPANY

Newton Upper Falls 64, Massachusetts



The
FISHER-PIERCE

**PHOTOELECTRIC
TOWER LIGHTING
CONTROL**

Turn-on 35 ft.-candles—off at 55 ft.-candles—independent of time of day or weather conditions.
Low first cost—negligible maintenance.
3000 watts contact capacity.
Over 20,000 in use for tower and street lighting.
Complete details available—ask for Bulletin 63305.

The FISHER-PIERCE COMPANY, Inc. 
42 Ceylon St., Boston 21, Mass.

Concertone
MAGNETIC TAPE
RECORDER

Model #401

**"just like
being there"**

Monitoring from tape while recording • Less than 0.1% flutter • 50 to 12,500 cycles \pm 2 db • Full 50 db signal to noise ratio • High speed forward and reverse—2500 feet in 60 secs • Instantaneous choice of 7.5" or 15" tape speeds • Handles 5", 7" and 10 1/2" reels (66 minutes) • All controls interlocked to prevent spilling or tearing tape • Write for Bulletin #103.

MODEL #401—Mechanism and electrical chassis ready for console installation. **\$295.00**

Manufactured by **berlant associates** USER'S NET COST
4917 W. Jefferson Boulevard,
Los Angeles 16, California

**WHITNEY METAL
TOOL COMPANY**
39 YEARS EXPERIENCE

49" — 20 Ga.

WHITNEY-JENSEN
49" — 20 Ga.
BENDING BRAKES

Portable or stationary bending brakes that form a 1/2" flange in 20 gauge mild steel their entire length. Made in two styles—for straight bending or for combination box and pan work as well as straight bending. Combination roller bearing bending brakes—in 18 ga. or 16, 14, 12, ga. capacities—are also available.

WHITNEY METAL TOOL CO.
150 FORBES ST., ROCKFORD, ILL.

STILL TOPS IN THE FIELD

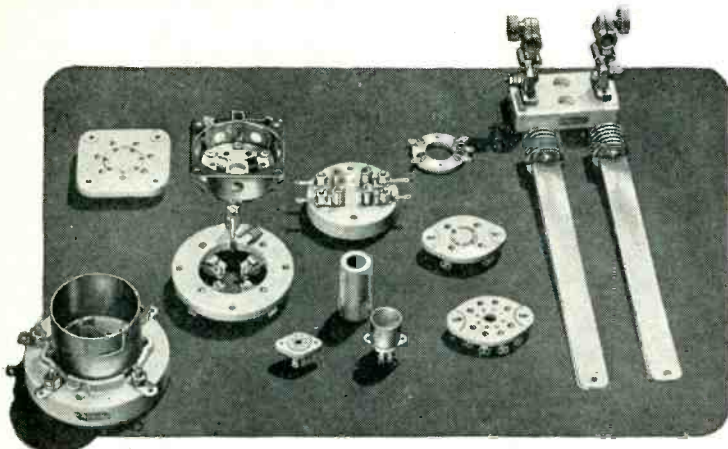

Whatever your power tube application may be, you can, in almost every case, find an ideally suited JOHNSON socket. This socket will have high frequency insulation, low contact resistance and will hold the tube securely. These are characteristics of all JOHNSON sockets.

JOHNSON sockets, furthermore, are easy to use. Design is such that mounting is simple. Insulation and spacing are more than adequate for voltages involved. High frequency tube performance is not impaired by stray capacity.

Write for catalog 971 which describes the most complete line of transmitting and industrial tube sockets on the market.

E. F. JOHNSON COMPANY . . . a famous name
in radio
WASECA, MINNESOTA

ords; the AC-AG with the all-groove stylus tip to play 33 $\frac{1}{3}$, 45 and 78-rpm records; and the ACD, a turnover cartridge with dual needles to play narrow-groove records on one side and 78 rpm on the other. Frequency range of all models is from 50 to 10,000 cps. Output at approximately 1,000 cps is 1.0 volt.



High-Speed Oscilloscope

EDGERTON, GERMESHAUSEN, & GRIER, INC., 160 Brookline Ave., Boston, Mass. Type 3112 oscilloscope and type 3114 scope camera are designed to record single fast-transient phenomena and provide writing speeds up to 800 in. per μ sec. A tap switch selects a 1, 3, 10, 30, 100 or 200 in.-per- μ sec sweep with the lowest speed comprising a plug-in, changeable unit. Sweep is linear within 1.0 percent over a 3-in. span. A built-in 60-cycle supply provides 24, 18 and 12-kv steps of accelerating voltage.



"Feathers are all right on birds and even on Indians — on them they look good and serve a useful purpose. But feathers don't even look good on tracing cloth, and what's more they don't belong either. Thanks to my unique fibre surface, I am always free from feathers despite repeated erasures. Yes, sir, work is faster and cleaner when you're working on MICRO-WEAVE."

MICRO-WEAVE exceeds all specifications in minute perfection of weave — in transparency — in better blueprints — in longer life. Test MICRO-WEAVE on your drawing board. Send for generous sample.



A HOLLISTON MILLS PRODUCT
Micro-Weave
All American
TRACING CLOTH
White or Blue for Ink or Pencil

THE HOLLISTON MILLS, INC.
NORWOOD, MASS.

NEW YORK PHILADELPHIA CHICAGO

★ MICRO-WEAVE is backed by Holliston's 50 years of leadership and experience in developing special cloths for industry.

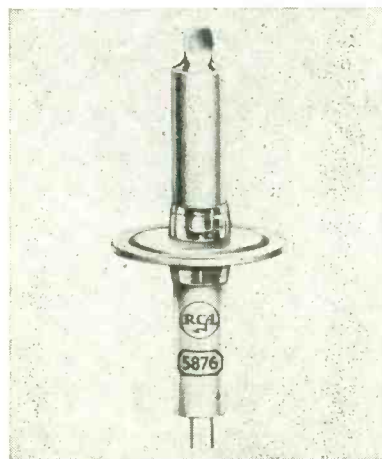

UHF High-Mu Triode

RADIO CORP. OF AMERICA, Harrison, N. J. The 5876 general-purpose,

Where the
Requirements
are Extreme...

Use SILVER GRAPHALLOY

For extraordinary
electrical performance



THE SUPREME BRUSH
AND CONTACT MATERIAL

IN BRUSHES

- for high current density
- minimum wear
- low contact drop
- low electrical noise
- self-lubrication

IN CONTACTS

- for low resistance
- non-welding character

SILVER GRAPHALLOY is a special silver-impregnated graphite

Accumulated design experience counts — call on us!

GRAPHITE METALLIZING CORPORATION

1055 NEPPERHAN AVENUE, YONKERS 3, NEW YORK

NEW PRODUCTS

(continued)

high-mu pencil-type triode is designed for use in grounded-grid circuits. As an unmodulated class-C r-f amplifier it is capable of giving a useful power output of 5 watts at 500 mc. As an unmodulated class-C oscillator it can deliver a useful power output of 3 watts at 500 mc and 750 mw at 1,700 mc.



Sound-Level Meter

HERMAN HOSMER SCOTT, INC., 385 Putnam Ave., Cambridge 39, Mass. Indoor and outdoor acoustics, machinery noise and hearing requirements are quickly and accurately measured with the type 410-A miniature sound-level meter. Using subminiature tubes and hearing-aid batteries, it weighs slightly over 2 lb and covers the range from 34 to 140 db above the standard ASA weighting characteristics which duplicate the ear response at various loudness levels. Batteries have a normal operating life of 50 hours.

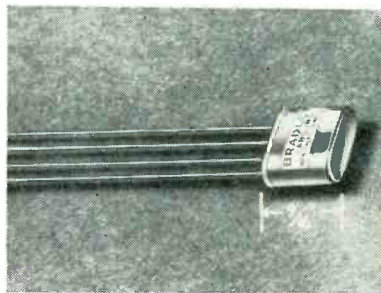

Copper-Oxide Rectifiers

BRADLEY LABORATORIES, INC., 82 Meadow St., New Haven, Conn. Model CX3 hermetically-sealed cop-

TEST SPECS HAVE YOU IN A SPIN?



If complicated USAF Specs or other Government Test Specifications have got you stymied, Bowser can put you in trim. Bowser Chambers for testing equipment under simulated environmental conditions meet all Govt. Test Specs, and some Bowser Units, like the Laboratory Units, provide facilities for testing under several conditions such as High or Low Temperature, High Altitude, Relative Humidity, etc. Bowser Units are custom built to meet individual testing, storage and processing requirements.

Why don't you capitalize on Bowser's experience in building Testing equipment of all kinds? Write NOW.

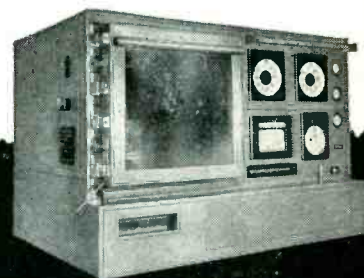

BOWSER INC.
Refrigeration Division
TERRYVILLE • CONN.

Send me free information on Bowser environmental simulating units.

Name _____ Pos. _____
Company _____
Street _____
City _____ Zone _____ State _____

**Cold heading
was the
only logical
way to
make this
special part**

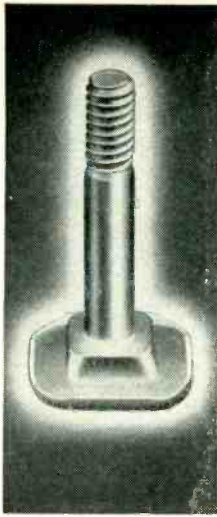

NEW PRODUCTS

(continued)

per-oxide rectifiers are available for conventional bridge, center tap, half-wave circuits or as balanced and matched units for modulators and related equipment. They are rated up to 6 volts a-c and 5 ma d-c; and supplied with four tinned leads. The sealed container is 11/16 in. wide x 9/16 in. high x 1/4 in. deep.



C-R Pattern Tracer

ROBERT A. WATERS, INC., 4 Gordon St., Waltham 54, Mass., announces the Oscillo-Tracer, an optical superpositioning device that permits tracing of c-r patterns of a repetitive nature directly on graph paper. Use of the unit for viewing oscillograms increases accuracy by elimination of parallax caused by curved-face c-r tubes and flat calibrated scales. The projected pattern is exactly the size of the original trace.

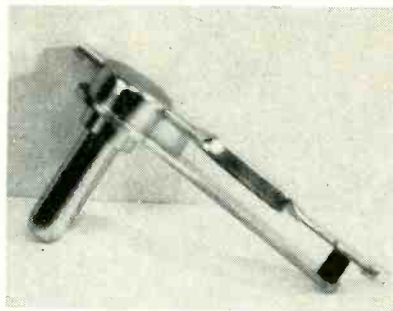

Stylus Assembly

GENERAL ELECTRIC Co., Syracuse, N. Y., has introduced a modified replaceable stylus assembly for use with its variable reluctance phonograph cartridge. The new design, in which the horizontal stylus arm

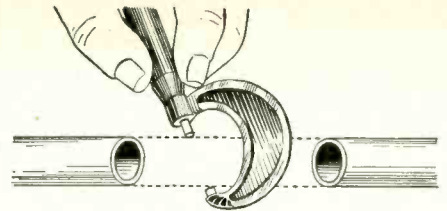

**Form to form
THEY'RE UNIFORM**

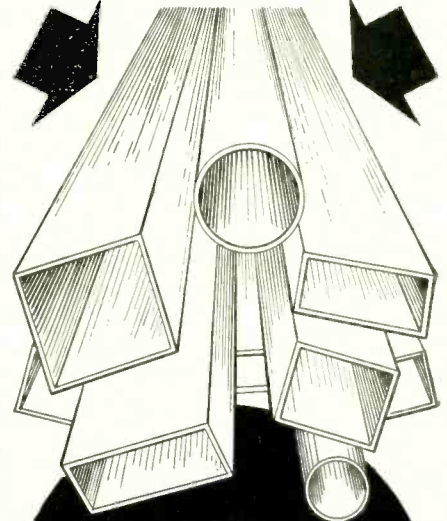

**PRECISION
paper
TUBES**

Die-formed under heat and pressure, each Precision Paper Tube is exactly the same as every other Precision Paper Tube that is made to the same specifications. This form-to-form uniformity helps assure more accurately-wound coils. Moreover, Precision Paper Tubes are made of finest dielectric Kraft, Fish Paper, Cellulose Acetate or combinations. Better heat dissipation, greater moisture resistance, and lighter weight are the results.

Let us make up a FREE sample for you!

We make Precision Paper Tubes precisely to your specifications. Any length, any size, any shape—round, square, oval, rectangular.

Write today for new mandrel list of over 1,000 sizes.

PRECISION PAPER TUBE CO.

Also makers of Precision Coil Bobbins
2041 W. Charleston St., Chicago 47, Ill.
Plant #2
79 Chapel St., Hartford, Conn.

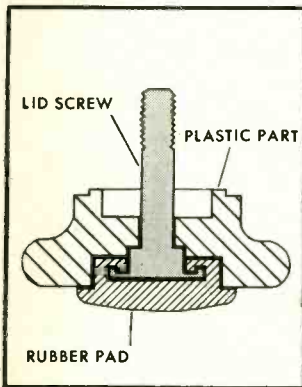

Cross-section drawing shows how lid screw fits into rubber pad and plastic mating part.

This refrigerator lid screw *might* have been made by other methods. With cold heading, however, in the hands of Scovill engineers, toolmakers and operators, this special part is produced in one piece, to close tolerances, with a better finish and greater strength, at lower cost.

Cold heading may open new possibilities for you to save money, speed production and improve your product. It's worth a try. Send your sample or blueprint for further information.

"Guide to the Profitable Use of Cold Heading"
— Bulletin No. 2 describes the advantages and limitations of this process for the designer. It's free for the asking.

A PRODUCT OF
SCOVILL
FASTENERS AND SPECIAL PARTS

Recessed Head Screws • Sems Tapping Screws • Standard Machine Screws • Special Cold Headed Parts

Industrial Fastener Sales, Waterville Division
Scovill Manufacturing Co., Waterville 14, Conn.

Montclair, N. J. • Detroit • Wheaton, Ill.
Los Angeles • Cleveland • San Francisco

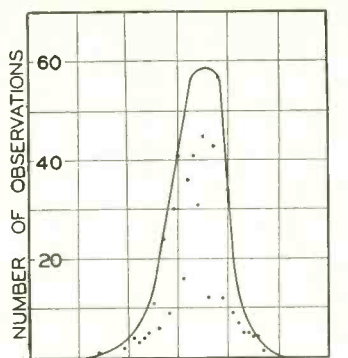

PER CENT ERROR, TYPE 105-A
MICROMETER FREQUENCY METER

PROBABILITY of error, when monitoring radio transmitter frequencies above 70 MC with the Type 105-A **MICROMETER FREQUENCY METER**, is graphically shown above.

RECENT improvements put guaranteed accuracy at 0.0025%. Write for the story—it's useful alike to old and to prospective customers.

LAMPKIN LABORATORIES, INC.
— Bradenton, Florida —

SPECIAL APPLICATIONS

GANGED LINEAR AND NON-LINEAR POTENTIOMETERS



This three-gang precision potentiometer assembly is just one more example of Fairchild's answer to customers' special-application problems.

The assembly combines on a common shaft, two 736 non-linear potentiometers, specially wound to an empirical function, with a highly accurate ($\pm .15\%$) 747 linear unit. Ganging in this manner saves considerable space and virtually eliminates error accumulation such as would occur if each unit were operated on its own shaft.

Fairchild's Potentiometer Sample Laboratory engineers can help you in analyzing your special applications. Write complete details on your requirements to Dept. 140-11A, 88-06 Van Wyck Boulevard, Jamaica 1, N. Y.



**For
Advanced
RELAYS
specify
ADVANCE**

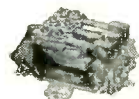

RELAYS for general circuit control, electronic, aircraft and marine applications. Crisp action, dependable and durable. ADVANCE offers sensitive, midget, midget telephone, keying, instrument, time-delay, overload, transmission line, impulse, hermetically sealed, and ceramic insulated relays. Wide variations of these types for special applications and special relays made to specifications.

ADVANCE'S engineering ability and manufacturing facilities will assist in engineering problems and supply special relays for the most exacting requirements. Your inquiry will receive prompt and courteous attention.



ADVANCE ELECTRIC & RELAY CO.
435 North Naomi Street ★ Burbank, California

Pioneer in Radio Engineering Instruction Since 1927

CAPITOL RADIO

ENGINEERING INSTITUTE

An Accredited Technical Institute

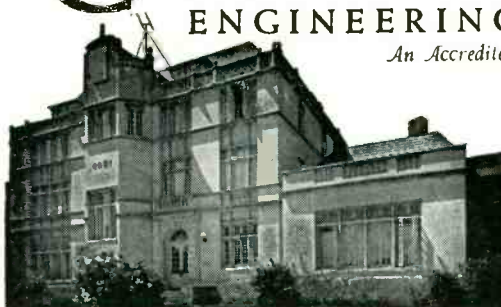

ADVANCED HOME STUDY
AND RESIDENCE COURSES IN
PRACTICAL RADIO-ELECTRONICS
AND TELEVISION ENGINEERING

Request your free home study or
resident school catalog by writing to:

DEPT. 288B
16th and PARK ROAD, N.W.
WASHINGTON 10, D.C.
Approved for Veteran Training

For Precision Washers... For Precision Stampings...

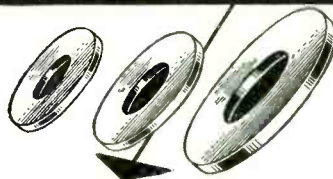

WHITEHEAD STAMPING CO.

A preferred source of precision-made WASHERS and STAMPINGS. 46 years of experience and up-to-the-minute facilities, assure highest quality and service.



EST.
1903

WHITEHEAD STAMPING CO.

1691 W. Lafayette Blvd.

Detroit 16, Michigan

EMSCO FREE-STANDING TRIANGULAR RADIO TOWERS

The Ultimate in Structural Rigidity

Less horizontal deflection . . . less wind area . . . less weight . . . less cost per lineal foot. These are the outstanding advantages afforded by Emsco's new free-standing triangular towers. Rigid, triangular design prevents distortion and assures uniform distribution of loads to foundation piers. Slender proportions provide maximum signal strength. Hot dip galvanizing insures long life, low maintenance cost and maximum electrical conductivity. Standard Emsco free-standing triangular towers available in heights from 300 to 700 feet with 30, 40, 50 or 60 lbs. per sq. ft. RMA design. Other towers available on special order.

EMSCO
TOWERS OF STRENGTH

New bulletin F-173 describes the complete line of Emsco guyed triangular and free-standing square and triangular towers. Write for your copy today!

EMSCO DERRICK & EQUIPMENT CO.
Houston, Texas • Garland, Texas
LOS ANGELES, CALIFORNIA

NEW PRODUCTS

(continued)

has been given a double twist and is double damped, gives improved tracking ability and reduces needle talk.

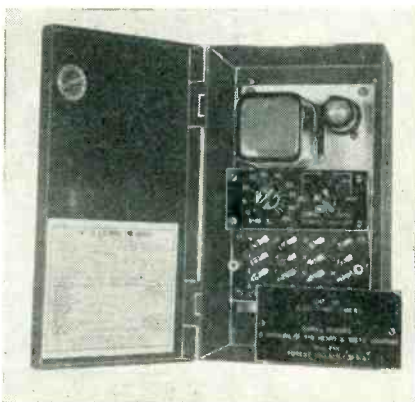

Electronic Time Switch

CORAL DESIGNS, Box 248, Forest Hills, N. Y. Catalog 110 electronic time switch incorporates every basic type of timing—automatic repeat, interval, delayed action and programming. All of these plus variations are available by merely changing external connections to the terminal board. Timing periods of 1/20th second to 4 minutes with an accuracy variation of less than ± 2.0 percent is accomplished by means of a selector switch and intermediate time variable resistor. Standard units are supplied for operation on either 115 v or 230 v, 50 or 60 cycles. All relay contacts are rated at 10 amperes to 115v a-c, 5 amperes to 230 v a-c, noninductive load.

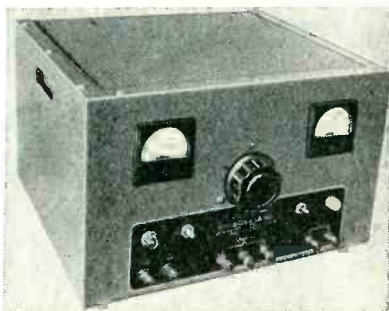

Regulated H-V D-C Supply

SORENSEN & Co., INC., 375 Fairfield Ave., Stamford, Conn., is manufacturing a line of regulated, high-voltage d-c supplies known as B-Nobatrons. Illustrated is the model 500BB. Output voltage is

JOHNSON



7/8" COAXIAL LINE

For communications and AM broadcast facilities up to 5 KW don't overlook JOHNSON 7/8" 70 ohm semi-flexible coaxial line. For convenience and low installation cost JOHNSON 141-22 line is shipped from the factory in sealed continuous length coils or reels. All desired fittings such as pressure gauge, inlet and purging valves, tees and end terminals can be installed without extra charge. After assembly the line is dehydrated, checked electrically, tested for gas tightness, sealed and shipped under pressure. Semi-flexible line requires no expansion joints, a minimum of support and has the lowest cost per foot of any line suitable for broadcasting use.

For phase sampling and other low power applications JOHNSON supplies 70 ohm semi-flexible line in 5/16" and 3/8" diameters. These too are furnished in continuous, pre-assembled lengths.

JOHNSON also manufactures 3/8" and larger rigid, flanged coaxial line for TV, AM and FM in both 51.5 and 70 ohms impedance. This line is shipped in straight 20 foot lengths, easily assembled in the field by simply bolting the sections together. Flanges utilize "O" ring packing for perfect seals. Necessary fittings such as 45 degree and 90 degree swivel bends, expansion joints, reducers, gas inlet couplings, gas barriers and solderless clamp flange assemblies are stock items for rigid flanged line. Convenient mounting hardware is available including single or multiple line spring suspension assembly.



JOHNSON
a famous name in Radio

E. F. JOHNSON CO. WASECA, MINN.

continuously adjustable between 0 and 500 v d-c. A 6.3-v a-c, 6-ampere, center-tapped unregulated filament source has been provided. Regulation is within 0.5 percent for voltages between 30 and 500 v from no load to full load. It is within 0.5 percent for line-voltage variations from 105 to 125 v at full-load current between 30 and 500-v output, and within 2 percent at 10 v. Hum is kept to within 10 mv at any voltage or load within ratings.

Literature

Medium-Mu Twin Triode. Hytron Radio & Electronics Corp., Salem, Mass. Bulletin E-149 is an engineering data sheet covering the 12HB7 double triode with semi-high-perveance units. The tube described is intended for use in tv receivers and other applications where the use of two similar triode sections in a single envelope is desirable from the viewpoint of space saving and lower cost.

Universal D-C Amplifier. Millivac Instruments, P.O. Box 3027, New Haven, Conn. Technical features, description, applications and other important data on the DCA-3 universal d-c amplifier are shown in a single-sheet bulletin. The unit described is intended for both industrial and laboratory use, and can also effectively be used as a wide-range v-t millivoltmeter.

Strain and Vibration Analyzer. Electronic Tube Corp., 1200 E. Mermaid Lane, Philadelphia 18, Pa. Two sides of a page give an illustrated description, general uses and specifications of the H-42 Strainalyzer. The instrument treated is composed of four units: indicator, indicator power supply, camera and camera speed control.

Wire-Wound Resistors. Cinema Engineering Co., 1510 W. Verdugo Ave., Burbank, Calif. Thirty styles of precision wire-wound resistors are illustrated in actual size in a four-page folder known as bulletin 7. Write for catalog 11AX for

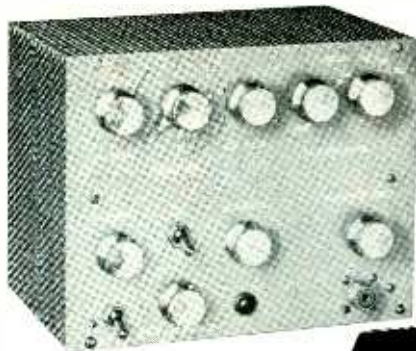

THE Berkeley MODEL 902 DOUBLE PULSE GENERATOR

TYPICAL PULSE COMBINATIONS



BRIEF SPECIFICATIONS

PULSE DURATION individually adjustable from 0.15 to 1.5 microseconds; **RISE TIME** is .05. **DECAY TIME** 0.10 microseconds. **SPACING** between pulses variable from -0.5 to +3 microseconds. **REPETITION RATE** adjustable in 3 ranges, 1 to 10, 10 to 100 and 100 to 1000 cycles; can be externally triggered. **OUTPUT IMPEDANCE** approximately 400 ohms, maximum output voltage, -200 v. **CONTROL CALIBRATION ACCURACY** $\pm 5\%$ over entire range.

The Berkeley Double Pulse Generator produces two pulses individually controllable in width, amplitude and time relation to each other. Pulse amplitude is individually adjustable without cross effect from 0 to +50 v. and 0 to -200 v. A fine control, plus a 10 to 1 step attenuator permits varying the amplitude of both pulses after mixing.

TYPICAL APPLICATIONS... Resolution tests of high speed scaling circuits, response simulation of scintillation and proportional counters, evaluation of electronic gate and switch response, TV equipment testing, characteristic checks of wide band amplifiers, etc.

COMPLETE INFORMATION is yours for the asking; please request Bulletin E-902.

Berkeley Scientific Company

SIXTH & NEVIN AVENUE • RICHMOND, CALIFORNIA

a + value for industry

Development and Production of

SPECIAL PURPOSE VACUUM TUBES BY ECLIPSE-PIONEER



TT-1 3000 mc Temperature Limited Noise Diode Tube.



Y-Type Position Convectron—Vertical Sensing Tube.



Chronotron Thermal Time Delay Tube.

We're not in the standard vacuum tube business. But we are definitely in the business of developing and manufacturing special purpose vacuum tubes — tubes that are not generally available. During the past three years, for example, our facilities have produced, such devices as the Chronotron thermal time delay tube, the Convectron* vertical sensing tube, the TT-1 3000 mc temperature limited noise diode tube, counter tubes, glass enclosed spark gaps, and phono pickup tubes. Quantities of all these are now serving many phases of industry in a wide variety of applications. We invite your use of our facilities to develop and produce your requirements of special purpose vacuum tubes. Your inquiries concerning the scope of our facilities or details of any of our tubes will be given immediate attention.

*REG. U.S. PAT. OFF.

Eclipse-Pioneer Division of
TETERBORO, NEW JERSEY



Export Sales—Bendix International Division, 72 Fifth Avenue, New York 11, N. Y.

EISLER Television Tube MACHINERY

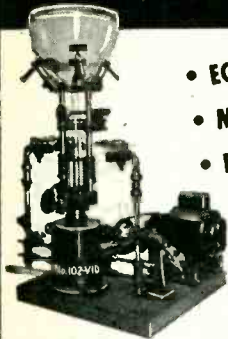

No. 102-VID



No. 57-VID

- ECONOMICAL
- MODERN DESIGN
- PRODUCTION ENHANCING

EISLER'S Electronic Equipment is especially Designed and Built to your exact requirements.

From 5" to huge 24" Television Tube

EISLER specializes in GLASS WORKING MACHINERY for the manufacture of: Cathode Ray; Radio Tubes (Standard, Miniature, Sub Miniature); Fluorescent Lamps; Glass Ampoules; Vials; Incandescent Lamps.

- Consultation without any obligation on your part is cordially invited.

EISLER ENGINEERING CO., INC.
751 SOUTH 13th ST. • NEWARK 3, NEW JERSEY

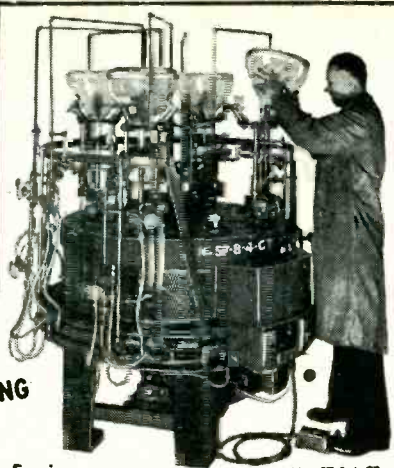

No. 57-8-4 CT

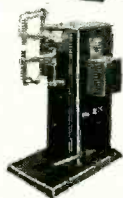

RESISTANCE WELDERS

1/4 to 300 KVA



EISLER TRANSFORMERS
STANDARD • SPECIAL
Air, Oil or Water
Cooled

Sizes From 1/4 to 500 KVA

Compact dependable instruments

Heiland
DENVER

Portable
OSCILLOGRAPH
Recorder

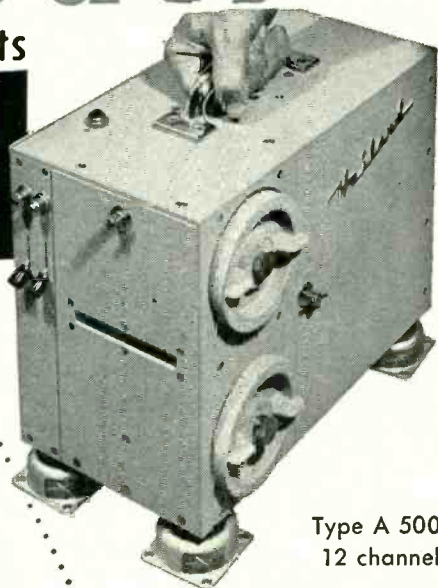

Type A 500
12 channel

6 3/4" x 9 7/8" x 12 3/4"

Designed and developed for applications where a minimum of space and weight are required. Small size...6 3/4" x 9 7/8" x 12 3/4". Lightweight...33 lbs. Versatility of operation...for the recording of strain, vibration, displacement, acceleration, pressure and temperature.

The Heiland A 500 Portable Oscillograph Recorder has many features found only in larger instruments... easy loading...four quick-change paper speeds...trace identification...simultaneous viewing and recording...zero mirror...film movement indicator...up to 12 channels.

Write for complete detailed information

HEILAND RESEARCH CORPORATION
133 E. Fifth Avenue Denver, Colorado

information on a complete line of Evanohm alloy resistors. It contains handy pricing charts and full particulars.

Field Intensity Meter. Stoddart Aircraft Radio Co., 6644 Santa Monica Blvd., Hollywood 38, Calif. A four-page folder is devoted to the NM-20A radio interference and field intensity meter. Typical and specialized applications, performance specifications and unusual features are pointed out.

Master Antenna Distribution. Technical Appliance Corp., Sherburne, N. Y. Catalog 34 gives an illustrated description of the master antenna distribution system for apartment houses, hotels or other multiple installations. Most of the 8-page folder is devoted to the master chassis, composed of a power supply for the r-f amplifier strips and a mixer unit which combines the signals from all the r-f amplifiers into one lead. A price list is included.

Loudspeakers. Racon Electric Co., Inc., 52 E. 19th St., New York 3, N. Y., has issued a 12-page booklet covering its line of exponentially designed loudspeakers. Illustrated and described herein are driver units, straight trumpets, re-entrant trumpets, cone projectors, marine speakers, tweeters, paging speakers, cobra-type loudspeakers and microphone stands. Specifications and chief features for all are given.

Power and Gas Tubes. Radio Corp. of America, Harrison, N. J. Form No. PG-101-A treats of such power and gas tubes as the company's vacuum power tubes, glow-discharge tubes, rectifier tubes, thyratrons and ignitrons. Description, photograph and technical data for each type are given. Included are a list and short summaries of publications on electron tubes. The publication is priced at 15 cents.

Hi-Fi Audio Equipment. Stephens Mfg. Corp., 8538 Warner Drive, Culver City, Calif., has issued a 4-page folder dealing with its

THIS IS IT!

World-wide recognition for this outstanding line of electric soldering irons —

HEXACON

— specified by the big names for the **TOUGH JOBS!**

WESTERN ELECTRIC, BENDIX, MINNEAPOLIS HONEYWELL RADIO CORP. OF AMERICA, STROMBERG CARLSON, SPERRY, WESTINGHOUSE, EMERSON, KAISER, etc.

PLUG OR SCREW TIPS 40 to 700 Watts
1/8" to 1 1/2" Tip Dia.

Follow the leaders and you'll specify HEXACON! They'll efficiently solve your soldering problems. Write for literature.

Here's the famous **HATCHET TYPE**

These irons feature better balance for reduced operator fatigue. Efficiency is stepped up, and quality of work is improved. The ideal iron for inaccessible and intricate jobs.

HEXACON ELECTRIC CO.

130 W. CLAY AVE., ROSELLE PARK, N. J.

SPECIALISTS IN ELECTRONIC GEARS

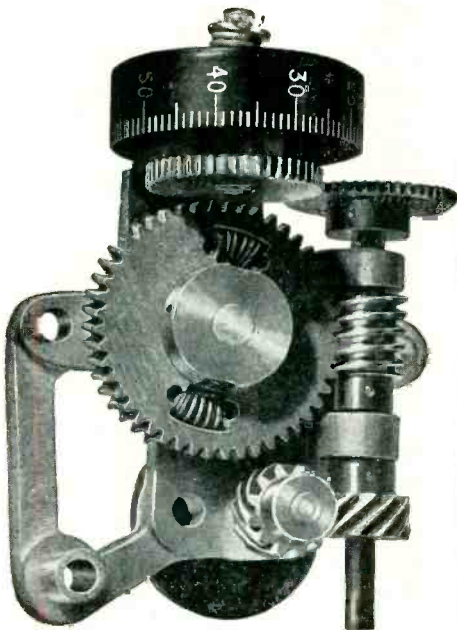

QUAKER CITY GEAR WORKS

1910 N. FRONT ST.
PHILADELPHIA 22, PA.



The Shape and Size YOU need!

PARAMOUNT SPIRAL WOUND PAPER TUBES

All Sizes in

Square and Rectangular Tubes

Leading manufacturers rely on the quality and exactness of PARAMOUNT paper tubes for coil forms and other uses. Here you have the advantage of long, specialized experience in producing the exact shapes and sizes for a great many applications. *Hi-Dielectric, Hi-Strength.* Kraft, Fish Paper, Red Rope, or any combination. Wound on automatic machines. Tolerances plus or minus .002". Made to your specifications or engineered for YOU.

SEND FOR ARBOR LIST OF OVER 1000 SIZES

Inside Perimeters from .592" to 19.0"

Convenient. Helpful. Lists great variety of stock arbors and tube sizes. Includes many odd sizes. Write for Arbor List today.

PARAMOUNT PAPER TUBE CORP.

616 LAFAYETTE ST., FORT WAYNE 2, IND.

Manufacturers of Paper Tubing for the Electrical Industry

SMALL PARTS

Filaments, anodes, supports, springs, etc. for electronic tubes. Small wire and flat metal formed parts to your prints for your assemblies. Double pointed pins. Wire straightened and cut diameter up to 1/8-inch. Any length up to 12 feet.

LUXON fishing tackle accessories.

Inquiries will receive prompt attention.

ART WIRE AND STAMPING CO.

227 High St.

Newark 2, N. J.

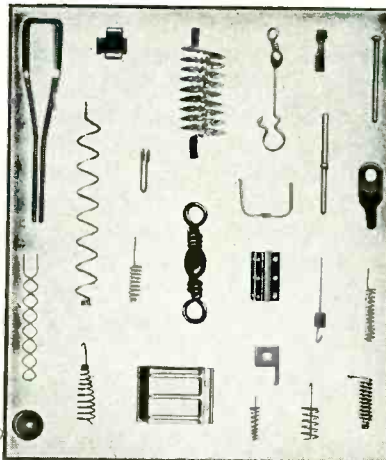

NEW

CONTINENTAL NOBLELOY

METAL FILM

NF RESISTOR

- Low Temperature Coefficient
- Range: 1 Ohm to 1 Megohm
- Axial Leads: 1/2 Watt
- Small Size 1/2" long x .150" Dia.
- Tolerance + - 1% & 5%

Continental type NF "Nobleloy" resistors were designed to meet the needs of miniature, stable, precision resistors in critical applications.

Write for further details

CONTINENTAL CARBON INC. CLEVELAND 11, OHIO



This
EDISON RELAY
is sensitive...
but only to
MICRO-CURRENTS



Sensitive is about the only word that can describe a relay which will operate on input powers as low as 25 micro-watts. Sensitivity also suggests lack of strength, but that's not true in this case. Electrically this Sensitive Relay will continuously withstand input powers 10,000 times its nominal ratings, and mechanically it's truly rugged. Originally developed for aircraft use, it is standard equipment on thousands of planes in the air today.

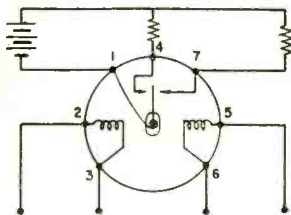

Schematic showing how coil leads are brought out to separate contacts in the relay base, permitting differential operation.

HOW YOU CAN TAKE ADVANTAGE OF THESE FEATURES

Sensitivity of this degree makes this relay well suited as a dependable circuit actuator for use directly with low output detectors, such as thermocouples, photocells, etc. It may be used for polarized or differential operation, as a null-seeking device, etc. Contacts SPST or SPDT, normally open or closed. Seated height, 2¼"; dia. 1⅜"; weight 68 grams; 7-pin small radio tube base.

Full information available. Write for Bulletin 3004-D.
184 Lakeside Avenue, West Orange, N. J.



high-fidelity audio equipment. Short descriptions and prices for the following units are given: separate two-way systems and cabinets, a coaxial two-way speaker, single voice coil speakers, low and high-frequency drivers, standard horns, crossover networks, theater sound units and microphone system. All products described are guaranteed for one year against defects of material and workmanship under normal usage.

TV Picture Tube Guide. National Union Radio Corp., Orange, N. J., has compiled and published a reference guide for television picture tubes including all types used in post-war U. S. television as of publication date regardless of manufacturers. It contains ratings and characteristic data, bulb drawings, basing diagrams and other information necessary to show differences between tube types. As new types are announced they will be included in periodic revised editions of this guide.

Precision Metal Parts. Haydu Brothers, Plainfield, N. J. A recent booklet illustrates and describes a wide line of precision metal parts, many of which are used in radio, electronic devices, radar, television, x-ray tubes, telephone and other communication applications. Burners and burner parts are also included.

Continuous TV/F-M Tuner. Allen B. DuMont Laboratories, Inc., 35 Market St., East Paterson, N. J. A single-page pamphlet covers the series T3A Inputuner, a continuous tv/f-m tuner for direct replacement of switch-type tuners. Featuring a 300-ohm input for exact match with existing antenna and lead-in system, the unit described comes complete with tubes, mixer-plate network, sound takeoff and attractive dial.

Electric Timing Devices. Haydon Mfg. Co., Inc., Torrington, Conn. Catalog 323 is an 8-page booklet on a line of electrical timing devices including units for time

HF and UHF power leakage positively and economically controlled by new gasket material

The unique combination of controlled resiliency, stability and conductivity found in Metex "Electronic Weather Stripping" makes it particularly effective as a shielding material for such electronic applications as radar equipment, high frequency heating, television broadcasting and high frequency communication.

It is available in strips or in die-formed gaskets of the shape, size and volume required by the particular application. Economical in cost, the use of this material permits further savings in assembly time and eliminates much costly machining of closure surfaces that would normally be required.

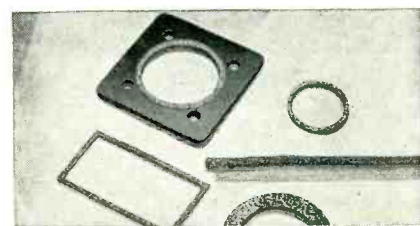

"Electronic Weather Stripping"

The base material is a knitted—not woven—wire mesh which is made from any metal that can be drawn into wire. Knitting produces a mesh consisting of a multiplicity of interlaced loops which increase the normal resiliency of the wire and, by their hinge-like action, permit freedom of motion without loss of stability.

These characteristics are retained even when multiple layers of this mesh are compressed to form gaskets or strips. The result is a compressible, resilient, cohesive, conducting material with a large internal surface area. Where hermetic sealing is also required, these gaskets are made in combination with neoprene or similar materials.

Applications

Among the varied applications where Metex "Electronic Weather Stripping" has already proved its effectiveness and economy are: Air craft pulse modulator shields, waveguide choke-flange gaskets, shielding metal housings, replacing beryllium-copper fingers and springs on TR or ATR tubes, and ignition shielding to prevent radio noise interference. The facilities of our engineering department are available at any time to assist you in determining the possible adaptability of "Electronic Weather Stripping" to your specific requirements. A letter, addressed to Mr. R. L. Hartwell, Executive Vice President, and outlining briefly your particular problem will receive immediate attention.

Metal Textile Corporation

641 East First Ave. Roselle, N. J.

delay, interval, repeat cycle and elapsed time functions. It is illustrated with photographs, dimensional drawings and diagrams. A brief discussion of each type gives important features, with specifications, ratings and ordering aids. Necessary data required for special designs is outlined for quick reference.

H-V Rectifier Data Sheet. Hytron Radio & Electronics Corp., Salem, Mass. Bulletin E-154 is a single-page data sheet on the 1X2A miniature filamentary-type rectifier designed for use in tv sets as h-v rectifier supplying power to the anode of the c-r tube. In new equipment applications the 1X2A when used within its maximum ratings, is a replacement for type 1B3GT/8016 at d-c output potentials as high as 14 to 15 kv.

Low-Loss Capacitors. Vitramon Inc., Stepney, Conn. Bulletin No. 5 covers a line of vitreous enamel capacitors (0.68 μ f to 1,000 μ f rated at 500 volts d-c). The description includes properties, curves showing dielectric loss and temperature characteristics, a table of physical dimensions and preferred nominal capacities as well as dimensional drawings.

Negative-Gradient Elastic Member. Hunter Spring Co., Lansdale, Pa., has published a two-color four-page bulletin which describes by engineering drawings and application photographs the four major forms of the Neg'ator—an elastic member which possesses either constant or negative force-deflection characteristics. In describing the four forms—(1) extension spring, (2) type A motor, (3) type B motor, and 4) clamps—drawings show how each is constructed and how it operates. Fifteen photographs complete the story by showing how the unique properties of the new device have been applied.

Vacuum-Pump Data Sheet. Eitel-McCullough, Inc., San Bruno, Calif., has available a new price and data sheet on the H^{V-1} vacuum pump and accessories. It gives detailed information on this oil-dif-



Here's the exact duplicate of the TEC Projection Oscilloscope developed for the U. S. Navy for mass electronics training. Makes waveforms brilliantly clear to groups as large as 750 persons! No more students hunching round a tiny image! No more mistaking what you mean!

Only TEC gives you such advanced features for top performance and flexibility:

External Screen: 8' x 10' or larger. Integral Screen: 18" x 24" for smaller groups. 5RPA tube, brightness 130 f.c., 20 KV acceleration. B & L 1/1.9 coated lens.

Y-AXIS: a-c gain 1 mv rms/in.; d-c gain 2.5 v/in. Response $\pm 10\%$ 2 cps. $\pm 10\%$ 750 kc, -3 db 825 kc. Input 2 megohms, 30 μ f. Attenuator 1, 10, 100X.

X-AXIS: a-c gain 60 mv rms/in. Also Z-axis input.

SWEEP CIRCUITS: Recurrent: 1 cps to 50 kc, auto. retrace blanking. Driven: 20 μ s to 10⁴ μ s, auto. brightening.

INTERNAL SIGNAL CALIBRATOR • INPUT: 105-130 v, 50/60 cps, 600 watts. SIZE: 33" L x 26" W x 66" H—350 lbs.

Med. Gain Wide-Band Units available on special order.

For full data and prices, write TODAY for Catalog P-E.



TELEVISION EQUIPMENT CORP.
238 William St. • New York 7, N. Y.

Manufacturers of Projection & Wide-Band Scopes, TV Cameras, Boosters, Antenna Telecouplers.

INTERCHANGEABLE MOTORS FOR ALL TIMING APPLICATIONS

A.C. Synchronous and D.C. Governed or Variable Speed



Standardize your timing motors. The A. W. Haydon Co. is the only supplier of interchangeable A. C. Synchronous and D. C. Chronometric governed or variable speed motors for precision time keeping.

Make A. W. Haydon your primary motor source for —

- A.C. — Synchronous
 - D.C. — Governed
 - D.C. — Variable Speed
- TIMING MOTORS**

THE **A.W.HAYDON** COMPANY

235 North Elm Street, Waterbury 32, Connecticut
Design and Manufacture of Electrical Timing Devices

IMMEDIATE DELIVERY ON ALTEC 21B MIKES

Production Facilities
Stepped Up To Meet
Unprecedented Demand

All Types Now Available...

Since March of '49, Altec has been scrambling to catch up with the deluge of orders that followed the introduction of the 21B miniature microphone. Now, the company is happy to announce that expanded production facilities are in operation, and deliveries will be made upon receipt of order. This is true for all models of the 21B stand, chestplate and lapel.

* A new brochure, giving full details on all models of the 21B, is available on request.



"The mike that became a must" with entertainers and public speakers



1161 N. VINE STREET, HOLLYWOOD 38, CALIF.
161 SIXTH AVENUE, NEW YORK 13, NEW YORK

NEW PRODUCTS

(continued)

fusion type pump which is adaptable where vacuum of the order of 4×10^{-7} mm Hg is required for use in the field of nuclear science, research and material processing and is designed to meet the most exacting production line requirements.

Air-Flow Switch. Coral Designs, Division of the Henry G. Dietz Co., P. O. Box 248, Forest Hills, New York, N. Y., has published a single-page bulletin on the Catalog 103-A vane-type air-flow switch for use in forced-air cooling of electronic equipment. The unit described in the data sheet is designed to operate a control relay to guard against tube failure in the event of blower failure or air-passage obstruction.

Induction Heating Unit. Lindberg Engineering Co., 2444 W. Hubbard St., Chicago 12, Ill. Bulletin T-1430 describes in detail a new induction heater capable of providing more than 10 kw into a suitable load on a 100-percent duty-cycle basis. Input power of the unit in question is 230 or 460 volts, 3 phase, 60 cycles. The bulletin shows features, applications, operation and specifications.

Thickness Tester. Branson Instruments, Inc., 436 Fairfield Ave., Stamford, Conn. A four-page folder gives an illustrated description of the Audigage model FMSS-5 thickness tester. The portable unit discussed locates laminar flaws rapidly by measuring wall thickness from one side of steel pipes and tanks, ship hulls and the like by use of an X-cut quartz crystal powered by an electronic oscillator for generating ultrasonic waves from 0.65 mc to 2.0 mc.

Television Equipment. Radio Corp. of America, Camden, N. J. Form 2J6384 is a 14-page booklet giving equipment specifications for uhf television transmitting equipment. Included are illustrations and block diagrams of the TTU-1A transmitter and a complete description with engineering data on the TFU-20A uhf tv antenna.

Standard • STANDARDIZE ON Standard • STANDARDIZE ON Standard

Eliminate CRYSTAL TEMPERATURE CONTROL COSTS . . .

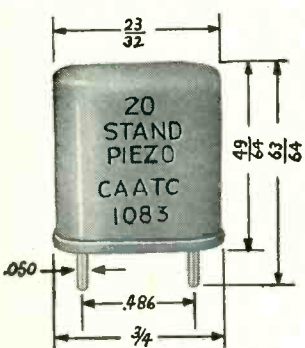

Now you can forget temperature control. Just specify Standard's Type 20 Crystal Unit for your products.

In addition to lowering power requirements and weight, it increases compactness, durability and dependability. Type 20 meets all Government specifications, too.

Discover how the Standard Type 20 can cut costs and increase sales for you. A letter will bring Engineering data and complete details by return mail.



Standard

Piezo COMPANY

CARLISLE, PENNSYLVANIA



Standard • STANDARDIZE ON Standard • STANDARDIZE ON Standard

The New STAVER MINI-SPRING

TRADE MARK REG. AND PAT. PEND.

**A quality
Tube
Guard
that is
Bargain
Priced**

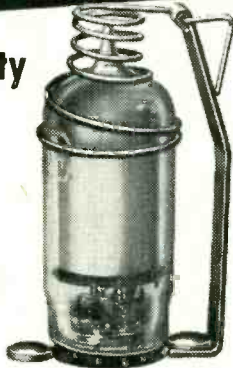

Gives support two ways—Keeps pressure downward and gives sideway support. The spring action is constant and resilient permanently. Send for catalog sheet.



91 PEARL ST. • BROOKLYN 1, N. Y.
ULSTER 5-6303



• MICROTORQUE Variable Resistors and Potentiometers require as little as .003 in. oz. torque to operate. This unique feature makes the MICROTORQUE invaluable for applications where the position of instrument pointers, gyroscopes, and delicate instruments in general must be recorded, transmitted or indicated at a distance, and Giannini are the sole makers of MICROTORQUE Potentiometers. A variety of resistance values and circuits available.

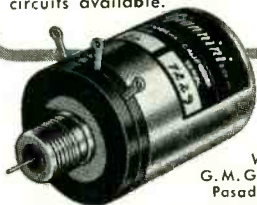

Write for booklet,
G. M. Giannini & Co., Inc.
Pasadena 1, California

giannini

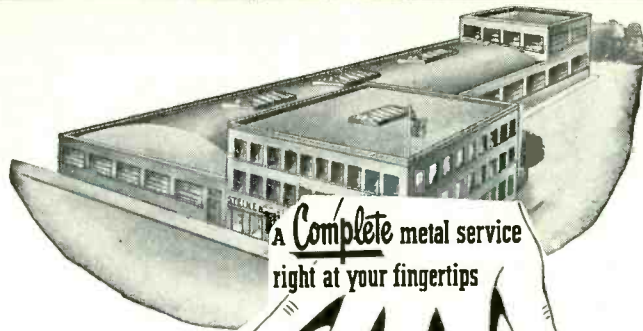

A **Complete** metal service
right at your fingertips

**SCREW
MACHINE
PRODUCTS**

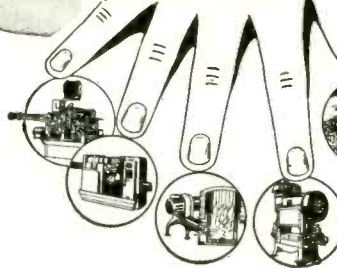

Housings
Assemblies
Metal Trimmings
Electronic Tube
Parts

STAMPINGS Metal • Fibre Phenolite • Plastic

Complete Fabrication Facilities Under One Roof
Exacting Specifications Met—Rigid Inspection System

WM. STEINEN MFG. CO.

Bruen Cor. Hamilton St.



Newark 5, New Jersey

WE INVITE

YOUR INQUIRY

DANO MEANS MORE COIL QUALITY

Whether you require untreated coil windings or specially treated vacuum impregnated coils with wax or varnish, Dano is always ready to furnish you with quality coils.

EVERY COIL MADE TO YOUR EXACT SPECIFICATIONS

- Form Wound
- Paper Section
- Acetate Bobbin
- Molded Coils
- Bakelite Bobbin
- Cotton Interweave
- Coils for High Temperature Applications

Also Transformers Made to Order



THE DANO ELECTRIC CO.
MAIN ST., WINSTED, CONN.

NEW! 12 MC BANDWIDTH HIGH GAIN OSCILLOSCOPE

MODEL T-601-A
TOP PERFORMANCE FOR ONLY \$349.50
Laboratories—Industry—TV—Broadcasters

AT LAST! an engineer's scope built by engineers for highest standards of quality and performance. Compare these specifications:

- * Y-AXIS: Sens. 10 mv rms/in; Good transient response, -3 db at 12 MC; L.F. -10% tilt at 10 cps.
- * SWEEPS: 10 cps to 100 KC; recurrent and driven, expansion 5x full scale—writes 2.5 inches/μsec.
- * Internal Calibrator and 60 cy phase shifted sweep. Uses 5UP1 CRT — ±Sync Amplifier.

WRITE FOR CATALOG E.
SEE US AT NEDA SHOW

TEC TELEVISION EQUIPMENT CORP.
238 WILLIAM ST. NEW YORK 7, N. Y.
IN CANADA: The Ahearn & Soper Co.,
Ltd., Ottawa



MEGOHMS
 MEGOHMS
 MEG
 MEG
 MEGOHMS
 MEGOHMS
 MEGOHMS
 MEGOHMS
 MEGOHMS
 MEGOHMS

Cheaper by the dozen with JELLIFF ALLOY 1000 RESISTANCE WIRE

This new material packs 1000 ohms/cm²—48% more than the widely-used nickel-chromium alloys.

And what's more, there's no loss of other important physical and electrical properties. High tensile strength—excellent solderability—TC of Resistance is 20—EMF vs Copper + 7 microvolts—Coefficient of Expansion 13.9—remarkable Surface-Corrosion Resistance—and many more vital characteristics make ALLOY 1000 a money-making, prestige-building component of compact, precision resistors. For complete data, get Bulletin 17



NEWS OF THE INDUSTRY

(continued from page 130)

tective walls and barriers exceeds that of the x-ray or betatron equipment itself. Accurate recommendations for barrier thicknesses in the high-energy field, similar to those previously developed by the NBS for lower energies, will result in large savings.

The new betatron laboratory, housing the 50-million volt betatron and adequate for the coming 180-million volt synchrotron, is specially designed for high-energy research work. For safety, it is made of reinforced concrete with walls varying in thickness between 2 and 8 feet.

The entire betatron research program offers to NBS scientists the opportunity to gain a more detailed understanding of high-energy radiation.

Multiplexed F-M

THE FEDERAL COMMUNICATIONS COMMISSION recently granted authority to Multiplex Development Corp., New York, N. Y. for a 90-day field test of a newly developed multiplex broadcast system. Former facilities of WGNV-FM are being used for the tests. The new system provides for simultaneous transmission of one or more multiplexed sound f-m programs at the same time the main sound program is transmitted. The quality of the main program in the range between 30 and 15,000 cycles is not impaired and the station does not exceed the present channel widths for f-m stations. Operation on 97.9 mc uses 4 kw power into a 905-foot antenna. Hours of testing are 0100-0600 and 0900-1200.

TV Use in Surgery

A SURGICAL operation at Bellevue Hospital, N. Y. C., was recently televised via a closed circuit to the United Nations building in N. Y., where it was witnessed by U. N. and World Health Organization dignitaries, Latin American officials and members of the medical profession. The occasion was a preview of Video-Medico, a televised demonstration co-sponsored by

Now! Synchronous Recording

WITH YOUR PRESENT TAPE RECORDER

Here's good news! The new Fairchild Control Track Generator makes possible picture synchronous sound-track recording with any tape recorder with response good to 14KC. Here's how! This new Fairchild instrument superimposes a high frequency signal on magnetic tape simultaneously with the sound track. This signal becomes the tape speed control when played back on a Fairchild Pic-Sync Tape Recorder. No extra heads or modifications to presently owned tape recorders are required.



This compact unit comes in a small carrying case—for on-location work—and may be removed for rack mounting. FR-117

WRITE FOR FULL
 ENGINEERING DATA TODAY



154TH STREET AND 7TH AVENUE

WHITESTONE, L. I., N. Y.

RAWSON METERS

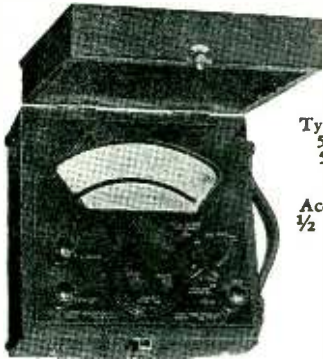

Types:
501A
501C

Accuracy
1/2 of 1%

MULTIMETERS and REGULAR METERS

AC and DC types, high accuracy, multiple ranges, 2 microamperes to 1 ampere DC. 2 milliamperes to 3 amperes AC.

ELECTROSTATIC VOLTMETERS

Ranges 100-v. to 35,000-v. AC or DC. Resistance exceeds million megohms. Can measure static electricity.

FLUXMETERS

Laboratory and production measurements on magnets and magnetic circuits. Single push button return-to-zero.

WATTMETERS

High sensitivities low power factors. New types soon to be announced.

Special apparatus built to order

RAWSON ELECTRICAL INSTRUMENT COMPANY

111 Potter St. Cambridge, Mass.
Representatives

Chicago

Los Angeles

Specify BREEZE "Monobloc" Waterproof and Pressure Sealed CONNECTORS



The only APPROVED Monobloc System for Advanced Radar, Communications, and Electronic Equipment

Breeze "Monoblocs", with single piece plastic inserts offer outstanding advantages in assembly, wiring, mounting and service in the field.

- Removable contact pins
- Single hole panel mounting
- Pressure sealed to 75 psi, or higher when required

Breeze "Monobloc" Waterproof and Pressure Sealed Connectors available in aluminum, brass, steel . . . all sizes and capacities . . . fully tested and approved.

WRITE FOR DETAILS . . .

If you have a tough connector problem ask BREEZE for the answer.

BREEZE Corporations, Inc.
41 South Sixth Street
Newark 7, New Jersey

NEWS OF THE INDUSTRY

(continued)

E. R. Squibb & Sons International Corp. and the International GE Co., Inc. The demonstration is to be presented in five Latin American countries this summer.

Operations are telecast by a two-camera chain. One is erected on a horizontal boom in a stationary position over the operating area. The other, with a 20-in. telephoto lens, is on a movable dolly so that it can cover the operating personnel as well as the commentator in an adjacent room.

The 9,000-lb television package involved, which includes all necessary equipment to transmit and receive up to 25 miles, recently left for San Juan, Puerto Rico, where the first demonstration of the tour was scheduled. Comprising the portable tv station are two cameras, control equipment, cable, microwave transmitter and antenna, receiving antenna, controls, loudspeakers and 20 receivers, as well as a two-way transmitter-receiver combination for emergency use.

Commercial Use of Radioactive Tracers

ONE of the first commercial uses of atomic energy in American industry was recently announced by Standard Oil Company of California. It involved the use of radioactive tracer materials in the transmission of oil products through a pipe line now under construction from Salt Lake City to Pasco, Washington.

This use of radioactive material involves the use of a chemical tracer material which has been exposed to radiation bombardment in an atomic pile. The radioactive material, diluted by thousands of times its volume of oil, becomes a tracer liquid, and this is the form in which it is used in the pipe line.

Each time the Salt Lake pump station changes the product being pumped through the line, a fraction of an ounce of diluted tracer liquid is added to the oil stream between the two products. As the junction of the two products moves along the line, the tracer moves with it. At each point where products are delivered sensitive instru-

Only CONSOLIDATED MULTITRACE Recording Oscillographs



offer ALL these ADVANCED FEATURES at NO EXTRA cost

- Simultaneous visual scanning and recording
- Dynamic events marker
- Trace identification
- Precision timing system
- Automatic record-length control
- Multiplex (parallel) operation
- Provision for 125-ft, 250-ft, and 600-ft magazines
- Hairline traces
- Compact, lightweight design
- Simulated center-of-gravity shockmount base
- Fast-loading, quick-change paper magazine
- Rigid, cast-aluminum frame
- Wide range of galvanometer types available
- Automatic record numbering
- Wide range of paper speed (1/2 to 100 in. per sec)
- Temperature-controlled ($\pm 1^\circ\text{F}$) galvanometer block
- Courtesy service visit by Field Engineer

These are only a few of the reasons why *more* Consolidated Oscillographs are in use by leading industrial and research laboratories throughout the world today than any other make.

Hundreds of satisfied customers rely on Consolidated leadership in the design and manufacture of precision multitrace recording oscillographs. Dollar for dollar you cannot buy a better instrument.

If you have a problem involving the recording of many test quantities simultaneously, Consolidated's application engineers will be glad to help —no obligation, of course.

For further information, write for Bulletin CEC-1500-X17.



Analytical Instruments for Science and Industry

CONSOLIDATED ENGINEERING CORPORATION
620 NORTH LAKE AVENUE,
PASADENA 4, CALIFORNIA

Maximum Reliability Every Time

with AIRPAX CHOPPERS

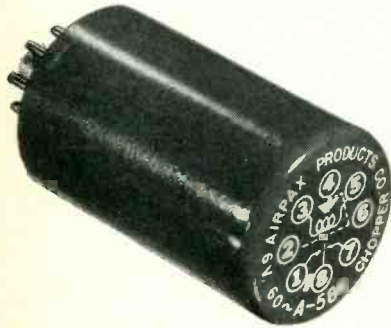

now . . . the A586

60 CYCLE CHOPPER

Precision engineered
for reliability . . .

for amplification of low level DC signals . . . The A586 is supplied hermetically sealed . . . almost unaffected by shock, vibration, temperature extremes.



1024 GREENMOUNT AVE.

BALTIMORE 2, MARYLAND

E-I HERMETIC SEALING COMPONENTS

ENGINEERS, DESIGNERS, PURCHASING AGENTS! SAVE TIME AND EFFORT

with the **E-I**
SAMPLE KIT!

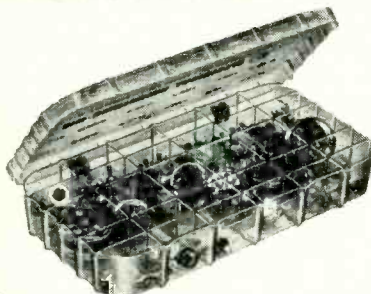

New designers kit contains 81 standard terminals and 11 different headers. These mass produced, economy-priced standard parts solve practically all problems requiring hermetic sealing. Transparent case with labeled bins makes it easy to select the correct component for your needs. The E-I SAMPLE KIT is available at the nominal price of \$10.00. Send check with order or request the free E-I illustrated brochure today!

Write for these descriptive bulletins:

- 849 - Hermetically Sealed Terminals
- 850 - Hermetically Sealed Multiple Headers
- 851 - Gasket Type Bushings



ELECTRICAL INDUSTRIES
INCORPORATED
44 SUMMER AVENUE • NEWARK 4, N. J.

ments, using Geiger counters attached to the pipe, respond to the arrival of the tracer. From these instruments, the operators know when one product has completed its arrival, and when to change the stream to another tank.

The amount of radiation present is much less than that occurring in many articles used in our daily life; for instance, it is less even than the radioactivity of a luminous watch dial. By the time the products appear in tankage, the tracer is so dilute that it can be detected only with the most delicate instruments. The material used is self-destroying, and its radioactivity falls off rapidly with time.

The pipe line in which this radioactive material is being used is an oil products carrier built and operated by the Salt Lake Pipe Line Company, a subsidiary of Standard Oil Company of California. Construction of this line was begun last summer to carry gasoline and other major petroleum products from Salt Lake into the northwest area of northern Utah, of Idaho, and eastern Oregon and Washington. It has been in operation from Salt Lake to Twin Falls since January, and began pumping products into Boise last month.

BUSINESS NEWS

ZENITH RADIO CORP., Chicago, Ill., recently purchased a building with 185,000 sq ft of floor space at 1500 N. Kostnax Ave., Chicago, Ill., to be used for the manufacture of radio and television components.

SYLVANIA ELECTRIC PRODUCTS INC. has begun construction of a new plant in Shawnee, Oklahoma, to expand its radio tube manufacturing facilities. It is expected that by the beginning of 1951 the new plant will produce more than a million radio tubes per month.

STACKPOLE CARBON Co., St. Marys, Pa., has purchased a 3-story building at Kane, Pa., where electronic component parts will be manufactured.

AUDIO INSTRUMENT Co., makers of intermodulation measuring sets and other a-f measuring equip-

**COIL SPRINGS
METAL STAMPINGS
WIRE FORMS**



TO
FIT
YOUR
NEEDS
TO
A
T

FREE
EXPERT
DESIGNING
SERVICE

Dudek and Bock's precision high speed equipment turns out your work faster and at lower cost!

Write, wire or phone for estimates!

DUDEK and BOCK

2100 W. Fulton Dept. E Chicago 12, Ill.
HAYmarket 1-3676

Kahle

specialists in custom-built, ultra-precision
ELECTRON TUBE MACHINERY

KAHLE CUSTOM-BUILDS machines to make the exact tubes you require—from big 20-inchers to tiny sub-miniature—from laboratory types to those for high-speed production. Kahle puts each unit through exhaustive trial runs in our plant to assure trouble-free operation in yours.

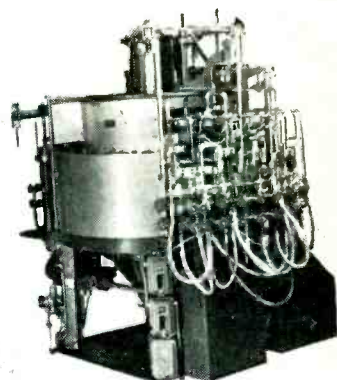

#1414 Button Stem Machine
For cathode ray tubes

Custom-built to individual requirements, turns out 400-500 TV stems per hr.—fine adjustment of speed, pressure, heat and sequence of operations—with labor-saving development for automatic tubulation flaring.

We specialize in cost-cutting production-boosting, labor-saving equipment for complete manufacture of cathode ray tubes, standard, miniature and sub-miniature radio tubes, sub-miniature tubes, fluorescent lamps, photocells, x-ray tubes, glass products.

Consultations invited
Send for our new catalog

Kahle ENGINEERING CO.

1309 Seventh Street, North Bergen, New Jersey

Lavite STEATITE CERAMIC

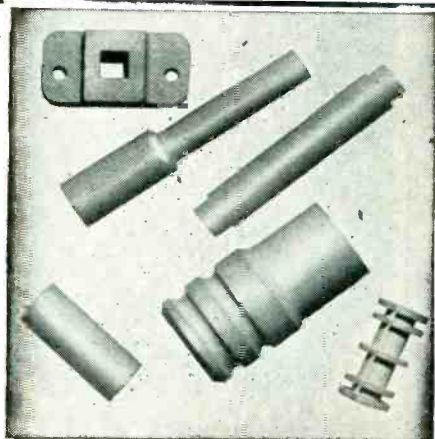

Design engineers and manufacturers in the radio, electrical and electronic fields are finding in LAVITE the precise qualities called for in their specifications. . . high compressive and dielectric strength, low moisture absorption and resistance to rot, fumes, acids, and high heat. The exceedingly low loss-factor of LAVITE plus its excellent workability makes it ideal for all high frequency applications.

Complete details on request

D. M. STEWARD MFG. COMPANY

Main Office & Works: Chattanooga, Tenn.
Needham, Mass. • Chicago • Los Angeles
New York • Philadelphia

Little-thought-of facts about capacitors

The short time breakdown voltage of a well-made D.C. capacitor is not less than 5 to 6 times the actual working voltage at 20°—

$$E = 5 \times e \text{ min}$$

E = Breakdown voltage
e = Rated d.c. working voltage

INDUSTRIAL CAPACITORS are unvaryingly held to this formula.

Designed for maximum safety factor and the smallest possible volume, INDUSTRIAL CAPACITORS are the most widely used capacitor in industrial applications.

WRITE TODAY FOR DETAILED CATALOG

INDUSTRIAL CONDENSER CORP.



Watch this space for other capacitor facts that will help you.

Sales Offices in
All Principal Cities
3243 N. California Ave.
Chicago 18, Illinois

WHAT MAKES A MAILING CLICK?



McGraw-Hill
DIRECT MAIL LIST SERVICE

Advertising men agree . . . the list is more than half the story. McGraw-Hill Mailing Lists, used by leading manufacturers and industrial service organizations, direct your advertising and sales promotional efforts to key purchasing power.

In view of present day difficulties in maintaining your own mailing lists, this efficient personalized service is particularly important in securing the comprehensive market coverage you need and want. Investigate today.

McGraw-Hill Publishing Co., Inc.
DIRECT MAIL DIVISION

330 West 42nd Street New York, 18, New York

WIND more COILS faster

WITH YOUR
PRESENT
COIL-WINDING
MACHINE!

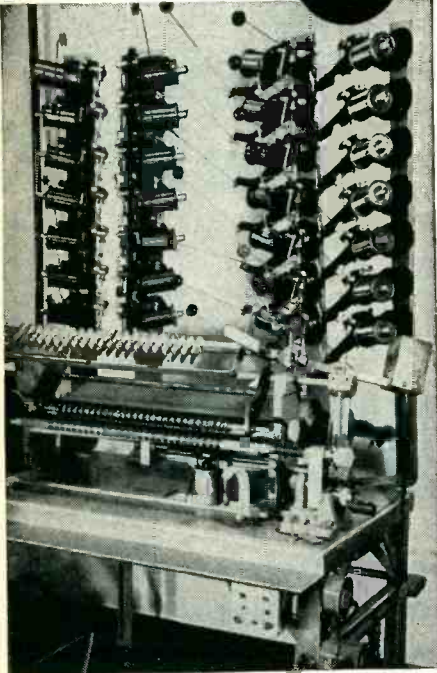

— use
PAMARCO
Wire DeReeling Tensions
for PERFECT COILS

Installation of these inexpensive PAMARCO tensions lowers winding costs because each machine will accommodate more coils at higher winding speeds. In addition to increased production, PAMARCO tensions raise production quality. Free-running action practically eliminates wire breakage and shorted turns. Simple thumb screw setting quickly adjusts for any wire gauge. No tools or special skill are needed for operation. For complete data call or write.

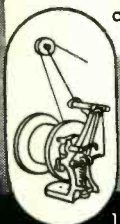

**PAPER MACHINERY
& RESEARCH, INC.**

1014 OAK STREET
ROSELLE, NEW JERSEY

ment, announce a removal to larger quarters at 133 W. 14th St., New York 11, N. Y.

THE SQUARE ROOT MFG. CORP., manufacturers of built-in and outside tv antennas, announces the purchase of a 30,000-sq ft plant at 391 Saw Mill River Rd., Yonkers, N. Y., for the expansion of present facilities in the tv component field.

BENDIX RADIO DIV. OF BENDIX AVIATION CORP. has provided facilities for quadrupling its television production by a 500-ft-long x 72 ft-wide addition to its plant on East Joppa Rd., Baltimore, Md. Construction schedule calls for completion by September 1, 1950.

RADIO CORP. OF AMERICA will expand its Canonsburg, Pa., plant to incorporate a new, modern radio set factory and will increase by several hundred percent its production of tv receivers at the Bloomington, Ind., plant.

THE RUEL H. SMITH ENTERPRISES, Warren, Pa., has leased the building of General Machine Co., Titusville, Pa., for assembly and manufacture of electric wiring devices and electronic component parts for tv.

PERSONNEL

ARTHUR W. STEWART, formerly with the engineering division of Colonial Radio Corp., has been appointed chief engineer of Clippard Instrument Laboratory, Inc., Cincinnati, Ohio, and will have full responsibility for all engineering in both the r-f and i-f coil department and the instrument division.

VINTON K. ULRICH, a wartime consultant to the OSRD, and since then affiliated with Hytron Radio & Electronics Corp., has been appointed manager of the renewal tubes sales division of the National Union Radio Corp., Orange, N. J.

JOSEPH W. CROWNOVER, formerly associated with Packard Bell Radio Co. and with the Sonotone Corp., was recently appointed section

COSSOR for QUALITY

TWIN-BEAM OSCILLOSCOPES

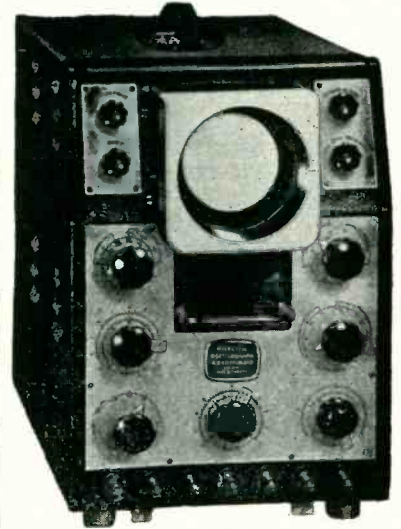

MODEL 1035 Provides FAST SWEEPS, from 150 Millisec. to 5 Microsec., and Video Frequency Amplifiers, Stepped -VE Feedback Type, with Gain of 3 at 7 Mc. Bandwidth to Gain of 3000 at 60 Kc. Bandwidth, ± 1.5 DB., PLUS Triggered Sweeps, Suppressed Flyback, \pm VE Sync.

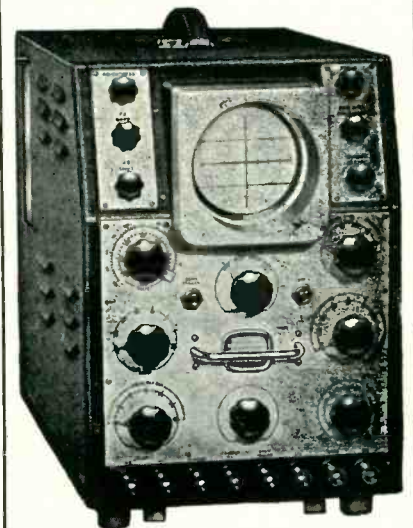

MODEL 1049 Provides SLOW SWEEPS from 1.5 Sec. to 50 Microsec., and D.O. Amplifiers Completely Stabilized Throughout, Response 0-100 Kc., ± 1.5 DB., Gain 900, PLUS Beam Blanking Circuits, Triggered Sweeps, \pm VE Sync.

PLUS

Unique TWIN BEAM Flat Face CRT in BOTH Instruments Providing Instant Directly Calibrated Measurement for Accurate Voltage, Time and Phase Comparisons.

WRITE TODAY FOR LITERATURE
AND DEMONSTRATION

COSSOR (CANADA) LIMITED
WINDSOR ST., HALIFAX, N.S.

BEAM INSTRUMENT CORP.
Room 907, 511 Fifth Ave., New York 17, N. Y.

chief in charge of the experimental and research electronics laboratory at Electrical Reactance Corp., Franklinville, N. Y.

CHARLES J. BRIODY, JR., formerly with the Brookhaven National Laboratory, has joined Airborne Instruments Laboratory, Mineola, N. Y., as supervisor of technical services.

RODNEY D. CHIPP, director of engineering for the Du Mont television network, has been elected chairman of the New York section of the IRE for the 1950-51 season.

V. A. CARPENTER, formerly vice-president of Continental Electric Co., has joined National Electronics, Inc., Geneva, Ill., as chief engineer.

ROGER BOWEN, previously associated with the U. S. Signal Corps as head of the electronic component research and development division, has been appointed head of the engineering department of Cannon Electric Development Co., Los Angeles, Calif.



R. Bowen



C. B. Dale

C. B. DALE, formerly director of research, has been named vice-president in charge of research at Webster-Chicago Corp., Chicago, Ill.

J. D. HEIBEL, former chief electrical engineer with Erie Resistor Corp., Pittsburgh, Pa., has been named director of research and development of the corporation's newly created Research and Development Department of its Electronics Division.

MEL BYRON, at one time a manufacturers' research consultant, was recently appointed president of Electronic Instrument Co. Inc., Brooklyn, N. Y.

Now Terminals Can Be
ATTACHED & SOLDERED
in ONE Automatic Operation!

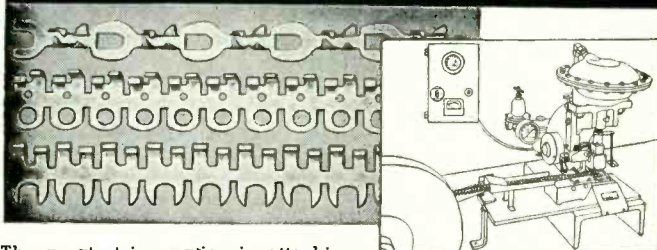

The greatest innovation in attaching terminals to wires is now available to the industry . . . "Pre-soldered" TANDEM TERMINALS! Made in various sizes and types, these remarkable, production-proved terminals (supplied on reels) can be applied at rates up to 1200 per hour by a new Terminal Attaching Machine that cuts off, clinches and solders terminals in one instantaneous operation. Handling of loose terminals, solder and flux are eliminated to reduce costs and boost production on long runs. Standard types available. Send for detailed information. enclose sample of wire and terminal now used. Address Dept. E.

For ordinary runs in moderate quantity we continue to produce
SEPARATE TERMINALS for ELECTRIC WIRES

We also make **SMALL METAL STAMPINGS** Exact to Customer's Prints. Modern Plant and Equipment. Moderate Die Charges. Precision Work. Prompt Service.

PATTON-MacGUYER COMPANY
17 Virginia Avenue, Providence, R.I.

Here's Why it Pays You . . . to Read the Advertising

The advertising is a rich source of valuable information. In this magazine it offers you ideas and products that may well apply advantageously to your business.

Every issue is a catalog of goods, materials; and services — quickly available to you — just for the reading.

Leaders in business and industry turn to the advertising because they've discovered it helps them run their businesses more profitably.

When you read all the ads in this magazine, the chances are good that you'll get a lead that will materially help you do a better job. For example, you may find a specific piece of equipment that will be a profitable time-saver. Or a tool that will increase worker efficiency. That's why it pays to read the advertising. It's good business.

HEADQUARTERS FOR BUSINESS INFORMATION

McGRAW-HILL publications

F-23

PROFESSIONAL SERVICES

CROSBY LABORATORIES, INC.

Murray G. Crosby & Staff

Radio-Electronic Engineering,
Research & Development
FM, Communications, TV
Test Equipment

Offices, Laboratory & Model Shop at:
126 Herricks Rd., Mineola, N. Y.
Garden City 7-0284

Eugene Mittelmann, E.E., Ph.D.

Consulting Engineer & Physicist

High Frequency Heating—Industrial Electronics
Applied Physics and Mathematics
549 W. Washington Blvd. Chicago 6, Ill.
State 2-8021

DUBROW DEVELOPMENT CO.

Design — Development — Mfr.

Quality Electronic Equipment

347-9 High St. Burlington, N. J.
Burlington 3-0446

NIAGARA ELECTRON LABORATORIES

CONSULTATION - DESIGN - CONSTRUCTION
MFG. THE THERMOCAP RELAY

Specializing in solution of problems of electronic
and electro-physical instrumentation for the re-
search or analytical laboratory. Industrial plant
problems also invited.
Andover, New York Cable Address: NIATRONLAB

EDGERTON, GERMESHAUSEN & GRIER, INC.

Consulting Engineers

Research Development and Manufacture
of Electronic and Stroboscopic Equipment
Specialists in High-Speed Photography

160 Brookline Avenue. Boston 15, Mass.

PICKARD AND BURNS, INC.

Consulting Electronic Engineers

Analysis and Evaluation
of Radio Systems

Research, Development & Design
of Special Electronic Equipment

240 Highland Ave., Needham 94, Mass.

ELECTRONIC ENGINEERING CO. of CALIFORNIA

Radio and Electronic Consulting and
Designing.

180 S. Alvarado Los Angeles
DUunkirk 2-7353 California

ALBERT PREISMAN

Consulting Engineer

Television, Pulse Techniques, Video
Amplifiers, Phasing Networks,
Industrial Appliances

Affiliated with
MANAGEMENT-TRAINING ASSOCIATES
3308-14th St., N.W. Washington 10, D. C.

ERCO RADIO LABORATORIES, INC.

Radio Communications Equipment

Engineering - Design - Development - Production
Pioneers in Frequency Shift Telegraph
Garden City • Long Island • New York

The Robert H. Streeter Co.

Electronic Design Specialists

Engineering Consultants
Representing Manufacturers
of Electronic Equipment
in Southern United States
Specialists in the design and construction of spe-
cialized pieces of equipment for specific applications
Tel. 97 Greenwood, Miss.

EDWARD A. GAUGLER, Ph.D.

Consulting Physicist

Magnetic Materials and their Applications

419 Shepherd St. Chevy Chase, Md.

THE TECHNICAL MATERIEL CORPORATION

Communications Consultants

Systems Engineering

General Offices and Laboratory
121 Spencer Place, Mamaroneck, N. Y.

PAUL GODLEY CO.

Consulting Radio Engineers

GREAT NOTCH, N. J.

Est. 1926 Little Falls 4-1000

ANDREW W. VINCENT

CONSULTANT

Development and Models

Electromagnetic relays & devices Audio and in-
tercommunication equip. Remote control selection
circuits, Telephone equipment.
300 W. High Terrace Rochester, N. Y.
Genesee 2648

HANSON-GORRILL-BRIAN INC.

Product & Mfg. Development

ELECTRICAL - ELECTRONIC
HYDRAULIC - MECHANICAL

One Continental Hill Glen Cove, N. Y.
Glen Cove 4-1922

YARDENY LABORATORIES INC.

Research and Development

Remote Controls and Electro Chemical
Generators of Energy

105 Chambers Street WO 2-3534, 35
New York, N. Y.

MEASUREMENTS CORPORATION

Research & Manufacturing Engineers

Harry W. Houck Jerry B. Minter
John M. van Beuren

Specialists in the Design and
Development of Electronic Test Instruments
Boonton, N. J.

WHEELER LABORATORIES, INC.

Radio and Electronics

Consulting—Research—Development

R-F Circuits—Lines—Antennas
Microwave Components—Test Equipment

Harold A. Wheeler and Engineering Staff
Great Neck, N. Y. Great Neck 2-7806

BACKTALK

(continued)

vestigation would show if it is possible to obtain the components of the final electron current sufficiently high in order to have an efficacious gain of amplification.

The job of simultaneously sensitizing the two photo surfaces in one bulb may be too difficult or perhaps it will be impossible to obtain a relatively high light sensitive Ag-C₂O-Cs layer with sufficient secondary radiation. In the further development there would be to consider fatigue phenomena in the second cathode.

As I said before I have at present no possibility to prove this proposal. But, perhaps I have at least succeeded to incite an investigation in this direction. Or maybe there is someone who would give me a chance?

B ——— L ———
Yugoslavia

It's All Greek

DEAR SIRs:

I AM sorry to say that Table I of my article in the May issue of ELECTRONICS, "Antifading Broadcast Antenna", contains an error for which I am responsible. The figures in the first two rows of this table are meters, not feet. There is another less important error in Figures 1 A and 1 D which certainly will be recognized by your readers as such. The equation

$$\alpha \equiv \frac{2\pi}{\lambda} \equiv \frac{\omega}{C}$$

must read correctly:

$$\beta \equiv \frac{2\pi}{\lambda} \equiv \frac{\omega}{C}$$

DR. - ING. HELLMUT BRUECKMANN
Oakhurst, New Jersey

Looking Ahead

DEAR SIRs:

AS LONG as the FCC is spending so much time considering bandwidth requirements and standards for color television, couldn't they also consider the problems that will come up with three-dimensional television? After color, three-dimensional pictures will be the next step, and it seems to me that now is the time to bring up the problem.

ROGER L. SISSON
Graduate Engineering Student
University of California at Los Angeles
Los Angeles, California

How
to
read
with
your
eyes
open
for
business!

Read the ads! Every issue of this magazine contains ads that offer valuable services and useful products by which your business may be run more profitably.

The time it takes to read all the ads is time well spent. One ad alone can pay off—by informing you of new developments and new sources of supply, by helping you do a more efficient job. For example, you may locate one machine that will cut your production costs, or step up your output. Or you may discover that the equipment you've been waiting for is now available.

This magazine displays more ideas and merchandise than a trade exposition. Make every issue your buyer's guide. Read the ads as well as the articles. That's reading with your eyes open for business.



McGRAW-HILL publications

F-24

• CONTACTS •

FOR THE FIELD OF ELECTRONICS

CEMENTS FOR THE RADIO INDUSTRY

NITROCELLULOSE
SYNTHETIC
MOISTURE RESISTANT
THERMO PLASTIC
THERMO SETTING
VINYL IN COLOR
COIL VARNISH

BARRETT VARNISH CO.
1532 South 50th Court
Cicero 50, Ill.

Write Us for Additional Information

**FINE RIBBONS
OF
TUNGSTEN and Molybdenum**
Quality and accuracy in our fabrication of Tungsten & Molybdenum Ribbons have characterized our service to the Electronic industry.
A development of
H. CROSS Co.
15 Beekman St., New York 7, N. Y.

EISLER Manufactures Complete Equipment for:
SPOT WELDERS, Electric, for 1/4 to 250 KVA.
TELEVISION TUBE GLASS WORKING EQUIPMENT.
TRANSFORMERS, Special and Standard Types.
INCANDESCENT LAMP Manufacturing Equipment.
FLUORESCENT TUBE Manufacturing Equipment.
NEON SIGN-MAKERS EQUIPMENT.
ELECTRONIC EQUIPMENT, Vacuum Pumps, etc.
WET GLASS SLICING and Cutting machines for Laboratory use.
EISLER ENGINEERING CO., Inc. 757 So. 13th St., Newark 3, N. J.

SUB-MINIATURE PRINTED ELECTRONIC CIRCUITS

produced from your schematics or existing electronic equipment. Circuits fired on ceramics or air dried on plastics and paper bases. Confidential service.

PLASTICS & ELECTRONICS CO.
272 Northland Ave., Buffalo 8, New York

EL-TRONICS, INC.

Research, development, and manufacture of electronic equipment—a single model to large quantities.
WRITE TODAY FOR FREE RESUME OF OUR PLANT FACILITIES
Specialists in Geiger-Muller equipment
2647-67 N. Howard St. • Phila. 33, Pa. • GARfield 5-2026

GRC WING NUTS TOP QUALITY PRICED LOWER
Rust-proof zinc alloy with GRC's recessed-wing finger-grip. All commercial finishes. All popular thread sizes. Special threads or untapped wing nuts; special designs to order.
Write today for samples and prices—and compare! Immediate Deliveries.
GRIES REPRODUCER CORP.
100 Willow Ave., New York 54, N. Y.

**MPB makes more than
50 different types & sizes**

Miniature ball bearings for application in precision mechanisms minimize friction and wear. High load capacity. Least weight and space. Special designs and complete engineering service for your application. Write for catalog E.

MPB MINIATURE Precision BEARINGS
INCORPORATED
KEENE, NEW HAMPSHIRE, U.S.A.

ALFAX PAPER & ENGINEERING COMPANY

Specialists in recording papers that record by simply passing current through the paper.
ALFAX LETS THE ELECTRICAL INFORMATION RECORD ITSELF.
Engineering services available for application of direct recording principles.
Write for brochures and Engineering Data.
41 Riverside Ave. Brockton, Mass.

FLUXES
SODERING
BRAZING & WELDING
L. B. ALLEN CO. INC. Chicago 31, Ill.
6751 BRYN MAWR AVE.

ROUND POWER RHEOSTATS

50 to 500 Watt.
Vitroeous enameled
UL approved
REX RHEOSTAT CO.
BALDWIN, N. Y.

high speed high sensitivity
SHORTED TURN INDICATOR
The Karton Shorted Turn and Open Circuit Coil Checker — Model 101B — indicates single shorted turns of #44 wire in unmounted coils. Standard mandrel 3/16 x 1/4 for all average size coils. Regulated vacuum tube circuit. Jack for audio indication to supplement i-ma. meter. Prompt deliveries. Price \$150.
KARTRON Huntington Beach, Calif.

SHORTAGE of RADIO & TELEVISION PARTS FLUORESCENT LAMPS & ACCESSORIES?

One EUROPEAN source of SUPPLY!

Societe Industrielle A L F A.
Rue de la Sonne, 80 BRUSSELS-Belgium.
Cables: RALFA-BRUSSELS.

Manufacturers and Exporters of World-Wide reputation.

SEARCHLIGHT SECTION

(Classified Advertising)

EMPLOYMENT: "OPPORTUNITIES" :EQUIPMENT
BUSINESS: :USED OR RESALE

POSITIONS OPEN

for
**MEN HOLDING Ph.D.
OR M.S. DEGREE**

Openings for men holding the Ph. D. or M.S. Degree in the fields of photo-surfaces, secondary emission, solid state, both light and electron optics, mechanics, electronic circuits, analog computers and servo-mechanisms.

Salary commensurate with experience and ability—Excellent opportunity for suitably qualified personnel.

Please furnish complete resume of education, experience and salary required to:

CAPEHART-FARNSWORTH CORP.

INDUSTRIAL RELATIONS &
PERSONNEL DEPARTMENT

FORT WAYNE 1 INDIANA

POSITION VACANT

Electronic materials development engineer wanted to take charge of development and control laboratory. Man with at least 5 years experience in vacuum tube production, engineering and development, degree in Engineering Physics, Electrical Engineering or Chemistry and some experience in vacuum tube material required. Minimum age 30. Work is primarily with cathode and emission problems. Give details including age, education, experience, marital status, references, availability and salary expected.

P-6943, Electronics
330 W. 42nd St., New York 18, N. Y.

REQUIRE KEY MEN FOR RESEARCH LABORATORIES

Outstanding opportunities now available in undertaking highly responsible research and development work in important electro-mechanical instrumentation laboratories. Require section chiefs with MS or PHD degree in E.E., M.E., or Physics with scholastic achievement in upper 10% of class.

Important to have more than 5 years practical experience in developmental work, supervision of projects or group activities to qualify applicant to supervise and direct several diversified projects and administer related activities.

Men with proven ingenuity, imagination, creative ability and with a record of tangible accomplishments can command attractive salaries.

P-6796 (A3), Electronics
520 N. Michigan Ave., Chicago, Ill.

MECHANICAL AND ELECTRICAL ENGINEERS

Long-established manufacturer located in south Central New York State, producing large volume of electro-mechanical devices, has several attractive, permanent positions for experienced men interested in creative design, development, and production engineering. Furnish complete resume of training and experience when applying.

P-7175, Electronics
330 W. 42nd St., New York 18, N. Y.

CIRCUITS ENGINEER

Rapidly expanding company in instrumentation field has opening for senior engineer. Prefer man with masters degree and 4 or more years of experience in design of pulsing circuits, VHF and UHF. Excellent opportunity for man who can meet requirements. Location Brooklyn. Send complete resume to

P-7202, Electronics
330 W. 42nd St., New York 18, N. Y.

SENIOR ELECTRONIC ENGINEERS

E.E. or M.S., not less than 4 years experience in electronics, preferably in the field of high speed digital computers, radar. Salary commensurate with ability. Positions with progressive New York research and development firm, excellent advancement possibilities. Give complete details.

P-7200, Electronics
330 W. 42nd St., New York 18, N. Y.

PROJECT RADIO ENGINEER

To take responsible charge of design of radio communications systems between the Hawaiian islands. Experience in VHF and Microwave links design desirable. College training or equivalent necessary. Live in Honolulu.

MUTUAL TELEPHONE COMPANY
Box 2200, Honolulu, T.H.

REPLIES (Box No.): Address to office nearest you
NEW YORK: 330 W. 42nd St. (18)
CHICAGO: 520 N. Michigan Ave. (11)
SAN FRANCISCO: 68 Post St. (4)

POSITION VACANT

WANTED: ELECTROSTATIC Capacitor Engineer—Experienced in design, processing and manufacture of paper dielectric capacitors. Knowledge of noise filters, metallized paper capacitors, ceramic capacitors, and mica capacitors desirable. Write full particulars as to experience—confidential. P-6552, Electronics.

SALES ENGINEER with thorough knowledge of all phases of electronic parts. Must have pleasing personality, executive ability and good contacts in industry. Permanent job with excellent prospects. Write full details, past experience and salary desired. P-7115, Electronics.

SALES ENGINEER with thorough knowledge of all phases of electronic parts. Must have pleasing personality, executive ability and good contacts in industry. Permanent job with excellent prospects. Write full details, past experience and salary desired. P-7118, Electronics.

PHYSICIST FOR fundamental electron tube research. Should be familiar with techniques of producing photo-electric, secondary emissive and fluorescent screens, experience with electron-optics, physical optics and solid state physics an advantage. P-7198, Electronics.

EMPLOYMENT AGENCY

ELECTRICAL ENGINEERS: Teaching: Power, Electronics. All ranks to Head Department Universities. Atlantic-Pacific. To \$8000. Give phone, Photo, Qualif. Cline Teachers Agency, East Lansing, Mich.

ELECTRONICS MEN

ENGINEERING DIRECTOR—VICE-PRES.—Production, etc., to \$20,000
ADMINISTRATIVE ENGR — Electro-Mechanical \$11,000
ASST. CHIEF ENGR—Flight Simulators \$11,000
QUALITY CONTROL MGRS. (1) Radio, Electronic (1) knl Metallurgy \$10,000

PROJECT & DEVEL ENGRS

TEST EQUIPMENT, FM Transmitters, Receivers, Digital Analog Computers, VHF, UHF Circuits, V-HIGH
PRODUCTION MGR—Signal Equipment... \$6000
MFG & PROCESS ENGRS..... HIGH
SALES ENGRS—Electronics..... HIGH

Submit duplicate resumes!

FRANKLIN EMPLOYMENT SERVICE

225 S. 15th St. Phila. 2, Pa.

Engineers - Executives - Technical Men

Salaried Positions, \$4,000 to \$30,000. This Confidential service for men who desire a new connection, will develop and conduct preliminary negotiations without risk to present position. Send name and address for details.

TOMSETT ASSOCIATES

1207-2 Berger Bldg., Pittsburgh 19, Pa.

EMPLOYMENT SERVICE

SALARIED PERSONNEL, \$3,000-\$25,000. This confidential service, established 1927, is geared to needs of high grade men who seek a change of connection under conditions assuring, if employed, full protection to present position. Send name and address only for details. Personal consultation invited. Jira Thayer Jennings, Dept. L, 241 Orange St., New Haven, Conn.

POSITIONS WANTED

RADIO ENGINEER, B.S.E.E. five years experience consulting radio engineering and research. Some teaching experience. PW-7123, Electronics.

OPENINGS: EE's, BS or equiv. Electronic Chief Engrs. (const.-maint.), Instructors, Anncr.-teach. (Exp. or student), Xmitter Engrs. 1st fone lic. nec. RRR-Radio-TV Employment Bureau, Box 413, Philadelphia.

ELECTRONICS ENGINEER, 29, B.S. '42 Cal Tech, 3 yrs. Sig. C Radar Officer, over 5 yrs. comm. exp. development engr. on inst. landing equip., metal detectors, geophysical expl. equip., meter calibration standards, V.H.F. Detectors, Radio Teletype, Govt. specs. Present salary \$5400, available after July. PW-7131, Electronics.

TUBE ENGINEER, Ph.D. physicist, wishes to leave government-sponsored projects for company breaking into commercial tube development. Competent to direct tube development, manufacture. Salary, \$10,000. PW-7146, Electronics.

RADIO-ELECTRONICS Technician: American, age 27, single, desires long term position anywhere in Philippines. Amiable disposition. Speaks some Tagalog and Visayan. 10 years military, amateur, and commercial radio experience. PW-6165, Electronics.

WANTED

ANYTHING within reason that is wanted in the field served by Electronics can be quickly located through bringing it to the attention of thousands of men whose interest is assured because this is the business paper they read.

MANUFACTURERS AGENT

Wants line of production items calling on electrical and radio equipment manufacturers. Territory: All of New York State excluding the metropolitan area. Selling the best manufacturers in this area for twenty years.

RA-7102, Electronics
330 W. 42nd St., New York 18, N. Y.

CAPITAL NEEDED

To finance the organization of a small plant to produce high dielectric titanate capacitors. Interest in business in return. For further details write

BO-7060, Electronics
520 N. Michigan Ave., Chicago 11, Ill.

RCA VICTOR Camden, N. J.

Requires Experienced Electronics Engineers

RCA's steady growth in the field of electronics results in attractive opportunities for electrical and mechanical engineers and physicists. Experienced engineers are finding the "right position" in the wide scope of RCA's activities. Equipment is being developed for the following applications: communications and navigational equipment for the aviation industry, mobile transmitters, microwave relay links, radar systems and components, and ultra high frequency test equipment.

These requirements represent permanent expansion in RCA Victor's Engineering Division at Camden, which will provide excellent opportunities for men of high caliber with appropriate training and experience.

If you meet these specifications, and if you are looking for a career which will open wide the door to the complete expression of your talents in the fields of electronics, write, giving full details to:

National Recruiting Division
Box 800, RCA Victor Division
Radio Corporation of America
Camden, New Jersey

PHYSICISTS SR. ELECTRONIC ENGINEERS

Familiar with ultra high frequency and micro wave technique.

Experience with electronic digital and/or analog, computer research and development program.

Salaries commensurate with experience and ability. Excellent opportunities for qualified personnel.

Contact:

C. G. Jones, Personnel Department
GOODYEAR AIRCRAFT CORPORATION
Akron 15, Ohio

Electronic Engineers

PROJECT ENGINEERS

Five or more years experience in the design and development, for production, of major components in radio and radar equipment.

ASSISTANT PROJECT ENGINEERS

Two or more years experience in the development, for production, of components in radio and radar equipment.

Well equipped laboratories in modern radio plant . . . Excellent opportunity . . . advancement on individual merit.

Baltimore Has Adequate Housing

Send resume to Mr. John Siena:

BENDIX RADIO DIVISION
BENDIX AVIATION CORPORATION
Baltimore 4, Maryland

SENIOR ELECTRONIC CIRCUIT PHYSICISTS

for
Advanced Research
and Development

MINIMUM REQUIREMENTS:

1. M.S. or Ph.D. in Physics or E.E.
2. Not less than five years experience in advanced electronic circuit development with a record of accomplishment giving evidence of an unusual degree of ingenuity and ability in the field.
3. Minimum age 28 years.

Hughes Aircraft Company

Attention: Mr. Jack Harwood
CULVER CITY, CALIFORNIA

SEVERAL ENGINEERS

Needed by contractor for work at Naval Air Missile Test Center, 50 miles northwest of Los Angeles. College Degree and experience essential. Radar, digital computer or general pulse technique experience required.

ELECTRONIC ENGINEERING CO.
OF CALIFORNIA
180 South Alvarado Street
Los Angeles 4, California

RADAR, COMMUNICATIONS and SONAR TECHNICIANS WANTED

For Overseas Assignments

Technical Qualifications:

1. At least 3 years' practical experience in installation and maintenance.
2. Navy veterans ETM 1/c or higher.
3. Army veterans TECH/SGT or higher.

Personal Qualifications:

1. Age, over 22—must pass physical examination.
2. Ability to assume responsibility.
3. Must stand thorough character investigation.
4. Willing to go overseas for 1 year.

Base pay, bonus, living allowance, vacation add up to \$7,000.00 per year. Permanent connection with company possible.

Apply by Writing to
A-1, P. O. Box 3414
Philadelphia 22, Pa.

Men qualified in RADAR, COMMUNICATIONS or SONAR give complete history. Interview will be arranged for successful applicants.

SCIENTISTS AND ENGINEERS

Wanted for interesting and professionally challenging research and advanced development in the fields of microwaves, radar, gyroscopes, servomechanisms, instrumentation, computers and general electronics. Scientific or engineering degree or extensive technical experience required. Salary commensurate with experience and ability. Direct inquiries to Mgr., Engineering Personnel, Bell Aircraft Corporation, P. O. Box 1, Buffalo 5, N. Y.

POSITIONS OPEN

SENIOR ELECTRICAL ENGINEERS

For microwave plumbing and antenna design and development. Must have from three to five years engineering experience in either of the above fields and have a record of achievement indicating ability to organize and execute development work. Project Engineer or equivalent experience. B.S. Degree from accredited engineering school.

Here are two excellent positions with future opportunity for the right men in an aggressive research engineering firm. Salaries open. Interviews will be arranged for applicants who submit satisfactory resume.

ENGINEERING RESEARCH ASSOCIATES, INC.
1902 West Minnehaha Ave. St. Paul 4, Minnesota

WANTED

RESISTORS

and

POTENTIOMETERS

single J—dual JJ—triple JJJ

made by

ALLEN BRADLEY CO.

any wattage

any ohmage

any tolerance

WE PAY HIGHEST PRICES

• • •

Resistors Other Makes Are Acceptable Too:

LEGRI S CO., INC.

130 West 102 St., New York, N. Y.

Phone: AC ademy 2-0018

WANTED MICROWAVE TEST EQUIPMENT

W-7142, Electronics
330 W. 42nd St., New York 18, N. Y.

WANTED WESTERN ELECTRIC VACUUM TUBES

Types 101F, 102F, 272A, 274A or B, 310A or B, 311A, 313C, 323A, 328A, 329A, 348A, 349A, 352A, 373A, 374A, 393A, 394A, 121A Ballast Lamps.

W-6863, Electronics
330 W. 42nd St., New York 18, N. Y.

WANTED

Teletypewriters complete, components or parts. Any quantity and condition.

W-6864, Electronics
330 W. 42nd St., New York 18, N. Y.

WANTED

500 RECEIVERS-TRANSMITTERS 4 to 6 Watts.
45 SCR-206—45 SCR-503
SURPLUS, COMPLETE, BRAND NEW, UNUSED.
Offers FOB New York to be submitted with complete lists of units composing each item to

W-6826, Electronics
330 W. 42nd St., New York 18, N. Y.

WANTED

INSULATORS; POLE LINE HARDWARE;
GUY STRAND WIRE; COPPERWELD WIRE;
WESTERN ELECTRIC TOOLS; SPLICING
SLEEVES.

VICTOR-BERNARD INDUSTRIES
NE Cor. 22nd & Lehigh Aves., Phila. 32, Pa.

WANTED TO BUY

PRIVATE LABORATORY Wishes To Purchase For Its Own Use High Grade Test Equipment and Basic Radio Components. Replies Held In Confidence

W-7171, Electronics
330 W. 42nd St., New York 18, N. Y.

BY WISELY

advertising your used or surplus new equipment in the Searchlight Section you turn it into CASH.

"SEARCHLIGHT" is the recognized national center for the buying and selling of such equipment.

Information Cheertfully Given.
Address: Classified Advertising
Division

WANTED

ONE USED 240 CYCLE GENERATOR

Single phase 110 or 220 V. AC., 1 to 2 K.V.A.

ADVANCE TRANSFORMER CO.

1122 West Catalpa Avenue, Chicago 40, Illinois

WANTED

WESTERN ELECTRIC AMPLIFIER

MODEL 1126C

Level Governing Type

W-7193, Electronics
330 W. 42nd St., New York 18, N. Y.

MICROWAVE TEST EQUIPMENT

THERMISTORS

D-167332 (tube)	\$.95
D-170396 (bead)	\$.95
D-167613 (button)	\$.95
D-164699 for MTG in "X" Band Guide \$2.50	
D-167018 (tube)	\$.95

VARIATORS

D-170225	\$1.25
D-167176	\$.95
D-168687	\$.95
D-171812	\$.95
D-171528	\$.95
D-171528	\$.95
D-168442	\$3.00
D-165939	\$1.25
D-98836	\$2.00
D-161871A	\$2.85
D-171121	\$.95
D-98836	\$1.50
D-162356 (308A)	\$2.00
D-165357	\$2.00
D-99946	\$2.95

**WRITE FOR
C.E.C. MICRO-
WAVE CATALOG
NOW AVAILABLE**

8500 Mc to 9600 Mc Bench Test

Slotted Line. Complete with adjustable probe, crystal output, precision vernier adjust. Humble oil type

Klystron Mount. DeMornay Budd type DB350 for 2K25, etc., includes tunable termination... \$70.00

Variable Attenuator. DeMornay Budd type DB383. Maximum attenuation 35DB. \$120.00

Variable Stub Tuner. DB536. 180 degree phase shifting capability \$70.00

Flap Attenuator. DB385. Maximum Attenuation 10DB \$25.00

Magic Tee. DB539 \$42.00

Wave Guide to Type "N" Adapter. DB377 \$15.00

Low Power Termination. DB381 \$18.50

Uni-Directional Coupler. DB390. 23DB type "N" output. \$18.50

Pick U Horn. Type "N" output. \$4.50

Wavemeter. 8500 to 9400 mcs. with calibration. Micrometer adjust head. Reaction type... \$85.00

Waveguide Lengths. Plated and fitted with couplings available in 6", 12", 24", 30", 60" sections \$2.00 per ft.

90 Degree Elbows. E or H plane, 2 1/2" radius. \$12.50

Mitered Elbows. E or H plane. \$10.00

45 Degree Offset Elbows. E or H plane. \$10.00

90 Degree Twist. 6" long. \$8.00

Bulkhead Feed-Thru Assembly. \$15.00

Pressure Gauge Section. 15 lb. gauge and press. nipple \$10.00

Pressure Gauge. 15 lbs. \$2.00

Crystal Mount. 1N23 type crystal holder. \$17.50

COUPLINGS—UG CONNECTORS

UG/15U	\$.75	UG 117 Choke	\$2.50
UG206U90	UG 51 Cover	1.00
UG87U89	UG 52 Choke	1.35
UG21U	1.69	UG 210 Cover	1.85
UG21U89	UG 212 Choke	2.40
UG167U	2.25	3/8 Coax Female Ring90
UG29U90	3/8 Coax Male Fitting50
UG254U	1.69	X Band Circ. Choke50
UG69U	1.40	Flange50
UG342U	3.25	X Band Flat Contact Flange 1/2 Thk.25
UG85U	1.45	Contact Ring 1/2" Thk 1 1/2" dia. hole25
UG58U60	UG 53/U. Cover	4.00
UG9U89	UG 54/U. Choke	4.75
UG102U45	UG 55/U. Cover	4.00
UG103U45	UG 56/U. Choke	4.75
UG255U	1.65	UG 65/U. Contact	6.50
UG 40/U Specif. for Mixer Assy.75	UG 149/U. Cover	3.00
UG 40A	1.10	UG 148/U. Choke	4.00
UG 343 Cover.	2.35	UG 150/U. Contact	3.00
UG 344 Choke.	3.00	UG 39/U. Cover60
UG 425 Contact.	2.00	UG 40/U. Choke80
UG 116 Cover & Coupl Ring	1.95	Write us your needs.	

3000 MC. BENCH TEST EQUIPMENT

10 CM Wavemeter WE type B435490 Transmission type, type N fittings, Vee-dor Rot Micrometer dial, Gold Plated W/Calib. Chart P/o Freq. Meter X66404A. New \$99.50

AS14A/AP-10 CM Pick up Dipole with "N" Cables \$4.50

LHTR. LIGHTHOUSE ASSEMBLY. Part of IT239 APG 5 & APG 15. Receiver and Trans Cavities w/ assoc. Tr. Cavity and Type N CPLG. To Revr. Uses 2C40, 2C43, 1B27, Tunable APX 2400-2700 MCS. Silver Plated \$49.50

Beacon Lighthouse cavity 10 cm with miniature 28 volt DC FM motor. Mfg. Bernard Rice. \$47.50 ea.

S. BAND

90° Twist, circular cover to circular cover... \$25.00

Magnetron to Waveguide Coupler with 721A Duplexer Cavity, gold-plated \$45.00

721A TR Box complete with tube and tuning plungers \$12.50

McNally Klystron Cavities for 707B or 2K28. Three types available \$4.00

F-29/SPR-2 Filters, Type "N", input and output \$12.50

726 Klystron Mount, Tunable output, to type "N"

PULSE EQUIPMENT

G.E.K.—2745

G.E.K.—2744-A. 11.5 KV High Voltage, 3.2 KV Low Voltage @ 200 KW oper. (270 KW max.) 1 microsec. or 1/4 microsec. @ 600 PPS. \$39.50

G.E. K2450A. Will receive 13 KV, 1/4 micro-second pulse on pri., secondary delivers 14KV. Peak power out 100KW G. E. \$34.50

TPS10 Modulator X Band. \$350.00

SO-4 Thyatron Modulator \$60.00

TS-286 Keyer units. \$95.00

715B Tubes

705A Tubes

705 Sockets

Complete line of high voltage pulse transformers, networks and dual lines.

All merch. guar. Mail orders promptly filled. All prices, F.O.B. N.Y.C. Send M.O. or Chk. Only shipping chgs. sent C.O.D. Rated concerns send P.O.

23,000 to 27,000 mc. BENCH TEST

Plumbing—1/2" to 1/4" Waveguide

Precision Slotted Line. DeMornay Budd type 337 Complete with adjustable probe and crystal output. Square flanges. \$400.00

Precision Slotted Line. Adjustable probe. Humble Oil type. CPK-2111U \$200.00

Directional Coupler-Wavemeter Mnt. 12DB. \$60.00

Precision Var Attenuator, mfg. Bernard Rice. \$30.00

Tunable Xtal Mnt. DB423 less tuning plug. \$30.00

Flap Attenuator. DB405 10DB attenuation. \$25.00

Low Power Load. \$20.00

Screw Tuner \$25.00

Shunt Tee \$35.00

Waveguide Lengths. 2" to 6" long, gold-plated with circular flanges and coupling nuts. \$2.25 per inch

APS-34 Rotating Joint. \$49.50

Right Angle Bend E or H Plane, specify combination of couplings desired. \$12.00

45° Bend E or H Plane, Choke to cover. \$12.00

PLUMBING—1/2" to 1/4" Waveguide

Directional coupler CU-103/APS32. \$49.50

Mitered Elbow, cover to cover. \$4.00

TR-ATR Section, choke to cover. \$4.00

Flexible Section 1" choke to choke. \$5.00

"S" Curve Choke to cover. \$4.50

Adaptor, round to square cover. \$5.00

Feedback to Parabola Horn with pressurized window. \$27.50

Low Power Load, less cards. \$18.50

K Band Mixer Block. \$45.00

Waveguide 1/2 x 1/4". \$1.00 per ft.

Circular Flanges. 50c

Flange Coupling Nuts. 50c

Slotted Line, DeMornay-Budd #397, new. \$450.00

90° Twist \$10.00

"K" Band Directional Coupler CUI04/APS-34 20 DB. \$49.50 ea.

K BAND 2K33 w/cav. \$115.00

3131 Magnetrons \$55.00

Plumbing—1" x 1/2" Waveguide

Dual Oscillator-Beacon Mount. P/O APS10 Radar for mounting two 726 Klystrons with crystal mts matching slugs, shields. \$42.50

Dual Oscillator Mounts. (Back to back) with crystal mount, tunable termination, attenuating slugs. \$18.50

Directional Coupler. UG-40/U Take off 20 DB \$17.50

Directional coupler, APS-6 type "N" take off 20 DB calibrated. \$17.50

Flexible Section 18" long. \$12.00

Rotary Joint Choke to Choke. \$10.00

2K25/723 AB Receiver local oscillator Klystron Mount, complete with crystal mount, iris coupling and choke couplings to TR. \$25.00

TR-ATR Duplexer section for above. \$8.50

1 1/2" x 3/8" WAVEGUIDE

Slotted Line. Complete with adjustable probe, crystal output, precision vernier adjust. Humble Oil type. \$225.00

Tunable Termination. Precision adjust. \$65.00

Low Power Termination. \$25.00

Magic Tee \$45.00

Transition. 1 1/2" x 3/8" to 1" x 1/2" \$19.50

Oscillator Mount. for four 723AB Klystron. \$38.50

90 Degree Elbows. E or H plane. \$12.50

Waveguide Lengths. Cut to size and supplied with 1 choke, 1 cover, per length. \$2.00 per ft.

Wavemeter. Absorption type. Precision micrometer adjust. Very high "Q". \$150.00

MAGNETRON SPACINGS

Gauss	Pole Diam.	Spacing	Price
4850	3/4 in.	3/4 in.	\$12.50
5200	11/32 in.	3/4 in.	\$17.50
1300	1 1/8 in.	1 1/8 in.	\$12.50
1860	1 1/8 in.	1 1/2 in.	\$14.50

Electromagnets for magnetrons. \$24.50 ea.

GE Magnetrons type M7765115, GI Distance Between pole faces variable. 2 1/16" (1900 Gauss) to 1 1/2" (2200 Gauss) Pole Dia. 1 3/4" New Part of SC/R 584 \$34.50

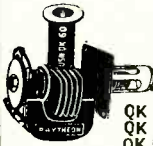

MAGNETRONS

QK 61 2J32	2J61	720CY
QK 60 2J37	2J62	725-A
2J21	2J38	3J31 730-A
2J22	2J39	5J30 728
QK 915 2J26	2J40	714AY 700
QK 62 2J27	2J49	718DY 706
QK 59 2J31j	2J34	720BY

Klystrons 723A, 707B, 417A, 2K41

6000 Mc. to 8500 Mc. Bench Test Plumbing

1 1/2" x 3/4" Waveguide

Klystron Mount. DB356 complete with shield and tunable termination \$125.00

Flap Attenuator. DB361 \$45.00

Precision Wavemeter. DB358. Micrometer adjust head \$190.00

Variable Stub Tuner \$90.00

Waveguide to Type "N" Adapter \$18.50

Wavemeter Tee. DB352 \$32.50

Slotted Line. DB354 Precision vernier adjust, less probe \$320.00

Magic Tee \$80.00

Directional Coupler, two hole 25DB coupling, type "N" output \$25.00

Precision Crystal Mount. Equipped with tuning slugs and tunable termination \$125.00

Tunable Termination. Precision adjust. \$70.00

Low Power Load. \$35.00

4000 to 6000 mcs. Bench Test Plumbing

2" x 1" Waveguide

Slotted Line. DeMornay type 332 complete with probe, etc. \$600.00

Flap Attenuator \$48.00

Variable Stub Tuner and Low Power Termination \$48.00

Wavemeter Tee \$48.00

Adapters: Choke to choke. \$18.00

Cover to cover. \$14.00

Choke to cover. \$16.00

Waveguide to Type "N" Adapter \$45.00

Directional Coupler. Two hole type, type "N" output \$48.00

Klystron Mount. Equipped with tunable termination and micrometer adjust. klystron \$110.00

tuning \$110.00

Crystal Mount. Equipped with tunable termination and micrometer adjust crystal tuning. \$125.00

Tunable Termination. Precision adjust. \$90.00

TEST PLUMBING

complete, with socket and mounting bracket \$12.50

WAVEGUIDE TO 3/8" RIGID COAX "DOOR-KNOB" ADAPTER, CHOKE FLANGE, SILVER PLATED BAND \$32.50

WAVEGUIDE DIRECTIONAL COUPLER, 27 db Navy type CABV-47AAN, with 4 in. shield \$32.50

section \$32.50

SQ. FLANGE to rd choke adapter, 18 in. long OA 1 1/2 in. x 3 in. guide, type "N" output and sampling probe \$27.50

AN/APR5A 10 cm antenna equipment consisting of two 10 cm waveguide sections, each polarized, 45 degree. \$75.00 per set.

POWER SPLITTER: 726 Klystron input dual "N" output \$5.00

3/8" RIGID COAX

10 CM FEEDBACK DIPOLE ANTENNA, in lucite ball, for use with parabola 3/8" Rigid Coax Input \$8.00

721A TR cavities, heavy silver plated. \$2.00 ea.

Magnetron Coupling with TR Loop. \$7.50

Snergy Rotating Joint, pressurized. \$22.50

5 Ft. Lengths Stub Supported, gold-plated, per length \$7.50

Short Right Angle Bends (for above) \$2.50

GENERAL TEST EQUIPMENT

Multi Frequency Generator. American Time Product type SC-16. Frequency 10 to 190. Precision Standard "Watch-Master"

UHF Signal Generator. R.C.A. type 710A. 370 to 500 mcs.

Heatstone Bridge. Industrial Inst. type RN-1. FM Signal Generator. Boonton Radio type 155-A. Freq. range 1 to 10 mcs., 38 to 50 mcs.

Condenser Weld Power. Cap. 56 mfd. max., max. chg. 1500 Volts.

Frequency Meter. Lavoie Model 105-300 to 600 mcs.

Megohm Bridge. Industrial Instruments type MB.

Visual Alignment Signal Generator. General Electric—0 to 60 mcs.

NEW TEST EQUIP. IN STOCK

1-185A Oscillator Write

1-158 Range Calibrator or

1-233—Range Calibrator

BC 438 Freq. Meter Phone

RF Pramp for

G.R. Capacity Brdg #216

G.R. Uni Galvo Shunt #229 Data

G.R. 1000 Aud. Osc. #213 and

TS 226A/AP Pwr. Mtr. 0-1000W.

Sig Gen #804 8-330 MC. Price

ARMY-NAVY TEST SETS

TS-45/APM—3 cm Signal Generator.

TS-226A/AP Power Meter.

TS62/AP 3 centimeter precision echo box.

TS36/AP 3 centimeter Thermistor Bridge—Power Meter.

TS89/AP Voltage divider.

TS268/U Crystal checker for 1N23 type crystals etc.

CW-60ABM 10 Centimeter Wavemeter. Coaxial type micrometer adjust carry, Resonance indicating meter, carrying case (similar to TS117/GP).

TS235/UP High Power Load. "L" band (1000 mcs.)

LU-1 FREQ. Meter and Test Oscillator. Type CBV-60ACL

TWN-9HU POWER SUPPLY. MIT Rad. Lab.

TVN-8SE KLYSTRON POWER SUPPLY. MIT. Rad. Lab.

CS80ABW WATT METER—Wavemeter. 3 CM. AP65 RECEIVER—1000 to 6000 mcs.

AN/CPN-8—10 centimeter 40 kw. output RF package. Includes magnetron oscillator, complete modulator, complete receiver, complete signal and power analyzer with 3' scope. 115V AC input.

Dehydrator Unit CPD 10137 Automatic cycling. Compressor to 50 lbs. Compl. for Radar XSMN. Line. New \$425.00

SD-3 Receiver, 30 mc. 1F. 6 stages 6AC7, 10 MC. Band width inpt. 6.1 mc. B.W. per stg. 1.8 volt gain per stage as desc. in ch. 13 vol. 23 M.I.T. Rad. Lab. Series. \$99.50

COMMUNICATIONS EQUIPMENT CO.

131 Liberty St., New York, N. Y. Dept. E-8

P. J. Plishner

Phone: Digby 9-4124

SONAR

QCQ2. ECHO RANGING AND LISTENING EQUIPMENT
 Use: Medium ASW ships.
 Keying Interval. 1,000, 2,000, 4,000, 8,000 yards and manual.
 Projector. Magnetostrictive, permanent magnet polarization, resonant frequency about 25 kc.
 Transmitting system. The electron tube driver oscillator and two amplifier stages are contained in the receiver chassis; the variable tuning condenser being ganged with the receiver tuning condensers in order to give uni-control of receiver and driver tuning. In another chassis are located the output tubes and the high voltage rectifier. Sweep frequency modulation is provided, giving a shift from 400 cycles below to 600 cycles above the operating frequency during the transmission.
 Receiving system. The receiver is of the tuned-radio-frequency type. It includes time varied gain, to reduce the volume of reverberations immediately following the transmission, and has a "Flat-Peak" audio filter, and an adjustable BFO to give an audible note above or below 800 cycles.
 Keying and indicating system. Keying is mechanical; cams in the indicator unit determine the pulse length and keying interval. Ranges are indicated by the flash of a neon lamp.
 Complete sets available less hoist. Also stacks alone.

QBF and QJA. ECHO RANGING AND LISTENING EQUIPMENT
 Use. Large ASW ships.
 QBF may be converted by field modification, to QJA available.
 Keying Interval. 1,000, 2,000, 3,000, 4,000, 5,000, 10,000 yards and manual.
 The electrical train system consists of a handwheel on the stack which selects, by commutation, three voltages from the secondary of a transformer-like device called a Commutator Transmitter.
 Projector. The projector is of the Rochelle salt crystal type with a single element used for both listening and ranging. The frequency is 22 to 28 kc.
 Transmitting system. The receiver-driver oscillator unit contains two electron tube oscillators, one fixed at about 150 kc and one tunable over the range from 160 to 180 kc. The outputs of the two are mixed, producing a difference frequency, which is then fed to the driver-amplifier unit and thus to the projector.
 Receiving system. The receiver is a superheterodyne type covering the range from 10 to 30 kc.
 Keying and indicating system. Ranges are indicated by the flash of a neon lamp which revolves at a constant speed, driven by a synchronous motor.

QCU, QCU-1 ECHO RANGING AND LISTENING EQUIPMENT
 Use. Small ASW Ships.
 Intended to be used as a replacement for the obsolete WEA-1 equipment the old hoist.
 Keying Interval. 1,000, 2,000, 4,000, 8,000 yards and manual.
 Training is electrical, controlled by hand crank at the remote station.
 Projector. Magnetostrictive, permanent magnet polarization, resonant frequency about 25 kc, split for BDI.
 Transmitting system. The electron tube driver oscillator and two amplifier stages are contained in the receiver chassis; the variable tuning condenser being ganged with the receiver tuning condensers in order to give uni-control of receiver and driver tuning. In another chassis are located two type 811 output tubes and two type 836 high voltage rectifier tubes. Sweep frequency modulation is provided, giving a shift from 400 cycles below to 600 cycles above the operating frequency during the transmission.
 Receiving system. The receiver is of the tuned radio frequency type. It includes time varied gain, to reduce the volume of reverberations immediately following the transmission, and has a "Flat-Peak" audio filter, and an adjustable BFO to give an audible note, above or below 800 cycles.

QCS, QCS-1, QCT-1 ECHO RANGING AND LISTENING EQUIPMENT
 Use. ASW ships.
 Keying Interval (original).—1,000, 2,000, 5,000, 10,000 yards and manual (field modification added 3,000 and 4,000 yards)
 Transmitting system. The driver-rectifier unit contains an electron-tube oscillator tunable over the range of 17 to 25.5 kc, and electron-tube amplifier and a rectifier power supply.
 Receiving system. The superheterodyne receiver covers the range from 13 to 37 kc and may be connected by a selector switch to either the "QCQ" or the "JK" face of the projector. It has separate audio amplifiers for the range indicator lamp and for the loudspeaker. The audible note may be adjusted over the range from 0 to 1600 cycles. Three degrees of i-f selectivity and two of audio are provided by selector switches connected to filters.
 Keying and indicating system. Keying is mechanical; cams driven by the range indicator disc shaft determine the pulse length and keying interval.

THE MUST OF THE MONTH

Complete 3 CM Radar System equipment 40 KW peak transmitter, pulse modulator, receiver, using 723AB, power supply operating from 115V 800 Cycle, antenna system. Complete radar set neatly packaged in less than 16 cubic feet, all tubes, in used but excellent condition—\$350.00. This price for laboratories, schools, and experimental purposes only.

High Voltage Power Supply

15 KV at 30 Ma DC, Bridge Rectifier, Western Electric... \$125.00

FM STATION

General Electric Kilowatt Amplifier
 Model 4BT2A1 Type BT2A Serial RC25
 General Electric 250 Watt Exciter
 Model 4BT1A1 Type 3T1A Serial CC833
 General Electric Station Monitor
 Model 4BM1A1 Type BM1A Serial WC268
 General Electric Power Supply
 Model BP241 Type BF2A Serial WC547
 General Electric Transmitter Console
 Model 4BC3A1 Type BC3A Serial WC5
 Type BX-2A Two Bay Circular Antenna with Mast, Transmission Line, Elevators and Matchers.
 100 Feet of 1 1/2" coax. transmission line including 90° elbows.
 Dehydrator for transmission line.
 Desk and Chair for Transmitter Console.
 Write or phone for data & price.

APS-2. 10 cm. airborne radar set designed for navigation and high altitude bombing. The antenna rotates through 360 degrees. Presentation is PPI and A Scope. The following units of the set are supplied: Antenna, transmitter-receiver, modulator, indicator, 24VDC input power unit. New with all tubes, incl. 714AY magnetron, 417A klystron.

APS-3. 3cm. airborne radar set designed for intercept of enemy aircraft and nominal navigation. Antenna is sector scan. Remote as well as master indicator is supplied. 725A magnetron operates the set at 45kw. Complete sets available with all tubes incl. magnetron and 723AB klystrons. Both new and used condition.

APS-4. 3 cm. airborne radar set designed for sector scan surface search, mapping and navigation, weather forecasting, intercepting of enemy aircraft. Entirely enclosed in a streamlined housing for optional mounting on aircraft bomb rack, or on nose of large bombers. Complete sets with indicator equipment, and power unit ready for installation.

APS-6. 3 cm Night Fighter radar with pencil beam antenna. Transmitter-receiver packages and antennas available in equal to new condition.

APS-6A. 3 cm airborne radar RF package, 45kw, using 725A magnetron, IF strip using 6AK5's, 723AB beacon and local oscillator.

ASP-10. 3 cm airborne radar using 2I42 magnetron. Modulator decks and low voltage power supply, only, available, less tubes. Beacon-local oscillator klystron mounts are available.

APQ-13. 3 cm airborne radar complete RF package in excellent condition including all tubes.

APS-15. 3 cm airborne radar designed for high altitude bombing, navigation, intercept of enemy aircraft weather forecasting. Antenna rotates 360 degrees. Presentation is PPI and A scope. The following units are supplied: Antenna, transmitter-receiver, modulator, indicator, slant-range computer, 24VDC input power unit. New with all tubes including 45kw 725A magnetron, 723AB local oscillator-beacon.

CPN-6. 3 cm Navigation Beacon ground station. Complete installation. High power coded beacon of latest JAN design. 115VAC input.

CPN-8. 10cm Navigation Beacon ground station. Complete and partial installations available. High power beacon of long range capability. Complete power, frequency, operation analyzer (5° scope) included.

CXBR. 10cm MIT navigation beacon equipment. Complete, in excellent condition.

FD & Mark IV. 800mc gunlaying radar mfg and designed by Western Electric for battleships. Complete consoles available with all tubes including 700A magnetron and modulator thyatron.

Mark 10. 10cm gunlaying radar, complete, for automatic firing of guns as antenna tracks target. 250 KW.

SA. 200mc Air Search radar especially designed for shipboard or mobile installation. Ideal for ground intercept and control of aircraft. PPI "A" indicator. Long range.

SD. 200mc radar similar to SA but designed for installation on submarines. New.

SE. 10cm shipboard Surface Search radar, using thyatron modulator. Complete installation available including spare parts. "A" scope presentation. 250 KW.

SF-1. 10cm shipboard Surface Search radar with PPI and A scope. Used for navigation and target range information on naval vessels. 250 KW.

SG. 10cm shipboard Surface Search radar with PPI and A scope. Heavy, rugged equipment designed for large naval and merchant vessels. 250 KW.

SJ-1. 10cm radar designed for installation on Submarines. Equipped with PPI and A scope. Complete installations.

SL. 10cm radar designed for Surface search on shipboard. PPI indicator console.

SN. 10cm portable radar. Lightweight, easily transportable complete radar installation using lighthouse tubes with a 25 mile maximum range. 115 VAC operation.

SO-1. 10cm shipboard radar for navigation on all types of vessels. 4, 20, and 80 mile range. PPI indicator. Large antenna. 115 VDC input.

SO-8. same as SO-1 but with a lightweight antenna.

SO-13. same as SO-1 but with lightweight antenna, 28VDC input. Designed for PT Boat installation.

SCR 518. Radar altimeter using pulse-echo-time principle, 400mc, 28 VDC input, CR tube altitude indication.

SCR 520. Airborne radar RF package, 10cm, complete with pulser, hard tube, 714AY magnetron.

SCR 533. IFF/Air Search trailer, complete, 500mc operation, A scope.

SCR 663. Sperry searchlight training, aircraft tracking ground installation. Used condition.

SQ. 10cm portable radar designed for use on landing barges and beach-heads. PPI, B, A indication on 3" scope. 115 VAC operation.

TPS-2. 1000mc Portable Early Warning System. Bedspring antenna. Complete with portable generator.

RT73/UPN-2. 10cm Portable Beacon Equipment.

RADIO SYSTEMS

White Radio Telephone Model #WRM55. Ship To Ship—Shore To Ship—Small Airports—Mines—Plantations—Inter Island—Ranches. 10 channel Fix Tuned Receiver & Transmitter XMTTR Pwr Output in excess of 100W unmodulated into antenna of 18 & 100 MMF. Freq. Range 2-12 MC. Can be modified to increase range. Xtal controlled. 110V 60 Cy or 220V 60 or 25 Cy. Meas. 24" H x 19" W x 14" D. 125 lbs. Write or phone for data.

TAJ. 500 Watt Low Frequency Transmitter, 150-550 KC, C.W., M.C.W.

TBK. 500 Watt High Frequency Transmitter 2 to 18 MC, A1, A2, A3, Emission. Mfg. by RCA.

RADAR
RADAR
RADAR
RADAR

R

A

D

A

R

SONAR
SONAR
SONAR
SONAR

All merch. guar. Mail orders promptly filled. All prices F.O.B. N.Y.C. Send MO or Chk. Only shipping chgs sent C.O.D. Rated concerns send P.O.

COMMUNICATIONS EQUIPMENT CO.

131 Liberty St., New York, N.Y. Dept. E-8 P. J. Plishner Phone: Digby 9-4124

**FULLY
GUARANTEED**

BRAND NEW SURPLUS OFFERED BY A LEADING

A.C. MOTORS

5071930, Delco, 115 V., 60 Cycle, 7000 r.p.m. Price \$4.50 each net.

36938-2, Haydon Timing Motor, 110 V., 60 cycle, 2.2 w.; 4/5 r.p.m. Price \$3.00 ea. net.



Type 1600 Haydon Timing Motor—110 V., 60 cycle, 3.2 w., 4 r.p.m., with brake. Price \$4.00 each net.

Type 1600 Haydon Timing Motor—110 V., 60 cycle, 2.2 w., 1/240 r.p.m. Price \$3.00 each net.

Type 1600 Haydon Timing Motor 110 V., 60 cycle, 2.3 w., 1 r.p.m. Price \$2.70 each net.

Type 1600 Haydon Timing Motor, 110 V., 60 cycle, 2.2 w., 1 1/5 r.p.m. Price \$2.70 each net.

Type 1600 Haydon Timing Motor 110 V., 60 cycle, 3.5 w., 1 r.p.m. With shift unit for automatic engaging and disengaging of gears. Price \$3.30 each net.

Type 1600 Haydon Timing Motor, 110 V., 60 cycle, 2.2 w., 1/60 r.p.m. Price \$3.00 each net.

Eastern Air Devices Type J33 Synchronous Motor 115 V., 400 cycle, 3 phase, 8,000 r.p.m. Price \$8.50 each net

Telechron Synchronous Motor, Type B3, 115 V., 60 cycle, 2 r.p.m., 4 w. Price \$5.00 each net.

Barber-Colman Control Motor, Type AYLC 5091, reversible 24 volts D.C. .7 amps 1 R.P.M., Torque 500 in. lbs. Contains 2 adjustable limit switches with contacts for position indication. Ideal for use as a remote positioner or a beam or television antenna rotator, will operate on A.C. 60 cycle. Price \$6.50 each net.

SERVO MOTORS

CK 1, Pioneer, 2 phase, 400 cycle. Price \$10.00 each net.

CK 2 Pioneer, 2 phase, 400 cycle. Price \$4.25 each net.

10047-2-A Pioneer 2 phase, 400 cycle, with 40:1 reduction gear. Price \$7.25 each net.

FPE-49-6 Diehl, Low-Inertia, 115 V., 60 cycle, 2 phase, .3 amps., 10 watt, output. Price \$34.50 each net.

FPE-25-16 Diehl Low-Inertia 20 V., 60 cycle, 2 phase, 1600 r.p.m., .85 amps. Price \$10.00 each net.

CK 2, Pioneer, 2 phase, 400 cycle, with 40:1 reduction gear. Price \$6.50 each net.

CK5 Pioneer, 2 phase, 400 cycle. Price \$20.00 ea. net

MINNEAPOLIS-HONEYWELL TYPE B Part No. G303AY, 115 V., 400 cycle, 2 phase, built-in gear reduction, 50 lbs. in torque. Price \$8.50 each net.

Kollsman Type 776-01 400 cycle 2 phase drag-cup type, fix phase voltage 29, variable phase 35V. maximum, frequency 400 cycle. Price \$10.50 each net.

REMOTE INDICATING MAGNESYN COMPASS SET

Pioneer Type AN5730-2 Indicator and AN5730-3 Transmitter 26 V., 400 cycle. Price \$40.00 per set new sealed boxes.



Kollsman Remote Indicating Compass Set Transmitter part No. 679-01, indicator part No. 680k-03, 26 V., 400 cycle. Price \$12.50 each net.

GYROS

Schwein Free & Rate Gyro type 45600. Consists of two 28 V. D.C. constant speed gyros. Size 8" x 4.25" x 4.25". Price \$10.00 ea. net.



Sperry A5 Directional Gyro, Part No. 656029, 115 volts, 400 cycle, 3 phase. Price \$17.50 each net.



Sperry A5 Vertical Gyro, Part No. 644841, 115 V., 400 cycle, 3 phase. Price \$20.00 each net.

Sperry A5 Amplifier Rack Part No. 644890. Contains Weston Frequency Meter. 350 to 450 cycle and 400 cycle, 0 to 130 voltmeter. Price \$10.00 each net.

Sperry A5 Control Unit Part No. 644836. Price \$7.50 each net.

Sperry A5 Azimuth Follow-Up Amplifier Part No. 656030. With tube. Price \$5.50 each net.

Sperry A5 Autopilot Indicator: contains Pioneer AY20 autosyn 26 V., 400 cycle. Price \$9.50 ea. net

Pioneer Type 12800-1-D Gyro Servo Unit. 115 V., 400 cycle, 3 phase. Price \$10.00 each net.

Norden Type M7 Vertical Gyro. 26 V., D.C. Price \$19.00 each net.

Allen Calculator, Type C1 Bank and Turn Indicator, Part No. 21500, 28 V. D.C. Contains 28 V. D.C. constant speed gyro. Price \$10.00 each net.

Type C1 auto-pilot formation stick, part No. G1080A3. Price \$15.00 each net.

C. A. A. approved instrument repair dept. No. 3564.

D.C. MOTORS



5069625, Delco Constant Speed, 27 V., 120 r.p.m. Built-in reduction gears and governor. Price \$3.90 each net.

A-7155, Delco Constant Speed Shunt Motor, 27 V., 2.4 amps., 3600 r.p.m., 1/30 h.p. Built-in governor. Price \$6.25 each net.

C-28P-1A, John Oster Series Motor, 27 V., 0.7 amps., 7000 r.p.m., 1/100 h.p. Price \$3.75 each net.

Jaeger Watch Co. Type 44-K-2 Contactor Motor, Operates on 3 to 4.5 volts D.C. Makes one contact per second. Price \$2.00 each net.

General Electric Type 5BA10AJ52C, 27 V. D. C., 0.65 amps., 14 oz. n. torque, 145 r.p.m. Shunt Wound, 4 lead reversible. Price \$5.00 each net.

General Electric Type 5BA10AJ37C, 27 V. D. C., 0.5 amps., 8 oz., in. torque, 250 r.p.m. Shunt Wound, 4 leads reversible. Price \$6.50 each net.

General Electric Type 5BA10J18D, 27 V. 0.7 amps. 110 R.P.M. 1 oz. ft. Price \$4.75 ea. net

D.C. ALNICO FIELD MOTORS

S. S. FD6-16, Diehl, 27 V., 10,000 r.p.m. Price \$4.50 each net.

S. S. FD6-18, Diehl, 27 V., 10,000 r.p.m. Price \$4.50 each net.

S. S. FD6-21, Diehl, 27 V., 10,000 r.p.m. Price \$4.50 each net.

5069600 Delco 27.5 V. 250 R.P.M. Price \$9.75 ea. net

706343 Delco 27.5 V. 10,000 R.P.M. Shaft 0.5 in. long. Price \$7.50 ea. net

5068571 Delco 27.5 V. 10,000 R.P.M. with blower assembly. Price \$10.00 ea. net

5071895 Delco 27.5 V. 250 R.P.M. Price \$8.50 ea. net

5072400 Delco 27.5 V. 10,000 R.P.M. Shaft 0.5 in. long with worm gear. Price \$6.75 ea. net

GENERAL ELECTRIC D. C. SELSYNS

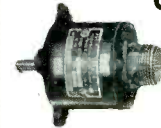

8TJ9-PDN Transmitter, 24 V. Price \$3.75 each net.

8TJ9-PAB Transmitter 24V. Price \$3.75 each net.

8DJ11-PCY Indicator, 24 V. Dial marked—10° to +65°. Price \$4.50 each net.

8DJ11-PCY Indicator, 24 V. Dial Marked 0 to 360°. Price \$7.50 each net.

AMPLIFIER

Pioneer Gyro Flux Gate Amplifier, Type 12076-1-A. Price \$17.50 ea. net, with tubes.

G. E. Servo Amplifier Type 2CV1C1, 115 V. 400 cycle. Price \$9.00 ea. net

Minneapolis Honeywell Amplifier Type G403, 115 V. 400 cycle. Price \$8.00

**INSTRUMENT
ASSOCIATES**

37 EAST BAYVIEW AVE., GREAT NECK, N. Y.
Telephone IMperial 7-1147

Write for Catalog NE100

U. S. Export License-2140

SUPPLIER OF ELECTRONIC & AIRCRAFT EQUIPMENT

**IMMEDIATE
DELIVERY**

INVERTERS

Wincharger Corp. Dynamotor Unit. PE 101-C. Input 13, V.D.C. or 26 V.D.C. D.C. AT, 12.6 or 6.3 amps. Output 400 V.D.C. AT. .135 amps., 800 V.D.C. AT. .02 amps., 9 V.A.C. 80 cycle at 1.12 amps.

Price \$10.00 each net.

153F, Holtzer Cabot, Input, 24 V.D.C. Output 115 V., 400 cycle, 3 phase, 750 V.A. and 26 V., 400 cycle, 1 phase, 250 V.A. Voltage and frequency regulated also built in radio filter.

Price \$115.00 each net.

149H, Holtzer Cabot. Input 28 V. at 44 amps. Output 26 V. at 250 V.A., 400 cycle and 115 V. at 500 V.A., 400 cycle.

Price \$40.00 each net.

149F, Holtzer Cabot. Input 28 V. at 36 amps. Output 26 V. at 250 V.A., 400 cycle and 115 V. at 500 V.A., 400 cycle.

Price \$40.00 each net.

12117, Pioneer. Input 12 V.D.C. Output 26 V., 400 cycle, 6 V.A.

Price \$22.50 each net.

12117-2 Pioneer. Input 24 V.D.C. Output 26 V. 400 cycle, 6 V.A.

Price \$20.00 each net.

12116-2-A Pioneer. Input 24 volts D.C., 5 amps. Output 115 volts 400 cycle single phase 45 watts.

Price \$100.00 each net.

5D21NJ3A General Electric. Input 24 V.D.C. Output 115 V., 400 cycle at 485 V.A.

Price \$12.00 each net.

PE218, Ballentine. Input 28 V.D.C. at 90 amps. Output 115 V., 400 cycle at 1.5 K.V.A.

Price \$50.00 each net.

METERS

Weston Frequency Meter. Model 637, 350 to 450 cycles, 115 volts.

Price \$10.00 each net.

Weston Voltmeter. Model 833, 0 to 130 volts, 400 cycle. Price \$4.00 each net.

Weston Voltmeter. Model 606, Type 204 P, 0 to 30 volts D. C.

Price \$4.25 each net.

Weston Ammeter. Model 506, Type S-61209, 20-0-100 amps. D. C.

Price \$7.50 each net with ext. shunt.

Weston Ammeter. Type F1, Dwg. No. 116465, 0 to 150 amps. D. C.

Price \$6.00 each net.

With ext. shunt \$9.00 each net.

Westinghouse Ammeter. Type 1090-D120, 120-0-120 amp. D. C.

Price \$4.50 each net.

Weston Model 545. Type 82PE Indicator. Calibrated 0 to 3000 RPM. 2 3/4" size. Has built-in rectifier, 270° meter movement.

Price \$15.00 each net.

RECTIFIER POWER SUPPLY

General Electric, input 230 V. 60 cycle 3 phase. Output 130 amps. at 28 V. D.C. Continuous duty, fan cooled, has adjustable input taps. G.E. model No. 6RC146F3. Size: Height 46", width 28", depth 17 1/2". Price \$200.00 each net. New

PIONEER AUTOSYNS

AY1, 26 V., 400 cycle.

Price \$5.50 each net.

AY14D, 26 V., 400 cycle, new with calibration curve.

Price \$15.00 each net.

AY20, 26 V., 400 cycle.

Price \$7.50 each net.



AY5, 26V., 400 cycle. Has hollow shaft.

Price \$7.50 ea. net

PRECISION AUTOSYNS

AY101D, new with calibration curve.



PRICE—WRITE OR CALL FOR SPECIAL QUANTITY PRICES

AY131D, new with calibration curve.

Price \$35.00 each net.

AY130D, new. Price \$35.00 each net.

PIONEER AUTOSYN

POSITION INDICATORS

Type 5907-17. Dial graduated 0 to 360°, 26 V., 400 cycle.

Price \$15.50 each net.

Type 6007-39, Dual, Dial graduated 0 to 360°, 26 V., 400 cycle.

Price \$30.00 each net.

PIONEER TORQUE UNIT

Type 12602-1-A.

Price \$40.00 each net.



Type 12606-1-A. Price \$40.00 each net.

Type 12627-1-A. Price \$80.00 each net.

MAGNETIC AMPLIFIER

ASSEMBLY

Pioneer Magnetic Amplifier Assembly Saturable Reactor type output transformer. Designed to supply one phase of 400 cycle servo motor.

Price \$8.50 each net.

PIONEER TORQUE UNIT

AMPLIFIER

Type 12073-1-A, 5 tube amplifier, Magnesyn input, 115 V., 400 cycle.

Price \$17.50 each net with tubes

ALL PRICES,
F. O. B.
GREAT NECK,
N. Y.

BLOWER ASSEMBLY MX-215/APG

John Oster, 28 V.D.C., 7000 r.p.m. 1/100 h.p. Price \$4.50 each net.

Westinghouse Type FL Blower, 115 V., 400 cycle, 6700 r.p.m., Airflow 17 C.F.M. Price \$3.70 each net.

RATE GENERATORS



PM2, Electric Indicator Co., .0175 V. per r.p.m. Price \$8.25 each net.

F16, Electric Indicator Co., two-phase, 22 V. per phase at 1800 r.p.m.

Price \$12.00 each net.

J36A, Eastern Air Devices, .02 V. per r.p.m. Price \$9.00 each net.

B-68, Electric Indicator Co., Rotation Indicator, 110 V., 60 cycle, 1 phase.

Price \$14.00 each net.

PM-1-M Electric Indicator Co. Same as type B35. 2 V. per 100 R.P.M. Max. speed 5,000 R.P.M. Can be used as D.C. motor, 1/77 H.P. 115 V. D.C.

Price \$9.75 ea. net

SINE-COSINE GENERATORS

(Resolvers)

FPE 43-1, Diehl, 115 V., 400 cycle.

Price \$20.00 each net.

SYNCHROS

1F Special Repeater, 115 V., 400 cycle. Will operate on 60 cycle at reduced voltage.



Price \$15.00 each net.

7G Generator, 115 V., 60 cycle.

Price \$30.00 each net.

2J1F3 Selsyn Generator 115 volts, 400 cycle. Price \$5.50 each net.

2J1M1 Control Transformer 105/63 V., 60 cycle. Price \$20.00 each net.

2J1G1 Control Transformer, 57.5/57.5 V., 400 cycle. Price \$1.90 each net.

2J1H1 Selsyn Differential Generator, 57.5/57.5 V., 400 cycle.

Price \$3.25 each net.

W. E. KS-5950-L2, Size 5 Generator, 115 V., 400 cycle.

Price \$4.50 each net.

5G Generator 115 volts, 60 cycle.

Price \$50.00 each net.

5G Special, Generator 115/90 V., 400 cycle. Price \$15.50 each net.

5SF Repeater, 115/90 V., 400 cycle.

Price \$19.00 each net.

2J1F1 Selsyn Generator, 115 V., 400 cycle. Price \$3.50 each net.

5SDG Differential Generator 90/90 V., 400 cycle. Price \$12.00 each net.

1CT Control Transformer. 90/55 volts, 60 cycle. Price \$40.00 each net.

POSITION TRANSMITTER

Pioneer Type 4550-2-A Position Transmitter, 26 volts 400 cycle, gear ratio 2:1. Price \$15.00 each net.

INSTRUMENT ASSOCIATES

37 EAST BAYVIEW AVE., GREAT NECK, N. Y.
Telephone Imperial 7-1147

Write for Catalog NE100

Western Union address:
WUX Great Neck, N. Y.

**LAVOIE FREQ. METER
MICRO-WAVE
375 to 725 MCS**

Model TS-127/U is a compact, self-contained, precision (± 1 MC) frequency meter which provides quick, accurate readings. Requires a standard 1.5V "A" and 45V "B" battery. Has 0-15 minute time switch. Contains sturdily constructed HI-Q resonator with average "Q" of 3000 working directly into detector tube. Uses 957, L86 and 3S4 Tubes. Complete, new with inst. book, probe and spare kit of tubes. Less batteries. **\$49.50**
Write for descriptive circular.

**MOTOR GENERATORS
DYNAMOTORS, INVERTERS, ETC.**

2.5 KVA MG SET, Diehl Elec. Co. 120V DC to 120V AC, 60 cy, 1 Ph. Complete with Magnetic Controller, 2 Field Rheos and Full Set of Spare Parts Including Spare Armatures for Generator and Motor. Full specs on request. **\$185.00**
2 KVA MG SET, O'Keefe and Merritt. 115V DC to 120V AC, 50 cy. Idles as 3 Ph. syncs motor on 208V, 50 cy. New. Export crated **\$165.00**
1.25 KVA MG SET, Allis-Chalmers. 115V DC to 120V AC, 60 cy, 1 Ph. Fully enclosed. Splashproof. Ball Bearings. Centrifugal Starter. New. **\$97.50**
Same machine but for 230V DC operation. **\$110.00**
Spare Parts for either machine. **\$15.00**
MG SET FOR NAVY TBS TRANSMITTER, Type CG-21302. 440V AC, 60 cy, 3 Ph. 1500VA to 875V DC and 300V DC. New. **\$45.00**
DYNAMOTOR, Navy Type CAJO-21144. 105/130V DC to 13V DC at 40A or 26V DC at 20A. Radio filtered. Complete with Line Switch. New. **\$69.50**
DYNAMOTOR, Ecor. 32V DC to 110V AC, 60 cy, 1 Ph. 2.0A Amps. New. **\$24.50**
DYNAMOTOR, Ecor. 32V DC to 110V AC, 60 cy, 1 Ph. 0.43 Amps. New. **\$17.50**

**MISCELLANEOUS SMALL MOTORS
INVERTERS, AMPLIDYNES**

AMPLIDYNE—G. E. Model 5AM31N19A. 530 Watts. 7500 R.P.M. Input: 27V. DC. Output: 60V. DC. Weight—34 1/4 lbs. New. **\$10.50**
AMPLIDYNE—G. E. Model 5AM21J17. 4600 R.P.M. Motor Compound wound. 150 Watts. Input: 27V. DC. Output: 60V. DC Sig. Corp. U. S. Army MG-27-R. New. **\$16.50**
INVERTER—Leland Elec. Co. Model PE200A. Input: 28V. DC. 38 Amps. Output: 80V., 800 cy. 485 VA. New. **\$12.50**
INVERTER—G. E. Model 5D-21N3JA. Input: 24V. DC. Output: 115V. 400 cy. 485 VA. New. **\$12.50**
INVERTER—Bendix Pioneer Type 12121-A. 24V DC to 115V AC, 400 cy, 3 Ph. 250 VA. New. **\$89.50**
D. C. MOTOR—G. E. Model 5BA 50J42A. 0.5 HP. Armature: 27V. at 8.3 Amps. Field: 60V. at 2.3 Amps. R.P.M. 400. New. **\$12.50**
DYNAMOTOR—Type PE04C. For use with SCR522 Transmitter-Receiver. Brand new in export cases. **\$9.50**

**U. S. NAVY
SOUND POWERED BATTLE
PHONES**

Western Electric No. D173312. Type O. Combination headset and chest microphone as illustrated. Brand new including 20 ft. of rubber covered cable. **\$17.50**
Automatic Elec. Co. No. GL843A0. Similar to above but including Throat microphone in addition to chest microphone. Brand new with 20 ft. rubber covered cable **\$13.50**



**SYNCHRO
GENERATORS**



Brand new—Gov't. sealed and inspected—Packed in overseas cans. Synchro Transmitters 115 V., 60 cy operation. Precision accuracy made for gun fire control. Cost Gov't \$90.00 each. Wgt. 5 lbs. Dimensions: 4 1/2" L x 3 3/4" H. Brand New **\$14.75** Per Pair

Differential Synchros



90/90 volts, 400 cycles. Brand new in sealed containers. Ford Inst. Co. type 5SDG. Brand new. **\$12.50**

MICROWAVE TUNING UNITS

Tuning Units for A1R-1 or A1R-4. TN-16 (38-95 mc). TN-17 (74-320 mc) TN-18 (300-1000 mc.) These front ends may be used with any 30 mc. 1F amplifier or as converters into receivers tuned to 30 mc.)

**MODEL AN/APA-10
PANORAMIC ADAPTER**

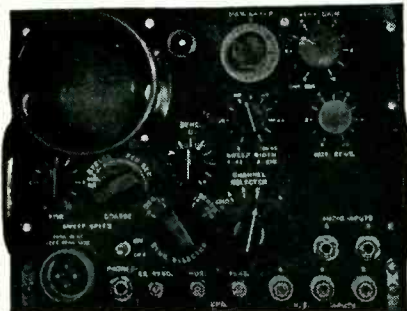

Provides 4 Types of Presentation:

- (1) Panoramic (2) Aural
- (3) Oscillographic (4) Oscilloscopic

Designed for use with receiving equipment AN/ARR-7, AN/ARR-8, AN/APR-4, SCR-587 or any receiver with I.F. of 455kc, 5.2mc. or 30mc. With 21 tubes including 3" scope tube. Converted for operation on 115 V. 60 cycle source. **PRICE \$195.00**



**THERMOSTATIC TIME
DELAY RELAY**

Amperite type 115 No.—45 Heater voltage 115V. Normally open SPST contacts. 45 sec. delay. Contact rating 115V-3A., A.C. or 410V., A.C. 2A) max. voltage on contacts—1000 max. voltage bet. contacts and heater—1500. Size 3 9/32 x 1 1/4" overall. Made for U. S. Navy. **\$1.10**

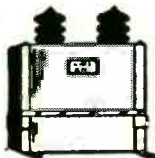

**High Voltage Capacitors
Oil Filled**

25 MFD., 20KV. **\$15.75**
.5 MFD., 25 KV. **\$23.50**
1 MFD., 15KV. **\$16.50**
1 MFD., 7.5KV. **\$4.95**

All brand new. Made by prominent manufacturers.

• **TUBE SPECIALS** •

2J26\$7.50	721A\$3.90
2J27\$12.50	725A\$8.50
2J49\$19.50	7BP7\$4.25
2J82\$35.00	814\$3.60
3B1P1\$2.00	826\$.40
3B22\$2.00	881\$10.00
3B24\$1.45	8020\$1.25
3CP1\$2.60	8025\$3.00
3C45\$10.00	9L17\$3.85
3D21A\$1.00	WE994A\$3.65
5FF7\$1.25	WL531\$6.75
700A\$19.50	C6J\$2.00
706CT\$18.50		

**LINEAR SAWTOOTH
POTENTIOMETER
No. KS 1513B**



\$5.50
Brand New

Has continuous resistance winding to which 24 volts D.C. is fed to two fixed taps 180° apart. Two rotating brushes 180° apart take off linear sawtooth wave voltage at output. Size approximately 3 3/4" dia. x 3" deep x 4 1/2" long. Enclosed in die cast alum. frame with AN connector socket.

**LINE VOLTAGE
STABILIZERS**



RAYTHEON—Navy Type. CRP-301407 Input: 92-138V., 57.63 CPS., 1 PH Output: 115V. 0.82 KVA., 1% Reg. 0.96 PF. Weight 385 lbs. Overall size—36" high x 20" wide x 12 1/4" deep. Enclosed in Navy Grey Ventilated Cabinet for Wall Mounting. **Brand New \$69.50**



RAYTHEON Adj. input taps 95-130V., 60 cy., 1 Ph Output: 115V., 60 Watts. 1/2 of 1% Reg. Wt. 20 lbs. 6 1/4" H x 8 1/4" L x 4 1/2" W. Overload protected. Sturdily constructed. Tropic-sized. **Special \$12.50**

400 CYCLE TRANSFORMERS

AUTO. 400 cy. G.E. Cat. No. 80G184 KVA. 345S—520P. Volts 460/345/230/115. New **\$3.45**
FILAMENT. 400/2600 cy. Input: 0.75/80/85/105/115/123V. Output: 5V3A/3V3A/3V3A/8V2A/5V6A/5V6A/6.3V2A/6.3V2A. New. **\$1.95**
HYDRATRON POWER. 400/1600 cy. Raytheon UX-3876. 400/1600 cy. Pri: 115V. Sec: 50-0-50V at 0.5A, 6.3V at 1.2A. Test r.m.s. 1780. New **\$2.75**
PLATE. WECO K59560. 400/800 cy. Pri: 115V. Sec: 1350-0-1350 at .057A. (2700V Total). Elecostat shielded. Wt. 2.3 lbs. New. **\$2.95**
SCOPE PL. & FIL. WECO 9556. 400/2400 cy. Pri: 115. HV. Wdg. 1125V at .008A. Fil. Wdgs. 6.4V4A/2.5V1.75A/6.3V.6A. Elecostat shielded. Wt. 1.4 lbs. New. **\$2.75**
FILAMENT. 400/2600 cps. WECO K59533. 400/115V. Sec: 3.2V1.25A/6.35V1.5A Elecostat shielded. Wt. 0.5 lbs. New. **\$1.65**
PLATE & FIL. 400/2600 cy. Pri: 0/80/115V. Sec. #1= 1200VDC at 1.5MA. Sec #2=400VDC at 130MA. Fil Secs: 6.4V4.3A/6.35V0.8A (Ins. 1500V)/5V2A/5V2A. WECO K59598. 4 Henry 100MA. 400cps. WECO K59598. 4 Henry 100MA **\$1.00**

400 CY. SERVO TRANSFORMERS

G.E. #68G665X Pri: 57.5V. Sec: #1=28.75V. Sec: #2=28.75V **\$1.50**
G.E. #68G666X Pri: 57.5V. Sec: 115V C.T. **\$1.50**
G.E. #68G667 Pri: 220 V C.T. Sec: 220V. C.T. **\$1.50**
G.E. #68G668X Pri: 115V. Sec: 275V/275V/275V/230V/230V/6.3V CT/ 6.3V CT. **\$3.50**

60 CYCLE TRANSFORMERS

1.5 KVA STEPDOWN. G.E. Cat. No. 760173. Pri: 115/230V Sec: 23/11.5V. Either high voltage connection may be used with either low voltage connection. Wt. 2.3 lbs. New. **\$23.55**
50KVA STEPDOWN. Standard Trans Corp. Oil trans type MD. Pri: 450V111A. Sec: 117V427A. Navy type. Ambient temp. 50 Deg. C. **\$125.00**
FILAMENT. Raytheon Hypersol Core. Pri: 115V. Sec: 6.3V22A/6.3V2.4A/6.3V2.25A/6.3V0.6A Ins. for 1700V **\$3.9.**

PULSE TRANSFORMER

PULSE. WECO KS-9563. Supplies voltage peaks of 3500V from 807 tube. Tested at 2000 Pulses/sec and 5000V peak. Wdg. 1-2=18 ohms. Wdg. 1-3=72 ohms. L of Wdg. 1-3= .073-.082H at 100 cps **\$5.50**

**12 and 24 Volt
POWER KIT**

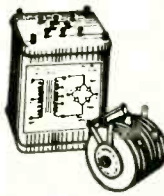

Consists of Power Trans. and full wave bridge selenium rectifier. Input: 115/230 A.C. Output: 12/24V D.C. at 1.1 amps. Fine for operating relays, small motors, dynamometers, or for low voltage D.C. source in laboratories, etc.

Brand New **\$7.95**

**SWEEP GENERATOR
CAPACITOR**

High speed ball bearings. Split stator silver plated coaxial type 5/10 mmfd. Brand new. **\$1.00**



PARABOLOIDS

Spun Magnesium dishes 1 1/2" dia., 4" deep. Mounting brackets for elevation and azimuth control on rear. 1 1/2" x 1 1/2" opening in center for dipole. Brand new per pair. **\$8.75**

All prices indicated are F O B Tuckahoe, New York. Shipments will be made via Railway Express unless other instructions issued.

ELECTRONICRAFT

INC.

5 WAVERLY PLACE TUCKAHOE 7, N. Y.
PHONE: TUCKAHOE 3-0044

All merchandise guaranteed. Immediate delivery, subject to prior sale. All Prices Subject to Change Without Notice

Latest WELLS Tube Price List

Many Types Are Now Scarce At These Low Prices. Check your requirements at once for your own protection. All tubes are standard

brand, new in original cartons, and guaranteed by Wells. Order directly from this ad or through your local Parts Jobber.

TYPE.	PRICE EA.	TYPE.	PRICE EA.	TYPE.	PRICE EA.	TYPE.	PRICE EA.	TYPE.	PRICE EA.	TYPE.	PRICE EA.	
0A4G	.95	5AP1	3.75	7B4	.55	RK60/1641	.65	HY615	.35	866A	1.30	
EL-C1A	3.95	EL-C5B	4.25	7B8	.60	VT62 BRITISH	1.00	WL632A	8.75	869	19.75	
1A3	.60	5BP1	2.45	7C4/1203A	.35	HY65	3.25	700	17.95	869B	27.25	
1A5GT	.65	5BP4	3.99	7C5	.60	66B4	.90	700B	17.95	872A	2.45	
C1B/3C31	3.75	5CP1	2.45	7C7	.60	VT67/30	.58	700C	17.95	874	.90	
1B4P	1.05	5D21	22.50	7E5/1201	.60	70L7	1.05	700D	17.95	876	.40	
1B21A/GL471A	2.55	5FP7	1.75	7E6	.55	CEQ72	1.45	701A	3.00	878	1.75	
1B22	3.40	5GP1	2.98	7F7	.60	CRP72	.95	702A	2.60	879/2X2	.45	
1B23	7.50	5H-4	BALLAST	.45	7H7	.60	CYN72	1.65	703A/368AS	3.60	902	3.75
1B27	7.75	5HP4	4.75	7L7	.65	RKR72	.90	704A	1.05	931A	3.95	
1B32/532A	1.85	5J23	13.00	7Y4	.50	RKR73	1.23	705A/8021	1.00	954	.30	
1B42	6.75	5J29	13.45	9-3 BALLAST	.45	76	.40	706AY	17.50	955	.45	
1B48	9.90	5U4G	.75	10	.50	77	.45	707A	12.95	957	.35	
EL-1C	4.85	5W4	.75	10 ACORN	.55	78	.45	707B	14.45	958A	.35	
1C5GT	.65	6-4 BALLAST	.35	10/VT25A	.53	VR78	.65	708A	3.45	967/FG17	3.75	
1C6	.75	6-7 BALLAST	.35	10E/146	1.00	80	.45	709A	4.75	991/NE16	.24	
1C7G	.85	5A3	.80	10T1 BALLAST	.50	FG81A	3.95	710A/8011	1.25	1005	.30	
1D8GT	.90	6A6	.65	10Y/VT25	.45	83V	.90	713A	1.45	1007	4.50	
1E7GT	.95	6AB7/1853	.95	12A6	.25	89	.42	714AY	3.55	CK1089	3.90	
1G6	.65	6AC7/1852	.90	12A6GT	.25	89Y	.40	715B	6.55	CK1090	2.65	
1L4	.50	6AF6G	1.10	12AH7GT	1.10	VR90	.95	717A	.60	1148	.35	
1LC6	.75	6AG5	1.20	12BD6	.65	VT90 BRITISH	2.55	721A	2.60	1201	.45	
1LN5	.80	6AH6	1.00	12C8	.40	VR92	.40	722A/287A	9.50	1203	.45	
1P24	1.75	6AK5	1.20	12F5GT	.55	FG95/DG1295	9.95	723AB	14.95	1203A	.65	
1Q5GT	.85	6AK6	.80	12H6	.35	VT98/REL5	14.95	724A	3.85	1236	1.75	
1R4	.55	5AL5	.85	12J5GT	.35	100R	1.05	724B	3.85	1294/1R4	.55	
1S5	.60	5A06	.65	12J7GT	.59	101/837	1.65	725A	6.85	DG1295	9.95	
1T4	.65	6AU6	.65	12K8	.59	102F	3.55	726A	4.95	1299/3D6	.45	
2A7	.70	6AV6	.65	12SA7GT	.62	FG105	9.75	726B	13.50	1299A	.60	
2B7	.70	6E4G	.90	12SF7	.50	VU111S	.45	730A	9.95	1613	.55	
2B22/GL559	1.75	6B7	.75	12SG7	.55	114B	.80	801	.40	1616	.75	
2C22/7193	.35	6B8	.65	12SH7	.40	121A	2.55	801A	.65	1619	.35	
2C26	.30	6B8G	.75	12SJ7	.60	122A	2.65	803	3.40	1624	1.25	
2C26A	.40	6BA6	.65	12SK7	.55	VT127 BRITISH	.35	804	6.90	1625	.35	
2C34	.40	6C4	.40	12SL7GT	.55	VT127A	2.95	805	5.75	1626	.35	
2C40	5.25	5C5	.55	12SN7GT	.59	VR150	.48	808	1.65	1629	.35	
2C44	1.25	5C6	.65	12SR7	.50	VT158	14.95	809	2.65	1630	2.75	
2E22	1.10	6C8G	.70	12X825 2A.TUNG1	.45	FG172	19.25	811	2.35	1638	.65	
2J21	10.45	6C21	19.10	13-4 BALLAST	.35	205B	1.35	812	2.95	1641/RK60	.65	
2J21A	10.45	6D6	.50	14B6	.75	211/VT4C	.40	813	8.95	1642	.55	
2J22	9.65	6F5	.65	14Q7	.55	215A/VT5	.28	814	2.60	1852/6AC7	.90	
2J26	8.45	6F6	.60	15E	1.40	221A	1.75	815	2.35	1853/6AB7	.95	
2J27	12.95	5F6G	.60	15R	.70	227A	2.90	826	.75	1960	.85	
2J31	9.95	5F8G	.85	16X879 2A.TUNG1	.35	231D	1.20	830B	3.95	1961/532A	1.85	
2J32	12.85	6G6G	.85	FG17/967	3.25	RX233A	1.95	832	6.50	1984	1.75	
2J33	18.95	6H6	.45	19	.85	257A	3.00	832A	7.95	2051	.75	
2J34	17.50	5H16 BALLAST	.45	20-4 BALLAST	.45	268A	2.95	834	5.75	UX6653	1.20	
2J37	13.85	6J5	.45	REL-21	2.10	274B	2.65	835/38111A	1.00	7193	.35	
2J38	9.95	6J5GT	.45	21-2 BALLAST	.45	282B	5.25	836	1.45	8011	2.55	
2J48	19.95	6J6	.85	23D4 BALLAST	.45	287A/722A	9.50	837	2.25	8012	2.75	
2J61	24.50	5J7	.65	RK24	1.55	304TH	3.70	838	3.10	8013	1.25	
2K25/723A/B	14.95	6J8G	.95	24A	.40	304TL	1.95	841	.40	8020	2.10	
2X2	.45	6K6GT	.55	VT25A/10	.45	307A/RK75	3.60	842	2.75	8025	6.75	
2Y3G	1.20	6K7	.65	25Z5	.65	316A	.45	843	.40	9001	.45	
3-16 BALLAST	.45	6K7G	.65	25Z6GT	.52	327A	2.50	851	39.00	9002	.40	
3A4	.35	6L6	1.10	26	.55	350B	1.85	852	6.10	9003	.45	
3A4/47	.45	6L7	.75	27	.55	354C	14.95	860	7.55	9004	.55	
3B7/1291	.40	6N7	.85	28D7	.40	356B	4.95	864	.40	9006	.30	
3B22	2.35	6N7GT	.85	30/VT57	.58	368AS/703A	3.75	865	1.85	38111A/835	1.00	
3B24	1.75	6Q7	.55	30	.40	371A	.80					
3BP1	3.45	6R7	.75	33	.70	371B	.80					
EL-3C	3.95	6R7G	.75	34	.33	388A	2.95					
3C21	4.85	6R7GT	.55	RK34/2C34	.35	393A	3.60					
3C24/24G	.45	6S7G	.85	35/51	.55	394A	3.60					
3C31/C1B	3.75	6SA7GT	.55	35W4	.45	395A	4.85					
3CP1/S1	1.95	6SC7GT	.65	35Y4	.50	MX408U BALLAST	.30					
3D6/1299	.30	6SF5GT	.69	36	.55	417A	14.25					
3D21A	.95	6SG7	.65	37	.35	434A	2.85					
3DP1	3.75	6SH7	.40	38	.35	446A	1.15					
3FP7	1.85	6SH7GT	.40	39/44	.30	446B	1.75					
3FP7A	2.25	6SK7GT	.50	43	.50	GL451	1.90					
3GP1	4.95	6SL7GT	.60	45SPEC. 7V. FIL.	.28	GL471A	2.75					
3H-1-7 BALLAST	.45	6SQ7	.55	46	.65	SS501	3.00					
3HP7	3.45	6SR7GT	.55	EF50	.45	527	12.85					
3Q5	.65	5U7G	.55	50B5	.65	WL530	2.75					
3Q5GT	.65	5V6GT	.75	50L6GT	.54	WL531	1.75					
3S4	.60	6X5GT	.73	VT52/45SPEC.	.28	WL532	1.65					
GA4	2.00	7-7-11 BALLAST	.56	56	.70	532A/1B32	1.85					
REL-5	14.95	7A4/XXL	.55	57	.45	GL559	2.10					
VT5/215A	.40	7A7	.56	58	.50	KU610	6.90					

JUST OUT - CATALOG H500
Manufacturers, Distributors and Amateurs: Write for the brand new Wells Electronic Catalog H500. It's full of Tremendous values in highest quality components.



PARTS SHOW VISITORS: Be Sure to See Our Huge Display at Our LaSalle Street Show Rooms

320 N. LA SALLE ST. DEPT. SL, CHICAGO 10, ILL.

SEARCHLIGHT SECTION

ASB YAGI ANTENNA

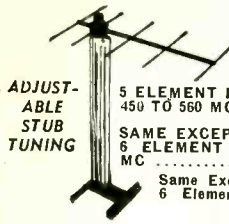

ADJUST-ABLE 5 ELEMENT ROTATABLE ARRAY—450 TO 560 MC \$7.00
 STUB SAME EXCEPT DOUBLE STACKED 6 ELEMENT 450 TO 560 MC \$12.70
 TUNING Same Except Double Stacked 6 Element 370 TO 430 MC \$29.40

Double stacked antennas can be supplied with hydraulic remote controls at \$29.50 per set additional.

PULSE TRANSFORMERS

UTAH 9262	\$1.50
UTAH 9278	\$1.50
G. E. 68C-627	\$3.75
AN/APN-9 (901756-501)	\$1.25
AN/APN-9 (901756-502)	\$1.25
AN/APN-4 Block. Osc88

CAPACITORS

MOLDED OIL-IMPREGNATED PAPER

.02 MFD	200VDC	.04 1/2 Ea.	\$3.00 per 100
.05	200	.04 1/2	3.00
.1	200	.06 1/2	3.00
.25	200	.06	4.00
.1	400	.09	6.00
.005	600	.04 1/2	3.00
.01	600	.07	4.75
.05	600	.08	5.50

OIL-FILLED CAPACITORS

50 MFD	220 VAC	\$2.95
60 MFD	330 VAC	\$4.89
32 MFD	2500 VDC	\$10.80
7 MFD	660 VAC	\$2.95
3.5-.5 MFD	1000 VDC	..77
.1 MFD	7000 VDC	\$1.79
.045 MFD	16 KVDC	\$4.70

SPECIAL
 2 MFD 12,500 VDC
 INERTEEN TYPE FP
 \$23.95

KOLLSMAN INSTRUMENT
 LOW INERTIA SERVO MOTORS
 Type 937-0240—85/68 Volts—100 Cycles
 2 Phase—5 Watts—2650 RPM
 Will Operate Satisfactorily at 60 Cycles
 Original Price \$34.50—Our Price—\$8.22 ea.
\$7.50 EACH—Lots of 10

STANDARD BRANDS ONLY

COAXIAL CONNECTORS



83-1AC	.42 UG-12/U	.63 UG-86/U	1.22
83-1AF	.15 UG-21/U	.67 UG-87/U	.68
83-1F	1.12 UG-22/U	.86 UG-171/U	1.33
83-1H	.10 UG-23/U	.63 UG-175/U	.15
83-1J	.80 UG-24/U	.67 UG-176/U	.15
83-1R	.28 UG-27/U	.68 UG-180A/U	3.82
83-1SP	.28 UG-29/U	.83 UG-191/AP	.57
83-1SPN	.28 UG-30/U	.94 MX-195/U	.41
83-1T	1.12 UG-34/U	12.80 UG-197/U	1.33
83-22AP	1.10 UG-36/U	12.80 UG-206/U	.58
83-22F	1.48 UG-37/U	12.80 UG-255/U	.82
83-22R	.48 UG-58/U	.57 UG-264/U	1.74
83-22SP	.60 UG-85/U	.62 MX-367/U	.15

FULL LINE OF JAN APPROVED COAXIAL CONNECTORS IN STOCK

GENERAL ELECTRIC
FG-172
 THYRATRONS
\$1450

\$1000 EA.
 IN LOTS OF 10
 BRAND NEW
 ORIGINAL CARTONS
 FULLY GUARANTEED

GENERAL ELECTRIC
FG-32 TUBES
\$425
 \$3.75 Ea. - Lots of 10
 Brand New
 Original Cartons

IGNITRONS
 GL-415/5550 \$22.00
 WL-681/5550 \$22.00
 WL-652/5551 \$38.00

SELENIUM RECTIFIER STACKS

FULL WAVE BRIDGE

MAXIMUM RATINGS	AC VOLTS INPUT	18	MAXIMUM RATINGS	AC VOLTS INPUT	40
DC VOLTS OUTPUT	14.5		DC VOLTS OUTPUT	34	

1.2 Amps	\$2.64	0.6 Amps	\$3.00
2.4	3.07	1.2	3.44
6.4	4.09	3.2	5.15
13.0	7.67	6.0	9.32
17.5	8.69	9.0	10.05
26	15.33	12	18.64
39	23.00	18	20.12
52	30.67	24	35.96
65	38.33	36	41.24

All voltage and current ratings based on continuous operation in 35°C. (95°F.) ambient, self-cooled. Current ratings can be increased up to 2 1/2 times normal ratings by intermittent operation or forced cooling.

GENERATORS

- Eclipse-Pioneer type 716-3A (Navy Model NEA-3A) Output—AC 115V 10.4A 800 to 1400 cy 1 φ DC 30 Volts 60 Amps. Brand New — Original Packing \$38.50
- Eclipse-Pioneer type 1235-1A. Output—30 Volts 15 Amps. Brand New—Original Packing.....\$9.50

NAVY MODEL AIA ANTENNAS
 3 CM Conical Scan Aircraft Intercept Antenna Assys. Brand New \$120.00

TEST EQUIPMENT

- Alfred W. Barber Labs. Mod. VM-25 VTVM * \$86.00
 - General Radio Model P-500A Standard Signal Generator (Same as G. R. 805A except covers 9KC to 32 MC) * \$450.00
 - Galvin Model CES-1 Standard Crystal Test Set * \$45.00
 - TS-10A/APN Delay Line Test Set..... \$25.00
 - TS-19/APQ-5 Calibrator..... \$75.00
 - AT-48/UP "X" Band Horn..... \$35.95
 - REL W-1158 Frequency Meter 60-220 MC..... \$32.95
 - CWI-60AAG Range Calibrator for ASB, ASE, ASV and ASVC Radars..... \$38.95
 - CRV-14AAS Phantom Antenna for Transmitters up to 400 MC..... \$11.75
 - Raytheon VR-5 Constant Voltage Transformer Input 95/130 V 60 cy—Output 115 V 500 W * \$38.50
 - Sola Constant Voltage Transformer Input 95/125 V 60 cy—Output 15.8 V 285 VA..... \$24.70
 - Federal Constant Voltage Transformer Input 95/135 V 50/60 cy—Output 115 V 210 W..... \$34.00
 - Sola Constant Voltage Transformer—Input 95/125 V 60 cy—Output 115 V 90 VA—Price on request.
 - TS-146/AP "X" Band Test Set. Price on request.
 - TS-184/AP "X" Band Test Set. Price on request.
 - CPR-60AAJ and CPR-60AAK—IFF Test Sets. (pair) \$16.95
 - Navy Model LD-3 Combined Heterodyne Freq. Meter and Crystal Controlled Calibrator Equip. Mfd. by General Radio—100 KC to 5000 KC—Input 115 V 60 cy —Output 15.8 V 285 VA..... \$370.00
 - C-D Quietone Filter Type IF-16 110/220 V AC/DC 20 Amps..... \$9.00
- All Items New Except Where Noted * (Exc. Used Condition)

TYPE "J" POTENTIOMETERS

38c each		38c each	
Resis.	Shaft	Resis.	Shaft
100	SS 10K	50K	5/8"
200	SS 10K	50K	SS
500	SS 15K	100K	5/8"
650	SS 15K	100K	SS
1000	SS 20K	150K	1/4"
5000	3/8" 25K	200K	SS
6500	SS 25K	250K	SS
10K	3/8" 30K	1 1/8" 1 MEG	SS

Triple 100K - 3/8" Shaft - 1.47
 All shaft lengths beyond bushing - SS (screw slot)

TUBE SPECIALS

BRAND NEW FIRST QUALITY

RECEIVING TUBES	6F6 .69	CATHODE RAY	2AP1 3.65	THYRATRONS AND IGNITRONS	0A4G .95	TRANSMITTING & SPECIAL PURPOSE TUBES	4B22/EL-5B 5.20	PG-190 12.15	561 1.45	813 7.25
OZ4G .59	6J6 .49	2AP2 5.95	2A1P 4.63	EA-C1A 3.35	4C28 8.95	4B25/EL-6CF 8.70	203B 4.33	579B 5.74	814 3.79	
1A3 .45	6J7 .52	2AP5 5.65	3AP1 4.63	2A4G 1.15	4C28 21.65	4C28 21.65	204A 27.90	HY615 .29	815 1.72	
1AB5 .73	6K6GT .72	3AP1 4.63	3AP1 4.63	2D21 1.09	4E27 12.75	5D21 26.50	CE-206 3.15	700B 16.90	826 .57	
1B3GT 1.18	6K7 .54	3AP4 5.94	3BP1 2.59	2D21 1.09	5D21 26.50	5E25 14.20	211 .62	700C 16.90	828 13.48	
1L4 .26	6K8 1.22	3BP1 2.59	3CP1 1.87	3C23 3.20	5E25 14.20	5E29 14.20	211 .62	700D 16.90	829 4.41	
1R4 .16	6L6 1.11	3CP1 1.87	3DPIA 5.75	3C31/EL-1B26 4.50	5E29 14.20	5E29 14.20	227A 2.40	700E 16.90	830B 3.35	
1R5 .69	6L6G 1.11	3CP1 1.87	3EPI 2.92	3C31/EL-1B26 4.50	5E29 14.20	5E29 14.20	227A 2.40	700F 16.90	831 4.91	
1S4 .86	6L6GA .87	3DPIA 5.75	3EP2 2.92	C1B 3.35	5E29 14.20	5E29 14.20	227A 2.40	700G 16.90	832 4.91	
1S5 .64	6SB7Y .79	3EP2 2.92	3EP3 4.91	4C35 21.00	5E29 14.20	5E29 14.20	227A 2.40	700H 16.90	833A 5.50	
1T4 .64	6SC7 .66	3FP7 3.98	3EP4 4.91	EL-C5B 8.95	5E29 14.20	5E29 14.20	227A 2.40	700I 16.90	833B 5.50	
2X2/879 .49	6SB7 .72	3HP7 4.91	4AP10 5.35	C6J 4.44	5E29 14.20	5E29 14.20	227A 2.40	700J 16.90	833C 5.50	
2X2A .79	6SG7 .69	4AP10 5.35	4AP11 3.75	FG-17 2.89	5E29 14.20	5E29 14.20	227A 2.40	700K 16.90	833D 5.50	
3A4 .61	6SH7 .49	5AP4 4.75	5AP4 4.75	FG-33 11.95	5E29 14.20	5E29 14.20	227A 2.40	700L 16.90	833E 5.50	
3A5 .96	6SJ7 .59	5AP4 4.75	5BP1 2.40	FG-67/- 8.85	5E29 14.20	5E29 14.20	227A 2.40	700M 16.90	833F 5.50	
3AB8T 1.76	6SL7GT .69	5BP1 2.40	5CP1 2.87	FG-81A 4.95	5E29 14.20	5E29 14.20	227A 2.40	700N 16.90	833G 5.50	
3B7/1291 .29	6SN7GT 1.45	5CP1 2.87	5EP7 1.05	5E29 14.20	5E29 14.20	5E29 14.20	227A 2.40	700O 16.90	833H 5.50	
3D6/1299 .29	6V6 1.07	5EP7 1.05	5HP4 3.35	5E29 14.20	5E29 14.20	5E29 14.20	227A 2.40	700P 16.90	833I 5.50	
3O5GT .79	6V6 1.07	5HP4 3.35	5JP2 9.55	5E29 14.20	5E29 14.20	5E29 14.20	227A 2.40	700Q 16.90	833J 5.50	
3S4 .61	6V6GT .65	5JP2 9.55	5LP1 13.95	5E29 14.20	5E29 14.20	5E29 14.20	227A 2.40	700R 16.90	833K 5.50	
5R4CY 1.30	6X4 .79	5LP1 13.95	5MP1 10.65	5E29 14.20	5E29 14.20	5E29 14.20	227A 2.40	700S 16.90	833L 5.50	
5T4 .89	6X4 .79	5MP1 10.65	5P1 12.87	5E29 14.20	5E29 14.20	5E29 14.20	227A 2.40	700T 16.90	833M 5.50	
5U4G .59	6X5GT .79	5P1 12.87	5P1 12.87	5E29 14.20	5E29 14.20	5E29 14.20	227A 2.40	700U 16.90	833N 5.50	
5V4G .84	7F7 .79	5P1 12.87	5P1 12.87	5E29 14.20	5E29 14.20	5E29 14.20	227A 2.40	700V 16.90	833O 5.50	
5Z3 .65	7N7 .79	5P1 12.87	5P1 12.87	5E29 14.20	5E29 14.20	5E29 14.20	227A 2.40	700W 16.90	833P 5.50	
6AB7/1853 .99	10Y .19	5P1 12.87	5P1 12.87	5E29 14.20	5E29 14.20	5E29 14.20	227A 2.40	700X 16.90	833Q 5.50	
6AC7/1852 .79	12A6 .24	5P1 12.87	5P1 12.87	5E29 14.20	5E29 14.20	5E29 14.20	227A 2.40	700Y 16.90	833R 5.50	
6AC7W 1.45	12AH7GT .87	5P1 12.87	5P1 12.87	5E29 14.20	5E29 14.20	5E29 14.20	227A 2.40	700Z 16.90	833S 5.50	
6AG5 .89	12AT6 .59	5P1 12.87	5P1 12.87	5E29 14.20	5E29 14.20	5E29 14.20	227A 2.40	700AA 16.90	833T 5.50	
6AG7 1.19	12AT7 .79	5P1 12.87	5P1 12.87	5E29 14.20	5E29 14.20	5E29 14.20	227A 2.40	700AB 16.90	833U 5.50	
6AJ5 .89	12AU6 .72	5P1 12.87	5P1 12.87	5E29 14.20	5E29 14.20	5E29 14.20	227A 2.40	700AC 16.90	833V 5.50	
6AK5 1.20	12AU7 .86	5P1 12.87	5P1 12.87	5E29 14.20	5E29 14.20	5E29 14.20	227A 2.40	700AD 16.90	833W 5.50	
6AK6 .82	12AX7 .86	5P1 12.87	5P1 12.87	5E29 14.20	5E29 14.20	5E29 14.20	227A 2.40	700AE 16.90	833X 5.50	
6AL5 .69	12BA6 .64	5P1 12.87	5P1 12.87	5E29 14.20	5E29 14.20	5E29 14.20	227A 2.40	700AF 16.90	833Y 5.50	
6AQ5 .72	12BA7 .86	5P1 12.87	5P1 12.87	5E29 14.20	5E29 14.20	5E29 14.20	227A 2.40	700AG 16.90	833Z 5.50	
6AQ6 .65	12BE6 .64	5P1 12.87	5P1 12.87	5E29 14.20	5E29 14.20	5E29 14.20	227A 2.40	700AH 16.90	833AA 5.50	
6AS7G 4.22	12C8 .59	5P1 12.87	5P1 12.87	5E29 14.20	5E29 14.20	5E29 14.20	227A 2.40	700AI 16.90	833AB 5.50	
6AT6 .54	12SG7 .69	5P1 12.87	5P1 12.87	5E29 14.20	5E29 14.20	5E29 14.20	227A 2.40	700AJ 16.90	833AC 5.50	
6AU6 .72	12SH7 .49	5P1 12.87	5P1 12.87	5E29 14.20	5E29 14.20	5E29 14.20	227A 2.40	700AK 16.90	833AD 5.50	
6AV6 .55	12SJ7 .49	5P1 12.87	5P1 12.87	5E29 14.20	5E29 14.20	5E29 14.20	227A 2.40	700AL 16.90	833AE 5.50	
6BA6 .65	12SK7 .59	5P1 12.87	5P1 12.87	5E29 14.20	5E29 14.20	5E29 14.20	227A 2.40	700AM 16.90	833AF 5.50	
6BA7 .86	12SL7GT .69	5P1 12.87	5P1 12.87	5E29 14.20	5E29 14.20	5E29 14.20	227A 2.40	700AN 16.90	833AG 5.50	
6BE6 .65	12SN7GT .79	5P1 12.87	5P1 12.87	5E29 14.20	5E29 14.20	5E29 14.20	227A 2.40	700AO 16.90	833AH 5.50	
6BG6G 1.72	12SR7 .69	5P1 12.87								

TEST EQUIPMENT

- | | |
|------------------------|------------------------|
| I 135 Test Set | TS 251 |
| BC 771 Frequency Meter | BC 221 Freq. Meter |
| BC1287 Scope | I 222 Signal Generator |
| TS 62/AP | LM Frequency Meters |
| TS 13/AP | |
| TS 102A/AP | |

RC 150 EQUIPMENT

- Receiver BC 1161 A
- Transmitter BC 1160 A
- Control Unit BC 1162 A
- Signal Generator I-198A

Miscellaneous Specials

- ID6/APN4 - Scope
- R78/A PS 15 - Scope
- R7/APS 2 Receiver and Scope
- ASB7 Scope
- SCR 522 Receiver-Transmitter
- MN26 C- or Y Receiver
- RA 10 Receiver
- BC 639 Receiver
- RA 42 Rectifier
- TA2J24 Transmitter
- SCR 269 G Compass Installation
- ARN7 Compass Installation
- MN 26 Compass Installation
- ILS Installation (BC733 & R89)
- SCR 584 components
- R 132/TPS10 Radar Receiver
- MD22 - URA/T1 Modulator
- AN/APRI Receiver and Tuning units
- ASB 7 Complete Radar Installation
- BD 71—6 position Field Switchboard
- E88 Field Phones
- RM 29 Remote Phone Control
- SCR 183 complete
- ARC/1 Transceiver
- ART 13 Transmitter
- BC348 Receiver
- RTA1B Transceiver
- Model 15 Radar Trainer
- BC-906-Frequency Meter

PRICES OF ABOVE UPON REQUEST

T-85/APTS UHF TRANSMITTER

Operating over a frequency range of 300 to 1400 MCPC with a nominal output of from 10 to 30 watts. Unit is equipped with 110 V 60 CFS filament transformer; blower; lecher wire test frequency set, and 8 tubes—1-931A; 2-6AC7; 2-6AG7; 1-6L6G; 2-829B; 1-3C22 (GL522) (oscillator).

New in original box with Operating Instruction Manual..... **\$69.50**

Portable VHF Communication Unit

Two-way radio telephone equipment designed for operation between 152 and 162 megacycles. Adaptable for many uses, a complete unit including the rechargeable storage battery weighs but fifteen pounds, and is housed in a sturdy case 11½" x 9" x 4¾", provided with shoulder straps.

This brand new set of big name manufacture comes complete with battery, battery tray, and handset but less crystal \$89.50. Battery charger is extra at \$19.95.

Mobile VHF Communication Unit

Adaptable for many mobile uses, this is a compact unit 3½" x 8" x 15½" operating on 152 to 162 megacycles. It is six volt powered direct from storage battery, and is complete with the tone filter and crystal; handset, control box, antenna and installation kit.

Brand new, ready to go **\$129.50**

Extra 18" stub type antennae are available, **\$2.95**

BC-603 Receiver—Good, Used..... **\$19.95**

BC-604 Transmitter FM 20-28 MC

11 and 15 meters. Can be operated on 10 meters-10 channel push button crystal. With all tubes and meter but less dynamotor. Excellent condition..... **\$12.95**

Crystals—Set of 80..... **14.95**

Condensers

2 mfd. 4000 VDC. OIL FILLED.....	Each	\$2.95
	4 for	10.00
1 mfd. 6000 VDC. OIL FILLED.....		1.98
.25 mfd. 15000 VDC. OIL FILLED.....		4.95
.00025 mfd. 25000 VDC. OIL FILLED.....		2.95
.4 mfd. 1500 VDC. OIL FILLED.....		.29
	10 for	2.49
2 mfd. 600 VDC. OIL FILLED.....		.39
	3 for	1.00
1 mfd. 600 VDC. OIL FILLED.....		.24
	5 for	1.00
.1x.1x.1—1200 VDC. OIL FILLED.....		.59
	2 for	1.00
50 mmfd—5KV—5 Amp. Vacuum Cond....		1.19

ARROW has the VALUES!

RADIO EQUIPMENT R. C.-100-B



This equipment made by General Electric, was designed for ground use as an identification of friendly aircraft.

Radio equipment RC-100-B consists of Cabinet CH-118 in which are mounted Transmitter BC-769, Keying unit BC-770, Radio Receiver BC-768, Rectifier RA-52, Wave Trap FL-25, wiring and Blower. Additional equipment consists of Antenna unit AN-82B; Transmission line MC-377, air compressor M-349, Oven M-348, control box BC-773, Amplifier BC-783B and associated cords and hardware.

Primary requirements are 110 to 120 volts, 50 to 60 cycle for the entire unit and accessories.

Cabinet CH-118 is of the Standard 19 inch rack type structural steel frame with runner angles for each of the units. A full length access door with safety interlocks forms the rear of the cabinet.

Transmitter BC-769 is designed to transmit RF pulsed signals at 470 megacycles with the use of two type 15E Tubes operating in push-pull with resonant grid, plate and filament lines.

Keying unit BC-770 furnishes the pulse of the Transmitter.

Receiver BC-768 was used to detect the 493.5 megacycle reply pulses from the interrogated station and to sufficiently amplify these signals for oscilloscope observation.

Rectifier RA-52 produces the high voltage. An 0-15 kilovolt DC Meter is connected across the output of the filter to measure the voltage fed to transmitter BC-769, while an 0-20 milliammeter is connected to the ground return to measure the average current drawn.

Antenna AN-82B consists of 24 vertically polarized, half wave radiating elements, a reflecting screen, open-wire transmission line sections and a concentric-line terminating section or elevator.

Wave trap FL-25 is used to separate received and transmitted signals.

Transmission line MC-377 is of 7/8 inch air-dielectric, 70 ohm concentric line type and is assembled by means of solderless air tight connectors.

Control Box BC-773 contains necessary controls for operation.

Amplifier BC-783-B is used to amplify the output of Receiver BC-768 for suitable oscilloscope presentation.

Air Compressor M-349

together with 12 feet of ¼ inch soft copper tubing and necessary hardware is used to fill and maintain transmission lines with dry air under pressure. Operation is direct from 110 V AC 60 Cycles.



Oven M-348

is furnished for removal of moisture from the dehydrating cylinders of the compressor. It too operates from 110V AC 60 cycles.

Frequency Meter BC-771

Frequency Meter BC-771 is used for frequency checking and for tuning operations on Radio Transmitter BC-769 and Radio Receiver BC-768. It is a separate unit mechanically and has its own power supply, which requires a 110 to 120 Volt, 50 to 60 cycle source.

The circuits consist of an r-f oscillator, a crystal oscillator, a 30,000 cycle oscillator and associated mixer, multiplier, and amplifier tubes. The crystal oscillator is used to set the r-f oscillator to exactly 94 or 98.7 megacycles.

For tuning Radio Transmitter BC-769 to 470 megacycles, the signal from the radio transmitter is mixed with the fifth harmonic of the r-f oscillator, operating at 94 megacycles, to produce an audio-beat frequency. For tuning Radio Receiver BC-768 to 493.5 megacycles, the fifth harmonic r-f oscillator, operating at 98.7 megacycles and modulated by the output of the 30,000 cycle oscillator, is fed into the radio receiver.

The entire RC 100 as described above—
all brand new—complete—

Technical Manual TM11-1113B is furnished with the complete set.

\$595.00

F.O.B. Warehouse

Prices on individual components will be furnished on request.

ARROW SALES, Inc.

Dept. 35
1712-14 S. Michigan Ave., Chicago 16, Ill.
PHONE: HARRISON 7-9374

All items FOB warehouse. 20% Deposit required on all orders. Minimum order accepted—\$5.00. Illinois residents, please add regular sales tax to your remittance.

Reliance Specials

WIRE WOUND PRECISION RESISTORS, 1% OR BETTER

1/4 WATT—25c												1 WATT—30c											
6.68Ω	12.32Ω	16.37Ω	125Ω	414 3Ω	1.01Ω	5.21Ω	270Ω	7.000Ω	50.000Ω			1.01Ω	5.21Ω	270Ω	7.000Ω	50.000Ω							
10.48	13.52	62.54	147.5	70.000Ω	2.58	10.1	1,250	9.000	55.000			2.58	10.1	1,250	9.000	55.000							
14.44	13.52	79.81	320.4	2193	3.39	10.9	3,300	18.000	65.000			3.39	10.9	3,300	18.000	65.000							
11.25	13.89	105.8	301.8	10,000				20,000	70,000														
11.74	14.98	123.8	366.6	59,148																			
				100,000																			
1/2 WATT—25c												1 WATT—40c											
.250Ω	1.53Ω	75Ω	260Ω	4,000Ω	8,500Ω	100,000Ω	128,000Ω	320,000Ω	522,000Ω			100,000Ω	128,000Ω	320,000Ω	470,000	522,000Ω							
.334	2.04	90	270	4,451	14,825	120,000	130,000	320,000	600,000			120,000	130,000	320,000	470,000	600,000							
.444	11.1	97.8	298.3	5,000	15,000	125,000			700,000			125,000				700,000							
.502	13.15	100	400	5,900	15,750																		
.557	18.75	125	723.1	6,500	17,000																		
.627	46	180	2,500	7,000	30,000																		
.76	52	210	2,850	7,500	37,000																		
1.01	55.1	235	3,427	8,000	100,000																		

1 Megohm—1 Watt 1%—65c; 5%—40c
 100 pieces—10% off; 1,000 pieces—20% off.

SELSYNS
 115 V., 60 Cyc.
 #C78248
 3 3/8" dia. x 5 1/8" long
 \$7.95 pair

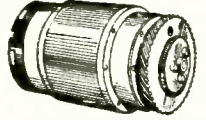

Mounting Brackets — (Bakelite) for selsyns, and differentials shown above 35¢ pair

DIFFERENTIAL
 115 V., 60 Cyc.
 #C78249
 3 3/8" dia. x 5 1/8" long
 \$2.95 ea.

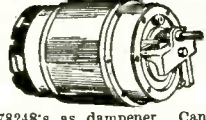

Used between two #C78248's as dampener. Can be converted to 3600 RPM Motor in 10 minutes. Conversion sheet supplied. (Converted).....\$3.50

CAPACITORS

POSTAGE STAMP MICAS

MMF	MMF	MMF	MMF	MFD	MFD
35	90	300	620	.0013	.005
5	39	100	330	.00136	.0051
6	40	110	350	.0015	.0056
8	43	120	370	.001625	.006
8-2	47	125	390	.0018	.0066
10	50	130	400	.002	.0065
15	51	150	430	.0023	.0068
18	56	160	470	.0025	.007
20	60	175	500	.0026	.0075
22	62	200	510	.0027	.008
24	68	220	560	MFD	.0082
25	75	240	580	.001	.0083
26	82	250	600	.0011	.009
30	85	270		.0012	.01

Price Schedule

1 MMF to .001 MFD 5¢
 .0012 MFD to .002 MFD 7¢
 .0023 MFD to .009 MFD 12¢
 .01 MFD 18¢

SILVER MICAS

MMF	MMF	MMF	MMF	MFD	MFD	
8	60	130	325	488	.001	.0033
10	62	150	350	500	.0012	.0039
22	66	180	360	510	.0013	.004
23	68	200	370	525	.001625	.0047
24	75	208	390	560	.0022	.005
30	82	225	400	680	.0023	.0051
33	85	240	410	700	.0024	.0056
39	100	250	430	750	.0027	.006
40	110	260	450	800	.00282	.0062
45	115	270	466	815	.002826	.01
50	120	300	470	820	.003	
51	125			875		

Price Schedule

8 MMF to .001 MFD 10¢
 .0012 MFD to .0027 MFD 20¢
 .00282 MFD to .0082 MFD 50¢
 .01 MFD 65¢

PRECISION CONTROLS

20,000Ω	Muter 314A	*1.70	500Ω	Centralab 48-501	\$9.90
20,000	GR 314A	2.50	50	De jur 292	.75
6,000	De jur 260	1.70	50	GR 301	1.10
6,000	Muter 314A	1.70	25	GR 301	1.10
5,000	Muter 314A	2.50	20	De jur 292	.75
5,000	GR 214A	1.40	12	GR 301	1.10
2,000	De jur 260	1.70			
			10,000	Muter 471A	\$2.00
			10,000Ω	De jur 271T	2.00
			5,000	De jur 271T	2.00

25 WATT
 100K GR 433A \$4.95

THROAT MIKE—MT 81-A
 Two Mikes in leather zipper case with 56" cord and PL-58—Brand New 49c
Gear Assortment \$6.50
 Experimenters dream, 100 pieces, many stainless steel.

2J1G1 SELSYNS
 BRAND NEW
 400 Cycle
 Can be used on 24 V. D. C. or 110 V. A. C.
\$1.65



3AG FUSES

AMP	Per 100	AMP	Per 100	AMP	Per 100
1/2	\$4.00	1 1/2	\$2.50	5	\$2.50
3/4	4.00	2	2.50	10	3.00
1	2.50	3	2.50	15	3.00

Fuse Holder—for 3AG Fuse. (Littlefuse or Bus).....18¢

4AG FUSES

AMP	Per 100	AMP	Per 100	AMP	Per 100
1/10	\$4.00	2	\$2.00	10	\$2.50
1/4	3.50	3	2.00	20	2.50
1/2	3.50	3.2	2.00	25	2.50
1	2.00	5	2.00	30	2.50

Fuse Holder—for 4AG Fuse. (Littlefuse of Bus).....18¢

Wrapped—BALL BEARINGS—New

Mfg	ID	OD	Width	Price
Fafnir 33K5	3/16"	1/2"	5/32"	\$0.25
N.D. 38	5/16"	7/8"	9/32"	.45
Fafnir K8A	1/2"	1 1/8"	5/16"	.60
N.D. 5202C13M	1/2"	1 3/8"	1/8"	1.00
Fafnir 7308W	1 37/64"	3 9/16"	5/16"	2.00
SKF 466430	6"	8"	1"	5.00
SKF 170645	3 11/32"	4 1/8"	7/16"	1.50
Fafnir 845	2 1/16"	2 5/8"	5/32"	1.00

ALLEN SET SCREWS

4-40 x 1/8	8-32 x 1/8	8-32 x 5/16
4-40 x 3/16	8-32 x 3/16	8-32 x 3/8

ALL SIZES \$1.50 per 100

TIME DELAY RELAY
 Haython CIPX 24166 KS 10193-60 Sec.
 • 115 V., 60 Cycle • Adj. 50-70 Seconds •
 2 1/2 second recycling time—spring return •
 Micro-switch contact, 10A. • Holds ON as long as power is applied • Fully cased
NOW ONLY \$5.50



DELAY NETWORK—ALL 1400Ω

T 113—Approx. 1.2 micro sec. delay	85c
T 114—Approx. 2.2 micro sec. delay	85c
T 115 Similar to T 114 with tap brought out	85c

Write for Monthly Bulletin

RELIANCE MERCHANDIZING CO.

Arch St. Cor. Croskey Phila. 3, Pa. Telephone RIttenhouse 6-4927

COAXIAL CABLES

GUARANTEED!! NEW!!

Ohms	Price per 1,000 ft	Ohms	Price per 1,000 ft
RG-5/U	53.5	RG-29/U	53.5
RG-6/U	75	RG-34/U	71
RG-7/U	97.5	RG-37/U	55
RG-8/U	52	RG-39/U	72.5
RG-9/U	51	RG-41/U	67.5
RG-10/U	52	RG-54/AU	58
RG-11/U	75	RG-54/AU	54
RG-13/U	74	RG-55/U	53.5
RG-15/U	76	RG-55/AU	53.5
RG-18/U	52	RG-57/U	95
RG-21/U	53	RG-58/U	53.5
RG-22/U	95	RG-59	73
RG-24/U	125	RG-62/U	93
RG-25/U	48	RG-74/U	52
RG-26/U	48	RG-77/U	48
RG-27/U	48	RG-78/U	48
RG-28/U	160		

Add 25% for orders less than 1,000 feet

COAXIAL CABLE CONNECTORS

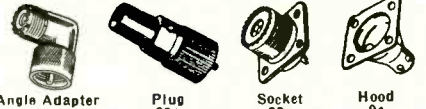

Angle Adapter	Plug	Socket	Hood
15c	28c		9c
M-359	PL-259A	SO-219	83-1H
83-1AP	83-1SPN	83-1R	

Adapter for PL-259 A for use on small coax. 12c each \$10.00 per 100

83-1AC	\$0.42	UG-19/U	.73	UG-85/U	.62
83-1F	1.48	UG-21/U	.60	UG-87/U	.68
83-1J	.80	UG-22/U	.60	UG-102/U	.60
83-1RTY	.45	UG-23/U	.63	UG-103/U	.48
83-1SP	.28	UG-24/U	.60	UG-104/U	.85
83-1T	1.12	UG-25/U	.60	UG-107/U	2.25
83-22AP	.72	UG-27/U	.60	UG-167/U	2.00
83-23P	.88	UG-28/U	2.10	UG-171/U	1.33
83-22P	.48	UG-29/U	.83	UG-175/U	.15
83-22SP	.60	UG-30/U	.94	UG-176/U	.15
83-168	.15	UG-33/U	14.80	UG-180A/U	3.82
83-185	.15	UG-31/U	12.80	UG-191/AP	.57
UG-7/AP	2.14	UG-36/U	12.80	UG-197/U	1.33
UG-12/U	.63	UG-37/U	12.80	UG-206/U	.58
UG-13/U	.60	UG-58/U	.57	UG-255/U	.82
UG-18/U	.63	UG-59/U	.60	UG-264/U	1.74
		UG-61/U	.60	UG-281/U	.60

CERAMICONS

2 MMF	30 MMF	400 MA
5.6	39	12 Hy.
10	45	90 OHM
12	82	HIGH VOLT
15	150	VOLT TEST
20		\$3.85
		10 for \$34.00

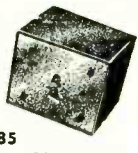

PULSE TRANSFORMERS
 X 124 T2, UTAH, marked 9262, 9340, small gray case. Ratio 1:1:1; hypercol core \$1.50
 D161310, 50 Kc to 4 Mc. 1 1/2" dia. x 1 1/2" high. 120 to 2350 ohms \$1.50
 352-7178—Spec. 10, 111 Chicago Trans. equivalent to 9262 (above) \$1.00
 D-166638 W. E. Permalloy core, Semi-toroidal windings \$1.25
 KS9800, Ratio, 1:1:1, 2:1, Freq. range 380 to 520 C.P.S. \$3.50
 D106173, W. E. Freq. resp. 10Kc to 2 MC 9.80
 800 KVA G.E. K2731, 25000 Volt pk. output; Bifilar; one microsecond pulse width \$28.50

HAYDON TIMING MOTORS
 I R.P.M., 115 V., 60 Cycle \$1.79



SOUND POWERED HANDSET
 Brand New!
 Includes 6 ft. cord & spring clips \$8.92 ea. \$17.60 pr.



FILAMENT TRANSFORMER
 Pri. 115 V., 60 Cyc.—Sec., 5V., 115 A. 8000 volt insulation \$9.95 each

FILAMENT TRANSFORMER
 Amertran Type WS
 For High Voltage Rectifiers. PRI. 115V., 60/60 Cycle.
 SEC. 5V., C/T @ 10 Amp.
 35 KV R.M.S. Test 12 KV D.C. Operating. Uses 872A Tube or other tubes.
NOW \$10.95
 OVERSEAS PACKED 872-A Tube.... \$1.88



Minimum Orders \$3..... All orders f.o.b. PHILA, PA.

OIL FILLED

MFD	V. D. C.	Price
.25	20,000	1.95
.3	7,500	1.55
1	7,000	1.55
1	7,000	1.25
1	6,000	4.35
1	4,000	2.25
.25	3,000	1.10
S	750 AC	.49
1	2,000	4.85
1	2,000	3.95
1	2,000	.95
1	1,000	.80
2	1,000	.65
1	800	.39
4	600	1.60
10	600	.39

METERS
 Brand New—Guaranteed

0-1 Amp. RF. 2 1/2"	\$3.29
0-300 V. D.C., 2 1/2"	3.50
0-500 Microamp. 2 1/2"	3.85
0-7.5 V. A. C., 3 1/2"	3.46

VERNIER DIAL (From BC-221)
 2 1/2" Dia. 0-100 in 360°. Black with silver marks. Has thumblock 85¢

UNIVERSAL JOINT
 3/16" hole x 3/8" O.D.
 1 1/8" long
 Steel or Aluminum
50¢



JONES BARRIER STRIPS

Type	Price	Type	Price	Type	Price
2-140Y	\$0.10	4-141 1/2 W	.25	3-142	.17
2-140 1/2 W	.11	5-141	.22	4-142Y	.30
3-140 1/2 W	.15	5-141 1/2 W	.30	5-142	.26
8-140 W	.36	5-141Y	.30	6-142	.31
10-140 1/2 W	.44	7-141	.29	6-142 1/2 W	.44

AUGUST SPECIAL
10 MFD 2 KVDC
STANDARD
BRAND
capacitor
\$3.95 ea.
10 for \$35.00



PEAK ELECTRONICS CO.

COMPONENTS

SELECTED AND GUARANTEED SURPLUS - AT A FRACTION OF ORIGINAL COST.
 188 WASHINGTON ST., NEW YORK 7, N.Y.

Phone
 CO-10447
 7-6443
 7-6486

All Prices
 FOB N. Y.
 Minimum Order
\$5.00
 Open Account
 to
 Rated Firms

GUARDIAN LATCHING RELAY
 Type RC 100. 110 volt 60 cycle coil. S.P.D.T. each impulse reverses the position of the contacts. Locks automatically. Contacts rated 1500 watts at 110V 60 cycles. Size 3" long, 2 1/2" wide, 1 1/2" high. Only \$1.95 ea.

HIGH WATTAGE ANTENNA RELAY
 110/220 volt 60 cycle coil. D.P.D.T. rated at 5000V. 15A. Heavy duty paralleled contacts. Sturdy construction. Isolantite insulation. Base 8" x 10 1/2".
 Made by Monitor Controller.....\$18.50
 Same specs. as above but DPST.....12.50
 Same specs. as above but SPST.....9.50

SENSITIVE RELAY
 Breaks at 3 MA. Beautifully constructed and delicately pivoted. Approx. 2000 ohms resistance. Housed in dustproof aluminum can. Plugs into 5 prong socket. Only 99c ea.

500 MICROAMP RELAY
 Delicately balanced, S.P.D.T., 10,000 ohm coil. Trips at .4 to .5 MA. 2 5/8" x 2 3/8" x 1 1/2" high. \$2.95
General Electric Overload Relay. Electrical Reset 110 Volts 60 Cycle
 Breaks at 640 Milliamps but easily adjustable for other currents. Terminate values at only \$2.50

WESTON PORTABLE AC VOLTMETER. Model 433.
 0-150 VAC. 3/4 of 1% from 25 to 2400 cycles. 2600 ohms resistance28.50

PANEL METERS
BRAND NEW
Government Surplus

2 1/2"	GE 0-5 Ma (Amp Scale)	\$1.95
2 1/2"	Simpson 0-5 MA, Basic, Square	2.25
2 1/2"	Westinghouse 0-10 MA	1.95
2 1/2"	Simpson 0-20 MA (Amp Scale)	1.95
2 1/2"	Sun 0-25 MA (0-100 Scale)	1.95
2 1/2"	GE 0-50 MA	2.45
2 1/2"	Sun 0-50 MA, Square (0-100 Scale)	1.95
2 1/2"	GE 0-1 Amp RF	1.95
2 1/2"	Simpson 0-2 Amp RF (Square)	1.95
2 1/2"	GE 0-4 Amp RF	1.95
2 1/2"	GE 0-250 MA AC	3.50
2 1/2"	Sun 0-20 Volts DC	1.75
2 1/2"	Weston 0-20 Volts DC	2.45
2 1/2"	GE 0-30 Volts DC (1000 ohms/volt)	2.95
2 1/2"	Triplet 0-300 Volts AC	2.95
2 1/2"	GE 0-50 Amps DC	1.95
2 1/2"	GE 0-25 Volts AC, Linear (0-100 Scale)	3.50
3"	Westinghouse 0-2 MA	3.75
3"	Westinghouse 0-15 MA (Square)	3.75
3"	Westinghouse 0-20 MA	3.75
3"	Western Electric 0-80 MA	3.75
3"	GE 0-200 MA DC	3.75
3"	Triplet 0-75 Amps AC	2.95
3"	GE 0-15 Volts AC	3.95
3"	GE 0-1 Amp DC	3.95
3"	Westinghouse 0-2 Amps DC	3.95
3"	Westinghouse 0-1 MA (Basic) KV Scale	3.95
3"	Westinghouse 0-750 Volts DC (1000 Ohms/Volt)	4.50
3 1/2"	Weston 0-150 Volts AC	5.95
3 1/2"	Weston 0-1 Volt DC, Model 301	3.95
3 1/2"	Simpson 75-0-75 Microamps	6.75
3 1/2"	GE 0-300 MA DC Square	3.95
3 1/2"	GE 0-100 MA DC Square	3.95
3 1/2"	GE 0-5 MA DC Square	3.95
3 1/2"	GE 0-30 MA DC Square	3.95
3 1/2"	GE 0-20 MA DC Square	3.95
3 1/2"	GE 0-2 Amp DC Square	3.95
3 1/2"	GE 0-300 VAC Square	3.95
3 1/2"	GE 0-1.5 Amps DC Square	3.95
3 1/2"	GE 0-150 MA DC Square	3.95
3 1/2"	GE 0-50 MA DC Square	3.95
3 1/2"	GE 0-3 Amp DC Square	3.95
3 1/2"	GE 0-5KVDC Square, with Multip.	9.95
3 1/2"	GE Running Time meter 220v 160 cy.	6.95
3 1/2"	GE 0-3KVDC with multimp.	6.95
3 1/2"	GE 0-300 Volts AC	5.95
3 1/2"	GE 0-8KVDC with multimp.	11.95
3 1/2"	GE 0-1 MA (0-200 scale)	5.95
3 1/2"	McIntook 0-200 microamps	9.95
3 1/2"	GE 0-12 KVDC with multimp. Mod. 8DE	12.95
3 1/2"	GE 0-20 Volts AC Model 8AB	6.95
3 1/2"	GE 0-10 Amp DC Model 8DB	6.95
3 1/2"	GE 0-15 Amps DC Model 8DB	6.95
3 1/2"	GE 0-25 Amps DC, Model 8DB	6.95
3 1/2"	GE 0-1.5 Amp DC Model 8DB	6.95

LINK TEST SET
 Type #1410. Contains two 3 1/2" meters—a 75-0-75 microamp Galvanometer and a 0-1 MA multi-scale meter. Has tap switch for changing range. Ranges are as follows: 75-0-75 microamps, 1 MA 2.5 MA, 50 MA, 25 volts, 500 volts. Ideal for balancing discriminators and general lab use. Housed in hard wood case with hinged cover. 10" x 8" x 4 1/2". Only \$14.95 ea.

WESTINGHOUSE SELENIUM RECTIFIER
 Hermetically sealed. Oil Immersed Full Wave Bridge. 30 Volts AC Input. 24 Volts at 2 Amps Output.
 Size 2 5/8 x 2 5/8 x 3 7/8 hi.\$3.75 ea.
 50 megohm 35 watt Resistor with mount. \$1.49 each; 10 for \$9.90.
 10 Meg 10 Watts.....49c; 2 Meg 5 Watt.....35c

30 WATT WIRE WOUND RESISTORS
 Ohms: 100-2500-3k-4k-4500-5k-5300-18k
 .15 ea. 8 for .90
 Precision 15 Meg. 1% Accuracy Resistor, Non-inductive, 1 watt, hermetically sealed in glass .25 ea 10 for \$1.90

WIRE WOUND RESISTORS
 5 watt ohms: 25-50-200-470-2500 .09 ea.
 10 watt ohms: 25-40-84-400-470-1325-2K-4K .15 ea.
 20 watt ohms: 50-70-100-300-700-1K-1.5K .20 ea.
 2.5K-2.7K-5K-10K-16K-20K

ADJUSTABLE RESISTORS
 20 Watt: 1, 5, 50 Ohms.....25
 50 Watt: 100, 500 Ohm.....35
 4 mfd 600 vdc-.59 1 mfd 5000 vdc-4.50
 75 Watt: 100, 150, 200 Ohms.....39
 100 Watt: 20, 50, 75, 120, 500 Ohms.....49

MIDGET VARIABLE CONDENSERS
 15 MMF (HF 15).....39
 Dual 15 MMF (HF 15 D).....68
 250 MMF (MC 250 S).....69

CERAMICS
 MMF: 1.5, 2, 3, 8, 10, 20, 22, 120, 500 .05 ea.

SILVER MICA CAPACITORS
 MMF: 10, 47, 50, 60, 340, 750, 780, 1000 .09 ea.

PLUG IN CAPACITOR
 8 x 8 Mfd 600 volts DC. Oil filled. Plugs into standard 4 prong socket. 3 3/4" h x 3 1/2" w x 1 1/2" d.\$1.39

OIL CONDENSERS
 50 mfd 220 vdc-3.95 8 mfd 2000 vdc-4.95
 2 mfd 600 vdc-.39 2 mfd 4000 vdc-4.95
 4 mfd 600 vdc-.59 1 mfd 5000 vdc-4.50
 6 mfd 600 vdc-.79 1.1 mfd 7000 vdc-2.25
 3/3 mfd 600 vdc-.79 2 mfd 6000 vdc-9.95
 10 mfd 600 vdc-.89 1 mfd 7500 vdc-6.50
 4 mfd 1000 vdc-.95 .01-.01 mfd 12 kv dc-5.75
 10 mfd 1000 vdc-1.99 .65mfd 12,500 vdc-12.95
 2 mfd 1500 vdc-.25 2 mfd 18 kv dc-49.55
 6 mfd 1500 vdc-2.95 1 mfd 2000 vdc-1.45
 1 mfd 2000 vdc-1.45 1 mfd 15 kv dc-15.95
 2 mfd 2000 vdc-2.25

HIGH CURRENT MICAS
 Type G4 Ceramic Case 5 1/4" High, 5" Diameter Tolerance 5% or Better.

CAP MFD	Amps	KV DC	Price	CAP MFD	Amps	KV DC	Price
.08	60	4	\$27.50	.009	40	15	\$29.50
.1	70	4	29.50	.0097	40	15	29.50
.65	60	5	24.50	.01	43	15	29.50
.037	45	6	26.50	.0025	23	20	29.50
.02	40	9	29.50	.0031	26	20	29.50
.02	55	10	29.50	.004	30	22	33.50
.0117	40	14	24.50	.0033	25	25	35.50
.0075	39	15	24.50				

TYPE G3 4" HIGH, 5" DIAMETER
 .0013 15 15 14.50 1
TYPE G2 3" HIGH 3 1/2" DIAMETER
 .0005 8 10 5.95 1 .01 25 7 7.95
TYPE G1 1 1/2" High 2 1/2 DIAMETER
 .00024 4 6 3.95 1

BAKELITE CASED MICAS

MMF	VDC	Price	MMF	VDC	Price
D .001	600	5.18	C .001	3 KV	\$.90
E .01	600	.26	C .002	3 KV	.95
D .02	600	.26	D .005	3 KV	.70
E .027	600	.26	C .005	3 KV	1.24
C .01	1 KV	.45	C .006	3 KV	1.50
C .07	1 KV	.55	D .002	3 KV	.70
D .02	1200	.35	C .0001	5 KV	.70
C .024	1500	.65	C .0005	5 KV	.85
C .033	1500	.75	C .0015	5 KV	1.60
C .015	2 KV	.80	C .003	5 KV	1.90
C .02	2 KV	.90	C .005	5 KV	2.50
D .002	2500	.45	C .002	6 KV	2.90
E .005	2500	.55	B .002	8 KV	5.95
C .025	2500	1.25	B .0005	8 KV	2.90
			B .0012	8 KV	4.50

SCR 522 TRANSMITTER/RECEIVER. Complete with dynamometer power supply. Excellent condition....39.50

FILAMENT TRANSFORMER
 6.3 volts at 12 amps. Primary 110 volts 60 cy. Size 3 1/4" H x 2 7/8" W x 3" D. Wt. 3 1/2 lbs. As illustrated. \$1.69 ea.

RAYTHEON SWINGING CHOKE
 2 to 12 Henrys, 1 Amp to 100 MA, fully cased, High voltage insulation, ceramic insulators. Very conservatively rated. Weight 60 Lbs.....\$12.95 ea.

THORDARSON PLATE TRANSFORMER
 CHT Series, Model T15P 22, 110/220 volt 60 cy. Primary: 3500V, 3000V, 2500V, 2000V C.T. Secondary: 625 watts. Weight 70 Lbs.....\$22.50 ea.

FILAMENT TRANSFORMERS
 110 V 60 CY Pri. Cased.
 5 Volt 15 Amp.....\$2.75
 2.5 Volt 10 Amp.....3.49
 2.5 Volt CT 21 Amps.....4.75
 5 Volt 4A, 6.3V, 3A.....2.45
 2.5V CT 20A, 2.5V CT 20A.....6.95

CHOKE BARGAINS
 6 Henry 50 ma 300 ohms.....3 for \$0.99
 8 Henry 150 ma 140 ohms......99
 1.5 Henry 250 MA 72 ohms, Hermetic. Sealed......59
 6 Henry 400 MA 97 Ohms, Hermetic. Sealed.....3.95
 20 Henry 36 MA 350 ohms, cased......75
 12 Henry 250 MA 190 ohms, cased.....2.00
 8 Henry 175 MA 39 ohms hermetic seal.....4.25
 10 Henry 350 MA 1250 ohms Tapped, Herm. seal 2.95
 15 Henry 250 MA 290 ohms, Tap, Herm. seal.....2.20

POWER TRANSFORMERS
 Hermetically sealed. Pri 110 volts 60 cy.
 .550 volts CT 125 MA, 6.3V, 5V, 2A.....\$1.99 ea.
 880 volts CT 100 MA, 6.3V 4A, 5V, 3A.....2.50 ea.
 1000 volts CT 400 MA, 6.3V 10A, 5V 3A.....5.95 ea.
 125V 50 MA.....69. ea.
 940 volts CT, 125MA, 6.3V 8A, 6.3V, 2.5A, 6.3, 1.2A, 6.3V, 5A, 5V, 3A.....3.95 ea.
 1110 volts CT 60 MA, 920 volts CT 160 MA, 6.3V, 18A, 6.3V, 1.25A, 5V2A, 5V2A.....4.95 ea.
 300 volts CT 300 MA, 2.5V7A, 2.5V7A, 6.3V, 1.5A.....2.75

H.V. SCOPE TRANSFORMERS
 Pri. 110V 60CY—Hermetically Sealed
 1050V & 20MA, 20V 4.5A, 2.5V 5A.....\$2.95

HIGH VOLTAGE VACUUM CONDENSERS
 6 MMF 32 KV EIMAC VC 6-32.....\$4.50
 12 MMF 32KV, EIMAC VC 12-32.....4.95
 50 MMF 32KV, EIMAC VC 50-32.....5.50

SCOPE AND FIL. TRANSFORMER
 Pri. 115 volts, 60 cycles, Sec. 4400 volts RMS 4.5 MA., 5 volts. CT 3 amps. Fil. Ins. 15 KV. RMS test. Hermetically sealed. Has insulated plate cap for rectifier. Made by Raytheon. 4 1/2 x 5 x 5 1/2.....Only 4.95

Mailroy Vibropack Transformer 6 Volt Input. Output 300 Volts at 100 MA.....\$3.95

MOSSMAN SWITCHES
 4 Pole Single Throw.....\$1.10
 3 PDT, plus 6 PST.....1.75

PRECISION 1% W.W. RESISTORS
 Ohms: 2K, 2500, 5K, 8500, 95K, 750K......25 ea.

MISCELLANEOUS BARGAINS
 .02 400 volt dc tubulars.....15 for .99
 2mfd 250 volts ac oil cond.....6 for .99
 10 meg 10 watt resistor.....2 for .99
 Heineman 25 amp 110 volt ac ckt breaker.....1.19
 Ceramicon .0005 mfd.....20 for .99
 .01 600 volt dc pigtail micas.....10 for .99
 .001 600 volt dc pigtail micas.....15 for .99
 .006 600 volt, pigtail micas.....12 for .99
 Butterfly cond. 2 to 11 mmf ball brngs.....3 for .99
 CD type 4 micas .001 600vdc.....10 for .99
 10,000 ohm potentiometers.....6 for .99
 500 ohm 100 watt non-induct. Resistor......99
 250 ohm 100 watt non-induct. Resistor......99
 16 mfd 450 volt electrolytic (EB9160).....3 for .99
 Var. cond. 150 mmf .07 spacing.....2 for .99
 Variable ceramicon 20 to 125 mmf type 823 5 for .99
 Western Electric silver variable .5 to 2.5 mmf 8 for .99
 50 K 1% W. W. Resistors, Precision......14
 .35 at 16 KV plus .75 at 8 KV Oil Cond.....3.95
 .1 MFD 7500 VDC Oil Cond......89
 .05 MFD 7500 VDC Oil Cond......75
 7 MFD 350 VAC Oil Cond......89
 Meter Multiplier 2 MEG. 1/2 of 1% 2KV.....1.48

SEARCHLIGHT SECTION

1000 KC crystal BT cut.....\$3.95
3" scope shield 1.29
2 speed dial drive for 1/2" shaft ratios 5:1 1 to 1 .39
ATC 100 mfd air trimmer screwdriver shaft..... .29
-10 +5 Weston modulation meter Weston 301. 8.95
J37 key69
500 watt 12.5 ohm power rheostat..... 3.49



50 mfd 5 KV GE vacuum condenser.....\$1.49
2v, 6v, 12v vibrators any type..... .98
Rotary switch GE Myleax, 2 deck SP3T..... .39
1 mfd 5000v oil condenser Micomold..... 2.98
2 mfd 3000v oil condenser Aerovox..... 3.25
3 mfd 4000v oil condenser Micomold..... 3.95
24 mfd 1500v DC 3KV flash. Excellent for speed lamp 3.95

TUBES!! BRAND NEW! STANDARD BRANDS! NO SECONDS! COMPARE! TUBES!!

Table of vacuum tubes with columns for tube type, price, and manufacturer. Includes types like 6X4, 6X5, 6X6, etc.

SELENIUM RECTIFIERS FULL WAVE BRIDGE TYPE

Table of selenium rectifiers listing input/output voltages, current ratings, and prices.

CENTER TAPPED RECTIFIERS Single Phase Full Wave Bridge

Table of center tapped rectifiers listing current ratings and prices.

TRANSFORMERS—115V 60 CY HI-VOLTAGE INSULATION

Table of 115V 60 cycle hi-voltage insulation transformers listing various ratings and prices.

TRANSFORMERS—220v 60 Cyc

Table of 220V 60 cycle transformers listing various ratings and prices.

EQUIPMENT SPECIALS

Table of equipment specials including receivers, modulators, and other electronic components.

FILTER CHOKES HI V INS

Table of filter chokes listing various ratings and prices.

RADIO HAM SHACK inc. 189 GREENWICH STREET. NEW YORK, N. Y. Includes contact information and a note about quantity prices.

IMMEDIATE DELIVERY • LOW PRICES • FULLY GUARANTEED

BROWN TELEPLOTTER RECEIVER



Model 791X1R
115 volt 60 cycles

Contains a pen driven by two balancing motors which writes on rear of a translucent chart. Pen arm position is in terms of two coordinates supplied balancing motors thru two amplifiers. Originally intended for recording plotted or written data from central plotting board. Writes at one half scale on 18 in. chart. Discriminator input circuit designed to operate unit as function of two varying R.F. frequencies varying about mean of approx. 430 KC. Further data on request. (Shipping weight 435 lbs.)

Price \$375.00

LP-21-LM Compass Loops



Motor driven loop enclosed in graphited zeppelin housing includes Autosyn transmitter. Stock #SA99.

\$19.50 each

G.E. Servo Amplifier—2CV1C1
Aircraft amplidyne control amplifier, 115 volt 400 cycles. Two channel. Uses 2 6SN7GT and 4 6V6GT tubes. Supplied less tubes. Stock #SA-168. Price \$9.50 each.

D.C. MOTORS



Universal Electric
W.E. KS-5603-1-02-28 v. d-c 0.6 amps. 1/100 hp. 4 lead shunt. Stock #SA-222. Price \$3.75 each



12 V.D.C. Motor John Oster B-9-2
1.4 amps. 5600 rpm.

1 1/2" diam. x 3 3/4" lg. Splines shaft. C.W. rotation. Stock #SA-46. Price \$1.95 each

DELCO CONSTANT SPEED MOTOR A-7155

1/30 hp. 27.5 v d-c 3600 rpm. Cont. duty. 2 1/2" diam. x 5 1/2" lg. 3/8" shaft extension, 5/32" diam. 4 hole base mounting. Stock #SA-94. Price \$6.00.



Delco 508925 Constant Speed DC Motor, 27 v. d-c 120 rpm. Governor controlled. Stock #SA-249. Price \$3.95 each.

General Electric 2 RPM Motor, Type 5BA10FJ228. 27 v. d-c @ 0.6 amps. 10 lb/in torque at 2 rpm. Shunt wound. D-C noise fitted. Stock #SA-274. Price \$12.50 each.

Synchron 10 RPM D.C. Timing Motor—24 V. Hanson Mfg. Co. Stock #SA-110. Price \$4.75 each.

General Electric Type 5BA10AJ52C 145 rpm. 27.5 volt D-C motor. 0.65 amps. 14 n/oz. torque. Shunt wound four lead reversible. Stock #SA-218. Price \$4.75 each.

D-C ALNICO FIELD MOTORS
Delco 5089456. 27.5 volts, 10,000 rpm. 1" x 1" x 2" lg. Stock #SA-236. Price \$8.75 each.

Other models also available

Prices F.O.B. Paterson
Phone ARmory 4-3366
Teletype PAT. 199
WRITE FOR LISTING

MICROWAVE ANTENNA



AS-217-APG 15B, 12 Cm dipole and 13 Inch Parabola housed in weatherproof Radome 16" dia. 24 v. DC spinner motor for conic scan. Stock #SA-96. Shipping wt. 70 lbs.

Price \$9.95 ea.

INVERTER SPECIALS 400 Cycles



Pioneer Type 12128-1-B. 27.5 volts D-C input. 26 volts 400 cycle 1 phase out. 6.0 V.A. (Current manufacture) Prices on Request.

General Electric 5D21N3A — Input 28 volts DC at 35 amps. Output 110 volts 400 cycles. 485 V.A. at 0.90 P.F. Weight 15 lbs. Stock #SA-41. Price \$14.50 each

General Electric 5AS131N3S — Input 26 volts DC at 100 amps. Output 115 volts 400 cycles. 1600 V.A. 0.8 PF. Stock #SA-286. Price \$19.50 each

SYNCHROS



Navy Types

1G, 1F, 1CT, 5G, 5F, 5CT, 5DG, 5HCT, 5SF, 5HSP, 5SDG, 6DG, 6G, 6DG, 7G, etc.

Prices on Request

SERVO AMPLIFIER



Minneapolis Honeywell 115 v. 400 cycle unit. For use with SA-268. Model G403ATCA3. Designed for use with A-C error signal from bridge circuit. Stock #SA-269A. Price \$8.50.

MOTOR SPECIALS

G.E. 5BA25AJ31A and 32A. Dual field reversible gear head shunt wound. 24 v. @ 2.9 amps. 9 rpm. 10 min. time rating. Aircraft type. Magnetic brake. Stock #SA-298. Special Price \$19.50 each.



G.E. 5PS56HC18 — Split field series reversible motor. 60 v. d-c at 1.4 amperes. 5500 rpm. 3" diam. x 5 1/2" lg. Ideal for servo applications. Stock #SA-273. Price \$8.75 each.



OSTER PM MOTOR

Alnico Field

27.5 v. d-c Can also be used as rate generator. #SA-281. Price \$3.75 each



Gyro and Housing Mirror Assembly. For K-14A sighting head. Gyro stabilized mirror assembly. Stock #SA-294. Price \$9.75 each.

AC-SERVO MOTORS



Pioneer Type CK-2. 26 v. 400 cycles fixed phase, var. phase 49 v. max. 40:1 gear reduction. Stock #SA-97A. Price \$8.75 each. Also available less gear train. Price \$6.75 each. Stock #SA-97.



PIONEER CK-17

400 cycle 2 phase, 26 v. fixed phase, 45 v. max. variable phase. Built in gear reduction. Output shaft speed approx. 4 rpm. Stock #SA-287. Price \$12.50.



FORD SERVO MOTOR

115 volt 60 cycle two phase low inertia motor. 15 watts output. BuOrd. 207927. Stock #SA-291. Price \$49.50 each.



MINNEAPOLIS-HONEYWELL

Type G303AY2CA4 Servo Motor

115 v. 400 cycles. Built in gear reduction. 50 in/lb. torque. Stock #SA-268. Price \$6.75 each.



SAWTOOTH POTENTIOMETER

W.E. KS-15138

Type RL-B-R. 100 ohm element. Non linear ring gives linear output with CRT deflection coil load. Cont. rotation. 2 brushes 180 degrees opposed. 2 taps 180 degrees opposed. Stock #SA-288. Price \$6.50 each.



400 Cycle Generators

Homelite 18A120D28-1 400 cycle out at 1 phase 115 v. 39 amps. Also a d-c output of 28 v. and 17.9 amps. Special at \$175.00 each.



G. E. 5ASB31J3S. 400 cycles out at 115 volts. 7.2 amps. Ideal for lab. 6" lg. x 6" diam. 8000 rpm. Stock #SA-292. Price \$79.50 ea.



PRECISION AUTOSYN

Pioneer Type AY-150 Control Autosyn. Precision type. 26 v. 400 cycle. Stock #SA-297. Special low price \$14.50 each.



A-5 Autopilot Indicator

Autosyn Type Pilot Indicator for A-5 Autopilot. 26 v. 400 cycles. Stock #SA-299. Price \$12.50 each.



ANTENNA TILT INDICATOR

D-C Selsyn type tilt indicator. G.E. 8DJ29AAK. 24 volt. Stock #SA-296. Price \$3.75 each.

Servo-Tek

products co.

4 Godwin Ave. Paterson, N. J.

SPECIALISTS IN FRACTIONAL HORSE POWER MOTOR SPEED CONTROL

FOR SALE

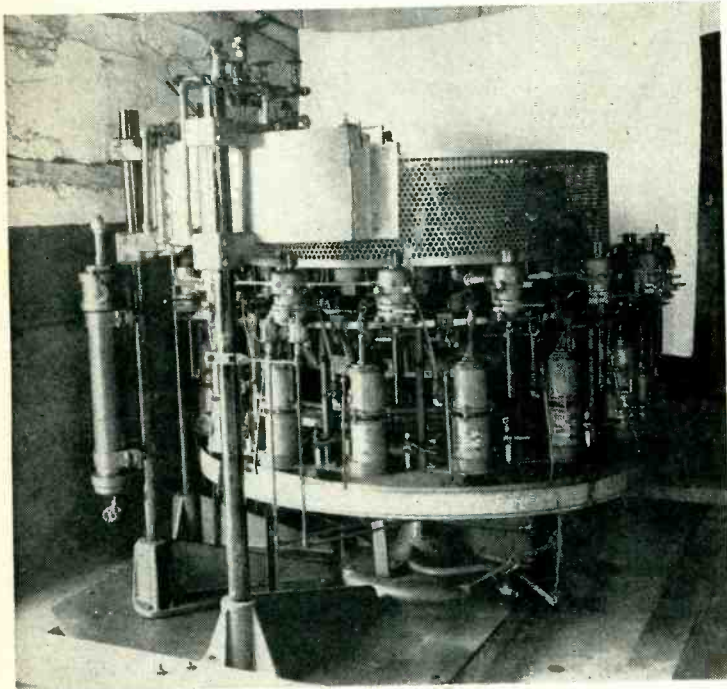

- Can be adapted to Television and Receiving Tube Manufacturing
- Electronics manufacturing equipment
- Used but in excellent condition
- Inspection invited, immediate shipment

TROLLEY EXHAUST MACHINE. GE, can be converted to standard tube production. Has all controls. 1 manually operated trolley system on angle iron structure, ten gas valve controls, six DLIC 21C27 plate transformers, two tube heat ovens, six GE mercury condensation pumps, two gen. radio variacs.

EQUIPMENT FOR MOUNT FLASHING UNIT. GE, can be used for different type tubes. 1 gen. radio variac. One hydrogen feed for flashing bottle, time switches, relays.

EXHAUST MACHINE. 16 heads. Mfd. by GE, can be converted to standard tube production. Has all controls, with trap transformer, gauges, controls for each head, timers, two Brown panel pyrometers.

GRID CARBONIZING & CLEANING EQUIPMENT. GE. One gen. radio variac 100Q, one hydrogen monometer, lifting mechanism for carbonizing unit.

TUBE STEM MACHINES. Mfd. by Kahle Eng. Co. 4-5-6-7-8 positions with Geneva movements.

LGE. SPOT WELDER. Mfd. by Natl. Welding Mach. Co. Type 2235. One GE water-cooled transformer, 500 KVA, air pressure control, two heat controls.

MAGNETIZING EQUIPMENT. Mfd. by G.E. for 486 and 505 magnetron tubes. One CR7503A125-G10 welding panel for GL415 tubes, one heat control, one welding time control.

BULB-PIERCING & TABULATING MACHINE. Mfd. by Kahle Eng. (any standard transmission tubes or thyatron.) 1/20 hp. motor, 1/60/110 v. gear drive, reduced to 108 rpm.

BASING CEMENT MIXER. Mfd. by J. H. Day Co. Model 1, with 2 hp. motor, GE, 3/60/550 v., 1735 rpm.

EXHAUST MACHINE 32 heads. Mfd. by Kahle Eng. Co., Capacity 60 tubes per hour, 60 W. type B174 Sealix chassis, with pumps, commutator and torch. Three power oscillators, panel board, transformer.

FLARE MACHINE. Mfd. by Kahle Eng. Co.

VACUUM FIRING EQUIPMENT. Mfd. by GE.

WIRE STRIPPING MACHINE. Model 9E, for stripping wire up to 8 gauge. Bench type with motor.

SEALING & STEM MACHINE, 16 heads. Mfd. GE, ¾ hp, GE motor.

ELECTRIC FURNACE. Contains electric control and resistor.

EXHAUST MACHINE. 16 heads. UNUSED, by Kahle Eng. Co., complete with 16 metal liquid air traps, 16 compression heads, 16 water-cooled compression levers with rollers, 7 mercury pumps D-239, 13 terminal boards, five GE timers.

INSULATOR EQUIPMENT. GE, consists of welding equipment.

GLASS CUT-OFF MACHINE. McCreery Machine Wks. 3" diamond disc. cutting wheel mounted under table.

CARBONIZING EQUIPMENT. GE, one water-cooled cylinder.

COMBINATION STEM & SEALING MACHINE. Dual drive, automatic operation.

MARKING MACHINE B. B. Marker Machine Company Model P. L. for labeling electronic tubes. With ½ hp motor coupled to reduction gear.

GRID WINDER & ROLLER WELDER. GE, for side rod tungsten welding.

SET: SUCTION & SAND BLAST UNIT. By Amer. Foundry Co. Model 1B, 3 hp. GE motor.

GAS PURIFYING FURNACE. GE, Cat #8236225G1, 1400° F. Brown pyrometer, panel & timers.

AUTO BUTTON STEM MACHINE. 1-12 Head, complete with fires—ready for immediate operation.

BAIRD. 4 slides, #00 reducer, with motor and oil pump.

FLETCHER Centrifuge.

GAS FIRED OVEN FURNACE. #210, AGF.

FEDERAL DUST GLASSIFIER. Laboratory unit.

STURTEVANT GAS BOOSTER with diaphragm regulator, bypass and ½ hp. motor, 110v. Many others.

AIR BLOWER. With motor, GE, HP:11, 3 phase, Blower. Type: MM-26-450-3.5 lbs. 3500—many others.

Subject to prior sale.

Many others for glass working for laboratories, lamp & neon use.

HAYDU BROTHERS

PLAINFIELD

NEW JERSEY



TEST EQUIPMENT



X Band Spectrum Analyzer 8500-9600 Mc., calibrated linear below cut-off attenuator, calibrated frequency meter, tuned mixer, 4 i.f. stages, 3 video stages overall gain 125 db., regulated power supply.

S Band Spectrum Analyzer 2700-3900 Mc., similar to above.

The above Spectrum Analyzer also available with S and X band tuning units.

K Band Test Load low power.....\$20.00

X Band Power, Frequency and SWR Measuring Equipment complete with R.F. source, A.S.D. equipment.

X Band Below Cut-Off Wave Guide Attenuator, with calibrated dial, type N input connector, output connects to 1/2" x 1" wave guide\$55.00

X Band Test Load, low power....\$15.00

TS-62 X Band Echo Box with r.f. cable and pick-up antenna.

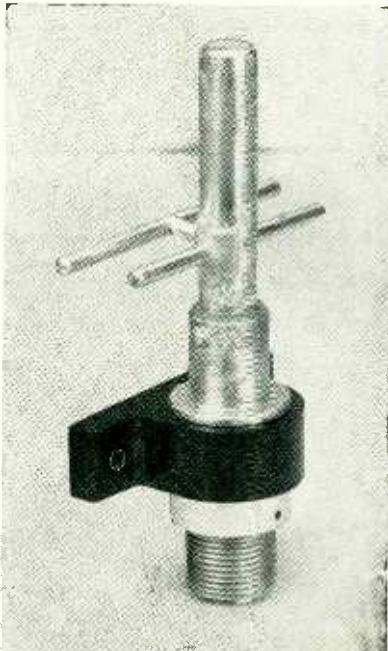

Turn Dipole Test Antenna for S Band, type N Connector\$10.00

TS-33 X Band Frequency Meter, 8500-9600 Mcs. Crystal detector and 50 micro-amp. meter. Indicates Resonance. Connection for scope available.

APR-1 or APR-4 Radar Search Receiver, 30 mc I.F., 2 mc wide.

Tuning Units For APR-1 or APR-4 Receivers (can be used with any 30 mc amplifier):

TN-19, range 1000-2000 mc, tuned mixer cavity\$150.00

TN-54, range 2000-4000 mc, tuned mixer cavity\$150.00

TS-110 S Band Echo Box 2400-2700 mc, portable\$110.00

TS-184 Echo Box and Attenuator for APS-13

TS-170 Test Oscillator for ARN-5

TS-226 Peak Power Meter for APS-13

TS-89 Voltage Divider for measuring high video pulses, ratios 1:10 and 1:100, transmission flat within 2 db 150 c.p.s. to 5 mc., with cable for attaching to syndroscope

30 Mc I.F. Strip and 110 Volt 60 cps Power Supply, bandwidth 10 mc, complete, new (part of APR-5 Receiver)\$65.00

TS-45A/APM-3 Signal Generator, 9200-9600 mc, 110 V, 60-800 cps.

TS-35/AP X Band Signal Generator, pulsed, calibrated power meter, frequency meter, 8700-9500 mc.

X Band VSWR Test Set TS-12/AP, complete with linear amplifier, direct reading VSWR meter, slotted waveguide with gear driven traveling probe, matched termination and various adapters, with carrying case, NEW UNITS I and II are available separately or together as a test set.

High Pass Filter F-29/SPR-2, cuts off at 1000 mc and below; used for receivers above 1000 mc\$12.00

S Band Test Load TPS-55P/BT, 50 ohms\$8.00

X Band Test Load, 50 Watts.....\$35.00

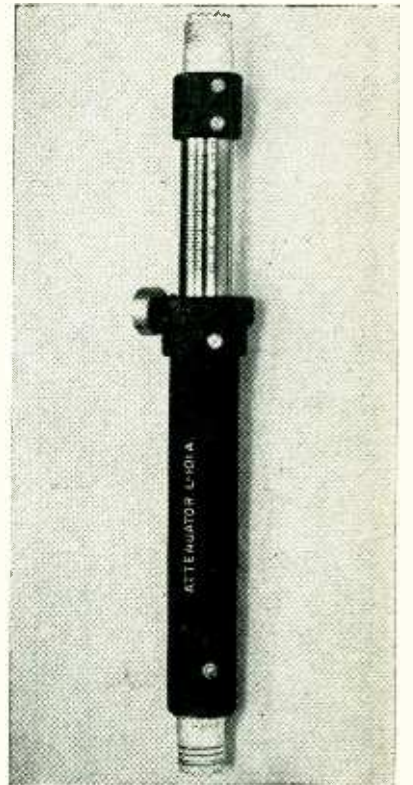

Waveguide Below Cut-off Attenuator L-101-A U.H.F. Connectors at each end, calibration 30-100 db\$10.00

250 Watt X Band Test Load, VSWR less than 1.15 between 7 and 10 KMC\$150.00

Standard Signal Generator Measurements 65B, 100 kc to 30 mc, 1-2,000,000 micro-volts, good working order.....\$400.00

S Band Crystal Mixer, Variable Oscillator Injection\$12.50

S Band Mixer, tunable by means of slider type N connector for the R.F. and local oscillator input, U.H.F., connector for the I.F. output, variable oscillator injection\$30.00

Fixed Attenuator Pads, 20 db + 0 - 2db, DC-1200 mc, 50 ohms, VSWR 1.3 or less, 2 watts average power....\$30.00

Waveguide Below Cut-Off Attenuator, type N connectors, rack and pinion drive, attenuation variable 120 decibels, calibrated 20-120 db, frequency range 300-2000 mc\$32.00

Waveguide Below Cut-Off Attenuator, similar to above except upper frequency limit is 3300 mc.....\$32.00

Waveguide Below Cut-Off Attenuator, same as above except input is matched in range of 2200-3300 mc. VSWR less than 1-2\$54.00

ELECTRO IMPULSE

LABORATORY

P. O. Box 250

Eatontown 3-0768

Red Bank, N. J.

NEW YORK'S RADIO TUBE EXCHANGE

TYPE	PRICE	TYPE	PRICE	TYPE	PRICE	TYPE	PRICE	TYPE	PRICE
0A4G	5.72	4C27	7.50	249C	3.75	720BY	45.00	878	2.25
C1B	3.95	4C30	1.25	250TH	19.25	720CY	45.00	884	1.45
1B22	2.95	4C35	22.50	250TL	17.50	720DY	45.00	885	1.25
1B23	8.95	4J25	95.00	250R	5.95	721A	2.40	931A	3.95
1B24	4.95	4J30	95.00	HK253	6.95	722A	3.95	954	.45
1B26	4.95	4J35	195.00	274B	1.75	723A/B	6.95	955	.45
1B38	32.50	4J31	95.00	287A	3.95	724A	2.95	957	.25
1B42	7.95	4J35	195.00	CE303	3.95	724B	3.95	958A	.55
1B56	45.00	4J38	95.00	304TH	3.95	725A	12.95	959	.75
1B60	45.00	4J40	195.00	307A	4.95	726A	9.95	975A	12.50
1N21	.85	4J47	250.00	310A	4.95	726B	19.95	CK1005	.50
1N21A	.95	4J52	250.00	316A	.69	726C	36.00	CK1006	.95
1N21B	1.50	5B1P	2.75	350A	2.40	726AY	45.00	1280	.99
1N23	.85	5B1P4	3.95	350B	1.80	730A	6.95	1611	1.50
1N23A	.95	5C22	45.00	368AS	2.40	801A	.69	1616	1.10
1S21	3.75	5C30	9.95	371B	.89	802	4.50	1619	.50
2A1	3.50	5CP1	1.95	388A	1.80	803	4.50	1622	1.50
2C33	1.95	5D21	19.95	394A	4.95	807	1.35	1625	.45
2C40	5.75	5C5B	9.95	394A	4.95	808	2.75	1626	.45
2C43	12.50	5FP7	1.95	417A	12.95	810	2.75	1629	.45
2C44	1.25	5J1P1	45.00	434A	3.50	819	2.75	1631	.39
2C51	7.50	5J1P2	10.95	450TL	37.50	819	2.75	1641	.89
2V21	1.35	5J1P4	25.00	450TH	19.95	811	2.11	1851	1.10
2J21	9.95	6CA	7.95	464B	.90	813	7.95	1852	.99
2J22	9.95	6AC7	.90	446B	1.80	814	2.95	1853	.99
2J26	8.75	6AC7W	1.75	WL468	5.95	815	1.50	2050	.99
2J27	9.75	6AK5	1.60	WL469	2.75	827R	90.00	2051	.55
2J31	9.75	6C21	19.95	WL525	7.95	829B	8.95	8012A	3.95
2J32	12.95	6F4	5.95	WL538	1.25	833	3.95	8013A	2.75
2J36	105.00	6J4	4.95	WL530	12.95	833A	4.50	8014A	25.00
2J38	7.95	6-8B	1.25	WL531	7.95	834	7.50	8016	1.25
2J40	25.00	6SU7GT	1.25	WL532	2.95	836	1.10	8019	1.75
2J42	150.00	7BP7	4.95	533	39.95	837	1.95	8020	2.95
2J48	29.95	7DP4	12.50	WL538	1.25	838	3.75	8021	1.75
2J49	37.50	10Y	5.95	GL570	1.25	845	4.50	8022	1.00
2J50	24.50	15E	1.50	575A	12.50	849	19.95	8025	3.75
2J61	45.00	15R	1.00	575B	5.95	851	9.95	9001	.55
2J62	45.00	RX21	2.50	595	19.50	852	3.95	9002	.35
2K25	19.95	5C22	45.00	700A to B	19.50	860	2.40	9003	.55
2K28	19.95	CV35	35.00	701A	3.95	861	19.95	9004	.45
2K29	24.95	OK47	55.00	703A	2.40	866A	1.15	9005	1.50
2K45 on Request		OK59	59.00	705A	.75	8691B	29.95	9006	.25
2X2A	.79	OK61	49.50	707A	14.95	872A	2.75		
2V3G	.99	OK77	249.00	707B	2.95	874	1.95		
3A4	.75	RK39	2.25	708A	1.25	876	.75		
3A5	.95	KK49	2.40	710A	4.95				
3AP1	4.95	KK72	.95	714AY	6.95				
3BP1	3.95	KK73	.95	715B	9.95				
3B2A	1.50	VR53	.29	715C	24.95				
3C23	3.95	VR95	.45	717A	.95				
3C24	3.95	100TH	9.95	717A	.95				
3C31	3.95	VR105	.89	720AY	45.00				
3C45	12.50	FL23A	8.95						
3DP1A	3.25	VR150	.63						
3E29	11.90	VT98	39.95						
3J31	59.95	X99	.75						
4A1	.95	211	.75						
4B30	1.75	217C	6.95						
4C21	1.25	242C	7.50						

TEST EQUIPMENT

Microwave K Band 2400 MC.

TSK1-SE Spectrum Analyzer

K Brand Flux Attenuator

X Band

TSX-4SE Spectrum Analyzer

TS 12 Unit 1 USWR Measuring Amplifier, 2 channel

TS 12 Unit 2 Plumbing for above TS13

TS16AA VSWR Measuring Amplifier Navy type TS 12 Unit 1

TA A-11BL VSWR Measuring Amplifier. Browning

TS 33 X Band Power and Frequency Meter

TS 35 X Band Pulsed Signal Generator

TS 36 X Band Power Meter

TS 45 X Band Signal Generator

TS 146 X Band Signal Generator

TS 263 Navy Version of TS 146

X Band Magic T Plumbing

X Band Tunable Crystal Mounts

TVN-8SE MIT Klystron pulse and power Supply

S Band

TS3A/AP S Band Power and Frequency Meter

RF 4 Electrically Tuned S Band Echo Box

BS 1277/80ABQ S Band Pulsed Signal Generator

PE 102 High Power S Band Signal Generator

L Band

Hazeltine 1030 Signal Generator 145 to 235 Megacycles

TS 69, 300 to 1000 MC Frequency Meter

Measurements Corp. type 84 Standard Signal Generator

TS 47, 40 to 400 MC Signal Generator

Broadcast Wave Bands

162C Rider Chanalyst Short Wave Adapter for 162C Ferris 22A, Signal Generator

TS 174 Signal

Oscilloscopes

BC 1287A used in LZ sets

TS 34 Oscilloscopes WE

Supreme 564

Audio Frequencies

RCA Audio Chanalyst

Hewlett Packard

Other test Equipment and Meters

TS 15/A Magnet Flux Meter

General Radio V T Voltmeter 728A

Calibrator WE 1-147

Hazeltine Pulse & Sweep Generator

UHF Radio Noise & Field Strength Meter Measurements Corp type 58

General Radio 1000 cycles type 213

Limit Bridges

Boonton Standard Inductances

Weston Meters types 430, 429, 741

Model 40 Pyrometer

Rawson, meters 0-10 Microampere 0-2 Millivolt

RADAR Sets & Parts

APS 3-APS 4-SCR 284

Receivers

PHONE WORTH 4-8262

135 LIBERTY ST., NEW YORK 6, N.Y.

LIBERTY ELECTRONICS, INC.

CALLING ALL ENGINEERS!

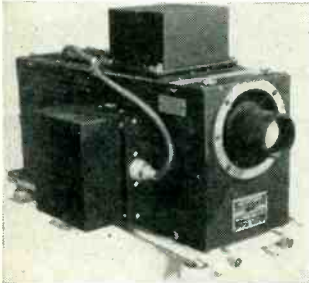

TELEVISION CAMERA

350 line resolution. Easily converted to present RMA standards. Circuits available with camera. Complete, like new.

**FLASH: 50 APN-9
LORAN RECEIVERS**

WE ARE LOOKING FOR ALL TYPES OF RADAR and AIRCRAFT RADIO EQUIPMENT

We want . . .

- BC-348 ART-13
- ARC-1 RTA-1B
- MN 62 R5A/ARN7
- BC-1000

TELL US WHAT YOU HAVE!
TELL US WHAT YOU NEED!

COLUMBIA ELECTRONICS LTD.
152 S. SAN PEDRO ST.
LOS ANGELES 13, CALIF.
Cable Address: COLELECT



MIRROR — front surface aluminized on optical glass 1 3/16" diameter 3/32" thick . . . \$.50



PRECISION LEVEL — interior ground tube level with 4 adjusting screws. Overall length 1 1/2", diam. 15/32". One end with shoulder 1/2" diam. \$.85



DELCO BLOWER — sirocco type D.C. Flange diameter 3 1/2" blade 3-3/16" RPM @ 12 volts 3400 RPM @ 6 volts 1600 . . . \$3.95



SELENIUM RECTIFIERS — G.E. model 6RS 5FB3 maximum A.C. volts 56 D.C. amps. 0.150 . . . \$1.35

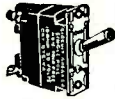

CIRCUIT BREAKER — 10 amp 30 volt D.C. C-H Cat. #8751K4. . . \$1.10



GLASS VIAL — to use as a permanent level on equipment . . . \$1.00



Miniature lamp T1 1/4, 3 volt .19 amp. Airplane Indicator, Amb. Ctd.
10 for \$.85
100 for \$7.50



Lamp Assembly C203 Genl. 1 Made by Eastman Kodak with Iris Diaphragm 12 volt lamp . . . each \$1.95

WATTHOUR METER SINGLE PHASE — G.E. type 1-16 two wire 5 amp. 115 volt 60 cycle \$5.75

SEND FOR FREE BULLETIN

TELEPHONE BEERMAN 3-8623

A. Cottone & COMPANY

ELECTRONIC MECHANICAL & OPTICAL COMPONENTS

336-340 CANAL ST., NEW YORK 6, N.Y.

ALL PRICES F.O.B. N. Y. CITY

FOR SALE BY:—

The President,
Tantalum Refining and Mining
Corporation of America Ltd.,
Post Office Box 698,
EDMONTON, Alberta.

"Scientific Electric" High Frequency Induction Heating Unit or Bombarder, Type WC 25, Serial 1065 complete with spare tubes and accessories. Input 208/240 volts, 25 KW, 60 cycles 3 phase \$2,700.00

"Scientific Electric" High Frequency Induction Heating Unit or Bombarder, Model WC-25A, Serial 1082 complete with spare tubes and accessories. Input —220 volts, 60 cycles single phase 25 KW \$2,700.00

"Scientific Electric" High Frequency Induction Heating Unit or Bombarder, Model 18-HF 2, Serial 20115 complete with spare tubes and accessories. Input —220 volts, 60 cycles single phase. 18 KW. \$1,600.00

"Scientific Electric" High Frequency Induction Heating Unit or Bombarder, Model 6HF2, Input—220 Volts, 60 cycles single phase, 6 KW. \$1,000.00

This equipment was made in U.S.A. and is practically unused having become redundant owing to changes in process.

Prices F.O.B. Edmonton

Select SURPLUS
ELECTRONIC Equipment

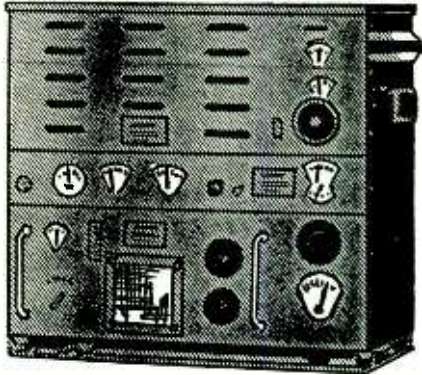

AIRCRAFT
RADIO TRANSMITTERS

Type BC-375-E

100 watt output. Frequency range 200-500 and 1500-12kc., complete, new, with all tuning units, dynamotor, tubes, plugs, etc. Brand new in original packing. Not removed from aircraft. Original cost \$1800.

\$97.50
ea.

Navy Model TDE Radio Transmitters

Frequency range 300 to 18,000 kc., 125 watt output on C. W., 25 watts on phone, for operation on 230 volts D.C. power supply, complete with tubes and ready for operation.

Our information indicates that these units cost the U. S. Navy \$8,000 ea. We offer them to you at a mere **\$675.00** fraction of the original price.

ea.

BD-72 Field Telephone Switchboards

These sets are sold individually packed in strong, steel-strapped, wooden cases, and they are ready to set up and operate.

\$37.50
ea.

Radiomarine Corporation

Telegraph Transmitter Model ET-8023 D1

Power output 200 watts master-oscillator or crystal controlled in operation. Frequency range 2,000 to 24,000 kc., in nine overlapping bands. New, in original export packing. Complete with tubes and typewriter table.

Does not include motor generator power supply. **\$375.00**

ea.

Generating Plants Type PE-197, 5 KW

Gasoline-engine driven. 120 volts, 60 cycles AC, manufactured by Hobart with Hercules 4-cylinder engine, water cooled, including cable, set of tools, automatic starting.

\$675.00
ea.

Navy Model TCS Transmitters-Receivers

Covering 1.5 to 12 mcs. Output 25 watts. Complete with remote control, power supply, antenna tuning unit, cables, key and microphone. Available for 110-220 volts AC and 12 or 24 volt operation. Ask for special leaflet and prices.

ALL ITEMS ARE OFFERED F.O.B. OUR WAREHOUSE, AND ARE SUBJECT TO PRIOR SALE. ALL ITEMS ARE NEW, UNUSED SURPLUS UNLESS OTHERWISE INDICATED. ASK FOR COMPLETE LISTING ON OTHER DESIRABLE EQUIPMENT. SEPARATE TECHNICAL BULLETINS ON ALL EQUIPMENT AVAILABLE UPON REQUEST.

FRENCH-VAN BREEMS, Inc.

405 Lexington Avenue, New York 17, N. Y.

SELENIUM RECTIFIERS and ASSOCIATED COMPONENTS

SINGLE PHASE FULL WAVE BRIDGE RECTIFIERS

Input 0-18VAC	Current	Output 0-12 VDC	Price
Type No. B1-250	250 MA.		\$0.98
B1-1	1 AMP.		2.49
B1-1X5	1.5 AMP.		2.95
B1-3X5	3.5 AMP.		4.50
B1-5	5 AMP.		5.95
B1-10	10 AMP.		9.95
B1-20	20 AMP.		15.95
B1-30	30 AMP.		24.95
B1-40	40 AMP.		27.95
B1-50	50 AMP.		32.95

Input 0-36VAC	Current	Output 0-24 VDC	Price
Type No. B2-150	150 MA.		\$0.98
B2-250	250 MA.		1.25
B2-300	300 MA.		1.50
B2-2	2 AMP.		4.95
B2-3X5	3.5 AMP.		6.95
B2-5	5 AMP.		9.95
B2-10	10 AMP.		15.95
B2-20	20 AMP.		27.95
B2-30	30 AMP.		36.95
B2-40	40 AMP.		44.95

Input 0-115VAC	Current	Output 0-90 VDC	Price
Type No. B6-250	250 MA.		\$2.95
B6-600	600 MA.		5.95
B6-750	750 MA.		6.95
B6-1X5	1.5 AMP.		10.95
B6-3X5	3.5 AMP.		18.95
B6-5	5 AMP.		24.95
B6-10	10 AMP.		36.95
B6-15	15 AMP.		54.95

THREE PHASE FULL WAVE BRIDGE RECTIFIERS

Input 0-234VAC	Current	Output 0-250 VDC	Price
Type No. 3B13-1	1 AMP.		\$22.00
3B13-2	2 AMP.		32.00
3B13-4	4 AMP.		56.00
3B13-8	8 AMP.		81.50
3B13-10	10 AMP.		105.00
3B13-15	15 AMP.		120.00

CENTER TAPPED RECTIFIERS SINGLE PHASE FULL WAVE

Input 16-0-16VAC	Current	Output 0-8 VDC	Price
Type No. C1-10	10 AMP.		\$6.95
C1-20	20 AMP.		10.95
C1-30	30 AMP.		14.95
C1-40	40 AMP.		17.95
C1-50	50 AMP.		20.95

RECTIFIER MOUNTING BRACKETS

For Types B1 through B6, and Type C1 \$.35 per set
For Types 3B. 1.05 per set

Selenium Rectifier Catalog

Write for our Catalog No. 719 which lists Selenium Rectifiers, associated transformers, condensers and filter chokes.

Minimum order \$5.00

No C.O.D.'s. Orders shipped via Rwy. Exp. Charges collect unless accompanied by additional 10% for Parcel Post and handling—15% west of Rockies. Add 10% for Prepaid Parcel Post and Handling. Terms: Net 10 days in the presence of approved credit.

All prices subject to change without notice. Prices and Delivery F.O.B. our NYC Warehouse. All merchandise subject to prior sale.

POWER SUPPLY KITS
24 to 28 VDC Filtered

Designed for continuous duty ground operation and bench testing of aircraft equipment, these kits provide a reliable means of obtaining a source of low ripple 24 VDC. from a 115 VAC 60 cycle line. Full wave bridge Selenium Rectifiers insure instantaneous and efficient operation. Adjustment of the DC output voltage is accomplished by transformer primary taps. Ripple is limited to within 2% of the average DC output by choke-input filters.

Kit No.	Amperes DC	Net Price
242	2.0	\$16.39
245	5.0	22.30
2410	10.0	47.44
2420	20.0	79.44

Write for descriptive Bulletin No. 201

RECTIFIER CAPACITORS

CF-14	3000 MFD 12VDC	\$1.69
CF-1	1000 MFD 15VDC	3.98
CF-2	2000 MFD 15VDC	1.69
CF-20	2500 MFD 15VDC	1.95
CF-3	1000 MFD 25VDC	1.25
CF-4	2X3600 MFD 25VDC	3.45
CF-6	4000 MFD 30VDC	3.25
CF-7	3000 MFD 35VDC	3.25
CF-8	100 MFD 50VDC	.98
CF-19	500 MFD 50VDC	1.95
CF-16	2000 MFD 50VDC	3.25
CF-21	1200 MFD 90VDC	3.25
CF-9	200 MFD 150VDC	1.69
CF-10	500 MFD 200VDC	2.25

Mounting clamps for above capacitors . . . 15c ea.

RECTIFIER TRANSFORMERS

Type No.	Volts	Amps.	Shpd. Wt.	Price
XF15-12	15	12	7 lbs.	\$3.95
TXF36-2	36	2	8 lbs.	3.95
TXF36-5	36	5	8 lbs.	4.95
TXF36-10	36	10	12 lbs.	7.95
TXF36-15	36	15	20 lbs.	11.95
TXF36-20	36	20	30 lbs.	17.95
XFC18-14 18VTC			14 lbs.	5.95

All TXF Types are Tapped to Deliver 32, 34, 36 Volts. XFC Type is Tapped to Deliver 16, 17, 18 Volts Center Tapped.

RECTIFIER CHOKES

Type No.	Hy.	Amps.	Dc Res.	Price
HY5A	.028	5	.20	\$3.95
HY10	.02	10	.30	9.95
HY1CA	.014	10	.04	7.95
HY20A	.007	20	.02	12.95

Type "A" low resistance chokes are specially suited to circuits requiring excellent voltage regulation.

D-C PANEL METERS

Attractive, rugged, and reasonably priced. Moving vane solenoid type with accuracy within 5%. Square case.
0-5 Amperes D-C
0-12 Amperes D-C
0-15 Volts D-C Any range \$2.49 each

SURPLUS CABLE SALE

- Army specs. W143—2 conductor #14 parallel pair 7 copper strands ea. 0216 dia. insulated.
 - 44 conductor copper Okonite "Armortite"—burial without costly conduit.
 - Field telephone wire W110B, 3 copper, 4 steel strands.
 - Perfect condition—large quantities
- JEFF LEE PRODUCTS
1919 Derry St., Harrisburg, Penna., Phone 67961

HIGH TENSION CABLE

Portable, Shielded, #10 AWG. Neoprene Jacket. Will bury 25,000-VAC or 35,000-VDC.

\$364.00/1000-ft.
CUNNINGHAM ENGINEERING CO.
Beaumont, Texas

ELECTRONIC TUBE-MAKING MACHINERY

For manufacturing radio tubes, electronic tubes, cathode-ray tubes, lamps. New and used. Reasonably priced, satisfaction guaranteed.

AMERICAN ELECTRICAL SALES CO.
67 E. 8th St. New York, N. Y.

FOR SALE
PRODUCTION MATERIALS

(Excepting Bulbs, Flares and Wire) for Tube Type 813. For Specifications and Quantities, write

FS-7103, Electronics
330 W. 42nd St., New York 18, N. Y.

NEW U. S. GOV'T. SURPLUS GUARANTEED

POWER RHEOSTATS



Ohms/watt ea.	Ohms watt ea.	Ohms watt ea.
2 225 \$4.95	150 150 \$3.50	
3 100 2.90	200 25 .98	
3 225 4.95	200 150 .50	
4 225 4.95	225 50 1.24	
5 50 1.24	350 25 .98	
5 100 2.90	350 100 2.70	
6 150 3.50	378 150 3.50	
6 25 .98	400 25 .98	
6 50 1.24	500 25 .98	
7 50 1.24	75 25 2.49	
10 25 .98	585 150 3.50	
10 100 2.70	750 25 .98	
12 25 .98	750 150 3.50	
15 25 .98	1000 25 .98	
16 50 1.24	1200 225 4.95	
22 50 1.24	1250 50 1.24	
25 25 .98	1250 150 3.50	
32 300 5.25	1500 50 1.24	
50 25 .98	2000 25 .98	
50 50 1.24	2000 50 1.24	
50 750 14.95	2500 100 2.90	
60 25 .98	3000 25 .98	
75 150 3.50	3000 100 2.90	
80 50 1.24	3500 50 1.24	
80 500 7.60	5000 25 .98	
100 25 .98	5000 50 1.24	
100 50 1.24	7500 100 2.90	
100 225 4.95	7500 100 2.90	
125 25 .98	10000 50 1.63	
125 500 7.60	10000 100 3.50	
150 50 1.24	20000 150 5.26	

Specify whether shaft required (is for knob or screwdriver adjust.) (Discount to Quantity Users.)

SELECTOR SWITCHES

Point	Pos.	Deck	Type	Each
1	6	1	Bak-shtg	.0
1	11	1	Bak-n/shtg	.50
1	12	1	Cer-n/shtg	.59
1	21	3	Bak-n/shtg	.60
1	24	2	Bak-n/shtg	.79
2	2	2	cer-shtg	.39
2	6	2	Bak-n/shtg	.49
2	8	2	Bak-shtg	.54
2	11	2	Bak-shtg	.60
4	4	2	cer-n/shtg	.54
4	11	4	Bak-shtg	1.20
5	3	2	cer-n/shtg	.56
6	11	6	Bak-n/shtg	1.98
10	5	5	cer-shtg	1.49
12	2	3	Bak-shtg	.75
16	2	4	Bak-n/shtg	.98

(many other types in stock)

"AN" CONNECTORS

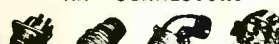

LARGE VARIETY AVAILABLE AT GREAT SAVINGS. Send your specs and let us quote

BIRTCHE TUBE CLAMPS

#926-A		#926-B22
#926-A1	14¢ ea.	#926-C
#926-B		#926-C1
#926-B1	\$12.00	#926-C5
#926-B2	per hundred	#926-C10
#926-B7		#926-C24

OIL CONDENSERS

Mfd	VDCW	Each
.1	3000	.75
.1	6000	1.89
.1	20,000	18.95
.25	3000	1.10
.5	1500	.89
1	600	.36
1	2000	1.95
2	400	.35
2	600	.39
2	1000	.79
4	600	.69
6	400	.75
6	600	.79
10	600	.98
14	600	1.75
15	600	1.98
15	1000	3.25
2 x .1	7000	3.95
2 x .5	9000	14.95

BATHTUBS

mfd	vdcw	each
.033	400	.17
.05	200	.17
.05	400	.19
.05	600	.21
.1	400	.20
.1	600	.22
.15	1000	.32
.15	600	.22
.25	260	.19
.25	600	.23
.35	400	.22
.5	400	.23
.5	600	.24
.5	1000	.35
1	200	.29
1	600	.35
2	400	.44
4	600	.59
4	50	.25
4	500	.59
5	50	.28
5	75	.30
5	25	.27
5	25	.28
5	12	.35
5	9	.39
5	600	.29
5	1500	.45
.05-.05	600	.29
.05-.1	1500	.45
.1-.05	200	.25
.1-.1	400	.26
.1-.1	600	.28
.16-.16	600	.28
.2-.2	600	.29
.25-.25	600	.30
.5-.5	600	.35
1.0-.1	300	.29
200-.200	3	.49
3 x .05	600	.40
3 x .1	400	.42
3 x .1	600	.45
3 x .25	600	.50
3 x 1.0	100	.40

Specify Top, Side, or Bottom Lugs.

"UG" Connectors

UG-12/U	.89
UG-13/U	1.49
UG-18/U	.89
UG-19/U	1.15
UG-21/U	.89
UG-22/U	.98
UG-24/U	.98
UG-25/U	1.15
UG-27/U	1.75
UG-57/U	.89
UG-58/U	.65
UG-123/U	.40

TYPE "J" POTENTIOMETERS

ohms	ohms	ohms	\$1.25 ohms	\$1.50 ohms
60*	1500†	25K†	100-100*	100K-100K*
100†	2000*	30K†	200-200†	100K-100K†
200†	2000†	50K†	500-500†	150K-150K†
300†	4000†	75K†	600-600†	250K-250K†
400*	5000*	100K*	1500-1500*	350K-5000†
500*	5000†	100K†	2000-2000*	500K-25K†
500†	10K*	200K*	2000-2000†	500K-8000†
500†	10K†	200K†	2200-24K†	500K-500K†
1000*	15K*	250K*	20K-2000†	800K-75K†
1000†	20K*	250K†	25K-10K†	1meg-1meg†
1500*	20K†	1meg*	35K-5000	2meg-2meg†
	25K†	2meg†	150K-50K†	5meg-5meg†

TYPE "JJ" 50¢	TYPE "JJJ"
20K-200K-20K†	750K-750K-750K†
45K-27K-2500†	800K-800K-800K†
700K-700K-700K†	1meg-1meg-1meg†

* 1/8" screwdriver slotted shaft. † Knob type shaft.

TRANSMITTING MICAS

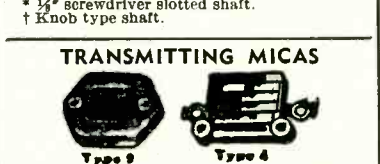

mfd	vdcw	type	ea.	mfd	vdcw	type	ea.
.00001	600	4	18.00162	600	4	18	
.00003	600	4	18.002	600	4	20	
.00005	600	4	18.002	1200	4	48	
.00015	2500	9	31.0022	2500	9	78	
.001	600	4	18.0025	600	4	23	
.001	2500	9	31.003	600	4	25	
.00152	600	4	18.0039	600	4	25	
.002	600	4	18.005	600	4	25	
.0025	600	4	18.005	1200	9	60	
.005	600	4	18.005	2500	9	118	
.0051	2500	4	43.0062	600	4	30	
.007	600	4	18.01	600	4	40	
.008	600	4	18.01	600	9	49	
.009	600	4	18.01	1200	9	98	
.001	600	4	18.0142	600	4	45	
.001	1200	4	31.02	600	4	55	
.001	1200	9	31.02	1250	9	136	
.0013	600	4	18.027	600	4	66	
.0015	600	4	18.043	600	4	99	

"UHF" CONNECTORS



Cat. No.	Army No.	Each	Per C
83-1AC	M-359	.42	.39
83-1AP	PL-271	1.25	1.00
83-1F	PL-274	1.10	.90
83-1R	SO-239	.35	.28
83-1SPN	PL-269A	.35	.28
83-221	SO-264	.50	.40
83-22SP	UG-102	.68	.60

Open Accounts to Rated Concerns. Prices net FOB our base NYC. SEND FOR BARGAINGRAM #503

NEW HOLTZER-CABOT TOTALLY ENCLOSED MOTORS

50 R.P.M. Reversible Single Phase Capacitor-Run type. 115 Volts AC 60 cycles 0.3 Amp. Torque 100 oz. Inches. 4 3/4" shaft 3/8" dia. 250 left. \$16.50 ea. SAMPLE \$17.50

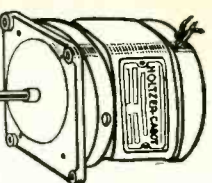

GRAIN OF WHEAT LAMPS



Used for illuminating meters, compass, dials, airplane instruments, etc. Soldering iron removes lamp from base to use in models, doll houses, miniature trains, Xmas trees, etc. Mazda G.E. 323 Mazda G.E. 328 3V. 19A. 6V. 2A. Either type, doz. \$1.50



MARKTIME 5 HOUR SWITCH. A 10 amp. timing device. Pointer moves back to zero after time elapses. Ideal for shutting off radios and TV sets when you go to bed. Limited supply at this special PRICE ... \$3.90

Also available in 30 min. and 1 hr. at \$5.90

ISOLATION TRANSFORMER \$1.95

Nat. known Mfgs. 50 watt 2 windings, 115 V. to 115 V. 60 cy. Ideal to prevent shocks from small radios and medical and electronic devices. Shipping Weight 5 lbs. Other sizes and 220-110 in stock. Kilowatt Demand Meter Totalizer containing heavy duty TELECHRON B-7, 1 RPM motor and hundreds of watch size gears, clutches, springs, etc. Shipping weight 2 lbs. 5 for \$10.00 \$2.50

Fractional H.P. Motor Brushes & Springs. Assorted Sizes will fit any motor. 20 for \$1.00 150 for \$5.00-500 for \$10.00

RUSSELL 110V AC MOTOR \$1.95 3 for \$5.00

RCA 100A Free Floating Cone Type-Magnetic-Loud Speaker. Removed from rooms of a large N. Y. Hotel. Original cost \$32.00. 3 for \$5.00 \$1.85

GONIOMETER CFT-47263 CFT-47372

We are Authorized Wholesalers for Micro Switch Corp. and carry the largest stock of Allen-Bradley Solenoids, Potter & Broomfield Relays, Guardian Electric Co. Solenoids and Relays and Haydon Clock Motors in all speeds. Electric Counters.

EST. 1923 BLAN EST. 1923

Experimenters and Inventors Supplies

64 Dey St., New York 7, N. Y.

FOR SALE BY:—

The President, Tantalum Refining and Mining Corporation of America Ltd., Post Office Box 698, EDMONTON, Alberta.

100 KV "Scientific Electric" AC-DC Rotary Rectifier Unit, Model PS246, Serial 1416; Input—220 Volts, 60 cycles single phase, Rating 10 KW, Regulated to 25,000 Volts. \$1,900.00

0-18,000 Volt Valve Type D.C. "Scientific Electric" Power Supply complete with regulators, meters, etc. Model PS240, Serial 1388, 115 Volt Input, 60 cycles single phase, Rating 3 KW. \$625.00

0-16,000 Volt "Scientific Electric" AC Power Supply complete with regulators, meters, etc. Model PS196, Serial 1140, etc. Input—220 volts, 60 cycle single phase rating 10 KW. \$500.00

0-28 KV "Scientific Electric" DC Valve type Power Supply complete with Regulators, Meters, etc., Model PS198, Serial 1415, Input 220 volts, 60 cycles single phase, 6 KW rating. \$1,400.00

Two—0-20 KV "Scientific Electric" DC Power Supply, Model PS195, Serial 1137, Input—120 volts, 60 cycles single phase, rating 3.6 KW \$500.00 each

0-5,000 Volt "Scientific Electric" DC Power Supply, Model PS203, Serial No. 1166, Input—220 volts, 60 cycles single phase, Rating 2.5 KW. \$300.00

20 KV 20 milliamperes "Scientific Electric" D.C. Power Supply, Input 115 Volts, 60 cycles single phase, rating .96 KW. \$300.00

The equipment was made in U.S.A. and is practically unused having become redundant owing to process changes.

Prices F.O.B. Edmonton

MILLIONS OF RESISTORS

1/2-1-2 Watts

FOR THOSE IMMEDIATE REQUIREMENTS

LIFE ELECTRONIC SALES

91 Gold St. DI 9-4154 N. Y. 7, N. Y.

ALEXANDER MOGULL CO., INC.

161 Washington St., N. Y. 6, N. Y. WOrth 4-0865

TESTED NEW PANEL METERS

EACH METER TESTED BEFORE SHIPMENT. CALIBRATIONS ARE FOR NON-MAGNETIC PANELS. IF METERS ARE FOR USE ON MAGNETIC PANELS SPEECH PANEL THICKNESS AND WE WILL CALIBRATE ACCORDINGLY AT NO EXTRA CHARGE. All meters have white scale and are flush mounted unless specified otherwise.
 S—Square M—Metal sc—scale
 J—Round r/v—Ohms per volt surf—surface
 B—Bakelite bl—Black mounted

A.C. VOLTMETERS

- 15 VOLTS, WESTINGHOUSE NA-35, 3/4" round flush bakelite case JANMR35W015ACVV. @ \$3.95
 - 15 VOLTS, AC-DC, GENERAL ELECTRIC AW-41, 2 1/2" flush bakelite case, black scale, Signal Corps Stock IS-122. @ \$2.50
 - 15 VOLTS, GENERAL ELECTRIC AW-41, 2 1/2" round flush bakelite case, black scale, with markings & calib. at 0, 10 & 15 only. Signal Corps Stock IS-122. @ 2.00
 - 15 VOLTS, GENERAL ELECTRIC AW-41, 2 1/2" round flush bakelite case, black scale, red mark at 10 volts, calib. for 800 cycles. @ \$3.00
 - 40 VOLTS, WESTINGHOUSE NA-33, 2 1/4" round flush metal case, black scale, luminous markings. These were originally calib. for 400 cycle use but have been adj. for 60 cycles. @ \$3.95
 - 40 VOLTS, WESTINGHOUSE NA-33, 2 1/4" round flush metal case, black scale, luminous markings, calibrated for 400 cycles. @ \$3.50
 - 40 VOLTS, WESTON 517, 2 1/2" round flush metal case, bl. scale, lum. mark, calib. 400 cycles. @ \$3.50
 - 75 VOLTS, WESTON 517, 2 1/2" round flush metal case, ring-clamp type mounting (non-flanged). @ \$2.95
 - 130 VOLTS, WESTINGHOUSE NA-35, 3/4" round flush bakelite case, BLANK scale with only red line at 110 volt calibration. @ \$3.00
 - 150 VOLTS, WESTON 517, 2 1/2" round flush bakelite case, JANMR24W150ACVV. @ \$4.50
 - 150 VOLTS, TRIPLETT 332-JP, 3/4" round flush metal case. @ \$4.00
 - 150 VOLTS, TRIPLETT 331-JP, 3/4" round flush bakelite case. (Note—See our COMBINATION OFFER) @ \$4.50
 - 150/300 VOLTS, DUAL RANGE, TRIPLETT 331-JP, 3/4" round flush bakelite case with external series res. for 300 volts, scale calibrated 150 double scale indications for 300 volts use (Note—See our Combination Offer) @ \$5.50
 - 300 VOLTS, TRIPLETT 232-C, 2 1/4" round flush metal case. @ \$6.00
 - 300 VOLTS, WESTINGHOUSE NA-35, 3/4" round flush bakelite case. @ \$8.00
- D.C. MILLIAMMETERS
- 1 MILLIAMMETER, GENERAL ELECTRIC DW-51, 2 1/4" round flush metal case. @ \$3.50

- 1 MILLIAMMETER, GENERAL ELECTRIC DW-41, round flush bakelite case, scale calibrated 130 volts & 500 MA, supplied with paper Volt-Ohm-Milliammeter scale. @ \$3.00
- 1 MILLIAMMETER, WESTINGHOUSE NX-35, 3/4" round flush bakelite, (JAN type MR35W001DCMA) approximately 53.7 ohms resistance. @ \$7.50
- 1 MILLIAMMETER, WESTINGHOUSE NX-33, 2 1/4" round flush bakelite case, special black scale calibrated 200 MA, caption PA Plate, Grid, Battery. @ \$3.00
- 2 MILLIAMMETERS, GENERAL ELECTRIC DW-55, 2 1/2" round flush bakelite case, (JAN MR35W002DCMA) @ \$3.95
- 2 MILLIAMMETERS, WESTINGHOUSE NX-35, 3/4" round flush bakelite case, (JAN MR35W002DCMA) @ \$5.50
- 3 MILLIAMMETERS, WESTON 506, 2 1/2" round flush bakelite case. @ \$3.95
- 3 MILLIAMMETERS, SIMPSON 126, 2 1/2" round flush bakelite case, (JAN type MR26W003DCMA) @ \$3.95
- 5 MILLIAMMETERS, SIMPSON, 2" square flush bakelite case, with red mark at 3 volts. @ \$3.50
- 5-0-5 MILLIAMMETERS, WESTERN ELECTRIC, 3/4" round flush bakelite case, concentric style movement approximately 180 degree deflection, scale calibrated 50-0-50. @ \$3.00
- 15 MILLIAMMETERS, GENERAL ELECTRIC DO-58, 4" x 4 1/2" rectangular flush bakelite case. @ \$4.95
- 15 MILLIAMMETERS, SIMPSON 26, 3/4" round flush bakelite case (JAN type MR25W015DCMA) @ \$4.95
- 20 MILLIAMMETERS, GENERAL ELECTRIC DO-53, 3" square flush bakelite case. @ \$3.75
- 30 MILLIAMMETERS, GENERAL ELECTRIC DO-41, 3/4" round flush bakelite. @ \$3.50
- 50 MILLIAMMETERS, GENERAL ELECTRIC DO-58, 4" x 4 1/2" rectangular flush bakelite case. @ \$4.95
- 50 MILLIAMMETERS, GENERAL ELECTRIC DO-41, 3/4" round flush bakelite. @ \$4.00
- 50-0-50 MILLIAMMETERS, WESTON 301, 3/4" round flush bakelite case. @ \$4.50
- 100 MILLIAMMETERS, ELECTEL 350, 3/4" round flush bakelite case (JAN MR35W100DCMA) Elect. Division of U. S. Time Corporation. @ \$4.00
- 150 MILLIAMMETERS, GENERAL ELECTRIC DO-41, 3/4" round flush bakelite. @ \$4.95
- 150 MILLIAMMETERS, ELECTEL 350, 3/4" round flush bakelite case, (Elect. Division of U. S. Time Corp.) @ \$4.00
- 150 MILLIAMMETERS, TRIPLETT, 2" square flush bakelite scale. @ \$2.95
- 150 MILLIAMMETERS, GRUEN 508, 2 1/2" round flush bakelite case. @ \$3.00
- 200 MILLIAMMETERS, GRUEN GW-511, 2 1/2" round flush bakelite case (JAN type MR25W002DCMA) @ \$3.00
- 200 MILLIAMMETERS, GENERAL ELECTRIC DO-41, 3/4" round flush bakelite. @ \$4.50

- 200 MILLIAMMETERS, SIMPSON 26, 3/4" round flush bakelite case, (JAN type MR35W200DCMA) @ \$4.95
- 200 MILLIAMMETERS, MARION, 3/4" round flush bakelite case. @ \$3.50
- 300-0-300 MILLIAMMETERS, GENERAL ELECTRIC DO-40, 3" round flush bakelite, ring clamp (Non-Flanged) @ \$3.00
- 500 MILLIAMMETERS, GENERAL ELECTRIC DW-41, 2 1/2" round flush bakelite case, black scale (SIGNAL CORPS STOCK NO. IS-22) @ \$3.50
- 500 MILLIAMMETERS, DEJUR AMSCO 312, 3" square flush bakelite case. @ \$4.50
- 800 MILLIAMMETERS, DEJUR AMSCO 310, 3 1/4" square flush bakelite case. @ \$3.50
- 800 MILLIAMMETERS, WESTON 301, 3 1/2" round flush bakelite case. @ \$4.95
- 1000 MILLIAMMETERS, WESTON 301, 3 1/2" round flush bakelite case. @ \$4.95
- 1000 MILLIAMMETERS, WESTERN ELECTRIC, 3 1/2" round flush bakelite, concentric style movement, with approx. 190 degree scale length. @ \$3.50

R.F. AMMETERS

- 100 MILLIAMMETERS, WESTON 425, 3/4" round flush bakelite case. @ \$11.50
- 120 MILLIAMMETERS, SIMPSON 125, 3/4" round flush bakelite, arbitrary linear scale calibrated 0-10, with caption OUTPUT UNITS, complete with external thermocouple. @ \$7.50
- 1 AMP, GENERAL ELECTRIC DW-52, 2 1/2" round flush metal. @ \$3.50
- 1 AMP, GENERAL ELECTRIC DW-44, 2 1/2" round flush bakelite case, black scale. @ \$2.95
- 1 AMP, GENERAL ELECTRIC DO-44, 3/4" round flush bakelite. @ \$11.00
- 1 AMP, WESTON 425, 3/4" round flush bakelite case. @ \$11.00
- 1.5 AMP, WESTON 507, 2 1/2" round flush metal, black scale. @ \$3.50
- 1.5 AMP, WESTINGHOUSE RT-35, 3" square flush bakelite. @ \$5.50
- 1.5 AMP, GENERAL ELECTRIC DO-44, 3/4" round flush bakelite. @ \$5.50
- 1.5 AMP, GENERAL ELECTRIC DW-52, 2 1/2" round flush metal case, black scale. @ \$2.95
- 2 AMPS, WESTINGHOUSE NT-36, 3/4" round flush bakelite case, with external thermocouple. @ \$6.50
- 2 AMPS, WESTINGHOUSE RT-35, 3" square flush bakelite case. @ \$5.50
- 2 AMPS, WESTON 425, 3/4" round flush bakelite case. @ \$8.50
- 2.5 AMPS, MCCLINTOCK MD 3001, 3/4" round flush bakelite, Signal Corps Stock IS-111 @ \$3.95
- 2.5 AMPS, SIMPSON 35, 3/4" round flush bakelite. @ \$4.95
- 2.5 AMPS, WESTON 425, 3/4" round flush bakelite. @ \$8.50

MARITIME SWITCHBOARD

338 Canal St., N. Y. 13, N. Y.

Worth 4-8217

ALL ITEMS ARE BRAND NEW-SURPLUS-GUARANTEED. All materials shipped from stock same day as order received, subject to prior sale.

Orders accepted from rated concerns, public institutions and agencies on open account, others please send 25% deposit, balance C.O.D. or check with order. All prices FOB our warehouse, N.Y.C.

RADIO BROADCAST TRANSMITTERS

PORTABLE—"TWT PB-50A"

Here is a complete portable broadcasting station made for the US Army. Operates from either 110 or 220 V. AC 50/60 cycle source. Has exceptionally high fidelity, extreme compactness and incorporates modern circuit design. Power output is 50 Watts in frequency range 1100 to 1500 Kcs, crystal or MO controlled, 100% modulation. Complete as follows:

- 1 Transmitter PB-50A with tubes
- 1 Power Supply PB-50
- 1 Cooling and Voltage Selector B-2
- 1 Control Console Mixer 2C4
- 1 Phono Turntable (2 speed)
- 2 Dynamic microphones
- 1 Complete set spare tubes
- 1 Complete set spare parts and tools
- 1 Set cables and Antenna Kit
- 1 Complete library of 16 inch recordings
- 2 Technical Manuals

All the above in five trucks for portability. Ten sets available.

BRAND NEW! ORIGINAL PACKING! COMPLETE!

RADIOTELEPHONES

5 WATT, Model JT-52 by Jefferson-Travis, 2 channel, crystal controlled recvr-transmitter, built-in speaker, hand microphone, 6 Volt DC power supply. Freq: 2000-3000 KCS, in compact steel cabinet, complete less xtals. New in original cartons. In dealer quantities.

50 AND 75 WATT, by Harvey-Wells, SIX channel xtal controlled recvr-transmitter, 2000-3000 Kcs, with built-in speaker, telephone hand set, (provisions for selector-ringer and external deck calling system) in handsome steel cabinet, for 32 and 115 Volt DC input. Complete, less crystals. NEW.

Cable: COMMUNIDEV

COMMUNICATION DEVICES CO.

2331 TWELFTH AVENUE

NEW YORK 27, N. Y.

Tel: AD-4-6174, 5

COMMUNICATION TRANSMITTERS

2000 to 20,000 KCS

350 Watts C.W.

250 Watts Radiotelephone

Model MI-8167 Manufactured by R.C.A.

The MI-8167 was made for US Army point-to-point ground communications use. Extremely compact (size: 60 in. High, 17 in. Wide, 27 in. Deep), and shock mounted. High speed keying and High Level Class "B" modulation incorporated. Input 190 to 250 Volts AC 50/60 cycles. No external coils needed—built-in band switching and antenna tuning included. Complete with tubes, built-in shielded oscillator unit (choice of crystal or M.O. units), with or without Speech Amplifier. Fully metered with instantaneous switching. Net weight 570 pounds. Quantities available.

BRAND NEW! ORIGINAL PACKING! COMPLETE!

WALKIE-TALKIES HANDY TALKIES

Many types to choose from in new and complete condition and guaranteed. Bulletins on request.

BC-610 Hallcraft, 2.0-18.0 mcs. 450 watts CW 350 watts phone. Antenna tuner & speech amplifier, cables, manuals, complete. Wt: 446 lbs. net.

BC-365 Federal Tel. & Tel. 150 to 550 Kcs. 350 watts CW, for Radio Range or carrier communication. Complete. Wt: 629 lbs. net.

BC-325 Federal Tel. & Tel., 1.5-18.0 Mcs. 400 W. phone 100 W. CW, complete with remote control. Wt.: 900 lbs. net.

SCR-508/528 FM at 35 Watts output: 20.0-27.9 Mcs., complete with receiver and transmitter, dynamotors, control boxes, crystals antennas.

SCR-608/628 as above, except for frequency of 27.0-35.9 Mcs.

TCS Mixed by Collins 40/20 W. Phone & CW for 12 W. DC, 1.5 to 12.0 Mcs. with all accessories.

DESCRIPTIVE LITERATURE ON REQUEST

MULTI-PURPOSE

ARD-2

RADAR SEARCH RECEIVER

Has continuous frequency range from 80 to 3000 MCS and pulse repetition rates from 50 to 8000 cycles. It can locate any RF signal source by either visual or aural indicators. Ideal as a frequency meter and perfect for operational communications requirements, researchers and manufacturers.

Operates from 115 V. AC at 60 to 2400 cycles input! Extremely versatile on the ground or airborne.

EQUIPMENT: Consists of the following: 1 ANTENNA-DETECTOR (CMD-66A) has variable length antennas (2), diode detector, and silver plated tuning stub with calibrated scale; 1 AMPLIFIER (CMD-50ADC) has three stage pulse amplifier, a trigger circuit, a pulse rate counter circuit and audio amplifier, a visual signal indicator, and a rectifier power supply which is operative on 115 Volts AC, single phase, at 60 to 2400 cycle current, regulated; 1 TEST OSCILLATOR (CMD-60ABG) has carrier frequency of 400 cycles with selection of four pulse repetition rates. With the above are included all cables with fittings, accessories, and shock mounted rack, a steel chest with complete spare parts and 200% additional tubes and 2 technical manuals. Gross weight 113 pounds.

BRAND NEW! ORIGINAL PACKING! COMPLETE!

Price, each \$175.00

PORTABLE RADAR LORAN

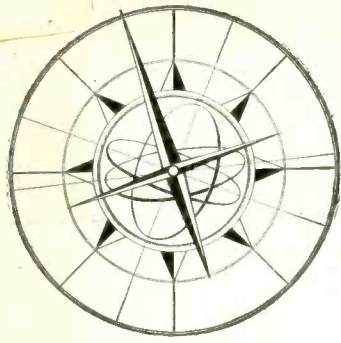

COMPASS COMMUNICATIONS COMPANY

393 GREENWICH ST., NEW YORK 13, N. Y.

CABLE ADDRESS: COMPRADIO

Phone: BEekman 3-6510

New and greatly enlarged quarters to serve our customers better

—RADAR—

(Complete and incomplete)
Marine Airborne

- SA APS-2
- SD APS-3
- SE APS-4
- SF APS-15
- SG APN-1
- SJ APN-2
- SL APN-4
- SN APN-9
- SO APQ
- SQ APT
- VJ ASB
- YJ
- YG

SONAR

30 New, complete
Model NAA "Herald"
underwater sound units

- TDE —complete, like new \$650
- TBS —complete, like new \$550
- TCS —complete, new and like new, 12, 24, 115 dc and 115 ac write
- TBL —complete, excellent w/speech input eqpt \$1,000
- TBK —complete, excellent — write
- TBM —radiotelephone, complete write
- TAJ —complete, excellent — \$850

400-800 watts WESTERN ELECTRIC Radiotelephone 110-220 ac, complete brand new —for ship or shore—write

SELECTED TEST EQUIPMENT

- TS-10 TS-45 IE-19
- TS-12/AP TS-59 IE-46
- TS-16 TS-69 IE-56
- TS-36 TS-100
- TS-263 3 cm multipurpose

We Supply also:
MAGNETRONS
KLYSTRONS
TRANSMITTING TUBES
RECTIFIERS
MOTOR-GENERATORS
CONVERTERS
INVERTERS
DYNAMOTORS

TRANSFORMERS
H. V. CAPACITORS
PRECISION
RESISTORS
and
SELECTED COMPONENTS

CATALOG SENT ON LETTERHEAD REQUEST

RADIOTELEPHONES • RADAR • SONAR • LORAN—FOR LAND, SEA, AND AIR

VACUUM EQUIP'T.

- DIFFUSION PUMPS
 - FORE PUMPS
 - VACUUM GAUGES, etc.
- Some Brand New—WRITE FOR LIST
ZENITH OPTICAL LAB.
123 W. 64 St., New York 23, N. Y.

Quick ANSWERS to your business problems . . .

HUNDREDS of miscellaneous business problems can be quickly and easily solved through the use of the Searchlight Section of this or other McGraw-Hill publications.

When you want additional employees or a position, want to buy or sell used or surplus equipment, want products to manufacture, seek new capital or have other business wants — advertise them in the Searchlight Section for quick, profitable results!

The SEARCHLIGHT SECTIONS OF McGRAW-HILL PUBLICATIONS

Classified Advertising

- American Machinist
- Aviation Week
- Business Week
- Bus Transportation
- Chemical Engineering
- Coal Age
- Construction Methods & Equipment
- Electrical Construction & Maintenance
- Electrical Merchandising
- Electrical World
- Electronics
- Engineering and Mining Journal
- E. & M. J. Metal & Mineral Markets
- Engineering News-Record
- Factory Management and Maintenance
- Fleet Owner
- Food Industries
- Nucleonics
- Operating Engineer
- Power
- Product Engineering
- Textile World
- Welding Eng.

Classified Advertising Division

McGRAW-HILL PUBLISHING CO., Inc.
330 West 42nd Street
NEW YORK 18, N. Y.

WHOLESALE ONLY

ELECTRONIC COMPONENTS
AIRCRAFT EQUIPMENT
HYDRAULICS

RADIO & ELECTRONIC SURPLUS
13933-9 Brush St. Detroit 3, Mich.
Phone Townsend 9-3403

PLATE TRANSFORMER BUY

New Westinghouse Plate Transformers, Hypersil core and coil construction. Primary: 115/230 60 CPS. Secondary: 1200V-0-1200V at 1.5 KVA. Measuring 10"H x 8"W x 6"D and weighing 42 pounds, this is truly a conservative value at \$18, FOB.

WESTON LABORATORIES
Weston 93, Massachusetts

METER MULTIPLIER

Westinghouse R5, 1 meg., w.w., noninductive 1/2% tol. \$.90 each, 10 for \$7.50 or 10 multipliers plus a Weston or Westinghouse 3", 1 ma. meter.....\$10.00

RECTIFIER

Copper Sulphide, F.W.B., 3.5 v. a-c in, 1.8 v. d-c @ 1 amp out. (Fine for 1.5 v. d-c filaments) New, boxed. \$.60 each, 10 for \$5.00, 100 for \$40.00.

TUBES:

Discount 20% on orders over \$50.00

- 1B22 \$4.25
- 1N21 .40
- 2J62 37.50
- 3B22 2.50
- 250TL 19.50
- 316A .35
- 388A 2.75
- 700A 9.75
- 701A 3.50
- 702A 2.75
- 703A 2.75
- 704A 1.00
- 707A 12.50
- 707B 7.00
- 708A 2.75
- 713A .75
- 714AY 3.75
- 715A 7.50
- 715B 6.50
- 721A 2.75
- 722A 7.50
- 724B 7.50
- 725A 8.50
- 730A 10.50
- 846 47.50
- 872A 1.75
- C5B 7.75
- C6A 8.25
- C8J 4.75
- FG81A 3.75
- VF-203A 8.75
- VT95 (Br.) 12.50

SPECIAL: Rectigon, Westinghouse Battery Charger Tube, 6 amp. 65 v., Cat. #289414/JAN4B28. New, orig. box. \$1.50 each, 4 for \$5.00.

Immersion heater, Westinghouse, low surface, 3 heat, oil type, 115 v. 200, 400, and 800 watt. 1 1/4" male pipe connection with carrol elements projecting 3". List \$17.20. Our price \$6.50 each, 2 for \$10.00.

NEW RA-38 RECTIFIERS

115v., 60 cy. 1 phase input, output 0-15,000 v. d-c @ 500 ma. Write for detailed information.

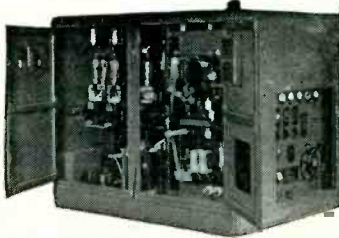

CIRCUIT BREAKERS Westinghouse Type "AB" De-Ion, Thermal Trip Without Enclosure, 3 pole, 50 amp frame size. Specify 15 amp, 25 amp, or 50 amp rating. New. \$3.75 each, 3 for \$10.00.

Filament Transformer

HIGH VOLTAGE FILAMENT TRANSFORMERS: Amertran type W.S. .050 KVA, 50/60 c., 1 phase; 35 KV test, 12 KV d-c operating; sec. 5 v c-t @ 10 amps. Has socket that takes 872A, 250T.



371, 5563 etc., rectifiers. Net Wt. 16 lbs. \$12.50 each, 2 for \$22.50, 4 for \$40.00.

NEW!

- low prices
- values
- equipment
- components

Note: All merchandise not designated as new is guaranteed to be in excellent to new condition.

EPCO
1527 E. 7th St.
Los Angeles 21, Calif.

VACUUM CAPACITOR: 50 mmfd. 22,000 v. d-c. New, original carton. \$4.50 each, 4 for \$15.00.

TRANSTAT, 115/220 v. 50/60 c., 0-260 v. 2 1/2 amp. cont. 5 amp. max. output. New. Original packing. List \$43.00. \$17.50 each, 2 for \$30.00.

METERS:
 0-150 Volt AC 3" Round.....\$3.95
 0-150 Volt 400 Cycle 2 1/2" Round..... 2.95
 0-5 Amp. AC 3" Rd. 0-100 A. Scale..... 3.95
 0-5 Amp. AC 3" Rd. 0-75 A. Scale..... 3.95
 0-5 Milliamp DC 2 1/2" Square..... 2.95
 0-500 Microamp 2 1/2" Rd. w/0-15 & 0-600 DC Volt Scale..... 3.95

SELENIUM RECTIFIER UNITS
HEAVY DUTY—30 VOLT DC OUTPUT:
 115/200 V. Three Phase 400 Cycle Input:
 TYPE 143 w/Transformer & VR 100 amp.....\$89.50
 TYPE 3FS-5 w/Trans., VR, & Blower 200 amp.....\$99.50
 TYPE 52A-11 Rectifier only, Cased 200 amp...\$49.50
 TYPE AI Rectifier only, Cased 300 amp.....\$59.50
 TYPE RE-60 Rectifier only, Cased 400 amp.....\$69.50

HAMMETT RECTIFIER
 MODEL SPS — 100 B — Input 220 Volts AC 60 cycle 3 Phase 13 Amps. Output DC 15/30 Volts 130/65 Amps. Price — NEW.....\$175.00

Brand New BLOWERS
 115 Volt 60 cycle, approx. 100 Cubic Ft. dia. 3 1/4" intake, 2" outlet. Motor size: 3 1/2" x 3". 1525 RPM. Complete with mounting bracket. Gov't surplus. Brand new and boxed.
 Order No. **\$7.95**
 E-3604

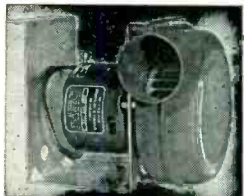

WRITE TODAY FOR QUOTATION ON YOUR DYNAMOTOR OR INVERTER NEEDS!

WHIP ANTENNA EQUIPMENT:
MAST BASES—INSULATED
 MP-132—1" heavy coil spring, 2" insulator. Overall length: 11 1/2". Weight: 2 1/2 lbs. Price.....\$3.95
 MP-22 Spring action direction of bracket. 7" x 6" mounting. Price.....\$2.95
MAST SECTIONS FOR ABOVE BASES:
 Tubular steel, copper coated, painted, 3 foot sections, screw in type. MS-53 can be used to make any length, with MS-52-51-50-49 for taper. Price, per section.....50¢
 SECTIONS MS-54—55 Larger than MS-53.....75¢ ea.
 BAG BG-56 for carrying 5 mast sections.....50¢ ea.

Address Dept. E • • • All Prices Are F.O.B. Lima, O. • 25% Deposit on C.O.D. Orders

FAIR RADIO SALES
 132 S. Main St. LIMA, OHIO

STEPPING SWITCHES
EXCESS INVENTORY LIQUIDATION
 This Low Price in Effect Only As Long as This Excess Stock Lasts
 Clare Type SD-14 20 Steps, 6 Levels, 120 Contacts Total, Coil 12V. D.C.
CLEARANCE \$13.00 PRICE
 (Immediate Delivery)
 Original Price \$40.26 List
 Satisfaction Guaranteed or Money Refunded
NEOMATIC INC.
 879 Wellesley Ave. Los Angeles, 49, Cal. Phone—ARizona 34897



D.C. MICROAMMETERS
 0-200 ua 3" sq. G.E. DO 50.....\$ 8.00
 0-100 ua 3" sq. G.E. DO 50..... 10.00
 0-50 ua 3" sq. G.E. DO 50..... 12.00

R.F. MILLIAMMETERS
 0-115 Ma 3 1/4" Weston 425.....\$12.00
 0-100 Ma 3 1/4" Weston 425..... 12.00

PRECISION PORTABLE INSTRUMENTS
 Single or multi-range
 D.C. Microammeters, from 5 ua full scale. Thermo-couple Milliammeters, from 1.5 Ma. Thermo-couple voltmeters.
Precision Electrical Instrument Co.
 146 Grand Street New York 13, N. Y.

ACORN Serves Schools, Labs, Industrials
 Top Values—Same Day Service



KENYON FILTER CHOKE
 12 hy 500 mils 95 ohms **\$9.95** ea.
 DC T177
 Kenyon Modulation Transformer
 Pri. 18000 ohms c.f. p.p. 811s
 Sec. 9400 ohms, 140 w. output **\$8.95** ea.
Kenyon Cased Filament Transformer
 Stock # T376. Pri. 115 50-60 cy
 Sec. #1: 6.3v c.t. @ 4 amps. **\$2.99** ea.
 #2: 6.3v c.t. @ 4 amps.
 #3: 5v @ 3 amps

ISOLATION TRANSFORMER
 Pri. 115v. 60 cy
 Sec. #1: 115v. @ 90 mils
 #2: 12.6v. c.t. @ 6.3v.
 @ 2 1/2 amps. Channel mt. **\$1.89** ea.

HEAVY DUTY POWER TRANSFORMER
 Pri. #1: 110/220 v. 60 cy. Sec. #1: 410-0-410 @ 400 mils. #2: 6.3 v. @ 3 amps. #3: 6.9 v. @ 13.5 amps. #4: 5 v. @ 3 amps. #5: 2.5 v. @ 1.7 amps. Dimensions: H-6 1/2" — W 6 1/2" — D 5 1/2" Wt. 33 lbs.
 Made by G. E. for U. S. Navy. **\$7.49**
 Exceptional value! Open frame.

MILLEN SHAFT COUPLERS
 39001 22¢ ea.
10 for \$1.89

SOUND POWERED RECEIVER and/or Transmitter
 Impedance 900 ohms. A pair can be used as either a receiver or transmitter for 2-way communication.
\$9.95 per pair

HY	FILTER CHOKES Channel Mount		
	MA	DC	Ohms Each
10	55	350	\$.69
10	75	200	.79
2 1/2	200	60	1.29
8 1/2	235	60	1.39
10	150	130	1.19
10	150	200	1.39
8	250	95	2.39

HERMETICALLY SEALED
 15 80 400 .69
 15 70 420 .79

INTERSTATE TRANSFORMER
 3-1 ratio. Channel mt. 49¢ ea.

R-G 58/U AMPHENOL COAXIAL CABLE
 25 ft. lengths fitted with end connectors that can be coupled to any length.
\$1.50 per length
 (Min. order 2 lengths)

APPROACH INDICATOR
 (Glide path indicator)
 1D-24/ARN-9
\$3.95 ea.

TV FOCUS COILS
 for 16" and 19" cine-scopes 470 ohms.
\$2.49 ea.



HANDIE TALKIE
 2" speaker and microphone. Self contained transformer; nylon parchment cone.
\$2.29 ea.

Weston Meter Current Transformer
 Model 604
 2500-5 amps. Brand New!
\$5.95

SELENIUM RECTIFIER
 Full wave bridge. 18 v. input, 14 v. output, 7 amps.
\$7.95

1 F TRANSFORMERS—MIDGETS
 455 KC 10.7 MC-FM **59¢ ea.**
 4.5 MC 23.5 MC-FM **3 for \$1.55**
 21.9 MC-TV Sound 24.5 MC-TV Video

DUAL TV UNIVERSAL TRAPS
 Eliminates FM interference
49¢ ea.

Suprenant Microphone Cable
 Waterproof. .06 per ft.
\$5 per C \$35 for M

POWER TRANSFORMER
 Perfect for TV.
 Pri: 115v. 50/60 cy.
 Sec. #1: 800 v. c.t. @ 260 mls
 #2: 6.3 v. @ 10 amps. **\$7.49** ea.
 #3: 6.3 v. @ 1.2 amps.
 #4: 5 v. @ 3 amps.
 Upright mount

10" SPEAKER—Quam Nichols
 Alnico V. 6.8 oz. magnet, 13 w. output, 3.2 ohm v.c. List \$14. Our price..... **\$3.99**

8" SPEAKER—G.E.
 S-810D With Aluminum Foil Base Voice Coil
 6.8 oz. Alnico V magnet, 3.2 ohms. 1" v.c. 12 w. output. Excellent frequency range
 List price \$12. Our price..... **now \$2.99**

ACORN ELECTRONICS CORP. TERMS: 20% cash with order. Balance C.O.D. unless rated. All prices F.O.B. our warehouses in New York City. No orders under \$2.50.
 76 Vesey St. Dept. E-8 New York 7, N. Y. PHONE WORTH 4-3270

UNIVERSAL SAVES U 50%

H-F TIE POST
 LOW-LOSS BAKELITE INSULATION
 \$7.00/C \$60.00/M

LARGE STOCKS OF
 AN Connectors Coils Resistors
 APC's Crystals Shock-
 Binding Posts Controls Mounts
 Cable Filters Sockets
 Capacitors Fuses Spaghetti
 Ceramics Hardware Servo Xfms
 Ceramics Knobs Pulse Xfms
 Chokes Potentiometers Trans-
 Circuit (Sine-Cosine) formers
 Breakers Relays Tubes

Write Us Your Needs for Immediate Quote
Min. Order \$2.50
Universal/general corp
 Note Our New Address
 324 Canal St. N.Y.C. WALKER 5-9642

RADAR EQUIPMENT
 APS-3 3cm Search Radar
 APS-4 3cm Search Radar
 SCR-717B 10cm Search Radar
 SO-9 10cm Search Radar
 APR-4 Receivers & Tuning Units
 TS-12 Standing Wave Amplifier
 Test Equipment and Signal Generators for 10 and 3cm
 Write for Catalogue
LERU LABORATORIES, INC.
 360 Bleecker St., New York 14, N. Y.
OREGON 5-3525

1 A B // TUBES THAT'S A BUY Tested-Guaranteed

Table of vacuum tube types and prices, including OA2, OA3/VR75, OA4G, OB2, etc.

Table of vacuum tube types and prices, including 6H6, 6C6, 6X4, 6X4GT, etc.

Table of vacuum tube types and prices, including FG17, RK18, 19B, 19B6G, etc.

Table of vacuum tube types and prices, including 704A, 705A/8021, 1A8, 1A8B, etc.

Precision Resistors section: Over 2 1/2 Million in Stock. Includes 'Williamson' and 'Basic Photoflash Kit'.

IN34 Crystals Diodes, 67¢ section: Infra-Red Sniperscope, 115 Volt 60 Cycle Xformers, Audio & Modulation Xformers.

Oil Capacitors - New! section: Table of capacitor specifications including Mfd, Each, Mfd, Each, Mfd, Each.

Blowers section: Cool That Tube! section: Rectifiers section: Precision Bradley Double Bridge.

'TAB' Money Back Guarantee section: THAT'S A BUY. DEPT. 8 E SIX CHURCH ST. NEW YORK 6, N.Y., U.S.A.

INDEX TO ADVERTISERS

Acheson Colloids Corp.	164	Dial Light Company of America	196
Adams and Westlake Company	27	Driver Co., W. B.	145
Advance Electric and Relay Co.	213	Driver-Harris Company	19
Advertising Council	193	Dudek and Bock	225
Aeronautical Communications Equipment, Inc.	50	Dumont Electric Corp.	191
Aerovox Corp.	20	Du Mont Laboratories, Inc., Allen B.	29
Airpax Products Company	224	du Pont de Nemours and Co., Inc., E. I.	171
Alden Products Co.	166		
Alifax Paper & Engineering Co.	229	Eastern Air Devices, Inc.	204
Allen-Bradley Co.	38	Eastman Kodak Company	
Allen Co., Inc., L. B.	229	Cellulose Products Div.	157
Allied Control Company, Inc.	36	Industrial Photographic Div.	123
Allmetal Screw Products Co., Inc.	186	Edison Inc., Thomas A.	176, 218
Altec Lansing Corporation	220	Edo Corporation	32
American Electrical Heater Co.	192	Eisler Engineering Company, Inc.	216, 229
American Lava Corp.	43	Eitel-McCullough, Inc.	57
American Smelting & Refining Co.	169	Electric Indicator Co.	200
American Television & Radio Co.	194	Electrical Industries, Inc.	224
American Time Products, Inc.	54	Electrical Reactance Corp.	47
Amperex Electric Corp.	3rd Cover	El-Tronics, Inc.	229
Amperite Company, Inc.	180	Electrons, Inc.	134
Ampex Electronic Corporation	256	Emsco Derrick & Equipment Co.	214
Anaconda Wire & Cable Co.	161	Eric Resistor Corp.	37
Antara Products Div., General Aniline & Film Corp.	34		
Arkwright Finishing Company	162	Fairchild Camera & Instrument Corp.	144, 213
Arco Steel Corporation	155	Fairchild Recording Equipment Corp.	222
Arnold Engineering Company	40	Fisher-Pierce Company, Inc.	209
Art Wire and Stamping Company	217	Freed Transformer Co., Inc.	175
Audak Company	256	Fusite Corporation	24
Automatic Coil Winder & Electrical Equipment Co., Ltd.	152		
Automatic Electric Sales Corp.	52		
		Gamewell Company	209
Ballantine Laboratories, Inc.	138	Garrett Co., Inc., George K.	202
Barrett Varnish Co.	229	Gates Radio Co.	18
Barry Corporation	62	General Electric Company	
Bead Chain Manufacturing Co.	196	Apparatus Dept.	16, 17, 173, 183
Bell Telephone Laboratories	181	Construction Materials Dept.	44
Bendix Aviation Corporation		Electronics Dept.	23, 30, 31, 49
Eclipse-Pioneer Division	215	General Radio Company	149
Red Bank Division	135	Giannini & Co., Inc., G. M.	221
Bentley, Harris Mfg. Co.	10	Graphite Metallizing Corp.	211
Berkeley Scientific Company	215	Green Instrument Co.	205
Berlant Associates	209	Gries Reproducer Corp.	229
Bird Electronic Corp.	208		
Bircher Corporation	203	Handy & Harman	191
Blake & Johnson Company	172	Hardwick, Hindle, Inc.	154
Boonton Radio Corporation	121	Hathaway Instrument Co.	198
Bowser Inc.	211	Haydon Company, A. W.	219
Breeze Corporations, Inc.	223	Haydon Mfg. Company, Inc.	176
Bridgeport Brass Co.	189	Helland Research Corporation	216
Brush Development Company	28	Helipot Corporation	187
Burnell and Company	59	Hewlett-Packard Company	55
		Hexacon Electric Company	217
Cambridge Thermionic Corp.	184	Hollist Mills, Inc.	210
Cannon Electric Development Co.	136		
Capitol Radio Engineering Institute	213	Industrial Condenser Corp.	225
Carborundum Co.	22	Inland Testing Laboratories Inc.	196
Carnegie-Illinois Steel Corp.	153	Instrument Resistors Company	182
Carter Motor Company	180	International Resistance Co.	4, 5
Central Paper Co., Inc.	184	Irrington Varnish & Insulator Company	151
Cinch Manufacturing Corp.	113		
Clare and Co., C. P.	9	Jelliff Manufacturing Corporation, C. O.	222
Clarostat Mfg. Company, Inc.	653	Jensen Manufacturing Co.	11
Cleveland Container Company	129	Johnson Co., E. F.	210, 224
Clippard Instrument Laboratory, Inc.	190	Jones Div., Howard B., Cinch Mfg. Corp.	205
Cohn Corporation, Sigmund	188	Joy Manufacturing Company	204
Collins Radio Company	33		
Communications Accessories Company	156	Kable Engineering Co.	225
Condenser Products Company	7	Karp Metal Products Co., Inc.	39
Consolidated Engineering Corporation	223	Kartron	229
Continental Carbon Inc.	217	Kenyon Transformer Company, Inc.	190
Continental-Diamond Fibre Co.	56	Kester Solder Company	117
Cornell-Dubilier Electric Corp.	137	Kinney Manufacturing Company	35
Corning Glass Works	163	Kollsman Instrument Div., Square D Company	12
Cornish Wire Company, Inc.	158		
Cossor (Canada) Limited	226	Lambda Electronics Corporation	203
Crane Packing Company	170	Lampkin Laboratories, Inc.	213
Cross Co., H.	229	LaPointe-Plascomold Corp.	202
Dano Electric Company	221		
Daven Co.	159		

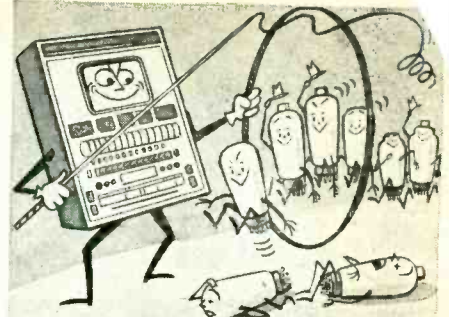

You Get **OVERALL Test Performance With**

PRECISION— SERIES 10-12 Electronamic* TUBE PERFORMANCE TESTER

with 12 ELEMENT free-point
Master Lever Selector System

To test modern tubes for only one characteristic will not necessarily reveal overall performance capabilities. Tube circuits look for more than just Mutual Conductance or other single factor.

In the Precision Electronamic Circuit, the tube PERFORMS under appropriately phased and selected individual element potentials, encompassing a wide range of plate family characteristic curves. This complete Path of Operation is integrated by the indicating meter in the positive PERFORMANCE terms of Replace-Weak-Good.

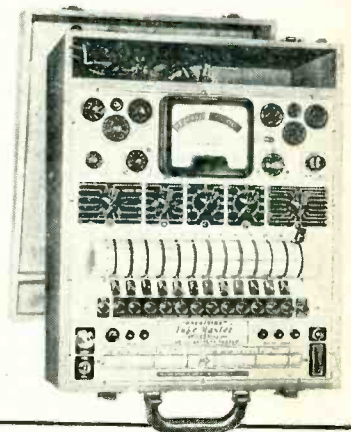

MODEL 10-12-P: in sloping, portable hardwood case with tool compartment and hinged removable cover. Size 13 3/4 x 17 1/4 x 6 3/4" \$96.10
Also in counter or rack-panel mounts.

- ★ Facilities to 12 element prongs.
- ★ Filament voltages from 3/4 to 117 volts.
- ★ Tests Noval 9 pins; 5 and 7 pin acorns; double-capped H.F. amplifiers; low power transmitting tubes; etc. REGARDLESS OF FILAMENT OR ANY OTHER ELEMENT PIN POSITIONS.
- ★ ISOLATES EACH TUBE ELEMENT REGARDLESS OF MULTIPLE PIN POSITIONS.
- ★ DUAL short check sensitivity for special purpose tube selection.
- ★ Battery Tests under dynamic load conditions.
- ★ Built-in Dual-Window, brass-g geared roller chart.
- ★ 4 1/2" Full Vision Meter.

SEE the "Precision" Master Electronamic Tube Testers at leading radio equipment distributors. Write for catalog describing Precision Test Equipment for all phases of modern A.M., F.M., and T.V.

Precision Apparatus Co., Inc.
92-27 HORACE HARDING BLVD.
ELMHURST 10, N. Y.

*Reg. U.S. Patent Office
Export: 458 B'way, N.Y.C., U.S.A. Cables: MORHANE
In Canada: Atlas Radio Corp. Ltd., Toronto, Ontario

when you use
the **Audax**
POLYPHASE...
ONE single unit
plays **ALL**
your records
SUPERBLY...
and at less
than the cost
of ordinary
magnetic pick-ups

"The Standard
by which
Others
Are Judged
and Valued"



Microgroove,
78. r.p.m., etc.

- Response 20 to over 10,000 cps.
- Jewel styl replaceable individually.
- Needle talk practically nil.
- Tracking remarkable.

See it at your local distributor or write us

Send for editorial reprint on POLYPHASE principles

AUDAK COMPANY

500 5th Ave., New York 18
Fine Music Reproducers Since 1915

Critical TAPE RECORDING
to 40,000 cycles

Tape recording is superior to all other reproduction methods and "AMPEXED TAPE" has the greatest fidelity and range now possible. Simplified operation plus sure results make AMPEX unexcelled for all critical recording uses. Dual tape speeds with automatic speed and equalization change is but one of many exclusive AMPEX features.

Unequaled for

TELEMETERING • BROADCASTING • RESEARCH

AMPEX

STANDARD OF THE GREAT RADIO SHOWS

Simultaneous

- ERASE
- RECORD
- PLAY BACK

MODEL 300
Price \$1575
(f.o.b. San Carlos)
Meter Control
Panel \$114 Extra

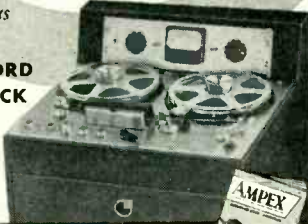

AMPEX ELECTRIC CORP., San Carlos, California

Without obligation please send 16-page illustrated booklet containing technical specifications of Amplex Magnetic Tape Recorders.

NAME _____
ADDRESS _____
CITY _____ STATE _____

Our need is for:

- | | |
|--|--|
| <input type="checkbox"/> Laboratory Research | <input type="checkbox"/> Telemetering |
| <input type="checkbox"/> Multi-Channel Recording | <input type="checkbox"/> Industrial Recording |
| <input type="checkbox"/> Recording-Broadcasting | <input type="checkbox"/> Aerophysical Research |

AMPEX ELECTRIC CORPORATION
SAN CARLOS, CALIFORNIA
DEALERS IN PRINCIPAL CITIES

Mallory and Company, Inc., P. R.	64, 115
Manning, Maxwell & Moore Inc.	133
Marion Electrical Instrument Co.	2
Metal Textile Corporation.	218
Millen Mfg. Co., Inc., James.	176
Miniature Precision Bearings, Inc.	229
Minneapolis-Honeywell Regulator Co., Industrial Division.	14
Mitchell-Rand Insulation Co., Inc.	167
Mosinee Paper Mills Company.	148
Muirhead & Co., Ltd.	3

National Company, Inc.	206
New Hampshire Ball Bearings, Inc.	200
New Hermes.	198
New York Transformer Co.	142
North American Aviation, Inc.	178
Nothelfer Winding Laboratories.	182

Ohmite Manufacturing Co.	32A, 32B
Oregon Electronics Mfg. Co.	165

Paper Machinery & Research, Inc.	226
Paramount Paper Tube Corp.	217
Patton-MacGuyver Co.	227
Phalo Plastics Corporation.	207
Plastics & Electronics Co.	229
Polarad Electronics Company.	201
Potter Instrument Co., Inc.	170
Precision Apparatus Co., Inc.	255
Precision Paper Tube Co.	212
Presto Recording Corporation.	25
Pyramid Electric Co.	60

Quaker City Gear Works, Inc.	217
-----------------------------------	-----

Radio Corp. of America.	13, 127, 160
	179, Back Cover

Radio Materials Corporation.	26
Railway Express Company, Air Express Division.	174
Rauland Corporation.	139
Rawson Electrical Instrument Co.	223
Raytheon Manufacturing Co.	125
Remler Company, Ltd.	186
Rex Rheostat Co.	229
Ruby Chemical Co.	196

Sanborn Company.	150
Sangamo Electric Company.	51
Scientific Electric, Div. of "S" Corrugated Quenched Gap Co.	192
Seovill Manufacturing Co.	212
Servomechanisms, Inc.	178
Sigma Instruments, Inc.	63
Societe Industrielle ALFA.	229
Sola Electric Company.	21
Sorensen and Company, Inc.	8
Specialty Battery Company.	208
Sperry Gyroscope Company.	141
Sprague Electric Company.	119
Stackpole Carbon Co.	6
Standard Piezo Company.	220
Standard Pressed Steel Co.	209
Standard Transformer Corporation.	205
Staver Company, Incorporated.	221
Stelmen Mfg. Co., Wm.	221
Stevens Mfg. Co., Inc., Geo.	199
Steward Manufacturing Co., D. M.	225
Stoddart Aircraft Radio Co.	46
Superior Tube Company.	177
Sylvania Electric Products, Inc.	61, 131

Tektronix, Inc.	195
Television Equipment Corp.	219, 221
Transradio Ltd.	203
Triplett Electrical Instrument Company.	48

United States Steel Corp.	153
United Transformer Co.	2nd Cover
Universal Winding Company.	143

Veeder-Root Inc.	15
Victoreen Instrument Company.	58
Vulcan Electric Company.	200

Waldes Kohinoor, Inc.	147
Waterman Products Co., Inc.	188
Webster Electric Co.	140
Weller Manufacturing Company.	206
Westinghouse Electric Corp.	41, 185
Weston Electrical Instrument Corp.	42
White Dental Mfg. Company, S. S.	197, 203
Whitehead Stamping Company.	213
Whitney Metal Tool Co.	209
Wilcox Electric Company.	45

Zophar Mills, Inc.	205
-------------------------	-----

PROFESSIONAL SERVICES ... 210

SEARCHLIGHT SECTION
(Classified Advertising)

EMPLOYMENT

Positions Vacant.	230, 231
Positions Wanted.	230
Selling Opportunities Wanted.	230
Employment Agencies.	230
Employment Services.	230

BUSINESS OPPORTUNITIES

Offered.	230
---------------	-----

EQUIPMENT

(Used or Surplus New) For Sale.	233-254
---	---------

WANTED

Equipment.	232
-----------------	-----

ADVERTISERS INDEX

Acorn Electronics Corp.	253
Advance Transformers Co.	432
American Electrical Sales Co.	249
Arrow Sales, Inc.	241
Bell Aircraft Corp.	231
Bendix Aviation Corp.	231
Blan.	250
Capehart Farnsworth Corp.	230
Columbia Electronics Ltd.	248
Communication Devices Co.	251
Communications Equipment Co.	233, 234, 235
Compass Communications Co.	252
Cotrone & Co., A.	248
Cunningham Engineering Co.	249
Electro Impulse Laboratory.	247
Electronic Engineering Co. of Calif.	231
Electroncraft, Inc.	238
Engineering Research Associates Inc.	231
EPSCO.	252
Fair Radio Sales.	253
Franklin Employment Service.	230
French-Van Breems, Inc.	249
Goodyear Aircraft Corp.	231
Haydu Bros.	246
Hughes Aircraft Co.	231
Instrument Associates.	236, 237
Lee Products, Jeff.	249
Lelectronic Research Laboratories.	240
Legri, S. Co., Inc.	232
Leru Laboratories Inc.	253
Liberty Electronics Inc.	248
Life Electronics.	250
Maritime Switchboard.	251
Mogull Co., Inc., Alexander.	250
Mutual Telephone Co.	230
Neomatic, Inc.	253
Lee Products, Jeff.	249
Peak Electronics Co.	243
Precision Electrical Instrument Co. Radio & Electronic Surplus.	253 252
Radio Corp. of America.	231
Radio Ham Shack, Inc.	244
Reliance Merchandizing Co.	242
Servo-Tek Products Co., Inc.	245
TAB.	254
Tantalum Refining & Mining Corp. of Amer- ica, Ltd.	248, 250
Tomsett Associates.	230
Universal General Corp.	253
Victor-Bernard Industries.	232
Wells Sales, Inc.	239
Weston Laboratories.	252
Zenith Optical Lab.	252

This Index is published as a convenience to the readers. Every care is taken to make it accurate, but ELECTRONICS assumes no responsibility for errors or omissions.