

AUGUST • 1949

electronics

A MCGRAW-HILL PUBLICATION



LANDING BY
MICROWAVES

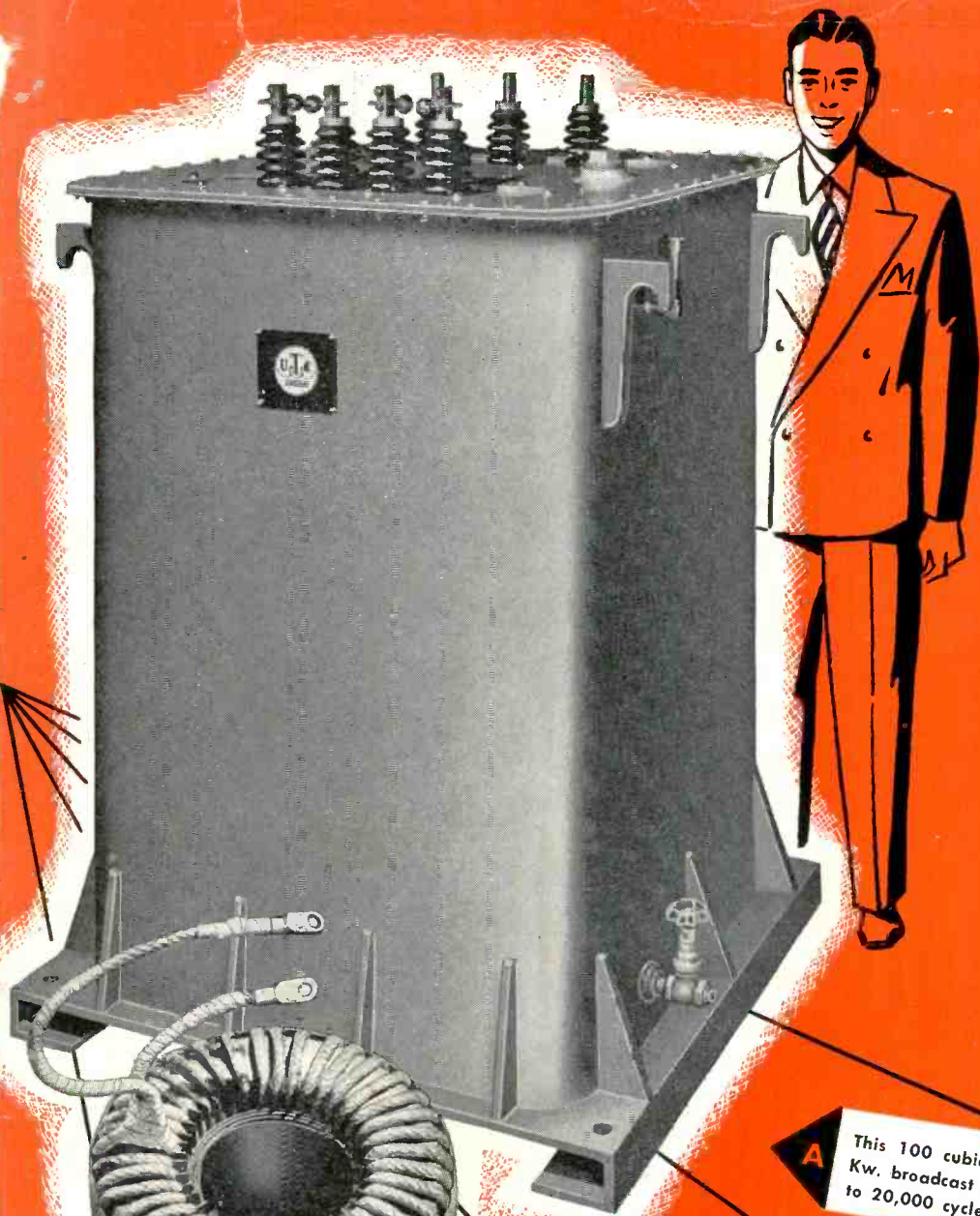

for every application

While the catalogue line of UTC components covers a wide variety of applications, many people are not familiar with the full range of products produced by UTC. It is impossible to describe the thousands of special UTC designs as they become available. The illustrations below are intended to indicate some of the range in size of these special products.

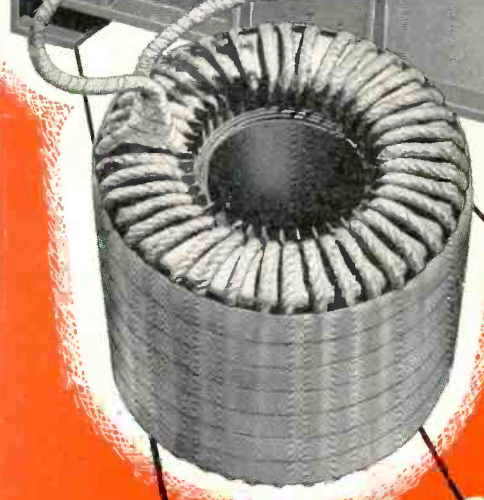

A This 100 cubic foot modulation transformer is for 50 Kw. broadcast service. Frequency response flat from 30 to 20,000 cycles.

B The high Q toroid coil shown is 12" in diameter. It operates in a 50 Kw. circuit at supersonic frequency.

C This sub-miniature (.18 cubic inch) output transformer is intended for hearing aid and other extreme compact service. While the dimensions are only 7/16" x 9/16" x 3/4", the fidelity is ample for voice frequency requirements.

D This sub-miniature (.18 cubic inch) permalloy dust core toroid is available in a wide range of inductances, and for frequencies from 1,000 cycles to 50 Kc.



United Transformer Co.
150 VARICK STREET NEW YORK 13, N. Y.
EXPORT DIVISION, 13 EAST 40th STREET, NEW YORK 16, N. Y., CABLES: "ARLAB"

write for catalog PS-409

electronics

A McGRAW - HILL
PUBLICATION



AUGUST • 1949

LANDING BY MICROWAVES	Cover
Adjusting antenna tilt control on experimental microwave glide path transmitter, with C-54 landing in background at Clinton County Air Force Base, Wilmington, Ohio. Official U. S. Air Force photograph	
NEW FCC RULES MEAN MORE MOBILE RADIO, by Jeremiah Courtney	66
Assignments of permanent frequencies for mobile services will permit vast expansion	
RADIOLOCATION IN OIL PROSPECTING, by E. A. Slusser	70
A survey of radiolocation systems used in locating oil fields under the Gulf of Mexico	
AUTOMATIC STATION CALL SELECTOR, by W. W. McGaffin and H. R. Schulz	75
Instrument reads preset International-Morse-code call letters and sounds alarm to summon operator	
WHAT WE LEARNED FROM THE BERLIN AIRLIFT, by M. A. Chaffee and R. B. Corby	78
Experience gained, using search radar with radio and GCA, proves feasibility of all-weather commercial operation	
PULSED STIMULATOR AIDS MEDICAL RESEARCH, by L. A. Woodbury, M. Nickerson and J. W. Woodbury	84
Constant-current pulse generator with variable pulse rate, length and amplitude	
UHF PROPAGATION CHARACTERISTICS, by Edward W. Allen, Jr.	86
Summary of several investigations which may help to determine proper spacing of new television stations	
TRANSISTOR OSCILLATOR FOR TELEMETERING, by Frank W. Lehan	90
Crystal-triode audio oscillator proves superior to vacuum-tube predecessor	
DESIGN OF A PIPELESS ORGAN, by John D. Goodell and Ellsworth Swedien	92
Teeth rotating past shaped pole pieces generate complex waveforms, giving tones indistinguishable from pipe organ	
CIRCUIT TECHNIQUES FOR MINIATURIZATION, by Peter G. Sulzer	98
Positive feedback eliminates need for cathode and screen bypass capacitors	
LOGARITHMIC-SCALE NOISE METER, by Walter J. Ives	100
A simple d-c vacuum-tube voltmeter with two-decade range for use with noise detector	
HIGH-FREQUENCY TRANSMISSION LINE CHART, by Preston R. Clement	104
Solution of terminating impedance and matching-stub problems using straight-line loci	
GENERAL-PURPOSE PRECISION OSCILLOSCOPE, by R. P. Abbenhouse	106
Well-known circuits, with refinements, provide extreme versatility	
SELECTIVITY CALCULATIONS, by Harold J. Peake	112
Equations, nomograph and chart relating 3-db bandwidth, Q, R, L and F for single, double and cascaded tuned circuits	
BUSINESS BRIEFS	66
CROSSTALK	71
TUBES AT WORK	116
ELECTRON ART	120
NEW PRODUCTS	124
NEWS OF THE INDUSTRY	128
NEW BOOKS BACKTALK INDEX TO ADVERTISERS	

DONALD G. FINK, Editor; W. W. MacDONALD, Managing Editor; John Markus, Vin Zeluff, A. A. McKenzie, Associate Editors; William P. O'Brien, James D. Fahnestock, Assistant Editors; Hal Adams Burleson, Ann Mastropolo, Sophie D. Feeney, Editorial Assistants; Gladys T. Montgomery, Washington Editor; Harry Phillips, Art Director; Eleanor Luke, Art Assistant

KEITH HENNEY, Consulting Editor

H. W. MATEER, Publisher; WALLACE B. BLOOD, Manager; R. S. Quint, Directory Manager; D. H. Miller, R. H. Denmead, Jr., New York; Wm. S. Hodgkinson, New England; Warren W. Shew, Philadelphia; C. D. Wardner, Chicago; J. L. Phillips, Cleveland; J. W. Otterson, San Francisco; Carl W. Dysinger, Los Angeles; Ralph C. Maultsby, Atlanta; Bernard H. Butler, London, England

Contents Copyright 1949, by McGraw-Hill Publishing Company, Inc. All Rights Reserved. McGRAW-HILL PUBLISHING COMPANY, INCORPORATED, JAMES H. McGRAW (1860-1948), Founder • PUBLICATION OFFICE, 99-129 North Broadway, Albany 1, N. Y., U. S. A. EDITORIAL AND EXECUTIVE OFFICES, 330 West 42nd St., New York 18, N. Y., U. S. A.—Member A. B. P. Member A. B. C.

James H. McGraw, Jr., President; Curtis W. McGraw, Vice-President and Treasurer; Eugene Duffield, Senior Vice-President, Publications Division; Nelson Bond, Vice-President and Director of Advertising; J. E. Blackburn, Jr., Vice-President and Director of Circulation; James A. Gerardi, Secretary; Dexter Keezer, Director Economics Department; Russell F. Anderson, Editor, World News.
ELECTRONICS, August, 1949, Vol. 22; No. 8. Published monthly, with an additional issue in June, price 75c a copy for U. S. and possessions, and Canada; \$1.50 for Latin America; \$2.00 for all other foreign countries. Directory issue \$2.00. Allow at least ten days for change of address. All communications about subscriptions should be addressed to the Director of Circulation. Subscription rates—United States and possessions, \$6.00 a year, \$9.00 two years, \$12.00 for three years. Canada (Canadian funds accepted), \$7.00 a year, \$11.00 for two years, \$14.00 for three years. Latin American countries \$15.00 for one year, \$25.00 for two years, \$30.00 for three years. All other countries \$20.00 for one year, \$30.00 for two years, \$40.00 for three years. Please indicate position and company connections on all subscription orders. Entered as Second Class matter August 29, 1936, at Post Office, Albany, New York, under the Act of March 3, 1879. BRANCH OFFICES: 520 North Michigan Avenue, Chicago 11, Ill.; 68 Post Street, San Francisco 4; Aldwych House, Aldwych, London, W.C. 2; Washington, D. C. 4; Philadelphia 3; Cleveland 15; Detroit 26; St. Louis 8; Boston 16; Atlanta 3, Ga.; 621 So. Hope St., Los Angeles 14; 738-9 Oliver Building, Pittsburgh 22. ELECTRONICS is indexed regularly in The Engineering Index.

MARION

... helps Polytechnic Research
and Development ...

... monitor microwave
oscillator operation

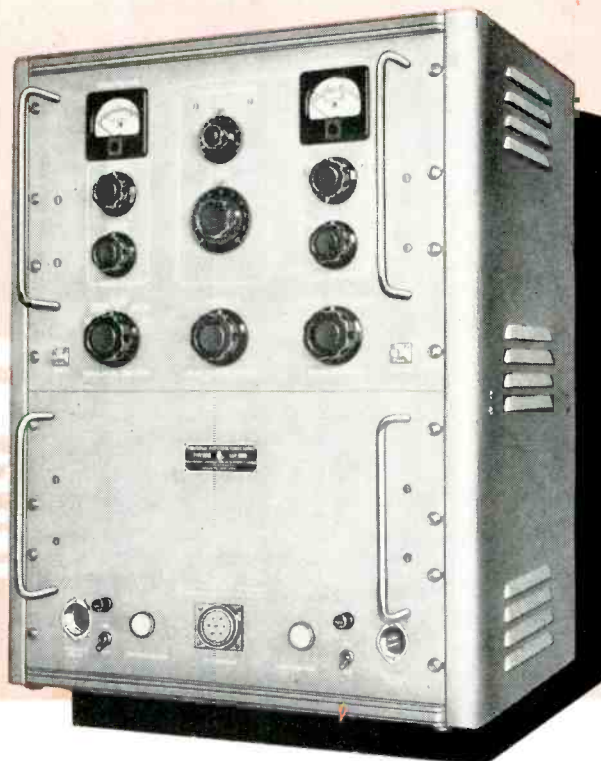

The PRD Type 801 Universal Klystron Power Supply is a new and versatile instrument. It was produced by Polytechnic Research and Development Company of Brooklyn for operating the many high voltage klystron tubes which are used as sources of microwave energy in the fields of Radar, Radio Relay and Microwave Spectroscopy.

When PRD developed the Type 801 it needed two extremely accurate, matched indicating instruments for measuring Beam Current and Beam Voltage. Because PRD had previous experience with Marion and because Marion is so well known for foolproof, troublefree instruments of this kind ... at reasonable cost, it was natural that PRD should turn to Marion. Marion's Standard Type 53SN was selected. This is a 3½" instrument, noted for accuracy and readability.

When you want standard or special purpose instruments for electrical indicating or measuring, we invite you to turn to us. Our long experience in helping others leads us to believe that we can help you too.

the
name
MARION
means
the most
in meters

ASK US FOR FURTHER INFORMATION



MARION ELECTRICAL INSTRUMENT COMPANY

M A N C H E S T E R , N E W H A M P S H I R E

Export Division, 458 Broadway, New York 13, U. S. A., Cables MORHANEX

IN CANADA: THE ASTRAL ELECTRIC COMPANY, SCARBORO BLUFFS, ONTARIO

FREE

**ON
REQUEST**

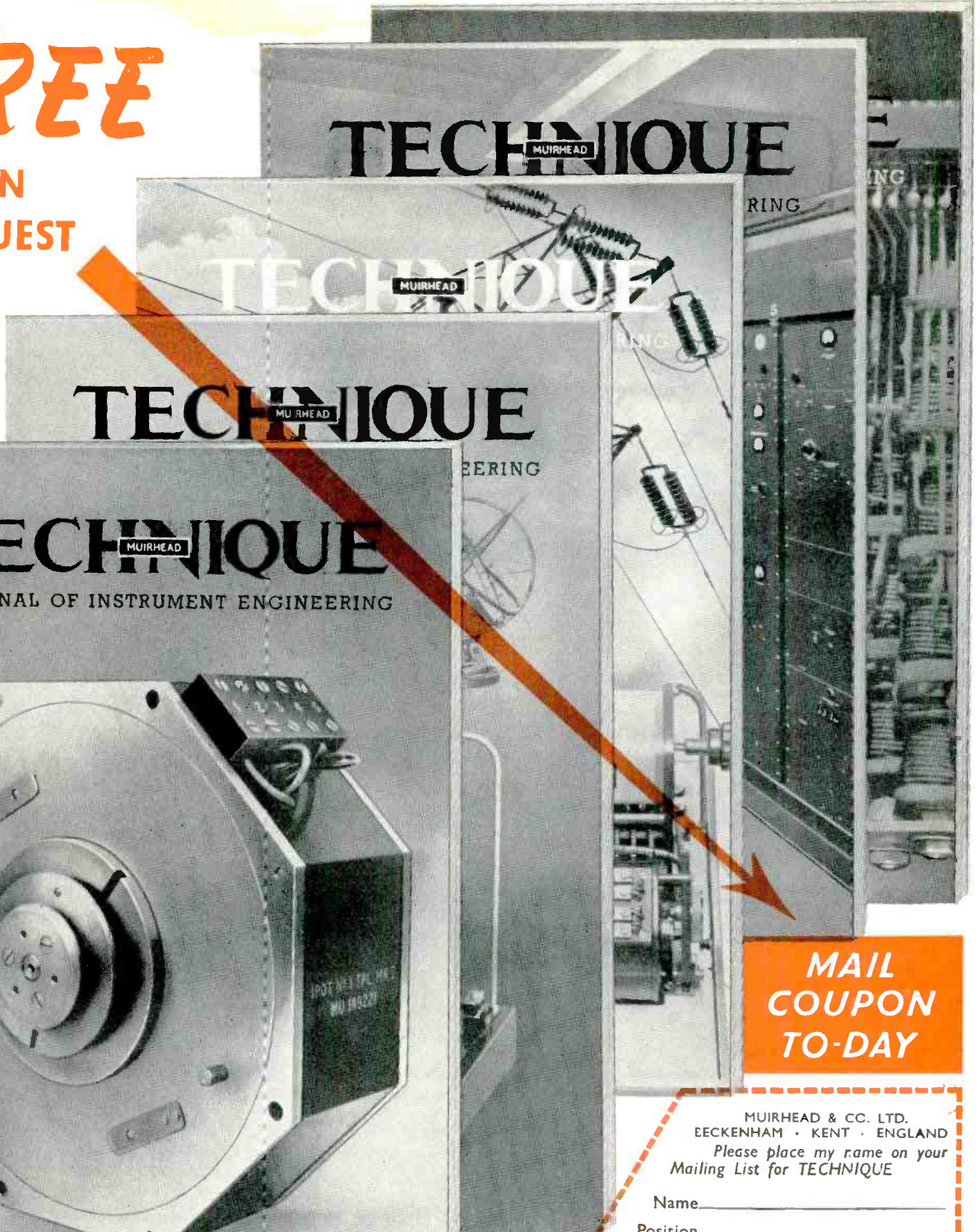
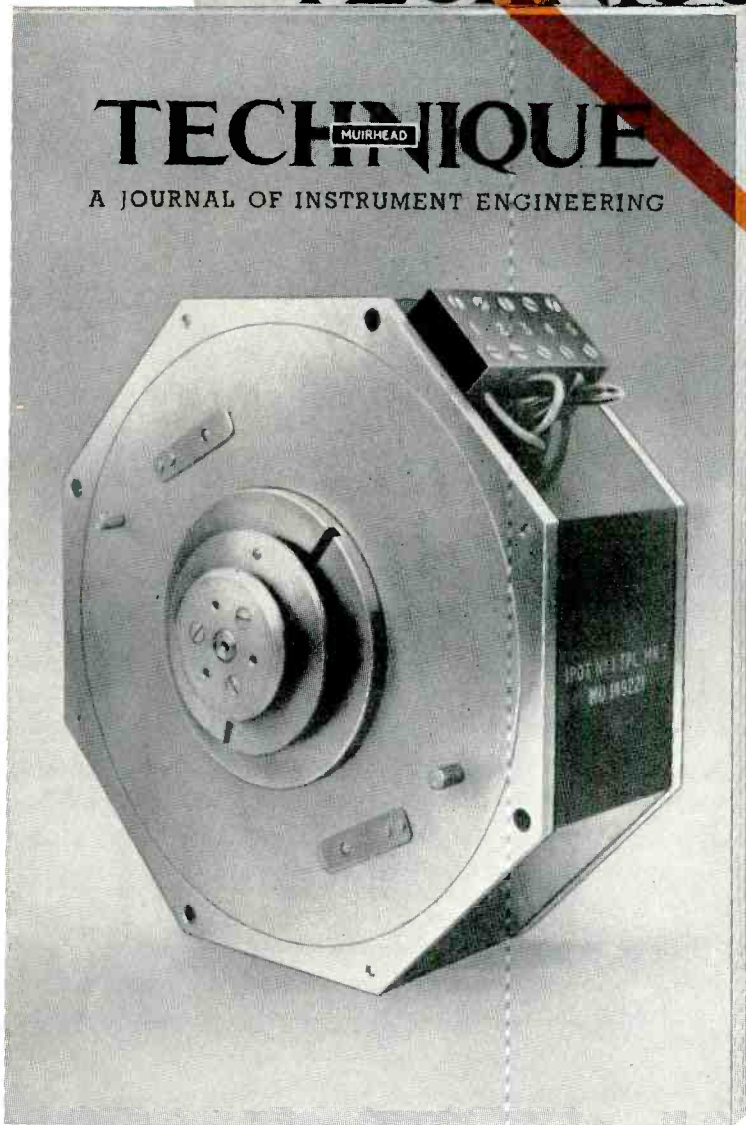

**MAIL
COUPON
TO-DAY**

MUIRHEAD & CO. LTD.
EECKENHAM · KENT · ENGLAND
*Please place my name on your
Mailing List for TECHNIQUE*

Name _____
Position _____
Company _____
Address _____

MUIRHEAD & Co. LTD.
PRECISION ELECTRICAL INSTRUMENT MAKERS
BECKENHAM · KENT · ENGLAND

Telegrams and Cables: MUIRHEADS ELMERS-END

PRECISION
MUIRHEAD
ELECTRICAL INSTRUMENTS

HIGH

in quality...



LOW

in cost

23C SPEECH INPUT EQUIPMENT for AM and FM Stations

HERE is a complete, compact, high-quality Amplifier and Control Assembly—available at minimum cost!

The Western Electric 23C Speech Input Equipment serves either one or two studio layouts, in either AM or FM stations—can be used as part of a larger system, with outputs switched in a master control room.

The 23C incorporates four microphone input circuits with pre-mixing amplifiers and one input circuit for incoming program lines—all combined in a 5-channel mixer. Three-stage amplifier boosts signals to level needed for outgoing program lines or output switching systems. Also includes independent monitoring amplifier.

The 23C will handle 8 studio microphones or low-output-level transcription turntables; 4 remote lines or other medium-level inputs; control room announce and talkback mike. Controls are conveniently arranged, easily operated.

Get the full facts on the 23C from your local Graybar Broadcast Representative—or write Graybar Electric Company, 420 Lexington Avenue, New York 17, N. Y.



DISTRIBUTORS: IN THE U. S. A.—Graybar Electric Company. IN CANADA AND NEW-FOUNDLAND—Northern Electric Co., Ltd.

—QUALITY COUNTS—

Western Electric

August, 1949 — ELECTRONICS

KILOVOLTS for KLYSTRONS

NEW

PRD

**POWER SUPPLY for
microwave oscillators**

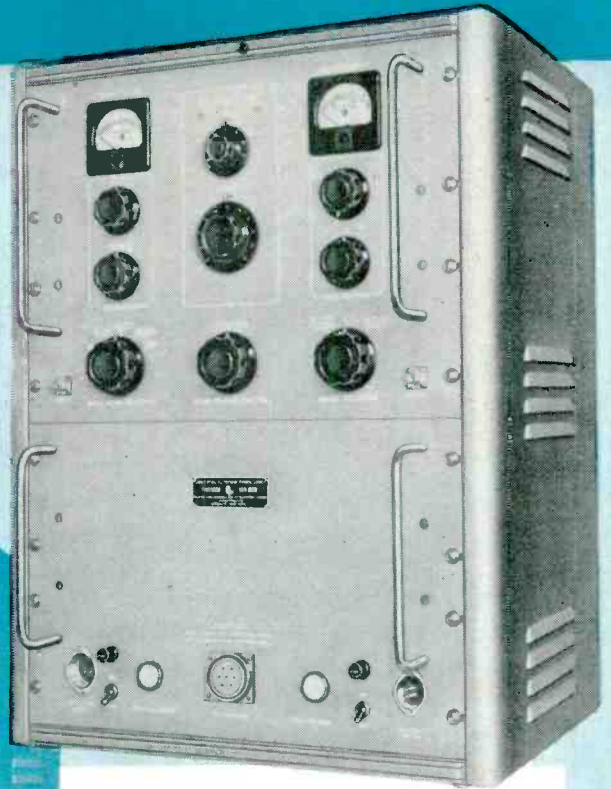

CONTINUOUSLY VARIABLE

Carefully regulated beam voltage supply provides cathode-to-grounded-anode potential in two ranges with choice of operation from 800 to 1500 volts at 65 ma or to 3600 volts at 25 ma.

DIRECT READING CONTROLS

— coarse and fine —
allow repeller voltage to be accurately adjusted from -20 to -750 volts.

GRID VOLTAGE

may be varied continuously from -300 volts to a positive value limited by the klystron grid current.

PANEL METERS

Indicate beam voltage and current directly.

The Type 801 Universal Klystron Power Supply has been developed by PRD to meet the increasing need of research and production engineers for a unit to operate the many high voltage klystrons now in use throughout the microwave spectrum.

Provision is made for c-w, square-wave, sawtooth, and external modulation of conventional internal cavity klystrons, external cavity oscillators, and the new millimeter tubes now coming into use in microwave spectroscopy.

Excellent voltage stabilization guarantees a maximum of oscillator frequency stability. Carefully controlled modulation wave-shapes insure accuracy of standing wave measurements and spectrum analysis when made with oscillators powered by this supply.

Polytechnic **RESEARCH
& DEVELOPMENT COMPANY, Inc.**

202 TILLARY ST., BROOKLYN 1, NEW YORK



JUST OFF THE PRESS!
The new 95-page catalog describing the complete PRD line of microwave test equipment is now available—write for your copy today to Dept. E-3.

Z

IRCON

Zirconium Silicate— 67% ZrO₂ + 33% SiO₂

FOR HIGH MELTING POINT,
HEAT SHOCK RESISTANCE,
LOW THERMAL EXPANSION,
ACID AND CORROSION RESISTANCE,
HIGH MECHANICAL STRENGTH,
GOOD ELECTRICAL RESISTIVITY.

MECHANICAL, THERMAL, CHEMICAL AND PHYSICAL PROPERTIES

Crystal Structure	Tetragonal	
Bulk Density —		
Granular Zircon	180 lbs./cu. ft.	0.104 lbs./cu. in.
Milled Zircon	102 lbs./cu. ft.	0.059 lbs./cu. in.
Fired Rammed Body	216 lbs./cu. ft.	0.125 lbs./cu. in.
Fired Slip Cast Body	250 lbs./cu. ft.	0.139 lbs./cu. in.
Thermal Conductivity cal/°C/sec/cm/cm (Up to 700°F = 0.031 BTU/°F/sec/in/sq. ft.)	= 0.0258	
Mean Specific Heat	(21-51°C)	0.132 cal/gram/°C
Softening Point	3452°F (1900°C)	
Cold Modulus of Rupture	Rammed Body—1600-2600 psi Slip Cast Body—7000-8000 psi	
Melting Point	4000-4100°F (2200-2260°C)	
Thermal Expansion (mean reversible 20°-1000°C)	4.5 x 10 ⁻⁶ /°C 2.5 x 10 ⁻⁶ /°F	
Insoluble in aqueous alkaline solutions and in all acids		

ELECTRICAL PROPERTIES

Dielectric Constant E	12 ± 1	
Resistivity at °F in Megohms/in. ³	1100°	170
	1200°	120
	1300°	70
	1400°	25
	1500°	7
	1600°	2.5

IN HIGH TEMPERATURE APPLICATIONS

Such as pyrometer tubes—gas turbine combustion chambers—cyanamide processing containers—aluminum remelting—phosphate, sulphuric acid and silica gel processing furnaces, Zircon offers definite advantages. Its properties make it an ideal body constituent in certain electrical porcelains. As a mold and core wash ingredient, it is in increasing demand and is receiving considerable attention as a mold material in precision alloy casting.

Granular and milled zircon of various purities are available also in addition to zircon refractories, ramming mixes and cements. During years of research and practical experience, a fund of information on the properties, applications and potentials of zircon compounds has been built up.

Specific data and practical suggestions may be obtained through our field engineers or by writing our New York office direct.

TAM

TAM is a registered trademark.

Registered U. S. Pat. Off.

TITANIUM ALLOY MFG. DIVISION NATIONAL LEAD COMPANY

Executive and Sales Offices: 111 BROADWAY, NEW YORK, N. Y. • General Offices and Works: NIAGARA FALLS, N. Y.



JET PLANE

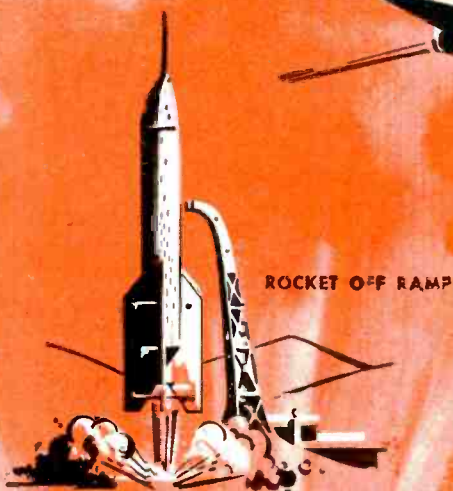

ROCKET OFF RAMP



AMPHIBIOUS TANK

EXPLOSION-PROOF, REGULATED DYNAMOTOR



RADAR

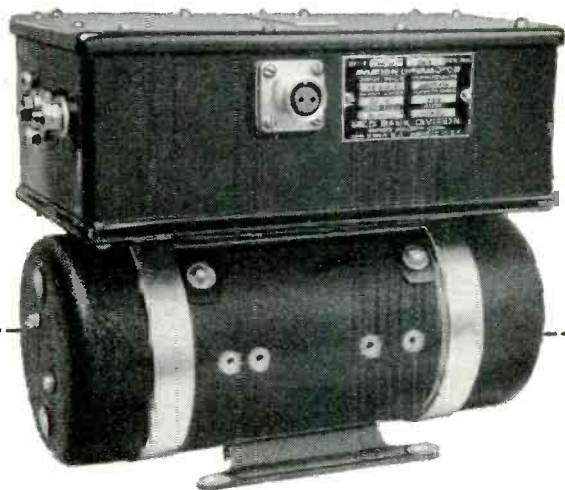

Bendix realizes that today's standards are tomorrow's discards. Our research program is designed to keep *ahead* of tomorrow's needs—to produce equipment that is *ready, when* it is needed. Typical of the results achieved by this far-sighted development work are explosion-proof dynamotors, regulated dynamotors, inverters and D.C. motors* manufactured by Bendix. In addition, Bendix research has produced rotating equipment that will withstand extreme conditions of altitude, temperature, humidity, immersion, shock, and acceleration. To those members of the electronic industry engaged in the design and development of guided missiles, telemetering apparatus, radio, radar, or other electronic devices, we suggest that you call on:

* Bendix motors meet specification ANM-40.

CHECK AND BE SURE

- Voltage regulation
- Frequency regulation
- Speed control
- High temperature operation
- High altitude operation
- Waterproof construction
- Noise proof (conducted and radiated)

Only Bendix can give you *all* of these important features.

For immediate information call our Engineering Staff—Red Bank 6-3600. • Staff Members:
W. H. Wells, Director, Sales Engineering
K. H. Fox, Chief Engineer
J. J. Korzdorfer, Project Engineer.

RED BANK DIVISION of
Red Bank, New Jersey



Dynamotors • Inverters • Converters • D. C. Motors • Carbon Pile Voltage Regulators

Pin point accuracy is

for resistors too!

And IRC provides it. Witness leading manufacturers who specify IRC resistors for advanced electronic circuits. In instrumentation and industrial applications, IRC resistors excel in every important characteristic.

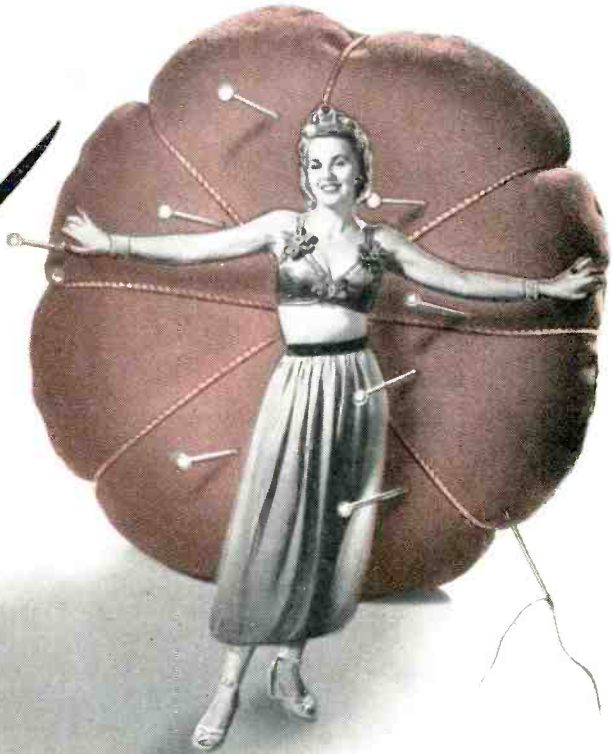

IN CRITICAL INSTRUMENTATION, IRC Precision Wire Wounds offer a fine balance of accuracy and dependability. Tolerances of 1% are standard, but 1/2%, 1/4% and 1/10% are available. IRC Precisions also afford maximum temperature coefficient of .002% per °C. at no extra cost. And in addition, their design and construction assure stability—even where recurring surges are encountered. Labels are acetate. May we send you complete technical data? Just check the coupon.

essential



SEALED PRECISION Voltmeter Multipliers find many critical applications such as are encountered in marine service because of absolute dependability under the most severe humidity conditions. Type MF's are compact, rugged, stable, fully moisture proof and easy to install. They consist of individual wire wound precision resistors, mounted, interconnected and encased in glazed ceramic tubes—and these may be either inductive or non-inductive, for use on AC as well as DC. Send coupon for technical data bulletin.

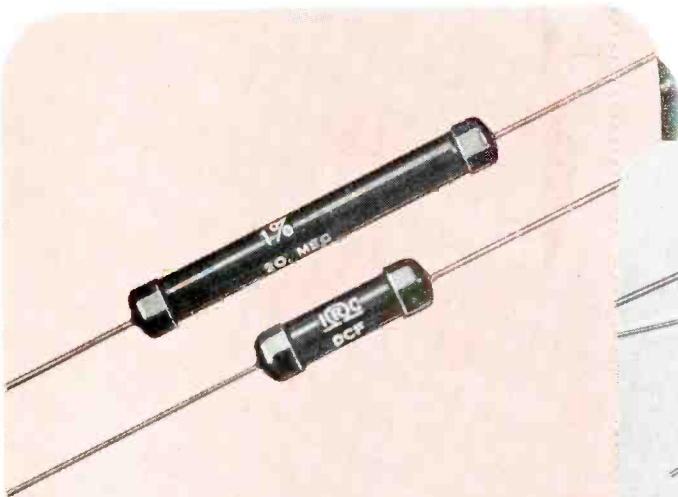

ACCURACY AND ECONOMY in close tolerance applications make IRC Deposited Carbon PRECISTORS ideal for television and similar circuits. They are outstanding in their ability to provide dependable performance in circuits where the characteristics of carbon composition resistors are unsuitable and wire-wound precisions too expensive. Manufactured in two sizes, 200 ohms to 20 megohms in 1%, 2% and 5% tolerance. Coupon brings full details.

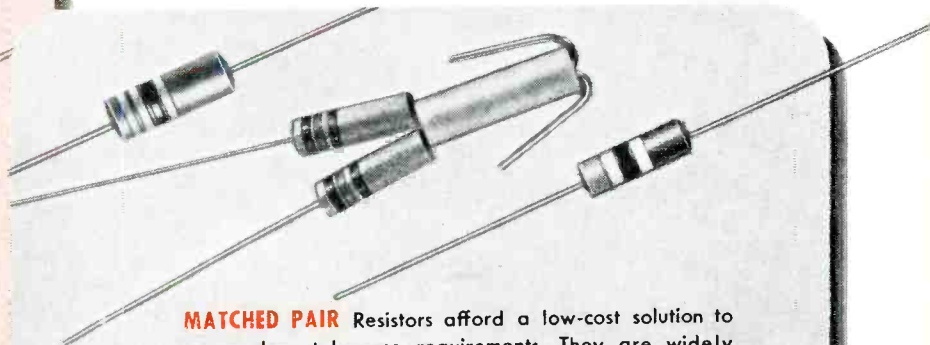

MATCHED PAIR Resistors afford a low-cost solution to many close tolerance requirements. They are widely used as dependable meter multipliers. Two insulated IRC resistors are matched in series or parallel to as close as .1% initial accuracy. Both JAN-R-11 approved Advanced BT resistors and low-range BW insulated wire wounds are available in Matched Pairs. Use the coupon to send for Bulletin B-3.

For fast, local service on standard IRC resistors, simply phone your IRC Distributor. IRC's Industrial Service Plan keeps him well supplied with the most popular types and ranges—enables him to give you prompt, round-the-corner delivery. We'll be glad to send you his name and address.



**INTERNATIONAL
RESISTANCE COMPANY**

401 N. Broad Street, Philadelphia 8, Pa.

In Canada: International Resistance Co., Ltd., Toronto, Licensee

Wherever the Circuit Says

Power Resistors • Voltmeter Multipliers
• Insulated Composition Resistors • Low
Wattage Wire Wounds • Controls
• Rheostats • Voltage Dividers •
Precisions • Deposited Carbon
Precistors • HF and High Voltage
Resistors • Insulated Chokes

INTERNATIONAL RESISTANCE CO.
403 N. BROAD ST., PHILADELPHIA 8, PA.

Please send me complete information on the items checked below:

- Precision Wire Wounds Deposited Carbon Precistors
 Wire Wound Controls Voltmeter multipliers
 Matched Pair Resistors Name of Local IRC Distributor

NAME

TITLE

COMPANY

ADDRESS

.....

J. F. ARNDT & CO., ADV. AGENT

COMPARE FACTS!

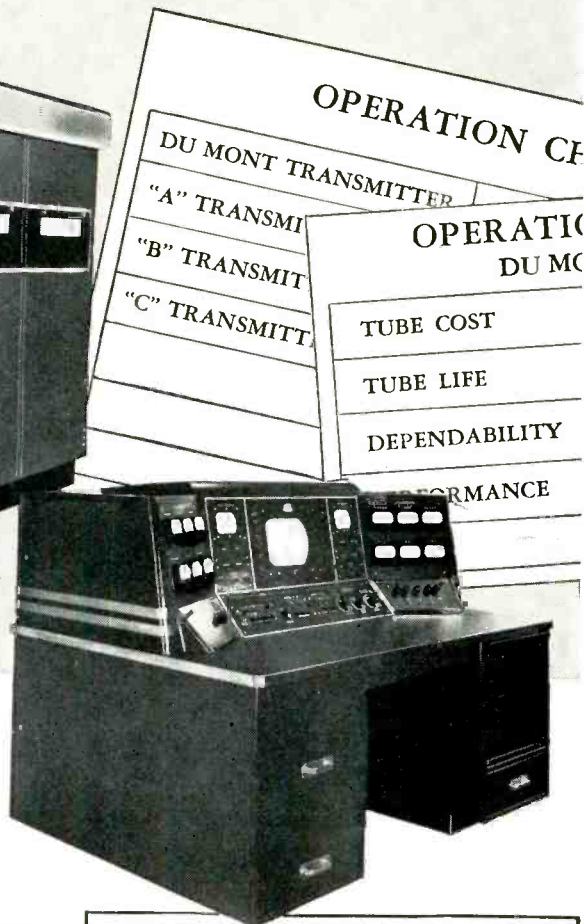
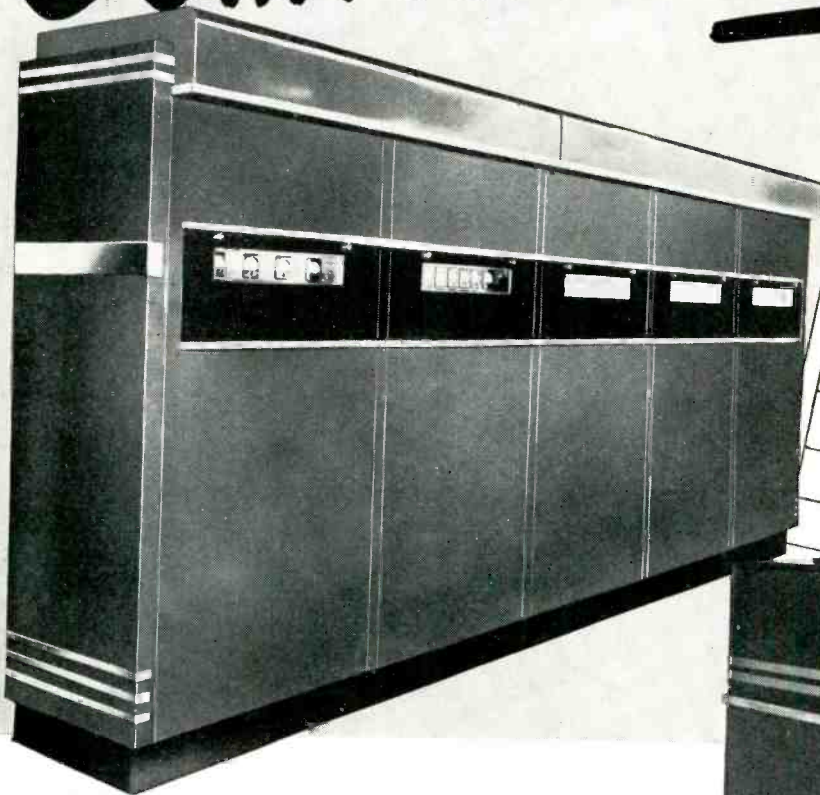

DU MONT MASTER SERIES TV TRANSMITTERS

Choose Du Mont transmitters for years of rugged, trouble-free performance at lower initial investment and lower operating costs.

Compare facts—not claims—compare transmitters on actual operating records. Check tube life, cost of tubes, performance, dependability.

Based on such facts, the Du Mont completely air-cooled transmitter leads in all factors that spell practical operation with the finest picture transmission.

Detailed information on the Du Mont Master Series Transmitters, on request.

Savings of almost 50% of tube costs.

Up to four times the service from each set of tubes.

Convenience and ease of operation.

The advantages of the complete Du Mont Transmitter Control Console housing all control and monitoring equipment for the transmitter.

These advantages, along with countless others, offer you the finest in telecasting operation with a minimum of operating expense.

© ALLEN B. DU MONT LABORATORIES, INC.

DU MONT *First with the Finest in Television*

DU MONT LABORATORIES, INC. • TELEVISION EQUIPMENT DIVISION, 42 HARDING AVE., CLIFTON, N. J. • DU MONT NETWORK AND WABD, 515 MADISON AVE., NEW YORK 22, N. Y. • DU MONT'S JOHN WANAMAKER TELEVISION STUDIOS, NEW YORK 3, N. Y. WITG, WASHINGTON, D. C. • STATION WDTV, PITTSBURGH, PA. • HOME OFFICES AND PLANTS, PASSAIC AND EAST PATERSON, N. J.

ADVENTURES IN ELECTRONIC DESIGN

Centralab Announces the NEW MODEL 2 RADIOHM CONTROL!

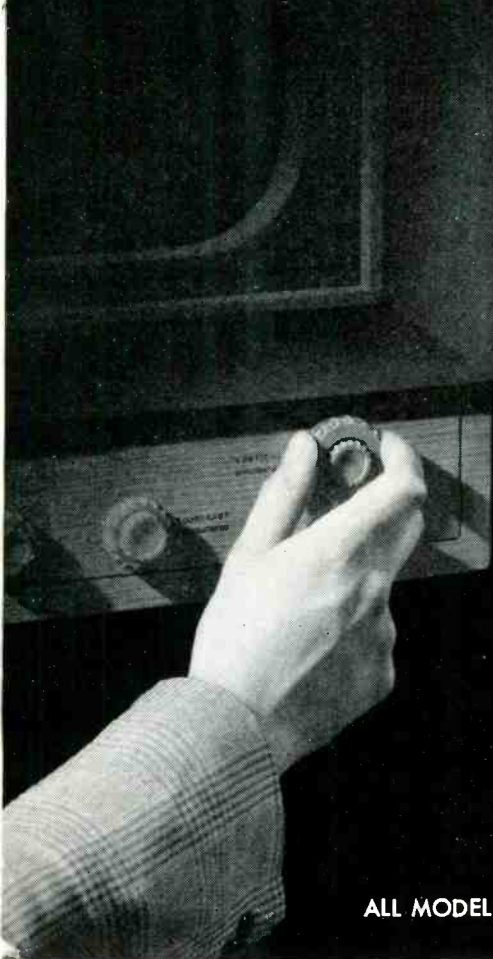

OTHER MODEL 2 RADIOHM CONTROLS

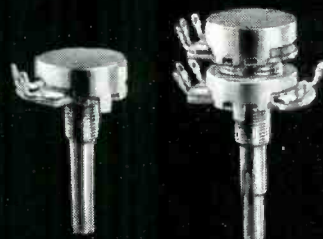

Left: plain type. Right: plain type — concentric shaft, twin with taps.

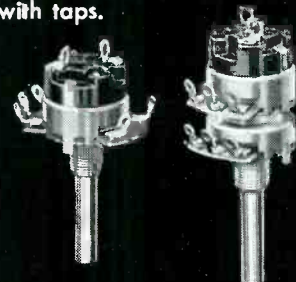

Left: switch type—with taps. Right: switch type—twin.

ALL MODEL 2 CONTROLS ARE $\frac{1}{8}$ " IN DIAMETER — RATED AT $\frac{1}{2}$ WATT.

HERE THEY ARE! Centralab's Model 2 Radiohm Controls. Designed by skilled Centralab engineers, these new quality controls are used in television, radio, sound, motion picture and other electronic equipment. Precision-built with a special composition resistance material securely bonded to a high quality phenolic base, they give you lower noise level . . . longer life. Yes — examine the new CRL Model 2 Radiohms and see why it will pay you to use these finer controls in the equipment you manufacture. See how Model 2's

clinched terminals insure firm, positive connections. See how Model 2's complete line of 3 basic switches (5, 8 and 1 amp.) gives you 24 switch combinations for real flexibility in application and design. See how Model 2's tap positions at $37\frac{1}{2}$, 50 and $62\frac{1}{2}$ percent of rotation simplify wiring problems. Yes — check *all of the outstanding advantages* of Centralab's fine new Model 2 Radiohm Controls and you'll agree they're the right controls for you. For complete information, see your Centralab representative or write direct.

Centralab — DEVELOPMENTS THAT CAN HELP YOU 

Division of GLOBE-UNION INC. • Milwaukee

Centralab reports to

AUGUST, 1949

How Frazer
Cut Costs 60%
with the Help of
Centralab's
P. E. C. Ampec!

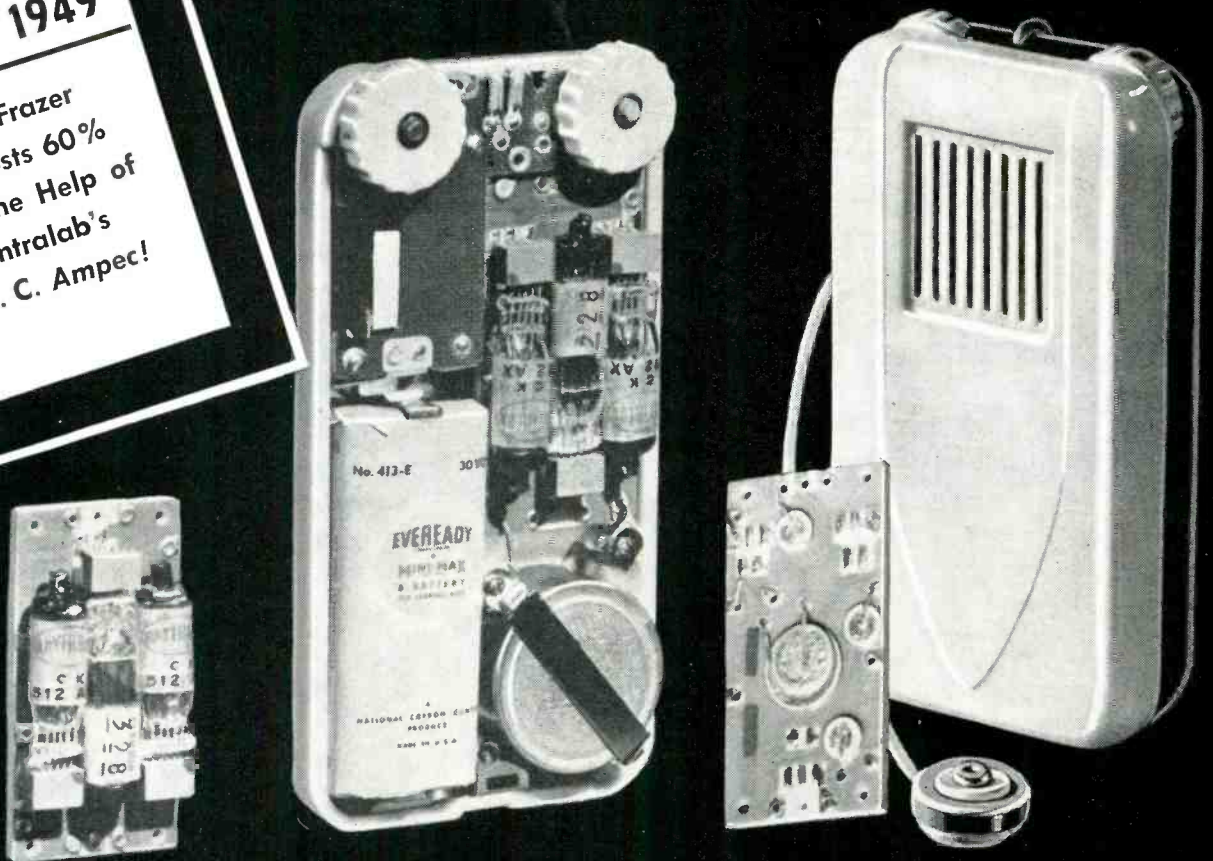

Models courtesy of the Frazer Company

I Size and weight were important considerations to the Frazer Company, Auckland, New Zealand. That's why this firm switched to Centralab's amazing *Printed Electronic Circuit* for use in the hearing aids it manufactures. Frazer found that *Ampec* did make

smaller and lighter units possible. It also found that this tiny 3-stage audio-amplifier helped cut production costs almost 60%. Is it any wonder Frazer is proud of being first in the British Empire to use *Ampec* in hearing aids?



2 Centralab's Ampec, above, is an integral assembly of tube sockets, capacitors, resistors and wiring combined into one miniature amplifier unit.

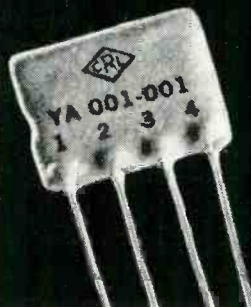

3 *Couplate* consists of plate lead and grid resistors, plate by-pass and coupling capacitors. Minimum soldered connections speed production.

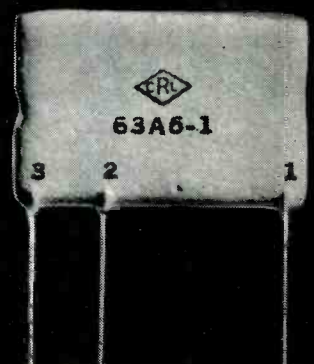

4 This is the new CRL *Vertical Integrator Network* used in TV sets. Variations of this Centralab Network are available on special order.

Electronic Industry

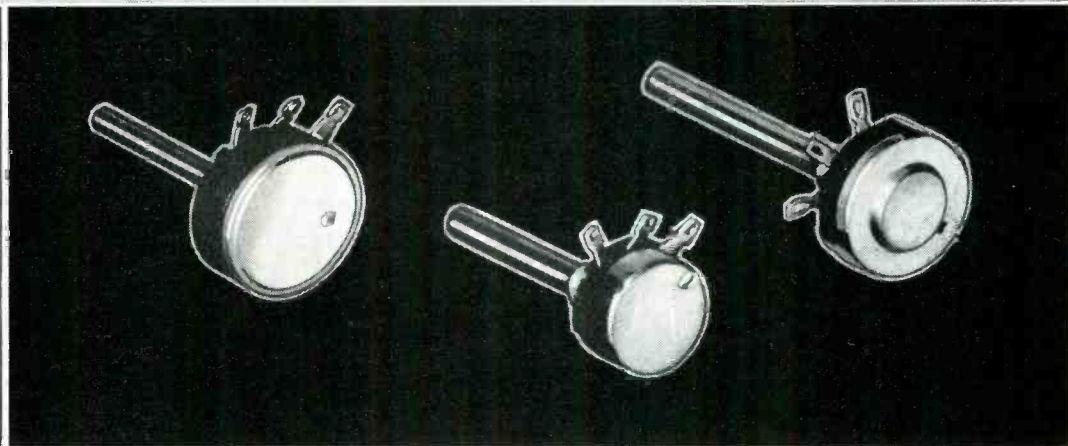

5 Model "1" *Radiobm* control — plain and switch types — is no larger than a dime. Especially designed for miniature applications.

6 Let Centralab's complete *Radiobm* line take care of your special needs. Wide range of variations: Model "R" — wire wound, 3 watts; or composition type, 1 watt. Model "E" — composition type, 1/4 watt. Direct contact, 6 resistance tapers. Model "M" — composition type, 1/2 watt.

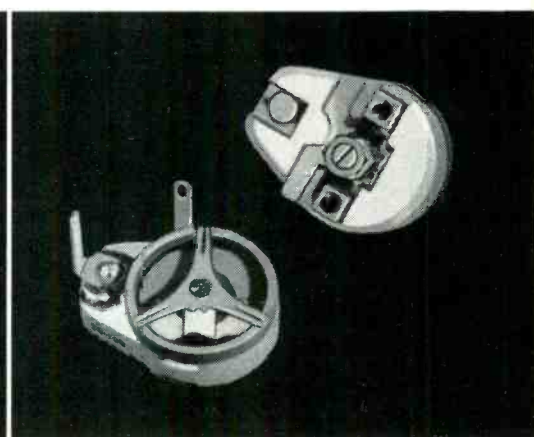
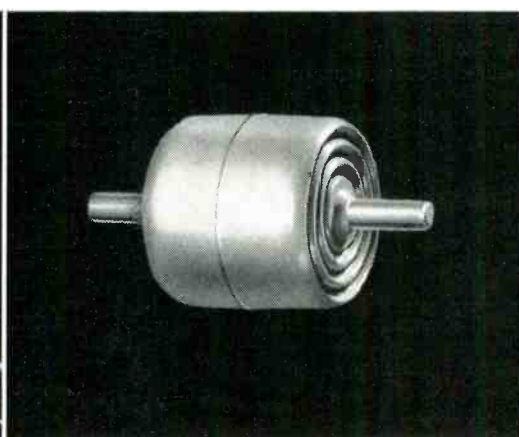
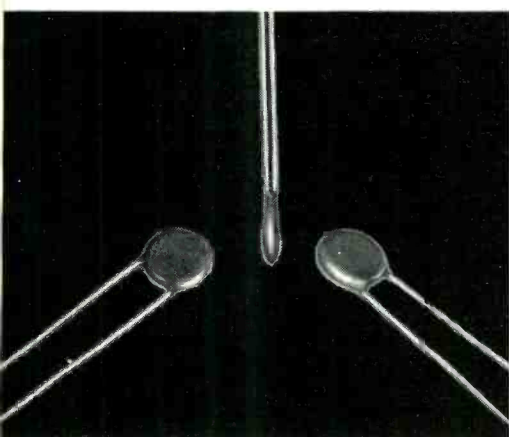

7 For by-pass or coupling applications, check CRL's original line of ceramic disc and tubular *Hi-Kaps*. *Disc Hi-Kaps* are smaller than a dime!

8 *Hi-Vo-Kaps* are filter and by-pass capacitors combining high voltage, small size and a variety of terminal connections to fit most TV needs.

9 *Ceramic Trimmers* are made in five basic types. Full capacity change within 180° rotation. Spring pressure maintains constant rotor balance.

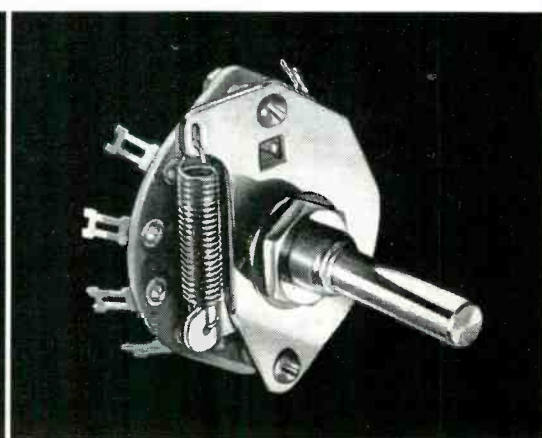
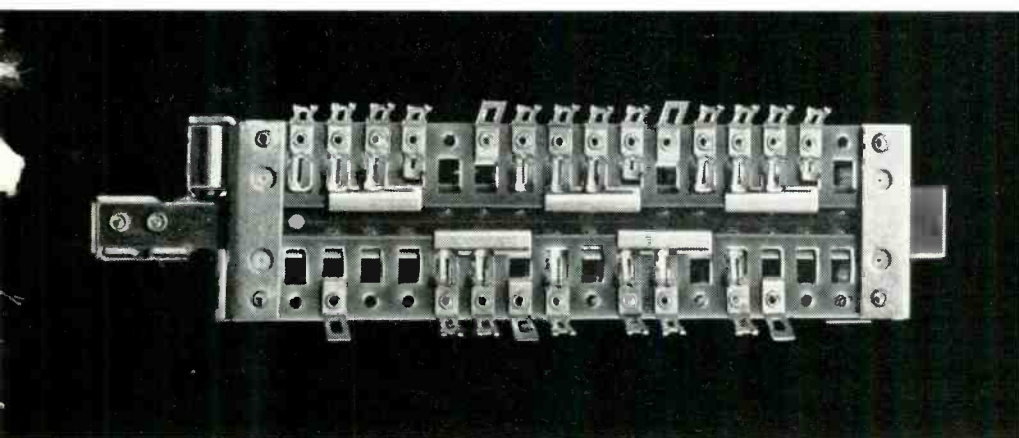

10 Centralab's development of a revolutionary, new *Slide Switch* gives you improved AM and FM performance! Flat, horizontal design saves valuable space, allows short leads, convenient location to coils, reduced lead inductances for increased efficiency in low and high frequencies. CRL *Slide Switches* are rugged and dependable.

11 Great Step forward in switching is CRL's New *Rotary Coil and Cam Index Switch*. Its coil spring gives you smoother action, longer life.

IMPORTANT BULLETINS FOR YOUR TECHNICAL LIBRARY!

They're factual!



THEY'RE FREE!

Choose From This List!

Centralab Printed Electronic Circuits

- 973 — AMPEC — three-tube P. E. C. amplifier.
- 42-6 — COUPLATE — P. E. C. interstage coupling plate.
- 999 — PENTODE COUPLATE — specialized P. E. C. coupling plate.
- 42-9 — FILPEC — Printed Electronic Circuit filter.

Centralab Capacitors

- 42-3 — BC TUBULAR HI-KAPS — capacitors for use where temperature compensation is unimportant.
- 42-4 — BC DISC HI-KAPS — miniature ceramic BC capacitors.
- 42-10 — HI-VO-KAPS — high voltage capacitors for TV application.
- 695 — CERAMIC TRIMMERS — CRL trimmer catalog.
- 981 — HI-VO-KAPS — capacitors for TV application. For jobbers.
- 42-18 — TC CAPACITORS — temperature compensating capacitors.
- 814 — CAPACITORS — high-voltage capacitors.
- 975 — FT HI-KAPS — feed-thru capacitors.

Centralab Switches

- 953 — SLIDE SWITCH — applies to AM and FM switching circuits.
- 970 — LEVER SWITCH — shows indexing combinations.
- 995 — ROTARY SWITCH — schematic application diagrams.
- 722 — SWITCH CATALOG — facts on CRL's complete line of switches.

Centralab Controls

- 42-7 — MODEL "1" RADIOHM — world's smallest commercially produced control.
- 697 — VARIABLE RESISTORS — full facts on CRL Variable Resistors.

Centralab Ceramics

- 720 — CERAMIC CATALOG — CRL's steatite and ceramic products.

General

- 26 — GENERAL CATALOG — Combines Centralab's line of products for jobber, ham, experimenter, serviceman or industrial user.

Look to CENTRALAB in 1949! First in component research that means lower costs for the electronic industry. If you're planning new equipment, let Centralab's sales and engineering service work with you. For complete information on all CRL products, get in touch with your Centralab Representative. Or write direct.

CENTRALAB
Division of Globe-Union Inc.
900 East Keefe Avenue, Milwaukee, Wisconsin

Yes—I would like to have the CRL bulletins, checked below, for my technical library!

- 973 42-9 42-18 953 953 722 720
 42-6 42-3 695 814 970 42-7 26
 999 42-4 981 975 995 697

Name.....

Address.....

City..... State.....

TEAR OUT COUPON

for the Bulletins you want

Centralab

Division of GLOBE-UNION INC. • Milwaukee



**It's
Amazing!**



TV Monitor Console



Desk Panel Cabinet Rack



Induction Heater Housing



Chassis



Marine Radio Housing



Cabinet

How Karp Makes Custom-Built Metal Cabinets and Boxes at Prices that Compete with those of Stock Items

The advantages and true economies of Karp custom-built cabinets, boxes, or housings over stock items are these:

- Your own exclusive design distinguishes and "styles" your product . . . gives it more market value.
- Flexibility of construction details speeds and simplifies your final assembly—saving you time and money.
- Our vast stock of dies can save you special die costs.
- Our 70,000 square feet of modern plant, with hundreds of craftsmen, means ample capacity for many types of work—simple or elaborate—at one time.
- Plant is fully equipped with every mechanical facility that aids economical production.
- Finishing is done in dustproof paint shop, with latest water-washed spray booths and gas-fired ovens mechanically and electronically controlled.
- We make no stock items or products of our own. Our plant, time and effort are 100% for our customers' work.
- Our engineering staff can help solve any possible design and production problems.
- It's results that count—and we give you the results you want.

Write for illustrated data book describing our facilities and showing the wide range of sheet metal fabrication we do.

CABINETS • BOXES • CHASSIS • HOUSINGS • ENCLOSURES

KARP METAL PRODUCTS CO., INC.

215 63rd STREET, BROOKLYN 20, NEW YORK

Custom Craftsmen in Sheet Metal

97 products made more saleable with General Electric miniature lamps!

AMUSEMENTS

coin-operated games
phonograph
football downs marker

AUTOMOTIVE

ignition keyhole light
backup lights
trouble lights
motor coach lamps

AVIATION

airplane marker lights
pilot balloon, observation light
instrument and indicator lights
passenger reading light

COMMERCIAL

elevator indicator lights
call light
lighted displays

COMMUNICATIONS

radio dial light
code signal light
portable telephone trouble lamp
telephone switchboard lamp

FARM

electric fence potential indicator
egg candling lamp
hand lantern
tractor lights

HOUSEHOLD

candlelight lamps
sewing machine lights
blown fuse indicator
darning light lamp
telephone dial light
bathroom scale illuminator
clock light
night light
switch locator

illuminated house numbers
closet lights
keyhole light
indicator lights on appliances
illuminated doorbell pushbutton
vacuum cleaner headlight

INDUSTRIAL

color comparator
oil well gauge
inspection lamps
voltage regulator
neon oscillator
neon volt meter
miner's cap lamp
lighted meters

INSTRUMENTS

seismograph lamp
oscillograph lamp
galvanometer lamp
microscope illuminator
optical pyrometer lamp
recording microphotometer lamp
electronic calculator lamps

MARINE

binnacle lamp
boat anchor light
buoy light
motor boat lamps

MEDICAL

hospital annunciators
surgical headlamp
illuminated tongue depressors
ear applicator
electrocardiograph lamp
surgical instrument lamps

MILITARY

range marker light
field artillery azimuth light
gun sight lamp
practice pistol lamp

MISCELLANEOUS

vending machines
fishing bobber light
motor scooter lamp

NOVELTY

ornamental flashlight
lighted pencil
lighted ornaments
razor light
compact light
illuminated magnifying glass
purse light

PHOTOGRAPHY

film printer lamp
film viewer
film slide projectors
photoflash battery tester

RAILROAD

trainman's hand lantern
train dispatcher's control board
subway car door indicator
locomotive control panel

SAFETY DEVICES

bicycle lights
truck signal flare
highway caution beacons
traffic baton
photocell exciter lamps
fire alarm signal

TOOLS

lighted screw driver
lighted plumb bob

TOYS

toy trains
lighted banks
wheeled toy lamps
doll house lamps
code practice set

Many a bright design idea starts with a little bulb!

DESIGNERS in more and more fields — from inexpensive novelties to costly instruments—are turning to the use of General Electric miniature lamp bulbs wherever light can add serviceability, convenience, safety, beauty or sales appeal to their products.

Listed above are 97 out of hundreds of successful products using G-E miniature

bulbs. Some of these should suggest a profitable G-E lamp application in *your* product. Remember, whatever lamps you need, General Electric makes them all—all types and sizes, all wattages and voltages, filament and neon glow, for delicate service or heavy duty. General Electric lamp specialists will gladly help you select the right bulbs for your job.



FREE! NEW MINIATURE LAMP CATALOG! Complete guide to selection of miniature lamps for all applications—the first ever published! Lists 175 types and sizes with specifications, applications and prices. For your free copy, write General Electric Company, Division 166-E-8, Nela Park, Cleveland 12, Ohio.

You can put your confidence in—

GENERAL  ELECTRIC



Let **OHMITE** Engineers **BACK UP Your Engineers**

IN SOLVING YOUR RESISTANCE PROBLEMS

THE valuable time of your engineering staff can be conserved appreciably by letting Ohmite help solve your difficult resistance problems. Because Ohmite engineers are resistance specialists, they can quickly analyze your requirements and recommend the correct rheostats and resistors—or frequently a money-saving combination—for your particular application. Both Ohmite's engineering help and its laboratory facilities are available to you for the asking. Years of experience in building dependable resistance units . . . and in helping others to economically solve their resistance problems . . . are your assurance Ohmite can help you.



Be Right with- **OHMITE**

Industry's FIRST Choice in **RHEOSTATS • RESISTORS • TAP SWITCHES**

OHMITE

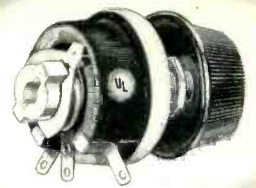

RHEOSTATS—Six stock sizes. Others to order. 25 to 1000 watts.



FIXED RESISTORS—Five sizes, 25 to 200 watts, 1 to 250,000 ohms.

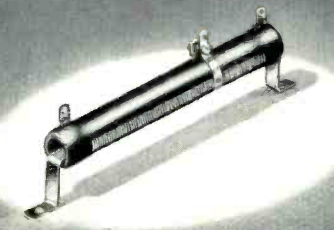

DIVIDOHM RESISTORS—Adjustable resistances. 10 to 200 watts.

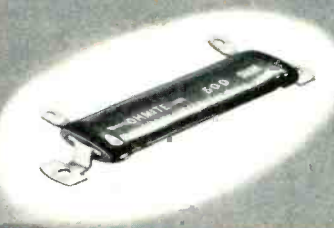

THIN TYPE RESISTORS—Made to order only—five wattage sizes.



BROWN DEVILS—Vitreous-enameled resistors. 5, 10, and 20 watts.



TAP SWITCHES—Five sizes from 10 to 100 amp. 2 to 12 taps.

AVAILABLE for Immediate Delivery

From a Stock of Several Million

RHEOSTATS • RESISTORS • TAP SWITCHES

WHEN your purchasing orders for resistance units are stamped "Rush" . . . *wire Ohmite*. Chances are the exact unit you need can be shipped immediately from Ohmite stock—believed to be the largest supply of power rheostats, wire-wound resistors, and rotary tap switches in the world. Actually several million units—in 1859 types, sizes, and values—are ready for delivery. All, of course, of typically high Ohmite quality—*Industry's First Choice*.

Ohmite rheostats are characterized by their all-ceramic construction . . . their smoothly gliding metal-graphite brush . . . their uniform windings locked in place by vitreous enamel . . . and their ability to provide close control and trouble-free service under the toughest operating conditions.

Ohmite resistors are built on a strong ceramic core . . . wound with even windings that prevent "hot spots" . . . protected by special vitreous enamel. Terminal lugs are tin-dipped for easy soldering.

Ohmite tap switches are unsurpassed in combining high current capacity . . . large number of taps . . . compactness. They have one-piece ceramic bodies unaffected by arcing . . . "slow-break, quick-make" action proved best for a-c use.

Why not let Ohmite serve you when you need resistance units *fast*?



Write on company letterhead for your copy of the Ohmite Catalog and Engineering Manual No. 40

OHMITE MANUFACTURING CO., 4816 Flournoy St., Chicago 44

Be Right with- **OHMITE**

electronic voltage regulators

by **sorensen**

- MAXIMUM ACCURACY
- MINIMUM DISTORTION
- FREQUENCY INSENSITIVITY



Standard DC

*Output voltage	6	12	28	48	125
**Load in amperes	5-15-40-100	5-15-50	5-10-30	15	5-10
Input voltage	95-125 VAC single phase 50-60 cycles: adapter available for 230 VAC operation				
Regulation Accuracy	0.25% from 1/4 (or no load in "0" models) to full load				
Ripple voltage RMS Max.	1%				
Recovery time	0.2 seconds — value includes charging time of filter circuit for the most severe change in load or input conditions				
*Adjustable +10%, -25%					
**Individual models identified by indicating output voltage first then amperes. Example: E-6-5 6 VDC @ 5 amperes					

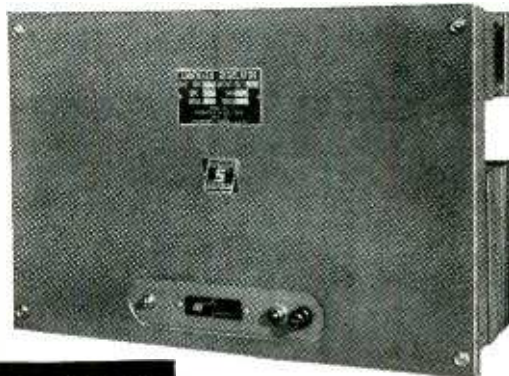

Standard AC

Model in VA Capacity	150	250	2000	5000
	500	1000	3000	15000
Regulation — Basic	0.5%	0.2%	0.2%	0.5%
Accuracy — S	0.2%	0.1%	0.1%	0.2%
Harmonic — Basic	5% max.	5% max.	5% max.	5% max.
Distortion — S	3% max.	2% max.	3% max.	3% max.
Input voltage	95-125 VAC also available for 190-250 VAC single phase 50-60 cycles			
Output voltage	adjustable between 110-120; 220-240 in 230 VAC models			
Load range	From 0.1 load or no load ("0" models) at rated accuracy			
P.F. range	Down to 0.7 P.F. all S models temperature com- pensated			
NOTE: Regulators can be hermetically sealed				

SPECIALS Your particular requirements can be met by employing the ORIGINAL SORENSEN CIRCUIT in your product or application. SORENSEN REGULATORS can be designed to meet JAN specifications. SORENSEN engineers are always available for consultation about unusual regulators to meet special needs not handled by THE STANDARD SORENSEN LINE.

Write for Complete Literature

Sorensen and company, inc.

375 Fairfield Avenue, Stamford, Conn.

As simple as **A B C** . . .

You can now select those characteristics in paper capacitors best fitting your operational requirements, by simply specifying

AEROVOX *Hyvol Impregnated* D, M, F or H

AEROVOX PAPER CAPACITOR IMPREGNANTS												
Numerals indicate impregnants in their order of preference												
Impregnant	Size	Weight	Insulation Resistance	Power Factor	Cap. variation with temperature	High temperature operation	Low temperature operation	A. C. operation	D. C. operation	High voltage A. C. operation	High voltage D. C. operation	High frequency operation
D	2	1	4	3	2	3	2	2	2	2	1	2
M	3	4	1	1	1	1	1	1	1	1	1	1
F	2	3	2	2	3	2	3	1	4	1	2	2
H	1	2	3	4	2	4	4	3	3	3	3	3

D = Castor Oil; M = Mineral Oil; F = Chlorinated Synthetic; H = Halowax.

• Don't settle for anything less than a custom-fitted capacitor—one definitely meeting your operational requirements—not just the usual hand-me-down capacitor.

And that spells Aerovox. For in addition to the widest range of casings, dimensions, mountings and terminals, Aerovox also offers a choice of impregnants. Those impregnants—HYVOL D (castor oil), HYVOL M (mineral oil), HYVOL F (chlorinated synthetic) and HYVOL H (halowax)—determine the operational characteristics of corresponding Aerovox paper capacitors. Each has distinct advantages as per the handy reference table above.

Such custom-fitting of capacitors to your particular capacitance problem is typical of Aerovox application-engineering service.

ENGINEERING AID...

• Send us those capacitance problems and requirements. Our engineers will gladly collaborate in working out the most satisfactory solutions. Further data on request.



FOR RADIO-ELECTRONIC AND INDUSTRIAL APPLICATIONS

AEROVOX CORPORATION, NEW BEDFORD, MASS., U.S.A.

SALES OFFICES IN ALL PRINCIPAL CITIES • Export: 13 E. 40th St., New York 16, N. Y.

Cable: 'ARLAB' • In Canada: AEROVOX CANADA LTD., HAMILTON, ONT.

2 Waldes Truarc Rings Save Space ...cut costs...Lock entire chuck

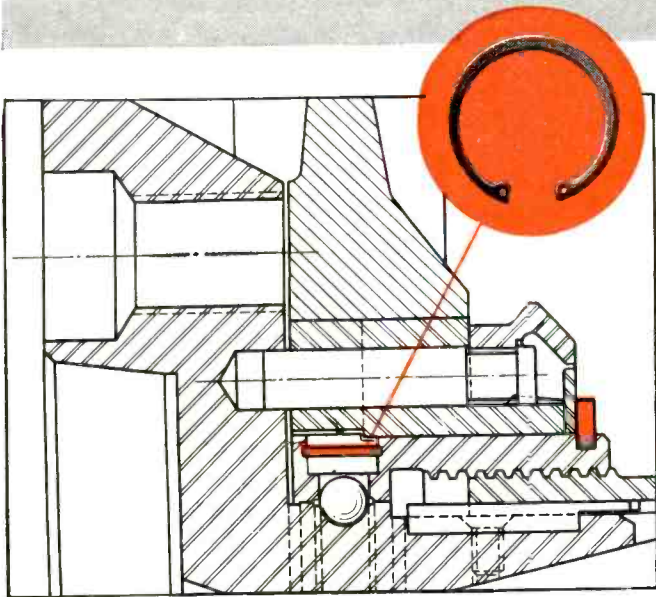

INTERNAL RING: Used instead of a shoulder screw, Truarc internal ring #5000-37 locks disc over ball loading hole. Saves 1/8 inch in overall diameter. Eliminates tapping. Withstands machine vibration and vibration from impact device within chuck. Used with Truarc pliers, it facilitates assembly and disassembly.

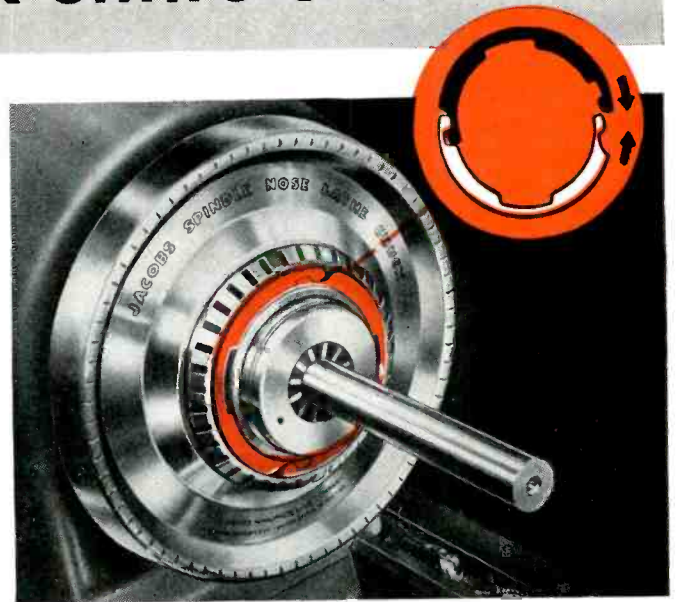

INTERLOCKING RING: Used instead of a locknut, Truarc interlocking ring #5107-343 locks handwheel assembly securely on impact sleeve of Jacobs chuck. Saves 7/32 inch in overall length. Eliminates tapping. Chuck's top speed: 5000 RPM; Truarc ring is dynamically balanced to withstand 50,000 RPM's. Services easily with a screwdriver.

2 Waldes Truarc Retaining Rings secure the entire mechanism of new spindle nose lathe chuck for Jacobs Mfg. Co., Hartford, Conn. Truarc gives Jacobs a finer, more compact product, and at lower cost than possible with any other fastening device.

Wherever you use machined shoulders, nuts, bolts, snap rings, cotter pins, there's a Truarc Ring that does a better job of holding parts together.

Truarc Rings are precision-engineered. Quick and easy to assemble, disassemble. Always circular to give a never-failing grip. They can be used over and over again.

Find out what Truarc Rings can do for you. Send your drawings to Waldes Truarc Engineers for individual attention, without obligation.

2 TRUARC RINGS GIVE 6 BIG ADVANTAGES

- Cut overall length 7/32 in.
- Cut overall diameter 1/8 in.
- Eliminate cost of tapping
- Withstand up to 50,000 RPM's, give a factor of assurance of 10
- Withstand machine vibration
- Facilitate assembly, disassembly

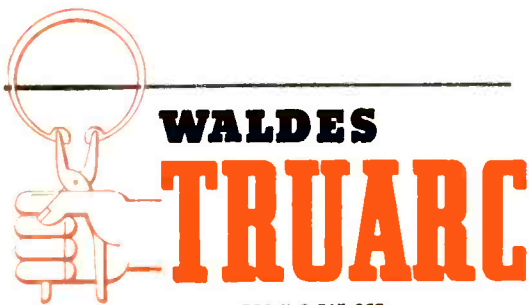

RETAINING RINGS

WALDES KOHINOOR, INC., LONG ISLAND CITY 1, NEW YORK

WALDES TRUARC RETAINING RINGS ARE PROTECTED BY U. S. PATS. 2,302,948; 2,026,454; 2,416,852 AND OTHER PATS. PEND.



Waldes Kohinoor, Inc., 47-16 Austel Place
Long Island City 1, N. Y.

E-8

Please send 28-page Data Book on Waldes Truarc Retaining Rings.

Name _____

Title _____

Company _____

Business Address _____

City _____ Zone _____ State _____ ★



The EDO symbol has been known and recognized for nearly a quarter of a century in the aircraft industry as the mark of quality equipment, engineered to perfection and manufactured with meticulous precision.

Now EDO's famed "Flying Fish" insignia is becoming increasingly evident on highly important electronic devices of the United States Navy.

EDO's Electronic Division has developed, engineered and is now manufacturing Sonar equipment for the Navy which makes possible new precision and accuracy in under-water detection equipment. Important commercial applications of EDO-developed methods and equipment are visualized for the future.

EDO CORPORATION

COLLEGE POINT
L. I., NEW YORK

• **SAVE SPACE** • **SAVE MONEY**

• **GET MORE WATTS FOR YOUR RECTIFIER DOLLAR**
WITH KOTRON SELENIUM RECTIFIERS!

NEW STANDARD FOR LOW-VOLTAGE HIGH-CURRENT SELENIUM RECTIFIERS

1 1/2, 9-volt, 100 amp. center-tap, fan-cooled, fast-charger KOTRON RECTIFIER (44 cu. in.)

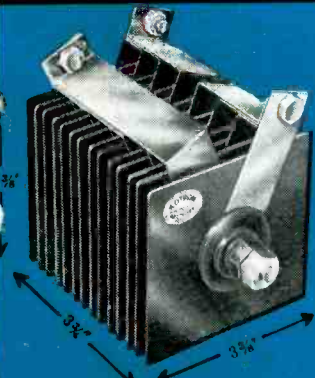

COMPARATIVE SIZES OF RECTIFIERS FOR SAME WATTS OUTPUT
 Proportionate savings in size and weight for low-voltage, high-current applications such as electro-plating, power supplies, etc.

NEW STANDARD FOR HIGH-VOLTAGE LOW-CURRENT SELENIUM RECTIFIERS

3 1/2 Bridge, 125 volt, 4.75 amp., self-cooled KOTRON RECTIFIER

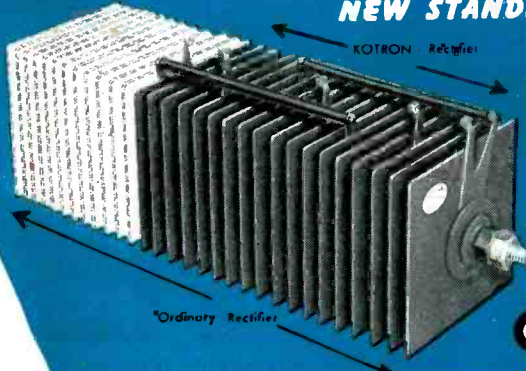

COMPARATIVE SIZES OF RECTIFIERS FOR SAME WATTS OUTPUT

KOTRON alone manufactures selenium rectifiers to block from 5 to 40 volts A.C. rms per cell with optimum current rating for each voltage. KOTRON is the first to produce commercial rectifiers embodying this relationship. In high voltage applications, KOTRON uses fewer cells than ordinary rectifiers—thus reducing size and cost. In low voltage applications, KOTRON works at higher current densities per sq. in. of rectifying area than ordinary selenium rectifiers, reducing size and lowering cost.

In either direction, KOTRON sets NEW standards!

KOTRON mechanical features match KOTRON superior electrical characteristics. Square or rectangular plates offer maximum wattage in minimum space. Rectifier cells and terminals are mechanically inter-locked to prevent twisting out of alignment in stack assembly (pat. pending). Double terminals, where necessary, facilitate connection to external circuits. Echelon terminal structure eliminates soldered or internal stack connections.

KOTRON POWERECTOR*



*Trademark—Reg. U. S. Pat. Off.

Utilizes new cooling principles increasing current capacity 10 times when self-cooled, up to 50 times when fan-cooled and in intermittent service. The KOTRON POWERECTOR* saves size, weight and money in many applications.

KOTRON HALF-WAVE STACK RECTIFIERS



250 MA.

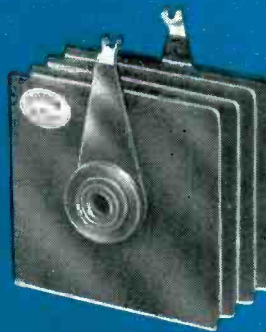

500 MA.

INDISPENSABLE AS DOUBLERS AND TRIPLERS FOR TELEVISION RECEIVERS

Max. A.C. line voltage input
 250 Ma. Type — 130 V. rms
 500 Ma. Type — 130 V. rms

Max. inverse peak voltage
 250 Ma. Type — 360
 500 Ma. Type — 360

Max. continuous D.C. current
 250 Ma. Type — 250 Ma.
 500 Ma. Type — 500 Ma.

Max. instantaneous peak current
 250 Ma. Type — 1.5 amp.
 500 Ma. Type — 3.0 amp.

Average operating temp. °F
 250 Ma. Type — 145°
 500 Ma. Type — 145°

STRIP SELENIUM RECTIFIERS



75, 100, & 200 Ma. HALF-WAVE STRIP RECTIFIERS

Planar Strip Assembly—

Easy mounting, Good Space Factor, Cooler Operation—
 Only 10 Piece Parts.

KOTRON rectifiers whether for 1 ampere or thousands of amperes, are custom-built and tailored to the application giving maximum efficiency with minimum cost. KOTRON rectifiers are manufactured by selenium rectifier specialists with years of technical experience. Their specialized engineering knowledge and consulting service is available without obligation. Write for descriptive sheets. Submit specifications on your requirements for quotations.



STANDARD ARCTURUS CORPORATION

KOTRON DIVISION

54 CLARK STREET, NEWARK 4, N. J.

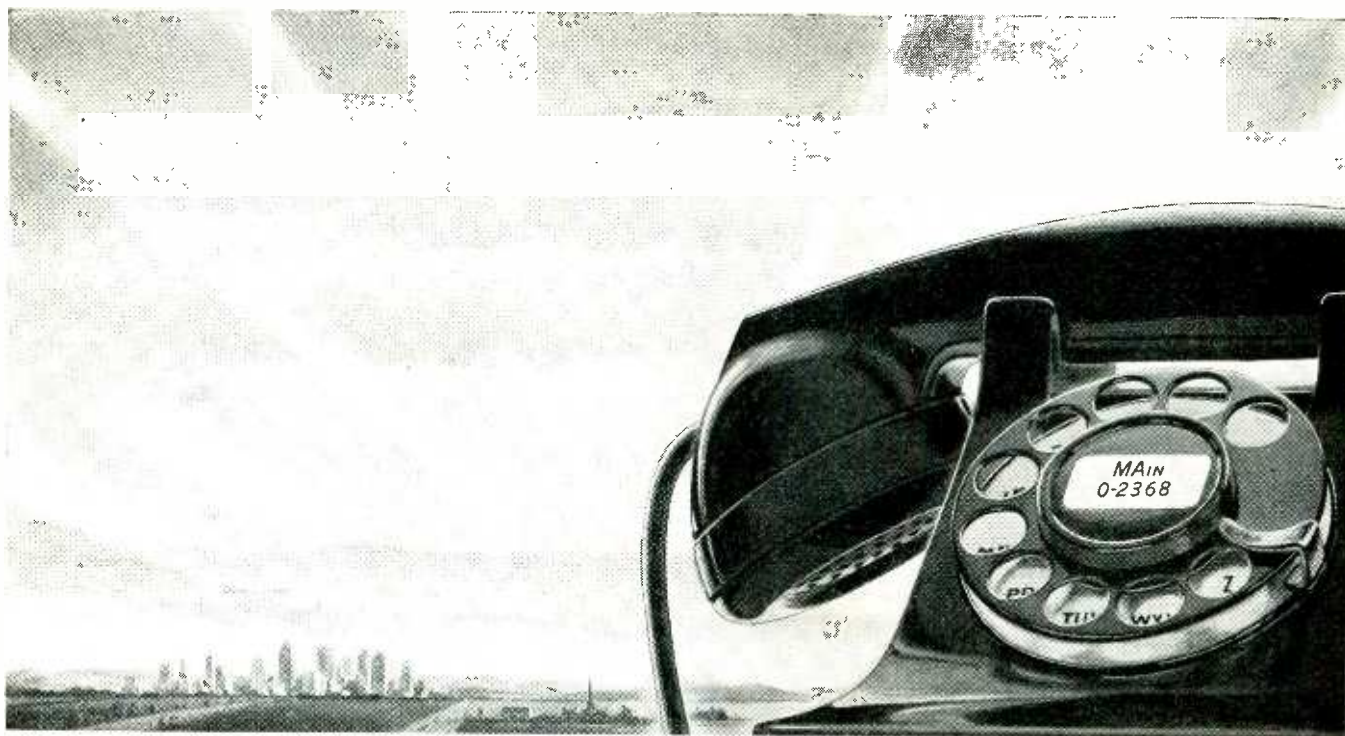

THE FUTURE HOLDS GREAT PROMISE

Neither chance nor mere good fortune has brought this nation the finest telephone service in the world. The service Americans enjoy in such abundance is directly the product of their own imagination, enterprise and common sense.

The people of America have put billions of dollars of their savings into building their telephone system. They have learned more and more ways to use the telephone to advantage, and have continuously encouraged invention and initiative to find new paths toward new horizons.

They have made the rendering of telephone service a public trust; at the same time, they have given the telephone companies, under regulation, the freedom and resources they must have to do their job as well as possible.

IN THIS climate of freedom and responsibility, the Bell System has provided service of steadily increasing value to more and more people. Our policy, often stated, is to give the best possible service at the lowest cost consistent with financial safety and fair treatment of employees. We are organized as we are in order to carry that policy out.

BELL Telephone Laboratories lead the world in improving communication devices and techniques.

Western Electric Company provides the Bell operating companies with telephone equipment of the highest quality at reasonable prices, and can always be counted on in emergencies to deliver the goods whenever and wherever needed.

The operating telephone companies and the parent company work together so that improvements in one place may spread quickly to others. Because all units of the System have the same service goals, great benefits flow to the public.

Similarly, the financial good health of the Bell System over a period of many years has been to the advantage of the public no less than the stockholders and employees.

It is equally essential and in the public interest that telephone rates and earnings now and in the future be adequate to continue to pay good wages, protect the billions of dollars of savings invested in the System, and attract the

new capital needed to meet the service opportunities and responsibilities ahead.

There is a tremendous amount of work to be done in the near future and the System's technical and human resources to do it have never been better. Our physical equipment is the best in history, though still heavily loaded, and we have many new and improved facilities to incorporate in the plant. Employees are competent and courteous. The long-standing Bell System policy of making promotions from the ranks assures the continuing vigor of the organization.

WITH these assets, with the traditional spirit of service to get the message through, and with confidence that the American people understand the need for maintaining on a sound financial basis the essential public services performed by the Bell System, we look forward to providing a service better and more valuable in the future than at any time in the past. We pledge our utmost efforts to that end.

LEROY A. WILSON, *President*
American Telephone and Telegraph Company.

(From the 1948 Annual Report.)

BELL TELEPHONE LABORATORIES EXPLORING AND INVENTING, DEVISING
AND PERFECTING, FOR CONTINUED IMPROVEMENTS AND ECONOMIES IN TELEPHONE SERVICE



MITCHELL-RAND

braided sleeveings

• COTTON

• MIRAGLAS*

treated or untreated



ALL SIZES: 00 to 13 and to 1½ inch inside diameter

ALL COLORS: red, white, blue, yellow, black and green

Ideal for use in covering coil leads, transformer leads, coil interconnectors, pigtail brush leads and other electrical insulation applications.

MITCHELL-RAND COTTON SLEEVIINGS, are of long staple fiber yarn, have all of the electrical insulation, strength and flexibility characteristics of Miraglas Sleeveings and are recommended to users who prefer cotton to fiberglass. COTTON SLEEVIINGS are available with treatment to prevent frayed ends and in sizes to 1½ inch ID.

MIRAGLAS* BRAIDED SLEEVIINGS, of continuous filament fiberglass yarn, are most efficient for insulation requirements which call for excessive heat resistance, high tensile and dielectric strength, space conservation and flexibility . . . they resist rotting, excessive heat, moisture, overload, acid and dirt. They are available in two average wall thicknesses: .008" and .006" with inside diameters from 1/16" to 1/2" in 1/16" increments (there is no 7/16" ID sleeveing) . . . MIRAGLAS SLEEVIINGS are available untreated or impregnated to prevent frayed ends.

M-R THE
ELECTRICAL
INSULATION
HEADQUARTERS
FOR 60 YEARS



MITCHELL-RAND INSULATION CO. Inc.

51 MURRAY STREET • CORTLANDT 7-9264 • NEW YORK 7, N. Y.

A PARTIAL LIST OF M-R PRODUCTS: FIBERGLAS VARNISHED TUBING, TAPE AND CLOTH • INSULATING PAPERS AND TWINES • CABLE FILLING AND POTHEAD COMPOUNDS • FRICTION TAPE AND SPLICE • TRANSFORMER COMPOUNDS • FIBERGLAS SATURATED SLEEVIING • ASBESTOS SLEEVIING AND TAPE • VARNISHED CAMBRIC CLOTH AND TAPE • MICA PLATE, TAPE, PAPER, CLOTH, TUBING • FIBERGLAS BRAIDED SLEEVIING • COTTON TAPES, WEBBINGS AND SLEEVIINGS • IMPREGNATED VARNISH TUBING • INSULATED VARNISHES OF ALL TYPES • EXTRUDED PLASTIC TUBING

IT'S NEWS in the Electrical World, and it's

BRAND-NEW PROOF OF THE VERSATILITY OF **ADLAKE RELAYS**

The new steam generator control shown here was built to the specifications of the Superheater Company, Inc. It posed special problems of timing, load and control, since it was originally designed for use on Diesel Locomotives. Adlake Relay engineers provided a first-class solution to these problems, as well as brand-new proof that Adlake Mercury Plunger-Type Relays are truly *versatile!*

If you have a problem involving relays, the same Adlake engineering skill is at your disposal! As in this case, where standard Adlake Relays were modified to meet requirements of the installation, we will custom-build the relay you need if you don't find it, ready-made, in our relay catalog.

Take advantage of this offer! And remember the advantages that all Adlake Relays already provide, for any relay job:

- **HERMETICALLY SEALED:** Dust, dirt, moisture, oxidation and temperature changes can't interfere with operation.
- **MERCURY-TO-MERCURY CONTACT** prevents burning, pitting and sticking.
- **SILENT AND CHATTERLESS -- NO MAINTENANCE REQUIRED**
- **ABSOLUTELY SAFE -- ARMORED AGAINST IMPACT AND VIBRATION**

WRITE TODAY for free, illustrated Adlake Relay folder. No obligation, of course. Address: 1107 No. Michigan, Elkhart, Indiana.

These are some uses of the new control:



Laundries

Diesel locomotives



Cleaning plants

THE Adams & Westlake COMPANY

Established 1857 • ELKHART, INDIANA • New York • Chicago

Manufacturers of Adlake Hermetically Sealed Mercury Relays for Timing, Load and Control Circuits

Adlake Engineers
cooperate with
The Superheater Co., Inc.,
Division of Combustion Engineering-
Superheater, Inc. to produce
an efficient, foolproof STEAM
GENERATOR CONTROL

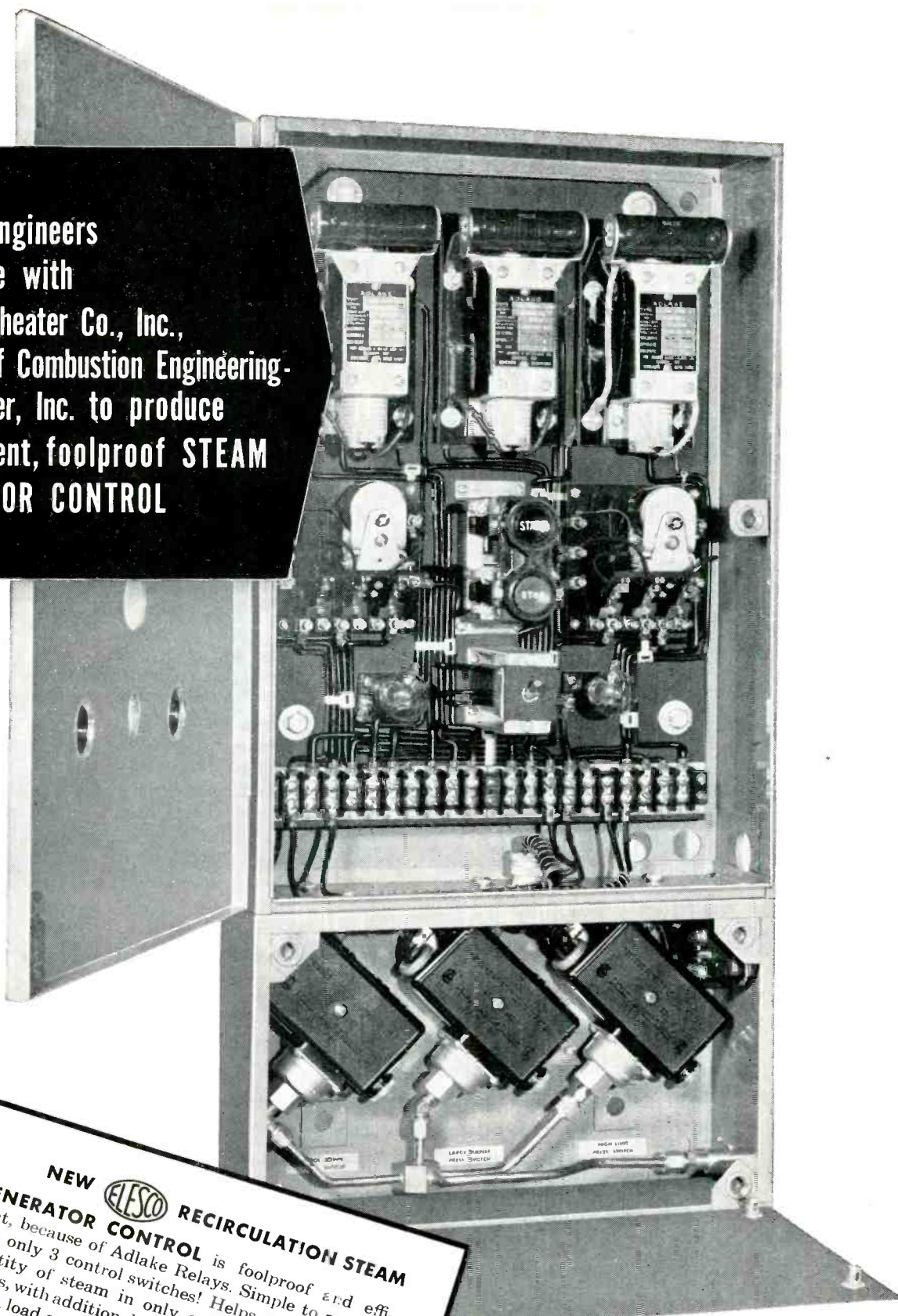

NEW  **RECIRCULATION STEAM**
GENERATOR CONTROL is foolproof and effi-
cient, because of Adlake Relays. Simple to operate,
with only 3 control switches! Helps provide needed
quantity of steam in only a few minutes. Adlake
Relays, with additional resistance coil built in, handle
timing, load and control. Relays are easily and quick-
ly removed, yet because of a special "gripper"
device their placement is unaffected by vibration.

Adlake
TRADE MARK

in communications...

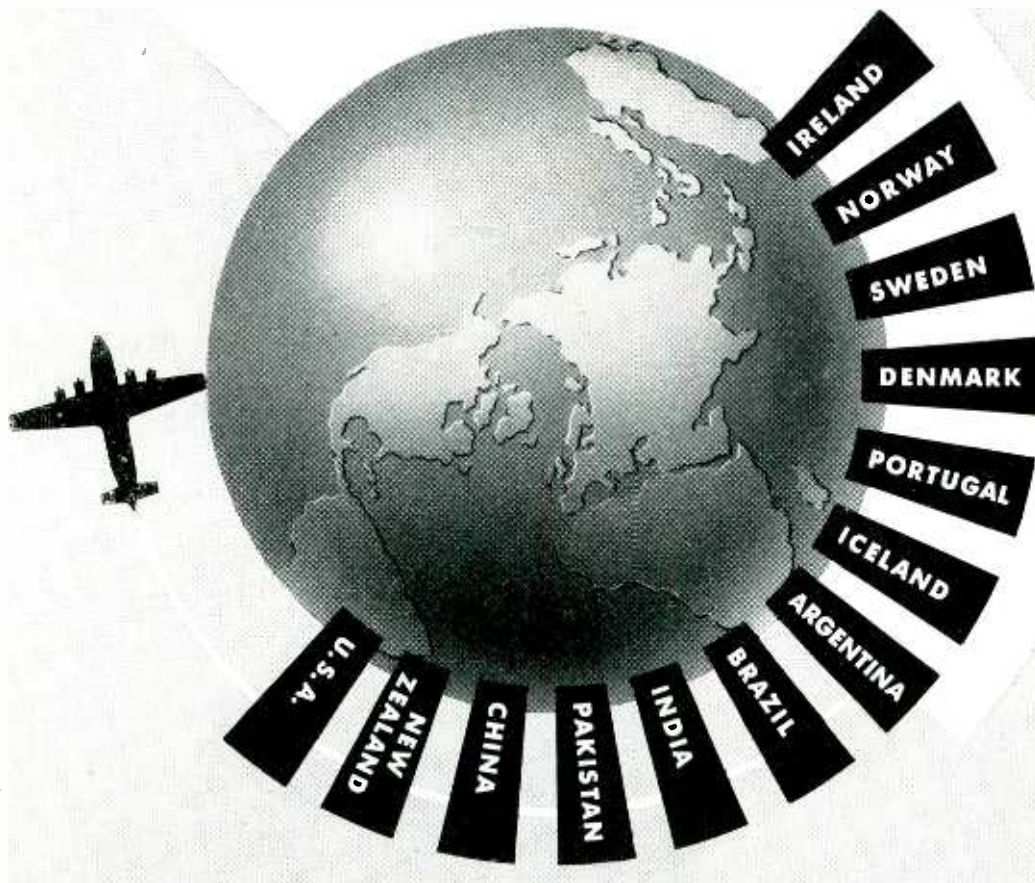

WILCOX SERVES THE GOVERNMENTS OF THE WORLD

Wherever airplanes fly—wherever lives depend on reliable communications—you'll find WILCOX radio transmitting and receiving equipment. From the Scandinavian countries to New Zealand...from Portugal to Pakistan, the governments of the world select WILCOX because of its *proven* performance under all extremes of climate, temperature, and humidity.

As with many governments, WILCOX is being used by the United States government in the basic communication systems for the Air Force, Signal Corps, and the Civil Aeronautics Authority.

The governments of the world have spanned the globe with WILCOX communications. From the Berlin Airlift to the Orient...WILCOX equipments carry the messages that help keep freedom a vital force in the turbulent affairs of the world.

WRITE TODAY... for complete information on all types of point-to-point, air-borne, ground station, or shore-to-ship communications equipment.



WILCOX ELECTRIC COMPANY

KANSAS CITY

MISSOURI

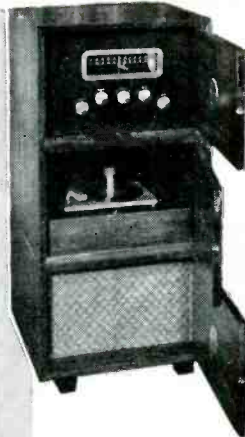
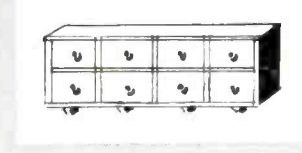
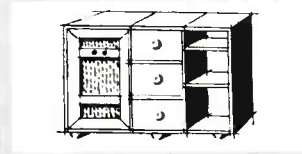
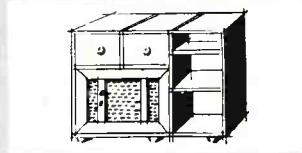
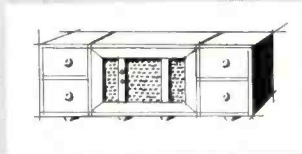
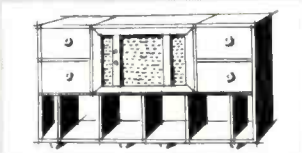

Jensen Customode

CUSTOMODE is the answer to the ever expanding requirements of audio-video equipment. Today you may install a tuner, an amplifier and a record changer with your loudspeaker. Tomorrow you can add a TV receiver, a pick-up for micro-groove records and a record cabinet. The illustrations show a few of the hundreds of possible arrangements for Home Entertainment Centers.

Designed by leading furniture stylists and acoustic engineers around a JENSEN 15-inch loudspeaker in a Bass Reflex Cabinet—the very ultimate in high-fidelity sound reproduction—CUSTOMODE is as functional as it is beautiful. Its "building block" versatility enables you to create your own layouts as you wish, when you wish.

Write today for literature and scale cut-outs. Jensen Manufacturing Company, Division of the Muter Company, 6607 South Laramie Avenue, Chicago 38, Illinois. In Canada: Copper Wire Products, Ltd., 351 Carlaw Ave., Toronto

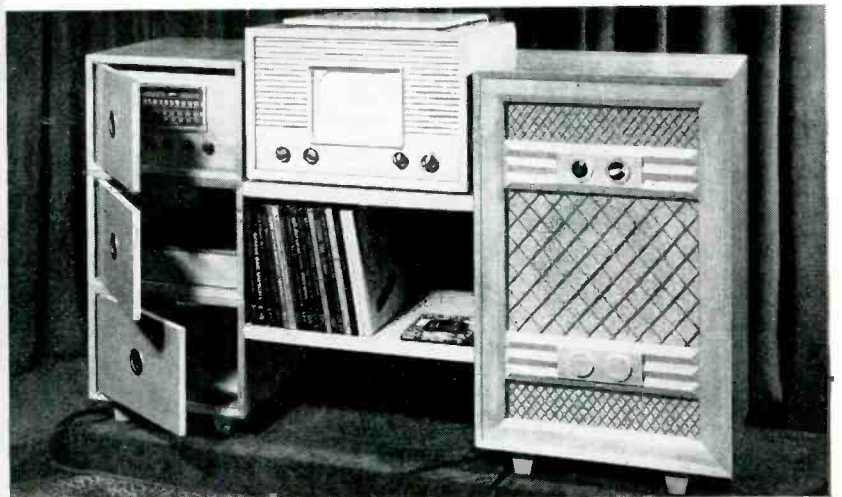

Shown above is Shelf which provides for inclusion of TV receiver or record albums in a CUSTOMODE ensemble.

DELTAMAX *-now available!*

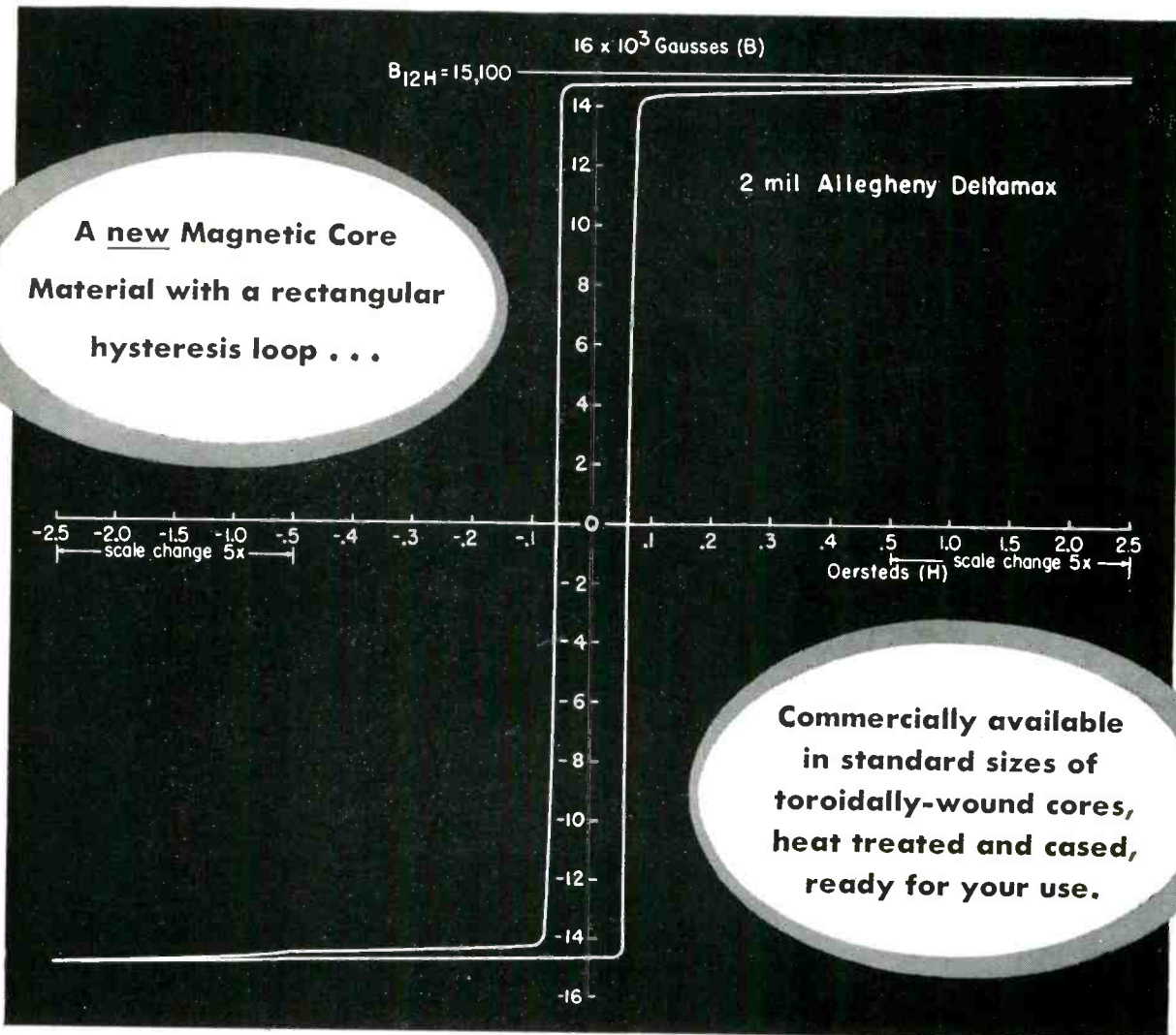

Where can YOU use a Magnetic Material with these specialized, dependable characteristics?

The properties of Deltamax are invaluable for many electronic applications, such as new and improved types of mechanical rectifiers, magnetic amplifiers, saturable reactors, peaking transformers, etc. This new magnetic material is available now as "packaged" units (cased cores ready for winding and final assembly) distributed by the Arnold organization. Every step in manufacture has been fully developed; designers can rely on

complete consistency in each standard size of core.

Deltamax is the most recent extension of the family of special, high-quality electrical materials produced by Allegheny Ludlum, steel-makers to the electrical industry. It is an orientated 50% nickel-iron alloy, characterized by a rectangular hysteresis loop with sharply defined knees, combining high saturation with low coercivity.

● Call on us for technical data.



THE ARNOLD ENGINEERING COMPANY

SUBSIDIARY OF ALLEGHENY LUDLUM STEEL CORPORATION
147 EAST ONTARIO STREET, CHICAGO 11, ILLINOIS

W&D 2379

YOU CAN BE **SURE**.. IF IT'S

Westinghouse

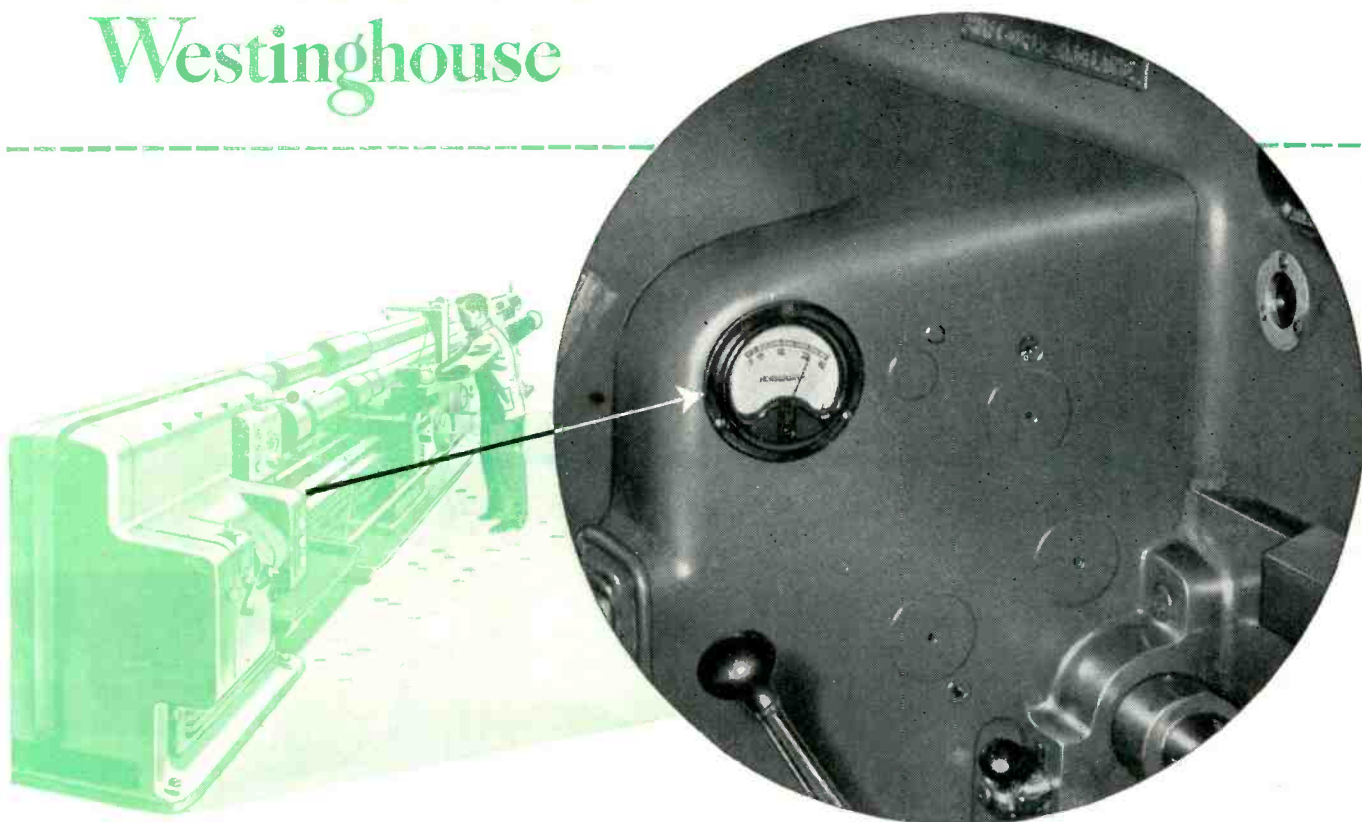

This Westinghouse Instrument helps set *New Production Records*

Savings in machine time up to 75% are common among the users of the American Tool Works Company's new hydraulic duplicating lathes!

A standard feature of these lathes is the Westinghouse horsepower instrument. It shows, at a glance, the horsepower being consumed by the cut. This enables the operator to take full advantage of the capabilities of the machine and to make maximum cuts without overloading. Machines can be easily operated at peak loads, without the dangers of overtaxed motors and damaged cutting tools.

This is another example of the application of Westinghouse instruments to *specific* problems. Westinghouse instruments are *engineered* and built to give you reliable performance in *every* application. The completeness of the line means electrical measuring instruments to fill *your* needs exactly in every field of industry.

Westinghouse instrument specialists are available in the field for consultation. Call your nearest Westinghouse office or write Westinghouse Electric Corporation, P. O. Box 868, Pittsburgh 30, Pennsylvania. J-40373



Westinghouse
ELECTRICAL
MEASURING INSTRUMENTS
FOR *ANY* JOB

How to

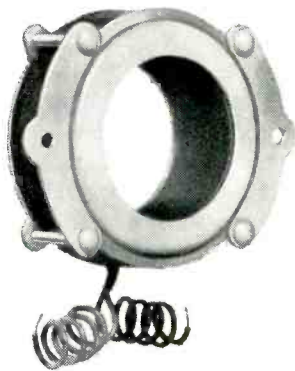

use

I-T-E PM-EM CONSTRUCTION

An I-T-E Type PM-EM Focus Coil combines a permanent magnet with an adjustable electro-magnet. Best uniform-cross-section enameled copper wire is wound on a core of acid-free, impregnated paper. Terminals are securely anchored. The entire wound assembly is completely enclosed in a pressed-steel case which is zinc-plated to resist corrosion. Inside diameter sizes are $1\frac{5}{8}$ " and $1\frac{3}{4}$ ". The latter size is designed for applications employing mechanical centering to provide a wider range of adjustment of raster.

*build better receivers
for less cost -*

I·T·E PM-EM FOCUS COILS

"Chain" savings cut production costs

I-T-E's performance-proved PM-EM Focus Coils cut your costs these two ways: First, the coils themselves cost less. Then, they operate on a smaller and less expensive power supply which, in turn, makes possible the use of less expensive controlling rheostats. I-T-E Focus Coils are small, compact, and lightweight — take up less space and help keep receiver weight down.

Set operation is improved

Among the many advantages of I-T-E PM-EM Focus Coils is their low operating temperature—gained through use of lower power wattages. I-T-E PM-EM Focus Coils will retain proper focusing over a wide range of line voltage variations. The outstanding endorsement of better set operation is the fact that today *one of every three* sets equipped with magnetic deflection means, utilizes an I-T-E Focus Coil.

Tailor-made for your production

I-T-E makes PM-EM focus coils for use with 10", 12" and 16" kinescopes. They are available in five standard mountings, and any specified mounting can be supplied upon request. For components to suit your particular application, I-T-E will produce tailor-made units to any specifications. Information needed to manufacture: Type of tube; second anode voltage; focusing current desired; special considerations for mountings and leads.

Use our engineering service

In many cases, receivers which now utilize ordinary EM type focus coils can easily be modified to take the I-T-E Type PM-EM. A simple change in design can mean production savings and improved operation of your receivers. I-T-E's design engineers will be glad to work with you on modifications—consult them without obligation. For complete information on I-T-E Focus Coils—or on any I-T-E wire-wound products—write, specifying your needs.



FOCUS COILS

The Leader In Technical Excellence

RESISTOR DIVISION, I-T-E CIRCUIT BREAKER CO.

19th & Hamilton Streets, Philadelphia 30, Pa.

I-T-E Wire-Wound Products: RESISTORS • DEFLECTION YOKES • FOCUS COILS • SPECIAL MANUFACTURES

INSUROK *By* RICHARDSON

dependable
names in
plastics

EXPERIENCE is just one of the factors that make the names of INSUROK and Richardson more significant to manufacturers whose products require laminated or molded plastics. Richardson customers benefit from this experience in many ways.

(1) Richardson experience with a wide variety of plastic materials helps you select the one that accomplishes your purpose most effectively, efficiently and economically.

(2) Richardson experience in the design and production of Laminated INSUROK and Molded INSUROK products has re-

sulted in savings to scores of manufacturers.

(3) Richardson's many proven grades of Laminated INSUROK are available in sheet, rod or tube stock or in fabricated, punched or post-formed component parts for an endless variety of applications.

(4) INSUROK plastic products and Richardson services have played an important part in the development and refinement of many products.

It might be to our mutual advantage to know how these materials and services can work for you.

INSUROK is a registered trade-mark of The Richardson Company

The RICHARDSON COMPANY

GENERAL OFFICES: LOCKLAND, OHIO

FOUNDED IN 1858

Sales Headquarters: MELROSE PARK, ILLINOIS

CLEVELAND • DETROIT • INDIANAPOLIS • MILWAUKEE • NEW BRUNSWICK, (N. J.) • NEW YORK • PHILADELPHIA • ROCHESTER • ST. LOUIS

TUNG-SOL

5687



a miniature twin triode

with unequalled performance capabilities

see other side for additional information

TUNG-SOL

5687



- 1** Exceptionally high performance and tremendous reserve emission.
- 2** Out-performs all other tubes of its class.
- 3** Performance potential equivalent to two-and-a-half times that of a 6SN7GT tube.
- 4** On the Army-Navy Preferred List.

This high-performance general-purpose tube may be used as a power amplifier, as a cw, or pulsed oscillator, and as a cathode follower. It is equally useful in balanced circuits, as a modulator or a servo amplifier and in the countless other applications for which twin triodes are so suitable. It is painstakingly produced under laboratory conditions. Each part is individually inspected and tested and every step of assembly is rigidly held to highest standard. The result is exceptional uniformity and reliability.

RATINGS

Interpreted according to RMA standard M8-210

Heater Voltage ($\pm 10\%$)	12.6	6.3	VOLTS
Maximum Heater-Cathode Voltage	90		VOLTS
Maximum Plate Voltage	300		VOLTS
Maximum Inverse Plate Voltage	1000		VOLTS
Maximum Plate Dissipation (each unit)	4.2		WATTS
Maximum Total Plate Dissipation (both units)	7.5		WATTS
Maximum Bulb Temperature (at any part of envelope)	220°		C
Maximum DC Grid Current (each unit)	6		MA.
Maximum External Grid Circuit Resistance (each unit)		1	MEG.

CHARACTERISTICS

Class A₁ Amplifier—Each Unit

Heater Voltage	12.6	6.3	VOLTS
Heater Current	450	900	MA.
Plate Voltage	120	180	250 VOLTS
Grid Voltage	-2	-7	-12.5 VOLTS
Plate Current	36	23	16 MA.
Plate Resistance	1650	2750	4000 OHMS
Transconductance	11000	6400	4100 μ MHOS
Amplification Factor	18	17.5	16.5
Grid Voltage (approx.) For $I_b=100 \mu$ A	-10	-15	-21 VOLTS

For more complete information about the 5687, write for these bulletins.

TUNG-SOL

ELECTRON TUBES

The Tung-Sol engineering which has produced the 5687 is constantly at work on a multitude of special electron tube developments for industry. Many exceptionally efficient general and special purpose tubes have resulted. Information about these and other types are available on request to Tung-Sol Commercial Engineering Department.



TUNG-SOL LAMP WORKS INC., NEWARK 4, NEW JERSEY

SALES OFFICES: ATLANTA • CHICAGO • DALLAS • DENVER • DETROIT • LOS ANGELES • NEWARK
 Also Mfrs. of: RECEIVING TUBES, MINIATURE INCANDESCENT LAMPS, ALL-GLASS SEALED BEAM HEADLIGHT LAMPS and CURRENT INTERMITTORS

AUGUST, 1949

KAY ELECTRIC COMPANY

PREPARE FOR UHF TESTING

WITH SWEEPING OSCILLATORS . . .
SCANNING REFLECTED ENERGY METERS . . .
VISUAL VOLTMETERS and SPECTRUM ANALYZERS

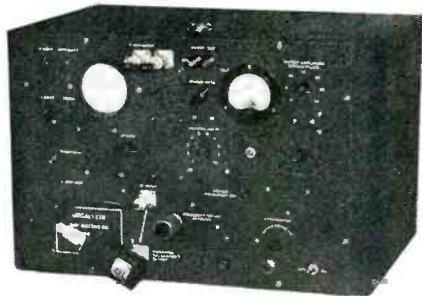

The UHF MEGALYZER

The UHF MEGALYZER now incorporates increased sensitivity, broadened frequency range, and improved linearity. The frequency range now extends from 30 to 500 mc and is useful to 1000 mc. The maximum sensitivity for linear operation is 100 microvolts. The equivalent noise input is approximately 20 microvolts. The frequency response from 30 to 500 mc is within 4 db. The flatness of the frequency response and sensitivity are only slightly deteriorated between 500 and 1000 mc. The frequency resolution is still 100 kc. The UHF MEGALYZER contains a sweeping oscillator, (The MEGA-SWEEP) and an oscilloscope, both of which can be used separately.

The UHF MEGALYZER contains a wavemeter for identifying the frequency of unknown signals. By use of an auxiliary calibrated signal generator, the level of any unknown signal may be determined.

Price: \$895.00 F. O. B. Factory



The MEGALYZER JR.

The MEGALYZER JR. is an accessory device for use with a MEGA-SWEEP sweeping oscillator and a standard oscilloscope. These three devices, when used together, comprise a Visual Voltmeter and Spectrum Analyzer system. The specifications of the system are the same as those for the MEGALYZER. Either the MEGALYZER JR. system or the MEGALYZER can be used for tuning circuits intended for selecting crystal harmonics, studying the spurious output of transmitters or generators, measuring C.W. oscillator radiation, observing the modulation on a carrier and many other applications at VHF or UHF.

Price: \$250.00 F. O. B. Factory



THE UHF MEGA-MATCH

The UHF MEGA-MATCH is an improved design of the widely used MEGA-MATCH which increases the useful frequency range from 10-250 mc up to 10 to 1000 mc. (VHF MEGA-MATCH still available.) The UHF MEGA-MATCH rapidly indicates reflected energy over a swept band width up to 30 mc through the VHF and UHF ranges. MEGA-MATCH units now in customers' hands may be converted to cover the wider frequency range at a price of \$200.00.

Price: VHF MEGA-MATCH—\$695.00 F. O. B. Factory

UHF MEGA-MATCH—\$895.00 F. O. B. Factory

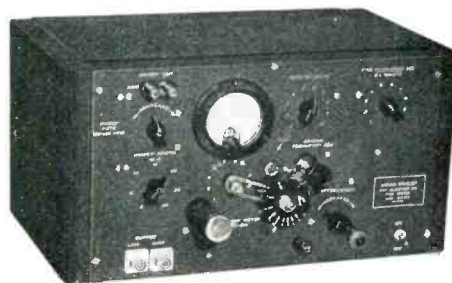

THE CALIBRATED MEGA-SWEEP

The CALIBRATED MEGA-SWEEP provides single dial tuning over the entire frequency range of the instrument. A calibrated dial is included which indicates the center frequency of the swept output to sufficient accuracy to place the wanted frequency within the swept range. After warm-up and one check of operation the CALIBRATED MEGA-SWEEP can be used for very long periods over a wide continuous frequency range (50 kc to 1000 mc) by varying only the single tuning knob. Sweep widths up to 30 mc.

MEGA-SWEEPS now in customers' hands can be changed to the CALIBRATED MEGA-SWEEP Model for \$50.00.

Price: \$425.00 F. O. B. Factory

The MEGA-NODE SR.—A NEW INSTRUMENT. Watch our next advertisement announcing the MEGA-NODE SR., a UHF and Microwave Random Noise Source—Frequency Range 100-3000 mc, Read Noise Figures to 20 db—Output impedance 50 ohms unbalanced, no tuning necessary. Price: \$895.00 F. O. B. Factory

Prices outside U. S. A. and Canada 10% higher.

FOR FURTHER DETAILS WRITE

KAY ELECTRIC CO., 25 MAPLE AVE., PINE BROOK, N. J.
Telephone CAldwell 6-4000

Manufacturers of: Mega-Match, Mega-Node, Megaligner, Mega-Pulser, Sonalater, Sona-Graph, Microwave Mega-Match, Micro-Pulser.

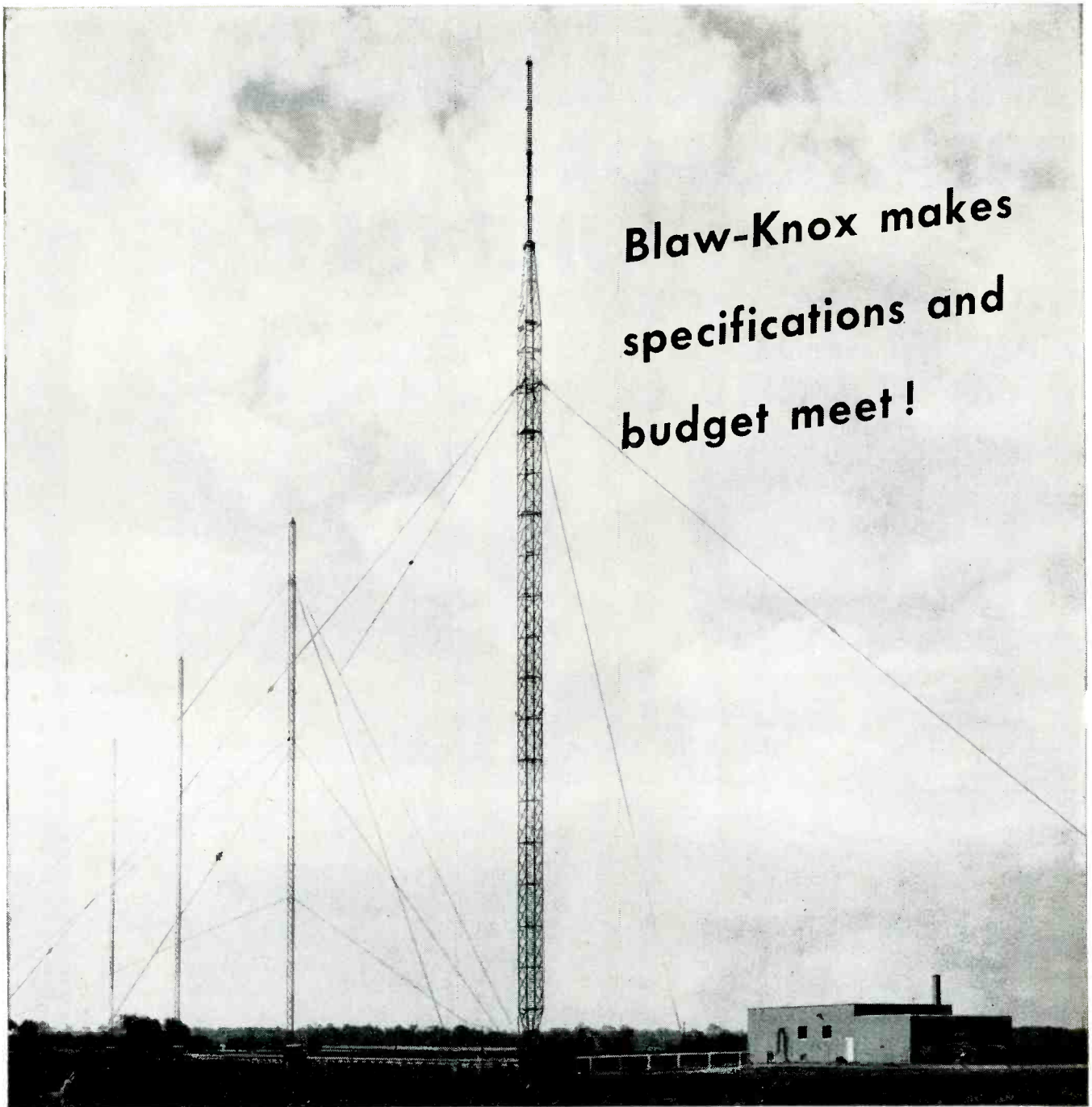

**Blaw-Knox makes
specifications and
budget meet!**

Station WICA, Ashtabula, Ohio

THE consulting radio engineer prescribed uniform cross section towers of maximum strength and efficiency for this directional array, but the budget demanded a minimum of expenditure. So there was only one place to take the prescription—BLAW-KNOX.

The three type LT towers illustrated, although low

in cost, have the strength and high factor of safety characteristic of Blaw-Knox design and engineering. The type SGN tower completing the array has the additional strength to support the heavy-duty FM pylon and any future TV requirements.

Your tower prescription will be promptly filled at BLAW-KNOX.

BLAW-KNOX DIVISION OF BLAW-KNOX COMPANY
2077 FARMERS BANK BUILDING, PITTSBURGH 22, PA.



BLAW-KNOX ANTENNA TOWERS



Precision Voltmeters... FAST ACCURATE READINGS

2 cps to 700 mc

ANOTHER -hp- SERVICE Person-to-Person Help With Your Measuring Problems

Almost anywhere in America, -hp- field representatives can give you personal help with your measuring problems. They have complete data on -hp- instruments, their performance, servicing and adaptability. Call the nearest -hp- field representative whenever, wherever you need help with a measuring problem.

BOSTON, MASSACHUSETTS

Burlingame Associates
270 Commonwealth Ave.
Kenmore 6-8100

CHICAGO 6, ILLINOIS

Alfred Crossley & Associates
549 W. Randolph St.
State 7444

CLEVELAND 12, OHIO

M. P. Odell
1748 Northfield Avenue
Potomac 6960

DALLAS 5, TEXAS

Earl W. Lipscomb
4433 Stanford Street
Logan 6-5097

DENVER 10, COLORADO

Ronald G. Bowen
1896 So. Humboldt Street
Spruce 9368

FORT MYERS, FLORIDA

Arthur Lynch and Associates
P. O. Box 466
Fort Myers 1269M

HIGH POINT, NORTH CAROLINA

Bivins & Caldwell
Room 807, Security Bank Building
Phone 3672

LOS ANGELES 46, CALIFORNIA

Norman B. Neely Enterprises
7422 Melrose Avenue
Whitney 1147

NEW YORK 7, NEW YORK

Burlingame Associates
11 Park Place
Digby 9-1240

SAN FRANCISCO 3, CALIFORNIA

Norman B. Neely Enterprises
954 Howard Street
Douglas 2-2609

TORONTO 1, CANADA

Atlas Radio Corporation, Ltd.
560 King Street West
Waverley 4761

WASHINGTON 9, D. C.

Burlingame Associates
2017 S. Street N. W.
Decatur 8000

**-hp-
MODEL
400C**



From 2 cycles to 700 megacycles, there's an accurate, easy-to-operate -hp- voltmeter to fit every voltage measurement requirement. You can choose from 5 precision voltmeters (including a battery-operated instrument) the ones which precisely fill your measuring need. Each has the familiar -hp- characteristics of high sensitivity, wide range, versatility, compact size, and time-saving ease of operation. These -hp- precision voltmeters are used by radio stations, manufacturers, research laboratories and scientific men throughout the world.

INSTRUMENT	FREQ. RANGE	VOLTAGE RANGE	ACCURACY	INPUT IMPEDANCE	PRICE
-hp-400A	10 cps to 1 mc	.005 to 300 v 9 ranges	Within 3%	1 meg., 16 μ fd shunt	\$185.00
-hp-400B	2 cps to 100 kc	.005 to 300 v 9 ranges	Within 3%	10 meg., 20 μ fd shunt	195.00
-hp-400C	20 cps to 2 mc	.0001 v to 300 v 12 ranges	Within 3%	10 meg., 15 μ fd shunt	200.00
-hp-404A (Battery Op'd.)	2 cps to 50 kc	.0005 v to 300 v 11 ranges	Within 5%	10 meg., 20 μ fd shunt	185.00
-hp-410A	20 cps to 700 mc	0.1 v to 300 v 7 ranges	Within 3%	10 meg., 1.3 μ fd shunt	245.00

For complete data on any -hp- instrument, write direct to factory or contact the nearest -hp- technical representative.

HEWLETT-PACKARD CO.

1876-A PAGE MILL ROAD • PALO ALTO, CALIFORNIA
Export Agents: Frazar & Hansen, Ltd.
301 Clay Street, San Francisco 11, California, U.S.A.

hp laboratory instruments
FOR SPEED AND ACCURACY

Here's WIRE with "WIND-ABILITY" PLUS

FOR MINIMUM
OVER-ALL WINDING
COST AND MAXIMUM
UNIFORMITY



HIGH SPEED winding—whether bobbin, random or gang—subjects magnet wire to punishing treatment. Insulating film must be tough, yet pliable. Copper must have the proper degree of anneal. The spool-to-spool uniformity must be right.

Essex Extra-Test Magnet Wire has earned an unexcelled reputation in the most exacting applications. It helps insure coils of uniform size and resistance value—maximum turns in available space—freedom from broken wires, pile-ups, crossed turns, runbacks, spaced turns, and frequent tension adjustments. When you specify Essex Extra-Test Magnet Wire you can be *sure*.



ESSEX WIRE CORPORATION FORT WAYNE 6, INDIANA

Plants: Anaheim, Calif.; Detroit, Mich.; Fort Wayne, Ind. Warehouses* and Sales Offices:
*Atlanta, Ga.; *Boston, Mass.; *Chicago, Ill.; Cleveland, Ohio; Dallas, Texas; Dayton, Ohio;
*Detroit, Mich.; *Kansas City, Mo.; *Los Angeles, Calif.; Milwaukee, Wis.; *Newark, N. J.;
Philadelphia, Pa.; *Portland, Oreg.; *St. Louis, Mo.; *San Diego, Calif.; *San Francisco, Calif.
EXPORT SALES OFFICE—LIONEL-ESSEX INTERNATIONAL CORPORATION, 15 E. 26th ST., NEW YORK 10, N. Y.

Check YOUR NETWORK PROBLEM WITH LOGIC

In any technical business the specialist has a unique value in his specific field. It is logical that a manufacturer of a specialty product should be of greater value in his particular field.

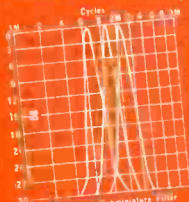
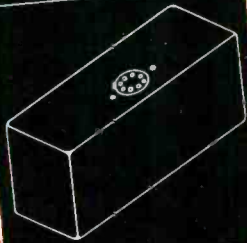
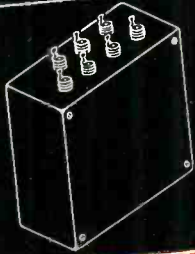

Three Channel Subminiature Filter
Volume 5 cc inches

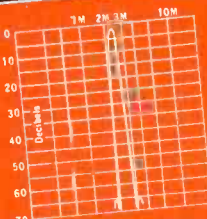

Telemetering Filters in sets up to 20 channels.

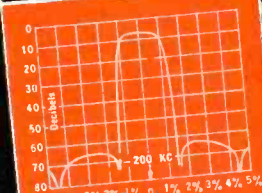

Crystal Filters for Telemetering and commercial radio.

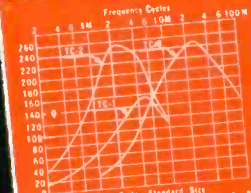
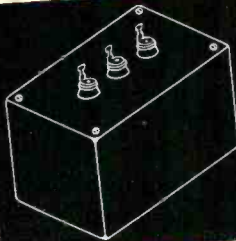

Toroidal Coils Standard Size
TC1 Size: 1 1/2" x 1 1/2" x 1 1/2" D 6 1/4"
TC2 Size: 2 1/2" x 2 1/2" x 2 1/2" D 8 1/4"

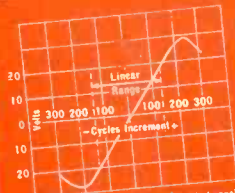
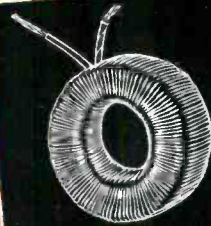

Audio discriminators for FM multi-channel applications.

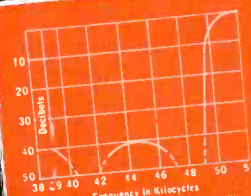

Extremely sharp side band suppression filter.
Size: 2 1/2" x 4" x 2 1/2"

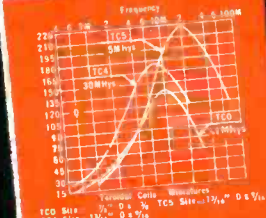

Toroidal Coils Standard Size
TCO Size: 1 1/2" x 1 1/2" x 1 1/2" D 6 1/4"
TCO Size: 2 1/2" x 2 1/2" x 2 1/2" D 8 1/4"

As one of the largest producers of toroidal coils and filters Burnell & Co's facilities and production experience have been of immeasurable technical and economical value to our customers. Many engineers have benefitted by our prompt technical service. Why not bring your network problem to us for the most practical and economical solution?

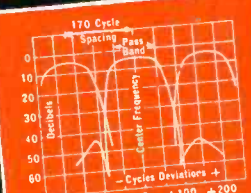
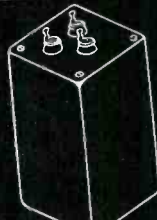

Tone channel filter for extremely high cross over alternation requirement.
Size: 2 1/2" x 2 1/2" x 5"



EXCLUSIVE MANUFACTURERS OF COMMUNICATIONS NETWORK COMPONENTS

WRITE FOR TECHNICAL INFORMATION
ALL INQUIRIES WILL BE PROMPTLY HANDLED

Burnell & Company

YONKERS 2, NEW YORK

CABLE ADDRESS "BURNELL"

Riding the Back of a "Banshee"

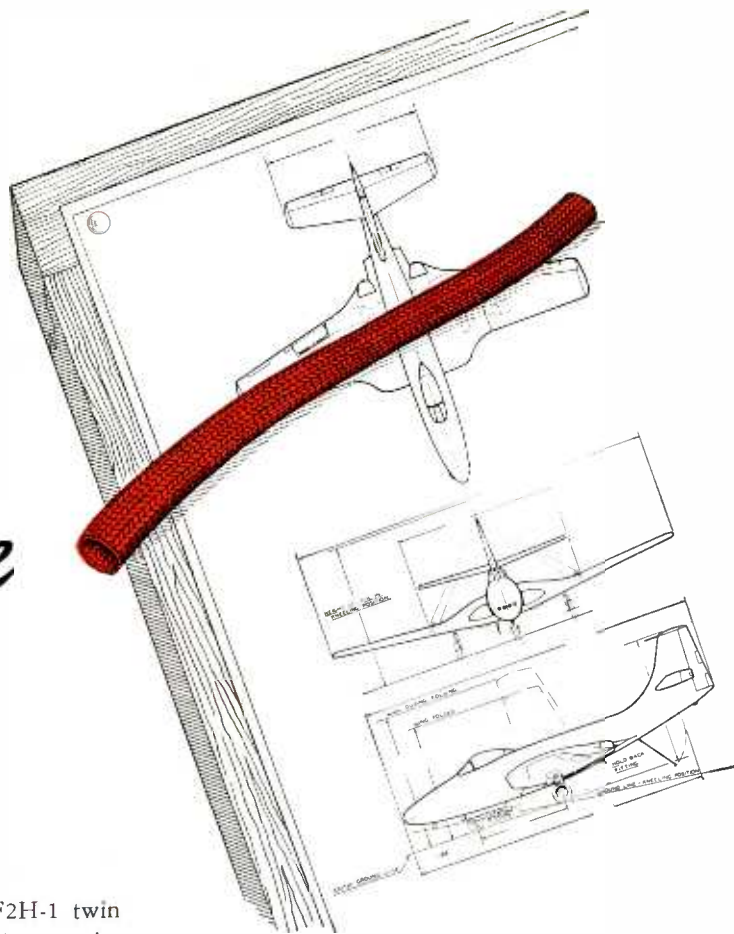

When the "Banshee", the Navy's F2H-1 twin jet fighter streaks away from a sleek Navy carrier and begins climbing "upstairs" at more than 7000 feet per minute, BH Fiberglas Sleeving rides along in its selected insulation job. This outstanding carrier-based fighter plane built by the McDonnell Aircraft Corporation now gives the Navy an additional aerial "punch".

BH Fiberglas Sleeving has been selected for use by many of the nation's leading aircraft manufacturers because it meets insulation requirements fully and completely. Whether the problem is one of high voltage, fraying, vibration or climatic changes, BH Fiberglas Sleeving can be depended

upon to do the job successfully because it *retains* its remarkable flexibility, heat resistance and dielectric strength.

BH Fiberglas Sleeveings are made to meet specific requirements. Furnished double-braided, triple-braided and heat resistant to 1200°F. if necessary. Stays flexible as string because no hardening varnish or lacquer is used in its manufacture. Cuts without fraying and won't deteriorate. Use it profitably in your plant and in your product. Write today for samples.

BENTLEY, HARRIS MFG. CO., CONSHOHOCKEN, PA.

BH Fiberglas* SLEEVINGS

*BH Non-Fraying Fiberglas Sleeveings are made by an exclusive Bentley, Harris process (U. S. Pat. No. 2393530). "Fiberglas" is Reg. TM of Owens-Corning Fiberglas Corp.

USE COUPON NOW

Bentley, Harris Mfg. Co., Dept. E-34, Conshohocken, Pa.

I am interested in BH Non-Fraying Fiberglas Sleeving _____ for _____ (size or I.D.) _____ operating at temperatures of _____°F. at _____ volts. Send samples (product) so I can see how BH Fiberglas Sleeving stays flexible as string, will not crack when bent.

NAME _____ COMPANY _____

ADDRESS _____

Send samples, pamphlet and prices on other BH Products as follows:

- Cotton or Rayon-base Sleeving and Tubing
- Ben-Har Special Treated Fiberglas Tubing

7 TOP TETRODES



and 7 reasons why they are the criteria of good design in any electronic equipment.

- ➔ These tubes bear the trademark "Eimac" . . . important . . . because it reflects the basic integrity of Eitel-McCullough, Inc.—a trademark synonymous with quality.
- ➔ Operational characteristics are conservatively rated; consequently . . . Eimac Tubes operate within their ratings at a fraction of their peak abilities.
- ➔ Outstanding operational stability is an inherent characteristic of all Eimac tubes.
- ➔ "Clean" mechanical design, plus a coordinate balance in the chemical and physical properties of internal-structure materials gives these tubes the ability to withstand abnormal momentary overloads, as well as thermal and physical shock.
- ➔ Millions of hours of proven performance in the key socket positions of electronic equipment is evidence of Eimac superiority.
- ➔ Standardization of test procedures and uniformity of production produce coinciding tube characteristics assuring unvarying equipment performance.
- ➔ There are Eimac representatives, qualified to assist with your vacuum tube problems and service . . . as close as your telephone. Please take advantage of their council . . . talk over your tube problems with them . . . there is no obligation.

EITEL - McCULLOUGH, INC.
San Bruno, California
 Export Agents: Frazar & Hansen, 301 Clay Street, San Francisco, California

COMPLETE DATA ON THESE EIMAC TETRODES MAY BE HAD BY WRITING TO
EITEL-McCULLOUGH, INC.
 San Bruno, California

EIMAC FIELD REPRESENTATIVES

- | | |
|---|---|
| Herb Becker
1406 So. Grand Ave.
Los Angeles 15, Calif. | Adolph Schwartz
220 Broadway, Rm. 1609
New York 7, N. Y. |
| Royal J. Higgins
Royal J. Higgins Co.
600 S. Michigan Ave.,
Chicago 5, Ill. | M. B. Patterson
Patterson & Company
1124 Irwin-Keasler Bldg.
Dallas 1, Texas |
| Dave M. Lee
Dave M. Lee Co.
2626 Second Ave.
Seattle 1, Wash. | Clyde H. Schryver
Clyde H. Schryver Sales Co.
4550 Main St., Rm. 224
Kansas City 5, Missouri |
| J. E. Joyner, Jr.
James Millar Associates
P. O. Box 116, Sta. C
Atlanta 5, Georgia | W. Clif McLoud
W. Clif McLoud & Co.
711 Colorado Bldg.
Denver 2, Colorado |
| | Tim Coakley
Coakley Sales Office
11 Beacon St.
Boston 8, Mass. |

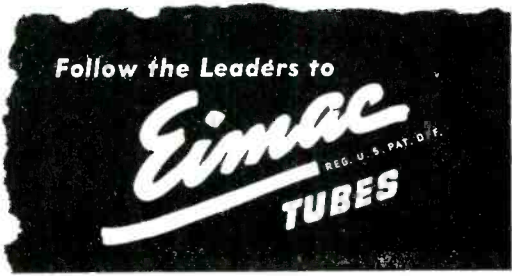



-35°C to +45°C

Aerocom's new V. H. frequency AM radiotelephone/telegraph transmitter is designed and built to operate amid ice and snow or steaming jungles, and what's more, this fine transmitter will give long trouble free efficient service with low maintenance and operating costs.

Model VH-200

The model illustrated (VH-200) operates on one Crystal Controlled frequency (plus one closely spaced frequency) anywhere in the range 118-132 Mcs. or 132-165 Mcs., A-1 or A-3 AM. Nominal carrier power 200 watts up to 132 Mcs., reduced power up to 165 Mcs. Low temperature operation using gas filled rectifiers. Normal temperature operation using mercury vapor rectifiers. Relative humidity up to 95%. Complete technical data on request. *Aerocom* builds other radio-telegraph/telephone transmitters with accessories, and invites your inquiry if you have a communications problem.



CONSULTANTS, DESIGNERS AND MANUFACTURERS OF STANDARD OR SPECIAL ELECTRONIC, METEOROLOGICAL AND COMMUNICATIONS EQUIPMENT

AER - O - COM

(Reg. U. S. Pat. Off.)

AERONAUTICAL COMMUNICATIONS EQUIPMENT, INC.
3090 Douglas Road, Miami 33, Florida

DEALERS: Equipeleto Ltda., Caixa Postal 1925, Rio de Janeiro, Brazil
★ Henry Newman Jr., Apartado Aereo 138, Barranquilla, Colombia
★ Radelec, Reconquista 46, Buenos Aires, Argentina

another C-D development . . .

an unusual material that can
change your ideas about molding plastics!

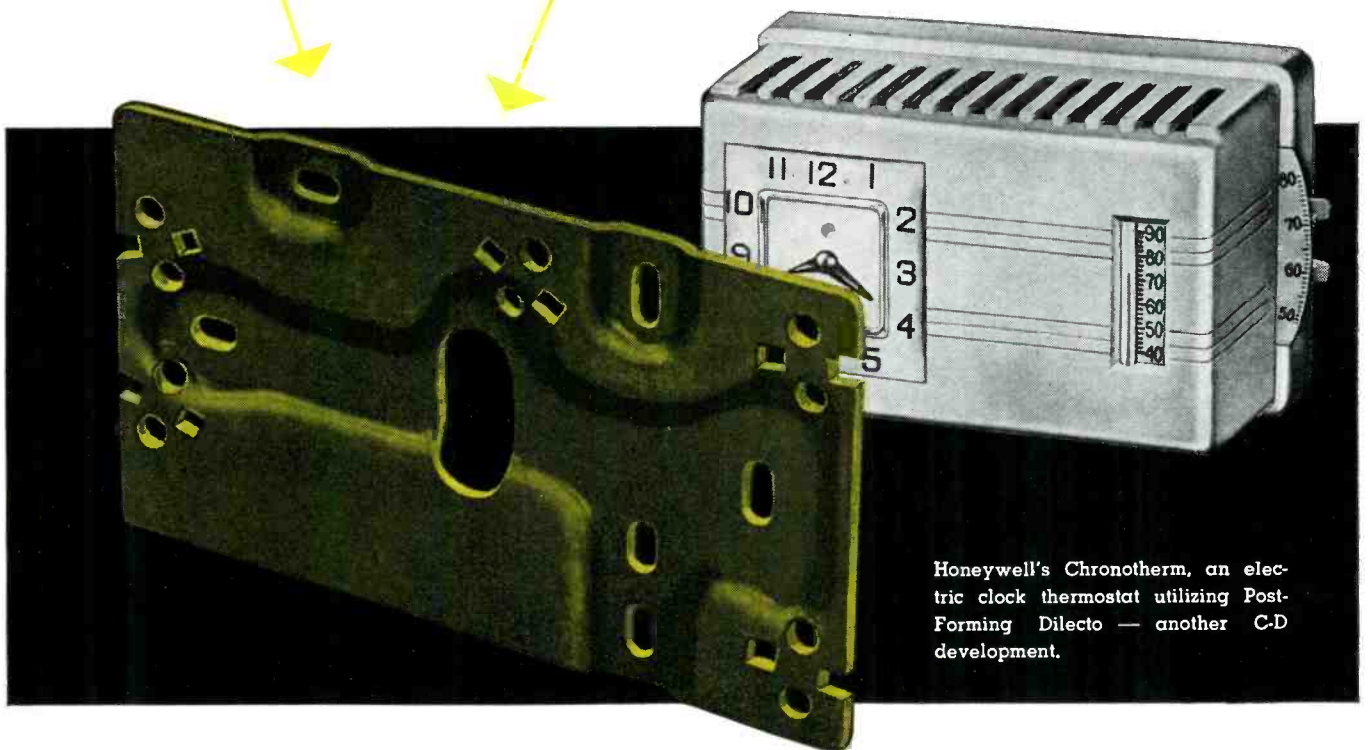

Honeywell's Chronotherm, an electric clock thermostat utilizing Post-Forming Dilecto — another C-D development.

From Continental-Diamond laboratories comes a different plastic that makes parts production faster, easier, and more economical! Post-Forming Dilecto can be formed at a temperature of only 300°F and 200 lbs. pressure. It faithfully retains the shape you give it—eliminates the need for molding many different shapes. Expensive molding dies are no longer necessary. Available in sheet form or finished parts.

Post-Forming Dilecto is another reason why it pays to see C-D first in your search for the right plastic. For C-D Plastics provide practical combinations of mechanical, electrical, and chemical properties—structural strength, light weight, moisture, heat and corrosion resistance. For fast delivery or additional information, call your nearest C-D office, now.

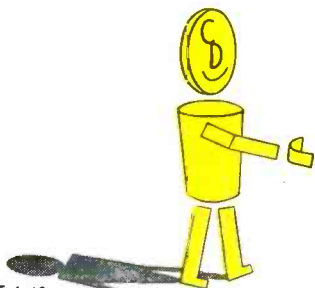

your partner in producing better products

DE-4-49
BRANCH OFFICES NEW YORK 17 • CLEVELAND 14 • CHICAGO 11 • SPARTANBURG, S. C. • SALES OFFICES IN PRINCIPAL CITIES.
WEST COAST REPRESENTATIVE MARWOOD LTD. SAN FRANCISCO 3 • IN CANADA: DIAMOND STATE FIBRE CO. OF CANADA, LTD., TORONTO 8

Continental - Diamond FIBRE COMPANY

Established 1895..Manufacturers of Laminated Plastics since 1911—NEWARK 16 • DELAWARE

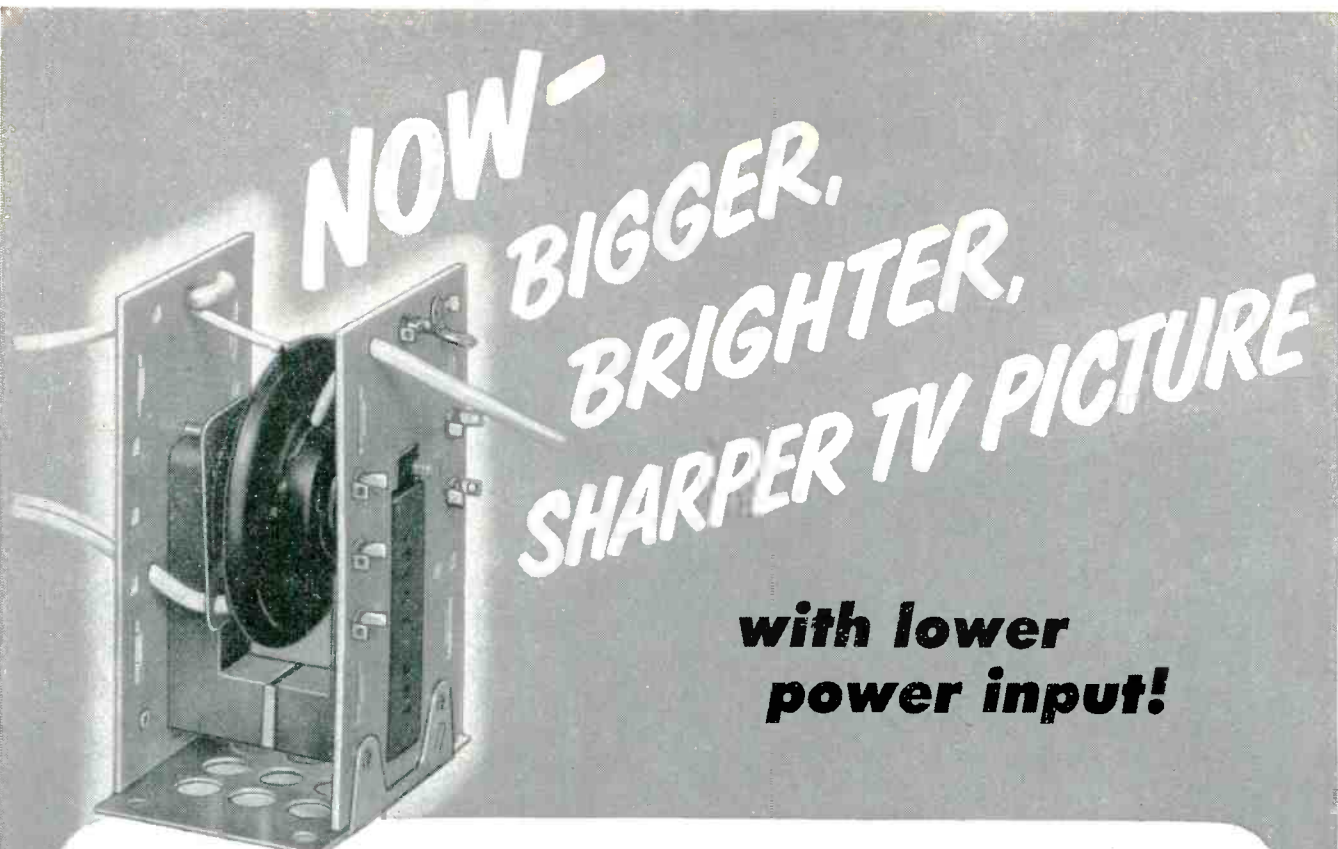

**NOW-
BIGGER,
BRIGHTER,
SHARPER TV PICTURE**

**with lower
power input!**



HORIZONTAL SWEEP TRANSFORMER

THE new General Electric Horizontal Sweep Transformer will sweep even a 60-degree 16" tube with a single 6BG6G tube and produce up to 13 KV anode supply with a single high voltage rectifier!

HERE ARE ITS ADVANTAGES:

- Unusually high efficiency reduces power supply requirements, *thus permitting a major cost reduction* —
- Additional cost reduction in manufacture of 16" sets — only one HV rectifier required —
- Improved mounting versatility —

- Designed for long life. Careful construction, conservative ratings, and close quality control assure a dependable product.

MEMO TO TELEVISION SET MANUFACTURERS
 General Electric application engineers are equipped to help you fit the G-E line of quality components into your designs, to make possible better television receivers at lower cost. For complete information, phone or wire:
*General Electric Company, Parts Section,
 Electronics Park, Syracuse, New York.*

You can put your confidence in—

GENERAL  ELECTRIC

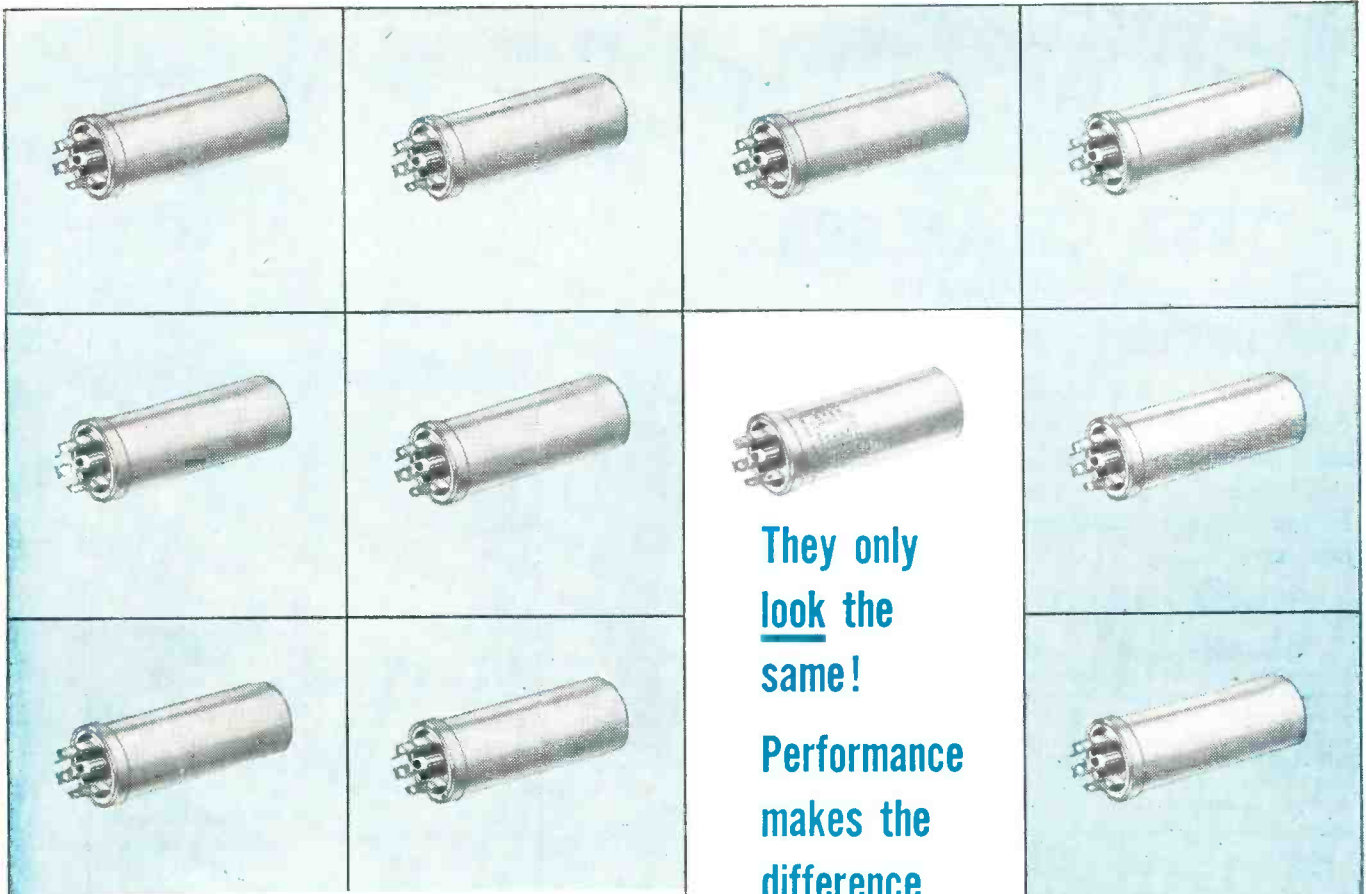

They only
look the
same!

Performance
makes the
difference

Typical of the C-D line of capacitors
with built-in quality
characteristics is the

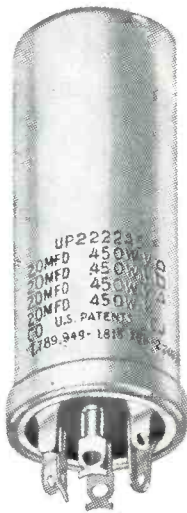

TYPE UP

SPECIAL TV ELECTROLYTIC

The only etched foil
electrolytic approved
by one of the country's
largest manufacturers
of television receivers
after a full year's en-
tirely satisfactory ex-
perience. Available in

round aluminum containers in sizes to
meet your specifications.

C-D Best by Field Test!

as in

**CORNELL-DUBILIER
CAPACITORS**

Long life, free from the troubles that beset
run-of-the-mill capacitors, is engineered into
every C-D unit. When you specify C-D's
you align yourself with the overwhelming
majority of engineers who agree that
none can match C-D. Your inquiry will receive
prompt and intelligent attention.

JAN Catalog No. 400 on paper capacitors
also available. Only requests on company
letterheads can be filled.



Cornell-Dubilier Electric Corporation,
South Plainfield, New Jersey, Dept.
K89. Other plants in New Bedford,
Brookline and Worcester, Mass.;
Providence, R. I., Indianapolis, Ind.,
and Cleveland, Ohio.

CORNELL-DUBILIER

CONSISTENTLY DEPENDABLE

- ★ CAPACITORS.
- ★ VIBRATORS
- ★ ANTENNAS
- ★ CONVERTERS



TEST CHAMBERS

TO SIMULATE

TEMPERATURE • ALTITUDE • HUMIDITY

Designed by Bowser, Inc., to meet the most rigid requirements for testing electronic components or equipment in relation to temperature, humidity or altitude. Used widely by government and industry in laboratories for research and development work and on the production line.

BOWSER LABORATORY UNITS—L-Series

These Units are designed so that industry may perform its testing and processing simply, accurately, and in a minimum of time. Electronic equipment or components which are to be subjected to severe weather conditions can be proved in a Bowser Laboratory Unit. The temperature ranges (+180°F. to -100°F) cover every conceivable application from Tropic heat to Arctic cold and from sea level to 75,000 ft. above the earth. These temperatures are controlled to within $\pm 2^\circ$ F. within the range. The range of Relative Humidity simulation (from 20% to 95%, see table) is equivalent to practically any condition, and the Vacuum simulation easily meets all present day needs for this type of equipment.

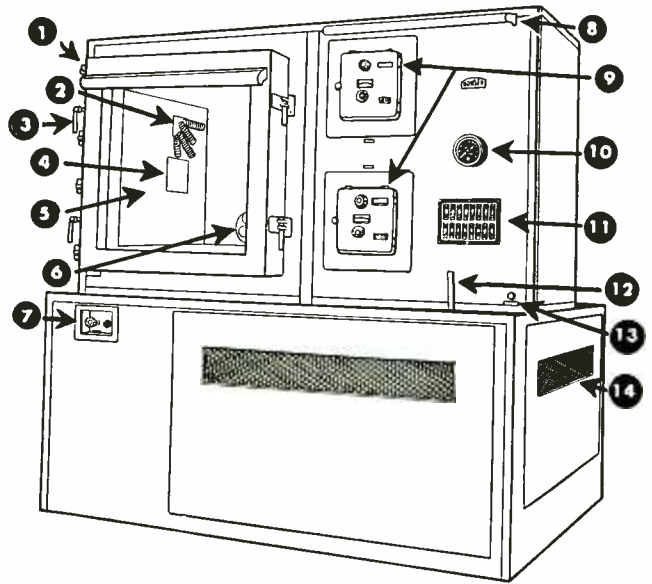

1. Door Light
2. Internal Terminal Pad
3. Cam Latch
4. Access Port
5. Inspection Window
6. Air Mover
7. Hand Regulating Water Valves
8. Instrument Panel Light
9. Indicating Potentiometer, Controller (Wet and Dry Bulb)
10. Altitude Gauge
11. Control Panel
12. Climb-Dive Valve
13. Manometer Connection
14. Condensing Unit Compartment

MODEL NO.	SIZE			LOW TEMP. POINT F.	PULL DOWN FROM AMB. MIN.	DISSIPATION AT LOW OPERATING POINT AT SEA LEVEL	MASS LOAD OF STEEL	8 POST. 4 THERMOCOUPLE TERMINAL PAD	CUT OUT AND REMOVABLE INSULATION BATT
	H	W	D						
L1-50 VH L1-76 VH L1-100 VH	12"	12"	12"	-50°F. -76°F. -100°F.	70 105 170	100 watts 100 watts 50 watts	25# 25# 25#	Available in all 3 L1 Units installed on left side wall, only if "cut out" not required	Available in all 3 L1 Units, installed on left side wall, only if Terminal Pad is not required
L5-50 VH L5-76 VH L5-100 VH	18"	30"	15½"	-50°F. -76°F. -100°F.	70 110 200	200 watts 200 watts 100 watts	50# 50# 50#	Installed in left side wall	Installed in left side wall
L8-50 VH L8-76 VH L8-100 VH	24"	24"	24"	-50°F. -76°F. -100°F.	70 110 200	200 watts 200 watts 100 watts	50# 50# 50#	Installed in left side wall	Installed in left side wall
L18-50 VH L18-76 VH L18-100 VH	30"	30"	36"	-50°F. -76°F. -100°F.	70 110 210	200 watts 200 watts 100 watts	25# 25# 25#	Installed in left side wall	Installed in left side wall
L27-50 VH L27-76 VH L27-100 VH	36"	36"	36"	-50°F. -76°F. -100°F.	75 110 210	200 watts 200 watts 100 watts	100# 100# 100#	Installed in left side wall	Installed in left side wall

THE FOLLOWING SPECIFICATIONS ARE STANDARD FOR ALL MODELS:

1. Reheat time from ambient to +180°F. is 70 minutes.
2. Thermocouple Type Indicating Controller; installed in instrument panel to right of free-working space. Range: -150°F. to +200°F.
3. Altitude Simulation Equipment: Laboratory Type, Oil Sealed Vacuum Pump and Hand Operated Climb - Neutral - Dive Valve.
4. Current (for control): 110 volt, 60 cycle, single phase. (for power): 220 volt, 60 cycle, three phase.
5. Average Climb Rate: 3,000 feet per minute to 50,000 feet.
6. Maximum Vacuum: 1" mercury absolute.
7. Vacuum Gauge: 4½" Dial Type, 0' to 80,000'.
8. ¾" I.D. Low Pressure Pipe: 50 psi. installed in left side wall.
9. Special instrumentation can be supplied at customer's request.

CONSTRUCTION

Cabinet mounted on rigid steel base of welded channel irons to prevent warpage or distortion. Refrigeration equipment and vacuum pump, etc., mounted on separate inner frame to minimize vibration. Work being tested checked during processing through inspection window mounted in door of chamber. Interior illuminated by means of a light mounted on door outside the chamber. Instrument panel is also supplied with a light mounted over it.

OTHER BOWSER UNITS

Some of the many Bowser units are shown and briefly described on this page. They have a wide scope of application throughout industry. Complete details regarding any of them are available upon request.

INDUSTRIAL

For the user whose requirements do not call for conditions of high altitude or relative humidity, the Industrial "low temperature" Unit is available. A typical application might be the expansion fitting of bushings.

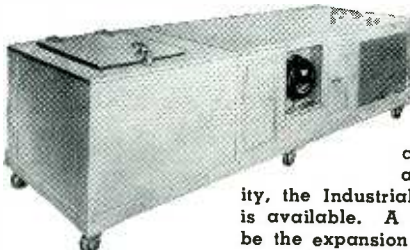

UTILITY UNITS

Designed for rapid, dependable production testing and processing. It is also capable of being used for limited amounts of research and development work. Adaptable to a wide range of applications from production processing of radio crystals to testing of cameras and camera lenses. Provided with temperature control from +158°F. to -80°F., with a tolerance of control of $\pm 3^\circ$ F. over the range.

BOWSER, INC. REFRIGERATION DIVISION — 420 LEXINGTON AVE., N. Y. C.

IN CANADA, S. F. BOWSER CO., LTD., 344 SHERMAN AVE., HAMILTON, ONTARIO

where X equals any a-c input voltage
between 95 and 130 volts, then . . .

X plus



= 115 volts

"X" is fine to "mark the spot," but when it's a symbol of uncertain input voltage, "X" can mean you're not getting maximum performance from your electric equipment. For a steady 115 volts, instead of the ups and downs of line voltage—use a G-E stabilizer. These fully automatic, low cost units give you far better performance from any apparatus that is sensitive to voltage fluctuations.

Stabilization is instantaneous (less than three cycles) and within ± 1 per cent for fixed, unity-power-factor loads. Since stabilizers have no moving parts, they require little or no maintenance. They will operate continuously at open or short circuit without damage. Available in standard ratings from 15 va to 5000 va.



**G-E Automatic
Voltage Stabilizers**

For general information, call your nearest G-E Apparatus Office and ask for GEA-3634B. Or address Apparatus Department, General Electric Company, Schenectady 5, N. Y.

Inquiries are invited on special units. Requests should include data and description of circuit and load. Address Specialty Transformer Sales Division, General Electric Company, 1635 Broadway, Fort Wayne, Indiana.

**DO YOU MAKE—OR USE
ANY OF THESE?**

Here are just a few of the applications where you may find a G-E automatic voltage stabilizer valuable:

- Radio transmitters and radar equipment*
- Laboratory testing equipment and precision processes*
- Motion-picture projectors and sound equipment*
- Telephone apparatus*
- Precision photographic equipment and photometers*
- Phototube equipment*
- Calibration of electric devices*
- Color comparators*
- Electron-tube apparatus*
- Electro-chemical analysis*
- Rectifiers (full-wave)*
- Lighting circuits*

GENERAL  ELECTRIC
411-59

Specify **Hi-Q** COMPONENTS-

BPD's (Disks) and BPF's (Flats)

for **SPACE SAVING** and **ECONOMY**

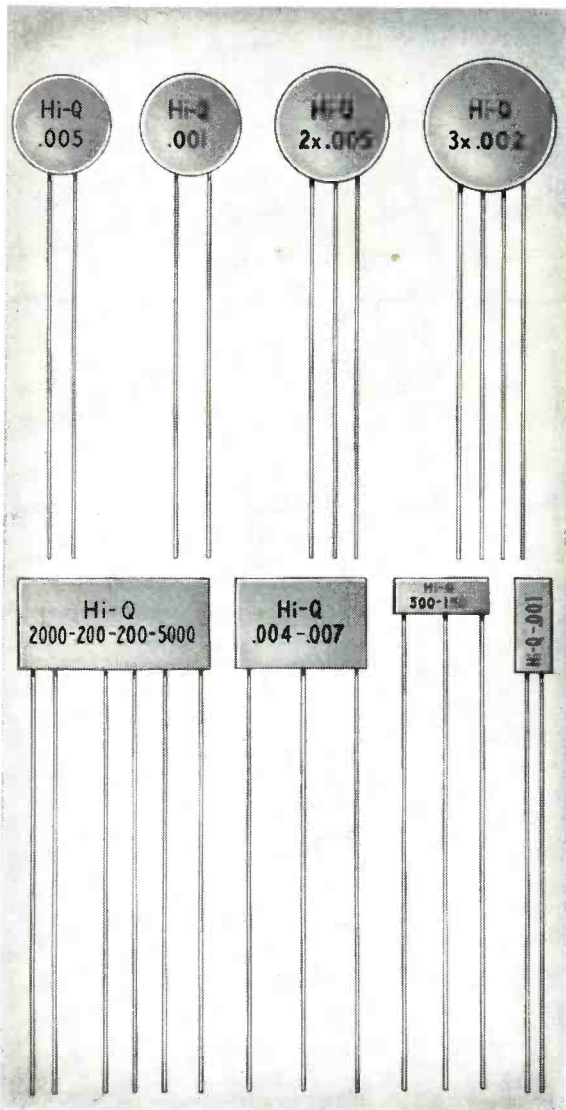

ILLUSTRATIONS APPROXIMATELY ACTUAL SIZE

Hi-Q Disk and **Hi-Q** Flat Ceramic Capacitors frequently save space simply because their physical shape is more adaptable than tubular units . . . and even more frequently because one of them serves in place of two, three or more individual capacitors. The multiple units also simplify soldering and wiring operations and thus effect substantial production economies.

These are just a few of the many types of **Hi-Q** Components which are setting the highest possible standards for *Precision, Quality, Uniformity* and *Miniaturization*. Our engineers are always available to work with you in developing capacitors or combinations of capacitors to best meet your specific needs. Please feel free to call on us at any time.

- **Hi-Q** BPD's (Disks) are available in capacities of from .001 mf. to .01 mf. Dual units range from 2x.001 mf. to 2x.005 mf. Triple units are supplied in standard rating of 3x.0015 mf. and 3x.002 mf. All are guaranteed minimum values.
- **Hi-Q** BPF's (Flats) can be produced in an unlimited range of capacities. The number of capacities on a plate is limited only by the "K" of the material and the physical size of the unit. They do *not* necessarily have to have a common ground as is the case with the disk type.

Hi-Q COMPONENTS
BETTER 4 WAYS

PRECISION Tested step by step from raw material to finished product. Accuracy guaranteed to your specified tolerance.

UNIFORMITY Constancy of quality is maintained over entire production through continuous manufacturing controls.

DEPENDABILITY Interpret this factor in terms of your customers' satisfaction . . . Year after year of trouble-free performance. Our Hi-Q makes your product better.

MINIATURIZATION The smallest BIG VALUE components in the business make possible space saving factors which reduce your production costs . . . increase your profits.

Hi-Q *Electrical Reactance Corp.*
FRANKLINVILLE, N. Y.

Plants: Franklinville, N. Y. — Jessup, Pa. — Myrtle Beach, S. C.
Sales Offices: New York, Philadelphia, Detroit, Chicago, Los Angeles

Stainless

... Presteel produces intricate parts from many metals including **STAINLESS STEEL!**



Photograph
3/4 actual size

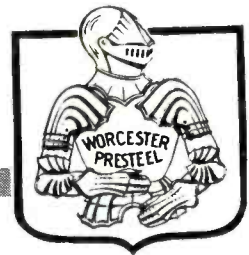

This stainless steel stamping is one of the many components of a modern time recording device. To allow uninterrupted production line assembly and accurate recording by the machine, several vital dimensions of this part must be held to close tolerances. Not only must the individual holes and slots, the lanced and formed fingers be held to specifications, but their relationship one to another must be precisely maintained.

More and more stampings are being made from stainless steel. It has many advantages including improved physical properties and resistance to corrosion.

Based on years of metal working experience and know-how, Presteel has developed new and special techniques demanded by the characteristics of this comparatively new material. Let us put this knowledge to work for you!

Representatives in

ALEXANDRIA, VA.
BUFFALO
CANTON, OHIO
CHICAGO
DENVER
DETROIT
FORT WORTH
INDIANAPOLIS
LOS ANGELES
NEW YORK
PHILADELPHIA
SYRACUSE
TORONTO, CANADA

**ALLOY STEELS AND OTHER
METALS COLD FASHIONED
SINCE 1883**

WORCESTER PRESSED STEEL CO.

308 BARBER AVENUE
WORCESTER 6, MASS.

Q.

Why is "dag" Colloidal Graphite best for CRT Exterior Wall Coating?

A.

It's cheaper
... Has better adhesion
... Requires no baking
... Resists scratching

"dag" Dispersion #194 is a lacquer-base dispersion of microscopically small graphite particles. It is easily applied to CRT surfaces by spraying, and dries very rapidly, enabling tubes to be handled in 2 or 3 minutes. Maximum adhesion is obtained by drying at room temperature for 24 hours, or by forced infra-red drying for 1/2 hour.

"dag" Dispersion #194 forms a smooth, uniform, conductive black coating on any type glass. Its adhesive properties are so good that it will resist scratching by a thumb nail or soaking in water.

Prominent CRT manufacturers have found "dag" colloidal graphite dispersions satisfactory and usually cheaper for wall coatings . . . for other electronics work, too. Let Acheson Colloids engineers show YOU how these versatile dispersions can solve many and varied electronics problems. Send the coupon NOW for more information.

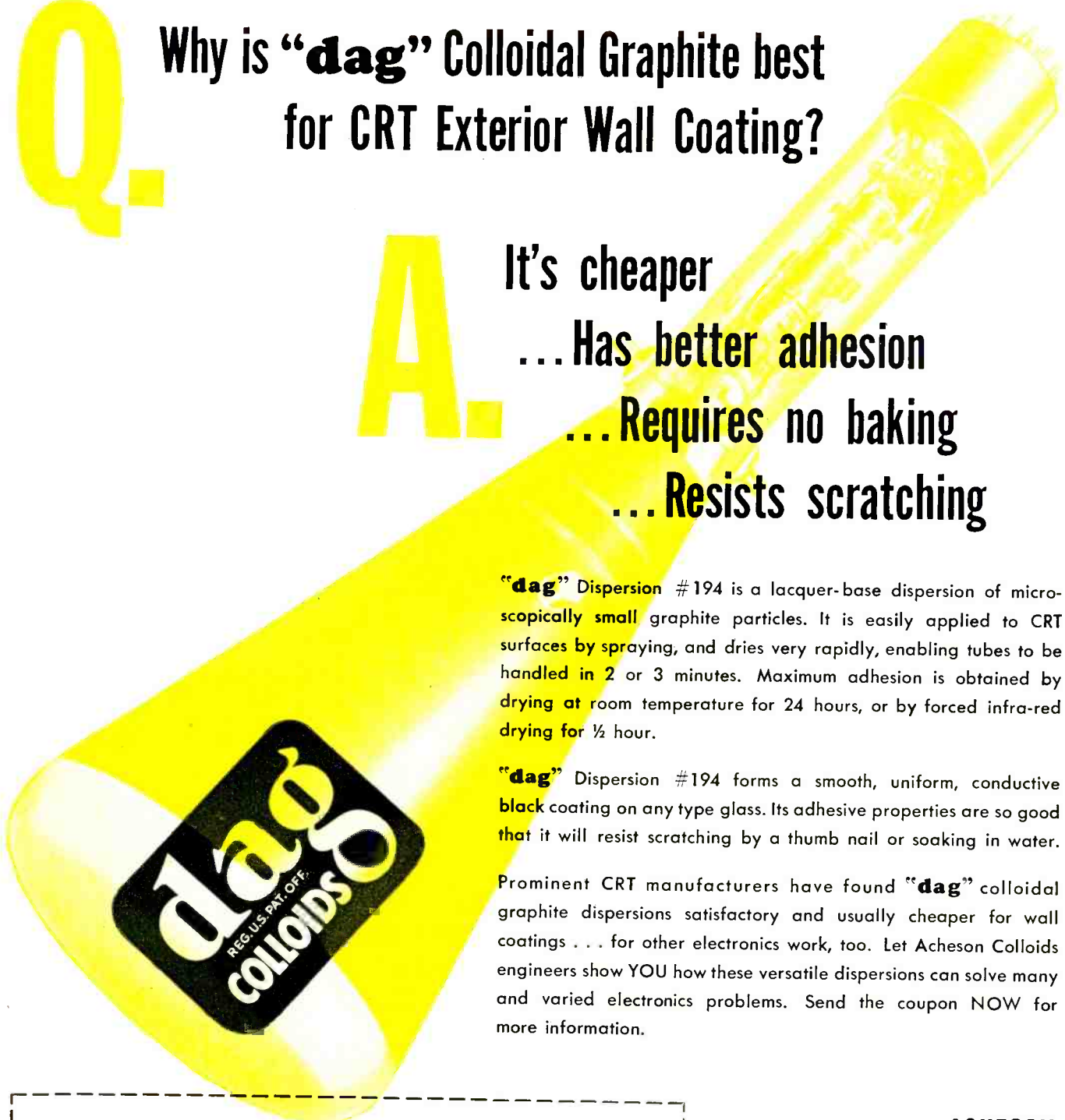

ACHESON COLLOIDS CORPORATION

Port Huron, Michigan

Send me more information on:

_____ "dag" Dispersion #194 for Exterior Wall Coating

_____ "dag" Colloidal Graphite in Electronics

Name.....

Company Name.....

Address.....

City..... Zone..... State.....

H-5

ACHESON
COLLOIDS
CORPORATION

Port Huron,
Michigan



A NEW 2-WATT TYPE

...to meet JAN and other exacting specifications

Only $\frac{11}{16}$ " long by $\frac{5}{16}$ " in diameter. Range from 10 to 100,000 ohms in tolerances of ± 5 , 10 or 20%. Fully insulated and highly moisture resistant.

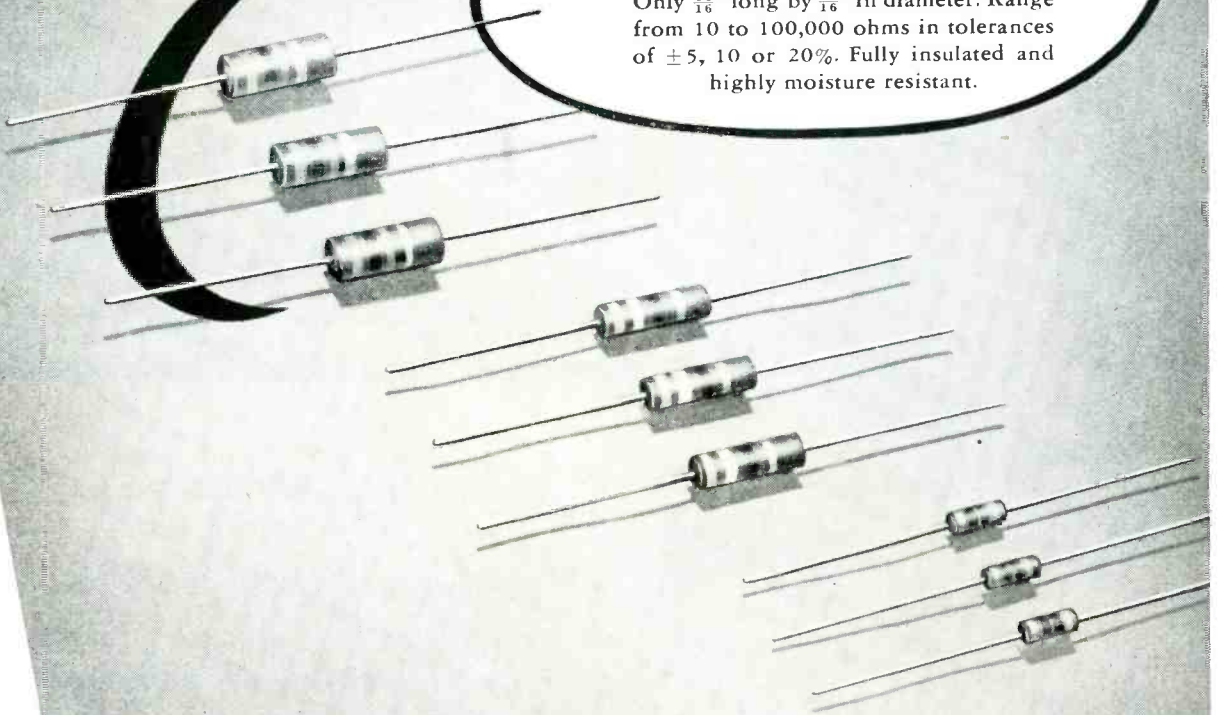

STACKPOLE

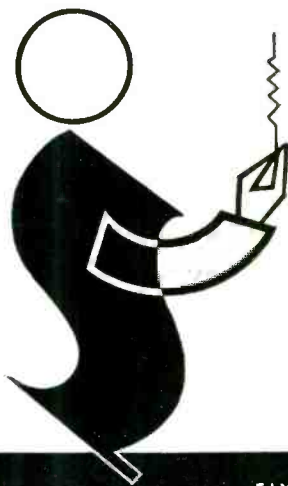

FIXED RESISTORS

Stackpole fixed resistors of molded carbon composition are now available in a complete range of $\frac{1}{2}$ -, 1- and 2-watt sizes to match modern design and production requirements. Deliveries are good—quality and prices are right—and Stackpole engineers welcome the opportunity to cooperate in matching your specifications to the letter. Samples to quantity users on request.

ELECTRONIC COMPONENTS DIVISION

STACKPOLE CARBON COMPANY • ST. MARYS, PA.

FIXED AND VARIABLE RESISTORS • IRON CORES • SINTERED ALNICO II
PERMANENT MAGNETS • INEXPENSIVE LINE AND SLIDE SWITCHES • CONTACTS • BRUSHES
FOR ALL ROTATING ELECTRICAL EQUIPMENT . . . and dozens of carbon and graphite specialties

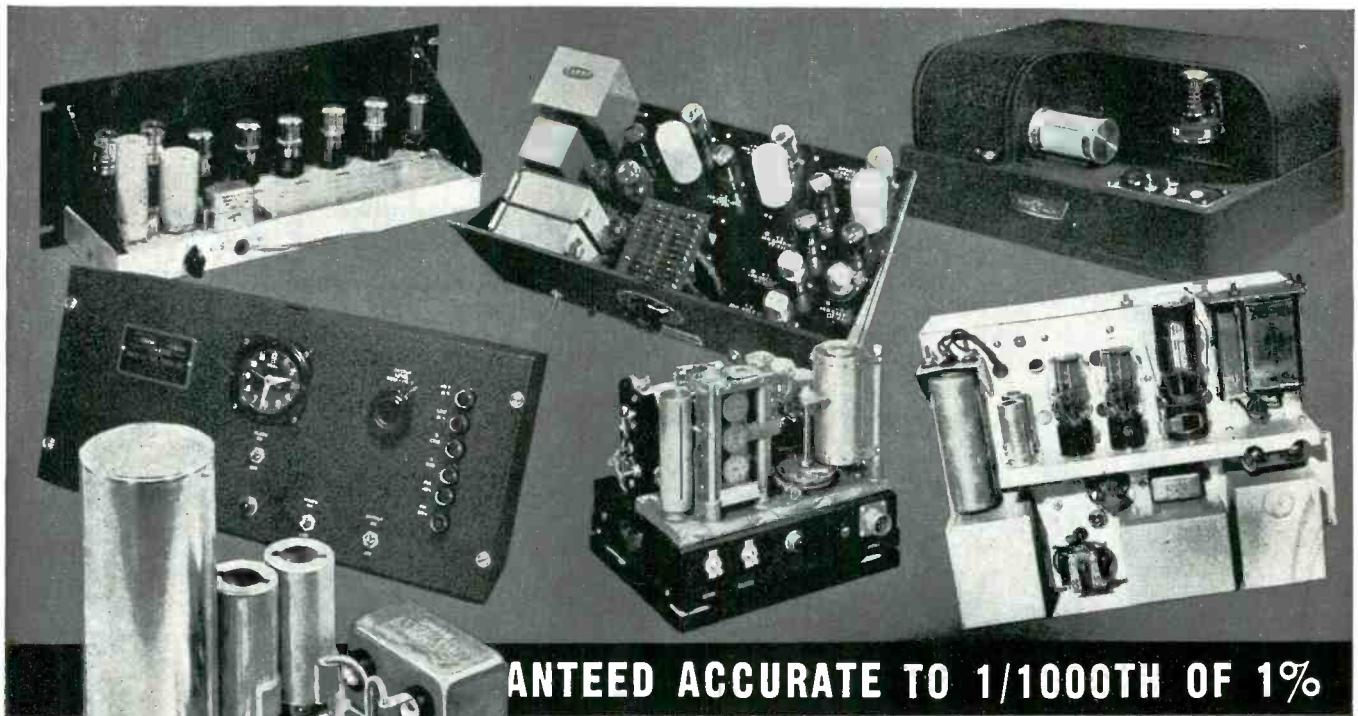

ELECTRONIC FREQUENCY STANDARDS AND GENERATORS

The basic unit of the frequency standards and generators presented here is an electrically driven tuning fork,—temperature-compensated and hermetically sealed against changes of humidity and barometric pressure. Through its use any frequency or multi-frequencies between 40 and 10,000, fractional or otherwise, are obtainable.

*Any Frequency
from 40 to 10,000
in fractions or otherwise*

FOR plant operations, for product development, for timing studies, wherever frequency generation or interval measurement is required, these instruments provide accuracy to 1 part in 100,000.

Their reliability and stability have been proven through the years here and abroad in Government Departments, aviation, industry and laboratories where precision is imperative.

The instruments with which the basic frequency standard unit is integrated are adaptable to an infinite number of uses. If you have a precision timing or frequency problem, we will be pleased to suggest a solution.

American Time Products, Inc.
580 Fifth Avenue New York 19, N. Y.

OPERATING UNDER PATENTS OF THE WESTERN ELECTRIC COMPANY

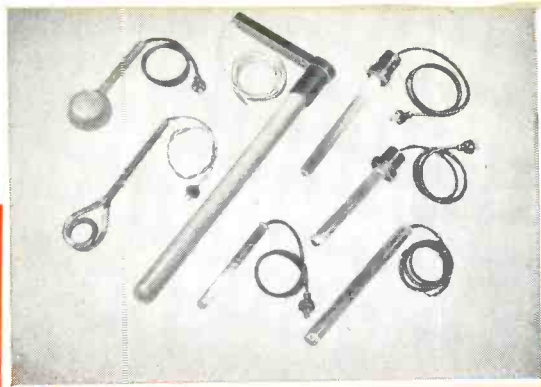

Amersil heaters are available in a variety of shapes and sizes for industrial and laboratory use.

NEW



Amersil heater—fused quartz shell, and element wound with high heat and corrosion-resistant Nichrome V.

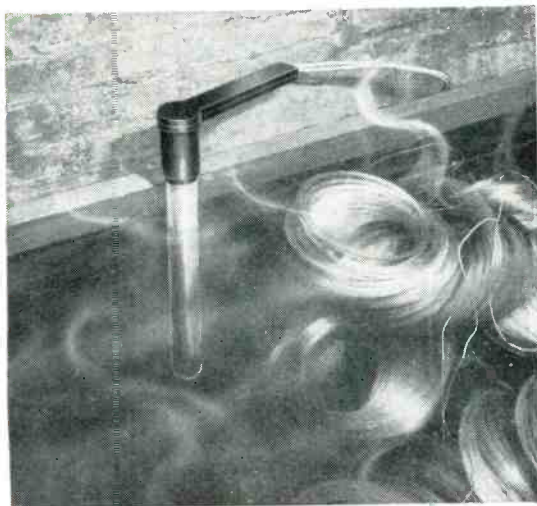

Amersil corrosion-proof immersion heater, heating acid solution in a pickling tank.

**SUPERIOR
IMMERSION
HEATER**
for corrosive
chemicals
employs fused
quartz and

NICHROME* V

Here is a new and superior unit for heating corrosive chemicals, manufactured by Amersil Company, Inc., Hillside, N. J.

A Nichrome V wire wound heating element is inserted into a shell of opaque fused quartz, which, in turn, is fitted with an acid-proof head or flange for operation in open or pressure sealed tanks.

The fused quartz shell is completely inert to corrosive chemicals, has a high rate of heat transfer, is a good electrical insulator, and is immune to thermal shock.

Since quartz filters out a very small percentage of infra-red heat waves, and the heat source is immersed, almost 100% efficiency is obtained. Moreover, the unusually compact design of the installation offers the added advantage of cutting heater obstruction within the tank to a negligible minimum—permitting freer flow of liquids.

Once the unit is assembled, it is good for a lifetime—because the shell is quartz and the heating element is *high heat and corrosion-resistant* Nichrome V.

This combination of features, makes the Amersil heater superior for service in chemical plant operations involving innumerable corrosive chemical heating problems.

If you have a product whose successful operation depends upon application of an alloy resistant to electrical heat and corrosion, send your specifications to us. In addition to world-famous Nichrome, there are more than 80 other Driver-Harris alloys specifically designed to fill the varied requirements of the electrical and electronic industries.

*Nichrome is manufactured only by

Driver-Harris Company

HARRISON, NEW JERSEY

BRANCHES: Chicago, Detroit, Cleveland, Los Angeles, San Francisco, Seattle

Manufactured and sold in Canada by

The B. GREENING WIRE COMPANY, LTD., Hamilton, Ontario, Canada



*T.M. Reg. U. S. Pat. Off.

IT & T

Welcomes

Capehart-Farnsworth

*and its
Nationwide Dealer
and
Distributor Organization*

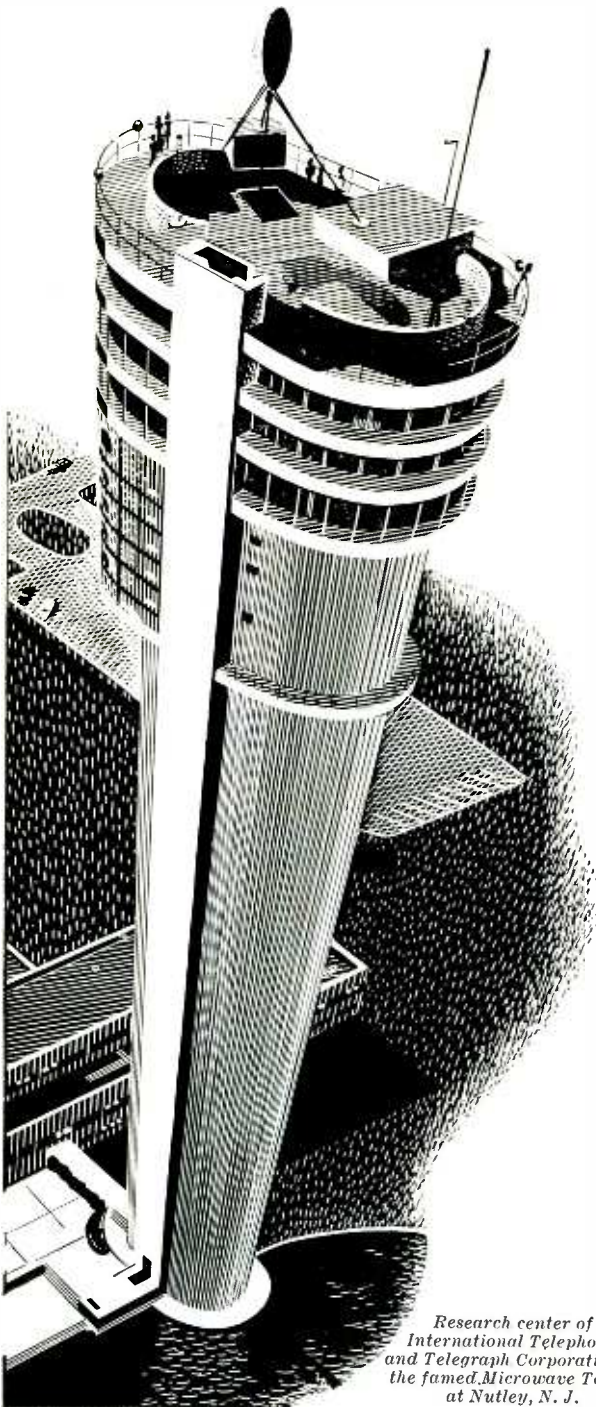

*Research center of
International Telephone
and Telegraph Corporation—
the famed Microwave Tower
at Nutley, N. J.*

A NEW DAY dawns for Capehart-Farnsworth Corporation and its organization of dealers and distributors, under the sponsorship of the International Telephone and Telegraph Corporation. Together, we will share in the development and production of "better television for more people."

Capehart and Farnsworth are pioneer names . . . names of world-wide distinction. This new association means that these great names . . . and all they stand for . . . will be backed by I T & T resources and strengthened by I T & T leadership.

Already known for its complete line of radio broadcasting equipment and important contributions in the television field—I T & T now joins forces with Capehart-Farnsworth Corporation in manufacturing and marketing home television receivers. I T & T's world-known research laboratories are now linked to the manufacturing facilities and merchandising organization of the new Capehart-Farnsworth Corporation.

For full details on the Capehart line of television, AM-FM radio and record changer combinations—present and soon to be forthcoming—write to Capehart-Farnsworth Corporation, Fort Wayne, Indiana. Ask about a Capehart franchise. A few choice territories are available.

IT & T

INTERNATIONAL TELEPHONE AND TELEGRAPH CORPORATION
67 Broad Street, New York 4, N. Y.

SELL
BEFORE YOU ~~BUY~~ ANY TELEVISION SET

Check the Answers
to these Important
5 QUESTIONS

HERE'S ONE
OF THE FIRST
of a new series of
Capehart newspaper
advertisements—
being run by
Capehart dealers in
the important
television markets.

- 1. What about the PICTURE?** Capehart gives you a large, clear, brilliant image—the finest picture yet produced by advanced television techniques. Sharp and steady in so-called “fringe” areas as well as favored city locations.
- 2. What about the TONE?** Listen to the Capehart with your eyes closed. This test will convince you of the quality of Capehart tone—the same rich beauty and fidelity that won world fame for the Capehart phonograph radio. Now it's yours in television!
- 3. What about the CABINET?** Your television set will occupy the place of honor in your living room. Capehart brings you that “heirloom” quality of cabinet-making, that authenticity of design which has always distinguished the Capehart.
- 4. What about the NAME?** The name Capehart is a guarantee of integrity. It stands for excellence in musical reproduction... excellence in workmanship... excellence in electronic design. Every television set that bears the Capehart name must live up to the Capehart reputation.
- 5. And what about PRICE?** Here's the best news of all. Capehart prices are astonishingly low. Find out for yourself how little it costs to own a Capehart and enjoy all that this great name means in quality and performance.



CAPEHART—Traditional. Authentic 18th Century English design... enduring beauty in lustrous mahogany finish... compact dimensions for any room arrangement. **\$299.50** Federal Tax Included



CAPEHART—Georgian
Fine period piece in richly finished mahogany—separate doors for screen and operating controls.

ONLY **Capehart**
ANSWERS ALL FIVE

A television set is a major investment! Choose yours with care. Check Capehart's answers to the five most important questions before you buy. Why not visit your Capehart dealer? When you have seen and heard the Capehart, you'll know why it's a distinction to own a Capehart!

AN **ITT**
ASSOCIATE

Capehart—Farnsworth
CORPORATION
Fort Wayne, Indiana

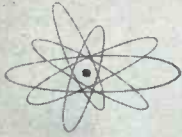

Designers

Now..higher voltage
 from
GENERAL ELECTRIC
SELENIUM STACKS

using new 18-volt (D-C) cells



New process for depositing selenium gives rectifier stacks greater uniformity, higher efficiency and longer useful life.

Here's real news for rectifier users. G.E.'s new 18-volt selenium cells, made by a special evaporation process which deposits selenium on the aluminum base with greater uniformity than otherwise possible, give you these advantages:

GREATER OUTPUT—With 50% more output than the standard 12-volt cells, the new design can be used for any application except those few which demand 24-hour, year-around service.

HIGHER EFFICIENCY—Not only is the initial efficiency higher, but more uniform coating keeps it high during the life of the stack.

SAVING IN SPACE—About one-quarter less space is required for the same output.

LOWER COST—Depending on the voltage across the stack, the 18-volt cells can save 25% in cost compared to standard 12-volt cells.

Selenium stacks are available in several standard sizes. Output in d-c voltage ranges from 18 to 126; applied a-c voltage, from 26 to 161. Bulletin GEA-5258 will give you detailed information. Send for it today!

**STYLED FOR READABILITY
 BUILT FOR RELIABILITY**

This brand-new line of 2½-inch thin panel instruments has streamlined features which will give your panels a "new look." Arc lines have been eliminated,

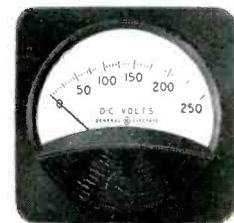

GENERAL  **ELECTRIC**

Digest

TIMELY HIGHLIGHTS ON G-E COMPONENTS

leaving only the upright scale divisions. New tapered pointer helps eye focus only on the reading. All but essential markings are masked by attractive case.

Internal mechanism is designed for extra reliability. High coercive Alnico magnet assures proper alignment, even under severe operating conditions. Large air gap reduces danger of stickiness caused by foreign particles. A variety of types and ratings in round or square cases are available for use in radio, television or testing equipment. Get complete details from Bulletin GEC-368.

DESIGNED FOR YOUR REQUIREMENTS



General Electric pulse transformers for radar and associated applications are designed to perform dependably in extremes of operating conditions. Many ratings in current production are of a special nature—designed to keep pace with rapidly changing requirements of the industry. However, for certain applications, they can be built to the specifications of electronic equipment manufacturers. Types available include interstage transformers, blocking oscillator transformers, charging chokes, current transformers, and pulse thyatron grid transformers. For a listing of available designs and ratings, send for bulletin GEC-481.

THEY'RE SMALL BUT THEY CAN TAKE IT

Cast-glass bushings with sealed-in nickel-steel hardware can be readily welded, soldered, or brazed directly to the apparatus, thus eliminating gaskets and providing a better seal. Small, compact structure often makes possible reduction of over-all size and weight of equipment. Practically unaffected by weathering, micro-organisms, and thermal shock, they're particularly well suited for use in electronic equipment and in installations where operating conditions are severe. Available in ratings up to 8.6 kv and for currents to 1200 amperes. Check Bul. GEA-5093.



Case style CP 63 (shown above) is rated 0.1-0.1 muf and 1000 volts. Other ratings range from .01 muf to 15 muf and from 100 to 12,500 volts. Write for detailed description and operating data in bulletin GEA-4357A. *Reg. U.S. Pat. Off.



RELY ON THESE FOR STABILITY

Fixed paper-dielectric capacitors are manufactured in accordance with joint Army-Navy specification JAN-C-25. They're constructed with thin Kraft paper, oil or Pyranol* impregnated, for stable characteristics and high dielectric strength. Plates are aluminum foil; special bushing construction provides for short internal leads, prevents possible grounds and short circuits. Cases have permanent hermetic seal.

DOES A BIG JOB IN CLOSE QUARTERS

G.E.'s midget soldering iron can do a big job with only one-fourth the wattage usually used. This handy 6-volt, 25-watt iron is only 8 inches long with 1/8" or 1/4" tips and weighs but 1 3/4 ounces. Designed for close-quarter, pinpoint precision soldering, the "midget" offers you all these advantages: low cost soldering; "finger-tip" operation; quick, continuous heat; easy renewal; long life; low maintenance. A real aid in designing radios, instruments, meters, electric appliances, and many other products requiring precision soldering. Available from stock. Check bulletin GEA-4519.

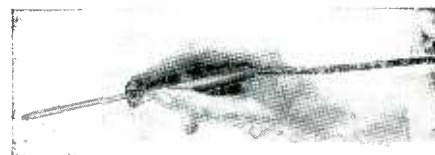

General Electric Company, Section C667-2
Apparatus Department, Schenectady, N. Y.

Please send me the following bulletins:

- GEA-4357A D-C Capacitors GEC-481 Pulse Transformers
 GEA-4519 Midget Soldering Iron
 GEA-5093 Glass Bushings
 GEA-5258 Selenium Stacks
 GEC-368 Panel Instruments

NAME

COMPANY

ADDRESS

CITY STATE

BEAT the HEAT

Specify



"NOFLAME-COR"

the TELEVISION hookup wire

APPROVED BY UNDERWRITERS LABORATORIES AT

90° CENTIGRADE — **600** VOLTS

Preferred by leading producers of television, F-M, quality radio and all exacting electronic equipment. All sizes, solid and stranded; over 200 color combinations.

Production Engineers: Avoid high percentage of line rejects by specifying "NOFLAME-COR" (not an extruded plastic). Insulation does not "blob" under heat of soldering iron.

- ✓ Flame Resistant
- ✓ High Dielectric
- ✓ High Insulation Resistance
- ✓ Facilitates Positive Soldering
- ✓ Heat Resistant
- ✓ Easy Stripping

✓ Also unaffected by the heat of impregnation—therefore, ideal for coil and transformer leads

RUBBER	_____	75°
PLASTIC	_____	80°
"NOFLAME-COR"	_____	90°

"made by engineers for engineers"

CORNISH WIRE COMPANY, Inc.

605 North Michigan Avenue,
Chicago 11

15 Park Row, New York 7, N. Y.

1237 Public Ledger Bldg.,
Philadelphia 6

MANUFACTURERS OF QUALITY WIRES AND CABLES FOR THE ELECTRICAL AND ELECTRONIC INDUSTRIES

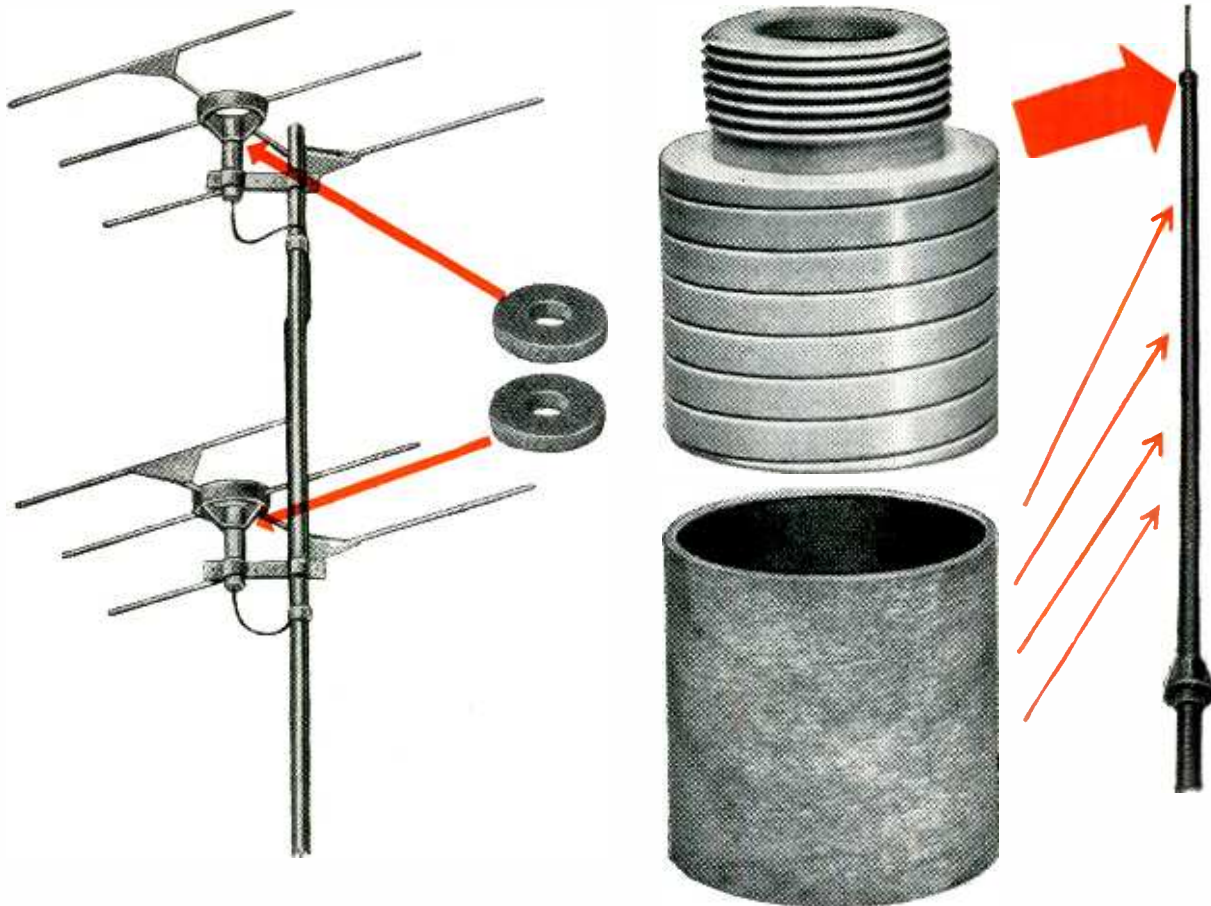

Lamicoid

Workshop Associates, Inc., specialists in high frequency antennas, use Lamicoid sheet, tubing and rod for many parts in television, FM radio and high-gain beacon antennas.

meets highest standards in custom-built TV and FM antennas

Workshop antennas are custom-built for exceptional performance. For dependability in parts serving structural and insulating functions, Workshop Associates rely on LAMICOID.

A thermosetting laminated plastic, LAMICOID combines tough-as-metal strength with lighter-than-wood weight. It has high dielectric strength, low power factor and good moisture and corrosion resistance. Made in sheet, rod and tube form, it can be readily fabricated by sawing, shearing, punching and machining into thousands of accurate shapes.

LAMICOID is made to the highest standards of quality, based on our 56 years of experience in making fine electrical insulating materials. Contact our nearest sales office or fabricator for further information.



MICA *Insulator* **COMPANY**

Schenectady 1, New York

Offices in Principal Cities

which Metallic Rectifier should you use?

No one type is "best." Each of the three popular metallic rectifiers has characteristics which have made it *better for a particular application where DC power is needed*, so choice depends on the job to be done.

Here are a few suggestions, based on 18 years of experience:

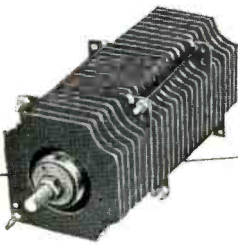

Because copper-oxide...

- costs less per cell
- stops "aging" after a few months
- is more efficient at high current densities
- will stand short-time voltage (as well as current) overloads

use it for such applications as...

- circuit breaker operation
- plating rectifiers
- battery chargers for industrial trucks
- operating whistle on toy train
- fast chargers
- blocking relays in control circuits
- exciter circuits for ignitrons

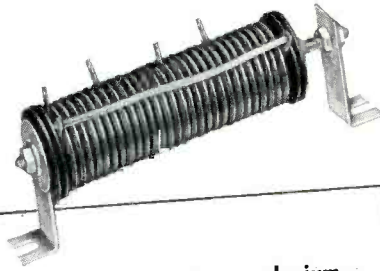

Because low-voltage selenium...

generally offers the best compromise between features of high-voltage selenium and stability or efficiency of copper-oxide

use it for such applications as...

- chargers for telephone batteries
- chargers for central station batteries
- rectifiers for cathodic protection
- elevator control
- power supply for field of motors and generators
- click suppressor in telephone
- charging lamp batteries used by miners
- magnetic separators
- battery eliminators

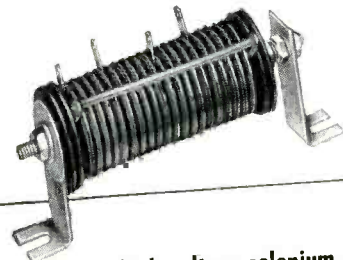

Because high-voltage selenium...

- requires fewer cells for all voltages above 12
- requires less space for all voltages above 12
- weighs far less per cell than copper-oxide

use it for such applications as...

- coin-operated machines
- magnetic amplifiers
- magnetic clutches
- calculating machines
- milking machines
- arc suppressor across switch
- pipe organ
- electric hammers

To fully meet your needs, General Electric makes all three types. If you have a rectifier problem, bring it to us—we play no favorites, we will give you an impartial recommendation. Contact your G-E Apparatus Agent, or write *Apparatus Dept., General Electric Company, Schenectady 5, N. Y.*

GENERAL  **ELECTRIC**

466-16

Photomicrographics are only part of the story...

EVERY KNOWN TEST QUALIFIES WILBUR B. DRIVER ALLOYS FOR SUPERIOR INSTRUMENTATION!

Photomicrographic checking of grain size and quality of metals is only one of the exhaustive tests which Wilbur B. Driver resistance alloys are subjected to throughout production. There are many others including ASTM life, tensile strength, yield point, hardness, micrometer and thorough testing for resistance. These constant checks plus industry-old experience, are the reasons you can depend on all Wilbur B. Driver alloys to perform as specified. The alloys listed are so produced, and are especially recommended for instrumentation.

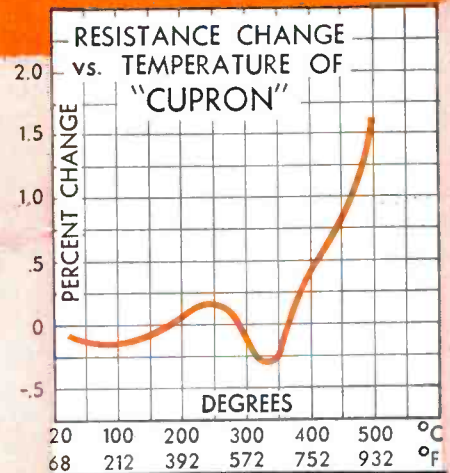

CUPRON:
FOR CONTROLS, RHEOSTATS, ETC. LOW TEMPERATURE COEFFICIENT OVER A WIDE RANGE OF TEMPERATURE.

MANGANIN:
FOR METER AND INSTRUMENT SHUNTS. LOW TEMPERATURE COEFFICIENT. LOW THERMAL EMF AGAINST COPPER.

EVANOHM:
HIGH RESISTANCE AND LOW TEMPERATURE COEFFICIENT REDUCE SIZE AND INCREASE OHMIC STABILITY OF WIRE WOUND RESISTORS.

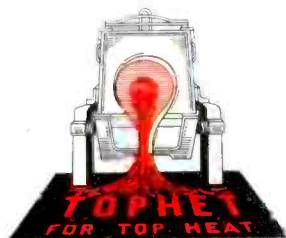
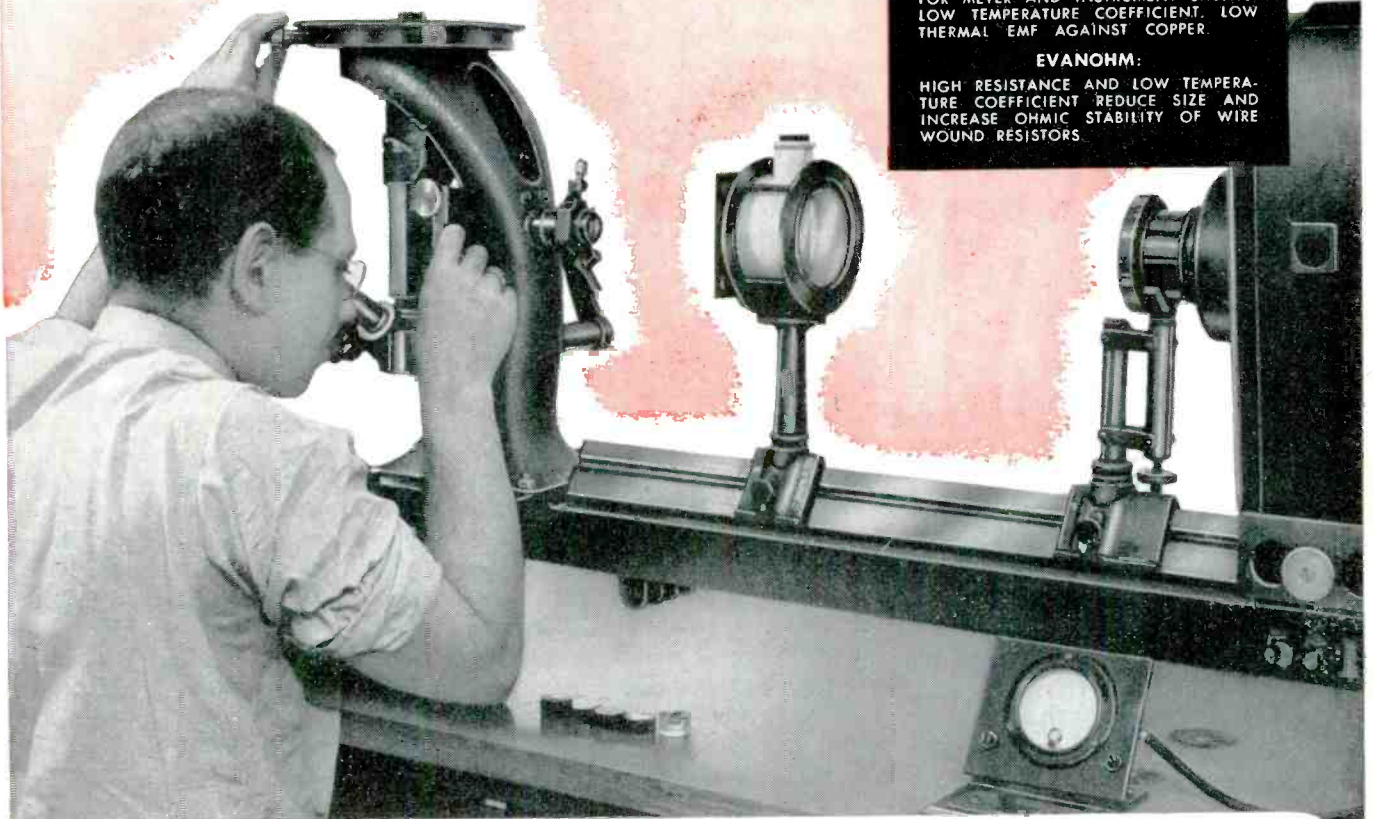

WILBUR B. DRIVER CO.
150 RIVERSIDE AVE., NEWARK 4, NEW JERSEY

BUSINESS BRIEFS

By W. W. MacDONALD

Development Contracts being placed by government at this writing are far too few to support all the people in our field who are bidding for them. And there is little reason to believe this situation will change materially in the near future.

From where we sit it is obvious that too many companies that supported their engineering organizations on development work alone during the war are still clinging to the idea they can continue to do so. Actually, they will have to accept the responsibility for production as well as development in order to get many government contracts in the first place, and in all probability it will be necessary to develop and produce something for commercial sale too.

Price-Cutting of television receivers, curiously at variance with continued healthy consumer demand, seems to be confined largely to the retail level. Sets are in some instances being sold too close to cost to even pay the overhead on a long-term basis, and in at least one instance what little profit the retailer gets comes out of the installation and maintenance charge.

Several friends in the retail branch of the publishing business tell us that the only possible explanation is a desire to turn merchandise into quick cash to tide over what they hope will be a temporary financial pinch. But we know of several instances in which price-cutting retailers have actually ordered merchandise not in stock and then sold it near cost. So we suspect that there is a little hysteria abroad, an overweening desire to get the business away from the shop across the street and some bad book-keeping involved.

CAA has blueprinted a three-year program for spending \$213,000,000 on electronic airways equipment. The program involves \$30,645,503 in the fiscal 1950 appropriation pending before Con-

gress, the balance to be requested in 1951 and 1952 budgets.

This Month: There is a lot of new business to be found between the lines of Jeremiah Courtney's article in this issue about the new Mobile Radio Rules . . . Frank Lehan's article concerning the transistor oscillator is commercially significant, even if it doesn't involve tubes . . . Peter Sulzer's story on circuit-miniaturization techniques should interest the front office.

Coming Months: September will contain a particularly thought-provoking article about general engineering practice by G. E.'s Bill White . . . The editors are preparing some especially hot stuff on television . . . A lot of useful data about little-understood conductive plastics will run if we can get it ready in time. And in October there will be a wad of material dealing with methods of increasing production and reducing costs that few readers will want to miss.

Interest In Export is increasing in direct proportion to decline in domestic business. For those toying with the idea of selling their electronic products abroad for the first time the major bug seems to be scarcity of American dollars elsewhere in the world. Many people overseas want our merchandise but the dollars they pay for it have to be spent in whole or in part within their country.

Work out some reasonably fool-proof way of matching or nearly matching imports with exports and you can probably cut yourself a nice slice of business.

Citizens Radio is, as predicted (p 78, June), looking up. In the past month we have received many requests for all kinds of information from people who want to use the band after reading newspaper reports that the FCC is now issuing licenses. And several manufacturers of communications equipment upon whom we have

You'll Get the **MOST FOR** Your **MONEY** by specifying **PYRAMID** Capacitors

WRITE FOR COMPLETE LITERATURE
Representatives and Distributors
Throughout the U.S.A. and Canada

PYRAMID
CAPACITORS

PYRAMID ELECTRIC COMPANY
155 Oxford Street
Paterson, N. J., U.S.A.
TELEGRAMS: WUX Paterson, N. J.
CABLE ADDRESS: Pyramidusa

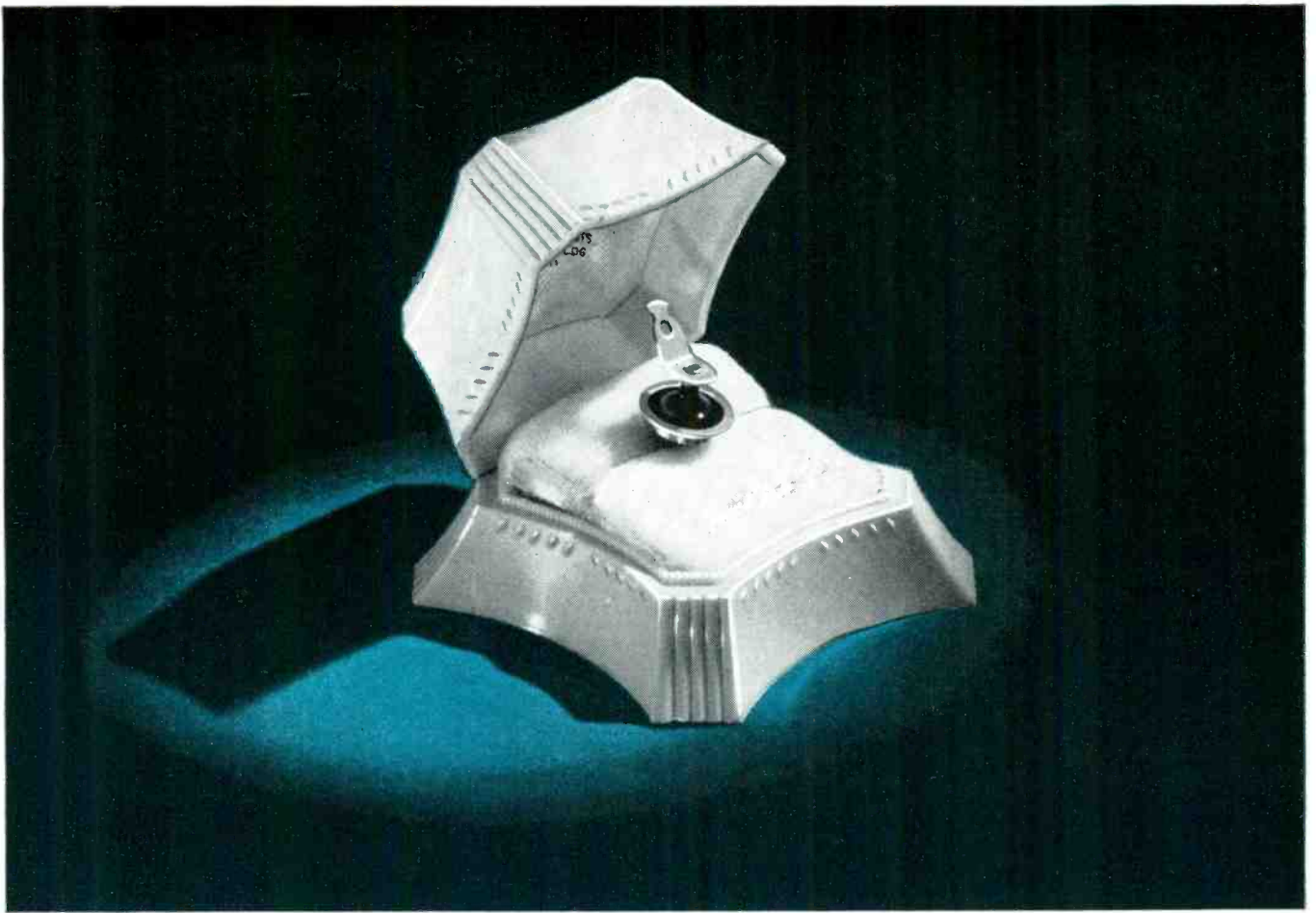

Why a Fusite Terminal Where a Diamond Ought To Be?

A Fusite Terminal would look much more natural performing its vital function in the hermetic sealing of your electrical product. But since it's every bit as valuable for 1000 other products that should be fusion sealed, we aren't playing favorites.

The smooth uniform interfusion of steel and inorganic glass that is a Fusite Terminal is as beautiful as a flawless diamond to any design engineer. In its own way, it's as rugged as the diamond used on the tip of a heavy duty drill.

It withstands the thermal shock of tortuous heat from soldering or welding and the rapid cooling that follows. It will carry up to 3000 A.C. volts (RMS) with a 10,000 megohms insulation factor after salt water immersion.

This is just one of a wide line of standard Fusite single and multiple electrode terminals.

Would you like to know more and see samples? Write to Dept. E.

TERMINAL ILLUSTRATED 112 HTL
SINGLE—HOLLOW TUBE ELECTRODE WITH LUG



THE FUSITE CORPORATION

CARTHAGE AT HANNAFORD, NORWOOD, CINCINNATI 12, OHIO

called have for the first time at least expressed interest.

Development of citizens'-radio-band gear is going on in several laboratories. We know, however, of nothing near the production stage at this writing. Equipment used in the months immediately ahead will obviously have to be more or less home-grown.

Australia's Department of Civil Aviation plans to install instrument landing systems at 12 airports, at a cost of a million dollars. It will probably take three years to complete the proposed program.

Foreign Subscribers to ELECTRONICS renew at a rate that tells us the magazine is ringing the bell overseas, where what goes on in advanced American engineering circles seems to be of paramount interest. There have even been instances where a foreign subscriber read first in our columns about something that went on in his own still technical journal-less country, and this gives us a pleasant feeling that we are rendering a needed international service.

Just the same, we feel woefully weak in our knowledge of precisely what foreign subscribers want. We'd like to know, if any of you out there feel like taking pen in hand.

McGraw-Hill's *Economist*, Dex Keezer, continues to be optimistic about the general business outlook despite current setbacks. His reasons, which seem good to us, include the following facts:

1. Goods continue to move into the hands of consumers in large volume.
2. The general public still has plenty of buying power.
3. Manufacturers who have been living off their inventories since prices turned down will soon be forced to become buyers again in order to keep going.

Frank Mansfield of Sylvania says, following a survey, that 58 percent of the television sets now in use are owned by families earning less than \$5,000; well-heeled people entered the market early but those down the line in income are now purchasing at a faster rate.

ELECTRONS INC.
NEWARK, N. J.

6C

MANUFACTURED UNDER ONE OR
OF THE FOLLOWING U. S. PATENTS

1,723,888	1,874,753	1,928,888
1,784,877	1,880,092	1,931,888
1,790,152	1,883,174	2,065,977
1,790,153	1,903,144	2,081,888
1,817,636	1,903,145	2,111,888
1,873,683	1,925,701	2,203,888

ELECTRONS INCORPORATED
127 SUSSEX AVENUE
NEWARK, N. J.

*A high overload current, full-wave
Xenon rectifier ideal for heavy
starting currents*

There is, as might be expected in view of the increase in purchases by the lower income group noted above, a trend toward lower-priced sets. Consolelets, are at present moving up in consumer interest but table models are still in greatest demand. Some over-production of large consoles and combinations appears possible.

Of 50 different television-receiver brands encountered during the survey only five had established themselves an industry position of better than five percent. These five brands accounted for 70 percent of the market, 10 others accounted for 28 percent and the remaining two percent was left for all the other brands.

Indoor antennas are used with 16 percent of the sets covered by the study.

Television's Popularity has caused many people to question the future of other entertainment media. To H. H. Frost, first president of RMA, we are indebted for the following quotes from speeches he read and heard in the early days of radio:

"Radio will never be profitable to the broadcaster and manufacturers of sets and parts will have to contribute to a fund in proportion to their sales volume."
 "Stage and motion-picture theatre attendance will be reduced more than fifty percent unless the actors are prohibited by contract from broadcasting."

"The phonograph-record business cannot survive."
 "Radio will not be used successfully in police work; the criminal will have the same type set and be warned in time to escape."

"If radio sets are used in automobiles the accident rate resulting will triple the rate from all other causes."

"Broadcasting of baseball, prize fights and other sports events will reduce the attendance below the average needed to remain solvent."

"News broadcasts will reduce newspaper and magazine paid circulation and advertising revenue."

Somehow, it seems, everything worked out nicely for everybody concerned once initial readjustments had been accomplished.

Night-Club Girls appearing on a recent television show looked nude from the waist up on sets lacking contrast. Now quite a few men whose receivers were good enough to distinguish between silk and skin want to know how to make them less good.

We Have It on what we consider good authority that the FCC is currently receiving about 300 complaints about television interference per month.

Sensitive Relays by SIGMA



SERIES 4

SPDT GENERAL PURPOSE SENSITIVE D. C. RELAY. Inexpensive. Balanced armature for vibration resistance on aircraft at 50 milliwatt adjustment. Sensitive enough for V-T operated relay circuits; can be set to operate down to 10 milliwatts. Precision adjustments for pull-on and drop-out. 2 amp. nominal contact rating. Coil resistance up to 14,000 ohms.



SERIES 5

SPDT VERY SENSITIVE D. C. RELAY. Balanced armature and magnetic efficiency resist aircraft vibration on inputs as low as 5 milliwatts. Withstands 500g shock without damage. Precision adjustments. 2 amp. nominal contact rating. Coil resistance up to 16,000 ohms. Special adaptations: Built-in rectifier, two-coil differential operation, constant voltage temperature compensation.

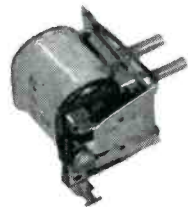

SERIES 41

SPDT SENSITIVE RELAY AC-DC-KEYING. Unusual characteristics at low cost. Same D. C. sensitivity as Series 4 but less flexibility of adjustment. Available with long life and bounce-free contacts, it is suited to high speed counting and keying. Mechanical life exceeds 10⁹ operations. Good for plate circuits needing moderate precision and vibration immunity. Contact ratings up to 5 amps. Coil resistance to 14,000 ohms. A. C. sensitivity exceeds 0.1 V.A. at 60 cps. Serviceable on frequencies from 16—400 cps. Protects delicate thermostat or instrument contacts.



SERIES 6

MULTICIRCUIT POLARIZED SENSITIVE RELAY. Single or double (differential) windings. Resistance up to 25000 ohms total. Contacts up to 4PDT, 5 amp. nominal rating. Balanced armature for strong vibration resistance. FORM X—Three Position or Null Seeking. For automatic positioning or 2-Way process control. Sensitivity (depending on contact complexity) from 10 to 100 milliwatts. FORM Y—Biased (Spring Return). Use as an ordinary sensitive relay if a complex contact combination is needed. Combines function of pilot relay and contactor. Sensitivity same as Form X. Responds only to one polarity. FORM Z—Latching (permanent, Magnetic). Replaces mechanical latch electrical reset relays, where longer life and greater vibration resistance is required. Sensitivity from 100 to 250 milliwatts.



SERIES 7

SPDT SENSITIVE HIGH SPEED POLARIZED RELAY. Single or multiple windings up to 14,000 ohms (single). Balanced armature. Nominal contact rating 2 amps. For repeating telegraphic signals at speeds up to 250 WPM. Small in size and weight. Hermetically sealed. Mechanical life exceeds 10⁹ operations. FORMS X, Y and Z (see Type 6 above) available in Series 7. Sensitivities from less than 1 to 10 milliwatts depending on form and requirements. Form X is useful as the detecting element in positioning bridge circuits.

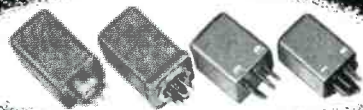

VARIETY OF ENCLOSURES

Some of the standard enclosures (including hermetically sealed) in which most Sigma relays are available.



Sigma Instruments, Inc.
Sensitive RELAYS

62 Ceylon St., Boston 21, Mass.

WRITE FOR FULLY
DESCRIPTIVE CATALOG.

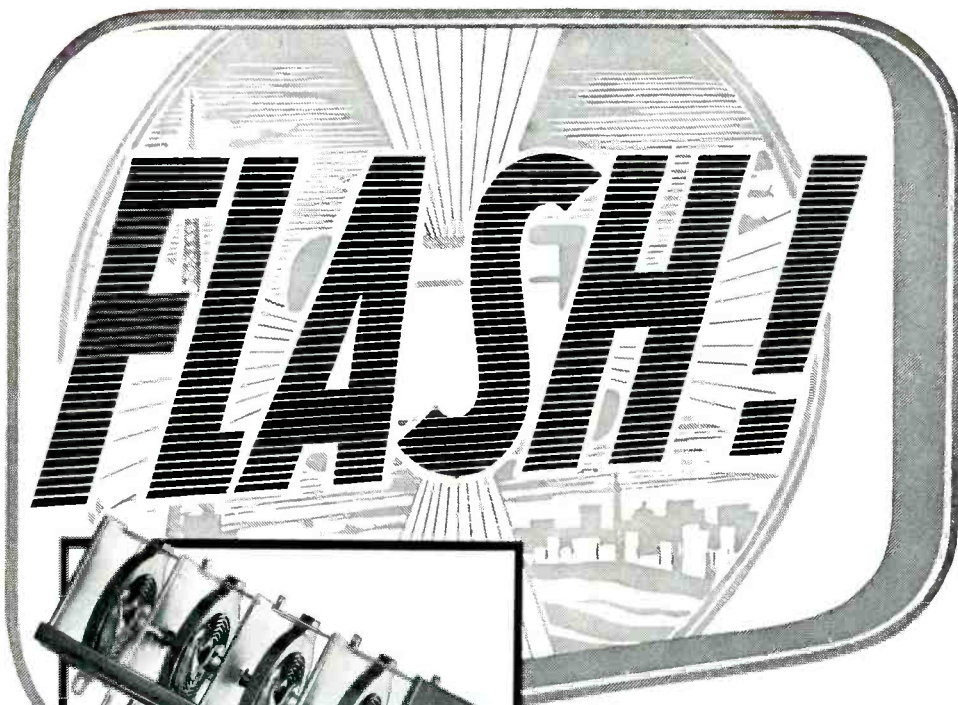

NEW

Mallory Spiral Inductuner* Gives Better Performance at Lower Costs!

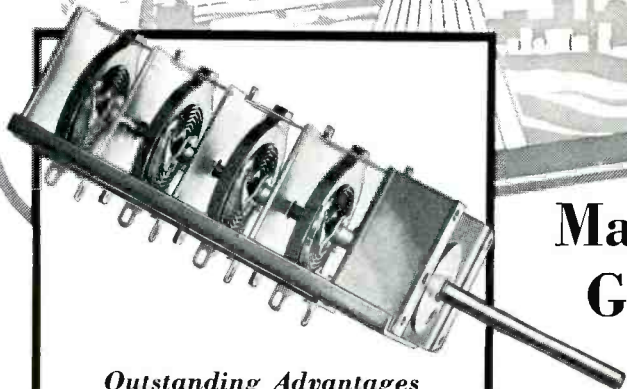

Outstanding Advantages of the new Mallory Spiral Inductuner:

1. *A single control for easy selection and fine tuning of any television or FM channel.*
2. *Excellent stability eliminates frequency drift.*
3. *Supplied in three or four-section designs.*
4. *Far more quiet operation; free from microphonics.*
5. *Greater selectivity on high frequency channels.*
6. *Eliminates "bunching" of high band channels. Covers entire range in only six turns.*
7. *Simplifies front end design and production.*
8. *Reduces assembly costs.*

There are hundreds of thousands of Mallory Inductuners in use today—all giving trouble-free service. And now, the *new* Mallory Spiral Inductuner is the biggest news in television for better performance and lower cost.

You can eliminate many costly methods on your assembly line with the new Mallory Spiral Inductuner. It permits faster alignment and far simpler front end design and assembly than any other system.

The Mallory Spiral Inductuner provides for infinitely accurate selection from 54 to 216 megacycles . . . gives FM tuning at no extra cost!

Check the advantages of the Mallory Spiral Inductuner. Improve the performance of your sets, and step ahead of competition at the same time at a cost that will surprise you.

Get in touch with Mallory now for complete information.

*Reg. trade mark of P. R. Mallory & Co., Inc. for inductance tuning devices covered by Mallory-Ware patents.

Precision Electronic Parts—Switches, Controls, Resistors

P. R. MALLORY & CO. Inc.
MALLORY

P. R. MALLORY & CO., Inc., INDIANAPOLIS 6, INDIANA

SERVING INDUSTRY WITH

Capacitors	Rectifiers
Contacts	Switches
Controls	Vibrators
Power Supplies	
Resistance Welding Materials	



CROSS TALK

► **SAGA** . . . It's seldom that technical workers in television find themselves embarrassed with riches, least of all when dealing with interference. But such is the case of Ray Kell and his fellow-workers. When "venetian-blind" interference between co-channel tv stations began to rear its ugly head a year ago, Kell and his group came up with an interesting, and feasible, system of reducing the interference by synchronizing the carriers of the stations. This method, duly chronicled in these pages (February, 1949, p 72), was endorsed in principle by JTAC and had every prospect of becoming an important factor in future tv allocations. Today carrier synchronization of tv stations is an abandoned project. Why? Because Kell and colleagues have come up with what appears to be an even better system, one which reduces the interference to the same degree with considerably less complicated apparatus. Ray says it's embarrassing. We say it's unusual, to say the least.

The new system, known as the "off-set" method, operates by introducing an appreciable frequency difference, of the order of 10.5 kc, between the interfering carriers. The frequency difference makes the venetian bars numerous and of small size, since the beat frequency between the carriers is a large multiple of the 60-cps vertical scanning rate.

The original proposal was that the frequency difference should be about 7,875 cps or one-half the line-scanning rate. There would then be about 130 black-and-white interference bars in the picture, and they would be smoothed out to a neutral gray by virtue of the interlacing of successive fields. But this system came a cropper when it was realized that three stations on the points of a triangle could not maintain this frequency relationship, since two of them would necessarily be separated by zero or 15,750 cps, neither of which would do the interference any good. So a compromise separation of 10,500 cps was worked out, tested and proved in. Moreover, the tolerance on the frequency separation was found to be such that it can be maintained by crystal con-

trol at each station, without any intermediate tie-lines between stations for sync.

It looked as though the boys had two systems on their hands until they reflected on the rate schedules for leased lines. Then they realized they had only one system worth pushing. And there it stands. Several pairs of stations are using off-set carriers, as of the time of writing, and all of them think it's wonderful. So do we. And we forgive the boys at Princeton for their double-take at the problem.

► **MICRO** . . . Since an occasional (and welcome) complaint we receive is that **ELECTRONICS** is so healthy that it's hard to file, we are happy to announce that all issues of this periodical are now available on microfilm. Details on page 128, this issue.

► **BOARD** . . . A consulting engineer in Washington suggests that the FCC needs engineering advice which is completely divorced from consideration of Commission policy. He argues that industry groups, such as NTSC, RTPB and JTAC, valuable as they are, must necessarily reflect the industry attitude on policy matters. The proposal is that a permanent board of engineering advisors to the Commission be chosen from among disinterested experts, particularly those in academic life, and that the members be paid an attractive fee on a per-diem basis. The board would operate under the chairmanship of an individual (possibly the FCC chief engineer) who knows Commission policy and is familiar with industry problems to guide the deliberations along essential lines. The proposal stems from the work of the FCC Ad Hoc Committee which has been studying vhf television propagation, but which cannot long continue on a voluntary no-fee basis.

The Ad Hoc group did a good job of work, more of which will be needed. But we don't know whether a board of experts could be attracted, even at \$50 a day, on a permanent basis. How about it, professor? Comment from you, and other interested readers, is earnestly solicited.

New FCC Rules Mean

By JEREMIAH COURTNEY

Attorney
Courtney, Krieger and Jorgensen
Washington, D. C.

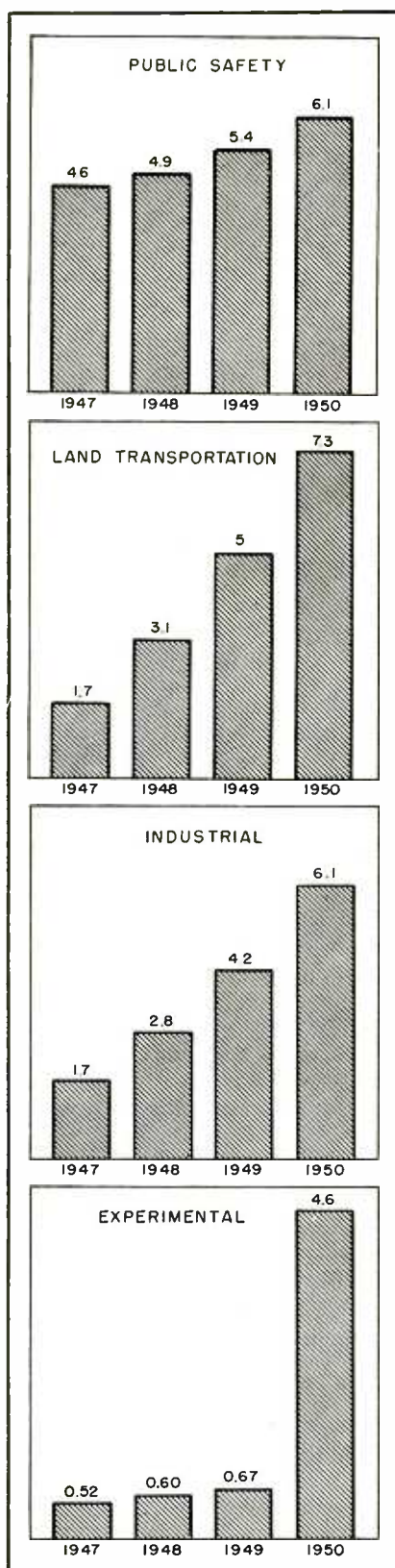

Past and potential growth of the safety and special services in thousands. Note that different relative scales have been used for each service. The graphs are not comparative

PRODUCT of the most comprehensive study ever made of public-safety and industry-operational communications requirements, new FCC land mobile radio service rules which become effective July 1 cancel out the miscellaneous assortment for regular and experimental services that formerly governed operations in mobile bands. Replacing the former hodge-podge of unrelated rules, which made the user's search for the applicable service and frequency a fine art, are four basic and well-integrated sets of rules henceforth governing all land-mobile radio operations.

These new Rules cover:

(1) *Land Transportation Radio Services.* This classification covers the Railroad, Urban Transit, Intercity Bus, Highway Truck, Taxicab, and Automobile Emergency Radio Services. These last four service sub-parts represent four of the new radio services which the Commission decided should be recognized on a regular basis following, in each case, a three- or four-year period of experimental operation. In the procedural reorganization effected, the Urban Transit Radio Service was transferred from the Utility Service (entirely cancelled) to the new Land Transportation Radio Services. The former separate Railroad Radio Service was also cancelled.

(2) *Industrial Radio Services.* This category covers the Power, Petroleum, Motion Picture, Relay Press, Forest Products, Special Industrial and Low-Power Industrial Radio Services. The last three services are new services bringing the advantages of radio communications on a regular basis to the lumber industry, operating in remote areas with one of the highest accident rates of any industry, and a

wide variety of other industries hitherto denied the use of radio. The Motion Picture and Relay Press services were formerly covered under the cancelled Miscellaneous Radio Service Rules but an expanded radio use was authorized to newspapers and press organizations. The Power and Petroleum users had also been formerly accommodated, in part, under the Miscellaneous Rules and the Utility Rules, both cancelled.

(3) *Public Safety Radio Services.* This service includes the Police, Fire, Forestry - Conservation, Highway Maintenance and Special Emergency Radio Services. The only new service among these is the Highway Maintenance. The coverage of the Special Emergency Radio Services was expanded. All the other services were formerly recognized under the Emergency Radio Services Rules, which were cancelled.

(4) *Domestic Public Mobile Radiotelephone Services.* This covers the common-carrier mobile radio organizations engaged in furnishing radio-communications service to mobile units of the general public on a charge basis. Both the telephone company direct-interconnection type of public mobile radio service and the non-telephone company message-relay radio dispatch service, formerly on an experimental basis, were permanently recognized.

Uniformity of Services

The sweeping nature of the procedural recasting accomplished appears from the bare summary of the actions taken. Like services have finally been collected in single rule parts. The pattern of the various rules has in all cases been made uniform: the general rules common

More Mobile Radio

Permanent frequency assignments in 25-50, 72-76, 152-156, and 450-460 mc bands clear the way for vast development of mobile services and orderly expansion into the uhf region

to the various sub-parts are first set out; then follow the special rules applicable to a particular sub-part.

Any organization interested in using radio for operational communications purposes may henceforth determine eligibility in most cases almost at a glance. Frequency availability is similarly easily determined now because each sub-part lists the specific frequencies available to each service in the various bands.

This situation is to be compared to that existing on September, 1947, when the author undertook for several oil companies the preparation of a summary outline of oil company frequency availability. The prospective petroleum radio user then was obliged to consult three different sets of Rules—the Experimental, Miscellaneous, and Utility, now all cancelled. The oil company's search for the best frequency for its purpose was further complicated then by the fact that, since the FCC issued its "final" report of frequency allocations above 25 megacycles in May 25, 1945, there had been by September 1947 no less than 37 public notices issued effecting frequency revisions, about one-half of which directly affected petroleum industry radio usage.

The new rules cure this situa-

MOBILE RULES

The full text of the Commission's Report and all the Rules discussed in this article have been published in the May 6, 1949 issue of the Federal Register.

Copies can be obtained from the Superintendent of Documents, Government Printing Office, Washington 25, D. C. at 20 cents per copy. Reprints of the separate Rule parts will be placed on sale later by the Superintendent of Documents.



Foreman contacts home office direct from his pickup-truck office

tion. The prospective petroleum radio user, for example, need now consult only the Industrial Radio Service Rules. There, in Sub-Part G, Petroleum Radio Service, he will find a complete listing of all the frequencies available for petroleum industry regular or developmental use, either exclusively or on a shared basis with other industries. The extensive study made by the Commission of mobile-service operational communications needs (the transcript of the final oral argument on the proposed new rules and frequency assignments held in October, 1948 totaled 1,913 pages) further assures that these last frequency assignments will stay fixed for many years to come.

Commercial Service Possible

The primary effect of the new rules will be to lift the pall of uncertainty that has hung over all mobile radio service use and frequency assignments for the past four years. This comes about in two ways. First, the formerly recognized regular services know what

they have in the way of final frequency assignments. Sound expansion of facilities may now go forward. To take the oil industry again for an example, the chairman of the American Petroleum Institute's radio committee has estimated the equipment backlog of orders awaiting final frequency revisions in that field alone as in excess of \$2,000,000.

Second, the newly recognized services, which had been laboring under the incubus of experimental authorizations in terms cancellable "without notice or hearing" are finally placed in position to invest in radio equipment without assuming the risk that it may be wiped out overnight. The importance of this last factor is best indicated by a listing of the experimental services which, effective July 1, 1949, go on a regular basis and in most cases with fairly adequate frequency assignments, thanks in large part to the final transfer of television channel No. 1, 44 to 50 mc, to mobile radio service use.

The new services with their regu-



Portable units are used to direct blasting operations in construction jobs where wire lines are not available

The lumbering industry uses mobile radio at remote locations for safety and in emergencies

lar frequency assignments are: Intercity Bus (16 frequencies); Taxi (previously promised at least one two-frequency channel on a regular basis, and finally assigned four channels); Highway Truck (7 frequencies); Automobile Emergency (1 frequency used by American Automobile Association clubs and garages); Forest Products (10 frequencies, exclusively; 16 frequencies shared; 20 developmental shared; 80 frequencies fixed, shared); Special Industrial (17 frequencies exclusively; 16 frequencies shared; 20 frequencies developmental; 80 frequencies fixed, shared); Low Power Industrial (4 frequencies, exclusively; 1 frequency, shared); Highway Maintenance (14 frequencies, exclusively; 11 frequencies shared, with possibility of others on special showings); and Special Emergency as enlarged to make eligible for the first time physicians in remote areas, ambulance services, beach patrols responsible for life saving activities and school bus operators in rural areas (6 frequencies, exclusively; 9 frequencies, shared, with possibility of others on special showings; 80 frequencies, fixed, shared); and Domestic Public Common Carrier (telephone company: 36 frequencies; non-telephone company: 8 frequencies).

Common-Carrier Philosophy

Probably the next most important effect of the recent decisions in the

various mobile radio service rule and frequency allocation proceedings was the laying to rest of the theory that the radio communications needs of the mobile radio services should be furnished exclusively through common carriers authorized for the purpose. Commissioner Robert F. Jones dissented from the Commission's Report on the sole ground that it was "a mistake to permit the growth and development of non-broadcast radio services on a private and unintegrated basis" as the rules of the majority assured. Although his views were not expressly commented upon by the majority of the Commission, it is clear that the adoption of Commissioner Jones' thesis would have drastically penalized the bulk-radio user both economically and in required speed of service, if it did not result in a total denial of radio service.

In the other principal fields of communications — telegraph, and telephone—the user can build his own facilities; he can lease the facilities of others; or he can use the message services of a common carrier. The distinction long recognized in other fields of communication between the individual-message type of service and the bulk-user type of service may now be regarded as accepted in the field of radio communications as well. The question of exclusively common-carrier mobile radio service has been raised and, it must be believed in

view of the staggering equipment investment made and to be made, finally laid to rest by providing for both types of service—direct user and common carrier.

This, incidentally, was the first time common-carrier mobile radio service was recognized, all the growth so far having been along direct-user lines. In recognizing the common-carrier service, which will find its principal use in congested urban areas, the Commission expressly stated that it had "taken particular care to provide a family of frequencies within which the development of common-carrier mobile radio systems by enterprises other than existing telephone companies may take place." These dispositions, the Commission report stated, had been "effected advisedly, and with the purpose, among others, of fostering the development of competing systems, techniques, and equipments."

Reduction of Railroad Frequencies

A third and highly important effect of the various decisions made is to be found in the reduction of the frequency assignments to the railroad industry. Sixty frequencies had originally been assigned for railroad communications purposes in the choice 152 to 162 mc band. The FCC found that the railroads had been slow to use these frequencies for the purpose for which they had been primarily assigned—end-to-end and wayside point-to-train

communications. The Commission report in this connection stated:

"The Commission believes that an allocation of 41 frequencies in the Chicago area will provide sufficient interference-free channels to handle any foreseeable expansion in the use of radio by the railroads in the immediate future. It has been pointed out that the original allocation of 60 frequencies was based upon an estimate that 30 usable frequencies would be necessary to handle the main line communications of the 32 roads operating in Chicago. Yet, more than 3 years after that allocation, at the time the oral argument herein, only 7 railroads in the area were using radio for such operations."

Despite the objections of the railroads and the reasons advanced in explanation of the delay in use, railroad assignments were reduced one-third, to 41 frequencies in the congested Chicago area and 39 frequencies elsewhere. The action taken in this respect is important because it stands as a warning to all other services that no frequencies will long be reserved for any service that does not use them.

Secondary-Use Principle

A fourth and also highly important principle established by the various decisions was that of the use on a secondary basis by the public-safety radio services of the frequencies allocated primarily to the railroad and maritime mobile radio services.

The 39 frequencies assigned for railroad use on a national basis, if not used by them in particular areas, may now be used by Public Safety Radio Services licensees in any area "on the condition that harmful interference will not be caused to stations in the Railroad Radio Service". The 19 frequencies assigned primarily for maritime mobile use are similarly available for assignment to Public Safety Radio Services users in any area on the basis of noninterference to maritime mobile use.

The taxi industry was the prime mover for Commission adoption of this sharing principle and could undoubtedly make the most and quickest use of the privilege. Although, as a Land Transportation Radio Service, the taxi industry does not obtain any immediate benefits from the grant made to the Public Safety users, nevertheless

the Commission indicated that sharing of unused frequencies by secondary services might be expanded in the future. In disposing of the taxi industry sharing request, the Commission Report stated:

"We have noted the request of the taxicab operators for the right to use railroad frequencies on a shared non-interference basis in areas outside of Chicago. While the railroads have expressed a willingness to permit sharing of their frequencies on a non-interference basis, we are not prepared, at this time, finally to dispose of that question. Since sharing on a non-interference basis to railroads of 39 of such frequencies is being provided in the case of the Public Safety Services, the implementation of the instant request must await (1) a determination of the availability of such frequencies for further shared use without interference to the primary needs of the railroads, and (2) a consideration of the needs and requests of any other services for eligibility to use such frequencies."

This secondary-service use principle assures a flexibility in frequency assignments formerly lacking in the FCC pattern of industry allocations exclusively on a national basis, regardless of the extent of the demand in particular areas. The new approach should therefore insure that 39 frequencies will not any longer be frozen in Miami, Florida, exclusively for railroad use, despite the fact that only two railroads operate into that city and they could never possibly use 39 frequencies.

Frequency Separations

Further indication of the Commission's desire to squeeze the most out of the available frequencies was evidenced in reluctant acceptance of need for basing assignments in the new 44 to 50 mc mobile band on a 40 kc rather than 20 kc interval. Said the Commission:

"We have considered the arguments addressed to the subject of frequency spacing and have established the assignments in the 44-50 mc band on a 40-kc interval, rather than on 20 kc as proposed originally. However, we wish to emphasize that the ultimate utilization of this band, which is urgently required to take care of the anticipated overflow from the 152-162 mc band, will necessitate the development of techniques and equipments which will operate on a closer spacing than 40 kc."

The same spirit was also evidenced in reluctant acceptance of fact that railroad assignments in

the 152 to 162-mc band could not presently be predicated on the basis of 60-kc adjacent-channel operation in the same geographical area. In discussing the adequacy of the taxi 152 to 162-mc assignments, the Commission again reverted to this subject, observing that "the availability of 60-kc adjacent-channel equipment cannot be too far in the future and an allocation of 8 frequencies will enable the taxicabs to use ultimately 4 (two-frequency) channels in any given area." Elsewhere in its report, the Commission was at pains to direct the attention of certain users "and equipment manufacturers" to the allocation of the 450-mc band also for the use of the various mobile radio services designated.

The pressure the Commission is obviously directing for the manufacture of improved equipments that will utilize less spectrum space is the clearest kind of indication of the vast expansion in land-mobile radio use that is anticipated by the regulatory agency itself. The pressures that expanded use will inevitably generate against the Commission for additional frequencies quite obviously the Commission would pass on to the manufacturers.

With mobile assignments effectively limited by technical considerations to the portion of the spectrum below 500 mc, it is indeed regrettable that the Commission should have rendered one of the few bands available for mobile radio service use—the choice 72 to 76 mc band—a veritable no-man's land by surrounding it with television channels 4 and 5. In consequence, this former mobile band is now limited to operational fixed-circuit use and may then be so used only "on the condition that harmful interference will not be caused to the reception of television stations on channels 4 or 5." In practice, it has been found impossible to satisfy the condition imposed for the restricted use of this band except in the remotest of areas, with the result that the demands of the mobile services for operational fixed circuits for control and repeater purposes may generally be satisfied only in the microwave bands where the present cost of equipment is a retarding factor in use.

THE EVER INCREASING DEMAND for oil products, and the inadequacy of our present petroleum supplies, is a problem which rarely comes to the minds of the average American. Few of us realize how great the domestic demand for oil has become. In order to maintain the level of our present reserves it will be necessary to discover two billion six hundred million barrels of oil in the coming year. This is the greatest assignment that has yet challenged the geophysicist.

An apparent solution to this problem lies in the fact that the geological formations that exist in the continental shelf of the Gulf of Mexico appear to be of the same salt-dome character as those formations now producing oil in southern Texas and Louisiana. These formations seem to continue throughout the length of the shelf below Texas and Louisiana, extending in some places as far as 150 miles into the Gulf. The fact that oil may exist in these formations is confirmed by the existence of producing oil wells on salt domes lying ten to twelve miles off shore. Industry has already paid twenty-five million dollars for the leasing of mineral rights to about two and one half million acres of Gulf area.

Searching Methods

In searching for formations likely to bear oil, the geophysicist employs several methods. Some of these methods are: (a) the measurement of the intensity of the earth's magnetic field by use of a magnetometer, (b) sounding of the strata below the earth's surface by use of a seismograph and (c) measurement of the earth's gravitational field by use of a gravity meter. Two of these systems are illustrated in Fig. 1 and 2.

When a geophysical survey is being made the geographical location of the readings taken is of prime importance. When a survey is made over water in sight of the shore line location can be computed by simple triangulation with a transit on known land points; however, this method is time-consuming and im-

* Formerly electronics engineer with the Heiland Research Corporation of Denver, Colorado.

Radiolocation in Oil Prospecting

Oil deposits under the Gulf of Mexico may help avert a future shortage. Radio aids developed during the war have proved highly satisfactory in detecting and locating these deposits. Several of the most widely used systems are described in this article

By **EUGENE A. SLUSSER***

*General Telephone Service Corp.
New York, N. Y.*

possible in a fast-moving airplane. As the survey party moves farther off shore, the need for better methods of location becomes acute. Apparently the only practicable solution lies in some sort of radio location device whose errors do not exceed plus or minus 100 to 150 feet within the required operating range.

Several types of radio location devices meeting these requirements are possible. These include: Radar, Ratran, Shoran, Lorac, and Raydist. Of these five systems, the longer-range Lorac and Raydist systems seem particularly useful for making overwater surveys. The FCC has recently granted construction permits to the Seismic Service Corporation of Tulsa, Oklahoma, for construction of a Lorac system, and to the Frost Geophysical Corporation, also of Tulsa, for the construction of a Raydist system. Both of these systems are to be located with-

in 150 miles of the shoreline of the Gulf of Mexico.

Let us briefly discuss each of the five aforementioned systems.

Radar

The simple radar method utilizing standard radar pulse techniques furnishes range and azimuth to and from a given location. It requires only a single station.

Since microwaves are employed the operational range is limited to line-of-sight conditions which for some installations might be from twelve to fifteen miles. Within this range accuracies of plus or minus 25 to 100 feet can be expected. For near shore use this method is generally satisfactory.

Ratran

The Ratran system is a radar triangulation system. It was developed by the Heiland Research Corporation on a contract placed by the

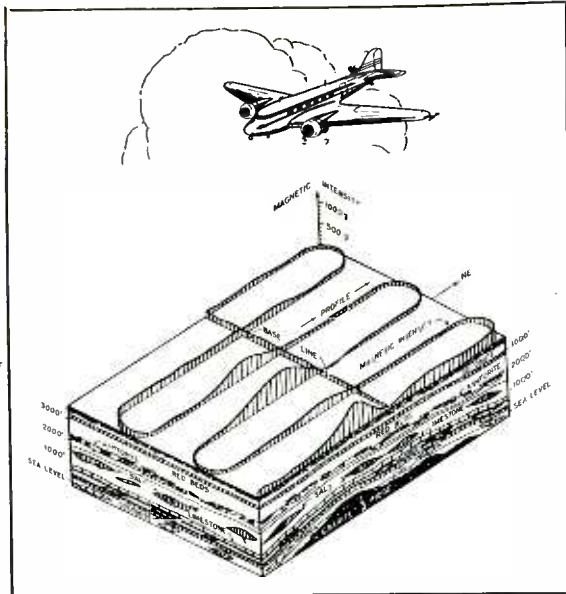

FIG. 1—A magnetic detector carried over a section of land or water records the intensity of the earth's magnetic field and locates oil-bearing strata irregularities by detecting their accompanying magnetic field anomalies

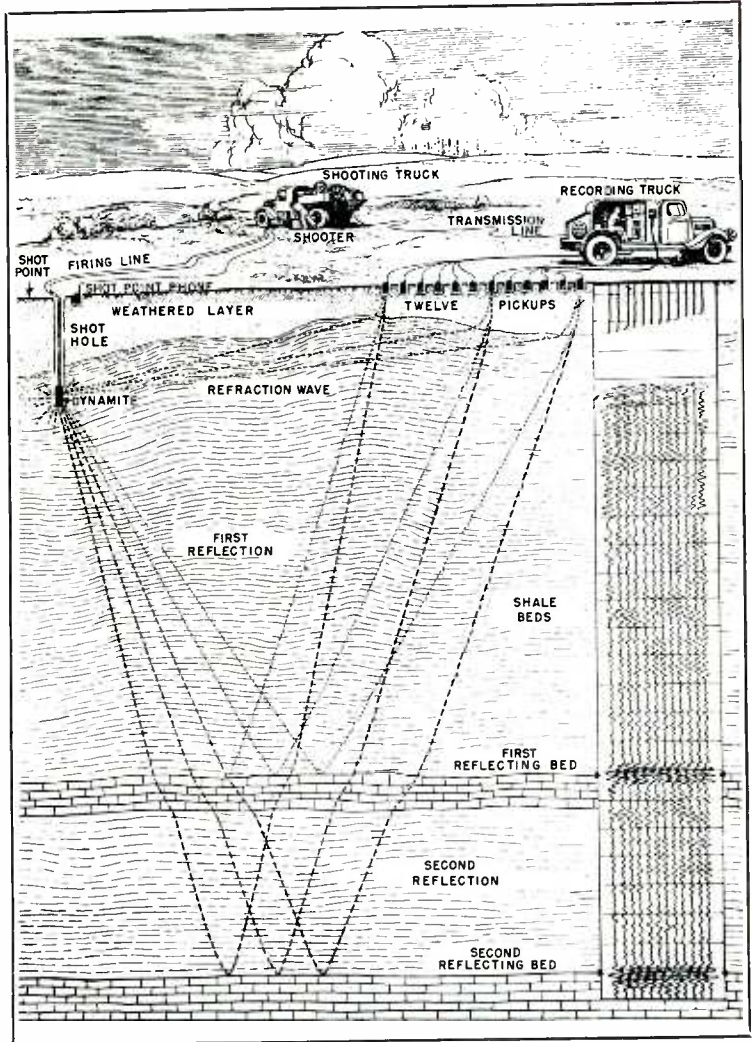

FIG. 2—The seismic method of underground and sea exploration employs sound waves which are reflected from different strata and picked up by several geophones or microphones. Recordings of reflected waves map underground strata

Geophysical Exploration Corporation (both of Denver, Colorado) and was designed for airborne use in conjunction with the Heiland Magnetometer.

Rather than using azimuth, it determines position by using ranges from two known points. The system consists of two APG-5 automatic range-only radar systems modified to work over approximately forty-mile ranges. These units are carried aboard the aircraft and each triggers a beacon station located at the known points. The ranges to the beacon stations appear as shaft rotations and are indicated on two clock-type dials.

The Ratran system embodies one interesting feature which is applicable to any type of double-range system, and of importance in making an airborne overwater survey. It provides a system whereby the geographical area being investigated is divided into invisible rec-

tangular coordinates. This is accomplished by a PLI (Pilot Location Indicator) computer.

The base line of the area investigated is the line drawn to intercept both beacon stations. In making a survey the pilot flies an S-shaped course with the major distances perpendicular to the base line as shown in Fig. 3. In this manner, at any instant during a survey, a triangle can be constructed having sides R_1 , the range to beacon number 1 from the aircraft, R_2 , the range to beacon number 2 from the aircraft, and the base line.

If we introduce the flight line perpendicular to the base line and intersecting the position of the aircraft, we form two right triangles, one having sides R_1 , a , and b , and the other having sides R_2 , a and c . It can be shown that $R_1^2 - R_2^2 = b^2 - c^2$.

For any particular line, $b^2 - c^2$ is a constant K and can be computed

mathematically for that line. This gives us the equation $R_1^2 - R_2^2 - K = 0$ to be solved electrically.

A standard method of solution is employed. Two potentiometers are geared to each of the range shafts. One of these is excited with a 400-cps a-c voltage and the other is connected as a load on the first. Since the potentiometers are positioned proportional to R , the fraction of the voltage appearing on the arm of the loaded pot is proportional to R and the fractional output voltage appearing on the arm of the loading potentiometer is proportional to R^2 . In this manner both R_1 and R_2 are squared.

The R_1^2 output is connected in series with the R_2^2 voltage in such a manner that a difference in voltage is obtained. In turn these are connected in series with another potentiometer which is excited with a 400-cycle voltage from the same source, and introduces a voltage

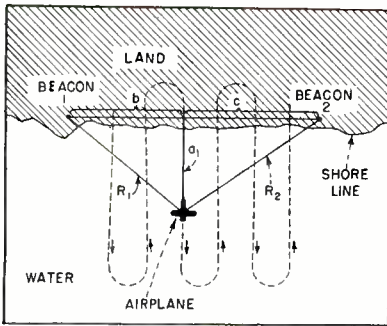

FIG. 3—The Ratan system of radiolocation employs two range-finding beacons which effectively divide search area into rectangular coordinates

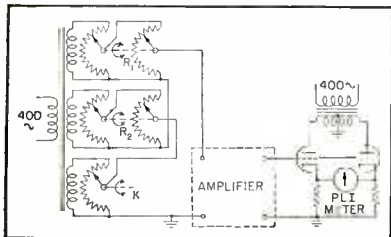

FIG. 4—Pilot Location Indicator computer gives actual physical position data

proportional to the constant K . When a value of K corresponding to a desired flight line is set on the K potentiometer and the output of the network is zero, the equation is solved; however if the equation is not perfectly solved, the phase of the output signal will indicate which R is larger and is therefore an indication of the position of the aircraft relative to the desired flight line.

This voltage is used indirectly to deflect a zero-centered PLI meter in the pilot's cockpit to assist him in flying the desired course without the aid of landmarks by telling him his position relative to the course line. In order to deflect the indicator, the voltage output of the potentiometer computers is first amplified and then rectified in a phase-sensitive rectifier, giving a d-c voltage whose polarity is determined by the phase of the computer signal. Figure 4 is a diagram showing the operation of the basic PLI computer.

Shoran

The Shoran or Short Range Navigational system was developed during the war to be used as a method of pin-point bombing. Shoran is a pulse-type triangulation system similar to Ratan inasmuch as it

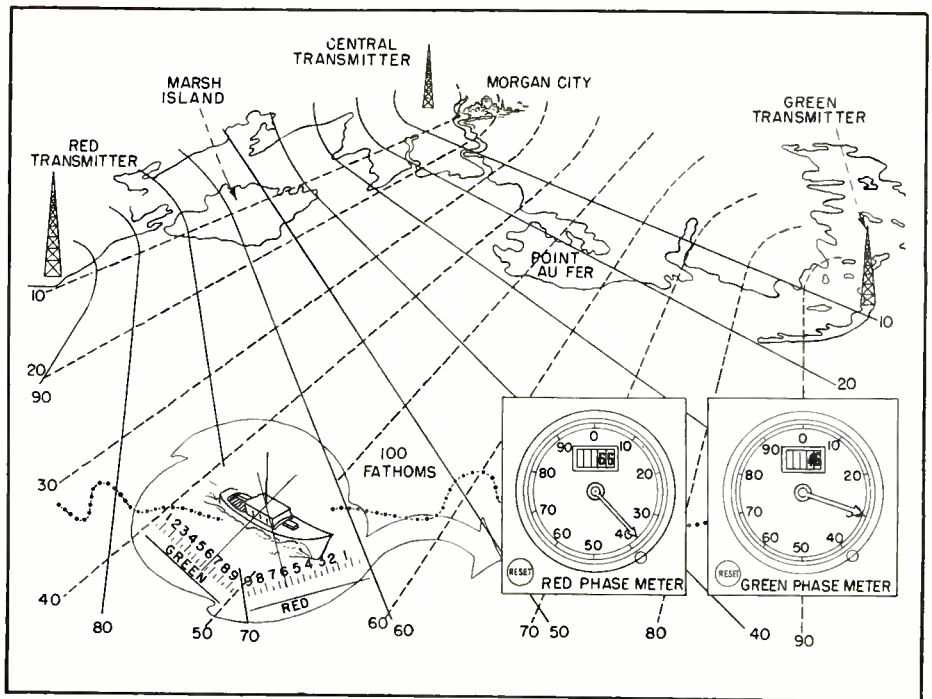

FIG. 5—Lorac (Long Range Accuracy) determines the location of a mobile unit by comparing the phase relationship between two pairs of received signals

determines the position or fix by using two ranges to two ground beacon stations whose positions are known.

The ranges are determined by standard radar means. A pulse from the mobile transmitter triggers the beacon transmitters and they retransmit to the mobile receivers. The time intervals representing the ranges to the two stations are recorded.

Three frequencies of transmission are used. Since these are in the vicinity of 250 mc the range of Shoran is limited for all practical purposes to line-of-sight distances. For shipboard use this may be of the order of 25 miles with accuracies of plus or minus 25 to 75 feet. Aboard an aircraft this range can be extended to about 42 miles, assuming the aircraft to be flying at an altitude of 1,000 feet above the shore-based station. The maximum effective altitude for aeromagnetic surveys appears to be 1,000 feet.

As is the case with the Ratan system, Shoran also provides a method whereby the pilot can be directed to fly given courses. These courses consist of successive arcs of constant range from one of the ground beacon stations. The pilot is directed on a desired arc by a PDI (pilot direction indicator),

which tells him his position relative to the course.

Lorac

The Lorac or Long Range Accuracy system is a system whereby the location of a mobile unit is determined by comparing the phase relationships between two pairs of received signals. Lorac resembles Loran, although Loran is a pulse-time comparison method.

If two c-w transmitters operating on the same frequency are located some distance apart, and lines of constant carrier-frequency phase difference are plotted between the transmitters on a map of the sites, a hyperbolic pattern will be produced. If a meter capable of measuring the phase difference between the two stations is moved so as to cross the hyperbolas, each 360-degree change in phase would be called a lane. This is illustrated in Fig. 5. On a line intersecting the two transmitters a lane would have a width of one-half wavelength. To establish one's position on a given hyperbola, it is necessary to count only the number of lanes and fractions of lanes from a known point. If a position or fix is desired, a second pair of transmitters must be used and a second hyperbola be determined. The intersection of

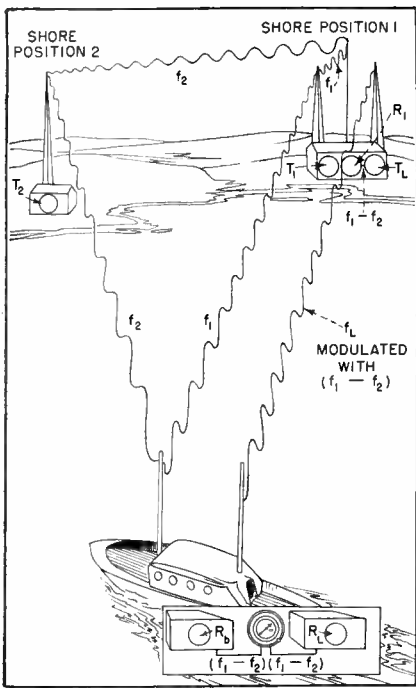

FIG. 6—Drawing of Lorac system, showing phase comparison principle

the two hyperbolas will be the fix. In actual use the lanes and fraction of lanes from a known point for intersecting hyperbolas are presented on two phase meter indicators.

The basic principle of Lorac can best be described by referring to Fig. 6 which illustrates two shore stations and a mobile station. The c-w station at shore position 2 transmits on frequency F_2 to receivers R_b in the mobile unit and R_1 at shore position 1. A second c-w transmitter located at shore position 1 transmits to R_b aboard the mobile unit and also to the adjacent receiver R_1 at shore position 1. The frequency of T_1 differs from the frequency of T_2 by an audio frequency $F_1 - F_2$. When the two transmitter's signals are received by R_1 they heterodyne and produce the difference beat frequency $F_1 - F_2$. Likewise the $F_1 - F_2$ beat frequency is produced aboard the mobile unit in receiver R_b . The $F_1 - F_2$ frequency is also retransmitted by T_1 to receiver R_L located on the mobile unit.

The phase difference of the two beat notes arriving at the mobile unit depends upon the difference in distance of travel of the original carriers before heterodyning. Since the positions of transmitters T_1 and T_2 and receiver R_1 are fixed, the beat frequencies at R_1 will remain con-

stant and be transmitted to R_L without change of phase. This beat frequency is the reference beat note.

If the mobile unit remains stationary, the phase of the beat note received from transmitters T_1 and T_2 in receiver R_b remains fixed; however, if the mobile unit moves, the phase will change. Since the phase of the reference beat note remains constant regardless of the location of the mobile unit, it can be used as a phase reference and the phase of the R_b beat note be compared with it. The phase relation between the two beat notes is displayed on an indicator which makes one full rotation per lane. Each time a lane is crossed a counter mechanism adds or subtracts a digit to a lane counter to identify the lane into which the unit has moved.

By use of the above described system the mobile unit can only lo-

cate itself as being somewhere on a given hyperbola, and to obtain a fix the equipment can be duplicated to determine location on a second hyperbola.

The basic Lorac system as discussed requires six frequencies of transmission. Seismic Service Corporation has developed a type A Lorac system which offers a savings in equipment and frequencies. Although the Type A system transmits on four frequencies, the frequencies are so chosen that they occupy only two channels. The type-A system uses four transmitters and four receivers. This system is illustrated in Fig. 7.

The accuracy of the Lorac system is a function of the frequency employed. In the 2,000-kc band, one-half wavelength on a base line is about 250 feet, corresponding to a phase shift of 360 degrees. Seismic

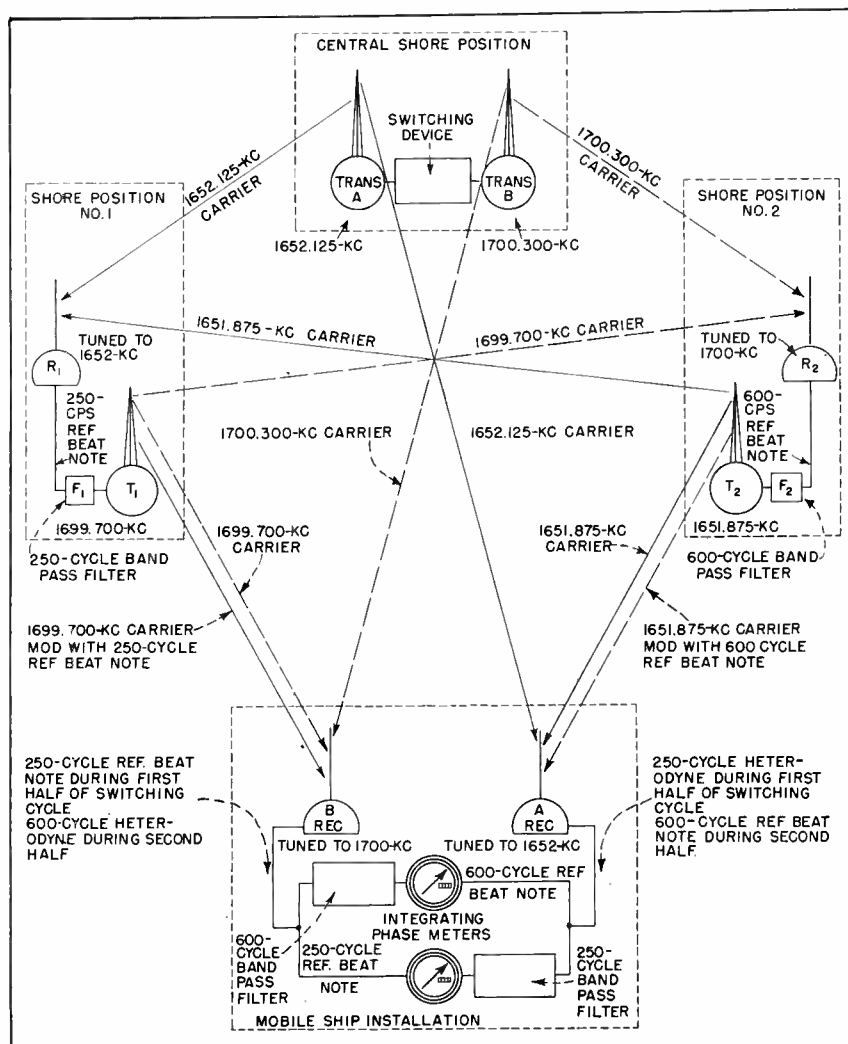

FIG. 7—Type-A Lorac offers savings in equipment and frequencies. Accuracies of better than ± 3 feet have been realized with this system

Service Corporation states that an accuracy of plus or minus 3.6 degrees is not difficult to obtain, and with this accuracy one should expect distance determination on the base line to about ± 2.5 feet. In actual use over short ranges, base line accuracies of better than three feet have been demonstrated. It should also be pointed out that should the emissions vary slightly in phase during operation, both beat notes will vary in phase by an equal amount and the effects will be cancelled. Thus the necessity of phase synchronization is obviated.

Another important characteristic of Lorac is that the system cannot become saturated with users.

Raydist

The Raydist system is generally similar to Lorac inasmuch as both systems are based on phase-measuring techniques. The Raydist system employs a transmitter in the mobile unit and can be arranged to have the indicators either in the mobile unit or at a fixed point. Raydist can be used as a pure range system or as a hyperbolic system.

A simple Raydist system for determining location along a given hyperbola requires four transmitters and four receivers as illustrated in Fig. 8. Receivers 1 and 2 can be located at any position desired provided they can receive suitable signals from transmitters T_2 and T_3 . For geophysical surveys it is best to have them located aboard the mobile unit.

The frequency of the mobile transmitter T_1 is such that it differs from the frequency of reference transmitter T_4 by an audio note. Transmitters T_1 and T_4 are received at green shore position receiver R_2 and the frequency-difference heterodyne is produced. This beat note modulates transmitter T_2 for purposes of relaying it to R_1 where it arrives with phase depending upon the relative transmission distances from T_4 to R_1 and T_1 to R_1 . Since the distance from T_1 to R_1 remains constant, the phase depends entirely upon the distance from T_1 to R_2 . The same audio beat note is produced in receiver R_4 from T_1 and T_4 and it is retransmitted maintaining its phase by T_3 to receiver

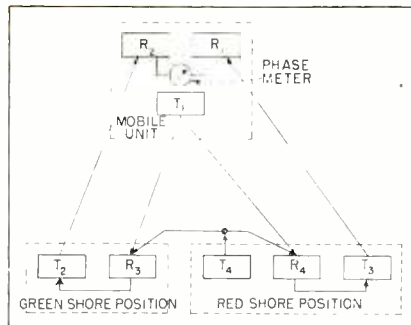

FIG. 8—The Radist system of radiolocation employs a transmitter at the mobile station. It can be arranged to give position indications at either the mobile or fixed stations

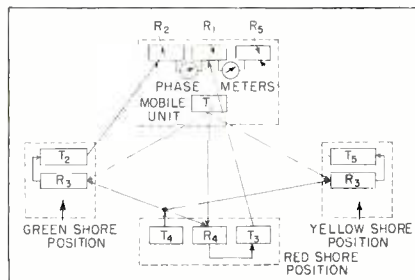

FIG. 9—Model-E Radist locates mobile station by intersection of a pair of hyperbolas. It employs an additional land station and one extra receiver over the system shown above

R_1 . The phase of the signal received at R_4 depends upon the distance from T_1 to R_4 .

If the mobile unit were to move along one of the hyperbolic lines, the phase of the beat notes received by R_1 and R_2 would remain constant. If, however, the mobile unit moves so as to cross the hyperbolas, the phase of the beat notes shifts. By indicating the relative phase and number of complete phase changes (360 degree) from a known geographical point, a given hyperbola can be determined.

Indication of the phase relationship is accomplished by feeding the outputs of the two receivers R_1 and R_2 to the rotor and stator windings of a synchro. The synchro indicates the phase relationship at any instant and a revolution counter geared to the synchro indicates the number of half wavelengths or lanes from a known location.

In order to obtain a fix, a location on a second hyperbola must be determined to obtain an intersection. Rather than duplicate the equipment discussed above, the Hastings Instrument Company has devised their model-E two-dimensional Ray-

dist system. Figure 9 illustrates the operation of the model-E system. Note that Fig. 9 contains the basic units in Fig. 8. The operation of these units is unchanged so that they give location along one hyperbola. An additional yellow shore station is necessary and another receiver R_3 is installed at the indicator location. The signal from transmitter T_1 beats with the signal received from the reference transmitter and this beat note is transmitted to R_3 by T_3 . A phase comparison between receivers R_3 and R_2 gives a second set of hyperbolas. The fix is at the geographical intersection of the first hyperbola with the second.

Also of interest to the geophysicist is the pure range Raydist system. In this system a c-w transmitter and receiver are located at both stations. Each receiver receives a beat note produced by the far transmitter and the adjacent transmitter because the frequencies of the transmitters are separated by an audio note. The beat note received at the far location is retransmitted to the other by means of a third transmitter where it is compared in phase with the locally-produced heterodyne. The two beat notes are fed to phase counting and measuring units which measure the distance from a known point by counting the one-half wavelength intervals.

In systems of the type involving beat frequencies discussed above, the rate of movement of one station either toward or away from a fixed station can be detected by the increase or decrease of heterodyne frequency due to the Doppler effect.

The Raydist system as so described permits only one user at a time. It is anticipated that future modifications will provide for the joint use of about twelve mobile units. This can be done by assigning a slightly different carrier frequency to each mobile unit and filtering desired audio beat notes.

The Hastings Instrument Company reports that for operational use accuracies of ± 25 feet may be obtained at ranges of fifty miles. No accuracies are quoted at greater ranges; however, it is believed that Raydist equipment operating in the 1,000 to 2,500 band will operate satisfactorily over a range of 250 miles.

Automatic Station Call Selector

Sounds alarm when radio station's call letters are received in standard code characters over a speed range of better than two to one. Has given reliable operation between New York and a ship docked at London, a distance of 3,000 miles

By **W. W. McGOFFIN** and **H. R. SCHULZ**

*Bretco Electronics Corporation
New York, N. Y.*

THE SHIP'S CALL ALARM is an instrument of the selector type which can be set to the characters of the international-Morse code, such as those comprising a radio station's or ship's call letters, and will ring an alarm bell when those call letters are received. The alarm bell, or bells, may be placed on the vessel's bridge, or in the radio operator's sleeping quarters.

The instrument has been highly successful in the marine industry. It provides a 24-hour radio watch even though only one operator is employed. Users claim that wireless telegraph without it is like a telephone without a bell.

Versatility

In order for a device of this kind to be practical in interpreting code characters, a primary requisite is flexibility in the range of code speed to which it will respond. In other words, it must not require a given definite code speed or perfect sending.

The instrument will operate properly and respond to a ratio of code speed of better than two to one. It even takes into consideration natural tendencies of operators, such as short spacing between letters which are seldom confused, such as C and Q. The code-speed range normally used for average sending covers 17 to 34 words per minute. However, four ranges are provided; 6 to 12, 8 to 16, 12 to 24 and 17 to 34 words per minute.

The unit is shown in its servicing

position in an accompanying photograph. The lower deck comprises the receiver, which is a conventional crystal-controlled superheterodyne designed for maximum stability. It has two fixed frequencies, 500 and 8,280 kc, to cover the two international calling frequencies.

An automatic-gain-control circuit is provided with a long time-constant in order that it will hold between code characters. The addition of agc also causes the receiver to favor the strongest signal in a field of great interference. The sensitivity is such that it will operate the signal relay with less than 5 micro-

volts input at the antenna.

The top portion of the unit is the selector and includes the relays which accept the particular ship's call letters and reject all others.

Timing Problem

The limits of the ratio of maximum to minimum code speed to which a unit of this type will respond are set by the timing structure of the code symbols. The timing method used to accomplish this instrument's code speed ratio of two to one is illustrated in Fig. 1.

Since the ratio in time of dot length to dash length is one third,

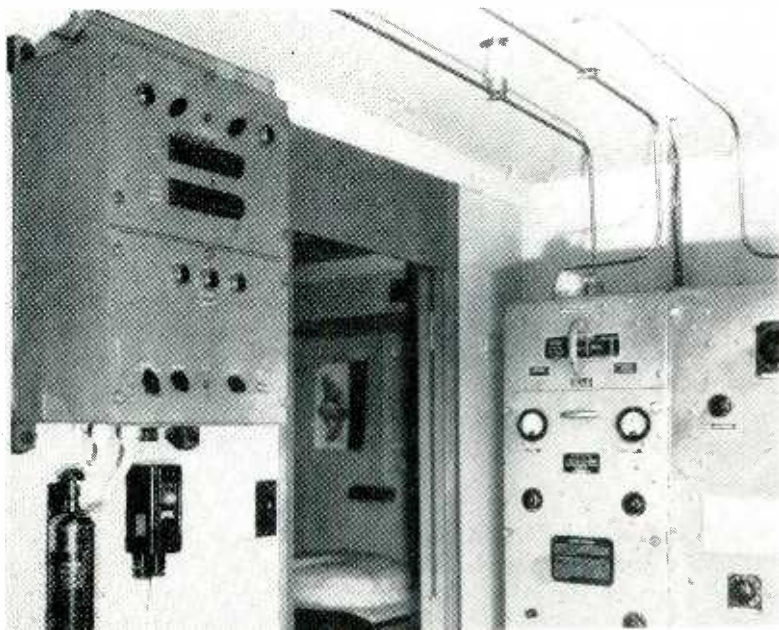

Call Alarm installed on wall of radio shack aboard the Moore-MacMail operates alarm in radio operator's quarters when his station is being called. (Photograph courtesy Hose-McCann Corporation, who made the installation)



Photograph of Ship's Call Alarm in servicing position. Bottom shelf contains the crystal-controlled receiver

a timing point one third of the dash time is used. Thus a ratio of two to one in code speed variance is obtained.

Any pulse duration between the length of time from *A* to *B* is accepted as a dot so long as the pulse is of sufficient duration to actuate the advancing circuit. Any pulsation of the duration from point *A* beyond point *B* is checked as a dash regardless of its duration.

In transmitting code and forming letters there are two other timing elements involved, the interval and letter-space time. The time between dots and dashes of international Morse characters forming a letter is known as the interval time.

The ratio of the letter-space time to the interval time in perfect sending is also three to one. Hence it is possible to place a point of timing at one third the letter-space time relative to the dot and dash timing so that intervals and spaces will be checked properly at a ratio of two to one variance in code speed in the same range.

Relays

In the Ship's Call Alarm, only two timing relays are involved. One relay, because of its slow closing time, which is accomplished by R-C circuits, never closes on dot pulsations unless the code speed is under the range setting used, and the dots

then become dashes relative to the relay timing. This same relay always closes on all dashes that do not exceed the maximum speed allowable by the range setting used. When the code speed exceeds this range, dashes will be shorter than the one-third point of timing at the minimum speed. This relay, by its operation or non-operation, according to the pre-set switching of each succeeding contact of a stepping relay, determines whether the pulse advances the stepper or causes a reject.

A relay, which immediately closes with the beginning of each pulsation but is delayed in releasing by R-C circuits, differentiates between intervals and spaces. The release or non-release of this relay, which is a function of the preselected stepping-switch circuits and the position of the stepper, determines whether the stepper is allowed to advance or is reset to home position.

Thus with two timing relays, four timing functions are accomplished. These are: (a) When set for a dot and a dot is received the stepper will advance. If a dash is received the stepper is reset. (b) When set for a dash and a dash is received it will advance the stepper. If a dot is received in this position it will be rejected. (c) When set for an interval and an interval is received it will be accepted. When set for an interval and a space is received it will be rejected. (d) When set for a space and a space is received it will be accepted. When set for a space and an interval only is received it will be rejected.

Figure 2 is a block diagram of the instrument showing a two-level stepper switch. Both swinger-arms *SW₁* and *SW₂* are mechanically connected and operate simultaneously. Level *A* distributes power during each pulse through each successive contact as it advances. Power is available to it for distribution only during pulses. Depending on preselected switch settings, this power is applied to either the dot, dash or reject circuit in each stepper position.

The reject circuit is connected directly to the reject coil, while the dot and dash circuits operate the reject coil only when the incoming pulse does not conform to the tim-

ing circuits of the delayed-to-close relay *RE₂* and its associate relay *RE₃*. If the reject coil is not operated the code characters are accepted as correct and the stepper continues to advance.

Level *B* swinger arm *SW₂* has power connected to it at all times but does not distribute power until after the first pulse, which corresponds to the second position of level *B*. This level checks the interval and space components of the code which do not occur until after the first dot or dash pulse.

Power from this level is distributed to either the interval, space, or alarm circuit depending upon the preselected switch settings and the position of the stepper. The interval and space circuits ultimately reach the reject coil through the slow-to-release relay *RE₁* and its associate relay *RE₄*. This occurs only when the incoming interval or space does not conform with the timing of the slow-to-release relay *RE₁*. As long as the intervals and letter spaces between dots and dashes conform to the operation or non-operation of *RE₁*, in accordance with the preselected circuits, the stepper relay is allowed to advance.

As soon as the stepper reaches the alarm circuit contact and a letter space is made allowing *RE₁* to fall out, *RE₁* is operated, operating the alarm. This relay also disconnects power from *RE₁*, stopping all further operation of the stepper. The alarm continues to ring until the reset button is pressed, applying power to the reject coil, returning the stepper to home position. If, when the *B* level of the stepper reaches the alarm position and another dot or dash is added, allowing only an interval and not a letter space, which would constitute an entirely different last letter than

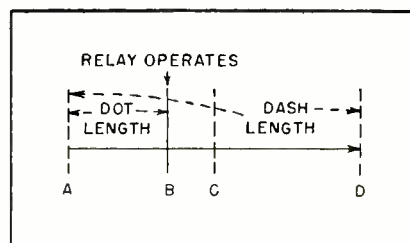

FIG. 1—Diagram of the basic timing structure of the international-Morse-code characters

What We Learned From

By M. A. CHAFFEE

and R. B. CORBY

*Airborne Instruments Laboratory
Mineola, N. Y.*

fronting commercial airlines. From a military standpoint too, the experience that was gained may have a direct bearing on planning for transportation methods and equipment in future emergencies.

The Airline Problem

Airlift traffic in and out of Berlin, over the Russian zone, was confined to three corridors, as shown in Fig. 1. These corridors were conventional 20-mile wide airways. From half a dozen loading airfields in the American and British zones, at round-trip distances between 300 and 600 airline miles from Berlin, planes funnelled into Berlin through two corridors and were directed into Tempelhof, Gatow or Tegel. After unloading, all planes returned along a third common corridor to their respective bases.

The joint American-British air-transport enterprise required the safe and efficient flow of high-density air traffic from a number of loading points through two narrow corridors to a comparatively small number of cargo-discharge points. The overall problem entailed the guidance of all aircraft from the loading points to the corridor entrances, safe control through the congested corridors, orientation and direction in the approach patterns over Berlin and precision landing control at each of the terminal fields.

The solution was achieved with a combination of conventional radio ranges and homing beacons with appropriate airborne range receivers, long-range surveillance radar, precision landing - approach - radar and vhf voice - communication equipment. With surveillance radar as the heart of the traffic-control

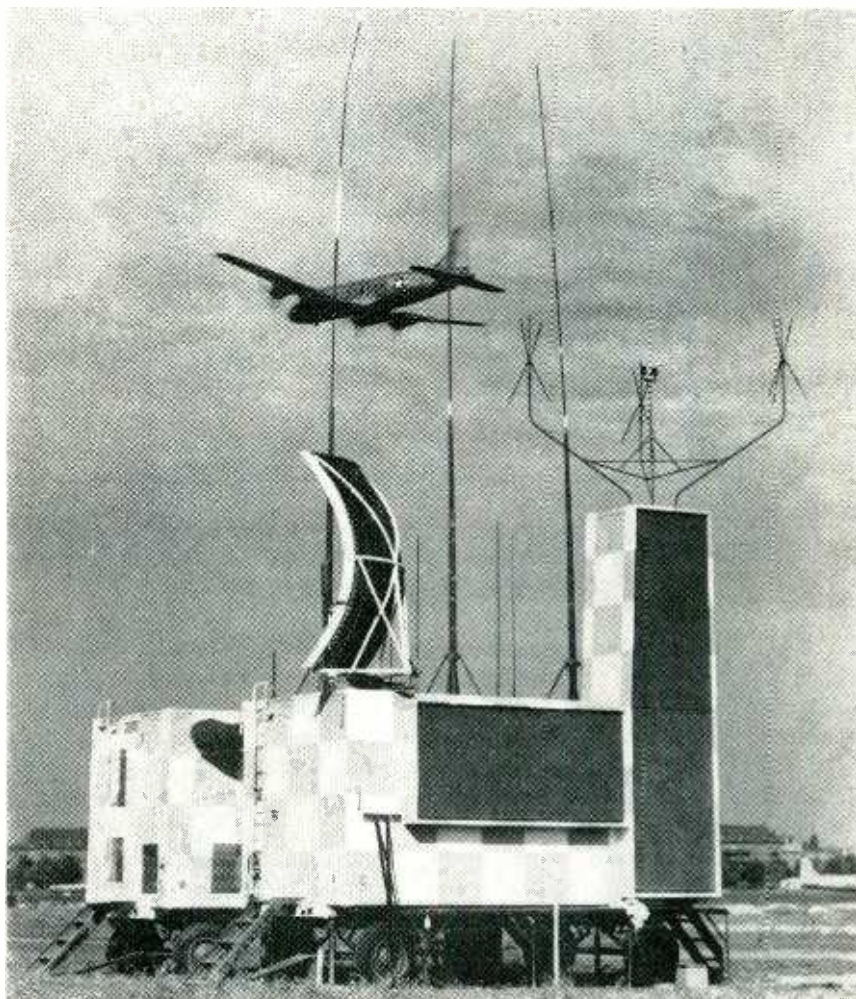

GCA trailer at Tempelhof, with power-generating trailer behind and C-54 coming in overhead. The three tall whip antennas provided two vhf channels and one standby for communication with planes. Elevation-beam antenna is behind dark vertical panel and azimuth-beam antenna is behind horizontal dark panel. Emergency radio antennas, not ordinarily used, are atop elevation-antenna box. Parabolic rotating search radar was not needed for airlift operations

DURING the closing months of Operation Vittles, a record tonnage of food, medicine and coal were moved into Berlin, by air, despite foul flying weather.

From December, 1948, when surveillance radar was installed at Tempelhof Airfield, until the blockade was lifted, more than double the earlier daily tonnage was flown into the city. Except for a few days when the ceiling stayed continuously below the 400-foot safe operating limit of GCA, Air Force C-54 cargo planes operated through the Frankfurt corridor and, along with a variety of British aircraft, down

the Hamburg corridor to Tempelhof, Gatow and Tegel airfields in Berlin with almost monotonous regularity. On maximum-effort days when all available planes were in use, air-traffic movements reached the rate of one plane a minute into the blockaded city.

This record of all-weather flying was made possible by efficient utilization of currently available electronic aids to air navigation. The practical experience gained from the use of these aids in Operation Vittles should help solve many of the instrument-weather traffic-control and landing problems now con-

The BERLIN AIRLIFT

Search radar teamed with radio and GCA brought C-54 cargo planes safely through the corridors to touch down at Tempelhof every three minutes despite fog, rain and snow. More specialized electronic aids proved unnecessary. The experience gained under pressure proves the feasibility of all-weather operation for commercial airlines

system, the combination proved entirely adequate for the all-American operations in the Frankfurt corridor, where all planes were C-54's with the same speed range and where take-off sequence information was sufficient for the initial radar identification. Along the Hamburg corridor, where American planes combined operations with various-speed British aircraft, the initial radar identification was implemented to some degree by British airborne-transponder equipment.

Flight Plan

Typical of the Airlift Task Force procedure was the following Frankfurt flight:

After takeoff from Weisbaden or Rhein-Main, the loaded C-54 homed first on the Darmstadt beacon, next on the Aschaffenburg beacon, and then swung northeast at an assigned altitude toward the Fulda Range Station. Monitoring the vhf airways communication channel, the pilot noted the time of the preceding aircraft's reporting its position over the Fulda Range Station. On crossing over Fulda, the pilot reported in and adjusted his speed to position himself approximately three minutes behind his predecessor. Swinging northeast on a predetermined heading to track the Berlin leg of the Fulda range, the plane proceeded for forty minutes at constant airspeed. Forty minutes out of Fulda the pilot reported on the airways channel to the radar-equipped Airways Control at Berlin.

By this time, a new radar pip had just appeared within the 100-mile range marker of the CPS-5 surveillance-radar ppi scope at Airways Control. Correlating this latest re-

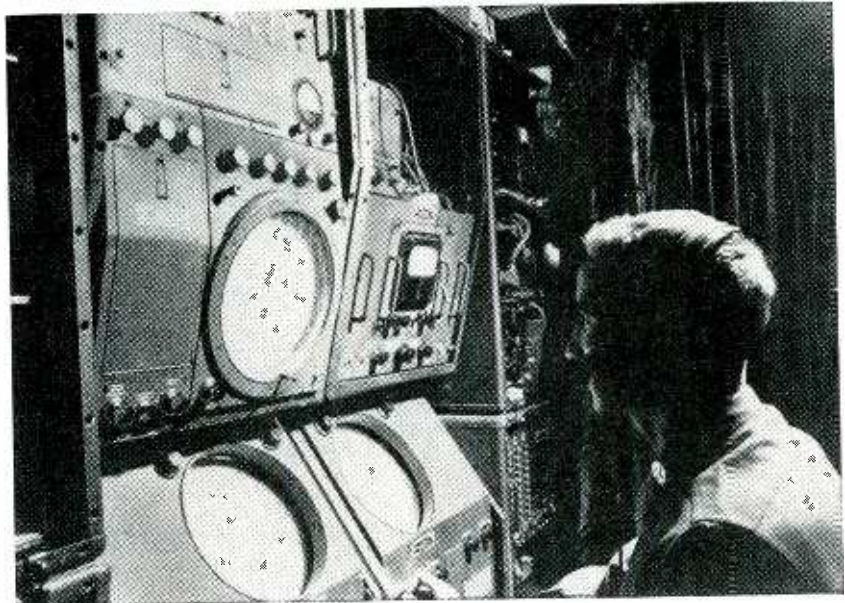

Operating positions in GCA trailer. Two men normally sat here to bring down alternate planes. Both angle-mounted scopes show same combined azimuth and elevation pattern. Search-radar scope mounted vertically to serve both positions was not used. Talkdown took about 3 minutes per plane. Note use of lip microphone

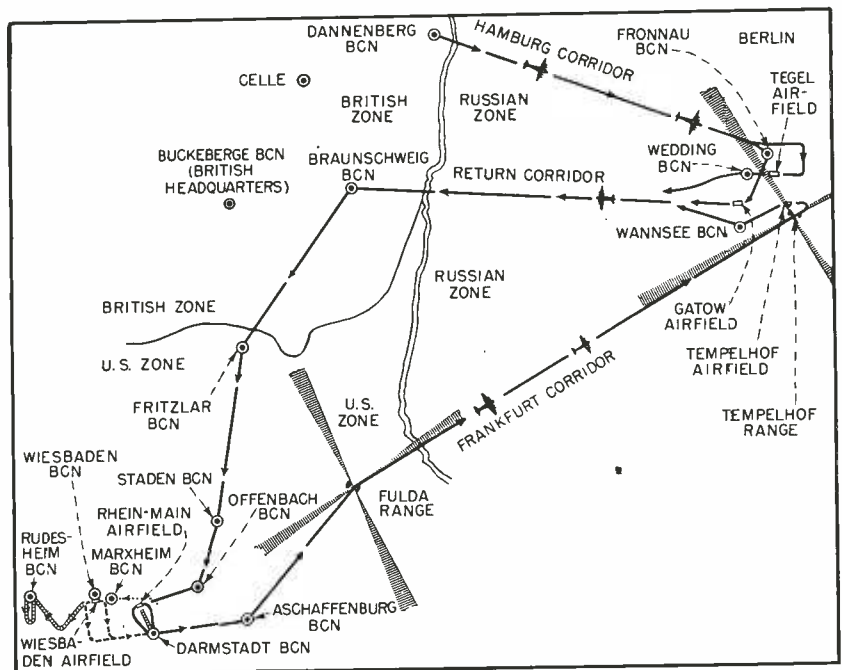

FIG. 1—Map of airlift operations, with Berlin area enlarged greatly out of proportion to show details of approach routes and return route used

PERSONNEL

- ① Pickup And Identification (P & I) For Frankfurt Corridor
- ② Platter For Entire Airlift—Tags And Tracks All Planes On Skiatron, Using P & I Info From 1 And 7
- ③ Airways Controller—Directs Traffic In All Three Corridors On Basis Of Radar Data On Skiatron
- ④ Approach Controller For Tempelhof—Takes Over Control Of Incoming Plane From 3 When It Enters Approach Zone, And Directs It Through Landing Pattern Onto Final Leg For GCA
- ⑤ GCA Coordinator For Tempelhof—Monitors GCA Voice Channel To Check Pickup Of Control By GCA When Plane Is Released By 4
- ⑥ Flight Status Board Man—Posts Flight Sequence Cards And Other CAA Type Flight Data Showing Status Of Every Incoming Plane, As Standby Measure Permitting Instant Changeover To Conventional Radio Traffic Control If Search Radar Fails

P & I Man For Hamburg Corridor

- ⑧ Approach Controller For Gatow
- ⑨ GCA Coordinator For Gatow
- ⑩ Approach Controller For Tegel

⑪ GCA Coordinator For Tegel

⑫ Chief Controller For Airlift

⑬ American Liaison Man

⑭ British Liaison Man

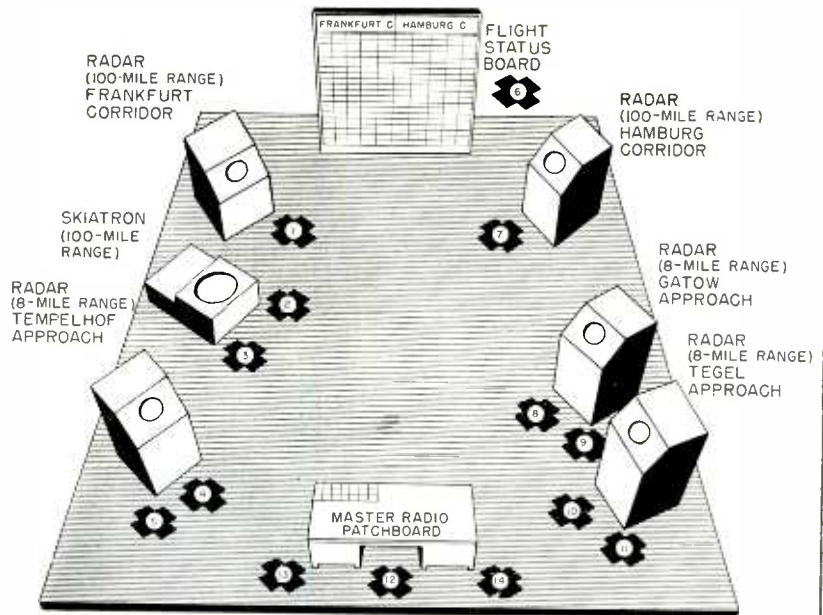

Traffic control room for entire airlift, located at Tempelhof airfield in Berlin. All radar screens here are fed by CPS-5 search radar on top of building, but are set for various ranges. Eight-mile range settings are also shifted off center to give enlarged effect of a sector scan

porting with the sequence reporting relayed forty minutes earlier from Fulda, the aircraft was identified and informed that it was in radar sight. In cases of uncertain identification, the reporting aircraft was requested to turn off course. A corresponding pip deviation would certify identification. Once identified on the ppi, the aircraft echo was tagged on a 24-inch Skiatron tube used at the control center as a master plotting board to permit tracking all aircraft movements.

Airways Control tracked the flight from the identification point, giving heading and speed corrections for maintenance of proper track in the corridor and safe spacing behind a preceding plane. Upon arrival in the Approach Zone over the Tempelhof Range Station, the plane was directed by Airways Control to turn left and to report immediately to Berlin Approach Control on the vhf approach-control channel.

The approach controller, provided with a radar ppi adjacent to the airway controller, assumed direction of the aircraft for guidance through an intricate and precise

approach pattern. To aid this guidance, the controller used an expanded (eight-mile radius) radar presentation covering the approach to Tempelhof. Further, a map of ground check points (beacons, runway alignment marks and Russian airfields to be avoided) had been superimposed on the radar scopes by electronic video-mapping techniques. Provided with this ground reference data, the approach controller directed the plane for precise navigation around the approach pattern and into the final approach leg to Tempelhof. Upon turning for final descent, the aircraft was directed to contact Landing Control at Tempelhof on whichever of two available vhf channels was momentarily not in use.

From approximately six miles out on the final approach, the pilot contacted the GCA landing controller. Within three minutes the GCA controller talked the plane down, using his precision-radar information to keep the plane safely on the steep four-degree glide path, down between rows of tall buildings and onto the runway. With only three-

minute intervals between planes, two GCA operating positions and two vhf channels were used alternately for successive approaches.

Flexibility of Traffic Control System

Each of the three Berlin airfields was assigned an approach controller in the radar air-traffic-control center and each field was equipped with GCA. The flexibility of the approach and landing system was such that if, for example, Rhein-Main and Weisbaden were closed-in by weather and the Frankfurt corridor traffic to Tempelhof decreased, the centralized Approach Control could distribute any increased American or British traffic in the Hamburg corridor to another airfield.

After unloading, planes from each field were cleared for takeoff and, entering the return corridor over the Wannsee beacon, homed westward on the Braunschweig beacon in the British zone. No accurate traffic control was effected in the return corridor but all takeoff clearances were monitored in Airways Control. Planes were identi-

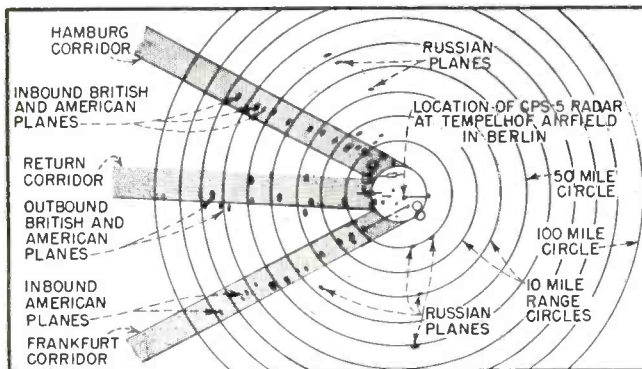
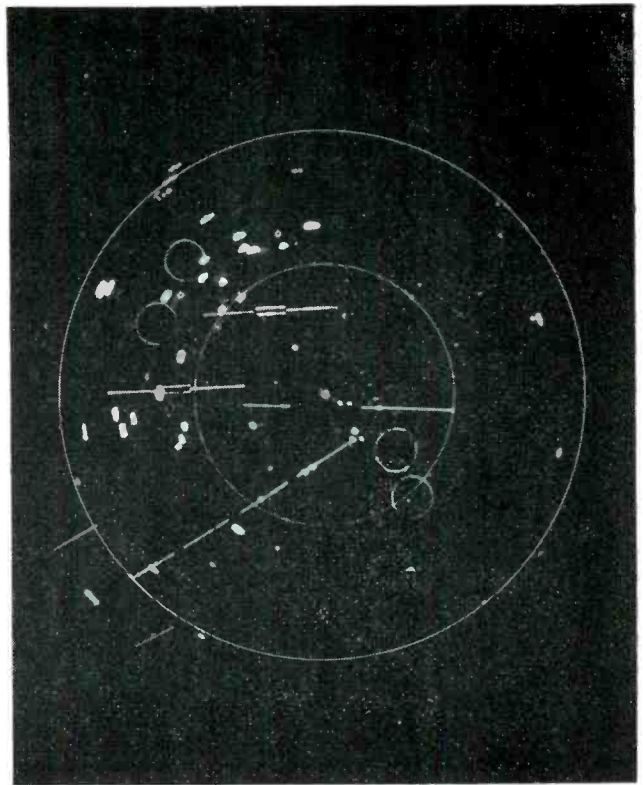
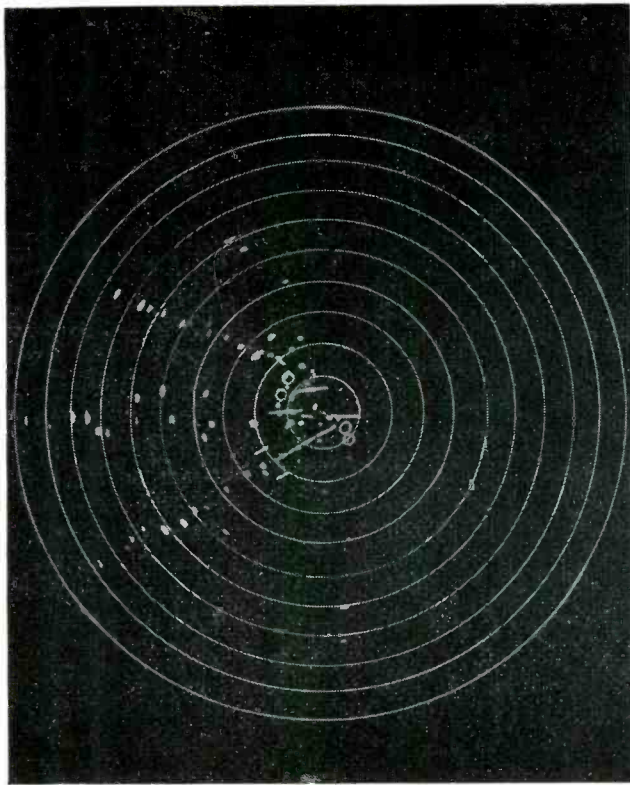

FIG. 2—Pattern seen on 100-mile screen of CPS-5 search radar on typical maximum-effort day near close of airlift operations. Diagram below identifies target pips and range circles

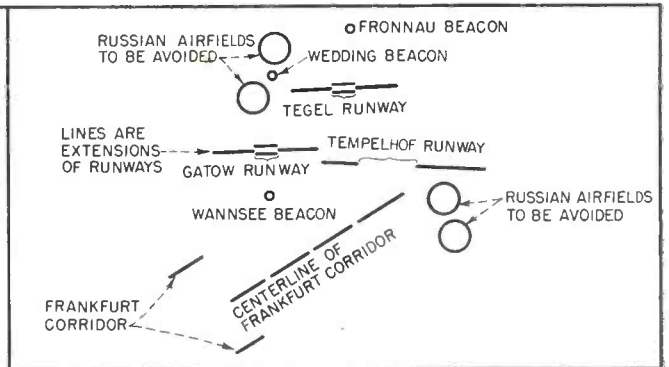

FIG. 3—Enlargement of pattern of Fig. 2, taken at approximately same time and obtained by switching scope to 20-mile range. Diagram identifies superimposed video mapping

fied on the Skiatron plot and movements monitored along the return corridor as anti-collision prevention.

Surveillance-Radar Presentations

Examples of the types of ppi presentation obtained with the CPS-5 surveillance radar installed at Tempelhof for air traffic control are shown in Fig. 2 and 3. The accompanying interpretive diagrams emphasize the thoroughness with which this particular radar can replace or extend human sight in instrument weather, with accuracy, from 100 miles away to within less than a mile of the radar antenna. This feat was made possible by incorporation of moving target indi-

cation and video mapping in the radar receiver circuits, for removing ground clutter and superimposing accurately the essential map data needed for approach control.

The 20-mile presentation of Fig. 3 was available at a flip of a switch for magnification of pips when approach regions became very crowded, but was not normally used by the approach controller. Instead, his scope was adjusted to show an 8-mile radius shifted off-center to get maximum enlargement of the area for control.

Airlift Radio Aids

The radio aids to air navigation which served the American effort in Operation Vittles consisted prima-

rily of vhf communication equipment and l-f navigation equipment. Each C-54 was equipped with an eight-channel push-button vhf communication set which sufficed for all normal communications. A small h-f communication set was installed as an emergency standby.

Conventional low-frequency A-N radio ranges and low-frequency homing beacons were installed at convenient locations in the American and British zones. The aircraft were equipped with standard radio-range and beacon receivers. No other equipment was used.

For British operations along the Hamburg corridor where various-speed aircraft presented a problem in sequencing and traffic control,



Antenna of CPS-5 search radar, weighing one ton and rotating at 10 rpm. At Berlin it was mounted on a 25-foot steel tower atop a five-story building

use was made of an available airborne transponder which enabled the pilots to give more accurate position and identification information to Airways Control and the radar plotters.

Choice of Radar

Full consideration was given to all available electronic aids to air navigation and traffic control during the planning stages of the airlift. Existing systems and components such as ground d-f systems, conventional l-f radio ranges and beacons were not considered sufficiently accurate for the special requirements of approach control to Berlin. On the basis of previous investigations by the All-Weather Flying Division, a combined navigation

and traffic-control device having the capability of handling the density of airlift traffic desired was seen in long-range surveillance radar.

The CPS-5 radar system was chosen in preference to other radars because:

- (1) Its range, in excess of 100 miles, was necessary.
- (2) It was capable of high accuracy.
- (3) It had minimum susceptibility to adverse effects of weather due to its operating frequency and narrow beam. Lower-frequency radars gave poorer resolution and, with antennas of reasonable proportions, wider beams. Higher-frequency radars were more prone to radar echo dispersion from mois-

ture, snow, sleet and storm clouds.

(4) A moving target indicator had been designed for the CPS-5.

(5) Height finding was not available, but was not required for airlift planes operating at assigned altitudes.

The selected radar was installed and operated at Berlin under the supervision of engineers from the Airborne Instruments Laboratory under an Air Materiel Command contract. The installation at Tempelhof provided five ppi radar scopes for the traffic controllers and one Skiatron for plotting and tracking. All scopes were provided with video mapping of the Approach Zone and the radar system was modified to incorporate moving-target indication (MTI).

Moving-Target Indication

The incorporation of MTI in the CPS-5 at Berlin was the first application to air traffic control of principles developed jointly at MIT and TRE (Telecommunications Research Establishment) for eliminating the ground clutter that gave short-range blindness to most ground radars.

Elimination of all indications from buildings, trees, mountains and other stationary objects, as shown in Fig. 4, is based on comparison of phase relations between succeeding echo pulses and a reference signal generated in the radar receiver. Each echo pulse is fed simultaneously into two receiving channels; one passes the pulse without delay to a comparator stage and the other has a delay line that retards each echo pulse for a time interval equal to that between outgoing radar pulses. Two successive echoes from the same target thus arrive simultaneously at the comparison point. If the target is stationary, the pulses in effect cancel and produce no trace; with radial target motion, the difference in phase of the echo pulse results in little or no cancellation, hence the pulses produce the desired pips on the scope.

Video Mapping

Video mapping is a technique which permits the presentation on a ppi scope of combined ground-reference and radar-echo data. In

operation, a negative transparency of a map containing desired information for presentation is interposed between a linearly scanning light spot and a photocell. The map is rotated in synchronism with the antenna while the light source, triggered in scan by each transmitted pulse, travels radially from the center of the map to its outer edge in a time commensurate with pulse propagation to the limits of the geographical area mapped.

The transparent lines or spots on the map negative permit the passage of light which is picked up by the photocell. The video output is amplified and mixed with the video data from radar echoes for presentation on the ppi. Thus, the reference map presented with the radar echoes is always correctly proportioned and oriented regardless of range switching or off-centering of the ppi.

Conclusions

The Berlin airlift showed that long-range radar having the inherent accuracy of the CPS-5 could in itself provide sufficient air-navigation and traffic-control information to permit the efficient flow of high-density air traffic along the corridors and in the approach areas of Berlin.

The high precision of GCA allowed safe descent of aircraft on the final approach leg, under instrument conditions when ceilings were down to 400 feet at Tempelhof and even lower at Gatow and Tegel where the approach terrain and rate of descent were less hazardous.

HOW VIDEO MAPPING WORKS

Antenna rotation drives map ring through servo system, making map negative of 100-mile-radius region rotate over face of cathode-ray tube serving as scanning light source.

Transparent lines and dots on negative pass light to photocell that feeds information of map through video amplifier to mixer for combining with radar signal. Synchronization insures that map appears on screen in proper position with reference to radar ppi presentation.

Changing range of radar presentation automatically changes scale of map since range-changing circuits are located after mixer stage.

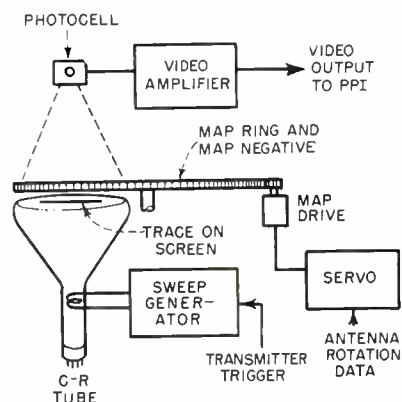

For commercial air transport activities, the airlift indicated that GCA, teamed with surveillance radar to provide direct control of aircraft movements by the radar controller, will have considerable merit as aids in reducing bad-weather cancellations, disruption of schedules under instrument conditions, and stacking delays at a terminal airport. Under the conditions which surrounded Operation Vittles, surveillance and landing radar proved effective for safe and efficient traffic flow. Although the strict airlift regulations for sequencing, speed control and altitude assignment are nowhere duplicated in domestic air transport operations today, the success of Operation Vittles suggests the need (a suggestion already being implemented by the CAA at Washington and Chicago airports) for investigating the

application of such radar control to existing domestic traffic control procedures.

Although the airlift functioned well with the tools available, it did reveal the need for improvements in equipment and in methods of gathering and communicating control intelligence. While it was proved along the corridors that radar alone could direct operations on the Enroute Zone, the existence of more accurate navigational devices would relieve the controller of all but purely traffic-control responsibilities in that area.

In the Approach Zone, the radar control could completely replace more complex navigational aids but again airlift experience indicated the need for more efficient utilization of the radio-frequency spectrum with better communication techniques, such as instantaneous transfer of detailed instructions and point-to-point or private-line communications wherein control information intended for a specific plane would be directed at only that plane to the exclusion of all others. Further, as emphasized by the problem in the Hamburg corridor, more positive identification equipment and techniques would greatly assist effective radar-monitored air traffic control.

In keeping the city of Berlin alive, the airlift accomplished a great feat. However, even more important is what it taught us concerning specific needs for future air-transport equipment and procedures.

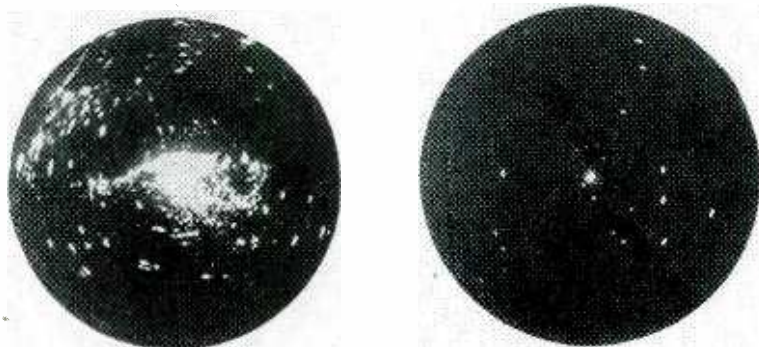

FIG. 4—Scope pictures taken with (right) and without moving-target indication on search-radar installation, showing effectiveness with which ground clutter is eliminated. On picture at left, pips in northwest sector represents buildings and solid white strip just above center represents hills

tor is from 0.1 to 1,000 pulses per second.

The one-shot multivibrator is cathode coupled and the width of the output pulse controlled by varying the capacitors in the plate-grid coupling circuit. The output is a positive pulse rising in about 10 μ sec. Four pulse widths of 1.5, 1.0, 0.5 and 0.025 milliseconds are provided. Other values could easily be obtained by a different choice of coupling capacitors.

Output amplitude control is obtained by varying the bias on a diode shunted across the positive output pulse of the one-shot multivibrator. The clipped pulse is applied to the grid of the output stage, a 6L6 beam power tube biased to cutoff, thus it conducts only during the pulse.

The stimulator output leads are the positive high-voltage supply and the plate connection. The tissue to be stimulated serves as the plate load. The strength of the output pulse can be varied from 0 to more than 100 ma. When it is desirable to isolate the stimulator from the tissue preparation (as during recording of action potentials with a high-gain amplifier), a switch allows a shielded isolating transformer to be inserted in the circuit. A potentiometer is placed across the transformer output and the center tap is grounded. This constitutes a Wagner ground and allows the output to be balanced to ground (a necessity when employing a differential amplifier for recording action potentials).

The constant-current characteristics are obtained by the use of the beam power tube and the placing of the material to be stimulated in the plate circuit of the tube. Measurements indicate that the current is independent of the load resistance within 5 percent up to 100,000 ohms at 1 ma and up to 1,000 ohms at 100 ma. Newman³ describes an ingenious constant-current arrangement that shifts the current from one tube to another as the load varies. This results in a constant load on the power supply which is a desirable feature. However, the range of current required in our work exceeded the steady-state current ratings of any of the small pentodes at present

available and we have consequently made use of the above described circuit.

The power supplies provide regulated voltages of +300 and -90, and 400 volts unregulated for the power output stage.

Timing Circuits

A timing circuit was also incorporated in the device to allow the stimulator to be turned on for fixed fractions of a second. It consists of a capacitor charged from the regulated power supply and discharged through a sensitive relay. The relay turns on the master multivibrator for the selected length of time. Variation in the duration of the capacitor discharge is obtained by series resistors. Durations of relay closure of 0.1, 0.25 and 1.0 second were employed.

Since the power tube is biased to cutoff, failure of the line current or the bias supply will allow the high-voltage power supply capacitors to discharge through the power tube, giving a damaging shock to the tissues being stimulated. To guard against this contingency a small relay was placed in the negative-return lead of the bias supply and the stimulator output leads were wired through the relay contacts. If the line current goes off or the bias fails, the relay opens the output circuit.

Oscilloscopic examination of the output of the stimulator shows that with a resistive load in the plate circuit a good approximation to a rectangular pulse is obtained.

With the output through the shielded isolating transformer, considerable distortion occurs at the wider pulse widths but a good rectangular pulse is obtained with short pulses. Inasmuch as short pulses are usually employed when recording from stimulated tissue, the distortion of the longer pulses was not felt to be a serious handicap.

Applications

This stimulator has been used successfully for widely varying purposes including: single and repetitive stimulation of autonomic and somatic sensory and motor nerves, direct stimulation of skeletal and cardiac muscle, including the induc-

tion of ventricular fibrillation, determination of pain thresholds and production of electrically induced seizures.

The constant-current characteristics of the instrument provide adequate compensation for changes in the placement of electrodes and are of special value in certain of these applications. In determining pain thresholds in mice by the electric grid method⁴, or in humans by the tooth stimulation method⁵, contact with the source of stimulus and consequently effective resistance may vary considerably. This stimulator appears to compensate adequately for such variations. For example, representative tooth pain thresholds on two medical students averaged 1.7 ± 0.02 ma and 2.3 ± 0.14 ma for 15 tests each over a 3-week period. Automatic compensation for changes in resistance is also important in studies of electrically induced seizures inasmuch as it has been shown that cerebral resistance changes markedly during passage of the stimulating current.⁶

The isolating transformer and Wagner ground have proved very useful in eliminating stimulation artefacts in experiments involving both stimulation and electrical recording, such as studies of the effects of vagal and accelerator nerve stimulation on the electrocardiogram and in studies involving stimulation of the cardiac auricles and electrical recording of the ventricular response. In the latter experiments involving auriculoventricular conduction the continuously variable frequency control of this instrument has also proved to be advantageous.

REFERENCES

- (1) F. Offner, Stimulation With Minimum Power, *J. Neurophysiol.*, 9, p 387, 1946.
- (2) N. Rashevsky, "Mathematical Biophysics," University of Chicago Press, p 151, 1938.
- (3) H. W. Newman, A Constant Current Square Wave Stimulator, *Proc. Soc. Exp. Biol. and Med.*, 63, p 201, 1946.
- (4) K. Kueter and R. K. Richards, A New Method for the Evaluation of Drugs Affecting the Reaction of Mice to Pain Stimulation, *J. Lab. and Clin. Med.*, 28, p 585, 1943.
- (5) F. R. Goetzl, D. Y. Burrill, and A. C. Ivy, A Critical Analysis of Algesimetric Methods with Suggestions for a Useful Procedure, *Quart. Bull. Northwestern Univ. Med. School*, 17, p 280, 1943.
- (6) C. A. Swinyard and L. A. Woodbury, Changes in the Head Tissue Impedance of the Albino Rat Under Conditions of Continuous Electrical Shock, *Anat. Rec.*, 91, p 46, 1946.

UHF Propagation Characteristics

Ultrahigh-frequency experience of several investigating groups is compared with FCC theoretical values and with vhf propagation. Signal strengths tabulated on a time-percentage or location-percentage basis may help determine spacing of new television stations

By **EDWARD W. ALLEN, Jr.**

*Chief, Technical Information Div.
Federal Communications Commission
Washington, D. C.*

PROPGATION of radio waves at the ultrahigh frequencies has been investigated by a number of groups, with a view to determining the probable required powers and the distance separations for television stations that will eventually operate in this region.

So far, too few field observations have been accumulated to allow final formulation of a general theory or working formula. The work of several investigators is summarized here, however, to show in a general way the trends so far determined. Wherever possible, the results have been interpreted on a comparative basis with those obtained in the frequency band 54 to 216 mc.

Theoretical Propagation

Let us consider first the propagation within line of sight over a plane earth, without atmosphere, between antennas that are sufficiently elevated so the surface-wave component is negligible. Under these conditions the wave fronts are

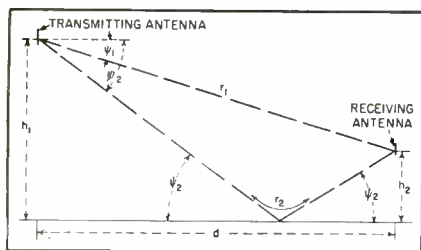

FIG. 1—Classic line-of-sight path and reflected ray for plane earth

not complex and the received fields may be considered as due to two rays r_1 and r_2 , shown in Fig. 1. These rays arrive at the receiving antenna in different phase, owing to the difference in path length $r_2 - r_1$, and to the change in phase of r_2 at the ground point of reflection.

At the ultrahigh frequencies, the difference in path length may be several wavelengths for short distances d , when the transmitting and receiving antenna heights are of the order of 500 feet and 30 feet, respectively. Thus, as the distance d is increased and the difference in path length $r_2 - r_1$ decreases, the two rays pass successively into and out of phase with each other, producing a succession of maxima and minima of field intensity. At distances beyond the point at which the field intensity becomes equal to the free-space value, after the last maximum, systematic destructive interference sets in, and the fields consistently decrease in intensity.

For a smooth curved earth, a similar geometry is valid out to distances near the horizon, at which point a diffraction component becomes predominant and determines the field intensities out to the maximum distances. Curves A, B, C and D of Fig. 2 show the behavior of the four frequencies 67.25, 288, 510, and 910 mc, respectively, for a transmitting antenna height of

1,250 feet and a receiving antenna height of 30 feet above surrounding terrain. These curves show that both the distance to the last maximum and the rate of attenuation in the diffraction region beyond the horizon increase with frequency.

Departures from the Theoretical

The validity of calculations of this type for vhf and uhf under conditions of substantially ideal terrain and normal atmospheric refraction has been verified for distances within line of sight. For elevated antennas, as in airplane communications, an appreciable departure from smooth-earth conditions appears to be possible before a modified approach is warranted. However, as the antenna heights are decreased to values of concern for a television broadcast service a considerable modification is necessary.

In the first place, even in average rural areas, the earth no longer appears smooth, and the reflected wave is scattered or broken up into components which combine randomly with the direct component. Under these conditions, the systematic maxima and minima disappear and the resulting field intensities undergo wide variations from point to point.

In urban, suburban or in rough or wooded rural areas, the receiv-

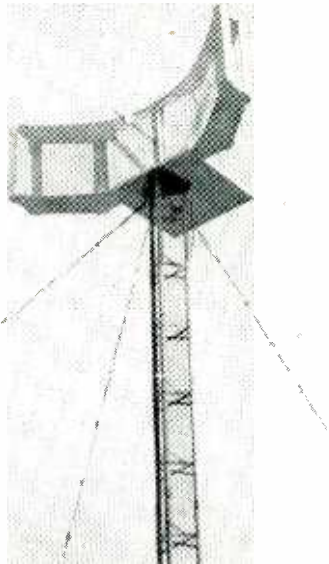

Closeup of 700-mc cylindrical parabolic receiving antenna used in tests



FCC measurement station at Laurel, Md., with 700-mc parabola on tower at left. The 47.1 and 106.5-mc dipoles are stretched between towers

ing-antenna site may be below the heights of nearby obstructions, so that there may no longer exist direct and ground-reflected waves as such, but the predominant field may consist of a partially absorbed, scattered and diffracted field which has passed through or around such obstructions. At other locations the direct field may be attenuated to a point where the predominant field or fields may be those reflected from one or more objects lying outside the direct path between the transmitter and the receiver. Many locations are found where reflections of this type are recognizable and may produce severe ghosts in television reception. This condition indicates that field-intensity surveys alone are inadequate in connection with coverage surveys of television stations and that some specification of ghost conditions is also required for completeness.

The analysis of several coverage surveys of f-m and television stations at vhf, and of a few surveys which have been made on experimental stations at uhf, indicates that the evaluation of the station coverage lends itself to a statistical treatment in order to estimate the percentage of receiver locations which will receive service of a particular grade at any specified distance from the transmitter. This type of approach, rather than the solid-contour approach employed in the medium-frequency or a-m

broadcast band, appears to be essential to a reasonable understanding of the character of the service rendered, because of the wide variations in signal intensity and signal quality which occur over comparatively small areas at essentially the same distance between receiver and transmitter.

Correction Factor

In December 1948, at an Engineering Conference held in Washington, D. C. in connection with the allocation of television stations, an Ad Hoc Committee was appointed to summarize the presently available data on vhf propagation.

A study of 13 vhf surveys made for the Committee¹ by a group at the National Bureau of Standards has resulted in the development of correction factors for expected median field intensities, applicable to the Ground Wave Signal Range Charts for 63 to 195 megacycles now contained in the Standards of Good Engineering Practice of the Federal Communications Commission. The correction factors are dependent upon frequency and distance, varying from -8 db for 195 mc at 15 miles to +1 db for 63 mc at distances beyond 37 miles. The same study has resulted in a graph indicating the relative field intensities to be expected at various percentages of the receiving locations at a given distance from the transmitter.

In Fig. 3, curve A, the distribution of field intensities at or near 63 mc, measured at distances within 50 miles of the transmitter, has been plotted in relationship to the 63-mc theoretical values. The absolute levels varied with frequency as indicated above but the levels relative to the 50-percent level were found to be substantially independent of frequency, distance and antenna height within the range of available data. This indicates that the median field intensity is about 11 db higher than the field intensity available to 90 percent of receiver locations. Reference has been made to this study because of a brief comparison of vhf and uhf coverage made below.

The above approach was initially

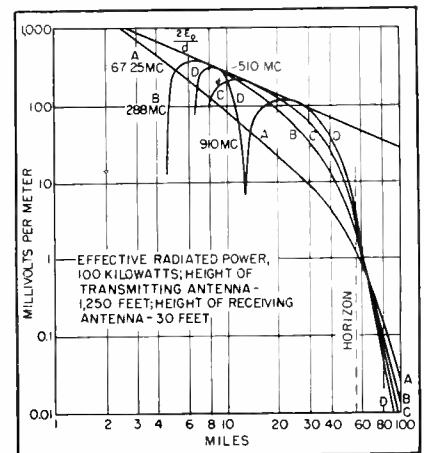

FIG. 2—Smooth curved-earth field intensities, showing diffraction effects

used by W. B. Lodge in the analysis of a survey at 490 mc made in New York City by the Columbia Broadcasting System in 1946.² This study indicated that the median fields were 9 db below the calculated fields for that frequency. An additional 5 db (a total of 14 db) was required for service at 70 percent of the locations and an additional 13 db (total of 22 db) for 90 percent of the locations, as shown in Fig. 3, curve B.

In a recent survey by the Radio Corporation of America of four stations atop the Empire State Building, operating on frequencies of 67.25, 288, 510 and 910 mc, reported by Brown, Epstein and Peterson,³ the median fields were +2, -12, -15 and -19 db, respectively, in comparison to the predicted fields for the specific frequencies involved. As compared to the 67-mc predicted fields, the median fields were +2, 0, -5 and -10 db (see Fig. 4), showing a progressively lower intensity as the frequency increased. There was also a slight increase in the range of the distributions with frequency, the 70-percent values lying 4, 7, 8 and 8 db, respectively, below the median or 50-percent values.

Surveys Compared

At first glance the measurements reported in the CBS and RCA surveys are somewhat more at variance with each other than would normally be expected of surveys made over the same area. The results can be reconciled because of the following differences in measurement and analysis. First, the calculated values used for the statistical analysis in the CBS survey followed the inverse distance curve at near distances, rather than becoming tangential to twice that value. This latter could account for a difference of 4 to 6 db in the ratio of calculated to median fields which were measured within 20 miles of the transmitter. When added to the 9 db reported, a total of 13 to 15 db is obtained to compare with the 15 db obtained in the RCA survey. An inspection of the data also reveals that the CBS data contained a smaller percentage of measurements in rough and shadowed areas. This could account for a small difference in the measured median

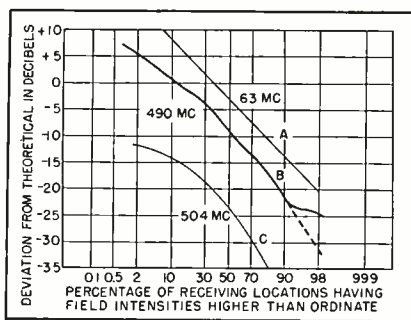

FIG. 3—Deviation of median fields from calculated field at several frequencies

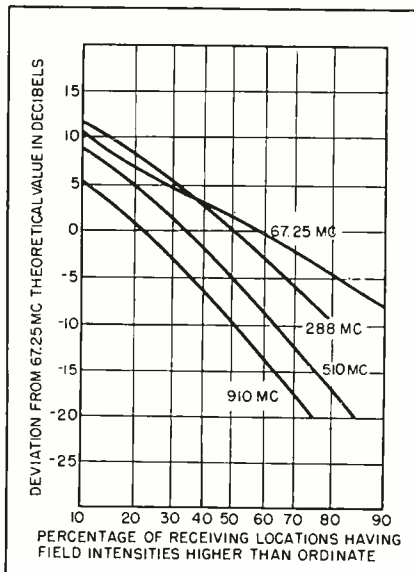

FIG. 4—Four frequency survey results, showing deviation from calculated fields

level and a considerable difference in the range of measured values. However, both surveys indicate that, for the type of topography in the New York City area, the 67-mc field intensities at 70 percent of the receiver locations may be expected to be higher than the 500-mc field intensity by about 11 db and higher than 900-mc field intensities by about 16 db, for equal radiated powers.

A comparative survey on frequencies of 77 and 612 mc was also made in the New York City area by Goldsmith and Wakeman of the Allen B. DuMont Laboratories.⁴ The measurements were not analyzed in terms of the percentage of receiver locations affected, but the results indicated that power increases of from 4 to 400 times, dependent upon the topography, and upon assumptions as to practical types of receiving antennas, might be required in order to provide the same terminal voltage to

the average television receiver.

In a second survey reported by G. H. Brown, made on a frequency of 504 mc in Washington, D. C.,⁵ the median signal level at receiver locations as shown in Fig. 3, curve C, was 24 db below the theoretical smooth earth value for 504 mc or 8 db below the 67-mc theoretical value. An additional 17 db was required to serve 90 percent of receiver locations with the same signal level. Using the median and 90-percent correction factors of -3 and -11 db at 63 mc, found in the vhf studies, it appears that an increase in radiated power of the order of 11 db will be required in order to provide a field intensity at 90 percent of receiving locations at 504 mc which is equivalent to that at 63 mc for the Washington area. An additional 10 or 12 db may be required in order to obtain a comparable signal-to-noise ratio at the receiver, because of differences in receiver noise figures, effective lengths of the receiving antennas and antenna line losses. This indicates a power increase of the order of 100 to 300 times to provide the same grade of service to 90 percent of the receiver locations over the same area in this type of terrain.

Power Comparison

A second approach to the evaluation of the service on 504 mc made by Brown indicated that a marginal service (216 microvolts at 300 ohms terminal impedance) to 90 percent of the actual locations studied in this survey might be provided by an effective radiated power of about 20 kw. All of the locations were within 10 miles of the transmitter, and a comparable coverage on 67 mc would have been provided by a station power of about 60 watts, based upon the receiver voltages measured at the various locations, and assuming a marginal service to be provided by a signal of 200 microvolts at the terminals of a set having the same noise figure of 10 db. This comparison is based upon the assumption that the service is limited by receiver noise alone and is not valid when noise and interference external to the receiver provide the limitation. Under the latter conditions the comparison must be based upon the

relative interference levels and upon the field intensities provided at the two frequencies being compared. At the present time such interference levels are less at 500 mc, but undoubtedly will increase as the use of this and neighboring frequencies increases.

Power Requirements

The foregoing surveys indicate that prohibitive amounts of power apparently will be required in order to serve large rugged areas from ground-based antennas at frequencies of 500 mc and above. The outlook for reasonably smooth areas is somewhat less forbidding.

The survey of the New York area reported by G. H. Brown consisted of a rugged radial to the west and of a relatively level radial to the southwest. The distributions were not analyzed individually for the two radials, but inspection of the plotted data for the smooth radial indicates that the medians were about 10 db below theoretical for 510 mc and 15 db below for 910 mc. Employing the same correction for the smooth radial as used by Brown for correcting for both radials, the medians are about 0 and -6 db, respectively, compared to the 67-mc theoretical. The median levels for smooth terrain therefore compare favorably with vhf field intensities. However, somewhat greater powers are indicated for a given service area by reason of the somewhat greater scatter of the measurements, but principally because of the smaller effective areas of practical receiving antennas. The use of airborne transmitters or the operation of satellite transmitters may be found to be practical alternatives to achieving large area coverage by individual land-based stations at the ultrahigh frequencies.

The two remaining figures present a comparison between the tropospheric field intensities at 63 and 700 mc. The 63-mc curves in Fig. 5 are taken from the results of the study of tropospheric data by the Ad Hoc Committee¹ and are believed to be typical of the average results to be expected along the upper Atlantic seaboard. On the other hand, the 700-mc measurements shown in Fig. 6 are the only ones available for a range of dis-

tances and for an extended period of time at uhf. They were made by personnel of the RCA Laboratories and the Federal Communications Commission for a period of about six months at three locations lying along the same path between New York City and Washington, D. C. from a 700-mc transmitter operated for the purpose by the Columbia Broadcasting System⁶.

It is extremely hazardous to base predictions on such an amount of data, taken over a span of only five summer months, because of the probable effects of terrain upon the absolute levels of measured intensity, and because of the differences in weather which are known to exist in various parts of the country. Taken at face value, these data,

plotted on a time-field intensity-distance basis, indicate that somewhat lesser station separations may be possible in the uhf on the basis of interference for 10 percent of the time, even though power of from 6 to 10 db higher may be required for smooth terrain, whereas somewhat greater spacings will be required in order to protect service for 99 percent of the time. However, a large amount of additional data is needed before a reliable evaluation can be made of the trend of station spacing with increasing frequency.

Over-Water Measurements

Measurements made over water near San Diego⁷ indicate that with surface-ducts or elevated-layer conditions, substantially equivalent field intensities in excess of free space may be expected for high antennas for both 170 and 520 mc, even at distances well beyond line of sight. Inasmuch as the fields under these ideal conditions are of comparable magnitude and since departures from ideal conditions are more likely to decrease the higher frequency fields to a greater extent than the lower frequency fields, it appears probable that the above comparison indicates qualitatively the relative spacings to be expected. For other areas, to which the terrain conditions and the distribution of layers applicable to the New York-to-Washington path may not apply, it is expected that measurements will not be in good agreement with either the 63- or 700-mc data discussed above; the station spacings should therefore be varied in accordance with experience in such areas.

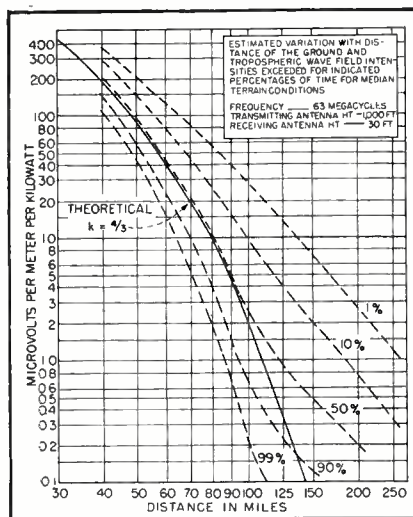

FIG. 5—Time-percentage field strengths expected at 63 mc

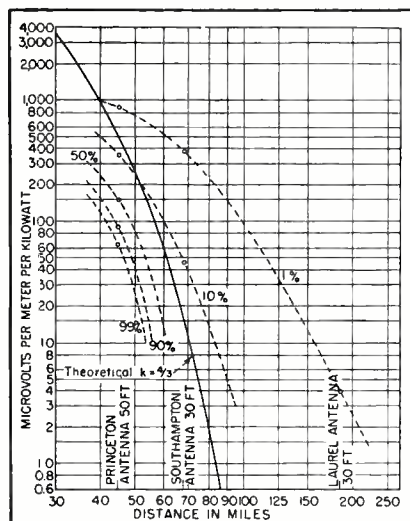
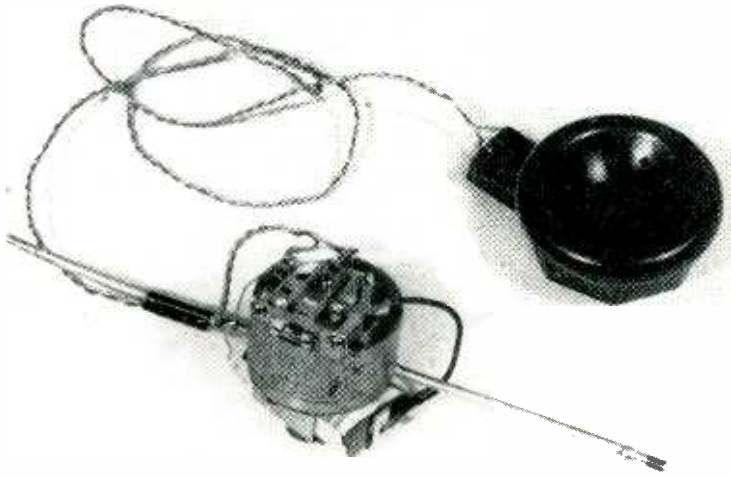

FIG. 6—May-through-September (1946) measurements of fields at 700 mc. Transmitting antenna 909 feet high

REFERENCES

- (1) Report of the Ad Hoc Committee for VHF Propagation, FCC Dockets 8736, 8975 and 9175. (To be released at a later date).
- (2) Testimony of W. B. Lodge, CBS Exhibit No. 79, FCC Docket No. 7896.
- (3) George H. Brown, Jess Epstein and Donald W. Peterson, Comparative Propagation Measurements: Television Transmitters at 67.25, 283, 510 and 910 Megacycles, *RCA Review*, p 177, June 1948.
- (4) T. T. Goldsmith and R. P. Wakeman, Comparative Field Strength Measurements and a Study of Received Picture Quality at 77.25 and 612 mc. Exhibit 5, FCC Docket 8976.
- (5) George H. Brown, Field Test of Ultra-High-Frequency Television in the Washington Area, *RCA Review*, p 565, December 1948.
- (6) FCC Dockets 8736, 8975 and 9175, Exhibit C-2, East Coast Tropospheric and Sporadic "E" Field Intensity Measurements on 47.1, 106.5 and 700 mc.
- (7) Smyth et al, Atmospheric Refraction, USNR&S Report No. WP-17.



An experimental transistor oscillator with a telemetering pressure gage attached. The battery, strapped below the gage, will run the unit for several days. Experimental performance curves are shown in Fig. 3

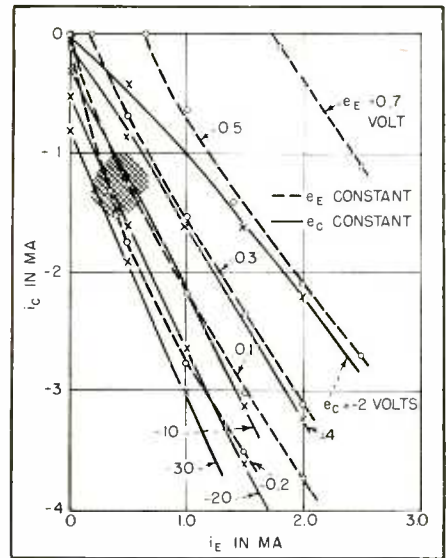

FIG. 1—Experimentally-determined characteristic curves of the transistor used. The desired operating region is shaded

Transistor Oscillator

Audio oscillator built around crystal triode, used to frequency modulate rocket telemetering system, has numerous advantages over vacuum-tube equivalent. Transistor characteristics are reviewed, and design data for similar circuits in other applications are presented

By **FRANK W. LEHAN**

Chief of Telemetering Section
Jet Propulsion Laboratory
California Institute of Technology
Pasadena, California

THERE EXIST TODAY many systems for the telemetering of information from rockets or other flight-test vehicles by means of a radio link. One of the more popular systems is known as the f-m/f-m system.^{1,2} This system uses the frequencies of a number of audio tones to convey the data to the ground on a frequency-modulated radio carrier.

One frequently-used method of converting a telemetered quantity into an audio frequency is the variable-inductance gage. With this technique an air gap in the magnetic circuit of the gage is made dependent upon the measured quantity. The gage is then used as an inductance in the tuned circuit of

an audio oscillator, thereby controlling its frequency.

Many audio oscillator circuits have been used. The oscillators are flown in rockets and they must operate under field conditions; hence certain design criteria are imposed upon them. Necessary characteristics of the audio oscillators include small size, light weight, low power consumption, simplicity, ruggedness, and frequency stability with changes of supply voltages or external conditions.

The Bell Telephone Laboratories transistor,³ used in an extremely simple oscillator circuit, shows promise of providing a useful solution to the telemetering audio-oscillator problem.

The Transistor

A transistor was procured through the efforts of the Army Ordnance Department and the Sig-

nal Corps. The audio-frequency behavior of the transistor is described by the experimentally obtained characteristic curves illustrated in Fig. 1 if its input and output voltages and currents are as designated in Fig. 2A.

For small increments of voltage and current (small signal operation), the incremental operation of the transistor may be expressed by any of a number of equation pairs. The following pair is convenient for this analysis:

$$E_E = R_E I_E + R_{CE} I_C \quad (1)$$

$$E_C = R_{EC} I_E + R_C I_C \quad (2)$$

The values of R_E , R_{CE} , R_{EC} , and R_C in Eq. 1 and 2 for a given region of operation may be determined from the characteristic curves or from more direct measurements, using methods similar to those used in determining the values of μ , R_p , and G_m for a vacuum tube. R_E , R_C , R_{CE} ,

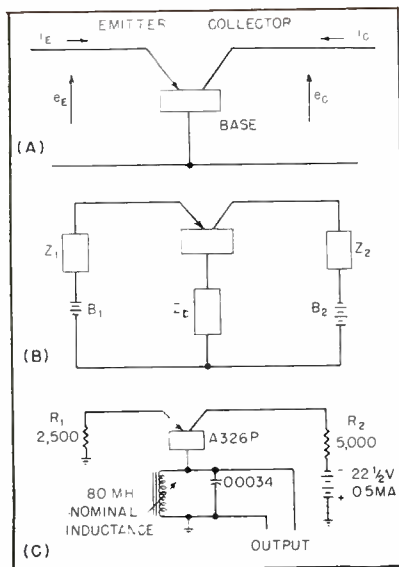

FIG. 2—Actual circuit diagram of transistor oscillator is shown in C. Basic circuits are shown in A and B

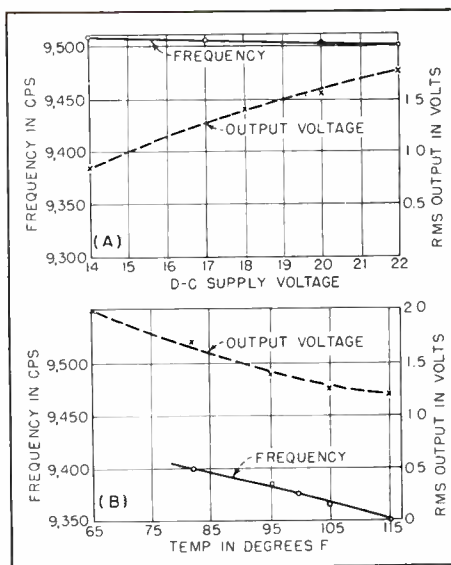

FIG. 3—Frequency and audio-output-voltage curves for experimental transistor oscillator shown in the photograph

for Telemetering

and R_{EC} may be written as follows:

$$R_E = \frac{\delta e_E}{\delta i_E}, i_C \text{ constant} \quad (3)$$

$$R_C = \frac{\delta e_C}{\delta i_C}, i_E \text{ constant} \quad (4)$$

$$R_{CE} = \frac{\delta e_E}{\delta i_C}, i_E \text{ constant} \quad (5)$$

$$R_{EC} = \frac{\delta e_C}{\delta i_E}, i_C \text{ constant} \quad (6)$$

Typical values of R_E , R_C , R_{EC} , and R_{CE} , found by using Eq. 3 through 6 and the characteristic curves, in the normal operating range of a transistor are, $R_E = 1,400$, $R_C = 33,000$, $R_{CE} = 700$ and $R_{EC} = 77,000$ ohms.

The Oscillator

Consider the transistor connected in the circuit shown in Fig. 2B. The batteries B_1 and B_2 are of such voltage that they cause the transistor to operate in the desired region of Fig. 1.

The two incremental mesh equations for the circuit of Fig. 2B are easily written by inspection as follows:

$$(Z_1 + R_E + Z_B) I_E + (R_{CE} + Z_B) I_C = 0 \quad (7)$$

$$(R_{EC} + Z_B) I_E + (Z_2 + R_C + Z_B) I_C = 0 \quad (8)$$

In order that Eq. 7 and 8 have a solution, other than the trivial one of $I_E = I_C = 0$, the determinant of the equations must equal zero. Thus

$$\begin{vmatrix} Z_1 + R_E + Z_B & R_{CE} + Z_B \\ R_{EC} + Z_B & Z_2 + R_C + Z_B \end{vmatrix} = 0 \quad (9)$$

Hence

$$(Z_1 + R_E + Z_B) (Z_2 + R_C + Z_B) = (R_{EC} + Z_B) (R_{CE} + Z_B) \quad (10)$$

$$Z_B = \frac{(Z_1 + R_E) (Z_2 + R_C) - R_{EC} R_{CE}}{R_{EC} + R_{CE} - (Z_1 + R_E) - (Z_2 + R_C)} \quad (11)$$

If stable oscillations are to occur, Eq. 11 must be satisfied at the desired real frequency ω_0 and at no other point in the complex frequency plane.

The circuit of Fig. 2C is one of several circuits suggested by Eq. 11 which, when tried, gave stable oscillation. It appeared to provide the most satisfactory operation. The circuit oscillates at the parallel resonant frequency of the tuned circuit, the frequency at which the circuit appears as a pure resistance of

magnitude approximately given by $Q\omega L$.

The sizes of R_1 and R_2 are not critical over a wide range since the transistor limits (in a manner similar to vacuum tubes) the oscillation amplitude by means of nonlinearities, which adjust the values of R_E , R_C , R_{EC} and R_{CE} . Values of 2,500 and 5,000 ohms for R_1 and R_2 , respectively, have proved satisfactory.

Caution should be observed in making R_1 and R_2 too small or in letting the d-c resistance of the parallel resonant circuit become too great; otherwise the transistor will become d-c unstable and be damaged by the excessive currents. By means of Eq. 11, d-c instability may be investigated.

When the values given for R_1 and R_2 are substituted in Eq. 11, a value of 2,600 ohms is obtained for Z_B . This value of Z_B , or greater, is readily achieved by a parallel resonant circuit which has reasonable values of Q and L/C . (The variable inductance used in the experimental oscillator had a Q of approximately 9 at the oscillation frequency.) The d-c resistance of the circuit may be easily made much smaller than 2,600 ohms so that d-c stability is assured.

An experimental transistor oscillator with a telemetering pressure gage is shown in the photograph. The battery shown will run the unit for a number of days.

Experimental values of frequency and output voltage for the circuit of Fig. 2C are shown plotted in Fig. 3 for variations in supply voltage (3A) and transistor temperature (3B). The variations with transistor temperature are undesirable, but it is considered that the temperature of the unit during flight time may be held reasonably constant. Temperature compensation is at present being investigated. The harmonic content of the output is under 5 percent. The battery drain is of the order of 0.5 to 1 ma.

REFERENCES

- (1) G. H. Melton, Multichannel Radio Telemetering for Rockets, *ELECTRONICS*, p 106, Dec. 1948.
- (2) J. C. Coe, Telemetering Guided-Missile Performance, *Proc. IRE*, p 1,404, Nov. 1948.
- (3) The Transistor—a Crystal Triode, *ELECTRONICS*, p 68, Sept. 1948.
- (4) E. A. Guillemin, "Communications Networks," 1, p 174, John Wiley and Sons, 1931.

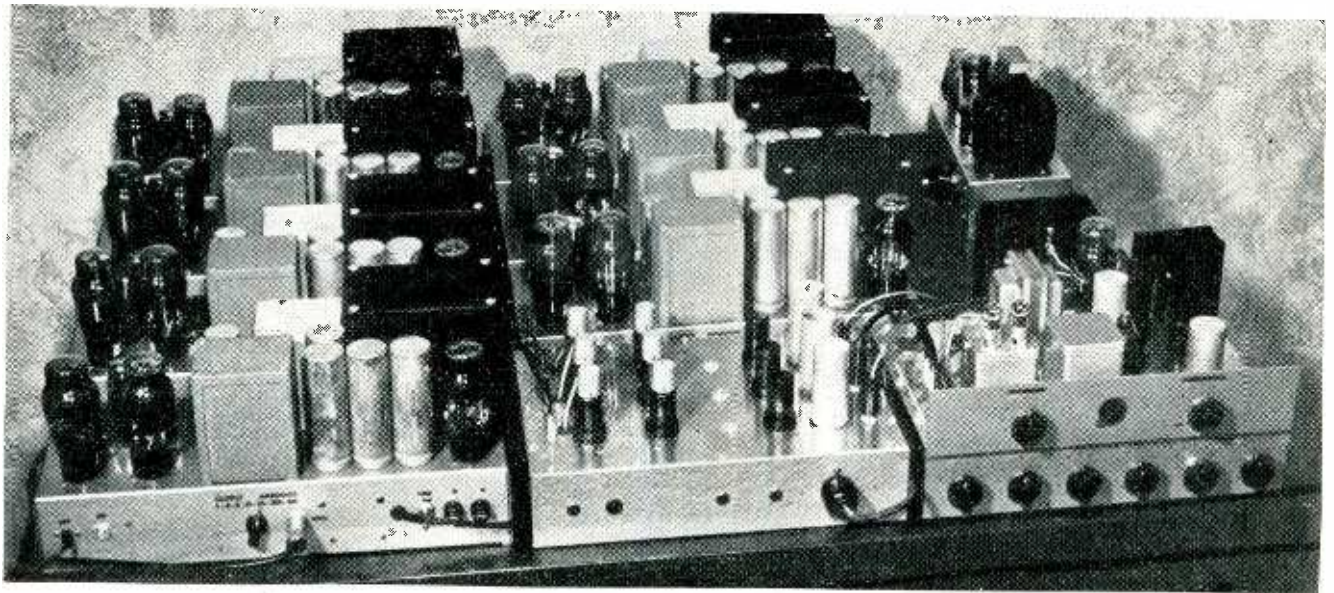

Power amplifiers and special preamplifiers for pipeless organ installation in a private home. Control panel includes facilities for feeding radio-phonograph through organ amplifiers and loudspeakers

DESIGN OF A

By **JOHN D. GOODELL**
The Minnesota Electronics Corp.
 St. Paul, Minn.

and

ELLSWORTH SWEDIEN
Mastersonics, Inc.
 Minneapolis, Minn.

Rectangular teeth moving past shaped pole pieces generate desired complex waveforms of pipe organ tones directly. Separate amplifiers and loudspeaker systems are used for each manual and for pedal keyboard. In direct-comparison listening test, performance could not be differentiated from that of corresponding three-manual pipe organ

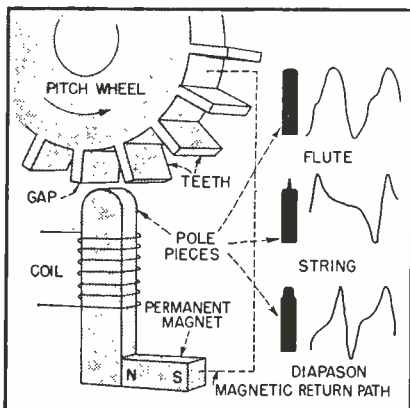

FIG. 1—Method used for generating complex waveforms directly by shaping pole piece so air gap varies as each tooth moves past, and examples of waveforms

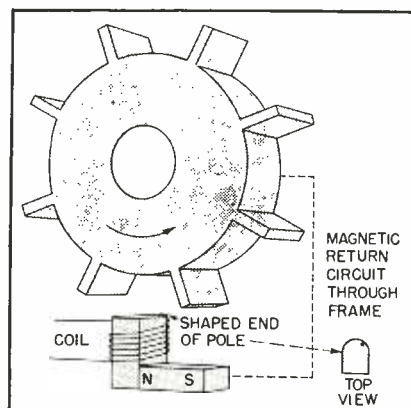
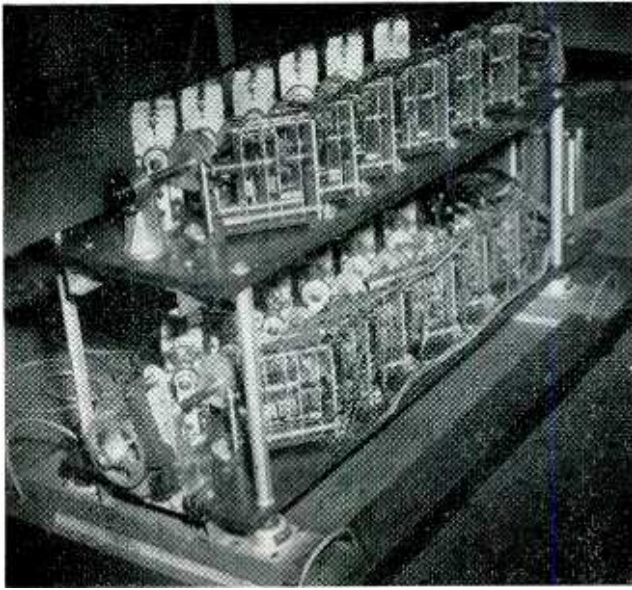

FIG. 2—Area-scanning method of generating complex waveforms, wherein air gap is constant but magnetic reluctance varies as each tooth moves past



Pitch-wheel assembly that determines frequency of one note in scale over range of seven octaves. Wheels have 1, 2, 4, 8, 16, 32 and 64 teeth respectively



Generator assembly for two-manual organ. Each manual has 12 pitch-wheel assemblies driven by synchronous motor



Console of two-manual pipeless organ. Wiring underneath and behind is similar to that of large telephone switchboard

PIPELESS ORGAN

TWO BASICALLY DIFFERENT approaches to synthesized tone qualities are possible. In one the various frequencies are generated in sinewave form, and the timbre of the steady-state tone is varied by the selection of harmonics from the sinewave source together with adjustment of their relative intensities. In this case a generator is required for each note, and, unless harmonics are drawn from the equally tempered scale, separate generators are used for each required harmonic.

The second method involves producing from each generator a complex wave representing the resultant of the fundamental and harmonic structures of the musical tone. Each stop corresponds to a complete set of generators in a manner exactly analogous to a rank of pipes. If the instrument is intended specifically to produce pipe-organ effects, this characteristic is essential. As a consequence, the complex waveform generators were chosen for the instrument to be described, which is intended to replace conventional large organs.

In most mechanisms using rotary generators the basic approach has been to shape a tone wheel so that the desired waveform will be generated in a pickup coil as the surface of the wheel moves past a pole piece. There are many obvious difficulties connected with the production of such wheels with required tolerances, and the cost is very high for the number of wheels needed.

In the organ described the rotating members are pitch rather than tone wheels. The wheels resemble conventional gears with teeth (vanes) distributed symmetrically around the periphery. The pole pieces of the pickup coils are shaped to produce the desired waveform. A number of pole pieces together with corresponding patterns are shown in Fig. 1.

There are many advantages in this system, not the least of which is the fact that a single pitch wheel may be used in conjunction with several coils and pole pieces oriented around its periphery to generate various waveforms. Pitch wheels with 1, 2, 4, 8, 16, 32 and 64 teeth respectively are assembled on a

single shaft so that each wheel corresponds to a successive octave of a single note. The shaft itself is made of non-magnetic stainless steel, and the spacers between the pitch wheels are of brass to avoid coupling between the circuits.

A total of twelve shafts with seven pitch wheels on each shaft produce all the fundamental frequencies of an organ keyboard. In order to generate the fundamentals corresponding to the 4-foot, 2-foot and 32-foot pipe pitches for various stops played in the top or bottom octaves of the keyboard respectively, it is necessary to add one or more pitch wheels to each shaft.

Each set of coil and pole piece assemblies generates a complete keyboard of corresponding waveforms. The output from the coils may be connected to one or more manuals of the organ. The only limitation on the number of stops that may be obtained in this manner is the physical dimension of each coil assembly by comparison with the outside circumference of the pitch wheels.

The complete generator assembly

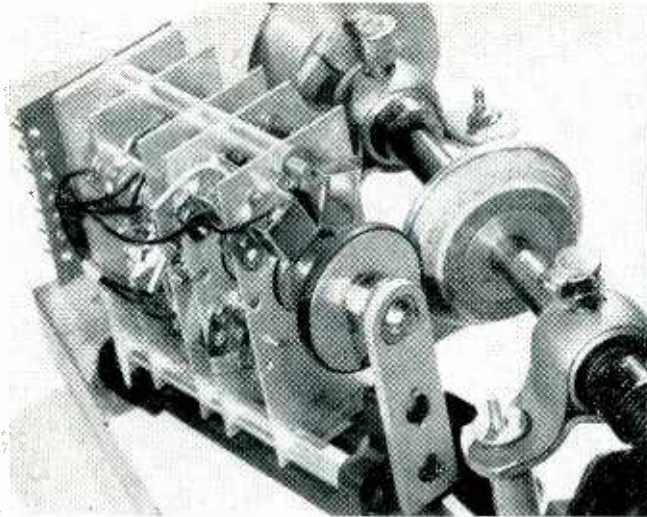

Drive system for pitch-wheel assembly (bench test setup). Tuning is done by sliding entire assembly so rubber-tired wheel shifts along surface of cone-shaped wood drive wheel. Changing diameter of drive wheel changes fundamental frequency

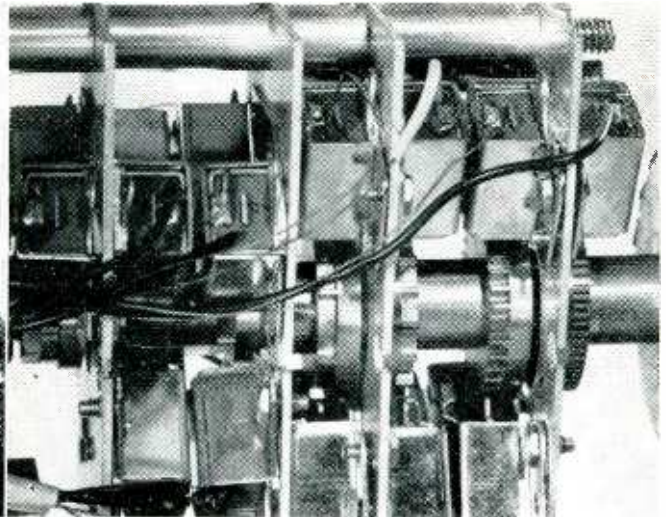

Closeup of pitch-wheel assembly, showing how coils (in rectangular shield boxes) and shaped pole pieces are distributed around periphery of each toothed wheel to get different complex waveforms and hence tones at each frequency

for a two-manual organ has twelve complete tone-wheel assemblies in the lower bank, corresponding to the complete organ keyboard fundamentals. Each tone wheel in this bank has four associated coil and pole-piece assemblies corresponding to flute, diapason, string and trumpet basic tone colors.

The upper bank of twelve complete tone-wheel assemblies includes only two sets of coil assemblies, corresponding to a flute and string tone color. The upper bank is tuned slightly sharp with respect to the lower bank and represents the celeste stops. This corresponds exactly to pipe-organ practice in which a separate rank of string pipes is tuned slightly sharp to provide a beat that sounds to the ear much like a vibrato, although the result is appreciably richer in quality than is achieved with the usual tremolo. This is one of the features of this design that contributes to its ability to conform to pipe-organ characteristics. Few pipe organs include more than a string celeste stop, but with the design described a flute celeste is not costly in comparison to adding a complete set of pipes in a pipe organ.

Tremolo Effect

Synchronous motors are used to drive the main pitch-wheel shafts through a flexible spring coupling. On the end of the main driveshaft in the lower bank is a flywheel. Sus-

ended from above and resting against this flywheel is a lever arm, with an electromagnet attached to the end just below the flywheel and with its pole piece facing an eccentric steel wheel that is driven by the main drive shaft. This is the mechanism used for obtaining a tremolo.

When the tremolo electromagnet is not energized, the lever arm simply places a small constant load on the drive shaft through friction against the flywheel. When the electromagnet is energized it is periodically attracted to the eccentric wheel so that the pressure of the lever arm is increased. This variation in load is absorbed by the spring coupling, momentarily slowing down the angular velocity of the main drive shaft and all the pitch wheels by a small amount.

When the overload is removed (as the eccentric rotates away from the magnetic structure) the spring coupling feeds the energy back into the system as a pulse that overshoots slightly, since it is not critically damped, and the angular velocity of the pitch wheels is increased beyond normal for an instant. The pickup coils see this as a variation in pitch that is alternately below and above normal, at a rate that is adjusted by the period of the eccentric wheel to be between six and seven cycles per second. The extent of the variation in pitch is determined by the amount of

energy supplied to the electromagnet. This is adjustable over a relatively wide range with a control on the console.

In this connection it is noted that there are two basic types of vibrato, one being amplitude modulation and the other frequency modulation. The frequency-modulation method is the more desirable of the two, but in many instruments is difficult to obtain with accuracy. The tremulant described may be set to produce any desired result and it is exceptionally stable in operation.

Method of Tuning

The drive system employs a simple arrangement for tuning the individual sets of pitch wheels. Spaced suitably along the drive shaft are cone-shaped wood wheels. On each side of each cone-shaped wheel is a pitch-wheel assembly, suitably oriented so that its rubber-tired drive wheel contacts the cone-shaped wheel at the correct angle.

The pitch-wheel assemblies are mounted to the base board through slots with adjustable pressure bolts so that they may be easily moved with relation to the cone-shaped wheels on the main driveshaft. The speed that they are driven depends on the size of the cone and the portion of the cone contacted by the rubber drive wheel. This permits rapid tuning of the instrument and maintains tuning over long periods of time without sensi-

tivity to temperature variables or line voltage variations within wide limits.

The entire pitch-wheel assembly is adequately shock mounted. Stability of drive requires careful attention to the mechanical reactances and resistances involved, and dynamic balance of the entire system is essential.

Scanning Methods

The waveform may be scanned either by shaping the pole piece in accordance with the instantaneous gap as in Fig. 1, which is termed profile scanning, or by the area scanning method where the gap distance is constant but the area of the pole piece is varied, as in Fig. 2.

With the profile-scanning method the effect of a given variation in the shape of the pole piece is inversely proportional to the width of the gap. It is also true that a deep sharp cleft in the pole piece does not have its full effect on the result because of fringe effects from the sides of the tooth to the steep sides of the cleft. Thus, very high harmonics are likely to be obscured, the design of the pole piece becomes critical and the dimensions of all the units in the system must be kept to a minimum.

With the area-scanning method the gap distance is a constant and the very high harmonic structures are easier to control.

The profile-scanning method is used in current designs for reasons of economy in production costs and

because it has been found possible to achieve entirely satisfactory basic organ tones with this orientation. In elaborate organs where very brilliant solo reeds are required, it is entirely practical to combine the two systems.

Pole-Piece Design

A rigorous and complete mathematical expression for predicting the dynamic flux patterns in a system of this kind in terms of the shape of the pole piece is completely impractical, if not impossible. Developing a pole piece to produce a desired voltage waveform may be approached as a first approximation by mathematical and graphic methods, however. This approximation turns out to be remarkably close to the end result, and the final touching up of the profile is accomplished on the basis of rationalizations and intuitive concepts resulting from laboratory experience.

In plotting the initial curve most of the constants and small variables are neglected and the reluctance of the gap is considered to be the only function of first order importance. The procedure is indicated in Fig. 3.

On a listening-test basis, the plotted first approximation for a pole-piece profile will usually come very close to the quality of tone for the complex waveform originally selected for synthesis and analyzed into its sine wave components. A number of small factors, such as the fact that the tooth leaving the gap is still producing some changes

in flux when the approaching tooth enters the gap, are compensated for by minor modifications of the profile.

For any given profile the higher-order harmonic content will be developed in inverse ratio to variations in the size of the gap actually established with the assembly completed. This may be used to advantage by spacing the pole piece intended to reproduce relatively pure sine wave flute tones as far as is practicable from the pitch wheels. Conversely, a trumpet pole piece may be deliberately moved in closer than planned in the initial design in order to increase its brilliance. The choice of gap for various stops is also somewhat dependent on the relative amplitude desired.

Balance of the output from various frequencies is partially accomplished by varying the number of turns on the coils. For example, a flute stop coil for the lowest frequency will require 6,500 turns of number 43 wire, while the upper register coils for the same stop will be wound with only a few hundred turns of number 39 wire.

The required shift in relative dimensions of pitch wheels and pole pieces is accomplished at the lower frequencies by making the diameter of the pitch wheels smaller and by increasing the size of the pole piece. At the higher frequencies the wheel size may be increased and the pole piece reduced.

At the low-frequency end only the portion of the pole piece that pro-

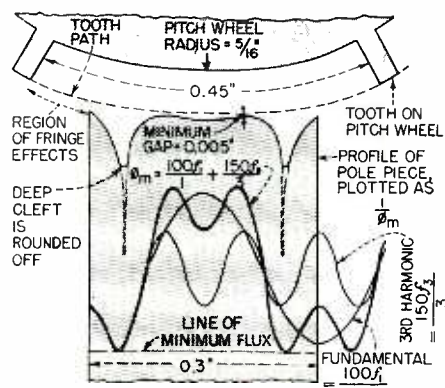

FIG. 3—Details of combined mathematical and graphical procedure for designing shaped pole piece to generate desired complex waveform of an organ tone

Mathematical Basis: The desired complex voltage waveform can be expressed in terms of its sine wave components as

$$E = A \sin \omega t + B \sin 2 \omega t + C \sin 3 \omega t + \dots \quad (1)$$

Since E is proportional to $d\phi/dt$, the flux ϕ is obtained by integration as

$$-\phi = \frac{A}{\omega} \cos \omega t + \frac{B}{2\omega} \cos 2 \omega t + \frac{C}{3\omega} \cos 3 \omega t + \dots \quad (2)$$

where A , B and C are the percentages of harmonics in the voltage waveform. Phase angles can be neglected because of the insensitivity of the ear to phase shift and unnecessary constants can be eliminated, giving for the required relative maximum flux amplitudes the simple expression

$$\phi_m = \frac{A}{1} + \frac{B}{2} + \frac{C}{3} + \dots \quad (3)$$

Graphical Design Procedure: Draw portion of tooth wheel. Draw path of tooth face (dotted). Draw pole-piece width, making it approximately two-thirds of space between teeth on wheel. Analyze desired waveform to determine relative amplitudes of harmonics. Draw fundamental so one cycle fills width of pole piece. Draw sine wave for each harmonic (only third harmonic used in example), and add to get ϕ_m . Harmonics may be shifted in relative phase to fundamental to get simplest pole-piece profile. Assume flux is inversely proportional to reluctance and hence to dimensions of gap. Measure maximum flux values with reference to minimum flux line, and plot points across edge of pole piece at distance from tooth path based on inverse ratio of respective flux values.

jects beyond the coil is enlarged. This permits holding coil dimensions constant, to simplify physical construction of the assemblies.

Output-Circuit Arrangements

The output circuit is designed so that all stops for an entire keyboard are brought to a single preamplifier input. This is schematically indicated in Fig. 4. Series resistors R_1, R_2, R_3, R_4 are used for isolation and to balance the output from various notes within a stop as well as between various stops. The resistor values range from 50,000 ohms to 1 megohm.

The key connections operate attenuators on bus-bar contacts. The circuit is designed so that the outputs from all the coils are grounded except when a key is depressed. This is essential in order to eliminate crosstalk between the circuits and requires somewhat unconventional methods.

In pipe organs the attack of the tone is modified by the discrete interval of time required for the valve to open and for the standing waves to be established in the pipe. There are many possible methods of obtaining control over the attack of the tone.

An experimental attack-controlling action used transformer coupling, with a separate transformer for each key. The primary was stationary and the secondary was moved physically by the key action so that the coupling was gradually

increased as the key was depressed. This type of action has the advantage of eliminating any possibility of clicks or other noises when the key is actuated. It has the disadvantage of being expensive to produce in satisfactory form because of coupling between circuits and such problems as obtaining adequate high-frequency response from such transformers.

In the practical organ design, the attack is controlled by attenuators carefully designed for long life and lack of noise. This type of action makes the instrument touch-sensitive, and it is possible for an experienced performer to use this feature to advantage. Careful attention to the design of this action, both mechanically and electrically, probably contributes more to the simulation of actual pipe organ effects than any other single feature. If an organist is not told in advance that this instrument generates the tones electrically, he will often have to be shown the generators before he will believe it.

Additional Tonal Variations

Since all of the generators are connected to all of the keyboards through conventional stops on the input side but are fed into separate preamplifiers at the output of each keyboard, it is possible to modify still further the tone colors available and to maintain the effect of adding ranks of pipes. For example, the output of the swell man-

ual may be fed through a flat preamplifier while the great organ is fed through a preamplifier with a pronounced rising high-frequency characteristic. Thus, although the same generator sources are used for both manuals, the stops on the great organ will be markedly more brilliant than those on the swell manual.

By using separate power amplifiers and loudspeakers for each manual, the effect obtained is analogous to doubling the number of available stops. Actually the flute stops with relatively small harmonic content will not be greatly affected by this procedure. In practice, therefore, the number of stop timbres available is increased only by approximately half in this manner. The results are entirely comparable in listening observations to adding ranks of pipes in a pipe organ.

The characteristic of a tone is modified not only by its harmonic content and the attack but also by its relative average loudness. Thus, a diapason tone generator may be fed to the same manual through two stop tabs and a distinct modification obtained by introducing a constant attenuation in the circuit of one tab only. There are innumerable permutations and combinations possible through circuitry of this kind, including octave couplers and couplers between manuals.

"On"-Effect Variations

There are many pipe-organ stops and musical instruments where the character of the sound is greatly dependent on fundamental and harmonic-content fluctuations at the start of the tone before it settles into a steady state. This is particularly true of such stops as the French horn and the gedekt flute. The design of the action and key contact arrangements make it relatively simple to obtain results of this kind.

"On" effects may be obtained through extra contactors that function only during the initial travel of the key, or through relays incorporating time-delay releases. A pitch fluctuation at the onset of a tone before it settles to a steady-state condition is easily obtained by providing a contact that momentarily energizes an arrangement

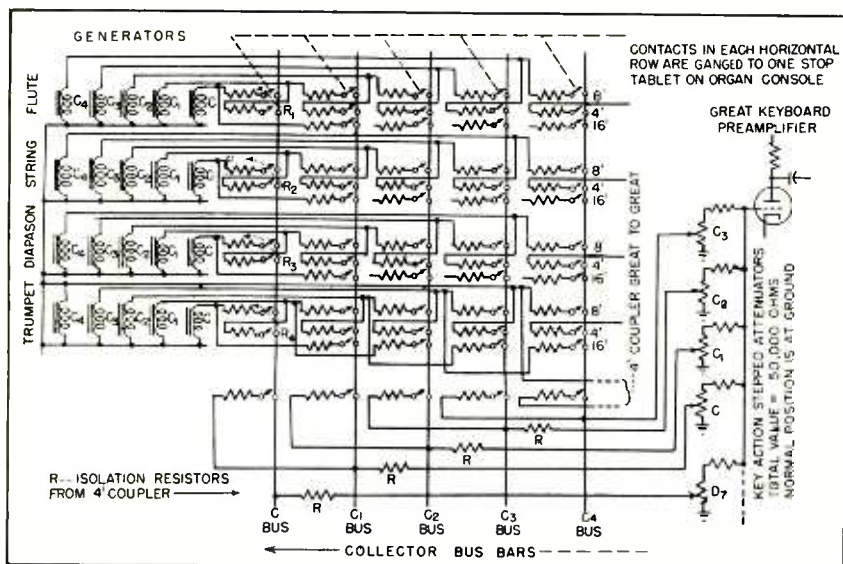

FIG. 4—Simplified schematic illustrating generator and control-circuit design principles employed in Mastertouch pipeless organ

similar to the tremulant described above.

In conventional pipe organs the variations in loudness are obtained by placing the pipes in an enclosed chamber with shutters that open and close through a foot control. In this organ an attenuator is used for this purpose, controlled by a shoe identical to those used in pipe organs. This arrangement permits precise control over the loudness and provides a dynamic range from the threshold of hearing to full organ.

A separate vernier control is provided for the pedal organ so that the organist may adjust the relative level from the pedal stops in accordance with the character of the music. This is comparable in many ways to providing additional pedal stops.

Amplifiers and Loudspeakers

In all installations a separate preamplifier and power amplifier channel are used for each manual and for the pedal keyboard. In elaborate installations one or more individual stops may be fed through separate channels. Each channel feeds a separate loudspeaker system so that a stop that appears on two or more manuals, even though it is derived from the same source, speaks from different loudspeakers often placed in different locations. Thus, even though the characteristics of the amplifiers are the same, the sound of a string when played on the great manual will be appreciably different than when played on the swell manual because of the difference in loudspeakers and the acoustic conditions of the loudspeaker locations.

It is this kind of elaboration that contributes considerably to the ability of a relatively small organ of this design, so far as tone color sources are concerned, to compete with very large pipe organs from a price standpoint. As an example, a recent installation was quoted at \$18,000 for a three-manual instrument in a large church. Pipe organ quotations for comparable results ranged from \$60,000 to \$100,000.

The electrical audio power required is greatly dependent on the acoustic characteristics of the au-

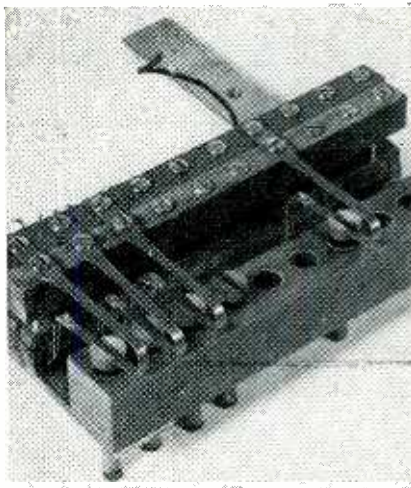

Attenuator arrangement used on keys for controlling attack. Wire contacts soldered to flat springs are moved over wire-wound attenuator when keys are pushed

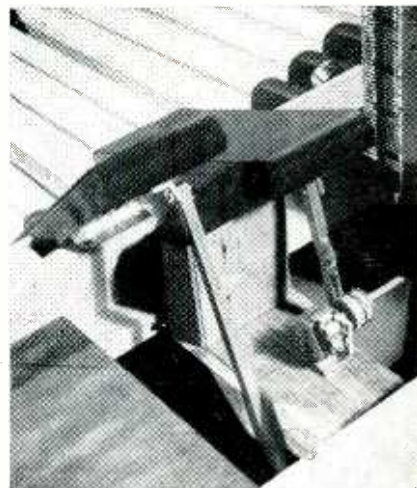

Method of obtaining potentiometer rotation with swell shade shoes. Pedal organ may be coupled to either section. Cable on lever rotates potentiometer shaft

ditorium in which the instrument is installed. The acoustic power output of a large pipe organ is greater than most people realize. In general, it is desirable to be able to produce with full organ a minimum of 100 decibels above the reference threshold as measured with a commercial sound-level meter in all listening locations.

The peak power from organ music is in the lowest pedal octave. In an effort to produce satisfactory pedal tones without duplicating the peak power output of a pipe organ, it is not uncommon to use 16-foot stops that are rich in harmonic structures. This simulates the loudness subjectively observed but falls far short of achieving the full deep foundation tone of a real 16-foot pipe.

Perhaps the most important pedal stop is the 16-foot bourdon (a relatively pure flute tone). To produce it from a loudspeaker system at full pipe organ level requires carefully designed enclosures and exceptionally clean power amplifiers. In a typical church installation where the seating capacity was around 1,500 and the reverberation time relatively low, 100 watts of electrical audio power fed to five efficient loudspeaker systems (consisting of a total of 130 loudspeakers) was required for satisfactory results.

The only really satisfactory subjective criterion of performance in audio work is direct comparison. In

the installation described above it was possible to make such a comparison with a three-manual pipe organ having eighteen ranks of pipes. The test was made with fifteen observers. All but two of the observers were critical listeners thoroughly familiar with pipe-organ tonal attributes, either by virtue of being professional organists, engineers who had participated in the installation, or because of an interest in organ music.

The test was made entirely on the basis of whether the observers could differentiate between the instruments. A few bars of music were played twelve times on each organ using various stops. Flute, diapason and string stops were used separately and in combination.

Several of the engineers admitted that their judgments included an intimate knowledge of characteristics in the organs that had little to do with the quality of the tone. Even with this added factor, no single score was high enough to be significant of anything except the close similarity in the basic character of the instruments.

BIBLIOGRAPHY

- G. T. Winch and A. M. Midgley, Electronic Musical Instruments and the Development of the Pipeless Organ, *The Journal of the Institution of Electrical Engineers*, June 1940.
- E. Meyer and G. Buchmann, Abhandlungen der Preussischen Akademie der Wissenschaften, 1931.
- J. D. Goodell and B. M. H. Michel, Auditory Perception, *ELECTRONICS*, July 1946.
- J. D. Goodell, Special Loudspeaker Systems, Part II, *Radio and Television News, Radio-Electronic Engineering Edition*, June 1949.

Circuit Techniques

Controlled positive feedback between stages can often eliminate such bulky circuit components as cathode and screen bypass capacitors and video-amplifier compensating inductors, with corresponding savings in physical size and cost

By **PETER G. SULZER**

*Engineering Experiment Station
The Pennsylvania State College
State College, Pennsylvania*

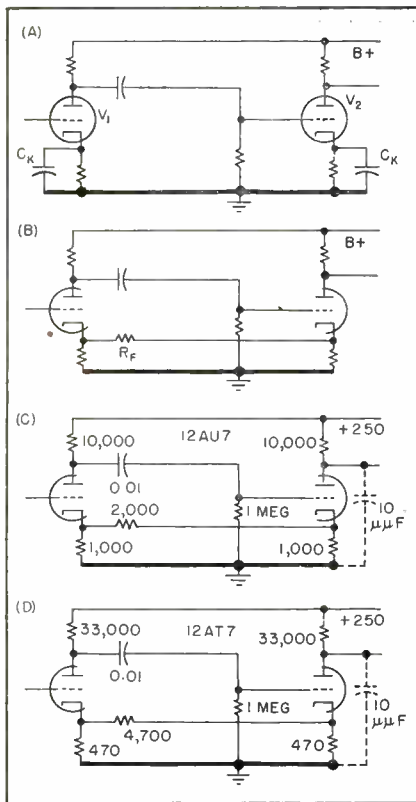

FIG. 1—Positive feedback circuits for eliminating cathode-bypass capacitors

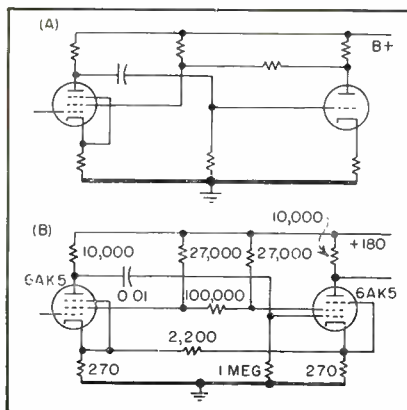

FIG. 2—Screen-bypass capacitors can often be eliminated by positive feedback

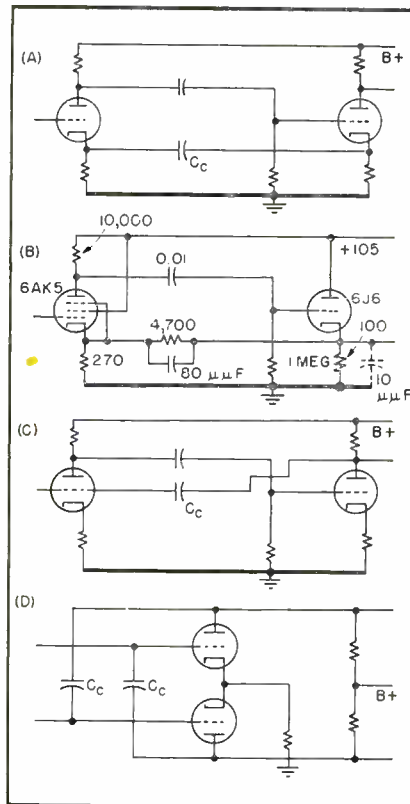

FIG. 3—Circuits for high-frequency compensation by means of positive feedback

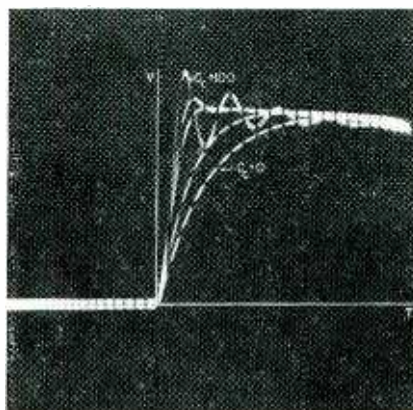

FIG. 4—Response of the circuit of Fig. 3B for various degrees of compensation

MODERN TRENDS toward compact equipment have resulted in the production of very small tubes and resistors. Unfortunately, however, high-value capacitors and air-core inductors have not seen a comparable reduction in size. Consequently these circuit elements are inconvenient to use when printed-circuit techniques are employed, since they must usually be treated as separate assemblies.

It is the purpose of this paper to point out that controlled positive feedback can often be used to avoid the use of such components. In this way, cathode-bypass and screen-bypass capacitors can often be eliminated, and video-amplifier compensating inductors can be replaced with small feedback capacitors.

Cathode-Bypass Capacitors

Figure 1A shows a conventional, two-stage triode amplifier. Capacitors C_K are the most bulky elements, 10 microfarads being a typical value for audio-frequency applications. If these capacitors are omitted, a serious reduction in gain occurs because of cathode degeneration.

It is apparent that, with the capacitors omitted, the voltages across the two cathode resistors will be 180 degrees out of phase. Furthermore, the cathode voltage of V_2 is greater than that of V_1 . This suggests positive feedback by means of a resistor R_F , connected between the cathodes as shown in Fig. 1B. With normal circuit values, the regeneration can be set to the point where the voltage gain is the same as that obtained with bypassed cathodes.

Since the feedback occurs at a low

For Miniaturization

impedance level, the feedback loop itself does not normally affect the frequency response of the amplifier. It should be noted, however, that defects in the response of the original amplifier will tend to be accentuated by regeneration.

An expression has been obtained for the optimum value of R_p ; however, it is too cumbersome to be of practical value. Therefore an experimental determination is necessary. Figure 1C shows a two-stage amplifier using a 12AU7 dual triode. The voltage gain is 80, while the bandwidth is 250 kc at 3 db down. A feedback resistor of 2,000 ohms was necessary.

The circuit of Fig. 1D is interesting since a voltage gain of over 1,000 is obtained in a single tube, with a bandwidth of 100 kc. This permits the construction of a two-tube (four-stage) amplifier with a gain of one million, and with a volume of only six cubic inches.

The amplifiers of Fig. 1C and 1D show a 12-percent reduction in gain for a 20-percent reduction in supply voltage. Although this is somewhat greater than would be obtained with bypassed cathodes, it is not considered excessive for most applications. Thus it is possible to replace two electrolytic capacitors by a single, $\frac{1}{2}$ -watt resistor and have almost equivalent performance.

Screen-Bypass Capacitors

It is evident that screen-bypass circuits can be handled in much the same manner as cathode-bypass circuits. The problem is slightly different, however, because of the higher impedance level of the screen circuits.

Figure 2A shows a method in which the screen transconductance of the first stage is balanced by a current supply obtained from the plate circuit of the second stage. This method can be applied to all but the last stage of a multistage amplifier. Since the impedance of the screen-supply source may be high, degeneration can occur at the higher frequencies. Therefore a

small bypass capacitor may be necessary in video applications. In some cases the resistor shown from screen to B+ may not be necessary.

Figure 2B shows another method which is the exact analog of the cathode-to-cathode feedback scheme. Here, sufficient positive feedback is applied to the screen of the first tube to offset the screen degeneration in both tubes. It should be noted that the frequency response may suffer if the screen-dropping resistors are of high value. However, small bypass capacitors cannot be applied because they would affect the feedback loop. The voltage gain of the voltage amplifier shown is 2,500, and the bandwidth is 100 kc.

High-Frequency Compensation

The voltage gain of a positive-feedback amplifier is given by

$$A_{FB} = \frac{A\beta}{1 - A\beta}$$

where A_{FB} is the gain with feedback, A is the gain without feedback, and β is a factor giving the portion of the output voltage fed back to the input.

Here the product $A\beta$ is taken as a positive quantity. At the higher frequencies, the magnitude of A will decrease because of circuit-capacitance loading. If, then, the magnitude of β can be made to increase at the proper rate with frequency, the numerator and denominator of A_{FB} would decrease together, and A_{FB} would be independent of frequency (neglecting phase shifts). Although this result cannot be achieved in practice, partial compensation is possible.

Figure 3A shows one simple method applied to a two-stage amplifier. A small capacitor is connected between the cathodes of two adjacent stages. Since the positive feedback increases with frequency, a rising gain characteristic can be obtained, which will tend to offset the decrease in gain caused by circuit capacitances. The equation giving the gain of the feedback

amplifier as a function of frequency is too complicated to be of value for obtaining the proper value of C_c . This must therefore be determined by experiment.

Figure 3B is a diagram of an amplifier employing this type of compensation. It consists of a high-gain pentode stage driving a cathode follower which provides low output impedance. It will be noted that the pentode cathode-bypass capacitor has been eliminated by the method given above. Therefore, there are two feedback paths between the cathodes, one for this purpose and one for high-frequency compensation. Figure 4 shows the response of the amplifier to a step function with different values of C_c . These range from 0 to 100 μf , the highest value providing the oscillatory transient. The blank spaces mark intervals of 0.2 microsecond.

Strictly speaking, this type of compensation should be considered applied only to the first stage of Fig. 3A. Compensation for the next stage must be obtained from the following stage, if any. In adjusting the compensating capacitor in Fig. 3A, care should be taken to prevent the frequency response of the following stage from confusing the issue. The question of just what degree of compensation can be obtained has not been answered analytically. It is found in practice, however, that the 3-db-down bandwidth can usually be doubled by this method.

Another method of compensation is shown in Fig. 3C. Here, capacitive feedback is used between the plate of each stage and the grid of the previous stage. This scheme, which can be considered as a negative-capacitance amplifier, has been described before.¹

Compensation can be applied to a push-pull amplifier by over-neutralization, as shown in Fig. 3D.

REFERENCE

- (1) MIT Radiation Series, "Waveforms," p 767, McGraw-Hill Book Co., New York, N. Y.

LOGARITHMIC-SCALE

A direct-current voltmeter developed as an output meter for a standard noise-measuring device has a range of more than two decades. Electrical multiplication and division by addition and subtraction of logarithms and measurements of sound or decaying intensity of a radioactive source are possible

THE LOGARITHMIC direct-current voltmeter circuit to be described was developed as an output meter for a proposed standard noise-measuring instrument. Because of its logarithmic characteristic, it has other possible useful applications.

The principal requirements of a logarithmic voltmeter are: (1) A truly linear relationship between the logarithm of the input and the output over a large range of inputs, (2) stability of response with respect to time and all uncontrollable factors (voltages, bias, electromagnetic and electrostatic pickup), (3) simple construction from readily available standard parts.

Principle of Operation

In Fig. 1, which is idealized, a hot, very large plane *K* emits thermal electrons that are collected on a plate *P* against a retarding potential of *E* volts. Because of the initial velocities, some of the electrons are able to reach the plate even when the plate has a negative or retarding potential. The number that reach the plate for any retarding potential *E* depend upon the temperature of the emitter and the distribution of velocities of the emitted electrons. Assuming that the emitted electrons obey the Maxwell-Boltzmann energy distribution, the fraction n/N_0 of the electrons which are capable of moving against a retarding potential *E* is given by the Boltzmann equation shown be-

low in which there is the relation

$$n/N_0 = e^{-Ee/KT} \quad (1)$$

This equation may be written

$$E = - (300 KT/e) \ln i + \text{constant} \quad (2)$$

$$= - (690 KT/e) \log i + \text{constant} \quad (3)$$

where $i = n/N_0$ is the current, *K* is the Boltzmann constant, *e* is the electronic charge in esu and *T* is the temperature which is characteristic of the Maxwellian distribution. This equation holds when there is no potential minimum between the two electrodes and when

the cathodes are perfectly homogeneous.

The principle of operation with the tube employed is based on the fact that the insertion of a resistance in series with the grid, large in comparison with grid-cathode resistance of the tube, will cause the grid-cathode voltage to be negative and hence act as a retarding potential. As the impressed voltage is increased the retarding potential (grid-to-cathode voltage) decreases and bears a logarithmic relation to the impressed voltage. Over the range in which the plate current is linear with the grid-cathode voltage the plate current will be logarithmic with the impressed voltage.

Experimental Circuit

In Fig. 2 is shown the experimental logarithmic circuit that employs a type 6J5 triode as the logarithm tube. The 6J5 tube was selected after testing several triodes and pentodes since it gave the most satisfactory straight-line characteristics. A normal heater voltage of 6.3 volts was used. The plate current that flows with zero applied voltage was balanced out of the meter by means of an equal and opposite current as shown in the diagram.

In Fig. 3A is shown the relationship of the change in plate current to the logarithm of the input voltage. The linearity of the response is apparent from the graph. The logarithmic relationship exists over

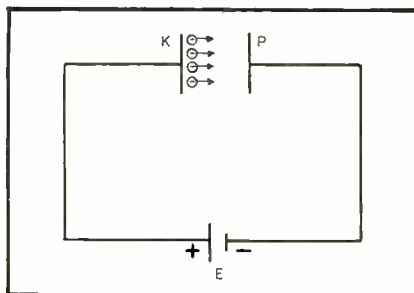

FIG. 1—Flow of electrons from *K* to *P* against retarding potential *E* is possible because of initial velocities

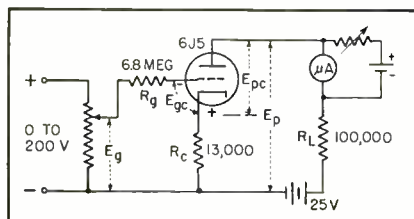
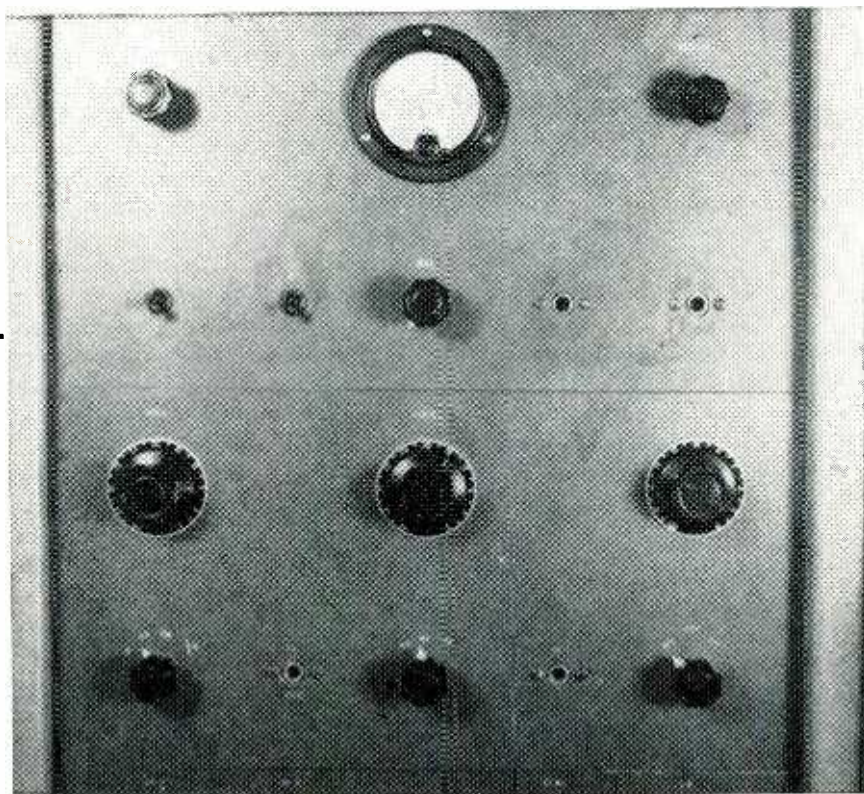

FIG. 2—Experimental d-c logarithmic voltmeter

NOISE METER



Rack-mounted logarithmic voltmeter used in CBC laboratory microphone calibrator for measuring the ratio of two microphone responses

a range of 0.5 to 200 volts, or

$$\text{db} = 20 \log_{10} \frac{200}{0.5} = 52 \text{ db}$$

Changing the heater voltage changes the slope of the straight line and therefore it is extremely important that no variation occur in the heater voltage.

The function of the cathode resistor R_c is to improve the logarithmic characteristic at low-voltage inputs; the circuit being a simple form of current feedback. The voltage fed back is that due to the current through R_c and is nearly proportional to it if R_c is much less than R_p . As the signal current is increased (if only slightly) the feedback voltage increases entirely at the expense of E_{cc} , which is thus unable to maintain the signal to the tube even at its original level. The tendency for the output cur-

rent to rise is therefore checked, just as if the tube had a large R_p . The dashed line B in Fig. 3 shows the resulting curve if R_c is not used. At higher impressed voltages the effect of the feedback is negligible.

A graph of the relationship between the logarithm of input voltage and the grid-cathode voltage is given in Fig. 4. This graph shows that a logarithmic relationship exists between the two over a range of approximately 40 db which is in accord with the principle of operation of the circuit.

Balanced Amplifier

The maximum sensitivity obtainable with the vacuum-tube voltmeter is limited by the stability that can be achieved in balancing out the d-c plate current from the meter. This condition results be-

By **WALTER J. IVES**

*Project Engineer
Northern Electric Co.
Belleville, Ontario
Canada*

cause the less the current required for full-scale deflection the more precise must be this balance if the deflection in the absence of a signal is not to drift appreciably from zero.

The chief difficulty in maintaining an accurate zero balance comes as a result of variations in tube voltages, through variations in tube characteristics either through aging or merely as a result of the warming up of the tube. By carefully regulating the power source, including the filament and anode, small voltages may be measured accurately with the vacuum-tube voltmeter. It is also helpful to employ circuit arrangements that are inherently stabilized against changes. A comprehensive balancing system is obtained by using an auxiliary balancing tube to prevent zero drift. This auxiliary tube must have an equivalent amplification factor and plate resistance that are the same as for the voltmeter tube, so that when the two tubes are placed in a bridge circuit, the effect of variations in the supply potential on the zero deflection of the output meter can be balanced out.

Such an arrangement is shown in the circuit of Fig. 5. The bridge circuit consists of a twin triode 6F8G tube with each triode connected in two adjacent arms and two equal resistors in the other adjacent arms. The output from this tube is further amplified by direct-coupled 6F6 tubes connected

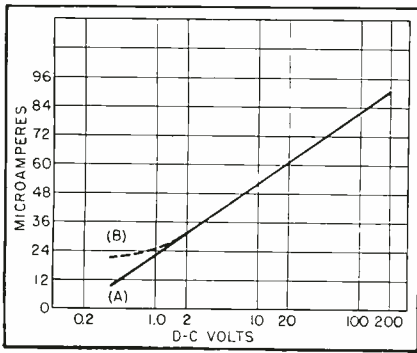

FIG. 3—Logarithmic characteristic with resistor (A) and decreased range (B) with resistor omitted

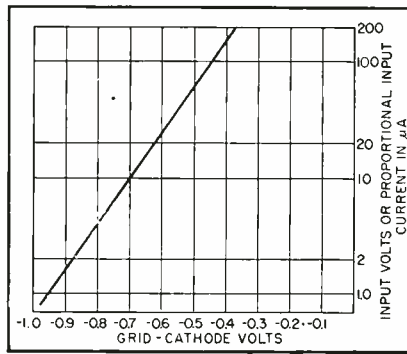

FIG. 4—Retarding potential characteristic of grid-cathode voltage versus input voltage or proportional input current

as cathode followers and fed to a milliammeter. A potentiometer at the midpoint of the cathode resistors of the 6F6 tubes enables the balancing out of any residual current for zero deflection on the meter.

The voltage to be measured is applied between grid and ground of one voltmeter tube, while the grid of the other voltmeter tube is directly grounded. With no input voltage, the plates of the two triodes are at the same potential, and no current flows in the indicating meter. With d-c voltage applied to the grid of the voltmeter triode, the plate resistance of this triode is changed and the bridge is unbalanced causing a current to flow in the indicating meter. The heater of the twin triode is common to both cathodes, so that changes in initial velocity of electron emission occurring because of any fluctuations of cathode temperature appear equally in both sides of the bridge circuit, and because they are balanced out, do not appear on the indicating instrument.

In this circuit arrangement the relationship of change in plate current to the logarithm of the input voltage is of the same form as that in Fig. 3A. The logarithmic relationship extends over a range of 0.5 to 200 volts or 52 db as before.

Using a type 5692 RCA red-base twin triode as the logarithm tube results similar to the above were obtained. This tube has some useful features for this type of application. Its rated long life, uniformity, stability and rigidity are

important features in the design of a noise meter. Used in the balanced circuit, a very small amount of compensation is required in balancing out the initial plate current at zero applied voltage.

Ratio Measurement

The circuit arrangement in Fig. 5 may be used for measuring the ratio of two d-c voltages by applying one to the upper half of the circuit and the second one to the lower half. The indicating meter will respond to the difference between the output of the two channels and so is equivalent to the difference of the logarithms or the ratio of the two applied d-c voltages. An indicating meter calibrated in decibels would give direct db readings.

For dealing with rapidly varying currents, it is necessary to take into account the rate at which the tube will follow the variations. It is possible to calculate this ability to follow. If the dynamic resistance R is defined as the rate of change of voltage with current, then it is inversely proportional to the current.

Differentiating Eq. 2.

$$R = \frac{d(-E)}{d i} = \frac{300 KT}{e} \frac{1}{i} \quad (4)$$

Differentiating Eq. 3

$$\frac{d(-E)}{d \log i} = \frac{690 KT}{e} = 0.25 \quad (5)$$

(Slope of Fig. 5)

therefore

$$R = \frac{0.25}{2.3 i} = \left(\frac{0.11}{i} \right) \quad (6)$$

Since there is an unavoidable capacitance C associated with the

logarithmic tube and its circuit, the time constant RC becomes

$$RC = \frac{0.11 C}{i}$$

For an assumed capacitance of 10^{-10} farads and a current of 10^{-8} amps, $RC = 10^{-5}$ seconds. Thus except for extremely rapid current variations or very small currents the logarithmic amplifier will follow.

In a noise meter the detector and the indicating device require extremely careful investigation. Specifications so far set up for such apparatus are definite, but the effectiveness of the devices so specified for measuring noise is questionable. This results in part from the wide variations in the peak values and waveforms of the voltages fed to the device.

A scale on the indicating meter which is logarithmic in character has several advantages over a linear scale. In the first place it fulfills the psychological conditions of Weber's Law and in addition makes the use of fewer attenuator taps possible in the measurement of widely varying amplitudes which are characteristic of some types of noise, with resultant increase in simplicity of construction and use.

Three devices which have been used to accomplish the logarithmic characteristic in a noise meter are 1. Automatic gain-controlled i-f stages using variable- μ tubes; 2. An indicating meter using specially shaped pole pieces; 3. A logarithmic d-c amplifier between the detector and a linear indicating device.

Various writers have shown that the avc circuit used to obtain the logarithmic response has a great influence on the charge and discharge times of the detecting circuit especially for signals for which the ratio of peak to average is large and result in inaccurate indicating meter readings. The logarithmic d-c amplifier described in the preceding paragraphs provides a simple and satisfactory means of obtaining a logarithmic response when coupled to the detector of the noise meter. The charge and discharge times may be readily determined by the circuit values of the detector without the undesirable

effect of automatic volume control.

Since a noise meter is basically a radio receiver, a laboratory NC-200 receiver was modified and adapted for use with the logarithmic d-c amplifier. To utilize fully the logarithmic amplifier, a linear output at the detector of the receiver with a range of 0 to 200 volts d-c is required. In order to approach this range it is necessary to use a complex type of coupling between the second i-f and second-detector stages. The modified detector and coupling circuit of the NC-200 receiver to which the d-c amplifier has been coupled is shown in Fig. 6. A 6H6 diode detector was chosen because of its simplicity and reliability of performance. Another advantage of its use here is that there is no fixed bias in the load circuit and hence for zero signal there is zero d-c output from the detector. Using this circuit the overall characteristics of the receiver from the r-f input to the output of the logarithmic d-c voltmeter were taken for various r-f gain settings. From these results it has been found that a logarithmic relationship exists over approximately two decades. The range of the voltmeter is not fully utilized due to the overloading of the receiver at high inputs and square-law detection taking place at low inputs. However, a range of 40 db is suitable for this application.

Functional Details

The range of inputs to the noise meter is in the order of 10 to 100,000 microvolts and since the meter scale is only useful over a ratio of inputs of about 100 to 1 by virtue of the logarithmic system used, a calibrated attenuator with multiples of 10 and 100 must be used. This attenuator may be of the resistance, capacitance, or mutual inductance type and operated in the i-f amplifier section of the noise meter.

It is desirable that the time constants of the noise meter be determined by the circuit values of the detector rather than by indicating meter constants, because the former are more readily determined and may be held more closely. By making the circuit charge time short

and discharge time long in comparison with the indicating meter time constant, this may be accomplished. In considering the mechanism of build-up of voltage to the peak value, it should be borne in mind that noise voltages consist of a series of impulses, the measured voltages reaching essentially peak value after the first few pulses. In the rare case of noise consisting of a single pulse or pulses with a repetition time longer than the discharge time constants of the meter-

ing circuit a value considerably less than the peak would be indicated. However, experience would tend to show that the disturbing effect of such noises on the listener is less than would be indicated by their peak amplitude. From a standpoint of circuit design limitations a charge time constant of the order of 10 milliseconds and a discharge time constant of 600 milliseconds appears to be desirable.

Further Applications

There are other possible applications for the logarithmic voltmeter. The principle might be used to measure a recording on a logarithmic scale, so that a large range of inputs can be measured with a constant fractional accuracy. It also makes possible electrical multiplication and division by the addition and subtraction of logarithms. The equipment might be particularly valuable in taking the logarithms of such quantities as sound intensity and decaying intensity of a radioactive source, in which the logarithm gives some specially useful property or has some special significance.

Acknowledgment

The author wishes to acknowledge the facilities kindly placed at his disposal by the Canadian Broadcasting Corporation, and also to J. E. Hayes of CBC who gave invaluable assistance throughout this work in 1946, at which time the author was engaged in graduate studies under the direction of F. S. Howes of McGill University.

BIBLIOGRAPHY

- C. V. Aggers & Foster, Instruments and Methods of Measuring Radio Noise, *AIEE Technical Paper*, May 1939.
- Investigations of the Measurement of Noise, University of Pennsylvania, October 31, 1945.
- K. A. Mackinnon, Measurements of Time Constants of Commercial Noise Meters, Canadian Broadcasting Corporation.
- E. L. Chaffee, "Theory of Thermionic Vacuum Tubes," McGraw-Hill Book Co., New York.
- Meagher & Bently, Vacuum Tube Voltmeter, *Rev. Sc. Instr.*, November 1939.
- F. E. Terman, "Radio Engineers' Handbook" McGraw-Hill Book Co., New York.
- C. W. Frick, Study of Wave Shape for Radio Noise Meter Calibration, *AIEE*, September 1945.
- J. T. McCarthy, Improved Vacuum Tube Voltmeter, *ELECTRONICS*, July 1945.
- D. H. Bastin, Microphone Calibrator, *ELECTRONICS*, November 1948.
- C. W. Burrill, Progress in the Development of Instruments for Measuring Noise, *Proc. IRE*, Vol 29, 1941.
- E. L. Ginzton, D. C. Amplifier Design Technique, *ELECTRONICS*, March 1944.

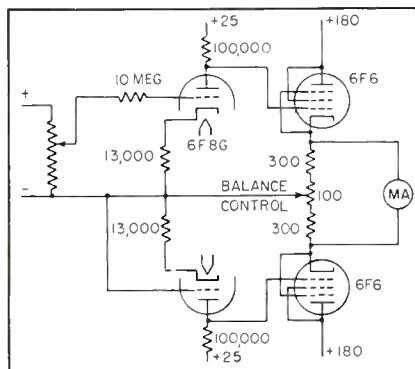

FIG. 5—Balanced d-c amplifier with logarithmic amplification over a 52-db range

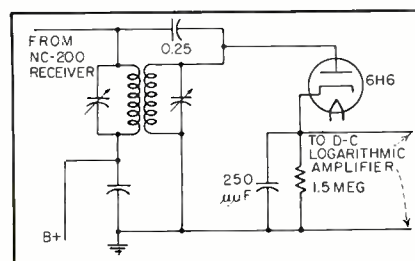

FIG. 6—Coupling circuit used between receiver and amplifier

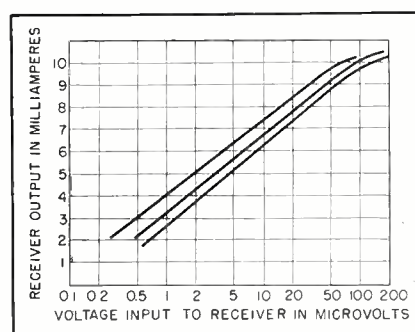

FIG. 7—Logarithmic output characteristic of the receiver using the d-c logarithmic voltmeter at three different r-f gain control settings. A linear range of 40 db for each r-f setting is indicated

High-Frequency

Determination of input impedances and matching-stub dimensions are simplified by the use of this chart which features straight-line loci instead of curves as in conventional circle diagram and Smith charts. Sample problems are shown

By **PRESTON R. CLEMENT***

*Department of Electrical Engineering
University of Kansas, Lawrence, Kansas*
**Now with Princeton University
Princeton, N. J.*

THE CIRCLE DIAGRAM and the Smith chart^{1,2} are convenient methods for solving input impedance and matching-stub problems on high-frequency dissipationless transmission lines. However, by properly manipulating the equations of which these two charts are a part, a third chart can be developed which has the advantage that in working such problems a straight-line locus is followed in the chart, rather than a curved one.

If a given transmission line has a length s , phase shift β radians per unit length, characteristic impedance R_c , and receiving end impedance \bar{Z}_R , then the impedance at the sending end is given by the well-known formula

$$\bar{Z}_s = R_c \frac{1 + \Gamma \epsilon^{j(\psi - 2\beta s)}}{1 - \Gamma \epsilon^{j(\psi - 2\beta s)}} \quad (1)$$

where $\Gamma \epsilon^{j\psi}$ is called the reflection coefficient of the line and is equal to the ratio of the reflected component to the incident component of voltage at the load. In terms of impedance

$$\Gamma \epsilon^{j\psi} = \frac{\bar{Z}_R - R_c}{\bar{Z}_R + R_c}$$

Letting $\phi = \psi - 2\beta s$

$$\bar{Z}_s = R_c \frac{1 + \Gamma \epsilon^{j\phi}}{1 - \Gamma \epsilon^{j\phi}} \quad (2)$$

To achieve a per unit basis, let $\bar{Z}_s/R_c = r + jx$. Then Eq. 2 becomes

$$r + jx = \frac{1 + \Gamma \epsilon^{j\phi}}{1 - \Gamma \epsilon^{j\phi}} \quad (3)$$

Thus

$$\Gamma \epsilon^{j\phi} = \frac{r - 1 + jx}{r + 1 + jx} \quad (4)$$

If this last equation is solved by equating magnitudes and equating

angles, the following pair of equations are obtained

$$\left[r - \frac{1 + \Gamma^2}{1 - \Gamma^2} \right]^2 + x^2 = \left[\frac{2\Gamma}{1 - \Gamma^2} \right]^2 \quad (5)$$

$$r^2 + (x - \cot \phi)^2 = \csc^2 \phi$$

These are equations of circles which when plotted give the circle diagram with families of constant Γ and constant ϕ circles superimposed on the r and x rectangular grid. To include all possible r and x values, however, a diagram infinite in extent is needed.

If Eq. 4 were solved by equating reals and equating imaginaries, the pair of equations that would be obtained are

$$\left[u - \frac{r}{1+r} \right]^2 + v^2 = \frac{1}{(1+r)^2} \quad (6)$$

$$(u-1)^2 + (v-1/x)^2 = 1/x^2$$

where $\Gamma \epsilon^{j\phi} = u + jv$. A plot of Eq. 6 gives the resistance and reactance circles on the familiar Smith chart.

However, if Eq. 3 were to be solved for Γ and ϕ , a new chart would result. By rationalizing the denominator in Eq. 3 and simplifying

$$r + jx = \frac{(1 - \Gamma^2) + j2\Gamma \sin \phi}{(1 - \Gamma \cos \phi)^2 + \Gamma^2 \sin^2 \phi} \quad (7)$$

Equating reals

$$\cos \phi = \frac{r(1 + \Gamma^2) - 1 + \Gamma^2}{2\Gamma r} \quad (8)$$

Equating imaginaries

$$x(1 + \Gamma^2) - 2\Gamma \sin \phi = 0 \quad (9)$$

The chart shows Eq. 8 and 9 plotted on a rectangular $\Gamma - \phi$ grid for constant r and x loci. The curves beginning at the right-hand axis where $\Gamma = 1$ and curving back to 1,0 are reactance loci, while the

resistance loci extend in quasi-radial curves from the point 1,0. This chart could also be obtained, of course, by a point-to-point plotting process from the other diagrams.

The chart shows only positive values of x . From Eq. 9 it is seen that if x were chosen negative and ϕ negative, (or ϕ greater than 180 deg), the equation has merely been multiplied through by (-1) . Therefore, to complete the chart, a second half-chart could be drawn for negative values of x , with ϕ ranging from 0 to -180 deg, but it would be merely a reflection of the chart shown about the Γ axis, and therefore not necessary, as the following example shows.

EXAMPLE 1. Calculation of input impedance. Let $R_c = 250$ ohms, $\bar{Z}_R = 500 + j375$ ohms, and $\beta s \pm 50$ deg. Then $\bar{Z}_R/R_c = 2 + j1.5$ and the chart shows a reflection coefficient of approximately $0.535/30$ deg. This corresponds to \bar{A} below. Now subtract $2\beta s$ or 100

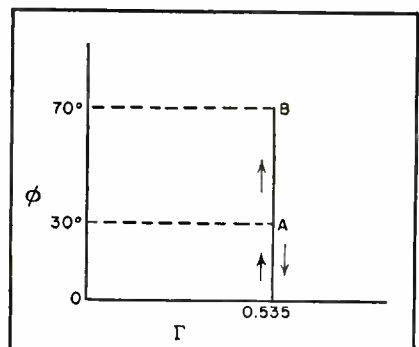

Partial diagram illustrating use of curve for finding input impedance

Transmission Line Chart

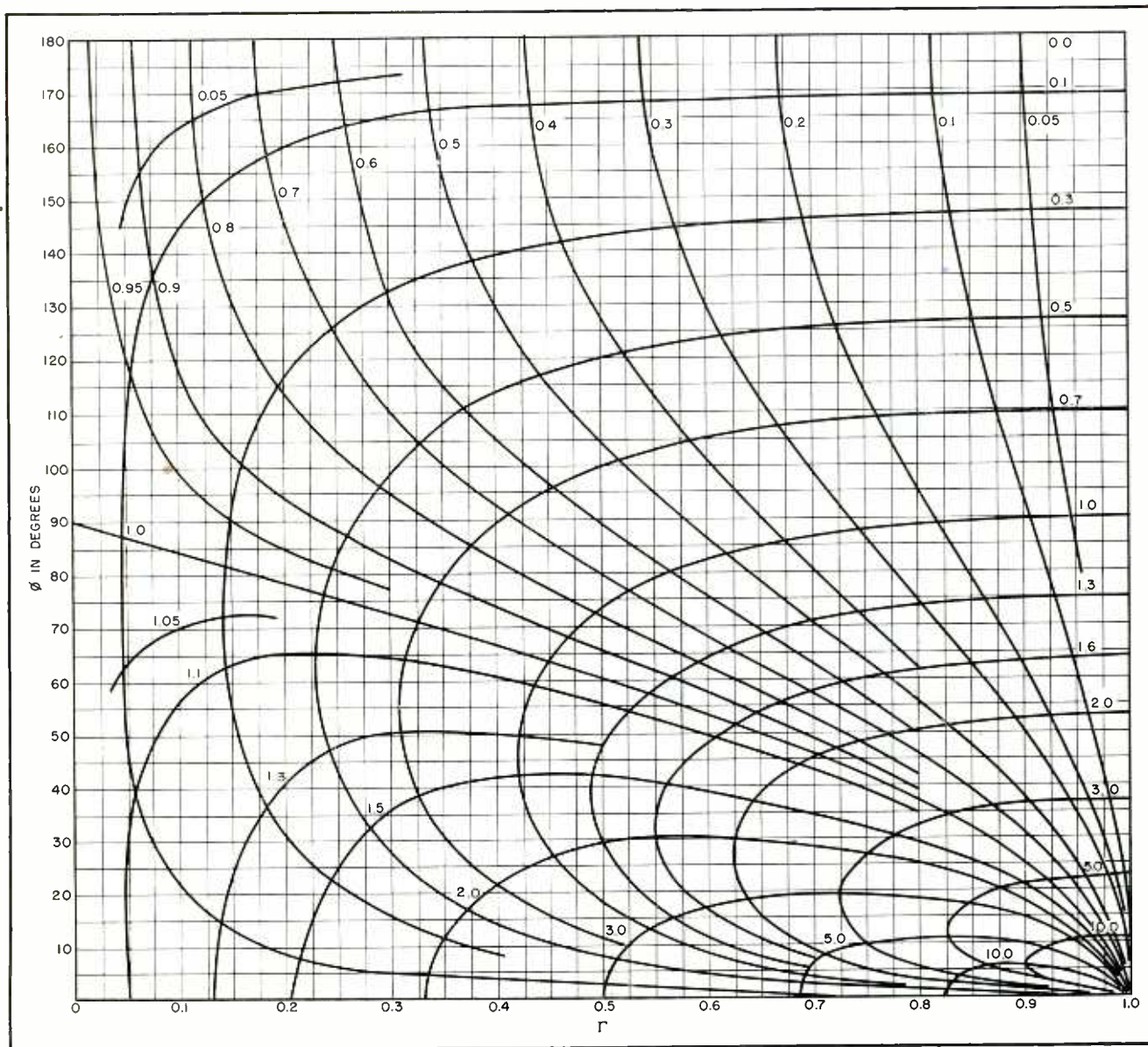

deg from 30 deg, giving -70 deg. We may read the proper value at $\phi = +70$ deg, keeping in mind that x would be negative in the other half chart.

Thus following the straight Γ line of 0.535 down to zero and back up to B or 70 deg, we read $0.77 - j1.1$. Therefore, $\bar{Z}_s = 250 (0.77 - j1.1) = 192 - j275$ ohms.

EXAMPLE 2. Single-stub impedance matching. If $R_c = 250$ ohms and $\bar{Z}_R = 80 - j60$ ohms, then $R_c/\bar{Z}_R = 2 + j1.5$. This locates the

same point as in example 1. Following the constant Γ line downward (corresponding to moving away from the load to zero and then upward, we would reach unit conductance when $\phi = 63$ deg. Thus $\beta s = (30 \text{ deg} + 63 \text{ deg})/2 = 46.5$ deg, or at a distance $46.5 \text{ deg}/\beta$ from the load, the stub should be placed. The susceptance at that point is approximately -1.25 mho, and the point $0, +1.25$ corresponds to about 77 deg. Thus the length of a shorted stub at that point should be $2(77$

deg) or 154 deg and for an open stub, $154 \text{ deg} - 90 \text{ deg} = 64$ deg.

The author wishes to express his appreciation to V. P. Hessler for his encouragement and inspiration and to D. G. Wilson for his helpful suggestions during the preparation of this paper.

REFERENCES

- (1) P. H. Smith, Transmission Line Calculator, *ELECTRONICS*, Jan. 1939.
- (2) P. H. Smith, An Improved Transmission Line Calculator, *ELECTRONICS*, Jan. 1944.

General-Purpose

Extreme versatility, especially for detailed study of television waveforms, is achieved through use of high-voltage cathode-ray tube, wide-band vertical deflection amplifier, sweep circuit providing a wide range of driven sweep speeds, and a calibrated delay circuit

PRECISE MEASUREMENTS of a wide range of time intervals associated with complex electrical or electronic phenomena are possible with the instrument described in this article. Because of the combination of functions available, it should find wide application in the industrial or academic laboratory for general-purpose development and research.

Suitable combinations of fairly well-known circuits provide, basically, a cathode-ray tube operating at a high accelerating potential, a wide-band vertical-deflection amplifier, a horizontal-sweep generator having a wide range of sweep speeds, a precision delay function, and suitable auxiliary functions for flexibility of operation. In addition,

special provision is made for television applications where it is often of interest or a necessity to determine the precise voltage-time characteristics of the standard television waveform as it is reproduced by television facilities. In fact, the television application was the prime mover in the development of this instrument, while general-purpose applications were a natural outgrowth of the functions that became available.

The primary objective in the development of the instrument was to devise some means for observing television waveforms in greater detail than is possible with ordinary types. It was also considered important to provide as many of the functions as practicable for

tests of television facilities according to the standards of television broadcasting. The detailed observation of television waveforms or small portions thereof requires a suitable wide-band deflection amplifier. Since operation of fast sweeps at low repetition frequencies was anticipated, the use of a high-voltage cathode-ray tube became a practical necessity to obtain a trace of sufficient brightness under such conditions for either visual observation or photographic recording. Then by adding another control knob or two the available functions could be utilized for more general applications in other fields.

The final result of the development program is the instrument shown in the photograph. The indi-

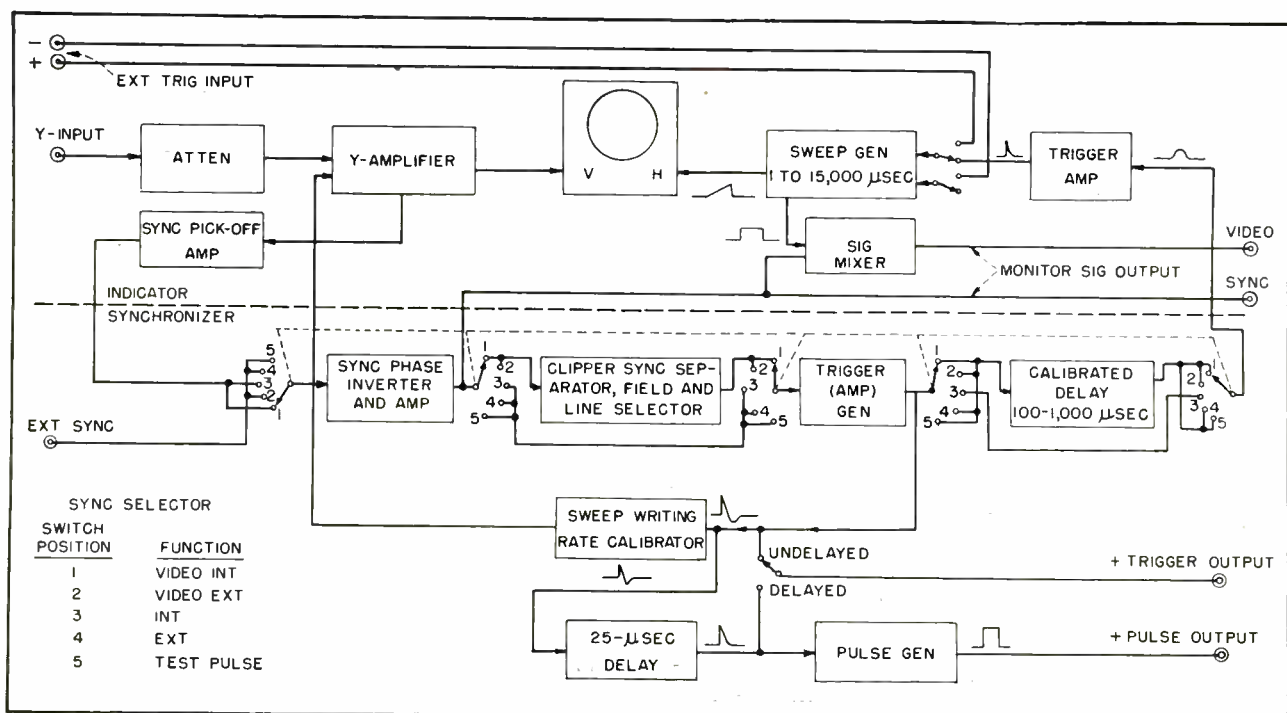

FIG. 1—Block diagram of general-purpose precision oscilloscope. Section above dashed line comprises indicator unit, while that below shows synchronizing circuits

Precision Oscilloscope

By **R. P. ABENHOUSE**

*Development Engineering Section
Instrument Division
Allen B. Du Mont Laboratories, Inc.
Clifton, New Jersey*

erator unit and necessary controls are mounted at eye level for convenience of operation and viewing.

General Description

A complete description of every detail of the performance specifications is beyond the scope of this article. Rather, the more significant features will be pointed out.

As previously mentioned, the basis of the instrument consists of a combination of a high-voltage cathode-ray tube, a wide-band vertical deflection amplifier, a sweep circuit providing a wide range of driven sweep speeds, and a calibrated delay circuit of suitable precision for maximum utility of the instrument. It is of interest to consider the principal features of this combination. Later in this discussion, the auxiliary functions neces-

sary to make this combination of practical use will be outlined. Figure 1 represents the block diagram of the instrument indicating the nature of these functions and shows them in their proper relation.

The block diagram is seen to be divided into two parts by means of a dashed line. Those blocks above the line comprise the circuits of the cathode-ray indicator unit mounted in the upper portion of the rack. The cathode-ray tube itself is thus at a convenient level for observation while standing in front of the equipment or while the operator is seated on a standard laboratory chair.

The lower portion of the block diagram comprises the synchronizing facilities providing for various modes of indicator sweep operation. These circuits are located in the next lower portion of the rack panel space at a convenient level for easy operation of controls. All power supplies are in the lower portion of the rack.

The following discussion considers the indicator and synchronizer units separately as delineated in the

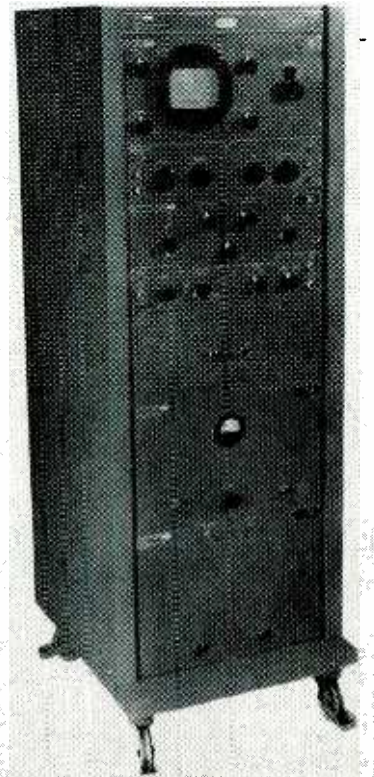

Complete Type 280 oscilloscope. Power supplies are on the bottom, synchronizing circuits in the middle, and the indicator components are mounted on top for convenient eye-level viewing

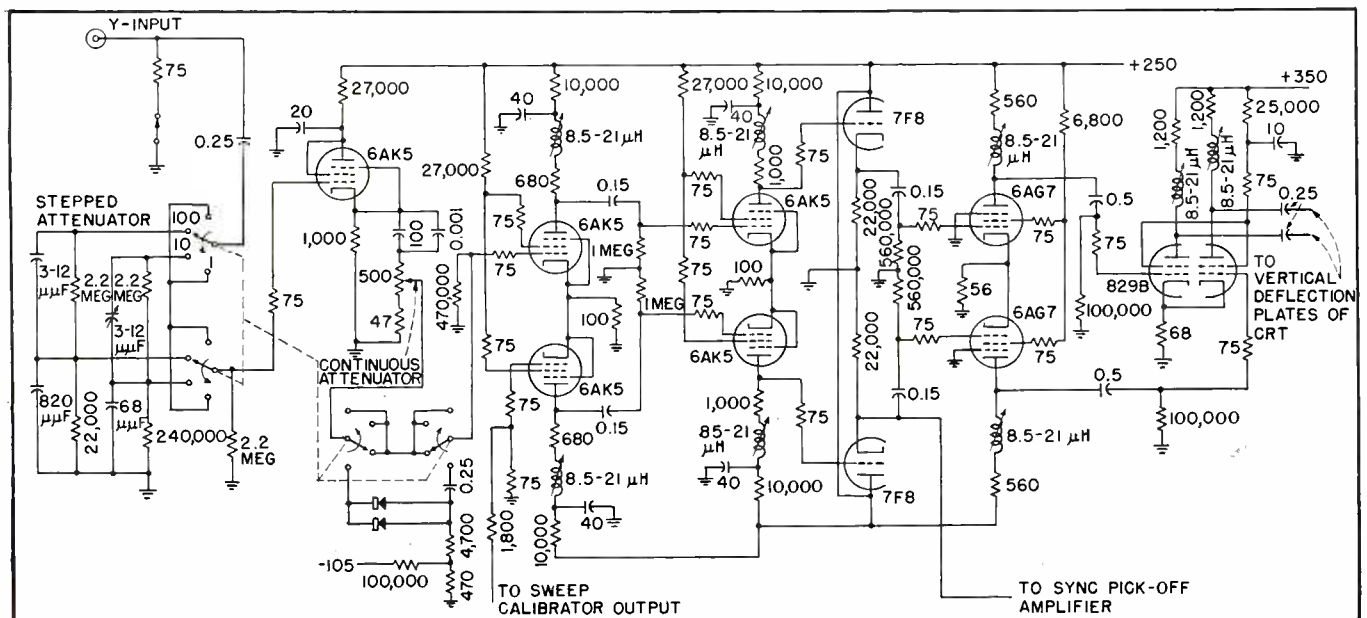

FIG. 2—Circuit diagram of wide-band vertical amplifier which employs shunt peaking adjusted to minimize transient overshoot and nonlinearity of phase shift

block diagram shown in Fig. 1.

The cathode-ray tube used in the indicator unit is the type 5RPA¹ and is operated at a total accelerating potential of from 7 to 12 kilovolts, two kilovolts of which are applied between cathode and second anode elements. The positive accelerating potential is obtained from a rectified radio-frequency voltage supply whose output is variable from 5 to 10 kv.

Experimental data shows that, aside from limitations imposed by the deflection amplifier, the maximum possible visible writing rate for these conditions, using a P2 screen, for example, is better by a factor of approximately 2.5 to 7 as compared to older tube types operating at maximum ratings of 4,400 volts acceleration. The use of a

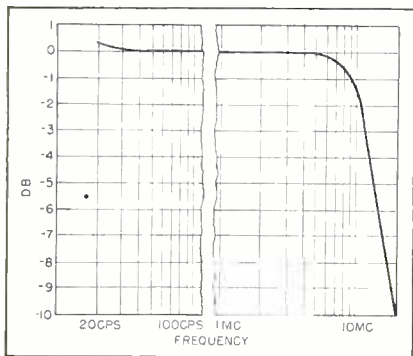

FIG. 3—Steady-state response curve for vertical amplifier

cathode-ray tube with a P2 screen is desirable in this equipment, since it has been found to be suitable as an all-purpose screen when operated at such high accelerating potentials. This is because the P2 screen combines long-persistent characteristics for high-speed low repetition-rate phenomena with high light output efficiency as compared with other screen materials. For maximum efficiency in photographic recording, however, a cathode-ray tube having a P11 screen is usually used to obtain maximum advantage of such factors as actinic intensity, film sensitivity and film development techniques².

Operation at even higher acceleration potentials in this equipment is sometimes desirable and even possible as will be pointed out later, but additional sacrifice must then be taken in deflection sensitivity

because of the decrease in deflection sensitivity as accelerating potential is increased.

Vertical Amplifier

The vertical deflection amplifier used in the indicator unit is a conventional push-pull circuit shown in Fig. 2, utilizing an 829B beam tetrode in the output stage. Preceding the output stage are two push-pull 6AK5 stages and a cathode-follower-driven push-pull 6AG7 stage which drives the 829B.

Shunt peaking is used throughout and adjusted slightly below optimum to minimize transient overshoot and nonlinearity of phase shift over the frequency range covered by this circuit. Phase inversion from unbalanced input is accomplished in the first stage with complete balance accumulated in the remaining stages. The first stage is isolated from the input terminal by a high-impedance stepped attenuator of 100 to 1, 10 to 1 and unity attenuation and a cathode follower. The cathode follower feeds a linear gain control arranged so that an additional attenuation of 10 to 1 is obtained at minimum gain. Input impedance is nominally 2.2 megohms shunted by 25 μ f. As a convenience in television applications, the input impedance may be reduced to 75 ohms by means of a toggle switch to match the standard signal distribution lines in a television system.

The performance of this amplifier is such that the minimum rise time that can be observed is 0.04 to 0.045 microsecond. As shown in Fig. 3, sinusoidal response is attenuated 2 db at 10 mc from 1-mc response. Low-frequency response is such that a 20-cps square wave will have a sawtooth distortion of 10 percent or less. This performance is obtained with a gain of approximately 560, resulting in a deflection factor of 0.1-volt rms per inch of peak-to-peak deflection with a total of 12 kilovolts applied to the cathode-ray tube.

Horizontal Sweep

The driven horizontal sweep provides a time base linear to within 5 percent or less over a continuous range of from 15,000 to 1-micro-

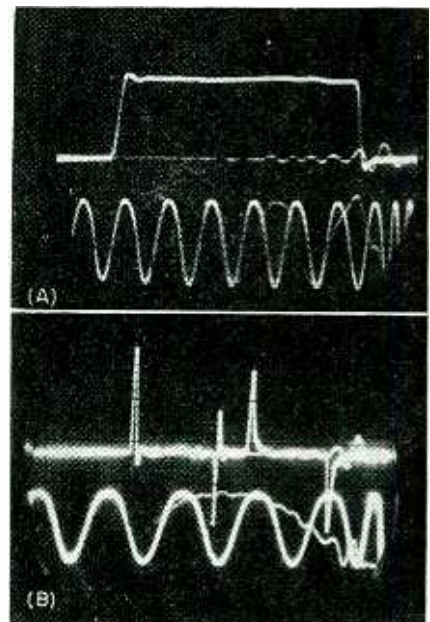

FIG. 4—Oscillograms showing (A) test pulse output with 0.2- μ sec calibrating signal and (B) transmission line test with differentiated test pulse and calibrating signal

second duration for four or more inches of deflection. This corresponds to a maximum sweep speed of 4 inches per microsecond. The circuit used is known in some circles as the bootstrap sawtooth generator, and with suitable alteration provides a sweep whose speed may be varied practically continuously over the entire range.

The sweep may be initiated, (as shown in the block diagram of Fig. 1) either externally or internally. External initiation is by means of a positive or negative trigger signal applied to terminals on the indicator panel suitably connected into the circuit by a panel switch. Internal initiation is accomplished by means of a triggering signal obtained from the synchronizer unit which in turn may be controlled by the signal applied to the vertical-deflection-amplifier input or a signal applied to an external sync terminal on the synchronizer. The sweep starting-time delay through the vertical deflection amplifier, and consequently the synchronizer circuit, is usually not more than 0.5 microsecond, while starting-time delay for direct external sweep triggering is about 0.1 microsecond or less, depending somewhat on trigger rise time.

The problem of signal delay to allow sufficient sweep starting time was considered in the development of the instrument. Because of the stringent requirements of uniform frequency characteristics over the wide response band of the amplifier, such a delay device proved unavailable at reasonable cost.

Synchronizer Unit

The synchronizer unit provides, basically, the function of timing the occurrence of the indicator sweep with respect to a reference time. Essentially two methods of precise timing are available. These consist of a time-calibrating marker oscillator to be described later, and a precision delay circuit delaying the occurrence of the sweep with respect to a reference trigger. This circuit consists of a temperature and linearity-compensated sawtooth generator whose output is compared in amplitude with a regulated d-c voltage⁸. The d-c voltage level is controlled by a 10-turn helical potentiometer having a high degree of linearity. Amplification of the signal resulting from this comparison results in a signal which, when differentiated, is used to trigger the indicator sweep. Two delay ranges are provided; namely 100 and 1,000 microseconds. Time delay between an initiating trigger and the start of the cathode-ray tube sweep is read on a dial controlling the 10-turn potentiometer, and readings are accurate to within plus or minus 0.1 percent full scale. The dial is mounted near the cathode-ray tube on the indicator panel for convenience in operation.

To provide versatility in the control of the sweep-timing functions in the synchronizer unit, certain auxiliary features are available and are described in the following paragraphs.

Internal Triggering

A trigger generator utilizing a blocking oscillator circuit is provided to operate the circuits of the instrument at repetition rates between 120 and 3,000 pps. This circuit, labelled TRIGGER (AMPLIFIER) GENERATOR in the synchronizer portion of the block diagram, may also be used optionally as a trigger amplifier by suitable switching of

blocking grid bias. It is preceded by a sync amplifier, and phase selector so that the operation of the circuits may be initiated by external signals of either polarity applied to an external sync terminal or through the vertical deflection amplifier. A trigger from this circuit is available at a front panel terminal and may be either undelayed or delayed 25 microseconds with respect to the generator output. This delay provision is intended for use in so called synchroscope applications where the internal trigger generator is used for initiating or synchronizing purposes.

The operation of the calibrated delay circuit is initiated by the output of the trigger generator, whether used as such or as a trigger amplifier. This circuit thus serves to provide the reference trigger for all subsequent time measurements. The use of the delayed-trigger output results in the possibility of observing before and after a subsequent circuit operation as well as to measure the time duration of such operation by suitable adjustment of the calibrated delay.

For purposes of sweep-speed calibration, a sine-wave-gated oscillator is provided which furnishes

either 10, 1, or 0.2-microsecond intervals in the form of vertical deflections available at any time independently of the normal deflection amplifier input signal. Some care was taken in temperature compensating this circuit to increase its accuracy over long periods. As a result, one-percent accuracy of calibration is obtained.

Television Circuits

A combination of circuits intended strictly for television applications is provided and is shown on the block diagram (Fig. 1) as CLIPPER, SYNC SEPARATOR, and FIELD and LINE SELECTOR. This combination of circuits, is inserted by means of a sync-selector switch between the sync phase inverter and amplifier and the trigger (amplifier) generator. When the instrument is used in connection with television facilities, either studio or receiving, any one of the 525 horizontal scanning lines of the television raster can be selected for detailed observation in expanded form through the vertical deflection amplifier. Video content of any line may thus be observed and measured in terms of test-pattern resolution, video i-f transient response and

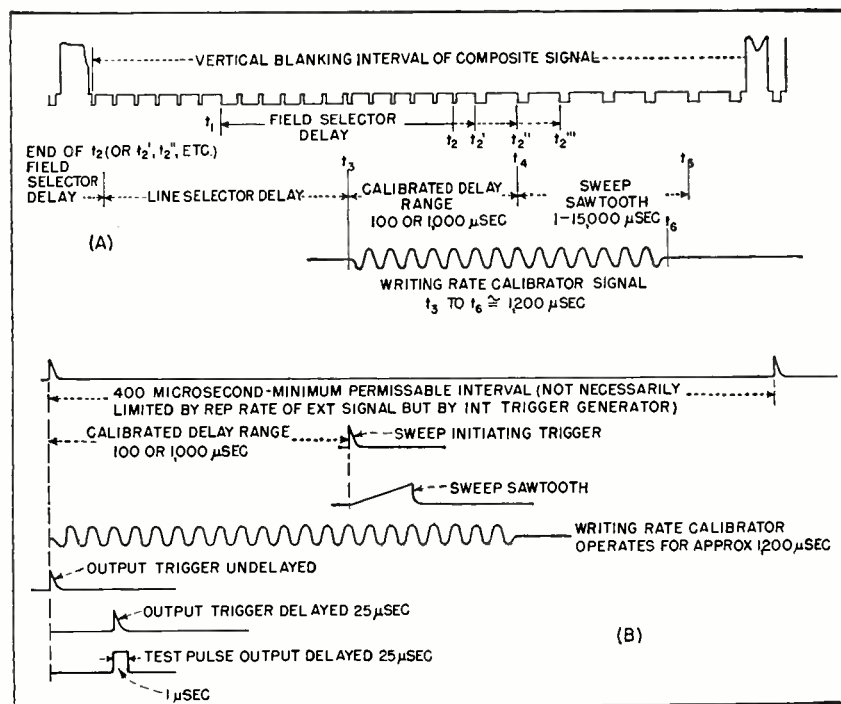

FIG. 5—Time sequence of circuit operation for the two principle types of application (A) Timing television synchronizing and video waveforms, and (B) General purpose timing

other characteristics not readily displayed by ordinary methods. The exact form of the synchronizing pulses may also be measured to accuracies required by the present Standards of Good Engineering Practice as defined by both the Federal Communications Commission and the RMA.

In this combination of circuits the operations employed to accomplish the function of line selection in terms of the television composite signal consist mainly of clipping off the video portion of the signal; separating out vertical sync; integrating, amplifying, and differentiating it; triggering a delay multivibrator, a blocking oscillator, and another delay multivibrator; and finally applying the differentiated output of the last-mentioned multivibrator to the trigger amplifier described above. Furthermore, in the application of these multivibrator and blocking-oscillator circuits, use is made of the difference between the alternate and interlaced field signals.

Since the line selector delays the sweep trigger in increments of a scanning line, the calibrated delay circuit is utilized to give continuous and smooth delay over the range of one or more lines. To stabilize the final line selector delay multivibrator against jitter inherent in such a circuit, a suitable amount of composite sync is applied to the timing portion of the circuit. This results in a timing error of only 0.02 microsecond or less, allowing full scale expansion of a pulse such as an equalizer through the sweep-speed control without serious conditions of pattern jitter.

Marker Pulses

As an auxiliary feature for television applications, a marker pulse is available at an output terminal on the indicator chassis which corresponds to the sweep in time. This pulse is mixed with a television composite signal when applied to the vertical-amplifier input terminal. This can be applied to a television monitor with the pulse serving as a marker to indicate the portion of the television video under observation on the horizontal sweep.

A test pulse is also available at a front panel terminal for use in

testing amplifier circuits on a transient basis. This pulse is of approximately 1-microsecond duration and has a rise time of something less than 0.02 microsecond, and it is generated by a well-known circuit consisting of two tetrode thyatrons in tandem with a lumped-constant delay line to form the pulse in one of the plate circuits. It is available at 75 ohms or less impedance and variable in amplitude up to 20 volts peak and is initiated by a trigger which is delayed approximately 25 microseconds with respect to the reference trigger.

Figure 4A is an oscillogram of this pulse on a sweep of approximately 1.5 microsecond, with Fig. 4B illustrating one of the many uses of this pulse. This particular application is a transmission-line test in which the pulse is differentiated and then applied to the line. The leading-edge pip is about 0.07 microsecond wide at 10-percent amplitude. The results shown here indicate a line short-circuited at the far end because of the negative reflection of the leading edge pip to the right of the differentiated trailing edge. The time between the initial leading edge and the first reflection measured at 10-percent amplitude points can then be measured accurately to determine certain electrical characteristics of the line.

All of the above auxiliary func-

tions are suitably combined in the instrument by appropriate switching of various stages.

Applications

Figure 5 shows the time sequence of circuit operation for the two principal types of application of the instrument.

The top portion of Fig. 5 indicates the timing of the horizontal sweep of the instrument with respect to the configuration of the television synchronizing and video waveform. In this case the sync selector switch in the synchronizer unit sets up a combination of the phase selector; sync amplifier; clipper, sync separator, field and line selector; trigger amplifier (trigger generator operating as a driven blocking oscillator) and calibrated delay.

The sweep calibrator is also optionally available. In effect, the sweep is delayed with respect to a vertical sync pulse and used as a reference point over a range which covers one complete field of the television raster. Either of the interlaced fields may be selected, as previously mentioned, by a circuit which makes use of the half-line difference in time intervals between the last equalizer and first horizontal sync pulse in the two fields. The range of the field selector control is such that at its minimum setting the indicator sweep is triggered at 60 pps, or field frequency; and at intermediate settings the indicator sweep is triggered at 30 pps, or frame frequency. One would expect that at such a low sweep-repetition rate and with the fastest sweep applied to expand a sync pulse (for example, so that only its rise time is displayed), the trace would hardly be visible. However, a trace of sufficient brightness and adequate pattern stability is still obtainable by reason of the high beam-accelerating potential for making photographic recordings. The illustrations shown in this article are reproductions of such photographs. Figure 6B was made at a $\frac{1}{2}$ -second exposure using an f 3.5 lens in a camera such as the Du Mont Type 271-A.

This method of observation of the television waveform gives im-

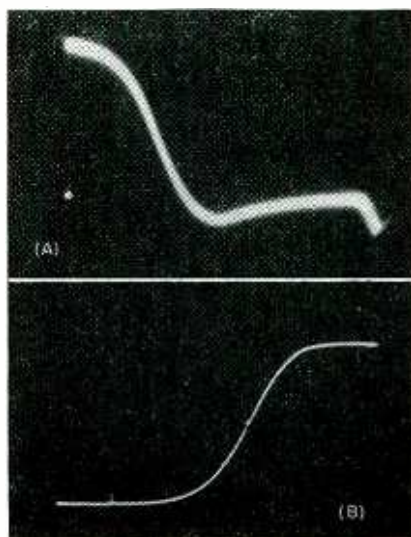

FIG. 6—Voltage waveforms (A) across an electronic photo-flash lamp (15,000- μ sec sweep) and (B) voltage rise across same lamp with 10- μ sec sweep

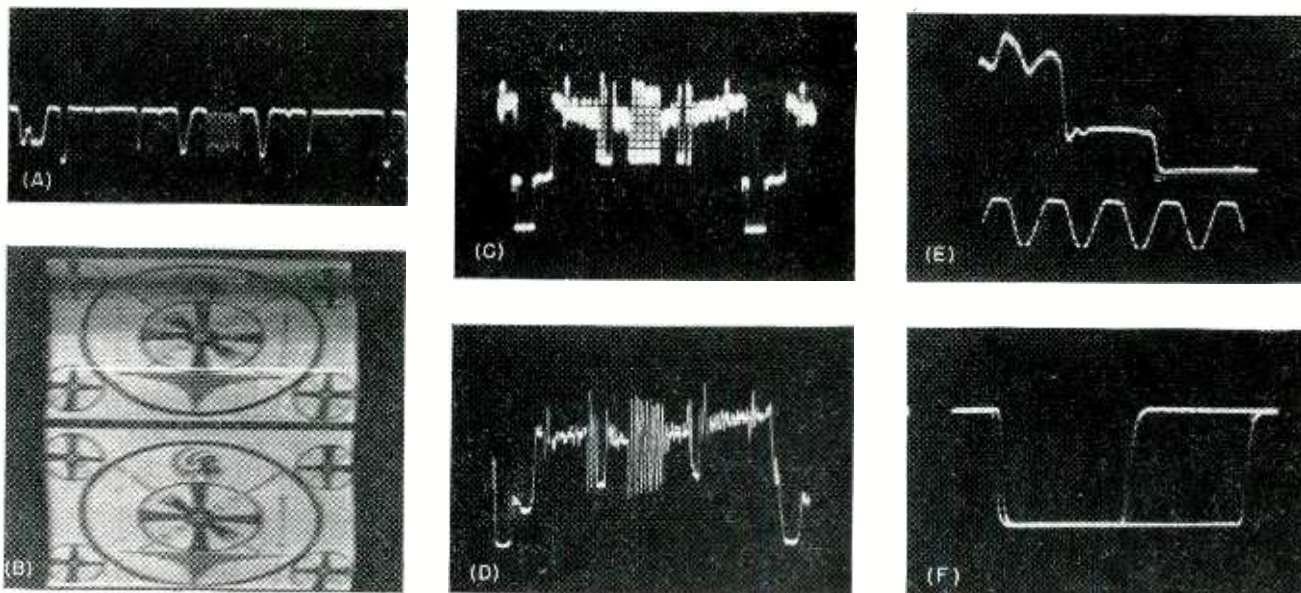

FIG. 7—Oscillograms made from the Type 280 oscilloscope. (A) Resolution wedge of a television test pattern, (B) Marker indicator on monitor raster displayed at half speed (marker identifies sweep shown in D), (C) One horizontal scanning interval at input of New York to Washington coax link, (D) Same interval as (C) observed at output end of link, (E) Front porch of horizontal blanking signal (calibrating signal is 1 μ sec per cycle), (F) Expanded horizontal sync and equalizer pulses superimposed on a 60-cps sweep as provided by field and line selector controls

mediate and direct information without recourse to auxiliary equipment, tables, or nomographs.

The lower portion of Fig. 5 indicates the time sequence of circuit operation in general-purpose applications. In this case the sync selector bypasses the television circuits so that the phase selector and sync amplifier feed sync into the trigger amplifier which may now be used as either a driven or free-running blocking oscillator to provide the proper trigger voltage required by subsequent circuits depending on the situation in which it is to be used. Thus the trigger generator, while initiating the operation of the sweep circuit, either initiates the operation of external devices or is initiated, or synchronized, by the external device. If operation of the cathode-ray tube sweep is to be dependent on the signal to be observed, only 0.25 inch of deflection is needed for stable operation. This corresponds to less than 0.07 volt peak-to-peak of signal.

It is to be noted that operation similar to the ordinary oscillograph is possible since the usual internal and external sync provisions are available. However, the calibrated sweep delay is available when the external sync operation is utilized. This system allows for precision time measurement of phenomena

up to 1,000 microseconds after some reference signal.

Thus, with the aid of these facilities plus the sweep calibrator, time measurements can be made of small intervals up to the ultimate resolution of the wide-band vertical amplifier and the fastest sweep available. In terms of writing speed, this turns out to be of the order of 20 inches per microsecond.

The usefulness of the instrument can be extended for some applications by applying higher accelerating potentials to the cathode-ray tube. Suitable insulation is provided so that up to 20 kilovolts may be applied by replacing the standard high-voltage power supply with another unit which has a maximum output of 25 kilovolts. In this instrument the voltage should be limited to 20 kilovolts because of a cathode-ray tube rating of 10 to 1 ratio of postdeflection to predeflection accelerating potentials. The brightness of the trace is increased by about four times by doubling the accelerating potential especially for fast single transient observations. This permits reliable photographic recording.

Figure 6 shows two oscillograms of the operation of an electronic photoflash lamp. In this case the delayed output trigger of the Type 280 is applied to the photoflash

lamp circuit to initiate its operation. The timing of the circuit operations in the Type 280 is then in accordance with the lower portion of Fig. 5, so that any portion of the voltage wave appearing across the lamp can be positioned on the trace by means of the sweep delay.

Figure 7 is a group of oscillograms typical of television waveform observation and the timing of the circuits of the Type 280 is in accordance with the upper portion of Fig. 5.

The helpful assistance of Horace Atwood, Jr. under whose supervision the project was carried through the development stage is sincerely appreciated. The assistance of Melvin B. Kline in handling some of the work of the synchronizer unit is also acknowledged. Many other valuable suggestions and much other assistance was furnished by other members of the Instrument Engineering Department of the Instrument Division of Allen B. Du Mont Laboratories, Inc.

REFERENCES

- (1) I. E. Lempert and R. Feldt, The 5RP Multiband Tube; An Intensifier Type Cathode-Ray Tube for High Voltage Operation, *Proc. IRE*, 34, July 1946.
- (2) R. Feldt, An All-Purpose Screen for High Voltage Cathode-Ray Tubes, *The Oscillographer*, Allen B. Du Mont Laboratories, 9, July-Aug. 1947.
- (3) V. A. Hughes, A Range Measuring System Using R-C Linear Sweep, Radiation Laboratory Report 540. Also Radiation Laboratory Series, 22, p 277.

SELECTIVITY CALCULATIONS

Equations, nomograph and chart relate 3-db bandwidth to Q , R , L and f for single parallel-tuned circuits, show effect of adding single or double-tuned circuits, and give bandwidth of up to ten cascaded circuits at attenuation levels up to 100 db

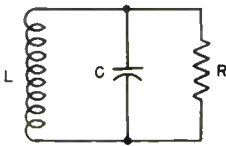

By **HAROLD J. PEAKE**

*Naval Research Laboratory
Washington, D. C.*

USE of the accompanying nomograph and curves allows rapid solution of bandwidth and selectivity problems involving one or more tuned circuits such as those employed in selective amplifiers.

The material given relates the following quantities: the number of tuned circuits, the half-power bandwidth of one circuit and the overall bandwidth at any attenuation level. Both single-tuned and double-tuned circuits are considered. For the case of double-tuned circuits, equal primary and secondary Q 's with critical coupling are assumed; in either case, all circuits are assumed to be resonant at the same frequency.

In a simple parallel-tuned circuit like that shown in Fig. 1, let R represent the losses in L and C combined with the external loading resistance. Disregarding the loss in C , the Q of this circuit is

$$Q = f_0 / \Delta f \quad (1)$$

where f_0 is resonant frequency and Δf is 3-db bandwidth, both in the same units of frequency. For example, if a tuned circuit resonant at 30 mc is required to have a 500-kc bandwidth, then $Q = 30 / 0.5 = 60$ is the required Q of the inductor.

If it is desired to adjust the

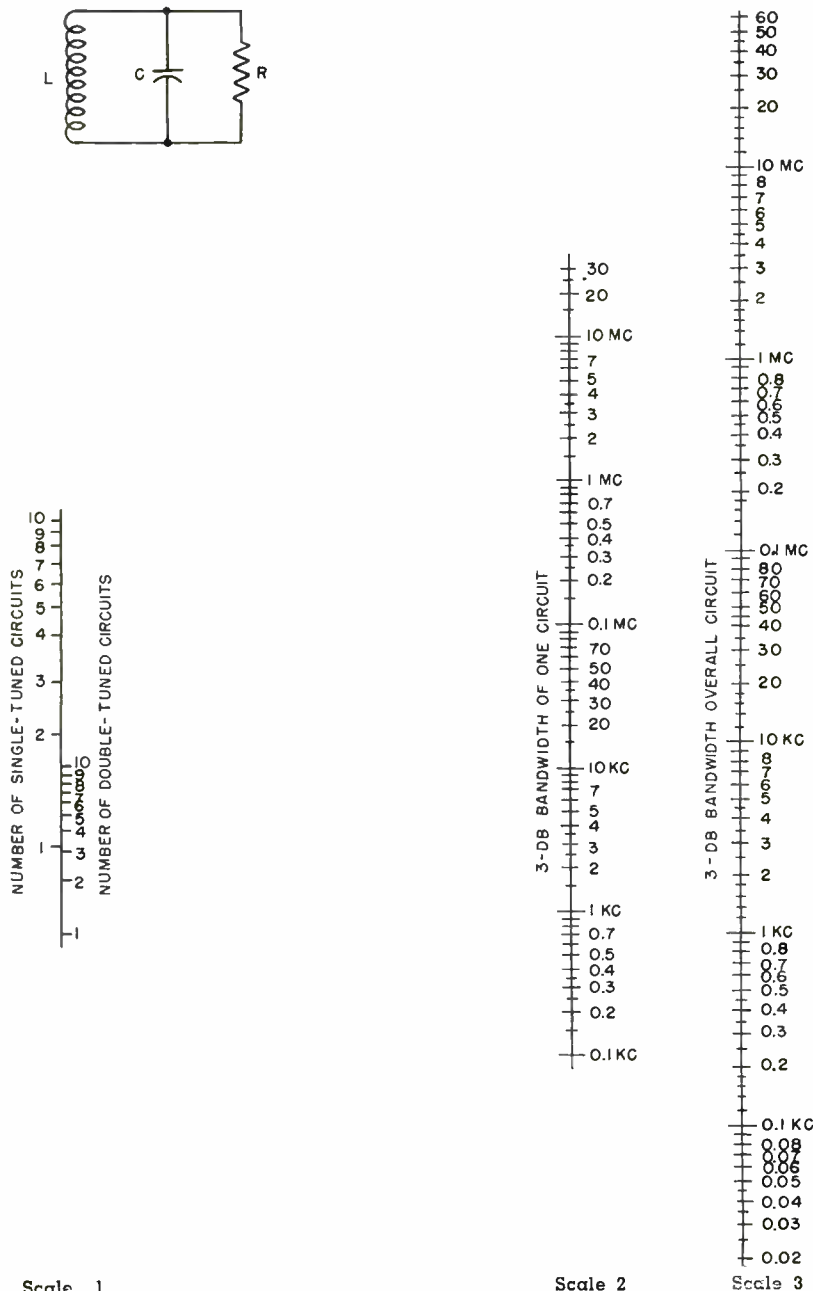

Scale 1

Scale 2

Scale 3

FIG. 1—Selectivity nomograph, showing directly the effect of cascading up to ten single or double-tuned circuits

Continued on page 114

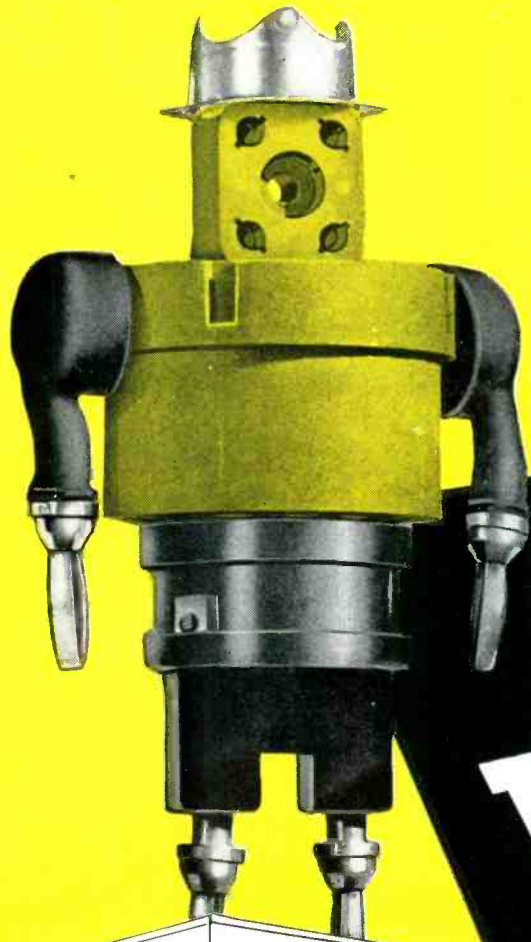

Cinch Facilities

CONSOLIDATED

... "keeping abreast of the changing conditions, often anticipating the need", Cinch has consolidated all departments, all production units that have made "Cinch sockets standard", Jones electrical parts demanded, into one large, modern unit—

FOR YOUR GREATER CONVENIENCE

1026
S. Homan Ave.
CHICAGO 24,
ILLINOIS

CINCH MFG.

CORPORATION

Subsidiary of United-Carr Fastener Corporation

Cambridge 42, Massachusetts

SELECTIVITY CALCULATIONS

(Continued from page 112)

bandwidth by resistance loading,
 $Q = R/2\pi f_o L$ (2)

Here R is in ohms, f_o is in cycles per second, and L is in henrys. For example, if a 0.75-mc bandwidth with a center frequency of 30 mc is to be obtained with a 1-microhenry coil of $Q = 60$, Eq. 2 gives the shunt resistance due to the coil loss as $R_1 = 2\pi f_o LQ_1 = 2\pi \times 30 \times 10^6 \times 10^{-6} \times 60 = 11,300$ ohms. From Eq. 1, the final Q desired is $Q = f_o/\Delta f = 30/0.75 = 40$, which corresponds to a final shunt resistance of $R = QR_1/Q_1 = 40 \times 11,300/60 = 7,530$ ohms. Now, there remains to determine what resistance R_2 paralleled with $R_1 = 11,300$ ohms produces a shunt resistance $R = 7,530$ ohms. This is calculated by $R_2 = RR_1/(R_1 - R) = 7,530 \times 11,300/(11,300 - 7,530) = 22,600$ ohms, the required load resistor value.

The 3-db bandwidth of the tuned circuit is also calculable from

$$\Delta f = 1/2\pi RC$$
 (3)

where, if R is in ohms and C is in farads, Δf is in cycles per second. In the preceding example, $f_o = 30$ mc and $L = 1\mu h$, requiring that $C = 28 \mu\mu f$. Then, since $R = 7,530$ ohms, Eq.

3 gives $\Delta f = 1/2 \pi \times 7,530 \times 28 \times 10^{-12} = 0.75$ mc. This equation is very useful for bandwidth calculation when the external load resistance is much less than the shunt resistance determined by the coil Q ; that is, when the effect of the latter resistance can be disregarded.

The preceding discussion applied only to single circuits of the type shown in Fig. 1. The nomograph has been prepared to facilitate bandwidth calculations for amplifiers having several such tuned circuits, all individual circuits having the same resonant frequency and bandwidth. On the nomograph a straight-edge intersecting the three scales connects corresponding values of number of circuits, 3-db bandwidth of one circuit and 3-db overall bandwidth of the combination. The left-hand scale has two sets of gradations, one for single-tuned circuits and one for double-tuned circuits. This nomograph allows determination of any one of the three quantities if the other two are known or assumed.

Example 1. Find the overall bandwidth (at the 3-db response points) of four single-tuned cir-

cuits, each with a 3-db bandwidth of 1 mc. Connecting 4 on the left-hand markings on scale 1 with 1 mc on scale 2, read 0.42 mc on scale 3.

Example 2. Find the bandwidth of each transformer if five are to be used to obtain a bandwidth of 0.3 mc. Connecting 5 on the right-hand markings on scale 1 with 0.3 mc on scale 3, read 0.34 mc on scale 2.

Example 3. Find the number of single-tuned circuits required for an overall bandwidth of 1 mc if each circuit has a 2-mc bandwidth. Connecting 1 mc on scale 3 and 2 mc on scale 2, read approximately three circuits on the left-hand side of scale 1.

Other Attenuation Levels

To determine the bandwidth of cascaded circuits at attenuation levels other than 3 db, use of Fig. 2 is helpful. Here is plotted the ratio of the bandwidth at any attenuation on the vertical scale to the bandwidth at the 3-db level; the number of single-tuned circuits n is the parameter. To determine the ratio r for double-tuned circuits, take the square root of r as read from Fig. 2.

For example, to obtain the 80-db bandwidth of five single-tuned circuits, read $r = 16$. If the 3-db bandwidth were 2 mc, then the 80-db bandwidth is $2 \times 16 = 32$ mc. If the circuits were transformers instead of single-tuned circuits, the 80-db bandwidth would be $2\sqrt{16} = 8$ mc.

Since the values of r at the 6-db points cannot be accurately read from Fig. 2, it is noted here that for single-tuned circuits the 6-db bandwidth is equal to the 3-db bandwidth multiplied by

$$\sqrt{\frac{4^{1/n} - 1}{2^{1/n} - 1}}$$

where n is the number of circuits. For double-tuned circuits the radical becomes a fourth root instead of a square root.

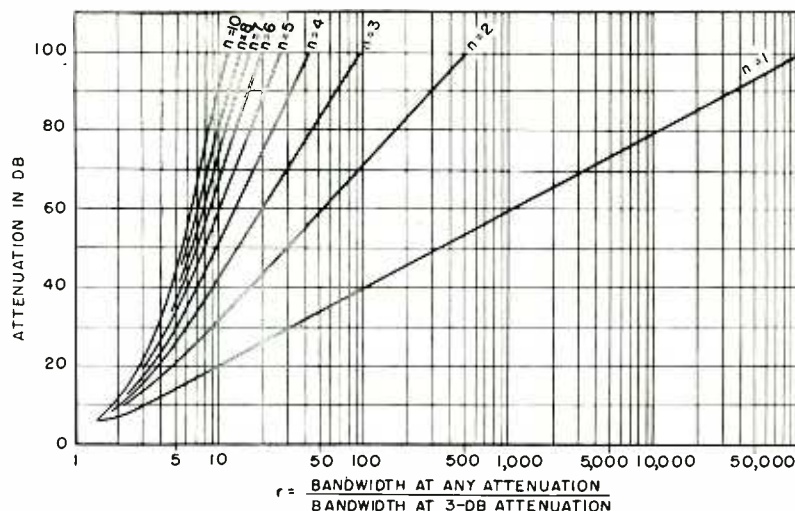
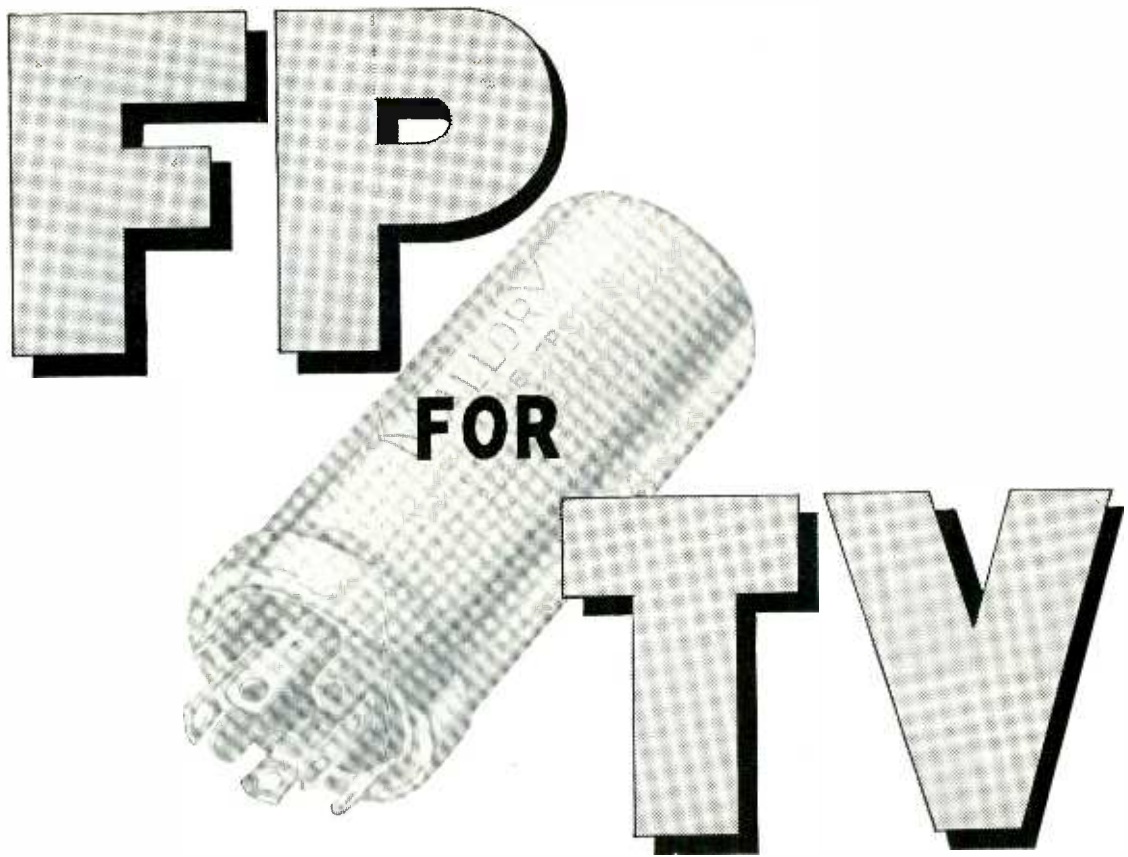

FIG. 2—Chart giving bandwidth at any attenuation up to 100 db in terms of that for 3 db attenuation, for cascading of up to ten single-tuned circuits



Television Demands Extra Margins of Safety

Everyone knows that higher temperatures hasten the destructive forces of corrosion. It's equally obvious that a capacitor which will take this extra punishment will stay on the job even longer at lower temperatures.

When you specify Mallory FP Capacitors for television receivers, or any equipment where heat is a problem, you can be sure

they will stand the gaff . . . they've always been designed to operate successfully at 85° C. And at normal temperatures, you get an extra margin of safety that pays off in longer, trouble-free performance.

Best of all, *you pay no premium* for this added dependability. Write for your copy of the new FP Capacitor Engineering Data Folder.

FP is the type designation of the Mallory developed electrolytic capacitor having the characteristic design pictured and famous throughout the industry for dependable performance.

P. R. MALLORY & CO. Inc.

MALLORY

P. R. MALLORY & CO., Inc., INDIANAPOLIS 6, INDIANA

SERVING INDUSTRY WITH

- Capacitors Rectifiers
- Contacts Switches
- Controls Vibrators
- Power Supplies
- Resistance Welding Materials

TUBES AT WORK

Including INDUSTRIAL CONTROL

Edited by VIN ZELUFF

Converts Piano to Organ.....	116
VHF Direction Finder for Light Planes.....	118
Thyratron Replaces Vibrator.....	140
Ultrasonic Generator for Clinics.....	144
Simplified Measurement of <i>L</i> and <i>k</i>	146
Tubes Guide Fish.....	154

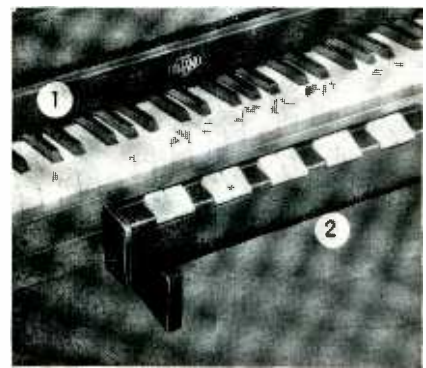

The key switch frame fits across the piano keyboard and is held in place by expanding clamps. It contains a bank of 60 contact switches operated by plungers that contact the white and the black keys (1). Mounted in front of the keyboard is the control panel (2) containing selector stops and knee-operated expression control

Converts Piano to Organ

NOVEL musical arrangements are now made possible by an electronic converter that attaches to a piano so that it becomes three instruments, a piano, an organ, or a piano-organ combination.

The conversion of the piano is accomplished by clamping a key

switch frame across the keyboard so that plungers make contact to the keys. Operation of the keys in the normal piano technique then actuates the switches to close the appropriate circuits of organ tone generators connected to an audio amplifier and loudspeaker system

in an adjacent cabinet.

The sources of all tones are 12 cascade generators. The circuit of one of these is shown in the diagram. Each cascade has five stages of 12AX7 twin triodes. Each cascade supplies the tones for the octavely related notes over the range of the instrument (for example, the C cascade supplies all the C tones and the C# cascade all the C# tones). There is one output from each stage of all cascades, thus providing a tone coverage of 60 notes extending from C1, 65 cycles, through B5, 1,976 cycles.

On each cascade the 12AX7 twin triode nearest the tuning coil is both the master oscillator and a reactance tube. The master oscillator triode is an inductively tuned oscillator having a sawtooth output waveform. The other triode is a reactance tube across the master oscillator tank circuit. Each master oscillator is the highest frequency generator on its cascade, and its output is used for the top octave of the range, C5 to B5.

Frequency Dividers

The four remaining tubes on each cascade are simple slave multivibrators, each locking in and oscillating at one-half of the frequency of the one driving it. The master oscillator drives the first multivibrator, which in turn drives the second, and so on, down the line, to produce the five tones, each an octave apart.

If a tube or one of its associated parts should fail, the indication is a

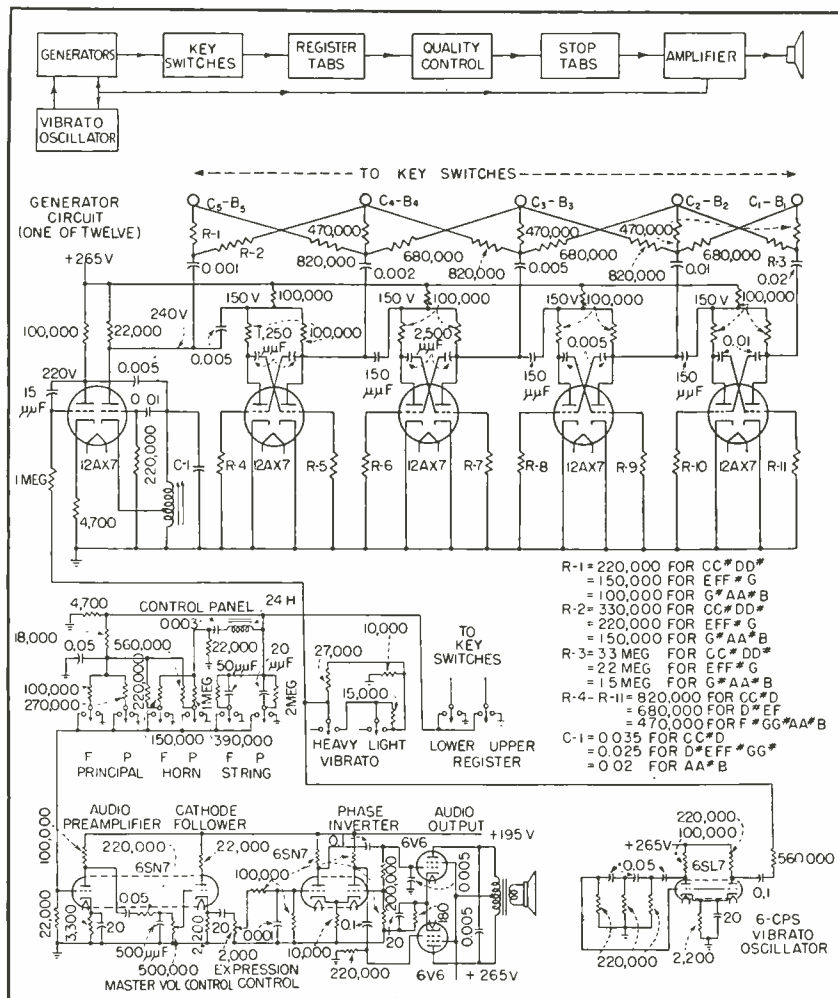

Circuit of multivibrator tone generators, audio amplifier, control panel and vibrato oscillator of the electronic piano-to-organ converter. The block diagram shows the sequence of functions

SOLDERING TIPS

"Soldering Tips" has received many inquiries lately concerning insulated copper wire that can be solder-tinned without stripping or manually removing the insulation before dipping the ends in the solder pot.

There has recently been introduced, by a number of wire manufacturers (names on request) a wire insulated with a cellulose acetate type of material developed mainly for the use of coil manufacturers. This cellulose acetate coating readily decomposes in a soldering pot operating at its normal temperature of 700° to 750° F.

It has been said that this type of wire can be tinned without the use of a soldering flux. Laboratory observations show that this statement is true under some specific soldering operations but not all. In other words, if the cellulose acetate material can be removed in the absence of any air and exposed to the action of solder at the same time, then tinning will take place. This is done by immersion in a hot solder pot which, of course, contains no air. When sufficient time has elapsed, evidences of tinning will be apparent, obviously gained without the use of an external flux.

This type of wire definitely is an improvement for certain manufacturing procedure and will increase the efficiency of the soldering operation. However, where externally applied soldering fluxes are necessary, consider the use of Kester's Liquid Rosin Flux Formulae No. 115, 215, 315, or 1015. Whenever the operation involves the use of "wire solder," then consider nothing but Kester Plastic Rosin-Core Solder or Kester "Resin-Five" Core Solder. All of the above, of course, are completely non-corrosive and non-conductive.

QUESTION: Do you manufacture a chemical that will remove the enamel from fine wire and at the same time have the fluxing properties of rosin?

ANSWER: We know of no such material. However, there has been a great deal of success in removing enamel from fine wire with a chemical preparation consisting of 49% TOLUOL, 40% WOOD ALCOHOL and 2% PARAFIN. This mixture is very volatile and should be used in a well ventilated room. The mixture is kept in a container having a narrow slit to prevent rapid volatilization. The fine wires are immersed for a few seconds, then placed on a piece of soft material like Celotex or a blotter and an orange wood stick is used to "push" off the softening enamel. This method seems to remove enamel quickly, without scratches and leaves the wire ready for soldering with any of the Kester Rosin Dip Fluxes. The inclusion of paraffin prevents the too rapid drying of the enamel when wire is removed from solvent and exposed to the air.

"Soldering Tips" will be pleased to answer any questions pertaining to solder and soldering fluxes. Address all questions to "Soldering Tips," 4204 Wrightwood Ave., Chicago 39, Ill.

NOW AVAILABLE... The New Manual— "SOLDER and Soldering Technique"!

Send for this complete analysis of the properties of soft solder alloys and soldering fluxes... a comprehensive reference book that you will want to retain. It's yours for the asking... request it NOW!

(ADVERTISEMENT)

ELECTRONICS — August, 1949



KESTER

**the Greatest Name
in Solder!**

THERE is a reason for Kester's tremendous success in the industrial field. A staff of highly-trained technical engineers and a half-century of Kester "know how" are teamed to bring you the finest flux-core solders made.

As a measure of this ability, Kester produces over 100,000 different types and sizes of flux-core solders.

Contact Kester's Technical Department on your soldering problems. There is no obligation.

WRITE FOR THE NEW, FREE MANUAL—"SOLDER AND SOLDERING TECHNIQUE"

A complete analysis of the application and properties of soft solder alloys and soldering fluxes.



KESTER SOLDER COMPANY
4204 Wrightwood Avenue, Chicago 39, Illinois

FACTORIES ALSO AT NEWARK, NEW JERSEY • BRANTFORD, CANADA





Tone generators and audio amplifier of the Organo are connected to the control elements on the piano by a multiwire cable

drop in pitch of the note concerned. All the lower octavely related notes will also be out of tune.

As the slave multivibrators are capacitively coupled and driven, any change in the tuning of the master oscillator, by moving the tuning coil core, will also tune the multivibrators directly. The reactance triode grid is driven by the output of the vibrato oscillator to frequency modulate the master oscillator, to produce vibrato.

Except for slight differences in the values of some of the components, all 12 cascades are similar.

The control panel that clamps to the front of the piano contains the register, vibrato, and tone-quality selector switches. It also contains the tone-control components and the expression control.

The register selector switches select either the bottom register, C1 through C3, or the upper register, C#3 through B5, by connecting collector bars on the key switches to the tone-quality selector switches.

Following the register selector switches, the notes played pass through the tone selectors, namely principal, horn, and string. From the tone selectors the notes played go to the amplifier input.

The principal tone is obtained by means of an RC filter comprised of an 18,000-ohm resistor and a 0.05 μ f capacitor, which attenuate the higher-frequency components of the generated sawtooth waveform.

The horn tone is obtained by

passing the generated signal through an LC filter. The filter consists of a 24-henry coil and a 0.003- μ f capacitor, and is peaked at approximately 600 cycles. The horn is augmented by borrowing some of the principal tone through a 560,000 and 220,000-ohm resistor.

The string tone is obtained by passing the signal through a very small capacitor shunted by a high resistance. The f string is produced by using a 50- μ f capacitor and 1-megohm resistor. The p string uses a 20 μ f capacitor and a 2-megohm resistor.

The 8-watt audio amplifier is conventional, using a master volume control after the preamplifier

stage and an expression control after the cathode follower.

The vibrato switches select either heavy or light vibrato. The vibrato oscillator is a 6SL7 twin triode, one triode of which is a phase-shift oscillator. Its frequency is determined by the three 220,000-ohm resistors and the three 0.05- μ f capacitors in the grid circuit. The second triode is a buffer amplifier between the vibrato oscillator triode and the reactance tubes on the cascade generators.

The instrument was developed and produced by engineers of the Lowrey Organ Division of Central Commercial Company of Chicago.

VHF Direction Finder For Light Planes

BY GUNNAR WENNERBERG
*Lear, Incorporated
Grand Rapids, Michigan*

THE OMNI-RANGE (officially named VOR for visual omni-range) is one answer to the need for improved aircraft radio navigational means. The present standard low-frequency range system has the limitation of providing only four definite courses and in bad weather; when it is needed the most, it is subject to severe interference from atmospheric and precipitation static.

The VOR provides azimuth information direct in degrees for an air-

craft in any location within the line of sight range of the transmitting station. The transmission is made on vhf which is not subject to disturbance from static. The frequency band between 108 and 132 mc is allocated for aviation purposes. A network of VOR transmitters, covering the whole nation, is now being put into operation. Nearly 500 transmitting stations are planned and most of these sta-

(Continued on p 132)

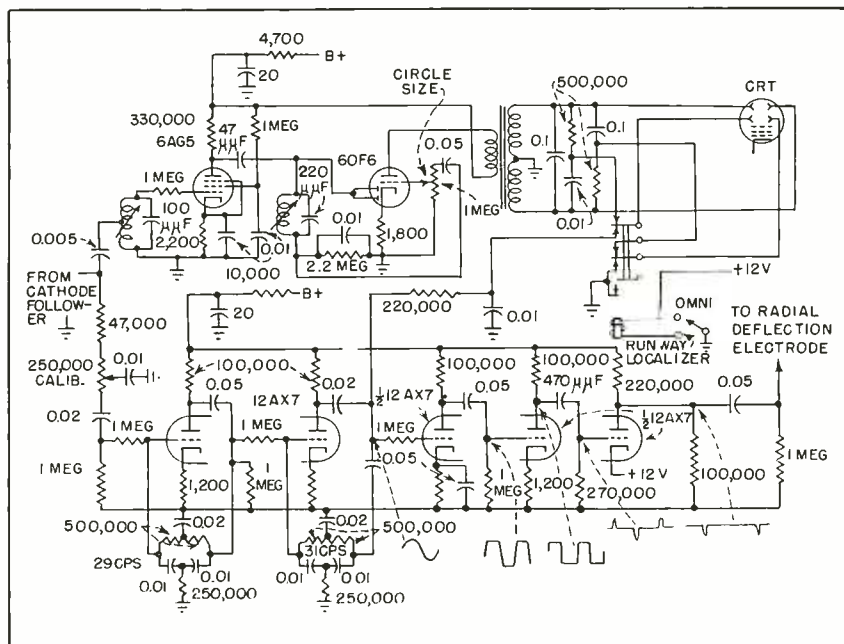

Schematic diagram of the signal-resolving portion of the Lear direction finder

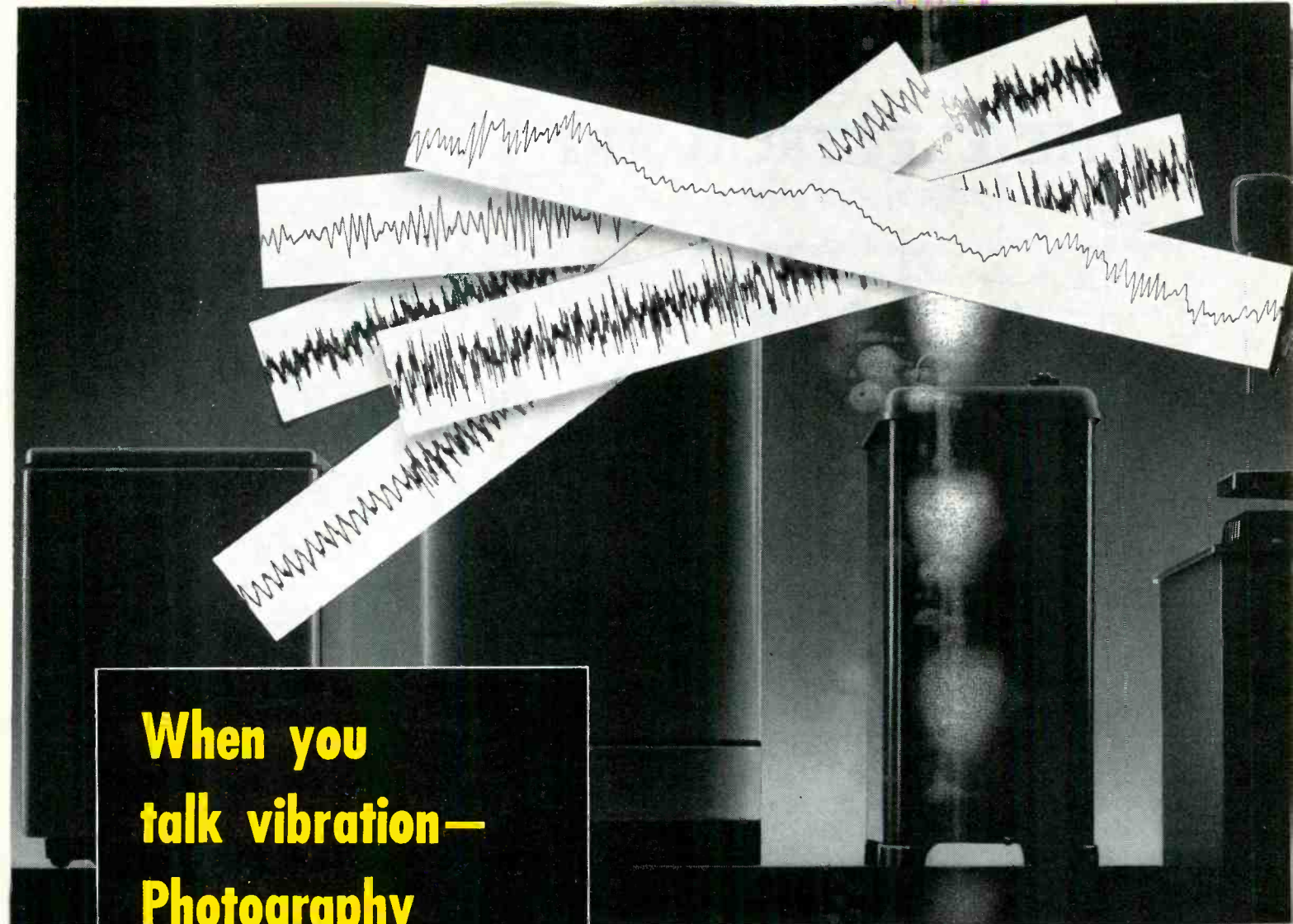

**When you
talk vibration—
Photography
clinches arguments**

Photographic records of oscillograph traces which tell how electrical appliances are behaving—foretelling how well they'll sell and work and how long they'll last.

YES, you can put your finger right on some revealing peculiarity of a trace—take time to study it—discuss it with others. That is, if you make it a practice to record important oscillograph traces photographically. It's the sure way of getting the most value out of your oscillograph studies.

Two Kodak Linagraph Films are made especially for cathode-ray oscillograph work.

Kodak Linagraph Pan Film is the fastest film for the blue-emitting screens used for studying fast transients, and for the long persistence red-emitting screens.

Kodak Linagraph Ortho Film is for green-emitting screens.

In both of these you get the high density of line and the cleanness of background that give you maximum information from your traces. They are supplied in cassettes for 35mm. cameras and also in special 16mm. and 35mm. spoolings for several recording cameras.

For special cases where you need to record blue traces at the highest speed, you can get Kodak Tri-X Pan Plates, Type B.

Kodak Linagraph Films may be obtained from the Kodak Industrial Dealer in your area. Eastman Kodak Company, Rochester 4, N. Y.

Instrument Recording

—ANOTHER FUNCTION OF PHOTOGRAPHY

"Kodak" is a trade-mark.

Kodak

THE ELECTRON ART

Edited by JOHN MARKUS

Characteristics of Three Transistor Circuits.....	120
Reflecting Microscope for X-Rays.....	122
Television Receiver Signal-Noise Evaluation.....	122
Transit-Time Effects in Television Front-End Design.....	158
Miniature Counter-Tube Power Supply.....	170
Survey of New Techniques.....	173

Characteristics of Three Transistor Circuits

PERFORMANCE characteristics of three different amplifier circuits employing transistors were summarized by R. M. Ryder of Bell Telephone Laboratories at an IRE New York Section meeting June 1, 1949. Advantages and drawbacks were cited for the conventional grounded-base arrangement and then for grounded collector and grounded emitter stages. For all three, design factors and performance criteria were expressed in terms of four-terminal networks of general network theory.

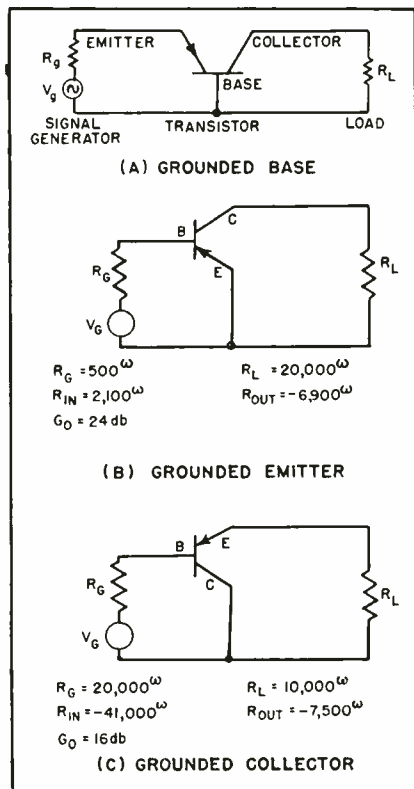

FIG. 1—Three transistor circuits. Values are for the type A transistor which has been made in considerable numbers and is now available for experimental use

The three possible basic circuit arrangements for transistors are given in Fig. 1. The well-known grounded-base arrangement of Fig. 1A is analogous to a grounded-grid circuit and its characteristics have now been quite thoroughly covered in the literature.

Grounded Emitter

The grounded-emitter arrangement of Fig. 1B is analogous to a grounded-cathode tube circuit. The collector is then analogous to the plate and the stage provides a change in signal polarity. The circuit may oscillate or sing if the load R_L is not large enough, even without feedback, since R_{out} is negative.

Grounded Collector

The grounded-collector arrangement of Fig. 1C is analogous to a cathode follower, and can similarly be used as an impedance transformer. Both input and output impedances may be negative, yet this circuit won't sing if properly terminated. Amplification may be bilateral, with the stage giving, for example, 15-db gain in the forward and 14-db gain in the backward direction. There is no phase change in the forward direction, but a reversal of phase when operated backward. Resistance in the base lead tends toward instability, while resistance in the emitter lead provides greater stability. Under certain conditions, the gain can actually be larger in the backward direction.

Cascading

Operation of grounded-base amplifiers in tandem is not favorable as the output impedance is high

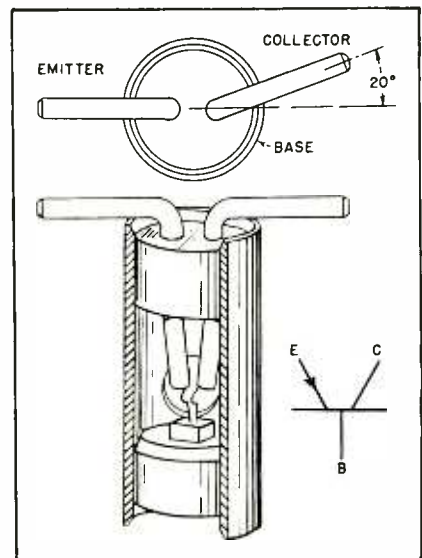

FIG. 2—Top and side views of type A transistor, and schematic symbol used by Bell Labs to represent a transistor

and the input impedance is low. Even with this mismatch between stages, however, a gain of about 5 db per stage can be realized. With transformers between stages for matching, the gain can be brought up to 15 db per stage, which is the full gain of a stage operating alone.

Cascading of grounded-emitter stages is trickier because of stability problems, but gives somewhat higher gain per stage if done properly. A three-stage amplifier has been built giving 55-db gain. Here it is easy to get feedback with resistors.

A grounded emitter followed by a grounded collector gave 16-db overall gain in one test. Here the output electrode is an emitter, a relatively low-current electrode, hence the arrangement overloads easily. Use of the grounded collector backward gives a higher output power level.

Bandpass Amplifiers

Transistor bandpass amplifiers may require that the impedance outside the band as well as in it be controlled. The usual vacuum tube practice of allowing impedances to go to the zero outside the band may cause oscillations when the transistor is short-circuit unstable, such as with grounded-emitter arrangements.

Noise Problems

Noise in transistor circuits is either a rushing sound or a frying or crackling sound. For circuit

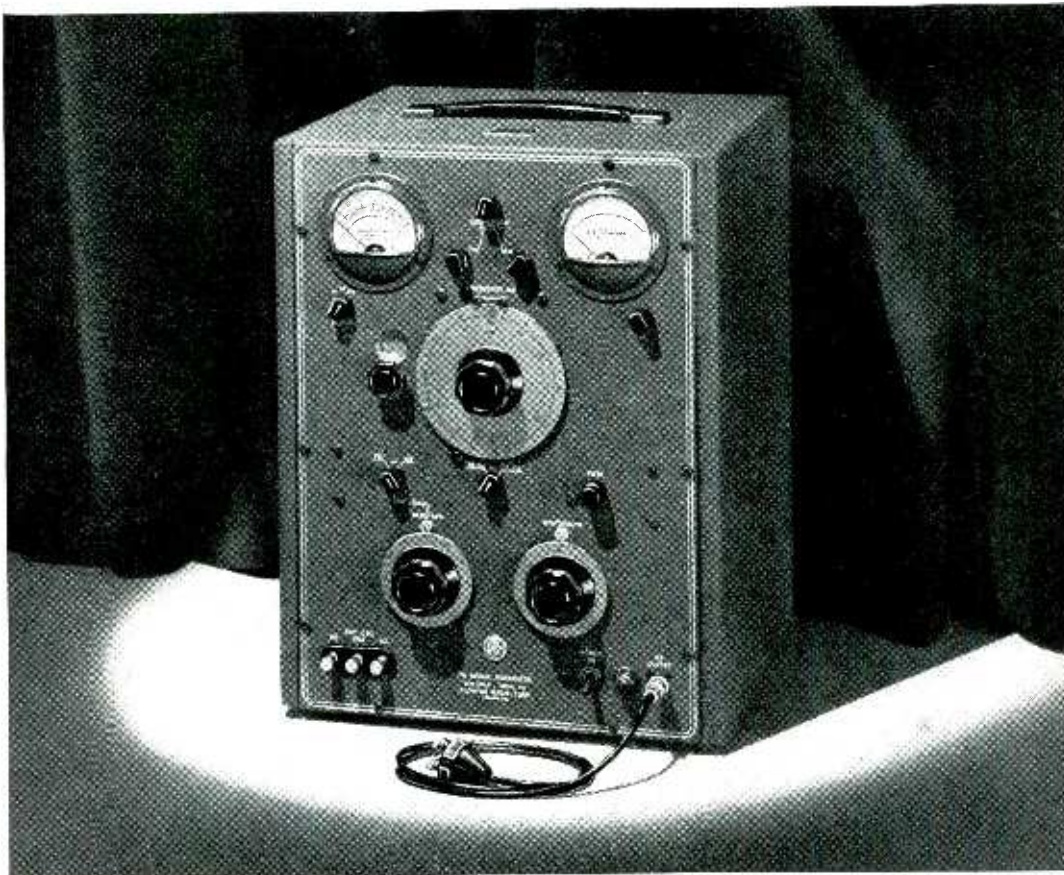

FM-AM SIGNAL GENERATOR Type 202-B • 54-216 megacycles

The Accepted Standard of Performance!

In January, 1946, at the I. R. E. National Convention in New York City, a preliminary engineering model of the type 202-A FM-AM Signal Generator was displayed for the first time. Many well known FM and television engineers, invited to comment frankly on performance specifications, suggested refinements and features which they believed would be most desirable in the finished design.

Utilizing this valuable information, Boonton Radio Corporation's engineers worked another full year before they were ready to place their approval on the final design—the type 202-B FM-AM Signal Generator.

The advantages of this essential instrument were recognized

immediately. Since its enthusiastic reception, the 202-B has increased in popularity and today it is generally accepted as the acknowledged standard of FM-AM signal generator performance. Practically every well known radio manufacturing concern is now placing increasing numbers of this versatile instrument in full time use, assisting their engineers and research staffs to design and produce better, lower cost radio and television receiving equipment.

If you have an FM or television instrument requirement, let us acquaint you with full particulars and technical data concerning the Type 202-B FM-AM Signal Generator. Write for Catalog F.



DESIGNERS AND MANUFACTURERS OF THE Q METER • QX CHECKER
FREQUENCY MODULATED SIGNAL GENERATOR • BEAT FREQUENCY GENERATOR AND OTHER DIRECT READING INSTRUMENTS

calculations the noise may be attributed to series voltage generators in the leads. The amount of noise power itself varies inversely with frequency, and depends a great deal on the operating point. Collector voltage is particularly critical as regards noise. With the grounded collector version, the operating point for best noise cannot be used because it gives instability.

The noise figure obtainable with transistors is considerably inferior to that of tubes, but fortunately the noise gradually drops out in transistors as frequency goes up. This characteristic corresponds to that of ordinary contact noise. About 40 percent of the standard type A transistors being made today (Fig. 2) give a frequency response extending beyond 5 mc, with the remainder cutting off at lower frequencies. The noise level so far is too high for most hearing aid work.

Reflecting Microscope for X-Rays

AN X-RAY MICROSCOPE has been developed by Paul H. Kirkpatrick, physicist at Stanford University. The instrument is an important contribution to microscopic study, formerly limited to optical and electron microscopes. Dime-sized mirrors form the heart of the device. The x-rays are reflected at grazing angle from one mirror to another set on a horizontal angle. Thus the tendency for an x-ray beam to be

Some of the advantages of transistors over tubes are small size, low power drain, complete absence of standby power, instantaneous response when turned on, ruggedness, and low heat production. The last factor is important in computers and telephone repeaters where many amplifying units must be mounted in minimum volume. Not much can be said about life as yet since the transistor was disclosed barely 10,000 hours ago, but life appears to be related closely to choice of operating point. Cost of a transistor is high at present, but should not be excessive when placed in mass production since construction is simple.

BIBLIOGRAPHY

- (1) R. M. Ryder, The Type-A Transistor, *Bell Laboratories Record*, p 89, March 1949.
- (2) J. A. Becker and J. N. Shive, The Transistor—A New Semiconductor Amplifier, *Electrical Engineer*, p 215, March 1949.
- (3) Transistor—A Crystal Triode, *ELECTRONICS*, p 68, Sept. 1948.

absorbed as it strikes at a sharp angle has been overcome. The x-ray microscope permits greater magnification than the optical enlarger because it uses shorter wavelengths, and, unlike the electron microscope in which specimens must be placed in a vacuum, it permits the study of living subjects. So far, magnifications of 60 diameters have been achieved but greater magnification is expected.

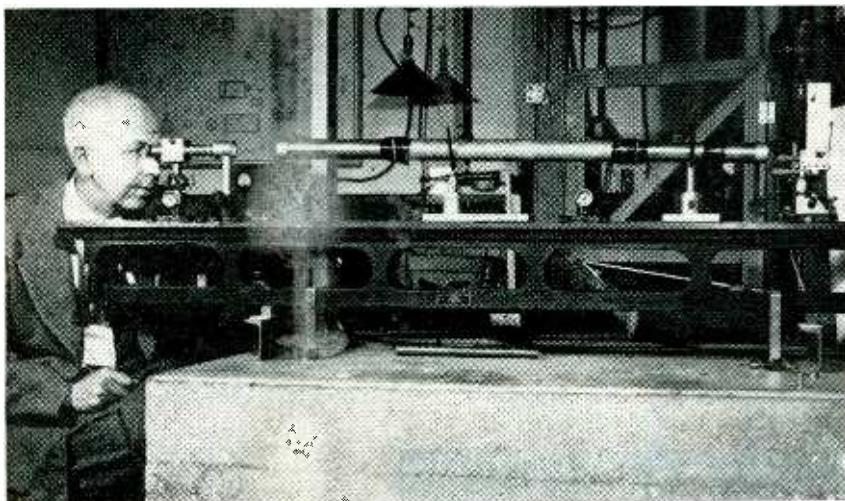

Dr. Kirkpatrick focuses the x-ray image on the fluorescent screen of the eyepiece of his microscope. In operation the eyepiece is replaced by a photographic film. The long tube contains helium

Television Receiver Signal-Noise Evaluation

By D. O. NORTH
RCA Laboratories
Princeton, New Jersey

THE OBJECT OF THIS PAPER is to formulate the relation between input picture signal strength and signal-noise appearing in the post-detector video circuits. The transformation of electrical quantities into luminance of the viewing screen, and the

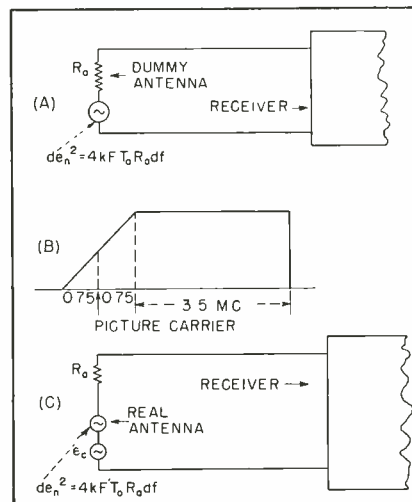

FIG. 1—Measurements of noise factor in television receivers require the use of dummy antennas whose impedance duplicates that seen looking into the open end of the feedline from the real antenna

relative acceptability of television pictures as a function of noise content are not discussed.

Pre-Detector Considerations

A receiver, tested with a dummy antenna at standard temperature T_0 , yields a noise factor F . This means that the receiver, when used with this dummy antenna, can be regarded as noise-free. The total noise output is in effect considered to originate in thermal noise of the dummy antenna, whose effective temperature is for this purpose taken to be FT_0 , as shown in Fig. 1A.

If the voltage gain from open antenna terminals to the input terminals of the detector be taken as $G(f)$, where for convenience G is assumed to be unity for frequencies lying in the flat portion of the receiver's video filter (Fig. 1B), the total rms noise voltage at the de-

(continued on page 156)

New

ELECTRICAL TUBING

gives

Better Performance

5-WAYS

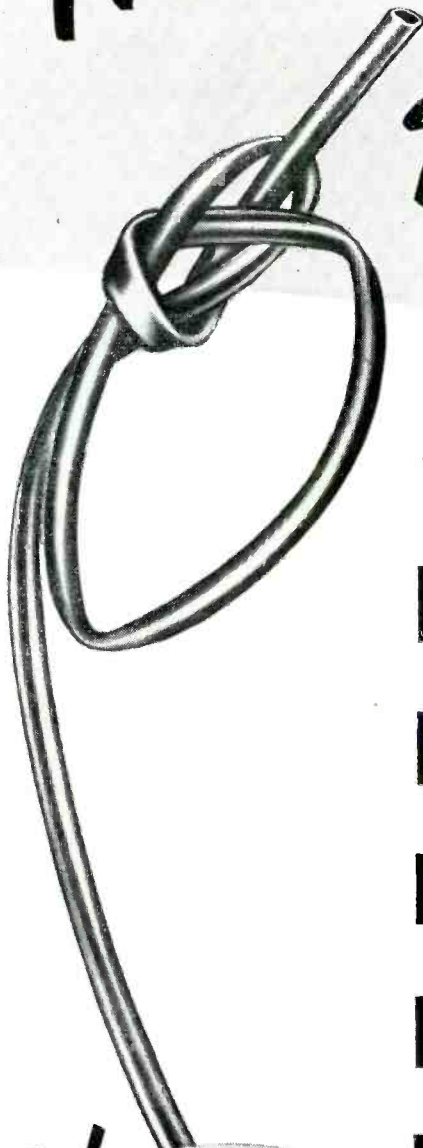

Here's why...

VARGLAS Tubing is now impregnated with **G. E. PERMAFIL**

Here's how...

1 BETTER DIELECTRIC RETENTION

... 7,000 volts — and keeps its high dielectric value under toughest service conditions.

2 BETTER FLEXIBILITY

... twist it — tie it — bend it — wrap it! No crack — no peel — no dielectric loss.

3 BETTER HEAT RESISTANCE

... withstands more than 2,000 hours at 105° to 110° C — 1,000 hours at 125° C — extensive periods even at 150° C.

4 AVAILABLE IN COILS

... so that you can cut the length you need — no more, no less, no waste. Standard colors — wide range of sizes — meets or exceeds all A.S.T.M. specifications.

5 CAN BE AFTER-TREATED

... in baking and varnishing operations. Reacts better than most oleoresinous materials and other synthetic coated tubings.

Varflex

CORPORATION

Makers of
Electrical Insulating
Tubing and Sleeving

Send for
FREE
Sample—
Full
Information

VARFLEX Corporation, 308 Jay St., Rome, N. Y.

Please send me full information as well as a free sample of your new Varglas Tubing impregnated with General Electric Permafil. I am particularly interested in samples suitable for

Name

Company

Street

City Zone State

NEW PRODUCTS

Edited by WILLIAM P. O'BRIEN

Burglar Alarm

EL-TRONICS, INC., 2647 N. Howard St., Philadelphia 33, Pa. The radio alarm illustrated detects intruders by changed or interrupted capacitance. The unit can be tuned for high sensitivity, detecting a person several feet from the antenna, or low sensitivity where the alarm goes off only on physical contact. A

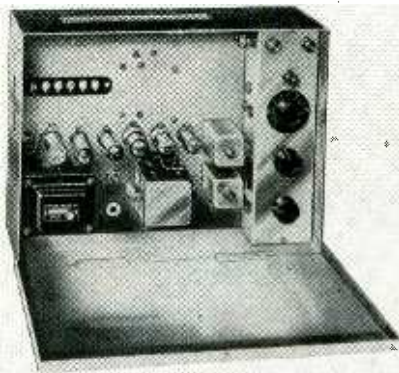

thermal attachment makes the set a fire detector as well. Any ungrounded metal object will serve as an antenna.

Fast Induction Heater

SHERMAN INDUSTRIAL ELECTRONICS Co., 505 Washington Ave., Belleville 9, N. J. The new ultra-fast 2-kw induction heater uses vacuum capacitors as well as the usual vacuum power tubes. Current in the heating coil is from 100 to 200 amperes, with an operating voltage



of 10 to 20 volts. Heating operation is completed before the heat travels over $\frac{1}{2}$ in. down the rod. A removable lower panel gives easy access to fuses and an adjustment which will match the entire machine to any single-phase factory line of 200-250 volts.

Field Strength Meter

CLARKE INSTRUMENT CORP., 910 King St., Silver Spring, Md., has announced a new field strength meter operating in the 200 to 560-kc range and designed particularly for



the communications and industrial heating fields. It makes possible direct reading of field strengths between 10 μ v and 10 volts per meter.

Coordinate Recording

AIRBORNE INSTRUMENTS LABORATORY, INC., 160 Old Country Road, Mineola, N. Y. Type 373 rectangular coordinate recording system provides, in Cartesian coordinates, an inked plot of voltage, or of the log of voltage, as a function of the

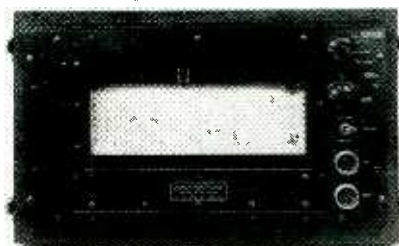

displacement angle of a measured element. Usable chart width corresponds to a voltage range of 10,000 to 1, or 80 db. The system is used to record voltage as a function of time or an angle. It consists of a selective amplifier, pen and paper servo amplifiers, a power supply and the recorder.

Packaged Controllers

INDUSTRIAL ELECTRONICS Co., INC., Hanover, Mass. Type REG-4 is a controller with automatic time-delay reset for color sensitive regis-

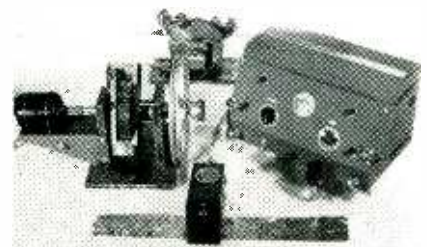

tration. The packaged unit can be applied to machines using a correction motor or those employing a solenoid. Type REG-8 is a color sensitive register controller with automatic time delay reset custom built for correction of a web either forwards or backwards.

Light-Weight Geiger Counter

OMAHA SCIENTIFIC SUPPLY Co., 3601F N. 24th St., Omaha 10, Nebraska, has announced the TX-9 Uranium Bug, a lightweight Geiger counter designed for prospectors and minerologists. Self-contained



except for headphones, it measures $7\frac{1}{4} \times 4\frac{1}{2} \times 3$ inches, weighs $3\frac{1}{2}$ pounds and features a new battery-conserving circuit.

Light Control

RIPLEY Co., INC., Middletown, Conn., has announced an electronic

RAYTHEON

COMMERCIAL MICROWAVE POWER

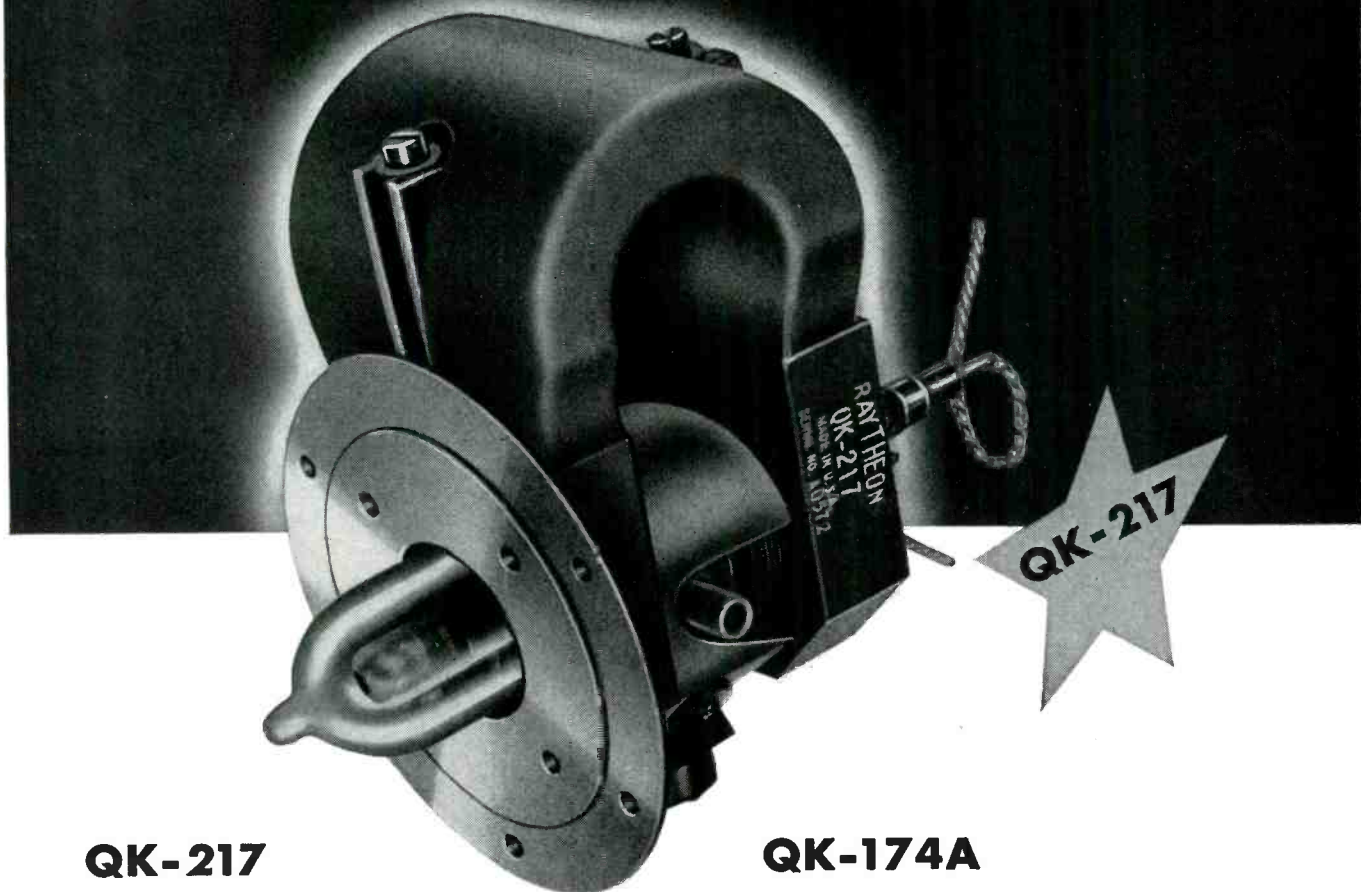

QK-217

- ★ 1500 watts continuous power at 2450 megacycles.
- ★ Efficiency 50%.
- ★ Unipotential indirectly heated cathode.
- ★ Integral magnet construction.
- ★ Pre-plumbed.

QK-174A

F-M communications magnetron

- ★ Tunable 1990-2110 megacycles.
- ★ Frequency modulation 15 megacycles.
- ★ Power 100 watts.
- ★ Efficiency 35%.

Also a complete line of low power klystrons from 6 millimeters to 30 centimeters

Data available on request

RAYTHEON

Excellence in Electronics

RAYTHEON MANUFACTURING COMPANY
POWER TUBE DIVISION
Waltham 54, Massachusetts



Light Watchman, entirely automatic in operation, designed to turn night lights on and off in home or store according to the foot-candle value of daylight. The unit operates on 105 to 120 volts, 50 or 60 cycles a-c. It carries a 300-watt, 110-volt load.

Audio Transformers

TRIAD TRANSFORMER MFG. Co., 423 No. Western Ave., Los Angeles, Calif., has announced two new hermetically sealed mounting types for audio transformers (illustrated in comparison with a miniature tube). Type JO is 15/16 in. in diameter, 1 13/32 in. in height, and weighs 1 1/2 ounces; type JOA is 15/16 in. in diameter, 1 25/32 in. high and weighs 1 1/2 ounces. Both are mounted by 2-56 studs on 9/16-in. centers,



and can be designed for a variety of low-level, low-power applications.

Motor Speed Control

GENERAL RADIO Co., 275 Massachusetts Ave., Cambridge 39, Mass. Type 1700-A Variac speed control was designed for operating a 1/2 h-p d-c shunt motor from an a-c line. Constant field voltage is supplied by a dry-disk rectifier, while the armature voltage can be varied by a

Variac autotransformer feeding an electronic rectifier. A single box houses both the control and the manual start-stop-reverse switch. Dynamic braking is provided in the stop position. Field voltage can be adjusted in steps to change maxi-

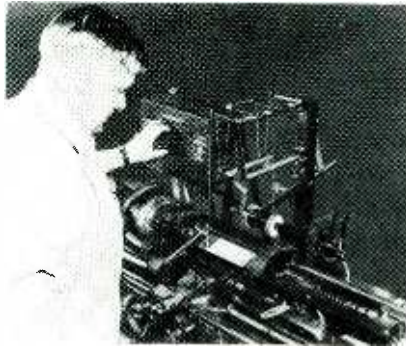

imum speed. Both 110 and 230-volt models are available.

R-F Capacitometer

GENERAL ELECTRIC Co., Syracuse, N. Y. YCL-1 capacitometer is a self-contained device for measuring capacitance and inductance at radio-frequency. The unit features two

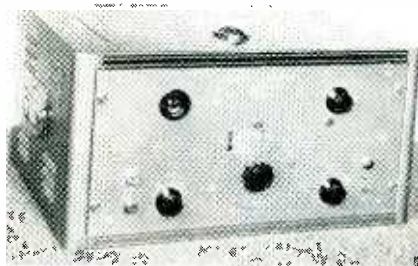

capacitance ranges, with direct reading from 0 to 1,000 μmf and by calibration chart up to 20,000 μmf . Inductance may be measured by calibration chart in three ranges up to 10,000 μh . In measuring capacitance accuracy is within 0.5 $\mu\text{mf} \pm 0.2$ percent for the 0 to 1,000 range and within 30 $\mu\text{mf} \pm 0.2$ percent for the higher range. Inductance measurements are accurate to within $\pm 0.5 \mu\text{h}$ or 0.5 percent, whichever is greater, for all ranges.

Miniature Pickup Instruments

FREDRIC FLADER, INC., North Tonawanda, N. Y. A new line of miniature Teleflight pickup instru-



ments comprises accelerometers (illustrated) and pressure transmitters for industrial use. All employ bonded strain gages as their sensitive element and produce an electrical output varying linearly with the imposed acceleration or pressure. Output can be used for remote indication, recording or control purposes. Pressure transmitters are available in ranges up to ± 100 psi and accelerometers up to ± 500 g. Frequency response of all instruments ranges between 50 and 500 cps.

Mobile Radiotelephone

KAAR ENGINEERING Co., Palo Alto, Calif., has announced a new mobile radiotelephone unit for the 152 to 162-mc band. It features an

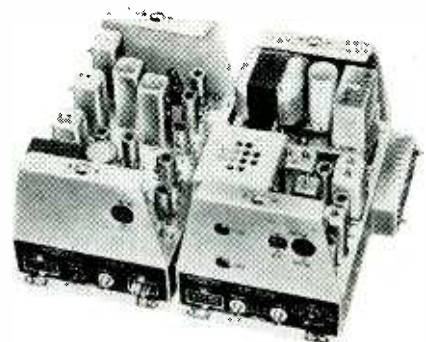

instant-heating transmitter which consumes no power from the battery during standby periods and a low-drain receiver which uses only 4 amperes.

Midget Relay

COMAR ELECTRIC Co., 3148 N. Washtenaw Ave., Chicago 18, Ill. The new midget relay features compact size and cool-running operation. Overall size is 1 1/4 in. high, 1 1/2

(continued on p 175)

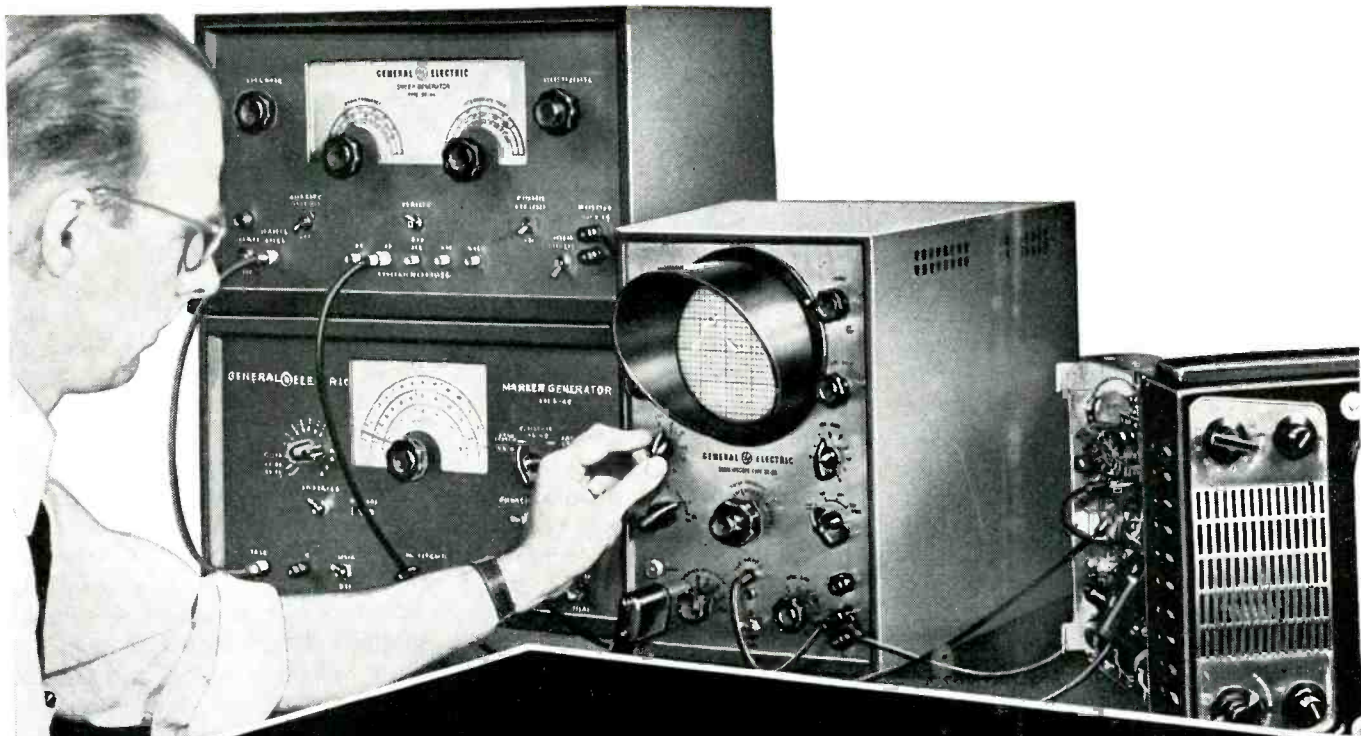

3 New Time-Saving, Profit-Building G-E TELEVISION LABORATORY INSTRUMENTS



Now — with this new G-E equipment — you can check TV receivers under conditions varying from fringe areas to "under the tower" and predict operation of the sets anywhere in the service area — at a glance!

VARIABLE Permeability Sweep Generator! Crystal Controlled Marker Generator! Cathode Ray Oscilloscope! Put them all together in one group and you have what manufacturers and servicing dealers have acclaimed the fastest, most accurate answer to television receiver testing problems ever offered!

Here's why—

- Variable Permeability Sweep Generator can be set quickly to any desired frequency, supplying high output and exceptionally wide linear sweep—

- Because of low leakage, complete over-all response from antenna terminals to picture detector can be viewed with contrast at maximum settings.

- All desired markers for complete alignment are obtained by one initial setting of the master dial on the marker generator.

- High quality general purpose oscilloscope presents accurate picture of wide range of phenomena from response curves to composite signal.



GET THE FACTS TODAY!

Specialty Division—Room 107
Electronics Park
Syracuse, New York

Send me specifications, pictures, and prices on the new G-E Television Test Equipment Package.

NAME _____
ADDRESS _____
CITY _____ STATE _____

You can put your confidence in—

GENERAL  ELECTRIC

NEWS OF THE INDUSTRY

Edited by WILLIAM P. O'BRIEN

Moving Target Indicator School

EXPERIENCE gained by Airborne Instruments Laboratory, Mineola, N. Y., in designing, installing and operating intricate special radar equipment for the U. S. Air Force's Berlin airlift is now being made available to 38 military and civilian students at Mitchel Air Force Base in the first Moving Target Indicator (MTI) school.

Equipment furnished by the Air Materiel Command for the school includes a CPS-5 radar set and the

special equipment, designed by AIL, which through involved circuitry eliminates all but moving objects on the radar scope.

An eleven-week course of theory and lab work prepares the students to form the nucleus of teams equipped to install, maintain and operate complicated radar kits similar to that which has helped the Air Force to maintain the Berlin airlift by facilitating flying in all kinds of weather.

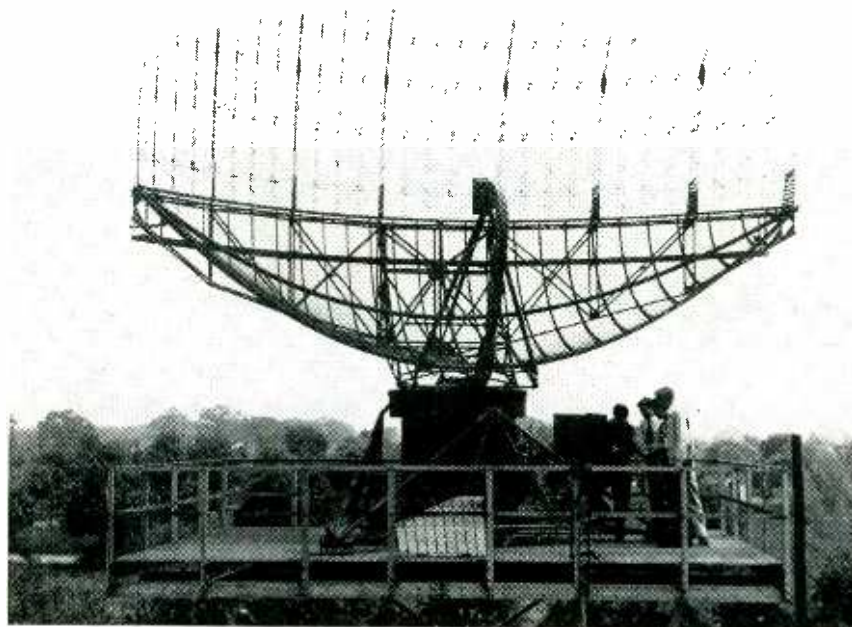

Students examine antenna and associated circuits on CPS-5 radar antenna tower at Mitchel Field, N. Y.

Mobile Radio Network Launched

FORMATION of the first national network of independent radiotelephone stations for mobile service to the general public was recently announced. The new interstate system offers a practical and low-cost means of communication between occupants of automobiles, trucks, buses and other vehicles with offices or homes hundreds of miles distant. It also has important potentialities as an auxiliary communications system in event of national emergency or disaster.

Officers of the National Mobile Radio System are Norman W. Medlar of station KEA274, Westchester Mobilfone System, Inc., White Plains, N. Y., president; Terence McCarthy of station KEA234, Telephone Exchange, New York City, vice-president; J. F. Donovan of station W1XNB, Autofone Inc., Springfield, Mass., treasurer; and George di Matteo of station W1XRK, Secretarial Exchange, Inc., Newton, Mass., secretary. Jeremiah Courtney, Washington, D.C., is

counsel. Other charter members are: E. J. Higgins of station W1XFF, Berkshire Radio Dispatch, Pittsfield, Mass.; Peter Kroeger of station KEA256, Mobile Radio Dispatch Service, New Brunswick, N. J.; Harold W. Graff of station KEA255, Hempstead, N. Y.; W. G. Evans of station W3XUQ, Rome, N. Y.; Curtis C. Young, Taunton, Mass.; and Tom Smith, Telephone Answering Service, Washington, D. C.

A technical coordinating committee, headed by Peter Kroeger, owner of stations in Trenton and New Brunswick, N. J., has been set up to integrate the communications facilities and practices of member stations of the network to make the most efficient use of the limited number of wavelengths assigned to the public radio services. William S. Halstead, head of Communications Research Corp., New York City, is operational consultant.

It is anticipated that by 1950 at least 100 stations will be active in the network.

ELECTRONICS in Microfilm

BACK ISSUES of ELECTRONICS have now been made available in microfilm form for use by libraries having space problems. Under the plan, a library keeps the printed issues unbound and circulates them in that form for from two to three years, which corresponds to the period of greatest use. When the paper copies begin to wear out or are not called for frequently, they are disposed of and the microfilm is substituted.

Sales are restricted to those subscribing to the paper edition, and the film copy is distributed only at the end of the volume year.

The microfilm is in the form of positive microfilm, and is furnished on metal reels, suitably labeled. Inquiries concerning purchase should be directed to University Microfilm, 313 N. First Street, Ann Arbor, Mich.

Advanced Television Course

NEW YORK UNIVERSITY, in cooperation with WPIX, the New York News television station, began in the week of June 13, the third ses-

FEDERAL'S F-134

Revolutionizes

**HIGH FREQUENCY
DIELECTRIC HEATING!**

**For the
First Time**

only one oscillator tube provides 150 KW power output in The Girdler Corporation's new Thermex Model 125T.

HERE'S A GREAT forward stride in industrial electronics . . . the most efficient circuit ever developed for high frequency dielectric heating.

Stout heart of this new circuit is Federal's F-134 — the single oscillator tube specified by Girdler Corporation engineers for the new Thermex 125T Dielectric Heater. *For the first time a power output of 150 KW is attained with only one oscillator tube.* This Federal tube has a maximum power output of 200 KW.

This record-making performance of F-134 points to new production economies . . . represents just one of the many contributions to the broad fields of industrial electronics made by Federal with its line of dependable, long life, advanced design power tubes. For full information on Federal tubes for industrial electronics, write to the Industrial Tube Sales Department.

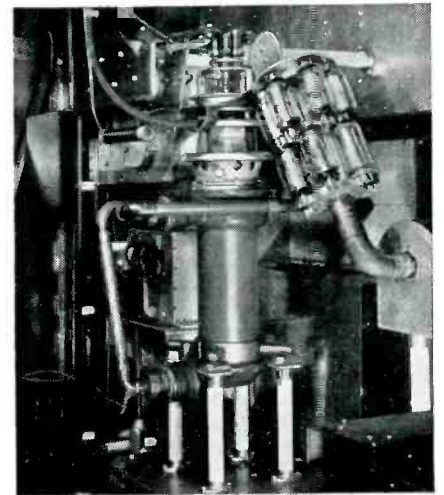
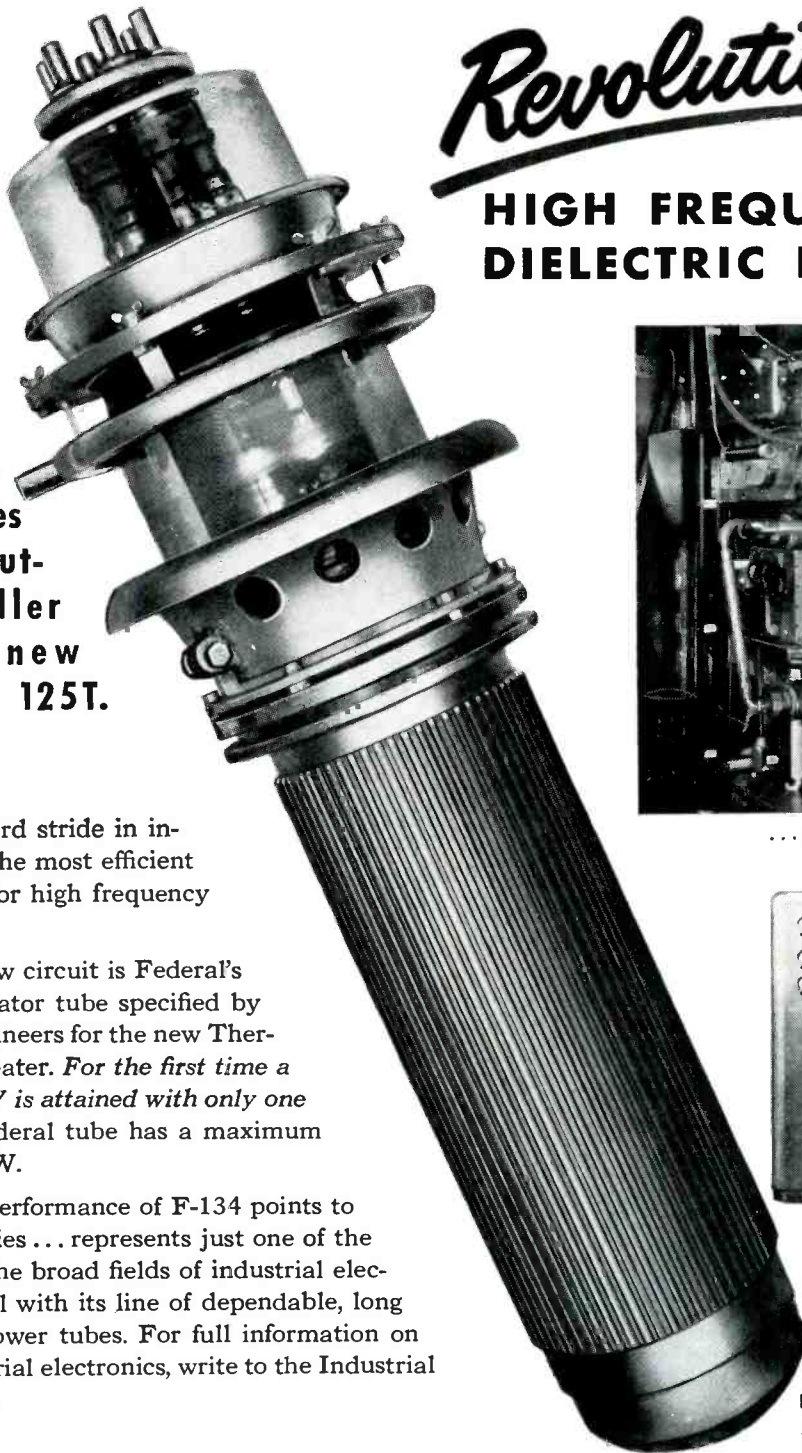

... as installed ...

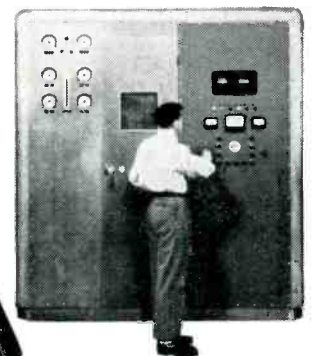

... in the new Girdler Thermex 125-T.

Federal Type F-134
High Frequency Oscillator,
150 KW Plate Dissipation.

Federal
Telephone and Radio Corporation

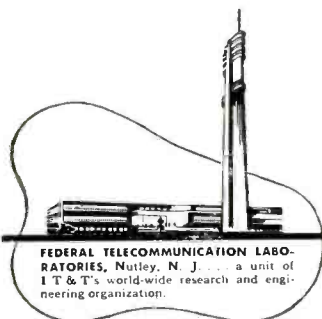

FEDERAL TELECOMMUNICATION LABORATORIES, Nutley, N. J. . . . a unit of I T & T's world-wide research and engineering organization.

100 KINGSLAND ROAD, CLIFTON, NEW JERSEY

In Canada: Federal Electric Manufacturing Company, Ltd., Montreal, P. Q.
Export Distributors: International Standard Electric Corp., 67 Broad St., N. Y.



An IT&T Associate

sion of a continuing course on the operation and maintenance of television equipment.

Instructors are Otis Freeman, assistant chief engineer at WPIX, and Louis Climent, WPIX maintenance supervisor. The university, through the cooperation of WPIX in lending studio facilities, is enabled to teach the advanced course without expending vast sums for a television laboratory.

The course includes installation and maintenance of camera, control-room, master control-room, projection room, and transmitter equipment and high-frequency relay transmitters. Special emphasis is being laid on the complexities of synchronizing pulse generators and shading generators, and camera control units.

MEETINGS

AUG. 29-SEPT. 1: National Conference of Associated Police Communications Officers, Hotel New Yorker, New York City.

AUG. 30-SEPT. 1: Fifth Annual Pacific Electronic Exhibit sponsored by the WCEMA and the 1949 IRE western regional convention, Civic Center, San Francisco, Calif.

SEPT. 12-16: Instrument Society of America National Conference and Exhibit, Municipal Auditorium, St. Louis, Mo.

SEPT. 15-16: Sixth joint Canadian-U. S. industrial conference of RMA Board of Directors, Greenbrier Hotel, White Sulphur Springs, West Va.

SEPT. 26-28: National Electronics Conference, Edge-

water Beach Hotel, Chicago, Ill.

SEPT. 27-29: Twenty-sixth Annual Session of the Communications Section, Association of American Railroads, Wentworth Hotel, Portsmouth, N. H.

OCT. 10-14: ASTM 1949 West Coast Meeting, Fairmont Hotel, San Francisco, Calif.

OCT. 17-21: Annual Meeting of the Society for Non-Destructive Testing, Public Auditorium, Cleveland, Ohio.

OCT. 31-Nov. 2: Second annual Conference on Electronic Instrumentation in Nucleonics and Medicine, Hotel Commodore, New York City.

Nov. 14-18: 23rd NEMA Annual Meeting, Haddon Hall Hotel, Atlantic City, N. J.

New Device Warns Pilots of Blackout Danger

ELECTRONIC engineers and neurologists of the USAF School of Aviation Medicine, Randolph Air Force Base, San Antonio, Texas, have developed a device which promises to minimize the occurrence of hypoxia by warning flyers that their oxygen intake is becoming dangerously low. At an altitude of 25,000 feet the time of useful consciousness between the onset of hypoxia and un-

consciousness is 270 seconds. The new instrument gives warning within 100 seconds of the beginning of oxygen lack, affording the pilot almost three minutes of safety time.

The electrical instrument is a small-scale model electroencephalograph which produces a graphic representation of the electrical waves which go through the brain. Brain-

waves are transmitted to it by head electrodes and connecting wires. Hypoxia induces changes in the pulsations, which are reflected in the same manner on the graph. When brainwave changes indicate the beginning of hypoxia the electroencephalograph sets off a signal warning the pilot to adjust his oxygen supply.

Allowing for slight individual variations in brainwaves, neurologists believe that the equipment will prove to be permanently valuable when experiments have been completed.

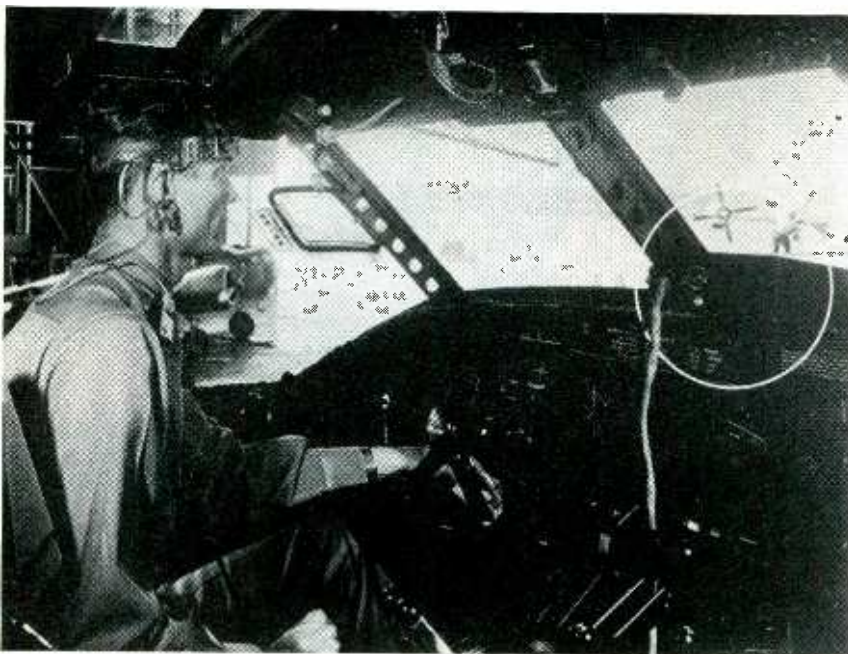

FCC Plans Further Tele Proceedings

THE FCC recently instituted further proceedings looking toward the following:

(1) Lifting the freeze on the present uhf television band; (2) providing an additional 42 uhf channels for 2,245 stations in 1,400 cities; (3) affording an opportunity for the submission of proposals looking toward the optional use of 6-mc color in all channels so as to permit reception on an ordinary receiver with relatively minor modifications; and (4) adopting a nation-wide assignment

Miniature electroencephalograph equipment reads a pilot's brainwave to warn him of danger from lack of oxygen. Electrodes attached to the head pick up and interpret the slight pulsations and transmit a signal to the warning box (circle, right) which warns the pilot to adjust his oxygen supply

(continued on p 200)

Sylvania Reflex Klystrons for CW

For CW or pulsed operation



6BL6

6BM6

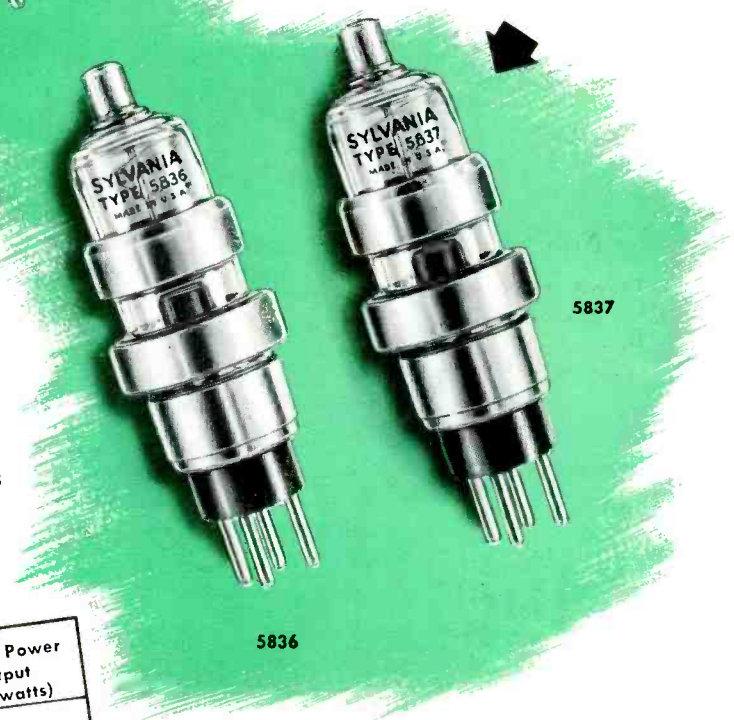

5836

5837

Sylvania Klystrons are of the external cavity type, designed for use in the microwave region. Highly efficient, they offer outstanding economies in heater supply.

Types 6BL6 and 6BM6 are reflex klystron oscillators for cw operation.

Types 5836 and 5837 incorporate control electrodes in addition to the conventional ones and are suitable for either cw or pulsed operation.

Frequency range and power output of the four types are shown in the table.

Type	Oscillation Range Reflector Mode	Frequency in mc.	Typical Power Output (milliwatts)
6BL6	1¾	1600-4000 2100-4500	225
	2¾		125
6BM6	1¾	550-2300 1100-3000	160
	2¾		60
5836	1¾	1600-4000 2100-4500	225
	2¾		125
5837	1¾	550-2300 1100-3000	160
	2¾		60

*Mail coupon for
further information!*

Sylvania Electric Products Inc.
Electronics Division, Dept. E-2908
500 Fifth Avenue, New York 18, N. Y.

Gentlemen:

Please send me data sheets on Sylvania Klystrons. I am also interested in receiving literature on your other products in the fields of:

- Communications, Television and Industrial Electronics
 Radioactivity Radar and Microwaves

NAME _____
HOME ADDRESS _____
CITY _____ STATE _____
COMPANY _____
POSITION _____

SYLVANIA ELECTRIC

Electronics Division, 500 Fifth Avenue, New York 18, N. Y.

ELECTRONIC DEVICES; RADIO TUBES; CATHODE RAY TUBES; PHOTOLAMPS; FLUORESCENT LAMPS, FIXTURES. WIRING DEVICES, SIGN TUBING; LIGHT BULBS

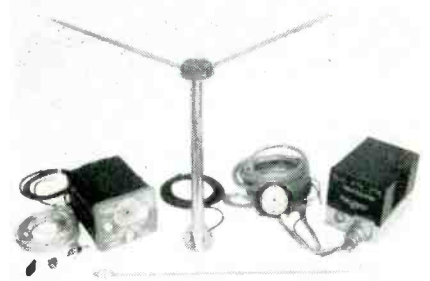

FIG. 1—Components comprising the Lear omni-range direction-finding system

tions are now undergoing service tests.

Only the New York to Chicago route is officially commissioned as yet. The useful working distance is 50 to 100 miles or more, depending upon flight altitude. Special aeronautical maps have been prepared, showing each omni-station in the center of a compass rose and giving frequencies and identification signals.

The basic principle of the VOR is the same as that used in what was known as the German Sonne system, except that considerable refinements have been added. Both systems work on the principle of supplying the navigational information as the time difference at the receiving point between a nondirectional signal and one transmitted on a rotating beam from the same transmitter.

The partial circuit diagram of the omni-system is as follows: The transmitter radiates two signals: one unmodulated carrier on a rotating directional pattern, and one reference signal. In a stationary receiver, the rotating pattern produces an amplitude-modulated signal. A broad beam (limaçon-shaped pattern) is used. In this way the modulation at the receiver end becomes sinusoidal, and the need for a highly directive transmitting antenna system is eliminated. The speed of rotation is 1,800 rpm which produces a modulation frequency of 30 cps. The reference signal is another 30-cps signal, radiated from a nondirectional antenna, using the same vhf carrier.

To make possible the separation of the signals in the receiver, the reference signal is put on a 9,960-cps subcarrier, the method of modulation being f-m with a swing of ± 480 cps. The subcarrier,

Ask for ALLEN HEADS by name

There are 1,588 standard items in the Allen line, including a type, size, thread and point to meet every normal requirement in . . .

COMPARE THE PRESSUR-FORMED HEADS FOR STRENGTH

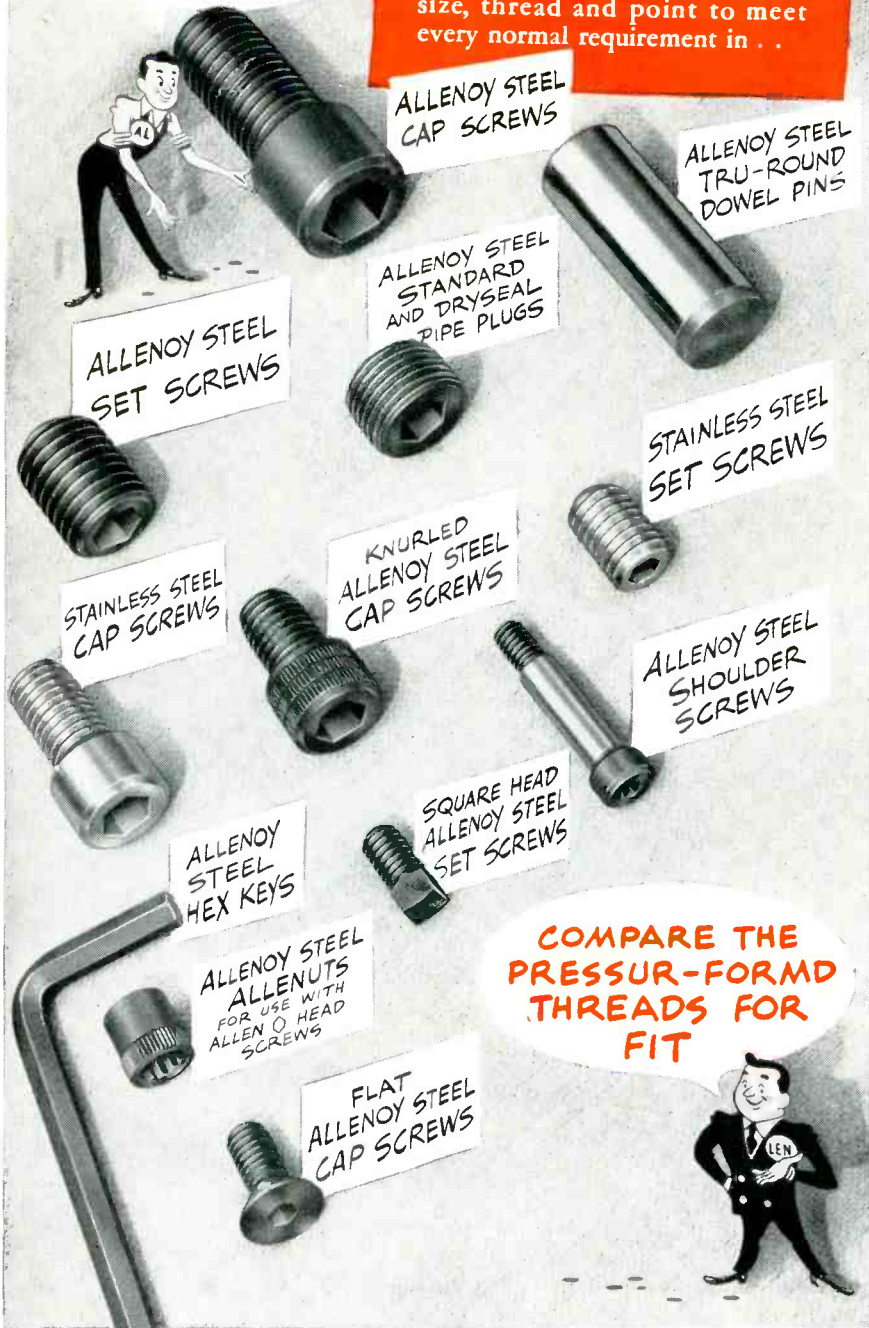

COMPARE THE PRESSUR-FORMED THREADS FOR FIT

SOLD ONLY THROUGH LEADING DISTRIBUTORS. Write the factory direct for technical information, or consult our engineers on any problem involving special sizes, shapes or materials.



ALLEN ALLEN HEAD

MANUFACTURING COMPANY
Hartford 2, Connecticut, U. S. A.
NEW YORK CLEVELAND DETROIT CHICAGO LOS ANGELES

FOR 40 YEARS THE BUY-WORD FOR SOCKET SCREWS

for UTMOST Dependability

Hermetically
Sealed
Relays
by



AUTOMATIC  **ELECTRIC**
CHICAGO

Where reliable performance is a prime requirement, depend on Automatic Electric Hermetically Sealed Relays. "Sealed-in" controlled atmosphere protects these relays from electrical or mechanical failure from varying conditions of temperature, dust, humidity, acid, fungus or air pressure—and makes them completely tamper-proof.

they're better relays, too!

The Automatic Electric Relays available in hermetically sealed housings include the new, outstanding Class "B" . . . the famous Class "A" . . . the small, lightweight Class "Z" . . . the tiny, but powerful Class "S." Hermetic sealing . . . highly favored by the Armed Forces . . . maintains all the quality for which these relays are famed.



send for circular!

When you need hermetically sealed relays, call in the Automatic Electric field engineer. Meanwhile, for full information, address: Automatic Electric Sales Corporation, Chicago 7, Ill. In Canada: Automatic Electric (Canada) Ltd., Toronto.

RELAYS

AUTOMATIC  **ELECTRIC**

SWITCHES

SYNTHETIC SAPPHIRE *for*



Resistance to Wear

Outlasting hardened steel and cemented carbides 2 to 5,000 times.



Resistance to Friction

Affording very low friction surfaces due to hardness and surface continuity.



Resistance to Heat Distortion

Retention of form at temperatures up to 1,000°C.



Retention of Insulating Properties

Excellent dielectric properties over a wide range of temperatures.

LINDE Synthetic Sapphire is available in a variety of forms. It can be polished by flame or ordinary diamond polishing; it can be formed and bent by flame. Polished sapphire surfaces keep free of dirt, and in many anti-friction applications, need not be lubricated.

The experience that LINDE engineers have in applying sapphire to industrial processes may be of help to you. Call or write the LINDE office nearest you. Get your copy of the "Synthetic Sapphire Data Sheet", and the "Synthetic Crystal Stock List" of forms available.

Linde
Trade-Mark

THE LINDE AIR PRODUCTS COMPANY

Unit of Union Carbide and Carbon Corporation

30 East 42nd St., New York 17, N.Y.  Offices in Other Principal Cities

In Canada: DOMINION OXYGEN COMPANY, LIMITED, Toronto

The term "Linde" is a trade-mark of The Linde Air Products Company.

TUBES AT WORK

(continued)

which is amplitude modulated on the vhf carrier, is generated in a very simple and straightforward way, using a tone-wheel with varying spacing between the teeth, driven by an 1,800-rpm synchronous motor. The same motor also drives a capacitive goniometer, distributing the energy to an antenna system which produces the rotary beam.

Direction Finding

It is apparent that the phase angle between the two 30-cps signals will be proportional to the geographical azimuth angle. The transmitters are lined up in such a manner that the two 30-cps signals are in phase on the magnetic meridian north of the transmitter. By lining up the transmitters for the magnetic north rather than the true north, an automatic compensation for magnetic variation is achieved.

To minimize errors caused by reflected waves, it is necessary to use horizontally polarized transmission. A V-type antenna, shown with the other components in Fig. 1, is required to offset the directional properties of an ordinary dipole and give satisfactory reception at all azimuth angles. This sweep-back arrangement also gives a minimum of air resistance.

The problem to be solved at the receiving end is to translate the received signals into visible course indication. After necessary detection and filtering is accomplished, the final problem becomes one of designing a 360-degree phase meter for 30 cps.

It became apparent that a cathode-ray tube indicator would have

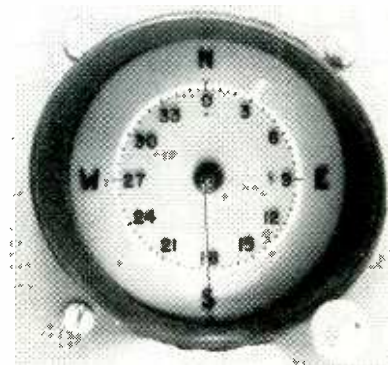
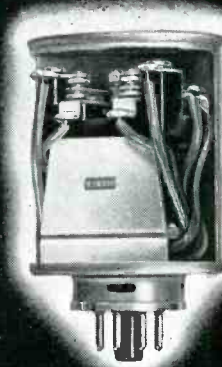

FIG. 2—Cathode-ray tube indicator for direction finder. Circular sweep is the time base and radial pip indicates the bearing to the omni-range station

RELAYS OF ADAPTABILITY



Type CN



Type BOHO

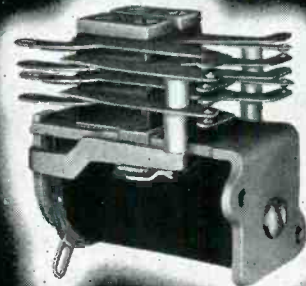

Type SK

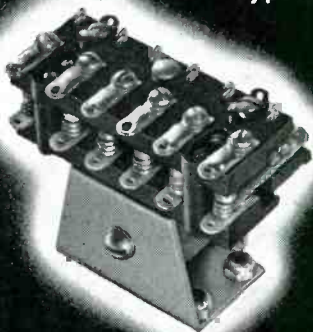

Type BN

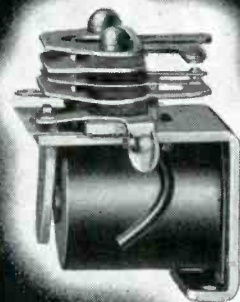

Type F

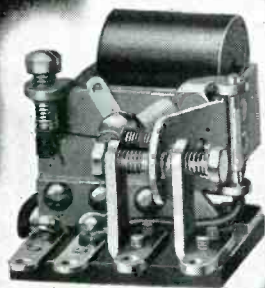

Type BG

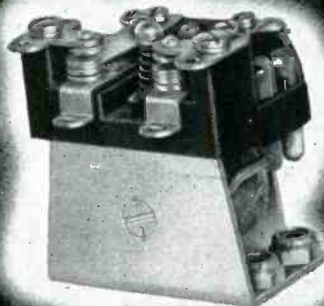

Type BO

Thousands of specifications are filled by the complete line of Allied Relays—seven of which are grouped around the Allied emblem of engineering leadership.

Allied Control engineers pioneered the design of relays from signal circuits to 75 ampere contacts, coils from 12 milliwatts to 3½ watts to give the smallest mounting area and accessible wiring facilities.

*Type "BOHO" is D.P.D.T. relay sealed with standard octal plug. Contact rating of 5 to 10 amperes and coil capacity of 115 v. D.C. at 2.5 watts and 220 volts; 25 and 60 cycles at 4.5 volt-amperes.

*Type "CN" is S.P.S.T. double break relay with 50 ampere contacts and coil capacity of 115 v. D.C. at 3.5 watts and 220 volts; 60 cycles at 10.5 volt-amperes.

*Type "BN" is 6 P.D.T. relay with 15 ampere contacts and coil capacity of 115 v. D.C. at 3.5 watts (not available

in A.C.).

*Type "BG" is S.P.D.T. relay with 2 ampere contacts and coil capacity of 25 v. D.C. at 50 milliwatts (not available in A.C.)

*Type "BO" is D.P.D.T. relay with 15 ampere contacts and coil capacity of 115 v. D.C. at 2.5 watts and 220 volts; 25 and 60 cycles at 4.5 volt-amperes.

*Type "F" is S.P.D.T. with 2 ampere contacts and coil capacity of 85 v. D. C. at 1.5 watts (not available in A.C.).

*Type "SK" from S.P.S.T. up to 4 P.D.T. with 1 ampere contacts and coil capacity of 60 v. D.C. at 750 milliwatts (for 4 P.D.T. relay) not available in A.C.

Allied Control representatives are located throughout the United States. A short note to our home office will give you the name of our nearest representative.

AL-119

ALLIED CONTROL CO., INC. 2 EAST END AVENUE, NEW YORK 21, N. Y.



Triad Transformers

Now Stocked by Distributors



**Formerly Available
Only as Components of
Fine Electronic Equipment**

Thoroughly tested and proved by years of exacting performance requirements on original equipment, Triad Transformers are designed and built to meet these specific applications:



ORIGINAL EQUIPMENT—TRIAD 'HS' transformers for original equipment embody superior techniques in transformer design and construction—*power transformers* of low temperature rise and good regulation—*chokes* of low resistance and high inductance—*audio transformers* of wide range both in frequency response and in power-handling capacity. Such transformers deserve the best in mechanical construction and protection against failure as exemplified by TRIAD's perfected hermetic sealing. Quantity production of hermetically sealed transformers for our Armed Services under JAN specifications has resulted in improved production techniques, and has lowered costs on these exceptionally long-lived units to permit their use in quality electronic apparatus.



REPLACEMENT—TRIAD is a major source of transformers for radio and television manufacturers. TRIAD replacement transformers, therefore, incorporate many parts and features to make them readily and universally adaptable to vacant spots in these chassis. Features include: High-quality materials, permitting small size without excessive temperature rise; vacuum varnish impregnation of both coil and core, copper foil static shields in all power coils, heavy drawn steel cases with sturdy baked enamel finish, and high temperature UL approved lead materials.



GEOPHYSICAL—TRIAD "Geoformers" are individually calibrated components for incorporation in 5-500 cycle measuring equipment of laboratory precision. Inductance is held within $\pm 5\%$ for the entire production and frequently within $\pm 2\%$ for any given shipment of transformers. "Geoformers" incorporate hum-bucking coils and multiple alloy shielding for minimum pickup; are of minimum size and weight, and are vacuum-filled and hermetically sealed. Designs are based on years of specialization in this difficult field by pioneers in geophysical transformer design. Standard designs for use in the most used circuits are carried in stock at the factory and by TRIAD distributors. Complete specifications for "Geoformers" are given in TRIAD Bulletin GP-49, available on request.



AMATEUR—TRIAD "DX'er" line of amateur transformers have been built around high-production, low-cost, transformer parts and simple coil constructions. This permits designs employing liberal quantities of high-quality material, at reasonable cost. Simple one-purpose designs with drawn steel cases and flexible leads eliminate much of the unnecessary cost involved in heavy castings and expensive tapped coil constructions, while still permitting extensive use of finest materials essential to good transformer design.

Write for Triad Transformer Catalog TR-49. Some territories still open for qualified manufacturers' agents.

BOOTH 74

5th Annual Pacific Electronic Exhibit

August 30, 31 and September 1

San Francisco Civic Auditorium



2254 SEPULVEDA BLVD. • LOS ANGELES 25, CALIFORNIA

advantages, both from the viewpoint of readability and circuit simplicity. Furthermore, practically every conceivable kind of failure of any part of the system is certain to make itself known by distorting the picture in one way or another.

After investigating the utility of different patterns the pattern shown in Fig. 2 was chosen, wherein a circular time base line is produced, upon which a pip indicates the bearing to the omni-station.

The circle is derived from the reference signal simply as a Lissajou pattern on a regular electrostatic deflection type cathode-ray tube. The 30-cps signal, carrying the azimuthal information, is transformed into pulses by using a tube with a radial deflection electrode.

System Details

Fig. 3 shows a block diagram of the whole receiving system, including the audio channel. The receiver is permeability tuned, consisting of one stage of r-f, a 12AT7 twin-triode mixer, and three stages of 10.7-mc i-f. The whole communication receiver part is placed in the instrument panel, while the signal resolving part and a vibrator-type power supply forms another unit. The audio amplifier part is also used as modulator for the plane's vhf transmitter. The whole system, including oscilloscope, antenna, and cables, weighs only 24 pounds.

The principal schematic of the

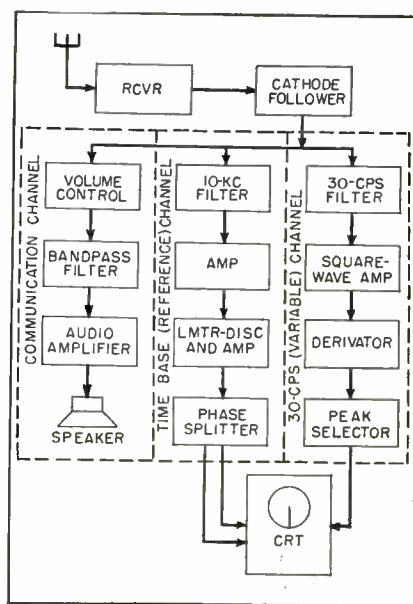
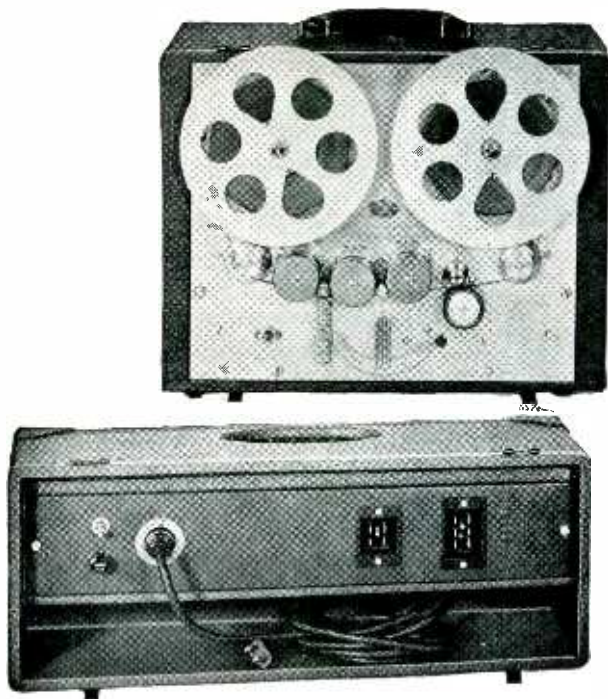

FIG. 3—Block diagram of complete direction-finding system



Comparisons

indicate this is the world's
finest recorder of its type



Complete in two easily portable cases—
one containing the recorder, the other
the amplifying equipment.

NEW PRESTO

Portable Tape Recorder 900-P

MANY OUTSTANDING FEATURES:

- Three separate heads for superior performance (and for monitoring direct from tape). One head each to erase, record and play back.
- 3 microphone channels with master gain control in recording amplifier.
- Weston type 30 V. U. meter with illuminated dial to indicate recording level, playback output level, bias current and erase current.
- 2-speed, single motor drive system. Toggle switch to change tape speeds from 7½" to 15" per second.

Don't choose your tape recorder until you see the *new* Presto Portable Tape Recorder. Write for complete details today.

Write today to be put on our mailing list for "The Presto Recorder," new house organ of practical ideas for anyone in the recording and broadcasting field.

Mailing Address: P. O. Box 500, Hackensack, N. J.
In Canada: WALTER P. DOWNS, Ltd., Dominion Square Building, Montreal



RECORDING CORPORATION
Paramus, New Jersey

WORLD'S LARGEST MANUFACTURER OF INSTANTANEOUS SOUND RECORDING EQUIPMENT AND DISCS

Ballantine's PEAK to PEAK Electronic VOLTMETER

Designed for
PULSE AMPLITUDE
MEASUREMENTS

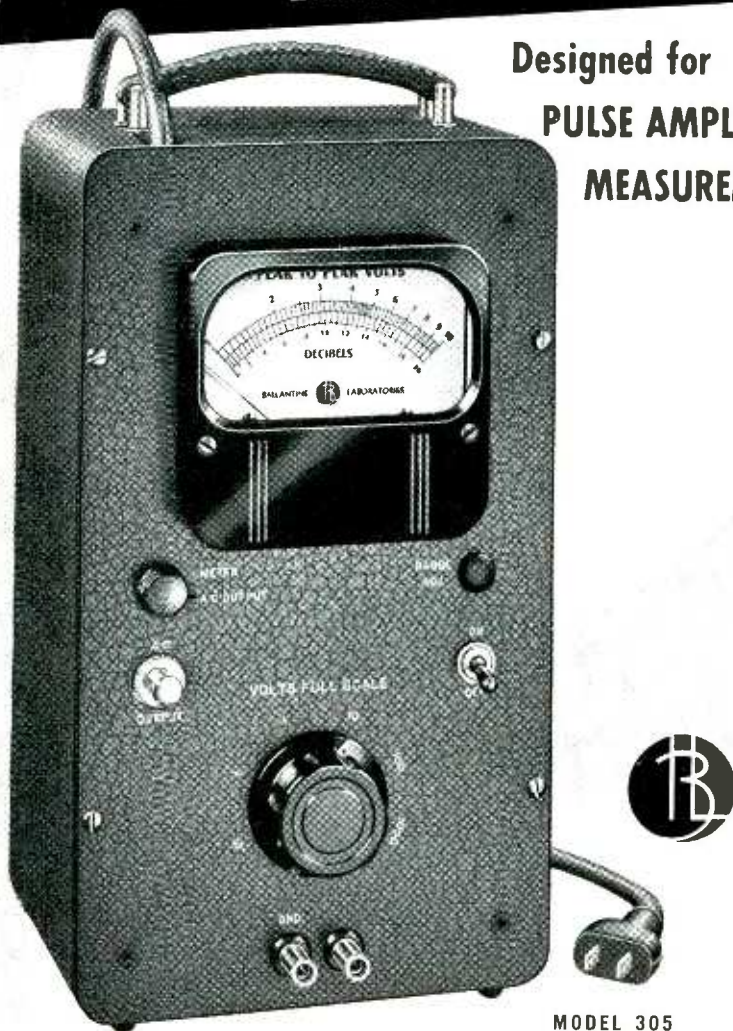

MODEL 305

The outstanding characteristic of the Model 305 Electronic Voltmeter is its ability to provide absolute indication of transient or pulse voltages of short duration. Reliable indication of pulses a few microseconds wide repeated only 10 times per second is readily obtained with this instrument. The Voltmeter is pre-calibrated, compact, easy to operate and observe. Positive and negative peaks are registered over the range of .001 volt to 1000 volts, peak to peak. Decade ranges and a logarithmic scale output meter are characteristic features, along with a separately available high gain, wide-band amplifier.

Send for Bulletin No. 12

BALLANTINE LABORATORIES, INC.

BOONTON, NEW JERSEY, U. S. A.

signal resolving part of the receiving system is shown at the beginning of this article. The many functions needed to convert the 10-kc f-m signal into a circle on the oscilloscope are performed with only two tubes and a minimum of parts. After a resonant circuit, tuned to 10 kc, and a 6AG5 pentode amplifier-limiter, there is a discriminator in the form of a side-tuned resonant circuit, feeding the diodes of a 6BF6. This simple type of frequency discriminator has been proved to work very satisfactorily. Necessary potentiometers for adjusting voltages so as to produce a circular pattern and for centering of the circle, are omitted in the schematic.

Bandwidth

A more serious design problem is encountered in the 30-cps variable phase channel. To obtain a steady indication, it is necessary to build a rather selective 30-cps filter and to avoid all intermodulation. Concerning intermodulation, the most critical point is the detector, which must be virtually distortion-free.

With vhf transmission, waves reflected from the airplane itself also become a source of interference. The main source of interference of this kind is metal propellers. When, for instance, a two-blade propeller approaches 1,800 rpm, the modulation frequency reaches 60 cps. In the presence of some distortion, a new signal with a frequency of approximately 30 cps is formed, which causes beats with the desired signal. Occasionally, noise created by varying contacts in control surface hinges has also been observed.

To minimize ignition noise and propeller modulation interference, the bandwidth of the 30-cps channel of the signal resolving unit should be so narrow as to correspond to the response time desired, say one cps or less. However, to allow for necessary tolerances in signal frequency and receiver components, a total bandwidth of about 3 cps has been found practical. The filtering has been obtained with two stages of gain employing negative feedback through bridged-T units, one being tuned to 29 cps and the other

ERIE "GP" CERAMICONS

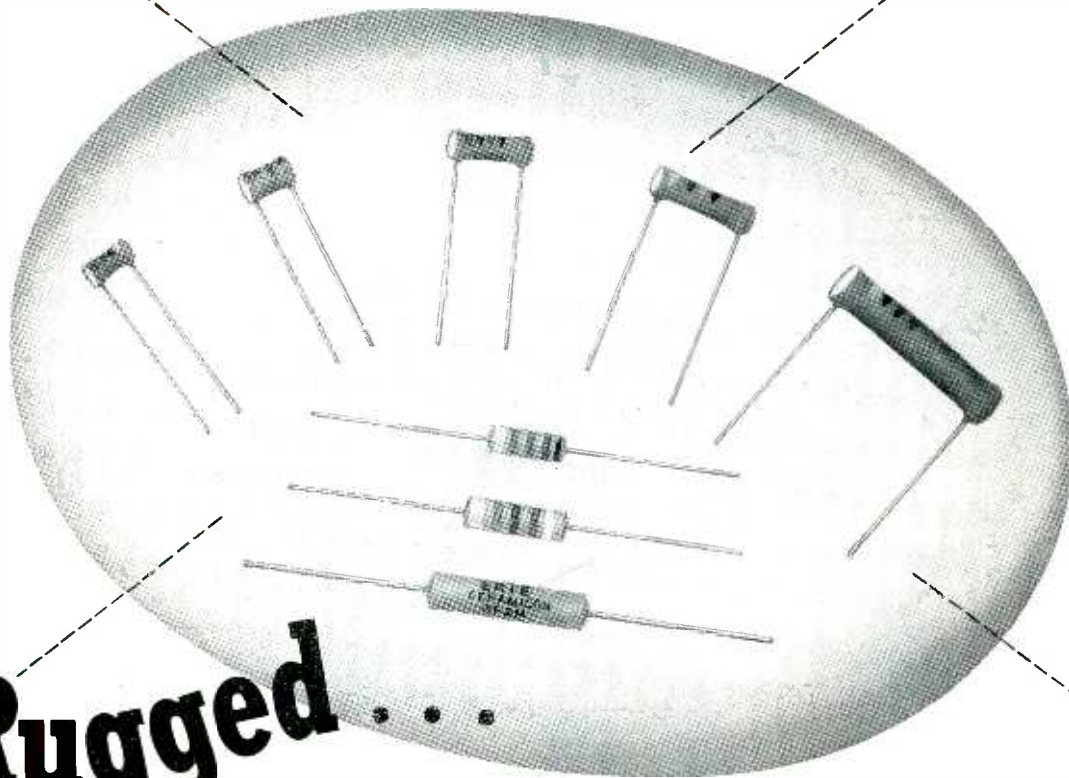

Rugged . . .

DO NOT BREAK IN ASSEMBLY—SERVICE

Erie General Purpose Ceramicons became favorites in the industry when TV sets were still a negligible part of total output. The qualities which recommended them for by-passing and coupling applications which were not frequency determining in radio receiving sets, become even more important in television assembly.

Erie "GP" Ceramicons are rugged and compact. Tubular form and phenolic insulation provide extra sturdiness that withstands rough handling both in installation and in service.

General Purpose Ceramic Condensers are economical because, by limiting them to definite capacity values, they can be manufactured in quantity without sacrifice of quality.

They are made in insulated and non-insulated styles, in popular capacity values up to 10,000 MMF. Write for detailed information and samples.

Electronics Division

ERIE RESISTOR CORP., ERIE, PA.

LONDON, ENGLAND • • TORONTO, CANADA





SPECIFICATION:

TYPE T/2

Overall Diameter	12.5/16"
Overall Depth638"
Fundamental Resonance.....	75 c.p.s.
Voice Coil Impedance... ..	15 ohms at 400 c.p.s.
Maximum Power Capacity... ..	12 watts Peak A.C.
Total Flux.....	145000 Lines
Net Weight.....	12 lbs. 4 ozs.

A speaker of unique versatility. Designed and built with Goodmans's tradition of excellence. Its performance and ideal frequency response have placed this unit in the forefront of medium heavy-duty loudspeakers.



GOODMANS

World-Famous

T2 12" R.M. LOUDSPEAKER
Fully Dustproof

GOODMANS INDUSTRIES LTD., Lancelot Road, WEMBLEY, Middlesex, ENGLAND

being tuned to 31 cps.

The filtering section is followed by two saturated stages producing a square wave. This square wave is differentiated in an R-C circuit. The end tube in this channel is biased beyond cutoff to permit only the positive peaks to pass and make the radial deflection mark on the screen. In this way, a pip with sharp corners at the bottom is produced.

Runway Localizer

The omni-range receiver, as described, is also fitted for use with the new phase-comparison type runway localizers. These work in a similar way as the traditional 90/150-cps type, but the 90 and 150-cps modulation is replaced with a 30-cps signal and a reference signal, of the same type as in the omnistations.

The 30-cps signal is in phase with the reference on the left side of the runway when approaching the airfield and 180 degrees out of phase on the right side. Consequently, without any changes in the receiving equipment, such a transmitter should produce a straight north or south indication on the scope, depending upon the airplane location with respect to the runway localizer beam. The distance to the correct path is measured by the amplitude of the signal.

With the exception of turning the picture ninety degrees, it is therefore desirable to make it register the size of the 30-cps signal. To do this, the signal is taken out of the last filter stage and fed to the horizontal deflection plates, while the reference signal is retained on the vertical plates, the necessary switching being done by a relay. The picture obtained this way is a vertical line which is inclined to the right or to the left, depending upon whether the craft is on one side of the runway or the other.

Thyratron Replaces Vibrator

THE CIRCUIT of an electronic converter that supplies alternating current for powering radio and other electronic units is shown in the diagram. It operates from a six-volt battery and contains no

IRVINGTON lowers costs

with
NEW
VARNISHED
FIBERGLAS*
Style OW Insulation



Here's a new Irvington insulating material that's important to investigate now. Important because it makes possible the use of Fiberglas (Class B Insulation) at a cost substantially lower than formerly. Important because it provides in a standard product the combination of higher dielectric strength, greater flexibility and high mechanical strength desired in many specific applications.

In making Varnished Fiberglas Style OW, Irvington employs base cloth woven by a new principle that permits the woven fiberglas to carry more insulating varnish. Not only test results, but actual applications have proved its advantages in such services as core wrappings, field coils and punchings. It is available in black or yellow, in thicknesses of .007", .010", .012"; in rolls 25 and 50 yards long; approximately 36" wide; tape in widths from 1/2" up. Write today for test reports, further details, and samples.

*T.M. Reg. U.S. Pat. Off. by Owens-Corning Fiberglas Corp.



IRVINGTON *Varnish & Insulator Company*

Irvington 11, New Jersey

Authorized distributors in Atlanta; Baltimore; Berkeley; Bluefield, W. Va.; Boston; Charlotte; Chicago; Cleveland; Dallas; Denver; Detroit; Los Angeles; Milwaukee; Minneapolis; New Hartford, N.Y.; New Orleans; Philadelphia; Pittsburgh; Portland, Ore.; St. Louis; Seattle; Hamilton, Ont., Canada.

The Case of the Ritzy Restaurant



Purchasing Agent: "I thought this was a first class place to eat. Just look — paper napkins!"

Chief Draftsman: "You should talk! Over at the plant you expect my department to produce useful drawings on perishable tracing paper instead of permanent Arkwright Tracing Cloth!"

As vital as each expertly drawn plan, is the material which receives, reproduces and preserves it. For this important purpose, the matted fibers of paper cannot compare with the selected, uniform, new cotton fibers woven and bonded into Arkwright Tracing Cloth! Use Arkwright, even for preliminary or one-job drawings that may be urgently needed for future use or reference. That's the safer, thriftier way!

Prove to yourself the extra worth and work ability of Arkwright for all drawings. Send for generous working samples. Arkwright is sold by leading drawing material dealers everywhere. Arkwright Finishing Co., Providence, R. I.

The Big Six Reasons Why Arkwright Tracing Cloths Excel

1. Erasures re-ink without feathering.
2. Prints are always sharp and clean.
3. Tracings never discolor or go brittle.
4. No surface oils, soaps or waxes to dry out.
5. No pinholes or thick threads.
6. Mechanical processing creates permanent transparency.



ARKWRIGHT

TRACING CLOTHS

AMERICA'S STANDARD FOR OVER 25 YEARS

moving parts.

Other types of tubes than the 2051 shown may operate as well. Cold-cathode types might permit instant starting and no power loss in heating the filament. The inventor of the circuit, Carl R. Peterson of Los Angeles, California, has used a UTC universal output transformed as L_1 and L_2 , with the 0 to 8-ohm tap as L_1 and 8 to 500-ohm tap as L_2 . Low ohmic resistance and high inductance would provide greater output. The circuit may be of interest to designers of truly portable television receivers as a picture tube anode

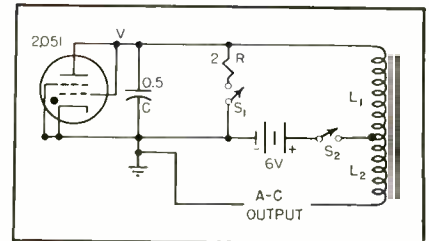

Simple thyatron circuit provides high-voltage a-c output

supply. A patent has been applied for.

With switch S_2 closed and S_1 depressed momentarily, current will flow from the battery through L_1 and R . The current is limited in value by the resistance R and the resistance of the inductive winding. When S_1 is opened and left in that position, an induced voltage appears across C and tube V . This voltage will be in series with the battery, and will either aid or oppose the battery voltage on each alternate cycle.

When both are in a positive direction with respect to the anode of the tube, the voltage will be sufficient to ionize the gas and the tube will then conduct current in that one direction. The gas-filled tube may be considered as a switch of zero resistance, and a back emf of about 5 volts. Therefore both the induced current and current from the battery will flow in the circuit.

When the induced voltage plus the battery voltage falls to about 12 volts, the tube will extinguish and thus effectively open the circuit. With the circuit open, the field in L_1 will collapse, the induced voltage will ionize the tube

To Top Flight Development, Design and Instrumentation Engineers:

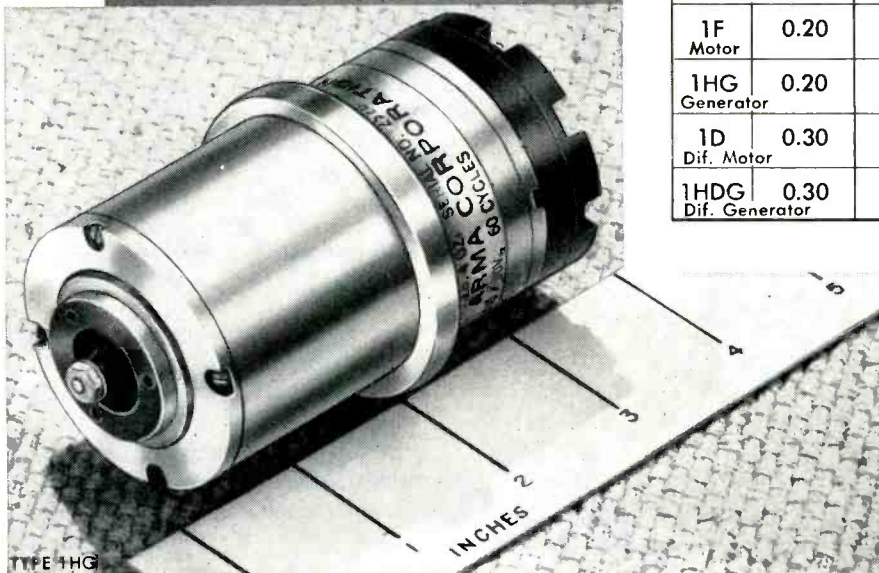

This table gives the essential characteristics of Arma Synchro Units. The information may suggest applications of these components to your designs.

Type	Open Circuit Primary Excitation		Torque Gradient oz. in./deg.	Rotor Inertia (oz. in. ²)	Weight (Approx.)
	Amps.	Watts			
1CT Control Transf.	0.03	0.5	—	0.36	1 lb. 5 oz.
1F Motor	0.20	3.5	0.10	0.52	1 lb. 5 oz.
1HG Generator	0.20	3.5	0.10	0.52	1 lb. 4 oz.
1D Dif. Motor	0.30	7.4	0.04	0.54	1 lb. 4 oz.
1HDG Dif. Generator	0.30	7.4	0.04	0.54	1 lb. 4 oz.

Power Supply 115 volt, Single-Phase, 60 cycle.

Convenient Accurate Mounting through concentric flanges.

Accurately - Ground, True - Running shaft extensions, with keyed tapers or clamps.

Bearings, (Free-Rotor Units), are Arma design, already used in over 1,000,000 units.

New "Tools" for Industrial Designers

It may pay you to re-examine, in the light of these high-accuracy Arma Synchros, instrumentation projects once abandoned because of the limitations of available components.

Use These Other Arma Components, Too

Tachometer-type Induction Generators for high performance in servo systems; two-phase Induction Motors for servo-mechanisms and control devices; Electrical Resolvers* for solving problems involving triangles, coordinates and vectors; high-precision Mechanical Differentials for computer applications.

Arma follows through to Realities

For over 30 years Arma Corporation has been quietly taking on (under wraps) one complex development and design problem after another for the U. S. military establishments—problems concerned with instrumentation. When Arma finishes, the problem is not only solved but the actual equipment to do the job, built.

Arma Synchro Units Meet Tomorrow's Industrial Instrumentation Needs

These five Arma Synchro Units are designed and built to operate accurately, with minimum servicing. The standards of accuracy, and resistance to vibration, shock and temperature are so high that they would appall most commercial generator and motor designers.

New

As components of some of the most precise control, computing and servo systems ever conceived, these Arma Synchro Units were previously restricted so that many engineers have never had an opportunity to consider applications of them to instrumentation and design problems.

Accurate

Combinations of these synchro units will transmit with high accuracy, rotary mo-

tion and position. They will indicate the sum or difference of position or rotation. Through an Arma control transformer, the varying voltages of a synchro system can be linked to electronic means of controlling large amounts of power.

In simple, "flexible-shaft" arrangements, Arma Synchro Systems are accurate to within 0.5 degree. However, accuracies of higher order are readily obtainable with multi-speed synchro systems such as that used on the 200 inch telescope at Mt. Palomar.

More Advantages of Arma Synchros

Conservative Electrical Design. Low power consumption, low temperature rise, large creepage distances and air gaps, 1,500 volt insulation, low loss laminations.

You are invited to request whatever information you may need to explore the possibilities of making use of any Arma product which has been released from security restrictions.

ARMA CORPORATION

254 361^h STREET, BROOKLYN 32, N. Y.

SUBSIDIARY OF AMERICAN BOSCH CORPORATION

ARMA
PRODUCTS
RELEASED
FOR
PRIVATE
INDUSTRY

ARMA ELECTRICAL RESOLVERS* ARMA SYNCHROS ARMA INDUCTION MOTORS ARMA INDUCTION GENERATORS ARMA MECHANICAL DIFFERENTIALS ARMA ALTERNATING VOLTAGE COMPARATOR COMPUTING MECHANISMS INDUSTRIAL CONTROLS STABILIZATION DEVICES NAVIGATIONAL EQUIPMENT LIMITRON AUTOMATIC INSPECTION SYSTEM

* Licensed for use under Arma patents Nos. 2,465,624 and 2,467,646. License information available.

QUALITY **ARMA** PRECISION
INSTRUMENT



PACK 8 SCREWS

**ONE
AT A
TIME**

**OR 8 SCREWS
AT ONCE**

PRE-COUNTED

in any number or supplied
uncut on spools

COLOR-CODED

for size or material

AVOIDS LOSS

cannot roll away

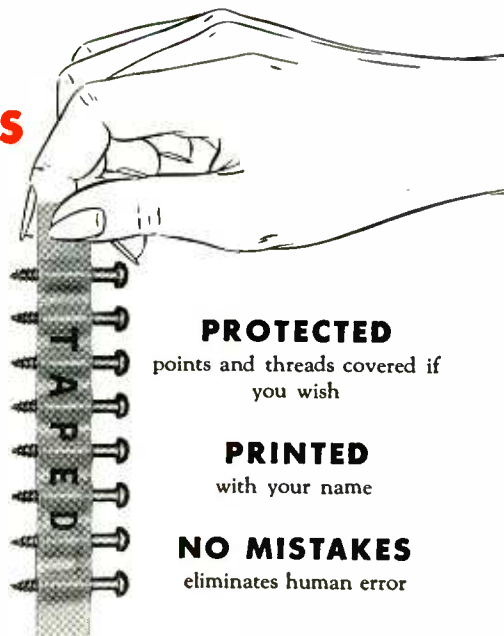

PROTECTED

points and threads covered if
you wish

PRINTED

with your name

NO MISTAKES

eliminates human error

HOLTITE

TAPED

SCREWS

... the sure, rapid, and economical answer for the manufacturer who must include a specific number of screws with his packaged product. Holtite Taped Screws eliminate the tedious and costly process of counting screws by hand. They save the expense of envelopes or bags. They allow the packer to put the exact number in the package — in a single operation — without a chance for error! For free sample and estimates, write to



1904

**CONTINENTAL
SCREW COMPANY**

NEW BEDFORD, MASS., U.S.A.



1949

and the cycle will repeat until S_2 is opened. The entire circuit is analogous to that of an ordinary ignition circuit with the exception that the breaker points are replaced by the gas-filled arc tube.

The output of the transformer may be rectified and filtered in the usual manner. The unit has been used to operate an ordinary a-c radio with 6V6 output tube, and the energy is sufficient to operate it in a satisfactory manner with good volume on local stations. There is no noise or hum present in the output.

Ultrasonic Generator for Clinics

ONE of a series of ultrasonic generators recently developed for industrial production and laboratory work is a model designed for continuous flow processing of liquids in manufacturing applications. A second model announced is a clinical-laboratory ultrasonic generator.

Principal feature of the latter equipment is the convertible transducer for transmitting the high-frequency vibrations to the skin of the patient, or to the specimen of tissue or other material under treatment. The transducer is connected to the generating unit by a coaxial cable carrying low-voltage (less than 100 volts) high-frequency current.

The base of the transducer comprises a transparent Lucite tube, surrounded by a ring containing the primary winding of the step-up Tesla coil from which a handle projects, with the connecting cable leading in through it.

Inside the tube is the secondary winding of the step-up coil. The crystal is mounted above the secondary coil upon nylon rods, between Bakelite and glass discs. The tube is closed by a cap containing a Bakelite diaphragm 0.01-inch thick, mechanically connected with the vibrating crystal by oil which fills the entire assembly. This diaphragm, placed against the skin of the patient under treatment, effectively transmits the ultrasonic vibrations generated by the crystal.

A second Lucite tube is provided, which may be screwed to the top of the base assembly and filled with oil, into which a test tube or other

New **ADC** Yeoman TRANSFORMER SERIES



Yeoman Series

The Yeoman series is a new line of low-price transformers not previously offered by ADC. Transformers in this series include some features of both the famous ADC Quality Plus and Industrial lines in open frame construction with flexible leads.

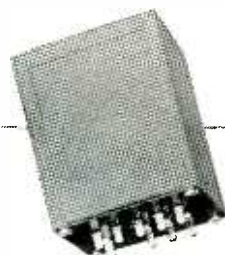

Quality Plus Series

1. $\pm 1/2$ db 30-15,000 cps, all types.
2. Low transmission loss.
3. Excellent longitudinal balance.
4. Top or bottom mounting.
5. Silver plated terminals.
6. High permeability mu-metal shielding.
7. Highest grade insulation materials.

Industrial Series

1. Dependable at lower cost.
2. $\pm 1/2$ db from 50 to 10,000 cps.
3. Minimum insertion loss.
4. Same construction, insulation and impregnation as Quality Plus series.



Provides Famous ADC Quality at Low Cost...

The unvarying high quality of ADC transformers has been recognized by electronics engineers through the years. The result has been consistent reorders whenever specifications call for dependability and close tolerances over wide frequency ranges.

This excellent record for quality results from experience and training in transformer design and a careful system of production testing in the ADC plant. Modern production methods and the use of only quality materials are a must in all ADC transformers.

NOW! A new line of transformers has been designed to meet a present day industry need for high transformer quality at lower prices.

YEOMAN Series for Quality at Lower Price

This is a new ADC transformer line for all types of applications; i.e., input, output, bridging, power transformers and chokes.

Open frame construction has been substituted for hermetic seals, and other design changes have been made in the interest of economy. The industry will find many applications for the accurate, dependable, trouble free performance of ADC transformers at the new Yeoman price range.

See specification outlines on this page. Then write for your new ADC catalog today.

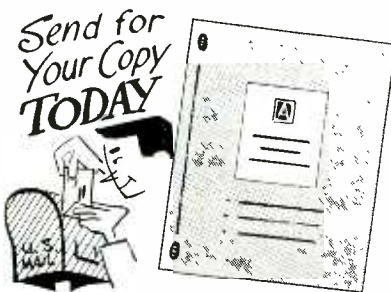

Audio Develops the Finest



Audio DEVELOPMENT CO.

2847 13th Avenue South, Minneapolis 7, Minn.

\$1,500 inventory abolished — at a cost of \$4.46!



With more than 700 vacuum tubes needed by industry, a tube distributor would find profits consumed by 100% inventories. But by ordering tubes as needed via Air Express, he holds stocks to 25%. Example: Orders \$1,500 tube at 9 A.M. from supplier 900 miles away. Delivered to customer 6 P.M. same day. 16 lbs.: cost, \$4.46.



Remember, \$4.46 included speedy pick-up and delivery service, too. More protection, because you get a receipt for every shipment. Air Express is the world's fastest shipping service.



Your Air Express shipments go by the Scheduled Airlines direct to over 1,000 airport cities; fastest air-rail for 22,000 off-airline offices. Shipments keep moving with 'round-the-clock service.

FACTS on low Air Express rates

19 lbs. of machine parts goes 600 miles for \$3.54.
9-lb. carton of new styles goes 1400 miles for \$3.99.
(Every kind of business finds Air Express pays.)

Only Air Express gives you all these advantages: Special pick-up and delivery at no extra cost. You get a receipt for every shipment and delivery is proved by signature of consignee. One-carrier responsibility. Assured protection, too—valuation coverage up to \$50 without extra charge. Practically no limitation on size or weight. For fast shipping action, phone Air Express Division, Railway Express Agency. And specify "Air Express delivery" on orders.

SPECIFY AIR EXPRESS
GETS THERE FIRST



Rates include special pick-up and delivery door to door in principal towns and cities



AIR EXPRESS, A SERVICE OF RAILWAY EXPRESS AGENCY AND THE
SCHEDULED AIRLINES OF THE U.S.

vessel containing either solid or liquid material to be treated may be immersed. Through this feature of convertibility, the equipment is readily adapted to most requirements of clinical or laboratory work.

The generating unit contains a self-excited oscillator which is coupled to the crystal circuit and is frequency-controlled by it. Thus the frequency of the oscillator is prevented from drifting out of phase with the natural period of the crystal, assuring constant and maximum energy delivery. Power control is adjustable, and is metered in the crystal circuit.

Standard frequency of the generator is 450 kc, with alternate crystal and coil available for quick conversion to 900 kc. Other frequencies are available upon special order from the manufacturer, Ultrasonic Engineering Co., Maywood, Ill.

Simplified Measurement of L and k

By V. A. SHERIDAN

Director
British Physical Laboratories
Rudlett, Herts
England

TO EMPLOY inductively-coupled circuits in electric wave filters and the like, it is necessary that the value of the self inductance of the inductors and the coefficient of coupling be known. The instrument described here renders this information quickly and with accuracies generally better than 1 percent.

The frequency at which measurements are made is 23 kc. Values of inductance between $0.9 \mu\text{h}$ and 1.234 h can be measured, and the useful range for values of coupling coefficient k is from about 0.005 to 0.995.

Design Considerations

Two methods for measuring the value of k were considered for use in the instrument. The first, the method which requires a knowledge of the self-inductance values of the two windings and the effective resistance of the two windings connected together in either series aiding or opposing, or parallel aiding or opposing, was discarded because three separate measurements

Federated ROSIN CORE SOLDER

Look for the orange package . . . the universally popular solder for use in electrical applications where bonding must be secure and free from corrosion.

The flux is in the solder . . . all you need is heat! Federated Rosin Core Solder is available in 1, 5, and 20-pound sizes.



Federated makes every commercial solder . . .

Asarco Body Filler Metal, acid-core, solid wire, spray-gun, and bar . . . purity and composition guaranteed by the world's leading supplier of solder.

Federated METALS

Division of AMERICAN SMELTING AND REFINING COMPANY
120 Broadway, New York 5, N. Y.
OFFICES IN PRINCIPAL CITIES ACROSS THE NATION



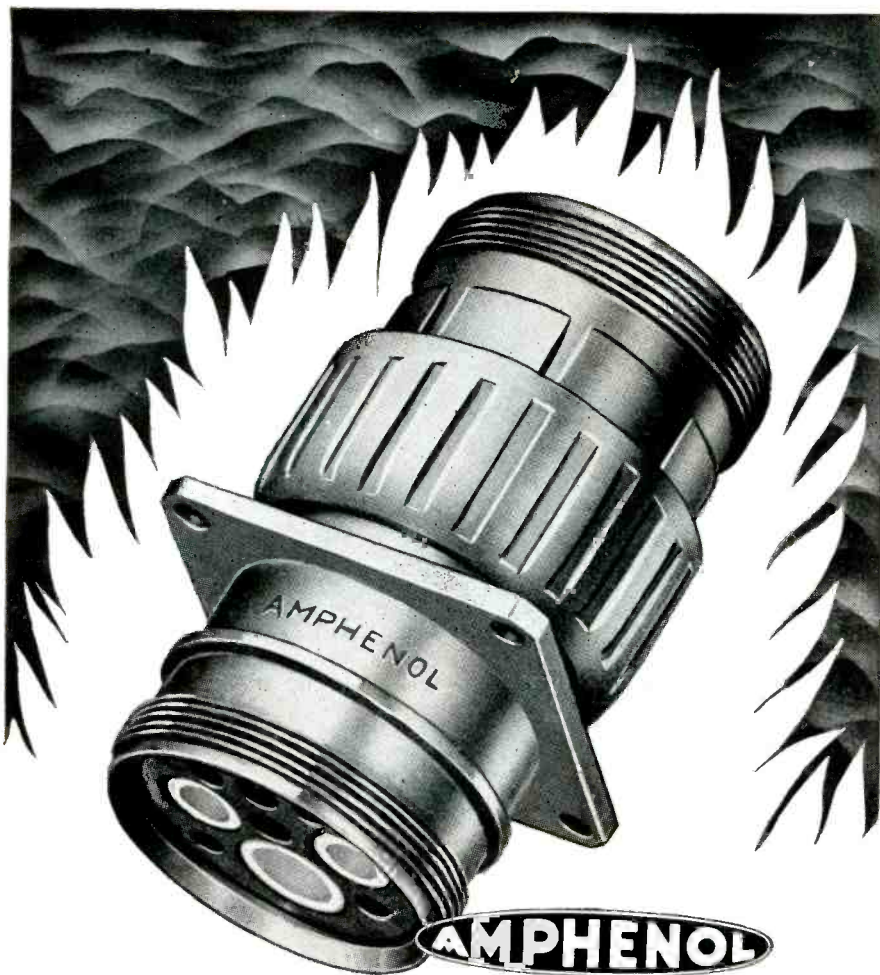

AMPHENOL FIREWALL CONNECTORS

Operate Continuously at Destructive Temperatures

For aircraft firewall, jet engine, thermocouple and other high temperature installations, Amphenol offers the best heat-resistant and vibration and shockproof electrical connectors. Connectors are of a unique one-piece design manufactured of steel protected by cadmium plating. Ceramic dielectric inserts, shock mounted, protect the contacts at abnormally high temperatures.

With silver plated contacts, circuit continuity is not impaired, and selected alloys retain spring tension and function with lowest millivolt drop.

Amphenol Firewall Connectors have been subjected to the full C.A.A. requirements and have continued to operate efficiently long beyond the test time limit. Amphenol, again, has given the aircraft industry a new contribution to safety in the air. Amphenol's Firewall Connectors are also an indispensable new tool for high temperature industrial applications.

AMPHENOL

Write to Department J on Company letterhead for Amphenol Catalog A-1 and the supplement A-1-B, a comprehensive listing of firewall connectors.

AMERICAN PHENOLIC CORPORATION
1830 SO. 54TH AVENUE
CHICAGO 50, ILLINOIS

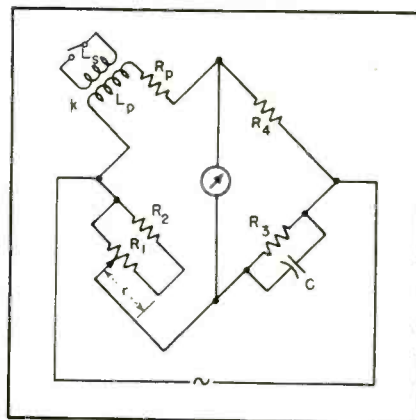

FIG. 1—Basic Maxwell bridge circuit used in British *L* and *k* bridge

were necessary, and the accuracy for low values of *k* was bad.

The method used depends on the change in effective inductance of one winding when the other winding is open and short-circuited. Only two separate measurements are necessary, and the accuracy of this system is usually of a high order.

If the effective inductances of the primary winding with the secondary open and short-circuited are L_{oc} and L_{sc} respectively, then

$$L_{oc} = L_p$$

$$L_{sc} = L_p - \frac{\omega k^2 L_p L_s}{\omega L_s}$$

$$k = \left(1 - \frac{L_{sc}}{L_{oc}}\right)^{1/2}$$

The inductance values of L_{oc} and L_{sc} may be measured separately on a suitable bridge and the value of *k* calculated; or on a special bridge, one of the resistance arms may be calibrated directly in values of *k*.

Consider the Maxwell bridge shown in Fig. 1. With R_1 set at maximum resistance, $r = 0$, and the transformer secondary open, the bridge is balanced by means of C and R_3 . The secondary is then short circuited and the bridge re-balanced by means of R_3 and R_1 , and the change in R_1 will be r . Assuming that the dissipation in the secondary is zero and that no self capacitance is present, the effective primary inductance falls from L_p to $L_p (1 - k^2)$. It may then be proved, from the balance equations for each condition, that $k = r/R_1$; then *k* is directly proportional to r , and R_1 may be calibrated linearly in values of *k*.

So far it has been assumed that no secondary dissipation or winding

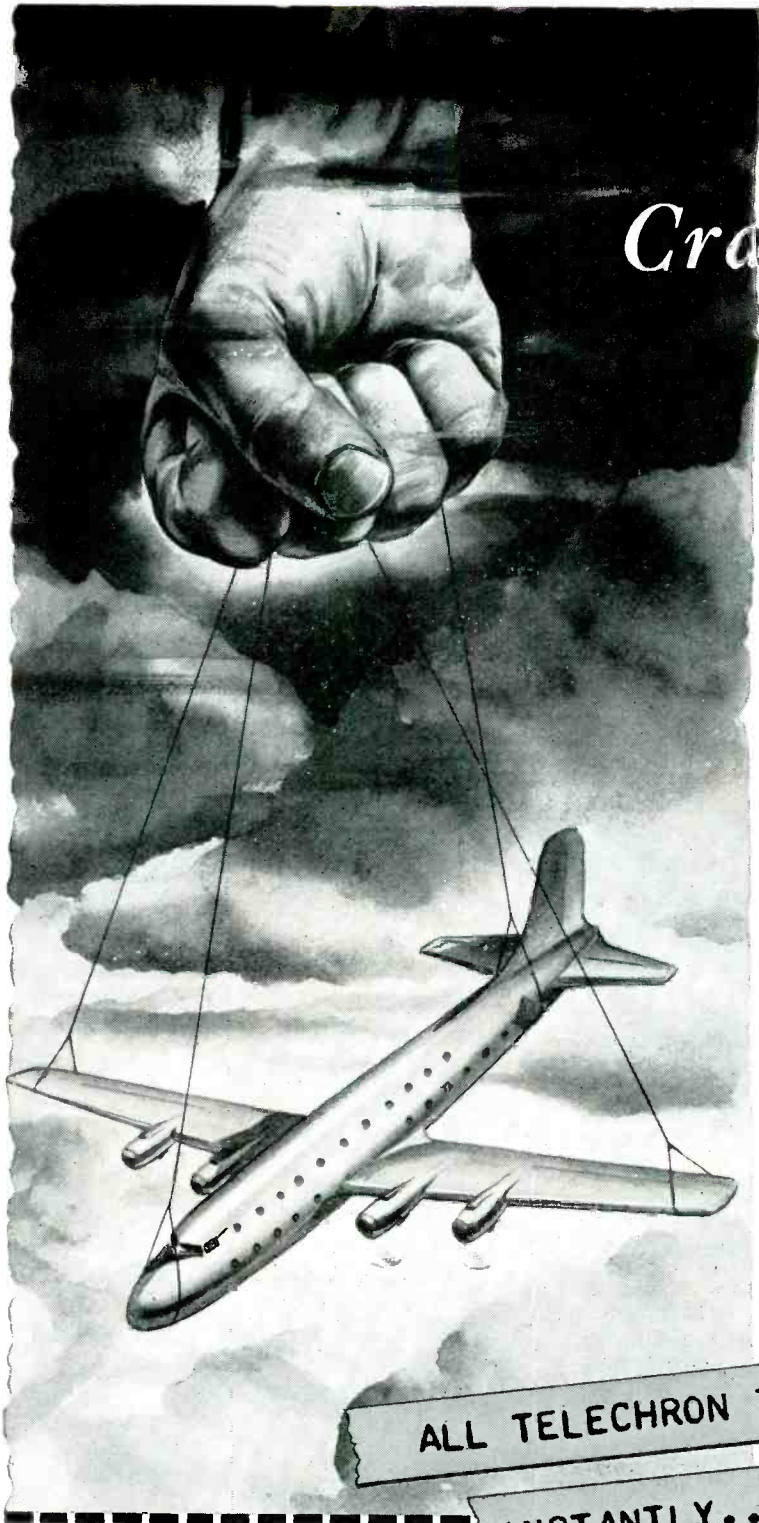

Crash prevention



... WITH AN
ASSIST FROM
TELECHRON TIMING MOTORS

Preventing aircraft failures tomorrow depends on knowing exactly what causes them today. That's why so many modern planes carry a sure-to-survive witness that tells what mechanical malfunction betrayed the pilot's skill. It's the amazing new Flight Recorder that charts a continuous log of the variables that might cause a crash.

THE FLIGHT RECORDER MUST STAY ON TIME

The heart of this pilot's loyal supporter is a Telechron Timing Motor . . . *instantly, constantly synchronous*. Only such an accurate, trouble-free motor could be trusted to time the chart that shows the aircraft industry's planners how to add ever-increasing safety to the age of flight.

IS YOUR TIMING OFF?

You, too, can control or record your variable factors with the ultimate in accuracy. Just call in a Telechron application engineer. Drawing on the broadest experience in the industry, he can probably show you how a standard Telechron motor can do your job. Consult him early in your planning for big savings in time and money. TELECHRON INC. A General Electric Affiliate.

Telechron[®]

**ALL TELECHRON TIMING MOTORS ARE
INSTANTLY...CONSTANTLY SYNCHRONOUS**

TELECHRON INC
40 Union Street
Ashland, Massachusetts

Please send me information on sizes and types of Telechron Synchronous Motors. My possible application is:

- | | | | |
|-------------------------------------|--------------------------|--|--------------------------|
| Instruments | <input type="checkbox"/> | Communications Equipment | <input type="checkbox"/> |
| Timers | <input type="checkbox"/> | Other (please fill in) | <input type="checkbox"/> |
| Electric Appliances | <input type="checkbox"/> | | <input type="checkbox"/> |
| Cost Recorders | <input type="checkbox"/> | | <input type="checkbox"/> |
| Advertising, Display Items | <input type="checkbox"/> | | <input type="checkbox"/> |
| Juke Boxes | <input type="checkbox"/> | | <input type="checkbox"/> |
| Air Conditioning & Heating Controls | <input type="checkbox"/> | <input type="checkbox"/> Please send new Catalog | |

NAME

COMPANY

ADDRESS

CITY ZONE

STATE



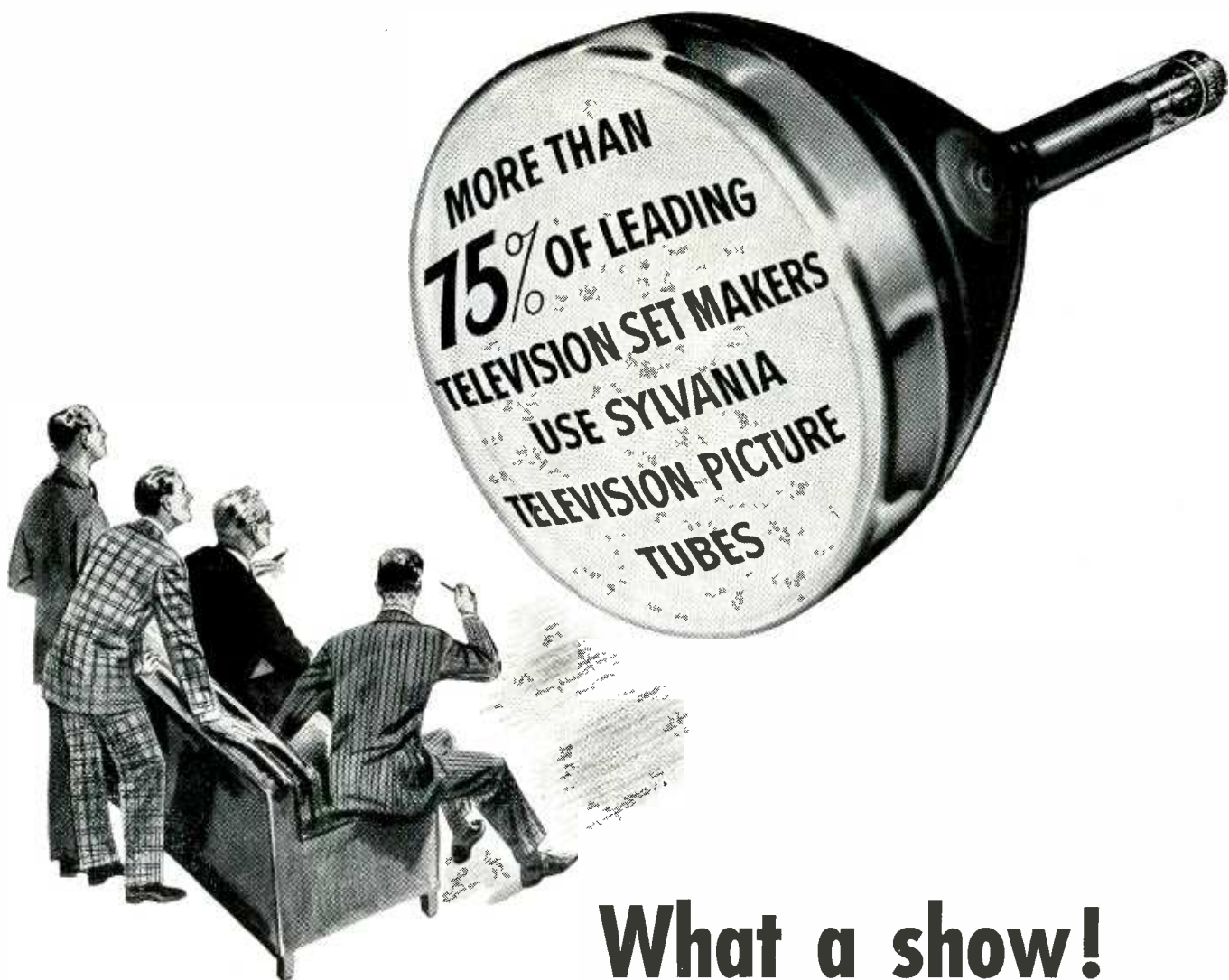

What a show!

A recent intensive survey discloses that among the major television set manufacturers, more than 75% use Sylvania cathode ray tubes!

This impressive showing is a tribute to the research and quality production techniques employed by Sylvania in the making of picture tubes that are unsurpassed.

If you wish full information about the entire Sylvania line of television picture tubes made by the manufacturers of highest quality radio tubes and electronic equipment, write Sylvania Electric Products Inc., Television Tube Division, Seneca Falls, N. Y.

These leading television set manufacturers use Sylvania Television Picture Tubes

Admiral • Air King • Andrea • Ansley • Automatic
 Bendix • Crosley • DeWald • Emerson • Fada
 Farnsworth • Garod • Hallicrafters • Hoffman
 Magnavox • Midwest • Motorola • National • Olympic
 Packard-Bell • Philco • Pilot • Raytheon-Belmont
 Regal • Scott • Sentinel • Silvertone • Sperton
 Stromberg-Carlson • Tele-King • Tele-tone • Temple
 Trav-ler • Westinghouse • Zenith

SYLVANIA ELECTRIC

CATHODE RAY TUBES; RADIO TUBES; ELECTRONIC DEVICES; FLUORESCENT LAMPS, FIXTURES, WIRING DEVICES, SIGN TUBING; LIGHT BULBS; PHOTOLAMPS



**Type H-12
SIGNAL GENERATOR
900-2100 MEGACYCLES**



**-Simplified
-Compact
-Portable**

- 900-2100 megacycles, single band
- Directly calibrated, single dial frequency control
- Directly calibrated attenuator, 0 to -120 dbm
- CW or AM pulse modulation
- Internal pulse generator with controls for width, delay, and rate. Provision for external pulsing
- Controls planned and grouped for ease of operation
- Weight: 42 lbs. Easily portable—ideal for airborne installations
- Immediate delivery

*Built to
Navy Specifications
for research
and production
testing*

Write for specifications—investigate the advantages of this outstanding new instrument.

DEPENDABLE ELECTRONIC EQUIPMENT SINCE 1928

Aircraft Radio Corporation
BOONTON, New Jersey



within the range of the instrument. The instrument is suitable for use with a majority of transformers used at radio frequencies.

The resistance in the circuit diagram which comprises R_3 in the basic circuit of Fig. 1 is continuously variable from 0 to 2.111 meg. The bank of capacitors which replace C of the basic circuit is calibrated directly in units of inductance from 0.9 to 123.4 μ h. This inductance range is extended by means of the three-point switch (in the schematic diagram) which selects different values for R_1 (basic circuit) and provides a scale factor of either 1, 100, or 10,000, providing inductance range of 0.9 μ h to 123.4 h.

The range of coefficients of inductive coupling of 0 to 1.0 is covered in steps of 0.0005 by the resistance-switching arrangement in the remaining resistance arm of the bridge.

The 23-kc oscillator feeds through a special double-tuned transformer into the bridge. The two-stage null amplifier is of the tuned type, using iron dust cores, and operates into a germanium crystal rectifier and a 1-ma null-indicating meter. The gain of the amplifier is adjusted by means of the sensitivity control.

Measuring Procedure

The transformer under test is connected to the bridge with the $L - k$ switch set to L . For maximum accuracy the k arms should be set to zero during inductance measurements. By proper manipulation of the sensitivity control and the inductance dials, the value of inductance may be read directly. The effective series resistance of this winding may be found by multiplying the ratio of the inductance range multiplying factor to the values indicated by the resistance dials by 5,000.

To measure the coupling coefficient, the $L - k$ switch is turned to k and the bridge rebalanced by means of the resistance dials and the three k dials.

The sensitivity of the bridge is very high and it is not usually necessary to use full sensitivity when making simple inductance measurements. However, when

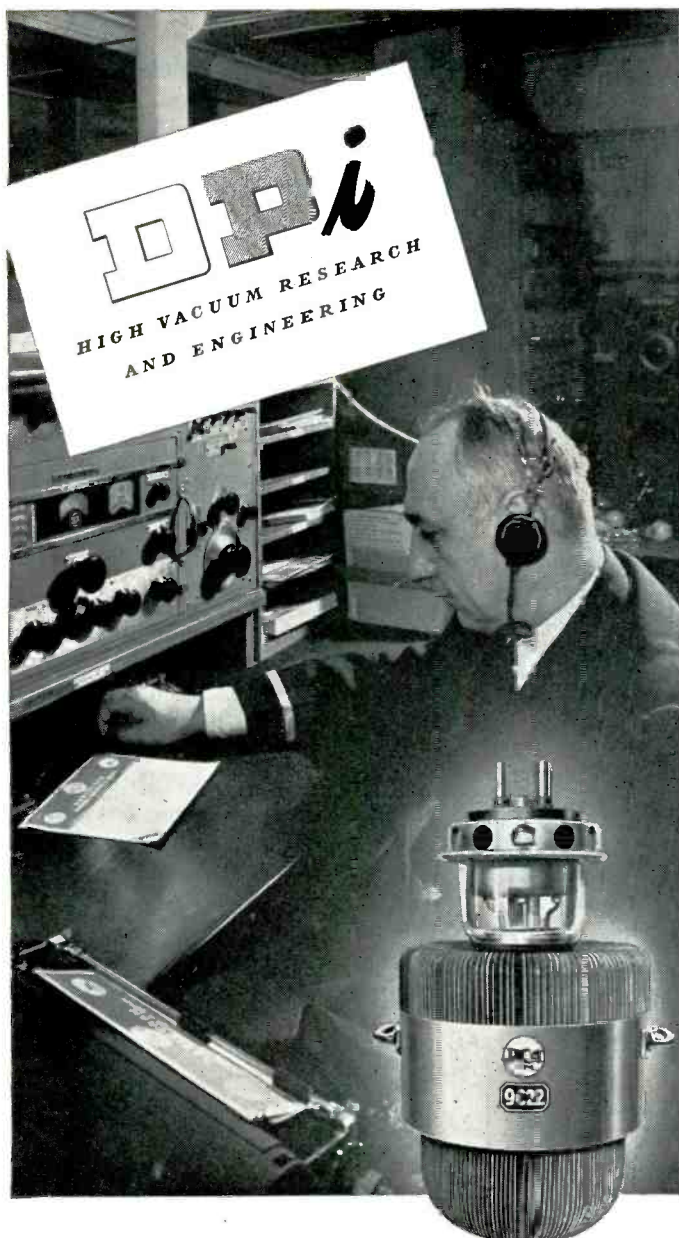

Longer Life for Giant and Midget

THE "giant" electron tube shown above is made in the Lancaster, Pennsylvania plant of the Radio Corporation of America. Said to be the largest forced-air-cooled radio transmitter tube yet made, it can send radio waves around the world. Capable of handling an input of 100,000 watts, this tube requires exceptional engineering and manufacturing skill for its production.

The "midget" tube is an electronic relay to replace mechanical relays in International Business Machines. As many as 300 of these tubes are used in some IBM accounting machines. A notable achievement of electronic engineering, they cut down the heat

factor and permit faster machines of more compact design.

The higher the vacuum in electron tubes, the better they work, and the longer they serve. DPI high vacuum pumps have been built into ingenious production line machines designed by RCA engineers to exhaust electron tubes to high vacuum at greater speed.

New ways of using high vacuum are constantly being discovered. In high-vacuum stills, materials once thought non-distillable are being fractionated

—made into profitable commercial commodities. In high-vacuum chambers precious vaccines are given longer potency because of better dehydration. High-vacuum coaters are depositing metallic coating on wood, paper, cloth, glass, and plastics.

Heads of businesses in all fields should learn what high vacuum may do for them—in making a better quality product, in cutting costs, in converting waste materials into valuable commodities. We invite inquiry.

DISTILLATION PRODUCTS, INC.

727 RIDGE ROAD WEST • ROCHESTER 13, N. Y.

Distillers of Oil-Soluble Vitamins and Other Concentrates for Science and Industry; Manufacturers of High-Vacuum Equipment.

if you prefer
GOOD INSULATION..

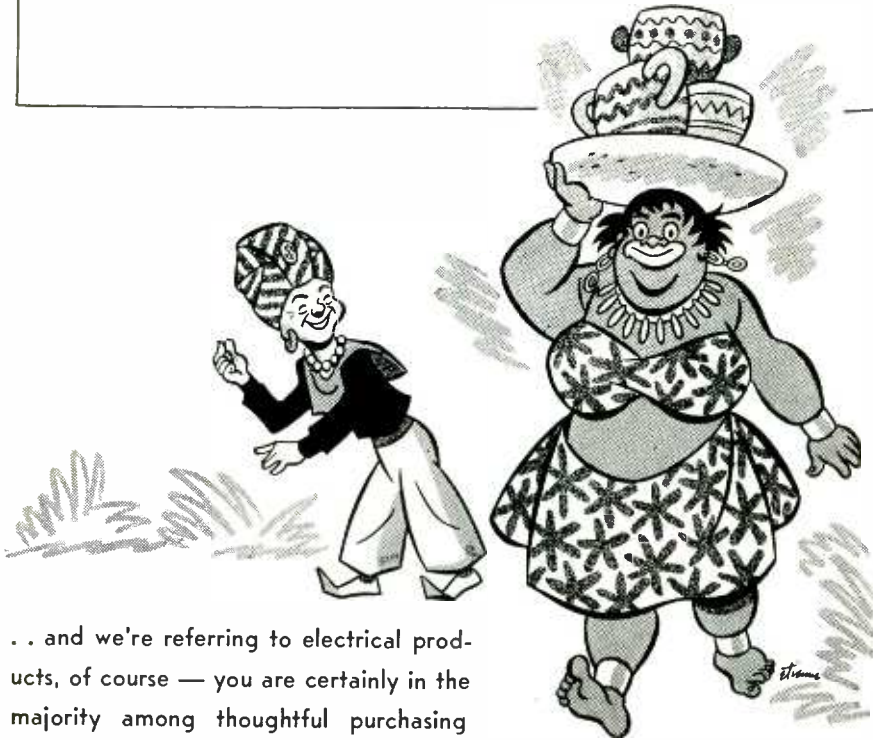

... and we're referring to electrical products, of course — you are certainly in the majority among thoughtful purchasing agents and specification writers. Yes — most men whose job is to buy products for maximum engineering results invariably specify MACALLEN MICA — not just plain mica. They know that MACALLEN means dependability, uniformity, and assurance that their products will not fail to perform as designed, so far as insulation quality is concerned. The MACALLEN MICA habit grows on many firms who grow big because of common-sense in buying.

it CAN be done ...

Don't limit your mica specifications to forms you know about. Specify the shape, thickness and size that will do the job — MACALLEN will probably have it, or can process it for you.

MACALLEN MICA

ALL FORMS, ALL QUANTITIES — ALL DEPENDABLE

when you think of MICA, think of MACALLEN



THE MACALLEN COMPANY • 16 MACALLEN ST., BOSTON 27, MASS.

CHICAGO: 565 W. WASHINGTON BLVD. • CLEVELAND: 1231 SUPERIOR AVE.

measuring small values of inductive coupling the first balance should be as accurate as possible.

Tubes Guide Fish

GAME FISH on Hood River, glacier-fed stream draining from Oregon's Mt. Hood, have the aid of a new electronic fish screen when finding their way downstream past the headworks of the Pacific Power & Light Co.'s Powerdale hydro-electric plant.

Performance of the screen is being watched closely by officials of the power company and by fish authorities. Major downstream migration, which the screen is designed to guide, comes early next spring.

The device consists of a lattice of 10-ft electrodes strung across the 80-ft. mouth of the intake canal. A ground wire is buried at the bottom of the opening. From the control mechanism, electrical impulses at 700 v are sent out at the rate of six per second.

Fish entering the field of the screen are tickled by the impulse and diverted to the natural channel of the stream. The device was manufactured by Electric Fish Screen Co., Hollywood, Calif., and installed by the utility's construction crew.



Electronic control cabinet for the fish screen

The transmitter that has the reputation in the 1 KW AM field



Collins 20T, front

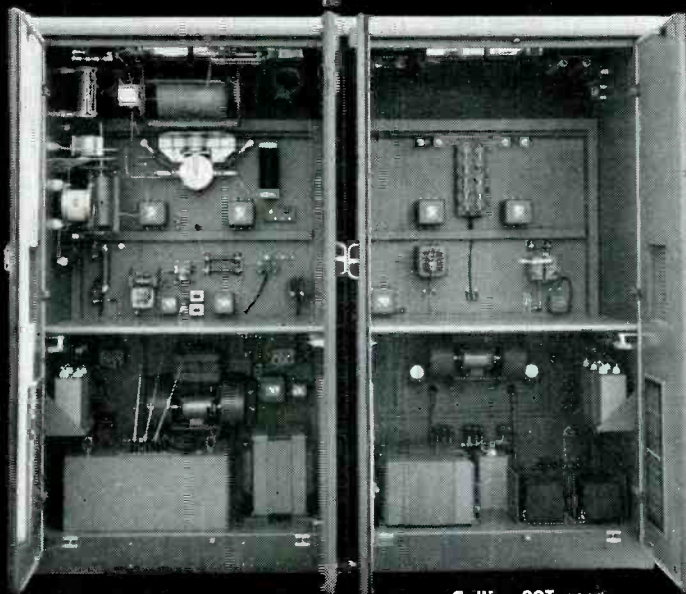

Collins 20T, rear

Here are some of the reasons why the Collins 20T 1,000 watt AM transmitter is held in such high esteem by broadcasters who are using it and the many engineers who have examined it:

- Sound, modern design throughout
- Finest components, conservatively rated
- Roomy cabinet construction
- Complete accessibility; easy maintenance
- Forced air ventilation
- Dust covers and filters
- Door interlocks and shorting switches for personnel protection
- Full a-c and d-c overload relay complement
- Constant voltage regulation on filament circuits
- Wiring coded for quick circuit tracing
- Fused high voltage capacitors
- Three cycle overload reset
- Dual plug-in oscillators
- All monitor connections provided
- All stages metered
- Complete front-of-panel tuning
- Pull-to-start, push-to-stop switch
- Automatic sequence starting
- Instant power change
- Individual modulator bias adjustment
- Continuous operation rating at 100% modulation
- Triode tubes in audio system
- Feedback for audio stability

Are you planning a 1 kw AM station, or intending to modernize your present station? By all means, write us for more information about the 20T.

FOR THE FINEST IN BROADCAST EQUIPMENT, IT'S . . .



COLLINS RADIO COMPANY, Cedar Rapids, Iowa

11 West 42nd St.
NEW YORK 18

2700 West Olive Ave.
BURBANK

M & W Tower
DALLAS 1

Talbot Building
DAYTON 2

Fountain City Bank Bldg.
KNOXVILLE

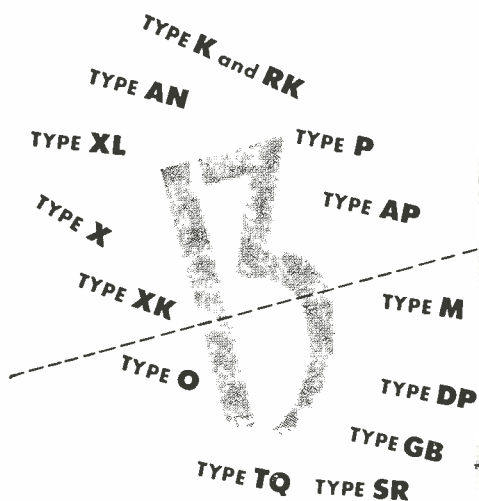

different types
of high-quality
multi-contact
electric connectors.

LOW - MEDIUM - HIGH

for most quick-disconnect needs

VOLTAGES - AMPERAGES

SHELLS SHELLS of Cannon Electric Connectors are variously aluminum alloy, zinc alloy, and steel to meet the requirements of the application. For instance, a Type AN is aluminum alloy, Type P plug is steel or zinc, Type XL zinc or steel.

INSERTS INSERTS are of good dielectric material to meet the needs of the application; and may be of melamine, Durez, Bakelite, Alkyd, etc. As new and better insulating materials are developed, Cannon Electric will have them.

CONTACTS CONTACTS are generally brass, silver-plated, or copper, and milled. Gold-plated contacts are available for certain Type DP Connectors.

COUPLING COUPLING means, too, vary with the needs of the application: the famous "latch-lock" for microphone applications in the "P", "XL" and "O"; AN, K, XK and AP have coupling nuts; X, TQ, SR, M and DP rely on friction hold.

Address Department H-120 for further information

CANNON ELECTRIC DEVELOPMENT COMPANY
 DIVISION OF CANNON MFG. CORP.
 3209 HUMBOLDT STREET
 LOS ANGELES 31, CALIFORNIA

SINCE 1915  REG U S PAT OFF

IN CANADA & BRITISH EMPIRE: CANNON ELECTRIC CO., LTD., TORONTO 13, ONT.
 • WORLD EXPORT (Excepting British Empire):
 FRAZAR & HANSEN, 301 CLAY ST., SAN FRANCISCO

THE ELECTRON ART

(continued from p. 122)

detector input is

$$e_n^2 = \int G^2(f) d\bar{e}^2 = 4kF T_o R_a \int G^2(f) df$$

OR

$$e_n = \sqrt{4kF T_o R_a \Delta f}$$
 (1)
 where $\Delta f = \int G^2(f) df = 4.0$ mc by calculation from Fig. 1B.

The noise voltage will still be this amount when a real antenna of the same impedance replaces the dummy, provided the real antenna looks into space which exhibits a noise temperature T_o . Otherwise one must replace F by

$$F' = F + \frac{1}{L} \left(\frac{T_a}{T_o} - 1 \right)$$
 (2)

where T_a is the noise temperature of space and L is the insertion loss of a line connecting the real antenna to the receiver ($1 < L < \infty$).

Suppose an existing signal field is producing, during the synchronizing pulse, an rms voltage e_c at the open end of the feed-line, as shown in Fig. 1C. If the receiver is properly tuned this carrier will lie half-way down the sloping skirt of the filter, as shown in Fig. 1B. Hence the carrier voltage produced at the detector input will be $e_c/2$.

Post-Detector Considerations

Assuming unity voltage gain from input to output of a linear detector, the peak detector output during synchronizing pulse and in the absence of noise is $\sqrt{2} e_c/2 = e_c/\sqrt{2}$. The standard black-white modulation occupies 60 percent of the spread between peak of synchronizing pulse and zero level. Hence, the peak-to-peak video signal is $0.6 e_c/\sqrt{2}$ and the rms video noise is $\sqrt{4kF' T_o R_a \Delta f}$. Now let S be the ratio of peak-to-peak video signal to rms video noise. Then

$$e_c = \frac{\sqrt{2}}{0.6} S \sqrt{4kF' T_o R_a \Delta f}$$
 (3)

which is the formulation sought.

Setting $k = 1.37 \times 10^{-23}$ joule per degree, $T_o = 290$ degrees Kelvin, $\Delta f = 4 \times 10^6$ sec⁻¹ we may rewrite Eq. 3 as

$$e_c (\mu v) = 10.5 S \sqrt{F'} \sqrt{\frac{R_a}{300}}$$
 (4a)

or

$$e_c (\text{db above } 1 \mu v) = 20.4 + S (\text{db}) + F' (\text{db}) + 10 \log \frac{R_a}{300}$$
 (4b)

As a numerical illustration of Eq.

Introducing—
Another Plasticon Development

HIVOLT POWER SUPPLIES

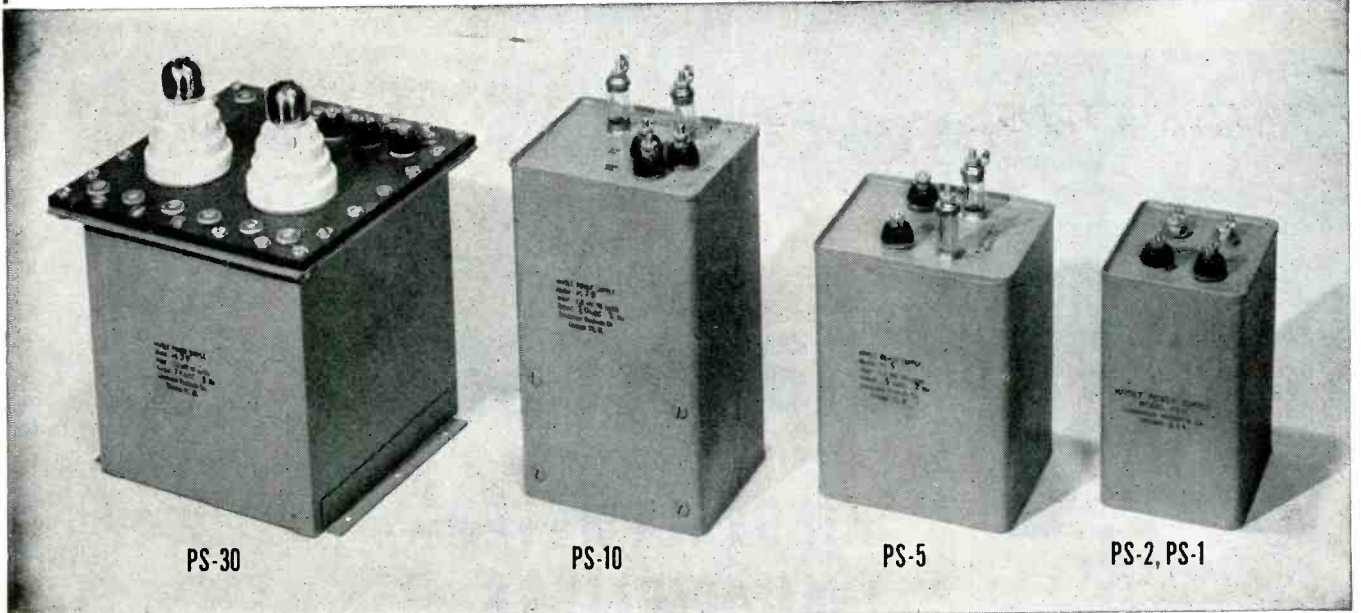

PS-30

PS-10

PS-5

PS-2, PS-1

HiVolt Supplies are self-contained in hermetically sealed metal containers. They are designed to transform low voltage AC to high voltage—low current DC.

PS-30-30,000 VDC; 1 Ma.; dimen. 7" x 7" x 7"

PS-10-10,000 VDC; 2 Ma.; dimen. 3 $\frac{3}{4}$ " x 4 $\frac{9}{16}$ " x 8"

PS-5-5,000 VDC; 5 Ma.; dimen. 3 $\frac{3}{4}$ " x 4 $\frac{9}{16}$ " x 6"

PS-2-2400 VDC; 5 Ma.; dimen. 3 $\frac{3}{4}$ " x 3 $\frac{3}{16}$ " x 5 $\frac{1}{2}$ "

PS-1-2400 VDC—Capacitor load; dimen. 3 $\frac{3}{4}$ " x 3 $\frac{3}{16}$ " x 5 $\frac{1}{2}$ "

High Voltage-Low Current DC Power Supplies

for

Television — Radiation Counters — Photo-flash Devices — Electrostatic Precipitators — Spectrographic Analysers—Oscilloscopes, etc.

Write for descriptive literature

Plasticon Capacitors, Pulse Forming Networks and HiVolt Power Supplies are available at all leading jobbers.



Condenser Products Company

1375 NORTH BRANCH STREET • CHICAGO 22, ILLINOIS

for REAL STABILITY in
HIGH-VOLTAGE STANDARDS

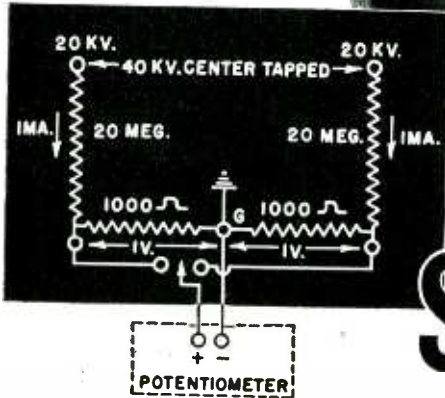

Schematic diagram
No. 791 kilovoltmeter
multiplier

Shallcross

HIGH-RANGE KILOVOLT METER MULTIPLIERS and voltage dividers

Types to 200,000 volts

Whether for direct high-voltage measurements or for use as standards in determining the exact voltage of a fractional segment of a high-voltage supply, Shallcross Kilovoltmeter Multipliers combine close accuracy with safety and dependability.

The No. 791 kilovoltmeter multiplier illustrated above provides a ready and accurate means of determining a-c and d-c potentials up to 40,000 volts with outstanding accuracy. Other Shallcross types have been supplied for voltages of 200,000 volts and higher. Whether your need is for a unit designed for ordinary voltage ranges or for nuclear research development, chances are that Shallcross standard designs or adaptations thereof can fill the bill. Write for recommendations, stating details of your application.

SHALLCROSS MFG. CO.

Resistors • Instruments • Switches • Attenuators
Dept. E-89 COLLINGDALE, PA.

4, suppose one wants $S = 31.6$ (30 db). If F' (power) = 15.9 (12 db) and $R_a = 300$ ohms, then e_c must be 1,328 μv (62.4 db above 1 μv), and half of this or 664 μv must appear on the input terminals of the receiver if it happens to be matched to the feeder.

Conversion of e_c into field strength can be made in straight-forward fashion, involving line-loss, impedance transformations and effective length of the antenna. It should particularly be noted that Eq. 4 is valid whether or not the receiver be matched to the antenna feedline; it is important that measurements of F' on the bench employ a dummy antenna whose impedance, within the television channel, duplicates that seen looking into the open end of the feedline from the real antenna, because F' is a function of this impedance, though usually not a very strong one.

The field intensity expressed in decibels above 1 microvolt per meter is

$$E = 14.8 + S + F' + L + 20 \log \left(\frac{f}{100} \right) - G \quad (5)$$

where S is the ratio of peak-to-peak video signal to the rms noise in db, F' the noise factor in db, L the transmission line loss in db, G the gain of the antenna relative to half-wave dipole in db, and f the frequency in megacycles.

REFERENCE

(1) Absolute Sensitivity of Radio Receivers, *RCA Review*, p 332, Jan. 1942.

Transit-Time Effects In Television Front-End Design

BY H. M. WATTS

Research Physicist
Radiation Laboratory
The Johns Hopkins Laboratory
Baltimore, Maryland

PAPERS analyzing transit-time effects in high-frequency tubes¹ show only qualitative correlation between theory and practice for most tube types. The 6AK5, and a few tube types not generally used in present-day television design, show good agreement between predicted and measured transit-time effects, while the 6J4, the 6J6 and others do not.

It has been shown² that the ef-

Electric eel foiled with...

Zoo attendant says, "No more shocks for me now that I have my G-E Textolite feeding pole."

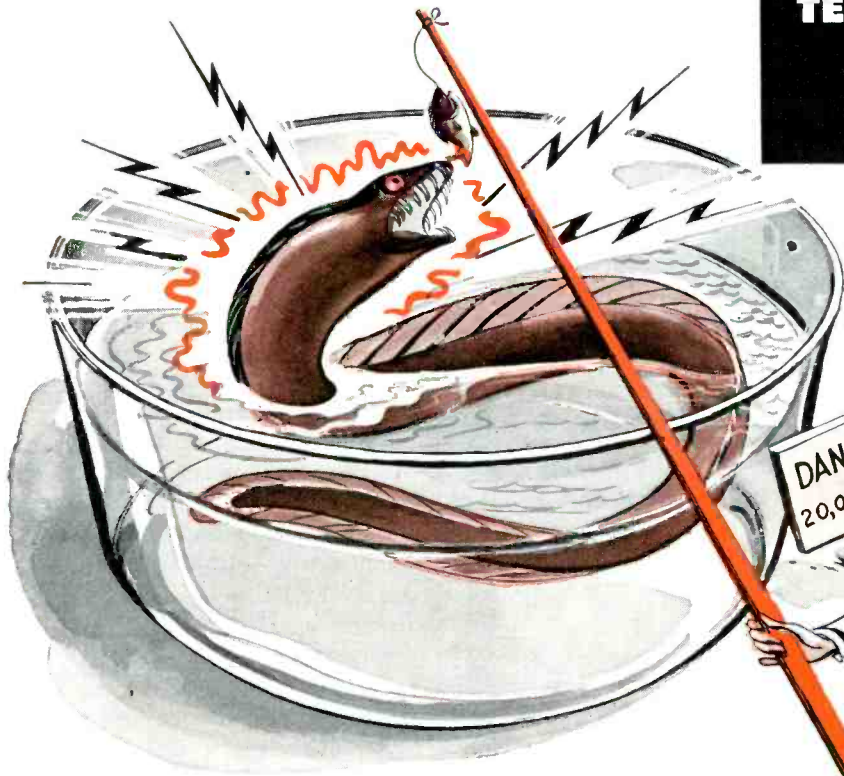

GENERAL  ELECTRIC
TEXTOLITE* LAMINATED
Plastics
*REG. U. S. PAT. OFF.



● Naturally you aren't expected to believe this story about the eel. One part of it *is* true, however . . . *General Electric Textolite has excellent electrical properties.* In addition, it has outstanding mechanical, chemical, and thermal characteristics.

Why not put this valuable combination to work for you. It may help you to lick your production problems—to reduce your manufacturing costs.

Versatile G-E Textolite is produced in more than fifty grades. Each of these grades has an *individual combination* of properties. None are alike. With this wide selection to choose from you are assured of getting a non-metallic material that will do your job in the most economical and satisfactory way. Plastics Division, Chemical Department, General Electric Company, Pittsfield, Mass.

For years electric eels have delighted in shocking zoo attendants. Now their game is up, thanks to the excellent electrical properties of General Electric Textolite.

G-E TEXTOLITE LAMINATED PLASTICS IS SUPPLIED IN:



LOW-PRESSURE MOLDED PARTS



MOLDED-LAMINATED PARTS



FABRICATED PARTS



SHEETS, TUBES RODS

GENERAL  ELECTRIC
CD49-J2

SEND FOR THIS HELPFUL BULLETIN TODAY— IT'S FREE

Write for your copy of "G-E Textolite Laminated Plastics." It lists grades, properties, fabricating instructions, and detailed information about Textolite industrial laminates.

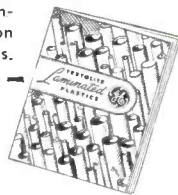

General Electric Company
 Chemical Department (9-8)
 One Plastics Ave.,
 Pittsfield, Mass.

Please send me the new G-E Textolite laminated plastics bulletin

Name

Firm

Address

City State

Listen for the words Transcribed by AMPEX after the great shows in radio

Here's why... the new model 300



MAGNETIC TAPE RECORDER answers industry need!

Designed by
engineers who had
your engineering
needs in mind!



Console Model 300* \$1,573.75

Portable Model 300 \$1,594.41

Rack Mounted \$1,491.75

*Meter panel extra

F. O. B. Factory, San Carlos, Calif.

★ You can depend on Ampex

Read what Frank Marx, Vice President in charge of Engineering, American Broadcasting Company, says: "For the past two years A.B.C. has successfully used magnetic tape for rebroadcast purposes... A.B.C. recorded on AMPEX in Chicago... 17 hours per day. For 2618 hours of playback time, the air time lost was less than 3 minutes: a truly remarkable record."

★ Original program quality preserved

Use of independent reproduction facilities allows instantaneous monitoring and makes possible the most stringent comparisons between recordings and originals.

SPECIFICATIONS

FREQUENCY RESPONSE:

At 15" ± 2 db. 50—15,000 cycles
At 7.5" ± 2 db. 50— 7,500 cycles

FLUTTER AND WOW: At 15 inches per second, well under 0.1% r.m.s., measuring all flutter components from 0 to 300 cycles, using a tone of 3000 cycles. At 7.5 inches, under .2%.

SIGNAL-TO-NOISE RATIO: The over-all unweighted system noise is 70 db. below tape saturation, and over 60 db. below 3% total harmonic distortion at 400 cycles.

STARTING TIME: Instantaneous. (When starting in the Normal Play mode of operation, the tape is up to full speed in less than .1 second.)

Manufactured by Ampex Electric Corporation, San Carlos, Calif.

DISTRIBUTED BY

GRAYBAR ELECTRIC CO. Inc. ★ BING CROSBY ENTERPRISES

420 Lexington Ave., New York 17, N. Y.

9028 Sunset Blvd., Hollywood 46, Calif.

Offices in principal cities

AUDIO & VIDEO PRODUCTS CORPORATION

1650 Broadway, New York, N. Y.

fects of transit-time loading for a grounded-cathode amplifier are as follows:

$$Y_{in} = G_1 + jB_1 + G_\tau \quad (1)$$

where Y_{in} is the total input admittance seen by the driving circuit, $G_1 + jB_1$ is the input admittance of the passive elements of input circuit, and G_τ is the transit-time loading conductance.

$$G_{\tau_{eq}} = \beta G_\tau \quad (2)$$

where β is the ratio of equivalent noise temperature of G_τ to room temperature and $G_{\tau_{eq}}$ is the equivalent noise conductance of transit-time loading.

$$F = 1 + \frac{1}{G_s} [G_1 + G_\tau + R_{eq} (Y_\tau + G_\tau)^2] \quad (3)$$

where G_s is the equivalent admittance of the signal source, R_{eq} is the grid-equivalent noise resistance of the tube excluding transit-time noise, $Y_\tau = G_s + G_1 + jB_1$, and F is the noise figure of the first stage. This noise figure is defined as the ratio of total noise power in the output circuit to the noise power output due to Johnson noise in the signal source admittance.

Noise Figure

The noise voltage output from a source resistance R is $E = \sqrt{4KTR\Delta f}$ and the maximum noise power that can be delivered to an equal load resistor R is $E^2/4R = KT\Delta f$, so that the available noise power from an input circuit of noise figure F is $FKT\Delta f$, and Δf is the effective bandwidth of the receiver, which is 4 mc.

The quantity β has been shown

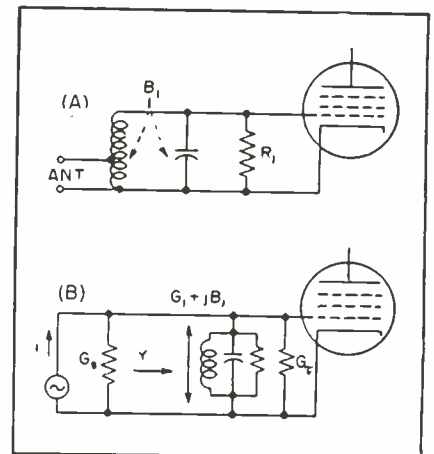

FIG. 1—Actual input circuit (A) of typical television front end and equivalent circuit (B) showing antenna replaced by a current source of transformed shunt conductance G_s .



COSMALITE* gives STAR performance in the new ZENITH

This internally threaded Cosmalite coil form of cloverleaf design in the very heart of the Zenith Television Transformer, permits quick tuning of both primary and secondary frequencies through the upper end. The hexagon shaft of the frequency setter easily passes through the upper core and engages in the lower core . . . adjusting the frequencies of both coils with the greatest ease.

Consult us on the many uses of Cosmalite (low cost phenolic tubing) in television and radio receivers.

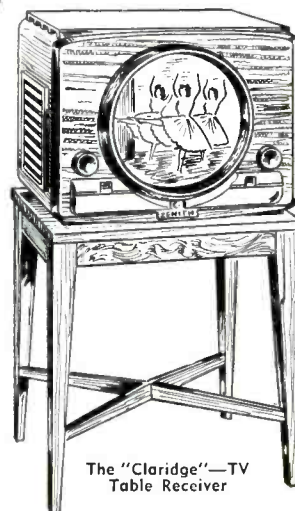

The "Claridge"—TV Table Receiver

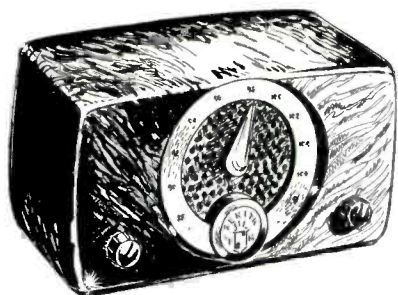

Cosmalite coil forms are also used in transformers of Zenith's table radios, such as the new Super-Sensitive "Major" FM receiver, above.

*Reg. U. S. Pat. Off.

The CLEVELAND CONTAINER Co.

6201 BARBERTON AVE. CLEVELAND 2, OHIO

PLANTS AND SALES OFFICES at Plymouth, Wisc., Chicago, Detroit, Ogdensburg, N.Y., Jamesburg, N.J.
ABRASIVE DIVISION at Cleveland, Ohio
CANADIAN PLANT: The Cleveland Container, Canada, Ltd., Prescott, Ontario

REPRESENTATIVES

CANADA	WM. T. BARRON, EIGHTH LINE, RR #1, OAKVILLE, ONTARIO
METROPOLITAN NEW YORK	R. T. MURRAY, 614 CENTRAL AVE., EAST ORANGE, N.J.
NEW ENGLAND	E. P. PACK AND ASSOCIATES, 968 FARMINGTON AVE. WEST HARTFORD, CONN.



MOSINEE

"More than Paper"



In the field of electronics and the electrical goods industry, MOSINEE is known for its *dependable uniformity*, and its scientifically controlled physical and chemical properties, such as:

Good dielectric strength . . .
 proper softness or stiffness . . .
 high tensile or tear strength . . .
 creped with controlled stretch or flexibility . . . specified pH for maximum-minimum acidity or alkalinity . . . accurate caliper, density, liquid repellency or absorbency.

If you have a fabricating or processing problem involving paper, a discussion with MOSINEE technicians might prove helpful. Please write Dept. E.



MOSINEE PAPER MILLS COMPANY, MOSINEE, WIS.

"Essential Paper Manufacturers"

to be about 5 and the transit-time loading conductance has been shown to vary as the square of frequency for the 6AK5 and the few other tubes which fit transit-time noise theory, so that as frequency increases, induced noise plays an increasingly important role. It will be noted that Eq. 3 has a minimum value, or best noise figure, when Y_T is minimum. A reasonable approximation where the input circuit has a wide band width compared to the overall system is to assume $B_1 = 0$, so we will use this approximation in the following work.

If we define ρ by

$$\rho G_{in} = G_1 + \beta G_T \quad (4)$$

Eq. 3 can be put in the form

$$F = 1 + \frac{G_{in}}{G_s} \left[\rho + R_{eq} G_{in} \left\{ 1 + \left(\frac{G_s}{G_{in}} \right)^2 \right\} \right] \quad (5)$$

From inspection of Eq. 5, it would appear that there may be a value of G_s that will minimize F . This has been shown to be the case.³ The optimum value G_s' is given by

$$G_s' = \sqrt{(\rho + R_{eq} G_{in}) \frac{G_{in}}{R_{eq}}} \quad (6)$$

The corresponding optimum noise figure is

$$F' = 1 + 2 \sqrt{(\rho + R_{eq} G_{in}) R_{eq} G_{in}} \quad (7)$$

The idea of mismatching generator to amplifier in order to optimize F is an excellent one for many purposes, but unfortunately it is somewhat impractical in television receivers because the accompanying signal reflections on the antenna transmission line destroy the picture detail at the picture output. We shall next consider the consequences in degradation of noise figure of matching antenna to receiver and the consequences in antenna lead-in reflections of optimizing noise figure.

Effect of Matching on Noise

If we match receiver to antenna, the transformation ratio of the input transformer of Fig. 1A is so adjusted that the value of transmission line impedance transformed to transformer output level G_s is equal to G_{in} . Then Eq. 5 reduces to

$$F = 1 + \rho + 2 R_{eq} G_{in} \quad (8)$$

As an example, consider a 6AK5 having $R_{eq} = 1,350$ ohms operating at a frequency where effectively G_T

FREED

"PRODUCTS of EXTENSIVE RESEARCH"

OUTSTANDING ADDITIONS TO OUR LINES OF *Instruments & Components*

NEW HI Q MINIATURE TOROIDAL COILS

HIGH FIDELITY OUTPUT TRANSFORMERS

FAMOUS
FREED
QUALITY

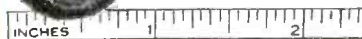

Size $\frac{7}{8}$ D. x $\frac{3}{8}$ — Wt. $\frac{3}{4}$ ounce.
Type TI-5 Frequency range 1000 cycles-15,000 cycles
Type TI-7 Frequency range 10,000 cycles-100,000 cycles
High quality toroidal coils wound on molybdenum permalloy dust cores. Can be supplied in hermetically sealed cans, commercial type construction or open units.

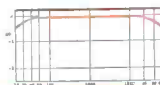

Type No.	Primary matches following typical tubes	Primary Impedance	Secondary Impedance	±1/2db from	Maximum level
FI950	Push pull 2A1, 6AS6B, 300A, 75A, 6A3, 6A5, 6A6, 6A7, 6A8, 6A9, 6X4, 6X5, 6X6, 6X7, 6X8, 6X9, 6Y6, 6Z5, 6Z6, 6Z7, 6Z8, 6Z9, 6Z10, 6Z11, 6Z12, 6Z13, 6Z14, 6Z15, 6Z16, 6Z17, 6Z18, 6Z19, 6Z20, 6Z21, 6Z22, 6Z23, 6Z24, 6Z25, 6Z26, 6Z27, 6Z28, 6Z29, 6Z30, 6Z31, 6Z32, 6Z33, 6Z34, 6Z35, 6Z36, 6Z37, 6Z38, 6Z39, 6Z40, 6Z41, 6Z42, 6Z43, 6Z44, 6Z45, 6Z46, 6Z47, 6Z48, 6Z49, 6Z50, 6Z51, 6Z52, 6Z53, 6Z54, 6Z55, 6Z56, 6Z57, 6Z58, 6Z59, 6Z60, 6Z61, 6Z62, 6Z63, 6Z64, 6Z65, 6Z66, 6Z67, 6Z68, 6Z69, 6Z70, 6Z71, 6Z72, 6Z73, 6Z74, 6Z75, 6Z76, 6Z77, 6Z78, 6Z79, 6Z80, 6Z81, 6Z82, 6Z83, 6Z84, 6Z85, 6Z86, 6Z87, 6Z88, 6Z89, 6Z90, 6Z91, 6Z92, 6Z93, 6Z94, 6Z95, 6Z96, 6Z97, 6Z98, 6Z99, 6Z100	5000 ohms	500, 333, 250, 200, 125, 50	20-30000 cycles	15 watts
FI951	Push pull 2A1, 6AS6B, 300A, 75A, 6A3, 6A5, 6A6, 6A7, 6A8, 6A9, 6X4, 6X5, 6X6, 6X7, 6X8, 6X9, 6Y6, 6Z5, 6Z6, 6Z7, 6Z8, 6Z9, 6Z10, 6Z11, 6Z12, 6Z13, 6Z14, 6Z15, 6Z16, 6Z17, 6Z18, 6Z19, 6Z20, 6Z21, 6Z22, 6Z23, 6Z24, 6Z25, 6Z26, 6Z27, 6Z28, 6Z29, 6Z30, 6Z31, 6Z32, 6Z33, 6Z34, 6Z35, 6Z36, 6Z37, 6Z38, 6Z39, 6Z40, 6Z41, 6Z42, 6Z43, 6Z44, 6Z45, 6Z46, 6Z47, 6Z48, 6Z49, 6Z50, 6Z51, 6Z52, 6Z53, 6Z54, 6Z55, 6Z56, 6Z57, 6Z58, 6Z59, 6Z60, 6Z61, 6Z62, 6Z63, 6Z64, 6Z65, 6Z66, 6Z67, 6Z68, 6Z69, 6Z70, 6Z71, 6Z72, 6Z73, 6Z74, 6Z75, 6Z76, 6Z77, 6Z78, 6Z79, 6Z80, 6Z81, 6Z82, 6Z83, 6Z84, 6Z85, 6Z86, 6Z87, 6Z88, 6Z89, 6Z90, 6Z91, 6Z92, 6Z93, 6Z94, 6Z95, 6Z96, 6Z97, 6Z98, 6Z99, 6Z100	5000 ohms	30, 20, 15, 10, 7.5, 5, 2.5, 1.2	20-30000 cycles	15 watts
FI954	Push pull 2A5, 250, 6V6, 42 or 2A5 A prime	8000 ohms	500, 333, 250, 200, 125, 50	20-30000 cycles	15 watts
FI955	Push pull 2A5, 250, 6V6, 42 or 2A5 A prime	8000 ohms	30, 20, 15, 10, 7.5, 5, 2.5, 1.2	20-30000 cycles	15 watts
FI958	Push pull 485, 6A4, 53, 6F6, 5F, 7F, 6T, 6V6, Class B 4x, 5F	10,000 ohms	500, 333, 250, 200, 125, 50	20-30000 cycles	15 watts
FI959	Push pull 485, 6A4, 53, 6F6, 5F, 7F, 6T, 6V6, Class B 4x, 5F	10,000 ohms	30, 20, 15, 10, 7.5, 5, 2.5, 1.2	20-30000 cycles	15 watts
FI962	Push pull parallel 2A1, 6AS6, 300A, 6A3, 6A5	2500 ohms	500, 333, 250, 200, 125, 50	20-30000 cycles	3x watts
FI963	Push pull parallel 2A1, 6AS6, 300A, 6A3, 6A5	2500 ohms	30, 20, 15, 10, 7.5, 5, 2.5, 1.2	20-30000 cycles	3x watts
FI964	Push pull 6L6 or Push pull Parallel 6L6	3800 ohms	500, 333, 250, 200, 125, 50	20-30000 cycles	50 watts
FI967	Push pull 6L6 or Push pull parallel 6L6	3800 ohms	30, 20, 15, 10, 7.5, 5, 2.5, 1.2	20-30000 cycles	50 watts

PRECISION LABORATORY EQUIPMENT

#1150 UNIVERSAL BRIDGE



Frequency Range — 20 cycles-20,000 cycles.
An Indispensable Laboratory Instrument for measurements of Inductors, Capacitors, and determination of Resistive and reactive components of impedances. Used as Maxwell Bridge, Hay Bridge, Resonance Bridge, Series Resistance Condenser Bridge, Parallel Resistance Condenser Bridge. 1% accuracy.

#1210 NULL DETECTOR AND VACUUM TUBE VOLTMETER



Designed for A.C. Bridge Measurements. Provides simultaneous measurement of the voltage across the unknown and the balance of the bridge. Vacuum tube voltmeter. Sensitivity .1, 1, 10, 100 volts. Input Impedance 50 megohms shunted by 20 mmfd. Frequency range 20 cycles-20,000 cycles. Null Detector—gain 94 Db. Selective Circuits for 60 cycles — 400 cycles — 1000 cycles. Frequency range 20 cycles-30,000 cycles.

FREED HERMETICALLY SEALED COMPONENTS CLASS A GRADE 1 COMPONENTS TO MEET JAN—T—27 SPECIFICATIONS.

FAMOUS
FREED
DEPENDABILITY



MANUFACTURERS OF
POWER TRANSFORMERS
FILTER REACTORS
AUDIO TRANSFORMERS
SUPERSONIC TRANSFORMERS
WAVE FILTERS
HI-Q COILS
DISCRIMINATORS
SATURABLE REACTORS
PULSE TRANSFORMERS
CHARGING CHOKES

SEND FOR THE *new* FREED CATALOG

FREED TRANSFORMER CO., Inc.

DEPT. EA 1718-36 WEIRFIELD ST., (RIDGWOOD) BROOKLYN 27, NEW YORK

Industrial Relays by Sterling

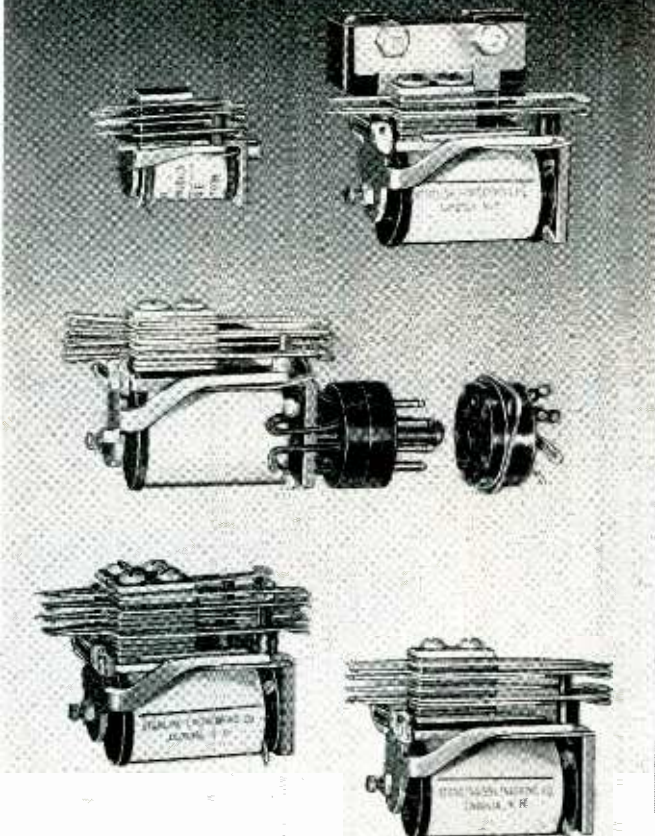

At all times, Sterling Engineers are ready to assist the industrial designer by developing a Sterling built relay to meet unusual requirements and new applications.

Types KS midget and GS relays illustrated.

Write today for your copy of Bulletin Number 110 containing valuable technical information.

*Sterling Engineering
Company, Inc.*

LACONIA, NEW HAMPSHIRE

= 0, with $R_i = 2,850$ ohms so that $G_{in} = G_i = 350 \times 10^{-6}$ mhos. From Eq. 4, $\rho = 1$, and we compute $R_{c,q}$ $G_{in} = 0.472$, so that $F' = 2.67$. If on the other hand we let $G_i = G_{in}$, we find $F = 2.94$, so that optimum transformation yields a noise figure smaller in the ratio 1.1 to 1 or 0.4 db better than matched impedances.

For a 6AK5 at 200 mc, $G\tau \cong 500 \times 10^{-6}$ mhos, so that for a circuit needing only 350×10^{-6} mhos of shunt conductance in order to provide sufficient bandwidth we would minimize G_i in Eq. 1. For an input coil Q of 150 at 200 mc, if tuning capacitance is $7 \mu\text{mf}$, $G_i = 60 \times 10^{-6}$ mhos, so $G_{in} = 560 \times 10^{-6}$ mhos. From Eq. 4, $\rho = (G_i + \beta G\tau) \div (G_{in}) = 4.4$, and we compute $R_{c,q}$ $G_{in} = 0.755$, so from Eq. 7, $F' = 4.95$ and from Eq. 8 $F = 6.91$. Thus the degradation of noise figure due to matching impedances rather than optimizing, for a 6AK5 grounded-cathode amplifier at 200 mc, is a factor of 1.39 or approximately 1.4 db.

Reflections in Transmission Line

The reflection coefficient R of a transmission line can be computed from the relationship

$$R = \frac{Z_o - Z_R}{Z_o + Z_R} \quad (9)$$

where Z_o is the characteristic impedance of the line and Z_R the terminating resistor.

From Eq. 6 we find that for the 6AK5 at 200 mc, $G_s' = 1,460 \times 10^{-6}$ mhos, so $R_s' = 685$ ohms. For the same conditions, $G_{in} = 560 \times 10^{-6}$ mhos so $R_{in} = 1,790$ ohms. But R_{in} is Z_R and R_s' is Z_o in Eq. 9 so $R = (685 - 1,790) / (685 + 1,790) = -0.446$

Most common television receiving antennas match the associated transmission line poorly over a few of the channels, so that a reflection from the receiver end of the transmission line would be re-reflected at the antenna. If we were to have the same mismatch at the antenna as at the receiver in the example above, we would have at the receiver input the desired signal plus an additional wave train of one-fourth the amplitude but delayed by the round-trip travel-time of the antenna lead-in.

Considering the possible variability of antenna output impedance

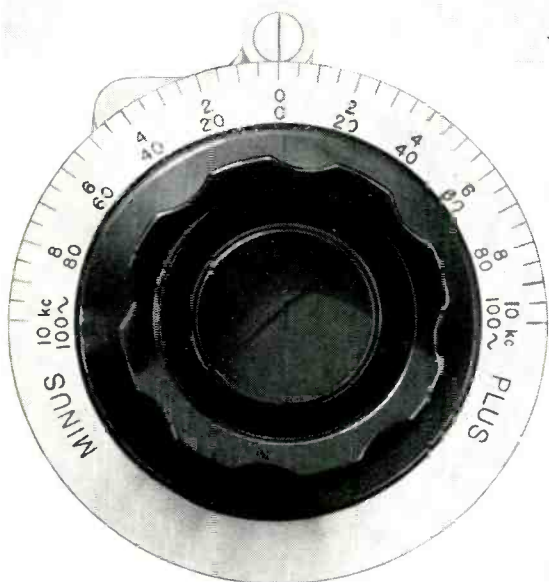
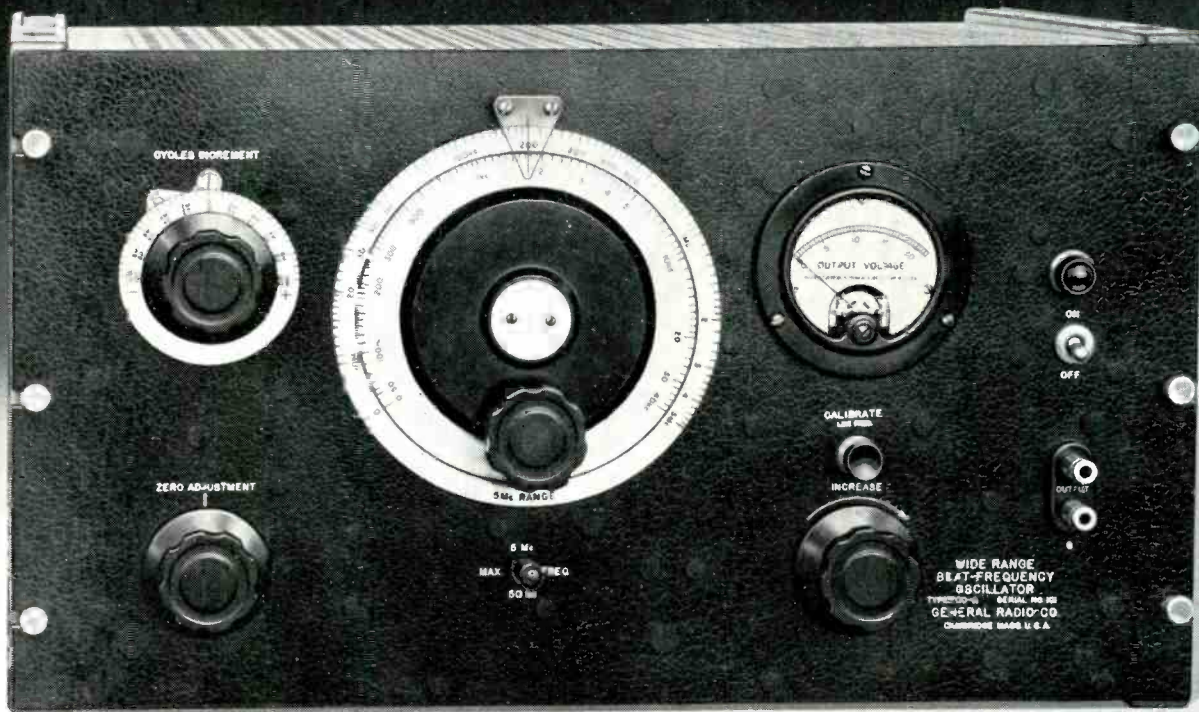

FREQUENCY CONTROL AND CALIBRATION

The main dial is direct-reading on two approximately logarithmic scales for 50 cycles to 40 kilocycles and 10 kilocycles to 5 megacycles. The incremental frequency control (above) is calibrated between -100 and +100 cycles and -10 and +10 kilocycles for the two respective ranges.

50 CYCLES TO 5 MEGACYCLES

THIS wide-range beat-frequency oscillator has a number of novel circuit arrangements which make it very valuable for use not only as a general-purpose laboratory oscillator, but also for testing all sorts of wide-band circuits and systems.

- 1 The exceptionally wide range is obtained with a single control knob and a two-position range selector switch
- 2 The output voltage, by means of an a-v-c circuit, is held constant within ± 1.5 decibels over the entire range
- 3 Frequency drift is held to a very small value through carefully designed thermal distribution and ventilation systems
- 4 Any small drift remaining may be eliminated by resetting the oscillator to zero beat
- 5 A degenerative amplifier minimizes hum and distortion and also equalizes the frequency response
- 6 The output voltage is measured by a v-t voltmeter across the output terminals
- 7 Calibration may be standardized at any time to within 5 cycles and 500 cycles on the low and the high ranges, respectively

For taking selectivity curves on tuned circuits over a wide range of frequencies this oscillator is especially useful in that these measurements may be made very rapidly and accurately with this instrument.

TYPE 700—A WIDE-RANGE BEAT-FREQUENCY OSCILLATOR \$700.00

WRITE FOR
COMPLETE DATA

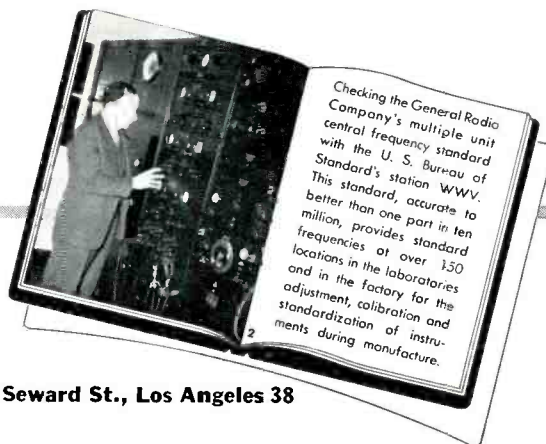

GENERAL RADIO COMPANY

Cambridge 39, Massachusetts

90 West St., New York 6 920 S. Michigan Ave., Chicago 5 1000 N. Seward St., Los Angeles 38

Microphones BY TURNER

TURNER MODEL 99 DYNAMIC

Response: 40—9000 c.p.s.
Level: 52 db below 1 volt/dyne/sq.cm. at high impedance.

* "Best all-purpose mike ever used"
"Very satisfied—excellent results—ruggedness an asset."

*
SOUND PERFORMANCE
as verified by letters in our files

TURNER MODEL 22X-22D

22X Crystal—50-9000 c.p.s.,
52 db below 1 volt/dyne/sq.cm.
22D Dynamic—50-9000 c.p.s.,
54 db below 1 volt/dyne/sq.cm.
at high impedance.

* "Good tonal quality and smart design."
"Does an excellent job on wire recording."

TURNER MODEL 33X-33D

33X Crystal—50-9000 c.p.s.,
52 db below 1 volt/dyne/sq.cm.
33D Dynamic—30-9000 c.p.s.,
54 db below 1 volt/dyne/sq.cm.
at high impedance.

* "Like small size and neat appearance."
"Higher percentage of contacts."

TURNER MODEL U9S DYNAMIC

4 impedances at your fingertips
Response: 40—9000 c.p.s.
Level: 52 db below 1 volt/dyne/sq.cm. at high impedance.

* "Excellent fidelity."
"Like variable impedance."
"Good response—rugged—good output."

Write for Complete Microphone Literature

THE TURNER COMPANY

905 17th Street N. E., Cedar Rapids, Iowa

IN CANADA: Canadian Marconi Co., Ltd., Montreal, P. Q., and branches

EXPORT: Ad. Auriema, 89 Broad Street, New York 4, N. Y.

Licensed under U. S. patents of the American Telephone and Telegraph Company, and Western Electric Company, Incorporated. Crystals licensed under patents of the Brush Development Company.



over the band as well as the variability of antenna lead-in lengths, the choice between design for best noise figure and best input impedance is assuredly a matter of design judgment.

Total Noise Voltage

In a previous paper⁴ signal-to-noise figures (K) were calculated for various types of commonly used television front-end circuits, such that $E_s/E_n = KE_{ant}$. If we wish to compute the total noise voltage that would have to be present at the input of a noiseless receiver in order to provide the same noise output as the receiver under scrutiny, we set $E_s/E_n = 1$ so that $KE_{ant} = 1$. But under this circumstance, the total equivalent noise voltage at the antenna is equal to the signal voltage E_{ant} so then $E_n = 1/K$.

This means that the noise power present in the receiver input is $E_n^2/R = 10^{-12}/K^2R$ watts, where R is the input resistance at the antenna terminals (75 ohms) and the factor 10^{-12} converts the signal to volts. The total Johnson noise power in a matched input resistor was previously shown to be $KT\Delta f$ (here K is Boltzmann's constant, not the K mentioned above) which is 1.65×10^{-14} watts for a 4-mc bandwidth.

From the definition of noise figure then,

$$F = \frac{10^{-12}}{1.65 \times 10^{-14} K^2 R} = \frac{0.808}{K^2}$$

In terms of this formula we can now express the previously-mentioned signal-to-noise figures in terms of noise figures as shown in Table I.

Transit-Time Effect

The manner of combining the transit-time component of noise factor with the other components is not simple and for the tubes for which $G\tau$ is known only with poor accuracy it is not worth the trouble. We rewrite Eq. 8 to include $G\tau$ explicitly,

$$F = 1 + \frac{G_1 + \beta G\tau}{G_1 + G\tau} + \frac{2R_{oq}(G_1 + G\tau)}{\quad} \quad (10)$$

where $G_1 + G\tau$ is held constant, as long as possible, against increase of $G\tau$ by decreasing G_1 . It will be noted that as $G\tau$ increases the second term increases smoothly from 1 to β (which is 5), and the third term

For today's broadcast power needs . . .

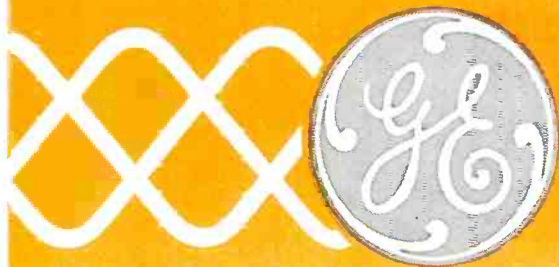

RECTIFIER TUBES

★ **PACEMAKERS IN DESIGN**

★ **SERVICE-PROVED**

★ **AVAILABLE IN A WIDE RANGE OF CAPACITIES**

MODULATION, amplification, final output, all need d-c power . . . continuous, *dependable* if off-the-air periods are to be avoided. Your rectifier tubes are basic; good rectifier tubes make for good broadcasting. So buy General Electric—buy the best!

Design improvement is constant, with G-E rectifier types ever-new in their efficiency. For example, the new straight-side bulbs of Types GL-8008 and GL-673 give an increased temperature margin of safety; their slim contour also makes the tubes easier to handle, better to install.

Future AM-FM-TV power-requirement possibilities are matched

by new G-E designs, such as the GL-5630 ignitron for a-c to d-c conversion. With this high-capacity tube it is possible to supply—economically, reliably—direct current in large amounts to broadcast transmitters.

If you build or design equipment, phone your nearby G-E electronics office for expert assistance in selecting the right G-E rectifier types. There are more than a dozen from which to choose. If a station operator needing tubes for replacement, your local G-E tube distributor will be glad to serve you promptly, efficiently, out of ample stocks on hand. *Electronics Department, General Electric Company, Schenectady 5, N. Y.*



GL-866-A



GL-8008
(also supplied with 50-watt base as Type GL-872-A)



GL-673
(also supplied with 50-watt base as Type GL-575-A)



GL-869-B



GL-857-B

GENERAL ELECTRIC

180-H5

FIRST AND GREATEST NAME IN ELECTRONICS

Type	Cathode voltage	Cathode current	Anode peak voltage	Anode peak current	Anode avg current
GL-866-A	2.5 v	5 amp	10,000 v	1 amp	0.25 amp
GL-8008	5 v	7.5 amp	7,000 v	5 amp	1.25 amp
GL-673	5 v	10 amp	5,000 v	6 amp	.5 amp
GL-869-B	5 v	19 amp	20,000 v	10 amp (*20 amp)	2.5 amp (*5 amp)
GL-857-B	5 v	30 amp	22,000 v	40 amp (*Quadrature operation)	10 amp

How RCA

PROTECTS PICTURE CLARITY

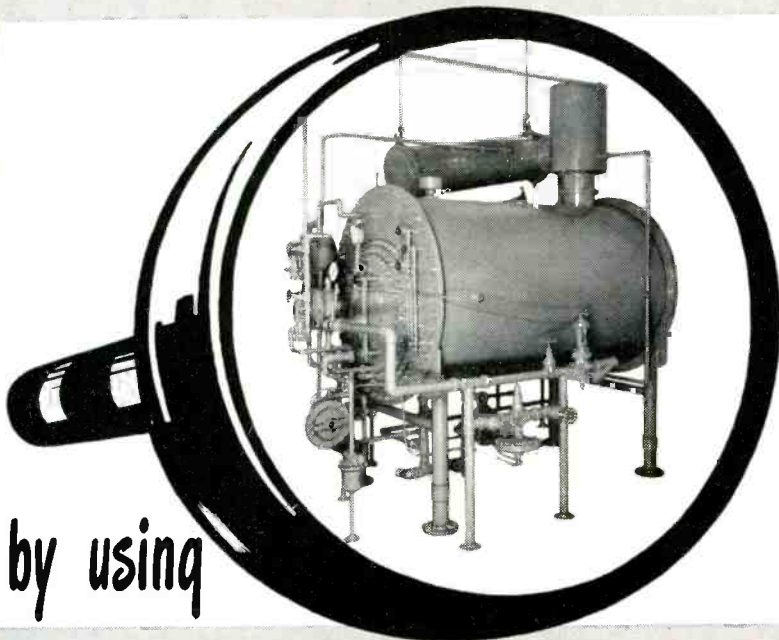

by using

BARNSTEAD PURE WATER

Offhand, Pure Water would not seem to be connected to the picture clarity of a television tube. But the fluorescent material which forms the screen, on the face of the tube, is floated into place in water suspension, and clings to the glass by molecular attraction — as a uniform and perfect coating. Any impurities present in the water can contaminate the material and impair the perfection of the television image. RCA guards against such possibilities by using twice-distilled Barnstead Water of extremely high unvarying purity.

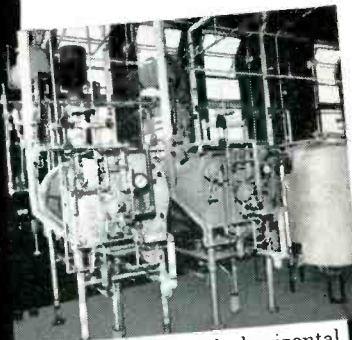

The two special horizontal type stills shown above were especially designed and built by Barnstead Engineers, for the RCA Television Tube plant at Lancaster, Pa.

There, as in hundreds of other little-known processes in the chemical, food, pharmaceutical, electronic and industrial fields, Pure Water plays its unobtrusive, but important part. Wherever there is such a need you are apt to find a Barnstead Water Still or Demineralizer. For Barnstead has been solving industries' needs for Pure Water exclusively since 1878.

MADE WITH 40% W.P. PAT. 2,011
Barnstead
 STILL & STERILIZER CO.

228 Lanesville Terrace, Forest Hills
 Boston 31, Mass.

Table I—Noise Figures for Typical Television Front-End Circuits^a

R-F Amp	Mixer	F Power Ratio	F db	Tuned Gain Circuits
Grounded-Cathode Input Circuit				
6AK5	6AK5	4.17	6.20	29.1 2
6AK5	6J6	4.31	6.34	9.2* 2
				18.4** 3
6AK5	6J4	4.25	6.28	20.0 2
Cathode-Follower Input Circuit				
6J4	6AK5	3.38	5.29	13.0 2
6J4	6J6	2.98	4.74	4.1* 2
				8.2** 3
Grounded-Grid Input Circuit				
6J4	6AK5	6.86	8.36	14.6 1
6J4	6J6	6.86	8.36	4.6* 1
				9.2** 2
6J4	6J4	5.36	7.29	9.7 1
Cathode-Coupled Input Circuit				
6J6	6AK5	4.00	6.02	14.2 2
6J6	6J6	3.88	5.89	4.5* 2
				9.0** 3
6J6	6J4	4.08	6.10	8.9 2
No R-F Circuit				
None	6AK5	7.33	8.65	11.8 1
None	6J6	3.88	5.85	3.44* 1
None	6J6	3.51	5.45	6.88** 2
None	6J4	14.13	11.5	1.93 0

* Fixed-Cathode Mixer Circuit
 ** Tuned-Cathode Mixer Circuit

does not begin to increase until G_1 has reached its minimum value, after which the increase is linear with $G\tau$. For the 6AK5 the third term rose from about 1 to about 1.5 as $G\tau$ rose from 0 to the value at 200 mc. Since R_{eq} is much smaller in triodes this term is even less significant for the 6J4 and 6J6 over the range of interest.

Conclusions

Thus we see in a general way that the effect of inclusion of transit-time effect is to add a number about equal to 4 to the noise figure, for the vicinity of the frequency where $G\tau$ equals the desired value of G_{cr} . If we select from Table 1 the four circuits utilizing the 6AK5 mixer, simply as a basis for comparison, and estimate F by arbitrarily adding the number 4 to each noise figure, we obtain the data shown in Table 2.

We note on inspecting Tables 1 and 2 that the effect of transit-time (as estimated) is to tend to level the differences between the various circuit combinations, so that for increasingly high frequencies the reduction of noise from sources other

The "EXTRA SOMETHING" that spells **TOP PERFORMANCE**

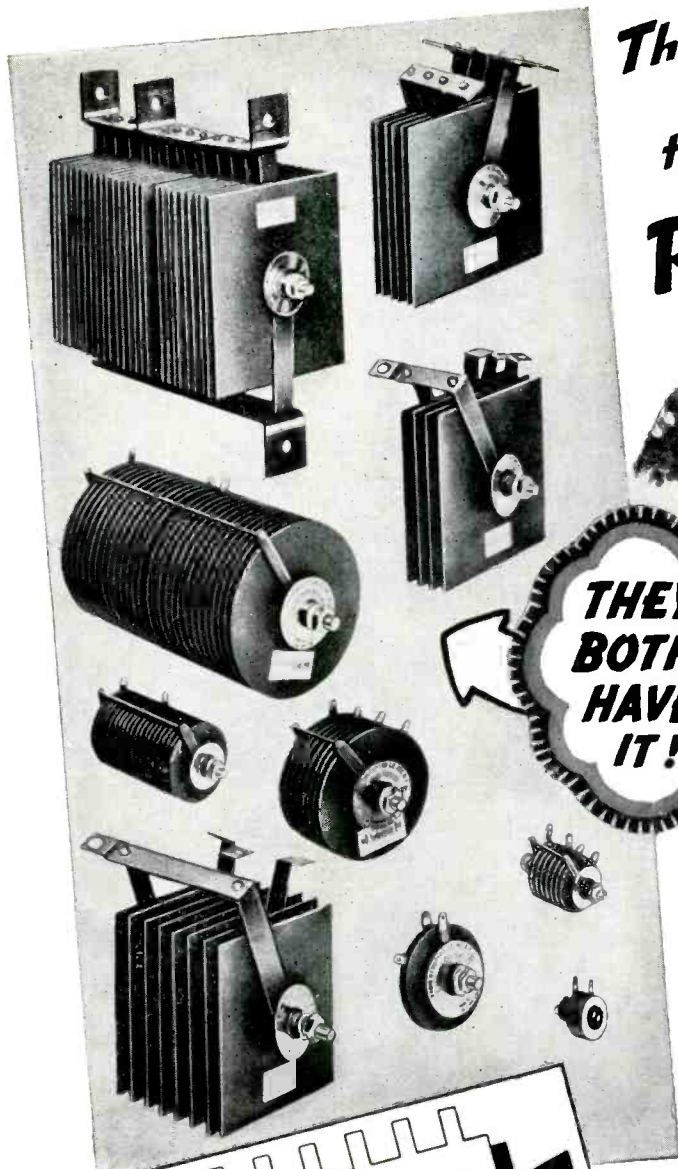

**THEY
BOTH
HAVE
IT!**

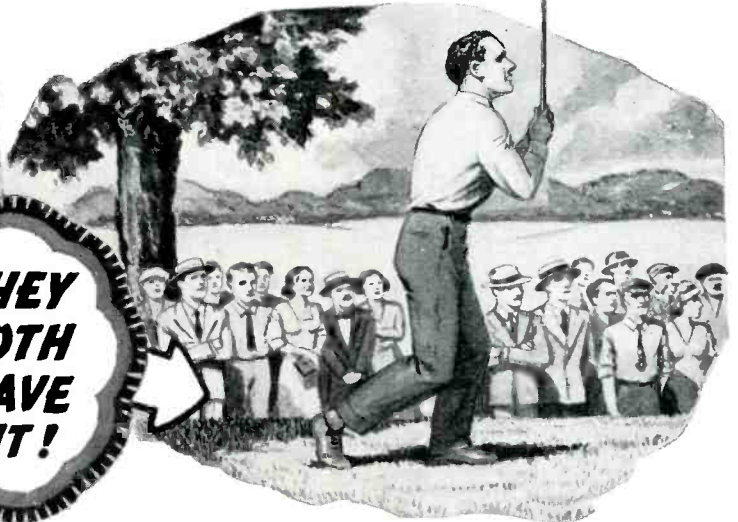

Championship honors in golf are not achieved by chance. The contender who grabs the title must have a more powerful drive, a keener sense of distance and steadier nerves—a combination that gives him the "extra something" required for championship performance.

MANY contributing factors are combined in Seleton Selenium Rectifiers to give them the "Extra Something" that spells Top Performance.

All processes are under rigid control. Mechanical operations involved in the fabrication of the product itself are held to an unvarying standard. Not only are the mechanical standards closely held but the rectifiers must pass individual electrical tests to assure the highest quality.

Backed by such precision methods it is small wonder that these famous rectifiers have earned a nation wide reputation for dependable service in every application. Each month adds additional names to the list of nationally known companies who are satisfied users of Seleton Rectifiers.

Seleton
SELETRON
SELENIUM RECTIFIERS

**FOR ALL ELECTRONIC AND
RADIO APPLICATIONS
SPECIFY "SELETRON MINIATURES"
They insure dependable service.**

Code Number	5M4	5M1	5P1	5R1	5Q1	5S1
Current Rating	75 ma.	100 ma.	150 ma.	200 ma.	250 ma.	500 ma.
Plate Height	1"	1"	13/16"	1 1/2"	1 1/2"	2"
Plate Width	1"	1"	1 3/16"	1 1/4"	1 1/2"	2"

Write today for Catalog. Address Dept. ES-20

For safety, protection and economy,
specify SELETRON Selenium Rectifiers.



SELETRON DIVISION
RADIO RECEPTOR COMPANY, Inc.

Since 1922 in Radio and Electronics

251 WEST 19TH STREET, NEW YORK 11, N. Y.



WHY IT PAYS TO SPECIFY "S.S. WHITE"

ON ALL FLEXIBLE SHAFT APPLICATIONS . . .

Here are four top reasons why you can count on S.S.White flexible shafts to do a better job on your power drive or remote control flexible shaft applications:

1. **SMOOTH, POSITIVE OPERATION**—Combining the best in design and construction, S.S.White flexible shafts of either the power drive or the remote control type give smooth, positive performance.
2. **LONG LIFE** — when properly applied, S.S.White shafts give years of dependable, troublefree service. They're made of special grades of wire to exacting quality standards. And they are engineered to operate with low internal friction.
3. **EXACT DUPLICATION**—S.S.White's strict adherence to original specifications and careful control over production and materials assures complete uniformity of desired characteristics in each and every foot of shafting supplied.
4. **BACKED BY LONG EXPERIENCE** — 70 years of leadership in the design and mass production of flexible shafts has given S.S.White the answers to the many details which determine successful flexible shaft performance.

GET FULL DETAILS IN THIS FLEXIBLE SHAFT HANDBOOK

260 pages of facts and data on flexible shaft construction, characteristics and application sent free, if you write for it on your business letterhead and mention your position.



S.S. WHITE INDUSTRIAL
 THE S. S. WHITE DENTAL MFG. CO. DIVISION
 DEPT. E 10 EAST 40th ST., NEW YORK 16, N. Y.



FLEXIBLE SHAFTS AND ACCESSORIES
 MOLDED PLASTICS PRODUCTS—MOLDED RESISTORS

One of America's AAAA Industrial Enterprises

Table II — Noise Figures for Various R-F Amplifiers Used With 6AK5 Mixers

R-F	Amp.	F $G_r = 0$	Est. F 200 mc	Est. F db
6AK5	Gr. Cath.	4.2	8.2	9.1
6J4	Cath. Fol.	3.4	7.4	8.7
6J4	Gr. Grid	6.9	10.9	10.4
6J6	Cath. Coupl.	4.0	8.0	9.0
None	—	7.3	11.3	10.5

than transit-time becomes diminishingly important.

REFERENCES

- (1) C. J. Bakker, Fluctuations and Electron Inertia, *Physica*, 8, Jan. 1941.
- (2) G. E. Valley, Jr. and H. Wallman, "Vacuum Tube Amplifiers," MIT Radiation Laboratory Series, 2, McGraw-Hill Book Co., Inc., N. Y., 1948.
- (3) Wallman, Macnee and Gadsden, Low-Noise Amplifier, *Proc. IRE*, 36, p 700, 1948.
- (4) H. M. Watts, Television Front-End Design, Part II, *ELECTRONICS*, p 106, May 1949.

Miniature Counter-Tube Power Supply

BY D. L. COLLINS

Director of Technical Services
 Victoreen Instrument Co.
 Cleveland, Ohio

THE COMPACT, low-power high-voltage power supply shown in the photograph takes advantage of recent developments in very small components. The high voltage is obtained across a miniature transformer in a blocking-oscillation circuit with a 1V5. The oscillator pulses are rectified by a low-power, high-voltage half-wave VX-21 rectifier. Regulation is obtained by a 900-volt corona voltage regulator.

For portable radiation instruments, one of the most important requirements is compactness. In some instances this has been considered to be even more important than reliability. It is the purpose of this paper to demonstrate that it is possible to combine compactness with reliability.

The specifications for the design of a portable power supply were set up as follows: The circuit must operate with 900-volt output at a maximum of 2 percent voltage regulation over varied loads of from one

to five microamperes, using all 1.5-volt batteries to a 1.1-volt end point. Batteries must supply one week's operation at eight hours per day, and the overall size and weight of the unit must be held to minimum.

In the preliminary work, comparison was made with several types of low-power, high-voltage supplies, including batteries, multivibrator circuits, r-f oscillators and mechanical vibrators¹. The choice of the blocking oscillator was made on the basis of the specifications calling for small size and weight.

Blocking Oscillator Circuit

The circuit consists of a UTC type 0-15 transformer used as a

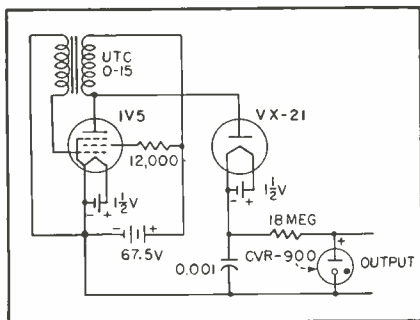

FIG. 1—Circuit diagram of counter-tube power supply with regulated 900-volt output at 0 to 8 ma. The CVR-900 regulator tube has been assigned RMA type number 5841, and the VX-21 diode is now 5799/VX-21

blocking oscillator. This transformer was the smallest available with sufficient inductance and turns ratio to provide the necessary output voltage. Design of the transformer is not critical, as satisfactory results may be obtained by using an ordinary output transformer. The 1V5 oscillator tube was selected for its high transconductance. Attempts were made to use the tubes as triodes, but this resulted in somewhat lower output voltage.

The VX-21 rectifier was selected for its extremely low filament power and high inverse peak voltage ratings. It is possible to operate the VX-21 from the same filament battery as the oscillator tube by taking the output from the plate side of the rectifier. This has the advantage of reducing the number of filament batteries and making possible common ground for all batteries. This system was not used in the final design, however, because of the reduced output voltage supply due to loss of the voltage across

HARDWICK, HINDLE

Crinkle Wound

Resistor

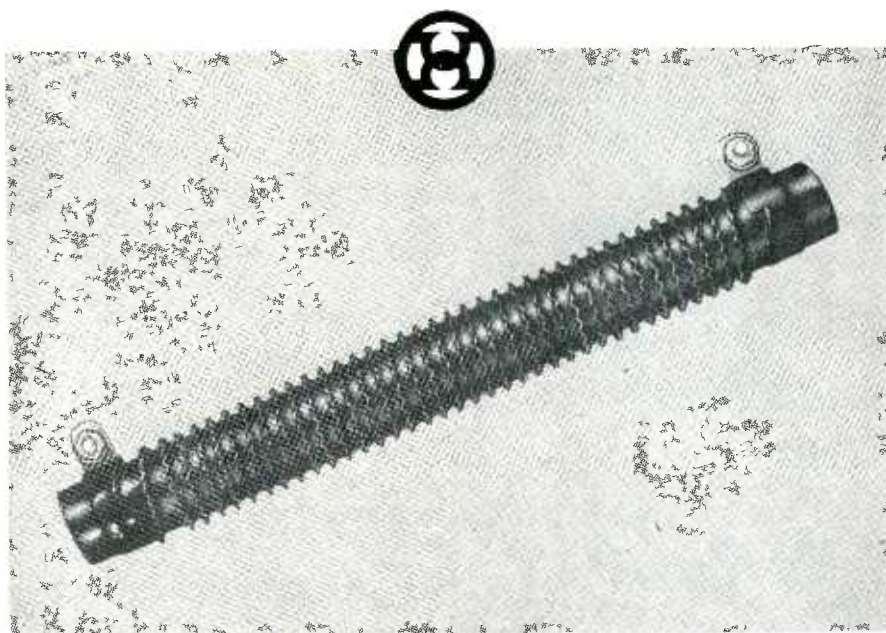

OUR CRINKLE WOUND resistors are designed especially for relatively low value of resistance with a high current carrying capacity.

They fall within the classification of bare resistors by NEMA and Underwriters' regulations, permitting operation at a temperature rise of 350 degrees C.

The ribbon of resistance alloy is wound on edge upon the refractory tube—the ends braised to heavy copper terminals. A vitreous enamel covering anchors the turns securely and prevents movement. *The result is an unusually large area for heat dissipation.*

Units with intermediate taps are available. There are 5 sizes: 155 to 420 watts, from .125 to 20.0 ohms.

Hardwick, Hindle resistors and rheostats offer many exclusive advantages. We ask you to give our engineers an opportunity to discuss your specific requirements.

HARDWICK, HINDLE, INC.

Rheostats and Resistors

Subsidiary of

THE NATIONAL LOCK WASHER COMPANY

NEWARK 5, N. J. Established 1886 U. S. A.

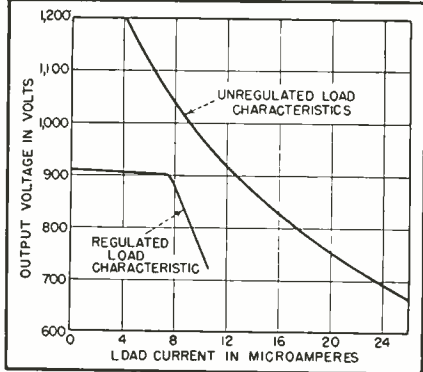

FIG. 2—Curves showing output voltage as functions of load, both regulated and unregulated

the transformer windings in the oscillator grid circuit.

Corona Voltage Regulator Tube

Regulation is obtained by the use of an R-C filter and corona voltage regulator tube. The corona tube was constructed in a standard sub-miniature T3 envelope. It was selected in preference to a series of VXR-130's because of the small size requirement and also because preliminary work indicated the possibility of better performance.

Batteries were selected to meet the operating life requirement and for convenience in physical size and shape. The type D cell has a much longer operating life in the VX-21 filament circuit than is required. However, the curves of the unregulated output voltage versus battery voltage (Fig. 3) show that the filament batteries may be used

THE
Master **VOLTOHMYST***
...the most versatile
instrument of its kind

- MEASURES . . .
- ✓ DC Voltage
 - ✓ Capacitance
 - ✓ DC Current
 - ✓ AC Voltage
 - ✓ Resistance

Truly the "master" electronic multimeter, the RCA WV-95A has no equal for fast and accurate test and measuring applications in the plant and laboratory. Measures ac and dc voltages to 1000 volts, dc current from 1 microampere to 10 amperes, resistance from 0.1 ohm to 1000 megohms, and capacitance from 4 mmf to 1000 mf. The ten-million-to-one current range makes the instrument useful as an electronic galvanometer. Zero-center indication is provided on five current ranges and on all dc voltage ranges. DC voltage can be measured in operating af and rf circuits. The meter is electronically protected on all but the two highest current ranges.

When used with the RCA WG-275 accessory diode probe, the WV-95A will measure rf voltages in communication equipment or in coaxial lines, and peak-to-peak voltages of recurrent pulses in sync signal generators, television receivers, radar units, and computing devices.

*Reg. Trade Mark, U. S. Pat. Off.

The WV-95A can also be used with the RCA WG-284 accessory high-voltage probe to measure up to 30,000 dc volts. For further details, ask your RCA Test Equipment Distributor for Bulletin 2F721—or write RCA, Commercial Engineering, Section 42HY, Harrison, N. J.

SPECIFICATIONS	
DC VOLT METER	Six Ranges..... 0 to 5, 10, 100, 500, 1000 dc volts
	Input Resistance, all ranges.....11 megohms
DC AMMETER	Seven Ranges:
	Through DC Amplifier
	0 to 10, 100 microamps; 0 to 1, 10, 100 ma.
	Direct to Meter Movement.....0 to 1, 10 amperes
OHMMETER	Six Ranges..... 0.1 ohm to 1000 megohms
	Center-scale Indications
	10, 100, 1000, 10000 ohms; 0.1, 10 megohms
AC VOLT METER	Seven Ranges
	0 to 1, 5, 10, 50, 100, 500, 1000 RMS Volts
	Input Resistance and Capacitance
	0.5 megohm shunted by 125 mmf.
	Frequency Response.....30 to 20,000 cps
CAPACITANCE METER	Six Ranges.....4 mmf. to 1000 mf.
	Center-scale Indications
	100, 1000 mmf.; 0.01, 0.1, 1, 10 mf.
RF VOLT METER	Ranges: (Requires WG-275 accessory probe)
	From 30 cps to 17.5 Mc.
	0 to 5, 10, 50, 100 RMS Volts
	At 75 Mc.....0 to 5, 10, 30 RMS Volts
	At 250 Mc.....0 to 5, 10 RMS Volts
	Dimensions.....10" high, 13 1/2" wide, 7 1/2" deep

Available from your RCA Test and Measuring Equipment Distributor



RADIO CORPORATION of AMERICA
TEST AND MEASURING EQUIPMENT
HARRISON, N. J.

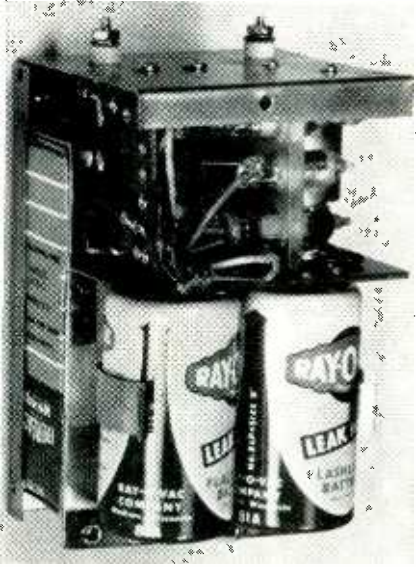

Photograph of extremely compact corona-voltage-regulated power supply for portable counters

until the one on the 1V5 filament has reached the end point. At this time, the two filament batteries may be interchanged. By using the curve of unregulated output voltage versus battery voltage, and the battery manufacturer's data sheets, batteries could be selected for any overall operating requirements. Curves of output voltage versus battery voltages are shown in Fig. 2 and 3.

The performance characteristics of the completed unit are as follows: Load limit, 0 to 8 microamperes;

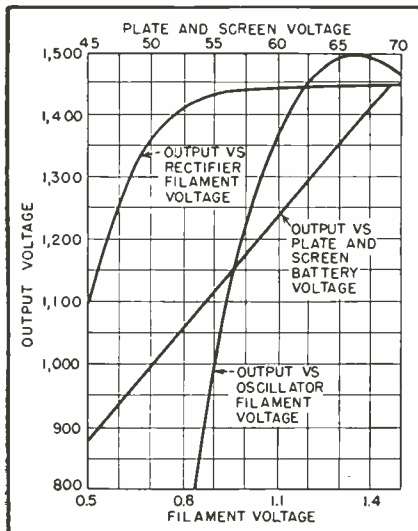

FIG. 3—Curves showing output voltage of counter-tube power supply with respect to the various battery voltages

A-battery voltage limits, 1.5 to 1 volt; B-battery limits, 67½ to 50 volts; output voltage, 900 volts with 2-percent regulation.

The corona voltage regulator could be made to regulate other output voltages, but if more than 1,200 volts of regulated voltage are required, the oscillator output must be increased by increasing the inductance of the transformer, increasing the turns ratio of the transformer, increasing the B-battery voltage, or by selecting a tube with greater transconductance.

REFERENCE

(1) A. Thomas, High-Voltage Supplies for G-M Counters, *ELECTRONICS*, p 100, Dec. 1948.

SURVEY OF NEW TECHNIQUES

GERMANIUM CRYSTAL TETRODES for mixer applications using input signals at least up to 200 mc were described by Rowland W. Haegele of



Verdict for COTO-COIL on every count

Coto-Coil Windings bring you the best for the least. Wherever electric or electronic controls are called for . . . Wherever precision is a prime necessity . . . Wherever there are special conditions to be overcome . . .

The Judgement Goes to Coto-Coil
Coil Specialists Since 1917

BOBBINS

ACETATE INTERLEAVE

(Cooled under W.E. Pats.)

PAPER INTERLEAVE

COTTON INTERWEAVE

TAPED FORM WOUND

UNIVERSAL SINGLE OR
MULTI-PIE CROSS WOUND



COTO-COIL CO., INC.

COIL SPECIALISTS SINCE 1917

65 Pavillion Avenue, Providence 5, R. I.

Another important ADC DEVELOPMENT

ADC AMPLIFIER (71 Series)



Compactness and functional design of the ADC Type 71 amplifier are shown above. Neatness of arrangement and ease of access are shown below.



The new ADC Type 71 Series of high fidelity 8-watt amplifiers is outstanding for its unusual versatility, and wide range frequency response with low distortion.

These new amplifiers are ideal for use in radio broadcasting studios, wired music applications, recording studios, home receivers and similar installations where bridging, line or high impedance inputs are required. Output impedances are provided for either line or voice coil connections.

ADC Type 71 amplifiers are readily adaptable for use in either a console or rack. Rapid exchange of units for servicing or change of terminal impedances is facilitated by plug-in connections.

Hum problems are minimized by a built-in power supply with low external magnetic fields.

The new ADC Type 71 Series will solve many of your amplifier problems.

Write TODAY for descriptive literature.

Features:

- Rated Power Output . . . 8 Watts
- Rated Response Flat within 0.5db, 40-12,000 cps
- Max. Input for full power output . . . Zero V. U. or 0.78 volts
- Max. Noise Level 78db below full output
- Gain Control Range 35db
- Distortion—Nominal Rating . . . 2%
- Net Weight 11½ Lbs.
- Overall Dimensions 3¾" x 16" x 6¾" High including Plugs and Control Knob

Applications:

Type	Gain	Input	Output
71A	38db	Bridged (10,000 ohms)	600/150 ohms
71B	38db	Bridged (10,000 ohms)	16/8/4 ohms
71C	50db	600/150 ohms	600/150 ohms
71D	50db	600/150 ohms	16/8/4 ohms
71F	70db	High-Impedance	16/8/4 ohms

Sylvania at the Princeton University Conference on Electron Tubes and Solid State Devices, sponsored by IRE. Advantages claimed include the high degree of isolation provided by the crystal tetrode, lower power even though conversion transconductance approaches that of ordinary tube mixers, and very small physical size.

TRANSITION of materials like lithium chloride from insulators to conductors at temperatures about 15 to 30 degrees below their fusion points is being used in England for measuring and controlling temperatures of engines and their exhaust ducts. The sensing element is like a coaxial cable with the annular space filled with the temperature-sensitive material. Mixtures of calcium and sodium chloride also work. An a-c voltage is applied between core and sheath, with a solenoid in series to operate an electrohydraulic fuel valve. When the exhaust duct gets too hot, the resulting increased current through the chloride material operates the solenoid valve and reduces fuel flow.

CHANGE IN PERMEABILITY with temperature as ferromagnetic substances approach their Curie point provides simple and direct control of temperature. A diaphragm of nickel-iron alloy, exposed to the heat source, is made a part of a magnetic circuit containing a movable armature. Changes in permeability cause movement of the armature, which in turn moves a flapper valve in the compressed air input to a diaphragm-actuated valve in the fuel line of the furnace.

A DOUBLE DIODE with elastically supported anodes has been developed in England for use as an all-electronic accelerometer. Plate impedance changes with acceleration or deceleration when the tube is clamped to the structure under test. The diodes form adjacent arms of a Wheatstone bridge whose output can be recorded directly with a low-impedance galvanometer or fed into an amplifier and c-r scope. Advantages are high output, excellent response at low frequencies, low mass, and absence of positioning restrictions.



Audio DEVELOPMENT CO.

"Audio Develops the Finest"

2847 13th Ave. South, Minneapolis 7, Minn.

NEW PRODUCTS
(continued from p 126)

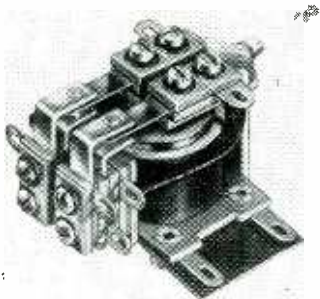

in. wide, $1\frac{1}{8}$ in. long. The unit is available in any combination of switches up to dpdt. Standard contacts are of fine silver, rated up to 5 amperes. Power consumption is 1 to 2 watts.

Microvolt Generator

THE HICKOK ELECTRICAL INSTRUMENT Co., 10527 Dupont Ave., Cleveland 8, Ohio. Model 292X microvolt generator covers all a-m, f-m, tele and mobile frequencies.



Modulated and unmodulated output is from 1 to 100,000 μ v. It may be externally modulated from 15 to 10,000 cps. The unit features a self-contained crystal oscillator circuit.

High-Impedance Attenuator

LIVINGSTON ELECTRONIC CORP., Livingston, N. J., announces the Model MB Loudness Control, a 23-step high-impedance attenuator with 23 degrees of equalization designed in



NEW STEVENS THERMOSTAT

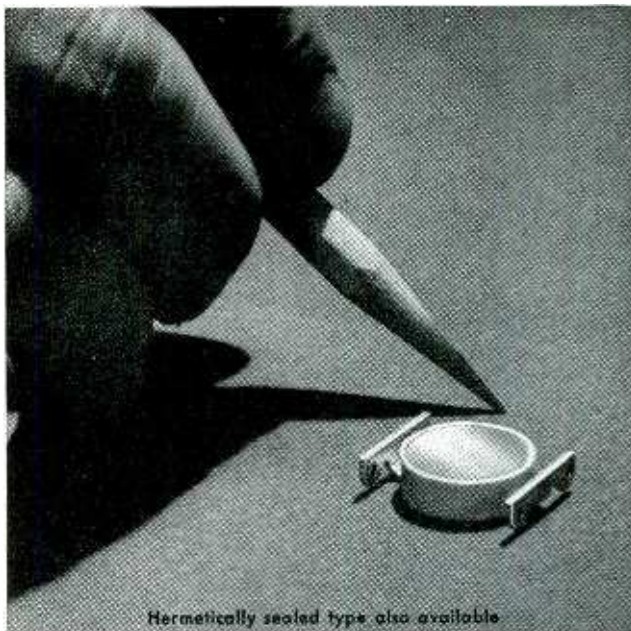

Hermetically sealed type also available

fast response • close temperature control

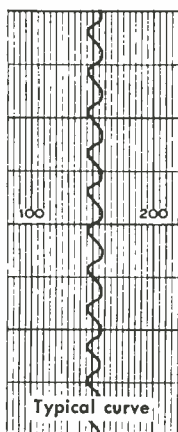

Specifically engineered for electronic, appliance and apparatus applications, compact Type M Stevens Thermostats assure *fast response and close temperature control*—characteristics of larger Stevens Thermostats.

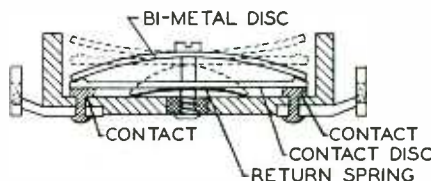

Action of new Type M thermostat is extremely precise because bi-metal element is electrically independent. Bi-metal disc rests on top of rigid Monel-backed contact disc, which carries current on its silver side because of minimum electrical resistance. Since bi-metal carries no current, artificial cycling and life-shortening "jitters" are eliminated.

Double, heavy-duty silver contacts in series minimize arcing, further increase thermostat life. Heat-resistant stainless steel or Inconel return spring assures positive On or Off position. Silver-plated brass or steel terminals, mounted on non-conducting Alsmag base, are furnished in standard or special shapes.

Get faster response and closer temperature control on small current differentials. Specify Stevens Type M Thermostats on your appliances and industrial apparatus — *for better performance, longer life.*

A-2269

STEVENS manufacturing company, inc.
MANSFIELD, OHIO

Designed for

Application



3/4 SIZE

**THE NO. 37001
SAFETY TERMINAL**

An old favorite in the line of exclusive Millen "Designed for Application" products. Combination high voltage terminal and thru-bushing. Tapered contact pin fits firmly into conical socket providing large area, low resistance connection. Pin is swivel mounted in cap to prevent twisting of lead wire. Easy to use. 1/4" o.d. insulation high voltage cable fits into opening in cap. Bared conductor passes thru pin for easy soldering to pre-tinned tip of contact plug.

Standard 37001 available in either black or red bakelite. No. 37501 is low loss mica filled yellow bakelite for R.F. applications.

**JAMES MILLEN
MFG. CO., INC.**

MAIN OFFICE AND FACTORY
**MALDEN
 MASSACHUSETTS**



NEW PRODUCTS

(continued)

conformance with the Fletcher-Munson curves. Over 50-db attenuation is available with a response varying from flat at zero attenuation to a 27-db bass rise at maximum attenuation.

Grid-Dip Oscillator

ELDICO OF N. Y. INC., 44-31 Douglaston Pkwy., Douglaston, N. Y. Model GDA grid dipper is designed to measure excited or non-excited circuits. Among its many uses it will serve as a signal generator, absorption wavemeter, r-f voltmeter and Q indicator. It features self-

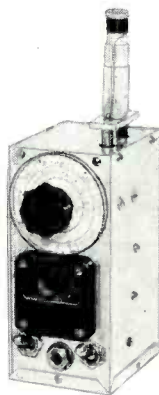

contained a-c power, sensitive direct coupling and a complete continuous range from 3 mc to 250 mc in 6 coil ranges. The unit is available wired and tested to order.

Capacitance Checking Unit

CLIPPARD INSTRUMENT LABORATORY, INC., 1125 Bank St., Cincinnati, Ohio. Model PC-4 capacitance comparator is designed to select, grade and calibrate capacitors of any type within an accuracy of 0.2 percent. It operates from any 110-volt a-c outlet. Range is from 10 μ f to 1,000 μ f. Three scales on the meter read in ranges of -5 to +5



**DO YOU HAVE AN
INSTRUMENTATION
PROBLEM?**

Bendix-Pacific telemetering facilities can provide you with any phase of a complete instrumentation service. These include:

- ★ The standard AN/DKT-3 sub-miniature telemetering components which remotely measure and indicate acceleration, motion and position, pressure, strain, temperature, vibration, velocity, voltage and current. Transmitters up to 15 watts of power are available.
- ★ Application engineering to adapt the Bendix-Pacific System to each specific problem.
- ★ Installation and calibration services.
- ★ Aircraft and missile antenna design and radiation analysis.
- ★ Flight testing, providing all ground station facilities and reduction and analysis of data.

RADAR BEACON

Bendix-Pacific has developed for restricted use an exceptionally small, compact radar beacon for use in the common radar bands to facilitate vehicle tracking.

Inquiries from qualified companies and agencies for complete engineering data are invited.



Eastern Engineering Office: 475 Fifth Ave., N. Y.
TO MEASURE—TO INDICATE—TO WARN AT A DISTANCE

and over a temperature range of -50 F. to +150 F.

Broadcast Cartridge

GENERAL ELECTRIC Co., Syracuse, N. Y. A broadcast type variable reluctance pickup cartridge for replaceable stylii has the same impedance as broadcast equalizers now in use with earlier models of the cartridge. Each unit holds to within plus or minus 2 db of its established frequency curve.

Selenium Rectifier

BRADLEY LABORATORIES, INC., 82 Meadow St., New Haven, Conn. Model SE8L selenium rectifier is a small high-voltage type designed for portable or sealed equipment.

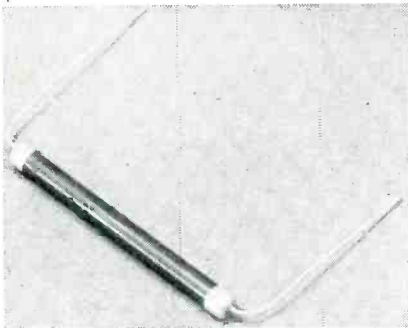

Diameter of the rectifier housing measures a quarter-inch and the length varies with type up to 3 inches. It is rated up to 3,000-v peak inverse at 1.5 ma d-c and can be arranged in series or in voltage multiplier circuits for higher voltage requirements.

Amplifier-Suppressor

HERMON HOSMER SCOTT, INC., 385 Putnam, Ave., Cambridge 39, Mass. Type 211A laboratory amplifier with noise suppressor has a frequency range from 20 to 20,000 cycles and a peak power output of

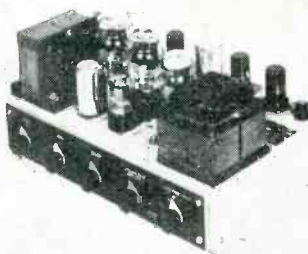

THE SYMBOL OF
Vibration Control

The list of current users of Robinson VIBRASHOCK products reads like a cross section of the blue book of leading American industrials. Engineers in all phases of manufacturing, where vibration is a problem factor, have learned to rely upon Robinson equipment and vibration engineering counsel. New high standards of performance, durability, and load tolerance are assured through the experience and ability of the Robinson organization. VIBRASHOCK mounts, (now available with MET-L-FLEX, a new all steel resilient material) protect valuable military and commercial instruments and equipment throughout the world. Detailed literature and performance curves will be sent upon request.



ROBINSON AVIATION, INC.
TETERBORO, NEW JERSEY
VIBRATION CONTROL ENGINEERS

KEPCO

MODEL 245

VOLTAGE REGULATED POWER SUPPLY . . . REGULATED WITHIN 1/2% 200 to 450 VOLTS

A.C. OUTPUT: 6.3 volts at 6 amperes unregulated.

RIPPLE VOLTAGE: Less than 5 millivolts.

OUTPUT IMPEDANCE: Less than 2 ohms.

FRONT PANEL: Voltage control; D.C. output terminals (isolated from chassis); A.C. centertapped output terminals (isolated from chassis); On off



for industrial and research use

For both load variation from 0 to 200 milliamperes and input variation from 105 to 125 volts.

Output D.C. voltage variation is within 0.5 volts between 200 and 450 volts for load variations from 0 to 200 MA.

switch and pilot light; D.C. output switch; Line fuse; D.C. output fuse; Meters, 0 to 200 milliamperes D.C. and 0 to 500 volts D.C. A ground terminal connected to the chassis is mounted at the back of the supply.

DIMENSIONS: Cabinet size, height 8", width 8", length 16". Weight 29 pounds.

Every well equipped engineering research laboratory, testing department, physics and electronic schoolroom should have its own

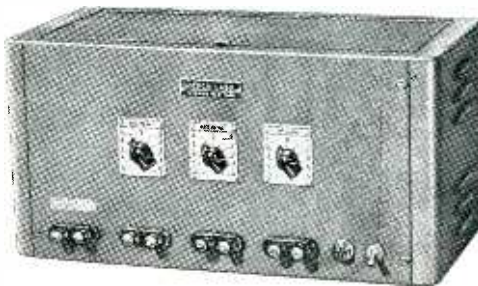

KEPCO MULTIPLE POWER SUPPLY

- Two continuously variable B supplies, from 0 to 300 volts at currents up to 150 ma. Ripple less than 10 millivolts.
- One continuously variable C supply, from minus 50 to plus 50 volts at 5 ma. Ripple less than 5 millivolts.
- One heater supply, 6.3 volts at 5 amperes.
- Power requirements: 105 to 125 volts, 50 to 60 cycles.
- B voltages are varied by new KEPCO "Electronic Voltage Divider."

Here, from one self-contained unit, is a source of power providing the four most commonly used voltages; heater, plate and grid:

KEPCO "Electronic Voltage Divider" eliminates use of heavy duty wire wound potential dividers . . . B voltage regulation characteristics are superior to standard designs . . . complete voltage control from front panel . . . all connections to sturdy front panel binding posts . . . voltages isolated from chassis.

For detailed information about the KEPCO MULTIPLE POWER SUPPLY and the KEPCO VOLTAGE REGULATED POWER SUPPLY, write to DEPARTMENT E.



Keeco Laboratories
Incorporated
149-14 41st Avenue
Flushing, N. Y.

NEW PRODUCTS

(continued)

14 watts. Distortion is less than 0.5 percent at 5 watts and 2 percent at 12 watts. Hum is approximately 80 db below maximum power output at normal volume. The amplifier is d-c operated throughout except for power and driver stages. A special transformer matches any speaker from 2 to 500 ohms. A 10-kc whistle filter is provided for a-m reception.

Static Voltage Regulator

VICKERS ELECTRIC DIVISION, VICKERS INC., 1815 Locust St., St. Louis 3, Mo. The static generator voltage regulator illustrated has a 2,100-watt output, an overload rating of 150 percent (4,000 watts) for 30 seconds, and a transient response time of 8 cycles, based on 400 cps.

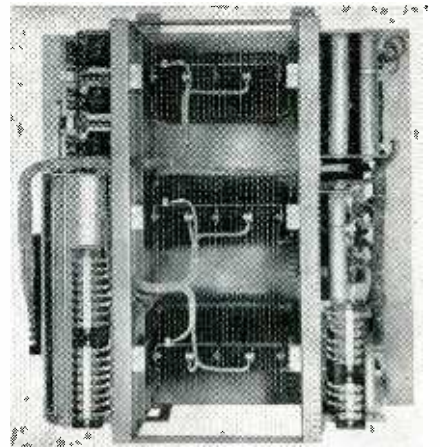

Designed to perform under severe shock conditions, its circuit consists largely of a voltage detection stage, an amplifier stage and a main power stage.

Interlocking Relay

PHILLIPS CONTROL CORP., Joliet, Ill. Series 30500 interlocking relay, consisting of two Type 2 relays, may be furnished to operate on either a-c or d-c. When the lockup relay is energized it automatically locks in mechanically by means of

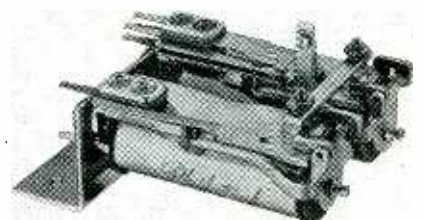

a tension spring catch, which holds the armature in the energized position even though the electrical circuit has been opened. When the release relay is energized the lockup relay is automatically released from its mechanically held position.

Recording Assembly

OFFNER ELECTRONICS INC., 5320 N. Kedzie Ave., Chicago 25, Ill. The Dynograph (right) is a direct ink-writing oscillograph which may be used with the type 133 amplifier (center) for direct recording in such applications as seismic pick-

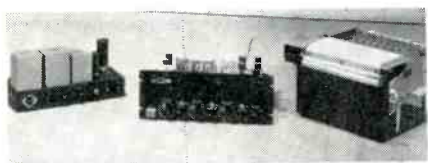

ups, reluctance pickups and tachometers. From a d-c source sensitivity is approximately 150 μ v per cm. Response time of the pen is less than 1/100 second. Type 133 is a 3-channel amplifier operated from the type 333 a-c power supply.

Multi-Installation Tele Antenna Unit

TELEVISION EQUIPMENT CORP., 238 William St., New York 7, N. Y. Model 5-501 Multicoupler permits the connection of up to eight extra tv or f-m sets to one ordinary tele antenna. No adjustment or tuning over the 40 to 220-mc range is required. The unit will operate either 300 or 75-ohm receivers, and uses eight type 6AK5 tubes. For special applications it may be connected to serve 8 to 75-ohm sets, or operate with separate high and low-band antennas when required.

Industrial Rectifier Tube

NATIONAL ELECTRONICS, INC., Geneva, Ill. The NL-614 is a new inert gas-filled 2.5-ampere rectifier tube designed for industrial electronic applications. It may be used at any ambient temperature between -75 and $+90$ C. Filament voltage is 2.5; filament amperes, 8.5; d-c ampere output 2.5; and peak current

HEADQUARTERS for Tubular Parts for Television

The Electronics Industry learned years ago to look to Superior's Electronics Division for tubular parts tailored to their needs. As one of the largest producers of tubing for electronics, Superior has played an important part in the development and perfection of these vital components. Used as anodes, grid cylinders and other parts for television and cathode ray tube gun structures, these parts can be rolled at either or both ends, straight or angle cut, expanded and rolled, or especially shaped to meet every requirement.

Rigid production procedures, together with constant metallurgical and chemical engineering control, form the important "base of operations" from which these tubular parts, and other products of the Electronics Division emerge. The major tube manufacturers know this "base of operations" means that Superior components give complete satisfaction.

The Electronics Division will be glad to send full information.

*For electronic products for export, contact
Driver-Harris Company, Harrison,
New Jersey.
Harrison
6-4800*

Superior

THE BIG NAME IN SMALL TUBING (.010" TO 5/8" O.D. MAX.)

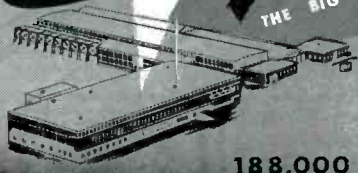

SUPERIOR TUBE COMPANY
2500 Germantown Ave., Norristown, Pa.
ELECTRONICS DIVISION

188,000 SQ. FT. PRODUCING METAL TUBING

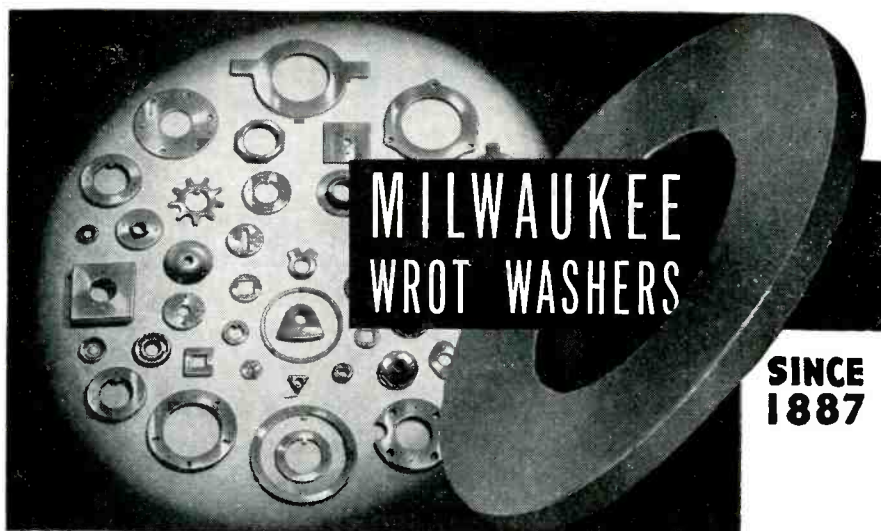

The SYMBOL of QUALITY for 62 YEARS

WASHERS . . . Standard and Special, Every Type, Material, Purpose, Finish . . . STAMPINGS of every Description . . . Blanking, Forming, Drawing, Extruding.

Your most dependable source of supply — the world's largest manufacturer of Washers, serving Industry since 1887. Over 22,000 sets of Dies.

Submit your blueprints and quantity requirements for estimates.

**WROUGHT WASHER
MANUFACTURING CO.**

The World's Largest Producer of Washers

2118 S. BAY ST., MILWAUKEE 7, WIS

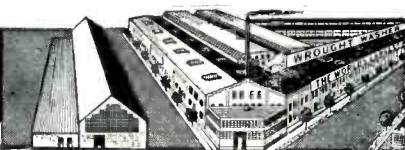

wave guide & coaxial assemblies

- RAPID INSTALLATION
- HIGH EFFICIENCY
- UNIFORM IMPEDANCE
- COMPLETE LINE OF FITTINGS

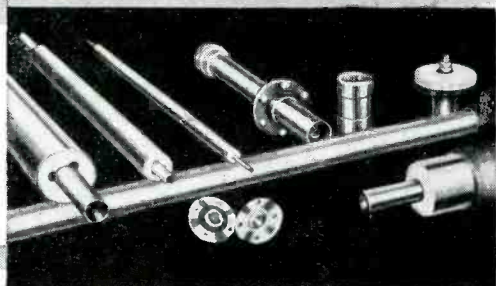

Transmission line in all types
including standard RMA sizes for FM and TV

GENERAL CERAMICS Transmission Lines are available in sizes to meet any installation requirement. All lines are of the bead supported type, in standard lengths. Fabrication to close tolerance assures highest efficiency. Special "clover leaf" spacer beads effectively reduce capacity effects and

arcing. Carefully designed end seals assure permanently gas-tight terminations. Pressurizing equipment, including gauges, valves, etc., impedance matching units, wave guide and coaxial assemblies for antennae and R.F. sections are supplied to exact requirements.

Our engineers are always pleased to check any project and furnish quotations.

General CERAMICS and STEATITE CORP.

GENERAL OFFICES and PLANT: 22 CROW'S MILL ROAD, KEASBEY, N. J.

MAKERS OF STEATITE, FERRIC, ZIRCON, PORCELAIN,
LIGHT DUTY REFRACTORIES AND CHEMICAL EQUIPMENT



output, 15 amperes. The 900-volt peak inverse voltage rating permits conservative use in 250-volt d-c circuits.

Static Converter

VARO MFG. CO., INC., Box 638, Garland, Texas. Model 30 converter is a d-c power supply designed for operating at extreme altitudes and

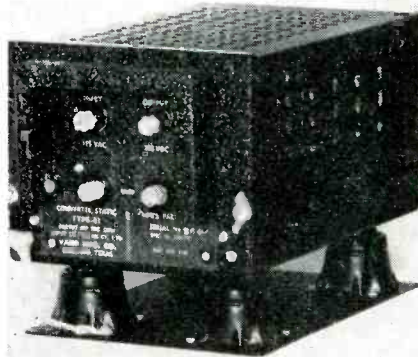

temperatures. Input is rated at 110 to 120 volts, 380 to 420 cycles, single phase, while the output rating is 300 volts d-c, 0 to 400 ma.

D-C Power Supply

ELECTRO PRODUCTS LABORATORIES, INC., 549 W. Randolph St., Chicago 6, Ill. Model B d-c power supply includes new type heavy-duty selen-



ium rectifiers with wide-range variable voltage control, damped voltmeter and ammeter, 8 power tap adjustments and heavy-duty switch. It will deliver from 3 to 9 volts with a rating of 6 volts at 20 amperes continuous and 35 amperes instantaneous from 50 to 60-cycle, 115-volt power source. Ripple is less than 3.0 percent.

Power Resistance Box

MARMA ELECTRONIC Co., 1632-36 North Halsted St., Chicago 14, Ill. Model 10 decade power resistance box, designed for service and laboratory work, will dissipate a minimum of 10 watts and a maximum of 30 watts depending on the setting, while maintaining a 2-percent accuracy. Total available resistance



is 99,990 ohms. Low inductance insures accuracy of readings for all audio and the lower radio frequencies.

Logarithmic Voltmeter

AUDIO INSTRUMENT Co., 1947 Broadway, New York 23, N. Y. Model 121 Logger, having a 50-db meter scale, reads both maximum and minimum program level on the same meter range, and measures system noise level in silent intervals of a program. Feeding output (linear in db) to a direct-writing oscillograph via suitable amplifier, it will record acoustical reverberation or the efficiency of studio operators in riding gain. In the former

Another
OUTSTANDING
ACHIEVEMENT *by*



AIRBORNE RECEIVING EQUIPMENT

**AN/FRN-8 LOW
FREQUENCY
OMNIDIRECTIONAL
RADIO RANGE SYSTEM
DESIGNED AND
DEVELOPED BY RADIO
RECEPTOR FOR U.S.
AIR FORCE**

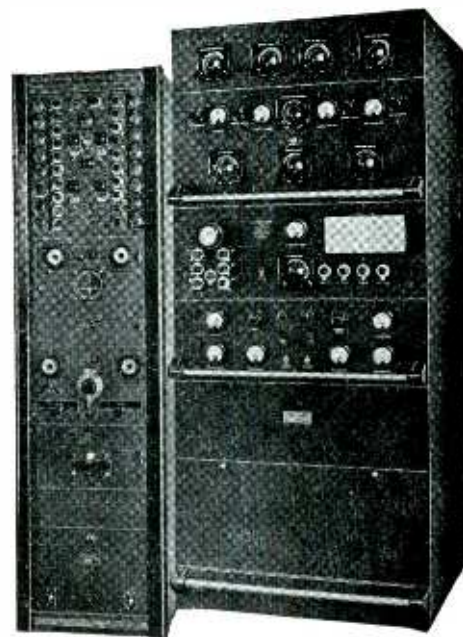

MONITOR UNIT

GROUND TRANSMITTER

Enables aircraft to navigate safely along any radial track to a ground station from distances up to 500 miles. The ground equipment is completely air transportable, permitting the expeditious setting up of a complete medium range navigation system when required.

A novel FM-AM system confines the navigational signal to a total r-f bandwidth of 60 c.p.s. permitting simultaneous voice broadcast on the same carrier. The airborne receiver employs push-button selected crystal control and has a navigational i-f bandwidth of only 150 c.p.s.

This entire project, from its original theoretical conception to final delivery to the U.S. Air Force, was undertaken by Radio Receptor. This includes preliminary research, development of the component equipments, production of a complete packaged station including transmitter, monitors, test equipment, antennas, and tuning units, production of airborne receivers and finally actual installation of the complete working system at a U.S. A. F. base.

Communications Division
RADIO RECEPTOR COMPANY, INC.
Since 1922 in Radio and Electronics
251 WEST 19th STREET • NEW YORK 11, N. Y.

NOW-

Brush Oscillographs mean you can prove better quality to your customers!

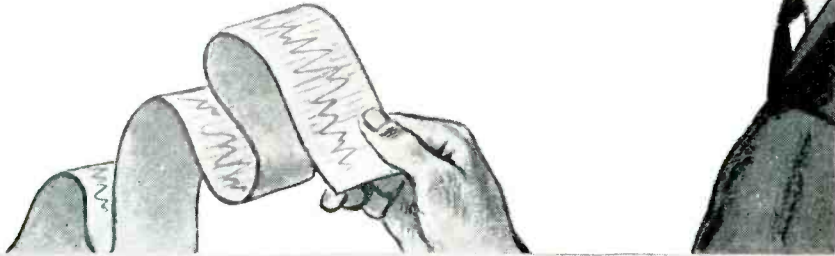

Send them ink-on-paper records of product characteristics . . . recordings that are—Instantaneous—Accurate—Permanent.

Recordings from D.C. to 100 cps. of surface characteristics, pressures, strains, vibrations, and countless other phenomena are easily made by Brush Oscillographs. Whenever desired, recordings may be stopped for notations on chart paper. A.C. or D.C. signals may be measured.

Investigate

Brush measuring devices before you buy...they offer more for your money. Why not have a Brush field engineer call? At no obligation, of course. Just call or write, today, you will find it worth a few seconds' time!



THE **Brush**
DEVELOPMENT COMPANY

3405 Perkins Avenue • Cleveland 14, Ohio, U.S.A.
MAGNETIC RECORDING DIV. • ACOUSTIC PROD. DIV.
INDUSTRIAL INSTRUMENTS DIV. • CRYSTAL DIVISION

Canadian Representative:
A. C. Wickman, (Canada) Ltd., P. O. Box 9, Station N, Toronto 14

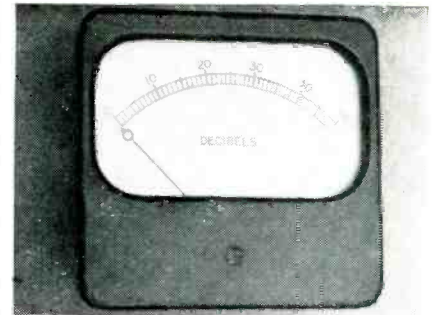

application the unit and oscillograph can record as fast as 2,500 db per second.

Tacking Device

MARKWELL MFG. Co., INC., 200 Hudson St., New York 13, N. Y. The L4 tv Tacker is designed for tacking round coax cable securely to wood or plastic using L4D staples. It is also used for tacking 300-ohm twin lead-in wire using the L4C staple which is driven parallel and between the two outside wires.

Phase Meter

CLARKE INSTRUMENT CORP., 910 King St., Silver Spring, Md. Model 108-C phase meter measures phase relations existing in directional antenna systems. Provision is made

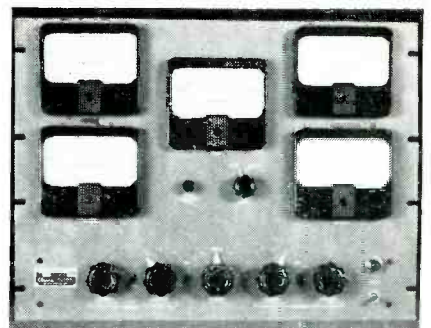

for remote monitoring of the amplitudes of the currents in the several elements of the array. Phase indication is displayed on a meter marked in two-degree intervals.

Single-Phone Headset

TELEX, INC., Telex Park, Minneapolis 1, Minn. The Earset is a single-phone headset that slips onto the ear and weighs only ½ ounce. It offers a comfortable listening level with 0.3-mw input and is available for either high or low impedances. The unit comes equipped with a

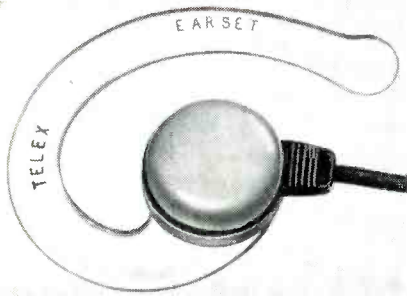

flexible removable 5-ft cord with a standard phone plug connection. Volume control is optional.

Sealed Relays

AUTOMATIC ELECTRIC SALES CORP., 1033 W. Van Buren St., Chicago 7, Ill., has announced a complete line of hermetically sealed relays. Relays available will accommodate operating potentials from a fraction of a volt to several hundred volts.

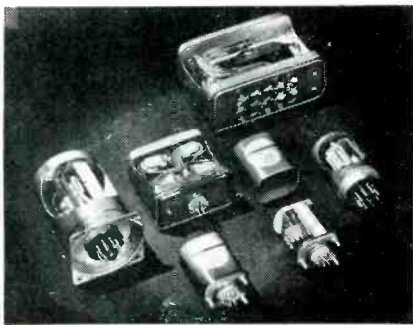

Contact ratings can vary from a few milliwatts to several hundred watts; operate times, from 1 to 100 milliseconds; and release times from 5 to 500 milliseconds. An illustrated descriptive circular is available.

Regulated D-C Power Supply

SORENSON & CO., INC., 375 Fairfield Ave., Stamford, Conn., has added to its line of voltage regulators a B-Nobatron. The new product is designed as a highly stabilized

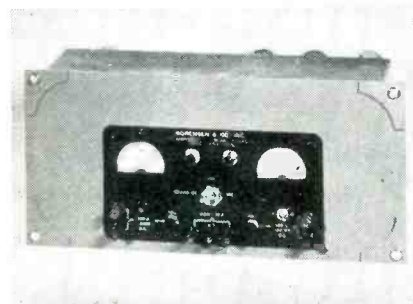

QUALITY in miniature

The Tiny, Five-Gram **ASTATIC** CQ CRYSTAL CARTRIDGE



Miniature size, light weight requirements in pickup cartridges have a splendid answer in Astatic's new CQ Crystal Cartridge. Literally, everything is reduced but the reproduction quality. Weighing only five grams, the CQ offers an excellence of frequency response that is enviable in any size unit. Output is 0.7 volts at 1,000 c.p.s. Needle pressure is five grams. Employs replaceable, one-mil tip radius Q-33 needle. Model CQ-J fits standard 1/2" mounting and RCA 45 RPM record changers. Model CQ-1J fits RMA No. 2 Specifications for top mounting .453" mounting centers. Have cast aluminum housings. Write for additional details.

THE Astatic CORPORATION
 CONNEAUT, OHIO
 IN CANADA CANADIAN ASTATIC LTD. TORONTO ONTARIO

Astatic
 Crystal
 Devices
 manufactured
 under
 Brush
 Development
 Co. patents

NOW YOU CAN AFFORD THE SPEAKER YOU HAVE ALWAYS WANTED!

NEW PRODUCTS

(continued)



PRICE REDUCED 18% on the famous ALTEC 604B DUPLEX SPEAKERS

You benefit from increased demand, and resultant manufacturing economies! Not one iota reduction in the quality of the speaker — the speaker you have always wanted! But you get it for 18 percent less!



PRICE REDUCED 16% ON THE ALTEC 600B DIA-CONE SPEAKER



Utilize the famous dia-cone principle of high-frequency reproduction. Ideal for PA, home, 16 MM and industrial uses. Quality remains the same — you save 16 percent on price!

YOUR DEALER HAS THESE NEW PRICES!

161 Sixth Ave., New York 13, N.Y.
1161 N. Vine St., Hollywood 38, Calif



IN THE PROFESSION, AN HONORED NAME

source of high-voltage, low-amperage d-c. Regulation accuracy for line-voltage variations between 105 and 125 volts is one percent at full load current for any voltage setting between 20 and 325 volts. Accuracy is within 2.0 percent at 10 volts. Complete technical data is available in a recent single-page bulletin.

50-KW A-M Transmitter

WESTINGHOUSE ELECTRIC CORP., Box 868, Pittsburgh 30, Pa. Type 50-H-2 is a high-level a-m broadcast transmitter with a nominal power output of 50 kw. It uses 20 operating tubes of seven types. The equipment features a complete supervisory control system, coordinated with a sequential interlock system and with an overload and safety protection system.

Signal Generator

ELECTRONIC INSTRUMENT CO., INC., 276 Newport St., Brooklyn 12, N. Y. Available either as a kit or factory-wired and tested, the model 320 signal generator can be used for f-m/a-m alignment and to provide tele-marker frequencies. It features



a Hartley oscillator with a frequency range of 150 kc to 100 mc with fundamentals to 34 mc. A Colpitts type audio oscillator supplies pure 400-cycle sine wave voltage for modulation.

Insulating Transformer

F. W. LYNCH Co., 149-151 Second St., San Francisco 5, Calif. Model 230 insulating transformer for carrier telephone is a completely

CO-A-X AIR-SPACED ARTICULATED R.F. CABLES

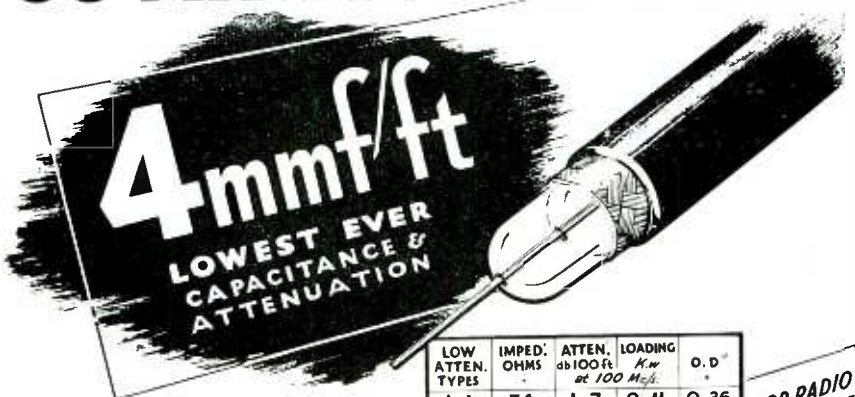

We are specially organized to handle direct enquiries from overseas and can give IMMEDIATE DELIVERIES to U.S.A.

Cable your rush order for delivery by air. Settlement in dollars by check on your own bank. Transaction as simple as any local purchase-and delivery just as quick.

HIGH POWER FLEXIBLE

PHOTOCELL CABLE

VERY LOW CAPACITANCE CABLES

LOW ATTEN. TYPES	IMPED. OHMS	ATTEN. db/100ft at 100 Mc/s	LOADING A.W.	O.D.
A.1	74	1.7	0.11	0.36
A.2	74	1.3	0.24	0.44
A.34	73	0.6	1.5	0.85

FOR RADIO FREQUENCIES

LOW CAPAC. TYPES	CAPAC. mmf/ft	IMPED. OHMS	ATTEN. db/100ft 100 Mc/s	O.D.
C.1	7.3	150	2.5	0.36
P.C.1	10.2	132	3.1	0.36
C.11	6.3	173	3.2	0.36
C.2	6.3	171	2.15	0.44
C.22	5.5	184	2.8	0.44
C.3	5.4	197	1.9	0.64
C.33	4.8	220	2.4	0.64
C.44	4.1	252	2.1	1.03

FOR VIDEO and SPECIAL APPLICATIONS

TRANSRADIO LTD
CONTRACTORS TO H.M. GOVERNMENT.

138A CROMWELL ROAD
LONDON, SW7-ENGLAND.

CABLES: TRANSRAD · LONDON

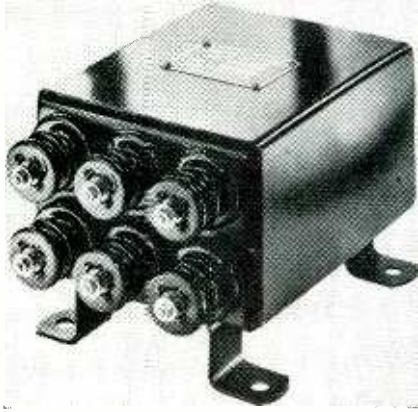

balanced, one-to-one ratio unit having very low insertion loss and relatively flat response over a wide frequency range. Its 10-kv insulating rating assures maximum surge protection to exposed telephone lines.

Bias Supply Rectifiers

RADIO RECEPTOR CO., INC., 84 North 9th St., Brooklyn 11, N. Y., has added to its line of selenium rectifiers two new miniature types for bias supply. Number 1X1, the cartridge type, is rated at 10-v a-c input and 10-ma d-c output; number 1M1, the plate type, is rated at

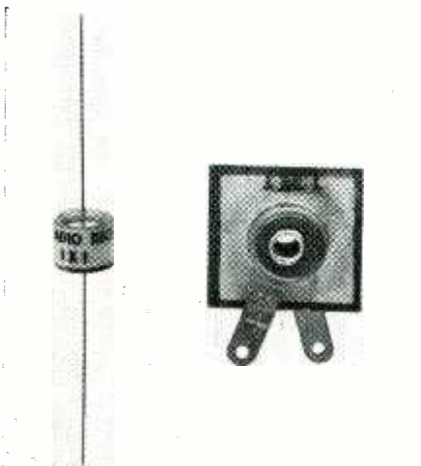

25-v a-c input and 100-ma d-c output. For bias use the current drain is usually negligible but the rectifiers may be applied to other half-wave applications within specified limits.

Noise Generator

Pub. Type No. 100
 Type No. 100
 in research
 Cambridge 39, Mass.
 generator, for use
 and pro-

MICROSEN D. C. AMPLIFIER

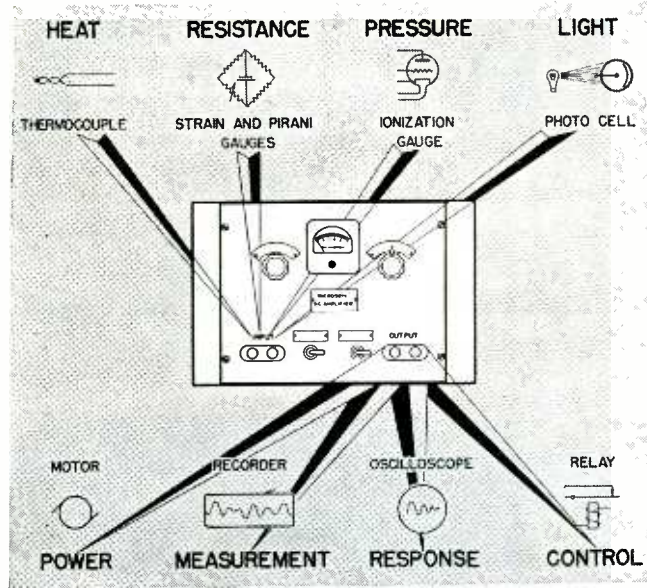

Performance plus Versatility

THE Microsen D. C. Amplifier provides stable and accurate amplification that is simple in operation, compact in design, moderate in cost. Particularly adaptable to laboratory and field work, the Microsen Balance principle assures the advantages of high gain with stability and fast response. The versatility and scope of this electronic instrument opens new fields in engineering research and process development work.

Line voltage variations of 15 per cent cause output changes of less than .5 per cent. There are no mechanical rectifiers or choppers. Tubes are standard. Time constant from .001 to .2 seconds. Drift less than 5 microvolts per day.

Models available include Voltage, Current and Potentiometer Type Amplifiers, Direct Current Converters, Direct Current Transformers and engineered designs to meet special requirements.

For complete data including operation, applications, advantages and specifications—write for the Microsen D. C. Amplifier Bulletin.



**MICROSEN
 D. C. AMPLIFIER**

A Product of
MANNING, MAXWELL & MOORE, INC.
 BRIDGEPORT 2, CONNECTICUT

Makers of 'American' Industrial Instruments, Hancock Valves, Ashcroft Gauges, Consolidated Safety and Relief Valves. Builders of 'Shaw-Box' Cranes, 'Budgit' and 'Load Lifter' Hoists and other lifting specialties.

NOW R. F. ATTENUATION NETWORK FOR YOUR WORK

To meet the increasing needs for accurate, dependable instruments to attenuate UHF, The Daven Company now offers RF attenuation boxes. These units are notably compact, provide a wide range of attenuation and are moderately priced.



RFA-650

— SPECIFICATIONS —

CIRCUIT: Pi network.
 STANDARD IMPEDANCES: 50 and 73 ohms. Other impedances on request.
 NO. OF STEPS: RFA-650—8 push-button steps. RFA-660—10 push-button steps.
 RESISTOR ACCURACY: $\pm 2\%$ at D.C.
 IMPEDANCE ACCURACY: Terminal impedance of loss network essentially flat from 0—225 MC.
 RECEPTACLES: Army-Navy Type UG-58/U will be supplied on standard units. Other receptacles may be obtained, if required.
 CABLE PLUGS: These will be supplied at a slight additional cost, if required.

TYPES	IMPEDANCE	
RFA-650	50 Ω OR 73 Ω	1, 2, 3, 4, 10, 20, 20, 20 db steps (80 db total in 1 db steps)
RFA-651	50 Ω OR 73 Ω	2, 4, 6, 8, 20, 20, 20, 20 db steps (100 db total in steps of 2 db)
RFA-660	50 Ω OR 73 Ω	1, 2, 3, 4, 10, 10, 10, 20, 20, 20 db steps (100 db total in steps of 1 db)
RFA-661	50 Ω OR 73 Ω	2, 4, 6, 8, 20, 10, 10, 20, 20, 20 db steps (120 db total in steps of 2 db)

— APPLICATIONS —

- In signal and sweep generators.
- In field strength measuring equipment.
- Nucleonic and atomic research.
- Television receiver testing.
- Wide-band amplifiers.
- Pulse amplifiers.
- Any application where attenuation of UHF is required.

For Additional Information Write to Dept. E-1

THE **DAVEN** CO.

191 CENTRAL AVENUE
 NEWARK 4, NEW JERSEY

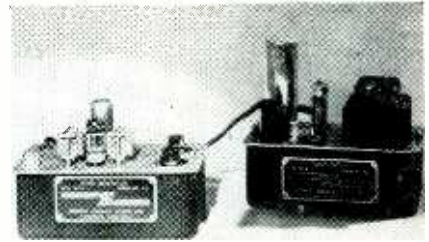

duction testing, provides a random noise with equal power in equal bands throughout the a-f spectrum and a substantial r-f output if desired. Operated with the type 20-A power supply, it uses one 6C4 and one 6D4 tube and has an a-f output from 0 to 0.2 volt. Range is from 30 to 50,000 cycles in r-f, and 30 to 20,000 cycles in the a-f spectrum.

Miniature Rectifier

HYTRON RADIO & ELECTRONICS CORP., Salem, Mass. The type 1X2 is a miniature filamentary-type rectifier designed for use in television sets as high-voltage rectifier sup-



plying power to the anode of the c-r tube. Maximum ratings are 15,000 volts inverse peak and one ma d-c load current. General characteristics are given in bulletin 139.

Pocket Chamber Electrometer

designed to
 GENERAL ELECTRIC type chambers
 N. Y. personnel working in
 char August, 1949 — ELECTRONICS



areas where radioactivity exists. Featuring a photoelectric system using a servo principle, the unit functions on two separate ranges, 0 to 50 and 0 to 250 milliroentgens, each with a separate scale on the meter. It operates on 117-volt a-c with an input of 50 watts.

Synchronous Motor

HAGEN MFG. Co., INC., Baraboo, Wisc., manufactures a self-starting synchronous motor with the two step-cut balanced flat-band spring rotor illustrated. Full speed is

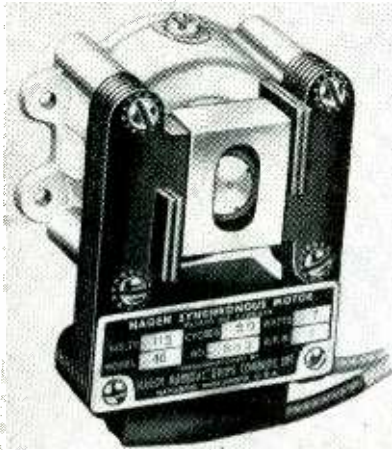

reached in a fraction of a second developing a torque of 40 inch ounces at 1 rpm. It is available in a range of speeds from 1 to 720 rpm. The solenoid brake attached to the back of the unit operates in conjunction with the on-off switch that operates the motor, eliminating coasting.

Coaxial Switches

DESIGNERS FOR INDUSTRY, INC., 2915 Detroit Ave., Cleveland 13, Ohio. Compact and lightweight coaxial

Mark of Progress... in Electrical Products



Of Vital Interest to the Electrical Industry...

**Vickers
Magnetic Amplifiers**

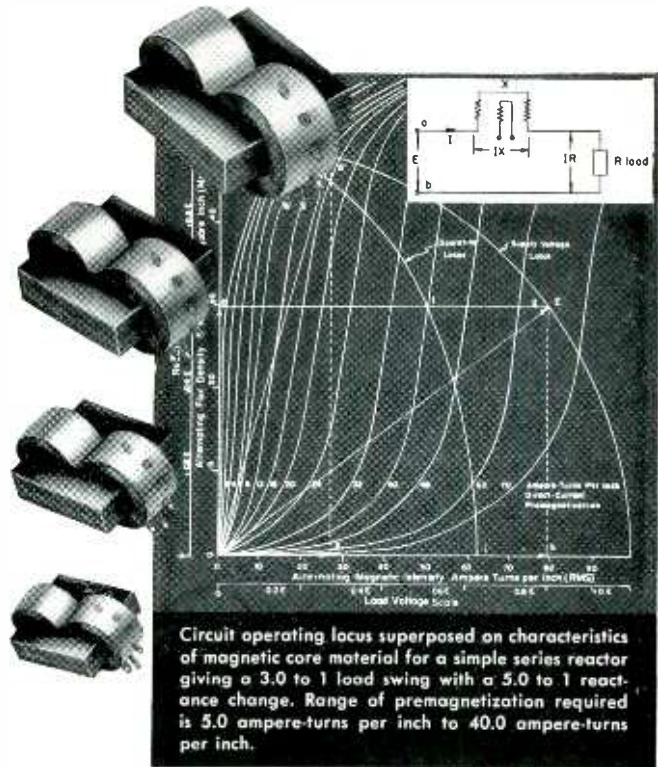

VICKERS ELECTRIC DIVISION, Vickers Inc., offers complete, extensive *Research, Engineering and Development* facilities which are available to the industry for technical problems and applications of VICKERS products relative to specific requirements.

- MAGNETIC AMPLIFIERS • STATIC VOLTAGE REGULATORS
- STATIC MOTOR SPEED CONTROLS • POWER SATURABLE REACTORS • RECTIFIERS • PHOTOELECTRIC CELLS
- SERVOMECHANISMS • MAGNETIC FLUID CLUTCHES
- SPECIAL MOTORS AND GENERATORS • TRANSFORMERS
- CONTROLLED POWER RECTIFIERS FOR ELECTRO-CHEMICAL PROCESSES

Request Magnetic Amplifier Bulletin VT-2000

VICKERS ELECTRIC DIVISION

1815 LOCUST ST., ST. LOUIS 3, MISSOURI
Manufacturers of Electrical Products • A Unit of the Sperry Corporation



A - B and G radiation survey meters



Model 356

Alpha survey meter

This self-contained portable instrument measures alpha radiation by means of an air ionization chamber and vacuum tube amplifier circuit which operates an indicating meter. The ionization chamber is located at the bottom and covered by a delicate nylon film approximately .0002 inches thick. A wire screen serves to protect the film.

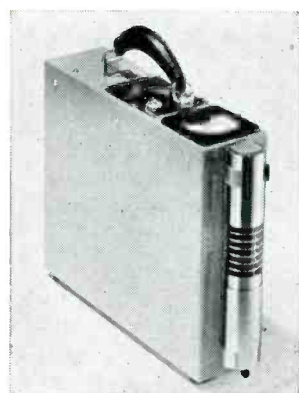

Model 263B

Beta and gamma survey meter

A portable Geiger-Mueller Counter for extreme sensitivity, capable of detecting individual ionizing particles. The instrument has three full scale ranges of 20.0—2.0—0.2 milliroentgens per hour measured with gamma radiation from radium.

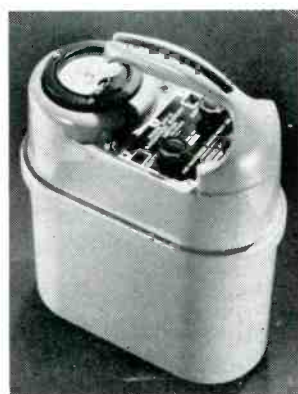

Model 247A

Gamma survey meter

A compact portable instrument designed to cover four ranges of gamma radiation intensities, 2.5—25—2500 milliroentgens (1/1000 r) per hour. The most sensitive range approximates that of a Geiger instrument and is inherently more stable. The ionization chamber and meter are hermetically sealed, and the case is watertight. Die castings have been used wherever possible for unusual rugged construction.

Quality components including bi-megohm resistors—sub-miniature tubes—and complete line of G-M counter tubes available without delay. Write for information and data sheets.

THE VICTOREEN INSTRUMENT CO.
5806 HOUGH AVENUE
CLEVELAND 3, OHIO



switches are announced with solenoid drive for remote control or with manual control for panel mounting. They are available in 2, 3, 4, and 6-way for use with RG-8/U and RG-11/U cable. All accept type N connectors. Standing wave ratio is less than 1.25 to 1 to 3,000 mc with peaks of not more than 2 to 1 to 10,000 mc. Crosstalk attenuation is not less than 60 db to 3,000 mc, and not less than 40 db to 10,000 mc.

R-F Bridge

GENERAL RADIO Co., 275 Massachusetts Ave., Cambridge 39, Mass., has available the type 916-AL, an impedance bridge for supersonic and low radio frequencies. The unit covers a nominal frequency range of 50 kc to 5 mc, and can be used at frequencies as low as 15 kc. Resistance range is 0 to 1,000 ohms.

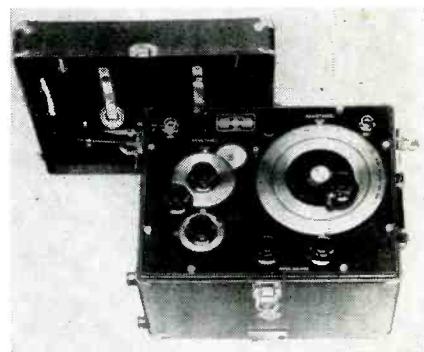

Reactance range at 100 kc is 11,000 ohms. Complete description is given in the March, 1949 issue of the *Experimenter*.

50-KW H-F Amplifier

WESTINGHOUSE ELECTRIC CORP., P. O. Box 868, Pittsburgh 30, Pa. The Symmetron is available either as a complete 50-kw f-m transmit-

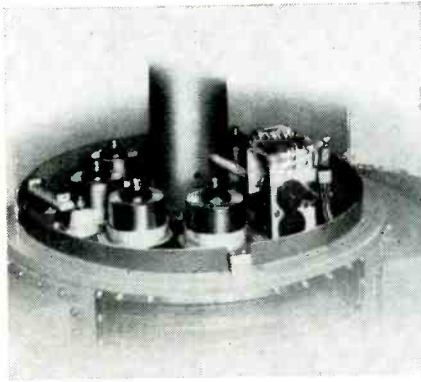

ter, or an amplifier to convert existing 10-kw f-m transmitters to 50-kw operation. It couples directly from a 10-kw driver to the antenna system with only one stage. The unit uses eight air-cooled, plug-in triodes in a concentric, symmetrical design.

Tin-Plate Counter

POTTER INSTRUMENT CO., INC., 136-56 Roosevelt Ave., Flushing, N. Y., announces a high-speed predetermined electronic counter for piling tin plate in precise quantities. The counter (for rates up to 60,000 per minute) is composed of two housings, one containing the light

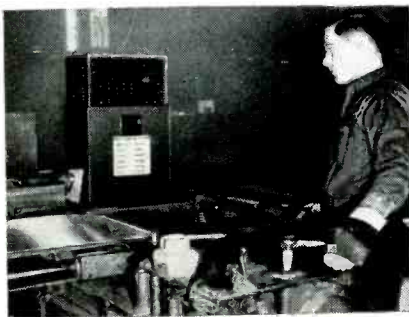

source, and the other, the photocell and output tube. Four tubes per digit are used in the basic circuit and the desired count is selected by dial switches on the front panel.

Tiny Relay

POTTER & BRUMFIELD, 549 Washington Blvd., Chicago 6, Ill., present the Model SM super-midget relay with windings up to 3400 ohms, permitting operation to 75 volts d-c with minimum sensitivity of 5 ma at 80 mw. Maximum coil dissipation is 1.75 watts at a temperature rise of 83C. Featured is a high resistance to shock and vibration. It is offered either open, dust sealed in



**IF IT'S
SPECIAL
SEE
PROGRESSIVE**





ENLARGED VIEW

KEEP YOUR COSTS DOWN

Progressive specializes in manufacturing special heads, threads and finishes on any metal or alloy adapted to cold upset. Please write for catalog showing many Progressive specials. Catalog includes purchasing and engineering helps.

The **PROGRESSIVE
MANUFACTURING CO.**

50 NORWOOD ST.
TORRINGTON, CONNECTICUT

**Do you need a DRY BATTERY
you can't find?**











If you are looking for hard-to-get or special dry batteries, write us. We design, create and manufacture to your requirements.

SEND FOR THIS FREE CATALOG

SPECIALTY BATTERY COMPANY

A SUBSIDIARY OF THE **RAY-O-VAC** RAY-O-VAC COMPANY
MADISON 4, WISCONSIN

when you need resistors—



IT WILL PAY YOU TO CONSULT THE NEW

IN-RES-CO CATALOG

Included are complete descriptions and specifications on wire wound resistors of all types and sizes. Each is precision wound to close tolerance, and many feature special moisture-proofing to assure proper functioning under severest climatic conditions. IN-RES-CO Resistors—available for IMMEDIATE DELIVERY—are supplied in standard or custom types to meet the most unusual design or operational requirements, and are offered at prices that benefit from mass production facilities. A copy of the new IN-RES-CO catalog will be helpful; write for it today. Prices, samples and estimates promptly on other than standard resistors.

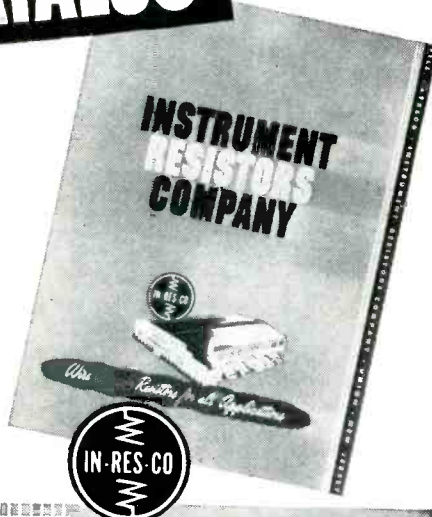

INSTRUMENT RESISTORS COMPANY

1036 COMMERCE AVE., UNION, N. J.

Wire Wound Resistors for Every Use in Electronics and Instrumentation

NEW PRODUCTS

(continued)

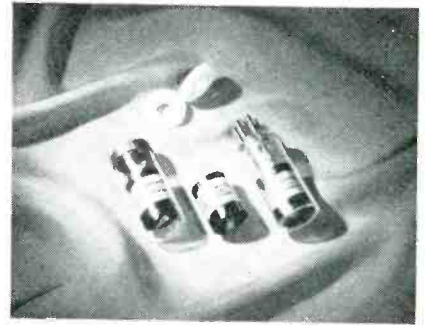

polystyrene 5-pin plug-in enclosure or hermetically sealed in glass with miniature 7-pin tube base.

Quartz Tubing

HANOVIA CHEMICAL & MFG. CO., Newark 5, N. J., announces production of precision bore quartz tubing drawn to close tolerances. Tubing is straight in length and dimensioned

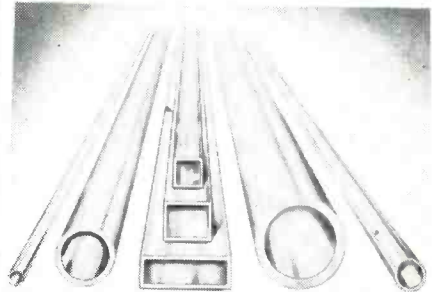

to round, square and oblong shapes with bore tolerances from 0.001 to 0.003 (for 1 inch and larger).

Waveguide Windows

SYLVANIA ELECTRIC PRODUCTS INC., 500 Fifth Ave., New York 18, N. Y., has announced glass waveguide windows designed to permit silver soldering, without damage, to microwave systems operating at frequencies ranging from 3,000 to 40,000 mc. Power losses range from 0.02 to 0.1 db. The new windows for frequencies above 3,500 mc will stand pressures up to 65 psi absolute. Dimensional tolerances range

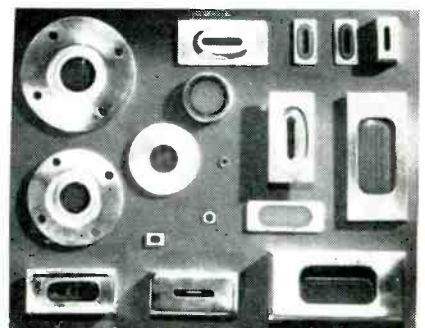

do you know what PAPER can do for you?



Central Engineered Electrical Papers are among the most versatile of materials. They can be accurately controlled in thickness, porosity, Ph, weight and many other characteristics. Central Electrical Papers can also be made with anti-rust and anti-tarnish properties . . . they can be creped for easier wrapping around corners . . . they can be juted for extra strength . . . they can be water-proofed . . . or almost any combination of these properties and special treatments may be had.

The Central Paper Engineer knows his papers and is backed by laboratory facilities second to none in the industry.

CENTRAL PAPER COMPANY INC.



2446 LAKESHORE DRIVE

MUSKEGON, MICHIGAN

from 0.005 inch at 3,000 mc to 0.0005 inch at 30,000 mc. Glass tolerances vary from 0.001 to 0.0001.

Portable Meters

WESTON ELECTRICAL INSTRUMENT CORP., 617 Frelinghuysen Ave., Newark 5, N. J. Model 901 series of a-c and d-c portable instruments have a nonbreakable window on a 5½-inch scale and are shielded against external magnetic fields.



Protection in d-c units is such that a 7,000-ampere conductor three feet from the instrument causes less than 0.5-percent error.

Literature

Instrumentation Booklets. Reeves Instrument Corp., 215 E. 91st St., New York 28, N. Y., recently published four booklets describing and illustrating (1) standard instrumentation parts and servo-mechanism components, (2) model VG401 all-purpose self-contained vertical gyro, (3) model RP110 remote positioner, and (4) the electronic analog computer and associated equipment.

Tube & Transformer Bulletins. Radio Corp. of America, Harrison, N. J. Description, technical data and dimensional outlines are available for the 811-A power-triode and the 203T1 and 203T2 high-reactance filament transformers for use with tube types 5771 and 5786 respectively.

Relay Catalog. Phillips Control Corp., 612 N. Michigan Ave., Chicago 11, Ill. Catalog No. 7 is a well-illustrated treatment of a

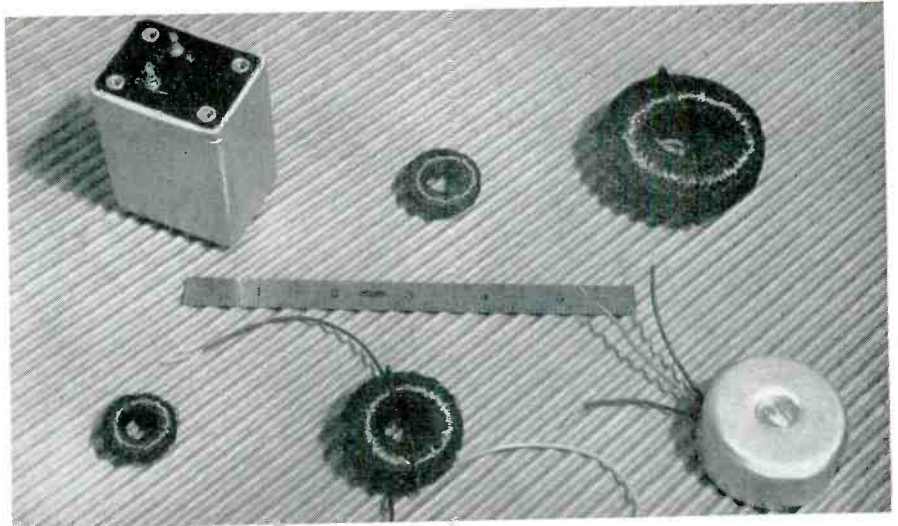

TOROIDS-*for Performance*

Close tolerance toroidal coils wound on ¾ inch diameter, or larger, cores. Inductance tolerances can be maintained to 0.1%. Available with balanced windings, taps and close-coupled secondaries.

Where a wide frequency range of operation is required, coils with extremely low distributed capacity are available.

Lenkurt knows how

LENKURT ELECTRIC CO.
SAN CARLOS • CALIFORNIA



TRANSIENT PHENOMENA?

Does your research problem include the necessity for observation of steep fronted pulses, non-recurrent or non-sinusoidal wave shapes?

The Tektronix Type 511-AD Oscilloscope has been designed specifically for coping with the above requirement.

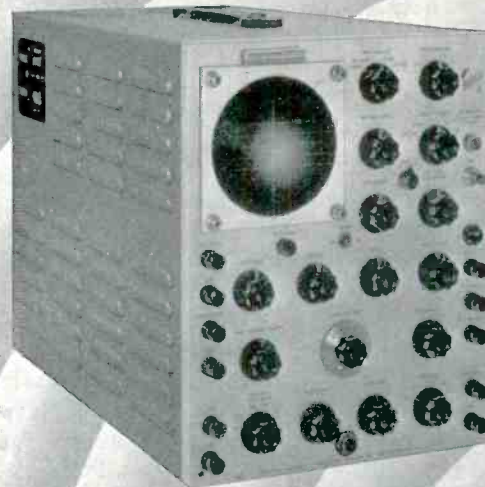

TEKTRONIX
TYPE 511-AD
OSCILLOSCOPE

\$84500

f.o.b. Portland, Ore.

- Video Band Pass — 5 Cycles, 10 Megacycles.
- Amplifier Rise Time, .05 Microsecond.
- Video Signal Delay Network, 0.25 Microsecond
- Cont. Var. Triggered Sweeps, .1 Sec., 1. Microsec.
- All DC Regulated Against Line Voltage Changes
- Self Contained — Total Weight 50 Pounds.
- Unusually Low Cost.

Engineering sales representation in principal areas



Cables:
Tektronix

TEKTRONIX, INC.

712 S. E. Hawthorne Blvd.
Portland 14, Oregon

EXTRA-SMALL . . . MOISTURE-RESISTANT

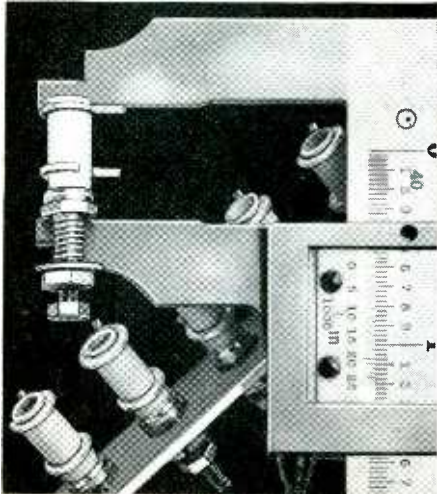

New CTC Ceramic Coil Form Is Ideal For Many Sub-Miniature Component Applications

Standing less than 5/8" high when mounted, and with a form diameter of only 3/16", CTC's new LST ceramic coil form fits easily into small spaces and hard-to-reach locations. In addition, its coil body of silicone impregnated ceramic (grade L-5, JAN-1-10) offers the advantage of extremely high resistance to moisture and fungi, and has well developed dielectric properties.

Mounting bushings and ring-type, adjustable terminals are of brass. Bushings are cadmium plated and terminals are silver plated. The powdered iron slug is adjustable. Accommodating solenoid or pie type windings, the LST is supplied as a coil form, or wound to specifications. Depending on the type of winding, inductance changes of approximately 2:1 can be expected.

You'll find the LST and many other *Guaranteed Components* fully described in CTC's new Catalog #300. This big illustrated booklet is packed with helpful information. Send for it today.

Turret Lugs



Split Lugs



Terminal Board



Double-End Lugs



Swager



**Custom or Standard
The Guaranteed
Components**

CAMBRIDGE THERMIONIC CORP.
437 Concord Ave., Cambridge 38, Mass.

NEW PRODUCTS

(continued)

wide line of relays. Included are dimensional drawings of each type, coil characteristics, contact assemblies and weights.

Components Catalog. Cambridge Thermionic Corp., 445 Concord Ave., Cambridge 38, Mass. Catalog No. 300 is made up of 70 pages subdivided into sections on terminal lugs, terminal boards, swagers, hardware, insulated units, coils and chokes. Each section is introduced by photographs and descriptions of the products, followed by pages of working drawings containing detailed specifications.

Electronic Mechanical Design. College of Engineering, New York University, New York 53, N. Y. A new 4-page reprint entitled "Mechanical Aspects of Electronic Assemblies," for mechanical design specialists when dealing with electronic equipment, is available for ten cents. The text covers shielding techniques, wiring methods, grounding practices, use of sub-assemblies and mounting of controls.

Exposure Photometer Literature. Photovolt Corp., 95 Madison Ave., New York 16, N. Y. The 4-page circular No. 810 and the 22-page technical information bulletin No. 812 on the new exposure photometers for photomicrography and metallography are now available. A fully illustrated description, exposure nomograph and price list are included.

Miniature Selenium Rectifiers. Federal Telephone and Radio Corp., 900 Passaic Ave., East Newark, N. J. Many new circuits for application in television, home receivers, electrical appliances, industrial and other equipment, as well as complete engineering information on miniature selenium rectifiers are contained in a recently published 48-page handbook. Price is twenty-five cents.

Subminiature Tube Data. Radio Corp. of America, Harrison, N. J. Four new technical bulletins give data, installation and application notes and average plate characteristics for the 1AC5 power pentode,

Speedy Accurate Testing

1. Resistance Testing

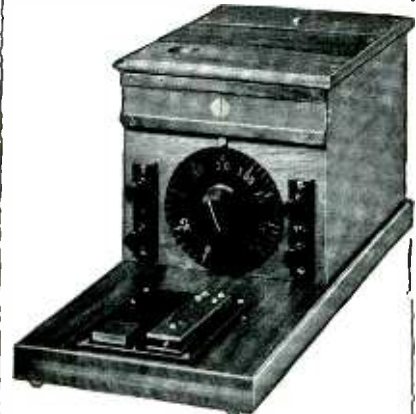

LIMIT BRIDGES

For high speed testing of resistors, coils, heater elements and similar products in production quantities where costs must be minimized. Designed for use by non-skilled operators, they are capable of checking as many as 2000 items per hour. Ranges from 1 ohm to 10 megohms. Simple and sturdy, these instruments will withstand hard usage for many years. Described in Bulletin 100.

2. Shorted-Turn Testing



COIL TESTERS

For detecting shorted turns or opens in coil windings of nearly every variety. Speeds of 2000 items per hour easily attained with non-skilled personnel. Will readily detect a single shorted turn of No. 44 copper wire. Operation at 60 cycles assures substantial freedom from capacity effects. Simple and sturdy for long service under hard usage. By detecting defective windings at negligible cost before assembly into completed units, these instruments greatly increase production efficiency and contribute to product quality. Described in Bulletin 109.

★Other Rubicon Products:

Wheatstone, Kelvin and Mueller Bridges; Potentiometers for precise measurement of DC voltages; Galvanometers; Photo-electric Colorimeters; Sanford-Bennett High H Permeameters; Magnetometers for intercomparing permanent magnets. Literature on request.

RUBICON COMPANY

Electrical Instrument Makers

3757 Ridge Avenue • Philadelphia 32, Pa.

3 GREAT NEW TITONES

meet changing pickup needs!

NOW a full line of Titone's amazing ceramic pick ups—made by famous Sonotone! All with these great basic features: Full frequency (response from 50 to 10,000 cycles.) Bell-like supertone makes new or old players thrilling. Climate-proof, moisture-proof, fungus-proof! Lightest pressure saves needle wear, revives worn records. NO needle talk! NO crystals, magnets, filaments to fail. NO pre-amplifiers. Performs perfectly for years!

3 NEWEST! TITONE MICROGROOVE PICKUP

For all 45 and 33 1/2 rpm players. Highest compliance and 5 to 6 grams needle pressure give minimum wear on record and needle! Aluminum case—1-mil permanent sapphire needle.

Order # W 7530 \$7.95 list

2 NEWER! TITONE 3-MIL PICKUP

New superlight aluminum pickup complements famous original Titone pickup below. 15 grams needle pressure gives unparalleled reproduction, lowest wear!

Order # W 7540 \$7.95 list

1 NEW! ORIGINAL CERAMIC TITONE

Within a few scant months in widest use from coast to coast! Plays at 20 grams needle pressure. Used instead of the newer aluminum Titone above for changers requiring over 15 grams pressure to "flip" records.

Order # 7500 \$7.50 list

NO TONE LIKE TITONE



Call your Jobber or write to SONOTONE, Box 5, Elmsford, N. Y.

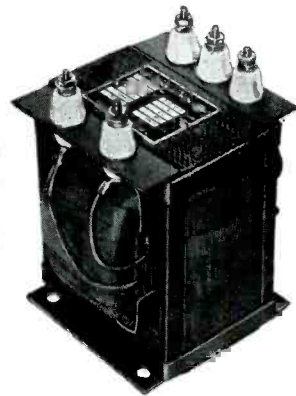
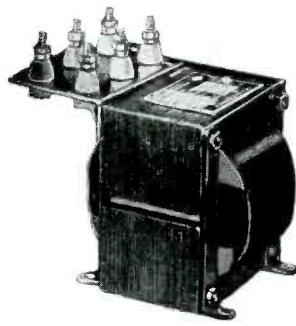

Check With NOTHELPER For Custom Built TRANSFORMERS

Over 25 years' experience in the manufacture of specials at cost that compares favorably with standard types. Built-in quality proved by years of actual use.

From 10VA to 300 KVA Dry-Type Only. Both Open and Encased. 1, 2, & 3 Phase 15 to 400 Cycles.

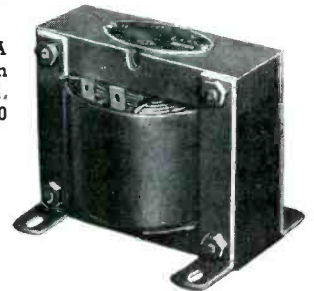

NOTHELPER

WINDING LABORATORIES

9 ALBERMARLE AVE., TRENTON 3, N. J.



STANDARDIZED READY-TO-USE METAL EQUIPMENT

ADAPTABLE FOR EVERY REQUIREMENT

Par-Metal Equipment offers many features, including functional streamlined design, rugged construction, beautiful finish . . . plus ADAPTABILITY. Eliminate need for special made-to-order units on many jobs.

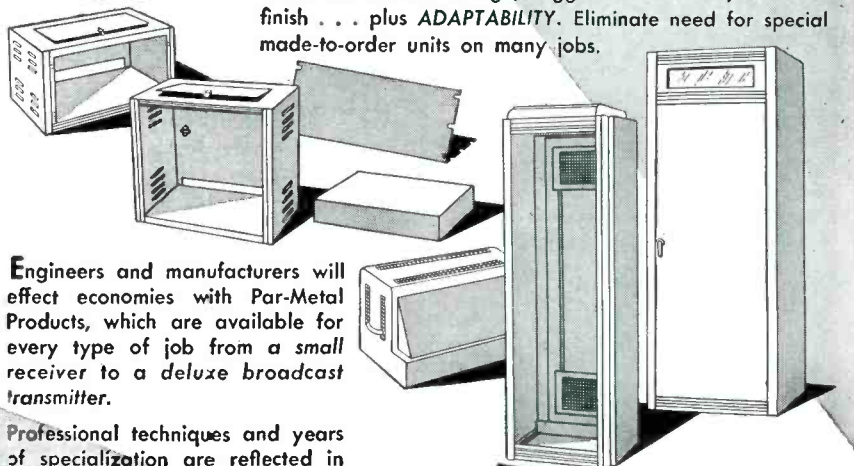

Engineers and manufacturers will effect economies with Par-Metal Products, which are available for every type of job from a small receiver to a deluxe broadcast transmitter.

Professional techniques and years of specialization are reflected in the high quality of Par-Metal. . .

CABINETS • CHASSIS
PANELS • RACKS

Write for Catalog

PAR-METAL PRODUCTS CORPORATION
32-62 - 49th STREET
LONG ISLAND CITY 3, NEW YORK
Export Dept., Rocke International Corp.
13 East 40 Street, New York 16

SPECIFY
CHICAGO for TV
Transformers



For today's leading circuits

To the engineer designing or experimenting with Television receivers, CHICAGO's catalog line of Television transformers offers the advantages of accepted design practices. Made by the largest single supplier of transformers to the TV industry, these CHICAGO units are exact equivalents to those used in the leading TV receiver circuits. Included in the line are power, vertical blocking oscillator, and both vertical and horizontal scanning output transformers—available now from stock at leading Jobbers.

Send today for your copy of the CHICAGO Television Transformer Catalog.

WRITE TODAY

CHICAGO TRANSFORMER
Division of Essex Wire Corporation
3501 ADDISON STREET • CHICAGO 18, ILLINOIS

the 1AD5 sharp-cutoff pentode, the 1E8 pentagrid converter and the 1T6 diode-pentode.

Tube Lifter. Hytron Radio and Electronics Corp., Salem, Mass. A single-sheet preprint describes and illustrates the stainless steel tube lifter. Directions for use of the tool are also given.

Cathode-Ray Equipment. Allen B. Du Mont Laboratories, Inc. 1000 Main Ave., Clifton, N. J. Form 760-B is a 16-page booklet treating of industrial c-r tubes and also general-purpose, high-voltage and precision-measurement oscillographs. Specialized c-r equipment, oscillograph-record cameras, auxiliary instruments and accessories are covered.

Electronic Test Instruments. Kay Electric Co., Pine Brook, N. J. A recent folder of catalog sheets includes a complete description and specifications of the Mega-Sweep, Mega-Match, Megalyzer, Mega-Pulser, Mega-Pipper and Mega-Marker instruments for testing wideband circuits. Ordering information is included.

Solderless Terminals. Aircraft-Marine Products, Inc., 1521-78 N. Fourth St., Harrisburg, Pa. The Amp-O-Lectric automatic, electrically operated wire terminator is described and illustrated in a four-page folder. Also available is a folder giving catalog numbers, wire ranges and stud sizes for a line of Auto-Crimp terminals.

Tele Tube Complement Chart. Sylvania Electric Products Inc., Emporium, Pa., has prepared a reference chart listing total tube complement, viewing tube type and number of tubes by type in 110 television receiver models produced by 44 manufacturers. The data chart is arranged in three pages folded and punched for filing in standard 8½ x 11 three-ring binder.

Vibration Cushion. Robinson Aviation, Inc., 53 Industrial Ave., Teterboro, N. J. A recent four-page folder discusses the Vibra-

SYNCHRON
TRADE MARK
TIMING MOTORS
AND
TIME MACHINES

*Synchronous
Self-starting
Self-oiling*



Never Need Oiling . . . Operate Efficiently In Any Position . . .

Motor is equipped with oil storage reservoir and patented oil feed to bearings. Rotor shaft, reduction train, and output shaft, all have double bearings to reduce vibration and assure quiet, efficient operation when mounted in any position.

Brass Gears Operate Against Steel Pinions—Steel Shafts Operate In Babbitt Bearings

There is no compromise for quality in the design and construction of SYNCHRON Timing Motors and Time Machines! If you have any timing design problems, SYNCHRON offers the benefit of long experience and capable design assistance. Write for catalog and engineering data.

HANSEN MANUFACTURING CO., INC.
Princeton 10, INDIANA

(2-49) Established 1907 - a Pioneer in Synchronous Motors

For extraordinary electrical performance

Use SILVER GRAPHALLOY*



THE SUPREME CONTACT MATERIAL



in BRUSHES
for high current density minimum wear low contact drop low electrical noise self-lubrication

in CONTACTS
for low resistance non-welding character

GRAPHALLOY works where others won't! Specify GRAPHALLOY with confidence.

*A special silver-impregnated graphite

GRAPHITE METALLIZING CORPORATION
1055 NEPPERHAN AVENUE, YONKERS 3, NEW YORK

a **+** value for industry
Development and Production of
SPECIAL PURPOSE VACUUM TUBES BY ECLIPSE-PIONEER



TT-1 3000 mc Temperature Limited Noise Diode Tube.



Y-Type Position Convectron—Vertical Sensing Tube.



Chronotron Thermal Time Delay Tube.

We're not in the standard vacuum tube business. But we are definitely in the business of developing and manufacturing special purpose vacuum tubes—tubes that are not generally available. During the past three years, for example, our facilities have produced, such devices as the Chronotron thermal time delay tube, the Convectron* vertical sensing tube, the TT-1 3000 mc temperature limited noise diode tube, counter tubes, glass enclosed spark gaps, and phono pickup tubes. Quantities of all these are now serving many phases of industry in a wide variety of applications. We invite your use of our facilities to develop and produce your requirements of special purpose vacuum tubes. Your inquiries concerning the scope of our facilities or details of any of our tubes will be given immediate attention.

*REG. U. S. PAT. OFF.

Eclipse-Pioneer Division of 
TETERBORO, NEW JERSEY
Export Sales—Bendix International Division, 72 Fifth Avenue, New York 11, N. Y.

Now Ready

The **NEW DIALCO**
HANDBOOK

... 192 PAGES of
USEFUL INFORMATION

Engineers, designers, purchasing agents —

GET YOUR COPY

You will find complete data on the lamps used in pilot lights.
And illustrations - all full size - of hundreds of items you will use.
There is a table of resistors for operation of lamps on all voltages.
Complete dimensional data on each unit.
More than 2,000 Underwriters' Listed Assemblies..

The DIAL LIGHT COMPANY of AMERICA
Foremost Manufacturer of Pilot Lights.
900 BROADWAY, NEW YORK 3, N. Y. TELEPHONE SPRING 7-1300

Write for Handbook D-149

Strain Recording Equipment



The type MRC-15 STRAIN GAGE CONTROL UNIT and the type S8-B OSCILLOGRAPH make up a complete strain recording laboratory. The MRC-15 contains complete equipment to power strain gages and to drive oscillograph galvanometers for recording from static strain to a frequency of 5000 cycles per second. It is complete with strain gage balancing controls, precision calibrating device, and power supply equipment.

The S8-B, with 12 to 48 elements, is a highly-refined general-purpose oscillograph with chart speeds of $\frac{1}{8}$ to 40 inches per second designed to accommodate a wide range of galvanometer types and characteristics. Precision optical system insures records of highest accuracy and quality. Many refinements contribute to versatility and convenience.

Write for Technical Bulletins

For the MRC-15, Bulletin No. SP-195G • For the S8-B, Bulletin No. SP-165G

Hathaway
INSTRUMENT COMPANY.
 1315 SO. CLARKSON STREET • DENVER 10, COLORADO

NEW PRODUCTS

(continued)

shock mounting systems which incorporate Met-L-Flex, a new, stainless steel resilient cushion providing protection against shock and vibration. Typical performance curves are shown.

Tube Summary. Raytheon Mfg. Co., 55 Chapel St., Newton 58, Mass., has published a comprehensive summary of almost 200 special-purpose and power tubes with their essential characteristics, classified and indexed for easy reference. Copies are available free upon request.

Coil Tube Fasteners. The Palnut Co., 77 Cordier St., Irvington 11, N. J. Engineering data sheet No. 558 outlines the advantages, construction and application of the newest types of coil tube fasteners. Typical assemblies are shown and full dimensional data given.

Translation Loss Correction. Fairchild Recording Equipment Corp., 154th St. & 7th Ave., Whitestone, N. Y. A single sheet covers the Unit 628 Diameter Equalizer which automatically applies the equalization necessary to compensate for loss in h-f reproduction that occurs at inner diameters while recording at $33\frac{1}{3}$ rpm. An illustration, technical description and specifications are given.

Industrial Use of Radioisotopes. Arthur D. Little, Inc., Cambridge 42, Mass., has prepared an extensive 13-page bibliography on the industrial uses of radioactive tracers. It contains general background references, a list of survey articles of industrial application and references dealing with specific fields. Copies are available without charge.

Connector Specifications. Cannon Electric Development Co., Catalog Dept., 3209 Humboldt St., Los Angeles 31, Calif., recently issued an Army-Navy connector specifications chart (AN-C-591) with the latest insert arrangements shown in detail at half scale for use by aircraft, radio, communication engineers, designers, maintenance men and purchasing agents. The

ZOPHAR Waxes, Compounds and Emulsions



Materials for potting, dipping or impregnating all types of radio components or all kinds of electrical units. • Tropicalized fungus proofing waxes. • Waterproofing finishes for wire jackets. • Rubber finishes. • Inquiries and problems invited by our engineering and development laboratories.

Zophar Mills, Inc. has been known for its dependable service and uniformity of product since 1846.

ZOPHAR MILLS, Inc.

ESTABLISHED 1846

117 26th STREET, BROOKLYN 32, N. Y.

For CONTROL and ELIMINATION of
SHOCK AND VIBRATION
BARRYMOUNTS

AIRCRAFT MOUNTING BASES

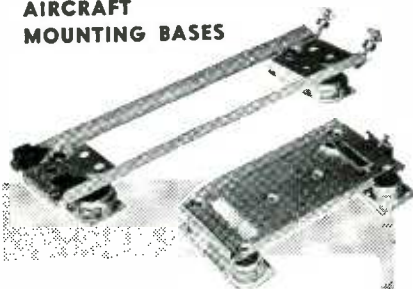

Standard bases with dimensions to government specifications. Special bases to customers' exact requirements.



AIRCRAFT VIBRATION ISOLATORS

Unit isolators designed to meet Army, Navy, and CAA requirements. Stock mountings — 1/4 pound to 45 pound load range. Others on order.

SHOCK MOUNTINGS



For mobile, railroad, and shipboard electronic and electrical equipment. Also for isolation above 2000 c.p.m., and for general sound isolation.



INSTRUMENT MOUNTINGS

For electronic components, tiny fractional H.P. motors, record changers, dictating machines, and other light-weight apparatus.

INDUSTRIAL MOUNTINGS



For fans, motor generator sets, transformers, punch presses, and other heavy industrial equipment.

Mountings designed and built for special applications. Consulting Engineering Service for research, product design, and laboratory testing.

THE BARRY CORP
 MAIN OFFICE 177 SIDNEY ST., CAMBRIDGE 39, MASSACHUSETTS
 New York Rochester Philadelphia Washington
 Cleveland Dayton Chicago Minneapolis
 St. Louis Los Angeles

BETTER METERS AT LOWER PRICES MEAN THE BEST BUY FOR YOU •

LOOK AT THESE NEW LOW PRICES

BETTER METERS AT LOWER PRICES MEAN THE BEST BUY FOR YOU •
 AT LOWER PRICES MEAN THE BEST BUY FOR YOU •
 FOR YOU • BETTER METERS AT LOWER PRICES MEAN THE BEST BUY FOR YOU •
 BEST BUY FOR YOU • BETTER METERS AT LOWER PRICES MEAN THE BEST BUY FOR YOU •
 • BETTER METERS AT LOWER PRICES MEAN THE BEST BUY FOR YOU •
 LOWER PRICES MEAN THE BEST BUY FOR YOU •
 BETTER METERS AT LOWER PRICES MEAN THE BEST BUY FOR YOU •
 BETTER METERS AT LOWER PRICES MEAN THE BEST BUY FOR YOU •
 METERS AT LOWER PRICES MEAN THE BEST BUY FOR YOU • BETTER METERS AT LOWER PRICES MEAN THE BEST BUY FOR YOU •



Now . . . more than ever Triplet gives you your best buy in meters, all with time-tested features, including famous Triplet Double-Bridge Construction; special pole piece design for the best accuracy and sensitivity; alnico V magnet; plus the finest engineered components, many of which are made in our own plants.

Representative Prices—3-Inch Panel Style Model 321-T D.C. Microammeters

0-20, \$13.60	0-50, \$10.90
0-100, \$10.40	0-200, \$8.90
0-500, \$8.30	

For detailed information see your distributor or write . . .

TRIPLET ELECTRICAL INSTRUMENT COMPANY
Bluffton, Ohio, U.S.A.

In Canada: Triplet Instruments of Canada
Georgetown, Ontario



BRAND NEW!

- ★ Only two holes in chassis
- ★ Readily-wired lugs
- ★ 19/32" dia. 1½, 2, 2½ and 3" h.
- ★ 10, 15, 20 and 25 w.
- ★ Max. res. 6,000, 9,000, 12,000 and 15,000 ohms



STANDEE--ABOVE-CHASSIS--MOUNTED POWER RESISTOR . . .

★ Just what the underwriter ordered! Mounts ABOVE chassis. Takes heat out in the open. 5/8" hole clears terminals below. Mounting bracket takes self-tapping screw.

Wire winding on fibre-glass core, bent in hairpin with mica separator between legs, placed in ceramic tube filled and sealed with cold-setting inorganic cement.

★ Write on business letter-head for literature, sample and quotations.

CLAROSTAT



Controls and Resistors



CLAROSTAT MFG. CO., INC. • DOVER, NEW HAMPSHIRE • In Canada: CANADIAN MARCONI CO., LTD. Montreal, P.Q. and branches

Volume users
of
Special Fasteners
and allied devices
turn first to
UNITED-CARR
for cost-cutting
design engineering
service

Send us your specifications or
requirements. Address Dept. 14

UNITED-CARR FASTENER CORP.
Cambridge 42, Mass.

MAKERS OF **DOT** FASTENERS

desk chart measures 17 x 22 inches. A full scale chart, 38 x 50 inches, is also available.

Radiation Instruments. The Victoreen Instrument Co., 5806 Hough Ave., Cleveland, Ohio. A recent booklet gives product information, data sheets, and a price sheet on a line of radiation instruments and components. Also included are several reprints of technical articles.

Small Synchronous Motors. Telechron Inc., Ashland, Mass. An eight-page catalog covers a line of timing motors which are instantly and constantly synchronous. Complete technical data and a selection guide chart are included. Typical motor and instrument movement applications are also given.

Television Booster. JFD Mfg. Co., Inc., 6101 16th Ave., Brooklyn 4, N. Y. The Video-Beam, a high-definition television booster for transforming weak signals into sharp, clear pictures, is described on one side of a sheet (bulletin No. TV10). An illustration and important features of the booster are given.

Transformer Catalog. Standard Transformer Corp., Elston, Kedzie and Addison, Chicago 18, Ill. Over 400 transformers and related components are listed in the 22-page 1949 catalog. Illustrations and dimensional diagrams are included.

Variable-Speed Drive. Metron Instrument Co., 432 Lincoln St., Denver 9, Colorado. Bulletin No. 99 gives a single-sheet description of the type 4A variable-ratio speed changer. Dimensional diagrams, characteristic curves and general specifications are shown.

Kinescope Application Note. Radio Corp. of America, Harrison, N. J. Recommendations for the support and insulation of the 16AP4 kinescope are covered in AN-140. Masking arrangements, grounding considerations, layout considerations and servicing precautions are also treated.

MICROSECOND TIMING! THE NEW 1.6 mc INTERVAL TIMER (COUNTER CHRONOGRAPH)



...measures and
records time intervals
with a resolution of
1/1,600,000
seconds

This instrument determines and indicates directly the elapsed time between electrical "Start" and "Stop" signals derived from the beginning and ending of a time interval to be measured. A 1,600,000 c.p.s. crystal oscillator is used as the time base. The instrument, which is completely self contained, counts the number of cycles from this time base which occurs during the time interval measured. Price \$925.00

High Speed Electronic Counters and
Precision Interval Timers for All Appli-
cations—Address Inquiries to Dept. 6-D

- ★ Extremely High Accuracy — 1.6 Megacycle crystal oscillator time base.
- ★ Direct Indication of Intervals up to one second — recycling of the counter can be observed or recorded for longer intervals.
- ★ High Resolution measures intervals in steps of 0.625 microsecond.
- ★ Retains Indication of Measurement until reset.
- ★ Easy to Actuate — positive pulses from common or separate sources can be used.
- ★ Stable — no adjustments required.

POTTER INSTRUMENT CO.
INCORPORATED
136-56 ROOSEVELT AVE., FLUSHING, NEW YORK



INSURE

Proven Quality

with **JONES PLUGS & SOCKETS**

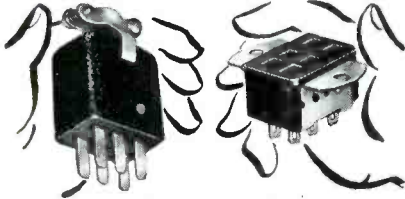

P-306-CCT — Plug, Cable Clamp in cap.

S-306-AB — Socket with Angle Brackets.

Series 300 Small Plugs & Sockets for 1001 Uses

Made in 2 to 33 contacts for 45 volts, 5 amps, for cap or panel mounting. Higher ratings where circuits permit. All plugs and sockets polarized. Knife switch socket contacts phosphor bronze, cadmium plated. Engage both sides of flat plug—double contact area. Bar type plug contacts hard brass cadmium plated. Body molded bakelite.

Get full details in Catalog 17. Complete Jones line of Electrical Connecting Devices, Plugs, Sockets, Terminal Strips. Write today.

HOWARD B. JONES DIVISION
Cinch Mfg. Corp.
1026 SOUTH HOMAN AVE. CHICAGO 24, ILL.

Faster Evacuation to Low Pressures with Top Efficiency

Beach-Russ Type RP Single Stage Vacuum Pump. Capacity —17 to 845 c. f. m.

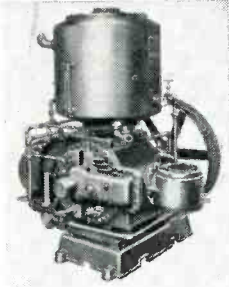

For vacuum exhausting and processing at low pressures in electronic or electrical operations, these pumps offer the advantages of positive rotary, automatically lubricated, noiseless operation. They are "tops" for producing high vacuum or for backing diffusion pumps. Test to absolute pressures as low as 4 microns.

BEACH-RUSS
high vacuum
PUMPS

Write for
Catalog
No. 84

BEACH-RUSS COMPANY
52 CHURCH ST. NEW YORK 7, N. Y.

PRECISION



POTENTIOMETER PERFORMANCE THAT EXCEEDS SPECIFICATIONS

In potentiometers, "Fairchild" and "Precision" are synonymous. Because in Fairchild Potentiometers, close-tolerance machining of all parts goes hand-in-hand with the careful selection of the right contact materials and the right resistance wire. This, plus painstaking assembly by skilled craftsmen and the exact adjustment of wiper arm pressure, adds up to potentiometer performance that assures sustained accuracy over a service life far exceeding the guaranteed 1,000,000 cycles of operation.

Fairchild engineers will be glad to help in the selection of both linear and non-linear potentiometers to meet your particular needs. Address: Dept. L, 88-06 Van Wyck Boulevard, Jamaica 1, New York.



AMPERITE

THERMOSTATIC METAL TYPE

Delay Relays

PROVIDE DELAYS RANGING FROM 1 TO 120 SECONDS



FEATURES: — Compensated for ambient temperature changes from -40° to 110° F . . . Hermetically sealed; not affected by altitude, moisture or other climate changes . . . Explosion-proof . . . Octal base . . . Compact, light, rugged, inexpensive . . . Circuits available: SPST Normally Open; SPST Normally Closed.

PROBLEM? Send for "Special Problem Sheet"

Regulators

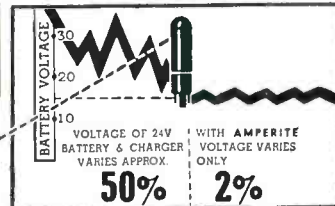

Amperite REGULATORS are the simplest, lightest, cheapest, and most compact method of obtaining current or voltage regulation . . . For currents of .060 to 6 Amps. . . Hermetically sealed; not affected by altitude, ambient temperature, humidity.

Write for 4-page Illustrated Bulletin.

AMPERITE CO., Inc., 561 Broadway, New York 12, N. Y.

In Canada: Atlas Radio Corp., Ltd., 560 King St., W. Toronto

**Why You'll Want
JOHNSON
Antenna Phasing
Equipment**

Each unit of every JOHNSON antenna phasing system is individually designed and built to meet the requirements of the installation. Features desired by your chief engineer are incorporated and the design is approved by consultant prior to production.

Careful selection of components to provide adequate safety factor, combined with expert workmanship and advanced engineering assure excellent performance.

Control of phase shift in each leg of the circuit and control of power division among towers from the front panel are standard features.

POWER RATINGS 1 TO 50 KW

JOHNSON, for many years a leading supplier of antenna phasing equipment, manufactures units with power ratings from 1 to 50 kw. Standard, as well as custom cabinets to match those of the well known transmitter manufacturers and virtually all the radio frequency components are made right in the JOHNSON plant. Non-standard components frequently required are made to suit particular applications.

This versatility of manufacturing to meet individual circuit design permits "custom work"—at standard price!

Additional phasing equipment accessories available from JOHNSON include:

- Tower Sampling Transformers
- Tower Lighting Chokes and Filters
- Remote Metering Equipment
- Sampling Loops
- Isolation Transformers
- Concentric Line

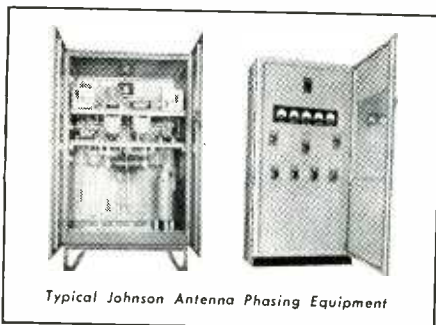

JOHNSON
E. F. JOHNSON CO., WASECA, MINN.

NEWS OF THE INDUSTRY (continued from p 130)

plan covering commercial operation in both bands.

The combined schedule calls for the issuance of proposed regulations, after which about 30 days will be allowed for submission of comment or alternative proposals by those interested. A hearing would follow in about two weeks. Within two weeks after the hearing the Commission will hold oral argument, preparatory to a final decision sometime in the fall.

IRE Emporium Seminar

THE TENTH annual summer seminar of the Emporium, Pa., section of the IRE will be held in that city August 19 and 20, 1949.

Speakers on Aug. 19 will include H. G. Clavier who will discuss carrier power requirements for long-distance communications by microwaves; and Allen A. Barco of RCA Industry Service Laboratories who will treat the problem of television deflection and high-voltage supplies.

On Aug. 20 Michael Landis of Allen B. Du Mont Laboratories, Inc., will speak on modern orthicon camera chains in television; and Garrard Montjoy and Henry Appel of Stromberg Carlson Co. will discuss design features for a new television receiver.

George Brunner of Sylvania Electric Products, Inc., Emporium, Pa., is chairman of the seminar committee.

Shortage of Atomic Power Plant Instruments

ENGINEERS working at the Knolls Atomic Power Laboratory, Schenectady, N. Y., recently announced at an ASME meeting in San Francisco that operation of the first atomic power plant would probably be limited because of inadequate development of instruments for use in radioactive areas. This inadequate development is due to a lack of instrument testing facilities.

Instruments are needed in the plant for control and safety of plant operation; for observing the condition and behavior of the plant as its operation proceeds; and for monitoring radiation leakage in the plant to insure protection of oper-

American Beauty

ELECTRIC SOLDERING IRONS



are sturdily built for the hard usage of industrial service. Have plug type tips and are constructed on the unit system with each vital part, such as heating element, easily removable and replaceable. In 5 sizes, from 50 watts to 550 watts.

TEMPERATURE REGULATING STAND

This is a thermostatically controlled device for the regulation of the temperature of an electric soldering iron. When placed on and connected to this stand, iron may be maintained at working temperature or through adjustment on bottom of stand at low or warm temperatures.



For descriptive literature write

110-1

**AMERICAN ELECTRICAL
HEATER COMPANY
DETROIT 2, MICH., U. S. A.**

ating personnel. To do these jobs, detecting devices must meet requirements not found in conventional power plant applications. Such requirements include extreme dependability, remote maintenance, resistance to neutron and gamma radiation, absolute leak tightness and long service.

The atomic power plant now being built by the General Electric Co. at the Knolls Atomic Power Laboratory is an experimental plant whose purpose is to investigate power production on a practical scale and to investigate breeding (the simultaneous production of new nuclear fuel at a rate greater than the fuel consumption).

Radio Fall Meeting

THE 1949 Radio Fall Meeting, formerly known as the Rochester Fall Meeting, will be held October 31, November 1 and 2 at the Hotel Syracuse, Syracuse, N. Y. It will be sponsored by the engineering department of the RMA for its members and members of the IRE.

Officers of the Fall Meeting Committee, in addition to the chairman, Virgil M. Graham, include: R. W. Ferrell of GE, vice chairman and treasurer; and R. A. Hackbusch of Stromberg-Carlson of Canada, Ltd., secretary.

Television Safety Rules

AS A SAFEGUARD against possible accidents precautionary safety rules for both tv set owners and servicemen were recently outlined by a special RMA committee. Prepared by a committee headed by R. E. Carlson, vice-president of Tung-Sol Lamp Works Inc. of Newark, N. J., the rules emphasize that the cathode-ray tube is not dangerous except when carelessly or improperly handled.

Five basic rules for the television set owner are as follows: (1) Read carefully the manufacturer's manual of instructions and observe all precautions. (2) Avoid tampering with inside equipment of the set in case of trouble; call a reputable serviceman. (3) Members of the family should not be permitted to hover around a serviceman working

Kahle

specialists in custom-built, ultra-precision
ELECTRON TUBE MACHINERY

KAHLE CUSTOM-BUILDS machines to make the exact tubes you require—from big 20-inchers to tiny sub-miniature—from laboratory types to those for high-speed production. Kahle puts each unit through exhaustive trial runs in our plant to assure trouble-free operation in yours.

MODEL 287 →

AUTOMATIC TABULATION FLARE MACHINE
(For Button Stem Flared Tabulations as used on Cathode Ray Tubes, etc.)

Especially adapted for production of extra-large pieces. When finished units are too long to be cut off automatically, the pre-cut tubing is stacked in the hopper. Automatic feeding, flaring, unloading.

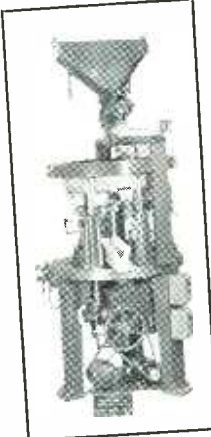

We specialize in cost-cutting, production-boosting, labor-saving equipment for complete manufacture of cathode ray tubes, standard, miniature and sub-miniature radio tubes, sub-miniature tubes, fluorescent lamps, photocells, x-ray tubes, glass products.

Consultations invited
Send for our new catalog

Kahle

ENGINEERING CO.

1309 Seventh Street, North Bergen, New Jersey

MEASUREMENTS CORPORATION MODEL 80

STANDARD SIGNAL GENERATOR



MANUFACTURERS OF

- Standard Signal Generators
- Pulse Generators
- FM Signal Generators
- Square Wave Generators
- Vacuum Tube Voltmeters
- WHF Radio Noise & Field Strength Meters
- Capacity Bridges
- Megohm Meters
- Phase Sequence Indicators
- Television and FM Test Equipment

2 to 400 MEGACYCLES

MODULATION: Amplitude modulation is continuously variable from 0 to 30%, indicated by a meter on the panel. An internal 400 or 1000 cycle audio oscillator is provided. Modulation may also be applied from an external source. Pulse modulation may be applied to the oscillator from an external source through a special connector. Pulses of 1 microsecond can be obtained at higher carrier frequencies.

FREQUENCY ACCURACY ±.5%

OUTPUT VOLTAGE
0.1 to 100,000 microvolts

OUTPUT IMPEDANCE
50 ohms

MEASUREMENTS CORPORATION

BOONTON  NEW JERSEY



All this—
FOR A SINGLE SHIPPING CHARGE

The complete, all-in-one-charge facilities of RAILWAY EXPRESS include pick-up and delivery in all cities and principal towns, receipt at both ends, liberal valuation allowance, one-carrier responsibility all the way. Here's everything you need for business-like, truly economical shipping, whether you're the sender or the receiver. And RAILWAY EXPRESS offers the widest scope as to contents, weight, size and shape of shipments.

Anything, anywhere — by fast, dependable rail or air service — that's RAILWAY EXPRESS!



Part of the American scene! Wherever you live, Railway Express means efficient, courteous shipping. The men and women of this American way business are your neighbors, friends — and customers, too!



NATION-WIDE RAIL-AIR SERVICE

on the set, especially when a picture tube is exposed. (4) The serviceman should be asked immediately to put the used picture tube in the protective container and to take it away when he leaves. (5) Avoid dusting or cleaning the interior of a tv receiver; this should be done by the serviceman when he makes adjustments or repairs.

The precautions laid down for the serviceman are: (1) Avoid exposing the picture tube until ready to use it. (2) Always wear goggles when handling a naked tube. (3) Keep people at a safe distance when a picture tube is exposed. (4) Place the used tube in the carton which contained the new tube and take it away. (5) Keep the picture tube in the protective container whenever possible. Always place an exposed tube on some sort of clean soft padding when necessary to set it down. (6) Do not leave picture tubes lying around. Two safe methods of disposal are: (a) place it in a shipping carton properly sealed and then drive a crowbar through the closed top of the container; (b) use a metal ash can with a plunger operated through the closed top. (7) Do not use regular picture tubes for displaying purposes. Contact your supplier for special display tubes.

Finally the RMA committee stated that careful investigations by competent radio engineers have shown that ultraviolet rays reputedly emitted by cathode-ray tubes are practically nonexistent.

BUSINESS NEWS

ELECTRONIC RESEARCH PUBLISHING Co., INC., New York City, is a new organization which will expand both compilation and publishing activities of the Electronic Engineering Master Index and the Electronic Engineering Patent Index, to include all foreign as well as domestic sources of electronic data. John F. Rider is president of the new organization.

THOMAS ELECTRONICS, INC., Passaic, N. J., recently added new and more adequate equipment for the manufacture of 15 and 16-in. all-glass television picture tubes.

TIN RESEARCH INSTITUTE, INC., Columbus, Ohio, was recently formed to provide free technical service to

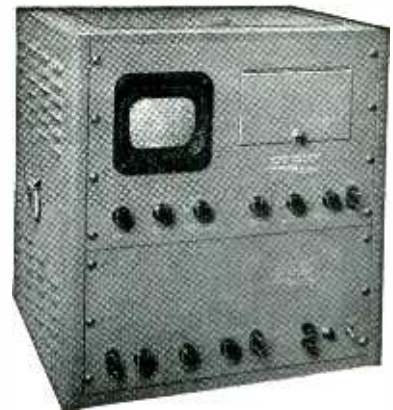

In only 1 SECOND!

COMPLETE AUDIO WAVEFORM ANALYSIS

with the

AP-1 PANORAMIC SONIC ANALYZER



Oscillograph of waveform to be analyzed



Panoramic Sonic Analysis of the same wave

Provides the very utmost in speed, simplicity and directness of complex waveform analysis. In only one second the AP-1 automatically separates and measures the frequency and amplitude of wave components between 40 and 20,000 cps. Optimum frequency resolution is maintained throughout the entire frequency range. Measures amplitude of components down to 0.1%.

- Direct Reading
- Logarithmic Frequency Scale
- Linear and Two Decade Log Voltage Scales
- Input voltage range 10,000,000:1

AP-1 is THE answer for practical investigations of waveforms which vary in a random manner or while operating or design constants are changed. If your problem is measurement of harmonics, high frequency vibration, noise, intermodulation, acoustics or other sonic phenomena, investigate the overall advantages offered by AP-1.

Write NOW for complete specifications, price and delivery.



consumers of tin in the U.S. The organization will maintain a sponsorship at Battelle Memorial Institute to handle new researches.

WEBSTER SPRING CORP., manufacturer of antenna coils and precision springs for radio and television, has moved to 176 Johnson St., Brooklyn, N. Y.

SYLVANIA ELECTRIC PRODUCTS INC. has formed a new division with headquarters at Seneca Falls, N. Y., to specialize in the design, engineering and production of television viewing tubes.

MARCOP DEVELOPMENT & SERVICE Co., Akron, Ohio, has been incorporated to manufacture and sell electronic equipment.

ACRO SWITCH Co., manufacturer of precision snap-action switches, has moved from Cleveland to 2040 E. Main St., Columbus, Ohio.

PERSONNEL

IRVING WOLFF, director of the radio tube research laboratory of RCA Laboratories, recently received the Distinguished Public Service Award of the Navy Department, in recognition of his achievements in electronics, especially in the field of radar.



I. Wolff



K. T. Compton

KARL T. COMPTON, chairman of the Research and Development Board of the National Military Establishment and chairman of the corporation of MIT, has been elected a director of the McGraw-Hill Publishing Co.

FRANK W. CLELLAND, JR., previously associated with the MIT Radiation Laboratory as a staff member of the Kerr group on microwave propagation, was recently appointed a research associate on the electri-

how to keep your "PLUG-INS" plugged in

THE TOP HAT RETAINER

Four standard sizes fit most tubes and components. Special types also available.

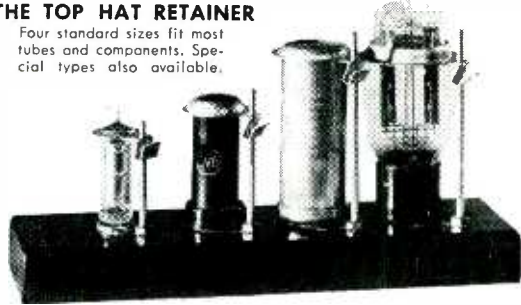

New stainless steel clamp for plug-in units subject to vibration.

Materials and finishes comply with Armed Forces specifications.

Recommended for use in military electronic equipment.

Please state in your inquiry the type of tube or component to which the retainer is to be applied, or supply sample or outline drawings with pertinent dimensions.

TIMES FACSIMILE CORPORATION

A Subsidiary of The New York Times Company
229 West 43rd Street, New York 18, N. Y.

MEGOHMS

MEGOHMS

MEG

MEG

MEGOHMS

MEGOHMS

MEGOHMS

MEGOHMS

MEGOHMS

Cheaper by the dozen with
JELLIFF
ALLOY 1000
RESISTANCE WIRE

This new material packs 1000 ohms/cm²—48% more than the widely-used nickel-chromium alloys.

And what's more, there's no loss of other important physical and electrical properties. High tensile strength—excellent solderability—TC of Resistance is 20—EMF vs Copper +7 microvolts—Coefficient of Expansion 13.9—remarkable Surface-Corrosion Resistance—and many more vital characteristics make ALLOY 1000 a money-making, prestige-building component of compact, precision resistors. For complete data, get Bulletin 17



S.S. White MOLDED RESISTORS

The All-Weather Resistors

ARE USED IN THIS SUPER-SENSITIVE ULTROHMMETER

An S.S. White 100 Megohm Resistor is used as the plate load resistor for the first tube in the D.C. amplifier in this instrument which measures very small d.c. currents and voltages over an extreme range of values. The manufacturer, Beckman Instruments Division of National Technical Laboratories, says of the S.S. White Resistor "it has been very satisfactory"—which checks with the experience of many other electronic equipment manufacturers who use S.S. White Resistors.

Photo courtesy of National Technical Laboratories, So. Pasadena, Calif.

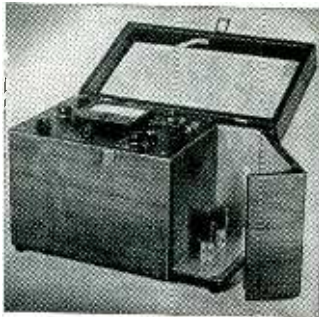

WRITE FOR BULLETIN 4505

It gives essential data about S.S. White Resistors including construction, characteristics, dimensions, etc. Copy with price list on request.



S. S. WHITE RESISTORS are of particular interest to all who need resistors with inherent low noise level and good stability in all climates.
HIGH VALUE RANGE
 10 to 10,000,000 MEGOHMS
STANDARD RANGE
 1000 OHMS to 9 MEGOHMS

S.S. WHITE INDUSTRIAL DIVISION

THE S. S. WHITE DENTAL MFG. CO. DEPT. R. 10 EAST 40th ST., NEW YORK 16, N. Y.



FLEXIBLE SHAFTS AND ACCESSORIES
 MOLDED PLASTICS PRODUCTS—MOLDED RESISTORS

One of America's AAAA Industrial Enterprises

REGULAR FLEXLOC ONE-PIECE SELF-LOCKING NUTS

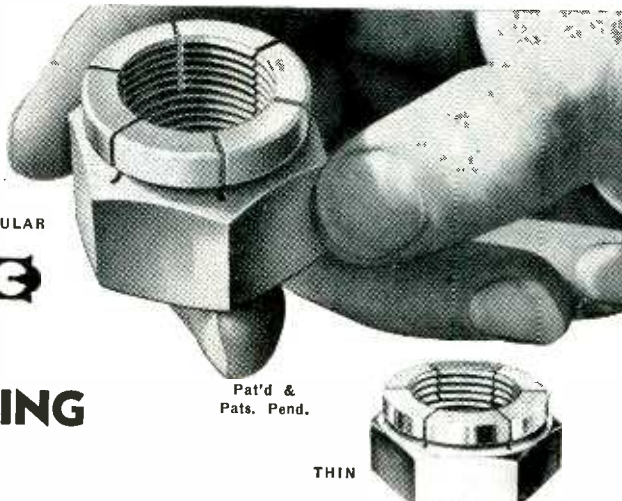

Pat'd & Pats. Pend.

THIN

... Won't Shake Loose ... Reduce Maintenance

Invariably, when nuts loosen, they cause shutdowns, loss of production, and bad tempers all around. All this can readily be eliminated by installing the one-piece, self-locking "FLEXLOC", because it positively will not shake loose and positively cuts cost of maintenance.

The all-metal, one-piece resilient "FLEXLOC" is becoming increasingly popular, because it is processed to have an exceptionally uniform torque and, because it packs a stop, lock and plain nut all in one. "FLEXLOC" accommodates itself to a wide range of thread tolerances and can be used over and over again without losing much of its torque. And, being a stop nut, it stays locked in any position on a threaded member. It is not affected by temperatures commonly met within the industrial field of Mechanical Engineering.

Available in "thin" and "regular" types—in sizes from #6 to 2" in diameter—in NC and NF thread series. Write for your copy of the "FLEXLOC" Catalog.

OVER 46 YEARS IN BUSINESS

STANDARD PRESSED STEEL CO.

Jenkintown, Pennsylvania, Box 596

Branches: Chicago • Detroit • St. Louis • San Francisco

cal engineering staff of Stanford Research Institute, Stanford, Calif.

R. J. DIPPY, one of the original team engaged in the development of Gee, has left England's Ministry of Supply where he was senior principal scientific officer to become Controller of Telecommunications (Civil Aviation) for the New Zealand Government.

FRANCIS DUNMORE, inventor of the electric hygrometer and instrumental in the development of the blind landing system and radiosonde, has retired from the National Bureau of Standards after 31 years of research in the Bureau's radio laboratories.

ALLEN B. DU MONT, president of Allen B. Du Mont Laboratories, Inc., has been presented with the honorary degree of Doctor of Engineering by the Polytechnic Institute of Brooklyn.



A. B. Du Mont



E. W. Engstrom

ELMER W. ENGSTROM, vice-president in charge of research for RCA, recently received the honorary degree of Doctor of Science from New York University.

J. E. SHEPHERD, engineering director for electron tubes at Sperry Gyroscope Co., was recently announced as the 1949-50 president of the Technical Societies Council of New York, Inc.

WILFRED L. KELLY, formerly equipment engineer for Western Electric Co., has joined the distributor sales department of the Radio Division of Sylvania Electric Products Inc.

HARRY F. DART, office manager of the electronics engineering department of Westinghouse Electric Corp., Bloomfield, N. J., was recently elected chairman of the New

READY... AIM...
SOLDER!



**IN JUST
5 SECONDS!**

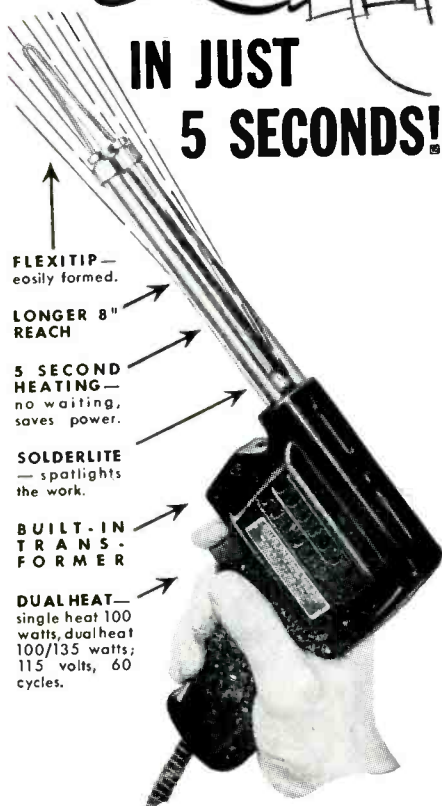

FLEXITIP—
easily formed.

LONGER 8" REACH

5 SECOND HEATING—
no waiting, saves power.

SOLDERLITE—
spotlights the work.

BUILT-IN TRANSFORMER

DUAL HEAT—
single heat 100 watts, dual heat 100/135 watts; 115 volts, 60 cycles.

Pull the trigger switch, make contact, and you solder. Then release the trigger and off goes the heat—automatically. No wasted time. No wasted current. No need to unplug the gun between jobs. The Weller Gun's Flexitip heats only when in use—saves hours and dollars. Your Weller Gun will pay for itself in a few months.

Solderlite, extra length, and the easily shaped Flexitip mean real soldering ease. And because the transformer is built in—not separate—the Weller Gun is a complete, self-contained unit, compact, convenient.

For laboratory and maintenance work, we recommend the efficient 8" model—DX-8 with dual heat; or 4" types S-107 single heat and D-207 dual heat. Order from your distributor or write for bulletin direct.



Be sure to get your copy—**SOLDERING TIPS**, the new Weller Handy Guide to easier, faster soldering—20 pages fully illustrated. Price 10c at your distributor's.

WELLER
MANUFACTURING COMPANY

806 Packer Street • Easton, Pa.

ANNOUNCING *Roanwell's* NEW
MOBILE MIKE

THIS NEW MOBILE MICROPHONE PROVIDES CONSISTENTLY HIGHER MODULATION PERFORMANCE

Weighs a mere 7 oz. Button is riveted on face of mic; allows easy change-over from speaking to hang-up position with turn of wrist. Tough, shock-proof aluminum alloy case; dustproof and moistureproof. Switch and all other internal elements completely enclosed. Mic element cushioned in rubber makes unit shock-and-vibration proof. Suitable for replacement on all existing equipment.

**COMPACT!
RELIABLE!
HANDLES
EASILY!**



STYLE No. 737

ROANWELL CORPORATION
662 Pacific St. • Brooklyn 17, N. Y.

Write for full particulars.



*Trade Mark

**MINIATURE
ELECTRICAL
TRANSMITTERS**

- Fully temperature compensated
- The most RELIABLE precision instruments employing strain gage elements ever constructed for industrial and aircraft applications

- CUSTOM INSTRUMENTATION
- ACCELEROMETERS
- ALTIMETERS
- AIRSPEED TRANSMITTERS
- PRESSURE TRANSMITTERS

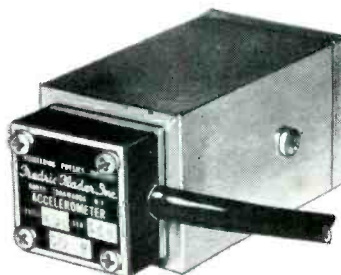
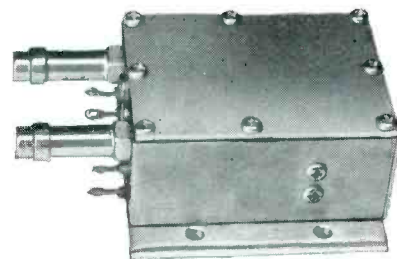

Specify Teleflight Instruments

Write for descriptive bulletin

ENGINEERING PHYSICS DIVISION
Fredric Flader, Inc.
North Tonawanda, New York, U. S. A.

York Section of the IRE for 1949-50.

THOMAS H. MEDEROS, JR., formerly senior electrical engineer in charge of development and testing of electronic applications in the research laboratory at the Underwood Corp., has been appointed supervisor of field engineering at the Brinnell Co., Granby, Conn.



T. H. Mederos, Jr.



Harold E. Strang

HAROLD E. STRANG, formerly engineering manager of the Affiliated Manufacturing Company Department of General Electric Co., Schenectady, N. Y., has been appointed manager of the Apparatus Department's Meter and Instrument Divisions at Lynn, Mass.

ALFRED C. VIEBRANZ, formerly government sales representative for the Electronics Division of Sylvania Electric Products Inc., at Boston, Mass., has been appointed special representative at Washington, D. C. for Sylvania's Electronics and Radio Divisions and the Central Engineering Laboratories. He will also serve as a technical consultant in all phases of government relations.

RALPH A. LAMM, previously associated with MIT as a staff member, and on the staff of the National Bureau of Standards since 1947, has been appointed chief of the Bureau's Missile Engineering Section, where he will direct guided missile engineering.

EDWIN A. SPEAKMAN, recipient of the Meritorious Civilian Service Award from the Navy for his work in radar, and branch head of the radio countermeasures section of Naval Research Laboratory since 1945, has been appointed executive director of the committee on electronics, Research and Development Board, National Military Establishment.

VULCAN

900
SERIES

THERMOSTAT
CONTROL

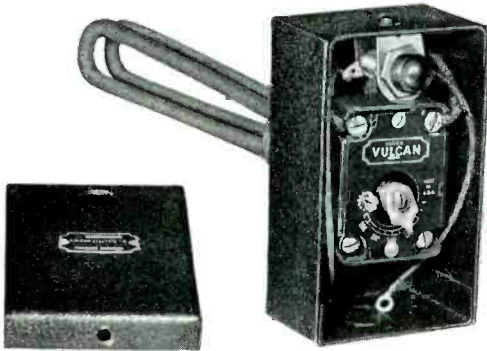

A NEW Electric Immersion Heater for water, oils and chemicals. Easily, quickly and economically installed in any present equipment that requires heat for liquids, without disturbing existing piping.

INDUSTRIAL AND DOMESTIC HOT WATER HEATERS
DISH WASHERS • STEAM TABLES • COFFEE URNS
STERILIZERS • STILLs • LABORATORY EQUIPMENT

Plugs in any convenient outlet

EFFICIENT FOR HEATER TANKS FOR PLASTIC COATING REQUIRING TEMPERATURES UP TO 200 DEGREES F.

VULCAN ELECTRIC COMPANY

DANVERS, 10, MASS.

Makers of Vulcan Electric Soldering Tools, Vulcan Electric Solder Pots and Glue Pots, Vulcan Electric Branding Irons and a wide variety of Heating Elements for assembly into manufacturers' own products and of Heating Specialties that use electricity.

Don't LET WASTE-TIME RUN AWAY WITH YOUR PROFITS!

GET
THE
NEW

Wheelock

CODE CALL
FOR INSTANT COMMUNICATION

Just Press
a Button



Saves time and increases efficiency in your office and plant. Code Call is made by a numerical code, sounding signals. Promptly completes telephone connections with organization personnel away from their own telephones. Write for new Bulletin B4-6

SIGNAL ENGINEERING
and MANUFACTURING COMPANY
154 WEST 14th ST. NEW YORK 11, N. Y.

Lavite STEATITE CERAMIC

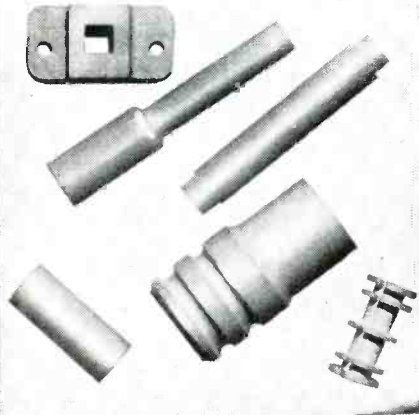

Design engineers and manufacturers in the radio, electrical and electronic fields are finding in LAVITE the precise qualities called for in their specifications . . . high compressive and dielectric strength, low moisture absorption and resistance to rot, fumes, acids, and high heat. The exceedingly low loss-factor of LAVITE plus its excellent workability makes it ideal for all high frequency applications.

Complete details on request

D. M. STEWARD MFG. COMPANY

Main Office & Works: Chattanooga, Tenn.
Needham, Mass. • Chicago • Los Angeles
New York • Philadelphia

BIRTCHEr STAINLESS STEEL - LOCKING TYPE TUBE CLAMPS

Stainless Steel

Corrosion Proof



83 VARIATIONS

Where vibration is a problem, Birtcher Locking TUBE CLAMPS offer a foolproof, practical solution. Recommended for all types of tubes and similar plug-in components.

More than three million of these clamps in use.

FREE CATALOG

Send for samples of Birtcher stainless steel tube clamps and our standard catalog listing tube base types, recommended clamp designs, and price list.

THE BIRTCHEr CORPORATION
5087 HUNTINGTON DR. LOS ANGELES 32

"DIE-FORMED TO GIVE YOU BETTER, MORE DEPENDABLE COILS!"



PRECISION PAPER TUBES . . .

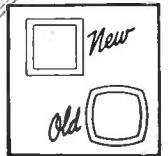

Precision gives you the plus . . . coil bases formed under heat and pressure. The result, a coil base of less weight—greater strength—more thorough insulation—more effective resistance to moisture, oil and heat. All at the very minimum of cost. It's a better coil that has a Precision base.

Precision Di-formed Paper Tubes are available in the best quality, dielectric Kraft, Fish Paper, Cellulose Acetate, Asbestos or combinations. Round, square or rectangular.

TODAY—WRITE FOR FREE SAMPLE AND COMPLETE MANDREL LIST OF OVER 1,000 SIZES.

LOOK AT THESE FEATURES:

- * No need for coil, forming after winding.
- * Automatic stacking.
- * Wire saved by closer engineering of coil.
- * No side bow.

PRECISION PAPER TUBE CO.

2041 West Charleston St.
Chicago 47, Ill.
Plant No. 2, 79 Chapel St.
Hartford, Conn.

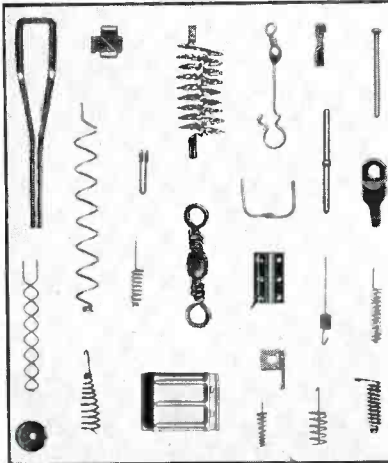

SMALL PARTS

Filaments, anodes, supports, springs, etc. for electronic tubes. Small wire and flat metal formed parts to your prints for your assemblies. Double pointed pins. Wire straightened and cut diameter up to 1/8-inch. Any length up to 12 feet.

LUXON fishing tackle accessories.

Inquiries will receive prompt attention.

ART WIRE AND STAMPING CO.

227 High St.

Newark 2, N. J.

DEPENDABLE COILS MADE TO YOUR SPECIFICATIONS

- Form Wound
- Paper Section
- Acetate Bobbin
- Bakelite Bobbin
- Cotton Interweave

Dano has made a reputation for handling even very difficult—or the simplest coil problems with equal efficiency. Send us your specifications for quotation whether you require an untreated coil or one that is vacuum impregnated with wax or varnish.

- COILS FOR HIGH TEMPERATURE APPLICATIONS ALSO TRANSFORMERS MADE TO ORDER

Don't let a COIL hold up production



THE DANO ELECTRIC CO.
MAIN ST., WINSTED, CONN.



JOHNSON SOCKETS . . .

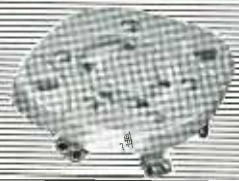

always a perfect choice!

The JOHNSON 122-225 wafer pictured above is insulated with glazed grade L-4 steatite. Contacts are brass with steel spring, cadmium plated. Mounted against phenolic washers in molded recesses to prevent movement. Rivets countersunk, mounting holes bossed to permit sub-panel mounting. Locating grooves facilitate tube insertion. Available also in 4, 6, and 7 contact as well as octal.

All JOHNSON sockets are of equally outstanding quality. Get the best—get JOHNSON sockets! See Your JOHNSON Dealer



E. F. JOHNSON CO.
WASECA, MINNESOTA

FOR EVERYTHING IN ELECTRONICS

Biggest stock of Radio Parts & Equipment in New York — speedy and courteous attention to your orders — alert salesmen who talk your language.

SOUND

Highest quality, sensibly priced sound equipment for all requirements. Ask for our big free Sound Catalog!

HAM GEAR

Radio amateurs' headquarters for all well-known lines of ham equipment.

TV

Television components, test equipment, tubes, antennas, accessories.

A HURRY?

Phone, wire, write, drop in! Terminal has it!

TERMINAL
RADIO CORPORATION

85 CORTLANDT ST., NEW YORK 7, N. Y.
Phone: WOrth 4-3311 Cable: TERMRADIO

NEW BOOKS

Invention and Innovation In the Radio Industry

BY W. RUPERT MACLAURIN, *Massachusetts Institute of Technology. The Macmillan Co., New York, 1949, 304 pages, \$6.00.*

FOR ANYONE who has been in the radio industry twenty or more years and has an interest in who did what and when, this is a most absorbing and instructive monograph. And for those newcomers who unfortunately did not exist during the good old days of radio and thus missed the great excitement, the great thrill of the pioneer, something of the feelings shared by the old timers can be secured from Professor Maclaurin's book.

The author uses the radio industry as a typical American product to get answers to such questions as why has the United States been largely dependent on older European countries for fundamental scientific development in many fields? Why, in this country, are some industries more successful and quicker than others in adapting scientific advances to practical application? Are there ways we can speed up the interval between research and application? What is the role to be played by the entrepreneur, the lone attic inventor, the realistic business man, by the patent system, by the large corporation—by all of the individual entities and aggregations of entities that make up our technico-business structures?

All the old boys of radio are in this book—Marconi, Fessenden, de Forest, Lodge, Pupin, Hazeltine—and the interrelations and interdependencies among them are clearly brought out. In reading of these early days one begins to see why one succeeded where another failed—Marconi and Fessenden for example. One gets a glimpse of the important place to be played by men like Sarnoff and Owen D. Young. One finds out the fact, though perhaps not the reason thereof, that the most successful companies have been dominated by strong personalities who were not technical men, but rather were innovators whose interests and skills were in commercial practice rather than in

For Proof Beyond Compare



Try

RUBYFLUID

Soldering Flux

Send for Ruby's \$1 Offer

For \$1 Ruby will send you 1 pint of liquid, one half pound of paste soldering flux and a new booklet on "How to Solder."

Take advantage of this offer now!

Send your \$1 today to—

RUBY CHEMICAL CO.



59 McDOWELL ST.
COLUMBUS, OHIO

Rubyfluid

Specify

GLASS JEWEL BEARINGS

for . . . Low Cost
. . . Long Life



Glass Jewel Bearings by Bird are highly accurate and surprisingly inexpensive. They're ideal for use in ammeters, volt meters, timing instruments, compasses and other instruments where large volume production and low cost must be maintained.

Of special interest to instrument manufacturers is Bird's method of mounting jewels. There's a minimum of stress and strain on the bearing itself as a result of Bird's special mounting technique. It is this special mounting feature which adds so materially to the useful life of Bird Jewel Bearings.

Whenever there's a need for jewel bearings — whether in glass or in sapphire — Bird can supply the right bearing to your specifications. Write today for more information and a quotation.

*Sapphire Bearings available in
all jewel styles and mountings*

Richard H. Bird & Co., Inc.

1 Spruce Street
Waltham 54, Mass.

"Serving Industry with Fine Jewels
Since 1913"

science and engineering.

Chapter contents reveal the aspects into which Professor MacLaurin has divided his studies, made under grant from the Rockefeller Foundation. Thus: the scientific pioneers of radio, the impact of new scientific advances on established industry, the process of innovation and invention, Marconi, Fessenden, deForest, the role of the large electrical firms, the struggle over patents, 1921-1928, the perennial gale of competition, the rise of industrial versus individual research, the relation between government regulation and technical progress.

The book is unhesitatingly recommended to all those who would like, if possible, to recapture the feeling of the early days and to those who would like to know first-hand what it is that the old timers share when they get together. It is a book for technical men as well as those who exploit technical advances.—K. H.

Ultrasonics

BY BENSON CARLIN, *Hillyer Instrument Company, McGraw-Hill Book Company, Inc., New York, 1949, 270 pages, \$5.00.*

ULTRASONICS, or supersonics as most of us have been calling it, is a new science. It is so new and so intriguing in some of its aspects that publicity releases on its wonders and peculiarities have been much more frequent, voluminous and available than engineering facts.

Also, it is a field in which much experimental work on ultrasonic effects and suggested applications has been carried on, but there is a dearth of useful basic data based on reported experiments. This condition may be due in part, as the author points out, to the fact that much of the real scientific work was done and published abroad and at an early date.

Thus, the author faced a most difficult task in writing a book for readers with an engineering viewpoint. There are chapters devoted to piezoelectric crystal and magnetostriction generators as well as continuous and pulsed systems. The author has been active in the use of ultrasonics for detection of flaws

IF

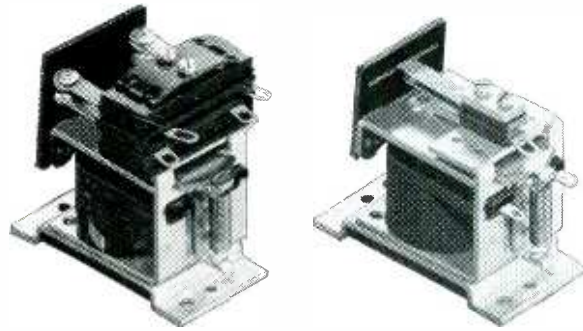
 you have a relay problem requiring low cost, small size and dependable performance...

...take a look at *R-B-M General Purpose AC and DC Relays*

WRITE FOR BULLETIN AND PRICE LIST

Dept. D-8, R-B-M DIVISION OF ESSEX WIRE CORP.

Logansport, Indiana



MANUAL AND MAGNETIC ELECTRIC CONTROLS
— FOR AUTOMOTIVE, INDUSTRIAL, COMMUNICATION AND ELECTRONIC USE

Over 1000 Sizes

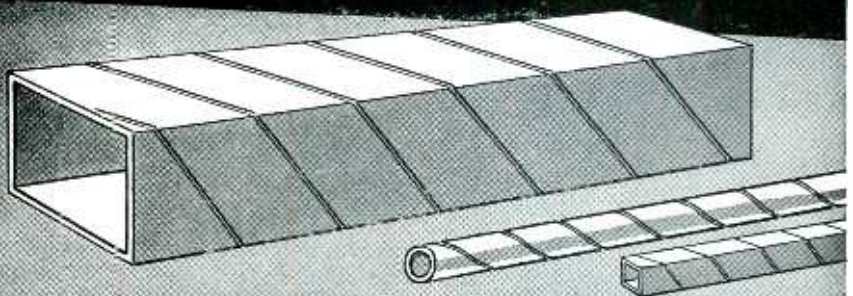

PARAMOUNT SPIRAL WOUND PAPER TUBES

Square • Rectangular • Triangular
Round and Half-Round

With a wide range of stock arbors... plus the specialized ability to engineer special tubes... PARAMOUNT can produce the exact shape and size you need for coil forms or other uses. *Hi-Dielectric, Hi-Strength, Kraft, Fish Paper, Red Rope*, or any combination, wound on automatic machines. Tolerances plus or minus .002". Made to your specifications or engineered for YOU.

Inside Perimeters from .592" to 19.0"

SEND FOR ARBOR LIST
OF OVER 1000 SIZES

Convenient, helpful listing of over 1000 stock arbors. Includes many odd sizes of square and rectangular tubes. Write for Arbor List today. No obligation.

PARAMOUNT PAPER TUBE CORP.

616 LAFAYETTE ST., FORT WAYNE 2, IND.

Manufacturers of Paper Tubing for the Electrical Industry

Etched TUNGSTEN WIRE

• From .0004" to
.00015" diameter
and even smaller

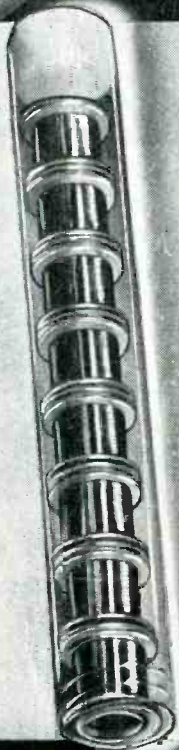

- Accurate
- Uniform
- Smooth

Also available
in Molybdenum
and other metals

Write for
Details and
List of
Products

SIGMUND COHN CORP.
44 GOLD ST. NEW YORK

SINCE  1901

NEW BOOKS

(continued)

in materials and this application is the one most thoroughly covered in the book. In general, however, definite, thorough information on specific topics is not given and, in many cases, is probably not available. Many engineers will be disappointed with the meager engineering facts and data presented.

The book is well illustrated with drawings and diagrams. If this book prompts some engineers to obtain and publish more useful fundamental data on the subject of ultrasonics, particularly as regards properties of materials, it will have served a valuable purpose.—W. C. WHITE, *General Electric Co.*

Fundamentals of Electric Waves

BY H. H. SKILLING. *John Wiley and Sons, Inc., New York, N. Y., Second Edition, 1948, 245 pages, \$4.00.*

FOLLOWING the wartime emphasis on meter and centimeter-wave apparatus, there is a continued demand for engineers familiar with the properties of short radio waves. The second edition of this well-known little book represents some amplification and extension of the previous edition; but it is unfortunate that the extension was not carried much further. Professor Skilling says he has found the book most effective as a text for seniors in electrical engineering, who (this reviewer judges) are expected to have no knowledge of vector analysis of electromagnetic theory beyond elementary physics. Consequently, it begins by explaining the minimum essentials of vector analysis and describes briefly the fundamental experiments which serve as the basis for Maxwell's equations, which appear as such in about the middle of the book. There follows the customary discussion of plane waves, the Poynting vector, reflection from plane surfaces, and finally all-too-brief chapters on radiation from simple antennas, transmission lines and waveguides, and the ionosphere. There are problems at the end of each chapter; but, if the student follows the author's suggestion to solve one or two each day, he will neither be overburdened nor greatly edified.

The outstanding feature of the



STANDARD AND HEAVY DUTY INVERTERS



For Inverting D. C. to A. C.

Specially Designed for operating A. C. Radios, Television Sets, Amplifiers, Address Systems, and Radio Test Equipment from D. C. Voltages in Vehicles, Ships, Trains, Planes and in D. C. Districts.

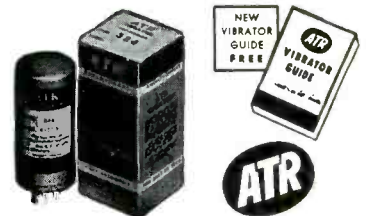

AUTO RADIO VIBRATORS

A Complete Line of Vibrators . . .

Designed for Use in Standard Vibrator-Operated Auto Radio Receivers. Built with Precision Construction, featuring Ceramic Stack Spacers for Longer Lasting Life.

NEW MODELS NEW DESIGNS
NEW LITERATURE
"A" Battery Eliminator, DC-AC
Inverters, Auto Radio Vibrators
See your jobber or write factory

AMERICAN TELEVISION & RADIO Co.
Quality Products Since 1931
SAINT PAUL, MINNESOTA-U. S. A.

RAWSON METERS



Types:
501A
501C

Accuracy:
1/2 of 1%

MULTIMETERS and REGULAR METERS

AC and DC types, high accuracy, multiple ranges, 2 microamperes to 1 ampere DC. 2 milliamperes to 3 amperes AC.

ELECTROSTATIC VOLTMETERS

Ranges 150-v. to 35,000-v. AC or DC. Resistance exceeds million megohms. Can measure static electricity.

FLUXMETERS

Laboratory and production measurements on magnets and magnetic circuits. Single push button return-to-zero.

WATTMETERS

High sensitivities, low power factors. New types soon to be announced.

Special apparatus built to order

RAWSON ELECTRICAL INSTRUMENT COMPANY

111 Potter St. Cambridge, Mass.
Representatives
Chicago Los Angeles

Now Terminals Can Be ATTACHED & SOLDERED in ONE Automatic Operation!

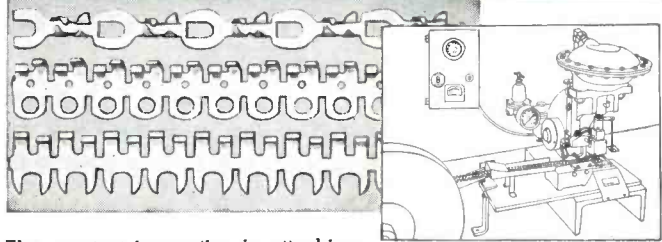

The greatest innovation in attaching terminals to wires is now available to the industry . . . "Pre-soldered" TANDEM TERMINALS! Made in various sizes and types, these remarkable, production-proved terminals (supplied on reels) can be applied at rates up to 1200 per hour by a new Terminal Attaching Machine that cuts off, clinches and solders terminals in one instantaneous operation. Handling of loose terminals, solder and flux are eliminated to reduce costs and boost production on long runs. Standard types available. Send for detailed information. Enclose sample of wire and terminal now used. Address Dept. E.

For ordinary runs in moderate quantity we continue to produce **SEPARATE TERMINALS for ELECTRIC WIRES**

We also make **SMALL METAL STAMPINGS** Exact to Customer's Prints. Modern Plant and Equipment. Moderate Die Charges. Precision Work. Prompt Service.

PATTON-MacGUYER COMPANY

17 Virginia Avenue, Providence, R.I.

Flexible Shafts

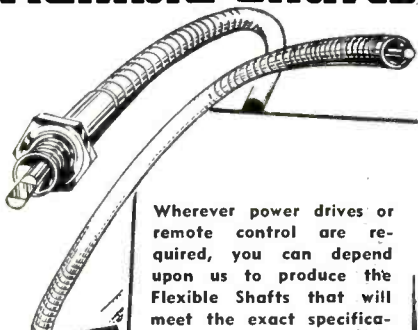

Wherever power drives or remote control are required, you can depend upon us to produce the Flexible Shafts that will meet the exact specifications. We have years of experience in manufacturing flexible shafting for all types of industry. If we do not have what you require in stock, we can make shafts to your specifications. Our engineers will be glad to work out your problems without obligation.

WRITE FOR MANUAL D

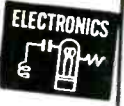

F. W. STEWART MFG. CORP.

4311-13 RAVENSWOOD AVE.
CHICAGO 13, ILL.

WEST COAST BRANCH:
431 VENICE BLVD. LOS ANGELES 15, CAL.

Pioneer in Radio Engineering Instruction Since 1927

CAPITOL RADIO ENGINEERING INSTITUTE

An Accredited Technical Institute



ADVANCED HOME STUDY AND RESIDENCE COURSES IN PRACTICAL RADIO-ELECTRONICS AND TELEVISION ENGINEERING

Request your free home study or residence school catalog by writing to:

REGISTRAR
16TH AND PARK ROAD, N.W.
WASHINGTON 10, D. C.

Approved for Veteran Training

WIDE BAND 5" OSCILLOSCOPE HIGH GAIN

2

MEGACYCLES

- BANDWIDTH 10 cycles to 2 MC (3 DB Down)
- SENSITIVITY .06 RMS Volts/inch
- Hor. Amp. 2 cycles to 500 kc
- Hor. Amp. Sensitivity .15 RMS Volts/inch
- Decade Attenuators (Frequency Compensated)
- Direct Connection to Deflection Plates
- Z Axis Input • Calibration Test Signal

IDEAL FOR TV WORK—CUTS EQUIPMENT COSTS
A QUALITY INSTRUMENT—AN AMAZING LOW PRICE

Vert. Amp. 1-6SN7, 1-6AC7, 2-6AG7, Hor. Amp. 2-6SN7, 5CPI CR tube 5Y3 and 2x2. Cased in hammetone grey cabinet, complete with instructions. GUARANTEED MODEL 50

\$149.50

F.O.B. N. Y.



Phone: SL ocum 6-7000

TELEMARK ELECTRONICS CORP - 325 TROY AVE - BROOKLYN 13, N.Y.



Internal View
Housing Removed



Complete Unit In Housing



SEND FOR
LATEST CATALOG

New... VARIABLE DELAY INTERVAL TIME DELAY RELAYS

By A. W. HAYDON

SERIES 11400 A. C. AND 6400 D. C.

Latest development of the A. W. Haydon Company is this extremely compact Time Delay Relay which can be supplied for an alternating or direct current operation. Availability of time proven A.C. and D.C. Timing Motors with a wide choice of speed and voltage ratings makes possible any desired delay interval from 1 second to 1½ hours.

SPECIAL FEATURES

1. Geared differential and positive electro-magnetic "capstan-type" clutch insure positive operation under adverse conditions.
2. Delay variable up to maximum rating of unit.
3. A. C. and D. C. Relays interchangeable.
4. Automatic instantaneous reset.
5. Low inertia of clutch components avoids trouble due to vibration and shock.
6. May be wired for either time delay or interval timing functions.



The
A.W. HAYDON
COMPANY

WATERBURY 32, CONNECTICUT

Design and Manufacture of Electrical Timing Devices

NEW BOOKS

(continued)

book is the emphasis on physical reasoning rather than on mathematical manipulation or deductions. The explanations of such ideas as the meaning of curl, gradient, and group velocity (illustrated by waves on a hurrying caterpillar) are homely but clear and well suited to the intended audience. The general level of the discussion does not go much beyond these elementary expositions, however, and will leave the above-average student unsatisfied as to the mechanism and significance of such phenomena as energy storage in the electromagnetic field and dielectric and magnetic polarization. These and numerous other fundamentals are passed over hurriedly in order to arrive at wave phenomena as soon as possible.

A change incorporated in the second edition that will be welcome to most engineers is the complete switch to the mks (Giorgi) system of units. There is the usual table for conversion to other systems, and the other systems are mentioned briefly, but there is no discussion of the physical significance of *dimensions* of units. It is unfortunate that this revision did not correct errors such as those concerning phase shift on reflection and the operation of a shielded loop antenna. There are also numerous statements that could have been made more precise without loss of clarity or forcefulness.

This book should be suitable for the student (or engineer) who desires a very readable elementary discussion of the physical ideas leading to electromagnetic wave theory and a speaking acquaintance with the transmission properties of waves, but the person intending to use such knowledge for research purposes will require considerably more elaboration on fundamental matters as well as on applications.

—DONALD E. KERR.

Components Handbook

EDITED BY JOHN F. BLACKBURN. Vol. 17 of MIT Radiation Laboratory Series. McGraw-Hill Book Co., New York, 1949, 626 pages, \$8.00.

ONLY components developed by or under sponsorship of the Radiation Laboratory or of primary importance in its work are covered thor-

MICROPOT

PRECISION TEN-TURN POTENTIOMETER

1. You get permanent accuracy because the resistance wire is locked in place. It is precision positioned and moulded integrally with the housing.
2. You get permanently accurate settings, smooth action and low uniform torque provided by the stainless steel, precision ground, double thread lead screw guiding the moving contact.
3. You get precise positioning of the moving contact because of the two bearings supporting the rotor assembly.
4. You get good rigid terminals because they are moulded integrally with the housings.
5. Terminals soldered to ends of resistance element before moulding. Entire resistance circuit is an integral part of the housing.
6. You get accurate setting and re-setting due to anti-backlash spring in contact guide.
7. You get a fine resolution because of the 43½" length of resistance wire in the spiral element.
8. You get a resistance output directly proportional to shaft rotation within ±0.1% of the total resistance. Every potentiometer is automatically machine tested for linearity at 101 points.

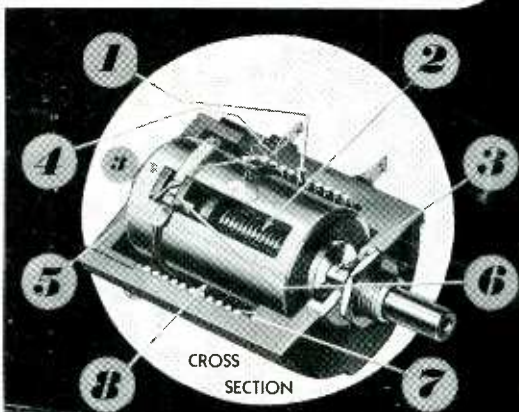

**LINEARITY
ACCURACY ± 0.1%**

Units for immediate shipment:
1,000 to 30,000 ohm range.
Special resistance values made to order.

WRITE TODAY FOR
ENGINEERING INFORMATION

GIBBS DIVISION

THE GEORGE W. BORG CORPORATION

DELANA • WISCONSIN



WANTED

SPECIAL TOROIDAL WINDING JOBS



Vickers Electric Division—

is equipped to custom wind toroidal cores. Core material furnished if necessary.

SIZE LIMITS: Max. O. D. 4½"
Min. I. D. ½"
Max. Stack Height 2"

WIRE SIZES: #40 to #12

Send your specifications for quotation today.

VICKERS  ELECTRIC DIVISION

1815 LOCUST ST., ST. LOUIS, MO.

DUMONT TINYMITE PAPER CAPACITORS

TYPE P2
ROUND



TYPE P1
FLAT



FROM 50 MMF. TO 2 MFD.
FROM 100 VOLTS TO 600 VOLTS

MOISTURE PROOF
65° - 85° - 100° C - SEAL

FOR DEPENDABILITY
ALWAYS SPECIFY DUMONT

DUMONT ELECTRIC CORP.

MFR'S OF CAPACITORS FOR EVERY REQUIREMENT
308 DYCKMAN ST., NEW YORK, N. Y.

KENYON Fits Your Production To A "T"



KENYON "T's"—high quality, uniform transformers, are your best bet for development, production and experimental work. For over 20 years, the KENYON "K" has been a sign of skillful engineering, progressive design and sound construction.

Now—reduce inventory problems, improve deliveries, maintain your quality—specify KENYON "T's," the finest transformer line for all high quality equipment applications.

New Catalog Edition! Write Today!

KENYON new modified edition tells the complete story about specific ratings on all transformers. Our standard line saves you time and expense.

Send for your copy of our latest catalog edition now!

KENYON TRANSFORMER CO., Inc.

840 BARRY STREET · NEW YORK 59, N. Y.

Do You Have Any Problems in

MANUFACTURING VACUUM TUBES

If so, let us help you solve them. We will build—to your specifications and design—any kind of equipment for the tube manufacturing or associated industries. Or, Buck engineers will design and build equipment to solve your problems. The carrier illustrated here is just one example of Buck Engineering's work in this field. Inquiries are invited.

CARRIER



Four 10" and 12" TUBES; greater capacity; less floor area; no dirt on screens.



BUCK ENGINEERING CO., INC.

37-49 MARCY STREET

FREEHOLD, N. J.

For Precision Washers... For Precision Stampings...

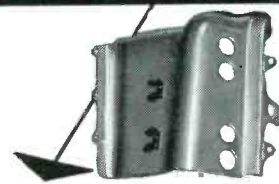
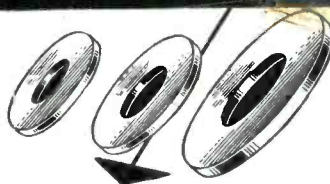

WHITEHEAD STAMPING CO.

A preferred source of precision-made WASHERS and STAMPINGS. 46 years of experience and up-to-the-minute facilities, assure highest quality and service.



EST. 1903

WHITEHEAD STAMPING CO.

1691 W. Lafayette Blvd.

Detroit 16, Michigan

YOU CAN BE **SURE** IF IT'S A

GRACOIL
"One Good Turn of a Million"

Transformer

because you **TRY** before you buy . . .
with a **PRODUCTION SAMPLE!**

OPEN TYPE—STRAP MOUNTING

★ For many years, The Gramer Company has engaged in the successful design and quantity production of Gracoil Transformers and Windings, making countless thousands for big name manufacturers in American industry. Such success is due in part to Gracoil's "production sample" method of testing in advance for physical and electrical correctness. No guesswork. Try it.

THE PRODUCTION SAMPLE IS YOUR
GUARANTEE OF DEPENDABLE PERFORMANCE!

Write today!

THE GRAMER COMPANY

Electrical Coils and Transformers

2734 N. PULASKI ROAD

CHICAGO 39, ILL., U.S.A.

ESTABLISHED IN 1935

"Gracoil" Transformers include:
Open Types—Step-Down-Up—Fully Enclosed—Line Voltage Regulating—Filament—Audio—Filter Reactors—Isolation—to specifications.



FULLY ENCLOSED

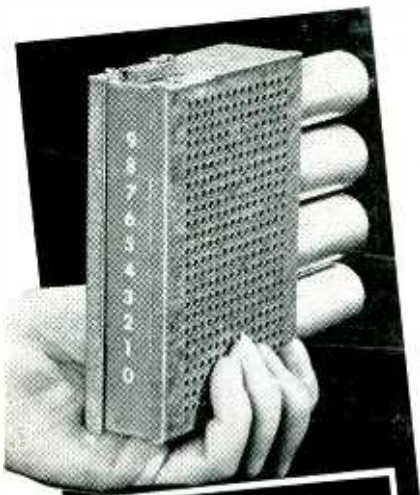

THE NEW
BERKELEY
MODEL 700
DECIMAL COUNTING UNIT

This unique packaged component is easily built into your apparatus. It has true decimal reading, and simple binary circuit with reliable automatic interpolation. Miniature size. Moderate price. Immediate shipment.

Send for Bulletin DCU-115

Berkeley Scientific Company
SIXTH AND NEVIN AVE - RICHMOND, CALIFORNIA

DYNAMOTOR SUPPLIES

FOR

ELECTRONICS

SUBRACO DS-400



A complete compact dynamotor power supply unit, especially designed for electronic mobile applications. The Subraco DS-400, with 5.6 volts DC input, delivers 400 volts at 175 MA intermittent duty. The complete unit contains adequate filtering, control relays, proper fusing, and measures only 4 3/4" wide, 7" long and 7" high.

The Subraco DS series is available in almost any voltage and current ratings. Send us your specifications. Write for our catalogue E-8.

SUBURBAN RADIO CO.

158 Central Ave. Rochelle Pk., N.J.

NEW BOOKS

(continued)

oughly in this volume, and several important classes of these components have been left out. As a result, many will consider this the least useful of all the books in the MIT series. Nevertheless, for the components that are covered, the data given is largely unpublished before and should prove useful to engineers and research workers alike in these particular specialized fields.

The fourteen chapters cover wires and cables, fixed composition resistors, fixed wire-wound and miscellaneous resistors, iron-core inductors, piezoelectric devices, electromagnetic delay lines, supersonic delay lines, potentiometers, special variable condensers, rotary inductors, instrument motors and tachometers, power supplies, relays and related devices, and receiving tubes. The most serious omissions, according to the editor, are the projected chapters on fixed condensers, air-core inductors and mechanical components. Termination of the Office of Publications is the reason given for the incompleteness of coverage.—J. M.

Books Received for Review

INTRODUCTORY RADIO THEORY AND SERVICING. By H. J. Hicks, radio and science instructor, Central High School, St. Louis, Missouri. McGraw-Hill Book Company, Inc., New York, 1949, second edition, 393 pages, \$3.20. Especially designed for beginning high-school classes in radio. Requires no previous knowledge of radio, electricity or magnetism. Theory is introduced at points where it can be immediately applied. Learn-by-doing methods are stressed, along with the how and why of radio servicing problems. Includes topics for discussion at end of each chapter. A complete teachers' manual is available.

MODERN OPERATIONAL CALCULUS WITH APPLICATIONS IN TECHNICAL MATHEMATICS. By N. W. McLachlan. MacMillan and Co., Ltd., London, 1948, 218 pages, \$5.00. Introduction to modern operational calculus based on the Laplace transform. Though intended primarily for post-graduate engineers and technologists, the purely mathematical parts are designed to be useful to advanced undergraduates in mathematics.

FOUNDATIONS OF NUCLEAR PHYSICS. Compiled Robert T. Beyer, Assistant Professor of Physics, Brown University. Dover Publications, Inc., New York, 1949, 272 pages, \$2.95. Facsimiles of thirteen fundamental studies as they were originally reported in various American and foreign scientific journals by leaders in the idea of atomic research. Bibliography of over 120 pages of nuclear physics references, listed according to subject matter, is included. Among thirteen papers presented are works by Fermi, Marie and Joliot, Hideki Yukawa's paper "On the Interaction of Elementary Particles" is reproduced from the *Proceedings of the Physico-Mathematical Society of Japan*.

PHOTOVOLT VIDEO

Brightness Tester
MOD. 205



A photoelectric instrument for measuring the brightness of television tubes and screens in foot-lamberts.

Price, \$68.

Write for literature to

PHOTOVOLT CORP.

95 Madison Ave. New York 16, N. Y.

Photoelectric and
Electronic Measuring Instruments

WATER REPELLENT



More than 50 years of leadership and experience in developing special purpose cloth for the industry. With a background in the industry, it is that Holliston Tracing Cloth is the best. Try PEL-X.

HOLLISTON PEL-X TRACING CLOTH HAS HIGH RESISTANCE TO MOISTURE

Holliston PEL-X positively will not make a tight cap to wear under your bathroom cap. It was never intended for any such use. It is highly resistant to moisture and perspiration.

Perspiration from a draftsman's face neither spoils a subject drawing nor the special PEL-X finish which "keep out." Drops of water on a PEL-X Tracing Cloth may be wiped off without harm to the drawing.

Try PEL-X on your own drawing. A sample sent on request.

THE H
CHICAGO

ONLY \$215 FOR
THE GREEN
ENGRAVER
... yet it's fast
and runs



The
graver
great
con
c



Very Much in the
V. PICTURE!

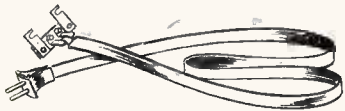

Special High Frequency Assemblies
for Television application.

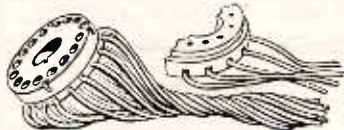

Kinescope Socket Assemblies



(Catalog No. 22007, 22007-A, 22007-B)
300 Ohm Parallel Twin
Construction Line Cables

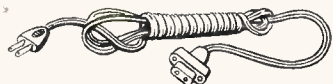

T. V. Power Supply Cords



(Catalog No. 42007)
Four Conductor Leads for
Rotating Antenna Controls

**PHALO SINGLE CONDUCTOR
AND HOOK-UP WIRE!**

Phalo is fully equipped to assemble special harness or assembly requirements for almost all Television applications. Send for your copy of the 22 page PHALO Catalog NOW!

PHALO
Plastics Corporation

Corner of Commercial Street
WORCESTER, MASS.

Manufacturers of Thermoplastic insulated wire,
cables, cord sets and tubing

BACKTALK

(continued)

appreciated and we leave it to you to choose the right form of this correction. We are very sorry indeed about this error. We thank you very much for your cooperation.

S. PAKSWER
Chief Engineer,
Continental Electric Co.,
Geneva, Illinois

F-M vs A-M

DEAR SIRs:

CONCERNING the two-part paper, "A-M and Narrow Band F-M in UHF Communication", which you published in February and March of this year, the conditions chosen by Mr. Toth were in my opinion somewhat unfavorable for f-m, so that the first sentence in the summary, "A-m is preferable to f-m for certain highly mobile conditions of operation owing to better weak-signal performance . . .", holds only for the conditions described in the paper.

In the first place Mr. Toth states, that for reasons of frequency stability the bandwidth chosen was 125 kc, and in this way he arrives at the results given in Fig. 5, 6 and 7. As Mr. Toth remarked, the ratio detector alone does not limit perfectly, so that adding a limiting device (see Fig. 16) gives a better signal-to-noise ratio.

Correcting Fig. 5A with the values from Fig. 16 gives Fig. A (this letter) where the a-m/f-m cross over point is shifted from + 20 db to + 10 db, and it remains to be seen if, when one has to make a decision to use a-m or f-m, one would not choose f-m, because of its generally better signal-to-noise ratio. It takes the loss in signal-to-noise ratio for very small signal frequencies.

See width of 50 kc f-m modulation of ± 20 kc, one sees that on 320 mc, using apparatus with the same relative frequency stability as on 160 mc, one could have a swing of ± 20 kc in a bandwidth of 60 kc.

In that case, in the same way as Mr. Toth does, and using his Eq. 1, 2 and 3, one can find the signal-to-noise ratios for f-m without and with limiter. For input carrier to

BRADLEY RECTIFIERS

MEDIUM POWER SELENIUM RECTIFIERS

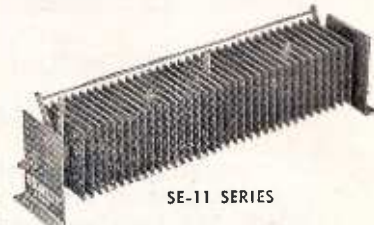

Rated from 50 ma up, these Bradley exclusive Vacuum-Processed rectifiers are available in half-wave, full-wave bridge, voltage multiplier, center-tap full-wave, polyphase and special connections. Aluminum plates, improved assembly hardware, afford best thermal characteristic and economy in size and weight. Hermetically-sealed or protectively coated.

PHOTO CELLS

Simplify Photo Cell Control



Luxtron* photo cells convert light into electrical energy. No external voltage is required to operate meters and meter relays directly from Bradley photo cells, improving control over your processes, reducing your costs. Housed model shown. Many different sizes and shapes, mounted and unmounted.

* T. M. REG. U. S. PAT. OFF.

Our engineers will select or develop Selenium or Copper Oxide Rectifiers or photo cells to meet your needs exactly. Write for BRADLEY LINE showing basic models.

BRADLEY
LABORATORIES, INC.
82 Meadow St. New Haven 10, Conn.

August, 1949 — ELECTRONICS

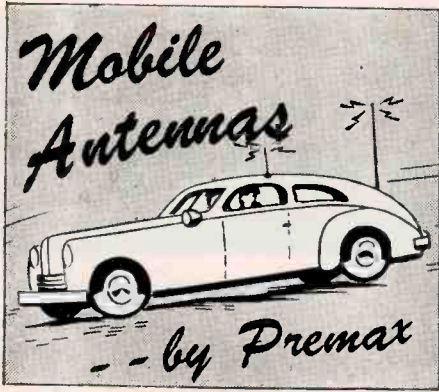

For Police, Commercial and General Mobile Use

You always get strong signals with Premax cadmium-plated or stainless steel "whip type" Antennas. Strong, sturdy — will stand abuse. All types of mountings to fit any job.

Send for special Mobile Antenna Bulletin.

PREMAX PRODUCTS
DIVISION CHISHOLM-RYDER CO., INC.

4902 Highland Ave., Niagara Falls, N. Y.

**—MICO—
ENGRAVER**



FEATURES

1. Ball Bearing Micrometer spindle for absolute control of depth of cutter in all four ratios.
2. Accuracy of reproduction in four ratios due to excellent precision machining of pantograph arms.
3. Absolute accuracy in three-dimensional duplicating.
4. Many attachments available to increase versatility, such as extension arm, rapid self-centering vise, extension post for pantograph and copy carrier, hand engraving spindle and many more.
5. Copy and work right-side up and in view of operator.

Catalog on Request

MICO INSTRUMENT CO.
76E Trowbridge St. Cambridge 38, Mass.

NOW! Modern, Comprehensive TV "Staging" plus NEW TV REVENUE from Pattern Time

with the **GRAY TELOP**



This most versatile telecasting optical projector enables dual projection with any desired optical dissolve under exact control.

The accessory **STAGE NUMBER 1** adds three functions separately or simultaneously: a) teletype news strip, b) vertical roll strip and c) revolving stage for small objects.

The **TELOP**, used with TV cameras, permits instant object to another, dissolve or by scene. Widest latitude is directors for maximum interest and increased income.

For full details write for Bulletin T-101

GRAY RESEARCH and Development Co., Inc.
16 Arbor St., Hartford 1, Conn.

Be **FIRST!**

with the **16" GLASS TUBE**
by **ZETKA**

famous for Quality and Dependability

- ★ Long life
- ★ Flat face
- ★ Ion trap
- ★ Shorter in length
- ★ 15" and 16" tubes available NOW!
- ★ Guaranteed unconditionally (not pro rated) for one full year!

write: **ZETKA TELEVISION TUBES, INC.**
131 Getty Ave., Clifton, N. J. or phone: PRescott 7-5020

about capacitors

The short time breakdown voltage of a well-made D.C. capacitor is not less than 5 to 6 times the actual working voltage at 20°—

$$E = 5 \times e \text{ min}$$

E = Breakdown voltage
e = Rated d.c. working voltage

INDUSTRIAL CAPACITORS are unvaryingly held to this formula.

Designed for maximum safety factor and the smallest possible volume, **INDUSTRIAL CAPACITORS** are the most widely used capacitor in industrial applications.

WRITE TODAY FOR DETAILED CATALOG

INDUSTRIAL CONDENSER CORP.



Watch this space for other capacitor facts that will help you.

Sales Offices in All Principal Cities
3243 N. California Ave.
Chicago 18, Illinois

• CONTACTS •

ONLY THE
EICO MODEL 400
5" 'SCOPE...
... has
BOTH
big
features*



\$69⁹⁵

***Lowest Price**
***Laboratory Precision**

When COST is a factor, and QUALITY is essential—specify EICO Model 400. Not a kit, but a fully-wired, laboratory-quality 5" oscilloscope of the most advanced design and construction. Widely used in production, research, service, and education. Write for folder 5-E. Also available in kit form, complete. **\$39.95**

ELECTRONIC INSTRUMENT CO., INC.
276 Newport Street • Brooklyn 12, N. Y.

**MICROMETER
FREQUENCY
METER**

will monitor any number of frequencies, FM or AM, 100 KC to 175 MC

LAMPKIN LABORATORIES, INC.
Bradenton, Fla., U. S. A.



**FINE RIBBONS
OF
TUNGSTEN and MOLYBDENUM**

Quality and accuracy in our fabrication of Tungsten & Molybdenum Ribbons have characterized our service to the Electronic industry.

A development of
H. CROSS Co.
15 Beekman St., New York 7, N. Y.

EL-TRONICS, INC.



Research, development, and manufacture of electronic equipment—a single source for large quantities.

Specialists in Geiger-Muller equipment

2547-67 N. Howard St., Phila.
Garfield 5-2026

EISLER—Manufactures Complete Equipment for:

SPOT WELDERS, Electric, for 1/4 to 250 KVA.
A.C. ARC WELDERS from 100 to 400 Amps.
TRANSFORMERS, Special and Standard Types.
INCANDESCENT LAMP Manufacturing Equipment.
FLUORESCENT TUBE Manufacturing Equipment.
NEON SIGN MAKERS EQUIPMENT.
ELECTRONIC EQUIPMENT, Vacuum Pumps, etc.
WET GLASS SLICING and Cutting machines for Laboratory use.
EISLER ENGINEERING CO., INC. 751 So. 13th St. Newark 3, N. J.

EISLER
SPECIALIZES IN EQUIPMENT FOR THE COMPLETE MANUFACTURE OF



Incandescent and Fluorescent Lamps, Luminous Neon Signs, Radio, Cathode Ray, Television and Electronic Tubes of All Sizes

36-Head Radio Tube Exhausting Machine.

**Transformers of All Types
IN SIZES FROM 1/4 TO 300 KVA**

For Lighting Power Welding Phase Changing Auto Testing

Special Transformers For Electronic Devices

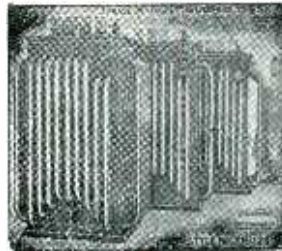

EISLER ENGINEERING CO. Inc.
751 So. 13th St. Newark 3, N. J.



Antennae, Precision Springs, Grid Clips, Dial Cord Springs and other springs of all types pertaining to Radio and Television.

Your Inquiries Invited

WEBSTER SPRING CORPORATION
176 Johnson St., U.L. ster 5-3196-7-8, Brooklyn 1, N. Y.

FLUXES
SOLDERING
BRAZING & WELDING

ALLEN

L. B. ALLEN CO. INC. Chicago 31, Ill.
6751 BRYN MAWR AVE.

NOW!

- ▶ the basic theory
- ▶ design techniques
- ▶ industrial uses

of Ultrasonics!

HERE is the first engineering consideration of the ultrasonic field... the essential theory, plus an abundance of practical information never before published! This important new book reviews electronic considerations and outlines of circuits. Mechanical and electrical design and construction techniques of ultrasonic systems are included... everything from the design considerations of holders for ultrasonic use to the experimental measurement of ultrasonic waves in various media.

ULTRASONICS

By Benson Carlin

Formerly, Product Research Supervisor, Sperry Products

264 pages • 162 illustrations • \$5.00

BOTH theoretical and practical, this book is definitely slanted toward engineering design and use in definite industrial applications. It brings you valuable information on: material testing, agitation, ultrasonic transducers, ultrasonic systems. It explains clearly the characteristics of ultrasonic waves that are important in practical applications: curves, waves, and complex waves; Fourier's theorem, wave trains and the law of angular transmission; the ways ultrasonic waves may be produced, and the electro-mechanical converting systems.

Spotlights Practical Uses in Many Fields

Brought out of the research laboratory and into industry, ultrasonics has tremendously-broad, practical applications. This guide points the way to greater use of ultrasonics in, for example, MATERIALS TESTING: to detect flaws in metals, plastics and glass, etc.; CHEMICAL INDUSTRIES: to make better mixtures and emulsions, etc.; METALLURGY: for extremely uniform mixtures free of air bubbles, etc. It likewise discusses experimental applications to systems of television, underwater signaling, depth sounding, communication, destruction of bacteria, etc.

CONTENTS

1. Ultrasonic Waves
2. Ultrasonic Waves: Further Theory
3. Crystals for Ultrasonic Use
4. Crystal Holders for Ultrasonic Use
5. Resonance and Reflection
6. Continuous-wave Ultrasonic Systems
7. Pulsed Ultrasonic Systems
8. Ultrasonic Agitation
9. Magnetostriction
10. Practical Considerations in the Application of Ultrasonics

**SEND NO MONEY
See it 10 Days
ON APPROVAL!**

McGraw-Hill Book Co.
330 W. 42d St., NYC 18

Send me Carlin's ULTRASONICS for 10 days' examination on approval. In 10 days I will send \$5.00, plus a few cents for delivery, or return the books. We pay for delivery if you remit with this coupon: same return privilege.

Name

Address

City Zone..... State.....

Company

Position

Books sent on approval in U. S. and Canada only.

When you're in need of some product or service to speed and improve operation, or save money, you may find it here—in the Where To Buy Section. *each issue.*

PRINTED CELLOPHANE

Colorful - Self Adhesive - Cellophane, processed in Rolls. Easy to buy - Easy to apply - used for Packaging - Point of Sale advertising - Parts marking and Aircraft Wire terminal identification.

TOPFLIGHT TAPE - YORK, PA.

TOROID COILS

in 3 sizes

wound to your specifications
OR
incorporated in filter designs



For coils with ultra-high Q—60 and up at 1000 cycles—consult CHICAGO. New precision winding equipment, plus unusual production techniques, make possible inductance values that are accurate within exceedingly close limits.

For filters designed to the most exacting specifications, consult CHICAGO. Engineering and manufacturing experience that has already produced successfully in this field is at your disposal.

Inquiries for coils or filters in any production quantity are invited. Prompt attention will be given to your requirements.

Illustrations show coils actual size



CHICAGO TRANSFORMER

Division of Essex Wire Corporation

3501 ADDISON STREET • CHICAGO 18, ILLINOIS

CUT COSTS

IN FREQUENCY CONTROL DESIGN . . .
ELIMINATE TEMPERATURE CONTROL OF CRYSTALS

WITH

±.0025%
-55°C to +90°C

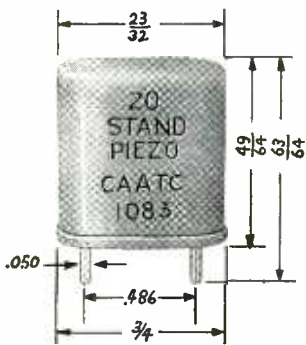

Improved processing of our hermetically sealed Type 20 unit has made it possible to eliminate the cost of temperature control.

Lower power requirements, reduced weight, compactness, ruggedness, and dependability in our improved Type 20 is your answer for reducing costs and increasing sales.

For complete details, write for free catalog.

Standard Piezo Company
CARLISLE, PA.

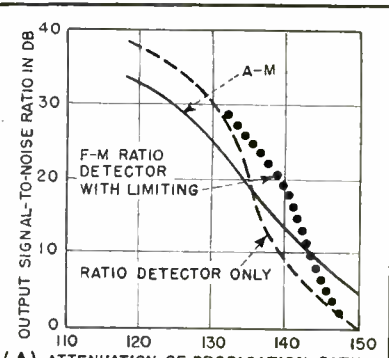

(A) ATTENUATION OF PROPAGATION PATH

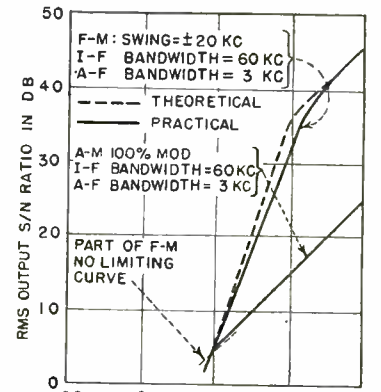

(B)

noise ratio 0 db f-m without limiter and ± 20 kc swing, an output signal-to-noise ratio of +4.5 db is found.

Following Mr. Toth, and considering this point the capture transition point, the f-m curve for perfect limiting runs from this point up to a point given by an input C/N ratio of 10 db and an output signal-to-noise ratio of 36 db.

Drawing Figure B it follows that for this case f-m is better than a-m down to an output signal-to-noise ratio of about +5db, so that even at this extremely low signal level f-m gives better or at least the same signal-to-noise ratio as a-m.

When using still narrower bandwidths, and corresponding smaller swings, the f-m improvement in relation to a-m can even be used at low signal levels. This is, however, not practically possible on uhf owing to frequency stability difficulties.

D. J. BRAAK

Philips Telecommunication Industries,
Hilversum, Holland

Editor's Note: The author of the original article mentioned above has prepared a detailed reply answering the comments made by Mr. Braak. This reply will be published in *Backtalk* in the next issue of *ELECTRONICS*.

PROFESSIONAL SERVICES

THE BARRY CORPORATION

Specialist in the Control of
VIBRATION IMPACT NOISE
*Engineering Development
Manufacturing*
185 Sidney Street Cambridge, Mass.
Telephone: ELIot 0861-0140

MEASUREMENT ENGINEERING LIMITED

Consultants on Special Equipment for measurements
and production tests, communications and audio
systems.
Head Office and Plant
Amprior Canada
60 Front Street West Montreal
Toronto, Canada Canada

S. BERTRAND BARNARD, LL.B., M.E.

REGISTERED PATENT ATTORNEY
Mechanical, Electronic,
Automotive and Aircraft Patents.
PATENT ANALYSES and INVESTIGATION
29-28 41st Avenue
Long Island City 1, N. Y. STIllwell 4-5428

Eugene Mittelman, E.E., Ph.D.

Consulting Engineer & Physicist
High Frequency Heating — Industrial Electronics
Applied Physics and Mathematics
549 W. Washington Blvd. Chicago 6, Ill.
State 2-8021

CROSBY LABORATORIES

Murray G. Crosby & Staff
FM, Communications, TV,
Industrial Electronics,
High-Frequency Heating
Offices, Laboratory & Model Shop at:
126 Old Country Rd., Mineola, N. Y.
Garden City 7-0284

NEWTON ENGINEERING SERVICE

Transformers for Electronics
Designs, prototypes and production quantities to
individual requirements. We offer a highly per-
sonal service and fast delivery on "Breadboard
models".
84 Linden Park Street Highlands 2-1310
Boston 20, Mass. Nights—Holidays LA Salle 7-4959

EDGERTON, GERMESHAUSEN & GRIER, Inc.

Consulting Engineers
Research, Development and Manufacture
of Electronic and Stroboscopic Equipment
Specialists in High-Speed Photography
160 Brookline Avenue, Boston 15, Mass.

NIAGARA ELECTRON LABORATORIES

CONSULTATION - DESIGN - CONSTRUCTION
MPG. - THE THERMOCAP RELAY
Specializing in solution of problems of electronic
and electro-physical instrumentation for the re-
search or analytical laboratory. Industrial plant
problems also invited.
Andover, New York Cable Address: NIATRONLAB

ELECTRO IMPULSE LABORATORY

Consulting Physicists
Radio Interference and Noise Meters; Interference
Suppression Methods for Ignition Systems and
Electrical Devices.
P. O. Box 250 Red Bank, New Jersey
Red Bank 6-4247

PICKARD AND BURNS, INC.

Consulting Electronic Engineers
Analysis and Evaluation
of Radio Systems
Research, Development & Design
of Special Electronic Equipment
240 Highland Ave., Needham 94, Mass.

ELECTRO-MECHANICAL RESEARCH INC.

Specialized Research and Manufacture
High and Low Frequency Circuit Development
Electronic Measuring and Test Equipment
Optical and Infra-Red Studies
Special Geophysical Equipment
Automatic Inspection Devices
Ridgefield, Conn.

ALBERT PREISMAN

Consulting Engineer
Television, Pulse Techniques, Video
Amplifiers, Phasing Networks,
Industrial Appliances
Affiliated with
MANAGEMENT TRAINING ASSOCIATES
3308-14th St., N.W. Washington 10, D.C.

ELECTRONIC ENGINEERING CO. of CALIFORNIA

Radio and Electronic Consulting and
Designing.
2008 W. Seventh St. Los Angeles
DRexel 8323 California

A. F. SMUCKLER & CO., INC.

Electronic and Communication
Engineers and Manufacturers
202-208 Tillary Street Brooklyn 1, N. Y.
ULster 5-5141

ERCO RADIO LABORATORIES, INC.

Radio Communications Equipment
Engineers - Design - Development - Production
Pioneers in Frequency Shift Telegraph
Garden City • Long Island • New York

TECHNICAL MATERIEL CORPORATION

Communications Consultants
RADIO TELETYPE • FREQUENT SHIFT
INK SLIP RECORDING
TELETYPE NETWORKS
453 West 47th Street New York 19, N. Y.

PAUL GODLEY CO.

Consulting Radio Engineers
GREAT NOTCH, N. J.
Est. 1926 Little Falls 4-1000

YARDENY LABORATORIES, INC.

Research and Development
Remote Controls and Electro Chemical
Generators of Energy
105 Chambers Street WO 2-3534, 35
New York, N. Y.

HANSON-GORRILL-BRIAN INC.

Product & Mfg. Development
ELECTRICAL - ELECTRONIC
HYDRAULIC - MECHANICAL
One Continental Hill Glen Cove, N. Y.
Glen Cove 1922

The Trend Toward Economy—

The service of the consulting engineer is a
real economy. With his knowledge of
organization and production problems and
his wide and varied experience, he can
usually reveal the points of waste and
inefficiency that are costing you money
and suggest inexpensive means for their
elimination.

SEARCHLIGHT SECTION

ELECTRONICS ENGINEER

A nationally known Chicago company
has permanent position for Electronic
Project Engineer. Must be college gradu-
ate with five or more years experience
in the design and development, for pro-
duction, of audio circuits. Salary is
commensurate with ability. Send com-
plete resumes.

P-9250, Electronics
520 N. Michigan Ave., Chicago 11, Ill.

REPLIES (Box No.): Address to office nearest you
NEW YORK: 330 W. 42nd St. (18)
CHICAGO: 520 N. Michigan Ave. (11)
SAN FRANCISCO: 68 Post St. (4)

POSITIONS VACANT

TECHNICAL WRITER: an Opportunity for an
experienced technical writer. Preferably
an electrical engineering graduate with experi-
ence in the field of electronic development. Re-
search Laboratory located adjacent to Wash-
ington, D. C. Salary commensurate with ex-
perience. P-9343, Electronics.

EMPLOYMENT SERVICES

SALARIED POSITIONS \$3,500-\$35,000. If you
are considering a new connection communi-
cate with the undersigned. We offer the origi-
nal personal employment service (39 years
recognized standing and reputation). The pro-
cedure, of highest ethical standards, is indi-
vidualized to your personal requirements and
develops overtures without initiative on your
part. Your identity covered and present posi-
tion protected. Send only name and address
for details. R. W. Bixby Inc., 278 Dun Bldg.,
Buffalo 2, N. Y.

EXECUTIVES \$3,000-\$25,000. This reliable
service, established 1927, is geared to needs
of high grade men who seek a change of con-
nection under conditions assuring, if employed,
full protection to present position. Send name
and address only for details. Personal consul-
tation invited. Jira Thayer Jennings, Dept. E.
241 Orange St., New Haven, Conn.

POSITIONS WANTED

ENGINEER-PHYSICIST. Available for direct-
ing and conducting original analysis, re-
search, and development in applied electronics.
Advanced educational background; compre-
hensive experience. PW-9116, Electronics.

SENIOR TELELECTRONIC Engineer. Now group
leader in charge of missile telemetering. 10
years experience: development of low frequency
circuits, instruments and instrumentation; liai-
son, Government spec., field work, report writ-
ing. Familiar with mechanical problems and
small shop methods. Energetic, imaginative,
resourceful. Excellent recommendations. Re-
ply PW-9399, Electronics, 68 Post St., San
Francisco, 4, California.

ELECTRICAL AND Electronic Engr., 17 yrs.
widely diversified experience. B.S. in E.E.
Univ. of Pgh. 1922. PW-9281, Electronics.

**Additional Employment
Advertising on page 222**

ELECTRICAL LINE WANTED

**FOR INDUSTRIAL PLANTS
MANUFACTURER'S REPRESENTATIVE
N. Y. C. & VICINITY**

20 years experience in distribution field &
application engineering in industrial field.
Can promise experienced, aggressive pro-
motion of good line.

RA-9364, Electronics
330 W. 42 St., New York 18, N. Y.

The great majority of this country's successful men have reached their present position after many years with the same organization. Top men in major industries have generally been with their respective companies for many years before they gained the knowledge and experience necessary to equip them for their present executive duties. On the other hand, those men who change their employment every two or three years are rarely in a position to be chosen for a responsible position.

Every organization places trust in its "old-timers". The employee with ten, twenty, or more years of service has the complete confidence of both his superiors and subordinates. His familiarity with his duties is unquestioned, and his ability to complete a given task is recognized.

If you are interested in a stable career holding ample opportunity for personal advancement, and are seriously interested in the field of Vacuum Tube Research, we would like to hear from you. Send your resume to:

DIVISIONAL PERSONNEL MANAGER

NATIONAL UNION RESEARCH DIVISION
350 SCOTLAND ROAD, ORANGE, NEW JERSEY

RESEARCH OPPORTUNITIES AT WESTINGHOUSE IN TELEVISION

Physicists and electronic engineers needed for an extensive project at the Westinghouse Research Laboratories in Pittsburgh. Excellent opportunities for specialists in optics, electron-optical devices, phosphors, photo surfaces, systems and circuits.

For application write Manager, Technical Employment

WESTINGHOUSE ELECTRIC CORP., 306 FOURTH AVE., PITTSBURGH, PA.

RADAR, COMMUNICATIONS and SONAR TECHNICIANS WANTED

For Overseas Assignments

Technical Qualifications:

1. At least 3 years' practical experience in installation and maintenance.
2. Navy veterans ETM 1/c or higher.
3. Army veterans TECH/SGT or higher.

Personal Qualifications:

1. Age, over 22—must pass physical examination.
 2. Ability to assume responsibility.
 3. Must stand thorough character investigation.
 4. Willing to go overseas for 1 year.
- Base pay, bonus, living allowance, vacation add up to \$7,000.00 per year. Permanent connection with company possible.

Apply by Writing to

A-1, P. O. Box 3414
Philadelphia 22, Pa.

Men qualified in RADAR, COMMUNICATIONS or SONAR give complete history. Interview will be arranged for successful applicants.

SCIENTISTS AND ENGINEERS

Wanted for interesting and professionally challenging research and advanced development in the fields of microwaves, radar, gyroscopes, servomechanisms, instrumentation, computers and general electronics. Scientific or engineering degrees or extensive technical experience required. Salary commensurate with experience and ability. Direct inquiries to Mgr., Engineering Personnel, Bell Aircraft Corporation, P. O. Box 1, Buffalo 6, N. Y.

ELECTRONIC ENGINEERS PHYSICISTS

"A leading Electronics Company in Los Angeles, California offers permanent employment to persons experienced in advanced research and development. State qualifications fully."

P 8606 Electronics
68 Post St., San Francisco 4, Calif.

WANTED REPRESENTATIVES

for induction dielectric heating equipment
High Frequency Heating Company

RW-9232, Electronics
520 N. Michigan Ave., Chicago 11, Ill.

Electronic Engineers

PROJECT ENGINEERS

Five or more years experience in the design and development, for production, of major components in radio and radar equipment.

ASSISTANT PROJECT ENGINEERS

Two or more years experience in the development, for production, of components in radio and radar equipment.

Well equipped laboratories in modern radio plant . . . Excellent opportunity . . . advancement on individual merit.

Baltimore Has Adequate Housing

Send resume to Mr. John Siena:

BENDIX RADIO DIVISION
BENDIX AVIATION CORPORATION
Baltimore 4, Maryland

2 SENIOR PROJECT ENGINEERS

WANTED FOR EXPANSION OF OPERATIONS

One with over 5 years experience in the design and development of complete radar units. Must know packaging of electronic prototypes.

One with over 5 years experience in circuits and thorough knowledge of DC amplifiers and pulse techniques.

Send resume to

AVION INSTRUMENT CORP.
121 E. 24 St. New York 10, N. Y.

WANTED

Electronic Engineer or Experimental Physicist with thorough theoretical knowledge and practical experience with electronic servo mechanisms for a permanent position in research and development of special instruments and electronic controls. Salary open. Give full details in first letter.

THE SHARLES CORPORATION
Research Laboratories
424 West Fourth Street, Bridgeport, Penna.

Additional
Business Opportunity Advertising
on page 244



PERMALLOY SHIELDS for CATHODE RAY TUBES

3" Shield	\$1.47
5" Shield	1.97

NOW AVAILABLE

1000 KC Crystal	\$.97
Socket	.07

SPECIALS OF THE MONTH

TUBES!! BRAND NEW! STANDARD BRANDS! NO SECONDS! COMPARE! TUBES!!

1B21	\$2.87	3EP1	2.87	304TTL	.99	838	3.45	C5B	7.95	OA2	1.57	5X4G	.57	68N6GT	.97	14F7	.69
1B22	4.57	3E20P7	8.97	305A	12.95	841	.49	C8A	8.45	OA4G	.95	5Y3GT	.39	68N7GT	.65	14F8	.89
1B23	4.89	3FP7	1.10	307A	3.95	843	.39	C6J	4.95	OB2	1.75	5Y4G	.49	68Q7	.50	12H7	.65
1B24	4.87	3GP1	4.97	316A	.39	845W	4.25	C100D	1.95	OZ4	.57	5Z3	.49	68R7GT	.57	14N7	.89
1B26	4.57	4-65A	14.49	327A	2.75	851	15.95	CK507AX	1.95	OIA	.47	5Z4	.49	68T7G	.59	12Q7	.57
1B27	4.89	4-125A	27.45	338A	3.95	860	1.89	CK1005	1.95	IA3	.47	6A7	.69	6U5	.65	15	.89
1B29	3.49	4-250A	37.45	350A	1.25	861	10.95	CK1090	2.95	IA4	.97	6A8	.79	6U7G	.55	19	.98
1B36	4.59	2AP10	5.95	350B	1.89	864	.49	EF50	.47	IA5GT	.49	6B7	.79	6V6	.67	24A	.67
1B38	37.50	4B2A	3.95	353A	2.95	865	.98	FI23A	12.95	IA6	.79	6B7G	.79	6V6GT	.97	25L6	.57
1D21	5.75	4C35	29.50	353B	7.95	866A	1.05	FI27A	14.95	IA7GT	.57	6AG7G	.79	6V6GT	.65	25L6	.57
1N21	.95	4E27	12.95	362A	1.95	866JR	1.10	FI27A	14.95	IA7GT	.57	6AG7G	.79	6V6GT	.65	25L6	.57
1N21B	1.95	4J32	97.50	368AS	3.95	869B	39.50	FI27A	14.95	IA7GT	.57	6AG7G	.79	6V6GT	.65	25L6	.57
1N23	1.75	5AP1	3.95	371B	.85	872A	1.47	FG06	22.50	IB5/25S	.69	6AJ5	1.29	6Z7G	1.15	27	.47
1N23B	2.25	5AP1	4.95	388A	2.95	874	.59	FG60	125.00	IC5GT	.67	6AK5	.85	7A4/XXL	.69	28D7	.37
1N34	4.85	5P1	1.89	385A	3.85	876	.98	FG60	125.00	IC5GT	.67	6AK5	.85	7A4/XXL	.69	28D7	.37
1P24	2.95	5BP4	2.85	394A	3.85	878	1.98	FG62A	450.00	IC6	.49	6AK6	.69	7A4/XXL	.69	31	.89
1B21	3.95	5CP1A	1.85	417A	14.50	884	1.39	PG17	2.89	IC7G	.89	6AK6	.69	7A4/XXL	.69	31	.89
2AP1	3.89	5CP1A	9.95	434A	3.50	885	.97	PG27A	9.75	ID5GP	.97	6AK6	.69	7A4/XXL	.69	31	.89
2C21	.27	5CP7	7.95	446A	1.25	902P1	3.85	PG95	3.95	ID5GT	.95	6AQ5	.69	7A7	.57	32	.97
2C32	.19	6C30	7.95	450TH	17.95	905	3.85	FG105	10.95	IF4	.75	6AT6	.47	7B6	.57	34	.67
2C32	3.25	5D21	34.95	450TL	52.50	908	4.95	FG172	12.95	IF5G	.75	6AU6	.79	7B7	.62	35/51	.57
2C34	.27	5FP7	1.35	527	7.95	923	.97	PT210	13.95	IF6	1.47	6AV6	.57	7C4	.37	35A5	.67
2C40	6.89	5GP1	4.95	559	.85	930	.85	GL146	9.95	IGACT	.69	6AV6	.57	7C5	.57	35B5	.65
2C43	9.97	5JP1	11.75	575A	12.95	931A	2.69	GL146	9.95	IGACT	.69	6B4G	.57	7C7	.67	35C5	.65
2C44	.67	5JP2	11.75	700A/B	953B	29.50	953B	GL582	85.00	IH4G	.69	6B7	.49	7E5	.67	35L6	.57
2C46	6.87	5J29	17.50	701A C/D	34.50	954	1.15	GL69A	69.50	IH5GT	.57	6B8G	.49	7E6	.59	35W4	.42
2C51	8.25	49.50	49.50	702A	3.25	956	.32	GL69A	69.50	IH5GT	.57	6B8G	.49	7E6	.59	35W4	.42
2D21	1.17	5LP1	13.95	702A	3.25	956	.32	GL69A	69.50	IH5GT	.57	6B8G	.49	7E6	.59	35W4	.42
2E22	1.29	5NP1	4.75	703A	3.95	957	.34	GL69A	69.50	IH5GT	.57	6B8G	.49	7E6	.59	35W4	.42
2E24	4.87	6C21	24.75	705A	1.10	958A	.35	GL69A	69.50	IH5GT	.57	6B8G	.49	7E6	.59	35W4	.42
2F26	3.49	6F4	5.59	706CY	18.75	959	.37	GL69A	69.50	IH5GT	.57	6B8G	.49	7E6	.59	35W4	.42
2J21A	9.95	6J4	5.95	707B	8.75	991	.27	GL69A	69.50	IH5GT	.57	6B8G	.49	7E6	.59	35W4	.42
2J26	3.50	7B7	4.69	708A	3.95	992	2.95	GL69A	69.50	IH5GT	.57	6B8G	.49	7E6	.59	35W4	.42
2J26	7.95	9GP7	12.50	713A	.95	1611	.97	GL69A	69.50	IH5GT	.57	6B8G	.49	7E6	.59	35W4	.42
2J27	8.95	9JP1	3.75	714A	12.95	1613	.59	GL69A	69.50	IH5GT	.57	6B8G	.49	7E6	.59	35W4	.42
2J30	32.50	9LP7	2.25	714AY	3.95	1614	1.45	GL69A	69.50	IH5GT	.57	6B8G	.49	7E6	.59	35W4	.42
2J31	9.75	10BP4	24.95	715C	34.95	1615	.98	GL69A	69.50	IH5GT	.57	6B8G	.49	7E6	.59	35W4	.42
2J32	9.75	10Y	7.15	717A	.65	1619	.98	GL69A	69.50	IH5GT	.57	6B8G	.49	7E6	.59	35W4	.42
2J33	39.50	12DP7	13.50	721A	1.95	1624	.69	GL69A	69.50	IH5GT	.57	6B8G	.49	7E6	.59	35W4	.42
2J34	39.50	12GP7	13.95	723A/B	24.95	1625	.37	GL69A	69.50	IH5GT	.57	6B8G	.49	7E6	.59	35W4	.42
2J37	17.50	12HP7	13.95	724A/B	3.95	1626	.37	GL69A	69.50	IH5GT	.57	6B8G	.49	7E6	.59	35W4	.42
2J38	12.95	15E	1.95	725A	9.50	1629	.27	GL69A	69.50	IH5GT	.57	6B8G	.49	7E6	.59	35W4	.42
2J39	34.50	15R	.79	726A	6.95	1630	1.98	GL69A	69.50	IH5GT	.57	6B8G	.49	7E6	.59	35W4	.42
2J40	49.50	23D4	.29	730A	10.95	1631	1.45	GL69A	69.50	IH5GT	.57	6B8G	.49	7E6	.59	35W4	.42
2J45	39.50	24C	4.47	750TL	45.00	1632	.98	GL69A	69.50	IH5GT	.57	6B8G	.49	7E6	.59	35W4	.42
2J48	39.50	30 spec	.35	800	1.95	1633	.98	GL69A	69.50	IH5GT	.57	6B8G	.49	7E6	.59	35W4	.42
2J49	24.95	45 spec	.29	801A	.49	1636	4.75	GL69A	69.50	IH5GT	.57	6B8G	.49	7E6	.59	35W4	.42
2J50	42.50	75TL	2.95	802	4.25	1638	.79	GL69A	69.50	IH5GT	.57	6B8G	.49	7E6	.59	35W4	.42
2J53	42.40	100R	1.85	803	4.95	1641	.69	GL69A	69.50	IH5GT	.57	6B8G	.49	7E6	.59	35W4	.42
2J54B	97.50	100TH	11.50	804	6.95	1642	.27	GL69A	69.50	IH5GT	.57	6B8G	.49	7E6	.59	35W4	.42
2F81	39.50	100TS	2.35	805	3.85	1655	1.10	GL69A	69.50	IH5GT	.57	6B8G	.49	7E6	.59	35W4	.42
2H2	39.50	20A	57.50	807	1.10	1851	.99	GL69A	69.50	IH5GT	.57	6B8G	.49	7E6	.59	35W4	.42
2K25	23.95	204B	1.75	808	1.39	1960	2.95	GL69A	69.50	IH5GT	.57	6B8G	.49	7E6	.59	35W4	.42
2K28	32.50	211	.49	809	2.45	2050	.65	GL69A	69.50	IH5GT	.57	6B8G	.49	7E6	.59	35W4	.42
3AP1	4.85	215A	.65	810	6.49	2061	.43	GL69A	69.50	IH5GT	.57	6B8G	.49	7E6	.59	35W4	.42
3B22	2.69	217C	1.69	811	1.69	2193	.19	GL69A	69.50	IH5GT	.57	6B8G	.49	7E6	.59	35W4	.42
3B23	2.15	218	47.50	812	2.65	8005	4.75	GL69A	69.50	IH5GT	.57	6B8G	.49	7E6	.59	35W4	.42
3B24	1.69	221A	1.95	812H	6.75	8011	.69	GL69A	69.50	IH5GT	.57	6B8G	.49	7E6	.59	35W4	.42
3B25	4.87	225A	8.70	813	6.27	8012	1.47	GL69A	69.50	IH5GT	.57	6B8G	.49	7E6	.59	35W4	.42
3B26	1.47	227A	2.95	814	2.75	8013A	1.45	GL69A	69.50	IH5GT	.57	6B8G	.49	7E6	.59	35W4	.42
3B27	3.85	231D	1.25	815	1.39	8014A	22.50	GL69A	69.50	IH5GT	.57	6B8G	.49	7E6	.59	35W4	.42
3BP1	1.39	249B	2.49	816	1.05	8016	1.95	GL69A	69.50	IH5GT	.57	6B8G	.49	7E6	.59	35W4	.42
3C21	5.95	250C	1.69	826	4.2	8025	3.75	GL69A	69.50	IH5GT	.57	6B8G	.49	7E6	.59	35W4	.42
3C22	39.50	250R	7.45	829B	7.45	8025	3.75	GL69A	69.50	IH5GT	.57	6B8G	.49	7E6	.59	35W4	.42
3C23	2.47	250TH	18.95	830B	3.49	9001	.34	GL69A	69.50	IH5GT	.57	6B8G	.49	7E6	.59	35W4	.42
3C24	.36	250TL	18.95	832A	4.25	9002	.34	GL69A	69.50	IH5GT	.57	6B8G	.49	7E6	.59	35W4	.42
3C30	.49	274B	1.19	833A	32.50	9003	.37	GL69A	69.50	IH5GT	.57	6B8G	.49	7E6	.59	35W4	.42
3C31	1.75	282B	9.75	834	5.75	9004	.37	GL69A	69.50	IH5GT	.57	6B8G	.49	7E6	.59	35W4	.42
3CP1	2.67	294A	4.57	836A	1.95	9005	1.95	GL69A	69.50	IH5GT	.57	6B8G	.49	7E6	.59	35W4	.42
3D21A	.98	294A	4.57	836A	1.95	9005	1.95	GL69A	69.50	IH5GT	.57	6B8G	.49	7E6	.59	35W4	.42
3DP1	1.97	304TH	3.45	837	1.25	9006	.24	GL69A	69.50	IH5GT	.57	6B8G	.49	7E6	.59	35W4	.42

OIL CONDENSERS NATIONALLY ADVERTISED BRANDS All Ratings D. C.

2x.1mfd.	600v	\$0.37	1mfd.	2000v	\$0.97
.25mfd.	600v	.37	2mfd.	2000v	1.27
.5mfd.	600v	.37	4mfd.	2000v	3.77
1mfd.	600v	.37	8mfd.	2000v	3.47
2mfd.	600v	.37	15mfd.	2000v	4.97
4mfd.	600v	.57	4mfd.	2500v	3.97
8mfd.	600v	1.07	2mfd.	2500v	2.37
10mfd.	600v	1.17	1mfd.	2500v	1.47
3x.1mfd.	1000v	4.47	.25mfd.	2500v	1.77
.25mfd.	1000v	.47	.5mfd.	2500v	1.77
1mfd.	1000v	.57	.5mfd.	3000v	1.97
2mfd.	1000v	.67	.25mfd.	3000v	2.67
4mfd.	1000v	.			



**FULLY
GUARANTEED**

BRAND NEW SURPLUS OFFERED BY A LEADING

A.C. MOTORS

5071930, Delco, 115 volts, 60 cycle, 7000 R. P. M.

Price \$4.50 each net.

36938-2, Haydon Timing Motor, 110 Volts, 60 Cycle, 2.2 Watts, 4/5 R. P. M.



Price \$3.00 each net.

Haydon Timing Motor—110 V. 60 cycle 3.2 Watts, 4 R. P. M., with brake.

Price \$4.00 each net

45629R Haydon Timing Motor, 110 volts, 60 cycle, 2.2 watts, 1/240 R. P. M.

Price \$3.15 each net.

36938-3, Haydon Timing Motor, 110 volts, 60 cycle, 2.2. Watts, 1 1/5 R. P. M.

Price \$3.15 each net.

36228 Haydon Timing Motor 110 volts, 60 cycle 2.2 watts 1/60 R. P. M.

Price \$3.00 ea. net

Eastern Air Devices Type J33 Synchronous Motor 115 V., 400 cycle, 3 phase, 8,000 R. P. M. Price \$8.50 ea. net

Telechron Synchronous Motor, Type B3, 115 volts, 60 cycle, 2 R. P. M., 4 watts.

Price \$5.00 each net.

SERVO MOTORS

CK1, Pioneer, 2 phase, 400 cycle.

Price \$10.00 each net.

CK2, Pioneer, 2 phase, 400 cycle.

Price \$4.50 each net.

10047-2-A Pioneer 2 phase 400 cycle with 40:1 reduction gear.

Price \$7.25 ea. net

FPE-25-11, Diehl, Low-Inertia, 75 to 115 V., 60 cycle, 2 phase.

Price \$16.00 each net.

FPE-49-7 Diehl, Low-Inertia, 115 volts, 60 cycle, 2 phase, 3.0 amps., 10 watts output.

Price \$34.50 ea. net

FP-25-2, Diehl, Low-Inertia, 20 volts, 60 cycle, 2 phase.

Price \$9.00 ea. net

FP-25-3, Diehl, Low-Inertia, 20 volts, 60 cycle, 2 phase.

Price \$9.00 ea. net

CK2, Pioneer, 2 phase, 400 cycle, with 40:1 reduction gear.

Price \$6.70 ea. net.

MINNEAPOLIS-HONEYWELL TYPE

B Part No. G303AY, 115 volts, 400 cycle, 2 phase, built-in gear reduction, 50 in lbs. torque. Price \$7.50 each net.

REMOTE INDICATING

MAGNESYN COMPASS SET

Pioneer Type AN5730-2 Indicator and AN5730-3 Transmitter 26 volts, 400 cycle.

Price \$40.00 per set new sealed boxes



Kollsman Remote Indicating Compass Set Transmitter part No. 679-01, indicator part No. 680k-03, 26 volts, 400 cycle. Price \$12.50 ea. net.

GYROS

Schwein Free & Rate Gyro type 45600. Consists of two 28 volt D. C. constant speed gyros. Size 8" x 4.25" x 4.25".



Price \$10.00 each net.

Schwein Free & Rate Gyro, type 46800. Same as above except later design.



Price \$11.00 each net.

Sperry A5 Directional Gyro Part No. 656029, 115 volts, 400 cycle, 3 phase.

Price \$17.50 each net.

Sperry A5 Vertical Gyro. Part No. 644841, 115 volts, 400 cycle, 3 phase.

Price \$20.00 each net.

Sperry A5 Amplifier Rack Part No. 644890. Contains Weston Frequency Meter. 350 to 450 cycle and 400 cycle, 0 to 130 voltmeter. Price \$10.00 each net.

Sperry A5 Control Unit Part No. 644836. Price \$7.50 each net.

Sperry A5 Azimuth Follow-Up Amplifier Part No. 656030. With tube. Price \$5.50 each net.

Pioneer Type 12800-1-D Gyro Servo Unit. 115 volts, 400 cycle, 3 phase.

Price \$8.00 each net.

Norden Type M7 Vertical Gyro. 26 volts D. C. Price \$19.00 each net

Norden Type M7 Servo Motor. 26 volts D. C. Price \$20.00 each net.

Allen Calculator, Type C1. Bank and Turn Indicator, Part No. 21500, 28 Volts, D.C. Contains 28V. D.C. constant speed gyro.

Price \$10.00 ea. net.

D.C. MOTORS

Jaeger Watch Co. Type 44-K-2 Contactor Motor, Operates on 3 to 4.5 volts D.C. Makes one contact per second.

Price \$2.00 ea. net.

General Electric Type 5BA10AJ52C, 27 volts D.C., 0.65 amps., 14 oz. in torque, 145 R. P. M. Shunt Wound, 4 leads reversible. Price \$4.70 ea. net.

General Electric Type 5BA10AJ37C, 27 volts D.C., .5 amps 8 oz. in. torque, 250 R. P. M. Shunt wound, 4 leads reversible. Price \$6.50 ea. net.

D.C. MOTORS



5069625, Delco Constant Speed, 27 volts, 120 R. P. M. Built-in reduction gears and governor. Price \$3.90 each net.

A-7155, Delco Constant Speed Shunt Motor, 27 volts, 2.4 amps., 3600 R. P. M., 1/30 H. P. Built-in governor.

Price \$6.25 each net.

C-28P-1A, John Oster Shunt Motor, 27 volts, 0.7 amps., 7000 R. P. M., 1/100 H. P. Price \$3.75 each net.

D.C. ALNICO FIELD MOTORS

5069456, Delco, 27.5 V., 10,000 RPM. Price \$4.70 each net.

5069600, Delco, 27 V., 250 R. P. M. Price \$4.70 each net.

5069466, Delco, 27 V., 10,000 R. P. M. Price \$3.00 each net.



5069370, Delco, 27 V., 10,000 R. P. M. Price \$4.70 each net.

5069230, Delco, 27 V. 145 R. P. M. Price \$5.00 each net.

S. S. FD6-16, Diehl, 27 V., 10,000 R. P. M. Price \$3.75 each net.

S. S. FD6-18, Diehl, 27 V., 10,000 R. P. M. Price \$3.75 each net.

S. S. FD-6-21, Diehl, 27 V., 10,000 R. P. M. Price \$3.75

Sampsel Time Control Inc. Alnico Field Motor, 27 Volts D. C. Overall length 3-5/16" by 1-3/8". Shaft 5/8" long by 3/16", 10,000 RPM.

Price \$4.50 each net.

GENERAL ELECTRIC D. C. SELSYNS



8TJ9-PDN Transmitter, 24 volts. Price \$3.75 each net.

8DJ11-PCY Indicator, 24 volts. Dial marked -10° to +65°. Price \$4.50 each net.

8DJ11-PCY Indicator, 24 volts. Dial marked 0 to 360°. Price \$7.50 each net.

AMPLIFIER

Pioneer Gyro Flux Gate Amplifier, Type 12076-1-A. Price \$17.50 ea. net, with tubes.

COMPLETE LINE OF AIRCRAFT THERMOCOUPLES

INSTRUMENT ASSOCIATES

147-57 41st AVENUE FLUSHING, N. Y.
Telephone INdependence 3-1919

Write for complete listings

U. S. Export License-2140

SUPPLIER OF ELECTRONIC & AIRCRAFT EQUIPMENT

IMMEDIATE DELIVERY

INVERTERS

Wincharger Corp. Dynamotor Unit. PE-101-C. Input 13, V.D.C. or 26 V.D.C. AT, 12.6 or 6.3 Amps. Output 400 V.D.C. AT. .135 Amps., 800 V.D.C. AT. .02 Amps, 9 V.A.C. 80 Cycle at 1.12 Amps. Price \$10.00 each net.

153F, Holtzer Cabot. Input, 24 volts D. C. Output 115 volts, 400 cycle 3 phase, 750 V. A. and 26 volts 400 cycle, 1 phase, 250 V. A., Voltage and frequency regulated also built in radio filter.

 Price \$115.00 each net.

149H, Holtzer Cabot. Input 28 volts at 44 amps. Output 26 volts at 250 V. A. 400 cycle and 115 volts at 500 V. A. 400 cycle. Price \$39.00 each net.

149F, Holtzer Cabot. Input 28 volts at 36 amps. Output 26 volts at 250 V. A. 400 cycle and 115 volts at 500 V. A. 400 cycle. Price \$35.00 each net.

12117, Pioneer. Input 12 volts D. C. Output 26 volts, 400 cycles, 6 V. A. Price \$22.50 each net.

12117-2, Pioneer. Input 24 volts D. C. Output 26 volts, 400 cycle, 6 V. A. Price \$20.00 each net.

5D21NJ3A General Electric. Input 24 volts D. C. Output 115 volts 400 cycle at 485 V. A. Price \$12.00 each net.

PE218, Ballentine, Input 28 volts D. C. at 90 amps. Output 115 volts 400 cycle at 1.5 K. V. A. Price \$45.00 each net.

WESTON FREQUENCY METER

Model 637, 350-450 cycle, 115 volts. Price \$10.00 each net.

WESTON VOLTMETER

Model 833, 0 to 130 volts, 400 cycle. Price \$4.00 each net.

VIBRATOR

Rauland Corp. vibrator non-synchros type. Stock No. 3H6694-11; 6, 12 or 24 volt D.C. input, frequency 200 cycle. Price \$3.25 ea. net.

PIONEER AUTOSYNS

AY1, 26 volts, 400 cycle. Price \$5.50 each net.

AY 14D, 26 volts, 400 cycle, new with calibration curve. Price \$15.00 each net.

AY20, 26 volts, 400 cycle. Price \$7.50 each net.

 AY31, 26 volts, 400 cycle. Shaft extends from both ends. Price \$10.00 ea. net.

AY38, 26 volts, 400 cycle. Shaft extends from both ends. Price \$10.00 ea. net.

PIONEER PRECISION AUTOSYNS

AY101D, new with calibration curve. 

PRICE—WRITE OR CALL FOR SPECIAL QUANTITY PRICES

AY131D, new with calibration curve. Price \$35.00 each net.

AY130D new Price \$35.00 each net.

PIONEER AUTOSYN POSITION INDICATORS

Type 5907-17. Dial graduated 0 to 360°, 26 volts 400 cycle. Price \$15.50 each net.

Type 6007-39, Dual, Dial graduated 0 to 360°, 26 volts 400 cycle. Price \$30.00 each net.

PIONEER TORQUE UNITS

Type 12602-1-A. Price \$30.00 each net.

Type 12604-3-A. Price \$30.00 each net.

Type 12606-1-A. Price \$40.00 each net.

Type 12627-1-A. Price \$80.00 each net.

MAGNETIC AMPLIFIER ASSEMBLY

Pioneer Magnetic Amplifier Assembly Saturable Reactor type output transformer. Designed to supply one phase of 400 cycle servo motor. Price \$8.50 each net.

PIONEER TORQUE UNIT AMPLIFIER

Type 12073-1-A, 5 tube amplifier, Magnesyne input, 115 volts, 400 cycle. Price \$17.50 each net with tubes.

Type 12077-1-A, single tube Amplifier, Autosyn input, 115 volts, 400 cycle. Price \$49.50 each net, with tube.

BLOWER ASSEMBLY

MX-215/APG John Oster, 28 volt D. C. 7000 R. P. M. 1/100HP. Price \$2.90 each net.

Westinghouse Type, FL Blower, 115 volts, 400 cycle, 67000 R. P. M., Air-flow 17 C. F. M. Price \$4.50 ea. net.

RATE GENERATORS



PM2, Electric Indicator Company, .0175 V. per R. P. M. Price \$8.25 ea. net.

F16, Electric Indicator Company, two-phase, 22 V. per phase at 1800 R. P. M. Price \$12.00 each net.

J36A, Eastern Air Devices, .02 V. per R. P. M. Price \$9.00 each net.

B-68 Electric Indicator Co., Rotation Indicator, 110 volts, 60 cycle, 1 phase. Price \$14.00 each net.

Weston Tachometer Generator (aircraft type) model 752-J4 single phase A.C. output. Price \$17.50 each net.

SINE-COSINE GENERATORS

(Resolvers)

FPE 43-1, Diehl, 115 volts, 400 cycle. Price \$20.00 each net.

FJE 43-9, Diehl, 115 volts, 400 cycle. Price \$20.00 each net.

SYNCHROS

If Special Repeater, 115 volts, 400 cycle. Will operate on 60 cycle at reduced voltage. 

7G Generator, 115 volts, 60 cycle. Price \$15.00 each net.

7G Generator, 115 volts, 60 cycle. Price \$30.00 each net.

6DG Differential Generator, 90-90 volts, 60 cycle. Price \$15.00 each net.

2J1M1 Control Transformer 105/63 Volts, 60 cycle. Price \$20.00 each net.

2J1G1 Control Transformer, 57.5/57.5 volts, 400 cycle. Price \$1.90 ea. net.

2J1H1 Selsyn Differential Generator, 57.5/57.5 volts, 400 cycle. Price \$3.25 each net.

2J5S1 Selsyn Differential Generator, 105-105 volts, 60 cycle. Price \$15.50 each net.

W. E. KS-5950-L2, Size 5 Generator, 115 volts, 400 cycle. Price \$3.50 ea. net.

5G Special, Generator 115/90 volts, 400 cycle. Price \$15.50 each net.

5SF Repeater, 115/90 volts, 400 cycle. Price \$19.00 each net.

2J1F1 Selsyn Generator, 115 volts, 400 cycle. Price \$3.50 each net.

1CT Control Transformer, 90/55 volts, 60 cycle. Price \$25.00 ea. net.

INSTRUMENT ASSOCIATES

Write for complete listings

ALL PRICES, F.O.B. FLUSHING, N. Y.

**147-57 41st AVENUE FLUSHING, N. Y.
Telephone INdependence 3-1919**

Western Union Address:
WUX Flushing, N. Y.

SEARCHLIGHT SECTION

MICROWAVE PLUMBING & ACCESSORIES



1.25 CENTIMETER
 "K" BAND DIRECTIONAL COUPLER CU104/APS-34 20 DB. \$49.50 ea.
 "K" BAND FEEDBACK TO PARABOLA HORN, with pressurized window. \$30.00
 MITRED ELBOW choke to cover. \$4.00
 TR/ATR SECTION choke to cover. \$4.00
 FLEXIBLE SECTION 1" choke to choke. \$5.00
 ADAPTER, rd. cover to sq. cover. \$5.00
 MITRED ELBOW and S sections choke to cover \$4.00
 WAVE GUIDE 1/2 x 1/2 per ft. \$1.00
 K BAND CIRCULAR FLANGES. \$50¢

10 CENTIMETER
 WAVEGUIDE TO 3/4" RIGID COAX "DOOR-KNOB" ADAPTER, CHOKE FLANGE, SILVER PLATED, BROAD BAND. \$49.50 EACH
 WAVEGUIDE DIRECTIONAL COUPLER, 27 db. Navy type CABV-47A, with 4 in. slotted section. \$42.50
 SQ. FLANGE choke adapter, 18 in. long OA 1 1/2 in. x 3 in. guide, type "N" output and sampling probe. \$32.00
 "S" BAND CRYSTAL MOUNT, gold plated, with 2 type "N" connectors. \$12.50
 PICKUP LOOP, Type "N" Output. \$2.75
 TR BOX Pick-up Loop. \$1.25
 POWER SPLITTER: 726 Klystron input, dual "N" output. \$5.00
 MAGNETRON TO WAVEGUIDE coupler with 721-A duplexer cavity, gold plated. \$27.50
 10 CM WAVEGUIDE SWITCHING UNIT, switches 1 input to any 3 outputs. Standard 1 1/2" x 3" guide with square flanges. Complete with 115 vac or dc arranged switching motor. Mfg. Raytheon. GRP 24AAS. New and complete. \$150.00
 10 CM END-FIRE ARRAY POLYPOIDS. \$175 ea.
 "S" BAND Mixer Assembly, with crystal mount, pick-up loop, tunable output. \$3.00
 721-A TR CAVITY WITH TUBE. Complete with tuning plungers. \$12.50
 10 CM. McNALLY CAVITY Type SG. \$3.50
 WAVEGUIDE SECTION, N. MC 445A, rt. angle bend, 5 1/4" ft. OA. 8" slotted section. \$21.00
 10 CM OSC. PICKUP LOOP, with male Horned output. \$2.00
 10 CM DIPOLE WITH REFLECTOR in lucite ball, with type "N" or Sperry fitting. \$4.50
 10 CM FEEDBACK DIPOLE ANTENNA, in lucite ball, for use with parabola 3/4" Rigid Coax input. \$8.00
 PHASE SHIFTER, 10 CM WAVEGUIDE TYPE ES-68381E, E PLANE TO H PLANE. MATCHING SLUGS. \$95.00
 721A TR cavities. Heavy silver plated. \$2.00 ea. ea. 10 cm. horn and rotating joint assembly, gold plated. \$65.00 ea.
 10 cm. right angle bend "E" or "H" plane less flanges. \$17.50 ea.
 "S" BAND "Y" JUNCTION, SQ. FLANGES. \$65.00

10 cm. waveguide to 3/4" rigid coax doorknob transition, 21" high with 8" slotted section. \$52.50 ea.
 10 cm. flexible section 4 feet long. \$42.50 ea.
 10 CM. FLANGES, UG65/U. \$35.00 ea.
 ADAPTER 1 1/2 x 3 TO 1 1/2 x 2" SQ. 10 CM FLANGE TO SQ 5 CM CHOKE. \$57.50
 KLYSTRON MOUNT W/TUNABLE MATCHING OUTPUT TO TYPE "N" CONNECTOR, SOCKET & TUBE CLAMP INCLUDED. \$12.50
 3/4" RIGID COAX-1/2" I.C. \$1.20
 SHORT RIGHT ANGLE BEND. \$2.50
 Rotating joint, with deck mounting. \$15.00
 RIGID COAX, slotted section CU-60/AP. \$5.00
 3/4" RIGID COAX-3/8" I.C. \$27.50
 7/8" RIGID COAX ROTARY JOINT, PRESSURIZED. SPERRY #S10613. GOLD PLATED.

Rotary assembly. Part of SCR 584. \$25.00 ea.
 Rotary joint. Part of SCR-584. \$35.00 ea.
 RIGHT ANGLE BEND, with flexible coax output pick-up loop. \$8.00
 SHORT RIGHT ANGLE bend, with pressurizing nipple. \$3.00
 RIGID COAX to flex coax connector. \$5.00
 STUB-SUPPORTED RIGID COAX, gold plated 5' lengths. Per length. \$5.00
 RT. ANGLES for above. \$2.50
 RT. ANGLE BEND 15" L. OA. \$3.50
 FLEXIBLE SECTION, 15" L. Male to female cable. \$4.25
 MAGNETRON COUPLING to 3/4" rigid coax. with TR pickup loop, gold plated. \$7.50
 FLEX COAX SECT. Approx. 30 ft. \$16.50

MISCELLANEOUS
 Type "N" patching cord UG11/U female to UG9/U using RG5/U cable 12" long. \$2.25 ea.
 AN/TPS-1B flanged nipple and insert assembly for rotary coupling. \$3.75 ea.
 Pulse connector Navy type 49579. \$1.50 ea.
 Transmission line pressure gauge. 2" 15 lbs \$1.85 ea.
 Pulse cable assembly. Western Electric type D162262, 10 feet long. \$4.50 ea.
 Holmdell Jack Western Electric #BO-12962-1 D.R. #J-102X. \$3.75 ea.
 Adapter type "N" RG8/U to RG17/U or 18/U cable. \$4.50 ea.
 ADAPTER TYPE "N" TO RG-17/U CONNECTOR. \$5.50
 F-29/SPR-2 HIGH PASS FILTER P/O AN/APR-5AX. TYPE "N" CONNECTORS. \$12.50
 Magnetron coupling to 3/4" rigid coax. \$5.00 ea.
 Hand pumps for pressurizing transmission line with humidity indicator. \$12.50 ea.

TEST EQUIPMENT
 TS-117/GP 10 CM WAVEMETER TEST SET, Mfg. "Sperry" 2400-3400 MC. Micrometer Adj. Coaxial Cavity. Freq. Meas by absorption or transmission method. Mounts Crystal Current Meter & Calib. Chart. \$175.00
 VSWR AMPLIFIER TS-12/AP. Unit 1 3 stages of Amplifier and Diode Rectifier w/direct VSWR, reading on meter. 115 volts 60 cyc. AC operation w/Inst. BK and COT diag. New. \$285.00
 SLOTTED LINE PROBE and Matched Termination Includ'g Accessories TS-12/AP Unit 2 Incl. UG81/U, CG92/U, CG91/U, CG89/U, UG79/U, CG87/U, MX158/U, CG88/U, CG90/U, UG80/U plus Tools. New. \$135.00
 COMPLETE TS-12/A UNITS 1 AND 2. \$350.00
 10 CM ECHO BOX CABV 14ABA-1 of OBU-3, 2890 MC to 3170 MCS. direct reading micrometer head. Ring prediction scale plus 9% to minus 9%. Type "N" input. Resonance indicator meter. New and Comp. w/access. Box and 10 CM Directional Coupler. \$350.00
 3 CM RECEIVER, SO-3. Complete with W.G. Ass'y (723 A/B) Reg. Fil. Power Supply, 6 Stages (7AC7) direct reading micrometer head. Ring prediction scale plus 9% to minus 9%. Type "N" input. Resonance indicator meter. New and Comp. w/access. Box and 10 CM Directional Coupler. \$350.00
 10 cm. horn assembly consisting of two 5" dishes with dipoles feeding single type "N" output. Includes UG28/U type "N" "T" junction and type "N" pickup probe. Mfg. Bernard Rice, RG/H cable. New. \$15.50 ea.
 10 cm. cavity type wavemeters 6" deep 8 1/2" in diameter. Coax. output. Silver plated. \$64.50 ea.
 10 cm. echo box. Part of SF-1 Radar with 115 volt DC tuning motor Sub Sig 1118A. \$47.50 ea.
 TS33AP WAVEMETER, MICROMETER ADJ. TYPE "N" FITTINGS. \$125.00

TS-268/U crystal test set for checking 1N21, 1N21A, 1N21B, 1N23A, 1N23B crystals New. \$35.00

THERMISTOR BRIDGE: Power meter I-203-A. 10 cm. mfg. W.E. Complete with meter, interpolation chart, portable carrying case. \$72.50
 W. E. I 138. Signal generator, 2700 to 2900 Mc. range. Light house tube oscillator with attenuator & output meter. 115 VAC input, reg. Pwr. supply. With circuit diagram. \$50.00
 3 cm. Wavemeter: 9200 to 11,000 mc. transmission type with square flanges. \$15.00
 3 cm. Stabilizer cavity, transmission type. \$2.00
 Bell Labs. Dual Mount mixer-beacon assemblies. 2 complete in 1. Beacon mounts on gold plated waveguide section. \$50.00
 TS-108A/P DUMMY LOAD. \$65.00
 3 CM. HORN AT-48/UP Model 710. Type "N" input. Hry. Silver Plated. \$6.50
 Sylvania 10 cm Signal Generator using 707B in precision micrometer adjust. McNally cavity. Equip. with wave guide below cut-off, attenuator, trigger input, supply: 115V, 50-1200 cycles. \$395.00
 BC1277 Sig. Gen. 500 mc with calib. atten. Supply: 115V, 50-1200 cycles. \$375.00
 3 CM Echo Box with 28 VDC PM sweep drive motor. Type "N" input. APS-3/6/15 \$35.00 each

MICROWAVE ANTENNAS
 SO-3 RADAR 3 CM. SURFACE SEARCH ANTENNA. Complete with 24 VDC Drive Motor, Selsyn, Gear Mechanisms, "X" Band Slotted "Peel" Reflector. Less Plumbing \$135.00
 As Shown
 APS-15 Antennas. New. \$99.50
 AN MPG-1 Antenna. Rotary feed type high speed scanner antenna assembly. Including horn parabola reflector. Less internal mechanisms. 10 deg. sector scan. Approx. 12" L x 4" W x 3" H. Unused. (Gov't Cost-\$4500.00). \$250.00
 APS-4 3 cm. antenna. Complete. 1 1/4" dish. Cutler feed dipole directional coupler, all standard 1" x 1/2" waveguide. Drive motor and gear mechanisms for horizontal and vertical scan. New complete. \$65.00
 AN/TPS3. Parabolic dish type reflector approx. 10" diam. Extremely lightweight construction New in 3 carrying cases. \$89.50
RELAY SYSTEM PARABOLIC REFLECTORS: approx. range: 2000 to 6000 mc. Dimensions: 4 1/2 x 3" rectangle, now. \$85.00
 TDY "JAM" RADAR ROTATING ANTENNA, 10 cm. 30 deg. beam, 115 v.a.c. drive. New. \$100.00
 SD-13 ANTENNA, 24" dish with feedback dipole 360 deg. rotation, complete with drive motor and selsyn. New. \$128.00
 Used. \$45.00
 DBM ANTENNA. Dual, back-to-back parabolas with dipoles. Freq. coverage 1,000-4,500 mc. No drive mechanism. \$65.00
 AS125/APR Cone type receiving antenna, 1080 to 3208 megacycles. New. \$4.50
 140-600 MC. CONE type antenna, complete with 25' sectional steel mast, guys, cables, carrying case, etc. New. \$49.50
 ASD 3 cm. antenna, used, ex cond. \$48.50
 YAGI ANTENNA AS-46A. APG-4. 5 elements \$14.50 ea.

MARINE RADAR
 SO-1 AND SO-8 RADAR SETS, complete. In Used but Excellent Condition. 10 CM. Surface Search using 2126 or 2127 Magnetron, 707B Mixer, PPI Indicator. Input 115VDC. Used on Merchant Ships throughout the world. FCC Approved. Guaranteed. \$1250.00

R. F. EQUIPMENT
 LHTR. LIGHTHOUSE ASSEMBLY. Part of RT-39/APG-5 & APG-15. Receiver and Transmitter Lighthouse Cavities with assoc. Tr Cavity and Type N CPLG. To Revr. Uses 2C40, 2C43, 1B27, Tuneable APX 2400-2700 MCS. Silver plated. \$49.50
 Receiver transmitter RT-39A/APG-5 10 cm. gun laying RF package using 2C40 and 2C43, new. \$150.00
 APS-2 10CM RF HEAD COMPLETE WITH HARD TUBE (715B) Pulsar, 714 Magnetron 417A Mixer all 3/4" rigid coax. incl. revr. front end \$210.00
 Beacon lighthouse cavity 10 cm with miniature 28 volt DC FM motor. Mfg. Bernard Rice. \$47.50 ea.
 T-128/APN-19 10 cm. radar Beacon transmitter package, used, less tubes. \$59.50 ea.
 SO-3 "X" band 3cm RF package, new complete, including receiver unit as illustrated on Page 37, Volume 23 RAD LAB Series. \$375.00 ea.
 Pre-Amplifier cavity type 71410690GL to use 446A lighthouse tube. Completely tunable. Heavy silver plated construction. \$37.50 ea.
 RT32/APG 6A RF HEAD, Compl. with 725A Magnetron magnet pulse xfmr. TRA-ATL. 723 A/B local osc. and beacon mount, pre amplifier. Used but exc. cond. \$97.50
 AN/APS-15A "X" Band compl. RF head and modulator, incl. 725-A magnetron and magnet, two 723A/B klystrons (local osc. & beacon), 1B24, TR, revr-ampl. duplexer, HV supply, blower, pulse trimmer. Peak Pwr Out: 45 KW apx. Input: 115, 400 cy. Modulator pulse duration .5 with all tubes incl. 715-B, 829B, RKR 73, type 715-B, compl. pkg. new. \$210.00
 "S" BAND AN/APS-2. Complete RF head and modulator, including magnetron and magnet, 417-A mixer, TR, receiver, duplexer, blower, etc., and complete pulser. With tubes, used, fair condition. \$75.00
 10 CM. RF Package. Consists of: 80 Xmr. receiver using 2-27 magnetron oscillator, 250 KW peak input. 707-B receiver mixer. \$125.00
 BC 758A Loran pulse modulator. \$125.00
 BC 758A pulse modulator. \$395.00

3 CENTIMETER (STD. 1" x 1/2" GUIDE UNLESS OTHERWISE SPECIFIED)
 3 cm. 180° bend with pressurizing nipple. \$4.00 ea.
 3 cm. 90° bend. 14" long 90° twist with pressurizing nipple. \$4.00 ea.
 3 cm. "S" curve 18" long. \$5.50 ea.
 3 cm. "E" curve 6" long. \$3.50 ea.
 3 cm. right angle bend. "E" plane 18" long. refer to cover. \$17.50 ea.
 3 cm. Cutler feed dipole. 11" from parabola mount to feed back. \$8.50 ea.
 3 cm. directional coupler. One way waveguide output. \$15.00 ea.
 TR ATR section for mounting 1B24 with 721A ATR cavity. Iris coupling flange. \$12.50 ea.
 chokes. \$12.50 ea.
 APS-31 mixer section for mounting two 2K25's Beacon reference cavity 1B24 TR tube. New and complete with attenuating slugs. \$42.50 ea.
 DUPLEXER SECTION for 1B24. \$10.00
 CIRCULAR CHOKE FLANGES, solid brass. .55
 SO. W. E. FLAT BRASS. \$1.50
 APS-10 TR/ATR DUPLEXER section with additional iris flange. \$10.00
 FLEX. WAVEGUIDE. \$4.00/ft.
 TRANSITION 1 x 1/2 to 1 1/2 x 3/4, 14 in. L. \$8.00
 "X" BAND PREAMPLIFIER, consisting of 2-723 A/B local oscillator-beacon feeding waveguide and TR/ATR Duplexer sect. Incl. 60 mA RF amp. \$67.50
 Random Lengths wavegd, 6" to 18" Lg. \$1.10 Ft.
 WAVEGUIDE RUN, 1 1/2" x 1/2" guide, consisting of 4 ft. section with Rt. angle bend on one end 2" 45 deg. bend other end. \$8.00
 WAVEGUIDE RUN, 1 1/2" x 1/2" guide, consisting of 4 ft. section with Lt. angle bend on one end 2" 45 deg. bend other end. \$8.00
 "X" BAND PRESSURIZING gauge section w/15-lbs. gauge & Pressurizing Nipple. \$18.50
 45 DEG. TWIST 6" Long. \$10.00
 12" SECTION 45 deg twist 90 deg. bend. \$6.00
 11" STRAIGHT WAVEGUIDE section choke to cover. Special Heavy Construction, silver plated. \$6.50
 15 DEG BEND 10" choke to cover. \$4.50
 5 FT SECTIONS choke to cover. Silver Plated. \$14.50
 18" FLEXIBLE SECTION. \$17.50
 "E" and "H" PLANE BENDS. \$12.50
 BULKHEAD FEED THRU. \$15.00
 "X" BAND WAVEGUIDE 1 1/2" x 1/2" OD 1/16" wall Aluminum. Per Foot. \$7.50
 WAVEGUIDE 1" x 1/2" I.D. Per Foot. \$1.50
 TR CAVITY FOR 724 A TR Tube. \$3.50
 3" FLEX SECT. sq. flange to Circo Flange Adapt. \$7.50
 724 TR TUBE (41-TR-1). \$22.50
 SWR MEAS. SECTION, 4" L. with 2 type "N" output probes. MTD full wave apart. Bell size guide. Silver plated. \$10.00
 ROTARY JOINT with slotted section and type "N" output pickup. \$17.50
 WAVEGUIDE SECTION, 12" long choke to cover 45 deg. twist & 2 1/2" radius, 90 deg. bend. \$4.50
 SLUICER TUNER/ATTENUATOR, W.E. guide, gold plated. \$6.50
 TWIST 90 deg. 5" choke to Cover w/press nipple. \$6.50
 WAVEGUIDE SECTIONS 2 1/2 ft. long silver plated with choke flange. \$5.75
 ROTARY JOINT choke to choke. \$17.50
 ROTARY JOINT choke to choke with deck mounting. \$7.50
 3 cm. mitred elbow "E" plane unplated. \$6.50 ea.

5 CM.
 2" x 1" RT. ANGLE BEND CHOKE TO COVER SILVER PLATED. \$39.50
 WAVEGUIDE MIXER CV-12/APR-6. \$55.00
 RAPID W. G. FASTENING CLAMPS. \$5.00

ALL MERCHANDISE GUARANTEED. MAIL ORDERS PROMPTLY FILLED. ALL PRICES F.O.B. NEW YORK CITY. SEND MONEY ORDER OR CHECK ONLY. SHIPPING CHARGES SENT C.O.D. RATED CONCERNS SEND P. O. MERCHANDISE SUBJECT TO PRIOR SALE

COMMUNICATIONS EQUIPMENT CO.
 131 E8 Liberty St., New York, N. Y. P. J. PLISHNER Cable "Comsupo" Ph. Digby 9-4124

www.americanradiohistory.com



SEARCHLIGHT SECTION



TS 268/U TEST SET

Test set designed to provide a means of rapid checking of crystal diodes IN21, IN21A, IN21B, IN23, IN23A, IN23B. Operates on 1/2 volt dry cell battery. 3x6x7.



New \$35.00

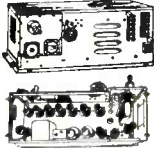

3 CM RECEIVER

SO-3 Complete with W.G. Mixer Assy (723 A/B) Reg. Fil. Power Supply, 6 Stages IF (6AC7) \$99.50

VARIATORS

- D-167176\$95
- D-168667\$95
- D-171812\$95
- D-171528\$95
- D-171121\$95
- 3A(12-43)\$1.50
- D-99946\$1.85
- D-172155\$2.25
- D-172307\$3.25
- D-162708E\$2.50
- D-97423\$1.95

THERMISTORS

- D-167332 (tube)\$95
- D-170396 (bead)\$95
- D-170613 (button)\$95
- D-166228 (button)\$95
- D-164699 for MTG. in "X" band Guide \$2.50
- D-167018 (tube)\$95
- D-168392\$95

WRITE FOR CEC CATALOGUE BARGAINS YOU NEED. FREE

PULSE EQUIPMENT

- MIT. MOD. 3 HARD TUBE PULSER: Output Pulse Power: 144 KW (12 KV at 12 amp). Duty Ratio: .001 max. Pulse duration: 5, 1.0, 2.0 microsec. Input voltage: 115 v. 400 to 2400 cps. Uses 1-715-B, 1-829-B, 3-72's, 1-773. New \$110.00
- APQ-13 PULSE MODULATOR. Pulse Width: 5 to 1.1 Micro Sec. Rep. rate 624 to 1348 Ips. Pk. pow. out 35 KW Energy 0.015 Joules. \$49.00
- TPS-3 PULSE MODULATOR. Pk. power 60 amp. 24 KV (1200 KW pk); pulse rate 200 PPS, 1.5 microsec; pulse line impedance 50 ohms. Circuit—series charging version of DC Resonance type. Uses two 705-A's as rectifiers. 115 v. 400 cycle input. New with all tubes \$49.50
- APS-10 MODULATOR DECK. Complete, less tubes. 75.00
- APS-10 Low voltage power supply, less tubes. \$18.50
- 725A magnetron pulse transformers. \$18.50 ea.

PULSE NETWORKS

- 15A-1-400-50: 15 KV, "A" CKT. 1 microsec. 400 PPS, 50 ohms imp. \$42.50
- G.E. #6E3-5-2000-50P2T, 6KV, "E" circuit, 3 sections, 5 microsecond. 2000 PPS, 50 ohms impedance. \$6.50
- G.E. #3E (3-94-810; 8-2-24-403) 50P4T; 3KV, "E" CKT. Dual Unit; Unit 1, 3 Sections, .84 Microsec. 810 PPS, 50 ohms imp.; Unit 2, 8 Sections, .24 Microsec. 405 PPS, 50 ohms imp. \$6.50
- 7.5E3-1-200-67P, 7.5 KV, "E" Circuit, 1 microsec, 200 PPS, 67 ohms impedance, 3 sections. \$7.50
- 7.5E4-16-60-67P, 7.5 KV, "E" Circuit, 4 sections, 16 microsec, 60 PPS, 67 ohms impedance. \$15.00
- 7.5E3-3-200-67P, 7.5 KV, "E" Circuit, 3 microsec, 200 PPS, 67 ohms imp., 3 sections. \$12.50

DELAY LINES

- D-168184: .5 microsec. up to 2000 PPS, 1800 ohm term \$4.00
- D-170499: .25/.50/.75/. microsec. 8 KV, 50 ohms imp. \$16.50
- D-165997: 1/4 microsec. \$7.50

PULSE TRANSFORMERS

- G.E.K.-2745\$39.50
- G.E.K.-2744: 115 KV High Voltage, 3.2 KV Low Voltage @ 200 KW oper. (270 KW max.) 1 microsec. or 1/4 microsec. @ 600 PPS. \$39.50
- W.E. #D166173 Hi-Volt input transformer, W.F. impedance ratio 50 ohms to 900 ohms. Freq. range: 10 kc to 2 mc, 2 sections parallel connected, potted in oil. \$36.00
- W.E. KS 9800 Input transformer. Winding ratio between 3 terminals 3-5 and 1-2 is 1:1.1, and between terminals 6-7 and 1-2 is 1:1. Frequency range: 380-520 cps. Permalloy core. \$6.00
- G.E. #K2731 Repetition Rate: 635 PPS. Pri. Imp: 50 Ohms, Sec. Imp: 450 Ohms. Pulse Width: 1 Microsec. Pri. Input: 9.5 KV PK. Sec. Output: 28 KV PK. Peak Output: 800 KW. Utiliza: 2.75 Amp \$64.50
- W.E. #D169211 Hi-Volt input pulse transformer. \$27.50
- G.E. K2450A. Will receive 4-5 micro-second pulse on pri., secondary delivers 14KV. Peak power out 100KW G.E. \$4.50
- G.E. #K2748A Pulse Input, line to magnetron. \$36.00
- #9280 Utah Pulse or Blocking Oscillator XFMR Freq. limits 790-810 cy-3 windings turns ratio 1:1:1 dimensions 1 13/16 x 3/4 x 1 1/2. \$1.50
- Raytheon U x 8693 3x32 Turns T.V. 1000 RMS. \$4.95
- G.E. 9318 Pulse XFMR 1:1:1. \$1.50
- UX 7350\$5.95

RADIO-RADAR SETS

- APS-15A SO-13 (used) QBG-1 (new)
- SE (new) SQ (used) TBM (used)
- SF (used) (new) CPN-6 (unused) TDE (used)
- SG (used) APS-3 (used) RAK-7 (new)
- SN (used) AS-4 (used & new) TBK-19 (new)
- SO-1 (used) APS-15 (near comp) SCR-545A (new)
- SO-12 SO-3 (new)

WRITE FOR DATA OF MANY OTHERS

COMMUNICATIONS EQUIPMENT for your needs COMPANY

UG TYPE CONNECTORS

Deduct 10% from prices shown on orders of 100 or more per type

AN #	Price ea.	AN #	Price ea.
UG-9/U	\$1.18	UG-115/U	\$1.69
UG-10/U	1.95	CW-123/U	7.56
UG-11/U	1.82	UG-131/U	2.81
UG-12/U	1.82	UG-134/U	6.69
UG-13/U	1.95	CW-155/U	.50
UG-14/U	1.82	UG-155/U	6.69
UG-15/U	1.18	UG-156/U	5.31
UG-16/U	1.95	UG-157/U	5.31
UG-17/U	1.82	UG-160/U	2.38
UG-18/U	1.25	UG-160A/U	1.98
UG-18A/U	1.95	UG-167/U	3.75
UG-18B/U	1.95	UG-167A/U	5.31
UG-19/U	1.57	UG-173/U	.38
UG-19A/U	1.72	UG-174/U	20.00
UG-19B/U	1.82	UG-175/U	.19
UG-20/U	1.46	UG-176/U	1.18
UG-20A/U	1.57	UG-178/U	.94
UG-20B/U	1.76	UG-185/U	6.25
UG-21/U	1.25	UG-186/U	2.89
UG-21A/U	1.31	UG-202/U	3.44
UG-21B/U	1.36	UG-203/U	.76
UG-22/U	1.35	UG-204/U	2.81
UG-22A/U	1.72	UG-204A/U	1.28
UG-22B/U	1.68	UG-207/U	22.50
UG-23/U	1.25	UG-208/U	22.50
UG-23A/U	1.25	UG-212/U	5.63
UG-23B/U	1.62	UG-213/U	5.63
UG-27A/U	3.44	UG-215/U	4.19
UG-28/U	2.93	UG-216/U	3.88
UG-29/U	1.53	UG-217/U	3.88
UG-29A/U	1.95	UG-218/U	8.13
UG-30/U	2.19	UG-222/U	43.75
UG-31/U	25.00	UG-231/U	2.50
UG-32/U	25.00	UG-235/U	35.63
UG-33/U	21.88	UG-236/U	14.69
UG-34/U	21.88	UG-239/U	.69
UG-35A/U	20.00	UG-241/U	2.75
UG-36/U	20.00	UG-242/U	3.13
UG-37/U	20.00	UG-243/U	3.44
UG-37A/U	20.00	UG-244/U	3.13
UG-38/U	2.19	UG-245/U	1.56
UG-39/U	.81	UG-246/U	1.85
UG-40/U	3.44	UG-252/U	5.63
UG-41/U	3.44	UG-253/U	2.81
UG-42/U	2.12	UG-254/U	2.81
UG-43/U	2.38	UG-255/U	2.31
UG-44/U	1.63	UG-256/U	13.75
UG-45/U	2.50	UG-257/U	13.75
UG-46/U	2.50	PL-258	1.22
UG-47/U	35.00	PL-259	.70
UG-48/U	1.88	PL-274	.78
UG-49/U	2.06	UG-259/U	5.13
UG-50/U	2.16	UG-260/U	1.24
UG-51/U	1.75	UG-261/U	1.19
UG-52/U	1.46	UG-262/U	1.31
UG-53/U	1.76	UG-268/U	3.25
UG-54/U	1.19	UG-270/U	8.13
UG-55/U	1.81	UG-271/U	4.13
UG-56/U	1.56	UG-273/U	1.88
UG-57/U	1.31	UG-274/U	2.48
UG-58/U	1.38	PL-274	1.40
UG-59/U	1.69	UG-275/U	5.63
UG-60/U	1.39	UG-276/U	5.63
UG-61/U	1.56	UG-279/U	3.00
UG-62/U	1.81	UG-287/U	6.56
UG-63/U	1.94	UG-290/U	1.06
UG-64/U	2.93	UG-291/U	1.31
UG-65/U	3.69	UG-306/U	2.54
UG-66/U	.90	UG-333/U	5.88
UG-67/U	.56	UG-334/U	7.19
UG-68/U	2.56	UG-335/U	13.75
UG-69/U	2.88	UG-352/U	7.50
UG-70/U	2.19	M-358	1.32
UG-71/U	2.19	M-359	1.32
UG-72/U	1.88		

PRECISION CAPACITORS

- D-163707: 0.4 mfd @ 1500 vdc. —50 to plus 85 deg C. \$4.50
- D-163035: 0.1 mfd @ 600 vdc, 0 to plus 65 deg C. \$2.00
- D-179998: 0.152 mfd, 300v, 400 cy. —50 to plus 85 deg C. \$2.50
- D-164960: 2.04 mfd @ 200 vdc, 0 to plus 65 deg C. \$2.50
- D-168344: 2.16 mfd @ 200 vdc, 0 to plus 55 deg C. \$3.00
- 0-161555: .5 mfd @ 400 vdc. —50 to plus 85 deg C. \$3.00
- D-166602: 16 mfd @ 400 vdc, temp comp 50 to 85 deg C. \$12.50
- D-161270: 1 mfd @ 200 vdc, temp comp —40 to plus 85 deg C. \$12.50

CERAMIC CONDENSERS

\$7.50 per 100

3 mmf	±5%	60 mmf	±3%
5 mmf	±5%	67 mmf	±20%
4 mmf	±5% mmf	115 mmf	±2%
3.5 mmf	±5% mmf	120 mmf	±3%
11 mmf	±5%	240 mmf	±5%
15 mmf	±2.5 mmf	250 mmf	±3%
50 mmf	±20%	1000 mmf	±5%

Silver-Mica Button Capacitors

(Standard Brand) \$9.50 per 100

185 mmf	±2.5 mmf
175 mmf	±2.5 mmf
500 mmf	±10%

RATED CONCERNS SEND P.O.

TUNABLE PKGD. "CW" MAGNETRONS

- OK 61 2975-3200 mc. OK 62 3150-3375 mc.
 - OK 60 2800-3025 mc. OK 59 2675-2900 mc.
- New Guaranteed. Each \$65.00

MAGNETRONS

Tube	Freq. Range	Pk. Pwr. Out	Price
2131	2820-2860 mc.	285 KW.	\$25.00
2121-A	9345-9405 mc.	50 KW.	\$25.00
2122	3267-3333 mc.	87 KW.	\$25.00
2126	2902-3019 mc.	265 KW.	\$25.00
2127	2965-2992 mc.	275 KW.	\$25.00
2132	2780-2820 mc.	285 KW.	\$25.00
2134			\$55.00
2137			\$45.00
2138 Pkg.	3249-3263 mc.	5 KW.	\$35.00
2139 Pkg.	3267-3333 mc.	10 KW.	\$65.00
2149	9600-9160 mc.	58 KW.	\$85.00
2161	3000-3100 mc.	35 KW.	\$65.00
2162	2914-3010 mc.	35 KW.	\$65.00
3J31	24,000 mc.	50 KW.	\$55.00
5J30			\$39.50
7144 Y, A			\$20.00
7187 Y			\$25.00
720BY	2800 mc.	1000 KW.	\$50.00
720CY			\$50.00
725-A	9345-9405 mc.	50 KW.	\$25.00
730-A	9345-9405 mc.	50 KW.	\$25.00
738-A, B, C, D, E, F, G, Y			@ \$50.00
706-A, B, Y, D, E, F, G, Y			@ \$50.00
Klystrons: 723A/B \$12.50; 707B W/Cavity \$20.00			
417A \$20.00			2xK41 \$65.00

MAGNETRON MAGNETS

Gauss	Pole Diam.	Spacing	Price
4850	3/4 in.	5/8 in.	\$12.50
5200	2 1/2 in.	3/4 in.	\$17.50
1300	1 5/8 in.	1 5/16 in.	\$12.50
1860	1 5/8 in.	1 1/2 in.	\$14.50

Electromagnets for magnetrons. \$24.50 ea.

- CPN-6—3 cm. beacon equipment. 115 v. 60 cy. oper. Complete installations, including wave guide and spare parts. \$2800
- CPN-3—10 cm. beacon equipment, in used but excellent cond. \$1500
- ASB 500 mc radar receiver. Equipped with 2 light-house cavities. New & complete, less tubes \$37.50
- VD Marker Beacon Equipment. Complete, mounted in trailer, with gas generator power supply. Full installation. \$1450
- WILCOX CS 390 CONTROL EQPT. ground station control of 10 transmitters, 2 modulators, 2 rectifiers, and 8 receivers. New, with spares. \$700 ea.

SUPERSONICS

- QCU Magneto striken head coil plate assembly, new. \$14.50
- QCQ-A-9/QCQ-B magneto striken head coil plate assembly. \$14.50
- QCQ—Complete Magneto striken heads RCA type CR 278225—New. \$75.00
- Stainless Steel streamlining housings for above \$18.50

INVERTERS

- PE 218-E: Input: 25-28 vdc, 92 amp. Output: 115 v. 350-500 cy. 1500 volt amps. Dim: 17" x 6 1/2" x 10". New, export packed. \$49.95
- PE-218-H: Same as above, except size: 16 1/2" x 6 1/2" x 10". \$49.95
- PE 218-I: Good cond. \$22.00
- PE 208: Input: 28 vdc, 35 amp. Output: 80 v. 800 cy, 500 volt-amps. Dim: 13" x 5 1/2" x 10 1/2". New \$12.50
- GE 5D21N13A: Input: 28 vdc, 35 amp. Output: 115 v. 400 cy, 485 volt-amps. Dim: 9" x 4 1/2" diameter. New \$49.95

400 CYCLE TRANSFORMERS

- 352-7273: Pri: 115V, 400 cy. Sec: 6.3V, 2.5 Amp, 6.3V, .06 Amp, 6.3V, .9 Amp, 5V, 6 Amp, 700 VCT, 2-5U4's. For APS-15, T201. \$4.75
- 352-7176: Pri: 115V, 400 cy. Sec: 6.3V, 20 Amp, 6.3V, .5 Amp, 6.3V, .5 Amp, 320V (2-6X5's). For APS-15, T202. \$5.25
- 352-7278: Pri: 115V, 400 cy. Sec: 2.5V, 1.75 Amp, 3500V (2x2). For APS-15, T203 (Anode #2 61P7). \$5.85
- 352-7070: Pri: 118V, 440 cy. Sec: 2.5V, 2.5 Amp, 2.5V, 2.5 Amp, (2000V. Ins.); 6.3V, 2.25 Amp, 1200V. Tpd at 1000 and 750V, P/O AN/APS 15 \$4.95
- #7489105: Pri: 115V, 400 cy. Sec: Tpd. to give 742.5V, 2.5A, 700V, 0.047 A, 671V, .05 A. \$2.95
- M-7474319: Pri: 115V, 400 cy. Sec: 6.3V, 2.7 Amp, 6.3V, .66Amp, 6.3V, .21 Amp. \$2.95
- 32332: Pri: 115V, 400-2400 cy. Sec: 400 Vct, 35 MA, 6.4V, 2.5 Amp, 6.4V, .15 Amp. \$2.25
- 332-7138M: Pri: 115V, 400-2400 cy Sec: 640 V, 5 MA, 2.5V, 1.75 Amp. \$3.85
- 352-7179: Pri: 115V, 400-2400 cy Sec: 6.5V, 12 Amp, Ct 250V, 100 MA; 5V, 2 Amp. \$3.50
- #9069: Pri: 115/80V, 400-2600 cy. Sec: 650 Vct, 50 MA, 6.3 Vct, 2 Amp; 5 Vct, 2 Amp. \$2.15
- 352-7096: Pri: 115/80V, 400-2400 cy. Sec: 2.5V, 1.75 Amp, 3 Kv. Ins.; 5V, 3 Amp; 6.5V, 6.5 Amp; 6.5V, 12 Amp. \$3.95
- KS 9607: Pri: 115V, 400-2400 cy. Sec: 734 Vct, 77 MA, 1710 Vct, 177 MA. \$5.95
- D-166333: Pri: 115V, 400-2400 cy. Sec: 6.3V, 0.9 Amp, 7.7V, 0.365 Amp. \$2.79
- GE #7471957: Pri: 100/110/120/130V, 400-2400 cy. Sec: 2.5V, 20 Amp, 11V ins. \$4.85
- D-163254: Pri: 115V, 4V cy. Sec: 6.3V, 12 Amp, 6.3V, 2A, 6.3V, 1A, P/O AN/APS 15. \$5.85
- KS-9685: Pri: 115V, 400-2400 cy. Sec: 6.4Vct, 7.5 Amp; 6.4V, 3.8 Amp; 6.4V, 2.5 Amp. \$4.33
- using 2127 magnetron oscillator, 250 KW peak input, 707-B receiver-mixer. \$150.00
- Modulator-motor-alternator unit for above. \$75.00
- Receiver-rectifier power unit for above. \$25.00

COMMUNICATIONS EQUIPMENT COMPANY

CABLE ADDRESS: COMSUPO
PHONE D1GBY 9, 4124
131 LIBERTY ST. DEPT. E
NEW YORK 7, N. Y.

RADIO TELEVISION ELECTRONICS **MICROWAVE** **FM** **RADIO SONAR**

C.E.C. MONEY BACK GUARANTEE, 43 MIN. ORDER
P.O. B. N. Y. C. SEND MONEY ORDER OR CHECK, ONLY SHIPPING CHARGES SENT C.O.D.

SEARCHLIGHT SECTION



PRECISION RESISTORS

1.01	125	1450	20000
3	128	1900	25000
5	150	2230	30000
5.05	200	4300	33000
10	250	5000	35000
10.1	300	7000	40000
18	430	7500	50000
43.5	468	8500	55000
50	800	10000	57000
75	920	12000	75000
82	1000	17000	Ship type
120	1100	17500	In stock

Above Ea. .30¢ Ten For. \$2.50
 100000 150000 200000 250000
 120000 170000 220000 500000
 Above Ea. .40¢ Ten For. \$3.50
 1,000,000 ohms. Each 75¢

MISCELLANEOUS

15 Watt Power Supply
 Consists of xfmr 600 vct/155MA.
 6.3v/5A, 253A, 2.7mfd 600r. dual
 10 hp 200MA choke, 1-STA, 1-
 socket. Price \$8.95

50 Watt Power Supply

Consists of xfmr 880vct/150MA.
 5v/3A, 6.3v/6.25A, 2-7 mfd 800r.
 1-57A, socket. Price \$10.95
 Filter Line GE 100amp w/2x5 mfd
 50v 0.1 Cond. operates on 110v

Filter Line 1kw. Clean up your
 BCI & TVI. Easy to mount, uses
 4-.002 Cond. Complete. \$4.25
 Deflection Yoke for 5" to 12" tube
 RA720A. \$4.49
 T 311 3000v/5MA, 720vct/200MA
 6.4v/8.7A, 6.4v/6A, 6.5v/3A, 1.25v
 1/3A Scoop. \$6.95
 T-462 10000v 5MA for 10"x15"
 \$10.95



TRANSFORMERS

115v 60cy. INPUT
 Equip. Conservatively Rated

FILAMENT TRANSFORMERS

5 Volts/6 Amp.	\$2.25
F083: 6.3VCT/6A, 5V/2A	1.85
F- 2.5VCT/6.5A	3.25
F- 6.3VCT/2A, 6.3VCT/2A	2.45
F087: 6.3VCT/1A, 6.3VCT/7A	2.75
F123: 6.3VCT/5A, 6.3V/1A	2.25
F127: 6.3VCT/3/2A, 6.3VCT/1A	2.25
F674: 8V/1.5A	2.75
F- 2.5/1.75A, 6.5/8A, 5V/3A, 6.5/6A	3.95
F414: 2 x 2.5VCT/6.5A	3.25
F161: 6.3VCT/7A, 6.3VCT/5A, 5VCT/6A	3.95
F- 2 x 6.3V/6A, 6.3V/3A	3.95
F38A: 6.3V/2.5A, 2 x 2.5V/7A	3.25
KS9905 6.3/6A	1.95

PLATE TRANSFORMERS

P410: 800VCT/40MA, 760VCT/500MA	6.50
P415: 680V/450MA	4.95
P699: 2 x 300VCT/25A	1.65
P403: 70V/1A	2.25
P413: 510VCT/150MA, 650VCT/15MA	4.95
P842: 600VCT/0166A, 250VCT/077A	2.95
P885: 1620VCT/400MA HV INS.	11.95
P894: 2 x 200V/350MA, 2 x 20V/.01A	1.95
P450: 2 x 150V/940MA	4.50
P371: 246VCT/330MA	3.95
P345: 1470VCT/1.2A, 3500T	24.00

COMMUNICATOR TRANSFORMERS

C965: 78V/600MA, 6.3V/2A	\$3.95
C111: 2 x 300V/42MA, 55V/125MA	3.95
45V/3.5 Amp	5.00
C608: 880VCT/150MA, 5V/3A, 6.3V/6.25A	3.95
C931: 585VCT/88MA, 5V/3A, 6.3V/6A	3.95
C055: 525VCT/75MA, 5V/2A, 6.3V/1.8A	4.45
10V/2A	5.95
T102: 1080VCT/55MA, 2 x 6.3V/2A	3.95
C848: 600VCT/155MA, 6.3VCT/5A	4.50
5VCT/3A HV Ins.	4.50
C899: 2 x 10VCT/01A, 6.3V/1A	4.50
2.5VCT/7A	5.50
C760: 6.3VCT/10A, 65V/1A, 100VCT/1A	2.95
40V/1A, 18VCT/1A, 18V-6V/1A, 6.3V/1A	2.95
C367: 5VCT/3A, 580VCT/040A	12.75
T160: 1120VCT/770MA, 590VCT/.082A	4.25
HV Ins	8.95
C579: 24V/900MA, 770V/.0025, 2.5V/3A	8.95
HV Ins	14.95
T378: 2300V/004A, 2.5V/2A HV Ins	1.95
C375: 1120VCT/600MA, 2 x 5VCT/6-2A	2.29
6.3VCT/3A, 6.3V/300MA	1.95
C434: 40V/01A, 6.3V/1.25A	2.29
C383: 215VCT/300MA, 5VCT/6A	8.95
C821: 1500V/4A, 6.3V/6A, 2.5V/1.75A, 3500T	

COMMUNICATIONS EQUIPMENT COMPANY for your needs

OIL CONDENSERS

.0016 MFD	15000 VDC	\$8.00
.015 MFD	18000 VDC	7.00
.01-.005-.005 MFD	10000 VDC	4.75
1 MFD	2500 VDC	1.25
1-.1 MFD	7000 VDC	3.49
1 MFD	6000 VDC	2.97
1 MFD	7500 VDC	3.00
2 x .1 MFD	4800 VDC	3.09
.15 MFD	4000 VDC	3.90
.15-.15 MFD	6000 VDC	4.00
2 x .15 MFD	8000 VDC	5.00
.25 MFD	1500 VDC	1.05
.4 MFD	5000 VDC	3.00
.5 MFD	1000 VDC	.70
.5 MFD	750 VDC	1.75
1 MFD	600 VDC	.49
1 MFD	2000 VDC	1.00
1 MFD	1500 VDC	.89
1.5 MFD	1500 VDC	.95
2 MFD	1500 VDC	1.05
4 MFD	750 VDC	.99
6 MFD	600 VDC	1.05
6 MFD	1500 VDC	2.25
7 MFD	600 VDC	1.05
7 MFD	800 VDC	1.25
10 MFD	1000 VDC	1.95
15 MFD	220 VDC	2.29
15 MFD	1000 VDC	2.25

H. V. OIL CONDENSERS

1.5 MFD	6000 VDC	10.00
1 MFD	15000 VDC	32.50
.5 MFD	25000 VDC	37.50
1 MFD	25000 VDC	85.00
1 MFD	10000 VDC	15.00
.06 MFD	15000 VDC	8.00
.25 MFD	20000 VDC	17.50
15 MFD	5000 VDC	27.50

AUTOMATIC CODE EQUIPMENT

TAPE PULLERS, (McElroy) TP 890, \$10-120
 TAPE BRIDGES, (McElroy) TG 815, complete \$2.50
 TAPE LOOPS: for TG-8 and TG-9.98
 BLACK CODE TAPE: 4" rolls, 3/4" wide. Per roll10

FREQ. MULT. UNIT

ART-13 XMTR Assy 2 to
 18MC Doubling Pack-
 age set up for two 1625
 Tubes. No Coils. Com-
 plete. Assy Less Tubes
 w/CKT Diagram. Price \$8.95

MICA

Mfd	Voltage	Price
.01	1200VWDC	2 for 95¢
.00025	2000VDC	2 for 55¢
.00004	2500VWDC	2 for 75¢
.01	2500VWDC	4 for 95¢
.002	3000VWDC	2 for \$2.00
.01	3000VWDC	2 for 2.90
.00003	2000VWDC	2 for 95¢
.00009	3000VWDC	2 for 1.45
.00082	3000VWDC	2 for 1.95
.002	3000VWDC	2 for 1.95
.005	5000VWDC	2 for 3.25
.0004	6000VWDC	2 for 2.95
.0006	3000VWDC	2 for 1.95
.0008	3000VWDC	2 for 1.85
.0016	3000VWDC	2 for 1.25
.00090	3000VWDC	2 for 75¢
.08	1500VWDC	2 for 19.50
.03	2000VWDC	2 for 23.50
.045	2000VWDC	2 for 23.50
.00015	20KVDC	2 for 47.50
.0001	20KVDC	2 for 47.50
.00027	2500VWDC	2 for 2.85
	2500VWDC	2 for 65¢

Send for Lists of Others

UPRIGHT OILS

Mfd	Voltage	Terminals	Price
.1	600VDC	2	3 for \$1.00
.25	400VDC	2	3 for 1.10
.5	600VDC	3	3 for 1.00
1	600VDC	2	3 for 1.10
2 x .5	600VDC	3	3 for 1.45
3 x .1	600VDC	3	2 for 1.05
.25	400VDC	2	3 for 1.10
.5	600VDC	2	3 for 1.00
1	600VDC	2	3 for 1.00
1	400VDC	2	3 for 1.00
.1	400VDC	2	2 for 75¢
.4	600VDC	2	3 for 1.10
1	600VDC	2	2 for 83¢
5	100VDC	2	2 for 95¢
1.75	400VDC	2	3 for 1.00
3 x .1	600VDC	3	2 for 1.05
2 x .5	600VDC	3	2 for 95¢
.1	600VDC	2	2 for 85¢
.1	600VDC	2	2 for 85¢
.1	500VDC	2	2 for 85¢
.1	500VDC	2	2 for 85¢
.1	600VDC	2	2 for 85¢

WRITE FOR LIST OF MANY OTHERS

FREE WRITE FOR OUR CATALOG TODAY AND SAVE

YOU'LL SAVE MANY DOLLARS WITH THIS FREE CATALOG

TRANSTAT AMERTRAN



Input: 0.115 v. 50-60 cycle. Max. output: 115 v. 100 amp. All units are new, guaranteed \$95 2 KVA: 90-130v input 50-60 cy cles, output 115v 2kva type RH Amertran \$29.95 each

KITS POWER SUPPLY

Basic TV 5" & 7" Pwr Supply
 Consists of xfmr 2300v/4MA, 2.5v/2A, 1 condenser, 1.1 mfd 1500v Pwr. 2x2 tube, socket 100K ohm resistor, price. \$9.95
 5BP1 \$1.95 5BP4 \$4.95 5CPI \$3.75

Basic TV 3" & 5" Pwr Supply
 Consists of xfmr 1080v/55MA, 2x6.3v/1.2A, 1 Cond., 1.1 mfd 7500v Pwr., 2x2 tube, socket 100 K ohm resistor. Price \$7.95
 3BP1 \$2.25 3DPI \$2.25 3EPI \$2.95

3" Oscilloscope Kits
 BC929 uses 9 tubes 3BP1, 6SN7, 6H6, 6H6G, 6X5 2X2 (now 400 cy) easily converted to 115v 60 cy New Complete w/tubes & Converter. \$22.50

5" Oscilloscope Kit
 BC 704 Less Pwr Supply Kit includes 8 tubes, 5BP1, 6AC7, 6H6 w/wooden Case & Diag. \$29.50

ELECTROLYTICS

TUBULAR PRONG MTG. LUG TERM DY. OR FR. TYPE

MFD	VOLT	PRICE
30	250	18¢

Mfd	Volt	Price
40	400	\$1.18
10-10	150	.18
20-20	25	.18
20-10	150	.18
10 for 1.70		.18
30-30	25	.18
40-40	150	.18
40-20	150	.18
40/20	150/25	.18
40-30	150	.18
10/50/100		.18
10/50/100	350/100/50	.18
10-10/10		.18
16	150/25	.18
20	350	.18
15	250	.18
20	450	.18
10	300	.18
8	450	.18
225	15	.29
20/20	350/25	.29
20-30	250	.29
30/20	350/25	.29
10/50/100		.29
10-15/20	450/100/50	.29
15	350/25	.49
10	450	.29
10	450	.29
20	525	.29
50	450	.60
60	500	.79
1000	15	.85
10-10	475	.49

Mfd	Volt	Price
30	450	\$4.49
30	300	.48
30	350	.45
40	450	.50
40	525	.50
16	350	.35
18	525	.45
16	450	.40
15	100	.24
20	25	.25
20	80	.25
20	450	.40
24	350	.30
8	400	.30
8	150	.15
10	150	.20
10	50	.15
12	450	.30
4	50	.10
4	150	.14
4	250	.20
8	25	.25
10-10	150	.25
25-25	50	.30
20-20	450	.60
50-30	150	.50
50-50	150	.55
50-40	450	.60
70-70	175	.69
20-20	450	.60

Many Others Avail.

TUBULAR SCREW MTG WIRELEADS D TYPE

Mfd	Volt	Price
4	600	\$3.35
8	250	.25
8-8	450	.50
16	450	.40
30	450	.45
40	450	.45
29	250	.45
29	250	.45
18	250	.30
8	600	.60
8	450	.30
18	600	.50
30	450	.50
20	150	.30
240	250	.80
30-30	450	.75

Send for List. RATED CONCERNS SEND P.O.

FILTER CHOKES

15-29HY/150MA	\$3.25	8.5HY/125MA	\$1.50
25HY/65MA	1.00	6HY/150MA	1.50
Dual 7HY/75MA, 11HY/65MA	1.65		
7HY/140MA	1.60	Dual 2HY/100MA	1.75
Dual 2.5HY/130MA	1.25	116HY/150MA	4.25
.01HY/2.5A	1.45	35HY/350MA	7.25
Dual 5HY/380MA	1.00	5HY/40MA	2.25
2HY/200MA	.75	Dual 12HY/177MA	2.45
30HY/20MA	.85	5HY/200MA	1.45
2.1HY/200MA	1.20	2 x 2.2HY/.55A	9.95
25HY/75MA	1.10	20HY/300MA	12.95
Swing 1-3HY/225-.02A, 1.75HY/225MA	2.25		
Tapped Choke 2 x 1.52HY/167MA	2.25		
.033HY/7.7A	0.50	Dual 10HY/150MA	3.50
Dual 1.52HY/167MA	2.49	Dual 2.2HY/550MA	5.95
12HY/100MA	1.75	1.35HY/1.1A	4.95
3.5HY/400MA	5.95	1HY/100MA	.60

Send For Lists of Others

POWER EQUIPMENT

-

SELENIUM RECTIFIERS

— and —
ELECTRONIC COMPONENTS

THREE PHASE BRIDGE RECTIFIERS

Input 0-126VAC Type #	Current	Output 0-130*VDC Price
3B7-4	4 AMP.	\$32.95
3B7-6	6 AMP.	48.90
3B7-15	15 AMP.	70.00

Input 0-234VAC Type #	Current	Output 0-250*VDC Price
3B13-4	4 AMP.	\$56.00
3B13-6	6 AMP.	81.50
3B13-15	15 AMP.	120.00

CENTER TAPPED RECTIFIERS

SINGLE PHASE

Input 10-0-10VAC Type #	Current	Output 0-8*VDC Price
C1-10	10 AMP.	\$6.95
C1-20	20 AMP.	10.95
C1-30	30 AMP.	14.95
C1-40	40 AMP.	17.95
C1-50	50 AMP.	20.95
C1-80	80 AMP.	26.95
C1-120	120 AMP.	34.95

CUSTOM DC POWER SUPPLIES
Built to your specifications.
For:

- INDUSTRY
- LABORATORIES
- UNIVERSITIES
- GOVERNMENT AGENCIES

We will be pleased to quote on your requirements.

*Select Proper Capacitor to Obtain Higher VDC Than Indicated.

VACUUM CAPACITORS

Standard Brands

12 Mmfd	20 Kv.	\$1.95
50 Mmfd	20 Kv.	4.95
50 Mmfd	32 Kv.	5.95

SILVER CERAMIC TRIMMERS

820-Z	5-20 Mmfd Zero Temp.	24¢
822-N	5-20 Mmfd Neg. 300	24¢
822-AZ	4.5-25 Mmfd Zero Temp.	24¢
823-AN	20-125 Mmfd Neg. 650	33¢

OIL CONDENSERS

2 Mfd 200VDC Bathub	\$.20
5 Mfd 400VDC telephone type	.20
2 Mfd 400VDC Bathub	.30
2X.1 Mfd 600VDC Bathub	.30
6 Mfd 600VDC w/mtg. Clamp	.79
10 Mfd 440VAC/1500VD w/Brkts	1.55
3 Mfd 660VAC/2000VDC w/Brkts	3.50
15-.15 Mfd 8000VDC Voltage Doubler	
Type 26F381 w/Brkts	3.95

ATTENTION!!!

INDUSTRIALS, EXPORTERS, SCHOOLS,
GOV'T AGENCIES, LABORATORIES

Our engineering staff is at your service to facilitate the application of rectifiers to your specific requirements.

SINGLE PHASE BRIDGE RECTIFIERS

Input 0-18VAC Type #	Current	Output 0-12*VDC Price
B1-500	500 MA.	\$1.95
B1-1	1 AMP.	2.49
B1-1X.5	1.5 AMP.	2.95
B1-3X.5	3.5 AMP.	4.50
B1-5	5 AMP.	5.95
B1-10	10 AMP.	9.95
B1-15	15 AMP.	13.95
B1-20	20 AMP.	15.95
B1-30	30 AMP.	24.95
B1-40	40 AMP.	27.95
B1-50	50 AMP.	32.95
B1-60	60 AMP.	36.95
B1-80	80 AMP.	44.95

Input 0-36VAC Type #	Current	Output 0-26*VDC Price
B2-150	150 MA.	1.25
B2-250	250 MA.	1.50
B2-300	300 MA.	1.95
B2-450	450 MA.	3.95
B2-1	1 AMP.	4.95
B2-2	2 AMP.	6.95
B2-3x5	3.5 AMP.	9.95
B2-5	5 AMP.	15.95
B2-10	10 AMP.	24.95
B2-15	15 AMP.	27.95
B2-20	20 AMP.	36.95
B2-30	30 AMP.	44.95
B2-40	40 AMP.	

Input 0-54VAC Type #	Current	Output 0-38*VDC Price
B3-150	150 MA.	1.25
B3-250	250 MA.	1.95
B3-600	600 MA.	3.25
B3-5	5 AMP.	13.95
B3-10	10 AMP.	24.95

Input 0-72VAC Type #	Current	Output 0-50*VDC Price
B4-600	600 MA.	\$3.95
B4-3	3 AMP.	14.95
B4-5	5 AMP.	17.95
B4-10	10 AMP.	27.95

Input 0-115VAC Type #	Current	Output 0-90*VDC Price
B6-150	150 MA.	\$1.95
B6-250	250 MA.	2.95
B6-600	600 MA.	5.95
B6-750	750 MA.	6.95
B6-1X5	1.5 AMP.	10.95
B6-3X5	3.5 AMP.	18.95
B6-5	5 AMP.	24.95
B6-10	10 AMP.	36.95
B6-15	15 AMP.	54.95

Input 0-234VAC Type #	Current	Output 0-190*VDC Price
B13-600	600 MA.	\$12.95
B13-1X5	1.5 AMP.	19.95
B13-3	3 AMP.	35.95
B13-5	5 AMP.	48.95
B13-10	10 AMP.	69.95

VOLTAGE REGULATORS

These solenoid operated carbon pile regulators will stabilize the output of 12-18 VDC power supplies, simply by connecting the coil leads across the output of the rectifier, and the carbon element leads in series with the load.
Price each\$2.49

D-C POWER SUPPLY FTR 3377-A5

Feating 115 VAC to 115 VDC, .77 Amperes. Operates fans, motors, magnetic chucks, business machines, relays, etc. Descriptive literature available.
Complete, ready to operate.....\$16.50

D-C PANEL METERS

Attractive, rugged, and reasonably priced. Moving vane solenoid type with accuracy within 5%.
0-5 Amperes D-C Any range
0-12 Amperes D-C \$2.49 each
0-15 Volts D-C

Minimum order \$3.00. No C.O.D.'s under \$25.00. 25% deposit on C.O.D. Add 10% for Prepaid Parcel Post and Handling. Terms: Net 10 days in the presence of approved credit.

All prices subject to change without notice.

Orders Promptly Filled from Our Stocks
All Prices F.O.B. our NYC Warehouse

RECTIFIER CAPACITORS

CF-13	6000 MFD	10VDC	\$2.49
CF-14	3000 MFD	12VDC	1.69
CF-15	6000 MFD	12VDC	2.95
CF-11	1000 MFD	15VDC	.98
CF-21	2000 MFD	15VDC	1.69
CF-20	2500 MFD	15VDC	1.95
CF-3	1000 MFD	25VDC	1.25
CF-4	2X3500 MFD	25VDC	3.45
CF-5	1500 MFD	30VDC	2.49
CF-6	4000 MFD	30VDC	3.25
CF-7	3000 MFD	35VDC	3.25
CF-8	100 MFD	50VDC	.98
CF-19	500 MFD	50VDC	1.95
CF-16	2000 MFD	50VDC	3.25
CF-9	200 MFD	150VDC	1.69
CF-10	500 MFD	200VDC	3.25
CF-12	125 MFD	350VDC	2.49

RECTIFIER TRANSFORMERS

All Primaries 115VAC, 50/60 Cycles

Type #	Volts	Amps.	Price
XXF15-12	15	12	\$3.95
TXF36-2	36	2	3.95
TXF36-5	36	5	4.95
TXF36-10	36	10	7.95
TXF36-15	36	15	11.95
TXF36-20	36	20	17.95
XFC18-14	18 VCT	14	5.95

All TXF Types are Tapped to Deliver 32, 34, 36 Volts. XFC type is tapped to deliver 15, 16, 17, 18 Volts Center-Tapped.

RECTIFIER CHOKES

Type	Volts	Amps.	Price
HY5	.02 Hy	5	\$3.25
HY8X5	.02 Hy	8.5	7.95
HY10	.02 Hy	10	9.95
HY12	.02 Hy	12	12.95
HY15	.015 Hy	15	13.95

RECTIFIER MOUNTING BRACKETS

For Types B1 through B6, and
Type C1\$.35 per set
For Types B1370 per set
For Types 3B 1.05 per set

RECTIFIER KIT

6 and 12 VDC at 10 Amps.

This unit will deliver unfiltered direct current for operation of motors, dynamos, solenoids, electroplating, battery charging and similar equipment.

The following components are supplied:

- 1 ea. Full Wave Bridge Rectifier
- 1 pr. Rectifier Mounting Brackets
- 1 ea. Transformer 115 VAC 50/60 CPS
- 3 ea. Silver-Plated Binding Posts
- 1 ea. 4-position Tap-Switch
- 1 ea. Fuse and Fuse Holder
- 1 ea. Line Cord and Plug
- 1 ea. Pilot Light Assembly and Bulb

The primary of the transformer is multi-tapped permitting adjustment of the DC output voltages.

Complete with schematic diagram \$15.95

Filter Kits For Above

- 1 Section choke input, 10% ripple... \$ 9.64
- 2 Section choke input, 2% ripple... 19.28

SYNCHRO MOTORS

Type 1F Special—KS-5949, L1 Western Electric 115/90 VAC—400 Cycles
Brand new, boxed. \$8.00
Price Each

WRITE FOR TECHNICAL BULLETIN AND CATALOG #719 ON COMPANY LETTER-HEADS

OPAD-GREEN COMPANY

71 Warren St.

New York 7, N. Y.

Phone: BEekman 3-7385-6

Finest of Surplus PEAK ELECTRONICS CO. Fraction of Cost

SELSYN MOTORS



115 volts 60 cycles. Large size, high torque. Made by Diehl and Bendix. Ideal for rotating TV beam, etc. Great value at

\$5.95 Per Pair

BARGAIN OF THE MONTH



As illustrated. 1500-8-1500 volts at 600 ma. Pri. 110/220 v. 50/60 cycles. 8 x 8 1/2 x 7 s.w.t. 78 lbs. Made by Amertran. Only.....\$19.95

WESTINGHOUSE



Type MN Overcurrent Relay, Adjustable from 250 ma. to 1 amp. External Push Button Reset. Enclosed in glass case. Hand calibrated adjustments, only \$5.95

PANEL METERS—BRAND NEW

2" SIMPSON 0-20 MA DC (Amp. Scale).....	\$1.75
2" WESTON 0-1 Ma Dc 26 ohms res.....	\$3.50
2" GE 0-1 Ma DC (volt scale).....	2.95
2" GE 0-5 Ma DC (amp scale).....	1.95
2" WESTINGHOUSE 0-10 Ma DC.....	2.45
2" GE 0-500 Ma DC.....	1.95
2" GE 0-10 Volts AC.....	2.50
2" GE 0-30 Volts DC 1000 Ohms/v.....	2.50
2" WESTON 0-250 Volts DC.....	2.50
2" WESTON 150-0-150 Microamps DC.....	3.49
2" GE 0-30 Amps DC.....	2.45
2" GE 0-1 Amp RF (Internal Thermo).....	2.50
2" WESTON 0-1 Amps RF (Internal Thermo).....	2.50
3" McCLINTOCK 0-1 Ma DC. (MA Scale).....	3.95
3" WESTINGHOUSE 0-2 Ma DC.....	3.95
3" GE 0-15 Ma DC (Square Case).....	3.95
3" WESTERN ELECTRIC 0-80 Ma DC.....	2.95
3" DEJUR 0-100 Ma DC.....	2.95
3" GE 0-200 Ma DC.....	3.95
3" WESTINGHOUSE 0-50 Amps AC.....	3.95
3" WESTON 0-50 Amps AC.....	4.95
3" TRIPLETT 0-75 Amps AC.....	2.95
3" WESTINGHOUSE 0-20 Ma DC.....	3.95
3" WESTINGHOUSE 0-150 Volts AC.....	3.95

H.V.-H. CURRENT PLATE TRANS.

1500-0-1500 volts at 1.5 amps. Tapped at 1350 and 1250. Pri. 110/220 volts 50/60 cycles in 2 Separate windings. Built to rigid Navy specs by Amertran. Suitable for broadcast transmitters, Induction heating, etc. Continuous duty. 10x10x7, wt. 125 lbs. New only.....\$39.50

HIGH CURRENT TRANSF. 820 Volts CT at 775 Ma. Pri. 110/220 Volts 60 cycles.

Fully Cased.....\$6.95

MALLORY VIBROPACK

6.3 Volt input—output 300 Volt @ 100 ma. Complete only.....each \$8.95

MALLORY TRANSFORMER & 534C Vibrator as used in above. Both for.....\$5.95

UTC type PA 5000 ohm plate to 500 ohm line and 6 ohm voice coil. 10 watts. 60 to 10,000 cps ±1 DB. GREAT VALUE.....ea. \$2.75

THORNTON TRANSF. 2370 volts CT at 250 MA tapped at 300-0-300 volts, plus 215 volts 55 MA bias winding. 110 volt 60 cy. pri. Fully shielded.....ea. \$11.95

2" GE 0-200 MICROAMPS

Model DW51.....\$4.50 ea.

FILAMENT TRANSFORMERS

110V 60Cy Pri. Fully Cased.

5 Volt 15 Amp.....	\$2.75
2.5 Volt 10 Amp.....	3.49
2.5 Volt CT 21 Amp.....	4.75
6.3 Volt 10 Amp.....	1.89

MULTIPLE SECONDARIES

5 1/2 V CT 21A, 7.5V 6A, 7.5V 6A.....	\$4.95
6.3V 21 Amp, 6.3V 2A, 2.5V 2A.....	3.95
5 Volt 4A, 6.3V, 3A.....	2.45
2.5V CT 20A, 2.5V CT 20A.....	6.95
2.5V CT 10A, 10V 3A, 5V 3A, 5V 3A.....	3.95

CHOKE BARGAINS

6 Henry 50 ma 300 ohms.....	3 for \$0.99
6 Henry 80 ma 220 ohms.....	2 for .99
8 Henry 160 ma 140 ohms.....	.99
1.5 Henry 250 ma 72 ohms.....	.59
6 Henry 300 ma 65 ohms.....	3.75
4.3 Henry 620 ma 42 ohms.....	6.95
Swing. Choke 1.6/12 Henry 1 Amp/100 ma 15 ohm.....	19.95

U. H. F. COAX CONNECTORS

831AP-UG12U—UG21U-UG-14U-831 R-831SP .39 ea.

FEDERAL ANTI-CAPACITY SWITCH. Double Pole, Double Throw.....85c each; 10 for \$7.50

MEGOHM METER



Industrial Instruments model L2AU 110/220 volts 60 cycle input. Direct reading from 0-100000 megohms on 4" meter can be extended to 500000 megohms with external supply. Sloping hardwood Cabinet 15"x8"x10" Brand new with tubes plus running spare parts including extra tubes. Great value Only \$69.50.

ADVANCE D.P.D.T. ANTENNA RELAY

110 V. 60 cycle coil Steatite insulation. Only \$1.95 each.

DUNCO RELAY 6 volt 60 cycle coil DPST.....\$1.39

GENERAL PURPOSE TRANSFORMERS

Ideal for Bias, Filament, Isolation, Stendown, etc.

2 isolated 110v pr. sec. 110v at 900 ma plus 6.3 @ 2 amps. Fully cased.....Now \$1.49 ea.

SCOPE TRANSFORMERS

Pri 110V 60Cy — Hermetically Sealed

2500V @ 12Ma.....	\$3.95
2300 @ 4Ma, 2.5 Volts @ 2 Amp.....	4.95
1050V @ 20Ma, 20V 4.5A, 2.5V 5A.....	4.75
4500V @ 4 Ma.....	8.50

PLATE AND FIL. TRANSF. PRI 110v 60 cy. sec. 1120 volts CT @ 600 ma. 6.3v CT # 3A, 2x5VCT @ 6A Hermetically sealed.....\$9.95 ea.

1500, 5000 Ohm 100 Watt Ferrule Resistors. 20,000 Ohm 50 Watt Ferrule Resistors. Any Types only .10 ea. Min. order 50 Pieces.

HS 30 HEADPHONES



250 ohms imp. Can be used for sound power Telephones. Brand new......69 ea.

LARGE QUANTITY AVAILABLE AT LOW PRICE

STEPDOWN TRANSFORMER

220/110 volts, 100 watts. Fully encased, 5 1/2 x 4 1/2 x 5 1/2. 110V. 60 cycle.....\$2.49 each

PHASE SHIFT CAPACITOR



4 Stator Single Rotor. 0-360 Degrees Rotation.....Only \$2.95 each

ODDS AND ENDS BARGAINS

.004 4000 VDC Micas.....	9 for .99
.01 600 VDC Mica Cond.....	9 for .99
GE 24V DC Relays.....	5 for .99
.02 400 V DC Tubulars.....	15 for .99
1000 MFD 25 Volt Electrolytic.....	2 for .99
25 MFD 25 Volt Elect. Tubular.....	6 for .99
JAN 6CX Tubes, New, Boxed.....	4 for .99
.05 600 VDC Oil Tubular.....	10 for .99
10 MMF Midget Variable Cond.....	4 for .99
Heineman 5 Amp 110 VAC CKT Breaker.....	.99
Heineman 25 Amp 110 VAC CKT Breaker.....	1.49
2 MFD 250 VAC Oil Cond.....	9 for .99
Solar .02 600 VDC Dominont.....	9 for .99
Erie .0005 N750D Ceramicon.....	15 for .99
.1x.1 2 KV DC Oil-Condenser.....	.79
H&H SPST P.B. Switch N.O.....	5 for .99
1/4 Amp (25 Ma) Littlefuses.....	15 for .99
.25 MFD 600 V. Tubulars.....	6 for .99
C-D 1 MFD 400 V Oil Tubulars.....	9 for .99
Butterfly Cond 2-11 MMF Ball Bearings.....	2 for .99
50 MFD 50 Volt Elect. Tubulars.....	5 for .99
.0015 5% Silver Micas.....	9 for .99
Midget Cased CKT Jacks.....	7 for .99
CD Type 4 .001 600 VDC Micas.....	50 for 4.99

WIRE WOUND RESISTORS

5 Watt type AA, 20-25-50-200-470-2500-4000 ohms.....	.09 ea.
10 watt type AB, 25-40-84-400-470-1325-1900-2000-4000 ohms.....	.15 ea.
20 watt type DG, 50-70-100-150-300-750-1000-1500-2500-2700-5000-7500-10000-16000-20000-30000 ohms.....	.20 ea.

30 WATT WIRE WOUND RESISTORS

Ohms: 100-150-1500-2500-3k-4k-4500-5k-5300-10k-15k-18k-40k......15 ea. 8 for .99

ADJUSTABLE RESISTORS

20 Watt: 1, 5, 50 Ohms.....	.25
50 Watt: 80, 100, 500 Ohms.....	.35
75 Watt: 40, 80, 100, 150, 200 Ohms.....	.39
100 Watt: 20, 50, 75, 120, 180 Ohms.....	.49
150 Watt: 50, 100 Ohms.....	.59

1% PRECISION RESISTORS

2000-2500-5000-8500-10,000 ohms.....	ea. .25
50000-95000 ohms.....	ea. .29
10000-750000-1 meg.....	ea. .69

Precision 15 Meg. 1% Accuracy Resistor. Non-inductive, 1 watt, hermetically sealed in glass. .29 ea. 10 for.....\$2.50

50 megohm 35 watt Resistor with mount.....\$1.95 each; 10 for \$15.00

W. W. POWER RHEOSTATS

25 Ohms 25 Watt.....	.49
150 Ohms 50 Watt.....	.59
250 Ohms 50 Watt.....	.59
300 Ohms 50 Watt.....	.59
Dual 200 Ohms 50 Watt.....	.79
8 Ohms 150 Watts.....	1.79

HIGH VOLTAGE—CURRENT MICAS



MMF	VDC	Price	MMF	VDC	Price
D .001	600	\$.18	D .002	3 KV	\$.70
E .01	600	.24	C .0001	5 KV	.76
E .02	600	.26	C .0005	5 KV	.83
E .027	600	.26	C .0015	5 KV	1.60
D .039	600	.39	C .003	5 KV	1.90
C .01	1 KV	.45	C .005	5 KV	2.50
C .056	1 KV	.50	B .007	5 KV	2.75
C .07	1 KV	.55	B .002	6 KV	3.50
D .02	1200	.35	B .003	6 KV	3.75
C .024	1500	.65	A .004	6 KV	4.95
C .033	1500	.75	B .006	6 KV	4.25
C .015	2 KV	.80	B .0085	8 KV	2.99
C .02	2 KV	.90	B .001	8 KV	3.25
D .002	2500	.45	B .002	8 KV	4.00
E .005	2500	.55	B .003	8 KV	4.75
C .025	2500	1.15	B .004	8 KV	5.50
C .001	3 KV	.70	A .006	15 KV	26.50
C .002	3 KV	.95	A .0098	15 KV	32.50
D .005	3 KV	.70	A .0059	18 KV	28.50
C .005	3 KV	1.24	A .0013	30 KV	36.50
C .006	3 KV	1.50			

OIL CONDENSERS

20 mfd 330 vac—1.85	6 mfd 2000 vdc—3.85
5 mfd 150 vac—.49	2 mfd 4000 vdc—4.85
1 mfd 600 vdc—.29	1 mfd 5000 vdc—4.50
2 mfd 600 vdc—.39	.1/.1 mfd 7000 vdc—2.25
4 mfd 600 vdc—.59	.1 mfd 7500 vdc—1.95
6 mfd 600 vdc—.79	1 mfd 7500 vdc—9.25
3/3 mfd 600 vdc—.79	.01/.01 mfd 12 kv do—5.75
10 mfd 600 vdc—.99	do—5.75
2 mfd 1000 vdc—.79	.005/.01 mfd 12 kv do—5.50
4 mfd 1000 vdc—.95	.015 mfd 16 kv do—5.75
15 mfd 1000 vdc—2.95	.65 mfd 12,500 do—12.95
2 mfd 1500 vdc—1.25	.75/35 mfd 8/16 kv—7.95
6 mfd 1500 vdc—2.95	2 mfd 18 kv do—59.50
1 mfd 2000 vdc—1.45	
2 mfd 2000 vdc—2.25	

Tremendous stocks on hand. Please send requests for quotes. Special quantity discounts. Price f.o.b. N. Y. 20% with order unless rated, balance C. O. D. Minimum order \$5.00.

PEAK ELECTRONICS CO.
188 Washington St., New York 7, N. Y.
PHONE CO-7-6443
DEPARTMENT EA
SEND FOR BULLETIN

SET OFFER—PRECISION LABORATORY INSTRUMENTS

The ideal combination of highly accurate laboratory instruments for those who require primary standards to supplement their present equipment or for those who wish to establish a superior electrical measuring laboratory.

Look at these features:

- Movement accuracy within 1/5 of 1%.
- Matching Portable Instruments.
- Knife edge pointer.
- Large mirror backed scale.
- A.C. instruments calibrated up to 133 cycles and have 3/10 of 1% accuracy on Direct Current.
- Voltmeters and Wattmeters are of the electric dynamometer type.

This set consists of 3 General Electric type P-3 (Single phase A.C.) Instruments and 3 General Electric type DP-2 (D.C. Instruments).

A.C. AMMETER, Dual Range, 0-5 and 0-10 Amperes.

A.C. VOLTMETER, Multiple Range, 0-150/300 and 750 Volts, complete with correction chart to 500 cycles.

A.C. WATTMETER, Multiple Range, 0-500/1000/2000/2500/5000 Watts single phase, 5 & 10 Amperes & 100/200 & 500 Volts normal rating.

D.C. AMMETER, Dual Range 0-3 & 9 Amperes.

D.C. VOLTMETER, Multiple Range, 0-150/300 & 600 Volts at 100 ohms per volt.

D.C. MILLIAMMETER, Dual Range, 0-10 & 100 Milliampères.

SURPLUS - NEW - GUARANTEED

This combination has a total List Price of approximately \$900.00 but can now be purchased for

ONLY \$385.00

net, per set

AC VOLTMETERS

0-15 G.E., AW-41, 2" R-B bl sc, 800 cyc.....	\$2.50
0-15 G.E., AW-41, 2" R-B bl sc, Signal Corps IS-122.....	\$2.50
0-15 G.E., AO-22, 3" R-B bl sc.....	\$3.00
0-15 Weston, 476, 3" R-B.....	\$4.50
0-15 W.H., NA-35, 3" R-B.....	\$3.95
0-40 Weston, 517, 2" R-M 400 cyc.....	\$3.50
0-40 W.H., NA-33, 2" R-B 400 cyc.....	\$3.50
0-75 Weston, 517, 2" R-M ring mtd.....	\$2.95
0-150 G.E., AO-22, 3" R-B 400 cyc.....	\$4.00
0-150 Triplet, 332-JP, 3" R-M.....	\$4.00
0-150 Triplet, 331-JP, 3" R-B.....	\$4.50
0-150 Triplet, 331-JP, 3" R-B W/Resistor for 300 volts.....	\$5.50
0-500 G.E., AO-22, 3" R-B.....	\$12.00

RF AMMETERS

0-120 MA Simpson, 25, 3" R-B.....	\$7.50
0-1 G.E., DW-44, 2" R-B bl sc.....	\$2.95
0-1 G.E., DW-44, 2" R-B.....	\$3.50
0-1 G.E., DW-52, 2" R-M.....	\$3.00
0-1.5 G.E., DW-52, 2" R-M bl sc.....	\$2.95
0-1.5 Weston, 507, 2" R-M bl sc.....	\$2.50
0-1.5 Weston, 425, 3" R-B.....	\$8.25
0-2 Simpson, 135, 2" R-B.....	\$3.50
0-2 Weston, 425, 3" R-B.....	\$8.50
0-2.5 Weston, 507, 2" R-B.....	\$3.95
0-2.5 McIntock, 3" R-B.....	\$4.50
0-2.5 Simpson, 35, 3" R-B.....	\$4.95
0-2.5 Weston, 425, 3" R-B.....	\$8.50
0-2.5 W.H., NT-35, 3" R-B.....	\$5.50
0-3 W.H., NT-35, 3" R-B.....	\$5.50
0-3 Weston, 425, 3" R-B.....	\$8.50
0-3 Weston, 425 3" R-B W/Ext couple.....	\$9.50
0-4 G.E., DW-44, 2" R-B bl sc.....	\$2.95
0-5 Weston, 425, 3" R-B.....	\$8.50
0-6 G.E., DW-44, 2" R-B bl sc.....	\$2.50
0-20 Weston, 507, 2" R-B.....	\$3.50
0-20 G.E., DO-44, 3" R-B.....	\$4.95
0-30 Triplet, 0347-A, 3" S-B W/Ext leads & couple.....	\$8.00

All meters are in round flush bakelite case with white scale and are standard in every respect unless otherwise specified. All items are Surplus — New — Guaranteed unless specified otherwise.

SPECIAL METERS

WATTMETER , 0-10 Watts Full Scale, Weston 498, 5/8" Square surface mtd case, Single phase A.C. or D.C., 115 Volt Normal, 140 volt Maximum, 80 M.A. Normal, 160 M.A. Maximum, Current coil 35 ohms. (These units have been used but have been completed, checked and tested and are fully guaranteed).....	\$27.50
FREQUENCY METER , 68 to 200 cycles, Westinghouse type IA, complete with external reactor, 5/8" Square flush or surface mtd. (State which you require).....	\$35.00
FREQUENCY METER , 55 to 65 cycles, James Bidle Co. type MF-11, Frahm vibrating reed type, 11 coils, 100 to 150 volt operation, 3/8" round flush bakelite case.....	\$7.50
FREQUENCY METER , Dual range, 48 to 52 & 58 to 62 cycles, J.B.T. type 30-F, dual element, vibrating reed, 115 volt, 3/8" rd fl metal case.....	\$5.95
FREQUENCY METER , 350-450 cycles, Weston 637, 3/8" Aircraft type, black scale, iron core dynamometer type, 50 cycles per volt.....	\$4.95
D.C. MILLIAMMETER , Weston 271, Fan type, 1-0-1 MA (60-0-60 M.V.) movement, Sc cal, 600-0-600 R.P.M.....	\$12.50
RECTIFIER TYPE MILLIAMMETER , Weston 345 type 81, Aircraft type, full scale equals 1.1 MA AC, 940 UA DC mvt, 70 ohms resistance, black scale cal 0-270.....	\$6.50
DECEL METER , Weston 301 type 61, minus 10 to plus 6 DB, 3/4" rd fl bake case, 6 MW 600 ohms, High speed type, with 3 external wire wound multipliers to extend range. List Price \$37.50.....	\$11.50
D.C. MILLIAMMETER , 0-12.5 miniature MA, black sc, Aircraft style G-1, 1 3/4" sq bake case, Bulova Watch Co.....	\$3.95
D.C. MILLIAMMETER , 0-2 miniature meter, Roller Smith 0-2 MA 0-20 MV movement, 1 1/2" square.....	\$2.50
D.C. MILLIAMMETER , 0-50 MV movement 1 3/4" square.....	\$4.50

PORTABLE TACHOMETERS

0-20,000 RPM Range, Jaeger #43 A-8 Chronometric type.....	\$24.50
300-1200, 1000-4000, 3000-12000 RPM, Jones Motorola Co., Multiple Range, Continuous Indicating.....	\$24.50
300-1500, 1000-5000, 3000-15000 RPM, Jones Motorola Co., Multiple Range, Continuous Indicating.....	\$25.50

METER SHUNTS

25 Amp 50 M.V. Weston, Portable type @.....	\$ 5.25
30 Amp 50 M.V. Westinghouse, Switchboard type @.....	\$2.50
35 Amp 50 M.V. Westinghouse, Switchboard type @.....	\$2.50
50 AMP 50 M.V. Weston, Portable type @.....	\$5.25
100 AMP 50 M.V. Weston, Switchboard type @.....	\$4.00
140 AMP 50 M.V. Weston, Switchboard type @.....	\$2.50
300 Amp 50 M.V. General Electric, Portable type @.....	\$7.50
750 Amp 50 M.V. Westinghouse, Switchboard type @.....	\$4.50
4,000 Amp 50 M.V. Westinghouse, Switchboard type @.....	\$43.00
5,000 Amp 50 M.V. Westinghouse, Switchboard type @.....	\$51.00
6,000 Amp 50 M.V. General Elec., Switchboard type @.....	\$60.00

AC AMMETERS

0-30 Triplet, 331-JP, 3" R-B.....	\$4.00
0-30 Triplet, 332-JP, 3" R-M.....	\$3.50
0-50 G.E., AO-22, 3" R-B.....	\$4.50
0-50 W.H., NA-35, 3" R-B.....	\$4.50
0-60/120 Burl, 32XC, 3" R-B w/Ext Trans.....	\$7.50
0-60/120 Burl, 32XC, 3" R-B without Ext Trans.....	\$4.50
0-150 G.E., AO-22, 3" R-B 5 Amp mvt, with ext. Trans.....	\$7.50

DC MICROAMMETERS

0-200 Superior, 4"x4 3/4" F-B.....	\$7.50
0-200 W.H., NX-35, 3" R-B MR 35 W 200 DC UA.....	\$8.50
0-400 Triumph, 4"x4 3/4" F-B.....	\$5.50
0-500 De Jur Amso, 2" R-B.....	\$3.00
0-500 Gruen, 221-T, 2" R-B.....	\$3.95
0-500 Simpson, 6103, 2" R-B.....	\$3.50
0-500 Triplet, 0221-T, 2" R-B.....	\$3.50

DC MILLIAMMETERS

0-1 G.E., DW-41, 2" R-B Spec Scale.....	\$3.00
0-1 G.E., DW-51, 2" R-B Spec Scale.....	\$3.50
0-1 W.H., NX-33, 2" R-B Black Spec Scale.....	\$3.00
0-1 G.E., DO-41, 3" R-B.....	\$5.50
0-1 G.E., DO-41, 3" R-B Spec Scale.....	\$4.50
0-1 McIntock 8-1811, 3" S-B Spec Scale.....	\$3.50
0-1 McIntock 8-1811, 3" R-B Spec Scale.....	\$3.50
0-1 W.H., NX-35, 3" R-B MR 35 W 00 1 DC UA.....	\$7.50
0-1 F. Hickok, 56-R, 2" R-B.....	\$2.00
0-3 Gruen, GW-580, 2" R-B.....	\$3.50
0-5 W.E., 3" R-B Concentric style.....	\$3.00
0-15 Simpson, 26, 3" R-B.....	\$3.50
0-20 G.E., DW-55, 2" R-B Black Scale.....	\$3.75
0-20 G.E., DW-53, 2" R-B.....	\$3.50
0-20 G.E., DO-41, 3" R-B.....	\$3.50
0-80 G.E., DO-41, 3" R-B.....	\$3.75
0-150 Gruen, 508, 2" R-B.....	\$3.00
0-200 Gruen, 511, 2" R-B.....	\$3.00

MARITIME SWITCHBOARD

338 CANAL STREET
NEW YORK 13, N. Y.
Worth 4-8217

PORTABLE METERS

A.C. AMMETER, 0-3 & 0-15, Weston 528 with case & leads.....	\$12.50
D.C. VOLTMETER, 0-0-3, W.H. FX-4, 100 ohms per volt.....	\$9.50
D.C. VOLTMETER, 0-3 & 0-150, W.H. FX-4, 200 ohms per volt.....	\$17.50
D.C. VOLTMETER, 0-15 & 0-150, Roller Smith "Steel Six" 100 ohms per volt.....	\$21.00
CURRENT TRANSFORMER, Weston 461 type 4, 5 Amp Secondary, 50, 100, 250, 500 & 1000 Amp Primary, 15 V.A. capacity, 1/4% acc.....	\$35.00
POTENTIAL TRANSFORMER, Weston 311, for use with 150 volt instruments, Max potential ratio of 1500 & 750 volts to 150 volts, 15 V.A., 1/5% acc.....	\$90.00
INSULATION TESTER, V-Protest Model 201, Range 0-200 Megohms & 0-2000 ohms & 0-150/300/600 Volts A.C. & D.C. (Slightly used—excellent condition—guaranteed).....	\$38.00
INDUSTRIAL ANALYZER, Weston 639 type 2, measures Volts, Amps, Power Factor & Kilo-watts, single & polyphase. (Used—excellent condition—guaranteed).....	\$245.00
DUAL RANGE MILLIAMMETER, Weston 264, 0-25 & 250 milliammeter, mtd on vertical stand with test cord.....	\$9.00

MISCELLANEOUS

TACHOMETER GENERATOR, Weston 752 type J4, 2 terminals.....	\$22.50
SALINITY INDICATOR, McNab Model M.....	\$95.00
CELLS for above panel.....	\$60.00
BC 1161-A RAD. RECEIVER, 150-210 Mega-cycles, operates off 115 volt 60 cycle, with 14 tubes.....	\$34.50
BC 1160-A TRANSMITTER, 157 to 187 Mega-cycles, operates off 117 volt 60 cycle, with blower, variac, 10 tubes, 3" 0-1 MA meter, etc.....	\$29.50
GASOLINE HEATER, Motorola GN-8-24, 15,000 B.T.U., 4 gal. gasoline lasts 8 hours, 24-28 volt D.C. supply, can be adapted to 115 volt 60 cycle by use of transformer & rectifier.....	\$22.50
BOWL INSULATOR, Clear Glass, all brass fittings, S. C. Stock #3G-1830-67076.1 Corning Glass Works #67076 type C, comprises flanged bowl 4 1/2" x 6 1/8" O.D. at base. Center lead-in 1/4" Dia. x 1 1/2" long, mounts by means of 6 studs through mtg. flange. Overall dia 8 3/4".....	\$6.00
THERMAL CIRCUIT BREAKER D.P.S.T. 15 Amp 120 volt A.C., Curve D, Heineman #0322.....	\$1.50
TERMINAL BOARD, with barrier strips, 6 Terminals with 2 connection points each, 4 1/2" long x 2" w x 1 1/4" H, minimum order 10 pieces.....	60¢ each
STRIP HEATERS, 50 Watt 115 volt, 250 ohms, 1 1/2" x 1/2" x 8" G.E. Catalog #2A301, minimum order 10 pieces.....	60¢ each
GENERATOR VOLTAGE REGULATOR, Eclipse-Pioneer #1317-2 A set at 117 volt, Carbon pile regulator complete with selenium rectifier unit.....	\$4.50 each

COMBINATION OFFER

30 Amp A.C. Meter—150 Volt A.C. Meter—Triplet 331-JP 3" rd fl bake case.
BOTH METERS FOR \$7.95

DC AMMETERS

0-2 Simpson, 25, 3" R-B.....	\$4.00
0-5 Gruen, 531, 2" R-B.....	\$3.50
0-15 Sun, AP-381, 3" R-B.....	\$3.50
0-15 Triplet, 6321-T, 3" R-B.....	\$4.00
0-30 Hoyt, 123, 2" R-M.....	\$2.50
30-0-30 Eoede, 2" R-M.....	\$2.95
30-0-30 G.E., DW-51, 2" R-B.....	\$3.50
30-0-30 U. S. Gauge, 2" R-M.....	\$1.50
0-150 Simpson, 125, 2" R-M with shunt.....	\$5.50
0-200 Weston, 506, 2" R-B with shunt.....	\$7.50
0-200 G.E., DO-41, 3" R-B with shunt.....	\$9.50
0-300 G.E., DW-51, 2" R-B with shunt.....	\$7.50
0-500 G.E., DW-51, 2" R-B less shunt.....	\$3.50

DC VOLTMETERS

0-3 Simpson, 125, 2" R-M ring mtd.....	\$2.00
0-5 W.H., NX-35, 3" R-B.....	\$3.50
0-10 Sun, 2AP458, 2" R-B 100 r/v.....	\$2.50
0-15 Gruen, GW 505, 2" R-B.....	\$3.50
0-15 McIntock, D-100-R-1, 2" R-B Black scale, 1000 r/v.....	\$3.00
0-30 DeJur Amso, 210, 2" R-B.....	\$2.50
0-30 G.E., DW-51, 2" R-B 250 r/v.....	\$2.95
0-50 Weston, 301, 3" R-B 200 r/v.....	\$5.50
0-50 Readrite, 2" R-M.....	\$1.00
0-150 Weston, 301, 3" R-B Surf mtd 200 r/v.....	\$4.50
0-150 G.E., DW-51, 2" R-B Special scale.....	\$3.95
0-500 Sun, 3" R-B MR35W500DCV.....	\$7.00
0-5 KV W.H., NX-35, 3" R-B 1 MA mvt, less resistor.....	\$4.95
0-1.5 KV W.H., NX-35, 3" R-B 1 MA mvt, with resistor.....	\$7.50
0-15 KV G.E., DO-53, 3" S-B 500 UA mvt, less resistor.....	\$4.95
0-15 KV W.H., NX-35, 3" R-B 1 MA mvt, less resistor.....	\$4.50
0-20 KV G.E., DO-41, 3" R-B 500 UA mvt, less resistor.....	\$4.95
0-20 KV G.E., OX-33, 2" R-B Black sc 1 MA mvt, less resistor.....	\$3.50
0-20 KV G.E., DO-41, 3" R-B 1 MA mvt, less resistor.....	\$4.50
0-35 KV W.H., NX-35, 3" R-B FS 1 Ma mvt, less resistor.....	\$4.95

Orders accepted from rated concerns, public institutions & agencies on open account, others please send 25% deposit, balance C. O. D. or check with order. All prices FOB our warehouse, N.Y.C.

SEARCHLIGHT SECTION



NEW LOW PRICES!

ALL BRAND NEW
STANDARD BRAND

MINIMUM ORDER \$5.00
QUANTITY PRICES ON REQUEST

WATCH THIS LISTING EACH MONTH FOR LATEST CHANGES

Type	Price	Type	Price	Type	Price	Type	Price	Type	Price	Type	Price	Type	Price
1B22	\$ 4.95	12LP4	\$55.00	838	\$3.95	ML101	\$150.00	3A5	\$ 1.49	6SA7GT	\$.66	12SN7GT	\$.80
1B23	9.50	15E	1.50	841	.69	REL36	.98	6SB7Y	1.98	6SB7Y	.88	12SO7GT	.60
1B24	4.95	15R	1.50	843	.69	RK22	4.95	3B7	.36	6SD7GT	.46	12SR7GT	.39
1B25A	4.95	23D4	.49	845/W	4.95	RK23	4.95	3D6	.36	6SF5GT	.66	12X3	.98
1B27	4.95	24G	.98	851	75.00	RK25	2.95	3LF4	1.28	6SF7	.80	12Z3	.88
1B29	2.89	35T	4.49	860	3.00	RK33	.98	3O4	.88	6SG7	.80	14A7/12B7	.88
1B32	4.95	45SPEC.	4.95	861	49.95	RK38	1.75	3O5GT	.96	6SH7	.39	14AF7/XXD	.88
1B36	4.95	75TL	3.95	864	6.49	RK38	1.75	3V4	.80	6SJ7	.66	14B8	.88
1B38	49.50	100TH	12.95	865	2.98	RK59	5.95	5A2A	.50	6SJ7GT	.66	14C7	.88
1B40	4.95	100TS	3.00	866/A	.99	RK60	.79	5R4GY	1.15	6SK7	.66	14C7GT	.88
1B60	4.95	114A	.69	866JR	1.19	RK65	24.95	5T4	1.28	6SK7GT	.66	14E6	.72
1P23	1.95	114B	1.25	869B	75.00	RK72	1.95	5U4G	.60	6SL7GT	.88	14F7	.88
1S21	1.96	120R	1.95	872A	2.95	RK73	3.95	5V4G	10.00	6SO7GT	.88	14H7	.88
2B4	.98	121A	2.65	874	2.49	RK73	3.95	5W4GT	.66	6SR7	.72	14J7	1.06
2AP1	3.95	203A	16.95	878	2.49	RK73	3.95	5X4G	.75	6SR7GT	.72	14K7	.88
2C4	1.18	205B	4.50	884	1.49	T20	1.50	5Y3GT	.42	6ST7	.66	14L7	1.06
2C21	.98	211	.98	885	.98	T55	3.95	5Y4G	.60	6ST7GT	.66	14M7	.88
2C22	.39	215A	3.00	891	110.00	T200	10.95	5Y4G	.60	6ST7GT	.66	14N7	1.06
2C26A	.28	217C	7.30	892	175.00	T220	1.50	5Z4	.72	6ST7GT	.66	14O7	1.06
2C34	.59	218	49.50	902P1	7.95	T240	2.95	6A3	1.08	6T7G	1.24	14P7	1.06
2C40	1.98	221A	2.95	904	9.95	UH50	5.95	6A6	1.06	6U5G5	.72	14Q7	.88
2C43	7.50	231D	1.49	905	11.95	VR75	.98	6A7	.80	6U6GT	.72	14R7	.88
2C44	1.75	242C	6.95	923	.98	VR78	.75	6A8	.80	6U7G	.72	14S7	.88
2C46	7.50	249C	3.49	925	1.40	VR78	.75	6A8GT	.80	6V6	1.28	14T7	1.06
2D21	1.15	250R	7.95	931A	4.95	VR90	1.49	6AB5/6N5	1.08	6W7G	.88	14U7	1.06
2E22	1.50	250TH	19.50	930	.98	VR91	1.49	6AB7/1853	1.16	6X4	.60	14V7	.88
2E24	4.95	250TL	19.50	951A	.98	VR105	1.49	6AC5GT	1.16	6X5GT	.96	14W7	1.06
2E25	4.25	252A	4.95	954	.75	VR150	.75	6AC7/1852	1.16	6Y6GT	.96	14X7	1.06
2E26	3.95	254	19.95	956	.75	VT127A	3.00	6AD6	.88	6Z7G	.88	14Y7	1.06
2E30	2.39	259A	4.95	957	.75	VU111	1.19	6AD7G	1.28	6Z7GT	1.28	15A7	1.06
2J12A	12.95	262A/B	3.50	958A	3.50	WL460	14.95	6AG5	1.25	6Z7GT	1.28	15B7	1.06
2J16	8.95	274A/B	1.25	959	2.95	WL532A	14.95	6AG7	1.06	6Z7GT	1.28	15C7	1.06
2J31	10.95	282A/B	4.95	901	.75	WL562	150.00	6AH6	1.56	7A4/XXL	.72	15D7	1.06
2J32	13.90	291A	4.95	1608	4.95	WL616	105.00	6AJ5	.99	7A5	.72	15E7	1.06
2J34	24.95	294A	4.95	1613	.75	Z225	1.95	6AK5	1.56	7A6	.72	15F7	1.06
2J37	17.95	304B	5.95	1614	1.75	ZB120	6.95	6AK5	1.56	7A7	.72	15G7	1.06
2J38	13.95	304TH	6.95	1616	1.49	ZP477/12DP8	14.95	6AK6	.96	7AD7	1.06	15H7	1.06
2J49	24.95	307A	4.95	1619	1.49	0A2	1.69	6AL5	.96	7AF7	.72	15I7	1.06
2J5B1	4.95	316A	4.95	1620	.75	0A3/VR75	1.98	6AL7GT	.80	7AG7	.88	15J7	1.06
2J54B	17.95	327A	4.95	1621	1.75	0A4G	1.06	6AO6	.80	7AH7	.88	15K7	1.06
2K23	24.95	327A	4.95	1622	1.75	0B2	2.05	6AO6GT	.72	7AJ7	.88	15L7	1.06
2K25	24.95	335A	24.95	1624	1.49	0B3/VR90	.75	6AO6GT	.72	7AK7	.88	15M7	1.06
2K28	24.95	338A	24.95	1625	4.95	0C3/VR105	.98	6AS7G	4.95	7B5	.72	15N7	1.06
2K41	24.95	350A/B	2.95	1626	4.95	0D3/VR150	.75	6AT6	.80	7B6	.72	15O7	1.06
3AP1	4.95	354C/D	19.95	1628	4.95	OY4	.88	6AU6	.80	7B7	.72	15P7	1.06
3B22	4.95	368AS	4.95	1629	.98	OZ4	.88	6AV6	.80	7B8	.72	15Q7	1.06
3B23	4.95	371A/B	.89	1634	.79	PZ4G	.88	6AV6GT	1.28	7C4/12303A	.39	15R7	1.06
3B24	1.98	394A	7.95	1635	1.10	OIA	.50	6B4G	1.56	7C6	.72	15S7	1.06
3B26	1.89	399A	2.50	1636	5.95	IA4	.72	6B6G	1.56	7C7	.72	15T7	1.06
3B27	3.95	400A	3.25	1638	.98	IA4P	1.56	6B7	.72	7C8	.72	15U7	1.06
3B28	5.95	401A	1.95	1641	.75	IA5GT	.72	6B8	1.28	7E5/1201	1.66	15V7	1.06
3BP1	3.95	403A/B	1.75	1644	1.49	IA6	1.28	6B8GT	1.28	7E6	1.28	15W7	1.06
3C22	18.95	408A	1.75	1644	1.49	IA7GT	.80	6B8GT	1.28	7E7	.80	15X7	1.06
3C23	4.95	408A/B	1.75	1644	1.49	IB3GT	1.49	6BA6	.80	7F7	.80	15Y7	1.06
3C24	6.49	407A	24.95	1851	1.25	IB4	1.56	6BE6	.72	7F7GT	.80	16A7	1.06
3C30	1.50	434A	7.95	1852	1.06	IB5/258	1.28	6BG6G	1.06	7G7/1232	1.06	16B7	1.06
3CP1	3.00	446A/B	1.95	1853	1.06	IB7GT	1.06	6BH6	.80	7H7	.80	16C7	1.06
3D21A	1.50	450TH	24.95	1960	1.19	IC5GT	.88	6BJ6	.80	7J7	1.06	16D7	1.06
3DF1	3.95	527	12.95	2051	.98	IC6	1.28	6C4	.39	7K7	1.06	16E7	1.06
3EP1	3.95	531	24.50	5514	4.95	IC7G	1.28	6C5GT	.66	7L7	.88	16F7	1.06
3EP2	4.95	532A	4.95	5516	5.95	ID5GP	1.28	6C6	.66	7M7	.88	16G7	1.06
3FP7	3.95	575A	14.95	5562	10.00	ID7G	1.28	6C7	.66	7N7	.88	16H7	1.06
3J31	49.50	701A	4.95	5793	.39	ID8GT	1.56	6C8	.66	7O7	.88	16I7	1.06
4-65A	14.50	703A	4.95	8003	5.95	IE5GT	1.38	6C8GT	1.28	7R7	.88	16J7	1.06
4-125A	27.50	705A	2.95	8011	2.95	IE7G	1.56	6D6	.66	7S7	1.06	16K7	1.06
4-250A	37.50	706GY	18.95	8012A	4.95	IF5G	1.56	6D8G	1.28	7T7	1.06	16L7	1.06
4A1	1.98	707A/B	24.95	8013A	2.95	IF6	1.56	6E6	.85	7X7/XXFM.	1.06	16M7	1.06
4AP10	6.95	708A	7.95	8014	24.95	IF7G	1.56	6F5	1.06	7Y4	.72	16N7	1.06
4B24	4.95	710A	2.95	8015	1.49	IG4GT	1.06	6F5GT	.66	7Z4	.72	16O7	1.06
4C35	19.95	713A	1.65	8020	3.95	IG6GT	1.06	6F6	.80	10	.69	16P7	1.06
4E27	12.95	714AY	6.95	8025	7.95	IH4C	.88	6F6GT	.80	12A	.66	16Q7	1.06
4J24	110.00	715A/B	9.95	8025	7.95	IH5GT	.66	6F8GT	1.06	12A6GT	.39	16R7	1.06
5AP1	4.95	715C	24.95	8025	7.95	IH6GT	1.28	6G6G	1.06	12A7	1.28	16S7	1.06
5AP4	5.95	717A	.99	8025	7.95	IJ6GT	1.28	6H6	.60	12A8GT	.80	16T7	1.06
5BP1	2.95	720DY	34.95	8025	7.95	IL4	.80	6H6GT	.60	12AH7GT	.88	16U7	1.06
5BP4	4.95	721A/B	4.35	8025	7.95	IL4A	1.06	6J5	.54	12AL5	.60	16V7	1.06
5CP1	3.95	723AB	7.95	8025	7.95	IL5	1.06	6J5GT	1.16	12AT6	.60	16W7	1.06
5CP7	13.95	724A/B	4.95	8025	7.95	IL6	1.06	6J7	.80	12AU6	.96	16X7	1.06
5D21	29.95	725A	9.95	8025	7.95	IL7	1.06	6J7GT	.80	12AV6	.96	16Y7	1.06
5FP7	3.95	726A	23.50	8025	7.95	IL8	1.06	6J8G	1.28	12BA6	.72	17A7	1.06
5GP1	9.95	750TL	49.50	8025	7.95	IL9	1.06	6K5GT	.96	12BE6	.72	17B7	1.06
5HP4	9.95	800	2.25	8025	7.95	IL10	1.06	6K7	.66	12C8	.69	17C7	1.06
5JP2	11.95	801A	.98	8025	7.95	IL11	1.06	6K7GT	.66	12F5GT	.72	17D7	1.06
5LP1	11.95	802	3.75	8025	7.95	IL12	1.06	6K8	.96	12J5GT	.39	17E7	1.06
5LP5	14.95	803	8.95	8025									

IMMEDIATE DELIVERY

LOW PRICES

FULLY GUARANTEED

FINCH Model F 115-G

DIRECTION FINDER

Handwheel rotatable beam with Azimuth dial. Adcock Antenna and Coupling Units. 3-24Mc. May be used with well shielded receiver of proper frequency range. Two 7 ft. rotating beam half section. Brand New. Only 4 available.

Special Price, \$45.00 ea.

MARINE DF SYSTEM

Bludworth Marine DF Receiver and Loop Antenna. Bulkhead mounting. 24 volt d-c operation. Good condition but need slight repairs.

Special Price \$100.00 each

DC GENERATOR



for laboratory use. Special low price \$2.95 ea. Stock #SA-258.

Ford Instrument Co. Compound Wound. Bu. of Ordnance dwg. 223128. 115 v. d-c @ 0.75 amperes. Cont. duty. Ideal



Remote Position Indicating System

6-12 v. 60 cycles 5 inch indicator with 0 to 360° dial. Heavy duty transmitter. Stock #SA-115. Price \$9.95 per system

LP-21-LM Compass Loops



New

QUANTITY PRICES ON REQUEST

MAGNESYNS



Pioneer CL-3 transmitter or indicator on 26 v. 400 cy. or 52 v. 800 cy. May be used as indicator with 360° potentiometer on DC. Stock #SA-6. Price \$1.95 each

DYNAMOTOR



D-101 27 v. DC in @ 1.5 amps. DC out. 285 v. @ 0.60 amps. Stock #SA-187. Price \$1.50 each

MINIATURE DC SELSYN INDICATOR



plug for zero dial adjustment. Stock #SA-268. Price \$6.75 each.

G.E. POSITION TRANSMITTER

Type 8TJ9—continuously rotatable 360° wound potentiometer. Taps every 120 degrees. Two 180° opposed sliders. 24 v. d-c operation with indicator described above. Stock #SA-13. Price \$4.75 each.

INVERTER SPECIALS

General Electric PE-218 D—Input 28 v. d-c @ 92 amps. Output 115 v. 400 cycles @ 1500 va. Power factor 0.90. Shipping wt. 100 lbs. New—Original Cartons. Stock #SA-112. Price \$29.50 each.

Leland or Russel PE-218 E or PE-218H. Similar to PE-218D. Stock #SA-112A. Special Price \$19.50 each.

800 Cycle Inverter—Navy Type CRV-21AAR. G.E. 5AS12LJ2. Input 27 v. d-c @ 45 amps. Output 120 v. 800 cycles @ 750 va. Power factor 0.90. Net. wt. 22.5 lbs. Stock #SA-192. Price \$39.50 each.

SERVO MOTOR SPECIAL



Stock #SA-97.

Pioneer Type CK-2. 26 v. 400 cycles fixed phase. Variable phase voltage 49 v. max. 1.05 in/oz stall torque. Rotor moment of inertia 7 gm/cm². Price \$4.75 each.



Bodine NYC-13 AC Motor

115 v. 60 cycles, 1/40 hp. 1800 rpm. Cont. duty, .55 amps. Stock #SA-245. Price \$9.50 each.

MERCURY CONTACT RELAY



W.E. D-168479 Millisecond switching at up to 60 c.p.s. Technical data on request. Stock #SA-259. Price \$4.75 ea. Special qty. prices.

D. C. MOTORS



Blower Assembly MX-215/APG

John Oster C-2P-1L 28 v. DC 7000 RPM 1/100 hp. #2 L-R Blower. Stock #SA-202. Price \$2.95 each



Universal Electric DC

W.E. KS-5603-L02, 28 v. DC 0.6 amps. 1/100 hp. 4 lead shunt. Stock #SA-233. Price \$1.95 ea. plus 15¢ p.p.



Delco 5069466 Motor

Alnico PM field, 27.5 v. DC. 1" x 1" x 2" lg. Pinion gear on shaft. Stock #SA-65. Price \$3.75 each plus 15¢ p.p.



DELCO CONSTANT SPEED MOTOR A-7155

1/30 hp. 3600 rpm. Cont. duty. 2 1/2" diam. x 5 1/2" lg. 3/8" shaft extension, 5/32" diam. 4 hole base mounting. Stock #SA-94. Price \$4.75 each.



Delco 506925 Constant Speed DC Motor

27 v. DC. 120 rpm. Governor controlled. Stock #SA-249. Price \$3.95 each. Qty. prices on request.

DC SERVO MOTORS

C-1 Autopilot Servo Unit—28 v. DC Shunt motor. 2250 rpm. 2 magnetic clutches, reduction gear, differential and 2 magnetic brakes. Output shaft 15 rpm. Torque 225 in./lbs. Stock #SA-180. Price \$19.50 each

Elinco B-64 DC Servo Unit—80 v. DC max. armature voltage, 27.5 v. field. 1/165 h.p. 3100 rpm. Field current 200 ma. Armature current 200 ma. at normal torque. Stock #SA-211. Price \$12.50 each

SYNCHROS

Navy Types

1G, 1F, 1CT, 5C, 5F, 5CT, 5DG, 5HCT, 5SF, 5HSF, 5SDG, 6DG, 6G, 6DG, 7G, etc.



Prices on Request

All prices F.O.B., Paterson.
Teletype PAT. 199
Phone ARmory 4-3366
Write for Listing.



THERMOSTATIC TIME DELAY RELAYS

Amperite type 115 No.-45.

Heater voltage 115V. Normally open SPST contacts, 45 sec. delay. Contact rating 115V-3A., A.C. (or 440V., A.C. 2A.) max. voltage on contacts—1000, max voltage bet. contacts and heater—1500. Size 3 9/32 x 1 1/4" overall. Made for U. S. Navy.



New surplus \$1.10



LINEAR SAWTOOTH POTENTIOMETER

W.E. No. KS 15138
Input 24 volts D.C. Output varies in accordance with linear sawtooth wave.

Brand New \$5.75

STEPDOWN TRANSFORMERS

Input: 115V, 60 cycles.
Output: 20 V., at 10 amps.
Also tapped at 6V., for pilot light. Ideal for Selenium Rectifier Applications, etc.



Brand New \$2.45



RELAY

Clare octal base Relay No. 30FMX 115V. 60 cy. 0.140 amp. Res. 75 ohms. Makes two breaks one.

Brand new \$2.45



SELENIUM RECTIFIER

Bridge Type
Input: 36 V. A.C.
Output: 28 V. D.C., 1-1 Amps.

Brand New \$2.75

MOTOR GENERATORS

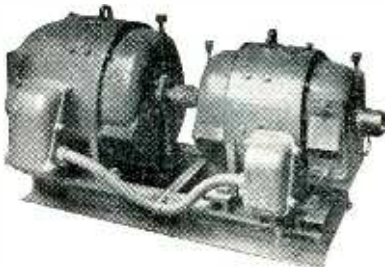

Diehl 120V. D.C. to 120V. A.C., 60 cy., 1 Ph. 2.5 K.V.A. Complete with magnetic controller, 2 field rheostats and full set of spare parts including spare armatures for generator and motor.

New \$185.00

Allis Chalmers 115V. D.C. to 120V. 60 cy., 1 Ph. 1.25 K.V.A., P.F., .80 Centrifugal starter. Fully enclosed.

New \$97.50

Same as above but for 230 V. D.C. input **\$125.00**

O'Keefe and Merritt, 115V. D.C. to 120V. A.C., 50 cycles, 2 K.V.A., Pf. .9.

New \$165.00

Electrolux Dynamator 105/130 V. D.C. at 6 amps. to 26 or 13V. D.C. at 20 amps. or 40 amps. respectively. Fully filtered for radio use and complete with Square "D" lineswitch. Navy type CAJO 211444.

New \$74.50

RADAR COMPONENTS

CRP-23AGC Load Dividers for use with S.G. Modernization Kits. New.

CBM-50AFO Navy type Radar Repeater Adapters. New and complete with 14 tubes, coax fittings, installation plans and wiring diagrams.

Synchro Amplifiers. New.

Type CARD 23AEK Bearing Control Units. New.

Type T.D.Y., SO-1, SO-13, SO-3 Radar Antenna Assemblies. New.

T.D.Y. Antenna Control Units.

Radar Tubes, types 4C35, 7BP7, 3B24, 3C45, 721A, 2J62, 9LP7, 3B22, 1B24, IN21B Crystals, etc.

Radar Crystals Raytheon 98.35 KC.

Type SO-11 Radar Modulator.

Type SO-1 and SO-3 Transmitter Receivers

MODEL AN/APA 10 PANORAMIC ADAPTER

Provides 4 Types of Presentation:

- (1) Panoramic (2) Aural
(3) Oscillographic (4) Oscilloscopic

Designed for use with receiving equipment AN/ARR-7, AN/ARR-5, AN/APR-4, SCR-587 or any receiver with I.F. of 455kc, 5.2mc. or 30 mc. With 21 tubes including 3" scope tube. Converted for operation on 115V. 60 cycle source.

Includes 80 page T.M. **\$195.00**

SHOCK MOUNTS

Lord #20, 3" x 3" x 1 1/4"40
U. S. Ruther #5150 C, 2 3/4" x 2 3/4" x 1 1/4"30
Lord #5, 2 3/4" x 2 3/4" x 1 1/4"25
Lord #10, 1 1/4" x 1 1/4" x 3/8"10
Lord #3, 1 1/4" x 1 1/4" x 3/8"10

PARABOLOIDS

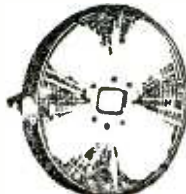

17 1/2" diameter, spun magnesium dishes, 4 inches deep. Reinforced perimeter. Two sets of mounting brackets on rear. Opening at apex for waveguide dipole assembly 1 1/2 x 1 1/8".

Brand new, per pair, \$8.75

WESTERN ELECTRIC

MERCURY CONTACT RELAYS

TYPE D-168479



These relays are glass sealed, mercury-wetted contact switches surrounded by operating coils and encased in metal housings, mounted on an octal tube base.

TYPICAL APPLICATIONS

- High speed keying
- Tabulating, sorting and computing machines
- Relay Amplifiers
- Vibrator Power Supplies
- Servo-mechanisms

CHARACTERISTICS

- High speed of operation
- Constant operating characteristics
- Freedom from chatter
- High current capacity
- Long, trouble-free service

Single Pole, Double Throw Contacts. Two coils of 700 ohms and 3300 ohms. Operating current with coils connected in series 6.6 ma. Release current 5.2 ma.

When operated under specified conditions this relay has a life expectancy of 1000 hours at 60 operations per second.

Overall length—3-3/8". Overall dia.—1-5/16"

**Brand new
Priced at a fraction
of Government cost**

\$4.75

Send for 4 page Technical data

25,000 CAPACITORS



Inerteen Type FP 25,000 volts .5 MFD. Size 13 1/2" x 16 1/2" x 4 1/2" with mounting brackets.

Brand new . . \$23.50

Shipping weight 35 lbs.

15,000 Capacitors

15,000 Volts 1MFD Cat. No. 1463. Size 12" x 16 1/2" x 4". With mounting flange.

Brand new . . \$14.50



SOUND POWERED TEL. FIELD SETS Type TP3

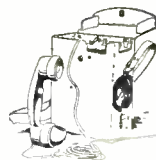

For two-way signalling for voice communication. No batteries needed. May be used on metallic or grounded circuits, open-wire lines, cables or circuits using local-battery telephones, switchboards; two-way-ring-down trunk circuits or common battery switchboards, etc. Contains a treated waterproof fabric cases with adjustable carrying straps.

**Brand new \$29.50
Per Pair \$55.00**

MICRO-WAVE RECEIVERS IN STOCK

TYPE AN/APR-5A
and TYPE AN/APR-4
Prices on Request

All prices indicated are F O B Tuckahoe, New York. Shipments will be made via Railway Express unless other instructions issued.

ELECTRONICRAFT INC.

5 WAVERLY PLACE TUCKAHOE 7, N. Y.
PHONE: TUCKAHOE 3-0044

All merchandise guaranteed. Immediate delivery, subject to prior sale.

**All Prices Subject to
Change Without Notice**

RELIANCE SPECIALS



UNIVERSAL JOINT ALUMINUM
 1/8" long x 1/2" O. D. 1/4" ID
ONLY 40c

CAPACITORS

POSTAGE STAMP MICAS

8.2mmf	56mmf	200mmf	560mmf	.0015mfd
10	60	220	600	.002
18	70	250	650	.0026
20	90	270	680	.0027
22	100	350	800	.003
25	140	370	.001mfd	.0039
40	150	400	.0012	.007
47	180	470	.0013	.008
50	180	500	.00135	.01

Price Schedule

8.2mmf to .001mfd 5c
 .0012mfd to .002mfd 7c
 .003mfd to .008mfd 12c
 .01 mfd 18c

SILVER MICAS

10mmf	125mmf	390mmf	680mmf	.0025mfd
22	150	400	700	.0027
39	180	430	750	.003
50	200	466	820	.0033
62	240	470	.001mfd	.0039
66	250	488	.0012	.004
68	300	510	.0013	.005
100	330	525	.0015	.0051
110	360	560	.002	.0068
120	370	665	.0024	.01

Price Schedule

10mmf to .001mfd 10c
 .0012mfd to .0027mfd 20c
 .003mfd to .0068mfd 50c
 .01mfd 65c

CERAMICS

3mmf	12mmf	22mmf	56mmf	110mmf	220mmf
3.44	13	27	62	115	1000
1.7	15	33	68	140	1090
6.8	16	40	75	150	\$4 per 100
8	18	47	82	180	
10	20	50	91	200	

OIL FILLED

MFD	V.D.C.	Price	MFD	V.D.C.	Price
.1	25,000	\$14.95	1-1	7,000	1.95
.03	16,000	4.50	1	7,000	\$1.75
.375@	18,000 and	8.95	.02-.02	7,000	1.65
.75@	8,000 (dual)	8.95	1	6,000	8.50
5	7,500	23.95	1	6,000	1.75
.1	7,500	1.85	.03-.03	6,000	1.65
			2	4,000	4.50
			2	3,000	1.75
			2	750 V.A.C.	.39
			2	2,000	.95
			3	1,000	.90
			4	1,000	.80
			1	1,000	.65
			2	800	.40
			10	600	1.60
			4	600	1.69
			2	600	.39



2 mfd.
4,000
 V. D. C.
#23F47
SPECIAL
\$4.50

WW PRECISION RESISTORS 1%

1/4 WATT—25c					
6.68Ω	12.32Ω	16.37Ω	123.8Ω	414.3Ω	
10 ³ 8	13.02	20	147.5	705	
10 ⁴ 84	13.52	62.54	220.4	2193	
10 ⁵ 3	13.89	79.81	301.8	10,000	
10 ⁶ 74	14.98	105.8	366.6	59,148	

1/2 WATT—25c					
250Ω	11.1Ω	210Ω	3,427Ω	10,000Ω	
.334	13.15	235	4,451	14,825	
.502	46	260	5,000	15,000	
.557	52	270	5,900	15,750	
.627	55	298.3	6,500	17,000	
.76	75	400	7,000	20,000	
1.01	97.8	723.1	7,500	30,000	
1.53	125	2,500	8,000	100,000	
2.04	180	1,850	8,500	150,000	

1 WATT—30c					
1.01Ω	5.21Ω	1,250Ω	9,000Ω	55,000Ω	
2.58	10.1	3,300	18,000	65,000	
3.39	10.9	7,000	50,000	70,000	
5.05	270			75,000	

1 WATT—40c					
100,000Ω	128,000Ω	180,000Ω	470,000Ω	525,000Ω	
120,000	130,000		522,000	600,000	
125,000	160,000	320,000		700,000	

1 Megohm, 1 Watt, 1%—65c; 5%—40c
 Orders for 100 pieces—10% off;
 Orders for 1,000 pieces—20% off.

PULSE TRANSFORMERS

X 124 T2, UTAH, marked 926 or 9280, small gray case, 1% high x 1 1/8" x 5/8" with two 6-32 mtg. studs. Ratio 1:1:1, hypersil core... \$1.50
 352-7178—Spec. 10, 111 Chicago Trans., equivalent to 9262 (above)... \$1.50
 TR 1048, Dinion Coil Co... \$1.25
 TR 1049, Dinion Coil Co... \$1.25
 352-7250-2A, cased 15/16" dia. x 1 1/8" high DC 10 ohms, 3 1/2 ohm, 140 cy. to 175 KC... \$1.25
 352-7251-2A, similar—shorter pulses... \$1.25
 300 KVA GE 7557296, 50 ohm pulse cable connection; 3,850 V. in., 17,300 V. out. (250 KVA @ 1/4 microsecond)... \$15.00
 800 KVA G.E. K2731, 28,000 Volt pk. output; Bifilar, pulse width; one-microsecond... \$19.50
 D166173, W. E. Freq. response 10KC to 2 MC... \$12.00
 KS9800, Ratio, 1:1:1, 2:1, Freq. range 380 to 520 C.P.S... \$4.00

COAXIAL CABLES

RG 8/U 52 OHM—Per 1,000 ft. \$50.00
 RG 22/U 95 OHM (2 cond.)
 per 1000 ft. \$120.00
 RG 62/U 93 OHM per 1000 ft. \$ 40.00

COAXIAL CABLE CONNECTORS

Angle Adapter 15c M-359 83-IAP	Plug 28c PL-259 83-ISP	Socket 28c SO-239 83-IR	Hood 9c 83-IH
83-1SPN \$.28	UG 13/U .60	UG 59/U .60	UG 60/U .60
83-1J .65	UG 21/U .60	UG 61/U .60	UG 62/U .60
83-1F .80	UG 22/U .60	UG 85/U .60	UG 87/U .60
83-1T 1.12	UG 24/U .60	UG 87/U .60	UG 167/U 2.00
3-22 1P .85	UG 25/U .60	UG 281/U .60	
83-22J .85	UG 27/U .60		
83-2AP 1.50			
83-2J 1.50			

ALLEN SET SCREWS

4-40 x 1/8 6-32 x 1/8 8-32 x 3/16
 4-40 x 3/16 8-32 x 1/8 8-32 x 5/16
 ALL SIZES (Cup Point).....\$1.50 per 100
 Wrenches for above.....2¢ ea.

RESISTORS—Asst.—Carbon Insulated—Color Coded—Mostly 1/2 & 1 Watt. 100 for only \$1.19

GEAR ASSORTMENT—Experimenter's dream. Approx. 100 pieces, many stainless....\$6.50

SPAGHETTI SLEEVING—Asst. sizes and colors, 3 ft. lengths.....99¢ ft—Only \$1.00

Glyptal Cement—5 gal. \$11, 1 gal. \$2.50, 1 qt. 75¢

Vernier dial For BC221, 2 1/2" dia. 0-100....\$8.5

DC AMMETER O-15A BASIC MOVE. 12 Ma 5" x 4" METAL CASE MIRROR SCALE Lots of 10—\$34		CHOKE 400 MA 12 H 90 Ω 6,000 V.D.C. TEST \$3.85	
--	--	---	--

MINIMUM ORDERS \$3. All orders f.o.b. PHILA., PA.

POWER RHEOSTATS

25 WATT				50 WATT				100 WATT							
Resist.	Mfg.	Shaft	Pr.	20Ω	Ohmite	1/2"	.69	50	Ohmite	1/2"	.69	2	Ohmite	1/2"	1.29
10Ω	Clarostat	1/8"	.49	50	Clarostat	1/2"	.69	90	Clarostat	1/2"	.69	2	Ohmite	1/2"	1.29
25	IRC	S.D.*	.49	1,000	Ohmite	1/2"	.69	1,250	Ohmite	1/2"	.79	1,000	Ohmite	1/2"	1.49
50	Clarostat	1/2"	.49	3,500	Ohmite	1/2"	.79					10,000	Ohmite	S.D.*	1.49
200	IRC	1/8"	.49												
250	Ohmite	1/8"	.59												
350	Ohmite	1/8"	.59												
1,500	Clarostat	1/8"	.49												
2,000	Ohmite	1/8"	.69												
2,500	Ohmite	S.D.*	.69												
3,500	Ohmite	1/8"	.69												
5,000	Ohmite	S.D.*	.69												

* Screw Driver Slot

TYPE AB

Carbon Resistors

1/2 Watt		1/2 Watt		1 Watt	
Resist	Tol.	Resist	Tol.	Resist	Tol.
430	5%	220K	10%	360	5%
1,300		500K	10%	560	5%
1,600		360K	5	3,300	10
3,300		390K	10	5,600	10
3,600		910K	10%	10K	5
12K		1 meg. Ω	10%	15K	5
30K		1.2 meg.	10		
33K		1.3 meg.	10		
33K		3 meg.	10		
33K		\$3 per Hundred			
39K		1 Watt			
75K		6.8 meg.	10		
150K		27 Ω	10		
180K		43	5		

SWITCHES

Push Button Type, Norm. Open.....29c
 10 for \$2.50
 Push Button Type, S.P.D.T...43¢. 10 for \$3.50
 Lever Type, Normally Closed...37¢. 10 for \$3.00
 G.E. Switchette, Norm. Closed...14¢ Norm. Open 16¢
 Toggle, 6 A, 125 V, S.P.D.T., Ball Handle...24¢
 Toggle, 6A, 125 V, D.P.S.T., Bat Handle...29c
 Same as above except 10 A.....34c
 Toggle, 6 A, 125 V, D.P.D.T., Bat Handle...54c

JONES BARRIER STRIPS

Type	Price	Type	Price	Type	Price
2-140 Y	.05	5-141 Y	.25	17-141 Y	.78
3-140 3/4 W	.12	7-141	.26	5-142 Y	.21
3-140	.10	8-141	.27	8-142 Y	.52
4-140	.13	8-141 3/4 W	.38	10-142 3/4 W	.58
8-140	.23	9-141 Y	.32	17-142 Y	.97
10-140 3/4 W	.31	10-141 3/4 W	.47	18-240 Y	.35
13-140	.36	12-141	.43	22-240	.45
15-140	.42	14-141	.51		
2-141	.09	17-141	.60		

Any order for 100 pieces—10% off

PRECISION POTENTIOMETERS

6 WATT			4 WATT		
20,000Ω	Muter 314A	\$1.70	500Ω	Centralab 48-501	\$9.00
20,000	GR 314A	2.50	50	De jur 292	.75
20,000	GR 314A	2.50	50	GR 301	1.10
6,000	De jur 260	1.70	25	GR 301	1.10
6,000	Muter 314A	1.70	20	De jur 292	.75
6,000	Muter 314A	2.50	20	GR 301	1.10
5,000	GR 314A	2.50	12	GR 301	1.10
5,000	GR 214A	1.40			
2,000	De jur 260	1.78			
600	GR 314A	2.25			
200	GR 214A	1.40			
40	GR 214A	1.40			

COAXIAL RELAY, Struthers Dunn—coil 12 V.D.C., 90Ω Equipped with three UG 87/U BN receptacles for small size RF cable.....\$8.95

WRITE FOR OUR NEWEST CATALOG!

RELIANCE MERCHANDIZING CO.

12th St. Cor. Buttonwood, Phila. 23, Pa. Telephone Market 7-2401

FOR SALE

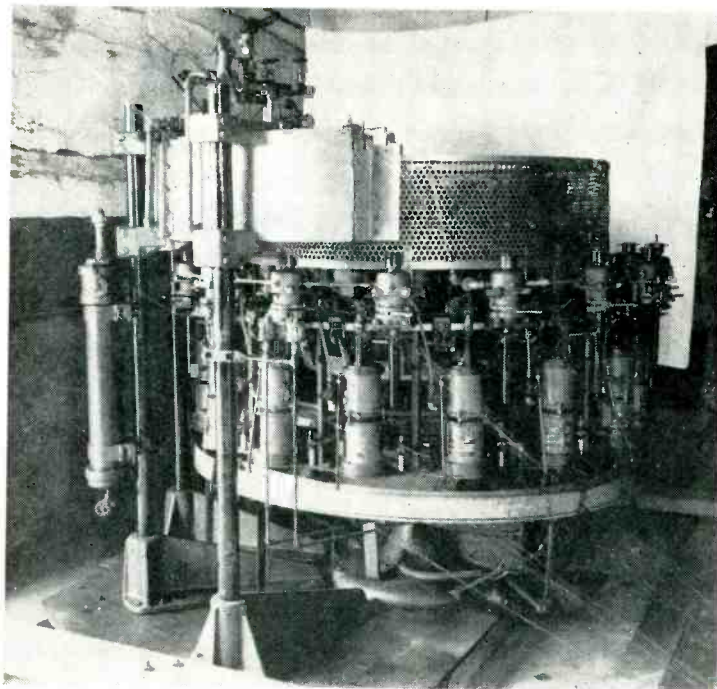

- Electronics manufacturing equipment
- Used but in excellent condition
- Can be adapted to Television Tube Manufacturing
- Inspection invited, immediate shipment

GRID CARBONIZING & CLEANING EQUIPMENT. GE. One gen. radio variac 100Q, one hydrogen monometer, lifting mechanism for carbonizing unit.

TUBE STEM MACHINES. Mfd. by Kahle Eng. Co. 4-5-6-7-8 positions with Geneva movements.

BASING EQUIPMENT. Remodeled from a delta 989. Mfd. by GE for large tubes. Drill press pedestal type, with automatic control.

HYDROGEN FURNACES. Complete with automatic controls. 20" x 7" x 4". Brick lined, with two Bristol automatic controllers. Brown pyrometers.

LGE. SPOT WELDER. Mfd. by Natl. Welding Mach. Co. Type 2235. One GE water-cooled transformer, 500 KVA, air pressure control, two heat controls.

MAGNETIZING EQUIPMENT. Mfd. by GE. for 486 and 505 magnetron tubes. One CR7503A125-G10 welding panel for GL415 tubes, one heat control, one welding time control.

ARCING BOTTLES. GE. Stanlifting mechanism to lift work up and down inside bottle.

BULB-PIERCING & TABULATING MACHINE. Mfd. by Kahle Eng. (any standard transmission tubes or thyratron.) 1/20 hp. motor, 1/60/110 v. gear drive, reduced to 108 rpm.

BASING CEMENT MIXER. Mfd. by J. H. Day Co. Model 1, with 2 hp. motor, GE, 3/60/550 v., 1735 rpm.

EXHAUST MACHINE. 32 heads, Mfd. by Kahle Eng. Co., Capacity 60 tubes per hour, 60 W. type B174 Sealix chassis, with pumps, commutator and torch. Three power oscillators, panel board, transformer.

FLARE MACHINE. Mfd. by Kahle Eng. Co.

VACUUM FIRING EQUIPMENT. Mfd. by GE.

WIRE STRIPPING MACHINE. Model 9E, for stripping wire up to 8 gauge. Bench type with motor.

SEALING & STEM MACHINE. 16 heads. Mfd. GE, 3/4 hp. GE motor.

ELECTRIC FURNACE. contains electric control and resistor.

EXHAUST MACHINE. 16 heads. UNUSED, by Kahle Eng. Co., complete with 16 metal liquid air traps, 16 compression heads, 16 water-cooled compression levers with rollers, 7 mercury pumps D-239, 13 terminal boards, five GE timers.

INSULATOR EQUIPMENT. GE, consists of welding equipment.

GLASS CUT-OFF MACHINE. McCreery Machine Wks. 3" diamond disc. cutting wheel mounted under table.

CARBONIZING EQUIPMENT. GE, one water-cooled cylinder.

COMBINATION STEM & SEALING MACHINE. Dual drive, automatic operation.

MARKING MACHINE B. B. Marker Machine Company Model P. L. for labeling electronic tubes. With 1/2 hp motor coupled to reduction gear.

GRID WINDER & ROLLER WELDER. GE, for side rod tungsten welding.

SET: SUCTION & SAND BLAST UNIT. By Amer. Foundry Co. Model 1B, 3 hp. GE motor.

GAS PURIFYING FURNACE. GE. Cat. #8236225G1, 1400°F. Brown pyrometer, panel & timers.

AUTO BUTTON STEM MACHINE. 1-12 Head, complete with fires—ready for immediate operation.

BAIRD. 4 slides, #00 reducer, with motor and oil pump

FLETCHER Centrifuge.

GAS FIRED OVEN FURNACE. #210, AGF.

FEDERAL DUST CLASSIFIER. Laboratory unit.

STURTEVANT GAS BOOSTER with diaphragm regulator, bypass and 1/2 hp. motor, 110v. Many others.

8 x8 KINNEY VACUUM PUMPS, with base, no motors.

AIR BLOWER. With motor, GE, HP:11, 3 phase, Blower, Type: MM-26-450-3.5 lbs. 3500—many others.

Many others for glass working for laboratories, lamp & neon use.



HAYDU BROTHERS

PLAINFIELD NEW JERSEY

- TRANSMITTING
- RECEIVING
- INDUSTRIAL
- SPECIAL PURPOSE

TUBES

Guaranteed
by
WELLS

IMMEDIATE DELIVERY AT THE LOWEST PRICES IN OUR HISTORY!

Check this list for exceptional values in magnetrons, cathode ray tubes, voltage regulators, transmitting tubes—also neon, pilot and flashlight bulbs. These are brand new, standard make tubes. Order enough for future needs directly from this ad or through your local parts jobber.

Type	Price	Type	Price	Type	Price	Type	Price
01A	\$0.45	12K8	.65	714AY	9.95	930	2.20
1B22	4.35	12SF7	.70	RK715B	7.95	954	.50
1N21 Xtal Diode	.65	12SH7	.40	717A	.90	955	.55
1N21B Xtal Diode	.80	12SK7	.60	721A	3.95	956	.55
1N23 Xtal Diode	.80	12SL7/GT	.70	724A	4.65	957	.55
1N23A Xtal Diode	.85	12SR7	.40	724B	4.25	991 (NE-16)	.30
1N27 Xtal Diode	.85	12x825 2 amp. Tungar	2.25	725A	19.95	1005	.35
1R4/1294	.65	13-4 Ballast	.35	726A	19.95	1148	.40
1R5	.95	15R	1.40	730A	11.95	1201	.75
1S5	.95	FG-17	2.85	801	.60	1616	1.25
1S21	1.10	REL-21	3.25	801A	.75	1619	.55
1T4	.95	23D4 Ballast	.45	803	6.95	1624	1.25
2C26	.35	25Z6/GT	.55	804	9.95	1625	.45
2C26A	.45	28D7	.40	805	5.45	1626	.45
2C34	.55	30/VT-67 (For Walkie)	.75	808	1.75	1629	.45
2J21A	11.45	33/VT-33 (Talkies)	.75	809	2.75	1635	.95
2J22	9.85	RK-34	.45	810	7.95	2051	.95
2J26	8.45	34	.35	811	2.35	7193	.35
2J27	14.45	39/44	.35	813	7.85	8011	2.55
2J31	9.95	45 Spec.	.55	814	3.75	8012	4.25
2J32	14.85	46	.80	815	2.85	8020	3.35
2J33	19.95	EF50/VT-250	.45	826	.49	8025	7.50
2J37	13.85	CEQ 72	1.50	829	3.25	9001	.70
2J38	12.95	72/3B24	1.75	830B	3.95	9002	.45
2J48	14.95	VR-75	.90	837	1.75	9003	.65
2X2/879	.65	76	.55	838	3.25	9004	.45
3A4	.35	VR-78	.65	841	.55	9006	.45
3A5	1.05	80	.45	843	.55		
3AP1 CRT	3.85	FG-81-A	3.95	851	39.50		
3B22	2.95	83	.85	WL-860	2.55		
3B24	1.75	83V	.95	861	32.50		
3BP1 CRT	3.75	89Y	.40	864	.55		
3CP1-S1	1.95	VR-90	.70	865	2.55		
3C24/24G	.47	VR-92	.65	866A	1.30	NE-2	\$0.06
3D6/1299	.65	100R	3.25	869	26.50	NE-15	.06
3FP7 CRT	2.95	FG-105	9.95	869B	28.95	NE-16	.24
3HP7 CRT	2.95	VR-105	.85	872A	2.45	NE-20	.06
3GP1 CRT	3.75	VU-111	.65	874	2.15	NE-21	.24
3Q5	.90	117Z3	.55	878	2.15	NE-28	.24
REL-5	17.95	VT-127 English	.25			NE-48	.06
5AP1 CRT	3.95	VT-127A	2.95			NE-51	.06
5BP1 CRT	2.95	VR-150	.55				
5CP1 CRT	3.85	VT-158	9.85				
5GP1 CRT	6.55	FG-172	29.50				
5J23	14.25	205B	1.95				
5J29	14.25	211 (VT-4-C)	.65				
5Y3G	.40	215A	1.95				
6A6	.90	231D	1.30				
6AB7	.95	282B	4.25				
6AC7	.90	304TH	5.95				
6AK6	.80	304TL	1.75				
6B7	.95	307A	4.25				
6BE6	.65	316A	.75				
6C4	.45	350B	2.55				
6C6	.75	371B	.85				
6C21	19.75	388A	4.95				
6D6	.60	417A	19.95				
6E5	.70	434A	7.45				
6H6	.50	446A	1.55				
6J5/GT	.50	450TH	19.95				
6J6	.90	GL-471A	2.75				
6N7/GT	.80	527	11.25				
6R7G	.80	WL-530	17.50				
6SF5	.65	WL-531	17.50				
6SG7	.70	532A/1B32	3.55				
6SH7	.65	GL 559	3.75				
6SJ7/GT	.65	KU-610	7.45				
6SK7/GT	.65	HY-615	1.20				
6S7/GT	.65	700B	9.95				
6SN7/GT	.80	700C	9.95				
6SQ7/GT	.60	700D	9.95				
7A4	.65	702A	2.95				
7A7	.65	703A	4.85				
7C4/1203	.40	705A	2.65				
7C7	.65	707A	19.50				
7E6	.65	707B	23.25				
7F7	.75	710A	2.15				
7H7	.75	713A	1.55				
7N7	.75						
7Q7	.65						
10/VT-25A	.40						
10Y/VT-25	.45						
12A6	.25						

NEON BULBS FOR RADIO USE

Pilot and Flashlight Bulbs

Stock No.	Mazda No.	Volts	Watts	Bulb	Base	Price
350-40	64	6-8	3CP	G-6	DC Bay	\$0.07
350-31	57	12-16	1.5CP	G-4½	Min. Bay	.08
350-42	Spec.	12	6	S-6	Cand. Scr.	.13
350-20	1446	12	.2 amp.	G-3½	Min. Scr.	.07
350-14	49	2	.06	T-3½	Min. Bay	.06
350-15	356	120	3	S-6	Can Bay	.11
348-22	PR-10	6	.5 amp.	B 3½	Min. Flang	.05
350-19	Proj. Bulb	120	500W	T-20	Med. Pf	1.45
LB-17 C		24	.035 A	T-2	Tel. Base	.18
LB-58A		110	7W	C-7	Cand. Scr.	.17
LB-57A		12-16V	1 CP		Min. Bay	.07
LB-100A Airplane Headlight	24V	239W	A-19		Med. Pf	.38
LB-101	323	3	(Aircraft)	T-1½	953	.22
LB-101A	LM-60	115V	250W	T-20	Med. Pf	.40
LB-102	1195	12-16	.50 CP	RP-11	DC Bay	.14
LB-102A	CC-13	110V	100W	T-8	DC Pf	.33
LB-102B	1491	2.4	.8 amp.		DC Bay	.14
LB-102C	3D2	28	(Airplane type)		DC Bay	.14
LB-104	313	28	.17 amp.	T-3½	Min. Bay	.12
LB-105	1816	13V	.33A		Min. Bay	.11
LB-106	12A	12	.09-.11	T-2	Tel. Base	.18
LB-107	24-A2 WE	24	.75-.105	T-2	Tel. Base	.18
LB-108	S-14 Argon	105	2½ Watt		Med. Scr.	.22
LB-109	S	Telephone Type	Neon	T2		.17
350-18	1477	24	17	T-3	Min. Scr.	.16

10% DISCOUNT ON ORDERS OF \$100.00 OR OVER

Manufacturers: We carry thousands of electronic parts in stock. Send us your requests for quotation.

Distributors: Our standard jobber arrangement applies. Order directly from this ad.



320 N. LA SALLE ST., DEPT. SL, CHICAGO 10, ILL.

149

Tube Bargains

SWITCHING

RECEIVING

CATHODE RAY

PHOTO

TRANSMITTING

RADIO SHACK price-cutters made a grand tour of our five-floor building . . . unearthed an amazing variety of 149 receiving, transmitting, rectifying, switching, photo and cathode ray tubes . . . went to work and cut our old (low) prices to smithereens! All are guaranteed new Gov't. surplus . . . inspected for mechanical breakage before shipment. Limited quantities of some types, so don't delay — ORDER TODAY. Discount 2% if your order totals \$50.00 or more!

TYPE	PRICE
C5B	\$8.50
CK501LX	.90
CK1089	1.10
DG1295	9.70
DG1605	9.70
ELC6A	8.10
F660	35.00
FG17	3.10
FG27	4.45
GL434A	3.50
HY615	.35
VR90	.75
VR105	.60
VR150	.60
QK60	49.50
QK61	65.00
QK72	75.00
HK25	2.90
KK60	.40
RK65	20.00
RK72	1.00
RX21	3.25
WL653B	75.00
WL681/686	12.00
X111	40.00
ZP653	75.00
605	18.00
ZP679	60.00
1B22	5.00
1B24	5.50
1B27	7.00
1C21	1.25
1P23	1.45
2A P1	3.50
2B22	2.50
2C22	.23
2C26A	.30
2C33	2.50
2C40	2.50
2C46	4.50
2D21	1.25
2E22	1.50
2J21	18.00
2J22	18.00
2J26	15.00
2J27	30.00
2J34	22.50
2J36	100.00
2J50	50.00
2J54	50.00
2J55	36.00
2J61A	110.00
2J62	47.50
2K33	\$40.00
2x2/879	.35
2A2A	.75
3AP1	5.00

TYPE	PRICE
3B24	.90
3B26	1.45
3CP1	4.50
3C23	2.40
3C24	.29
3DP1	4.50
3EP1	4.50
3E29	3.29
3FP7	2.25
3GP1	4.75
3JP12	14.00
4J36	36.00
4J37	36.00
5BP1	2.40
5BP4	4.95
5CP1	4.75
5FP7	2.00
5JP1	24.00
5JP2	14.00
5JP4	12.50
5LP1	11.80
7BP7	7.50
10BP4	27.39
10 Spec.	.60
10	.35
15R	.75
23D4	.27
45 Spec.	.27
53A	17.50
204	75.00
211	.49
VT127A	2.50
227A	3.50
250TH	19.00
274B	1.15
304TH	3.00
304TL	3.00
316A	.49
350A	2.25
359A	.90
371B	1.50
388A	3.50
394A	3.50
417A	24.00
446A	2.40
GL446	1.95
450TH	24.50
450TL	24.00
464A	7.00
532A	2.25
562	37.50
615	.45
705A	2.75
706	17.50
707A	19.50
707B	19.50
708A	7.00
710A	\$3.50
713A	7.00
714A	6.50
715A	11.50
715B	13.50
721A	4.00
723A/B	10.95
724A	4.95
724B	1.70
725A (2J53)	17.50
726A	12.95
750TL	45.00
800	2.00
801A	.48
802	2.90
803	3.50
804	6.50
805	3.50
807	1.15
808	1.90
809	1.50
810	6.15
811	1.29
812	2.75
813	5.20
814	1.95
815	1.39
816	.95
822	8.00
826	.45
828	6.50
829	4.95
829B	4.85
830B	3.00
832	2.75
836	.75
837	2.45
838	2.85
845	3.15
864	.25

TYPE	PRICE
865	4.00
866A	.80
869B	45.00
872A	1.20
884	1.39
902	7.50
954	.35
955	.35
957	.25
958	.35
959	.40
1613	.80
1616	.65
1619	.25
1624	.80
1625	.15
1626	.25
1632	.75
1645	\$1.50
1655	.65
1672	2.00
1809P1	14.50
1851	.85
2050	1.00
2051	.75
7193	.25
8013	1.50
8014A	17.50
8020	2.75
8025	5.75
9001	.49
9002	.49
9003	.49
9004	.25
9006	.49
1A3	.39
1A5GT	.49
1A7	.59
1T4	.59
2A3	1.05
3A4	.39
3B7/1291	.36
3D6	.36
5T4	.70
5U4C	.60
5W4	.98
5Z3	.60
6A6	.98
6AC7/1852	.70
6AG5	.79
6AG7	.89
6AJ5	.79
6AJ6	.79
6AK5	.89
6AK6	.89
6B6	.79
6C4	.25
6C6	.45
6C8G	.75
6H6	.45
6J5	.49
6J6	1.08
6K7	.50
6K8	1.00
6L6	1.25
6SA7	.50
6SC7	.50
6SH7	.40
6SJ7	.50
6SK7	.50
6SN7	.75
6V6	.75
6X5	.60
7C4	.35
7C7	.80
7E5/1201	.60
7E6	.60
12A6	.24
12H6	.35
12J5GT	.39
12SF7	.60
12SJ7	.50
12SK7	.50
14H7	.75
24A	.67
30 Spec.	.30
33	.40
36	.40
38	.40
39/44	.40
45	.62
76	.47
77	.50
78	.50
83V	.90
112A	.50

The RADIO SHACK Corp.

CABLE ADDRESS · RADIOSHACK
167 WASHINGTON ST., BOSTON, MASS., U.S.A.

NEW RADIO SHACK CATALOG CALLED "RADIO'S FINEST"!

Send for your FREE copy of our 108-page 1949 catalog TODAY, also copy of new 8-page Summer Clearance surplus flyer!

BONUS: 2% DISCOUNT ON ORDERS OF \$50.00 OR MORE!

BRAND NEW U. S. GOV'T. SURPLUS GUARANTEED

NOISE FILTERS

Mallory #NFI2-7, 115 VAC., \$1.15
 Mallory #NFI-1, Heavy Duty, 1.98
 Sprague #JX-51, 10a 6-30 VDC .75
 Sprague #JX-55D, 4a 6-30 VDC .49
 Tobe "Filterette" #1164A, 15A 30V AC/DC 1.48



OIL CONDENSERS

FAMOUS MAKES

most with ceramic pillar insulators.

.1 Mfd—3000 vdcw.....	\$0.75
.25 Mfd—3500 vdcw.....	1.15
1.0 Mfd—500 vdcw.....	.35
1.0 Mfd—600 vdcw.....	.28
2.0 Mfd—400 vdcw.....	.35
2.0 Mfd—600 vdcw.....	.39
4.0 Mfd—500 vdcw.....	.59
4.0 Mfd—600 vdcw.....	.69
6.0 Mfd—400 vdcw.....	.75
6.0 Mfd—600 vdcw.....	.79
10.0 Mfd—600 vdcw.....	.98
14.0 Mfd—600 vdcw.....	1.75
15.0 Mfd—600 vdcw.....	1.98
15.0 Mfd—1000 vdcw.....	2.25
4-4-4 Mfd 400 vdcw 3 sec. 4 prong plugs in can 4 1/2" high x 3" Dia. \$1.49	



BATHTUB CAPACITORS

FAMOUS MAKES

.033/400V... 17¢	1.0/200V... 29¢
.05/200V... 13¢	1.0/600V... 35¢
.05/400V... 19¢	2.0/600V... 45¢
.05/600V... 21¢	2x.05/1500V... 33¢
.1/200V... 17¢	2x.1/800V... 29¢
.1/400V... 20¢	2x.1/1000V... 31¢
.1/600V... 22¢	2x.16/600V... 28¢
.15/600V... 23¢	2x.25/600V... 29¢
.25/200V... 19¢	2x.5/600V... 34¢
.25/400V... 21¢	3x.1/600V... 30¢
.25/600V... 23¢	3x.1/800V... 33¢
.5/200V... 20¢	3x.25/600V... 30¢
.5/400V... 23¢	3x.1.0/100V... 35¢
.5/600V... 25¢	
4.0/50V... 35¢	200/12V... 25¢
25/25V... 27¢	300/6V... 35¢
25/50V... 28¢	2x10/25V... 25¢
25/75V... 30¢	2x200/9V... 49¢
50/25V... 28¢	



SELECTOR SWITCHES
NATIONALLY KNOWN MFRS.

Total Poles	Poles	Total Decks	Type	Price
1	12	1	ceramic	\$0.45
1	21	3	bakelite	.55
2	11	2	bakelite	.50
4	11	4	bakelite	1.17
6	11	6	bakelite	1.68
18	5	9	ceramic	1.90

OTHER TYPES AVAILABLE

ALLEN-BRADLEY

potentiometers

Largest Variety in the following TYPE "J" sizes

50	1200	10000	75000
60	1300	11000	80000
100	1500	12000	100,000
110	2000	16000	150,000
140	2100	16000	150,000
150	2500	20000	250,000
200	4000	22000	300,000
400	4700	25000	350,000
500	5000	30000	500,000
600	6000	50000	1.0 meg
1000	6500		5.0 meg

Price 50c each

TYPE "JJ" DUALS

60-6C	25K-10K	200K-200K
100-100	35K-5K	250K-250K
200-200	35K-35K	300K-300K
500-500	40K-7K	350K-5K
600-600	40K-40K	350K-25K
1K-1K	50K-50K	350K-350K
2K-2K	100K-100K	400K-400K
5K-5K	130K-130K	700K-700K
10K-10K	150K-150K	800K-75K
20K-2K		5.0 meg/5.0 meg

Price \$1.00 each

TYPE "JJJ" TRIPLES

20K-200K-15K	700K-700K-700K
20K-200K-20K	750K-750K-750K
45K-27K-2500	800K-800K-800K
	1.0 meg-1.0 meg-1.0 meg

Price \$1.50 each

Also Available at Surplus Large Variety of Other Make Controls

AMPHENOL "AN" CONNECTORS



LARGE VARIETY AVAILABLE AT GREAT SAVINGS
Send your specs and let us quote

REAL BARGAINS!

DRY ELECTROLYTICS IN CANS

Standard Brands

MFD	Volt	Each	lots of 10	lots of 100
8	600	.59	.49	.39
8-16	475	.64	.57	.49
8-8	350	.39	.35	.29
20	120			
25	25	.29	.24	.19
25	25	.25	.20	.15
32	450	.69	.64	.54
10-10	@ 300			
10	@ 150	.38	.34	.28
10	@ 25			
40-40	@ 150 (Plug-In)	.53	.45	.39
40-40	@ 300	.56	.49	.41
80	@ 50	.69	.59	.49
1000	15	.89	.79	.69
1000	25	.89	.79	.69
1250-1250	10	1.37	1.15	.98

POWER RHEOSTATS

(nationally known mfrs)



Ohms	watt ea.	ohms	watt ea.
5	50 \$1.24	378	150 \$2.74
5	150 2.74	400	25 .98
6	25 .98	500	25 .98
6	50 1.24	500	75 1.97
7	25 .98	585	150 2.74
7.5	100 2.25	750	25 .98
8	50 1.24	750	150 2.74
10	25 .98	1000	25 .98
12	25 .98	1200	225 3.25
15	25 .98	1250	50 1.24
16	50 1.24	1250	150 2.74
22	50 1.24	1500	50 1.24
25	25 .98	2000	25 .98
50	25 .98	2000	50 1.24
50	50 1.24	2500	100 2.25
60	25 .98	3000	25 .98
75	150 2.74	3000	100 2.25
80	50 1.24	3500	50 1.24
80	500 4.95	5000	25 .98
100	50 1.24	5000	50 1.24
125	25 .98	7500	50 1.24
150	50 1.24	7500	100 2.25
200	25 .98	10000	50 1.24
250	25 .98	10000	100 2.25
350	25 .98	20000	150 2.74

(Discounts to Quantity Users.)

BIRTCHEER TUBE CLAMPS

#926-A	
#926-A1	
#926-B	
#926-B2	
#926-C	
#926-C5	

18c ea.



PRECISION RESISTORS

Nationally Known Mfr.

6	248	1155	5000	29500
24	280	1250	5294	29870
28	286	1260	5470	30000
34.6	300	1280	5500	32000
35.7	370	1400	5910	33800
38.6	400	1477	6000	37500
40	450	1485	6207	38140
47.7	480	1607	6550	39000
75	636	2000	6800	40500
78.8	650	2142	7000	47710
80	680	2170	7500	60000
88	700	2500	16000	61000
100	733	3480	17000	61430
107.85	743	3500	18300	70000
110	750	3760	19500	72000
125	900	3900	20000	75000
200	946	4000	20500	76100
215	1000	4280	21000	83700
225	4500	22000	80000	

Any Above Each 3¢; 10 for \$2.50
 100000 125000 145000 347000
 110000 130000 220000 390000
 115000 135000 235000 500000
 120000 140000 260000 750000
 800000
 Any Above Each 4¢; 10 for \$3.50
 1.0 meg 4.0 meg 10.0 meg
 Any Above each 75¢; 10 for \$6.50
 Many Other Types in Stock

Open Accounts to Rated Concerns Prices net FOB our whse NYC

UNITED'S SUMMER VALUES TOP QUALITY COMPONENTS

PRECISION MICA CONDENSERS (Silver-Cap. 1%)

Size 3/4" x 1" 400 Mmfd., 1500 Mmfd., 2000 Mmfd. 19c. each 100 assorted for \$15.00

PRECISION RESISTORS

WW-3 150,000 Ohms 3/4" x 1 1/2" .25¢, 100 for \$21.00
 W-1 10,000 Ohms 1% 9/16" x 9/16" .25¢, 100 for \$21.00

GLASS, VACUUM SEALED

Within 1/2% or 1% minus tolerance. Each unit marked with exact value to the 6th place. With pigtail leads. 4.0 Megohms at 85¢, each. 10 for \$7.50.

FERULE TYPE RESISTORS

Supplied with clips for mounting. Well-known makes.

GLASS TYPES

15 Watts, 19c ea.	30 Watts, 35¢ ea.	90 Watts, 59¢
1800 Ohms	400 Ohms	4 Ohms
2000 Ohms	650 Ohms	4000 Ohms
3000 Ohms	5000 Ohms	7500 Ohms
3150 Ohms	10,000 Ohms	15,000 Ohms
120 Watts.....	79c ea.	

83 Ohms 750 Ohms
 INSTRUMEN MULTIPLIER, 3 Megohms 3 Watts 3000 V. 1.0 Ma Ea. 98¢

VITREOUS TYPES

25 W. 8 Ohms.....	15c	100 W. 800 Ohms.....	65c
25 W. 20 Ohms.....	15c	100 W. 3000 Ohms.....	65c
30 W. 2800 Ohms.....	29c	100 W. 6500 Ohms.....	65c
90 W. 800 Ohms.....	59c	200 W. 10,000 Ohms.....	85c

OIL FILLED TUBULAR CONDENSERS

Phenolic shell over metal case. Size 3/4" x 3/4". 8-32 screw terminals. 1 Mid. 1250 V.D.C. Each 23¢. 10 for \$2.00.

ROUND METAL CAN UPRIGHT FILTER CONDENSERS

40 + 40 Mfd. 250 V.D.C. 1 1/2" D. x 4" L. 55¢ Ea. 10 for \$5.00; 400 Mfd. 200 V.D.C.W. 2" D. x 4 1/2" L. With mtg. bracket. Ea. \$1.19. 10 for \$11.00.

AMMETER SHUNT

Lecce-Neville #S-24602. .005 Ohms mounted on asbestos base with aluminum mounting plate. Perforated metal shield for personnel protection and air cooling. C-pable of handling at least 200 Amps. New—\$1.50.

CURRENT TRANSFORMER

Model 880—Ratio 75:1. Freq. 50 to 133 Cycles. With mounting bracket. Shpg. Wt. Approx. 1 Lb. New—\$2.75.

D. C. AMMETER RELAY

Well known brand. 6 1/2" Diameter 3 1/2" Deep. Industrial. Stand-off type. 0-50 Amps. for 250 Mv. drop. Relay is adjustable over full scale. Relay operates when cur. mt drops to present minimum. *Approx. Shpg. Wt. 10 Lbs. New—\$10.50.

COAXIAL CABLE

RG-21/u 53 Ohms. New—\$3.49 per 100 Ft. *Approx. Shpg. Wt.—12 1/2 Lbs.

COAXIAL FITTINGS

Female SO-231-3 for 55¢. Right Angle—Male and Female M-359-A. 3 for 55¢.

NAVY TYPE DYNAMOTOR

High efficiency P.M. field units. May be used on 6 V.D.C. with 1/2 output voltage may be used on 6 #516 REC.—(output: 275 V. Settings. MODEL 12 to 24 V.D.C. Approx. Shpg. Wt.—10 1/2 Lbs. \$2.50 MODEL #515 TR.—Output: 500 V. @ 50 Ma. Approx. Shpg. Wt. 10 1/2 Lbs. \$3.50 New in cartons.

OUNCEP TRANSFORMER W-226262-4

AF OUTPUT Impedance 10,000 Ohms. Sec. Impedance 250 Ohms. Metal case. 1 1/2" dia. 1 1/2" high. 10% at 75 Mw. @ 75 Mw. @ 250 Cye. Response: ± 3 DB. Glass sealed. New—\$4.75.

ICER TRANSFORMER #7254502

Pril. Impedance 5000 Ohms. Sec. Impedance: 250 Ohms. Size: 1 1/4" Lg. x 1" Overall. Diagram on case. Hermetically sealed. New—89¢ each.

STEPPER RELAY

Type H-706. 4 circuits 25 positions, continuous. Position indicator on drum. D.C. Coil resistance 12 Ohms. Like New condition—\$4.75.

WAVE GUIDES

5' long with flange at both ends. Approx. 3 CM. Completely silver plated. Outside finished in Battle-ship Gray. Flange ends are sealed. New with Flange Hdwe.—\$3.39. *Approx. Shpg. Wt.—4 Lbs. *Shipped Railway Express only.

WRITE FOR QUANTITY PRICES

Stocks are limited! Order now! C.O.D. orders require 25% deposit. All prices F.O.B. Chicago. Minimum order—\$2.00.

UNITED SURPLUS MATERIALS
 312 South Halsted St.,
 Chicago 6, Illinois
 Telephone
Central 6-4899

ALEXANDER MOGULL CO., INC.
 161 Washington St., N. Y. 6, N. Y. WOrth 4-0865

Better Buy 4

WESTERN ELECTRIC DRIVER UNIT with REFLEX PROJECTOR

WAY BELOW MANUFACTURERS' COST

\$19.95

F. O. B. N. Y. C. 4 FOR \$75.00

SPECIAL! 25% DEPOSIT WITH ORDER, BALANCE C. O. D.

MANUEL KLEIN 72 CORTLANDT ST. NEW YORK 7, NEW YORK
 Phones: BE 3-9530 — RE 2-6668

GUARANTEED GOVT SURPLUS

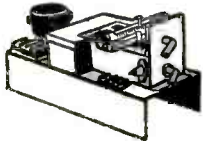

220-750 MC OSCILLATOR.

Compact, beautifully built line oscillator employing two W.E. 368AS (703A) "door-knob" tubes in push pull. Exceptionally stable. 5W output at 420mc, 2W at 700 mc. Independent grid and plate tuning. Adjustable output coupling and tuning assembly. Coaxial output connection. Built-in blower may be operated from 110VAC. Power requirements: 300VDC/150ma, 2V/4A, 1.2V/4A, 5 1/4"x6 1/2"x11 1/2". 7 lb. Supplied complete with tubes. Ideal for 420mc amateur operation or for use in the 460-470mc citizens radio band. Stock No. APO-66...\$8.95 Spare 368AS/703A tubes\$1.69

UHF 50 OHM COAXIAL POWER MEASURING ASSEMBLY. Panel with integrally coupled crystal mounting, silver-plated assembly mount. Type "N" UG-58U female receptacle (easily replaced by SO-239). Originally designed for power measurement at frequencies up to 700 mc. Stock No. AMP-89\$3.95
MATING TYPE "N" MALE PLUG. For use with above. Stock No. PCM-17.....\$0.49

SPEYER MODEL 12 KLYSTRON TUNER for use with 2K33, 2K42, 2K43, 2K44, 417A. Stock No. YKT-27.....\$1.95
MAGNETRON MAGNET 1900 GAUSS. Pole dia. 1-1/2". Gap 1 1/2". Stock No. UMM-21\$5.75
MAGNETRON MAGNET 4800 GAUSS. Pole tip dia. 3/4". Gap 0.635". Stock No. UMM-48\$7.00



50 OHM COAXIAL RELAY. Double coil actuating relay operates from either 12VDC/120ma or 24 DC/60ma. May be operated in plate return circuits to provide automatic transmitter-receiver antenna changeover. Supplied with British type connectors which are easily replaced by standard SO-239 (83-1R) receptacles or soldered to directly. Completely enclosed in compact housing. 2-3/4" x 3" x 4-3/4". An outstanding buy at \$2.49. Stock No. KDC-723.



VARIABLE INDUCTOR. 67 microhenries max. Minimum near zero. Wheel type sliding short. Ceramic insulation. Quality construction. Barker-Williamson #1665. Originally used as transmitter plate tank coil to tune from 1 1/2 to 20mc. Ideal for pi-networks, antenna tuners and plate tanks. Stock No. LRF-32.....\$1.95

APC AIR TRIMMER. 35 mmf max. Screw slot adjust. Stock No. CAV-105. 10 for \$10.00
APC AIR TRIMMER. Two separate trimmers on ceramic base. Shield between sections. Each section 20 mmf max. Stock No. CAV-104\$1.00
AIR CAPACITOR 100 MMF. Ceramic insulation. shaft. Receiving type. Similar to MC-100-M. Standard Brand. Similar to AV-15. Straight-line capacity. Stock No. CAV-104\$0.72

SUPER-FLEXIBLE PICTAL. Part No. P55357. Consists of 35 strands of 0.002" diameter soft copper wire. Total diameter: 1/32". Useful in applications where electrical connection is to be made to moving parts, e.g., variometers, variable capacitors, motor-brushes, etc. Stock No. WFP-350. 10 foot rolls. \$0.69 per roll.

750 CPS BANDPASS TRANSFORMER. Center frequency adjustable over a small range. Input 23,000 ohms. Output 225,000 ohms. Triple alloy shielded. 1 1/2" x 1 1/2" x 2". Stock No. ZBP-750\$2.49

BLOCKING OSCILLATOR TRANSFORMER. Two winding 1.35:1. Ideal for television sweep oscillators. Compact. Stock No. TFF-64 \$0.95.



INVERTER PE 218D. Output 115V/400 cps/1500VA/1ph. Input 24-28 VDC. Made by Win-charger. Complete with starting relays, hash filters, voltage and speed regulators. 5 1/2"x11"x15". Brand new in original packings. Stock No. GAC-10. \$27.50

3" SCOPE INDICATOR. 3BP1 cathode ray tube mounted in a mu-metal housing with an adjustable light shield. May be mounted on a panel, table-top or clamped to a bar. When mounted on a table top or wall, the scope housing may be tilted at any angle up to 45° from the mount for comfortable viewing. Ideal for remote scope indicators. An outstanding buy at \$5.95. Stock No. AS1-35.



Wide Range Butterfly Wavemeter & Oscillator Elements



Precision wide range butterfly circuit elements. Sturdily constructed. Mounted in ball bearings. Suitable for motor drive. Ideal for use as wavemeters and oscillators (see description below).

Stock No.	Freq. (mc.)	Notes	Unit Price
TN-20	105-330	1, 3	\$4.95
TN2A	75-300	1, 4	4.95
TN-30	135-485	2, 3	5.95
TN3A	300-1000	2, 5	6.95

Brand new, in original packing.

*NOTES: 1) Aluminum construction
 2) Silver-plated brass
 3) Designed as oscillator element (955 acorn triode)
 4) Has diode socket mounted on unit (955 as diode)
 5) Has crystal diode mount for 1N21 crystal

Tube Specials

1A7GT	\$0.72	6SA7GT	.60	211	.25
1G6GT	.49	6SC7	.69	215A	.95
1V	.49	6SF7	.72	304TH	7.75
2A3	.98	6SH7GT	.39	304TL	1.95
2C4	.95	6SK7	.57	316A	.89
2C21/1642	.29	6SG7	.49	350A	2.95
2C4/RK34	.29	6SK7GT	.72	417A	14.95
2C40	1.98	6SL7GT	.69	559	1.19
2C44	.75	6SN7GT	.79	705A	2.95
2D21	1.49	6SR7	.67	725A/B	12.95
2J26	14.95	6SU7GT/Y	1.29	725A	14.95
2J38	14.95	6V6GT	.79	730A	12.50
2J48	15.95	6V6	1.09	801	.79
2K28	12.95	6X4	.69	805	3.95
2X2	.69	6X5GT	.63	807	1.49
3B7/1291	.39	6Y6G	.88	811	1.95
3C23	2.95	6Z5Y5G	.81	814	3.95
3D21A	1.95	7C7	.72	815	1.95
3F7	1.95	7E6	.87	817	1.95
3Q4	.69	7G7	1.06	837	1.95
4A1	.49	7H7	.72	861	15.00
5B1P	1.95	7J7	.72	874	.59
6CP	1.95	7K7	.72	874A	.59
6E4GY	1.09	7Y4	.72	902A	3.95
6U4G	.65	7Z4	.72	931A	3.95
6V4G	1.09	12SF7	.59	954	.39
5Y3GT/G	.49	12SG7	.59	955	.39
6A07	.79	12SH7	.59	956	.49
6B4G	1.09	12T7	.59	957	.39
6AE5GT	1.29	12SL7GT	.79	958A	.39
6AG7	1.29	12B7GT	.65	959	.39
6A5K5	.95	12SR7	.72	991/NE-16	.29
6AU6	.95	12SQ7	.72	1625	.49
6C4	.49	14F7	.72	1626	.39
6C8G	.72	14H7	.72	1629	.29
6F6	.85	14X7	.72	1625	.49
6F8G	.89	RK21	.95	1641/RK60	.95
6G6G	.49	25Z6	.59	2050	.79
6H6	.49	25Z6GT	.59	8013	1.49
6H6GT/G	.29	35W4	.49	9001	.39
6J5	1.57	36	.72	9002	.39
6J6	1.15	36F50	1.49	9003	.39
6J7	.69	RK69	1.49	9004	.39
6K6GT/G	.65	RK72	1.49	9006	.39
6K8	.88	RK73	.39	VR90	.89
6L6	1.28	80	.45	VR105	.89
6L6GA	.85	85	.72	VR150	.69
6L7	.98	89Y	.54	VR75	1.09
6N7	.95	117Z6GT/G	.88		
6Q7	.72	FG178	1.95		

OIL-FILLED CAPACITORS

Mfd	Rating	Price	Mfd	Rating	Price	
2-2	600 VDC	\$0.75	0.1	5000 VDC	\$1.95	
4	600 VDC	.84	2	5000 VDC	7.30	
7	600 VDC	1.15	1	6000 VDC	6.95	
10	600 VDC	1.37	1	7000 VDC	1.95	
10	330 VAC	4.95	.05	7500 VDC	1.75	
2	1000 VDC	.95	2	7500 VDC	11.95	
4	1000 VDC	1.19	0.2	10 KV DC	2.95	
8	1000 VDC	1.71	1	15 KV DC	19.95	
0.25	2500 VDC	1.06	0.2	5	20 KV DC	15.95
2	4000 VDC	4.95	.5	440 VAC/		
3	4000 VDC	5.95		1500 VDC		

Notes: 10 or more capacitors of a type 10% dis.

RF and DC PANEL METERS

Stock	Description	Price
MAD-251	2-ma DC Westinghouse 3 1/2" round	\$3.95
MAD-262	0-20 ma DC Westinghouse 3 1/2" round	3.95
MAD-265	0-80 ma DC Westinghouse 3 1/2" round	3.49
MAD-503	0-1000 micro DC DeJur 3 1/2" round	3.95
MAD-276	0-30 AD Westinghouse 425 3 1/2" round	11.95
MRT-355	0-100 ma DC Westinghouse 507 2 1/2" round	8.95
MRT-372	0-120 ma RF GE 2 1/2" round	2.95
MRT-367	0-1A RF GE 2 1/2" round	6.95
MRT-394	0-20A RF GE 3 1/2" round	6.95

BLILEY SMC-100 100 AND 1000KC CRYSTAL. Regularly sells for \$8.75. Stock No. QCM-19\$5.95

HAMMARLUND CERAMIC ACORN SOCKETS. 5 contact. Silver-Plated. Stock No. XRT-2529 for \$1.00

CINCH MICA FILLED OCTAL SOCKETS. 1" dia. 1-5/16" mtg ctrs. Stock No. XRT-20 for\$1.00

DELAY LINE. 2 microsecond (one direction). 1500 ohms. Bandwidth 1mc. 8 section tapped. Stock No. ZAL-22.....\$1.69

DELAY LINE. 1 1/2 microsecond (one direction). 1500 ohms. Bandwidth 1mc. 6 section tapped. Stock No. ZAL-13.....\$1.49

DELAY LINE. 5 microsecond (one direction). 1500 ohms. Bandwidth 1/2mc. Stock No. ZAL-14\$0.85

4200 VOLT TELEVISION OR SCOPE TRANSFORMER. Primary 115V/60c. Secondary: 3000VRMS (4200 Volts Peak) 10ma. Hermetically sealed. 4 1/2"x4-3/4"x5 1/2". Stock No. TFF-83\$5.95

HV TFRM. 10,000-0-10,000 VOLTS @ 42 MA. Oil-filled, hermetically sealed. 11"x13"x6". Stock No. TFF-451.....\$29.95

FILTER CHOKES

Stock No.	Description	Price
LFF-45	10H/120ma/600 ohms	\$0.95
LFF-21	20H/300ma/125 ohms/5000V	9.95
LFF-144	21H/700ma/16 ohms/1500V	4.95

MULTIPLIER PHOTOTUBE HOUSING. Cast aluminum cylindrical housing containing a submagnal 11 pin socket (for 931A, 1P21, 1P22) and a dynode voltage divider network. Moisture proof construction. An integral 6 volt pilot lamp provides light source when used as a noise generator. A window may be drilled in the housing for use with an external light source. Operates with approximately 700 volts at 3-4ma. 2" dia x 4" long. Supplied less phototube. Stock No. AMP-65\$3.95
PRECISION HIGH TORQUE TYPE 5 SELSYNS. Bronze housing 4 1/2" dia. x 5" long. 115V/60c operation. Brand new in original packing. Stock No. SEL-44.....\$4.95 each

110/60CPS/0.38A BLOWER. Exceptionally quiet. 50 cu. ft. min. Stock No. BLR-344...\$8.95

TERMS

Delivery: Immed. from stock (subj. to prior sale). Minimum Order: \$5.00.
 Terms: Rated organizations (U. S. and Canada). Open account.
 Others: Cash with order, or 20% with order, balance C. O. D.
 Foreign: Payment in U. S. funds with order or irrevocable letter of credit payable against documents in U. S. funds at New York.
 Condition of material: The major portion of the material listed above is brand new. Some of the items have been removed from new equipments. We guarantee material to be clean and in perfect operating condition.
 All prices above are quoted domestic packed f.o.b. our warehouse, Corona, New York.

DUBIN

Tel. Hickory Cable: "Dublectron, New York". We will be pleased to send our bulletins 6-3066-7-8 to you regularly. Write or phone Dept. E-8 for our latest catalog.
 ELECTRONICS CO. INC., 103-02 NORTH WATKINS BLVD., CORONA, N. Y.

DESIRABLE SELECT Unused SURPLUS ITEMS

- Link Radio Transmitter-Receiver
Type 50 UFS.....Price on Request
- Radar Type SF, complete with all
components\$1,480.00
- R5/ARN-7 Radio Compasses,
complete 125.00
- BD-72 Field Telephone Switch-
boards 37.50
- BC-375-E's, complete new with
all tuning units, dynamotor,
tubes, plugs, etc..... 97.50
- TDE Radio Transmitters..... 675.00
- Type SCR-522's—(Slightly Used) 65.00
- Collins TCS's Navy units..... 575.00
- Hallcrafters Radios, Model No.
S-40, 110/240 Volts AC, 50/60
Cycle—Universal 87.50
- Telegraph Transmitters — Model
ET-8023 D1..... 425.00
- Generator Lighting Plants—Type
PE197, 5KW, 120 Volt AC,
50/60 Cycle, Single Phase... 675.00
- Generator Gasoline Engine Driven
Lighting Plants Type 5KW, 110
Volt AC, 50/60 Cycle, Single
Phase 550.00
- Reading Storage Batteries, 185
amp-hours, 6 volts..... 7.50
- Exide Storage Batteries, 150 amp-
hours, 12 volts..... 17.50
- Prism Binoculars—7 x 50 Navy
Type—Regular Optics 30 per
case * 44.00
NEW—Not Surplus
- Prism Binoculars—7 x 50 Navy
Type—Coated Optics 20 per
case * 54.00
NEW—Not Surplus

TUBES

Type	Price	Type	Price
10Y	\$.55	805	3.80
211	.85	807	1.14
250TH	21.30	808	2.80
304TL	1.10	810	5.50
450TH	22.75	836	.95
450TL	36.50	861	27.50
803	4.50		

* Plus 20% Federal Excise Tax

All Equipment Subject to Prior Sale

FRENCH-VAN BREEMS, INC.
405 Lexington Avenue
NEW YORK 17, N. Y.
Oregon 9-3650
Cable Address: Frexvan, N. Y.



for worthwhile savings to you

ASD RADAR TRANSMITTER

3 centimeter, complete w/725A magnetron, cavity,
two 723A/B Klystrons, 3RKR 73, four 72's 715B,
829B, two 724B's, two 6AC7's, IN23 crystal diode,
high voltage supply, cooling blowers, etc. Input:
115 v 400 c. N-2 condition.....\$110.00

PARTS FROM ABOVE EQUIPMENT

Pre. Amp. Assembly: includes plumbing, two
723A/B Klystrons, two 6AC7's, two 724B's, IN23
crystal diode etc.....\$37.50
Power transformer: D9178, two 2.5 volt windings,
6.3 volt winding and high voltage winding, 115 v.
400 cy. Pri.....\$11.50
725A Magnetron.....\$12.50
Magnet for 725A, Pole dia. 1/2", spacing 3/8"
Gauss.....7.50
Tubes, filaments guaranteed: CRP 72.....\$1.10;
3RKR73.....\$1.30; 715B.....\$5.25; 829B.....\$2.50
Capacitor: Vitamin Q, .50 mfd @ 2,000 v d-c......85
Capacitor: Vitamin Q, 2 x .15 mfd @ 8,000 v or
.075 mfd. @ 16,000 volts.....2.90
Telephone Type Relays: #21 DPST normally open;
#2 same as #1 plus a SPDT contact; 1,000 ohm
coils both mounted in metal case 3/4 x 3/4 x 1 1/2"
Motor blowers: 28 v a-c/d-c.....2.95

NEW RA-38 RECTIFIERS

115 v. 60 cy. 1 phase input, output 0-15,000
v., d-c or 500 ma. Write for detailed informa-
tion.



CONSTANT VOLTAGE TRANSFORMERS SOLA

95 to 125 volt 50 cycle single phase
input; 115 volt output
60 va ...\$ 8.40 380 va ...\$27.00
120 va ...13.20 500 va ...34.00
190 to 250 volt input; 220 volt output;
60 va ... 8.40 250 va ...18.00

RAYTHEON

198 to 242 volts 50/60 cycle single
phase input; 220 volt 500 watt output
\$38.00

NEW CAPACITORS

2 mfd 600 v. d-c tubular. \$.30; 10 for
\$2.50; \$20.00 per C.
3.5/5 mfd 1,000 v. d-c. \$.90; 4 for
\$3.00.
3 x 1.0 mfd 1,200 v. d-c wk; isolated
sections\$1.20
1.25/1.25 mfd 7.5 kv d-c or .625 mfd
15 kv d-c; Pyranol.....\$12.50
2.5/2.5 mfd 6 kv d-o or .125 mfd 12
kv d-c\$36.00
1.0 mfd 25 kv d-c; Pyranol.....\$36.00
500 mfd 200 wv d-c electrolytic; insu-
lated terminal\$.95
.001 mfd 25 kv d-c mica; 25 A. @
3,000 kc, 18 A. @ 1,000 kc, 11 A. @
300 kc.....\$25.00
50 mmfd 32 kv d-c tubular vacuum
\$4.95

METERS

Weston or Westinghouse

3" 0-120 a-c amps, w/current trans \$ 8.50
3" 0-20 kv d-c w/precision multiplier 18.00
3" 0-4 kv d-c w/precision multiplier 9.50
3" —10 to + 6db, 6 mw 600 ohms 6.50

SPECIALS

Westinghouse Meter Multiplier: 1
meg., 1/2% tol., w.w. noninduc-
tive\$1.25
Running Time Meter: Cramer RT3H;
220 v., 60 c; 3" square; five
figure\$6.95
Filament Transformer: Constant cur-
rent; 110/220 v., 50/60 c; sec. 21.5
v. 40.5 A.....\$17.50
Tube WL 386/ML-3W; 125 KV X-ray
oil immersion rect; 10 v. 11.6 A.
fil.....\$32.00
CRAMER Time Delay Relay: T92
120S; 0-120 sec., 115 v. 60 c, syn.
motor driven; 10 A., 115 v., S.P.N.O.
contact\$4.95
Motor: 27 v. d-c, 0.7 A., 110 R.P.M.,
1 oz./ft. torque\$3.50
Solenoids: 115 v., 60 c; continuous,
wt. 5 1/4 lbs\$2.75
intermittent, wt. 9 lbs.....\$2.75

TUBES

TII Tubes are New.
of Standard Mfg., in
original boxes.

Type	Price
1B22	\$5.75
1B23	9.75
1B24	4.75
2D	1.25, 70.00/C
2J62	47.50
3B22	2.75
3B24	1.75
3C23	3.75
4E28	2.75
4E28	1.25
VT127A	2.95
250R	7.50
250TH	19.50
250TL	19.50
*304TL	7.50
307A/RK75	4.50
316A	4.75
371B	2.75
388A	2.75
450TH	22.50
700A	37.50
701A	4.75
702A	3.75
703A	4.75
704A	2.25
705A	2.25
706BY	17.50
706EY	19.50
707A	14.75
707B	16.50
708A	4.75
713A	1.25
714AY	5.75
715A	9.50
717A	7.75
719A	11.75
721A	2.75
722A	13.75
725A	17.50
730A	19.50
750TL	47.50
811	41.75
830B	4.75
872A	2.25
921	1.25
931A	2.75
C5B	8.50
C6A	8.50
C6J	9.50
F60H	4.75
WE-203A	4.75
WL-531	17.50
WL-533	17.50

*Includes 115 v 60 c
H.V. ii. trans &
socket.

POWER FACTOR

Correction
9-12 mfd 1265 v a-c, 60 c, 1 ph. 5
kilovolt amps reactance. New
G.E. Pyranol.....\$17.50

TRANSTATS, AMERTRAN

115 v. 50/60 c; 0-115 v. 100 amp
output.....\$95.00
115 v. 50/60 c; 0-130 v. 10 amp
output.....\$24.50
115 v. 60 c; 103-126 v. 2.17 amp
output.....\$ 9.50
115/230 v. 50/60 c; 0-260 v. 2.5
amp output.....\$21.50

TRANSFORMERS

115 v. 60c, primaries
Amertran: 17,800 v. @ 10.4
K.V.A. cont.\$65.00
Amertran: 8,800-0-8,800 v. @ 10.4
K.V.A. cont.\$75.00
Westinghouse: 13,400-0-18,400 v.
@ 9 K.V.A. cont., plus 2 WL-
631 rect. tubes, fil. transf. &
50 h 575 ma choke.....\$160.00
Kenyon: 2.5 v. c-t @ 10 amps,
15,000 v. test.....\$4.50
Kenyon: 7.5 v. c-t @ 12 amps,
15,000 v. test.....\$6.50
24 v. @ 1 amp, uncase.....\$1.60

RELAYS

Westinghouse Type SC-M Over-
current relay, 2 to 1 A., 3 A.
cont. rating 20-40% drop out
ratio\$12.95
A-B #810 Overload Relay, 6-3-
18.1 A., 600 v. max.....\$7.95

CHOKES

Amertran: Swinging, 900 h @ 16
ma, 25 h @ 525 ma, 35,000 v.
test.....\$42.00
Kenyon: 20 h @ 30 ma, 15,000 v.
test\$12.00

CONTACTORS

I. T. E.: 115 v. 60 c. coil. Single
pole 115 A. 600 v. with barriers,
adj. time delay & remote con-
tact control trip.....\$10.95
A-B #RC-3301: 115 v. 60 c. coil.
D.P.S.T. 15 amp contactor \$4.95
Monitor: 115 v. 60 c. coil.
N.O.D.P. contactor, 100 A. 600
v. N. C. 15,000 v. 1.0 A. contact.
One N. O. & one N. C. interlock
w/150 A & 30A. renewable fuse
.....\$8.95

RESISTORS

200 watt wire wound resistors,
ferrule ends 160,000 ohm, 5,000
ohm, or 1,000 ohm\$1.00

All merchandise in "as new" condition. Add approx. 20% to net weights for estimated shipping weights. Terms are 30% with order, balance C. O. D. All prices f.o.b. Los Angeles Warehouse. Write for additional detail information on any of the above items and for special quantity discounts. Telephone MAdisor 6-5391

1527 E. SEVENTH ST.

EPCO

LOS ANGELES 21, CALIF.

TS-155B/UP S BAND SIGNAL GENERATOR, pulsed, calibrated output, 110 V, 60 cy. NEW.

S BAND STANDARD REFERENCE CAVITY, Type N input connector, crystal holder \$15.00

APR-1 RADAR SEARCH RECEIVER, complete with tuning units for range of 38-4000 mc, 30 mic I.F., 2 mc wide

TUNING UNITS for APR-1 or APR-4 RECEIVERS (can be used with any 30 mc amplifier):

- TN-16, range 30-90 mc
- TN-17, range 80-300 mc
- TN-19, range 1000-2000 mc
- TN-54, range 2000-4000 mc

X BAND VSWR TEST SET TS-12/AP, complete with linear amplifier, direct reading VSWR meter, slotted wave guide with gear driven travelling probe, matched termination and various adapters, with carrying case, NEW.

X BAND PICK-UP HORN AT-48/UP, with coaxial fittings.....\$5.00

S BAND SIGNAL GENERATOR CAVITY with cut-off attenuator, 2700-2950 mc, 2C40 tube, with modulator chassis \$30.00

TEST SET TS-278/AP, for AN/APS-13, synchronized, delayed pulse signal generator, 400-430 mc, calibrated wave guide below cut-off attenuator, synchronized marker generator, 115 V, 60 cps. NEW, COMPLETE.

S BAND TEST LOAD, TPS-55PB/T, 50 ohms\$8.00

X BAND TEST LOAD, TS-108/AP, 150 watts, accessories\$35.00

COAXIAL WAVEMETER, MICO INSTRUMENT, from 1250 mc to 4000 mc\$60.00

NOISE FIGURE METER 10-400 mc, measures N. to 30, for 50 ohm impedance. 75 and 270 impedance also supplied.

MUTUAL INDUCTANCE ATTENUATOR, Calibrated; frequency range 1 to 1000 mc by means of plug-in coils, attenuation range 120 db.....\$100.00

MUTUAL INDUCTANCE OR PISTON TYPE ATTENUATOR, type N connectors, rack and pinion drive, attenuation variable 120 decibels, calibrated 20-120 db, frequency range 300-2000 mc\$32.00

MUTUAL INDUCTANCE OR PISTON TYPE ATTENUATOR, similar to above, except upper frequency limit is 3300 mc\$32.00

LOSSY LINE ATTENUATOR, consisting of RG-21/U cable rolled in metal box with UG-10/U connectors, furnished in any attenuation up to 20 db at 3000 mc\$15.00

S BAND MIXER, type N signal output, oscillator input, and I.F. output connectors, variable oscillator injection\$17.50

METERS:

O-350 VOLTS, WESTINGHOUSE NX-35 METER, 1000 ohms per volt.....\$4.50

1-0-1 MA, MARION SEALED METER HM3, scale 100-0-100 ma, and 115-0-115 volts, 3 1/2".....\$4.00

PULSE INPUT TRANSFORMER, permalloy core, 50 to 4000 kc impedance ratio 120 to 2350 ohms.....\$2.00

PULSE TRANSFORMER, UTAH 9280\$1.50

PULSE TRANSFORMER 132-AWP\$6.00

PULSE TRANSFORMER, GE 68G, 828G-1\$5.00

PULSE TRANSFORMER, Westinghouse 145-EWP.....\$10.00

CONNECTORS:

UG-10/U80	UG-190/U 1.00
UG-12/U80	UG-201/U60
UG-21/U80	UG-245/U60
UG-22/U80	SO-23928
UG-24/U80	PL-25928
UG-25/U80	(for small cable)
UG-27/U50	M-35928
UG-29/U 1.00	UG-266 1.00
UG-30/U 1.00	
UG-30/U special 1.00	
UG-58/U60	PL 5410
UG-59/U 1.00	PL 8150
UG-83/U 1.00	AN-3102-14S-5P .25
UG-86/U 1.00	AN-3102-14S-2P .25
UG-167/U 2.00	RC-10066-20-1P .50

ELECTRO IMPULSE LABORATORY

P. O. Box 250 Red Bank, N. J.
Eatontown 3-0768

YAGI ANTENNA

DOUBLE STACKED
6 ELEMENT
ROTATABLE ARRAY



ADJUSTABLE STUB TUNING

ASB (450-560 MC) \$12⁷⁰

ASA (370-430 MC) \$29⁴⁰

COAXIAL CONNECTORS

83-1AP09	UG-12/U63
83-1H10	UG-21/U67
83-1J68	UG-23/U63
83-1R28	UG-24/U67
83-1RTY45	UG-27/U68
83-1SP28	UG-30/U94
83-1SPN28	UG-58/U57
83-1T 1.12	UG-85/U62
83-22AP48	UG-86/U 1.22
83-22I88	UG-87/U63
83-22R52	UG-206/U58
83-22SP48	UG-255/U62

Antennas for AN/APR-4 Receivers

AT-38A/APT—(70 to 400 MC).....\$13.70
AT-49/APR-4—(300 to 3300 MC).....\$13.70

AT-48/UP—3CM ANTENNA HORN for receiving or transmitting\$3.95
FILTER CHOKE—10H 400MA DC Res. 90 ohms—hermetically sealed\$2.93
Kolsman 2 Phase Low Inertia motors—Type 937-0240\$8.22
Model ASB-4 Radar Equipment—Complete.....\$69.75
CW1-60 AAG Range Calibrator for ASB.....\$39.95

ELECTRONIC RESEARCH LABORATORIES

1021-23 Callowhill St.

Phila. 23, Pa.

Telephones: Market 7-6590 and 6591

ASB YAGI ANTENNA

ADJUSTABLE STUB TUNING

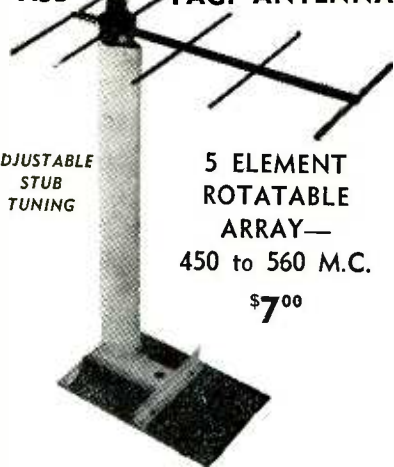

5 ELEMENT ROTATABLE ARRAY—

450 to 560 M.C.

\$7⁰⁰

GENERAL ELECTRIC FG-172 THYRATONS

\$14⁵⁰ EA.

\$10⁰⁰ EA.

IN LOTS OF 10 BRAND NEW ORIGINAL CARTONS FULLY GUARANTEED

SOUND POWERED PHONES

RCA or Western Electric Navy Head and Chest sets—Brand New\$14.88

Western Electric Chest Mike with 20 ft. cable\$3.88

Allen Bradley Potentiometers in stock.

BRAND NEW!

PORTABLE RADIOTELEPHONE

SCR-511, Mfg. Galvin, freq: 2 to 6 Mcs. Has three times the power of the SCR-536 Handy Talkie. Includes all equipment spares, 11 spare tubes plus operating tubes, 13 Tuning units (2 Xtals in each). Vibrator Supply with speaker, with wet cell, also dry cells mountings for all purpose usage, cables 2 tech. manuals and more. In original export cartons contained in one box 11", 20", 51". Gross wt. 104 lbs. Transceiver wt. in use 8 lbs. Price each \$100.00

PORTABLE POWER SUPPLY—AVA-126A, RCA Mfg. for mobile, boats, planes. In grey crackle steel box 7 7/8" x 7 1/2" wt. 10 lbs. Input 6 or 12 Volts DC and delivers 320 V. at 110 Ma. with taps for rcv or transmitter. Has OZ4GT rect. 3 built-in relays, complete filters, 2 vibrators (6 & 12 V) and mtg accessories. BRAND NEW.....\$15.50

PORTABLE RECEIVER—AVR-20A, RCA Mfg. companion to above supply, receives CW & phone signals. Has vernier manual tuning & two xtal positions. Covers 2300 to 6700 Kcs. Use on 6 V DC and small "B" supply or our AVA-126A. Size 5 1/2" x 6 1/2" x 6", wt. 6 lbs. NEW & NEAR NEW \$15.50

BULLETINS on request.

Cable: Communidev
Tel: AD-4-9277

COMMUNICATION DEVICES CO.

2331 TWELFTH AVENUE

NEW YORK 27, N. Y.

Subject to prior sale.
FOB: WHSE

TRANSMITTERS

BC-610, Hallicrafter Mfg., 450 watt CW & phone complete with NEW tubes and accessories.

ART-13, Collins Mfg. never used, with 110 Volts AC power supply, New Tubes, Manual & cables, \$260.00

TDE, Westinghouse Mfg., designed for US Navy, 300 to 18,100 Kcs, CW, ICW & Phone. For use on ships or land stations. In most input voltages.

F.M. Radiotelephone Relay

For remote broadcasting, Mobile, Industrial and Point-to-Point communication. The SCR-528 designed by Western Electric Co. is especially adaptable for two-way voice communication in 20.0 to 27.9 Mc channels & COMPLETE for 12 or 24 Volts DC or with husky 110 V. AC Supply. Descriptive bulletin on request.

RADAR

Western Electric Model SL, NEW.....\$1600.00
Raytheon Mfg. Co., Model SD-4, NEW.....\$900.00

HIGH VOLTAGE OIL FILLED Condensers—Standard Brand—25 Mfd x 20,000 Volts in the better brands. Brand NEW in cartons. Low priced at.....\$12.95

WESTINGHOUSE HIPERSIL CORES

OVER 30,000 UNITS IN 20 DIMENSIONS. SEVERAL GAUGES; UP TO 16,000 UNITS IN SOME SIZES. AVAILABLE FOR IMMEDIATE DELIVERY. SEND FOR LIST WITH COMPLETE DESCRIPTIONS.

RAYTHEON MFG. CO.

Surplus Sales Dept. Waltham, Mass.
Tel. Waltham 5-5860—Ext. 2

200 NEW SURPLUS RELAYS OR CONTACTORS

All in original manufacturer's cartons

- 110 Volt, 60 Cycle
- Cutler Hammer Type 619 unmounted contactors
- 4 Pole, 25 amp., 600 Volt normally open contactors
- Some have pilots contacts

L. R. ROUFF

94-18 51st Ave. Elmhurst, N. Y.

GRAIN of WHEAT LAMPS



Used for illuminating meters, compass dials, airplane instruments, etc. Soldering iron removes lamp from base to use in models, doll houses, miniature trains, Xmas trees, etc.

Mazda G.E. 323 Mazda G.E. 328
3V. .19 A 6V. .2 A

Photo actual size. Glass Bulb 1/8"x3/8"
Either type **doz. \$1.50** 75.00 per M.



MARKTIME 5 HOUR SWITCH
A 10 amp. timing device. Pointer moves back to zero after time elapses. Ideal for shutting off radios and TV sets when you go to bed. Limited supply at this special **PRICE..... \$3.90**

Also available in 15 min.-30 min.-1 hr. at \$6.55

D.P.S.T. LEACH RELAY

Split coil 12 or 24 V.D.C. 10 amp. 45c each, 3 for \$1.00, 7 for \$2.00, 15 for \$3.00. Min. shipment. \$1.00



ISOLATION TRANSFORMER

Nat. known Mfrs. 50 watt 2 windings, 115 V. to 115 V. 60 cy. Ideal to prevent shocks from small radios and medical and electronic devices. **\$1.95**

Shipping Weight 5 lbs. Other sizes and 220-110 in stock.

A Newly Written (1948) Book on Photoelectric (Electric Eye) Circuits..... **\$1.00**
10 for \$7.50

Kilowatt Demand Meter Totalizer containing heavy-duty TELECHRON B-7, 1 RPM motor and hundreds of watch size gears, clutches, springs, etc. Shipping weight 2 lbs. 5 for \$10.00 **\$2.50**

WE are Authorized Wholesalers for Micro Switch Corporation and carry the largest stock of Allen-Bradley Solenoids Potter and Broomfield Relays Guardian Electric Co. Solenoids and Relays Haydon Clock Motors in all speeds

EST. 1923 **BLAN** EST. 1923

Experimenters and Inventors Supplies
64 Dey St., New York 7, N. Y.

PRECISION resistor WIRE

Size	Ohm ft.	per lb.	Price/lb.
#22 dec	.459 (180 alloy)	515	\$1.20
#24 dec	.725	820	1.35
#25 dec	.917	1,020	1.50
#26 dec	1.163	1,300	1.58
#27 dec	1.458	1,650	1.70
#28 dec	1.852	2,075	1.99
#29 dec	2.302	2,534	2.30
#30 dec	2.940	3,300	2.20
#35 dec	5.822	6,546	2.35
		10,522	3.90

#34 S.E.	7.408	8,314	\$3.25
#35 S.E.	9.375	10,522	3.90
#36 S.E.	11.76	13,200	4.60
#39 S.E.	24.00	26,930	8.50
#40 S.E.	30.59	34,330	10.50

ORDERING INSTRUCTIONS Unless specified we will ship any of the types advertised above.
MINIMUM ORDERS D.C.C. #22 to 35, 1 lb.+30% -15%, respoled from original 3 lb. av. spools.
ENAMELED #34-35-36, min. order 1 lb., ±30%; sizes 39 & 40, 1/2 lb., ±30% min. Enameled wire is spooled on mgr's precision spools. All quart'd.

ATLANTIC INDUSTRIAL CO.
101-38 91st St. Ozone Park, New York

ELECTRONIC TUBE-MAKING MACHINERY

For manufacturing radio tubes, electronic tubes, cathode-ray tubes, lamps. New and used. Reasonably priced, satisfaction guaranteed.

AMERICAN ELECTRICAL SALES CO.
67 E. 8th St. New York, N. Y.

LIFE Offers Savings in "Hard to Get" Items.

COAXIAL CABLE AND CONNECTORS

UG TYPE CONNECTORS

AN No.	Price Ea.	AN No.	Price Ea.
UG9/U	\$.95	UG96A/U	1.45
UG10/U	1.55	UG97/U	3.50
UG11/U	1.45	UG98/U	1.55
UG12/U	.95	UG100/U	2.34
UG13/U	1.56	UG101/U	2.95
UG14/U	1.45	UG107/U	2.25
UG15/U	.95	UG108/U	1.75
UG16/U	1.56	UG109/U	1.75
UG17/U	1.45	UG114/U	1.50
UG18/U	.99	UG115/U	1.33
UG18A/U	1.05	CW123/U	.45
UG18B/U	1.09	UG131/U	6.00
UG19/U	1.28	UG146/U	2.25
UG19A/U	1.38	CW155/U	.40
UG19B/U	1.45	UG154/U	5.35
UG20/U	1.17	UG156/U	4.25
UG20A/U	1.26	UG157/U	4.25
UG20B/U	1.41	UG160/U	1.90
UG21/U	.99	UG160A/U	1.55
UG21A/U	1.05	UG167/U	3.00
UG21B/U	1.09	UG173/U	.30
UG22/U	1.08	UG174/U	16.00
UG22A/U	1.38	UG188/U	.95
UG22B/U	1.34	MX195/U	.75
UG23/U	.99	UG197/U	5.00
UG23A/U	1.26	UG201/U	1.63
UG23B/U	1.29	UG202/U	1.75
UG27A/U	2.25	UG204/U	2.25
UG28/U	2.34	UG206/U	1.02
UG29/U	1.22	UG208/U	28.50
UG29A/U	1.56	UG212/M	4.50
UG30/U	1.75	UG213/U	4.50
UG32/U	20.00	UG215/U	3.35
UG33/U	20.00	UG216/U	8.70
UG34/U	17.50	UG217/U	3.10
UG35A/U	16.00	UG218/U	6.50
UG36/U	16.00	UG222/U	35.00
UG37/U	16.00	UG231/U	2.00
UG37A/U	16.00	UG235/U	28.50
UG57/U	.99	UG236/U	11.75
UG58/U	.65	UG241/U	2.20
UG59/U	2.75	UG242/U	2.50
UG59A/U	1.70	UG243/U	2.75
UG60/U	1.90	UG244/U	2.50
UG60A/U	1.30	UG245/U	1.25
UG61/U	2.05	UG246/U	1.45
UG61A/U	1.80	UG252/U	4.50
UG62/U	28.00	UG254/U	1.82
UG63/U	1.50	UG255/U	1.85
UG65/U	1.65	UG259/U	4.10
UG66/U	1.69	UG260/U	.99
UG67/U	1.40	UG261/U	.95
UG68/U	1.17	UG262/U	1.05
UG69/U	.95	UG269/U	2.60
UG90/U	1.05	UG270/U	6.50
UG91/U	1.25	UG273/U	1.50
UG91A/U	1.05	UG274/U	1.98
UG92/U	1.10	UG279/U	2.40
UG92A/U	1.35	UG287/U	5.25
UG93/U	1.25	UG290/U	.85
UG93A/U	1.45	UG291/U	1.05
UG94/U	1.25	UG306/U	2.03
UG94A/U	1.05	UG333/U	4.70
UG95/U	1.10	UG334/U	5.75
UG95A/U	1.35	UG352/U	6.00
UG96/U	1.25		

"UH" COAXIAL CABLE CONNECTORS 83 SERIES



83-11-PN

83-1T

No.	AN No.	Description	Each	Price Per C
83-1SP	(PL259)	Plug	.35	.28
83-168	(UG176U)	Adapter	.15	.12
83-185	(UG175U)	Adapter	.15	.13
83-185PN	(PL269A)	Plug	.35	.28
83-776	(UG203U)	Plug	.61	.55
83-1R	(SO239)	Recept.	.35	.28
83-1RTY		Recept.	.66	.60
83-H	(UG166U)	Hood	.12	.10
83-65	(UG177U)	Hood	.31	.25
83-AC		Cap & Chain	.61	.50
83-BC		Cap & Chain	.38	.34
83-T	(M358)	T Connect	1.12	.98
83-AP	(M369A)	Angle Adapt.	.35	.28
83-J	(PL258)	Junction	.85	.70
83-F	(PL274)	Feed-Thru	1.12	.98
83-2SP	(UG102U)	Twin Plug	.50	.40
83-2R	(UG103U)	Twin Recept.	.50	.40
83-2AP	(UG104U)	Twin Adapt.	.98	.80
83-2T	(UG105U)	Twin Junction	1.25	1.12
83-2T	(UG193U)	Twin Tee	1.65	1.50

COAXIAL CABLE



No.	Impedance	Price per M ft.
RG5U	52.5 ohms	\$70.00
RG6U	76.0 ohms	120.00
RG7U	97.5 ohms	70.00
RG8U	52.0 ohms	55.00
RG9U	51.0 ohms	135.00
RG9AU	51.0 ohms	135.00
RG10U	52.0 ohms	125.00
RG11U	75.0 ohms	100.00
RG12U	75.0 ohms	190.00
RG13U	75.0 ohms	125.00
RG18U	52.0 ohms	450.00
RG19U	52.0 ohms	350.00
RG20U	52.0 ohms	450.00
RG22U	95.0 ohms	120.00
RG24U	125.0 ohms	240.00
RG25U	48.0 ohms	575.00
RG27U	48.0 ohms	290.00
RG29U	55.0 ohms	50.00
RG34U	71.0 ohms	175.00
RG39U	72.5 ohms	180.00
RG41U	87.5 ohms	575.00
RG44U	58.0 ohms	65.00
RG44A	58.0 ohms	75.00
RG37U	95.0 ohms	100.00
RG38U	53.5 ohms	55.00
RG40U	73.0 ohms	45.00
RG42U	93.0 ohms	50.00
RG1U	93.0 ohms	175.00
RG4U	52.0 ohms	225.00

Min. quantity 500 ft. per type. For cuts lengths add 50% to prices shown.

FREE! LIFE ELECTRONIC SALES

Send for our bulletin L-500

91 GOLD STREET N. Y. 7 N. Y. DIGBY 9-4154-5

We offer Subject to prior Sale, the following Motors:

- 27 V.D.C. 5,000 RPM 0.6 Amps. (Universal) 4 wire-Shunt @ \$1.60 ea.
- 115 V.D.C. Type PM-1-M (Electric Indicator) @ \$7.50 ea.
- 115 V. 400 cycle 3 Phase 8,000 RPM Type J33 (Eastern Air Devices). Synchronous. @ \$7.20 ea.

FOB NYC

SAVE-T-ELECTRONICS CO.
177 Broadway New York 7, N. Y.
Tel. Cortlandt 7-8033-4

D. C. MICROAMMETERS

- 0-100 ua 4" sq. G.E. DO 58.....\$12.00
- 0-100 ua 4 1/2" round Weston 643..... 14.00
- 0-50 ua 4 1/2" round Weston 643..... 15.00
- 0-200 ua 3" sq. G.E. DO 50..... 8.00
- 0-50 ua 3" sq. G.E. DO 50..... 12.00

R. F. MILLIAMMETERS

- 0-100 Ma 3 1/2" r. Weston 425.....\$11.00
- 0-120 Ma 3 1/2" r. Weston 507..... 7.00
- 0-10 Ma 4 1/2" r. Weston (vacuum) 22.00
- 0-2 Ma 4 1/2" r. Weston (vacuum) 26.00

A. C. VOLTMETERS

- 0-300 v 3 1/2" r. Weston 476.....\$8.00

Precision Electrical Instrument Co.
146 Grand Street New York 13, N. Y.