

AUGUST - 1946

# electronics

A M c G R A W - H I L L P U B L I C A T I O N

F-M ANTENNA

# VITAL DEVELOPMENTS IN NEW 889R-A

these bring impressive improvements in:

1 — MECHANICAL STRENGTH

2 — HIGH FREQUENCY OPERATION AT PEAK VOLTAGE LEVELS

## REPORT....

### Summary of Developments

Both filament and grid structures are mounted from one piece, oxygen free, high conductivity copper supports (A) making possible the use of heavy shoulder sections (B). The older, outmoded structure necessitated both the internal brazing of thimble and the external brazing of a small reinforcing disk. Complete elimination of the brazing procedure eliminates not only a weaker mechanical area but also its detrimental effects on the copper and the glass seal. A strong conical form (C) replaces the less desirable cylindrical form at the seals (D). The anode and grid shields (E) have been relocated and redesigned.

### Summary of Tests

**Distortion:** Equal forces were applied to the old and new structures (Fig. 1). The old structure was heavily distorted; the new structure showed no change. Force on the new structure was increased in the endeavor to distort it, but the glass dish invariably failed first (Fig. 2).

**Thermal Fatigue:** At the end of 200 cycles no apparent fatigue fail-

ure was discernible, thus assuring freedom from grid-filament shorts caused by stresses on the terminals.

**Copper Seals:** Copper seals were chosen for this tube because the pure metal is non-magnetic, has very low rf resistance and high conductivity. The seals were not heated by rf during operation. Terminals ran much cooler.

**Electric Field:** Relocation and redesigning of the anode and grid shields reduced the high concentration of the electric field in the glass envelope. Glass heating and resultant punctures were traced to this concentration in the out-moded design.

**Conclusion:** The redesigning has resulted in an impressive increase in mechanical strength and improvement in high frequency operation at peak voltage levels.

WRITE FOR technical rating and data sheets.

**AMPEREX  
ELECTRONIC  
CORPORATION**



25 WASHINGTON STREET, BROOKLYN 1, N. Y.  
In Canada and Newfoundland: Rogers Majestic Limited  
622 Fleet Street West, Toronto 2B, Canada

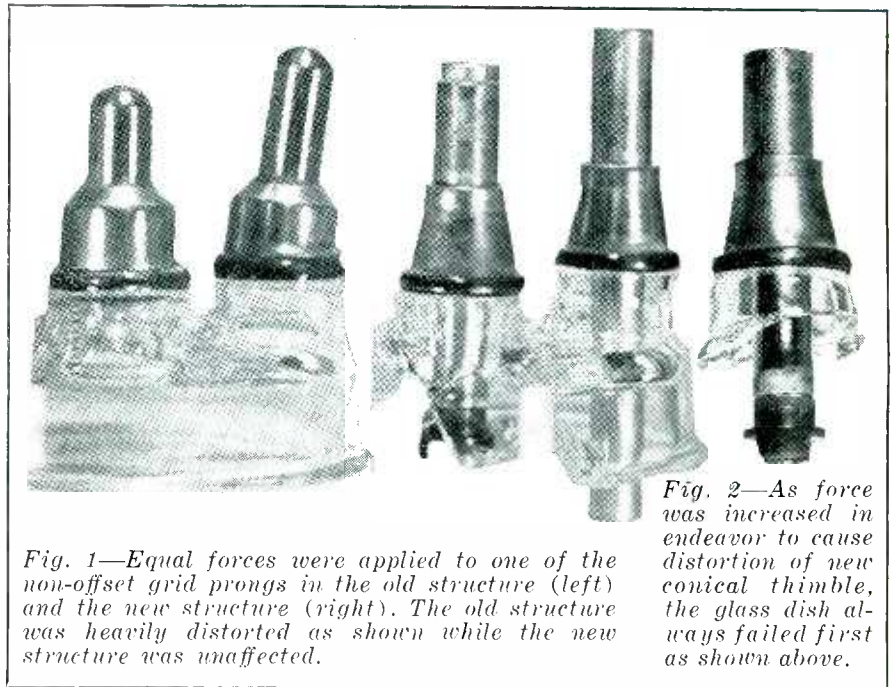
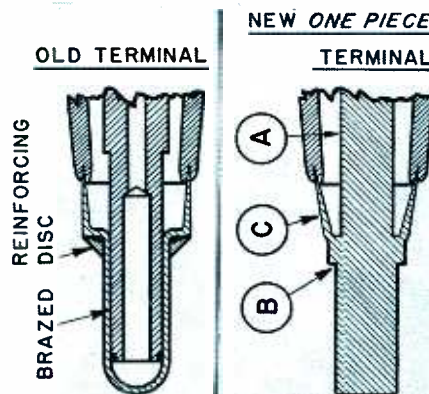
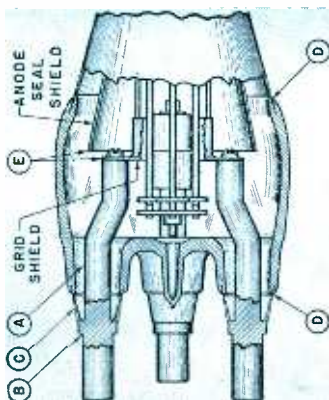

Fig. 1—Equal forces were applied to one of the non-offset grid prongs in the old structure (left) and the new structure (right). The old structure was heavily distorted as shown while the new structure was unaffected.

Fig. 2—As force was increased in endeavor to cause distortion of new conical thimble, the glass dish always failed first as shown above.



# electronics



AUGUST • 1946

<b>F-M ANTENNA</b> .....	<b>Cover</b>
Model of Western Electric's Cloverleaf design, photographed by Nick Lazarnick against the New York skyline	
<b>READING AID FOR THE BLIND, by V. K. Zworykin and L. E. Flory</b> .....	<b>84</b>
Shapes of printed letters are converted into audible sounds	
<b>ECHO RANGING SONAR, by Richard J. Evans</b> .....	<b>88</b>
Details of QCS/T equipment, which employs a magnetostriction projector and revolving-lamp indicator	
<b>MODERN HOME RECEIVER DESIGN, by Z. Benin</b> .....	<b>94</b>
Design criteria for choosing circuits of a combination f-m and a-m receiver	
<b>CATHODE FOLLOWER COUPLING IN D-C AMPLIFIERS, by Y. P. Yu</b> .....	<b>99</b>
New interstage coupling arrangements permit operation of three-tube d-c amplifier from single 250-volt supply	
<b>FLEXIBLE WAVE GUIDES, by Alton R. Anderson and Alfred M. Winchell</b> .....	<b>104</b>
Interlocked, vertebra, and seamless guides are frequently useful in forming bends or making flexible connections	
<b>ELECTRONIC COMPUTERS, by William Shannon</b> .....	<b>110</b>
A primer of basic computer principles illustrated by a series of practical examples	
<b>MAGNETIC TESTING OF METALS, by P. E. Cavanagh, E. R. Mann, and R. T. Cavanagh</b> .....	<b>114</b>
Nondestructive testing for metallurgical properties of ferromagnetic materials	
<b>ISOLATION AMPLIFIERS FOR AIRCRAFT, by Gordon F. Rogers</b> .....	<b>122</b>
Interphone and radio receiver signals can be individually mixed by each crew member without interference	
<b>PORTABLE VIDEO PICKUP EQUIPMENT, by William A. Howard</b> .....	<b>124</b>
Suitcase-type television camera and control units can be set up at an indoor or outdoor location in a few minutes	
<b>NONLINEAR CIRCUIT ELEMENT APPLICATIONS, by Heinz E. Kallman</b> .....	<b>130</b>
Circuits and uses for nonlinear resistors and contact rectifiers	
<b>MIXER FREQUENCY CHARTS, by R. S. Badessa</b> .....	<b>138</b>
Charts give nature and order of unwanted harmonic components that are close to desired output frequency	
<b>CROSSTALK</b> .....	<b>83</b>
<b>TUBES AT WORK</b> .....	<b>140</b>
<b>INDUSTRIAL CONTROL</b> .....	<b>166</b>
<b>ELECTRON ART</b> .....	<b>190</b>
<b>NEW PRODUCTS</b> .....	<b>208</b>
<b>NEWS OF THE INDUSTRY</b> .....	<b>264</b>
<b>NEW BOOKS</b> .....	<b>292</b>
<b>BACKTALK</b> .....	<b>298</b>
<b>INDEX TO ADVERTISERS</b> .....	<b>305</b>

**KEITH HENNEY**, Editor; **DONALD G. FINK**, Executive Editor; **W. W. MacDonald**, Managing Editor; **John Markus**, Vin Zeluff, Associate Editors; **Frank Rockett**, **A. A. McKenzie**, Assistant Editors; **J. A. Myers**, Chicago Editor; **Frank Haylock**, Los Angeles Editor; **Glady T. Montgomery**, Washington Editor; **Jeanne M. Heron**, Make-up Editor; **Jeanne E. Grolimund**, Editorial Assistant; **Harry Phillips**, Art Director; **Eleanore Luke**, Art Assistant

**H. W. MATEER**, Publisher; **J. E. Blackburn, Jr.**, Director of Circulation, *Electronics*; **Dexter Keezer**, Director, Economics Department; **John Chapman**, World News Director; **Wallace B. Blood**, Manager; **D. H. Miller**, **H. R. Denmead, Jr.**, New York; **Ralph H. Flynn**, **H. D. Randall, Jr.**, New England; **F. P. Coyle**, **R. E. Miller**, Philadelphia; **C. D. Wardner**, **A. F. Tischer**, Chicago; **E. J. Smith**, Cleveland; **J. W. Otterson**, San Francisco; **Roy N. Phelan**, Los Angeles; **Ralph C. Maulsby**, Atlanta

Contents Copyright, 1946, by McGraw-Hill Publishing Company, Inc. All Rights Reserved. MCGRAW-HILL PUBLISHING COMPANY INCORPORATED, JAMES H. MCGRAW, Founder and Honorary Chairman • PUBLICATION OFFICE 99-129 North Broadway, Albany 1, N. Y., U. S. A. EDITORIAL AND EXECUTIVE OFFICES 330 West 42nd St., New York 18, N. Y., U. S. A.—Member A. B. P. Member A. B. C.

James H. McGraw, Jr., President; Curtis W. McGraw, Senior Vice-President and Treasurer; Nelson Bond, Director of Advertising; Eugene Duffield, Editorial Assistant to the President; Joseph A. Gerardi, Secretary; and J. E. Blackburn, Jr., Vice-President (for circulation operations).  
**ELECTRONICS**, August 1946, Vol. 19: No. 8. Published monthly, price 75c a copy. Directory Issue \$1.00. Allow at least ten days for change of address. All communications about subscriptions should be addressed to the Director of Circulation.  
Subscription rates—United States and possessions, \$6.00 a year, \$9.00 for two years, \$12.00 for three years. Canada (Canadian funds accepted) \$7.00 a year, \$11.00 for two years, \$14.00 for three years. Pan American countries \$10.00 for one year, \$16.00 for two years, \$20.00 for three years. All other countries \$15.00 for one year, \$30.00 for three years. Please indicate position and company connection on all subscription orders. Entered as Second Class matter August 29, 1936, at Post Office, Albany, New York, under the Act of March 3, 1879. BRANCH OFFICES: 520 North Michigan Avenue, Chicago 11, Ill.; 68 Post Street, San Francisco 4; Aldwych House, Aldwych, London, W.C. 2; Washington, D. C. 4; Philadelphia 2; Cleveland 15; Detroit 26; St. Louis 8; Boston 16; Atlanta 3, Ga.; 621 So. Hope St., Los Angeles 14; 738-9 Oliver Building, Pittsburgh 22.



# VARITRAN

(VARIABLE VOLTAGE TRANSFORMER)

EXCELLENT REGULATION  
 HIGH EFFICIENCY  
 LOW TEMPERATURE RISE  
 SMOOTH CONTROL  
 NO DISTORTION  
 RUGGED DESIGN

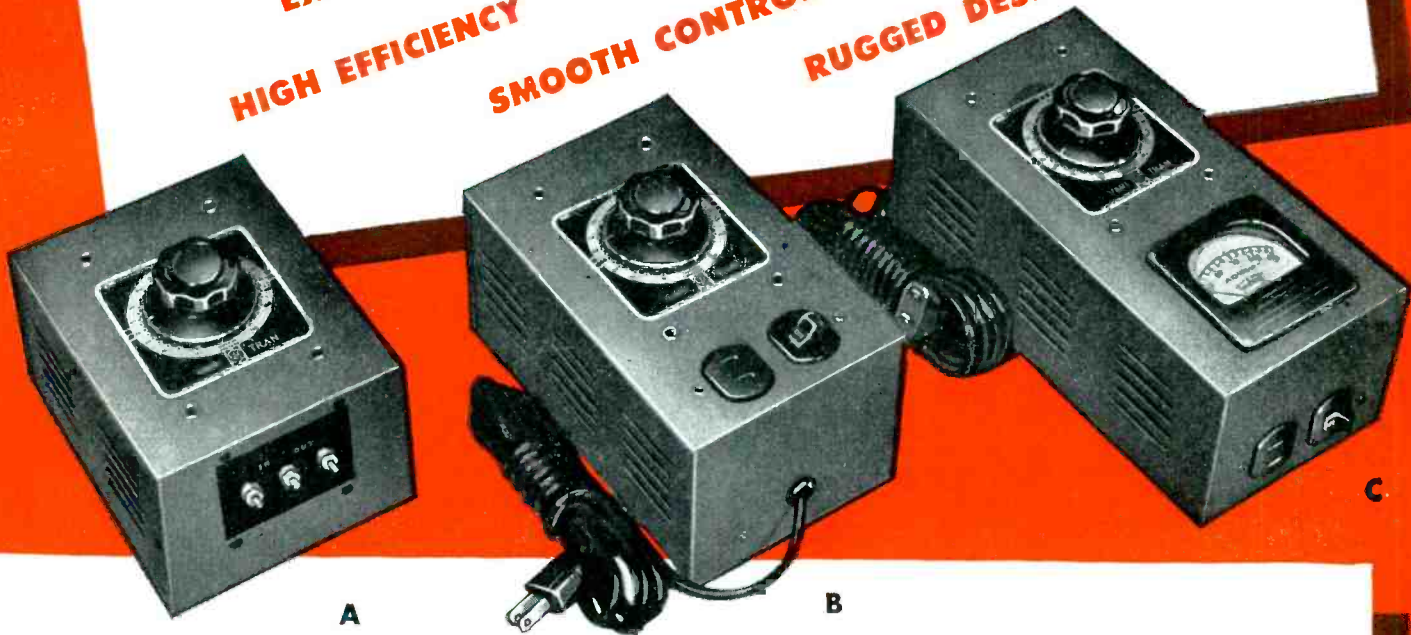

The UTC Varitran is a simple autotransformer whose turns are arranged on one layer with the insulation removed so that every exposed turn may be used as a tap of the winding. A special non-fusing contact, having resistance to minimize circulating currents, is mechanically arranged so that it can be moved to any position on the winding, permitting the exact voltage desired to be obtained.

## STANDARD VARITRANS

Standard Varitrans are designed for 115 or 230 volt service. The respective output voltages are 0-130 and 0-260 volts.

Type	Input Voltage	Output Voltage	Watts	Maximum Amps.	Figure	Net Price
V-O	115 volts	0-130	230	2	A	\$10.10
V-O-B	230 volts	0-260	230	1	A	12.45
V-1	115 volts	0-130	570	5	B	14.25
V-1-M	115 volts	0-130	570	5	C	23.80
V-2	115 volts	0-130	570	5	A	11.90
V-2-B	230 volts	0-260	570	2.5	A	14.85
V-3	115 volts	0-130	850	7.5	A	17.85
V-3-B	230 volts	0-260	850	3.75	A	23.80
V-4	115 volts	0-130	1,250	11	A	26.15
V-4-B	230 volts	0-260	1,250	5.5	A	33.30

## UNIVERSAL VARITRANS

Universal Varitrans have two 110 volt Primary windings (110 or 220V connection) and a 28 volt variable secondary winding. This winding can be used as a 0-28 volt low voltage source. It can also be used in autotransformer connection with the primaries to effect . . . 115 in/87 to 143 out, 220 in/192 to 248 out, 220 in/82 to 138 out, 115 in/202 to 258 out.

Type	Max. Amps. Output	Approx. Dimensions	Approx. Weight, Lbs.	Figure	Net Price
VL-O	1.5	4 1/2 x 6 1/2 x 2 1/2	5	A	\$ 8.30
VL-1	3.5	4 1/2 x 6 1/2 x 3	7	A	9.50
VL-2	6	4 1/2 x 6 1/2 x 4	10	A	11.90
VL-3	11	5 x 7 x 5	15	A	19.00

PRICES ARE SUBJECT TO CHANGE

*United Transformer Corp.*

150 VARICK STREET

NEW YORK 13, N. Y.

EXPORT DIVISION: 13 EAST 40th STREET, NEW YORK 16, N. Y.,

CABLES: "ARLAB"

● Even K & E has never devised an instrument that would make it unnecessary to think. But we have spent 78 years designing and producing things that make it easier to act after thinking . . . drafting instruments and related materials that give the engineering hand and eye almost the same precision as the engineering brain. How well K & E products serve as partners in creating is shown by the reliance placed in them by engineers and draftsmen throughout the world.

So widely is this equipment used that practically every great American engineering project has been completed with the help of K & E. Could you wish any surer guidance than this in the selection of your own instruments and materials?

To make measurements with the greatest ease and the least chance of error, choose a WYTEFACE\* steel tape or tape rule of the type made especially for your work. Their jet black markings against their white background are as easy to read in the brightest glare as in the dimmest light. They are readily kept clean, are rust-resisting and hard to kink. For full information about them write to your nearest K & E Distributor or to Keuffel & Esser Co., Hoboken, N. J.

\*Trade Mark

WYTEFACE Steel Tapes and Tape Rules are protected by U. S. Pat. 2,089,209

## partners in creating

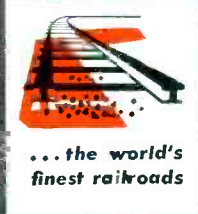

**KEUFFEL & ESSER CO.**  
EST. 1867  
NEW YORK • HOBOKEN, N. J.  
CHICAGO • ST. LOUIS • DETROIT • SAN FRANCISCO  
LOS ANGELES • MONTREAL

# THE LOGICAL CHOICE...

## Eimac 4-250A Tetrode

### ELECTRICAL CHARACTERISTICS—EIMAC 4-250A

Filament: Thoriated Tungsten	5.0 volts
Voltage	14.5 amps
Current	250 watts
Plate Dissipation (Maximum)	
Direct Interelectrode Capacitances: (Average)	
Grid-Plate (Without shielding, base grounded)	0.12 $\mu$ fd
Input	12.7 $\mu$ fd
Output	4.5 $\mu$ fd

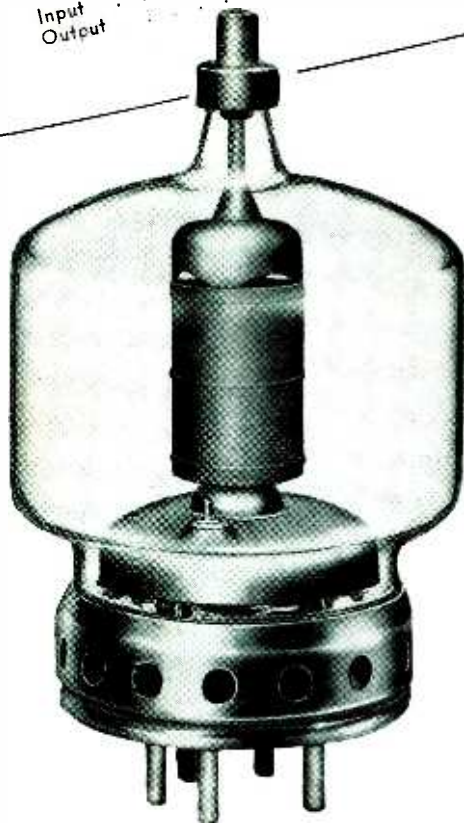

Proven performance is the reason why the EIMAC 4-250A tetrode is the logical choice when a dependable power-amplifier tube is needed. Below are listed characteristics and design features of the EIMAC 4-250A which explain why this tetrode is *picked for power*.

#### HIGH POWER—LOW DRIVE:

At frequencies up to 70 Mc. the EIMAC 4-250A develops a power output of 750 watts with a drive of less than 6 watts.

#### LOW PLATE—GRID CAPACITANCE:

Extremely low plate to grid capacitance, only 0.12  $\mu$ fd, permits operating without neutralization in many cases—simplifies neutralization in others.

#### OPERATIONAL STABILITY:

The unique arrangement of low inductance leads, plus especially treated grids insures exceptionally stable operation.

#### COMPACT—RUGGED:

Approximately 3½ x 6½ inches in size, the 4-250A has been constructed to withstand abnormal abuse—and give extra long life.

The 4-250A is just one of a host of EIMAC tubes designed for long-life and trouble-free operation. Investigate the possibilities of their use in your transmitters today. Contact your nearest EIMAC representative, or write direct for full technical information.

EITEL-McCULLOUGH, INC., 1265E San Mateo Ave., San Bruno, Calif.  
Export Agents: Frazar and Hansen, 301 Clay St., San Francisco 11, Calif., U.S.A.

#### CALL IN AN EIMAC REPRESENTATIVE FOR INFORMATION

ROYAL J. HIGGINS (W9AD), 600 So. Michigan Ave., Room 818, Chicago 5, Ill. Phone: Harrison 5948.  
VERNER O. JENSEN, Verner O. Jensen Company, 2618 Second Ave., Seattle 1, Wash., Phone: Elliott 6871.  
M. B. PATTERSON (W5CD), Patterson & Co., 1124 Irwin-Kearney Bldg., Dallas 1, Tex. Phone: Central 5764.  
ADOLPH SCHWARTZ (W2CN), 120 Broadway, Room 210, New York 1, N. Y., Phone: Cortland 5-0811.

HERB BECKER (W6QD), 1100 So. Grand Avenue, Los Angeles 15, California, Telephone: Richmond 6191.  
TIM COAKLEY (WIKKP), 11 Beacon Street, Boston 8, Massachusetts, Telephone: Capital 0030.  
RONALD G. BOWEN, 1286 South Humboldt Street, Denver 10, Colorado, Telephone: Spruce 9506.  
JAMES MILLAR ASSOCIATES, J. E. Joyner, Jr. (W7CD), 1006 Peachtree Street, N.E., Atlanta, Georgia.

Follow the Leaders to

**Eimac**  
TUBES

THE COUNTERSIGN  
OF DEPENDABILITY IN ANY  
ELECTRONIC EQUIPMENT

# For Performance and Dependability

## *Another endorsement of* **EIMAC 4-250A TETRODES**

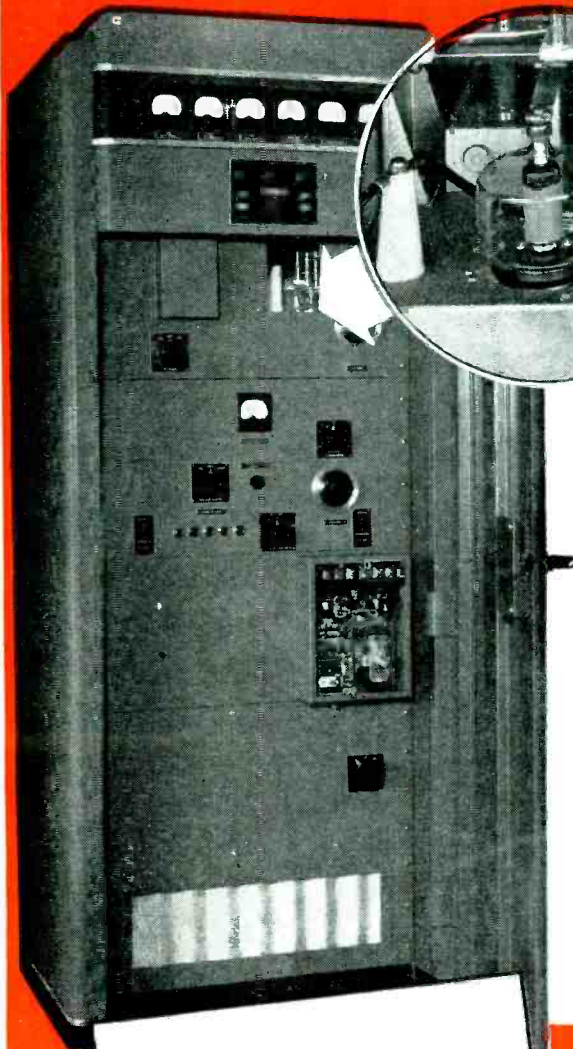

In the power amplifier of the 1000-GA transmitter, TEMCO employs two EIMAC 4-250A tetrodes to obtain a kilowatt input on CW and high level modulated radio telephone. The characteristics of this tube make it the obvious choice for this assignment.

The low driving power requirements of the EIMAC 4-250A permitted TEMCO engineers to build an exciter stage combining new simplicity with greater ease in servicing. Also contributing to circuit simplicity is the low plate-grid capacitance of these tetrodes (0.12 *μfd*) which means that neutralization is ordinarily unnecessary at frequencies up to 40 Mc.

TEMCO is one of a number of large electronic equipment manufacturers using EIMAC tubes. No matter what your power requirement, there's a dependable, long-lasting EIMAC tube for the job.

### **TEMCO 1000-GA**

The Transmitter Equipment Manufacturing Company's 1000-GA is a radio telephone and telegraph manually-controlled transmitter for operation on 5 frequency bands. It is rated at 1. KW input for phone and CW, on 5 crystal-controlled frequencies from 3.5 to 29.7 megacycles.

Follow the Leaders to

**Eimac**  
REG. U. S. PAT. OFF.  
**TUBES**

**EITEL-McCULLOUGH, INC., 1265E San Mateo Ave., San Bruno, Calif.**  
Export Agents: Frazar and Hansen, 301 Clay St., San Francisco 11, Calif., U.S.A.

# TELEVISION

*Capacitors  
Capacitors*

Constructed for  
long life  
under the usage  
requirements of  
television equipment,  
these mineral oil  
impregnated and filled  
capacitors withstand  
high voltage at high temperatures.

Hermetically sealed in metal cases  
with hook, flange, or adjustable  
mounting brackets, these capacitors are  
available in varied sizes and ratings.

Quotations for early  
delivery on request.

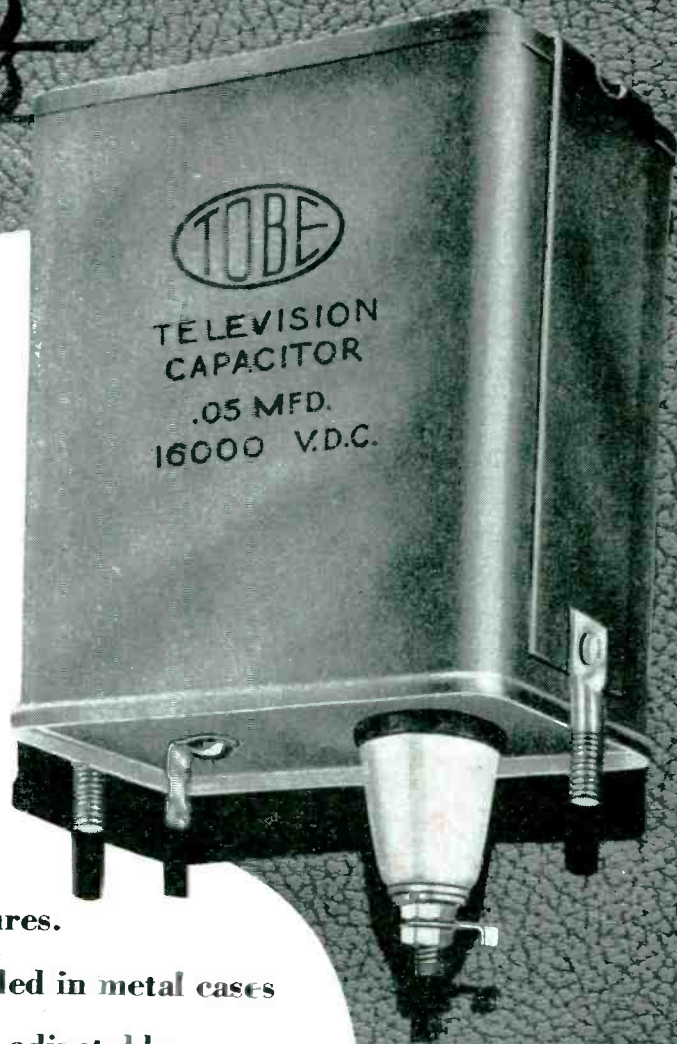

**TOBE DEUTSCHMANN  
CORPORATION**  
CANTON, MASSACHUSETTS





**DIE COSTS  
TAKE A  
NOSE DIVE**

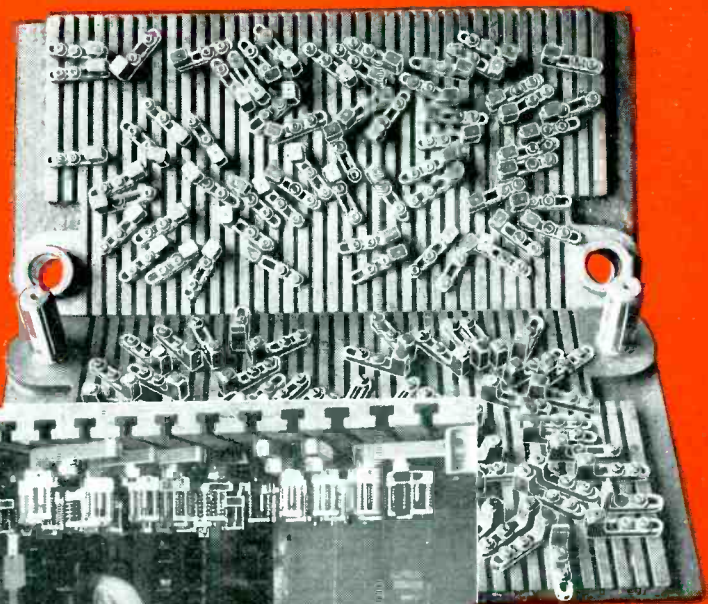
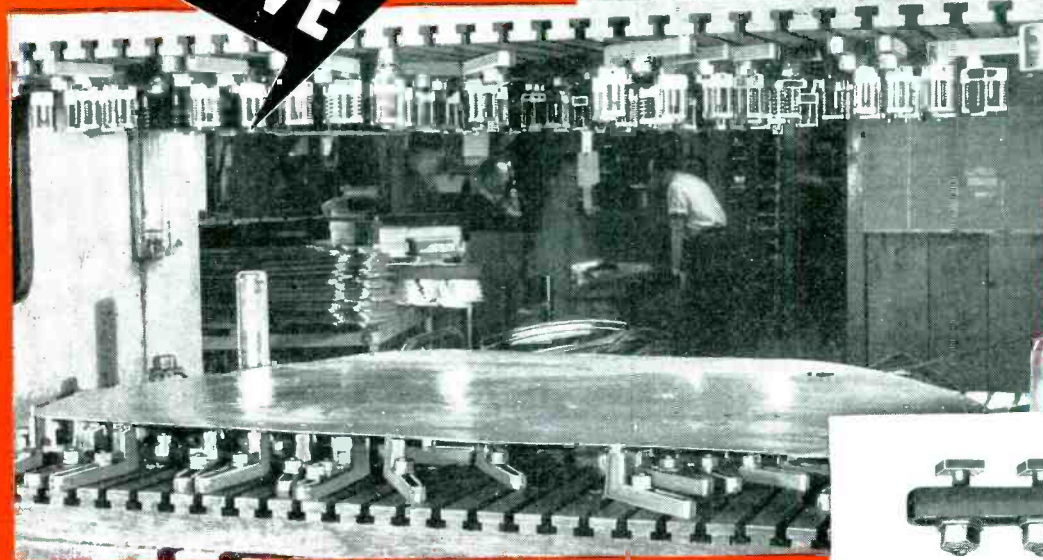

Typical examples of set-ups made from stock units. No delay in starting production.

**WHISTLER Adjustable Perforating Dies Offer Added Production Economy**

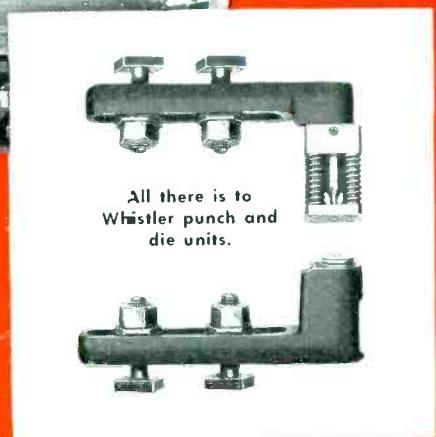

All there is to Whistler punch and die units.



**WRITE FOR YOUR WHISTLER CATALOGS.** Know the production advantages of Whistler Adjustable Dies.

5-10-50 and even more different set-ups with the same dies? Impossible? Not when you use Whistler Multi-Use Adjustable Dies. For it's simple to rearrange these units...add or delete...get back into production within a few hours. Even so-called complicated arrangements are easy to set up. And, with first cost invariably less than for single purpose dies, this continued re-use of the same dies effects added economy in quickly writing off initial die invest-

ment. Over 750 prominent manufacturers have proven in their own plants that Whistler Adjustable Dies have sent costs into a nose dive.

No special tools are needed. Work in practically any size and type of press. Ordering now is particularly advantageous. Large stocks of standard diameter units from 1/32" up are available for overnight shipments. Notching, group dies and special shapes and sizes can be quickly made to order. Write today to:

**S. B. WHISTLER & SONS, Inc.**  
752-756 MILITARY ROAD      BUFFALO 17, NEW YORK

TO HER TRAINED EAR... *Every*

# AMERICAN PHILLIPS

## BOLT and SCREW

Even Has to *RING* True!



Every modern method of inspection and quality-control is used in American's plant. And American's inspectors become so highly efficient . . . so keenly attuned to their work . . . that even their ears become "educated." For example, these final inspectors can literally "hear" the presence of an undiscovered blank, an imperfect screw, or a screw of some other metal than that specified in the particular order under inspection. For as they pass their forks through each box, the slightest variations in sound of metal against metal are detected . . . and out comes the offending screw or bolt.

Here's another good reason why there's a higher "perfection-percentage" in every order for American Phillips Screws and Bolts . . . at least 144 perfect screws in every gross-box . . . regardless of type of screw or kind of metal: steel, brass, commercial bronze, stainless steel, aluminum, monel, everdur (silicon bronze). Add to this the basic American Phillips advantages . . . fast and fumble-proof handling, automatically straight and *50% faster* driving, positive protection against split screwheads and scarred work-surfaces . . . and you have gained one of the few major cost-cuts that *any* plant can gain today.

4-WINGED DRIVER CAN'T SLIP OUT OF PHILLIPS TAPERED RECESS

AMERICAN SCREW COMPANY, PROVIDENCE 1, RHODE ISLAND

Chicago 11: 589 E. Illinois St.

Detroit 2: 502 Stephenson Bldg.

# AMERICAN PHILLIPS

*Screws*



ALL TYPES  
ALL METALS: Steel,  
Brass, Commercial  
Bronze, Stainless  
Steel, Aluminum,  
Monel, Everdur (silicon  
bronze)

**NEW... an  
ELECTRONIC STOPWATCH  
for microsecond timing  
and high-speed counting**

**2 models  
2 ranges**

**TYPE WF-99A** measures time intervals up to 0.1 second in one-microsecond steps. Counts at speeds up to 1,000,000 per second.

**TYPE WF-98A** measures time intervals up to one second in five-microseconds steps. Counts at speeds up to 200,000 per second.

- Extreme accuracy maintained by temperature-controlled, crystal oscillator
- Silent operation—no moving parts to wear out
- Direct reading—figures in columns light up

**T**HIS *electronic* time-interval counter makes it easy for you to accurately time or count operations too fast for mechanical counters. There are no moving parts to wear out prematurely under the strain of high-speed, continuous service.

Counting or measuring is started and stopped by means of electrical impulses. Results are read directly each time the stopping action is triggered.

Here are a few of the many ways you can use this new instrument profitably:

**For Measuring:** Velocities and accelerations of projectiles, etc.; opening and closing time of circuit breakers

and relays; electric impulses from generators, switches, and amplifiers.

**For Counting** (when used with phototube equipment): Items on rapid conveyors; drops falling from viscosity testing apparatus; rpm.

**For Built-in Applications:** As part of electronic calculators; with industrial control devices for control based on a preselected number of items. Counts pills, packages, etc.

*Size:* 17 inches high, 11 inches wide, 9 inches deep.

Use the coupon below for additional information on how this instrument can help you.

**Radio Corporation of America**  
**Dept. 30-H, Test and Measuring Equipment Section**  
**Camden, New Jersey**

Please send me the complete story on the new RCA Time-Interval Counters for microsecond timing and high-speed counting.

Name \_\_\_\_\_

Company \_\_\_\_\_

Street \_\_\_\_\_

City \_\_\_\_\_ Zone \_\_\_\_\_ State \_\_\_\_\_



**TEST AND MEASURING EQUIPMENT  
RADIO CORPORATION  
of AMERICA**

**ENGINEERING PRODUCTS DEPARTMENT  
CAMDEN, N. J.**

In Canada: RCA VICTOR Company Limited, Montreal

**This handsome Radio  
goes to market...**



**and this metallized  
trimmer cuts cost!**



**T**HAT, in a nutshell, is the story of component parts made of Corning Metallized glass. In this case it's a trimmer capacitor as used in Stromberg-Carlson's beautiful new "Imperial" radio. It eliminates other parts and speeds up assembly.

Some other advantages are that it permits permanent, precise and undistorted tuning even under vibration and in high frequency FM bands. Adjustment is made at the electrically cold end of the trimmer. It has a high Q. It is another example of Corning metallized glass that permits glass parts to be soldered to hardware, permanently, quickly and, where necessary, to form hermetic seals.

For more information about metallized trimmer capacitors write for Bulletins EI-B-1 and B-2. For the complete story on Corning Metallized Glass Components, write for Bulletin EL-Z-Z-10.

Electronic Sales Department, E-8  
Corning Glass Works  
Corning, New York

*Sales offices in New York, Chicago and San Francisco*

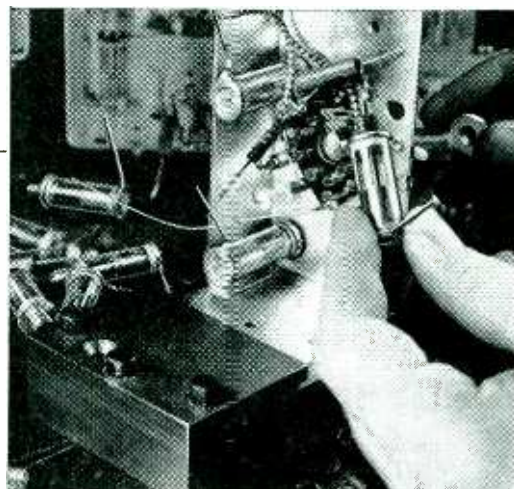

*Clamping metallized trimmer in place*

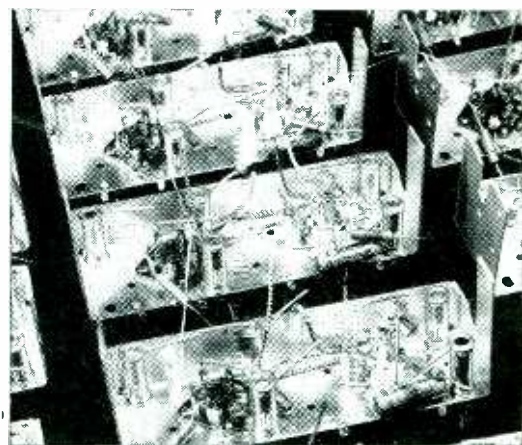

*Trimmers assembled in chassis*

**CORNING**  
— means —  
Research in Glass

**Electronic Glassware**



"PYREX", "VYCOR" and "CORNING" are registered trade-marks and indicate manufacture by Corning Glass Works, Corning, N. Y.

AS *Easy*  
AS THIS!

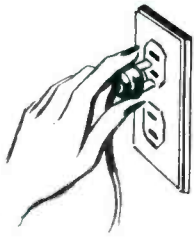

# Exclusive! New Type **CONCORD** AMPLIFIERS

with amazing  
**ADD-A-UNIT**  
features!

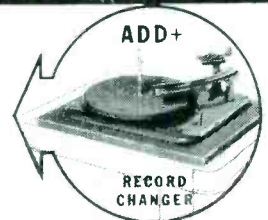
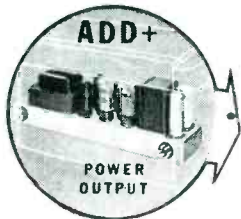
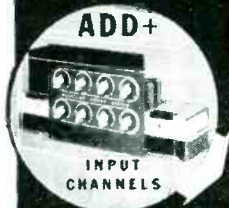

## Add any or all of these units in a **SINGLE** cabinet!

Now available for **IMMEDIATE SHIPMENT**, the new, original and revolutionary Concord line of Multiamp Add-A-Unit Amplifiers and complete systems. Sets new high standards of flexibility, fidelity, performance, beauty and economy! 30 to 45 watt amplification increased, in a single cabinet, to 60, 75, or 90 watts *in minutes* with plug-in Add-A-Unit output stages—at minimum cost! Add two more input channels to total six channels if needed! Separate bass and treble tone-controls open a new world of tonal beauty and fidelity! Add a phono player, record changer, output indicator—any or all on the same Multiamp amplifier cabinet—eliminating extra space requirements and additional cabinet cost!

For every sound amplifier requirement, permanent installations or portable, the revolutionary, exclusive fea-

tures of Concord Multiamp Add-A-Unit Amplifiers, in complete systems or single units, offer the utmost in flexibility, perfection of performance and low cost.

**Immediate Shipment from CHICAGO or ATLANTA**

### Mail Coupon for New Complete Catalog — **FREE!**

Your copy is ready now—featuring the exciting new Concord line of Multiamp Add-A-Unit Amplifiers and Accessories—plus Radio Sets, Phono-Radio Combinations—the latest, greatest complete selection of **RADIO PARTS, ELECTRONIC EQUIPMENT, TOOLS, AMATEUR GEAR, KITS and SUPPLIES**—every requirement for all radio and electronic use. Thousands of items—including nationally-known standard top-quality lines—money-saving prices. Mail coupon for your copy now!

# CONCORD

## RADIO CORPORATION

LAFAYETTE RADIO CORP.

CHICAGO 7

ATLANTA 3

901 W. Jackson Blvd.

265 Peachtree Street



CONCORD RADIO CORPORATION  
901 W. Jackson Blvd.  
Dept. G-86, Chicago 7, Ill.

Yes, rush **FREE COPY** of the comprehensive new Concord Radio Catalog.

Name .....

Address .....

City ..... State .....

# "Induction Heater Increased Output from 20 to 200 Units Per Hour"



"FORMERLY we torch-brazed these small assemblies, but found that production was low, only 20 units per hour, with a large number of rejects. The slow application of torch heat caused a chemical reaction which affected the cadmium plating and caused it to flake in a short time. Today, with the new Allis-Chalmers Induction Heater, our rejects are negligible, plating is unaffected and a completely inexperienced operator now turns out 200 units per hour . . . an actual production increase of 1000%!"

## What's your heating problem?

Is it hardening? Brazing? Soldering? Annealing? Forging? Perhaps the new Allis-Chalmers Induction Heater can solve it for you . . . and, chances are, do it better and at lower cost. For further information on induction heating, write today for Bulletin 14B6430. ALLIS-CHALMERS, MILWAUKEE 1, WIS.

A 2083



# ALLIS CHALMERS

One of the Big 3 in Electric Power Equipment —  
Biggest of All in Range of Industrial Products

## INDUCTION HEATERS



World-Wide Photo

# Sure Cure for Hay "Fever"



## With This New Electrical Resistance Thermometer

**W**ATCH that hay! When it runs a temperature it may ignite and burn down the barn. That's spontaneous combustion and to prevent it an extremely sensitive Electrical Resistance Thermometer Bulb, developed by Edison-Splitdorf Corporation, is used to detect temperature changes.

Not only does this wonder bulb detect overheating in hay mows; it also determines ground and air temperatures in greenhouses — reports temperature changes in the bearings of power station generators, railroad cars, vital spots of airplanes, chemical reactions, hospital rooms and even in patients undergoing operations. Its uses are unlimited and it will measure temperatures ranging from  $-200^{\circ}\text{F}$  to  $600^{\circ}\text{F}$  in solids, liquids and gases. Time constant is less than 2 seconds.

The heart of this bulb is a resistance element wound with a wire having a Temperature Coefficient of Resistance of .00636 per degree C. A change of  $1^{\circ}\text{C}$  produces a .39

ohms change in the unit which in turn produces a corresponding change in the current flowing through the recording meter.

Although this type thermometer has been used in industry for many years it was never successfully developed for volume production because of a lack of an adequate supply of a resistance wire with a stable T. C.

Spurred by the urgency of the war, Driver-Harris Metallurgists working with Edison Engineers speedily developed D-H 99 Alloy to meet this need. It is a resistance wire having a stable T. C. of .00636 per degree C when drawn to .002" diameter and available in large quantities with dependably uniform properties from spool to spool.

Today Driver-Harris manufactures over 80 electrical heat and corrosion-resistant alloys. If, like Edison-Splitdorf, the alloy wire you need has not been developed, tell us about it. We've solved many difficult metallurgical problems in 47 years.

1. STAINLESS STEEL BULB
2. PORCELAIN SEAL
3. D-H 99 ALLOY
4. SILVER SPRINGS
5. MICA INSULATION

Construction details of the temperature sensitive element which is hermetically sealed into the stainless steel bulb of the Edison-Splitdorf Electrical Resistance Thermometer. Made for the Foxboro Company and other instrument manufacturers.



## Driver-Harris COMPANY

Exclusive Manufacturers of Nichrome  
HARRISON, N. J.

BRANCHES: Chicago • Detroit • Cleveland  
Los Angeles • San Francisco • Seattle  
The B. GREENING WIRE COMPANY, LTD.  
Hamilton, Ontario, Canada

# FIRST TWO FM STATIONS

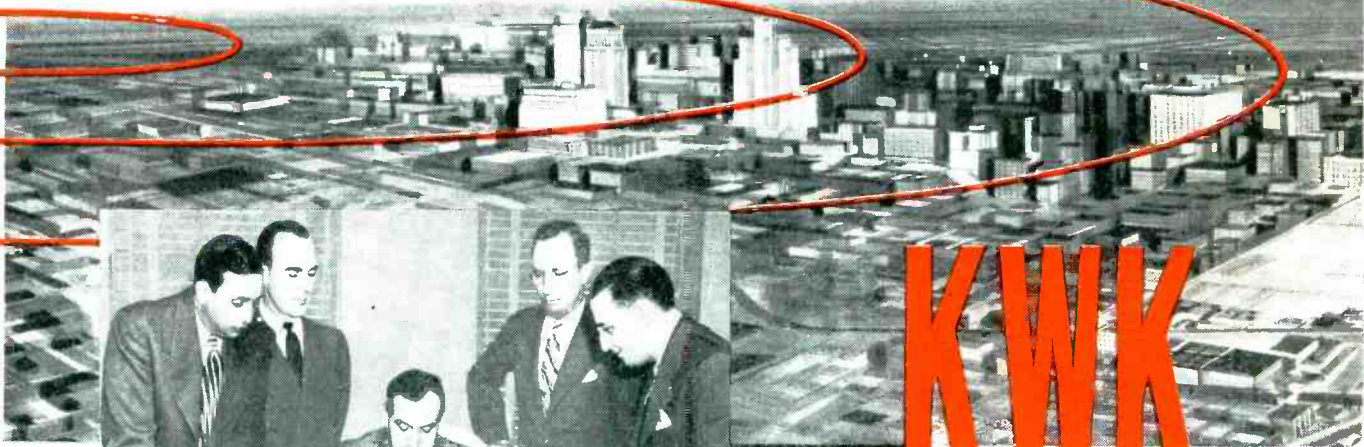

Robert T. Convey, President of Station KWK, signing the contract for the 50-kw FM transmitter. L. to R.: Ray E. Dady, Station Director; V. E. Carmichael, Commercial Manager; Mr. Convey; Nick. J. Zehr, Chief Engineer; William Albright, Federal Representative.

**50 KW** **KWK** **AND**

**go on**  
**with FM by**

RADIO LISTENERS in the St. Louis area will get a new thrill from finer, high-fidelity, interference-free broadcasting when Station KWK goes on the air this summer with FM—powered by Federal's new 50-kilowatt transmitter. To assure maximum output, KWK will use a Federal 8-Element, Square-

Loop antenna with a power gain of 9, so that the 50-kw transmitter will actually deliver an effective radiated power of 450 kw.

As this station is a member of the Mutual Broadcasting System, its powerful FM transmitter will undoubtedly be an important link in Mutual's proposed FM network.

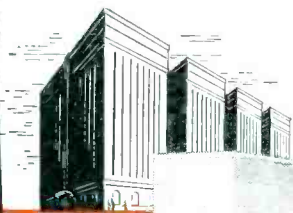

Both transmitters incorporate Federal's exclusive "Frequematic"\* modulator, assuring outstanding fidelity and mean-carrier stability. As with all of its

8-Element Square-Loop Antenna will be able to deliver effective radiated power of approximately 450 kw.

*Federal Telephone*

In Canada: Federal Electric Manufacturing Company, Ltd., Montreal  
Expert Distributor: International Standard Electric Corporation



# IN THE ST. LOUIS AREA!

# WEW

10 KW

the air  
**FEDERAL**



Nicholas Pagliara, General Manager of Station WEW, signs for Federal's complete 10-kw FM station. Left—W. E. Albright, Federal Representative. Right—N. E. Wunderlich, Executive Sales Director, Federal Telephone and Radio Corporation.

STATION WEW of the University of St. Louis—second oldest radio broadcasting station in the United States—has contracted with Federal for a 10-kilowatt FM transmitting station, completely Federal engineered and equipped from microphone to antenna. With the new 8-Element, Square-Loop antenna, WEW will actually

have an effective radiated power of 90 kw.—providing more power and greater listening pleasure for the University's vitally important educational, religious and commercial programs. Space will be left above the FM antenna array for future 485-600 Mc color television antenna.

FM equipment, Federal is making available to KWK and WEW, the services of factory-trained engineers to supervise the installation, make the initial "tune-up," and see the stations successfully on the air. Write for general and technical data.

\*TRADE MARK

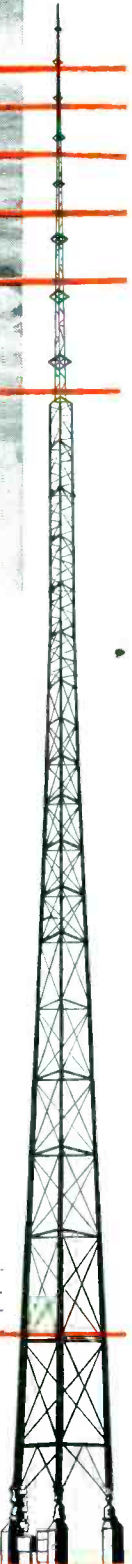

*and Radio Corporation*

Newark 1, New Jersey



8-Element, Square-Loop Antenna will be able to deliver effective radiated power of approximately 90 kw.

# An Outstanding New Line of A.C. and D.C. RELAYS

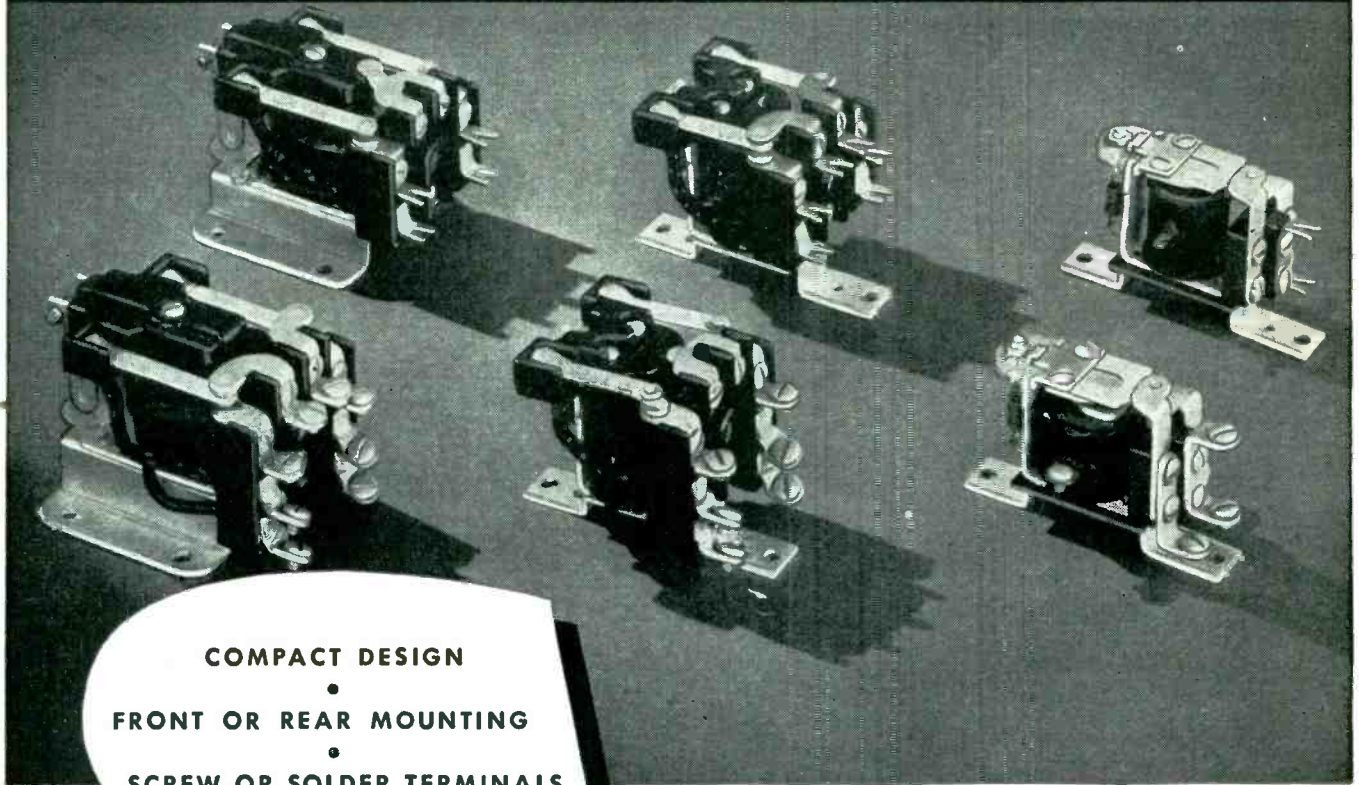

**COMPACT DESIGN**  
•  
**FRONT OR REAR MOUNTING**  
•  
**SCREW OR SOLDER TERMINALS**

● R-B-M announces a new and improved design of magnetic relays rated 10 amperes at 24 volts D. C. and 110 volts A. C. and 5 amperes at 220 A. C. Relays rated at one horse power single phase 110 and 220 volts A. C. Silver to silver contacts. Self-aligning armature. All wiring terminals accessible from front. Contact arrangement—single and double pole; normally open, normally closed and double throw. Steel

mounting with A. C. and D. C. relay mounting dimensions interchangeable. Available in open type or with sheet steel general purpose enclosure. Bulletin 510 on D. C. relays and Bulletin 550 on A. C. relays available upon request. Write Department A.

**R-B-M MANUFACTURING COMPANY**  
*Division of*  
**ESSEX WIRE CORPORATION**  
**LOGANSPORT, INDIANA**



MANUAL AND MAGNETIC ELECTRIC CONTROLS — FOR  
AUTOMOTIVE, INDUSTRIAL, COMMUNICATION AND ELECTRONIC USE



## Using Resistance to Chemicals and Wear

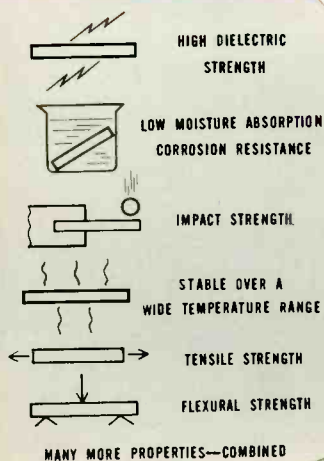

**T**HIS is a *Plating Barrel*. And you might look a long while before finding a more appropriate application of plastics.

Several kinds of plating barrels are made of Synthane *laminated* plastics. Which is understandable because Synthane opposes the inroads of a variety of corrosive plating solutions, resists punishment from tumbling pieces.

Synthane has many more good properties and an army of practical uses . . . electrically, chemically, mechanically. If you've a place for this versatile material, let us pitch in and help you . . . with the right design, the right plastics for the job . . . the right men and equipment for economical fabrication. Write for our complete catalog of Synthane Plastics today.

**SYNTHANE CORPORATION • 6 RIVER ROAD • OAKS • PENNSYLVANIA**

**SYNTHANE**  
S

SYNTHANE TECHNICAL PLASTICS • DESIGN • MATERIALS • FABRICATION • SHEETS • RODS • TUBES • FABRICATED PARTS • MOLDED-MACERATED • MOLDED-LAMINATED



THE *Egyptians* STARTED IT

THE *Romans* HAD A WORD\* FOR IT

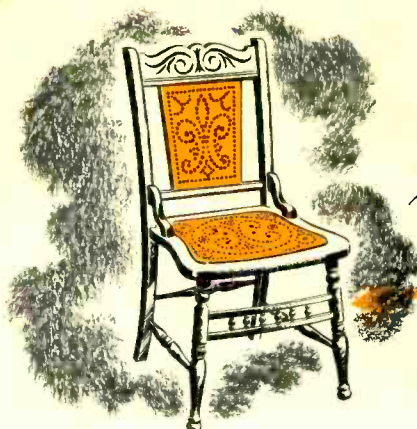

GRANDPA SAT ON IT

# You HAVE A USE FOR THIS MODERN VERSION

Our type of plastics—laminated phenolics—is exactly what its name implies—made by applying heat and pressure to layers or *\*laminae* of paper, fabric or other materials impregnated with heat-reactive resins.

The Egyptians were probably the first to discover the principles of laminating, using thin overlayers of wood chiefly for beauty. Later, however, thin sheets of wood were bonded for economy and strength as well.

Now, in laminated phenolics such as Synthane, you

have in a single non-metallic material an excellent dielectric, resistance to corrosion from many chemicals, oils, waters, and atmospheres, mechanical strength, light weight (½ the weight of aluminum), ease of machining, and many more useful properties.

If you have not yet fully investigated the "laminates", or through military service have been out of touch with their uses, write in for a copy of the complete Synthane catalog today.



GET THIS GUIDE TO SYNTHANE

# SYNTHANE

# S

PLAN YOUR PRESENT AND FUTURE WITH SYNTHANE  
TECHNICAL PLASTICS • SHEETS • RODS • TUBES • FABRICATED  
PARTS • MOLDED • LAMINATED • MOLDED-MACERATED

SYNTHANE CORPORATION, 6 RIVER ROAD, OAKS, PA.

Gentlemen:

Please send me without obligation the complete catalog of Synthane technical plastics.

NAME \_\_\_\_\_

COMPANY \_\_\_\_\_

ADDRESS \_\_\_\_\_

CITY \_\_\_\_\_

ZONE \_\_\_\_\_

STATE \_\_\_\_\_



**DRIVE**  
**YOUR PRODUCTS**  
**to market**  
 with  
**alliance**  
**MOTORS**

**THE NEW MODEL A** shaded pole, induction-type Alliance Fan Motor for speeds from 500 to 1050 R.P.M. operates on 50 or 60 cycles at voltages up to 220, 1/30th horse-power, size 4 3/8 x 2 3/4 inches. Porous bronze, oilless-type sleeve bearings. Open or fully enclosed construction. Approx. 8 to 40 oz. in. full load running torque, depending on stack length. Exceptionally quiet. For continuous or intermittent duty. Runs clockwise or counter clockwise — not reversible.

**OTHER ALLIANCE POWR-PAKT MOTORS** in shaded pole induction and split-phase reversible resistor types rated from less than 1/400th h. p. on up to 1/20th h.p. for powering valves, switches, controls, driving turntables, fans, record changers and automatic devices.

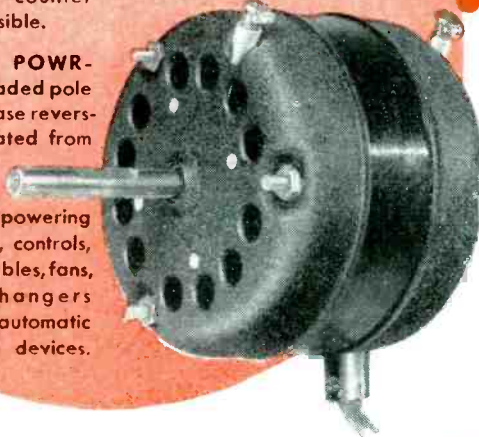

**SLOWER SPEEDS • LOWER CURRENT COSTS**  
**QUIETER OPERATION • SMALLER SIZE**

Here are four *big* advantages built into the new Alliance Powr-Pakt fan motors. Results are longer life — less repair — smoother performance. This new Alliance shaded pole fan motor reflects advanced engineering! Mass-produced at low cost! Write.

**WHEN YOU DESIGN — KEEP**

**alliance**  
**MOTORS IN MIND**

**ALLIANCE MANUFACTURING COMPANY • ALLIANCE, OHIO**  
 ALLIANCE TOOL AND MOTOR LTD., TORONTO 14, CANADA

**AT LAST!**

★ SPECIAL WARTIME  
DEVELOPMENT AVAILABLE  
FOR PUBLIC USE . . . . .

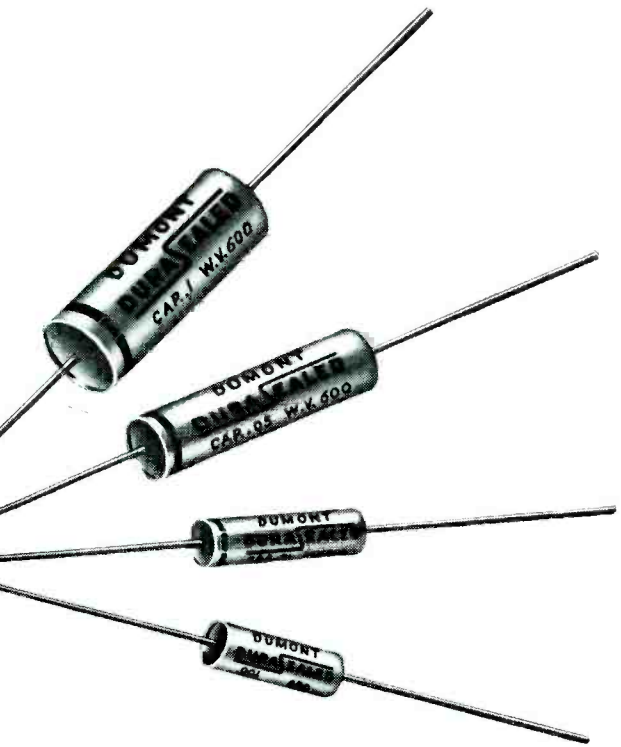

**DUMONT DURA SEALED**  
TYPE P6 - P7\*

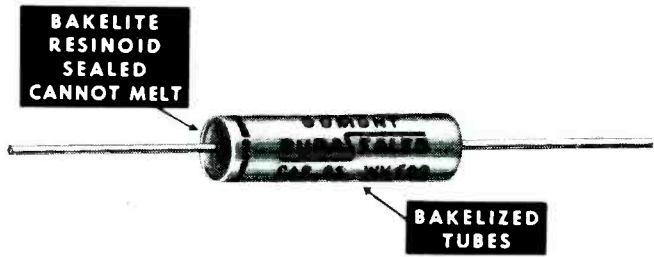

★ Dumont engineers scored in the greatest single achievement in paper tubular capacitors . . . meeting the most exacting requirements. This type P6 has the ends sealed in BAKELITE RESINOID. Leads cannot PULL OUT or MELT OUT. Bakelite treated tubes sealed in vacuum.

- ★ HEAT PROOF
- ★ MOISTURE PROOF
- ★ LONGER LIFE
- ★ VACUUM SEALED
- ★ SOLVES SPACE PROBLEMS

Distributors—  
Write for Prices  
and Territory  
Available now

**DUMONT**  
**ELECTRIC CORP.**  
MFR'S OF  
CAPACITORS FOR EVERY REQUIREMENT  
34 HUBERT STREET NEW YORK, N. Y.

\*P-7  
OIL UNITS

# TINY OR TITANIC

**No Job in Metal is Too Big  
or Too Small for KARP**

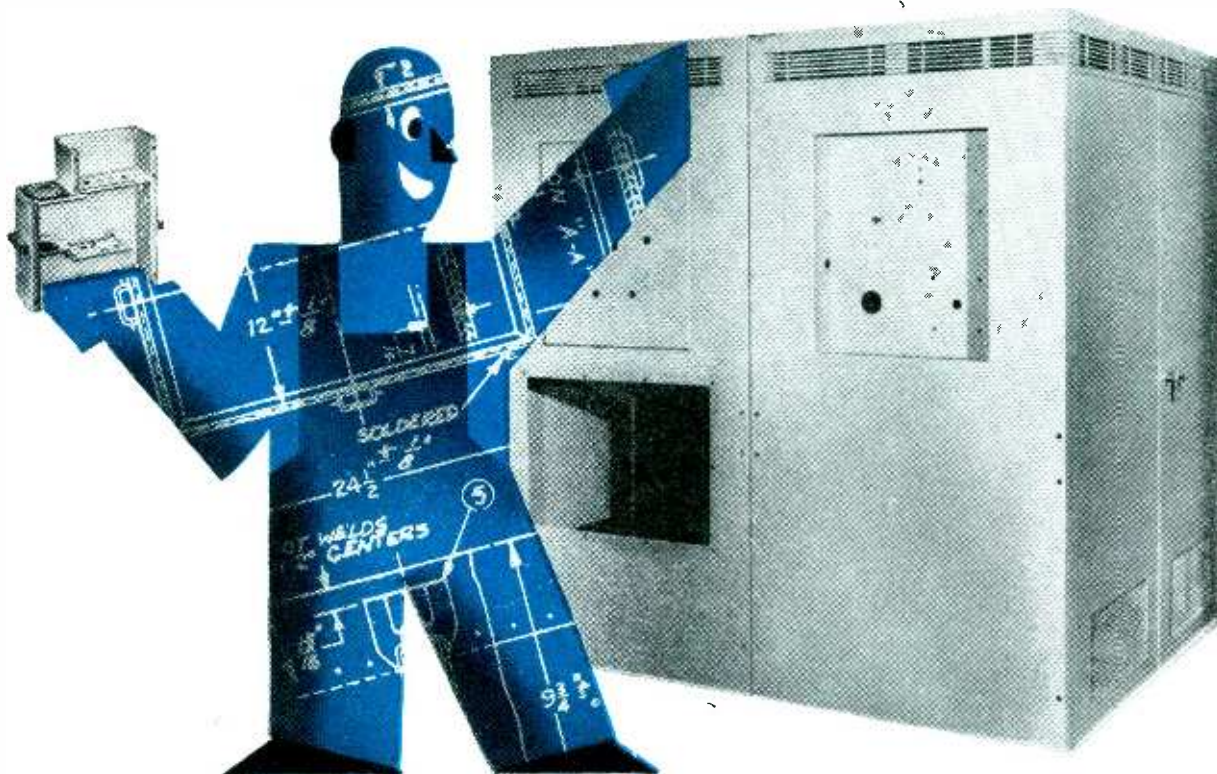

Bring your metal fabrication problems to KARP . . . and enjoy the superior individualized services of an organization that has been solving the toughest problems in precision metal craftsmanship for more than 20 years. Whether it's a tiny chassis, shield, or cabinet . . . or a giant rack or housing for broadcast or induction heating apparatus, KARP has the skill, the engineering "know how" and the plant facilities to serve you . . . and to assure you of reasonable delivery time. KARP ideas often effect important savings in both materials and machine tool time. KARP'S extensive stocks of dies often result in custom-made jobs at "ready-made" economies.

ANY METAL • ANY SIZE • ANY FINISH

# KARP

124-30th Street, Brooklyn 32, N. Y.

**METAL PRODUCTS CO., INC.**

*Custom Craftsmen in Metal*



# NEW FLEXIBLE VARNISHED TUBING AND SLEEVING

# TURBOTUF



**Non-cracking, non-chipping, non-peeling  
even under repeated bends and twists!**

Resistance to mechanical strain is one of the most remarkable qualities of NEW TURBOTUF. In actual use as well as in accelerated destruction tests, TURBOTUF insulating tubings and sleeveings stand up under unbelievably punishing treatment . . . defy even a trace of cracking when bent under most severe conditions of twist and deformation . . . over a complete 180°

angle . . . for hundreds of bends.

Exclusive TURBOTUF varnish impregnation, thoroughly saturating the fabric, provides this superior mechanical resistance. Furthermore, such treatment is the basis for other TURBOTUF advantages . . . improved oil, moisture, heat and flame resistance . . . high dielectric values . . . better tensile strength and anti-fray construction.

Wherever insulating materials must stand up under especially severe operating conditions, extremes of temperature . . . bending or twisting . . . high voltages . . . moisture . . . oils, acids or other reagents . . . overall wear—there is a TURBOTUF tubing, sleeving, wire or other insulating specialty to fit into your specification sheet.

## THERMOPLASTIC INSULATED WIRE:

TURBOTHERM wire features high dielectric properties and resistance to heat and other destructive elements. Nos. 18 to 30 stranded and solid conductor.

## FLEXIBLE VARNISHED TUBING:

TURBOTUF tubings in two top grades—Magneflo and Radio grade available in standard sizes from No. 24 (.020" ID) to No. 1 (1.000" ID).

## SATURATED SLEEVING:

TURBOTUF Sleeveing—an all-purpose insulation for the lower dielectric ranges—in standard sizes from No. 20 (.034" ID) to No. 1/2 (.500" ID).

## FIBROUS GLASS TUBING:

TURBO Glass Fibre Tubing possesses superior electrical and physical characteristics—supplied in sizes from No. 20 (.034" ID) to No. 3/8 (.375" ID).

## EXTRUDED PLASTIC TUBING:

A smooth wall plastic tubing with notable resistance to severe low temperatures and subsequent embrittlement.



REMEMBER . . . IF IT'S

# TURBO

. . . IT SAFEGUARDS!

## WILLIAM BRAND & COMPANY

276 FOURTH AVE., NEW YORK 10, N. Y. • 325 W. HURON ST., CHICAGO 10, ILL.



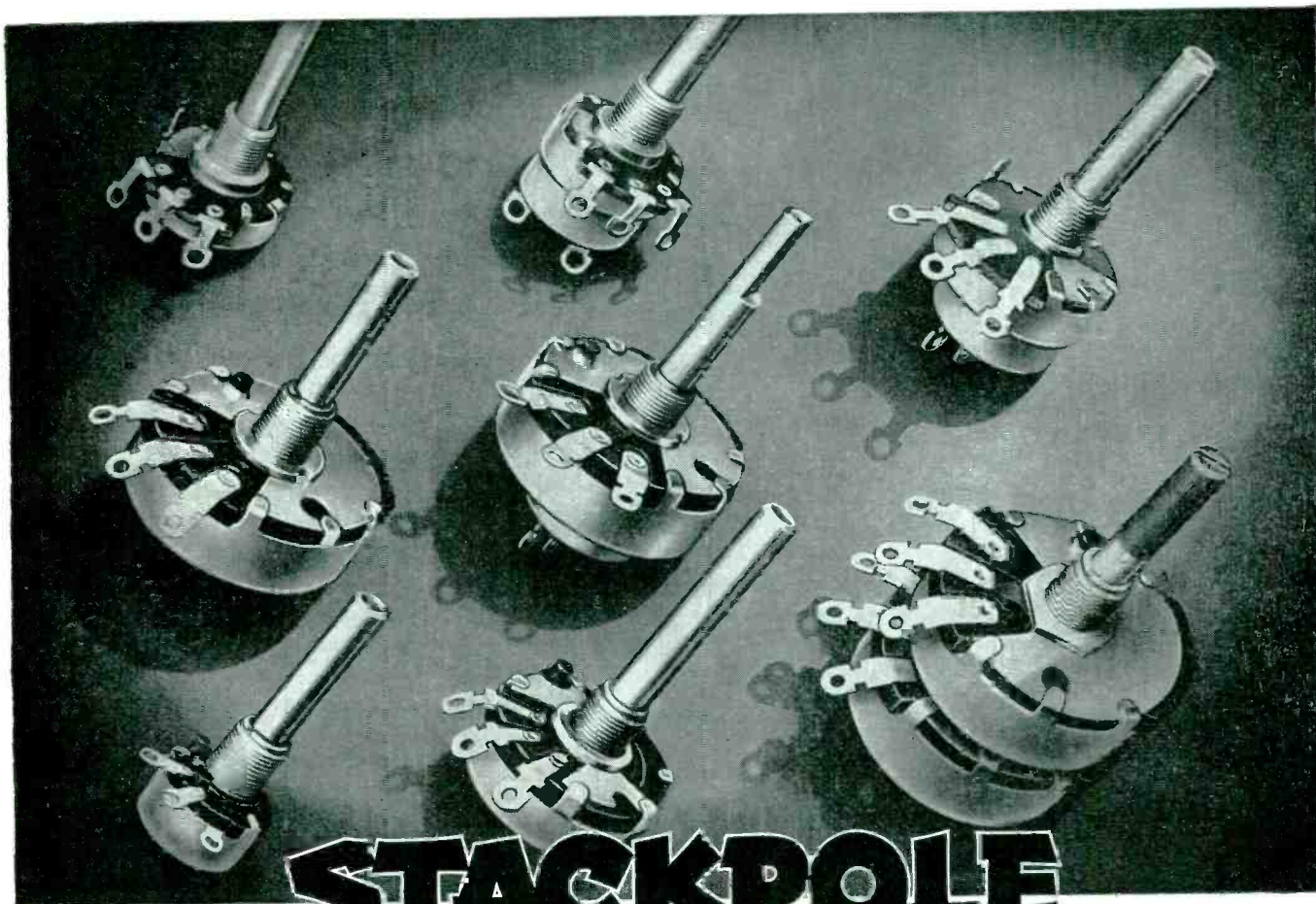

# STACKPOLE FIXED AND VARIABLE RESISTORS

One of the nation's largest producers, Stackpole offers a dependable source of supply for both fixed and variable resistors for a wide variety of applications. Fixed types include 1/2- and 1-watt insulated units in smallest sizes consistent with modern performance demands. Variables include standard-size units, midgets, sealed designs and numerous special types. Write today for Stackpole Electronic Components Catalog RC6.

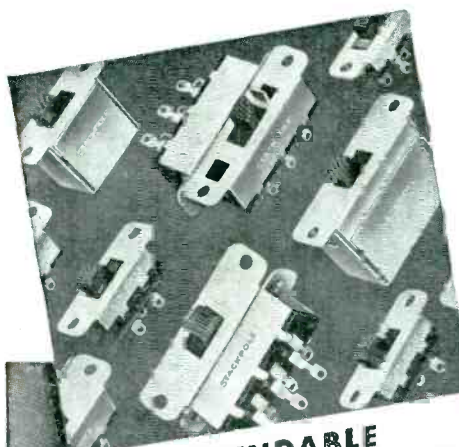

## DEPENDABLE LOW-COST SWITCHES

Line, Slide, Rotary Action Types  
Ideal for radios, toys and all electrical equipment where high-grade but inexpensive switching is required. Available in standard types to meet almost any requirement. Write for Catalog RC6.

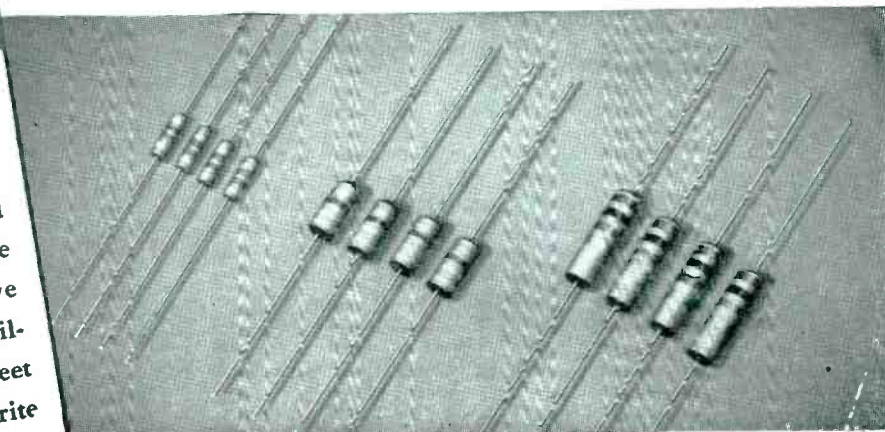

**STACKPOLE CARBON COMPANY**  
(Electronic Components Division)  
ST. MARY'S, PA.

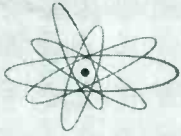

# Designers

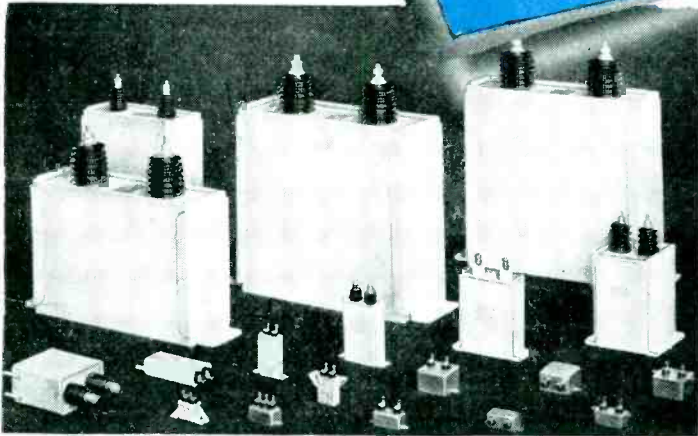

## NEW PYRANOL\* CAPACITORS

*new sizes, new quality*

Strict quality control, new manufacturing techniques, and improved materials — the basis of the excellent war-time records of G-E d-c capacitors — are now incorporated in a new line of Pyranol capacitors designed to meet rigorous commercial requirements.

This new line makes possible a broad selection of sizes, ratings and mounting arrangements, with characteristics which permit operation over a wide temperature range (from 85C to -55C), at altitudes up to 7,500 feet. Sizes and shapes range from "bathtub" and small rectangular case styles to large, welded steel-case designs. Capacitance ratings are offered from .01 muf to 100 muf, and voltage ratings from 100 to 100,000 volts. Write *Transformer Division, General Electric Co., Pittsfield, Mass.*



## MORE COMPACT COILS

*wound faster*

Formex\* magnet wire, available in all standard wire sizes, puts more turns and more copper in a given coil cross-section area than fibrous-covered wire does, particularly if square or rectangular Formex wire is used. It's a natural where coil shapes require acute angle bends. Higher winding speeds are practical without increasing rejects; time-saving steps are possible that you wouldn't dare use with ordinary magnet wire. In most sizes, first cost of Formex is less than fibrous-covered wire, and only slightly greater than enameled. Check Bulletin GEA-3911.

\*Reg. U.S. Pat. Off.

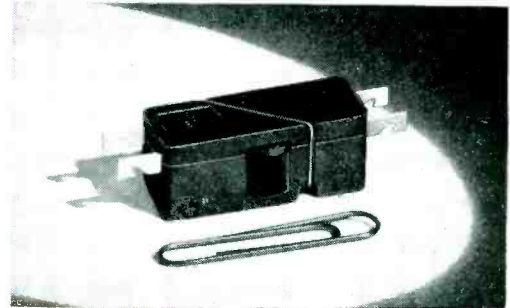

## SWITCHETTES do big jobs

*in cramped quarters*

G-E manually-operated Switchettes are outstanding for the long life and lightning-fast snap action packed into an unusually small, lightweight case. The Size 1 Switchette weighs only 9 grams, and is approximately 1 1/4 in. by 1/2 in. by 1/2 in. Size 1 Switchettes are available in ratings up to 10 amperes at 24 volts d-c, or 230 volts a-c, and in ten different contact arrangements. Size 2 Switchettes are rated 25 amperes at 24 volts d-c, (230 volts a-c), and are available in three contact arrangements: single circuit, normally open; single circuit, normally closed; and two circuit. Totally enclosed, with screw terminals, size 2 Switchettes measure about 2 by 1 3/8 by 1 inch, and weigh approximately 2 ounces. Write for Bulletin GEA-3818C (Size 1) or GEA-4259 (Size 2).

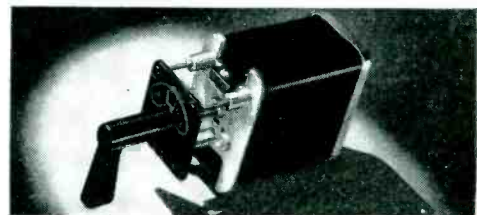

## A VERSATILE SWITCH

*with 4,000 possibilities*

There's a standard SB-1 switch for most of the ordinary control and transfer jobs. Where the number or arrangement of circuits is unusual, special switches can be made from standard SB-1 cams, contacts, fingers, and other parts, giving great flexibility of application. Precision-built parts make even a 40-stage tandem switch easy to operate.

Already more than 4,000 different arrangements of circuits and sequences have been made by varying contacts and cam arrangements. Others can be made to meet your specifications. Write for Bulletin GEA-1631E.

**GENERAL  ELECTRIC**



# How many of YOUR problems can be **TRAPPED FOR GOOD?**

Small as mice or big as rats, your lubrication, parting, coating and conduction difficulties can cause plenty of trouble—nibbling at production efficiency and profits.

That's where the 18 "dag" dispersions of pure colloidal graphite come in. A wide range of liquid carriers (alcohols, oils, volatile hydrocarbons and water) deliver this unique substance in controlled concentrations wherever any of its interesting properties are needed. "dag" colloidal graphite is chemically inert, softer than talc, slippery as oil, opaque, and a conductor of heat and electricity.

Once you have found which of the "dag" family will solve your maintenance and production problems, they're licked permanently. Check off below the fields of usefulness you're concerned with—and mail the coupon to us.



## colloidal products

ACHESON COLLOIDS CORPORATION, Port Huron, Michigan

This new literature on "dag" colloidal graphite is yours for the asking:

- 460** A data and reference booklet regarding "dag" colloidal graphite dispersions and their applications. 16 pages profusely illustrated.
- 421** Facts about "dag" colloidal graphite for ASSEMBLING AND RUNNING-IN ENGINES AND MACHINERY.
- 422** Facts about "dag" colloidal graphite as a PARTING COMPOUND.
- 423** Facts about "dag" colloidal graphite as a HIGH TEMPERATURE LUBRICANT.
- 431** Facts about "dag" colloidal graphite for IMPREGNATION AND SURFACE COATINGS.
- 432** Facts about "dag" colloidal graphite in the FIELD OF ELECTRONICS.

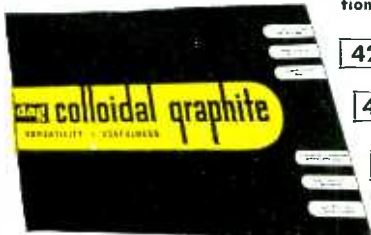

ACHESON COLLOIDS CORPORATION  
PORT HURON, MICHIGAN DEPT. HH-5

JM100-V-111

Please send me without obligation, a copy of each of the bulletins checked:

NAME \_\_\_\_\_  
 POSITION \_\_\_\_\_  
 FIRM \_\_\_\_\_  
 ADDRESS \_\_\_\_\_  
 ZONE No. \_\_\_\_\_ STATE \_\_\_\_\_  
 OUR PRESENT OIL SUPPLIER IS \_\_\_\_\_

(Lubricants containing "dag" colloidal graphite are available from major oil companies.)

# A New Carbonyl Iron Powder...“HP”

...NOW RELEASED FOR CIVILIAN APPLICATIONS



**C**ARBONYL Iron Powder “HP” made it possible to bring bomber loop antennas inboard.

Why? Because an *extra* step in the carbonyl process greatly reduces the size of the particles and minimizes the impurities. At frequencies up to several megacycles—magnetic coils from “HP” powder combine *high* permeability with *low* losses.

High “Q” values and high permeability offered by Carbonyl Iron Powder “HP” make its application to *permeability tuning* outstanding.

Check your requirements against these basic features of Carbonyl Iron Powder “HP.”

## HOW DOES “HP” DIFFER PHYSICALLY?

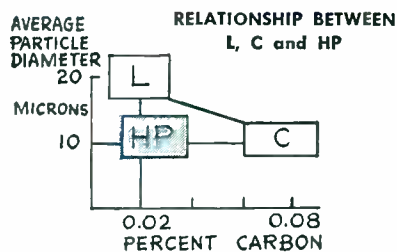

Carbonyl Iron Powder Grade	Average Diameter (microns)	Carbon Content %
HP	10	.01 - .03
L	20	.005 - .03
C	10	.03 - .12

1. “HP” powder has a smaller particle size than Carbonyl Iron Powder “L”—a higher degree of purity than Carbonyl Iron Powder “C.” (Note, however, that possibly “HP” will

show no superiority over a “C” powder core in many cores of high dilution or insulation content.)

## HOW DOES “HP” DIFFER ELECTROMAGNETICALLY?

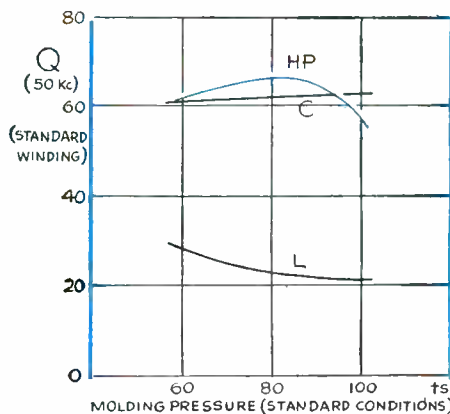
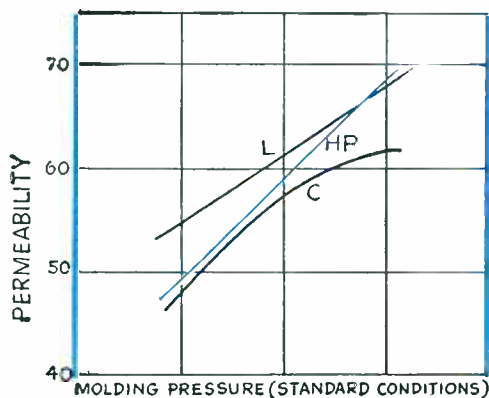

2. “HP” powder has distinct advantages in permeability and “Q” value (plotted against molding pressure). For com-

parative purposes, toroid core curves for Carbonyl Iron Powders “L” and “C” are shown against “HP.”

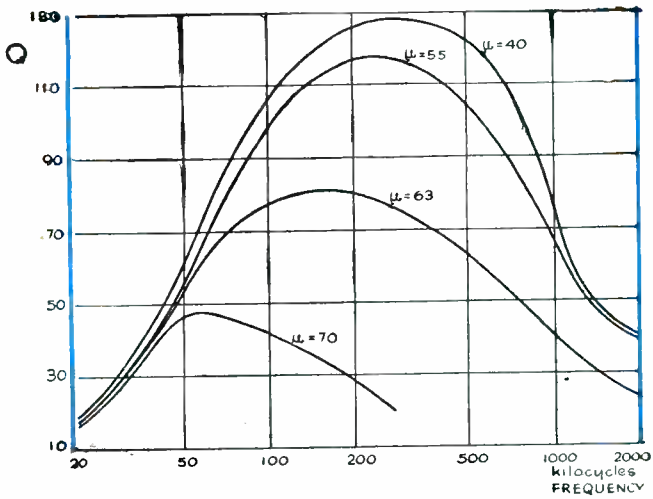

3. These curves show "Q" values versus frequency for several "HP" and comparison toroid cores. Even at relatively

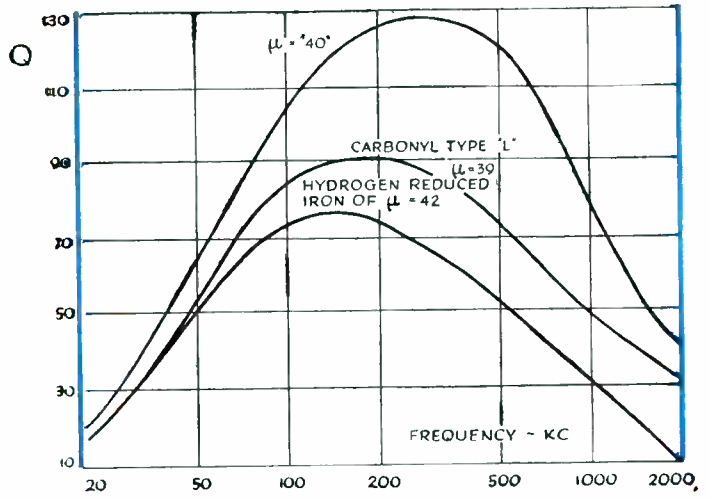

high frequencies, working permeabilities up to 70 can be obtained with reasonable "Q" values.

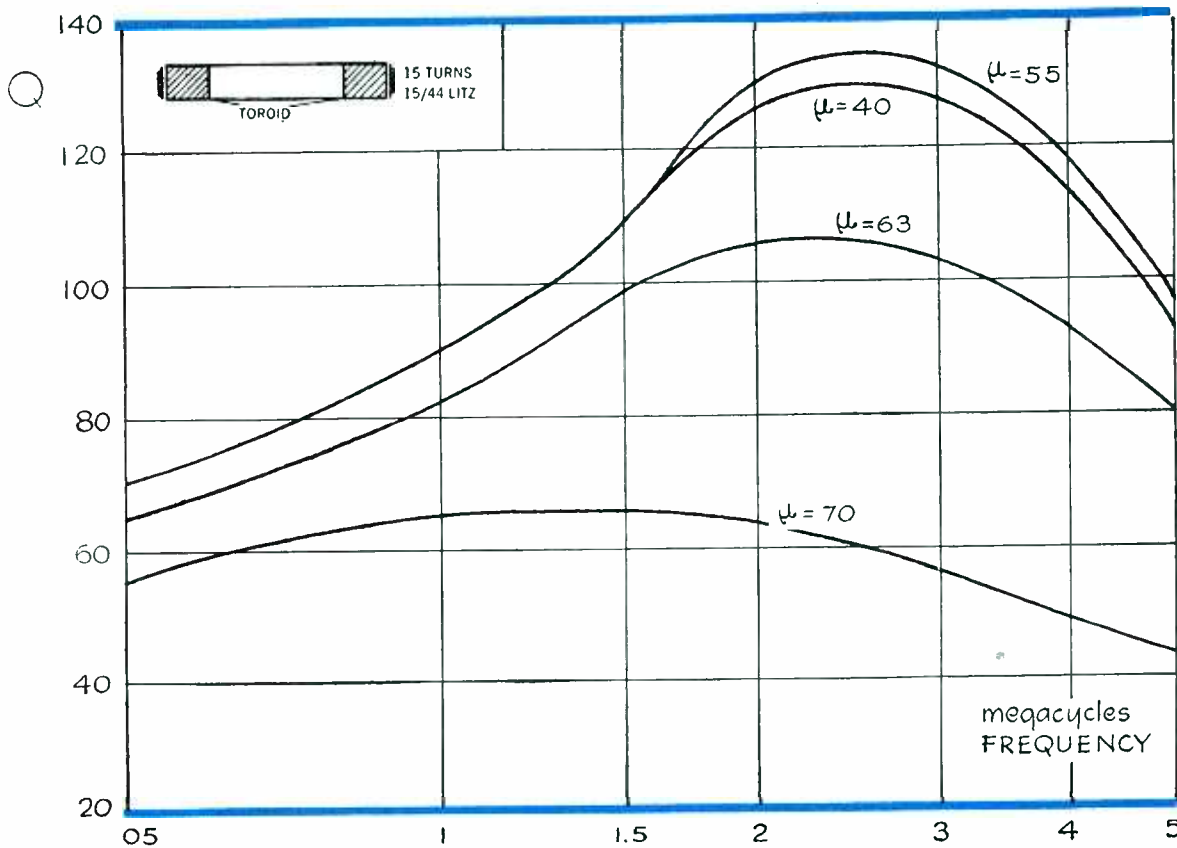

4. "HP" powder has superiority in cylindrical winding, as illustrated by this curve.

Particular requirements can be met by applications of Carbonyl Iron Powder "HP." Additional specific informa-

tion and technical data are available without obligation.

Write or wire collect: Special Products Sales Division, General Aniline & Film Corporation, 270 Park Avenue, New York 17, N. Y.



**G.A.F. CARBONYL IRON POWDERS**

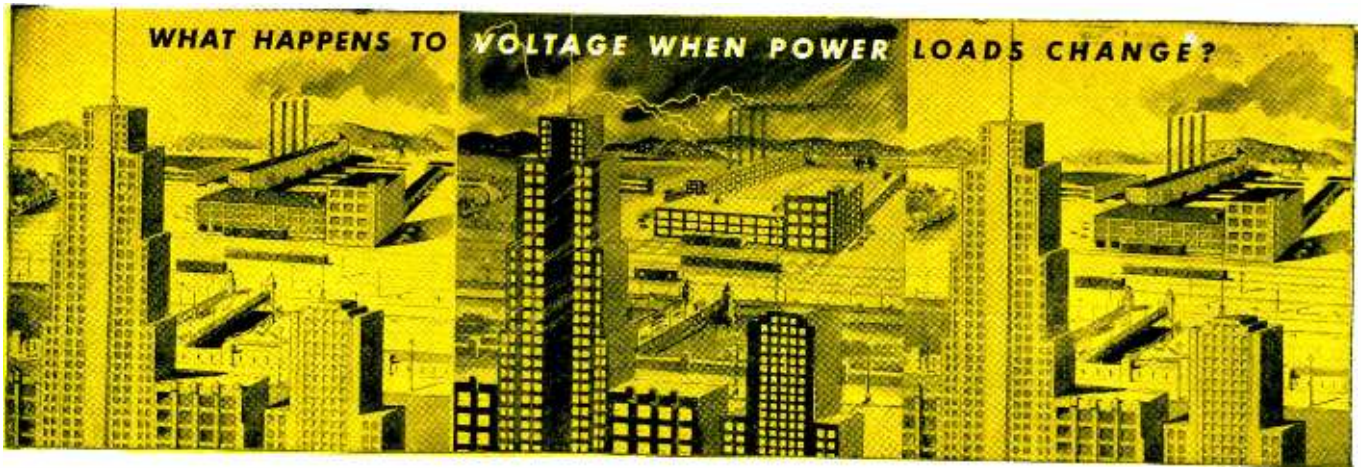

**UNDER NORMAL CONDITIONS** line voltage remains fairly stable, fluctuating only slightly above or below rated value.

**A SUDDEN INCREASE** in power demands may cause a sharp drop in voltage until adjustments can be made at the source.

**LESSENING DEMANDS** may cause a sharp surge considerably above rated value before adjustments can be made.



## SOLA CONSTANT VOLTAGE TRANSFORMERS provide automatic protection against changing power loads



FOR MILLIONS OF UNITS OF ELECTRICALLY OPERATED EQUIPMENT NOW IN SERVICE that are dependent on a precise voltage for efficient operation there is available a standard line of SOLA Constant Voltage Transformers in capacities ranging from 10VA to 15KVA. These units can be quickly and easily installed as a protection against the voltage drops and surges that may occur on the supply line. They are fully automatic and require no supervision or manual adjustments. They will maintain voltage within  $\pm 1\%$  of rated requirements regardless of line voltage variations as great as 30%.



FOR MILLIONS OF UNITS OF ELECTRICALLY OPERATED EQUIPMENT YET TO BE BUILT, there are small, compact SOLA Constant Voltage Transformers specially designed for chassis mounting as a built-in component. These units are low in cost and their use will obviate the need for other, more costly components. You can effect a very substantial saving to the purchaser of your equipment, both in original cost and maintenance costs, by incorporating a SOLA Constant Voltage Transformer as a built-in feature. If standard designs are not suitable, special units can be built to your exact specifications.

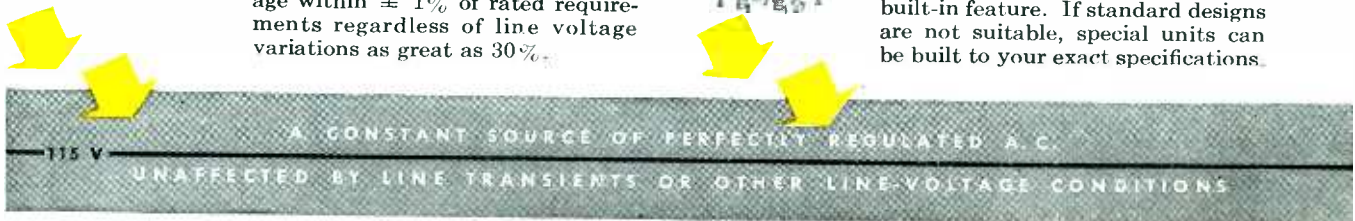

# Constant Voltage Transformers SOLA

**Write for new Handbook**

A complete treatise on the subject of voltage stabilization. It provides the answer to a problem that confronts every manufacturer or user of electrically operated or electronic equipment.

Ask for Bulletin DCV-102

Transformers for: Constant Voltage • Cold Cathode Lighting • Mercury Lamps • Series Lighting • Fluorescent Lighting • X-Ray Equipment • Luminous Tube Signs  
Oil Burner Ignition • Radio • Power • Controls • Signal Systems • etc. SOLA ELECTRIC COMPANY, 2525 Clybourn Avenue, Chicago 14, Illinois



**BOTH ARE** *Perfectly Designed*  
**FOR THE JOB THEY HAVE TO DO**

Like the feather designed by nature, Gears by G.S. are highly efficient components. They are designed with the greatest possible skill and precision to function smoothly, quietly, and economically for years. Type of gear, choice of proper material, best and least costly method of production... these and all other factors affecting the custom-building of the finest Fractional Horsepower Gears are familiar subjects to our gear *specialists*. You are well advised to submit Small Gear problems to our competent engineers. Their friendly counsel incurs no obligation.



**G**EAR **Specialties**  
 Spurs • Spirals • Helicals • Bevels • Internals • Worm Gearing • Racks • Thread Grinding  
 2635 WEST MEDILL AVENUE • CHICAGO 47, ILLINOIS

⚙️ WORLD'S LARGEST EXCLUSIVE MANUFACTURERS OF FRACTIONAL HORSEPOWER GEARS ⚙️

# AVAILABLE NOW!

REVERE MAGNESIUM SHEET CAN HELP PUT YOUR PRODUCT IN A PROFITABLE CLASS BY ITSELF

If sheet metal deliveries are all that is holding up your production, you can quickly give your plant the green light. Revere magnesium alloy sheet can be shipped to you in short order. It comes in a variety of standard sizes and gauges or it will be produced to your specifications—in either of two qualities: Commercial or Aircraft.

This means not only that you can start producing without further delay, but also that you can market a new, improved product without extensive redesign. For Revere magnesium alloys, with nearly the strength of steel, are so feather-light that they often eliminate from a product one-third to one-half of its weight.

Such products offer new values to the user, tend to rise above competition and command more attractive selling prices. That is why Revere magnesium alloy sheet can help you produce *now* at a profit! Revere magnesium products include sheet, plate and strip, rod and bar, pipe and tube, extruded shapes, and forgings. Revere aluminum alloy products include pipe and tube, extruded shapes, and forgings. A Revere Technical Advisor will gladly consult with you about the application of these metals to your business. For prompt service on magnesium sheet call Revere today.

Like other metals, magnesium is priced by the pound. But a pound of magnesium is so much greater in volume and goes so much further that a price comparison on a cents-per-pound basis is misleading. Always compare magnesium's cost with that of another metal after first finding how many pounds you will save with magnesium. You will likely discover that Revere magnesium alloy is entirely within your reach.

## REVERE

COPPER AND BRASS INCORPORATED

Founded by Paul Revere in 1801

230 Park Avenue, New York 17, New York  
Mills, Easton, Md.; Chicago, Ill.; Detroit, Mich.; New Bedford, Mass., home, N. Y. — Sales Offices in Principal Cities,  
Distributors Everywhere.



# MAKING TUBES IS EASY

If YOU  
KNOW HOW!

HYTRON KNOW-HOW

IS MODERN . . .

**S**UPPOSE you were given the job of making certain that micas for Hytron tubes were punched exactly to specifications. How would you go about it? You might use a gage or a precise rule. For a modern, faster, more accurate method, however, you would probably choose the illustrated J & L comparator.

The light beam of the comparator would project optically the magnified image of the mica. By adjusting precision controls, you could then compare visually to .0001 inch the dimensions and orientations of the mica's holes with allowable tolerances in the factory specification book.

That is the way this Hytron inspector is doing the job. Note the tiny mica just below the circular screen. Observe the image magnified 20 times. Many other Hytron tube parts are checked in this manner: plates, shields, leads, cathode sleeves, radiators, grids, ceramic insulators, filament springs.

The comparator is only one of numerous modern inspection tools employed by Hytron's Materials In-

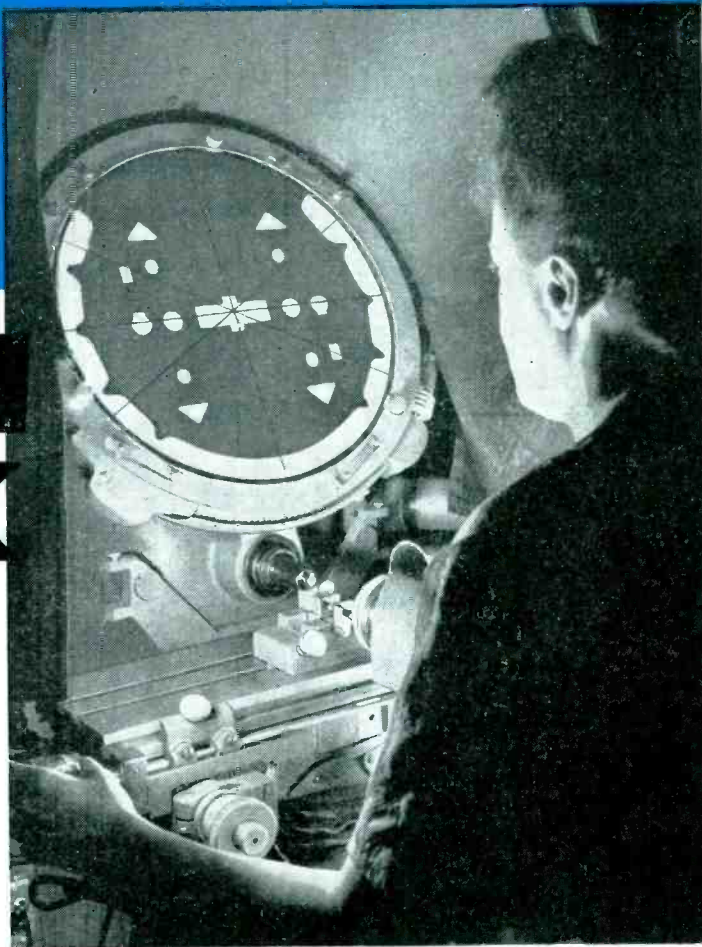

spection Department. For example, a Scott wire tester records graphically elongation, yield point, and breaking load of heater, filament, and grid wire. An amazing variety of precision balances, gages, and micrometers checks parts to .01 milligram or .0001 inch. Qualitative and quantitative chemical and metallurgical analyses assure adherence to specifications of coatings and alloys.

Every modern method is used to maintain exacting control over every part that goes into every Hytron tube you buy. If there is a newer way to do the job better — easier — Hytron is alert to expand the know-how which means the best in tubes for you.



SPECIALISTS IN RADIO RECEIVING TUBES SINCE 1921

# HYTRON

RADIO AND ELECTRONICS CORP.

MAIN OFFICE: SALEM, MASSACHUSETTS



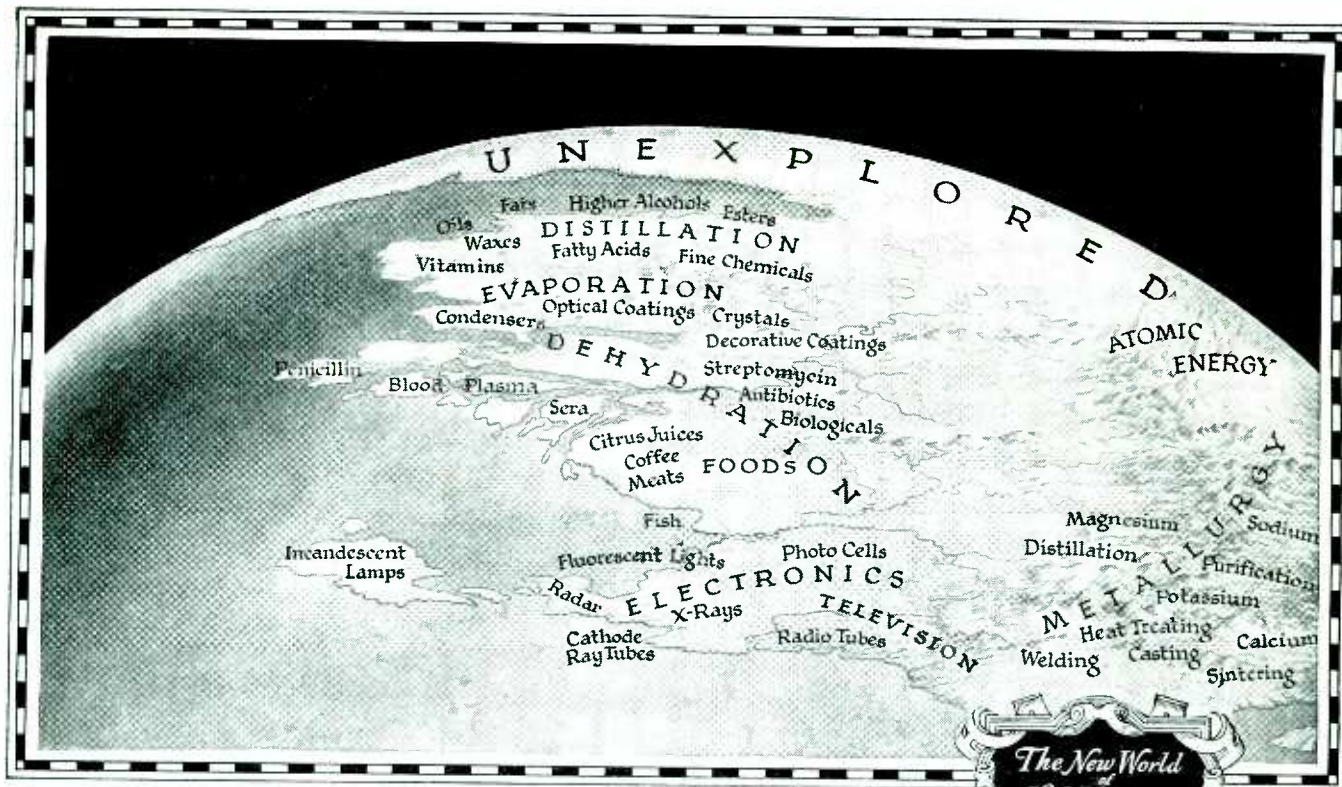

*"I was sufficiently interested - - to pursue the subject"*

ALEXANDER FLEMING

High Vacuum offers to industry a vast new area, virtually unexplored. No one knows its extent or its resources. No one can say what opportunities are there for your industry, but National Research Corporation can help you find out as it has helped others. It can furnish the technology and equipment as it did for the Dehydration of Penicillin.

For thousands of years men had looked at the blue-green mold, *Penicillium Notatum*, and had seen nothing of importance to humanity until, in 1928, Professor Alexander Fleming found that his staphylococcus cultures had been spoiled by an air borne mold and realized the significance of the accident.

For ten years, busy Dr. Fleming "pursued the subject" in such times as he could. In the mold he found a minute quantity of a sensitive, active antibiotic that he called "Penicillin." But the problems of its extraction and utilization were tremendous.

With war looming, English medical scientists turned to Dr. Fleming's discovery. Dr. Florey of Oxford organized a group to study its extraction and by 1939 enough penicillin had been prepared to successfully treat eight mice. In another month enough was available to treat one man. Basic facts were established after treatment of ten cases of staphylococcus septicemia.

In 1941, Dr. Florey and his associate Heatley came to the United States and OSRD went into action. The mold was grown by "kitchen culture" in milk bottles, idle vats and mushroom cellars. Production was pitifully slow. Only fifty patients could be treated in 1942. In May, 1943, WPB took over production with the almost unbelievable objective of enough penicillin for 500,000 persons monthly.

Two major obstacles to quantity production remained: large-scale fermentation processes and correspondingly large-scale low-temperature dehydration equipment. The answer came in terms of modern American engineering "know-how." The chemical and pharmaceutical industries developed the deep tank fermentation method, and National Research Corporation offered its Vacuum Diffusion Process of Dehydration to all penicillin producers royalty free.

At the request of the Chief of the Penicillin Unit, WPB, the National Research process was demonstrated to top ranking Army and Navy medical personnel. The possibility of removing large quantities of water vapor at pressures in the micron range was proven, and top priorities granted for equipment construction.

In February, 1944, the first full-scale industrial plant began to ship penicillin. In one month, the entire production for 1943 was equalled. In March, 1945, less than two years after WPB had made their seemingly impossible demand, the goal was achieved. Today, practically every major penicillin producer, both here and abroad, uses our equipment in the High Vacuum phase of the process.

We suggest that you yourself consider High Vacuum as a new approach in your industry. There may be an application that should be explored, whether you are concerned with antibiotics or other heat-sensitive materials—foods, citrus products, yeasts, enzymes, amino acids. We are fully prepared to help you with both laboratory-scale and full-size plant equipment.

VACUUM ENGINEERING DIVISION, National Research Corporation, Boston 15, Massachusetts.



We engineer Plant installations and manufacture High Vacuum Gauges, Valves, Seals, Diffusion Pumps, Stills, Furnaces, Coating Equipment and Dehydration Equipment

HIGH VACUUM FOR INDUSTRY  
**NATIONAL RESEARCH CORPORATION**  
 Vacuum ENGINEERING DIVISION



# Rheostats?

We use Ohmite, of course!

In thousands of plants, design engineers automatically turn to Ohmite when rheostats are called for. They know that the reputation of their product rests upon the unfailing dependability of each part that goes into its construction — that a product is no better than the component parts from which it is built.

Ohmite rheostats have established a reputation for dependability—for unfailing performance day in and day out, under frequent service and adverse operating conditions. That's why it will pay you to standardize on Ohmite rheostats for your product.

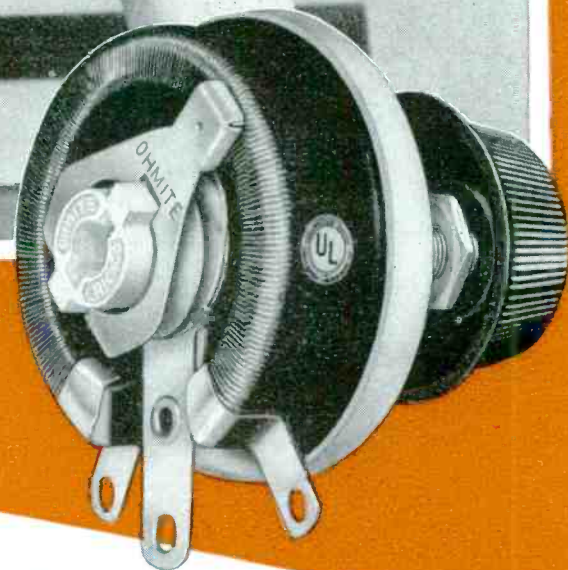

**OHMITE**  
RHEOSTATS • RESISTORS  
TAP SWITCHES



*Be Right with Ohmite*

Special Rheostats gladly  
built to meet your specifications

SEE NEXT PAGE

# RHEOSTATS for every Need

## Ten Standard Sizes—25 to 1,000 watts



• You can get a *standard* Ohmite rheostat for practically any application. The Ohmite line of standard rheostats is the most extensive available. Furthermore, six wattage sizes, in many resistance values, are carried in stock for immediate shipment. Special resistance values, tapered windings, tandem assemblies, and many other variations can be made to order quickly at small extra cost. All models are carefully engineered to give long operating life. All have the distinctive, time-proven Ohmite features—the all-ceramic construction, windings permanently locked in vitreous enamel, and smoothly gliding metal-graphite brush. Whatever your needs, Ohmite engineers can provide a rheostat of unfailing dependability to meet your exact requirements.

## How to Select a RHEOSTAT

### 1 UNIFORM WINDING

It's easy to choose the right uniformly wound rheostat if you have certain basic data. Knowing the *resistance* required and the *maximum current* for the circuit (circuit current with rheostat shorted out), the rheostat wattage can be calculated by the formula:  $W=I^2R$ . A standard rheostat, the wattage of which is not less than the calculated value, can then be selected from the Ohmite catalog. If the resistance and maximum current are not known, Ohmite engineers can calculate them from various circuit information you can supply about the application.

### 2 TAPERED WINDING

In a tapered winding rheostat the winding is made up of two to six sections of diminishing wire sizes. This construction

allows a large resistance change to be "telescoped" into a small part of the winding, thus providing more uniform control and reducing over-all rheostat size.

The design of a tapered rheostat is not as simple as choosing a uniformly wound unit. Taper-wound rheostats can be selected from the standard designs listed in the Ohmite catalog for field control of generators, or Ohmite engineers will be glad to make specific recommendations.

Send for Catalog and Engineering Manual No. 40

Write for this Ohmite Catalog and Engineering Manual on your letterhead. It contains the complete line plus a wealth of engineering information.



**OHMITE  
MANUFACTURING  
COMPANY**  
4816 FLOURNOY ST.  
CHICAGO 44, ILL.

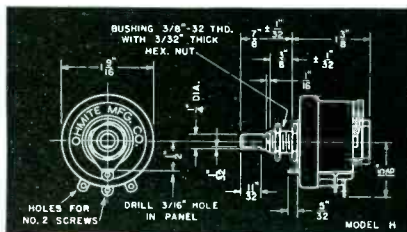

25 WATT

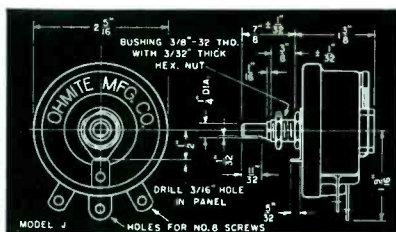

50 WATT

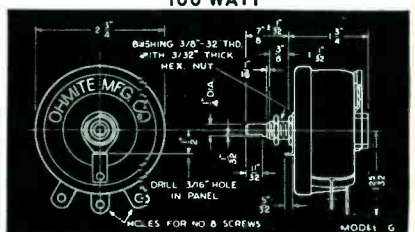

75 WATT

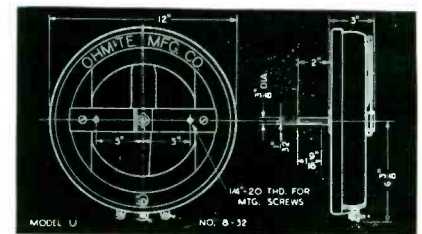

1,000 WATT

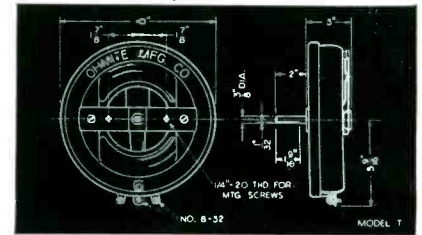

750 WATT

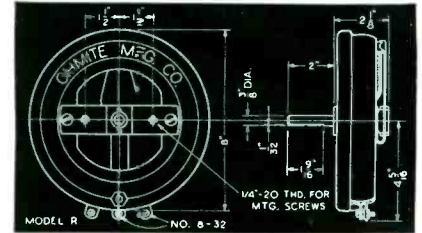

500 WATT

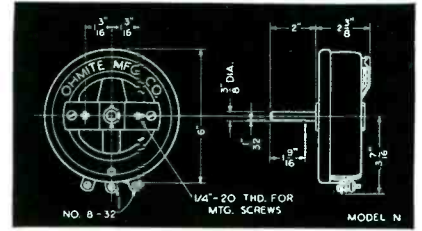

300 WATT

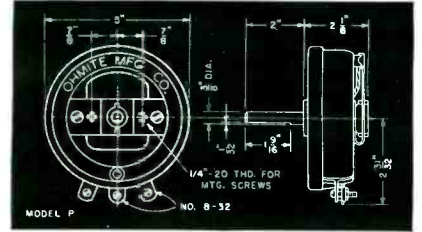

225 WATT

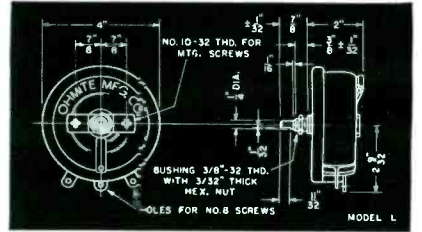

150 WATT

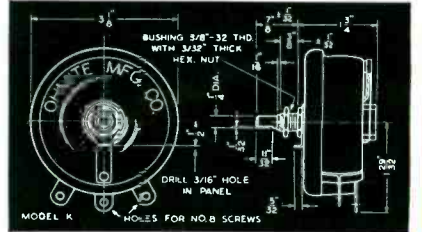

100 WATT

Just published!



Electronic

# MANUAL OF TRANSMITTING TUBES



OVER 600 LARGE PAGES \$2

## COMPLETE — UP-TO-THE-MINUTE — packed with application data!

NEW AND AUTHORITATIVE, G. E.'s transmitting tube manual contains photographs, outline drawings, ratings, performance curves, and application data on 94 different tube types, covering the full scope of AM-Television-FM broadcasting and communications. It is a modern and complete reference work.

PHASITRON AND LIGHTHOUSE TUBES are included, along with other new developments in the high and ultra-high-frequency fields. Throughout the range of tube types, exhaustive application data is given in the form of definitions, classes of operation, examples of tube operating conditions, and typical circuits.

DESIGNERS OF EQUIPMENT for broadcasting and communications, and owners and engineers of broadcast stations, need General Electric's comprehensive new manual so they can be fully posted on transmitting tubes and their electrical and other characteristics.

TABBED DIVIDERS AND INDEXED PAGE CORNERS make it easy to locate information. The loose-leaf format and new sheets mailed to you whenever changes occur, mean that G. E.'s transmitting tube manual is kept constantly up-to-date. Order direct from *Electronics Department, General Electric Company, Schenectady 5, N. Y.*

"Electronic Tubes, Transmitting Types" comes to you for \$2. Also, for an annual service charge of \$1 new and revised pages will be sent to you regularly as issued . . . ORDER TODAY, enclosing payment, or giving authority on your company letterhead to invoice you.

# GENERAL ELECTRIC

FIRST AND GREATEST NAME IN ELECTRONICS

**NOW IN FULL  
PRODUCTION—**

**CHATHAM**

**1Z2**

**compact, high voltage**

**RECTIFIER**



MECHANICAL SPECIFICATIONS:  
TUBE MOUNTS  
IN ANY POSITION  
BASE IS MINIATURE  
BUTTON, 7 PIN  
CAP IS SKIRTED MINIATURE  
BULB .5 1/2

*Applicable for:*

- C-R TUBE POWER SUPPLY
- ELECTROSTATIC PRECIPITATION
- VACUUM TUBE VOLTMETER
- DIELECTRIC TESTING

**IMMEDIATE DELIVERY!** The 1Z2 is a small bulb, high vacuum rectifier. It features low cathode heating power and low dielectric loss which permits operation in rectifier circuits utilizing either a 60 cycle or radio frequency supply. Ratings are as follows: Filament Voltage 1.5; Filament Current 290 Ma; Peak Inverse Voltage 20,000; Peak Plate Current 10 Ma; Average Plate Current 2 Ma; Anode to Filament Capacitance 0.6 MMF. Two tubes in a voltage doubler circuit will supply 2 Ma at 20,000 volts.

**WRITE FOR NEW CHATHAM CATALOG**

The new CHATHAM catalog contains complete information on CHATHAM high vacuum, mercury vapor, inert gas rectifiers and grid controlled rectifiers. Write for your copy on company letterhead; no obligation.



**CHATHAM ELECTRONICS**

475 WASHINGTON ST., NEWARK 2, NEW JERSEY

# Introducing... the new Aerovox Series 83

## PLASTIC-CASE PAPER TUBULAR

that withstands

# HEAT and HUMIDITY



Combination of special plastic casing and special sealing compounds for ends, insures immunity to moisture.

Already rated for operation at maximum temperature of 95° C. (203° F.).

Will not deteriorate under normal storage conditions.

Overall dimensions identical with those of Aerovox paper tubulars of corresponding voltages and capacitance values.

Somewhat higher in cost than corresponding paper tubulars.



*"Slick as a Seal"*

• Forget about that melting and dripping wax when it comes to tubular capacitors operating at elevated temperatures. Especially in auto radios. Also forget about humidity; capacitors sticking together and picking up dirt; premature breakdown.

The new Aerovox plastic-case bonded-seal tubulars (Series -83) now protect your good name with *performance insurance*. Slick as a seal, these clean, bright, handy tubulars are immune to temperatures ranging from sub-zero cold up to sizzling heat, and

impervious to moisture penetration.

This latest Aerovox development (patents pending) overcomes usual objections to paper tubulars for the *more critical* applications. The rigid plastic case with bonded-seal ends, provides real protection for the capacitor section. Overall wax dip becomes a thing of the past, while rigid humidity tests are readily met.

Simply install them—forget them—and be insured!

• Write for further details...



### FOR RADIO-ELECTRONIC AND INDUSTRIAL APPLICATIONS

AEROVOX CORPORATION, NEW BEDFORD, MASS., U.S.A.

SALES OFFICES IN ALL PRINCIPAL CITIES • Export: 13 E. 40th St., NEW YORK 16, N. Y.

Cable: 'ARLAB' • In Canada: AEROVOX CANADA LTD., HAMILTON, ONT.

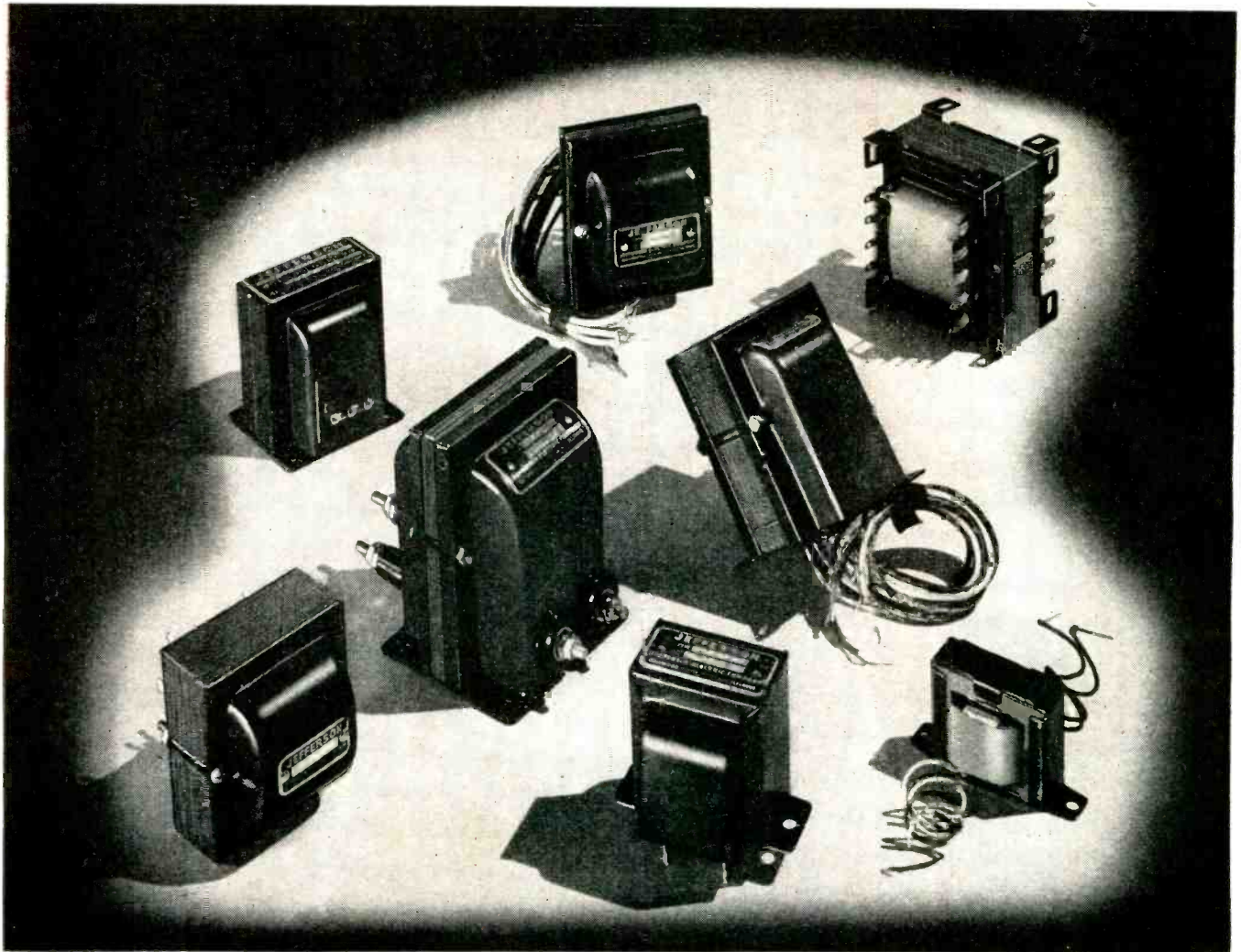

## Quality in Quantity

**W**ITH complete control of the design, selection of all materials, and methods of manufacture of all parts to the final assembly, inspection and delivery—Jefferson Electric Transformers are laboratory correct whether required in small lots or hundreds of thousands.

Many years of performance have strikingly demonstrated the ability to maintain rigid high standards of uniformity of quality on a mass production basis. And along with this quality insurance, Jefferson Electric Trans-

formers incorporate advancements in engineering design that include fundamental and vital quality characteristics.

Consulting now with Jefferson Electric transformer engineering specialists will save time for you later... JEFFERSON ELECTRIC COMPANY, Bellwood (Chicago Suburb), Illinois. *In Canada:* Canadian Jefferson Electric Company, Limited, 384 Pape Avenue, Toronto, Ontario.



# TRANSFORMERS



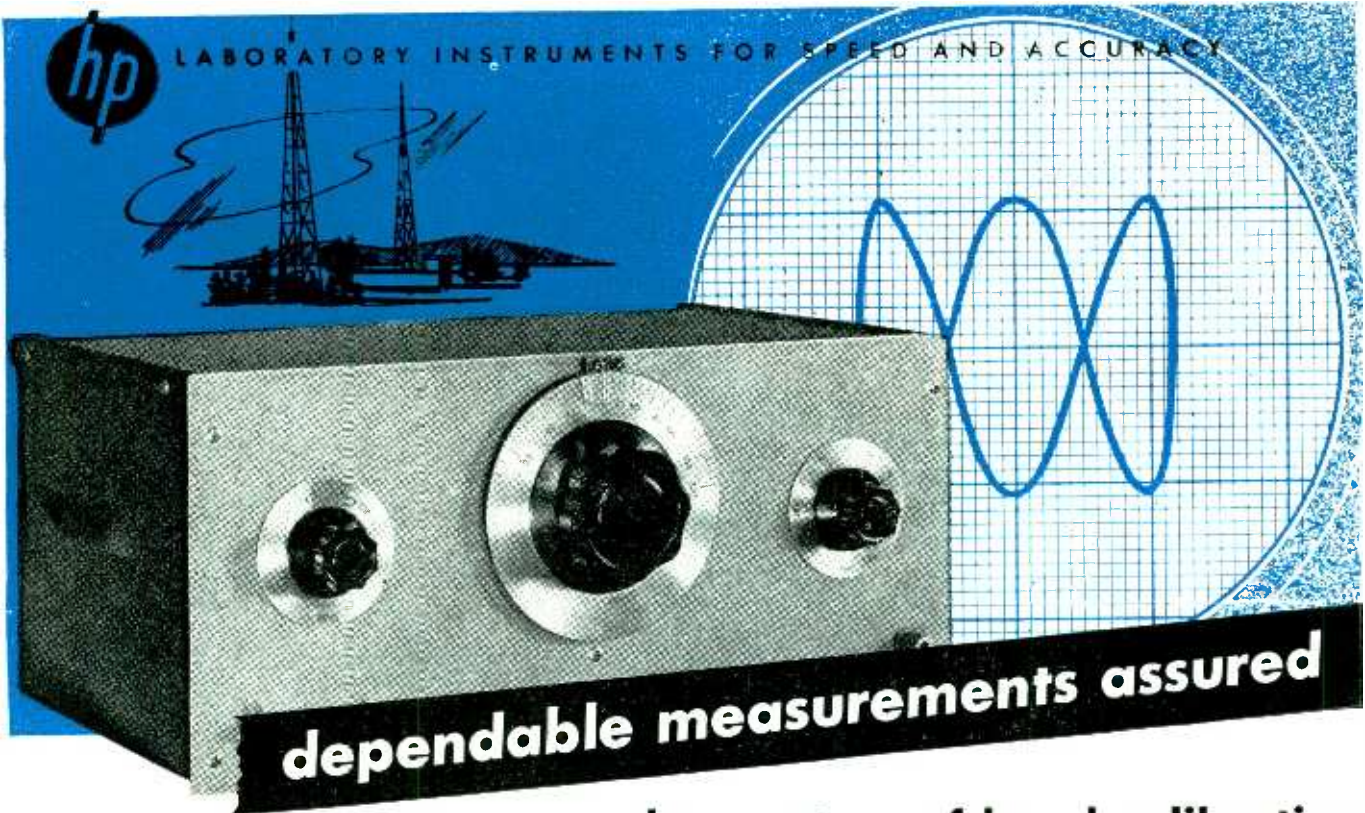

LABORATORY INSTRUMENTS FOR SPEED AND ACCURACY

**dependable measurements assured**

**OTHER OUTSTANDING  
-hp- INSTRUMENTS**



**-hp- MODEL 205AG  
AUDIO SIGNAL GENERATOR**

Frequency range—20 cps to 20 kc  
Power output—5 watts  
Output impedance—50, 200, 500, and  
5000 ohms, all ct



**-hp- MODEL 200I  
SPREAD SCALE AUDIO OSCILLATOR**

Frequency range—6 cps to 6 kc  
Hair-line tuning, no parallax  
Effective scale length nearly eight feet

**-hp- system of hand calibration  
guarantees accuracy of AF oscillators**

The calibration of every -hp- Resistance Tuned Oscillator is guaranteed accurate to within 2%—a guarantee that is possible only because of the high inherent stability of these instruments. To exploit this stability to the utmost, each -hp- oscillator is hand-calibrated using an extremely accurate technique.

The frequency source used in this procedure is the Model 100B Secondary Frequency Standard. This provides frequencies of 100 cps, 1000 cps, and 10,000 cps, accurate to within 0.001%. By frequent comparison with U. S. Bureau of Standards Station WWV this accuracy is increased to within 0.0002%.

The output of the oscillator under test is compared with these standard frequencies by means of a cathode-ray

oscilloscope. Using Lissajous figures of high order a large number of calibration points are established over the entire frequency range; the Model 200I Spread-Scale Audio Oscillator, for example, has a total of 277 calibration points.

Individual hand-calibration is but one of the many precautions taken to insure the dependability and accuracy of -hp- oscillators. Rugged mechanical design maintains the calibration. Careful layout minimizes temperature effects. Unique circuit arrangements assure high stability.

Ten models are available, covering the frequency-range from 2 cps to 200 kc, and with various power outputs and impedance terminations. Write today for full technical information.



**HEWLETT-PACKARD COMPANY**

1200A PAGE MILL ROAD, PALO ALTO, CALIFORNIA, U.S.A.

Audio Frequency Oscillators    Signal Generators    Vacuum Tube Voltmeters  
Noise and Distortion Analyzers    Wave Analyzers    Frequency Meters  
Square Wave Generators    Frequency Standards    Attenuators    Electronic Tachometers

# MICA CERAMIC INSULATION

## Molded TO YOUR SPECIFICATIONS

**MYKROY**  
PERFECTED MICA CERAMIC INSULATION



### Holds to Tolerances up to $\pm .001''$

In part after part, and in any quantity, Mykroy molds and holds to critical tolerances. In this, the only ceramic which can be molded under heat and pressure to such close tolerances, are combined many other highly desirable properties that distinguish Mykroy from all other types of insulating materials.

Unique in the class of glass-bonded mica ceramics, Mykroy possesses electrical characteristics of the highest order which do not shift under any conditions short of actual destruction of the material itself. Furthermore it will not warp—is imper-

vicious to gas, oil and water—withstands heat up to 1000° F and will not char or carbonize.

Its mechanical strength is comparable to cast iron and because it bonds firmly to metals it is particularly suited to molding parts with metal inserts. Even where price is a factor it competes with many standard insulating materials of lower electrical properties.

For improved performance and better quality in your new products investigate the many advantages of Mykroy. Write for samples and full information.



MADE EXCLUSIVELY BY

**ELECTRONIC MECHANICS**  
INC.

70 CLIFTON BLVD., CLIFTON, N. J.  
CHICAGO 47; 1917 N. Springfield Ave., Tel. Albany 4310  
EXPORT OFFICE: 89 Broad Street, New York 4, New York

NEW OFFICIAL SERVICE  
CENTERS FOR  
**hallicrafters**  
EQUIPMENT

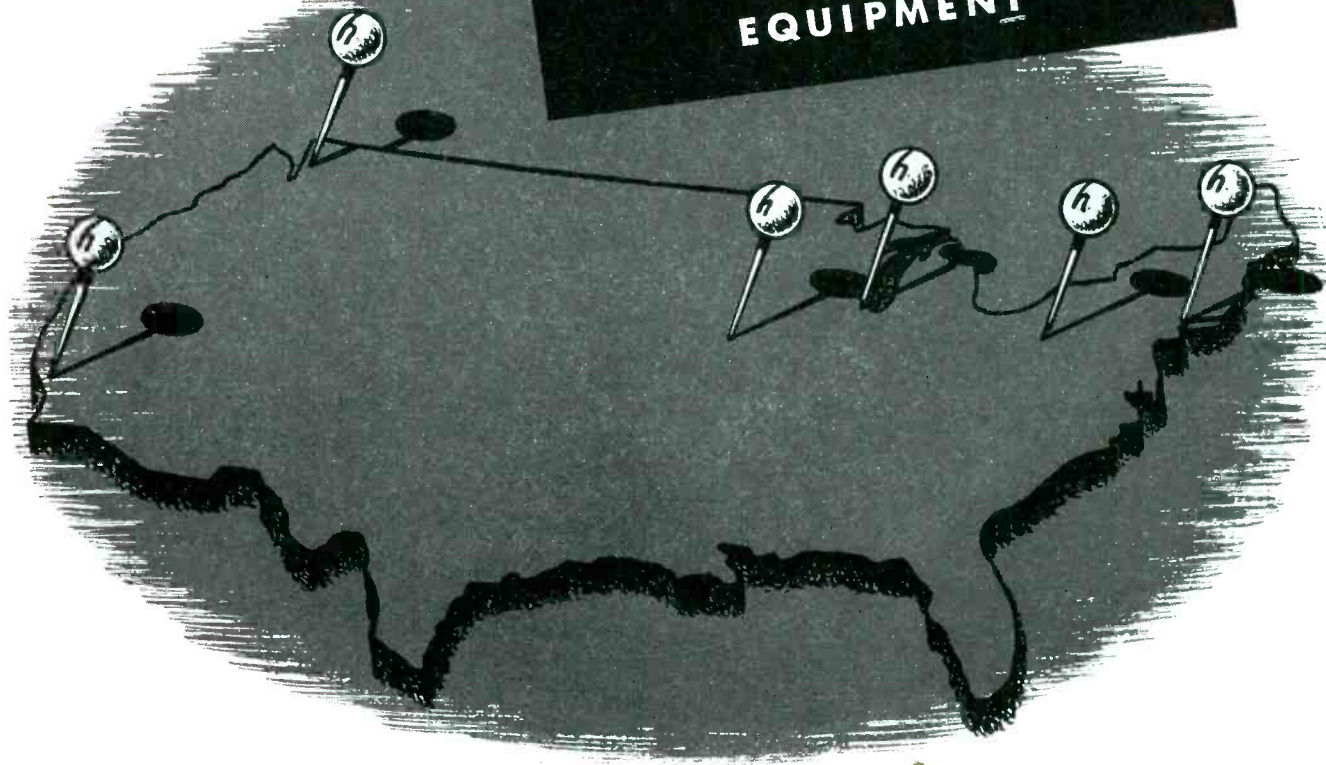

## hallicrafters establishes national network of strategically located SERVICE CENTERS

The Hallicrafters Co., Chicago, announces the beginning of a new national network of official service centers to specialize in repair and servicing of all Hallicrafters communications equipment: marine and aviation radio, ham transmitters and receivers. Service centers have already been established at New York, Pittsburgh, Kansas City, Mo., Los Angeles and Seattle. Service at these locations will be equal in every way to that offered by the Chicago factory.

As production and distribution can be increased, more such centers will be established so that Hallicrafters users everywhere will be given the fastest, most efficient service possible.

See your local Hallicrafters distributor to learn how and where you can benefit from this new service system. Your high precision Hallicrafters equipment deserves the finest care . . . put your repair and service problems in the hands of specialists: Hallicrafters official service centers.

COPYRIGHT 1946 THE HALLICRAFTERS CO.

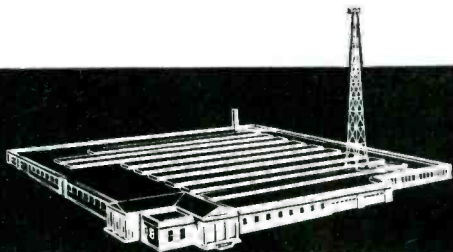

**hallicrafters RADIO**  
THE HALLICRAFTERS CO., MANUFACTURERS OF RADIO  
AND ELECTRONIC EQUIPMENT, CHICAGO 16, U. S. A.

# Water's no Worry

When the  
**DeJUR Miniature's**  
on the job

★ Send details of  
your requirements to  
DeJUR-Amsco Corporation,  
45-12 Northern Boulevard,  
Long Island City 1, New York.

*It's tiny... it's accurate  
... and it's waterproof*

The DeJUR 1½" precision panel instrument can be immersed in water at a depth of 30 feet for as long as seven days without harming the mechanism.

Model 120 has a special water-protection design, including locking device for exerting pressure against rubber gaskets on either side of the glass... and a watertight gasket back of the flange waterproofing the juncture between meter and panel. Terminal studs on both models have watertight sealing.

## MAXIMUM ACCURACY IN SMALL SPACE

*External pivots prevent rocking of the pointer... reduce side friction between panels and pivots... increase bearing life.*

*Other features: highest-grade Alnico magnets... A.S.A. standards in all respects but size... variety of ranges... self-contained up to 1 ampere and up to 150 volts.*



**MODEL 112**  
Square plastic case is designed for screw-mounting.



**MODEL 120**  
Smallest ring-mounted meter available. Metal case.

## DeJUR Products



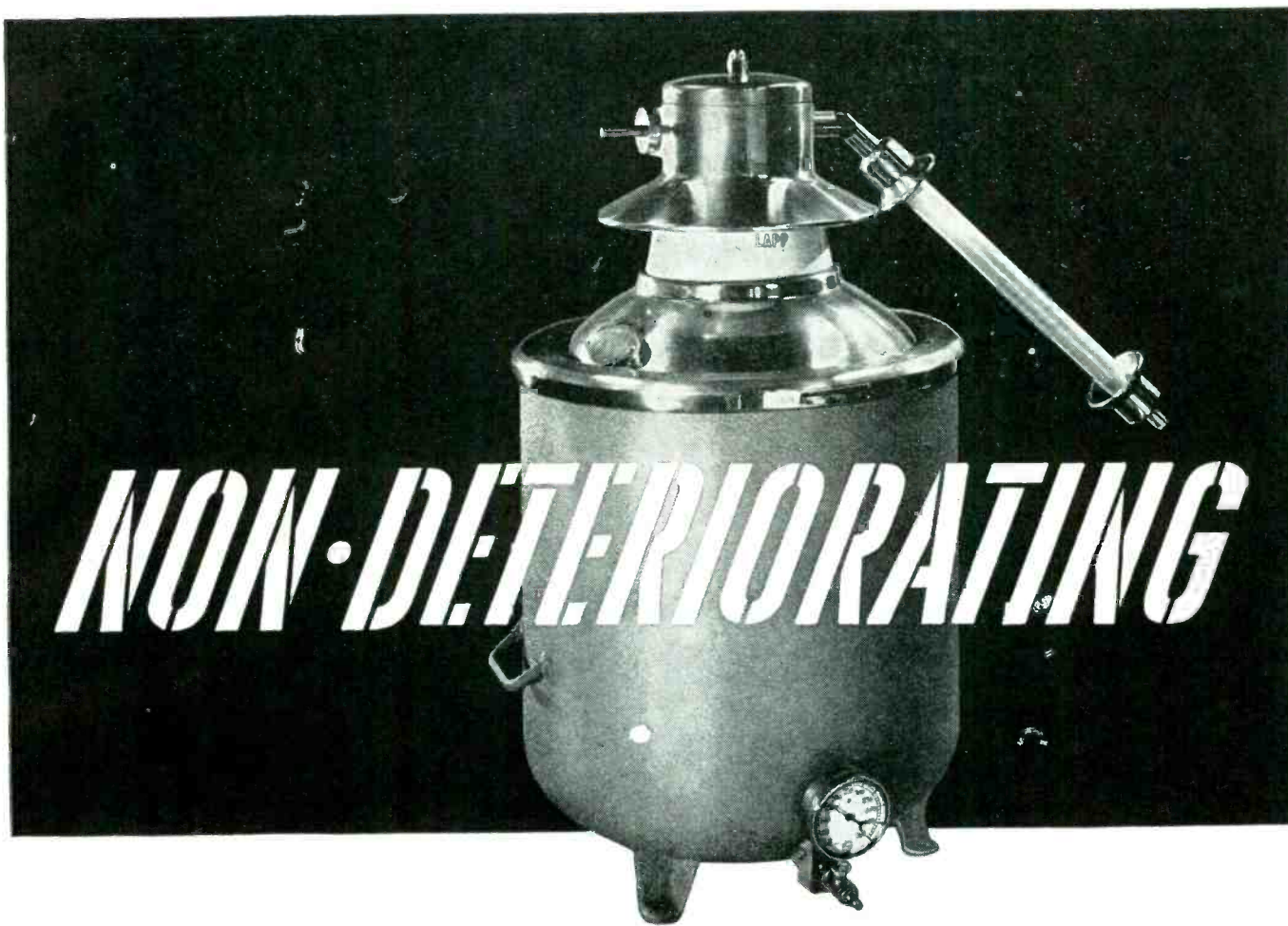

**NON-DETERIORATING**

**.... PUNCTURE-PROOF, FOR LONG, UNIFORM PERFORMANCE.**

“Fail-proof” is a reasonable and honest description of the Lapp Gas-filled Condenser. It has no fixed or solid dielectric to deteriorate or puncture, and should out-last any electronic circuit of which it is a part. Also, it offers correspondingly lower loss and economy of power. Not needing to “warm up,” it provides constant capacitance under temperature variation. Variable, adjustable, and fixed capacitance units are available. Fixed condensers have been made with capacitance up to 60,000 mmf., variable and adjustable units up to 16,000 mmf. Current ratings range up to 500 amperes R. M. S., and voltage ratings up to 60 Kv peak. *Above, Unit No. 25,934, rated at 200 amperes, 6500 volts, capacitance continuously variable from 4300 mmf. to 1100 mmf.* Lapp Insulator Co., Inc., Le Roy, N. Y.

**Lapp**

**INSULATOR CO., INC.  
LEROY, N. Y.**



# WESTON Mutual Conductance Tubechecker and Circuit Analyzer

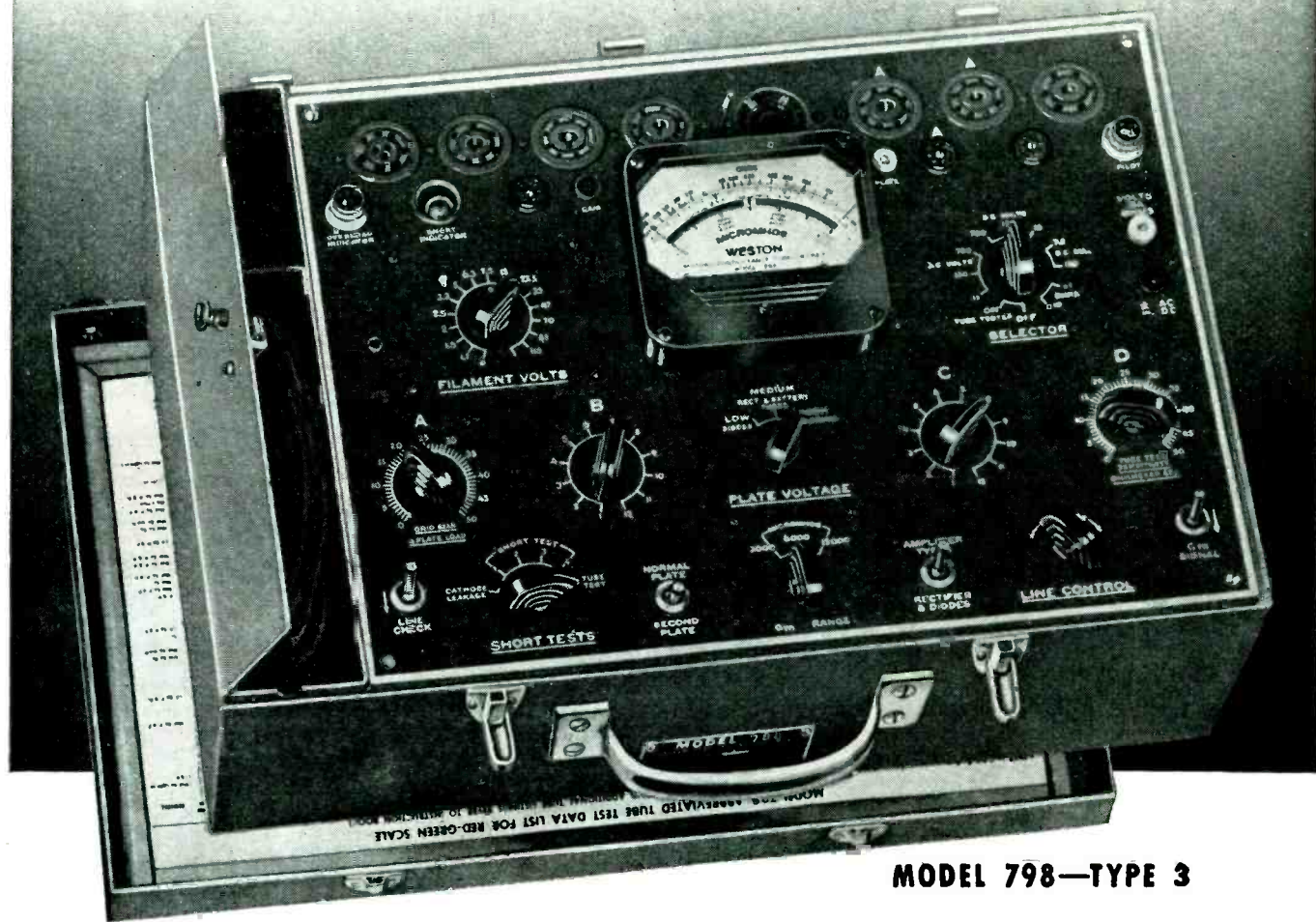

**MODEL 798—TYPE 3**

*Outstanding Features*

- ✓ Direct-reading mutual conductance tests, and "Good-Bad" indications.
- ✓ New patented high frequency tube testing circuit.
- ✓ AC-DC volt-ohm-milliamperere ranges.
- ✓ Tests 4, 5, 6, 7 prong octal, loctal, miniature, and acorn tubes... spare octal and miniature sockets.
- ✓ Hot neon leakage test between any two tube elements... neon short check.

- ✓ Adjustable plate, screen, grid bias, and signal voltages.
- ✓ Flexibility in switching simplifies testing present and future tubes.
- ✓ Durable heavy-gauge, light-weight aluminum case.

Model 798 combines broad utility, ruggedness, and dependable accuracy for maintenance of sound and electronic equipment. Detailed bulletin available. Weston Electrical Instrument Corporation, 618 Frelinghuysen Avenue, Newark 5, New Jersey.

## Weston Instruments

ALBANY • ATLANTA • BOSTON • BUFFALO • CHARLOTTE • CHICAGO • CINCINNATI • CLEVELAND • DALLAS • DENVER • DETROIT • JACKSONVILLE • KNOXVILLE • LOS ANGELES • MERIDEN • MINNEAPOLIS • NEWARK  
NEW ORLEANS • NEW YORK • PHILADELPHIA • PHOENIX • PITTSBURGH • ROCHESTER • SAN FRANCISCO • SEATTLE • ST LOUIS • SYRACUSE • IN CANADA, NORTHERN ELECTRIC CO., LTD., POWERLITE DEVICES, LTD.

# Q.C.



what's this "Q.C." behind an Armco salesman?

When the Armco salesman sends your order for special-purpose Electrical Steels to the Armco mills, he sets in motion a complete chain of "Quality Controls."

For more than 20 years supervisors at Armco have referred to these special prescriptions as "Q.C." A few years ago this program was supplemented by the use of control charts and statistical analyses.



Summed up quickly this is what Armco "Q.C." means to you: You get the *one right steel* for the electrical products and equipment you make.

#### STARTS WITH SALESMAN

The salesman indicates the kind of Electrical Steel you want—for what purpose it will be used and how it will be fabricated. Frequently he will ask for blueprints and other information about your application.

This is the reason: Back of him metallurgical and operating supervisors are ready with the "follow-through" to help insure Quality Con-

trol for the special-purpose sheets and coils you buy. They weigh and sift requirements . . . determine the correct annealing and the sequence of operations that will give your sheet steels the electrical properties they need. Previous orders and similar applications are studied too.

All these data go on a routing card. From open-hearth to shipping department, this individual card accompanies your order. It is your assurance of a high "Q.C." in the Armco special-purpose Electrical Steels that go into the products bearing your name. The American Rolling Mill Company, 3451 Curtis Street, Middletown, Ohio.

Export: The Armco International Corporation

## THE AMERICAN ROLLING MILL COMPANY

# Micanite Takes "Insulation-



Machlett Thermax tube combines outstanding insulating properties of Micanite with rayproof qualities of lead shield to assure efficient, longer-lasting tube performance.

In looking for dependable, long-lasting insulating shields for X-ray tubes, Machlett Laboratories naturally selected Micanite. For here was a material offering positive protection against high operating temperatures, and possessing exceptional dimensional stability...both extremely important in providing and safeguarding superior tube performance.

That is why, for numberless applications in electrical and electronic fields, there is no adequate substitute for Micanite insulation. Its unique combination of high dielectric strength, capacitance stability, electrical resistivity and uniform dielectric constant is comparable to that of sheet mica—yet Micanite costs considerably less. It is readily substituted for sheet mica except where extreme thinness, very high heat resistance, great dielectric strength and very low power factor are essential.

Micanite is made with superimposed mica splittings bonded together with specially selected resins. It is available in easily machined sheets and tubes of

Components of simple and complex design are readily fabricated from Micanite. A wide range of resins and various types of mica splittings enable Micanite to be produced with various electrical and mechanical properties.





# Risk" Out of X-Ray Tubes

These accurately punched mica stampings for use in vacuum tubes help cut rejects and contribute to high standard of tube performance.



various types and sizes, as well as in the form of segment plate, flexible plate, heater plate and composite sheets or wrappings.

Mica Insulator Company offers the electrical industry a single source of supply for every type of insulation. The next time you have an insulating problem, consult our technical representatives. You can be sure they'll come up with an unbiased solution that will help keep your product costs in line.

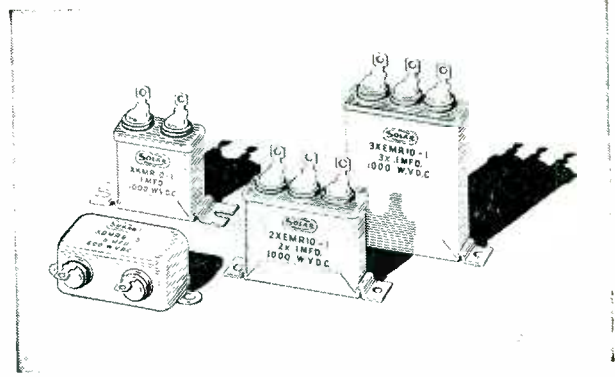

Sealed capacitors made by Solar Manufacturing Corporation utilize Mica Insulator Company's Lamicoid and synthetic rubber seals as part of terminal construction to provide reliable performance under a wide range of temperatures.

## MICA *Insulator* COMPANY

797 Broadway, Dept. 22, Schenectady 1, N. Y.

SALES OFFICES: Boston: 285 Columbus Avenue • Chicago: 600 West Van Buren Street • Cincinnati: 3403 Hazelwood Avenue  
 Cleveland: 1276 West 3rd St. • Detroit: Book Building • Houston: Bakoring, Inc., 1020 Houston Ave. • New York: 200 Varick St.  
 St. Louis: 455 Paul Brown Building • Triangle Pacific Co. at Los Angeles: 340 Azusa Street • San Francisco: 1045 Bryant Street



### JUST OUT

New 4-page bulletin on Micanite and Super-Micanite insulation. Contains information about various grades and suggested applications. Send for your free copy.

Mica Insulator Company, Dept. 22,  
 797 Broadway, Schenectady 1, N. Y.

Gentlemen:

- Please rush my copy of your new four-page bulletin on Micanite<sup>™</sup> insulating material.
- Enclose price list.
- Please have your application engineer see me when in my vicinity.

Name \_\_\_\_\_  
 Position \_\_\_\_\_  
 Company \_\_\_\_\_  
 Address \_\_\_\_\_  
 City \_\_\_\_\_ State \_\_\_\_\_

# NEW

## FM TRANSMITTERS

### Unexcelled Performance of Western Electric FM Transmitters

Audio Frequency Response .....	$\pm 0.25$ DB from 30 to 15,000 cycles.
Harmonic distortion—for $\pm 75$ KC swing .....	Less than 0.5% from 30 to 15,000 cycles.
—for $\pm 100$ KC swing .....	Less than 0.75% from 30 to 15,000 cycles.
Intermodulation—for $\pm 75$ KC swing .....	Less than 0.5% for 80% 50 cycles and 20% 1000 cycles; less than 1.0% for 80% 50 cycles and 20% 7000 cycles.
FM noise level .....	65 DB below $\pm 75$ KC swing.
AM noise level .....	50 DB below 100% amplitude modulation.
Carrier frequency stability .....	Less than 2000 cycles deviation (no crystal heater).

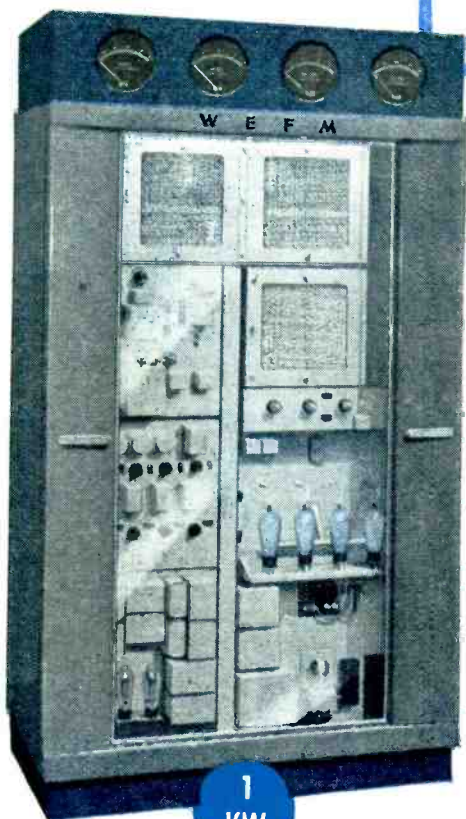

1  
KW

Not only a transmitter in itself, this unit serves as the basic driver for all higher powered transmitters.

Has its own rectifier and power components, with completely shielded air-cooled triode in broad-band circuit.

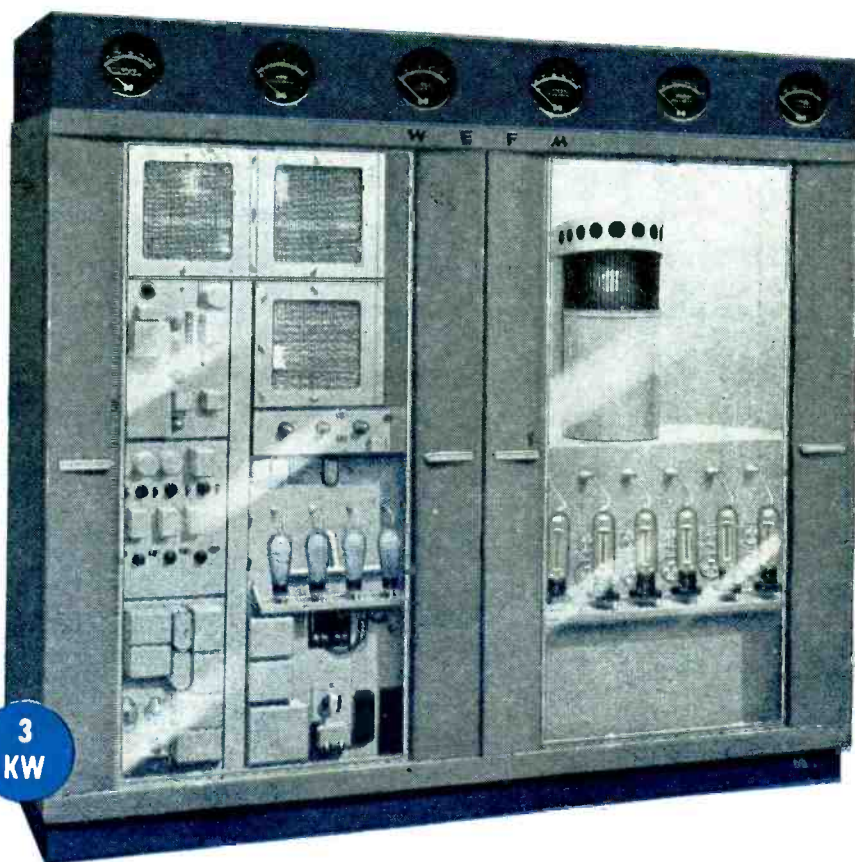

3  
KW

# BY *Western Electric*

## *NEW Line is Keynoted by 1, 3 and 10 KW Units*

New in appearance, new in performance, these FM transmitters, specially designed for operation on the higher frequencies, incorporate Synchronized Frequency Control, developed by Bell Telephone Laboratories and Western Electric.

Outstanding new cabinet designs keep pace with circuit improvements. For the first time in FM broadcasting, all tubes are visible to the operator at a glance.

For your convenience, all units are standard width, make use of identical door assemblies and

use the same top and side panels. Where more than one unit is used, a common base and meter panel provide single unit appearance.

In addition to the 1, 3 and 10 KW transmitters, Western Electric's full line will include 250 watt, 25 KW and 50 KW units.

For complete information, see your nearest Graybar Broadcast Equipment Representative, or write Graybar Electric Co., 420 Lexington Avenue, New York 17, N. Y.



— QUALITY COUNTS —

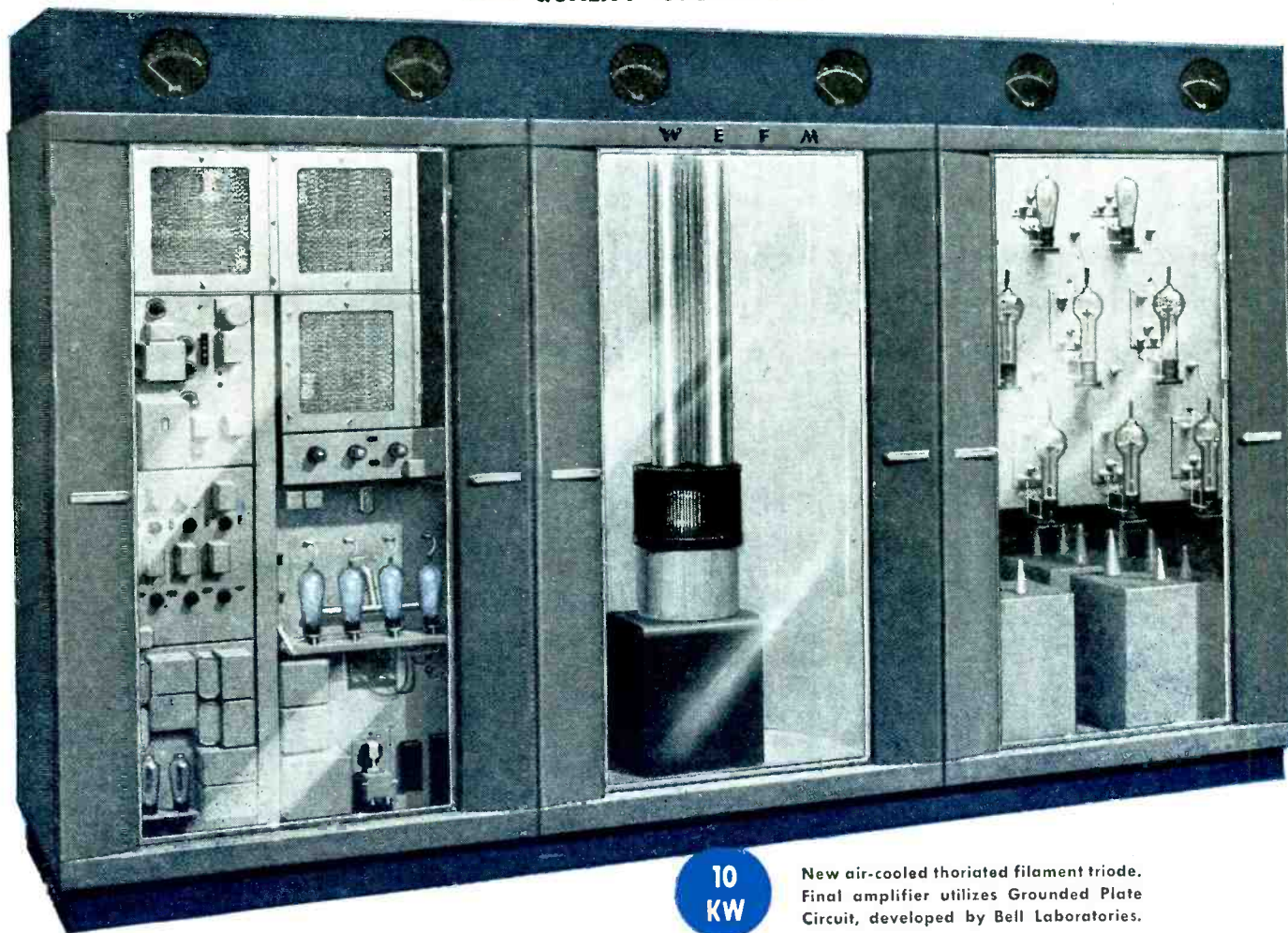

10  
KW

New air-cooled thoriated filament triode. Final amplifier utilizes Grounded Plate Circuit, developed by Bell Laboratories.

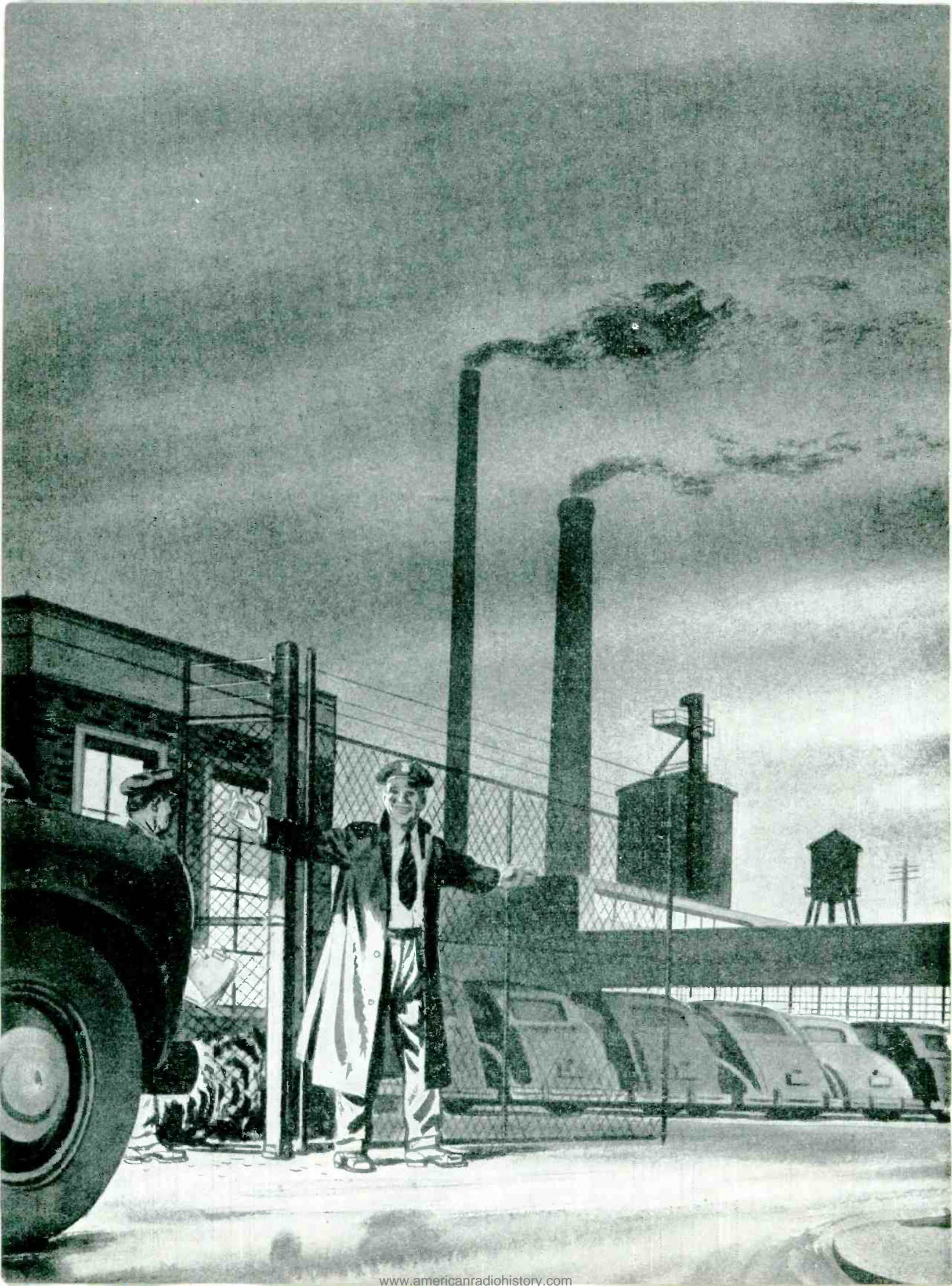

**MEN  
AT WORK**

**JACK & HEINTZ  
PRECISION  
INDUSTRIES  
INC.**

**Solve Complicated  
Heavy-Duty Contact  
Problems with...**

**GENERAL  
PLATE**  
*Laminated  
Contact Buttons*  
FOR WELDING OR SOLDERING

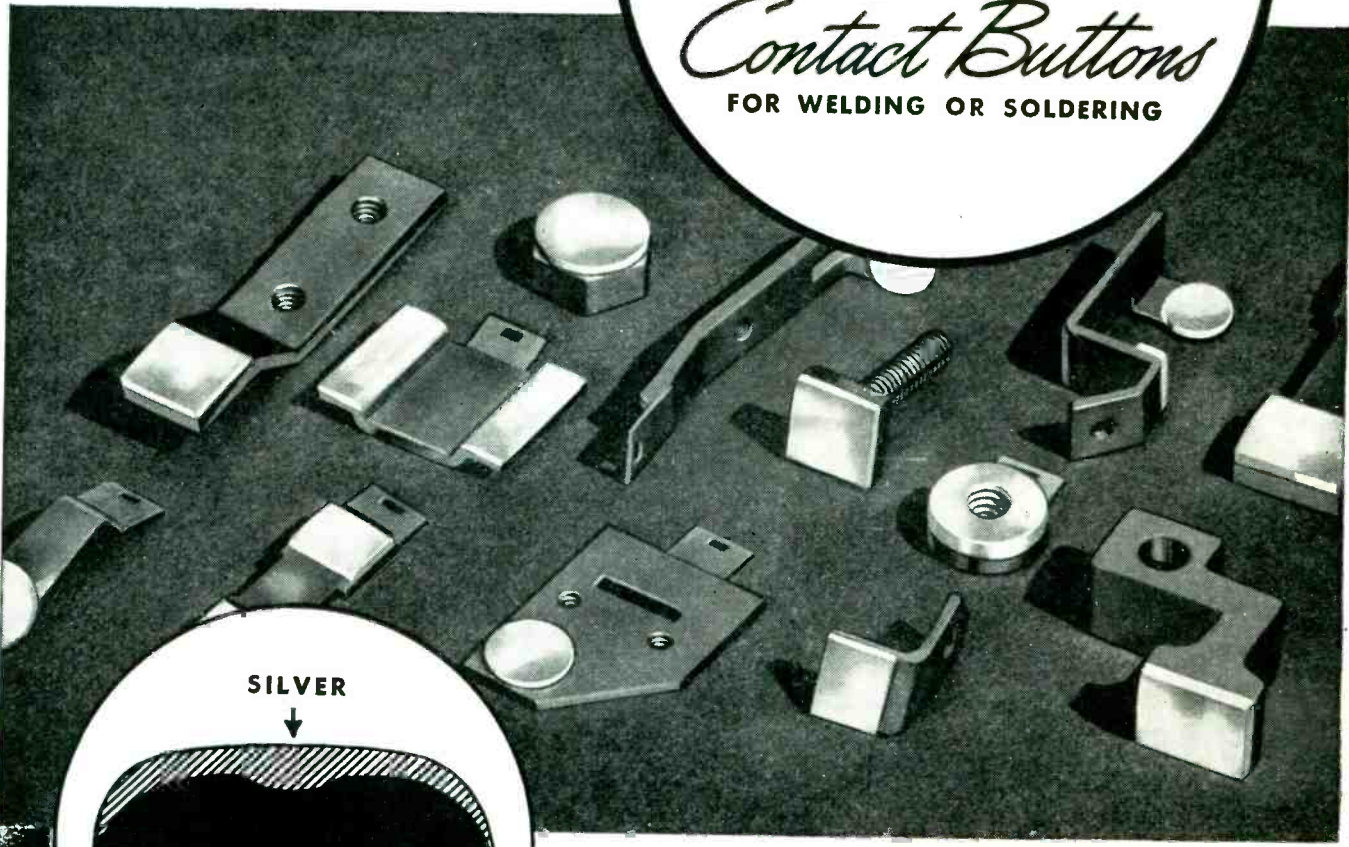

If you manufacture your own contact assemblies, investigate General Plate Laminated Contacts and Buttons. Made by permanently bonding silver, platinum or other precious metals to inexpensive steel, brass or other base metals, they can be easily applied to your parts by projection welding, electric brazing or soldering methods. They come with flat or dome tops . . . have projection backs for welding or solder flush backs for brazing. They'll speed production, save costs and give solid precious metal electrical performance at a fraction of the cost of solid precious metals.

If you have a contact problem, investigate General Plate Laminated metals. Our engineers are available for consultation. Write, specifying your particular requirements.

**GENERAL PLATE DIVISION**

OF METALS & CONTROLS CORPORATION  
50 Church St., New York, N. Y.; 205 W. Wacker Drive, Chicago, Ill.; 2635 Page Drive, Altadena, California; Grant Bldg., Pittsburgh, Pa.  
**ATTLEBORO, MASSACHUSETTS**



Cardioid (heart-shaped) Polar Pattern. Wide-angle front pick-up, horizontally and vertically, diminishes sharply to dead zone at rear. Sound at rear dead zone cancels out and is not reproduced. Solves everyday sound problems—in a great many applications.

**Only the Cardyne Gives You All This!**

- New E-V Mechanophase<sup>®</sup> Principle
- True Cardioid Unidirectional Performance
- Reduces Background Noise, Reverberation
- Stops Feedback—Permits Greater Volume
- Relatively High Output
- New E-V Acoustalloy Diaphragm
- Substantially Flat, Wide-Range Response
- And other E-V Features

\*Patents Pending

*Announcing*

**NEW  
Electro-Voice  
CARDYNE**

Now you get More Features...  
More Advantages than ever...in a Single Head

**Cardioid Dynamic  
Microphone**

New E-V developments bring you true cardioid unidirectionality... smooth, wide-range response... high output... and other desirable advantages in a rugged single-head dynamic.

Through the exclusive new E-V *Mechanophase*<sup>\*</sup> principle, the CARDYNE virtually eliminates unwanted sounds... gives you only the sound you want, with greater definition and fidelity. Substantially reduces background noise and reverberation. Increases effective working distance from microphone. Stops feedback. Permits increased loud-speaker volume. Gives extremely accurate pick-up and reproduction of music and speech... indoors and outdoors. Highly suitable for the most exacting sound pick-up work... in studio and remote broadcasting, disc and film recording, public address and communications.

Trim, modern, functional design, finished in rich satin chromium. Smooth, firm tilting action. "On-Off" switch. Ruggedly built to withstand severe operating conditions. Available in 50, 250, 500 ohms impedance, or Hi-Z (direct-to-grid, 25,000 ohms). Low impedances balanced to ground. Also available without "On-Off" switch. *Send now for Cardyne Bulletin No. 131.*

**CARDYNE II. Model 731.** List Price ..... **\$75.00**  
Frequency response, substantially flat, 30-12,000 c.p.s.

**CARDYNE I. Model 726.** List Price ..... **\$55.00**  
Frequency response, substantially flat, 40-10,000 c.p.s.

*No finer choice than*

**Electro-Voice**

ELECTRO-VOICE, INC., 1241 South Bend Ave., South Bend 24, Indiana  
Export Division: 13 East 40th St., New York 16, N. Y., Cables: Arlab



# Shhhh... they're designing a new ADLAKE RELAY

Although there's an Adlake Relay for 999 out of 1000 control jobs, occasionally our engineers—bless 'em—are asked to design one for new or unusual applications.

Helping you solve your out-of-the-ordinary problems is a specialty of ours. Just as giving dependable, trouble-free service is a specialty of Adlake Plunger-type Mercury Relays.

## LOOK AT ALL THESE ADVANTAGES!

- ① *Hermetically sealed* contact mechanism; impervious to dust, dirt, moisture.
- ② Liquid mercury-to-mercury contact; no burning, pitting, sticking; positive in action, chatterless, silent.
- ③ Armored against outside vibration or impact; designed for either stationary or moving equipment.

Write today for free, illustrated Adlake Relay folder!

### HOW ADLAKE RELAYS WORK

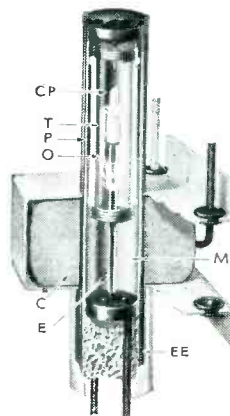

**ENERGIZED**—Coil C pulls plunger P down into mercury M. Mercury thus displaced enters thimble T through orifice O. Inert gas in thimble gradually escapes through ceramic plug CP.

Mercury now fills thimble T, is completely leveled off and mercury-to-mercury contact established between electrodes E and EE. Degree of porosity of ceramic plug CP determines time delay.



# THE ADAMS & WESTLAKE COMPANY

ESTABLISHED IN 1857

ELKHART, INDIANA

NEW YORK · CHICAGO

MANUFACTURERS OF ADLAKE HERMETICALLY SEALED MERCURY RELAYS FOR TIMING, LOAD AND CONTROL CIRCUITS



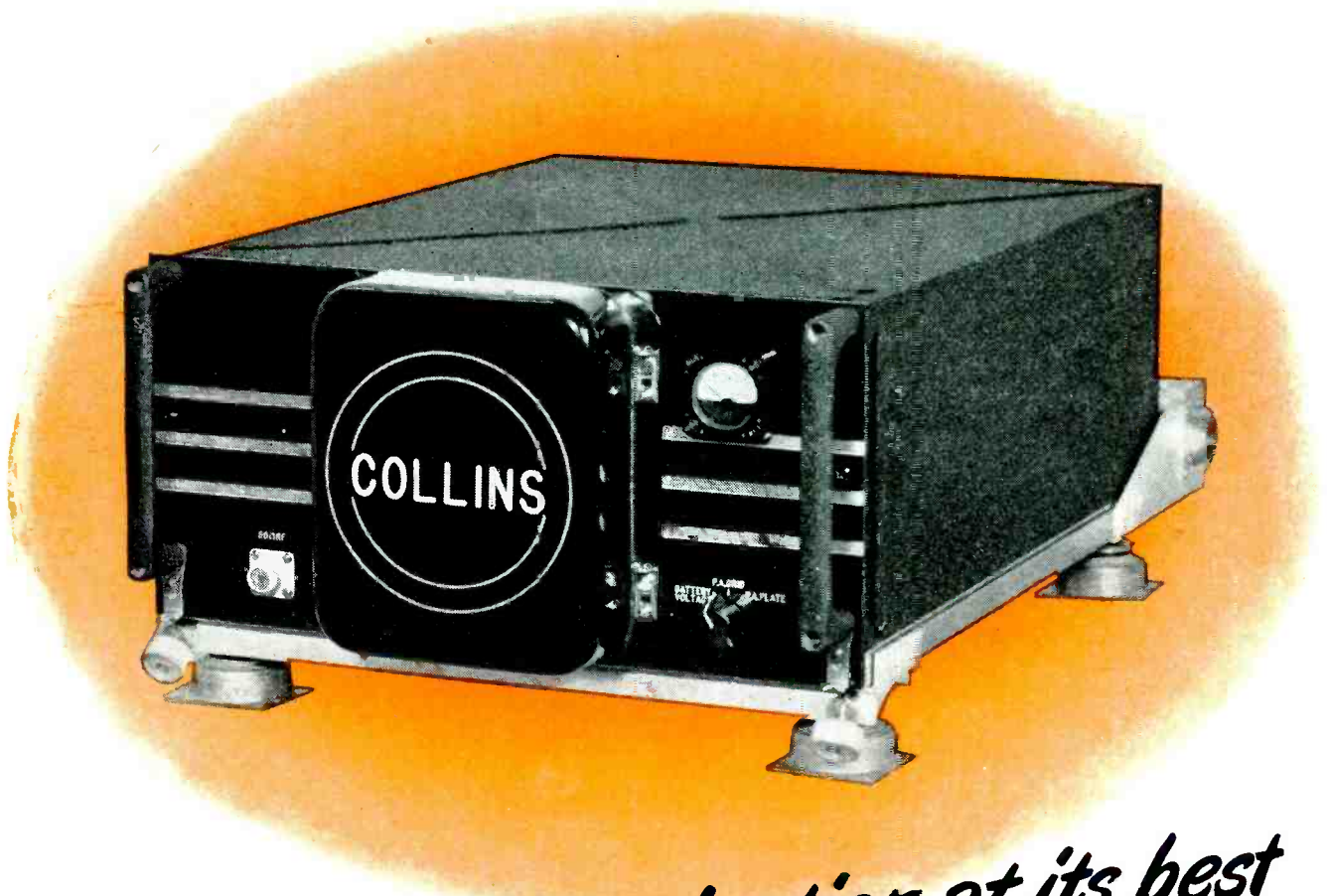

## *Aircraft communication at its best*

**THE COLLINS 18S-1** transmitter-receiver is engineered for highest performance in aviation communications. It is specifically designed for commercial airlines and executive aircraft. Reflecting years of experience and proved dependability in the field of aircraft radio, the 18S-1 is new in every respect, and has performed superbly under flight tests.

Ten channels, with twenty crystal controlled frequencies are available for transmission between 2.5—10.0 mc. Power output from the transmitter is more than 100 watts. The receiver is controlled by a separate group of 20 crystals, and does not necessarily operate on the transmitting frequency. Quick, automatic frequency selection is provided, with all circuits tuned and ready to operate. Remote control encourages locating the unit with respect to proper weight distribution within the plane. The 18S-1 works into a 50 ohm transmission line.

A single 1½ ATR unit cabinet contains transmitter, receiver, and dynamotor power supply for the transmitter. The receiver operates directly from the 26.5 volt d-c source. The entire weight, including shock mount, is 60 lbs.

The first group of these equipments is scheduled for delivery to airlines in September of this year. Write today for further information.

**Collins Radio Company, Cedar Rapids, Iowa**

11 West 42nd Street  
New York 18, N.Y.

458 South Spring Street  
Los Angeles 13, California

— IN RADIO COMMUNICATIONS, IT'S ...



**THE 180K-1** antenna loading unit efficiently transfers the power output from the 18S-1 to any standard commercial fixed antenna. Remote controlled, pretuned operation for ten channels is provided. The nominal input impedance is 50 ohms. Weight, 10 lbs. Size, 7½" h, 10½" d, 12" l.



*One of a new line of  
Du Mont De Luxe  
Television Receivers,  
incorporating the  
finest in video and  
audio entertainment.*

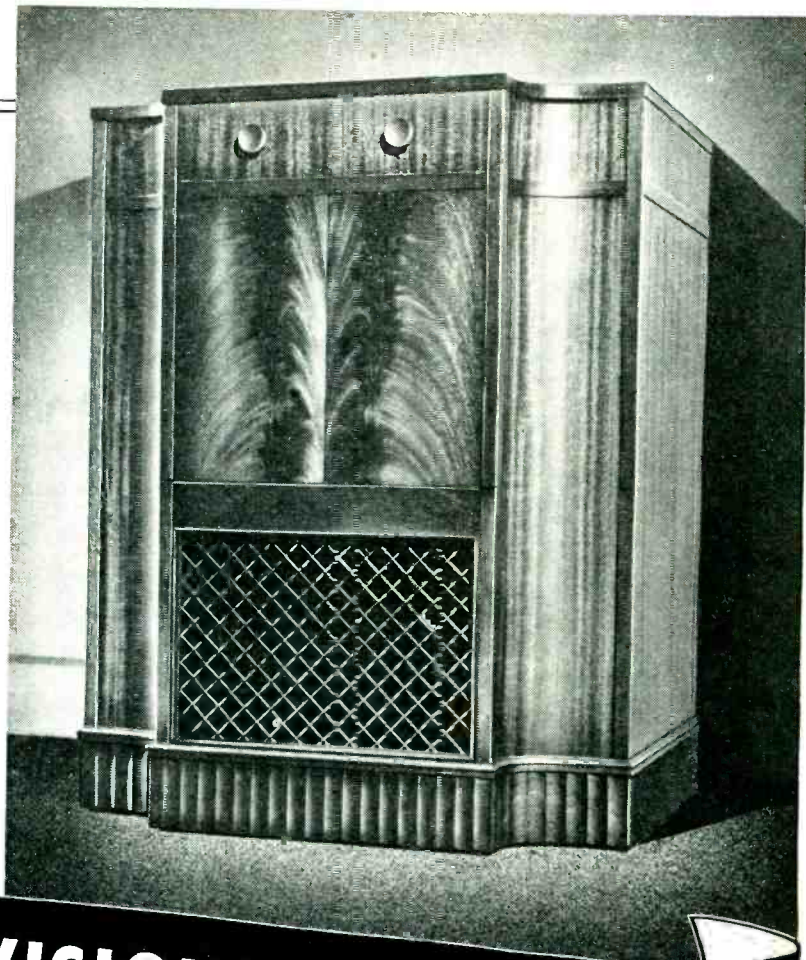

# "20-20 teleVISION" by DU MONT



We at AmerTran are pleased that cooperation  
between Du Mont engineers and those of our staff  
have resulted in the choice of  
AmerTran Transformers in important circuits  
of these television receivers.



**AMERICAN TRANSFORMER COMPANY**

178 Emmet St., Newark 5, N. J.



*Transformer Suppliers  
to the Electronics Industry*



AmerTran Transformers and Reactors are component parts in the best-known communications, broadcast and electronic equipment now produced.

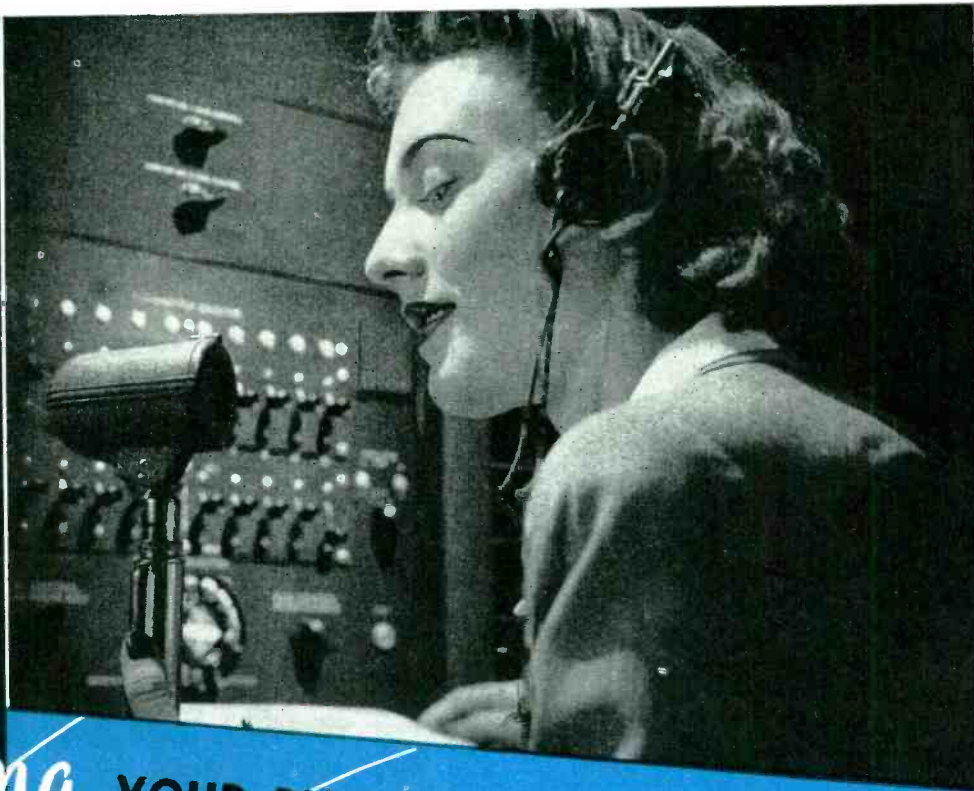

# Bringing YOUR BIRDS HOME TO ROOST

Dependable communication between planes and airports is yours with Wilcox radio equipment. Its high performance is but one of many virtues. Economy, convenience, easy maintenance, and protection against frequency obsolescence are provided through extensive research, careful assembly, and thorough testing. Check the features of the Wilcox Type 99A Transmitter and see what they mean to you.

★ Four transmitting channels, in the following frequency ranges:

- 125-525 Kc. Low Frequency
- 2-20 Mc. High Frequency
- 100-160 Mc. Very High Frequency
- Other frequencies by special order

★ Simultaneous channel operation, in following maximum combinations:

- 3 Channels telegraph
- 2 Channels telephone
- 1 Channel telephone, 2 Channels telegraph

★ Complete remote control by a single telephone pair per operator

★ 400 Watts plus carrier power

★ REMOVABLE R.F. HEADS are protection against frequency obsolescence. All connections to the transmitter are by means of plugs and receptacles. Instant removability means quick and easy maintenance.

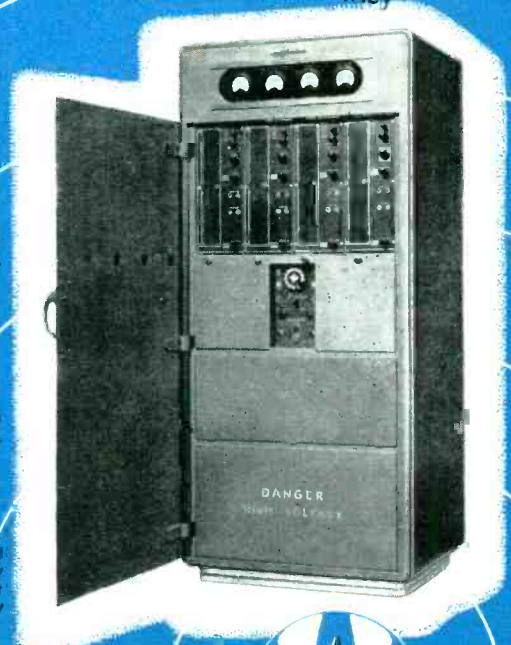

WRITE FOR COMPLETE INFORMATION

**WILCOX ELECTRIC COMPANY, INC.**  
KANSAS CITY, MISSOURI



**the sum of the components**

**equals**

**the whole**

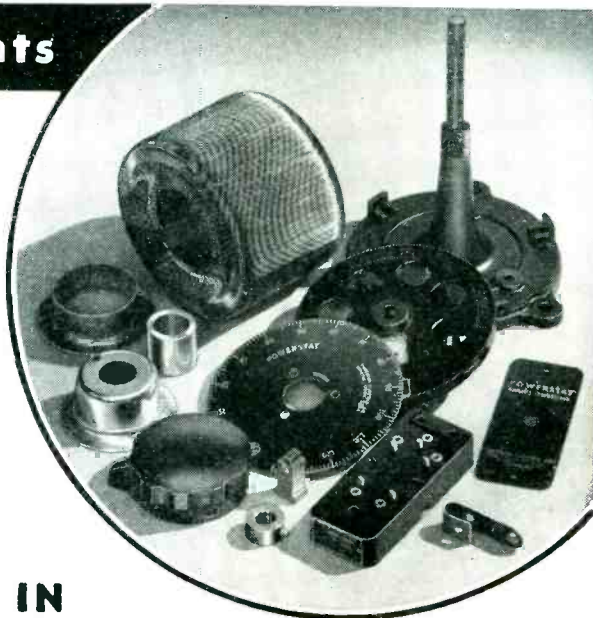

**IN**

# **POWERSTAT VARIABLE TRANSFORMERS**

The maxim "a chain is only as strong as its weakest link" may be applied with equal truthfulness to any manufactured device. We, at SECO, realizing the correctness of this statement, expend every effort to insure that all component parts of POWERSTAT variable transformers are of the highest possible quality. The keynote is . . . purchase the best . . . process by the highest standards . . . assemble in the most competent manner . . . inspect and inspect again each part, each operation, and the finished POWERSTAT. This is your assurance that a POWERSTAT is a superior variable voltage transformer.

## **and...in your own product**

Just as components assembled into final form constitute the POWERSTAT so do individual parts make up your own product. It can be only as good as the summation of these parts. Therefore; when the need arises for a variable transformer to be used as the variable a-c voltage source in apparatus of your manufacture—we invite you to—investigate POWERSTATS. You will find these controllers offer a durable, light weight, and easily mounted mechanical construction and such desirable electrical features as smooth control, excellent regulation, and high efficiency. POWERSTATS will go a long way toward producing a superior finished product for you.



*Send for Bulletin LE*

**THE SUPERIOR  ELECTRIC COMPANY**

708 LAUREL STREET

BRISTOL, CONNECTICUT, U. S. A.

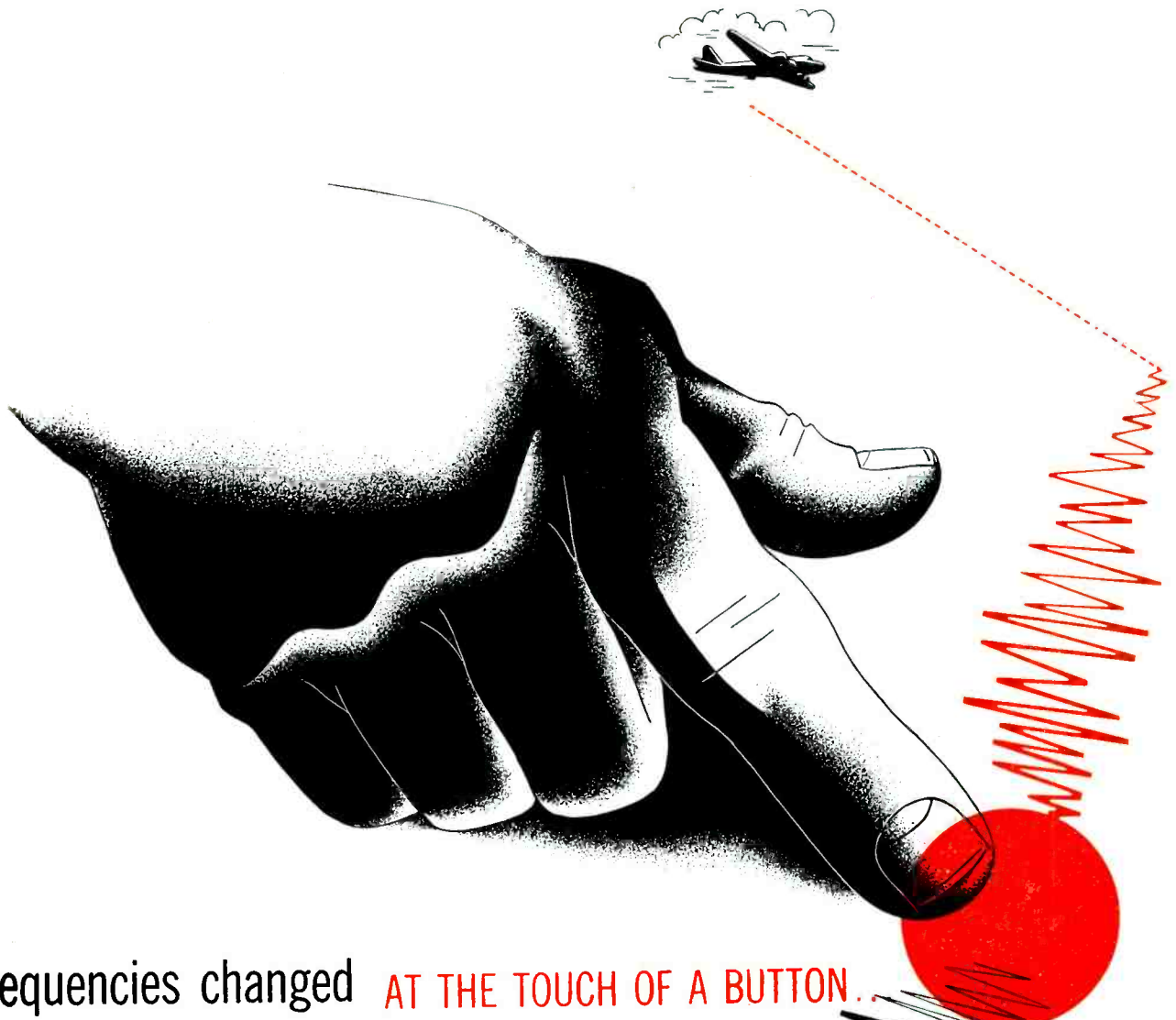

frequencies changed **AT THE TOUCH OF A BUTTON.**

The Collins Autotune is a repositioning mechanism for transmitters and receivers which quick-shifts all tuning controls simultaneously and with extreme precision to any one of a number of pre-selected frequencies.

The Collins Radio Company chose Callite Silver Contacts for the tap switches driven by the Collins Autotune in the grid and plate networks of this amazing device.

Callite contacts are made with a uniformity that insures faultless product performance. Our highly specialized experience in the selection and application of contacts for specific applications is worth investigating. Write to Callite Tungsten Corporation, 547 Thirty-ninth St., Union City, N. J. Branch Offices: Chicago, Cleveland.



*Standard and special shapes in tungsten, molybdenum, silver, platinum, palladium and alloys of these metals. Calliflex Thermostatic Bi-Metals.*



the  
Collins  
autotune  
uses  
Callite  
contacts





$CQ (bsmc) + ed + \frac{73c}{7s(8at)} + 4(ii) = (Tfp + eoi) (iyUHFe) *$



\* CENTRALAB Quality button silver mica capacitors + early delivery + 73 combinations made up of 7 styles with 8 available terminals + 4 individual inspections (capacitance, power factor, voltage breakdown and leakage resistance) = Trouble free performance and ease of installation in your Ultra High Frequency equipment.

Send for Bulletin 586

# Centralab

Division of GLOBE-UNION INC., Milwaukee

PRODUCERS OF



Silver Mica Capacitors  
Bulletin 630



Ceramics  
Bulletin 720



Ceramic High Voltage Capacitors  
Bulletin 630



Ceramic Trimmers  
Bulletin 630



Radiohms  
Bulletin 697



Tubular Ceramic  
Capacitors  
Bulletin 630



Ceramic Plate Capacitors  
Bulletin 630



Selector Switches  
Bulletin 722

# ANOTHER **FIRST** FOR **PRESTO**



**PRESTO 88-A** amplifier has three calibrated frequency response curves...one flat from 30 to 17,000...two with rising high frequency characteristics complement either the NBC "Orthacoustic" playback system or standard high fidelity transcription playback equipment.

## **88-A RECORDING AMPLIFIER**

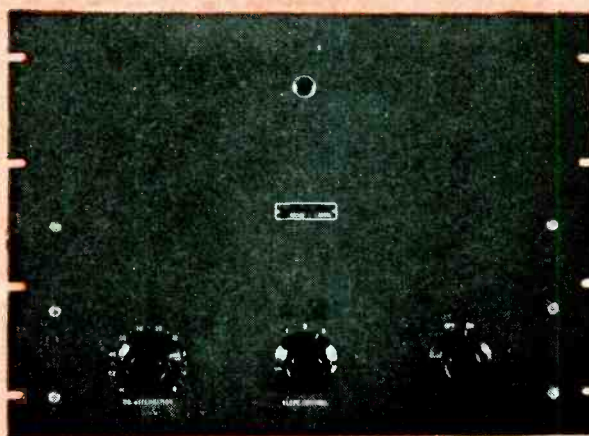

**T**HE *FIRST* recording amplifier capable of standardizing frequency response of instantaneous recordings so that they will complement the characteristics of high fidelity reproducing equipment now used in most broadcasting stations.

Instantaneous recordings made with the 88-A amplifier and the Presto 1-C cutting head equal the response of the finest commercial recordings and reproduce uniformly a range from 50 to 9,000 cps.

Ample reserve power makes it possible to obtain complete groove modulation at all cutting pitches without distortion. Delivery 30 days after order.



**RECORDING CORPORATION**  
242 West 55th Street, New York 19, N. Y.  
WALTER P. DOWNS, LTD., in Canada

**WORLD'S LARGEST MANUFACTURER OF INSTANTANEOUS SOUND RECORDING EQUIPMENT**

For determining **AMPLITUDE**  
**DURATION**  
**SHAPE** of short video pulses

# SYLVANIA Model 5 SYNCHROSCOPE

## VERTICAL DEFLECTION

Vertical deflection sensitivity of deflecting plates is approximately 65 volts per inch of deflection of cathode ray tube trace.

Vertical deflection sensitivity calibration circuit is provided with connectors for voltmeter having sensitivity of at least 1000 ohms/volt.

Space and power are available for: video amplifier requiring not more than 2.2 amps at 6.3 v and 70 ma at 360 v; or r-f envelope viewer.

## TIME DELAY

Circuits incorporated in Model 5 Synchroscope give following types of operation:

(a) Sweep delayed 90 microseconds from the internal trigger, or from an external positive or negative trigger. Positive output trigger is adjustable in time from 75 microseconds before to 25 microseconds after start of sweep; reaches amplitude of at least 200 volts in 0.3 microseconds.

(b) Sweep starting with positive or negative signal of at least 50 volts amplitude, rising to 35 volts in not more than 0.5 microseconds. Repetition frequency of from 50 to 5000 cps.

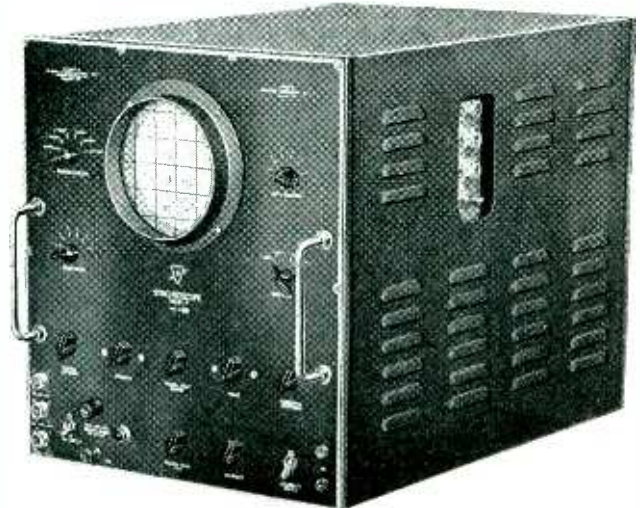

**HORIZONTAL SWEEP SPEEDS** 0.01, 0.05, 0.2, 1, 2, and 5" per microsecond with sweep amplitude of 4" or more on 5" cathode ray tube.

**INPUT CONNECTIONS** for 7 circuits; selector switch permits observation of operation of any one of the 7.

**POWER SUPPLY:** 200-watt input (without video attachments) from 105-125 volt source, 50-60 cps.

## TRIGGERING

Time delay circuits may be synchronized with:

(a) Internal trigger generator, with repetition frequencies of 500, 1000, 2000 and 4000 cps.

(b) Positive or negative trigger of at least 50 volts amplitude rising to 35 volts in not more than 0.5 microseconds and a frequency of 50 to 5000 cps.

Connection is also provided at back of chassis, so that external trigger generator (not supplied with Synchroscope), similar to internal trigger generator, may be operated from delay circuits in Synchroscope, thus providing another trigger adjustable in time phase.

The Model 5 Synchroscope is typical of many precision testing instruments, for laboratory and production purposes, manufactured by Sylvania Electric. Other Sylvania instruments include Spectrum Analyzers, Thermister Bridges, Dilatometers and 5-inch Oscilloscopes. Inquiries are invited.



Share Wheat And Fats.  
Fight Famine!

# SYLVANIA ELECTRIC

Electronics Division . . . 500 Fifth Avenue, New York 18, N. Y.

MAKERS OF ELECTRONIC DEVICES: RADIO TUBES; CATHODE RAY TUBES; FLUORESCENT LAMPS; FIXTURES; WIRING DEVICES; ELECTRIC LIGHT BULBS



# OTIS ELEVATOR COMPANY

Tells Independent Investigator

*"Phillips Screws Licked 3 Serious Problems..."*

The investigator, from James O. Peck Co., industrial research authorities, is studying assembly methods in leading plants. At Otis Elevator Co. he asked the same questions you would ask — and here are some of the money-saving reasons they gave him for using Phillips Screws.



**"THEY BANISHED BURRS** — always a hazard in equipment used by the public. Slotted screws burred easily, and if unnoticed in assembly, might later scratch limbs or snag clothing, especially on a moving escalator, with resulting damage claims. If the burr was noticed, the screw had to be replaced, wasting time.

**"THEY DISCOURAGED TAMPERING.** When slotted screws were used, people could turn them out with a coin, a nail file, or even with finger nails. This malicious mischief is a constant 'headache' in buildings used by the public. Phillips Screws are relatively tamper-proof.

**"THEY ENDED DRIVER SKIDS.** Plates and panels scarred by slipping drivers are a serious problem to us, since our products are assembled in the field. Refinishing by expert touchup men comes high. Sometimes new parts must be procured from the plant, and the cost of time lost in installation mounts fast. The Phillips driver stays in the recess, doesn't skid."

His complete, idea-crammed report, with others now ready, and more to come, comprise a practical manual of modern assembly practice — a guide to savings you can't afford to miss. All types of products are covered — metal, plastic, wood. The coupon will bring the reports ready now and the rest as they are issued.

**Whatever You Make, There Are Savings Suggestions for You in These Reports. They Are FREE . . . Mail the Coupon Today!**

**"SLOTTED HEADS COULDN'T TAKE** the 'oomph' we use when we set 'em up, sometimes with a cross bar on the driver, without breaking or burring. Phillips Screws can — they start easier, drive easier, too."

**"PHILLIPS SCREWS ADD GOOD** looks to safety," said Otis engineers. "The ornamental recess blends with the modern, finished appearance of the escalators — saves us getting the special head design we formerly used."



## PHILLIPS Recessed Head SCREWS

Wood Screws • Machine Screws • Self-tapping Screws • Stove Bolts

American Screw Co.  
Atlantic Screw Works  
Atlas Bolt & Screw Co.  
Central Screw Co.  
Chandler Products Corp.  
Continental Screw Co.  
Corbin Screw Div. of  
American Hdwe. Corp.  
The H. M. Harper Co.  
International Screw Co.  
Lawson & Sessions Co.

**26 SOURCES**

Manufacturers Screw Products  
Milford Rivet and Machine Co.  
National Lock Co.  
National Screw & Mfg. Co.  
New England Screw Co.  
Parker-Kalun Corporation

Pawtucket Screw Co.  
Pheoll Manufacturing Co.  
Reading Screw Co.  
Russell Eurdall & Ward  
Bolt & Nut Co.  
Scovill Manufacturing Co.  
Shakeproof Inc.  
The Southington Hardware Mfg. Co.  
The Steel Company of Canada, Ltd.  
Sterling Bolt Co.  
Wolverine Bolt Company

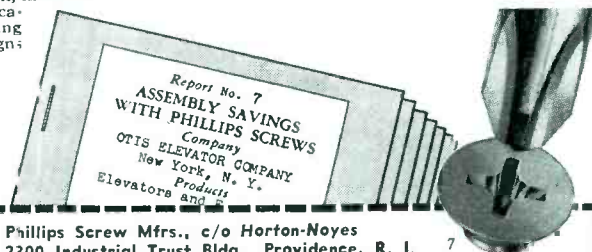

Phillips Screw Mfrs., c/o Horton-Noyes  
2300 Industrial Trust Bldg., Providence, R. I. 7

Send me reports on Assembly Savings with Phillips Screws.

Name .....

Company .....

Address .....

*Precision Quality Control...*



*... A Year 'Round  
Feature of ALL*

## **STUPAKOFF CERAMICS**

Stupakoff precision quality control gives you uniform, dimensionally accurate ceramic parts. By standardizing on STUPAKOFF products, you minimize production losses... gain assurance of maximum mechanical strength and maximum electrical protection.

The advantages of Stupakoff ceramics have been developed through years of engineering experience and research.

Carefully selected and laboratory controlled materials, modern manufacturing facilities and constant inspection insure highest quality of finished products at all times. Specify Stupakoff—and be sure of the finest. *Write for Bulletin 245.*

EXPORT DEPARTMENT  
13 E. 40th St., New York 16, N.Y.  
Cable Address: ARLAB all codes

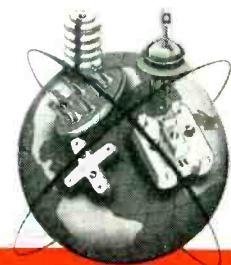

# **STUPAKOFF**

**CERAMIC AND MANUFACTURING CO. • LATROBE, PA.**

# Jensen

TYPE "RD"

*Reproducer*

WITH THE NEW TYPE "H"

**ARTICULATED**

*Coaxial*



This new Reproducer, combining the Type "H" Coaxial speaker with the new Jensen Type "D" Bass Reflex cabinet, offers superior reproduction of your favorite program material and is unconditionally recommended for FM receivers, high quality phonograph reproduction, reviewing studios, monitoring, and home and public entertainment generally.

The cabinet is beautifully styled and fashioned of satin finish striped walnut. The harmonizing grille fabric is overlaid with a protecting pattern of flat, interlaced bronzed strips.

The Type "H" Coaxial, with all **ALNICO 5** design, employs a h-f horn and l-f (15-inch) cone which are electrically and acoustically coordinated to achieve brilliant and natural response throughout the entire useful frequency range. The frequency dividing network has variable control in the range above 4,000 cycles. Nominal input impedance to dividing network, 500 ohms; maximum power handling capacity 25 watts, in speech and music systems.

Model RD-151 Reproducer complete, approximate list price \$180.

\*Trade Mark Registered

**JENSEN MANUFACTURING COMPANY**

6607 S. LARAMIE AVE., CHICAGO 38, ILLINOIS

In Canada—Copper Wire Products, Ltd., 11 King Street, West, Toronto

**JENSEN  
BASS REFLEX**

Acoustically-correct Bass Reflex Cabinet gives smooth & extended low register. Better than cr. "Tri-Limit" baffle . . . efficiently uses back radiation too

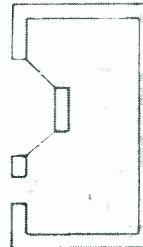

*Specialists in Design  
and Manufacture of Fine  
Acoustic Equipment*

**FOR YOUR EXACTING ELECTRONIC REQUIREMENTS!**

**THORDARSON**

**TRANSFORMERS** for all requirements... communications, sound amplifier, industrial, experimental and amateur.  
**TRU-FIDELITY AMPLIFIERS** with advanced tone compensation, conservative ratings, multiple input channels, low hum level, etc.

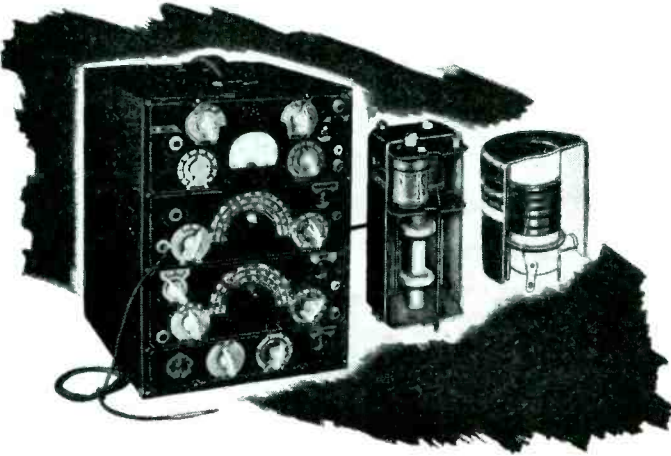
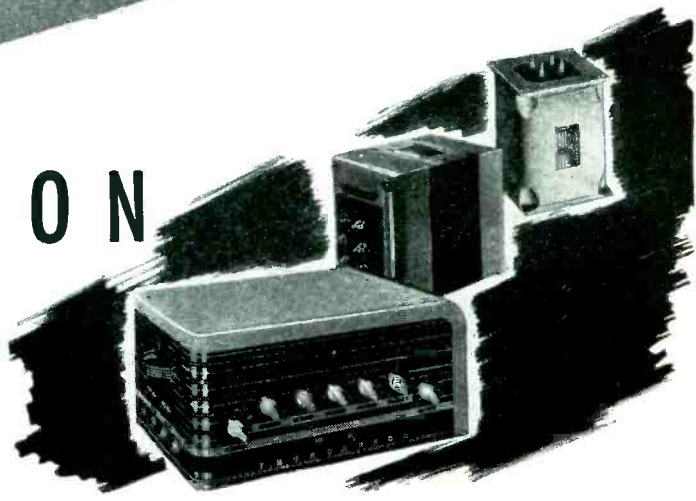

**RADIART**

**VIBRATORS.** Exact duplicate Vibrators, individually-engineered... long life, low noise level, minimum interference.  
**RUST-PROOF AERIALS.** A complete line, newly designed to fit all cars... cowl, hood and under hood types. Many exclusive features.

**MEISSNER**

**COMPONENTS.** Standard, plastic and Ferrocarr transformers; antenna, R.F. and oscillator coils; accessories.  
**SERVICE INSTRUMENTS.** Meissner Analyst... a complete servicing instrument; Signal Calibrator... self-contained and portable.

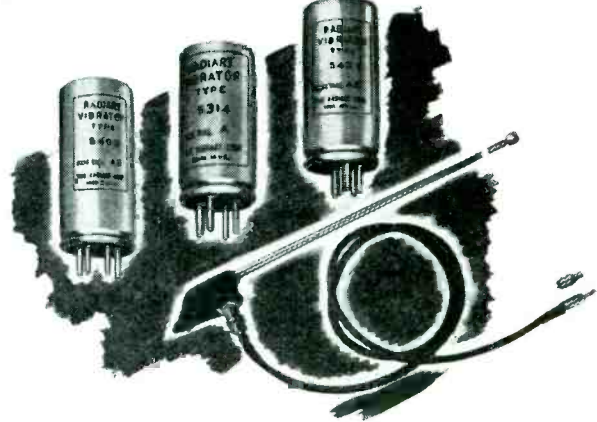

**ELECTRONIC DISTRIBUTOR AND INDUSTRIAL SALES DEPARTMENT OF  
MAGUIRE INDUSTRIES, INCORPORATED  
936 NORTH MICHIGAN AVENUE, CHICAGO 11, ILLINOIS**

up to **1000**  
 solderless electrical  
 connections  
*per hour*

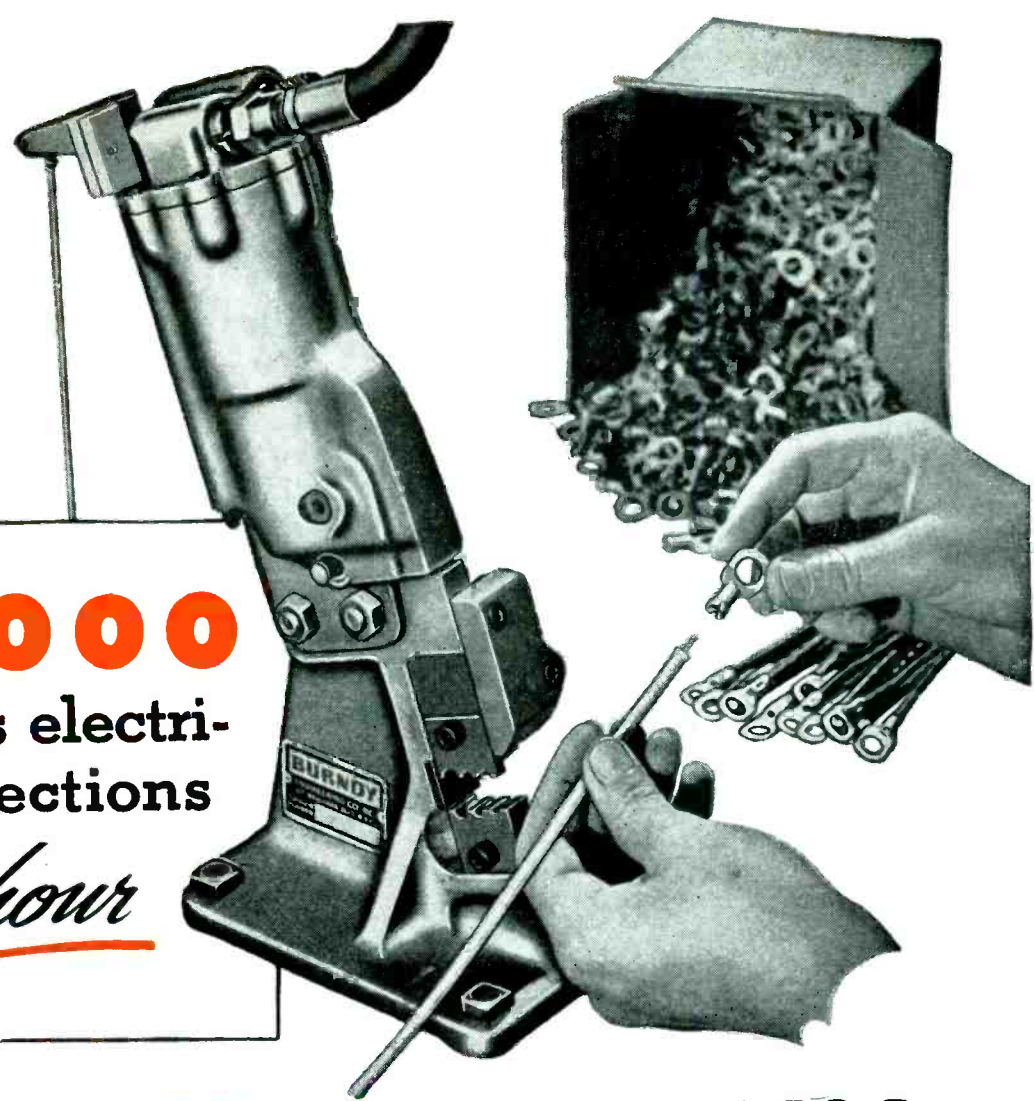

# BURNDY HYPRESS

(Pneumatic Foot Operation)

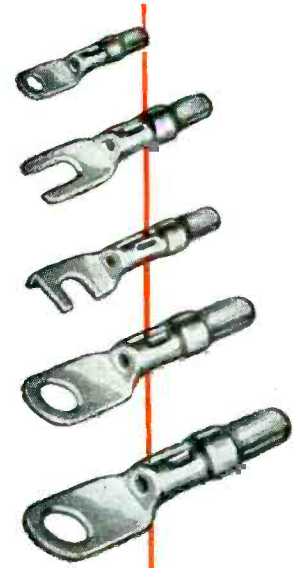

- One operator attaches up to 1000 HYDENT connectors per hour.
- Multiple 3-groove die accommodates cables from #22 through #10 without die change.
- Press tilt and wide jaw opening permit full vision of work and facilitate ease and speed of operation.
- HYDENT connectors used are of one-piece, pure copper construction . . . high electrical efficiency and mechanical strength.
- Full details from your local Burndy representative, or by writing Burndy Engineering Co., Inc., 107L Bruckner Blvd., New York 54, N. Y.

**BURNDY ENGINEERING COMPANY**

In Canada: Canadian Line Materials, Ltd., Toronto 13.

# Service

## IS BACK AGAIN



**M**ACHINING equipment for insulating parts of all grades and types—which was greatly expanded to take care of war requirements—is now at the service of Formica customers, and the service is as prompt and complete as it ever was.

New and modern tools have made quantity production of accurately machined parts easier than it used to be. Workers with years of experience on just one material—who know all the

tricks of grinding the tools, speeds, feeds and other details that mean so much to quick satisfactory production, man this equipment.

You can add the Formica machine shop to your production equipment by sending us your blue prints for quotations on your requirements. Give us a detailed explanation of the functions of the part and we will see that you get the right grade for efficiency and economy.

### THE FORMICA INSULATION CO.

4661 SPRING GROVE AVE.

CINCINNATI 32, OHIO

**FORMICA**

# BUILT-IN TEMPERATURE ANTICIPATION\*



How can a thermostat have built-in temperature anticipation? Fenwal engineers, in designing THERMOSWITCH Control components, have selected materials with suitable coefficients of expansion to provide anticipation effects. The engineered heat transfer lag between these components creates built-in temperature anticipation without a change in calibration point. Built-in temperature anticipation in the THERMOSWITCH Control is a function of heat transfer only and it is not affected by increase in electrical load. No auxiliary heating units are needed.

Conventional practice of using auxiliary heaters for producing temperature anticipation effects always results in loss of control temperature with increased electrical load.

Chart shows the small variance of set point of the THERMOSWITCH Control with increased electrical load in comparison to the change in set point with increasing load found in Type 1 or Type 2 thermostats.

The Fenwal THERMOSWITCH Control embodies many other advantages not found in other types of thermal control units. Write for a copy of the *Thermotechnics Booklet* which includes "Fourteen Facts in Fenwal's Favor."

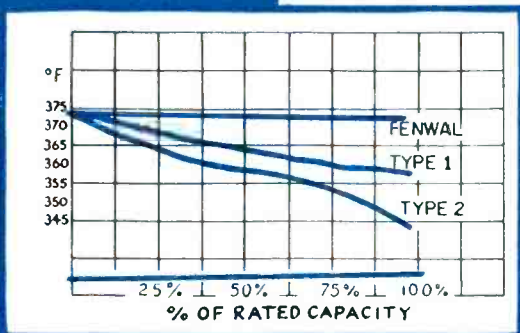

EFFECT OF LOAD ON CONTROL POINT



COUPLING HEAD THERMOSWITCH CONTROL

## FOURTEEN FACTS IN FENWAL'S FAVOR

- 1.—Fast reaction time
- 2.—Large heat sensitive area, small heat storage
- 3.—Short heat transfer path
- 4.—Small temperature differential
- 5.—Built-in temperature anticipation
- 6.—Enclosed assembly
- 7.—Minimal vibration effects
- 8.—Tamper-proof and sealed
- 9.—Rugged construction
- 10.—Adjustable over wide temperature range
- 11.—Minimum size
- 12.—Directly responsive to radiant heat
- 13.—Uniform sensitivity over adjustable temperature range
- 14.—Readily installed

\* #5 of "Fourteen Facts in Fenwal's Favor"



**FENWAL INCORPORATED**

43 PLEASANT STREET

ASHLAND MASSACHUSETTS

Thermotechnics for Complete Temperature Regulation

# WHAT NEW PRODUCT would you design WITH THIS SMALLEST METER?

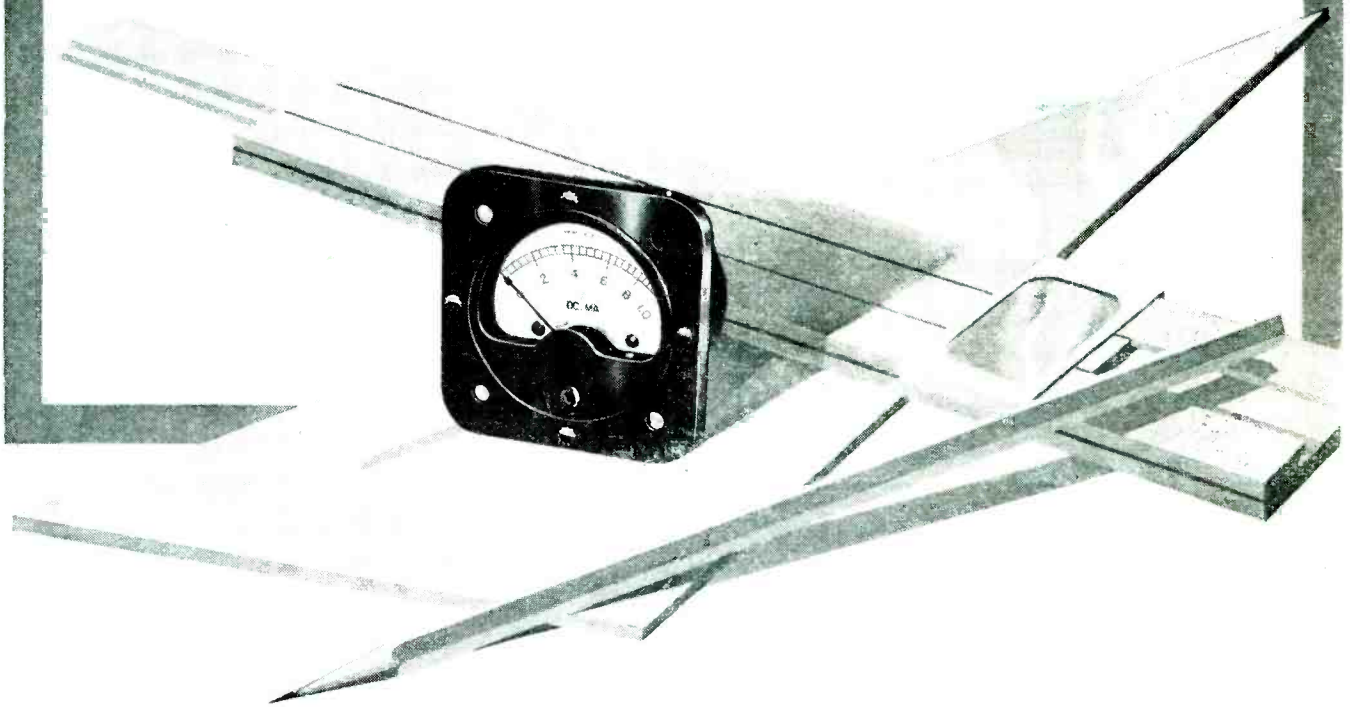

## MB MINIATURES OFFER EXTRA POSSIBILITIES

THINK OF HOW MANY NEW PRODUCT DESIGNS are now possible — products which could gain a competitive "edge" if made smaller — because large-meter performance is packed into *the smallest unit produced today!*

The hearing-aid battery tester, for instance—a voltmeter for consumer use so small it can be carried in pocket with utmost ease. Or smaller photo exposure meters, or miniature, portable galvanometers—all of which house MB movements, adapted by MB engineers to turn a design idea into a practical product.

Equally important, MB miniatures help you im-

prove space factors in present designs. Whether used as a tank circuit tuning indicator or a thermocouple thermometer, an MB meter gives you greater freedom of design—and freedom from trouble. For not only is it smallest, but it's also built to *last*—with materials like Alnico No. 5 magnet and sapphire bearings.

MB instruments are available in round and square models, in 1-inch sizes and 1½-inch sizes. We will be glad to discuss any uses you see for them and have an MB engineer work out adaptations if necessary. Write for the MB catalog with full specifications and prices.

THE  
**MB** MANUFACTURING COMPANY, INC.  
331 East Street, New Haven 11, Conn.



MINIATURE ELECTRICAL INSTRUMENTS FOR ANY PURPOSE



FOR  
**vhf**  
**uhf**  
**shf**

## UNRIVALED MECHANICAL CHARACTERISTICS

### LOW LOSS COAXIAL LINE SPACERS CUSTOM MADE OF ALSIMAG 243

The mechanical properties of AlSiMag 243, coupled with excellent dielectric characteristics, make this material highly desirable for vhf, uhf and shf coaxial line insulators. This permanently rigid, mechanically strong material does not leave conducting paths after flashover. It does not warp or distort with age.

Coaxial line spacers of AlSiMag 243 are custom made to your design and to

the tolerances you specify. Extremely close tolerances involve commensurate cost. The material is non-hygroscopic. Glazed finish available if desired.

A coaxial line is expensive. Electric power at high frequencies is expensive. Repairs to a coaxial line are expensive. Thus it is economy to use permanently stable, mechanically strong, low loss insulation . . . AlSiMag 243.

### ABBREVIATED PROPERTY CHART ALSIMAG 243

(Complete chart on request)

Softening Temperature	.....	2624° F
Resistance to Heat (Safe limit for constant temperature)	.....	1832° F
Tensile Strength—lbs. per sq. in.	.....	10,000
Compressive Strength—lbs. per sq. in.	.....	85,000
Flexural Strength—lbs. per sq. in.	.....	20,000
Dielectric	1 MC.....	6.2
Constant	10 MC.....	6.2
	100 MC.....	6.1
Power	1 MC.....	.0004
Factor	10 MC.....	.0003
	100 MC.....	.0003
Loss	1 MC.....	.0025
Factor	10 MC.....	.0019
	100 MC.....	.0018

**ALSiMAG**  
TRADE MARK REGISTERED U.S. PATENT OFFICE



Original Award July 27, 1942  
 Second Award February 13, 1943  
 Third Award September 25, 1943  
 Fourth Award May 27, 1944  
 Fifth Award December 2, 1944

## AMERICAN LAVA CORPORATION

CHATTANOOGA 5, TENNESSEE  
 43RD YEAR OF CERAMIC LEADERSHIP

### ENGINEERING SERVICE OFFICES:

ST. LOUIS, Mo., 1123 Washington Ave., Tel: Garfield 4959 • NEWARK, N. J., 671 Broad Street, Tel: Mitchell 2-8159  
 CAMBRIDGE, Mass., 38-B Brattle St., Tel: Kirkland 4498 • CHICAGO, 9 S. Clinton St., Tel: Central 1721  
 SAN FRANCISCO, 163 Second St., Tel: Douglas 2464 • LOS ANGELES, 324 N. San Pedro St., Tel: Mutual 9076

*Only a drop... but look at the stir*

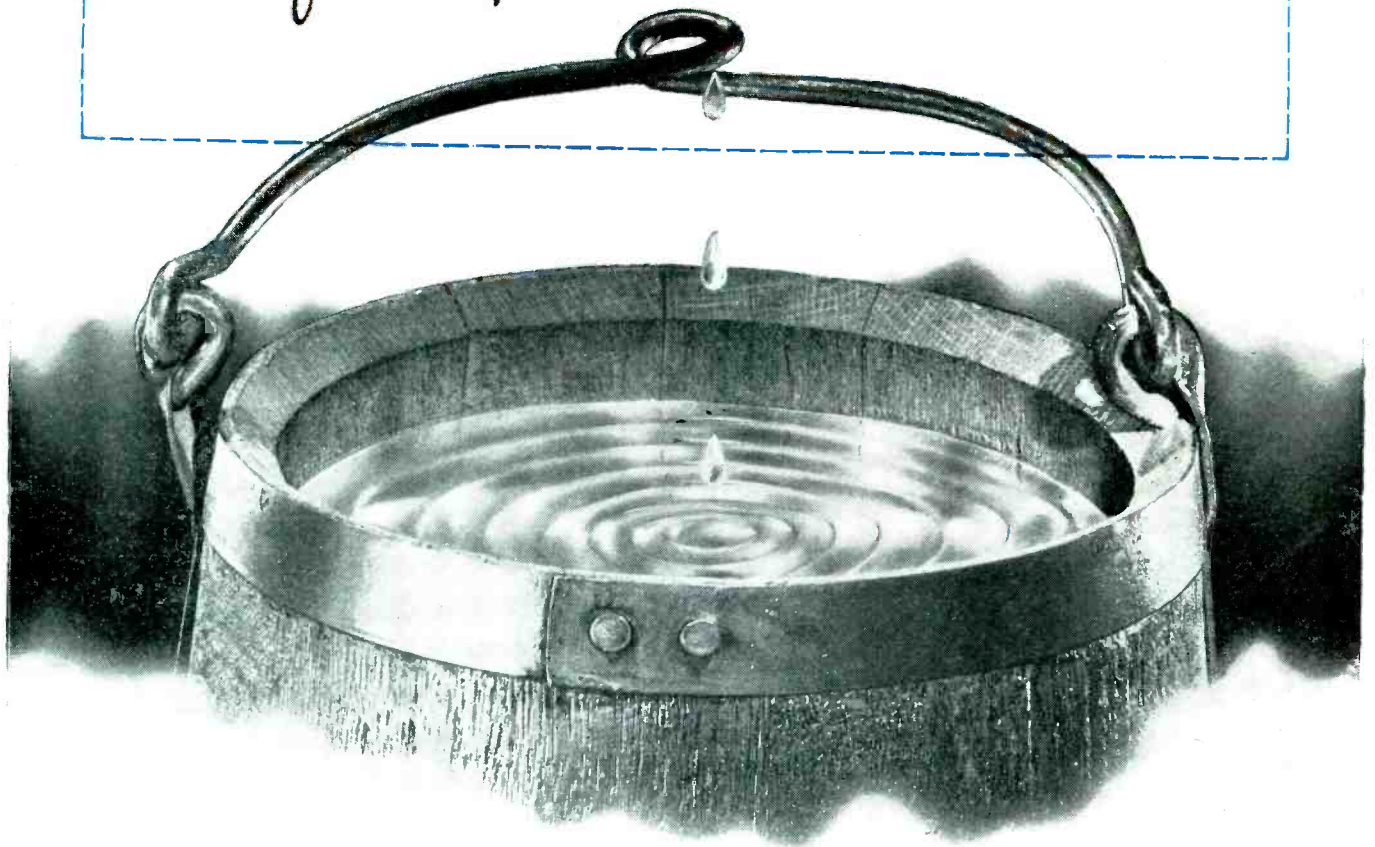

**EVEN THE TINIEST COMPONENT** is important. Like capacitors. If they "sit in" and do exactly the job you've visualized for them, your final product performs as planned.

That doesn't mean—make a major issue of capacitor purchases! Buy the kind you *don't* have to worry about . . . the kind we make at Cornell-Dubilier. They're inconspicuous, because they're so dependable.

*If you have a special capacitor problem, our engineers can turn their thinking to it immediately. Consult us. Cornell-Dubilier Electric Corporation, South Plainfield, N. J. Other plants in New Bedford, Providence, Brookline and Worcester.*

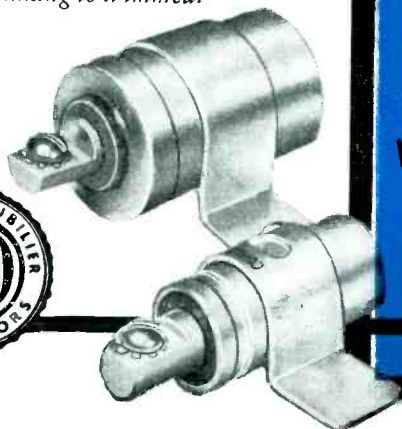

Others have tried to build capacitors like C-D's. They can imitate, but not duplicate. Because it's more than the paper and foil we use that makes C-D's different. It's the experience and engineering flexibility that comes of having made more capacitors of more different designs than anyone else. When you buy C-D, you buy a helpful amount of "freedom from worry".

**CORNELL-DUBILIER**  
world's largest manufacturer of  
**CAPACITORS**

MICA • DYKANOL • PAPER • ELECTROLYTICS

# The Curve is UP

## FOR ELECTRONIC-HEATING INSTALLATIONS!



*Profit* BY DESIGNING YOUR EQUIPMENT AROUND HIGH-EFFICIENCY G-E TUBES LIKE THE NEW, COMPACT GL-592 POWER TRIODE...

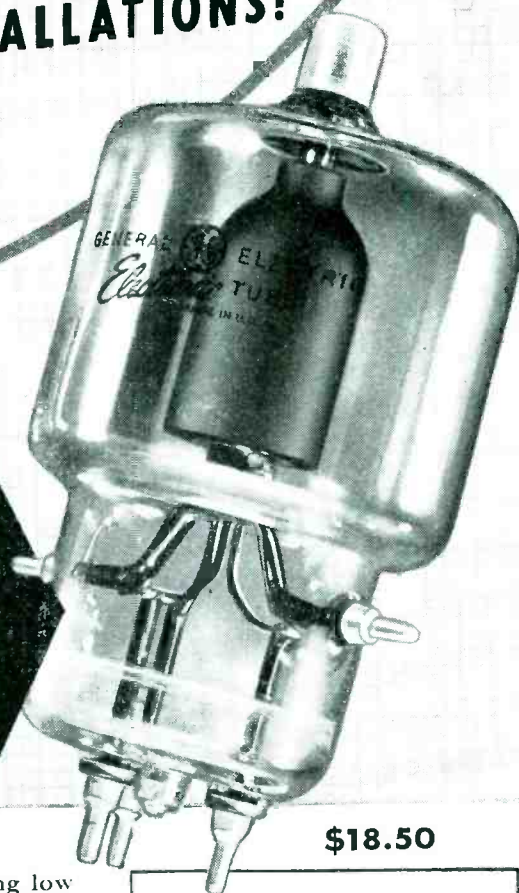

**\$18.50**

THERE'S good business ahead—as well as *now*—for builders of electronic-heating equipment! And the heart of this equipment is the tubes. As industry finds wider applications for high-frequency heating—develops revolutionary new processes, like stitching plastic sheets electronically and cooking foods in seconds instead of minutes or hours—General Electric keeps step by its tube research. *For every high-frequency heating application, there's a G-E tube ready to do the job!*

Type GL-592—NEW efficient power triode—typifies G-E progress. Designers today are considering higher frequencies for dielectric-type heating . . . and the GL-592 will operate up to 110 megacycles at max ratings! Many heating jobs call for small to medium-size installations, with economy paramount.

So the GL-592—besides being low in first cost—*conserves power* with its anode input of 600 watts and dissipation of 200 watts!

The tube is sturdily built for hard service. Cathode, grid, and anode are solidly mounted and braced. All leads are short. Fernico metal-to-glass seals make possible (1) elimination of a base with its dielectric losses, (2) the non-soldered anode terminal that withstands high temperatures. All contacts are silver-plated for efficiency.

Whether your heating application be induction or dielectric—whether large or small—*G.E. has the right electronic tube for you.* And G-E tube engineers are glad to work closely with your designers. See your nearest G-E office, or write to *Electronics Dept., General Electric Company, Schenectady 5, N.Y.*

### RATINGS

Cathode voltage	10 v
Cathode current	5 amp
Max anode ratings:	
voltage	3,500 v
current	250 ma
input	600 w
dissipation	200 w
Type of cooling	forced-air

● The G-E line of power triodes for high-frequency heating is complete, covering every need and application. There are 17 types. Max anode voltages range from 2,000 v to 20,000 v—current from 250 ma to 10 amp—dissipation from 125 w to 100 kw. Prices and details on any or all types are available on request.

# GENERAL ELECTRIC

162-EG-8880

FIRST AND GREATEST NAME IN ELECTRONICS

*For the  
Laboratory*

## BEAT FREQUENCY GENERATOR

TYPE 140-A

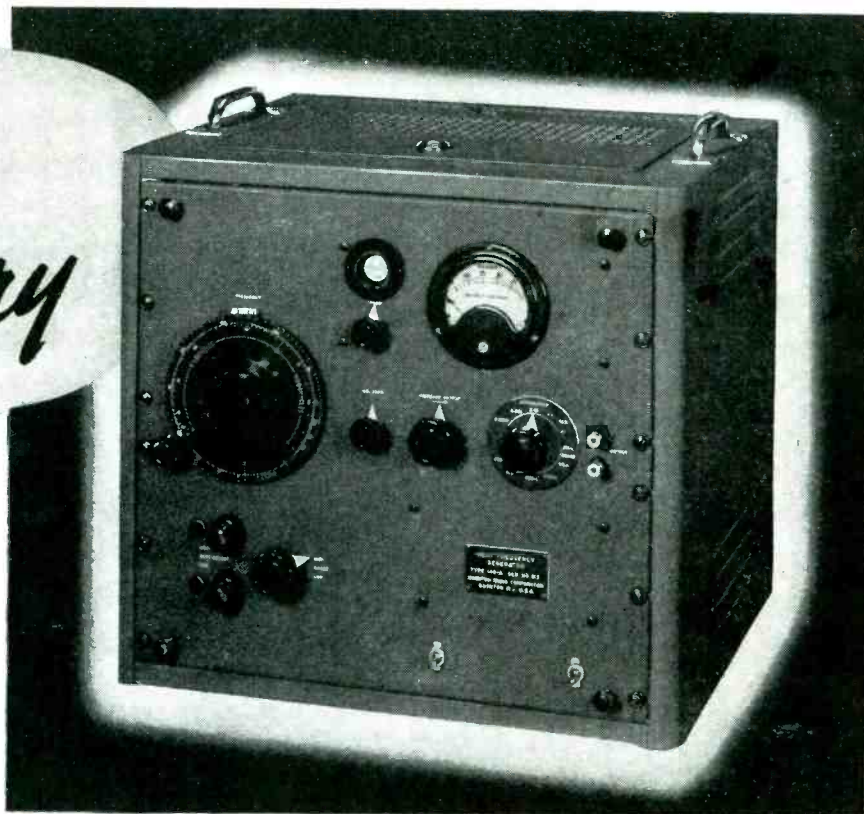

This instrument has found universal acceptance because of its wide frequency coverage from 20 cycles to 5 megacycles. A five step decade attenuator provides a means by which extremely small output voltages can be accurately set and a six position switch enables any one of a variety of output impedances to be quickly selected.

### SPECIFICATIONS:

**FREQUENCY RANGE:** 20 cycles to 5 megacycles in two ranges.

Low range: 20 to 30,000 cycles.

High range: 30 kc to 5 megacycles.

**FREQUENCY CALIBRATION:** Accuracy  $\pm 2$  cycles up to 100 cycles,  $\pm 2\%$  above 100 cycles.

**STABILITY:** About 5 cycles drift below 1000 cycles. On low range, drift becomes negligible percentage with increasing frequency. On high range, drift is 3% or less.

**ADJUSTMENT:** High and low ranges have individual zero beat adjustments. Low range may be checked against power line frequency with front panel 1 inch cathode ray tube.

**OUTPUT POWER AND IMPEDANCES:** Rated power output: One watt, available over the low frequency range from output impedances of 20, 50, 200, 500, 1000 ohms, and over both high and low frequency ranges from an output impedance of 1000 ohms.

**DISTORTION:** 5% or less at 1 watt output, 2% or less for  $\frac{1}{2}$  voltage output.

**VOLTMETER ACCURACY:**  $\pm 3\%$  of full scale reading.

Q-METER TYPE 170-A now available for immediate delivery.  
Write for Catalog C containing information on all instruments.

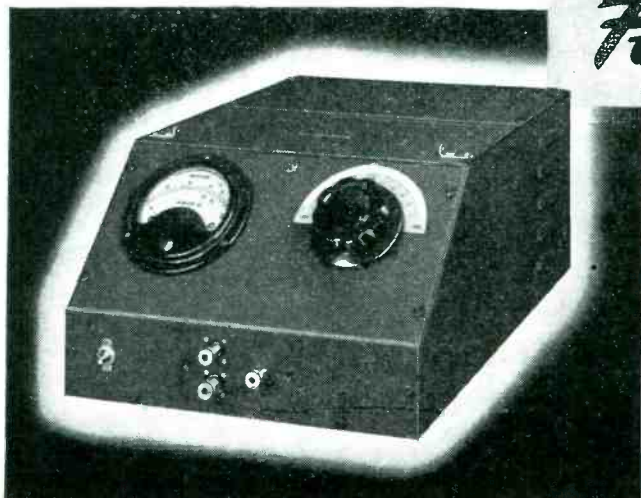

*For the Production Line*

## QX-CHECKER TYPE 110-A

This production-test instrument is specifically designed to compare relative losses or Q simultaneously with inductance or capacitance in one operation and with a single setting. Built to laboratory precision standards, the QX-Checker is a sturdy, foolproof instrument for use in production work by any usual factory personnel.

### SPECIFICATIONS:

**FREQUENCY RANGE:** 100 kc to 25 mc in 6 ranges using plug-in coils.

**ACCURACY OF COIL CHECKS:** May be checked against standard to within about 0.2% with coil values of 10 microhenries to 10 millihenries and Q of 100 or greater.

**CAPACITANCE RANGE:** Capacitance values ranging between approximately 2-1000 mmf may be checked against a standard to an accuracy of a few tenths of one mmf if the Q of the capacitor is high.

DESIGNERS AND MANUFACTURERS OF  
THE "Q" METER . . . QX-CHECKER  
FREQUENCY MODULATED SIGNAL GENERATOR  
BEAT FREQUENCY GENERATOR  
AND OTHER DIRECT READING TEST INSTRUMENTS



**BOONTON RADIO**  
CORPORATION  
BOONTON · N.J. · U.S.A.



# FOR ELECTRONICS PRODUCTS IN METAL TUBING

UP TO  $5\frac{1}{8}$ " O. D. MAXIMUM

Superior's new mill represents the ultimate in modern equipment of mill and laboratory to which the industry can look for leadership in the production, control and development of electronic tubing.

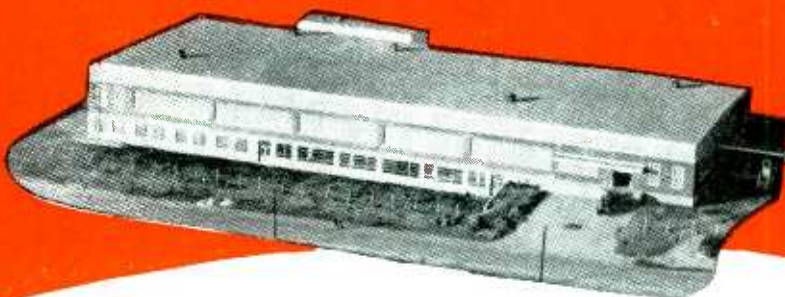

## Superior

**FOR YOUR CATHODES  
FOR YOUR OTHER NEEDS TOO**

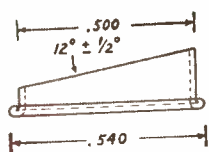

**ANODE TUBING**—For Cathode Ray Tube Gun Structures, Ion Traps, Anodes, Stamped Parts.

You name the material and size—we have it!



**FORMED TUBING**—With rolled edges, flared and expanded ends, to solve your particular problems of high voltages and tricky electric fields.

The above drawings and dimensions are typical examples

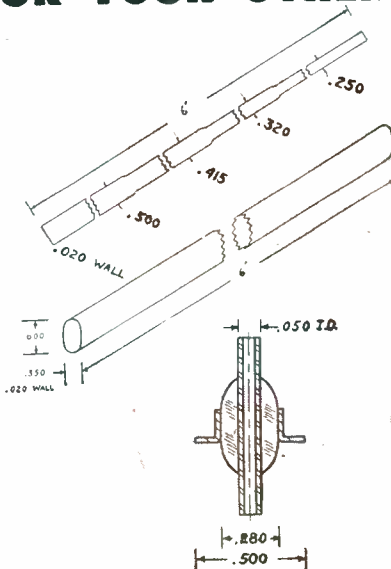

**ANTENNA TUBING**—shaped, tapered or formed tubing for vertical or horizontal antenna, of materials that save weight, have greater strength, and last longer.

**GLASS SEALING TUBING**—for soft or hard glass. Can you use one piece of tubing for a glass seal, electrode support and exhaust tubulation? The more unusual the application, the better we like it.

**OTHER SUPERIOR DEVELOPMENTS ARE ON THE WAY—  
THEY ARE WHAT YOU WANT—WATCH FOR THEM!**

We have unusual laboratory and engineering facilities, all at your service. You will like Superior Quality—Control—Speed.

Call us in at the start of your development program, in order to take full advantage of Superior's experience in this field.

Write for our new catalog and bulletins.

THE **BIGGER NAME IN SMALL TUBING**  
**Superior**

**SUPERIOR TUBE COMPANY  
ELECTRONICS DIVISION**

Post Office Drawer 191 • Norristown, Pa.  
Telephone, Norristown 2070

For the Man Who Takes Pride in His Work



Model 2432  
Signal Generator

**FM AND TELEVISION BAND COVERAGE ON STRONG HARMONICS  
STRONG FUNDAMENTALS TO 50 (MC)**

Another member of the Triplet Square Line of matched units this signal generator embodies features normally found only in "custom priced" laboratory models.

**FREQUENCY COVERAGE**—Continuous and overlapping 75 KC to 50 MC. Six bands. All fundamentals. **TURRET TYPE COIL ASSEMBLY**—Six-position turret type coil switching with complete shielding. Coil assembly rotates inside a copper-plated steel shield. **ATTENUATION**—Individually shielded and adjustable, by fine and course

controls, to zero for all practical purposes. **STABILITY**—Greatly increased by use of air trimmer capacitors, electron coupled oscillator circuit, and permeability adjusted coils. **INTERNAL MODULATION**—Approximately 30% at 400 cycles. **POWER SUPPLY**—115 Volts, 50-60 cycles A.C. Voltage regulated for increased oscillator stability. **CASE**—Heavy metal with tan and brown hammered enamel finish.

There are many other features in this beautiful model of equal interest to the man who takes pride in his work.



**Triplet**

**ELECTRICAL INSTRUMENT CO. BLUFFTON, OHIO**



# MACHLETT ELECTRON TUBES FOR ALL RADIO TRANSMITTING AND INDUSTRIAL PURPOSES

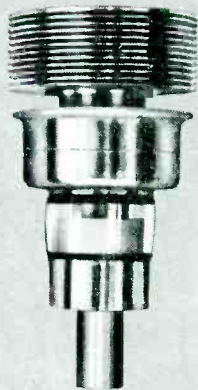

2C-39

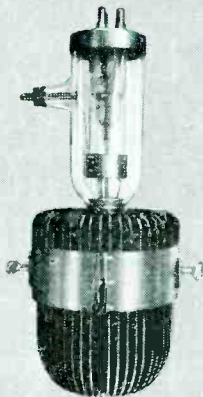

ML-891R



ML-893A

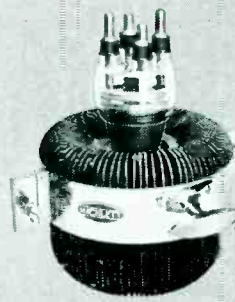

ML-889RA



ML-889A

**M**ACHLETT LABORATORIES, Incorporated, one of the country's earliest producers of electron tubes, and today the world's largest supplier of tubes for X-ray purposes, brings to the radio and industrial fields its half century of electron tube experience. The tubes illustrated are typical examples of the Machlett line of radio transmitting and industrial tubes.

Machlett's comprehensive background of leadership in the design and production of X-ray tubes places it in a most effective position to meet the increasingly stringent requirements of modern electron tube manufacture. The production methods used in the manufacture of quality X-ray tubes are, more than ever before, essential to meet the constantly increasing requirements for higher power, higher frequencies and higher voltages in practically all fields of electron tube application. Processes essential to assure quality, performance and long useful life at voltages of 50 KV and higher, precision assembly of parts for the accurate control of electron stream, complete and permanent outgassing of the assembled tube and its individual parts have long been characteristic of X-ray tube manufacture and inherent in Machlett's design and productive operation. These skills and techniques developed for, and long used in its X-ray activities, now find unique additional value in their application to electron tubes for radio and industrial purposes.

The Machlett background of almost 50 years of continuous electron tube production, modern, laboratory-like manufacturing facilities, and up-to-the-minute experience assures the user that he will receive tubes engineered and processed for a long life of trouble-free operation.

For complete information write our nearest representative, or the factory at Springdale, Connecticut.

**MACHLETT LABORATORIES, INC., Springdale, Connecticut**



ML-892



ML-207



ML-88C



APPLIES TO RADIO AND INDUSTRIAL USES  
ITS 49 YEARS OF ELECTRON TUBE EXPERIENCE

# A NEW DEVELOPMENT IN SANGAMO CAPACITORS

# PLASTIC MOLDED

# PAPER TUBULARS

**Now**

[ LIKE MICAS ]

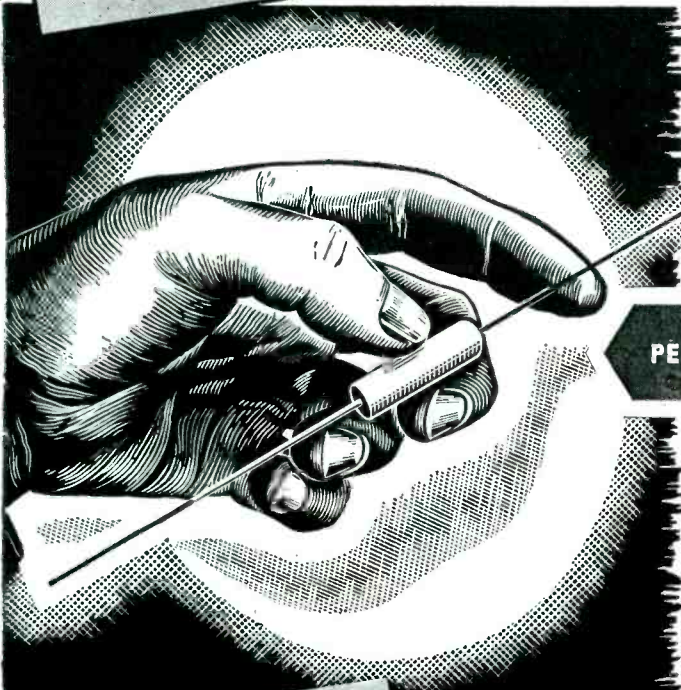

IN Nineteen hundred and twenty-three, Sangamo made capacitor history by being first to develop successfully molded mica capacitors. History repeats itself today, as again Sangamo is first to offer, this time, paper tubulars—molded, like

**PERMANENTLY SEALED AGAINST MOISTURE**

micas in a thermo-setting plastic! The same advantages, derived in the past, from molding micas, are now inherent in the new plastic molded paper tubulars: capacity values are permanently sealed in—moisture is sealed out; the life of these tubulars is prolonged; they can be applied at higher temperatures; their finish is smooth, therefore less susceptible to catching dust. Priced only slightly higher than ordinary types, Sangamo Plastic Molded Paper Tubulars are readily applicable wherever ordinary types are used—but are much more economical and satisfactory in the long run.

**NEW ADVANTAGES OF MOLDED TUBULARS**

- Moisture can't get in.
- Capacity values won't change.
- Applicable at higher temperatures.
- Longer Life. Low power factor.
- Molded, non-dust-catching finish.

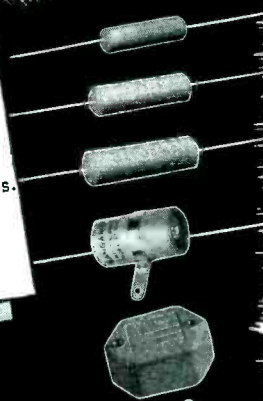

WRITE FOR NEW CAPACITOR CATALOG

- MOLDED Paper Tubulars
- Metal-Encased Tubulars (Paper)
- Transmitting Oil-Filled
- Bathtub (Oil or Wax-Filled)
- Diacitor (A Paper Transmitting)

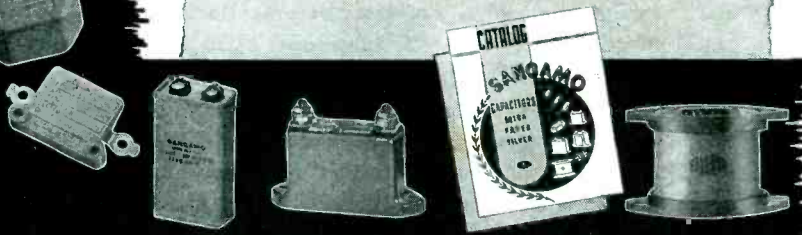

**CHECK YOUR REQUIREMENTS AGAINST THE SANGAMO LINE...**

- Mineral Oil (For E Characteristics)
- Failast Capacitors (Paper)
- Motor Starting, for A. C. and D. C.
- Tubular Transmitting (Oil-Filled Paper)
- Tubular Transmitting (Diacitor, Paper)
- Receiving Micas
- Transmitting Micas
- Silvered Micas
- Silvered Mica Buttons

**SANGAMO**  
**ELECTRIC COMPANY**  
 SPRINGFIELD • ILLINOIS



HERE'S WHY YOU SHOULD USE  
**THE NEW**  *Ceramic Insulated*  
**MULTI-CONTACT CONNECTOR**



This type of outer shell construction is suitable for multi-conductor cable or open wiring. Shell construction for use with shielded cabling is also available on request.

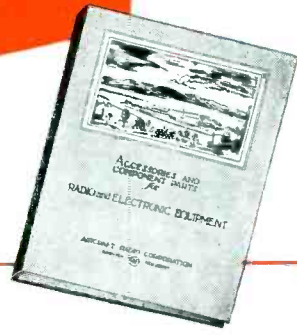
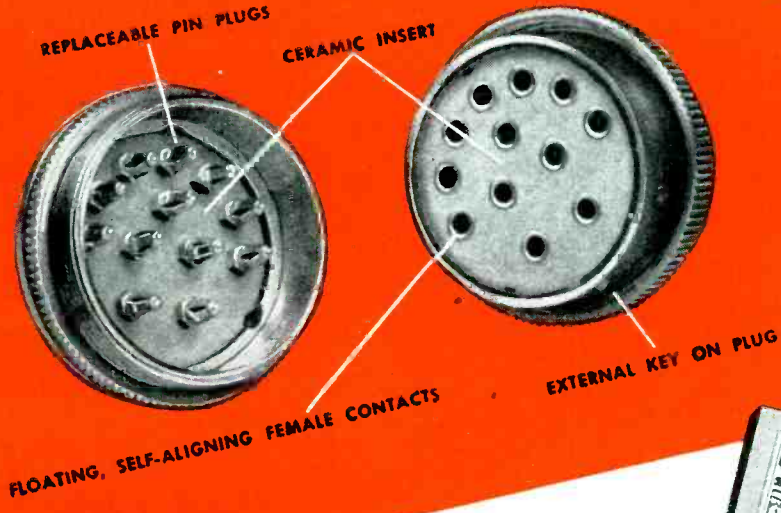

**ALSO AVAILABLE:** Free, illustrated catalog of A.R.C. components, including

- Variable and Adjustable Air Condensers
- Sealed Condensers, Chokes and Transformers
- Miniaturized D. C. Relays
- Precision-Built Switches
- Snap-slide Fasteners
- Mica Base Terminal Boards
- Microwave Plumbing and Accessories

Ceramic insulation, the latest development in multi-contact plug and receptacle design, is now brought to you by A. R. C. The ceramic type of insulation combats the common problem of carbon-tracking due to flashover, thus eliminating the possibility of sustained short circuits and permanent damage to connectors or equipment from this cause.

Other features of the Ceramic-insulated connector include the use of replaceable pin plugs and floating, self-aligning female contacts. Similar in general appearance and dimensions to A. R. C. Bakelite-Insulated Plugs and Receptacles, the Ceramic Type are completely interchangeable with them, and are available in 4, 6, 8, 12, and 19-pin combinations.

Your inquiries are invited. For complete information, write

**AIRCRAFT RADIO CORPORATION**  
 BOONTON, NEW JERSEY



# PERMANENTLY LOCKED

...against  
external  
damage

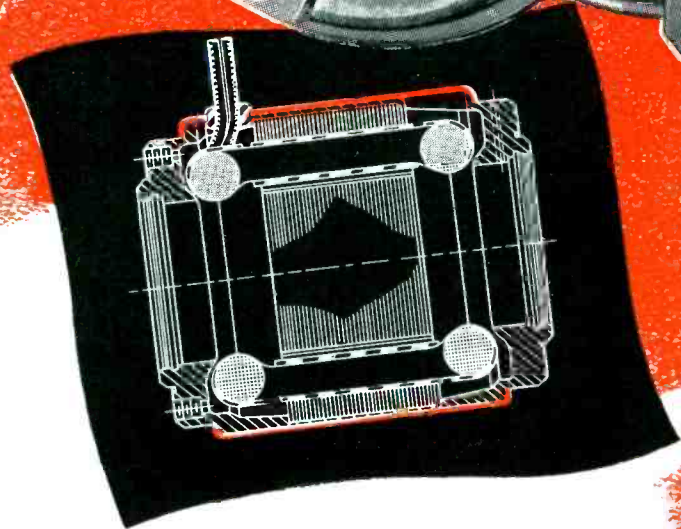

**D**erived from our exclusive war-time design which won high praise in service, the type 73 frame represents a notable step forward in the mechanical protection of motor windings. The two end castings and the lamination stack are carefully aligned and are permanently locked in place by the drawn shell which is spun over them. Thereafter, the windings cannot be scratched, cut, dented, broken or tampered with, no matter how often the rotor is removed or bearings are replaced.

## *Other Features* OF E.A.D. MOTORS

- (1) Replaceable "capsule" bearings.
- (2) Snap-ring construction for easy disassembly.
- (3) Radically improved cooling means, insuring long life with minimum size and weight.

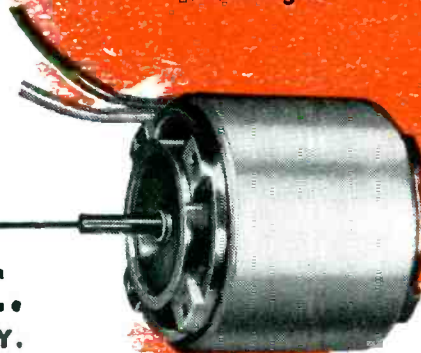

## EASTERN AIR DEVICES, INC.

585 DEAN STREET • BROOKLYN 17, N. Y.

An Affiliate of THE FRED GOAT CO., INC., Est. 1893

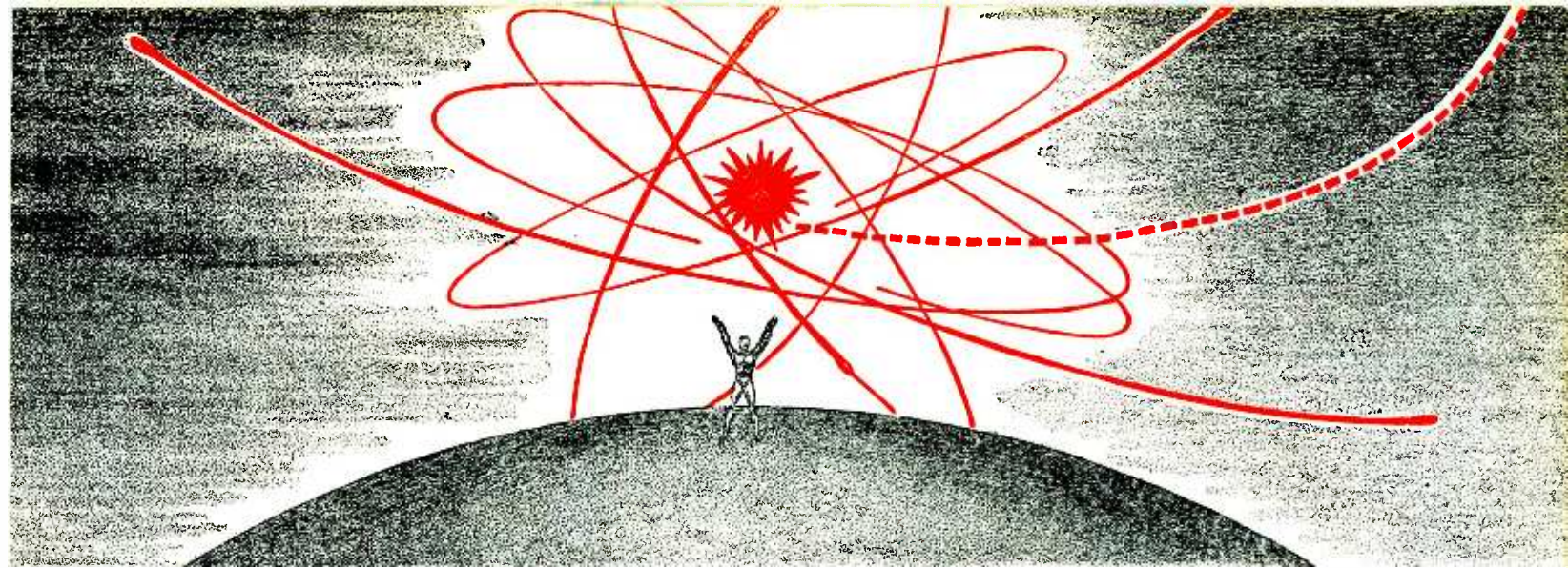

# MAN vs ATOM - YEAR 1

WHEREIN WE SIGNALIZE THE FIRST ANNIVERSARY OF THE ATOMIC AGE, CONSIDER THE ALTERNATIVES INHERENT IN BOTH GOOD AND EVIL POTENTIALITIES OF NUCLEAR FISSION, THEN VENTURE A GLIMPSE INTO THE FUTURE

**A** YEAR AGO, July 16, 1945, at Alamogordo, New Mexico, man created the first atomic explosion. Most impressive events diminish in stature as they recede in time. This one grows bigger with each passing day. It truly marked the beginning of a new age.

As Year 1 of the Atomic Age ends and Year 2 begins, we are engaged in three portentous projects.

At Bikini Atoll we are detonating the fourth and, possibly, the fifth atomic explosions in the history of the world.

At Oak Ridge, Tennessee, we are building the first atomic energy plant for peaceful purposes.

Most important, in New York we and all the other United Nations are engaged in the first attempt to subject atomic energy to international control. Literally, the fate of the world hangs on this attempt.

As this introduction is written, the United Nations Atomic Energy Commission has just begun its work. People everywhere pray for its success—for their own sake, but even more for their children and for their grandchildren. If this Commission fails let everyone everywhere be warned: the world has taken a step toward destruction.

As we enter the second year of the Atomic Age, the nations of the earth are embarked on an atomic armaments race. There is no blinking that fact. We have had official notice served on us. Therefore, we must understand that unless the United Nations Commission can

arrest the drift of events, we are moving toward a horrible war. The Commission must succeed.

The American delegate, Mr. Baruch, has brought to the Commission an ably thought out plan. It would internationalize nuclear science, and release for mankind the beneficent applications of atomic energy. But it would "control" atomic bombs only to the extent of giving the world brief warning of any nation's preparation to use them, so that we might have foreknowledge of disaster.

Therefore, the real and enormous task before the world becomes clear. We must end war. No other control of atomic weapons exists. If war comes, atomic weapons will be used. If they are used, our children who survive will curse their fathers. Understanding the consequences of failure, we *must* succeed.

Because we cannot succeed without knowledge, I have asked my associates at McGraw-Hill to condense into the following pages what we know at the close of Year 1 about this great new atomic force—its basic science, its possible uses and its political repercussions.

President, McGraw-Hill Publishing Co., Inc.

# This Fateful Atom...

## 1 ORE TO U235

Only 0.7% of natural uranium is U235

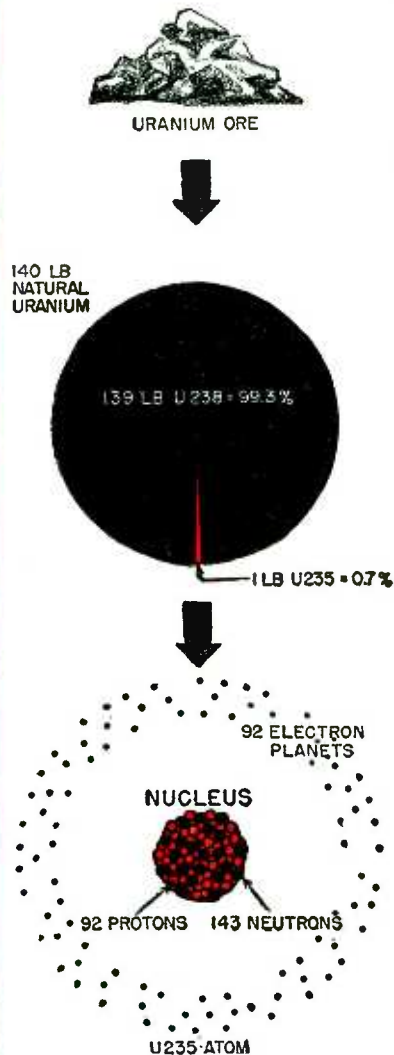

## 2 CHAIN REACTION

Fragments from earlier nuclear explosions smash other nuclei

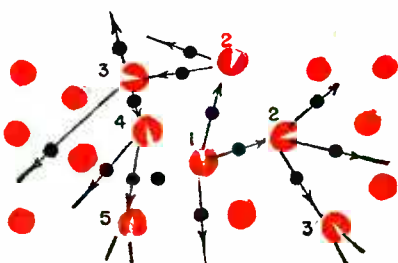

LOOKING BACK twelve months to the birth of Year 1, Atomic Age, we begin to sense the majestic import of the atomic bomb that blasted the naked desert at Alamogordo, N. M., on July 16, 1945. There man first shattered atoms in an explosive *fast-chain* reaction. Then came Hiroshima and Nagasaki.

In every case the fateful atom was either uranium 235 (U235), or plutonium derived from the action of U235 on U238. Every pound of U235 atoms split in these unprecedented blasts yielded the energy of 11.4 million kilowatt-hours, or 1400 tons of coal — slightly more for plutonium.

No matter where one mines uranium ore, the purified natural uranium (Fig. 1) always contains 99.3% of the "garden" variety U238, and a mere 0.7% of the precious U235.

An atom is like our solar system. The central sun is the nucleus—a bunched mass of protons and neutrons, each weighing one unit. The planets are electrons. Each proton has one plus electrical charge — each electron an equal negative charge. There must be as many negative electron planets as positive protons in the nucleus. This is also the "number" of the atom. Neutrons have no charge, but add weight.

The atomic number of uranium is 92 because the uranium atom always has 92 nuclear protons and 92 electron planets. The isotopes U238 and U235 differ only in the number of neutrons; U238 has 146 neutrons, and weighs  $92 + 146 = 238$  units. U235 has 143 neutrons, and weighs  $92 + 143 = 235$  units.

Ordinary chemical reactions, such as TNT explosions, release only a fraction of

the modest energy of the whirling electrons in the outer atom. Nuclear reactions unlock the immensely greater energies which bind together the nucleus.

Even the gentle tap of a slow-moving neutron bullet will split the atom of U235 or of man-made plutonium into two medium-weight atoms, yielding also one to three spare neutrons plus energy. Thus these *fissionable* materials supply both their own bullets and a highly sensitive lot of high-explosive targets — a perfect setup for a *chain reaction* (Fig. 2).

Chain reactions work like chain letters. Neutrons from one nuclear explosion hit and explode other nuclei. But, since atoms are mostly open spaces a chain started in a small block of U235 or plutonium quickly dies out because most of the released neutrons escape from the block.

The bigger the block, the smaller will be the percentage of escaping neutrons, and the more left to split other nuclei. When the block is rapidly built up beyond a certain secret size the fragments of 1000 nuclear fissions split many more than 1000 additional nuclei. Then fissions multiply geometrically, and the block disintegrates with explosive speed and violence — as in a bomb (Fig. 3).

This bomb explosion is a fast-neutron chain. For economy and ease of control, uranium piles for the gradual release of nuclear energy for commercial purposes will normally use a lean fuel—that is U235 or plutonium diluted with U238, thorium or other less costly materials.

To maintain a chain reaction such piles must be large and artificially stimulated by using carbon blocks or some other *moderator* (Fig. 4) to slow many of the neutrons. Slow neutrons make more hits than fast neutrons because there is more time for them to be swerved from a straight path by the attraction of nearby nuclei, as shown below.

## 3 WHY BOMB EXPLODES

When block of rapidly assembled U235 passes secret critical size it explodes spontaneously

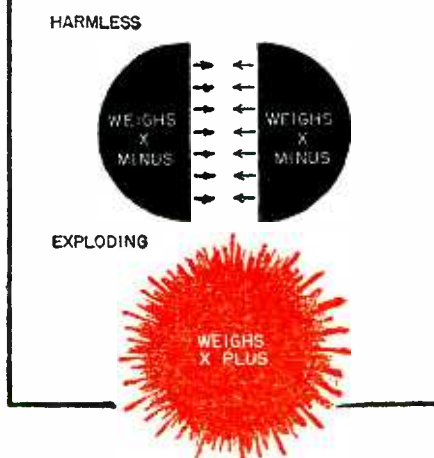

## 4 SLOW NEUTRONS MAKE MORE HITS

A slow neutron is more easily swerved from a straight line

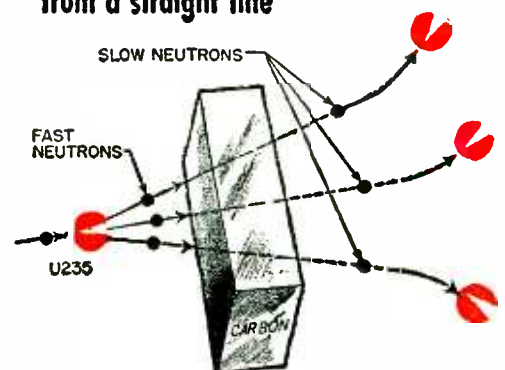

# can Serve Man...

**T**HE FATEFUL U235 ATOM can serve man as a new, compact source of heat energy for power generation, comfort heating or industrial processing. Peacetime applications of atomic energy will use dilute U235 or plutonium as a "fuel," mixed with carbon or some other moderator to slow some of the neutrons and thus keep the chain reaction going.

The diluting agent may be either U238 or thorium, or both. These will do double duty, because neutron bullets convert U238 into the energy-yielding plutonium, and thorium into U233, which may prove equally serviceable.

Thus the commercial piles of the future will "burn" U235 to make other atomic fuels, plutonium and possibly U233, which in turn will deliver heat energy to the pile. In that way it will be possible to get from the pile far more heat than the equivalent of 1400 tons of coal for each pound of U235 split. This highly attractive prospect will speed the day when nuclear energy can compete with coal.

While already mechanically obsolete, the piles making plutonium for bombs at Hanford, Wash. (Fig. 1) reveal the basic principle on which future piles for power and heat will operate. The heat now wasted in vast quantities will be put to work. The plutonium, now removed for bomb manufacture, will be returned to the pile (or left in) as supplementary fuel.

## ATOMIC POWER

The possible everyday applications of nuclear heat pictured in Fig. 2 have been recognized from the very first day of the Atomic Age. Year 2 will see the building of the world's first atomic power plant (a pilot plant) at Oak Ridge, Tenn.

Beyond question such installations will produce power, but it may be years or decades before they prove economical. To compete with conventional plants the piles must first be redesigned to run at temperatures high enough for good power-plant efficiency. Also the techniques of operating piles by remote control through the heavy radiation screens must be radically streamlined.

The Hanford piles run on natural uranium containing only 0.7% of U235. The typical commercial atomic power plant of the future will use more than 0.7% of U235 or plutonium, but less than 50%. This will avoid both the low efficiency of the too-lean mixture and the excessive fuel cost of the rich mixture. It will permit piles of moderate size and take maximum advantage of U238 and thorium as potential sources of plutonium and U233.

One should not expect U235 to replace coal generally in this generation, although a few central power stations and ships will

try it out before Year 10 of the Atomic Age. Plants far from traditional sources of fuels may turn much sooner to uranium and thorium as concentrated heat sources, that may easily be transported even to remote corners of the earth.

Atomic power, in forms now known, is impracticable for automobiles and small airplanes, because of the large initial investment in uranium and the need to carry 50 tons of shielding to protect riders and pedestrians against the deadly radioactivity accompanying nuclear fission.

## RADIOACTIVE ISOTOPES

More immediately important than the heat and power applications of nuclear energy are the services that the radioactive byproducts of pile operation can render. Because these materials act chemically like their ordinary non-radioactive cousins, but can be followed and detected easily, they are expected to play tremendously vital parts in medicine and biology. For more details, see the last page of this section.

## 1 SLOW-NEUTRON PILE

Can make plutonium for bombs—or heat for power, process and comfort

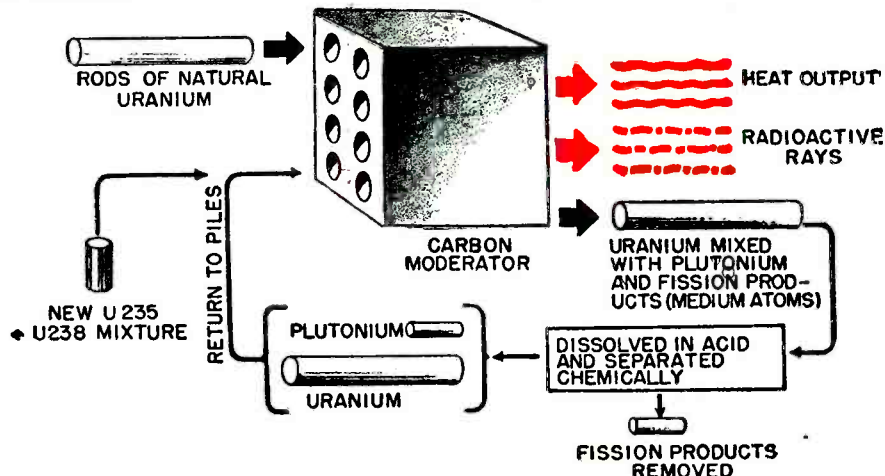

## 2 PRACTICAL APPLICATIONS

Include steam for turbines, process and comfort heating—also heat for gas turbines

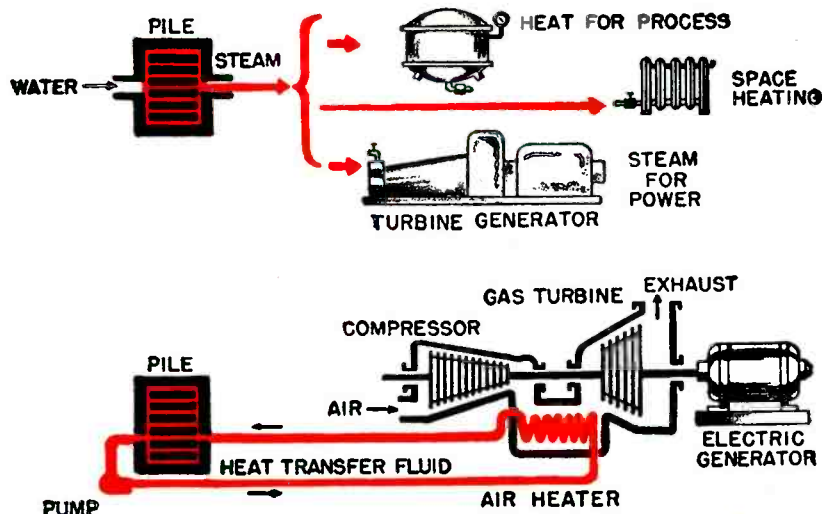

# or Destroy him . . .

**U**RANIUM 235 and plutonium are now man's slaves. They will build or destroy as he orders. Man dreads this vast force only because he distrusts himself. War is proof that man in the mass has never achieved self-control. He has always sought better weapons; yet the perfect weapon now brings him no satisfaction for he sees in the atom bomb his own destruction as well as that of his enemy.

The ultimate benefits of nuclear energy may well surpass its present terrors, but the terrors are here now in awful dimension, and man must face them. He must pay this price for unlocking the wealth of the inner atom.

## ATOMIC BOMB

This page, then, is about the atomic bomb. Nothing will be said here that is not either a certified scientific fact or a conclusion shared by the majority of the leading scientists, engineers and statesmen who have studied the matter.

As already explained, an explosive nuclear chain reaction spontaneously sweeps through a block of U235 or plutonium when the block is rapidly enlarged beyond a certain "critical" weight X. That weight is still a military secret; the official Smyth

report vaguely suggests that it is more than 4 lb and less than 200 lb. Each piece of U235 in the dormant bomb must weigh less than X. At the desired instant of explosion the bomb mechanism assembles these pieces rapidly into a single piece considerably heavier than X.

The explosion itself drives the U235 pieces apart, thereby quenching the atomic conflagration before all the atoms are split, so the bomb efficiency is far less than 100%. For each pound of U235 (or plutonium) atoms actually split, the bomb releases the energy of 1400 tons of coal.

This explosion is mainly ordinary heat at work in unprecedented concentration. Bomb metals become incandescent vapor millions of degrees hot. This, and the enveloping sphere of glowing air, radiate a blinding flash that chars human flesh at half a mile and blisters at over a mile. There is a destructive shock wave (sound) and a second-long hurricane of unimaginable force — the outrushing of the expanding heated air. Deadly neutrons and gamma rays speed out from the bomb.

A single atomic bomb killed about 100,000 at Hiroshima. Fewer died at Nagasaki only because the circle of potential destruction included much vacant land. Bombs ten times more powerful can be made by the thousands in any major industrial country with the plants and the know-how. One bomb could saturate Minneapolis or downtown Manhattan.

Many experts estimate that a complete set of American atomic "secrets" and blueprints might save a foreign power two to three years at best in its race for atomic arms. With no help at all from us, any advanced industrial nation can, in five to ten years, acquire the raw materials, the plants, the know-how and enough bombs to knock out the big cities of any other country overnight. In Year 2 of the Atomic Age this arms race is already on.

It will not fail for lack of raw materials; every country has lean ores worth working for bombs.

## THE CHEAPEST DEATH

Cost need not deter, for the atomic bomb is by far the cheapest method of destruction ever devised. General H. H. Arnold estimates that atomic bombs can be manu-



A single improved atomic bomb can devastate ten square miles of city

factured and delivered for less than \$500,000 per square mile of destruction.

Don't be misled by the two billion dollars America spent on a project that dropped only two bombs on the enemy. New plants can be built at a fraction of wartime cost, and the investment spread over thousands of bombs, not just two.

## NO DEFENSE

So the bombs can be made in ample quantity and paid for, but can they be delivered? The answer is: "Yes; by the time the bombs are ready they can be delivered anywhere and overnight." If the defenses of the target country are weak, piloted planes can get through in ample number. Ten percent would be enough.

For more effective delivery radio-steered pilotless planes and rockets can carry the atom bombs faster than sound. Such weapons will be almost untouchable by either anti-aircraft artillery or manflown fighters.

Greatest threat of all will be the transoceanic rockets. The German V-2 rocket, which never once was stopped by Britain's defenders, points one way. It needs only transatlantic range (with atomic propulsion) and an atomic bomb in the nose. Forty-six feet long, loaded with 7500 lb of alcohol fuel and 11,000 lb of liquid oxygen, the V-2 of World War II rose 60 miles in the air and arced 200 miles in five minutes to deposit one ton of TNT in London.

Seeing so many strange things come to pass, the man in the street cannot distinguish between possible miracles and the impossible variety. From the very start of the Atomic Age he has been hoping for a "ray" that will explode the atom bomb far off. Competent scientists and engineers say that cannot be.

There is no known defense against the atomic rocket attacking at mile-per-second speed



The only way to bring down a 3500-mile-per-hour rocket at a safe distance is to chase it with your own 4000-mph rocket. You can't win at this game often enough to establish ironclad protection.

The only specific defense against the atomic rocket known in Year 2 of the Atomic Age is to disperse all cities and put key industries underground. This would be very costly in time, money and national morale.

#### MORE AND BETTER BOMBS?

Some will ask whether the U.S., as the most powerful industrial nation, could not build more and better bombs and carriers than any other nation. Probably yes, but there is still no real security. If the "weak"

opponent has enough atomic weapons to destroy us once, what advantage is there in being able to destroy him twice?

Shooting first could protect us now, but not after the world is atomically armed. If we were to destroy the enemy's cities, we would probably miss his well-concealed and protected bomb magazines and rocket launchers. A few minutes later he could return the atomic fire. In brutal simplicity, that is the picture of future atomic war. Everybody loses.

At this point one grasps at another straw: "If everybody is to lose who would be so foolish as to start an atomic war? And didn't the Germans refrain from using gas for a similar reason?" Possibly yes. It *may* work that way. But in a world

atomically armed to the teeth some nervous finger *may* pull the fatal trigger.

#### ONLY ONE WAY OUT

Throughout history each new offensive weapon has called out its appropriate defense. But now the offense leaps centuries ahead in a single bound and the defense lies almost helpless everywhere, unless some technical protection, unknown as Year 2 begins, can be devised.

The situation is extremely dangerous. There is no clear way out except through some sort of international action first to stop the atomic arms race and, before it is too late, to hobble war itself.

Can it be done? Perhaps not, but there is no alternative except atomic chaos.

# ...so he faces the Atomic Dilemma...

THE NUMBERED statements that follow in somewhat logical pattern are too fateful to be accepted on anybody's say-so. Every reader should test them in the light of his own information and understanding.

The points below sum up the conclusions of the previous article — and these in turn reflect a great mass of thought and discussion among leading scientists, engineers and statesmen close to the problem. To an amazing degree they concur on both facts and conclusions. For authoritative statements of their line of thought, in detail not possible here, the reader should see the recent book, *One World or None*.

## THE DILEMMA

**Nations must either face the probability of an atomic World War III, which would surely be the most deadly in history . . .**

**Or, the experts propose, yield both atomic weapons and war potential to international authority backed by superior force.**

### What the Experts Say

1. In five to ten years any major industrial nation can make enough atom bombs to destroy all the major cities of any other country overnight.
2. This assumes no "secret" information or other help from us.
3. The necessary uranium ores will be at hand.
4. The cost will not be too high.
5. The bombs produced can then be carried thousands of miles by bombers, or by atomically powered guided missiles moving faster than sound.
6. There will probably be no effective military defense against such weapons.
7. Dispersing cities, and putting key industries deep underground, will give some protection if accomplished in time,

but at incredible cost in money and human discomfort.

8. In a world atomically armed, nations can probably protect their bomb stocks and rocket launchers from enemy assault.
9. If so, nation A can destroy the cities of any other nation B, after which B's rockets will destroy the cities of A. Shooting first will not win an atomic war.
10. This knowledge may not restrain the trigger finger of a suspicious power.
11. Having more and better atomic weapons than the other fellow won't help much if he has enough to destroy us. No use to kill a man twice or rebomb urban ruins.
12. Every nation is vulnerable in the Atomic Age, including the U. S. A.
13. National security will be impossible without (first) international control of atomic arms and (not too long there-

after) international control of all war potential, both backed by superior physical power.

14. If action to this end is long delayed, it may become impossible to halt the atomic arms race already started.

15. At best, the necessary degree of international control, with some real delegation of national sovereignty, will be a revolution in human affairs. It may prove to be humanly unobtainable at this time. If so, men and women everywhere must face the probability of an atomic third world war—by far the most destructive in all history.

In this atomic age no nation can be safe through its own unaided might



# ...and the Great Debate unfolds

**A**TOM YEAR 1 has probably been marked by more debate on a single subject than any other twelve months in the world's history. Social, economic and political as well as purely technical issues have been pressing for realistic solution. Let us look at these issues and see where we stand:

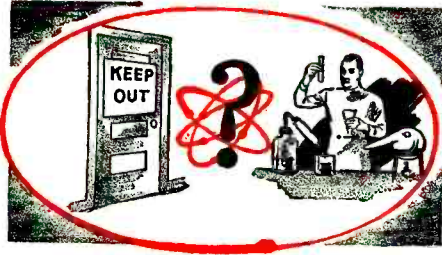

## SECURITY VS. FREE SCIENCE

Throughout the first year of the Atomic Age hot debate has raged around "keeping the secret of the bomb." To prevent potential enemies from making atom bombs some have urged a complete black-

out of all phases of atomic energy — even of the scientific fundamentals of nuclear physics. Others have sought immediate and complete disclosure of all bomb "secrets," both scientific and technological. These have held that such information cannot be effectively hidden, that secrecy blocks progress and breeds wars.

A year of debate has brought the great mass of vocal opinion to this middle ground: (1) Ease restrictions on the exchange of basic physical knowledge. (2) Release for industry's benefit many of the devices and methods developed for the bomb project. (3) Hold tight to specialized information on atomic bombs and bomb-material production until international safeguards are fully operative.

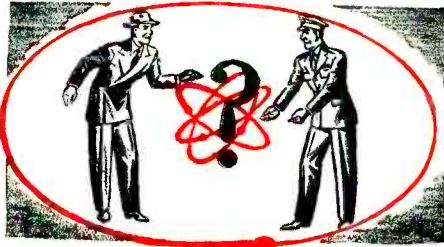

## CIVILIAN VS. MILITARY

Because the atomic bomb is the world's greatest weapon, the armed forces would like to control it. But because atomic energy can also be used for peaceful, beneficial purposes, civilian control seems equally essential. These conflicting viewpoints had their strong proponents before the Congress which finally reached a fairly satisfactory compromise in the Atomic Energy Bill of 1946, setting up a competent civil board with which the armed forces will have continuing liaison. As we go to press, just before Year 2 of the Atomic Age begins, this bill has passed the Senate, but there is still a question how rapidly it will be enacted into law.

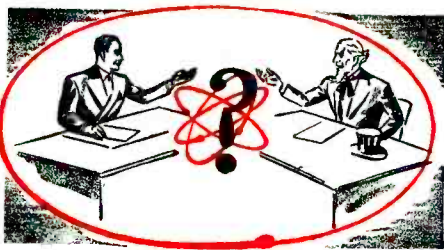

## PRIVATE VS. PUBLIC

Atomic energy is "too big" and "too hot" to be handled privately. It must be nationalized and internationalized. The questions are *how* and *to what extent*. Fortunately, as the "boxes" on these pages show, there are means that may attain reasonable safety against misuse of the atom, and still do so without public control of many "non-dangerous" applications.

## DOMESTIC CONTROL AS PLANNED IN THE ATOMIC ENERGY BILL OF 1946

*McMahon Committee Bill contains the following provisions.*

**Policy.** Declares it the policy of the U. S. to develop and utilize atomic energy to improve the public welfare, increase living standards, strengthen competitive enterprise and promote world peace.

**Organization.** Establishes the Atomic Energy Commission (AEC) of five administrators to direct four divisions on research, production, engineering, and military applications—to work in liaison with three committees from (1) the armed forces, (2) outstanding civilians, and (3) joint Congressional representatives.

**Production.** AEC to own and operate (under management contracts with industry if deemed desirable) all facilities for the production of fissionable materials, such products to be distributed under license for private industrial and medical research.

**Military Application.** AEC to engage in development work and produce atomic bombs as directed by the President, to be delivered only on his order to the Armed Forces.

**Industrial Utilization.** Permits AEC to conduct research, design and manufacture equipment for atomic-energy utilization, license its use, produce and sell power obtained as a byproduct in the production of fissionable materials. Directs AEC to give widest safe scope to private initiative.

**Control of Information.** AEC to enforce a ban on the dissemination of restricted data that might be used to injure the U. S. or secure advantage to a foreign nation, yet to provide leeway for ultimately relaxing restrictions as future conditions warrant.

**Patents and Inventions.** No private patents permitted for production of fissionable materials or their utilization for military weapons, but AEC will justly compensate for such inventions, when made by private citizens. Patents for non-military applications may be purchased or condemned by the AEC only when public interest is affected.

**Appropriations.** "Such sums as may be necessary and appropriate to carry out the purposes and provisions of the act" plus unexpended funds of the Manhattan Engineer District.



# while Time runs out



## NATIONAL VS. INTERNATIONAL

Born of nationalism, the Atomic Age began when three nations discovered a weapon that today gives them the greatest military power on earth. The prime question is: Shall the atom remain the

servant of its conqueror, nationalism?

During Year 1 of the Atomic Age the Truman-Atlee-King declaration, the masterly report of the State Department's atomic consultants, and the U.S. representative on the United Nations Atomic Energy Commission, have all called for international control of atomic energy. Year 2 will start with no such control. This failure to decide and act is in part a natural result of the extreme difficulty of the problem and the obvious dangers of unwise decisions. Nations everywhere face a triple dilemma in this Atomic Year 2: the dangers of nationalism, the dangers of internationalism, the supreme danger of not being able to make any decision in time to meet the atomic bomb threat.



Leading industrial nations can produce atomic bombs in five years, competent scientists announced after Hiroshima. Already one year of the precious five has been consumed in debate without international action. Soon it may be too late to check the growing momentum of the atomic arms race.

## INTERNATIONAL CONTROL AS PROPOSED BY THE U.S. TO U.N. ATOMIC COMMISSION

*Baruch statement follows constructive path laid out by Atomic Consultants in "Acheson-Lilienthal Report."*

**The Plan.** The U. S. has proposed that all nations band together to outlaw the use of atomic energy for war and to promote and harness its development for the benefit of mankind. To this end an International Atomic Development Authority would be set up, and to it the U. S. would turn over, at various stages of its organization, all atomic bombs, know-how, raw materials, facilities, and stockpiles of fissionable material. Thus IADA eventually would supersede national authorities on some matters and supplement them on others.

**Owner and Operator.** IADA would take over from national authorities or private ownership full management and control of all atomic energy matters that afford a possible threat to World security. These include:

1. Raw Materials—Supplies of uranium and thorium to be inventoried, controlled, and developed by IADA.
2. Facilities—IADA to control and operate plants producing fissionable materials and to own and control their products.
3. Research—IADA to undertake research and development on all aspects of atomic energy and to possess exclusive right of research on atomic explosives.

**Private Initiative.** Will have its chance to push forward the use of atomic energy for peacetime (non-dangerous) purposes. With IADA providing raw materials and carrying out necessary inspection, national and private enterprise may operate "safe" power piles, and produce and use radioactive isotopes for research, clinical and other applications. Radioactive isotopes produced by IADA also can be distributed for peacetime use.

**The Mechanics of Safety.** No plan is a certain guarantee against future atomic war. This plan should, however, prevent surprise attack with atomic weapons; for IADA is to buttress positive ownership or management controls with wide powers of inspection. Obviously, successful inspection rests on complete freedom of access or egress in any area.

**Sanctions.** At the heart of the plan lies the problem of penalty for violation—a matter for profound statecraft. To the U.S., one aspect of sanctions appears crystal clear: Here is an area where the veto right now held by the five great Powers must be redefined if it is not to be incompatible with the meaning and purpose of the proposed control.

## TIMETABLE—ATOM YEAR 1

1. July 16, 1945. World's first atomic bomb detonated in New Mexico.
2. July 26, 1945. President Truman and Prime Minister Churchill issue Potsdam ultimatum threatening Japan's destruction if she continues.
3. August 6, 1945. Atomic bomb dropped on Hiroshima.
4. August 9, 1945. Atomic bomb hits Nagasaki.
5. August 11, 1945. Army releases Smyth Report on "Atomic Energy for Military Purposes."
6. August 14, 1945. Japan accepts terms of Potsdam declaration.
7. November 15, 1945. Truman-Atlee-King issue declaration of intention and procedures looking toward international control of atomic energy by United Nations.
8. March 28, 1946. State Department issues Acheson-Lilienthal Report on the "International Control of Atomic Energy."
9. April 12, 1946. Manhattan Engineer District announces program for experimental development of atomic power.
10. June 1, 1946. "Atomic Energy Bill of 1946" passes Senate unanimously, is referred to House of Representatives.
11. June 14, 1946. First meeting of United Nations Atomic Energy Commission (Bernard Baruch as American member). Manhattan District announces availability of radioactive isotopes for research use.
12. July 1946. Joint Army-Navy tests of atomic bombs at Bikini.

# ...but if Man Masters Atom...

**I**F MUTUAL DESTRUCTION by the atomic bomb can be avoided, the first century of the atomic age will bring immense advances in scientific knowledge, health and living standards. Already many prospective benefits can be outlined, but those we can neither foresee nor suspect may be even more important.

This prediction is grounded in scientific experience; the most fundamental discoveries have always been the most fruitful. The study of molecules gave us chemistry. Faraday's experiments with electricity and magnetism are the foundation stones of the great electrical industry. Can one expect any less from an understanding of the heart of every atom?

## BENEFITS

Atom-splitting benefits clearly visible today fall mainly in three classes: (1) heat and power applications of the uranium piles; (2) general industrial applications of equipment and methods originally developed for the bomb project; (3) chemical, biological and medical uses of the "tagged atoms" (radioactive isotopes) now abundantly available from pile operation.

It is now evident that the energy yield of the U235 in an atomic pile can be multiplied many times by returning to (or leaving in) the pile the plutonium and possibly the U233 produced respectively from the U238 and the thorium in the pile. This is an indirect way to "burn" inexpensive U238 and thorium, and thus greatly extend the supply and reduce the cost of atomic fuels.

## POWER APPLICATIONS

Although present piles run at low temperatures, it is certain that temperatures high enough for the efficient operation of steam and gas turbines will be attained. Already an experimental atomic power plant has been ordered. Atomic power for certain remote installations (say, for heating Arctic airports) may not be far off.

In five or ten years uranium piles will be driving a few experimental ships and submarines. In 20 or 30 years uranium may begin to compete widely with coal as a fuel for suitably situated large central heating and power plants. The 50-ton minimum weight of shielding rules out nuclear power for automobiles and small piloted planes.

## SPECIAL USES

Some day ultra-high temperatures from splitting atoms will be used for special industrial operations on metals and other materials. Even the dread atomic bomb might easily serve peaceful ends — blasting lakes in deserts, changing the course of rivers, leveling mountains.

## INDUSTRIAL BYPRODUCTS

The special industrial equipment and methods developed for the bomb project will find hundreds of important uses — mostly for purposes unrelated to atomic energy. These developments include pumps with neither seals nor leaks, leak detectors of amazing sensitivity, ultratight welding, a portable mass spectograph for quick and automatic gas analysis, new ways of handling corrosive and poisonous materials, new diffusion barriers for the separation of gases and of petroleum products.

## TAGGED ATOMS

Yet more important than any of these, in the long run, will be the hundreds of radioactive isotopes now available as by-products of pile operation. Chemically indistinguishable from the ordinary forms of the elements, these isotopes serve as tagged atoms or "spies" if mixed with common stable atoms of the same species. They "fly with the flock," and can later be identified as surely as banded birds. With these amazing tools of research, the course of any element or compound may be traced through the bodies of men, animals and plants. Similarly, tagged atoms

may be used in studying the course of many kinds of industrial and chemical operations.

## BIOLOGY AND MEDICINE

A suspected hyperthyroid condition can be diagnosed by feeding the patient a minute measured amount of radioactive iodine. The click of a "Geiger" counter placed on the patient's neck will tell (1) what percentage of the swallowed iodine concentrates in the thyroid cells and (2) how rapidly that concentration is accomplished — giving a definite indication of the state of the gland.

In similar fashion the radioactive isotopes of hydrogen, oxygen and carbon will trace out the intricate transformations of carbohydrates and proteins in the human body. Radioactive phosphorus will explore the bones. Radioactive iron will show how and where blood cells are formed. Radioactive sodium will time the circulation of blood.

## USES IN INDUSTRY

In chemistry the radioactive isotopes will speed the understanding of metallurgical and organic reactions. In industry they will measure flow, detect leaks, and do other useful work.

Meanwhile the uranium piles will be manufacturing certain radioactive isotopes that can serve as cheap but effective substitutes for high-cost medical radium.

## KNOWLEDGE COMES FIRST

It is already clear that the chief benefits of atom splitting will come first as new scientific knowledge rather than as new engines and gadgets. But in the long run man's new understanding of the inner atom will enrich the whole range of human activity. This has always been the case with less fundamental discoveries in science. It can hardly be less with this most fundamental discovery.

## ATOM SPLITTING WILL SERVE MAN IN:

### CENTRAL POWER PLANTS



### GIANT BLASTING OPERATIONS



### MEDICAL DIAGNOSIS AND TREATMENT



### NEW FUNDAMENTAL KNOWLEDGE



### SHIP POWER PLANTS



### BETTER INDUSTRIAL PROCESSES



### RESEARCH TECHNIQUES



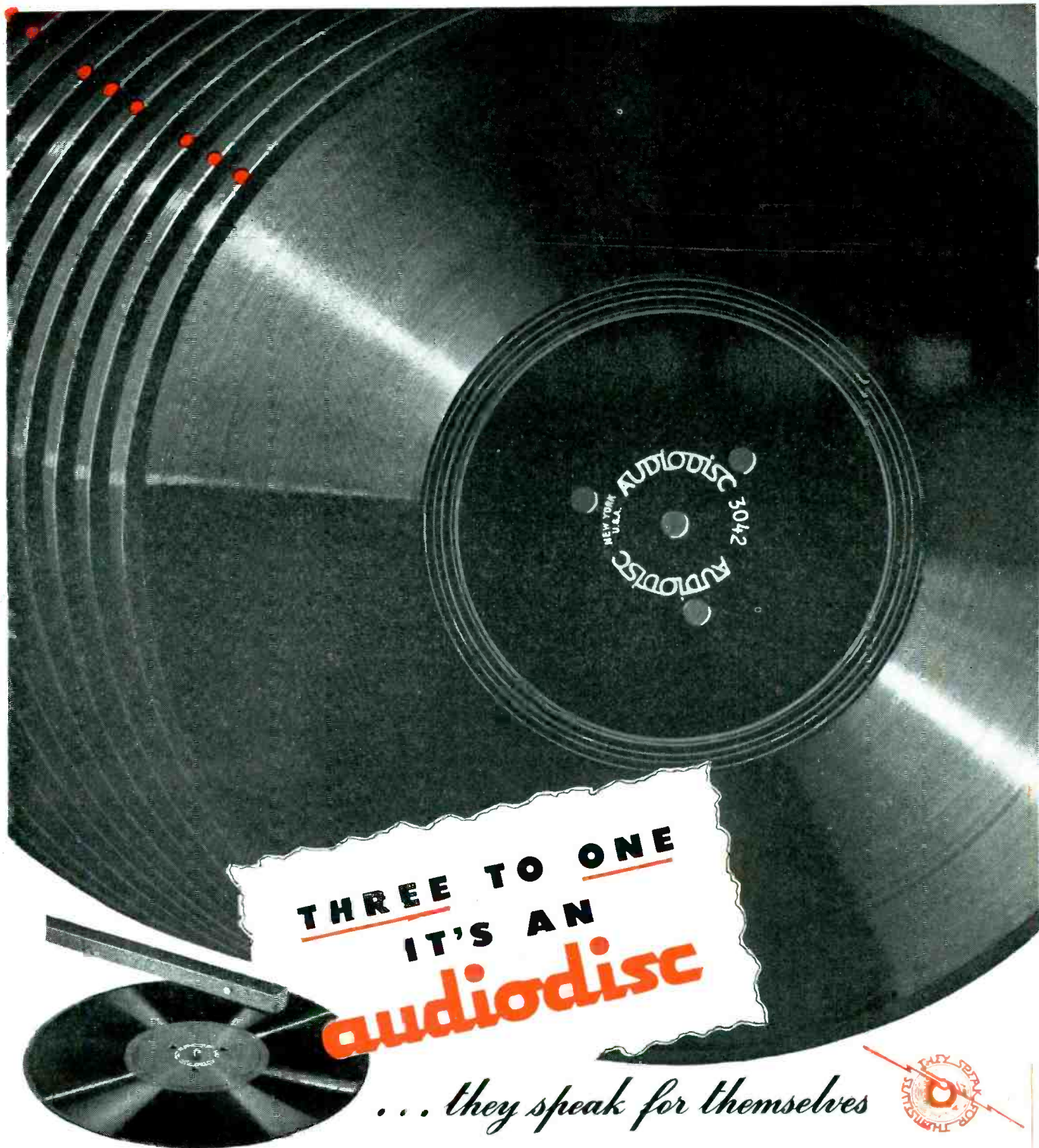

**THREE TO ONE**  
**IT'S AN**  
**audiogram**

*... they speak for themselves*

**IN THE BROADCASTING STATIONS** throughout the nation, when a live program is recorded for broadcast — when an off-the-air program is recorded for rebroadcast — when recordings are made for clients or for rehearsal and audition purposes — when recordings are made for reference files — in fact when any recording work is done, Audiograms are used three to one.

This outstanding preference for Audiograms has been recently confirmed by a double-check survey covering 400 radio stations. Approximately half these stations were called upon and reported the actual number of discs used — Audiograms and others. The remainder reported by letter stating the proportion of Audiograms used to all other makes. In the first group the Audiogram percentage was 81, in the second 78%.

Since first produced, these fine discs have consistently maintained those qualities required in the increasingly important work of radio recording. Thus Audiograms have gained their place of eminent leadership in the field of sound reproduction.

*Audiograms are manufactured in the U.S.A. under Exclusive License from La Soci t  des Vernis Pyrolac—France.*

**AUDIO DEVICES, INC., 444 Madison Ave., New York 22, N.Y.**



*Yes, we make switches... but that's only part of the story*



If any of the publications listed below are not in your Engineering Library, contact your Mallory representative. He'll be glad to make up a special portfolio.

Approved Precision Products Catalog • Electrical Contact Catalog • Electrical Contact Data Book (\$2.50) • Capacitor Catalog • AC Capacitor Data Folder • Grid Bias Cells Data Folder • Heavy Duty Rectifier Catalog • RN Resistor Data Folder • Radio Interference Eliminator Folder • Radio Service Encyclopedia (\$1.25) • Resistance Welding Catalog • Resistance Welding Data Book (\$2.50) • RL, RS, MC, and 3100 Switch Data Folders • Technical Manual (\$2.00) • Replacement Vibrator Guide • Vibrator Engineering Data Folder • Vibrator Data Book (in preparation).

NAME the kind of switch you want and, likely as not, Mallory will be able to supply the very thing you want from standard stock. That's one kind of service that Mallory offers—service that saves you time and money.

Still another kind of Mallory service is available to you in the form of technical literature. The three data folders illustrated above, for example, contain everything your engineers want to know about *standard* switches—show how your switch requirements can be met by Mallory basic designs. Once again, a service that extends beyond the immediate sale.

As Mallory is a pioneer in the field of switches, so it leads in many other precision products. A mere glance at the list of Mallory publications at the left—most of them available to you without cost—will show why so many manufacturers say, "You expect more and get more from Mallory."

P. R. MALLORY & CO. Inc.  
**MALLORY SWITCHES**  
 (INDUSTRIAL AND ELECTRONIC)  
 P. R. MALLORY & CO., Inc., INDIANAPOLIS 6, INDIANA



## CROSS TALK

► **BIKINI** . . . Newspaper men reporting the test "Able" day events were obviously disappointed that the bomb did not go off with much more noise and a brighter flash. Situated as they were 20 miles from the burst the modest boom could not have been as awe-inspiring as if they had been 5 miles distant. A more sober appraisal, however, must convince anyone that a single bomb dropped a quarter of a mile away from its targets and which even at that distance could create the havoc which resulted must be something to take with extreme seriousness.

Aside from man's childish enjoyment of anything that makes a big noise and lots of smoke and the news-men's desire for a more dramatic spectacle, the actual aim of the first bomb drop must not be forgotten. It was to create graded damage from great to slight, not to sink ships. The true aim was to secure data which could be plotted in curves rather than to assemble figures which could be made into a box score. More ships could be sunk by the mere expedient of placing them closer together.

More valuable than any world's record in one-shot ship sinking will be the information for which the tests were planned—the correlation of pressure, temperature and damage to every ship and every part of every ship with distance. Such information is vital if we must continue to live and, if necessary, to fight in an atomic age. In addition the information secured in the field of pure science, particularly with respect to radiation from high-temperature sources, in oceanography, radioactivity, biology and botany will be pure velvet.

► **SEE-SAW** . . . During the war the demand for engineers went up and the demand for salesman went down. This was natural. There was a lot of new equipment to design in a hurry, and the government bought it all.

Business is like a see-saw, striving for a balance

between supply and demand but rarely achieving it more than momentarily. At the moment the demand for engineers is declining, while the demand for salesmen is healthy though not yet robust. This too is natural. The need for new designs is not as critical, and is not likely to be for some time. But salesmen are necessary even to move existing gear. And when materials are readily available it is a good bet that still more of them will be needed.

Manufacturers should preserve their technical staff through times like these, because engineering develops the product upon which long-term success is based. But many of them will not and we might as well be realistic about it. Juniors, especially, would do well to switch from engineering to sales. That is one way, at least, of staying in the business for which they were trained. And technicians who can sell are, as they have always been, a great need of the electronics field.

► **MODERNIZATION** . . . In case you missed it, one of the best modernization stories of this marvelous post-war age broke in the New York papers recently. It seems that four youths headed by a former USS Lexington electronic technician had brought to the ancient art of safe cracking all modern conveniences. Not only did the boys use a walkie-talkie to protect the inside gang, warning them to stop making a racket with their high-speed diamond-pointed drills when a cop came by, but they had developed supersonic listening aids to tell them when the tumblers of the safe clicked, thus giving away the combination. And they were working on an infrared flashlight.

Had the gang not been too lavish with the proceeds of their ingenuity they might not now be in the jug, but, on the contrary, would be well on their way toward their ambition, putting crime on a modern scientific basis.

# READING AID

## For the

**T**O THE AVERAGE INDIVIDUAL, the most tragic handicap imaginable would be loss of eyesight. The loss of any of any of the other senses can, to a large degree, be compensated for by wider use of the eyes. Much more difficult, however, is the substitution of the other senses for lost eyesight.

The loss of visual contact with the persons and the world around, while frightening to imagine, might not in the end be so great a loss as the inability to read, to be completely dependent upon others for the pleasure, education or relaxation of reading.

Wonderful things have been accomplished by the blind in the reading of Braille, but the Braille reader is limited in his choice of reading matter to the relatively small amount of material which has been selected and transcribed into Braille. The talking book suffers the same limitation of choice and in addition it has the psychological disadvantage of forcing the listener to "read" at a predetermined speed, which of necessity must be an average speed, too slow for some and too fast for others. There is therefore great need for some device which would enable the blind to read ordinary printed matter: books, magazines, and type-written letters.

The first known attempt to devise a machine for reading print was made by Fournier D'Albe in 1914. His device, known as the Optophone, divided the lines of type into five horizontal zones. Along a vertical line were placed five spots of light, one in each zone, each spot being modulated at a different frequency. The light reflected from the paper was picked up by a system of selenium cells and, by means of a balancing arrangement, made to produce an audible sound when one or more of the spots rested on the black part of a letter. Thus, as the line of light spots was moved along the lines of

Letters are converted into distinctive sounds by which, it is hoped, a blind person may read this article as well as you. Light from a scanning beam is reflected from the printed page and made to operate a modulated oscillator in accordance with each letter's shape

print, tones or chords were produced, varying with the character of the letters.

This system, while operative and giving a learnable signal, suffered from several limitations. First, the production of five separately modulated spots of light in the required small space introduced difficult mechanical problems. Second, the alignment of the spots must necessarily be very accurate, requiring that printed matter be accurately aligned and clamped to the machine. Thirdly, the range of type sizes which could be read was limited and an adjustment for different sizes was difficult.

#### Requirements of a Reading Aid

From the Fournier D'Albe experiments, several conclusions have been

drawn which are believed valid: (1) A reading device to be successful must have a small, easily manipulated, preferably hand held, probe or stylus for scanning the type. (2) The alignment with the type must be tolerant to such an extent as to make necessary only the simplest, if any, mechanical guides or alignment aids. (3) Different type sizes should be accommodated with no, or a simple, adjustment. (4) The device should be "black reading". That is, it should give a signal from the black letter, not from the surrounding white. (5) The instrument should give a distinctive and easily learnable signal.

A reading device will necessarily produce a signal varying in time because language conveys information in a time sequence as contrasted with

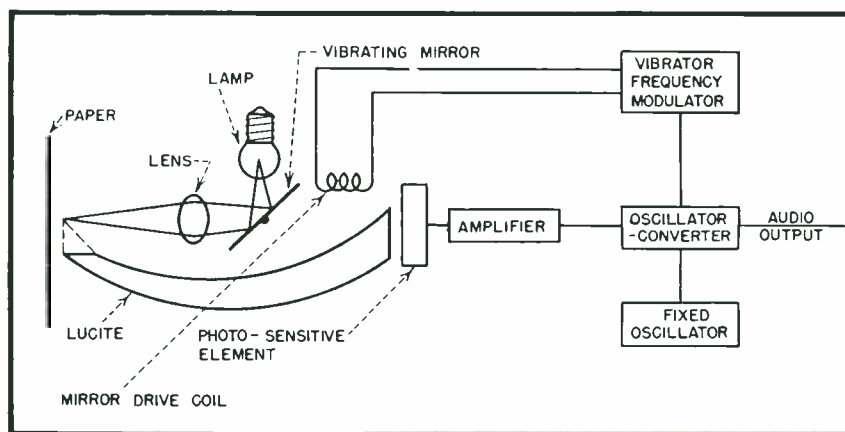

FIG. 1—The light scanning system of the reading aid is shown schematically; the rest of the unit is shown in blocks

# Blind

By  
**V. K. ZWORYKIN**  
and  
**L. E. FLORY**

*RCA Laboratories  
Princeton, N. J.*



To read a printed page, a blind person moves the scanning stylus along each line of type. The electronic reading aid converts the shape of the letters into sounds

pictorial or spatial presentation. The time variation will, of course, be obtained in the usual manner of reading by scanning the page line by line. The stimulus may be auditory, or possibly tactual such as raised characters produced in response to the electrical signal from the scanned print and which are identified by touch. The present discussion will be limited to auditory methods.

There are two approaches to the problem of reading by auditory methods. One is word recognition as is used in ordinary speech and reading, and the other is letter recognition. For high reading speeds word recognition is essential, but simple tests of reading aloud by pronouncing each letter separately indicate that the limit of reading speed by letter recognition would be in excess of sixty words per minute. In addition, the ear or brain has an integrating effect, blending the individual letter sounds into word patterns, as is nicely shown in the case of Morse Code where word recognition is used at high speeds although each letter signal is intact. Thus a letter recognition system may operate as a word recognition system at higher reading speeds.

There are various ways of obtaining information from a line of printed letters, such as scanning with one or more vertical or inclined slits, multiple spots, or rapidly moving spots. A great many of those

methods resolve themselves basically into scanning the print with the equivalent of a narrow vertical slit of slightly more than letter height. The information concerning the parts of the letter under the slit may be used in many ways to produce an audible signal.

There are four characteristics of the print viewed through the slit which are obvious and on variations of which a reading aid must depend for identifying information as the print is scanned by the slit or its equivalent: (1) Total amount of black area under the slit. (2) Integration of the area, that is, is the area a single unit or divided into two or more units. (3) Size of individual units if more than one. (4) Position of the unit or units vertically along the slit.

#### Electronic Reading Aid

In the present device, a small spot of light is caused to move up and down along a vertical line corresponding to the slit mentioned above. In synchronism with the motion of the light spot, an audio oscillator is frequency modulated so that when the spot is at the top of the line the frequency is high and when the spot is at the bottom the frequency is low. The light reflected from the page is picked up by a phototube and used to operate an amplifier tube allowing the audio frequency to reach the reader's ear only when the

light spot is on black. The frequency of the tone that is heard will depend upon the vertical position of the black area. If the black area has a large vertical dimension, the audio frequency will vary appreciably during the period it is applied to the ear, giving a warbled character to the tone, the range of the frequency variation being a measure of the vertical extent of the black area. As the lines of letters are manually scanned, audible information is thus obtained as to number, size, and position of areas of black under the scanning line at any instant. The variation of the sounds representing these characteristics as the letters and words move under the scanning line constitutes the signal applied to the ear.

The frequency of vertical scanning is determined by the reading speed. If, for example, a reading speed of sixty words per minute is assumed, the letter frequency would be three hundred per minute or five per second, on the basis of the standard five letter word. If it is assumed further that a minimum of five complete scans would be necessary to make sure of complete coverage of the letter, then the minimum scanning speed would be 25 cps. In this instrument, the actual scanning frequency is 30 cps. The lower limit of the audio frequency is set by the minimum duration of tone which may be expected. The upper fre-

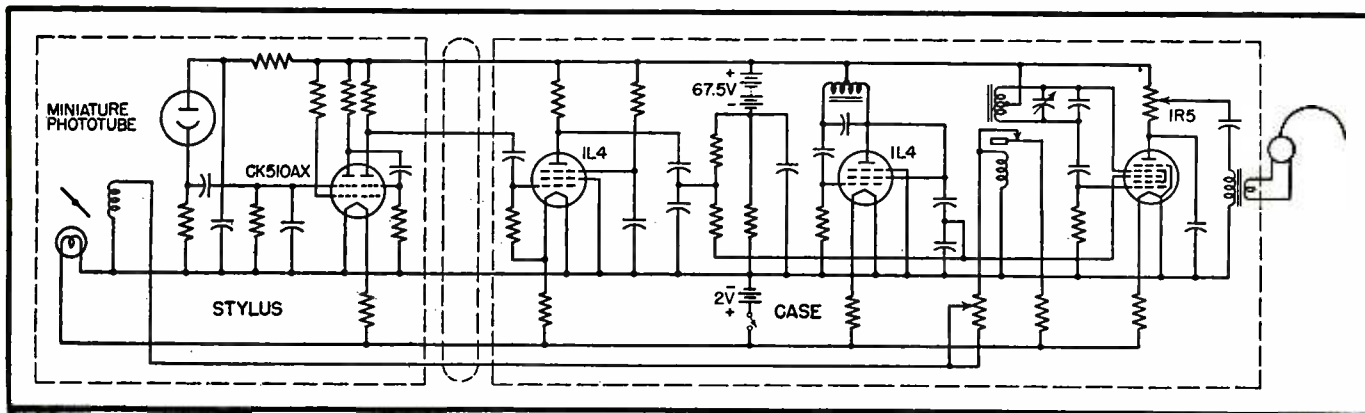

FIG. 2—The reading aid consists of a scanning system and a preamplifier in the stylus, and an additional amplifier and two beating oscillators, one of which is frequency modulated by a vibrator, in a case with the batteries

frequency is limited fundamentally by the limit of audibility; practically by the usual limits of frequency response of components in the small sizes that are necessarily used. In the instrument described, the upper frequency is approximately 4,000 cps.

If the vertical extent of the smallest portion of a letter to be identified, such as the top bar of an *n* or *m*, is taken as 15 percent of the maximum height of letter then the duration of this sound will be, at the 30 cycle (60 scans) rate  $(1/60) \times (15/100) = 1/400$  sec. Then the lowest frequency that can be used to obtain even one full cycle per scan will be 400 cps.

With such a short duration, the sounds lose their tonal character, at least 4 to 12 cycles being necessary to recognize a sound as a tone in this frequency range<sup>2</sup>. There is, however, a distinct difference between a sound of 1/400 second duration at 400 cps and one of the same duration at 2,000 cps, the first being popularly described as a "thump" and the latter taking on the character of a "click". Longer durations, as represented by the vertical parts of an *n*, of course take on a more tonal character.

#### Instrument Operation

The instrument is composed of two parts: the stylus which is hand held, and a small case containing the batteries and auxiliary circuits. The total weight is 5½ lb. A block diagram of the circuit is shown in Fig. 1 and a schematic in Fig. 2.

The audible frequency is gen-

erated by conventional beat frequency methods, the two oscillators operating at approximately 50 kc. One oscillator is fixed in frequency while the frequency of the second is varied. A vibrator similar to the automobile radio type carries a powdered iron armature. The tuning inductance of the variable oscillator is wound on a U-shaped laminated core and so mounted that the powdered iron armature swings very close to the core on its upward excursion, practically closing the gap in the core. This alters the reluctance of the magnetic path and thereby the inductance of the coil and the frequency of the oscillator. A ten percent variation in inductance at 50 kc can easily be obtained by this method with sufficient safety factor to make sure that the armature does not strike the core. The variation of inductance with position of the armature is very nearly logarithmic over the useful range but is influenced to some extent by the shape of the pole pieces and the armature.

The fixed oscillator uses a 1L4 tube in a conventional Hartley circuit. The variable oscillator uses the oscillator section of a 1R5 pentagrid converter tube. The fixed oscillator frequency is applied to the third grid of the 1R5 so that the frequency appearing in the plate circuit is the beat between the two oscillator frequencies. The output circuit consists of a volume control potentiometer followed by a high pass filter step down transformer combination feeding a hearing aid type headphone. The high pass char-

acteristic is necessary to remove any of the 30 cps modulating frequency remaining in the signal. The third grid of the converter is maintained at a potential sufficiently negative to prevent plate current flow. A positive pulse from the phototube amplifier applied to this same grid permits the signal to reach the plate circuit only when the scanning spot crosses a black part of the print.

#### Reading Stylus

An interior view of the stylus is shown in Fig. 3. The scanner assembly and the light collector are shown in Fig. 4. Light is provided by a small aircraft indicator type lamp in the housing at A. The 45-degree mirror *M* and the lens *L* combine to project an image of the lamp filament on the plane of the paper. The mirror is mounted on a magnetized armature which is caused to vibrate by a current flowing in the coil *C*. This vibration causes the light spot to move in a line to scan the print in a vertical direction. The coil *C* is excited by the voltage across the main vibrator coil. A variable resistor in series with the scanning coil is used to adjust the scanning height to match the print being read. The natural period of the mirror armature is adjusted by means of a hair spring as in a watch, so that it vibrates in phase with the reed of the main vibrator.

The light reflected from the paper is collected by a Lucite light conductor *B* and carried along the scanning unit to the phototube, *P*. This phototube is a developmental model of the end view type. The output of the



tube is amplified by a two stage hearing aid type tube in the stylus, followed by another pentode stage in the case. An overall voltage gain of approximately 3,000 is used. The gain of the two stage stylus amplifier is about 300 so that the signal level on the connecting cable is quite high, preventing any trouble from microphonics and stray fields.

The filaments, lamp and vibrator are supplied by a 10 ampere-hour storage cell. The current consumption is about 0.8 ampere so that the battery life is about 12 hours, after which it must be recharged. The plate voltage is supplied by a 67.5-volt hearing aid type B-battery. The total plate current is 2.5 ma, giving a B-battery life of the order of 50 hours.

By releasing and lifting one end of the plastic tray in the top of the case, the batteries are disconnected and made available for instant change. To facilitate battery changing by the blind, two sets of contacts are provided on the under side of the tray, which obviates any attention to the polarity of either battery. An external charger is provided to recharge the storage cell.

In operation, the stylus is hand held. During the learning period some form of guide is necessary but it is hoped that a proficient reader will be able to dispense with any mechanical aid because any wandering from the line will be indicated immediately by a change in pitch of the signal before the deviation is sufficient to cause a loss of letter identity. This change in pitch is made possible by slightly overscan-

ning the letter, which permits some tolerance in the position of the scanner relative to the print without losing any of the information concerning the letter. The pitch of the signal, however, changes with the position of the letter along the scanning line, giving the necessary clue when the stylus wanders from the line.

#### Performance

As was pointed out at the beginning of this discussion, the instrument gives complete information as to the number, extent, and location of black areas under the scanner at any time. By means of this information, it should be possible to reconstruct the complete letters from the signal produced by the instrument. To test this possibility, the vertical sweep on an oscillograph was driven by the voltage on the mirror drive coil; the horizontal sweep was synchronized with the manual scanning of the line; the oscillograph beam was modulated by the output signal. As was expected, complete reproduction of the print was obtained.

The described equipment is not presented as the ultimate solution to the reading problem. It is, however, an approach which has given some interesting results and is believed to possess a number of advantages over previous machines.

Actual learning tests have indicated that quite a high degree of accuracy in letter identification can be attained in a reasonable time. In actual reading tests on simple text, reading speeds in excess of ten words per minute have been reached.

The instrument is not commercially available and before any such equipment can be made available a great many more tests with substantial numbers of blind subjects under controlled conditions will have to be made. Some tests of this type are now in progress as it is hoped that they will produce results which will be very valuable for future work in this field.

This paper is based in whole or in part on work done for the Committee on Sensory Devices, which was formerly under the Office of Scientific Research and Development, on Contract OEMsr-1407 with Radio Corporation of America. The Committee on Sensory Devices is now of the National Academy of Sciences and work is continuing under sub-contract No. 13 of prime contract W-49-007-MD347. The Committee on Sensory Devices, under Dr. George W. Corner, has been very cooperative and helpful in the carrying on of the work. The authors wish also to acknowledge the cooperation of the Haskins Laboratories in New York, The Medical Research Institute of the National Naval Medical Center, Bethesda, Maryland; of Solomon Lasof, C. J. Young and K. Magnusson for their help in working out some of the engineering problems, and of other members of RCA Laboratories for their helpful suggestions.

#### REFERENCES

- (1) Fournier D'Albe, On a Type Reading Optophone, Proc of the Royal Society, 80, 1914.
- (2) Stevens and Davis, "Hearing, Its Psychology and Physiology", John Wiley & Sons.

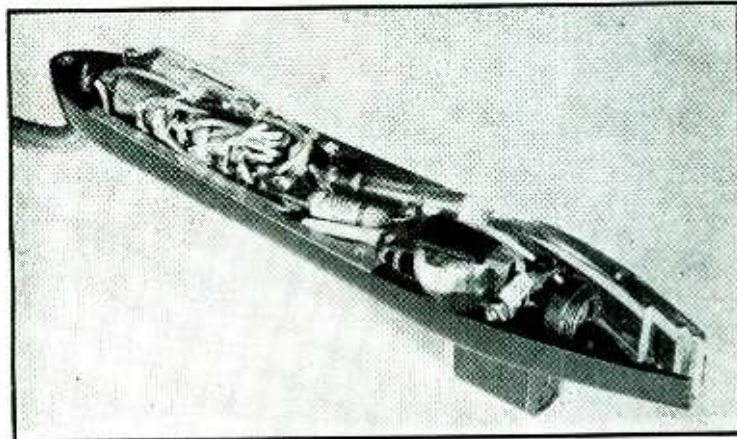

FIG. 3—A Lucite rod conducts reflected light to a phototube. A sub-miniature tube preamplifies the resulting electrical impulse

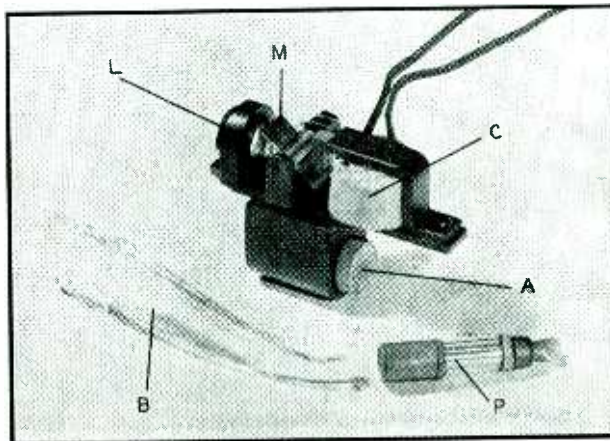

FIG. 4—To reduce the power required to vibrate the mirror, it is mechanically resonated by a hair spring

# Echo Ranging Sonar

Technical details of model QCS/T equipment, which delivers a 600-watt pulse to a magnetostriction projector at some frequency in the supersonic range from 17 to 26 kc. The receiver is an inverted superheterodyne with a 60-kc i-f value, varistor detectors, and a neon-lamp indicator. The echo from an underwater target is converted into azimuth and range indications

**S**ONAR, a word coined from Sound Navigation and Ranging, covers all types of underwater sound equipment used on ships for locating and tracking submarines, for depth sounding, for underwater communication, and as a navigational aid. The most important of these from a military standpoint is echo ranging sonar, used for determining accurately the range, bearing, and motion of an underwater target such as a submarine. A representative example of this equipment, recently declassified, will be described in detail, with emphasis on basic principles and on electronic circuits employed.

## General Principles

In modern electronic echo ranging equipment, pulses of sound energy are transmitted into the water from an under-the-ship sound projector in a directional beam. The sound energy travels approximately 4,800 feet per second in salt water. Upon striking a target or water discontinuity, a portion of the sound is reflected back as an echo to the projector, which also serves as a microphone just as a radar antenna serves for both transmitting and receiving.

The time interval between the transmitted pulse and the returned echo is measured and indicates the range of the target. (Multiplying one-half the time interval in seconds, by 4,800 gives range in feet.) The projector is rotated under water much as radar antennas cover their area of search above water, so that the position of the projector at which an echo is received corresponds to the bearing of the target.

Three major factors limit the distance at which echo ranging in water

is effective: (1) normal spreading of sound waves, which makes received energy vary inversely with the square of the distance from the projector; (2) attenuation of the energy (manifested by heating of the water); (3) refraction or bending of the sound beam as it travels outward from the projector.

Spreading of sound waves is minimized by using a highly directional projector as the sound source.

Attenuation increases directly with frequency, making the choice of sonar frequencies extremely important. Frequencies employed in echo ranging are usually in the supersonic range between 10 and 30 kc. These values are a compromise between two considerations, the attenuation of sound in water and the size of the sound projector. Since directivity is related to frequency just as with radio antennas, at the lower frequencies the size of a projector having the desired directivity would be prohibitively large. Also, at lower frequencies the ambient water noise is loudest because attenuation increases with frequency for noise as well as for desired sounds. On the other hand, too high a frequency calls for excessively high power output from

the projector to obtain a given echo signal strength.

A slight upward bending of the sound beam is caused by the increase of pressure and salinity of the water with depth, because the speed of sound increases with both pressure and salinity. Ordinarily, however, this bending is insignificant in comparison to the bending due to changes in water temperature with depth, illustrated in Fig. 1. The normal effective limit for echo ranging is several thousand yards, but a large negative temperature gradient may limit the range to less than 1,000 yards. A positive temperature gradient has little effect on echo ranging, as ranging is still possible when the path of the sound waves involves reflections from the surface of the ocean.

## Typical Sonar Equipment

A representative example of modern electronic echo ranging and sound listening sonar used on destroyers and smaller antisubmarine ships is the model QCS/T, made by Submarine Signal Co. of Boston and shown in block diagram form in Fig. 2. The installation is divided into three major sections, designated as

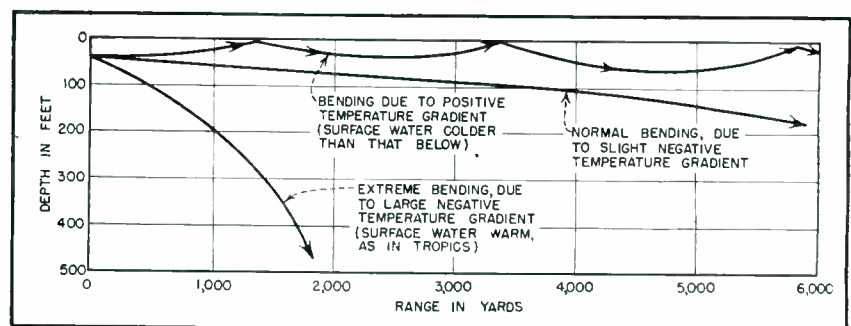

FIG. 1—Bending of underwater sound beams due to various temperature gradients in water

## By RICHARD J. EVANS

St. Paul, Minnesota\*

the driver, the control console (sometimes called the "stack"), and the projector.

The driver consists essentially of a self-excited oscillator that generates a 24-kc supersonic frequency, a two-stage amplifier that builds up the oscillator output to a maximum power of 600 watts, and a keying relay that clicks out the 0.1 to 0.2-second duration pulses at intervals of several seconds. Driver equipment is mounted on a rack in the lower sonar room, usually located in a forward hold of the ship.

The magnetostriction projector, which also serves as a microphone for picking up echoes, is located in a retractable dome under the ship. It is connected through the keying relay contacts to the driver during transmission of a sound pulse, and to the receiver immediately thereafter for picking up the returning echo. Rotation of the projector through a complete circle horizontally, or through a sector of a circle, is accomplished by a training system employing a generator synchro, control transformer, amplidyne control unit, amplidyne generator, and d-c training motor, all controlled by a training handwheel manipulated manually by the sonar operator at the stack.

The dome for the projector is streamlined as shown in Fig. 3 to reduce water turbulence, permitting echo ranging at speeds up to 15 knots. In shallow water the entire dome is drawn up into the hold of the

\* Formerly Instructor in Sonar, Radio Materiel School, Naval Research Laboratory, Washington, D. C.



Control console of representative modern echo-ranging sonar, showing operator tuning the equipment. Training handwheel is at lower right of slant panel on which is the neon-type indicator

ship by an electrically operated retracting mechanism, since it normally projects four feet below the keel and might strike ground in locations where the ship itself would ride clear.

The stack contains a superheterodyne receiver for amplifying the extremely weak echo signals, a range indicator for converting the received echo into a distance indication automatically, and a loudspeaker for pro-

viding an audible echo. Since the range indicator mechanically measures the time between the transmitted pulse and the returned echo, it must also control the keying relay that initiates each pulse.

### Range Indicator

The range indicator consists of a neon indicator light mounted on the circumference of a wheel that is positioned behind a fixed circular range scale. The neon wheel is driven at a constant rate by a synchronous motor, one revolution of the neon light corresponding to 1,000 yards of range. The neon light, which is visible only through a narrow slit of the rotating circular disc on which it is mounted, receives its firing potential from the receiver through slip rings.

At the instant that the neon light arrives at zero on the range scale, a cam arrangement on the shaft of the neon wheel closes contacts that energize the keying relays, causing a

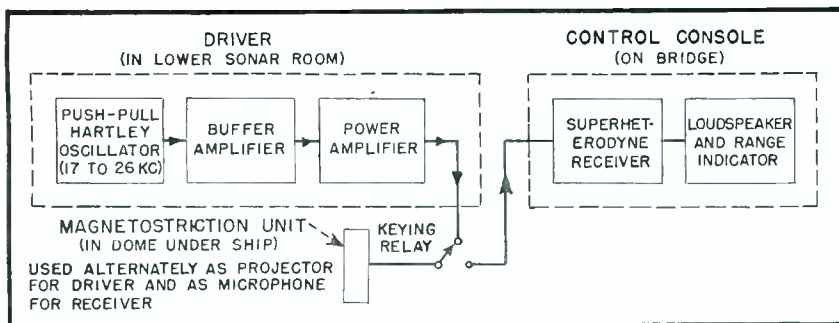

FIG. 2—Block diagram of model QCS/T sonar, which uses a 24-kc oscillator

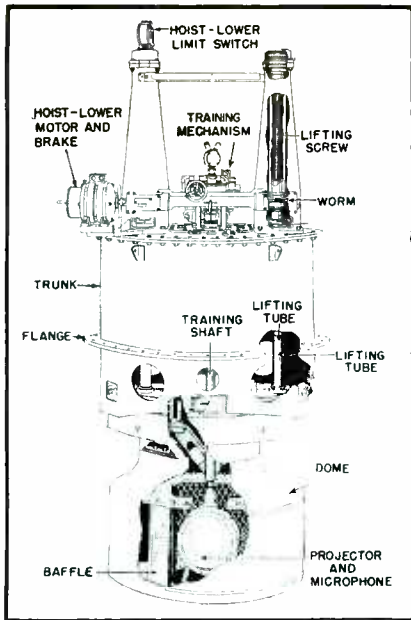

FIG. 3—Projector, dome, and retracting mechanism, located in lower sonar room of ship. When in use, the dome projects about four feet below the hull

sound pulse to be sent out into the water. The indicator light continues to move along the circular range scale, which is calibrated in such a way that when an echo is received and the neon light flashed, it will be at a point on the range scale corresponding to the range of the target. The cam contacts are designed to permit zero adjustment of the keying pulse and to permit varying the pulse length from 0 to 0.2 second. This will indicate a sound pulse length of from 0 to 160 yards on the range indicator. On 5,000-yard ranging, the neon indicator light is rotated at a slower speed by a separate synchronous motor, and the position at which the light flashes is read on a 5,000-yard scale.

When echoes returning from long distances are not strong enough to flash the neon light on the range indicator, a constantly energized white light is substituted for the neon light and the range is determined by noting the position of the white light on the range scale when the echo is heard in the loudspeaker.

#### Driver Circuits

As shown in Fig. 4, the driver employs a push-pull Hartley oscillator whose frequency is variable from 17 to 26 kc, a push-pull buffer amplifier, and a class-C operated push-pull-parallel power amplifier to excite the

projector. Keying of the driver is accomplished by completing the cathode circuit of the oscillator (by grounding the center tap of the filament winding for the oscillator tubes) and by connecting the projector to the power amplifier stage of the driver through contacts of the keying relay during keying. A small portion of the driver output is applied to the receiver through 5-megohm resistors to provide a visual indication of keying on the range indicator. Power for the driver comes from a three-phase full-wave rectifier employing mercury-vapor rectifiers.

#### Sweep-Frequency Modulation

Under certain water conditions, a large number of weak reverberations would be produced when the transmitted pulse struck water discontinuities and foreign matter. Since the transmitted pulse is up to 0.2 second long, reverberations from different distances could arrive at the projector simultaneously if they were reflections resulting from different portions of the transmitted pulse. When a great many reverberations from different distances arrive at the projector simultaneously, they may reinforce each other to produce a loud crashing or rolling noise in the loudspeaker that will tend to hide the target echo.

If the frequency of the oscillator in the driver is varied over a band of frequencies during keying (during transmission of a pulse), the reverberations arriving at the projector simultaneously from different distances will be of different frequencies and will not reinforce each other. Sweep-frequency modulation

of the oscillator thus reduces reverberations to a low level, while echoes from a target are heard as a clear chirp of varying frequency. This modulation is generally used during search, but after a target has been picked up the sweep is usually disconnected to permit utilization of the Doppler effect for tracking an evasive moving target.

The transmitted pulse begins at 800 cycles above the frequency to which the oscillator is tuned and sweeps down to 800 cycles below the oscillator frequency. This is achieved by shunting across the oscillator tank circuit a saturable reactor whose inductance is made to vary by charging a capacitor through a coil on the center leg each time the keying relay is closed. An adjustable capacitor across the primary winding of the reactor permits adjusting the sweep frequency range with relation to the natural frequency of the oscillator.

The values shown give a 0.1-second sweep. Provision is made in the equipment for inserting a larger charging capacitor to give a 0.2-second sweep for use with the longer keying pulses employed when using echo ranging at longer range. A resistor in shunt with the charging capacitor provides a discharge path between keying and prevents the current through the d-c winding from decreasing to zero when the capacitor becomes fully charged.

#### Magnetostriction Projector

The magnetostriction projector used to convert the output of the driver to supersonic sound energy is composed of 600 nickel tubes encircled by coils of wire connected in

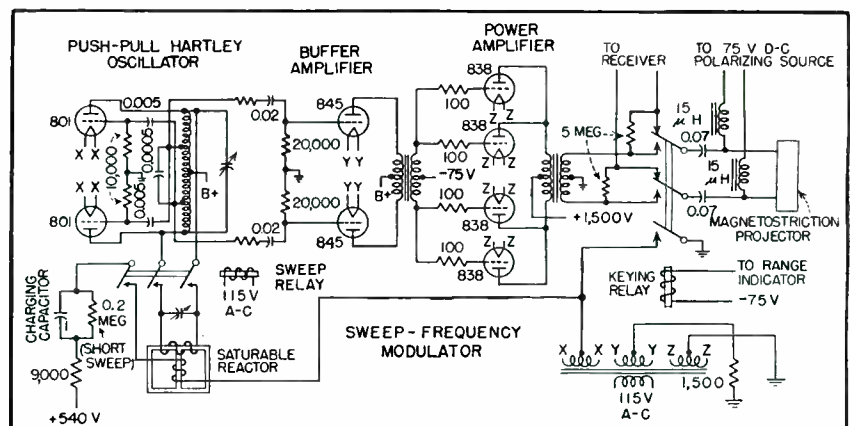

FIG. 4—Simplified schematic circuit diagram of driver unit

series-parallel. One end of each tube is free, while the other end is fastened to a one-inch thick steel diaphragm about 16 inches in diameter, as shown in Fig. 5. A d-c polarizing current flows through the coils at all times to shorten the nickel tubes, for the same reason that a permanent magnet is used in diaphragm-type headphones (to prevent frequency doubling). The tubes contract according to the quantity of current, regardless of its direction. If no polarizing current were used, the tubes would contract for both plus and minus swings of an a-c signal and hence twice each cycle, whereas a sufficiently large d-c polarizing current added to the alternating current eliminates the negative swing and the tubes contract once each cycle.

During transmission the nickel tubes contract and expand in length as the magnetic field applied to them is increased and decreased by the electrical output of the driver. The motion of the nickel tubes is transmitted to the water by the steel diaphragm. The length of each nickel tube added to the diaphragm thickness equals a half wavelength at the operating frequency, giving mechanical resonance and increased amplitude of vibration.

Echoes returning to the projector move the diaphragm back and forth, causing the nickel tubes to contract and expand. The resulting variation in magnetic properties causes an alternating voltage to be induced in the coils for application to the receiver. Capacitors in series with the magnetostriction coils make the projector equivalent to a resistive load of 100 ohms.

#### Crystal Projector

For underwater listening, as contrasted with echo ranging, a crystal pickup unit is used because its high sensitivity and wide band pass enable detection of noise associated with targets at far greater distances than would be possible with a magnetostriction unit. The crystal unit is composed of a large number of Rochelle-salt crystals mounted on a steel backing plate and connected in series. The individual crystals have gold evaporated on their electrical faces to form the electrical plates. One of the mechanical faces of each crystal is mounted on the steel back-

ing plate. The opposite face serves as the receiving surface for noises, this face being coupled to the water through castor oil and a thin steel sound-transparent window. Underwater sound waves cause the crystals to contract and expand and develop voltages across their electrical faces.

The frequency response curve of a crystal pickup unit is shown in Fig. 6, along with that of a typical magnetostriction unit. Note that response is plotted in db down from maximum; the peak response of the crystal unit is very much greater, however, than that of the magnetostriction unit. The broad pass band and high sensitivity make the crystal unit ideal for listening, but it is not suited for echo ranging in this equipment because it is capable of handling only small amounts of power.

#### The Receiver

The receiver, shown in block form in Fig. 7, is an inverted superheterodyne in which the i-f value is above the frequency of the incoming signal. It is impractical to use an intermediate frequency below the input frequency because it would then be operating in the audio band.

The r-f amplifier is tunable over the frequency range from 13 to 37 kc and the oscillator tunes from 73 to 97 kc, with the tuning capacitors ganged together to give a 60-kc i-f signal. In the i-f channel, three amplifiers in cascade provide either a broad or sharp pass band depending on which of two sets of i-f transformer secondary coils is switched in. The broad pass band is more than adequate for use with sweep-frequency modulation, wherein the received signal varies between limits 800 cycles above and below the center frequency. Gain control is applied to the first two i-f stages to regulate the output of the receiver. In addition, the operator can switch into the circuit a time-varied gain system that reduces the gain of the receiver simultaneously with each transmission of a pulse, restoring the gain to normal automatically by the time an echo arrives.

With modulated incoming signals such as are obtained during underwater listening, the i-f output is detected and applied directly to the audio channel. For unmodulated

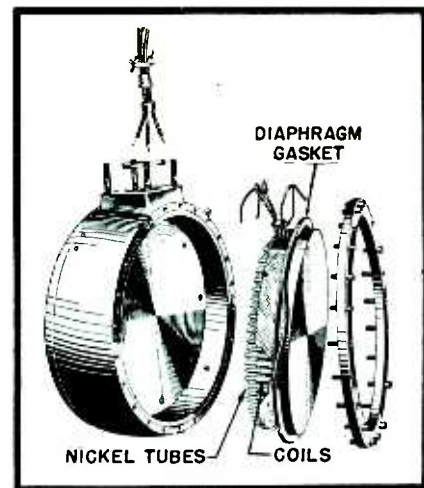

FIG. 5—Construction of magnetostriction unit used for both transmitting and receiving during echo ranging. A crystal receiving unit (not shown) is mounted on the back side, and the pickup unit is rotated through 180 degrees to bring it into use when higher sensitivity is required for listening to under-water sounds as contrasted with echo ranging

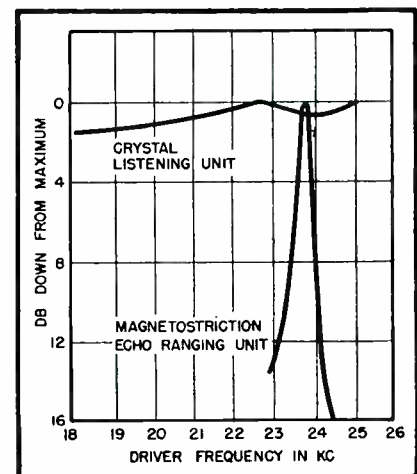

FIG. 6—Frequency response curves of the magnetostriction unit and of the crystal unit used in its place for listening only

signals of echo ranging the i-f output is mixed with the signal from the beat-frequency oscillator to produce an audio note which is applied to the audio channel. The frequency of the audio note can be set anywhere from 0 to 1,800 cycles by adjusting the frequency of the beat oscillator to any frequency between 60 and 61.8 kc. After further amplification in a-f stages, the receiver excites the loudspeaker or headphones and the range indicator lamp.

#### Receiver Circuit Analysis

Signal circuits of the receiver are shown in simplified form in Fig. 8. The r-f amplifier stage is protected

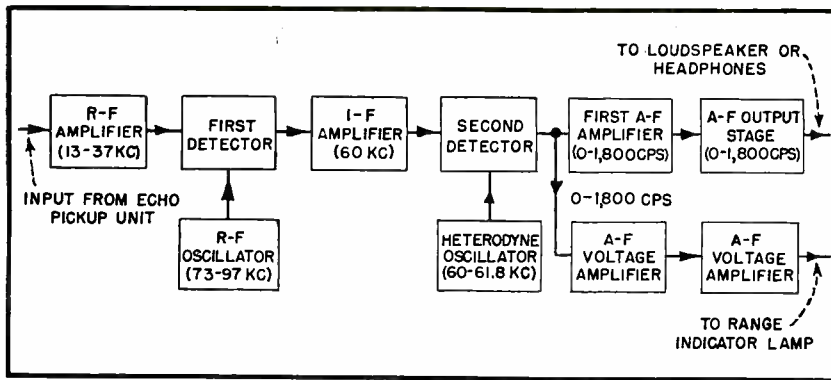

FIG. 7—Block diagram of superheterodyne sonar receiver

from voltage surges by a type 874 gas discharge tube in series with a 2,000-ohm current-limiting resistor. If the potential across the secondary of the input transformer reaches 125 volts, the gas tube becomes conductive and drops the voltage to 80 volts. A 0.1-megohm resistor in the grid circuit provides additional protection by preventing high signal voltages from blocking the grid. The voltage gain of the r-f stage is approximately 25.

The first r-f oscillator stage employs inductive feedback. Padder and trimmer capacitors, not shown, enable oscillator and r-f stages to track together, with the oscillator frequency always 60 kc above that of the r-f stage.

The term varistor applied to the first detector is derived from its ac-

tion as a variable resistor. Each of the four copper-oxide rectifier junctions acts as a resistor whose resistance is controlled by the polarity of the voltage applied across it. With no voltage, the resistance of a junction is approximately 300 ohms; with voltage of one polarity this drops to 50 ohms, and with voltage of opposite polarity it goes up to 10,000 ohms. The alternating voltage supplied by the oscillator to the center taps of the two varistor circuit transformer windings is much larger than the incoming a-c signal and hence completely controls the varistor values. When point A is positive with respect to B, junctions 1 and 2 have low resistance and junctions 3 and 4 have high resistance, so that most of the signal current takes the straight-through path

through 1 and 2. When A is negative, junctions 1 and 2 have high resistance and 3 and 4 have low resistance, so that most of the signal current now takes the crossed paths through junctions 3 and 4. In effect, then, the varistors act like a reversing switch controlled by the local oscillator.

Each time the oscillator voltage reverses, the conductivity of the varistor system reverses, and the current through the output transformer reverses its direction. Similarly, the current through the output transformer reverses each time the incoming signal reverses. The total number of reversals is thus equal to the sum of the two, giving a resultant output wave with a frequency equal to the sum of the oscillator and signal frequencies. There is also a difference frequency in the output, as can be shown by mathematical analysis or by plotting and combining individual waveforms, so that performance of the varistor circuit is exactly comparable to that of a conventional mixer-first detector. The output of the r-f oscillator is coupled to the first detector varistor circuit through a resistor and adjustable capacitor network that permits proper balancing of the varistor circuit so that neither of the input frequencies are in the output. This feature and an extremely long life

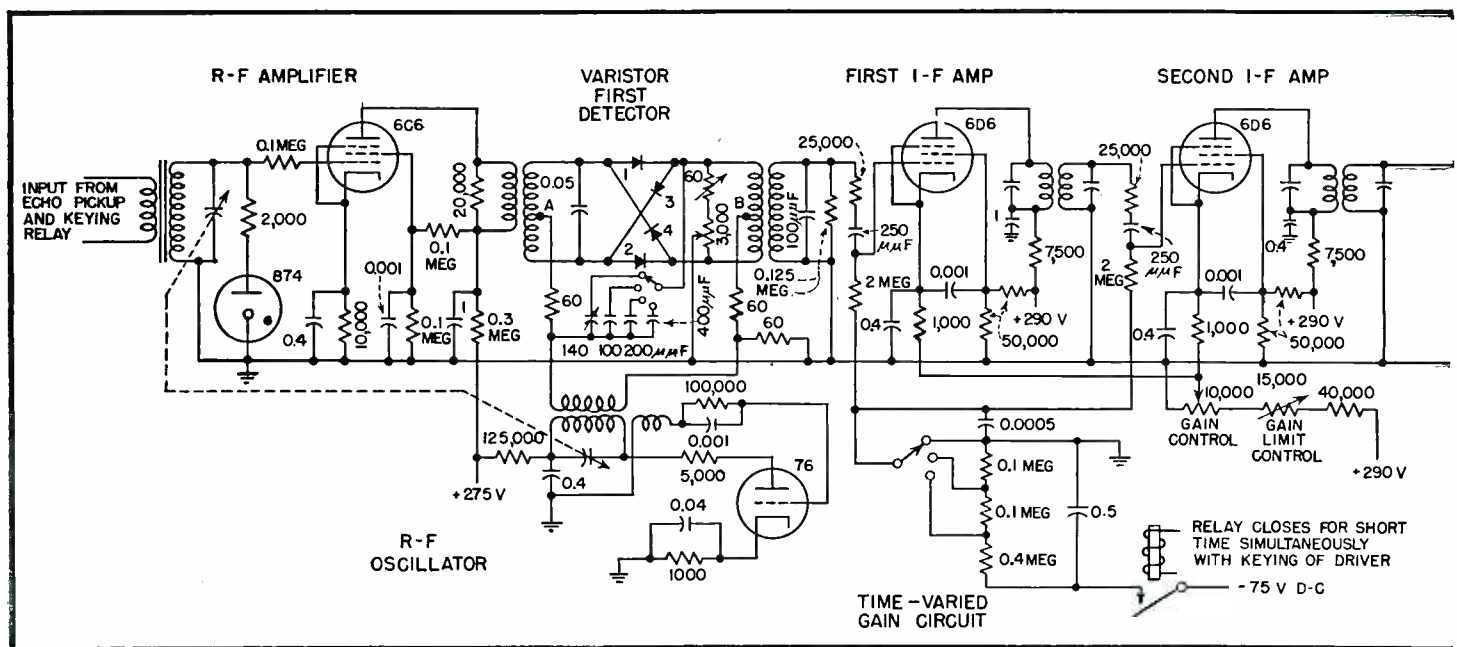

FIG. 8—Simplified schematic circuit diagrams of superheterodyne

are two outstanding advantages of varistor modulators.

Each i-f transformer has two secondaries (not shown), one being closely coupled to give a broad frequency response and the other being loosely coupled to give a sharp response, with a ganged bandwidth switch provided for changeover. A potentiometer in the common cathode circuit for the first two i-f stages provides a gain-control range of 100 db, affecting both audible and range indicator output.

When the heterodyne switch for the second detector is off, the varistor second detector is biased only by d-c and the diagonally connected junctions are ineffective; in addition, the junction on one side is shorted out and a resistor (not shown) is inserted in the detector circuit to distribute bias voltage properly so that the varistor acts as a simple half-wave rectifier-type detector in separating audible modulation from the 60-kc modulated i-f output signal. When heterodyne operation is employed to change an unmodulated i-f signal to an audible beat note, connections are as shown and operation is essentially as for the varistor first detector and its oscillator.

A 200- $\mu\text{f}$  capacitor shunted across the audio amplifier input acts as a low-pass filter and effectively bypasses to ground the sum-

frequency component of the second detector output. With the filter switch (between audio stages) in the flat position, there are no filters in the circuit and frequencies from 200 to 3,000 cps are passed. This switch provides two degrees of frequency discrimination by inserting either of the LC bandpass filter networks.

The pass band of the receiver is made variable to meet two requirements. While listening for underwater noises, the receiver should have a wide pass band to give maximum response to noise. On echo ranging, however, the receiver pass band should be narrow and the output peaked at the frequency of the echo to discriminate against noises which tend to hide the echo.

The time-varied gain circuit acts on the control grids of the first two i-f stages to reduce receiver gain to a minimum at the instant of keying and allow the gain to return to normal gradually as the initially strong reverberations decrease. This suppresses the loud crashing reverberation noise that would otherwise be reproduced by the loudspeaker. While a signal is being sent, the time-varied gain circuit applies a potential of minus 75 volts across a 0.5- $\mu\text{f}$  capacitor, leaving it charged. By means of a bank of resistors arranged as a potentiometer, the de-

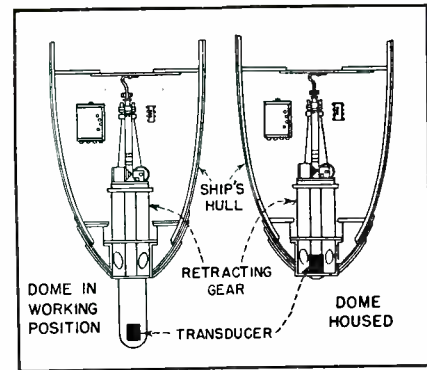

Cross-section of hull, showing how dome can be retracted in shallow water

sired fraction of this voltage is applied to the control grids, either blocking or greatly reducing their gain. After keying is completed, the charging potential is removed by release of the keying relay, and the capacitor gradually discharges through the potentiometer to restore normal bias in from 2 to 20 milliseconds after keying.

During keying, it is quite possible for extremely high surge voltages to be built up across the primary windings of the a-f output transformers. To prevent insulation breakdown, a silicon-carbide protector is connected across each primary. The resistance of this device decreases as the voltage is raised, so that the transformer windings are effectively short-circuited for the duration of any surges.

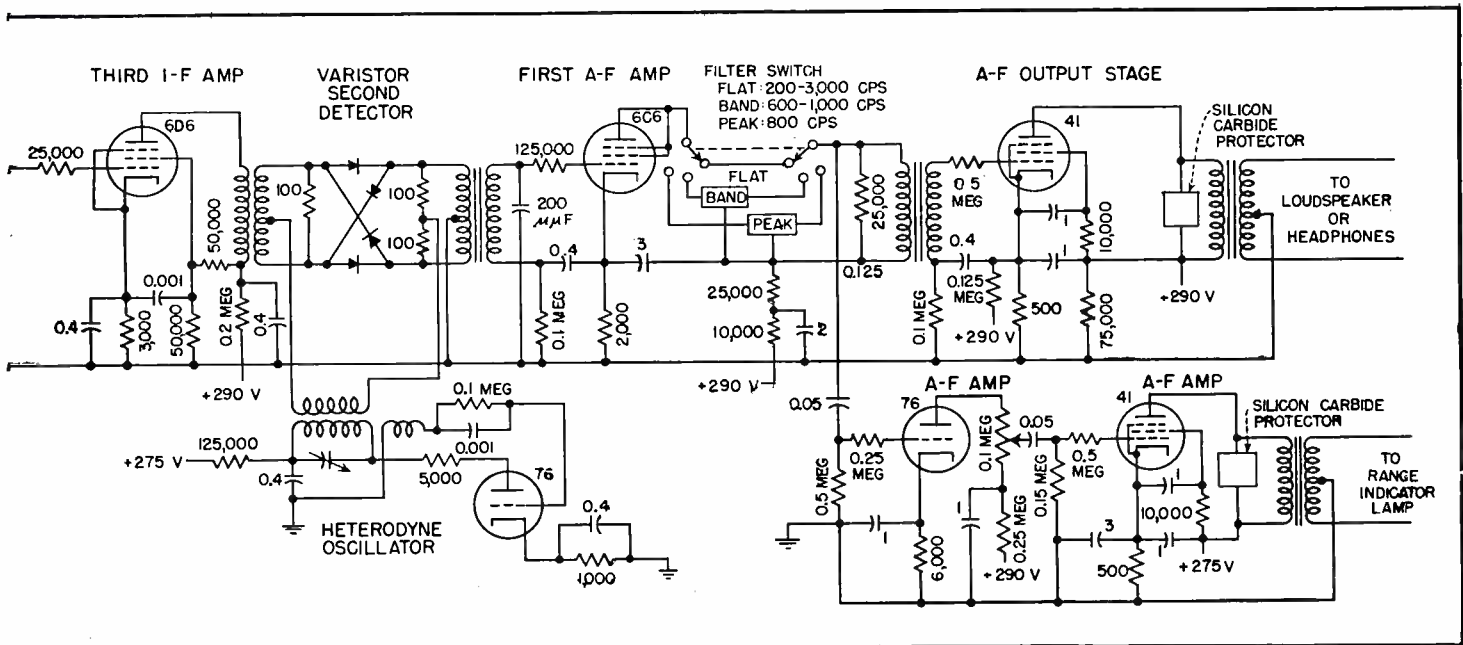

receiver, showing time-varied gain circuit and varistor detectors

# MODERN HOME

By Z. BENIN

Engineering Department  
Zenith Radio Corporation  
Chicago, Illinois

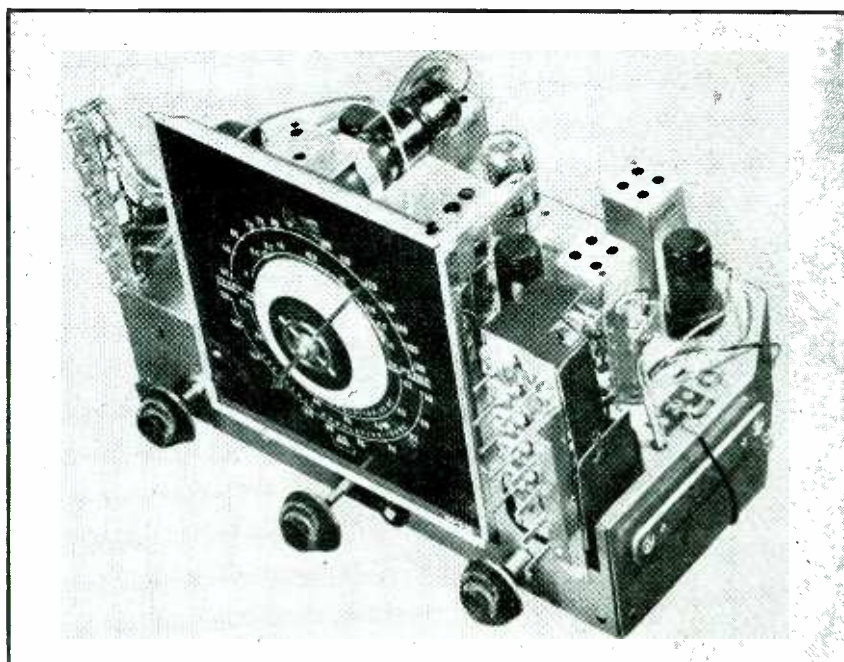

Chassis of receiver designed to cover the standard broadcast and short-wave bands, and the two f-m bands

**T**O SATISFY the widest demand, a complete home radio receiver must have standard broadcast and shortwave a-m bands, two f-m bands and automatic tuning. The major problem is development of an 88 to 108-mc frequency-modulation circuit providing maximum performance at a minimum price. This circuit must be so designed that conventional a-m sections may be added economically.

In following paragraphs, one particular design solution is discussed and other engineering possibilities are indicated. The circuit of the receiver is shown in Fig. 1. Tubes and circuits for the 100-mc band were so chosen that they could be satisfactorily switched to conventional a-m service. High-gain tubes and the extra i-f stage necessary for the f-m receiver made solution of gain and selectivity problems on the a-m band simple.

## Demodulator Circuits

The f-m design is based on a limiter tube combined with a balanced discriminator or phase detector. This design has had the most field experience and was chosen for initial production, while ratio detectors and synchronized oscillators are being extensively worked on in the laboratory. The demodulator re-

quires three diodes, two for f-m and one for a-m. These must be separate diodes to avoid circuit switching of high i-f voltage at this point.

At least one of the diodes must have a separate cathode to operate at the high potential end of the discriminator. With economy in mind, the Type 6S8GT triple-diode, high- $\mu$  triode was designed. The circuit switching is accomplished at audio frequency, and the volume control is switched from the a-m audio load resistor to the f-m audio load resistor.

The design requirements of a suitable discriminator are many. It must be linear in output versus frequency for the full 75-kc deviation each side of the center frequency. It must be linear over an additional frequency range to take care of user errors in tuning. (Even radio engineers will sometimes mistune 40 kilocycles off the discriminator center during program periods of low deviation.) This, added to the rapid departure from linearity close to the discriminator peaks, requires a design in which

peak-to-peak frequency separation is a minimum of 300 kc, with production variations to 400 kc. A proper discriminator characteristic results in a substantial loss in audio output, an undesirable increase in distortion, and a tendency for spurious detection responses beyond the peaks to become more noticeable.

## Audio Level

A high audio or deviation sensitivity of the discriminator is necessary so that a-m to f-m switching shall occur with a minimum change of audio level. On a-m, a mediocre avc characteristic is tolerable and not easily avoidable with the current use of high-gain, semi-remote-cutoff tubes and the removal of avc from converter tubes. The f-m output, due to the more stringent limiter requirements, results in a better equivalent avc and, while always higher than a-m at low input, it must also be equal to the highest a-m audio level.

To meet the above audio level requirements, an i-f voltage of approximately 10 volts is necessary and this



# RECEIVER DESIGN

Analysis of various possible circuit arrangements adaptable to a combination f-m and a-m receiver. Reasons for selection of each, with simplicity of operation and satisfactory response as the end result, are given

appears at the discriminator at all inputs including the minimum usable signal. This contrasts with about 0.2 volt required at the a-m demodulator diode. Thus the gain on f-m must be 50 times greater than the gain required on a-m.

## Limiter Stage

In the limiter stage, economy calls for a single-tube limiter, and the grid-bias limiter using a sharp cut-off tube with low screen voltage op-

erates satisfactorily. The inherent contact potential of approximately 0.5 volt on all thermionic tubes imposes a low limit on the voltage necessary for operation. A minimum of one volt to the tube grid will permit a 50-percent change in amplitude and still be on the operating range of the tube  $E_v-I_p$  characteristic. This is the minimum voltage for which the limiter can suppress a-m modulation due to the i-f selectivity characteristic and similarly, noise. This input

must also produce the required 10 volts output to the discriminator.

Where further improvement is desired, overloading of the limiter grid may be reduced by designing the last i-f stage for some measure of additional limiting such as the addition of a diode to the last transformer to limit the voltage level, or the use of avc from the limiter to control the r-f tubes. The use of avc on the i-f tubes is undesirable since it results in a change of effec-

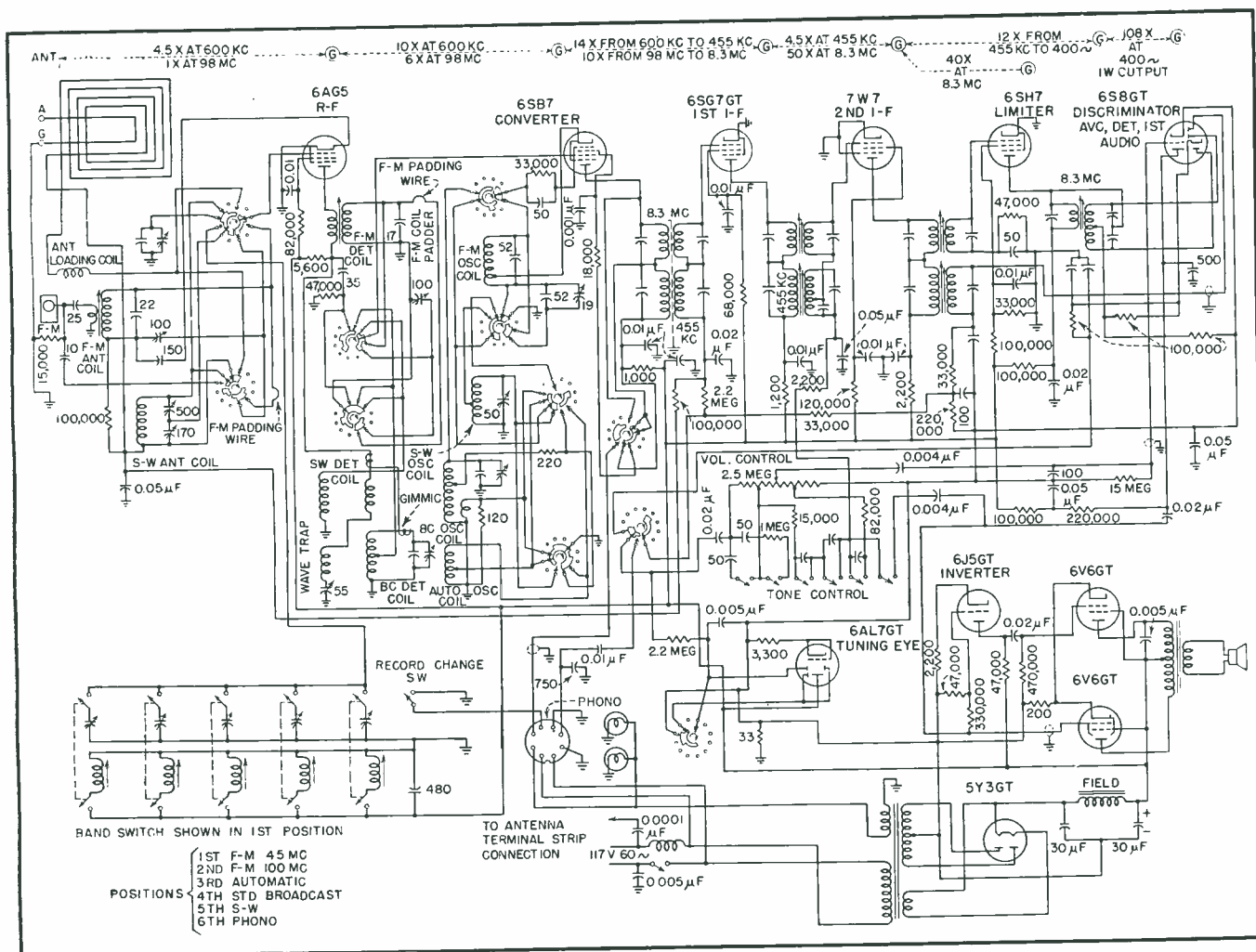

FIG. 1—Schematic circuit of the complete receiver. Capacitor values are given in micromicrofarads unless otherwise indicated

tive grid circuit capacitance and mistuning of the i-f circuit, with consequent dissymmetry. Such dissymmetry, it has been shown, makes for poor impulse noise rejection, f-m phase distortion and undesirable manual tuning characteristics. Since the peak noise volts at the avc filter network may be high, causing grid current to flow, a low time-constant RC network will change a short duration pulse to one of longer duration and result in audible noise.

#### Intermediate Stages

Since the overall sensitivity must be as high as possible to enable operation with the minimum antenna, as represented by the one installed within the radio cabinet, it is desirable that as much gain as possible be achieved at the intermediate frequency. The limiting factor is the equivalent grid circuit noise voltage of converter tubes. For an advantageous signal-to-noise ratio at this point, the maximum desirable sensitivity was about 50 microvolts for 1 volt at the limiter, or a gain of 20,000 times in the i-f amplifier.

The i-f tubes were chosen for maximum voltage gain stability. This is given by the ratio of  $G_m/C_{g-p}$ . Some typical tubes and their pertinent characteristics follow in the approximate order of choice:

Tube Type	$G_m$	$C_{g-p}$	$G_m/C_{g-p}$
7W7	5800	.0025	2,300 M
6SH7	4900	.003	1,600 M
6SG7	4000	.003	1,300 M
6BA6	4400	.0035	1,250 M

The highest stable gain obtained was about 50 times. The stage feed-

ing the limiter is loaded by the limiter grid resistor and its gain is about 40 times. The converter gain at the intermediate frequency was about 10 with the tubes used. The resultant is  $40 \times 50 \times 10 = 20,000$  times.

The selectivity characteristic of the broad band i-f channel was required to be 180 to 200 kc at two times down and about 700 kc at 1000 times down. The first figure was decided on to avoid phase distortion and to minimize undesirable amplitude modulation which makes tuning more critical and requires a greater degree of limiting from the limiter stage. The latter selectivity figure is due to the assignment by the FCC of local channels spaced 400 kilocycles and a desire to achieve a high degree of adjacent channel selectivity. To achieve the bandwidth at two times, over-coupled transformers were used. This necessitates oscilloscope alignment. When aligned in the field by servicemen, these transformers are shunted by resistors, aligned for maximum output, and then the alignment resistors are removed.

#### Combination Transformers

The mechanical design of the i-f transformers is illustrated in Fig. 2. It was felt that these transformers represented a large part of the performance and cost of the receiver and considerable work was done to make them simple and compact. Permeability tuned inductors and silvered mica capacitors are used for good temperature-frequency stability.

A single molded piece provides the

four posts for the individual primaries and secondaries of the four tuned circuits, which work at 455 kc and 8.3 mc. A well in the molded piece below the posts contains a stack of silvered mica discs which comprise the tuned circuit capacitors. Contact to the silvered surfaces is made by double-ended formed metal pieces, one end providing the coil terminal and the other end providing a terminal for chassis wiring. In each hollow coil post is a plastic liner into which is screwed a short, threaded iron core to provide adjustment. The elasticity of the liner economically substitutes for inside coil form threads and eliminates the difficult problem of maintaining close tolerances between an inside thread in a plastic tube and the outside thread of a molded iron core.

Both primary capacitors are

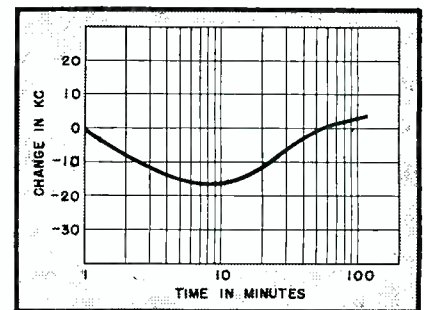

FIG. 3—The effectiveness of a ceramic compensating capacitor in the high-frequency oscillator circuit of the receiver is shown by this curve of frequency change versus warm-up time



printed in silver upon a single mica disc, with another disc providing the secondary capacitors. By-pass capacitors associated with these circuits are incorporated in the unit by means of additional mica discs. The result is a unit whose frequency drift for 30 C change in ambient temperature is approximately 10 to 20 kc without the erratic behavior of the compression trimmer units used in the past.

#### Converter Stage

The converter design places a severe load upon the single tube which

FIG. 2—Composite i-f transformer for 455 and 8.3 mc. The silvered mica discs show at the bottom of the shield can

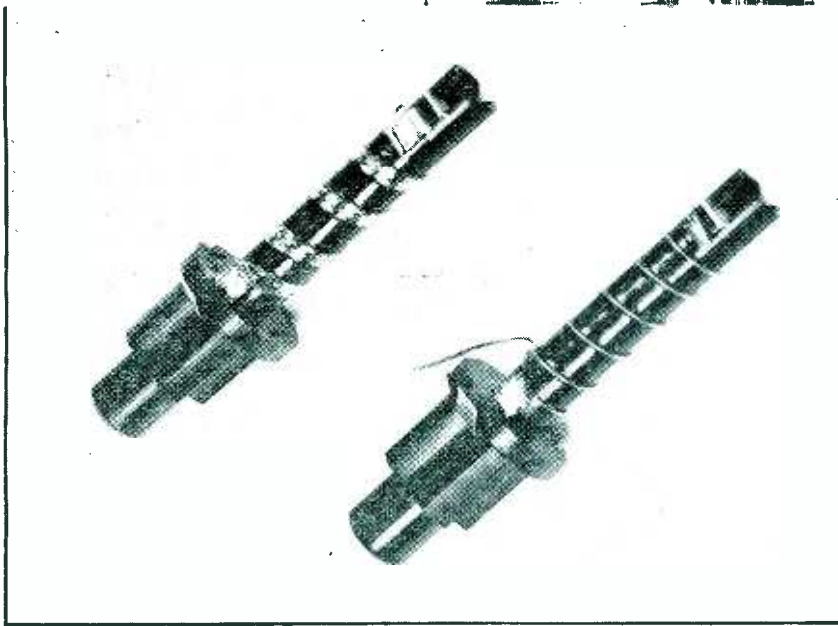

FIG. 4—The winding of the r-f coil at left is tinsel ribbon. The oscillator coil at right is tuned to a frequency that is one-half the signal frequency plus 8.3 mc

economy specifies. The main requirements are a high conversion conductance for gain and a high oscillator  $G_m$  to support oscillation with low impedance circuits at low line voltages. The 6SB7 pentagrid converter and the double-triodes 6J6 and 7F8 best fill these requirements. The negative signal-grid input conductance of pentagrid converters improves r-f selectivity, which is much needed at 100 mc, and the internal oscillator modulation feature simplifies band switching. But the high cathode impedance, necessary for oscillator operation of this type of tube, makes a suitable circuit difficult to design and prone to spurious oscillation. Double triodes result in higher conversion conductances but suffer from low signal-grid impedance as a result of plate circuit degeneration through the triode mixer grid-to-plate capacitance.

Before a choice of tube is made, the oscillator frequency-temperature stability must be examined. This is of great importance in an f-m set since a drift of 20 to 30 kc may be noticeable at the discriminator, affecting audio distortion and noise rejection. Such a drift is but a small fraction of 100 mc and necessitates careful design. Most of the frequency drift is due to capacitance changes within the oscillator tube during warm-up and to stray circuit changes such as in the socket, band switch, and wiring. Since these total to an irreducible minimum capacitance regardless of frequency, it is desirable to make the change a small part of the total tuned circuit capacitance. For this reason, second har-

monic operation of the oscillator was used with a high lump circuit capacitance. The drift of the oscillator during the heating time is shown in Fig. 3.

Harmonic operation is not feasible with dual-triode tubes where mixer voltage injection is across an impedance. Since the oscillator circuit to signal circuit impedance is a considerable mismatch, more power is required for impedance injection. A pentagrid converter was chosen, although it appears that a high  $G_m$  pentode in the same tube envelope with a high  $G_m$  triode and interconnected by an injection grid would make a better converter. Such a tube does not exist and poses a serious design problem. It may be that such a tube can be developed in the near future.

#### Tuning Systems

A choice must be made between capacitor tuning, permeability tuning, or reactance tuning by means of vanes, metal slugs or variations of these. For loop tuning on a-m, the variable capacitor produces the highest signal pick-up sensitivity, especially where the loop size is limited by the cabinet.

For f-m tuning, a variable capacitor suffers from inductance in its plates and its rotor wipers and from its size, which makes it difficult to obtain short wiring. Circuit coupling through the common shaft may cause regeneration and the structure and assembly of the gang capacitor cause instability with temperature change.

For frequency stability, iron-core

permeability tuning was chosen for the 100-mc band. There are available extremely fine particle-size iron powders which maintain circuit Q and permeability at this frequency. To further enhance frequency stability, the normal trimmer capacitor was eliminated, although various improved silver-ceramic, glass and air-dielectric trimmers have been designed to improve stability of this adjustment.

If the inductance of the coil varies logarithmically versus linear movement of the tuning element, then a fixed increment, plus or minus, of external circuit capacitance may be compensated for by a fixed displacement of the tuning element. After this adjustment is made at any one point of the travel, the inductance-versus-travel curve is the same as before. To satisfy such a tuning characteristic, the r-f and oscillator coils are wound with a variable pitch determined initially by experiment. Thereafter the winding design is duplicated on accurate cam-driven winding machines to an inductance accuracy of approximately  $\pm \frac{1}{2}$  of one percent along the entire length of the coil. These coils are pictured in Fig. 4 and their slugs are operated by the cam arrangement shown in Fig. 5.

The coils were designed so that

FIG. 5—Complete tuning assembly of the receiver. The shaft of the capacitor gang for a-m tuning operates the cam that drives the tuning slugs of the f-m circuits

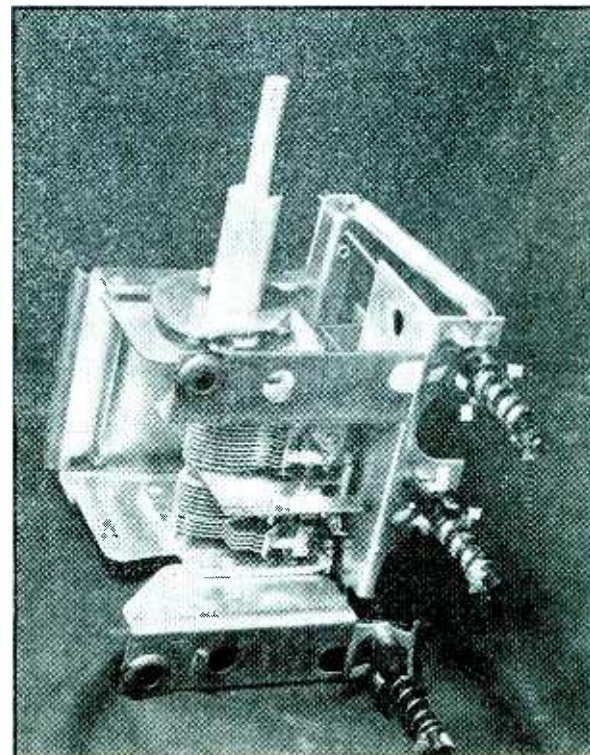

they could be placed close to their accompanying tubes and the band switch contacts pertinent to 100 mc were nested between coil and tube. The result was short leads with the major portion of the tuned circuit capacitance lumped directly across the coil.

#### R-F Problem

The choice of an r-f tube involves gain, selectivity, and signal-to-noise ratio to such an extent that as good a tube as can be afforded is desirable. The gain and selectivity may be evaluated by the product of mutual conductance and input resistance for each tube. The tube noise factor depends on mutual conductance divided by the square root of plate current. The ratio of plate current to total cathode current should be high. Some tube choices are:

Tube	$G_m$	$R_i$
6AK5	5100	7000
6AG5	5000	3500
6SG7	4000	1000
6BA6	4400	1000

where  $R_i$  = approximate input resistance at 100 mc. The 6AG5 seemed a good compromise between tube cost and performance.

The tube input resistance is comparable to the circuit impedance since  $Q/\omega c$  at these frequencies may be about 3000 to 5000 ohms, thus the tube seriously affects selectivity. The r-f selectivity is of concern since 400-kc station separation represents 0.4 percent of the average signal frequency, whereas in the standard broadcast band the local station separation of 50 kc represents five percent of the average signal frequency. This means the f-m local stations are 12 times closer together than the local a-m stations are to each other.

The r-f selectivity may be evaluated by the image ratio and is given by:

$$Q \times 4 F_i / F_s$$

where  $F_i$  and  $F_s$  are intermediate and signal frequency respectively. Using 8.3 mc and 100 mc and  $Q = 80$ , the image ratio for an r-f stage is 26 and for an antenna stage is one-half this due to antenna loading. The overall image ratio is approximately 250 times. The image ratio is considered of prime importance as a measure not so much of direct image frequency interference but rather as

a measure of front end selectivity against the spurious harmonic responses of a superheterodyne receiver.

The satisfactory value for image ratio is yet to be determined by field experience. One interesting derivation points out that on a-m the ratio of desired to undesired signal at the second detector should be at least 100 to 1. For f-m signals at the limiter grid, the comparable ratio is approximately 3 to 1 for the same interference output ratio. The advantage of f-m over a-m is 100/3 or approximately 30 times. An image ratio of 250 times for f-m might be considered as equivalent to  $250 \times 30$  or 7500 times for a-m. The latter figure, we know, is quite satisfactory in performance.

The sensitivity of the receiver was found to be better than ten microvolts in production. The sensitivity figure for f-m sets means the minimum input that will provide the freedom from noise and interference inherent in the f-m system. This may be expressed as the minimum input which with full 75-kc modulation deviation delivers an audio output free from distortion due to i-f curvature and free from noise due to input resistors and r-f tubes. Observations show that with the best practical tubes the maximum sensitivity using a 300-ohm dummy is about three microvolts and is limited by tube and antenna noise.

The resultant design of the basic f-m section will vary widely in the next few years as engineers answer differently the problems of gain, drift, and selectivity, until field experience and competitive performance point to the best solution.

#### Audio System

The audio amplifier utilizes the plate-current efficiency and low driving voltage requirement of beam-power tubes and the low cost and flat frequency response of resistance-coupled phase inversion. The total power output is 15 watts, with 9 watts at 10 percent distortion, and the audio gain is 1500.

The need of a common audio channel for both a-m reception and the higher quality f-m reception has resulted in an amplifier that is capable of higher fidelity than the a-m system will allow. The limitation in

the a-m system is usually loss of high audio frequencies due to side-band cutting of selective circuits. Additional attenuation of high audio frequencies is necessary to lower reception noise and hiss. Such attenuation of high frequencies does not occur appreciably in f-m selective circuits and the noise rejection is a function of the system and makes unnecessary such high-frequency attenuation. As a result the audio amplifier is identical for both systems, the receiver selectivity accounting for the difference in high-frequency response.

In practical design, some compromise must be made as to the high-frequency cutoff on f-m. Recordings are still being used to some extent on f-m stations and distortion is often present at the highest audio frequencies which is unnoticed in a-m or usual phonograph playing. Therefore, some attenuation of the highest audio frequencies is advisable at the f-m detector output until such time as records are improved, direct studio pickup more widely used, and wire lines are made better.

At the low-frequency end of a receiver audio spectrum, some trouble is encountered in the bass-boost design. For a-m reception, the audio amplifier input network has a rising gain characteristic for decreasing frequencies. This makes up for speaker and cabinet deficiencies and does not become excessive at extremely low frequencies since transmitter modulation on a-m falls off rapidly at extremely low audio frequencies.

For f-m reception, such an audio amplifier characteristic may be unsatisfactory. This is due to the better low-frequency modulation characteristic of f-m transmitters where modulation is often carried out directly by tube characteristics acting on r-f circuits, as against a-m transmitters where modulation is carried out by audio transformers of limited low-frequency characteristics. The result could be excessive bass-boost on f-m and calls for a balance between the necessary low-frequency accentuation of a-m and the added low frequencies present on f-m. This can be finally adjusted by the low-frequency design of the f-m detector audio-output characteristic.

# Cathode Follower Coupling in D-C Amplifiers

New screen-coupled cathode follower and phase inverter circuits permit design of three-tube d-c amplifier operating from a single 250-volt power supply, providing a gain of 60 db with flat response from 0 to 20,000 kc and almost unmeasurably low circuit noise level

By Y. P. YU *Project Engineer, Ansley Radio Corporation, Trenton, N. J.*

THE method of coupling between stages is one of the difficulties in the design of d-c amplifiers with a single power supply, because the output of a given stage is usually at a high quiescent d-c potential above ground. In order to couple this output to the next stage, the high d-c potential must be cancelled in some manner.

One method employs a separate power source, as shown in Fig. 1A<sup>1</sup>. Here feedback through the power supply introduces oscillation or other undesirable effects, and highly regulated power supplies are needed.

Another method utilizes a type VR cold-cathode gas tube, as shown in Fig. 1B<sup>2</sup>. The defects of this ar-

angement are noise due to discharge in the gas, and heavy current drawn by the VR tube.

In order to overcome these difficulties, two methods are introduced in this paper. One is a pushpull phase inverter arrangement wherein a large cathode bias may be employed without the usual attendant disadvantage of negative feedback, and the other involves coupling the plate of one stage to the screen of a cathode follower stage.

## Phase Inverter Circuit

The quiescent d-c cathode potential of a vacuum tube can be raised to a high value by means of a large resistance connected from the cathode to ground. In Fig. 2, the cathode quiescent d-c potential of  $T_2$  or  $T_3$  is equal to the voltage drop across resistor  $R_k$ . Also,  $E_k$  is equal to  $E_{b01}$  (the quiescent plate potential of  $T_1$ ) plus  $E_{cc}$  (the bias voltage of  $T_2$  or  $T_3$ ).

In an ideal phase inverter, the input of  $T_2$  should be equal and 180 degrees out of phase with the input of  $T_3$ . Likewise, the output of  $T_2$  should be equal and 180 degrees out of phase with the output of  $T_3$ . Therefore, the negative feedback produced in  $R_k$  by the plate current of  $T_2$  is canceled completely by the negative feedback produced in  $R_k$  by the plate current of  $T_3$ , since they are equal and 180 degrees out of phase.

The values of  $R_1$ ,  $R_2$ ,  $R_3$ ,  $R_4$ ,  $R_5$ , and  $R_k$  in the circuit of Fig. 2 can be calculated as follows:

$$R_2 + R_3 = R_1 \quad (1)$$

$$R_k = \frac{E_{b01} + E_{cc}}{2I_{b02}} \quad (2)$$

where  $E_{b01}$  is the quiescent plate voltage of  $T_1$ ,  $E_{cc}$  is the bias voltage of  $T_2$  or  $T_3$ , and  $I_{b02}$  is the quiescent plate current of  $T_2$  or  $T_3$ . For ideal phase inversion, the input of  $T_3$  has its quiescent d-c potential equal to  $E_{b01}$ , and its instantaneous signal component equal to minus  $e_{02}$ , which is the signal component of the grid potential of  $T_2$ . Since the input of  $T_3$  is taken at point B, we have

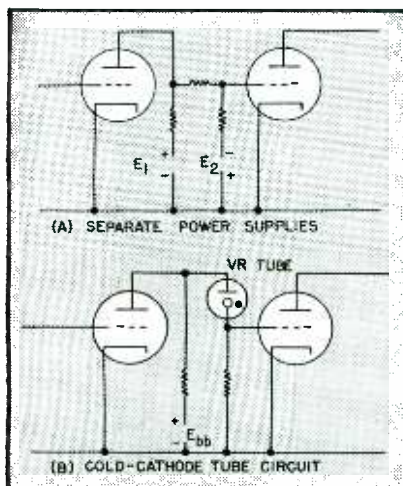

FIG. 1—Two conventional methods of coupling between stages in a d-c amplifier

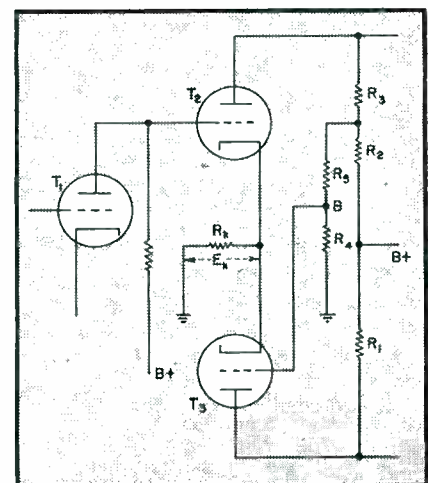

FIG. 2—Pushpull phase inverter circuit for d-c amplifier

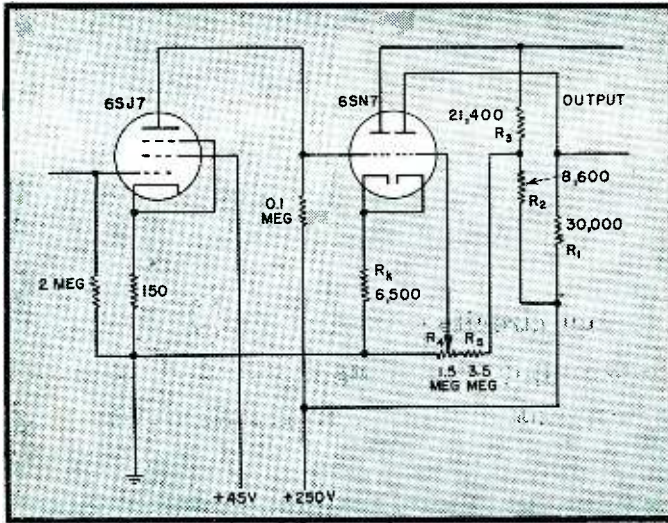

FIG. 3—Practical d-c amplifier circuit employing phase inverter stage and requiring only 250-volt plate supply

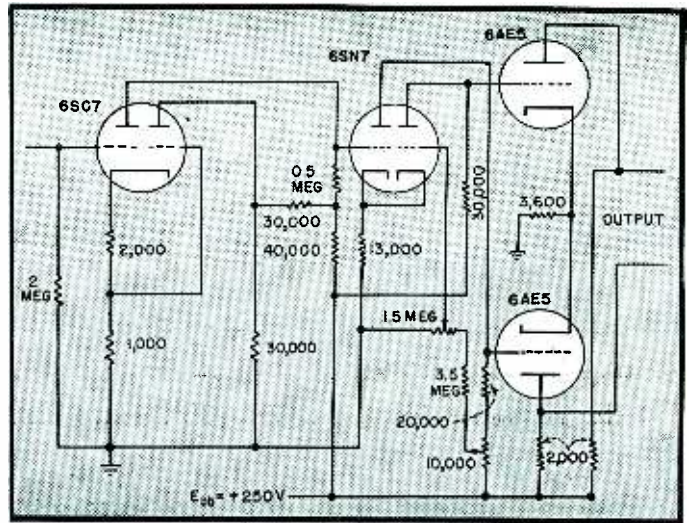

FIG. 4—Direct-current amplifier using double triode ahead of phase inverter to cancel plate current changes in first stage due to changes in cathode surface

$$\frac{E_{bb} - I_{bo2} R_2}{-g_2 e_{g2} R_2} = \frac{E_{bo1}}{-e_{g2}} \quad (3)$$

$$g_2 = \frac{\delta i_{p2}}{\delta e_{g2}} \Big|_0 \quad (3a)$$

$$R_2 = E_{bb} / (g_2 E_{bo1} + I_{bo2}) \quad (4)$$

where  $(E_{bb} - I_{bo2} R_2)$  is the quiescent d-c potential at point B,  $E_{bb}$  is the B power supply voltage,  $g_2$  is the transconductance of  $T_2$  at the operating point,  $i_{p2}$  is the instantaneous signal component of the plate current of  $T_2$ ,  $e_{g2}$  is the instantaneous signal component of the grid potential of  $T_2$ , and  $-e_{g2} R_2 g_2$  is the instantaneous signal component of the potential at point B.

The magnitude of the input voltage at the control grid of  $T_2$  is set by adjusting the ratio of  $R_4/R_5$ , where  $R_4$  and  $R_5$  are simply arranged as a potentiometer. In other words, the ratio  $E_{bo1}/e_{g2}$  determines the values of  $R_2$ , and the magnitude of  $E_{bo1}$  or  $e_{g2}$  determines the value of the ratio  $R_4/R_5$ .

The value of  $R_4 + R_5$  should be very large in comparison to  $R_2$ , because the potential at point B should not change appreciably after connection of resistors  $R_4 + R_5$  from point B to ground. Also, the value of  $R_4$  should not exceed the allowable grid leak value of  $T_2$ . About 3 to 7 megohms for  $R_4 + R_5$  is satisfactory in most cases.

The ratio  $R_4/(R_4 + R_5)$  may be expressed in two ways:

$$\frac{R_4}{R_4 + R_5} = \frac{E_k}{E_{bb} - I_{bo2} R_2} \quad (5)$$

$$\frac{R_4}{R_4 + R_5} = \frac{1}{R_2 g_2} \quad (6)$$

#### Design Considerations

Suppose a d-c amplifier is to be designed by using a 6SJ7 as  $T_1$  and a double triode 6SN7 as  $T_2$  and  $T_3$ , with a plate supply voltage  $E_{bb}$  of 250 volts, as shown in Fig. 3. From manufacturer's specifications giving

the characteristics of these two tubes, we have:

6SJ7	6SN7
$E_{bo1} = 50$ volts	$E_{bo2} = 85$ volts
$E_{s\sigma 1} = 40$ volts	$E_{cc2} = -2$ volts
$E_{cc1} = -0.5$ volt	$I_{bo2} = 4$ ma
$I_{bo1} = 2$ ma	$g_2 = 500 \times 10^{-6}$

Calculation gives the following values for the resistors:

$$E_k = E_{bo1} + E_{cc2} = 50 + 2$$

$$R_k = \frac{E_{bo1} + E_{cc2}}{2 I_{bo2}} = \frac{50 + 2}{2 \times 4 \times 10^{-3}} = 6,500 \text{ ohms}$$

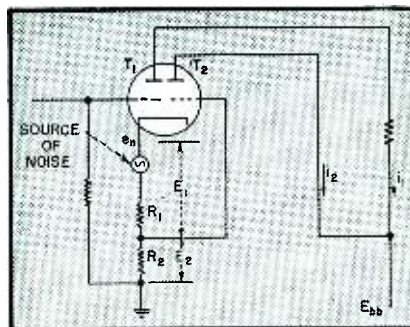

FIG. 5 (above)—Basic double-triode circuit used to cancel effects of cathode noise

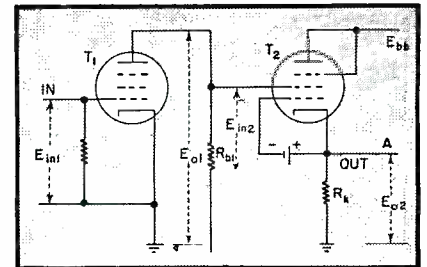

FIG. 6 (upper right)—Basic screen-coupled cathode follower circuit

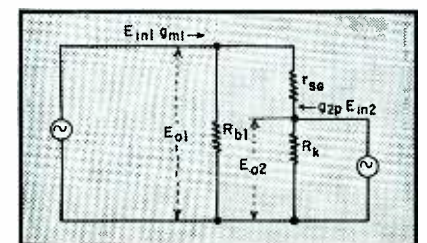

FIG. 7 (lower right)—Equivalent circuit of screen-coupled cathode follower

$$R_2 = \frac{E_{b1}}{g_2 E_{b1} + I_{b2}}$$

$$= \frac{250}{500 \times 10^{-6} \times 50 + 4 \times 10^{-3}} = 8,620 \text{ ohms}$$

If  $R_4 + R_5 = 5$  megohms is used, from Eq. 6  $R_4/5$  megohms =  $1/(8,620 \times 500 \times 10^{-6})$ ,  $R_4 = 1.14$  ohms, and  $R_5 = 5 - 1.14 = 3.86$  ohms.

If the exact values of resistance are not obtainable, a potentiometer may be used for  $R_4$  and adjusted to the right value. The total voltage gain of this amplifier is about 67 db, with uniform gain up to 12 kilocycles. A high-gain stage should not be used for this type of phase inverter circuit because when the ratio  $R_1/R_2$  is very high, stability may be poor unless temperature-compensated resistors are used.

#### Low Noise Level Circuit

In Fig. 4, a double-triode 6SC7 is used instead of a 6SJ7, in order to cancel the change in plate current of the first stage due to the changes in work function of the cathode surface of the tube.<sup>2</sup> The basic circuit is shown in Fig. 5, and the function of this circuit is explained as follows:

$$E_1 = e_n - (i_1 + i_2) R_1$$

$$E_2 = (i_1 + i_2) R_2$$

where  $i_1$  and  $i_2$  are plate currents of

Table I—Mathematical Analysis of Screen-Coupled Cathode Follower Circuit

$E_{in1}$	= input voltage to $T_1$
$E_{in2}$	= input voltage to $T_2$
$E_{o1}$	= output signal voltage from $T_1$
$E_{o2}$	= output signal voltage from $T_2$
$r_{sg}$	= screen grid resistance of $T_2$
$g_{m1}$	= control grid-to-plate transconductance of $T_1$
$g_{m2}$	= control grid-to-plate transconductance of $T_2$
$i_{sg}$	= screen current of $T_2$
$R_{b1}$	= load resistor in plate circuit of $T_1$
$R_k$	= bias resistor for $T_2$
$g_{2p}$	= screen grid-to-plate transconductance of $T_2$
$E_{o2}$	$= (g_{2p} E_{in2} + i_{sg}) R_k$ $E_{in2} = E_{o1} - E_{o2}$
$i_{sg}$	$= \frac{E_{in2}}{r_{sg}} = \frac{E_{o1} - E_{o2}}{r_{sg}}$ so $E_{o2} = (E_{o1} - E_{o2}) (g_{2p} + 1/r_{sg}) R_k$
$E_{o1}$	$= (g_{m1} E_{in1} - i_{sg}) R_{b1} = g_{m1} E_{in1} R_{b1} - \frac{E_{o1} - E_{o2}}{r_{sg}} R_{b1}$
$E_{o1}$	$= \frac{g_{m1} E_{in1} R_{b1} + E_{o2} R_{b1}/r_{sg}}{1 + (R_{b1}/r_{sg})}$
$E_{o2}$	$= \left( g_{2p} R_k + \frac{R_k}{r_{sg}} \right) (E_{o1} - E_{o2})$
$E_{o2}$	$= \left( g_{2p} R_k + \frac{R_k}{r_{sg}} \right) E_{o1} / \left( 1 + g_{2p} R_k + \frac{R_k}{r_{sg}} \right)$
$E_{o2}$	$\left[ \left( 1 + g_{2p} R_k + \frac{R_k}{r_{sg}} \right) - \frac{\left( g_{2p} R_k + \frac{R_k}{r_{sg}} \right) R_{b1}}{1 + (R_{b1}/r_{sg})} \right] =$
$E_{o2}$	$\frac{\left( g_{2p} R_k + \frac{R_k}{r_{sg}} \right) \left( \frac{g_{m1} E_{in1} R_{b1}}{1 + (R_{b1}/r_{sg})} \right)}{\left( \frac{1}{R_k} + g_{2p} + \frac{1}{r_{sg}} \right) \left( 1 + \frac{R_{b1}}{r_{sg}} \right) - \frac{R_{b1}}{r_{sg}} \left( g_{2p} + \frac{1}{r_{sg}} \right)}$
when $r_{sg} \gg R_{b1}$ $r_{sg} \gg R_k$	$E_{o2} = \frac{g_{m1} R_{b1} \left( g_{2p} + \frac{1}{r_{sg}} \right)}{\frac{1}{R_k} + g_{2p}} E_{in1}$

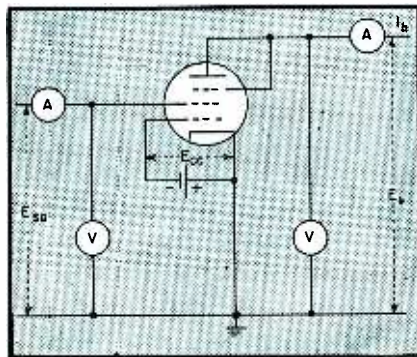
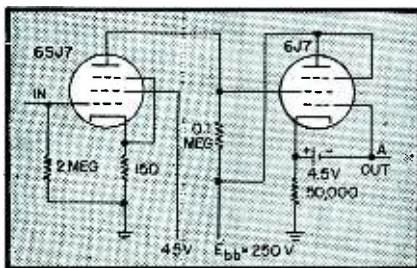

FIG. 8 (upper left)—Practical version of screen-coupled cathode follower

FIG. 9 (lower left)—Screen-coupled cathode follower with higher negative bias

FIG. 10 (above)—Laboratory circuit used to obtain screen characteristics of 6J7

$T_1$  and  $T_2$  respectively. When the signal input to the grid of  $T_1$  is zero,  $i_1 = g_1 (E_1 - E_2)$  and  $i_2 = g_2 E_2$ , where  $g_1$  and  $g_2$  are the transconductances of  $T_1$  and  $T_2$  respectively. Therefore

$$E_1 - E_2 = E_1 - [g_2 E_1 + g_1 (E_1 - E_2)] R_2$$

By rearranging and simplifying the above expression, we obtain an equation from which the performance of the circuit can more readily be deduced:

$$E_1 - E_2 = \frac{E_1 - g_2 E_1 R_2}{1 + g_1 R_2}$$

When  $R_2$  is equal to  $1/g_2$ ,  $E_1 - g_2 E_1 R_2 = 0$  and  $E_1 - E_2 = 0$ . The net change in plate current  $i$ , due to random changes in work function of the cathode surface or changes in heater voltage is therefore zero. A gain of 30 to 32 db can be expected

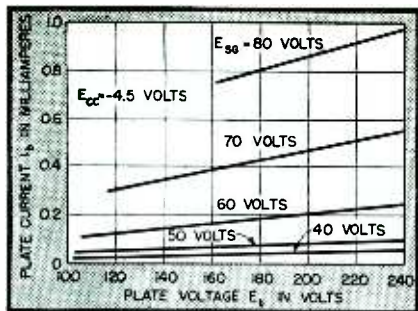

FIG. 11—Static characteristics of 6J7 for 4.5-volt bias

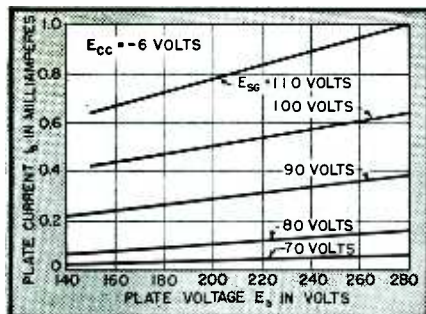

FIG. 12—Static characteristics of 6J7 for 6-volt bias

from a 6SC7 in this type of operation.

The noise level in the amplifier circuit of Fig. 4 is down to practically zero (about 0.01 microvolt referred to the input) with the input terminals shorted. The voltage gain is 70 db with a flat frequency response up to 12 kilocycles and less than 1 percent distortion for 5 millivolts sensitivity. Only one regulated 250-volt power supply is required. Good stability (practically constant output) has been had for a five-hour run after the initial warmup period. Feedback can be provided from the output of 6AE5 to the bias resistor of 6SC7 when wider frequency response is desired.

The remarkable feature of this method of coupling is that the noise level and the distortion percentage can be reduced to an extremely low value. The operation also can be stabilized to a very high degree if all resistors are temperature compensated and all heater voltages are carefully regulated.

The objectionable feature of this method of coupling is that the plate supply voltage available for the last stage is low (only 95 volts in the circuit of Fig. 4). This defect can

be avoided by the method of coupling next to be discussed.

#### Screen-Coupled Cathode Follower Circuit

If the input of a cathode follower circuit is coupled to the screen grid instead of the control grid as in the usual arrangement, a circuit is obtained which steps down the quiescent d-c potential to as low as a few volts at the output of the stage.

In Fig. 6, the input from the plate of the preceding stage feeds directly to the screen grid of  $T_2$ . The output of  $T_2$  is taken from  $R_k$  and directly feeds to the control grid of the next stage. The quiescent d-c potential at point A, equal to  $R_k (I_{b02} + I_{s0})$ , can be made less than a few volts.

The equivalent circuit of Fig. 6 is shown in Fig. 7. The equation

$$\text{gain} = g_{2p} / \left( \frac{1}{R_k} + g_{2p} \right)$$

Therefore the maximum gain for the screen-coupled cathode follower stage (being equal to one) can be obtained when  $g_{2p} \gg 1/R_k$ . When the plate current and the screen current both are small,  $R_k$  can be made large because even with a large  $R_k$  the cathode-to-ground potential, equal to  $R_k (I_{b0} + I_{s0})$ , is still not too large to make difficult the coupling into the next stage.

The plate current and the screen current of a tube can both be lowered by increasing the negative bias voltage on the tube. Unfortunately, when the negative bias voltage increases, the screen grid-to-plate transconductance  $g_{2p}$  decreases.

In Fig. 8, where a 6SJ7 is used as the first stage and a 6J7 is used as the screen-coupled cathode follower stage, the total voltage gain  $E_{o2}/E_{i1}$  is 30 db with 0.85 volt peak output. The quiescent d-c potential at point A, the output terminal, is minus 1.5 volts. This negative 1.5 volts can be utilized as the bias voltage for the succeeding stage, and therefore point A can be connected directly to the control grid of the next stage.

In Fig. 9, with the negative bias increased to 12 volts, the quiescent d-c potential at point P, the input terminal, is 210 volts; after the screen-coupled cathode follower stage, the quiescent d-c potential at point A, the output terminal, is minus 1.5 volts. Point A can be connected directly to the control grid of the succeeding stage, utilizing this minus 1.5 volts as the bias voltage. About 8 db loss in voltage gain resulted from the screen-coupled cathode follower stage.

The screen characteristics of a type 6J7 tube were obtained by use of the laboratory setup shown in Fig. 10, with results as given in Fig. 11, 12, 13, and 14. The portions of the curves from zero plate potential to near the values of the screen grid potentials have been neglected, because the screen currents are so high in these ranges that the preceding stage might be overloaded; also, the curvatures of the plate characteristics are so high that large percentages of distortion may be expected. Many other types of pentodes no doubt are able to serve

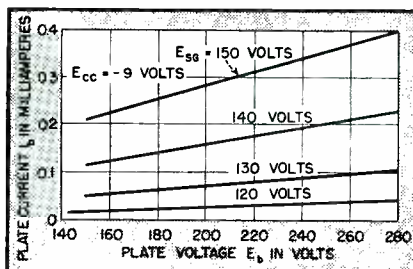

FIG. 13—Static characteristics of 6J7 for 9-volt bias

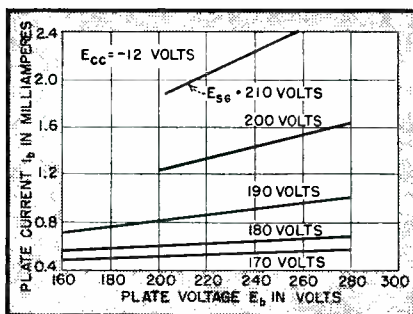

FIG. 14—Static characteristics of 6J7 for 12-volt bias

for the voltage gain can be obtained by a mathematical analysis of this circuit, as given in Table I.

When the value of  $1/r_{s0}$  is very small in comparison with the other terms, the voltage gain equation may be simplified to

$$E_{o2} = g_{m1} E_{i1} R_{b1} g_{2p} / \left( \frac{1}{R_k} + g_{2p} \right)$$

Then the gain for the screen-coupled cathode follower stage alone is



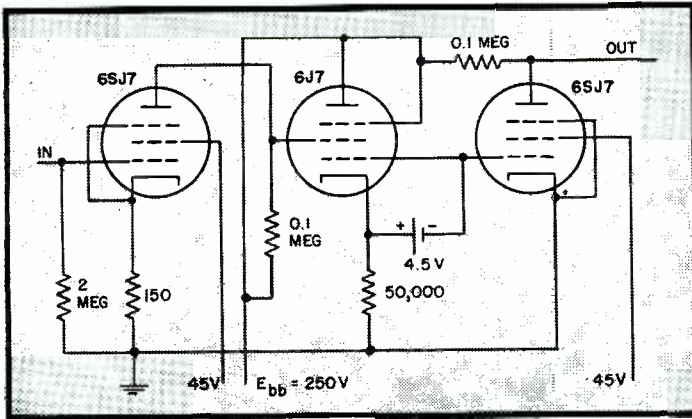

FIG. 15—Screen-coupled cathode-follower in d-c amplifier having 76 db voltage gain and flat response up to 12 kc

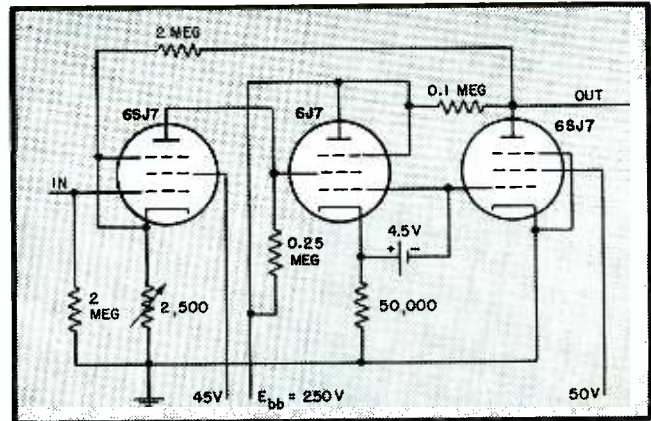

FIG. 16—Circuit of Fig. 15 with feedback resistor, giving 60 db gain but extending flat response up to 20 kc

in this kind of arrangement. The choice lies mainly in the specification required.

#### Results and Discussion

The amplifier circuit in Fig. 15, with a 6SJ7 as the first stage, a 6J7 as a screen-coupled cathode follower stage, and another 6SJ7 as the final stage, has a total voltage gain of 76 db with 2.5 percent total distortion at 15 volts peak output. The frequency response is flat up to 12 kilocycles. The amplifier circuit in Fig. 16 is essentially identical except that a feedback resistor is provided from the output of the last stage (the plate of the 6SJ7) to the cathode of the first stage. The frequency response is raised to 20 kilocycles with a voltage gain of 60 db, and the distortion is reduced to less than one percent at 15 volts peak output.

The operation of screen-coupled cathode followers is stable with wide-band frequency response, because the circuit is highly degenerative. There is no appreciable change in output for a six-hour run after the initial warmup period.

A small percentage of distortion is to be expected in screen-coupled cathode follower circuits due to the nonproportional change of screen current with respect to change of screen potential; in other words, the screen grid resistance is not exactly constant when the screen potential is varying; also, the screen grid-to-plate transconductance  $g_{sp}$  is not exactly constant when the screen potential is varying. About 0.5 per-

cent distortion is produced by the screen-coupled cathode follower circuit in Fig. 8 when the output is 0.85 volt peak value.

#### Conclusions

Fortunately, most of the total distortion in a screen-coupled cathode follower circuit (about 85 percent of the total distortion in the amplifier circuit of Fig. 8) can be cancelled by a pushpull phase inverter arrangement such as the amplifier circuit shown in Fig. 17. Therefore, the pushpull arrangement which has been discussed in the early part of this paper may be incorporated with

the screen-coupled cathode follower circuit to solve the problem of coupling between stages in a high-gain d-c amplifier using one common power supply of limited d-c voltage output.

The author wishes to acknowledge that this paper was prepared in the Electrical Engineering Department of Lehigh University with valuable advice from Professor E. M. Mode.

#### REFERENCES

- (1) Ginzton, Edward L., D. C. Amplifier Design Techniques, *ELECTRONICS*, Mar. 1944.
- (2) Miller, Stewart E., Sensitive D. C. Amplifier for A. C. Operation, *ELECTRONICS*, Nov. 1941.

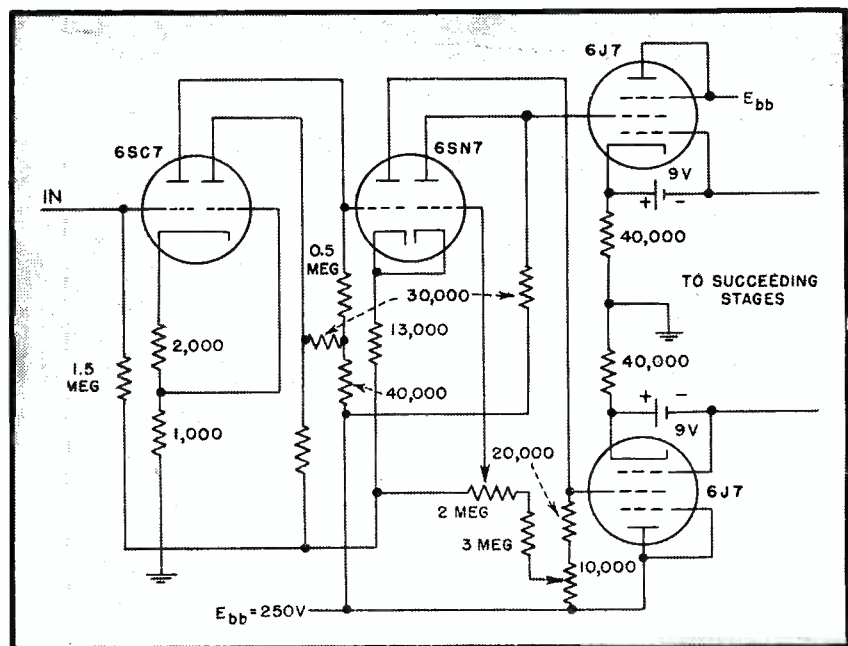

FIG. 17—Practical circuit combining screen-coupled cathode follower with pushpull phase inverter to give high-gain, wide-band operation with only a single conventional 250-volt power supply

# Flexible Wave Guides

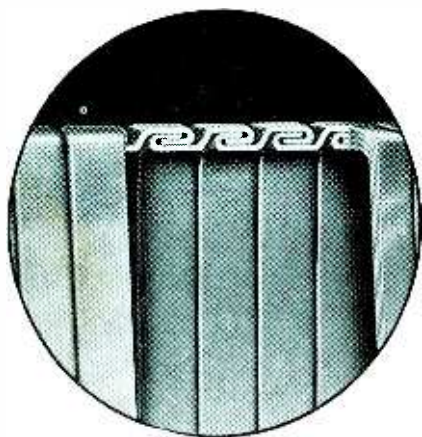

FIG. 1—Enlarged cut-away view showing construction of interlocked type of flexible wave guide

**A**LTHOUGH Lord Rayleigh published a paper<sup>1</sup> nearly fifty years ago dealing with the transmission of electromagnetic waves through hollow conducting tubes, it was not until recent years that this technique found practical application. With the advent of radar and other microwave equipments transmission of radio-frequency energy through such tubes, now known as wave guides, became commonplace.

There are several reasons why wave guides are used at the higher frequencies among them being that they provide lower attenuation and will handle more power than other types of transmission line such as coaxial cable or parallel wire lines. At wavelengths greater than about 20 centimeters (1,500 megacycles) however, the size of guide required is too large to be generally useful. On the other hand, at wavelengths below about 3 centimeters (10,000 megacycles) they are almost invariably used since they are by far the most efficient and satisfactory type of transmission line available for operation in this region. In the region from about 3 to 20 centimeters either wave guides or coaxial cables are used, depending upon the requirements of a given application. Parallel wire lines, owing to difficulties in construction and excessive losses by radiation at the high frequencies involved, are practically never used for microwave work.

Three types of guides are described which are used in systems requiring one or more flexible components able to bend, twist, stretch or compress at the time of installation or repeatedly thereafter

By **ALTON R. ANDERSON** and **ALFRED M. WINCHELL**

*American Metal Hose Branch  
American Brass Co.  
Waterbury, Conn.*

Although it is possible to transmit radio-frequency energy through hollow pipes of various cross-sectional shapes, wave guides of rectangular, or nearly rectangular cross-section made of copper, brass, bronze and aluminum have been commonly used and are frequently silver plated to provide a corrosion-resisting highly conducting surface layer. Sometimes gold plate is used; this has fair conductivity and is practically immune to corrosion. The attenuation of a given guide decreases as the electrical conductivity of its inside surface is increased but, since at microwave frequencies depth of penetration is small, only a thin layer of good conducting material is needed. This may be applied to a base of relatively high resistance metal or even to a nonconducting material.

#### Angles in Guide Systems

The piped wave follows the guide so that it is possible to make bends, angles, or twists in the tubing—pro-

vided they are made gradually enough to avoid setting up large reflections. It is frequently desired to transmit energy from one piece of equipment to another where for mechanical reasons the path cannot be a straight line. Furthermore, in applications such as connection of an r-f head to a scanner, where one part must move with respect to the other, a rigid guide will not accommodate itself to the required motion. Some form of flexible coupling obviously has to be employed and a flexible wave guide frequently can be used. For some installations, as with aircraft and sea-borne equipment, a floating mount may be required for certain units necessitating the use of a flexible wave guide.

#### Types of Flexible Wave Guides

In an attempt to produce a satisfactory flexible wave guide various groups in this country and elsewhere have experimented with a number of different constructions. Rectangular

FIG. 2—Interlocked type flexible wave guide assemblies with and without synthetic rubber jacket. These mate mechanically and electrically with  $\frac{3}{8}$  by  $1\frac{1}{4}$  in. rigid guide

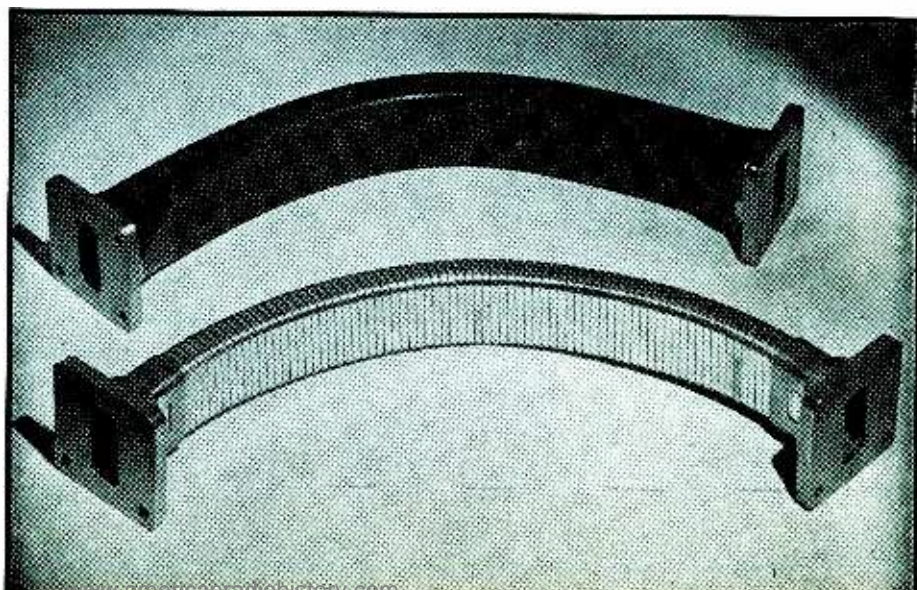

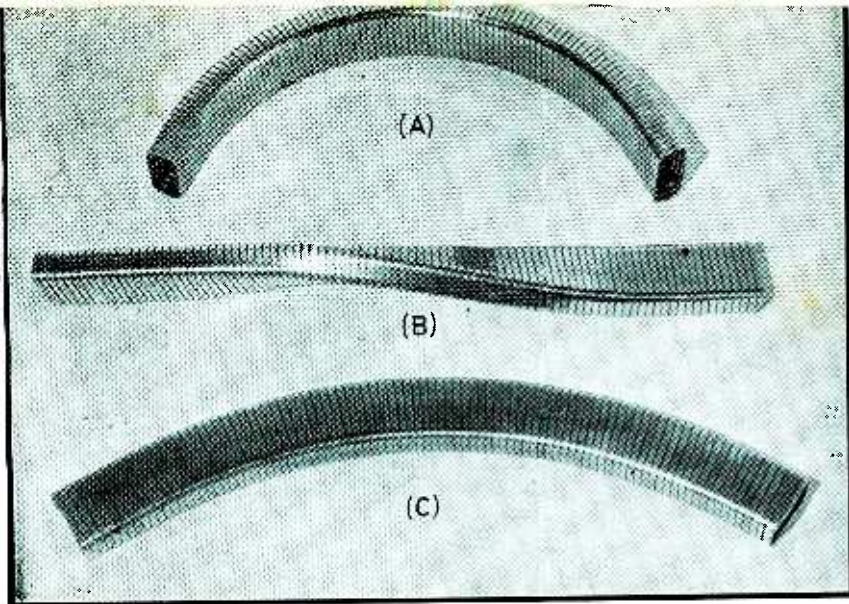

FIG. 3—Interlocked type of rectangular flexible wave guide, (A) bent in E-plane; (B) twisted axially; (C) bent in H-plane

tubing made from wire screening and a round-bellows type of guide having choke convolutions and a rectangular hole between convolutions were both tried and used with some success. Radiation Laboratory, Massachusetts Institute of Technology, operating with the National Defense Research Committee through a contract placed with the Office of Scientific Research and Development and working in close cooperation with industrial organizations developed other types of flexible wave guide three of which were produced during the War by the American Metal Hose Branch of The American Brass Company.

The first type, used in large quantity, is made by spirally winding a metal strip about a rectangular arbor, folding in and interlocking the edges. It is, therefore, often referred to as the interlocked type. The second type is the so-called vertebra wave guide which consists essentially of a stack of round metallic wafers with rectangular holes, called choke sections. These wafers are spaced slightly and held in place by an internally ribbed synthetic rubber

jacket. The third type is referred to as the seamless type because it is made by corrugating a thin-wall, seamless, rectangular metal tube.

At least one other type of flexible guide has been made and used. It consists of a rectangular convoluted metal hose, in appearance somewhat like the seamless guide. However, instead of being formed from seamless metal tube, this guide is made by spirally winding a thin, formed metal strip about a rectangular arbor, soft soldering the over-lapped edges. The present article will be confined to describing the interlocked, vertebra and seamless types of flexible wave guide, their properties and applications.

#### Interlocked Flexible Guides

The interlocked type of flexible wave guide sometimes called full four-wall interlocked has been most commonly made from silver-laminated bronze strip but has also been fabricated from other metals such as bronze, aluminum and tinned stainless steel. As the silver-laminated strip is wound about an arbor the edges are folded under and inter-

locked in such a manner as to provide a multiple contact which, when the wall is sectioned, appears as shown in Fig. 1. There are three parallel silver-to-silver contact surfaces joining each convolution to the next. The guide flexes by virtue of a sliding motion which takes place between convolutions as the guide is bent, twisted or stretched.

The cross-section of the guide is a rectangle with rounded corners but, due to the convoluted construction, the inside surfaces obviously are not perfectly plane. Despite this, however, it has been found in practice that resultant reflections from such a guide actually are very small. Although there are numerous small reflections from the irregularities between convolutions it should be borne in mind that most of these are cancelled by equal reflections, 180 degrees out of phase, from other points along the guide. Because of these surface irregularities and the rounded corners the optimum cross-sectional dimensions of such a flexible guide may differ slightly from those of the corresponding size of rigid guide with which it is to mate. However, when properly dimensioned, a good impedance match can be obtained between the flexible and rigid guide.

This type of guide is usually made up into assemblies consisting of a length of the interlocked metal tubing with appropriate plate, contact, or choke flanges hard or soft soldered to the ends. Such an assembly, with a pressure-tight, molded, synthetic-rubber jacket, is known by the trade name of Moldlock flexible wave guide and is available in standard lengths from 6 inches to 6 feet. Figure 2 shows a 3-centimeter Moldlock assembly and a similar assembly before application of the jacket. The molded jacket protects the guide, makes it pressure-tight, improves its mechanical properties and helps maintain good electrical contact between convolutions. Interlocked flexible wave guide is at present available in sizes suitable for operation at

FIG. 4—Components that make up a vertebra-type flexible wave guide assembly for use in the 3-centimeter region

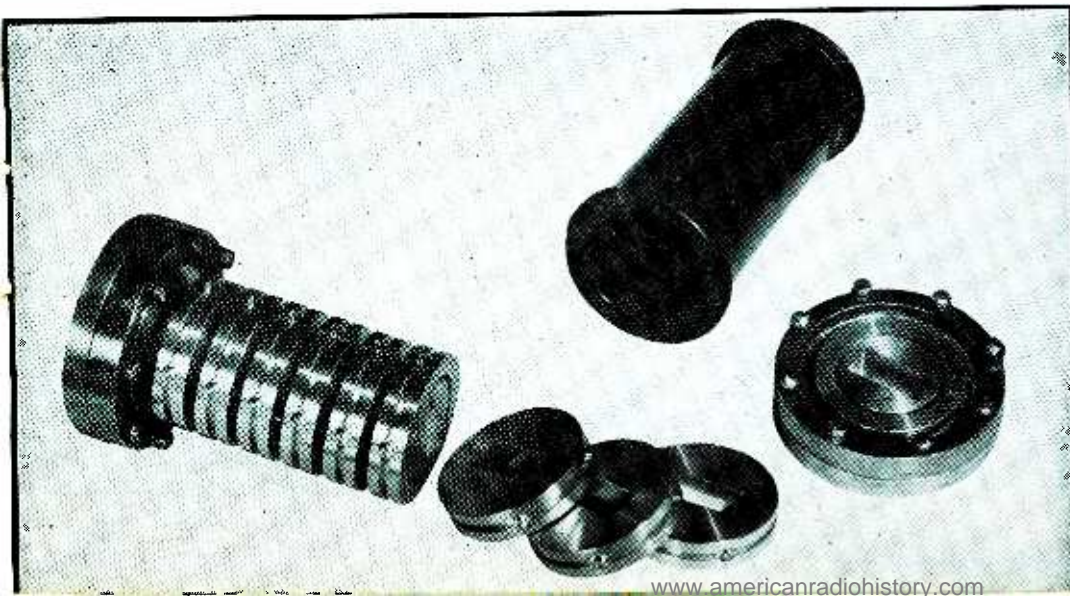

most wavelengths from about 25 to less than 3 centimeters.

The interlocked type of guide can be twisted axially or bent in either or both of two planes, as in Fig. 3, and will stretch or compress slightly. It is well adapted to withstand repeated flexing of considerable amplitude provided the rate of flexure is not too rapid. Table I gives representative data on 4-foot assemblies of several sizes of Moldlock guide with standard flanges. The silver-laminated strip used in its construction is relatively immune to corrosion. Assemblies have been subjected, both inside and out, to 20 percent salt spray for more than 500 hours with no impairment of either mechanical or electrical properties. A molded assembly will safely withstand internal pressurization in excess of 1½ atmospheres. It is rugged, the 3-centimeter size, for example, being able to withstand without significant distortion a load of 250 pounds applied with a one-inch square plunger to the wider surface.

Attenuation of a wave passing through interlocked flexible guide is somewhat, but not greatly, higher than the attenuation through a similar rigid guide. Nominal values of attenuation for molded assemblies of interlocked flexible wave guide made of silver-laminated strip are shown in Table I.

#### Standing-wave Ratios

Of interest in most applications are the reflections of the wave which take place due to impedance mismatches when any unit is inserted in a transmission line. The magni-

tude of the resultant of such reflections can be stated in terms of the ratio (maximum to minimum) of the standing waves which are set up in the line as a result of insertion of the unit. With wave-guides this ratio, rather than values of characteristic impedances, is customarily given to indicate the impedance match obtained. Thus, the vswr (voltage standing wave ratio) of a flexible wave guide assembly is an important electrical property. Representative values of vswr (measured at specific test frequencies) for Moldlock flexible wave guide assemblies are included in Table I. In general, vswr depends upon cross-sectional dimensions, smoothness of the interior, electrical contact between convolutions and alignment and contact between the tubing and flanges but is relatively independent of length and metal used.

#### Vertebra Flexible Wave Guide

Construction of the vertebra-type flexible wave guide can be seen from Fig. 4. It consists of a specified number of aluminum alloy choke sections held in alignment and properly spaced by means of a suitable ribbed synthetic rubber jacket. The choke sections are so named because there is a choke groove in one face which presents a high impedance at the junction between it and the flat face of the adjacent wafer making for low-loss transmission across the space between wafers. This type of construction deviates markedly from the popular conception of a wave guide having highly conducting walls free of electrical discontinuities.

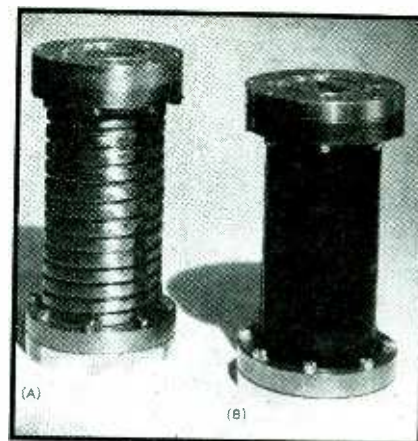

FIG. 5—Vertebra-type flexible wave guide assemblies which mate with ½ x 1 in. rigid guide. (B) for use in systems at atmospheric pressure, and (A) with addition of flexible metal hose casing for use in pressurized systems

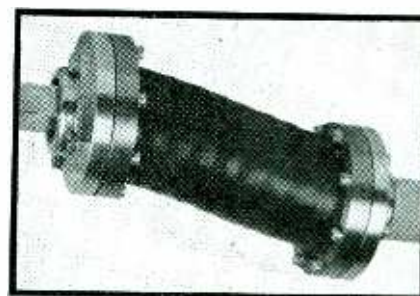

FIG. 6—Vertebra type flexible wave guide assembly coupling two displaced sections of rigid guide

There obviously is no d-c continuity from one end to the other but, due to the peculiar function of the choke sections, good r-f continuity is preserved. True, there is some loss of power by radiation from the spaces between wafers but this is small and increases the attenuation but slightly. Flexibility is obtained in this type of guide by a yielding of

Table I—Representative Mechanical and Electrical Data for 4-ft Moldlock Assemblies

AN type designation	Equivalent rigid guide (inches, outside)	Outside dimensions (inches)	Approx weight of assembly (pounds)	Max safe axial twist (degrees)	Min safe bending radius (inches)		Max safe extension or compression (inches)	Approximate operating range (cm)	Nominal attenuation (db)	Nominal vswr
					E-plane	H-plane				
CG-164/U (48")	½ x 1	1 1/8 x 1 1/4	2.6	225	7 1/2	15	± 1/4	2.1-3.7	0.30	1.10
CG-166/U (48")	3/8 x 1 1/4	3/4 x 1 1/2	3.3	180	9	17	± 1/4	3.0-4.7	0.29	1.10
	3/4 x 1 1/2	7/8 x 1 3/4	4.4	135	10	18	± 3/8	3.7-5.7	0.25	1.10
CG-168/U (48")	1 x 2	1 1/8 x 2 5/16	5.9	70	19	32	± 3/8	5.0-7.6	0.11	1.10
CG-170/U (48")	1 1/2 x 3	1 9/16 x 3 1/16	9.9	10	45	65	± 1/8	7.6-11.8	0.06	1.10

Table II—Representative Data 3-CM Vertebra Flexible Wave Guide Assemblies Without Armor

Number of chokes	Overall length (inches)	Equivalent rigid guide (inches, outside)	Outside diameter (inches)	Approx weight (pounds)	Max safe axial twist (degrees)	Max safe bend (degrees)		Max safe extension or compression (inches)	Max safe shear (inches)		Nominal attenuation (db)	Nominal vswr
						E-plane	H-plane		E-plane	H-plane		
5	3 7/8	½ x 1	1 7/8	1.0	23	30	30	1/2	1/2	1/2	0.16	1.08
9	5 1/4	½ x 1	1 7/8	1.3	45	60	60	1	1	1	0.20	1.08

**Table III—Representative Data 3-CM Seamless Flexible Wave Guide Assemblies**

Overall length (inches)	Equivalent rigid guide (inches, outside)	Outside dimensions (inches)	Approx weight (pounds)	Min bending radii (inches)		Maximum extension or compression (inches)	Maximum shear (inches)	Approximate operating range (cm)	Nominal attenuation (db)	Nominal vswr
				E-plane	H-plane					
1 1/4	1/2 x 1	5/8 x 1 3/8	0.18	1	1 1/2	+ 1/16 - 1/8	1/8	2.4-3.7	0.02	1.08
6 1/4	1/2 x 1	5/8 x 1 3/8	0.25	1	1 1/2	+ 3/8 - 1/8	3/4	2.4-3.7	0.05	1.08
12 1/4	1/2 x 1	5/8 x 1 3/8	0.33	1	1 1/2	+ 3/4 - 1/8	1 1/2	2.4-3.7	0.07	1.08
1 1/4	5/8 x 1 1/4	3/4 x 1 3/8	0.45	1	1 1/2	+ 1/16 - 1/8	1/8	3.0-4.7	0.02	1.08
6 1/4	5/8 x 1 1/4	3/4 x 1 3/8	0.55	1	1 1/2	+ 3/8 - 1/8	3/4	3.0-4.7	0.05	1.08
12 1/4	5/8 x 1 1/4	3/4 x 1 3/8	0.67	1	1 1/2	+ 3/4 - 1/8	1 1/2	3.0-4.7	0.07	1.08

the rubber jacket accompanied by small changes in the spacings between individual choke sections.

**Armored Vertebra Guide**

To complete a vertebra assembly, suitable plate or choke flanges are incorporated in the end sections being held in place by clamping rings. Such an assembly is shown in Fig. 5B. Although pressure-tight, the assembly as pictured will not withstand much internal pressure without ballooning of the jacket. Consequently, when a vertebra assembly must be pressurized the jacket is surrounded by a flexible metallic hose armor, as shown in Fig. 5A. Such an assembly with armor can safely be pressurized to 1 1/2 atmospheres.

The vertebra type of guide can be bent appreciably in any direction in a plane normal to its axis without mechanical damage or serious impairment to its electrical properties. It likewise can be twisted, sheared, stretched or compressed considerably, as illustrated in Fig. 6. Although possessing more degrees of flexibility than either of the other two types of guide described it is heavier and considerably more bulky and at present is available only in short lengths (up to 8 1/2 inches) and for operation at wavelengths not greater than about 3 1/2 centimeters. Representative mechanical and electrical data for two 3-centimeter vertebra-type flexible wave guide assemblies are given in Table II.

Because of the type of construction used the attenuation per unit length of vertebra guides is somewhat higher than that of the other flexible guides described. However, since this kind of guide is ordinarily used only in short lengths the attenuation of the assembly is not too high for most applications. The table lists the nominal electrical properties in the relaxed position. Provided the

assembly is not deflected beyond its nominal working range these properties do not vary greatly beyond the value shown. The vswr is at least as low as for the other flexible assemblies.

**Seamless Flexible Wave Guide**

The seamless type of flexible wave guide is made by convoluting a thin-wall, seamless, rectangular metal tube in a manner which will be made clear by reference to Fig. 7. The metal used for making this kind of guide is usually copper or bronze. It is made from various thicknesses of metal and finished either hard or annealed depending upon the application for which it is intended. In Fig. 8 are shown two seamless flexible wave guide assemblies with soft soldered flanges. These have been silver plated to provide a highly conducting layer and protect them against corrosion. Guide of this construction flexes accordion-fashion.

The seamless guide is conspicuous for its ability to withstand relatively sharp bends in either the E or H planes. Consequently, it is capable of taking relatively high unit shear. It can be stretched or compressed appreciably but is damaged by axial twisting. However, a bent assembly can be twisted considerably. Figure

9 shows a complicated elbow made from this type of guide. Data for several different 3-centimeter seamless flexible wave guide assemblies are shown in Table III. As currently made the seamless guide, without reinforcement, can be pressurized to 1 1/2 atmospheres. It is sometimes wrapped with a synthetic rubber tape for mechanical or corrosion protection, as shown in Fig. 8B.

This type of guide will withstand a large number of cycles of vibration or repeated deflection of moderate amplitude. It is ideally suited for fabrication into elbows, bends and the like, or to provide for static misalignment between units. Because of its light weight and ease of flexibility it is well suited for coupling to units of glass or other brittle or fragile materials. Up to the present time seamless flexible wave guide has been found particularly useful in lengths not exceeding 15 inches. It is not currently made in as many different cross-sectional sizes as is the interlocked type but it is expected that additional sizes will be made available in the near future.

**Flexible Guide Without Joints**

The type of construction employed in the seamless flexible wave guide provides a complete jointless con-

**FIG. 7—Cut-away view showing construction of seamless type rectangular flexible wave guide**

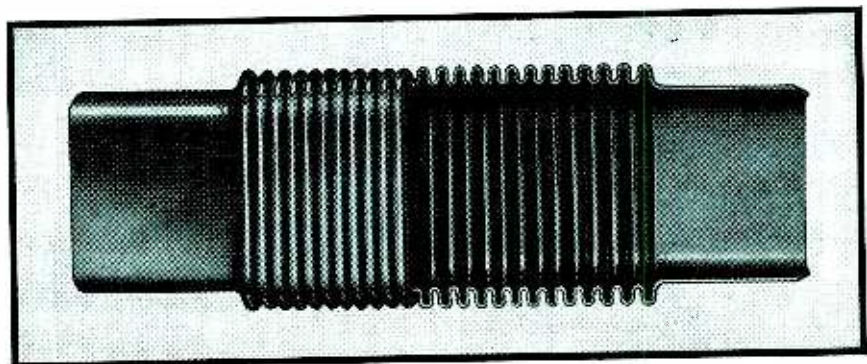

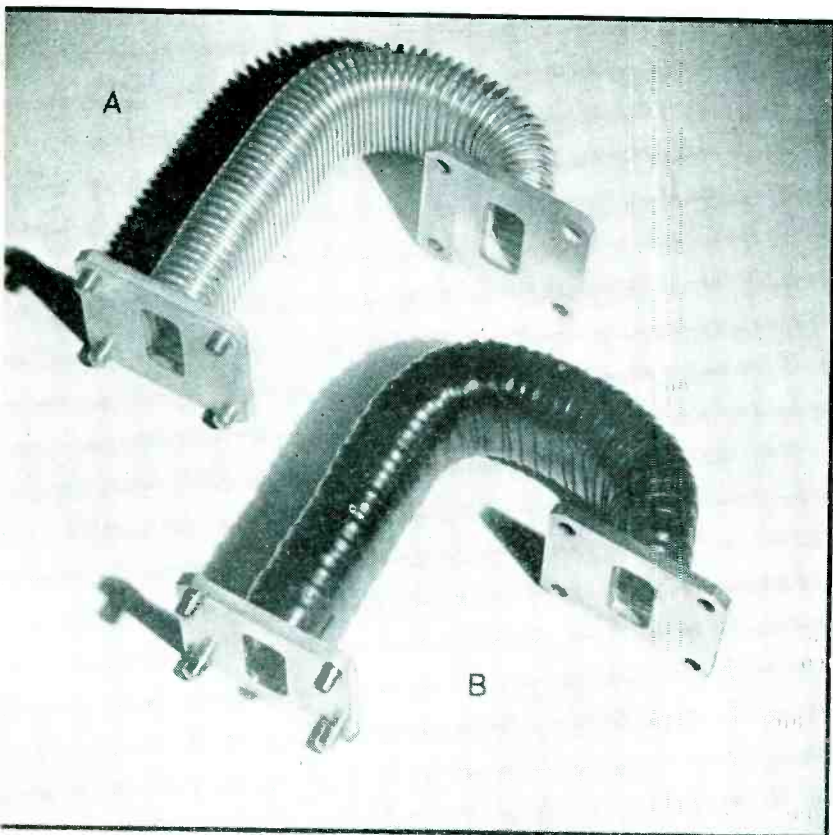

FIG. 8—Bent assemblies of seamless flexible wave guide, (A) silver-plated copper guide, (B) with tape-wrapped synthetic rubber cover

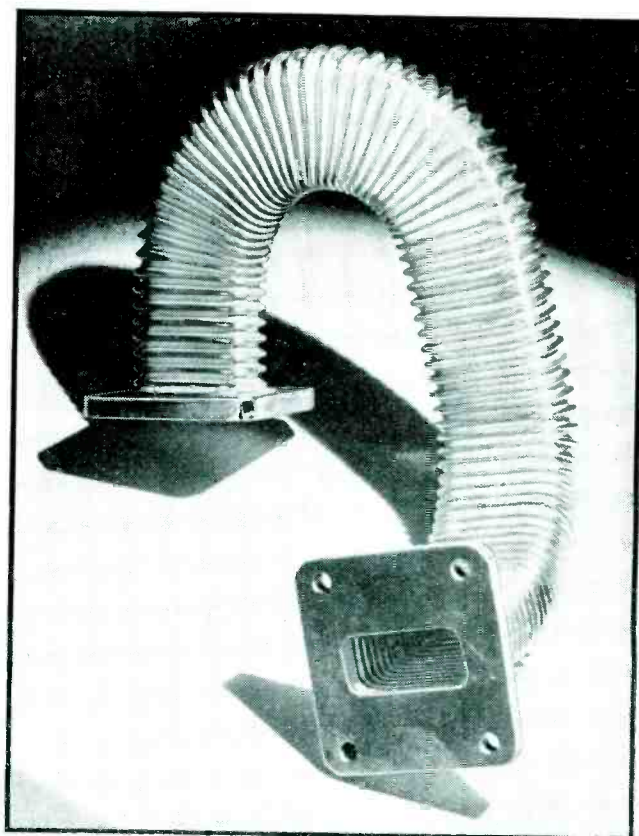

FIG. 9—Complicated elbow made of silver-plated seamless flexible wave guide, bent in both E- and H-plane

ducting path from one end of the assembly to the other. When silver plated, the attenuation per foot is only slightly greater than that of silver rigid guide and does not vary sensibly with flexing. Nominal electrical data for assemblies of two sizes of seamless flexible guide are included in Table III.

Although the inside surfaces of a seamless flexible guide are far from smooth (the convolutions of a 3-centimeter guide are 0.1 inch deep) the same sort of reflection cancellation is obtained as with the interlocked type of guide. With proper cross-sectional dimensions the overall standing wave ratio of an assembly is quite low. The values in Table III are representative of values ordinarily encountered in production for several 3-centimeter assemblies.

#### Comparison of Different Types

Each of the three types of flexible guide differs in certain respects from the others, and should be considered as supplementary rather than competitive. Although they vary somewhat in electrical properties the

principal differences between types are physical or mechanical.

At present the interlocked type is available for operation at the largest number of different frequencies whereas the vertebra and seamless types are made only in a limited number of cross-sectional sizes. For applications requiring flexible assemblies longer than 15 inches the interlocked type is currently available; for shorter lengths the type selected will depend upon availability and specific requirements of the applica-

tion, excepting that interlocked guide is not ordinarily made in assemblies less than 6 inches long. Other types are available in lengths as short as 1½ inches. Sometimes it is advantageously used in conjunction with a length of rigid guide or rigid angle, as shown in Fig. 10.

#### Vertebra Guide Needs Shielding

The vertebra type of guide provides a flexible coupling unit for use between floating and rigidly mounted units. It is particularly well adapted

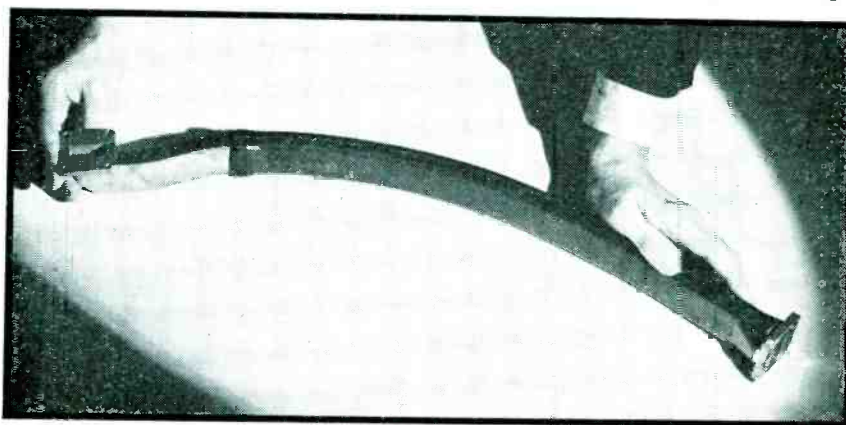

FIG. 10—An assembly consisting of interlocked flexible wave guide hard-soldered to a rigid elbow

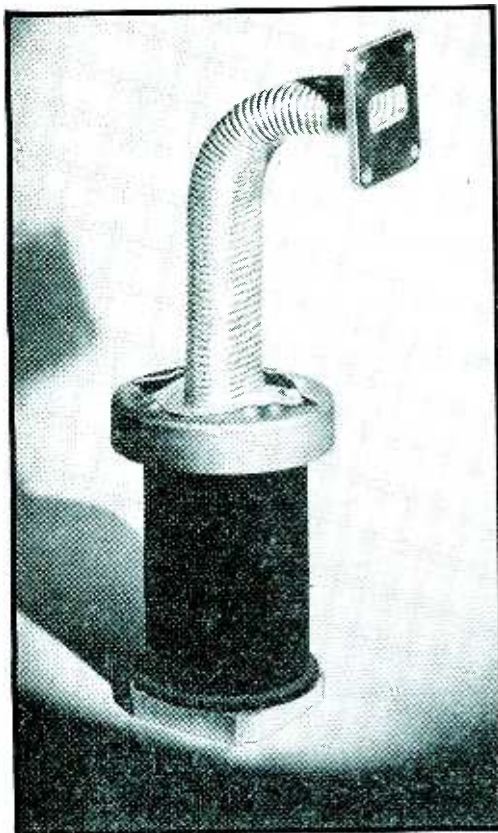

FIG. 11—An assembly of seamless and vertebra-type flexible wave guides

to withstanding continuous vibration or flexure and transmits but a relatively small force from one end to the other. Combinations of two types of flexible wave guide are occasionally used, as illustrated in Fig. 11.

If stray leakage of r-f from a guide must be kept to the lowest possible level the vertebra type should not be used without supplementary shielding. The flexible armor currently used to permit pressurization is not an effective shield.

Because of the resonant choke grooves in the wafers comprising the vertebra guide this type is useful over a narrower range of frequency than are the other two untuned varieties.

#### Variety of Seamless Guides

Since it can be bent to very small radii in either or both the E- and H-planes the seamless type of flexible wave guide is ideal for making complicated bent sections which are difficult or expensive to make from rigid guide. Seamless guide of relatively heavy wall can be bent as desired and will retain the desired shape at the same time providing enough flexibility to allow for reasonable dimensional tolerances, a fea-

ture not found in a similar section fabricated from rigid guide. Such heavy-wall seamless, however, is not intended to withstand continuous flexure or vibration. For applications requiring frequent flexure or continuous vibration thinner-wall seamless assemblies, in fairly long lengths, are employed to obtain maximum life. Short lengths of thin-wall, annealed seamless guide are used for connections to fragile components to prevent undue stress which might result from slight misalignment or from expansion or contraction with temperature changes. When made to the proper cross-sectional dimensions seamless guide has been found suitable for making flexible step transformers. Such a transformer, designed to match  $\frac{1}{2} \times 1$  inch to  $\frac{3}{8} \times 1\frac{1}{4}$  inch rigid guides (or their flexible equivalents) is shown in Fig. 12. For certain applications an assembly consisting of part rigid and part flexible guide has been used. One of these assemblies made with the seamless type of guide is shown in Fig. 13.

#### Conclusion

Because of their versatility, flexible guides find use in a wide variety of applications. They can be used for nod or tilt joint couplings to parabolic antennas, to replace rotating joints of scanners where a complete revolution is not required, and for connections to all sorts of shock-mounted or vibrating pieces of equipment. Sections of flexible guide facilitate connections between units which are not perfectly aligned or provide shock-reducing expansion-contraction couplings to magnetrons

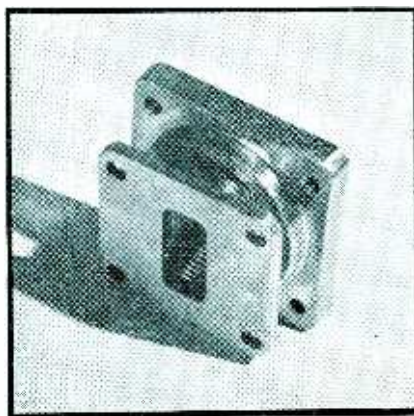

FIG. 12—A flexible step transformer made from the seamless type of wave guide

and other delicate components. Complex bent or twisted elbows, which possess considerable flexibility, can be formed directly from such guide. They are used for making flexible step transformers and as flexible leads for a variety of test equipments. That the number of possible applications for flexible wave guides is great is evidenced by the ingenuity of the many designers who have used them for diverse purposes.

Each of the three types of flexible wave guide has properties peculiar to its construction. The type most appropriate for a given application depends upon the specific requirements of the installation. By their use, in addition to or in physical combination with sections of rigid guide, many seemingly impossible problems have been quickly and easily solved.

#### REFERENCES

1. Lord Rayleigh, On the Passage of Electric Waves Through Tubes, or the Vibrations of Dielectric Cylinders, *Phil. Mag.* 43, p 125, 1897. Also Scientific Papers, 4, p 276.

#### BIBLIOGRAPHY

- Barrow, W. L., Transmission of Electromagnetic Waves in Hollow Tubes of Metal, *Proc. IRE*, 24, p. 1,298, 1936.
- Southworth, G. C., Hyper-Frequency Wave Guides—General Considerations and Experimental Results, *BSTJ*, 15, p 284, 1936.
- Carson, J. R., Mead, S. P. and Schelkunoff, S. A., Hyper-Frequency Wave Guides—Mathematical Theory, *BSTJ*, 15, p 310, 1936.
- Chu, L. J., and Barrow, W. L., Electromagnetic Waves in Hollow Metal Tubes of Rectangular Cross Section, *Proc. IRE*, 26, p 1,520, 1938.
- Skilling, Hugh, Hildreth, Fundamentals of Electric Waves, John Wiley & Sons, Inc. New York, 1942.
- Brainerd, J. G., Koehler, Glenn, Reich, Herbert J., and Woodruff, L. F., Ultra-High-Frequency Techniques, D. Van Nostrand Company, Inc., New York, 1942.
- Schelkunoff, S. A., Electromagnetic Waves, D. Van Nostrand Company, Inc., New York, 1943.
- Sarbacher, Robert I., and Edson, William A., Hyper and Ultrahigh Frequency Engineering, John Wiley & Sons, Inc., New York, 1943.
- Microwave Transmission Design Data, Publication No. 23-80, Sperry Gyroscope Company, Inc., Brooklyn, New York, 1944.

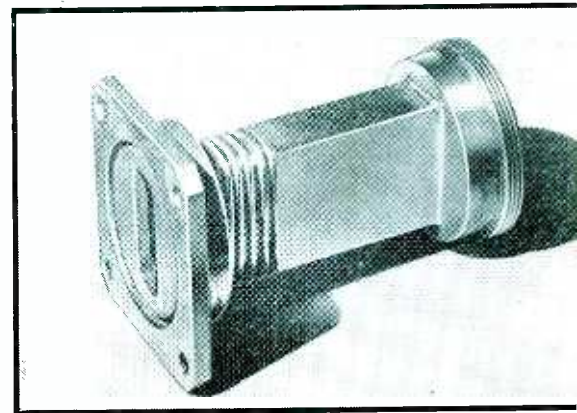

FIG. 13—An assembly of rigid guide and seamless flexible guide joined by soft-soldering

# ELECTRONIC COMPUTERS

A potentiometer rotation that is proportional to an independent variable is the basis of lightweight computers. Several potentiometers can be used with servomechanisms to produce the dependent variable, or answer, as a shaft deflection

By WILLIAM SHANNON

Physicist  
Fairchild Camera and Instrument Corp.  
Jamaica, N. Y.

**M**ANY TYPES of mechanical and electrical computers were developed during the war. One form in particular was brought to a high state of perfection, namely the electrical network type.

In general the independent variables are caused to turn the shafts of potentiometers, and the potentiometers, together with fixed resistors, are connected to fixed sources of potential. The circuit is so connected that at some point in the network a voltage will be found that is a function of the dependent variable or answer.

It is often desirable and sometimes necessary to produce the answer as a shaft deflection, thus a position servomechanism is employed to produce a shaft deflection and a voltage, the latter being equal to the computer network voltage. The shaft deflection can be arranged to be proportional to the dependent variable. In this sense the servomechanism is part of the computer, and since it is more often than not predominantly electronic, computers of this type have become known as electronic computers.

A typical example is found in the following paragraphs.

## Gun-firing Problem

A gun ballistic computer is one

that continually computes the lateral and vertical ballistic corrections as two voltages. The voltages are translated into the respective correction angles by small position servos. The inputs to the computer are fed in continuously. In a typical case they are gun position, azimuth and elevation, target range, aircraft true air speed, relative air density, the muzzle velocity of the type of ammunition used, and a factor called the ammunition constant.

The lateral and vertical ballistic corrections are related to the input variables by the following four equations:

$$W = A + B \cos C \sin D \quad (1)$$

$$(1 + ZEF\sqrt{W})H + Z^2EFB\sqrt{W} \cos C \sin D + 1/2GZ^2 \cos D - AZ = 0 \quad (2)$$

$$(1 + ZEF\sqrt{W})HY - Z^2EFB\sqrt{W} \cos C \cos D + 1/2GZ^2 \sin D = 0 \quad (3)$$

$$(1 + ZEF\sqrt{W})HX - Z^2EFB\sqrt{W} \sin C = 0 \quad (4)$$

where:  $A$  = projectile muzzle velocity  
 $B$  = aircraft true air speed

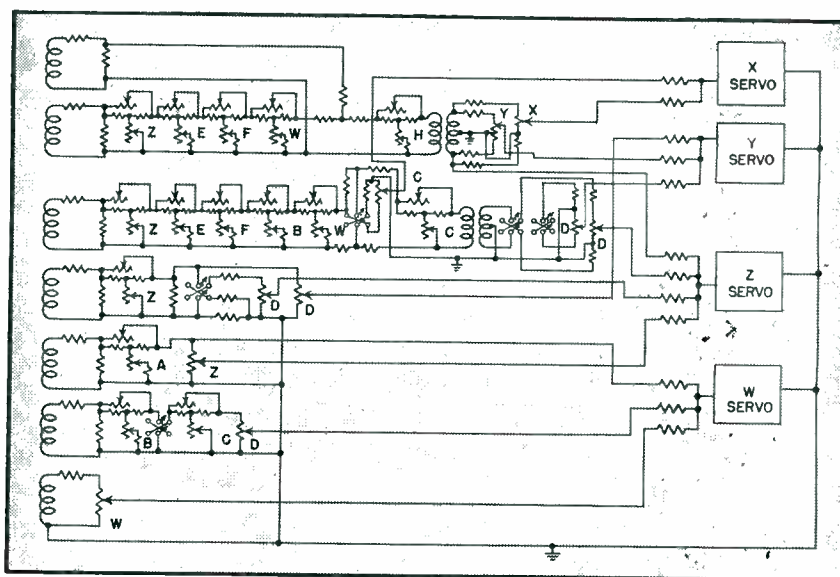

FIG. 1—Simplified functional diagram of a typical gun-sight computer



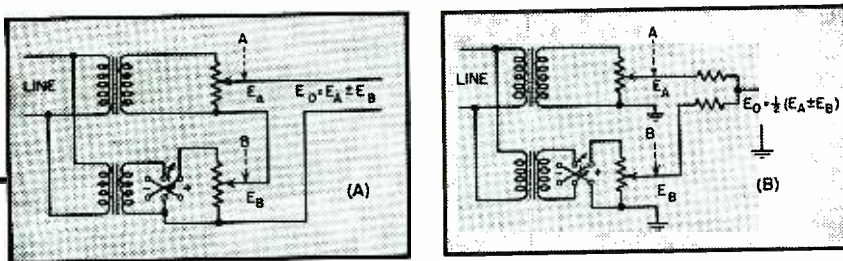

FIG. 2—Fundamental circuit (A) used for addition or subtraction, and (B) a simple modification for computing half sums

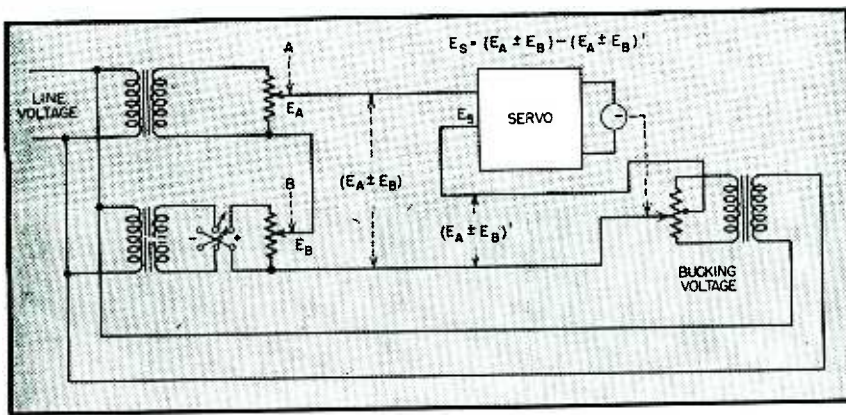

FIG. 3—Simplified circuit demonstrating the use of a servomechanism as an indicator for an adding computer

- $C$  = gun azimuth
- $D$  = gun zenith
- $E$  = ammunition constant (for the particular type used)
- $F$  = relative air density
- $G$  = gravitational acceleration
- $H$  = target range
- $X$  = lateral ballistic sight line correction
- $Y$  = vertical ballistic sight line correction
- $Z$  = computed time of flight of projectile to target
- $W$  = computed projectile initial true air speed

The difficult problem is to embody or mechanize these expressions into a device or computer which can use the input information as shaft rotations and turn out two quantities, the magnitudes of which will be proportional to the lateral and vertical ballistic corrections.

There are several ways to mechanize such expressions—mechanically, electrically, or combinations thereof. A method of mechanization which is consistent with the requirements of lightness, compactness and accuracy for airborne equipment is indicated in Fig. 1. Here seven input variables, indicated above enter the com-

puter as rotations of seven different shafts, the angular deflections of which are proportional to the magnitudes of the variables.

A number of variable resistors are mounted on each of the shafts. These resistors in conjunction with a number of fixed resistors are connected to form a resistive network that is excited by seven sources of a-c voltage. The quantities,  $Z$  and  $W$  are computed as necessary adjuncts to the final computation of the lateral and vertical ballistic corrections. To perform the computation, it is necessary to turn these two quantities, as well as the lateral and vertical corrections, into shaft rotations. Position servos fulfill this last requirement, and in the case of the lateral and vertical corrections the servos may also be used physically to orient the sight line from the gun bores.

To develop a satisfactory understanding of this general type of computation, it is well to consider some of its simpler aspects. To compute or solve an analytical expression auto-

matically, it is necessary to transform each of the variables involved into some common form such as shaft rotations, so that the magnitude of the variables is represented by the amount of rotation of the shaft. Mathematical manipulations of the variables (such as addition and multiplication) are accomplished by further translation through devices chosen to perform the desired manipulation.

#### Addition and Subtraction

To add  $A$  and  $B$ , when each is an independent variable such as aircraft true air speed and projectile muzzle velocity, each variable is converted into a shaft rotation. The amount of rotation of shaft  $A$  is proportional to air speed, and the angular position of shaft  $B$  is proportional to muzzle velocity. A variable resistor or potentiometer is mounted on each shaft, excited by a separate source of constant voltage. If the potentiometers contain linear resistance tapers, then the output voltage between the movable contact and one end is proportional to the variable involved.

The output voltages are connected in series when the total voltage is the sum of the two, or is proportional to  $A + B$ . By reversing the polarity or phase of one of the constant exciting

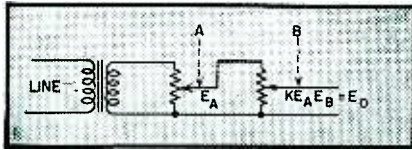

FIG. 4—A multiplying circuit in its simplest form

voltages, subtraction can be performed. This mechanization is schematically represented in Fig. 2. An alternate means of adding the output voltages is also included in the figure.

It may be desirable to convert the total output voltage back into another shaft rotation such that the angular position of the shaft will be proportional to  $A \pm B$ , as depicted in Fig. 3. The servo runs until  $E$ , is essentially zero or the bucking voltage is equal to the total output voltage of the summing circuit. The deflection of the servo shaft positioning the bucking voltage potentiometer is proportional to  $A \pm B$ . The bucking potentiometer is center-tapped. With this provision the bucking voltage reverses polarity as the movable arm passes through center. This provision allows the servo to accommodate polarity reversals of the summing circuit.

The proportionalities referred to are controlled by the magnitudes of the fixed potentiometer exciting voltages. Care is exercised in choosing these voltages to obtain the required accuracies consistent with the servo sensitivity and a-c circuit problems. It is interesting to note that the accuracy of the system is unaffected by line voltage variations since all the so-called constant exciting voltages vary together.

### Multiplication

To multiply  $A$  by  $B$ , if each is an independent variable, each variable is translated into a shaft rotation with a potentiometer mounted on each shaft. One potentiometer is excited by a source of constant voltage. The output of this potentiometer is proportional to the variable involved, provided, of course, there is a linear relation between resistance and shaft rotation. The second potentiometer is excited by the output of the first potentiometer. The output of the second potentiometer is proportional to the magnitude of the second variable as well as the magnitude of the first

variable, and therefore is proportional to the product of the two variables. The circuit arrangement is shown in Fig. 4. The constant of proportionality is controlled by the magnitude of the constant exciting voltage.

The resistance of the  $B$  potentiometer presents a load on the output of the  $A$  potentiometer, which detrimentally alters the magnitude of  $E_A$ . To avoid this effect the resistance of  $B$  can be made very large compared to that of  $A$ , so that the alteration of  $E_A$  is negligibly small. An alternative is to taper the resistance versus shaft rotation characteristic of the  $A$  potentiometer. The degree of taper can be designed to allow  $E_A$  to be proportional to  $A$  for the load presented by the  $B$  potentiometer.

To multiply three variables, three potentiometers can be connected in cascade. To diminish the effects of loading, the resistance of successive potentiometers can be increased. In practice this has the disadvantage of causing the latter portion of the circuit, which is at a high impedance

level, to be subject to noise pick-up. The threshold of the servo must be raised to avoid the noise, resulting in decreased sensitivity. The process of tapering the potentiometers to avoid the effects of loading is not always satisfactory since a constant load is no longer presented to the first potentiometer. Where accuracy is not of prime importance, the method outlined above may suffice; but where extreme accuracy is required a completely different circuit arrangement is needed.

Figure 5 indicates a method of attenuating current with bridged-T attenuators which, independent of setting, present a constant impedance looking either way.<sup>1, 2</sup> The current flowing out of attenuator  $A$  is proportional to  $A$  if the two variable resistors comprising the  $A$  attenuator are properly designed. The current flowing from the  $B$  attenuator is proportional to  $B$  and  $A$ , therefore to  $A$  times  $B$ . The current flowing from the  $C$  attenuator is proportional to  $ABC$  and develops a voltage across the terminating resistance propor-

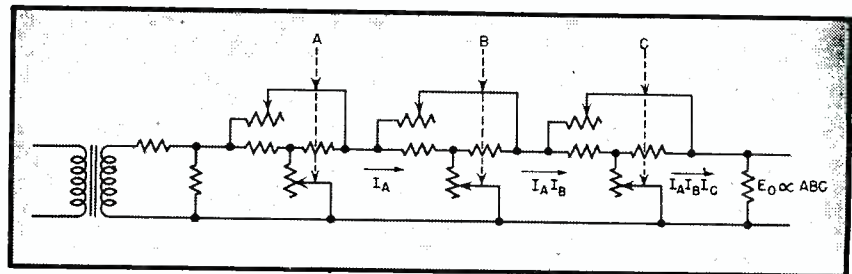

FIG. 5—Multiplying circuit necessary when more than three quantities are involved

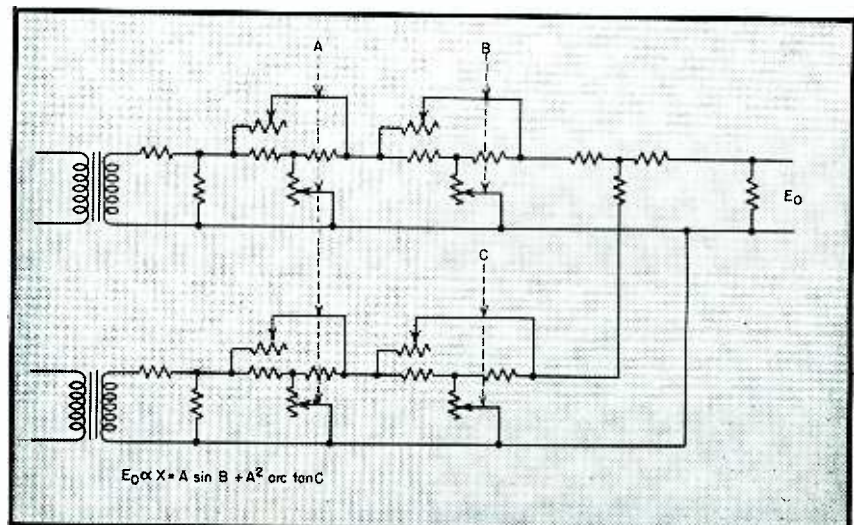

FIG. 6—Fundamental circuit for multiplying trigonometric functions

tional to  $ABC$ . The results of a second such circuit can be added to the output of this circuit by a resistance-matching network wherein the terminating resistances are eliminated. The two input resistors are used to match the resistance of the first attenuator to the transformer and to trim the input voltage to any desired amount.

### Squaring a Variable

If a given independent variable is to be squared it may be introduced to the variable arms of two potentiometers connected in cascade. The output will be proportional to the product, for example,  $A$  times  $A$ . A simpler way is to arrange the resistance versus shaft rotation characteristic of a potentiometer to apportion out a voltage proportional to the square of the shaft rotation. In other words, the potentiometer has a square taper. Any power or root can be mechanized by this method. If the required taper is mechanically too steep to be practical, the variable can be divided among two or more elements as explained above.

### Trigonometric Manipulation

If a trigonometric manipulation is to be performed upon a variable the taper of the potentiometer or attenuator can be designed to apportion out a voltage or current proportional to the sine, cosine, or tangent of the shaft rotation representing the variable.

A sample mechanization appears in Fig. 6. Attenuator  $A$  in the top circuit has a linear taper whereas the lower  $A$  attenuator has a square taper. The  $B$  attenuator has a sine taper and the  $C$  attenuator has an arctangent taper. The adding network is a symmetrical  $T$ . Another attenuator in place of the terminating

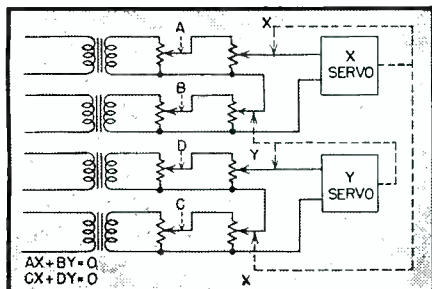

FIG. 7—Circuit of simultaneous equation solver

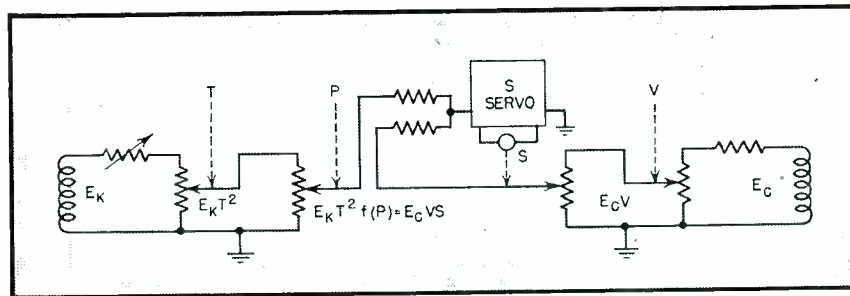

FIG. 8—Industrial control problem solved by a simple computer that directly regulates flow through a valve

resistor could be used to multiply the whole relation  $A \sin B + A^2 \arctan C$  by some function of another variable.

### Division

Division by a variable is accomplished by multiplying by its reciprocal. In the example above the total expression to the right of the equals sign (Fig. 6) can be divided by  $D$  by replacing the terminal resistor with an attenuator having a  $1/D$  taper. If  $X$  were desired as a shaft rotation a servo could be utilized as mentioned earlier.

When using a servo, another method can be employed wherein division by  $D$  is effectively accomplished. To divide the right hand side of the expression multiply the left side of the equation by  $D$  or  $XD = A \sin B + A^2 \arctan C$ . The bucking attenuator apportioning out  $X$  is followed by another attenuator having a linear taper controlled by  $D$ . The output voltage from this circuit is then bucked against  $E_0$ . The unbalance voltage controls the servo which positions the  $X$  attenuator. The servo runs until the unbalance voltage is zero, or until  $X$  has the proper value to balance the equation. This is essentially an implicit solution.

### Simultaneous Equations

If it is desired to solve two equations simultaneously in which each equation contains the same two unknowns, the first equation is mechanized for the solution of one of the unknowns ( $X$ ) treating the other unknown ( $Y$ ) as a known variable. The second equation is independently mechanized for the solution of the latter unknown ( $Y$ ) treating the former unknown ( $X$ ) as a known variable. The two mechanizations are then interconnected, the output

of each feeding the unknown of the other. The system then comes into balance only when each mechanization or equation is satisfied. This process can be followed through by reference to Fig. 7.

A tremendous amount of latitude is available in this method of mechanizing. The only special requirement is the production of the odd tapers of the potentiometers and of the variable resistors in the attenuators. This problem has been solved by the construction of special wire resistance-winding machines. These machines wind resistance rather than just wire in the sense that the feeder which lays out the lead of the windings is servo controlled. This servo is continually balancing the resistance of the wire already wound against the resistance of a master.

### Typical Industrial Use

As a final example, consider an industrial problem in which a valve is to be positionally adjusted to meet the demands of three variables that are related by the analytical expression

$$S = T^2 f(P) / V$$

when  $S$  = desired valve setting  
 $T$  = temperature of a vat  
 $V$  = rate of flow of a constituent  
 $f(P)$  = function of the pressure of a constituent

(The latter is an empirical relation which through experience has been determined and can be plotted graphically.)

The problem is solved by obtaining four potentiometers designated  $S$ ,  $T$ ,  $V$ ,  $P$  in Fig. 8.  $S$  and  $V$  have linear tapers,  $T$  has a square taper, while  $P$  has a taper corresponding to the empirical plot of  $f(P)$  versus  $P$ .

### REFERENCES

- (1) Attenuator Design, *ELECTRONICS*, No. 1941.
- (2) Designing Resistive Attenuator Networks, *Proc. IRE*, March 1935.

# MAGNETIC TESTING OF METALS

Correlation between magnetic properties, particularly remanent magnetism which predominates at the low test frequency that is used, and metallurgical properties makes possible the determination of composition and condition of ferromagnetic materials by magnetic testing.

Operation, methods of indication, and application of test equipment are described

By **P. E. CAVANAGH**

*Chief Metallurgist  
Allen B. Du Mont Laboratories, Inc.  
Passaic, N. J.*

**E. R. MANN**

*Head, Special Instrument Section  
Allen B. Du Mont Laboratories, Inc.  
Passaic, N. J.*

**R. T. CAVANAGH**

*Development Engineer  
Cyclograph Services Co., Ltd.*

**I**NSPECTION OF METALS by magnetic analysis has come into fairly wide-spread use. Basically, all the instruments used depend on some correlation between the magnetic and physical properties of ferromagnetic material. Seldom is there a direct correlation between a given set of magnetic properties and a desired set of physical properties. The problem of devising a practical test consists of finding some easily and quickly measured set of magnetic properties which does give practical correlation with physical properties, such as hardness or strength.

### Types of Instruments

The most commonly used type of apparatus for performing such an inspection utilizes what could be called the transformer principle. An energizing coil is used to establish an alternating magnetic field in the metal sample, which is made the core of this coil. The voltage induced in a secondary coil, placed around the sample, is then examined.

This principle may be used in inspecting metals on a comparison basis. If it can be determined that a certain sample represents the combination of physical properties desired, this sample can be compared to all unknown samples, and those samples which are like the standard in magnetic properties—and therefore, in certain physical properties—

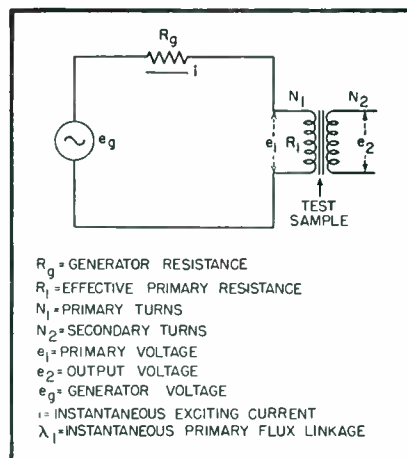

FIG. 1—Fundamental test circuit and definitions of symbols

can be selected. Because only the differences obtained in such a scheme are of interest, the most obvious means of applying this principle to the inspection of metals is to design the test transformer to provide one array of coils around a standard sample and another array around the unknown sample. The induced voltages in the secondary coils are opposed so that only the difference in magnetic properties of the two samples appears. If no difference is obtained between the secondary output voltages, the samples are usually the same in metallurgical properties.

It is possible to obtain two widely different samples, where a difference in permeability may be counterbalanced by a wide difference in hysteresis. These samples may show no difference in the amplitude of the secondary voltage, although they differ widely in magnetic and physical properties. This compensation has always been a limiting feature of this type of equipment, but if it is thoroughly understood, the useful field of application of this type of inspection can be extensive in the average steel plant.

There are various instruments in existence using different methods of examining the output voltage from a system of bucking coils such as described above. Most of the instruments utilize a meter to show the amplitude of the voltage difference. The operator is looking for a zero

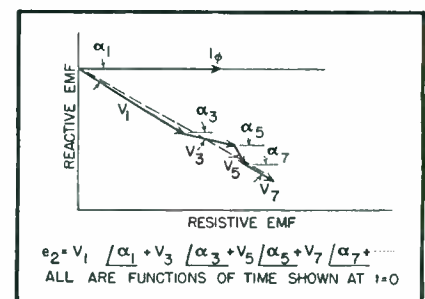
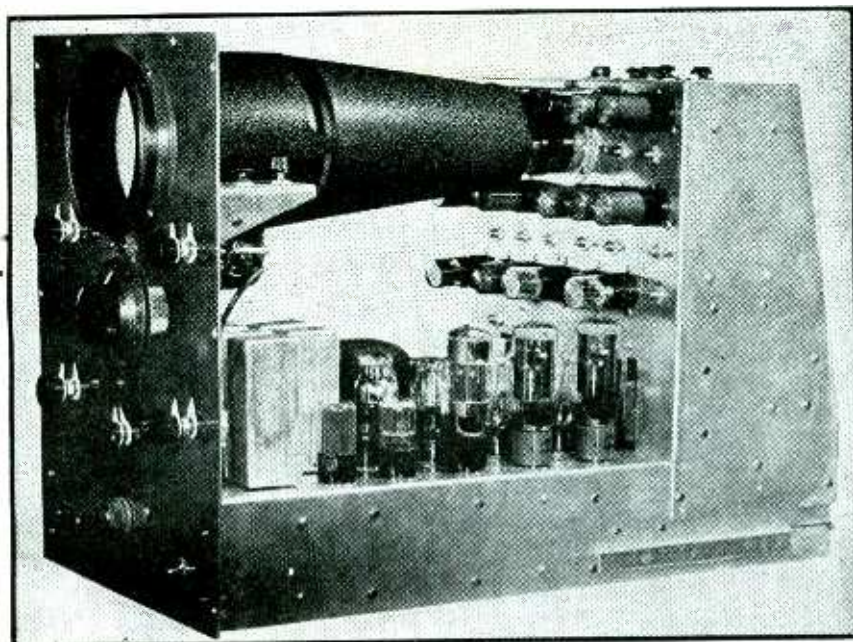

FIG. 2—Vector contributions of harmonics to total indication



Electronic instrument provides nondestructive testing for metallurgical properties of ferromagnetic materials

voltage difference, indicating that his unknown sample is the same as his carefully chosen standard. The General Electric Magnetic Comparator and the comparator made by the Magnetic Analysis Corporation use this form of indication<sup>1</sup>.

Besides influencing the amplitude of the secondary voltage in the test coils, the magnetic characteristics of a sample change the harmonic content of the exciting wave. The amplitude of each harmonic may be measured and its phase relation to the fundamental frequency found by means of suitable circuits using meter indication. This method is followed in the Waugh Laboratories Magnetic Tester.

Alternatively, the output of the bucking coils may be examined on an oscilloscope. The harmonic content can be seen on the cathode-ray tube screen, as well as the amplitude of the harmonics. Several instruments are in use in which the output of the special set of coils is examined on a cathode-ray tube screen. If there is no difference between samples, a straight line is obtained on the screen. The magnetic comparator used by the Republic Steel Corporation and the Magnescope, which has been used for some years in the Canadian steel industry, both take this form<sup>2</sup>.

The most commonly used frequency for the exciting coil is 60 cps, obtained from the power line. If tests

are carried out at higher frequencies of 500 to 3,000 cps, somewhat different results may be obtained, because the effect of eddy current losses increases, and the relative effect of magnetic hysteresis losses is less important. A comparator operating at 3,000 cps and taking advantage of the above fact has been developed by the Magnetic Analysis Corporation<sup>3</sup>.

If tests are carried out at a very low frequency, less than 25 cps, the reversals of the magnetic field are slow enough so that an appreciable effect is obtained from remanent magnetism. Results of comparisons carried out on the same samples at different frequency ranges are not the same, because the changes in remanent magnetism, permeability, hysteresis, and eddy current losses are not the same for a given change in physical properties.

An instrument called the Ferrograph, taking advantage of the low-frequency range, has been developed by the Allen B. Du Mont Laboratories, Inc. The instrument uses an energizing field of a frequency below 25 cps and examines the harmonic voltage components generated by the test transformer in which the core is the sample to be tested.

#### Principle of Operation

A brief discussion of some of the principles involved will aid in an understanding of the practical oper-

ation of the instrument. Assuming a test circuit as indicated in Fig. 1

$$e_g = (R_g + R_1) i + \frac{d\lambda_1}{dt}$$

With no appreciable secondary load, the counter emf induced in the primary is

$$e_1 = N_1 \frac{d\phi}{dt}$$

where  $\phi$  is the total flux, then

$$e_g = (R_g + R_1) i + N_1 \frac{d\phi}{dt}$$

Assuming further that most of the flux is confined to the core, and the core flux links all  $N_2$  turns of the secondary, that is,  $\lambda_1$  equals  $\phi$

$$e_2 = N_2 \frac{d\phi}{dt}$$

The flux density in the core is proportional to the core flux, but the magnetizing force is only approximately proportional in amplitude to the exciting current. At best, then, the flux-current loop is a rough approximation of the hysteresis loop of the core material at the corresponding maximum flux density.

In the Ferrograph, a sinusoidal exciting current is utilized, as defined by  $i = I \sin \omega t$ . The secondary induced emf as previously given is

$$e_2 = N_2 \frac{d\phi}{dt}$$

or converting from total flux to flux density

$$e_2 = k \frac{dB}{dt}$$

The secondary emf induced by the alternating flux may be expressed generally as a Fourier series

$$e_2 = V_1 \sin(\omega t + \alpha_1) + V_2 \sin(2\omega t + \alpha_2) + V_3 \sin(3\omega t + \alpha_3) + V_4 \sin(4\omega t + \alpha_4) + \dots + V_N \sin(N\omega t + \alpha_N)$$

where  $V_N$  is the maximum value of each harmonic component in emf

units, and  $\alpha_N$  is the phase angle of the harmonic with respect to an arbitrary zero phase angle of the exciting current, and  $\omega$  is  $2\pi f$ .

From extensive investigations it has been proven that for most purposes only a limited number of these terms need be considered, and that for symmetrical magnetization (no magnetized materials or superposed static magnetic fields) only the odd harmonic terms are present. As these conditions exist in the Ferrograph, the induced emf in the secondary can be expressed as

$$e_2 = V_1 \sin(\omega t + \alpha_1) + V_3 \sin(3\omega t + \alpha_3) + V_5 \sin(5\omega t + \alpha_5) + V_7 \sin(7\omega t + \alpha_7) + \dots + V_{2N-1} \sin[(2N-1)\omega t + \alpha_{2N-1}]$$

Except for high values of exciting current far beyond the flux saturation value, the relative amplitudes of the harmonic components compared to the fundamental amplitude component are negligible beyond the seventh harmonic. If the harmonic voltages, as given by the Fourier expansion, are added as vector quantities in polar coordinate form for ease in plotting, interesting results may be obtained. A sample plot is shown in Fig. 2.

The first term of the Fourier series,  $V_1 \angle \alpha_1$ , (Fig. 2) is significant because it contains most of the equivalent resistive component, or energy loss term, in phase with the constant magnetizing current. The first and all other terms contribute to the reactance component. It follows that the expression  $V_1 \cos \alpha_1$  can be correlated with the hysteresis loss which in turn may be correlated with physical or metallurgical properties of the core material. The amplitudes and phase angles of the various harmonic components also may be correlated with the properties of the core material.

In general, the resistive component  $V_1 \cos \alpha_1$  depends on the hysteresis coefficient, and the reactive components  $V_1 \sin \alpha_1$ ,  $V_3 \sin \alpha_3$ ,  $V_5 \sin \alpha_5$ , . . . depend on the coefficients of the normal magnetization curve. The relation of resistive to reactive components of the induced secondary voltage may prove to be the desired solution to the interpretation of some problems of correlation of magnetic to physical properties.

At low values of flux density, it is interesting to note that the produc-

tion of harmonic components is due primarily to hysteresis and not permeability change.

### Correlation of Metallurgical and Electrical Properties

From preceding statements, it follows that any physical or metallurgical factor influencing hysteresis loss will vary the quantity  $V_1 \cos \alpha_1$ , as well as the amplitudes and phase angles of the various harmonic components. Any factor influencing any of the other common magnetic properties (magnetic saturation, residual magnetism, coercive force, and permeability) will similarly influence the amplitudes and phase angles of the various harmonic components. Ideally, then, if a sensitive means of complete harmonic analysis is available, a correlation of harmonic content with any variation in magnetic properties and hence with some physical or metallurgical properties is possible.

Only the fundamental and third harmonic amplitudes and phases will be discussed, because all common magnetic variables can be correlated with these components and the utilization of higher harmonic components is impractical for generalized industrial applications.

If variation of magnetic properties with carbon content alone is considered, it is to be expected that with the addition of carbon up to the eutectic point, the amplitude of the third harmonic  $V_3$  will increase, as will the resistive component  $V_1 \cos \alpha_1$ , because hysteresis loss is increased and saturation point lowered.

The major effect of adding alloying elements (manganese, chromium, nickel, vanadium, and molybdenum) is the same as increasing the rate of cooling. Both actions produce a harder structure with a flatter, wider hysteresis loop and attending variations in  $V_1$ ,  $V_3$ ,  $\alpha_1$ , and  $\alpha_3$ .

The effect of structure variation alone on magnetic properties is very marked. A low carbon steel at a flux value below saturation possesses relatively small hysteresis loss. If the same steel is hardened by first heating above the transformation temperature so that the carbide is dissolved and by then quenching in water, the steel is in its hardest state. Hysteresis loss will be a maximum and saturation will take place at a flux density which would not previously saturate the steel in its normal condition. If this hard steel is drawn or tempered by heating for some time at a temperature below

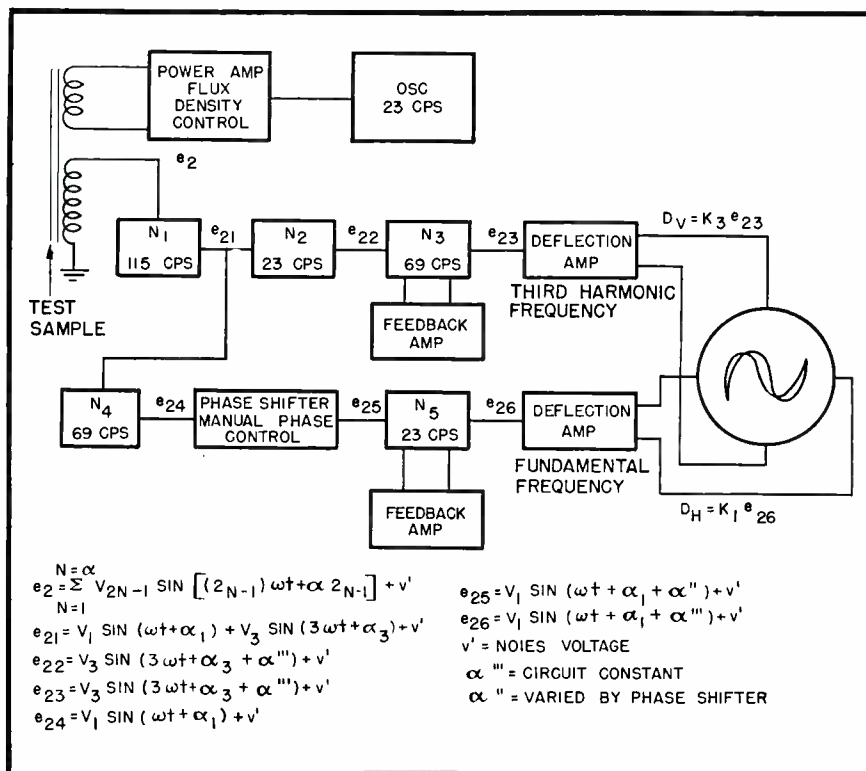

FIG. 3—Block diagram shows method by which Lissajous indication is obtained

the transformation point, internal stresses are relieved, and some of the brittleness of the fully hardened steel is removed. Saturation is then not so pronounced and the hysteresis loss is less. A practical correlation of  $V_1$ ,  $V_3$ ,  $\alpha_1$ ,  $\alpha_3$ , and  $V_1 \cos \alpha_1$  with metallurgical and physical properties is clearly indicated.

#### Indications of Amplitude and Phase

In the past, galvanometers and moving coil oscillographs have been applied to laboratory harmonic analysis and peak, rms, or average reading voltmeters and cathode-ray indicators applied to industrial sorting. With recent advances in cathode-ray technique, the cathode-ray tube indication now presents many advantages for industrial and laboratory uses. High sensitivity can be attained with portability, the complete waveforms can be seen and so need not be estimated; phase angles can be measured and compared by relatively unskilled personnel using the pattern on the cathode-ray tube.

The cathode-ray tube indication itself can be correlated with a maximum of four variables at one time. In the Ferrograph, only the two deflection variables are utilized, with

a switch-over to provide for a total indication of four variables.

Previously it has been found that certain harmonic components of amplitude, phase, or both may provide direct correlation with certain variables in metallurgical or physical properties. Kinsley<sup>4</sup>, by means of the seventh harmonic component alone, was able to detect and locate decarburization in the presence of varying analysis and structure in the base metal.

Individual problems may be solved by correlation with specific harmonic components, and pulse-triggered sorting circuits can be controlled by these components. Amplitude unbalance, phase unbalance, or phase-discriminating circuits, all are practical. Unfortunately, any devices of this nature are limited to the special application for which they are developed because the great variety of metallurgical and physical testing problems encountered cannot all be solved by a general test.

In laboratory investigations, complete harmonic analyzers would be desirable to obtain exact measurements of the harmonic component amplitudes and phases. From these measurements all possible correla-

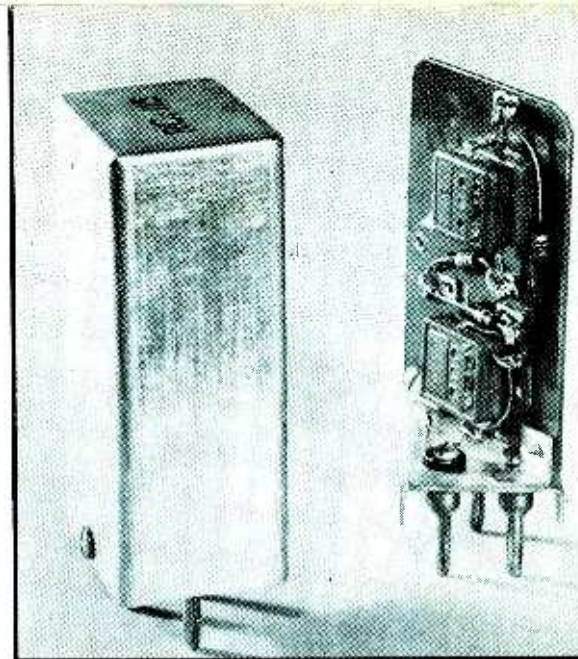

Resistance-capacitance band-pass filters are used to separate fundamental and third harmonic of the 23cps test frequency used for metal testing

tions of harmonic analysis with metallurgical and physical factors could be determined.

The basic principle of operation of the Ferrograph is the harmonic analysis of the induced voltage in the secondary of a test transformer in which the sample to be tested is made the core of the transformer. The ideal instrument would give amplitudes and phase angles of fundamental and odd harmonic components of the induced voltage up to the seventh harmonic. From previous discussions it is clear that an instrument indicating the amplitudes and phase angles of the fundamental and third harmonic components serves for most practical problems in industry, and provides an instrument not too involved for use by unskilled industrial personnel.

#### An Industrial Instrument

To compare the relative amplitudes of  $V_1$  and  $V_3$  and the difference in phase angle between  $\alpha_1$  and  $\alpha_3$ , the oscilloscopic indication is a Lissajous pattern. A block diagram of the circuit is shown in Fig. 3. The resultant pattern on the cathode-ray tube is a familiar Lissajous pattern showing a frequency ratio of 3:1.

The vertical deflection on the cathode-ray tube is proportional to  $V_3 \sin(3\omega t + \alpha_3 + \alpha''')$ , the horizontal deflection to  $V_1 \sin(\omega t + \alpha_1 + \alpha'')$ , the phase difference being  $(\alpha_1 + \alpha'') -$

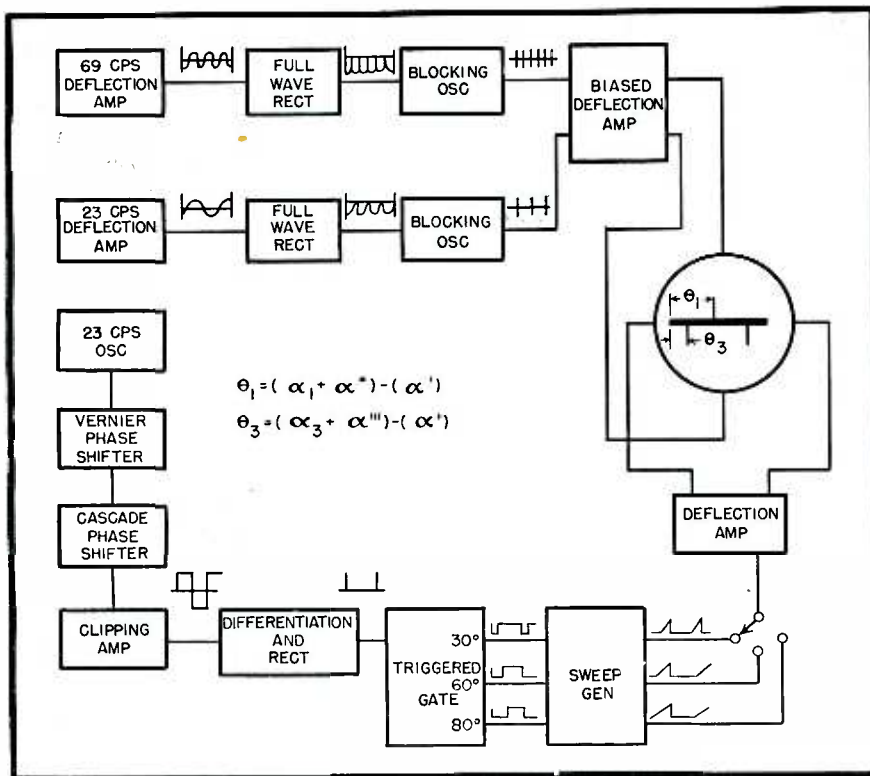

FIG. 4—Block diagram shows sequence of wave shaping to produce phase indication

$(\alpha_3 + \alpha''')$ . The filter networks of  $N_1$  to  $N_6$  are resistance-capacitance parallel-T networks tuned to the frequencies shown. As these are frequency rejection networks, the harmonic components not desired are eliminated.

To improve the signal-to-noise ratio, amplifiers with feedback controlled by similar networks are utilized.

The second indication desired is a comparison of the phase angles  $\alpha_1$  and  $\alpha_3$  with an accuracy of  $\pm 0.5$  degree at the oscillator frequency. A block diagram of the circuit is shown in Fig. 4, with the waveforms sketched at various points.

It is necessary to have the phase indicators independent of the ampli-

Blocking oscillators are used as the phase pulse markers. The firing points of the two blocking oscillators are controlled by the intercepts of the sine waves  $V_1 \sin(\omega t + \alpha_1 + \alpha'')$  and  $V_3 \sin(3\omega t + \alpha_3 + \alpha''')$  with the zero axis, full-wave rectification and direct coupling to the blocking oscillators being used for this purpose. To obtain the  $\alpha_1$  pulse as a positive vertical deflection and the  $\alpha_3$  pulse as negative vertical deflection, a biased vertical deflection amplifier is utilized.

#### Circuit Details

A schematic diagram is shown in Fig. 5. Only those circuits which are uniquely essential to this instrument are shown.

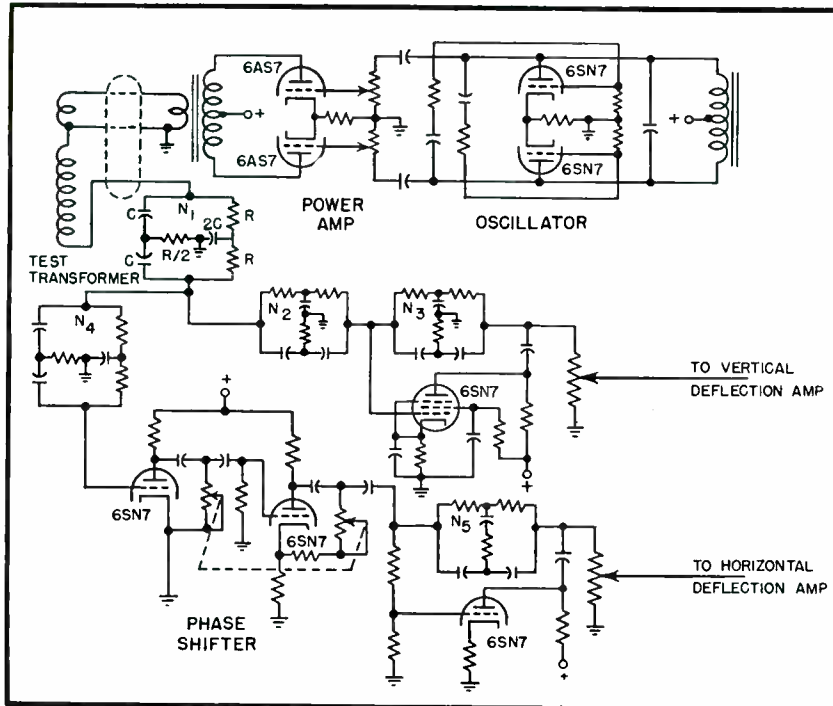

FIG. 5—Filter circuits indicated by blocks in Fig. 3

tude of the harmonic components. The horizontal sweep is a time base triggered by the oscillator, with the duration controlled in three steps by a resistance-capacitance gate circuit, the duration of the gate being 30, 60, or 80 electrical degrees at the oscillator frequency. The linear sawtooth sweep is generated by these rectangular pulses of definite duration. This sawtooth wave is then amplified for deflecting purposes.

The oscillator is easily recognizable as a Kallitron type, a very stable push-pull oscillator producing a sine wave with negligible harmonics by means of controlled feedback and degeneration. The oscillator frequency is 23 cps to give the best correlation with the desired magnetic properties and is not a submultiple of any power frequency. This nonconformity to the power frequency is necessary to achieve the high degree of filtering

required in the separation of the induced voltage into fundamental and third harmonic components.

The power amplifier is of the standard push-pull type giving a maximum power output of six watts. This power is sufficient, for with the output matched by a transformer to the test transformer a maximum magnetomotive force of 1,000 gilberts is possible. For most practical purposes this is the highest magnetizing force required. The mmf is continuously variable below this limit.

The four-terminal filter networks give a frequency rejection characteristic similar to a two-terminal series-resonant inductance-capacitance network used at higher frequencies; at the rejection frequency  $f_s = 1/2\pi R_N C_N$ , where  $f$ ,  $R$ , and  $C$  are as given in Fig. 5<sup>o</sup>. These networks when properly matched have an effective Q of six. The networks  $N_3$  and  $N_6$  are degenerative feedback controls in the two amplifiers containing these networks. The signal-to-noise ratio is considerably improved by their use.

The vertical and horizontal deflection amplifiers are of the conventional push-pull phase inverter type.

A similar diagram of the phase pulse indicating circuits is shown in Fig. 6 as two separate diagrams. As the production of the blocking oscillator pulse is the same for both the fundamental and third harmonic component voltages in two separate channels, only one is given in detail.

The output of the third harmonic deflection amplifier is matched by a push-pull cathode follower stage and transformer coupling to the full-wave rectifier. This matching is necessary to eliminate the distortion of waveform resulting from any impedance mismatch. The output of the full-wave rectifier is directly coupled to the grid of the biased blocking oscillator, with impedance matching again being carefully considered. The blocking oscillator is biased so that it will only fire when the grid is at zero voltage, this being at the intercepts of the voltage  $V_3 \sin(3\omega t + \alpha_3 + \alpha''')$  with the zero axis. Thus the firing of the blocking oscillator is independent of the amplitude  $V_3$ , is synchronized to the frequency  $3f$ , and possesses a phase angle of  $(\alpha_3 + \alpha''')$  with respect to



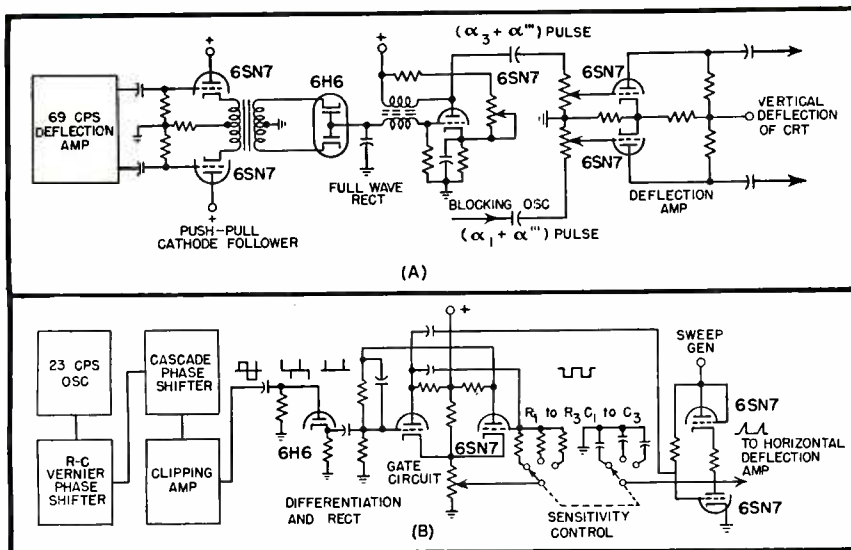

FIG. 6—(A) Circuit detail of vertical deflection pulse generator that is shown by blocks at the top of Fig. 4. (B) Details of final stages of horizontal sweep circuits that are shown as blocks at the bottom of Fig. 4

the energizing current in the test transformer.

The production of the blocking oscillator pulse independent of the amplitude  $V_1$ , synchronized to the frequency  $f$  and the phase angle  $\alpha_1 + \alpha''$ , is identical to the above. The phase angles  $\alpha''$  and  $\alpha'''$  are introduced by circuit time constants,  $\alpha''$  being variable by manual control. As it is necessary to exhibit the fundamental and third harmonic pulse markers on the cathode-ray tube screen at the same time, a class B push-pull deflection amplifier is utilized for the vertical amplifier. The blocking oscillator pulse of frequency  $f$  and phase angle  $\alpha_1 + \alpha''$  is therefore in a positive vertical direction,

and the pulse of frequency  $3f$  and phase angle  $\alpha_3 + \alpha'''$  is in the negative vertical direction.

The procedure followed in Fig. 6B is straightforward up to the differentiation. A series resistance-capacitance linear network differentiates the square wave. As only the positive differentiation is required, a half-wave rectifier is used. These positive pulses, which are independent of the amplitude of the exciting current, and are of frequency  $f$  and phase angle  $\alpha'$  (due to circuit time constants, phase vernier control, and manually set cascade phase shifter), trigger the gate circuit shown. The duration of the gate is controlled by the resistors  $R_1, R_2, R_3$ , which are set

for 30, 60, and 80 electrical degrees at the fundamental frequency. The resultant negative rectangular pulse controls the linear charge and quick discharge of capacitors  $C_1, C_2, C_3$ . The charge-discharge curve is amplified to provide the horizontal sweep of the cathode-ray tube. Thus, the horizontal sweep is of controlled duration, of frequency  $f$ , and of phase angle  $\alpha'$ .

Throughout all circuits, the signal-to-noise ratio must be kept as high as possible. This can be achieved only by careful design and layout.

The oscillator output must be stable in amplitude and frequency within  $\pm 0.25$  percent to utilize the high  $Q$  of the filter networks. The filter networks themselves must be carefully shielded and necessarily of high-grade components balanced in value within  $\pm 0.25$  percent to attain and retain the maximum  $Q$ .

In the exhibition of the Lissajous pattern, it is desirable to keep the electron beam in the cathode-ray tube at a fairly high level of intensity. Protection must be provided for the cathode-ray tube to cut the beam off when the vertical and horizontal deflection amplitudes are of such low values that the beam is confined to a short tracing path. This cutoff is controlled by the amplitude of the vertical deflecting voltage  $V_s \sin 3\omega t$ , as shown in Fig. 7.

During the phase pulse indications, the electron beam in the cathode-ray tube is stationary for a maximum of 90 percent of the fundamental period. When the beam is stationary the in-

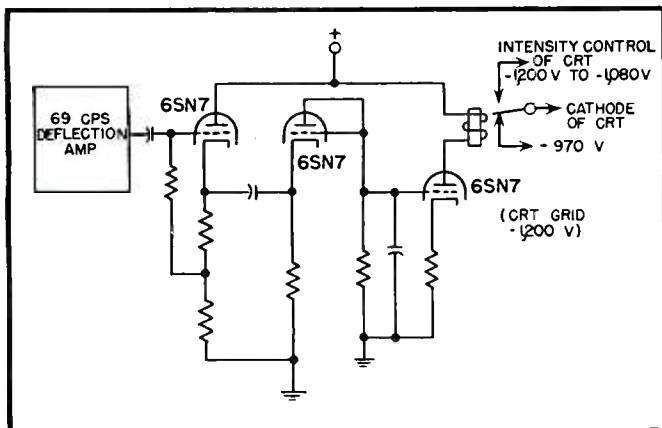

FIG. 7—To protect the screen of the cathode-ray tube, this circuit switches on the beam only if the third harmonic deflection is strong enough to produce a usable pattern

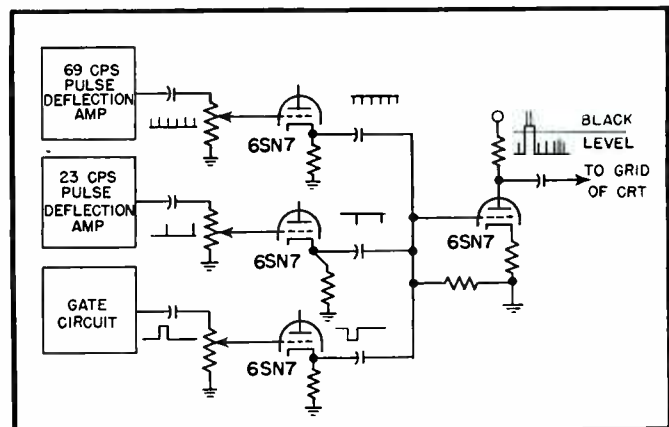

FIG. 8—The electronic beam of the cathode-ray tube is intensified by this circuit during each phase-indicating pulse so that the trace will remain bright enough to be readable

tensity level can be set so that the beam is extinguished if the rectangular pulse output of the gate circuit controls the beam intensity. To intensify the short-duration blocking oscillator pulses on the cathode-ray tube screen, they are mixed with the gate output to modulate the beam intensity. The circuit with the wave forms is shown in Fig. 8.

### Operation

The instrument as used practically has two selectable indications on the cathode-ray tube. The first (or indication A) is the Lissajous pattern of vertical amplitude  $K_3V_3$ , horizontal amplitude  $K_1V_1$  and relative phase deviation  $(\alpha_1 + \alpha'') - (\alpha_3 + \alpha''')$ , where  $V_1, V_3, \alpha_1, \alpha_3, \alpha''$ , and  $\alpha'''$  are as given before;  $K_1$  and  $K_3$  are constants of circuit amplification. The flux density control sets the amplitudes of the indication; the phase set control gives an easily recognizable pattern. The sample to be tested with this indication is placed in the test coil and the flux density increased until

a pattern appears on the screen. The phase of the pattern may then be set at will.

Where much higher sensitivity of phase indication is desired, the second (or indication B) is switched in. The B indication has a horizontal sweep of relative phase  $\alpha'$  and three selectable sensitivities, 80 degrees (sensitivity of 20 degrees per inch deflection), 60 degrees (sensitivity of 15 degrees per inch), and 30 degrees (sensitivity of  $7\frac{1}{2}$  degrees per inch). Pulse vertical deflections are used, the positive deflection being the  $\alpha_1 + \alpha''$  pulse, the negative deflection the  $\alpha_3 + \alpha'''$  pulse. The second phase control, which varies  $\alpha'$ , is used to bring the pulse markers into the time interval of the cycle given by the horizontal sweep. The phase vernier control is used to return the fundamental and third harmonic pulses to a null position.

### Correlation With Physical Properties of Ferromagnetic Materials

A great deal of data is available

in the literature giving a correlation of magnetic properties evaluated by harmonic analysis to various metallurgical properties such as hardness, impact strength, and structure. Most of the data has been obtained on carefully prepared sets of samples in which all variables were kept constant with the exception of the one under investigation. One of the least understood points concerning the application of magnetic testing to the metallurgical field is that unimportant variables, usually ignored because they do not affect the service life of a metal part, may have a major effect on magnetic properties. For this reason, the translation of fundamental relationships between magnetic and physical properties into practical tests should be done very carefully.

The relationship between carbon content of steel and its magnetic properties gives a useful method of classifying steels according to carbon content. Before the metallurgist can use an electronic instrument for this

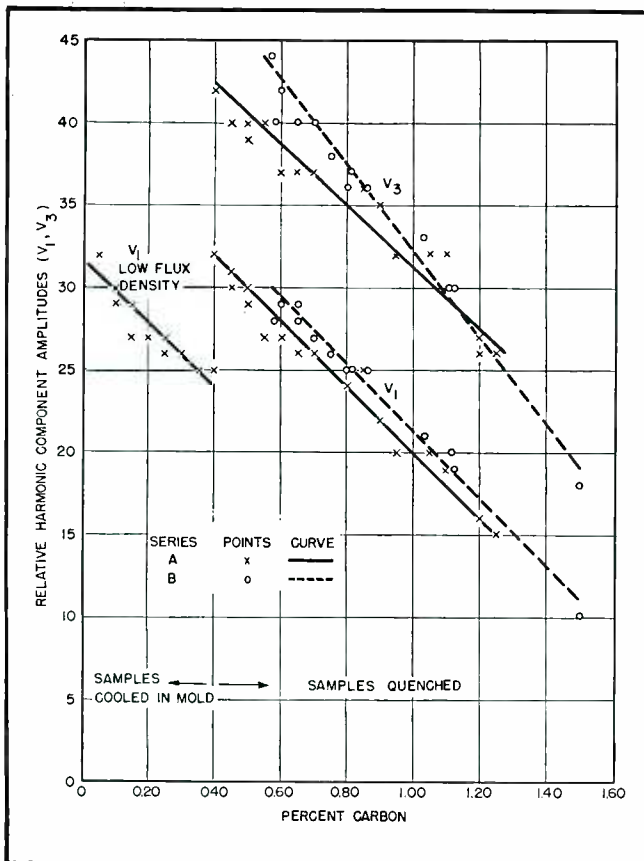

FIG. 9—Relative amplitudes of fundamental and third harmonic voltages vary with percent carbon content of test sample

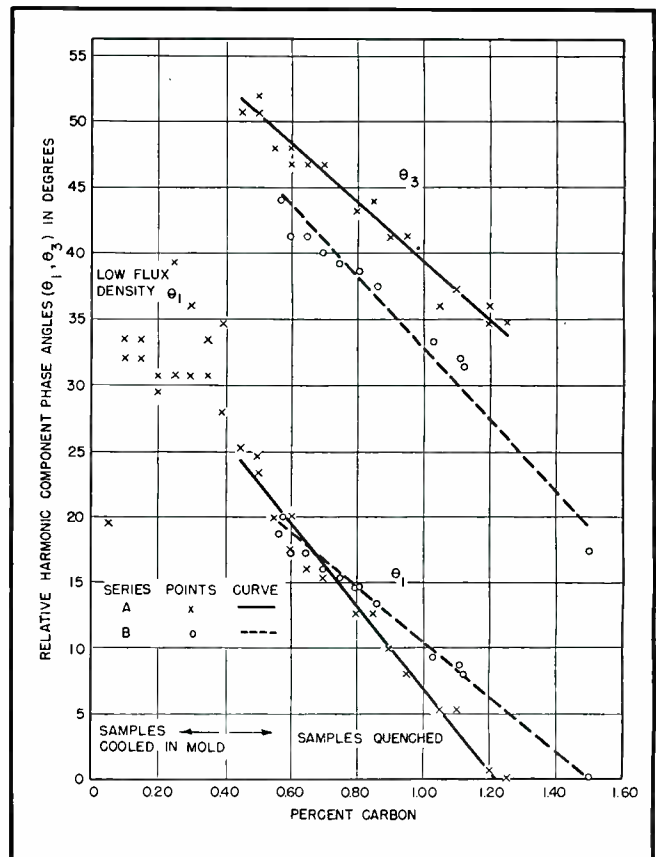

FIG. 10—Variation of phase angle between fundamental and third harmonic voltages indicates carbon content of sample

purpose, he must make sure that extraneous variables such as alloy content and heat treating history do not produce a significant change in the magnetic properties being compared, which might completely mask the desired correlation.

From test results, Fig. 9 and 10 illustrate the correlation between Ferrograph readings on standard Carbometer steel samples and their carbon content. By determining relative amplitudes and phase relations of the first and third harmonics, satisfactory correlation with carbon content is obtained on samples with 0.40 percent carbon content and over, which are all cast from the molten metal and quenched in water. On samples with less than 0.40 percent carbon which are allowed to cool slowly in the mold, no reliable correlation is obtained because of differences in cooling rate in hot and cold molds.

The A-series of samples tested varied from 0.08 percent to 0.40 percent manganese and had the usual variations in sulphur, phosphorus, and silicon found in a series of heats of open hearth steel. Only traces of chromium, nickel, molybdenum, and copper were present. These normal changes in analysis from heat to heat did not interfere with the carbon correlation.

Series-B samples contain about 0.10 percent chromium, 0.50 percent nickel, and 0.07 percent molybdenum. This alloy content affects magnetic properties sufficiently to interfere with carbon correlation. Samples of series-B can be identified by the Ferrograph and can be tested separately for carbon content. These graphs show that the instrument can correlate carbon content in samples of similar analysis, can distinguish between high and low alloy content samples, and can separate high and low alloy samples with the same carbon content.

#### Applications

Practical uses of the instrument are illustrated by the following examples. Steel bars were sorted to reject those softer than Rockwell C 32. Readings of first and third harmonic amplitude did not provide a practical separation. However, ob-

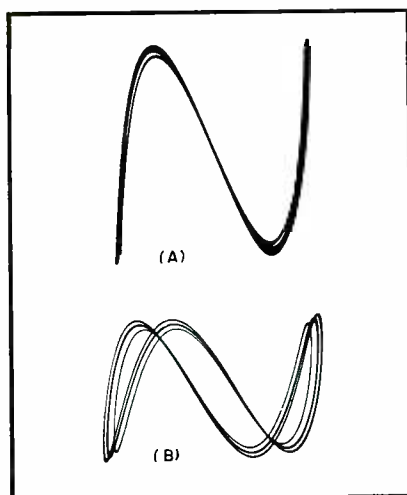

FIG. 11—Separation of soft bolts from hard ones was done by obtaining pattern at (A) for soft bolts and pattern at (B) for hard bolts. Both the relative amplitude and the phase of third harmonic relative to the fundamental changed to give the indication of hardness in this instance

servation of the relative phases provided a sufficiently sensitive test for correlation with hardness so that the separation could be made.

In many instances, as the foregoing illustration indicates, one of the two types of display gives the better and more easily read indication of metallurgical differences. There is also an optimum test magnetomotive flux density for a particular sorting problem. A few tests at various values of energizing current will establish the most satisfactory flux density in each instance.

Steel bolts half an inch in diameter and three inches long were accidentally made of two different steels. The error was not discovered until after the bolts had been heat treated. The bolts made of SAE 1035 were satisfactory but those made of lower carbon SAE 1020 were too soft. The hardness of the two lots differed by fifteen points Rockwell C. A few samples of bolts made of each steel were identified in a hardness machine. A soft bolt was placed in the instrument test coil and the flux density and harmonic phase adjusted to give the pattern of Fig. 11A. Inserting a bolt made from SAE 1035 steel gave the pattern of Fig. 11B. The several traces in each pattern indicate the limits of variation of the

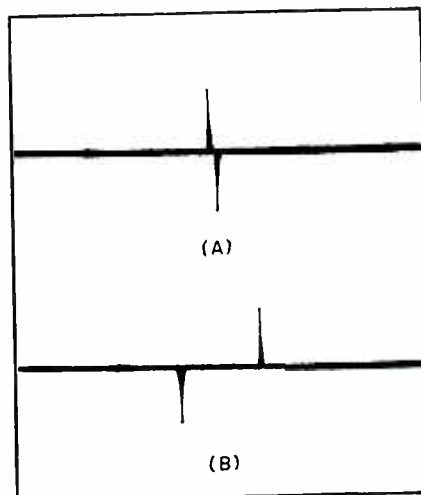

FIG. 12—Phase angle between fundamental and third harmonic was used to identify samples having too soft a core. (A) The two phase pulses are made to approximately coincide for satisfactorily hard samples. (B) Separation of pulses indicates, in this case, that core is soft

patterns for fifty samples. This preliminary work established the fact that there was no overlapping of the indications for bolts made from the two steels at the flux density chosen. Sorting proceeded on the mixed bolts at a rate of about one per second.

Among 700,000 case-hardened track pins were some whose core hardness did not meet specifications, although the surface hardness was satisfactory. Obviously it was impossible to segregate the unsatisfactory pins by hardness testing.

Satisfactory pins ranged from 32 to 38 Rockwell C in the core; unsatisfactory pins ranged well above and below these limits. The differences in phase angle between acceptable and unacceptable samples were more evident than differences in harmonic amplitudes. Figure 12 shows the indications obtained for satisfactory and soft cored pins.

#### REFERENCES

- (1) Smith, J. J., Instruments to Establish Identity, *Metal Progress*, p 997, Oct. 1945.
- (2) Cavanagh, F. E., Magnetic Comparators, *Metal Progress*, Sept. 1942.
- (3) Zuschlag, T., Magnetic Testing Applied to Inspection of Bar Stock and Pipe, *ASTM Bulletin* 99, p 35, Aug. 1939.
- (4) Kinsley, C., Steel Structures Identified and Flaws Located by Means of Balancing Wave Tests, *Proc. ASTM*, 38, Part II, p 36, 1938.
- (5) Peterson, E., Harmonic Production in Ferromagnetic Materials at Low Frequencies and Low Flux Densities, *BSTJ*, 7, p 762, 1928.
- (6) Hastings, A. E., R-C Parallel-T Network Analysis, *Proc. IRE*, p. 126, Mar. 1946.

# ISOLATION

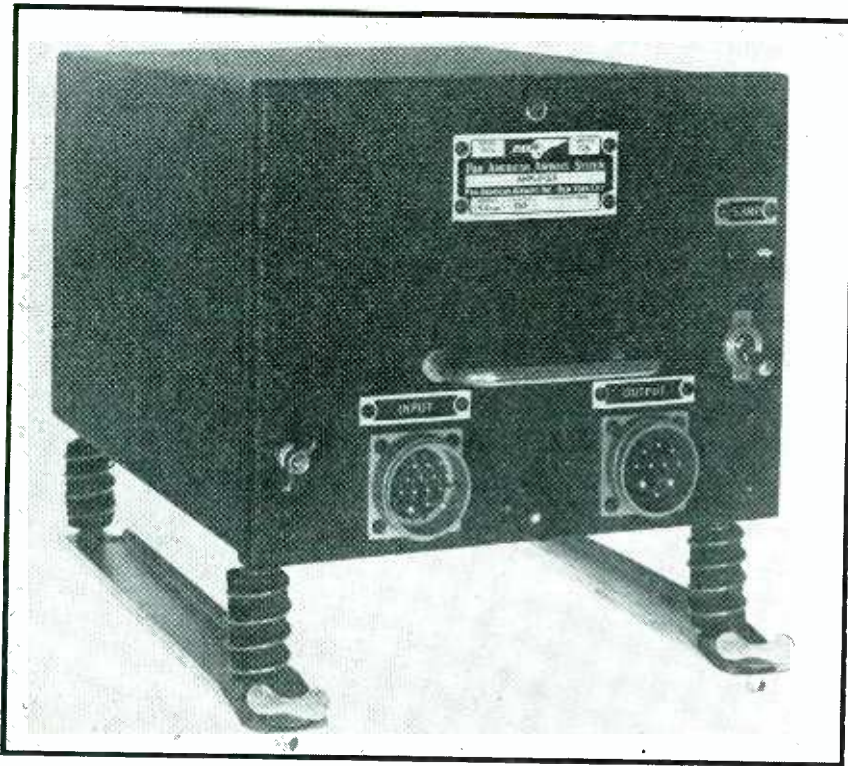

Isolation amplifier for three crew members. An interphone amplifier and vibrator power supply are included in the shock-mounted unit which weighs 10.2 lb

**T**HE larger present-day aircraft carry numerous radio receivers. A typical installation includes one or two automatic direction-finder receivers, one range receiver, one communications receiver, and one Z-marker receiver. Installations sometimes include a spare communications receiver, a vhf receiver, localizer and glide-path receivers.

In addition to the above receivers, the pilot must be able to listen to interphone and transmitter-monitoring sidetone circuits. The copilot and radio officer should also be able to listen to some if not all of the above receiver, interphone and transmitter monitoring circuits.

### Simple Switching Inadequate

Quite often the pilot may want to listen to more than one receiver at a time. The copilot may desire to listen to some other receivers while the radio officer is listening to still another combination of radio facilities.

These requirements present a problem in the design of control panels. To enable each crew member to listen to any combination of radio

circuits at his position, we might simply provide toggle switches to connect each crew member's headphones to each output. This method is satisfactory when none of the crew members connects his headphones to more than one facility at a time. But if any crew member connects his headphones to two circuits he connects the circuits together not only for himself but for all the other crew members, as shown in Fig. 1.

One method used to overcome the above difficulty is to provide each facility with a separate output circuit for each crew member as shown in Fig. 2. Each output is usually obtained by adding another tube and associated transformer in each facility. This method, used by most of the domestic airlines, becomes unwieldy when more than two crew members must have radio facilities. Another disadvantage is the reduction in volume of each output due to the loading effect of the other equipment connected to it. When several facilities are connected to the headphones at one station this reduction is appreciable. Due to the inde-

By **GORDON F. ROGERS**

*Radio Receiver Laboratory Chief  
Pamsco Branch  
Pan American Airways  
Coral Gables, Florida*

pendent outputs the reduction of volume appears only at the crew member's position where the facilities are connected together. Several methods of eliminating this fault are in use but are not entirely satisfactory with a large number of facilities.

A satisfactory method of overcom-

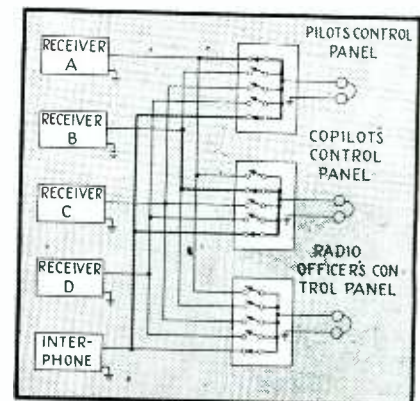

FIG. 1—Conventional switching system for three crew members. With the switches thrown as indicated, the pilot, copilot and radio officer will all hear receiver A, receiver B, and the interphone. Heavy lines indicate the circuit interconnections.

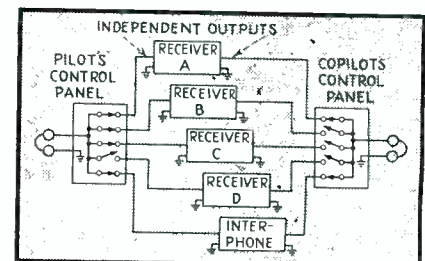

FIG. 2—Improved switching system for two crew members. With switches in positions shown the pilot hears receivers A, B, C and the interphone. Copilot hears receiver A and interphone much louder than the pilot. Even with no provision for the radio officer a total of five extra tubes is required in order to provide each crew member with a separate output circuit for each facility

# AMPLIFIERS for Aircraft

Signals from interphone and four or more receivers must be immediately available in various combinations to pilot, copilot and radio officer of large commercial planes. Isolation amplifiers allow a maximum of different connections without crosstalk or attenuation

ing all the above difficulties was developed by the author in 1942, and has been used on aircraft in scheduled operation since that time.

### Complete Circuit Isolation

By means of isolation amplifiers, the pilot, copilot, and radio officer may each listen to any combination of facilities without affecting the volume or combinations of facilities in use by the others. In this method, shown in Fig. 3, each crew member has a set of toggle switches which connect the desired circuits together through high resistances to the grid of a vacuum-tube amplifier. Each crew member has his own amplifier which is isolated electrically from the others. Since the facilities are connected together only through high resistances they are effectively isolated from each other.

The grid of the vacuum-tube isolation amplifier requires no power, so the only loss encountered is that due to the interconnecting resistors. This loss is proportional to the total number of facilities, and is made constant whether the circuits are in use or not by using another resistor of the proper size connected between the receiver end of each high resistance and ground. The gain of a single amplifier tube is sufficient to bring the net loss to zero when five facilities are used.

The value of the resistor used to connect the high resistance to ground when the facility is disconnected should be several times the output impedance of the device so as not to affect its output voltage sensibly by connection or disconnection.

The amount of loss in the series grid resistors can be shown by an example. If they are each 1 megohm

and the receiver outputs are each 500 ohms, the voltage from any one output will feed to the grid of the amplifier connected, then through the other four 1-megohm resistors to ground, by way of the low-impedance outputs. This path will have a resistance of about 250,000 ohms. Thus, the voltage on the grid will be about  $250,000/1,250,000$  or one-fifth of that at the output. This is a loss of 14 db.

An extension of the same example shows the effectiveness of the series grid resistors. Voltage at any grid from any one facility is fed back to the output terminals of every other facility in use through a 1-megohm resistor. Thus the voltage fed to each equipment of 500-ohm impedance is 500 divided by 1,000,500, times the voltage on the grid. This represents a loss of about 66 db. Since the voltage on the grid is a

fifth of that fed from a facility (as shown above) there is an additional attenuation of 14 db, making a total of 80 db down. However, since there may be other paths not considered, the minimum coupling could be as high as -69 db.

Two alternatives in the application of the method are possible. A complete isolation amplifier for each crew member can be built into his control panel, or each control panel may contain only the resistors used to connect the facilities together, all the amplifier tubes being mounted in one unit with a common power supply. The latter alternative was used by the author, and an isolation amplifier was designed, using three 14C5 tubes as the three isolation amplifier tubes. An interphone amplifier and power supply are included. The total weight of the unit complete with shock mounts is about 10 lb.

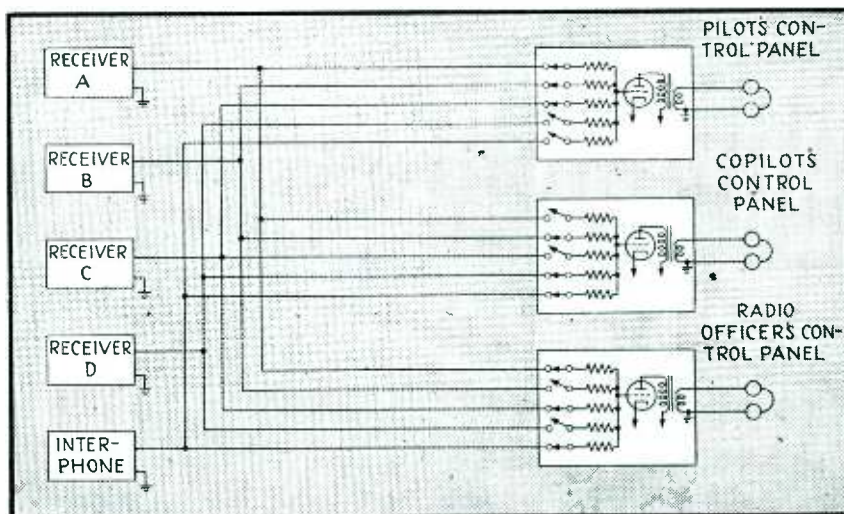

FIG. 3—Isolation amplifier method. With these connections, the pilot hears receivers A, B, and C. Copilot hears B, D. Radio officer hears receivers A, C, and the interphone. All signals are at the same level. A total of four extra tubes is required, one of which (not shown) is used in the amplifier power supply. Resistors from each switch arm to ground are not shown



New 35-pound television camera, connected by cable to suitcase-type portable camera auxiliary unit

# Portable VIDEO

By **WILLIAM A. HOWARD**

*Television Engineering Division  
Philco Corporation  
Philadelphia, Pennsylvania*

camera control, and remote monitor. Provisions are made for three camera chains, used with a single master control unit and synchronizing generator, as indicated in Fig. 1. Each camera chain operates independently so that one, two, or three cameras may be used, depending upon the requirements of the program to be televised.

The equipment is designed to produce a composite output which consists of the video signal and FCC standard synchronizing signals. The amplitude of the output is approximately  $1\frac{1}{2}$  to 2 volts peak-to-peak of video signal developed across 70 ohms, and a 2 to 1 ratio of video to synchronizing signals. The video-frequency amplifiers are designed and adjusted to amplify frequencies

**T**HE purpose of this article is to describe a new lightweight television camera and associated control, monitoring, and synchronizing equipment developed in the Philco television engineering laboratories. With this equipment, several camera chains can easily be operated from a single portable master control unit fed by a portable synchronizing generator, as required for televising on-the-spot news, sports events, street parades, conventions, and other outdoor or indoor scenes. However, this portable equipment can also be adapted readily for studio work. It offers the advantages that each unit is designed to be as compact, sturdy and light in weight as possible, easy to operate and maintain, and easy to set up.

At the time when development of this new video equipment was initiated, the sole camera tube suitable for a portable camera of the suitcase type was the 1848 iconoscope. Realizing that other camera tubes might soon be available, it was decided to design the new portable equipment in such a way that other camera chains, incorporating such newer tubes as the image orthicon, for example, could readily become part of the same system by merely adding three

units: the modified camera, a camera auxiliary, and a camera control unit.

### General Characteristics

Since the equipment is truly portable and of the suitcase type, it was necessary to divide it into several units. A single camera chain consists of a camera, camera auxiliary,

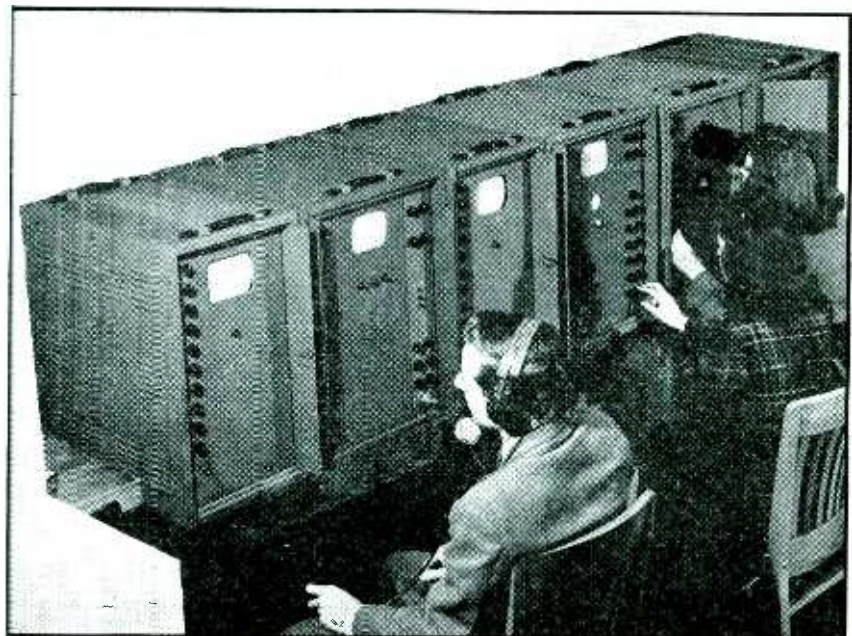

Portable television control setup for operating a two-camera chain. Units are, left to right, remote monitor No. 2, master control, remote monitor No. 1, camera control No. 2, synchronizing generator, and camera control No. 1

# PICKUP EQUIPMENT

Description of new suitcase-type television control units and 35-lb camera. Three camera chains fed by a single synchronizing generator can be set up in a few minutes for use with a common master control unit for remote indoor or outdoor program pickups

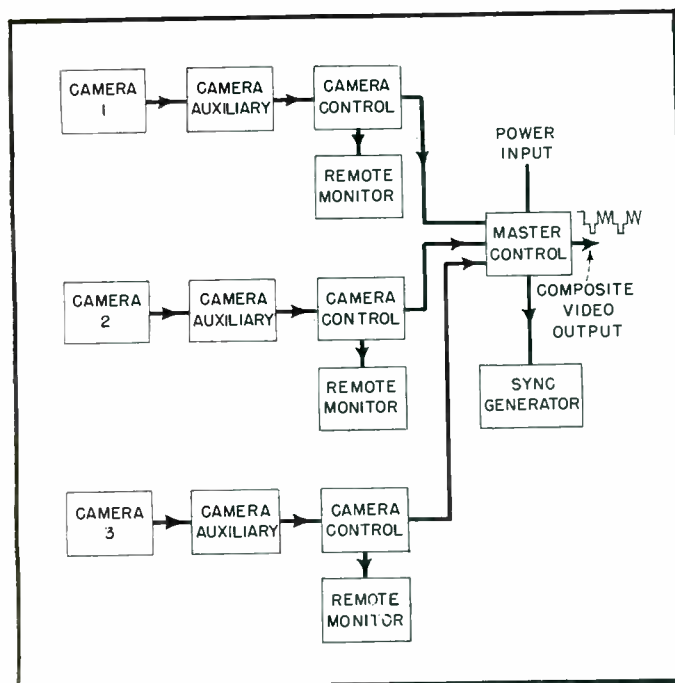

FIG. 1—Block diagram showing portable video pickup units employed for a three-camera program

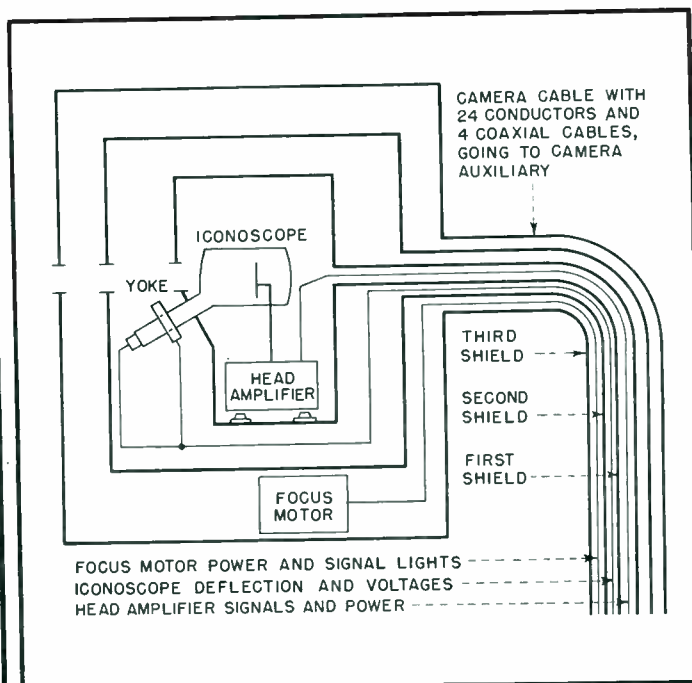

FIG. 2—Method of shielding iconoscope in camera unit to permit operation near a radio transmitter

from below 30 cps up to 5 mc with uniform response.

The length of the cable from camera auxiliary to camera control unit can be as long as 500 feet, making it possible for any two cameras to be separated by distances up to 1,000 feet. The lengths of all other cables vary from 10 to 15 feet. The length of cable from camera auxiliary to camera control, remote monitor, master control, and synchronizing generator units to be set up in some type of control room (mobile or stationary), while the cameras and their auxiliary units may be at some distance from the control room.

The equipment operates from any suitable 115-volt, 60-cps single-phase power supply system. The current consumption for the equipment with one, two, or three cameras is approximately 15, 23, or 31 amperes, respectively. Each unit, except the camera, contains its own +175-volt regulated power supply.

The chassis and frames of each unit are constructed from aluminum and dural. The sides of each unit are easily removed, to make tubes and parts accessible. In operating the equipment there is need only to open the front and back doors, which slide back into the sides. All cables are attached to the rear of each unit,

and all controls are located on the front.

## Camera

The components in the camera are the iconoscope, deflection coils, an induction motor for optical focusing, a three-stage head amplifier, and bias and signal lights. The power and deflection circuits for the camera are located in the camera auxiliary unit.

One of the special features of the camera consists of three shields around the iconoscope, shown in Fig. 2. It is often necessary to operate remote pickup equipment near radio broadcasting transmitters or in a location where there is consider-

able electrical disturbance. The presence of broadcast pickup in the picture signal can become very annoying to the viewer of the picture. One shield is not sufficient, since the r-f current must flow through the outer shield and can then be picked up by the inner conductor which carries the picture signal. It was found from experiments in the laboratory and during field tests that three shields were necessary for satisfactory shielding from outside electrical disturbances and broadcast pickup. These three shields are carried through to the camera auxiliary unit where each has a common ground.

Only a three-stage head amplifier, the iconoscope, and power and signal leads for the head amplifier are contained within the first shield of the camera. The deflection coils are inside the second shield, along with deflection, filament, and anode voltage leads for the iconoscope. The focus motor, signal lights, the outlet for the order wire system, and the conductors for these components are inside the third shield.

The head amplifier consists of a 6J4 input tube with its grid connected directly to the signal plate of the iconoscope, a 6AK5 amplifier, and a 6J6 cathode follower. Approximately 0.5 volt peak-to-peak of picture signal is developed across 90 ohms in the cathode follower and is carried to the amplifiers in the auxiliary unit through a 90-ohm coaxial line. The triode input stage permits a good signal-to-noise ratio to be developed for the system. The shading signals are inserted on the grid of the 6J4 input tube.

A small 115-volt a-c reversible motor is used to drive the lens carriage for optical focusing. The motor has a speed of 10 rpm and has dynamic braking. The switching for the motor is done remotely in the camera control unit with a spdt switch handled by the video operator while observing a line monitor.

#### Camera Auxiliary Unit

A block diagram of the camera auxiliary unit appears in Fig. 3. The iconoscope high-voltage supply consists of a -1,000-volt supply using a 2 X 2 rectifier. The iconoscope focus and bias controls, which are in the bleeder of this supply, are located in the camera control unit.

Since a high-velocity electron beam is used in scanning the mosaic of the iconoscope, it is necessary to provide protective circuits in case either horizontal or vertical deflection should fail. Figure 4 shows how this is accomplished. A negative pulse is taken from across a two-ohm resistor  $R_1$  in series with the deflection yoke. This pulse is stepped up in a transformer and amplified by  $VT_1$ . The resulting positive pulse drives  $VT_2$ , the grid of which is biased well below cutoff. The plate of  $VT_2$  is in series with the solenoid of the relay

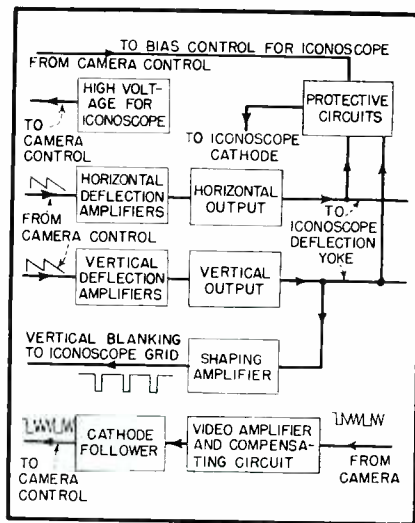

FIG. 3—Block diagram of camera auxiliary unit

so that when there is sufficient deflection,  $VT_2$  conducts, closing the contacts of the relay and putting the proper voltage on the cathode of the iconoscope. When there is not sufficient deflection,  $VT_2$  is biased off, which opens the cathode circuit of the iconoscope.

The video-frequency amplifiers in the camera auxiliary unit consist of three 6AK5 amplifiers and a 6J6 cathode follower. Because of the high load impedance of the iconoscope and the shunt capacitance of the input stage, it is necessary to compensate for the loss of high frequencies at some point in the video amplifier chain. This compensation is accomplished in the plate circuit of the first amplifier stage in this unit, as shown in Fig. 5. The low frequencies are divided down by the ratio of  $R_1$  to  $R_0$ . For best results the ratio is approximately 100 to 1. Capacitor  $C_1$  can be adjusted for proper high-frequency response. The output

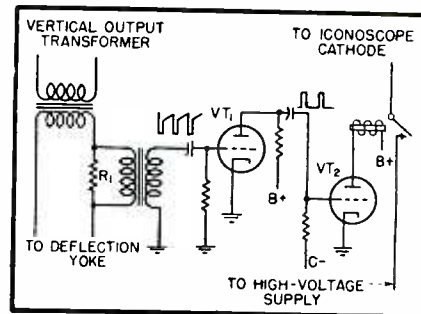

FIG. 4—Circuit used to open cathode circuit of iconoscope if either vertical or horizontal deflection fails

of the cathode follower is approximately 1 volt peak-to-peak of video across 90 ohms.

It is necessary to blank out the vertical retrace on the iconoscope. A pulse is taken from the secondary of the vertical output transformer and shaped up as shown in Fig. 6. Here  $C_1$ ,  $R_1$  determines the width of the pulse, and  $VT_2$  selects only the pulse component of the combined pulse and saw-tooth waveform taken from the secondary of the output transformer. Proper amplitude of this pulse is fed to the grid of the iconoscope to cut it off during the vertical retrace time.

Two selenium rectifiers in this unit furnish d-c voltage for the head amplifier filaments and for horizontal and vertical centering. Other power supplies consist of a +175-volt regulated supply, a -105-volt supply for bias, and a +350-volt filtered supply for deflection output stages.

#### Camera Control Unit

The camera control unit is normally the central control point at which all the operating adjustments are made while the equipment is in operation. This unit contains a picture monitor using a 6AP4 flat-face cathode-ray tube used in monitoring the signal after it has been mixed with blanking pulses, and a two-inch oscilloscope for examining either a line or a frame of the picture signal.

The block diagram of the camera control unit is given in Fig. 7. The video amplifiers consist of a 6AC7 amplifier, a 6AG7 amplifier, and a 6V6 cathode follower. Blanking pulses are mixed with the video signal by having the plate of the 6AG7 video amplifier common with the plate of a 6V6 which has positive mixed blanking on its grid. The black level is controlled by changing



supplies a signal for both sections of a 6SN7 cathode follower. One section of the 6SN7 supplies the signal for the video amplifiers of the 6AP4 picture monitor in this unit, and the other section supplies video for the three-inch oscilloscope in the synchronizing generator. A leveling diode, tied to the grid of the 6AG7 cathode follower, holds the synchronizing tips to ground level at the output point. The video amplifiers are provided with a pushbutton switching arrangement, permitting selection of the video signal from any one of three camera control units. Signal lights are also controlled by the same switch to indicate to the operators at any given camera control unit and camera that the picture from their camera chain is on the air.

Program and order amplifiers are included in the master control unit. They provide a two-way interphone system with outlets in the master control, camera control, camera auxiliary, and camera units. Provision is made for feeding the program audio into these amplifiers, thus enabling the operators to hear both program and order information. A program microphone input to these amplifiers is also provided, so that sound can be picked up at any desired point.

The a-c power input and switching for the three camera chains are also in the master control. Mercury relays are used for switching power. The filaments and plates are on separate lines. A half-minute time delay switches the plate power on. Power supplies in this unit consist of a +175-volt regulated supply and

a +4,000-volt anode supply for the 6AP4 monitor.

### Monoscope

A monoscope unit is provided for generating a test pattern when such a signal is desired. A camera and camera auxiliary unit may be replaced by this unit, which will enable the program director to select picture signals from either of two camera chains or a signal test pattern from the monoscope.

This test pattern generator utilizes a monoscope tube for supplying the pattern, which is printed on an aluminum sheet with carbonized ink. When this pattern is scanned by a high-velocity electron beam, the difference in the secondary emission of the carbonized ink and the aluminum produces a video signal across a load resistor which is connected to this signal plate.

Due to the high signal output of the monoscope, only two stages of amplification are necessary in this unit. These amplifiers consist of two 6AK5 tubes, each using shunt peaking in the plate circuit. A 6J6 cathode follower supplies video signal to a 90-ohm coaxial cable which carries the signal to the line mixing amplifiers in the camera control unit.

Deflection for the monoscope is accomplished in the same manner as for the iconoscope. Since the blocking oscillators and discharge circuits are in the camera control unit, only deflection amplifiers and output stages are needed in this monoscope unit. The vertical deflection circuits consist of one section of a 6SN7 amplifier and two sections of a 6SN7 in parallel for the output stage. The

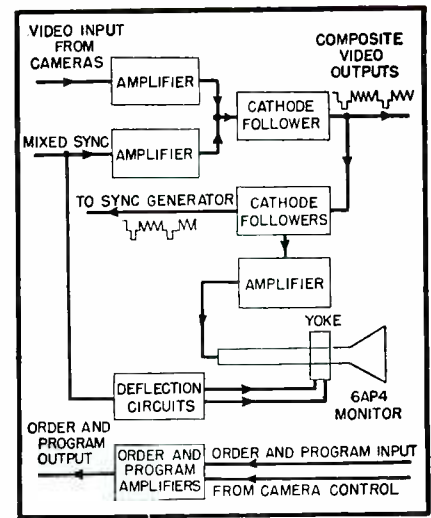

FIG. 11—Block diagram of master control

horizontal deflection circuits consist of one section of a 6SN7 as an amplifier, a 6L6 output stage, and a 6X5 diode as a damping tube across the primary of the horizontal output transformer.

Power supplies in this unit consist of a +175-volt regulated supply, a +350-volt filtered supply, a -1,000-volt anode supply, and a -105-volt supply for bias.

The monoscope unit is of the same physical size and weight as the camera auxiliary unit.

### Conclusions

The performance of this new lightweight equipment has been satisfactory. Under normal lighting conditions, it is possible to obtain excellent resolution from the system. Field tests have proved that the equipment can be operated in locations where there is a large amount of electrical disturbance without having any of it appear in the picture. The performance of this equipment during the past football season has indicated that it will be particularly valuable for remote pickup telecasts. Under good lighting conditions, the quality of the picture obtained from this equipment has been far superior to that obtained from an orthicon chain under the same conditions. A picture of commercial quality has also been televised with the new video equipment, even when handicapped by poor lighting. Perhaps an equally important advantage is that this entire system can be set up, cabled, and put in operation within a few minutes.

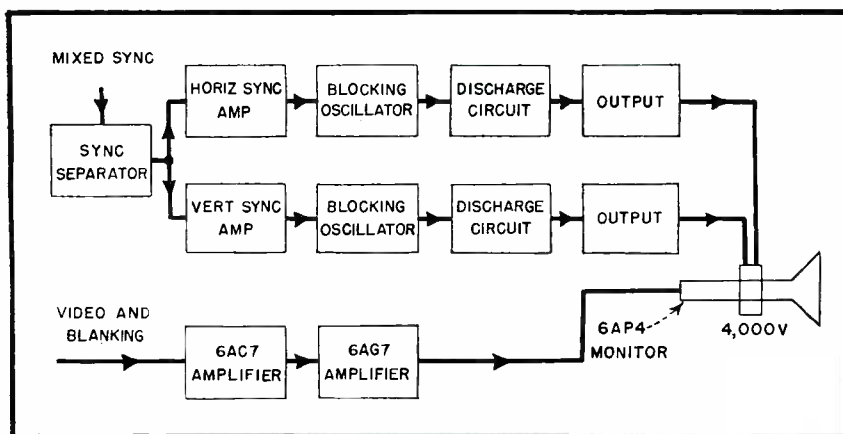

FIG. 10—Block diagram of monitor unit

# Nonlinear Circuit

Regulators for direct or alternating current can be built by using nonlinear elements. Contact rectifiers have characteristics that are suitable for use in logarithmic voltmeters and ratio meters having a linear decibel scale. Characteristics and design requirements are given

By HEINZ E. KALLMANN

Consultant  
New York, N. Y.

**N**ONLINEAR CIRCUIT ELEMENTS can be advantageously used in a variety of ways. Nonlinear lattice networks and other simple bridge circuits can supply power with good regulation for large changes of input voltage. They consist only of ordinary resistances and nonlinear resistances, are suitable for any current and voltage, are independent of frequency and are therefore suitable in test equipment. They are particularly useful for regulation of large currents at low voltages, such as in heater circuits, where tube regulators are impractical, but they consume relatively large power.

An absolute reference level can be established for power supply regulation by comparing nonlinear resistances with constant resistances. A bridge built with two nonlinear resistors and two constant resistors, and fed from the output of a power supply that is to be regulated develops a strong control voltage at any desired voltage level, and consumes less current and space than the usual gas discharge tube circuit.

A current flowing through a copper-oxide or germanium crystal rectifier produces a voltage that is closely proportional to the logarithm of the current over a substantial range of the rectifier's forward characteristic. If both source and load impedances of a logarithmic voltage divider are high, the errors are low. A logarithmic bridge circuit can be designed to have small errors despite moderate source and load impedances, and, in addition, to present substantially constant input and output impedances.

These networks may be considered

as bridges composed solely of ordinary resistances (obeying Ohm's Law) and nonlinear resistances whose conductivity rises with the applied voltage. There are several types of nonlinear resistances.

## Nonlinear Resistors

In Thyrite, a resistance material comprising silicon carbide, current  $i$  rises with applied voltage  $e$  according to  $i = \sigma_1 e^n$ , where  $\sigma_1$  is conductivity in amperes at one volt, and  $n$  is an exponent of the order of four. This material can, by choice of  $\sigma_1$  and dimensions, be adapted to voltages from 0.1 volt to many kilovolts and to currents from microamperes to amperes. Change in conductivity is instantaneous, irrespective of polarity, peak amplitude, or frequency of the applied potential. The current through these units, for constant voltage, rises about one percent for each degree Fahrenheit increase in ambient temperature.

Thyrite may be imagined as a composition resistor, which it closely resembles, incorporating a multitude of minute spark gaps; the higher the potential gradient, the more of these gaps break down and conduct. Stray capacitances are negligible until far above the audio frequency range.

Rectifiers, tubes or metal contacts, single for d-c or in biased two-way pairs for a-c, have nonlinear characteristics. Like Thyrite they respond instantaneously to voltage changes.

Temperature-sensitive resistances, such as iron-hydrogen ballast tubes and Thermistors, vary in resistance if the power dissipated in them changes, but, because of their thermal capacity, are slow in response.

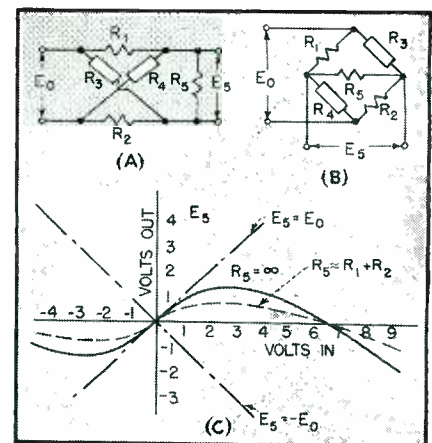

FIG. 1—Basic lattice network (A) in which nonlinear resistors are used is a bridge circuit (B). Its characteristic (C) shows output voltage reversing with increasing input voltage

The basic lattice regulator network in which nonlinear resistances are used is shown in Fig. 1A and is redrawn as a bridge in Fig. 1B. It has, in opposite arms, two ordinary resistances  $R_1$  and  $R_2$ , and two nonlinear resistances, such as Thyrite,  $R_3$  and  $R_4$ . The output voltage  $E_5$  on the load resistance  $R_5$  is an S-shaped function of the input voltage  $E_0$ . For very small  $E_0$ ,  $R_3$  and  $R_4$  will be very large resistances compared with  $R_1$  and  $R_2$ ; thus  $E_5$  will rise initially as if across a voltage divider formed by  $R_1, R_2$ , and  $R_2$ . For very large  $E_0$ ,  $R_3$  and  $R_4$  will become very small compared with  $R_1$  and  $R_2$ ;  $E_5$  will reverse

This paper is based on work done for the Office of Scientific Research and Development under contract OEMsr-262 with the Radiation Laboratory, Massachusetts Institute of Technology.

# Element Applications

its polarity and rise as on a voltage divider formed by  $R_3$ ,  $R_5$ , and  $R_4$ . The bridge will balance ( $E_s = 0$ ) at a certain intermediate potential regardless of the value of the load resistance  $R_L$ . (An application where this potential is used as a reference voltage will be discussed later.)

Assuming for simplicity that  $R_1 = R_2$  and  $R_3 = R_4$ , a typical characteristic of such a Thyrite bridge is shown in Fig. 1C. The flat regions around  $E_0 = \pm 3$  volts can be used for regulation. A model of a simple power supply was built according to the circuit diagram of Fig. 2A. The nonlinear resistors  $R_3$  and  $R_4$  are Thyrite units  $T_1$  and  $T_2$ . Figure 2B shows the measured over-all regulation when this unit is fed from the 60-cps line. Output voltage  $E_L$  across a load of 0.1 megohm stays within plus or minus 5 percent for an input voltage  $E_p$ , varying between 104 and 130 volts. However, the regulation for varying load current is poor, the output voltage dropping steadily with

increased load current, as shown in Fig. 2C. In the model tested, this drop corresponds to a source impedance  $R_i$  of about 12,000 ohms, equal to that of each series resistance.

Typical data, upon which to base design estimates, are

$$\begin{aligned} R_1 &= R_2 \\ R_3 &= R_4 \\ E_{L0} &\approx 0.55 E_0 \\ E_{R1} &\approx 1/3 E_{R2} \\ R_i &\approx R_1 \end{aligned}$$

where  $E_{L0}$  is the open load voltage. For these conditions, the bridge circuit then delivers to the load one quarter, or less, of the energy fed to it, dissipating the balance.

### Simplified Regulator

If a nonlinear element is used in only one bridge arm, the bridge circuit is less efficient, yet still useful. One of the two nonlinear resistances is replaced by an ordinary one  $R_4$ , as in Fig. 3A and 3B. The larger this resistance, the more retarded is the drop in output voltage. Figure 3C shows some curves measured at 60 cps with a rectifier-type a-c voltmeter.

Regulation of alternating current by means of a nonlinear bridge depends on whether the nonlinear elements are responding slowly, as do Thermistors, or instantaneously as does Thyrite. With the former, regulation of a-c is substantially the same as for d-c; with the latter, however, the output-input relation differs somewhat from that of d-c depending on the waveform of the input voltage. Only in the case of a square-wave input has the output of a nonlinear device the same waveform as the input and can be computed as for a direct current of the same magnitude. All other waveforms emerge distorted, the more so the less they approximate a square wave. For example, due to the limiter action of the regulator circuit,

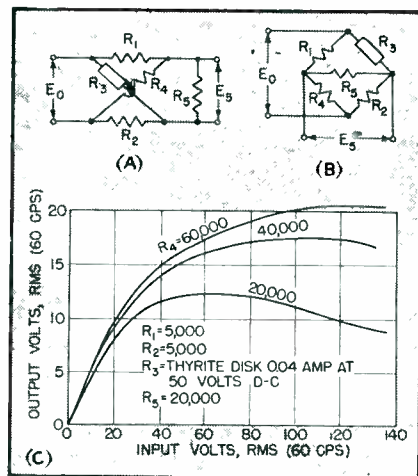

FIG. 3—Bridge circuit can be used to regulate alternating voltage. Choice of resistance in arm opposite nonlinear resistance determines the turnover voltage of the regulator

sine waves emerge with flattened, or even indented peaks. The regulation, though much more difficult to compute, is for a-c at least as good as for d-c. The curves of Fig. 3C are thus similar to, but not strictly comparable with, those in Fig. 1C and 2B.

It is evident from Fig. 3B that the resistances  $R_1$  and  $R_4$ , acting as voltage divider, might profitably be replaced by a tap on the source of input voltage. This can, for a-c, be a tap on a transformer winding as shown in Fig. 4A. In it, the branch  $R_3$  is represented by the Thyrite unit and the series resistance  $R_5$  such as in the transformer winding, and the branch  $R_2$  by a resistance of 20 ohms. The output voltage  $E_s$  is developed across a load resistance  $R_L$  of 20 ohms. Figure 4B shows computed plots of the instantaneous values of  $E_s$  versus  $E_0$ , strictly applicable to the regulation of square waves, and of d-c from a balanced source.

The formulas from which the curves of Fig. 4B were calculated are simple but not handy. The result depends considerably on the exact value

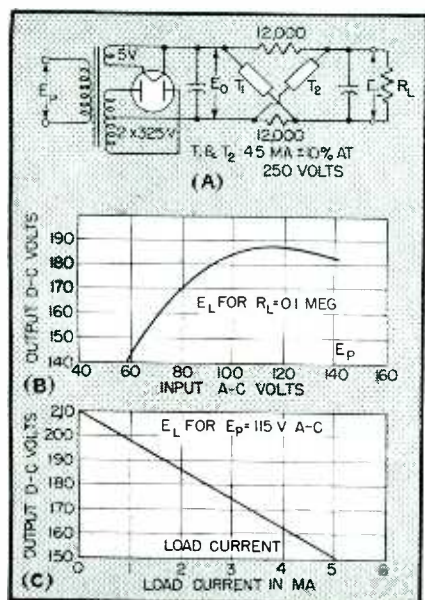

FIG. 2—Nonlinear bridge elements regulate rectifier (A), giving characteristics (B) and (C)

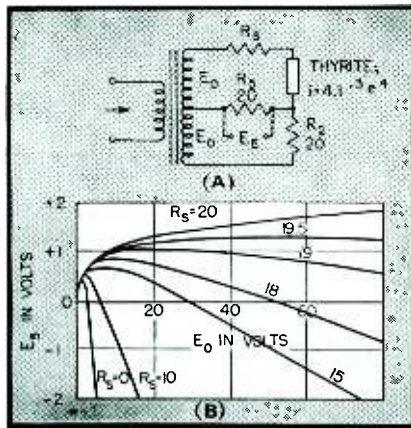

FIG. 4—Circuit of Fig. 3A can be modified (A) to give regulating characteristics (B) which were theoretically determined

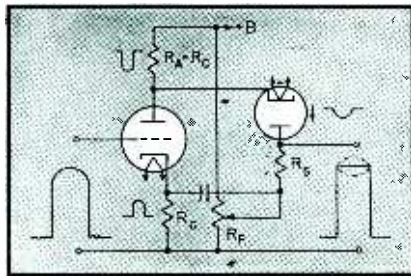

FIG. 5—At high frequencies, the nonlinear resistor of Fig. 3A is replaced by a diode in this pulse limiter circuit

of  $n$  and is thus only qualitatively reliable

$$\begin{aligned}
 E_0 &= A E_T + \sigma B E_T^n \\
 E_s &= C E_T + \sigma_1 D E_T^n \\
 A &= (R_2 + R_s) / (R_2 + 2R_s) \\
 B &= (R_2 R_s + R_2 R_s + R_s R_s) / (R_2 + 2R_s) \\
 C &= R_s / (R_2 + 2R_s) \\
 D &= (R_s R_s - R_2 R_s) / (R_2 + 2R_s) \\
 n &= 4; \sigma = 4 \cdot 10^{-3}; R_s = 20 \text{ ohms}; \\
 &R_2 = 10 \text{ to } 20 \text{ ohms}
 \end{aligned}$$

#### Pulse Limiter

If frequencies of the order of megacycles are involved, both transformer and Thyrite become impracticable, but the basic nonlinear circuit remains the same. Instead of a center-tapped transformer winding, a tube circuit may be used as a balanced source, with the load evenly split between cathode and anode circuit. The nonlinear element is a diode tube.

Such a circuit is suitable for signal limiting, as shown for a pulse limiter in Fig. 5. A round-topped pulse and background noise are fed to the grid of a tube, in this case a

triode. The background is suppressed by biasing the tube beyond cut-off; thus a clean pair of round pulses appears on the cathode resistance  $R_c$  and, in opposite sense, on the anode resistance  $R_a$ . The main signal is fed to the output from the cathode via a large insulating capacitor and a small series resistance  $R_s$ . The anode is connected to the output via a diode which is biased so far, by means of a potentiometer  $R_p$ , as to conduct only during the peak of the pulse. The round peak of the pulse thus reaches the output with opposite phase from both cathode and anode and may be exactly cancelled by adjusting  $R_s$  to equal the residual resistance of the diode while conducting. This resistance is usually a few hundred ohms. The output pulse then has the shape of the solid line; maladjustment of  $R_s$  will result in under or over compensation as shown in broken lines.

#### Controlled Regulator

Another type of regulator circuit is based on the control of a nonlinear shunt resistance by an auxiliary source of unregulated power. It is thus possible to control one d-c by another, one a-c by another, or d-c by a-c, a-c by d-c, or each by itself. Figure 6A serves as an example. Input voltage is fed via a transformer to a

voltage divider consisting of a series resistance  $R$  and a bridge of four nonlinear resistances. The latter can be four Thyrite units, one slab with terminals in four corners, or a ring with four terminals.

The output voltage across such a Thyrite bridge will rise less than linearly with the input voltage due to the progressively rising shunt conductance offered by the bridge. This slight regulation of the output voltage is greatly increased by an auxiliary control current fed across the bridge from an auxiliary source, in this case on additional transformer winding. Any current passing through Thyrite increases its conductivity in all directions. The current drawn from the auxiliary winding may be much larger than even the whole current through  $R$ , and the conductance of the Thyrite shunt can thus be controlled to any desired degree, with only slight coupling between the two currents if they are from different sources.

Figure 6B is a variant of 6A using input voltage to the transformer as the auxiliary source. Figure 6C is another variant, using a center-tapped auxiliary winding and thus eliminating two of the four nonlinear bridge arms without change in performance. Figure 6D shows a combination of both these modifica-

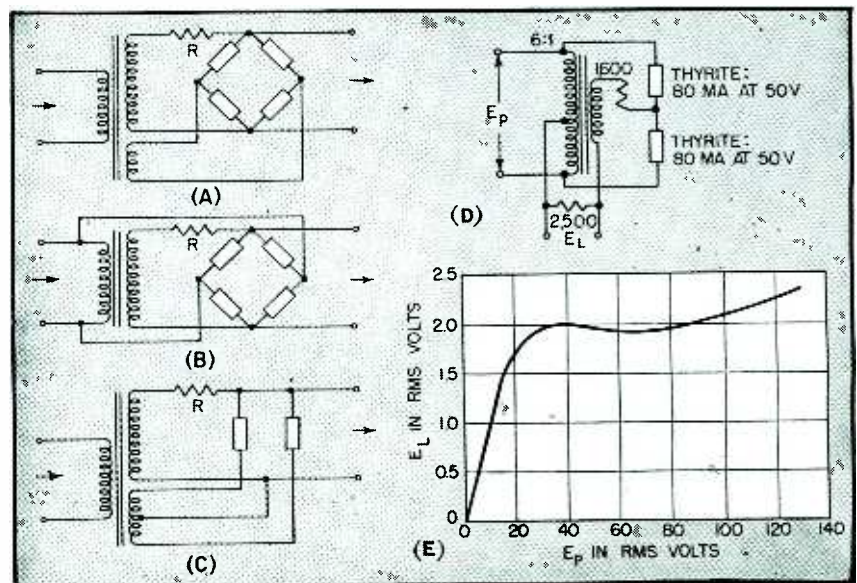

FIG. 6—Voltage to be regulated can be variously used (A, B, C) to control the nonlinear regulator circuit. A practical modification (D) gives nearly flat regulation (E) over a two to one input range of voltage

tions, using a center-tapped primary as the auxiliary winding; its performance was measured at 60 cps with the values of the components as noted. The result is plotted in Fig. 6E. Regulation for a range of two to one in input voltage can be made flat by slight adjustment in any resistance.

### Bridge-Controlled Tube Regulator

Voltage regulator circuits, as commonly used in power supplies, comprise three parts whose functions are (1) to establish a standard reference voltage; (2) to compare a part of the regulated voltage with this standard and to amplify any voltage difference; (3) to control, by means of this amplified voltage difference, the voltage drop in a series element inserted between raw and regulated voltages so as to minimize changes in the latter. The second and third functions are commonly performed by amplifier tubes. The first function is performed either by a battery or, more commonly, by a gas discharge tube such as the regulator types VR 105 or VR 150. In the simplified regulator circuit, the same source of raw voltage is used, as well as the usual type of control voltage amplifier and series tube. But the source of standard reference voltage is eliminated; it is replaced by a nonlinear bridge composed of two ordinary resistances and two nonlinear resistances such as Thyrite, as shown in Fig. 7A.

As has been previously explained in connection with Fig. 1, the output-input characteristic of such a bridge is S-shaped, as plotted in the observed characteristic Fig. 7C.

The broken diagonal lines represent the cases of  $E_{out} = E_{in}$ , and  $E_{out} = -E_{in}$ , approached respectively for very large and for very small input voltages. The output voltage in this example changes sign at an input voltage of  $\pm 283$  volts. The shape of this characteristic remains and only the voltage scale changes when the values of  $R_1$  and  $R_2$  are chosen differently; the larger  $R_1$  and  $R_2$ , the lower the potential at which given units of Thyrite equal them, and thus the lower the input voltages at which the bridge is balanced. With negligible load to the bridge, the characteristic depends only on the two ratios

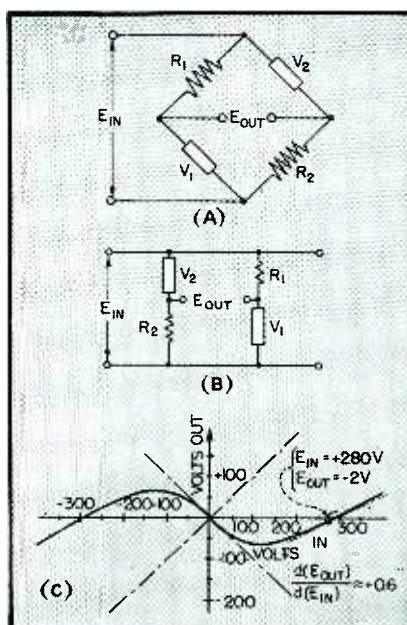

FIG. 7—Basic bridge circuit (A) is used to develop the control voltage for a power supply regulator (B). Instead of using bridge at the point on its characteristic of constant output, Fig. 1C, it is used at the point of changing polarity (C)

$R_1/V_1$  and  $R_2/V_2$ ; it retains its shape for  $R_1 \neq R_2$ . The input voltage required for bridge balance, as well as for any desired small output voltage, can thus be controlled by varying either  $R_1$  or  $R_2$ . When used in a con-

trol circuit, all four resistances may be made as high as the load impedance permits, thus saving current and power.

The desired voltage is defined as that which balances a preset Thyrite bridge, or more precisely, as that  $E_{IN}$  which makes the bridge yield a certain small control voltage  $E_{OUT}$ . The latter is applied to grid and cathode of the control voltage amplifier tube with such polarity as to minimize the variations of the regulated voltage  $E_{IN}$  of the Thyrite bridge.

Figure 8 is the diagram of a typical regulated rectifier circuit consisting of a full-wave rectifier and filter followed by a series low-impedance triode regulator and an amplifier pentode. The regulated voltage is that from the cathode of the series tube to ground; it is fed to the positive output terminal. The voltage across the output terminals serves as  $E_{IN}$  for the Thyrite bridge composed of the resistors  $R_1$  and  $R_2$ , and the Thyrite units  $V_1$  and  $V_2$ , as illustrated in Fig. 7B, and shown in the regulator of Fig. 8. Either  $R_1$  or  $R_2$  can be adjusted until the bridge is approximately balanced at the desired regulated voltage  $E_{IN}$ . Then an increase of this voltage would increase the bridge voltage  $E_{OUT}$  fed

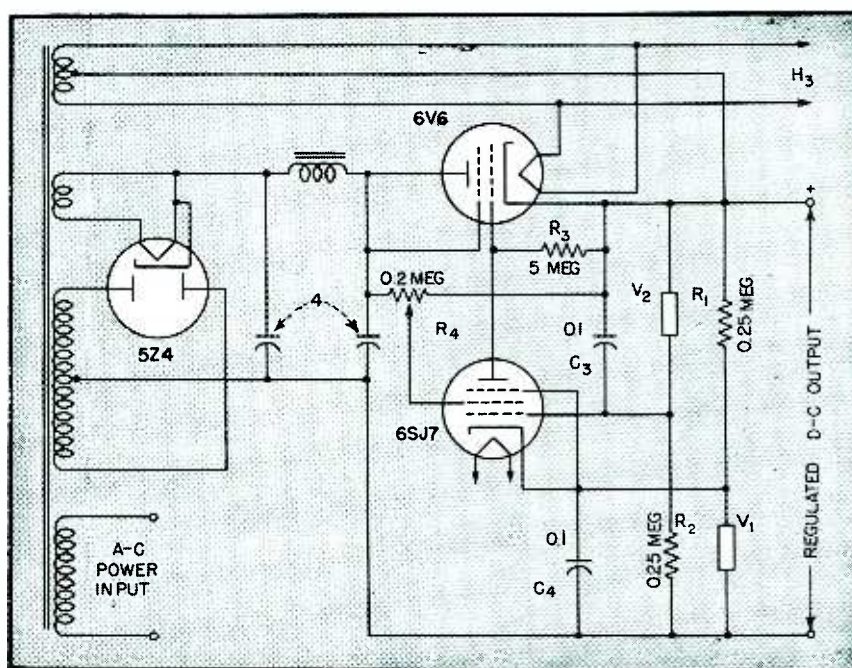

FIG. 8—Regulated power supply uses nonlinear resistances in place of gas tube to develop control voltage

to the amplifier pentode, making its grid less negative relative to its cathode. This causes an increase in its plate current, in the voltage drop on the load resistor  $R_s$ , and in the bias on the series regulator triode. Reducing the current through the latter then counteracts the initially assumed rise in the regulated voltage.

The point at which the bridge can be used, marked on Fig. 7C, yields approximately minus two volts as the average control voltage on the amplifier grid. The slope of the curve at that point is approximately six-tenths and the efficiency of a Thyrite bridge is thus approximately six-tenths of the maximum possible value of unity. As in other control circuits, the proportion can, for fast changes, be raised to nearly unity by the addition of by-pass capacitors, shown as  $C_s$  and  $C_i$  in Fig. 8.

The screen grid of the voltage amplifier can be used for additional control by returning it to a preset high-impedance voltage divider  $R_i$ , connected between raw and regulated voltages. The larger the proportion of raw voltage that is fed to the screen, the more changes of line voltage, and the ripple are compensated or overcompensated.

Component values tried with a load current of 30 milliamperes are noted in Fig. 8. The output voltage rose or sank, or was constant, according to adjustment of  $R_i$ , with change of line voltages between 90 volts and 140 volts, and between even wider limits with lower load current. The average plate current of the amplifier tube was four microamperes, yielding an average bias voltage of minus 20 volts at the grid of the series tube. This current is so small that its effect on  $V_z$  in the Thyrite bridge can be neglected. The bridge was built with Thyrite units resembling one watt composition resistors, each passing 0.4 ma at 101 volts. The regulated output was 200 volts.

#### Logarithmic Impedance Characteristics

Of particular interest are those nonlinear circuit elements whose resistance varies with applied voltage in accordance with a logarithmic law. It has been observed that the impedance of certain metal contact rectifiers follows the law  $e = r \log i$  over a substantial range of their forward

characteristics. Copper-oxide rectifiers follow that law consistently for a current range of 1:50 above a potential of about 0.070 volt per contact layer. Certain microwave mixer-type germanium contacts follow the logarithmic law through a current range of at least five decades, from the lowest measured value of one microampere (with 0.16 volt) to about ten milliamperes (0.50 volt) in any circuit, and up to about 0.25 ampere if the then appreciable current-proportional voltage drop within the semiconductor is cancelled.

Logarithmic distortion can be applied to any desired range of input currents, or voltages, provided only that the circuit is proportioned to produce the proper current density, and therefore the proper voltage drop at the rectifier. Thus, assuming 0.15 volt as the design center for one layer of copper-oxide rectifier, larger average output voltages require a proportionally larger number

of contacts in series. The area of the contacts is then so chosen that the design-center input current produces a voltage drop of 0.15 volt on each layer. Using germanium contacts may not always be convenient because larger currents require many contacts in parallel.

#### Logarithmic Potentiometer

The simplest electrical circuit for obtaining logarithmic distortion is the voltage divider shown in Fig. 9A. The output of this voltage divider is strictly logarithmic only if: (1) the ohmic resistance  $R_i$  within the rectifier is negligible compared with the logarithmic contact resistance  $Z$ ; (2) if the source, or series, resistance  $R_s$  is large compared with  $Z$ ; (3) if the load, or meter, resistance  $R_M$  is large compared with  $Z$ . The error due to  $R_i$  is noticeable only for relatively large input currents; the errors due to finite  $R_s$  and  $R_M$  both tend to reduce the meter current  $I_M$  in the region of small input currents, when  $Z$  is growing large. Neglecting the influence of  $R_i$ , the output-to-input relation of the voltage divider is given by

$$\frac{I_M}{E_0} = \frac{Z}{R_s R_M + Z(R_s + R_M)}$$

From this equation it follows that (1)  $R_s$  and  $R_M$  are of equal influence; (2) the error  $\alpha$  by which the meter current  $I_M$  drops below the desired law is  $\alpha = Z(R_s + R_M)/R_s R_M$ . This latter equation permits us to compute how high the value of  $Z/R_s$  can rise for any given error  $\alpha$  and for any value of  $R_M/R_s$ . Let it be assumed that the error  $\alpha$  should not exceed minus ten percent. The broken line in Fig. 10A then shows the upper limit for the value of  $Z/R_s$  as a function of  $R_M/R_s$ . It is seen that the lower the meter resistance  $R_M$ , the more severe are the limitations in the ratio  $Z/R_s$ . The important consequence of this limitation is that it raises the minimum input voltage  $E_{0 \text{ MIN}}$  that is required in order to produce  $E_z \text{ MIN}$ , the lowest usable potential drop on the rectifier contact. This potential is found from

$$\frac{E_0}{E_z} = 1 + \frac{Z R_s + R_M R_s}{Z R_M}$$

The lowest value of  $E_0/E_z$  is that where the error in  $I_M$  is just  $\alpha$ ; thus, setting  $R_M/R_s = K$ , we have

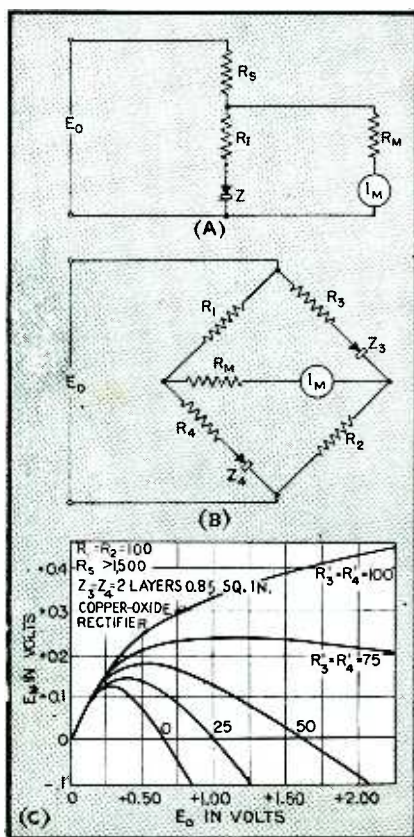

FIG. 9—To develop a logarithmic indication of the applied potential, a potentiometer (A) or bridge (B) circuit can be used. The bridge has characteristics shown at (C)

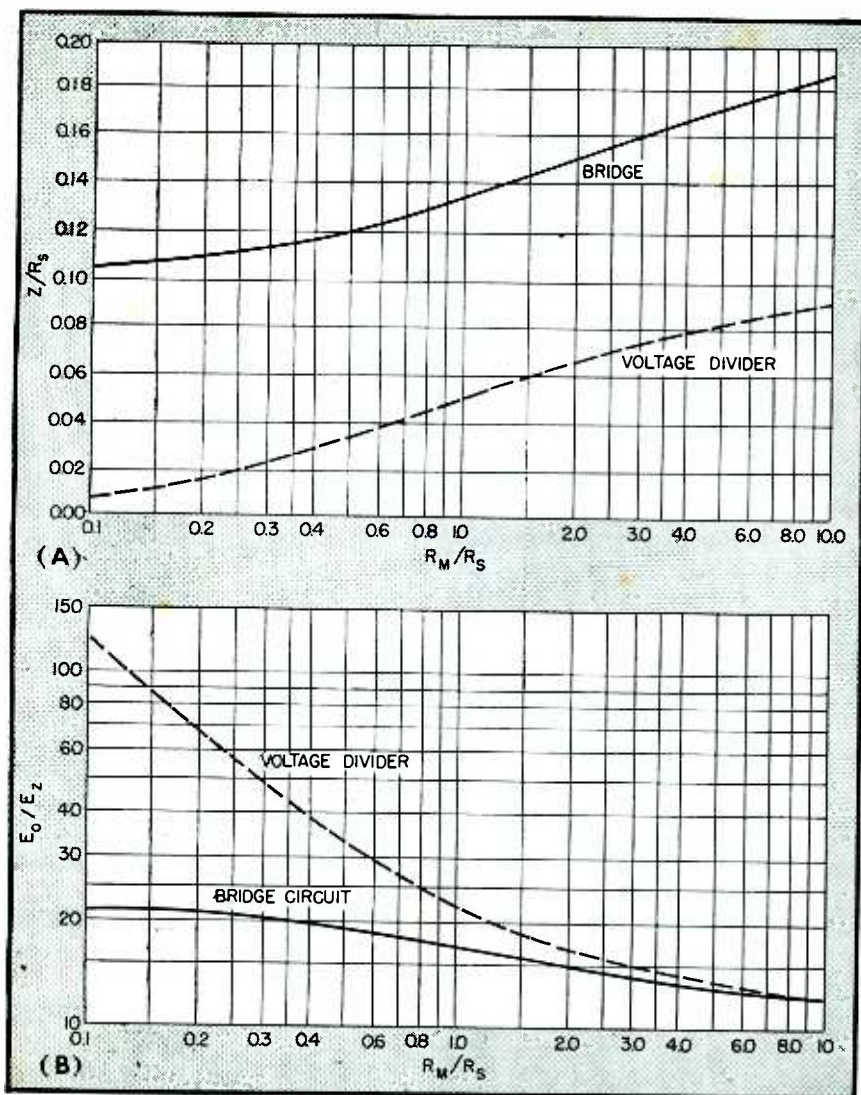

FIG. 10—(A) Design values for an error of less than ten percent must lie below the appropriate curve. Minimum input voltage requirements for ten percent or less error are shown at (B). Voltage divider and bridge circuits for which curves were determined are shown in Figs 9A and 9B

$$\left(\frac{E_o}{E_z}\right)_{\text{MIN}} = \frac{(1 + K)(1 + \alpha)}{\alpha K}$$

The minimum input voltage for a maximum error  $\alpha$  of ten percent is plotted as a function of  $K = R_M/R_S$  as the broken line in Fig. 10B. Because for one layer of copper-oxide rectifier,  $E_{z \text{ MIN}}$  is about 0.070 volt, it follows that, for example for  $K=1$ , the minimum input voltage  $E_{o \text{ MIN}}$  becomes  $22 \times 0.07 = 1.54$  volts; but for a low meter resistance,  $K = 0.1$ ,  $E_{o \text{ MIN}}$  for  $\alpha = 10\%$  rises to  $121 \times 0.07 = 8.5$  volts.

#### Logarithmic Bridge

An alternative circuit for logarithmic distortion is the bridge circuit shown in Fig. 9B. For conven-

ience, symmetry will be assumed, with  $R_1 = R_2$ ;  $R_3 = R_4$ ;  $Z_3 = Z_4$ .

Nonlinear bridges of this type are known to have an output-input characteristic as plotted in Fig. 9C for negligible load current ( $R_M \rightarrow \infty$ ). All curves were plotted with  $R_1 = R_2 = 100$  ohms,  $Z_3 = Z_4$  are each two layers of 0.85 square inch copper-oxide rectifiers in series, and with values of  $R_3 = R_4$  varied from zero to 100 ohms as indicated. The larger these resistances, which are in series with the rectifier contacts, the higher the input voltage at which the bridge balances ( $E_M = 0$ ).

In particular, when  $R_1 = R_2 = R_3 = R_4 = R$ , the output voltage  $E_M$  no longer reverses. It then presents an

exact replica of the voltage  $E_z$  on the copper-oxide rectifiers, rising logarithmically with rising bridge input. This result will be seen more clearly if the curve  $R_3 = R_4 = 100$  is replotted on a semilogarithmic scale as in Fig. 11. The straight line thus obtained indicates a strictly logarithmic relation over an input range of 34 db.

An evident merit of the bridge circuit is that the residual resistivity  $R_r$  of the contacts can be allowed for in the adjustment of the resistances  $R_3$  and  $R_4$ . Proper adjustment of initial bridge balance will thus be indicated by the least deviation, either way, from the straight, solid line in Fig. 10A, at the high-current end of the usable range.

As in the voltage divider circuit, the output of the bridge circuit departs from the desired law at the low-current end of the range when  $Z$  becomes comparable to  $R$ . The relation between meter current  $I_M$  and input voltage  $E_o$  is given by

$$\frac{I_M}{E_o} = \frac{Z}{2R^2 + 2RR_M + Z(2R + R_M)}$$

It follows from this equation that the meter current  $I_M$  will drop below the desired value by an error  $\alpha$  proportional to  $Z$

$$\alpha = \frac{Z(2R + R_M)}{2R(R + R_M)}$$

for the bridge circuit of Fig. 9B;

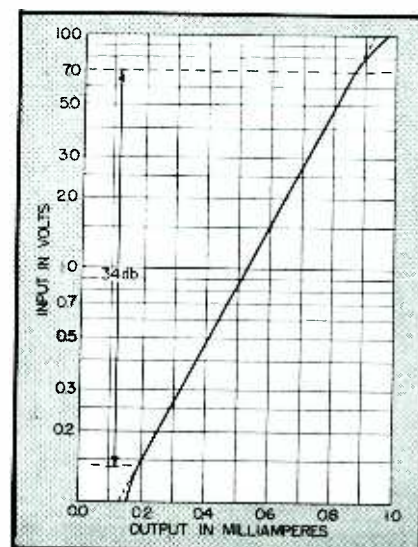

FIG. 11—Circuit of Fig. 9B gives logarithmic input-output relation over a 34-decibel range

here also, the error  $\alpha$  depends on the meter resistance  $R_M$ . The solid curve in Fig. 10A shows for any value of  $R_M/R_S$  how high  $Z$  may rise in proportion to  $R$  so that the error  $\alpha$  just reaches ten percent. It will be noted that, under strictly comparable conditions,  $Z$  may attain larger values in the bridge circuit than in the voltage divider. It may rise 2.7 times higher for  $R_M/R = 1$  and 11 times higher for a low meter resistance  $R_M/R_S = 0.1$ .

This advantage of the bridge circuit reflects in the much lower input voltage  $E_{0\text{ MIN}}$  at which it may operate without exceeding a specified error  $\alpha$ . The relation of minimum bridge input voltage  $E_0$  to the voltage  $E_Z$  on the contacts  $Z$  is given by

$$\left(\frac{E_0}{E_Z}\right)_{\text{MIN}} = \frac{(1 + \alpha)(2 + K)}{\alpha(1 + K)}$$

where again  $K = R_M/R$ .

This relation is plotted as a function of  $K$  and for an error  $\alpha$  of ten percent as the solid curve in Fig. 10B. It will be noted that for very large meter resistances ( $R_M/R \geq 10$ ) the bridge is in this respect not superior to the ordinary voltage divider. However, for  $K = 1$ , the bridge, for equal error, requires only  $\frac{2}{3}$  as much input voltage as the voltage divider and for low meter re-

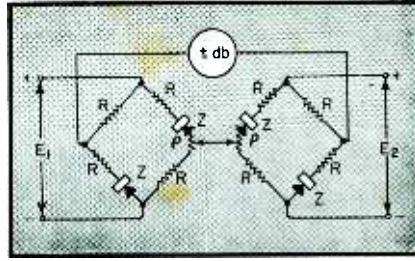

FIG. 12—Combining output from two bridges incorporating contact rectifiers gives a wide-range decibel meter

sistance ( $R_M/R = 0.1$ ) it requires only 18 percent of the input needed for the voltage divider. Indeed, even for negligible meter resistance ( $R_M \rightarrow 0$ ), the bridge requires for ten percent maximum error, only 22 times the minimum contact voltage  $E_{Z\text{ MIN}}$ .

Because  $E_{Z\text{ MIN}}$  for one layer of copper oxide is about 0.070 volt, it follows that a minimum bridge input of  $22 \times 0.07 = 1.54$  volts will suffice for any meter resistance  $R_M$  without causing an error exceeding ten percent.

Both input and output impedances of the bridge circuit are nearly constant over the usable range. This consistency permits full freedom of matching and the use as both current and voltage meters. A disad-

vantage of the bridge circuit, as compared with the voltage divider, is that the input and output have no common terminal.

Logarithmic circuits lend themselves to combinations for the purpose of electric multiplication or division. Figure 12 shows, as an example, the combination of two logarithmic bridges. Their outputs are connected in series and fed, with opposite sign, to a meter which thus reads the difference of their output currents. The current is then  $I_{M1} - I_{M2} = A \log E_{01} - A \log E_{02} = A \log (E_{01}/E_{02})$  or proportional to the logarithm of the ratio of the two bridge inputs. The meter can thus be calibrated directly in decibels with a linear scale. Two small resistors  $\rho$  with adjustable tap are shown in Fig. 12 for the initial adjustment of bridge balance. A model with each  $R = 200$  ohms, each  $Z$  one layer of 0.85 square inch copper oxide,  $\rho = 5$  ohms and a meter for 100 microamperes full scale with  $R_M = 1800$  ohms, was found reliable within plus or minus two percent of full scale for either input voltage varying from 0.14 to 7 volts, that is, up to ratios of plus or minus 35 decibels.

Attempts at biasing the copper-oxide contacts yielded no reduction of minimum required input voltage.

#### BIBLIOGRAPHY\*

- (1) The Basic Principles of Semi-Conductors by F. Seitz, *Jour. App. Physics*, Oct. 1945, p 553. Deviation from ordinary stoichiometric proportions and electrical conductivity of several semi-conducting compounds indicates that similar deviations will occur in homopolar compounds at elevated temperatures and extends rules of combining proportions. References.
- (2) The Electrical Properties of Semi-Conductors by R. J. Maurer, *Jour. App. Physics*, Oct. 1945, p 563. Measurements of electrical conductivity and temperature coefficient indicate properties of semi-conductors. Density and mean free path of conduction electrons give semi-conductors their peculiar properties. See also Method for Measuring Effective Contact Emf Between a Metal and a Semi-Conductor by W. E. Stephens and others, *Phys. Rev.*, Jan. 1945; and Resistance-Temperature Coefficients of Metals and Semi-Conductors by F. Ashworth and E. D. Taylor, *Jour. Inst. of E. E.* (England) Nov. 1945.
- (3) "Electronics" by J. Millman and S. Seely, McGraw-Hill Book Co., Inc. 1941, Chapter IV Electrons in Metals, and Chapter V Phenomena at the Surface of Metals. Survey of published literature on contact potential and barrier layer provides an organized theoretical background.
- (4) The Thermistor, *Jour. Franklin Inst.*, Feb. 1945, p 158. News item; history, properties, and survey of anticipated applications.
- (5) Thermistor Techniques by J. C. Johnson, *Electronic Industries*, Aug. 1945, p 74. Gain control of amplifiers by thermistors which can be controlled by external, direct, or indirect heating. See also Thermistors in Electronic Circuits by R. R. Batchler, *Elec-*

*tronic Industries*, Jan. 1945, p 76. Characteristics and applications of thermally sensitive resistor material having negative temperature-resistance characteristic, thermal capacity causes delay in response.

(6) Thermal Resistor Elements for Electrical Circuit Applications by R. S. Goodyear, *Prod. Eng.*, Feb. 1945, p 93. Types and performances of metallic semi-conductors, specifically Thermistors, with applications to temperature compensation of circuits.

(7) Germanium Crystal Diode, paper by E. C. Cornelius presented at 1945 Rochester Fall Meeting, abstracted *ELECTRONICS*, Jan. 1945, p 252, revised manuscript published *ELECTRONICS*, Feb. 1946, p 118. Theory, construction and performance characteristics of commercial germanium crystal diode for use as a detector in receivers, as modulator, and as sine-wave or relaxation oscillator. Bibliography of NDRC reports. See also Ultra-High-Frequency Converter Analysis by H. Stockman, *ELECTRONICS*, Feb. 1945, p 140. Study of diode and crystal converters using conversion diagrams.

(8) Current Rectification at Metal Contacts by S. P. Chakravarti and S. R. Kantabet, *Proc. IRE*, Sept. 1932, p 1519. Measurement of effect on rectification at contact of Cu-Fe, Cu-Sn, Sn-Zn, Zn-Fe, and Pb-Sn of contact area, pressure, and temperature. Point-to-point found best, heating straightens characteristic. Phenomena explained by assumed thermo emf. German and French Bibliography.

(9) Copper-Oxide Rectifier Used for Radio Detection and Automatic Volume Control by L. O. Grondal and W. P. Place, *Proc. IRE*, Oct. 1932, p 1599. Use of copper-oxide rectifiers as high-frequency detector requires low shunt capacitance and high current. These conditions are obtained by making discs small

and resonating the capacitance with an inductance. Harmonic distortion is reduced in bridge circuit.

(10) The Use of the Copper-Oxide Rectifier for Instrument Purposes by J. Sahagan, *Proc. IRE*, Feb. 1931, p 233. Need for sensitive a-c instruments led to development of rectifier type instruments; current, temperature, frequency, and wave-form effects are presented graphically. See also Multirange Rectifier Instruments Having the Same Scale Graduation for All Ranges by F. E. Terman, *Proc. IRE*, Mar. 1935, p 234. Scale depends on impedance across rectifier. Series and shunt elements of range switch maintain constant impedance.

(11) Copper Oxide Modulators in Carrier Telephone Systems by R. S. Caruthers, *B.S.T.J.* Apr. 1939, p 315. Single and multiple signal modulation of carrier by copper oxide discs. In the case of large carrier controlling the impedance variations of the modulator, superposition and reciprocity theorems hold. Open and short circuit measurements of four-terminal network are usable as in analysis of linear circuits. See also Copper-Oxide Modulators, *Bell Lab. Record*, June 1945, p 200. Historical review, including patents, of development of subject. See also U. S. Patent 2,377,858 issued June 12, 1945. Cancellation of second harmonic distortion in carrier wave modulator.

(12) Selenium Rectifiers and Their Design by J. E. Yarmack, *Elec. Comm.*, 1942, p 275. Choice of size disc for various power supply rectifier applications. Bibliography.

\*Compiled by Editor as a partial guide to historical, theoretical, and application literature.





# NOW . . . capacitors replaced like tubes with **CINCH SOCKETS**

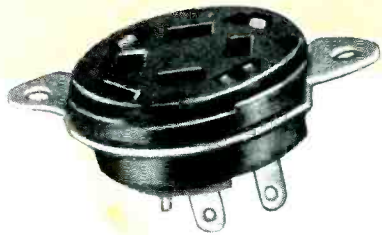

An engineer and a service man combined their ideas and with Cinch coordination and "know how" there resulted the first practical capacitor socket.

## *Features*

- ◆ Polarized for the Mallory PF type capacitor.
- ◆ Riveted to chassis just like any socket.
- ◆ Socket so marked that wiring for capacitor and socket is same for each.
- ◆ Two standard sizes available and in production—1" and 1 3/8".
- ◆ Simplifies the service problem of capacitors, especially export sets.

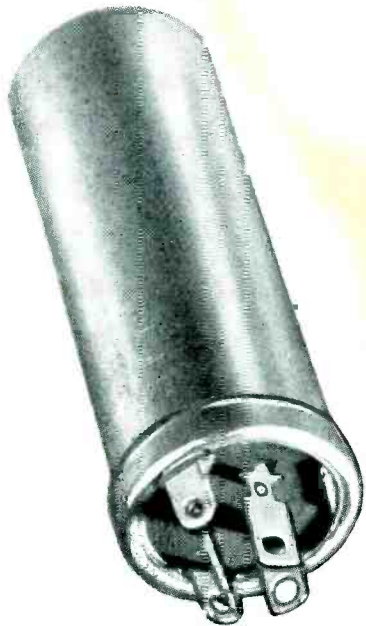

IT'S *Cinch*  
KNOW HOW!

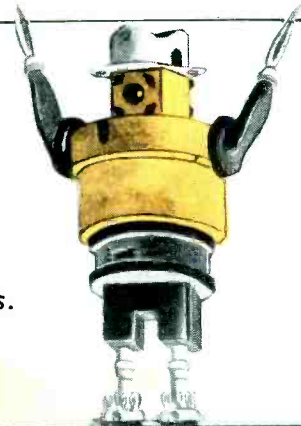

*We suggest you send for samples.*

# CINCH

**MANUFACTURING CORPORATION**  
2335 West Van Buren Street, Chicago 12, Illinois  
Subsidiary of United-Carr Fastener Corporation, Cambridge, Massachusetts

# Mixer Frequency Charts

By R. S. BADESSA

Radio Countermeasures Section  
Naval Research Laboratory  
Washington, D. C.

WHEN two frequencies,  $B$  and  $A$ , are mixed to produce the sum frequency  $B + A$  or the difference frequency  $B - A$ , a possibility exists that some harmonic of  $B$ , or some harmonic of  $A$ , or some combination of the harmonics of  $B$  and  $A$  will produce unwanted components lying close to the desired frequency. In some cases the magnitude and frequency of these unwanted components are such as to present serious problems in selectivity, often to the extent of requiring a different choice of input frequencies.

The two charts shown provide a means of determining in advance the unwanted components capable of arising from a given choice of mixer input frequencies. The charts are based on the fact that when the ratio of the two input frequencies,  $A/B$ , is also equal to the ratio  $k/l$  where  $k$

and  $l$  are integers and  $A$  is the smaller of the two input frequencies, two unwanted components exist capable of coinciding or zero beating with the sum frequency  $B + A$ . These are  $(l + 1)A - (k - 1)B$  and  $(k + 1)B - (l - 1)A$ . Where the wanted frequency is  $B - A$ , the corresponding unwanted components are  $(l - 1)A - (k - 1)B$  and  $(k + 1)B - (l + 1)A$ .

Unwanted components up to the 15th order are classified in the charts according to the ratio  $A/B$  for which coincidence with the wanted sum or difference frequency occurs.

If coincidence does not exist, notice the components corresponding to ratios not far removed from the ratio being investigated. The fre-

quencies of these components, especially those of low order, should be calculated to determine how difficult a selectivity problem exists.

*Example.* A frequency of 4.9 mc is mixed with a frequency of 2.1 mc to produce a sum frequency of 7.0 mc. For this case  $R = 2.1/4.9 = 0.429$ . On chart No. 2 the interfering components for  $R = 0.429$  are of the tenth order and have the forms  $4B - 6A$  and  $8A - 2B$ . Since a tenth-order component is probably not very serious, coincidence can be neglected. Other ratios in the vicinity of 0.429 are investigated next. For the ratio 0.500, there are two third-order components, of the form  $2B - A$  and  $3A$ . These, when evaluated, are 7.7 mc and 6.3 mc respectively and may or may not cause trouble, depending on the selectivity of the 7-mc channel employed.

CHART I. Output Frequency =  $B - A$

R = A/B	ORDER														
	1	2	3	4	5	6	7	8	9	10	11	12	13	14	15
0.000	B	B+A	B±2A	B±3A	B±4A	B±5A	B±6A	B±7A	B±8A	B±9A	B±10A	B±11A	B±12A	B±13A	B±14A
0.063															15A
0.067														14A	
0.072													13A		
0.077															
0.083											11A				
0.091										10A					2B-13A
0.100														2B-12A	
0.111								9A							
0.125							7A	8A							
0.133										2B-9A					14A-B
0.143														13A-B	
0.154						6A				2B-8A					
0.167					5A										
0.182										2B-7A					
0.200															
0.214										10A-B					
0.222															
0.231										8A-B					
0.250															
0.273			3A												
0.286															
0.300															
0.308															
0.333															
0.364															
0.375															
0.400															
0.416															
0.429															
0.445															
0.455															
0.500															
0.545															
0.555															
0.571															
0.600															
0.625															
0.667															
0.700															
0.715															
0.750															
0.778															
0.800															
0.833															
0.858															
0.875															
1.000															

**PROCEDURE:** Divide smaller mixer input frequency by larger to get  $R$ . If this value of  $R$  is on chart applying to case, coincidence exists and components causing it are given somewhere to the right, with their order given at top of chart. If coincidence does not exist, calculate low-order component frequencies for nearest ratios to determine selectivity requirements

CHART II. Output Frequency =  $B + A$

R = A/B	ORDER														
	1	2	3	4	5	6	7	8	9	10	11	12	13	14	15
0.000	B	B-A	B±2A	B±3A	B±4A	B±5A	B±6A	B±7A	B±8A	B±9A	B±10A	B±11A	B±12A	B±13A	B±14A
0.072															2B-13A
0.077															15A
0.083															
0.091															
0.100															
0.111															
0.125															
0.133															
0.143															
0.154															
0.167															
0.182															
0.200															
0.214															
0.222															
0.231															
0.250															
0.273															
0.286															
0.300															
0.308															
0.333															
0.364															
0.375															
0.400															
0.416															
0.429															
0.445															
0.455															
0.500															
0.545															
0.555															
0.571															
0.600															
0.625															
0.667															
0.700															
0.715															
0.750															
0.778															
0.800															
0.833															
0.858															
0.875															
1.000															

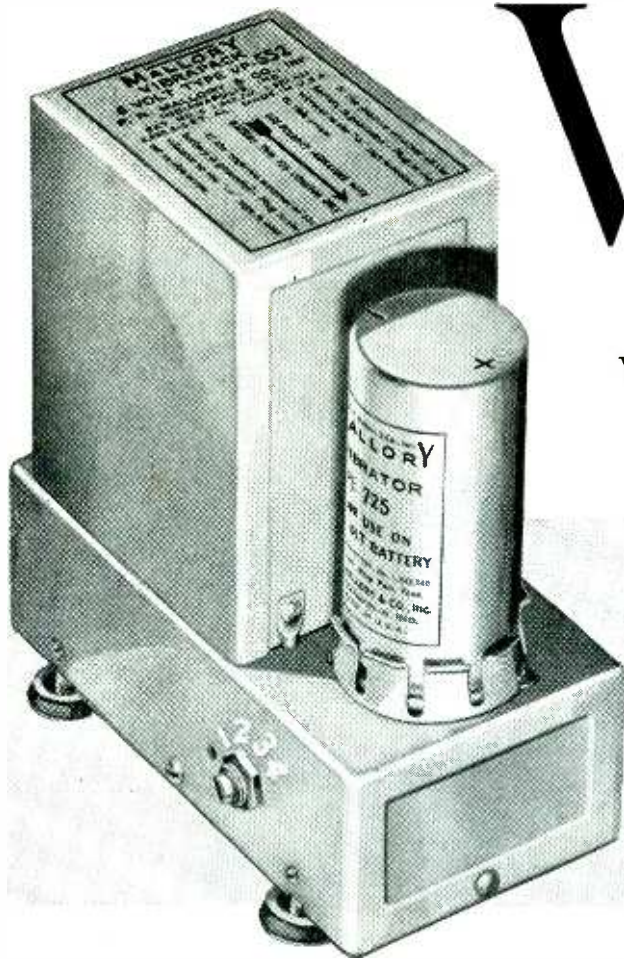

# Vibrapack\*

\* (TRADE MARK REG. U. S. PAT. OFFICE)

the answer to every  
Vibrator Power Supply Problem



For years now, Vibrapacks have furnished a dependable, low-cost, *standardized* means of obtaining high voltage direct current from low voltage storage batteries. This is because, among other things, they provide a good match between vibrators, transformers, buffer condensers and load.

All cataloged Vibrapacks now contain *hermetically sealed vibrators*. These assure even greater dependability than ever — immunity to moisture and corrosive fumes, complete freedom from ionization breakdowns.

Do you need a vibrator power supply for radio receivers, transmitters, public address amplifiers, direction finders, other electronic apparatus? Vibrapacks have served them all — *ideally*.

*Coming Soon* . . . the Mallory Vibrator Data Book — with all the answers to your vibrator problems . . . watch for it!

## OUTSTANDING ADVANTAGES

Low battery drain . . . low cost, low maintenance . . . compactness, light weight . . . ease of installation . . . dependability, long life . . . flexibility. Cataloged single unit Vibrapacks can be adjusted to give 4 output voltage ranges each.



FOR COMPLETE INFORMATION on all Vibrapack models, write NOW for Form No. 555-E — Detailed descriptions of each model — Data on selection of the proper Vibrapack for every application — Installation instructions — Wiring diagrams — and a host of other vital information.

P. R. MALLORY & CO. Inc.

# MALLORY VIBRATORS

## AND VIBRATOR POWER SUPPLIES

P. R. MALLORY & CO., Inc., INDIANAPOLIS 6, INDIANA

# TUBES AT WORK

Edited by VIN ZELUFF

Progress in Magnetic Recording.....	140
Inverse Vacuum-tube Voltmeter.....	140
Rotary Converter for Portable Power Supplies.....	142
Measuring Mutual Inductance and Capacitance....	142
Auxiliary Pilot Guides Ships.....	154

## Progress in Magnetic Recording

A NUMBER OF technical improvements have permitted the establishment of certain tentative standards for magnetic recording. According to a report from Armour Research Foundation of Illinois Institute of Technology, it is expected that nearly all instruments of this type will employ wire 0.004 inch in diameter, traveling at a uniform speed of 2 feet per second, instead of earlier speeds of 2.5 and 5 feet per second. Normal wire consumption has thus been reduced from about 0.5 to approximately 0.2 lb per hour. It is possible with these standards to

make sound recordings with a frequency response flat within 3 db from 60 to 8,000 cps and with very low distortion and background noise.

Also tentatively standardized are the dimensions of the spools on which the wire is wound, enabling them to be interchanged among the various units to be manufactured for many different recording purposes.

Among other developments has been the construction of a wire tester designed to measure quantitatively the residual magnetism, coercive force, and noise characteristics of recording wire during the process of

manufacture. The instrument is now in regular use in the plant of one of the wire producers.

For making a large number of duplicate wire records from a single master copy, the Foundation has built experimental equipment employing recording heads, amplifiers, and wire drive mechanisms. It is hoped that ultimately banks of these units can be so arranged as to produce simultaneously practically an unlimited number of copies.

## Inverse Vacuum-tube Voltmeter

By SHELDON H. DIKE

Research Engineer  
Glenn L. Martin Company  
Baltimore, Md.

IN SOME RESEARCH conducted on precipitation static for the National Defense Research Committee under contract No. OEM sr-000, a voltmeter was needed which would have very high input impedance and which would measure high voltages. After some work with conventional voltmeters and after experiencing considerable trouble with positive ion currents, the familiar inverse vacuum-tube voltmeter was adapted to the job. In this circuit, the input voltage is placed upon the plate which is maintained at a negative potential with respect to the cathode, the current in the grid circuit being a measure of this input voltage.

The circuit of the voltmeter which operated satisfactorily is shown in Fig. 1 and the calibrations of the low and high ranges of the completed instrument in Fig. 2. When positive input voltage is applied to the plate, more grid current flows than when no potential is applied.

In operation,  $SW_1$  and  $R_1$  are

## C-R TUBE PRODUCTION



Steps in the processing of type 3BP1 cathode-ray tubes. From left to right, the operators are recording test results, preparing tubes for evacuation, using high-frequency heat to drive off occluded gas from elements during exhausting, and connecting heater, cathode and other tube elements for test. Because of heat, girls wear shorts at the Dobbs Ferry plant of North American Philips

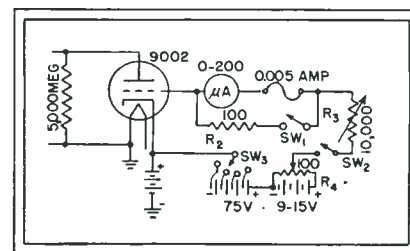

Fig. 1—Circuit of electronic inverse voltmeter

for every control need...

# RELAYS *by* GUARDIAN



Whether the principle is electronic or magnetic . . . here are some of the latest, greatest basic design Guardian Relays, Solenoids and Stepping Switches we are privileged to present to design engineers.

Each unit offers an unlimited number of variations . . . often making a standard Guardian Relay a "special," effecting big savings in time and money. Highly efficient, compact, low-priced, long life, you can depend on it—they'll increase the dependability and quality of your product.

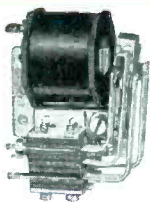

### Series 40 A. C. Laminated Relay

This laminated relay is designed to produce maximum output with minimum current input. Typical uses include control of call system bells; auxiliary for automatic radio tuning; remote control of fractional motors; safety devices; instruments; sound movie auxiliaries.

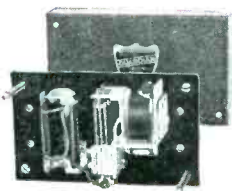

### Series T-110 Time Delay Relay

This relay employs a resistance wound bimetal strip to achieve a delayed operation from 10 to 60 seconds. Current flows through the windings generating heat, causing the bimetal strip to bend, closing a contact after the required time delay.



### Series 120

The Series 120 is a small, compact relay. It is an economical unit designed for control needs which do not exceed single pole, double throw combination. Economy and simplicity of construction make it possible to offer the Series 120 at a low price compared with its high quality performance.



### Series 1-A Solenoid

The series 1-A Solenoid by Guardian is one of numerous types for intermittent and continuous duty. Applications include valve control and operation; electrical locking; clutch and brake operation; material ejector; spray gun operation among others.

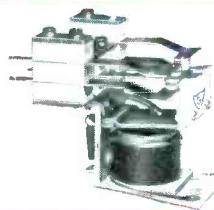

### Series A-100 High Frequency

This A15iMag insulated relay is compact, convenient, low in cost. In radio applications it is used for antenna change-over, break-in, high voltage keying, grid controlled rectifier keying, remote control of receiver and transmitter, and other high frequency applications.

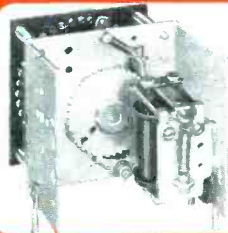

### Series R Stepper

This Relay is built in three basic types for A.C. and D.C. operation: (1) Continuous rotation, (2) Electrical reset, (3) Add and subtract. Its principle application is automatic circuit selection including automatic sequence, automatic wave changing on short wave transmitters, automatic business machines, totalizing units, conveyor control.



# GUARDIAN ELECTRIC

1625-J W. WALNUT STREET

CHICAGO 12, ILLINOIS

A COMPLETE LINE OF RELAYS SERVING AMERICAN INDUSTRY

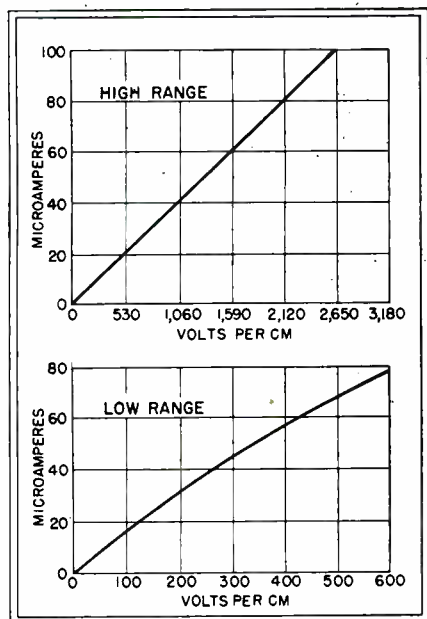

Fig. 2—Calibration curves for the inverse voltmeter when used to measure the high-potential-gradient fields between two metal plates. The separation of the plates is expressed in centimeters

adjusted to give midscale reading with no applied input voltage.  $R_3$  is used to adjust the sensitivity. The range of the instrument is changed by closing  $SW_1$  and adjusting  $SW_2$  and  $R_1$  to return the meter reading to midscale.

The curves shown in Fig. 2 are for volts per centimeter since we were interested in measuring high-potential-gradient fields. The circuit will measure d-c voltage directly; the curves will have approximately the same shape but the voltage values will be somewhat different.

In general, where high voltages are to be measured with extremely low current being drawn from the measured source, such voltages may be placed on two plates of known separation. Then the curves illustrated will be applicable in terms of volts per centimeter. The circuit was adjusted to give a mid-scale reading to indicate polarity, the curve on the other side of zero then being a mirror of the one shown.

### Rotary Converter for Portable Power Supplies

INSTEAD OF A vibrating reed and contact points, a rotary contactor has been developed for automobile radio

power supplies. Electrical breakdown due to arcing is minimized by making and breaking the contacts in a vacuum.

The heart of the Dynectron rotary converter is a "cell" formed in two halves of specially developed steel; a glass sphere with four tungsten-tipped electrodes is sealed to one half-cell. The two halves are then welded together. A small quantity of mercury is injected into the glass sphere and the gases removed in the same manner as employed in the manufacture of vacuum tubes.

Two sets of coils are arranged around the cell assembly so that four wound poles are formed. These are free to rotate with the assembly in the magnetic field set up by alnico permanent magnets. Energizing the coils starts the rotation of the cell, which permits the mercury to make contact with each of the four electrodes successively, causing interruption of the current.

The complete cased unit resembles a conventional vibrator in appear-

ance and electrical arrangement of the plug-in contacts. According to the manufacturer, Ohio Tool Com-

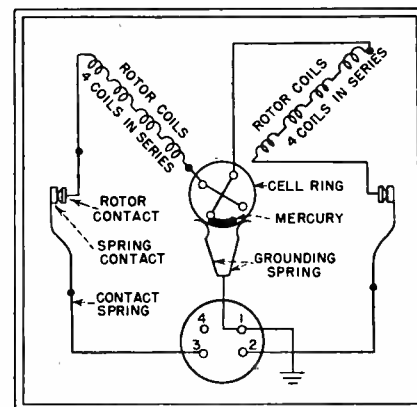

Circuit of the rotary unit designed for interrupting current when converting battery power of alternating current

pany of Cleveland, thousands of hours of continuous tests on the rotary converter have been made. None have worn out and the same efficiency has been maintained.

## Measuring Mutual Inductance and Capacitance

By A. W. SIMON

Stewart Warner Corporation  
Chicago, Illinois

MOST STANDARD METHODS OF measuring mutual inductance become inaccurate when applied to the measurement of mutual inductances corresponding to small coefficients of coupling, such as those commonly encountered in radio circuits. This is true in particular of the widely used method of determining mutual inductance in terms of self-inductance, by connecting the two windings series-aiding and series-opposing.

For example, to determine mutual inductance accurately to 1 percent by this method, for a case where the coefficient of coupling is 5 percent, the self-inductance has to be measured with an accuracy of 0.5 percent, which is beyond the accuracy of ordinary inductometers and bridges. It is readily seen that an error of 0.5 percent in the latter, under the same conditions, could lead to an error of 10 percent in the mutual inductance.

The method of simple opposition

devised by Felici is not subject to this difficulty and enables the mutual inductance to be determined with an accuracy equal to that of the inductometer used. Furthermore, if an inductometer of the Brooks type is employed, the range of the Felici method can be extended in the direction of lower inductances by incorporating a switch, by means of which one winding of the inductometer can be reversed; the unknown inductance is then equal to one-fourth of the difference of the inductometer readings for the two positions of the switch.

Unfortunately, if the two coils to be measured are enclosed in a shield can, the simple Felici arrangement fails to give a perfect null. This is due to the fact that the shield introduces an out-of-phase component, which cannot be balanced out by mutual inductance alone. In this case, it is necessary to resort to Campbell's modification of the Felici circuit, in which this component is balanced out

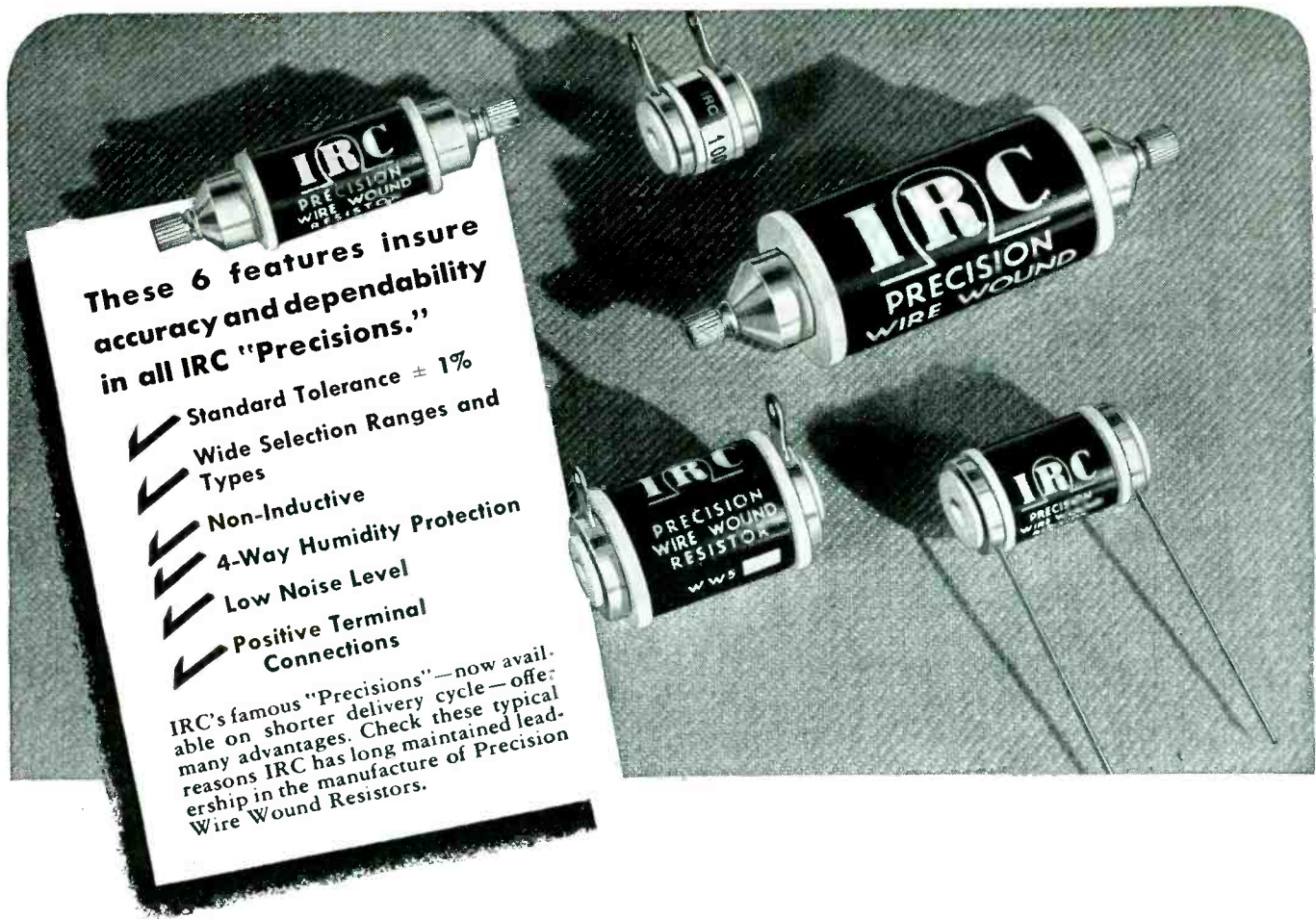

These 6 features insure accuracy and dependability in all IRC "Precisions."

- ✓ Standard Tolerance  $\pm 1\%$
- ✓ Wide Selection Ranges and Types
- ✓ Non-Inductive
- ✓ 4-Way Humidity Protection
- ✓ Low Noise Level
- ✓ Positive Terminal Connections

IRC's famous "Precisions"—now available on shorter delivery cycle—offer many advantages. Check these typical reasons IRC has long maintained leadership in the manufacture of Precision Wire Wound Resistors.

## SHORT DELIVERY CYCLE!

### IRC PRECISION WIRE WOUND RESISTORS

**1. Accuracy.** IRC offers standard tolerance of  $\pm 1\%$  . . . tolerances as low as .5, .25 and .10% available on special order.

**2. Wide Selection Ranges and Types.** Select whatever range, size or type you need to suit your design. IRC Precision Wire Wound Resistors are available in ranges from 0.1 ohm to 2.5 megohms. IRC also offers a wide selection of sizes and terminal types.

**3. Non-Inductive.** The largest possible special alloy enamelled wire, wound on winding forms without a break in insulation, with adjacent sections in opposite

directions, allows windings of low residual inductance. The frequency characteristics of IRC Precision Wire Wound Resistors suit them for use at audio and carrier frequencies up to 50 KC.

**4. Low Noise Level.** Specify IRC Precision Wire Wound Resistors for instruments that require lowest possible noise level.

**5. Protection Against Atmospheric Conditions.** Non-hygroscopic ceramic winding forms are specially impregnated for additional moisture protection and to prevent abrasion of enamelled-wire windings. Windings are impregnated with special varnish, which improves insulation, eliminates breakdowns and shorted turns. This impregnating compound hardens with high temperatures instead of softening as is the case with wax impregnation found in some wire wound resistors. Baked impregnation of windings secures wires rigidly in place and gives effective protection from high humidity. For further protection, extra insulation coatings are applied before and after labeling.

**6. Terminals.** To insure positive terminal connections, IRC molded contacts are used on Precision Wire Wound Resistors.

Your IRC Sales Engineer can quote you definite delivery schedules, or address inquiries to Dept. 1-H.



# INTERNATIONAL RESISTANCE CO.

401 N. BROAD ST., PHILADELPHIA 8, PA.

In Canada: International Resistance Co., Ltd., Toronto, Licensee

# K-TRAN



*Automatic proudly presents the first completely post-war radio component.*

*The K-TRAN makes available to Radio Receiver Designers the performance of pre-war I. F. TRANSFORMERS in a size to match the smallest tubes.*

*The K-TRAN for the first time makes possible the use of standard I. F. Transformers throughout a complete line of chassis.*

*Data sheets on initial types are now available to manufacturers.*



**MASS PRODUCTION COILS & MICA TRIMMER CONDENSERS**

900 PASSAIC AVE.

EAST NEWARK, N. J.



# SPECIAL FEATURES



**IN ROLLER-SMITH  
SWITCHBOARD INSTRUMENTS  
AVAILABLE FOR SPECIFIC NEEDS**

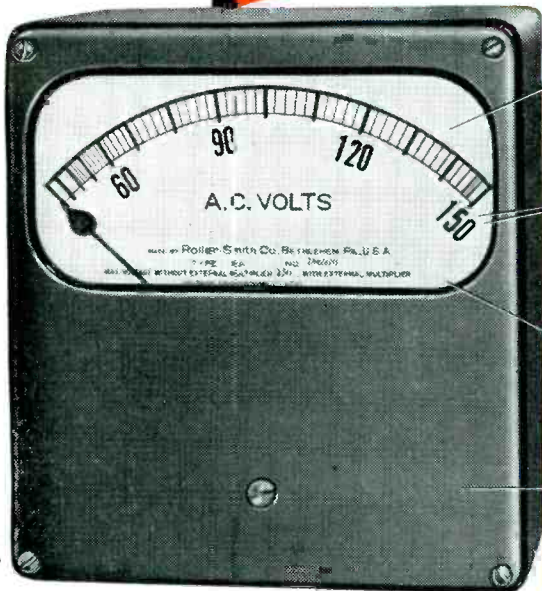

**BLACK DIAL**



**DOUBLE SCALE**



**DOUBLE RANGE**

**NO GLARE GLASS**



**SPECIAL CASE FINISHES**



**CASES**



ROUND



SQUARE

**MOUNTINGS**

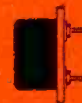

SURFACE



FLUSH



CONDUIT



EXPLOSION-PROOF CASE

● Standard Roller-Smith Switchboard Instruments are available with features that will meet the requirements of a particular job.

Of course, there is the choice of round or square case, surface or flush mounting . . . so that the appearance of the finished board will satisfy job specifications or personal preference. This choice includes AC and DC Voltmeters, AC and DC Ammeters, Frequency Meter, Power Factor Meter, Var Meter, Wattmeter, Synchroscope.

Special non-standard features available on order include: no-glare glass, special case

finishes and colors, black dials, double range instruments, double scale instruments. Conduit mounting and explosion proof enclosures for round surface mounted AC and DC instruments help provide quick, low cost answers to special job requirements.

If you have a special instrument problem, the Roller-Smith engineering department will help you get a low cost practical solution.

Write for full details or request Catalog 4220.

# ROLLER-SMITH

*Switchboard Instruments*

**BETHLEHEM • PENNSYLVANIA**

In Canada: Roller-Smith Marsland, Ltd., Kitchener, Ontario

ELECTRICAL INDICATING INSTRUMENTS • AIRCRAFT INSTRUMENTS • SWITCHGEAR  
AIR AND OIL CIRCUIT BREAKERS • ROTARY SWITCHES • RELAYS • PRECISION BALANCES



# A Ballantine ELECTRONIC VOLTMETER

For every requirement

ALL MODELS HAVE THE  
**SIMPLIFIED  
LOGARITHMIC  
SCALE**

STANDARD  
Model 300



Ideal for the *Accurate* measurement of AC voltages in the Audio, Supersonic, Carrier Current and Television ranges.

Use of Logarithmic voltage scale assures uniform accuracy of reading over whole scale while permitting range switching in decade steps.

Each Voltmeter equipped with an output jack so that the instruments can be used as a high-gain stable amplifier.

### SPECIFICATIONS

#### MODEL 300

RANGE—.001 to 100 volts.  
FREQUENCY—10 to 150,000 cycles.  
ACCURACY—2% at any point on scale.  
AC OPERATION—110-120 volts.

#### MODEL 304

RANGE—.001 to 100 volts.  
FREQUENCY—30 c.p.s. to 5.5 megacycles  
ACCURACY—0.5 DB.  
AC OPERATION—110-120 volts.

#### MODEL 302

RANGE—.001 to 100 volts  
FREQUENCY—5 to 150,000 cycles.  
ACCURACY—2% at any point on scale.  
DC OPERATION—self-contained batteries.

Send for Bulletin for further description

Model 302  
BATTERY  
OPERATED

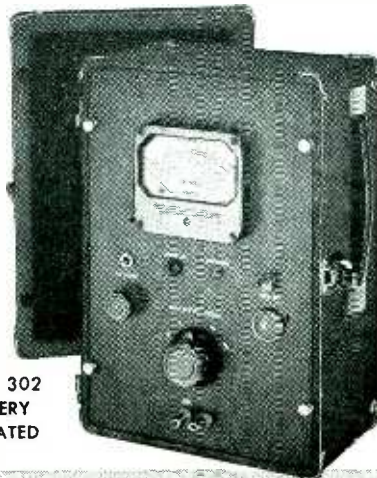

## BALLANTINE LABORATORIES, INC.

BOONTON, NEW JERSEY, U. S. A.

by a portion of the primary voltage introduced into the secondary by means of a slide wire potentiometer. With an inductometer of the Brooks type, this arrangement also can be extended in the direction of lower mutual inductances by incorporating a reversing switch and taking one-fourth of the difference of the corresponding readings.

### Improved Circuit

A practical circuit is given in Fig. 1 for the measurement of mutual inductance between coils, both unenclosed and enclosed in shield cans. This circuit is based on the Campbell modification of the Felici circuit and employs an inductometer of the Brooks (or other  $\pm 2M$ ) type and reversing switch. It is particularly suitable for the accurate measurement of mutual inductance between coils with small coefficients of coupling such as are frequently encountered in radio work, and enables such a measurement to be carried out with an accuracy equal to that of the inductometer used. It can also be used to set coils very quickly and accurately to a predetermined mutual inductance or coefficient of coupling—a feat which is only difficultly accomplished by means of a bridge. The circuit is particularly recommended to the radio industry for use in connection with the determination of the coefficient of coupling of i-f transformers, instead of the now widely used but inaccurate method employing a self-inductance bridge.

### Operation

To make a measurement of mutual inductance, the inductometer is read for the two positions of the reversing switch. The unknown inductance is then equal to one-fourth of the difference between the corresponding self-inductance readings. To get a

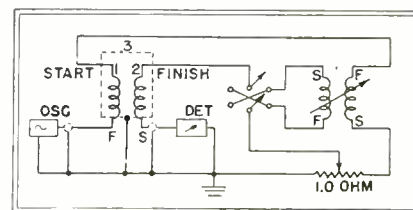

Fig. 1—Useful circuit for measuring mutual inductance between coils having small coefficient of coupling

# 6 ANSWERS TO 6 PROBLEMS through Scovill Cold-Forging



**PROBLEM:** To produce a necessary electrical part with minimum metal, money, motion.

**ANSWER:** The part shown as made by Scovill. Cold forged from flat wire (gilding metal) plus trimming. Economical!



**PROBLEM:** To shape a special copper stud at an economy price to a manufacturer.

**ANSWER:** Stud was cold forged from copper wire—plus trimming, drilling and roll-threading.



**PROBLEM:** To turn out the special steel part above without expensive machining.

**ANSWER:** Scovill produced the part in quantity from alloy steel wire with four operations—head, re-head, trim and turn. "Know how!"



**PROBLEM:** Economical production of an important steel part for the caliber .30 M1 carbine.

**ANSWER:** Scovill cold-forging. It saved money, materials, and motions, while meeting the most exacting requirements.



**PROBLEM:** To make a quality fastening in quantity... at an economy price.

**ANSWER:** Again, Scovill cold forging. The part was cold forged from alloy steel, with subsequent secondary operations.



**PROBLEM:** To produce an intricately-shaped fastening without high cost to the buyer.

**ANSWER:** Two cold forging operations accomplished the unusual combination of square, circle and taper.

Before your product engineer sharpens his pencil or your factory superintendent starts to tear his hair, depending upon whether production is in design stage or is being redesigned for greater efficiency, it pays to look at two fastenings records. One is your own experience, which may or may not have given you

fastest assembly time and maximum practical efficiency. The other is the Scovill record for cold-forging special fastenings that will do both. When you plan fastenings, get in touch with one of the Scovill experts listed below. There is no obligation in consulting these representatives. Make an appointment with one... now!

## SCOVILL MANUFACTURING COMPANY

### WATERVILLE SCREW PRODUCTS DIVISION

WATERVILLE 48, CONN.



TEL. WATERBURY 3-3151

NEW YORK, Chrysler Building • DETROIT, 6460 Kercheval Avenue • CHICAGO, 135 South LaSalle Street • PITTSBURGH, 2882 W. Liberty Ave.  
SYRACUSE, Syracuse-Kemper Insurance Building • LOS ANGELES, 2627 South Soto Street • SAN FRANCISCO, 434 Brannan Street

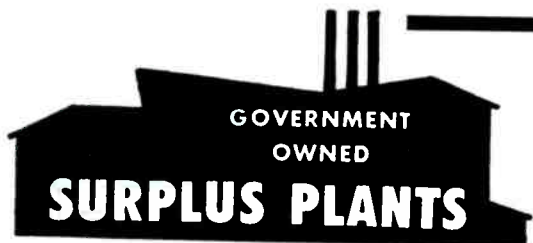

GOVERNMENT-OWNED

# INDUSTRIAL PLANTS

**For Sale or Lease**

**Ipswich, Mass. (NOrd (F) 1164)**  
**Sylvania Electric Products, Inc.**

Total floor area approx. 54,000 sq. ft.

**LAND:** Approx. 2/5 acre.

**MACHINERY & EQUIPMENT:** Standard and special production machinery and test equipment for the manufacture of radio and similar electronic equipment.

**UTILITIES:** Complete.

**TRANSPORTATION:** Railroad, water, highways and airport are within short distance of plant.

**BUILDING:** A four story building with masonry foundation and brick bearing walls. Sprinkler system throughout. Elevator services all floors.

**Binghamton, N. Y. (NOrd (F) 1179)**  
**National Carbon Co.**

Standard and special production machinery and equipment for the manufacture of dry cell batteries including laboratory and testing equipment.

Plant consists of land, buildings, machinery and equipment designed for the manufacture of dry cell batteries.

**LAND:** Approx. 3 1/4 acres.

**BUILDINGS:** Main plant is a three story U-shaped structure consisting of 6 interconnected buildings with a total floor area of approx. 105,000 sq. ft. Construction generally 16" stone foundation, 12" brick walls, wood columns, beams and joists with built-up roofing. Also one story storage and time clock building with a total area of approx. 3,600 sq. ft. There are 6-100 K.V.A. Transformers on concrete mat making up the outdoor substation.

**MACHINERY & EQUIPMENT:** Production items of machine tools such as lathes, grinders, band saws, presses, etc. Items of production equipment include annealing furnaces, granulating machine, spot coating machine, mixers, degreasers, tanks, conveyors, hoists, etc. Furniture and fixtures.

**UTILITIES:** Complete.

**TRANSPORTATION:** Siding of Erie R.R. serves site and property adjoins Lackawanna R.R.

The War Assets Administration, a disposal agency, invites proposals for the purchase or lease of the above properties in the interest of continued employment. These properties were acquired by various agencies of the Government for production in the war effort, and are now, or shortly will be, declared surplus to Government needs. Listing of these plants by name of lessee is for identification purposes only, and has no connection with the lessee's own plants or facilities. General information is available from your nearest War Assets Administration Office. For specific data, contact the office indicated below. All data contained herein are necessarily abbreviated and subject to correction. They are not intended for use as a basis for negotiations. WAR ASSETS ADMINISTRATION reserves the unqualified right to reject any or all proposals or offers received for the above properties.

**CREDIT TERMS MAY BE ARRANGED FOR THE PURCHASE OF THESE PLANTS**

## WAR ASSETS ADMINISTRATION

**Office of Real Property Disposal**  
**44 PINE STREET, NEW YORK 5, NEW YORK**  
**Phone: Whitehall 3-3640**

631

# THEY'RE ALL JIM DANDIES

**HALL O'WELL**

## SPEED TOOL KITS



← **"AUTO" KIT**  
with interchangeable parts



**"HOME" KIT** →  
with interchangeable parts

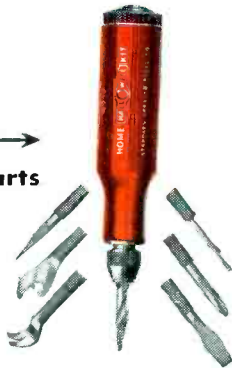

← **"SOCKET SCREW" KIT**  
with interchangeable bits

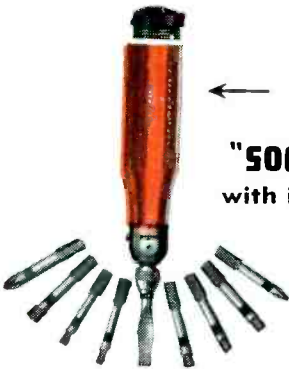

→ **"SOCKET WRENCH" KIT**  
with interchangeable sockets



Every one's a beauty in appearance . . . and saves time and trouble. The handle of each Kit is filled with useful tools . . . ones that are needed constantly.

Three of these Kits come in two sizes, for a greater range of tools. They are: the "Socket Screw" Kits, with a variety of hex, Phillips and flat screw driver bits to fit most all screws; the "Socket Wrench" Kits containing 6 and 12 point hex sockets with openings from 1/4" up to 3/4"; the "Auto" Kits . . . that mechanics will keep in their pockets, car owners will want in the glove compartments . . . having a choice assortment of Phillips, and flat screw driver bits, a tapered reamer and several clutch head bits. The "Home" Kit, in one size only, is the smallest of the lot . . . only 4 1/4" long . . . with 7 important tools in the handle: Phillips and flat screw driver bits, a tapered reamer, a gimlet and a bottle opener. The seven kits hold a total of 50 tools.

The Kits are made according to strict "Standard" specifications. All but the "Home" Kit have swivel bit-chucks for better leverage. Handles are of durable Celanese\* plastic; tools of high-grade alloy steel. Write for our 8-page booklet that fully describes these dandy compact Kits.

Obtainable at Suppliers throughout the country. If your Supplier does not carry them, send his name to us, along with yours, and you will be taken care of promptly.

*These Kits make grand holiday gifts or prizes.*



Molded  
Celanese\*  
Plastic Handles

OVER 43 YEARS IN BUSINESS

\*Reg. U. S. Pat. Off.

Kits: Patents Pending

# STANDARD PRESSED STEEL CO.

JENKINTOWN, PENNA., BOX 596 • BRANCHES: BOSTON • CHICAGO • DETROIT • INDIANAPOLIS • ST. LOUIS • SAN FRANCISCO



Cannon manufactures the largest line of electric plugs and receptacles in the industry. Most connector needs can be met by some standard Cannon Connector. Four major factors govern the selection of the right one:



**INSERTS**

*must be large enough to provide required contact diameters and spacing to meet specified voltage and amperage loads.*

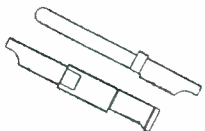

**CONTACTS**

*size, construction and materials are governed by the type of circuit—high frequency, heavy duty, low level or thermocouple.*

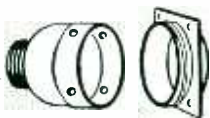

**SHELLS**

*vary in shape, (round, square, oval or angular) to meet weather, mechanical and safety requirements of the application.*

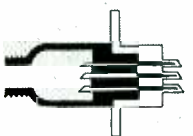

**COUPLING METHODS**

*depend on vibration frequency of use, and the force needed to couple or disconnect, critical in some locations.*



Write for this new bulletin, "Helps in Selecting an Electric Connector," just printed. Address Dept. H-120, Cannon Electric Development Company, 3209 Humboldt Street, Los Angeles 31, California.

**CANNON ELECTRIC**

Cannon Electric Development Co.  
Los Angeles 31, California



Canadian Factory and Engineering Office:  
Cannon Electric Co., Ltd., Toronto, Canada

REPRESENTATIVES IN PRINCIPAL CITIES—CONSULT YOUR LOCAL TELEPHONE BOOK

perfect null in both positions, the manner of connection of the unknown must be carefully preserved. If a perfect null is obtained for only one throw of the switch, the connections of one coil of the unknown should be reversed. For the measurement of coils unenclosed in shield cans, the slider is set to the zero position.

Analysis of the circuit of Fig. 1, as well as that employing a self-inductance bridge, reveals that for coils enclosed in shield cans, the "mutual inductance" actually measured is the quantity

$$M_{12} - \frac{M_{13}M_{23}}{L_3} \frac{Q_3^2}{(Q_3^2 + 1)}$$

where  $M_{12}$  is the mutual inductance between the coils 1 and 2,  $M_{13}$  and  $M_{23}$  are the mutual inductances between the respective coils and the shields, and  $L_3$  and  $Q_3$  are the self inductance and  $Q$  respectively of the shield itself.

For setting the coupling between two coils to a definite value  $k$ , the self-inductance  $L_1$  and  $L_2$  of the coils is first measured on a bridge and the required mutual inductance  $M$  calculated from the equation

$$M = k \sqrt{L_1 L_2}$$

The reading  $L$  of the inductometer for the neutral position of the inductometer coils is then determined, and the inductometer set to a self-inductance reading given by

$$L_a = L + 2M$$

One of the coils is then moved until the null point is reached. The setting can be checked by throwing the reversing switch and observing whether a null point occurs at the reading  $L_b$  given by

$$L_b = L - 2M$$

The given procedure is very useful in making up standards for i-f transformers and other units.

*Mutual Capacitance*

For control of the capacitive coupling of coils enclosed in shield cans, particularly i-f transformers, a measurement of the "mutual capacitance" or intercoil capacitance (more correctly, the coefficient of electrostatic induction between the coils) becomes desirable. This meas-



"HAUL AWAY," calls Gus, and from the next floor Elmer pulls four wires through the old conduit. They're modernizing a building the practical, economical way—doubling the number of circuits by installing wires with thin-walled, high-dielectric insulation of VINYLITE plastic.

But small-diameter compactness is only one of the outstanding advantages of VINYLITE plastic insulation for wires and cables. Highly resistant to moisture, oils, abrasion and most chemicals, it stays flexible at extremely low temperatures and has an extremely low rate of water absorption. Some types are non-flammable; others slow-burning. All are virtually

non-aging. They're available in a wide color range for ready circuit identification—opaque, transparent, and crystal clear.

VINYLITE plastic insulation is bringing new safety and service life to makers of electric and electronic equipment, public utilities, construction firms, and automotive, marine, and airplane manufacturers. Adopt it now for your own requirements. Write Department 18-W for booklet W-4, "VINYLITE Plastics for Wire and Cable Insulation." It describes the various types now in use in widely diversified applications, and serving dependably year after year under conditions frequently destructive to other insulating materials.

# VINYLITE

TRADE-MARK

## PLASTICS

BAKELITE CORPORATION, Unit of Union Carbide and Carbon Corporation  30 EAST 42ND STREET, NEW YORK 17, NEW YORK

ELECTRONICS — August, 1946

151

# A New Thrill

FOR MUSIC LOVERS



It's a thrill for any music lover to hear his favorite album of records played on a phonograph equipped with a Seeburg Record Changer.

Quietly the records move into place with a minimum of time lost between discs.

Gently the featherweight pickup glides along the grooves, picking up all the subtle harmonies.

Swiftly the constant speed motor brings the turntable up to speed and holds it, permitting no wavers—no wows.

The newly engineered Seeburg Record Changer also brings long life—trouble-free operation. That is why it continues to be the favorite of phonograph manufacturers and phonograph buyers.

## Wire Recorder

Sound on a wire as thin as a hair! The new Seeburg Wire Recorder permits perfect home recording of speeches, plays, music—it takes radio programs off the air. One simple control knob makes anyone a skilled sound technician. A new development everyone will want in tomorrow's phonograph.

*It Will Be Necessary for radio manufacturers to make provision in their circuits to accommodate the Seeburg Wire Recorder. We invite inquiries from radio manufacturers.*



MINIMUM FRICTION  
SILENT  
LONG LIFE  
CONSTANT SPEED  
TROUBLE-FREE OPERATION

# Seeburg

RECORD CHANGERS ★ WIRE RECORDERS  
J. P. SEEBURG CORPORATION  
1500 N. DAYTON ST. • CHICAGO 22



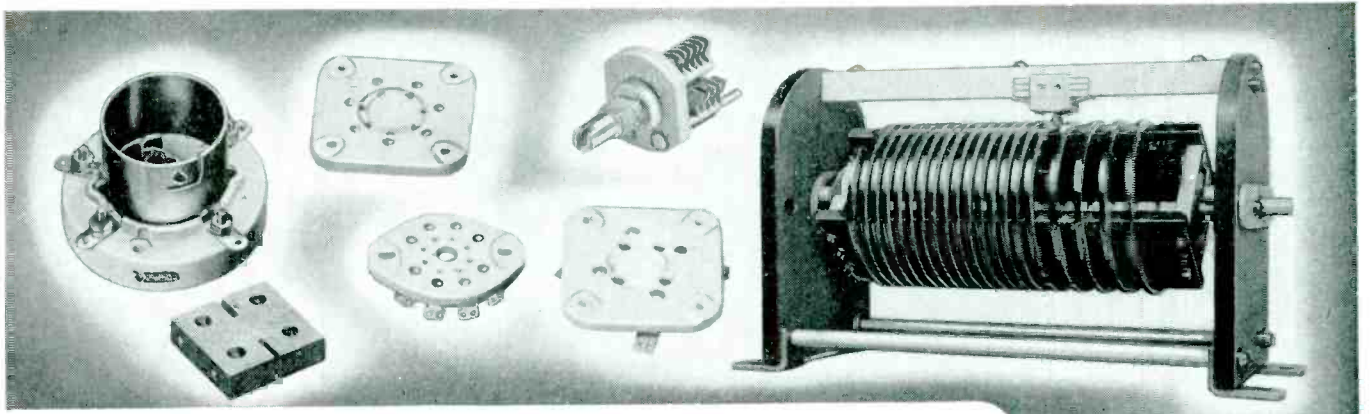

**JOHNSON** components are widely used and have proven their dependability through outstanding performance in industrial electronic, commercial transmitting and amateur radio applications.

**CAPACITORS**--Variable and fixed, Air and Pressurized Gas dielectrics. From thimble size miniatures to man-size cast plate models.

**INDUCTORS**--Wire wound, edgewise-wound copper strip, copper ribbon and copper tubing, plated to meet requirements. Fixed, tapped, continuously variable and variable pitch types.

**TUBE SOCKETS**--Bayonet, Wafer, Miniature, Acorn and Special Types. Designed to meet the rigid requirements of present day electronic circuits.

**INSULATORS**--Stand-Off, Thru-Pane, Cone and Antenna. Engineered for maximum mechanical strength and breakdown voltages.

**CONNECTORS**--Spring Sleeve and Banana Spring type Plugs and Jacks, Tip Plugs and Jacks, Multi-Wire Cable Connectors, Inductor Clips, Soldering Terminals and Tube Cap Connectors.

**SHAFT COUPLINGS, R. F. CHOKES, PANEL and PILOT LIGHTS** and machined **GLASS BONDED MICA PARTS** are among the other outstanding **JOHNSON** components engineered for flexible, trouble-free service.

**JOHNSON** standard components, only a few of which are shown here, are highly adaptable to special applications. The result to **JOHNSON** customers is time and money saved!

All standard products stocked by leading radio-electronic parts jobbers.

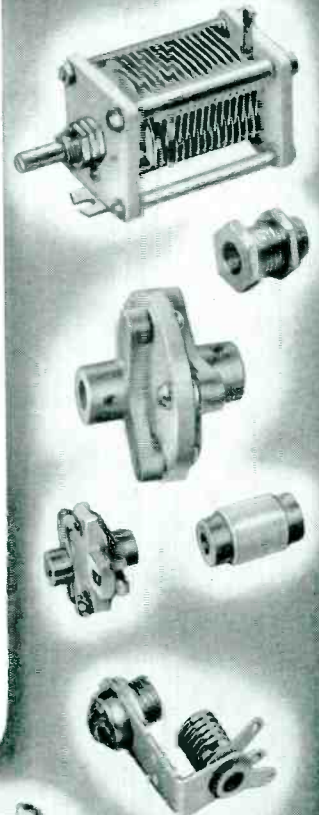

**JOHNSON**  
*a famous name in Radio*

E. F. JOHNSON CO. • WASECA • MINNESOTA

**Crystalab**  
TRADE MARK REG. U. S. PAT. OFF.

# MYCONS

Higher "Q" in UHF }  
Higher Capacity } smaller size

Special purpose or standard type, oil impregnated, silvered mica capacitors. An exclusive pure silver plating method, identical to silver plating on fine instruments (not silk screened), used on the individual mica discs gives MYCONS extremely LOW inductances. Current flow is equally distributed in a 360° pattern from the center terminal, a shorter electrical path to ground. Both are standard for CRYSTALAB MYCONS.

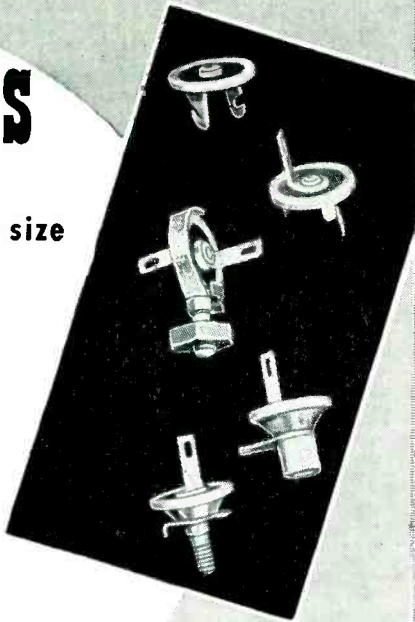

TECHNICAL DATA	
Standard production sizes	5-100, 250, 500, 1,000 and 1,500 mmfds.
Tolerances	2½%, 5%, 10%, 20%
Working Voltage	750 volts DC - Continuous
Overload	1,000 volts DC - 15 min.
Insulation Resistance	10,000 megohms minimum
Temperature Coefficient	-50 - +100 parts/million/°C
"Q" Factor	1,000 for all values available
Voltage Breakdown and Dielectric Strength	
Discs	Best available capacitor mica.
Seal	Silver plated.
Outside Rim	Correctly stacked to eliminate "book" effect.
Terminals	High vacuum transil oil impregnated.
	Silver plated brass.

Each order for MYCONS is processed to your specifications. Write for new specification and data sheets.

**CRYSTAL RESEARCH**  
LABORATORIES INC.  
29 ALLYN ST., HARTFORD, 3, CONN., PHONE 7-3215

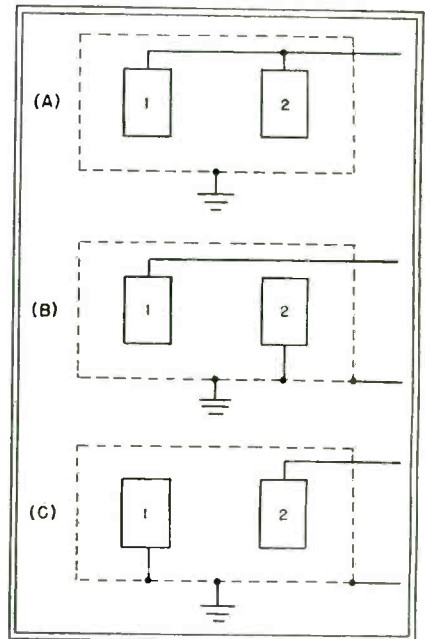

Fig. 2—Three steps for determining mutual capacitance between two coils

urement can be carried out as follows (Fig. 2):

(A) Capacitance  $C_{12,12}$  of coils 1 and 2 connected together with respect to the shield (grounded) is measured.

(B) Capacitance  $C_{11}$  of coil 1 with respect to the shield and coil 2 (both grounded) is measured.

(C) Capacitance  $C_{22}$  of coil 2 with respect to the shield and coil 1 (both grounded) is measured.

The "mutual capacitance" or coefficient of electrostatic induction  $C_{12}$  of coil 1 with respect to coil 2 is then given by

$$C_{12} = 0.5 (C_{12,12} - C_{11} - C_{22})$$

In accordance with electrostatic theory, the quantity  $C_{12}$  is negative.

• • •

## Auxiliary Pilot Guides Ships

By JOHN H. JUPE  
London Correspondent

THE ORDINARY sea marker buoy is a visual indicator only useful within telescopic range and navigational skill of a high order is needed to pilot ships to a spot pin-pointed by such a buoy. In some cases skill is not sufficient and must be reinforced by knowledge of local conditions.

To overcome this and other difficulties the radio marker buoy or Jellyfish was developed and used

# achievements of today

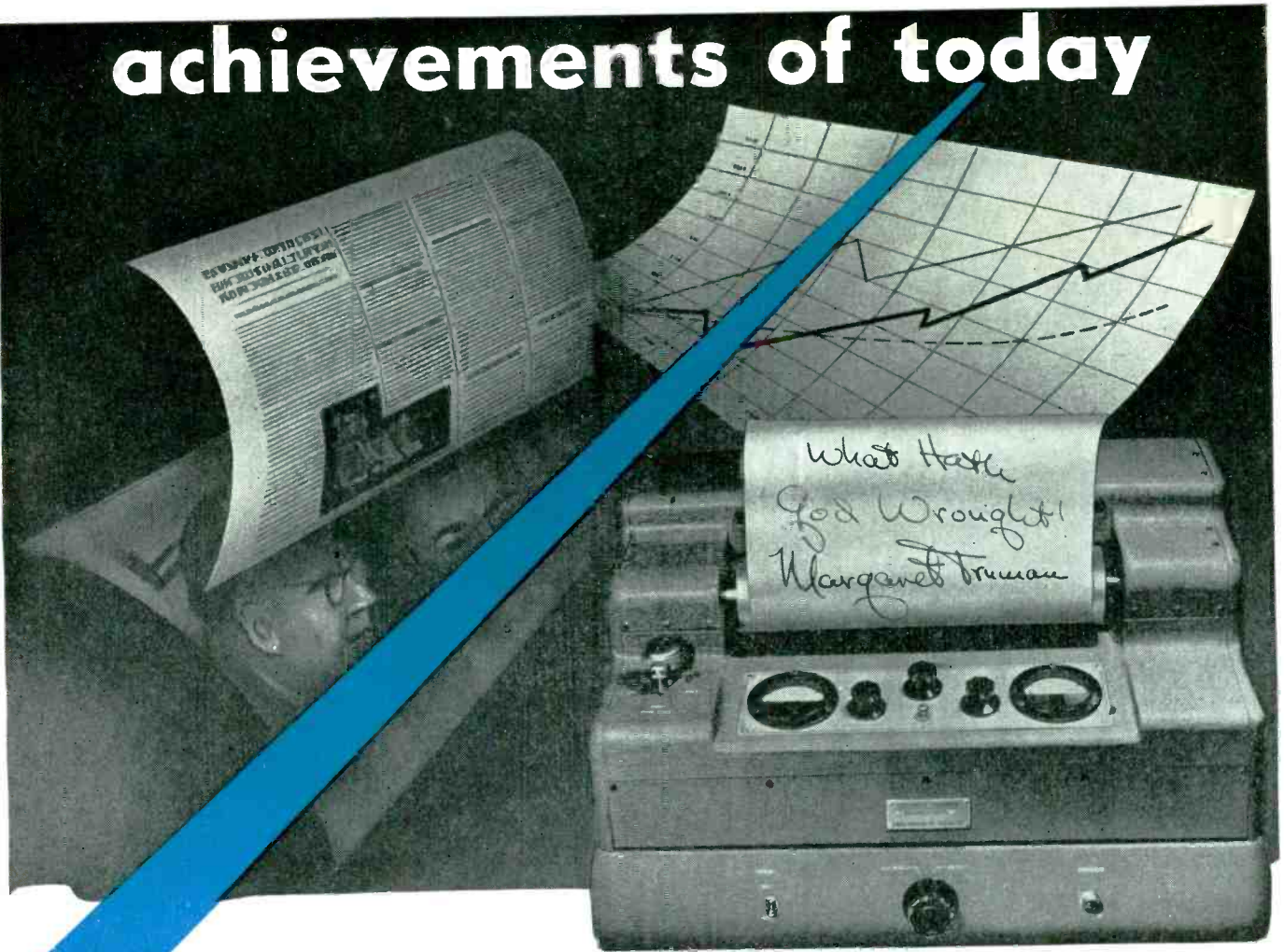

## tomorrow's routine

Achievement indeed was Samuel B. Morse's invention of the Telegraph, symbolized by his first message "What Hath God Wrought" . . . and today 102 years later another achievement takes form . . . reproduced above is the message Miss Margaret Truman, daughter of President Truman, wrote and which was Press Wireless Photo-Facsimiled from the Law Library of the Capitol to a train speeding from Baltimore to Washington, D. C. . . . today's achievements are tomorrow's routine . . . and so it is and will be with Press Wireless Photo-Facsimile Communications . . . letters, memoranda of instruction and commerce, newspaper copy, charts, maps, graphs, photos and anything that can be put on paper will be split-second transmitted and received by this communication system.

Illustrated is Press Wireless PHOTO-FACSIMILE SCANNER FT-1 . . . a precision instrument which is the sending part of the Photo-Facsimile Communication System. The equipment is simple to operate and works on a standard 110-220 volt, single-phase power source. Either an amplitude-modulated 1800-cycle signal or a frequency-shifted audio tone is available at the output.

Actual synchronization between this unit and the recording equipment is not necessary due to the precision frequency-controlled circuits employed.

### CHARACTERISTICS

Index of cooperation	289.5
Drum Speed	100 rpm
Drum Diameter	2.83 inches
Drum Length	Two 7" drums (may be used singly or in tandem to accommodate 14" copy.)
Lines per inch	102.3
Subject copy size	7" x 8.5"
Frequency Control	Compensated Tuning Fork
AM Carrier Frequency	1800 cps
FS Frequency Range	2100 to 3000 cps
Output Level (AM)	8 to 28 vu
Output Level (FS)	8 vu



## PRESS WIRELESS MANUFACTURING

C O R P O R A T I O N

Executive Offices: 38-01 35th AVENUE, LONG ISLAND CITY 1, NEW YORK

**LOW FREQUENCIES ACCURACY TO 1/1,000th of 1%**

*Actual Size*

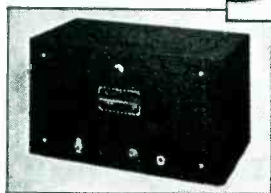
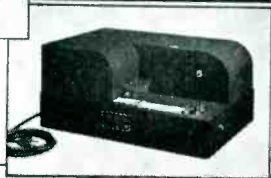
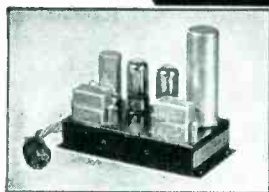

**TOP**  
**FREQUENCY STANDARD**  
(60 cycle) for use with external power supply

**CENTER**  
**CHRONOGRAPH**  
Records time intervals with resolution to .001 second

**BOTTOM**  
**FREQUENCY STANDARD**  
(120 cycles) with self-contained power supply

These tuning forks which include new engineering principles, provide frequencies from 120 to 1,000 cycles directly with an unqualified guarantee of accuracy to 1 part in 100,000 over a wide temperature range. (Better than 1 second in 24 hours). Closer tolerances are obtainable on special order.

These tuning fork assemblies are available only in single or multi-frequency instruments of our own manufacture which are de-

signed to test, measure or control other precision equipment by mechanical, electrical, acoustical or optical means.

The dependability of these frequency standards is being demonstrated for myriad purposes in all climates and under all working conditions.

If you have need for low frequency standards of exceptional accuracy, your inquiries are invited.

**American Time Products, Inc.**

**580 Fifth Ave.**

**New York, N. Y.**

Dist. of Western Electric & **Watch Master** Watch-rate Recorders



# M-R FIBERGLAS

tapes...tying cords  
braided sleeveings

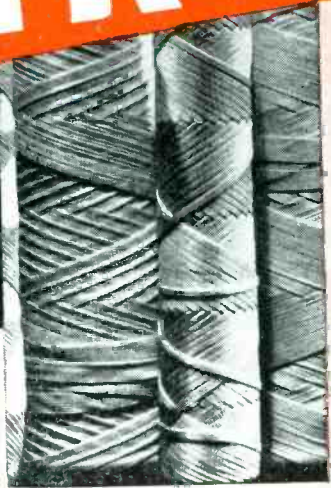

AVAILABLE FOR  
**IMMEDIATE  
DELIVERY**  
FROM  
WAREHOUSE  
STOCKS

at no increase  
in price . . . . .

. . . It is noteworthy  
that despite price  
increases for most  
electrical insulation  
materials, the prices  
for M-R Fiberglas  
Tapes, Tying Cords  
and Braided Sleeve-  
ings are the same as  
they were prior to  
the war, 6 years ago.

**1. M-R FIBERGLAS TAPES** . . . available in a wide variety of widths, thicknesses and styles for practically every electrical insulation requirement where high tensile strength and dimensional stability are desired. Continuous filament Fiberglas Tapes, used in over 95% of all applications, are supplied in sizes from .003" to .015" in thickness and from 3/8" to 1 1/2" in width. Medium weave tapes for machine taping are furnished in thicknesses from .005" to .015", while tight weave tapes for manual taping are furnished in thicknesses from .003" to .007" only. Staple fiber tapes in thicknesses from .010" to .025" and widths from 1/2" to 1 1/2" are also available for applications where space is not a primary consideration or where a more resilient wrapper cushion is wanted.

**2. M-R FIBERGLAS TYING CORDS** . . . three to five times stronger than ordinary electrical twines—provide all the insulation advantages inherent in Fiberglas: heat-moisture-acid resistance and exceptionally high tensile strength. They are used for all kinds of tying purposes: banding field coils, wrapping string bands on armatures, protecting commutator V-rings from flash-overs, banding on V-ring extensions on DC equipment, as filling in winding coils, reset strings and for tying slot insulation in place. They are also used to lash ends of coils in large motors and generators and to hold spacer blocks in place . . . and for many other tying purposes.

Treated cord is used primarily for its exceptional knot strength and resistance to abrasion and is preferred for construction and repair of electrical equipment. Untreated cord is frequently used where space is to be filled, regardless of strength requirements.

**3. M-R FIBERGLAS BRAIDED SLEEVINGS** . . . available only in the continuous filament construction, are most efficient for insulation requirements which call for high tensile and dielectric strength, space conservation and flexibility. M-R Fiberglas Sleeveing resists excessive heat, moisture, overload, acid and dirt to make it ideal for use in covering coil leads, transformer leads, coil interconnectors, pigtail brush leads and for other insulation applications.

Fiberglas Braided Sleeveings are furnished in two average wall thicknesses, .008" and .006" with inside diameters from 1/16" to 1/2" in 1/16" increments (there is no 7/16" ID sleeveing). They are available plain (untreated) or impregnated, to prevent ends from fraying, in natural, blue, red, green, black, brown or yellow for circuit or phase identification purposes.

Write to Mitchell-Rand, "the Electrical Insulation Headquarters", for the new Fiberglas Catalog EL 44-7, containing performance and application data of interest to all concerned with electrical insulation . . . as well as description and data covering Fiberglas Tapes, Tying Cords, Sleeveings, Cloths, Mica Combinations, Laminates and other Fiberglas insulation materials.



## MITCHELL-RAND INSULATION COMPANY, INC.

51 MURRAY STREET      Cortlandt 7-9264      NEW YORK 7, N. Y.

Fiberglas Varnished Tape and Cloth  
Insulating Papers and Twines  
Cable Filling and Pothead Compounds  
Friction Tape and Splice  
Transformer Compounds

**A PARTIAL LIST OF M-R PRODUCTS**  
Fiberglas Saturated Sleeveing, Varnished Tubing  
Asbestos Sleeveing and Tape  
Varnished Cambric Cloth and Tape  
Mica Plate, Tape, Paper, Cloth, Tubing

Fiberglas Braided Sleeveing  
Cotton Tapes, Webbing and Sleeveings  
Impregnated Varnish Tubing  
Insulating Varnishes of all types  
Extruded Plastic Tubing



FIRST AWARD . . . JUNE 23, 1944

FIRST RENEWAL WITH STAR . . . DEC. 16, 1944

SECOND RENEWAL WITH STAR . . . MAY 26, 1945

# Jacks

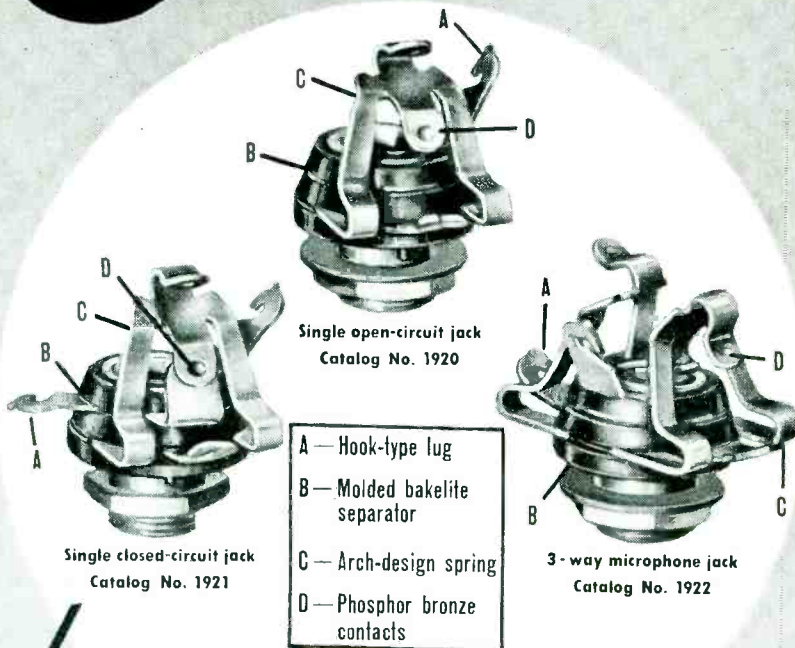

by **insuline**

Here is something for which the radio world has been waiting. Small and lightweight, these brand new and exclusive ICA jacks will prove ideal wherever space is limited and high performance essential.

Like the hundreds of other ICA radio parts, these jacks are precision-made of the *right* materials. The separators are molded bakelite; the tooled-brass body and phosphor bronze spring members are nickle-plated; all non-ferrous materials.

Note too these engineering features: Arched design to minimize tension fatigue; functional design to minimize creepage and dust accumulation; interlocked component parts to prevent turning and shorts; hook-type soldering lugs permit easier wiring.

You will certainly want to investigate this new and exclusive ICA development as well as the rest of the ICA line of quality radio parts. Send for complete catalog today.



**insuline**  
CORPORATION OF AMERICA

INSULINE BUILDING • LONG ISLAND CITY, N. Y.

QUALITY PRODUCTS SINCE 1921

RADIO BUOY

(continued)

by Britain very successfully during the war. It is positioned beforehand by a skilled navigator and in circumstances known only to following ships, and can be made to reveal its position automatically over considerable areas. The buoy consists of three main parts: (1) A buoyant and approximately cylindrical tank containing radar transmitting and receiving equipment and designed to float horizontally with a minimum of bow wash; (2) A telescopic aerial fitting into a recess approximating the deck of the buoy; (3) An anchor line and weight, attached to the buoy and stowed in its stern immediately before launching.

### Operation

The buoy is launched into the sea, stern first and, after the buoy has sunk to a chosen depth, the anchor line pays out the mooring weight to the sea bed. Removal of the weight from the buoy restores its buoyancy and it rises to the surface and attains a horizontal position. This last action causes the antenna of the radar equipment to start telescoping to its full extent and at the same time move to a vertical position.

The receiver-transmitter is in the receiving condition as soon as the buoy surfaces. On reception of a pulse signal from the ship-borne interrogator, the receiver switches itself into a transmitter which then returns a greatly amplified version of the signal received.

The circuit consists basically of a supersonically quenched r-f amplifier followed by a demodulator and a pulse amplifier. For transmitting, provision is made to cause the r-f amplifier to oscillate violently and so radiate a signal from the antenna. Batteries of special light-weight design are used to operate the radio equipment.

### Special Features

Immersion of the buoy also starts a sequence of events accomplished electrically before the buoy reaches the surface. One is the connection of the power supplies to the transmitter-receiver and the other is the arming of the buoy for self-destruction.

A "sea cell" and a "corrosion cell" are mounted on the buoy and remain submerged once it has been launched. The sea cell is similar in construc-



# FOR *Higher* VOLT-AMPERE RATINGS IN *Smaller* EQUIPMENT

Sprague CEROC 200, an inorganic ceramic class "C" wire insulation, paves the way for important engineering advancements wherever coils or other windings can utilize its ability to operate continuously at 200° C. Its advantages are such that it warrants careful investigation in connection with a wide variety of equipment.

## SMALLER COILS FOR LARGER JOBS!

Wire insulated with CEROC 200 permits a substantial volt-ampere rating increase without a corresponding increase in space. As a result, midget-size coils can be wound to do man-size jobs.

## IT'S FLEXIBLE!

Despite its ceramic nature, CEROC 200 is sufficiently flexible to permit wire insulated with it to be wound on conventional equipment with little or no change in most cases. It can safely withstand 16% elongation by bending.

## HIGH-TEMPERATURE ADVANTAGES

Applied to copper, nickel or other types of wire, CEROC 200 permits continuous operation at 200° C. Wound in coils, the thermal conductivity of Ceroc-insulated wire is high. This assures much of the volt-ampere gain to be expected from high-temperature operation.

## EXCEPTIONALLY HIGH SPACE FACTOR

Typical percentages of wire area to total cross-sectional area of insulated wire are 96% for CEROC, as against 59% to 69% for conventional insulations suitable for high-temperature applications. CEROC is only about 1/4 mil thick and is uniform throughout the length of the wire.

WRITE FOR  
CEROC BULLETIN  
505A

SPRAGUE ELECTRIC CO., North Adams, Mass.

# SPRAGUE *Ceroc 200*

PIONEERED BY THE MAKERS OF SPRAGUE CAPACITORS AND \*KOOLOHM RESISTORS

\*Trademarks Registered U. S. Pat. Off.

No electrical equipment can be any better than its insulation

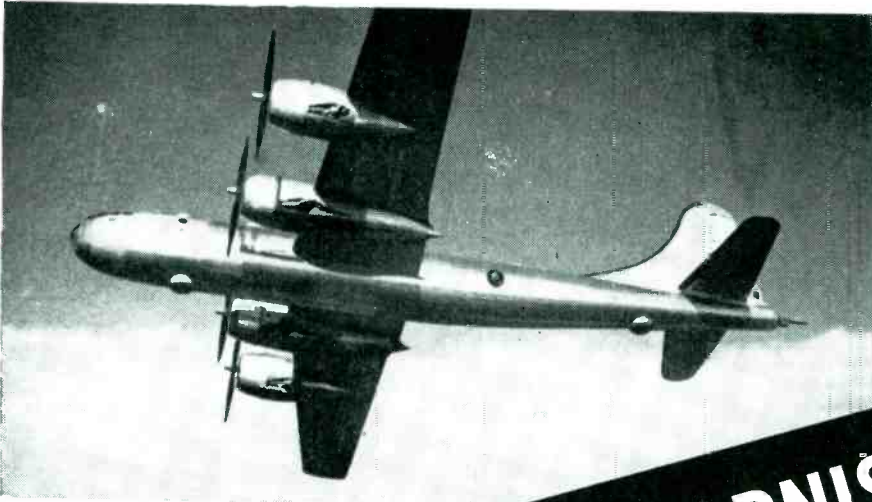

This insulating varnish helped revolutionize fractional horsepower motors for warplanes...

# G-E INSULATING VARNISH 9535

A clear baking synthetic resin varnish . . . exceptional bonding and moisture resistance properties . . . recommended for small electric motors.

... and the same varnish can make washing machine motors better

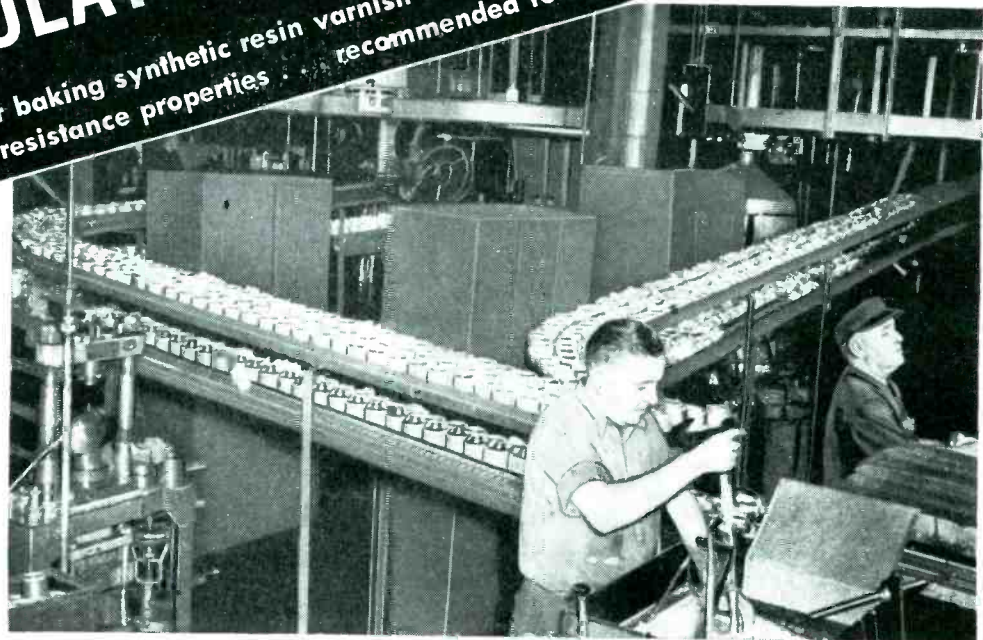

**SPECIFY** G-E Insulating Varnishes with confidence. Now available to all industry, these products have been proved in a myriad of war applications. General Electric offers you the benefit of huge productive capacity . . . 45 years of experience in varnish research and manufacture . . . expert technical service. And strict G-E Quality Control assures uniformity of product in every shipment. For full details consult your local Merchandise Distributor. Or write direct to Section RIMA-8614, Resin and Insulation Materials Division, Chemical Department, General Electric Co., Schenectady 5, N. Y.

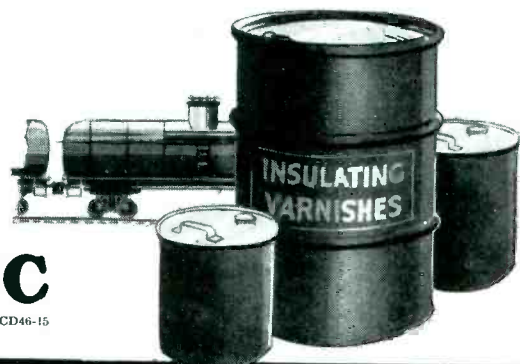

**GENERAL  ELECTRIC**

CD46-15

**G. E. OFFERS A COMPLETE LINE OF INSULATING MATERIALS**



# PACKAGED R. F. RADAR ASSEMBLY ELIMINATES DESIGN HEADACHES

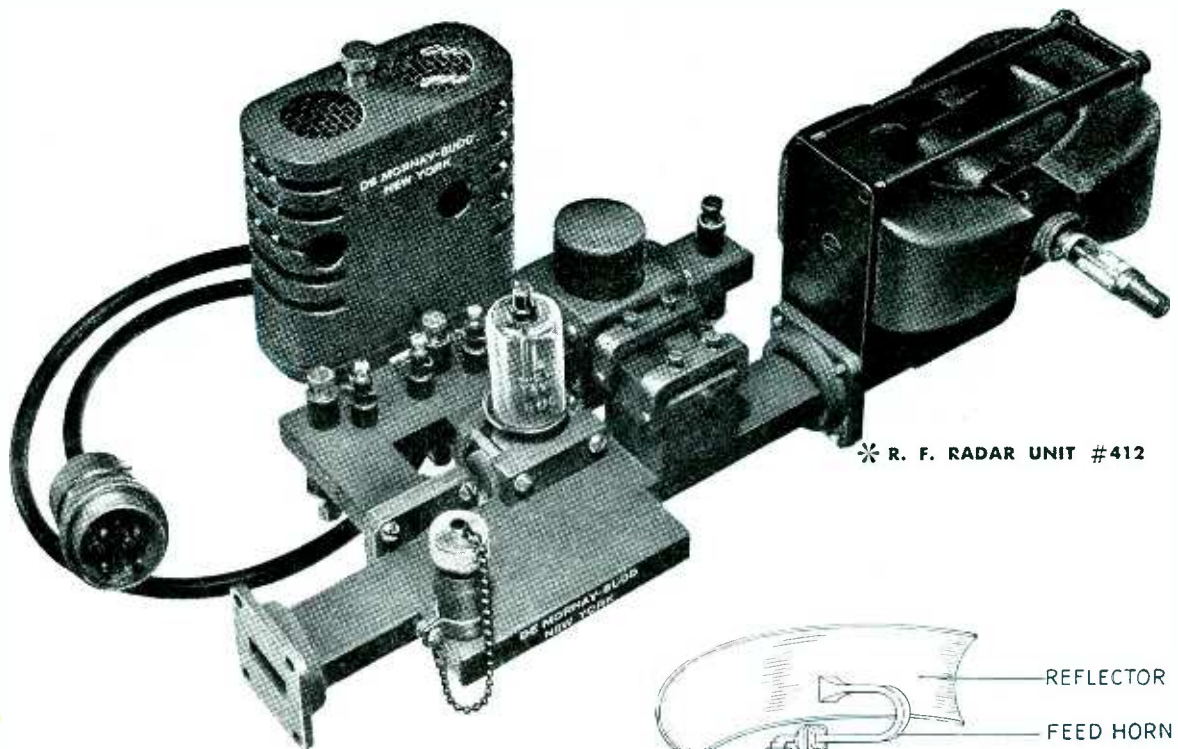

\* R. F. RADAR UNIT #412

The DeMornay-Budd packaged R. F. Unit provides a complete R. F. assembly for microwave radar. It is now possible to obtain as standard items all the microwave R. F. components necessary in the fabrication of a complete radar—DeMornay-Budd Standard Transmission Line Components plus packaged R. F. Unit.

The R. F. Radar Unit is delivered complete and ready to operate. It is wired and contains all the necessary tubes and crystals. The unit uses a packaged magnetron capable of delivering 20 kw., peak power, at 9375 mc. Two type 2K25 local oscillator tubes are provided, one for receiver and A.F.C. and the other for beacon operation. A type 1B35 A-T-R tube, a type 1B24 T-R tube and the necessary type 1N21 crystals are included in the assembly. A 20 db. directional coupler permits accurate measurements to be made at any time with a maximum of convenience and safety.

Since the use of radar beacons is contemplated in the near future, the unit has been designed with a beacon cavity and crystal mount. The unit can be supplied without the beacon cavity and crystal mount and beacon local oscillator, and a termination supplied in their place so that it becomes a simple matter to convert to beacon operation when necessary.

We offer complete laboratory research facilities and have available such production test equipment as: Standing Wave Detectors, Calibrated Attenuators, Slug Tuners, Power Supplies, Square Wave Modulators, in addition to transmission line components shown in diagram above. Write for information or catalog.

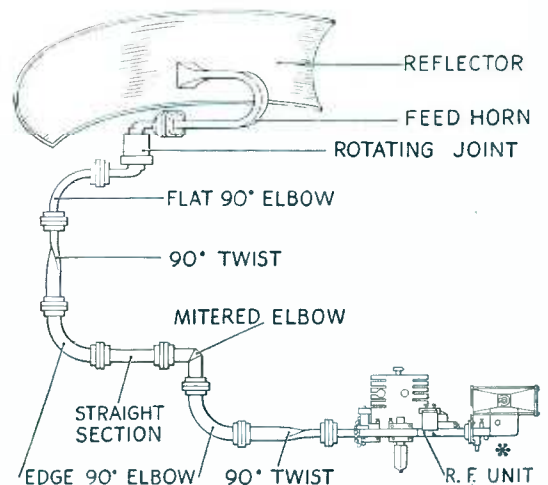

R. F. Radar unit #412 (indicated by asterisk) used in conjunction with standard DeMornay-Budd transmission line components.

Write for catalog of standard bench test equipment.



EQUIPMENT  
FOR  
97% OF ALL  
RADAR SETS

DE MORNAY-BUDD, INC.  
475 GRAND CONCOURSE, NEW YORK, N. Y.

FROM BLUEPRINT TO PRODUCT IN PLASTICS BY FELSENTHAL . . . FROM BLUEPRINT TO PRODUCT IN PLASTICS BY FELSENTHAL . . . FROM BLUEPRINT TO PRODUCT IN PLASTICS BY FELSENTHAL . . .



"... and, now we present

*'Felsy'*

**THE PLASTIC PERFECTIONIST"**

"In conclusion," says Felsy, who believes in short speeches, "I want to thank all of you for the wonderful cooperation you have given the Felsenthal Organization during the difficult years just past. . . . And to promise increasingly finer service in the years ahead." . . .

With a heart pure as lucite, skills as flexible as Cellophane, and prices lower than the melting-point of latex, our new trade-character "Felsy" will meet you in these pages. . . . Watch for him. . . . He will have many messages of timely interest for everyone whose problems involve injection molding, plastic laminating, or fabricating.

Write for booklet 3-A on your letterhead



**FELSENTHAL  
PLASTICS**  
G. FELSENTHAL & SONS  
4122 W. GRAND AVE. CHICAGO 51, ILL.  
BRANCH OFFICES: NEW YORK • DETROIT  
Est. 1899

tion to an air-spaced parallel-plate capacitor and is connected across the radio low-voltage circuits. It does not operate as a cell until sea water becomes the electrolyte, generates a current and melts a steel wire which had previously prevented a switch from closing.

With the closing of the switch, a relay switches on tube heater and anode supplies. A subsidiary sea cell passes current in a similar manner when its circuit has been completed by the first switch. The current through the second circuit operates a series of relays which are arranged so that any subsequent interruption of the current through the second sea cell connects a detonator across the low-voltage supply and fires it.

*Dry Storage*

Prior to launching, the cells are protected by thin rubber sleeves, to prevent the accidental ingress of water and to permit the safe handling of the buoy should the deck of the launching craft be awash. The sleeves are automatically removed by the act of launching. The Jellyfish has only a small silhouette and in view of the fact that it depends on radar for recognition purposes this is a great advantage.



**TUBES AT WORK**

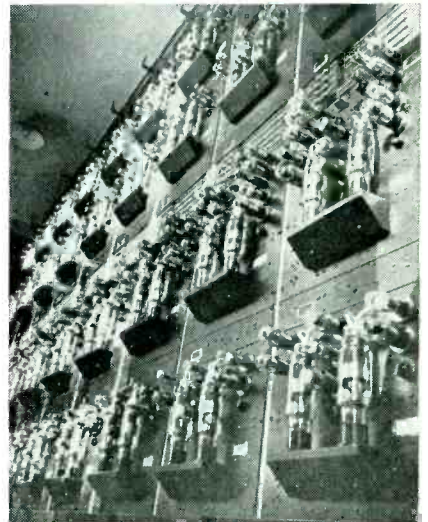

Some of the 2,000 tubes in the 100-ton calculator at MIT. The differential analyzer contains several thousand relays, 150 motors, and nearly 200 miles of wire

FOR

EXTRA



#128 CICLFX5 SELENIUM RECTIFIER. Designed with the new type 128 rectifier plate. 100 Amperes, 6 Volts, for High Rate Battery Chargers. Full wave, single phase, center-top, connection. Mounting dimensions: 8 7/8" high, 5 3/8" wide, 5 1/2" deep. Approximate weight: 4 lbs.

**POWER**  
**VOLTAGE**  
**RIGIDITY**  
**DEPENDABILITY**

**in Heavy Duty Applications**

**FEDERAL'S**

### Selenium Rectifier Stack with the New Heavy Duty Plate

THE NEW type 128 rectifier plate — latest of Federal's many contributions to the advancement of the metal plate rectifier — embodies all the refinements of design which have made Federal Selenium Rectifiers standards of quality. This plate offers you the advantage of *double* "center contact" construction. And with increased area and higher voltage per plate, stacks are especially suited to heavy power applications. Built on aluminum base for light weight.

Rectangular plates provide a more efficient space factor for group mounting — and also simplify the baffles needed for uniform air distribution. Stacks may be arranged vertically or horizontally. Four-point mounting, plus double-stud assembly, provides a rigid structure more resistant to shock and vibration than any previous design.

To learn how this new rectifier can be applied to your problem, write for full details to department F216.

#### EXCLUSIVE FEDERAL FEATURES

- Double mounting studs — for increased rigidity.
- Double current collection points — for higher current-carrying capacity.
- Double Center-Contact construction — for increased resistance to corrosion.
- Maximum reverse voltage per plate — 26-volts R.M.S. — for greater breakdown strength.

Among the many possible applications are:

Large battery chargers	Anodizing
Electroplating	Aircraft equipment
Arc welding	Cathodic protection

... or wherever heavy loads are required.

*Federal Telephone and Radio Corporation*

In Canada:—Federal Electric Manufacturing Company, Ltd., Montreal  
Export Distributor:—International Standard Electric Corporation



Newark 1,  
New Jersey



# WE SPECIALIZE IN "Specials"

**FOR NEARLY 20 YEARS**, the Kenyon Transformer Company has done an outstanding job of satisfying the demand of large manufacturers for "special units" to fit exactly their most critical needs, with the same care that other manufacturers could provide items of their standard catalog lines.

**THIS ACHIEVEMENT** is a tribute to the skillful engineering ability of the Kenyon Pioneers who have maintained a leading place in the development of outstanding transformer equipment.

**WE INVITE INQUIRIES** from manufacturers of electronic and other types of equipment, and from industrial and commercial users of transformers.

**KENYON PREDICTS** that the small additional cost of "specials" will be more than offset by the superior product—streamlined to fit each manufacturer's requirement.

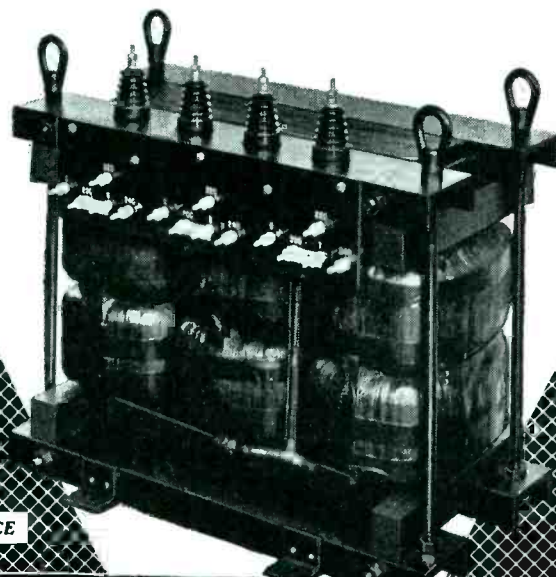

THE MARK OF

EXCELLENCE

**KENYON TRANSFORMER CO., Inc.** 840 BARRY STREET  
NEW YORK, U. S. A.

The New Way to  
*Insulate and Protect*  
 harnesses and leads

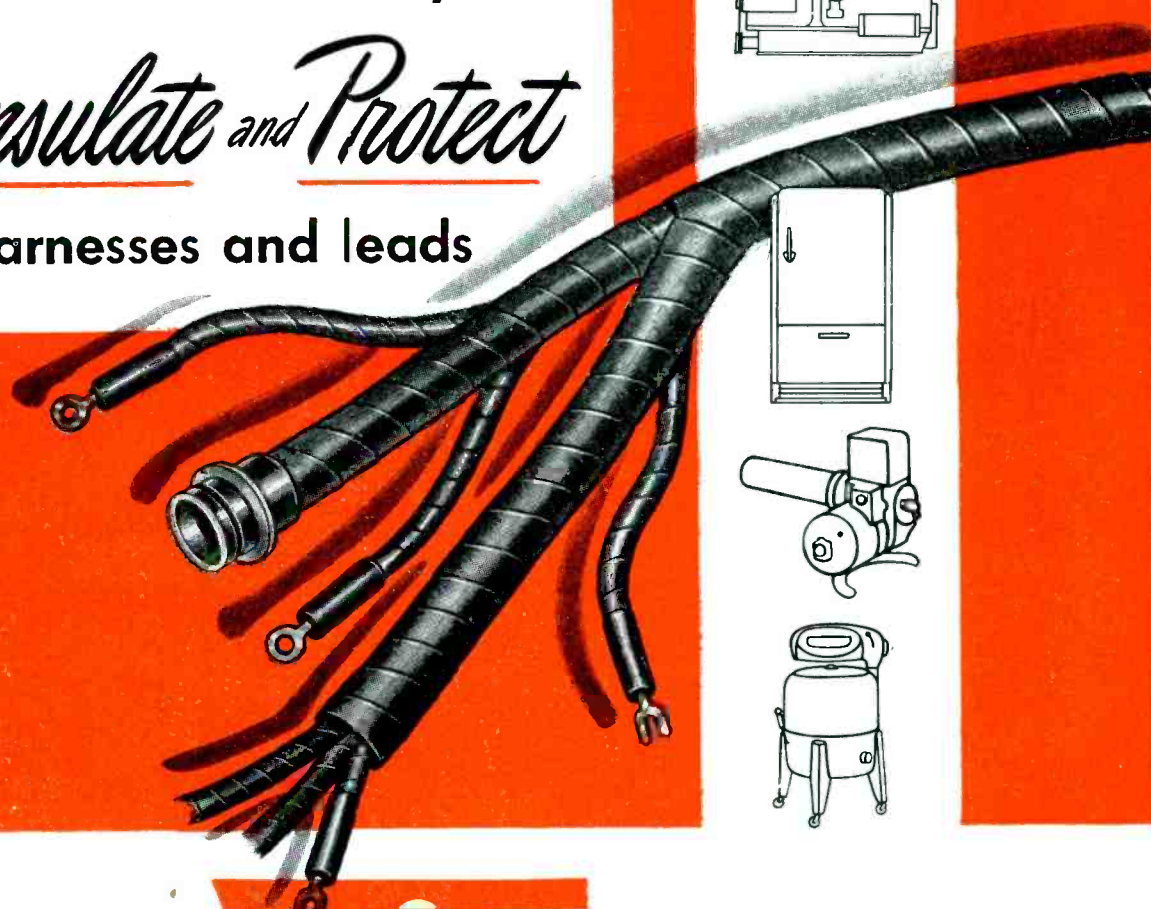

WRAP WITH **Fibron** PLASTIC TAPE



Transparent Fibron Plastic Tape permits ready inspection.  
 Plastic gaskets also available.

**IRVINGTON**



*Varnish and Insulator Company*

Irvington 11, New Jersey, U.S.A.

Whenever equipment wiring must withstand severe operating conditions, attacks from moisture, oils, and chemical fumes as well as mechanical abuse, wrap harnesses and leads with protective Fibron Plastic Tape. This black or transparent tape is tough, remains flexible at low temperatures, and has good insulating properties.

Extremely elastic, Fibron Plastic Tape wraps smoothly and evenly over irregular surfaces and will not bulk in sharp corners.

*Can be Fused into Homogeneous Structure*

Ends can be instantly bonded by heat sealing, or the completely wrapped harnesses infra-red or oven baked to form a solid mass of insulation.

Note the outstanding characteristics of Fibron Plastic Tapes as listed below. Plan to test these products now. Generous samples will be gladly sent on request.

**Outstanding Properties of Fibron Plastic Tapes**

	#1 Black	#3 Transparent
Thicknesses	.008" .012" .020"	.020"
Widths	1/2" to 3"	1/2" to 3"
Dielectric Strength (.012" tape)	1000 VPM	750 VPM
Tensile Strength, lb. per sq. in. (dumbbell specimen tested)	1600	1600
Elongation	250% to 400%	350%
Brittleness Temperature	-41 deg. C.	-38 deg. C.
Bonding Temperature (depending on method used)	130°-150°C.	135°-155°C.
Specific Gravity	1.25	1.22

# INDUSTRIAL CONTROL

Edited by VIN ZELUFF

Current-force Recording in Resistance Welding.....	166
Testing Heat Exchanger Tubing.....	174
Electronics in Medicine.....	186

## Current-force Recording in Resistance Welding

By J. M. POPP

*Special Products Division  
General Electric Co.  
Schenectady, N. Y.*

RESISTANCE WELDING of aluminum requires a relatively large current which decays to zero value within approximately one-sixth of a second when energy storage type welding machines are used. The electrode force is relatively high at first, to insure good contact between the surfaces to be welded. It is then decreased so that the pieces being

recording these events so that the operator will know when the welding control is properly adjusted.

Today, the Navy requires that all resistance welding machines used for welding aluminum aircraft primary structures be checked monthly to make certain that the machines are properly adjusted. To comply with this Navy specification, resist-

ance-welding machine operators make use of the current-force recorder to record simultaneously a timing wave, the rapidly changing electrode force, and the electrode current. It is also useful in welding research and the records are helpful to users of energy storage welding machines in determining when forge pressure is applied to the work with respect to the discharge of welding current. The record also shows squeeze time, the duration and magnitude of welding current, the rate of rise of forge pressure, and the hold time.

The equipment includes a special electrode holder that closely resembles a standard holder, except that resistance-wire strain gages are attached and a shunt for measuring current is built in. The strain gages are arranged in a bridge circuit to measure the compressive strain, which is a measure of the force in the electrode. The shunt diverts from the electrode a proportional amount of current which is used to operate as oscillograph galvanometer.

### Operation

A 5,000-cycle carrier voltage from an oscillator unit is applied to two diametrically opposite points on the bridge circuit. The output from the other two points of the circuit is a measure of the unbalance of the bridge. While the strain gages are not under stress, the controls are adjusted so that the bridge has a moderate output corresponding to zero

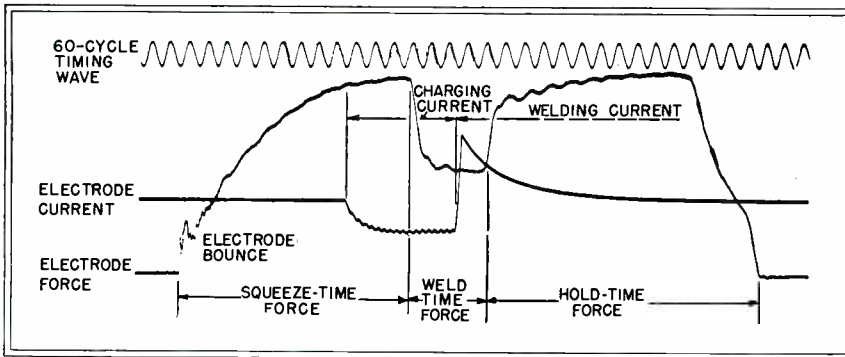

Oscillographic record obtained with the recorder and the events that occur during the welding cycle

welded will not be badly deformed while the larger portion of the welding current flows and softens the aluminum.

Reduction in electrode force also increases electrical resistance between the parts being welded and thus smaller current will produce the same heat that higher current would produce without the reduction in electrode force. During the decay time of the welding current, the electrode force is increased to its original high value to forge the welded metal together.

### Recording the Cycle

The entire welding cycle requires only a fraction of a second and all the various events must be accurately timed. This requires careful adjustment of the controls and a means of

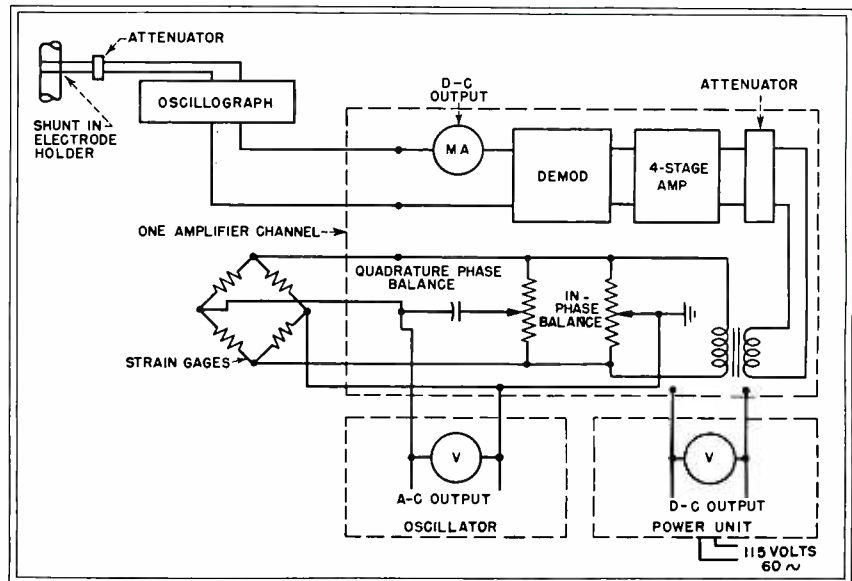

Arrangement of essential circuits in the General Electric current-force recorder

This is what you see



... This is what you get



Every genuine Lord Mounting carries the name "LORD" embossed in the rubber or in raised letters on the forgings.



a flexible mounting which protects your equipment from shock and vibration; increases service life, improves accuracy, permits lighter construction and wider manufacturing tolerances, reduces noise and decreases personnel fatigue. It is compact in design and easy to install.

The picture shows a very simple looking little gadget, made of rubber and metal. It's a typical Lord Bonded Rubber Plate Form Mounting, of which millions are in use. They are produced to accommodate loads ranging from one half to several hundred pounds.

So far as application is concerned, it's just as simple as it looks. But years of study, research and experiment have gone into its construction and design. The development of a rubber to metal bond of great strength, enabled Lord to produce this mounting which utilizes the flexibility of rubber stressed in shear to isolate vibration.

When you come to Lord with your vibration problems, you are getting an answer that represents the last word to date in scientific research and development. Send for Bulletin 104.

★ BUY VICTORY BONDS ★

IT TAKES BONDED RUBBER *In Shear* TO ABSORB VIBRATION

**LORD MANUFACTURING COMPANY**  
ERIE, PENNSYLVANIA

SALES REPRESENTATIVES  
NEW YORK - 280 MADISON AVE.  
CHICAGO - 520 N. MICHIGAN AVE.  
DETROIT - 7310 WOODWARD AVE.  
BURBANK, CAL. - 245 E. OLIVE AVE.  
CANADIAN REPRESENTATIVES  
RAILWAY & POWER ENGINEERING CORP., LTD.  
TORONTO, CANADA

Originators of Shear Type Bonded Rubber Mountings



**G**RAPHITE has a higher thermal conductivity than other anode materials. Thus, by using "National" graphite in your anodes, you'll get greater protection from excess surface temperature — a cause of secondary or back electron emission.

Moreover, you'll lessen the danger from local hot spots so often found in anodes of other materials — the result of thin spots or concentrations of the electron stream.

High thermal conductivity is but one impor-

tant advantage that "National" graphite offers. This promising anode material also provides high electrical conductivity, low electron emission, high thermal emissivity, extremely low thermal expansion . . . and *no* melting point! Furthermore, graphite can be machined into intricate shapes to very close tolerances.

It can pay you to look more closely at the possibility of using graphite for your anodes. National Carbon Company, Inc., engineers will be glad to work with you. Write Dept. E.

The word "National" is a registered trade-mark of

**NATIONAL CARBON COMPANY, INC.**

*Unit of Union Carbide and Carbon Corporation*



30 East 42nd Street, New York 17, N. Y.

*Division Sales Offices: Atlanta, Chicago, Dallas, Kansas City, New York, Pittsburgh, San Francisco*





## ... Impromptu Discussions about Miniature Tubes



"I'm planning to use a Tung-Sol miniature rectifier in it... it's an indirectly heated cathode type. And it has an ample overload safety factor. I've found that their small size not only makes them easily adaptable to both large and small sets, but they're also mechanically superior.

"Take Tung-Sol's 117Z3 for instance. It's a half wave, high vacuum rectifier. Just the tube for a 3-way portable where a battery powered set has to do double duty as a home AC or DC power receiver. For plate and filament power, it more than satisfies the demands of a normal 4, 5, or even 6 tube portable receiver. That's because it supplies 100 ma. continuous current.

It'll deliver 110 volts at full load rating, or 125 volts at half load rating across the input filter condenser. That's with 117 volts rms. supply to the plate. Furthermore, its heater is reliable and consumes less than five watts. It can be placed directly across the normal house lighting system. Its generous cathode structure permits full use of the 6 to 1 peak to average current ratio with a source impedance of 30 ohms and as much as 70 uf input condenser. That's important in simplifying the design for minimum ripple. And the ability of the 117Z3 to withstand

momentary plate current surges of 2 amperes without damage is of particular value in many designs.

"Besides the 117Z3, Tung-Sol makes the 35W4 and 6X4 miniature rectifiers as well as complete super-het kits of miniature tubes. They all provide 'big tube' performance. When I'm designing new circuits and considering the selection of tubes, I always get in touch with the Tung-Sol engineers. You see, they're tube manufacturers, not set builders, so I know I can talk to them in confidence."

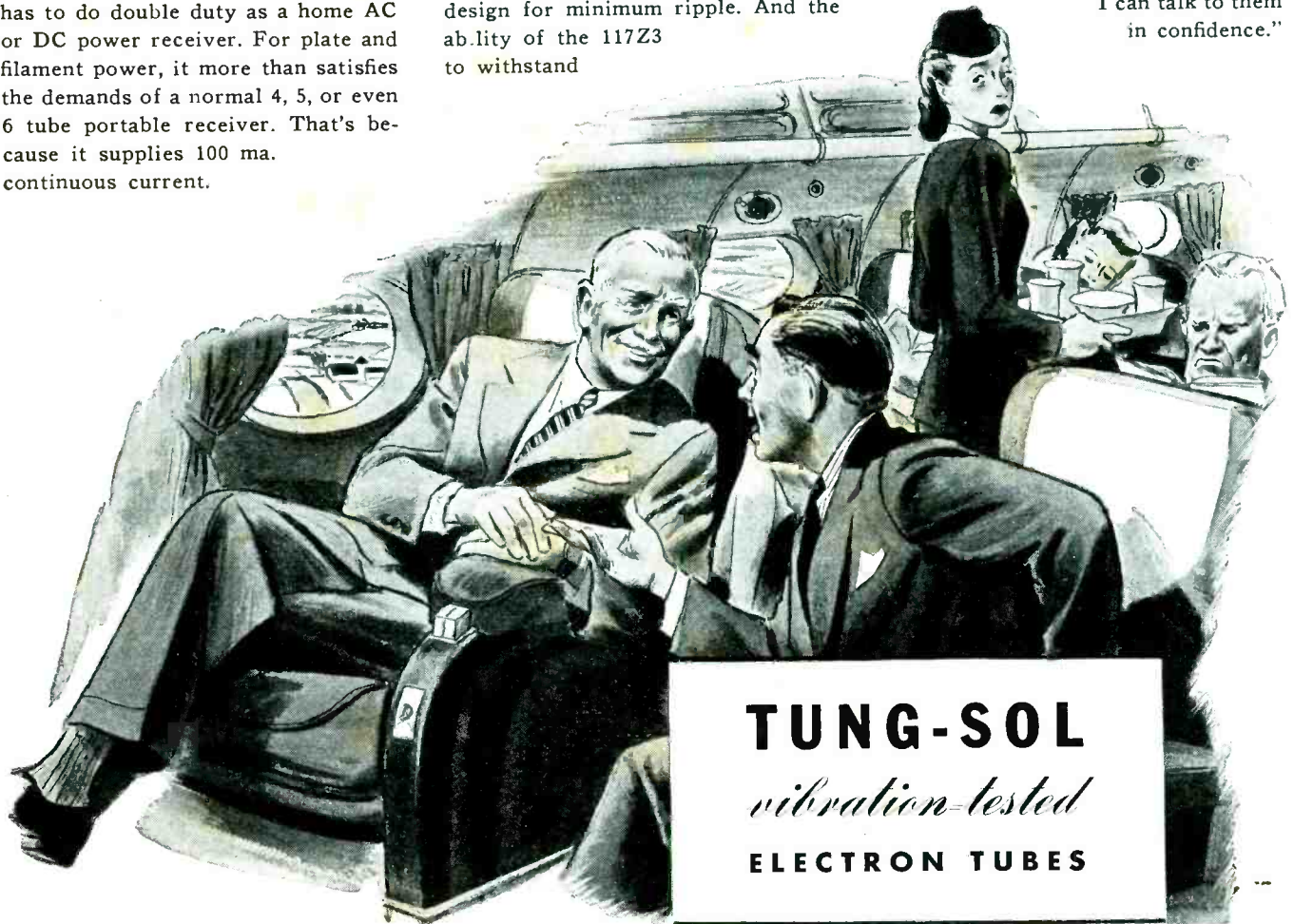

**TUNG-SOL**  
*vibration-tested*  
**ELECTRON TUBES**

**TUNG-SOL LAMP WORKS INC., NEWARK 4, NEW JERSEY**  
Sales Offices: Atlanta • Chicago • Dallas • Denver • Detroit • Los Angeles • New York  
Also Manufacturers of Miniature Incandescent Lamps, All-Glass Sealed Beam Headlight Lamps and Current Intermittors

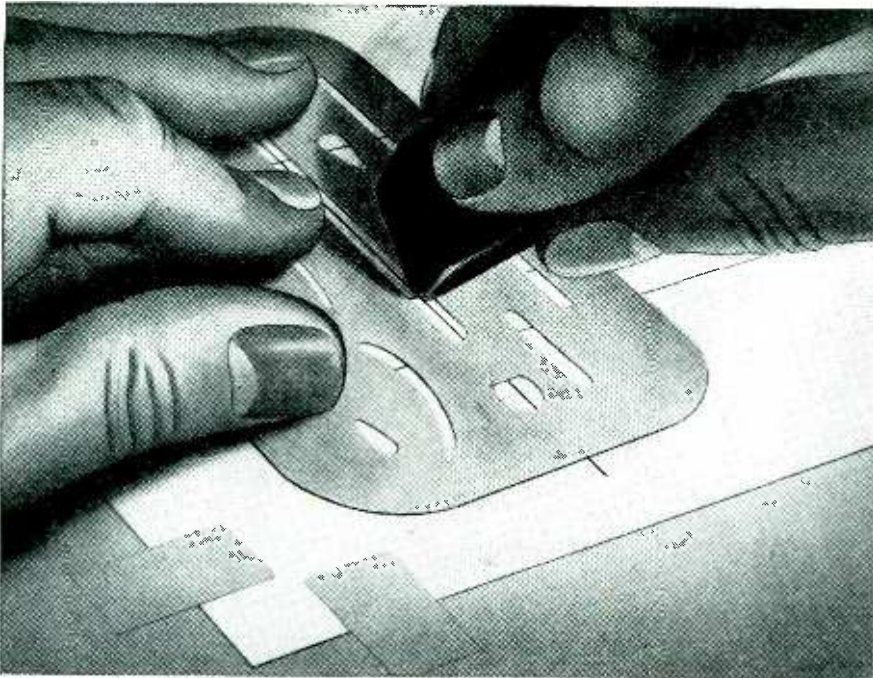

strain. Variation in the compressive force on the special electrode holder causes a corresponding change in the output of the bridge circuit.

The output of the bridge is fed into the amplifier, which amplifies the modulated carrier, and rectifies and filters the amplified output. This output signal is then fed to the oscillograph where the record is made. The output of the amplifier is proportional to the output of the bridge, and the input to the oscillograph is, therefore, a measure of the unbalance of the bridge and of the compressive force in the special electrode holder.

*Amplifier-Oscillograph*

The amplifier-oscillograph unit is illustrated in Fig. 1. It consists of a single-channel amplifier, an oscillograph, a power unit, and a small magnetic oscillograph. This electronic unit can be used with resistance-

# Friend OR ENEMY?

An eraser is an important part of any draftsman's equipment. But an eraser can do plenty of damage to your drawings if lines feather when you re-ink over an erasure. That's why Arkwright Tracing Cloth is made to stand erasures and still take clear sharp lines in pencil or ink.

High, permanent transparency, greater strength, and freedom from

dirt, specks, pin-holes and other imperfections have made Arkwright Tracing Cloth the choice of experienced draftsmen for over twenty years. That's a record you'd do well to look into, and learn for yourself the "reasons why". For free samples of Arkwright Tracing Cloth write - right now - to Arkwright Finishing Company, Providence, R. I.

★  
*Sold by leading  
drawing material  
dealers everywhere*  
★



# Arkwright

## TRACING CLOTHS

AMERICA'S STANDARD FOR OVER 20 YEARS

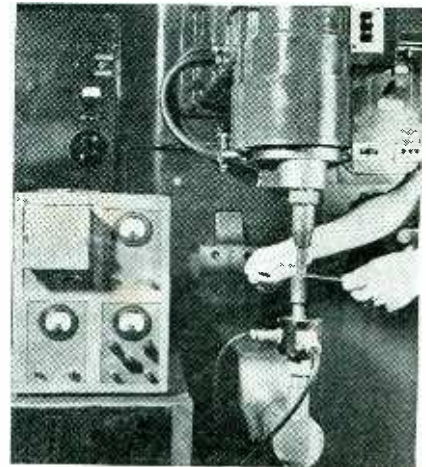

Left, the current-force recorder set up for timing the welding cycle of an energy-storage welding machine. It contains a single-channel amplifier at lower right on the panel, oscillograph at upper left, oscillator at upper right, and power supply at lower left

wire-type, electromagnetic, or magnetostrictive gages, for general-purpose testing such as measuring strain, pressure, and other values. The minimum permissible impedance of any gage used with this equipment is 100 ohms at a frequency of 5,000 cycles.

The amplifier has four stages and is stabilized to a high degree against the normal variations in plate voltage and tube characteristics. Each amplifier is provided with a filter circuit to suppress both the carrier

# 3 UNIQUE ADVANTAGES OF THE **HEINEMANN** *MAGNETIC CIRCUIT BREAKER*

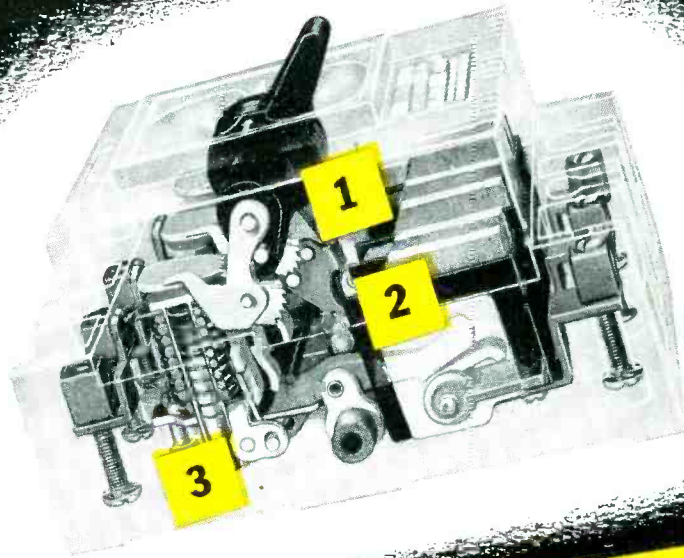

## 1 —HIGH SPEED LATCH

One of the fastest operating latch mechanisms known. It functions with minimum friction, opening the breaker with the least mechanical delay and independently of handle operation.

## 2 —MAGNETIC HIGH SPEED BLOWOUT

It adds speed to the arc interruption. Magnetic blowout contacts are mounted in individual arcing chambers carefully insulated from each other. As the value of the current to be interrupted increases, the quenching effect becomes greater due to the intensified magnetic blowout field.

## 3 —MAGNETIC-HYDRAULIC TIME DELAY

HEINEMANN Magnetic Circuit Breakers are available with any one of three different inverse time delays controlled by a hermetically sealed trip unit. The breaker acts instantly on excessive overload or short circuit, but is not affected by minor overloads or temporary inrush current.



# HEINEMANN ELECTRIC COMPANY

Established 1888

97 PLUM STREET

TRENTON, N. J.

# PERMANENT MAGNETS MAY DO IT BETTER

## MAGNETIZING A PERMANENT MAGNET

The lodestone is the only natural permanent magnet—and was produced by accident centuries ago, when the electrical forces of nature charged this primitive magnetic material with energy. Man-made permanent magnets must be subjected to a controlled magnetizing force in order to utilize efficiently the inherent energy of the material. This process is one of the most essential features in obtaining the maximum efficiency of permanent magnets.

They may be magnetized in a fraction of a second, but should be magnetized to saturation. This may be done by placing them in a magnetic field established by electro-magnets, solenoids, or special coils energized by half-cycled transformers, or condenser discharge or batteries. This applied magnetic field must not only be of sufficient intensity, but also should have proper orientation with respect to the

magnet. For maximum results it is necessary not only to magnetize the magnet thoroughly, but it must be done at a certain point in the assembly operation. For manufacturing purposes it is generally the best practice to magnetize the magnets in the customer's plant, as this prevents demagnetization and collection of foreign matter in handling.

The Indiana Steel Products Company is the world's largest sole producer of "packaged energy," having made more than 24,000 permanent magnet applications; and is uniquely well qualified, both through experience and equipment, to help you in your magnetizing, testing, and magnet aging problems. Our engineers invite you to consult with them. For complete information, write for free copy of our technical "Permanent Magnet Manual." Your request will receive our prompt attention.

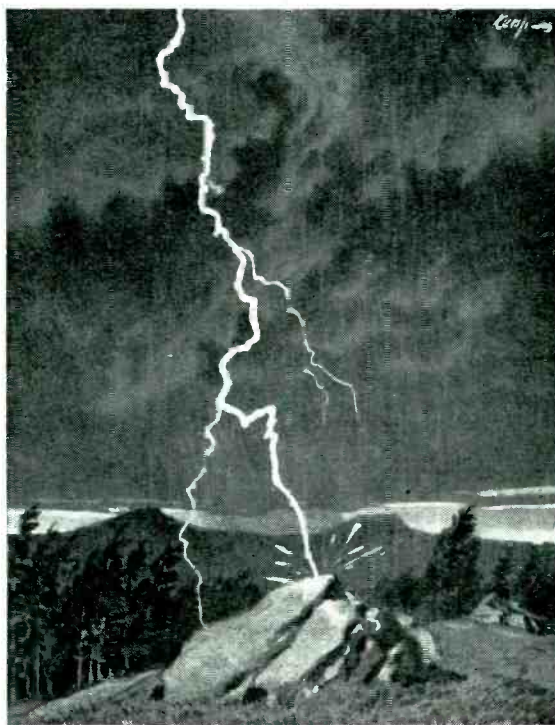

### PRODUCERS OF "PACKAGED ENERGY"

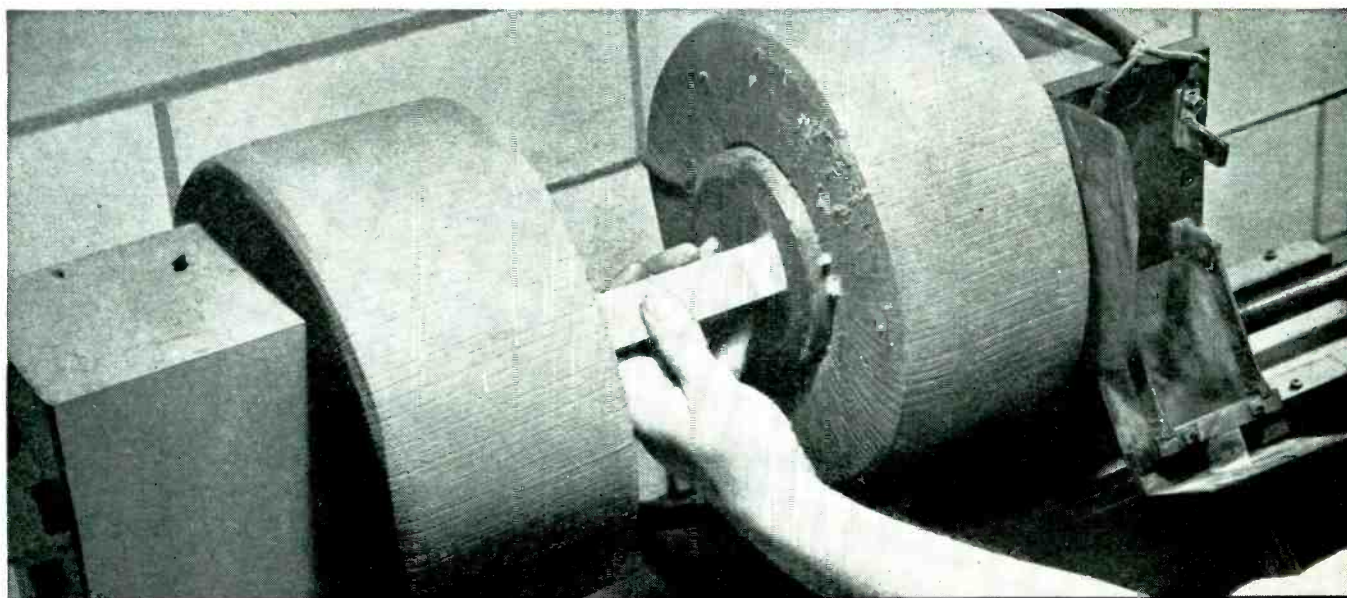

★ ★ ★ **THE INDIANA STEEL**

6 NORTH MICHIGAN AVENUE, CHICAGO, 2 ILL NOIS



**PRODUCTS COMPANY** ★ ★ ★

Corpr. 1946, The Indiana Steel Products Co.

**SPECIALISTS IN PERMANENT MAGNETS SINCE 1910**

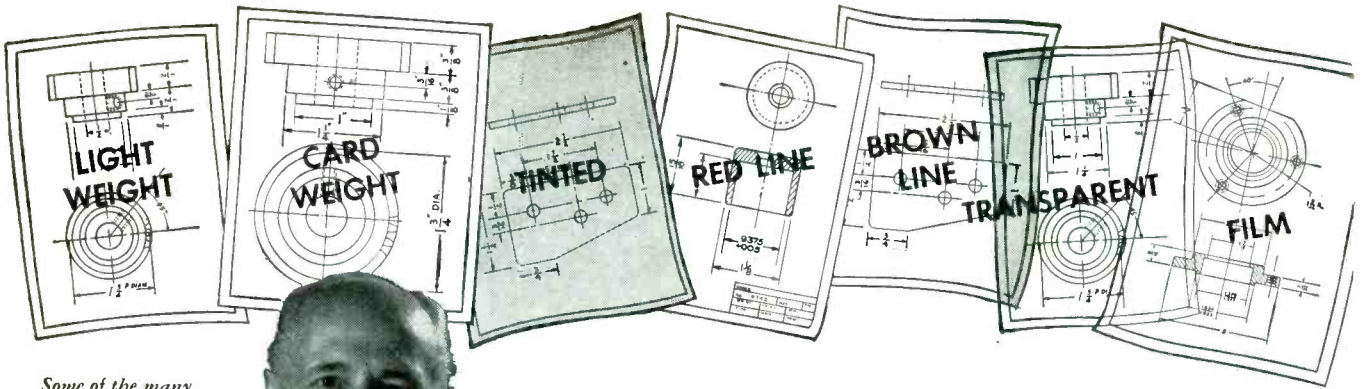

Some of the many different varieties of BW Prints.

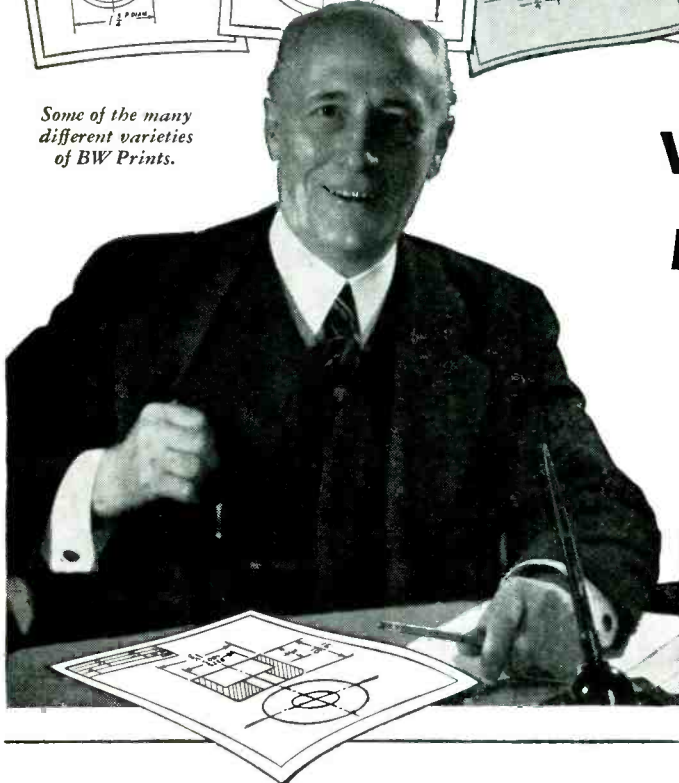

## What can YOU do with BRUNING BW PRINTS?

What print-making advantages does the Bruning BW system give me?



BW Prints—black line positive prints made directly from your tracings—cover a wide variety of needs. In addition to the regular (medium-weight), BW Prints may also be produced on a lightweight white paper for greater convenience in filing. BW Prints, too, can be made on card-weight paper where durability is required. For departmental differentiation, BW Prints may be made with black, brown or red lines on green tinted paper, or brown and red lines on white paper.

How can I use BW transparents and BW film?

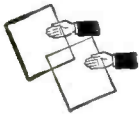

BW Transparents safeguard valuable original tracings by providing exact duplicates on thin, transparent paper. BW Transparents are also useful in making changes without altering original drawings. BW Film—a matte finish transparent acetate film—is used to intensify the lines of pencil tracings in reproduction, thus increasing printing speed and assuring clean, sharp detail in subsequent BW Prints produced from the BW film.

Can I have photographic prints, too?



The Model 2 BW and Copyflex Printer—one of many Bruning machines—enables you to change at will from BW Prints to Copyflex photographic prints. Copyflex prints may be made from anything drawn, typed, written or illustrated on opaque material and one or both sides of the original may be reproduced. Increase the flexibility of your print production with this versatile Bruning equipment.

### You Get These Six Major Advantages with the BRUNING BW SYSTEM

1. A versatile, simple method for making black line or colored line prints directly from tracings.
2. 17 years' experience in analyzing printmaking needs.
3. A complete line of materials, including white and green-tinted papers, thin, medium and card-weight papers, black, red or brown line prints, BW Transparents to supplement original tracings and BW Film for intensifying pencil lines in reproduction.
4. A complete line of printing and developing machines to fit every requirement.
5. A continuing service... because Bruning sells everything for the engineer and draftsman, not just BW equipment. Buying a BW machine is, therefore, not a "one time sale."
6. Continuing research and development in the customer's interest.

## CHARLES BRUNING COMPANY, INC.

Since 1897

### NEW YORK

Atlanta  
Kansas City  
St. Louis

### CHICAGO

Boston  
Milwaukee  
San Francisco

### LOS ANGELES

Detroit  
Newark  
Seattle

Houston  
Pittsburgh

CHARLES BRUNING COMPANY, INC.  
4712-20 Montrose Avenue, Chicago 41, Illinois

Gentlemen: I want to know more about Bruning BW Prints and equipment. Please send me information.

Name \_\_\_\_\_  
Company \_\_\_\_\_  
Street \_\_\_\_\_  
City \_\_\_\_\_ State \_\_\_\_\_



What goes on beyond 8000 cycles? Do you know... or do you "suppose" and "hope"? No more of that! Now you can monitor your full FM range, clear through 15,000 cycles. The Altec Lansing Duplex is available for immediate delivery. See your dealer, or write to us.



**the altec lansing model 604 duplex loudspeaker system**

Both high and low frequency units are combined in one horn, reproducing the entire FM range, from 50 to 15,000 cycles, without intermodulation effects or distortion. In actual performance the Altec Lansing Loudspeaker System delivers up to 500% greater efficiency in monitoring, radio, public address and recording.



"KEEP ADVANCING WITH ALTEC LANSING"

frequency and other undesirable frequencies in the output signal.

On the front panel of the amplifier is an indicator of the amplifier output in d-c milliamperes. This shows the balance of the bridge circuit, and provides a convenient means of frequently checking the amplifier performance. When measuring electrode force, the bridge circuit is located on the special electrode holder.

The amplifier gain can be adjusted in eleven steps by means of the attenuator control. The highest-gain setting on the attenuator allows two millivolts input to be amplified to provide 200 milliamperes output current into a two-ohm load. The usable modulation-frequency response of the amplifier is from 0 to 1,000 cycles per second. Zero-frequency response allows static calibration.

The oscillator unit furnishes the necessary a-c excitation for the bridge circuit and has an output of 5,000 cycles at approximately 10 volts. It is automatically stabilized against normal variations in the supply voltage and against variations in tube characteristics.

*Oscillograph*

The oscillograph case includes three principal systems: the optical system, six parallel galvanometer channels, and the photosensitive material transporting mechanism.

The recording paper or film is 3 1/2 inches wide by 20 feet long. The oscillograph is designed for daylight loading and unloading. The film is carried in the front end of the oscillograph (nearest to the operator). A motor drives the film at a speed of approximately 10 inches per second.



**Testing Heat Exchanger Tubing**

ONE OF THE MOST serious problems in oil refineries, chemical plants, and steam power plants afloat and ashore has been the constant threat of failure of the tubing in heat exchange equipment due to internal corrosion. Such heat exchange equipment consists of many tubes arranged in parallel and gathered into bundles inside a metal container or shell. Through the tubes of heat exchangers, used in the petroleum industry for example, pass all crude oils en

*Liberty*  
**LEADS AGAIN**

**DECADE BOX**



The model OP-113 Decade Box is an instrument designed to service by substitution any condenser in a radio receiver from .0001 mfd mica unit or a 40 mfd filter unit. There are 82 individual mica and oil filled paper condensers arranged in 13 isolated net works, non-interlocking, permitting servicing of from one to 13 condensers at the same time. No electrolytic condensers have been used in this instrument thus, no need to observe polarity when making tests. A whole shop full of condensers in one box.

**\$ 99.50**



**FILMGRAPH**

Filmgraph, a sound device for recording and reproducing sound on film instantaneously and at low cost.

Filmgraph recordings are reproduced with high fidelity and in volume from a whisper to tones loud enough to fill an auditorium. The sound track is indented, not cut, into the film and the recording may be played back instantaneously without treatment or processing of any kind.

Filmgraph is a complete portable recorder and reproducer equipped with amplifier, speaker, microphone, cables, and controls. Filmgraph can also be used as a public address system. Designed to operate on 110 Volts at 60 cycles AC or from any other current by using a suitable converter or step down transformer.

**\$ 400.**

TERMS: 10% DEPOSIT WITH ORDER—BALANCE C. O. D.

**LIBERTY SALES CO., INC.**  
115 WEST BROADWAY · NEW YORK 13, N. Y.

# ISN'T IT SAFER . . .

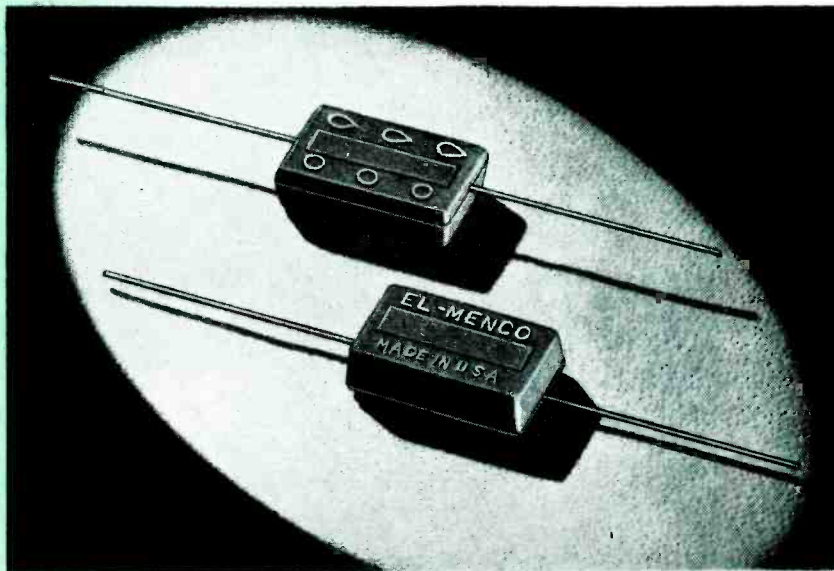

## To use

### These Time-Tested Capacitors?

On the land, in the air and under the sea  
in the steaming heat of the jungles and the sub-  
zero temperatures of the Arctic . . . El-Menco  
Capacitors proved to the men bent on Victory  
that they had what it takes.

. Electronics manufacturers will wisely choose  
these time-tested capacitors as further insurance  
for the success of their products . . . Write—send-  
ing us your specifications.

THE ELECTRO MOTIVE MFG. CO., INC.  
WILLIMANTIC, CONNECTICUT



MOLDED MICA

# El-Menco

Foreign radio and electronic manufacturers com-  
municate direct with our Export Department at  
Willimantic, Connecticut for information.

MICA TRIMMER

## CAPACITORS

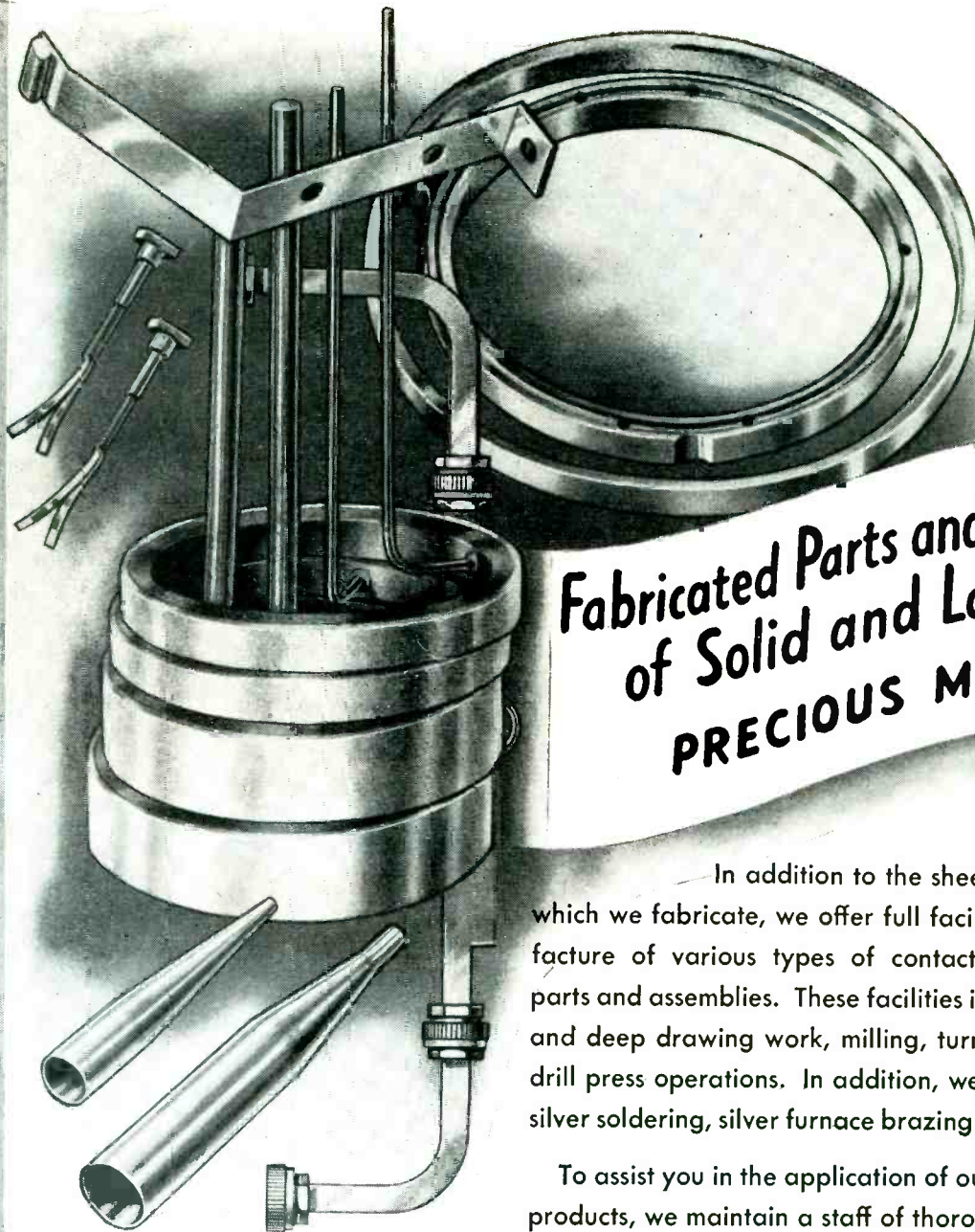

## Fabricated Parts and Assemblies of Solid and Laminated PRECIOUS METALS

In addition to the sheet, wire and tubing which we fabricate, we offer full facilities for the manufacture of various types of contact rings, fabricated parts and assemblies. These facilities include punch press and deep drawing work, milling, turning, grinding and drill press operations. In addition, we have facilities for silver soldering, silver furnace brazing and fine polishing.

To assist you in the application of our products to your products, we maintain a staff of thoroughly experienced metallurgists, chemists, designers and consultants . . . an up-to-date research and testing laboratory . . . and a splendidly equipped tool room. These are all at your service to cooperate with your own staff to the full extent of our facilities.

Your inquiries are cordially invited. Ask, too, for a copy of our descriptive folders on laminated metals or silver solders.



# *Makepeace* PRODUCTS

SHEETS • WIRE • TUBING • SOLDERS • FABRICATED PARTS AND ASSEMBLIES

**D. E. MAKEPEACE COMPANY**  
Main Office and Plant, Attleboro, Massachusetts

NEW YORK OFFICE, 30 CHURCH ST. CHICAGO OFFICE, 55 EAST WASHINGTON ST.





**TOPS IN...**

# Techniquality

**THE WORLD OVER!**

Creative engineering at Bliley is never at a standstill. Since the early days of home built sets to the present era of frequency modulation, radar and world wide communications, Bliley techniquality has kept pace with every important development in communications engineering. With Bliley techniquality "at the controls" frequency precision is never a problem. Bliley techniquality signifies original engineering and "follow-through" It's an ability that has been developed through 15 years of frequency control engineering exclusively To communications engineers the world over Bliley techniquality means the right crystal for the specific job.

**Bliley**  
CRYSTALS

Radio Engineers  
write for  
bulletin E-27

**BLILEY ELECTRIC COMPANY • UNION STATION BUILDING, ERIE, PENNSYLVANIA**

# Check Your Requirements

**WEBSTER ELECTRIC CARTRIDGES  
MEET THEM FOR:**

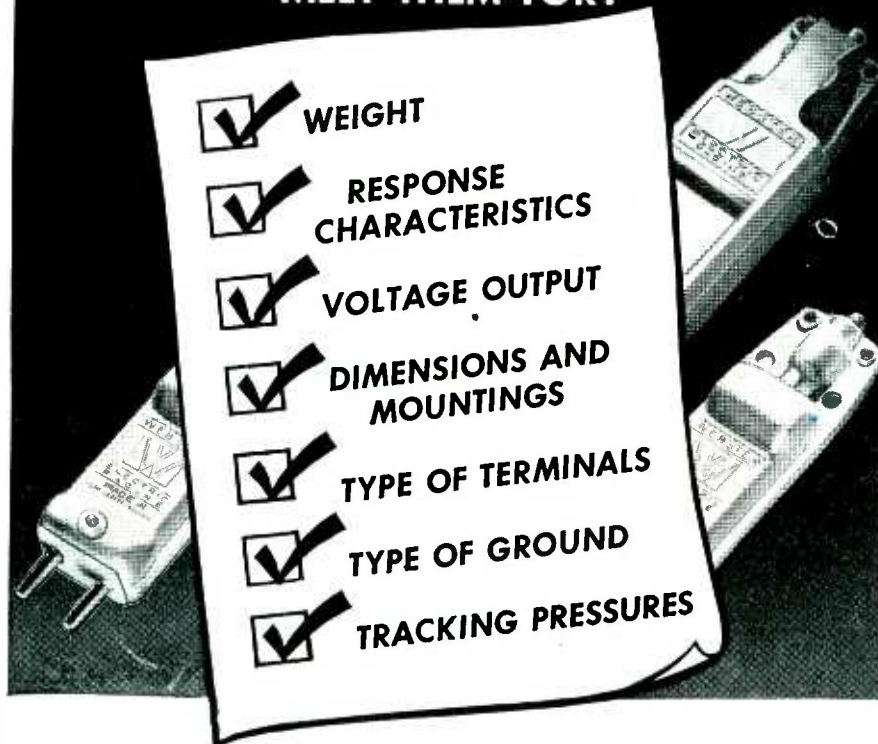

● The Webster Electric line of cartridges offers a complete selection to meet the requirements of your present day designs, for you are able to select a cartridge with your requirements for all of the above characteristics.

Webster Electric Cartridges are carefully designed and manufactured under highest quality standards. They have been on the market for years, and during this time have proved their value for long life and top performance.

You'll find that all models offer exceptionally uniform response over a desired range of frequencies, and are made to give low distortion and minimum needle noise.

In addition to the Webster Electric line of cartridges, complete tone arm assemblies of improved design are available for incorporating in new equipment.

For full information on both cartridges and tone arms, write today to Webster Electric Company, Racine, Wis.

(Licensed under patents of the Brush Development Company)

**WEBSTER**  
RACINE



**ELECTRIC**  
WISCONSIN

Established 1909

Export Dept. 13 E. 40th Street, New York (16), N. Y. Cable Address "ARLAB" New York City

**"Where Quality is a Responsibility and Fair Dealing an Obligation"**

route to refining process equipment. These oils are heated in the exchangers by an exchange of heat from outgoing gases or liquid on the outside of the tubes. The condensing of gasoline from a vapor to usable liquid is performed in condensers where the outgoing gases pass around many tubes cooled internally by a constant flow of water. Similar equipment is used in chemical plants and in steam power plants.

To offset corrosion, engineers make generous allowances in the design of heat exchange equipment. Testing is done by forcing water into the shell of the exchanger around

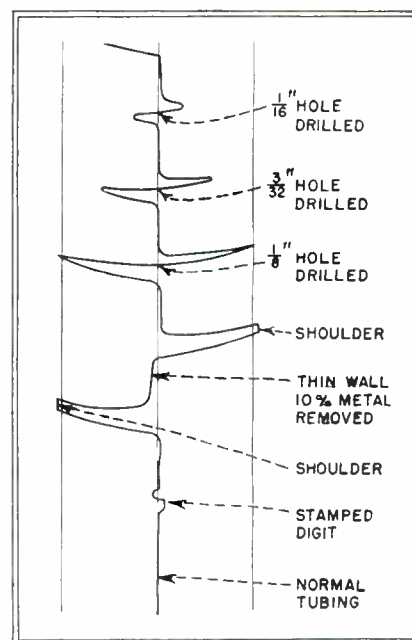

Sample record made with the Probolog when used to test a section of tubing that has had holes and other defects positioned along its length

the tubes, so that tubes which fail completely are detected by water leakage. Another test method is to cut out and split open individual tubes from different sections of the exchanger bundle for visual inspection or examination by chemical, physical, or metallurgical tests.

### Electronic Tester

To fill the need for a nondestructive test, a new electronic instrument has been developed that detects and records quantitatively all types of irregularities in tubes of nonmagnetic metals, including such defects as pinholes, cracks, corrosion and erosion pits, difference in wall thick-

*Definitely* in the Picture

# FOR TELEVISION

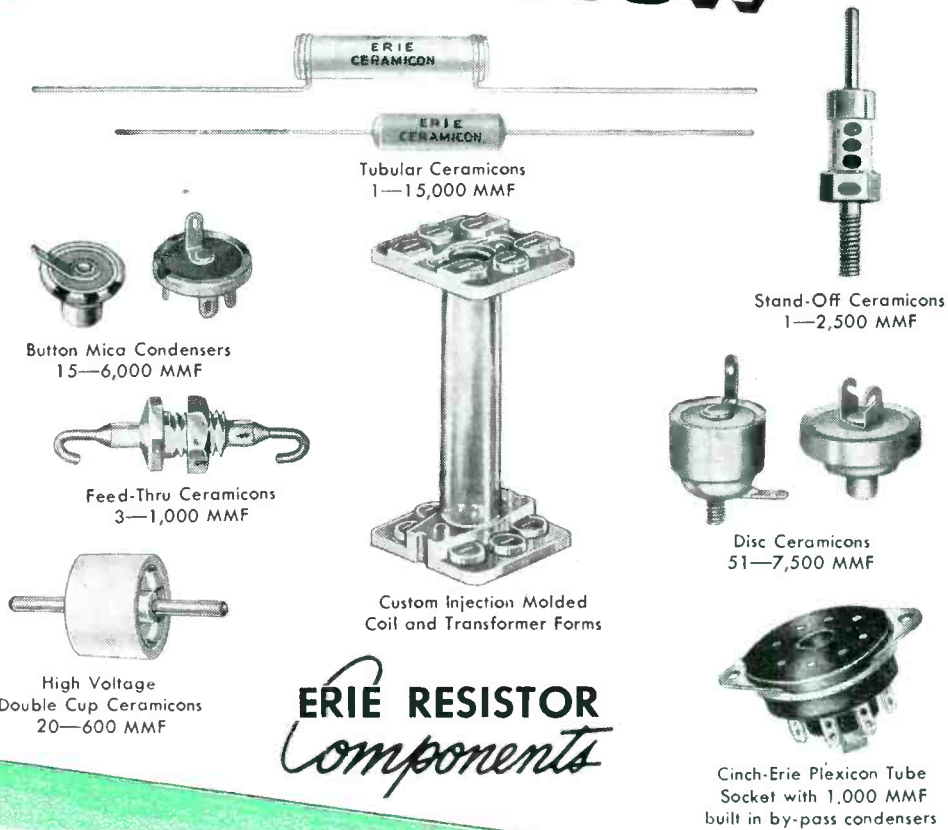

**T**HE special problems inherent in television receivers have been given careful attention by Erie Resistor engineers in designing condensers for these applications.

The components illustrated above have been correctly designed for efficient operation at high frequencies. The condensers have low series inductance and incorporate specially designed terminals and mounting arrangements. Of special interest is the high voltage Erie Double Cup condenser for power supply

filtering circuits. Rated at 10,000 volts D.C., and having a capacity of .006 mfd. these units are unusually compact and economical. Plastic coil and transformer forms are custom injection molded to customer's specifications.

We will be glad to send you technical data and samples on any of the condensers shown above. Our engineers are at your service to develop special ceramic or mica condensers for television applications.

★  
BUY VICTORY  
BONDS  
★

**ERIE RESISTOR CORP.**

**ERIE, PENNSYLVANIA**

**LONDON, ENGLAND . . . TORONTO, CANADA**



# HIGHER EMISSION POWER

## ...STEPPED-UP TUBE CHARACTERISTICS

### with SPEER GRAPHITE ANODES



Tube anodes built of SPEER Graphite radiate 100% more power at 1290° F. than widely-used *metallic* anode materials. In fact, 'SPEER Anodes dissipate *four times* more power before the anode becomes red hot.

That is why leading tube manufacturers specify SPEER Graphite Anodes—use them to make small, fast-operating tube elements with large-element performance.

They radiate uniformly—without hot spots that change tube characteristics — without frequency drifts during warming-up period.

SPEER Graphite Anodes will conform perfectly to the precision requirements of your tube design. Internal face spacings of SPEER Anodes can be held to .002 inch. And SPEER Anodes will *maintain* your specifications during tube operation, because they will not warp at temperatures as high as 3500° F.

Tube manufacturers can give better characteristics to almost any electronic tube by using SPEER Graphite Anodes. Write today for more information.

#### ▼ SPEER GRAPHITE ANODES

5.4 watts/sq. cm.

#### ▼ MATERIAL "A"

2.7 watts/sq. cm.

#### ▼ MATERIAL "B"

.59 watts/sq. cm.

RELATIVE POWER RADIATION AT 1290° F. (Watts/sq. cm.)

CHICAGO • CLEVELAND • DETROIT  
MILWAUKEE • NEW YORK • PITTSBURGH

  
**SPEER**  
CARBON COMPANY  
ST. MARYS, PA.

# Franklin AIRLOOPS

have left the stage of  
experiment and investigation!

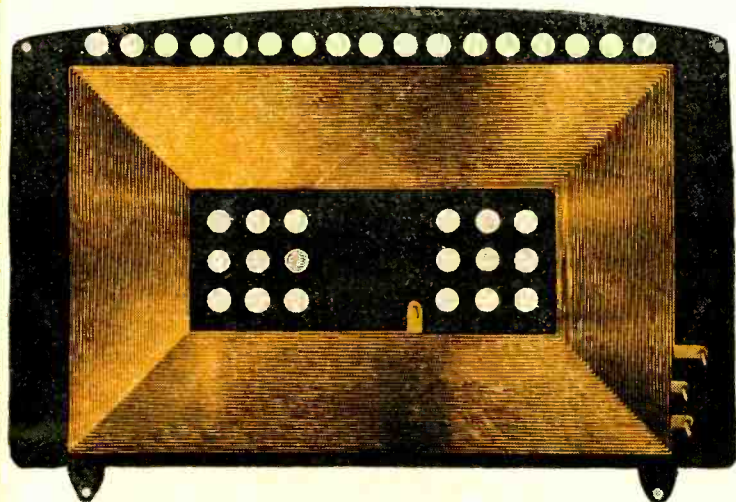
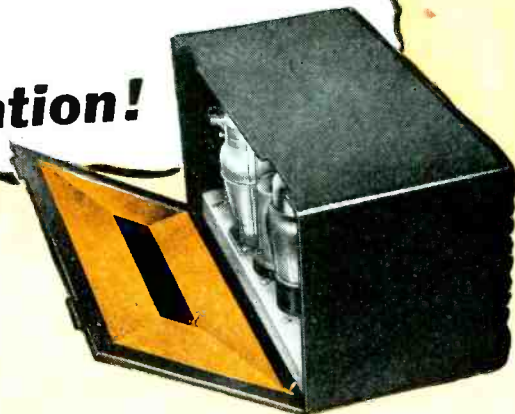

**HUNDREDS OF THOUSANDS  
ARE NOW BEING PRODUCED  
FOR SOME OF THE LARGEST  
MANUFACTURERS OF  
RADIO RECEIVERS.**

**IF** loops are bottlenecking your assembly lines?  
you want the best loop for your set?  
you are cost conscious?

*consult Franklin*  
for large scale delivery of  
**AIRLOOPS**

A radio engineer's dream come true! The greatest development in loop antenna design and manufacture since 1920! Flat sheets of copper die-stamped into perfect supersensitive loops . . . air dielectric throughout their entire length . . . being rectangular they have 27% more effective area . . . better performance at lower cost . . . no set builder can afford to overlook the significance of the AIRLOOP.

Compare these AIRLOOP values with conventional loop values and you too will SPECIFY AIRLOOPS.

- Optimum sensitivity
- High uniform "Q" over entire band
- Inductance to close tolerance without adjustable turn
- Low distributed capacity
- 27% greater effective loop area
- Electrical and mechanical stability
- Backboard and loop in one
- Lower cost
- Elimination of individual loop adjustment on assembly line
- Maximum space utilization
- No haywire

Franklin **AIRLOOP**  
175 VARICK ST., NEW YORK 14, N. Y. *corp.*

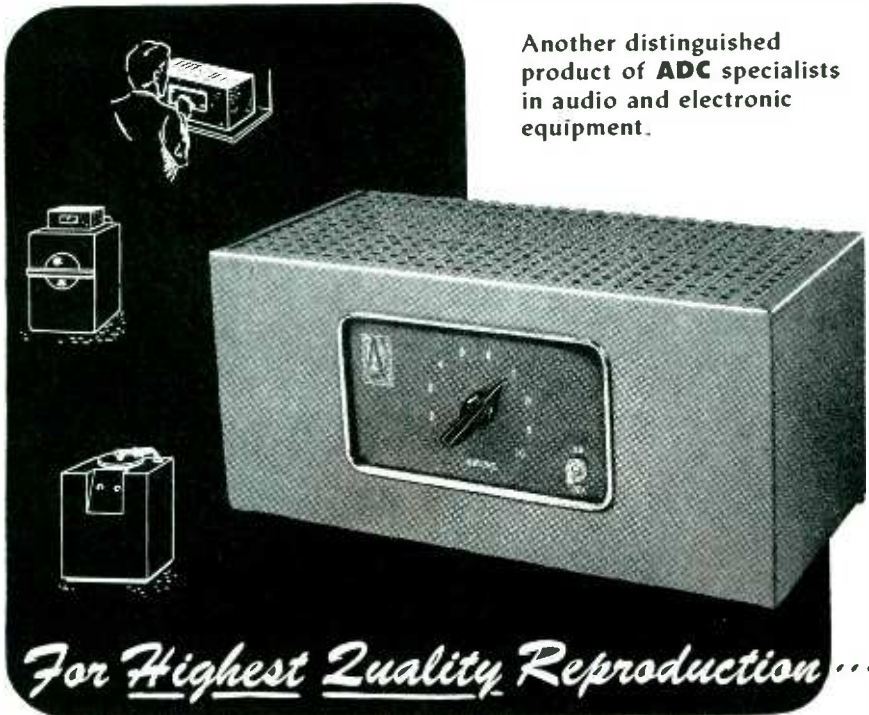

Another distinguished product of **ADC** specialists in audio and electronic equipment.

*For Highest Quality Reproduction...*

**10 WATT**  
**"ADC"**  
**LINE AMPLIFIER**

For important applications requiring extreme *quality* in reproduction of sound, you'll appreciate the superb performance of this compact, dependable unit—the **ADC** 10 watt Line Amplifier.

Originally designed to meet the exacting needs of wired music applications, this high fidelity amplifier is also excellent for use as a line or monitoring unit for recording studios and similar installations where wide-range tonal quality must be preserved. These typical features suggest the superior results *you* will get with an **ADC** Line Amplifier.

**CHECK THESE FEATURES**

**DELIVERS FULL 10 WATTS** of audio power at any frequency between 50 and 10,000 cycles; *no harmonic component of any fundamental exceeds 2% at 10 watts output.*

**NO INTER-MODULATION** product of 50 and 1000 cycles is greater than 2% at 10 watts output.

**FREQUENCY RESPONSE** is flat within  $\pm 1$  db between 50 and 10,000 cycles (bass and treble boost in off position).

**LOW HUM LEVEL.** Noise and hum level is more than 65 db below maximum output.

**INDIRECT LIGHTED PANEL** of lucite, on front of chassis, has volume control and on-off switch. Very neat and attractive. All connections plug-in at rear.

**OVER 20 DB BASS BOOST** and over 17 db treble boost are provided; screw-driver type slotted controls are on chassis proper. *Gain Limit Control* can be set to maximum level to which installation should be held.

**RUGGED AND COMPACT.** Unit is housed in heavy steel cabinet; attractive grill cover. Overall size: 16" x 8" x 7".

WRITE TODAY for free catalog sheets describing complete line of **ADC** Amplifiers.



*Audio Development Co.*  
 2833 13th AVE. S., MINNEAPOLIS 7, MINN.

*"Audio Develops the Finest"*

ness, and differences in chemical composition. It is portable, and can be operated by one man at the normal location of the exchanger in the plant. It inspects the tubes from the inside and requires no preparation of the equipment before inspection other than removal of the exchanger head. It may be operated either as an indicator to make a record that can be retained for direct comparison with those of other tubes or with those from other inspections of the same tube at different lengths of service.

The new electronic instrument, called the Probolog, is a product of Shell Development Co. It performs routine testing of nonmagnetic tubes,

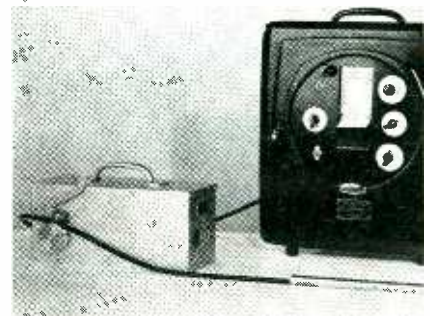

Complete equipment for determining defects in tubing. The probe, inside the sample tube at lower right, is pulled through tubing by the automatic unit at left. Six electronic tubes are in the recorder at right

and consists of one or more interchangeable probes of different diameters, a mechanical probe puller, usually synchronized with the chart drive of the recorder, and an electronic recorder, equipped with a continuous strip-chart but also incorporating a neon lamp as an indicator. Any defect encountered by the probe upsets the balance in the bridge circuit of which the probe is a part. This is transmitted to the recorder by the electronic amplifier to make a characteristic record of each defect.

*Operation*

The instrument is first used as a visual indicator and a rapid preliminary survey is made of all the tubes. The electronic equipment is adjusted to flash the neon lamp whenever a signal exceeding a specified minimum intensity is transmitted by the probe, and the operator explores the tubes as rapidly as he can draw the probe through. Those tubes

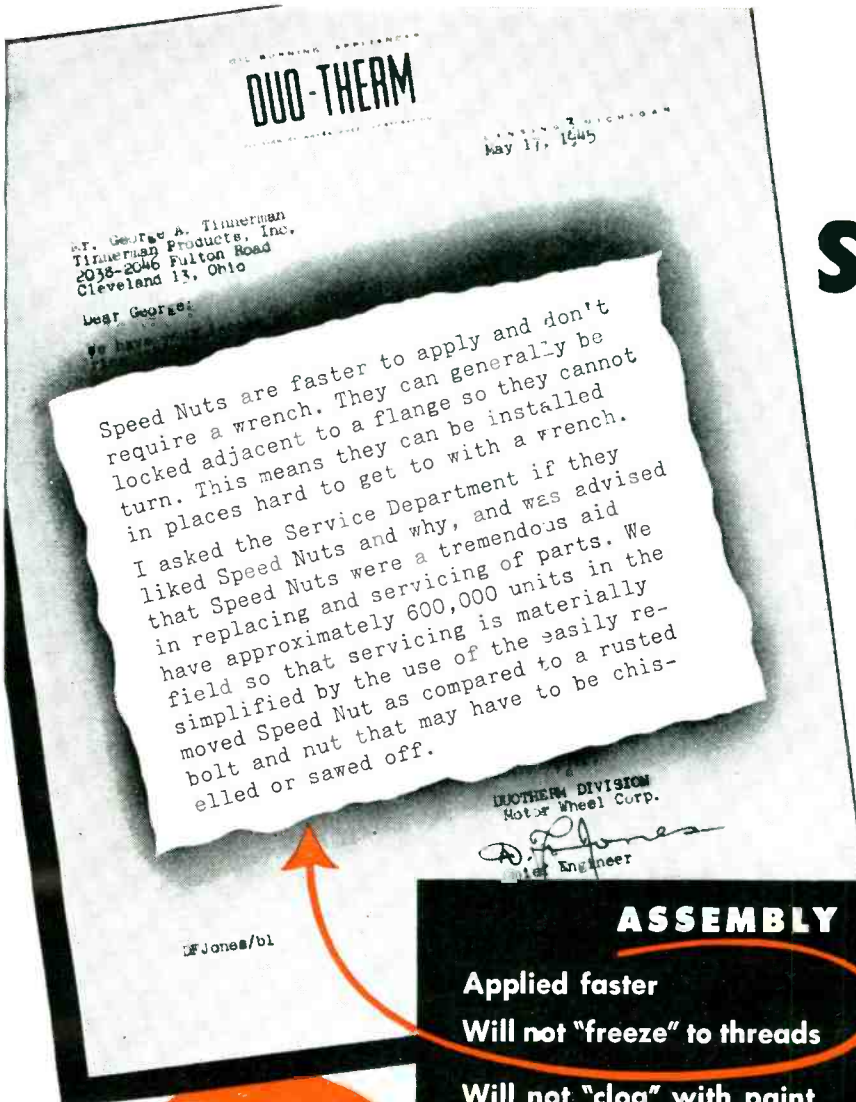

*Let*

# SPEED NUT USERS

*tell you why*

# They Changed to SPEED NUTS

No. 2 in a series, "The Customer Talks"

**ASSEMBLY ADVANTAGES**

- Applied faster
- Will not "freeze" to threads
- Will not "clog" with paint
- Reduce assembly costs
- Eliminate lock washers
- Eliminate handling of material
- Perform multiple functions
- Weigh less
- Prevent vibration loosening
- Protect fragile materials against damage



Let Duo-Therm's Chief Engineer, D. F. Jones, tell you what he thinks. His letter above leaves no doubt about the advantages of SPEED NUTS in the manufacture and servicing of hundreds of thousands of fuel oil heaters by the

Duo-Therm Division of Motor Wheel Corporation. SPEED NUTS help keep down the costs on Duo-Therm's modernized assembly lines. And the ease with which SPEED NUTS are removed greatly speeds up servicing their units in the field. Why postpone the improvement of your product assembly? Eliminate waste motions, unnecessary parts and useless weight by changing to SPEED NUTS. Send your complete assembly details when writing for samples as SPEED NUTS are made in over 3,000 shapes and sizes.

**TINNERMAN PRODUCTS, INC. • 2106 FULTON ROAD, CLEVELAND 13, OHIO**  
 In Canada: Wallace Barnes Co., Ltd., Hamilton, Ontario  
 In England: Simmonds Aerocessories, Ltd., London  
 In France: Aerocessories Simmonds, S. A., Paris  
 In Australia: Simmonds Aerocessories, Pty. Ltd., Melbourne



**F A S T E S T   T H I N G   I N   F A S T E N I N G S**

# A CHANGE FOR THE BETTER

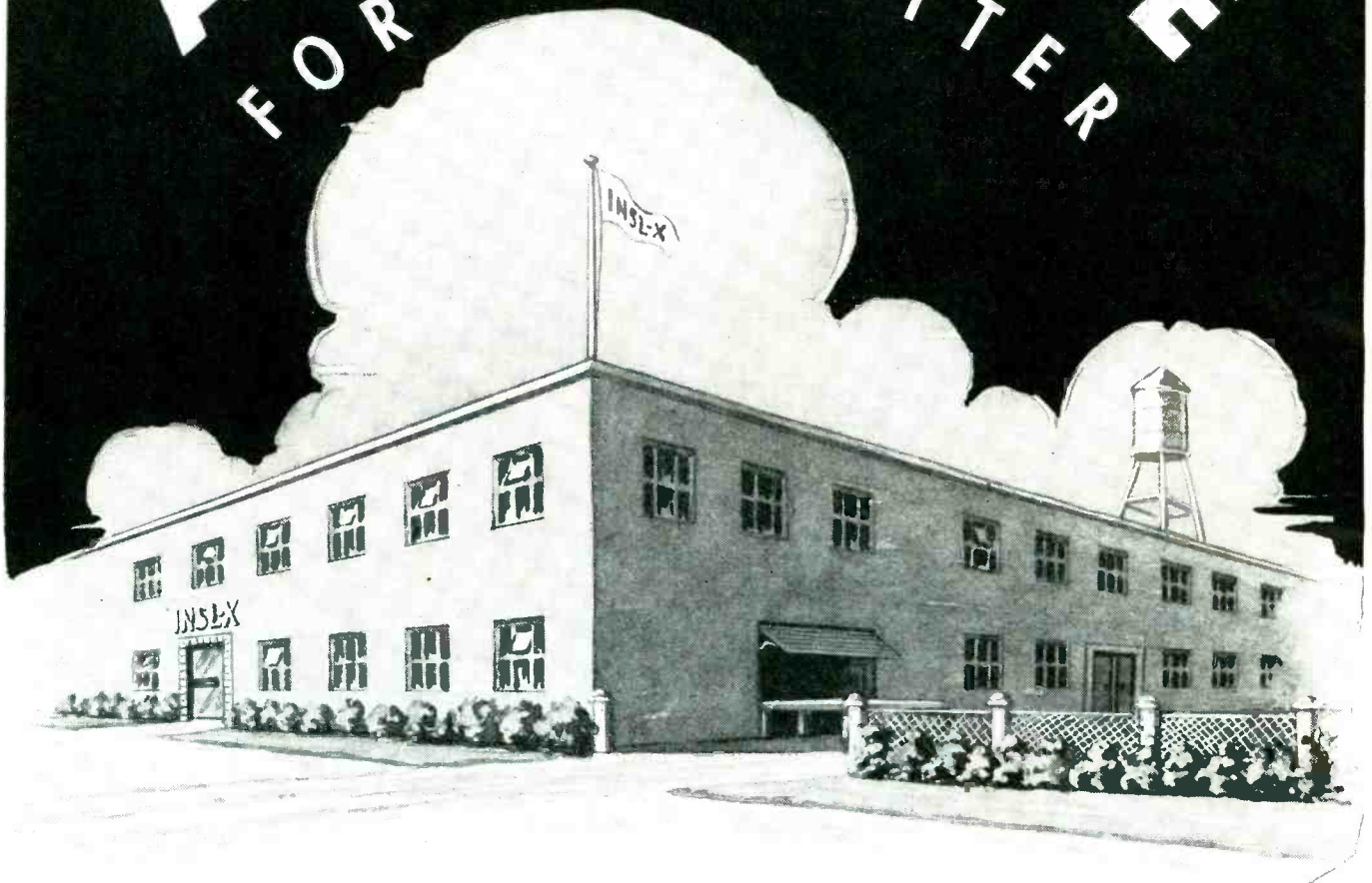

**A**N ENTIRE new building devoted to the development and production of modern electrical insulation compounds. Enlarged, ultra-modern facilities will make it possible for INSL-X to serve you with even greater efficiency than heretofore.

LITERATURE ON REQUEST

**INSL-X**  
MEANS MODERN  
INSULATION

## THE INSL-X COMPANY INC.

OSSINING, NEW YORK

CHICAGO • DETROIT • LOS ANGELES • PHILADELPHIA • CLEVELAND • ST. LOUIS



# Field Strength Measurements from 88mc to 400mc

Obtain dependable field strength patterns. The new Stoddart Model NMA-5 Field Strength Meter is an instrument designed to acceptable government specifications and standards. The Stoddart Field Strength Meter is a highly sensitive precision type receiver of extreme stability with sufficient amplification to operate a Vacuum Tube Voltmeter as the Indicating Meter.

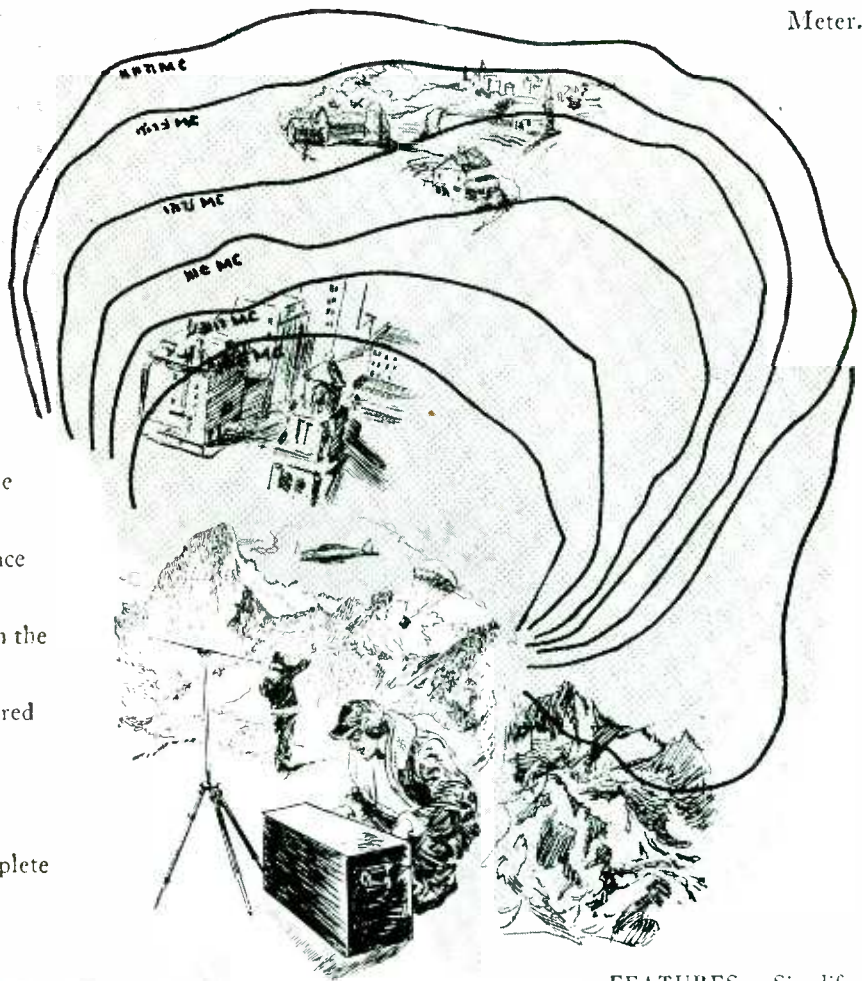
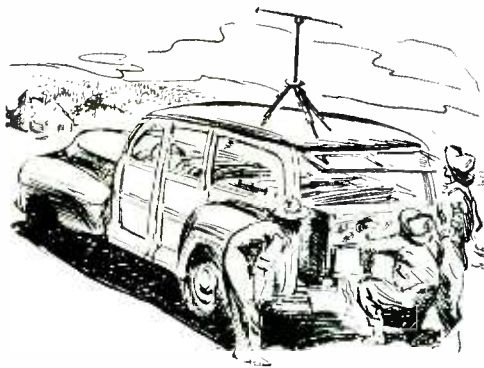

The single band, wide range R.F. Unit offers noiseless tuning from 88 MC to 400 MC. This is made possible by the use of "Butterfly" circuit elements which vary capacitance and inductance simultaneously without the use of sliding contacts. By means of compensator controls on the R.F. and mixer "Butterfly" circuit elements, maximum resonance and sensitivity are assured over the entire frequency range. It is ruggedly constructed and suitably protected to meet the rigid requirements for Laboratory and Field Service. Write for complete specifications and technical data.



## MODEL NMA-5

**FEATURES:** Simplified calibration control. External outlet for recording. Dipole antenna tunable over entire range. Power source 110 Volts A.C., 60 Cycles. Rotary converter for 12- or 24-Volt storage battery operation. Sensitivity — 5 MV to 100,000 MV per meter.

## STODDART AIRCRAFT RADIO CO.

GENERAL OFFICE AND FACTORY • HILLSIDE 9294

6644 Santa Monica Boulevard • Hollywood 38, California

2-159 G.M. Bldg.	2718 Grand Central Terminal Bldg.	110 W. Broadway
Detroit 2, Mich.	New York 17, N.Y.	Glendale 4, Calif.
TRinity 1-9260	MURray Hill 4-2558	CItrus 1-0871

## Can this NEW Thermal Relay fit your needs?

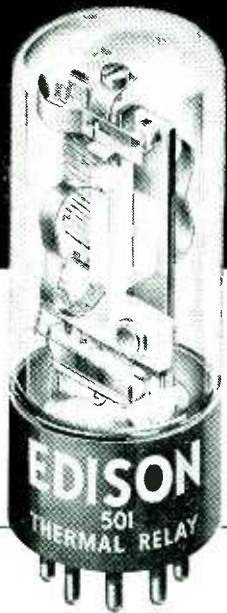

### OPERATING CHARACTERISTICS:

#### CONTACT RATING

6 amps. at 450 volts AC or DC (maximum).

#### HEATER INPUT

5 watts nominal continuous excitation at up to 150 volts AC/DC.

#### DELAY PERIOD

5 seconds to 8 minutes, preset at factory.

#### CONTACTS

s.p.s.t.; normally open or normally closed.

#### DIMENSIONS

1¼" diameter x 3¼" height (seated).

#### AMBIENT RANGE

compensated for operation from -65° C to +100° C.

#### WEIGHT

0.08 lb.

#### MOUNTING

Standard octal or 4-pronged tube base.

**E**NGINEERS are finding many new applications for this versatile new relay—to simplify and improve control circuits of many types.

Timing, such as delaying plate current application to thermionic tubes, is only one of its uses. In addition, it indicates or controls over- or under-current or voltage. It carries heavy AC or DC loads; it prevents chatter when actuated by delicate controls. Its insensitivity to transients stems from heat storage, hence it can be used as an energy integrator. It can do dozens of jobs better, at lower cost, than other types of relays.

### Operating Principle and Advantages

**THE EDISON MODEL 501** Thermal Relay operates its contacts by an electrical heater, rather than a magnetic coil. This principle results in unusual timing characteristics, insensitivity to transients, non-inductive loading, AC/DC operation, simple construction.

The design of the Edison Model 501 adds other advantages. The entire mechanism is hermetically sealed in glass, which protects all parts from dust, dirt, corrosion; guarantees consistent operation and long, useful life; makes operation independent of atmospheric pressure or humidity. The contacts operate noiselessly in an arc-quenching atmosphere, therefore have equal AC/DC current ratings. A compensating bimetal assures uniform response time regardless of the ambient temperature. The relay will operate in any position. Both thermodynamic and mechanical design assure consistent operation,

and permit a wide range of characteristics.

**ARE THESE PROPERTIES** useful to you? Edison Engineers may be able to help in applying the Model 501 Thermal Relay, the Sensitive Magnetic Relay, Sealed Thermostats, or other specialized Edison controls to your problem. A letter giving as much data as possible on your proposed use will receive prompt attention. Address Instrument Division, Thomas A. Edison, Incorporated, 11 Lakeside Avenue, West Orange, New Jersey.

AN

# EDISON

CONTROL

which are shown by flashes of the lamp to contain a defective area are marked for further inspection, and the remainder passed as satisfactory.

A second inspection of the marked tubes is then made, using the strip-chart recorder and the probe puller synchronized so as to draw the probe through the tube at a standard rate of speed. A permanent record is thus obtained of the internal condition of each suspected tube, in which each defect is not only shown graphically but is located along the tube. The record of a faulty tube consists of a series of deflections from a central line (at which the pen is originally set by testing a tube known to be in good condition) and the magnitude of each deflection is proportional to the extent of the particular defect.

• • •

### Electronics In Medicine

**MEDICAL LABORATORIES** are now able to eliminate manual difficulties and human errors in taking and recording temperatures of animals employed for pyrogen testing through the use of a recently developed electronic three-point testing assembly. It consists of an unbreakable stainless steel thermometer, an electronic precision indicator that permits the taking of temperatures of 48 animals at one time in a matter of seconds, and an electronic recorder that provides permanent records for the government and distributors.

A pyrogen test, prescribed by law, is the taking of animal temperature before and after the animals receive an injection of a drug eventually intended for the relief of human illness and suffering. The purpose of the test is to determine the quality of the drug and whether or to what degree the drug will create a fever or cause unfavorable reactions when administered. The new testing equipment, developed by Brown Instrument Company of Philadelphia, assures production of more perfect drugs and provides the Food and Drug Administration with a permanent and electronically produced record. Although the pyrogen testing equipment is now being used only for the taking of animal temperatures, it is believed the new development may find use in hospitals for taking temperatures of the sick.

# Want to Lift the Lid on OUR Top Secret?

UNKNOWN but to a handful of outsiders, Hunter quietly conceived a Special Apparatus Division two years ago. Boxscore to date: a string of amazing electronic testing devices and highly specialized machines designed and developed for upping the quality and speed of our Spring Division.

Most recent prodigy of our S.A. Division is a spring-forming machine (see below and left) controlled by an electronic brain. While one end swallows wire by the mile the other disgorges finished parts 300% faster than they were ever made before, performing 7 interlocked and sequenced functions.

Reward for our new division: separate quarters, more equipment, more people. The future: bright.

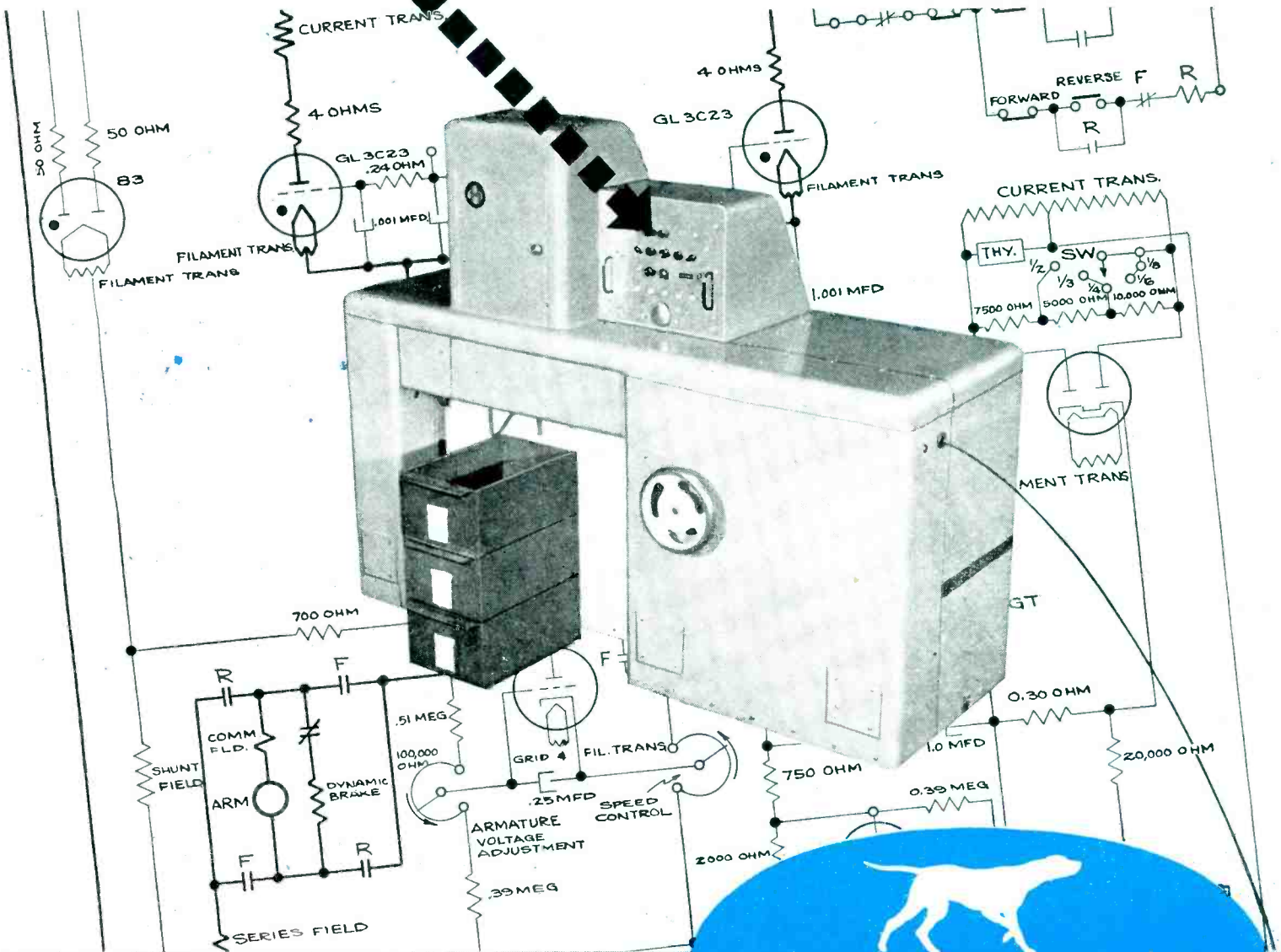
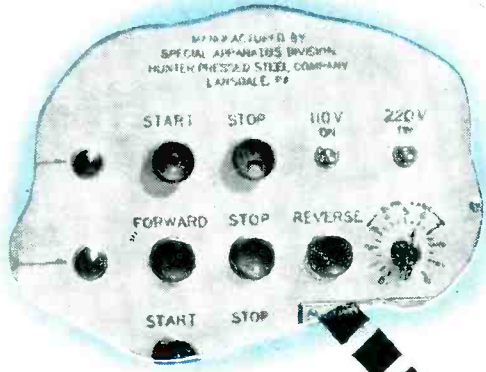

HUNTER PRESSED STEEL COMPANY, LANSDALE, PENNA.

Springs, Metal Stampings, Wire Forms, Mechanical and Electrical Assemblies.



## a rigid steel plate is the foundation of a GOOD RHEOSTAT

The first Ward Leonard Rheostats were built with a steel plate foundation. Its rigidity protected the insulating enamels, proved an excellent dissipater of heat and gave a substantial foundation for contacts, terminals and control members. Many of those early Rheostats are in active service today.

While the present day Ward Leonard Plate Type Rheostats have been modernized, made even smoother in action and offer many more steps of control in smaller diameters, they are still built on a rigid steel plate foundation.



*With the wide range of types and sizes of Ward Leonard Rheostats, you will find the one to meet your requirements — from the smallest electronic to the largest industrial application. Send for Rheostat Bulletins today.*

# WARD LEONARD

## RELAYS • RESISTORS • RHEOSTATS

Electric control  devices since 1892

**WARD LEONARD ELECTRIC COMPANY**  
**32 SOUTH STREET, MOUNT VERNON, N.Y. • OFFICES IN PRINCIPAL CITIES**

For the  
 "WHERE and HOW  
 to use  
 WHAT PLASTIC"

Paper base Grade XX Dilecto part used in electrical equipment as an insulating terminal board . . . a strong, durable laminate with high electrical insulating properties and stability under extremes of temperature and moisture conditions.

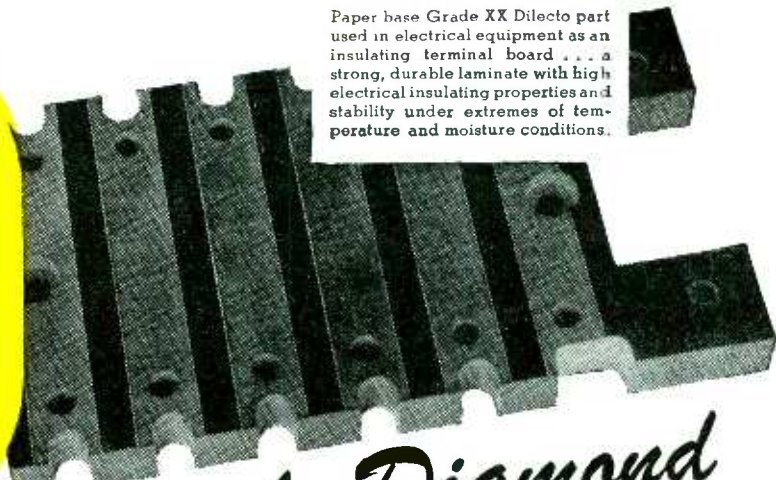

Come to Continental-Diamond

ELECTRICAL AND MECHANICAL PROPERTIES OF DILECTO SHEET GRADES (1). APPROXIMATE AVERAGE VALUES (2).

STANDARD SIZES OF DILECTO SHEETS

Grade	Description	Standard Sheet Sizes		Thickness	Density	Tensile Strength	Elongation	Modulus of Elasticity	Volume Resistance	Surface Resistance	Dielectric Constant	Dielectric Loss	Volume Resistivity	Surface Resistivity	Dielectric Strength	Temperature Range	Notes
		Length	Width														
GF-46	Spotlighting Properties	18"	36"	0.015"	1.40	100,000	2.0	100,000	10 <sup>12</sup>	10 <sup>11</sup>	2.5	0.0005	10 <sup>12</sup>	10 <sup>11</sup>	100	-100 to +200	See Bulletin GF-46
GF-47	Spotlighting Properties	18"	36"	0.015"	1.40	100,000	2.0	100,000	10 <sup>12</sup>	10 <sup>11</sup>	2.5	0.0005	10 <sup>12</sup>	10 <sup>11</sup>	100	-100 to +200	See Bulletin GF-46
GF-48	Spotlighting Properties	18"	36"	0.015"	1.40	100,000	2.0	100,000	10 <sup>12</sup>	10 <sup>11</sup>	2.5	0.0005	10 <sup>12</sup>	10 <sup>11</sup>	100	-100 to +200	See Bulletin GF-46

As shown in New C-D Bulletin GF-46 spotlighting properties of part illustrated.

For help in selecting and applying the non-metallic that will give you what you want in more effective insulation, let a C-D technician work it out with you. Make use of our research and engineering facilities which for half a century have kept up with the rising standards of product performance.

The right time to decide what material to use is while your product is in the planning stage . . . before blueprints and detailed specifications are completed. Save yourself costly errors in production and performance by knowing in advance the non-metallic that best meets your required electrical and physical properties.

As a starter, send for our new Bulletin GF-46 which contains engineering data on the complete line of C-D insulating materials.

SEC-46



C-D PRODUCTS

THE PLASTICS

- DILECTO—Thermosetting Laminates.
- CELORON—A Molded Phenolic.
- DILECTENE—A Pure Resin Plastic Especially Suited to U-H-F Insulation.
- HAVEG—Plastic Chemical Equipment, Pipe, Valves and Fittings.

THE NON-METALLICS

- DIAMOND Vulcanized FIBRE.
- VULCOID—Resin Impregnated Vulcanized Fibre.
- MICABOND—Built-Up Mica Electrical Insulation.

STANDARD & SPECIAL FORMS

Available in Standard Sheets, Rods and Tubes; and Parts Fabricated, Formed or Molded to Specifications.

DESCRIPTIVE LITERATURE

Bulletin GF gives Comprehensive Data on all C-D Products. Individual Catalogs are also available.



BRANCH OFFICES: NEW YORK 17 • CLEVELAND 14 • CHICAGO 11 • SPARTANBURG, S. C. • SALES OFFICES IN PRINCIPAL CITIES  
 WEST COAST REPRESENTATIVES: MARWOOD LTD., SAN FRANCISCO 3 • IN CANADA: DIAMOND STATE FIBRE CO. OF CANADA, LTD., TORONTO 8

**Continental - Diamond** FIBRE COMPANY  
 Established 1895.. Manufacturers of Laminated Plastics since 1911—NEWARK 16 • DELAWARE

# THE ELECTRON ART

Edited by FRANK ROCKETT

Electrical Solution of Thermal Problems . . . . .	190
Meteorology . . . . .	198
Uhf Wave Propagation . . . . .	200
Galactic and Solar Noise . . . . .	200
Rising Sun Magnetron . . . . .	202
Cathode Follower . . . . .	204
Patents . . . . .	206

## Electrical Solution of Thermal Problems

By FRANK GORDON WILLEY

*Project Engineer  
Fairchild Camera and Inst. Corp.  
New York, N. Y.*

CATHODE-RAY OSCILLOGRAPHIC plots of electrical analogies of physical phenomena can sometimes be made more quickly than the actual phenomena can be studied. For example, temperature response of turbine blades of jet power plants had to be determined. Manufacturers chose as a standard of comparison the response of a steel rod immersed in an air stream of definite temperature and velocity. The problem was then

to accurately establish the response of the standard. By using an electrical analogy, the solution was obtained simply and with a great saving of man-hours and tedious calculations. The technique has applications in allied fields.

### Use of Analogies

Thermal, mechanical, and electrical engineering are analogous in many respects. Often a difficult prob-

lem in its own field can be solved expeditiously by setting up and observing its analogue in one of the other fields. For example, in the problem at hand, determination of heat flow and maximum temperature, especially at specific locations inside the solid, by measurement is extremely difficult. Furthermore, transients create additional problems over those of steady state conditions. In particular it was essential to know the time lag in the heat transfer to avoid overshooting the required temperature conditions<sup>1</sup>.

To set up an electrical analogue of a thermal system, the analogous quantities shown in Table I are used. A circuit is set up using electrical resistance in place of thermal resistance, capacitance in place of thermal storage capacity, a voltage source

Table I—Analogous Units and Equations

Heat	Electricity
Quantity of heat	Quantity of charge
$q$	$Q$
Rate of heat flow	Rate of current flow
$\frac{dq}{dt}$	$I = \frac{dQ}{dt}$
Temperature	Electromotive force (volts)
$T$	$E$
Thermal conductivity	Electrical conductivity
$K$	$\rho$
Resistance to heat flow	Electrical resistance
$\frac{L}{KA}$	$R = \frac{\rho L}{A}$
Thermal capacity is the product of specific heat ( $S$ ), volume ( $V$ ), and density ( $\rho$ ), and equals the quantity of heat required to raise a given mass one unit of temperature.	Capacitance is the quantity of charge required to raise the potential difference across a capacitor one unit of potential
$SV\rho$	$C$
The temperature difference ( $\Delta T$ ) between two points is the product of the thermal resistance between those points and the heat flowing between them.	Potential difference ( $\Delta E$ ) between two points is the product of the resistance between the two points and the current flowing between them.
$T_1 - T_2 = \frac{L}{KA} \frac{dq}{dt}$	$E_1 - E_2 = IR$
The quantity of heat required to change the temperature of a mass $\Delta T$ degrees, where $\Delta T = T_1 - T_2$ , equals the product of the thermal capacity of the mass and that temperature difference.	The quantity of charge required to change the potential across a capacitor equals the product of the capacitance and that potential difference.
$q = (SV\rho) \Delta T$	$Q = C\Delta E$
Note: In notations dealing with heat, it is established practice to use $\rho$ for density of the body under discussion; in notations dealing with electricity, $\rho$ is conventionally used for unit conductivity. The two uses should not be confused.	



Fig. 1—Rod and cylinder used to illustrate electrical method of solving thermal problems

—either constant, periodic, or transient as required—in place of a temperature source, and current flow for heat flow. Temperature at any point in the circuit is then represented by voltage. The circuit constants may be chosen so that the analogue operates at a slower or faster speed than the prototype, as best suits the convenience of the operator and the measuring instruments. A calculating board using these principles can solve the most difficult problems in a few hours<sup>2</sup>. The technique used for the problem at hand gives results within seconds.

Assume that the rod and cylinder of Fig. 1 are at a constant uniform temperature. The extreme end of the rod is brought to a new constant tem-



The handles of the Speed-Meal pressure cooker are transfer molded. Flash lines are held to an absolute minimum. They are cored all the way through for easy assembly. Plugs in ends of handles are compression molded. The Red-Top pressure release knob is also transfer molded—with a screw-type insert.

Again **HI-EFF** PLASTICS  
ADD SALES APPEAL...

Sound, functional design is the prime requirement of every new product for home use. But smart lines and striking colors are just as important to the housewife. To her, efficiency is often judged by appearance. That's why when Carl Nelson, prominent pressure-cooker engineer, designed the Speed-Meal Pressure Cooker, he chose Hi-Eff Plastic parts for handles and pressure release knob. These modern parts serve a dual purpose, for aside from assuring durability, their clean-cut design adds strong eye appeal to a modern and popular new product.

If planning plastic parts for your new products, investigate HI-EFF quality and reliability. Take advantage of our experience in developing and producing molded parts. Your inquiry will receive expert attention. Taylor Manufacturing Co., 3078 W. Meinecke Ave., Milwaukee 10, Wis.



# TAYLOR OF MILWAUKEE

CUSTOM MOLDERS OF **HI-EFF** PLASTIC AND RUBBER PARTS

# TIME DELAY RELAY

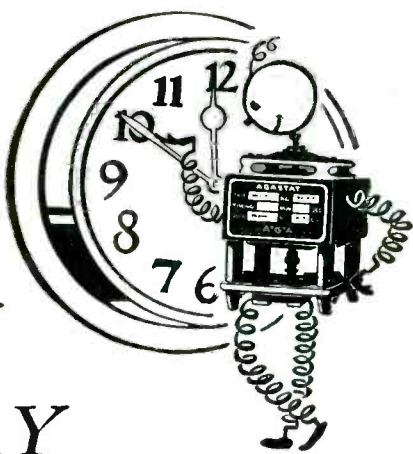

● Timing control for Power machinery... Motors... Generators  
... Radio and Electronic Circuits... Industrial process timing...  
Radio tube preheating... Signalling circuits—and many other  
applications. Time delay adjustable—a fraction of a second  
to several minutes.

*Write for information and literature... No obligation*

## AGASTAT

Electro-Pneumatic *TIME DELAY RELAY*

ELIZABETH **A'G'A** NEW JERSEY  
AMERICAN GAS ACCUMULATOR COMPANY

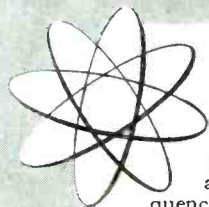

## REGULATED POWER SUPPLY 250-450 VOLTS

Wide fields of application have been opened up both in research and industry for this unit. A-C ripple is negligible and extreme care has been taken to eliminate high-frequency noise. Regulated power supply units are invaluable for such applications as amplifiers, television pulse generators, constant frequency oscillators, and measuring equipment.

Other G-E regulated power-supplies are available in the following ranges: 180-300 volts 160-1500 volts Dual Regulated

Write today: Electronics Department, Specialty Division, General Electric Company, Syracuse 1, N. Y.

*Electronic Measuring Instruments*

**GENERAL  ELECTRIC**  
164-E2

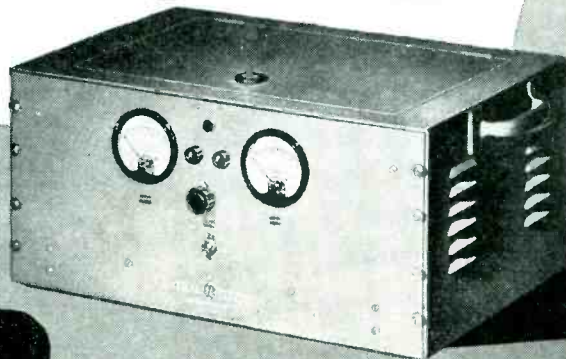

**PS-1**

# American Beauty

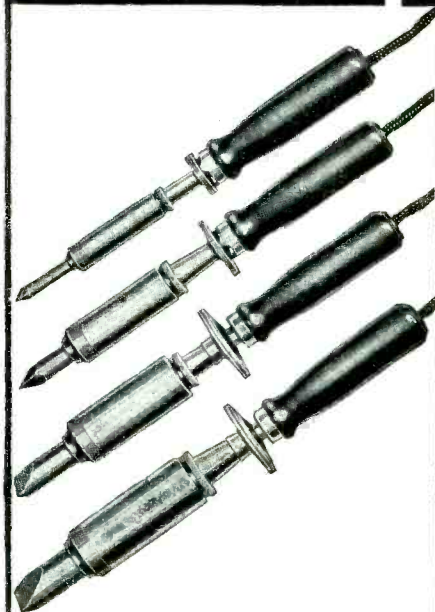

## ELECTRIC SOLDERING IRONS

are sturdily built for the hard usage of industrial service. Have plug type tips and are constructed on the unit system with each vital part, such as heating element, easily removable and replaceable. In 5 sizes, from 50 watts to 550 watts.

## TEMPERATURE REGULATING STAND

This is a thermostatically controlled device for the regulation of the temperature of an electric soldering iron. When placed on and connected to this stand, iron may be maintained at working temperature or through adjustment on bottom of stand at low or warm temperatures.



*For descriptive literature write*

111-1

**AMERICAN ELECTRICAL  
HEATER COMPANY**  
DETROIT 2, MICH., U. S. A.



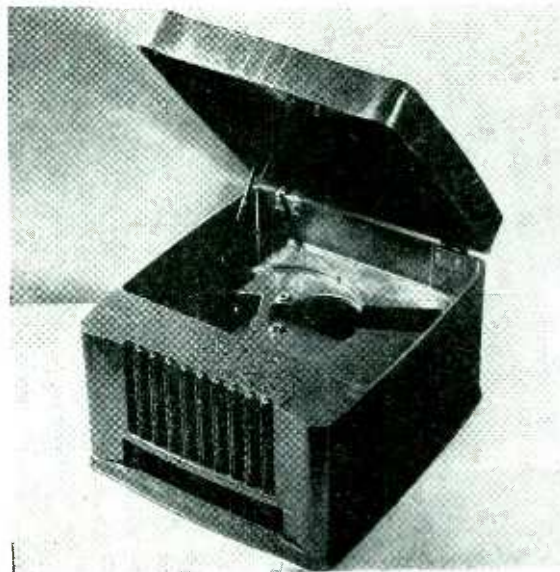

## INTERESTED IN LARGE PLASTIC PIECES ?

Dispelling the time-worn theory that large molded plastic pieces are impractical and uneconomical, these Admiral phonograph and radio-phonograph cabinets effectively demonstrate that large products as well as small can be molded of Durez phenolic plastics.

The bigger cabinet (right) when assembled contains a five-tube radio and automatic record player. The molded Durez body weighs 9½ pounds and the cover 3½ pounds. This makes a total cabinet weight of only 13 pounds.

### Radio Frequency Preheat

Compression-molded in a 400-ton press, the special Durez compound used in this larger unit is preheated by radio frequency. This modern method of production facilitates the

molding operation considerably and results in the strong, attractive cabinet shown.

The smaller unit, Admiral's automatic record player, is also molded of Durez but in a 300-ton press.

### Why Plastics?

The progressive Admiral Corporation experimented and found that for top quality cabinets of this type—having light weight and an integral, lustrous finish, plastics were better suited than any other material.

### Why Phenolic Plastics?

The excellent moldability, impact strength, eye-appealing finish, and the non-resonance of phenolic plastics proved the decisive factors in the choice of these most-versatile-of-all-plastics.

### Why Durez Phenolic Plastics?

As specialists in the production of phenolic plastics for the past quarter century, the Durez staff have developed more than 300 multi-proprietary Durez phenolic molding compounds from which to select the plastic that precisely fits the job.

### Write for Free Booklet

"Machining Data on Phenolic Plastics" is an informative manual which covers all the standard machining operations encountered in the average plant. Write for your free copy. No obligation; of course. Durez Plastics & Chemicals, Inc., 88 Walck Road, North Tonawanda, New York. *Expert Agents: Omni Products Corporation 40 East 34th Street, New York 16, N. Y.*



PHENOLIC  
RESINS

MOLDING COMPOUNDS

INDUSTRIAL RESINS

OIL SOLUBLE RESINS

## PLASTICS THAT FIT THE JOB

# there is NO SUBSTITUTE

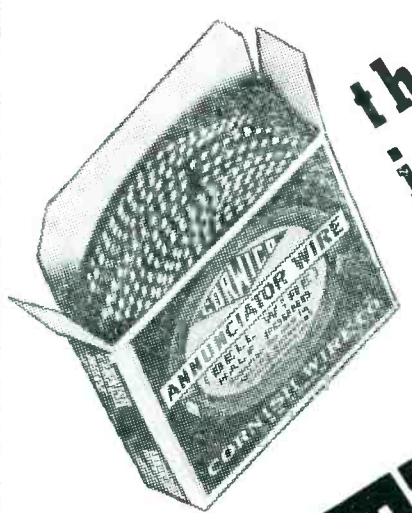

for good, honest WIRE, unwinding itself cross-country, through mighty public buildings and humble cottages, in and out of America's radio sets and legion other communications units. You are getting some CORWICO Wire now . . . and more is on the way . . .

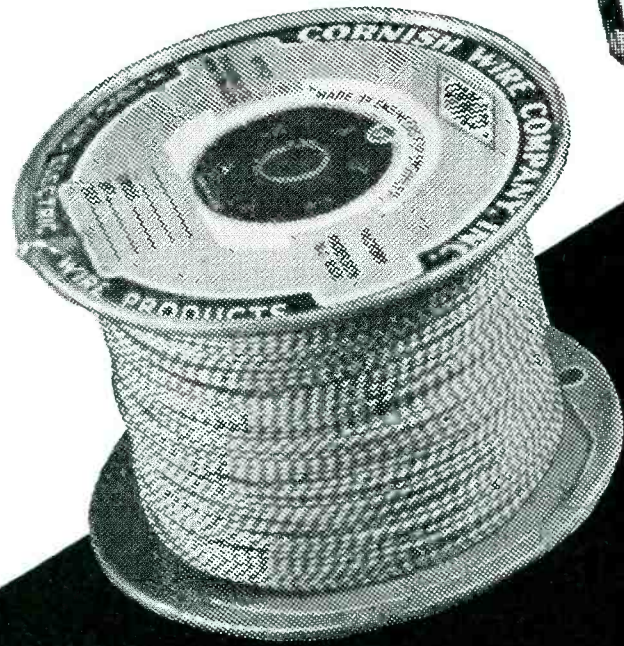
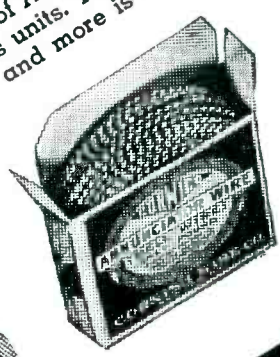

## cornish

WIRE COMPANY, INC.

15 Park Row, New York 7, N. Y.

"Made by Engineers for Engineers"

perature. (A hypothetical "infinite source" of heat is assumed.) The temperature of the large mass is to be determined with respect to time.

Making the simplifying assumptions that the thermal capacity of the rod, the thermal resistivity of the cylinder, and the heat loss from all outside surfaces are all negligible, one sets up the circuit of Fig. 2. The

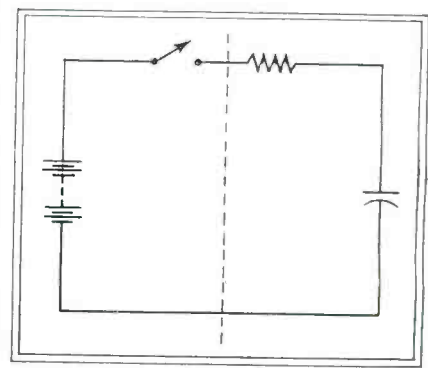

Fig. 2—Equivalent circuit showing electrical (heat) source and resistance-capacitance load (rod and cylinder)

equations for the thermal and the electrical systems are

$$\Delta T = \frac{dq}{dt} \frac{L}{KA} + \frac{q}{SV\rho} \quad (1)$$

$$\Delta E = \frac{dQ}{dt} R + \frac{Q}{C} = IR + \frac{1}{C} \int Idt \quad (2)$$

- where
- $\Delta T$  : suddenly applied temperature difference
  - $L$  : length of rod
  - $A$  : area normal to axial of rod
  - $V$  : volume of cylinder
  - $\Delta E$  : battery voltage

Let  $T$  and  $E$  represent the temperature of the cylinder and the voltage of the capacitor that represents it respectively. The solutions of Eq. 1 and 2 are then

$$\frac{E}{\Delta E} = 1 - e^{-t/RC} \quad (3)$$

$$\frac{T}{\Delta T} = 1 - e^{-t/(L/KA)(SV\rho)} \quad (4)$$

Thus, if  $RC$  is made equal to some value  $N(L/KA)(SV\rho)$ , the two systems are equivalent, except that the corresponding action in the electrical system will occur at  $1/N$  times the speed of the thermal system. The electrical solution, obtained oscillographically in less than a second, and the results of thermal measurements are shown in Fig. 3. Discrepancies between the two curves are due to the simplifying assumptions.

Were the heat flow radially instead

*For the first time...*

**A BASIC VACUUM COATING  
UNIT FOR YOUR \$ 975  
LABORATORY AT**

**D. P. I.** now offers the **LABORATORY VACUUM COATING UNIT**—a small unit ideal for a myriad of experimental purposes, yet inexpensive enough to meet the requirements of modest budgets.

Like the larger units—the Single and Double Vacuum Coaters—this complete unit will deposit metals or metallic salts on glass, other metals, and plastics. It is equipped with a simple indicator to denote pressures in the bell jar. Additional gauges can be used if desired by means of outlets already installed. Within the production limitations of its size, it is capable of any of the jobs performed by the larger units—such as experiments in electronics, surface replicas, dehydration, and other subjects, as your interests may dictate.



The **D. P. I. Manual**—"High-Vacuum Equipment"—now carries all available catalog pages of **D. P. I.** products and is constantly being expanded. Keep informed of the latest developments. Write for your copy.



**Vacuum Equipment Division  
DISTILLATION PRODUCTS, INC.  
Rochester 13, New York**

# COILS and TRANSFORMERS by Gramer

## GRACOIL

"One Good Turn - or a Million"

Choose wisely when you select coils and transformers and your product will be more efficient, less costly, more saleable. Write to Gramer—arrange for a production sample. Get prompt quotations and quantities shipped in accordance with present-day delivery schedules.



FULLY ENCLOSED TRANSFORMER

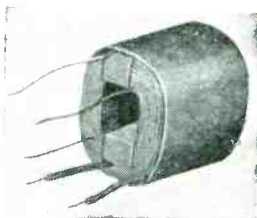

LAYER WOUND COIL



MAGNET COIL

Just off the press—write for NEW CIRCULAR on Coils and Transformers

## THE GRAMER COMPANY

Electrical Coils and Transformers

2736 N. PULASKI RD.

CHICAGO 39, ILL.

U. S. A.

# ZOPHAR

## Waxes, Compounds and Emulsions



Materials for potting, dipping or impregnating all types of radio components or all kinds of electrical units. • Tropicalized fungus proofing waxes. • Waterproofing finishes for wire jackets. • Rubber finishes. • Inquiries and problems invited by our engineering and development laboratories.

Zophar Mills, Inc. has been known for its dependable service and uniformity of product since 1846.

## ZOPHAR MILLS, Inc.

ESTABLISHED 1846

117 26th STREET, BROOKLYN, 32 N. Y.

# Tracing cloth that defies time

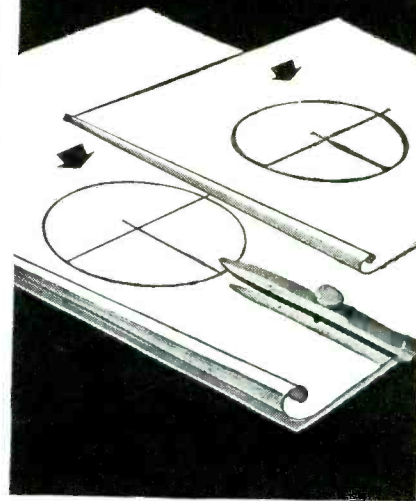

• The renown of Imperial as the finest in Tracing Cloth goes back well over half a century. Draftsmen all over the world prefer it for the uniformity of its high transparency and ink-taking surface and the superb quality of its cloth foundation.

Imperial takes erasures readily, without damage. It gives sharp contrasting prints of even the finest lines. Drawings made on Imperial over fifty years ago are still as good as ever, neither brittle nor opaque.

If you like a duller surface, for clear, hard pencil lines, try Imperial Pencil Tracing Cloth. It is good for ink as well.



## IMPERIAL TRACING CLOTH



SOLD BY LEADING STATIONERY AND DRAWING MATERIAL DEALERS EVERYWHERE

# R.C.P.

first in world sales\* . . .



MODEL 668 VACUUM TUBE VOLT, OHM, CAPACITIMETER

\*Radio City Products has built and sold more vacuum tube voltmeters than any other manufacturer in the world.

**VACUUM TUBE AC AND VACUUM TUBE DC voltmeters** provided in this quality test unit. A highly accurate instrument, sensitive and flexible, designed to speed production and laboratory test work.

★ **DC VACUUM-TUBE VOLTMETER**—Direct Reading Sensitivity: 160 to 16 megohms. Six ranges: 0-6-30-150-600-1500-6000 Volts. Voltmeter readings can be taken without affecting circuit contents.

★ **AC VACUUM-TUBE VOLTMETER**—Direct Reading. Input capacity 0.00005 mfd. at terminals of instrument. Input resistance: 160 to 16 megohms. Seven ranges 0-3-6-30-150-600-1500-6000 volts. Measures signal and output voltages from 10 cps to 10,000 cps.

★ **VACUUM TUBE OHMMETER**—Direct reading. From 0.1 ohm to 1,000 megohms. Seven ranges: 0-1,000-10,000-100,000 ohms; 1- 10- 100- 1,000 megohms.

★ **CAPACITY METER**—Accurate measurements from 0.00005 to 2,000 mfd. Seven ranges: 0-0.002-0.02-0.2-20-200-2,000 mfd.

**MODEL 668.** Size 9 $\frac{3}{4}$ " x 9 $\frac{1}{4}$ " x 7 $\frac{3}{8}$ ". Weight 7 $\frac{3}{4}$  lbs. Available for 110 volt, 60 cycles a.c.; 210-270 volt, 50-60 cycles.

**ACCURACY**—Adjustable line voltage compensator assures complete accuracy on all capacity readings. Constant accuracy of low resistance ohmmeter ranges assured by test of ohmmeter battery under load to determine need for battery replacement. Accurate capacitometer reads direct in microfarads—40,000,000 to 1 measurement ratio.

**SAFETY**—Meter cannot be damaged by using low range on high voltage reading. No danger of shock on high resistance or low capacity measurements. Entire instrument is thoroughly shielded. Easy replacement of line fuse at front panel.

## RADIO CITY PRODUCTS COMPANY, INC.

127 WEST 26th STREET

NEW YORK CITY 1, N.Y.

MANUFACTURERS OF PRECISION ELECTRONIC  
OHM-MILLIAMMETERS, SIGNAL GENERATORS



LIMIT BRIDGES, VACUUM TUBE VOLTMETERS, VOLT-ANALYZER UNITS, TUBE TESTERS, MULTI-TESTERS.

# THE "4 FOR 1" APPLICATION ADVANTAGE OF Marion Glass-to-Metal Truly Hermetically Sealed 2½" and 3½" Electrical Indicating Instruments

THERMAL PROBLEMS

(continued)

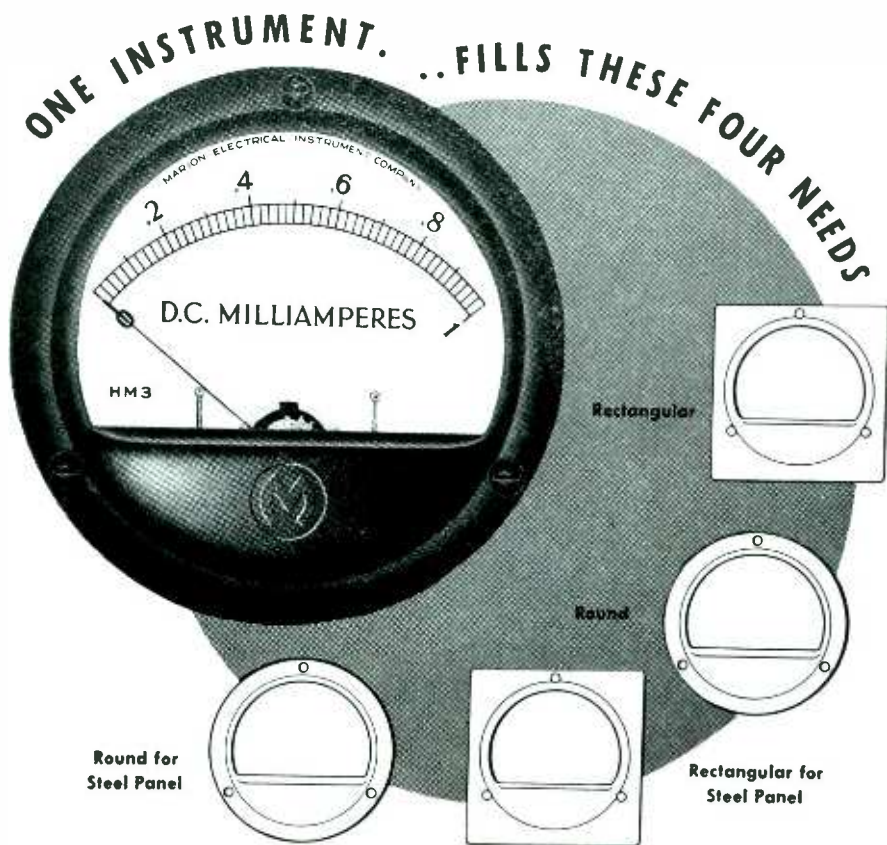

Marion "hermetics" offer new flexibility in application, stocking and sales. Just one instrument, with its appropriate flanges, fills four different requirements . . . the only thing that's necessary is to fit the flange to the need in question. In addition to being truly hermetically sealed, these instruments are magnetically and electrostatically shielded. And are supplied with

## Interchangeable Round and Square Colored Flanges

. . . which are the key to the "4 for 1" Advantage. With these, it is possible to order a minimum number of instruments in the most popular ranges, and apply either the round or square flange according to usage. This feature simplifies ordering and inventory procedures for the manufacturer . . . and stocking and selling for the jobber. Besides black, the flanges are available in 12 iridescent colors — including red, blue, green, gold and silver. The use of color has been found to add to the eye-appeal and, consequently, to the sales value of otherwise drab equipment.

### 100% GUARANTEED

for six months — after that, regardless of condition and provided the seal has not been broken, we will replace any 2½" or 3½" instrument from 200 microamperes upward for \$1.50; and 2½" and 3½" type with sensitivity greater than 200 microamperes for \$2.50.



MARION ELECTRICAL INSTRUMENT CO.

MANCHESTER, NEW HAMPSHIRE

EXPORT DIVISION - 458 BROADWAY - NEW YORK 13, N. Y., U. S. A. - CABLES MOEHEANEX

IN CANADA: THE ASTRAL ELECTRIC COMPANY, SCARBORO BLUFFS, ONTARIO

of axially, it would be necessary to use a tapered network of as many sections as necessary to represent the distributed thermal path by a lumped electrical path.<sup>3</sup> In making the oscillographic observations, the beam can be modulated by a timing signal, and the sweep expanded over regions of rapid change to facilitate accurate measurements.

Many thermal processes are non-linear, but some lend themselves to electrical representation. For exam-

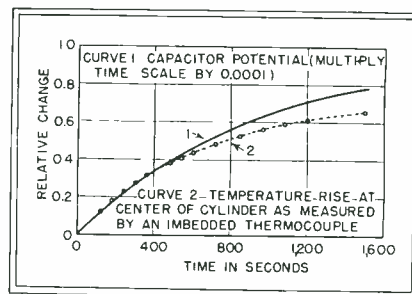

Fig. 3—Comparison of actual and analogous results

ple, radiation of heat varies approximately as the fourth power of the temperature difference<sup>4</sup>: Thyrite resistors approximate this characteristic. Change in specific heat with change of state, heat of fusion, and such characteristics can sometimes be closely represented by switching in extra capacitors using biased diodes or thyratrons arranged to conduct when the proper voltage is reached. More difficult functions can be handled manually if the electrical system operates slowly enough.

#### REFERENCES

- (1) Remarks on On-Off Control in Resistor Type Furnaces by V. Paschakis, *A.S.M.E. paper* No. 44-A-45.
- (2) A Method for Determining Unsteady State Heat Transfer by Means of an Electrical Analogy by V. Paschakis and H. D. Baker, *Trans. A.S.M.E.* Feb. 1942, p 105.
- (3) Radial Heat Flow by Jaeger, *Proc Phys Soc London*, May 1944, p 197.
- (4) Basic Laws and Data of Heat Transmission by W. J. King, *Mech. Engr.*, Mar.-Aug. 1932.

#### Meteorology

SODAR, a technique whereby trains of audio-frequency acoustic waves are launched toward a target and the reflection detected, was used to detect tropospheric discontinuities. Correlation was found between reflection of these waves from temperature inversions and other nonhomogeneities in the lower atmosphere with disturbances of microwave

# 5 POINTS MAKE A STAR

MOISTURE RESISTANCE

DIELECTRIC STRENGTH

CORROSION RESISTANCE

ECONOMY

LONG LIFE



In these cardboard tubular DRY ELECTROLYTIC CAPACITORS manufactured by Solar Manufacturing Corporation, New York, LUMARITH (cellulose acetate) film wraps supply long-life protection against absorption of atmospheric moisture, and at the same time prevents the electrolyte from drying out at elevated temperatures.

Get all 5 advantages  
for your products with

## LUMARITH\* *Cellulose Acetate* FILM INSULATION

Service-wise, production-wise and cost-wise, Lumarith (cellulose acetate) transparent film insulation can solve many of your product planning problems. In resistance to electro-chemical corrosion, it ranks with the most chemically inert dielectrics. The thinnest Lumarith film, laminated to standard insulation paper, will give low cost humidity protection to many types of coils, small motors, etc. with minimum space requirements.

Transparent film is but one of the

forms in which Lumarith is produced. Lumarith is available in sheets, rods, tubes and molding materials as well. Lumarith films can be supplied in crystal-clear transparent or with special (A-78) mat finish, one side. For additional information on this Celanese Plastic, send for booklet entitled, "Celanese Synthetics for the Electrical Industry". Celanese Plastics Corporation, a division of Celanese Corporation of America, 180 Madison Avenue, New York 16, N. Y.

\*Reg. U. S. Pat. Off.

*Celanese\**  
*Plastic*

# SERVICE

STEPPED UP

AT LOWER COST  
FOR ALL AIR EXPRESS SHIPMENTS



**NOW! THE LID IS OFF**  
More Planes, More Flights — For Everybody. Priorities No Longer Needed!

**More Planes** in service, more flights, more space available for all kinds of traffic! Bigger planes, swifter planes, faster air schedules on many runs!

*Every way you figure, Air Express service is stepped up to an all-time high at an all-time low in cost to the shipper.*

**Reduced Rates** (see table) include special pick-up and delivery between airport towns and cities. Rapid air-rail schedules to and from 23,000 other communities in this country.

**Foreign Service** direct by air to and from scores of foreign countries — the world's best service, in the world's best planes.

**Write Today** for the Time and Rate Schedule on Air Express. It contains illuminating facts to help you solve many a shipping problem. Air Express Division, Railway Express Agency, 230 Park Avenue, New York 17. Or ask for it at any Airline or Railway Express office.

RATES CUT 22% SINCE 1943 (U. S. A.)					
AIR MILES	2 lbs.	5 lbs.	25 lbs.	40 lbs.	Over 40 lbs. Cents per lb.
149	\$1.00	\$1.00	\$1.00	\$1.23	3.07c
349	1.02	1.18	2.30	3.68	9.21c
549	1.07	1.42	3.84	6.14	15.35c
1049	1.17	1.98	7.68	12.28	30.70c
2349	1.45	3.53	17.65	28.24	70.61c
Over 2350	1.47	3.68	18.42	29.47	73.68c

INTERNATIONAL RATES ALSO REDUCED

**AIR EXPRESS**  
GETS THERE FIRST

Phone AIR EXPRESS DIVISION, RAILWAY EXPRESS AGENCY  
Representing the AIRLINES of the United States

transmission. Observations and equipment were described at the April meeting of the American Physical Society held in Cambridge, Mass. by G. W. Gilman and F. H. Willis, Bell Telephone Labs. Other papers covered theoretical and experimental behavior of shock waves, and other physical phenomena.

• • •

## Uhf Wave Propagation

RADAR OPERATION on the ultrashort wavelengths is adversely influenced by the ionosphere and by radio noise originating in the sun and other stars. In reviewing and interpreting the available data on these two phenomena, Sir Edward Appleton, lecturing at the March Radiolocation Convention in England, told how transient radio echoes are received from scattering centers, that is, bursts of ionization, at about the level of the E-layer. Trouble was marked on wavelengths of 13 meters and above, but when the wavelength was halved the interference was negligible. This kind of trouble is entirely absent on centimeter waves.

Long-distance scatter, present if the radar frequency in use is reflected by the ionosphere, is due to waves being (1) reflected by the F-layer on their outward journey, (2) scattered back, and (3) reflected again by the F-layer on their inward journey. Frequencies used by British radar sets have generally exceeded the maximum value necessary for penetration, rather than reflection, at the F-layer, and thus this interference has been avoided.

• • •

## Galactic and Solar Noise

Atmospheric noise of tropospheric origin causes practically no interference on frequencies above which ionospheric reflection is ineffective when directional arrays are used. However, at wavelengths that are short enough to penetrate the ionosphere, radiation from the Milky Way and from the sun causes galactic and solar radio noise respectively.

The main source of galactic noise



# TWO GREAT NEW LABORATORY INSTRUMENTS



Full, accurate use of station WWV, the world's finest primary frequency and time standard, is obtained from the Browning Model RH-10 Standard Frequency Calibrator. The standard Browning RH-10 is pre-tuned for 5 and 10 megacycles per second reception, at sensitivities better than  $\frac{1}{2}$  microvolt on either band. A dual filter system provides selection of either the 440 or 4000 cycle modulation of WWV for use as a primary frequency standard.

Checking equipment against station WWV, at accuracies up to one part in five million, the Browning Frequency Calibrator enables compar-

- isons to be made in three general categories:
1. Precision radio frequency standards measurements.
  2. Precision audio frequency standards measurements.
  3. Precision time and pulse standards for physical measurements.

The Browning RH-10 consists of a high  $Q$  antenna transformer, a sharply tuned R-F amplifier, converter, oscillator, two IF stages, detector, selective amplifier output stages and a cathode ray zero beat indicator. Although normally supplied for 5 and 10 megacycles per second operation, any two combinations of 2.5, 5, 10, or 15 megacycles may be had on special order.

WRITE FOR DESCRIPTIVE LITERATURE

## BROWNING MODEL OL-15 OSCILLOSCOPE

Designed for observing phenomena requiring extended range amplifiers and a wide variety of time bases, the Browning Model OL-15 Oscilloscope incorporates improvements that make it useful in numerous applications where ordinary oscilloscopes are inadequate.

For instance, the Browning OL-15 is particularly adaptable to television, radar and facsimile work, as well as with radio-frequency equipment where it is desirable to know actual r.f. waveform composition. The low repetition sweep gives visual observation when recurring phenomena of a few sweeps per second are encountered.

Suitable time base facilities for studying signals with a constant time difference, or those with an inconstant time separation between consecutive phenomena, are provided by the Browning OL-15. In general, the improved design and superior construction of the Browning OL-15 make it a highly flexible instrument for use in all laboratory work, production testing, or research applications.

WRITE FOR DESCRIPTIVE LITERATURE

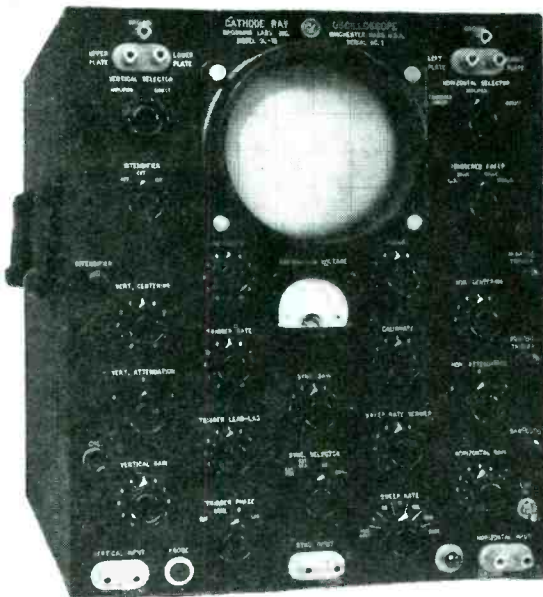

# BROWNING LABORATORIES, INC. WINCHESTER, MASS.

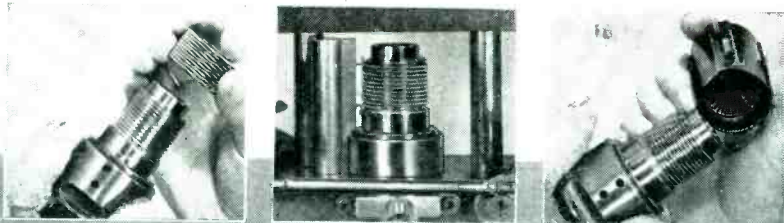

**ONE OF THE REASONS WHY MORE AND MORE GIBBS MICROPOTS ARE SPECIFIED**

The coiled resistance element is threaded on the mould core and made ready for the moulding process.

Core, holding resistance element, ready for mould closure and injection of bakelite. Note side core holding terminals.

Finished potentiometer unscrewed from core—resistance element and terminals are one integral part of housing.



**GIBBS**  
MICROPOT FEATURES

CROSS-SECTION VIEW

**GIBBS MICROPOT**

*The World's Finest*

**PRECISION TEN TURN POTENTIOMETER**

and here are the reasons why!

- 1** Moulding of resistance element as integral part of housing solidly locks every turn of resistance wire in place—No loosening or shifting.
- 2** Precision ground, stainless steel, double thread, lead screw guides the rotating contact, *guarantees* smooth action, low uniform torque and accurate settings—*permanently*.
- 3** Rotor assembly, supported on two bearings, assures long life and low torque.
- 4** The Gibbs 10 turn Micropot has terminals *moulded-in* as integral part of housing.
- 5** Ends of resistance element *soldered* to terminals *before* moulding.
- 6** Anti backlash spring in contact guide—assures you positive setting and resetting.

**7** The 4 1/2" length of resistance element gives you a finer resolution.

**8** The resistance wire used in the element, is processed through diamond finishing dies in our laboratories to insure a constant, uniform resistance over its entire length.

**WRITE TODAY!**

For engineering specifications and numerous recommended applications. Submit any problems to our engineering staff for recommendations. Units for immediate shipment — 1,000 to 30,000 ohm range. Special resistance values made to order.

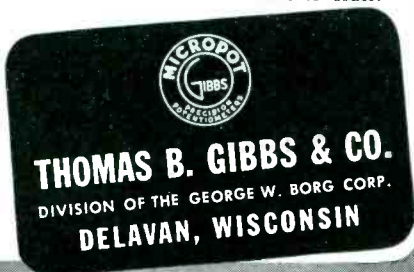

**THOMAS B. GIBBS & CO.**  
DIVISION OF THE GEORGE W. BORG CORP.  
DELAN, WISCONSIN

is in the region of Scorpio-Sagittarius; a second peak is in Cygnus. Experimental measurements have confirmed theoretical predictions based on radiation from interstellar gas that, at wavelengths below 15 meters, noise varies approximately as the square of the wavelength. The galactic noise now being received was generated in the Milky Way long before radio was thought of here!

The sun emits electromagnetic radiation appropriate to its black-body radiation at 6,000 K, although sunspots radiate electromagnetic energy on the meter wavelengths that is greatly in excess of the expected black-body radiation. However, we cannot be sure about the distribution of energy in the solar spectrum because of the low-frequency cutoff of the ionosphere. These and further measurements made possible by technical developments in radar will benefit geophysicists, solar physicists, and astrophysicists.



**Rising Sun Magnetron**

AN ANODE STRUCTURE using alternate large and small cavities has been developed to improve stability of oscillations in a mode other than the plus-minus mode of strapped magnetrons. Cavities are alternately about 1.5 or 2.5 times larger than a cavity that is resonant at the oscillating frequency. As can be seen in the picture, this construction leads to a cavity pattern similar to the rays drawn about



Anode block of rising sun magnetron is about one inch across overall

# 6 Reasons Why

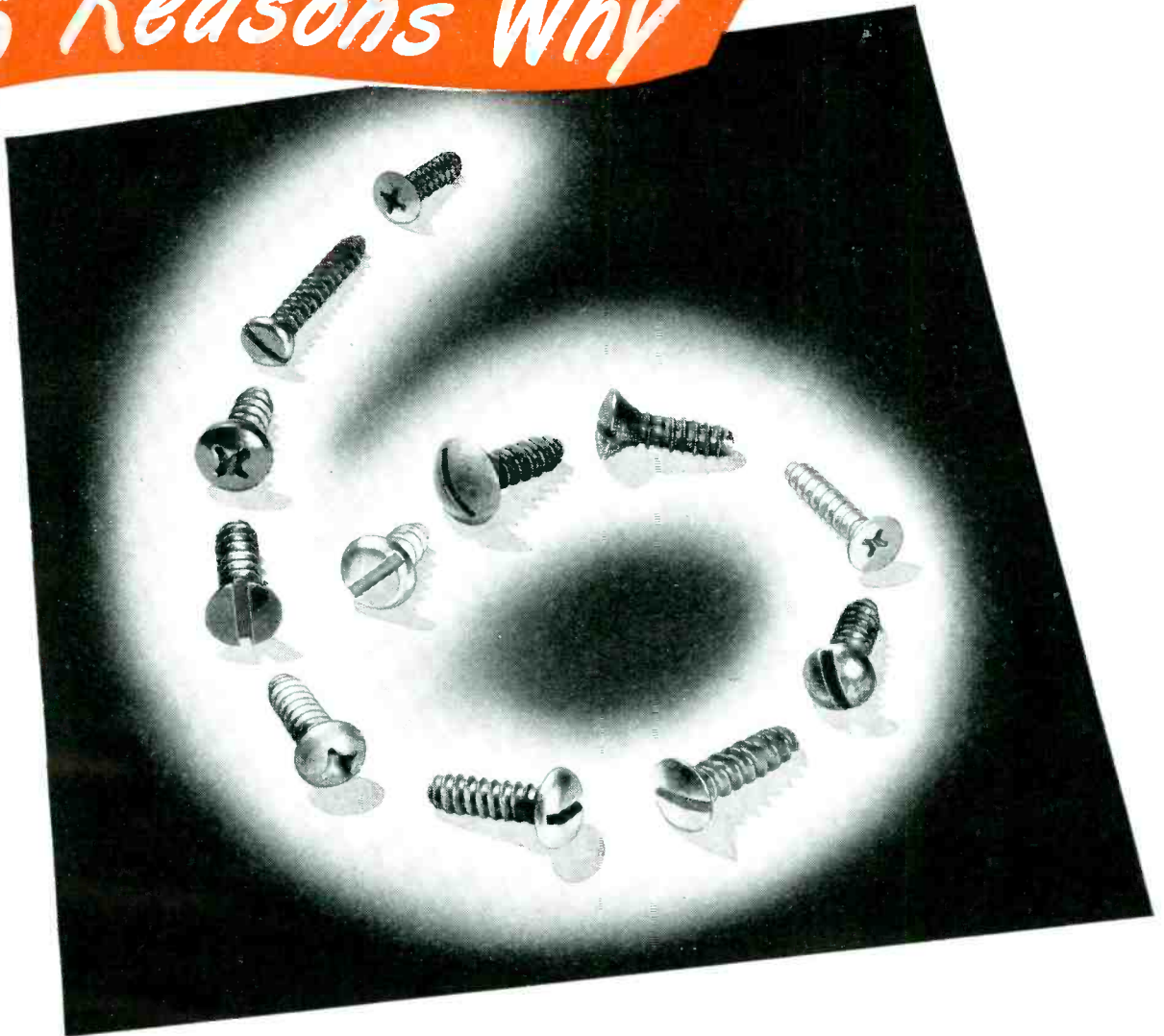

Hardened sheet metal or tapping screws by "NATIONAL" are "TOPS"

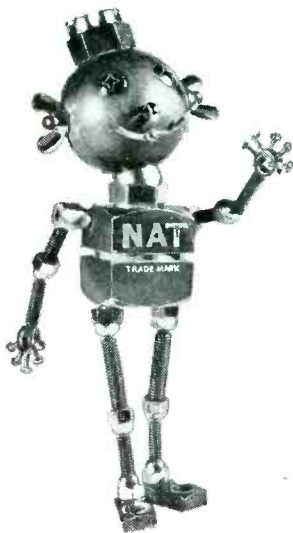

1. Materials are carefully selected and tested.
2. Case hardening is expertly controlled to assure strength without brittleness.
3. Threads are sharp, smooth and hard, accurately dimensioned for driving and holding power. All screws are threaded to the head.
4. Heads are concentric, free from burrs, and with true seating surface on all types.
5. Slot or Phillips Recess is correctly formed and well-centered, and dimensioned for ample driving torque.
6. Points are properly shaped—equally important on both gimlet and blunt point styles.

"National" Hardened Sheet Metal or Tapping Screws, Types A and B (formerly known as Type Z), are furnished in regular stock sizes: Round Head, Binding Head, Stove or Low Round Head, Oval and Flat Head.

We will gladly furnish information on types and sizes of screws to be used with various metals and metal thicknesses and for specific applications.

*National*  
HEADED AND THREADED  
PRODUCTS

THE NATIONAL SCREW & MFG. CO., CLEVELAND 4, O.

# NEW DI-FAN RECEIVING ANTENNA



...covers ALL television and FM frequencies

THE Andrew Co., pioneer specialist in the manufacture of a complete line of antenna equipment, continues its forward pace with the introduction of this new DI-FAN receiving antenna.

The DI-FAN antenna provides excellent reception on all television and FM channels. It thus supersedes ordinary dipole antennas or dipole-reflector arrays which work well over only one or two television channels.

In addition, the following advanced features will recommend the DI-FAN to dealers and receiver manufacturers who want the best possible antenna for use with their FM and TV receivers:

- Impedance of DI-FAN matched to impedance of transmission line, preventing ghost images.
- Designed for use with 300 ohm transmission lines, conforming to RMA standards for FM and TV receivers.
- DI-FAN has a graceful, attractive shape—looks well on any building.
- Light in weight but strong and durable. High strength aluminum alloy elements. Supporting members of heavily plated steel.
- All insulators are high grade glazed steatite.
- Mounting supports available for either chimney or roof installations.

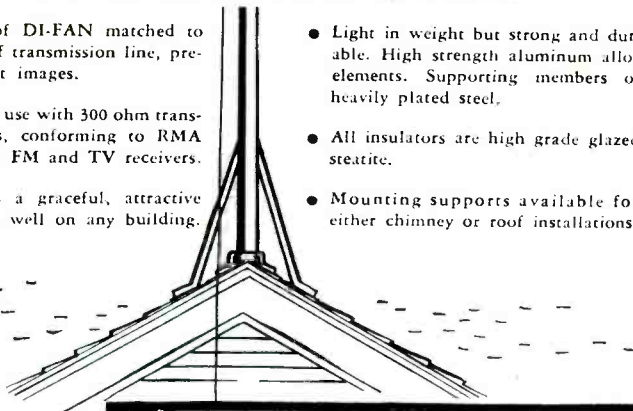

**ANDREW**  
**CO.**  
363 E. 75th St.  
Chicago 19, Ill.

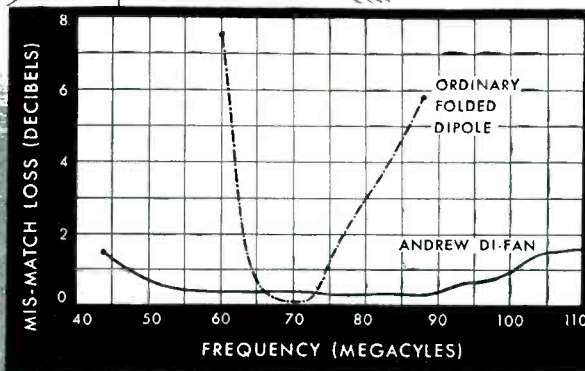

This graph illustrates the superiority of the Andrew DI-FAN over an ordinary folded dipole.

the rising sun. At 3 cm, one megawatt is obtained at an output efficiency of 45 percent from such a magnetron for pulsed operation at 35 kv and 6,500 gauss. The illustration shows the anode structure and output waveguide of the one centimeter rising sun magnetron developed at Columbia University Radiation Laboratory.

• • •

## Cathode Follower

CATHODE FOLLOWERS can be used to provide large undistorted output power for small receivers. Because of their negative feedback, the output from a tube for a given percent distortion can be increased by a factor of two to three if 100 percent negative feedback is used. Large input voltage is required, and optimum load impedance is changed, but only slightly. Under these conditions the practical limits to output are (1) grid current on positive half of cycle, and (2) plate current cutoff on negative half of input cycle.

When the plate is run directly to high voltage, pentodes and tetrodes

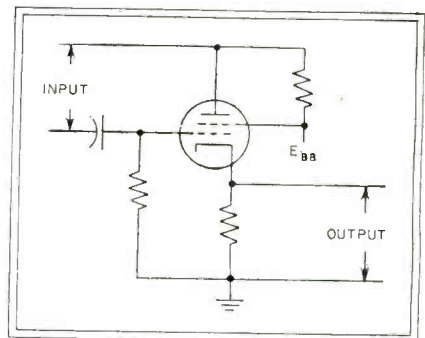

Circuit for obtaining 100 percent negative feedback without losing power sensitivity of tetrode as a cathode follower

act as triodes. However, with the circuit shown herein the power sensitivity of these tubes can be retained and 100-percent negative feedback retained. Because cathode-follower gain (always less than unity) changes little with load impedance, the circuit is advantageous in driving such loads as loudspeakers.

Shunting the cathode resistor with a capacitor gives an infinite-impedance detector where needed. However, it should be remembered that

**PRECISION MEASUREMENTS IN  
MICROWAVE FREQUENCY BANDS . . .  
PROVIDED BY THE NEW**

# Sperry *Microline*\*

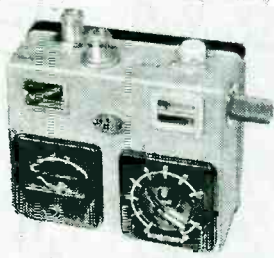

122—DETECTOR WAVEMETER

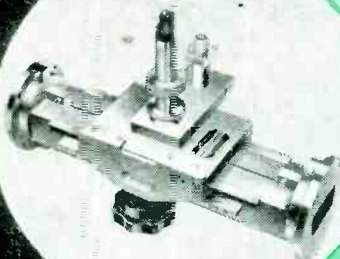

103—PRECISION IMPEDANCE METER



34A—TRIPLE STUB TRANSFORMER



123—WATTMETER BRIDGE

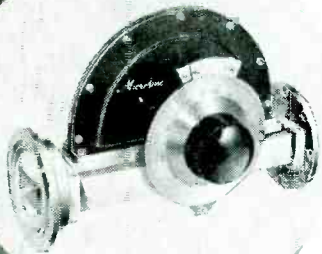

102—SPIRAL CARD ATTENUATOR

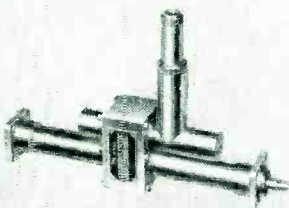

730—DIRECTIONAL COUPLER

Adequate microwave test and measurement equipment is of vital importance both in laboratory and field. Sperry provides it in its comprehensive MICROLINE. Virtually every type of instrument, essential to precision microwave measurements, is represented in this new Sperry line. The instruments shown in the illustrations but partly suggest the wide range of Sperry Microline instruments, among which are included many new designs and developments for obtaining quick, accurate measurements in the microwave frequency bands. For more complete information regarding these Sperry instruments, and their applications to your individual problems and requirements, write our Special Electronics Department.

\*Trade Mark



## Sperry Gyroscope Company, Inc.

EXECUTIVE OFFICES: GREAT NECK, N.Y. • DIVISION OF THE SPERRY CORPORATION  
LOS ANGELES • SAN FRANCISCO • SEATTLE • NEW ORLEANS • CLEVELAND • HONOLULU  
**Aircraft:** Gyropilots • Gyrosyn Compasses • Altitude Gyros • Directional Gyros • Gyro-Horizons • Detonation Indicators • Automatic Radio Direction Finders • Instrument Landing Systems • Traffic Control Systems • **Marine:** Gyro-Compasses • Gyro-Pilots • Gyro-Magnetic Compasses • Incandescent Searchlights Steering Systems • Radar • Loran • **Industrial:** Railroad Radio • Microwave Relays  
Microline-Test Equipment • Klystron Tubes • Strobodone • Knockometer

**ULTRA MODERN DESIGN**

**cuts feedback to the minimum**



## THE TURNER 34X

### Semi-Directional Crystal Microphone

Here's functional styling that serves both beauty and performance. The ultra modern design of the Turner 34X combined with Turner precision engineering results in a semi-directional unit with remarkably low feedback characteristics. Equipped with a high quality crystal, its response is smooth and even with a variation of only  $\pm 5$ DB from 30 to 10,000 cycles. Ideal for both voice or music pickups, the Turner 34X is a perfect mate for your quality recording, call system, and P.A. equipment. Ask your dealer or write for complete details.

**THE TURNER COMPANY**

905 17th Street, N.E., Cedar Rapids, Iowa

#### SPECIFICATIONS

- Moisture proofed crystal
- Blast and mechanical shock proofed
- Automatic barometric compensator
- Turner precision diaphragm
- 90° tilting head
- 20 ft. removable cable set
- Chrome finish
- Level -52DB (1 volt/dyne/sq. cm.)
- Response 30-10,000 cycles within  $\pm 5$ DB
- High impedance output

there is always such a capacitance present because of strays and therefore at high frequencies a cathode follower will act as such a detector whether it is intended to or not. Because of this detection action, the cathode follower can introduce much distortion to television signals. (The Cathode Follower, *Wireless World*, Nov. 1945, p 322; Negative Feedback, *Wireless World*, March 1946, p 76; and Cathode-Follower Dangers by W. T. Cocking, *Wireless World*, Mar. 1946, p 79.)

• • •

#### Patents

TONE AND VOLUME control combination accentuates low frequencies as volume is increased (U. S. Patent 2,377,121, General Electric Co.) A square-law detector is obtained by electrostatically driving a dielectric plate in mechanical vibration responsive to the square of the driving signal amplitude. Electrical potential proportional to the mechanical vibration is developed across the axis perpendicular to these vibrations (U. S. Patent 2,387,472, Radio Corp. of America). By loading the tuned circuit of a receiver with a diode whose conductivity is controlled by the automatic volume control action, a combined volume and selectivity control is produced (U. S. Patent 2,388,590, Radio Corp of America).

MAGNETRONS can be amplitude modulated by changing the angle between the cathode axis and magnetic field. In general, the maximum amplitude of high frequency oscillation will be obtained with the magnetic field slightly out of line with the cathode. If the magnetic field is further rotated, as described by Waldemar Ilberg of Berlin, Germany in U. S. patent 2,142,192 issued Jan. 2, 1939, the amplitude of the high frequency oscillation of the magnetron will decrease rapidly. The technique lacks the disadvantages of amplitude modulating magnetrons by changing their anode potential with simultaneous frequency modulation, and of varying the magnetic field strength which requires controlling high current through a reactive load.

**TURN TO TURNER FOR THE FINEST IN ELECTRONIC EQUIPMENT**

Licensed under patents of the Brush Development Company

COMPONENTS FOR

# FM and

# TV

FREQUENCIES

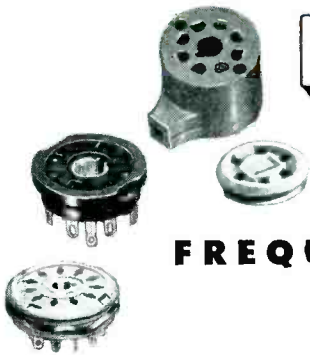

Now that the emphasis in communications is turning more and more toward the FM and Television frequencies, there is a great demand for quality components made to increasingly critical specifications. Amphenol products have kept abreast of developments and are available now—in quantity—to manufacturers of equipment operating in these frequencies and to amateurs.

In addition to the long line of standard parts, Amphenol engineers announce the following new products particularly adaptable to FM and Television:

**Radio Frequency Cable and Connectors** and a new line of low-capacitance microphone cables. Also, new cables especially developed for Television color cameras and for Facsimile work.

**Hi-Q Tube Sockets.** Standard, miniature and sub-miniature. Also new sockets for cathode ray viewing tubes and similar applications.

**Twin-Lead.** This Amphenol-developed parallel transmission line is widely used as antenna lead-in and, in addition, has become standard for built-in folded dipole antenna construction.

**FM Antennas.** New Amphenol designs for standard reception that deliver the greatest gain, particularly in low signal areas. Write for complete information.

**Plastic Components,** in a wide variety, adaptable where this superb dielectric is an integral part of the engineering of critical circuits.

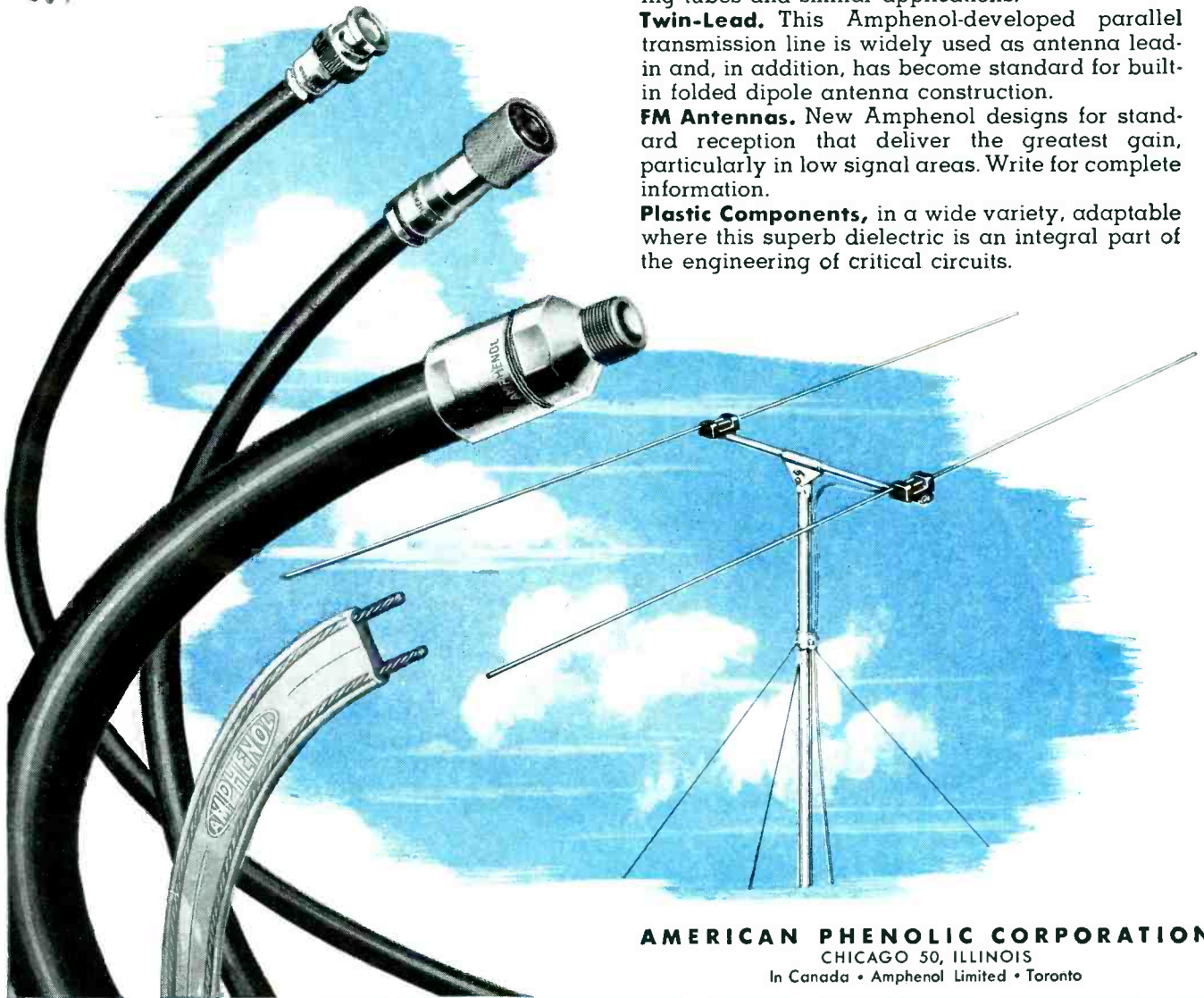

**AMERICAN PHENOLIC CORPORATION**  
CHICAGO 50, ILLINOIS  
In Canada • Amphenol Limited • Toronto

COAXIAL CABLES AND CONNECTORS • INDUSTRIAL CONNECTORS FITTINGS AND CONDUIT • ANTENNAS • RADIO COMPONENTS • PLASTICS FOR ELECTRONICS

# NEW PRODUCTS

Edited By ALEX A. MCKENZIE

**Latest developments in new apparatus, components, materials. New literature**

## High Frequency Voltmeter

HEWLETT-PACKARD Co., Palo Alto, Calif. The model 410A high frequency vacuum-tube voltmeter is convenient for laboratory and production-line use. It measures a-c voltage from 20 cycles to 700 megacycles, d-c voltage at 100 megohms input impedance, and resistance from 0.2 ohms to 500 megohms. For making a-c measurements a special low-capacitance probe is employed which

incorporates a new diode developed by Eimac for this instrument. Input capacitance is only 1.3 micromicrofarads; input resistance is 6 megohms below 10 megacycles, less at higher frequencies owing to dielectric losses. On a-c the meter reads 1 volt full scale to 300 volts full scale in 6 ranges. D-c measurements may be made from 1 volt full scale to 1,000 volts full scale in 7 ranges.



## Miniature Equipment Components

INTERNATIONAL RESISTANCE Co., 401 N. Broad St., Philadelphia 8, Pa. A fingertip-operated four-position rotary switch and a similar variable resistor control are offered to the makers of miniature electronic devices. Construction of the components is such that only the fluted edge of the knob and its identifying position markings need show. Complete specifications are available in Bulletin A-1.

## Amateur Kilowatt

T.W.T. Co., INC., 6127 S. Western Ave., Los Angeles, Calif. The Model 900A transmitter has been designed for maximum input (1,000 watts) on the 10, 15, 20, 40 and 75 meter amateur bands, with phone operation possible at frequencies designated by the FCC. Four tubes, including one 4-250A as power amplifier, are used

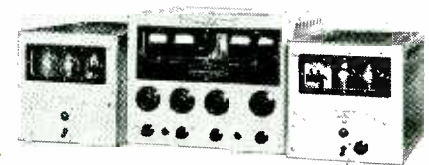

in the radio frequency section. A modulation system featured by the company utilizes three tubes to furnish 100-percent modulation with an audio characteristic within 1 db from 200 to 10,000 cps. Complete equipment including all power supplies, as illustrated, occupies a space  $42 \times 15 \times 21$  inches. The transmitter can be operated on either 110 or 220 volts, 50 to 60 cps.

## Laboratory Oscilloscope

BROWNING LABORATORIES, INC., Winchester, Mass. The model OL-15 cathode-ray oscilloscope has been designed for observation of wave forms and transients requiring a variety of time bases, triggers, phasing and delay circuits, and extended range amplifiers. The sawtooth sweep with a range of 5 cps to 500 kc permits observation of radio frequency wave



*To avoid damage  
from Oxidation . . .*

# protect with **NITROGEN**

LINDE Nitrogen provides an ideal means of protection against oxidation and corrosion by air. For packaging dehydrated foods; for deaerating, processing, storing and packaging fats and oils of all kinds; or for providing an inert atmosphere, free of impurities, for the complete protection of practically any material susceptible to oxidation, use LINDE Nitrogen.

LINDE Nitrogen is 99.7% pure, but is also available bone dry and at higher purity for special applications. It is supplied as a compressed gas in cylinders containing 224 cu. ft. each, or in bulk in tank-truck and tank-car lots as a liquid which is converted into gaseous nitrogen as required. LINDE Nitrogen in bulk offers remarkable savings in cost and eliminates cylinder handling.

*Write or call the Linde office nearest you.*

## **THE LINDE AIR PRODUCTS COMPANY**

*Unit of Union Carbide and Carbon Corporation*



30 E. 42nd St., New York 17, N. Y. • **Offices in Other Principal Cities**

The words "Linde" and "Prest-O-Lite" are registered trade-marks.

**HYDROGEN · NITROGEN · OXYGEN**  
**ARGON · HELIUM · KRYPTON · NEON**  
**XENON — Prest-O-Lite ACETYLENE**

### **LINDE has offices in Principal Cities**

#### **Eastern States**

Baltimore, Md.  
Boston, Mass.  
Buffalo, N. Y.  
Charleston, W. Va.  
New York, N. Y.  
Philadelphia, Pa.  
Pittsburgh, Pa.

#### **Central States**

Chicago, Ill.  
Cincinnati, Ohio  
Cleveland, Ohio  
Detroit, Mich.  
Indianapolis, Ind.  
Milwaukee, Wis.  
Minneapolis, Minn.  
St. Louis, Mo.

#### **Southern States**

Atlanta, Ga.  
Birmingham, Ala.  
Jacksonville, Fla.  
Memphis, Tenn.  
New Orleans, La.

#### **Southwestern States**

Dallas, Texas  
Denver, Colo.  
Houston, Texas  
Kansas City, Mo.  
Tulsa, Okla.

#### **Western States**

Butte, Mont.  
El Paso, Texas  
Los Angeles, Calif.  
Phoenix, Ariz.  
Portland, Ore.  
Salt Lake City, Utah  
San Francisco, Calif.  
Seattle, Wash.  
Spokane, Wash.



forms on the 5-inch tube face. The horizontal amplifier is flat within 10 percent of the average value from 20 cps to 1 megacycle; the vertical amplifier has an even wider range. A high impedance probe is furnished. The unit is  $15\frac{1}{2} \times 12\frac{1}{2} \times 19\frac{1}{2}$  inches and weighs 80 pounds.

### New Variac

GENERAL RADIO Co., 275 Massachusetts Ave., Cambridge 39, Mass. The familiar Type 200-C Variac has been superseded by the Type V-5 which is lighter and more convenient



to use and service. Rated output for the 115-volt models is 5 amperes with maximum current 7.5 amperes. Voltage output can be varied from 0 to 17 percent above line voltage. The units are available in several models, some for 220-volt operation.

### New Chokes

THE NATIONAL Co., Malden, Mass. The R-100S  $2\frac{1}{2}$  millihenry choke carries 125 milliamperes and has a d-c resistance of 50 ohms; the R-300S carries 300 milliamperes, has an inductance of 1 millihenry and a d-c resistance of 10 ohms. Wound on iso-

lantite forms, the units both measure  $2 \times \frac{1}{2}$  inches.

### Recording Cartridge

UNIVERSAL MICROPHONE Co., Inglewood, Calif. The A132 recording head has been designed for replacement in popular makes of home recorders. Response range is 50 to



5,000 cycles per second. Impedance of the device is 3.2 ohms.

### Sensitive Relay

AUTOMATIC TEMPERATURE CONTROL Co., 34 E. Logan St., Philadelphia 44, Pa. A relay device operating from 110-volt, 60-cps mains is designed for

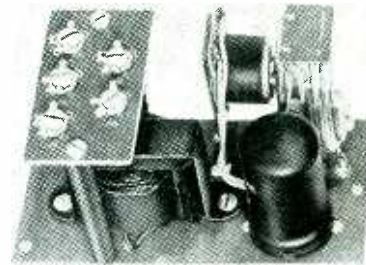

industrial control applications, the initiating impulse for which is of the order of 3 microamperes. The control can be located 100 feet from the actuating source.

### Dual-channel Oscilloscope

ELECTRONIC TUBE CORP., 1200 E. Mermaid Ave., Philadelphia 18, Pa. The E-2G47 dual-channel oscilloscope comprises two separate channels operating into a type 5Z2P1 dual-gun cathode-ray tube. The nominal screen diameter is 5 inches, and can

be supplied with any of the standard phosphors.

The vertical amplifiers for each channel have a uniform frequency response from 2 cycles to 100 kilocycles at any attenuator setting and down 10 percent at 200 kilocycles. The

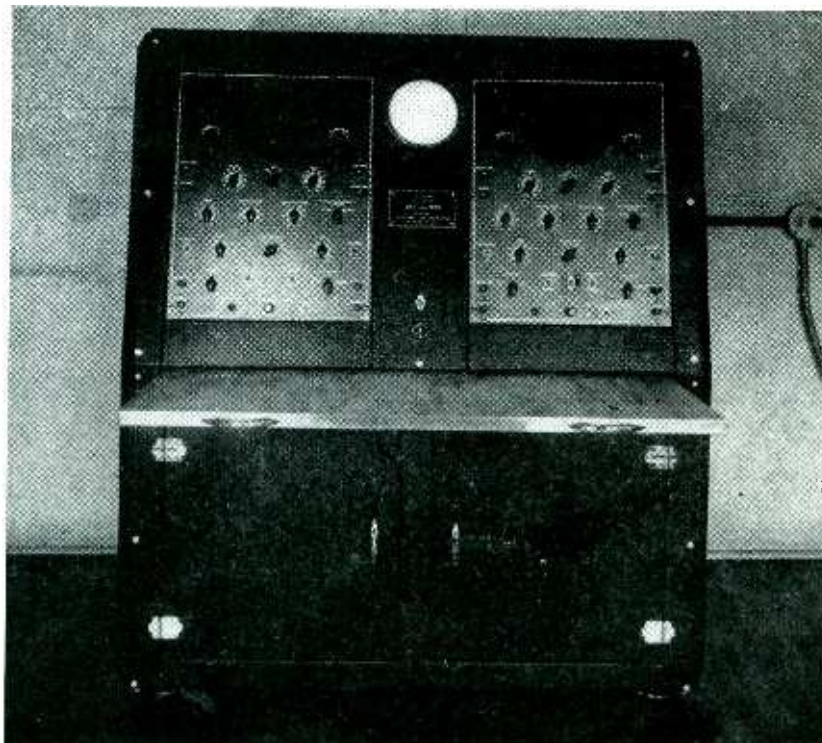

# ELECTRONIC BRAZING

## UNIT with 24 Station INDEXING Work Carrier

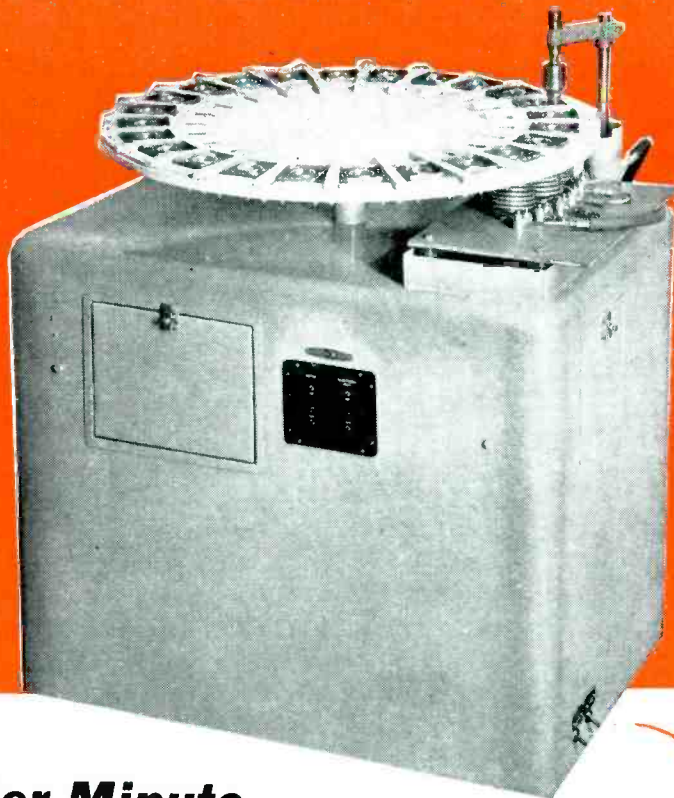

### Delivers 5 Complete Assemblies Per Minute



**H**ERE'S a striking example of how Scientific Electric Engineers increased brazing production output by designing a special automatic machine to operate in conjunction with Electronic heating.

A manufacturer of weather-proof control box covers was already using electronic heat to speed up production in the brazing operation involved. But greater production was urgently needed. Each assembly was being inserted and removed from a single heater coil . . . one at a time.

To increase output Scientific Electric engineers designed this compact circular, 24 station indexing work carrier which operates from the 18 KW electronic generator at the left.

The operator merely loads the stations as they come around empty. Heat is applied by three water-cooled induction coils under three of the work positions. The coils are followed by the vertically operating ejecting mechanism and a complete assembly is ejected from the carrier each 12 seconds.

The carrier, which is operated by a small motor can be applied to any of our electronic generators depending upon the heat input requirements of the work to be handled. Normal output of the unit illustrated is at 200 to 600 kc.

Workpiece output up to 20 per minute can be obtained and carriers, custom tailored to your requirements, can be delivered within 30 days. Send us your requirements today.

Scientific Electric Electronic Heaters are made in these power sizes... and a range of frequencies up to 300 Megacycles depending upon power requirements.

3 KW	18 KW
5 KW	25 KW
7½ KW	40 KW
8 KW	60 KW
10 KW	80 KW
12½ KW	100 KW
15 KW	250 KW

## Scientific Electric

Division of

"S" CORRUGATED QUENCHED GAP COMPANY

119 MONROE ST.



GARFIELD, N. J.

Manufacturers of

Vacuum Tube and Spark Gap Converters Since 1921

horizontal amplifiers have a uniform frequency response from 1 cycle to 30 kilocycles, down 20 percent at 100 kilocycles at full gain, down 30 percent at 100 kilocycles at half gain control setting. The Z amplifiers or grid modulation amplifiers have a uniform frequency response from 1 kilocycle to 0.1 megacycle, down 10 percent at 1 megacycle at any attenuation, down 30 percent at 30 cycles.

Single sweep operation and automatic beam control are provided. Switching means allow independent operation of the sweep and the grid modulation functions or operation of the two channels with common sweep and/or common grid modulation. Provision is made for separate external connection to all 8 deflection plates and the 2 second anodes. These terminals are mounted on a rear panel behind the dual-gun cathode-ray tube and are accessible from the rear of the cabinet.

### Electronic Voltmeter

INSTRUMENT ELECTRONICS, 253-21 Northern Boulevard, Little Neck, L. I., N. Y. The model 45 voltmeter has a range from 0.0005 to 500 volts from 7 cps to 1.6 mc plus 2 percent. Input impedance is represented by 5 megohms and 15 micromicrofarads. The instrument is little affected by line voltage variations between 105 and 125 volts. Price is \$185 fob Little Neck.

### Coaxial Cable Connector

BARKER AND WILLIAMSON, 235 Fairfield Ave., Upper Darby, Pa. The CC-50 connector consists of an aluminum housing to hold a coaxial cable and two steatite insulators with steel



eyebolts to which are fastened the center ends of a doublet antenna. The total assembly weighs only 12 ounces.

### Soil Moisture Meter

INDUSTRIAL INSTRUMENTS, INC., 17 Pollock Ave., Jersey City 5, N. J. The RC-12C soil moisture conductivity bridge measures resistances in the range 0.2 to 2,500,000 ohms. It is battery operated and consists essentially of a 1,000-cps a-c bridge with a magic-eye indicator.

### Cleat-mounted Electrolytic

AEROVOX CORPORATION, New Bedford, Mass. The type PRVC electrolytic capacitor is mechanically designed as a simple replacement for other



types of the same capacitance values. Wire leads are insulated from the metal can. The unit is mounted by removing the screw holding the cleat, passing wires through the mounting hole and replacing the cleat on the under side of the chassis.

### Interference Filter

CORNELL-DUBILIER ELECTRIC CORP., South Plainfield, N. J. The IF-54

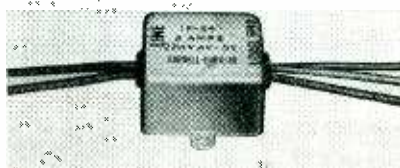

interference filter is a capacitive-inductive type designed to eliminate radio frequency disturbance arising from fluorescent lighting and many kinds of electrical machinery. The unit is rated at 2 amperes for 120 to 200 volts a-c.

### Multicell Speaker

ALTEC LANSING CORP., 250 West 57th St., New York 19, N. Y. The Model 603 Multicell Diacone speaker is the first of a new series of speakers to be sold at a lower price than the Model 604. The speaker has a metal high frequency diaphragm and a low frequency cone coupled by a mechanical dividing network and driven by a single 3-inch voice coil. The high frequency diaphragm operates into a metal horn. Voice coil impedance is 15 ohms and power rating 18 watts. The 15-inch speaker has a horizontal distribution angle of 60 degrees and a vertical distribution angle of 40 degrees.

### Sweep Frequency Transcription

CLARKSTAN CORP., 11927 W. Pico Blvd., Los Angeles, Calif. Used with an oscilloscope, the transcription gives a complete audio-response picture of the equipment under test. The transcription has a frequency range from 100 cps to 10,000 cps with a repetitive rate of 20 cps recorded at constant amplitude below 500 cps and constant velocity above 500 cps. The sweep is logarithmic. There is a synchronizing pulse of 200 microseconds duration at the start of the sweep to lock the oscilloscope. Frequency markers are provided at alternate thousand-cycle points. Fre-

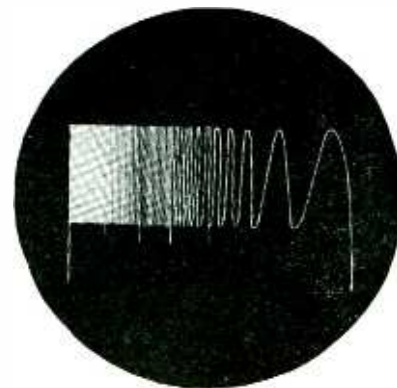

**USE SPRING LOCK WASHERS**

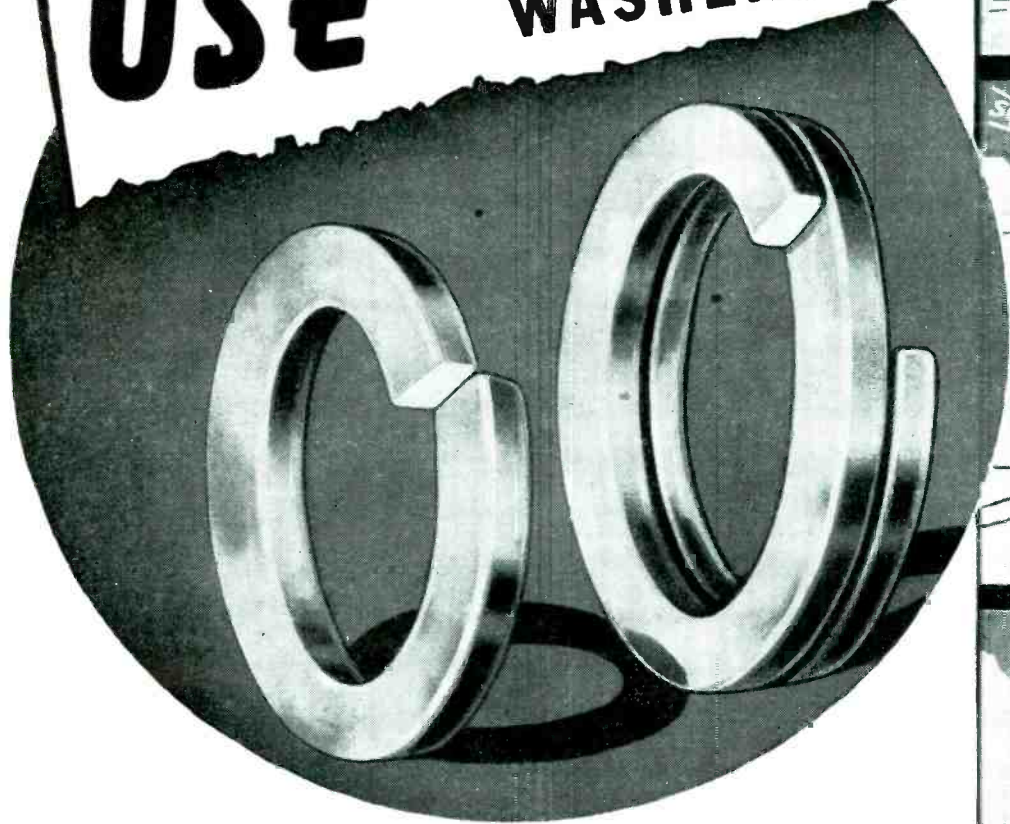

**TO SAFEGUARD AGAINST  
VIBRATION**

Refrigerators . . . washing machines . . . automobiles . . . in every mechanical and electrical device vibration is a constant threat to efficient operation. Vibration caused by stretching of bolt or screw, rusting or corrosion, not only weakens the original spot, but ultimately other parts of the unit as well.

Safeguard your products against unnecessary vibration with spring lock washers on every assembly. The exclusive "Controlled Tension" built into

every Diamond G Lock Washer assures positive, unfailing spring tension under all conditions . . . plus the advantage of a thrust washer bearing.

Diamond G Lock Washers permit the full tightening of bolt and screw with assurance against vibration, shock and excessive wear.

Stop vibration before it starts. Specify Diamond G Lock Washers. Deliveries are quick, prices right, quality unsurpassed. Write for free booklet, and ASA and SAE specifications.

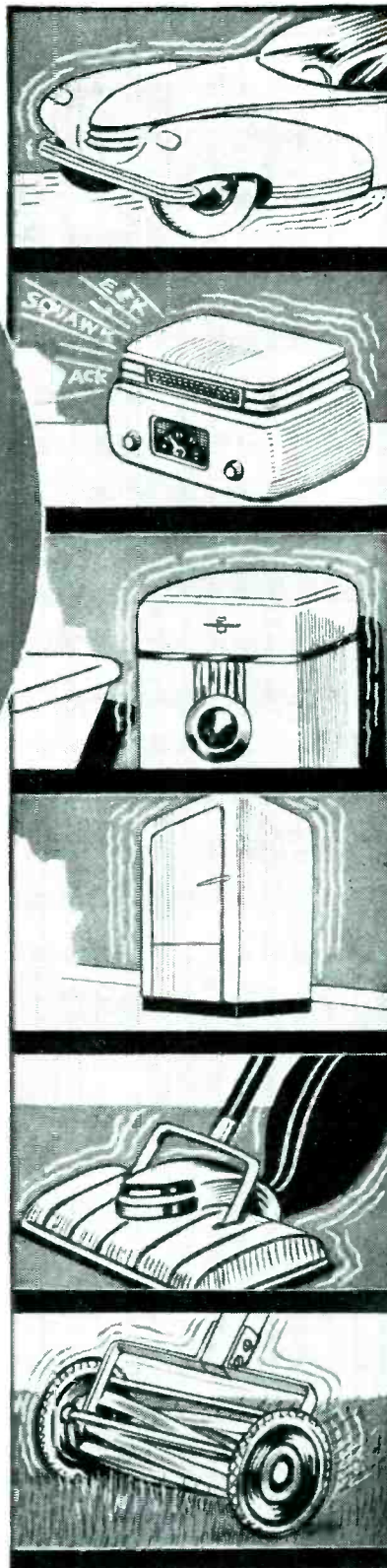

**GEORGE K. GARRETT CO., INC.**

1421 CHESTNUT STREET, PHILADELPHIA 2, PA.

MANUFACTURERS OF



**DIAMOND PRODUCTS**

LOCK WASHERS • FLAT WASHERS • STAMPINGS • SPRINGS • HOSE CLAMPS • SNAP AND RETAINER RINGS



## AN UNCOMMON RIVET



## REPLACES THE COMMON SCREW

... in answer to the age-old cry for a better fastener

**CHERRY** plus **MONEL** equals a new Cherry Blind Rivet for specialized service. *Cherry* means tight, neat blind rivets . . . while *Monel* means resistance to corrosion. This combination of virtues is being applied to the manufacture of stainless steel railway cars, where the Cherry Monel Rivet is being used in several interesting applications.

**CAR FLOORS** are laminated wood on stainless steel. How to fasten wood to steel? Screws have been used, but screws work loose. Riveting is logical, but ordinary riveting requires two men and means difficult access problems. Hence the use of tight, neat Cherry Blind Rivets, installed with an easy, controlled pull from one side of the work.

**LIKEWISE**, Cherry Blind Rivets provide a secure and permanent method for anchoring exterior and interior trim as well as interior sheathing. A unique war-born fastener carves itself another niche by doing the job better and faster.

**THE CHERRY MONEL RIVET** is available in all standard types, head styles, diameters and lengths. Cherry Blind Rivets are also available in aluminum, steel and brass.

**SPECIAL CHARACTERISTICS** establish Cherry superiority over other blind fasteners: (a) Greater shank expansion (b) Greater allowable variance in material thickness for a given grip-length.

Get this Cherry Handbook D-45 to find out all about Cherry Blind Rivets and their many applications. Write to Dept. A-120, Cherry Rivet Company, 231 Winston Street, Los Angeles 13, California.



quency response variations are held within plus or minus one decibel. The recording is made on a 10-inch vinylite disc at 78 rpm and on a 16-inch disc at 33½ rpm.

### X-ray Photometer

GENERAL ELECTRIC Co., Schenectady, N. Y. A new X-ray photometer indicates and records the concentration of one chemical element in the presence of others in solids, liquids or gases. The new instrument, which is nondestructive to most materials, accomplishes this by measuring the change in absorption of X-rays between a sample and a standard. It can be used in such applications as determining the ash content of coal, sulphur content of oil, hydrocarbon, chlorine or fluorine content of plas-



tics, tetraethyl lead content of gasoline, and bromine concentration in certain brominated compounds. The sensitivity of this method of analysis varies from 0.01 percent to 1.0 percent, depending upon the difference in atomic numbers of the components making up the specimens. The unit is housed in a standard control cabinet, 72 x 28 x 20 inches. The tube has a beryllium window and a tungsten target, and requires half a gallon of water per minute at 20 pounds per square inch for cooling.

### Stepping Switch

C. P. CLARE AND Co., 4719 West Sunnyside Ave., Chicago 30, Ill., announces a new stepping switch with reset magnet. Ten contacts are provided but the switch may be obtained

## "THIS PIONEERING EFFORT..."

*"The Chicago and North Western Railroad, always interested in technological developments which promise improvement in the efficiency and safety of railway operations, participated in the first regular use of very high frequency railway radio. This installation went into operation in our Proviso Yards in September, 1940, and continued for over a year thereafter.*

*"We are happy that the technical and operating information secured from this pioneering effort was subsequently useful to the Army Ordnance Department and to the operators of the large Army Ordnance Plants in making their decision to use railroad radio in connection with the war effort.*

*"The case histories provided by the use of radio at Proviso and in the large ordnance plants were later to become an important part of the railroad testimony in the Federal Communications Commission hearing which brought about the present allocation of frequencies for railway use."*



PRESIDENT,  
*Chicago and North Western  
Railway System*



**W**hen the Chicago and North Western Railway conducted its Proviso Yards pioneering of high frequency radio for communications purposes, some of the present members of the Farnsworth Mobile Communications Division assisted in a technical capacity. These individuals, too, were largely responsible for the Army Ordnance Department's first use of radio in railway operations.

These events occurred more than five years ago, long before the Federal Communications Commission's recent allocation of frequencies for railway use—and at a time when the future of railroad radio was fraught

with doubt, and only one organization was pressing for recognition of the railroads' right to frequencies.

Today, the results of almost a decade of pioneering effort and engineering appear in the new Farnsworth 152-162 megacycle railroad radio equipment—*systematized equipment designed to guarantee maximum availability and flexibility with simplified, low-cost maintenance*—equipment meeting all of the presently-established requirements of the Federal Communications Commission and the Interstate Commerce Commission. Farnsworth Television & Radio Corporation, Dept. E-8, Fort Wayne 1, Indiana.

# FARNSWORTH TELEVISION & RADIO CORPORATION

Farnsworth Radio and Television Receivers and Transmitters • Aircraft Radio Equipment • Farnsworth Television Tubes • Halstead Mobile Communications and Traffic Control Systems for Rail and Highway • the Farnsworth Phonograph-Radio • the Capehart • the Panamuse by Capehart

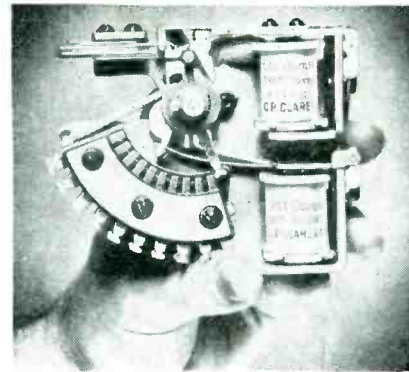
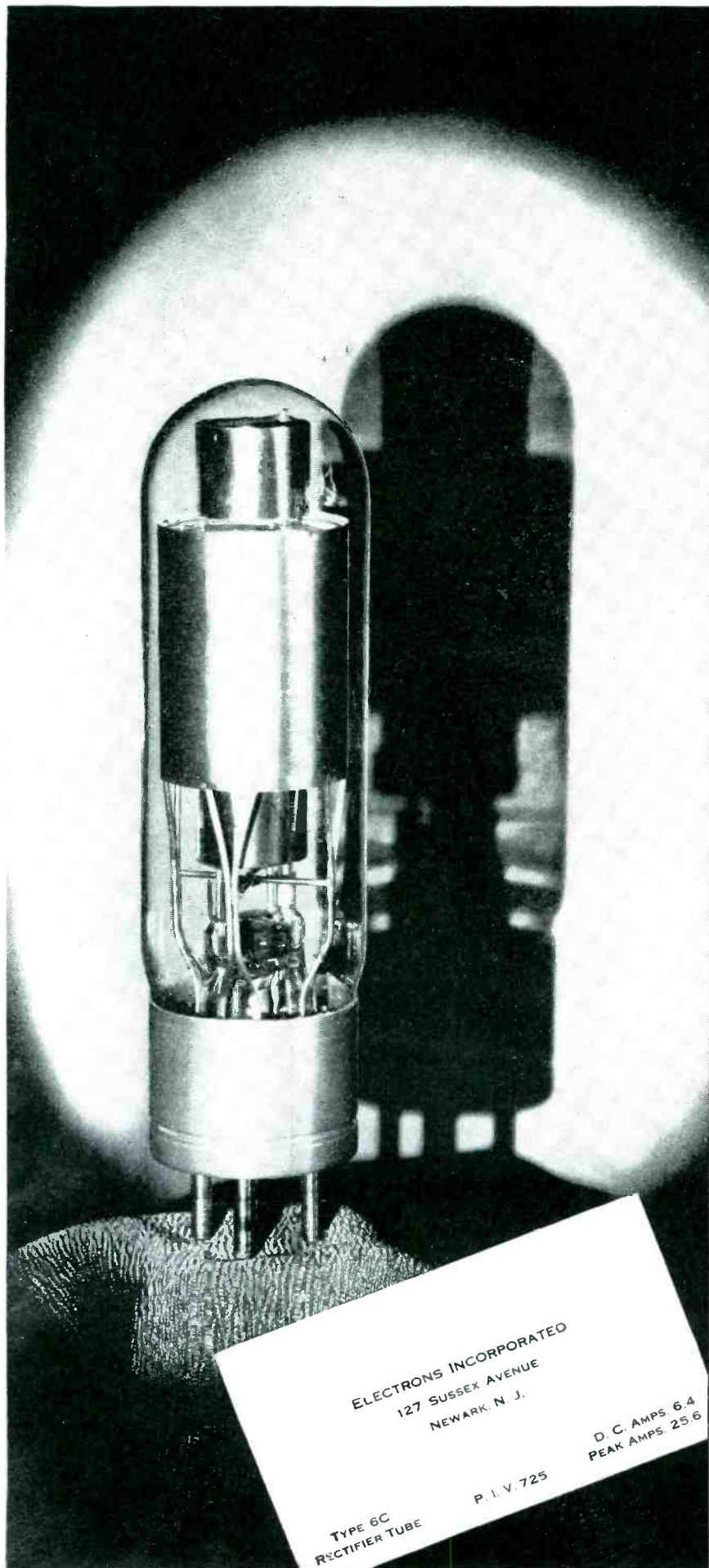

with one, two or three banks operated at 6, 12, 24 or 48 volts. These switches can be made to operate at 35 steps per second and have a release time of 0.03 second. Overall height is  $4\frac{1}{2} \times 1\frac{1}{2} \times 3\frac{1}{2}$  inches and the weight is between 13 and 19 ounces, depending upon the number of banks.

### Insulation Resistance Meter

ASSOCIATED RESEARCH, INC., 231 South Green St., Chicago 7, Ill., announces a self-contained, portable insulation tester capable of meas-

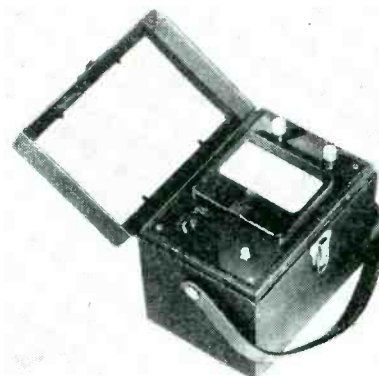

uring up to 50,000 megohms. The Model 261 Vibrotest is powered by two No. 6 cells, so that it is not necessary to crank a magneto to obtain 500 volts for testing. The meter is constructed to operate from minus 40 to plus 140 F under conditions of extreme humidity and is housed in a weatherproof metal case with carrying strap. The unit measures  $8\frac{1}{2} \times 6 \times 8\frac{1}{2}$  inches and weighs 17½ pounds.

### Flash Capacitors

GENERAL ELECTRIC Co., Schenectady 5, N. Y., announces development of



Where There is Horsepower . . .

# THERE IS WIRE

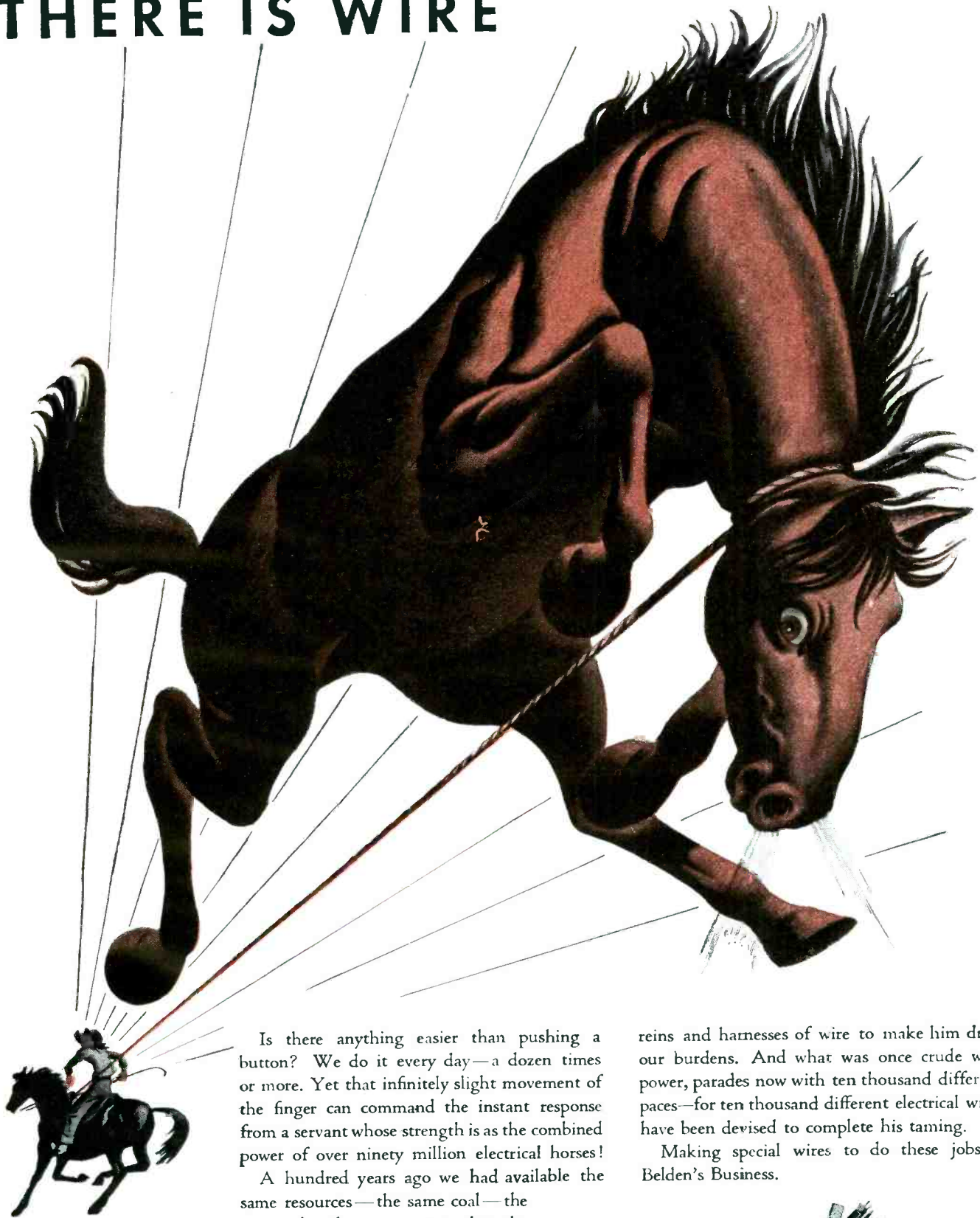

Is there anything easier than pushing a button? We do it every day—a dozen times or more. Yet that infinitely slight movement of the finger can command the instant response from a servant whose strength is as the combined power of over ninety million electrical horses!

A hundred years ago we had available the same resources—the same coal—the same oil—the same water—but the great herd of horsepower went untamed. Then came lariats of electrical wire to rope the stallion—and training gear of wire to gentle him—and

reins and harnesses of wire to make him draw our burdens. And what was once crude wild power, parades now with ten thousand different paces—for ten thousand different electrical wires have been devised to complete his taming.

Making special wires to do these jobs is Belden's Business.

## Belden



WIREMAKER  
FOR INDUSTRY

# ACRO'S Sturdier MODEL "M"

1. BASIC  
MODEL "M".

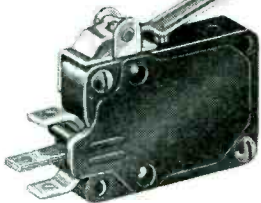
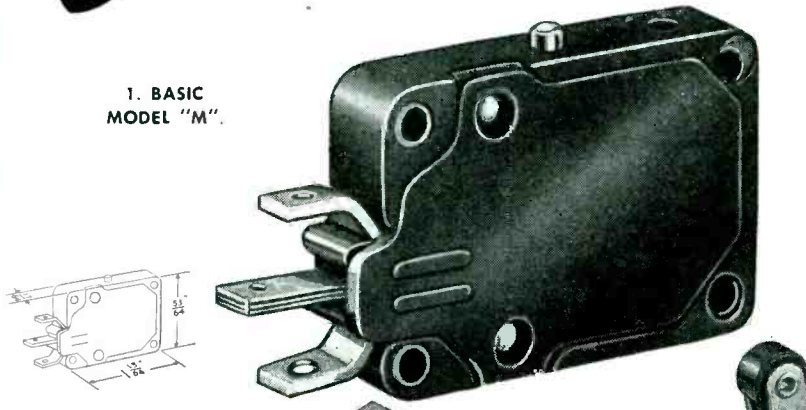

2. MODEL "M"  
WITH A-18 LEAF BRACKET.

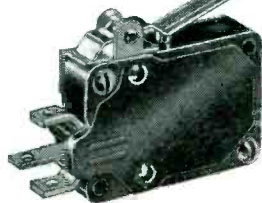

3. MODEL "M" WITH  
A-18-M ROLLER LEAF BRACKET.

In keeping with the ever-widening demand for small ACRO Snap Action Switches, built with the patented Beryllium Rolling Spring and with the experience gained in building hundreds of thousands, ACRO now adds a sturdier, more durable housing for its popular long life Model "M".

#### NEW FEATURES

1. **New stronger molded case**—cover recessed into case, clear of the four 3/32" mounting holes.
2. **Sturdier barriers between terminals**, affording generous electrical clearances.
3. **Heavier solder terminals** with .082" terminal holes for easier wiring.
4. **Greater compactness** for multiple assemblies—four can be mounted in a space of less than 1 1/4".

This better built, better performing switch is made with single pole, single or double throw contacts—rated at 10 amps. 125 volts A. C. Can be fitted with leaf actuators illustrated above. For immediate help on your switch problems, send full details of operating characteristics required and proposed assembly.

**ACRO ELECTRIC COMPANY**

1316 SUPERIOR AVENUE • CLEVELAND 14, OHIO

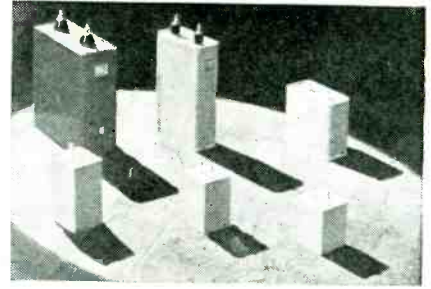

a complete new line of Pyranol capacitors for use in flash photography, light welding and similar applications. They are available in a wide range of ratings, with ambient temperature operating limits at rated voltage ranging from 0 to 50 degrees C and capacitance tolerances at 25 degrees  $\pm$ 10 percent.

#### All-wave Receiver

HALLICRAFTERS Co., 2611 Indiana Ave., Chicago 16, Ill. The S-38 is a new six-tube superheterodyne re-



ceiver which tunes continuously in four ranges, from 540 kilocycles to 30 megacycles. The amateur bands are indicated and a fine tuning control is furnished. A beat-frequency oscillator can be switched in for code reception.

#### Panoramic Adaptor

PANORAMIC RADIO CORP., 242 West 55th St., New York 19, N. Y. The Panadaptor can be attached to any good communications receiver having an intermediate frequency in the



**There is a  
High  
Sensitivity**

**RAULAND  
VISITRON**

**for every  
photo tube  
application**

The *Rauland VISITRON* family of Phototubes includes the widest selection of versatile types for practical application in the field of light-sensitive devices. (Representative *VISITRONS* are described here briefly.) Whatever the application . . . for industrial electronic control, sound-on-film, or research and development, there is a dependable, high sensitivity *Rauland VISITRON* available to do the job perfectly. *Rauland* phototube engineers are ready to consult with you on your special phototube requirements.

To be sure . . . specify *VISITRON!*



**Send for this  
Descriptive Catalog**

This valuable new *Rauland VISITRON* Catalog is yours for the asking. It's packed with informative data on phototube theory, characteristics and circuit applications. You will want this important treatise for your engineering reference library.



**R-58 SERIES**

Exceptionally dependable for use in electronic control equipment (for counting, sorting, burglar and smoke alarms, etc.) A preferred type for use in 16 MM sound-on-film equipment.

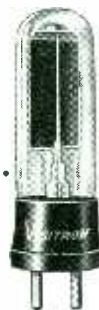

**R-59 SERIES**

Widely employed in theater sound projection equipment. Popularly used in 35 MM semi-portable systems. Rugged design makes it unusually adaptable to industrial electronic equipment. One of several series of *Rauland VISITRONS* also available for blue and ultra-violet applications.



**R-60 SERIES**

A dual-type phototube designed primarily for dual sound track systems; ideal wherever dual tube operation is required and space is at a premium.



**R-64 SERIES**

This rugged phototube in a short glass envelope is recommended for industrial light-operated relay and measurement applications where space is a limiting factor.



**R-71 SERIES**

One of the most widely used *VISITRONS*. Ideal for sound-on-film applications. Used extensively in electronic control devices for weighing, conveying; illumination controls; safety devices; flame control work; smoke and turbidity measurement controls.

**ALSO MANUFACTURERS OF DIRECT-VIEWING AND PROJECTION TYPE CATHODE RAY TUBES**

**RADIO • RADAR • SOUND •**

**Rauland**

**COMMUNICATIONS • TELEVISION**

*Electroneering is our business*

**THE RAULAND CORPORATION • CHICAGO 41, ILLINOIS**

**X-RAY VIEW**

*Astatic Nylon 1-J*

**PICKUP CARTRIDGE**

A. 2-64 Ejection Screw  
 B. Crystal  
 C. Needle Guard  
 D. Taper Nylon Chuck  
 E. Taper Nylon Needle Knee  
 F. Sapphire Playing Tip  
 G. Needle Locating Fin



**GIVES AND MAINTAINS IMPROVED PERFORMANCE**

**T**HIS important, new-type Crystal Pickup Cartridge, employing a Nylon Chuck and matched, replaceable, sapphire-tipped Nylon Needle, contributes immeasurably to improved phonograph reproduction. Among its many advantages are: suppression of mechanical resonances of crystal element, improved tracking at low needle pressure, reduced record wear, and permanent needle reproduction with needle replacement advantages. The use of Astatic's Nylon 1-J Cartridge assures phonograph manufacturers and ultimate users or owners alike that the quality of reproduction will remain constant regardless of needle replacements because the Nylon needle is matched to the cartridge and **NO OTHER** type of needle may be used.

The Nylon 1-J Cartridge is furnished with Astatic Studio Master 400 Transcription Pickups and new Model 508 Pickups for 10" and 12" records.



**THE Astatic CORPORATION**  
 CONNEAUT, OHIO

Astatic Crystal Devices manufactured under Brush Development Co. patents.

IN CANADA: CANADIAN ASTATIC LTD., TORONTO, ONTARIO

range 450 to 470 kilocycles. A band of frequencies 100 kilocycles on either side of the frequency to which the receiver is tuned is visible at all times. Or, the band may be narrowed down towards zero, allowing a detailed study of the signal received. The unit operates from 115-volt 50 to 60-cycle power.

### Regulated D-c Unit

POLARAD ELECTRONICS Co., 135 Liberty St., New York 6, N. Y., has available the Model PT111D dual regulated d-c power unit which oper-

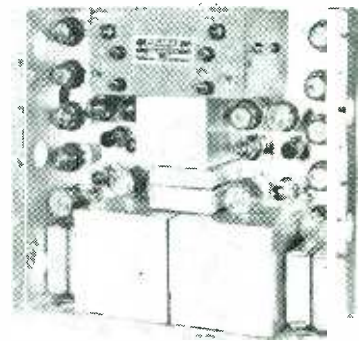

ates from a 115-volt 50 to 60-cps line to give 400 milliamperes (each unit) at 250 to 300 volts. It has ripple less than 0.001 percent. Each section of the unit illustrated has its own controls.

### Midget Variable Capacitor

THE HAMMARLUND MFG. Co., INC., 460 W. 34th St., New York 1, N. Y. The type RMC midget variable air

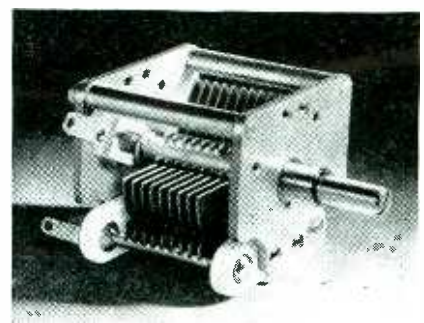

capacitor has 3/32-inch end plates reinforced by three horizontal pillars. Two low-loss silicone-treated ceramic bars support the stator. Stock sizes rated at 1,000 volts are available in maximum capacitances from 50 to 327 micromicrofarads.

### Antenna Tuning Unit

COLLINS RADIO Co., Cedar Rapids,

DESIGNED AND ENGINEERED AT NO. 1 PLASTICS AVENUE



**PROBLEM** —  
*MOLD CONTACT YOKE FOR HIGH-FREQUENCY APPLICATION MUST HAVE MECHANICAL STRENGTH TO DRIVE MOVING PART AND BE DIMENSIONALLY STABLE.*

## G-E MYCALEX . . . FOR PRECISION-MOLDED INSULATION

● This contact yoke was designed to drive a vital moving part in a high-frequency application. A dimensionally stable part was required.

At No. 1 Plastics Avenue the problem was solved by specifying G-E mycalex—compound of glass and powdered mica with a unique combination of properties.

Molded in G-E mycalex by new techniques, this contact yoke has everything required of a high-frequency component—dielectric

strength . . . low loss factor . . . stability . . . flatness . . . rigidity.

G-E mycalex is now available to all industry in standard rods and sheets, or molded to your own design. G-E designers and engineers will give you the benefit of their experience in molding hundreds of G-E mycalex parts. Write to Section S-12, Plastics Divisions, Chemical Department, General Electric Co., 1 Plastics Avenue, Pittsfield, Mass.

### HOW THE G-E MYCALEX SERVICES CAN BENEFIT YOU NOW

You may order fabrication of sample G-E mycalex parts at surprisingly low cost. Test them yourself in your own equipment. Then, if you decide to specify G-E mycalex, your design can be converted to a molding process which permits speedy and economical production runs.



MOLDING SERVICE



FABRICATING SERVICE

Get This Unique Combination of Properties with G-E Mycalex

1. High dielectric strength
2. Low power factor
3. Prolonged resistance to electrical arcs
4. Chemical stability—no deterioration with age
5. Dimensional stability—freedom from warpage and shrinkage
6. Impervious to water, oil, and gas
7. Resistance to sudden temperature changes
8. Low coefficient of thermal expansion
9. High heat resistance

*Samples Supplied on Request*



# GENERAL ELECTRIC

CD16-M12

# THE *Individual* TOUCH

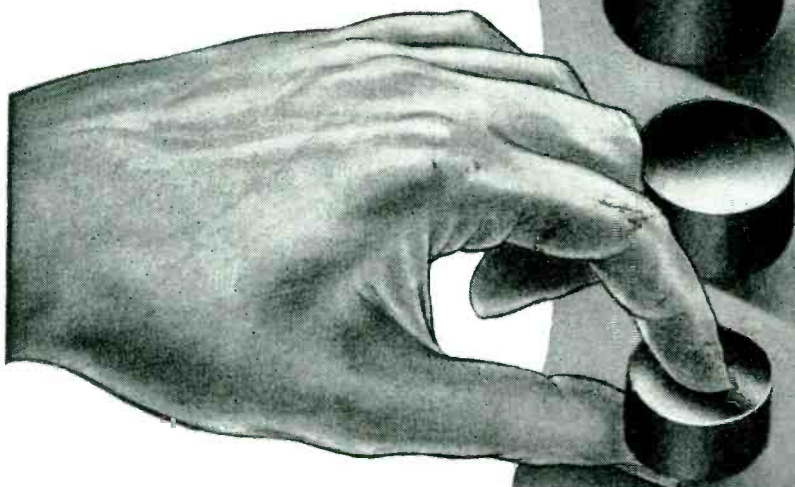

• Every magnet individually tested in loud speaker structure before shipping . . .

• Every magnet meets R. M. A. proposed standards . . .

• Every magnet meets Arnold's minimum passing standards of 4,500,000 BHmax.

Here's what the individual touch means. Thousands of the nine different sizes of speaker magnets shown at right are now being turned out daily. Each one is individually tested in a loud speaker structure before shipping. Each magnet is made to meet R. M. A. proposed standard for the industry. Each magnet must meet Arnold's own minimum passing standard of 4,500,000 BHmax for Alnico V material. Thus by careful attention to the important "individual touch" in volume production can Arnold promise you top quality in each individual magnet you select.

## THE ARNOLD ENGINEERING COMPANY

147 EAST ONTARIO STREET, CHICAGO 11, ILLINOIS

Specialists in the Manufacture of ALNICO PERMANENT MAGNETS



Iowa. An aircraft antenna loading unit designed primarily as a companion unit for the Collins 18S-1 transmitter-receiver, will function equally well with any transmitter with suitable characteristics. Designated the Type 180K-1, this unit has a nominal input impedance of 50 ohms and will handle input power of up to 125 watts. It is designed to couple into typical aircraft antennas of 46-foot length over a frequency range of 2.5-10 megacycles, up to 25,000 feet altitude, and over a temperature range of minus 40 C to plus 50 C. Ten pretuned channels are provided in the 180K-1, with Autotune control for quick frequency change.

### Strain Gage Indicator

STATHAM LABORATORIES, 8222 Beverly Blvd., Los Angeles 36, Calif., announces production of a new strain gage indicator, Model RD, which en-



ables the measurement of changes in length of specimen under test to one millionth of an inch per inch. Two ranges provide for measurements of plus or minus 1,000 microinches per inch and plus or minus 10,000 microinches per inch. A gage factor control permit direct readings of strain gages with factors between 1.7 and

# VITAL CONTINUITY

**T**HE heart of a relay is the coil—wire in the coil the bloodstream. Flaws in the wire of a relay coil can no more be tolerated than imperfections in the human bloodstream.

The use of Essex Extra Test Magnet Wire in the vital spot is a real hedge against a high electrical apparatus mortality rate.



**ESSEX WIRE CORPORATION**  
FORT WAYNE 6, INDIANA

Plants: Fort Wayne, Indiana; Detroit, Michigan; Anaheim, Calif.  
Warehouses\* and Sales Offices: \*Atlanta, Georgia; \*Boston, Mass.; \*Chicago, Ill.; Cleveland, Ohio; Dayton, Ohio; \*Detroit, Mich.; Kansas City, Mo.; \*Los Angeles, Calif.; Milwaukee, Wisc.; \*Minneapolis, Minnesota; \*Newark, N. J.; Philadelphia, Pa.; San Francisco, California; \*St. Louis, Mo.

1000 FT. ?

# HOW HIGH?

The world's tallest antenna tower—over 1000 ft.—was designed, fabricated and erected by Blaw-Knox. Blaw-Knox has constructed some 12,000 other Vertical Radiators and towers of lesser heights for all types of electronic transmission.

Experience that dates back to the birth of commercial radio adds nothing to the cost of Blaw-Knox towers today. Our engineers are available for discussion.

## BLAW-KNOX DIVISION of Blaw-Knox Company

2077 Farmers Bank Building  
Pittsburgh, Pa.

600 FT. ?

400 FT. ?

100 FT. ?

# BLAW-KNOX ANTENNA TOWERS

2.1. Batteries are self-contained in a hardwood case 6 3/4 x 11 x 21 inches which is provided with a carrying handle. Total weight is 25 pounds.

## Small Boat Direction Finder

RADIOMARINE CORP. of America, 75 Varick St., New York 13, N. Y., has designed a new compact radio direction finder, Model AR-8702-A, for use aboard yachts and other small craft where only limited space is available. The set comprises a six-tube superheterodyne receiver, with a tuning range from 270 to 520 kilocycles, and a balancer control with provision for sense determination,

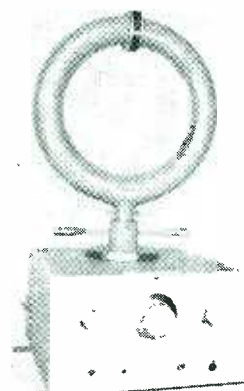

in a corrosion-resistant cabinet 14 inches wide, 7 inches high, and 12 inches deep; plus a watertight 18-gauge copper antenna loop 13 inches in outside diameter, with a drum-type azimuth scale, mounted directly on top of the receiver cabinet. The model is supplied with a telephone headset and a battery box containing a 6-volt storage battery, two 45-volt dry batteries, and a battery charger; however, it can be adapted for 6, 12, 24, 32, 110, or 230-volt d-c ship's supply or, by means of a separate rectifier unit, for 110-volt 60-cps a-c supply.

## Blower Motor

JOHN OSTER MFG. Co., Racine, Wis., announces a new motor designed for continuous duty fan and blower applications and other uses where similar operation is essential. The type KS-837 delivers up to 1/10 hp at 1,725 rpm. It is a split-phase induction, continuous-duty model, operating on 115 volts, a-c. The motor is totally enclosed. The bronze sleeve bearings are grooved and felt oil re-



# PROVED...

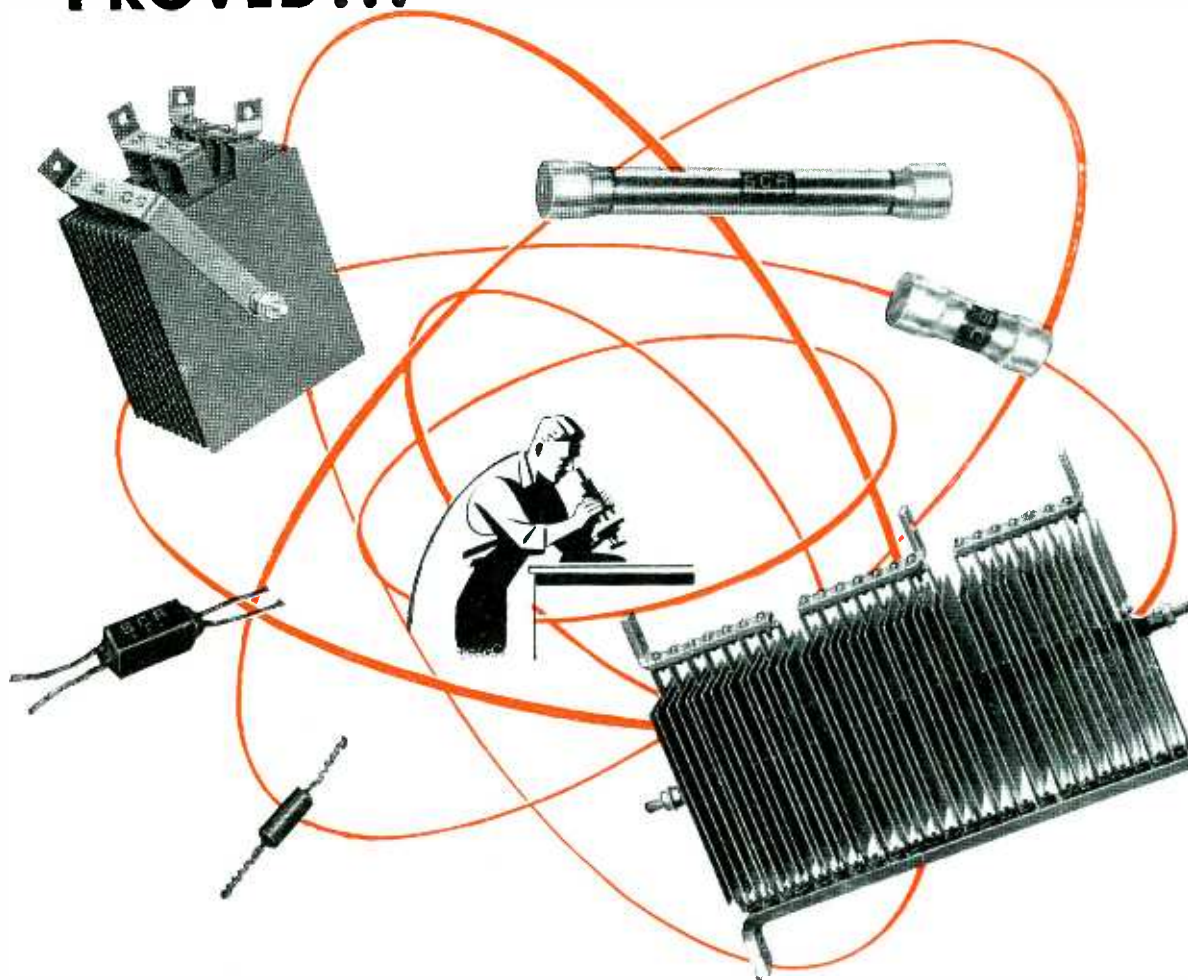

## ...and IMPROVED

### SELENIUM RECTIFIERS

FROM 10 MICRO AMPERES TO 10,000 AMPERES

Manufacturers of a broad line of SELENIUM Power and Instrument Rectifiers, Photo-Electric Cells and allied scientific products.

Solve your rectification problems with SELENIUM. SELENIUM rectifiers are rapidly becoming standard in industry. Check these outstanding features:

- ✓ Permanent characteristics.
- ✓ Adaptability to all types of circuits and loads.
- ✓ Unlimited life—no moving parts.
- ✓ Immunity to atmospheric changes.
- ✓ High efficiency per unit weight.
- ✓ Hermetically sealed assemblies available.
- ✓ From 1 volt to 50,000 volts RMS.
- ✓ From 10 micro-amperes to 10,000 amperes.
- ✓ Economical—No maintenance cost.



### SELENIUM CORPORATION OF AMERICA

Affiliate of **VICKERS**, Incorporated  
1719 WEST PICO BOULEVARD • LOS ANGELES 15, CALIFORNIA  
Export Division: Frazer & Hansen, 301 Clay Street, San Francisco 11, Calif.  
In Canada: Canadian Line Materials, Ltd., Toronto 13, Canada

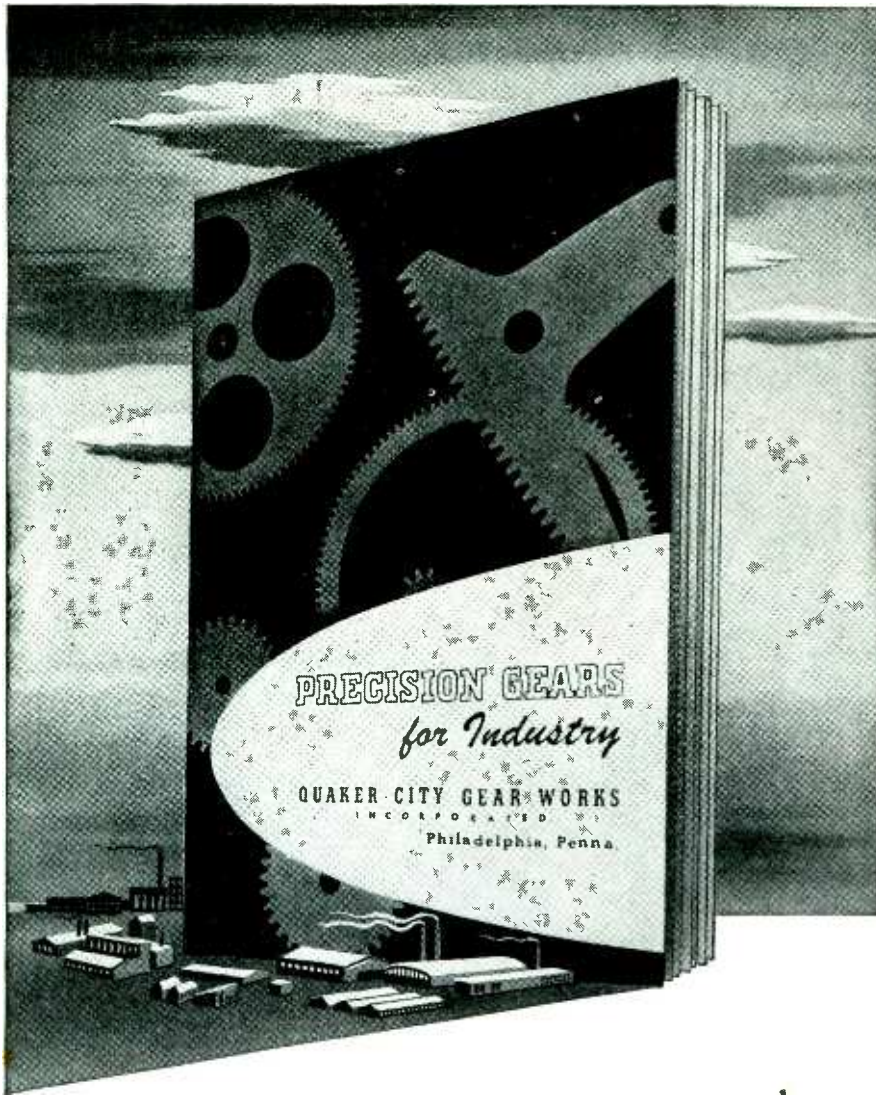

## Yours for the asking

A new informative booklet on gears.

It has illustrated sections  on practically every known form of gearing,

together with  many reference tables and formulas. Write for your copy

today on your company stationery. 

 **Quaker City Gear Works**  
INCORPORATED

1910 N. Front Street, Philadelphia 22, Pa.

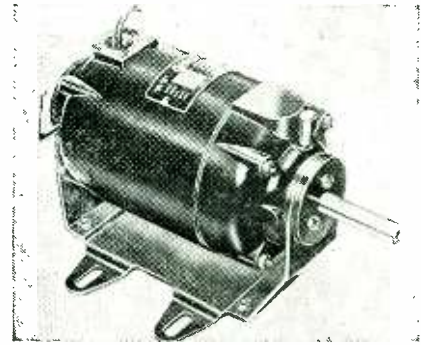

tainers feed oil to the shaft through two spring tension wicks at each bearing.

Neoprene motor mountings which absorb vibration are not affected by oil or grease. Length over bearings  $8\frac{3}{4}$  inches, housing diameter  $4\frac{1}{4}$  inches, weight 15 pounds.

### Remote Indicator

W. C. DILLON AND Co., INC., 5410 West Harrison St., Chicago 44, Ill. The Tenstrol is essentially a self-synchronous motor designed for mounting on a dynamometer beam

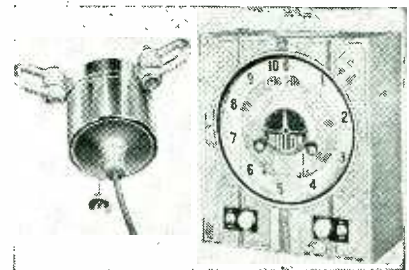

in such a way that its slightest motion is repeated, through a wire cable, at one or more repeater stations with an accuracy of better than  $1\frac{1}{2}$  percent. Each repeater measures  $12 \times 14 \times 5$  inches and weighs 10 pounds. Operation requires a source of 12 volts d-c.

### Megohmmeter

FREED TRANSFORMER Co., INC., 72-78 Spring St., New York 12, N. Y. The Model 1020 megohmmeter can be used to measure insulating materials, capacitors and transformer windings. An internal source of high-voltage is provided. Measurements can be made in the range 1 to 1,000,000 megohms to an accuracy of between plus or minus 3 and plus or

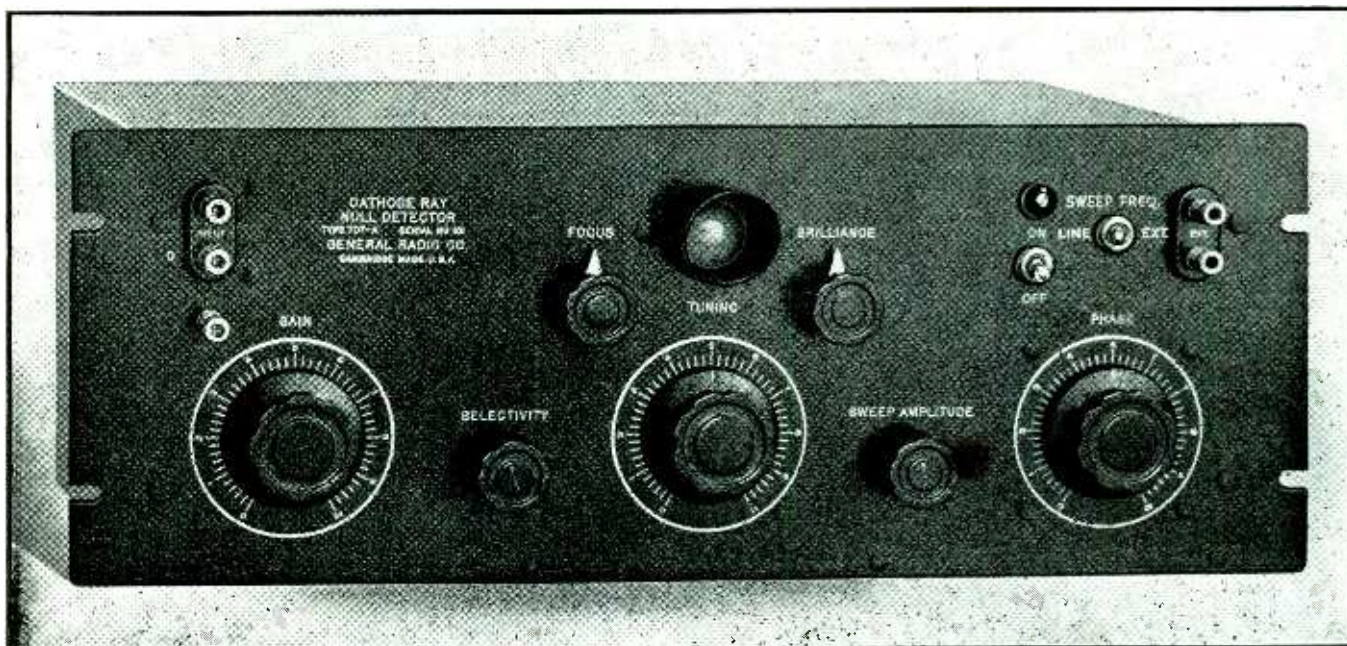

## IMPROVED NULL DETECTOR

### for a-c Impedance Bridges

### SENSITIVE • RUGGED • CONVENIENT TO OPERATE

**T**HE G-R Type 707-A Null Detector, temporarily withdrawn from production during the war, is now available again. It uses a one-inch cathode-ray tube in a non-inductive degenerative amplifier circuit, with tuning and phasing networks and sweep and sensitivity controls. As a null detector on any a-c impedance bridge its advantages over former types of detectors are numerous, and include:

- |  |  |
|--|--|
| <p>1 —Operation in noisy locations</p> <p>2 —Not affected by strong fields</p> <p>3 —May be used at all frequencies up to 2 kilocycles, and higher as an untuned amplifier</p> <p>4 —Separately indicates balance of the resistive and reactive components</p> <p>5 —Makes possible precise balancing of either component with only moderately close balance of the other</p> <p>6 —Precise measurement of the steady component can be made while the other varies erratically</p> | <p>7 —Shows immediately any drift of either or both components</p> <p>8 —Provides positive indication of the direction of off-balance for either component, as selected</p> <p>9 —Can be calibrated to show the degree of unbalance</p> <p>10 —Can be used at all times at maximum sensitivity, even with the bridge far off-balance</p> <p>11 —Supplies instantaneous response</p> <p>12 —Will withstand any overload caused by marked off-balance and is instantaneous in recovery</p> |
|--|--|

The input impedance of the detector is one megohm. Its sensitivity is 100 microvolts at 60 cycles and 200 to 300 microvolts at 1,000 cycles. Its selectivity is 40 db against the second harmonic. Plug-in units tune the amplifier to any operating frequency desired between 20 and 2,000 cycles with a continuous tuning range of  $\pm 5\%$  for each unit.

Type 707—A CATHODE-RAY NULL DETECTOR . . . \$250.<sup>00</sup>

**NOTE! We have a few in stock. ORDER NOW!**

# GENERAL RADIO COMPANY

Cambridge 39,  
Massachusetts

90 West St., New York 6

920 S. Michigan Ave., Chicago 5

950 N. Highland Ave., Los Angeles 38

## Now You Can Make Direct-Inking Recordings from D. C. to 100 cycles per second!

*Brush Magnetic Oscillographs  
Revolutionize Measurement-Recording*



6 channel magnetic oscillograph recording 6 signals simultaneously. With all Brush Magnetic Oscillographs recording is direct and instantaneous—may be stopped for chart paper notations.

The Brush Double-Channel Oscillograph with cover off.

Especially suited for synchronizing problems where two simultaneous recordings are required.

Two recording penmotors and pens. Three-speed paper drive, 5, 25, 125 mm per sec. Chart paper 3 $\frac{1}{2}$ " wide.

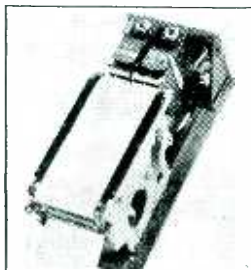

Brush Magnetic Oscillographs may be used for detailed recording of virtually every conceivable type of measurement that can be made in the form of electrical impulses. The Magnetic Pen Motor is capable of recording a D. C. signal. Used with the BL-905 amplifier, the frequency range is from .2 to 100 cycles per second. Recordings are direct, instantaneous, ink-on-paper graphs.

Usefulness of Brush Magnetic Oscillographs is almost unlimited. Can be used for recording strains, pressures, vibrations, temperatures, light intensity, displacement, counting, phase relationships, currents and voltage, acceleration and deceleration, inertia and countless other phenomena.

Brush engineers will be glad to work with you in determining the equipment needed to meet your particular problems. Write today for detailed bulletin.



The Brush Single-Channel Oscillograph—ideal for counting, temperature recording, etc. One recording penmotor and pen. Three-speed paper drive, 5, 25, 125 mm per sec. Chart paper 2 $\frac{3}{8}$ " wide.



minus 8 percent. Operation from a 105- to 125-volt, 60-cps line consumes 32 watts. The unit measures 9 $\frac{1}{2}$  × 10 $\frac{1}{2}$  × 8 inches and weighs 21 pounds.

### Vibrotron Tube

RADIO CORPORATION OF AMERICA, Camden, N. J. Not in production but available to manufacturers is a new tube, essentially a triode with an electrode movable externally. One



use for the new device is as a direct phonograph pickup. Other uses wherein a mechanical motion is desired as a circuit variation will suggest themselves.

### Autoscaler

TRACERLAB, INC., 55 Oliver St., Boston 10, Mass. In anticipation of research involving the use of radioactive isotopes, the Autoscaler has been designed to supply operating voltage for a Geiger tube, a means of counting impulses and measuring the time required for reception of a given number of impulses. Predetermined counts from 128 to 4,096 are chosen by electronic scaler circuits with an overall resolving time

**THE BRUSH DEVELOPMENT CO.** 3405 Perkins Ave.  
Cleveland 14, Ohio

Canadian Representatives:

A. C. WICKMAN, (Canada) Ltd., P. O. Box 9, Station N • Toronto, 14

# G-E LAMINATED PLASTICS

## FABRICATED TO YOUR SPECIFICATIONS

**YOU GET ACCURATELY FINISHED PARTS  
MADE OF THE RIGHT MATERIAL  
READY FOR THE JOB**

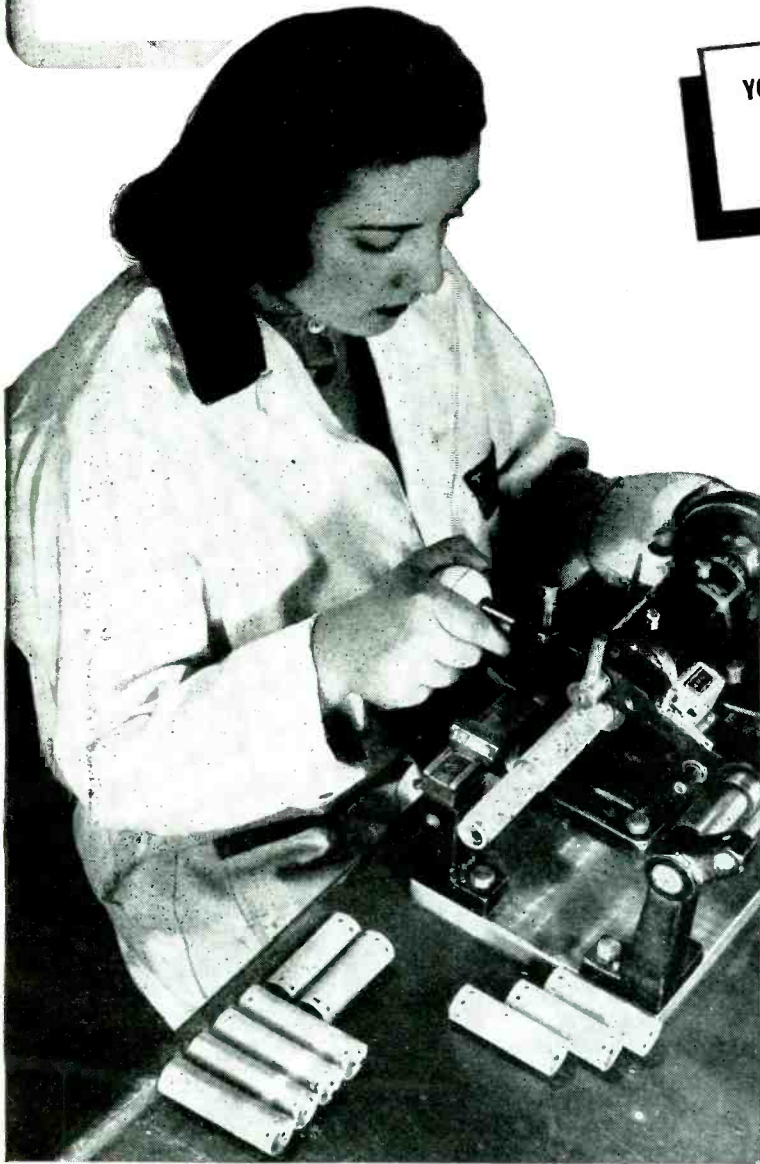

G-E Textolite sheets, tubes and rods are fabricated in an almost unlimited variety of sizes and shapes, and the General Electric Company has the necessary equipment to do this rapidly and economically—lathes, saws, shears, punches, hobs and mills . . . even specially designed machinery to speed up and lower the cost on large production runs.

And because there are over 50 grades of G-E Textolite to select from, each having an individual combination of properties—electrical, mechanical, chemical, thermal—you get a grade that fits your needs.

Correctly machined and made of the right material for your application, you can be assured that when G-E Textolite fabricated parts reach you they will do the job.

Let us know your requirements. Write to Section S-8, General Electric Co., Plastics Divisions, One Plastics Ave., Pittsfield, Mass.



G-E Textolite tubing is shown being threaded to exacting mechanical and electrical specifications for radio coil forms.

### G-E TEXTOLITE IS SUPPLIED IN THE FOLLOWING FORMS:

Sheets, Tubes, and Rods	Molded Laminated Parts
Fabricated Parts	Post-Formed Laminates
Nameplates	Translucent Laminates
Low-Pressure Molded Parts	

CD-46-E8

*everything in Plastics*

# GENERAL ELECTRIC

# CONSOLIDATED'S

## *Complete* Analysis Equipment

provides the answer to **DYNAMIC**  
pressure, vibration and strain measurement

Complete sets of any of the following components can be furnished to meet your specific applications.

### ACCELEROMETERS

#### AMPLIFIERS

*Linear*  
*Integrating*  
*Carrier*

1 k.c., 3 k.c., 10 k.c.  
Compact, lightweight.

### BRIDGE BALANCE UNITS

*Carrier and d.c. types*

### RECORDING OSCILLOGRAPHS

Employing high-sensitivity  
... wide frequency range  
D'Arsonval Galvanometers.

### ELECTRICAL STRESS- STRAIN COMPUTERS

### POWER SUPPLIES and OSCILLATORS

### PRESSURE MEASURING CAPSULES

### VIBRATION PICKUPS

*Linear*  
*Torsional*

## CONSOLIDATED Portable, Recording OSCILLOGRAPH

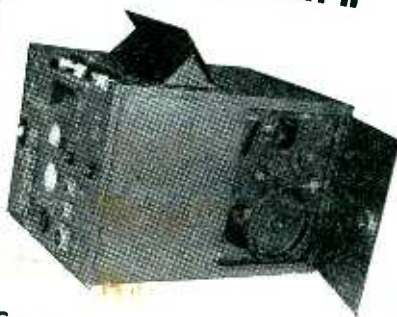

**Cameras Available to Handle  
from 8 to 36 Traces**  
Consolidated Recording Oscillographs are portable, compact, lightweight, precision-built instruments. They are built to highest precision standards and offer the advantages of completeness and simplicity of operation required for modern test work.

Consolidated vibration and strain equipment is manufactured by specialists in the design and construction of scientific instruments.

**CONSOLIDATED ENGINEERING CORP.**  
620 N. LAKE AVENUE PASADENA 4, CALIF.

Manufacturers of Mass Spectrometers, Vibration and Strain Analysis and Recording Equipment

ages are exceeded. Calibration is easily and quickly checked by unskilled personnel. Operating from any outlet, the equipment uses 40 watts of power. It weighs 14 pounds and is 8 × 10 × 8 inches.

### Plastic Capacitors

CONDENSER PRODUCTS Co., 1375 North Branch St., Chicago 22, Ill. Type AOCE Plasticon capacitors utilize a plastic-film dielectric claimed to reduce weight and show lower losses

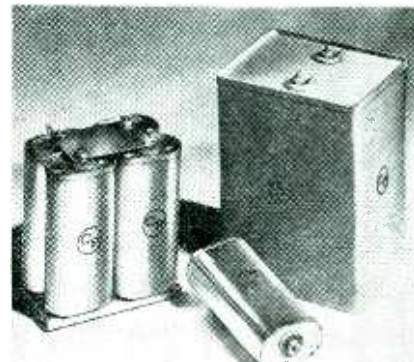

than equivalent paper types. The new line has been designed for industrial applications such as welding and stroboscopic devices.

### Orthocoustic Equalizer

CINEMA ENGINEERING Co., 1510 W. Verdugo Ave., Burbank, Calif. The type 4137 equalizer meets NAB specifications for 500- and 600-ohm circuits. Insertion loss is 16 db. The units measure 2½ × 3½ × 2½ inches overall.

### Two-inch Oscilloscope

THE NATIONAL Co., Inc., Malden, Mass. The CRU table-model oscilloscope can be adapted for panel mounting and is particularly useful in monitoring modulation percentage by the trapezoidal method. A 60-cps sweep can be switched on if desired. A 6X5 rectifier and 2AP-1A cathode-ray tube are employed.

### Electronic Counter

ATOMIC INSTRUMENT Co., 156 Charles St., Boston, Mass. The Model 101 Scaler selects impulses to within plus or minus 1 percent between minus 50 and plus 100 volts and occurring

**Write** - Dept. 5R  
for catalog and state your problem.

THE FINEST CORED SOLDER IN THE WORLD



**AVAILABLE**

**Special  
High Conductivity  
RADIO ALLOY  
90 tin/10 lead**

Our claim is a simple one. We believe that Ersin Multicore is the finest cored solder in the world. If you are not already familiar with our product, we believe it can be of special assistance to you in your soldering processes whether you are manufacturing 10,000 radio receivers or repairing one • Ersin Multicore is solder in the form of a wire containing 3 cores of non-corrosive Ersin Flux • You get a guarantee of flux continuity. The Multicore construction gives you extra-rapid melting. Combined with a super active Ersin Flux—**Exclusive with Multicore**—you enjoy a speedy and consistently high standard of precision soldering • Available in 5 alloys and 9 gauges. Please write for detailed technical information and samples.

**ERSIN MULTICORE**

Exclusive U.S.A. Distributors: British Industries Sales Corp., (Dept. M.) 401 Broadway, New York 13, N.Y.

*Case Histories from the RICHARDSON files*

## PRODUCT RE-DESIGN

**Problem:** To produce containers to hold either hot or refrigerated foods. Must be compact, lightweight; must resist abuse and possess good insulating characteristics.

**Solution:** Richardson Plastics recommended use of INSUROK, Grade T-705 post forming material for outer and inner liners, as well as for tray supports and dry ice containers. Low thermal conductivity reduces wall thickness required for standard insulation materials.

Valco Mfg. Co., Chicago, makes these food storage boxes for United Air Lines . . . using INSUROK T-705. The designing skill behind the successful material recommendation made here is available to you now. Let Richardson Plastics give you complete information.

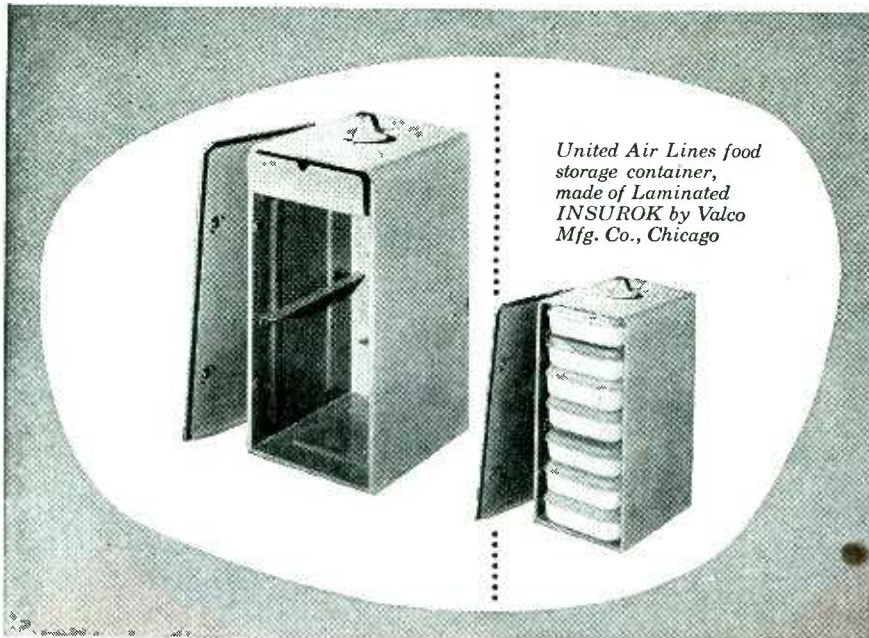

*United Air Lines food storage container, made of Laminated INSUROK by Valco Mfg. Co., Chicago*

# INSUROK *Precision Plastics*

*The RICHARDSON COMPANY*

Sales Headquarters: MELROSE PARK, ILL. FOUNDED 1858 LOCKLAND, CINCINNATI 15, OHIO

NEW YORK 6, N. Y., 75 WEST STREET  
DETROIT 2, MICH., 6-252 G. M. BUILDING Sales Offices  
ST. LOUIS 12, MO., 5579 PERSHING AVE.

ROCHESTER 4, N. Y., 1031 SIBLEY TOWERS BLDG.  
MILWAUKEE 3, WIS., 743 NO. FOURTH STREET  
CLEVELAND 15, OHIO, 326-7 PLYMOUTH BLDG.

PHILADELPHIA 40, PA., 3728 NO. BROAD ST.

Factories: MELROSE PARK, ILL. • NEW BRUNSWICK, N. J. • INDIANAPOLIS, IND.



as frequently as 5 microseconds. Scaling factors of 8 or 64 are selected by a toggle switch. The unit operates on 105 to 125 volts, 50 to 60 cps. It measures  $20\frac{1}{2} \times 8\frac{1}{2} \times 10\frac{1}{2}$  inches and weighs 40 pounds.

### Vacuum-tube Voltmeter

RADIO CITY PRODUCTS Co., Inc., 127 W. 26th St., New York, N. Y. The Model 668 vacuum-tube voltmeter can be used to measure resistance



and capacitance as well as d-c and a-c voltages. As a d-c voltmeter, the instrument has a sensitivity of 160 to 16 ohms and measures to 6,000 volts in six ranges. The a-c voltmeter range has an input resistance of 160 to 16 megohms and can be used from 10 cps to 10,000 cps. Measurements of capacitance from 0.00005 to 2,000 microfarads and resistance to 100,000 ohms are possible.

### Aircraft Transmitter-receiver

COLLINS RADIO Co., Cedar Rapids, Iowa. A new aircraft transmitter-receiver, type 18S-1, features quick, automatic frequency shift with all





# NEW **EBY** MINIATURE SOCKETS

## FLAT SADDLE

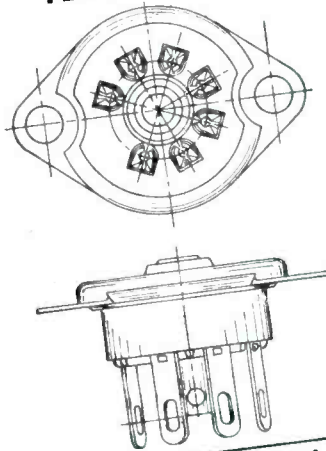

INSULATOR PART NO.	CONTACTS	
	Phos. Bronze	Beryl. Copper
General Purpose	8323	8100
Ceramic	8326	8083
Mica-filled Phenolic	8327	8082

## SHOCK SHIELD

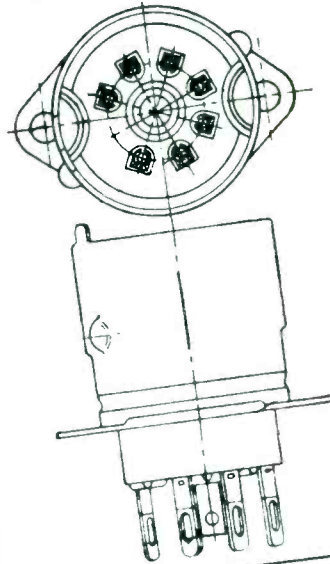

INSULATOR PART NO.	CONTACTS	
	Phos. Bronze	Beryl. Copper
General Purpose	8322	
Ceramic	8328	7676
Mica-filled Phenolic	8329	7670

## NON-MICROPHONIC

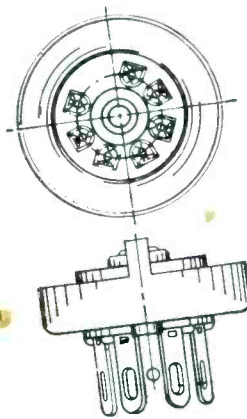

PART NO. 8341

Flat Saddle  
Shock Shield  
Non-Microphonic

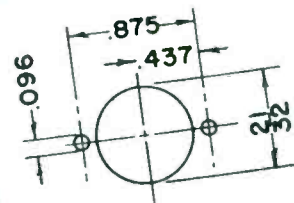

**MOUNTING LAYOUT**

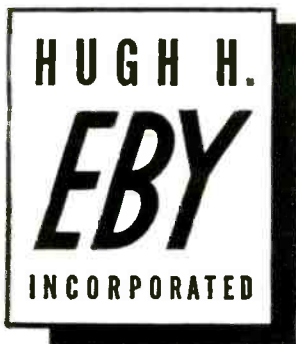

**WRITE TODAY for complete details —**

**HUGH H. EBY, INC.**

**18 W. Cheltenham Ave.**

**Phila. 44, Pa.**

# It is a BETTER Electronic Component, when it is a POTTER CAPACITOR

**Metal-Contained — Oil-Filled  
with Neoprene Bakelite Seals**

**VASTLY SUPERIOR TO ORDINARY CARDBOARD TUBULARS**

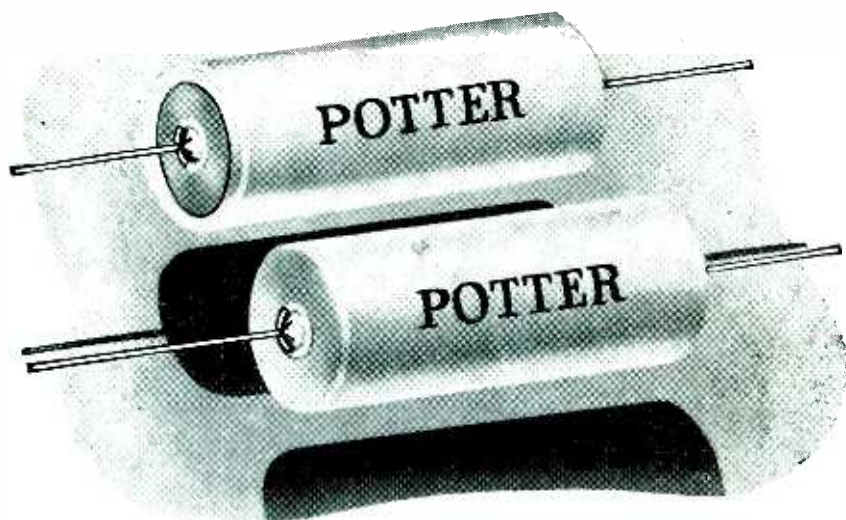

**Now**—with the increasing multitude of electronic applications, exacting the utmost in dependability, make sure with Potter Quality. Light, durable, space-saving—the highest achievement in capacitor material design and construction, for *today's* precision requirements in electronics. *Aluminum-contained—oil-filled—neoprene bakelite seals. Durable. Space-saving. Far surpassing cardboard tubulars in every point.*

### **Here's Evidence! Remarkable Record of Potter Acceptance**

Under the most rigid Signal Corps inspection—under conditions of the most intense humidity, acceptance of POTTER CAPACITORS ran 99 9/10 percent. Potter Capacitors have been specified for many types of Army, Navy, and C.A.C. equipment.

Assure your product the constant, high fidelity reproduction of Potter Capacitors to your specifications—performance always faithful to the ideal, under any and every condition of operation.

**In ratings up to 2,500 volts**

Ask for full details. Get *all* the facts on Potter superiorities—and compare! **PROMPT DELIVERY. Wire or Write**



circuits pretuned. The equipment has ten operating channels with two frequencies per channel. The receiver unit is controlled by a separate group of crystals. The frequency range covered by this equipment is 2.0 to 10.0 megacycles. Altitude range is 25,000 feet for full power operation of better than 100 watts output. The equipment is designed to operate into a 50-ohm transmission line. Remote control is provided.

The receiver features avc, automatic noise limiter, optional dual output, one stage of tuned r-f amplification, and an output of 100 milliwatts. It operates directly from a 26.5-volt d-c source.

The entire weight, including transmitter, receiver, dynamotor for transmitter, and shock mount, is 60 pounds. All equipment excluding shock mount is contained in a single dust cover of 1 1/2 ATR unit size.

### **Recorder-drive Mechanism**

CLARKE INSTRUMENT CORP., 4236 Forty-fifth St., N. W., Washington 16, D. C. The continuous-graph re-



recorder-drive mechanism type 102 and the speedometer tee type 101 are both necessary in adapting standard Esterline-Angus recorders for mobile recording of field strength as required by FCC for proof of performance of television and f-m station operation. Various chart speeds can be selected at will or the recorder can be disengaged quickly.

### **Grid-control Rectifier**

ELECTRONS, INC., 127 Sussex Ave., Newark 4, N. J. The C16J is a xenon-filled rectifier of the thyatron type. Filament voltage is 2.5 volts; cur-

# American Shielding Conduit

"Saves Money and Time for "

A YEAR OR SO AGO, Capital Airlines—PCA found that the replacement of spark plug leads reached nearly 50% at 750 hours.

The new American Type HTCD Shielding Conduit assemblies were accordingly tried out, and Luther Harris, Vice President in Charge of Engineering and Maintenance, reports as follows:

"Several American Brass assemblies have reached 3000 hours total operating time with no replacement of parts necessary in the field or at overhaul. The sharp change in replacement rate plus the fewer delays due to harness malfunctioning have saved much of both money and time for Capital Airlines."

Equally important are the exceptional shielding properties characteristic of American HTCD conduit—conclusively demonstrated, time and again, by both laboratory and field tests. Consisting of an interlocked, coated stainless steel flexible inner-core, two carefully designed tinned copper wire braids and a water-tight synthetic jacket, this conduit combines desirable electrical properties with *proven* mechanical construction. American HTCD types of conduit are suitable for any ignition shielding application or for use wherever a rugged, long-lived flexible conduit having a high degree of shielding effectiveness is required. Ask for our "Data Book for Electronics Industries."

46321



  
**American**  
**METAL HOSE**

**THE AMERICAN BRASS COMPANY**  
*American Metal Hose Branch*  
General Offices: Waterbury 88, Connecticut  
*Subsidiary of Anaconda Copper Mining Company*  
In Canada: ANACONDA AMERICAN BRASS LTD.,  
New Toronto, Ont.

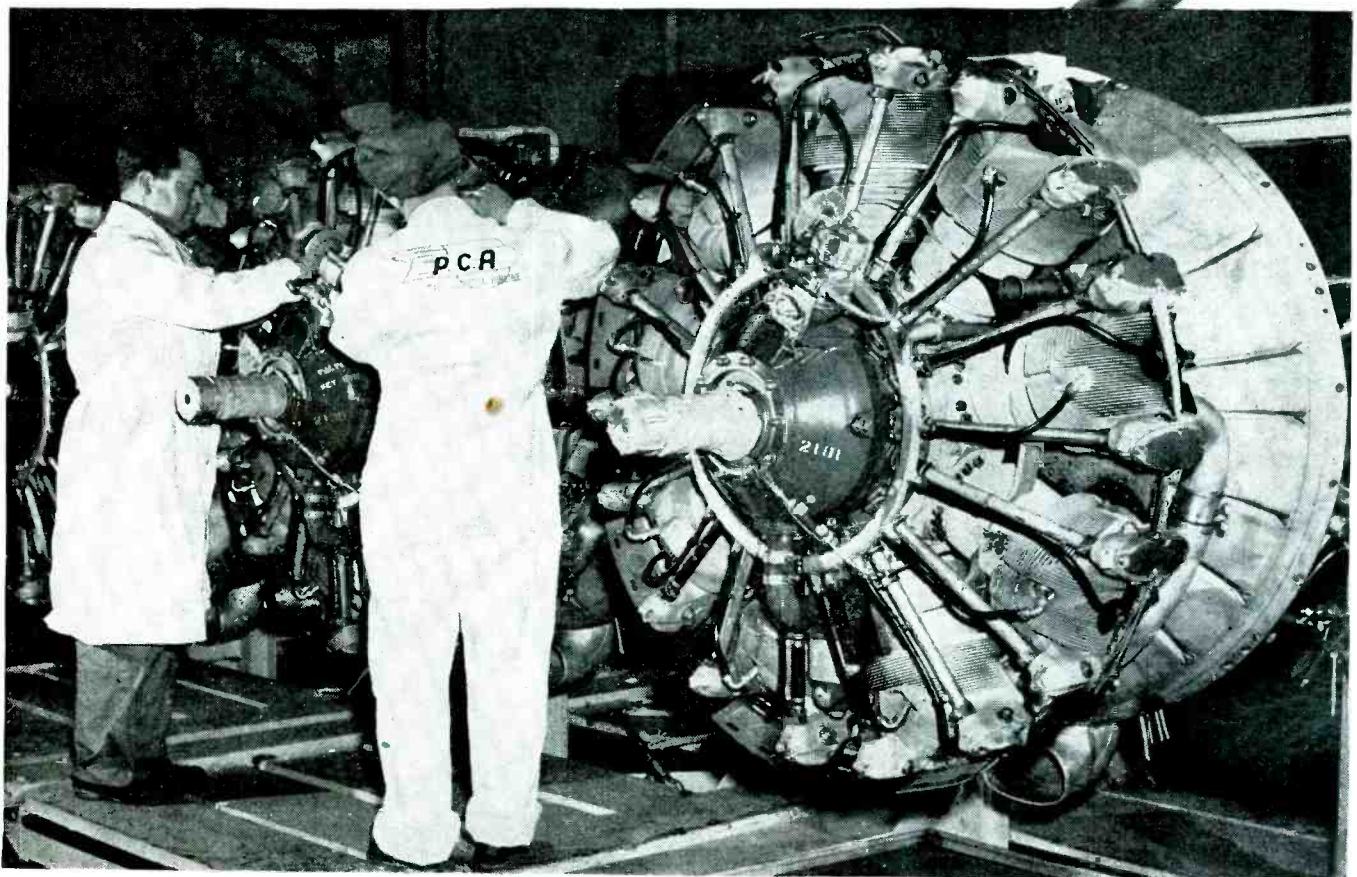

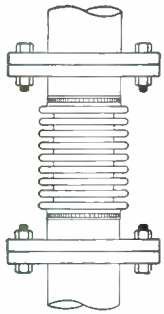

Expansion Joint

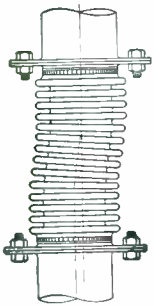

Flexible Connector

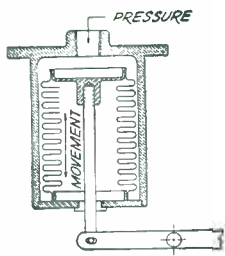

Pressure Motor

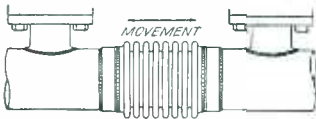

Compensator for Headers



## C. M. H. STAINLESS STEEL BELLOWS

*Assure*

### long life low maintenance

The outstanding features of corrosion-resistant 18-8 Austenitic *Stainless Steel* enable wider application of C. M. H. Bellows. This is because *stainless steel* has the necessary characteristics to assure long life and low maintenance cost.

C. M. H. Bellows, for example, with a working range of sub-zero to a scaling-point of 1800° F. are not bothered by temperatures hot or cold. In addition, they have multiple-ply construction for greater strength; ferrous fittings, attached by Circular Seam Welding to insure leakproof joints; uni-metal assemblies which avoid troubles often encountered when bi-metal or solder joints are used. These and other features warrant your consideration. Write for Bulletin SS B-46.



rent, 31 amperes; peak forward voltage, 1,000; steady direct current, 12 amperes; peak direct current, 100 amperes. Useful for welding control or power rectifier, the tube is 12½ inches high.

### Vhf Receiver

FEDERAL TELEPHONE AND RADIO CORP., Newark, N. J. The 139-A receiver is a single-channel, crystal-controlled vhf equipment for use in the commercial aviation field at any desired point in the 108-132 mega-

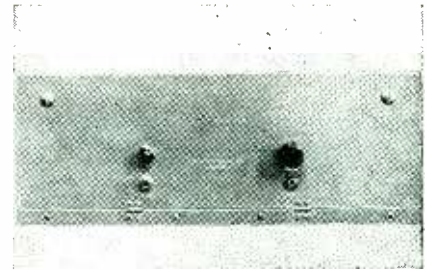

cycle band. It mounts on a standard relay rack, requiring a depth of 9 inches. The 7-inch front panel is hinged for access. Components are mounted horizontally on the rear of the chassis as well as behind the panel so that maintenance is easily accomplished.

### Record Changer

REXON, INC., 295 Fifth Avenue, New York City, is general distributor of the Thorens type CD 40 record changer which combines several interesting features. Any record can be wholly or partially repeated without removing other records. Any record can be rejected before or during playing or delayed without shutting off the machine. Eight records, either 10 or 12 inches, can be mixed

Flexible Metal Hose for Every Industrial Use



# CHICAGO METAL HOSE CORPORATION

MAYWOOD, ILLINOIS

Plants: Maywood and Elgin, Ill.



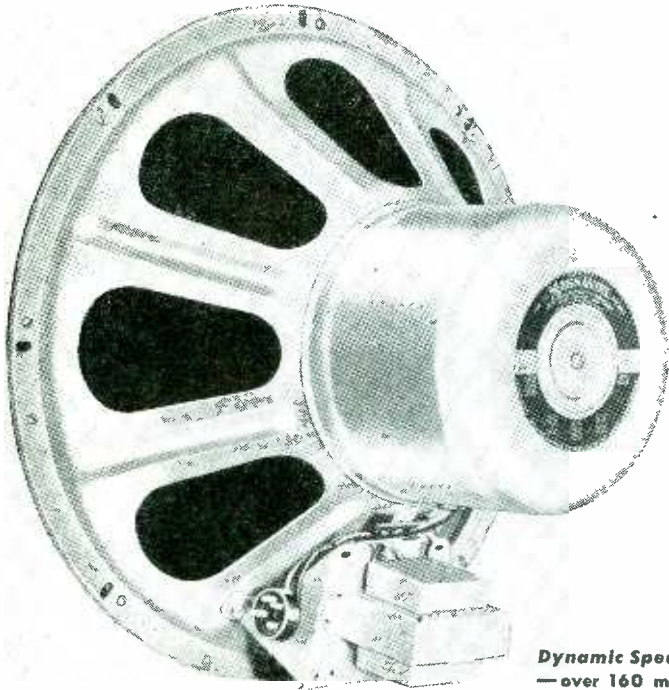

**Dynamic Speakers**  
— over 160 models.

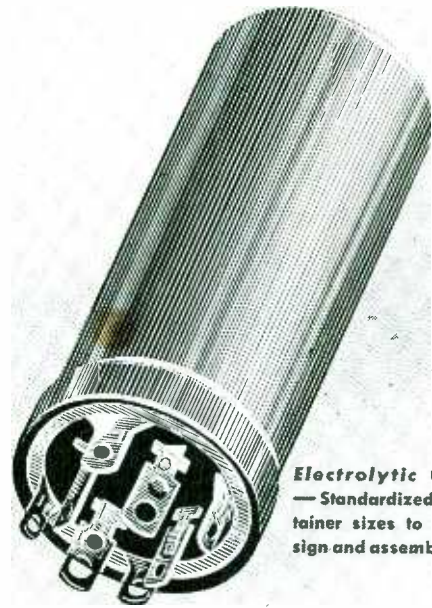

**Electrolytic Capacitors**  
— Standardized into 8 container sizes to simplify design and assembly problems.

**Magnavox . . . specialists in quality components for quantity production**

**Dependability! Economy!  
Durability! Time-Tested Qualities  
of Magnavox Components.**

**F**OR over thirty years Magnavox has set the pace in the manufacture of loud-speakers and component parts. The inventions and developments of Magnavox engineers and designers are established as standards of the radio industry.

Magnavox specializes in custom

applications for quantity production. The oldest and largest manufacturer of loud-speakers, Magnavox is your guarantee of the finest speakers and electrolytic capacitors. There is no substitute for experience! The Magnavox Company, Components Division, Fort Wayne 4, Indiana.

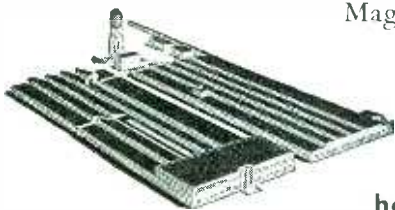

**Magnavox**

has served the radio industry for over 30 years

**S P E A K E R S • C A P A C I T O R S • E L E C T R O N I C E Q U I P M E N T**

**MILFORD FASTENING EQUIPMENT**

*Important* **Memo**  
for **DESIGN** and **PRODUCTION ENGINEERS**

With Milford Fastening Equipment, rivets and rivet-setting machines, heavily oversold temporarily, it is foresighted to plan assembly operations while future products are still on the drawing board. Milford will gladly work with you along this line.

**MAGNETIC WINDINGS CO.**  
EASTON, PENNA.

**SMASHED ASSEMBLY BOTTLENECK**  
by fastening this robot bomb part with standard-sized tubular rivets set automatically by machine

Jumped assemblies  
from 85 to 260  
units per hour  
**BETTER THAN  
300% INCREASE**

Two small end rivets were depended on to hold permanently together a set of metal plates. Setting these rivets by hand was slow and tedious; delayed a vitally needed part.

But since the rivets were standard-sized, they could be set immediately by a standard machine. The change-over was easy; the production increase inevitable.

To users of Milford Fastening

Equipment this is not news. Ever since Milford rivets and rivet-setting machines first fastened metal, wood, fabric or plastic parts together, they have been smashing assembly bottlenecks, often with even greater savings in time and labor costs. Catalog on request.

PLEASE NOTE: Until material becomes regularly available to fill back orders, immediate deliveries are not always possible.

**THE MILFORD RIVET & MACHINE CO.**

859 Bridgeport Ave.  
**MILFORD, CONN.**

1002 West River St.  
**ELYRIA, OHIO**

*Inquiries may also be addressed to our subsidiary:*

THE PENN RIVET & MACHINE CO., PHILADELPHIA 33, PENNA.

Designers and Manufacturers of: SPECIAL COLD-HEADED PARTS; SPLIT, SEMI-TUBULAR AND DEEP-DRILLED RIVETS; RIVET-SETTING MACHINES; SPECIAL MACHINE SCREWS AND SCREW MACHINE PARTS.

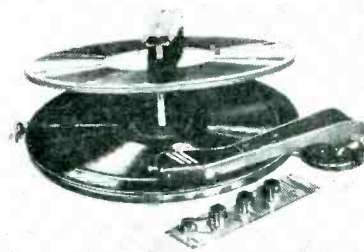

and played, the machine stopping automatically at the end of the series. The equipment is spring-mounted and well constructed mechanically. A crystal pickup is included. The a-c motor operates on 100 to 250 volts, 50 to 60 cps.

**Microwave Demonstrator**

GENERAL ELECTRIC Co., Syracuse, N. Y. Designed for microwave demonstrations and amateur use, a new lighthouse tube cavity oscillator, an-



tenna and reflector operate at 2,400 megacycles. Power for operation is obtained from any 110-volt, 60-cps outlet. A simple crystal detector and microammeter are used to demonstrate reception phenomena.

**Video Amplifier**

POLARAD ELECTRONICS Co., 135 Liberty St., New York, N. Y., Designed for television and other broad-band applications the video amplifier now available has a gain of 41.5 db and is flat within plus or minus 1½ db from 100 cps to 20 mc. Input impedance of the attached probe is 12 micro-microfarads across 4.7 megohms. Output voltage is 56 volts peak to peak. A frequency compensated attenuator is calibrated in 10 db steps

LET BENTLEY, HARRIS WAR-TIME RESEARCH PAY DIVIDENDS FOR YOU TODAY.

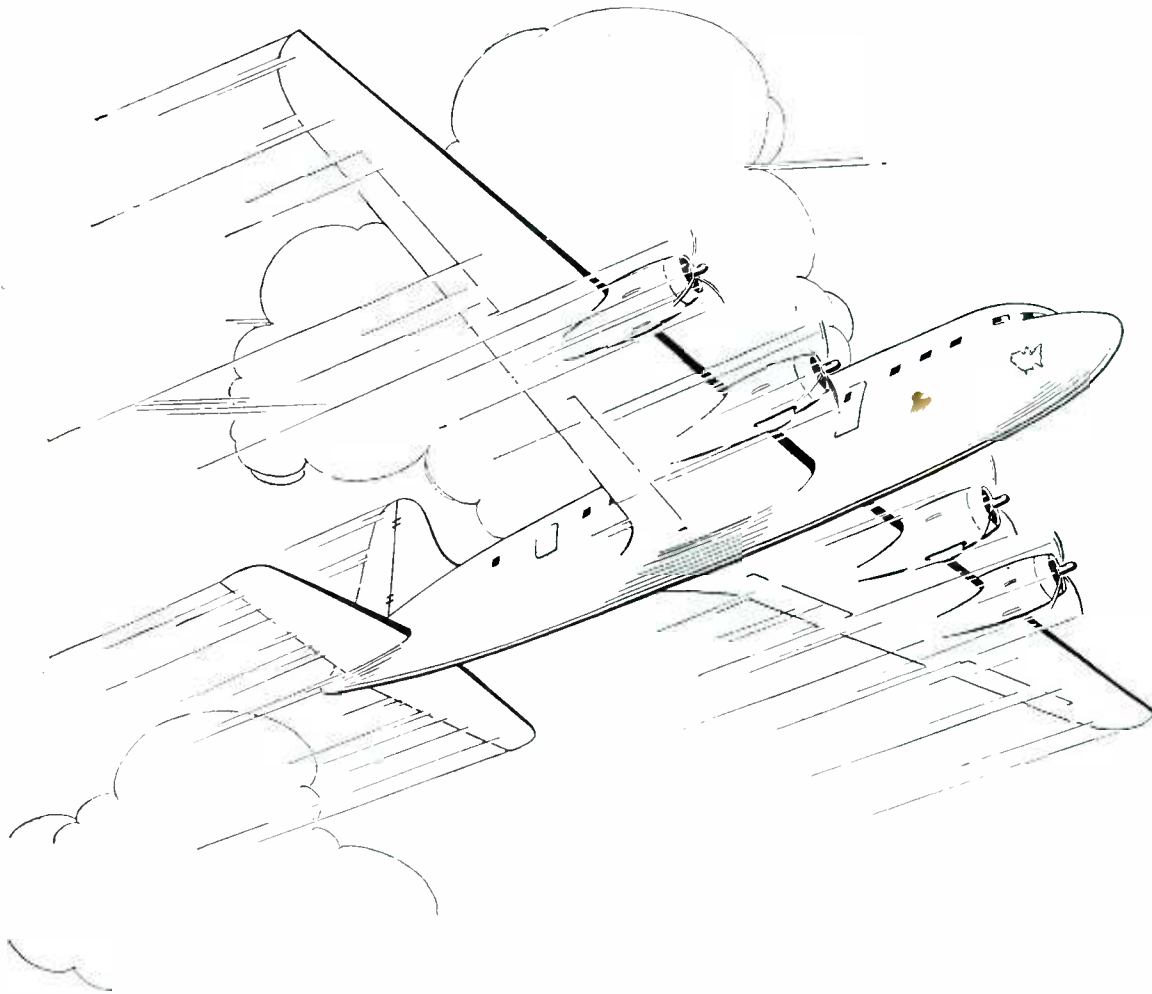

In the giant transports that carried American supplies over the Hump to China, brush shunts on the generators required an electrical insulation that would not burn even in direct contact with flame, would not crystallize even at sub-zero temperatures. Now read what the brush manufacturer reported: "The flexible, non-fraying Fiberglas Sleev-ing with high dielectric strength, which Bentley, Harris developed for our brush shunts, was the answer to one of our most vexing problems."

Test BH Fiberglas Sleev-ing in your own plant, in your own product—under actual service con-ditions. Compare it with ordinary saturated sleev-ing. See how it speeds up assembly. Resists grease, oil and moisture. Will not burn even in direct contact with flame. Learn why America's leading makers of home appliances, radios and industrial equipment have standardized on BH Fiberglas Sleev-ings in their plans for post-war production.

BENTLEY, HARRIS MFG. CO., CONSHOHOCKEN, PA.

# BH *Fiberglas\** SLEEVINGS

\*BH Non-Fraying Fiberglas Sleevings are made by an exclusive Bentley, Harris process (U. S. Pat. No. 239530). "Fiberglas" is Reg. TM of Owens-Corning Fiberglas Corp.

----- USE COUPON NOW -----

Bentley, Harris Mfg. Co., Dept. E-1, Conshohocken, Pa.

Send samples of BH Fiberglas Sleev-ing for \_\_\_\_\_ (product)

I am principally interested in an insulation that is:  Non-fraying;  Flexible as string;  Non-burning;  Heat Resistant to 1200°;  Unaffected by oil, moisture, grease;  Non-cracking when bent;  High dielectric.

NAME \_\_\_\_\_ COMPANY \_\_\_\_\_

ADDRESS \_\_\_\_\_

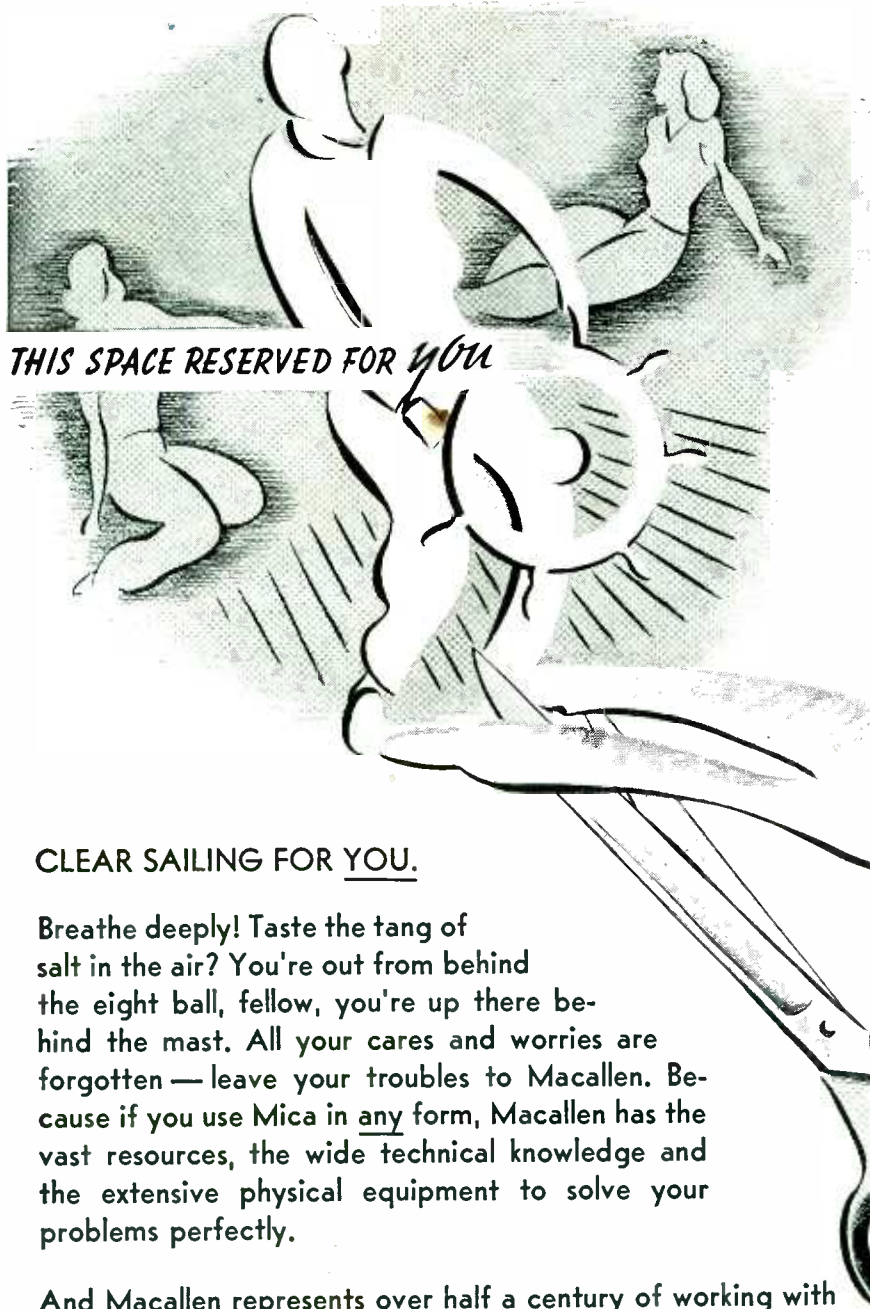

THIS SPACE RESERVED FOR YOU

### CLEAR SAILING FOR YOU.

Breathe deeply! Taste the tang of salt in the air? You're out from behind the eight ball, fellow, you're up there behind the mast. All your cares and worries are forgotten — leave your troubles to Macallen. Because if you use Mica in any form, Macallen has the vast resources, the wide technical knowledge and the extensive physical equipment to solve your problems perfectly.

And Macallen represents over half a century of working with Mica. Whether you make motors or generators, condensers or transformers, if you use Mica, then Macallen is your most reliable and dependable source of supply. For clear sailing ahead — leave your troubles to Macallen.

When You Think of MICA, Think of MACALLEN



from 0 to 50 db and a fine control operates over a 10 db range.

### Miniature R-f Coils

BARKER AND WILLIAMSON, 235 Fairfield Ave., Upper Darby, Pa. Mini-inductors are high-Q, r-f coils useful

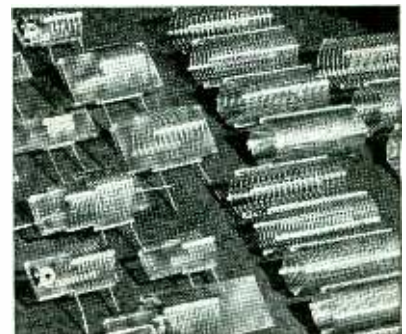

as tank coils, high-frequency transformers and loading coils. Available in several diameters and wound in four different pitches, the inductors are being packaged in two- and three-inch lengths.

### Ship's Radio Station

MACKAY RADIO AND TELEGRAPH CO., 67 Broad St., New York 4, N. Y. Main features of the new ship's equipment are, main transmitter and receiver, high frequency transmitter and receiver, emergency transmitter and receiver, automatic alarm receiver, all components contained within a space  $80 \times 19\frac{1}{2} \times 54\frac{1}{2}$  inches.

### Percentage Timer

R. W. CRAMER CO., Centerbrook, Conn. Time percentage control of industrial operations eliminates the lag encountered in the use of stand-



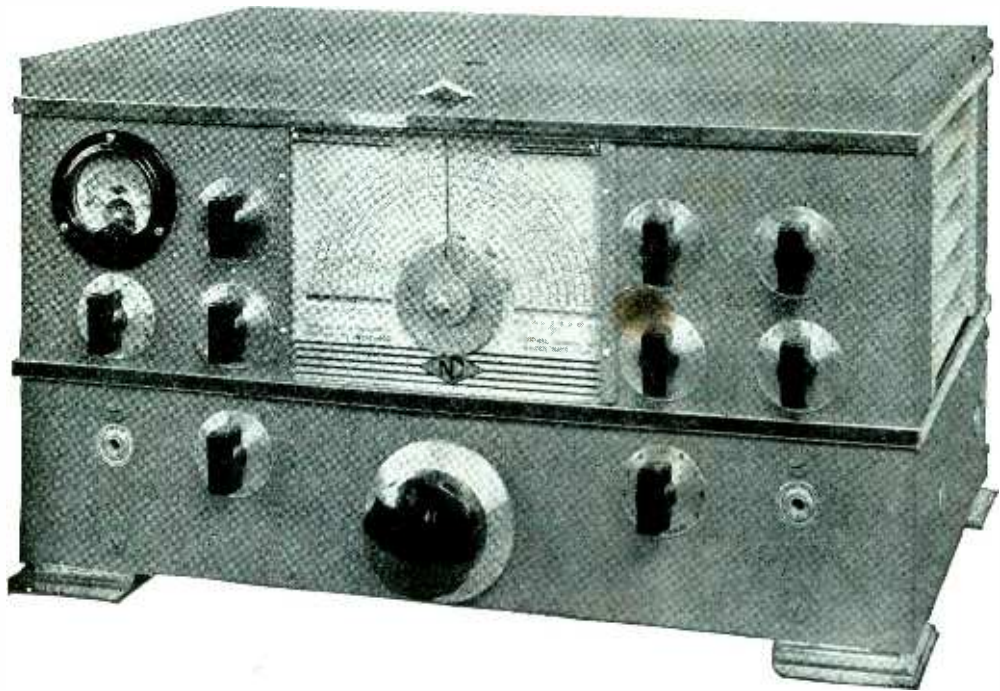

## THE NC-2-40D

*... WITH AMATEUR BAND COVERAGE*

Every feature the amateur needs is found in the superb NC-2-40D receiver. Special expanded coil ranges for the 10, 20, 40 and 80 meter bands are included in addition to general coverage from 490 Kc. to 30 Mc. Each amateur band is spread over 80% of the dial range and the full vision dial shows your location in the band at a glance. Stability and sensitivity are outstanding. A wide range crystal filter gives optimum selectivity under all conditions. The series-valve noise limiter, the AVC, beat oscillator, tone control and S-meter are among the many auxiliary circuits that contribute toward the all-around excellence of the NC-2-40D. See it at your dealer's.



**NATIONAL COMPANY, INC., MALDEN, MASSACHUSETTS**

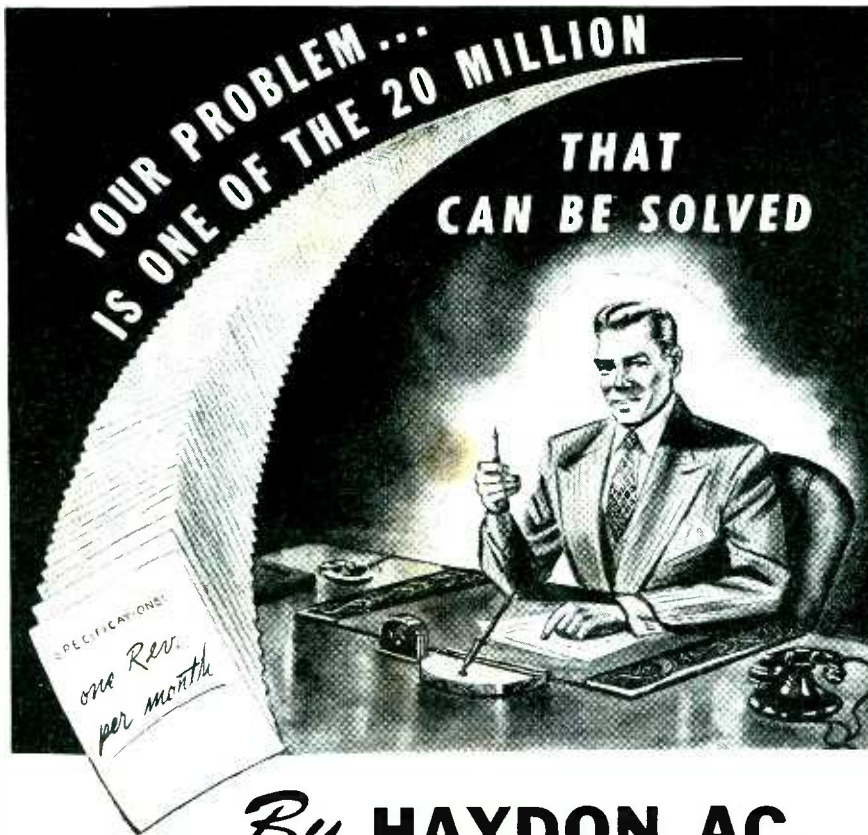

## By HAYDON AC Timing Motors

HAYDON AC Timing Motors can be made to perform one revolution every 1000 hours or 27 million times as many. Whatever your particular requirement may be, a HAYDON AC Timing Motor can be engineered to fit.

More than a million HAYDON units now measure and motivate industrial operations.

SEND FOR ENGINEERING DATA BOOK



ELECTRONEERED TIMING  
**Haydon**  
MANUFACTURING COMPANY  
INCORPORATED  
Forestville, Connecticut

and thermostatic devices. The type PE timer is designed to close or open an electric circuit for a percentage of a definite length of time. It operates on alternating current and can be furnished in a number of contact combinations.

### Ion Gage

GENERAL ELECTRIC Co., Schenectady, N. Y. A new ion gage and control unit are capable of measuring pressures as low as  $10^{-7}$  millimeters of mercury. Detection of small changes

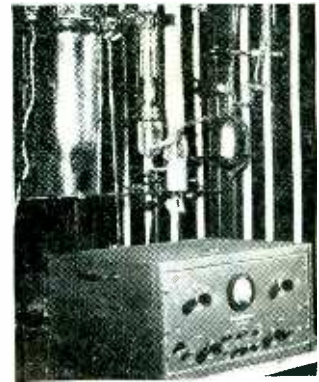

is possible and a protective circuit turns off the gage tube filament at pressures above  $10^{-1}$  millimeters. The tube itself is a special glass triode with a tubulation for connecting to the vacuum system.

### F-m Antenna

FEDERAL TELEPHONE AND RADIO CORP., Newark, N. J. A square loop antenna when used in 8-bay assemblies provides a power gain of 9; a 16-bay gives a gain of 20. Under present FCC restrictions on the effective radiated power from f-m stations, broadcasters can use lower power transmitters in conjunction with antennas of this type. The antenna units are supported by a lattice





# TUNGSTEN CONTACTS

**CAN BE TAKEN AT FACE VALUE!**

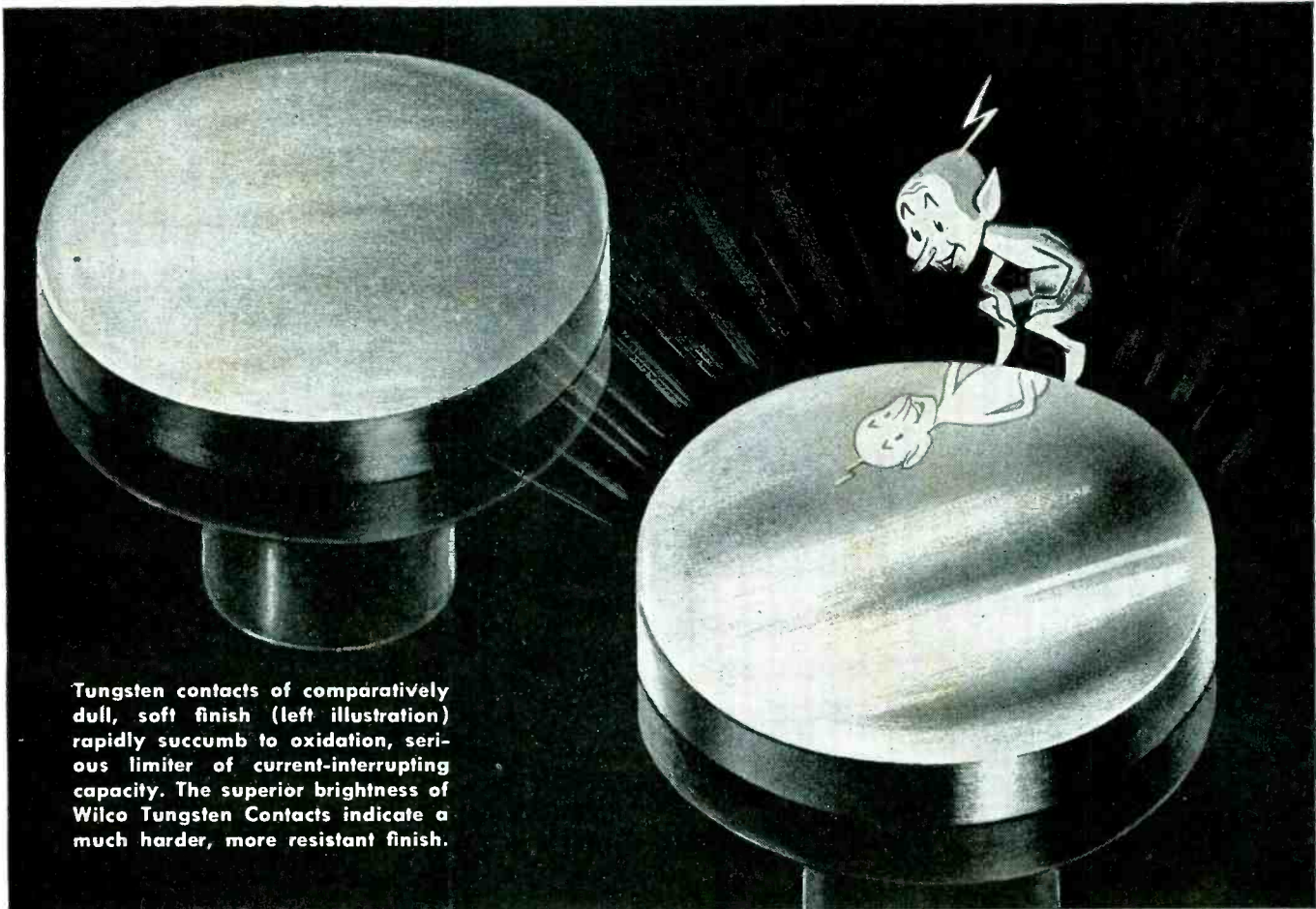

Tungsten contacts of comparatively dull, soft finish (left illustration) rapidly succumb to oxidation, serious limiter of current-interrupting capacity. The superior brightness of Wilco Tungsten Contacts indicate a much harder, more resistant finish.

**Their brighter, harder finish resists oxidation—  
makes for longer life and higher standards of performance**

**WILCO  
PRODUCTS INCLUDE:**

**CONTACTS**

Silver  
Platinum  
Tungsten  
Alloys  
Sintered Powder Metal

**THERMOSTATIC BIMETAL**

All temperature ranges, deflection rates and electrical resistivities

**SILVER CLAD STEEL  
JACKETED WIRE**

Silver on Steel, Copper, Invar or other combination requested.

**ROLLED GOLD PLATE  
AND WIRE  
SPECIAL MATERIALS**

To manufacturers of medium and high-speed make-or-break mechanisms, the cleaner, brighter appearance of WILCO Tungsten Contacts is a valuable clue. Their positive and lasting luster—which makes the finish of other tungsten contacts seem dull by comparison—is the hallmark of contacts uniquely able to resist oxidation. This is not only because Wilco Tungsten Contacts are made of 99.9% pure tungsten, but because they are brought to the hardest possible finish by exclusive Wilco processes developed under Wilco Technicians . . . men of vast skill, knowledge and experience.

Wilco Tungsten Contacts have extremely high melting point, lasting resistance to oxidation, high density, low vapor pressure at elevated temperatures, high strength and arc resisting properties.

**CONSULT OUR ENGINEERING DEPARTMENT**—A representative of the WILCO Sales and Engineering Department will gladly help develop the proper application of WILCO materials to your products.

**THE H. A. WILSON COMPANY**

105 Chestnut St., Newark 5, N. J. • Branch Offices: Chicago, Detroit, Los Angeles

**SPECIALISTS FOR 30 YEARS IN THE MANUFACTURE OF THERMOMETALS • ELECTRICAL CONTACTS • PRECIOUS METAL BIMETALLIC PRODUCTS  
ELECTRONICS — August, 1946**

1917

1946

MODERN  
COIL WINDINGS

## General Grant Was Right

He had one idea . . . to win a war. He had one plan . . . and he stuck to that plan until the war was won.

We wind coils for those who need them. That's our business and we're going to stick to it. We're specialists and do not make apparatus requiring coils, thus avoiding competition with those we hope to serve.

So far, we have been able to do a rather remarkable job as winders of coils in spite of postwar limitations. If you require coil windings, we should be pleased to show you how well we can serve you.

# COTO-COIL CO., INC.

COIL SPECIALISTS SINCE 1917

65 PAVILION AVE.

PROVIDENCE 5, R. I.

tower designed not to disturb the radiation pattern of the loop.

### Warble-tone Oscillator

SOUND APPARATUS CO., 233 Broadway, New York 7, N. Y. The oscillator has been designed for use with the Model PL Automatic high-speed power level recorder and model FR

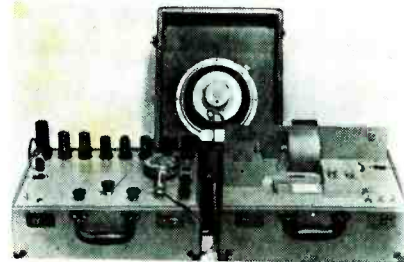

automatic frequency-response recorder for executing measurements such as reverberation time and sound absorption of acoustic materials. A loudspeaker and microphone are included.

### Feed-through Capacitors

CORNELL-DUBILIER ELECTRIC CORP., South Plainfield, N. J. Hermetically sealed metal cased capacitors with a low inductance are now available for

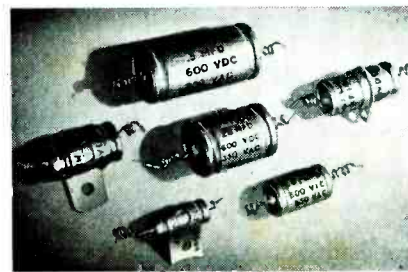

noise-filter service on electrical machinery. Rated at 600 volts d-c, the units have capacitances in the range 0.01 to 0.5 microfarads. They have a low power factor and are unaffected by temperatures as high as 85 C.

### Low-loss Feeder

FEDERAL TELEPHONE AND RADIO CORP., Newark, N. J. Polyethylene-insulated twin-conductor transmission line with characteristic impedances of 100, 200 or 300 ohms is available for television, f-m or other high-frequency antenna sys-



*In Preparation — First volumes ready in 1947*

**Massachusetts Institute of Technology  
RADIATION LABORATORY SERIES**

This series of 27 titles and a general index were written and edited principally by members of the Radiation Laboratory, maintained during the war at the Massachusetts Institute of Technology under contract with the National Defense Research Committee of the Office of Scientific Research and Development. The Laboratory was the foremost U. S. research and development institution in the field of microwave radar.

It is the aim of the Series to treat the advances arising from radar work in a fashion which will emphasize the role of these advances as the basis for the new electronics,

LOUIS N. RIDENOUR  
Editor in Chief

GEORGE B. COLLINS  
Deputy Editor in Chief

rather than to treat each part of the work in terms of its contributions to radar. The

usefulness of the Series will thus extend over all the fields—communication, television, industrial instrumentation and control, research in the biological and physical sciences, and radar itself—in which electronic techniques are of great and increasing applicability and importance.

The volumes in the Series will be priced and sold separately. They will be published in early 1947.

**Volumes in the Series**

- |                                     |   |                                       |
|-------------------------------------|---|---------------------------------------|
| 1. Radar System Engineering         | 11. Technique of Microwave Measurements | 19. Waveforms                         |
| 2. Radar Aids to Navigation         | 12. Microwave Antenna Theory and Design | 20. Electronic Time Measurements      |
| 3. Radar Beacons                    | 13. Propagation of Short Radio Waves    | 21. Electronic Instruments            |
| 4. Loran                            | 14. Microwave Duplexers                 | 22. Cathode Ray Tube Displays         |
| 5. Pulse Generators                 | 15. Crystal Rectifiers                  | 23. Microwave Receivers               |
| 6. Microwave Transmission Circuits  | 16. Microwave Mixers                    | 24. Threshold Signals                 |
| 7. Klystrons and Microwave Triodes  | 17. Components Handbook                 | 25. Theory of Servomechanisms         |
| 8. Principles of Microwave Circuits | 18. Vacuum Tube Amplifiers              | 26. Radar Scanners and Radomes        |
| 9. Microwave Transmission Circuits  |   | 27. Computing Mechanisms and Linkages |
| 10. Waveguide Handbook              |   | 28. Index                             |

**FOR FURTHER INFORMATION**

We invite you to place your name on file, without obligation, to receive notification and further details when specific volumes in this series are about to be published. Just send the coupon, checking the volume or volumes in which you are interested.

McGraw-Hill Book Company, 330 West 42nd Street, New York 18, N. Y.

Send me descriptive information and notice of publication date on the books in the M.I.T. Radiation Laboratory Series which I have circled below. I understand that this obligates me in no way whatever.

ALL 1 2 3 4 5 6 7 8 9 10 11 12 13 14 15  
16 17 18 19 20 21 22 23 24 25 26 27 28

Name .....

Address .....

City and State .....

Company .....

Position ..... L. 8-46

# For Particular SOLDERING . . .

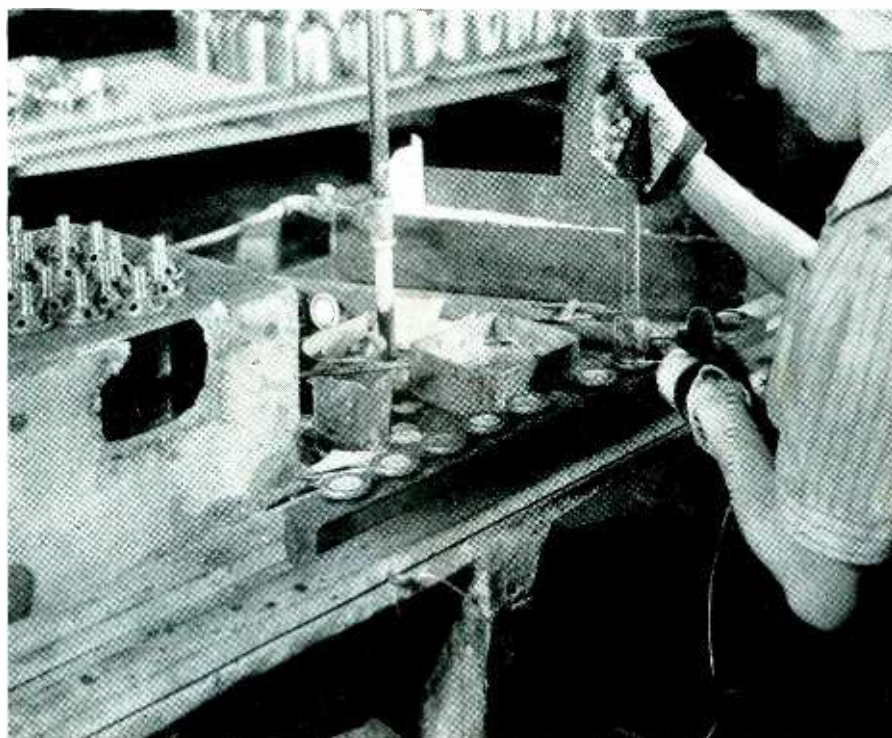

Photo courtesy Metal Stampings Limited, Toronto

## Have the *Right Flux* . . . from **KESTER**

Tight, permanent solder bonds depend on the flux . . . a chemically and physically correct flux that properly cleans the work and prevents re-oxidation.

Different solder jobs require different fluxes, another important point to consider.

You can get the right flux for your particular soldering operation . . . right in kind and right in quality . . . from Kester, for 47 years the recognized solder authority. Consult Kester engineers at any time, without obligation.

### KESTER SOLDER COMPANY

4204 Wrightwood Ave., Chicago 39, Illinois  
Eastern Plant: Newark, N. J. Canadian Plant: Brantford, Ont.



**KESTER**  
*Cored Solders*  
STANDARD FOR INDUSTRY

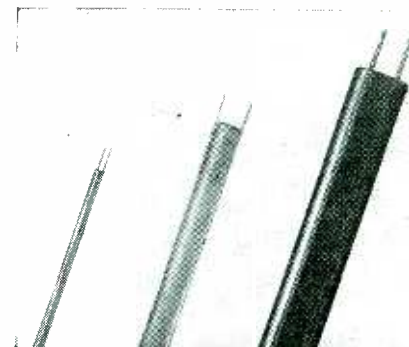

tems. It is small in size, unobtrusive, and easy to install.

### Midget Servo

TRANSICOIL CORP., 114 Worth St., New York, N. Y. The Model 2A servo motor is a 2-phase, 60-cps de-



vice that does not run single phase. It can be wound to operate from 10 to 80 volts or more, with a practically constant impedance from full speed to stall.

### Multiple Connector

THE WINCHESTER CO., 6 East 46th St., New York 17, N. Y. The type QRE multiple connector has spring-loaded contacts for rapid separation and a simple locking device. Two sizes are available, for 12 and 18 con-

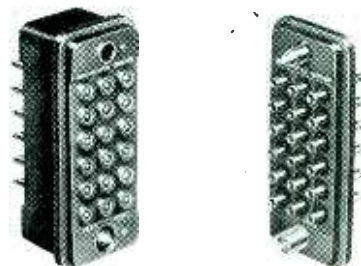

# It counts the Zips in a zipper

Eighteen G-E Neon Glow Lamps for indicators play a vital role in the new Potter Electronic Counter. Used by slide fastener makers to gain exact length and spacing of the fasteners, the dual predetermined Electronic Counter finds many diverse industrial uses. It employs G-E Neon Glow Lamps (1) to reduce current consumed, (2) for extremely long life, (3) to add more sales appeal.

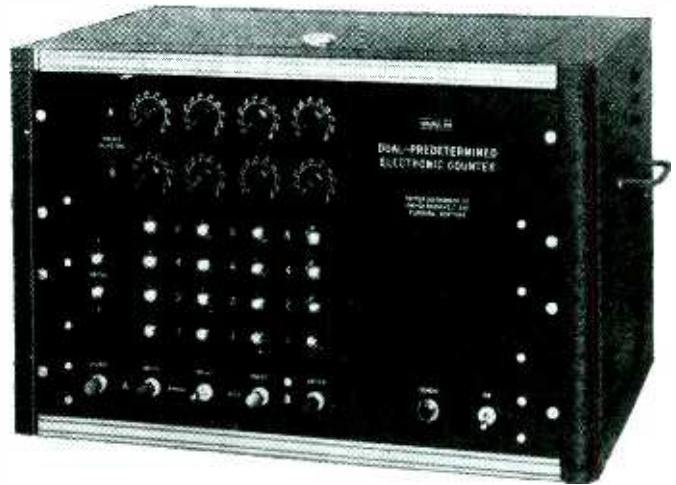

*This dual predetermined electronic counter is a product of Potter Instrument Co., 136-56 Roosevelt Ave., Flushing, N. Y.*

## -and it can improve your product

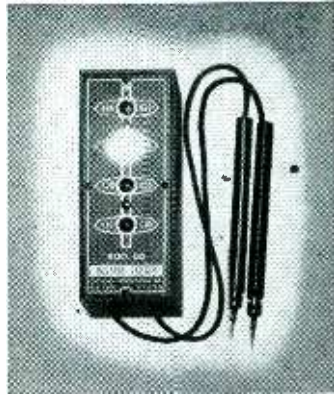

**T**YPICAL new products improved with G-E Glow Lamps are pictured here. They merely hint at hundreds of other unbelievably low cost applications on home appliances, wiring devices, and many types of industrial equipment. Why not consider the following sales features of G-E Glow Lamps on *your* new products:

1. Distinctive orange red glow, needs no cover glass.
2. Dependable long life—rated at 3,000 hours.
3. Very low current consumption.
4. Variety of sizes and wattages.
5. High resistance to vibration and shock.
6. Usable on AC or DC circuits.
7. Work on regular 105-125 volt circuits without the use of step-down transformers.
8. Practically no heat.

**FREE NEW FOLDER** describes typical uses for G-E Neon Glow Lamps and gives lamp data. Write address below.

# G-E LAMPS

GENERAL  ELECTRIC

*Nela Specialty Div. Lamp Dept., 1 Newark St., Hoboken, N. J.*

**..tagged for the big jobs!**

**HEXACON  
SOLDERING  
ELECTRIC  
IRONS**

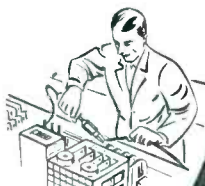
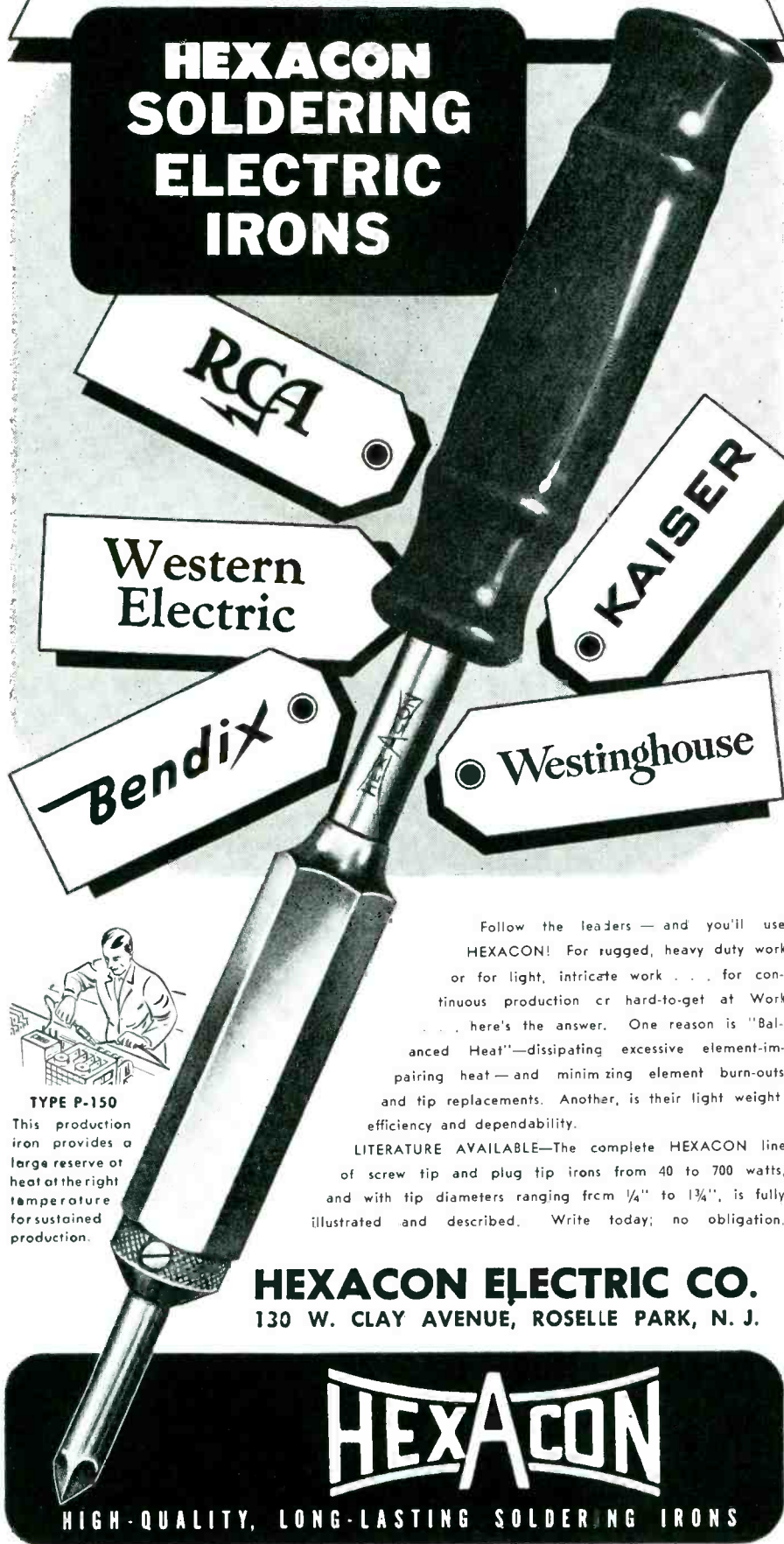

**TYPE P-150**  
This production iron provides a large reserve of heat at the right temperature for sustained production.

Follow the leaders — and you'll use HEXACON! For rugged, heavy duty work or for light, intricate work . . . for continuous production or hard-to-get at Work . . . here's the answer. One reason is "Balanced Heat"—dissipating excessive element-impairing heat—and minimizing element burn-outs and tip replacements. Another, is their light weight efficiency and dependability.

**LITERATURE AVAILABLE**—The complete HEXACON line of screw tip and plug tip irons from 40 to 700 watts, and with tip diameters ranging from 1/4" to 1 3/4", is fully illustrated and described. Write today; no obligation.

**HEXACON ELECTRIC CO.**  
130 W. CLAY AVENUE, ROSELLE PARK, N. J.

**HEXACON**

**HIGH-QUALITY, LONG-LASTING SOLDERING IRONS**

tacts. Maximum wire size that can be used is No. 16. This material is further described in bulletin 831-K.

**Omnidirectional Receiver**

AIRCRAFT RADIO CORP., Boonton, N. J. Development of a new tunable vhf receiver for operation on the experimental CAA-installed New York-Chicago omnidirectional range

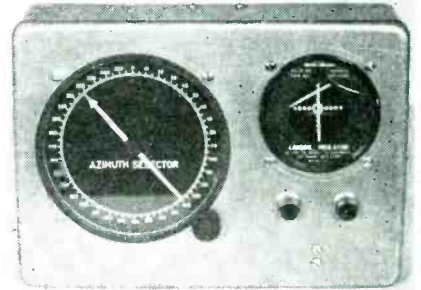

system has been announced. The equipment covers the range 108 to 135 megacycles and includes indicating units illustrated.

**Electronic Metronome**

G. SCHIRMER, INC., 3 East 43rd St., New York 17, N. Y. is distributor for the Metronoma electronic metronome manufactured by Crystal Research Laboratories, Inc., Hartford, Conn. The unit operating on 110- to 120-volt, 60-cps circuits consists essentially of a thyration oscillator, loudspeaker, and neon lamp. A numbered dial allows adjustment of the oscillator frequency to give 40 to 208 beats per minute.

**Outdoor Microphone**

ST. LOUIS MICROPHONE Co., 2726-28 Brentwood Blvd., St. Louis 17, Missouri. The Rugged Outdoor Microphone designed for severe climatic conditions and rough usage has a

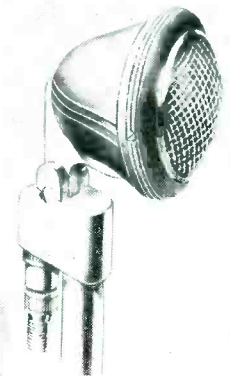



# A MULTI-PURPOSE AMPLIFIER *of Broadcast Quality*

Worthy of an  
Engineer's Careful  
Consideration



Langevin 114-A Amplifier in 204-A Cabinet

**T**HE Langevin 114-A Amplifier is primarily a monitor amplifier. It is used in offices, auditor and control rooms of radio stations and recording studios, and also fits the needs of wired music installations and other industrial uses wherever an amplifier for a single or dual speaker installation is required.

This amplifier operates on 110-120 volts AC or DC. It can be rack mounted or used in its own metal cabinet, Type 204-A; it has a frequency response of 30 to 15,000 cycles and delivers 3 watts of audio power at less than 2% RSS total harmonic distortion at 400 cycle single frequency. At 4 watts output the distortion is less than 5%.

## ELECTRICAL CHARACTERISTICS

**GAIN**—Approximately 61 db high gain and 43 db when bridging a 600 ohm source. **OPERATES FROM**—0-1000 ohms using nominal 600 ohm input, 0-25,000 ohms using nominal 25,000 ohm input, with maximum gain depending upon impedance of bridge source. **OPERATES INTO**—Nominal load impedance of 4 ohms. Working range 2 to 8 ohms. **OUTPUT POWER**—Approximately 4 watts with less than 5%, and 3 watts with less than 2%, RSS total harmonic distortion at 400 cycles single frequency into nominal 4 ohm load. **OUTPUT NOISE** 42 db below +35 VU (7 db below .001 watt) or better. **FREQUENCY CHARACTERISTIC**—Production run  $\pm 1.5$  db over the range of 30-15,000 cycles. **POWER REQUIREMENT**—110-120 volts, 25-1000 cycles AC, or 110-120 volts DC. Amplifier draws 70 watts at 120 volts. **SIZE**—Maximum length 10 1/4", depth 6 1/2", height 6 3/4".

# The Langevin Company

INCORPORATED

SOUND REINFORCEMENT AND REPRODUCTION ENGINEERING

NEW YORK, 37 W. 65 St., 23 • SAN FRANCISCO, 1050 Howard St., 3 • LOS ANGELES, 1000 N. Seward St., EE



## WILL YOU BE READY?

### CREI Can Prepare You Now for a Better Job and a Secure Future in RADIO-ELECTRONICS

**CREI home study training prepares you for the secure radio jobs that pay good money for technical ability.**

You can be ready to enjoy the security of an important technical position and take advantage of new career opportunities . . . if you prepare yourself *now*.

Join the ambitious radiomen who are assuring themselves of secure good-paying jobs with a planned program of advancement made possible by CREI home study training in Practical Radio-Electronics Engineering.

You can study at home—in your spare time—develop your technical ability—increase your knowledge to keep pace with the many new, important developments now taking place in the industry.

CREI home study courses are constantly being revised and kept up-to-date with these rapid developments. You will have the benefit of individual guidance and supervision of a trained instructor on each step of your work. U. H. F. as well as all other basic principles of modern, practical radio-electronics engineering are covered in CREI home study courses.

All indications point to a continually growing demand for highly trained radio engineers and technicians. CREI can help you join this select group.

You are now in an era that will see the "survival of the fittest". Make sure that *you* will not be left behind. Get ready now, for a better job and more money in the new world of Electronics. *CREI training for Veterans is available under the G. I. Bill.*



**WRITE FOR FREE 36-PAGE BOOKLET**

**"Your Opportunity in the New World of Electronics"**

Tells how CREI Courses can be adopted to your particular needs.

If you have had professional or amateur radio experience and want to make more money, let us prove to you we have something you need to qualify for a better radio job. To help us intelligently answer your inquiry—

PLEASE STATE BRIEFLY YOUR BACKGROUND OF EXPERIENCE, EDUCATION AND PRESENT POSITION

## Capitol Radio Engineering Institute

E. H. RIETZKE, *President*

Dept. E-8, 16th and Park Road, N.W.,

Washington 10, D. C.

Branch Offices:

New York (7): 170 Broadway

Chicago (2): 30 N. LaSalle Street

San Diego (1): 316 C Street

San Francisco (2): 760 Market Street

Member: NATIONAL HOME STUDY COUNCIL • NATIONAL COUNCIL OF TECHNICAL SCHOOLS

range of 40 to 9,000 cps and an adjustable impedance output.

### Flash Tube

SYLVANIA ELECTRIC PRODUCTS INC., 500 Fifth Ave., New York 18, N. Y. The R4330 flash tube can be operated from a simple capacitor discharge circuit to provide flashes of 1/5,000 second duration with a peak light output of 12 million lumens. The tube

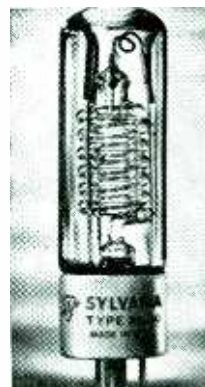

is useful for photography, marine and airways obstruction markers or for stroboscopic devices. The T-11 bulb and medium ceramic octal base do not exceed a diameter of 1 1/2 inches and the unit is 5 1/2 inches high.

### Television Rectifier

CHATHAM ELECTRONICS, 475 Washington St., Newark 2, N. J. The type 1Z2 rectifier tube is a small-bulb, high-voltage, low-current rectifier



designed for use in circuits supplying up to 20,000 volts and 2 milliamperes. Filament voltage is 1.5 volts and filament current 0.29 ampere. The base is miniature button, 7-pin and the cap is a skirted miniature.

### Coaxial Antenna

ANDREW Co., 363 East 75th St., Chi-



**"There's a Meyercord Decal for every kind of commercial surface"**

**THIS PRACTICAL "SLIDE-RULE" WILL HELP YOU SELECT THE RIGHT**

## **MEYERCORD DECAL NAMEPLATES**

Don't take a chance on just "any Decal" to do your product identification job. Conditions, type and use of surface should determine the kind of Decal and adhesion method. Meyercord technicians have prepared this Decal Selector to assist in the selection of the right Decal...for use as trademarks, instructions, patent data, etc...particularly on difficult surfaces. There's a Meyercord Decal for every surface,

from standard Kwik-Ways to highly specialized types resistant to acid, abrasion, temperature extremes, moisture... for application on any shape or kind of commercial surface. No rivets, bolts or screws required. They can be produced in any size, design or number of colors. Write today for the new Meyercord Decal Selector to help you specify the right Decal. Please address your inquiries to Department 9-8

**• IDENTIFY  
• DECORATE  
• ADVERTISE  
your products  
with  
MEYERCORD  
DECALS**

# **THE MEYERCORD CO.**

*World's Largest Decalcomania Manufacturers*

**5323 WEST LAKE STREET • • • CHICAGO 44, ILLINOIS**

**MERIT**  
CVC  
Since 1924  
FINE RADIO PARTS

Is your order in for the Merit Replacement Line of Transformers?

**MERIT COIL & TRANSFORMER CORP.**  
TELEPHONE  
4427 North Clark St. Long Beach 6311 CHICAGO 40, ILL.

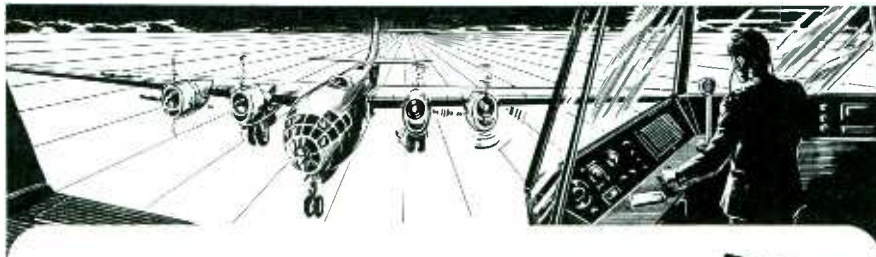

An Invitation to All Electrical Designers to  
**TRY SILVER GRAPHALLOY**

**FOR BRUSHES**

High current density, low contact drop, low electrical noise, and self-lubrication are characteristics of this silver-impregnated molded graphite that may be the answer to your electrical brush problems

SAMPLES of Silver Graphalloy will be gladly furnished for test on your applications. Silver Graphalloy is usually silver plated to permit easy soldering to leaf springs or holders. Why not WRITE NOW for your test samples?

**FOR CONTACTS**

Low contact resistance and non-welding when breaking surge currents are inherent properties of this unique combination of conductive silver and self-lubricating graphite



**GRAPHITE METALLIZING CORPORATION**  
1055 NEPPERHAN AVE • YONKERS, NEW YORK



cago 19, Ill. The type 704 coaxial antenna is furnished complete with two mounting straps and 15 feet of solid dielectric coaxial cable. It can be furnished for frequencies in the range 108 to 186 megacycles. Price is \$16.00 fob Chicago.

**829 Socket**

E. F. JOHNSON Co., Waseca, Minn. The new type 122-101 ceramic socket is designed for type 826, 829 and 832

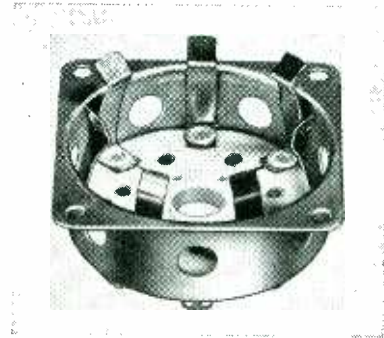

tubes. The aluminum base shield allows the mounting of button mica bypass capacitors for high frequency operation. The grid terminals have been arranged for attachment of grid coils. Retainer springs hold the tube securely.

**Sealnut**

RADIO FREQUENCY LABORATORIES, Inc., Boonton, N. J. A new mounting and sealing nut that prevents dirt and moisture from entering

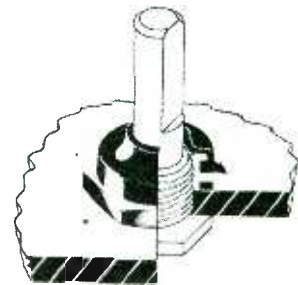

equipment through control apertures is now available. It can be readily substituted for standard mounting nuts now in service.

**Vhf Transmitter**

BENDIX RADIO, BALTIMORE 4, MD. The PAT-50 transmitter operates on

# S.S. WHITE FLEXIBLE SHAFTS

## CUT *assembly* TIME AND COSTS

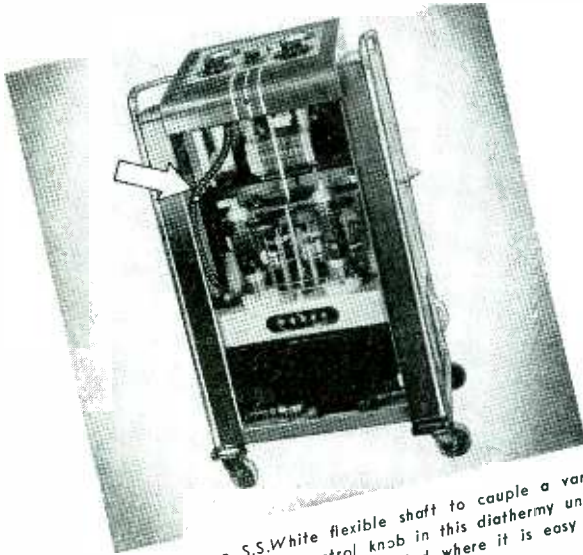

Use of an S.S. White flexible shaft to couple a variable element to its control knob in this diathermy unit, permits the element to be located where it is easy to mount and to wire.



Use of short pieces of S.S. White flexible shafts to couple external remote control shafts to tuning elements in this radio receiver eliminates the need for precise mounting and alignment of the elements.

WHERE equipment includes power transmission or remote control, S.S. White flexible shafts serve to cut assembly time and costs **three ways**—

1. They reduce the number of parts to assemble because—just one easily connected shaft is all you need to direct-connect any two points regardless of curves, obstacles, or distance.
2. They eliminate the need for accurate alignment of parts—and with it the expensive close-tolerance workmanship needed to get accurate alignment.
3. They make it possible to place both driving and driven or controlled parts anywhere you want them to facilitate assembly.

For essential facts and technical data about S.S. White flexible shafts and their application—

**WRITE FOR BULLETIN 4501**



**S.S. WHITE**  
 THE S. S. WHITE DENTAL MFG. CO. **INDUSTRIAL** DIVISION  
 DEPT. E. 10 EAST 40th ST., NEW YORK 16, N. Y.—



FLEXIBLE SHAFTS • FLEXIBLE SHAFT TOOLS • AIRCRAFT ACCESSORIES  
 SMALL CUTTING AND GRINDING TOOLS • SPECIAL FORMULA RUBBERS  
 MOLDED RESISTORS • PLASTIC SPECIALTIES • CONTRACT PLASTICS MOLDING

*One of America's AAAA Industrial Enterprises*

Designed for



Application



90902

**90900 Series  
Cathode Ray Oscilloscopes**

The No. 90902 and No. 90903 Rack Panel (3½") Oscilloscopes, for two and three inch tubes, respectively, are inexpensive basic units comprising power supply, brilliancy and centering controls, safety features, magnetic shielding, switches, etc. As a transmitter monitor, no additional equipment or accessories are required. The well-known trapezoidal monitoring patterns are secured by feeding modulated carrier voltage from a pick up loop directly to vertical plates of the cathode ray tube and audio modulating voltage to horizontal plates. By the addition of such units as sweeps, pulse generators, amplifiers, servo sweeps, etc., all of which can be conveniently and neatly constructed on companion rack panels, the original basic 'scope unit may be expanded to serve any conceivable application.

**JAMES MILLEN  
MFG. CO., INC.**

MAIN OFFICE AND FACTORY  
**MALDEN  
MASSACHUSETTS**



131.9 and 131.7 megacycles to provide communication from private planes to airway control stations. The unit is designed to operate in conjunction with other equipment in the Flightweight line, so that its voltage requirements differ with different combinations. Additional channels are available by plugging in extra crystals. Power output to a 22-inch vertical rod antenna is about one watt, sufficient for operation at 75 miles with reasonable altitude.

**Literature**

**Catalog.** Centralab, Div. of Globe-Union Inc., 900 E. Keefe Ave., Milwaukee 1, Wis. Catalog 25 contains 20 pages and brings the Centralab line up to date. Included is information on switches, resistors, capacitors and special items.

**Radar Booklet.** Radiomarine Corp. of America, 75 Varick St., New York 13, N. Y. A 12-page booklet describes Model CR-101 shipboard radar equipment for installation on cargo or passenger vessels as an aid to navigation.

**Relays and Timers.** Potter & Brumfield Sales Co., Dept. 214, 549 W. Washington Blvd., Chicago 6, Ill. A new catalog gives sales information on this company's line of standard relay and electrical timing devices. The 24 pages are well illustrated. All relays are rated on the current-carrying capacity of the contact possible without damage to any portion of the relay assembly.

**Loran Folder.** Radiomarine Corp. of America, 75 Varick St., New York 13, N. Y. An accurate fix within three minutes without aid from any other navigational system is a feature of the loran long range aid to navigation operating over the Atlantic and Pacific oceans. Compact ship receiver-indicators based upon equipment designed for airplane service are described in a 4-page folder.

**Color Codes.** Solar Manufacturing Co., 285 Madison Ave., New York 17, N. Y. In the May-June issue of "The Solar System" are listed the 1946



Tube-type  
**RESISTORS**

★ Clarostat Series MT tube-type resistors remain the ideal voltage-dropping means in AC-DC receivers and other compact electronic assemblies. Handy. Compact. Inexpensive. Identical in size, shape, appearance and mounting to the 25Z6 and 25A6 metal radio tubes. Also readily serviced out in the field with Clarostat replacements.

This type provides connections to "hot" leads under the chassis, yet dissipates the heat above it.

Exceedingly high leakage resistance — well over 1000 megohms under adverse conditions — between resistance element and chassis, permits use in the most sensitive circuits without introduction of AC hum.

Terminal connections and leakage resistance meet Underwriters requirements.

Available in a wide range of pilot lamp combinations.

Resistance element comprises coiled resistance winding supported on notched mica form. No sagging. No shorts.

★ Write for DATA . . .

Clarostat Engineering Bulletin 107 contains all necessary technical details. Write for your copy. And submit that resistance or control problem!



CLAROSTAT MFG. CO., Inc. · 285-7 N. 6th St., Brooklyn, N. Y.

# Speaking of STABILIZATION

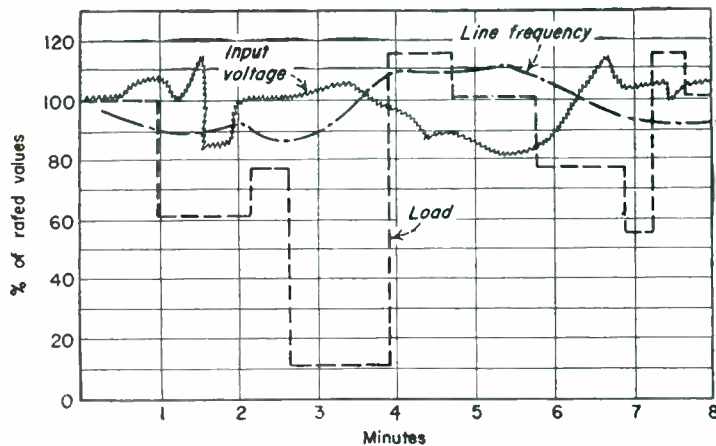

With  
**THESE**  
Variations

You get **THIS**  
**STABILIZATION**  
**ONLY**

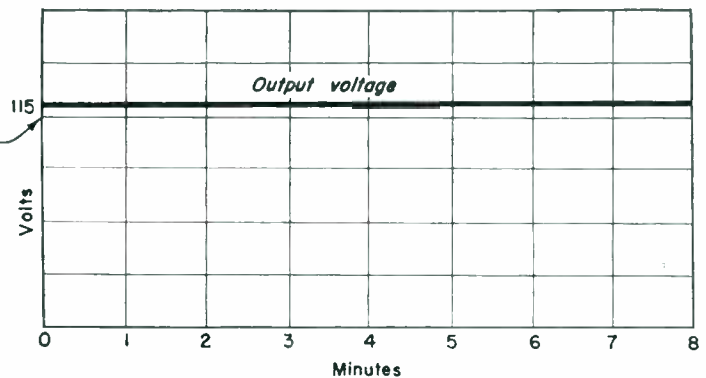

## When using SORENSEN ELECTRONIC REGULATORS

SORENSEN REGULATORS are based on a unique principle that results in extremely accurate voltage regulation —independently of variations in INPUT VOLTAGE, LINE FREQUENCY, LOAD & POWER FACTOR, within wide limits.

Regulation is accomplished electronically without moving parts of any kind. This means QUICK RESPONSE, LOW MAINTENANCE and LONG LIFE.

Whatever the peculiarities of your regulation problem, investigate the SORENSEN REGULATOR.

Here are a few of the characteristics available in the various models:—

- Regulation Accuracy .....0.2%
- Load Ranges.....25 V.A. to 10 K.V.A.
- Harmonic Distortion.....5% max.\*  
\* Less than 2%—Special Models.
- Response Time.....6 cycles max.
- Adjustable output voltage.

★  
**INTRODUCING**

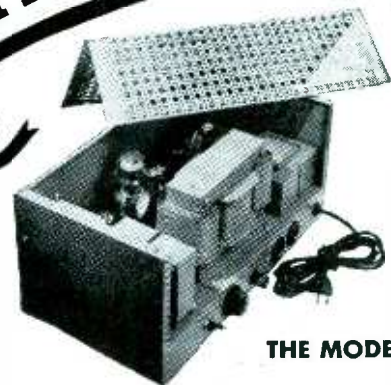

**THE MODEL 500**

Load range.....50 V.A. to 500 V.A.  
Regulation accuracy.....±0.5%  
Price .....\$98.00

F.O.B. Stamford, Conn.

Write for descriptive bulletin

# SORENSEN & CO., INC.

375 FAIRFIELD AVE., STAMFORD, CONN.

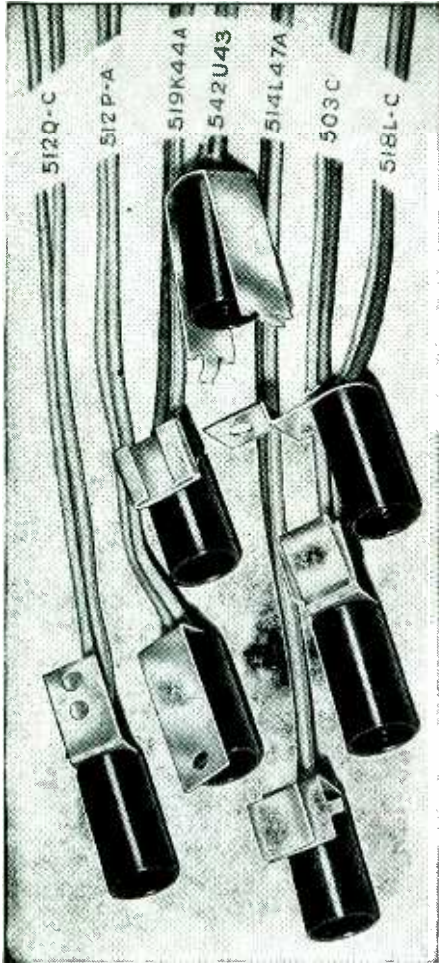

## TOP QUALITY AT LOW COST

DRAKE patents plus modern high speed methods and machinery go a long way toward achieving the traditional excellence and economy of our products. It should pay you in better performance and *lower costs* to specify DRAKE for all of the Socket and Jewel Light Assemblies you need. Ask for prices and the newest Drake Catalog.

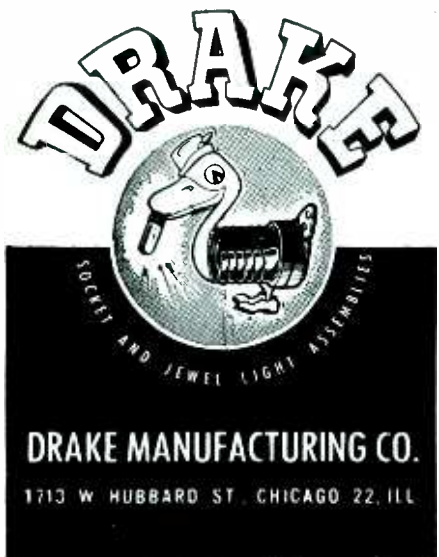

RMA and the JAN codes for molded mica capacitors. Other timely articles are included.

**Loudspeakers.** University Loudspeakers, Inc., 225 Varick St., New York 14, N. Y. The latest catalog of outdoor type loudspeakers and projectors, some of which are explosion-proof, others capable of operating under water, is now available.

**Transformers.** Merit Coil and Transformer Corp., 4427 North Clark St., Chicago 40, Ill. A 4-page folder describing a complete line of power and output transformers and chokes has just been printed.

**Parts and Equipment.** James Millen Mfg. Co., Inc., 150 Exchange St., Malden, Mass. Three new catalogs are now available from the company describing component parts and complete assemblies of laboratory equipment. A condensed general catalog gives notice of a forthcoming catalog of transmitting and receiving equipment.

**Apprenticeship Program.** Apprenticeship-Training Service, U. S. Department of Labor, Washington 25, D. C. A 30-page booklet describes the procedures of setting up a program under the GI Bill. The steps necessary for an employer to obtain approval are fully outlined.

**Seamless Tubing.** Precision Tube Co., 3824 Terrace St., Philadelphia 28, Pa. An 8-page catalog has been prepared describing seamless metal tubing with particular emphasis laid on new methods of forming coaxial cables. Small capacitors and unity-coupled coils can be furnished by this method of construction.

**Subminiature Tubes.** Rathen Manufacturing Co., Inc., 60 East 42nd St., New York 17, N. Y. Tentative data on the CK515BX hearing aid triode as well as other subminiature tubes are available from the manufacturer.

**Midget Rectifier.** Federal Telephone and Radio Corp., Newark 1, N. J. Two bulletins describe the new midget selenium rectifier and ways of using it in console radios, portables and intercommunicators.

**Dry Rectifiers.** Federal Telephone and Radio Corp., Newark 1, N. J. A 6-page booklet describes the com-

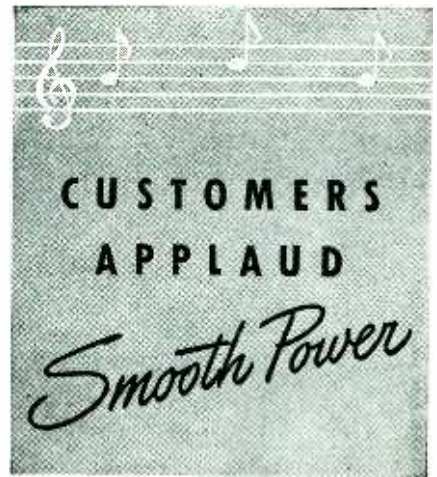

• Build your line of new phonographs and record-changers around *Smooth Power* motors and you'll get that quietness, uniform speed and smooth-as-velvet operation that your customers will approve.

That's because these qualities are engineered and built into every motor and assembly in the wide GI line. It's the result of many years of successful experience in the production of phono motors.

You'll win your markets faster and gain more applause from customers when you *standardize on Smooth Power motors.*



DEPT. ME • ELYRIA, OHIO



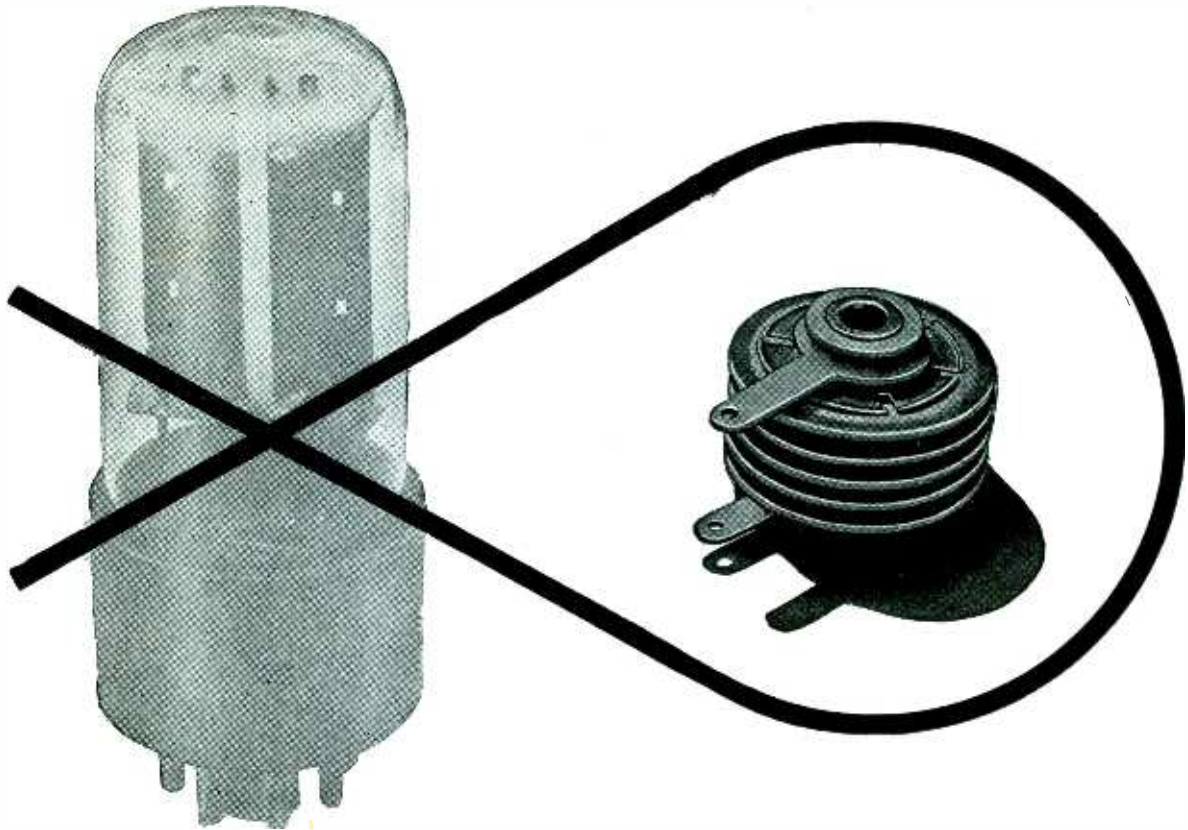

# SIMPLER — SMALLER — STRONGER NEW G-E SELENIUM RECTIFIER REPLACES TUBE IN PORTABLE RADIOS

This new selenium rectifier, *less than one inch long* and only one inch in diameter, offers builders of portable and car radios a new way to cut manufacturing costs and to build a better product.

You gain *six ways* when you incorporate it in your designs:

**Saves Space** — Can be mounted in places where a rectifier tube and socket won't fit. Radio cabinets can be made smaller when this new selenium rectifier is used.

**Cuts Installation Cost** — No socket or filament circuit is necessary. Only two soldering operations and a minimum of mounting hardware are required.

**Ample Current Capacity** — Designed to withstand safely the inverse peak voltages obtained when rectifying (half-wave) 110-125 volts, rms, and feeding into a capacitor as required in various radio circuits. Half-wave rectification of the a-c line is employed.

**Withstands Rough Usage** — Withstands rougher handling than the fragile tubes which it replaces. It won't break when dropped.

**Gives Instant Starting** — Eliminates usual warm-up period before radio starts. It runs cool, too, because of the absence of the heat-producing filament in the tube which it supplants.

**Longer Life** — Continuous tests have proved that this new selenium rectifier will outlast several 117-volt rectifier tubes — last the life of the product for which it is designed.

For information that will help you make efficient use of G-E selenium rectifiers in your designs, write for our booklet *Two Steps Ahead*. Section A23-8119, Appliance and Merchandise Department, General Electric Company, Bridgeport 2, Connecticut.

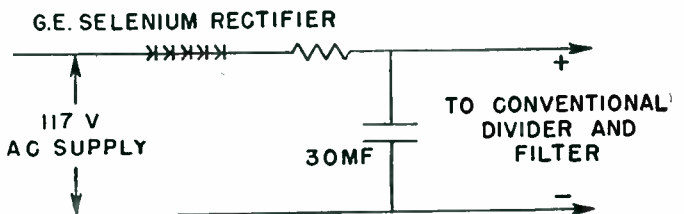

# GENERAL ELECTRIC

# ALLIED

## for everything in Electronics and Sound

Equipment for Research  
Development • Maintenance

### 1946 Catalog FREE

### Largest Stocks • Complete Service From one Central Supply Service

Leading industrial and engineering firms depend on the ALLIED Catalog as their Buying Guide for everything in radio, electronics and sound. Lists more than 10,000 quality items . . . radio and electronic parts, vacuum tubes, tools, test instruments, audio amplifiers, accessories . . . complete lines stocked by a single reliable source. Try ALLIED'S expert, specialized industrial service. Send for FREE Catalog now!

*Everything in Radio and Electronics*

**ALLIED RADIO CORP.**

833 W. Jackson Blvd., Dept. 24-H-6, Chicago 7, Illinois



#### Sound Equipment

See ALLIED'S wide selection of Intercom, Paging and Public Address systems. Models for every industrial purpose.

Send for

Your

ALLIED  
CATALOG

## VACUUM CONDENSERS

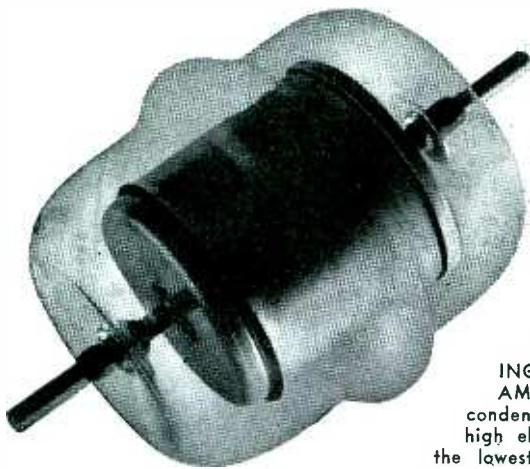

**DIMENSIONS**  
Overall length, 3 1/2 inches  
Glass length, 2 1/4 inches  
Diameter, 2 1/2 inches  
Standard Tolerances

**DESIGNERS OF COMMUNICATION, INDUCTION HEATING, DIATHERMY, AIRCRAFT AND AMATEUR EQUIPMENT:** this vacuum condenser was designed to give you the high electrical ratings you require with the lowest loss at ultra-high or low frequencies; in the most compact unit at the **LOWEST PRICE.**

High conductivity leads, 1/8 inch in diameter, may be conveniently used in mounting in your equipment.

The same high conductivity, treated metals are used which have made our other lines of vacuum condensers outstanding.

We shall be pleased to furnish you with additional information.

### PRICES!

SERIES 20G2 - 20 AMPERES		
Capacitance, microfarads	Peak Voltage	List Price
6	20,000	\$7.50
12	20,000	7.50
25	20,000	8.00
50	20,000	8.00

## GILANDUN ELECTRONICS

14 UNION AVENUE

CAMPBELL, CALIFORNIA

plete line of selenium rectifiers for all industrial and communications uses.

**Relays.** Leach Relay Co., 5915 Avalon Blvd., Los Angeles 3, Calif. Catalog No. 46 describes the complete line of this company's product in detail, occupying 49 pages that are well illustrated.

**Maintenance Handbook.** Westinghouse Electric Corp., P. O. Box 868, Pittsburgh 30, Pa. Basic maintenance operations for electrical equipment are described in a small (6 1/4 x 3 1/2 inches) handbook of 30 pages. Copies may be had for the asking.

**Interchangeable Relay Coils.** Guardian Electric Mfg. Co., 1625 West Walnut St., Chicago 12, Ill. A 4-page bulletin describes the Series-200 relays with interchangeable coil and contact assemblies for use on various voltages, a-c or d-c.

**Power Measurement Lamps.** Sylvania Electric Products, Inc., Emporium, Pa. Four loose-leaf sheets have been published outlining the ratings and characteristics of lamps used for measuring high frequency power output. Three graphs are included.

**Vhf Principles.** Aerovox Corp., New Bedford, Mass. A series of articles is running in the bulletin "Aerovox Research" starting with the March 1946 issue and running through December. The purpose of the articles is to bring readers up to date on latest developments and practice in the field of microwave equipment.

**Sound Equipment.** Stromberg-Carlson Mfg. Co., 100 Carlson Road, Rochester, N. Y. A 4-page brochure describes complete rack-mounted or portable sound equipment together with horns and microphones.

**Precision Resistors.** Resistance Products Co., 140 South Second Street, Harrisburg, Pa. A revised catalog sheet has been printed giving engineering data and dimensions of precision wire-wound resistors.

**Radar Booklet.** Sperry Gyroscope Co., Inc., Great Neck, N. Y. The new marine radar system for private vessels or commercial shipping is illustrated in a 6-page booklet recently released by the company.

**Induction Heater.** Induction Heat-

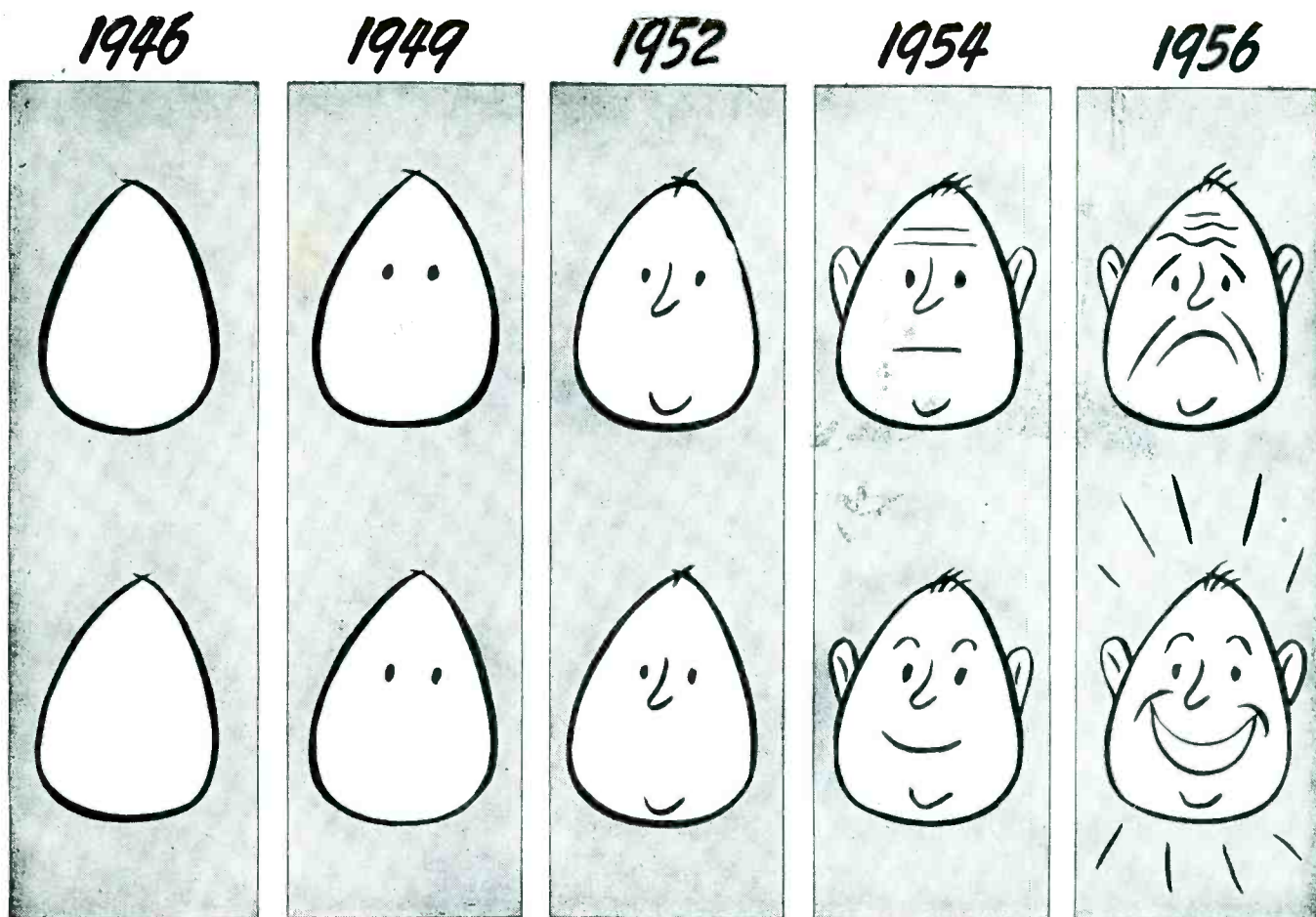

## Two ways your face can grow in the next few years

**U**SUALLY, our faces show what's happening to us. For instance, suppose financial matters are constantly on your mind.

Suppose you know that there's practically no cash reserve between you and trouble.

**It would be surprising if your face didn't show it.**

But suppose that, on the contrary, you've managed to get yourself on a pretty sound financial basis.

Suppose that you're putting aside part of everything

you earn . . . that those dollars you save are busy earning *extra* dollars for you . . . that you have a nest egg and an emergency fund.

Naturally, your face will show *that*, too.

There's a simple and pretty accurate way to tell which way your face is going to go in the next few years:

**If you are buying, regularly, and holding as many U. S. Savings Bonds as you can, you needn't worry.**

Your face will be among the ones that wear a smile.

*Buy all the Bonds you can... keep all the Bonds you buy*

# Electronics

*This is an official U. S. Treasury advertisement—prepared under auspices of Treasury Department and War Advertising Council*

## LOGARITHMIC AC VOLTMETER — WIDE BAND AMPLIFIER —



Advanced Design gives you a sensitivity and frequency response never before obtained.

No other Voltmeter offers all these advantages

- Range .0005 to 500 volts
- Frequency 5 CPS to 2.0 MC
- Logarithmic voltage scale
- Linear DB scale
- Input 2 Megohm 15 MMF
- Accuracy  $\pm 2\%$
- Stability  $\pm 1\%$  105 to 125 V.

Ideal for Audio, Supersonics, Lower Radio Frequency Spectrum. Measures Stage Gain, RF and IF Amplifiers on Broadcast Receivers.

Write For Complete Information

### Instrument Electronics

253-21 Northern Blvd.

Little Neck, L. I., N. Y.

# Electrical Papers

## ANTI-CORROSIVE

# CORE BASE

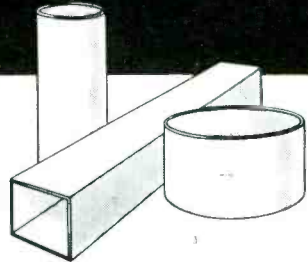

Designed for strength, pliability and non-corrosion — plus uniform thickness for efficient production and conversion.

All Central Electrical Papers are laboratory engineered for electrical applications and can be custom treated to meet any specification.

**FREE SAMPLES:** Send for book of Central Electrical Papers — if you have a special problem, state requirements.

### ENGINEERED



PAPERS FOR  
THE ELECTRICAL  
FIELD



REG. U. S. PAT. OFF.

**CENTRAL PAPER COMPANY**  
INCORPORATED

2442 LAKESHORE DRIVE, MUSKEGON, MICH

OFFICES IN: BOSTON, NEW YORK, BALTIMORE, ROCHESTER, CLEVELAND, CINCINNATI, DETROIT, CHICAGO, ST. LOUIS, SAN FRANCISCO

SPECIALIZED

# Skill in METAL

PANELS • CHASSIS • RACKS  
*with Beautiful Chrome Trim*

CABINETS

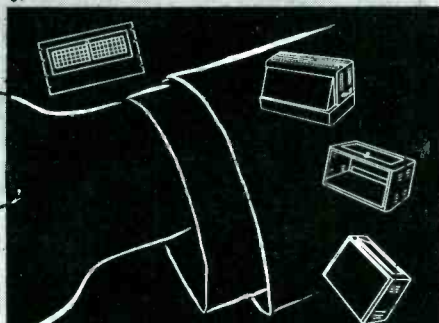

The time-tested Par-Metal line presents superior features of styling, design, and construction. True to policy, Par-Metal continues to specialize in Electronic Housings exclusively... and is therefore able to offer leadership in value. Compare! Write for Catalogue.

**PAR-METAL**  
PRODUCTS CORPORATION

32-62 — 49th STREET  
LONG ISLAND CITY 3, NEW YORK  
Export Dept.: Rocke International Corp.  
13 East 40 Street, New York 16

ing Corp., 389 Lafayette St., New York 3, N. Y. Thermionic generators used in industrial heating applications are pictured in a recent 6-page booklet. Work tables designed for particular assembly problems are included in the list of products.

**Metal Fabrication.** Bernard Rice's Sons, Inc., 325 Fifth Ave., New York 16, N. Y. Metal fabrication for the electronic industry is described in a two-color booklet showing microwave fittings, wave guides and unusual formed metal components.

**Concentrated-arc Lamp.** The Western Union Telegraph Co., 60 Hudson St, New York 13, N. Y. Special arc lamps with a light-emitting source less than a tenth of an inch in diameter give brightnesses up to 65,000 candles per square inch. Types, specifications and prices are given in a leaflet now available.

**Microphones.** Universal Microphone Co., Inglewood, Calif. Catalog 1483 presents the company's complete line of microphones and recording components in an 8-page brochure.

**Tube Insulators.** M. Kirchberger & Co., Inc., 1425 37th St., Brooklyn, N. Y. Lava insulation for electronic tubes is described in a pamphlet recently written. Technical data are neatly summed up in a table on the last page.

**Quarterly House Organ.** The Brown Instrument Co., Wayne and Roberts Ave., Philadelphia 44, Pa. The quarterly "Instrumentation" runs to 30-odd pages and includes a number of interesting articles on instrument technology.

**R-f and I-f Components.** Pioneer Electric and Research Corp., Forest Park, Ill. A four-page, well-illustrated leaflet describes a line of small transformers suitable for use at radio frequencies. Small chokes and trimmer capacitors are also listed.

**Metal Locator.** Fisher Research Laboratory, Palo Alto, Calif. The M-Scope is described in a booklet and in the "M-Scope News". The equipment uses electronic means of detecting ore, pipes or cables. Other equipment is used in detecting and tracing the location of leaks in water mains.



*Transformers*  
designed with  
**STANDARDIZED** basic mountings  
to fit the customer's  
**SPECIALIZED** requirements

To achieve economy and speed of production in meeting customers' transformer requirements, Chicago Transformer manufactures and stocks a wide range of sizes in vertical shields and drawn steel cases, which are standardized in construction and appearance, yet are readily adaptable to a variety of special applications. For details on how transformers using these mounting parts will benefit your new product plans, consult Chicago Transformer's sales and engineering staffs.



**CHICAGO TRANSFORMER**  
DIVISION OF ESSEX WIRE CORPORATION  
3501 ADDISON STREET · CHICAGO, 18

TRADE MARK REG.

# NEWS OF THE INDUSTRY

Edited by JOHN MARKUS

**Airborne magnetometers; complete technical program of National Electronics Conference, Chicago, Oct. 3-5; radio production figures**

## V-2 Rockets Explore Ionosphere E Layer

MINIATURE SCIENTIFIC LABORATORIES of various types are being carried regularly a hundred miles up into the ionosphere on board V-2 rockets fired at White Sands Proving Ground, Las Cruces, New Mexico. For one of the tests, on June 27, Naval Research Laboratory scientists prepared the instruments that were fitted into the rocket's warhead to increase man's knowledge of the E layer of the ionosphere. Scientists stationed at many observation posts operated a massive array of equipment to track the rocket in its six-minute flight and record the data sent down to earth over an elaborate 22-channel radio telemetering system employing pulse-time modulation.

The NRL experiments involve transmission of three different frequencies from the rocket to ground, harmonically related in such a manner that if all three suffer no delay or the same delay in the ionosphere, the harmonic relation will be undisturbed. However, if there is a change in the harmonic relationship, it can be detected and recorded on

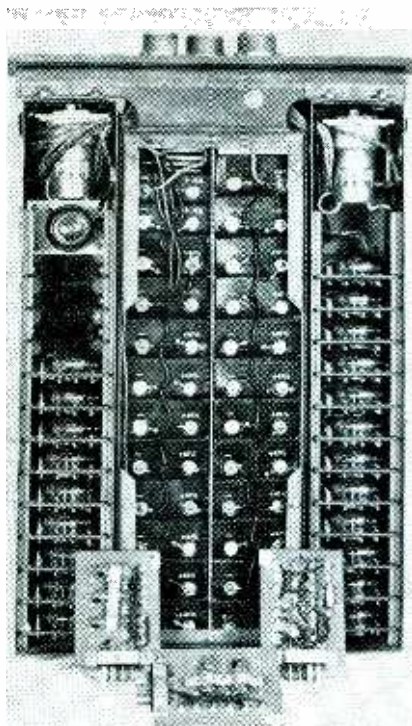

Telemetering transmitter of rocket, showing premodulator stages and self-contained battery power supply. Plug-in construction is employed for entire section



NRL scientists making final adjustments of miniature laboratory assembled in warhead of V-2 rocket for ionosphere research

the ground as a phase beat that can be interpreted in terms of various characteristics of the ionosphere. Reception of the signals at various remote points will give additional information on long-path propagation of radio waves through the ionosphere.

During later tests the University of Michigan and Princeton University are making ionosphere studies

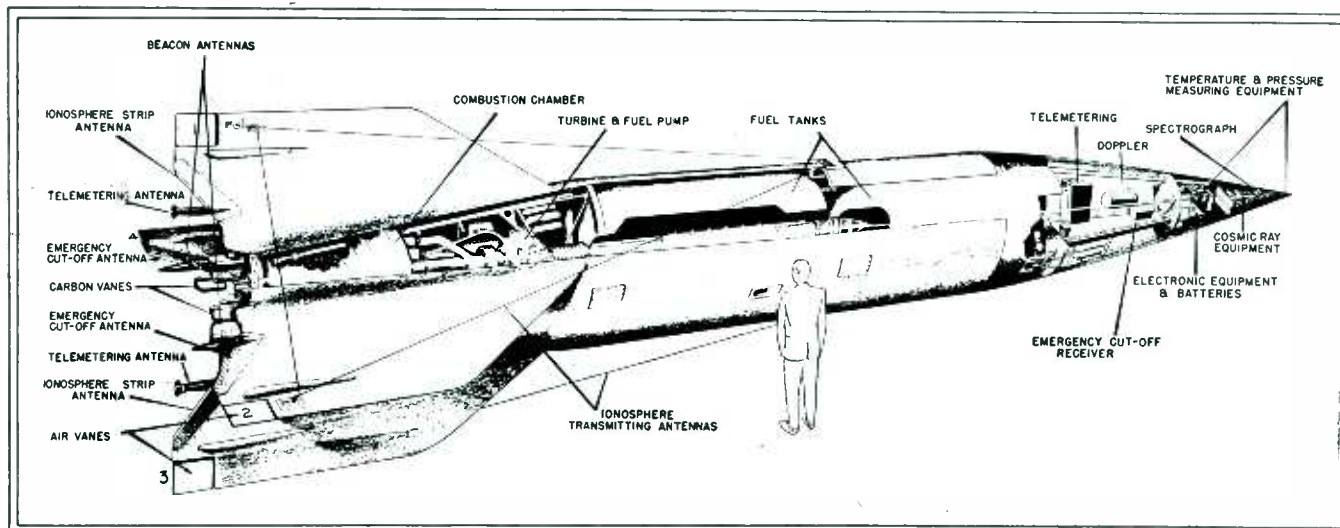

Cutaway diagram of V-2 rocket equipped for upper-atmosphere studies

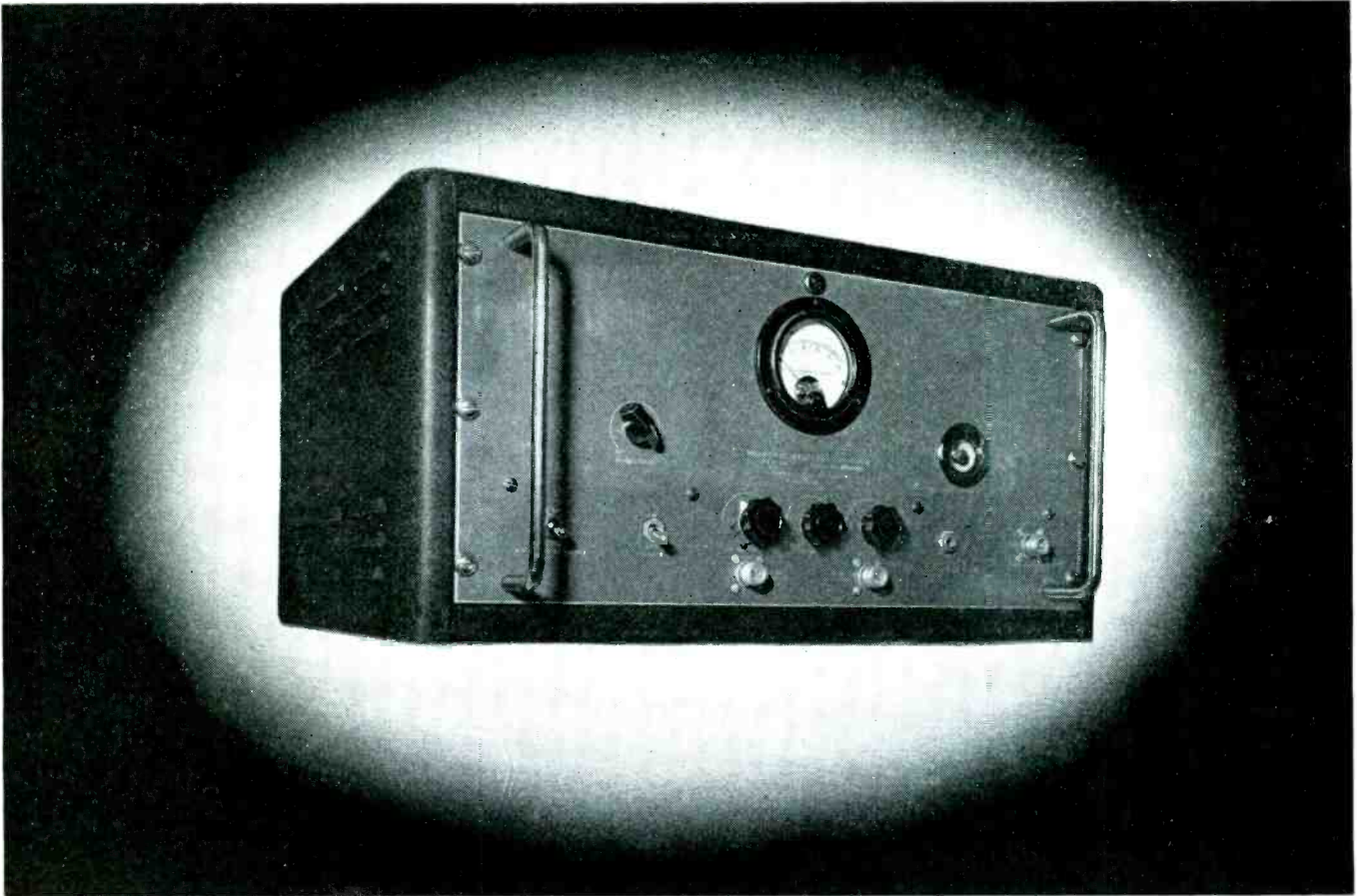

## LAVOIE C-200

### Harmonic Frequency Generator

Now you can obtain precision calibration up to and beyond 2000 megacycles of receivers and wavemeters at a fraction of the time previously required. Also, by means of a Beat Detector built into the instrument, you can calibrate oscillators and signal generators with equal ease.

The C-200 Harmonic Frequency Generator is a secondary frequency standard, designed especially for calibration work above 100 MC, with an accuracy of .02%. If greater accuracy is desired, the crystal may be supplied with temperature control.

The output voltage is supplied at a UG 58/U, 50 ohm connector with output coupling controls to obtain peak performance for a given harmonic. A milliammeter is incorporated in the instrument to facilitate easy adjustment of the output controls. The output voltage may be either unmodulated, or modulated with 400 C.P.S. internal oscillator. The calibrator provides output voltages every 10 MC, or every 40 MC. This selection is made by a switch on the front panel. The harmonic voltage is in the order of

thousands of microvolts for each harmonic with a value of approximately 50,000 microvolts at 100 MC's and 1500 microvolts at 1000 MC's.

Provision is made for the calibration of signal generators and oscillators by the incorporation of a beat frequency detector in the calibrator. The output of this beat frequency detector may be monitored, either aurally or visually with a tuning eye indicator.

To facilitate harmonic identification, frequency identifiers can be supplied for any harmonic frequency (multiple of 10 MC) between 100 and 1000 MC. The identifier is adjusted at our factory.

The C-200 Harmonic Frequency Generator can be used to calibrate signal generators, receivers, transmitters, wavemeters and oscillators. It provides a fast, accurate and easy method of calibrating in 10 or 40 MC steps.

This instrument is supplied with accessories needed for its operation, including tubes, 5 MC crystal, output coupling cable and instruction book.



Write for Illustrated  
Descriptive Folder

## Lavoie Laboratories

RADIO ENGINEERS AND MANUFACTURERS  
MORGANVILLE, N. J.

**Specialists in the Development and Manufacture of UHF Equipment**

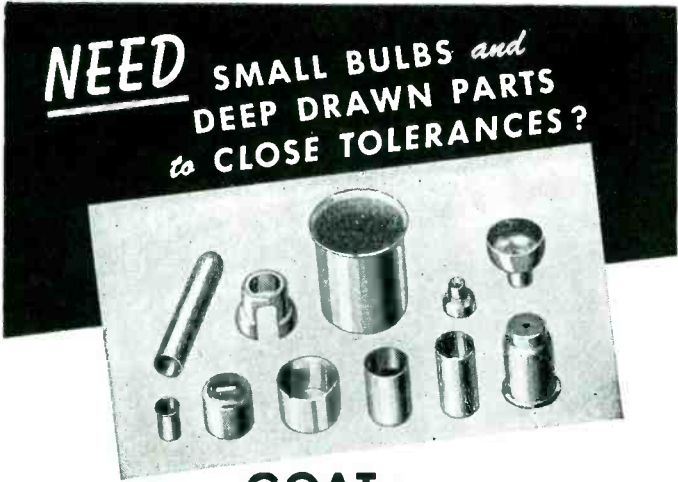

**NEED** SMALL BULBS and DEEP DRAWN PARTS to CLOSE TOLERANCES?

**GOAT PRECISE-FORMED DEEP-DRAWN METAL PARTS**

*Improved Quality at Lower Cost!*

Deep drawing, sizing and coining, in conjunction with quality control techniques devised by the Goat Company, make possible the economical production of small parts to tolerances unattainable a few years ago. The new method makes expensive annealing operations unnecessary. The use of these economically produced, precision parts reduces both material costs and assembly costs.

Send us your design prints for engineering recommendations  
Address Dept. EL



LET US REDESIGN FOR STAMPING

**GOAT METAL STAMPINGS, INC.**  
Affiliate of The Fred Goat Co., Inc.  
314 DEAN STREET BROOKLYN, N. Y.



**RADIO HARDWARE**  
Wires and Cables

Quality Since 1923

... also pioneers in the design and manufacture of

Ceramic, Porcelain & Steatite insulators, Antennas Hook-Up Wires, Shielded Microphone Cable and S. J. Cable.



Specify and use "Birnbach" products. Complete Stock at your jobber.

**BIRNBACH RADIO CO., Inc.**  
145 HUDSON ST. NEW YORK, 13, N. Y.

**Don't Overlook C.T.C.'s New I-F Slug Tuned INDUCTOR**

This compact, easy-to-mount LS-3 coil is available in four windings (see below). Total possible frequency span is from 1/2 mc. to better than 150 mc. You'll find them ideal for many applications.

The chart gives the individual characteristics:

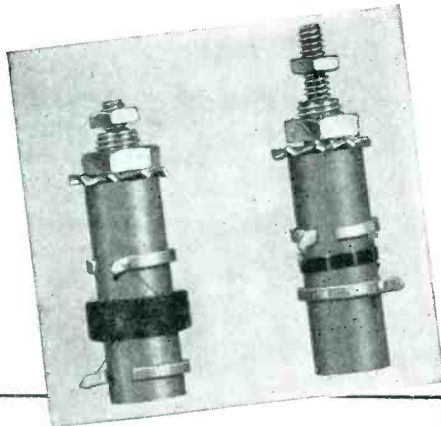

	Q	DC RESISTANCE	INDUCTANCE	VARIATION OF INDUCTANCE	TYPE & SIZE OF WIRE	NO. OF TURNS	TYPE OF WINDING
1 meg. unit	56	18.14 ohm @23°C.	420 microhenries ± 5%	.325 to 750 microhenries	#38 SCE	198	Multiple
10 meg. unit	44	1.90 ohm @19.5°C.	8.4 microhenries ± 5%	4.75 to 14.25 microhenries	#38 SCE	24.5	Multiple
30 meg. unit	46	.126 ohm @20°C.	.07 microhenries ± 5%	.350 to 1.0 microhenries	#28 E	7	Single layer
60 meg. unit	46-50	.126 ohm @20°C.	.061 .102 microhenries ± 5%	.065 to .095 microhenries	#28 E	2	Single layer

If these standard LS-3 don't meet your requirements, we'll be pleased to submit quotations on coils built to your specifications. Write for C.T.C. Catalog No. 100.



**CAMBRIDGE THERMIONIC CORPORATION**  
439 Concord Avenue • Cambridge 38, Mass.

**YOU GET MANY Extras!**

Rowe No. 7 Permanent Magnetic Driver Unit



Extra power, extra long life, extra freedom from break-downs, extra ease of replacement . . . these are but a few of the many extras you get in the ROWE No. 7 PERMANENT MAGNET . . . first choice of sound engineers who investigate thoroughly and analyze carefully.

The 3 lb., 4 oz. ALNICO Magnet gives power and permanency; combined voice coil and diaphragm assembly heads off trouble, provides for quick replacement if necessary. Write for circular 41E, giving complete details.

**ELECTRONICS DIVISION**

**Rowe Industries**  
3120 MONROE ST., TOLEDO 6, OHIO



with the rockets, employing a pulse system and a continuous-wave Doppler system respectively.

From a vantage point 100 miles above the earth it is possible to extend appreciably the experimentally obtained spectrum of the sun, because the filtering action of the earth's atmosphere is greatly reduced at that height. This will permit more accurate determination of the black-body temperature of the sun and give additional information on its composition and on temperatures in the vicinity of the sun.

A special grating spectrograph has been designed by NRL for the V-2 rocket. Spectrum pictures are taken throughout the flight at about three-second intervals, through special lithium-fluoride windows inserted in the nose. After exposure the film is automatically wound into a chamber having  $\frac{3}{4}$ -inch thick steel walls designed to resist the impact velocity of the rocket, which may be almost 3,000 mph.

### Airborne Magnetometers

SUCCESSFUL USE of airborne submarine detector equipment for exploring inaccessible territory in search of hidden mineral deposits was announced by the Navy Department recently. Shoran (short-range navigation), special mapping cameras, and other new devices have been modified and combined with a new airborne magnetometer developed by Bell Telephone Laboratories in cooperation with the Naval Ordnance Laboratory. Other magnetometers of this general type were developed by Gulf Research and Development Co. working independently and later

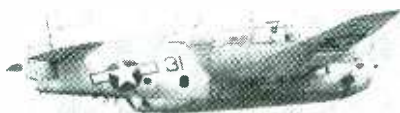

Magnetometer in bomb-like casing suspended from Navy torpedo bomber to free it from magnetic influences of the plane

# HOW TO CUT INSPECTION COSTS and improve STANDARDS OF PERFORMANCE

## ROTOBRIDGE

REG. U. S. PAT. OFF.

ROTOBRIDGE, automatic high speed mass production tester, reduces inspection time, releases skilled labor for other work.

**SPEED—ACCURACY:** ROTOBRIDGE makes bridge-type measurements, comparing completed units against your engineering standard, right on the assembly line, at the rate of a circuit a second.

Rotobridge automatically checks wiring errors, resistance and reactance values on all types of communication, electrical and electronic equipment. It can be operated by unskilled labor and since the human element is almost entirely eliminated, specified tolerances are absolutely maintained.

**VERSATILITY:** The ROTOBRIDGE is adaptable either to several small-sub assemblies, or a complete set comprising as many as 120 circuits. Two or three Rotobridge units working simultaneously, will inspect a 30 or 40 tube set-up . . . in five minutes.

Write for Bulletins

## COMMUNICATION MEASUREMENTS LABORATORY

120 Greenwich St., New York 6, N.Y.

Sales Offices { Chicago: 612 N. Michigan Avenue  
Washington: 924 19th Street, N. W.  
Philadelphia: Ridge & Crawford



**DEPENDABLE PORTABLE ELECTRIC  
POWER**

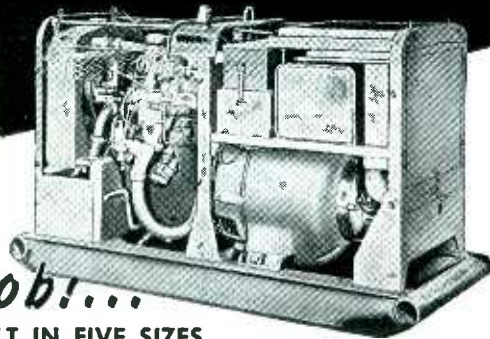

*For Your Job!...*

... BUILT IN FIVE SIZES, ranging from 3 K. W. to 15 K. W., these portable electric power plants are manufactured to give dependable service under the most rugged conditions. Write today for specifications.

Models Range from 3000 to 15000 Watts, A. C. 120 to 440 Volts, 50 and 60 Cycles, Single or Three Phase.

**DEALERS WANTED!** Some profitable franchises still available. Write or wire

**PIONEER ELECTRIC Co.** 3700 East Olympic Boulevard Los Angeles 23, California

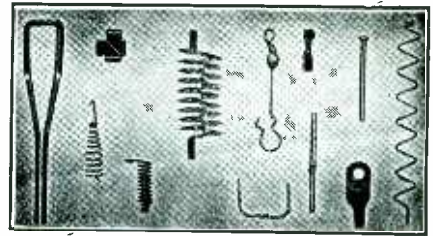

**SMALL PARTS**

Filaments, anodes, supports, springs, etc. for electronic tubes. Small wire and flat metal formed parts to your prints for your assemblies. LUXON fishing tackle accessories, double pointed pins, fine size wire straightened. Inquiries will receive prompt attention.

**ART WIRE AND STAMPING CO.**

227 High St. Newark 2, N. J.

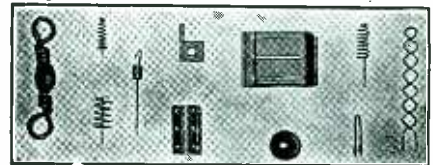

**Automatic Bowling Pinboy\***

THOUSANDS of precision made parts are necessary for the dependable operation of this amazing device.

This remarkable robot will set the pins faster and more accurately than the human hand, thereby providing greater enjoyment for millions of bowling enthusiasts.

The economical, mass production

of precision parts make such conveniences possible.

Ericsson specializes in such precision parts...has for 35 years.

\*The above machine is shown for its interest value. It is not manufactured by Ericsson.



**2 VITAL AIDS**  
TO THE MANUFACTURER OF  
*Miniature Tube Radios*

★ **STAR**

**DOUBLE-CHECK SYSTEM**

#JE-10 — Miniature socket wiring plug for accurate alignment of miniature socket contacts during wiring. Precision cast of zinc base alloy — Pins of stainless steel.



#JE-12 — (Hardened tool steel insert) or JE-13 (Stainless steel insert) Miniature tube pin straightener to obtain a perfect fit when the tube is placed in the set.



For complete information and prices—write  
RADIO ACCESSORY DIVISION  
**STAR EXPANSION PRODUCTS CO.**  
147 Cedar St., New York 6, N. Y.

August, 1946 — ELECTRONICS

under NDRC contract, and by Columbia University's Division of War Research also under contract with NDRC.

During the war the equipment was used for detecting and tracking deeply submerged submarines from the air, with the electronically-operated magnetometer mounted in a streamlined casing suspended from a low-flying plane or blimp. The first model was placed in use the month of Pearl Harbor, 1941, and an appreciable number of enemy undersea craft were sunk as a result of this detection by planes carrying the magnetometers. The Germans never did learn of this method of submarine detection during the war, and only now have secrecy restrictions been lifted enough to reveal general characteristics of the equipment.

Aerial prospecting of uncharted oil resources of the world is an outgrowth of this first airborne magnetometer. Previous instruments used by oil geologists had to be mounted on a solid platform and carefully leveled. The chief value of the new prospecting system is in making preliminary or reconnaissance surveys to outline promising areas for intensive investigation by ground parties. More than 40,000 square miles of this country and Alaska have already been surveyed with the apparatus, along with vast offshore areas in the Gulf of Mexico. In Alaska, a single survey party succeeded in mapping areas at the rate of over 1,000 square miles per day.

### Radio Propagation Predictions

DUTIES AND FUNCTIONS of the Inter-service Radio Propagation Laboratory have been absorbed by the Central Radio Propagation Laboratory, established at the National Bureau of Standards to act as an organization for centralizing and coordinating basic research and prediction service in the field of radio wave propagation. J. H. Dellinger is chief of the Laboratory.

Beginning with the July 1946 issue, copies of *Basic Radio Propagation Predictions* will be available from the Superintendent of Documents, U. S. Government Printing Office, Washington 25, D. C. at 15



## HERE COMES PRINTED-AND-ILLUSTRATED RADIO

self-synchronizing  
**finch facsimile**

The new Finch Telefax Facsimile Broadcasting Equipment embraces every new development of Finch experience and research — backed by more than 100 issued patents and many others pending.

Assembly shown above consists of a monitor control desk flanked by two transmitting scanners, which assure a continuous flow of program material through the transmitter.

Operation is simple, reliable, time-saving, with automatic copy loading controlled by push button, and automatic return of scanner carriage at end of each page. The extra recorder on the control desk provides a file copy of the program.

The Finch sales contract carries with it complete license benefit and rights under the more than 100 facsimile patents and applications owned by Finch for the use of Finch Facsimile equipment. Orders are now being accepted for fall deliveries. And the cost is much less than some estimates have been. Write for full particulars.

**FINCH TELECOMMUNICATIONS, INC.**  
10 EAST 40th STREET, NEW YORK 16, NEW YORK  
Also manufacturers of Finch ROCKET Antennas for FM Stations.

# HARVEY

has greatly needed  
components for  
engineers and  
experimenters

We carry at all times a complete and extensive assortment of test equipment made by all the better-known manufacturers.

IN STOCK NOW FOR IMMEDIATE DELIVERY

Brand New  
Weston Model 779-Type 1 Analyzer

Ranges:

DC Volts: 0-2.5-10-50-250-1000 (at 20,000 or 1000 ohms per volt)

AC Volts: 0-2.5-10-50-250-1000

DC Current: 0-1-1-1-10-50-250 ma; 0-1-10 amperes

Decibels: -14 to +2, -2 to +14; +12 to +28, +26 to +42, +38 to +54

Ohms: 0-3000-25 ohms center scale  
0-30,000-250 ohms center scale  
0-300,000-2500 ohms center scale  
0-30 megohms-250,000 ohms center scale

In beautifully finished antique oak case with cover, complete with self-contained batteries for all ranges, test leads and comprehensive instruction book . . . . . Net, \$74.70

Weston Model 785 Industrial Circuit Tester. Ranges similar to 779 plus AC current ranges of .5-1-5-10 amperes. A really rugged unit built to take the physical abuse it might encounter when used in field electrical shops, laboratories, broadcast stations and aboard ship. . . . Net, \$101.25

Brand New—Just released—Weston Model 798 Proportional Mutual Conductance Tube Checker. Tests every American-made tube known, regardless of date of manufacture, or type in the receiving tube category—plus all acorns and midgets in the 9000 series, 807's, 6AK5, 6AK6, 6AQ6, 6AT6, etc. All filament voltages from 1.1 to 115. Meter scale calibrated in micromhos 0-3000-6000-12,000, also red and green sections for good and bad indication and diode check. Sensitivity of tester can be varied. It also contains a volt-ohmmeter reading up to 750 volts AC or DC, 3 ranges each; reads current in 2 ranges 7.5 or 150 mills and has resistance scales 0-100,000 ohms and 0-1 megohm. Unit is supplied in grey wrinkle finish steel case with cover, test leads, instruction manual and tube charts. . . . Net, \$182.65

The ever popular Weston Model 697 Pocket Meter. Ruggedly constructed with heavy molded bakelite case. AC/DC voltage scales 0-7.5-15-150-750; DC current 0-7.5-75 mills; resistance 0-500-5000-50,000 ohms. This unit is very compact and is just the thing to slip in your pocket for that job away from the lab. Weston high quality construction throughout, all multipliers are 1% wire wound on bobbins by Weston precision methods. This unit complete with self contained batteries and test leads at only . . . . . \$25.92

Do you need a small meter for that special job requiring low resistance scales such as checking DC resistance of electric motor windings, transformers of all types, etc.? This Weston 698-1F reads very accurately as low as 1/20th ohm. Two scales: 0-10 and 0-1000 ohms full scale. Very compact, measuring only 5" x 2 1/4" x 1 1/2" and almost fits a vest pocket. Specially priced at . . . . . \$16.22

A companion unit for the higher ranges. Weston Model 689. Two scales: 0-5000 and 0-50,000 ohms, at only . . . . . \$14.58

Also Weston panel meters, all types—301, 501, 517, 425—AC-DC-RF-VU—all ranges . . . most of them in stock right now.

Remember, HARVEY has full stocks . . . same-day shipping service . . . fair prices. Send us your order now!

Telephone: **3hr** LO. 3-1800

**HARVEY**  
RADIO COMPANY INC.

105 West 43rd St., New York 18, N. Y.

cents each or \$1.50 for an annual subscription (12 issues). Each issue gives complete charts and information enabling the user to calculate best sky-wave operating frequencies over any path at any time of day for average conditions for the month of prediction. Predictions are issued three months in advance.

## Program of Chicago Conference

THE TENTATIVE LIST of speakers and subjects scheduled for the National Electronics Conference to be held at the Edgewater Beach Hotel, Chicago, on October 3, 4, and 5 is as follows:

### PRINCIPAL SPEAKERS

Dr. E. U. Condon, director of National Bureau of Standards—Electronics and the Future.

Dr. F. L. Hovde, president of Purdue University—subject to be announced later.

Dr. G. C. Suits, vice-president of General Electric Co.—Physics of Today Becomes the Engineering of Tomorrow.

Dr. J. O. Perrine, vice-president of Bell Telephone Laboratories—Radar and Microwaves (a demonstration lecture).

### TELEVISION

C. E. Nobles of Westinghouse Electric Corp. and W. K. Ebel of Glenn L. Martin Co.—Stratovision System of Communication.

D. L. Balthis of Westinghouse Electric Corp.—Westinghouse Color Television Equipment.

Dr. Peter Goldmark of Columbia Broadcasting System—Color Television—Latest State of the Art.

Dr. H. Saling of Farnsworth Television and Radio Corp.—The Electrostatic Image Dissector.

N. Young of Federal Telecommunication Laboratories—Television Transmitter for Black and White and Color Television.

A. W. Friend of RCA—The Use of Powdered Iron in Television Deflecting Circuits.

### ANTENNAS AND WAVE PROPAGATION

A. G. Kandoian of Federal Telecommunication Laboratories—Problems in Wide-Band Antenna Design.

Dr. Andrew Alford, Consulting Engineer—Slot Radiators.

Bruce Montgomery of United Airlines—Improvements in 75-mc Aircraft Marker Systems.

K. Bullington of Bell Telephone Laboratories—Radio Propagation at Frequencies above 30 Megacycles.

W. R. Young, Jr. of Bell Telephone Laboratories—Interference between VHF Radio Communication Circuits.

William B. Lodge of Columbia Broadcasting System—Propagation of UHF Signals.

Otto Schmitt of Airborne Instruments Laboratories—Aircraft Antenna Pattern Measuring System.

### MICROWAVE GENERATORS

Professor W. G. Dow of University of Michigan—Continuous-wave UHF Power at the Fifty-Kilowatt Level.

Dr. A. E. Harrison of Sperry Gyroscope Co.—Microwave Frequency Stability.

Dr. Franzo H. Crawford of Williams College—An All-Metal Tunable Squirrel-Cage Magnetron.

Joseph W. Kearney of Airborne Instruments Laboratories—Design of Wide-range Coaxial-cavity Oscillators Using Reflex Klystron Tubes.

### AIR-NAVIGATION SYSTEMS

F. L. Moseley of Collins Radio Company—

It Costs You Less  
to Pay  
a Little More  
for  
SILCOCKS-MILLER  
PLASTIC DIALS

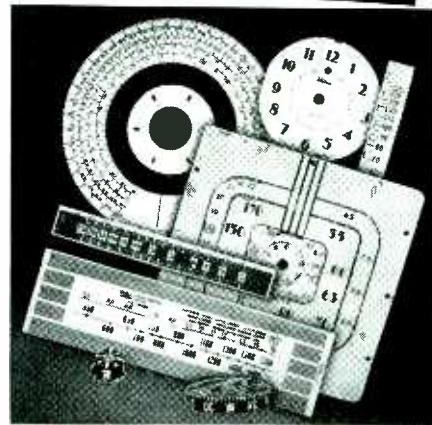

Quality, not quantity is the tradition at Silcocks-Miller.

Of course, we cannot make all the plastic dials industry requires, so we concentrate on producing only the best.

That's why design engineers who need plastic dials fabricated to close tolerances have come to depend on Silcocks-Miller craftsmanship through the years.

Our understanding of the problems, our ability to produce accurately and our thorough knowledge of all types of plastics enable us to supply your needs quickly and with a minimum of effort on your part.

That's why we can say "It costs you less to pay a little more for Silcocks-Miller quality."

Write for illustrated brochure today.

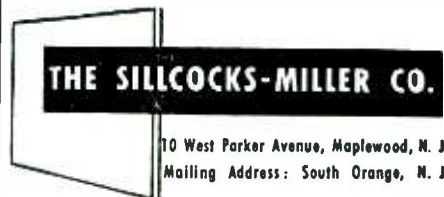

10 West Parker Avenue, Maplewood, N. J.  
Mailing Address: South Orange, N. J.

SPECIALISTS IN HIGH QUALITY, PRECISION-MADE PLASTICS FABRICATED FOR COMMERCIAL, TECHNICAL AND INDUSTRIAL REQUIREMENTS.

**NEW MODELS**  
Available Now  
of  
**ATR**  
QUALITY PRODUCTS



**ATR  
"A"**

**BATTERY ELIMINATORS**

FOR CONVERTING A.C. TO D.C.  
New Models . . . designed for testing D.C. electrical apparatus on regular A.C. lines. Equipped with full-wave dry disc type rectifier, assuring noiseless, interference-free operation and extreme long life and reliability.

- Eliminates Storage Batteries and Battery Chargers.
- Operates the Equipment at Maximum Efficiency at All Times.
- Fully Automatic and Fool-Proof.

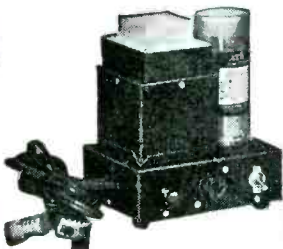

**ATR**

**LOW POWER INVERTERS**

FOR INVERTING D.C. TO A.C.  
Another New ATR Model . . . designed for operating small A.C. motors, electric razors, and a host of other small A.C. devices from D.C. voltages sources.



**ATR**

**STANDARD AND HEAVY DUTY INVERTERS**

FOR INVERTING D.C. TO A.C.  
Specially designed for operating A.C. radios, television sets, amplifiers, address systems, and radio test equipment from D.C. voltages in vehicles, ships, trains, planes, and in D.C. districts.

WRITE FOR NEW CATALOG—  
JUST OFF THE PRESS!

**AMERICAN TELEVISION & RADIO CO.**  
Quality Products Since 1931  
ST. PAUL 1, MINN. U.S.A.

**ANOTHER SPECIAL BY PROGRESSIVE**

**QUALITY PROMCO BRAND**

ACTUAL SIZE

ENLARGED FOR DETAIL

**CATALOG SHOWS DOZENS MORE**  
Special heads, threads and finishes on any metal or alloy adapted to cold upset. Weekly output: 25,000,000 pieces. Many specials, suggesting production savings for you, illustrated in latest catalog. Includes weights per 1M standard pieces, dec. equivs. of fractions, other purchasing and engineering helps. Write for Catalog 18.

*The* **PROGRESSIVE MFG CO.**  
50 NORWOOD ST., TORRINGTON, CONN.

# PERFECTION

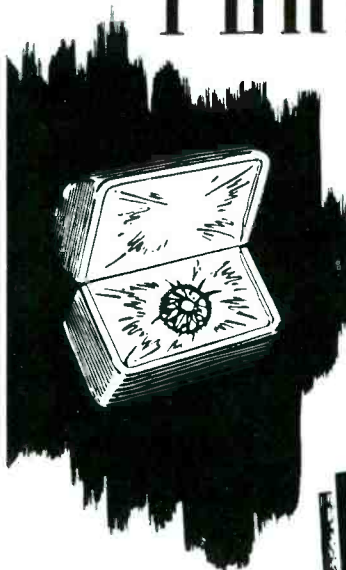

A fine-cut diamond is perfection in beauty and formation. But to you as a transformer-user, perfection lies in performance, day in, day out, under the exacting conditions of your particular application.

Finest engineering talent and most complete electronic laboratories are ready to consult with and help you with your problem—and to design and produce the transformer that will give you perfection in performance.

**ELECTRONIC**  
*Engineering*  
**COMPANY**  
INC.

"SPECIALIZED  
*Transformer*  
ENGINEERS"

3223-9 W. ARMITAGE

AVENUE • CHICAGO 47, ILLINOIS

# BRADLEY

## PHOTO ELECTRIC CELLS



**Many Standard Mountings.**

In addition to the housed model shown here, with its plug-in contacts, Bradley also offers tube socket, nut-and-bolt types and pig-tail contact mountings.

The shapes of Luxtron photocells vary from circles to squares, with every in-between shape desired. Their sizes range from very small to the largest required.

For direct conversion of light into electric energy, specify Bradley's photocells. They are rugged, lightweight and true-to-rating.

Illustrated literature, available on request, shows more models of Bradley photocells, plus a line of copper oxide and selenium rectifiers. Write for "The Bradley Line."

# BRADLEY LABORATORIES, INC.

82 Meadow St. New Haven 10, Conn.

Automatic Radio Flight Control.  
Paul Adams and R. L. Colin of Federal Telecommunication Laboratories—Aerial Navigation.  
D. H. Ewing and R. W. K. Smith of RCA—Telecan—Air Navigation and Traffic Control by Means of Television and Radar.

#### RADIO RELAY SYSTEMS

G. G. Gerlach of RCA—Development of a Microwave Relay Communication System.  
D. D. Grieg and A. D. Kandoian of Federal Telecommunication Laboratories—Multiplex Broadcasting.  
J. J. Glauber of Federal Telecommunication Laboratories—The Cyclophon.  
N. I. Korman of RCA—The Theory and Design of Several Types of Wave Selectors.

#### FREQUENCY MODULATION

Panel on Design of F-M Receivers.  
Z. Benin of Zenith Radio Corp.—A Permeability-Tuned 100-mc Amplifier.  
G. Wallin and C. W. Dymond of Galvin Mfg. Co.—VHF Tuner Design.  
I. J. Kaar of General Electric Co.—Front-End Design of F-M Receivers.  
David Smith of Philco Radio and Television Corp.—F-M Limiter of the Locked-in Oscillator Variety.

#### MOBILE RADIO COMMUNICATION

A panel on selective calling systems in mobile radio communication will be included.

#### INFRARED COMMUNICATION SYSTEMS

Dr. W. S. Huxford of Northwestern University—Modulation of Infrared Systems for Signaling Purposes.  
Dr. R. J. Cashman of Northwestern University—Photo Detectors for Ultraviolet, Visible, and Infrared Light.

#### RECORDING AND FACSIMILE

H. H. Scott of Technology Instrument Co.—The Reduction of Background Noise in the Reproduction of Music From Records.  
Henry F. Burkhard of Camp Coles Signal Laboratories—Review of Facsimile Developments.  
Dr. R. B. Vaile, Jr., of Armour Research Foundation—Recent Developments in Magnetic Recording.

#### THEORETICAL DEVELOPMENTS

Dr. L. Brillouin of Craft Laboratory, Harvard University—Bunching Conditions for Electron Beams with Space Charge.  
Dr. C. E. Roys of Illinois Inst. of Tech.—Conformal Transformations in Orthogonal Reference Systems.  
Dr. S. A. Schelkunoff of Bell Telephone Laboratories—Generalized Boundary Conditions in Electromagnetic Problems.

#### INDUSTRIAL APPLICATIONS

M. M. Morack of Industrial Eng. Division, General Electric Co.—Large Electronic Direct-current Motor Drives.  
J. Morgan of General Electric Co.—The Electronic Contour Follower Control.  
William H. Elliot of Cutler-Hammer Co.—Electronic Speed Control of A-C Motors.  
W. L. Lyndon of RCA—Production Test Facilities for High-Power Tubes.

#### ELECTRONIC INSTRUMENTATION

Earle L. Kent of C. G. Conn, Ltd.—A Method for Changing the Frequency of a Complex Wave.  
W. L. Gaines of Bell Telephone Laboratories—Cathode-Ray Oscilloscope as a Research Tool.  
Alfred Crossley of Alfred Crossley Associates—The Pressuregraph.  
L. F. Curtis of Hazeltine Electronics Corp.—Detectors for Buried Metallic Bodies.  
D. F. Bowman of Hazeltine Electronics Corp.—The Notch Wattmeter.  
G. D. McCann of Westinghouse Electric Corp.—The Mechanical Transients Analyzer.  
K. E. Schreiner of MIT Servomechanisms

# ALLEN

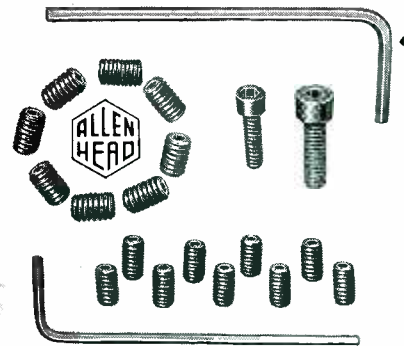

**Hex-socket screws  
in numbered sizes  
extra-dependable  
for electronic devices**

Tiny hex-socket Cap Screws and Set Screws steeled to stand amazingly tight set-ups. Cap Screws in the numbered sizes from 1 to 10 inclusive; Set Screws from No. 2 to 10.

The Cap Screws are Allen "pressurform" for maximum strength of head and socket. This process makes the steel-fibres conform to the shape of the head, — no cut fibres. Threads also formed by pressure-process to a high Class 3 fit, ensuring a high degree of frictional holding-power.

The Set Screws have die-cut threads accurate to a high Class 3 fit, with perfectly-formed hex sockets. The screws can be held on either end of the handy hex keys and turned into the tapped hole without fingering. Allen Hand Drivers are available to facilitate fast assembling.

In radio and television sets, radio telephones, radar equipment, electronic controls, these screws HOLD fine adjustments and intricate assemblies.

*Order of your local Industrial Distributor*

**THE ALLEN MFG. CO.,  
HARTFORD 1, CONN., U. S. A.**

## RAWSON TWIN MULTIMETER



Type 5012 Accuracy 1/2 of 1% DC  
Size 12"x8"x6"

A Combination AC. Multimeter and DC Multimeter

### Range of Measurements

- DC 1 microampere to 1 Ampere.
- 20 Microvolts to 1000 volts.
- AC (thermocouple type)
- 2 Milliampere to 3 Amperes.
- 60 Millivolts to 1000 volts.

Write for bulletin  
WE ALSO SUPPLY

REGULAR DC METERS  
THERMOUPLE AC METERS  
MULTIMETERS  
FLUXMETERS  
ELECTROSTATIC VOLTMETERS

Special apparatus built to order

**RAWSON ELECTRICAL INSTRUMENT COMPANY**

111 POTTER ST. CAMBRIDGE, MASS.

Representatives  
CHICAGO LOS ANGELES NEW YORK CITY

## EISLER EQUIPMENT\*

... COMPLETE AND DIVERSIFIED FOR EVERY PHASE OF ELECTRONIC MANUFACTURE!

### TRANSFORMERS

of all types — furnace, distribution, power, phase changing, air, oil, induction, water cooled, plate, filament and auto-transformers. Filter chokes and inter-phase reactors.



Transformers supplied from 1/4 to 300 KVA.

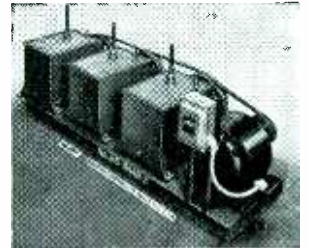

EISLER Compound Vacuum Pump.



24 Head Radio Tube Exhausting Machine.



EISLER Spotwelders from 1/4 to 250 KVA.

\*EISLER machines are in use and in production by 99% of all American radio tube and incandescent lamp manufacturers and throughout the world.

**CHAS. EISLER**

**EISLER ENGINEERING CO.**

751 SO. 13th ST. (Near Avon Ave.)

NEWARK 3, NEW JERSEY



SCREW MACHINE PARTS

DKE

... for exacting needs!

Facilities for rapid production of all screw machine parts. Close tolerance work a specialty. Expanded modern facilities permit fast delivery. All tools, jigs, fixtures produced on premises for precision and economy.

INQUIRIES INVITED

**THE ENGINEERING CO.**

DANIEL KONDAKJIAN  
27 WRIGHT ST., NEWARK, N. J.

# One of 10 TYPES OF TERMINAL BLOCKS

BURKE provides a complete range of styles and sizes of Terminal Blocks to speed the connection of wires at Panel, Switchboard or Control Box.

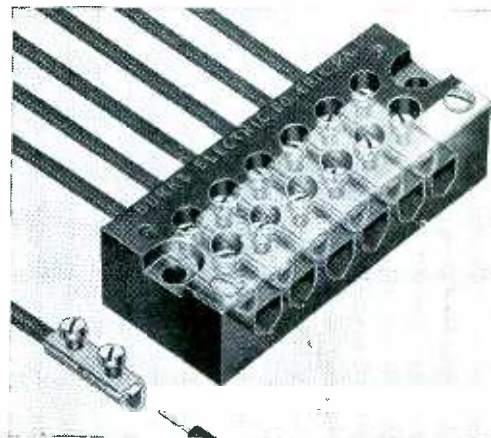

**SERIES 1000** is the most compact style of terminal block with 750 Volt and 30 Amp maximum capacity available for 4, 6, 8, or 12 wires to handle #8 solid to #18 and smaller wire sizes. This and 9 other types are illustrated and described in new catalog and price list.

\* Write for New Booklet

ADDRESS:  
1168 W.  
12th ST.



AC AND DC MOTORS AND GENERATORS  
**BURKE Terminal BLOCKS**  
BURKE ELECTRIC COMPANY • ERIE, PENNSYLVANIA

# "DIE-LESS" DUPLICATING

**SAVES MAN HOURS AND DELAYS**

**DIE ACCURACY WITHOUT DIES**

**Send for CATALOG**

**BENDER**

**SHEAR**

**BRAKE**  
DI-ACRO is Pronounced "DIE-ACK-RO"

**"DIE-LESS" DUPLICATING**  
The DI-ACRO System of METAL DUPLICATING Without Dies

**DI-ACRO**  
PRECISION MACHINES  
DIE-LESS DUPLICATING

**O'NEIL-IRWIN MFG. CO.**  
321 EIGHTH AVENUE SO. • MINNEAPOLIS 15, MINN.

Lab.—High-Performance Demodulators for Servomechanisms.

#### HIGH-FREQUENCY INDUCTION AND DIELECTRIC HEATING

D. E. Watts, G. F. Leland, and T. N. Wilcox of General Electric Co.—Dielectric Heating in the Plastics Industry.  
R. J. Ballard and J. L. Boyer of Westinghouse Electric Corp.—Ignitron Converters for Induction Heating.  
T. P. Kinn of Westinghouse Electric Corp.—Microwaves and Their Use in High-Frequency Heating.  
Dr. Eugene Mittelmann of Illinois Tool Works—The Problem of Constant Frequency in Industrial High-Frequency Generators.

#### NUCLEAR PHYSICS

Dr. E. E. Charlton and W. F. Westendorp of General Electric Co.—The Betatron Accelerator Applied to Nuclear Physics.  
E. T. Neubauer of Allis-Chalmers Co.—Some Fundamental Problems of Nuclear Power Plant Engineering.  
R. R. Machlett of Machlett Laboratories—An Accelerator Column for Two to Six Million Volts.

#### SPECTROSCOPY AND MEDICAL APPLICATIONS

Dr. A. O. Nier of University of Minnesota—The Mass Spectrometer as an Industrial Tool.  
J. T. Wilson of Allis-Chalmers Co.—The Use of Radioactive Materials in Clinical Diagnosis and Medical Therapy.  
R. Felt and C. Berkley of Allen B. DuMont Laboratories—Cathode-Ray Spectrograph.

#### Libraries to Get OSRD Reports

APPROXIMATELY three million copies of OSRD reports, including some 45,000 titles, are now being transferred to the Library of Congress for free distribution to universities and libraries throughout the United States. The Office of Scientific Research and Development, now in process of liquidation, has given funds for this project to the Library of Congress. This great mass of technical information is comparable to the entire contents of the New York Public Library. It is estimated that 80 percent of the material will be free from security regulations, with the remainder limited to properly authorized personnel.

#### Salt-Water Battery

AN ARMY AIR FORCES radio locator buoy that transmitted radio signals for direction-finding purposes a few minutes after being tossed into the ocean by downed airmen was made possible by a battery development of Signal Corps Engineering Laboratories, Fort Monmouth, N. J., working in collaboration with several industrial concerns. The new battery is cylindrical, about 7 inches in diameter and 10 inches long, and has a positive electrode of magnesium and a negative electrode consisting of a coating of silver chloride on a silver screen. The battery is activated by

*Laboratory Standards*

# FM

MODEL 78  
SIGNAL GENERATOR

**SPECIFICATIONS:**

**CARRIER FREQUENCY RANGE:** 86 to 108 megacycles.  
Individually calibrated dial.

**OUTPUT SYSTEM:** 1 to 100,000 microvolts with negligible carrier leakage.

**OUTPUT IMPEDANCE:** Constant at 17 ohms.

**MODULATION:** 400 cycle internal audio oscillator.  
Deviation directly calibrated in two ranges: 0 to 30 kc. and 0 to 300 kc.  
Can be modulated from external audio source.  
Audio fidelity is flat within two db from d.c. to 15,000 cycles.  
Distortion is less than 1% at 75 kc. deviation.

**PROMPT DELIVERY**

**MANUFACTURERS OF**  
Standard Signal Generators  
Pulse Generators  
FM Signal Generators  
Square Wave Generators  
Vacuum Tube Voltmeters  
UHF Radio Noise & Field Strength Meters  
Capacity Bridges  
Megohm Meters  
Phase Sequence Indicators  
Television and FM Test Equipment

**MEASUREMENTS CORPORATION**  
BOONTON NEW JERSEY



**SCREW COSTS REDUCED;  
ON SPECIAL DEVELOPMENT  
DIVERSIFICATION CITED**

KEENE, N H (Special)—An approximate 80% reduction in screw costs for a customer of the New England Screw Company of this city, was said to be due largely to the company's policy of diversification which has made it possible for them to handle special screws with the same facility as standard screws.

"While we manufacture nothing but screws, nuts, bolts, rivets, pins, etc.," the president of New England Screw pointed out, "our entire manufacturing process has been set up with a view to making conversion from one type of screw to another a simple and economical matter. Our equipment, as well as our highly trained personnel, is extremely flexible. And we are thereby able to apply quantity production methods to the manufacture of special screws, with a resultant considerable saving to the customer, as in this case."

Illustration at left shows one of the many special screws made by this fifty year old firm. A large Engineering Department is maintained especially to work with those manufacturers who use standard or special screws or headed shanks. Their modern manufacturing methods are explained in their new catalog which will be sent to any company requesting it.

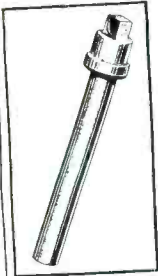

**NEW ENGLAND SCREW CO.**  
KEENE, NEW HAMPSHIRE

**LOOK ME OVER!**

I'm a  
**Western Electric  
CARDIOD**

I don't want to brag, but I can give you a choice of six directional microphone patterns with the pick-up selector that's right on the back of my head. I'm at home anywhere—in the finest broadcast studios and in high quality sound systems indoors and outdoors.

My performance has made me popular the world over. To learn more about me—

ASK YOUR  
**GraybaR**

BROADCAST REPRESENTATIVE

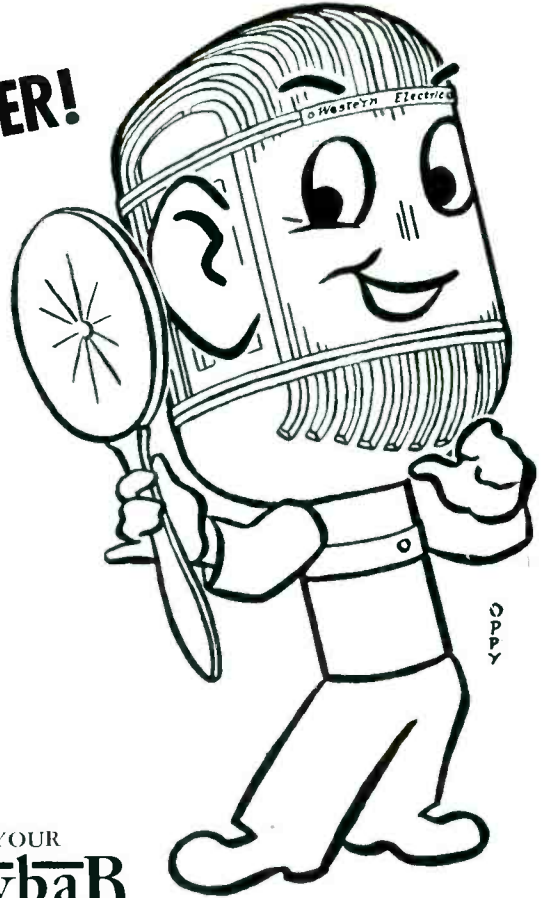

**Bagshaw's  
NEEDLES**  
FAMOUS SINCE 1892  
for Better Record Performance

**ACTONE  
TRANSCRIPTION NEEDLES**  
FOR PROFESSIONAL RECORDINGS

This is the needle that has set Performance Standards in laboratories and studios the world over! It is remarkable for hi-fidelity playback . . . and our drastic SHADOW-GRAPHING eliminates all except perfect points. A professional's needle, indeed, vindicating the BAGSHAW slogan:

*After all . . .  
you can't beat the BEST!*

**H. W. ACTON CO., INC.**  
SOLE DISTRIBUTOR FOR  
370 SEVENTH AVENUE NEW YORK 1, N. Y.

**IN-RES-CO  
RESISTORS**

Close tolerance units for precision performance

IN-RES-CO resistors are engineered to meet all important electronic application needs. They are wire wound for permanent, exact resistance value and both inductive and non-inductive types are standard. Standard tolerances are 1 and 2%—closer tolerances on special order. Rigid quality control assures a uniform standard of excellence and modern manufacturing facilities result in low unit cost and prompt delivery. Manufacturers of electrical and electronic instruments and equipment should investigate the advantages of designating IN-RES-CO as their exclusive wire wound resistor source.

TYPES RN AND SN Tropic-proof resistors—  
RN: 3/4" long x 5/8" dia., Max. Res. 1/2 Megohm, 1/2 watt; SN: 1-3/16" long x 5/8" dia., Max. Res. 1 Megohm, 1 watt

**IN-RES-CO**

**INSTRUMENT  
RESISTORS CO.**  
25 AMITY STREET, LITTLE FALLS, N. J.



## Is your soldering equipment OUTDATED?

Kwikheat is as modern as tomorrow—the only soldering iron with built-in thermostat plus the many other valuable features shown below. Compare your present soldering equipment with Kwikheat and you'll agree—from tip to plug Kwikheat is in a class by itself!

List \$11.00

### KWIKHEAT is modern in every respect!

- HOT IN 90 SECONDS
- HEAT CONTROL BUILT-IN
- SAFE... CAN'T OVERHEAT
- LESS RETINNING NEEDED
- LIGHT WEIGHT—13½ OZ.
- COOL PROTECTING HANDLE
- HEAVY POWER—225 WATTS
- EXTRA-DURABLE TIPS

SIX

Each \$1.25

#### TIP STYLES



**KWIKHEAT**  
THERMOSTATIC  
SOLDERING IRON

Kwikheat Division - Sound Equipment Corp. of Calif.  
3903 San Fernando Rd., Glendale 4, Calif.

dunking it in sea water, which enters through a hole in the jacket and serves as the electrolyte. Common tap water may also be used.

This new battery met the requirement that it be storable for long periods of time without deterioration yet be ready for instant use in event of an emergency at sea.

### Receiver Production

Shipments of radio receivers for May 1946 were estimated at 1,075,000 sets by the Civilian Production Administration. This is about 8 percent higher than April shipments of 1,000,000 sets, and comparable to the prewar 1940-41 rate of 1.1 million. Of May shipments, 88 percent were table models, 5.5 percent consoles, and 6.5 percent auto radios. Scarcity of lumber is still holding down production of consoles.

### PERSONNEL

EDWARD J. CONTENT, with radio station WOR since April 1926, has left to set up his own business as acoustical consultant and studio design specialist.

NIELS EKLUND, for many years a consulting engineer in Stockholm, Sweden, has been made chief physicist of Lear, Inc.

LEE ALVIN DUBRIDGE, recently elected president of California Institute of Technology, and before that director of Radiation Laboratory, MIT, received the honorary degree of Doctor of Science from Polytechnic Institute of Brooklyn at commencement exercises held on June 12.

KAY L. JOHNSON, formerly a signal officer in the Army, has joined Battelle Institute, Columbus, Ohio, as physicist.

MAX J. MANAHAN, formerly chief electrical engineer for Delco Radio Division of General Motors, becomes director of engineering at Hoffman Radio Corp., Los Angeles.

C. R. KNIGHT, with G-E in Schenectady for the past six years, has been appointed application engineer in

THE IMC ENGINEER IS

ON YOUR STAFF



BUT NOT ON YOUR PAYROLL



### ASK HIM TO...

1. Assist you in the selection of the best insulating material for the job.
2. Familiarize you with their proper application.
3. Suggest ways to eliminate waste.
4. Increase your production.

The IMC engineer makes his recommendations on the basis of his knowledge and experience—not of one or a few electrical insulating materials but of many. He and the IMC organization are at your service to give technical assistance as well as to see you get what you need when you need it.



CHICAGO 6, 565 W. Washington Blvd.  
CLEVELAND 14, 1231 Superior Ave., N. E.

BRANCHES in MILWAUKEE 2, 312 East Wisconsin Ave., DETROIT 2, 11341 Woodward Ave., MINNEAPOLIS 3, 1208 Harmon Pl., PEORIA 5, 101 Heinz Court, and other cities



**APPROVED**

*Leakproof*

**ENAMELED  
MAGNET WIRE**

● Much of the success of this Hudson Wire product is due to a new coating method that gives a smooth, permanently-adherent enameling. Mercury-process tests guarantee perfect uniformity; great tensile strength assures perfect laying even at high winding speeds. Especially adaptable for reduction in coil dimensions without sacrificing electrical values.

*Our engineering and design facilities are at your disposal—details and quotations on request.*

**HUDSON WIRE COMPANY**  
*Winsted Division*

**WINSTED CONNECTICUT**

**PERMANENT MAGNETS**

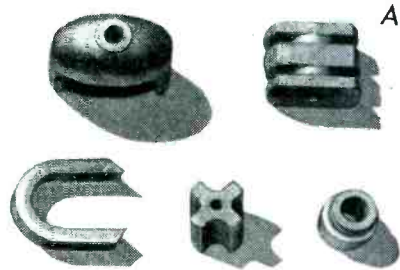

Alloys: **COBALT • CHROME • ALNICO**

The making of permanent magnets is an alloy, too . . . of experience, engineering, facilities. We'll be glad to tell you more. Write for bulletin.

**THOMAS & SKINNER STEEL PRODUCTS CO.**  
1116 E. 23rd St., Indianapolis 5, Ind.

**Thomas & Skinner**

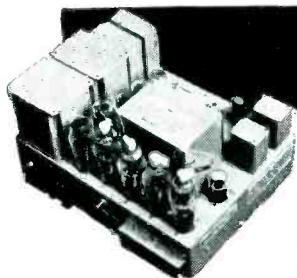

**LATERAL FEEDBACK CUTTER**  
—Driver Amplifier Combination

**FIRST ON THE MARKET:** 16 db of feedback providing electro-mechanical damping — low distortion — extended frequency response — high stability

**CHARACTERISTICS:** ● Overall feedback velocity damping ●  $\pm 2$  vu 30 — 12,000 — ● Interchangeability of cutters ● Stability over long periods ● Instant selection of recording characteristic ● Undistorted modulation capability well above normal recording level ● Intermodulation unbelievably low ● Current feedback stabilizing loop ● 50 watt amplifier push-pull throughout ● Regular size cutter ● Standard mounting holes and stylus

"For recordings indistinguishable from live talent . . . !"  
Write for descriptive pamphlet.

Engineering staff available for special requirements

**Recording Systems**  
Licensed under U. S. Pats. of  
**Western Electric Co., Inc.**

**COOK LABORATORIES • 139 Gordon Blvd. • Floral Park • New York**

**New dry battery  
design problems  
quickly solved!**

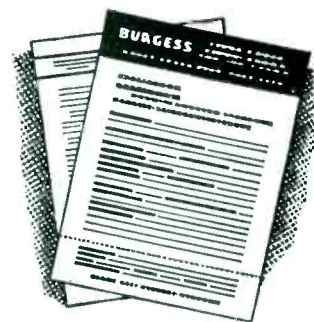

**Handy Burgess check sheet**

. . . enables you quickly to fill in complete details on the dry battery for your special application . . . providing Burgess engineers with necessary information to give you facts on the battery that will answer your problem. Send for check sheet today.

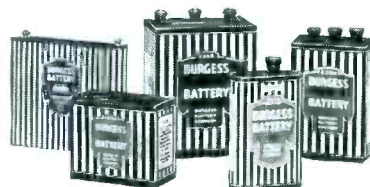

**SPECIAL PURPOSE BATTERIES**

. . . Burgess engineers are constantly developing special batteries for new instruments or electronic equipment . . . the battery you need may be among them. Send coupon to Burgess today.

**BURGESS  
BATTERY  
COMPANY**

**BURGESS BATTERY CO.**

Freeport, Illinois Dept. E-8  
Gentlemen:

Send me the free check sheet to aid in new dry battery development.

Name \_\_\_\_\_  
Company \_\_\_\_\_  
Address \_\_\_\_\_  
City \_\_\_\_\_ State \_\_\_\_\_

# MICRO-DIMENSIONAL

**WIRE & RIBBON for  
VACUUM TUBE  
FILAMENTS & GRIDS**

● Many sizes and alloys for a range of applications such as miniature tubes, hearing aid tubes, low-current-drain battery tubes, receiving tubes . . .

● Melted and worked to assure maximum uniformity and strength. WIRES drawn to .0004" diameter; RIBBON rolled to .0001" thickness . . .

● Wollaston Process Wire drawn as small as .000010"; made to your specifications for diameter and resistance.

**SPECIAL ALLOYS made to meet individual requirements. Write for list of stock alloys.**

**SIGMUND COHN & CO.**

44 GOLD ST. NEW YORK  
SINCE  1901

the Tube Division of the company's Electronics Department.

CARL J. BIVER is now an application engineer for the Ken-Rad Division of General Electric Co., in Owensboro, Ky.

HARRY S. JONES, formerly chief engineer of the Instrument Division of Thomas A. Edison, Inc., is now assistant chief engineer in charge of research and development for Lear, Inc., Grand Rapids, Mich.



H. S. Jones

W. L. Jenkins

WILLIAM L. JENKINS is manager of the recently created Electronic Applications Development Department at B. F. Goodrich Co., Akron, Ohio.

RALPH BOWN is director of research at Bell Telephone Laboratories, New York City, succeeding M. J. Kelly who will now devote all his time to his duties as executive vice-president of the Laboratories. Dr. Bown has been associated with the Bell System since 1919, and has been assistant director of research since 1944.



R. Bown

G. C. Hale

GEORGE C. HALE has been appointed vice-president in charge of operations for Jefferson-Travis Corp., New York, N. Y. He spent three years as communication equipment officer on the staff of General Arnold during the war, resigning with the rank of Colonel.

DAVID S. SAXON is associate physicist

## Oscillograph

CATHODE-RAY  
RECORDING CAMERAS  
—35 and 70 MM.—

## Instrumentation

CINE CAMERAS

## Micro-Second

Drum Cameras  
and  
ACCESSORIES

The science of  
"Electronic  
Measurement"

Has Been  
Advanced  
by

AVIMO Limited  
TAUNTON,  
SOMERSET  
ENGLAND

If your photographic problem cannot be solved by the range of cameras offered by



or under development by them, they are prepared to modify their cameras or design and develop new cameras and equipment to perform whatever function is required.

BROCHURE AVAILABLE ON REQUEST TO

**CANADIAN AIRCRAFT INSTRUMENTS  
& ACCESSORIES LIMITED**  
Leaside, Ontario,  
CANADA.

"North American distributors"

**KIRKLAND Pioneer**  
INDICATING LAMPS

**TYPE T2 UNITS**

T2 LAMPHOLDER

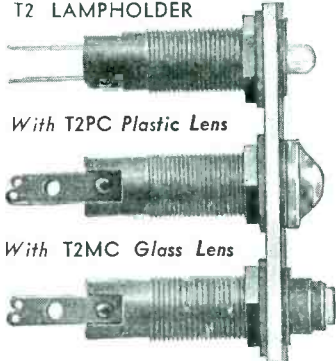

With T2PC Plastic Lens

With T2MC Glass Lens

T2 lampholder, molded of bakelite, holding lip, dia. 11/16". Tip of lamp bulb protrudes sufficiently to be removed from front of panel without use of special tool.

Very low current consumption bulb (0.038 max. amp. on 24 volts). Series resistor of small size on 120-220-440 volts, etc.

T2PC Lens-cap, molded in plastic.  
T2MC Lens-cap, metal with glass lens.

WRITE TODAY FOR CATALOGUE

THE H. R. KIRKLAND COMPANY  
8 King Street Morristown, N. J.

**MASSIVE WINDING CORE**  
25% More Capacity

Another exclusive Hardwick-Hindle advantage is this great ceramic core of unusually large cross section for the wattage rating—*more wire, more surface and, less temperature rise.*

And between this ceramic winding core and the rugged die cast base there is ample space for full ventilation to insure low operating temperature for the mounting panel.

This is only one of several exclusive features. Let us tell you of other Hardwick-Hindle advantages in this and in other rheostats, as well as in our resistors.

Our engineering service is always available for specific problems. Write us today.

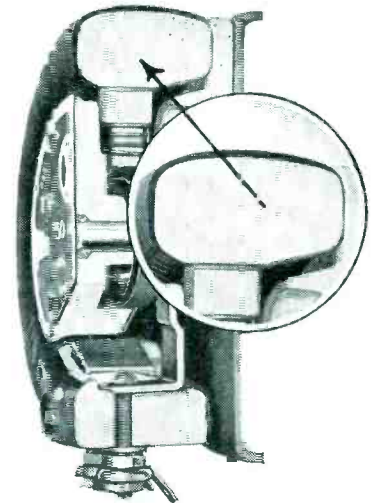

**HARDWICK, HINDLE, INC.**  
RHEOSTATS and RESISTORS

Subsidiary of THE NATIONAL LOCK WASHER COMPANY  
NEWARK 5, N. J. ESTABLISHED 1886 U. S. A.

**25c WILL GET YOU**  
**2 TRIAL CANS**

*Rubyfluid*

**Paste & Liquid**  
**Soldering Flux**

Prove to yourself that Rubyfluid fluxes are the best for soldering any type of electrical connections—that they are easy and economical to use—have no harmful or objectionable fumes—wet out freely.

Send 25c in Coin or Stamps today for 2 trial cans.

**RUBY CHEMICAL**

61 McDowell  
Columbus 8, Ohio



**Rubyfluid**

**PLASTIC**  
**FABRICATING**  
**... O.K!**

BAKELITE SHEETS, RODS, TUBES  
FABRICATED PARTS



Twenty Years of Experience  
**ELECTRICAL INSULATION CO., INC.**  
12 VESTRY ST., NEW YORK 13, N. Y.

# PARDON ME!



**BUT IS YOUR SLIP SHOWING?**

Sometimes much more embarrassing or disastrous results can come from slip-page or unintentional movement of a dial than from having the girl friend's slip hang below her dress. The NEW BUD DIAL LOCK, DL-1947, absolutely prevents this occurrence.

DL-1947 is a new addition to the BUD line and fills a need of long standing. It is a precision unit especially designed for apparatus requiring an accurate, fast-acting dial-lock and tuning indicator.



**DON'T FAIL TO SEE IT AT YOUR LOCAL DISTRIBUTOR TODAY!!!**

**BUD Can Supply All Your Needs! . . .**

. . . with the latest types of equipment including: condensers — chokes — coils — insulators — plugs — jacks — switches — dials — test leads — jewel lights and a complete line of ultra-modern cabinets and chassis.



**BUD RADIO, INC.**  
CLEVELAND 3, OHIO

the war he instructed Navy personnel in operation and maintenance of underwater sound equipment at the Navy's San Diego laboratory.

RICHARD G. LEITNER was appointed chief electronic engineer of Lear, Incorporated of California, located in Los Angeles. His past experience includes six years as chief engineer for Jackson-Bell Radio Co. and five years in a similar position with Synco Sound Corp.



R. G. Leitner



G. E. Webster

GLENN E. WEBSTER becomes chief engineer of The Turner Co., Cedar Rapids, Iowa. He was formerly in charge of speech equipment for Collins Radio Co.

ROLLIN H. MAYER was elected vice-president and general manager of the newly organized St. Louis Microphone Co., St. Louis, Missouri.

HARADEN PRATT, vice-president of Federal Telephone and Radio Corp. and chairman of RTPB, is an official guest of the Army and Navy and a civilian observer at the Bikini Atoll atom bomb tests.

JAMES LAWRENCE FLY has joined with W. C. Fitts, Jr. and P. Shuebruk to form the law firm of Fly, Fitts and Shuebruk, with offices in Rockefeller Plaza, New York City.

R. F. SHEA, designer of the first line of G-E Musaphonic receivers, has been named engineering consultant in the Specialty Division of G-E's Electronics Department.

CYRUS T. READ has left the engineering staff of Hallicrafters to become supervising buyer of electronic equipment for Montgomery Ward & Co., Chicago.

ROBERT B. ANDERSON, radar field engineer with Submarine Signal Co. until recently, has organized The

**KANTHAL... FOR OPERATING TEMPERATURES UP TO 2462°F. ... In Fine Sizes**

## KANTHAL RESISTANCE WIRE

is manufactured in three grades, KANTHAL A-1, A and DS, in the form of wire, ribbon, and strip. KANTHAL is an alloy of iron, chromium, aluminum and cobalt, selected and controlled as to proportions for desired variations in electrical and physical properties.



## KANTHAL RESISTANCE WIRE

Characterized by high resistivity and outstanding resistance to scaling at high temperatures, combined with sufficient ductility for cold-forming operations and economy of application. Maximum continuous service temperatures 2462°F, 2372°F, and 2102°F; resistivity, 872, 837 and 812 ohms/C. M. F. at 68°F, for KANTHAL A-1, A, and DS respectively.



## KANTHAL RESISTANCE WIRE

Much less susceptible to attack by sulphur fumes and compounds than the nickel-base alloys; KANTHAL A, under attack by sulphurous acid, shows an increase in weight in grams per m<sup>2</sup> per hour of only 6.8 grams at 2282°F.



### the Kanthal Handbook

Comprising 115 pages of complete technical reference material covering all data on the properties, fields of application, and design consideration of the Kanthal alloys, will be sent upon request to engineers writing on company letter-heads.



**THE C. O. JELLIFF MFG. CORP.**  
SOUTHPORT — CONN.

## Optical Glass Specialties



### Television Reflectors

Precision-polished optical face plates for cathode ray tubes

Optical lenses, prisms and flats

FS Precision-Bore Glass Tubes with bore exact within .0002"

Contact us for such requirements

FISH-SCHURMAN CORPORATION  
230 East 45th St., New York 17, N. Y.

**Fish-Schurman**

## SMASH VALUES in ELECTRONIC & COMMUNICATION SUPPLIES

ORDER TODAY—IMMEDIATE DELIVERY

HEWLETT - PACKARD AUDIO OSCILLATOR MODEL 200B, frequency range 20 cycles to 20,000 cycles in 3 ranges. A Precision Laboratory Instrument. Complete with tubes and power supply, reconditioned and guaranteed.



Special .....\$75.00

### PLATE TRANSFORMER



6200 Volt CT—700 Mils.  
110 Volts 60 Cycles  
tapped primary 2 KVA  
Amertran. Limited  
Quantity .....\$39.95

### ADDITIONAL BARGAINS

CRAMER RUNNING TIME METER. 110 Volts 60 Cycles — reads to .9999.9 hrs. ....\$4.95  
WESTINGHOUSE NA 35-312, 0 to 150 volts AC .....\$4.95  
WESTON #301—0-1 amp. ....\$4.95  
VARIAC #200B—1 amp. ....\$5.95  
PLATE TRANSFORMER 1450 CT at 420 mils—Kenyon 110 Volt, 60 cycles. ....\$7.95

### COMBINATION SPECIAL

BE29-829B and RCA shielded socket UT107 with Built-in by-pass condenser. Your cost. ....\$6.95

All prices FOB our warehouse New York City, N. Y.

Write for our latest Bulletin 4E

NIAGARA RADIO SUPPLY  
160 Greenwich St., New York 6, N. Y.  
Bowling Green 9-7993

# PULL THE TRIGGER— START TO SOLDER

## New Transformer Type SOLDERING GUN

HEATS IN  
5 SECONDS



Release trigger and circuit breaks automatically. Intermittent heat saves power when continuous use is unnecessary. Fast heating, SPEED IRON is always ready for use.

- SOLDER IN TIGHT PLACES—AROUND CORNERS
- PERFECTLY BALANCED—EASY TO HANDLE
- STAYS TINNED—NO TIP BURNING
- LOW VOLTAGE, HIGH CURRENT FROM BUILT-IN TRANSFORMER
- IMPACT RESISTANT PLASTIC CASE AND HANDLE—STAYS COOL

**WELLER MFG. CO.**  
510 NORTHAMPTON ST. • EASTON, PA.

\*TRADE MARK REG. U. S. PAT. OFF.

100 WATTS  
115 VOLTS  
60 CYCLES

NEW TRANSFORMER PRINCIPLE FOR FAST HEAT

SEE WHAT YOU SOLDER

Ask for SPEED IRON at your RADIO PARTS DISTRIBUTOR

# ATTENUATORS by TECH LABS



MIDGET  
TYPE  
600

"Midget" model is especially designed for crowded apparatus or portable equipment.



STANDARD  
TYPE  
700

- Solid silver contacts and stainless silver alloy wiper arms.
- Rotor hub pinned to shaft prevents unauthorized tampering and keeps wiper arms in perfect adjustment.
- Can be furnished in any practical impedance and db. loss per step upon request.
- TECH LABS can furnish a unit for every purpose.
- Write for bulletin No. 431.

**TECH**  
LABORATORIES

Manufacturers of Precision Electrical Resistance Instruments  
337 CENTRAL AVE. • JERSEY CITY 7, N. J.

## PRECISION PARTS

### GEARED-UP FOR SPEED



As a plane takes to the air it neatly tucks its landing gears underneath its belly, speeding its flight and increasing the efficiency of its engines. The effortless, fool-proof meshing of hydraulic worm and worm gear which makes this possible demands precision of the highest order . . . precision that Ace is well qualified to deliver.

Producing such a worm in mass quantities is really quite simple, if you have the engineering skill and the up-to-date machines that Ace has. The piece must be machined from the blank, rough turning all the diameters and rough grinding the worm. The entire piece is then heat-treated. After heat-treating, it is returned to the thread grinder and the worm is finish ground to a tolerance of  $\pm .0003$ ". The four other diameters used as bearing surfaces are cylindrical-ground concentric to the major diameter of the worm and to each other . . . within a total indicator reading of  $\pm .0002$ ".

Worms or threads, spindles or valves . . . small parts and assemblies whatever their nature . . . are all the same to Ace. Where precision is required, we will produce it, and in production quantities. Ace has complete facilities for tool and die work, stamping, machining, heat-treating and grinding. Send us a sample, blueprint, or sketch for quotation.



Capacity open on Centerless Grinders



**ACE MANUFACTURING CORPORATION**  
for Precision Parts  
1255 E. ERIE AVE., PHILADELPHIA 24, PA.

Anderson Sales Co. in Boston, Mass. to serve the electronics field.

JOHN L. BAIRD, British pioneer in television, died in London in June at the age of 58.

RALPH P. GLOVER, consulting engineer in Oak Park, Illinois, has been retained by Technology Instrument Corp., Waltham, Mass. as technical representative for the Chicago area.

A. J. MONACK has left Mycalex Corporation of America to engage in consulting services on glass, glass-metal seals, and electronic insulation.

GORDON M. LEE, now technical director of Central Research Laboratories, Inc., Red Wing, Minn., was awarded the Browder J. Thompson Memorial Prize, established by the IRE to stimulate radio and electronic research by young scientists, for his paper "A Three-beam Oscillograph for Recording at Frequencies Up to 10,000 Megacycles" (*Proc. IRE*, p 121W, Mar. 1946).



G. M. Lee



V. M. Graham

VIRGIL M. GRAHAM becomes manager of technical relations for Sylvania Electric Products Inc., and will coordinate activities of the various engineering groups as well as maintain liaison with advertising and public relations activities.

#### BUSINESS NEWS

RIPLEY Co., Inc., Torrington, Conn., has been organized as a merger of United Cinephone Corp., The Ripley Co., and the L-R Mfg. Co., all of Connecticut, and will continue to design and manufacture electronic equipment for industrial applications and for laboratories. To provide additional plant facilities, the new company has purchased the former Pratt, Read & Co. plant at Deep River,

**NEW!**

Interior view showing simplicity of making rigid connections

**B & W**

**COAXIAL  
CABLE  
CONNECTOR**

- Easy to install
- Watertight
- Seals Cable Ends

**SERVES AS CENTER  
INSULATOR ON  
HALF-WAVE DOUBLET**

The new B & W CC-50 Connector does an excellent job of providing a waterproof termination for a coaxial line where it joins the center of a half-wave doublet antenna. Made of cast aluminum with steatite insulation and forged steel eyebolt with easy soldering connections. Weighs only 12 ounces. Absolutely watertight. Write for details.

**BARKER &  
WILLIAMSON**  
Inductor Coil Headquarters  
237 Fairfield Ave., Upper Darby, Pa.



- SOFT SOLDER RINGS AND PREFORMS
- SILVER SOLDER RINGS
- COPPER BRAZING RINGS

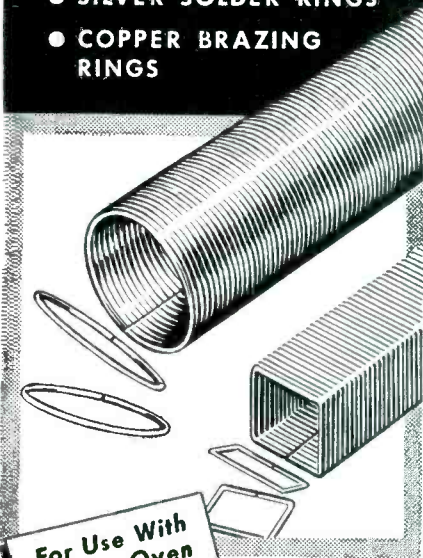

For Use With  
Flame, Oven  
or Induction  
Heating

Large range of wire sizes carried in stock for immediate fabrication into Rings and Preforms.

**ELECTRONIC SPECIALTIES  
MANUFACTURING COMPANY**  
127 North Main Street, Elkhart, Indiana

*Have you a High  
Temperature  
Capacitor  
Application?*

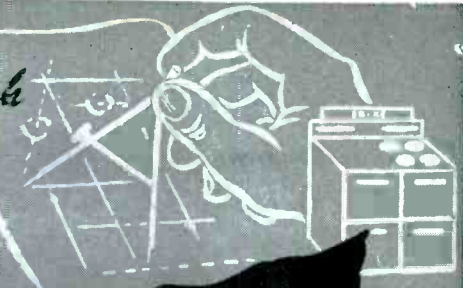

**PLASTICONS**  
Operate at **256° F.**

Plasticon Types AS are silicone impregnated plastic film dielectric capacitors. They will operate from  $-80^{\circ}\text{F.}$  to  $+256^{\circ}\text{F.}$  with less than 10% capacitance change. Plasticons are small in size as they are not "voltage derated."



**Condenser  
Products Company**

1375 NORTH BRANCH STREET • CHICAGO 22, ILLINOIS

**BEFORE YOU BUY AN FM  
TRANSMITTER—Investigate!**

**REL**



1 KW FM TRANSMITTER

**PIONEER  
MANUFACTURERS  
OF FM  
TRANSMITTERS  
EMPLOYING  
ARMSTRONG  
PHASE-SHIFT  
MODULATION**

**RADIO ENGINEERING LABS., INC.**  
Long Island City, N. Y.

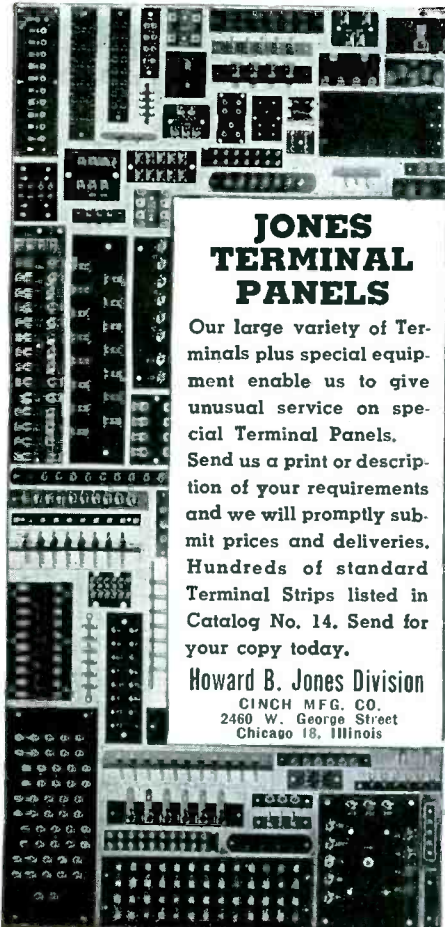

**JONES  
TERMINAL  
PANELS**

Our large variety of Terminals plus special equipment enable us to give unusual service on special Terminal Panels. Send us a print or description of your requirements and we will promptly submit prices and deliveries. Hundreds of standard Terminal Strips listed in Catalog No. 14. Send for your copy today.

Howard B. Jones Division  
CINCH MFG. CO.  
2460 W. George Street  
Chicago 18, Illinois

# Electricity

## FOR RADIO AND ELECTRONIC APPLICATIONS



ONAN ELECTRIC GENERATING PLANTS supply reliable, economical electrical service for electronics and television applications as well as for scores of general uses.

Driven by Onan 4-cycle gasoline engines, these power units are of single-unit, compact design and sturdy construction. Suitable for mobile, stationary or emergency service.

Capacity range: 350 to 35,000 watts; 115 to 660 volts A.C., 50 to 800 cycles; 6 to 500 volts D.C.; combination A.C.—D.C. types.

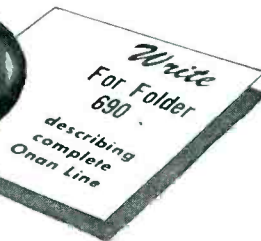
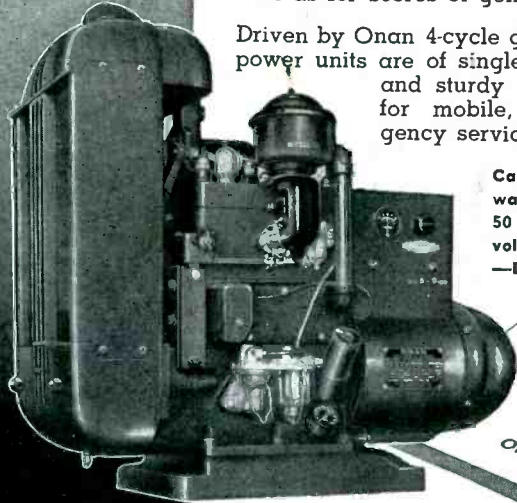

Model shown is from W2C series: 2000 to 3500 watts; powered by Onan two-cylinder, water-cooled engine.

**D. W. ONAN & SONS**  
3554 Royalston Ave. Minneapolis 5, Minn.

Conn., comprising a total of eleven buildings.

RADIO CONDENSER Co. purchased from War Assets Corp. for \$154,986.11 the Camden, N. J. plant it operated during the war for production of variable capacitors, and plans to continue production of capacitors for radio and radar equipment. Between 2,300 and 3,000 persons are to be employed.

THE 1946 RADIO PARTS & ELECTRONIC EQUIPMENT CONFERENCE & SHOW in Chicago broke all industry records with a registered attendance of 7,652, with 169 manufacturing lines and 14 publications in booths.

ELECTRONIC CORPORATION OF AMERICA formally opened its new one-city-block-square plant in Brooklyn, N. Y. on June 13.



ECA's new plant, completely built for straight-line radio set manufacture and featuring suspended-duct wiring for maximum flexibility. Engineering and research laboratories are on a balcony that runs around the entire plant

## HERE'S THE PORTABLE NEW OSCILLOSCOPE LIGHT, FLEXIBLE, INEXPENSIVE AND COMPLETE

### The POCKETSCOPE



- So SMALL in size (4" x 6 3/8" x 10")
- So LIGHT in weight (5 3/4 lbs.)
- So COMPLETE in performance
- So INEXPENSIVE in price
- Plus WIDE-ANGLE VISION: on shelf, on floor, on bench
- Plus RETRACTABLE LIGHT SHIELD: for increased visibility

A 2" "pocket-size" scope incorporating the cathode ray tube, vertical and horizontal amplifiers, linear time base oscillator, synchronization means and self-contained power supply.

**FOR DELIVERY:**

Contact your nearest jobber. If he doesn't have the POCKETSCOPE available, contact us direct.

**WATERMAN PRODUCTS CO.**  
INCORPORATED  
Phila. 25, Pa.



MOTION PICTURE SUPPLIES LTD., St. Johns, Newfoundland, points out that Newfoundland is not a Province of Canada, but a separate Dominion with its own customs tariff, and hence merchandise manufactured in the United States should be quoted direct rather than through Canadian agents or jobbers.

LABORATORY FOR ELECTRONICS, INC., formed recently in Boston, Mass., has as officers all three members of the dissolved partnership of Cole, Holdam & McGrath, along with D. F. Cutler, Jr. as executive vice-president.

WESTERN ELECTRIC Co. has leased the Kenmore plant of Curtiss-Wright Corp., Buffalo, N. Y. for manufacture of switchboard cable and other tele-

# Alnico permanent magnets

Specializing in the production of highest quality Alnico Magnets in all grades including new triple strength No. 5.

Production material checked to assure highest uniform quality of product.

Castings made to customer's special order on the basis of sketches or blue prints furnished.

Information and suggestions furnished on request.

**GENERAL**

MANUFACTURERS OF HIGH COERCIVE MAGNETIC ALLOY



**MAGNETIC CORPORATION**

10001 ERWIN AVENUE  
DETROIT 5, MICHIGAN



CUP WASHERS  
for Binding Screws

*Preferred*  
as a source of precision-made  
WASHERS and  
STAMPINGS  
manufactured to  
your specifications

**WHITEHEAD STAMPING CO.**

1691 W. Lafayette Blvd.

Detroit 16, Michigan



## PRECIOUS METALS IN ALL FORMS FOR THE ELECTRONIC INDUSTRIES

**PLATINUM**  
WIRE · RIBBON  
FOIL  
SEAMLESS TUBING



**SILVER**  
WIRE · SHEET · TUBING  
SILVER BRAZING  
ALLOYS & FLUXES

FOR A COMPLETE LIST OF OUR PRODUCTS

SEND FOR OUR NEW FOLDER, E-20

"PLATINUM, GOLD & SILVER FOR SCIENCE, INDUSTRY & THE ARTS"

**THE AMERICAN PLATINUM WORKS**

231 NEW JERSEY R. R. AVE.  
NEWARK 5, N. J.

PRECIOUS METALS SINCE 1875

**Attention  
GI JOE!**

Here's Your Opportunity to be First to

## Start Your Own RADIO SERVICE SHOP

Complete Starting-in-Business  
Package Stocks of

TEST EQUIPMENT  
TUBES, PARTS, TOOLS **\$350 up**

Act quickly! Meet the pent up demand for radio service. Turn your special service training into a profitable business of your own. No fuss. No worry. Here's everything you need—\$350 up. Details upon request! Write, wire or phone

### RCP 448

"POCKET" VOM  
A.C.-D.C. Volts  
0-5-50-250-1000  
D.C. Mills  
0-5-10-100-1000  
Ohms  
0-2,000-20,000-200,000-  
2 Meg.  
Size 3" x 5 7/8" x 2 1/2"

**\$24.50 net**

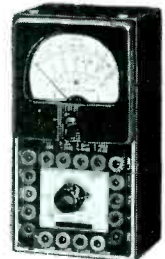

### RECORD CHANGERS

UTAH-DETROIT \$530C ..... \$18.27  
WEBSTER-CHICAGO \$56 ..... 27.20

### HALLICRAFTERS SX-28A

**\$223**



SUPER DEFIANT ..... SX25 \$94.50  
SKY CHAMPION ..... S20R 60.00  
SKYRIDER MARINE ..... S22R 74.50  
S40 NEW MODEL ..... Approximately 79.50  
SKYRIDER JR. S41 ..... 33.50

**HAMMARLUND HQ-129-X \$129**

### TRIPLETT 625-N

20000 ohms per volt D.C.  
10000 ohms per volt A.C.  
5" Scale-TOPMOST QUALITY  
(12) D.C. Volt Ranges to 5000  
(6) A.C. Volt Ranges to 5000  
(3) OHM Ranges 0-400-50000-  
10 Meg.  
(5) D.C. Current Ranges 1 Ma.  
to 10 Amp.  
PLUS OUTPUT and DB.  
RANGES

**\$45.00** with test leads.



### PHILCO BEAM OF LIGHT

Selenium Cell only, no holder ..... **1.80**

20% deposit required on all C.O.D. orders. 2% transportation allowance on orders of \$25.00 or more accompanied by payment in full.

**RADIO SUPPLY & ENGINEERING CO., Inc.**  
127 SELDEN AVE. DETROIT 1, MICH.

Write for  
FREE CATALOG

**Proper tools  
simplify the  
hard problems**

## VX Series Subminiature tubes

... now available as pentodes, tetrodes, triodes and diodes operate at 10 milliamperes filament current,  $10^{-14}$  amperes grid current, and have an extremely high grid resistance of  $10^{16}$  ohms or greater.

Developed for the finest in instrumentation—solving the problem of making new and intricate circuits simple and feasible.

Victoreen vacuum sealed hi-megohm resistors have filled the void of quality resistances in a range from 100 to 10,000,000 megohms. Used wherever resistors of these values require unusual stability with relatively low temperature and voltage co-efficients.

*Write for our free technical data booklet on tubes and resistors.*



**THE VICTOREEN INSTRUMENT CO.**  
3800 PERKINS AVENUE  
CLEVELAND 14, OHIO

phone products. The plant has 760,000 sq ft of floor space and is expected to employ 3,000 people.

ST. LOUIS MICROPHONE Co. moves into its newly constructed building in St. Louis, Mo. early in August, and will produce a complete line of dynamic microphones.

PHILCO CORPORATION, Philadelphia, purchased approximately 22,000 acres of standing timber in North and South Carolina in a move to overcome the cabinet shortage facing the radio industry. Logging operations will be carried on by Southeastern Industries, Inc., a wholly-owned Philco subsidiary.

HARVARD UNIVERSITY will move its 51-foot-long automatic calculator into a new two-story building to be known as the Computation Laboratory, hav-

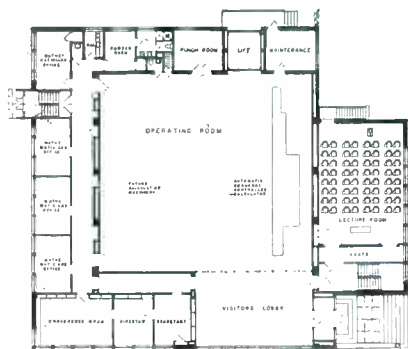

First floor plan of new Computation Laboratory for Harvard University. Visitors can watch calculators in operation through a window two stories high

ing facilities for instruction of graduate students and room for additional calculating machines.

THE INDIANA STEEL PRODUCTS Co., Chicago, Ill., has acquired the plant and facilities of Cinaudagraph Corp., Stamford, Conn. and can now offer a two-source supply of permanent magnets.

TRACERLAB INC., Boston, Mass. has been organized to develop and manufacture instruments for use in connection with newly available radioactive isotopes, and will also make radioactivity analyses and provide consultation services.

ACME ELECTRIC CORPORATION is the new name of Acme Electric & Mfg. Co., Cuba, N. Y.

BROWN INSTRUMENT Co., Philadelphia, has purchased a five-story build-

# From out of the west ... America's finest transformers

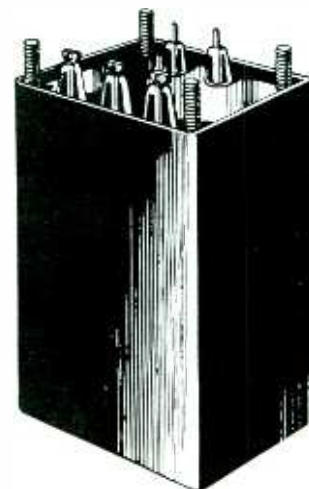

Thermador is a name remembered when the utmost in transformer quality is desired, and when exceptional engineering skill is required.



"Seven Leagues Ahead"

## THERMADOR

THERMADOR ELECTRICAL MFG. CO  
5119 District Blvd. Los Angeles 22, California

# BAER

## PHENOL AND VULCANIZED FIBRE FABRICATIONS



### Close tolerances, any quantity—

Volume production and accuracy of BAER phenol and vulcanized fibre parts have resulted in their wide specification for every type of product and equipment. Expanded facilities now make it possible to offer BAER production to manufacturers needing quality parts to exact requirements. Write today for Bulletin 120.

### N. S. BAER COMPANY

*Craftsmen in Fibre Fabrication*

7-11 MONTGOMERY ST. • HILLSIDE N. J.

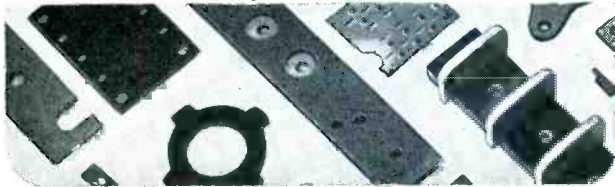

**PUNCHED  
STAMPED  
SHAVED  
SAWED  
DRILLED  
MILLED  
TAPPED**

## GASES

## HYDROGEN NITROGEN-OXYGEN

COMPLETE  
GAS PRODUCTION  
PLANTS INSTALLED  
FOR LOWEST COST  
OPERATION

FORMING MIXTURES  
CARBON DIOXIDE  
ACETYLENE

HIGHEST QUALITIES • ANY QUANTITY  
DELIVERED ANYWHERE

### AMERICAN GAS & CHEMICAL CO.

HARRISON, NEW JERSEY • Contracted Complete Service on All Gases

ARGON • NEON  
HELIUM • KRYPTON  
XENON



SP&R1

● METAL AND  
PLASTIC  
SPECIALTIES

● STAMPINGS

● SCREW  
MACHINE  
PARTS

### INSTRUMENT HOUSINGS • PANELS • CHASSIS

*Manufactured to your Requirements*

Experienced fabrication and dependable service for all types of radio and electronic parts. Send us your drawings and specifications for quotation.

STAMFORD METAL SPECIALTY CO., 429 W. BROADWAY, N. Y. 12

*Metal Work of Every Description*



### "POST-WAR" MIDGET RELAYS

These relays are unusually small. Actually, the panel area required for installation of one of these units is just slightly over 1 square inch. The small size, moreover, is supplemented by the highest quality construction. Armature hinge is Beryllium copper. All metallic parts are cadmium or nickel plated. Pure silver contact points with wiping action. Laminated phenolic (linen electric base) insulation.

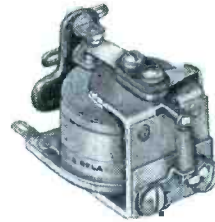

K 1503-S  
A C TYPE

K 1603-S  
D C TYPE

Available in either single or double throw, open or closed contacts. Coils 1.5 to 220 v A.C.—2 to 110 v D.C. Overall size—1-in. x 1 3/4-in. x 1 1/8-in.

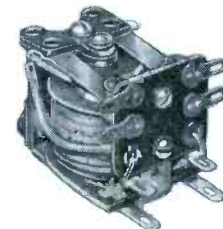

K 1504  
A C TYPE

K 1604  
D C TYPE

Available in either single or double throw, open or closed contacts. Coils 1.5 to 220 v A.C.—2 to 110 v D.C. Overall size—1 1/4-in. x 1 3/4-in. x 1 1/8-in.



K 1509  
A C TYPE

K 1609  
D C TYPE

Available in either single or double throw, open or closed contacts. Coils 1.5 to 220 v A.C.—2 to 110 v D.C. Overall size—1 1/4-in. x 1 3/4-in. x 1 1/8-in.

Write for catalog and price list.

## Advance Relays

ADVANCE ELECTRIC & RELAY CO.  
1260 W. 2nd St., Los Angeles 26, Calif., U.S.A.

# New . . . "DIALCO" PLN-849 Pilot Light

features the

**New Neon NE-51 Bulb**

with

**BUILT-IN RESISTOR**

For 110 Volts (and higher)

A RUGGED UNIT. Consumes a small amount of current (under one milliamper) and has dependable long life.

Note these important features of the PLN-849 Pilot Light: (1) RESISTOR INTEGRAL with socket assembly. Value to suit supply voltage. (2) Moulded Bakelite Socket. (3) Full-view Jewel Plastic Cap for visibility at all angles. (4) Rugged terminals, binding screw or permanent soldering type.

(5) High resistance to vibration or shock. (6) Supplied complete with General Electric Neon NE-51 Bulbs. May also be adapted to accommodate General Electric Radio Panel Bulbs such as 47, 44, etc., for low voltage circuits. Bulbs removable from front of panel.



Write today for samples and prices.  
There is no obligation.

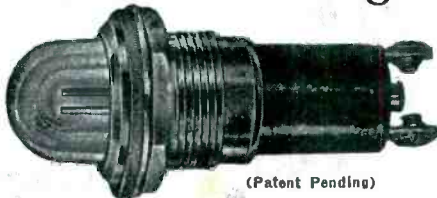

(Patent Pending)

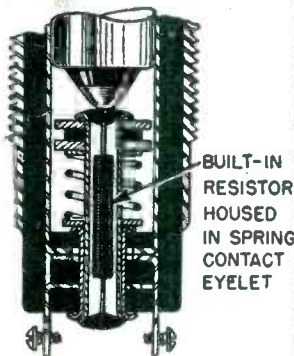

BUILT-IN RESISTOR HOUSED IN SPRING CONTACT EYELET

**DIAL LIGHT CO.** of America, Inc.

900 BROADWAY • NEW YORK 3, N. Y.

Telephone: ALgonquin 4-5180-1-2-3

WRITE FOR NEW ILLUSTRATED BROCHURE

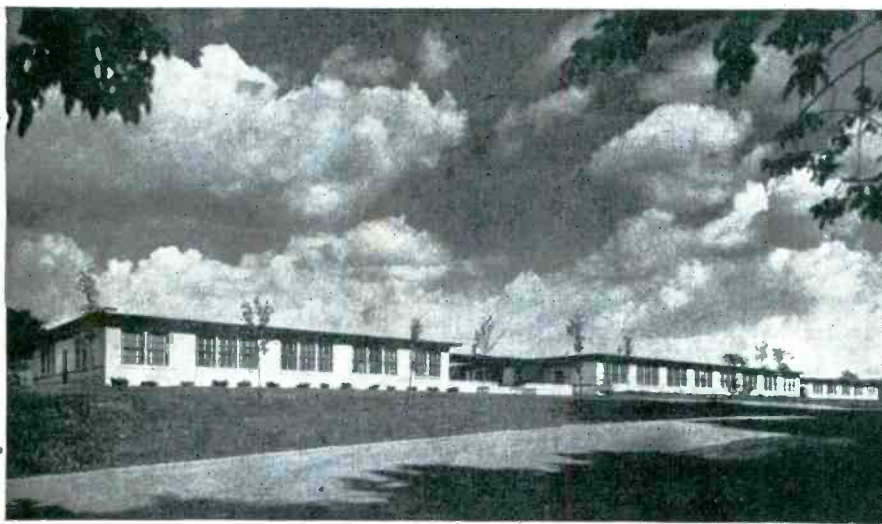

MANUFACTURERS OF RADIO, ELECTRICAL AND ELECTRONIC COMPONENTS

**VOKAR** Corporation

7300 HURON RIVER DRIVE • DEXTER, MICHIGAN

ing in that city in preparation for physical expansion and business growth.

RAYTHEON MFG. Co., New York, N. Y., announces the merger of Submarine Signal Co. with Raytheon on May 31, 1946.

PRINCETON UNIVERSITY will receive a minimum of \$100,000 for research for the Bureau of Ordnance in accordance with a two-year contract signed with the Navy Department. The Navy is also constructing on the campus a laboratory and office building for this project, at a cost of approximately \$120,000.

### MEETINGS TO COME

SEPT. 10-14; NATIONAL CHEMICAL EXPOSITION; Coliseum, 15th and Wabash Ave., Chicago, Ill.

SEPT. 16-20; INSTRUMENTATION FOR TOMORROW—EXHIBIT AND CONFERENCE; Wm. Penn Hotel, Pittsburgh, Pa.; daily technical sessions and program of short educational courses.

OCT. 3-5; NATIONAL ELECTRONICS CONFERENCE; Edgewater Beach Hotel, Chicago, Ill.; technical programs under three main heads—communications, industrial electronics, and scientific and medical developments.

OCT. 10-11; TELEVISION BROADCASTERS ASSOCIATION CONFERENCE; Waldorf-Astoria Hotel, New York City; latest television equipment will be exhibited.

### DRONES GET THROUGH



Four radio-controlled drone planes sent through this atomic blast cloud at altitudes of 13, 18, 24, and 30 thousand feet at Bikini were all recovered by mother planes without mishap and returned to perfect landings at Niwetok atoll. There was no observable interference with radio, television, or electric systems of the drones

# Performance

of most carefully built electrical equipment needs support of Washers made for the job.



Positive locking action . . . compensation for expansion and contraction . . . full gripping area . . . these and other factors are engineered in Quadriga for electrical manufacture.

## QUADRIGA Quality WASHERS



Exactly to your specifications. Any washer material. Flat, Special Dimensions, Irregular, Contour, Finishing, Tension, Cupped and Drawn, Friction, etc. Also wire terminals.

### SMALL METAL STAMPINGS Any Design

Put your problems in Washers and Stampings up to Quadriga. Immediate attention, prompt delivery of any quantity, small or large.

### QUADRIGA BOOKLET FREE

Shows many types from photographs, with valuable information. Should be in your file. Write

**THE QUADRIGA MANUFACTURING CO.**  
221 A West Grand Ave., Chicago 10, Illinois

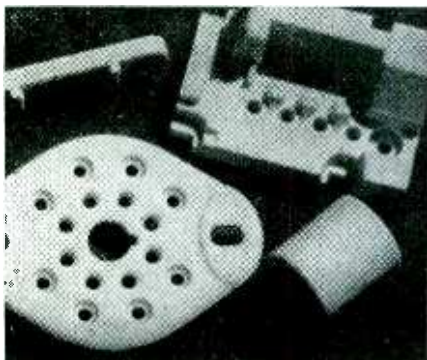

## Lavite STEATITE CERAMIC

### Properties and Characteristics of Our LAVITE SI-5 Steatite Ceramic Body

Compressive Strength	96,000 lbs. per square inch
Tensile Strength	7,200 lbs. per square inch
Flexural Strength	10,500 lbs. per square inch
Modulus of Rupture	20,000 lbs. per square inch
Dielectric Strength	235 volts per mil
Dielectric Constant	6.42
Loss Factor	2.90
Power Factor	4.46
Bulk Specific Gravity	2.664%
Density (from above gravity)	0.096 lbs. per cubic inch
Hardness (Mohr scale)	7.0
Softening Temperature	2,350°F.
Linear Coefficient of Expansion	8.13x10 <sup>-6</sup>
Moisture Absorption (ASTM D-116-42-A)	0.009%

Design engineers and manufacturers in the radio, electrical and electronic fields are finding in LAVITE the precise qualities called for in their specifications . . . high compressive and dielectric strength, low moisture absorption and resistance to rot, fumes, acids, and high heat. The exceedingly low loss-factor of LAVITE plus its excellent workability makes it ideal for all high frequency applications.

We will gladly supply samples for testing.

**D. M. STEWARD MFG. COMPANY**  
Main Office & Works: Chattanooga, Tenn.  
Needham, Mass. Chicago Los Angeles



M-32A

## Specifications

- Motor Type KS-837
- Model I-S 225S
- Approx. 1/20 H.P.
- Speed 1140 R.P.M.
- 115 V. A.C. 60 cycles
- Split phase induction
- Continuous duty

Where quiet, vibrationless operation and long life are essential, we recommend this special *Ostermotor*

for your continuous-duty fan and blower applications, such as oil, gas, or steam unit heaters—oil burners — air-conditioning units — etc.

Construction features: Motor is totally enclosed. Tubular steel stator housings are rabbeted to fit die cast end bells, providing perfect alignment. Bronze sleeve bearings are grooved for best oil distribution. Oversize felt oil retainers feed oil to shaft through two spring tension wicks at each bearing.

Resilient neoprene motor mountings absorb vibration — are not affected by oil and grease. Can be furnished with standard motor mounting dimensions. Finished in black, baked enamel. Length over bearings, 8 1/8". Housing diameter 4-27/64". Weight 15 lbs.

Orders for this motor are now in production. If you need special motors for your products, write for information.

John Oster Mfg. Co., 4 Main St., Racine, Wis.

Specialists in special motors — series, split phase, capacitor, synchronous, and shaded pole in fractional h.p. ratings.

**WEAR RESISTANT**

**NON-CORROSIVE**

**NON-ABRASIVE**

**NON-MAGNETIC**

**SUPER-POLISHED**

**PERMOPIVOTS**

*Yes, Extra Value!*

Long after the ordinary pivot has worn out you'll find PERMO-PIVOTS in the prime of life — faithfully keeping precision instruments precise! It's all due to the special PERMOMETAL tip — the ideal osmium alloy. . . . Made to your specifications. Write for information!

**PERMO**  
INCORPORATED  
6427 RAVENSWOOD AVE., CHICAGO 26  
MANUFACTURING METALLURGISTS

# CLIPPARD EXPANDS FACILITIES

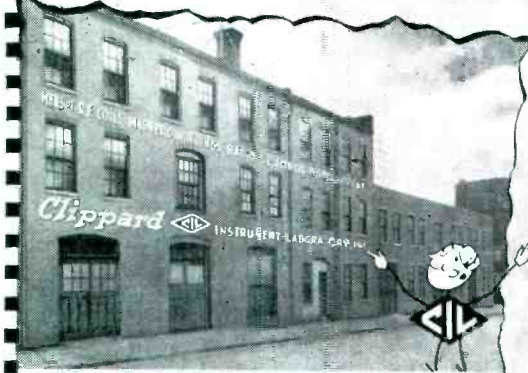

*New Plant to Speed Production of R. F. Coils, Windings, Sub-assemblies and Radio and Electrical Test Equipment!*

## YOUR INQUIRIES INVITED

The recent acquisition of new and greatly enlarged plant facilities at 1125 Bank Street, Cincinnati, Ohio, by Clippard Instrument Laboratory, Inc., marks a new step forward in the march of services now offered radio, electrical and electronics manufacturers.

Clippard, with 25,000 additional square feet of production space, is now in an ideal position to handle your R. F. Coil, Electro-Magnetic Winding, Sub-Assembly or Specialized Test Instrument problems with precision and dispatch.

Additional inquiries are cordially solicited from discriminating manufacturers seeking coils and assemblies of finest quality.

Do you need precision R. F. Coils, Electro-magnetic windings, Sub-assemblies, or Specialized Electrical and Electronic Test Equipment for the laboratory or production line? Have you a tricky engineering, assembly or production job on which you need help?

Take advantage of Clippard's reputation for "know how" and Clippard's enlarged production facilities. Skill, accuracy and dependability remain our creed, and we can now give service and delivery heretofore impossible.

Let us know your R. F. Coil and instrument needs, TODAY!



## NEW BOOKS

### Electron Optics and the Electron Microscope

By V. K. ZWORYKIN, G. A. MORTON, E. G. RAMBERG, J. HILLIER, and A. W. VANCE, all of RCA Laboratories, Princeton, N. J. John Wiley & Sons, Inc., New York, and Chapman & Hall, Ltd., London, 766 pages, \$10.00.

A COMPREHENSIVE treatment of the electron microscope and electron optics is presented in this thoroughly annotated and indexed volume. Actually, the work consists of two books combined as Part I—Practical Electron Optics and Electron Microscopy, and Part II—Theoretical Basis of Electron Optics and the Electron Microscope.

In the first part a general descriptive series of chapters explains the characteristics, methods of utilizing, and limitations of electron optical systems in the various practical applications such as electron multipliers and mass spectrographs. On this foundation the components and their functions in the electron microscope are explained in qualitative form; the several commercial electron microscopes are used to illustrate the points and the applications and manipulations of the instruments in biological, chemical, and metallurgical research are explained.

In the second part the various components of the electron microscope are analysed in quantitative detail. Beginning from basic theoretical properties of electrons, fields, and waves, the analysis proceeds through computation of potential distribution and trajectories to their concrete utilization in designing electron optical systems, aberrations and image formation encountered with such systems, and a statement of the limits of resolution. An appendix discusses the added effects of noise.

### The Electron Microscope

By E. F. BURTON, University of Toronto, and W. H. KOHL, formerly Rogers Electronic Tubes, Ltd., Toronto. Reinhold Publishing Corp., New York, second edition, 325 pages, \$4.00.

CLEARLY PRESENTED for the technician who uses the instrument, this cleverly illustrated book outlines the fundamental principles and the manner in which they are applied in the electron microscope. The presenta-

## The FINEST MICROPHONES

for P. A. and RECORDING!



**AMPERITE VELOCITY MICROPHONE WITH PATENTED ACOUSTIC COMPENSATOR**

**New P. G. DYNAMIC WITH NEW SUPERIOR ELIPSOID PICK UP PATTERN!**



**AMPERITE KONTAK MIKES IDEAL FOR AMPLIFYING STRINGED INSTRUMENTS USED WITH ANY AMPLIFIER AND WITH RADIO SETS.**



ASK YOUR JOBBER . . . WRITE FOR FOLDER

# AMPERITE

561 BROADWAY NEW YORK





**PREMAX**

CATALOG R-46

*Premax*  
*Antennas*  
*and Accessories*

VERTICAL RADIATORS  
HORIZONTAL ELEMENTS  
MOUNTINGS AND INSULATORS  
For Amateur, Police, Public Utility,  
Marine and Commercial Services

*Just Off the Press!*

Send at once to your jobber for a copy of the NEW Premax Catalog. It shows the complete line of Vertical Antennas in Steel, Aluminum, Monel and Stainless, as well as Corulite Elements and other elements for arrays. If your jobber can't supply you, write direct, giving us his name.

**Premax Products**

Division Chisholm-Ryder Co., Inc.  
4611 Highland Ave., Niagara Falls, N. Y.

CUSTOM MOLDED  
**PLASTICS PARTS**  
FOR THE ELECTRONICS INDUSTRY

*Compression Molded... to meet specific requirements... by an experienced organization... tooled for the production of plastics parts for electrical or general applications. Inquiries acknowledged promptly.*

**Midwest Molding and Manufacturing Co.**  
335 NORTH WHIPPLE ST. • CHICAGO 12, ILL.

# PRECISION CRYSTALS

for MARINE, AIRCRAFT, POLICE  
Frequency Range 1000 KC to 10.5 MC

Type Z-1, the new standard crystal unit for marine, aircraft and police service, is a precision low temperature coefficient unit that meets all F.C.C. requirements. Temperature coefficient less than 2 cycles per MC. °C. Calibrated to within .005% of specified frequency.

**PETERSEN RADIO COMPANY**  
2800 WEST BROADWAY — TELEPHONE 2760  
COUNCIL BLUFFS, IOWA

SINCE 1934

THERE'S A **DRAKE** SOLDERING IRON FOR EVERY TYPE OF ELECTRONIC WORK

From that mighty mite

the Drake No. 400 to the high-speed production "honey"

the Drake No. 600-10 there is a high quality Drake Soldering Iron "just right" for the job.

Drake Heat Controls and the Drake "Magic Cup" Stand are important soldering aids.

SEE YOUR RADIO PARTS JOBBER

**DRAKE ELECTRIC WORKS, INC.**  
3656 LINCOLN AVE. CHICAGO, ILL.

*Soundcraft*

**DAWN OF A DISC!**

The Features  
You've Always Wanted  
You Can Now Have

- MORE PERFECT RECORDING SURFACE. Soundcraft discs are free from outer-edge ridge — increasing usable area.
- "FULL SPECTRUM" FREQUENCY RESPONSE. Soundcraft's superior coating consistency provides the utmost resistance to break down of minute modulations.
- LOWER SURFACE NOISE. Soundcraft's coating lacquer is filtered microscopically clean, thus reducing the most objectional type of surface noise, the crackle.
- NEW QUALITY CONTROL. Soundcraft's Disc Prover, a revolutionary testing method, eliminates the need for numbering discs to locate poor lots in the field. "Mistake" discs cannot reach the shipping room.

Ask your radio parts jobber or write for the new Soundcraft Catalog

**REEVES SOUNDCRAFT CORP.**  
10 EAST 52 ST., NEW YORK 22, N. Y.  
PROGRESS ALONG SOUND LINES

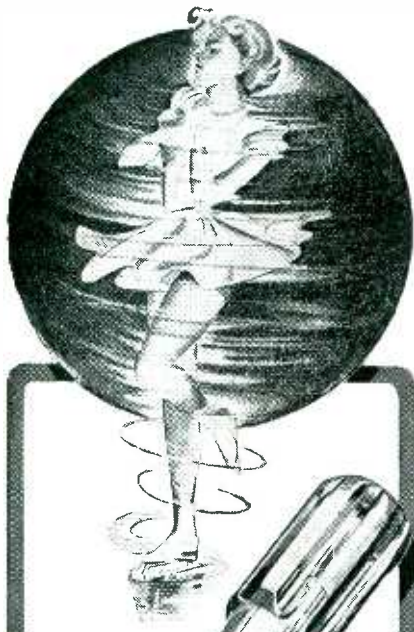

The Original  
**SPINTITE**  
**WRENCH**  
 SPINS With  
 Ease and Speed

Encourages nimble hands along the assembly line. Made in eleven sizes from 3/16" to 5/8" square, hex or knurled . . . . .

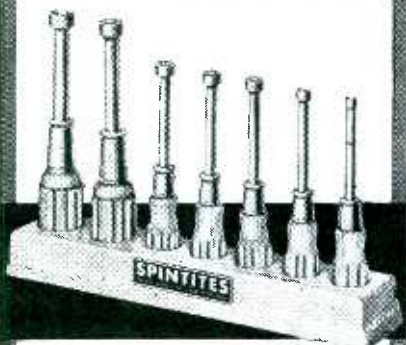

POPULAR SPINTITE T-73 SET Wood Handles

A useful Tool in every Radio and Electrical Shop.

Deluxe T-8 SET the same with Plastic Handles

Send for Catalog 141 picturing Aircraft Radio and Automobile Tool.

**WALDEN**  
 WORCESTER  
 WRENCHES

**STEVENS WALDEN, INC.**  
 468 SHREWSBURY STREET  
 WORCESTER, MASSACHUSETTS

tion begins with vision itself and discusses light and waves before undertaking the main portion of the subject. All the essential functions of the magnetic and electric electron microscopes are explained so that the laboratorian can understand just what the instrument can do and how it does it. A classified bibliography at the back of the book enables one to read more on their special interests.

**The Electron Microscope**

By D. GABOR, *Research Laboratory of Thomson-Houston Co., Ltd., Rugby. Hulton Press, Ltd., London, 103 pages, 4/6.*

THIS TECHNICAL MONOGRAPH issued by *Electronic Engineering* forms a concise discussion of the major factors to be considered in designing an electron microscope. The ways in which the points that have been discussed are applied are illustrated by reference to several American-made instruments.

*Critical Comments*

Of the three current works annotated above on the electron microscope, the first is by far the most important, not only for the wealth of material both for user and designer of electron microscopes, but also for the discussion of electron optics that is applicable in all fields of electron ballistics and waves. The book serves as a full statement of what has been done and found important by one of the most active and productive research laboratory staffs in this highly mathematical and abstract field. The first part constitutes an easy stepping-stone for the beginner in passing on to the more valuable second part.

The second book, written specifically for laboratory technicians, fills admirably its single purpose—more so than the first part of the previously reviewed book. The simple and catching drawings by Dorothy Stone add to the readability and attractiveness of the book. For those who have a background in the biological sciences rather than the physical sciences the explanations will be found comprehensible. This consideration alone recommends this book for technicians in chemical and biological laboratories.

The monograph is a concise introduction to the problems of electron optics. For the engineer first enter-

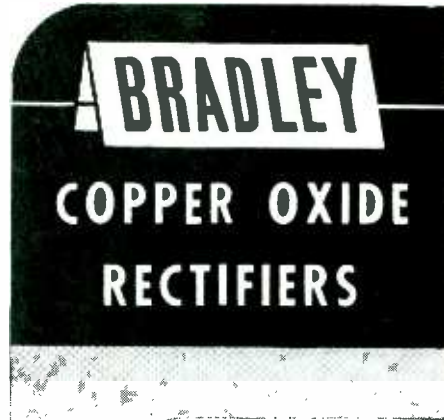

**New Battery Charging Rectifiers**

A new design, giving maximum output in minimum space, has been developed by Bradley for copper oxide rectifiers for battery charging. Rated for 2, 3, and 4½ volts D. C. output, with D. C. current up to 1½ amperes. Bradley production is geared for economical runs.

"Coprox" rectifiers by Bradley have special features that assure long life, easy assembly and accurate performance. All ratings of Bradley rectifiers are conservative. Bradley engineers are available to assist you in the development, production and application of special rectifiers for special jobs.

Illustrated literature, available on request, shows more models of copper oxide rectifiers, plus a line of selenium rectifiers and photocells. Write for "The Bradley Line."

**BRADLEY**  
**LABORATORIES, INC.**  
 82 Meadow St. New Haven 10, Conn.

# PROFESSIONAL SERVICES

Consulting — Patents — Design — Development — Measurements

in

Radio, Audio, Industrial Electronic Applications

## H. RUSSELL BROWNELL

*Consulting Engineer*

Specializing in Measurements & Testing  
Instruments & Techniques - Electrical - Elec-  
tronic - Magnetic.  
188 West 4th St. New York 14, N. Y.  
Chelsea 2-4208

## ELECTRO ENGINEERING WORKS

Specializing in High Voltage Filament and  
Plate Transformers for Electronic Projects

*Quick Deliveries*

6021 College Ave. Oakland 11, Calif.

## MIDLAND ASSOCIATES

*Consulting Engineers*

Engineering Design & Development  
Television Receivers—Technical Manuals  
F.M. Receivers—Test Instruments  
A.M. Receivers—Special Problems  
in all phases of Electronics  
1959 Lunt Ave. Chicago 26, Ill.

## EDWARD J. CONTENT

*Acoustical Consultant*

and

Audio Systems Engineering, FM Standard Board-  
cast and Television Studio Design. Stamford 3-7459  
Roxbury Road Stamford  
Stamford, Conn.

## ELM LABORATORIES

*Research and Design*

RADIO TRANSMITTERS AND RECEIVERS

Designs for Home Radios, Electro-Mechanical  
Devices and Components.  
20 South Broadway Dobbs Ferry, New York  
Phone Dobbs Ferry 4058

## NATIONAL DESIGN SERVICE

*Designers and Developers of*

FACTORY TEST EQUIPMENT  
TELEVISION R.F. SWEEP GENERATORS  
F.M. SIGNAL GENERATORS  
COMPLETE CENTRALIZED MODULATED  
SYSTEMS

96 Liberty St. New York 6, N. Y.

## E. STUART DAVIS

*Consulting Engineer*

Research—Design—Development  
Radio - Carrier Current - Supersonics - Radiant  
Energy - Control and Measurement - Methods and  
Devices, Communication Transportation & In-  
dustrial applications.

Marine Laboratory facilities aboard  
the yacht "ELECTRON"  
422 N. E. River Drive Ft. Lauderdale, Florida

## F. T. FISHER'S SONS LIMITED

*Consulting Engineers*

Broadcast Transmitters, Antenna Systems  
Studio Equipment, Mobile and Fixed Com-  
munication Systems.  
1425 Dorchester St. West, Montreal

## ALBERT PREISMAN

*Consulting Engineer*

Television, pulse Techniques, Video  
Amplifiers, Phasing Networks,  
Industrial Applications

Affiliated with  
MANAGEMENT-TRAINING ASSOCIATES  
3308-14th St., N. W. Washington 10, D. C.

## STANLEY D. EILENBERGER

*Consulting Engineer*

INDUSTRIAL ELECTRONICS

Design—Development—Models  
Complete Laboratory and Shop Facilities  
6309-13—27th Ave.  
Kenosha, Wis. Telephone 2-4213

## PAUL E. GERST & CO.

CONSULTING ENGINEERS

Specialists in

Electrical Product Design  
El. Machinery, Apparatus & Applications  
El. Appliances, Hi-Frequency Apparatus  
Electronics, Radio Communication  
205 W. Wacker Dr. Chicago 6, Ill.

## JOSEPH RAZEK, Ph.D.

*Consulting Physicist*

Electric and Mechanical Engineering Problems  
Instruments and Control Devices Electronics  
Specialists in Colorimetry, Spectrophotometry and  
Industrial Color Control  
Laboratory and Shop Facilities  
202 Darby Road Llaneroh, Pa.  
Phone Hilltop 6910

## ELECTRONIC RESEARCH ASSOCIATES

ERA will apply progressive, war-proven de-  
velopments in electronic research . . . count-  
ing . . . timing . . . measuring . . . industrial  
controls . . . to your manufacturing advan-  
tage.  
Box 333, 305 Linden Av., South San Francisco, Cal.

## C. M. HATHAWAY

*Consulting Engineer*

Research and Development

Product Designs  
Tool & Methods Engineering  
Pilot Manufacturing

1315 S. Clarkson St., Denver 10, Colorado

## RAYMOND M. WILMOTTE INC.

A Complete Engineering Service

for the  
Application of Electronics to Industry  
*Consultation Design Construction*

236 W. 55 St. 1469 Church St. N.W.  
New York 19, N. Y. Washington 5, D. C.

## READERS MAY CONTACT THE CONSULTANTS

whose cards appear on this page  
with the confidence justified by the offer-  
ing of these special services nationally.

## J. L. A. McLAUGHLIN

*Designer of*

Communication Receivers

Specializing in the elimination of heterodyne  
P. O. Box 529, La Jolla, Calif.

## PAUL D. ZOTTU

*Consulting Engineer*

INDUSTRIAL ELECTRONICS

High Frequency Dielectric and Induction Heating  
Applications, Equipment Selection, Equipment and  
Component Design, Development, Models.  
272 Centre St. Newton, Mass.  
BIG-9240

THE

REAL

VALUE

*of placing your unusual problem in the hands of  
a competent consultant eliminates the elements  
of chance and uncertainty from the problem and  
provides real facts upon which to base decisions.*

## FOR THE MOST EXACTING APPLICATIONS

Where dependability and economy are vital, leading manufacturers specify Westfield nuts of special design.

Send us your drawings and specifications for recommendations and prices.

**WMP**  
**WESTFIELD METAL PRODUCTS CO. Inc.**  
 WESTFIELD, MASS.  
 Custom Made Nuts In Brass, Steel and Various Alloys

# RADIO CABINETS

*Rare Excellence in Workmanship • Quantity Production*

Backed by 15 years of experience in production for many leading radio manufacturers, we invite your cabinet problems for solution. Authoritative "know-how" with all woods and all finishes. May we have your specifications.

**MOUNT VERNON CABINET CO., INC**  
 • 47 SOUTH FIFTH AVENUE, MOUNT VERNON, NEW YORK •

ing this field or giving it a cursory once over, it states the fundamental in his language. The discussions seems to be a foundation for and presentation of the author's method of correcting the objective of an electron microscope.—F. R.

• • •

### The Radio Amateur's Handbook

By THE HEADQUARTER'S STAFF, *American Radio Relay League, Hartford, Conn.*, 1946, 688 pages, \$1.00.

THE TWENTY-THIRD EDITION of this standard radio communication handbook is as nearly up to date as the changing status of amateur licensing and frequency assignments permits. Previously published chapters on War Emergency Radio Service equipment and carrier-current techniques have been omitted. The chapter on emergency and portable equipment is necessarily thinner than one would like, but it makes a brave start on its postwar career. The sections on vhf equipment are particularly interesting and timely. In general, the Handbook has added another cubit to its stature and will continue to be the best dollar's worth not only for amateurs, but also for engineers, educators, students, and other who need the ready reference material available in its pages.—A. A. MCK.

• • •

### A Chronological History of Electrical Development

PUBLISHED BY NATIONAL ELECTRICAL MANUFACTURERS ASSOCIATION, *New York 17, N. Y.*, 143 pages, \$2.00.

A HANDY REFERENCE WORK, starting traditionally at 600 B.C. with Thales and his piece of amber but containing many interesting and significant names and dates not ordinarily seen in histories of electricity. Seven pages serve for events before 1800, 68 pages for 1800 to 1900, and 31 pages for the next 44 years. A detailed index of topics and names adds greatly to the reference value of the book. Noteworthy also is the publisher's statement, "Excerpts from this book may be used without permission."—J. M.

—♦—

THE RADIOTELEGRAPH station built by Italians at Addis Ababa during the Ethiopian war and which they sabotaged when driven out by the British is being restored to service.

# CONTACTS

FOR THE FIELD OF ELECTRONICS

## Electron Tube Machinery

of every type, — standard, and special design

Specialists in Equipment for the manufacture of Radio Tubes, Cathode Ray Tubes, Fluorescent Lamps, Incandescent Lamps, Neon Tubes, Photo Cells, X-ray Tubes and other glass or electronic products, on production or laboratory basis.

**Kable**  
ENGINEERING COMPANY

1307-1309 Seventh St., North Bergen, N.J.

MORE RF KILOWATT HOURS  
PER DOLLAR WITH

## F & O TRANSMITTING TUBES

Inquiries Invited—Let us explain how Savings are effected and the F & O greater guarantee.

FREELAND & OLSCHNER PRODUCTS Inc.

611 Baronne St., New Orleans 13, La.  
Raymond 4756

High Power Tube Specialists Exclusively  
(5 KW to 100 KW)



**REX**  
RHEOSTATS

REX RHEOSTAT COMPANY, BALDWIN, L. I., N. Y.

PROTECTED & UNPROTECTED  
RHEOSTATS  
WITH LUBRICATED CONTACTS  
ROTARY DRIVE RHEOSTATS  
WITHOUT BACK LASH  
PROTECTED & UNPROTECTED  
ADJUSTABLE RESISTORS  
UP TO 1000 WATT  
PROMPT SHIPMENTS



We manufacture a complete line of equipment

SPOT WELDERS, electric from ¼ to 50 KVA  
TRANSFORMERS, special and standard types  
INCANDESCENT LAMP manufacturing equipment  
FLUORESCENT TUBE MAKING EQUIPMENT  
ELECTRONIC EQUIPMENT, vacuum pumps, etc.  
400 Amps  
WET GLASS SLICING and cutting machines for laboratory use  
GENERAL GLASS working machines and burners  
COLLEGE GLASS working units for students and Laboratory  
EISLER ENGINEERING CO.  
731 So. 13th St. (near Avon Ave.) Newark, New Jersey



## QUICK ACTION HETERODYNE ELIMINATORS

Automatic and manually operated models. Adaptor units for standard type receivers and complete receiving systems designed.

Used by the FCC and the OSS and other communications experts.

J. L. A. McLAUGHLIN  
Mira Monte Plaza  
P. O. BOX 529 LA JOLLA, CALIF.

FINE RIBBONS  
OF  
TUNGSTEN and MOLYBDENUM  
Quality and accuracy in our fabrication of Tungsten & Molybdenum Ribbons have characterized our service to the Electronic industry.  
A development of  
**H. CROSS Co.**  
15 Beekman St., New York 7, N. Y.

**FILMOGRAPH**  
CONFERENCE, TELEPHONE, DICTATION  
Permanent recorders & instantaneous play-back machines for all industrial purposes. Safety film cost 5c per hour.  
MILES REPRODUCER CO., INC.  
812 B'way, Dept. E, New York, 3, N. Y.

## Your Inquiry Will Have Special Value

if you mention that it is in response to advertising in this publication. Advertisers value such acknowledgments highly; so does the publisher. You benefit —as a reader—in the enlarged future service such acknowledgments help to make possible.

MICROMETER  
FREQUENCY  
METER

for checking Transmitters  
from 100 Kc to 175 Mc.  
within 0.01 per cent

LAMPKIN LABORATORIES  
Bradenton, Fla., U. S. A.

Strip Insulated Wires  
QUICKER... BETTER

with "Speedex"  
AUTOMATIC WIRE STRIPPER  
...Speeds Production

Strips Insulation from all types of wire — instantly, easily, perfectly. Just press the handles and the job is done. Cuts wire too. Strips 800 to 1000 wires per hour. Available for all size solid or stranded wires —No. 8 to No. 30. List Price \$6.00  
Write Dept. E for Full Particulars



**GENERAL CEMENT MFG. CO.**  
Rockford, Illinois, U.S.A.

## 18 YEARS IN RADIO



GET THIS  
New CATALOG  
By This Old Firm

Latest developments in radio and electronic parts and devices, newest ham gear, gadgets for experimenters, bargains in war surplus items.

**FREE TO YOU**

Mail the coupon below and get this new catalog FREE.

BURSTEIN-APPLEBEE CO.,  
1012 McGee, Kansas City 6, Mo.  
Send me FREE catalog advertised in Electronics.

I AM \_\_\_\_\_  
STATE CONNECTION IN INDUSTRY

NAME \_\_\_\_\_

ADDRESS \_\_\_\_\_

TOWN \_\_\_\_\_

STATE \_\_\_\_\_



# NORTHERN

*Originality Backed-up By*

# EXPERIENCE

Since 1909

Originality backed-up by years of practical experience is what really counts when it comes to producing plastics for products efficiently, economically and on schedule.

Northern provides that type of experience plus complete quantity production facilities. Specially designed equipment is available for producing unusual type plastic jobs, impossible to duplicate with standard molding presses.

*Our engineers will be glad to help you with any plastic problem.*

*Northern*

**INDUSTRIAL CHEMICAL CO.**

38 Years of Plastic Molding Experience

7-11 ELKINS ST., SO. BOSTON 27, MASS.



*— Let this modern signalling timer watch it!*

Now, no chance for inaccuracies, no danger of a spoiled piece of work from over or under exposure to a time element. The new Signalling Timer, Model Series S keeps an automatic eye on any time interval, and audibly and visually signals the operator when that specific time cycle has elapsed. Can be set for seconds or minutes with the highest degree of precision. Used extensively by the Armed Forces and in industry. Write for details.

**INDUSTRIAL TIMER CORPORATION**

110 EDISON PLACE NEWARK, NEW JERSEY



## Backtalk

This department is operated as an open forum where our readers may discuss problems of the electronics industry or comment upon articles which ELECTRONICS has published.

### Encabulator is English

DOES AMERICA have to take the credit for everything? The first description of that important new wartime development, the Turbo Encabulator (ELECTRONICS, p. 354, Apr. 1946, "Spoof"), appeared by special permission in the *Students' Quarterly Journal* of the Institution of Electrical Engineers, 15, p. 22, Dec. 1944, under the title "The Turbo-Encabulator in Industry" by J. H. Quick.

I agree that it is unfortunate that no photographs are available at the moment. In the initial publication we had to be content with a nevertheless interesting group of technicians who appeared to be responsible for this outstanding discovery.

JOHN C. FINLAY  
East Boldon, England

### Public Apathy to Fire

Dear Editor:

I READ WITH EXTREME interest your item on "Fire" in the Crosstalk page of ELECTRONICS for April.

One of our clients recently considered the possibility of manufacturing a fire alarm device consisting of a bimetallic strip, two flashlight cells, and a bell.

We discouraged them from this because of two reasons. The first is that, from the experience of another company which had sold a similar item, it is very difficult to sell. It is something the public needs, but not something the public wants. The second reason is the possible danger of lawsuits if the alarm failed to function properly. Gravity operation of the bell ringer would eliminate the danger of battery failure, but dust or moisture over a period of years might exact

(Continued on page 304)



## ENGINEERING PERSONNEL WANTED FOR PERMANENT EMPLOYMENT BY HAZELTINE ELECTRONICS CORPORATION

A total of 13 engineers, experienced in radio design, are required for work on home receivers, television receivers, and radar equipment. Minimum design experience of one year required. Of these positions, 12 are located in the New York area and 1 in the Chicago area. Salary commensurate with age and experience.

Apply by mail to

### HAZELTINE ELECTRONICS CORPORATION

58-25 Little Neck Parkway  
LITTLE NECK, N. Y.

Attention: Personnel Manager

giving age, education, previous experience, and salary expected.

## WANTED...

### 6 EXPERIENCED ENGINEERS

The following positions are in the East and are with one of the country's largest producers of electronic equipment.

\* \* \*

**Chemical Engineer or Physicist** with Ph.D. degree, 2 or more years of industrial experience or equivalent in research.

**Mica Capacitor Designers (2)** with at least 3 years' experience in the design of mica capacitors for power and high-frequency applications; to investigate and evaluate new materials for use in this field.

**Design Engineers (2)** with at least 3 years' experience in the design of RF coils and/or RF circuits, to undertake development of new types.

**Transformer Engineer**—5 years' experience in design of laminated iron core coils and transformers—capable of original development work and designing of power and special application transformers such as filters and special audio types.

\* \* \*

In applying please give details of education, experience, special achievements and personal history.

P-198, Electronics

330 West 42nd St., New York 18, N. Y.

## ELECTRICAL ENGINEER

An established New England manufacturer with national distribution of pressure and temperature instruments and control devices requires the services of an electrical engineer well versed in electronic principles to work on new developments. Interesting, non-routine work. Please give summary of education and experience. Include small photograph which will not be returned.

P-194, Electronics  
330 West 42nd St., New York 18, N. Y.

## PHYSICISTS AND ELECTRICAL ENGINEERS

Research project leaders for work combining electronics and general applied physics. Bachelor's degree in physics or engineering plus graduate work and two to four years practical experience.

Junior research engineers for work in electronics. Bachelor's degree in electrical engineering or physics plus one or two years of graduate work or practical experience.

Communicate with R. F. Simons,

**Airborne Instruments Laboratory, Inc.**

160 Old Country Road Mineola, N. Y.

## WANTED

**Acoustic Engineers  
Acoustic Physicists  
Acoustic Research Assistants  
to do  
Research in the field of  
Acoustics**

Full time or part time while carrying Graduate Work in Allied Subjects at Washington University. Stipend commensurate with proven ability and past earnings. Contact:

**ST. LOUIS MICROPHONE COMPANY**  
Box 3440 Maplewood 17, Mo.

## POSITIONS VACANT

**RADIO INSTRUCTORS.** Receiver servicing experience. College degree preferred. \$3600 a year to start. \$4200 after four months. Work in the heart of the Radio Industry. Write Raleigh G. Dougherty, 158 Market Street, Newark 2, New Jersey, c/o New York Technical Institute of New Jersey.

**ENGINEER: ELECTRICAL** and Chief Engineer having experience with electrical indicating instruments and/or voltage control regulators. Furnish full detail of experience. P-200, Electronics, 520 N. Michigan Ave., Chicago 11, Ill.

**ELECTRON TUBE** General Development and Magnetron Section Heads (Two); Completely equipped laboratory; 10 scientists and technicians now in each group; extremely broad, going research and development program; salary above \$5000. Thorough physics background, varied tube experience, creative ability, administrative ability required. State education, experience, salary expected. Replies will be treated confidentially. Present groups informed of this notice. P-201, Electronics, 330 W. 42nd St., New York 18, N. Y.

**GLASSBLOWER: WITH** glass lathe experience, for research projects. Must be proficient in every phase of electronic tube construction, familiar with all modern techniques in glass-to-metal seals, able to fabricate unusual and intricate designs. Will be expected to set up new special shop. Retatron Laboratory, Ohio State University, Columbus, Ohio.

(Continued on page 300)

RCA Victor Division, Radio Corporation of America, Camden, New Jersey, has openings for experienced capable engineers for the design and development of special radio, radar and electronics equipment."

## WANTED MAGNET ENGINEER

To do development and process engineering work. Must have had permanent magnet experience, some manufacturing experience and prefer man with supervisory ability. Reply by letter giving education, experience, salary expected and availability.

P-199, Electronics  
520 North Michigan Ave., Chicago 11, Ill.

There are now a few positions  
open for

## ELECTRON TUBE ENGINEERS

who have a background of experience and responsibility in the design and production of high and ultra-high frequency electron tubes, including magnetron and related micro-wave devices, and who are seeking advancement on the basis of ability, ingenuity and accomplishment. For a limited number of men of this type Machlett Laboratories has something unique and attractive to offer.

Address Executive Offices—Engineering Division—

**Machlett Laboratories, Inc.**  
Springdale, Conn.

(Additional Employment Advertising on page 300— Business Opportunity Advertising on page 303)



# SEARCHLIGHT SECTION



## EMPLOYMENT SERVICE

**SALARIED POSITIONS \$2,500-\$25,000.** This thoroughly organized confidential service of 38 years' recognized standing and reputation carries on preliminary negotiations for supervisory, technical and executive positions of the calibre indicated, through a procedure individualized to each client's requirements. Retaining fee protected by refund provision. Identity covered and present position protected. Send only name and address for details. R. W. Bixby, Inc., 278 Dun Bldg., Buffalo 2, N. Y.

### POSITIONS WANTED

**TELEVISION POSITION** desired. 20 years commercial radio experience. All phases technical operation, production and direction of television programs. Lieutenant Commander with demonstrated executive ability. 10 years to-date with major network plus training abroad. PW-192, Electronics, 330 W. 42nd St., New York 18, N. Y.

## EXECUTIVE AVAILABLE NOW

Consideration to leading corporations only. Gifted in analysis and direction of personnel. Talented in technical lines.

Aggressive.

Engineering graduate.

Background identified with development of electronics equipment. Previous connections with pioneering firms in the field. Particular interest in industrial applications. Age 27.

PW-183, Electronics  
520 North Michigan Ave., Chicago 11, Ill.

## POSITIONS WANTED

**PHYSICAL CHEMIST:** Ph.D. extensive experience in lamp and electronic tube design, manufacturing and materials, high-vacuum technique. Interested in research or development position as senior engineer. New York Metropolitan area preferred. PW-178, Electronics, 520 N. Michigan Ave., Chicago 11, Ill.

**DISCHARGE NAVY** radio technician, with five years experience serving industrial electronic equipment, desires position as service engineer and/or sales representative for manufacturers of industrial electronic equipment. PW-202, Electronics, 520 N. Michigan Ave., Chicago 11, Ill.

**SALES ENGINEER:** Senior engineer, 42 in electronic development laboratory will consider connection as sales engineer. Experience: 20 years design and administration in electronic and power fields. Languages: English, Spanish. PW-203, Electronics, 330 W. 42nd St., New York 18, N. Y.

### SELLING OPPORTUNITY WANTED

**FIELD REPRESENTATIVE:** for leading manufacturer of F.M. Communication equipment available soon. Engineering experience in facsimile systems, specialized electrical test equipment, radar and F.M. Communications. Willing to work on part percentage or commission arrangement. As executive, willing to accept interest in business as partial remuneration. RA-204, Electronics, 520 N. Michigan Ave., Chicago 11, Ill.

### NATIONAL DISTRIBUTION AVAILABLE

For Manufacturers who make products suitable for sale to radio and electronic jobbers. We have a complete sales staff for national and export distribution. Reply with samples or description of products.

RA-870, Electronics  
330 West 42nd St., New York 18, N. Y.

## ELECTRONIC SALES

Ex-Marine administrative and technical radar officer. Capable, dynamic man, single, 28, height 6-2, pleasing personality. B.S., M.A., (Columbia); postgraduate study in electronics and microwave techniques at Harvard Univ. Grad. School of Engineering and at MIT. Pre-war experience as sales promotion manager, industrial lecturer, and school principal. Now employed as a college instructor, but seeking a permanent, challenging assignment in industry where intelligence, drive, and executive ability can be rewarded. Available September 15.

SA-195, Electronics  
330 West 42nd St., New York 18, N. Y.

## SALES ORGANIZATION

With 20 years experience selling basic component to industrial and electronic industries. Interested in representing, additional line in Metropolitan N. Y. and Northern N. Y. area.

RA-196, Electronics  
330 West 42nd St., New York 18, N. Y.

## Manufacturer's Representative SALES ENGINEER

Representing Minnesota, North Dakota, South Dakota and parts of Wisconsin, Iowa and Nebraska.

Desires additional lines of radio parts, tubes and equipment, of high quality. Also desire lines of equipment requiring engineering ability and experience for sales, installation, supervision of installation, maintenance and repair. Have all necessary licenses required for installation and test work (Master Electrician, Registered Professional Engineer, Radio Operator). Willing to maintain service agency. Will spend a period of time at manufacturer's plant to become acquainted with manufacture, design and test procedures of specialized communication equipment.

RA-170, Electronics  
520 North Michigan Ave., Chicago 11, Ill.

## ELECTRONIC MANUFACTURERS' SALES REPRESENTATIVES

Newly organized firm of Electronic Engineers wants to represent high grade manufacturers of Electronic equipment, both industrial and otherwise, in fertile Detroit and surrounding territory.

We offer aggressive, honest, and capable Sales Engineering of these products, and invite correspondence from manufacturers desirous of expansion.

RA-171, Electronics  
520 North Michigan Ave., Chicago 11, Ill.

## SALES REPRESENTATIVE WANTS LINES

Chicago and Vicinity  
Prime materials or parts for Mechanical, Electrical, Radio and Radio Parts Manufacturing Trade.

RA-149, Electronics  
520 North Michigan Ave., Chicago 11, Ill.

### Facilities available for preparing:

Technical Manuscript  
Technical and Scientific Mathematics  
Blueprinting—Drafting  
Radio and all types of electronic assembly design, testing and servicing.

SS-197, Electronics  
330 West 42nd St., New York 18, N. Y.

### WANTED

## AMPLIFIER PARTS

We need 250 power transformers, output transformers, filter chokes and 4" P. M. speakers for audio amplifiers using 6L6 tubes. Anyone having surplus materials of this nature please write to

MELLAPHONE CORPORATION  
1462 East Main Rochester, New York

# MAGNET WIRE URGENTLY NEEDED!

Wire  
or  
Phone  
Information

Collect to Mr. D. J. Wallace

# PICKER

## ANY AMOUNT UP TO THESE QUANTITIES:

Plain Enameled Magnet Wire—20,000 lbs., Nos. 27, 28 and 32.

Plain Enameled Magnet Wire—2,500 lbs., Nos. 38 and 40.

**X-RAY CORPORATION**  
WAITE MANUFACTURING DIVISION, INC.  
17325 EUCLID AVENUE  
CLEVELAND 12, OHIO

## NEW WESTON TEST EQUIPMENT

In Stock — For Immediate Delivery

**MODEL 798—JUST OUT—MUTUAL CONDUCTANCE TUBE CHECKER & SET ANALYZER.** Tube Checker Ranges 0-3000, 6000, 12,000 micromhos and Good-Bad Scale

Analyzer Ranges 0-15, 150, 750 Volts A.C. & D.C. 7.5 & 150 M.A.

D.C., 100,000 & 1,000,000 ohms. \$182.64

**MODEL 785—INDUSTRIAL CIRCUIT TESTER—Ideal for Radio & Industrial Applications**  
For Shop Use, less carrying case. \$ 85.37  
with carrying case. \$101.63

**MODEL 779—SUPERSENSITIVE ANALYZER—For Simplified Radio Set Analysis.** \$ 74.62

**MODEL 697—VOLT-OHM MILLI-AMMETER** \$ 25.89

MARITIME SWITCHBOARD, 336 CANAL STREET, N. Y. C. WORTH 4-82



# SURPLUS NEW METERS

## D. C. METERS

### MICROAMMETERS — GALVONOMETERS

- Weston Model 301, 3 1/2", short scale galvanometer, 10 microamp each side of center, scale 0-20 .....\$3.95
- Weston, 506, 2 1/2", metal case, 30-0-30 microamp movement, 20-0-20 black scale, increased sensitivity near zero.....\$3.50
- Weston, 301, 3 1/2", 0-50 microamp, list price \$23.50, your cost.....\$11.00
- Marion, 2 1/2", 0-200 microamp movement, knife edge pointer, special milliwatt and DBM scale, needs 500 ohm external damping resistor .....\$3.50
- Marion, 3 1/2", 0-200 microamp, 68 ohms undamped movement .....\$4.95
- Weston, 301, 3 1/2", 0-200 microamp.....\$7.50
- General Electric, DO-41, 3 1/2", 0-200 microamp movement, scale marked in volts and D.B. knife edge pointer, complete with paper volt ohm milliammeter scale.....\$6.00
- Weston Sangamo, 301, 3 1/2", 500-0-500 microamp movement, scale 100-0-100.....\$3.95
- General Electric, DO-41, 3 1/2", 0-500 microamp movement, scale 0-20 K.V.....\$4.95

### MILLIAMMETERS

- Weston, 506, 2 1/2", metal case, 0.1 MA, black blank scale, caption "tuning".....\$2.95
- General Electric, DO-41, 3 1/2", 0-1 movement, semi-knife edge pointer, special black scale .....\$3.95
- Weston, 506, 2 1/2", metal case, 0-1 MA, black scale .....\$3.50
- G.E. DW 41, 2 1/2", 0-1 MA.....\$3.95
- G.E. DO-41, 3 1/2", 0-1 MA.....\$4.95
- G.E. DO-53, 3 1/2" square case, 0-1 MA movement, 0-50 scale 5000 ohms internal resistors .....\$3.95
- DeJur Amso, 2 1/2", 0-1 MA movement 0-10 scale, no caption.....\$3.50
- Marion, 2", ring mounting, made for National Co., 0-1 MA movement, scale 1-9 "S" units, 0-40 D.B. above Q.....\$3.50
- General Electric, DO-41, ring mounting, 3", 0-2.5-25 MA dual range, zero center..\$2.50
- Hickok, 3 1/2", 0-1.6 MA movement, used in Dynamic Mutual Conductance tube checker model I-177 .....\$5.50
- Weston, 506, 2 1/2", 0-1.5 MA.....\$3.50
- Simpson, 127, 2" square, 0-5 MA special scale .....\$2.50
- Roller-Smith, miniature, 1 1/2" square, 1.37 MA, 675 M.V. movement, special black scale .....\$2.50
- Roller-Smith, miniature, 1 1/2" square, 0.2 MA movement, with 2" lead and plug jack black scale 0-10.....\$2.50
- G.E. DO-41, 3 1/2", 0-5 movement 0-15 MA scale .....\$3.95
- G.E. DO-53, 3 1/2", square case, 0-10 MA..\$4.95
- G.E. DO-53, 3 1/2", square case, 0-20 MA..\$4.95
- Westinghouse, NX 35, 3 1/2", 0-24 MA...\$2.50
- General Electric, DO-41, 3 1/2", 0-30 MA..\$3.95
- Weston, 506, 2 1/2", 0-50 MA.....\$3.95
- Weston, 301, 3 1/2", 0-50 MA.....\$4.95
- General Electric, DO-41, 3 1/2", 0-50 MA black scale .....\$3.95
- General Electric, DO-41, 3 1/2", 0-50 MA..\$4.50
- General Electric, DO-53, 3" square, 0-50 MA .....\$4.50
- G.E. DO-41, 3 1/2", 0-80 MA.....\$4.50
- Simpson, 26, 3 1/2", 0-100 MA.....\$4.50
- Marion, 3 1/2", 0-200 MA.....\$4.50
- General Electric, DO-41, 3 1/2", 0-200 MA..\$4.95
- Weston, 506, 2 1/2", 0-200 MA.....\$3.95
- Westinghouse, NX 33, 2 1/2", 0-500 MA...\$3.95

## D. C. VOLTMETERS & KILOVOLT METERS

- Simpson, 2", ring mounting, metal case, 0-3 volts, black scale.....\$1.50
- Weston, 506, ring mounting, metal case, 0-3 volts .....\$1.75
- Weston, 301, 3 1/2", metal case, 0-30 volt..\$4.50
- W.E., 40 Volt D.C., 400 microamp movement, 4 1/2" Round Concentric Style Meter...\$3.95
- Weston, 506, 2 1/2", dual range 0-50 and 0-500 volts, black scale, 1000 ohms per volt..\$3.95
- Westinghouse, BX, 2 1/2", dual range 0-3.5 and 0-140 volt .....\$1.98
- Weston, 301, 3 1/2", 0-150 volt.....\$4.95
- Weston, 301, 3 1/2", 0-150 volt, black scale..\$4.50
- Gruen, 2 1/2", 0-150 volts DC.....\$3.50
- G.E., DO-41, 3 1/2", 0-500 volt 1000 ohms per volt, black scale.....\$5.95
- W.H., NX-35, 3 1/2", 0-750 volt 1000 ohms per volt .....\$10.50
- G.E., DO-41, 3 1/2", 0-1.5 KV, complete with external multiplier, black scale.....\$6.95
- G.E., DO 53, 3 1/2", square case, 0-15 KV, complete with external multiplier.....\$16.00
- Westinghouse, NX-35, 3 1/2", 0-15 Kilovolt, complete with 1000 ohms per volt, external wire wound resistor. List price \$160.00. Your cost .....\$16.00
- Westinghouse, NX-35, 3 1/2", 0-20 Kilovolt, complete with 1000 ohms per volt, external wire wound resistor. List price \$210.00. Your cost .....\$21.00

## D. C. AMMETERS

- General Electric, DO-41, 3 1/2", 0-1 Amp, black scale .....\$3.50
- Weston, 301, 3 1/2", 2-0-2 Amperes.....\$4.00
- Westinghouse, NX 35, 3 1/2", 10 Amp....\$4.95
- Weston, 506, 2 1/2", 15 Amp.....\$3.95
- Triplett-Gruen, 0321-T, 3 1/2", 0-15 Amp. DC .....\$4.50
- Weston, 506, 2 1/2", 0-200 Amp, with external shunt .....\$9.50
- General Electric, DO 41, 3 1/2", 0-200 Amp, complete with external shunt.....\$12.50

## RADIO FREQUENCY AMMETERS AND MILLIAMMETERS

- W.H., NT-35, 3 1/2", 0-50 M.A. R.F. complete with internal thermocouple. List price \$50.00. Your cost .....\$15.00
- G.E., DO-44, 3 1/2", 0-50 M.A. R.F. complete with internal thermocouple. List price \$50.00. Your cost .....\$15.00
- G.E., DW-52, 250 M.A. R.F. mount complete with internal thermocouple, black scale, 0-5. Caption Antennae Current..\$3.50
- Weston, 507, 2 1/2", 750 M.A. R.F., metal case, black scale marked 0-10, antennae current indicator comes with external thermocouple. This combination has almost linear characteristics .....\$3.50
- General Electric, DW-44, 2 1/2", 0-1 Amp. R.F., black scale .....\$2.95
- Weston, 425, 3 1/2", 0-1 Amp. R.F.....\$6.50
- General Electric, DO-44, 3 1/2", 0-1.5 Amp. R.F. ....\$6.50
- Simpson, 2", 0-3 Amp. R.F., expanded at lower part of scale.....\$3.50
- Weston, 507, 2 1/2", 0-3 Amp. R.F., black scale .....\$3.50
- G.E., DW-44, 2 1/2", 0-4 Amp. R.F., black scale .....\$3.50
- Simpson, 35, 3 1/2", 0-5 Amp. R.F.....\$6.50
- Westinghouse, NT-35, 3 1/2", 0-5 Amp. R.F..\$6.50

## A. C. AMMETERS

- General Electric, AO-22, 3 1/2", 0-5 Amp. movement, 50 Amp. per scale, comes complete with external current transformer. By adding primary turns to the donut transformer, the range of the meter can be made 5-10-25-50 Amperes. A.C. Diagram furnished with meter .....\$7.00
- General Electric, AO-22, 3 1/2", 0-50 Amp. self-contained .....\$4.50
- Simpson, 3 1/2", square case, 0-60 Amp. A.C. .....\$4.50
- General Electric, AO-22, 3 1/2", 0-80 Amps. self-contained .....\$4.50
- Weston, 476, 3 1/2", 0-120 Amps. complete with external current transformer.....\$6.50

## A. C. VOLTMETERS

- Weston, 476, 3 1/2", 0-8 Volts A.C.....\$4.50
- G.E., AO-22, 3 1/2", 0-15 Volts A.C., black scale .....\$4.50
- Weston, 517, 2 1/2", ring mounted metal case, 0-15 volts .....\$2.95
- General Electric, AO-22, 3 1/2", 1000 cycle, 0-50 volts, mounted on metal angle bracket with 6" Tyrex leads and clips.....\$2.50
- Weston, 517, 2 1/2", ring mounted, metal case, 0.75 volts .....\$2.95
- Weston, 476, 3 1/2", 0-130 Volts.....\$5.95
- Westinghouse, NA-35, 3 1/2", 0-150 Volts..\$5.50
- General Electric, AO-22, 3 1/2", 0-150 Volts..\$5.50
- G.E., AO-22, 3 1/2", 0-150 Volts A.C., black scale .....\$4.50
- G.E., AO-25, 3 1/2", square case 0-150 Volts A.C. ....\$5.50
- W.H., BA-33, 2 1/2", 0-150 Volts A.C.....\$2.95
- General Electric, AO-22, 3 1/2", 0-300 Volts..\$8.00

## SPECIAL METERS

- G.E., Running Time Meters, 3 1/2", 5 Digits, 99,999 Hrs., 115 Volts, 60 Cycles.....\$4.95
- G.E. DW-46, 2 1/2", DB meter, —10 to 5, 6 MW, —600 ohms, ODB equals 1.90 Volts..\$4.50
- Weston, 301, Power Level Indicator, 625 Microamperes, 1.2 volts A.C. movement, complete with self-contained rectifier.....\$6.00
- General Electric, DO-46, 3 1/2", Rectifier Type Meter, Special scale, 400 microamperes & 3 Volts A.C. movement, complete with self-contained rectifier .....\$5.50
- J.B.T., 34F, 3 1/2", Frequency Meter 55-65 cycle, 11 reed, 100-150 Volts.....\$6.00
- Weston, 705, Sensitrol Relay, 0-100 Microamperes, Solenoid reset, S.P. normally closed. ....\$7.50
- Western Electric, 3 1/2", 100-0-100 Microamperes D.C. ....\$4.00
- Western Electric, 3 1/2", 20-0-20 Ampere D.C. ....\$3.00
- Western Electric, 3 1/2", 0-500 Volts D.C., 1000 ohms per volts.....\$5.00
- Western Electric, 3 1/2", D.B. meter —4-6, 1 Milliwatt in 600 ohms, full scale —1 M.A. A.C. ....\$6.00
- Hickok Model 47 wattmeter, 3 1/2", 0-75 watts, 120 volt, 1.8 Ampere, black scale. Has three color scale silver, green and red.....\$6.00

## SIGNAL CORPS TEST SET I-85-D

Made by Western Electric Co. Consists of a Weston 3 1/2" Model 301 0-1 Milliammeter with a 5 point switch and 5 precision resistors mounted in a metal case. Connected to measure 50, 500 and 1000 Volts D.C. and 25 and 250 M.A. D.C. Can be readily adapted for use as a volt-ohm-milliammeter. Only \$7.50.

*All meters are white scale in round, flush, bakelite cases, unless specified otherwise.  
Add sufficient money on parcel post orders, excess will be refunded.*

**MARITIME SWITCHES** • D • Worth, 4-8277 • 336 Canal St., New York 13, N. Y.

## SURPLUS NEW VARIACS



General Radio type 200 CU, 860 volt-ampere rating, 115 volt input, output variable from 0 to 135 volts at a maximum current of 7½ amperes. Comes complete with knob as pictured above. Shipped in original G.R. carton.

**Only \$12.00 F.O.B., N. Y. C.**

## Portable A. C. Ammeter Surplus New WESTON MODEL 528



Dual Range 0-3 Amp. and 0-15 Amp. full scale for use on any frequency from 25 to 500 cycles. The ideal instrument for all commercial, industrial, experimental, home, radio, motor and general repair shop testing. Comes complete with a genuine leather, plush-lined carrying case and a pair of test leads. A very convenient pocket sized test meter priced at less than 50% of manufacture list.

Your cost ONLY .....\$12.50

Westinghouse, BA-33,  
2½" Round Flush,  
0-150 Volts, A. C.

Price .....\$2.95

## Maritime Switchboard

336 Canal Street,  
New York 13, New York

## OUR PRICES ARE DOWN FOR RADIO SURPLUS HI-POWER COMPONENTS

### CONDENSERS

Cardwell TC-300-US air variable. 300 mmf., 2" spacing List 40.50 our price.....9.85  
Johnson 500D35 air variable. 501 mmf., .08" spacing. List 12.00 our price.....5.95  
Sangamo G-4 .004 mfd. 20,000 VDC. (List \$110.) mica. your cost.....35.50  
Sangamo F3L .0005 mfd 8000 VDC (List 29.50) mica. A buy at.....5.25  
Sangamo G-3, G-4 and F3L in other capacitances in stock. Inquire.  
G.E. Pyranol 23F47 2mfd. 4000 VDC (List 30.00) 8.95  
G.E. Aerovox, C-D, .25 mfd 20,000 VDC oil Impreg. (List \$150) your cost.....10.00  
G.E. pyranol 1-1 mfd. @ 7000 VDC (List at 65.50) priced at.....5.00  
INCCO .4 mfd @ 5000 VDC (List at \$20) reduced to sell at .....3.25

### TRANSFORMERS



115v 60c/ 3200 v—150 mills ½ wave rect. Plate xfmr. ....9.95  
115v 60c/ 2750 v—750ma ½ wave Plate xfmr. ....35.00  
115v 60c/750v-ct-110 ma/6.3v — 5a/5v-3a Pwr. supply.....5.95  
115v 60c/115a-5v filament transformer 8.95  
Newark xfmr. 220v input 60c/5 volt output .050 KVA 20,000 volt insulation priced at.....14.95  
Choke, 1 Hy, 800 ma. 10,000 volt insulation...5.95

**SPECIAL: Amertron hi-voltage plate transformer. 115v 60c input. Secondary is 6200v-ct-700 ma. Priced at 39.95**

Modulation Transformer; 807 to pair of 807's...2.65  
Modulation Transformer; 811's to 813.....5.00  
Driver; 6v6 to pair 811's.....3.00  
Single and double button mike-to-grid transformers .....1.49

**Large Inventory of 400 cps Transformers. Send for Listing.**

### CIRCUIT BREAKERS

I.T.E. Circuit breaker. 125/250 v ac 90 amps. Frame type 100.....29.95  
Heineman Circuit breaker; 8 and 25 amp 230v ac. perfect list at 8.95 our Price.....3.95  
Selsyns, Diahl, 115v 60c input size 5G. perfect. A steal at .....7.75  
Switches, wafer, 6 section. 2 circuit, 5 contact per ckt. ....1.39

### RESISTORS

100 watt resistors; 175, 200, 500, 1700 ohms ferrule mount type. List 2.20, Each \$1.75

### TUBES

304 TL einac .....perfect 10.00  
5FP7 Phillips New .....8.95  
5JPI Phillips New .....6.95  
9JPI Phillips New .....9.95  
723a/b Klystons New .....7.50

### COMMUNICATION SETS

RAK-7 R.C.A. SHIPBOARD RECEIVER  
9 tubes 15 kc-600 Kc. 115v/60 cps oper. each 77.50  
BC-603 85% COMPLETE, with MANUAL.....5.00  
ARC-5 Receivers complete.....37.50  
ARC-5 Transmitters compl. less dyn.....59.50  
BC-78-B Boonton Signal Gen. 15 mc to 55 mc; 190 mc to 230 mc. Used .....55.00  
BC-221 Frequency meter, complete.....82.50  
Ra-58-A Power unit from SCR-547.....116.00  
BC-412 Scope from SCR-268, with tubes.....59.50  
BC-409 Pulse Ampl. from SCR-268 with tubes 59.50  
BC-406 Receiver, from SCR-268 Freq. range 201-210 mc. 20 mc. IF. Freq. 2 mc band-width. 15 tubes with tubes.....26.95

### SEND FOR FLYER

All merchandise guaranteed. Mail orders promptly filled. All prices F.O.B. New York City. Send Money Order or Check. Shipping charges sent C.O.D.

## COMMUNICATIONS EQUIPMENT CO.

131-E Liberty St., N. Y. C., 7, N. Y.  
Telephone WH 4-7658

## Remler Appointed Agent for WAR ASSETS ADMINISTRATION

(Under Contract No. 59A-3-48)

... to handle and sell a wide variety of

### ELECTRONIC EQUIPMENT

released for civilian use

Write for Bulletin Z-1A

REMLER COMPANY LTD.  
2117 Bryant St. San Francisco 10, Calif.

# REMLER

Since 1918

Radio • Communications • Electronics

WRITE FOR 24 P. CATALOG OF

# METERS

AND INSTRUMENTS

VOLTMETERS	BRIDGES (Wheatstone)
AMMETERS	MEGOhmmeters
MICRO	RHEOSTATS
AMMETERS	VARIABLE
Ohmmeters	TRANSFORMERS
FREQ. METERS	RELAYS

**ELECTRO-TECH** Equipment Co.

119 Lafayette St., New York 13, N. Y.

## PAN-OSCILLO RECEIVER

Performs Work of 4 Units

Latest design, 3" Oscilloscope, Panoramic Adapter, Synchroscope, Receiver (when used with converter). Push-pull vertical and horizontal amplifiers. Ideal for laboratory, television, and general use, 60 cycle transformer provided (if wanted installed and tested add \$8.00 extra.) New in orig. cartons.

Originally \$2,000—your cost with 21 tubes \$97.50 F.O.B.

Write for picture flyer or send 50c for eighty-page technical manual.

5G Selsyn Generators, 110V AC 60 Cycles Direction Indicators \$12 a pair. Hour Time Meters (new) G.E. model 8KT8 \$5.95

Frequency Meters (new) 48-62 cycles \$2.95 Both types flush mount 3", match Weston 301, for 115 v. 60 cycles.

Westchester Electronic Products  
29 Milburne St. Bronxville, N. Y.

## Purchasing Agents, Radio Manufacturers

That hard to find component, that elusive part, that bottle-neck item is here.

We have thousands of potentiometers, condensers, resistors, transformers, etc.

Our prices are the lowest in the industry. We are one of the largest surplus houses in the east.

Wire or write us today.

### ELECTRO SALES COMPANY

531 Atlantic Ave.  
Boston 10, Mass.

## SURPLUS PARTS and EQUIPMENT

55,000 Sq. Ft. of Government-owned electronic parts and equipment. All material inspected and tested; backed by usual 90-day manufacturers' guarantee.

Sorry, no retail sales; all purchases against company orders only.

### COMMUNICATION MEASUREMENTS LABORATORY

Central Agent for War Assets Adm.  
DISPLAY ROOM: 350 W. 40TH ST.  
Main Office: 120 Greenwich St., New York 6

### BEST QUALITY, USED ELECTRON TUBE MACHINERY

Equipment for the manufacture of all kinds of electron tubes, radio tubes, incandescent lamps, neon tubes, photo electric cells, X-ray tubes, etc.

AMERICAN ELECTRICAL SALES CO., Inc.  
65-67 East 8th St. New York, N. Y.

### HAZELTON INSTRUMENT CO.

Electric Meter Laboratory  
Electrical Instruments, Tube Checkers  
and Analyzers repaired.

War surplus meters converted for civilian use.  
140 Liberty St., New York, N. Y.  
Tel. Barclay 7-4239

## INSTRUMENT MANUFACTURERS

### Looking for a New Product?

Here is one with a big future. A hook-on type, direct current, milliammeter, for measuring currents in electronic equipment without breaking the circuit or interrupting the current flow. Range (approx.) 10 MA. to 1 Amp.—may be extended. Easy to use and inexpensive to manufacture. The measuring probe is similar in shape to long nosed pliers, making it convenient for use in a confined space.

Will sell patents out-right or will consider any reasonable offer.

BO-188, Electronics  
68 Post St., San Francisco 4, Calif.

FOR EVERY  
BUSINESS WANT

"Think Searchlight First"

## STAINLESS STEEL SHEETS

COLD ROLLED—2D FINISH—SOFT TEMPER (except where noted)

Item No.	Approx. Quantity	Gauge	Size	Type and Description
1	275#	.005"	60" x 144"	302, 2B, D. S.
2	28000#	.008 (34 ga.)	32" x 72"	302, 2B, 1/4 H.
3	3195#	.010 (31 ga.)	36" x 114"	321, Ann.
4	428#	.010	12" x 120"	347
5	303#	.010	30" x 54"	347
6	9249#	.014 (29 ga.)	34 1/2" x 83 1/2"	302, D. S.
7	750#	.016 (28 ga.)	18" x 124"	347
8	800# (76 pcs.)	.016	18" x 124"	347
10	290#	.018 (26 ga.)	36" x 53"	347
11	630#	.018	18" x 124"	347
12	1977#	.018	18" x 124"	347
13	2160# (69 pcs.)	.022 (25 ga.)	40" x 120"	347
14	42215#	.025 (24 ga.)	35 1/2" x 61 1/2"	302, 1/2 H.
15	2100#	.025	36" x 96"	347
17	9466#	.032	25" x 114" & 119"	316
18	2688#	.032	25" x 144"	316
19	4644#	.032	30" x 100"	316
20	6813#	.032	22" x 96"	316
21	2245#	.031	40" x 120"	347
22	5100#	.037 (20 ga.)	36" x 96"	347, 1/4 H.
24	420#	.050	24" x 60"	347
25	57410#	.050	37" x 121"	321, H. R. P. & A. D. D.
26	488#	.0625 (16 ga.)	36" x 96"	347
27	714#	.0625	48" x 120"	347
28	17230#	.063	37" x 121"	321, H. R. P. & A. D. D.
29	2288#	.078 (14 ga.)	29" x 34"	316
30	964#	.093 (13 ga.)	24" x 60"	347
31	1260#	.093	24" x 60"	347
32	3624#	.109 (12 ga.)	38" x 96"	316
33	8088#	.109	34 1/2" x 85 1/2"	316, #1 fin.

## STAINLESS STEEL PLATES—HOT ROLLED—PICKLED AND ANNEALED

34	235#	.312"	31" x 78"	321
35	200#	.312"	30" x 70"	321
36	220#	.312"	31" x 72"	321
37	230#	.312"	31" x 79"	321
38	210#	.312"	29" x 80"	321
39	380#	.312"	34" x 106"	321
40	360#	.312"	37" x 100"	321
41	340#	.312"	37" x 98"	321
42	1310#	.312"	35" x 72"	321

## STAINLESS STEEL STRIPS & COIL STOCK

43	3029#	.010 (32 ga.)	2, 1" Coils	302, 1/4 H.
44	20832#	.015 (28 ga.)	23 15/16" Coils	302, Ann.
45	22502#	.017 (27 ga.)	1" Coils	321, C. R. 2D
46	3790#	.049 (18 ga.)	27 1/2" Coils	347, C. R. med. soft
49	500#	.050	7" Coils	302, C. R., soft
50	1282#	.050	21 1/2" Coils	321, C. R., soft
51	303#	.055 (17 ga.)	1 3/16" Coils	302, C. R., 2B
52	416#	.055	1 1/16" Coils	302, C. R., 2B
53	5780#	.080 (16 ga.)	23" Coils (2)	347, H. R., P. & A.
54	17160#	.082	37 1/2" Coils	321, H. R., P. & A.
55	7030#	.125 (11 ga.)	37" Coils	302, H. R., P. & A.
56	18103#	.060 (16 ga.)	8 13/16" Coils (29)	Type 347, C. R. Bright Fin.—H. Temper
57	213#	.120 (11 ga.)	27/64" Coils	Type 410, soft to 1/4 H., Ann., C. R.
58	2748#	.1379 (10 ga.)	17" Coils	Type 310, H. R., P. & A.
59	11806#	.140	24" Coils (6)	Type 347, H. R., P. & A.
60	3268#	.156 (9 ga.)	14 3/8" Coils	Type 302, Cold Rolled 1/4 H., P. & A.
61	3156#	.156	14 1/2" Coils	Type 302, Cold Rolled, 1/4 H., P. & A.
62	2875#	.187	25 1/2" Coils	Type 302, Cold Rolled, 1/4 H., P. & A.

## ROUND BARS

63	30510#		1" Diameter	Type 347, 10' to 12' lengths, quenched, machine straightened, centerless ground finish
64	10070#		1" Diameter	Type 347, C. R., mill lengths

LIST # 202B—JULY 1946

# DULIEN STEEL PRODUCTS, INC.

2280 Woolworth Bldg., 233 Broadway, New York, N. Y.

Telephone—Cortlandt 7-4676

Member of the Association Steel Distributors

**WANT HIGH-SPEED SOLDERING?**

**SEE THE NEW LINE OF  
G-E SOLDERING IRONS**

*STURDILY BUILT  
EASILY REPAIRED  
MODERATELY PRICED*

*A NEW AND IMPROVED LINE  
OF G-E SOLDERING IRONS  
FOR INDUSTRIAL USE*

*THEY GIVE YOU  
THESE IMPORTANT  
ADVANTAGES:*

- HIGH-SPEED SOLDERING
- BETTER PERFORMANCE
- LONG LIFE AND LOW MAINTENANCE
- CONVENIENT AND LOW-COST REPAIRS

Write today for Bulletin  
GEA-4519. Address  
Section A675-127,  
Apparatus Dept.,  
General Electric  
Company, Schenectady 5, N. Y.

**FREE BOOKLET**

**GENERAL ELECTRIC**  
BFD-127-8708

# STANDARD CRYSTALS

For commercial airline, civilian aircraft, marine, police, railway, automotive, and other communication equipment.

Complete line for the amateur bands.

Custom units for laboratory, experimental, and specialized applications.

Let us engineer your frequency control problems.

Write for free catalog and other information.

**STANDARD PIEZO COMPANY**

Established 1936

Quartz Crystals and Frequency Control Equipment  
Office and Development Laboratory

SCRANTON, PA.      CARLISLE, PA., P. O. BOX 164      CARLISLE, PA.

their toll and damage the alarm. Periodic inspection and cleaning would eliminate this danger, but people would not do this.

It appears to me that the only way to get a fire alarm protective device in every home is to make it mandatory by law; fire department of the locality to install and make periodic inspections of the device. Perhaps the municipality should buy them.

You and I would no doubt buy one of these devices if placed on the market, but the main problem is to get it across to the public. I personally believe that the mandatory method would be worth the effort, because of the large number of lives that could be saved.

FORREST G. BAKER  
Electrical Engineer  
Mast Development Co., Inc.  
Davenport, Iowa

## Vibration Error

Dear Sir:

IN THE ARTICLE on vibration in the April issue, "Vibration & Shock Testing of Mobile Equipment", two of the formulas as published are erroneous. The first (correctly,  $FN = 3.1 \sqrt{1/\Delta v}$ ) at the top of page 128 is an obvious typographical error in a well known formula and occasions no concern. The second error, immediately below, is in a set of formulas not previously widely published, and can cause considerable trouble to any one attempting to use the information:

As published,  $B$  is given as  $\frac{S(L/2)(2 + H^2 + R^2)}{\Delta v SR^2}$   
and  $C = \frac{L^2/2}{\Delta v^2 SR}$

Correctly, these should be  $B = \frac{S(L/2)^2 + H^2 + R^2}{\Delta v SR^2}$   
and  $C = \frac{L/2v^2}{\Delta v^2 SR}$

The obvious cause of the error is the spacing resulting from the typing of such a formula on a standard typewriter.

J. H. BEST  
Bendix Radio, Division of  
Bendix Aviation Corporation

THE AZON is a radio-controlled fin that can be attached to an ordinary bomb. The bombardier uses a small radio transmitter beamed to the receiver in the fin to turn the bomb to right or left as it plunges toward the target.



**A major  
advancement  
in the  
recording blank  
field . . .**

*10 Year*  
**GUARANTEE**  
**GOULD-MOODY**  
*"Black Seal"*  
**ALUMINUM  
RECORDING BLANKS**

**. . . at no increase  
in price !**

After prolonged research and experimentation, we have introduced technological improvements into "Black Seal" blanks that not only increase life span, but materially enhance the other finer characteristics of these blanks. And so positive are we of the worth of these perfected "Black Seals" that we're offering them to you on an unconditional ten-year guarantee basis.

**You can't afford to be a  
recording isolationist . . .**

"Black Seal" blanks will not rip up, disintegrate or powder after the first playing if kept in storage for any long period of time. You are in no danger of losing valuable recordings in what, up until now, you have considered your safe library of recording blanks. No matter how well you may be satisfied with your present blanks, you can't afford to be a recording isolationist. Try "Black Seals"—if, for any reason whatsoever, you aren't satisfied, return them at our expense.



**THE GOULD-MOODY CO.**  
*Recording Blank Division*  
**395 BROADWAY NEW YORK 13, N. Y.**

	Page		Page
General Radio Company	227	Miles Reproducing Co., Inc.	297
Gibbs & Co., Thomas B.	202	Milford River & Machine Co.	240
Gilandun Electronics	260	Millen Mfg. Co., Inc., James	256
Goat Metal Stampings, Inc.	266	Mitchell-Rand Insulation Co., Inc.	157
Goodrich Chemical Co., B. F.	308	Mount Vernon Cabinet Co., Inc.	296
Gould-Moody Co.	306	Multicore Solders, Ltd.	233
Gramer Company, The	196	Mycalex Corporation of America	43
Graphite Metallizing Corp.	254		
Graybar Electric Co.	275	National Carbon Co., Inc.	168
Guardian Electric Mfg. Co.	141	Nation Co., Inc.	243
		National Research Corporation	32
Hallcrafters Company	39	National Screw & Mfg. Co.	203
Hardwick, Hindle, Inc.	279	New England Screw Co.	275
Harvey Radio Company	270	Niagara Radio & Supply Co.	283
Hathaway Instrument Co.	280	Northern Industrial Chemical Co.	298
Haydon Manufacturing Co., Inc.	244		
Heinemann Electric Co.	171	Ohmite Manufacturing Company	32a, 32b
Hewlett-Packard Company	37	Onan & Sons, D. W.	286
Hexacon Electric Co.	250	O'Neil-Irwin Mfg. Co.	274
Hudson Wire Company	277	Oster Mfg. Co., John	291
Hunter Pressed Steel Company	187		
Hytron Radio & Electronics Corp.	31		
		Par-Metal Products Corporation	262
Imperial Tracing Cloth	196	Permo, Inc.	293
Indiana Steel Products Co.	172	Petersen Radio Co.	293
Industrial Timer Corporation	298	Phillips Screw Manufacturers	63
Ins-X Co., Inc., The	184	Pioneer Electric Co.	268
Instrument Electronics	262	Potter Co., The	236
Instrument Resistors Co.	275	Premax Products	293
Insulation Manufacturers Corp.	276	Press Wireless Manufacturing Corp.	155
Insuline Corporation of America	158	Presto Recording Corporation	61
International Machine Works	281	Progressive Mfg. Co.	271
International Resistance Co.	143		
Irvington Varnish & Insulator Co.	165		
		Quadrige Manufacturing Co.	291
Jack & Heintz Precision Industries, Inc.	50, 51	Quaker City Gear Works, Inc.	226
Jefferson Electric Co.	36		
Jelliff Mfg. Corp., C. O.	282	Radio City Products, Inc.	197
Jensen Radio Manufacturing Co.	65	Radio Corp. of America, Victor Div.	9, Back Cover
Johnson Co., E. F.	153	Radio Engineering Lab's, Inc.	285
Jones Div., Howard B., Cinch Mfg. Co.	285	Radio Supply & Engineering Co., Inc.	287
		Railway Express Agency, Air Express Div.	200
Kahle Engineering Co.	297	Rauland Corporation	219
Karp Metal Products Co., Inc.	19	Rawson Electrical Instrument Co.	273
Kenyon Transformer Co., Inc.	164	R-B-M Manufacturing Company	16
Kester Solder Co.	248	Reeves Soundcraft Corp.	293
Keuffel & Esser Co.	3	Revere Copper & Brass, Inc.	30
Kirkland Co., H. R.	279	Rex Rheostat Co.	297
Kwikheat Div., Sound Equipment Corp.	276	Richardson Company, The	234
		Rockbestos Products Corp.	24
Lampkin Laboratories	297	Roller-Smith Co.	145
Langevin Company	251	Rowe Industries	266
Lapp Insulator Co., Inc.	41	Ruby Chemical Co.	279
Lavoie Laboratories	265		
Liberty Sales Co., Inc.	174	Sangamo Electric Company	78
Linde Air Products Company	209	Scientific Electric, Div. of "S" Corrugated Quenched Gap Co.	211
Lord Manufacturing Co.	167	Scovill Mfg. Co., Waterville Screw Products Div.	147
		Seeburg Corporation, J. P.	152
Macallen Company	242	Selenium Corp. of America	225
Machlett Laboratories, Inc.	77	Sillcocks-Miller Co.	270
Magnavox Co., The	239	Sola Electric Company	28
Maguire Industries, Inc.	66	Sorensen & Company, Inc.	257
Makepeace Co., D. E.	176	Speer Carbon Co.	180
Mallory & Co., Inc., P. R.	82, 139	Sperry Gyroscope Co., Inc.	205
Marion Electrical Instrument Co.	198	Sprague Electric Co.	159
MB Manufacturing Co., Inc.	70	Stackpole Carbon Company	21
McGraw-Hill Book Co.	247	Stamford Metal Specialty Co.	289
McLaughlin, J. L. A.	297	Standard Pi-zo Company	304
Measurements Corporation	274	Standard Pressed Steel Co.	149
Merit Coil & Transformer Co.	254	Star Expansion Products Co.	263
Meyercord Company	253	Star Porcelain Company	281
Mica Insulator Company	46, 47	Sta-Warm Electric Co.	231
Midwest Molding & Mfg. Co.	293	Stevens-Walden, Inc.	294
		Steward Mfg. Co., D. M.	291

Stoddart Aircraft Radio Co.	Page 185
Stupakoff Ceramic & Mfg. Co.	64
Sun Radio & Electronics Co., Inc.	297
Superior Electric Co.	58
Superior Tube Company	75
Sylvania Electric, Electronics Div.	62
Synthane Corporation	16a, 16b

Taylor Manufacturing Co.	191
Tech Laboratories	273
Thermador Electrical Mfg. Co.	298
Thomas & Skinner Steel Products Co.	277
Tinnerman Products, Inc.	183
Triplet Electrical Instrument Co.	76
Tung-Sol Lamp Works, Inc.	169
Turner Co.	206

Union Carbide & Carbon Corp.	151, 168, 209
United Transformer Corp.	2

Victoreen Instrument Co.	288
Vokar Corporation	290

Waldes Kohinoor, Inc.	229
Walker-Turner Co., Inc.	280
War Assets Administration	148
Ward Leonard Electric Co.	188
Waterman Products Co.	286
Webster Electric Co.	178
Weller Mfg. Co.	283
Western Electric Co.	48, 49, 275
Westfield Metal Products Co., Inc.	296
Weston Electrical Instrument Corp.	44
Whistler & Sons, Inc., S. B.	7
White Dental Mfg. Co., S. S.	255
Whitehead Stamping Co.	287
Wilcox Electric Company, Inc.	57
Wilson Co., H. A.	245

Zophar Mills, Inc.	196
--------------------	-----

PROFESSIONAL SERVICES	295
-----------------------	-----

SEARCHLIGHT SECTION  
(Classified Advertising)

EMPLOYMENT	299, 300
REPAIRING	303
SPECIAL SERVICES	300
USED EQUIPMENT	300-303
American Electric Sales Co., Inc.	303
Communication Measurements Laboratory	303
Communications Equipment Co.	302
Dulien Steel Product Inc.	303
Electro Sales Co.	303
Electro-Tech. Equipment Co.	302
Maritime Switchboard	300, 301, 302
Mellaphone Corp.	300
Picker X-Ray Corp.	300
Remler Co., Ltd.	302
Westchester Electronic Products	302



# Audax

## EAR-ACCEPTABILITY

Driving, patient years of intensive specialization have enabled AUDAX to master wide range thoroughly.

Today even the lowest priced MICRODYNE has a range to 7,000 cycles — other models to 10,000 cycles.

Yes, wide range makes for naturalness, but is highly objectionable if without quality. Thus, of two singers capable of reaching high C, one may have a pleasing voice — the other, not at all. It is so with pick-ups, too.

To achieve ear-acceptability, all other factors must be satisfied. Of these, vibratory-momentum is most important. The only way to test ear-acceptability of a pick-up is to put it to the EAR TEST.

MICRODYNE's sharp, clean-cut *facsimile* performance — regardless of climatic conditions — is a marvel to all who know that ear-acceptability is the real criterion.

Send for complimentary copy of  
"PICK-UP FACTS"

# AUDAK COMPANY

500 Fifth Avenue. New York 18

"Creators of Fine Electro-Acoustical Apparatus since 1915"

THE  
STANDARD  
BY WHICH  
OTHERS  
ARE JUDGED  
AND  
VALUED

# He runs his road with GEON-insulated wire

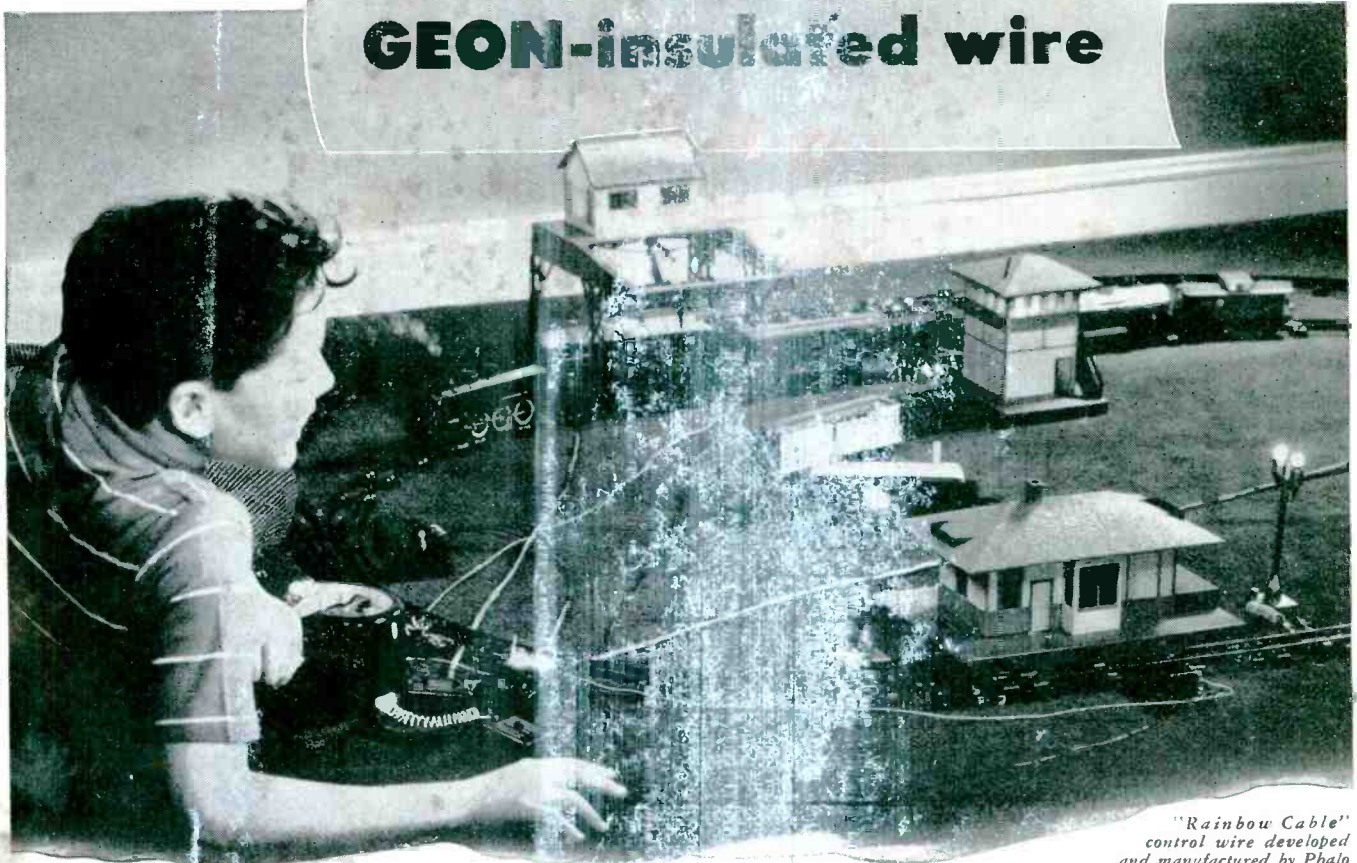

"Rainbow Cable" control wire developed and manufactured by Phalo Plastics Corp., Worcester, Mass.

**GEON's** advantages make it ideal insulating material for instrument, home, industrial and utilities wiring

**T**HE things that Bill used to do with his hands to keep his railroad running—coupling and uncoupling cars, loading and unloading, turning switches—are all done by electricity on the modern American Flyer that huffs and puffs and belches smoke just like its full-sized counterpart.

That calls for connecting wires that are easy to identify, that stand rough usage, that won't crack, get gummy or peel, that will keep fire hazards to a minimum. That's why the A. C. Gilbert Company selected wire with insulation made from GEON. It can be brilliantly colored in a wide range, it wears inde-

finately, resists aging and ozone, and is self-extinguishing—won't support combustion.

These and other properties of insulation made from GEON have earned it an important place in every part of the electrical industry. The thinner coating of insulation made possible by GEON's electrical properties permit more conductors per conduit. Resistance to oil and grease, acids, alkalis, moisture, heat, cold, and most other normally destructive factors mean that insulation made from GEON can be used *everywhere*.

The next time you order wire—for manufacturing, home, or industrial wiring—be sure to specify wire insulated with GEON, now being made by leading wire and cable manufacturers. Or for information about special applications please write Department F-8, B.F. Goodrich Chemical Co., Rose Building, Cleveland 15, Ohio. In Canada: W. H. Trencher, Ontario.



**B. F. Goodrich Chemical Company**

A DIVISION OF  
THE B. F. GOODRICH COMPANY



# DAVEN

# TONE COMPENSATING

# ATTENUATOR

**TYPE LAC-720-1**—This network, developed at the request of leading sound engineers, is designed to attenuate the musical spectrum to follow, very closely the perception sensitivity curves of the human ear. Base frequencies suffer smaller loss than the middle or upper registers . . . without rendering a false or "pumped" response.

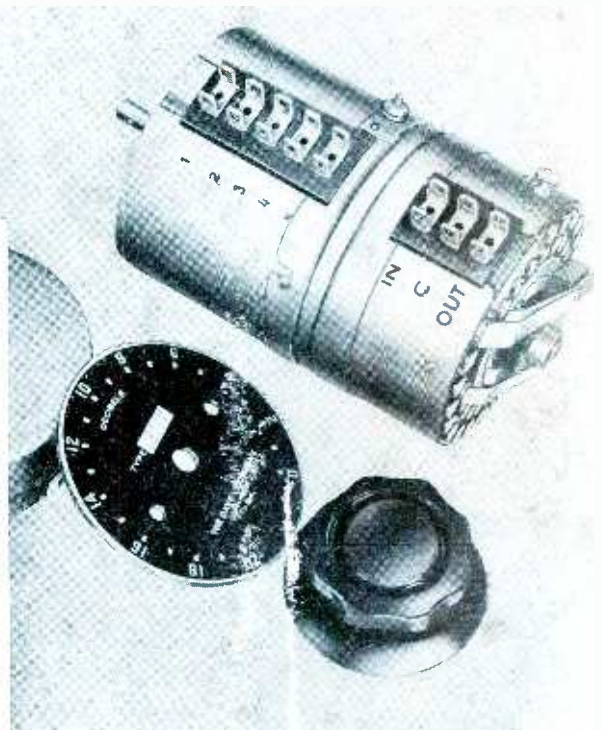
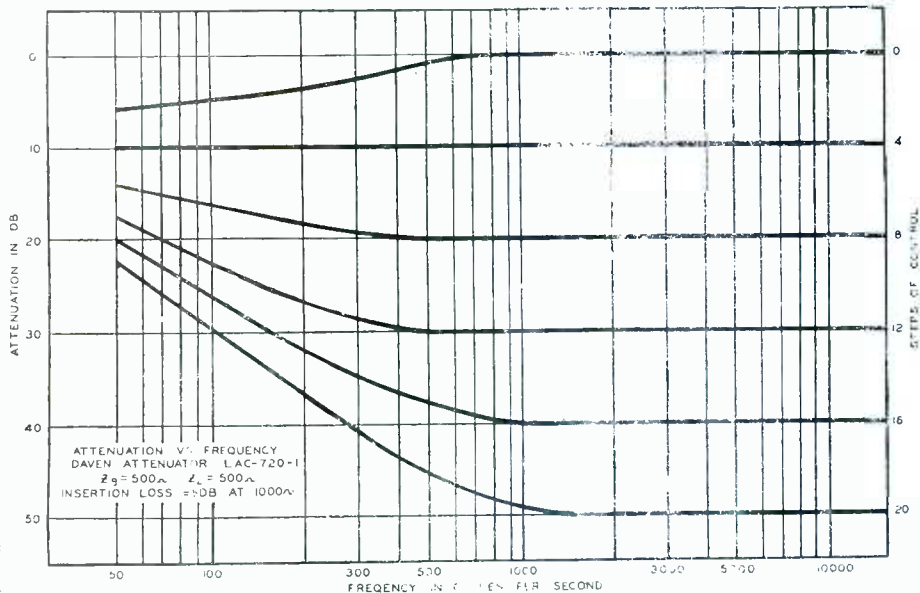

By connecting the control from the IN, OUT, and COMMON terminals into the circuit, the attenuator functions in accordance with the illustrated curves. However, by externally wiring the 5 additional lugs, this unit can be converted to a straight ladder of 2.5 dB per step with a flat frequency response. By selecting several combinations of these terminals, a whole family of curve characteristics can be obtained to meet the user's individual requirements.

As always we welcome suggestions or comments from engineers in the industry, not only concerning this unit, but any special "family of curves" to meet individual needs or requirements.

#### Primary applications are in:

- ★ Quality reproduction of wired music for restaurants and public gathering places
- ★ High fidelity broadcast monitoring amplifier controls
- ★ Deluxe, custom-built home receivers
- ★ Psychological testing and experiments in hearing perception
- ★ Research and development in the study of music appreciation

THE **DAVEN** CO.  
191 CENTRAL AVENUE  
NEWARK 4, NEW JERSEY

# How to select RCA Phototubes



**P**HOTOTUBES have found such a wide variety of applications that many types have been developed to meet special needs. The complete RCA line includes both gas and vacuum phototubes, with various spectral responses and a variety of sizes and shapes. And for applications requiring extreme sensitivity, RCA supplies multiplier phototubes with various spectral responses within the red to ultra-violet region.

**Color Sensitivity:** The cathode coating material and the envelope glass determine color sensitivity. RCA phototubes fall into four "color groups":

Use	Tube Types	Medium Color Sensitivity
With incandescent lamps —and for infra-red application	Vacuum: 917, 919, 922, 925 Gas: 1P40, 1P41, 868, 918, 920, 921, 923, 927, 928, 930	Red and infra-red
With incandescent lamps —and for infra-red application	Vacuum: 1P22, 926 Gas: 1P29	Blue light. Approximates the human eye
With light source for colorimetry application	Vacuum: 1P39, 929, 934. Gas: 1P21, 1P37, 931-A	Blue light. Very sensitive to incandescent light at a color temperature above 2700° K.
For ultra-violet measurement	Vacuum: 1P28, 935	Same as above, but special glass envelope permits high ultra-violet sensitivity

**Vacuum-or-Gas or Multiplier-Type:** Several important factors to be considered in selecting the general type of phototube for a service are given in the following table. Specific values should be considered in selecting a specific tube type.

Characteristic	High-Vacuum Type	Gas-filled Type	Multiplier Type
Sensitivity	Low	Medium	Very High
Current Output	Low	Medium	Very High
Amplification	1	Up to 10	Up to 2,000,000
Relative signal-to-noise ratio (including amplifier stage)	Low	Intermediate	High
Anode Volts	Up to 500	Not over 90	Up to 1250
Distortion (audio)	Negligible	Appreciable in some cases	Negligible
Frequency Range	Limited by capacitance effects	Limited by gas amplification effects	Limited by capacitance effects

Gas phototubes are, at present, extensively used for sound-on-film reproduction and for relay work. Vacuum types are widely used where high sensitivity is not needed; for precision measurements where stability of calibration is essential; and for high-speed work.

**Sensitivity:** The sensitivity of a phototube may vary according to whether the light change is abrupt or continuous. *Static sensitivity* is the quotient of anode direct current divided by constant light input. *Dynamic sensitivity* is the quotient of the variation

of anode current divided by the variation of light input. The sensitivity of gas phototubes drops off at high audio frequencies.

**Optical Systems:** The performance of phototubes can be greatly improved by the judicious choice of a suitable optical system.

**Mechanical Features:** As illustrated above, several types of tubes are available. Space, vibration, directional requirements, insulation, etc., all may affect phototube selection.

**Phototube Life:** RCA phototubes are inherently sturdy, long-lived tubes and, when operated under recommended conditions, give very reliable service.

**Application Hints:** Here are a few general suggestions for applying phototubes:

1. In general, for measurement work, a vacuum phototube is required because of its high stability of performance; for relay work the high sensitivity of a gas tube often determines its choice, since high stability is of minor importance.
2. In sensitive relay and measurement circuits where tubes must respond to very small amounts of light, avoid external leakage currents. Keep tube terminals and sockets clean. Erratic leakage currents will affect results.
3. In amplifiers where low leakage is important, select top cap types such as the RCA 917, 919, or 935.
4. Shield phototube and leads to amplifier or relay tubes when amplifier gain or phototube load resistance is high.
5. Where high-frequency response is important, keep phototube leads short to minimize capacitance shunting of output.
6. For constant calibration of high-precision vacuum phototube devices, keep anode potential at or below 20 volts. Keep incident light spread over wide cathode area. Keep current density below 10 amp. per sq. in.
7. Choice of circuit constants should be based on tests with the equipment operating over the expected range of line-voltage variation, and should provide sufficient circuit adjustment or safety factor to allow for normal characteristic variations between tubes.
8. RCA voltage-regulator tubes can improve phototube circuit performance.
9. Anode characteristic curves on phototubes can be used to predict average performance under given operating conditions.
10. The phototube types underlined in the color tabulation are recommended as RCA Preferred Types for design considerations.

## WHAT PHOTOTUBE DO YOU NEED?

If you have a specific application problem or wish further published information on RCA Phototubes and how to use them, write RCA, Commercial Engineering Department, Section D-6H, Harrison, N. J.

THE FOUNTAINHEAD OF  
MODERN TUBE DEVELOPMENT IS RCA

RCA PRINCETON LABORATORIES



**TUBE DEPARTMENT**

**RADIO CORPORATION of AMERICA**

**HARRISON, N. J.**