

JUNE · 1945

electronics

A MCGRAW-HILL PUBLICATION



BUY BONDS . . . 7th War Loan

Another New "AMPEREXTRA" for Designers of Industrial Equipment



AMPEREX 235-R

R. F. POWER AMPLIFIER AND OSCILLATOR

The AMPEREX 235-R is a forced-air cooled triode, particularly well suited for high-frequency industrial use. Characteristics of the grid have been given especial attention so that operation to full output may be obtained at comparatively low plate voltages. This is an advantage which should merit the interest of industrial equipment designers now working on postwar products. Built into the 235-R, of course, are those notable "Amperextras" which give *Amperex* tubes peak performance over a greater period of working life.

GENERAL CHARACTERISTICS

Filament: Voltage	14.5-15.0 Volts	Direct Interelectrode Capacitance (approximate)	
Current	39.0 Amperes	Grid to Plate	9.0- μf
Amplification Factor	14.0	Grid to Filament	10.0- μf
Grid to Plate Transconductance @ 500 ma.	6500 Micromhos	Plate to Filament	1.5- μf

Write for Additional Information



AMPEREX
the high performance tube

NOTE: The more popular types of *Amperex* tubes are now available through leading radio distributors.

AMPEREX ELECTRONIC CORPORATION

79 WASHINGTON STREET BROOKLYN 1, N. Y.
Export Division: 13 E. 40th St., New York 16, N. Y., Cables: "Arlab"

You haven't done everything you can . . . until you've donated to help your blood to the Red Cross Blood Bank

electronics



JUNE • 1945

BETATRON	Cover
Prof. E. E. Dreese of Ohio State examines the accelerating unit of the Betatron described in this issue	
ELECTRONIC WELDING OF GLASS, by E. M. Guyer	92
Localized heating without destructive surface-boiling is accomplished with the aid of high-frequency guns	
U-H-F IMPEDANCE MEASUREMENTS, by N. Marchand and R. Chapman	97
Using special probes, impedance measurements can be made with low-power laboratory equipment	
A PRETUNED TURNSTILE ANTENNA, by George H. Brown and J. Epstein	102
Description of a unit that can be adjusted before being erected	
MOVING-COIL PICKUP DESIGN, by Theodore Lindenberg, Jr.	108
Description of dynamic pickup whose resonance peaks are beyond the usual audio range	
ELECTRONIC SALES ENGINEERING, by S. S. Egert	111
Young men, with technical as well as sales training, are the key to the industrial market	
PREDIMENSIONING QUARTZ CRYSTAL PLATES, by B. P. Haines, C. D. O'Neal and S. A. Robinson	112
New mass-production method keeps temperature-cycling rejects below 2 percent	
AUDIO MIXER DESIGN, by Richard W. Crane	120
Various types of high and low-impedance mixer circuits for audio amplifiers	
INDUSTRIAL RADIOGRAPHY, by Wayne T. Sproull	122
Practical instructions for inspecting welds, castings, and finished products with x-rays or radium	
THE BETATRON, by Theodore J. Wang	128
Comprehensive survey of induction electron accelerators, with basic design equations	
ARTIFICIAL DELAY-LINE DESIGN, by J. B. Trevor, Jr.	135
Chart simplifies design of artificial line for signal delay	
AIR TERMINAL SOUND SYSTEM, by William W. Brockway and Don C. Brockway	138
West Coast system features speech compression and flexibility by using multiple amplifiers	
MEASURING R-F POWER WITH THREE AMMETERS, by J. L. Hollis	142
Chart speeds conversion of r-f ammeter readings into r-f resistance, reactance and power of load	
COMPUTING MUTUAL INDUCTANCES, by Michael J. DiToro	144
Chart simplifies computation of <i>M</i> for coaxial circular coils to a simple multiplication	
CROSSTALK	91
INDUSTRIAL CONTROL	151
TUBES AT WORK	204
ELECTRON ART	252
NEWS OF THE INDUSTRY	294
NEW PRODUCTS	360
NEW BOOKS	402
BACKTALK	408
INDEX TO ADVERTISERS	416

KEITH HENNEY, Editor; **W. W. MacDonald**, Managing Editor; **John Markus**, Associate Editor; **Vin Zeluff**, Associate Editor; **Assistant Editors**—**Frank Haylock**, **Frank Rockett**, **J. M. Heron**, **M. L. Matthey**, and **J. E. Grolimund**; **G. T. Montgomery**, Washington Editor; **Donald G. Fink** (on leave); **Harry Phillips**, Art Director

H. W. MATEER, Publisher; **J. E. Blackburn, Jr.**, Director of Circulation, *Electronics*; **Wallace B. Blood**, Manager

DISTRICT MANAGERS, **D. H. Miller**, **H. R. Denmead, Jr.**, New York; **R. H. Flynn**, New England; **F. P. Coyle**, Philadelphia; **C. D. Wardner**, **A. F. Tischer**, **R. A. Werth**, Chicago; **E. J. Smith**, **J. L. Phillips**, Cleveland

Contents Copyright, 1945, by McGraw-Hill Publishing Company, Inc.
McGraw-Hill Publishing Company, Incorporated
JAMES H. McGRAW, Founder and Honorary Chairman
 PUBLICATION OFFICE 99-129 North Broadway, Albany, N. Y., U. S. A.
 EDITORIAL AND EXECUTIVE OFFICES 330 West 42nd St., New York 18, N. Y., U. S. A.

James H. McGraw, Jr., President; **Curtis W. McGraw**, Senior Vice-President and Treasurer; **Howard Ehrlich**, Vice-President (for business operations); **John Abtink**, Vice-President (for editorial operations); **Joseph A. Gerardi**, Secretary; and **J. E. Blackburn, Jr.**, Director of Circulation.

ELECTRONICS, June, 1945, Vol. 18, No. 6. Published monthly, price 50c a copy. June Directory Issue \$1.00. Allow at least 10 days for change of address. All communications about subscriptions should be addressed to the Director of Circulation, 330 W. 42nd St., New York 18, N. Y.

Subscription rates—United States and possessions, Mexico, Central and South American countries, \$5.00 a

year, \$8.00 for two years, \$10.00 for three years. Canada (Canadian funds accepted) \$5.50 a year, \$9.00 for two years, \$11.00 for three years. Great Britain and British Possessions, 42 shillings for one year, 84 shillings for three years. All other countries \$7.00 for one year, \$14.00 for three years. Please indicate position and company connection on all subscription orders. Entered as Second Class matter August 29, 1936, at Post Office, Albany, New York, under the Act of March 3, 1879.

BRANCH OFFICES: 320 North Michigan Avenue, Chicago 11, Ill.; 68 Post Street, San Francisco 4; Aldwych House, Aldwych, London, W.C. 2; Washington, D. C. 4; Philadelphia 2; Cleveland 15; Detroit 26; St. Louis 8; Boston 16; Atlanta 3, Ga.; 821 So. Hope St., Los Angeles 14; 38-9 Oliver Building, Pittsburgh 22.

CHANGE OF ADDRESS

Director of Circulation,
ELECTRONICS,
 330 West 42nd Street
 New York 18, N. Y.

Please change the address of my *Electronics* subscription.

Name

Old Address

New Address

New Company Connection

New Title or Position

TRANSFORMER COMPONENTS

for every application

RADIO

Set components

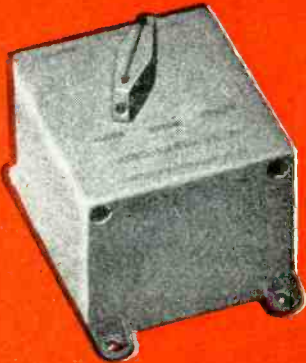

Radio Filters

TELEPHONY

Loading Coils



Repeat Coils



Pulse Transformers



Mine Detection Components



Selective Amplifier Filters



Inter-phone Amplifier Components

DETECTION

AMPLIFICATION

Foremost Manufacturers of Transformers to the Electronic Industry



ALL PLANTS

May we cooperate with you on design savings for your applications, . . . war or postwar?

United Transformer Corp.
150 VARICK STREET
EXPORT DIVISION: 13 EAST 40th STREET,
NEW YORK 13, N. Y.
NEW YORK 16, N. Y., CABLES: "ARLAB"



Still Young at 99 . .

Who wants a tracing paper that's still good—and we mean *good*—still white, transparent, flexible—99 years later? Well, you can never tell. Maybe more tragic things have happened than having a drawing go to ruin in its sleep, but nevertheless, that can be awfully serious. That's only one reason why we developed ALBANENE white tracing paper. It's permanent, because it's made of 100% long-fibre pure white rags, treated with Albanite. In drafting rooms today there are drawings on ALBANENE that are years old and still in perfect condition.

What's Albanite? It's a crystal-clear, unaltering synthetic developed by the K&E Laboratories, and is simply tops as an impregnating medium for long-fibre paper stock. That gives ALBANENE extra transparency. And because ALBANENE stays white, it gives strong, contrasting prints. It's fine to work on too, with pencil or ink—keeps clean and takes erasures well. That's not the whole story; to get it all, write us on your letterhead for a sample sheet. Made in rolls, sheets, and pads.

K&E

Drafting, Reproduction, Surveying
Equipment and Materials
Slide Rules, Measuring Tapes

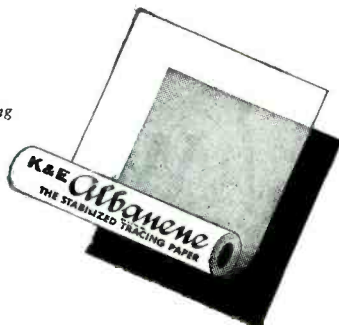

Albanene

REG. U. S. PAT. OFF.

KEUFFEL & ESSER CO.

EST. 1867

NEW YORK • HOBOKEN, N. J.

CHICAGO • DETROIT • ST. LOUIS
SAN FRANCISCO • LOS ANGELES • MONTREAL

How many keys to acceptance can
you find in this **HELPFUL BOOK?**

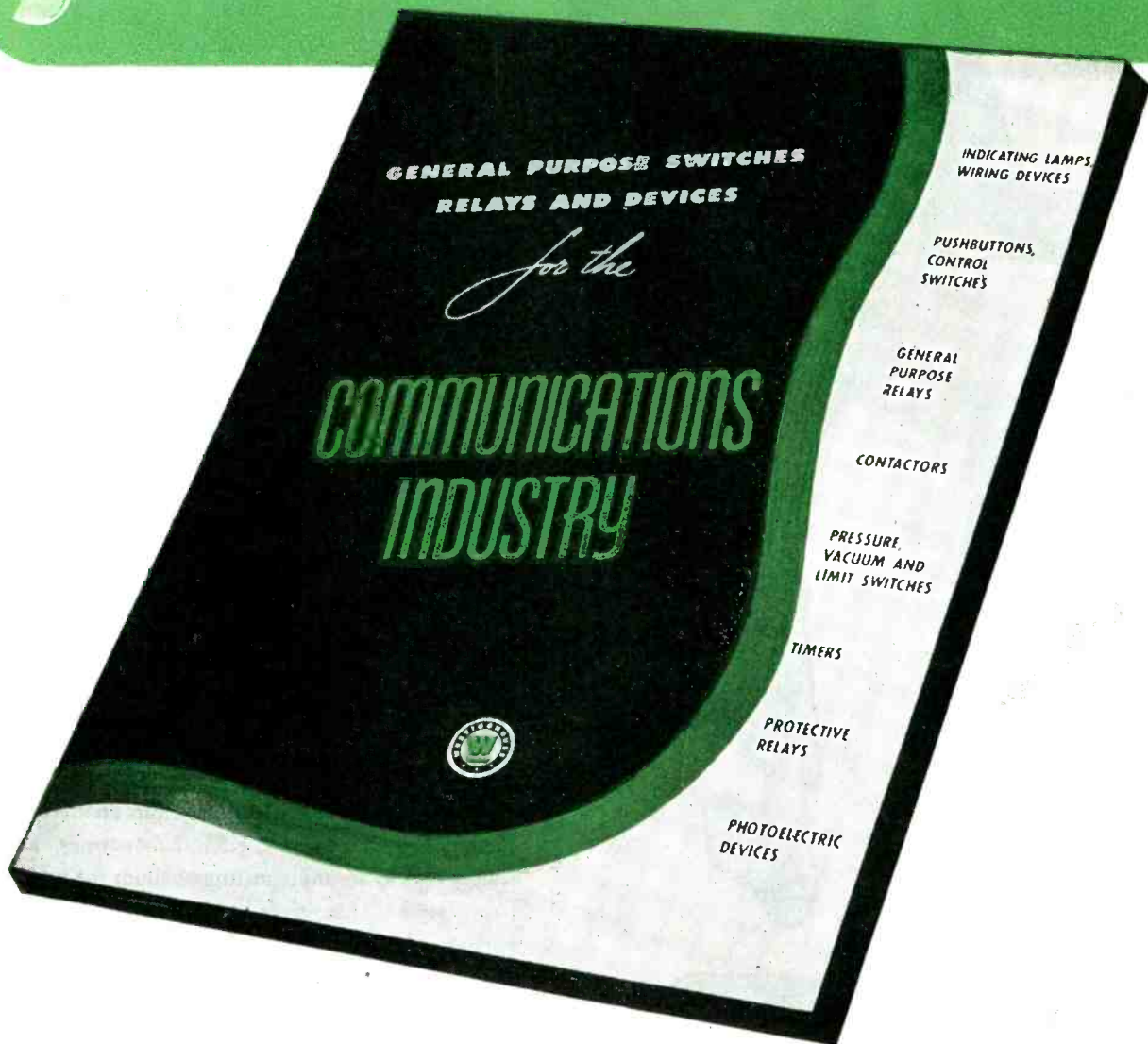

This new book includes complete engineering data applying to Westinghouse "industrial-duty" contacting devices already proved useful to communications and electronic engineers.

It shows devices refined over many years to meet the rigid demands of the engineer responsible for his plant's performance—devices that will help gain acceptance for your equipment.

A free copy of this fact-packed book is waiting for you at your nearest Westinghouse office. Ask for descriptive data SA-802. Westinghouse Electric Corporation, P. O. Box 868, Pittsburgh 30, Pa. J-94670

Westinghouse
PLANTS IN 25 CITIES . . . OFFICES EVERYWHERE



...one of many Westinghouse contributions to progress in electronic and communications equipment design.

This informative collection of technical data is just one of many Westinghouse services developed especially for those designers who must win engineers' approval for their product.

Here is a quick check list of some of the Westinghouse products described in this book... what they are, where to use them, what they will do.

Your nearest Westinghouse office will be glad to work with you in applying these products to your own designs.

A QUICK CHECK LIST OF WESTINGHOUSE PRODUCTS IN THIS BOOK

Indicating Lamps



Whether for racks, miniature panelboards and desks or for full size, erect switchboards, a Westinghouse indicating lamp—especially designed for the purpose—is available. In round, rectangular and large sizes, all are available in various colors and for 25 to 250 volts. The rectangular Minalite (illustrated) is readily visible from extreme angles. Compact, attractive.

Pushbuttons and Control Switches



Westinghouse heavy-duty pushbuttons permit interchangeability of pushbutton, rotary selector switch, and indicating lamp units providing almost unlimited combinations of functions. Control switches—Minatrol, Type W and auxiliary styles—are widely accepted for their simplicity, ruggedness, adaptability and reliable operation. Available with removable handles, crank arm, solenoids, stay-put or return-to-neutral mechanisms in combination with variety of contacts for all control circuits.

EQUIPMENT FOR THE COMMUNICATIONS INDUSTRY

Timers

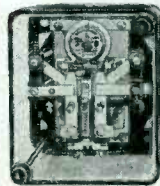

Standard electronic timers are adjustable from .1 to 45 seconds. Mechanical timers or relays accurately driven by synchronous motors are adjustable from 2 seconds to 50 minutes for industrial duty.

Contactors

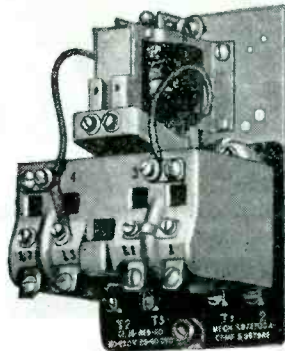

"De-ion" breakers used on many of these contactors, are recognized as a Westinghouse development of unusual significance to quickly and positively extinguish arcs drawn between opening contacts. Applications range from the smaller contactors to large oil circuit breakers.

Protective Relays

As segregated in this book, protective relays are those which think and act for themselves. Included are thermostatic flow switches (for liquids), and relays which may be adjusted to operate on varying degrees of overload, underload, overvoltage, undervoltage, temperature and reverse current.

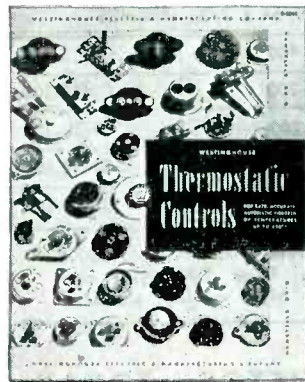

Thermostat Catalog... new Westinghouse catalog helpful in problems involving the control of heat. These thermostats are also used in the newer applications by electronic engineers as time-delay relays.



Without Exception

these molded, oil-paper capacitors meet the performance requirements of

American War Standard C 75/221.

AVAILABLE IN STANDARD RATINGS		
CAPACITANCE MMFD.	VOLTAGE D-C WKG.	TYPE DESIGNATION
SIZE: 13/16 x 13/16 x 19/64 INCHES		
3000	800	CN35-302
6000	600	CN35-602
10000	600	CN35-103
20000	300	CN35-203
SIZE: 11/16 x 29/64 x 7/32 INCHES		
1000	400	CN20-102
2000	200	CN20-202
3000	200	CN20-302
6000	200	CN20-602
10000	120	CN20-103
Other capacitances from 1000 mmfd. to 50000 mmfd., available in Tobe DP style, conform to the same high quality standard.		

- ★ **MOISTURE SEAL** . . . adequate to ensure compliance with thermal cycle, immersion, and humidity requirements.
- ★ **SHUNT RESISTANCE** . . .
40,000 megohms at 25° C.
1,000 megohms at 85° C.
- ★ **WORKING TEMPERATURES** . . .
-55° C. to + 105° C.
- ★ **OPERATING FREQUENCIES** . . .
up to 40 megacycles.
- ★ **POWER FACTOR**
.004 to .006 at 1,000 cycles.



A SMALL PART IN VICTORY TODAY — A BIG PART IN INDUSTRY TOMORROW



better recordings

And they are better! Radio experts cannot be sure whether they are listening to a "live" show or an audiodisc transcription. For high fidelity, minimum surface noise, low distortion and maximum frequency range, there is nothing finer than an Audiodisc.

AUDIO DEVICES, INC., 444
Madison Ave.,



RIGHT

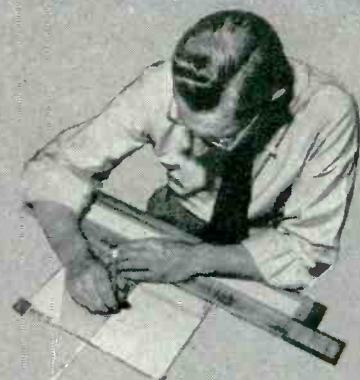

... *from the start*

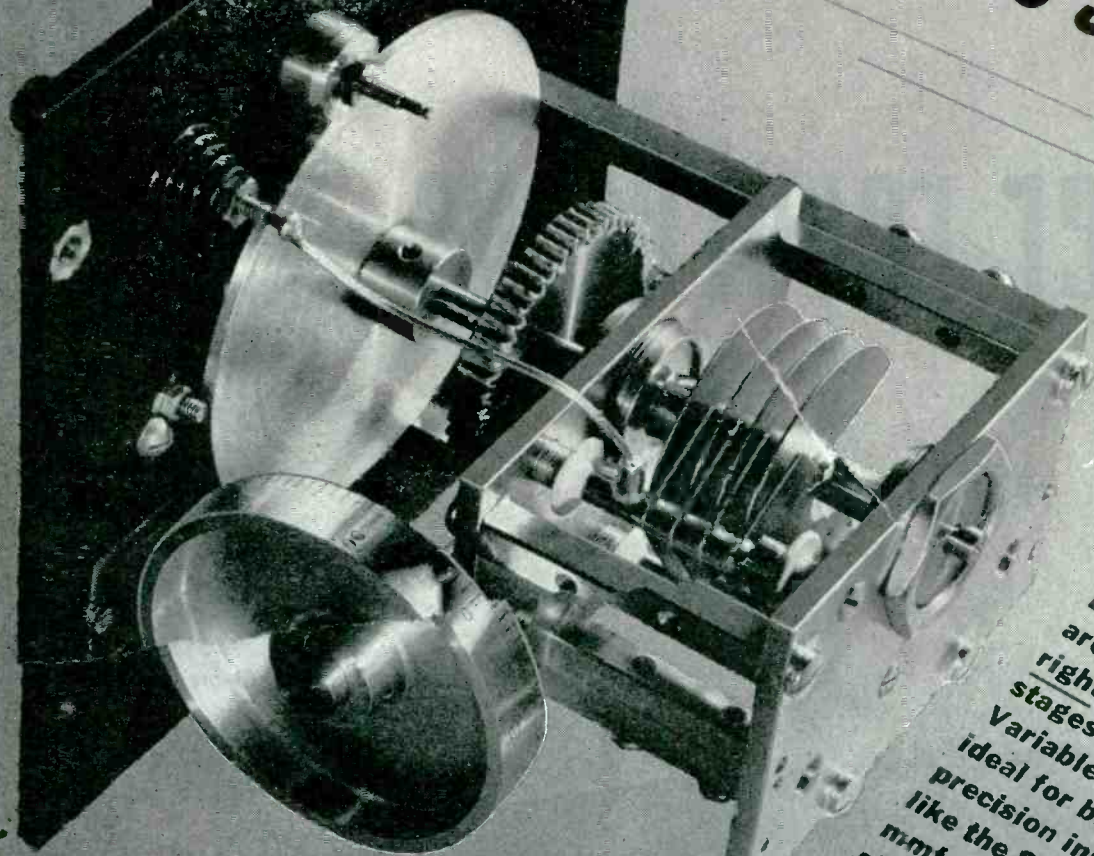

Because they are designed right in their early stages Hammarlund variables are ideal for building into precision instruments like the Standard 25 m.m.f. Capacitor shown in the illustration.

HAMMARLUND

THE HAMMARLUND MFG. CO., INC., 460 W. 34TH ST., NEW YORK 1, N.Y.
MANUFACTURERS OF PRECISION COMMUNICATIONS EQUIPMENT



ERIE CERAMICONS*

Superior
WARTIME PERFORMANCE
Dependable
for POSTWAR APPLICATIONS

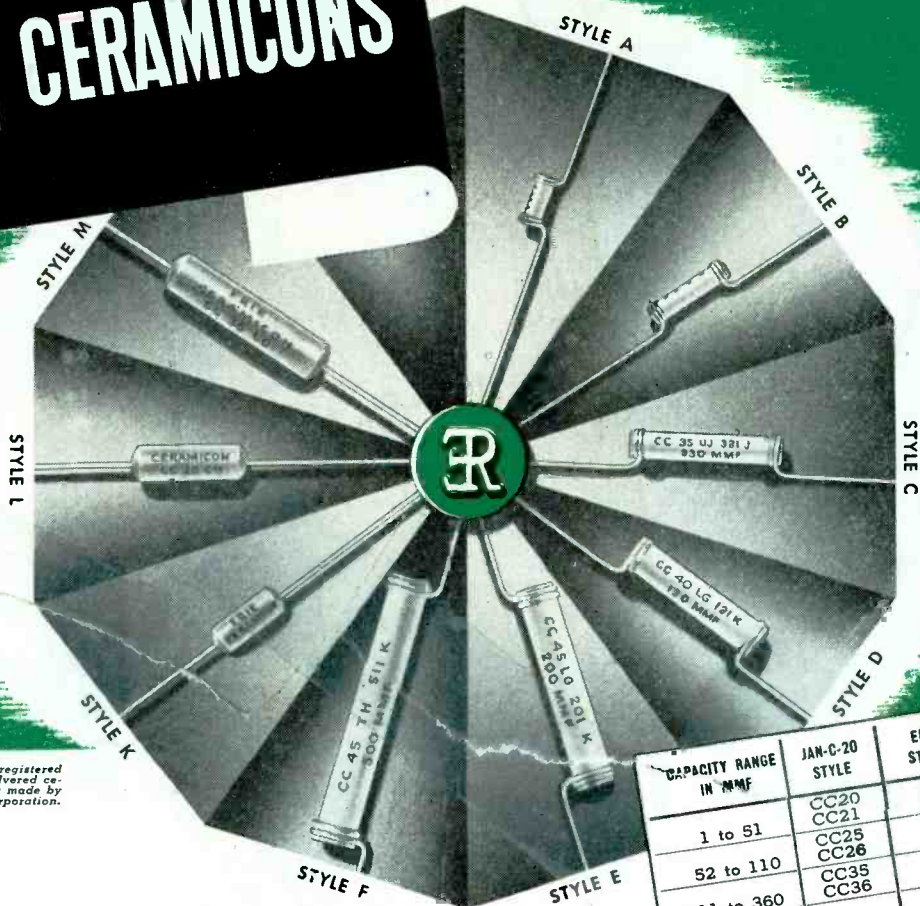

* Ceramicon is the registered trade name of silvered ceramic condensers made by Erie Resistor Corporation.

CHARACTERISTICS

CAPACITY RANGE IN MMF	JAN-C-20 STYLE	ERIE STYLE	MAXIMUM OVERALL DIMENSIONS
1 to 51	CC20 CC21	A K	.200 x .400 .250 x .562
52 to 110	CC25 CC26	B L	.200 x .656 .250 x .812
111 to 360	CC35 CC36	C M	.265 x 1.125 .340 x 1.328
361 to 510	CC40	D	.375 x 1.110
511 to 820	CC45	E	.375 x 1.660
821 to 1100	CC45	F	.375 x 2.00

as GENERAL PURPOSE CONDENSERS

The superior performance of Erie Ceramicons as general purpose condensers in wartime communications equipment assures their more than meeting your requirements for peacetime applications.

For general purpose use where a moderate degree of capacity change with temperature is permissible, JAN-C-20 characteristic "SL" should be given. If Erie designation is used, specify—"Any temperature coefficient between P100 and N750." These units will have a temperature coefficient between +150 and -870 parts/million/°C. Capacity ranges are shown in the table above.

For peacetime applications up to 375 MMF, where silver mica condensers are specified on prewar parts lists, zero temperature coefficient (NPO) Ceramicons will provide excellent stability and retrace characteristics. Standard temperature coefficient tolerance on these units is +30 parts/million/°C, as measured between +25° and +85°C.

In many cases, particularly in the lower capacity ranges, prompt shipments can be made from stock. Samples of these condensers in any desired capacity range will be sent on request.

Electronics Division

ERIE RESISTOR CORP., ERIE, PA.

LONDON, ENGLAND • • TORONTO, CANADA



Back the 7th
War Loan
Buy More Bonds

PLASTIC PARTS... *Post-Formed*



A New Production Technique

Recently developed methods of post-forming fully cured Formica laminated plastic sheets have adapted the material for very much wider use in a great many applications that were formerly thought impractical.

In this process the sheets are heated, and formed quickly with inexpensive wooden or Pregwood dies into many curved shapes.

Previously to secure such shapes it was thought necessary to mold the material in curing with the use of very elaborate and expensive steel molds—which were impractical for any but a few large volume applications.

This shaping method provides a very light (specific gravity 1.35) material, that is strong, stable in dimensions, inert chemically and therefore possessing a finish that is free from corrosion and long of life.

Formica engineers will be glad to tell you the story.



THE FORMICA INSULATION COMPANY, 4661 SPRING GROVE AVENUE, CINCINNATI 32, OHIO

New!

For improved rectifier service to broadcasters and industrial users

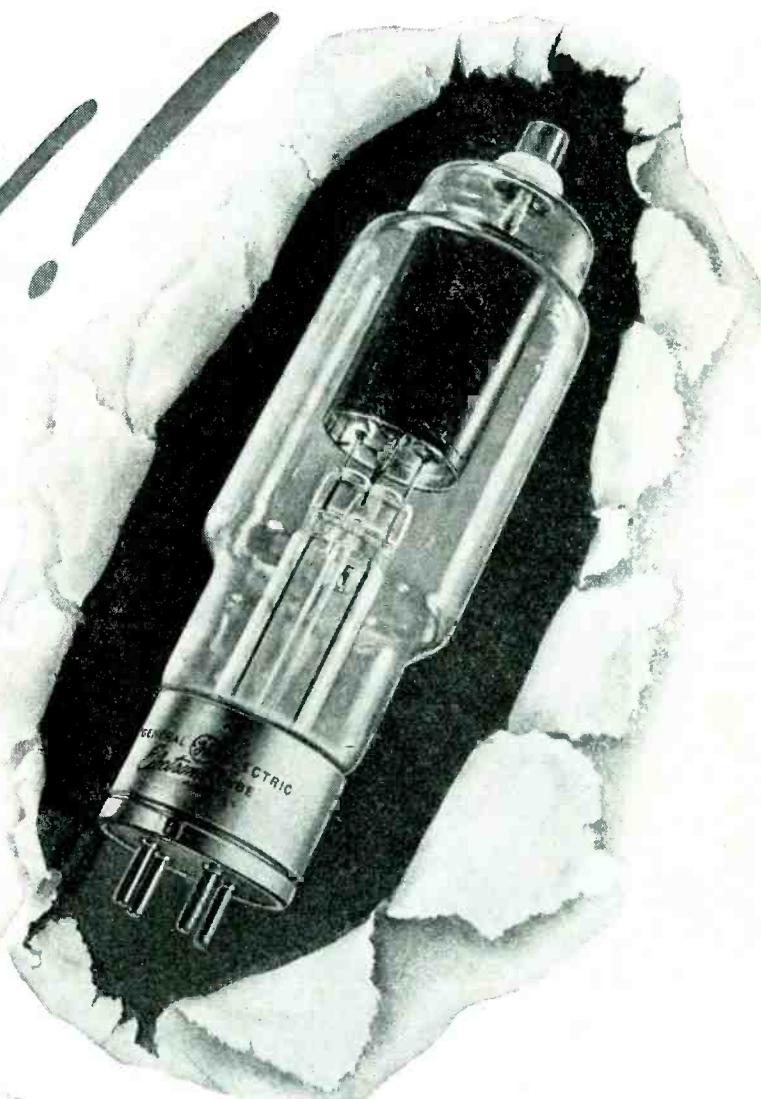

TYPE GL-673
PRICE \$30

es

General Electric offers you a tube that see the new hot-cathode, mercury-vapor rectifier tube with useful "in-between" ratings — priced economically — with a heavy-duty base giving large pin-contact area

Of interest to designers and operators of radio transmitters and of electronic heating equipment, G.E.'s new Type GL-673 hot-cathode, mercury-vapor rectifier occupies a useful position between rectifiers of the higher and lower ratings, as exemplified by Types GL-869-B and GL-872-A/872 respectively.

- **The base** with which the improved GL-673 is equipped is of the heavy-duty type, with large pin-contact area, increasing the dependability of performance.

- **The anode** is zirconium-coated nickel for the sake of more uniform quality in production, and to avoid

the gassing that occasionally results when carbonized nickel or graphite are employed.

- **The cathode** structure has been specially designed to withstand vibration and shocks in transit or in service.

- **A price of \$30** reflects the line production methods, employing newly designed equipment, found in G.E.'s modern tube factory. Telephone your nearest G-E office or distributor for further information on Type GL-673 or other tubes in G.E.'s complete line, or write to *Electronics Department, General Electric, Schenectady 5, N. Y.*

Characteristics of Type GL-673

Half-wave, hot-cathode, mercury-vapor rectifier tube for use in radio transmitting and industrial heating applications. 2-electrode type, convection-cooled. Height 10½", diameter 3". Filamentary cathode, with voltage 5.0 v, current 10.0 amp, typical heating time 30 seconds. Maximum anode ratings are: peak inverse voltage 15,000 v, instantaneous current 6.0 amp, average current 1.5 amp. Fitted with heavy-duty base affording greater pin-contact area.

Type GL-673 is recommended for new installations. However, if desired, the same tube will be supplied as Type GL-575-A with 4-pin jumbo base, for replacement use in existing equipment.

Hear the G-E radio programs: "The World Today" news, Monday through Friday 6:45 p. m., EWT, CBS. "The G-E All-Girl Orchestra," Sunday 10 p. m., EWT, NBC. "The G-E House Party," Monday through Friday, 4 p. m., EWT, CBS.

GENERAL ELECTRIC

161-DG-8880

Tomorrow's television broadcasters are visiting Schenectady *today*

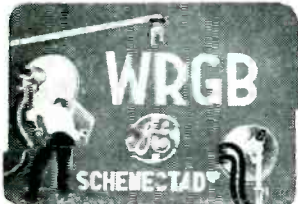

ADVERTISERS

ADVERTISING AGENCIES

PUBLISHERS

BROADCASTERS

INDUSTRIALISTS

**DEPARTMENT STORE
MANAGEMENT**

MOTION PICTURE EXECUTIVES

AT THE world's most powerful and best equipped television station, General Electric's WRGB in Schenectady, future telecasters from all over the United States and from many foreign countries are acquiring a knowledge of the actual equipment needed for producing the finest of television pictures. Here they are studying station operation and management, promotion, programming, and maintenance.

WRGB is a *complete* television broadcast station. It contains all

of the studio equipment necessary for modern television broadcasting, including workshops for building props, workshops for constructing experimental electrical equipment, dressing rooms for actors, transmitting and receiving equipment, studio control and monitoring equipment, film projectors. At WRGB you will have an opportunity to analyze the elements of your future television station and to discuss at length your plans with G-E experts — for the WRGB staff in-

cludes television specialists experienced in script writing, costume and stage set designing, lighting effects, camera operation, stage and technical direction, equipment design, maintenance, and operation.

If you have not yet seen General Electric television in action and are not yet making use of General Electric's 20 years of television experience, plan to visit WRGB at Schenectady—now. *Electronics Department, General Electric, Schenectady 5, N. Y.*

STUDIO AND STATION EQUIPMENT • TRANSMITTERS

GENERAL  **ELECTRIC**

156-D2-6912

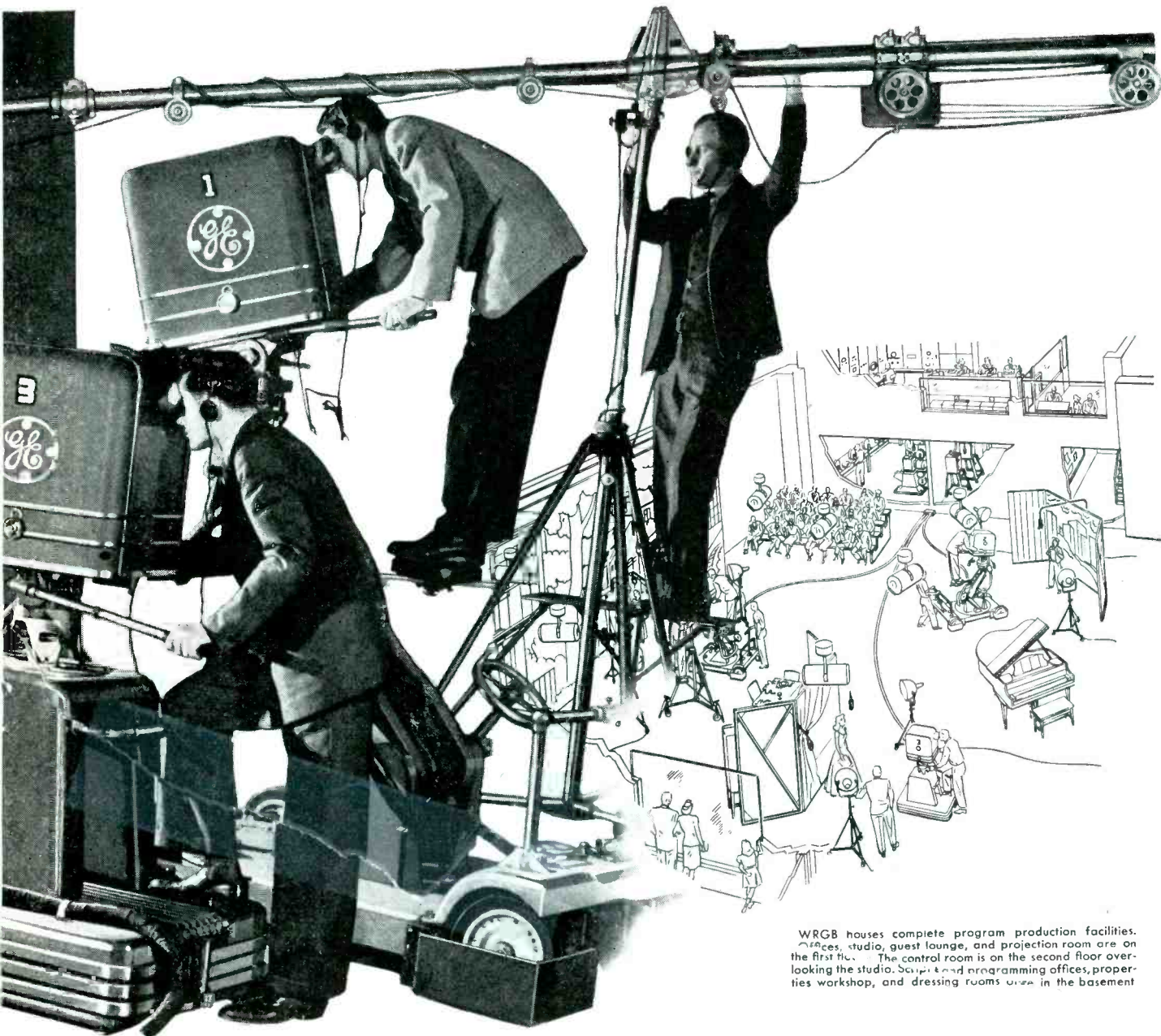

WRGB houses complete program production facilities. Offices, studio, guest lounge, and projection room are on the first floor. The control room is on the second floor overlooking the studio. Script and programming offices, properties workshop, and dressing rooms are in the basement.

PRODUCTION TECHNIQUE. At WRGB, programs are created, studied and analyzed. Every phase of show production is included—auditioning, casting, scene design, script writing, rehearsing, make-up, and lighting. Programming records, rich in experience, are available for your study. G. E. invites you to use them.

STUDIO AND TRANSMITTER EQUIPMENT. G. E. will have equipment for everything in television—from cameras and microphones to transmitting antennas and home receivers. G. E. can supply you with complete lighting, heating, air-conditioning and substation installations. General Electric is the only manufacturer who can offer this complete service.

AUDIENCE SURVEYS. WRGB checks audience reaction and establishes a rating for every show. The response from the television audience measures the success of WRGB's weekly features—reactions that provide abundant information which G. E. is gladly sharing with tomorrow's television broadcasters.

BUSINESS ASPECTS. Television is destined to become a great new industry that provides sales power unsurpassed by any other advertising medium. Every advertiser, manufacturer, and merchandiser is a prospective time-buyer. Estimates put the potential television audience at 48,000,000 people—twenty-four months after equipment production begins.

PLAN NOW to visit Schenectady to study G-E facilities. Every Wednesday and Friday are "open house" days. Write for the folder, "How to get to Schenectady," or see your G-E broadcast equipment representative. He will be glad to help you plan your visit. Electronics Department, General Electric, Schenectady 5, N. Y.

Establish a priority on delivery of your television equipment. Write for your copy of the "G-E Television Equipment Reservation Plan."

Hear the G-E radio programs: "The World Today" news, Monday through Friday 6:45 p. m., EWT, CBS. "The G-E All-Girl Orchestra," Sunday 10 p. m., EWT, NBC. "The G-E House Party," Monday through Friday, 4 p. m., EWT, CBS.

ANTENNAS • ELECTRONIC TUBES • HOME RECEIVERS

FM • TELEVISION • AM

See G.E. for all three!

These tubes team up to produce high frequencies for electronic heating

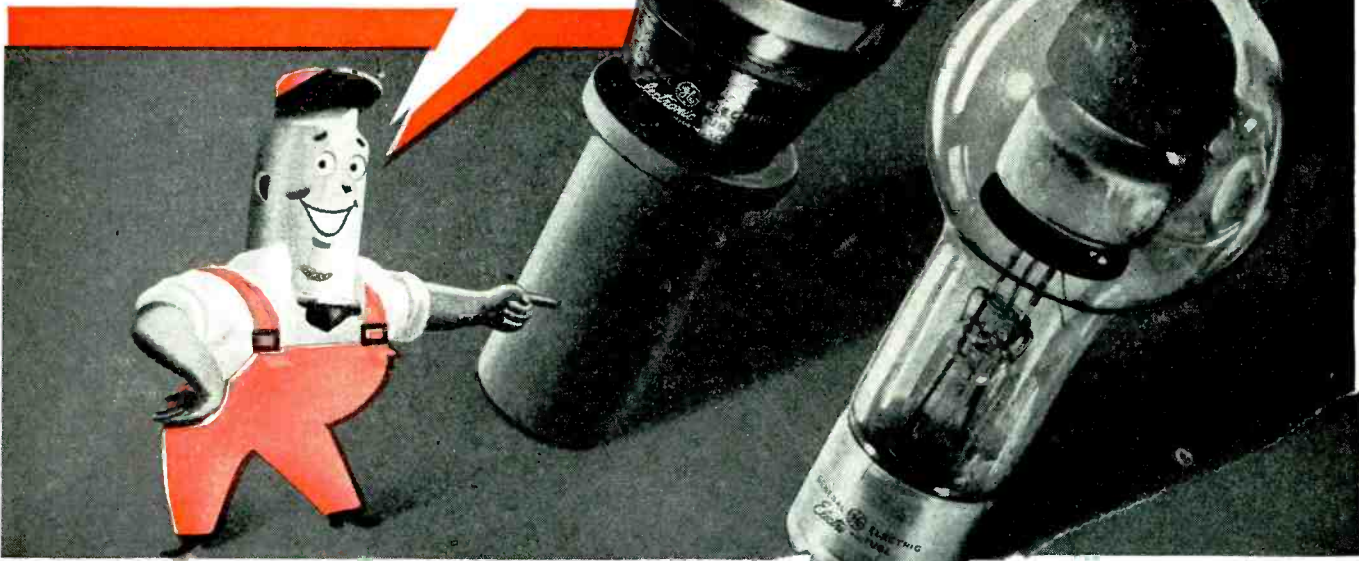

At left, above: Type GL-889-A high-frequency oscillator tube—price \$160. Right: Type GL-869-B mercury-vapor rectifier tube—price \$100.

TO produce the high-frequency current needed for electronic heating—the fast, precise method used widely in industrial processes—specify a G-E oscillator tube like the one shown on the left.

To change standard a-c power to the d-c used by the oscillator tubes, specify a G-E rectifier tube like the one shown on the right.

Whether your electronic heating design calls for induction heating (used for metals) or dielectric (for bonding plywood and treating other non-metallic materials) these two types of tubes are the heart of the equipment.

General Electric has engineered a wide variety of tubes for electronic

heating applications. All are backed by extensive research and broad field experience. All have been proved in service over substantial periods—give the solid performance so essential to meeting high production schedules.

Consult G-E tube engineers on all of your tube requirements. Also ask for your copy of the booklet "How Electronic Tubes Work." Your nearest G-E office or distributor will be glad to serve you, or you may write to *Electronics Department, General Electric, Schenectady 5, New York.*

Hear the G-E radio programs: "The World Today" news, Monday through Friday, 6:45 p. m., EWT, CBS. "The G-E All-Girl Orchestra," Sunday 10 p. m., EWT, NBC. "The G-E House Party," Monday through Friday, 4 p. m., EWT, CBS.

Characteristics of Type GL-889-A

Three-electrode vacuum oscillator tube. Its water-cooled anode suits Type GL-889-A for induction heating, where water-cooling generally is employed. Filament voltage and current are 11 v and 125 amp. Maximum anode ratings are: voltage 8,500 v, current 2 amp; input 16 kw, dissipation 5 kw. For dielectric heating, Type GL-889R-A is available with copper-fin radiator for forced-air cooling. Price \$280. Ratings are the same as those given for Type GL-889-A.

Characteristics of Type GL-869-B

Two-electrode mercury-vapor rectifier tube. Special filament design allows either in-phase or quadrature excitation. Filament voltage and current are 5 v and 18 amp. Anode ratings for in-phase operation are: peak voltage with natural ventilation 10,000 v, with forced ventilation 20,000 v, peak current 10 amp, avg current 2.5 amp. For quadrature operation: peak voltage (forced ventilation) 15,000 volts, peak current 15 amperes, avg current 5 amperes.

G. E. HAS MADE MORE BASIC ELECTRONIC-TUBE DEVELOPMENTS THAN ANY OTHER MANUFACTURER

GENERAL ELECTRIC

162-010-8850

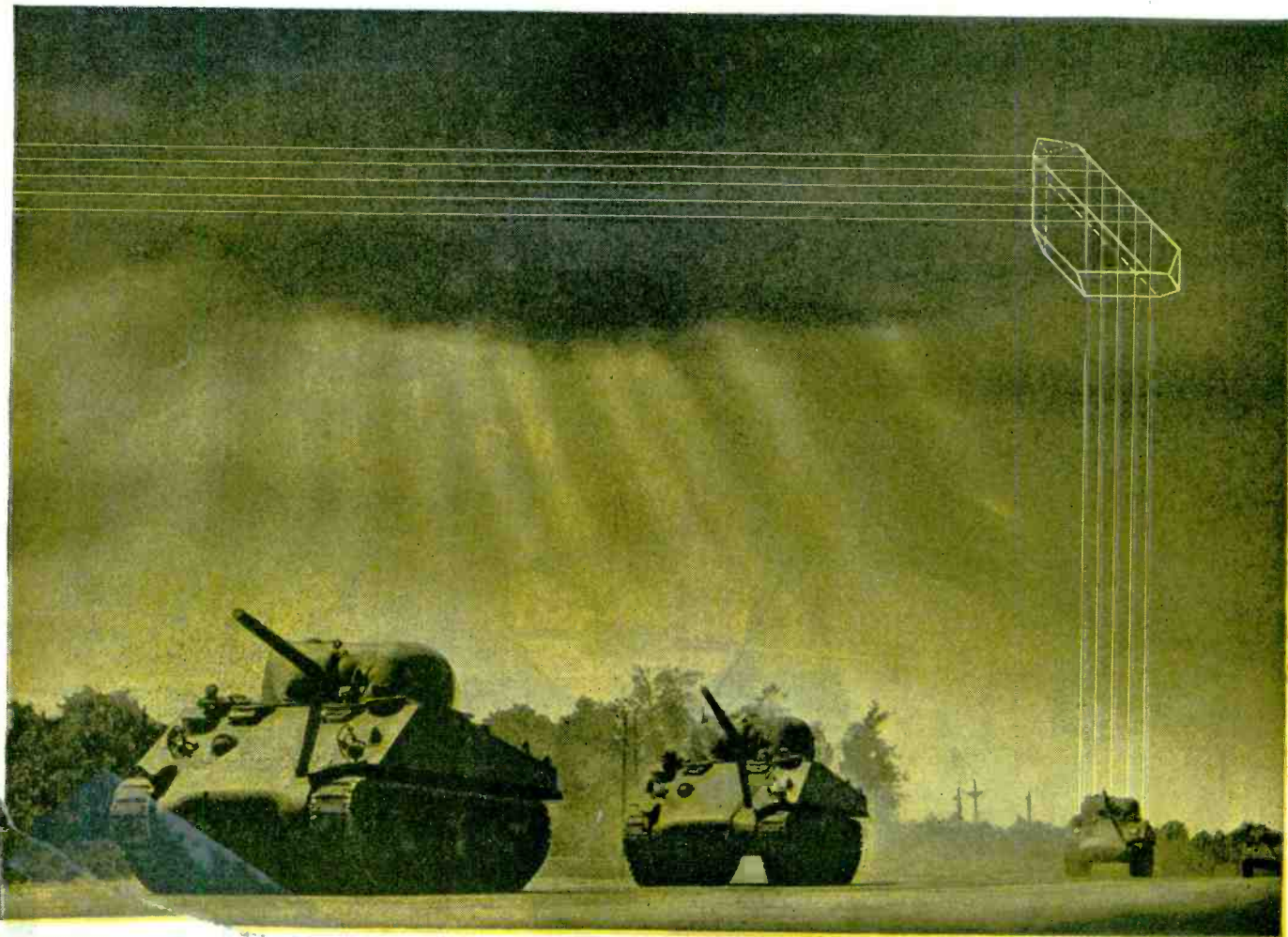

War babies with glass eyes

These are the M4 tanks—30-ton war babies that find their enemy through the glass eyes of their fire control instruments and then shoot straight. Accurate optics for these and many other American tanks have been coming out of our plant in record quantities to meet urgent Army demands.

Keeping pace with the unusual speed of American tank production, while still maintaining the highest optical standards, is but one of the many jobs that is sharpening our skills for peace.

When the rush of war work is over, our compact group of precision lens specialists will be able to give you finer

optics and faster ways to produce ~~of~~ constantly finding better stiffest specifications. ~~to meet the~~

That's why the Army and Navy keep coming to us with many of their most exacting optical problems. And that is why you will find the kind of service you need here when you are ready to manufacture peacetime optical or electronic products. For we specialize in working for others. We make nothing but optical components—no complete products of our own.

We will be able to give postwar manufacturers production with precision, quality with economy and original ideas based on sound scientific principles.

for precision OPTICS come to

AMERICAN LENS COMPANY, INC.

45 Lispenard Street, New York 13, N. Y.



LENSES • • • PRISMS • • • FLATS • • • REFLECTORS

The TINYMITE

SMALLEST PAPER
CAPACITOR - - -

yet 100%

MOISTUREPROOF

TYPE
P5N

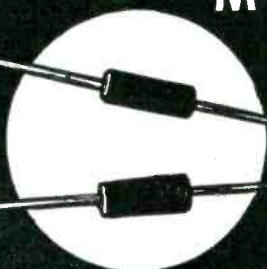

TYPE
P4N

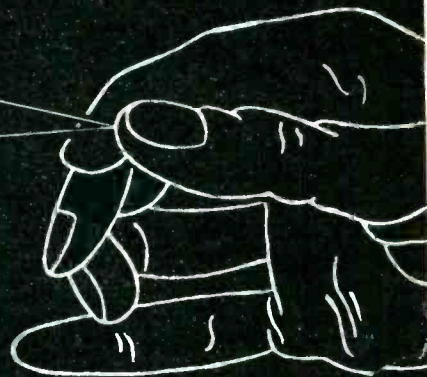

FEATURES

1. Bakelite Resin Ends. Lead wire cannot
pull out even under hot conditions.
Non-inductive.

2. Excellent Temperature Coefficient.
3. Excellent Temperature Coefficient.
4. Very high leakage Resistance.
5. Fine Power-Factor.
6. Range from 20 MMFD to .25 MFD.
From 150 volts to 600 volts.
7. Types P4N, P5N for 100% humidity operation.
8. Types P4, P5 for 95% humidity operation.

Samples and price list on request

Pat.
Pend.

BUY EXTRA WAR BONDS . . .
. . . 'TIL THE WAR IS OVER

DUMONT ELECTRIC CO.

MFR'S OF
CAPACITORS FOR EVERY REQUIREMENT
34 HUBERT STREET NEW YORK, N. Y.

**SIMPLE—
ISN'T IT?**

*— yet, sealed
for all time!*

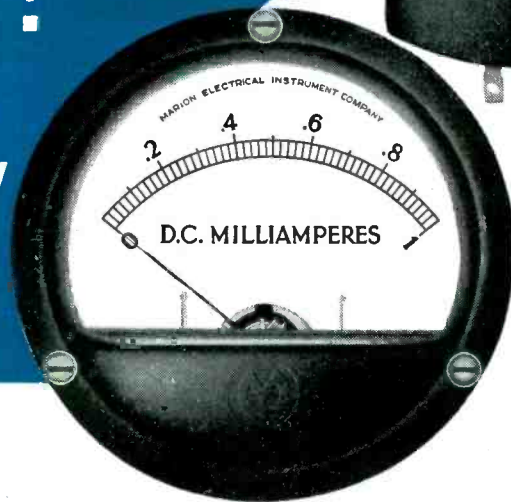

MARION

***Glass-to-Metal Truly Hermetically Sealed
2 1/2" and 3 1/2" Electrical Indicating Instruments***

A One-piece drawn steel cup-shaped case with high frequency induction soldered Kovar glass bead terminals. Black phosphate finished to meet 200 hour salt spray test.

B Marion Alnico magnet and moving system, with hardened beryllium copper instrument frame.

C Lithographed metal scale plate, individually printed.

D Double thickness glass window with Corning Glass Works metallized band on rim — high frequency induction soldered to steel case.

E Aluminum cover plate and flange, with anodic black satin finish.

"How is it done?" — this is the question on the tongues of hundreds of engineers from coast-to-coast. A simple basic design in conjunction with electronic production methods is the answer. And with it comes the final solution to the problem of completely tropicalizing electrical indicating instruments. There are no rubber gaskets and no cement seals. These instruments can be immersed in boiling brine or frozen in a cake of ice, for weeks, without deterioration of their seals or harm to their operating efficiency. And they are positively interchangeable: Type HM 2 with AWS Types MR 24 and 25 and Type HM 3 with AWS Types MR 34 and 35. Available in all DC ranges, for present or postwar applications. Write for additional information.

SPECIAL NOTE: Marion Glass-to-Metal Truly Hermetically Sealed Instruments cost no more than standard unsealed instruments.



MARION ELECTRICAL INSTRUMENT CO.
MANCHESTER, NEW HAMPSHIRE

ONE TO GO!

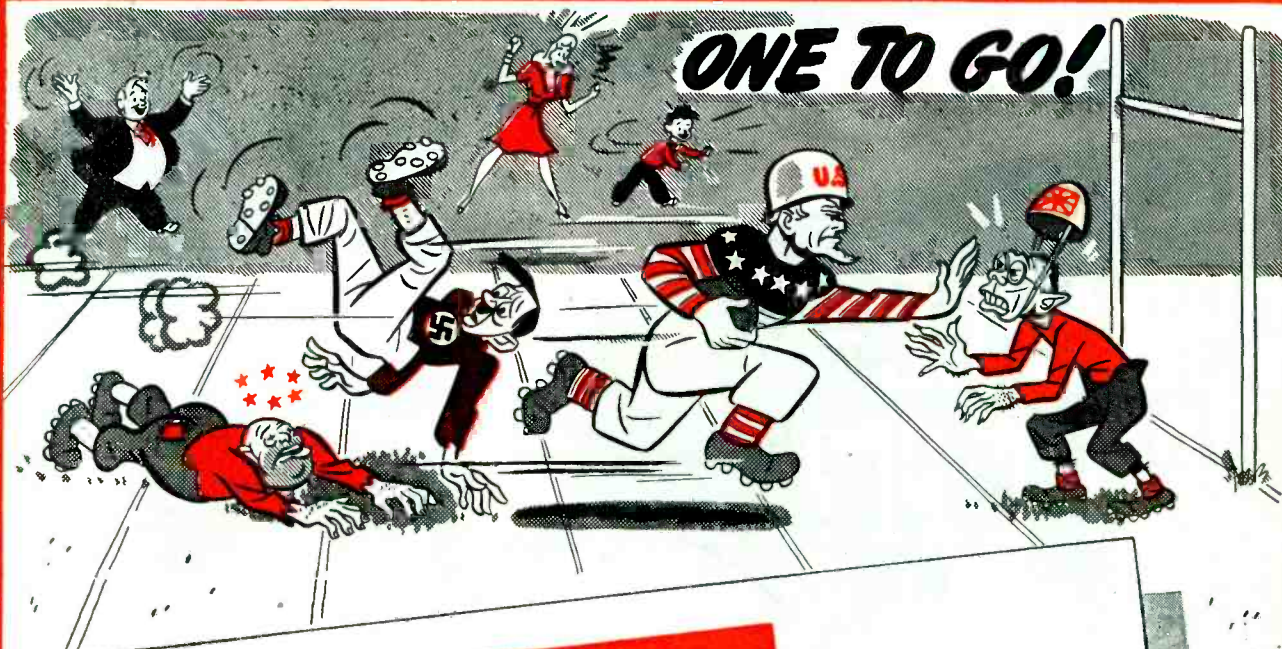

V-E DAY

To All Hytron Employees:

Put yourself in the shoes of that friend of yours who is now a combat infantryman fighting Japs. How is he going to feel on V-E Day?

Sure, he is going to be pleased and proud that the Nazis have got the thrashing they asked for -- but his joy in that Victory is going to be overshadowed by the grim realization that he has a long, hard fight ahead.

All of us at Hytron will have a tough job ahead, too, after Victory in Europe. The production demands of the Navy alone for the Jap war are staggering. The tubes we are producing will go far toward making possible the bombing raids, the bold fleet actions, the many invasion thrusts that will bring Japan to her knees.

GI Joe will have no time out for celebrations. He doesn't want that now. He wants to finish the job, so that he may come home and join with us all in a real celebration.

The management feels that we, too, have no time to spare -- will have none to spare until final Victory is won. Hytron plants will not close down on V-E Day.

Those boys overseas expect us to keep on backing them up; the management believes you want to do just that. On V-E Day -- and until V-J Day -- let us all give vent to our enthusiasm by redoubling our production efforts for final Victory.

Bruce A. Coffin
Bruce A. Coffin
General Manager

Post: 3-31-45
Remove: After V-E Day



OLDEST EXCLUSIVE MANUFACTURER OF RADIO RECEIVING TUBES

HYTRON

RADIO AND ELECTRONICS CORP.

MAIN OFFICE: SALEM, MASSACHUSETTS
PLANTS: SALEM, NEWBURYPORT, BEVERLY & LAWRENCE

FORMERLY HYTRON CORPORATION

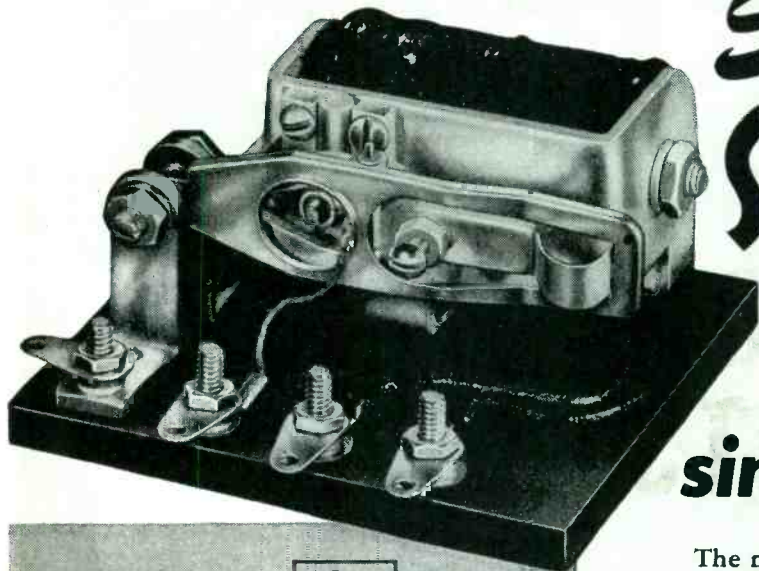

Sensitive **SNAP-ACTION**

**...in a new,
simplified design**

The new, simplified construction of the Struthers-Dunn Type 79XAX Sensitive Snap-Action Relay makes it particularly suitable for a wide range of applications because of its ease of adjustment. Snap-action design assures full normally-closed and normally-open contact pressures. Erratic operations and varying contact resistance encountered with ordinary sensitive relays, due to slowly changing coil flux balancing armature spring tension, are eliminated.

The armature of the 79XAX almost completes its travel in either direction before the contacts snap into the new position. This feature permits an unusually broad range of use from vacuum tube circuits, to overcurrent protection, pulsing circuits, and jobs where extremely close differential or extreme sensitivity of operation is required.

The standard adjustment using 60 ampere turns in the coil at approximately .02 watts results in contact pressures of 5 grams with contacts rated 5 amperes, 115 volts a-c; or 0.5 amperes, 115 volts d-c, non-inductive. Contact ratings up to 10 amperes, 115 volts a-c may be obtained with 100 or more ampere turns and a corresponding increase in power. A sensitivity of 0.005 watts, with 30 ampere turns, is obtainable with reduced contact pressures and ratings, and at an increase in price of the unit.

STRUTHERS - DUNN INCORPORATED
1321 ARCH STREET, PHILADELPHIA 7, PA.

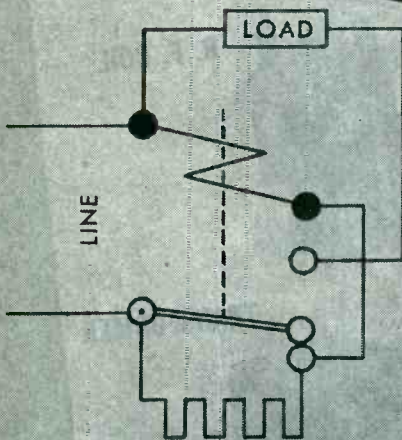

A TYPICAL CLOSE DIFFERENTIAL APPLICATION

In using the Struthers-Dunn 79XAX Relay, extremely close differential between pick-up and drop-out may be obtained for potential operation as shown above. The resistor is chosen so that, when the armature closes, the coil current is automatically reduced to a value just sufficient to hold it closed. Any further decrease in voltage will cause the relay to return to its normal de-energized position as shown.

STRUTHERS-DUNN

5,312 RELAY TYPES

DISTRICT ENGINEERING OFFICES: ATLANTA • BALTIMORE • BOSTON • BUFFALO • CHICAGO • CINCINNATI • CLEVELAND
DALLAS • DENVER • DETROIT • HARTFORD • INDIANAPOLIS • LOS ANGELES • MINNEAPOLIS • MONTREAL
NEW YORK • PITTSBURGH • ST. LOUIS • SAN FRANCISCO • SEATTLE • SYRACUSE • TORONTO • WASHINGTON

SUPER ELECTRIC

FOR

TELEVISION COMPONENTS

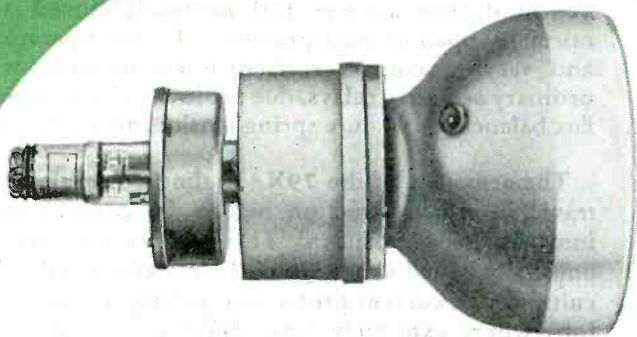

Our work in the field of television is partly suggested in the components shown here.

We offer you a complete service — from laboratory through manufacturing. Call on our engineering department to collaborate with you.

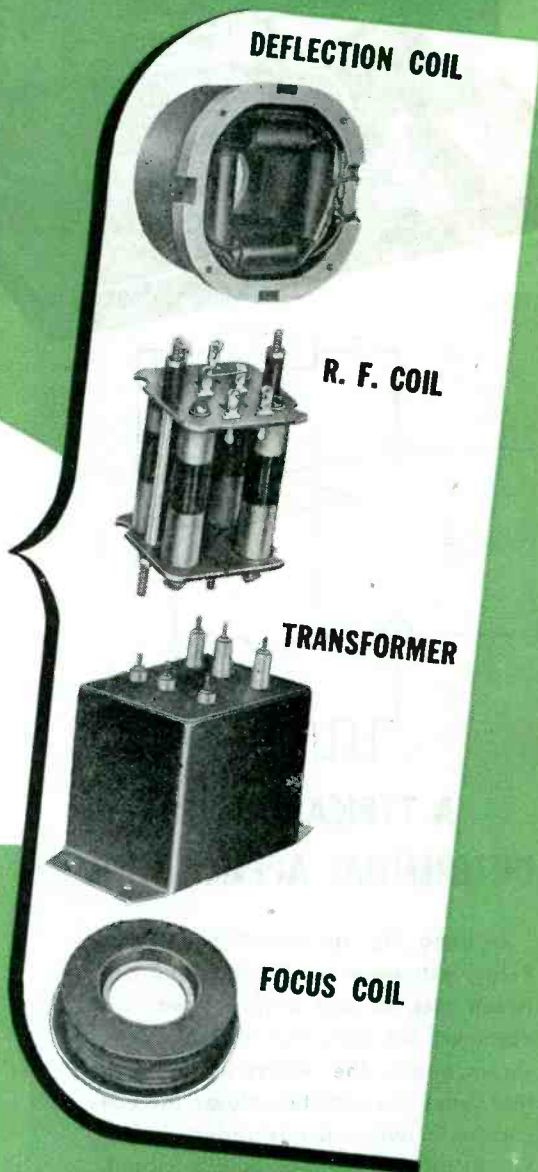

SUPER ELECTRIC PRODUCTS CORP.

1057 Summit Avenue

Jersey City, N. J.

R. F. COILS • TRANSFORMERS • SPECIAL WINDINGS



WHAT ABOUT FM?

Frequency Modulation poses obvious problems in the design and building of loud speakers and loud speaker systems. The answers to these problems are not simple; but research and precise engineering based on long experience in and knowledge of audio-acoustics, will result in a complete postwar line of JENSEN speakers to meet the most particular requirements of FM. Other new and special loud speaker applications will be met just as satisfactorily with other JENSEN postwar products, some of which will employ the new JENSEN **ALNICO 5**.

To help the service man, dealer and engineer solve the special problems of FM sound reproduction, JENSEN has made available technical Monograph No. 3, entitled, "Frequency Range in Music Reproduction." This Monograph, one of a series of four, is available for 25c.

Other Monographs

- No. 1—"Loud Speaker Frequency-Response Measurement"
- No. 2—"Impedance Matching and Power Distribution"
- No. 4—"The Effective Reproduction of Speech"



Jensen
SPEAKERS WITH

ALNICO 5

Specialists in Design and Manufacture of Acoustic Equipment

JENSEN RADIO MANUFACTURING COMPANY, 6601 SOUTH LARAMIE AVENUE, CHICAGO 38, ILLINOIS

21

GREAT COMPANIES TURN TO

VIBRASHOCK*

ADMIRAL CORPORATION

AIRADIO, INCORPORATED

BELL LABORATORIES

BENDIX RADIO DIVISION

BRUSH DEVELOPMENT COMPANY

COLLINS RADIO COMPANY

ECLIPSE-PIONEER DIVISION

FREED RADIO CORPORATION

GALVIN MANUFACTURING COMPANY

GENERAL ELECTRIC COMPANY

INTERNATIONAL DETROLA CORP.

MEMOVOX, INCORPORATED

NATIONAL BROADCASTING COMPANY

PHILCO CORPORATION

RADIO CORPORATION OF AMERICA

REMINGTON RAND, INC.

SPERRY GYROSCOPE CO., INC.

STEWART-WARNER CORP.

WESTERN ELECTRIC CO., INC.

WESTINGHOUSE ELECTRIC &
MANUFACTURING COMPANY

ZENITH RADIO CORPORATION

These companies, leaders in developing and manufacturing airborne equipment, have discovered in Vibrashock what efficient vibration control can do when applied to their products. Operational and maintenance difficulties have been eliminated.

Consider the conditions to which delicate flight instruments, gun cameras, airborne radio and electronic equipment are exposed. The complex vibration found in the modern high-powered airplane posed a problem not hitherto encountered by these companies.

Robinson engineers were ready with the solution to this problem, offering a radically different method of isolating airborne equipment from vibration and shock — one that could guarantee better than 90% absorption of vibration throughout the entire operating range of aircraft.

Let Robinson engineers assist in solving your vibration problem.

*Trade Mark

ROBINSON AVIATION, INC.

730 Fifth Avenue, New York 19, N. Y.
3757 Wilshire Blvd., Los Angeles 3, Calif.

MASTERS OF PRECISION

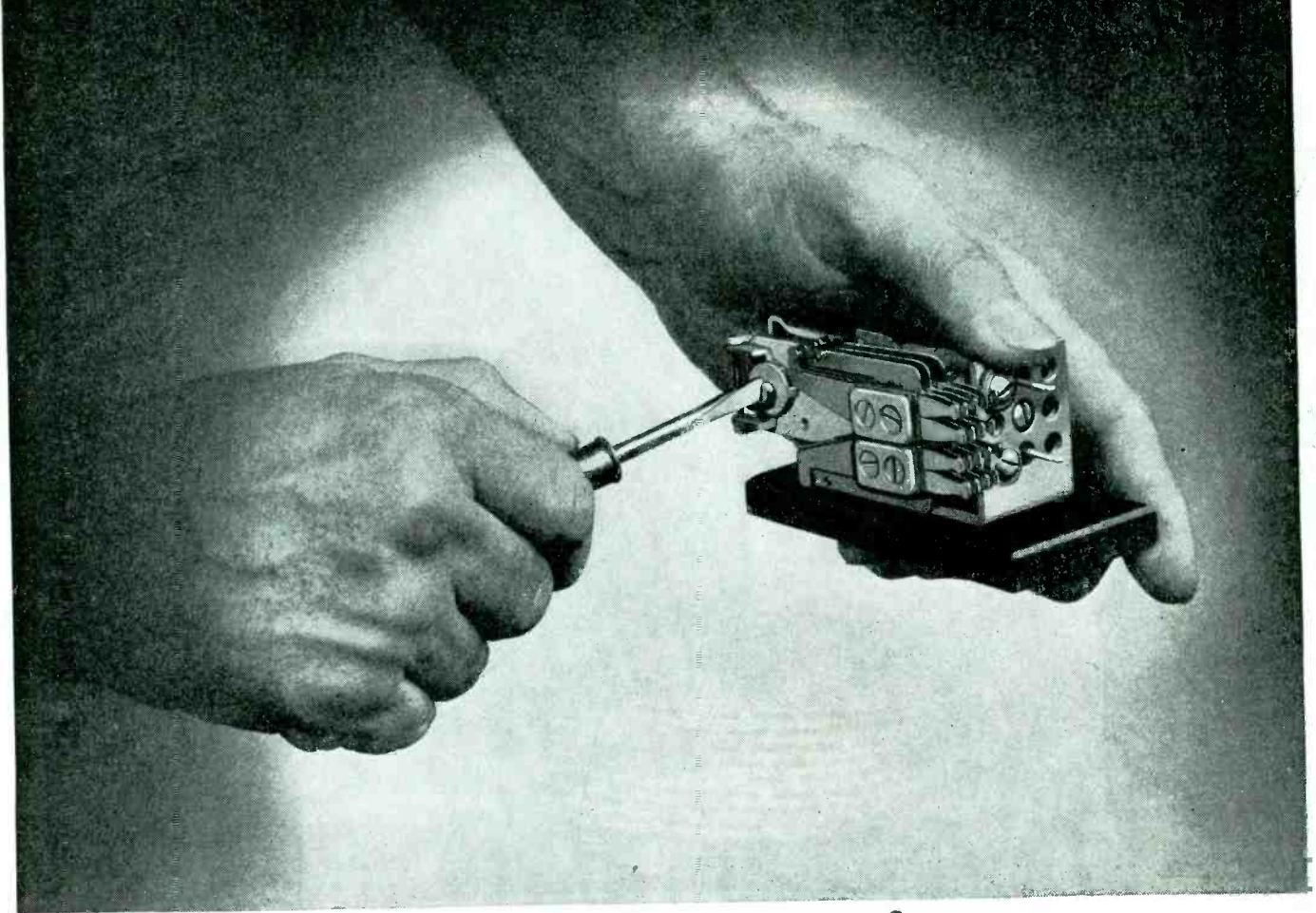

Meeting Rigid Specifications for Dependable Metals

Producing "tailor-made" metals for products built to exacting standards is everyday procedure for Western Brass Mills. One of these metals, Super-X Nickel Silver, is meeting many rigid individual specifications for a wide variety of vital functional uses.

If your needs call for an alloy that can be

blanked, drawn, spun, formed, machined or pierced, use Super-X Nickel Silver.

Our mills are conveniently located at East Alton, Ill. and New Haven, Conn. We would appreciate an opportunity to discuss your requirements for Nickel Silver and other copper-base alloys.



WESTERN BRASS MILLS

DIVISION OF OLIN INDUSTRIES, INC.

East Alton, Illinois



BRASS • BRONZE • PHOSPHOR BRONZE • NICKEL SILVER • COPPER

LONGEVITY

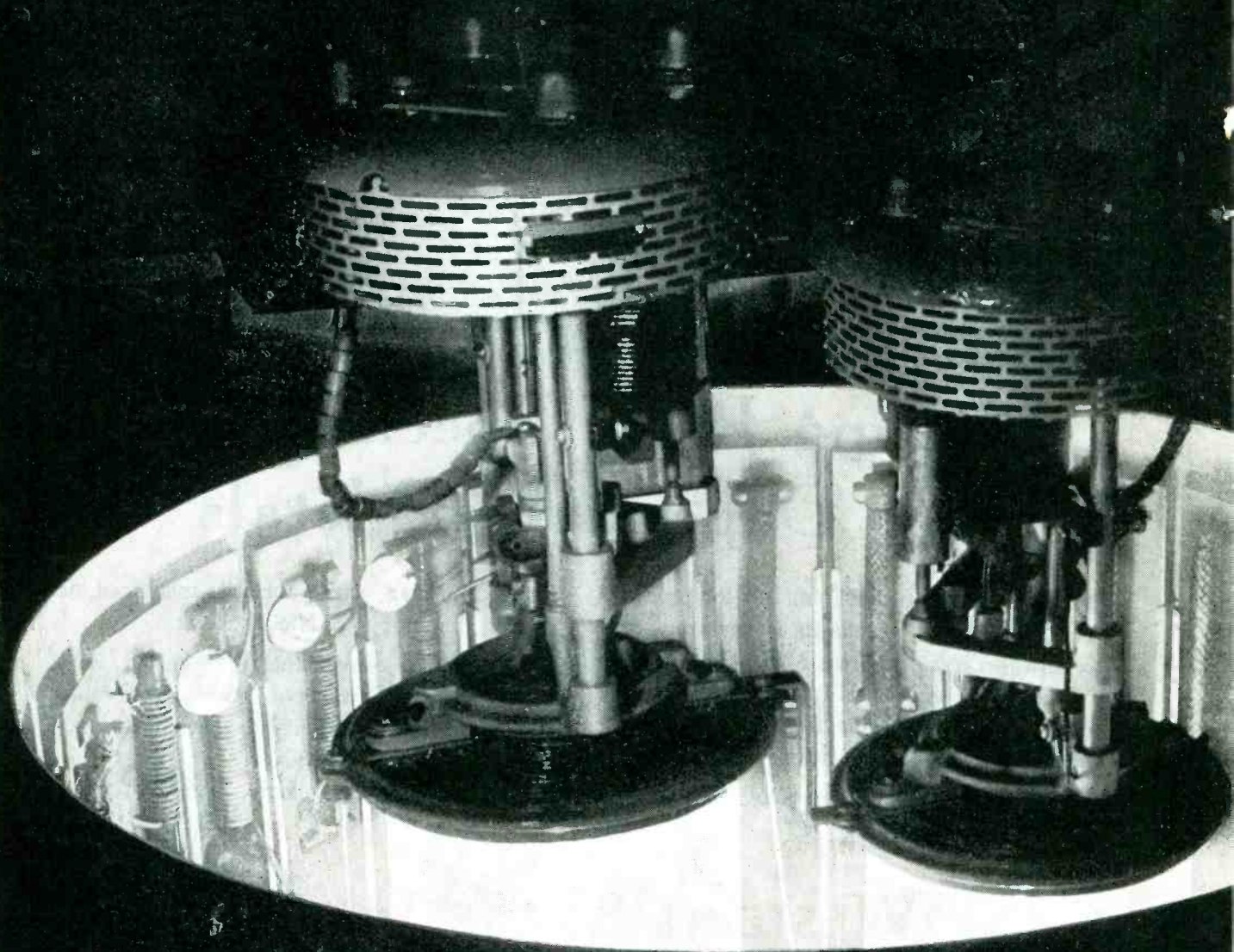

Here, the moisture-permeability of a synthetic is tested in the "Weatherometer", a device which accurately measures the relative time-resistance of various insulating materials to the most damaging elements of weather:—ultra-violet rays, wind, moisture.

OF PRODUCT

Accelerated laboratory "punishment," plus decades of test-yard exposure, cross-check each creative advance through General Cable Research.

Can the inevitable slow deterioration of electrical wires and cables through age and exposure be made 50% slower? Active seeking for such an attainment continues throughout the years of General Cable Research. Now, with ultra-modern sub-zero and tropical temperature cabinets at command — with salt air, acid earth and all other destructive conditions accurately reproduced in the laboratory and its auxiliary test-yard, the search for ultimate longevity strides constantly ahead. From the discoveries of methods such as this are better specifications written, better products born, and the Company's legend "A Standard of Quality for over Half a Century" steadily translated into fact.

GENERAL CABLE CORPORATION



*Manufacturers of Bare and Insulated Wires and Cables
for Every Electrical Purpose*

Federal ANNOUNCES ITS *Industrial Tube Policy*

BECAUSE of the totally different and unusually severe operating conditions that have to be met by power tubes used in industrial heating equipment

— in installation and maintenance by personnel unfamiliar with vacuum tubes,

— under operating conditions involving extreme variations in load during processing and between operations... the shocks, jars, vibration due to nearby presses, punches, drilling machines,

Federal ANNOUNCES ITS *Industrial Tube Policy*

ALL Federal Industrial Tubes . . .

- ☐ will be specifically proportioned for industrial use.
- ☐ will have *ample* factors of safety for long life and economy under the severe operating conditions met in industrial service.
- ☐ will be of *rugged mechanical design* to meet the requirements of industrial installation and operation.
- ☐ will carry a *full guarantee* against defective materials and workmanship for 18 months after date of shipment, or *2000 hours effective life**, whichever occurs first, when operated under rated conditions, as against the *1000 hours effective life** rating, the common practice in rating ordinary tubes.

**Federal recognizes that in many industrial applications tubes will be operated with filament power only, for a considerable portion of the time. For this reason effective tube*

life will be computed as the sum of the hours with filament and plate power applied, and 20% of the hours with only filament power applied.



Federal Telephone and Radio Corporation



Newark 1, N. J.

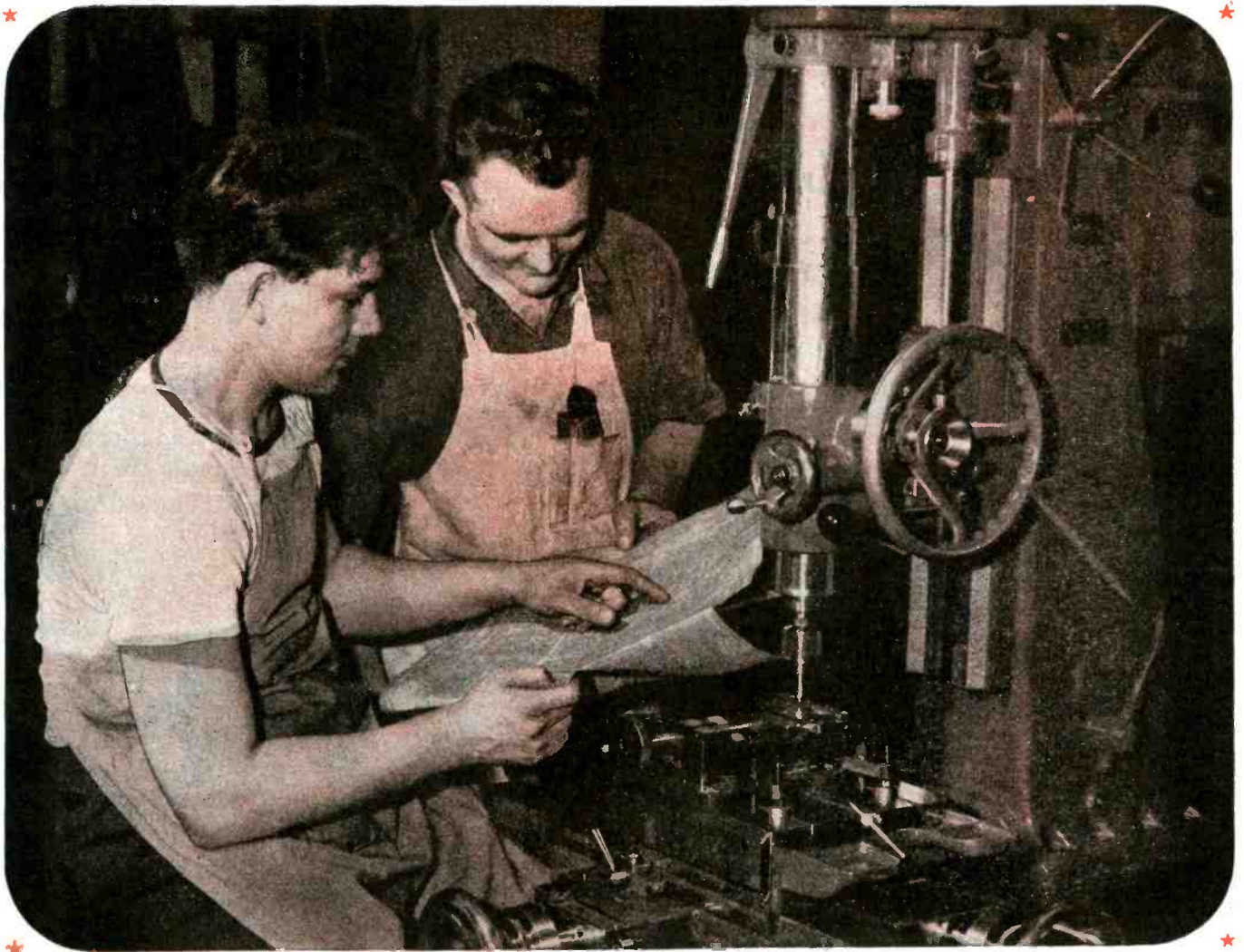

The Men that Know "HOW" and "WHY"

PUT OUT MORE PRODUCTION . . . WITH LESS WASTE !

At your Service . . .

ALLEGHENY LUDLUM'S FILM LIBRARY

Instructional films on tool and stainless steels—some in full color, all with sound—available for free showings by companies, trade & industrial groups, student training courses, technical schools and colleges, etc., upon request.

WRITE FOR DETAILS

ADDRESS DEPT. E-33

THE special high-alloy steels take more knowing than ordinary materials, that's sure. But they also *give* you more—so much more that their uses have taken one of the steepest upward climbs of any class of materials in recent years.

Electric furnace steels are on the march. Our principal special steel products—corrosion and heat-resisting alloys, tool and die steels, electrical, valve and nitriding steels—have been among those in keenest demand for war use. They're also products which offer you the greatest future promise.

As pioneers and originators in these fields, we have the data your

engineers and designers need, and the working information for your shopmen to handle special steels well and speedily. Let us help you.



Allegheny Ludlum

STEEL CORPORATION

GENERAL OFFICES: BRACKENRIDGE, PENNA.

W&D . . . B-9332

HOW EXCELLENCE IS BUILT INTO .

Battery of Capacitance Measuring Instruments



SANGAMO ELECTRIC

ESTABLISHED 1898 . . . MICA CAPACITORS . . .

SANGAMO MICA CAPACITORS

Checking Capacitance

Excellence as reflected in the quality of mica capacitors is the result of advanced manufacturing techniques and constant vigilance, coupled with scientific measurements, frequent checks and inspections. Such advanced methods and techniques are incorporated as an integral part in the manufacture of Sangamo Mica Capacitors.

Advanced manufacturing techniques necessarily include precision equipment operated by trained skillful operators. While a great variety of accurate measuring equipment is commercially available, for the most part Sangamo has designed, developed, and built much of the test equipment used in testing capacitors in various stages of manufacture.

In the step checking, that is, the frequent checking of units at various stages of their manufacture, the equipment used is of particular importance. In many instances variations of only a few parts in a million mean the difference between a quality product and one that would not function satisfactorily. It is obvious that such testing equipment must be interchangeable, and identical readings must be obtained on each of the many pieces of apparatus which may be used in the processing of a single capacitor unit. It is also necessary that this equipment be designed for production operation and be capable of long, hard use without deviation in accuracy. Further, it is essential that such checks be made under conditions of controlled temperature and humidity. For this reason, Sangamo Capacitors are manufactured in completely air-conditioned departments. This eliminates undesirable moisture from the operators' fingers and prevents, in a large measure, the absorption of moisture from the atmosphere. Thus, excellence in quality as incorporated in Sangamo Capacitors is the result of careful planning and accurately controlled production methods.

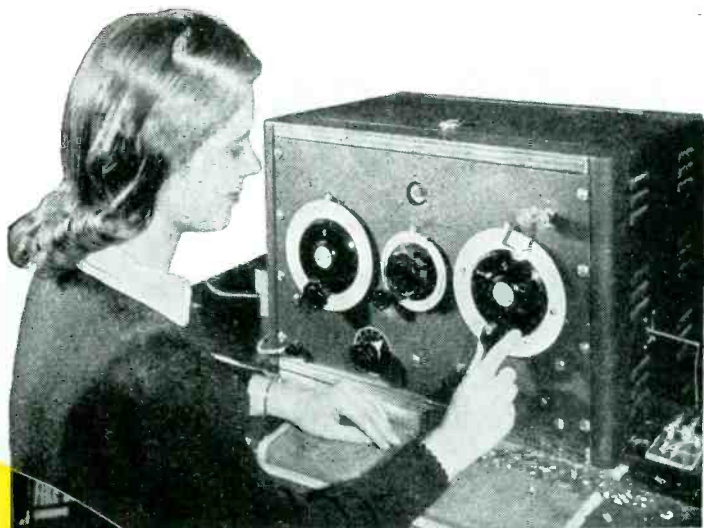

● Here, capacitance of silvered mica lamination used in the manufacture of Sangamo Mica Capacitors is measured on Sangamo built equipment. Extremely accurate calibration of each individual lamination insures a resultant capacitance within prescribed limits.

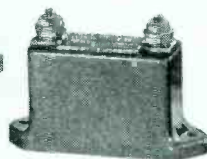
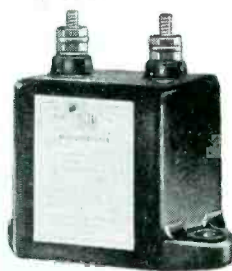
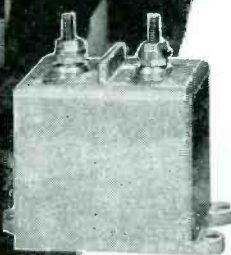
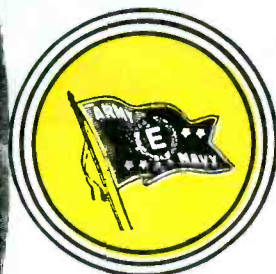
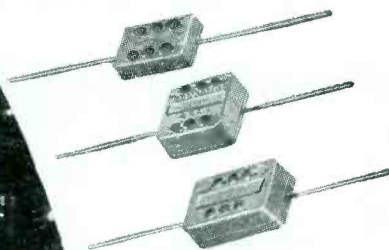

COMPANY **SPRINGFIELD**
ILLINOIS

• • WATT HOUR METERS • • • TIME SWITCHES • • •

FM Station WSBF uses from



Left— The control room in the studios shared by FM station WSBF and AM station WSBT. Two RCA 76-B2 Consolettes handle the output of two studios. A master control console (center) provides monitoring and switching of outgoing lines to the two transmitters. The RCA 70-C Turntables may be seen in the foreground. In the studios RCA 44-BX Microphones are used.

Below— The FM-10-A Transmitter at WSBF is installed in the center of the operating room. This 10 KW Transmitter, presently operated at reduced power, will resume operation at full-power rating as soon as wartime restrictions are lifted. To the left and right of the FM transmitter are racks containing the AM and FM monitors; and beyond them, at either end, are the main and standby transmitters of WSBT.

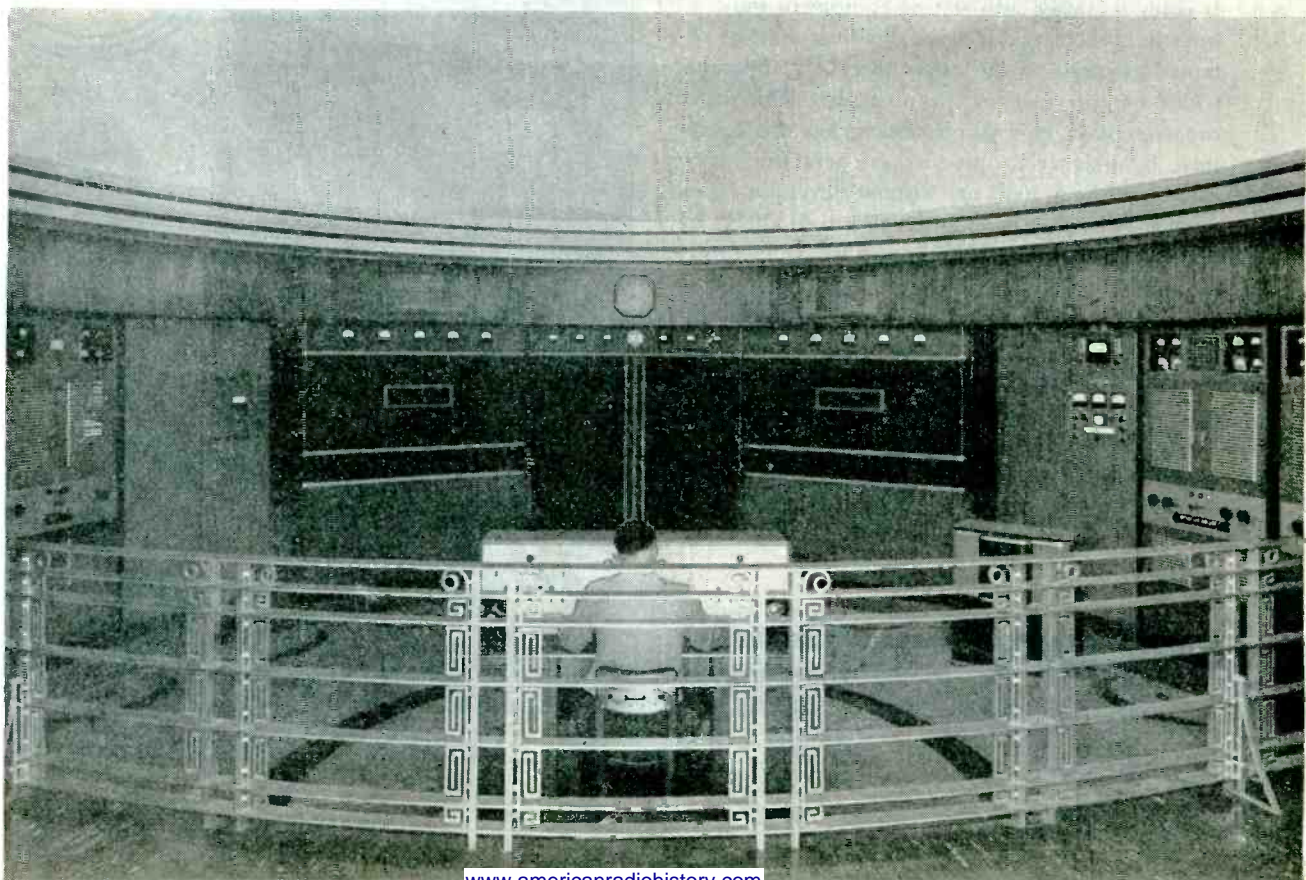

RCA Equipment

Microphone to Antenna



WSBF, the FM station of the South Bend Tribune, uses RCA equipment throughout. In the studios are RCA 44-BX Microphones; in the control room are RCA 70-C Turntables, RCA 76-B Consolettes and a special RCA-built master control console. At the transmitter building are an RCA FM-10-A Transmitter and RCA frequency and modulation monitors. The antenna is an RCA-developed four-bay turnstile using concentric feeders.

WSBF is a sister station of WSBT, the AM station operated by the South Bend Tribune. It is interesting to note that WSBT, like hundreds of other AM

stations is also completely RCA equipped. Operators of AM stations know the meaning of "RCA all the way." And they know that in RCA FM equipment they will find the same dependability and the same advanced design features that they have come to expect in RCA AM equipment.

Operators of both AM and FM stations—and station applicants—can make reservations right now for early delivery of RCA postwar broadcast equipment. For information on our Broadcast Equipment Priority Plan write Broadcast Equipment Section, Radio Corporation of America, Camden, N. J.

BUY WAR BONDS



RADIO CORPORATION OF AMERICA

RCA VICTOR DIVISION • CAMDEN, N. J.

In Canada, RCA VICTOR COMPANY LIMITED, Montreal

Below—The transmitter building and antenna system of the South Bend Tribune's dual installation. This building houses the 10 KW FM Transmitter of WSBF, the 1 KW AM Transmitter of WSBT, an auxiliary AM transmitter, audio and monitoring equipment for both AM and FM systems and necessary maintenance facilities. The 4-bay turnstile of WSBF is mounted on the top of one of the towers of WSBT's 3-tower directional array.



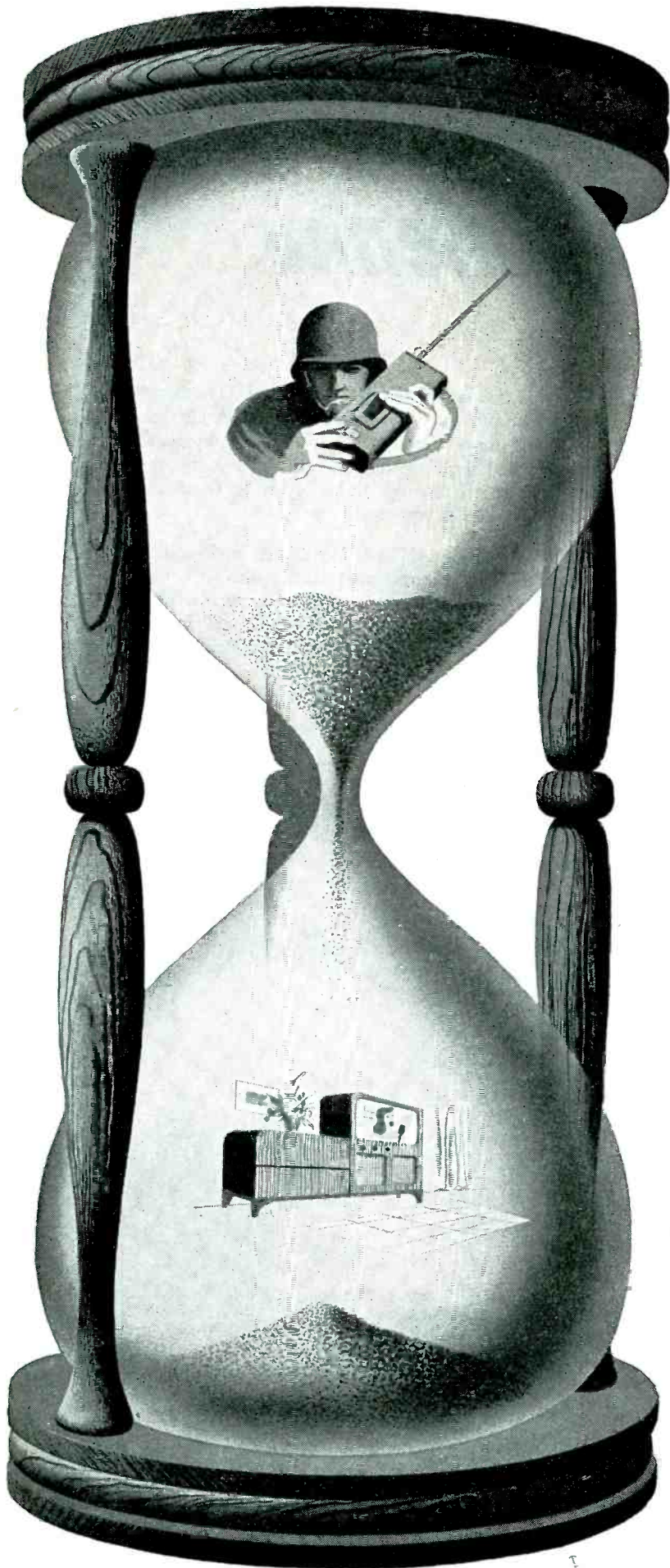

Every MANUFACTURING CUSTOMER Will Benefit

Industrial users of WILCO Products will find the increased facilities, the new products and techniques developed by WILCO for war service of great advantage to their own postwar products.

As the Hourglass indicates . . . with the coming of peace, many WILCO products now making for precision performance in airplanes, ships, tanks, guns and instruments of the Army and Navy will play an equally important role in meeting civilian needs for hundreds of useful and reliable products.

The demand of all branches of the service for Thermostatic Bimetals and Electrical Contacts has motivated many WILCO developments of great potential value to postwar industry. New products added to an already extensive line; increased facilities for refining and fabricating precious metals; greatly extended rolling mill facilities—these new additions and improvements, now devoted principally to the war effort, will prove equally helpful to manufacturing customers in meeting their peacetime production and marketing problems.

WILCO PRODUCTS ARE: *Contacts* — Silver, Platinum, Tungsten, Alloys, Sintered Powder Metal. *Thermostatic Bimetal* — High and Low Temperature with new high temperature deflection rates. *Precious Metal Collector Rings* for rotating controls. *Silver Clad Steel* — for bearings, shims, reflectors. *Jacketed Wire* — Silver on Steel, Copper, Invar, or other combinations requested. Rolled Gold Plate. Special materials.

THE H. A. WILSON COMPANY
105 Chestnut Street, Newark 5, New Jersey

Branches: Detroit • Chicago



**Thermometals—Electrical Contacts
Precious Metal Bimetallic Products**

From Drawing Board to Final Products

STEATITE BUSHINGS

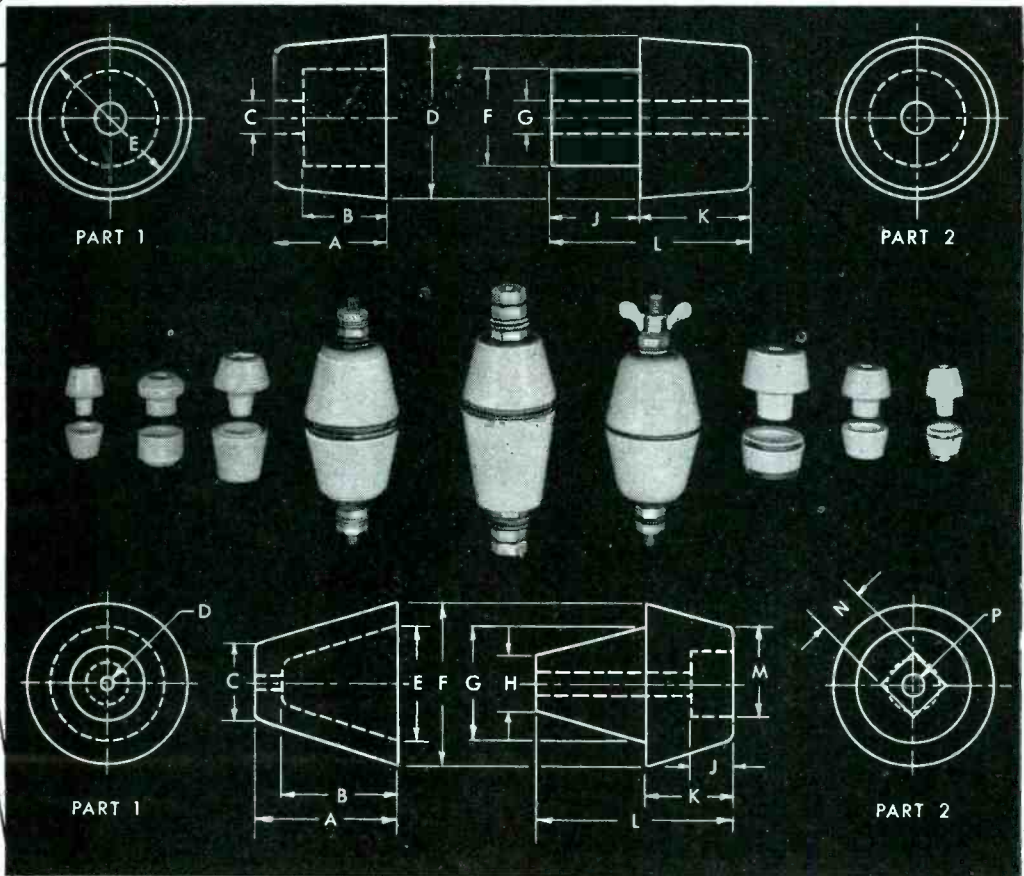
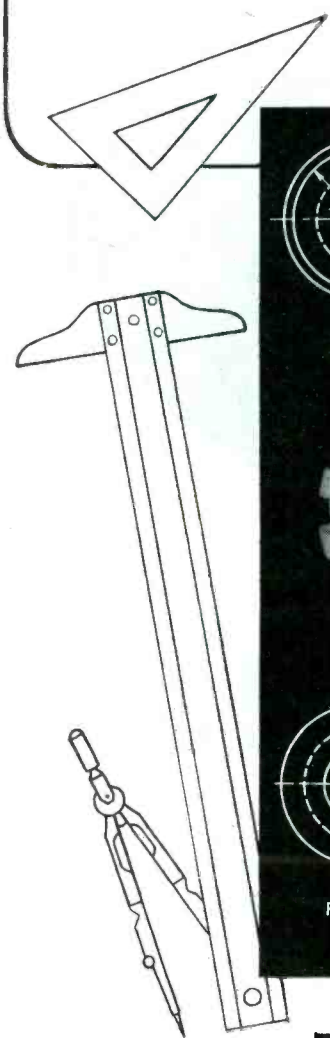

For TRANSFORMERS • LEAD-INS • ANTENNAS

CERAMIC BUSHINGS are but one of the thousands of items which we produce for the electronic industry. Attention to every design detail, plus the Stupakoff precision method of manufacture, produces bushings of maximum mechanical strength and minimum electrical loss.

METAL BANDED CERAMIC BUSHINGS for SOLDER SEALING are manufactured by Stupakoff for positive sealing applications. They are used in components where a sealed lead into a container is required, such as in transformer construction of the hermetically sealed type. This construction offers adequate protection, ease of assembly and clean, rugged appearance at a moderate cost.

Stupakoff stocks many styles of ceramic bushings for immediate shipment—special designs will be made promptly to your specifications. For complete information on types and sizes available, write for Technical Data Series NL-4. Your inquiries will be given immediate attention.



Products for the World of Electronics

STUPAKOFF CERAMIC AND MANUFACTURING CO., LATROBE, PA.

"The following is electrically transcribed..."



on **PRESTO** discs!

How are great commercials born? Rinso's happy little wash-day song was born in the woods. An advertising man, trying to get away from it all, listened raptly to the song of a bob-white—the special three-note call Bob uses to sell himself to his mate. "Golly," said the ad man, "why couldn't we..." And the rest is soap history.

Rinso "spots" are cut on PRESTO discs. *Most*

important transcriptions are. For recording engineers know that PRESTO discs give finer results with less margin for error—*actually perform better than most of the recording equipment on which they are used.* That's why you'll find, in most large broadcasting stations, recording studios and research laboratories, the standard recording disc is a PRESTO.

WHY BROADCASTING STUDIOS USE MORE PRESTO DISCS THAN ANY OTHER BRAND

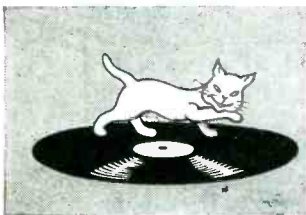

Less Surface Noise

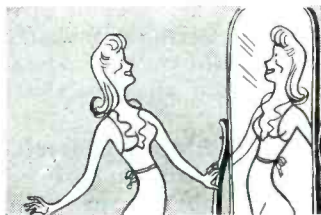

No Distortion

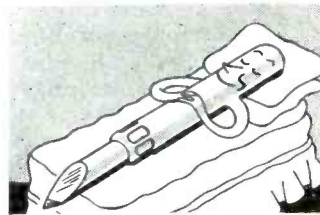

Easier on Cutting Needle



No Fussy Needle Adjustments

**WORLD'S LARGEST MANUFACTURER
OF INSTANTANEOUS SOUND
RECORDING EQUIPMENT
AND DISCS**

PRESTO

RECORDING CORPORATION

242 West 55th Street, New York 19, N. Y.

Walter P. Downs Ltd., in Canada



RAYTHEON TYPE 1B48

A HIGH VOLTAGE COLD CATHODE MINIATURE GAS RECTIFIER

● There are many applications in which a high DC voltage, at a relatively low current, must be obtained in a minimum space and with maximum power efficiency.

If tubes necessitating a heater voltage supply are used, the space and weight requirements of a filament transformer insulated to withstand high potentials—and the additional power consumption—are often detrimental factors. Numerous oscilloscope applications are in this category.

Thus there is often a real need for a small modified miniature type cold cathode gas rectifier like the 1B48—which can easily deliver 1000 volts DC at 6 milliamperes average current. Furthermore, several tubes may be operated in series to obtain even higher voltages.

Shown below are the physical and electrical features of the 1B48. The schematic diagram indicates cascade operation in a half wave circuit. Full wave rectification may be accomplished in the conventional manner.

This Raytheon tube represents just one more entry in Raytheon's record of tube development . . . a continuing engineering program that is making possible still finer tubes for your postwar products.

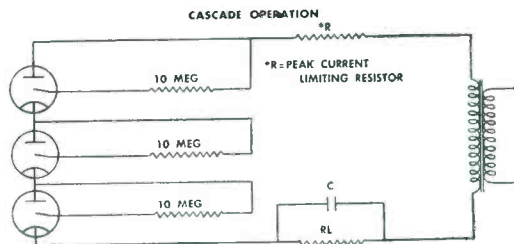

SPECIFICATIONS OF 1B48

PHYSICAL:

Maximum Over-all Length	2-1/4 inches
Maximum Seated Height	1-9/16 inches
Maximum Diameter	3/4 inches

ELECTRICAL:

Maximum Peak Inverse Voltage	2700 volts
Maximum Peak Plate Current	50 ma
Average DC Voltage Drop at 6 ma	100 volts
Maximum DC Output Current	6 ma
Minimum Peak AC Starting Voltage	800 volts
Maximum Starter Anode Current	100 ma

RAYTHEON

MANUFACTURING COMPANY
RADIO RECEIVING TUBE DIVISION

Newton, Massachusetts • Los Angeles • New York • Chicago • Atlanta

Listen to
"MEET YOUR NAVY"
Every Saturday Night
AMERICAN BROADCASTING CO.
Coast to Coast
181 Stations



All Four Divisions
Have Been Awarded
Army-Navy "E"
With Stars

DEVOTED TO RESEARCH AND THE MANUFACTURE OF TUBES AND EQUIPMENT FOR THE NEW ERA OF ELECTRONICS

Give your Assembly Plans the THIRD DEGREE

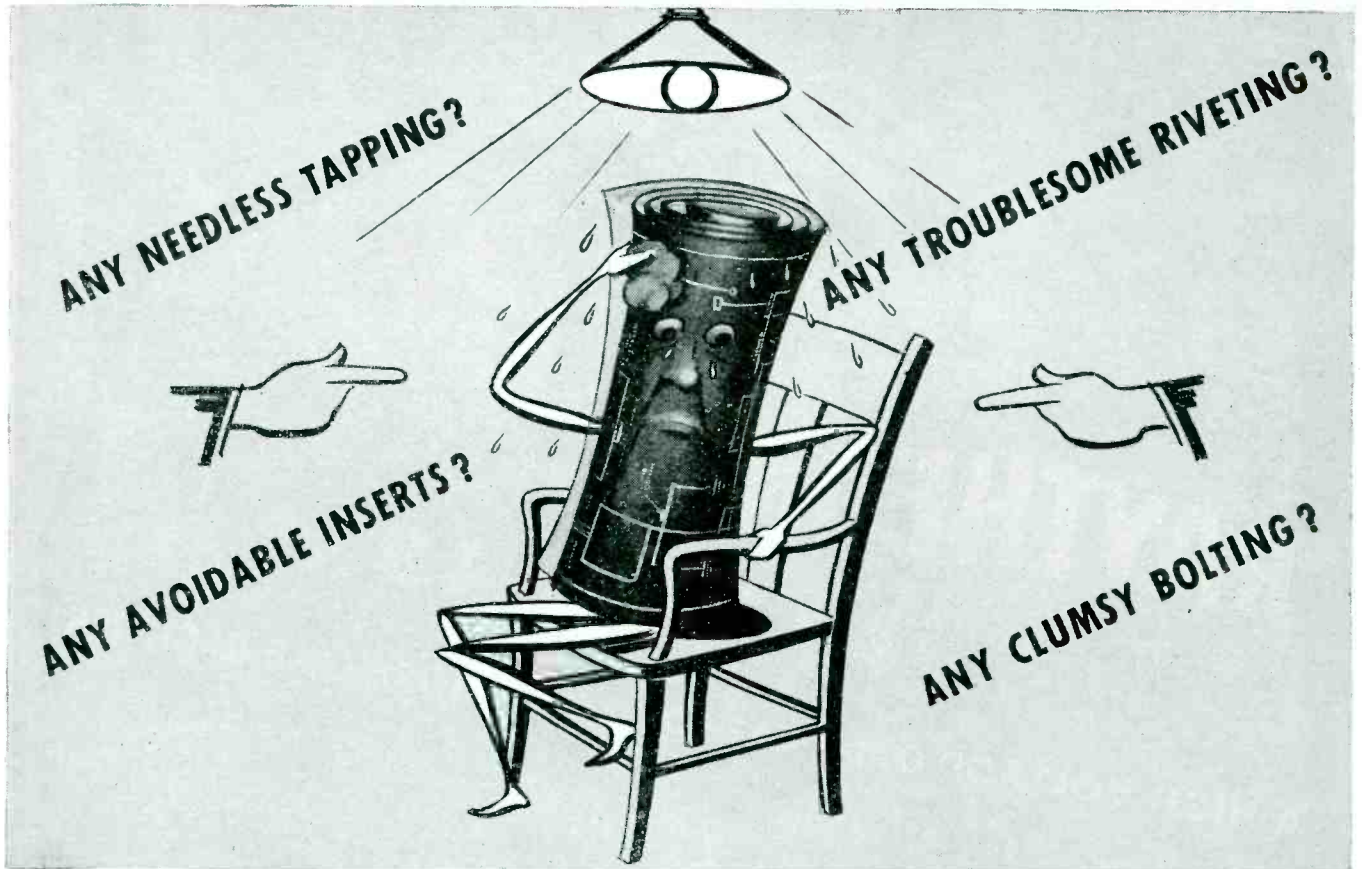

...before you set up for post-war products

SAVINGS UP TO 50% in assembly time and labor costs have been made by thousands of manufacturers when they switched to the short cut fastening method - Parker-Kalon Self-tapping Screws.

YOU CAN START SAVING when you start production if you question every fastening *now*, while your plans are still in process. Why wait to find fastening "bugs" later, when a change now requires only a little pencil work.

WHATEVER MATERIAL you are working with - plastics, die castings, sheet steel, aluminum, brass, fibre - in 7 out of 10 cases you'll find you can save with P-K Screws, and improve your product as well!

WILL YOU BE ALL TOOLED UP FOR TROUBLE?

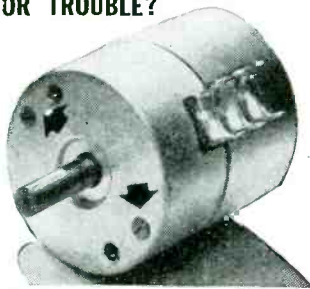

The Daven Company, Newark, N. J., makers of radio and electronic equipment, says, "We had loads of trouble tapping sheet brass... couldn't get good, clean threads, especially with unskilled help."

"Now, in these attenuators, we fasten the aluminum cover to a brass stamping, .065" thick, with P-K Type "Z" Self-tapping Screws, and our trouble is ended. Besides eliminating tapping and speeding the work, the P-K Screws form threads that are near to perfection, hold securely."

Find "bugs" like this beforehand in your product - save the needless cost of tooling up for trouble!

P-K SELF-TAPPING SCREWS save by eliminating the tapping and tap expense necessary for machine screws, and the slow fumbling with bolts and nuts. They also eliminate costly insert in plastics, and riveting in hard-to-reach places.

ASK A P-K ASSEMBLY ENGINEER to check over your plans with you to make sure you find all the fastening "bugs". Or, mail us assembly details for recommendations. Parker-Kalon Corp., 208 Varick St., New York 14, N. Y.

PARKER-KALON
Quality-Controlled
SELF-TAPPING SCREWS



FOR EVERY METAL AND PLASTIC ASSEMBLY

HOW hallicrafters EQUIPMENT COVERS THE SPECTRUM

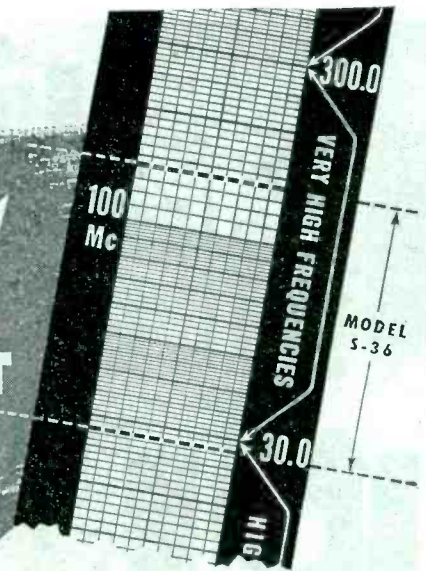
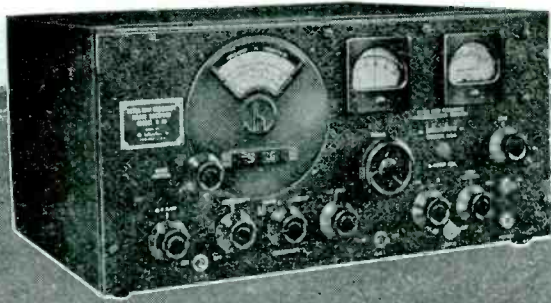

THE Model S-36 is probably the most versatile VHF receiver ever designed. Covering a frequency range of 27.8 to 143 megacycles it performs equally well on AM, FM, or as a communications receiver for CW telegraphy. Equipment of this type was introduced by Hallicrafters more than five years ago and clearly anticipated the present trend toward improved service on the higher frequencies.

Fifteen tubes are employed in the S-36 including voltage regulator and rectifier. The RF section uses three acorn tubes. The type 956 RF amplifier in conjunction with an intermediate frequency of 5.25 megacycles assures adequate image rejection over the entire range of the receiver. The average over-all sensitivity is better than 5 microvolts and the performance of the S-36 on the very high frequencies is in every way comparable to that of the best communications receivers on the normal short wave and broadcast bands.

The audio response curve is essentially flat within wide limits and an output of over 3 watts with less than 5% distortion is available. Output terminals for 500 and 5000 ohms are provided.

Model S-36

FM-AM-CW

27.8 to 143 Mc.

Covers old and new FM Bands

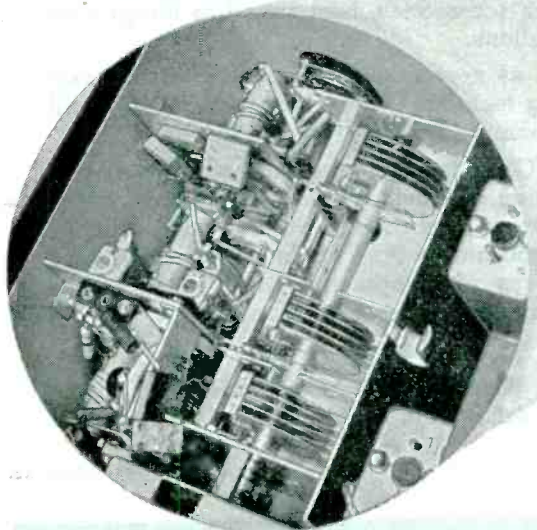
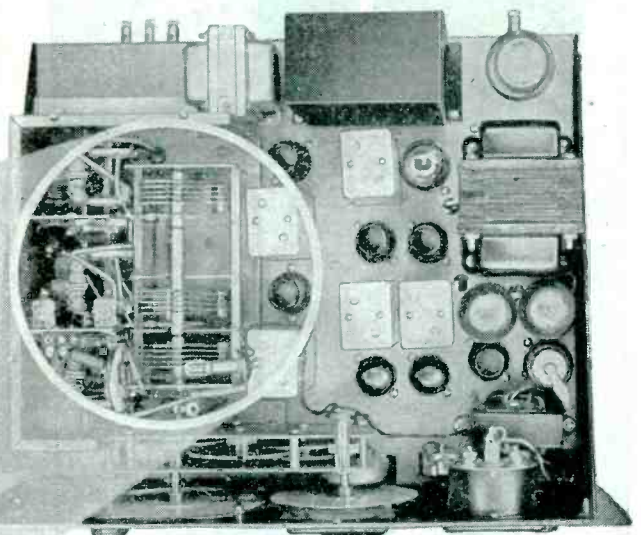

The RF section is built as a unit on a separate chassis which may easily be removed for servicing and incorporates a three position ceramic band switch. The positive action mechanical bandspread dial turns through more than 2200 divisions for each of the three ranges, 27.8 to 47, 46 to 82, and 82 to 143 megacycles.

For details on the entire Hallicrafters line of precision built receivers and transmitters write for Catalog 36-G.



hallicrafters RADIO



THE HALLICTRAFTERS CO., MANUFACTURERS OF RADIO AND ELECTRONIC EQUIPMENT • CHICAGO 16, U. S. A.

COPYRIGHT 1945 THE HALLICTRAFTERS CO.

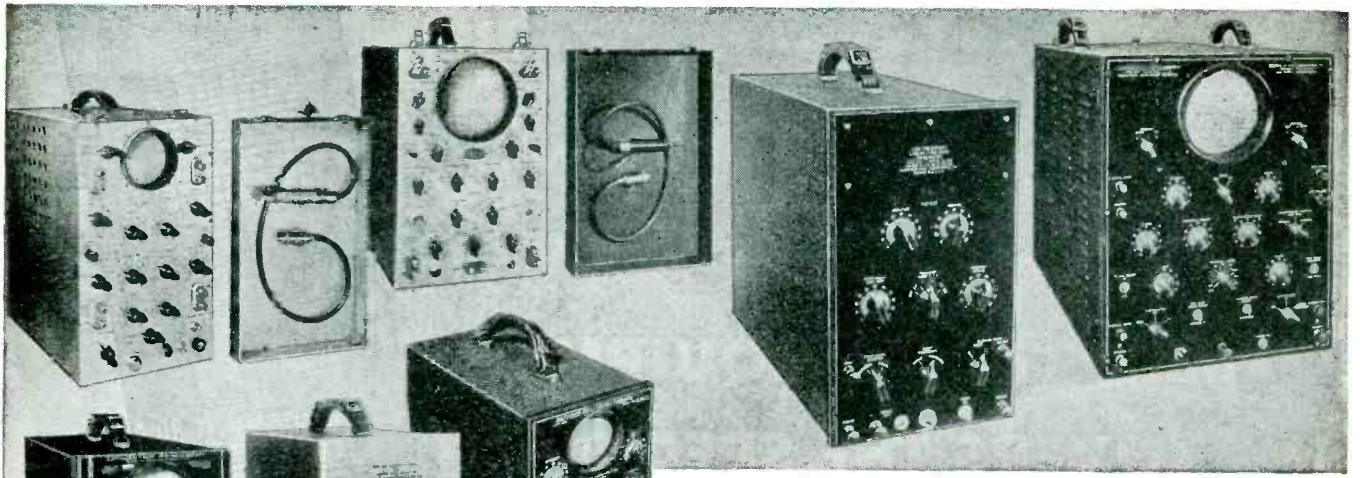

**A standard type to meet the
widest range of requirements**

DuMONT *Oscillographs*

◆ The maintenance man in need of a low-cost, simple, portable, rugged instrument; the laboratory technician requiring an instrument covering an exceptionally wide range of frequencies; the instructor demonstrating intricate wave forms to large student bodies—for each of these widely varying applications, and all those between, there is a DuMont cathode-ray oscillograph and cathode-ray tube, as well as accessories, best suited to the precise operating conditions.

Furthermore, as new requirements arise in this rapidly developing technique there become available still more up-to-the-minute DuMont types to fill the bill.

The DuMont Cathode-Ray Manual already lists an outstanding selection of oscillographs, tubes, accessories. New bulletins are constantly being issued on new items, refinements, applications. And for "scoops" on the very latest cathode-ray developments, just follow these monthly DuMont advertisements.

◆ Write on business stationery
for literature . . .

© ALLEN B. DUMONT LABORATORIES, INC.



DUMONT Precision Electronics & Television

ALLEN B. DUMONT LABORATORIES, INC., PASSAIC, NEW JERSEY • CABLE ADDRESS: WESPEXLIN, NEW YORK



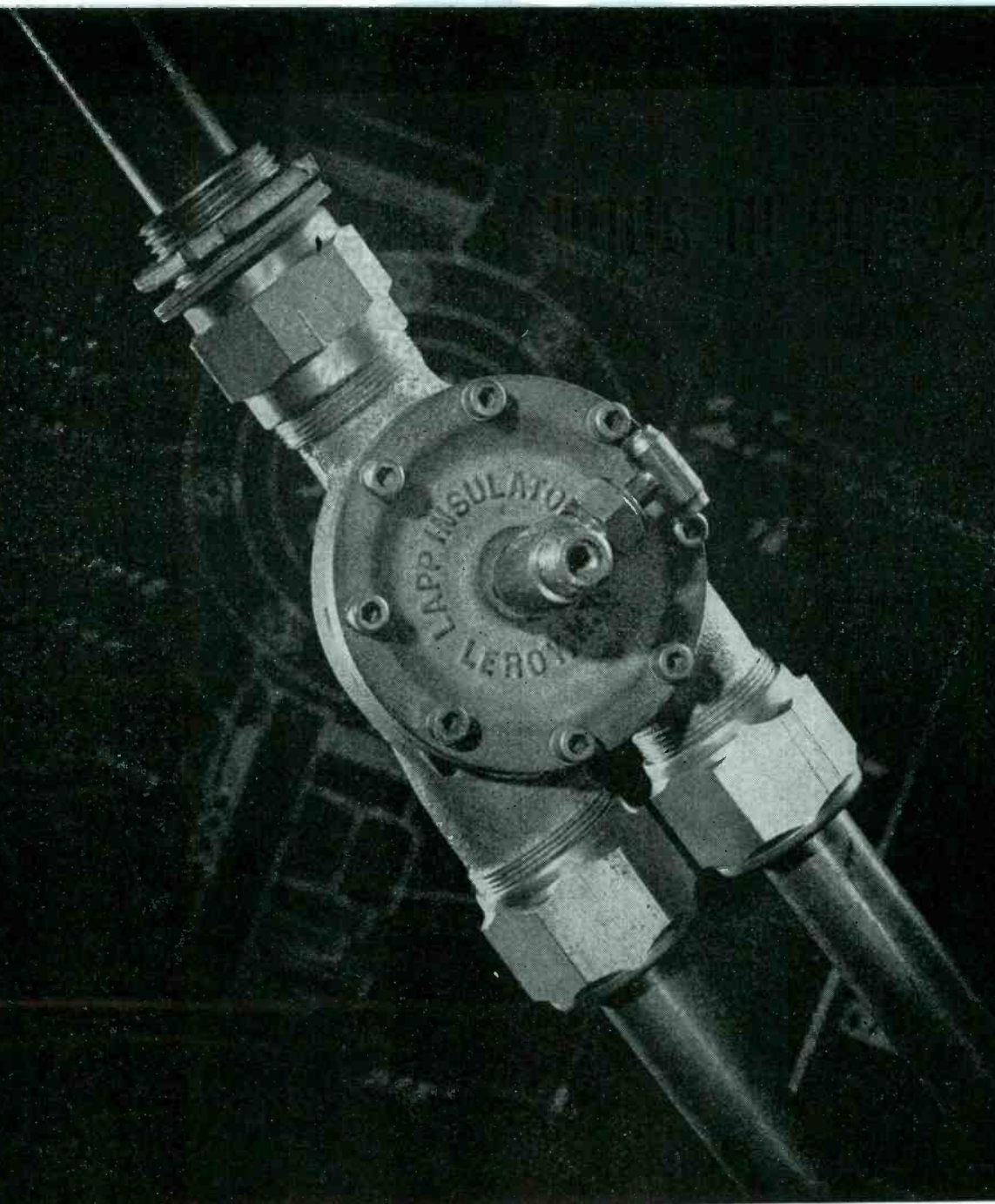

Electronic Parts: ENGINEERING AND PRODUCTION

The gadget above is a junction box for a co-axial gas-filled transmission line. It is one of a series of coupling units, end seals and other fittings for high-frequency transmission—designed and built by Lapp.

To this type of construction, Lapp brings several innovations and improvements. For example, such a line from Lapp parts is genuinely leak-proof. Every gasket is under spring loading, so there's no leakage created by vibration or thermal change.

Whether or not you're interested in gas-filled transmission lines, you ought to know about Lapp. Here is an organization of engineers and manufacturers with broad basic knowledge of ceramics and their application. With experience in hundreds upon hundreds of special-purpose electronic parts, we have been able countless times to improve performance, or reduce costs, or cut production time through

the application of our specialized skills to design and manufacture of parts involving porcelain or steatite and associated metal parts.

For quick and efficient assistance on a war production subcontract—or for the competitive advantage Lapp-designed and Lapp-built parts will give to you in the postwar battle—an inquiry to Lapp now may pay you dividends. *Lapp Insulator Co., Inc., LeRoy, N. Y.*



Scope in application—

- INDUSTRIAL ELECTRONIC EQUIPMENT
- FIXED COMMUNICATION INSTALLATIONS
- MOBILE AND AIRBORNE TRANSMITTERS
- EXPERIMENTAL AND RESEARCH USE
- CARRIER CURRENT INSTALLATIONS

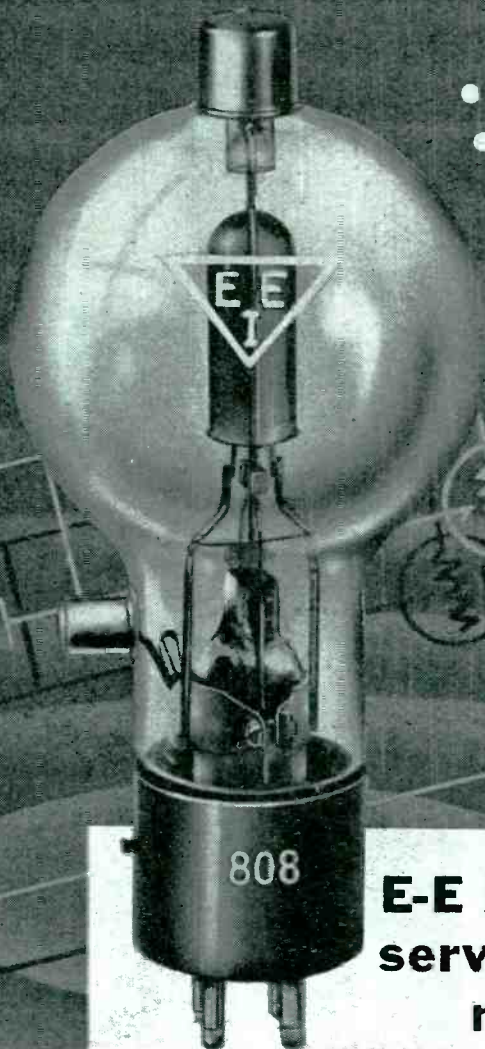

E-E Power Oscillators serve ever-widening requirements!

Specifically engineered to meet the diversification of present-day needs, these E-E vacuum tube units offer high functional efficiency. They are ruggedly designed to maintain inter-electrode spacing, whether utilized in industrial fixed or mobile applications.

Virtually immune to mechanical shock and vibration, integrated materials and component parts are subject to rigid inspection and selection to insure long tube life with maximum performance.

E-E 808, illustrated, is recommended as Class B or C amplifier, modulator or oscillator. This triode is suitable for plate voltages to 1500. Carrier output, Class C, 140 watts. Write today for Data Book describing the complete E-E line of quality vacuum tubes

ELECTRONIC ENTERPRISES • INC



GENERAL OFFICES: 65-67 SEVEN AVENUE, NEWARK, N. J. EXPORT DEPT. 25 WARREN STREET, NEW YORK CITY, N. Y., CABLE ADDRESS: SIMONTRICE, N. Y.



How small strips of
*** Nichrome**
protect

EQUIPMENT WORTH MILLIONS

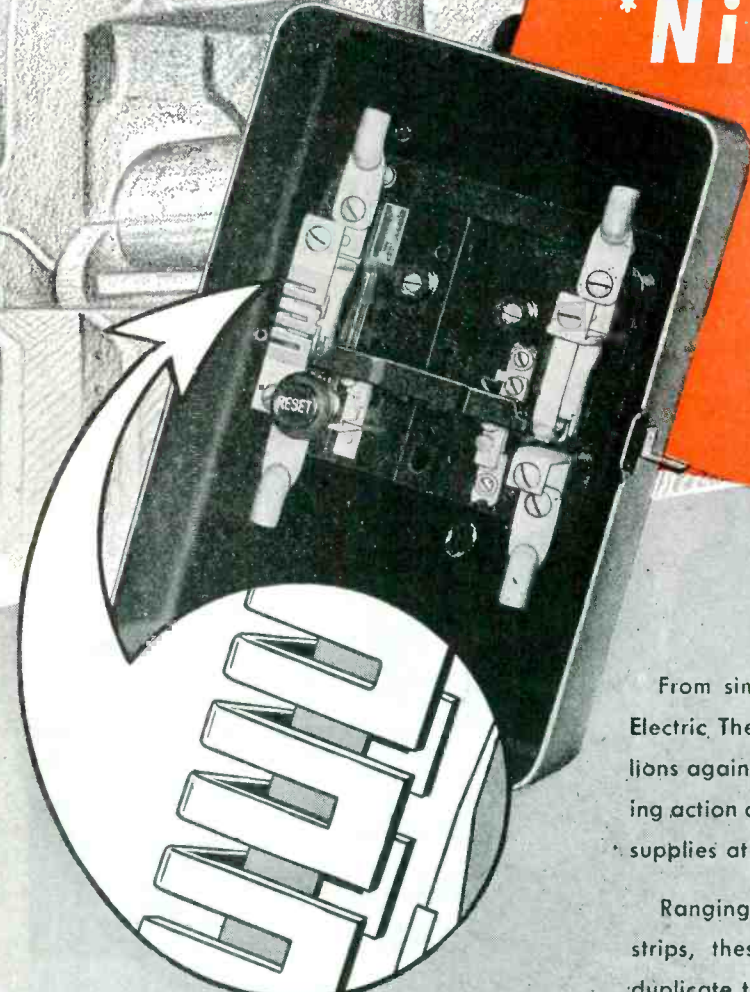

From simple home refrigerators to giant industrial equipment Electric Thermal Relays like this one protect machines worth millions against damaging overloads. In these applications the heating action of special resistance units trips switches—cuts off power supplies at predetermined danger points.

Ranging in form from plain wire wound units to specially formed strips, these "Heaters" must generate heat to simultaneously duplicate the rate and cycle of overload heating in the electrical equipment being guarded. Also they must resist the full impact of direct shorts, until other protective devices operate.

To meet these severe requirements, Nichrome, made only by Driver-Harris, is used, for this is the alloy that possesses high thermal retentivity combined with excellent heat and corrosion resistance.

Typical of the heavy-duty Thermal Overload Relays employing Nichrome is this 90 ampere, 600 volt Push-Button-Reset type which guards large Rolling Mill equipment in a steel plant. The right "Heater" has been removed to expose the thermal tripping mechanism.

If such dependable protection interests you why not investigate Nichrome and the 80 other Driver-Harris alloys. Write for further facts today.



Driver-Harris
COMPANY

HARRISON, N. J.

Branches: Chicago • Detroit • Cleveland
Los Angeles • San Francisco • Seattle

*Trade Mark Reg. U.S. Pat. Off.

Place your Electronic Problem before these Temco Engineers



● Accomplished Radio and Electronic Engineers sit at this Temco Table and by combining their engineering and inventive abilities, they have produced numerous new electronic devices.

From Radar to Chronaximeters, they have designed and manufactured electronic equipment which reflects and incorporates great technical achievements. Backed by a very flexible and efficient manufacturing organization, they are one of the best equipped staffs of Engineers to consult regarding problems involving electronic equipment.

No matter how complicated your problem may appear, a Temco-engineered device can provide the answer. The Temco Table, therefore, is the best place for such problems. For proof, ask us to show you what we have accomplished for others. Write for facts today.

From left to right: S. L. Sack, J. C. Cardon, Morton Kahn, E. E. Baker, E. E. Horrocks, H. H. MacAdams

TEMCO

**RADIO COMMUNICATION
EQUIPMENT**

TRANSMITTER EQUIPMENT MFG. CO., INC.
345 Hudson Street • New York 14, N. Y.



7th
WAR LOAN

We've just
begun to fight

Our fighting men have accomplished miracles in the Pacific. Maybe that's led you to believe that Japan is a pushover. Think again. We still have to meet and crush the main body of the Japanese Army *inside the inner Empire*. ■ To do this, we've got to move millions of fighting men—*freshly outfitted and equipped*—halfway around the globe! And *keep* them supplied over vast stretches of water. More of everything will be needed.

This is going to call for more money than your mind can grasp. Money that *has* to come from you. Not later, but *now*—during the 7th War Loan Drive. It'll take the larger part of a month's salary from most of us to meet the quota—in *addition* to the Bonds we're buying regularly. ■ You *can* buy bigger extra bonds just as the Marines found a way to take Iwo Jima. *They* paid in coin they'll never get back. *You* get *yours* back with interest!

Aireon

MANUFACTURING CORPORATION

Formerly AIRCRAFT ACCESSORIES CORPORATION

Radio and Electronics • Engineered Power Controls

NEW YORK • CHICAGO • KANSAS CITY • BURBANK

CAPACITORS FOR GI JOBS

G-E fixed paper-dielectric capacitors built to the exacting requirements of (proposed) Joint Army-Navy Specification JAN-C-25 are now available in Characteristic F, in case styles CP-50, -51, and -52. These small compact "bathtub" capacitors, hermetically sealed in metallic cases, are built to withstand the severe conditions encountered by electronic equipments for the armed services.

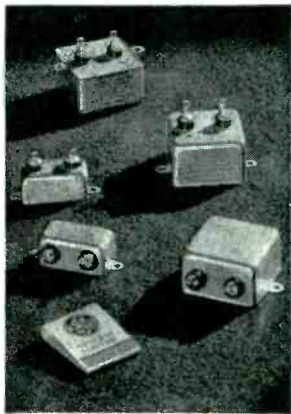

Single-, dual-, or triple-section units can be supplied for voltages of 600 or 1000 volts, in sizes from 0.05 to 2 microfarads. All units provided with solder-lug "B" terminals. Ask for Bulletin GEA-4357.

LITTLE INSTRUMENTS THAT CAN "TAKE" A LOT

Internal-pivot construction of G-E small panel instruments makes for compact construction. Accuracy is high, and construction strong. These instruments will withstand momentary overloads of ten times their rated capacity, are resistant to vibration and to temperature, giving accurate reading in the ambient temperature range from -50 C to 70 C. This line (DW-51 and DW-52) includes 15 d-c voltmeters, 10 d-c ammeters, 14 d-c milliammeters, 8 d-c microammeters, 9 r-f ammeters, and 9 r-f milliammeters, all calibrated to cover a wide range of applications in shielded and unshielded types. Send for Bulletin GEA-4064.



INDUSTRIOUS TUBES FOR INDUSTRIAL USES

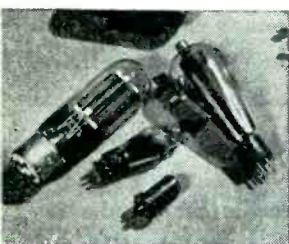

From the ignitron, supplying hundreds of amperes, to the tiny photo tube that inspects sheet metal at speeds as high as 1000 feet per minute, you'll find G-E tubes putting electronics to work, on all sorts of industrial jobs.

Phantrons convert a-c to d-c. Kenotrons and ignitrons convert a-c to d-c, and also serve as high-speed circuit interruptors. Thyratrons give "trigger action" or controlled rectification; pilotrons act as amplifiers. Photo tubes are applied to a

wide range of control and measurement functions. Ballast tubes, vacuum switches, and indicator tubes complete the G-E line, which is sufficiently broad to cover nearly any electronic application. Send for Bulletin ETI-12.

ALNICO MAGNETS—POWERFUL AND PERMANENT

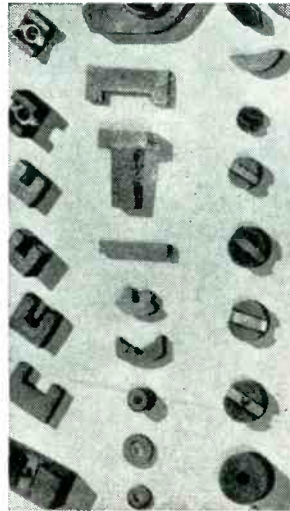

Alnico magnets make possible compact designs of electronic and electric equipment, because of their high energy content per unit volume. They are highly resistant to demagnetization by vibration, heat, or stray magnetic fields. Sintered alnico lends itself to large-quantity production of small magnets both simple and intricate in shape. Cast alnico, available in five different grades, including the high-energy alnico 5, is best suited

for magnets weighing more than 1/10 lb. Ask for Bulletin GEA-3682B on sintered alnico magnets.

TERMINAL BOARDS FOR EASIER CONTROL WIRING

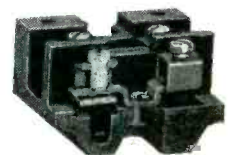

With G-E Type EB-2 terminal boards, you just strip the wire end, and screw the connector down on the bare wire. These solderless pressure connectors will take one No. 8 Awg stranded conductor, two No. 12 stranded, or three No. 12 solid conductors. Type EB-1 is the same as EB-2, except for connectors, which are the conventional washer-head screw type. Both boards are molded from strong, durable Textolite, both are available in 4-, 6-, 8-, and 12-pole sizes, and both come equipped with marking strips. Covers are available.

For small wires, a fabricated terminal board (EB-3) is available in sizes ranging from 4 to 38 poles. Send for Bulletin GEA-1497A.

DIGEST

Timely Highlights on G-E Components

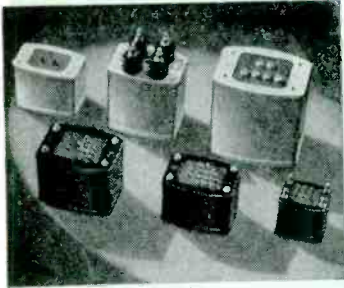

TRANSFORMERS AND REACTORS SEALED AGAINST SALT WATER

G-E compound-filled hermetically sealed transformers and reactors are built to withstand the rigorous salt-water immersion and salt-spray tests, as specified by the

Signal Corps, Air Forces, and Navy. This hermetic sealing also keeps out dust, dirt, and micro-organisms. The line includes transformers for plate and filament supply; also microphone, input, interstage (or grid), and modulation transformers and output units for the audio-frequency range. Reactors are included for filter, modulation, microphone, and plate circuits. Standard hermetic cases vary from approximately two cubic inches to 150 cubic inches in volume. Send for Bulletin GEA-4280.

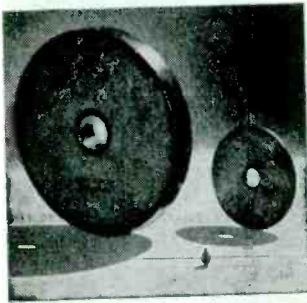

RESISTORS IN WHICH I VARIES AS Eⁿ

In Thyrite*, G.E.'s nonlinear, silicon-carbide resistance material, current varies as a power of the applied voltage (I varies as Eⁿ). Doubling the voltage in a wire-wound resistor doubles the current. Doubling voltage in Thyrite increases the current

16 times, where the exponent (n) of the Thyrite is 4. Because of this characteristic, Thyrite has solved many problems in electronic circuits, by protecting them against voltage surges, stabilizing power voltages, controlling voltage-selective circuits, etc. Thyrite is usually supplied in disk or rod form, in diameters ranging from 0.25 in. to 6.00 in. Send for Bulletin GEA-4138A.

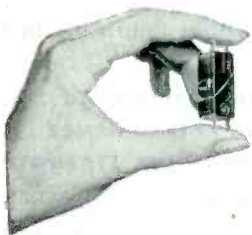

A LITTLE SWITCH FOR BIG JOBS

The G-E Switchette weighs less than one-third of an ounce; its case measures only 1/2 by 21/32 by 1 1/4 inches, yet it is rated 230 volts; 10 amperes a-c.

Low-inertia moving parts, and high, contact pressure assure fast, positive action even where vibration is severe. The spring-return button can be actuated manually, or by cam or bellows. Switchettes are available in three general-purpose double-break contact arrangements with terminals on top or at ends. Switchettes are designed to meet the 50-hour Government salt-spray test, and operate from sea level to 50,000 feet altitude. Bulletin GEA-3818A describes more than 100 types and arrangements.

*Trade-mark reg. U.S. Pat. Off.

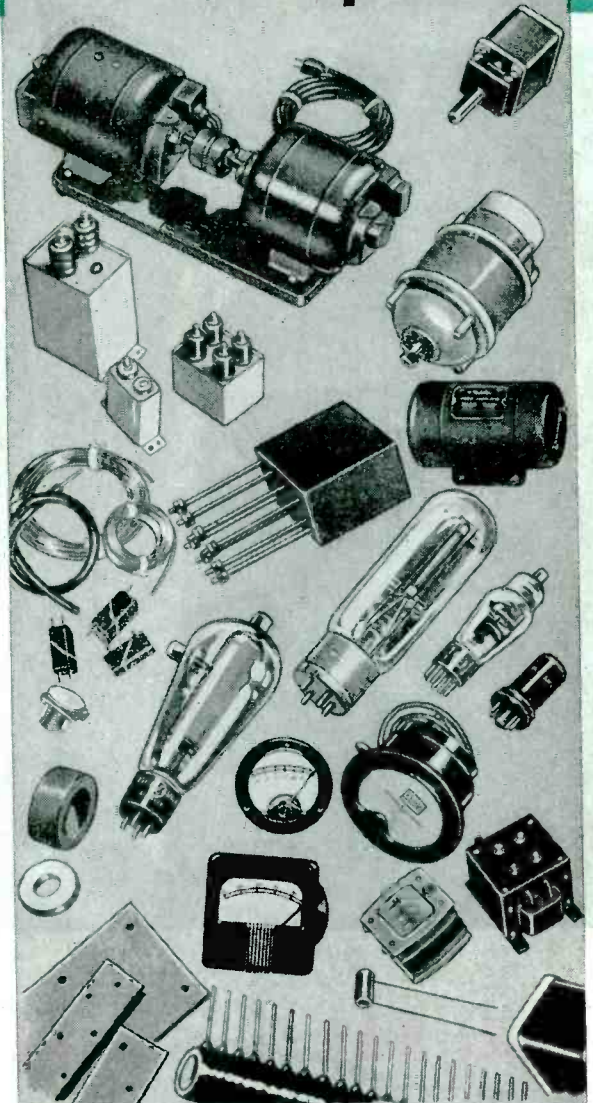

Capacitors • Sensitive control and time-delay relays • Limit switches • Motors, dynamotors, amplidyne • Motor-generator sets • Alnico magnets • Small panel instruments • Formex magnet wire • Radio transformers • Switchettes • Selsyns • Chokes • also tubes, crystals, plastics products, insulation materials, and many others

General Electric Company, Sec. 642-7
Schenectady 5, N. Y.

Please send me

..... GEA-4357
..... GEA-4064
..... ETI-12
..... GEA-3682B

..... GEA-1497A
..... GEA-4280
..... GEA-4138A
..... GEA-3818A

NAME

COMPANY

ADDRESS

CITY

STATE

Buy all the BONDS you can—and keep all you buy

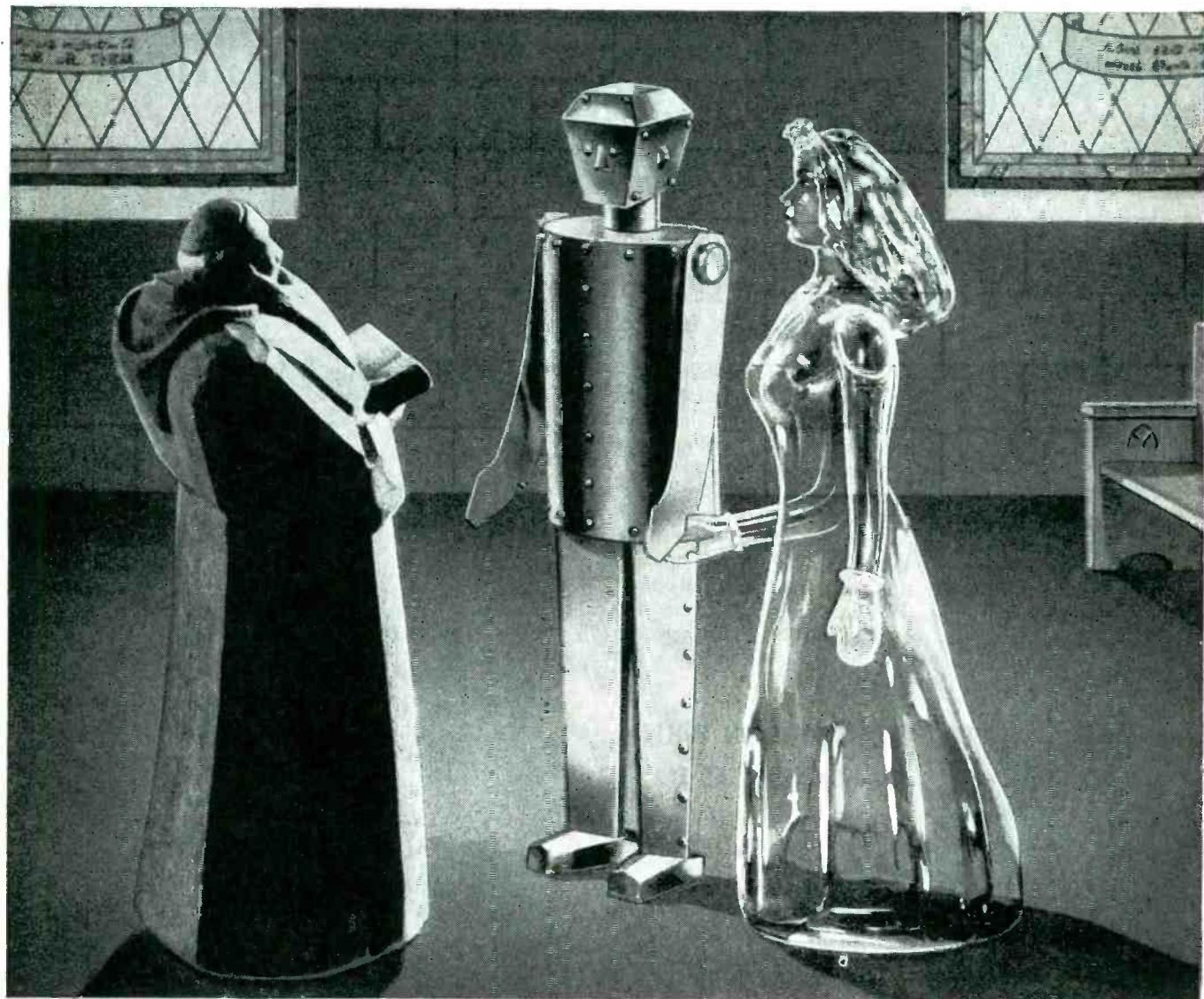

JOINED...FOR LIFE *through Corning Metallizing!*

REMEMBER when glass and metal just wouldn't stay hitched? They joined together readily but when the going got rough they parted company in the best Hollywood tradition.

Things are different now. *Corning's* metallizing process weds glass and metal with a bond that lasts like an old-fashioned marriage. Through heat and cold . . . under severe conditions of stress and strain, they stick together in a lasting union.

This happy union can boast a whole family of fine qualities:

**HERMETIC SEALING . . . PRECISION METALLIZING . . .
SUPERIOR PHYSICAL PROPERTIES . . . PERMANENCE . . .
THERMAL ENDURANCE . . . MECHANICAL STRENGTH**

Which of these can you use? Write us about it. We'll be glad to work with you to see if metallized glass can help solve your problem. Address Electronic Sales Department, E-6, Bulb and Tubing Division, Corning Glass Works, Corning, New York.

CORNING
— means —
Research in Glass

Electronic Glassware



“PYREX”, “VYCOR” and “CORNING” are registered trade-marks and indicate manufacture by Corning Glass Works, Corning, N. Y.

PROTECTION

ALL THE WAY UP
AND DOWN WITH

THORDARSON

HERMETICALLY SEALED
UNITS

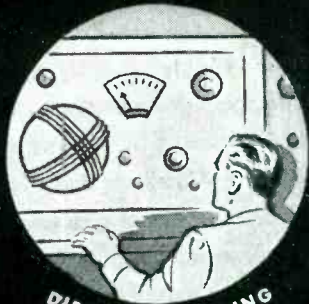
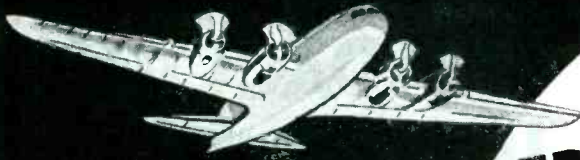

DIRECTION FINDING

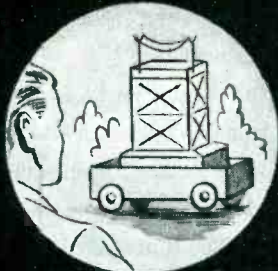

RADIO-RADAR



SONIC RANGE FINDER



Thordarson pioneered with multi-terminal glass headers, thus insuring dependable service under all manner of conditions... in the tropics... high in the air... beneath the sea... *complete protection "from top to bottom"*! Your post-war transformers for communications and all types of electronic and industrial services will be available with Thordarson's hermetic seal.



THORDARSON

TRANSFORMER DIVISION
THORDARSON ELECTRIC MFG. CO.
500 WEST HURON STREET, CHICAGO, ILL.

Transformer Specialists Since 1895
ORIGINATORS OF TRUE FIDELITY AMPLIFIERS

NOW...It can be told...

RADACOR **IRON CORES**

The **LARGEST** ever built
helped the B-29's
accomplish their tasks



RADACOR Iron Cores—actual size

FOR YOUR POSTWAR NEEDS

High "Q", high permeability (appr. 30) Iron Cores
for use from 400 KC to 2000 KC. Write us your
postwar requirements today.

MICRO PRODUCTS *Corporation*

Associated with **FERROCAST CORPORATION OF AMERICA**
Hastings-on-Hudson 6, N. Y.

Earl S. Patch, Hastings-on-Hudson, N. Y., Powder Metallurgy Division

New York, N. Y.: E. J. Frederick, 347 Madison Avenue,
Railway Sales Division

Chicago, Ill.: Midwestern office, 840 N. Michigan Ave.
Ray E. Berg, E. C. Winkenwerder

Indianapolis, Ind.: 108 E. 9th Street, Queisser Bros.

Jenkinstown, Pa.: P. O. Box 246, D. M. Hilliard

Kansas City, Mo.: Broadway at 34th Street, E. W. McGrade

Canada: 1041 Des Marchais Boulevard, Verdun, Quebec, W. T. Hawes

Affiliated with MAGUIRE INDUSTRIES, INC.

B-29's were vital to victory. Exacting communication equipment was needed . . . fast. General Electric Company was to build antenna loading units. Iron Cores, retaining quality in high R.F. voltage fields, were essential. At no time, heretofore, was as large a Core with precision milling and the extreme electrical and physical tolerances demanded. And our resourceful engineering paired with our new RADACOR material accomplished results . . . never achieved before or since.

Orders followed from Stewart-Warner Corporation, Hammarlund Manufacturing Co., Inc., and Sentinel Radio Corporation. We received the largest orders ever placed for one type of iron core within a period of a few weeks, totaling almost a Half-Million Dollars. In addition, we received orders for our other types of iron cores especially developed as components for B-29 applications. Crash delivery schedules were accomplished.

RADACOR Iron Cores are now available in a wide variety of sizes, shapes and ranges, in addition to our complete line of electronic cores.

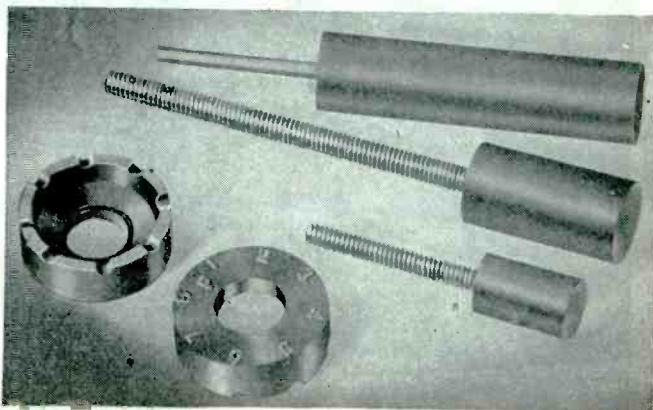

Actual Size

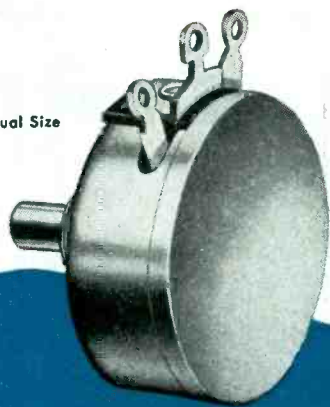

*A Distinctive
and Valuable
Service*

**SPACE REQUIREMENTS FOR
25 SERIES AND AC-25 SERIES**

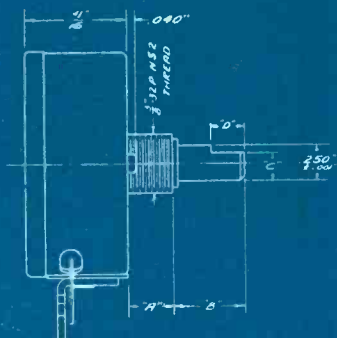

25 SERIES

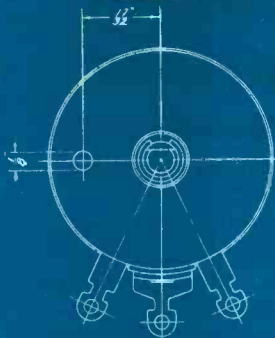

AC-25 SERIES

CTS does considerably more than make variable resistors whose superlative quality is recognized all over the world. CTS makes *absolutely sure* that every resistor which they deliver is precisely the one to do its particular job.

Customers' specifications are thoroughly analyzed. A slight change has saved many a customer considerable money or time or both.

But whether or not alterations in specifications are necessary, it is CTS policy not to start production on orders for new applications until samples have been delivered, tested and found satisfactory. Thus costly delays are avoided because CTS resistors always have the right characteristics to do the job.

CTS delivery promises are as reliable as CTS service. Consult Chicago Telephone Supply Company for help in solving your variable resistor problems.

VARIABLE RESISTORS • PLUGS AND JACKS
SWITCHES • RINGERS • TELEPHONE GENERATORS

REPRESENTATIVES

R. W. Farris Co.
406 West Thirty-fourth Street
Kansas City 2, Missouri
Phone: Logan 7495

Frank A. Emmet Co.
2837 West Pico Boulevard
Los Angeles 6, California
Phone: Rochester 9111

BRANCH OFFICES

S. J. Hutchinson, Jr.
401 North Broad Street
Philadelphia 8, Pennsylvania
Phone: Walnut 5369

IN SOUTH AMERICA

Jose Luis Pontet
Cordoba 1472
Buenos Aires, Argentina
South America

IN CANADA

C. C. Meredith & Co.
Streetsville, Ontario

Masculino 2624
Montevideo, Uruguay
South America

IN ENGLAND

Chicago Telephone Supply Co.
St. John's Woods
103 Grove End Gardens
London, N. W. 8, England

Avda. Conselheiro Rodrigues
Alves 1067
Villa Mariano
Sao Paulo, Brazil
South America



**CHICAGO TELEPHONE SUPPLY
Company**

ELKHART • INDIANA

Manufacturers of Quality Electro-Mechanical Components Since 1896

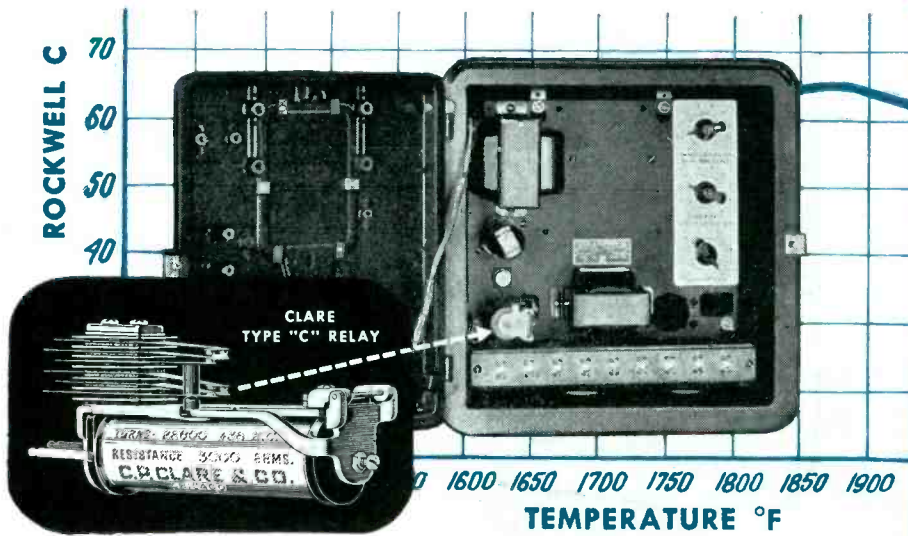

CLARE "Custom-Built" RELAYS

**Help Micromax Electric Controls
Maintain Precise Furnace Temperatures**

Clare Type "C" Relay is used to regulate the flow of electric energy in the Micromax Electric Control. This product of Leeds & Northrup Company of Philadelphia, Pa., proportions the duration of "on-heat" to "off-heat" which provides the precise, even heat control demanded in the operation of electric furnaces, ovens and baths.

To maintain precise temperature the Micromax Electric Control employs two electrical balances: one to measure temperature; the other to carry out control action. A knob on the control instrument is set to prevent temperature from overshooting the control point . . . especially important when a furnace is being brought to temperature under a full heat-head.

Whenever the temperature leaves the control point, a Clare Relay modifies the on-off action of the contactor to readjust heat-input and restores balance in the control circuit.

Leeds & Northrup engineers chose a Clare Relay for this important part of their control unit because the flexibility of Clare "custom-building" gave them the sensitive, positive action, the absolute dependability, and the accuracy to meet most exactly their requirements.

This use of Clare "Custom-Built" Relays to operate delicate controls is typical of the way in which engineers and designers everywhere are finding Clare the exact relay for the unusual application. The Type "C" Relay offers you a design that permits a wide range of contact ratings, the choice of five different contact forms or any combination of them, either flat or hemispherical contacts of rare metals or special alloys, coil windings to match the circuit and application.

What is your problem? Let Clare "custom-build" a relay to your specifications. Investigate the possibilities for higher efficiency and reduced relay costs. Send for the Clare catalog and data book. Address C. P. Clare & Co., 4719 Sunnyside Avenue, Chicago 30, Illinois. Sales engineers in all principal cities. Cable address: CLARELAY.

Contact springs employing any of these forms can be furnished.



FORM A



FORM B



FORM C



FORM D



FORM E

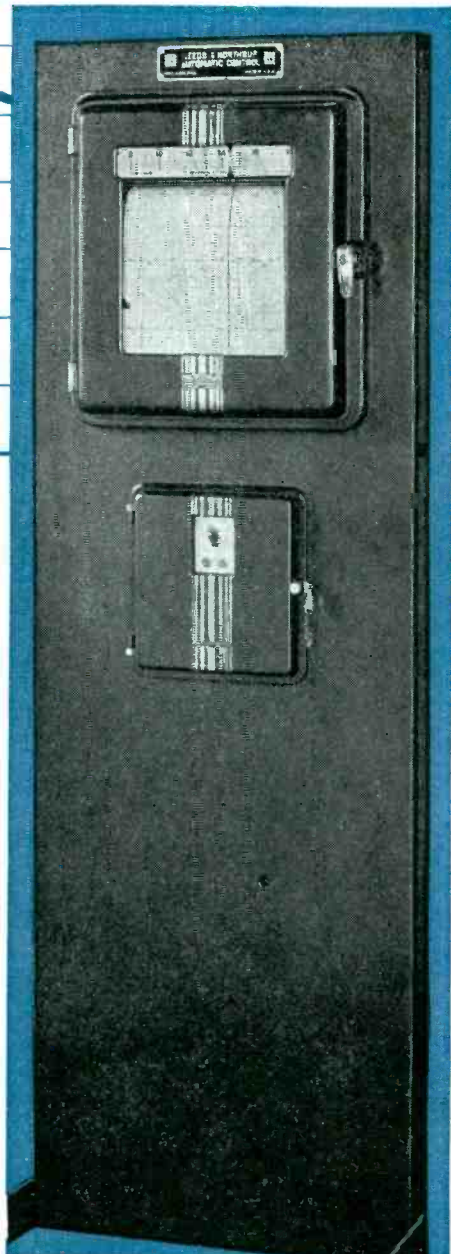

High voltage pile-up insulation withstands heavy break-down tests.

Contacts of rare metals and special alloys, welded to nickel silver springs.

Spring bushing insulators made by a patented process from Bakelite rod

Double arm armature, stainless steel shaft in brass yoke can be furnished.

CLARE RELAYS

"Custom-Built" Multiple Contact Relays for Electrical, Electronic and Industrial Use



P-T BOAT*

Collins Radio Equipped

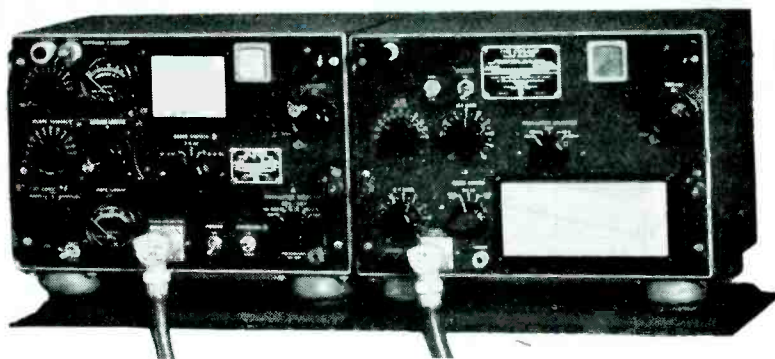

HERE ARE A FEW of many types of the Navy's small craft which maintain communication with this Collins designed TCS radio transmitter and receiver combination. This equipment is so sturdy, handy and reliable, and packs so much power and sensitivity into so little space, that it finds numerous Naval applications ashore as well as afloat. Usually the first radio installation on

the beach-head, it is also standard on fire, rescue and crash trucks, and is often used on jeeps and command cars. The TCS is another example of the variety and quality of radio communication equipment Collins will be able to supply to industry after the war. Collins Radio Company, Cedar Rapids, Iowa; 11 West 42nd Street, New York 18, N. Y.

**Official U. S. Navy Photo*



BOMB TARGET BOAT*

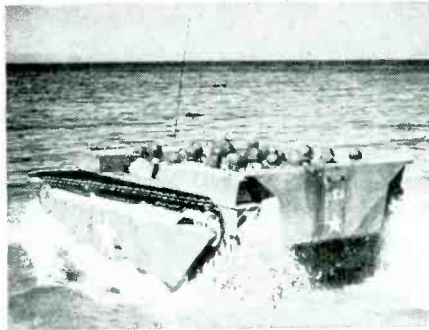

LVT-4 LANDING VEHICLE TRACK*



AIRCRAFT RESCUE BOAT*



IN RADIO COMMUNICATIONS, IT'S . . .



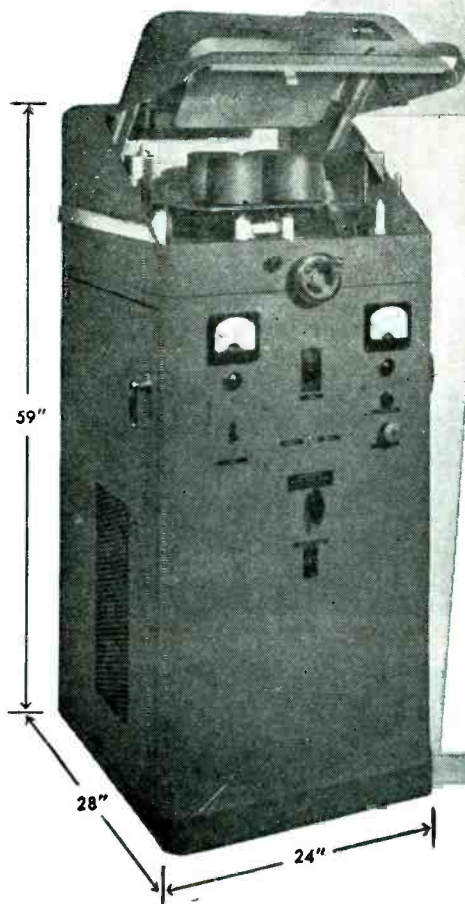

"Built-in Brains"

THE NEW

Thermatron
"HEATMASTER"

ELECTRONIC DIELECTRIC
HEAT GENERATOR

5 KW — 17,000 B.T.U. Per Hour Output

The new "Heatmaster" has its "brains" built in — so that in production it may be operated safely by unskilled help. Operation is truly automatic — being limited to the insertion and removal of preforms on any designated time cycle.

For laboratory work, or manual operation, its advantages are equally outstanding. Owing to its one major control, the technician is enabled to concentrate his attention on the effect of high frequency rather than in the manipulation of electrical controls to produce a desired result.

The inclusion of fluorescent lighting in the electrode cage — while only a detail — illustrates the carefulness of design. The use of new long-life radial fin tubes cuts down operation expense. It has power to heat a 3.3 pound preform in one minute — 5 pounds in 90 seconds.

For plastic or for general purpose use, for research or production, the THERMATRON "Heatmaster" with its rugged construction, simplified controls, and generous power represents an outstanding development in electronic dielectric heaters.

All **Thermatron** ratings based on output

Send for new circular describing the 5 KW "Heatmaster" and other models in the THERMATRON LINE, ranging from 500 watts to 30 KW in output. Address Desk E-6.

Thermatron Division



RADIO RECEPTOR COMPANY, Inc.
251 WEST 19th STREET NEW YORK 11, N. Y.

Engineers and Manufacturers of Airway and Airport Radio Equipment
SINCE 1922 IN RADIO AND ELECTRONICS



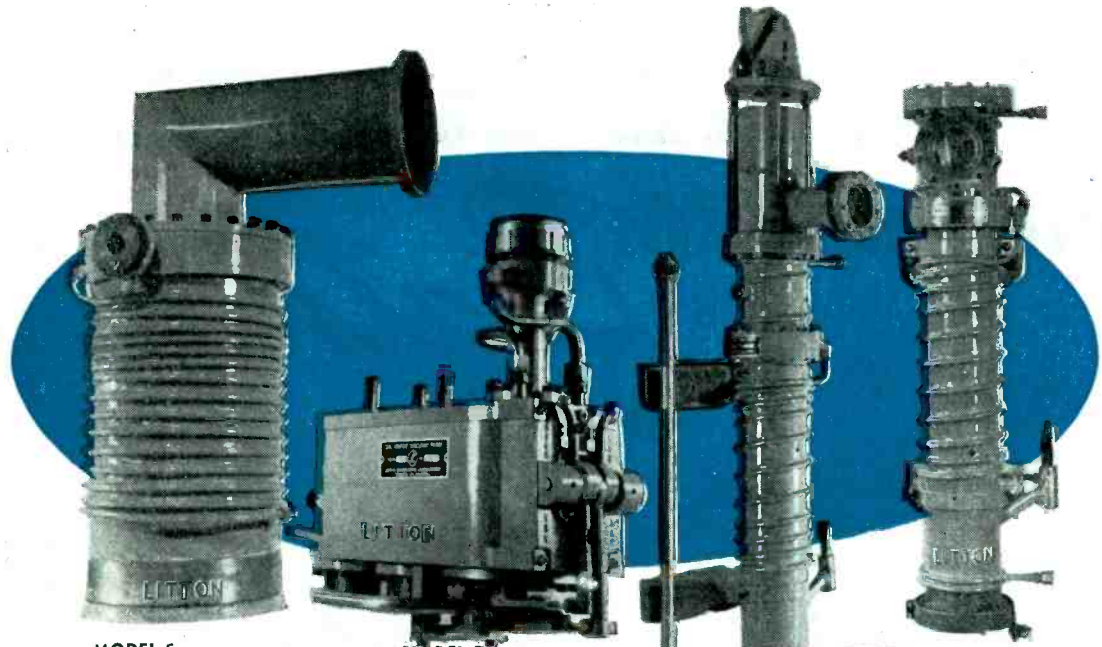

MODEL S
Height 29½ inches
Weight 100 lbs. (approx.)

MODEL T
(A Complete Exhaust System with High and Low Vacuum Valve and Charcoal Trap)
Height 11½ inches
Weight 12½ lbs.

MODEL R
(With Valve and Charcoal Trap)
Height 38¼ inches
Weight 40 lbs.

MODEL P
(With Charcoal Trap)
Height 24¾ inches
Weight 31 lbs.

What you may expect from LITTON



VACUUM TUBES for radio, radar and other communications owe their existence, continuing improvement to the high vacuum pump.



HIGH VACUUM has made possible the efficient processing of penicillin, foods, vitamins, etc.



LABORATORY RESEARCH in many fields to create new and useful products requires the use of high vacuum.

OIL VAPOR VACUUM PUMPS. Litton All Metal Vapor High Vacuum Pumps are specifically designed to serve a wide variety of high vacuum uses such as manufacturing all types of vacuum and gas filled tubes . . . heat treating and vacuum casting of metals . . . petroleum industrial applications . . . processing of pharmaceuticals and chemicals. Litton pumps serve scientists and technicians who today are creating tomorrow's world of induction heating, electronic controls and other wonders.

Designed by engineers experienced in high vacuum installation for many years, Litton pumps reach their maximum efficiency in a very short time. Their sturdy, compact structure insures lower installation costs, higher vacuum and longer life. The easily demountable boiler and charcoal baffle and the low cost, long lasting Litton Molecular Lubricant provide greater economies in operation and maintenance.

Litton Engineering service is available for all high vacuum installations or problems. Catalogs will be furnished upon request.

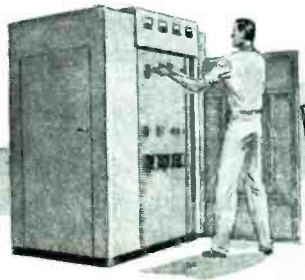

Many metals and alloys used in warfare and modern industry are refined under high vacuum.



Litton

ENGINEERING LABORATORIES
REDWOOD CITY, CALIFORNIA, U. S. A.

Aerovox Standard Types *Plus* Aerovox Engineering Ingenuity Meet High-Altitude Operation Requirements

PILLAR-TERMINAL

Bathtubs

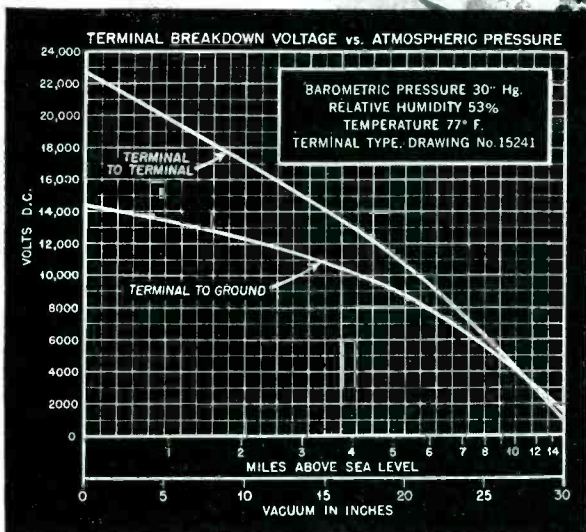

● Aerovox "know-how" is multiplying the outstanding choice of standard Aerovox capacitors countless fold in meeting extraordinary needs. For instance:
To meet certain aircraft requirements for compact

oil-filled capacitors to operate at high altitudes, Aerovox engineers fitted high-voltage pillar terminals to the well-known Type 30 "bathtubs". The result is the unit here shown. The small pillar terminals of feed-through design are normally rated at 3500 V. D.C.W. maximum. At this rating they can be used at altitudes corresponding to 35,000 feet or almost 7 miles. At 50,000 these terminals could be used on capacitors rated at 2000 V. or less. The accompanying chart tells the story.

Just another example of that outstanding Aerovox "know-how" that is saving time, money, headaches, for more and more critical capacitor buyers.

● Submit your problem.



Capacitors

INDIVIDUALLY TESTED

AEROVOX CORPORATION, NEW BEDFORD, MASS., U. S. A.

SALES OFFICES IN ALL PRINCIPAL CITIES

Export: 13 E. 40 St., New York 16, N. Y. • Cable: 'ARLAB' • In Canada: AEROVOX CANADA LTD., HAMILTON, ONT.



transmitting tube protection

**ADLAKE RELAYS
SEALED IN GLASS
with CALLITE
'MOLY' WIRE**



Callite molybdenum wire is selected because it has the qualities required for efficient glass sealing and does not amalgamate with the mercury in the relay.

Callite carefully processes molybdenum to obtain high purity ductile wire and sheet. Callite's Type 400 Molybdenum Wire is available in five types, each grade especially processed for its intended application as heater elements, filament mandrels, side rods, hooks, grids, tube and lamp supports.

Molybdenum wire is only one of Callite's complete range of metallurgical components for electrical and electronic manufacture. It will pay you to investigate our tungsten and molybdenum products of all kinds. Callite Tungsten Corporation, 544 Thirty-ninth St., Union City, N. J. Branch Offices: Chicago, Cleveland.

The Adlake plunger-type mercury relay serves to protect transmitter tubes from high plate voltage. The Adlake Model 1040's contact mechanism is hermetically sealed in an armored glass cylinder—proof against dirt, dust, moisture and explosive atmospheres. The Adams & Westlake Company uses Callite molybdenum wire as a lead wire which is sealed through the glass.



Callite

SPECIALISTS IN HARD GLASS LEADS, WELDS, TUNGSTEN AND MOLYBDENUM WIRE, ROD AND SHEET, FORMED PARTS AND OTHER COMPONENTS FOR ELECTRON TUBES AND INCANDESCENT LAMPS. ELECTRICAL CONTACTS OF TUNGSTEN, MOLYBDENUM, SILVER, PLATINUM, PALLADIUM AND ALLOYS OF THESE METALS; THERMOSTATIC BI-METALS.

Hand Holes to Pass the Ammunition . . .

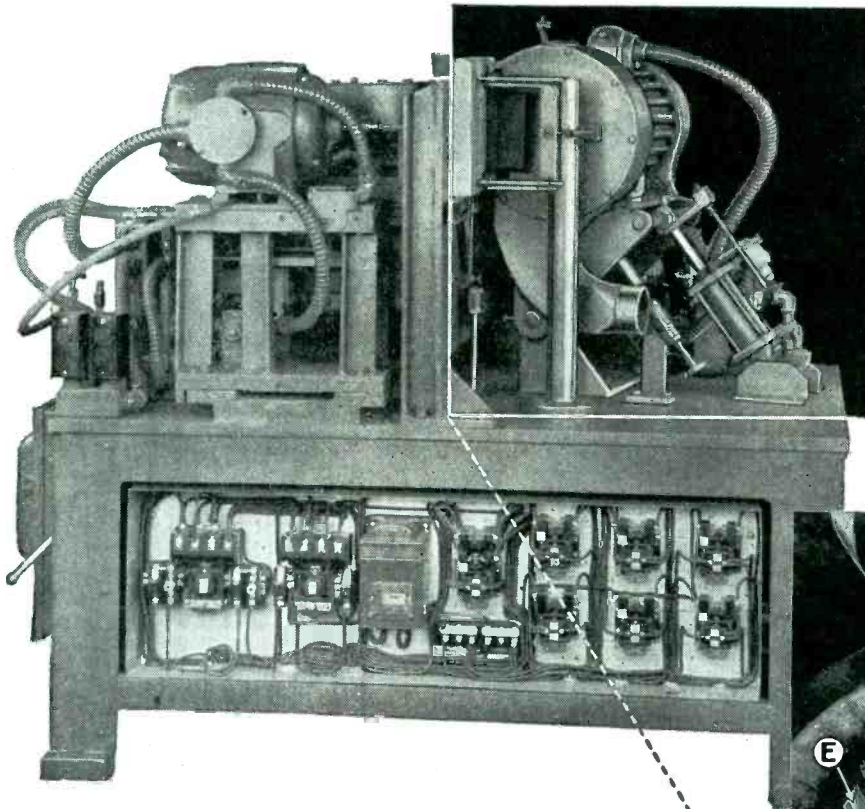

Cut Automatically
with aid of
**MICRO
SWITCH**
SNAP-ACTION

Hand hole grooves and slots in the ends of ammunition cases are accurately made in short order by this automatic machine manufactured by the C. O. Porter Machinery Company of Grand Rapids, Michigan.

Five Micro Switch snap-action switches, three of which are shown in the photograph, provide the automatic sequence for the operation. The first switch starts the sequence when the stock is pushed into cutting position and the outer switches complete the cycle. A switch with a roller actuator, not shown, holds the position of the carriage until the boring operation is completed.

The switches employed are of the die cast enclosed type, two of them with sealed plungers to protect the operating mechanism from dust and wood shavings.

These Micro Switch products were chosen as electrical controls for this impulse-sequence cycle because of their long life and rugged dependability, plus the fact that the compact housings made them easy to fit into the design. Micro Switch snap-action switches, with housings and actuators supplied to make them fully usable under every condition, meet the demands of design engineers who are looking for a precise, accurate, tiny switch that will handle substantial amounts of power at line voltage. Whether for use in delicate instruments and gages, or in heavy machinery, Micro Switch products can be easily adapted as an integral part of a device.

Whether your designs are for war or peace production, you will want to know all about Micro Switch. Send for Handbook-Catalog No. 60 today. If you are designing for aircraft, you will want to have a Handbook-Catalog No. 71, too. Write Micro Switch today.

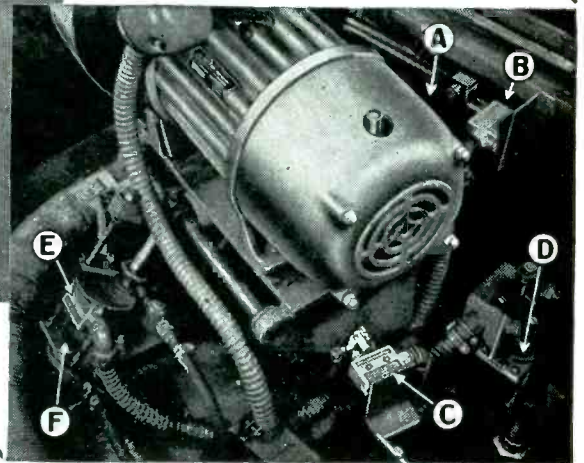

Here is How it Works

Pushing the box end into the machine simultaneously saws the slot and moves rod "A" which contacts switch "B". This progressively operates a large contactor, solenoid air valve and cylinder to move the saw and drill carriage to drilling position.

At the end of this carriage stroke, the drill and hand hole cutter units move in unison to make their cuts. As the hand hole unit moves, switch "C" closes and through a contactor energizes stock clamp solenoid "D".

When the hand hole cutter bottoms in the cut, switch "E" is contacted by arm "F", reversing the movement of the cutter unit. As the cutter returns to the start position, switch "C" opens to de-energize the solenoid stock clamp.



LET'S ALL BACK THE ATTACK

BUY EXTRA WAR BONDS

© First Industrial Corporation

MICRO MARK
TRADE **MS** **SWITCH**

A DIVISION OF FIRST INDUSTRIAL CORPORATION

Freeport, Illinois, U. S. A., Sales Offices in Principal Cities



The basic switch is a thumb-size, feather-light, plastic enclosed, precision, snap-action switch. Underwriters' listed and rated at 1200 V.A., at 125 to 460 volts a-c. Capacity on d-c depends on load characteristics. Accurate reproducibility of performance is

maintained over millions of operations. Basic switches of different characteristics are combined with various actuators and metal housings to meet a wide range of requirements.

INSIST ON PROOF BY TRIAL

before you buy an
Electronic Heater

This is how Scientific Electric proved the value of electronic heating to the Progressive Welding Company of Norwalk, Connecticut . . .

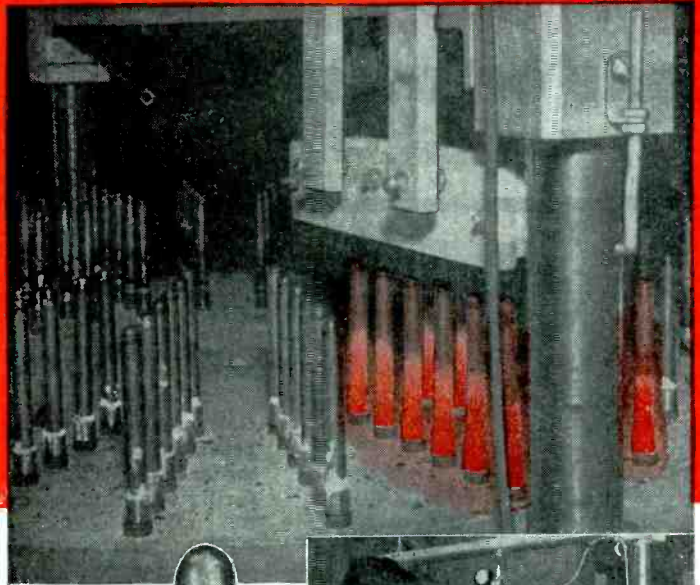

GREAT improvements in product quality and remarkable savings in time and money are being achieved by means of electronic heating. Industrialists everywhere are now acclaiming its many advantages. But don't let your enthusiasm lead you to invest in an electronic heater before you have seen it perform the work you expect of it.

Another important point is this . . . in order to work at maximum efficiency and live up to its reputation for doing things better, faster and cheaper . . . electronic heating must be "tailored" to the job. That is why we never sell a Scientific Electric unit until it has been satisfactorily demonstrated. Regardless of the amount of time and effort required, our engineers will not release a single machine for sale until it has fulfilled every claim we make for it.

So here is a word of counsel . . . get plenty of advice before you buy. Consult with our recognized engineers who have pioneered in electronic heating since 1921 and, without obligation, they will demonstrate what electronic heating can do for you.

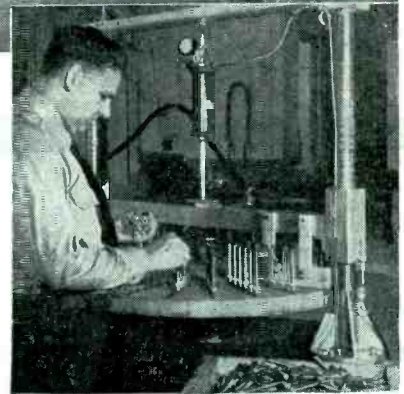

Above: This practical, automatic brazing turntable powered by a 40 KW. Scientific Electric heater speeded up production 730%—cut costs 87% and reduced rejects by 90%.

Left: Close-up of the finished two-piece tube assembly after being brazed by induction heating. Three complete brazing installations have been built for Progressive.

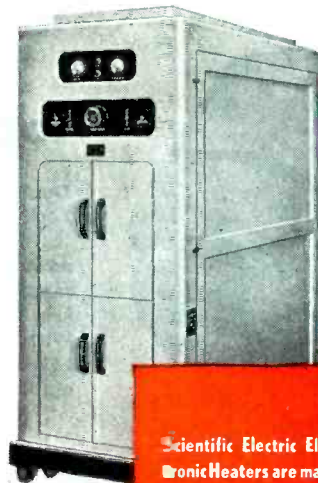

Write for a free copy of our handbook . . . *The ABC of Electronic Heating* which contains an easily understood explanation of this new heating method.

40 KW INDUCTION HEATER

Scientific Electric

Division of

"S" CORRUGATED QUENCHED GAP COMPANY

119 MONROE ST.  GARFIELD, N. J.

Manufacturers of

Vacuum Tube and Spark Gap Converters Since 1921

Scientific Electric Electronic Heaters are made in these power sizes... and a range of frequencies up to 300 Megacycles depending upon power requirements.

3 KW	18 KW
5 KW	25 KW
7½ KW	40 KW
8 KW	60 KW
10 KW	80 KW
12½ KW	100 KW
15 KW	250 KW

ONE OF THESE NEW

fastening

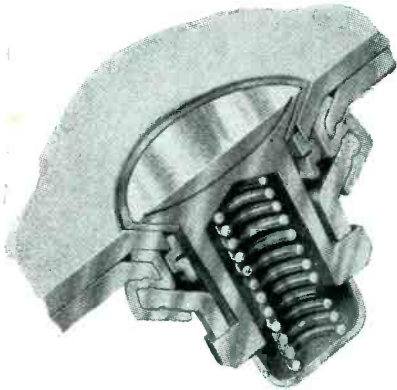

QUICK-LOCK

Only initial loads are carried by helical spring. Increased loads are taken by solid supports, assuring minimum deflection. 90° rotation locks or unlocks fastener. Stud is self-ejecting when unlocked. No special tools required for stud installation.

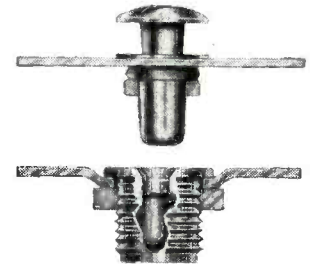

Standard studs can be used with air and water tight receptacle assemblies. Handles large range of material thicknesses by varying depth of receptacle-installation dimple.

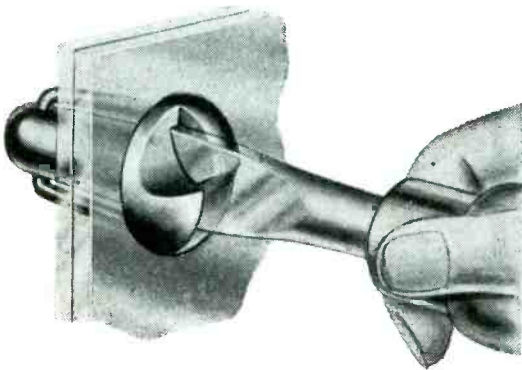

SPRING-LOCK

An inexpensive one-piece fastener—simple to install, self-adjusting for various thicknesses. Locks and unlocks with a quarter-turn in a 90° clockwise rotation. Can be permanently installed for use as a blind rivet.

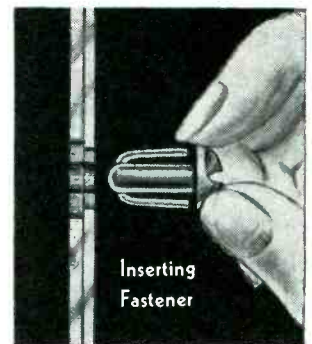

Inserting Fastener

HOW SIMPLE

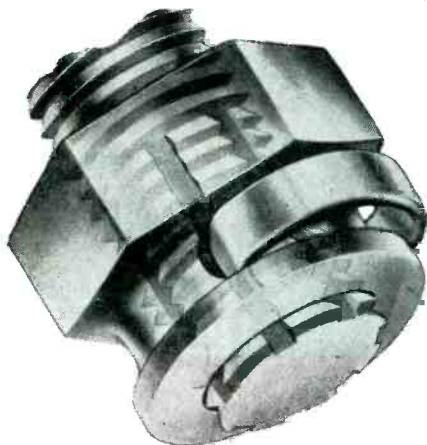

LOCK NUT

Double Duty Safety Nut—Lock Nut and Stop Nut.

AS A LOCK NUT. One end of safety ring engages nearest serration on bolt thread. With 7 serrations there are 14 locking positions per revolution.



Safety Ring in unlocked position on long thread. Serrations on the bolt threads can be cut by a simple broaching operation on a production basis in a fraction of the time it takes to drill a cotter pin hole.

Write for samples of Simmons Fasteners or call in a Simmons Engineer. He will be glad to help you to adapt any of these principles to your particular application.

methods

SOLVES YOUR PROBLEM

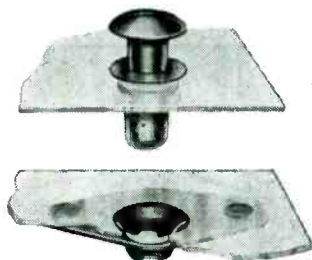

Oval-Head Stud and Plate-Type Receptacle. Plate-type is interchangeable with all standard A-N Receptacles. No special tools required.

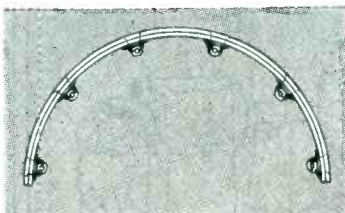

Tapered principle is particularly valuable in assembling curved sheets such as engine cowlings.

Adjustable fastener, using one stud and one adjustable receptacle fastens material thicknesses ranging from 1/32" to 5/16". By reversing flange, increased range 5/16" to 3/4" can be obtained.

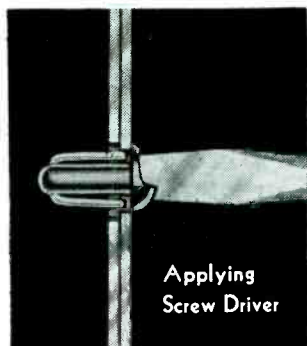
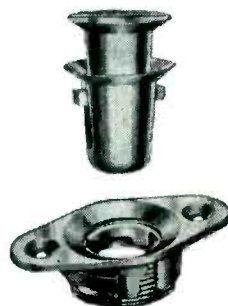

Applying
Screw Driver

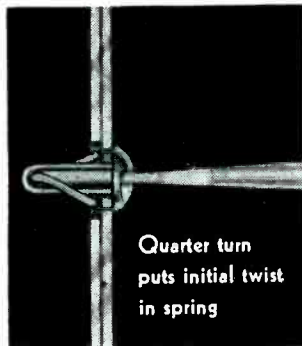

Quarter turn
puts initial twist
in spring



Another quarter
turn locks Fas-
tener in place

IT IS TO INSTALL THE SPRING-LOCK FASTENER

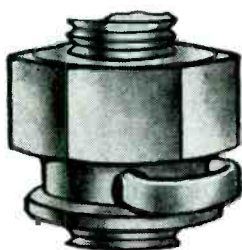

AS A STOP NUT. Can be used without serrated thread, providing close adjustment. When nut is tightened and safety ring snapped in locked position,

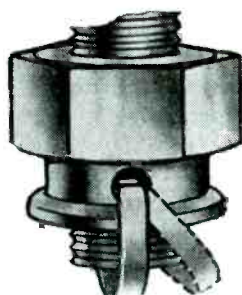

ends of ring bite into thread, providing stops for nut.

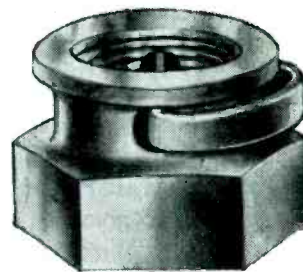

One Safety Nut for all purposes. Assures highest degree of permanence and safety—reduces assembly time.

U. S. AND FOREIGN PATENTS APPLIED FOR

SIMMONS FASTENERS

SIMMONS FASTENER CORPORATION • 1750 NORTH BROADWAY, ALBANY 1, N. Y.

DUMONT—FOR THE TOOLS OF TELEVISION

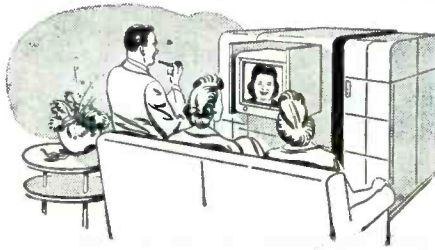

DUMONT POSTWAR TELEVISION BROADCASTING EQUIPMENT

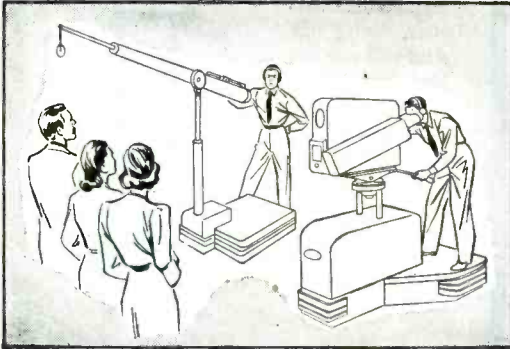

LIVE TALENT STUDIO. DuMont's Iconoscope Cameras pick up the scene and action. An electronic viewfinder enables cameramen to see exactly what looker-listeners see at home. DuMont's Sound Boom picks up voices and music.

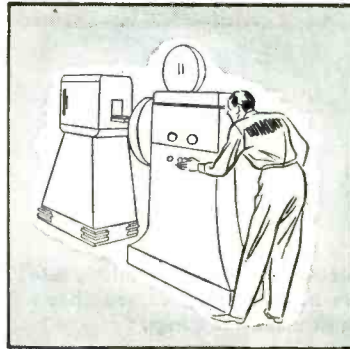

FILM STUDIO. Motion pictures, newsreels, commercials, etc., on 16 mm and 35 mm films require specially adapted projectors and DuMont Film Pickup Cameras.

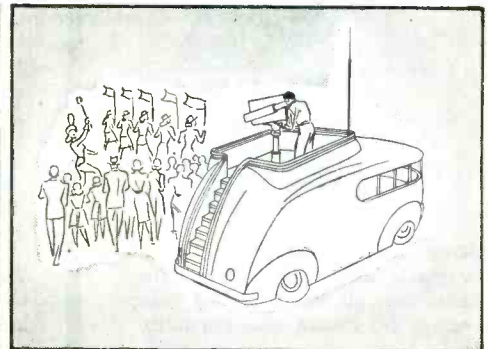

FIELD EVENTS. A DuMont-equipped Television Truck is a small station in itself... including cameras, control and sound equipment, relay transmitter and directional antenna. The relay receiver is located with the main transmitter.

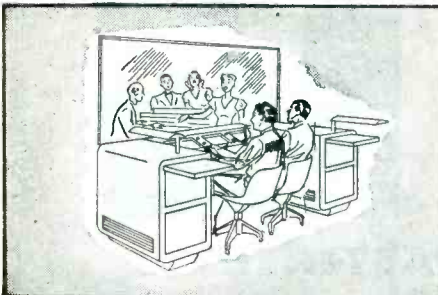

PRODUCER'S CONTROL DESK. Monitors show scenes being picked up by different cameras... with the largest monitor showing the scene selected for broadcasting. The producer sees the scene exactly as looker-listeners see it on DuMont Telesets.

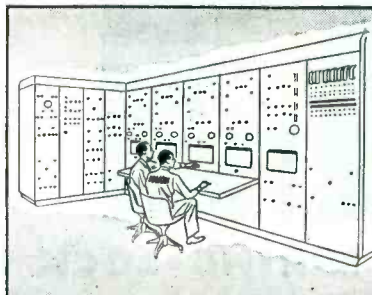

MASTER CONTROL BOARD. The Master Control Board is the heart of the television station. Engineers manipulate shading and other controls to add technical refinements with electronic artistry to all programs.

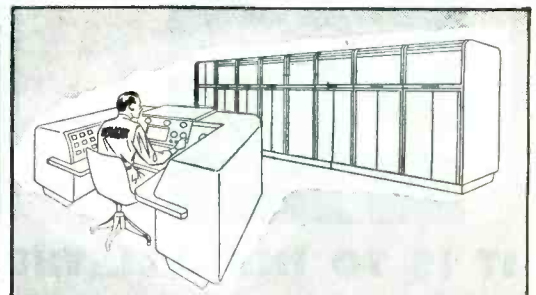

TRANSMITTER AND CONSOLE. All meters, oscillographs, controls and clocks are separately mounted in the console for safety, easy visibility and centralized operation. Video and audio signals (sight and sound) are transmitted from different antennae located on the same transmitting tower.

DuMont knows television. • DuMont has equipped more television stations than any other company. These stations are demonstrating the efficiency, the extreme flexibility, the rugged dependability and the greater economy of DuMont Television Broadcasting Equipment.

- DuMont has pioneered in television station operation. It has thus set a broad profit pattern for post-war commercial television.
- DuMont recognizes your needs. It offers the DuMont Equipment Reservation Plan which insures early peacetime delivery and personnel training.
- Study television's economies — get in touch with DuMont today.

Copyright 1945, Allen B. DuMont Laboratories, Inc.

DUMONT



Precision Electronics and Television

ALLEN B. DUMONT LABORATORIES, INC., GENERAL OFFICES AND PLANT, 2 MAIN AVENUE, PASSAIC, N. J.
TELEVISION STUDIOS AND STATION WABD, 515 MADISON AVENUE, NEW YORK 22, NEW YORK

from  arctic to  tropics



THIS BOND REMAINS PERMANENT

● From the arctic to the tropics—at all altitudes—this permanent hermetic seal of steel and steatite is now successfully protecting all types of communication equipment.

For SEALEX combinations—a new method of joining steatite and metal permanently in various combinations—produces a bond which not only withstands great extremes of temperature, but gives proved protection against vibration, humidity, and Salt Spray Corrosion, as well.

SEALEX Bushings will contain air at 50 pounds per square inch after a thermal change test of 25 cycles from -65°C to $+125^{\circ}\text{C}$. They are available in single terminal and multiple terminal designs for high and low voltage requirements.

For long-life, dependable, trouble-free service, specify SEALEX Combinations. Specifications and complete data on all SEALEX Bushings available for quick delivery are listed in the SEALEX catalog. Send for a copy today. Write us for any special assistance you may require, when confronted with hermetic sealing problems.

SALES REPRESENTATIVES
 H. W. GERHARD
 737 No. Michigan Ave., Chicago, Illinois
 J. J. PERLMUTH & ASSOCIATES
 942 Maple Avenue, Los Angeles, Calif.
 MICA COMPANY OF CANADA LTD.
 P. O. Box 189, Montreal, Quebec



RAYTHEON VOLTAGE STABILIZERS

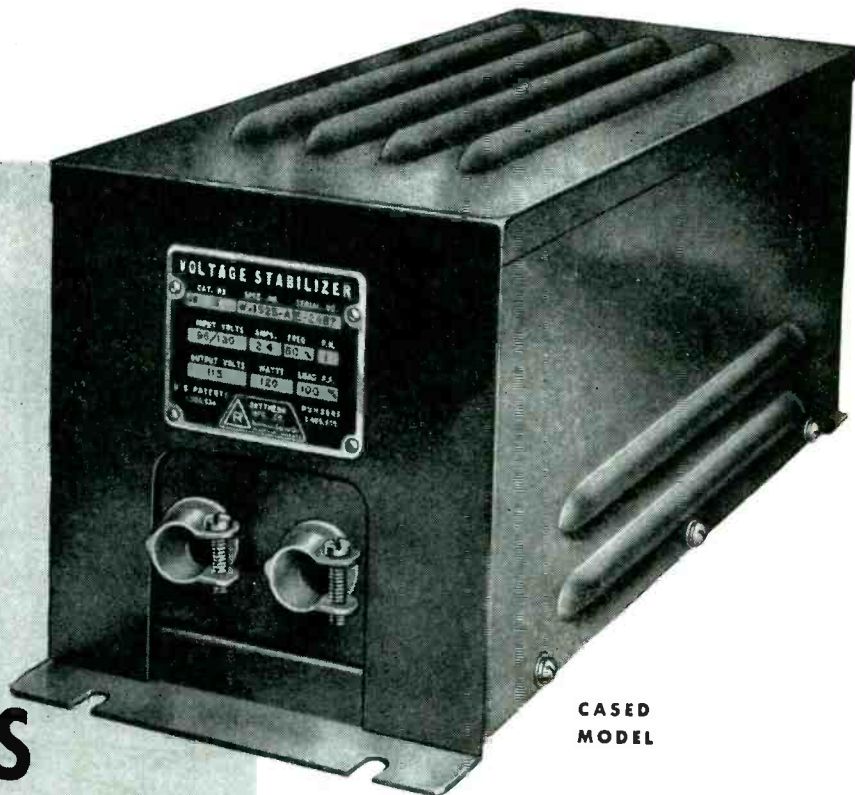

CASED
MODEL

- STABILIZE VARYING LINE VOLTAGES TO $\pm 1/2\%$
- STABILIZE WITHIN 2 CYCLES
- STABILIZE VOLTAGES FROM 95 TO 130 VOLTS OR 190 TO 260 VOLTS
- ARE FULLY AUTOMATIC IN OPERATION
- SIMPLY CONNECT THEM . . . AND THEY'LL TAKE CARE OF THEMSELVES

By controlling varying input voltage to $\pm 1/2\%$, Raytheon Voltage Stabilizers improve the performance and assure reliable operation of a wide variety of electrical equipment where close voltage regulation is a must for accurate operation. Entirely automatic in operation, they require no maintenance once installed. Raytheon Voltage Stabilizers are available in three styles, as illustrated, and many models to meet practically every installation requirement. They can be built into new equipment or incorporated in products already in use. Write for Bulletin DL48-537. It gives the complete story.

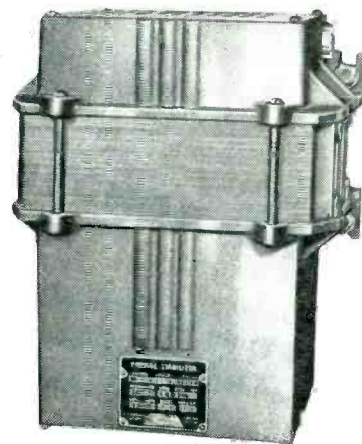

ENDBELL
MODEL

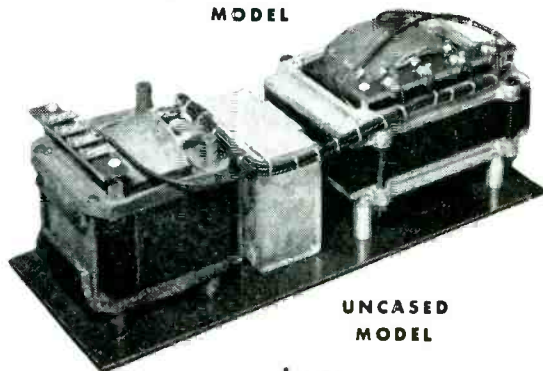

UNCASED
MODEL

Tune in the Raytheon radio program: "MEET YOUR NAVY," every Saturday night on the Blue Network. Consult your local newspaper  for time and station



RAYTHEON

MANUFACTURING COMPANY

Electrical Equipment Division

190 WILLOW STREET, WALTHAM, MASS.

Devoted to research and manufacture of complete electronic equipment; receiving, transmitting and hearing aid tubes; transformers; and voltage stabilizers.

The coveted Army-Navy "E," for Excellence in the manufacture of war equipment and tubes, flies over all four Raytheon Plants where over 16,000 men and women are producing for VICTORY.

Rubber Engineered by GENERAL

One entire General plant, at Wabash, Ind., and its Engineering Department specialize on mechanical rubber goods, some of which are shown here. If your products use rubber parts, General engineers can help you specify the rubber and design appli-

cations for highest efficiency. Broad experience and ample facilities qualify General as a dependable source for your needs in precision-engineered rubber goods. The General Tire & Rubber Co., Mechanical Goods Division, Wabash, Indiana.

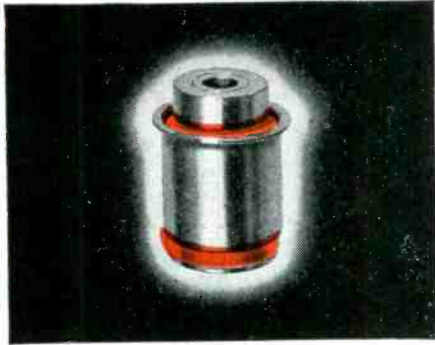

SILENTBLOC Vibration Mountings give engineered accuracy in control of vibration and shock load in motors and equipment.

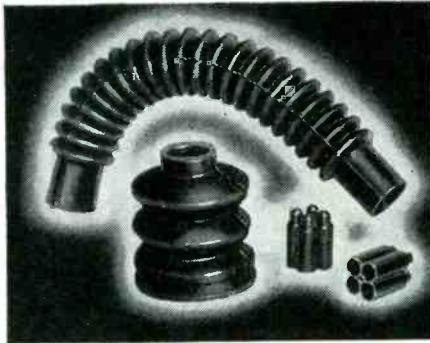

MOULDED RUBBER parts of any size, shape and type of rubber, to meet your specifications for accuracy and performance.

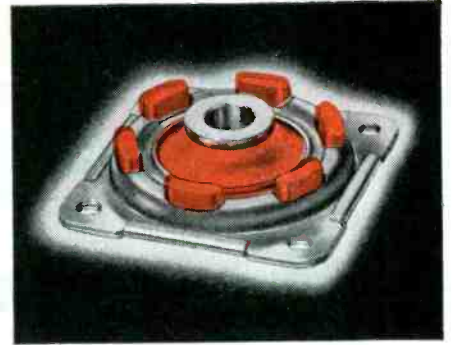
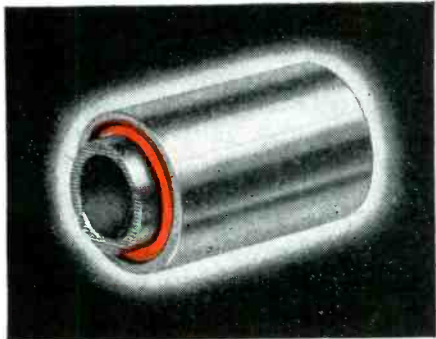
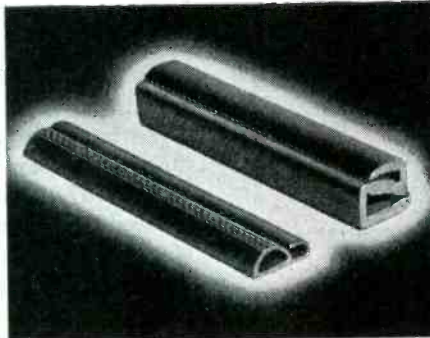

PLATE MOUNTS of any metal and rubber, for vibration isolation in aircraft, radio, electrical equipment, instruments.



SILENTBLOC BEARINGS for oscillating equipment—need no lubrication, work silently, long lasting, unharmed by dust or liquid.



EXTRUDED RUBBER in any solid or hollow shape, made accurately to your specifications from any type of rubber.

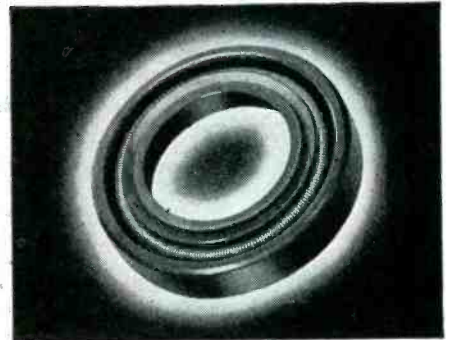

OIL SEALS for lubricant and hydraulic applications, engineered to meet your needs in efficiency and long service.



RUBBER-bonded-to-metal parts of all kinds, made to specification. In ROTOL drive, shown at right, rubber is bonded to metal.

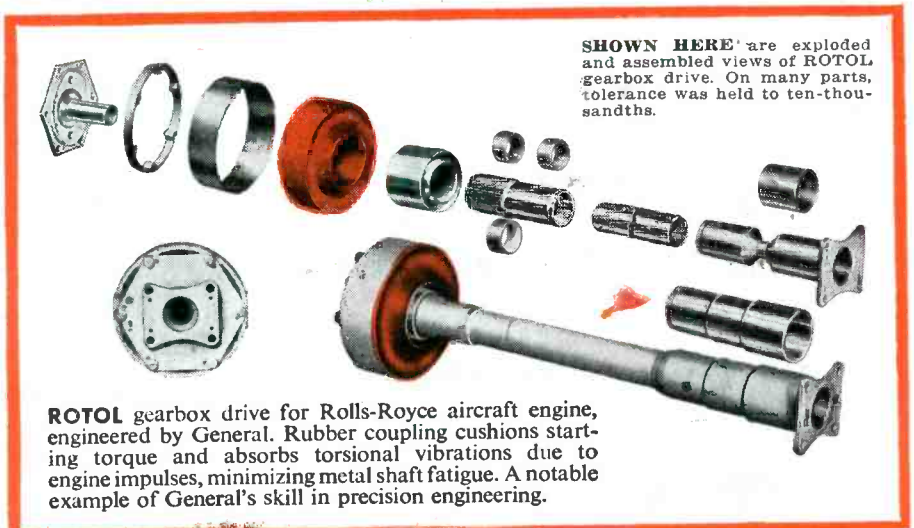

SHOWN HERE are exploded and assembled views of ROTOL gearbox drive. On many parts, tolerance was held to ten-thousandths.

ROTOL gearbox drive for Rolls-Royce aircraft engine, engineered by General. Rubber coupling cushions starting torque and absorbs torsional vibrations due to engine impulses, minimizing metal shaft fatigue. A notable example of General's skill in precision engineering.

MECHANICAL GOODS DIVISION • WABASH, INDIANA

THE GENERAL TIRE & RUBBER CO.

Makers of America's Top Quality Tire

BH SPECIAL TREATED FIBERGLAS SLEEVING



HEAT RESISTANT TO

1200° F!



SNUB TEST

Proves BH Non-Fray Feature

Make this test yourself. Tap a piece of ordinary saturated sleeving on your desk top and see how easily it frays. Then do the same with BH Extra Flexible Fibreglas Sleeving. It only fuzzes a little—doesn't break down—doesn't fray.

THE RESULT



◀ The BH Way



The Ordinary Way ▶

BH EXTRA FLEXIBLE FIBERGLAS SLEEVING

2 WAYS BETTER

NON-FRAYING • NON-STIFFENING

IF YOU NEED an electrical insulation that's not affected by temperatures up to 1200°F., yet is unusually flexible, workable and durable, you'll find it in BH Special Treated Fibreglas Sleeving. Even in direct contact with heat units this remarkable sleeving won't burn.

Reason? It's made of inorganic Fibreglas and treated by the exclusive BH process. No saturant is used, yet the sleeving won't fray when cut and it is *permanently* flexible. In addition to many other properties it is moisture, oil and grease resistant . . . works easier, simplifies assembly and lasts longer. Made in natural color only—all standard sizes. Get your free samples today and compare!

HERE'S ANOTHER NON-BURNING SLEEVING

BH Extra Flexible Fibreglas Sleeving won't burn because both yarns and impregnation are non-inflammable. This high quality sleeving has all the advantages of pure Fibreglas, is toughened against abrasion, is non-fraying and non-stiffening. It lasts indefinitely without rotting or cracking—the ideal all-purpose electrical insulation for all kinds of industrial equipment and home appliances. Available in all standard colors and sizes from No. 20 to 5/8", inclusive. Put it to the toughest tests you know and watch the results!

ALL BH PRODUCTS AVAILABLE IN STANDARD 36" LENGTHS AND 500-FT. COILS



ALSO SLOW-BURNING IMPREGNATED MAGNETO TUBING • SLOW-BURNING FLEXIBLE VARNISHED TUBING • SATURATED SLEEVING • A.S.T.M. SPECIFICATIONS

BENTLEY, HARRIS MANUFACTURING CO.

Dept. E Conshohocken, Penna.

MEMO: From the Publisher of Electronics

“... WE REGRET TO ANNOUNCE THAT THE PAPER SHORTAGE FORCES US TO POSTPONE PUBLISHING THE ANNUAL ELECTRONICS BUYERS' GUIDE, USUALLY PRINTED AS PART OF THIS MONTH'S ISSUE.”

ELECTRONICS

FRANKLIN foresaw this possibility and, with the feeling that changes and additions would not be too significant, reprinted the latest published BUYERS' GUIDE, bound it into the 1945 FRANKLIN CATALOGUE and now offers both

The ELECTRONIC'S BUYERS' GUIDE and FRANKLIN'S 1945 CATALOGUE

FREE UPON WRITTEN REQUEST

Write for these two valuable aids ... Free for the asking!

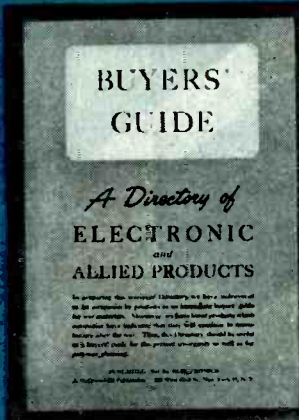

Electronics Buyers' Guide contains the names and addresses of sources for everything that goes into the manufacture of Electronic and Radio Equipment. 48 pages of invaluable reference for engineers and purchasing departments.

Franklin's 1945 Catalogue contains engineering data and illustrations of Franklin's very complete line of Sockets, Plugs, Switches, Terminal Strips, Plastic Fabrications, Metal Stampings, etc. Everything in Radio Hardware.

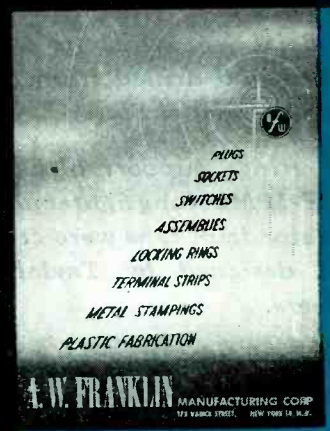

A.W. FRANKLIN MANUFACTURING CORP.

175 VARICK ST., NEW YORK 14, N.Y.

SOCKETS • TERMINAL STRIPS • PLUGS • SWITCHES • PLASTIC FABRICATION • METAL STAMPINGS • ASSEMBLIES

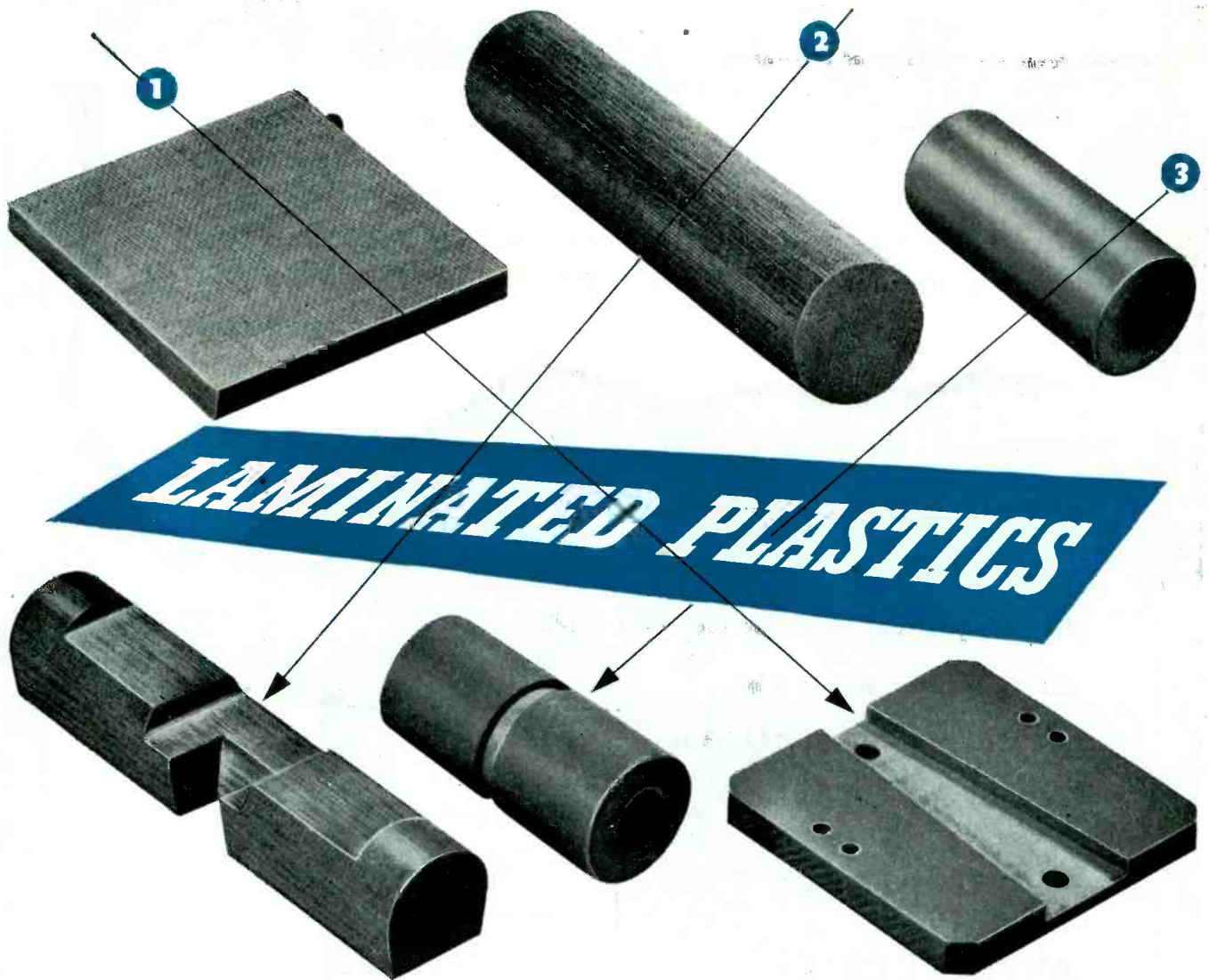

Thousands of Fabricated Parts from Taylor's Sheets, Rods, Tubes

1 One of several parts for an artificial leg, which is sawed, milled and drilled from a flat sheet of Phenol Fibre.

2 Hinge support blocks for the P-51 Mustang fighter planes' elevator trim tabs were created and designed by Taylor engineers.

3 Switch spacers, made from tubes of Phenol Fibre, are quickly and accurately finished on a Taylor automatic screw machine.

From sheets, rods, and tubes of Phenol Fibre or Vulcanized Fibre, Taylor makes thousands of different fabricated parts, turning them out by the millions and doing it quickly, accurately, and economically.

Almost every one of these parts is specially designed for a special purpose and calls for a laminated plastic with special characteristics. Their common feature is light weight with great strength. In addition, they have insulating, electrical, and dielectrical properties unequalled by any other material.

Having been in this business for more than fifty years, Taylor also has a stock of standard tools for turning out such things as plain washers, and shoulder bushings, in so many different sizes that the chances are good that the size you need is in stock and your fabricated part can therefore be made more quickly and more inexpensively.

Whatever your problem, our engineers will gladly tell you, without obligation, exactly what Taylor Laminated Plastics can contribute to its solution. Write us today, sending sketch or blueprint.

TAYLOR FIBRE COMPANY

LAMINATED PLASTICS: PHENOL FIBRE · VULCANIZED FIBRE · Sheets, Rods, Tubes, and Fabricated Parts
 NORRISTOWN, PENNSYLVANIA · OFFICES IN PRINCIPAL CITIES · PACIFIC COAST HEADQUARTERS: 544 S. SAN PEDRO ST., LOS ANGELES 43

**The "Sweepings"
Prove it!**



**ELIMINATE WASTED LOCK WASHERS
AND SAVE VITAL ASSEMBLY TIME WITH**

SEMS *Fastener Units*

Reg. U. S. Pat. Off.

Putting lock washers on screws is definitely "out-of-date". Not only are lock washers dropped and wasted, but think of the slow, costly, tedious task of putting them together. Your assembly line can achieve a faster tempo with SEMS Units because the lock washer and screw are handled as a single piece—they drive easier and there's no chance for the operator to "forget" the lock washer. Get the facts on comparative costs now—see how you can step up assembly efficiency and save money, too!



The Lock Washer can't drop off!

SEND FOR FREE TEST KIT!

Examine this pre-assembled fastener unit. See how the lock washer is held securely on the screw and yet is free to rotate. Note the superior locking power provided by the tapered-twisted teeth. Here's proof of economy and better product protection—write for your Test Kit No. 23 now!



SHAKEPROOF inc.
Fastening Headquarters

Distributor of Shakeproof Products Manufactured by ILLINOIS TOOL WORKS
2501 North Keeler Avenue, Chicago 39, Illinois
Plants at Chicago and Elgin, Illinois
In Canada: Canada Illinois Tools, Ltd., Toronto, Ontario
Los Angeles Office Detroit Office
5670 Wilshire Blvd., Los Angeles 36, Calif. 2895 E. Grand Blvd., Detroit 2, Mich.

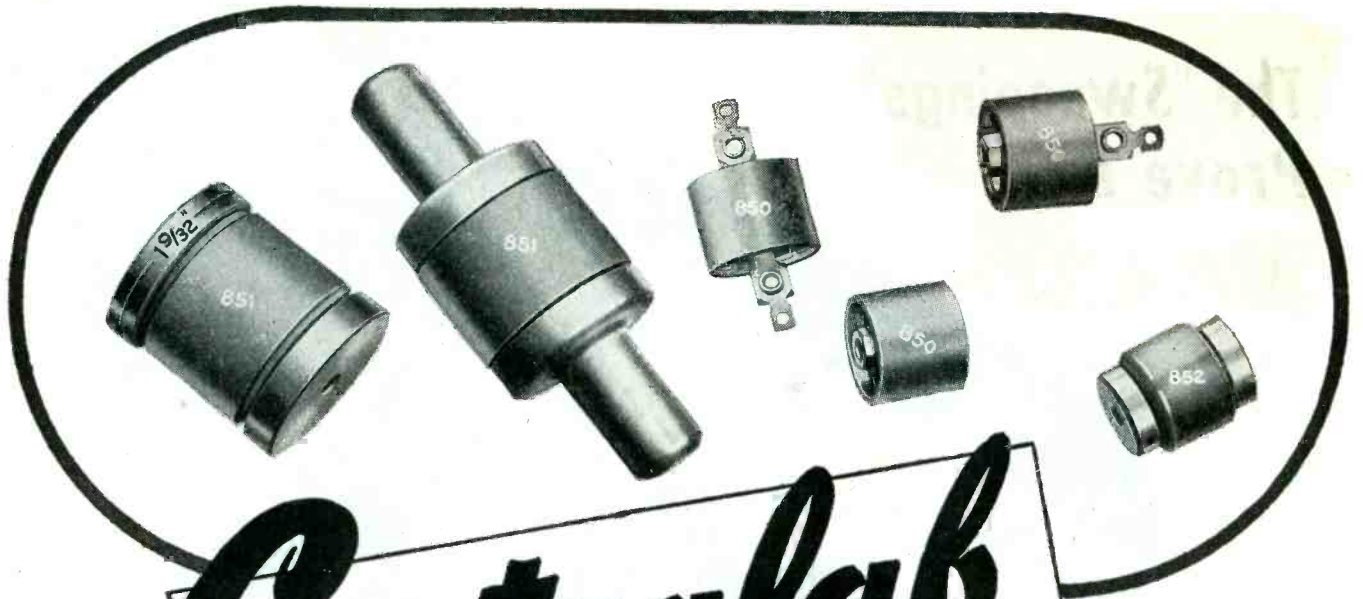

Centralab

CERAMIC CAPACITORS FOR HIGH VOLTAGE

Type 850, 851, and 852 shown above are double cup style ceramic capacitors engineered by Centralab for applications where high working voltages and loads are required.

Capacities: 850 — 25 MMF, NPO to 100 MMF, N750; 851 — 25 MMF, NPO to 200 MMF, N750; 852 — 10 MMF, NPO to 25 MMF, N750. Working voltages to 15,000 D.C. Types 853, 854 and 855 shown below are also double cup design and have accumulative capacities ranging from 2 MMF to 20 MMF in zero T. C. to MMF to 40 MMF in maximum negative T. C. (N750). Working voltages to 7500 D. C.

Send for Bulletin 721 and 814.



Centralab

Producers of: Variable Resistors • Selector Switches • Ceramic Capacitors,
Fixed and Variable • Steatite Insulators • Button Type Silver Mica Capacitors.



"RADIO-SONDE" *Performance*

25 MILES UP

*largely depends upon
this Thumb Size
"HUSKY" RELAY*

SCIENTIFIC weather forecasting today is greatly aided by "RADIO-SONDE" the tiny radio sounding unit borne into the stratosphere by balloon and returned by parachute. Naturally such a delicate device demands dependable operating components.

The "Husky" relay used in Radio-Sonde is our TYPE 400 MIDGET. It weighs but 25 grams and measures 1 1/8" x 7/8" x 25/32".

This relay is widely adaptable for use with portable battery equipment where coil current, weight and size are the prime consideration. The magnetic circuit is highly efficient. The contact arm and armature spring are one continuous piece with NO coil spring or pigtails. This feature results in a rugged, compact design, which will maintain adjustment under severe conditions, wide variations of temperature and rough handling.

The moving contact is grounded to the relay frame, but if isolation of this contact is required the relay is readily mounted on a phenolic base. The contact material is palladium, rated at 250 milliamperes.

Send for
Catalog E-56

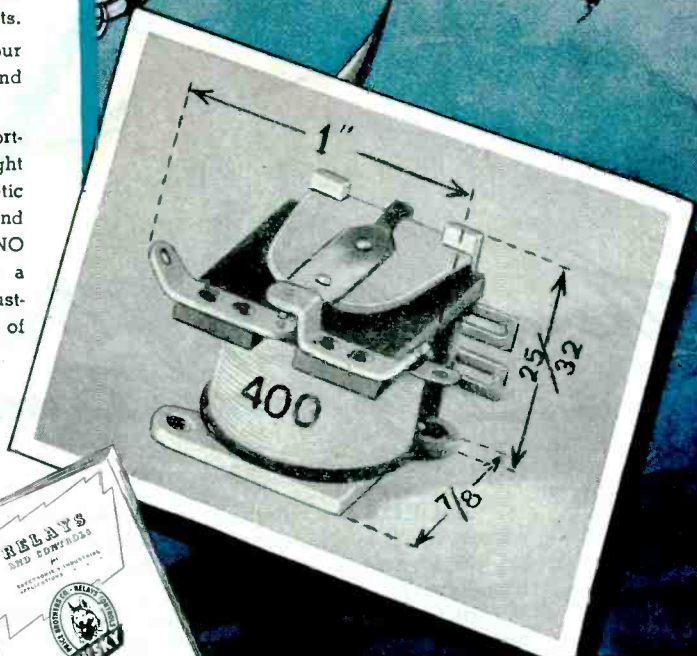

"RO-T-RY" introduces a new basic principle to relay operation especially designed to withstand severe vibration, temperature and humidity conditions. It is widely adaptable to

operate a great variety of switch wafer arrangements. The basic unit is a contact two position driven mechanism operated by 30° clockwise or counter-clockwise rotation from normal (power off) position. The shaft rotates one way under power and returns to normal position by spring action. "RO-T-RY" is being specified in the design of many postwar products. Get complete facts about "RO-T-RY" now.



PRICE Brothers Co. FREDERICK, MARYLAND.

RELAYS, CONTROLS, AND MAGNETIC DEVICES FOR ELECTRONIC & INDUSTRIAL APPLICATION

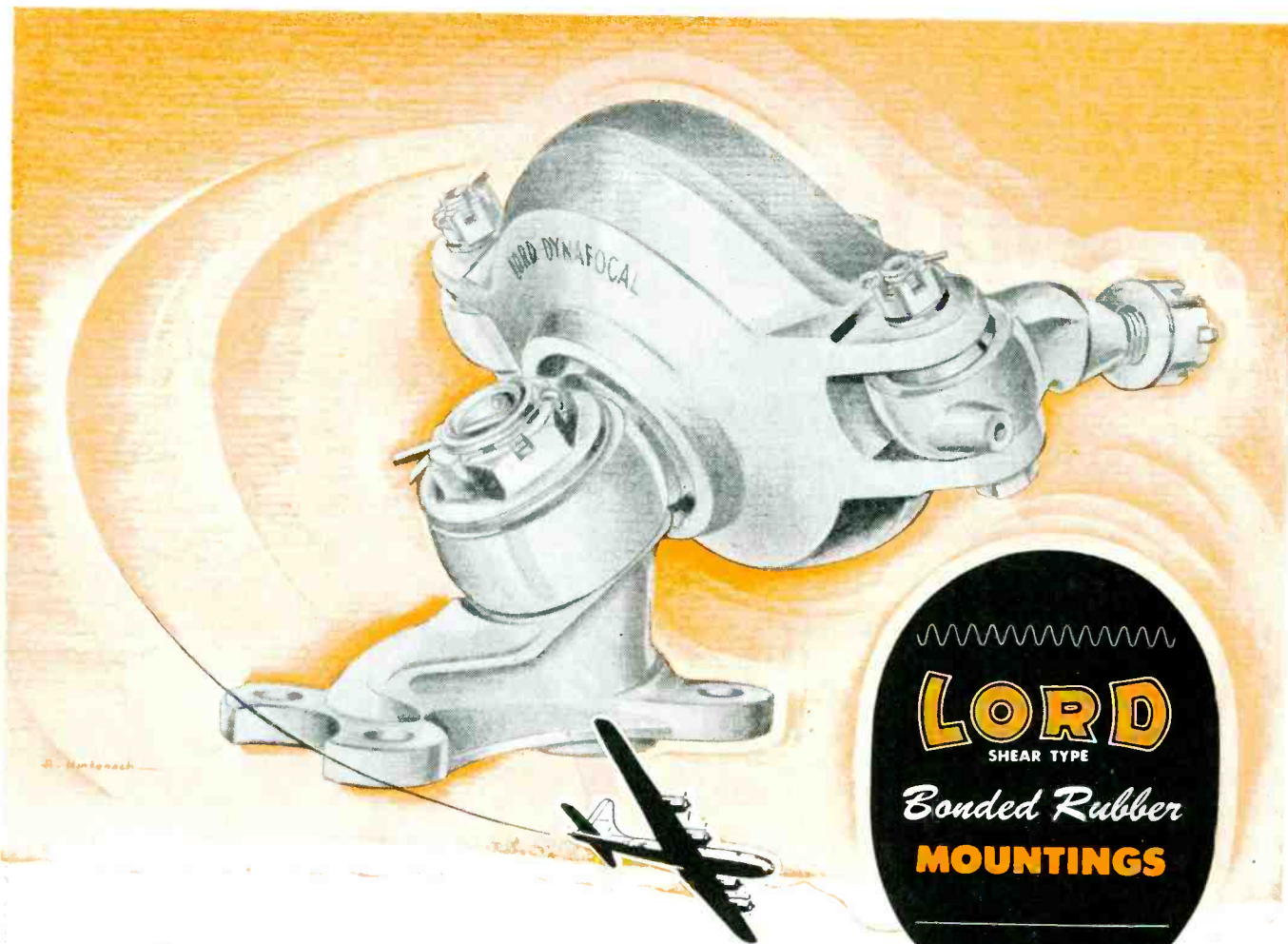

The untold story of "B-29" Long Range Bombing

LORD'S contribution to the remarkable success of "B-29" long range bombing is the Lord RS-40F Dynafocal Suspension. These assemblies harness over 8,000 horsepower from the four Wright Cyclone Engines powering the Army "B-29 Super Fortress". Essential to the operation of the "B-29", the RS-40F Dynafocal Assembly affords a resilient means of attaching the engine to the airframe, protecting the plane, precision instruments and other auxiliary equipment, as well as the crew, from the destructive and fatiguing forces of vibration.

Designed and developed by Lord, the RS-40F Dynafocal Assembly incorporates the combined use of rubber, steel and dural forgings, and compo bronze bearings, all integrated to effect an efficient,

flexible suspension, to fulfill the rigid vibration-control and load-carrying requirements. Only six sub-assemblies (RS-40F-SA) are required to attach a Wright Cyclone Power Plant and Propeller to the airframe, thus meeting the aircrafters' challenge of weight saving.

Thousands of various Dynafocal Suspensions and other types of Lord Mountings are used in all American combat planes for vibration control and isolation on engines, instrument panels and countless instruments and auxiliary equipment.

The "know-how" developed in meeting the critical problems involved in safeguarding the lives of our combat fliers will result in greater refinements of resilient mountings for the aircraft and other industries, and for scientific applications in the future.

IT TAKES BONDED RUBBER *In Shear* TO ABSORB VIBRATION

LORD MANUFACTURING COMPANY

ERIE, PENNSYLVANIA

Back the 7th
War Loan
Buy More Bonds

Originators of Shear Type Bonded Rubber Mountings

SALES REPRESENTATIVES
NEW YORK - 280 MADISON AVE.
CHICAGO - 520 N. MICHIGAN AVE.
DETROIT - 7310 WOODWARD AVE.
BURBANK, CAL. - 245 E. OLIVE AVE.
CANADIAN REPRESENTATIVES
RAILWAY & POWER ENGINEERING CORP., LTD.
TORONTO, CANADA

GET THE LATEST DATA

On U. H. F. Cables and Connectors!

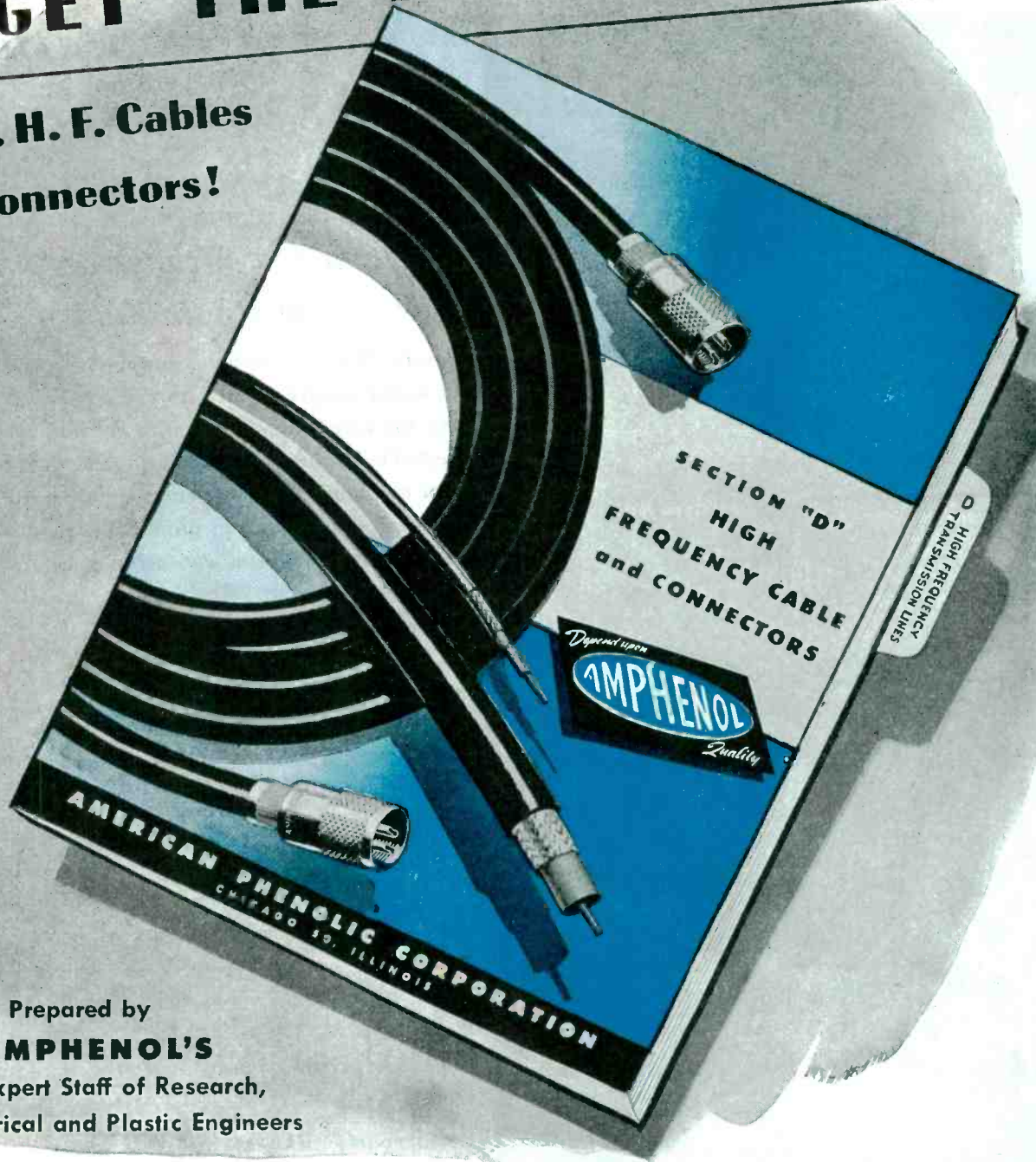

Prepared by
AMPHENOL'S
Expert Staff of Research,
Electrical and Plastic Engineers

Complete data is available on Amphenol's cables for the latest requirements—incorporating the solid, flexible, low-loss, mechanically stable, thermoplastic polyethylene.

Explanatory charts and technical information given on Amphenol precision-engineered manufacturing methods. The in-

formation contained in the new catalog Section "D" has been compiled thru the close cooperation of Amphenol Engineers, Army-Navy Engineers and large industrial concerns.

This explains why Amphenol U.H.F. Cables embody the same built-in quality, perfection and performance that typify

every Amphenol-Engineered product.

For quick reference there is also included a complete chart listing Amphenol cable sizes, characteristics and dimensions as approved by Government Agencies.

Send today for your copy of Section "D" High Frequency Cables and Connectors. Use the coupon!

AMERICAN PHENOLIC CORPORATION

Chicago 59, Illinois

In Canada: Amphenol Limited • Toronto

U.H.F. Cables and Connectors—Radio Parts—Plastics
for Electronics and Industry—Conduit—Connectors
(A-N and British)—Fittings—Cable Assemblies

*Please send a copy of the new
catalog Section "D"*

Name _____

Company _____

Address _____

Also send information on _____

WEBSTER DYNAMOTORS

*have a reputation
for outstanding
performance*

*... and the Webster organization
meets schedules.*

Webster Dynamotors have shown in actual service that the *extra quality* built into them pays out. They reflect the care with which parts are fabricated and inspected before assembly to assure good balance, freedom from minimum vibration and maximum durability. If you need dynamotors in production quantities for the war program, Webster can serve you. Just write us about your problem.

The Webster Dynamotors listed here are our basic, standard, large-scale production models.

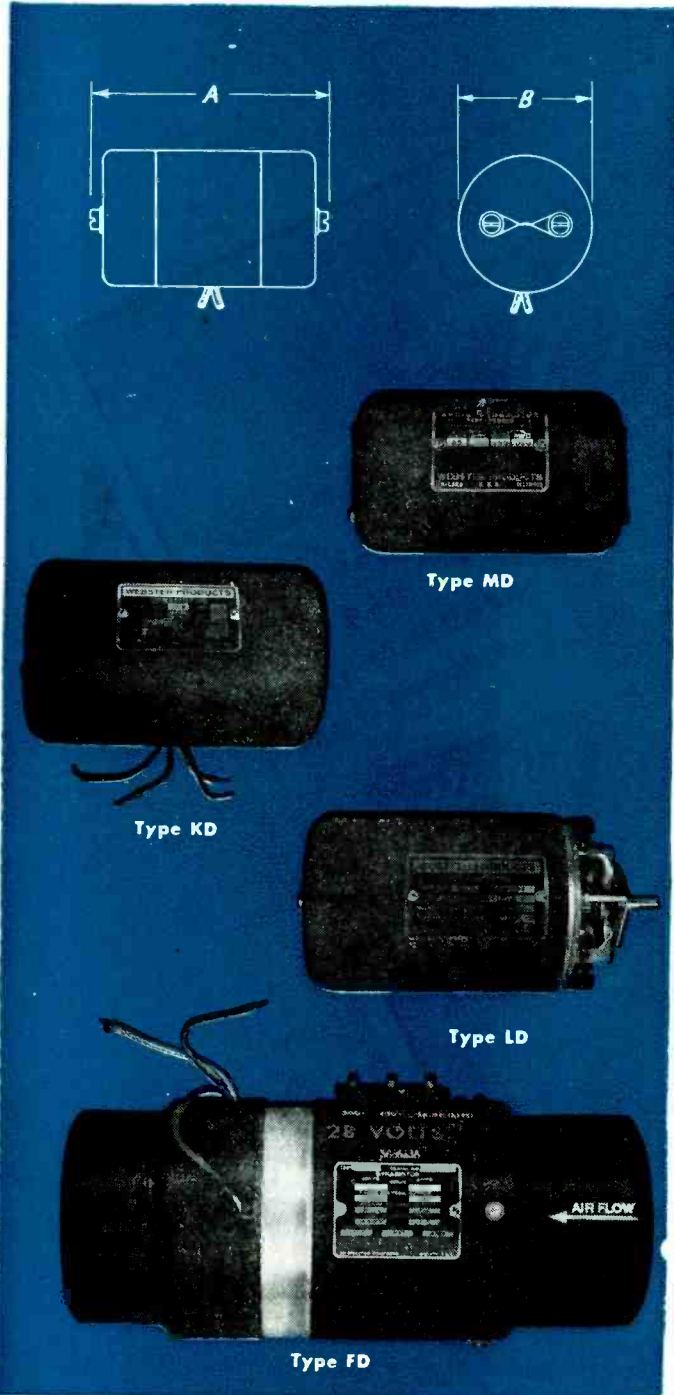

Watt- age	Webster Model Number	Input		Output*		Net Wt. Lbs.	Dimensions	
		Volts	Max. Amp.	Volts	Amp.		A	B
10 to 15	MD-1020	14	2.4	250	.060	2 ⁹ / ₁₆	4 ¹³ / ₁₆	2 ³ / ₄
	MD-1021	28	1.15	250	.060	2 ⁹ / ₁₆	4 ¹³ / ₁₆	2 ³ / ₄
	MD-1024	27	1.15	250	.060	2 ⁹ / ₁₆	4 ¹³ / ₁₆	2 ³ / ₄
	MD-1025	24	1.6	190	.100	2 ⁹ / ₁₆	4 ¹³ / ₁₆	2 ³ / ₄
	MD-1026	13.7	2.8	230	.080	2 ⁹ / ₁₆	4 ¹³ / ₁₆	2 ³ / ₄
	MD-1027	27.9	1.4	230	.080	2 ⁹ / ₁₆	4 ¹³ / ₁₆	2 ³ / ₄
	MD-1028	27	1.75	300	.075	2 ⁹ / ₁₆	4 ¹³ / ₁₆	2 ³ / ₄
15 to 20	KD-1000	14	2.8	220	.080	5	5 ⁵ / ₈	3 ⁷ / ₁₆
	KD-1001	12	3.8	220	.100	5 ¹ / ₄	5 ⁵ / ₈	3 ⁷ / ₁₆
	KD-1002	13.8	2.5	230	.070	4 ⁷ / ₁₆	5 ⁵ / ₈	3 ⁷ / ₁₆
	KD-1004	27.9	1.25	230	.070	4 ⁷ / ₁₆	5 ⁵ / ₈	3 ⁷ / ₁₆
20 to 30	LD-1010	12.2	3.3	230	.090	5 ³ / ₈	5 ²⁹ / ₃₂	3 ⁷ / ₁₆
	LD-1011	28	1.6	230	.100	5	5 ²⁹ / ₃₂	3 ⁷ / ₁₆
	LD-1012	9	6.4	450	.060	5 ³ / ₄	6 ⁷ / ₁₆	3 ⁷ / ₁₆
	LD-1013	18	3.3	450	.060	5 ³ / ₄	6 ⁷ / ₁₆	3 ⁷ / ₁₆
	LD-1014	18.5	3.3	400	.080	5 ³ / ₄	6 ⁷ / ₁₆	3 ⁷ / ₁₆
	LD-1015	8.9	7.5	425	.095	5 ³ / ₄	6 ⁷ / ₁₆	3 ⁷ / ₁₆
165	FD-1060	28	10.5	High 300	.260	21	12 ¹ / ₁₆	5 ¹¹ / ₃₂
				Med. 150	.010			
				Low 14.5	4.9			

*Ratings shown are for continuous duty with temperature rise and secondary ripple voltage well within the limits of Government Specifications. Mounting brackets or filters are available when required.

Formerly known as Webster Products, the same organization continues to serve with the same facilities but now as a division of Webster-Chicago Corporation. Watch for later important technical information over this new signature.

Again Postwar, You Will Find
Webster Record Changers in
High Quality Combinations

WEBSTER  **CHICAGO**
ELECTRONICS
DIVISION

3825 ARMITAGE AVENUE, CHICAGO 47, ILLINOIS

You are cordially invited
to help write the "specs"
for this new
Gammatron Tube



Heintz and Kaufman Ltd.—first to design and produce such popular tube types as the 24, 24G, 54, and 257B—cordially invite you as a designer or manufacturer of electronic equipment to have a hand in the development of a new series of H & K "firsts." ☆ Our engineering staff welcomes your suggestions for additions to the Gammatron line. If you have a requirement not adequately met by existing tubes, please let us know so that our development program may be directed accordingly. ☆ It will be to our mutual benefit if you will take a few minutes now to set forth your suggestions, and thus participate in the designing of outstanding new Gammatrons.



**BUY WAR
BONDS**

HEINTZ AND KAUFMAN LTD.

SOUTH SAN FRANCISCO • CALIFORNIA

Gammatron Tubes

Export Agents: M. Simons & Son Co., Inc. 25 Warren Street, New York City, N. Y., U. S. A.

... TRAINED HANDS assure PERFECT WORK

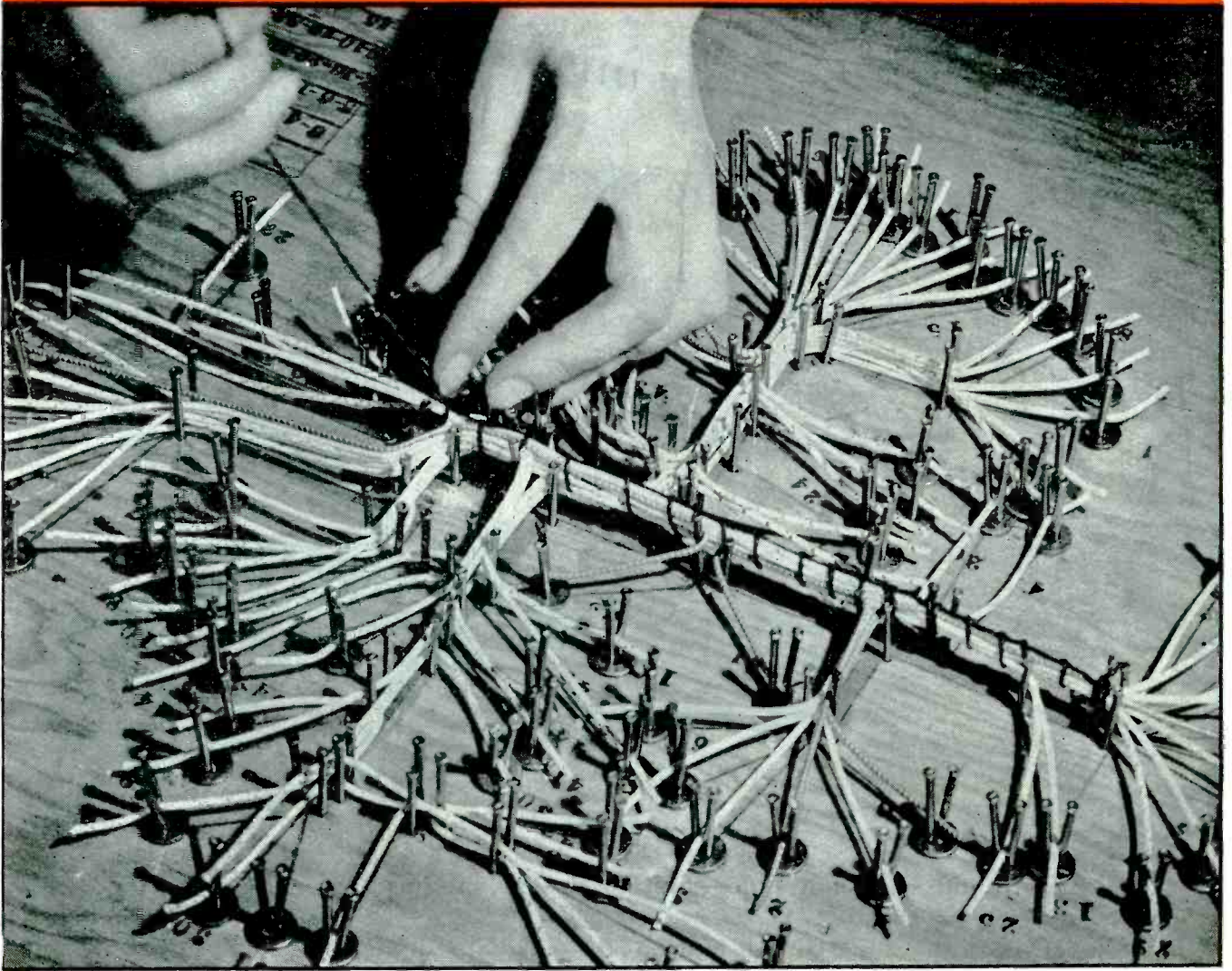

Let **WHITAKER** produce your wiring assemblies!

A lower cost of manufacturing is one of many important advantages Whitaker offers you on Cables, Wiring Harnesses and Assemblies you may require to produce finished products... We are wiring *specialists*, and the trained hands of our skilled workers assure perfect work.

You can avoid grief, and save time and money through our specialized service. You have everything to gain by utilizing the full

benefits of our 25 years of experience, our ample engineering and production facilities, trained manpower, exacting inspections, and the economies resulting from our use of modern methods, and special equipment.

In addition to an engineered wiring service, Whitaker also offers a quality line of standard cable products.

We cordially invite you to write us.

*Whitaker
Can
Wire It*

WHITAKER CABLE CORPORATION

General Offices: 1307 Burlington Avenue, Kansas City 16, Missouri
Factories: Kansas City, Mo. • St. Joseph, Mo. • Philadelphia • Oakland

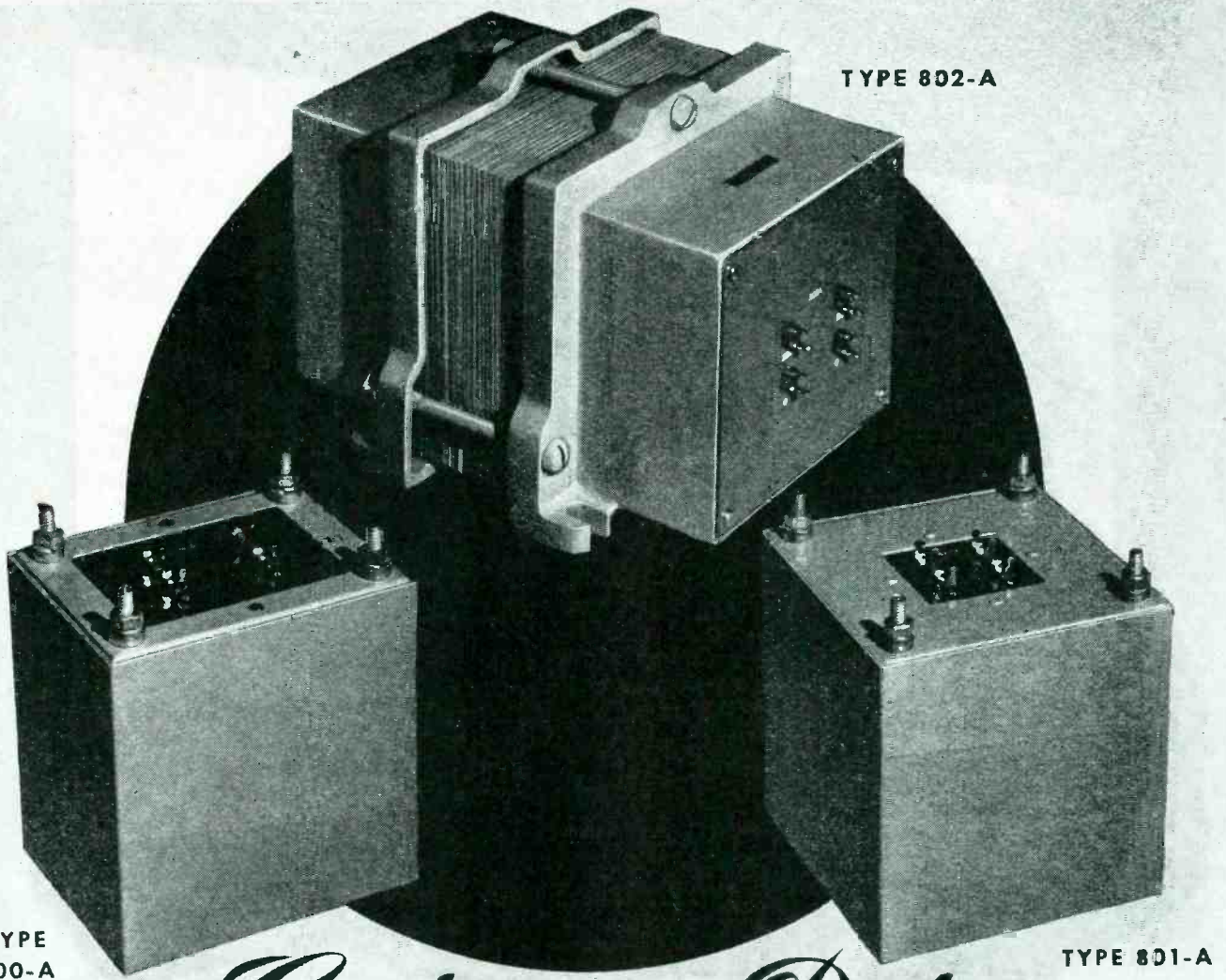

TYPE 802-A

TYPE 800-A

TYPE 801-A

Continuous Duty AUTO TRANSFORMERS

Continuous-duty Auto Transformers—These units incorporate heavy lugs on black bakelite terminal boards and are finished in standard baked gray enamel. Types 800 and 801 are manufactured with exclusive Hermi-lock case construction. They are also available in hermetically sealed units to strict Army-Navy specifications.

TYPE 800-A — primary 220 volts, 60 cycles; secondary 110 volts, 250 watts; 5AS case, length 4-5-16", width 3-13-16", height 5". Weight 10 lbs.

TYPE 801-A — primary 220 volts, 60 cycles; secondary 110 volts,

500 watts; 6AS case, length 5-1-16", width 4-15-16", height 5". Weight 16 lbs.

TYPE 802-A — primary 220 volts, 60 cycles; secondary 110 volts, 1000 watts; housed in #6 casting poured with humidity-proof compound, length 9-1/4", width 7-1/4", height 6-3/4". Weight 33 lbs.

SEND TODAY FOR COMPLETE LITERATURE ON OTHER TYPES OF LANGEVIN APPARATUS

The Langevin Company

INCORPORATED

SOUND REINFORCEMENT AND REPRODUCTION ENGINEERING

NEW YORK

37 W. 65 St., 23

SAN FRANCISCO

1050 Howard St., 3

LOS ANGELES

1000 N. Seward St. 38

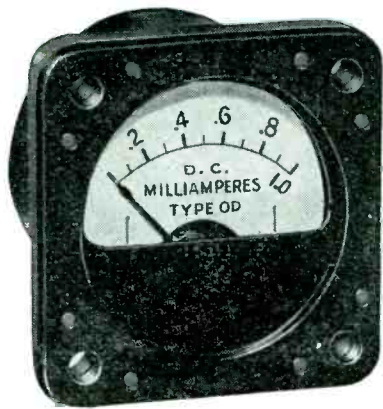

1.5" Commercial Type OD d-c Milliammeter

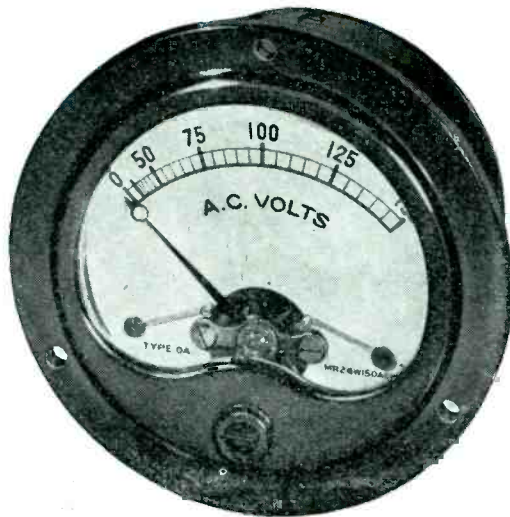

2.5" Commercial Type DA a-c Voltmeter. 400 cycle

New R-S Instruments -

built to Rigid Specifications

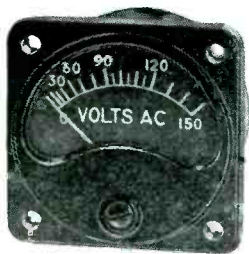

2.5" Aircraft Type AN
a-c Voltmeter, 400 cycle



1.5" Aircraft Type G-1
d-c Ammeter.
Immersion Proof

In the air, where life itself is at stake, no failure of instruments because of construction or assembly can be tolerated. Roller-Smith aircraft instruments have always been built to the most rigid specifications. We are naturally proud of the fact that the Army Air Forces, Air Technical Service Command has assigned us an "Approved" Quality Control Rating covering instruments delivered in accordance with contract specifications.

Commercial types of these two aircraft miniature panel instruments are built in conformity with the same exacting requirements.



Sales Representatives
In all Principal Cities

ROLLER-SMITH BETHLEHEM, PENNA.

Canadian Plant: ROLLER-SMITH MARSLAND, LTD., Kitchener, Ontario

STANDARD AND PRECISION ELECTRICAL INSTRUMENTS • AIRCRAFT INSTRUMENTS • SWITCHGEAR •
AIR AND OIL CIRCUIT BREAKERS • ROTARY SWITCHES • RELAYS • PRECISION BALANCES

ANNOUNCING AN ENTIRELY NEW CERAMIC CAPACITOR DIELECTRIC MYCALEX K

The MYCALEX CORPORATION OF AMERICA has developed and now has in production a new capacitor dielectric which embodies important new advancements in properties.

Designated MYCALEX "K," this new ceramic material is unique in that it offers a *selective* range of dielectric constants, from 8 to 15 at one megacycle.

Engineers whose requirements call for a material with a dielectric constant of 10, need only specify MYCALEX K-10. If a dielectric constant of 8 is indicated, MYCALEX K-8 will meet that exact requirement. Other applications might call for use of MYCALEX K-11 or K-12, etc.

MYCALEX K-10 already has been approved by the Army and Navy as Grade H1C5H4 Class H material (JAN-I-12). While other Class H materials are available, to the best of our knowledge these are all steatite or bonded titania or titanate types, obtainable only in relatively small dimensions and subject to wide variations in tolerances. MYCALEX K is available in sheets 14" x 18" in thicknesses of 1/8" to 1"; in thicknesses down to 1/32" in smaller sheets, and in rods 1/4" to 1" in diameter.

Of importance also is the fact that MYCALEX K series can be molded to specifications, with electrodes or metal inserts molded in. It can be fabricated to close tolerances.

So far as we are aware, the MYCALEX CORPORATION OF AMERICA is the exclusive developer and only supplier of this kind of capacitor dielectric.

Write today for further information to Department 12.

MYCALEX K-10

Grade H1C5H4, in accordance with JAN-I-12

Dielectric constant	10.6	} 1 megacycle
Q-Factor	310	
Loss Factor	0.034	
Volume resistivity	2.0×10^{12} ohms-cms.	
Dielectric strength	270 volts/mil (0.10" thickness)	
Modulus of rupture	9000 lbs./sq.in.	
Fractional decrease of capacitance with temperature change	0.0056	
Fractional increase of capacitance with temperature change	0.0076	
Porosity—no dye penetration after six hours at 10,000 lbs./sq. in.		

The above properties were measured in accordance with the procedures of JAN-I-12.

Density	0.116 lbs. per cu.in.
Specific gravity	3.22
Softening temperature	400° C.

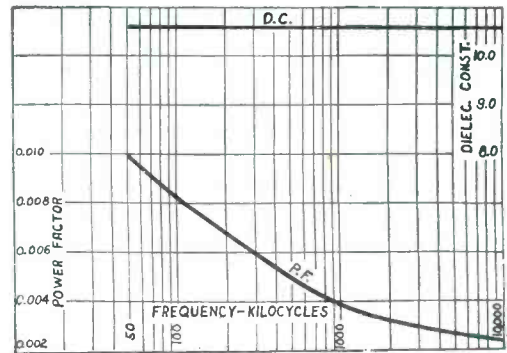
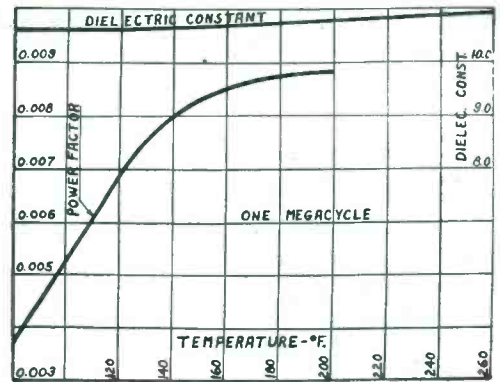

Other Products of Mycalex Are:

MYCALEX 400—the most highly perfected form of MYCALEX insulation, approved by Army and Navy as Grade L-4 insulation. In sheets, rods and fabricated form.

MOLDED MYCALEX available to specifications in irregular shapes and into which metal inserts may be incorporated.



MYCALEX CORPORATION OF AMERICA

"OWNERS OF 'MYCALEX' PATENTS"

Plant and General Offices
Clifton, N. J.

Executive Offices
30 Rockefeller Plaza
New York 20, N. Y.



IRON CORES

Standard and High-Frequency Types

Long the acknowledged leader in Iron Core manufacture, Stackpole can supply practically any desired type from 100 cycles to 175 megacycles and even higher. Both the Stackpole Standard and High-Frequency types are produced in an almost infinite variety of shapes, sizes, and characteristics to match your needs *exactly*. Also available is a complete line of Stackpole High-Resistivity Cores in either insulated or non-insulated types, and showing a resistance of practical infinity.

Insulated Types

The screws in these integrally-constructed units are insulated from the iron cores. Thus, the screw is kept out of the coil field and "Q" is greatly increased. The distributed capacity of the coil is reduced and, in applications where the screw is not grounded, there is also a big reduction in hand capacity effect. Ask for Stackpole Engineering Bulletin No. 7.

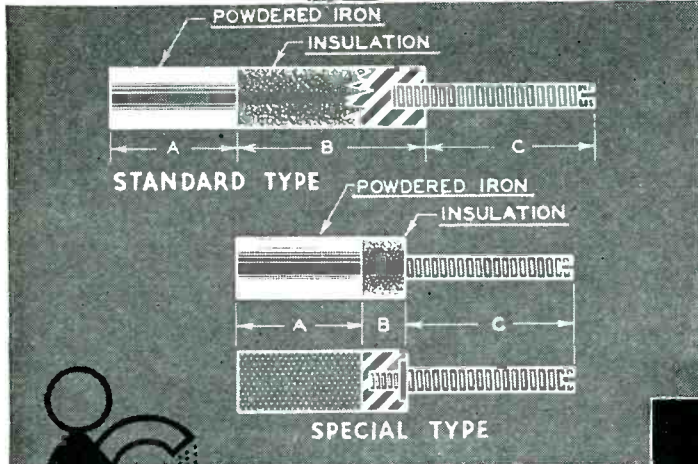

Iron Cores for CHOKE COILS

These popular Stackpole Cores are designed for use with audio chokes, "hash" chokes, r-f chokes, etc. Not only do they permit reductions in choke coil dimensions, but the iron materially increases the "Q". Insulated leads serve as coil connections and permit convenient point-to-point wiring.

- Brushes—Contacts
- Sintered Iron Components—Carbon
- Regulator Discs—
- Battery Carbons—
- Fixed and Variable Resistors—
- Switches, etc., etc.

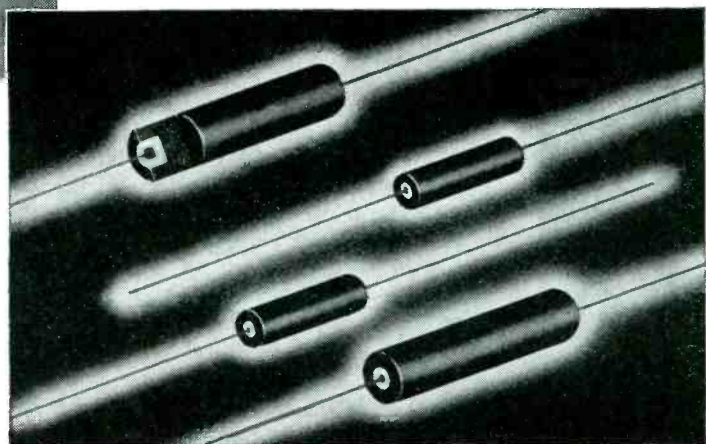

STACKPOLE

STACKPOLE CARBON COMPANY, ST. MARYS, PA.

TURBO serves communications in every corner of the World—

The correct specification of insulation sleeving is a basic factor in uninterrupted radio transmission and reception. In facilitating radio functioning — communication, ranging, locating, detecting, broadcast, etc.—TURBO insulation sleeveings provide the exacting solutions to usually-encountered deterrents.

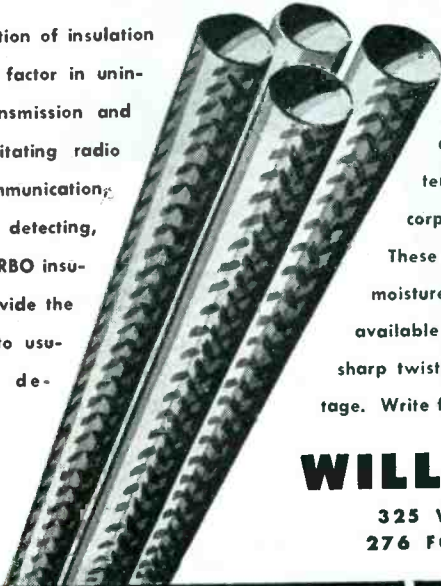

For example, Varnished Glass Tubing tempers the weather extremes of the Torrid zones by lengthening equipment service-life. Dielectric strength is high, and mechanical properties are unimpaired even by high climatic temperatures. Other TURBO application-designed sleeveings incorporate desirable characteristics for specific operational hazards. These embody types for high heat, chemical and corrosive fumes, moisture and humidity, as well as general purpose sleeveings. All are available in a range of permanent colors, and are easily applied around sharp twists and bends; rapid snaking and fishing is an added advantage. Write for TURBO Sample Board today—

WILLIAM BRAND & CO.

325 W. HURON STREET, CHICAGO 10, ILL.
276 FOURTH AVENUE, NEW YORK 10, N. Y.

VARNISHED GLASS TUBING: for radio wiring and cabling subjected to high ambient temperatures—filament, resistor, rheostat leads—this TURBO product provides an ideal solution. It has high dielectric strength and mechanical properties are unimpaired by heat.

IDENTIFICATION MARKERS: the rigid operating requirements of modern radio transmitters make simplified trouble shooting imperative. TURBO sleeve and tab type markers make rapid tracing possible.

TURBO SLEEVEINGS: simplify service and repair. They are supplied in a full range of permanent colors. Identification and tracing is easy in the most complex equipment.

FLEXIBLE VARNISHED OIL TUBING: hermetically sealed units—transformers, chokes and wiring subjected to humidity—should be designed to include this type insulation. Non-hygroscopic this tubing retains its high insulating qualities, resists deterioration due to moisture.

..and points the way to electrical insulation economies in all applications!



SATURATED SLEEVING • VARNISHED CAMBRIC • CLOTHS AND COMPOSITES • BLOCK MICA • MICA PLATE • VARNISHED OIL TUBING

YOURS!

Just write us, on your letterhead, for your copy of this valuable booklet on permanent magnets

● As a service to industry, The Arnold Engineering Company is "lending a hand" in the distribution of what Arnold engineers believe to be a very informative study on the subject of permanent magnets.

This 39-page book of permanent magnet theory, design data and references was published by the government. Arnold is pleased to make it available to you free of charge and without obligation. Write for it today!

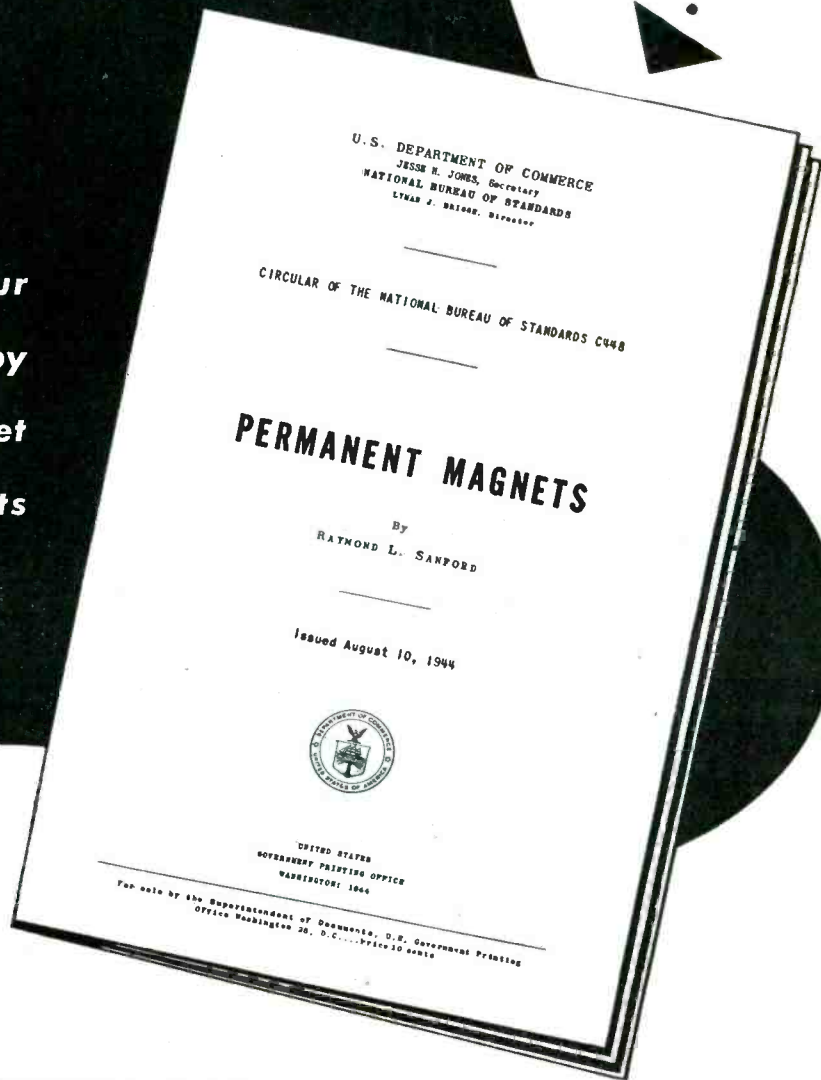

THE ARNOLD ENGINEERING COMPANY

147 EAST ONTARIO STREET, CHICAGO 11, ILLINOIS

Specialists in the Manufacture of ALNICO PERMANENT MAGNETS

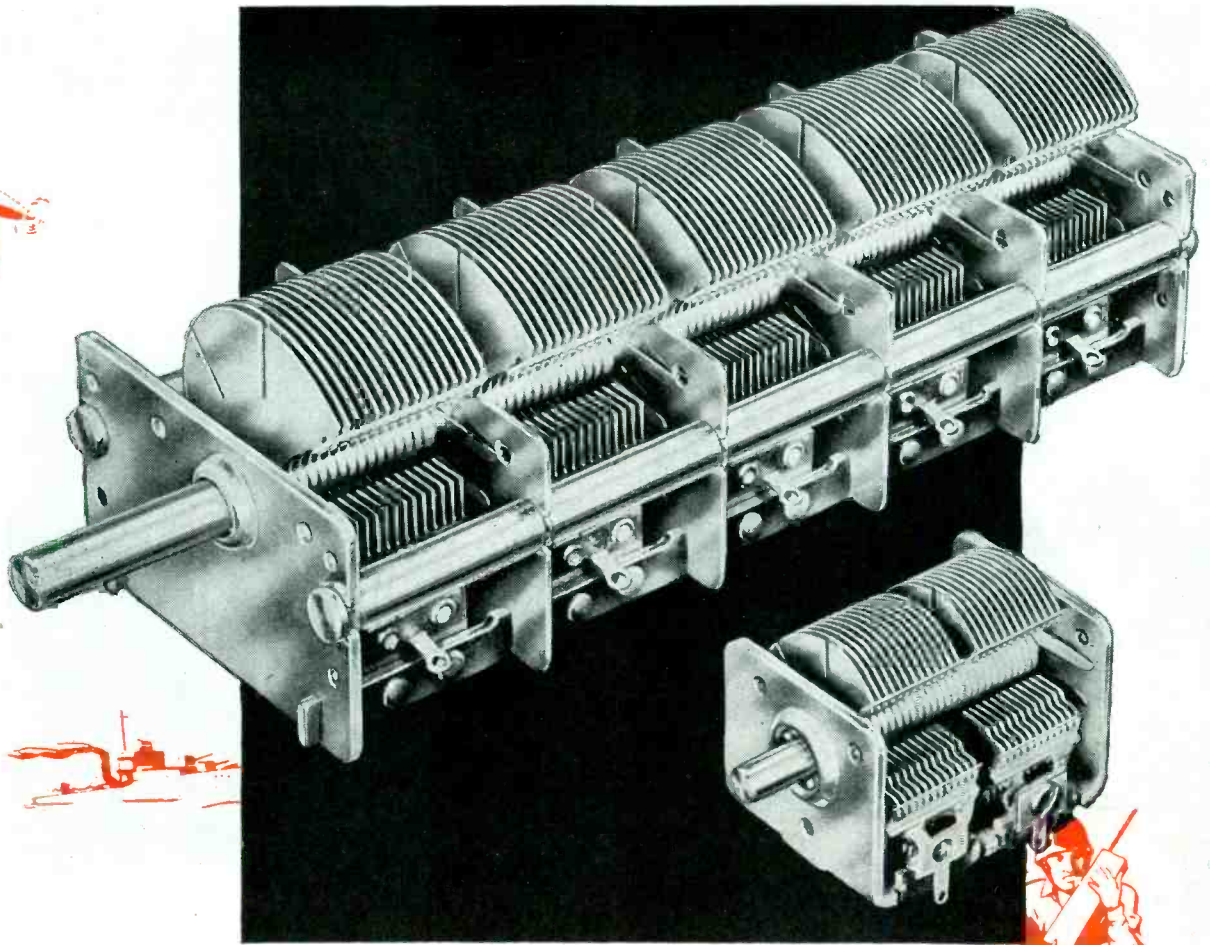

THE LONG and SHORT of R/C capacitors

THE vast extremes in sizes and design of modern Radio equipment call for components varying in size from this R/C midget Capacitor to the extra long five-gang capacitor shown beside it.

In between these extremes can be found R/C Capacitors in shapes, sizes and styles covering practically every standard application conceivable today. In addition, long experience in matching the needs of the armed forces, makes R/C ideally equipped for meeting any special requirements.

Ours is a background founded on a single aim that of building ONLY Variable Capacitors and Mechanical Push Button Tuning Devices—building them in all needed designs—and building them well.

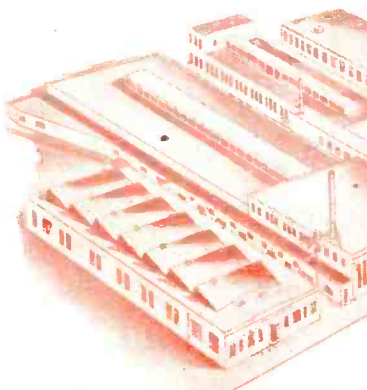

RADIO CONDENSER CO.
CAMDEN, N. J.

RADIO CONDENSER COMPANY, LTD., TORONTO, CANADA

From A F



Why Western Electric equipment leads the way!

1. Western Electric products are designed by Bell Telephone Laboratories—world's largest organization devoted exclusively to research and development in all phases of electrical communication.

2. Since 1869, Western Electric has been the leading maker of communications apparatus. Today this company is the nation's largest producer of electronic and communications equipment.

3. The outstanding quality of Western Electric equipment is being proved daily on land, at sea, in the air, under every extreme of climate. No other company has supplied so much equipment of so many different kinds for military communications.

As you probably know, many of the electronic marvels of this war have been made possible by the successful harnessing of Super High Frequencies. The scientists at Bell Telephone Laboratories have taken a leading part in this work with MICROWAVES.

The devices they have designed have been built in vast quantities by Western Electric. In this work, Western Electric has added greatly to its fund of spe-



AM • BROADCASTING • FM

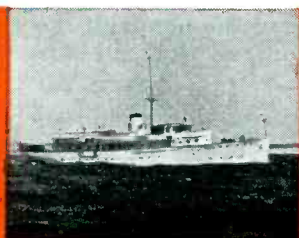

MARINE RADIO



AVIATION RADIO



MOBILE RADIO

Western Electric has specialized

to SHF

Electric

equipment leads the way!

cialized knowledge and its manufacturing techniques.

These wartime microwave developments hold great promise for the future of communications and television transmissions.

From the audio band and extending through the many services in the radio frequency spectrum up to the frontiers of super high frequencies, count on Western Electric equipment to lead the way!



*During the 7th War Loan Drive,
buy bigger, extra War Bonds!*



SOUND SYSTEMS



TELEVISION



SOUND MOTION PICTURES



COMPONENT PARTS

knowledge in all of these fields

LOUD SPEAKERS by



with "Controlled Performance"

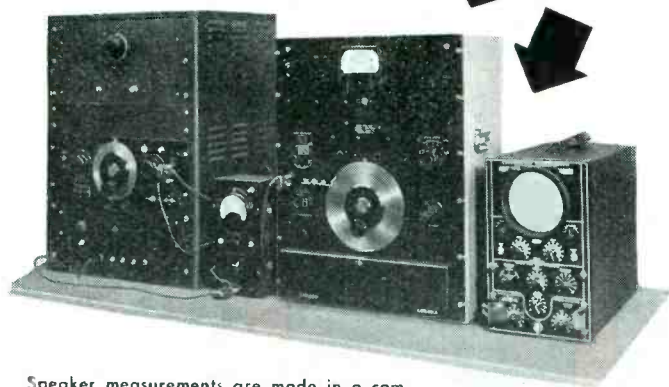

Speaker measurements are made in a complete and modern laboratory under the close supervision of veteran speaker engineers. Careful attention to every detail of product design and use of the ultimate in accurate measuring instruments has resulted in the development of the BEST "controlled performance" loud speakers.

Each BEST loud speaker is subjected to a variety of most exacting tests before it may be released for delivery. Because of the pre-eminent part quality and performance play in our speakers, we maintain inspections at each stage in production beginning with raw material checks, continuing with inspections after each operation and ending only after final testing of the finished product. No test is overlooked . . . nothing is left to chance. For BEST Alnico 5 loud speakers are designed to give "controlled performance" and they are not approved unless they justify the name BEST. We invite your inquiry.

BEST MANUFACTURING CO., INC.

Electronic and Sound Reproducing Equipment

1200 GROVE STREET • IRVINGTON 11, N. J.

a "must" in
product design
is noise suppression...



that means

CORNELL-DUBILIER CAPACITORS

THANKS TO ADVANCED capacitor engineering, small compact capacitors with a variety of bracket arrangements and sturdy screw-type terminals, are available for suppressing noise from generators, inverters, motors and other equipment.

C-D has a complete line of radio-noise capacitors and filters.

They can be mounted in any position and will operate over a temperature range of plus 85° to minus 55°C. Ratings are .01 mfd. to 0.5 mfd. 100 V.D.C. and .01 mfd. to .25 mfd. 500 V. A.C.-D.C. in the types illustrated. Other types are available for every noise suppression problem.

Cornell-Dubilier engineers will be glad to advise on the selection of these and other types of capacitors and filters for noise suppression. Write for information. Cornell-Dubilier Electric Corporation, South Plainfield, N. J. Other plants at New Bedford, Brookline, Worcester, Mass., and Providence, R. I.

CORNELL-DUBILIER CAPACITORS



1945

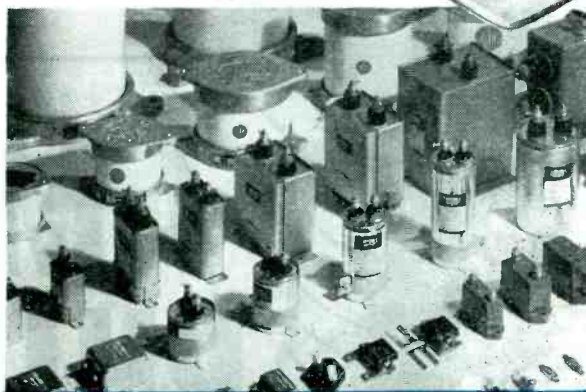
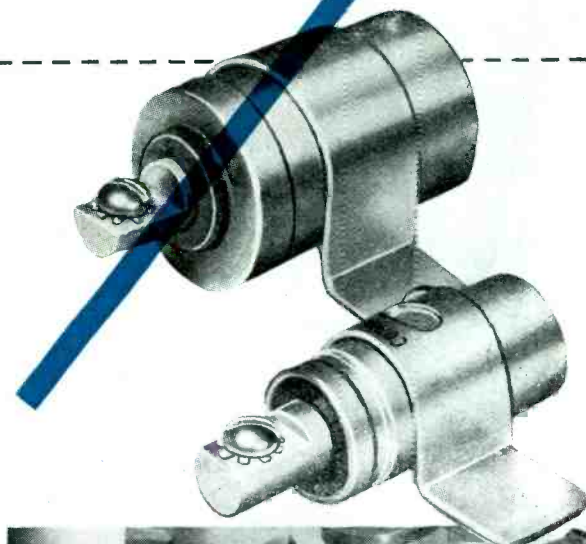

MICA ★ DYKANOL ★ PAPER ★ ELECTROLYTICS

Johnny Gets a Gun

and AMERICAN PHILLIPS SCREWS...

*Now watch
his Output
Shoot Up!*



Discard slow hand-driving on your screw assemblies. Arm your workers with American Phillips Screws... which fit onto the 4-winged bits of power-drivers as straight and firm as fixed bayonets. Then watch output soar, while costs, spoilage and rejects dive! For even unskilled workers can drive these *self-aligning* American Phillips Screws with bullet-like speed and accuracy, straight to the mark, every time. No fumbling, no scarred work-surfaces, no crooked or broken screws. Time savings climb as high as 50% over slotted screws.

And here's another advantage over slotted screws: Where stress is a factor, the allowable load (in pounds per screw)

is far greater with Phillips... 24% greater, according to tests in one of the biggest bomber plants in this country.

All these advantages sum up to one plain fact: For *any* screw-driving job, in small shop or large plant, *American Phillips Screws cost least to use.* And American adds extra savings by its individual inspection of screw heads, threads, and points... also by automatic weigh-count that assures full quantity in every order. Try American Phillips Screws on your own assemblies.

AMERICAN SCREW COMPANY, PROVIDENCE 1, RHODE ISLAND

Chicago 11: 589 E. Illinois Street — Detroit 2: 502 Stephenson Building

PUT THE SCREWS
ON THE JAPS...
BUY WAR BONDS

AMERICAN PHILLIPS *Screws*

A NEW CATALOGUE THAT WILL HELP YOUR PRODUCT PLANNING

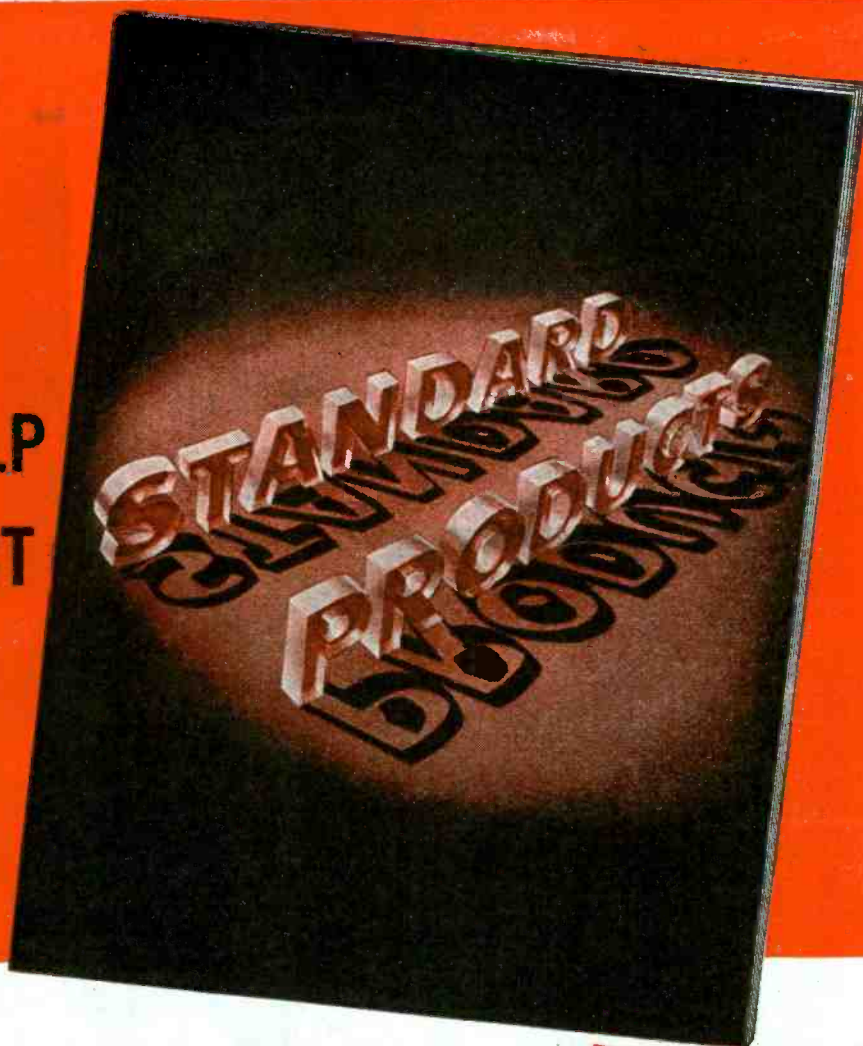

The Standard Products Co., manufacturers of thermo-plastics, thermo-setting plastics, molded mechanical rubber goods, metal stampings, glass run window channel, munitions and automobile hardware, have compiled a comprehensive brochure of their diversified manufacturing.

The new Standard Products Co. Catalogue is profusely illustrated and offers many ideas to manufacturers in the use of plastics, steel stampings, and molded rubber.



**MAIL THE COUPON
FOR YOUR COPY
OF THE CATALOGUE
AT ONCE**

Standard Products Co., 505 Boulevard Building,
East Grand Boulevard, Detroit 2, Michigan.

Gentlemen:
Please forward me a copy of your latest catalogue.
Thank you.

Name _____
Title _____
Company _____
Street _____
City _____ State _____

THE STANDARD PRODUCTS COMPANY

General Offices and Research Laboratory

505 Boulevard Bldg.

Woodward Ave. at E. Grand Blvd.

Detroit 2, Mich.

MEMO TO Purchasing Dept.

For postwar, recommend we standardize on Solar's hermetically-sealed, patented special twist-prong base Type DY electrolytic. They're properly protected against moisture.

E.M.

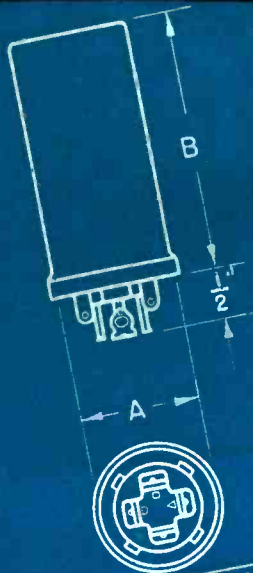

ENGINEERING
SPECIFY
Solar
DEPARTMENT

LEADING MANUFACTURERS
EVERYWHERE

PART NO.	SOLAR PART NO.	CAPY MFD.	WKG VOLTS	DIMENSIONS	
				A	B
51 B50-1	DY-61	20+20	150	1"	2"
51 B50-2	DY-92	20+20	450	1"	3-3/8"
51 B50-3	DY-94	10+10	450	1"	2-1/2"
51 B50-4	DY-132	15+10+20	350-350-25	1"	2-1/2"
51 B50-5	DY-141	10+10+20	450-450-25	1"	3"

DATE 1/4/45
DWG. No. 51 B50
ISSUE
DRAWN E.O.H.
TRACED M.
APPROVED J.C.

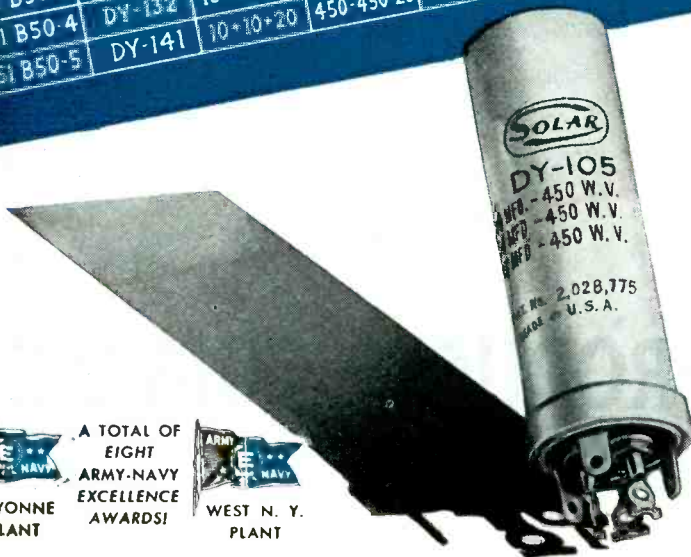

Prominent engineers consistently show their preference for Solar Capacitors. Solar pledges continued production of superior quality capacitors to merit that preference. Solar Manufacturing Corporation, 285 Madison Avenue, New York 17, N. Y.



A TOTAL OF EIGHT
ARMY-NAVY
EXCELLENCE
AWARDS!



CAPACITORS &
ELIM-O-STATS

7759

RUSSIA AND AMERICA

ALLIES— or else . . .

VICTORY in Europe was won only through the combined endeavor of the United Nations. Only through sustained joint effort can the fruits of that victory be reaped.

Without disparaging the truly heroic contributions of others, three of the Allies may fairly be credited with having made the major contributions to victory over the European Axis—the United Kingdom, Russia, and the United States. The close accord of these three nations is no less crucial to the accomplishment of the tasks that remain.

First of these is the war against Japan. It still requires winning. Even without any help from others, the United States could make good this victory, but the war's duration will be speeded by the marshaled effort of the United Nations.

Next, and not less important, is the task of establishing a basis for enduring peace. In this struggle our enemies are more formidable than any we have faced—national ambitions, prejudices, suspicions and distrusts, the staggering burden of tradition and debilitating cynicism born of past failure, the cleaving wedges of divergent languages, thought patterns, economic creeds and procedures—an array of difficulties as baffling as fog and as formidable as a deluge. They can be vanquished only by a continuance of the working accord between the United States, Russia, and Britain that was forged on the anvil of European conflict.

☆ ☆ ☆

This high appraisal of the decisive importance of the Big Three in determining the destiny of the United Nations organization, in no way depreciates the importance of the role to be played by France, by China, or the other freedom-seeking nations represented at San Francisco. All of us are committed to the building of a genuinely representative security organization in the conviction that by such means alone can we possibly achieve a just and lasting peace. But the strength of any international machinery will depend upon the validity of Russian-British-American cooperation. If these three are able to achieve substantial harmony of aim and procedure, a world organization that includes them can operate with effective coherence. If they pull apart, the United Nations will break up into competing and jealously hostile blocs.

This is inevitable because of the sheer weight of these three nations in the world's affairs. Between

them they account for perhaps half of the world's income and from two-thirds to three-quarters of its industrial output. Once Japan has been crushed, they will control an overwhelming preponderance of the world's armed might. Each of them will wield military power on a scale quite beyond the power of any embryo security league to hold in check. Only if all three are resolved to keep the peace and to enforce it through the Security Council, can that body hope to accomplish its aim.

Although there is a tendency on both sides of the Atlantic to indulge somewhat recklessly in mutual criticism, the ties between Britain and America are too firm to be severed by any foreseeable strain. But that has not been true of our relations with Russia. Even while fighting a war in which our respective ways-of-life were at stake, the inestimable services of each to the other were rendered as friendly but independent associates rather than as fully trusted partners. Now again, as we approach the difficult and vitally important task of building a world organization and of devising a European peace, the task of our delegates is complicated by national attitudes under which each hopes for the best from the other, while fearing the worst.

But the stakes for us both—and for the rest of the world—are too high to be played for in a diplomatic poker game. Russia has no inhibitions in demanding what she wants, and our own vital interests must be stated and upheld with undeviating firmness. Yet we both must face the stark fact that few advantages that either nation might gain at the cost of dissipating the good will of our wartime association could be worth the price thus paid.

☆ ☆ ☆

The first steps toward establishing confidence lie in a frank recognition of what may contribute to the lack of it and in a definition of what can be done to restore it.

1. *Probably the greatest single area of reciprocal distrust between Russia and our own country is based on the fear of each that the other may try to interfere with its domestic, economic, and political affairs.* Each purports to see the beam of meddling intervention in the other's eye, while it ignores the mote in its own. Thus the Soviet Union remembers that we participated in the foreign military intervention at the time of her civil revolution, and afterwards lent our support to successive boycotts of her trade, of her gold, and of her credit needs. For our part, we remember the Soviet Union's doctrine, and

aggressive support, of revolutionary international communism.

We feel that Russia should find satisfactory evidence of our present willingness to have her develop her internal institutions as she will in the aid that we have given her during the war, and in the record of our good-neighbor policy as applied to Latin America. She, no doubt, resents our lingering suspicions in the face of her declared policy of 1941 to refrain from any attempt to influence the political or economic structure of foreign nations. Certainly, each of us will need the repeated reassurance that can come only through sustained performance by the other in the years ahead. Meanwhile, much will be gained if each will give to the other's good faith the benefit of the doubt, while it scrupulously guards its own conduct to avoid even the appearance of backsliding.

2. *A second zone of suspicion is created by those measures which each of us interprets as natural and necessary bulwarks of national security when they are our own, but as evidence of dangerously aggressive imperialism when taken by the other.* In our view, at least, such demands as we have voiced for island trusteeships or for other naval bases appear mildly conservative as compared with Soviet claims for annexation of territory and for a general orbit of influence, under governments friendly to her, throughout eastern Europe in particular.

There can be no easy solution to that problem. Bi-focal vision, by which one nation can look through a second lens ground to the prescription of another, seldom is achieved in international affairs. The success of the San Francisco Conference will provide a mechanism for international definition of principles and procedures which at least might relieve the inevitable strains. Most important will be the record of how each of us proceeds in our respective courses of action. Soviet performance thus far is highly unsatisfactory to us. While we have taken pains to clear our procedure with her, she has taken action in the Baltic, in Austria, and in Poland without even advance notice to us.

A major test of our ability to cooperate may be found in the Allied administration of conquered Germany. The proposed four-headed control of a four-way partitioned nation promises to be at best an extremely awkward mechanism of administration. At worst, it can result in continuous and dangerous bickering between the representatives of Britain, France, the United States, and Russia in the Berlin coordinating center, and in hopelessly divergent procedures in their several zones of administration. There will be a compelling need for all of us to exercise all of the wisdom and cooperative resolve that we possibly can muster.

3. *A third testing ground for the future of American-Soviet relationships will be defined by the course of Russia in our continuing war with Japan. We are not unmindful of the toll paid by the Soviet Union in its magnificent European war effort. But we still are locked in a desperate struggle with an enemy that exemplifies the Fascism which America and Russia equally denounce. And that war is being fought in an area where Russian interests are importantly at stake.*

Russia has an extraordinary opportunity to create good will by throwing her weight speedily and effectively on our side. There is no doubt but that the final Pacific settlement will generate problems comparable with those

of the European peace, but it is equally certain that the continuation of the European comradeship in arms can do much to promote an enduring and confident postwar friendship.

4. *A fourth, and highly important, potential source of suspicion and irritation is the intellectual blockade that the Soviet Union has maintained against the free flow of travel, intercourse, and exchange of ideas.* We can understand the genesis of this policy and the reasons for its continuance while Russia entertained a constant fear of attack by powerful enemies. But the sustained perpetuation of such a quarantine by so strong a nation as the present U.S.S.R. could not be accepted as a protective measure. Inevitably it would generate suspicion that it was rather an instrument of nationalistic isolation or even of contemplated aggression. A way-of-living, at arm's length, with a nation that maintains such intellectual quarantines is possible; any whole-hearted partnership of effort is quite impracticable.

5. *Trading between a free-enterprise nation and one that operates all foreign commerce as a government monopoly can give rise to many frictions.* That subject is too complicated for exposition here. Suffice it to say that, while difficult, it is not impossible to conduct such trade with mutual advantage. We are in a position to help Russia greatly with her program of industrial rehabilitation and expansion at great saving of cost in terms of her current scale of living. In return, we must have assurance that her government monopoly trading will be conducted for commercial rather than political ends, and that it will be used to encourage rather than to restrict multilateral and non-discriminatory world trade.

★ ★ ★

This is a representative list of the major areas in which misunderstanding and distrust may be generated, or allayed, in Russian-American relationships. No doubt, an equally honest list drawn by a citizen of the Soviet Union would be more heavily weighted by those features of our behavior which irritate and stimulate distrust on their side. If such a catalog were to be presented, it should receive our most searching and responsible consideration.

For it is of utmost importance that our two nations, in concert with the other United Nations, learn how to get along in mutual confidence and respect. Our understanding of each other now is so imperfect that our negotiations are punctuated with continuous irritations over *little issues*. This, inevitably, will continue until such matters are submerged in the general confidence that can be achieved only through satisfactory settlement of the *big issues*. We must succeed in this, or the defeat of Japan will merely mark the end of the Second in a series of World Wars.

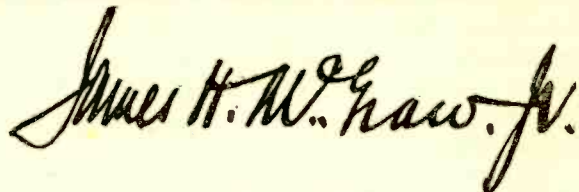

President, McGraw-Hill Publishing Co., Inc.



A. H. Brolly . . . Chief Engineer of Television Station WBKB, Chicago, adjusts the grid circuit of the Eimac 304-T's in the Class B linear stage of the video transmitter.



Mr. Brolly calls attention to the Eimac 1000-T's in the final stage of the Audio FM Transmitter which operates at 65.75 megacycles. It is a very stable amplifier of good efficiency.

**IT'S EIMAC AGAIN!
FIRST CHOICE FOR
THE KEY SOCKETS
AT TELEVISION
STATION WBKB**

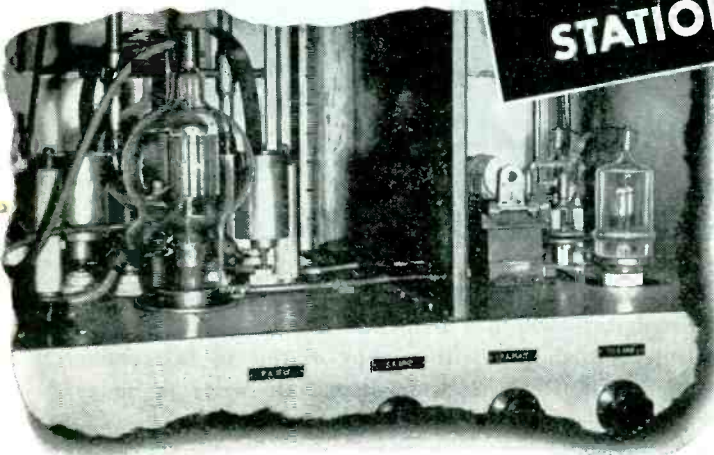

The video transmitter operates at 61.25 megacycles; peak power output is 4 KW which provides a television service throughout metropolitan Chicago and reaches suburbs out to 35 miles or more.

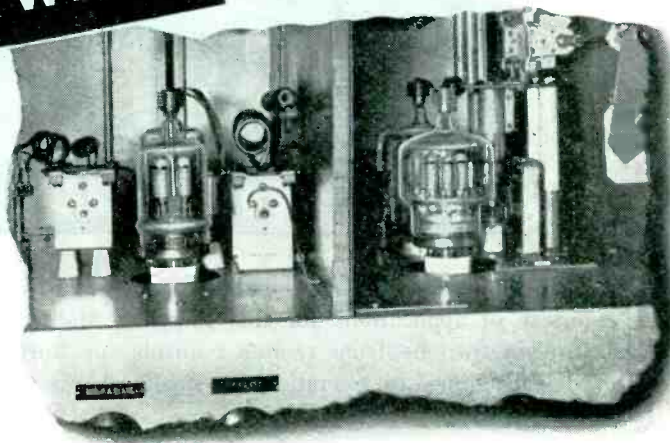

Eimac 152-T's are used in the modulated stage and 304-T's in the first Class B linear amplifier of the video transmitter.

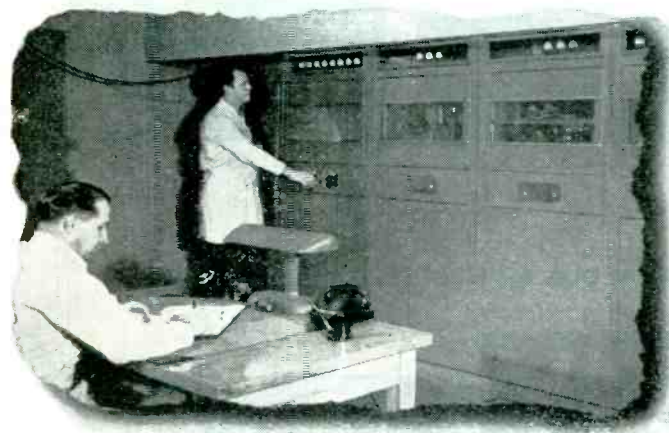

E. F. Cawthon and W. R. Brock are operating the station which has been broadcasting television programs with the present equipment since 1942 and began operation on a commercial schedule in October, 1943.

Grid modulation is employed at WBKB and a broad band of frequencies must be passed in all stages following the modulated amplifier. Multiple-tuned resistance loaded coupling circuits are used between stages.

Performance, stability, dependability are good reasons why Eimac tubes are to be found in the key sockets of the outstanding new developments in Electronics. Balaban & Katz, owners of television station WBKB of Chicago, offer potent confirmation of the fact that Eimac tubes are first choice of leading Electronic Engineers the world over.

FOLLOW THE LEADERS TO



ELECTRONIC TELESIS—fully illustrated. Send for a copy now. *The Science of Electronics* written in simple language. You'll find it of valuable assistance in explaining electronics to the layman. No obligation.

EITEL-McCULLOUGH, INC., 1032 San Mateo Ave., San Bruno, Calif.
Plants located at: San Bruno, California and Salt Lake City, Utah
Export Agents: Frazer & Hansen
301 Clay Street, San Francisco 11, California, U. S. A.

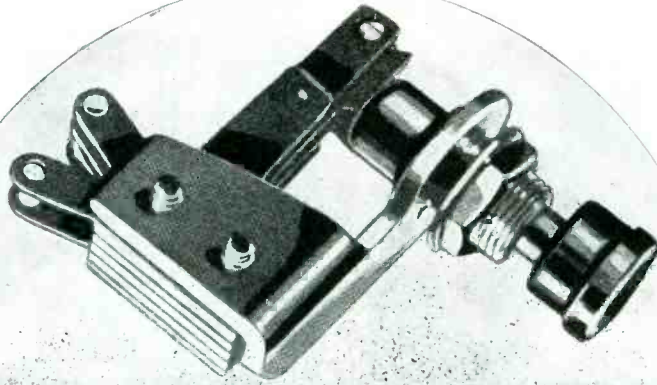

Mallory Push Button Switch Provides Sure Control for Big Machines or Little Instruments



EIGHT different circuit combinations permit a wide variety of applications for this Standard Mallory Push Button Switch—from remote controls for huge industrial machines to operation of small laboratory test instruments.

Each circuit combination of this Mallory switch is available in either a locking or a non-locking type. Locking types keep the circuit closed until the button is pulled out. Non-locking types maintain contact only while the button is held depressed.

Special construction features provide improved electrical characteristics and assure long operating life. The switch frame and bushing are nickel-plated brass. Low-resistance contacts are silver. Contact springs are nickel-plated phosphor bronze.

Select the push button or circuit selector switches you

need from the Mallory catalog. Your nearest Mallory Distributor—who has a stock of standard switches—will gladly furnish you with a copy of this useful catalog, which lists 1646 precision items. Or write us today.

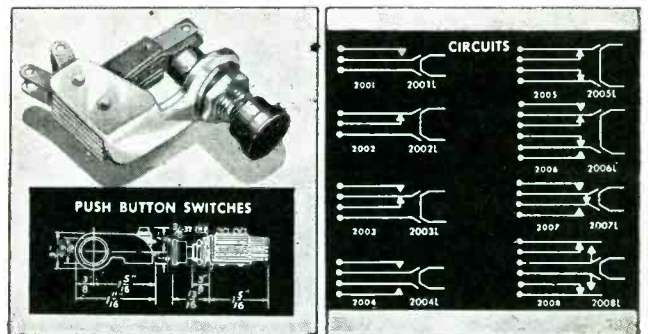

P. R. MALLORY & CO., Inc., INDIANAPOLIS 6, INDIANA



P. R. MALLORY & CO. Inc.

MALLORY

Industrial and Electronic Switches



CROSS TALK

► **LAW** . . . Regularly throughout the years someone pops up with the idea that television, or some other form of communication, can be transmitted on a narrower bandwidth or in less time than is ordinarily believed possible. So far as is known all of these proposed systems have failed; in fact any such proposals nowadays are almost certain to damn the suggestion and the inventor before a fair hearing is had.

Through the courtesy of W. C. White of General Electric and Paul Findley of the Bell Laboratories, the following facts are presented.

The first publication giving the relationship between information, frequency range and time appeared in the *Bell Laboratories Record* of February 1926. At the International Congress of Telegraphy and Telephony, Lake Como, Italy, September 1927, R. V. L. Hartley of the Bell Laboratories delivered a paper entitled, "The Transmission of Intelligence." In this paper, published in the *Bell System Technical Journal*, July 1928, appears the first succinct and exact statement of the "law" which so many engineers seem bent on circumventing.

Mr. Hartley stated the matter in the following words: "*The total amount of information which may be transmitted over a system whose transmission is limited to frequencies lying in a restricted range is proportional to the product of the frequency-range which it transmits by the time during which it is available for transmission.*"

This means, simply, that one must take longer to transmit a given amount of information over a narrow band than over a wide band, and conversely, to transmit more information in a given amount of time (fine-detail television, for example) requires a wider frequency-range than to transmit less information (coarse-detail television.)

It seems impossible to determine just who first recognized these relationships. It is probably one of those things that workers in the field began to understand a little at a time, and was recognized and utilized in one way or another long before any complete formulation was attempted.

Although it may be impossible—certainly most difficult—to prove that Hartley discovered this relationship, it is undoubtedly true that he was the first to publish a formulation of it. In the absence of knowledge concerning the actual discoverer of the "law", if indeed such a discoverer exists, it seems eminently fair that the relationship between bandwidth, quantity of information and time be known, henceforth, as the "Hartley law" and such honor to R. V. L. Hartley is hereby proposed.

► **TIME** . . . Chauncey Depew is credited with the story of the scientist who invented a system of feeding hogs that would require less time than the time-honored method of putting the swill in the trough only to have a farmer reply "What is time to a hog?"

Scientists, however, still take time very seriously. The early efforts to make quartz-crystal "clocks" that were "more accurate than the sun" seemed rather academic to many hard boiled engineers. But such accuracy, and all the circuits that made it possible, have borne fruit of major value during the recent years.

Radar, for example, involves a method of measuring time to an extremely high degree of accuracy. Radio waves travel at a speed of approximately 1000 feet per microsecond; that is, out to a target 500 feet away and back to the transmitter. An error of timing of one microsecond, therefore, might cause a shell to miss a target by what would not be called even a "near miss."

Time, therefore, as one of our essential "dimensions" is no longer of academic interest only.

► **IRE** . . . The fact that the campaign to raise funds for a permanent home for the IRE headquarters has reached the half-way mark should indicate to all members who have not contributed their bit that the time to get busy is right now. Most of the contributions so far have come from industry. No real member of the Institute should let the opportunity go past without having his own share in this worthwhile campaign.

Electronic WELDING

Localized heating of restricted areas that must be softened and flowed without destructive surface-boiling is accomplished by conduction. Novel high-frequency guns utilize auxiliary pin-point flames to lower glass resistance, provide a sharply defined gaseous conduction path from gun to glass, and facilitate close control of heating

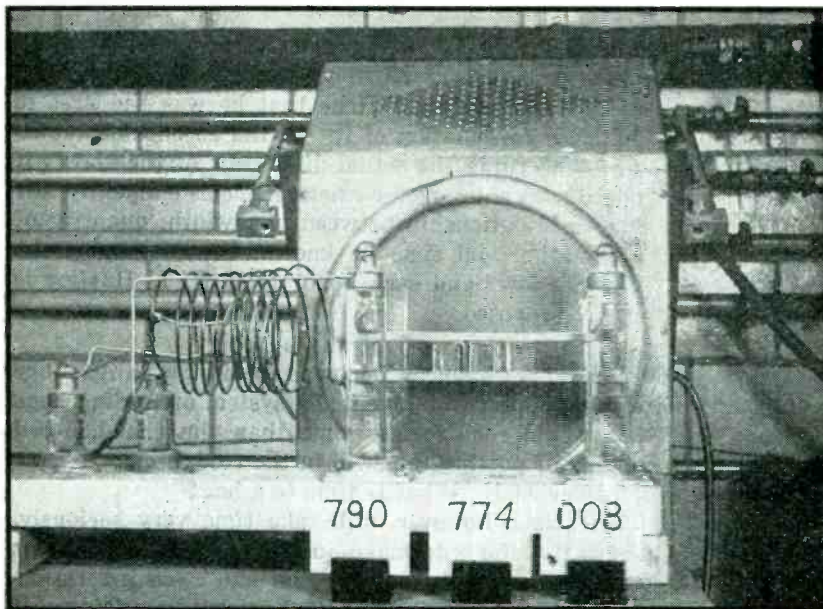
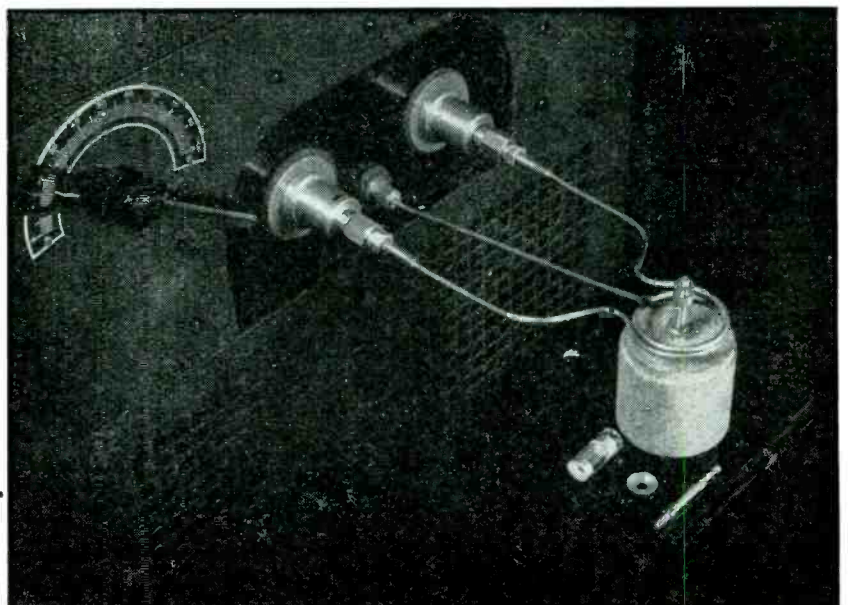

FIG. 1—Laboratory setup for the heating of glass by the dielectric-loss method. Three samples may be seen between the capacitor plates. Behind the samples is a source of polarized light later used to detect signs of strain

RIGHT

FIG. 2—Experimental induction-heating equipment employed to test the efficacy of the eddy-current method. This type of heating is proving effective in heating metal-to-glass seal assemblies and in soldering or brazing to metallized-glass parts



By E. M. GUYER

*Research Laboratories
Corning Glass Works
Corning, N. Y.*

IN THE OPERATION of a modern glass factory, there are numerous problems in process control and regulation of automatic machines that offer a wide field of application for many types of electronic devices.

The glass art, however, is essentially the art of heating highly refractory materials to elevated temperatures where they ultimately

OF GLASS

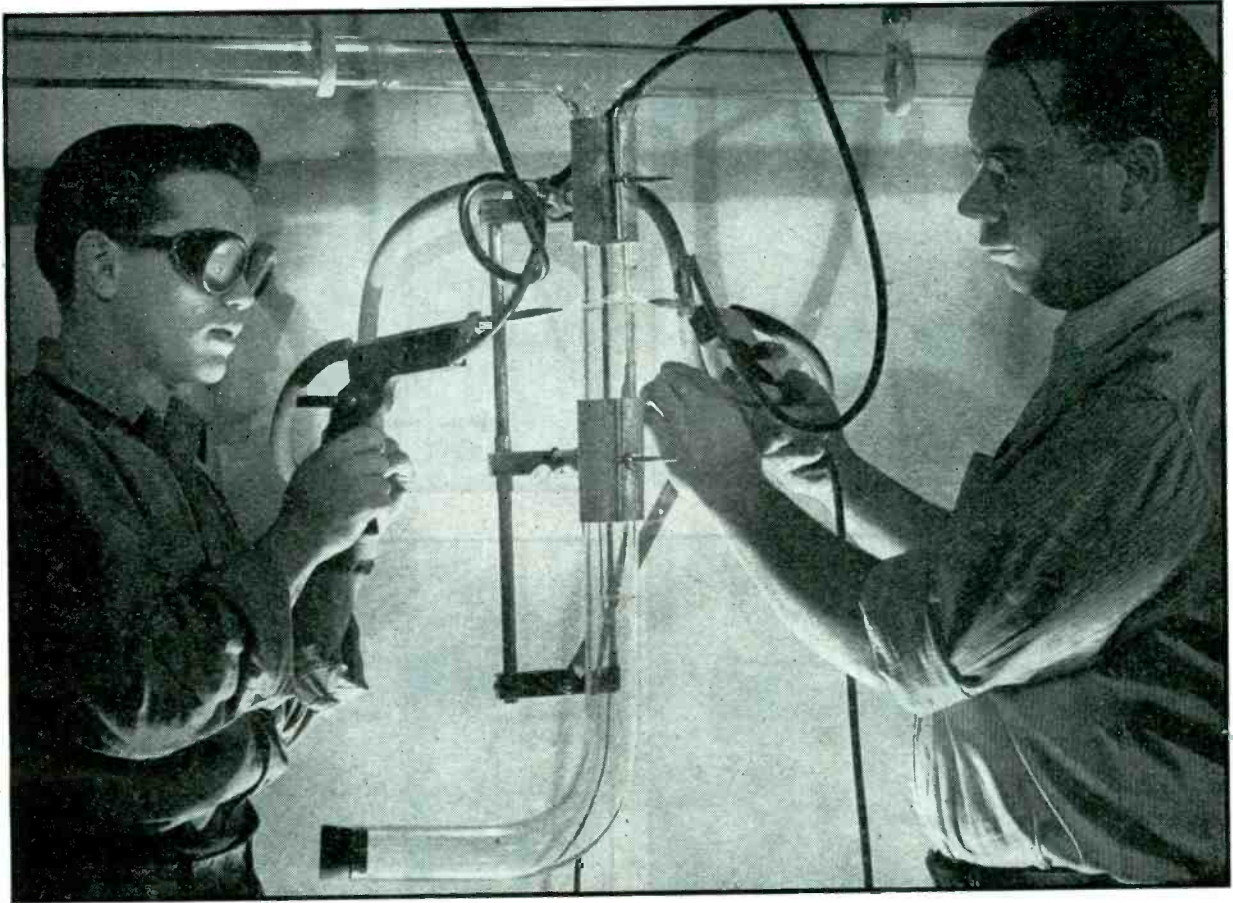

FIG. 3—Conduction heating lends itself admirably to the high-frequency welding of glass tubing. Current is conducted to two guns used as a cross-fire arrangement by means of cables and clips. Pin-point gas flames projected by the guns perform three essential functions described in the text

melt into glasses, and the subsequent working of these viscous plastic bodies into a wide variety of useful products.

Advantages of Electronic Heating

Glass may be heated in two distinctly different ways—through the surface, by conventional glassworking fires, or internally, by the transformation of electronic energy into heat within the glass itself. The latter method avoids the surface boiling and destructive loss of volatile constituents which definitely limit heating speed and the size and thickness of parts that can be heated.

Research with damped and undamped waves ranging in frequency from 60 cycles to many megacycles

has shown that under proper conditions glass can be heated by dielectric loss between capacitor plates as shown in Fig. 1, by eddy current induction in coils or inductive links as shown in Fig. 2, and by conduction with special gas-flame electrodes such as those shown in Fig. 3.

Selection of one or more of these three basic types of internal heating is governed by the nature of the particular operation to be performed, the temperature range required, and the properties of the glass under treatment.

Included in the several different kinds of useful operations which can be performed on glass during or immediately following internal heating are:

(a) *Perforation of parts, or hole-punching.*

(b) *Glass-to-metal seals and soldering operations on metallized glass.*

(c) *Welding together of parts.*

It is the last-mentioned operation, the welding of glass parts, which is the subject of this article.

High-frequency Welding

Superficially, electronic glass welding resembles arc welding, but in reality it is true resistance welding. Melting is accomplished by the passage of high-frequency heating current through the glass in restricted regions, where it is to be softened and flowed in the welding process.

What sometimes confuses the beholder is that pin points of flame

TYPICAL GLASS PRODUCTS INVOLVING ELECTRONIC PRODUCTION METHODS

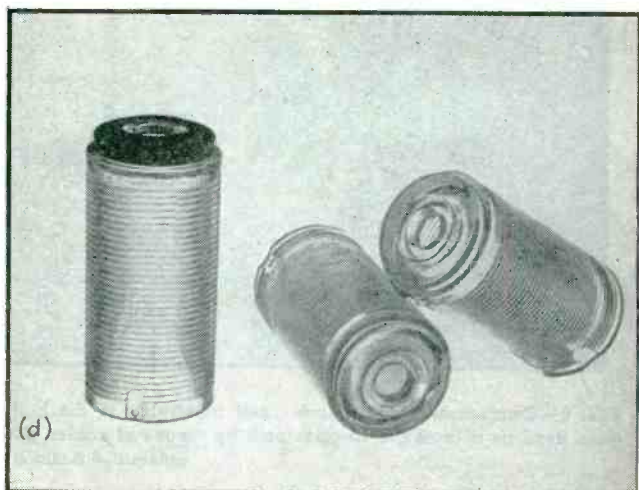
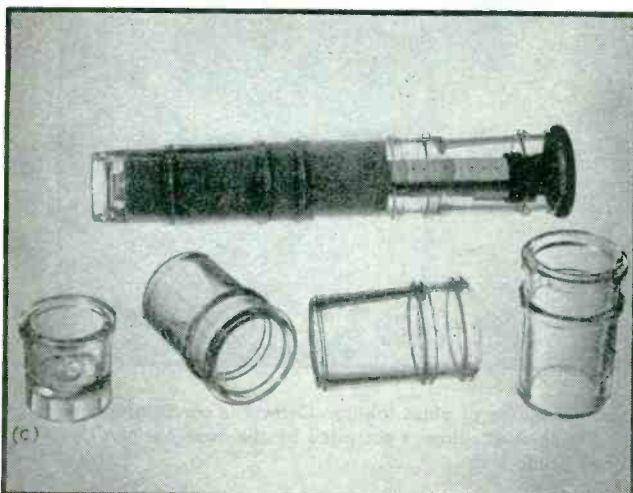
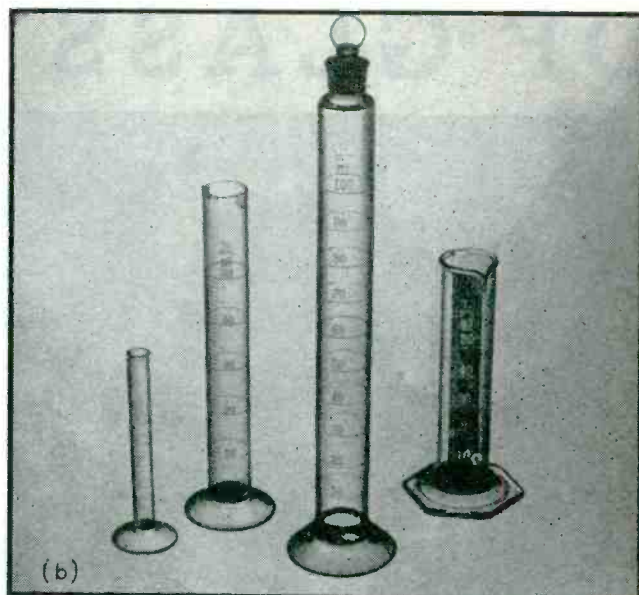
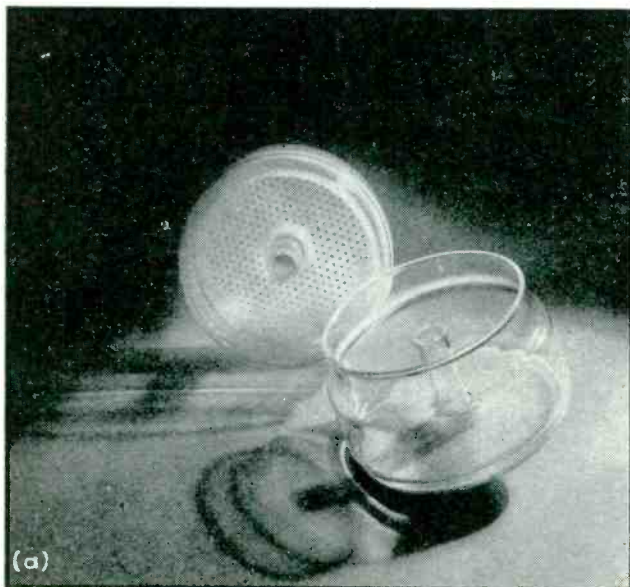

(a) Two glass pieces are combined by an automatic seam welder to complete a coffee-maker basket. (b) Glass bases are welded to graduated cylinders. (c) Lightning arresters are built up of several glass segments. (d) Holes are punched in coil-forms at hot spots developed by electronic cross-fire guns

from small oxyhydrogen burners are often used on the tips of the high-frequency welding electrodes, as shown in Fig. 3, to serve a three-fold purpose:

(1) They preheat the glass parts to be welded in the restricted areas of the surface to which they are directed. Since the flames are very small and sharp, restriction of the preheated area can be closely regulated. Although the preheater flames are too small to melt and work the glass, they can and do raise the glass temperature to the point where it ceases to be an insulator and becomes a high-resist-

ance conductor. This happens at temperatures below the melting point and thus avoids destructive surface boiling.

(2) These same pin points of flame next serve as gaseous conductors to direct high-frequency currents from the metal burner tips to the conducting paths already established in the glass by the localized preheating operation. Since the pin points are velocity directed, they impart controlled direction to the high-frequency discharge passing through them to the glass, thus serving as flexible, non-sticking, electrical brushes.

(3) The flame-electrodes also serve as variable resistances in series with the glass load, and exert a certain degree of control over the flow of the high-frequency heating current as they are moved closer to or farther away from the glass. Since the high-frequency current passing through the preheated paths in the glass produces a much greater heating effect inside the material than the small preheat flames which started the process, variation of the welding current provides exact regulation of glass temperature.

A pair of flame-electrode welding

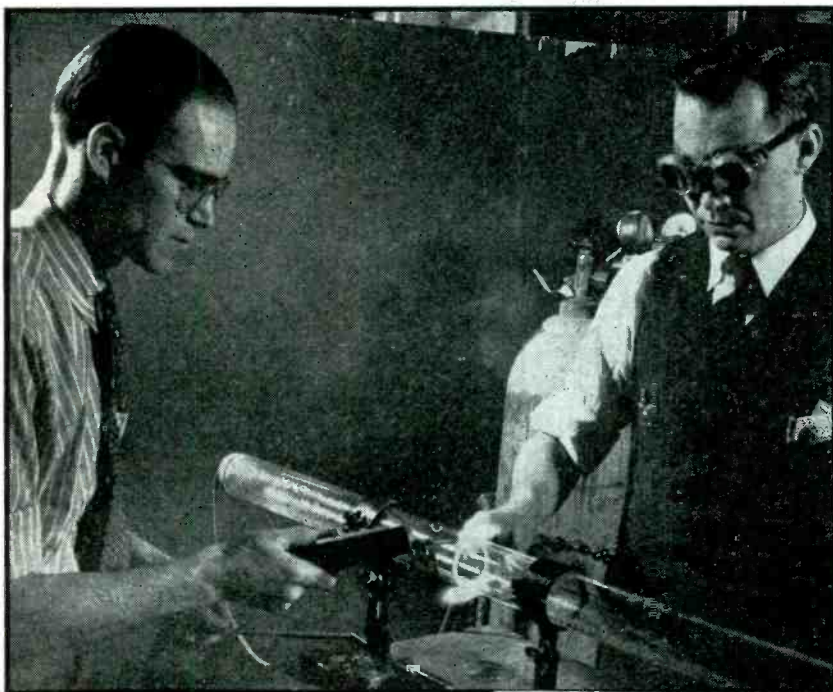

LEFT

FIG. 4(b)—High-frequency current is passed through flames into axially aligned glass-pipe interfaces, softening and melting restricted portions

BELOW

FIG. 4(a)—Glass pipe is prepared for electronic welding by removal of irregular edges with a conventional hot-wire crack-off tool

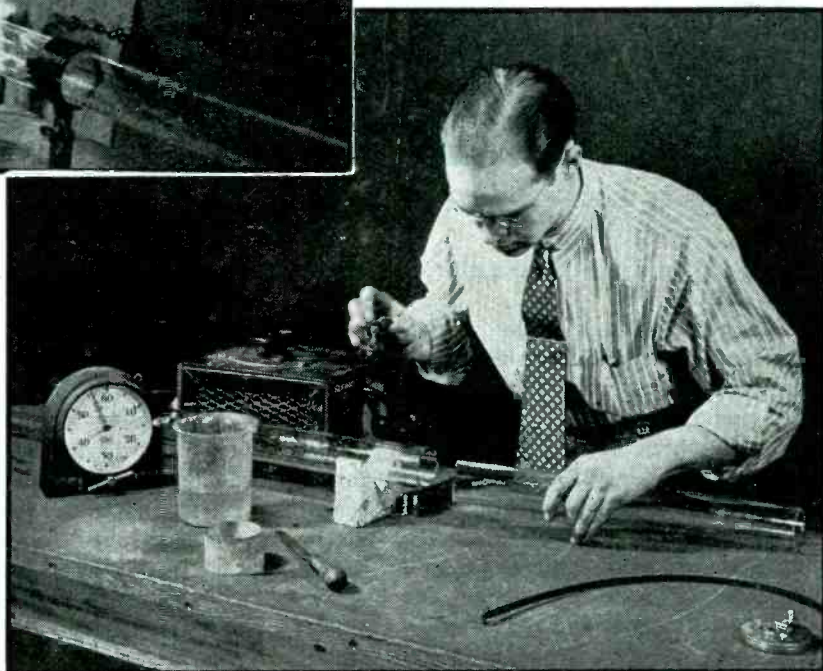

guns, manipulated by hand or mounted in opposition on a glass-working machine and excited by a high-frequency wave generator of suitable characteristics, constitutes one simple, effective solution of the difficult load impedance matching problem by reduction of the otherwise excessive range of variation in resistance.

High-frequency electric cross-fire systems have been applied with success, not only to hand-welding operations and to rotating electrical sealing lathes, but also to automatic machines.

Welding of Glass Pipe

The new products produced since the development of low-expansion, high-melting-temperature borosilicate glass exceed in number and diversity those of the preceding 4,000 years of glassmaking. The resistance to thermal abuse and chemical attack which resulted from this happy deviation from the traditional lime-soda-sand formula gives to new types of glass a dependability that has opened up a new era of widely expanded industrial uses.

Glass pipe lines, for example, show great promise. In one very important direction, however, there is still room for improvement.

While the success of the glass pipe line has been due, in no small measure, to the cleverly designed and carefully engineered flanged-joint system by which convenient lengths are coupled and clamped together in the process of assembly, there remain certain types of service where an all-glass, one-piece pipe line system would have very definite advantages.

The high melting temperature of thick-walled borosilicate glass pipes makes the process of sealing together lengths of pipe with no other tool than a conventional glass-fire a tedious, time-consuming job requiring great skill on the part of the glassworker and result-

ing in a costly installation. One of the most important applications of the high-frequency cross-fire, therefore, has been in the recent successful welding of all-glass pipe lines. The simple portable equipment developed for this purpose makes possible for the first time the rapid installation, repair, and servicing of all-glass lines of any length in the field.

Glass pipe ends are prepared for welding by removal of irregular edges with a conventional hot-wire crack-off tool, as shown in Fig. 4(a). (The same instrument permits removal of a damaged section from a service line, preparatory to rapid repair by welding-in a new

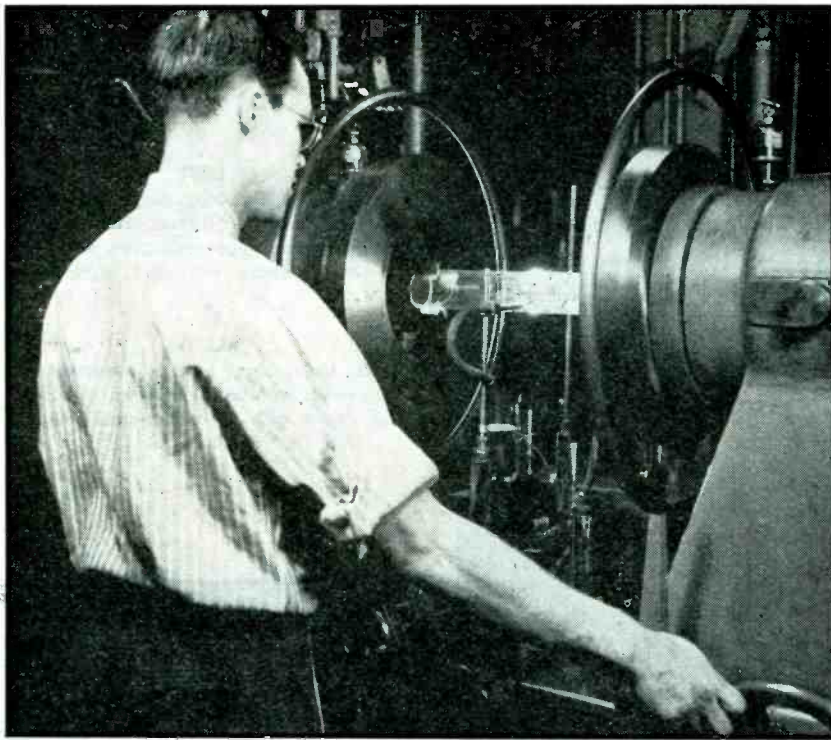

FIG. 5—Electronic cross-fire guns mounted on a glass-sealing lathe

section cut to length at the site of the installation.)

The pipe sections to be welded together are mounted in accurate axial alignment on a clamping jig with ends slightly separated by a distance which can be varied by means of a small toggle lever. This simple fixture permits free, easily controlled manipulation without loss of axial alignment and provides the necessary means for the smooth application of welding pressures, or for the application of stretching forces to remove excessive upset.

The two glass faces about to be welded are preheated by the pin-fires at the tips of the welding guns until the glass becomes conducting. The operator and his assistant, located opposite each other so that both sides of the weld can be critically inspected at all stages of the operation, move the hand guns to and fro in slow rotary oscillation until the pipe ends reach a uniform, barely visible dull red.

High-frequency electric heating is then started and rapidly melts the two pipe sections together as shown in Fig. 4(b), while pressure is applied with the toggle lever and followed, immediately after the high-frequency power is shut off, by blowing and stretching to reduce

the upset. After any electric glass-working operation, annealing is necessary to eliminate strains.

Welding With Rotating Machine

In the high-frequency hand-welding operations just described, uniform heating of the glass requires coordinated dexterity in the manipulation of the electrodes by skilled operators. High-frequency sealing on rotating machines demands less skill on the part of the operator since uniform heat distribution to the work is provided by the mechanically synchronized, regular, and continuous motion of the glass parts as they rotate in the cross-fire as shown in Fig. 5.

Judgment of glass temperature and experience in the systematic performance of a sequence of properly timed steps are still necessary, however, in the operation of high-frequency glass sealing lathes. Mounting and centering irregular pieces on the rotating heads accurately enough to avoid wobbling and fast enough to keep up with modern streamline production schedules likewise require practice.

Thus the high-frequency electrical sealing project would not be complete without the development of a fully automatic machine into which glass parts could be loaded

and from which completely finished welded glass products could be unloaded. While this phase of the development is still relatively recent, such machines have been constructed and are in operation at the present time.

Economic Considerations

High-frequency sealing can be applied to many different glasses and many different kinds of glassware with important advantages over conventional methods. An equally important question remains to be answered, however, namely where not to use high-frequency methods.

Since high-frequency wave-generators cost considerably more than gas burners, there are many operations where the electronic heating method does not show sufficient improvement over gas to warrant the extra expense. In particular, when close heat restriction and control are unimportant, as when working with easily melted soft glasses where the total operating time is largely determined by incidental handling and not by the melting process, there is little to be gained from the new methods.

On the other hand, in operations where melting time is a significant factor in total production time and where accurately controlled and sharply localized melting can produce a superior article or perform a desirable operation which otherwise would be impossible, the high-frequency methods are unsurpassed.

As tested not only by numerous laboratory experiments but also by production operators in the manufacturing department over a period of several years, high-frequency welding has shown the following definite advantages:

- Production of stronger seals*
- Reduction of shrinkage due to re-jection*
- Insurance of adequate penetration of heat into thick sections of hard glass*
- Sharp localization of heat and exact control of temperature pattern*
- Avoidance of injurious loss of volatile constituents*
- Freedom from deleterious reactions with products of combustion*
- Higher melting speeds*

Modern methods of research in glass have developed their modest inheritance from the primitive arts of yesterday into an amazingly versatile array of useful products.

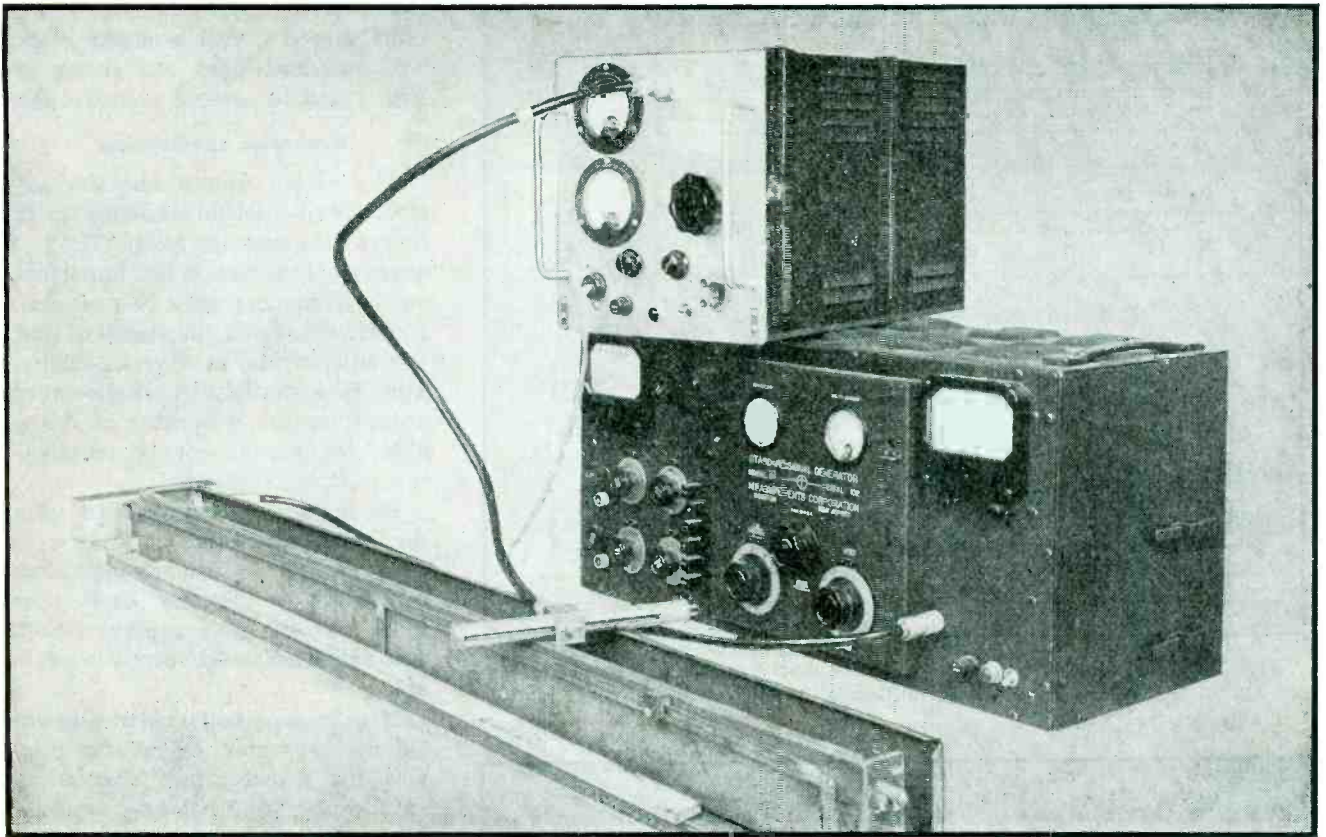

High-impedance probe loosely coupled to a sensitive receiver, and a section of transmission line, enables impedance measurements to be made using low-power laboratory equipment

U-H-F IMPEDANCE MEASUREMENTS

By measuring standing waves on transmission lines, the terminating impedance can be determined. Low-power equipment can be used if the measuring probes have high impedance. Resonance and loose coupling are used to obtain high-impedance probes

By **N. MARCHAND**
and
R. CHAPMAN

*Federal Telephone and Radio Laboratories
New York, N. Y.*

MEASUREMENT of impedances at ultrahigh frequencies by the standing-wave method is well known. The majority of these measurements are made on power equipment where the energy consumed by the measuring device does not disturb the system.

When the power available begins to approach the power consumed by the measuring device, conventional equipment begins to decrease in accuracy until a point is reached where the measurements are mean-

ingless. All types of receiving apparatus and receiving antennas fall in this latter group. Measuring the impedance of these devices calls for a new type of equipment.

Improved Equipment

The equipment described in this article is primarily a high-imped-

ance voltage-reading device usable at frequencies from 150 to 1000 megacycles. The average accuracy of these measurements is in the order of 10 percent, although accuracies of five percent are possible under optimum conditions.

An oscillator is used to excite a transmission line of known impedance. The unknown impedance is used to terminate the standard line. The standing-wave ratio and the positions of several nulls on the line are noted with the aid of a high-im-

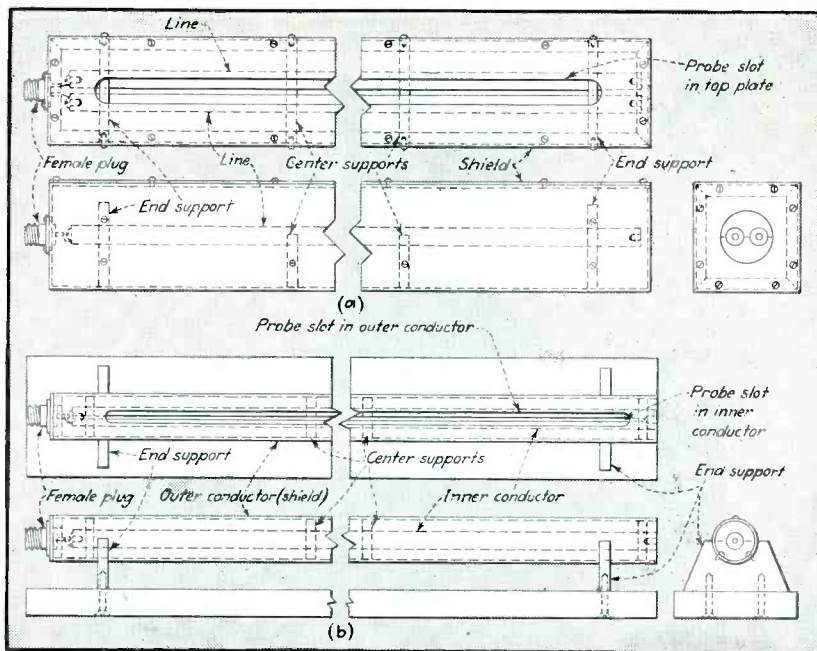

FIG. 1—(a) Balanced line used in impedance measurements, constructed in a trough for shielding. (b) Coaxial line construction

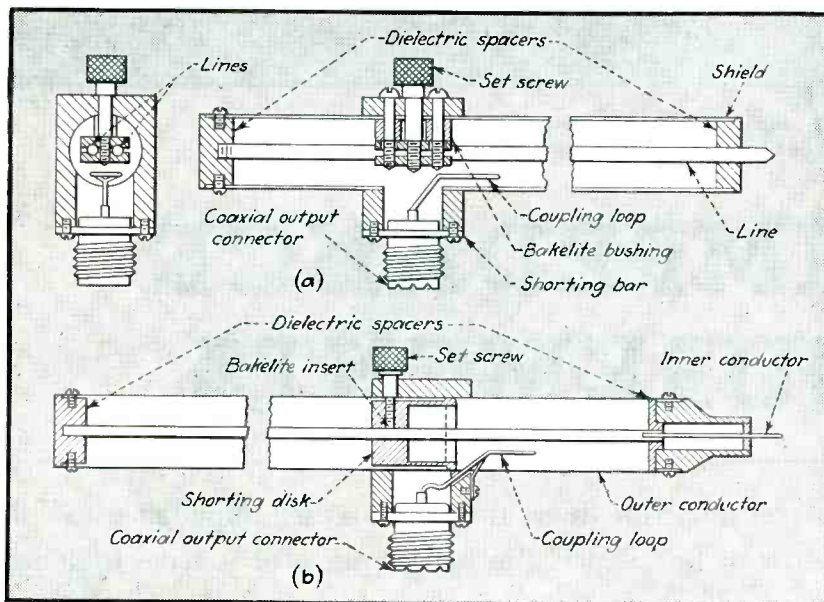

FIG. 2—(a) Balanced u-h-f probe construction provides a movable shorting bar and a pickup loop assembled inside a shield. (b) Coaxial probe is similarly constructed, with shorting disk and pickup loop inside the outer conductor of the probe

found relatively easy to measure the nulls directly with a meter stick. The standard lines are shown in Fig. 1 and in several photographs.

Generator and Receiver

The signal source may be any stable, well-shielded oscillator which covers the necessary range. The frequency calibration is not important as the frequency may be measured experimentally on the standard line, but an accurate, easily-read attenuator is essential. A single-ended output on the generator is desirable; for making coaxial measurements it is necessary.

In making measurements with the balanced system it is best to rely on an unbalance-to-balance converter to properly excite the lines, even though a generator with a so-called balanced output is available.

If a balance box (balance-to-unbalance converter, essentially a device for transferring from a coaxial system to a balanced system) is used when exciting any type of balanced system, the balance to ground will be preserved. This is generally safer than relying on the balance of the output of the generator, especially where accurate measurements are being made. Design data and general characteristics of this type of converter have already been discussed and analyzed. The balance box is shown in Fig. 4.

The receiver, like the oscillator, may be any model which will cover the desired range. Similarly, it must be well shielded. It should contain a diode-type output meter. This meter need have no special calibration as it is used only for indicating nulls.

High Impedance Probes

The probe which is connected to the receiver input is the critical part of the system. It must be an easily tuned, high-impedance device which will consume negligible power from the standard line. Two types are used. For the low-frequency range (150 to 350 megacycles) standard LC tuning is employed. In the high-frequency ranges (350 to 1000 megacycles) coaxial and balanced lines are tuned by means of sliding shorts.

The greater the characteristic

pedance probe coupled to the input of a receiver. A reference point for calculating the phase angle of the load is established by shorting the standard line at the termination.

Although designed primarily for the impedance measuring equipment, the high impedance probes were found useable for several other interesting applications. Voltage distribution and balance were accurately checked on dipoles, folded

dipoles, loops and various other assemblies.

The standard lines in use are a 50-ohm coaxial line, and a 95-ohm balanced line. The coaxial line is slotted along its length to permit insertion of the probe. The balanced system is equipped with a mechanical means of marking nulls. The same system of indicating nulls could be applied to the coaxial system, but in the coaxial case it was

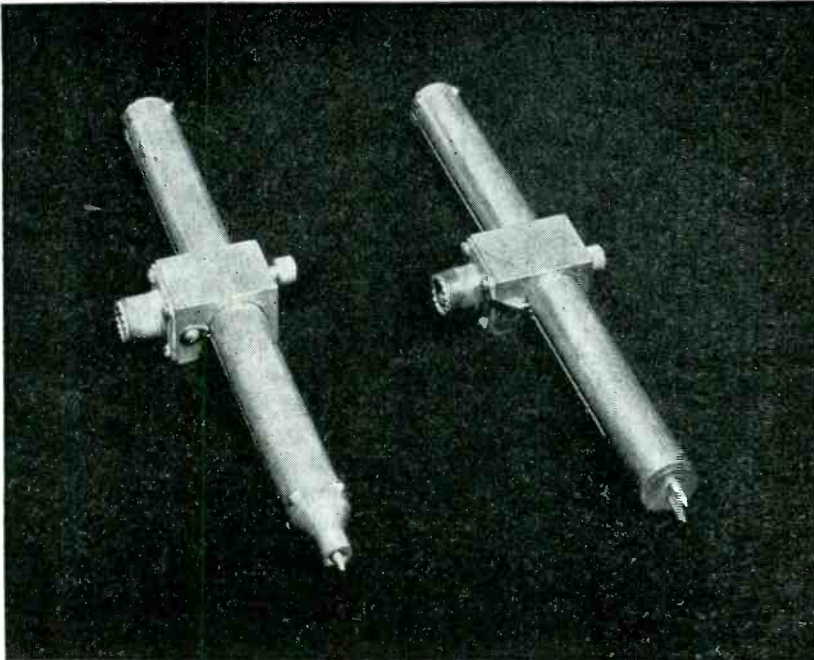

The probe at the right is used when impedance measurements are being made with balanced lines, and the probe at the left when measurements are made with coaxial lines

impedance of the shorted quarter-wavelength line section of the probe, the less critical the tuning becomes. When the line is tuned to exactly one-quarter of a wavelength, the impedance is real and very high. As long as the input impedance of the probe remains in the order of twenty-five times the impedance of the standard line it will produce no detrimental effects (for standing wave ratios of five or less). This means that the characteristic impedance of the probe will determine the ease with which it may be tuned, as indicated by the relation $Z = jZ_0 \tan (2\pi l/\lambda)$. This, and the obvious mechanical limitations, set the value of the characteristic impedance of a practical probe at 100 ohms.

Output from the probe is obtained by loosely coupling to the high-current end of the quarter-wavelength section with a loop connected to a coaxial line.

Loose coupling is necessary for several reasons:

The probe can consume only a small amount of power from the standard line. The amount of power being consumed can be adjusted by varying the coupling to the receiver. The coupling can be adjusted by varying the pickup-coil

size, distance from the center conductor, or its orientation with respect to the center conductor. The lowest value of coupling which will give a suitable reading on the receiver output meter is used.

Of secondary importance is the unbalance which the pickup loop introduces into the system. Each side of this loop presents a different impedance to ground. This

lack of symmetry, if the coupling becomes excessive, will unbalance the tuned section. Consequently the balanced line begins to look like a coaxial line. The two lines look like the inner conductor, in conjunction with the shield, of a coaxial line. This produces several effects. As shield currents begin to flow, a solid connection to the standard-line shield from the probe shield becomes essential to prevent detuning. When this connection does not exist, the circuit is completed by capacitance between the probe shield and the standard line. As the unbalance is being constantly changed by the position of the operator, it is impossible to take an accurate reading.

Another effect of coupling is upon the standard line. As the unbalance increases, the two central conductors look increasingly like a single line, and introduce unbalance errors in the measurements.

In the event that extremely close coupling is necessary, the unbalancing effect of the loop may be removed by installing a balanced-to-unbalanced converter loop as a pickup. This type of pickup presents the same impedance to ground from either side of the line.

When the probe is used in conjunction with a sensitive receiver, the coupling may be maintained at

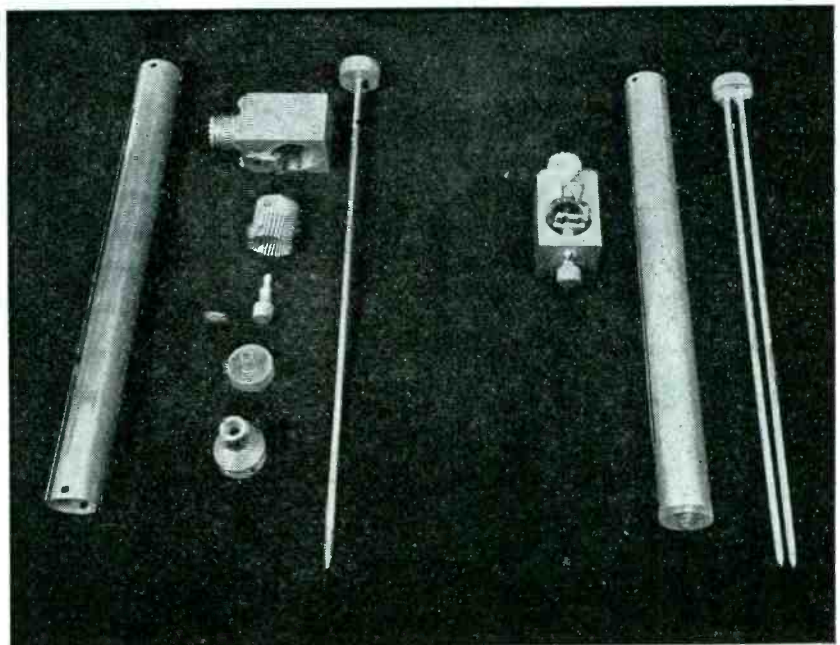

Machined parts of the high-impedance probes shown in the drawings of Fig. 2

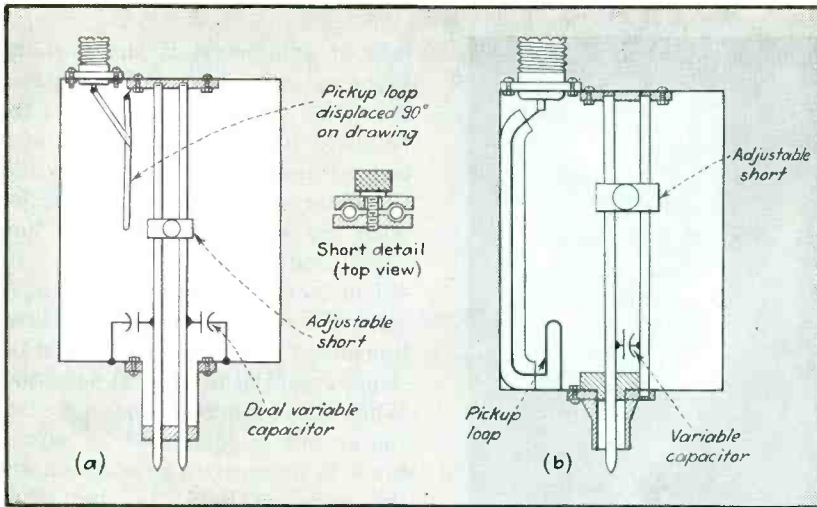

FIG. 3—For operation at v-h-f, capacitor-tuning supplements the shorting-bar tuning used at u-h-f as in (a) the balanced probe and (b) the coaxial probe

The probe used on the 150 to 350 megacycles portion of the range consists of a length of balanced line tuned with a variable capacitor as shown in Fig. 3(a). An adjustable short is shunted across the line to permit the probe to be used on several ranges with a low tuning capacitance.

The coaxial probe is similar to the balanced probe in most respects. It consists of a single conductor, a shield, and a short controlled from outside the shield for tuning as shown in Fig. 2(b). Energy is removed by means of a pickup loop mounted directly under the short. The major axis of the pickup is on the shield diameter. The 150-to-350 megacycle coaxial probe is capacitor tuned as illustrated in Fig. 3(b).

a value small enough to avoid any of the previously mentioned effects.

Construction

The size of the coupling loop is such that it will resonate at approximately 2000 megacycles. This eliminates sharp changes in sensitivity over the range of the probe due to resonance effects.

The tuning short of the probe is controlled by a knurled setscrew, which is used to lock and adjust it.

This setscrew is an integral part of the block upon which the output plug and pickup loop are mounted. The pickup loop moves with the short, and is always at the low-current end of the dual line.

The balanced probe illustrated in Fig. 2(a) is basically a dual line with a shield. A short, controlled from outside the shield, may be used to tune this line to one-quarter of a wavelength between 350 and 1000 megacycles.

Measuring Procedure

When making measurements, the standard line is shorted at the point where the unknown impedance is to be placed. The oscillator is fed into the standard line. The receiver-input cable is connected to an auxiliary pickup. This may be any device which can be used to couple loosely to the standard line. The best position is approximately half-

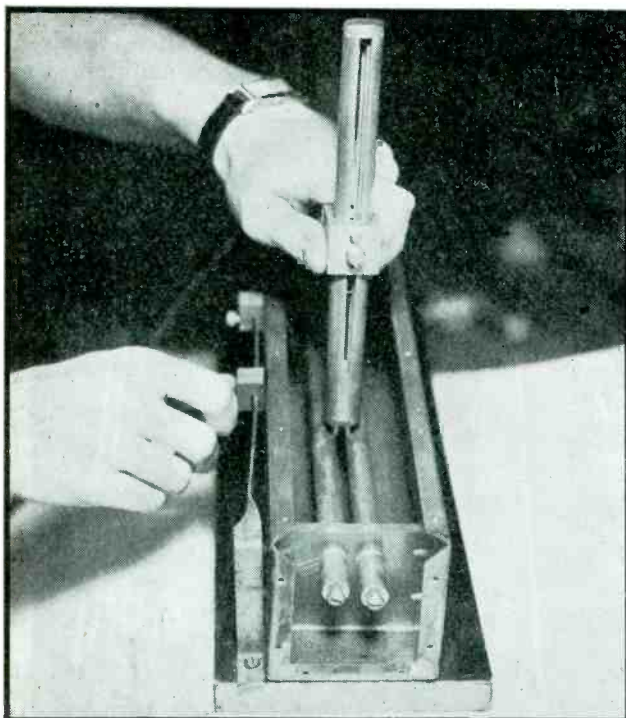

Use of probe on balanced line illustrates method of adjusting probe for maximum impedance

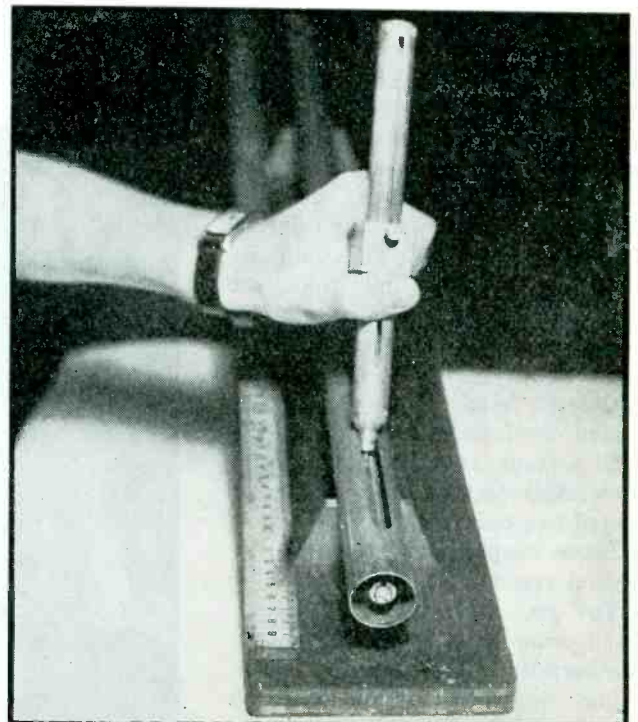

A slot is cut in the outer conductor of the coaxial line to admit the probe

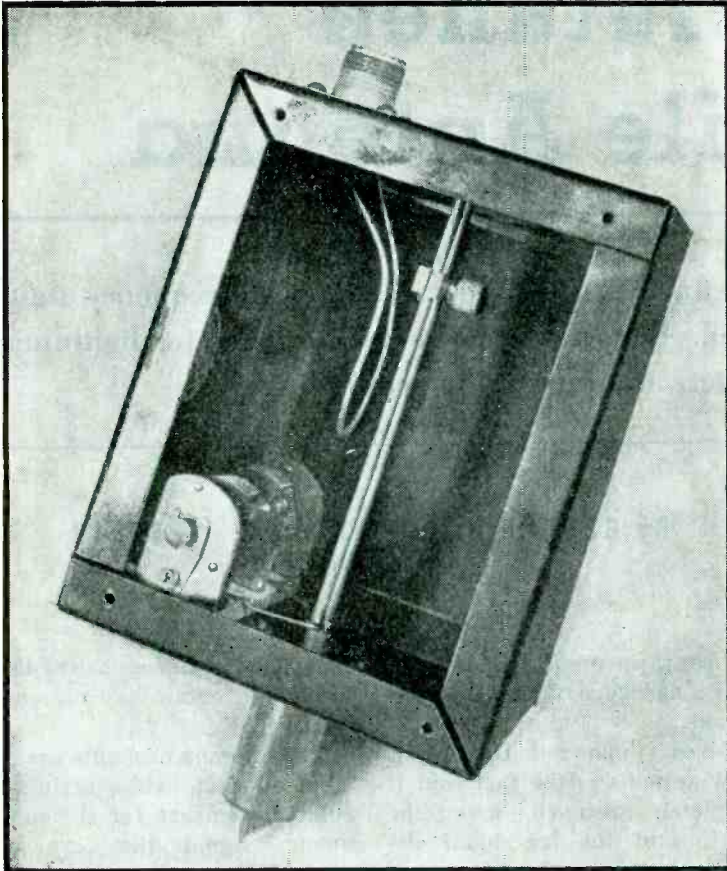

Construction of the v-h-f high-impedance probe illustrated in Fig. 3(a)

way between points of maximum and minimum pickup.

With the auxiliary pickup in this position, any disturbance on the line will produce a deflection on the receiver-output meter. The probe may now be tuned by sliding it along the standard line and adjusting the short until no visible deflection is produced on the receiver-output meter. When this condition is reached the probe is tuned to one-quarter wavelength and presents a high impedance to the standard line. The auxiliary pickup is now replaced with the probe.

With the short in place, the probe is used to determine the positions of several nulls.

If the receiver and oscillator are well shielded, the ratio of maximums to minimums should be extremely high. At the minimum, the voltage should be zero. If this is not the case, there is direct pickup between oscillator and receiver.

One of the ways of minimizing direct pickup is to run the oscillator at the lowest level consistent with accurate readings. Direct pickup has no effect on the positions of the

nulls, except to make them less pronounced, but causes a serious discrepancy in the measurement of the ratio of voltage maximum to voltage minimum.

After several nulls have been located the frequency may be calculated. These same nulls are used as reference points for measuring the unknown impedance. The short is removed and the unknown impedance is placed at the end of the line. The positions of the new nulls are noted. The relation of the null ob-

tained when the line was shorted to the latter null is noted. It is also necessary to note whether the first null, obtained when the line was shorted, is toward the generator or toward the load in relation to the null obtained with the line terminated in the unknown impedance. It may be measured in either direction as long as the direction is noted.

The last piece of information necessary is the standing-wave ratio. With the short removed, the probe is placed at a minimum. The signal-generator attenuator setting and the receiver output meter reading are noted. The probe is moved to a maximum. The signal-generator attenuator is adjusted until the receiver output meter returns to its former reading. The signal-generator attenuator reading is again noted. The standing-wave ratio is equal to the maximum signal-generator attenuator reading over the minimum attenuator reading. From the information obtained about the frequency, the null shift and the standing wave ratio, the characteristics of the load may be calculated.^{2, 3}

When making measurements with the coaxial system the balance box is not used in feeding the transmission line. This is the only physical difference between the two systems.

REFERENCES

- (1) Marchand, N. Transmission-Line Conversion Transformers. *ELECTRONICS*, p. 142, Dec. 1944.
- (2) Stewart. Measurement of Antenna Impedance. *QST*, p. 30, Dec. 1943, also Notes on Transmission Lines. *QST*, p. 25, Aug. 1943.
- (3) Terman, F. E. "Radio Engineers' Handbook," McGraw-Hill Book Co., 1943, p. 172-192.

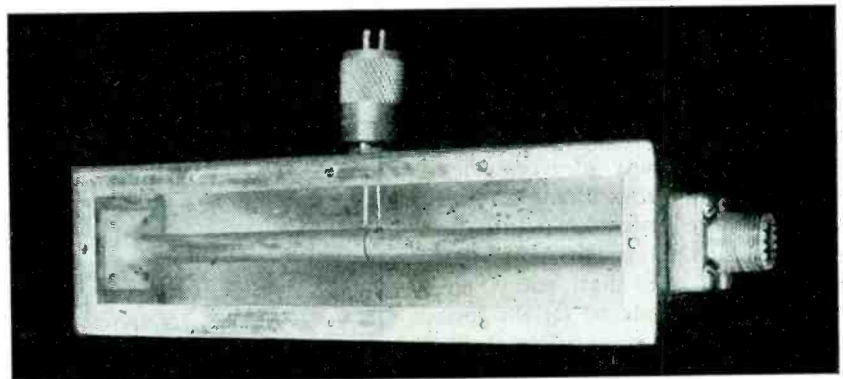

FIG. 4—Conversion transformer used to preserve balance when changing from a coaxial to a balanced termination

A Pretuned Turnstile Antenna

Electrical and mechanical design refinements provide an ultrahigh-frequency unit that can be adjusted before being erected. Elements are directly grounded for lightning protection and heaters are provided to prevent icing

By **GEORGE H. BROWN** and **J. EPSTEIN**

*RCA Laboratories
Princeton, N. J.*

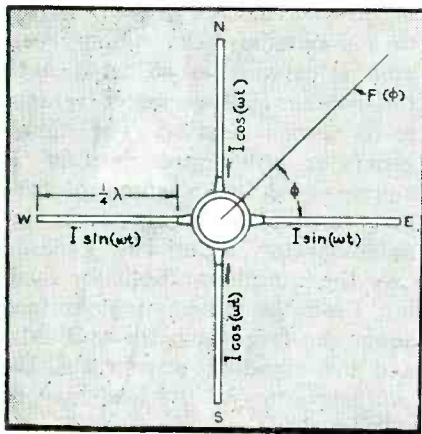

FIG. 1—Elemental turnstile unit

THE PURPOSE of this paper is to describe a new turnstile antenna design for ultrahigh-frequency broadcasting.

The original turnstile¹ was so constructed that the elements were fed by means of open wires twisting around the supporting mast. Adjustment of the phase relationships and current magnitudes was accomplished by means of two properly matched transmission lines cut to the proper lengths and combined in a common terminal. The adjustment of these lines at the base of the antenna proper was rather critical and involved a certain amount of patient effort.

With the advent of frequency modulation on the ultrahigh-frequencies, the turnstile antenna found many applications. It soon became apparent that many antennas would be placed on the tops of extremely tall supporting structures, where the matching and phasing adjustments become very difficult if not impossible. With

these factors in mind, the development of a new type of turnstile was undertaken.²

The most important feature of the new antenna is the fact that it is completely pretuned during the fabrication of the individual elements so that no work of an engineering nature is necessary to put the antenna into operation.

The 90-degree phase relation is accomplished in the construction of the antenna elements themselves, so

that no adjustments at the base are needed to obtain the circular pattern.

The antenna elements are so constructed that, while acting as insulated members for the radio-frequency signal, they are actually grounded to the pole to afford lightning protection. Because of the grounding feature, it is a simple matter to include sleet-melting units in each radiator.

Two concentric feed lines con-

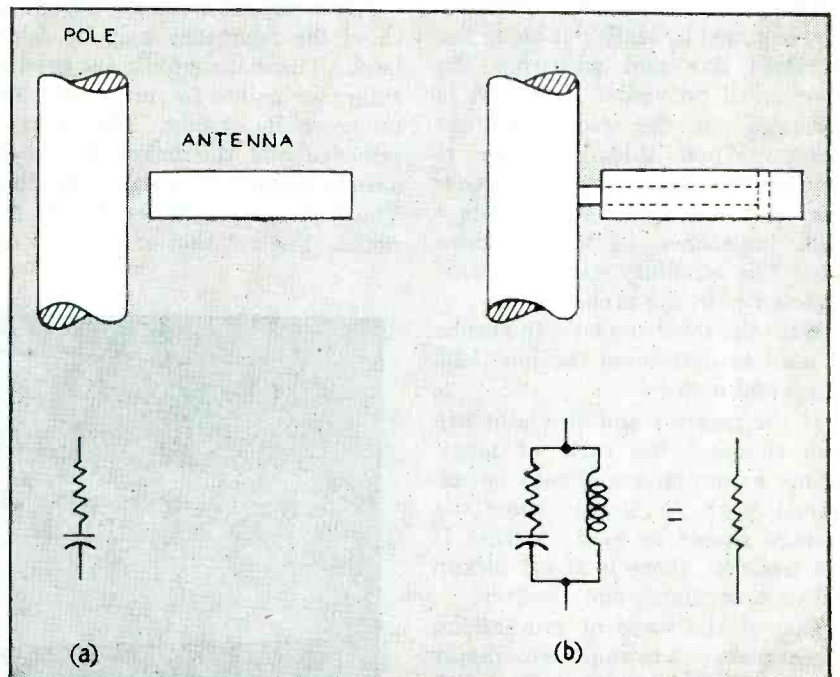
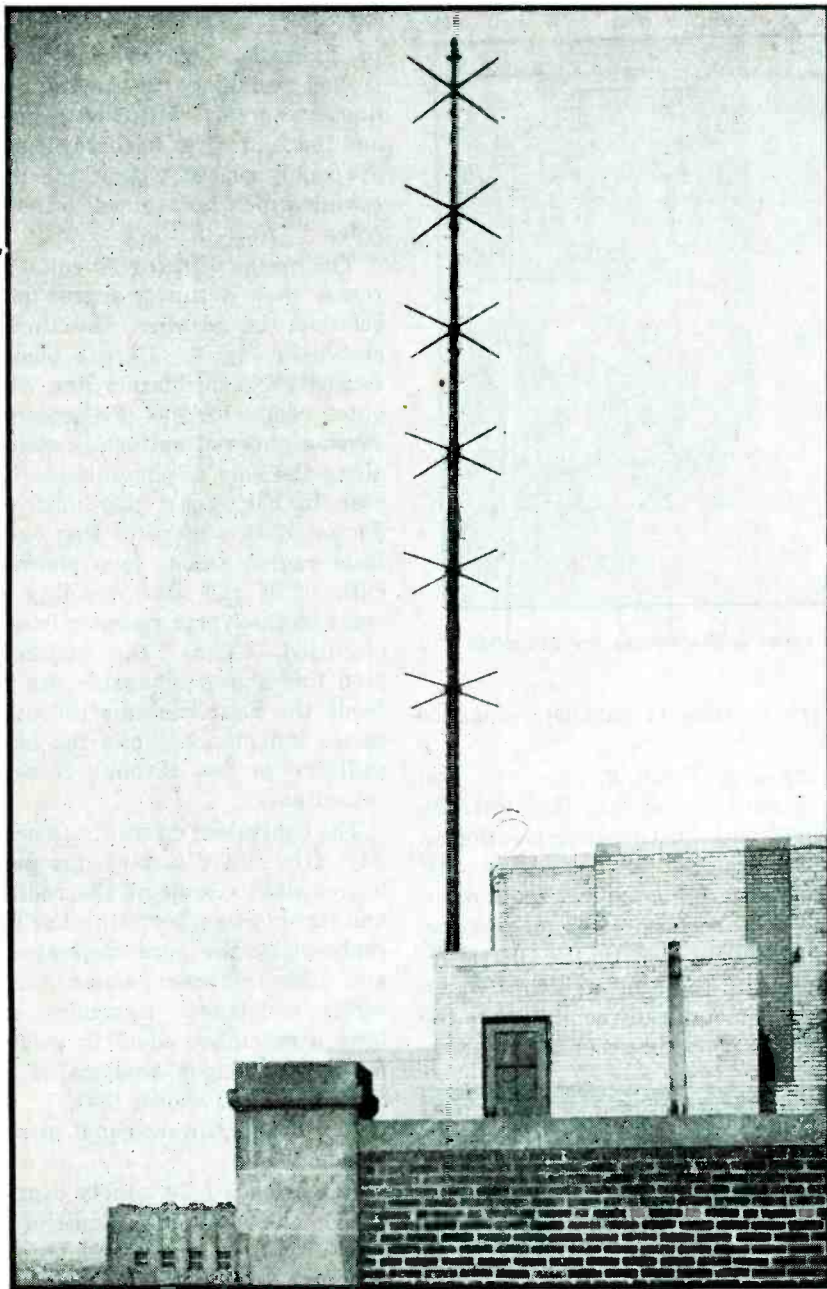

FIG. 2—By properly mounting antenna elements on the supporting pole impedances may be controlled and zero reactances obtained



A modern turnstile antenna, serving WCAU's f-m audience in the Philadelphia area

nect the several units, replacing the open wires formerly used. By means of standard concentric line, these two feed lines are fed in push-pull from a single concentric feed line which runs back to the transmitter. This feed line is terminated to eliminate standing waves.

Principle of Turnstile Antenna

The fundamental objectives of the turnstile antenna are twofold, first, to produce a radiation pattern which has circular symmetry in the horizontal plane, and second, to concentrate the energy in the vertical plane so that the signal strength

toward the horizon for a given power input will be considerably greater than that obtained from a single half-wave vertical antenna with the same power input.

The principle involved in producing a circular pattern can best be explained by referring to Fig. 1, which shows an elemental unit that could be used to produce the required pattern. As can be seen, it consists of four quarter-wavelength radiators symmetrically oriented in space, carrying equal currents, and so phased that the East-West radiator voltages are out of phase with each other and in

time quadrature with the North-South radiator voltages, which are likewise out of phase with one another. The field at any point in the horizontal plane, due to the East-West radiators, is equal to

$$F_1 = (60 I/r) \sin(\omega t) \sin(\phi) \quad (1)$$

where ϕ and r are the coordinates at the point. The field due to the North-South radiators is

$$F_2 = (60 I/r) \cos(\omega t) \cos(\phi) \quad (2)$$

The sum of Eq. (1) and Eq. (2) gives the total resultant field

$$\begin{aligned} F(\phi) &= F_1 + F_2 \\ &= (60 I/r) [\sin(\omega t) \sin(\phi) + \cos(\omega t) \cos(\phi)] \\ &= (60 I/r) \cos(\omega t - \phi) \end{aligned} \quad (3)$$

Thus the total field at any distance r is constant in magnitude and changes in phase as ϕ changes, giving a circularly symmetrical horizontal pattern.

The concentration of energy in the vertical plane is obtained by stacking a number of elemental turnstile units along the vertical axis. The vertical radiation pattern of n units spaced a half-wave length apart and cophased is equal to

$$F(\theta) = \frac{\sin[(n\pi/2) \sin \theta]}{n \sin[(\pi/2) \sin \theta]} \quad (4)$$

where

$F(\theta)$ = vertical radiation pattern

n = number of layers

θ = elevation angle measured with respect to the horizontal plane.

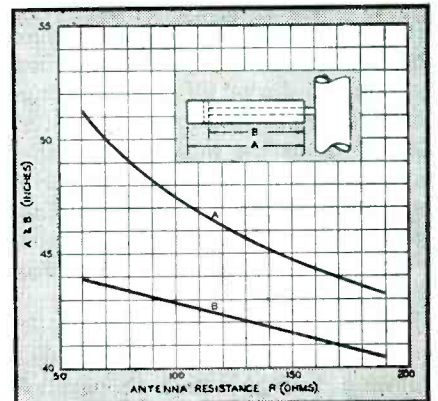

FIG. 3—By changing the antenna length and the shunting-plug position a wide range of parallel antenna resistance is available

Equation (4) shows that maximum radiation occurs for $\theta = 0$, or in the horizontal plane.

Radiator Elements and Feed Lines

The radiator elements for the new turnstile design were constructed from copper tubing having a two-inch diameter. One of these

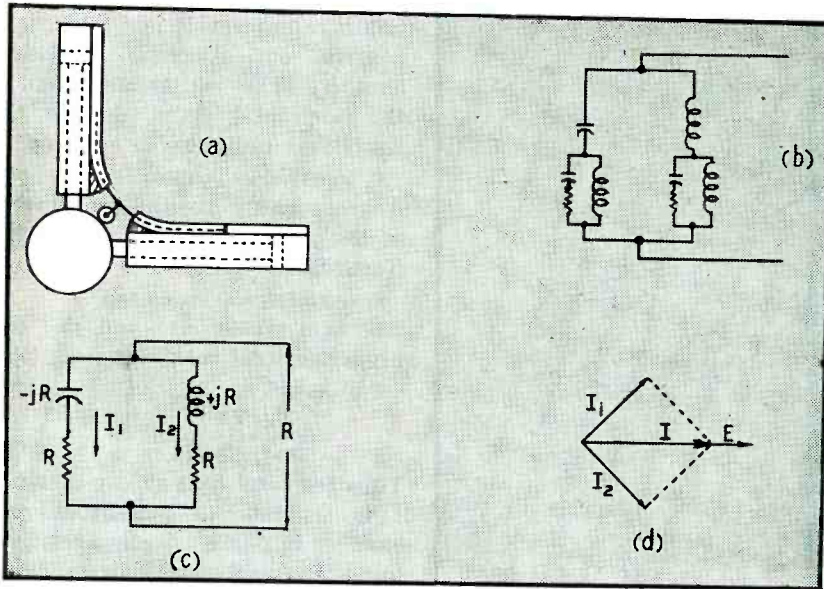

FIG. 4—How phase relations and current ratios in the dipoles are controlled

elements is shown in Fig. 2(a) in its proper position with respect to the supporting pole. Since the radiator is made slightly less than one-quarter wave in length, the impedance measured between the end adjacent to the pole and the pole consists of a resistance component and a capacitive component, as shown in the lower section of Fig. 2(a).

The method of supporting the antenna is shown in Fig. 2(b). Here a one-inch tube extends from the support pole out through the radiator, and a metal shorting-plug connects the inner tube to the outer sleeve. Thus the impedance of the radiator is shunted by the inductive reactance of the transmission line formed by the outer sleeve and the outer surface of the inner tube.

If the shorting plug is placed in the proper place, the entire combination will be tuned to parallel resonance and the impedance will be a pure resistance, as shown in the lower part of Fig. 2(b). The magnitude of this pure resistance will be determined by the length chosen for the outer sleeve. If R_a is the resistance of the outer sleeve and X_a is the capacitive reactance of this same sleeve, the parallel resonant resistance is

$$R = R_a^2 + X_a^2 / R_a \quad (5)$$

and we see that R increases as the length is decreased.

The inductive reactance neces-

sary to tune to parallel resonance is

$$X_p = (R_a^2 + X_a^2) / X_a \quad (6)$$

Figure 3 shows the antenna length and shorting-plug position as a function of the desired parallel resistance for a typical radiator in the neighborhood of 45 megacycles.

It will be seen that we have arrived at a radiator structure which may be metallically connected to the support pole and grounded to static

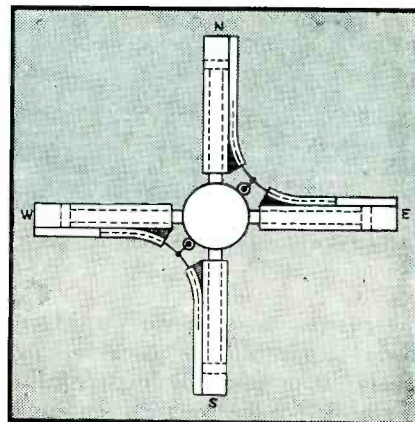

FIG. 5—A complete turnstile layer

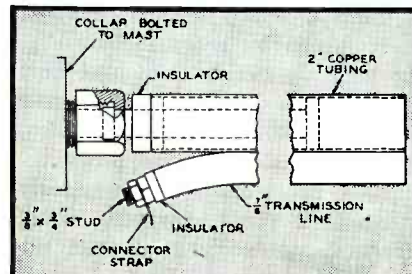

FIG. 6—Details of one radiator element

or lightning, yet offering a controlled resistance to the radio-frequency signal. Heating elements and the feed wires to these elements are easily placed within the inner tubing which is fastened to the flag pole.

The means of securing equal currents, with a ninety-degree phase relation, in adjacent radiators is shown in Fig. 4. Here a piece of concentric transmission line whose outer conductor has a diameter of seven-eighths of an inch is soldered along the side of the antenna. As seen in Fig. 4(a), the inner conductor of this piece of line on the East radiator ends in a short-circuit, while the corresponding element on the North radiator is open-circuited. Thus, the concentric feed line shown alongside the pole feeds the East radiator through a series inductance, while the North radiator is fed through a series capacitance.

The equivalent circuit is shown in Fig. 4(b). In Fig. 4(c), the parallel resonant circuit of the radiator and its shunt-support stub has been replaced by the pure resistance R , and the series-capacitance and series-inductance elements each have a reactance equal in value to R . In a previous analysis of this circuit³, it was shown that

(1) I_1 and I_2 were equal in magnitude.

(2) I_1 leads I_2 by ninety degrees.

(3) The input impedance of the total circuit is a pure resistance of R ohms.

The first condition, equality of the two currents, is evident from an inspection of Fig. 4(c). A vector diagram of the currents and the driving voltage is shown in Fig. 4(d), and helps to show the quadrature relation as well as the fact that the input impedance is a pure resistance.

A complete single layer of a turnstile combination is shown in Fig. 5. Here the East and North radiators are fed from one concentric line, while the West and South radiators are fed by another concentric line, which is out of phase with the first line by 180 degrees. This arrangement fulfills the conditions required to give a circularly symmetrical horizontal pattern.

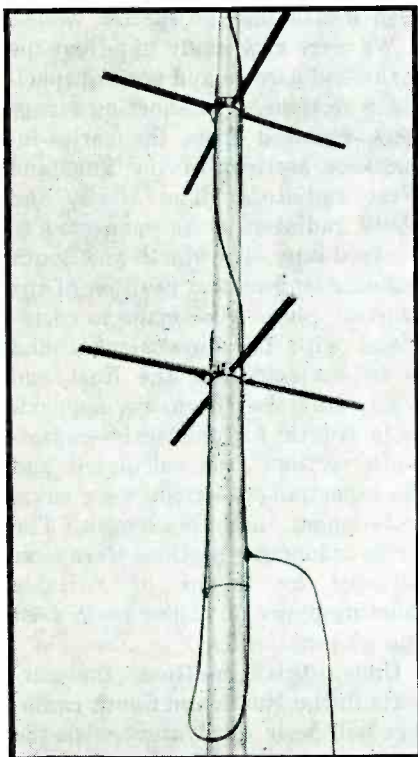

FIG. 7—Individual layers are connected together by means of two concentric lines which spiral around the pole. A simple matching network is also shown

Details of one radiator are shown in Fig. 6. It will be noted that a cylindrical insulator is added at the mouth of the antenna to furnish additional support and to seal off the interior of the inductive section. A smaller cylindrical insulator is used on the phasing section.

Figure 7 shows a photograph of the feed lines and coupling network of a typical turnstile antenna. It may be seen that the feed lines spiral around the support pole. This is necessary since the radiator layers are one-half wave apart and it is desired to feed these layers in corresponding phase.

The concentric feed lines are shown laid out in a plane in Fig. 8. It will be noted that the feed line on the left is one-half wave longer than the feed line on the right. This insures the necessary push-pull feed to each layer. Since each radiator has a resistance R , a resistance of R ohms is present at each little end-seal. The half-wave connecting lines transfer impedance without conversion, so that the impedance at point a on the right-hand line is that of the four sets in parallel, that is, $R/4$. In the general

case, with n layers of radiators, the impedance at point a would be R/n ohms. The input impedance of a line which is one-quarter wave in length and of characteristic impedance Z_0 is Z_0^2/Z out, so the impedance at point b , looking up the right-hand line, is $Z_0^2/(R/n)$, or nZ_0^2/R .

An equal impedance is seen at point b looking into the left-hand transmission line. Since these two impedances are equal, the total impedance at point b is $nZ_0^2/2R$. Now, if we choose the individual radiator resistance such that

$$R = nZ_0/2 \quad (7)$$

the input resistance is equal to Z_0 and the main feed line is matched in its characteristic impedance. The following table shows the values of R which would be chosen for a number of layers of Turnstile:

TABLE I

Number of Layers (n)	R/Z_0	R (ohms) when Z_0 is 70 ohms
1	0.5	35
2	1.0	70
3	1.5	105
4	2.0	140

While we could theoretically extend this procedure to many more layers, it was found that the antenna dimensions became quite critical when more than four layers were used. In order to obtain high parallel resistance, the radiators had been shortened to a point where the resistance changed a great deal with a slight change in antenna length.

A practical feed system used for six or more layers is shown in Fig. 9. Here the main feed line enters at a point midway in the antenna structure. To match the main feed line, the radiator parallel resistance must satisfy the condition

$$R = nZ_0/8 \quad (8)$$

The table below shows the appropriate value of R :

In order to provide a design

TABLE II

Number of Layers (n)	R/Z_0	R (ohms) when Z_0 is 70 ohms
6	0.75	52.5
8	1.0	70.0
10	1.25	87.5
12	1.5	105.0

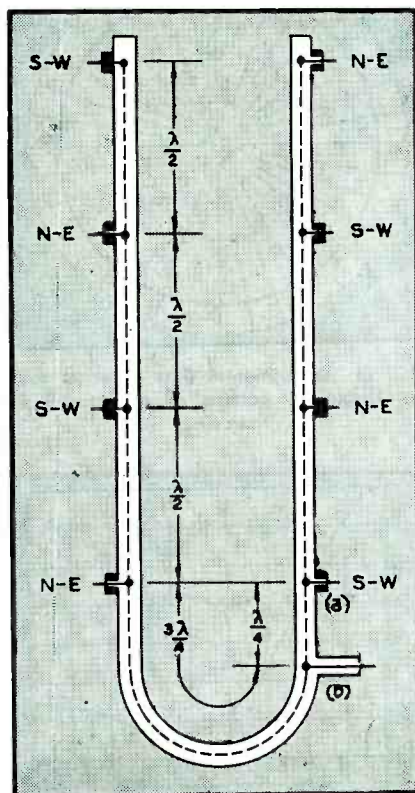

FIG. 8—A simplified layout of feed lines for four layers or less

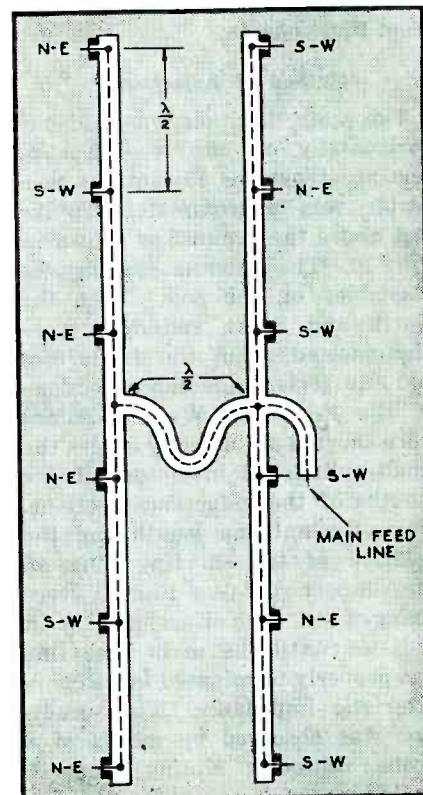

FIG. 9—A practical feed system for six layers or more

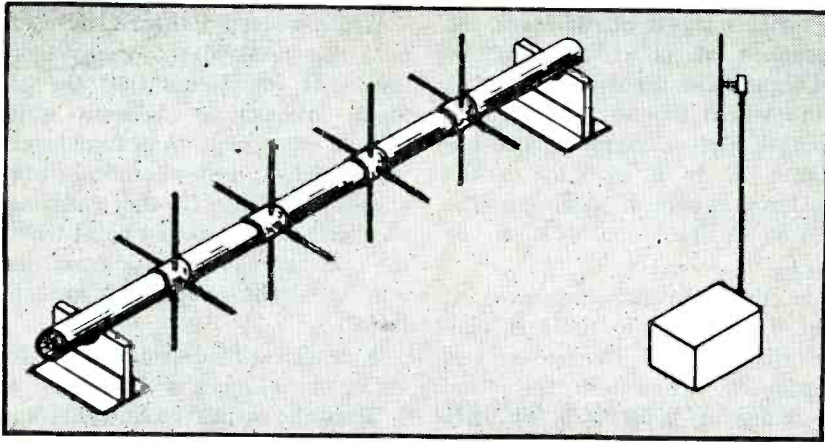

FIG. 10—Arrangement used for adjusting the new turnstile antenna on the ground

which would be installed in the field without adjustment, tests were made on typical arrangements to assure ourselves that close tolerances on dimensions were not necessary. Our objective was to adjust and test an antenna of, say, four layers at some frequency in the f-m broadcast band, learn what scale factor should be applied to each dimension in order to build an antenna for any frequency in the band, and provide charts so that any future antennas which were to be provided could be constructed from these charts.

Method of Adjustment

The main flag pole was laid out horizontally on two wooden supporting structures so that the pole center was approximately twelve feet above the ground, as shown in Fig. 10. The antenna system was assembled on the pole. Then the North and South radiators were disconnected from the feed lines and the series inductance sections of the East and West radiators were shorted out directly across the small cylindrical insulators at the mouths of the inductance sections. Next, the antenna length and the position of the shorting plug on the support rod (see Fig. 3) were changed on each East and West radiator until the main feed line was properly terminated in its characteristic impedance. This condition was observed by means of a probe voltmeter sliding along a slotted measuring line. The antenna length adjustment was made by sliding very thin-walled sleeves over

the end of the radiator, while shorting plugs with spring-contact fingers were used to adjust the shunt tuning inductance.

This adjustment insured that the correct value of R was present for each radiator. It should be noted that even though mutual impedance was present between radiators, this method of adjustment takes account of the mutual impedances without

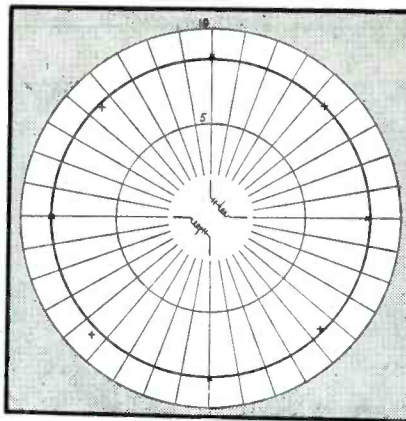

FIG. 11—Experimental data showing that the horizontal pattern of a turnstile is circular

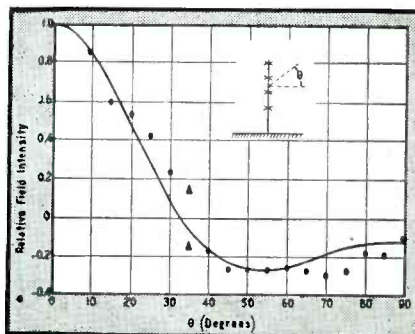

FIG. 12—Vertical field intensity pattern of a four-layer turnstile

even measuring the specific values.

We were now ready to adjust the series-inductance and series-capacitance sections. The shorting straps were removed from the series-inductance sections of the East and West radiators. The North and South radiators were connected to the feed lines. The North and South radiator lengths and position of the shorting plugs were made to correspond with the dimensions found to be desirable for the East and West radiators. Then, the approximate length for the series-capacitance sections was calculated and the capacitance sections were cut a little longer than this length. The series inductance sections were next adjusted by means of variable shorting-plugs until the main feed line was matched.

Under this condition, the currents in the North and South radiators will be in quadrature with the currents in the East and West radiators, but may be somewhat greater in magnitude than the latter. A field-intensity meter was placed a few hundred feet away from the antenna. The turnstile antenna was then rotated about the axis of the flagpole and observations of field intensity were made at the remote point. If the maximum field intensity was obtained when the North and South radiators were pointing straight up and down, it was necessary to shorten the capacitance sections to obtain a circular pattern. When the capacitance sections were shortened, the series-inductance sections were re-adjusted to again match the main feed line. Then observations were again made of the field intensity as the pole was rotated. Three or

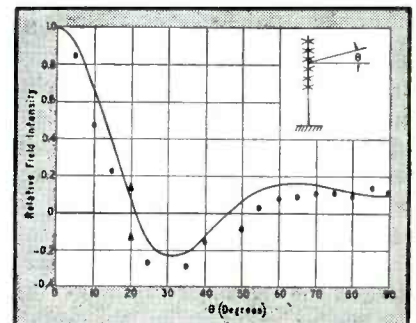

FIG. 13—Vertical field intensity pattern of a six-layer turnstile

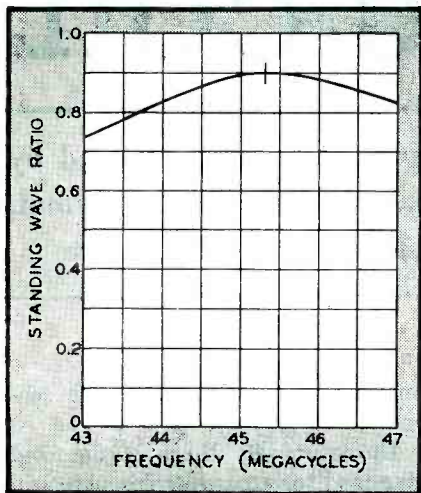

FIG. 14—Standing-wave ratio on the main feed line of a four-layer turnstile

four adjustments of this type are sufficient to obtain a circular pattern.

Measurements of a typical well-adjusted turnstile are shown in Fig. 11. This may be regarded as the horizontal field pattern of the antenna.

Vertical Field Intensity Patterns

With the pole mounted horizontally above the ground, we were afforded an excellent opportunity to measure the vertical radiation pattern by simply moving the field-intensity meter on the circumference of a circle, where the center of the circle corresponds with the mid-point of the antenna.

Figure 12 shows the vertical pattern of a four-layer turnstile. The solid line is the calculated characteristic. The radiators are not quite one-half wave apart since the velocity of propagation on the feed lines is about ninety-two percent of the velocity in free space, and the feed lines were shortened to take this factor into account.

At an angle of thirty-five degrees, two experimental points are shown as solid triangles. It was not possible to tell from the field-intensity meter readings whether this point should be shown positive or negative.

A vertical field intensity pattern for a six layer turnstile is shown in Fig. 13.

Impedance Characteristics

After the antennas were adjusted,

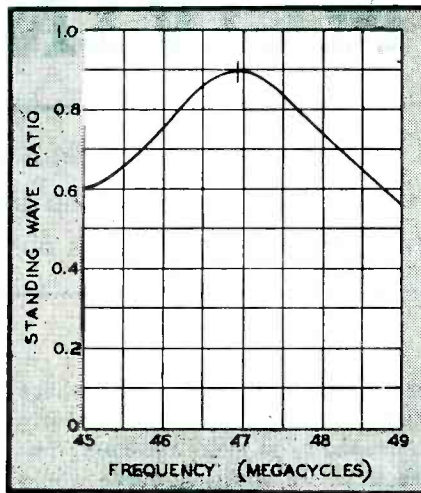

FIG. 15—Standing-wave ratio on the main feed line of a six-layer turnstile

observations were made of the standing-wave ratio on the main feed line, that is, the ratio of minimum to maximum voltage. This standing-wave ratio on a four-layer antenna which had been adjusted at 45.3 megacycles is shown in Fig. 14. Observe that the curve is rather broad.

A similar curve for a six-layer turnstile which had been adjusted at 46.9 megacycles is shown in Fig. 15. It is seen that the curve is somewhat sharper for the six-layer turnstile than for the four-layer, but curves are more than adequate for transmission of an f-m signal.

Voltage and Currents on the Feed System

Since the feed lines twist about the pole, we are limited as to the size of the feed lines. It is quite possible to bend concentric lines whose outer conductor has a diameter of seven-eighths of an inch, but when one considers the possibility of using a tubing diameter of one and one-half inches, the prospects appear discouraging. It thus at first appears that this antenna design is limited in power-handling capabilities. An examination of the currents and voltages appearing on the feed lines and on the radiators will, at this point, prove interesting and illuminating.

Let us take, as an example, the case of a six-layer turnstile operating with a power of 10,000 watts. In the equivalent circuit (Fig. 4c) the resistance R is 52.5 ohms. Since

the power into each radiator is one twenty-fourth of the total power, the voltage from each radiator to the flagpole is 149.0 volts, with a similar voltage across each series—capacitance and series—inductance. The feed straps carry approximately 2.8 amperes, with a voltage from feed strap to ground of 209.0 volts. The voltage and currents along the feed lines are shown in Fig. 16. These values speak for themselves.

It is the authors' wish to acknowledge the helpful assistance of their colleagues Donald W. Peterson and O. M. Woodward, Jr.

REFERENCES

- (1) Brown, George H., A Turnstile Antenna for Use at Ultra-High-Frequencies. *ELECTRONICS*, Apr. 1936.
- (2) Brown, George H., and Epstein, J., A Turnstile Antenna for Ultra High Frequency Broadcasting, presented at the I.R.E. Summer Convention, Detroit, Mich., June 23, 1941.
- (3) Brown, George H., and Baldwin, John M., Adjusting Unequal Tower Broadcast Arrays. *ELECTRONICS*, Dec. 1943.

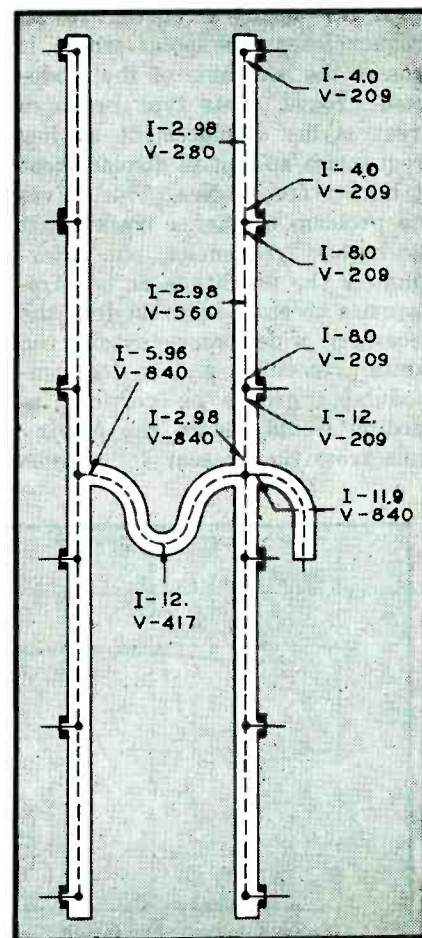

FIG. 16—Voltage and currents on the feed lines of a six-layer turnstile, operating with a power of 10,000 watts

MOVING-COIL

Problems involving mechanical resonance of phonograph reproducers can be solved by extending the frequencies at which it takes place to the limits of audibility or beyond.

The pickup described achieves this and also makes possible light needle pressure

IN both lateral and vertical recordings, there are two basic recording characteristics, constant amplitude and constant velocity. In the former, the stylus is displaced equally at all frequencies. This would be ideal from the standpoint of recording time but, due to the limited groove speed, the higher frequencies present such a steep wave front that both the recording and reproducing stylus could not possibly produce and track such a groove.

In constant-velocity recording, the stylus velocity is constant for all frequencies at the point where it crosses the zero axis of the modulated groove. This type produces great stylus displacement at low frequencies and small displacement at higher frequencies. This solves the problem of stylus tracking at the higher frequencies, but unfortunately the amplitude at low frequencies becomes so great that the necessary wide groove spacing on lateral recording and a deep unmodulated groove on vertical recording would reduce the playing time from the present 15 minutes

on a 16-inch disc to a point where the playing time would be so greatly shortened as to make recording impractical. In addition, there would be mechanical problems of cutter and pickup design to properly track such extreme amplitudes at the lower frequencies.

At present, standard phonograph records contain constant-amplitude recording for the lower end of the frequency spectrum, crossing over to constant-velocity recording at around 500 cycles per second, although in the past this crossover point has varied from 250 to 1,000 cycles.

In lateral transcriptions for broadcast use, the standard characteristic is varied, in that pre-emphasis is applied to the cutter in the constant-velocity portion of the curve, increasing to 16 decibels at 10,000 cycles per second. The standard vertical characteristic calls for a crossover at approximately 300 cycles per second, and the pre-emphasis of the constant-velocity portion of the curve does not take effect until close to 2,000 cycles, from which point the curve rises to 18-db

increase at 10,000 cycles per second.

Unfortunately there is no fixed standard for crossover frequency in general use, and the design of a pickup to respond to the several various characteristics with any degree of accuracy is almost an impossibility.

Crystal Compensation

Theoretically, an ideal crystal pickup would produce a constant voltage at all frequencies from a constant-amplitude recording, and all that would be necessary to achieve the desired results would be to introduce the proper electrical network to equalize the pickup output on the constant-velocity portion of the recording up to the output on the constant-amplitude portion of the disc. Practically, however, the mass of the stylus, stylus bearing, and drive fork, together with the considerable mass of the crystal, usually introduces a resonance peak in the neighborhood of 2,500 to 4,000 cycles per second. This peak is generally controlled to some degree by damping pads on both sides of the crystal and the result is that the rising characteristic up to this peak compensates for the reduced output of the constant-velocity portion of the recording.

At the same time, crystal stiffness, together with damping, introduce a resonance at the lower frequencies, usually at from 70 to 100 cycles per second. The peak may be lowered in frequency by the addition of a considerable mass to the tone arm. It has been found that a great deal of record wear takes place at this frequency, if not actual failure of the needle to track the groove at high amplitudes. In favor of the crystal pickup it may be said, however, that the voltage out-

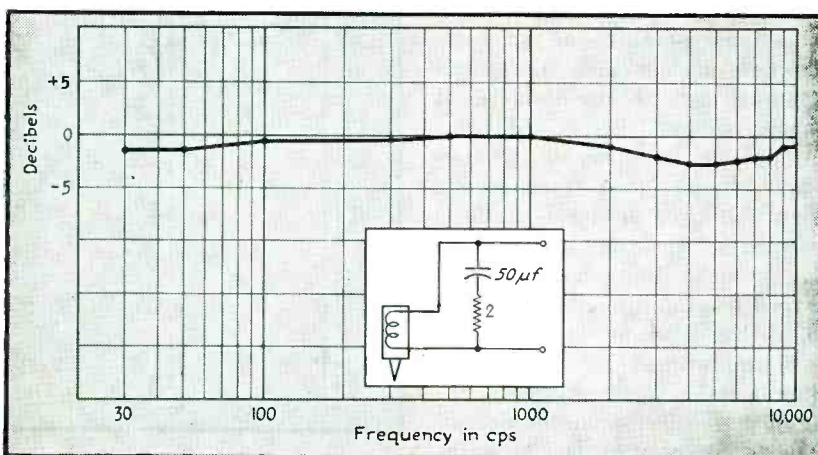

Frequency response of moving-coil pickup with low-frequency correction as provided by the circuit shown

PICKUP DESIGN

By Theodore Lindenberg, Jr.

Sound Project Engineer
Fairchild Camera and Instrument Corporation
New York, N. Y.

put is usually sufficiently high to require little amplification and its performance is quite adequate within its frequency range.

The magnetic and moving-coil types of pickups in their ideal form would both be true generators; that is, their output would be constant at all frequencies from a constant-velocity recording. In the theoretically ideal unit of either type, the output on the constant-amplitude portion of the record would have to be equalized up at the rate of approximately six decibels per octave below the crossover point, to compensate for the corresponding downward slope of the recording characteristic.

Two Peaks

The upper resonance peak on most magnetic pickups, due to the physical mass of the armature, lies well within the audible spectrum, usually between 2,500 and 4,000 cycles per second. This peak must be suppressed by damping and also some means provided for keeping the armature centered between pole pieces in the magnetic gap. However, the damping block often lowers the needle compliance to such a degree of stiffness as to cause severe record wear and poor tracking.

Many magnetic pickup manufacturers use the resonance peak at the lower end of the response curve, caused by the natural period of vibration of the tone arm impinged against the stiffness of the stylus, to equalize the falling off below the crossover point of the recording. Such a method results in apparent "one-note bass" and severe record wear at frequencies near the resonance point of the arm.

The moving-coil type of pickup has one great advantage over the magnetic type; the coil has no af-

finity to the poles of the magnetic circuit. This makes possible maximum stylus compliance, and the physical mass of the coil and stylus assembly may be reduced to a point as low as mechanical strength and the electrical output desired will permit.

The writer has developed a new moving-coil pickup design in which reasonable mechanical strength and electrical output have been retained, with a natural high-frequency resonance of the order of 12,000 to 15,000 cycles per second. The coil itself pivots on its own center of gravity and the mass of the jeweled tip of the stylus determines the natural period. A resonance at this frequency is nearly above the audible range of hearing and amounts to only a couple of decibels in amplitude. The very slight cushioning necessary to maintain the stylus in a vertical position is ample to suppress this peak.

The higher order of stylus compliance coupled with a tone arm of usual mass places the natural low-frequency resonance at about 18 cycles. This is below any frequency on the record and was purposely chosen to miss the 15, 30, 60, and 120-cycle components which might appear as vibration from the turn-

table motor assembly or hum components recorded into the disc.

Further, the very free displacement makes possible a much lighter needle pressure than formerly was practical.

Result of Tests

Experiments were run in which perfect tracking was obtained from flat and true-running records with pressures as low as five grams. Off-center and warped records, and the possibility of the player being bumped or the floor being shaken by heavy footsteps or other jars, made a pressure this low impractical, and a pressure of 25 to 30 grams produced negligible wear and perfect tracking.

One rather interesting phenomenon was noticed on warped records at 78 rpm; the inertia of the arm increased the stylus pressure to as high as half a pound on the rising portion of the disc and caused the point to rise completely off the disc on the downward side of the warp. This problem was solved for lateral records by pivoting the pickup head as close to the record as possible, about an inch behind the stylus. With the arm held above the record at a predetermined point and the head floating vertically at the end,



Resonance peaks below 18 cps and above 12,000 cps are a feature of this new pickup design. A pressure as low as five grams has been achieved

the necessary lateral mass and inertia is retained and the vertical inertia never sends the stylus pressure over 50 grams, even on badly warped records.

Moving-coil pickups have been used for some time on vertical recordings and their mechanical design for this purpose consists simply of a short stylus with a small coil mounted on the end opposite from the tip, the whole mounted upon two flexible flat springs so that the coil is in a magnetic field.

Vertical modulation from the record groove causes the stylus and coil to vibrate in plunger-like manner, thereby generating a current in the coil. Heretofore, a pickup of this type has not been generally available for lateral recordings.

These factors were kept in mind during development of the writer's design:

(1) The mass of all vibrating parts must be kept as low and as close to the axis of rotation as possible.

(2) The stylus must not reproduce vertical components in a lateral record or vertical vibration from the turntable.

Construction

As no generally-used pickup bearing construction seemed to fulfill the above, a unique method of stylus pivoting was developed. The coil is wound directly over a very thin split sleeve of silicon steel, which in turn is mounted around one end of a short duralumin stylus. This coil is of No. 46 enamelled wire and has a direct-current resistance of 50 ohms.

Two thin plastic vanes extend at right angles to the stylus and di-

rectly opposite each other from opposite sides of the coil to the towers of a plastic supporting bridge where their ends are anchored securely. These vanes are in the plane of the stylus and are in line with the record groove. When the jeweled tip of the stylus engages the record groove, lateral modulation causes the vanes to flex on the center line of the vanes and coil. This results in an oscillatory motion of the coil on its center of gravity.

The poles of a small Alnico permanent magnet are adjusted close to each side of the coil, each pole having a thin cushion of very soft synthetic rubber facing it. These pads are brought into gentle contact with each side of the coil and serve both to hold the stylus vertical to the record laterally and prevent abrasion between the coil and the pole pieces. These parts are mounted on a heavy aluminum plate, and a chromium-plated copper case with a suitable opening for the stylus protects the head. An extremely thin tapered rubber diaphragm about the stylus at the opening in the case prevents the entry of foreign particles which might cause trouble within.

The stylus is tipped with a tiny diamond pin, ground and polished to a radius on the tip, which will couple the pickup most effectively to various types of recordings. Too much emphasis cannot be placed upon the importance of the proper stylus tip contour. The familiar steel phonograph needle is ground down by the record to fit the groove during the first few revolutions on all records sold for home use, an abrasive being present in the mix for this purpose. The diamond is the only material known which will

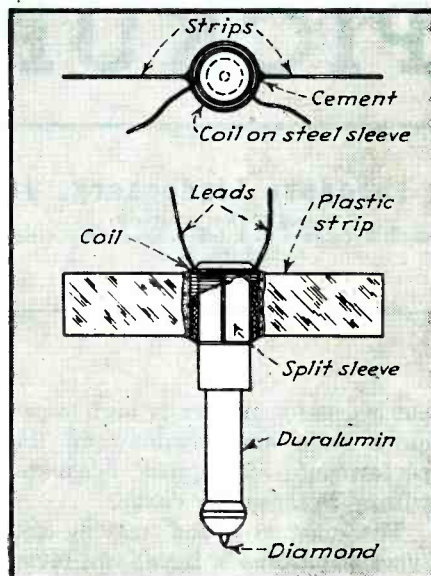

Construction of the stylus assembly. The coil is cemented to two cellulose-nitrate strips for support

resist this abrasive action and its contour must be correct from the start.

Tone Arm Housing

The head is mounted inside a protective housing on the end of the reproducer arm and a suitable handle extends through a slot in the side of this housing so the reproducer head may be lowered gently to the record. When the reproducer head is raised by the handle from the record as far as the slot permits, the whole arm rises from an adjustable stop at the rear. Ball bearings at two points on the arm are provided for perfectly free tracking at low stylus pressures.

In general, the low frequencies must be equalized up to the crossover point of the recording and there are various means of achieving this. Provisions must be made, however, for altering this equalization to match the various recording characteristics now in general use. Mechanical resonance as a means of providing a low-frequency emphasis is to be avoided. Equalization in the amplifier which is used is one method of providing the necessary bass accentuation, but a simple unit to go directly in the pickup circuit would be more satisfactory, particularly if accurate means can be provided for switching to match the unit to various recording characteristics and for preferences of tonal balance.

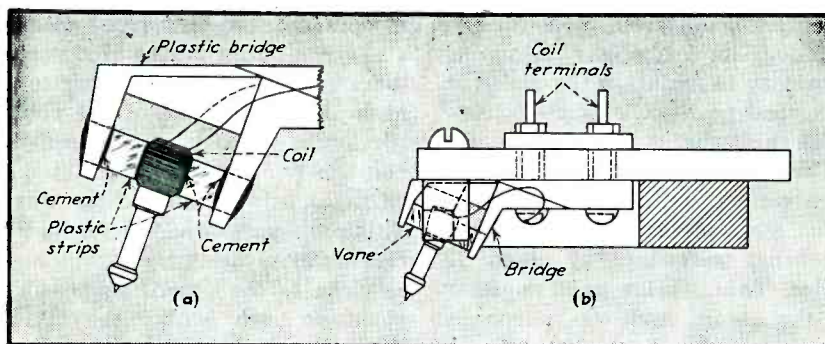

At (a) the method of supporting the coil and its associated cellulose-nitrate strips by means of a plastic bridge is shown. At (b) is a complete mounting

ELECTRONIC SALES ENGINEERING

Selling electronic equipment to industry in the post-war years will not be easy, in spite of the progress that has been made during the war. It will require many young men, with technical as well as sales training, to do the job

By S. S. EGERT

New York, N. Y.

IN SPITE of the tremendous strides made during the war, the problem of selling industrial electronic products to industry in the post-war years will be no easy task.

Experience has shown the difficulties involved when introducing new things into the consumer market. Selling the industrial market is doubly difficult. It involves, first, the necessity of attracting the attention of more exacting people to a new product. Secondly it will require a marshalling of technical as well as economic facts relative to each item involved, and a proper presentation of these facts.

Salesmen Must Be Technicians

In the main, the man who must be sold industrial electronics is himself an engineer, or at least a technician. The men who sell him must, therefore, be at least technicians if not engineers.

All are agreed that the electronic developments of the war represent a fascinating story. Almost all who are aware of the problems involved in industry nevertheless agree that men with the proper technical and sales training are necessary to tell it. In fact, the use of electronic equipment in industry after the war will in the author's opinion advance in almost direct proportion to the number of capable sales engineers that are available to tell that story.

It would, of course, be impossible to quickly develop men capable of expertly handling all the problems involved in electronic sales engineering. Complete development usually requires years of practical experience along with a natural

talent for the work. It is not too soon to start developing such men now.

Need for Young Men

The greatest need immediately after the war will be for young sales engineers capable of making effective personal contacts in the field. Screening and carefully choosing applicants for this work as soon as possible will prove highly profitable.

Good sales engineers are difficult to make and it would be wise to start training with proper material. A study of the steps taken by other and older industries shows the careful attention directed toward the proper selection and schooling of youngsters. Courses which are carefully planned, extending from one month to two years, combining theoretical training and practical experience, have been employed extensively. The electronic industry must adapt a similar course of training. Actually, its need for such training is greater than that of any other industry today because of the almost complete lack of adequately trained personnel in the field at the moment as well as the tremendous scope of applications.

It is interesting to analyze what makes a good sales engineer "tick". Essentially, his most important qualification should be his ability to sell. Engineering can be taught, but sales ability is largely an innate characteristic. When choosing possible applicants, therefore, make certain the man has some natural sales ability.

The sales engineer must obvi-

ously know his product thoroughly. Time spent in training the young applicant before he goes into the field is extremely important

Probably the most important single qualification to develop in a man is an extension of any innate ability he might have to employ his technical and sales training in the right proportions. Such judgment is usually difficult to find.

Opportunities

The term "engineering" covers much more than just design. Large industrial companies are looking more and more to the engineer for business management, market analysis, distribution leadership and selling.

The electronic sales engineer, particularly, will have very great opportunities after the war. Working in a widening market, and in constant contact with actual conditions in the field, he will necessarily enter into the planning of every phase of manufacture and distribution of the products he is selling.

A basic training in sales engineering offers the young technician an important background for future leadership in the electronic field. There is no substitute for the practical business experience gained from selling. It teaches a man to get along with others and develops a sense of economic right and wrong which must be inherent in good business management.

From a remunerative standpoint, the sales engineer also has a good future to look forward to. Men combining selling talent and engineering experience will always be at a premium and well paid.

Predimensioning

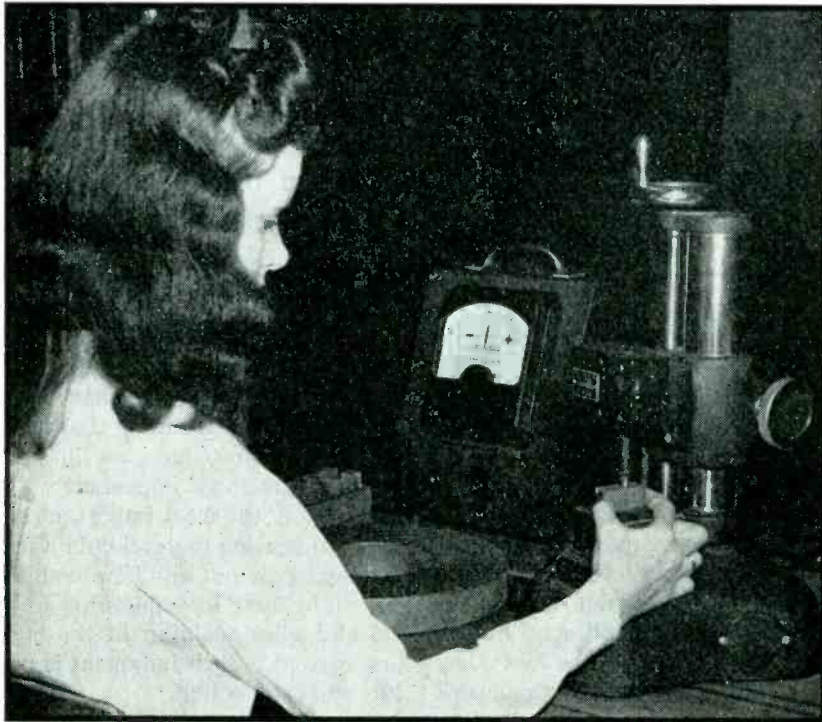

Measuring an edge dimension of a loaf of 100 crystal blanks with an Electro-Limit Gage during hand lapping of edge dimensions to a tolerance of 0.0002 inch. Each scale division on the meter of the gage represents 0.00002 inch

By **B. P. HAINES**, **C. D. O'NEAL**, and **S. A. ROBINSON**
Chief Engineer Factory Engineer Development Engineer
Crystal Division, Philco Corp., Philadelphia

THE Art method of lapping or beveling the edge of each individual quartz crystal plate to bring up activity has been used since the inception of quartz crystal cutting, and is still the most commonly used method in the industry today. This procedure, while effective, tends to produce crystal plates which show large differences in their behavior from unit to unit, particularly in respect to deviations in activity when subjected to considerable change in temperature.

Predimensioning, the alternative method of making crystal plates, is based upon the premise that the properties of crystalline quartz are consistent and insofar as piezoelectric and elastic properties are concerned, each mother crystal is similar to every other crystal. Therefore, it should be possible to cut and finish plates in such a manner that when all are handled in exactly the same way, equal per-

formance can be expected from each of the resulting crystal plates without resorting to beveling.

Fluctuations in activity, indicated by a drop in the reading of a grid current meter, occur during temperature cycling as the various modes of motion interfere due to coupling between the different vibrations*. Since in the *BT*-cut plates the interfering vibrations are dependent largely on the edge or square dimensions, and the basic frequency-determining shear vibrations are dependent on the thickness dimensions, the several dimensions must bear certain proportional relationships that will create stable and uniform amplitude of vibration through the relatively wide ranges of unequal expansion and changes in elastic properties in

* For details of vibration theory and the particular interferences between modes which produce undesirable results, see Sykes, R. A., Modes of Motion in Quartz Crystals, the Effects of Coupling and Methods of Design. *Bell System Technical Journal*, XXIII, Jan., 1944.

different directions that are due to changes in temperature.

Predimensioning is a technique for so determining dimensions of crystal plates of given orientation, made from crystalline quartz, that the crystal units will operate at the desired frequency and activity in a stable and uniform manner over wide ranges of temperature. It is a feature of this method that mechanical variables resulting in differences in the electrical or elastic characteristics must be held within close yet workable limits.

Principal factors governing the consistency of performance are found to be the uniformity of (1) orientation, (2) dimensions, (3) contour, (4) surface finish, (5) electrode characteristics, (6) cleanliness, and (7) perfection of the crystalline quartz.

Advantages of Predimensioning

There are many advantages in using the predimensioning technique in addition to the elimination of undesirable coupling and the production of uniform activity over the temperature range. Outstanding among these is that predimensioning lends itself to mass-production methods, particularly in the finishing operation. It permits more uniform production and quality, requires only one size blank per frequency, permits contouring the surface for maximum activity, reduces the number of rejections at the calibrating positions, reduces tendency to lap or etch beyond the desired frequency, and avoids most of the failures in temperature cycling.

The basis of mass-production methods is the breaking down of operations in order to simplify them, thus permitting more units to be handled in a given time. With crystal plates made by predimensioning, all the blanks of a particular frequency are exactly the same at the finishing position, and it is therefore possible to calibrate large numbers of plates simultaneously. Production methods and procedures can be simplified, since

Quartz Crystal Plates

Loaves of blanks for a particular frequency are lapped to final square-edge dimensions within 0.0002-inch tolerance, permitting mass-production methods for final finishing and calibrating and giving better than 98-percent acceptance in temperature-cycling tests. Charts give optimum edge dimensions for square *BT*-cut plates from 4.5 to 8.1 Mc

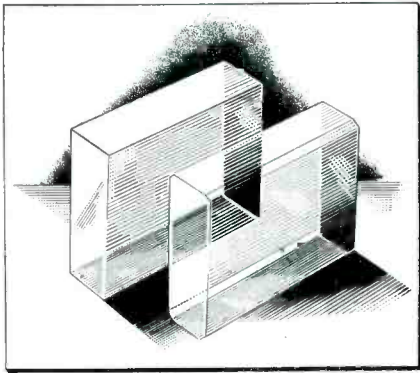

Comparison of predimensioned crystal plate (having square edges) with a plate finished by the Art method (having beveled edges)

each blank is handled in exactly the same manner. This makes for greater uniformity and definitely increases the quality of performance obtainable at each operation. Since all crystal plates are alike, the process permits using a uniform contour for the surface of the crystal and obtaining this by automatic means.

One of the main causes for rejection when crystal plates are calibrated to frequency by the Art method is their loss of activity as the plate is brought into frequency. On the other hand, when a crystal plate has been dimensioned properly, no such activity dip will occur. As a rule, a dimension is not considered satisfactory unless at least 95 percent of all crystal plates maintain their high activity through the temperature cycling test.

Crystal plates of frequency for which sufficient production volume is needed to permit proper analysis can be economically dimensioned so that 95 to 98 percent of the production will prove satisfactory over the entire temperature cycle re-

quirements from -55°C (-67°F) to $+90^{\circ}\text{C}$ ($+194^{\circ}\text{F}$). At Philco Corporation such percentages have been maintained for over a year on crystal plates of the DC-30 and DC-31 types, which significantly have relatively high activity requirements in comparison with the better-known CR-1 types.

Frequency Constants

The frequency of *AT* and *BT*-cut crystal plates vibrating in high-frequency shear is controlled by the thickness of the blank, so that a reduction in the thickness of the blank increases the frequency. The frequency follows the formula $f =$

K/t , where f is the frequency in kilocycles, t the thickness of the plate in millimeters, and K a constant. For *AT* cuts, $K = 1670$; for *BT* cuts, $K = 2560$. For Philco crystals the *BT* constant is 2560 over the frequency range of 4 to 8 megacycles when using appropriate contours for the sizes covered in the edge dimensioning charts now available.

Contouring Crystal Plates

Experiments prompted by problems encountered in mass production of quartz crystal plates have shown that surface contour is not only an important factor determin-

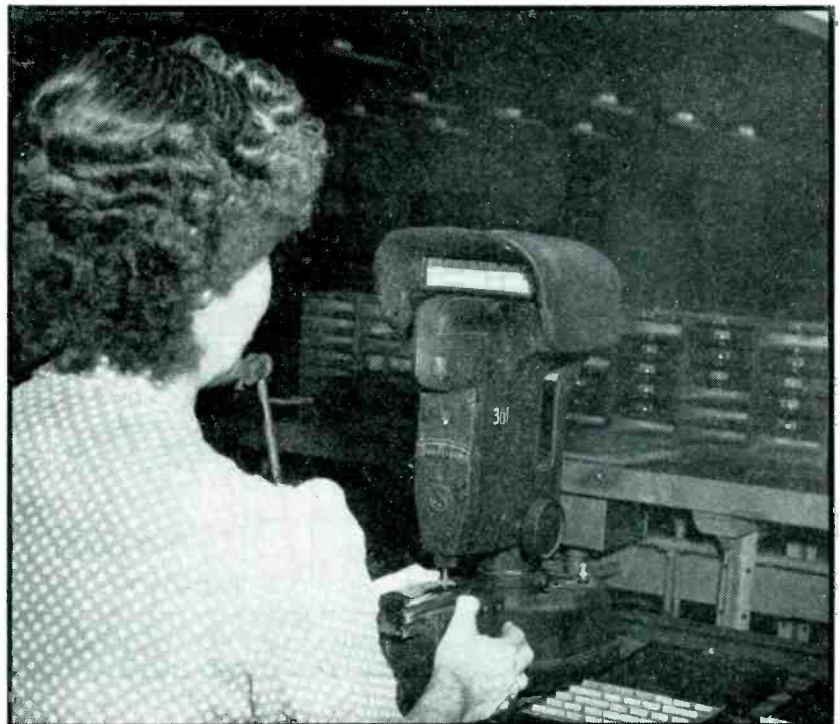

Checking the double convexity of an individual crystal plate with a visual gage on which each scale division represents 0.00001 inch

ing activity, but requires a critical specification within very narrow tolerances. The lower-frequency BT-cut crystal plates (4 to 5 megacycles) require somewhat greater convexity of contour than do the higher frequencies.

In order to determine the best contour for a given frequency, each finishing operator was required to save her most active crystal plate, with its electrodes, from each day's production for a period of four months. These plates were collected at the end of each shift and analyzed for contour, orientation, edge dimensions, electrode land heights and quality of the electrodes. From the resulting accumulated data it was found that the amount of double convexity required for maximum activity ranged from twenty millionths of an inch for 8-megacycle plates to eighty millionths of an inch for 4-megacycle plates, as shown in Fig. 1.

The measurements of surface convexity were made on a Sheffield visual ten-millionths gage by using the following procedure; (1) The gauge was set to read zero at the center of the plate; (2) the plate was then moved along its diagonal until the spindle was resting at a point $\frac{1}{2}$ inch in from the corner of the plate; (3) the number of divisions negative on the scale of the gage from the original zero setting was read to determine the extent

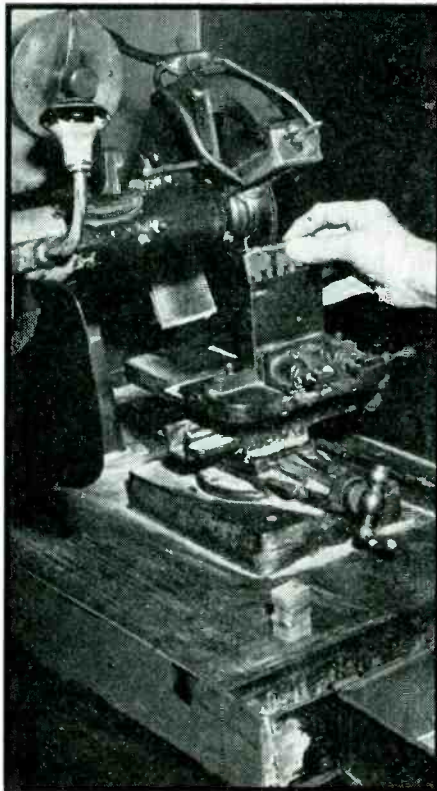

Trimming a crystal blank square in relation to its X edge in order to hold accurate edge orientation

of the double convexity. Each scale division for this instrument is ten millionths of an inch.

Such measurements should be made at all four corners. The thickness differences should agree at the four corners within one scale division, or 0.000010 inch. When a pro-

cedure for maintaining proper contouring in lapping was developed, this specification for convexity was rigidly enforced, and played a large part in making possible the following results of production by the dimensioning process: (1) Rejections in final calibration and temperature cycling were reduced 13 percent on crystal plates ranging from 4 to 6 megacycles, and 30 percent on plates ranging from 6 to 8.5 megacycles (DC-31 and DC-30 types); (2) elimination of special reprocessing of rejected plates by trained operators; (3) a more stable crystal plate with a higher constant activity reading; (4) lapping by machine to within 1 to 2 kc of channel frequency, with its resulting increase in output per operator in the calibration department.

When hand lapping to frequency was replaced by etching to frequency, surface contouring assumed even greater importance.

Cleaning of Crystal Plates

Of all the requirements necessary in establishing a high degree of uniformity in production, cleaning is probably the most important because both activity and frequency are affected by traces of foreign matter. A quartz crystal plate is affected mechanically by the slightest change in loading and this shows up in its electrical performance. Since all materials and gases with which the quartz may come in contact are contaminated with foreign matter, it becomes a major problem to control this variable.

If one touches a quartz crystal plate with the fingers, the quartz becomes loaded with both organic and inorganic matter. The organic oils may be removed by a degreasing process, while the inorganic salts must be dissolved with water since the degreasing agents will not remove them. Actual brushing of the surface is required to remove many embedded particles. No chemical has yet been discovered that will clean quartz without scrubbing. (Contrary to common impression pure, clean hydrofluoric acid does not clean quartz.)

Scrubbing is aided by soaps, but a soap that lathers is not necessarily the cleaner soap, because of the need for greater care in rinsing.

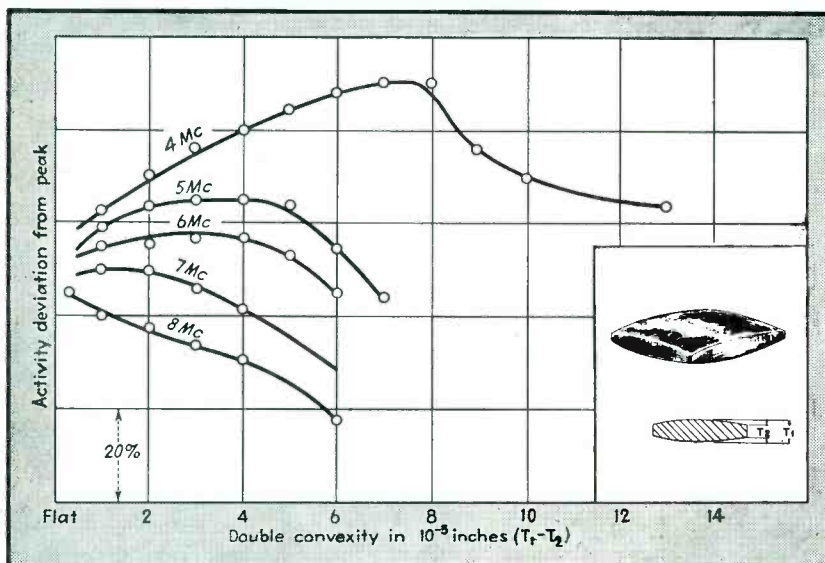

FIG. 1—Effect of convexity on activity at five different frequencies for BT-cut crystal plates. All crystal plates for a given frequency are alike in the predimensioning method, permitting production of a uniform surface contour for the plates by automatic means

As soon as ordinary tap water contacts latherly soap, an insoluble precipitate is usually formed, which may load the crystal plate. There are a few powdered, latherless soaps on the market which go readily into solution in water to form a very fine scrubbing solution which is easily rinsed away. When it is necessary to rinse a crystal plate it should be spun dry and then handled only with ivory-tipped tweezers.

While it is believed that no crystal plate can be truly cleaned without scrubbing, it is also true that a hot chemical vapor degreasing treatment is equally essential. The use of hot vapors avoids the necessity of drying with rags or tissue, which is always poor practice. Cleaned crystal plates should not come into contact with dirty air, if ideal results are expected.

It is quite easy to determine whether a crystal plate has been properly cleaned by measuring its frequency after every cleaning operation, care being taken to replace the plate between its electrodes in the same orientation and position as when removed. When a crystal plate is clean, scrubbing, degreasing, stripping, boiling or any other cleaning method will not raise its frequency unless quartz is removed as by abrasive action. It is noted that many soaps and cleansing powders contain abrasives which will wear away quartz, even though the Mohs hardness of the abrasive particles is below that of quartz.

A good definition, therefore, for a clean crystal plate would be one which cannot be raised in frequency by any cleansing method which does not include abrasive action.

It is self-evident that the more nearly clean a crystal plate is, the higher is its activity. We have, therefore, a double check on cleanliness since both activity and frequency will increase with cleaning.

Surface Character

The character of the surface and the degree of polish on a crystal plate are dependent on the size, hardness and sharpness of the cutting material used in lapping, or on the method and degree of chemical reaction due to etching. The more regular and even the surface of a

crystal plate, the better the stability and activity. To obtain good results a very fine abrasive, similar to optical powder No. 304, should be used for the final lapping and finishing operations. A fine abrasive should be used even when crystal plates are to be finished finally by etching to frequency, because a smooth surface is an important factor in insuring consistency in the rate of etching.

Numerous life tests on crystal plates have proven the great importance of good surfacing in order to obtain a constant frequency and activity performance over an unlimited period of time.

Pressure-Type Electrodes

Electrodes of the pressure type, commonly used for support of high-frequency shear-type crystal plates, are designed to support the crystal plate at its four corners. The supporting areas or lands are critical for the proper performance of the crystal plate.

The crystal plate is a vibrating electromechanical body, supported, coupled, and electrically driven by electrodes which are rigid and fixed. The supporting of the crystal plate by its four corners should be accomplished with the use of clamping areas as small as possible. The areas must be large enough, however, to provide stability and not to chip the corners of the plate. The supporting areas should all be in a plane to prevent torque stresses on

the plate and should be well polished to indicate cleanliness and to insure good electrical contact.

The activity of a quartz crystal plate becomes greater as the effective electrode surfaces are brought closer to the surface of the quartz. This is by reason of the increased electrical effectiveness of the plates. On the other hand, when electrodes are so close to the quartz as to introduce mechanical damping, there is a reduction in activity. With extremely minute air gaps the problem of dust-free mounting becomes particularly serious because of the damping effects of minute particles in this constricted region. A further damping effect is that of acoustic waves when the air gap is an even quarter-wavelength of the supersonic wave. A minimum amount of acoustic damping is produced, however, when the air gap is exactly an odd quarter-wavelength.

Figure 2 is drawn to show as a function of frequency (based on a velocity of sound of 33,000 centimeters per second) the calculated values of the air gap for an odd quarter wavelength, and the allowable deviation from the optimum value. The region beyond the usable limits should be avoided in the design of crystal plates because of the increased damping produced by the acoustic waves.

The frequency change with land heights permits a vernier frequency-controlling method as shown in Fig. 3; however, this variation



Transferring finished crystal plates and electrodes from the hot-vapor cleaning rack into holders, using ivory-tipped tweezers to prevent further contamination



Machine-lapping a loaf of 100 crystal blanks on all four sides to a tolerance of 0.001 inch during rough predimensioning. The blanks are held together with wax during predimensioning

should still be in agreement with the allowable land height tolerances set by their effects on activity as shown in Fig. 2.

The metal used in electrodes should have a coefficient of expansion which is the same as that of the quartz of the given orientation and should be a metal which does not oxidize or corrode easily.

Natural Flaws in Quartz

Any breaking up of the molecular regularity in a quartz crystal plate will affect its elastic characteristics to some extent, even though the ef-

and their effect on temperature cycling and ageing. *BT*-cut crystal plates which had been rejected on a visual inspection for bubbles were used in the experiment. Forty-six percent of the plates containing bubbles passed on DC-31 specifications on temperature cycling. The location, size and number of bubbles definitely controlled the effect they had on activity. A bubble located in the center of the plate either made the plate dead or unusable for activity, but bubbles near the corners had only a small effect on the activity, and no noticeable effect on

One thousand plates in the eight-megacycle band were processed from heavily blue-needled quartz with no noticeable change in yield or percentage of rejections in temperature cycling. If in processing these plates the procedure had not been accurately controlled to exact specifications, a difference would probably have been noticed. Since there is a wide safety margin for activity in the design of the unit for perfect quartz a slight loss in activity was not critical.

Rutile is foreign matter which renders the crystal plate useless when such needles are present, because of extreme damping action.

Phantom areas in the quartz have no noticeable effect on the oscillating plate. Plates have been noted in production which are dark in one half and light in the other half, but which show a normal activity.

Other types of flaws may also produce undesirable effects, but the data now available on these does not permit drawing any definite conclusions.

Operational Requirements

For predimensioning to work satisfactorily it is necessary that certain tolerances be maintained in various operations. In sawing wafers a tolerance of ± 10 minutes of arc from the *ZZ'* and *XX'* is permitted. These limits are easily held, but in order to guarantee that the specification has been met, each blank is X-ray checked after trimming but before it is forwarded to the next operation. Holding this tolerance at the sawing operation guarantees that all blanks reaching the finishing room will be within ± 15 minutes on *ZZ'* angle and 15 minutes on the *XX'* angle. These tolerances should be the maximum variation allowed when plates are being designed to operate over wide temperature ranges with rigid activity and frequency requirements. There is, however, some leeway in these limits depending on the degree of control of other variables.

The required accuracy of edge orientation is determined by the type of crystal plate being manufactured. At Philco Corporation all crystal plates are held on the edge orientation to ± 15 minutes. However, if the *ZZ'* and *XX'* angles are

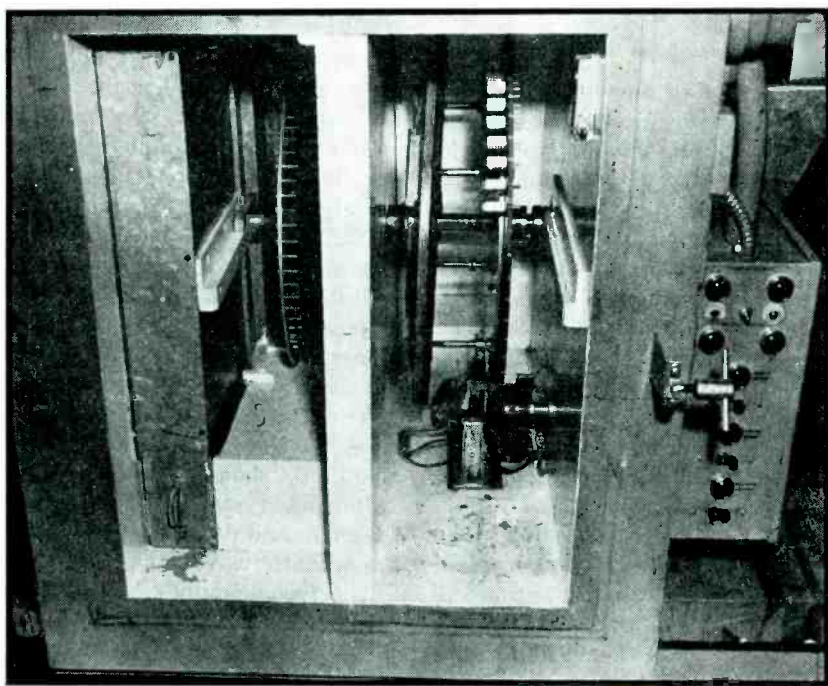

Interior of temperature-cycling equipment, showing solenoid-actuated mechanism used to dab red paint on frequency rejects and green paint on activity rejects during the temperature-cycling test

fect may be too small to evaluate. There are, however, certain allowable tolerances in activity requirements which make it possible to use many types of flaws within certain degree of size and prevalence.

It is doubtful whether twinning of any size can be tolerated in a plate of high activity requirement, unless the twinned region be very small and located near an area of least motion, as under the lands.

An intensive study of bubbles was made to determine the regions in a plate which are most affected by the presence of bubbles, the types and sizes of these allowable,

the type of activity curve in the temperature cycling.

Frequency and activity curves on crystal plates that contained bubbles but which had once passed frequency and activity tests did not reveal any effects or ageing beyond the specified limits caused by the presence of bubbles. The average frequency change in six months was minus 30 cycles on a 4.5-Mc crystal plate. In addition to the periodic checks on activity and frequency, these plates were overdriven at the end of 3 months for a period of ten minutes at twice their normal peak activity, with no resulting casualties.

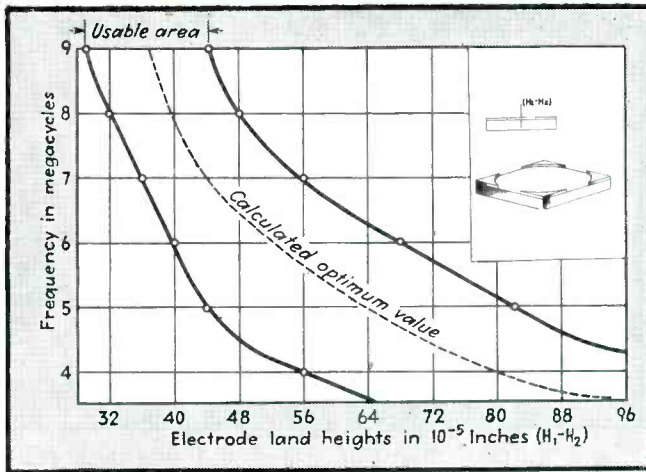

FIG. 2—Permissible range of variation in land heights for good activity performance at any frequency in the range from 3.5 to 9 Mc

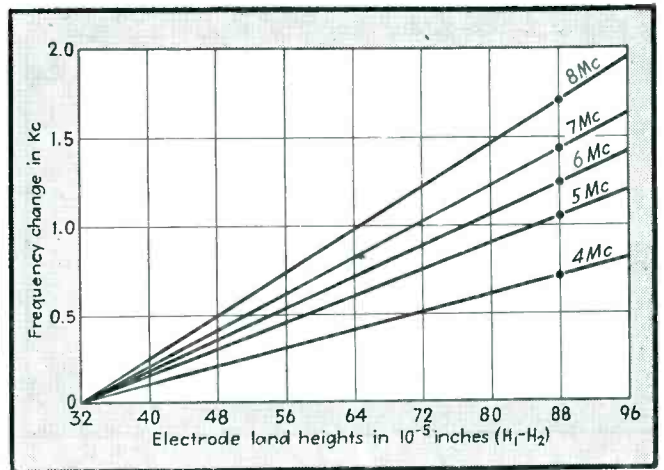

FIG. 3—Vernier adjustment of the frequency of a BT-cut quartz crystal plate by varying electrode land heights is entirely possible, as shown here

close to the zero-tolerance condition edge orientation can be off as much as ± 45 minutes. Crystal plates that are beyond 45 minutes on this edge angle will not perform satisfactorily over the temperature cycle if the requirements on activity are rigid.

After the crystal plates have been rough-lapped, approximately one hundred are stacked in a loaf, with wax holding them together. This loaf is lapped by machine on all four sides until the loaf is within 0.001 of an inch of the final square edge dimensions desired. The last 0.001 inch of material is removed by hand lapping on a sta-

tionary lap. The tolerances usually specified in the hand lapping of the loaf on the length and width are ± 0.0002 inch for a crystal plate whose length and width are equal. Some frequencies offer difficulty in finding a suitable dimension with length and width equal for the 0.0002-inch tolerance and one must use a tolerance of ± 0.0001 inch. This is a tolerance which can easily be held when crystal plates are finished in loaves by hand. If it is felt in a given plant that this tolerance is too small or too critical or if it fails to give the desired yield in the temperature cycle, a pair of dimensions can be sought for a

slightly rectangular plate. This involves the necessity of keeping track of the X' and Z' directions in the blanks.

Edge dimensioning charts can be prepared for rectangular crystal plates where the length and width are shown for the various bands; however, confining the charts to square plates avoids complicating the manufacturing process.

Temperature Cycle

Temperature cycling during edge dimensional investigations was carried out by observation of activity and frequency meters, with manual recording over the temperature range at a fairly rapid rate of change. This method was supplemented by cycling the units in laboratory apparatus capable of automatically recording activity, frequency and temperature of the units while the temperature was varied at a rate of 2°C per minute.

In order that the dimensions released by the laboratory for production runs could be properly evaluated by the quality control department, special automatic indicating equipment was designed. This equipment, used in conjunction with the temperature cycling equipment, has on its control panel on the side of the temperature box 120 lights connected through locking relays which keep an accurate record of all crystal plates and show when one is rejected during the temperature cycling test. A run may thus be checked at any time and the exact point in the tempera-



Temperature-cycling instrument panel and separate control panel containing 120 indicating lights that show the temperature at which a reject occurs due to low activity or excessive deviation in frequency

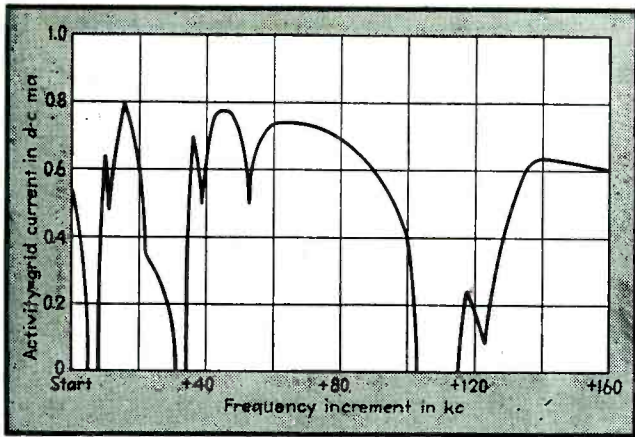

FIG. 4—Typical variation in the activity of a crystal plate when thickness is gradually reduced while edge dimensions are held constant. Note the three points at which the crystal stops oscillating

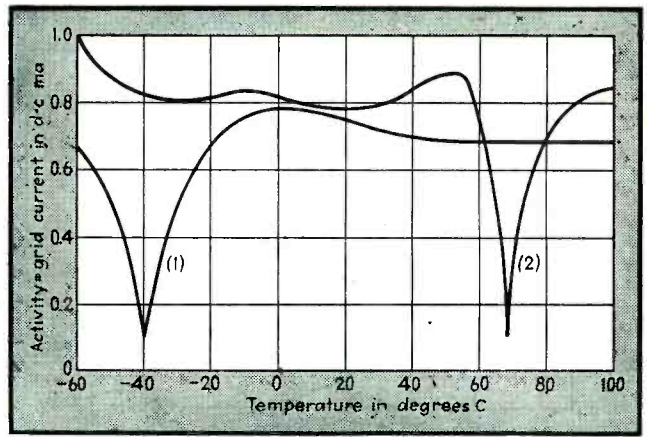

FIG. 5—Typical activity curves during temperature cycling, showing dips caused by incorrect edge dimensions. In curve (1) the crystal edges were too thin, and in curve (2) the crystal edges were too thick

ture cycle at which a failure occurs can be observed and, if necessary, charted. A clearing switch is provided so that a recheck may be made at all temperatures if a complete analysis is desirable. A complete chart made in this manner will show how often any one crystal plate is below passing and at what temperature.

From the charts obtained in this manner the temperature at which any crystal plate is rejected makes it possible to determine whether the dimensions are too large or too small. From experience it is usually possible to estimate exactly how much of a dimensional change is necessary to make the crystal plate satisfactory.

In order to eliminate the human error in recording any failures while making the temperature cycling tests, automatic marking mechanisms were also provided inside the box. These are controlled by a limiting relay that marks each rejected crystal unit with a dab of colored paint. Frequency rejects are marked red and activity rejects are marked green; thus, during the temperature cycle all rejects are properly marked.

Chart Preparation

In arriving at our edge dimension channels for BT-cut (IRE standard orientation $\phi -90^{\circ}00' \pm 15'$, $\theta -41^{\circ}00' \pm 15'$, $\psi +90^{\circ}00' \pm 15'$) quartz crystal plates, we restricted our investigation to the area between 0.6745 inches and 0.7120 inches square (18 mm) and fre-

quencies of $4\frac{1}{2}$ to $8\frac{1}{2}$ megacycles. All plates were made in the manner and within the tolerances previously described.

The procedure followed in determining these channels was, first, selection of plates properly finished at a convenient frequency and edge dimension. Then this dimension was held constant and the frequency increased 1 kc at a time by hand lapping, recording the activity with each change of frequency. A portion of a typical activity curve obtained in this manner is shown in Fig. 4.

It was considered better to proceed in this manner rather than attempt to reduce the edge and keep the frequency constant. In reducing the edge, some quartz is usually removed from the major surfaces with consequent rise in frequency. Some quartz also might be removed from the edges when the blank is lapped on the major surface, but the effect on frequency will be extremely small since the thickness controls the frequency to a much greater degree than any other dimension.

Investigation was begun at a frequency of $4\frac{1}{2}$ megacycles, using crystal plates having the maximum permissible edge dimensions. By holding these latter dimensions constant and raising the frequency in steps of 1 kc, with all measurements taken at essentially the same room temperature, we were enabled to chart an accurate activity curve showing all frequencies covered at this edge.

The same procedure was followed with numerous smaller edge dimensions within the allowable range, thus giving us a composite picture showing at which frequencies any given edge dimension produced the highest consistent activity. From these results we were able to plot definite edge dimension channels showing the highest activity at all frequencies.

The channels shown on our graphs are only those considered wide enough for specifying a dimension that would prove satisfactory as to ease of manufacture and still provide constant activity throughout the temperature cycling from -55°C to $+90^{\circ}\text{C}$.

In arriving at a final edge dimension for a given frequency, plates are heat-cycled starting at the largest edge dimension of the channel and re-cycled with a reduction of 0.0002 inch per run throughout the channel. With this method we are able to ascertain at exactly which edge dimension the activity is most nearly constant over the range.

It will be observed that as the edge dimensions are decreased, the most pronounced dips in activity will shift toward the hot extreme of the temperature cycle and finally go out beyond the range to be covered. In like manner, if a dip is noted near the cold end of the cycle, it may be moved out of the range by using a greater edge dimension. Typical curves showing these effects are given in Fig. 5.

Orientation of the plate, in par-

ticular with respect to the θ or complementary ZZ' angle, will influence the position of dips with respect to temperature in the same fashion. For example, a decrease beyond tolerance of the θ angle may result in bringing a dip into range.

Other possibly usable bands at the desired frequency are then explored in like manner and that dimension which results in the best overall characteristic is specified for a trial production run of 100 units. If these prove satisfactory in activity and the yield of passing crystal plates over the complete temperature cycle is 98 to 100 percent, the edge dimension is officially released for production use.

Although the edge dimension charts in Fig. 6 show usable areas as bounded by straight lines, they actually should be slightly curved (hyperbolas), with the slope of the line increasing as the frequency is increased. These charts, prepared for square *BT*-cut crystal plates, show that a great many choices of dimension are available for a fixed frequency. Exploring all of the possible usable bands may be worth while in order to obtain an edge dimension that will give an extremely high yield.

The preparation of the dimensional charts was carried on under careful engineering supervision, with considerable attention to details and extreme accuracy of measurements. The time consumed in making this investigation and compiling the charts for the 4 to 8-megacycle range *BT* cuts was upward of 10,000 man-hours.

Conclusion

Phileo Corporation has manufactured over half a million crystal plates to meet high activity requirements using the predimensioning technique. From this experience it can be stated that when crystal plates are to be made in which exacting and difficult requirements must be met and guaranteed for any length of time under extreme conditions, it will be necessary to manufacture them by the predimensioning technique.

The authors are indebted to Dr. Karl S. Van Dyke for his kind assistance in the compilation and critical reading of the text.

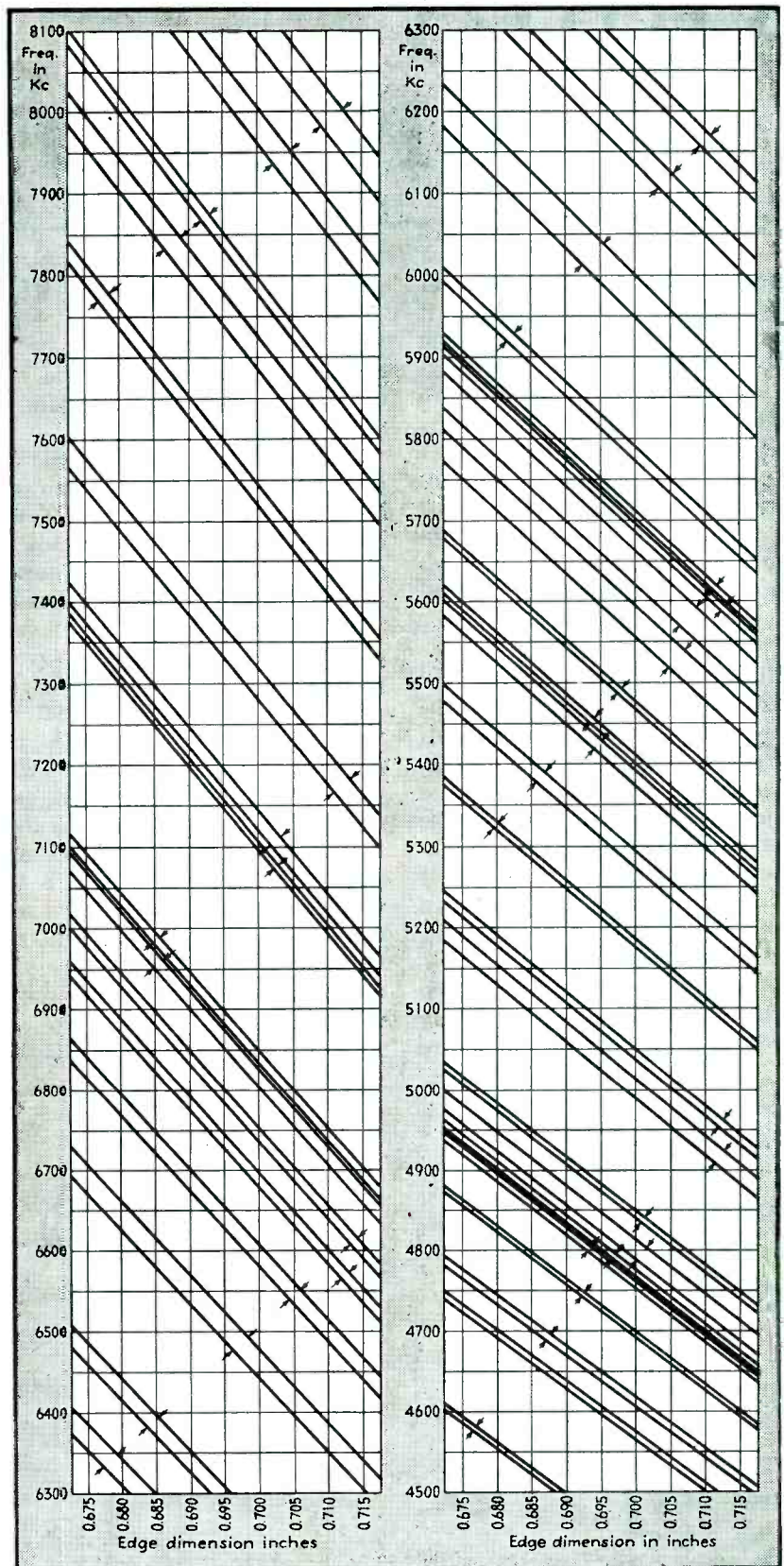

FIG. 6—Edge dimension charts for square *BT*-cut quartz crystal plates in the frequency range from 4.5 to 8.1 Mc, showing the areas, bounded by any pair of lines, from which the usable dimensions for a given frequency can be determined. Many choices of dimensions are available for a given frequency, and for the best possible performance all usable areas should be explored. Preparation of these charts involved over 10,000 man-hours of work

AUDIO MIXER DESIGN

IN the design of studio equipment and public-address systems, it is usually necessary to incorporate circuits capable of mixing anywhere from two to eight or more input elements, and these circuits must operate in such a manner that (1) the input and output impedances will be constant for any setting of the controls, (2) there will be no crosstalk, and (3) a variation in the setting of one control will not affect the attenuation of the other positions.

Mixer circuits in use today fall pretty well into two classes, the high-impedance type used in public address amplifiers and the low-impedance type used in broadcast and recording equipment. Two of the most common networks of the high-impedance type are shown in Fig. 1 and 2. The first circuit utilizes a double triode, such as a 6C8G or a 6F8G, and is excellent for a two-position mixer. It can also be used for three or four positions by using two tubes and, since all inputs are

By **RICHARD W. CRANE**

Concord, N. H.

completely isolated from one another, there can be no crosstalk or other interaction.

As the plate resistances of the two sections are in parallel, one section sees a load consisting of the other section's plate resistance in parallel with the load resistance, giving an insertion loss whose exact value will depend on the circuit constants, but which will be not more than 6 db in the two position circuit shown. There is no real insertion loss, of course, since the tube amplifies, but it is obvious that the gain of the two sections connected as in Fig. 1 will be less than that of a single section alone and can never be greater than $\mu/2$, for the load resistance one section sees is always less than R_p . Similarly, for a three-position mixer $\alpha < \mu/3$, and for a four position mixer $\alpha < \mu/4$.

Figure 2 represents a circuit that

works quite well for any number of positions. The series resistors should have the same value as that of the potentiometers, and the maximum insertion loss = $20 \log n$ where n is the number of positions in the mixer.

Insertion Loss

The main disadvantage of this circuit is that the insertion loss will vary, depending on the setting of the potentiometers; for a four-position mixer, for example, the insertion loss of one channel may be only 8 db if the other three controls are wide open, while it will be 12 db if they are all in the off position. However, the maximum variation in insertion loss any one potentiometer can cause will range from 2.5 db for a two position circuit to 1.7 db for an eight-position mixer. (These figures are obtained by assuming that position 1 is the generator, calculating the insertion loss with all the controls wide open, then calculating the insertion loss with one potentiometer closed, and subtracting one from the other.) This variation will be quite a bit smaller if the source impedances are low compared to the values of resistance used in the mixer, and, in general, this circuit is useful in sound systems where too exact control is not needed.

Another type of high-impedance mixer is one in which the controls are connected in series as in Fig. 3. Such a circuit requires that all inputs except one be ungrounded, but since this tends to develop hum and crosstalk, such networks should be avoided.

In these high-impedance circuits, there is no attempt made to match impedances; instead they are designed using potentiometers whose resistance is high (usually $\frac{1}{2}$ to 1 megohm) compared to the source impedance of the preamplifier, phono pickup, or microphone. A source whose impedance is very low

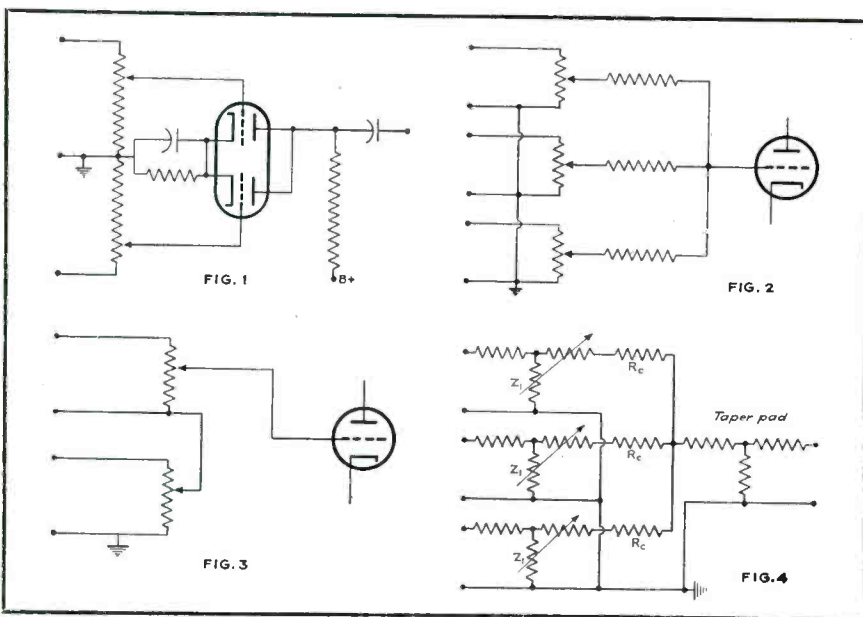

FIG. 1—Two-position high-impedance mixer feeding a double triode

FIG. 2—Three-position high-impedance mixer, parallel type

FIG. 3—Two-position high-impedance mixer, series-type

FIG. 4—Three-position low-impedance mixer, parallel type

High and low-impedance circuits for mixing multiple inputs to an audio system. Features of the various arrangements are included, as well as possibility of cross-talk, hum problems, calculation of insertion loss and impedance matching

in relation to the mixer input impedance, such as an 8-ohm magnetic pickup, or a 250-ohm line, will require an input transformer.

Low-Impedance Types

There are many types of low-impedance mixers used and four of these are shown in Fig. 4, 5, 6, and 8. All four of these networks will give an exact input-to-output impedance match for any position of the controls.

Figure 4 is a parallel-type mixer where Z_1 is a variable, symmetrical T-pad whose input impedance = output impedance, as it is in all four low-impedance mixers.

Unit R_c is a fixed resistor, and a taper pad is used to convert the mixer's output impedance to the desired output impedance (this pad may be replaced by a transformer if one with the correct impedance ratio is available). For this network the following relations hold:

$$R_c = Z_1 \left(\frac{n-1}{n} \right)$$

$$Z_2 = Z_1 \left(\frac{2n-1}{n^2} \right)$$

Insertion loss = $10 \log(2n-1)$ where Z_2 is the impedance looking back into the mixer (without the taper pad connected), n is the number of positions, and insertion loss is the mixer loss in db, not including the taper pad.

Example

Thus if we want a three-position, 500-ohm input, 500-ohm output mixer, $R_c = 333$ ohms, $Z_2 = 278$ ohms, insertion loss = 7 db; and we would use three 333 ohm resistors and a 278 to 500 ohm taper pad (which would give an additional loss of about 7 db). The procedure for the design of taper pads is given in ELECTRONICS for November, 1941².

Figure 5 shows a series-type mixer and for this circuit

$$R_c = Z_1 \left(\frac{n}{n-1} \right)$$

$$Z_2 = Z_1 \left(\frac{n^2}{2n-1} \right)$$

As in Fig. 4, the insertion loss = $10 \log(2n-1)$. This circuit differs from Fig. 4 in that it must be grounded at only one point, and thus only one input can be grounded.

Figure 6 shows a bridge-type mixer and is the best circuit for a four-position system, provided that the inputs can be ungrounded (although the system can be grounded at some one point). Figure 7 represents the equivalent circuit when position 1, for instance, is the generator. From this it can be seen that $Z_1 = R_c = Z_2$. Thus a master gain control identical with the individual attenuators can be used as an integral part of the mixer. If a master gain control is not used, the circuit should be arranged so that the mixer sees a resistive load equal to Z_1 otherwise the bridge will not balance. This circuit has an insertion loss of 6 db, which is less than that of any other four-position mixer.

The circuit of Fig. 8 can be used for any even number of positions from four up, and in this circuit:

$$Z_2 = \frac{4Z_1(2n-3)}{n^2}$$

$$R_c = \frac{Z_1(n-3)^2}{n}$$

Insertion loss = $10 \log(2n-3)$ The taper pad in this network is an ungrounded H pad. This is an especially good design to use for a six-position circuit for in that case $Z_2 = Z_1$.

Crosstalk

As to crosstalk in mixers, it may be said that circuits with grounded inputs, such as Fig. 1, 2, 4, and 8, will not develop any, but Fig. 3, 5, and 6 may develop some, depending on the physical design of the equipment (shielding, placement of parts, etc.).

REFERENCES

- (1) Microphone Mixer Circuits, *Jour. Soc. of Motion Picture Engineers*, June, 1937, p. 604-613.
- (2) Attenuator Design, *ELECTRONICS*, Nov. 1941, p. 51-54.

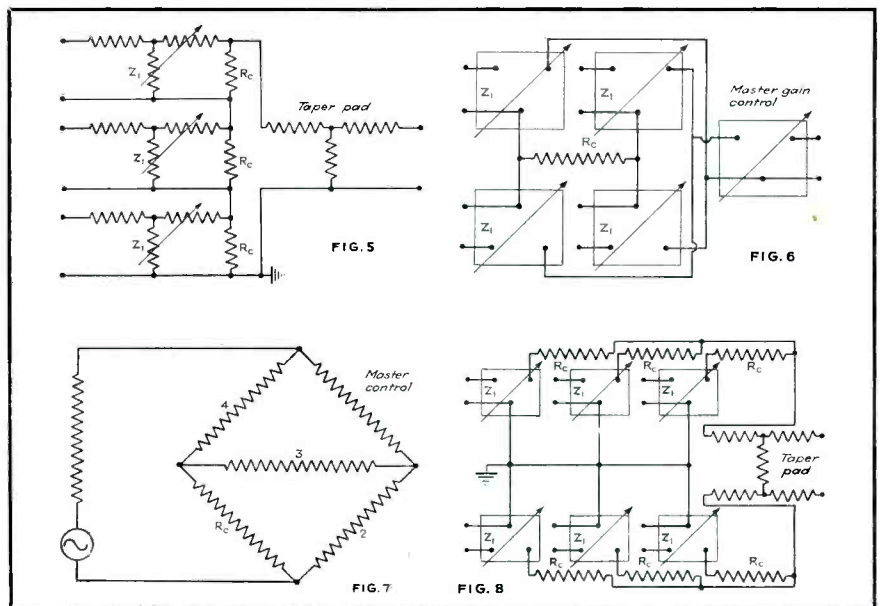

FIG. 5—Series-type low-impedance mixer for three inputs

FIG. 6—Bridge-circuit mixer with T-pads for four positions

FIG. 7—Equivalent circuit of bridge-type mixer

FIG. 8—Series-parallel mixer network of T-pads

Industrial Radiography

How x-rays and radium can be used most effectively in the factory for inspection of welds, castings, and finished products. Practical information for industrial readers, with explanations of how x-rays behave under various conditions

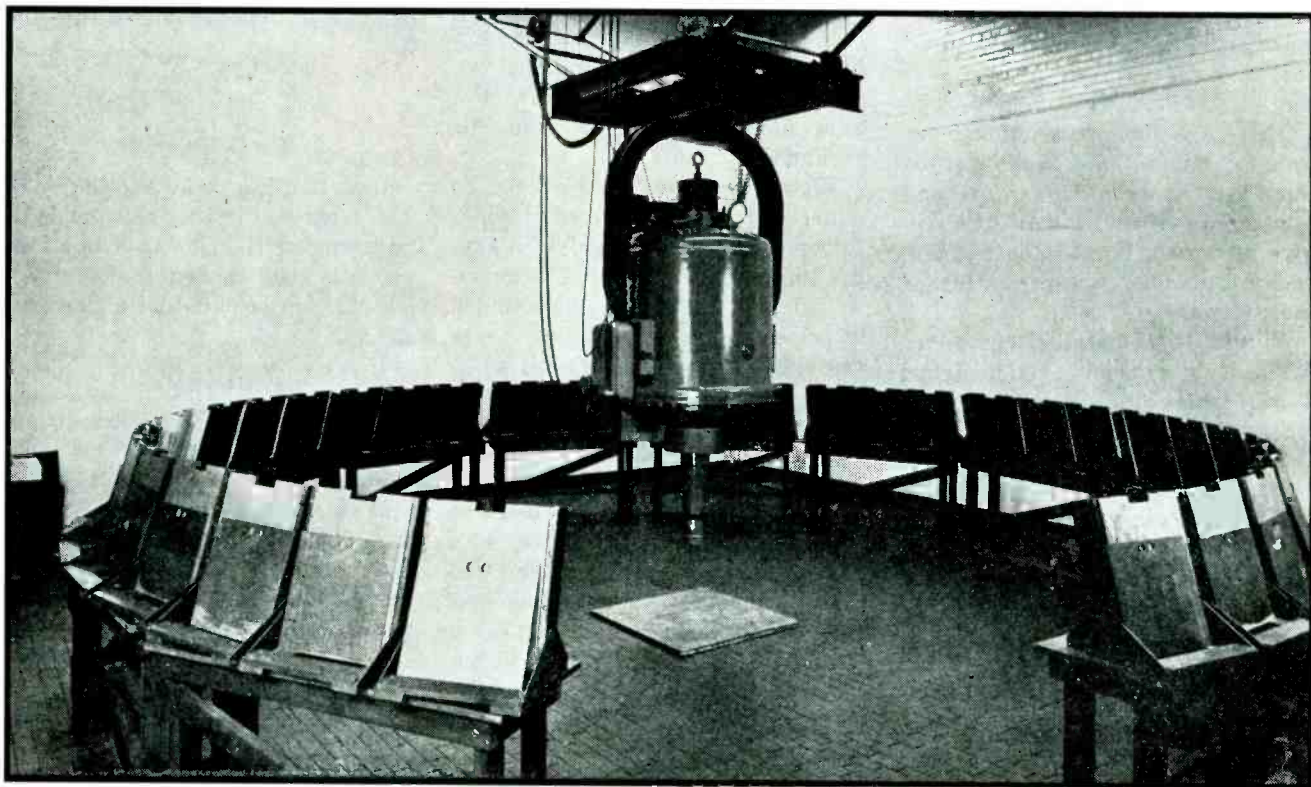

Million-volt General Electric industrial x-ray unit as used to inspect turbo-supercharger parts. The cassettes and objects are arranged in a circle around the machine and all are exposed simultaneously by adjusting the x-ray machine to radiate x-rays uniformly over 360 degrees in a horizontal plane

WHEN x-rays are passed through a metal casting, a weld, or a finished article like a hand grenade, the rays emerging on the far side of the object may be allowed to strike a photographically sensitive x-ray film. After the film is developed, it bears an impression of the object, showing details of its inner structure, and thus internal defects may be revealed. Such a film, after development, is called a radiograph, and the process of taking radiographs for industrial applications is called industrial radiography. Occasionally the gamma rays from radium are used in place

Abridged by the author from his book, "X-rays in Practice," to be published in the fall by McGraw-Hill Book Co., New York, N. Y.

By **WAYNE T. SPROULL**

*Research Laboratories Division
General Motors Corporation
Detroit, Mich.*

of x-rays in the process just described. The word radiography is not a grandiloquent term for any process employing x-rays; there are many applications of x-rays not related to radiography.

Generation of X-rays

An x-ray tube is a special diode type of vacuum tube. The electrons thermionically emitted from the hot cathode of an x-ray tube are focused into a beam and accelerated to an enormous velocity by the high voltage applied between the electrodes. When these streaming elec-

trons, called cathode-rays, strike a block of metal called the target, x-rays are generated at the spot where they strike. This spot is called the focal spot.

The x-rays radiating from the focal spot are generated by two distinct processes: (1) Those generated directly by the sudden stoppage of the cathode rays are called the continuous radiation; (2) those generated by the atoms in the target during their recovery from the ionized state in which they find themselves as a result of the cathode-ray bombardment are called the characteristic radiation.

The continuous radiation consists of a broad band of x-ray wavelengths. The shortest wavelength

λ_0 , found in this band depends upon the peak voltage V applied to the tube, in the following way:

$$hc \frac{1}{\lambda_0} = h\nu_0 = \frac{1}{300} Ve \quad (1)$$

where h is Planck's constant, equal to 6.624×10^{-27} erg-second, c is the velocity at which x-rays or other electromagnetic radiation (such as ordinary light) travel in free space and is 3×10^{10} centimeters per second, λ_0 is in centimeters, ν_0 is the corresponding frequency in cycles per second found from the familiar relation

$$c = \nu\lambda \quad (2)$$

and e is the electronic charge, equal to 4.8×10^{-10} electrostatic units. Inserting these values, Eq. (1) becomes

$$\lambda_0 = 12,400/V \quad (3)$$

where V is still in volts but λ_0 is now in angstroms (one angstrom equals 10^{-8} centimeter).

The wavelengths present in the continuous radiation extend from λ_0 upward to values several times λ_0 , but the most intense part lies between about $1.5 \lambda_0$ and $2.5 \lambda_0$ roughly. One sees from Eq. (3) that an increase in the tube voltage V decreases the wavelengths of the x-rays, and this makes them harder or more penetrating. Soft rays, generated at lower voltages, are less penetrating. In actual practice, V is rarely less than 5 kilovolts or more than 2 million volts.

The characteristic radiation consists of a few definite discrete wavelengths, roughly analogous to the yellow light emitted from a sodium vapor lamp. In this line spectrum,

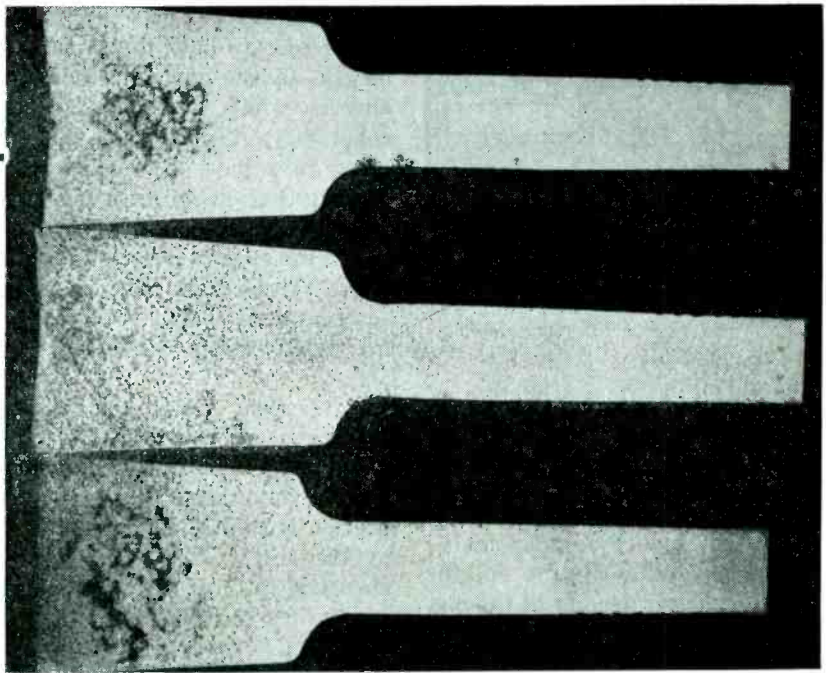

Radiograph of three aluminum test bars cast under different conditions. With thin flat bars, radiography will reveal fine pin-point porosity as well as shrinkage cavities. All examples shown here are true radiographic duplicates, dark where the original film was dark, and light where the original film was light

the most prominent wavelengths or lines are designated as the K alpha and K beta lines. There are really two K alpha lines, called K alpha 1 and K alpha 2, and they have almost but not quite the same wavelength as indicated in Table I, which also lists the most prominent K beta line. The minimum tube voltage required to excite these lines, listed in the last column, depends upon the nature of the target element. Note the systematic variation of these quantities as related to the atomic number of the target element.

It is the continuous radiation which is of primary interest in most industrial radiography, and x-ray tubes for this type of work are usually provided with a tungsten target because of its high melting point and high atomic number.

The intensity of the continuous radiation increases with the atomic number of the target element.

Absorption of X-rays

X-rays of a single wavelength, like the K alpha 1 line of molybdenum, are called monochromatic x-rays. When a beam of such rays strikes an object, such as a cedar shingle, 10 percent of them may pass straight through and emerge on the other side, and these transmitted rays may be made to strike an x-ray film and thus yield a radiograph of the shingle. If there is a worm hole in the shingle, 15 percent of the primary rays may pass through this region (as contrasted with 10 percent elsewhere), and so the defect is revealed as a dark place on the radiograph.

If one attempts to pass the same x-ray beam through two shingles instead of one, only 1 percent of the rays may be transmitted, rather than 10 percent for a single shingle. The relation is

$$I = I_0 e^{-\mu x} \quad (4)$$

where I is the intensity of the transmitted rays, I_0 is the intensity of the primary rays as they strike the shingle, e is the Napierian log base, μ is the linear absorption coefficient of molybdenum K alpha rays in cedar (in this case) and x

TABLE I. CHARACTERISTIC WAVELENGTHS OF TARGET MATERIALS

Target element	Atomic number	Characteristic wavelengths in angstroms			Not excited below
		K alpha 1	K alpha 2	K beta 1	
Iron	26	1.9321	1.9360	1.7530	7.10 kv
Cobalt	27	1.7853	1.7892	1.6174	7.71 kv
Nickel	28	1.6545	1.6584	1.4970	8.29 kv
Copper	29	1.5374	1.5412	1.3894	8.86 kv
Molybdenum	42	0.7078	0.7121	0.6310	20.0 kv
Tungsten	74	0.2086	0.2134	0.1842	69.3 kv

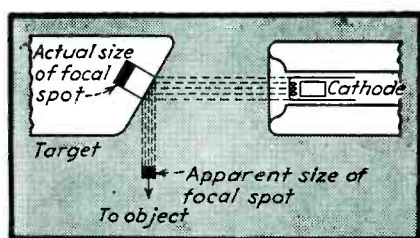

FIG. 1—Directing a long narrow beam of electrons at a sloping target gives an x-ray beam having a small focal spot

is the thickness in centimeters of the shingle or shingles.

Tables usually list the mass absorption coefficient rather than the linear absorption coefficient, but the latter is obtained by simply multiplying the former by the specific gravity or metric density of the material. In general, the absorption coefficient increases with the wavelength of the x-rays, and also with the atomic number of the chemical element or elements composing the absorbing material. This increasing absorption with wavelength is interrupted by discontinuities called absorption edges. For example, the mass absorption coefficient of iron increases from 325 for 1.54-angstrom x-rays to 410 for 1.65-angstrom rays. Then it drops suddenly to only 54 at the absorption edge for 1.74-angstrom rays, after which it resumes its rise to 71, 115 and 147 for wavelengths of 1.93, 2.29, 2.50 angstroms, etc., respectively.

Scattering of X-rays

From the exponential form of Eq. (4), one sees that as the thickness x of the object increases, the transmitted rays soon drop to an intensity I so low that the image on the x-ray film is much too faint, even after a very long exposure, say an hour. When one attempts to radiograph thick objects by using very long exposures, another difficulty arises. The x-ray film will be found to be fogged so badly that the faint image otherwise obtainable may be practically obliterated. The cause of this undesirable fogging is scattered and secondary x-rays.

Scattered rays may be tentatively defined as rays which emerge from the object travelling in directions different from that in which the incident rays entered. This definition is only tentative because it fails to rule out the secondary radi-

ation, as will be seen. Part of the scattered rays have the same wavelength as the incident primaries, and are said to have been scattered coherently. The rest of the scattered rays have a wavelength exceeding that of the primaries by an amount depending on the angle at which the rays in question are scattered. These rays have undergone scattering of a type called Compton scattering or incoherent scattering.

If 5 percent of the primary x-rays are transmitted by the object and 10 percent are scattered, what happens to the other 85 percent? This portion is said to be truly absorbed by the object. The energy of the absorbed x-rays is transformed mostly into heat, but the absorption process also results in the emission of characteristic x-rays by the object itself, if the primary rays are somewhat harder than the characteristic rays in question (Table 1). These x-rays radiated by the object itself are called secondary x-rays. For example, if molybdenum K alpha primary x-rays pass through a piece of copper foil, the foil will radiate some copper K characteristic secondary rays having wavelengths of 1.54 and 1.39 angstroms,

since the molybdenum primaries (0.71 angstrom) are considerably harder than this.

In the above example, it is also found that electrons are photoelectrically ejected from the copper foil by the primary rays which are absorbed. Since the quantum energy, $h\nu$, of x-rays is high, these photoelectrons are quite energetic and are capable of exposing a photographic film if it is in intimate contact with the foil.

Tube Voltage and Current

The maximum tube voltage which modern industrial radiographic installations are capable of attaining is usually 75 kv, 110 kv, 140 kv, 200 kv, 220 kv, 250 kv, 400 kv, one million volts, or two million volts. Except for the last two, the operator may select a reduced voltage. For example, one may operate 200-kilovolt equipment at 100 kilovolts. However, one may find it impossible to operate such equipment at 5 kilovolts because space charge will limit the electron current through the tube at such low potentials. At normal operating voltages, this tube current is limited by the thermionic emission of the cathode and controlled by the filament heating current.

The hardness or penetrating power of x-rays increases with the tube voltage. The intensity of the continuous radiation also increases approximately as the square of the voltage.

For industrial radiography, the tube current is usually somewhere in the range between three and thirty milliamperes. The intensity of the x-rays emitted is directly proportional to the tube current, for a given tube voltage. However, the tube current must not be increased above the rating of the x-ray tube, or the target may be melted or otherwise destroyed.

Focal Spot Size

Since flaws are detected by the shadows they cast in a radiograph, the quality and value of a radiograph improves as the size of the focal spot is reduced, just as a candle casts sharper shadows than a fluorescent lamp. As the focal spot size is reduced, however, the maximum permissible tube current also

TABLE II GENERAL RULES

TO INCREASE CONTRAST, as in radiographing welds in flat plate:

- (1) Reduce tube voltage until fogging from scattered and secondary rays begins to appear
- (2) Use long exposure time—1 minute or more
- (3) Use fine-grained film of non-screen type

TO INCREASE LATITUDE, as in radiographing irregular castings:

- (1) Increase tube voltage
- (2) Use short exposure time—a fraction of a minute
- (3) Use fast film

TO IMPROVE DEFINITION:

- (1) Increase tube-to-film distance
- (2) Keep film holder snug against object
- (3) Use fine-grained film

WHEN MAXIMUM VOLTAGE SEEMS INSUFFICIENT for thick dense objects:

- (1) Use maximum voltage
- (2) Use fluorescent screens
- (3) Use lead-foil filter in front of screens in cassette
- (4) Use copper filter 1 mm thick or less at tube
- (5) Use blocking material
- (6) Decrease tube-to-film distance as much as possible without violating requirements for definition and distortion

TO RADIOGRAPH THIN OBJECTS:

- (1) Use voltage low enough so exposure time is at least one-half minute when usual tube current and target-to-film distance are employed
- (2) Use non-screen technique
- (3) Use no filters
- (4) Fine-grained film usually preferable

decreases because of the greater concentration of heat from the electronic bombardment of the focal spot. Nevertheless, it is possible to reduce the apparent size of the focal spot without reducing its actual size, by giving it a long narrow shape and working at a small angle to the target face, as indicated in Fig. 1.

Target-to-Film Distance

Ideally, the film holder or cassette should be placed in contact with the object on the side opposite the x-ray tube, perpendicular to a line from the focal spot T through the center of the portion being examined. This line should strike the center of the film at a point which may be designated as F. The greater this distance TF, the more nearly parallel are the rays passing through various portions of the object, and hence the less the distortion of the image. Likewise, the greater the distance TF, the more nearly parallel are the rays originating at various points of the focal spot and passing through any one chosen point in the object, and hence the less the blurring of the image and

the better the definition. However, the intensity of the rays striking the film varies inversely as the square of the distance TF, so that the time required to expose the film is quadrupled when TF is doubled. Therefore the value selected for the TF distance must be large enough to give acceptable definition and distortion, yet small enough to give an acceptable exposure time.

If the long axis of the x-ray tube is north-and-south, the long axis of the object and the film should be east-and-west, for better uniformity of exposure over the film area.

Screens and Film

The film holder or cassette may be provided with lead-foil screens which make intimate contact with the front and rear faces of the film. The front screen, nearest the x-ray tube, is usually about five thousandths of an inch thick. The rear screen may be ten thousandths to thirty thousandths of an inch thick or more, and it serves to intercept scattered radiation from the floor or table or other objects nearby. The photoelectrons from the foil help expose the film and thus reduce

the exposure time. The front screen also absorbs the undesired secondary and incoherently scattered rays more than it does the harder primary x-rays, and thus reduces film fogging.

When exposure times are short, and scattered and secondary radiation are comparatively feeble (as with very hard x-rays from million volt equipment, or in the radiography of "transparent" objects like plates less than $\frac{3}{8}$ inch thick or small aluminum or magnesium parts), lead screens are usually not desirable. Otherwise, they are.

When the x-ray equipment is being worked at or near the limit of its penetrating ability, as in the radiography of two inches of steel with a 200-kilovolt unit, exposure time with the above techniques will rise to impractical lengths, such as several hours. In other words, the equipment can not generate x-rays hard enough for the job. In these cases, one can sometimes obtain a passable radiograph by using fluorescent intensifying screens. These are pieces of cardboard coated with calcium tungstate which fluoresces and exposes the

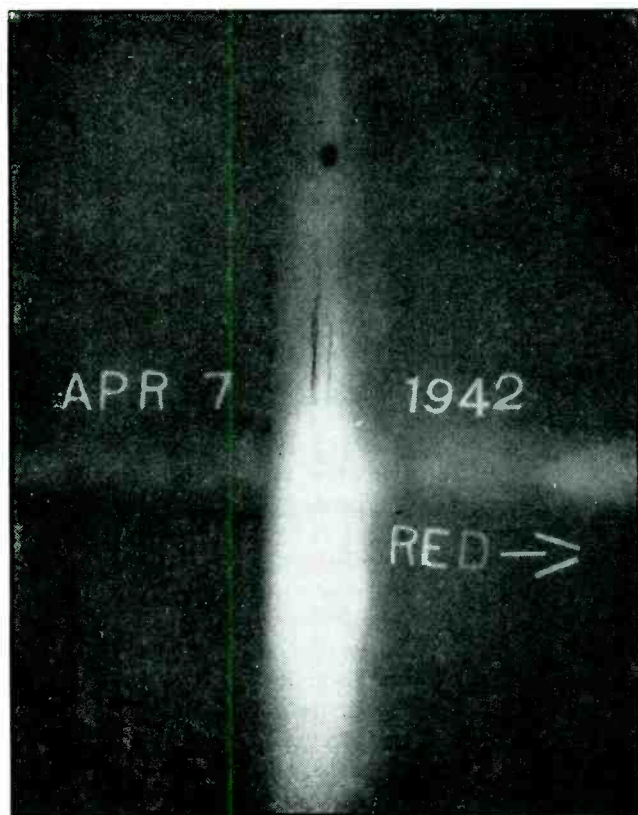

Radiographic print showing cracks in a weld near its intersection with a second weld in armor plate

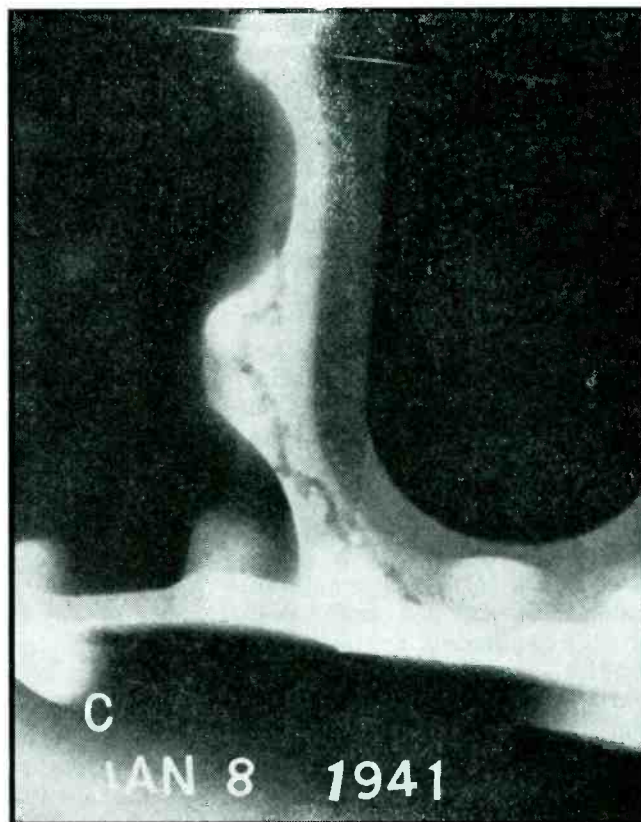

Radiographic print showing a long "worm hole" flaw extending irregularly through an aluminum casting

film by the visible light emitted.

Industrial x-ray films are duplicated; that is, they bear a photographic emulsion on both sides, in order to increase their x-ray absorption and hence their sensitivity.

When using fluorescent intensifying screens, use a film like Agfa Industrial, DuPont 504, or Eastman F.

When using no screens, or when using lead screens, the selection of the film depends on the size, shape, and composition of the object, and the hardness of the x-rays used. For objects of irregular shape, a wide-latitude film is required so that the thin portions will not be too dark and the thick portions will not be too light in the radiograph, especially if soft (low-voltage) x-rays are used. Such a film is Agfa Non-screen, DuPont 506, or Eastman K.

When fine detail and high contrast are desired, as in radiographing objects of uniform thickness like welded flat metal plate, film like Agfa Superay A or Eastman A should be used. These films are finer grained, but require about five times the exposure needed for the wide-latitude, ordinary-grain films. For still finer detail and contrast (at further sacrifice of speed), use Agfa Superay B or Eastman M. These films are quite useful for million-volt work, because the higher the voltage and the harder the rays, the less the contrast becomes, and with such powerful units slow film is no handicap.

The correct tube voltage, tube current, TF distance, type of film and screens, time of exposure, and the thickness of the object being radiographed (assuming that all objects are to be of the same material, such as steel) are all interrelated in a way that can be represented simply by a series of graphs on semilogarithmic graph paper, based on Eq. (4). Such graphs are customarily supplied with radiographic equipment by the manufacturer, and are called technique charts. An example is given in Fig. 2.

Improving Quality of Radiographs

When an x-ray unit is being used near the limit of its penetrating ability, especially when fluorescent

screens are being used, the scattered and secondary rays reaching the film near the edges of the object have an intensity greater than that of the primaries. The resulting fog may be greatly reduced by pouring fine steel shot around the edges of the object, as described by Moriarty¹ and illustrated in Fig. 3. Blocking material of this sort is not necessary when very hard radiation is available, as with million-volt equipment, or when the very hard gamma rays from radium are used for industrial radiography.

Another procedure which sometimes improves the quality of the radiograph of a thick massive object nearly opaque to x-rays is to use a sheet-aluminum filter next to

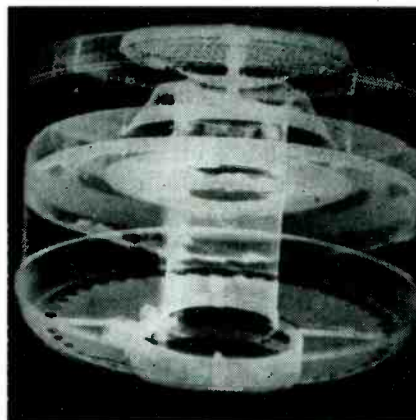

Radiographic print of a welded automobile-intake silencer and air cleaner, made to reveal whether or not the internal parts are properly aligned

the tube, with a sheet-copper filter between it and the tube. The aluminum should be about a millimeter thick, and the copper about a half or a quarter as thick. The copper absorbs the softer primary rays, allowing only the harder ones to reach the object. The aluminum absorbs the secondary radiation from the copper.

With 250 and 400-kilovolt units, an industrial version of the Potter-Bucky grid used in medical radiography is sometimes employed for the radiography of thick dense objects. This is a parallel network of lead ribbons which has a slow lateral motion during the exposure. It intercepts rays which deviate considerably from the direction of the primary rays, and thus greatly reduces the scattered and secondary radiation reaching the film. The

grid is placed between the object and the cassette.

General rules for obtaining the best possible radiographs are summarized in Table II.

Inspection of Welds

In welding shops, industrial radiography reveals incomplete fusion, incomplete penetration, porosity, slag inclusions, undercutting, cracks, etc. If the technique is correct, any flaw having an extent of 2 percent or more of the thickness of the specimen will be revealed. Thus a cavity one fiftieth of an inch in diameter is readily detected in a weld in armor plate one inch thick. As a constant check on the technique, it is ordinarily required that a small piece of sheet steel (if the specimen is steel) having a thickness equal to 2 percent of that of the specimen, and containing drilled holes having a diameter of 2 percent of the specimen thickness, be laid on top of the specimen and radiographed with it. The small piece and the tiny holes in it must be visible in the radiograph. These test pieces are called penetrameters. Certain standard radiographic requirements have been established, such as the A.S.M.E. boiler code of radiographic inspection² which sets forth the specifications which must be met if a weld is to be accepted.

The radiographic inspection of spot welds in sheet metal³ is usually performed at low voltages, such as 12 to 50 kilovolts, and fine-grained films are used, permitting subsequent enlargement to five or ten diameters.

Inspection of Castings

Radiography reveals blow holes, shrinkage cavities, cracks, pipes, slag inclusions, dross, cold shuts, shifted core, and similar defects. As with welds, the defect should have dimensions of roughly 2 percent or more of the thickness of the casting if it is to be revealed. Lead letters and figures are usually placed on the casting or portion of the casting or other object being radiographed for identification purposes.

For the inspection of a limited number of heavy castings, the purchase of million-volt equipment is not economical. In such cases, the

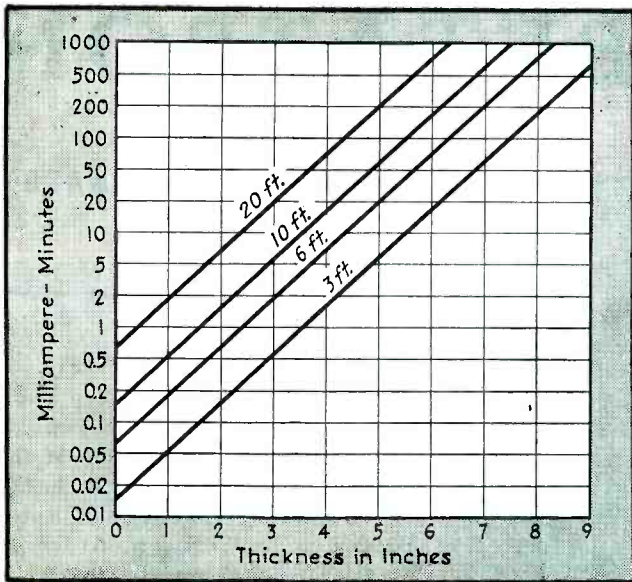

FIG. 2—Technique chart for million-volt x-rays produced by a General Electric unit in which voltage is fixed but current can be varied from zero to three milliamperes. Curves are shown for four different target-to-film distances when using 0.005-inch lead screens and industrial x-ray film having a film density of 1.0, for examination of rolled-steel plates in thicknesses up to 9 inches

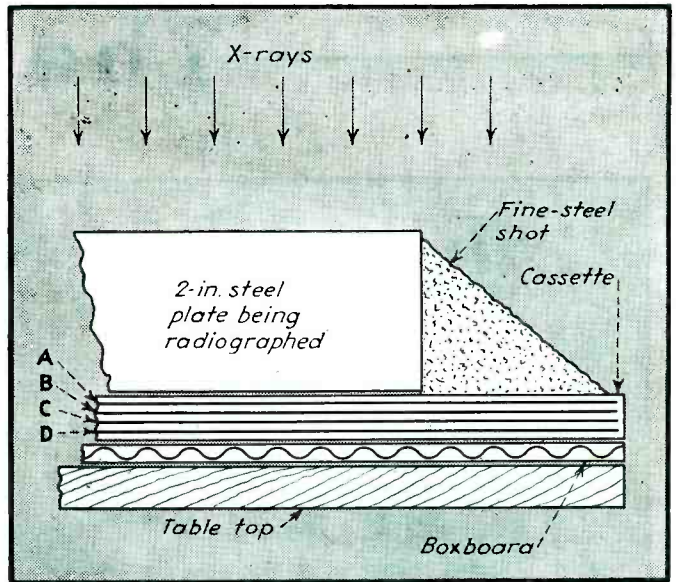

FIG. 3—Use of steel shot (about 0.015 inch diameter) as blocking material in the radiography of a small steel plate that can be placed directly on top of the cassette. Industrial screen film C is sandwiched between double fluorescent intensifying screens B and D, with a 0.005-inch thick lead-foil sheet A on top to serve as a filter in the cassette. The boxboard merely serves to collect the shot when the cassette is removed

rental or purchase of about 200 milligrams of radium' is often a practical solution. The gamma rays emitted from such a radium capsule have a line spectrum similar to that of characteristic x-rays, but the lines are of such short wavelength that the rays are about as hard as two million volt x-rays, although their intensity is very much less. This latter fact results in exposure times of many hours when using radium, but such exposures can usually be made overnight. The small size of a radium capsule permits suspending it inside thick-walled hollow castings and placing the cassettes around the outside—a procedure which is sometimes impossible with x-rays because of the large size of the x-ray tube.

Other objects radiographed include die castings, forgings, bronze bearings, concealed assemblies such as welded auto-mufflers, wire-reinforced rubber belts, ceramic products, etc.

Various Types of Radiography

Semi-automatic radiographic cabinet machines with conveyors are sometimes employed for production-line inspection of thousands of identical parts per day, when the failure of a single part would be disastrous as in the case of a few critical aircraft parts.

Thin metallographic specimens are sometimes radiographed with characteristic x-rays from x-ray tubes having targets of molybdenum, copper, iron, etc. By using a film like Eastman spectrographic type 548-0, subsequent enlargement up to 100 diameters or more is possible. By proper choice of the tube target material, segregation is readily detected in alloys because of the phenomena of the absorption edge. This type of radiography is called microradiography.⁶

By using a surge generator and a special field-emission type of x-ray tube, it is possible to take radiographic snapshots in a millionth of a second,⁶ showing how a bullet pierces a piece of armor plate.

By substituting an ionization chamber for the x-ray film, it is possible to make x-ray inspection entirely automatic in certain simple cases, such as hand-grenade fuses and table knives.⁷

By substituting a fluoroscopic screen for the x-ray film, it is possible to inspect certain objects fluoroscopically rather than radiographically. This method is commonly used for the inspection of small ammunition, wire and cable (for breaks and for centering in the insulation), golf balls, fire brick, arc carbons, packaged foods such as corn flakes, candy, etc.,

canned foods, vegetables in bulk, citrus fruits, meats, oysters, and clams. It is also employed to examine auto tires for injuries; to fit shoes in shoe stores; to locate concealed wires, pipes, reinforcing rods, etc; and to check the assembly of radio tubes, shell fuses, etc.

Precautions

Both x-rays and gamma rays are dangerous and injurious to persons not adequately protected and familiar with the necessary precautions. Before planning any x-ray or gamma-ray installation or undertaking any such activity, it is essential to learn the details of obtaining adequate protection. For this purpose, one may begin by reading U. S. Bureau of Standards Handbook 20 (X-ray Protection) and Handbook 23 (Radium Protection).⁸

REFERENCES

- (1) Moriarity, C. D., *G. E. Review*, 42, p. 109, 1939.
- (2) *Mechanical Engineering*, 55, p. 267, 1933; 62, p. 333, 1940.
- (3) See, for example, Smith, D. W., and Keller, F., *Journ. Am. Welding Soc.*, 21, p. 573—supplement, 1942.
- (4) Canadian Radium and Uranium Corp., 630 Fifth Ave., New York City, or Radium Chemical Co., Inc., 570 Lexington Ave., New York City.
- (5) Clark, G. L., and Gross, S. T., *Ind. & Eng. Chem., Analyt. Ed.*, 14, p. 676, 1942.
- (6) Slack, C. M., Thilo, E. R., and Zavallas, C. T., *Electronic Industries*, 3, p. 104, Nov. 1944.
- (7) Woods, R. C., and Kenna, L. P., *ELECTRONICS*, 14, p. 29, Apr. 1941; *Science News Letter*, 44, p. 259, 1943.
- (8) Obtainable from Supt. of Documents, Govt. Printing Office, Washington, D. C., for 10 cents postpaid.

The BETATRON

By THEODORE J. WANG

The Ohio State University
Columbus, Ohio

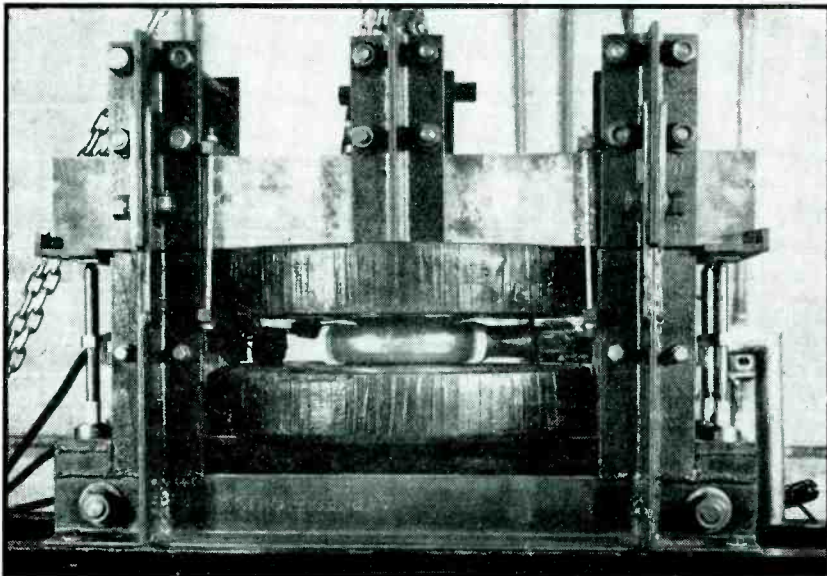

Closeup of Ohio State betatron, showing position of evacuated doughnut between the coils. Betatrons work with electrons whereas cyclotrons act on 1,800-times heavier protons, but both types of machines serve essentially the same purpose of imparting great speeds to atomic particles for x-ray generation and other tasks

from a consideration of Fig. 1. Magnetic flux is here depicted as directed upward through a circular loop of wire. The solid line of the loop indicates the portion nearer the reader, and the dotted line indicates the portion farther away. At the instant of examination the flux is assumed to be increasing in magnitude. Experimentally, with such a changing flux is associated an induced electric field whose direction at various points on the loop is as indicated by the arrows labelled E in Fig. 1(a). An electric field so directed would accelerate positive charges around the loop in the same sense as that of the electric field, and the resulting current would give rise in turn to a magnetic flux which is directed downward through the center of the loop in opposition to the time-change of the original magnetic flux.

If the original magnetic flux had been assumed to be decreasing, al-

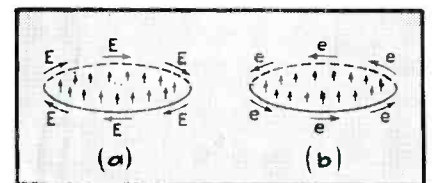

FIG. 1—(a) Electric field induced by time-increasing vertically directed magnetic flux; (b) electron acceleration in the electric field of (a)

THE BETATRON is an induction electron accelerator capable of generating electron beams of energies heretofore unattainable by any man-made device. The machine can produce the equivalent of hundreds of millions of volts, and promises to influence materially the course of many fields of engineering, of science, and of medicine.

The betatron represents the culmination of a decade of intensive study and experiment by scientists all over the world seeking to produce a high-potential induction electron accelerator.¹⁻¹⁰ Dr. Donald W. Kerst of the University of Illinois has brilliantly developed the machine into its present practical form¹¹⁻¹⁶ although Dr. Max Steenback of Berlin-Siemensstadt, Germany, claims credit for the prior invention.¹⁷

Fundamental Theory of Betatron

In its manner of accelerating, the betatron is essentially a shell-type transformer carrying on the central core leg a few-turn primary consisting of two series sections, and a many-turn secondary wound

between the primary sections. An instantaneous electromotive force

$$\varepsilon = - \frac{1}{c} \frac{d\Phi}{dt} \quad (1)$$

is induced in each turn of the secondary by the changing flux ϕ . The quantity c in the denominator of the right side of Eq. (1) represents the ratio between the numerical values of charge expressed in electrostatic and electromagnetic units respectively ($c = 3 \times 10^{10}$ cm. per sec). It is introduced in conformity with the Gaussian system of units which is employed throughout this article.

The significance of the minus sign in Eq. (1) may be appreciated

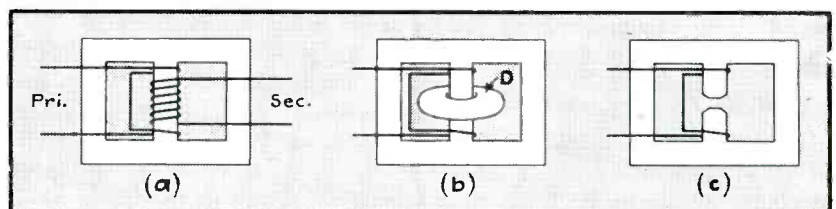

FIG. 2—(a) Shell-type transformer; (b) transformer of (a) with evacuated electron accelerating chamber D (called a doughnut) replacing the secondary winding; (c) betatron with doughnut removed, showing air gap in central core leg and tapered pole faces used to provide appropriate magnetic field space characteristics for simultaneous acceleration and confinement of electrons

Basic design equations and analysis of pole-face shapes. In just one spinning push, a-c magnets bring electrons in an evacuated doughnut to the highest velocity created by man—185,000 miles per second—for transmutation of elements, generation of the most powerful x-rays known today, and investigation of cosmic-ray effects

though still directed upward, or what is the same thing, increasing in a downward direction, the arrows of the electric field should then have been reversed, and the magnetic flux associated with the induced electric field should then have been up, again in opposition to the time-change of the original magnetic flux. It is the opposing effects of inducing and of induced magnetic fields—as expressed by Lenz's Law—which are indicated in mathematical symbolism by the minus sign of Eq. (1).

In this treatment of the betatron we shall consider only a time-increasing upward-directed magnetic flux. Under this condition positive charges which may be confined to a circular path are accelerated in the directions of the electric field arrows of Fig. 1(a), and negative charges e are accelerated in the opposite senses, as in Fig. 1(b). Because the betatron is primarily an electron accelerator, we shall henceforth refer to Fig. 1(b) for the space relationship of a time-changing magnetic flux and the associated induction electron acceleration.

Wire Path Not Necessary For Induced EMF

Now it is to be observed that an emf attributed to the time-changing magnetic flux is associated with any and with every closed path which surrounds the changing flux regardless of whether the path coincides with a wire or simply lies in space. In the case where the path is that of a loop of wire, free electrons present in the wire are displaced along the relatively low-resistance conductor, and this electron manifests itself as a current flow by a reading on a meter joining the ends of the loop. In the case of a closed path in a vacuum where the path is not shared by a conductor but where the path, neverthe-



T. J. Wang, author of this paper, with the accelerating unit of the Ohio State betatron. Machines like this can produce the world's most powerful x-rays

less, encloses changing flux, there is still an induced emf which is given by Eq. (1), wherein by ϕ we here mean that flux which is enclosed by the particular path under discussion. Evidence that the existence of an emf in the latter case is real is perhaps best established by the successful operation of the betatron itself.

In the betatron the shell-type transformer as represented by Fig. 2(a) is modified to dispense entirely with the secondary winding, as shown in Fig. 2(b), and the iron of the central leg is interrupted as shown in Fig. 2(c). In place of the secondary winding is put the evacuated doughnut-shaped acceleration chamber D in Fig. 2(b), generally called the doughnut.

Electron Gun Is Injector

Electrons are introduced tangentially into the doughnut from a hot-cathode injector. The injector is similar to the electron gun of the ordinary cathode-ray tube and is

provided with an accelerating electrode onto which a high-positive-potential pulse is periodically applied to shoot electrons in bunches into the chamber. Injection is electronically triggered to transpire for a few microseconds at the beginning of each cycle of the magnetic field, as at A and A' of Fig. 3. (Space charge repulsion within the electron beam sets the upper limit to the duration of effective injection pulses.)

During the quarter cycle following injection, acceleration of the electron beam is accomplished by the time-changing flux. Confinement of the beam to repetitive circular paths to permit extended acceleration up to the time of the peak of the cycle (when the electron energies are utilized) is achieved through the interaction of the electron velocity with the appropriately space-shaped magnetic field of the accelerating unit.

The centripetal force on a single electron is given by

$$F = H \frac{e}{c} \quad (2)$$

where H is the intensity of the magnetic field at the position of the electron, and v is the electron velocity. The interaction force is perpendicular both to the field and to the electron velocity, providing centripetal action in the horizontal median plane of the doughnut.

Equation (2) can be obtained directly from the common motor force relation for a conductor of length l centimeters which carries a current of I amperes in a field of H gauss: $F = HIl/10$. Since $I = Anev$, where A is the cross-section area of the conductor in square centimeters, n the number of electrons per cubic centimeter, e the charge per electron in coulombs, and v the velocity of the electrons in centimeters per second, we obtain $F = H A n e v l / 10$. If we take e in electrostatic units as in the Gaussian system, we get for the above expression $F = H A n e v l / c$. Now the total number of electrons in the length l is $A n l$, and on the average the force per individual electron in the wire is equal to the total force divided by the total number of electrons. Evaluation of the force per electron in this manner yields Eq. (2).

Power Factor Correction Needed

Incidentally, with the air gap essential for the correct magnetic field distribution through the doughnut, the betatron excitation voltampere requirements are considerably higher than those of a comparable closed-core transformer. Also, with the betatron as it is employed at present the secondary load contributes negligible reflected impedance into the primary so that from the standpoint of input the betatron more closely resembles a transformer at no load or simply a choke coil. In practice it is found economically necessary to employ a large power-factor-correction capacitor bank either in series with the line for series resonant operation or across the line for parallel resonant operation. This capacitor bank represents a major item in the initial cost of a betatron

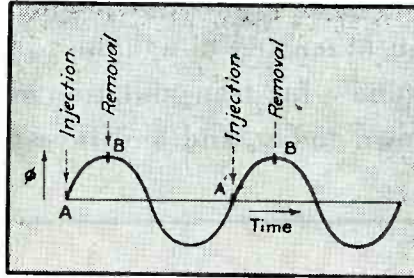

FIG. 3—Magnetic field cycle. Injection of electrons occurs at A, with the acceleration period lasting until B. The next burst of electrons is released into the chamber at A' of the following cycle

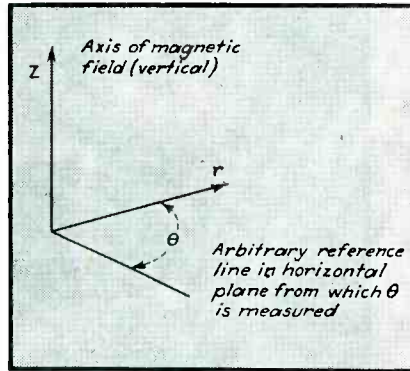

FIG. 4—Cylindrical coordinate system for analysis of betatron operation

installation. (General Electric's hundred million-volt betatron boasts the largest capacitor bank in the world.)

Equations for Betatron Operation

The general mode of operation of the betatron can be appreciated from a consideration of a few elementary principles. The central core legs, and consequently the magnetic field through the doughnut, are of cylindrical symmetry suggesting the use of cylindrical coordinates r , θ , and z for analysis (Fig. 4). We shall first assume the desired condition of a circular electron orbit of radius r_0 in the median plane of the doughnut and see what restrictions this implies for the magnetic field. By Eq. (1) the emf—work per unit charge—induced around the circular path at any particular time is given by

$$\xi = - \frac{1}{c} \frac{d\Phi}{dt}$$

Because of the radial symmetry of the magnetic field the electric force acting on a unit charge at any point in the circular orbit is independent of θ or, in other words, is the same

as the force which the charge would experience if it were located at any other point in the orbit at the same time. Hence, we can say that the electric field—force per unit charge—at any point in the orbit is given by

$$E = \frac{\xi}{2\pi r_0} = - \frac{1}{2\pi r_0 c} \frac{d\Phi}{dt} \quad (3)$$

The symmetry property is essential for Eq. (3) because otherwise we could say only that at any given time

$$\xi = \int E dl \cos \alpha,$$

where dl represents an infinitesimal path length forming an angle α with E , and where both α and E conceivably vary in magnitude from point to point around the orbit.

From Eq. (3), the force on an electron at any instant is given by

$$F = \frac{\xi e}{2\pi r_0} = - \frac{e}{2\pi r_0 c} \frac{d\Phi}{dt} \quad (4)$$

For the present we are concerned only with the magnitude and not with the sense of direction of F , so the minus sign of Eq. (4) may be dropped. Equating the magnitude of the force to the time derivative of the momentum of the electron in accordance with Newton's Second Law, we obtain

$$\frac{d(mv)}{dt} = \frac{e}{2\pi r_0 c} \frac{d\Phi}{dt} \quad (5)$$

Integration of Eq. (5) gives for the momentum of the electron at any instant

$$mv = \frac{e}{2\pi r_0 c} (\Phi - \Phi_0) \quad (6)$$

where Φ_0 is the flux through the orbit at the instant corresponding to zero momentum, that is, at the beginning of the magnetic field cycle. At this time the flux is zero, and hence Eq. (6) becomes

$$mv = \frac{e\Phi}{2\pi r_0 c} \quad (7)$$

At this point it may be well to note that in Eq. (5), $d(mv)/dt$ is specifically employed instead of $m dv/dt$, inasmuch as the mass of the electron is a function of its velocity relative to the observer in accordance with the relation

$$m = \frac{m_0}{\sqrt{1 - (v/c)^2}} \quad (8)$$

In Eq. (8) m_0 is the so-called rest mass of the electron. In what follows it will be tacitly considered that, except possibly for the first few revolutions following injection

where the speed of the electron is relatively low (i.e., where $v/c \ll 1$) and where, consequently, $m \cong m_0$, any reference to the mass of an electron will imply mass as expressed by Eq. (8).

In order that the electron may be confined to the circular orbit of radius r_0 while it is simultaneously accelerated, it is essential that the magnetic field H_0 at the position of the orbit at each instant satisfies the centripetal force relation

$$H_0 \frac{e}{c} v = \frac{m v^2}{r_0}$$

or the equivalent relation

$$m v = H_0 \frac{e}{c} r_0 \quad (9)$$

With the maximum (in time) field intensity H_0 limited by the characteristics of the magnetic steel, a machine which is to yield high final electron momentum must be necessarily large in size in accordance with the high value of r_0 demanded by Eq. (9). A 50 million-volt betatron would have an orbital radius of about 2 feet; a 500 million-volt betatron would have an orbital radius of about 15 feet.

The 1:2 Field-Flux Condition

Equation (9), the confining relation, together with Eq. (7), the accelerating relation, impose the necessary field-flux condition for simultaneous acceleration and radial confinement:

$$\frac{e \Phi_0}{2\pi r_0 c} = H_0 \frac{e}{c} r_0$$

$$\Phi_0 = 2\pi r_0^2 H_0 \quad (10)$$

Equation (10) shows that at all times during the acceleration cycle the space configuration of the magnetic field through the doughnut must be such that the flux enclosed by the orbit is just twice that which would obtain if the magnetic field was uniform across the doughnut and of strength H_0 at each point. Following Steenbeck,⁵ we shall henceforth refer to Eq. (10) as the 1:2 condition.

Shape of Pole Faces

A not unnatural procedure in the design of an induction accelerator of the betatron type might be to shape the pole pieces in the general manner of Fig. 5(a), with a taper from wide to narrow gap in the di-

rection of increasing radii. With this design the magnitude of the magnetic field in the median plane of the doughnut is radially increasing, corresponding to the radially decreasing reluctance of the outwardly narrowing air gap. Intuitively, the radially increasing field strength makes for increased centripetal force at large radii, which should presumably self-compensate for any tendency of the electron beam to spiral outward at high speeds. This type of field configuration, however, fails to satisfy the 1:2 condition, and, thus, fails to provide a possible orbit, at any radius within the confines of the pole faces. It was employed by several investigators before Walton first indicated the necessity of the 1:2 relation⁴ and was even employed by some designers after this,^{8,9} partly accounting for the unsuccessful operation of many otherwise ingenious machines.

An additional serious disadvantage of the field configuration which results from the pole shape of Fig. 5(a) is an inherent vertical instability of the electron beam. This is evident on examination of Fig.

5(b) wherein are shown the directions of the field-velocity interaction forces for electrons which are traveling in the manner specified by Fig. 2(b) and which are above or below the median plane of the doughnut. For an electron which happens to stray a small distance above or below the median plane (for example, through collision, or through space charge repulsion from the remainder of the beam), the interaction force provides a component which shifts the electron even further away and in short order causes the electron to collide with the walls of the vessel.

In Fig. 6(a) are shown pole faces which taper so as to produce a radially increasing reluctance of the flux through the doughnut and, hence, a radially decreasing median-plane field. The corresponding field-velocity interaction forces for electrons which deviate from the median plane are shown in Fig. 6(b). These forces are such that an electron which strays either above or below the median plane experiences a vertical component of force which acts to restore it to the median plane. Strongly tapered pole faces

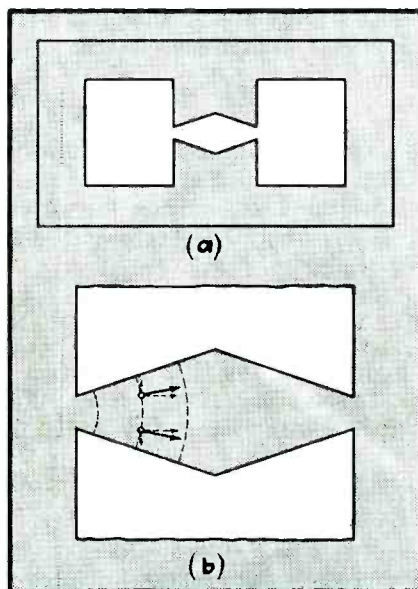

FIG. 5—(a) Transformer yoke with pole faces tapered so as to narrow the gap and strengthen the field toward the outside; (b) magnified section through pole pieces, showing velocity-field interaction forces (radial and vertical components dotted) on electrons which find themselves above or below the median plane

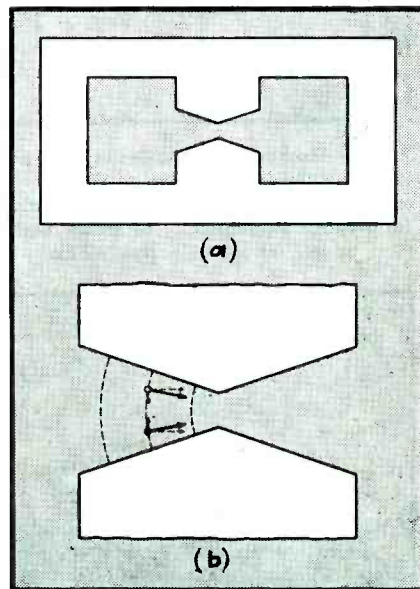

FIG. 6—(a) Transformer yoke with pole faces tapered so as to widen the gap and weaken the field toward the outside; (b) magnified section through pole pieces, showing velocity-field interaction forces (radial and vertical components dotted) on electrons which find themselves above or below the median plane

produce bowed field lines and, hence, provide best vertical focusing. Horizontal (no-taper) pole faces provide vertical field lines throughout the doughnut and so provide no vertical focusing.

Requirements for Stable Electron Orbits in the Doughnut

To exactly what extent the field should be caused to fall off with the radius in a practical machine depends on the limitations of the simultaneous radial and vertical focusing requirements. These requirements are: (a) at least one possible orbital radius (that is, at least one value of r within the chamber for which the 1:2 condition is realized); (b) radial stability (in order to maintain the beam at the position of the 1:2 radius in spite of

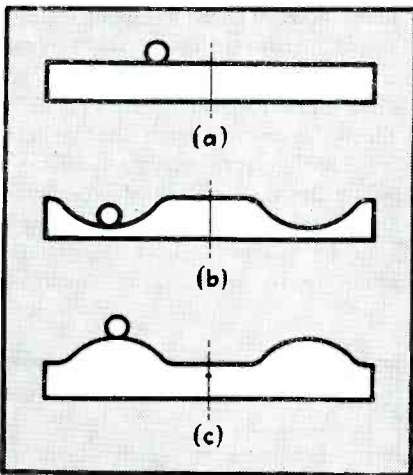

FIG. 7—Mechanical analogies of three possible equilibrium conditions in the betatron, involving a marble on a circular table. (a) Neutral equilibrium; (b) stable equilibrium; (c) unstable equilibrium

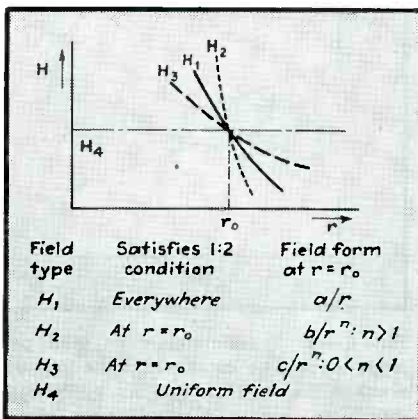

FIG. 8—Relationships of magnetic field H to electron orbit radius r for a betatron

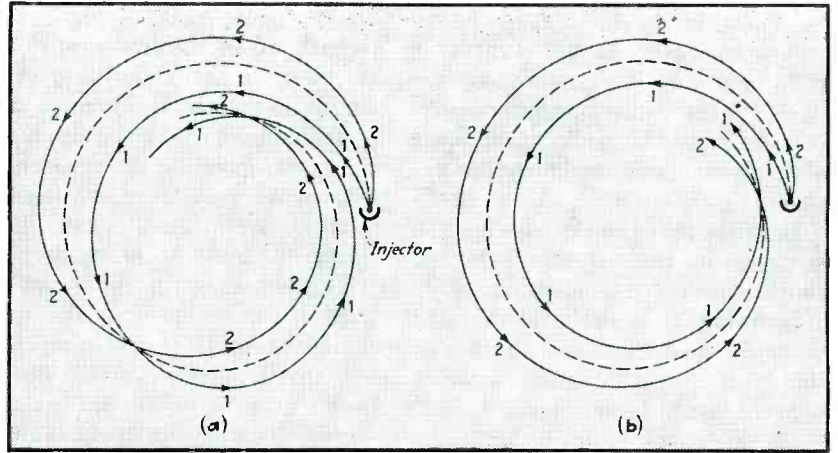

FIG. 9—(a) Vertical projection of trajectories of individual electrons immediately after injection. Extreme edges of beam are labeled 1 and 2, and center of beam is shown dotted; (b) electron orbits on first revolution following injection for the case of median-plane field intensity proportional to $r^{-0.15}$. The focusing forces produce an image of the injector adjacent to the injector on each revolution of the beam

radial components of space charge repulsion and collision forces); (c) vertical stability (in order to maintain the beam in the median plane of the chamber against vertical components of space charge repulsion and collision forces).

Because of the cylindrical symmetry the magnetic flux ϕ which is included within the radius r in the median plane of the doughnut may be expressed as the summation of the elementary fluxes included within individual median-plane ring elements, each of area $2\pi\rho d\rho$. Thus,

$$\Phi = \int_{\rho=0}^{\rho=r} H 2\pi\rho d\rho \quad (11)$$

A median-plane field configuration, $H = f(r)$, which is such that it satisfies the 1:2 condition for all values of r may be obtained then by writing

$$\int_{\rho=0}^{\rho=r} H 2\pi\rho d\rho = 2\pi r^2 H \quad (12)$$

and solving for H as a function of r . To solve Eq. (12) for H we differentiate with respect to r , obtaining

$$Hr = 2rH + r^2 dH/dr \text{ or } \frac{dH}{H} = -\frac{dr}{r} \quad (13)$$

Equation (13) integrates into

$$\log H = \log a - \log r \quad (14)$$

where a is the constant of integration. Equation (14) yields

$$H = a/r \quad (15)$$

Equation (15) then represents a median-plane field configuration which satisfies the 1:2 condition for all values of r .

In a field of the type given by Eq. (15), electrons within the doughnut can take up stable orbits at any and at every radius. This type of field presents a condition of neutral equilibrium as far as concerns radial displacements of electrons. An analogous mechanical system is that of a marble on a flat table wherein every position on the table is one of equilibrium, as in Fig. 7(a).

Three Conditions of Equilibrium

What is desired in the betatron is a condition of stable equilibrium at a particular radius; that is, a condition wherein the 1:2 relation is satisfied at the orbital radius and where, for radii in the neighborhood of the orbital radius, restoring forces exist at all times during the accelerating cycle and tend to return straying electrons to the position of the orbital radius. The analogous mechanical case with the marble would be obtained with an annular depression in the table at the desired orbital radius, as in Fig. 7(b).

A third possible condition—an obviously undesirable one—is that of unstable equilibrium wherein although the 1:2 relation is satisfied at a particular radius, the field forces in the neighborhood of this radius act in such a manner as to increase any displacement of electrons from this radius. The me-

chanical analogy is provided by an annular ridge on the table as in Fig. 7(c).

The first type of equilibrium with respect to radial displacements—neutral equilibrium—is obtained, as we have noted, with the inverse radius type of magnetic field. The second and third types of equilibrium—stable and unstable—can be obtained with slightly different field configurations.

In Fig. 8 are shown three possible field-radius relationships, labelled H_1 , H_2 , H_3 . These are taken such that at the desired orbital radius, r_0 , $H_1 = H_2 = H_3$. H_1 represents the inverse radius function which satisfies the 1:2 condition for every value of r . H_2 and H_3 are presumed to satisfy the 1:2 condition at the one abscissa $r = r_0$ but not necessarily at any other radius. In the neighborhood of the radius r_0 , both H_2 and H_3 decrease with increasing radius but with

$$\left| \frac{dH_2}{dr} \right| > \left| \frac{dH_1}{dr} \right| > \left| \frac{dH_3}{dr} \right| \text{ at } r = r_0$$

For radii slightly greater than r_0 , where H_2 is less than H_1 , H_2 is too small to satisfy the 1:2 condition; for radii slightly less than r_0 , where H_2 is greater than H_1 , H_2 is too large to satisfy the 1:2 condition.

The net result is that with a field of the type of H_2 an electron which for any reason drifts outward from the normal orbital radius experiences a reduction in centripetal force with consequent further outward drift, and an electron which drifts inward experiences increased centripetal force which in turn encourages the inward motion. Thus, a field such as H_2 provides only unstable equilibrium at $r = r_0$. The situation corresponds to the mechanical analogy of Fig. 7(c). On the other hand, a field such as H_3 provides genuine radial stability corresponding to the mechanical analogy of Fig. 7(b), for in this case an outward drift of an electron is counteracted with an increased centripetal force, and an inward drift is counteracted with a decreased centripetal force. There is no need to consider any field with a positive gradient at $r = r_0$ because such a field, as we have seen,

fails to provide vertical stability for the electron path.

Geometry of a Practical Betatron

To summarize, we have arrived at the necessary geometry for the median-plane field of a practical induction accelerator in which we have an equilibrium orbit and both radial and vertical restoring forces: (a) the field must be such that in the neighborhood of the equilibrium orbit

$$H \propto 1/r^n, \text{ where } 0 < n < 1 \quad (16)$$

and (b) the flux of this field contained within the equilibrium orbit the 1:2 condition. Equation (16) was first specifically pointed out by Steenbeck.⁶

The limits on n in Eq. (16) are in accord with the following considerations. It will be noted with reference to Fig. 8 that greatest radial restoring action is obtained for those type H_3 fields which in the neighborhood of r_0 have slopes approaching zero, corresponding in Eq. (16) to the exponent n approaching zero. Low values of n , however, mean gradual radial decrease of reluctance of the air gap through the doughnut as provided by gently tapered pole faces, and this we have seen in connection with considerations of Fig. 6 implies poor vertical focusing. On the other hand, a value of n equal to unity

in Eq. (16) yields best vertical focusing and no radial focusing.

It might be presumed that an optimum value of n would be $\frac{1}{2}$ in order to compromise between radial and vertical stability. However, there are other considerations which affect the choice of n , as shown by a detailed study of the transient trajectory phenomena presented by Kerst and Serber.¹⁴ In the analysis of the transient state of affairs just following injection—or just following any displacement of an electron from its normal equilibrium orbit—it is shown that the path of the electron is approximately as depicted in Fig. 9(a). Here not only does the electron orbit as a whole shift toward the equilibrium radius, but during the time of this shift, the electron executes local oscillations, oscillating radially in and out across the equilibrium radius and vertically above and below the equilibrium plane. The oscillatory motion is occasioned by the radial and vertical focusing forces. These forces increase with time as the magnetic field rises during the cycle, so that the amplitude of the oscillations decreases with time.

Making the Electron Beam Clear the Injector

Kerst and Serber demonstrate that for pole faces which are shaped

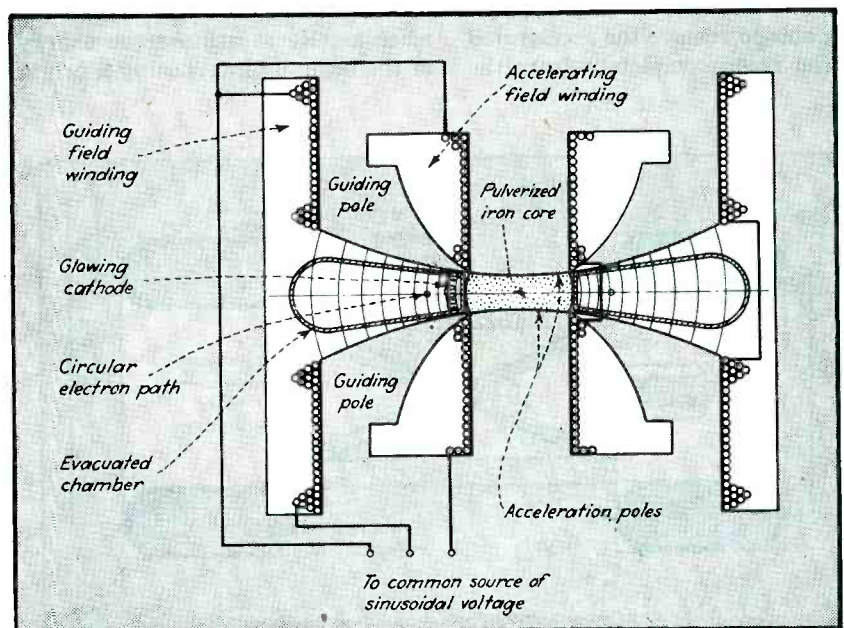

FIG. 10—Section through electron accelerator designed by Steenbeck illustrating use of two pairs of a-c energized coils

to give a field of the type $H \propto r^{-3/4}$ in the neighborhood of the equilibrium orbit, the radial oscillatory motions of the electrons in an injected pulse are such as to yield images of the injector (in the manner of optical images) at, and only at, points which are adjacent to the injector. The nature of the orbits within the beam for the first revolution following injection is shown in Fig. 9(b). This type of electron beam action is highly desirable in that it means that if one electron of the beam clears the injector on coming around the doughnut, then all electrons of the beam clear the injector. This is particularly useful inasmuch as it is obligatory to locate the injector reasonably near to the ultimate equilibrium orbit in order to insure capture within the orbit of a practical percentage of the injected beam.

With any type of field other than $r^{-3/4}$ a certain number of electrons would very likely collide with the back of the injector on each revolution even though the main portion of the beam might be adequately clearing.

Use of Saturation

The beam may be displaced laterally within the doughnut by upsetting those magnetic field conditions which make for confinement at a particular radius. In the hopes of being able to remove the accelerated electron beam completely from the

chamber near the peak of the magnetic field cycle Steenbeck so designed his iron structure as to cause magnetic saturation to set in earliest at the outer rim of the pole faces.

A section through Steenbeck's pole pieces is shown in Fig. 10, based on his American patent.⁵ With this arrangement, for a short time in the cycle following the onset of saturation at the outer rim of the pole face the field at the normal position of the beam rises only slightly, while the flux through the unsaturated center still continues to rise in proportion to the exciting current. The result is that the field at the orbit is then too weak to provide the necessary restraining force demanded by the 1:2 condition, and the beam shifts outward.

Kerst^{13, 16} improved the differential saturation technique by using central caps of iron dust on simple tapered pole pieces. The cross section through Kerst's accelerator, shown in Fig. 11, is based on his U. S. patent.¹⁶ The central pole caps, having a lower density than the rest of the iron, saturate earliest in the cycle and cause the beam to spiral inward.

Target in Doughnut

Being aware of the focusing difficulties of attempting to remove the intact beam completely from the machine, Kerst utilized the energy of the beam by interposing a target

in the path of the inwardly displaced accelerated beam within the doughnut. Collision of the electrons with the target gives rise to x-radiation which passes, unmolested by the magnetic field, directly through the walls of the chamber.

In Kerst's second machine¹⁷ he expands rather than contracts the orbit, and he uses the back of the injector as a target. Expansion is accomplished at any desired time in the cycle, and hence at any desired electron energy up to the maximum of the machine, by electronically discharging a capacitor through a pair of single-turn coils which are mounted directly onto the pole faces above and below, and slightly toward the center of the normal equilibrium orbit. The momentary surge of current through these coils causes a strengthening of the central flux with little change, however, in the field at the position of the orbit. As a consequence, the field at the orbit becomes inadequate to retain the electrons, and the beam spirals outward.

REFERENCES

- (1) Slepian, J., U. S. Patent No. 1,645,304, Oct. 11, 1927.
- (2) Breit, G., Tuve, M. A., and Dahl, O., *Carnegie Institution Yearbook for 1927-28*, p. 209.
- (3) Wideroe, R., *Archiv für Elektrotechnik*, 21, p. 387, 1928.
- (4) Walton, E. T. S., *Proceedings of the Cambridge Philosophical Society*, 25, p. 463, 1929.
- (5) Steenbeck, M., U. S. Patent No. 2,103,303, Dec. 28, 1937.
- (6) Jassinsky, W. W., *Journal of Experimental and Theoretical Physics (U.S.S.R.)*, 5, p. 983, 1935.
- (7) Jassinsky, W. W., *Electricity (U.S.S.R.)*, 3, p. 37, 1936.
- (8) Jassinsky, W. W., *Archiv für Elektrotechnik*, 30, p. 500, 1936.
- (9) Penney, G. W., U. S. Patent No. 2,193,602, March 12, 1940.
- (10) Terletzky, Ia. P., *Journal of Experimental and Theoretical Physics (U.S.S.R.)*, 11, p. 96, 1941.
- (11) Kerst, D. W., Acceleration of Electrons by Magnetic Induction, *Physical Review*, 58, p. 841, 1940.
- (12) Kerst, D. W., *Physical Review*, 59, p. 110, 1941.
- (13) Kerst, D. W., Acceleration of Electrons by Magnetic Induction, *Physical Review*, 60, p. 47-53, July 1, 1941.
- (14) Kerst, D. W., and Serber, R., Electron Orbits in Induction Accelerator, *Physical Review*, 60, p. 53-58, July 1, 1941.
- (15) Kerst, D. W., Twenty-Million Electron-Volt Betatron—or Induction Accelerator, *Review of Scientific Instruments*, 13, p. 387-94, Sept. 9, 1942.
- (16) Kerst, D. W., U. S. Patent No. 2,297,305, Sept. 29, 1942.
- (17) Steenbeck, M., *Naturwissenschaften*, 19, p. 234, 1943.

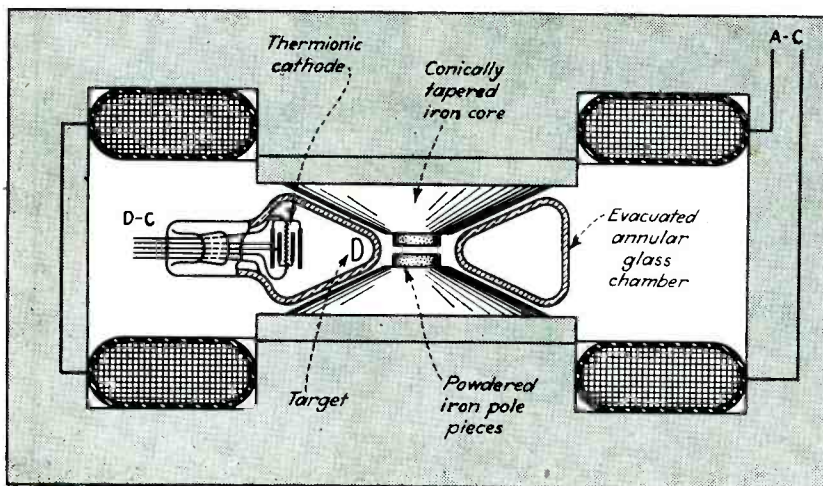

FIG. 11—Section through Kerst's first accelerator, using one pair of coils like those on the Ohio State betatron

Artificial Delay-Line Design

Design of artificial line for signal delay is facilitated by a chart. Permissible delay per section is determined from equations on the basis of tolerable distortion of the signal by the line. This information is used with the chart to determine line components

By **J. B. TREVOR, Jr.**

Chief Project Engineer
Naval Research Laboratory
Anacostia, D. C.

USE of low-pass filters to delay^{1, 2} and generate³ rectangular pulses is well known. Design of such filters, while not difficult, is often tedious due to repeated computations which must be made to satisfy performance specifications with available components. A graphical method for designing the low-pass filter type of delay line will be developed which materially reduces the labor involved.

Permissible Distortion

The first step in design of an artificial delay line is to fix the degree by which the wave shape of the response may differ from that of the driving force. This step is important because the greater the variation which can be tolerated between

driving force and response, the fewer sections there need be in the filter, other factors being equal. The most practical approach is to analyze a delay line with ideal characteristics, and then estimate the per-

formance of actual delay lines in terms of their departure from the ideal.

An ideal delay line is one in which the response function, which is the ratio of the response voltage to the driving voltage for steady-state sine-wave excitation, is a complex number with constant amplitude K from 0 cps to f_1 , the cutoff frequency, and with a phase function θ which is given by $\theta = 2\pi f t_d$ over the same limits. Outside the limits $0 < f < f_1$ (more properly $-f_1 < f < f_1$) the amplitude of the response function is zero.

When a rectangular pulse of voltage is applied to the input terminals of a line with these ideal characteristics, the output voltage has the form of the following equation^{4, 5}

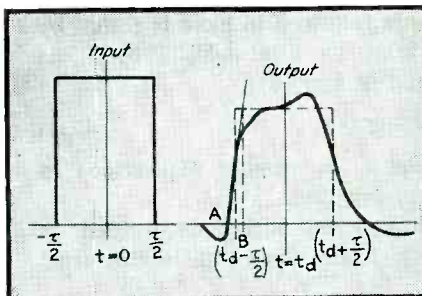

FIG. 1—Rate of rise of the resultant pulse from the delay line is taken as the distortion factor in determining maximum delay per section

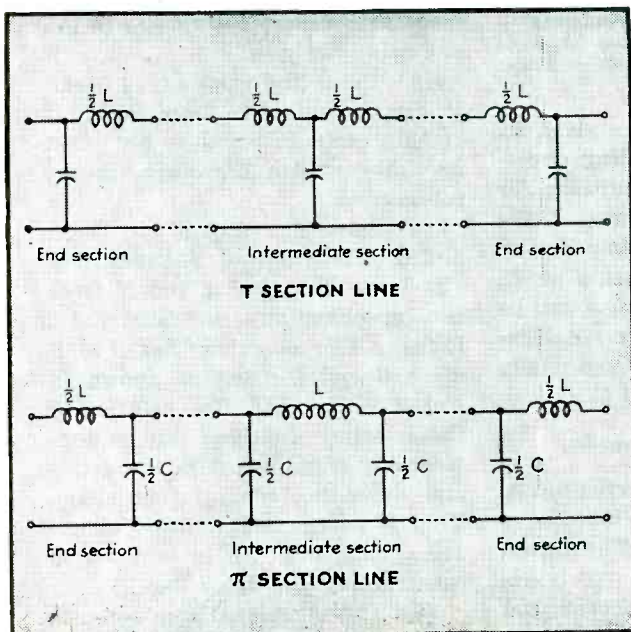

FIG. 2—Artificial line used for delay consists of end sections and as many intermediate sections as are necessary to produce the required delay

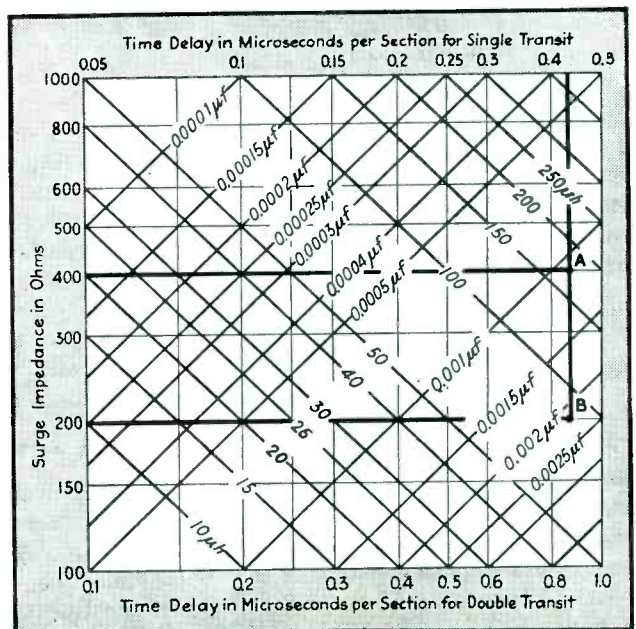

FIG. 3—The final operation in designing the artificial line is to read reactances from the chart as illustrated here for the example in the text

$$e(t) = \frac{EK}{\pi} \left[Si 2\pi f_1 \tau \left(\frac{t-t_d}{\tau} + \frac{1}{2} \right) - Si 2\pi f_1 \tau \left(\frac{t-t_d}{\tau} - \frac{1}{2} \right) \right] \quad (1)$$

where

- E = amplitude of original pulse
- K = amplitude of response function
- τ = pulse period
- t_d = time delay introduced by the line.
- This quantity is equal to the slope of the phase function
- Si = symbol for the sine integral

$$Si x = \int_0^x \frac{\sin u}{u} du$$

$e(t)$ = output voltage

f_1 = cutoff frequency of line

t = time, measured from center of the applied pulse

If Eq. (1) is solved, it is found that the form of $e(t)$ more nearly approaches the input wave form as the product $f_1\tau$ is made greater. This is equivalent to stating that as the cutoff frequency of a line is raised the form of the output approaches more closely that of an input of arbitrary shape.

Transient Distortion

If it is required that a line pass a rectangular pulse with less than a specified amount of distortion, it is necessary to define distortion. A convenient criterion is that the *rise time* shall be held within certain limits. Rise time can be defined as the time which a pulse, with a slope in the rise period equal to the first derivative of Eq. (1) at the instant $t = t_d - \tau/2$, takes to rise from zero to an amplitude EK . According to this definition the rise time can be found from

$$T_r = \frac{EK}{(de(t)/dt)_{t=t_d-\tau/2}} \quad (2)$$

where T_r = rise time.

Assuming that $f_1 \geq 4/\tau$, which will be the case for a line which gives at least a fairly good reproduction of the applied emf, the first derivative of the second sine integral in Eq. (1) can be neglected for practical purposes, and

$$(de(t)/dt)_{t=t_d-\tau/2} \cong 2\pi f_1 EK/\pi \quad (3)$$

From Eq. (2) and (3)

$$T_r \cong 1/2f_1 \quad (4)$$

This result allows the rise time of an ideal filter to be expressed in terms of cutoff frequency. For a physically realizable filter it is necessary to include a constant M in Eq. (4) to take care of the difference between actual and ideal characteristics:

$$T_r = M/2f_1 \quad (5)$$

Figure 1 shows the rise time for the actual pulse output from a delay line with rectangular-pulse input. The rise time T_r is given by the length AB . For this particular filter and pulse, $M = 1.4$ in Eq. (5). Quite frequently $1.4 \leq M \leq 2.0$ for actual delay lines.

Delay-Line Design Equations

It is of advantage to rewrite Eq. (5) in terms of the delay per section, T_s , instead of f_1 . Thus $T_r = A/\pi f_1$, where, as in a low-pass filter, $f_1 = 1/\pi\sqrt{LC}$, and A is unity for a single transit, and two for a double transit (these terms will be explained later). Now Eq. (5) can be written

$$T_r = (2A/\pi M) T_s \quad (6)$$

If the maximum allowable rise time is given, the maximum delay per section can be computed by means of Eq. (6).

The number of sections which the line is required to have is found by dividing the total delay T by T_s , as found in Eq. (6)

$$N = T/AT_s \quad (7)$$

where N = number of sections in the delay line.

Additional equations needed to complete the design of the line are:

$$T_s = A\sqrt{LC} \quad (8)$$

$$R = \sqrt{L/C} \quad (9)$$

where

- R = characteristic impedance of the line in ohms
- L = inductance per section in henrys
- C = capacitance per section in farads
- A = constant of unity value for single transit, and equal to two for double transit

Using a value of R as given by Eq. (9) for the terminating resistance of the line, the conditions for minimum reflections are met. If the external circuits do not impose any very stringent requirements on R , the value of this resistance can be so chosen that the other specifications are met with commercially available values of L and C .

Single or Double Transit

The constant A is inserted in Eq. (8) to take care of the two ways of using a delay line: The initial pulse may be allowed to travel down the line to the opposite end from which it is applied, and, if the latter end is terminated in the characteristic impedance R of the

line, there will be no reflection. Such a pulse is said to make a single transit of the line. On the other hand, if the end of the delay line is open- or short-circuited, the pulse upon reaching the end of the line is reflected back along the line. In this case the pulse makes a double transit of the line. In the double transit case it is, of course, necessary to terminate the input end of the line with the characteristic impedance R and take the delayed pulse from the input end. Double transit gives twice the delay for a given line that is found for single transit, so its use is of advantage if the presence of both the incident pulse and the delayed pulse can be tolerated at the same point in the external circuit.

Design Procedure

The following steps are necessary to design a delay line.

(1) Specifications of the line are established. These include the delay time T , whether or not single or double transit is to be used, the maximum allowable rise time T_r (if $T_r \leq \tau/8$ distortion will not be excessive), and the limits within which R must be kept. If standard components, particularly capacitors, are to be used, this fact should be stated.

(2) Substitute the value of T_r from the specifications into Eq. (6). This gives T_s . The constant M in Eq. (6) can be taken as 1.5 unless a better value is known from experience with delay lines similar to the one being designed.

(3) Using the value of T_s found in Step (2), find N from Eq. (7). If this computation does not yield an integer, use the next largest integer for N .

(4) Solve Eq. (8) and (9) for L and C . The value of T_s from Step (2) is needed, and A and R from the specifications in Step (1). Either a T or π section filter of middle and end sections as shown in Fig. 2 can be used. The solution of these latter equations can be considerably simplified with the artificial delay-line computation chart. This is particularly true if standard components are to be used in constructing the delay line.

(5) The completed line consists of $N - 1$ T or π sections terminated at each end in a half-section as shown in Fig. 2.

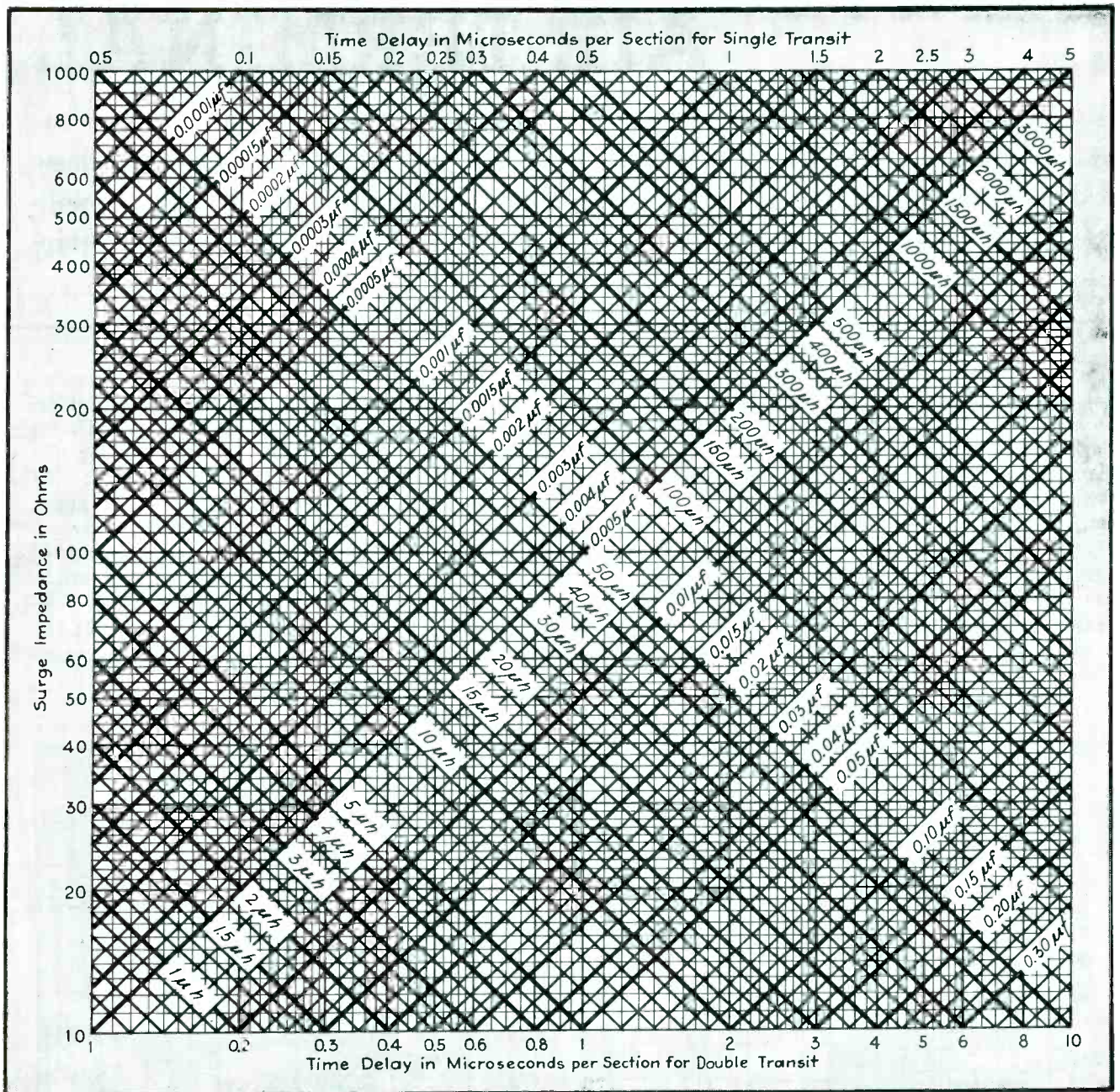

Delay-line chart from which reactances are read once the maximum delay per section and characteristic impedance have been determined from equations given in the text

The procedure will be demonstrated by an illustrative example. Let it be required to design a single transit delay line which will delay a 10-microsecond pulse by 8 microseconds. The rise time shall be not more than one microsecond. The surge impedance of the line is to lie between 200 and 400 ohms. Commercially available capacitors are to be used, but the inductors may have any value. From Eq. (6) $T_s = 2AT/1.5\pi = 2 \times 1 \times 1/1.5\pi = 0.432 \mu \text{ sec}$, and from Eq. (7) $N = T/AT_s = 8/0.432 \cong 19$.

The problem is now stated in a form which allows the use of the artificial delay-line chart. We have $200 < R < 400$, and $T_s = 0.432 \mu \text{ sec}$ for a single transit. Substitution in the chart, illustrated in Fig. 3, shows that a range of solutions lies over the line segment AB. At any point of AB the values of inductance and capacitance given by the intersecting diagonals is a solution. Recalling that the capacitor is to be of a commercially available size, C can be fixed at $0.002 \mu \text{ f}$, giving $L = 93 \mu \text{ h}$

$$C = 0.002 \mu \text{ f}$$

$$R = 214 \text{ ohms}$$

The complete delay line consists of 18 full sections with $L = 93 \mu \text{ h}$ and $C = 0.002 \mu \text{ f}$, and two half sections with $L = 46.5 \mu \text{ h}$ and $C = 0.001 \mu \text{ f}$.

REFERENCES

- (1) Sullivan, W. L., Analysis of Systems with Known Transmission-Frequency Characteristics by Fourier Integrals, *Electrical Engineering*, 61, No. 5, May, 1942.
- (2) Guillemin, E. A., "Communication Networks," John Wiley and Sons, 2, Chap. XI.
- (3) Puckle, O. S., "Time Bases," John Wiley and Sons, p. 186.
- (4) Guillemin, ref. (2), p. 485.
- (5) Sullivan, ref (1), Eq. (14).
- (6) Puckle, ref (3), p. 187.

AIR TERMINAL

How an up-to-date sound system was engineered to solve the problems peculiar to the busy Lockheed Air Terminal at Burbank. Special features include the use of six 20-watt amplifiers, speech compression, instant operation, and standby units. Circuit-checking equipment is built-in

AT Lockheed Air Terminal in Burbank, Calif., one of the major Pacific-Coast airports, a modern sound system has been installed. Former equipment involved use of a number of microphones by various individuals and a circuit which required a wait for tubes to warm up. The general character of operation has been markedly improved by making all announce-

ments from the PBX switchboard. Seven hundred or more announcements are now made daily with less than 15-sec time lapse between the announcement and the request that originates it.

In the design and engineering of the new system, these requirements were established in advance: (1) 120 watts of audio power; (2) Microphone input from one or more

locations without cross interference; (3) Speech compression at high input levels; (4) Music distribution to selected areas; (5) Speech distribution to all areas, mixed with music at selected areas; (6) Automatic fader control of music with push-to-talk operation; (7) Instant operation; (8) Adequate circuit-checking method; (9) Spare amplifiers for speech chan-

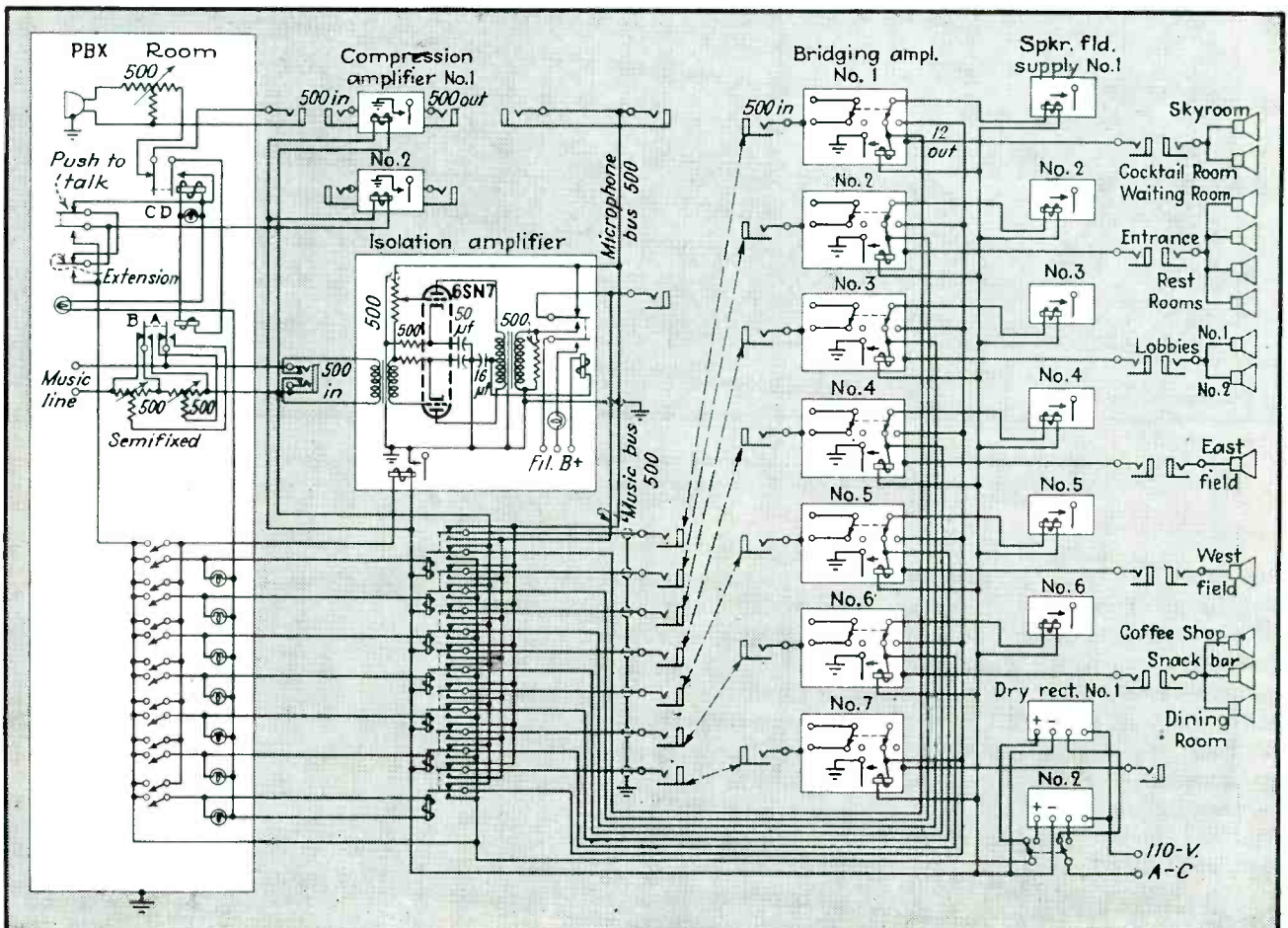

FIG. 1—Control-circuit diagram relates functions of compression amplifier, isolation amplifier, and bridging amplifiers with associated switching, relays, and power supplies

SOUND SYSTEM

By **WILLIAM W. BROCKWAY**

Sound Engineer, Metro-Goldwyn-Mayer Studios, Culver City, Calif.

and

DON C. BROCKWAY

Instructor in Radio & Sound, City Schools Los Angeles, Calif.



Sound-system problems at the Lockheed Air Terminal in Burbank include coverage of dining rooms as well as large field areas outside. Music and speech are mixed in some areas, not mixed in others

nels; (10) Wide-range two-way speaker systems; (11) Modern mechanical design; and (12) Continuous trouble-free service.

Main Amplifiers

Six 20-watt bridging amplifiers are used to supply the areas designated in Fig. 1. A seventh is used as a spare and is normally tied to the bridging bus. The use of several low-power units instead of one large unit provides flexibility of distribution as well as spare units for emergency operation.

These amplifiers, shown in Fig. 2, are of conventional design, using a 6SJ7 pentode, a 6SJ7 triode phase inverter, and push-pull 6L6's operating Class A. Each amplifier has its own power supply and all tubes are operated from a pre-heated condition. A control relay shunts out a resistance in series with the power-transformer primary and also completes the high-voltage supply circuit to ground when the system is in use. This series resistance is so adjusted as to reduce voltage on the filaments 20 percent in the standby condition.

Fifteen-decibel negative feedback is employed. The frequency characteristics are minus $1\frac{1}{2}$ db from 20 to 20,000 cps. The gain is 50 db from a 500-ohm bridging bus. Harmonic distortion is held to less than 2 percent due to the special design of the output transformer.

Associated with six of the bridging amplifiers are speaker field power supplies adequate to take care of all speaker units operating with each individual amplifier. To reduce the possibility of failure of any of these speaker power supplies, two 5U4-G tubes are used in each unit.

A special switching arrangement associated with the power switch of each bridging amplifier provides automatic switching of the associated speaker-field power supply to the spare amplifier when the bridging amplifier is turned off and the spare bridging amplifier is turned on. (See Fig. 1)

Pre-Amplifier and Compressor

The compression amplifier or microphone pre-amplifier shown in Fig. 3 is of the feedback compression type* and was selected for smoothness of operation and lack of thumps. It has a self-contained power supply and associated relay with the same function as that of the previously described relays incorporated in the bridging amplifiers and speaker-field power supplies.

This amplifier, which will compress up to 13 db, has a gain of 65 db with 25 db of feedback on the first two tubes. It is normally operated with 6 db of feedback. The frequency characteristics are flat from 50 to 20,000 cps and minus $\frac{1}{2}$ db at 20 cps. Harmonic distortion is less than 2 percent with no com-

pression and 1 percent with 8 db of compression.

A 6F5 and one section of a 6SN7-GT are the pre-amplifier section. A second 6SN7-GT is used in push-pull for the compression section of the amplifier. A 6H6 operating as a full-wave rectifier supplies the bias for the two 1612 or 6L7 variable-impedance feedback control tubes. The second section of the first 6SN7-GT is used as an amplifier for the compression circuit control.

The microphone feeds directly into the 500-ohm input. The output of the amplifier feeds into an artificial line of 500 ohms which is designated as the microphone bus. On the control relay that normally shorts out the artificial line a set of contacts breaks after all others make. This reduces clicks when the push-to-talk switch is operated.

Isolation Amplifier

Hill-and-dale type of recorded music is supplied to the system by Muzak over leased lines from Los Angeles, 15 miles distant, and goes into an attenuator control at the PBX board. The music is then fed into an isolation amplifier (Fig. 1) located on the rack. The music is sent at zero level and has a flat

* Pollock, H. S., & Stewart, H. H., Compression with Feedback; *ELECTRONICS*, Feb., 1940.

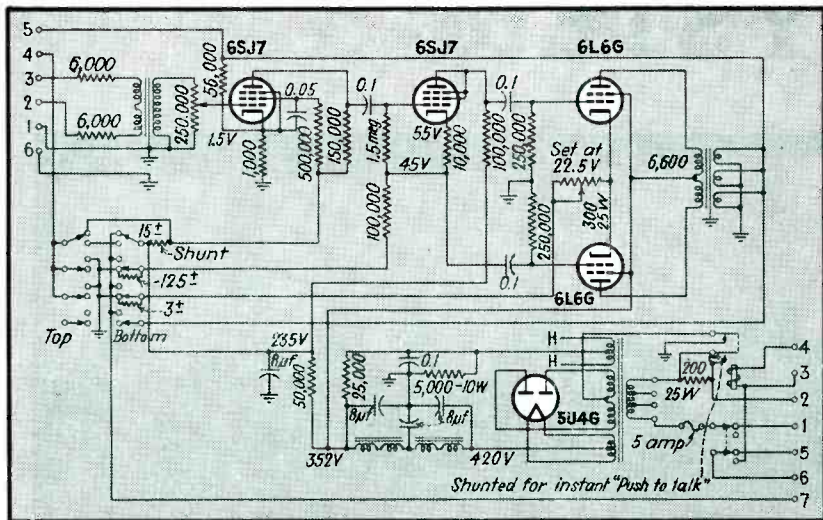

FIG. 2—Six bridging amplifiers, each with this circuit, normally supply the 120 watts of audio power required. A seventh stands by as spare

characteristic. A 2-db rising characteristic is added at the rack to compensate for reproduction at lower than normal levels.

The isolation amplifier acts as a music booster and mixing amplifier. The music is fed into a 500-ohm input to one half of a 6SN7-GT. The microphone bus feeds into the second section of the 6SN7-GT. The plates of the tube operate in a plate current bucking connection into a push-pull-to-line transformer.

The voice section of this amplifier is adjusted for zero gain. The output of this isolation amplifier is terminated to a 500-ohm artificial line designated as the music bus. The characteristics of both sections of this amplifier are equal to those of the compression amplifier.

A plate-circuit relay operates when the tube heats sufficiently to draw plate current. The isolation amplifier is coupled to the music bus when this plate circuit relay is energized. Normally, the microphone and music bus are in multiple to provide for normal microphone operation in case the isolation amplifier should fail.

Also, a pilot light associated with the relay is used as a check on plate-circuit operation of the amplifier. This amplifier operates only when music is required and is therefore not operated from a pre-heated condition. Another relay is used to turn on the power to the isolation amplifier.

After the main power switch at

the rack is turned on, all other control of the system is at the PBX board. A control box is mounted alongside the board for use by the telephone operator. The microphone is mounted upon the PBX board.

An attenuator for music and an attenuator for the microphone are located on the control panel. So are seven music distribution switches and associated pilot lights, a push-to-talk key, an "in use" pilot light, and an additional switch to control the speaker in the spare dining room.

The music distribution switches (lower left-hand corner of Fig. 1) operate seven relays on the rack. The music-distribution-relay contacts normally connect the seven bridging amplifiers to the microphone bus and the seven bridging amplifier power relays to the push-to-talk line.

When any of the seven music distribution switches at the control box is turned to the "on" position, a pilot light indicates on the control panel and the associated relay on the rack operates to connect the designated bridging amplifier to the music bus and also turn it on.

Any one of the music-distribution switches at the control panel will also operate the power relay on the isolation amplifier and put it in operating condition. Any one of the music distribution switches will also put the system in operation to reproduce music in any one of the designated areas associated with

the respective bridging amplifiers.

Should an announcement be necessary while music is being reproduced through any one or group of the bridging amplifiers, the manually-controlled music attenuator at the control box is replaced by a preset attenuator. A relay operating in multiple with the "push-to-talk" line makes this possible.

Adjustment of the contacts of this relay is such as to avoid clicks in the system. Contacts A (Fig. 1) make before break and contacts B break before make. In operation, this relay-operated attenuation gives the effect of a manually-operated fader if the difference in level is not too great.

Circuit Checking

The bridging-amplifier plate circuits are checked by means of a common meter and a series of interlocking push-buttons. The amplifier to be checked is first selected by a push-button located on the meter panel and then the circuit to be checked is selected by the proper push-button on the bridging amplifier panel.

This common meter also is used for a volume indicator and push buttons are used to select the ranges. A monitor speaker is bridged across the output of the bridging amplifier under check when the volume indicator is in use. The volume indicator is also used to check the level at the microphone bus.

The compression amplifier has a self-contained meter associated with an interlocking circuit-selecting switch. The meter is calibrated to read percent of normal plate circuit current, and degree of compression in db.

The voltage outputs of the speaker power supplies are checked by means of an interlocking selector switch and a voltmeter. The dry rectifier voltage of the relay power supply is also checked by this meter. A spare dry rectifier is placed in operation by rotating a single switch. All power supplies—six speaker supply units and two dry rectifier units—are mounted on sub-chassis assemblies. All relays operate on 6-volt dc supplied by the dry rectifiers.

Any number of microphones can, if desired, be operated individually through this system. A relay associated with each microphone normally connects each microphone to a common microphone line. When any of the push-to-talk keys associated with each of the microphones is pushed, all the relays operate except the one at the operated location, thus only one microphone is on the line at a time. A pilot light in multiple with each relay indicates when the system is in use but besides, the relay circuit makes it impossible to take the system away from anyone when it is in use.

An extension of the microphone position at the PBX board is provided for use when a specially-trained sound system announcer is on duty. This extension is located in a special acoustically-treated section of the PBX room.

Speaker Systems

Wide-range two-way "Tru-Sonic"* speakers are used throughout the terminal except in the rest-rooms, entrance, and spare dining room, which use standard cone type units.

Three types of systems are used: The east and west fields use 800-cycle crossover networks, 800-cycle two-by-four multi-cellular high-frequency horns with heavy duty metal diaphragm drivers and 15-inch heavy-duty-cone low-frequency speakers mounted in six-foot directional baffles.

The snack bar has a specially designed coaxial-type wide-range speaker. This speaker has a 1500 cycle crossover network, and a 1500-cycle concentric circular-cell high-frequency horn with a metal-diaphragm high-frequency driver. The circular-cell high-frequency horn is located in the center of the 15-inch low-frequency cone. Both high- and low-frequency driving units use the same speaker field and pole piece.

This is an experimental model and has proved to be very satisfactory.

All other speaker systems are designed to operate with a 1000-cycle crossover network and use a two by four multiple-cell high frequency horn and metal-diaphragm

high-frequency driver. These systems use a 15-inch cone-type low-frequency unit with reflex baffles and mounted in recesses covered with decorative grills.

Mechanical Design

The mechanical design of the sound system includes a number of new features. Standard rack-and-panel dimensions are used. The recessed-pan chassis are mounted on flanges recessed one inch behind the panel. This construction allows for front-of-rack harness-wiring and greatly facilitates construction and service. The rack is built to form the gutter for wiring and removal of all panels and gutter facings leaves the wiring accessible without lacing through holes.

Each chassis has an individually removable panel. All fuses and relay contacts can be reached from the front of the rack by removing the right hand dial plate and switch. This dial plate is held in place by means of spring ball catches and a light pull loosens it. The groups of relays are accessible by removal of a panel mounted with knob and screw assembly. All routine service and checking is immediately accomplished from the front of the

rack, to facilitate maintenance.

The 61 tubes in the system are reached from the rear of the rack by removing a one-piece chimney-type dust cover. Only seven tube types are used in the whole system. The terminal air-conditioning plant operating in the amplifier room aids in cooling the system.

Operation

Control of the system, once it is turned on, is in the PBX room. Paging and announcements of arrival and departure of planes are made in both English and Spanish by PBX operators or a sound-system operator at the extended microphone position.

Timing of announcements is aided by calls on the telephone from the radio control tower, airline offices, and landing gates. The system operates on a twenty-four hour basis.

Original requirements were set up by M. E. Tait, supervisor of communications, Lockheed Air Terminal and the unique and very successful operating technique developed for this sound system is due to the foresight and capable management of Dudley M. Steel, airport manager.

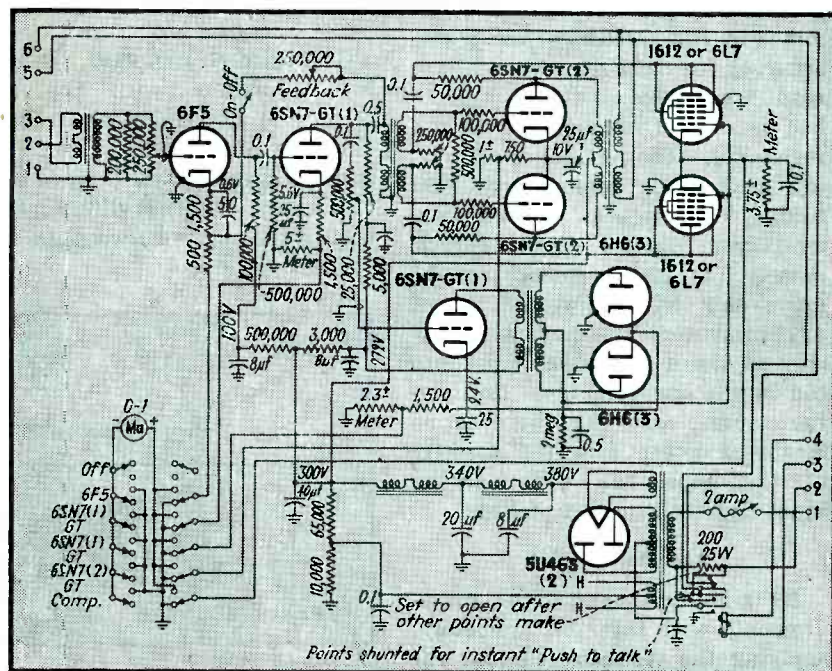

FIG. 3—Compression type microphone pre-amplifier is capable of compressing 13 db. Under normal operation, feedback is 6 db and response is flat from 50 to 20,000 cps, ½ db down at 20

* Stephens Mfg. Co., Los Angeles, Calif.

Measuring R-F Power

With a known capacitor across the load, currents at full power are measured with r-f ammeters and their ratios applied to accompanying chart and formulas to determine r-f resistance of load. A computation of I^2R then gives power. Uses include checking directional antenna systems

AN r-f wattmeter as simple and accurate as the wattmeters used in 60-cycle power systems would receive universal acclaim by engineers in all branches of radio and electronics, but as yet no single instrument meets the requirements. The three-ammeter method described here for measuring r-f impedance and power is by no means as simple as might be desired, nor is it suitable for universal application, but nevertheless it has proven highly satisfactory and quite useful on several occasions at broadcast frequencies.

It is an accepted fact that power at radio frequencies can be determined by I^2R . Meters of acceptable accuracy for measuring current are readily available so the only problem is one of measuring the r-f resistance. The resistance-measuring methods in common use (r-f bridge, resistance substitution, etc.) have several disadvantages, namely (1) measurements can be made only with very low power, (2) measurements must be made only at times when the impedance can be disconnected from its driving source, and (3) there is no means of determining the stability of the impedance with varying input or over a period of time.

Ammeter Circuit

By simultaneous current measurements with three r-f ammeters, applying the resulting current ratios to a chart, constants are obtained from which the R and X components of the unknown load impedance are readily calculated.

By **J. L. HOLLIS**

Chief Design Engineer
Broadcasting Branch
Crosley Corporation
Cincinnati, Ohio

The measuring arrangement used is shown in Fig. 1. Here r-f ammeter I_3 measures the current in the unknown load Z . Ammeter I_2 in series with a known capacitance X_c gives the value of the source voltage E , since $E = I_2 X_c$. For greatest accuracy, X_c should be somewhere near the value of Z . From these two meter readings and the value of X_c the absolute value of Z can be determined:

$$Z = \frac{E}{I_3} = \frac{I_2 X_c}{I_3} = \frac{X_c}{I_3/I_2} \quad (1)$$

The third r-f ammeter, I_1 , is used in conjunction with the other meters to determine the relationship between R and X . Since I_2 and I_3 must always equal I_1 when added vectorially, it is not difficult to establish the angles between the three current vectors.

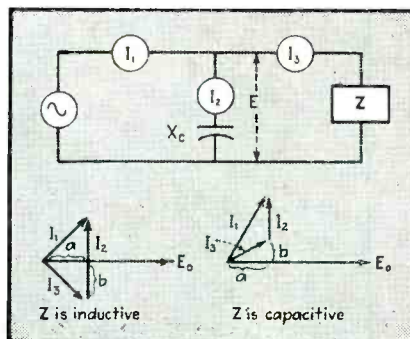

FIG. 1—Circuit for measuring the reactance, r-f resistance and power drawn by an unknown load Z , with vector diagrams showing current relations for two types of loads

If the relationship of one of the current vectors to the voltage can be determined, then any of the vector angles can likewise be determined. Since I_2 is the current through a pure capacitive reactance its phase angle with the voltage is 90 degrees leading. This then is the relationship needed in order to determine the phase angle of I_3 or I_1 .

Mathematical Solution

The following mathematical method may be used for determining R and X , but the graphical solution shown later has the advantage of speed and simplicity and its accuracy is within the accuracy of the ammeters themselves.

The vector diagrams in Fig. 1 show the phase relationships of the three currents for an inductive load Z and for a capacitive load Z . In both cases the currents are related as follows:

$$I_1^2 - (I_2 + b)^2 = a^2 = I_3^2 - b^2 \quad (2)$$

Solving in turn for a and b ,

$$a = \sqrt{I_3^2 - b^2} \quad (3)$$

$$b = \frac{I_1^2 - I_2^2 - I_3^2}{2I_2} \quad (4)$$

Since the current triangle having sides a , b and I_3 is proportional to the impedance triangle having sides R , X and Z respectively, these relations also exist:

$$R = \frac{a}{I_3} Z \quad (5)$$

$$X = \frac{b}{I_2} Z \quad (6)$$

Since it is usually more convenient to work with current ratios, let $B = b/I_2$ and let $A = a/I_3$, then

with THREE AMMETERS

divide both sides of Eq. (3) and (4) by I_2 and simplify:

$$B = \frac{b}{I_2} = \pm \frac{1}{2} \left[\left(\frac{I_3}{I_2} \right)^2 - \left(\frac{I_1}{I_2} \right)^2 + 1 \right] \quad (7)$$

$$A = \frac{a}{I_2} = \sqrt{\frac{I_3^2 - b^2}{I_2^2}} = \sqrt{\left(\frac{I_3}{I_2} \right)^2 - B^2} \quad (8)$$

Similar substitutions in Eq. (5) and (6) give

$$R = \frac{AZ}{I_2/I_2} \quad (9)$$

$$X = \frac{BZ}{I_2/I_2} \quad (10)$$

Graphical Solution

The graphical solution presented here is an easy method of determining the values of A and B . To use the chart in Fig. 2, find the intersection of the ratios of I_1/I_2 and I_3/I_2 (a draftsman's compass is very useful here) and pick off the values of A and B corresponding to the point of intersection. These values, when substituted in Eq. (9) and (10) after measuring the currents and finding Z from Eq. (1), give actual values of R and X .

It should be pointed out here that although the resistance of thermocouple elements is usually negligible the reactance is not necessarily so. This means that the value of X_c as determined from $X_c = 1/\omega C$ must be corrected by the reactance of meter I_2 . Likewise the reactance of I_3 will be included in the measurement of Z and must be compensated for. It was found that the Weston type 640 r-f ammeter thermocouple has approximately 0.5 microhenry inductance.

This circuit has been found useful in a broadcast-frequency directional-antenna system, being used here to aid in properly terminating the transmission lines to the antennas. In this case the capacitance is considered as part of the terminating equipment and the three equations for R , X and Z have I_1/I_2 in their denominator in place of I_3/I_2 . A new scale C is now used

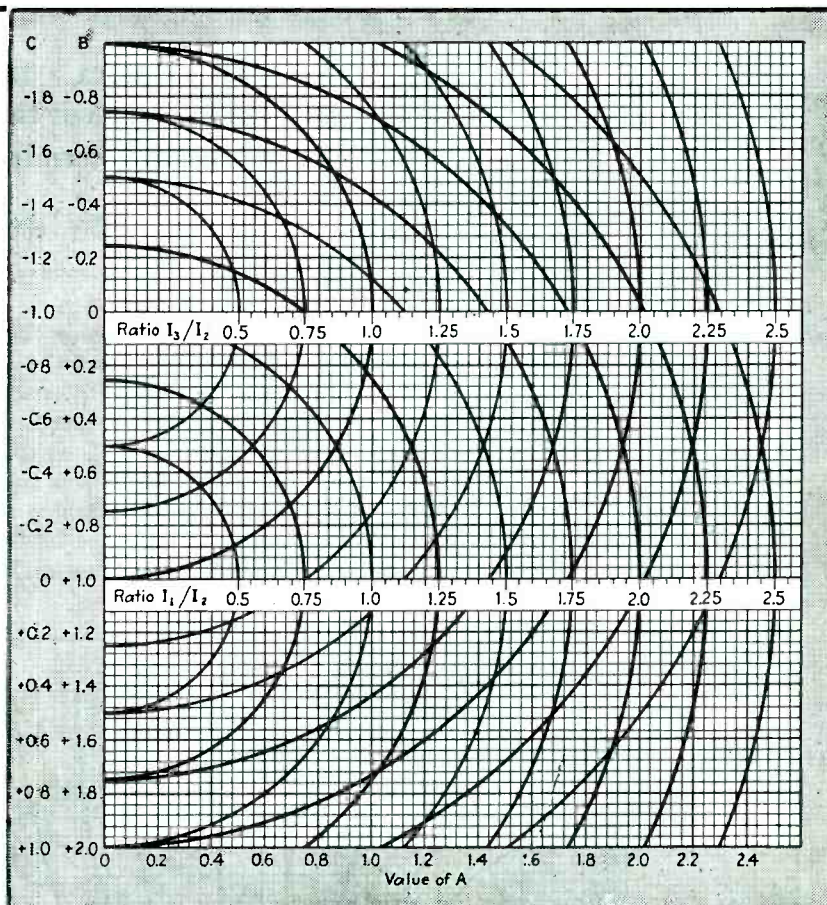

FIG. 2—Chart for converting current ratios into factors A and B (or A and C for transmission line terminations at antennas) from which the r-f resistance, the reactance and the load power may readily be computed

in place of B in Fig. 2 since the origin is different for this vector.

The circuit has also been found useful as a means of determining and maintaining a continuous check on the input impedance to a directional antenna system at the point of common feed, as any change in the current ratios is indicative of a change of input impedance. There are naturally many other useful applications for this circuit.

Example

Find the r-f power being delivered to an unknown load Z , if the meter readings give ratios of 2.38 for I_1/I_2 and 1.8 for I_3/I_2 when using a reactance X_c of 33.8 ohms in the circuit of Fig. 1. Solution: Set the

compass point at 0 on the I_3/I_2 scale of Fig. 2, adjust its radius to 1.8 on this scale and swing an arc. Set the compass point next at 0 on the I_1/I_2 scale, adjust the radius to 2.38 on this scale and swing another arc. From the intersection of the arcs, read on the bottom scale the value 1.66 for A . From Eq. (1), $Z = 33.8/1.8 = 18.75$ ohms, and from Eq. (9) $R = 1.66 \times 18.75/1.8 = 17.3$ ohms. With this value and the measured value of I_3 the power can now be computed from $P = I_3^2 R$.

If the load reactance value is desired, read the value of B in Fig. 2 corresponding to the intersection of the arcs as $B = -0.69$, then use Eq. (10) to find $X = -0.69 \times 18.75/1.8 = 7.2$ ohms.

COMPUTING Mutual Inductance

VARIOUS types of apparatus, such as i-f transformers, electric wave filters, and tank circuits of radio transmitters, use mutually coupled coils. The value of mutual inductance required between such coils is usually determined experimentally or by circuit analysis. After this is done, the remaining problem is the design and layout of a suitable coil geometry with the desired mutual inductance.

Exact and complicated approximation formulas are available for computing the mutual inductance between coaxial circular coils of small and thick cross section, and coaxial solenoids.^{1, 2, 3} It has been

Chart gives a factor from which the mutual inductance of two coaxial circular coils can be readily determined by a simple multiplication

By **MICHAEL J. Di TORO**

Senior Electrical Engineer
Hazeltine Corporation, Little Neck, N. Y.

the author's experience, however, that these fail to meet the designers' needs because of their complexity. If an attempt is made to simplify the formulas at the expense of accuracy, the result is a collection of assorted formulas which are not very accurate, and are useful only for extreme or impractical ranges

of coil configurations. Moreover, the formulas give no simple physical picture of the way in which mutual inductance depends upon the physical geometry of the coupled coils.

Mutual Inductance Chart

A number of these objections are

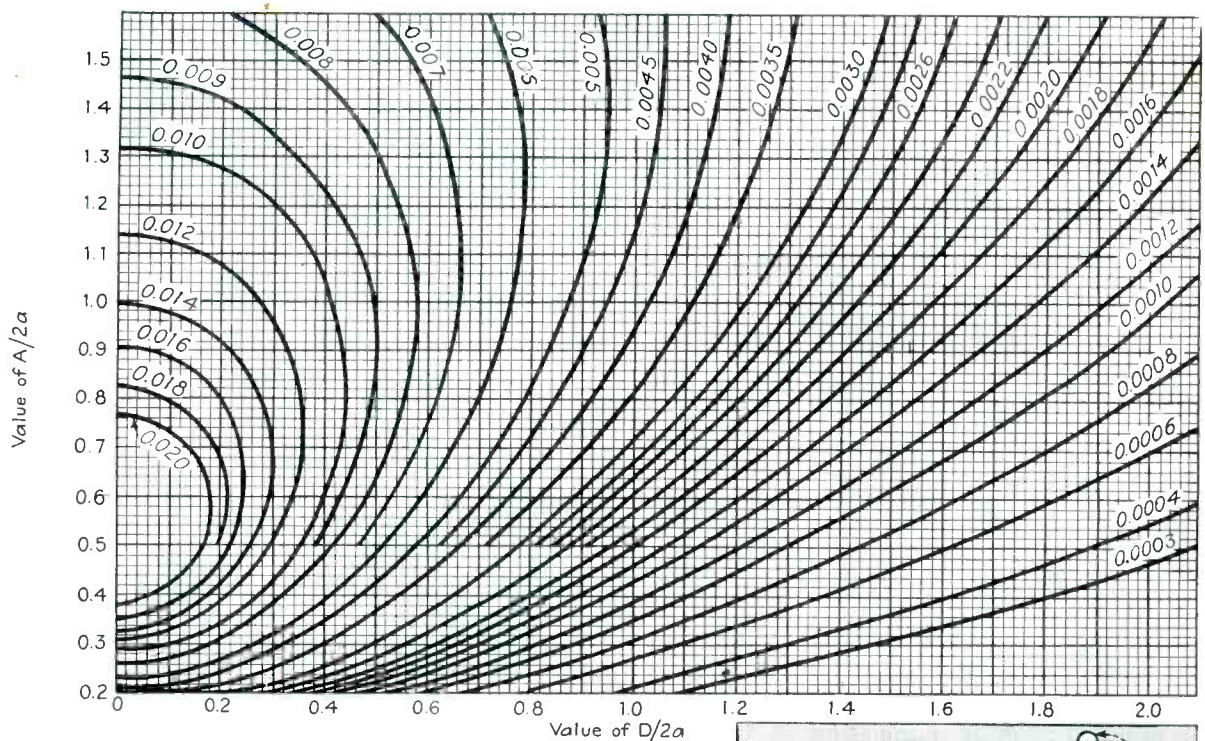
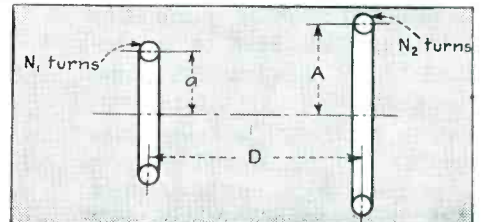
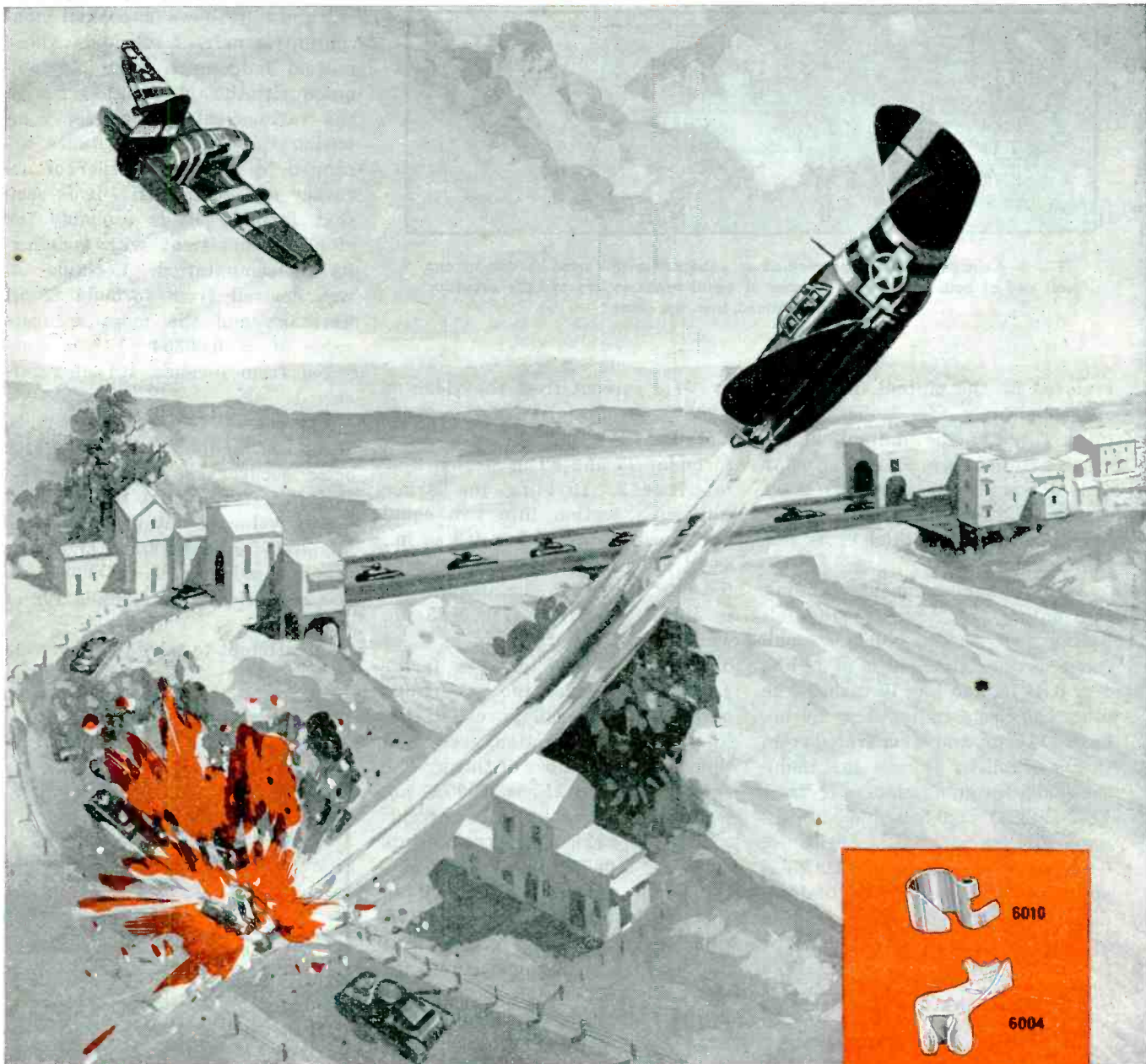

FIG. 1—Chart for finding the mutual inductance between two coaxial circular coils having infinitesimally small cross section. To use, find $D/2a$ and $A/2a$ from the known dimensions in inches, determine the chart reading for the coordinates (the value of the curve that would pass through the coordinates), and multiply the chart reading by $2aN_1N_2$ to get the mutual inductance in microhenrys



MORE OFTEN THAN NOT THE **GRID CLIP** IN SERVICE IS A CINCH



it's "know how"

A grid clip serves to provide a mechanical electrical connection between the grid of the tube and the radio set. Cinch KNOW HOW includes selection of material and ingenious tooling, and is typical of the way Cinch Engineers and Production men tackle and solve a prob-

lem and develop a line of parts for radio use. The grid clips here illustrated are tooled for production quantities, are surprisingly economical and there are many more shapes, styles and sizes. We suggest you write for samples. Complete catalogue information is available.



CINCH MANUFACTURING CORPORATION

2335 W. Van Buren Street, Chicago 12, Illinois
Subsidiary of United-Carr Fastener Corp., Cambridge, Mass.



• The NEW CINCH catalog, 140 pages describing metal parts and metal plastic assemblies.

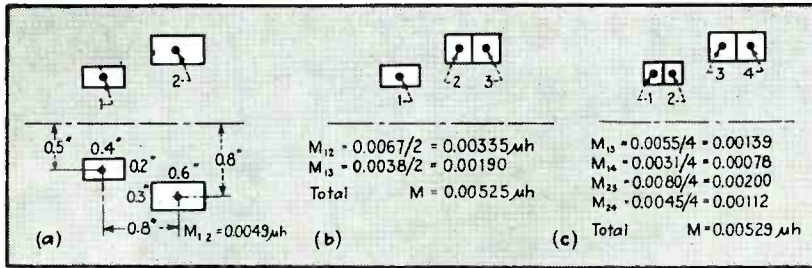

FIG. 2—Examples illustrating method of subdividing the cross section of one coil and of both coils into a number of equal areas to improve the accuracy of values obtained from the chart

removed by the mutual inductance chart shown in Fig. 1. This chart gives directly the mutual inductance between two coaxial circular coils of small (infinitesimal) cross section. Later, the application of the chart to coils of thick cross section is shown.

As an example, consider finding the mutual inductance of the following two coaxial coils of small cross section. One coil is of radius $a = 0.85$ in. and has 10 turns. The other coil has a radius $A = 1.6$ in., has 100 turns, and is separated from the first coil by $D = 1$ in. Using the chart, for an abscissa of $D/2a = 1/(2 \times 0.85) = 0.589$, and an ordinate of $A/2a = 1.6/(2 \times 0.85) = 0.942$, a chart reading of 0.0078 is obtained. The desired mutual inductance is then the chart reading multiplied by $2a N_1 N_2$, or $0.0078 \times 2 \times 0.85 \times 10 \times 100 = 13.2 \mu\text{h}$.

Coils of Thick Cross Section

When both coils have cross-sectional dimensions smaller than about 15 percent of the coil diameter, it is sufficiently accurate to determine the mutual inductance from that of circles at the center of the cross sections. For coils of larger cross sections, however, this method is not accurate enough. More accurate results may be obtained by subdivision of the cross section into a number of equal areas.

To show the process, consider the problem of finding the mutual inductance between the two thick cross-section coils shown in Fig. 2(a). As the number of turns of the coils does not affect the computation, it is assumed that each coil has one turn. For no subdivision, the chart indicates a value of $M_{12} = 0.0049 \mu\text{h}$. This is in error

by -8.4 percent from the value of $0.00535 \mu\text{h}$ obtained from accurate and lengthy computations using formulas 77 and 89 in section 2 of reference 2. Dividing the larger coil cross section into two equal parts each of area 0.3×0.3 sq in., as in Fig. 2(b), the inductance of the part nearer to the smaller coil is $M_{12} = 0.0067/2 = 0.00335 \mu\text{h}$, while that of the other part is $M_{13} = 0.0038/2 = 0.0019 \mu\text{h}$. The factor $\frac{1}{2}$ appears because the subdivided portions of the coil have half the total coil cross section area, and thus half the number of turns. The sum of M_{12} and M_{13} is $0.00525 \mu\text{h}$, which is in error by -1.9 percent.

Further calculations indicate values of $0.00529 \mu\text{h}$, or -1.3 percent error, for subdivision of both the small and large coil into two equal parts, as in Fig. 2(c). A nine-point calculation using the chart and formula 89 of reference 2 gives an answer of $0.00538 \mu\text{h}$, or +0.6 percent error. From this it is evident that for large cross-section coils, subdivision into equal areas of the thicker coil or both coils gives results consistent with the accuracy of the chart. Only in cases of extremely thick coils it is justified to use the more complicated nine-point formula.

Coaxial Solenoids

For a solenoid, or coil whose length and diameter are much greater than its thickness, the chart may still be used. The results, however, will not be as accurate as for coils whose cross section is almost square. In general, the accuracy decreases with increase in the ratio of coil length to diameter. More accurate results are obtained for coaxial solenoids which are also concentric.

Figure 3 shows a coaxial non-concentric pair of solenoids whose mutual inductance is to be computed with the aid of the chart, with the various calculations for computing the mutual inductance arranged in increasing order of accuracy and complexity. It is seen that formula M_2 is probably the simplest consistent with complexity of computation. Formula M_3 was derived from formula 89 of Terman², and the more accurate value $M = 0.00354 \mu\text{h}$ was computed from formula 191 of reference 1.

For coaxial concentric solenoids, as in Fig. 4, the chart values give better accuracy, as is to be expected. It is interesting that the most accurate value is obtained with the simplest formula (M_1). The more accurate value of $M = 0.00878 \mu\text{h}$ was computed from formula 192 of reference 1.

An attempt to solve the above ex-

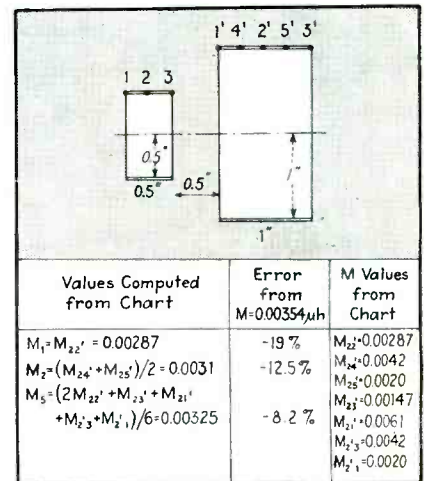

FIG. 3—Comparison of results for coaxial nonconcentric solenoids

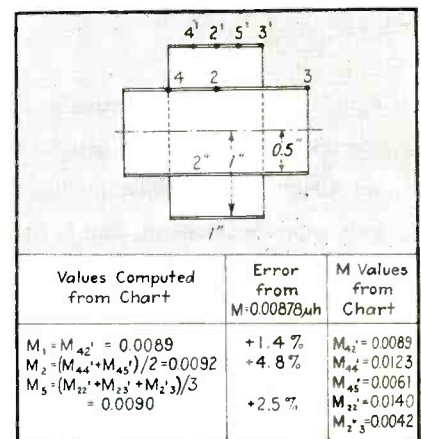
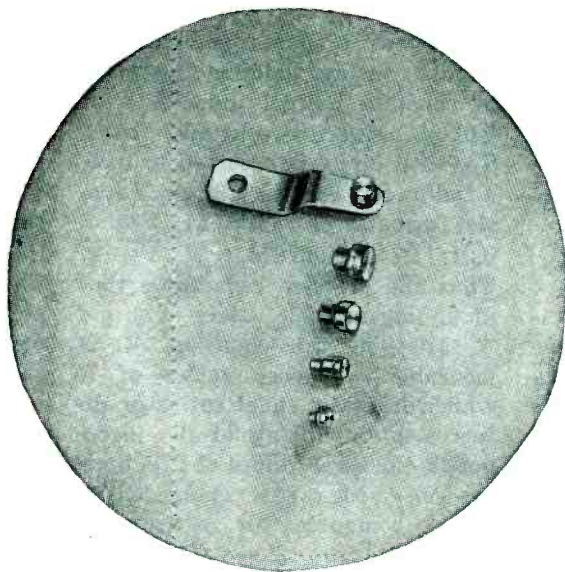

FIG. 4—Comparison of results for coaxial concentric solenoids

Infinitesimal..



..but essential!

Hardly bigger than a pin-point are some of the contacts and contact assemblies manufactured by Mallory—yet they help to control huge industrial machines.

For more than 22 years, Mallory has developed improved alloys and materials for contacts and assemblies. Today Mallory provides a complete range of contact materials . . . silver, platinum, tungsten, Elkonium*, Elkonite* and other special alloys. Mallory engineers have adapted these materials to more than 5000 designs, from tiny relay contacts to large contact assemblies for heavy-duty circuit breakers.

Before your equipment designs are blueprinted, it will pay you to consult Mallory. Then you'll be sure to save time and money, with experienced engineering help and the most complete production facilities in the industry. You can readily obtain entire contact assemblies, individual contacts, or contacts assembled to your own studs, springs, arms or brackets.

P. R. MALLORY & CO., Inc., INDIANAPOLIS 6, INDIANA

*Reg. U. S. Pat. Off. for electric contacting elements.



P. R. MALLORY & CO. Inc.

MALLORY

ELECTRICAL CONTACTS AND CONTACT ASSEMBLIES

amples with the usual complicated formulas will show the time-saving feature of the chart. It should be noted that the chart also gives a physical picture of the way in which the mutual inductance varies with the geometry of the two coupled coils. For this reason, a scale tracing of the coils superimposed on the chart will simplify the calculations.

Derivation of Chart

The derivation of the chart is outlined in Fig. 5. It is based upon the well-known formula for the mutual inductance between the two coaxial circular coils shown in Fig. 5(a). The factor F is a function of R , the ratio of the smallest to largest distance between the two circles. Tables have been computed^{1,2} giving F vs. R for various coil dimensions.

The coordinates are first transformed, for simplicity of calculation, to the nondimensional system shown in Fig. 5(b). The construction of the chart is based upon the fact that the loci of constant values of R are a family of circles whose centers lie on the Y axis at a dis-

tance k from the origin, and whose radii are equal to r , where k and r are the functions of R shown in Fig. 5(b).

To show the chart construction in detail, consider finding the locus of constant mutual inductance of $0.01 \mu\text{h}$ between two coaxial circles. The first circle is assumed to have a radius of 0.5 in. or 1.27 cm. From the formulas of Fig. 5(b), $M/a = 0.01/1.27 = 0.007874 = F\sqrt{1+y}$. Thus the problem reduces to that of finding suitable values of y and F satisfying this equation. It is desirable to choose values of F which differ by equal ratios or db increments. Using 1-db increments, the three values of Fig. 5(c) are obtained. The corresponding values computed for y are also shown.

From the tables of F vs. R , the values of R are computed, and the corresponding loci of constant R are drawn, as indicated in Fig. 5(c). Horizontal lines are drawn for the values of y . The intersection of these horizontal lines with the family of circles, such as points 1, 2 and 3, are points on the locus of $M = 0.01 \mu\text{h}$.

Other diagonal points such as 4,5 and 6,7 are next obtained. These points lie on the loci of constant M for values of M one db above and below $M = 0.01 \mu\text{h}$. Thus for 4 and 5, $M = 0.01122 \mu\text{h}$, and for 6 and 7, $M = 0.00891 \mu\text{h}$. By proceeding in this manner for other values of M , all the loci of constant M differing by 1-db intervals, are found. From these, the curves of the chart in Fig. 1 were drawn. These curves are not in equal db steps, but are rather in equal arithmetic increments, in order to facilitate interpolation.

In the more useful central portions, accurate test calculations show that the chart accuracy is better than 2 percent. For extreme regions, i.e., large coil separation and small diameter of the second coil, the error is not over 5 percent. It is felt that this is sufficient accuracy for most design applications.

REFERENCES

- (1) "Radio Instruments and Measurements," Bureau of Standards Circular No. 74, Mar. 1924, formulas 187, 190, 191, 192 and 193.
- (2) Terman, F. D., "Radio Engineers Handbook," McGraw-Hill Book Co., 1943, Section 2, formulas 77, 78, 85, 86 and 89.
- (3) Pollack, D., "Mutual Inductance Calculations," ELECTRONICS, July 1937.

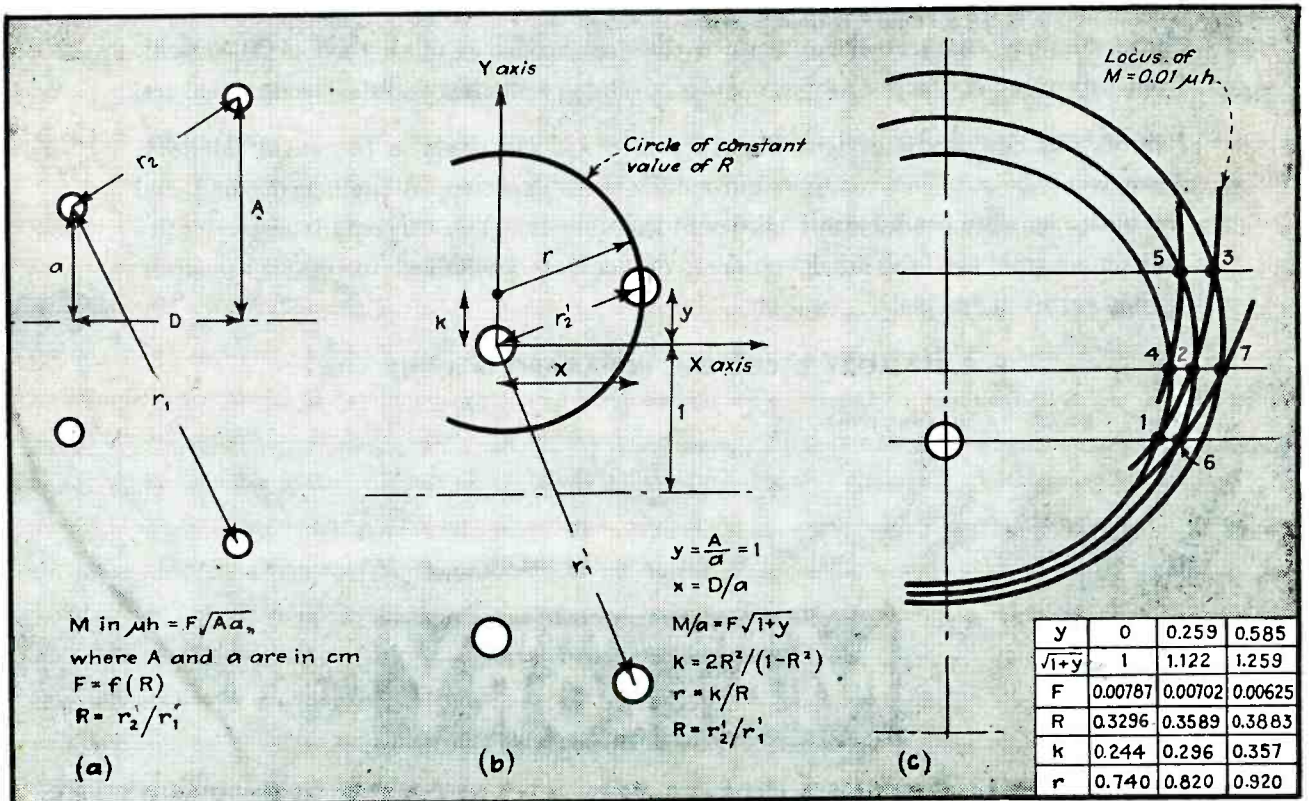
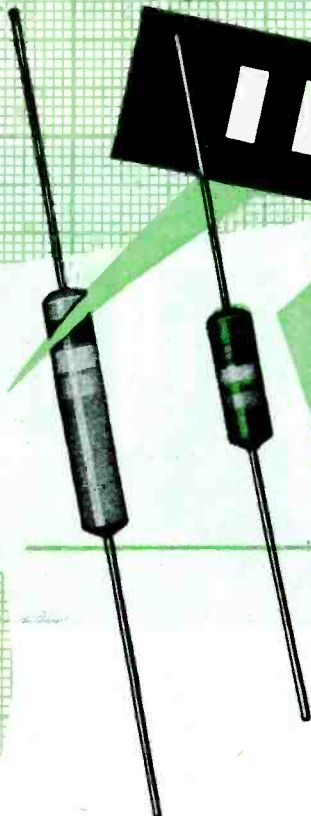

FIG. 5—Method of constructing the curves for the mutual inductance chart in Fig. 1

IRC is ready with...



THE NEW **BTA**
RESISTOR

Lowest Temperature Rise ➔

Like all BT Resistors, the operating temperature of the new BTA is lower than other resistors of comparative size!

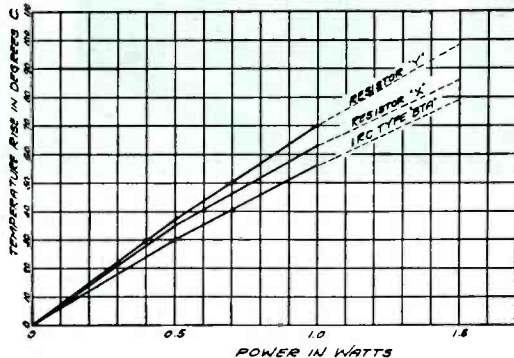

Only the extreme pressure of essential war production has delayed our release of this small one-watt AWS RC 30 type *insulated* resistor.

You'll find the BTA insulated resistor a worthy and important addition to the BT family. Built to meet American War Standards specifications, the BTA is only 0.718 inches long and 0.250 inches in diameter. Wattage rating, 1 Watt at 40° C ambient. Voltage rating, 500 volts. Minimum range, 330 ohms. Maximum range, Standard: 20 megohms.

Write today for comprehensive bulletin containing engineering data and charts. Address Dept. 1-F.



INTERNATIONAL RESISTANCE CO.

401 NORTH BROAD STREET PHILADELPHIA 8, PA.

IRC makes more types of resistance units, in more shapes, for more applications than any other manufacturer in the world.

NOTE: ALL CURRENT SHIPMENTS OF IRC BT AND BW RESISTORS ARE FUNGICIDE TREATED

FOR SALE: A machine that will multiply glue-department output

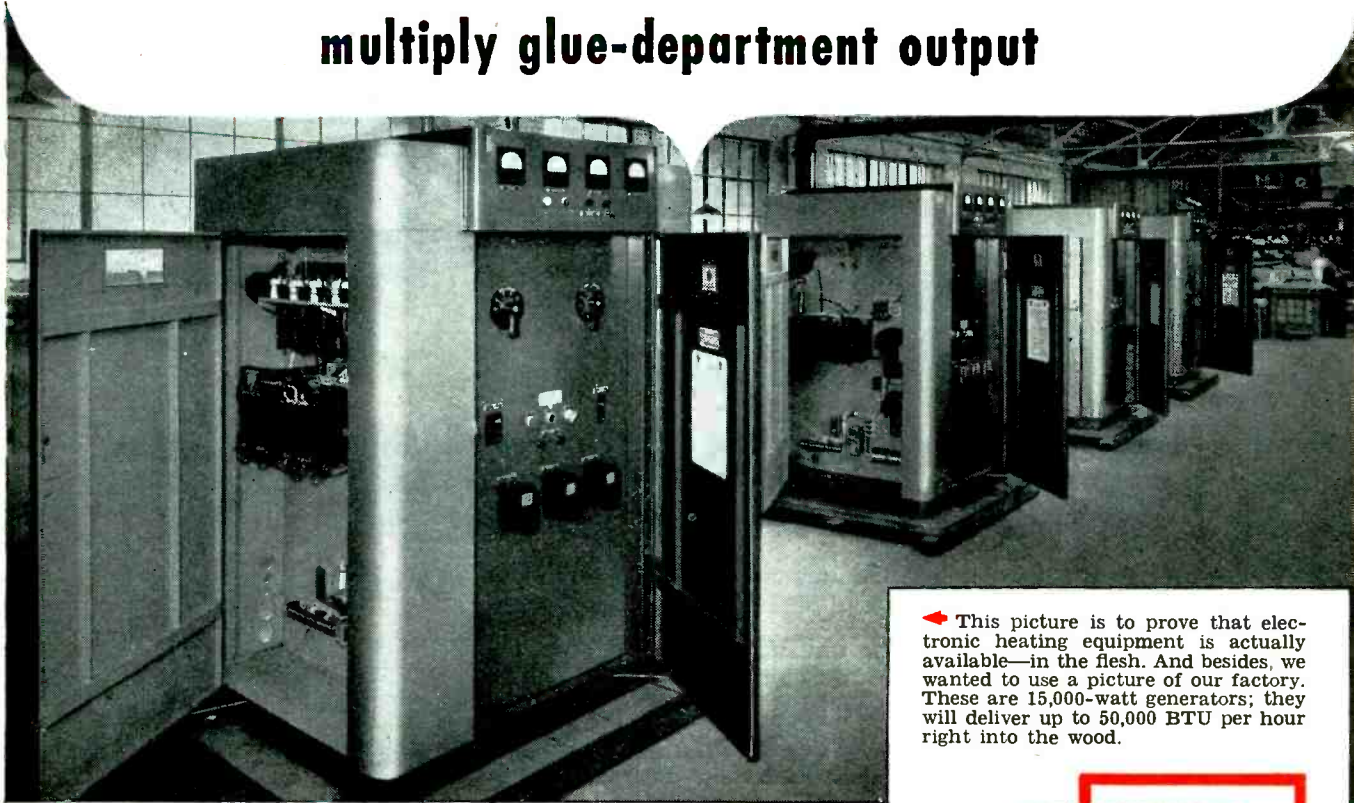

Offered with misgivings because we realize it has certain drawbacks

One of the best stories we know about this machine is that when a wood manufacturer out in the Midwest tried it he found he could increase his output to about eight times normal. But we don't feel that we should tell you this story without adding some of the unfavorable aspects. We want you to judge this remarkable machine on both its merits and its disadvantages.

In the first place, as soon as he installed the machine, he found that it speeded up the output of his gluing department so much that he soon ran out of work. He had to go out and get more orders, because the factory was not working up to capacity.

BUT THAT WASN'T ALL. He used to keep a good part of the plant full of glued parts that were drying. Since the new method has gone into use, this long drying time is unnecessary, and he now finds himself with a big investment in clamps, etc. that are of little or no use to him. Also, he had to find something to occupy the large floor area that used to be devoted to "drying space."

THIS INCREASED OUTPUT — it's now 700% over what it used to be—made other problems. There was a scarcity of wood. So when he

tried to get big pieces for some of his jobs, he found that there weren't enough. Well, his engineers got busy, and figured out a way to use up Grade-A scrap. So now he's getting about 67% more output from a given amount of raw material because this new machine made it practical to scarf and edge-glue random pieces together.

Of course, this meant a reduction in lumber costs of 40%, so his government contracts will probably have to be renegotiated because of the additional profits.

And some of the boys who set the specifications for the pieces he was making are now a little worried because his new scarf-edge-laminated pieces are testing so far above specifications that they're afraid they made a mistake when they set them up.

SO YOU CAN SEE that this new gadget just got him into a lot of trouble. And after the war he'll have to hire extra salesmen, probably, to keep the plant busy, because the way things look, he won't be satisfied with the pre-war output.

YOU can put yourself in this unhappy state of affluence, too. Just install RCA electronic heat, and watch the glue go dry.

We have a few equipments available for quick delivery. Please include shipping instructions with your order.

RCA, Electronic Apparatus Section, Box 70-193H, Camden, N. J.

◀ This picture is to prove that electronic heating equipment is actually available—in the flesh. And besides, we wanted to use a picture of our factory. These are 15,000-watt generators; they will deliver up to 50,000 BTU per hour right into the wood.

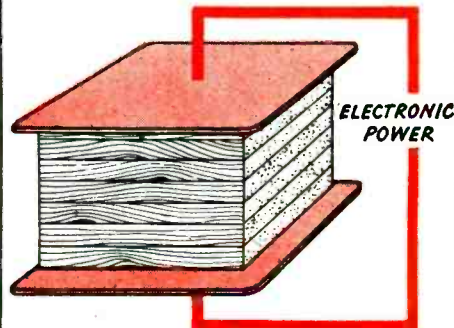

▶ This will give you a rough idea of how electronic heating works. The power from the electronic generator is applied to the "electronic platens." All the glue lines heat up at the same time. Of course, the pieces don't have to be flat. They can be curved sections.

RCA ELECTRONIC HEAT



BUY
WAR
BONDS

RADIO CORPORATION OF AMERICA

RCA VICTOR DIVISION • CAMDEN, N. J.

20-0000-100

GET OUT THE SCISSORS

This coupon is to get you to send for some RCA literature that will give you additional information on what you'll get with electronic heat. We'll send you "Heating Wood with Electronic Power" and "Electronic Heat Sets Glue in Laminated Aircraft Spars." Mail to:

RCA, Electronic Apparatus Section, Box 70-193H, Camden, N. J.

Name..... Title.....

Company.....

Address.....

City..... Zone..... State.....

INDUSTRIAL CONTROL

Tensile Testing of Textiles with Electronic Control.....	151
Automatic Metal Pouring in Foundries.....	152
Defrosting Frozen Food for Bakeries.....	154
Electronic Joy Stick for Large Aircraft.....	156
Measurement and Control with Vibrating Wire Instrument... ..	160
Turbidity Measurement of Oil in Water.....	180
Automatic Control of Glazing Furnace.....	188
Electrolysis Prevention on Underground Pipe.....	192

Tensile Testing of Textiles with Electronic Control

IN THE TEXTILE INDUSTRY, testing of single-end yarns and light-weight fabrics under constant rate of loading conditions has been confined to the inclined-plane type of testing machines. Recent developments now permit tests under constant-rate-of-load conditions on heavier yarns and fabrics to be handled on pendulum-type testing machines of the type shown in the photograph. In these, the fabric to be tested is stretched under increasing load between two metal jaws. Although a single-speed driving motor causes the lower jaw to move downward at a constant rate, the pendulum arm which increases the loading

control has been designed and successfully applied as an attachment to the standard pendulum-type tester as shown to permit constant-rate-of-load tests to be run.

Control Voltage

Since many of the factors involved in determining the load or pull through the sample are fixed quantities, it was concluded that the load varies as the sine of the angle made by the pendulum arm from the machine center line. An

induction voltage regulator provides the means for continuous measurement of $\sin \phi$. The two pole windings are energized from a 115-volt a-c line and by transformer action they induce a voltage in the rotor winding.

When the rotor is positioned so that its coil axis is parallel to the flux path between the two stator poles, the induced voltage is a maximum; when the rotor is in a position 90 deg from this setting, the voltage is a minimum. Plotted values of voltage versus rotor position, when plotted over the intermediate range (0 to 90 deg), lie on a sine curve.

If the shaft of this regulator is connected directly to the torque-balance shaft of the pendulum machine, moving the pendulum through its arc will cause an increasing voltage to be generated, increasing in direct proportion to the sine of successive values of ϕ .

An electronic rectifier tube is used for conversion of the alter-

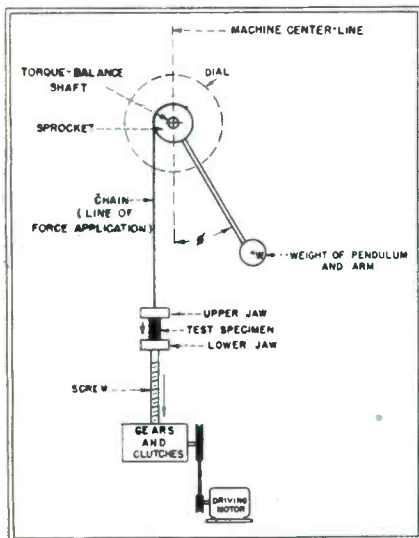

Elements of pendulum-type testing machine used in the textile industry

bumps its way through the loading cycle and does not provide a constant rate of loading. Also, fabrics of different stretch characteristics cause the pendulum to move at correspondingly differing average rates.

To extend the working range of the instrument, a new electronic

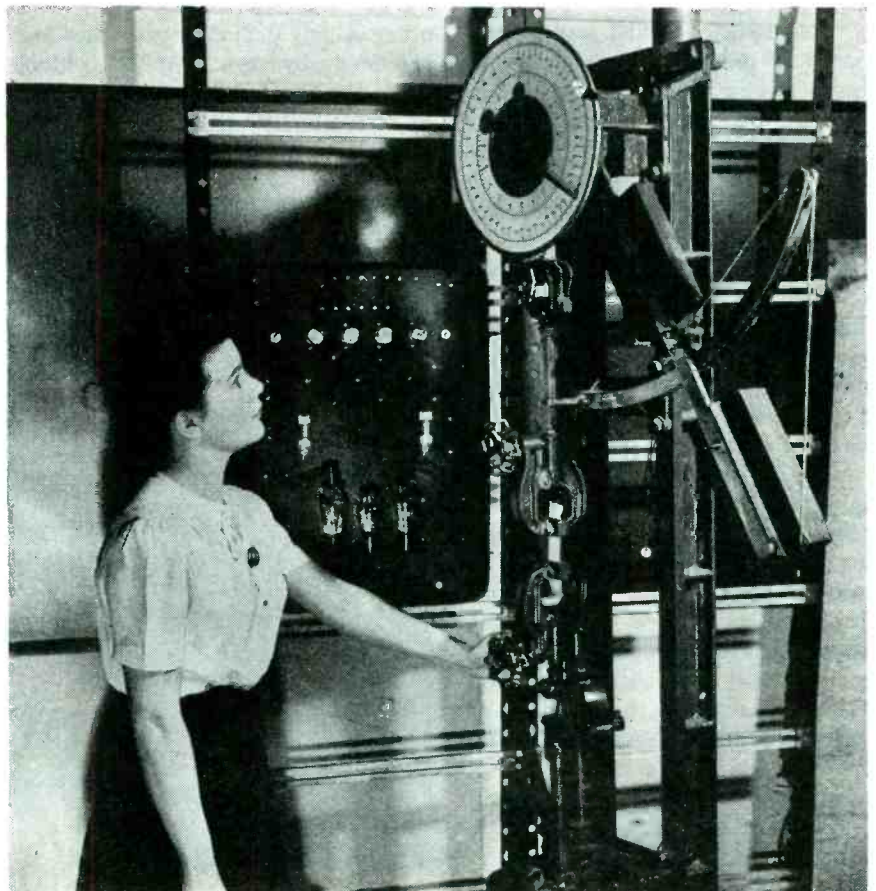

Tensile strength of textiles is determined by this pendulum-type machine. Addition of the electronic equipment in the background permits constant-rate-of-load tests to be run

nating current to direct current which is then applied to the capacitor. The magnitude of the current passed by the capacitor varies as the product of the value of capacitance, which is fixed, and the rate of change of voltage impressed on the capacitor. The latter is determined by the rate at which the pendulum arm swings through its arc, i.e., the rate of increase of $\sin \phi$. The resulting voltage drop is applied to the grid of the speed control tube.

Motor Control

The driving motor always attempts to run at constant speed and will do so as long as $\sin \phi$ increases at a uniform rate. Should the test specimen have a high-stretch characteristic, movement of the lower jaw will tend to be largely absorbed in the stretching, and the pendulum will tend to move at a rate slower than required. But when this lag develops, current passed by the ca-

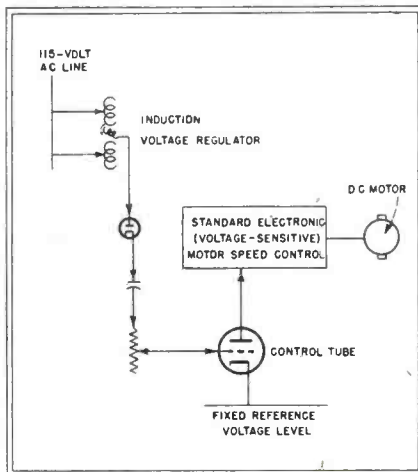

Principle of operation of the electronic constant-rate-of-load control is illustrated by this single-line diagram

pacitor decreases, as does the current and the voltage impressed on the grid of the speed-control tube. The motor is thereby immediately called upon to increase speed. As a result, the lower jaw is driven downward at a more rapid pace and the rate of travel of the pendulum

is caused to increase to that required to maintain a constant rate of loading.

Conversely, if the specimen has a low-stretch characteristic—as is the case when a high-count fabric is tested at short gage-length—the pendulum attempts to move along too rapidly, and the control operates to decrease motor speed. The corrective action is completed within a few cycles.

The electronic control is capable of handling fabrics covering a wide range of stretch characteristics.

As described by R. J. De Martini, G-E textile application engineer, in *Textile World* for March 1945, the electronic control is designed for application on standard pendulum-type machines of capacities up to 2000 lb and requiring driving motors rated at $\frac{1}{2}$ hp or less. By adjusting a dial on the panel, the operator may select the rate of load he requires. The total range available on the panel is 3.5 to 1.

Automatic Metal Pouring in Foundries

IN FOUNDRIES, molds have been poured by means of a manually operated buggy ladle handled by an operator who was subjected to intense heat from the iron and occasional burns resulting from iron splash. By using phototubes, one operator, working from a remote station, now controls the pouring of several ladles simultaneously. The hazards encountered in hand pouring are completely eliminated and several molds are now poured in less time than was needed to pour one by the former method.

As each of the group of empty molds moves into position before a ladle, a Photoswitch photoelectric control mounted directly above watches through a viewing tube. When the molds are in place, the operator, through pushbutton control of the hydraulic actuating mechanism, tips the ladles of molten iron and the white-hot metal flows into the molds. As it reaches the riser of each mold, the brilliant light thrown off signals the phototube that the mold is full. The electronic unit causes the ladle to drop back and the pouring automatically stops.

Precise control of this and many

other widely differing processes are provided by type A20C control made by Photoswitch, Inc., because of its ability to detect minute changes in light intensity. An ad-

justment on the control housing may be set so that the control will remain inoperative at one level of illumination, but will be actuated when the amount of light reaching

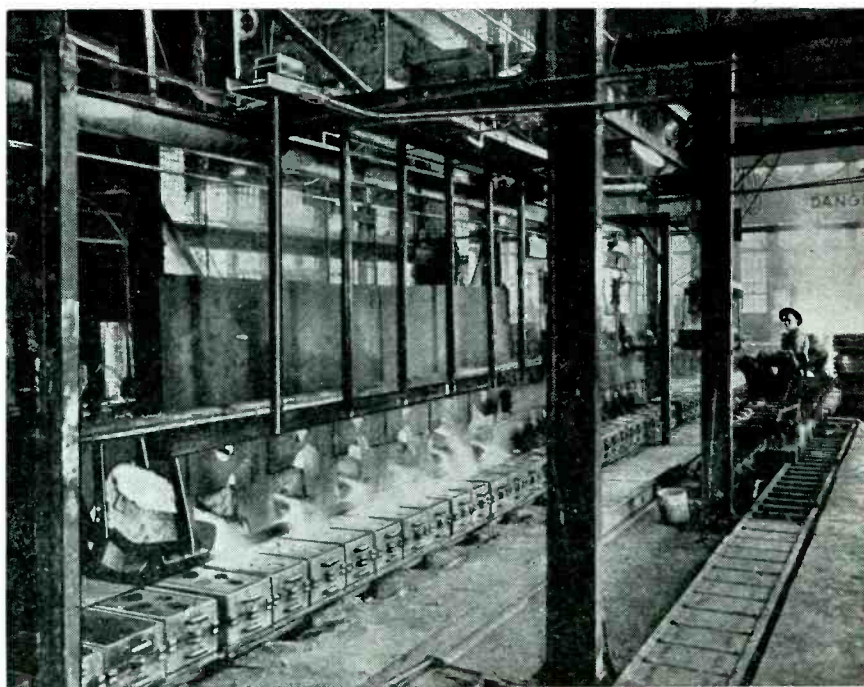

Photoelectric control units installed in a foundry of the American Brake Shoe Company. The phototube views the mold through vertically mounted tubing and is actuated by light from the molten metal as it appears in the riser of the mold. As each mold is filled, the pouring ladle is automatically tipped back by the Photoswitch control

**SHAER & TURNER ENGINEERING CO. FINDS
L^s IDEAL for
PRODUCTION LINE
ASSEMBLY**

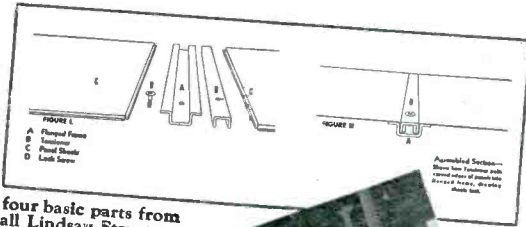

1. The four basic parts from which all Lindsay Structure units are made.

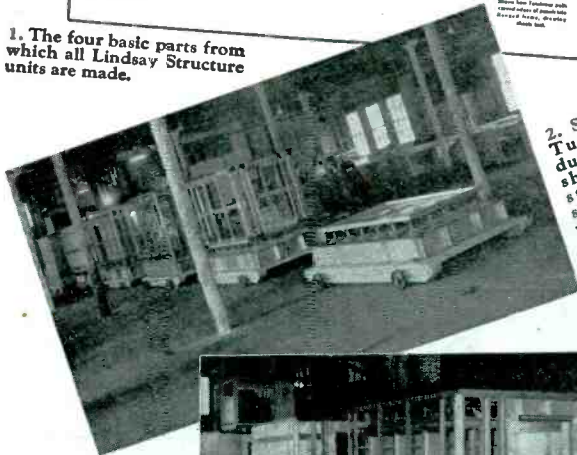

2. Shaer & Turner production line, showing six stages in assembly of refrigerator boxes.

THIS MODERN METHOD OF PREFORMED LIGHT METAL CONSTRUCTION REQUIRES NO TRIMMING, FITTING, WELDING, RIVETING, OR USE OF SPECIAL TOOLS

Lindsay Structure, modern method of light metal construction, materially speeds and simplifies line production of cabinets and equipment housings. Typical example is this application—sturdy two-compartment deck refrigerators for destroyers. Manufactured by Shaer & Turner, Boston engineering firm, the refrigerators are produced rapidly and in quantity by standard production line methods.

Lindsay Structure, consisting of only four basic parts, requires no welding, riveting, trimming, fitting, or special tools for its assembly. Parts are preformed to exact specifications, and structures may be any desired size or style. Ls-housed units are remarkably compact; no bulky, space-wasting additional supports are necessary even when equipment is unusually heavy. And no part of any equipment housed in Ls is inaccessible; removal of the nearest panel leaves the section beneath readily available.

Check the possibilities of Lindsay Structure—in either steel or aluminum—as a housing for your product. Write to Lindsay and Lindsay, 222-D W. Adams St., Chicago 6, Ill.; 60 E. 42nd St., New York 17, N. Y.; or Lindsay Structure (Canada) Ltd., Dominion Square Bldg., Montreal.

Left: Stages in production of Ls refrigerator boxes. Photographs 2, 3, 4, and 5 were taken at the Shaer & Turner plant.

3. Close-up of later stages of assembly. Note phenolic pencil spacers, which eliminate through-metal contact.

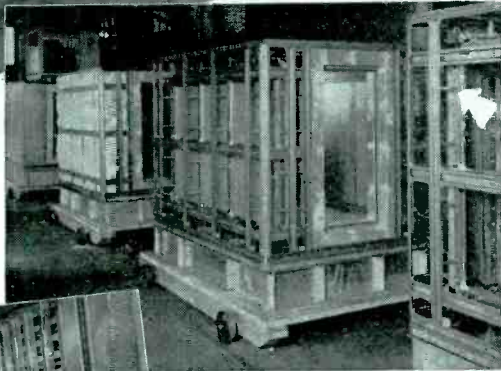

4. Interior of unit, showing refrigerator coils. Ls is particularly adaptable to heat-cold insulation.

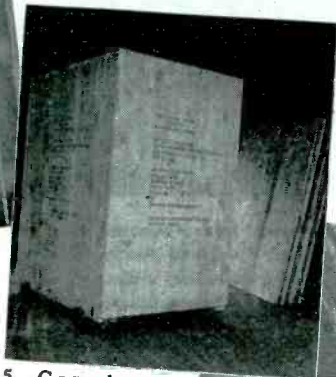

5. Completed equipment crated for shipping. Here, too, the compactness of Ls plays an important part.

Photos courtesy of Shaer & Turner Engineering Co., Boston, Massachusetts

6. Exterior of finished unit, showing compressor installed in housing at top.

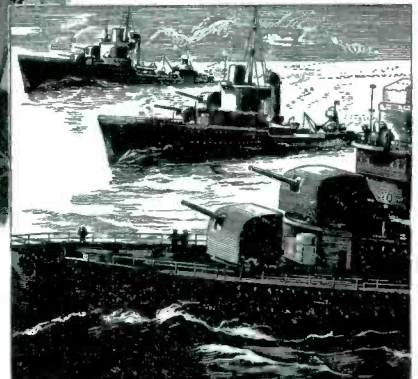
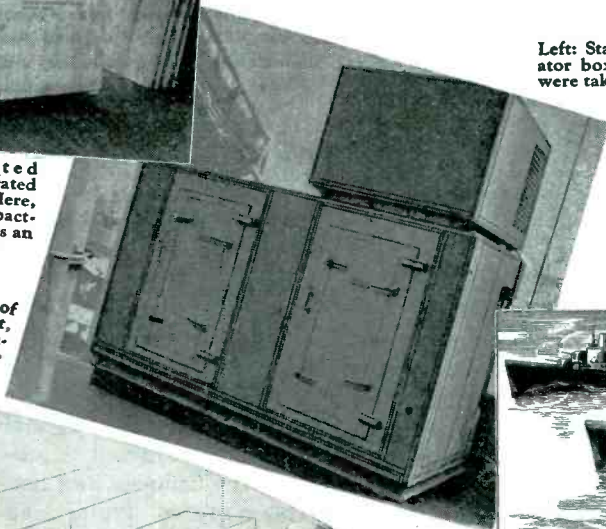

7. Drawing of destroyers on which refrigerators are installed.

LINDSAY
L^s STRUCTURE

U. S. Patents 2,017,600, 2,263,510, 2,263,511—U. S. and Foreign Patents and Patents Pending

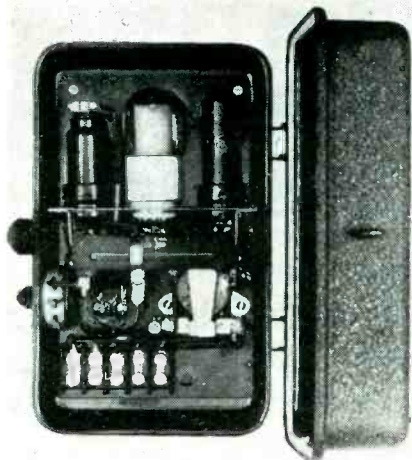

Pouring of white-hot metal from ladles, as shown in the large photo, is stopped by this type of photoelectric control unit when the mold is full

the phototube varies slightly. It is therefore used to indicate and control the density of gases as well as turbidity in liquids. In addition, it can distinguish between a clear liquid such as water and air above it, or can detect an interface between two liquids differing slightly in translucency.

Defrosting Frozen Food for Bakeries

DIELECTRIC HEATING, which has done war service in dehydrating army K-rations, has now been successfully applied by A & P Food Stores as a high-speed defroster of frozen foods in bulk. The bakery division of the company has been experimenting in the new field for nearly six months.

The new technique is being pioneered by Dr. William Cathcart, head of the food chain's bakery laboratories, working in conjunction with Federal Telephone and Radio Corp.

The most recent test of dielectric heating conducted by Dr. Cathcart at Federal's Newark laboratory resulted in successful quick-thawing of fully ripened peaches, among the most highly perishable foods. When frozen solid, thirty-pound cartons of the fruit, normally require 20 hours to defrost safely. They were thawed in less than fifteen minutes with Megatherm equipment.

Technique

The new defrosting method uses an oven whose floor and ceiling are

insulated metal plates which are connected to the high-frequency generator. Frozen food is placed between the plates and is subjected to dielectric heating to reach the core of the frozen substance as well as its surfaces and provide uniform defrosting.

It has been found that if the defrosted food is allowed to remain

eggs and other ingredients move through quick defrosters into dough and batter mixers. Besides cutting time and space outlays, the new method prevents decomposition and discoloration which often occur when frozen foods are defrosted in water or at room temperatures.

It has been found that different foods require different amounts of



Eleven seconds after cubes of frozen peaches were placed in the dielectric heating unit, they were completely defrosted and ready to eat. Dr. William Cathcart of A & P bakery laboratories, shown sampling slices, expects the new method of defrosting to save thousands of hours annually at company's 37 bakeries

between the plates after it is fully thawed, it actually begins cooking. Food prepared in this manner would be done in much shorter time and be uniformly well-done or rare throughout.

Electronic defrosting is achieved so rapidly that there is no chemical breakdown in the structure of the food such as occurs under normal thawing procedure. Thus, it is possible to retain the firmness and texture of tree-matured fruits and vine-fresh berries.

Storage of frozen eggs requires considerable space in large-scale bakery operations, and additional room is necessarily tied up by the tedious defrosting process. Dielectric heating is expected to save thousands of hours of waiting time annually at A & P bakeries as frozen

thawing time and that the quantity of a food being defrosted also affects the timing. Thus, a barrel of

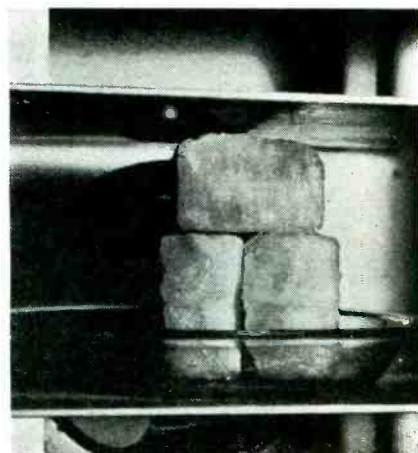

Frozen sliced peaches look like this when first placed between the electrodes of a Megatherm unit

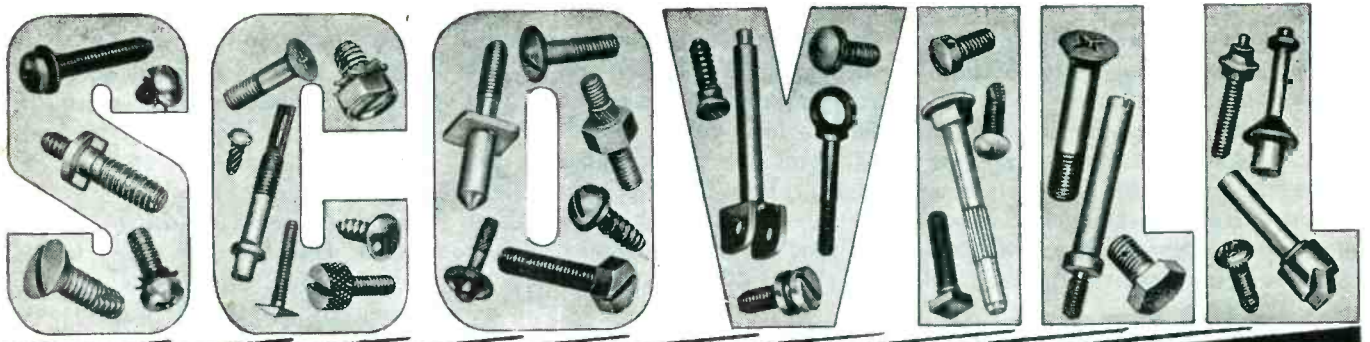

AVOID ASSEMBLY DELAYS



PLAN FASTENINGS TODAY

"Cold-forging"—proof #32... more each month

PLAN TODAY:

... because properly planned fastenings started in the product design stage may well mean "make" or "break" to that fast and precise assembly job—no assembled product can be better than its fastenings.

... because you must choose between a standard fastening or a part especially designed to meet your specific need—early action allows time for an exacting choice.

CHOOSE SCOVILL:

... because we can aid you in that selection—our broad experience in fastenings qualifies us as specialists. Our demonstrated ability in special design* makes Scovill your logical choice.

... because our skill in special design, our special processing with our ingenuity in cold-forging, means a substantial savings in money—materials—motions.

CALL A SCOVILL FASTENINGS EXPERT TODAY

**The special purpose item illustrated above is one of many examples of Scovill ingenuity in cold-forging and demonstrated ability in special design.*

3 Standard Fastenings for Production Efficiency



1 Phillips Recessed Head Screws—The modern, effective, time-saving fastening device proven in tens of thousands of assembly lines. Other standard head styles are also available.



2 Self-Tapping Machine Screws—Eliminate separate tapping operations for fastenings to castings, heavy gauge sheet metal, and plastics. Also available with Phillips Recessed Head.



3 Washer-Screw Assemblies—When use of lock washers is indicated, the time-saving of pre-assemblies is obvious. Also available in standard slotted head styles.

SCOVILL MANUFACTURING COMPANY

WATERVILLE SCREW PRODUCTS DIVISION

WATERVILLE 48, CONN.



TEL. WATERBURY 3-3151

NEW YORK, Chrysler Building • DETROIT, 714 Fisher Building • CHICAGO, 135 South LaSalle Street • PHILADELPHIA, 18 W. Chelton Avenue Building
PITTSBURGH, 2882 W. Liberty Ave. • SYRACUSE, Syracuse - Kemper Insurance Bldg. • LOS ANGELES, 2627 S. Soto St. • SAN FRANCISCO, 434 Brannan St.

frozen berries intended for baking or processing must now stand in room temperature for seven days before it can be emptied into the cooker. Berries in the center of the barrel may still be frozen if many cold barrels are kept close enough to insulate each other. Dielectric heating cuts down the thawing time

to one hour, with level defrosting throughout the barrel. When precise time schedules are worked out for various foods, the technique will probably involve placing cartons or barrels on conveyor belts which will pass through the oven at a speed to be determined by the type of food being frosted.

stick enables pilots to fly their bombers with an ease and accuracy hitherto unattainable even in smaller planes. With it, pilots can fly tighter formations thereby obtaining greater security for the flight against attacking enemy planes, can arrive over the target less fatigued, and better able to maneuver their planes during evasive action.

Electronic Joy Stick for Large Aircraft

AS AN AID TO PILOTS flying heavy airplanes, research engineers of the aeronautical division of Minneapolis-Honeywell Regulator Company in cooperation with armament laboratory engineers of the Air Technical Service Command have developed a completely automatic, electronic control stick. This new one-hand pistol-grip control lever, illustrated in Fig. 1 and first installed on Consolidated Liberators and now in use on the B-29 Superfortress and other four-engined bombers, reduces pilot fatigue and increases controllability. On post-war transport aircraft, it will improve smoothness of flight and increase safety.

Improved Bomber Control

In the present war-time application to heavy bombers, the control

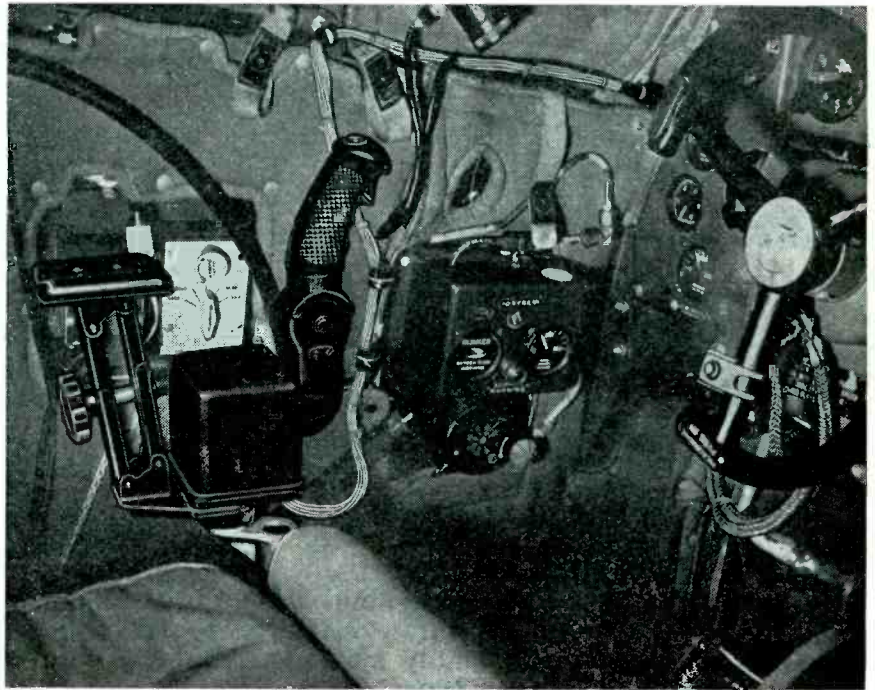
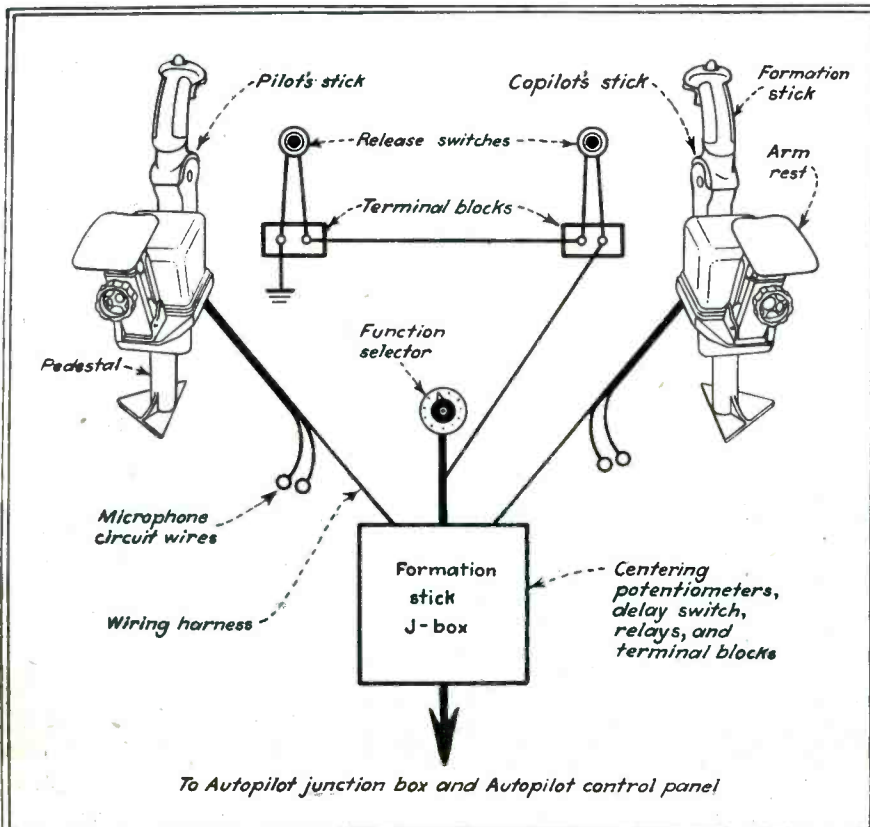
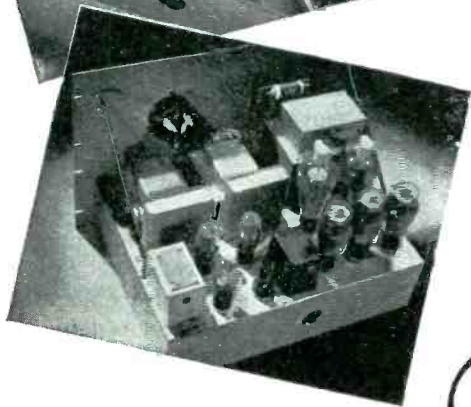
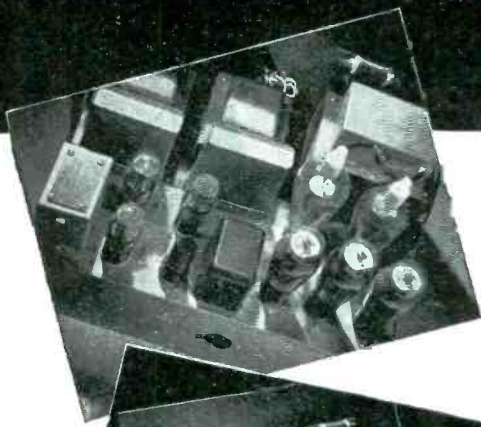
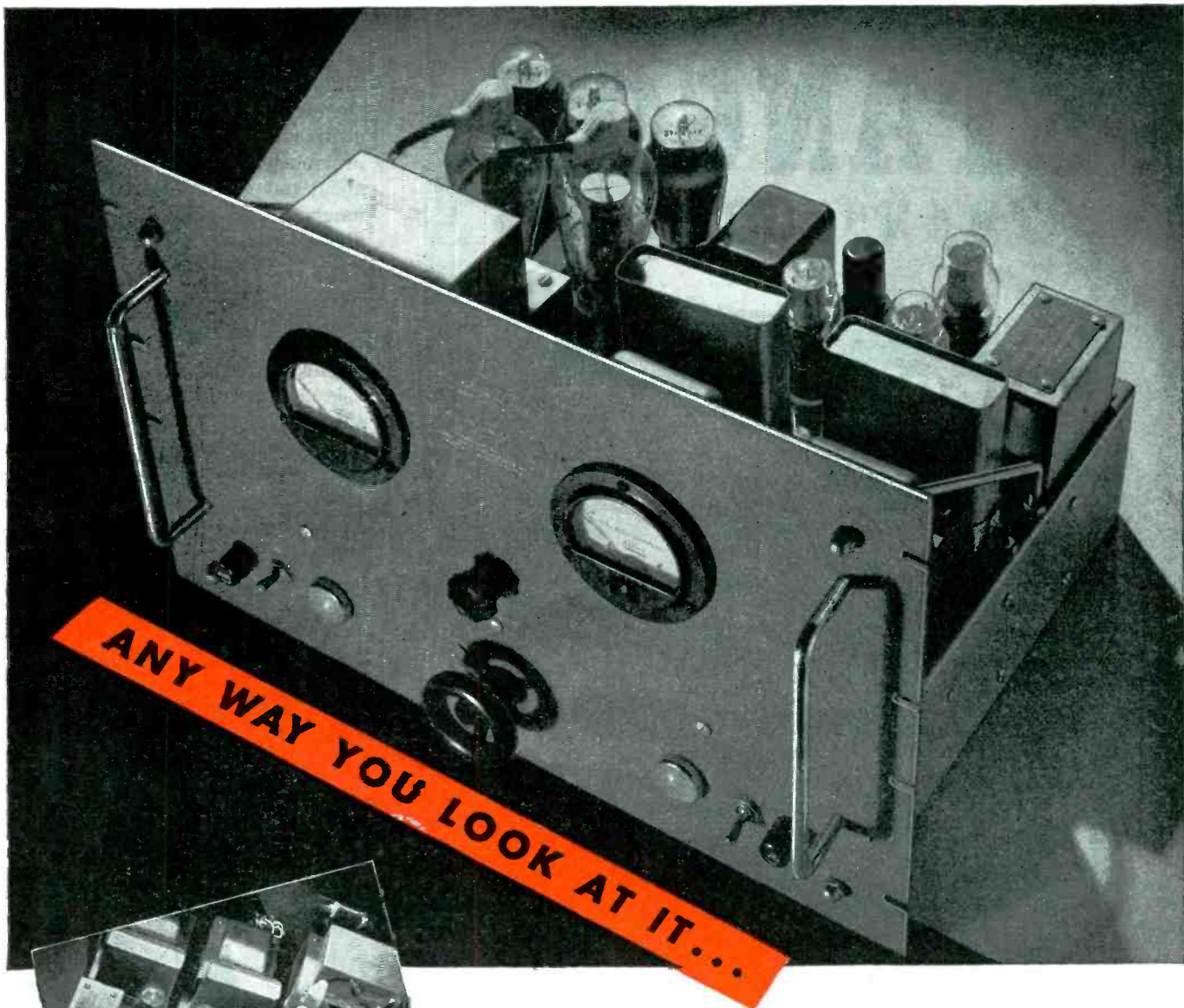

Fig. 2—Mounted beside the co-pilot's seat in a Consolidated Liberator B-24, the formation stick with its arm rest reduces pilot fatigue by its simplicity and ease of control and the relaxed position from which it is operated

Fig. 3—Schematic diagram shows how pilot and co-pilot have direct one-hand control of the plane's autopilot. A few changes in the wiring of the autopilot junction box and control panel are all that are necessary for the addition of the formation sticks to aircraft already equipped with an autopilot



Increased turbulence of the air from close formation flying requires a great deal of effort on the part of pilots. Without the new so-called "formation stick," pilots arrived over targets fatigued. In formations held so tight that planes are flying wing-tip to wing-tip, the air becomes so turbulent that with earlier controls both the pilot and co-pilot had to exert their full strength to hold their plane steadily on its course and in its fixed position in the formation. Planes falling out of formation became prey



The HARVEY Regulated Power Supply 206 PA is your best source of laboratory D.C. power between ranges of 500 to 1000 volts. The HARVEY 206 PA operates in two ranges — 500-700 volts at $\frac{1}{4}$ amp., 700 to 1000 volts at $\frac{1}{5}$ amp. Regulation is 1% or better in both ranges and output remains constant even though line voltage varies between 95 and 130 volts . . . The HARVEY 206 PA is designed for safe and convenient operation. It has overload relay and interlocking relay protection at all voltages. Time delay for high voltage circuit applications and pilot lights to indicate unit in use. It is mounted on a standard relay rack panel and all components are easily accessible. Sturdy, precision-built, its dimensions are $12\frac{1}{4}$ " x 19" with a depth of 13". Weight but 72 pounds. . . . For complete information write



HARVEY RADIO LABORATORIES, INC.

439 CONCORD AVENUE • CAMBRIDGE 38, MASSACHUSETTS

STANCOR TRANSFORMERS

WITH
Hipersil Cores

SAVES
Copper and Steel



SMALLER SIZE

LIGHTER WEIGHT

WIDER RANGE
OF LINEAR RESPONSE

*3 Types of
Transformers*

THE use of Hipersil Steel Cores now adapted to some Stancor Transformer types permit a reduction in the size of the transformer without sacrifice of capacity, making it ideal for tank, submarine, walkie-talkie and similar installations where restricted space areas are a primal factor... Write us your requirements enclosing B/P for further information.

★ ★ ★

Keep Stancor on top of your list for post-war transformer needs. A wider range of applications will be ready for quick-action on V-Day.



**STANDARD TRANSFORMER
CORPORATION**

1500 N. HALSTED ST., CHICAGO 22, ILL.

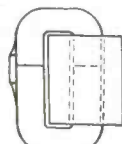

SIMPLE CORE
TRANSFORMER

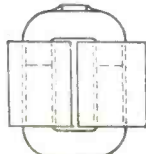

CORE TYPE
TRANSFORMER

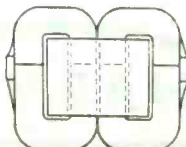

SHELL TYPE
TRANSFORMER

to enemy pursuits. With the new flight stick, the pilot can achieve the same result by a one-pound pull of his right hand as he could obtain previously by a combined force of about 100 pounds exerted with both hands and feet. Thus the pilot flies a better, safer formation with less effort and returns to his base less exhausted.

Formation Stick Operation

The control handle shown in Fig. 2 is mounted with an arm rest beside the pilot. The lever is free to move in all directions and is operated in the same manner as the joy stick of lighter aircraft. Motion of the control governs, through electronic amplifiers, the servo motors



Fig. 1—Formation stick, operated by pilot in joy-stick fashion, controls heavy bombers through electronic amplifiers and servo motors

that operate the control surfaces of the bomber. The airplane is thus moved by the servo motors in the same direction and to the same degree as the stick is moved by the pilot.

The servo system which the control lever governs as illustrated in Fig. 3 is the electronic flight-control system developed by Minneapolis-Honeywell as the autopilot. Used to hold the plane on a set course during bombing runs, at which time it is under the bombardier's control, this autopilot is now made to maneuver the plane during flight under the pilot's control.

A stabilizing mechanism has

what you should know about

STYRALOY

Dow's new plastic for electrical applications

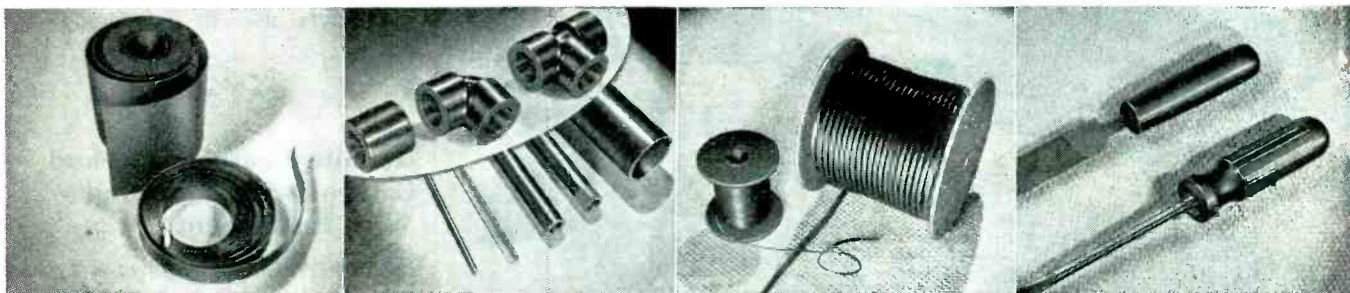

Enthusiastic response from many electrical engineers followed the recent announcement of Styraloy 22. Such special interest is well-founded for this new, Dow developed synthetic elastomer already occupies an important place in the field of low-loss, low capacitance, high dielectric strength, insulating material.

Developed initially for insulation uses where low loss at high frequency was an important factor, Styraloy 22 soon attracted attention for other uses . . . for aircraft ignition installations because of its flexibility at low temperatures and freedom from corona attack even at high altitudes . . . for radio gaskets, bushings, and similar products . . . for combining with synthetic rubber to provide flexible, water resistant wire insulation.

These are some of the things you should know about Styraloy 22—so you can determine where this new product can best fit into your own plans. Complete data is available on request.

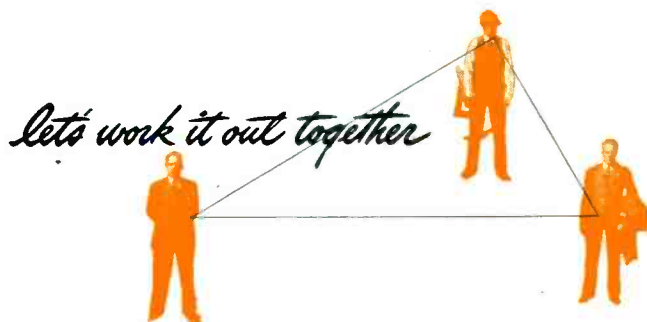

We at Dow know from experience that success in plastics is not a one-man nor even a one-industry job. It calls for the combined skill and cooperation of manufacturer or designer, plus fabricator, plus raw materials producer. Working together, this team saves time and money and puts plastics to work successfully. Call us—we'll do our part.

PRESENT AND POTENTIAL USES: One-piece cable sheathing; handles for tools, household appliances, etc.; gaskets; bushings; coil forms; floor mats; scuff plates; many applications still to be ascertained.

PROPERTIES AND ADVANTAGES: High dielectric strength, low power loss. Power factor only .005 at 100-300 megacycles. Flexible and shock resistant from -90° F. to 212° F. Specific gravity less than 1 (floats in water). Water absorption only .2 to .5%. Resists heat, ozone, and most chemicals. Highly resistant to abrasion. Resists permanent indentation. Ideally suited to extrusion of complex cross sections and readily fabricated by other molding techniques. Easily machined.

THE DOW CHEMICAL COMPANY • MIDLAND, MICHIGAN

New York • Boston • Philadelphia • Washington • Cleveland • Detroit
Chicago • St. Louis • Houston • San Francisco • Los Angeles • Seattle



ETHOCEL • ETHOCEL SHEETING • STRIPCOAT
SARAN • SARAN FILM • STYRON • STYRALOY

In doubt about SILICON STEELS to meet your design requirements

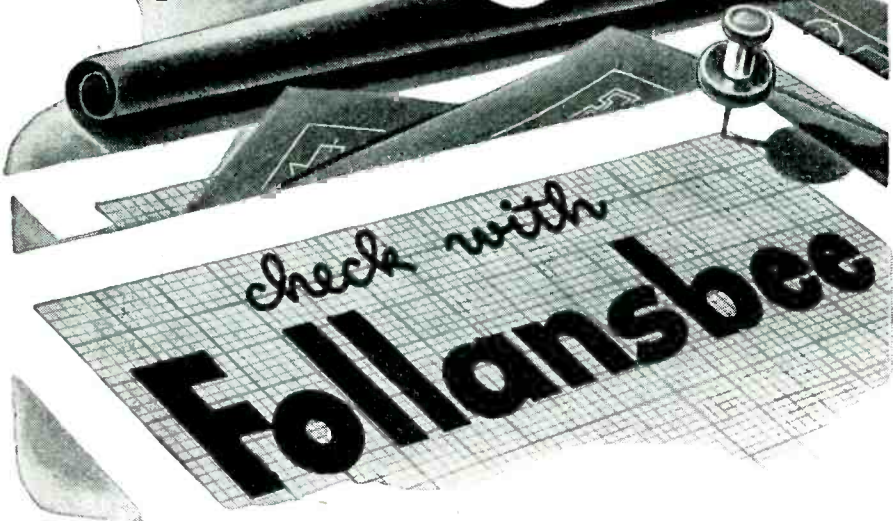

Designs for electrical and electronic equipment are necessarily influenced by the electrical and mechanical properties of Electrical Sheets. There should be no unnecessary limits placed on your designs by the performance of yesterday's Electrical Sheets. Spurred by the needs of war, silicon steels are now being produced which far excel those of just a few years ago.

If you're in doubt about the availability of Electrical Sheets and Strip to perform the functions required by the designs you contemplate, check with Follansbee . . . experts in the manufacture of high quality silicon steels for every application.

FOLLANSBEE STEEL CORPORATION

GENERAL OFFICES • PITTSBURGH 30, PA.

Sales Offices—New York, Philadelphia, Rochester, Cleveland, Detroit, Milwaukee,
Sales Agents—Chicago, Indianapolis, St. Louis, Nashville, Houston, Los Angeles,
San Francisco, Seattle; Toronto and Montreal, Canada.

Plants—Follansbee, W. Va., and Toronto, Ohio



ALLOY BLOOMS & BILLETS, SHEETS & STRIP • CLAD METALS • COLD ROLLED CARBON SHEETS & STRIP
POLISHED BLUE SHEETS • ELECTRICAL SHEETS & STRIP • SEAMLESS TERNE ROLL ROOFING

been added to the Autopilot to give "feel" to the control stick in the hand of the pilot so that, although the formation stick interposes a servo motor between the pilot and the plane's motion, it does not interfere with the pilot's being aware of that motion. Other changes in the basic circuit have also been made to obtain this greater flexibility.

Need for the autopilot and the formation stick is so great that Minneapolis-Honeywell, which has two plants devoted to their production, has turned over complete engineering and manufacturing data to the Jack & Heintz Co. for that company's use in producing the units.

• • •

Remote Measurement and Control with Vibrating Wire Instrument

IN INDUSTRIAL processes, a typical telemetering system takes a measurement at one place and indicates it or records it at another place. Such a system may be used for telecontrol, by setting a magnitude at the original location, converting it into a frequency, and conducting it to the distant location where it is reconverted into a controlling force capable of adjusting a process to conform to the magnitude first established.

In a new method that has been developed by Rieber Research Laboratory, the intelligence is transmitted in the form of a frequency rather than as a magnitude. The method employs the use of a vibrating wire whose frequency can be made to vary by the quantity being measured. This converted measurement can then be transmitted by wire or radio. At the receiving end, a similar vibrating wire is used to indicate the quantity measured with a high degree of accuracy.

Called a Vibratron, the unit consists essentially of a stretched wire, placed in a magnetic field, and driven electrically and continuously at its own resonant frequency. The measured quantity is permitted to change the length of, or the tension applied to the wire. All other small parasitic changes are completely compensated. The electrically maintained vibratory frequency of the

COMPRESSOR AMPLIFIERS



Compressor Amplifier E-165

BY PRESS WIRELESS

- RAPID COMPRESSION** Less than 0.5 millisecond
- FLAT COMPRESSION CHARACTERISTICS** Output rises only 2.5 db for 20 db input above compression threshold
- FAST COMPRESSION RELEASE** 250 and 750 milliseconds
- LOW DISTORTION** ½% or less below compression threshold
Less than 1½% with 15 db compression
- LOW NOISE LEVEL** 60 db below output level at compression threshold
- FREQUENCY RESPONSE** Within ±1 db from 50-10,000 cps.
- AMPLIFICATION** 45 db

Standard 19 Inch Rack Mounting

Operates from 110/115 volts, 50/60 cycles AC
Available in strict priority sequence
Send for free data sheet

OPPORTUNITIES

Opportunities in present & postwar work for Senior and Junior Graduate Engineers.

Phone, call or write, stating experience, education, etc.

Personnel Department,
Manufacturing Division,

PRESS WIRELESS, INC.

1475 Broadway
N. Y. C. -18

PRESS WIRELESS, INC.

Executive and Sales Office, 1475 BROADWAY, NEW YORK 18

PARIS · NEW YORK · CHICAGO · LOS ANGELES · LONDON · HAVANA
RIO DE JANIERO · MONTEVIDEO · MANILLA · BERNE · SANTIAGO DE CHILE



Awarded to our Micksville, L. I. plant for outstanding achievement in war production.

PRECISION-BUILT RELAYS

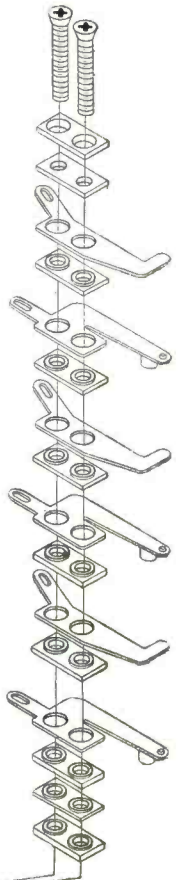
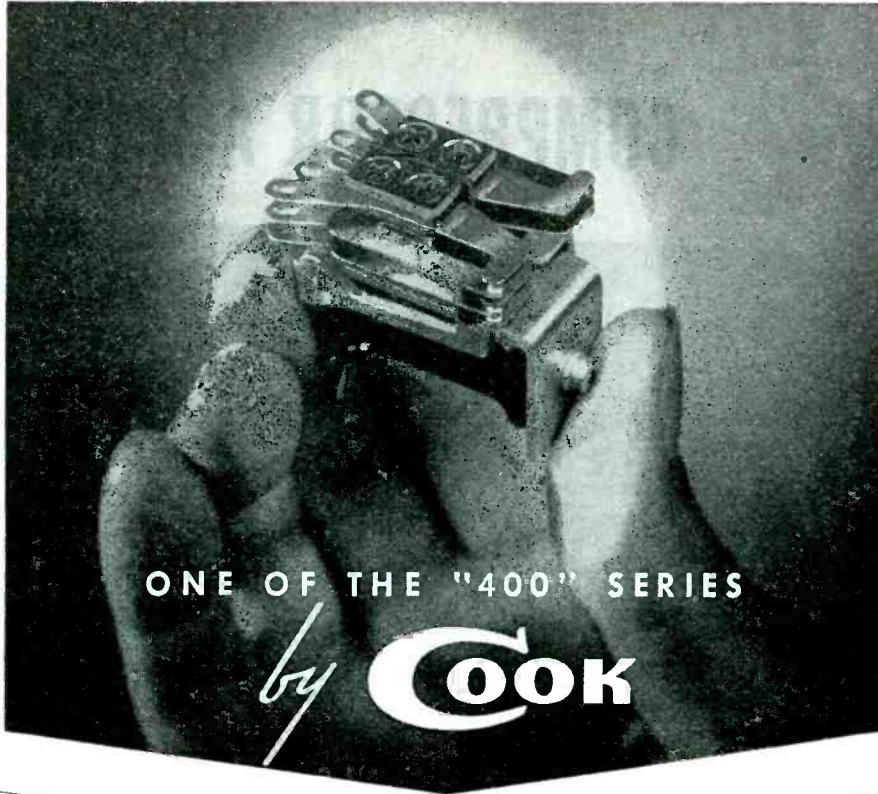
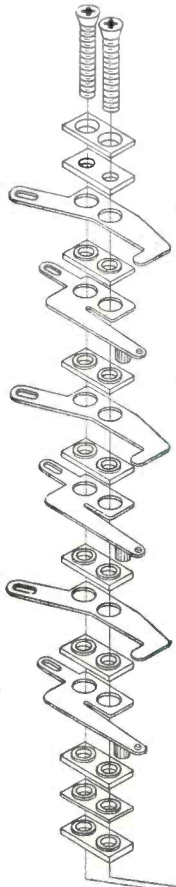

"Extra-Ordinary" ENGINEERING

Cook relays are designed and engineered in modern laboratories by engineers who have the finest production and testing equipment at their disposal. Fine equipment in itself, however, is not always the basis of good engineering. The men in Cook laboratories must also qualify by possessing sound, practical and theoretical engineering principles. These principles are not only prevalent in the men in our laboratories, but are also characteristics of our entire staff of field engineers. These are the men located throughout the principal cities in the United States and Canada, who are at your disposal when any relay problems present themselves.

2700 SOUTHPORT
AVENUE

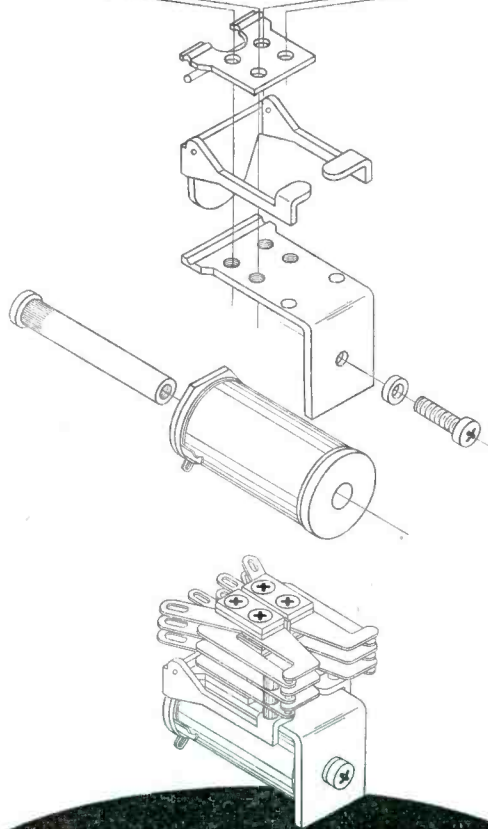

"Extra-Ordinary" CRAFTSMANSHIP

The stamp of craftsmanship in the manufacture of Cook relays starts in the drafting room. It is there that careful drawings, such as the accompanying illustration, are prepared. From this drawing through the specification of the best and highest grades of materials, precision manufacture of all parts, the careful assembly, and the rigid testing of the completed relay, every step along the way is an operation in which Cook craftsmen take pride.

The relay illustrated is one of the new "400" series of small Cook relays. It is 1-7/16" L. by 1-5/16" W. by 1-7/16" H., operates normal coil voltage of 28 volts. Will operate at 14 volts and maintain proper contact pressure over 30 grams. Operating time less than 10 milliseconds.



CHICAGO 14,
ILLINOIS



DOESN'T CARBONIZE!

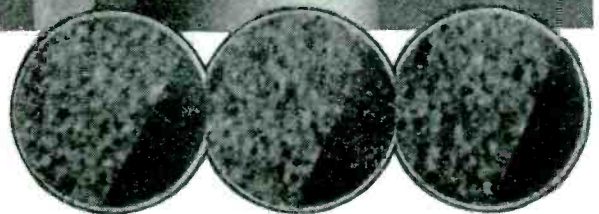
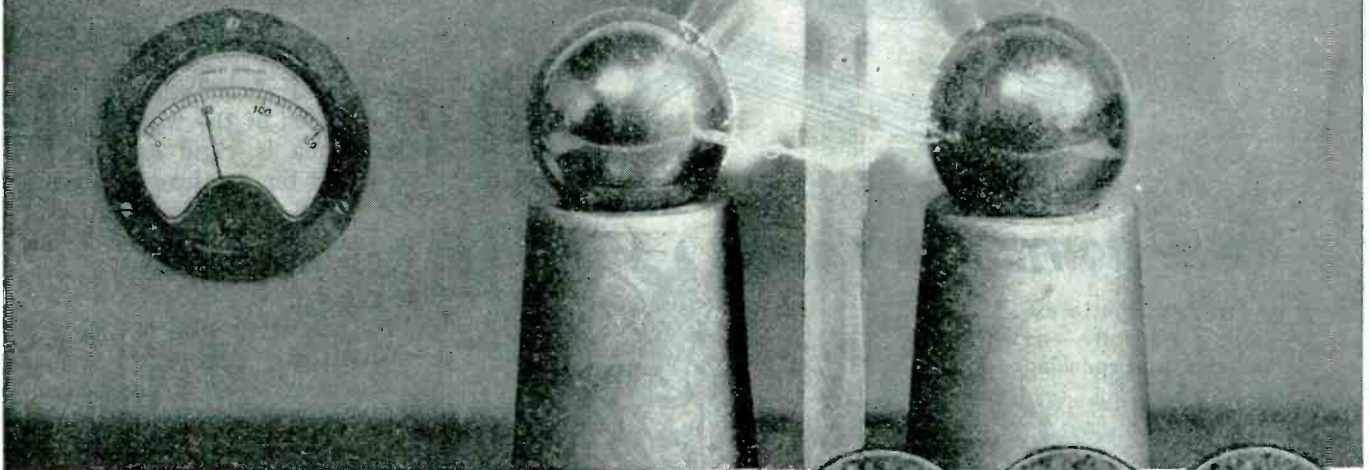

Cross sections of the test sheet made at the point of exposure to the 50,000 volt arc (magnified 10 times) show no trace of damage.

This high frequency insulation will not carbonize under arc, yet it possesses dielectric properties of the highest order. Made entirely of inorganic materials, Mykroy cannot char or turn to carbon even when exposed to continuous arcs and flashovers.

The sheet of Mykroy in the photo was exposed to a 50,000 volt arc after which it was sectioned and carefully examined for signs of damage. None were found . . . not even the slightest excoriations were present, hence no low resistance paths formed to support breakdown.

Engineers everywhere are turning more and more to Mykroy because the electrical characteristics of this perfected glass-bonded ceramic are of the highest order—and do not shift under any conditions short of actual destruction of the material itself. Furthermore Mykroy will not warp—holds its form permanently—molds to critical dimensions and is impervious to gas, oil and water. For more efficient insulation investigate Mykroy. Write for copies of the latest Mykroy Bulletins.

MECHANICAL PROPERTIES*	
MODULUS OF RUPTURE.....	18000-21000psi
HARDNESS	
Mohs Scale 3-4 BHN. BHN 500 K9 Load. 63-74	
IMPACT STRENGTH.....	ASTM Charpy .34-.41 ft. lbs.
COMPRESSION STRENGTH.....	42000 psi
SPECIFIC GRAVITY.....	2.75-3.8
THERMAL EXPANSION.....	.00006 per Degree Fahr.
APPEARANCE.....	Brownish Grey to Light Tan

ELECTRICAL PROPERTIES*	
DIELECTRIC CONSTANT.....	6.5-7
DIELECTRIC STRENGTH (1/8").....	630 Volts per Mil
POWER FACTOR.....	.001-.002 (Meets AWS L-4)

*THESE VALUES COVER THE VARIOUS GRADES OF MYKROY

GRADE 8	Best for low loss requirements.
GRADE 38.	Best for low loss combined with high mechanical strength.
GRADE 51	Best for molding applications.

Special formulas compounded for special requirements.

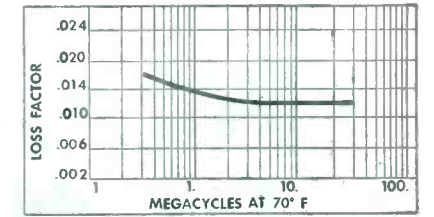

Based on Power Factor Measurements made by Boonton Radio Corp. on standard Mykroy stock.

MADE EXCLUSIVELY BY

ELECTRONIC MECHANICS INC.

70 CLIFTON BLVD., CLIFTON, N. J.
 CHICAGO 47; 1917 N. Springfield Ave., Tel. Albany 4310
 EXPORT OFFICE: 89 Broad Street, New York 4, New York

MYKROY IS SUPPLIED IN SHEETS AND RODS — MACHINED OR MOLDED TO SPECIFICATIONS

NEVER A SQUAWK!

Draftsmen who use Arkwright Tracing Cloths never get put on the mat for smudged drawings.

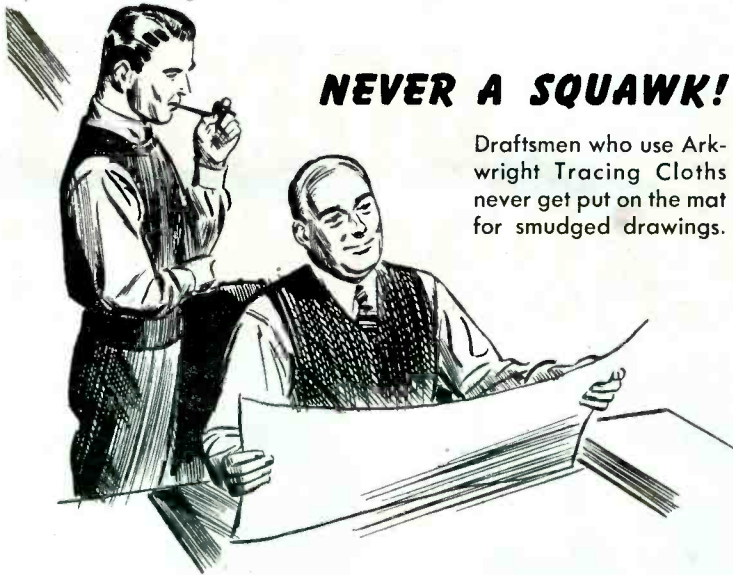

ARKWRIGHTS DON'T BALK

at erasures. They erase easily and neatly — no smudges. Take re-inking beautifully, too!

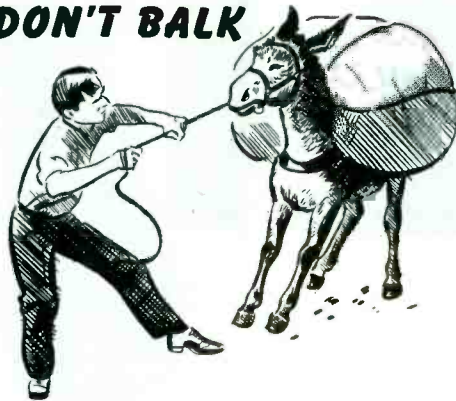

COCK-O'-THE-WALK!

Another reason why many draftsmen rate American-made Arkwright Cloths head and shoulders over everything else! Try them. Arkwright Finishing Co., Providence, R. I.



Sold by leading drawing material dealers everywhere

Arkwright

TRACING CLOTHS

AMERICA'S STANDARD FOR OVER 20 YEARS

wire then represents the quantity to be measured.

A similar wire, used in the receiving system, may be attached to a scanning mechanism by which the tension on the wire is varied, until resonance occurs, at which point the magnitude of the tension is indicated or recorded. This magnitude should correspond to the original quantity applied at the transmitting station.

Mechanical Construction

Figure 1 shows the elementary construction of the wire structure. The frame is rigid and compensated for temperature changes so that it will expand and contract at the same general rate as the tungsten wire which is stretched across the frame.

The vibrating wire is suspended between two insulated terminals, the lower of which is mounted on a hinge member, which is pressed back by the action of the calibrated

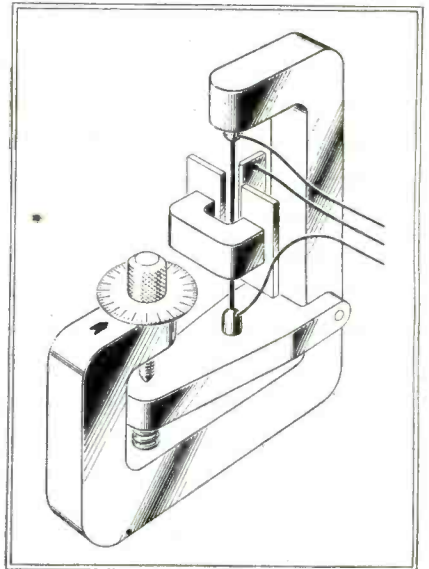
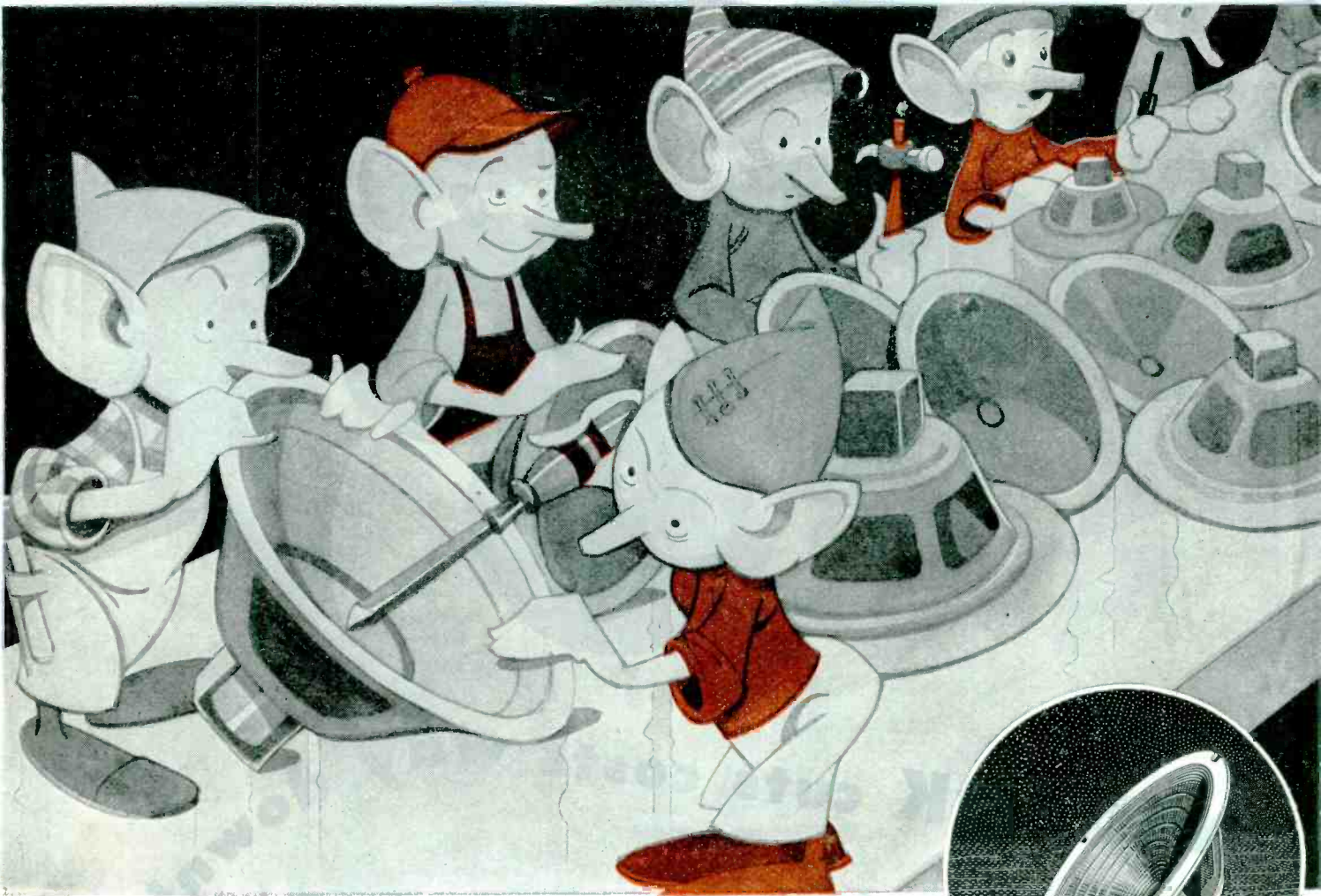
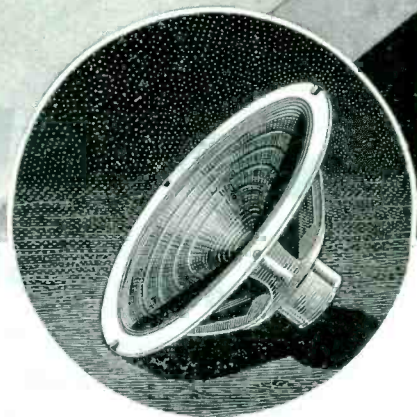

Fig. 1—Basic construction of the Vibatron. Although the lower support for the wire is shown mounted on a pivot, a hinge has been found preferable in practice

screw shown. The wire passes through a magnetic field, created by the small magnet shown, in between two extended pole pieces. A supplementary electrode, adjacent to but not touching the wire, is mounted on insulating supports (not shown) and is used to convert the vibratory motion of the wire directly into frequency modulation



★ *Utah Speakers: More than 20 million Utah speakers have been made for radio, and public address systems.*



NO GUESSWORK HERE!

The manufacture of electronic devices and radio parts is an exacting job. It's a precision job and Utah does it to a plus degree. Take the loud speaker for instance: Utah's "precision-plus" methods go 'way back to the buying of raw materials that make the speaker. They go even further.

The tools used in the manufacture of the

speaker are likewise made at Utah, to Utah's specifications. You see, every single phase in the manufacture of Utah is guess-proof . . . tool making, welding, punch press, electroplating, and all the other steps, to the shipping of the final finished product. *Check, re-check, test . . . supervise* are Utah words. Here Utah workers (with Utalins* back of 'em) know their value. Know they make for "precision-plus" performance—the proof of Utah quality.

*Utah's Helpers



UTAH RADIO PRODUCTS COMPANY, 820 ORLEANS ST., CHICAGO 10, ILL,
Utah Electronics (Canada) Ltd., 300 Chambly Road, Longueuil, Montreal (23) P.Q. • Ucoa Radio, S.A., Misiones 48, Buenos Aires

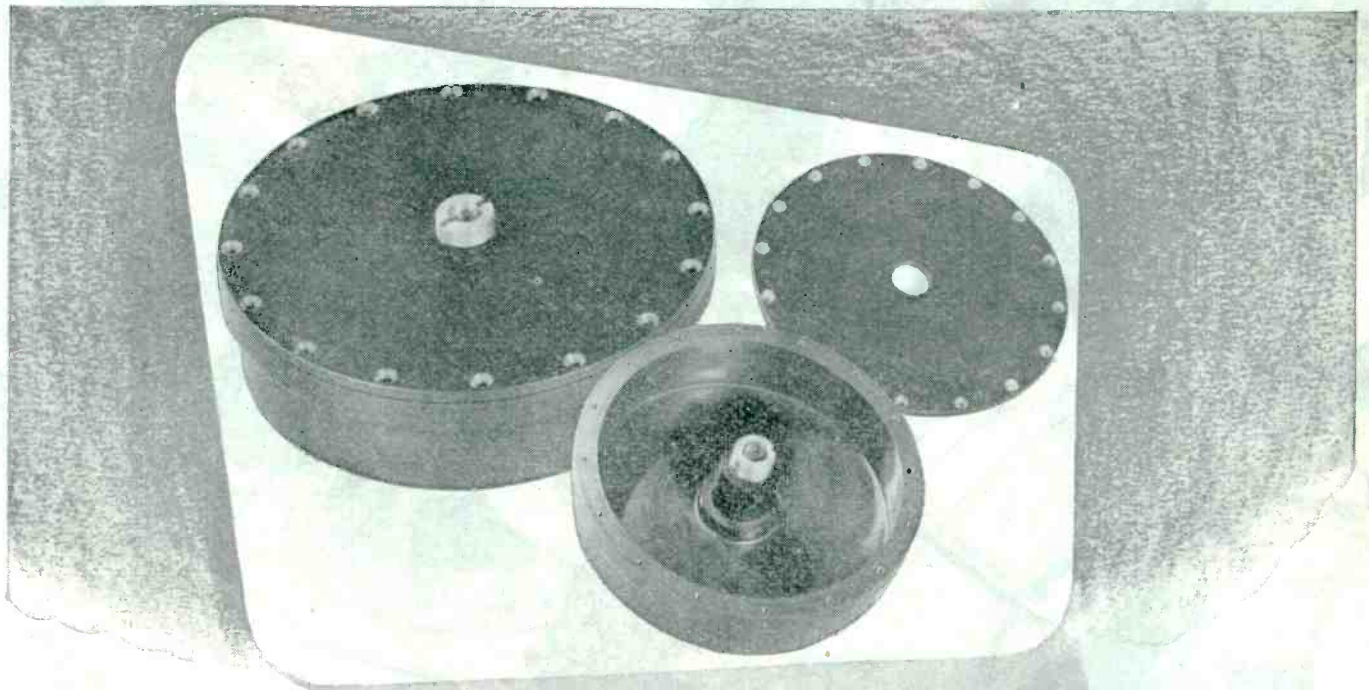

INSUROK cuts costs way down!

—for Motiograph of Chicago!

Motiograph saves at least \$2.50 every time they make a rotary stabilizer for the sound head of a motion picture projector—thanks to the use of INSUROK—recommended by Richardson Plastics. Stabilizer housings are made of Molded INSUROK; the covers, of Laminated INSUROK. The combination holds a flywheel which operates in a special liquid to reduce film flutter and prevent annoying tone distortion.

This outstanding industrial application is typical of the way in which

INSUROK Precision Plastics—with their high mechanical and dielectric strength, lightness, easy workability, and smooth, shiny finish—are meeting exacting requirements with unusual economy and efficiency. INSUROK is ready to go to work for you on your present or postwar products. Write Richardson Plastics now for complete information.

Shown Above: Complete Rotary Stabilizer unit, with Molded INSUROK housing—metal insert—and Laminated INSUROK cover. Used by Motiograph, Chicago, Ill.

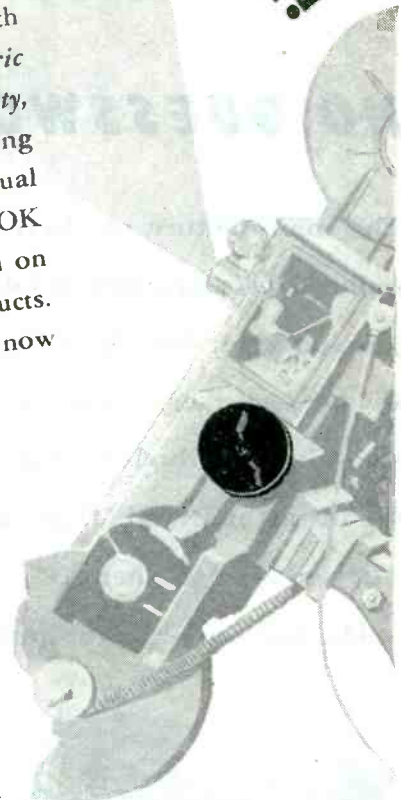

INSUROK Precision Plastics

The RICHARDSON COMPANY

MELROSE PARK, ILL. NEW BRUNSWICK, N. J. FOUNDED 1868 INDIANAPOLIS 1, IND. LOCKLAND, CINCINNATI 13, OHIO
 DETROIT OFFICE: 6-252 G. M. BUILDING, DETROIT 2, MICHIGAN NEW YORK OFFICE: 75 WEST STREET, NEW YORK 6, N. Y.
 CLEVELAND OFFICE: 326-7 PLYMOUTH BLDG., CLEVELAND 15, OHIO



Many Armed Servant

The many arms of the FEDERAL organization are the arms of a versatile servant . . . making war goods now and preparing for the new and greater demands of a world at peace.

For example, FEDERAL INSTRUMENT LANDING AND RADIO RANGE equipment is pioneering new concepts of faster, safer air travel.

FEDERAL'S MEGATHERM dielectric and heat induction units are revolutionizing production processes in the plastics, metal, food, plywood, textile and other industries.

FEDERAL always *has* made better tubes. Today, as the result of continuous scientific development, FEDERAL'S TRANSMITTING, RECTIFYING AND INDUSTRIAL POWER TUBES are proving even more dependable and long lasting.

To fill a vital war need, FEDERAL developed INTELIN ULTRA HIGH FREQUENCY TRANSMISSION LINE — now is the world's largest manufacturer.

FEDERAL'S MARINE RADIO EQUIPMENT, first in serving America's merchant fleet, includes DIRECTION FINDERS, AUTO ALARMS, packaged TRANS-

MITTING AND RECEIVING UNITS and LIFEBOAT TRANSMITTERS.

Back of every FEDERAL TRANSMITTER are years of engineering and manufacturing experience which assure the ability to produce any type or power of communications equipment from walkie-talkie to 200 K.W. transmitters.

QUARTZ CRYSTALS, precision cut and mass produced at FEDERAL, are performing many secret military jobs.

SELENIUM RECTIFIERS, introduced by FEDERAL, are accepted as standard for converting alternating to direct current. Power equipment and battery chargers, powered by FEDERAL SELENIUM RECTIFIERS, are known for long life, high efficiency and low cost.

Yes, FEDERAL's many arms make many things — all to one high standard. Here some of the world's keenest scientific minds combine their talents with three decades of FEDERAL leadership for developing and producing better communications and industrial electronic equipment.

Federal Telephone and Radio Corporation

Newark 1, N. J.

AN **IT&T**
ASSOCIATE



BUILT FOR **TOUGH** SERVICE

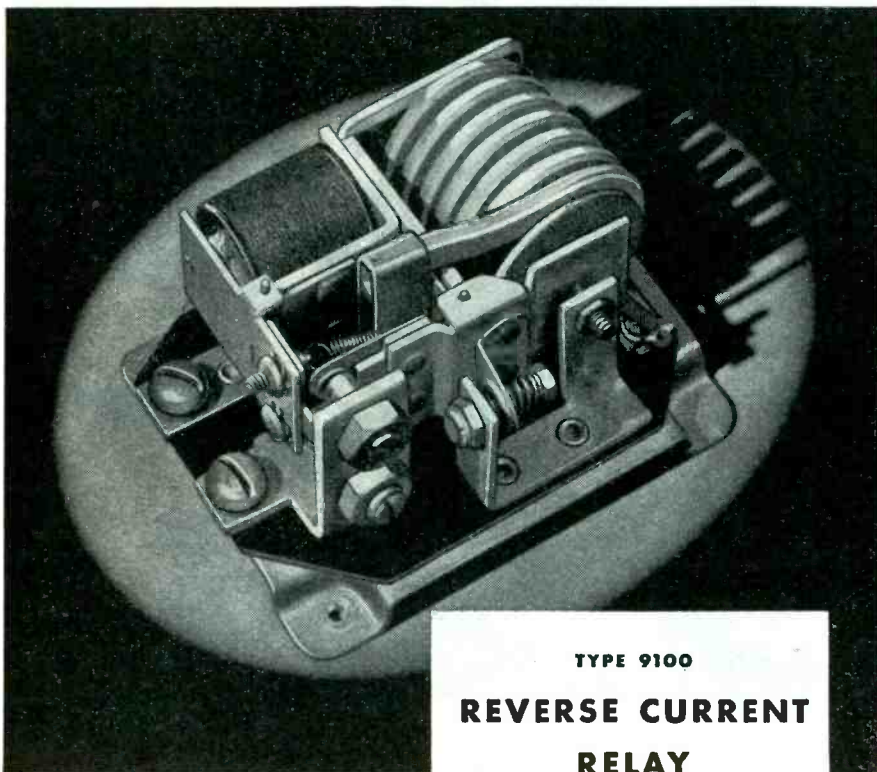

**TYPE 9100
REVERSE CURRENT
RELAY**

... FOR POWER GENERATORS

Operating under toughest conditions, this R-B-M Reverse Current Relay has done a remarkable job on auxiliary engine-driven generators in plane and tank service. It is equally effective for any low voltage D. C. application.

In addition to extra strength and durability, design incorporates a magnetic latch which prevents closing of contact under great vibration or shock. Contacts rated 100 amps at 30 volts D. C. maximum. Dimensions — width 4-1/16", depth 3-7/16", height 2-1/16". Average weight 1.62 pounds.

Other R-B-M equipment available for low voltage D. C. applications includes toggle, rotary, and push button switches, voltage regulators, engine-starting solenoids, light and signal relays. For additional information, write Dept. A-6...

R-B-M MANUFACTURING COMPANY
Division of
ESSEX WIRE CORPORATION
LOGANSPORT, INDIANA



MANUAL AND MAGNETIC ELECTRIC CONTROLS — FOR
AUTOMOTIVE, INDUSTRIAL, COMMUNICATION AND ELECTRONIC USE

of a radio transmitter. This is done by using the vibrating wire and the adjacent electrode as two terminals of a capacitor which is included in the tuning capacitor of the radio transmitter.

The wave form of such frequency modulation is not ideal, but it is amply good for most telemetering applications. In order to drive this wire, alternating current is passed through it, derived from an electronic amplifying system, into which are fed impulses, derived from the motion of the wire, that maintain the continuous series of driving impulses.

Bridge Circuit

Figure 2 is a schematic diagram showing one circuit which has been used with this type of Vibratron. The two input terminals shown

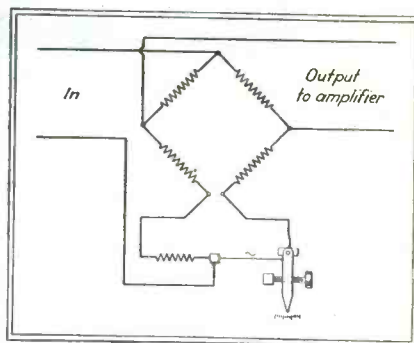

Fig. 2—The vibrating wire is connected in one side of this bridge circuit and a second wire is installed in the same case and connected in the opposite side for compensation

feed into two opposite corners of a Wheatstone network composed of four equal resistors having a resistance of 500 ohms each. This bridge network is balanced rather carefully.

The network is completed by the inclusion, in one side of the bridge, of the vibrating tungsten wire, maintained under tension which is varied by the rotation of a screw. The other side of the network is balanced by the inclusion of a resistance, equivalent to that of the vibrating wire. This resistance element is made of the same kind of material, and is installed in the same case with the vibrating wire, in order to compensate for all effects of changing temperature on the total resistance of the bridge.

The bridge is set up and bal-

There is a

WINNING COMBINATION

for Maximum Efficiency with



PEDIGREE

Insulating

VARNISHES

**IMC ENGINEER
CAN POINT IT OUT TO YOU**

Maximum efficiency of electrical windings can only be obtained with the correct combination of insulating materials. Pedigree Insulating Varnishes, as manufactured by The P. D. George Company, compensate for the deficiencies of the other material in the combination and insure superior performance.

There is a "balanced" Pedigree product for every electrical application, providing excellent mechanical, chemical, thermal, and electrical protection.

The I. M. C. engineer is qualified to consider the operating requirement and processing facilities after which the correct product providing the longest life is recommended.

A copy of the latest catalog of The P. D. George Company and the latest descriptive data on all of the standard Pedigree Insulating Varnishes is available on request. Investigate the products with a Pedigree.

OTHER IMC PRODUCTS

Macallen Mica Products — Vartex Varnished Cloth and Tapes — Varslot Combination Slot Insulation — Varnished Silk and Paper — Fibreglas Electrical Insulation — Manning Insulating Papers and Press Boards — Dow Corning Silicones — Dieflex Varnished Tubings and Saturated Sleeveings of Cotton and Fibreglas — National Hard Fibre and Fishpaper — Phenolite Bakelite — Adhesive Tapes — Asbestos Woven Tapes and Sleeveings — Cotton Tapes, Webbing, and Sleeveings — Wood Wedges.

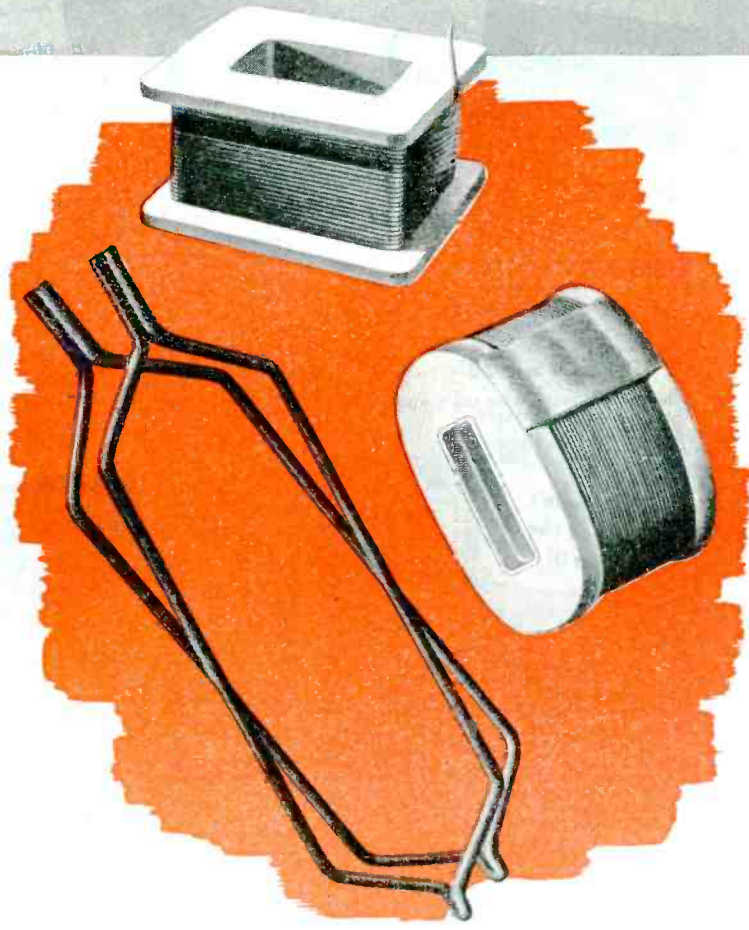

SERVICE TO MANUFACTURERS IN THE MIDWEST

INSULATION MANUFACTURERS CORPORATION

- ★ CHICAGO 6 • 565 West Washington Blvd.
- ★ CLEVELAND 14 • 1005 Leader Building

Representatives in {
 MILWAUKEE: 312 East Wisconsin Avenue
 DETROIT: 11341 Woodward Avenue
 MINNEAPOLIS: 316 Fourth Ave., South
 PEORIA: 101 Heinz Court

SYLVANIA NEWS

ELECTRONIC EQUIPMENT EDITION

JUNE Published by SYLVANIA ELECTRIC PRODUCTS INC., Emporium, Pa. 1945

SYLVANIA ISSUES NEW BOOKLET ON PUBLIC'S POST-WAR WANTS IN RADIO AND TELEVISION

YOU LIKE YOUR RADIO!



Our question:
How do you consider the performance of your latest set?

The answer:



Good **75%** Fair **20%** Poor **5%**

Prophecy: You'll like the new post-war radios even better!

Your latest set has short wave!



Our question:
Do you have short wave band on your latest set?

The answer:



YES! 52% **NO!** 48%

But--in spite of much wartime short wave broadcasting, our survey shows you hardly ever tune in on it!

... And here's what you like about it!



Our question:
What features do you like most about your present radio set?

The answer:

Tone quality	52.4%
Model	29.6%
Appearance	22.6%
Reception clarity	21.7%
Push button restore	10.1%
Record player	8.7%
Sensitivity-selectivity	8.2%
Range	7.7%
Volume	5.6%

Hint: Sylvania radio tubes go a long way to make any radio sound better.

You like to push a button when you tune-in!



Our question:
If your radio has push-button tuning, what do you think of it?

The answer:



Like it **78%**

Could be improved **22%**

Post-war radios will doubtless have quicker, easier push-button tuning.

Summarizing the results of a recent nationwide survey, a new booklet, "They Know What They Want," is now being widely distributed. This survey was conducted by one of America's leading market research organizations—at the request of Sylvania Electric's Sales Research Department.

CIRCULATION AMONG CONSUMERS

The booklet is being mailed to consumers in response to inquiries stimulated by questionnaire-type advertisements appearing in national magazines. Through these advertisements Sylvania Electric is continuing its study of public preferences in radio sets. Public distribution of the booklet is expected to be helpful in maintaining the popular interest in post-war radio sets which has been created by Sylvania's advertising.

VALUE TO INDUSTRY

In addition, "They Know What They Want" is being widely circulated among the electronic equipment manufacturing industry. Providing a convenient digest of the public's desires, the booklet should prove helpful to set manufacturers in planning post-war designs that will appeal to buyers' tastes.

Copies of the booklet are available on request to set manufacturers for distribution to their engineering departments and sales forces. A more complete and detailed presentation of the survey findings has also been prepared, and will be shown to interested manufacturers on request to the nearest Sylvania sales office.

Here is a typical two-page spread from the booklet "They Know What They Want," which summarizes the results of a nationwide survey of public preferences in radio sets.

SYLVANIA ELECTRIC

MAKERS OF RADIO TUBES; CATHODE RAY TUBES; ELECTRONIC DEVICES; FLUORESCENT LAMPS, FIXTURES, ACCESSORIES; INCANDESCENT LAMPS

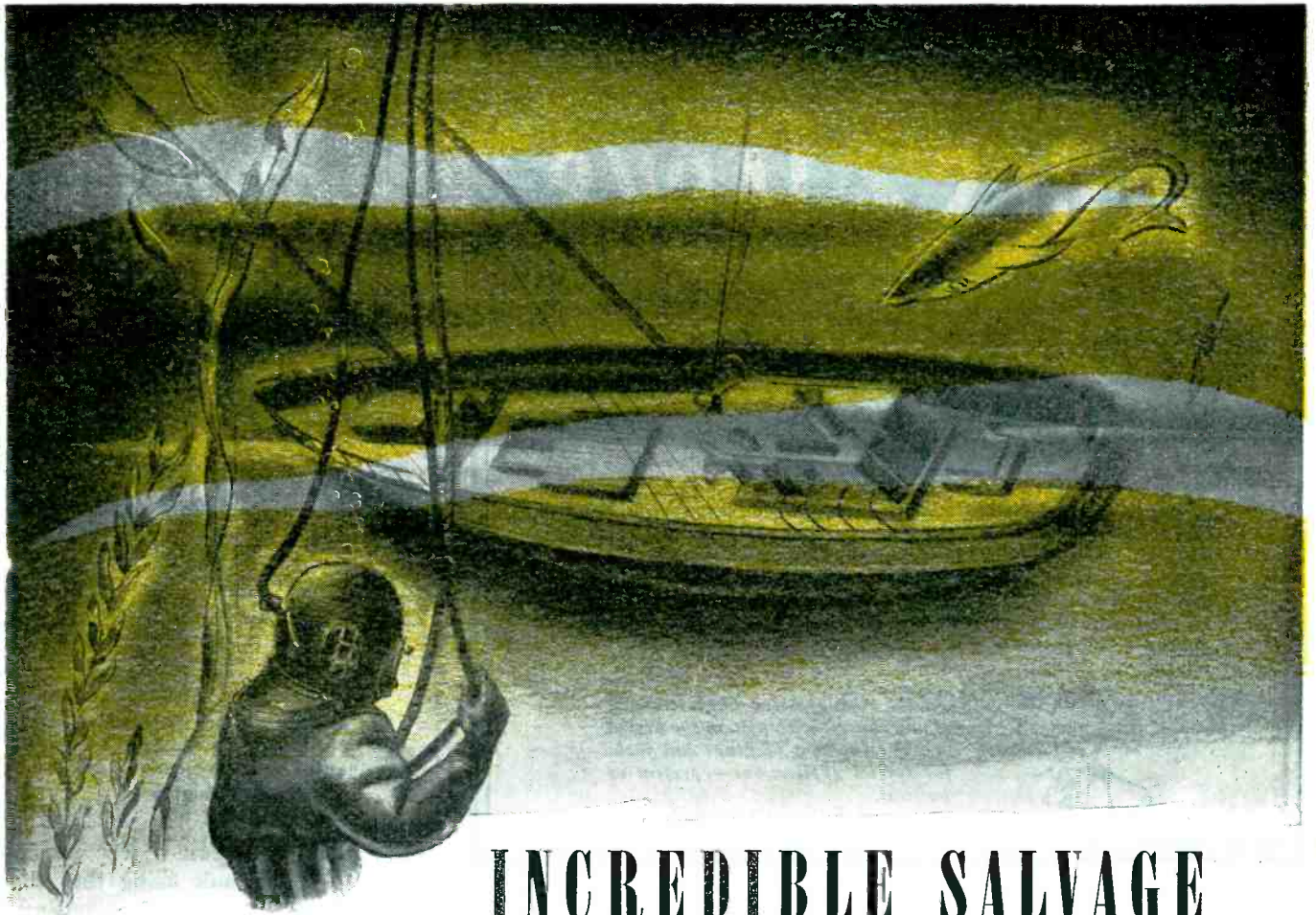

INCREDIBLE SALVAGE

The Case of the Flying Gull . . .

During the storm season of 1942, *The Flying Gull* ran into heavy seas in the Gulf of Mexico.* Running before a terrific wind, she all but made port. Then, just as she was putting about near Hunter's Point, she shipped a gigantic wave and foundered. All hands were saved. But *The Flying Gull* rested in eight fathoms of Gulf water.

Salvage operations were started. Later in 1942, when *The Flying Gull* was in the dock and her electrical equipment ripped out, an amazing thing occurred. George Long, of The Harris Salvage and Drydock Company of Galveston, put the Thermador transformer equipment on a shelf in the sunshine—mentally assigning it to the scrap metal drive. Three days later, out of curiosity, he hooked the transformers onto a testing bench and flipped on the current. To his amazement, they still showed signs of life. He then ran standard tests. To his further astonishment, all twelve of the transformers were not only working—they

were working perfectly.

Harvy Stark, owner of the boat, had already ordered a complete new set of transformers from Thermador. He cancelled the re-order. And today *The Flying Gull* sails with her original Thermador transformers. Not designed for the briny deep—but they could take it!

Such stories of plus performance are not accidents, for Thermador transformers are

built to perform beyond normal expectations. They are completely manufactured—not just assembled—under one roof on a vast array of modern precision equipment. They are made *only* from the finest materials, engineered by men of broad experience. The result is not alone quality but *quality in quantity*. If that meets your specifications, better discuss transformers with Thermador.

**THERMADOR
TRANSFORMERS**
DEFEAT HEAT • COLD • HUMIDITY



**An actual case history from Thermador files; however names, dates, and location have been altered. Buy MORE War Bonds.*

THERMADOR ELECTRICAL MANUFACTURING COMPANY
5119 SOUTH RIVERSIDE DRIVE • LOS ANGELES 22, CALIFORNIA

PLUGS *and* JACKS

...for every known application!

Built in accordance with latest Signal Corps and Navy specifications, Amalgamated Plugs and Jacks are tropicalized to make them fungus resistant, waterproof and moistureproof when called for. Insulators of these components are designed to withstand extremes of temperatures for -67°F to $+167^{\circ}\text{F}$, at humidities up to 100%. We also specialize in producing Plugs which will bear up under the high heat met in rubber molding cord sets.



NOTE: Amalgamated Engineers will gladly consult with you on the design and development of Plugs and Jacks for special applications — present or postwar.

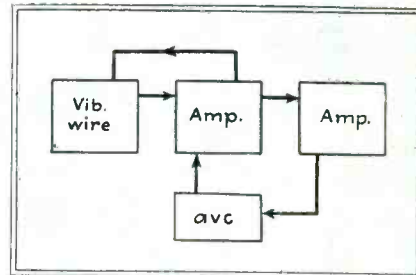

Fig. 3—Arrangement of electronic amplifier to feed back energy to maintain oscillations of the vibrating wire at the proper amplitude

to the input circuit of the amplifier, the net result being that the amplifier drives the wire continuously at its own resonant frequency. An automatic volume control of a conventional sort is indicated in the diagram of Fig. 3 and serves to keep the amplitude of vibration within appropriate limits.

Multiple Magnets

Another form of Vibratron employs two composite rods, upon which the wire is supported as shown in Fig. 4 and between which it is permitted to vibrate. The composite rods are made of alternate sections of Invar and brass soldered together. The space between the supporting columns is narrow and constitutes the pole gap in which the wire vibrates. The Invar sections of the adjacent rods, in addition to serving as temperature-compensating members, also serve as the magnetic poles against which the vibrating wire reacts. Magnetic flux is supplied to each one of these layers of Invar sections by attaching a small permanent magnet.

This construction permits the vibrating wire to be driven in any one of three different modes. The choice of modes is made by the arrangement of the polarities of the



PLUG PL-55 and JACK JK-26, N.A.F. 1136-1

Long sleeve, two-conductor plug, mate to Jack JK-34-A. Withstands minimum of 60 cycles AC, potential of 500 volts effective, applied between any two terminals for not less than two seconds. Meets minimum insulation value of 2000 megohms between conductors at 68°F , at humidities up to 100%.



JACK JK-26, N.A.F. 215284-2

Two-conductor Jack, mate to PL-54. Tropicalized. Withstands 60 cycle AC potential of 500 volts effective, applied between any two terminals for not less than two seconds. Meets minimum insulation value of 2000 megohms between conductors at 68°F , at humidities up to 100%.



PLUG, STYLE "A"

Two-conductor, special type plug for use with Neoprene or Buna S molded cords. Same specifications as PL-55.



JACK JK-48

Light duty, two-conductor Jack, mate to Plug PL-291 and Plug 291-A.



PLUG PL-204

Hand set. A special plug wherein both a modified plug, PL-55 and PL-68, are held in place by a phenolic case. Same specifications as PL-55 and PL-68.



PLUG PL-54, PL-540, PL-354, N.A.F. 215285-2

Short sleeve, two-conductor plug, mate to Jack JK-26. Same specifications as PL-55.



PLUG, STYLE "D"

Two-conductor, special type plug for use with Neoprene or Buna S molded cords. Same specifications as PL-55.

AMALGAMATED RADIO TELEVISION CORP.

476 BROADWAY • NEW YORK 13, N. Y.

Oh, Mr. Weather-bottom



ETCHINGS ARE OUT

Evidently "Mr. Weather-bottom" doesn't know that Meyercord Decal Name Plates are the accepted practice today; an established combat-tested routine for such precision equipment as cameras, radar, combat communications, optical devices and other fine products. Types C and G Decals are commonly applied to crinkle, aluminum, federal gray enamel, and practically any easy or difficult finish.

In properly evaluating Meyercord Decal Name Plates bear in mind that to "color" and "clarity" must be added speed, economy and a total lack of "edges" to catch dirt. No holes need be bored for Decal Name Plates and the indication, trademark, chart, direction or diagram is permanent and positive.

Both for your priority and postwar requirements plan for modern economical Meyercord Decals for Wiring Diagrams, Lubricating Guides, Operating Instructions, Stowage Charts, Spare Parts Listings; Communication Designations, Trademark, Name Plates, etc. Free designing service. Write Department 9-6

THE MEYERCORD CO.

CHICAGO 44, ILL.

World's Largest Manufacturer of Decalomania



*Buy War Bonds
... and Keep Them!*

MEYERCORD DECALS

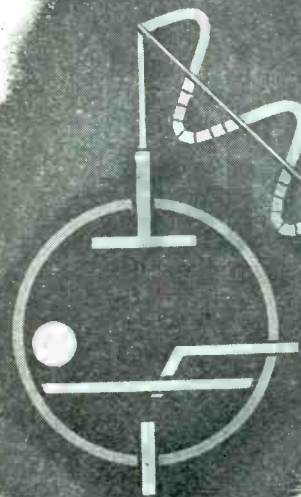

Seven Reasons Why "NATIONAL" GRAPHITE

IS USED IN IGNITRONS AND
OTHER ELECTRONIC TUBES

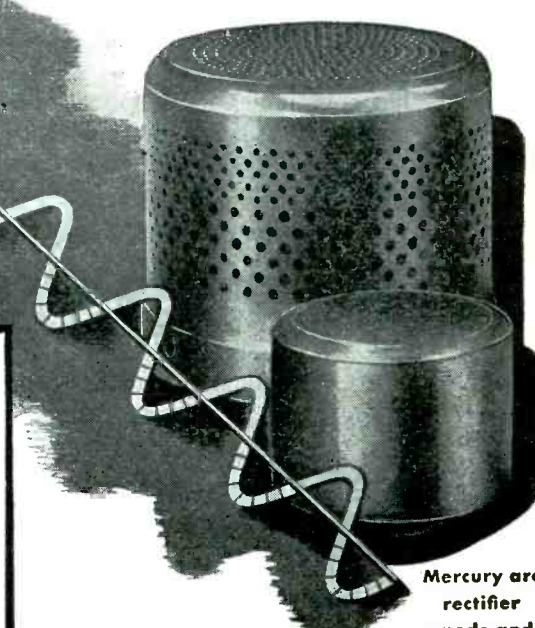

Mercury arc
rectifier
anode and
shield

In ignitron rectifiers . . . and in many types of industrial and radio tubes . . . "National" electronic graphite is used for anodes and other tube components because of:

1. Purity higher than any other anode material.
2. Greater energy dissipation, permitting higher tube ratings.
3. Higher permissible operating temperatures than with other anode materials, allowing wider range of applications.
4. Low expansion characteristics and absence of distortion and warping.
5. Close dimensions.
6. Ease of machining, providing more latitude of design and construction.
7. Light in weight.

In addition, the reduction of heat lessens the tendency of other tube parts to warp, while the structural strength of "National" electronic graphite gives added assurance against breakage from vibration and shock.

Representatives of National Carbon Company will gladly consult with you in the design and on the advantages of "National" electronic graphite for components of any type of tube. Inquire at our nearest Division Office.

The registered trade-mark "National" distinguishes products of National Carbon Company, Inc.

NATIONAL CARBON COMPANY, INC.

Unit of Union Carbide and Carbon Corporation



General Offices: 30 East 42nd Street, New York 17, N. Y.

Division Sales Offices: Atlanta, Chicago, Dallas, Kansas City, New York, Pittsburgh, San Francisco

KEEP YOUR EYE ON THE INFANTRY . . . THE DOUGHBOY DOES IT!



CENTER-SEALED . . . ALWAYS
BY *Lexel* Insulation TAPE

Cut into a roll of Lexel insulated wire, anywhere, and you'll see for yourself how perfectly the conductor is centered within the insulation. The helically-wound, heat-bonded tape effectively bars leakage losses and dielectric failures in a wide variety of low tension installations.

are provided with about 25% less bulk and weight than ordinary primary insulation.

Ask for test data on Lexel tape for instrument, control, lead-in and hook-up wires, electronic and communication circuits and similar uses. Quick deliveries on priority orders.

CUSTOM-MADE INSULATION

As a regular service, Dobeckmun engineers also develop laminated insulation products, custom-made to special purpose specifications, such as slot cell and phase insulation for motors, insulation for shipboard cables and other uses. If your requirements are unusual, call on us.

Other Lexel characteristics, contributed by its cellulose acetate butyrate base, include high dielectric strength and insulation resistance and low moisture absorption. It is noncorrosive. All these qualities

"LEXEL" is a registered trade-mark of The Dobeckmun Company.



Made by the makers of DOBAR insulation paper and DOPLEX laminated tape.

THE **DOBECKMUN** COMPANY



CLEVELAND PLANT

INDUSTRIAL PRODUCTS DIVISION • CLEVELAND 1, OHIO

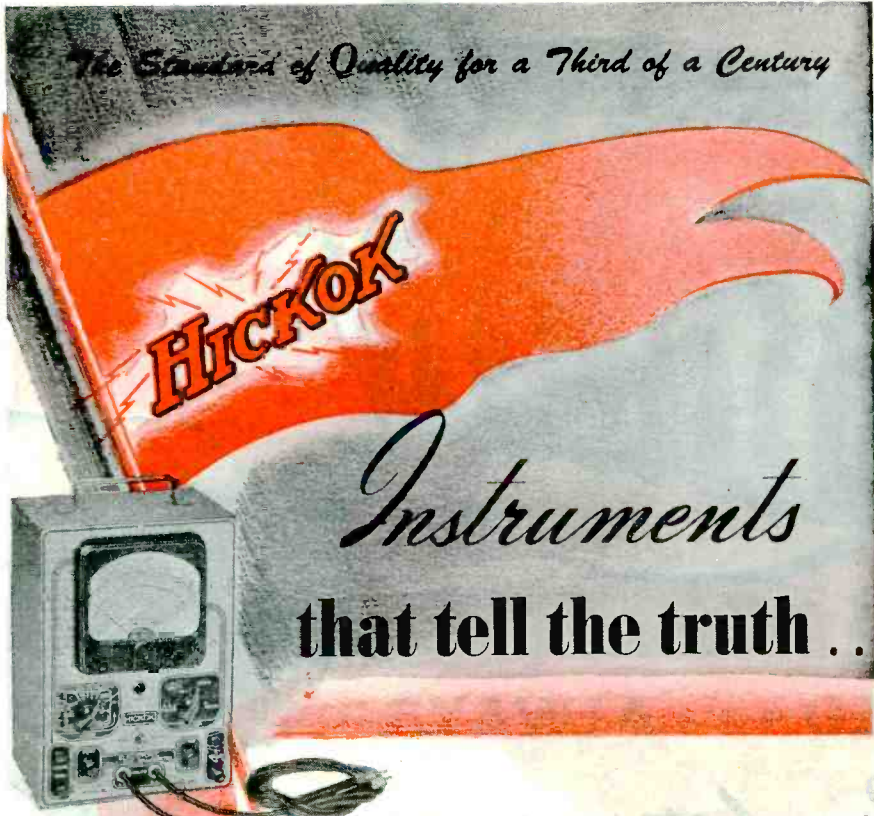

The Standard of Quality for a Third of a Century
HICKOK
Instruments
that tell the truth..

Volt-Ohm-Milliammeter

● In maintaining the highest standard of excellence the one and only HICKOK aim must always be the building of instruments that tell all the truth all the time. When quality is built up to a high standard instead of down to a price, the user has greater confidence in his work.

Whether you are selecting tube and set testers, signal generators, oscillographs, volt-ohm-milliammeters or any other service equipment, remember that the standard of quality for a third of a century has never been excelled. Having pioneered the major new developments and vindicated maximum accuracy and dependability, HICKOK equipment has been specified by the armed forces in both world wars. We are still bending every effort to speed the war program and trust it will not be long until we can again take care of your civilian needs with the service equipment that is held in highest esteem. Write for Radio Equipment catalogue.

THE HICKOK ELECTRICAL INSTRUMENT COMPANY
 10527, Dupont Ave., Cleveland 8, Ohio

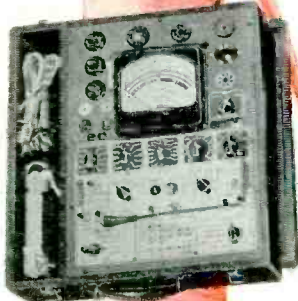

All-Purpose Tube and Set Tester



Signal Generators

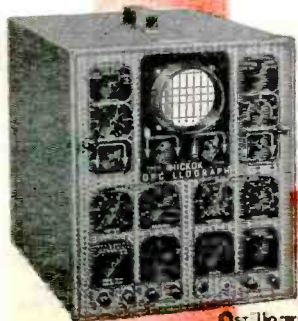

Oscillograph

successive magnetic fields. At the left of the illustration, all four energizing magnets are placed with identical polarities, so that the two parallel bars constitute in effect two continuous poles. Under these conditions, the wire will vibrate in its fundamental mode.

In the second drawing of Fig. 4 the upper two magnets are placed in the same flux relationship, while the lower two magnets are reversed in the direction of their field. Under these circumstances, the wire will vibrate as shown in the second

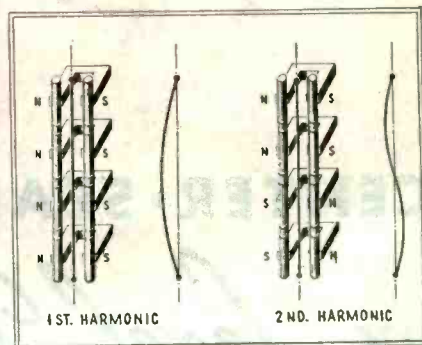

Fig. 4—Composite rods of brass and magnetized Invar form multipolar fields for generation of harmonics

mode. If the magnets are alternated in direction to the series, the wire will vibrate in its fourth mode. The first mode of wire vibration covers a frequency range from 1,500 to 3,000 cycles, the second mode from 3,000 to 6,000 cycles, and the fourth mode from 6,000 to 12,000 cycles.

Complete Assembly

Figure 5 shows an instrument constructed around a barometric capsule used in one of the higher grades of aviation altimeters. Motion of the capsule is coupled, by a properly designed lever, to cause extension of the wire. The coupling ratio should preferably be made such that a change in air pressure is divided evenly between elastic deformation of the capsule and elastic deformation of the measuring wire. The bellows is shown at the lower part of the assembly, while the two plates seen in front define the poles between which the wire vibrates. The wire is mounted on a column of Mikroy with provision for correcting the slight differential between the coefficient of expansion of this

Fort Monmouth
Red Bank, New Jersey

SCGSA
(SIGNAL CORPS GROUND SIGNAL AGENCY)

* MYCOLOGISTS *in the Signal Corps*

***Mycologist!** A botanical scientist specializing in the study of fungi



By the persevering research of Signal Corps Mycologists at Squier Laboratories, Fort Monmouth, the enemy's most powerful ally, fungus growth, was thoroughly

whipped! When reports came in that myriad species of fungi were literally and quickly destroying our communications equipment, Squier Laboratories attacked the problem by duplicating jungle conditions at Red Bank, New Jersey. At the same time RAULAND became the first manufacturer to build its own jungle laboratory to study at first hand the destructive effects of fungus growth on electronic equipment. These efforts soon led not only to the correct "anti-fungus treatment" for communications equipment but to a complete tropicalization program which helped pave the way for the decisive victories which followed.



—brought the Jungle to Chicago

To study the vital problem of fungus destruction at close hand, RAULAND engineers cre-

ated a miniature jungle in our own laboratories! Early in 1942 they built a large, glass-enclosed air-tight cabinet (pictured above) . . . filled it with the dripping wetness of saturated, super-heated jungle air, tropical plants and lush vegetation, deep rooted in mossy loam. Into this "torture chamber" went RAULAND Communications equipment . . . to finally emerge with the correct anti-fungus answers. A typical example of RAULAND engineering thoroughness in making certain that its precision electronic instruments serve dependably under even the most adverse conditions.

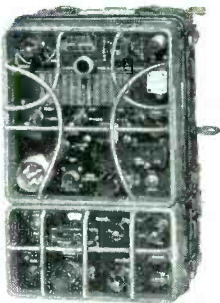

SCR-694 TRANSMITTER-RECEIVER

SCR-694 IS ANTI-FUNGUS TREATED

Veteran of many U. S. invasions, the RAULAND SCR-694 Transmitter-Receiver has battle-proved itself under all operating conditions. Compact, light-weight (22 lbs.), waterproof, fungus proof, this highly versatile and efficient two-way radio serves in vehicles, as a portable ground station or front line command post. Ideally adapted to either jungle or sub-zero operation.

EXCERPTS FROM FIELD REPORTS:

FROM THE PACIFIC: "during a rainstorm the SCR-694's were the only sets in one section that remained operative."

FROM ITALY: "An SCR-694 set was mounted in a ¼-ton, 4x4, for demonstration purposes during instructional tours. In the two months of travel over typically rough Italian terrain visiting various units to be instructed, at no time was this set found to be inoperative."

FROM AIR-BORNE SOURCE: "one set (SCR-694) landed in a stream of water and although completely submerged (time undetermined) worked normally."

Electroneering is our business

RADIO • RADAR • SOUND

Rauland

COMMUNICATIONS • TELEVISION

THE RAULAND CORPORATION • CHICAGO 41, ILLINOIS
www.americanradiohistory.com

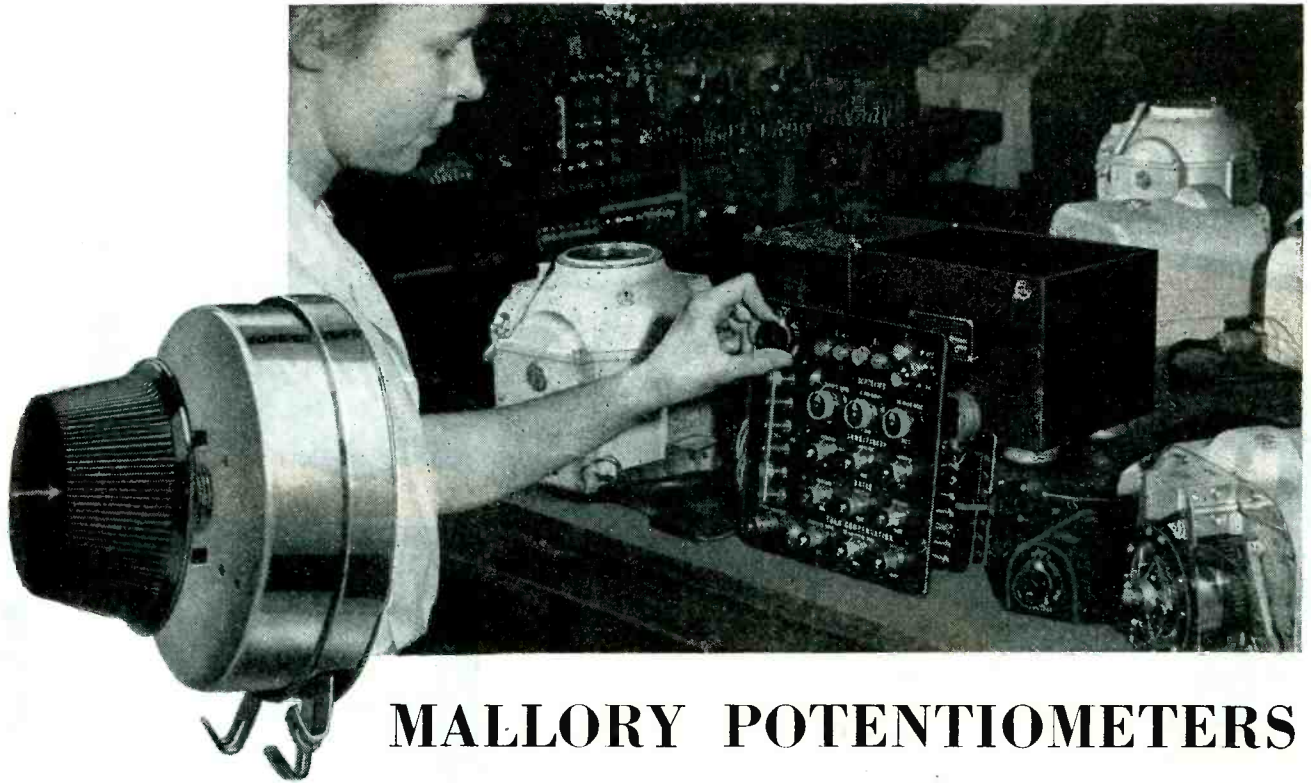

MALLORY POTENTIOMETERS Provide Precision Control for the Electronic Pilot

CAPABLE of making more than 300 flight corrections per minute, the electronic automatic pilot made by Minneapolis-Honeywell Regulator Co. has helped thousands of four-engined bombers to hit targets accurately and then fly home safely. Dependable, precise performance of the autopilot has been possible because it is built with precision parts such as wire-wound Mallory Potentiometers.

In precision instruments, communication, test, laboratory, medical and industrial electronic and electrical equipment . . . potentiometers and volume controls, variable and fixed resistors made by Mallory are standard equipment. Engineers specify these Mallory precision parts because of their sturdy construction, efficient design and excellent electrical characteristics under all operating conditions.

Variable Wire-Wound Resistors — Available in three standard types, from 0.5 to 150,000

ohms, 2 to 9 watts. Single and multiple units, with or without AC switch.

Variable Carbon Resistors—In standard and midget types from 5000 ohms to 9 megohms. Noiseless in operation. Rugged terminal construction and improved resistance to humidity.

Fixed and Adjustable Wire-Wound Resistors — Available from 1 to 100,000 ohms and 10 to 200 watts. Maximum wattage dissipation. Resistant to humidity.

Resistors, volume controls, capacitors, switches, jacks, plugs, vibrators, rectifiers, power supplies and other precision standard electronic parts are available from your nearest Mallory distributor. Ask him for your copy of the Mallory catalog, or write us today.

Make it a policy to consult Mallory for engineering assistance while your designs are still in the blue print stage.

P. R. MALLORY & CO., Inc., INDIANAPOLIS 6, INDIANA

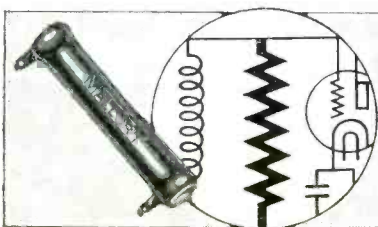

P. R. MALLORY & CO. Inc.
MALLORY
FIXED AND VARIABLE
RESISTORS

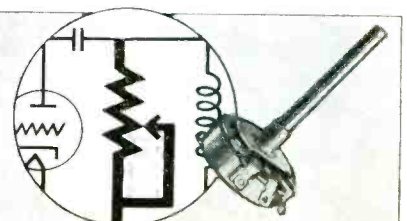

HERMASEAL

HERMETICALLY SEALED TRANSFORMERS —DEPENDABLE IN ARCTIC WARFARE

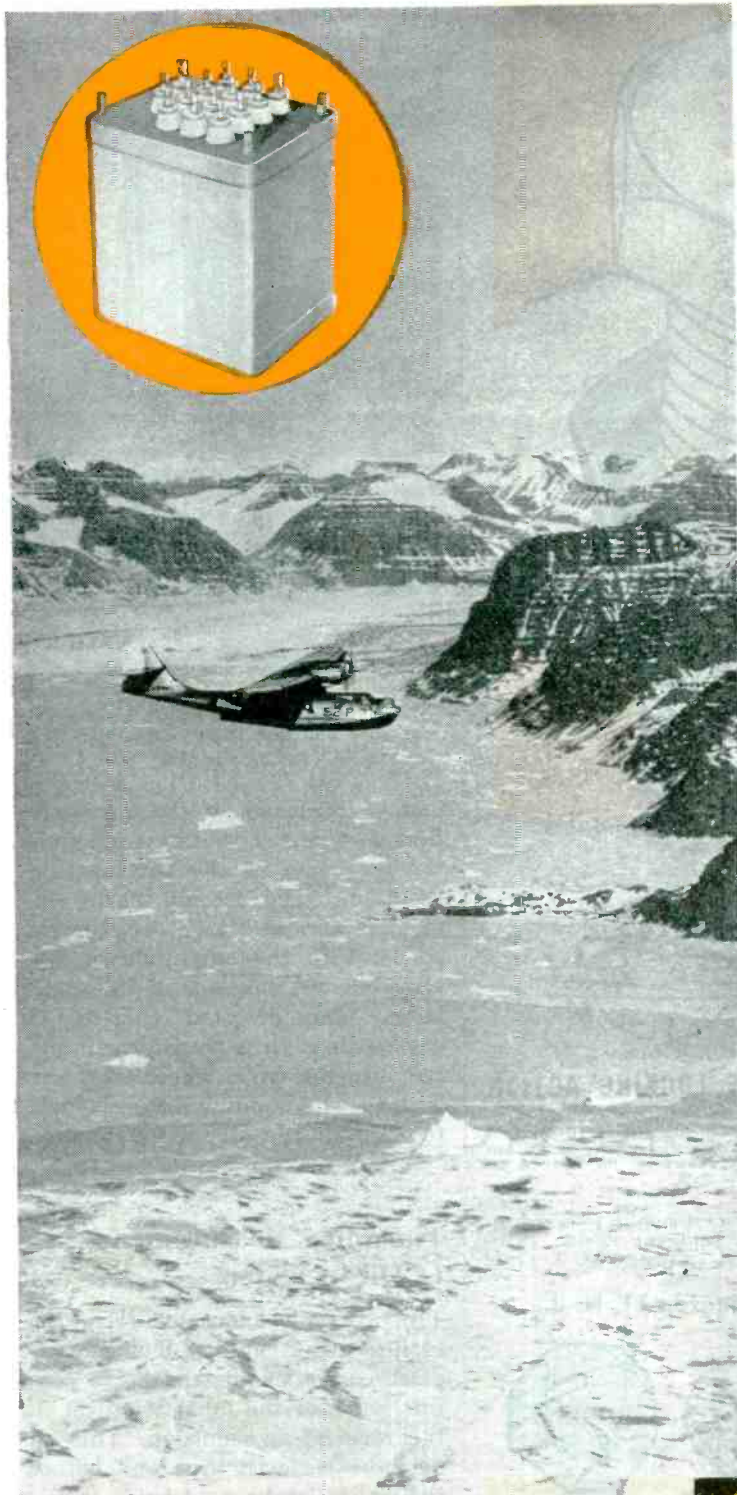

OFFICIAL U.S. NAVY PHOTO

Pioneer Manufacturers of Transformers, Reactors and Rectifiers for Electronics and Power Transmission

Hermaseal Hermetically Sealed Transformers are as effective in the intense cold of the Arctic as in torrid zones. For moisture cannot penetrate nor does it remain in the enclosing cases to deteriorate insulation.

At AmerTran, moisture is removed in the vacuum varnish impregnation of core and coil and the whole unit is thoroughly dried by pre-heating before filling with compound. To make each unit impervious to moisture, all case seams are induction soldered and the terminals are solder sealed or pressure type according to requirements. Every unit, not just random units, is tested by vacuum immersion—upon which it receives the symbol of perfect Hermetic Sealing—the Hermaseal.

Submit your specifications covering magnetic components for airborne communications equipment to AmerTran.



THE AMERICAN TRANSFORMER CO., 178 Emmet St., Newark 5, N. J.

AMERTRAN ASSIGNED "APPROVED" QUALITY CONTROL RATING BY AIR FORCES

On March 14, 1945, the Air Technical Service Command of the Army Air Forces delegated to the American Transformer Company full responsibility for meeting contract requirements. This assignment of an "Approved" Quality Control Rating which eliminates duplicate inspection during fabrication was awarded on the basis of AmerTran's record in adhering to quality standards.

AMERTRAN

MANUFACTURING SINCE 1901 AT NEWARK, N. J.

Use PALNUTS to lock Set Screws in Position!

Hold Accurate Settings Under Severest Vibration!

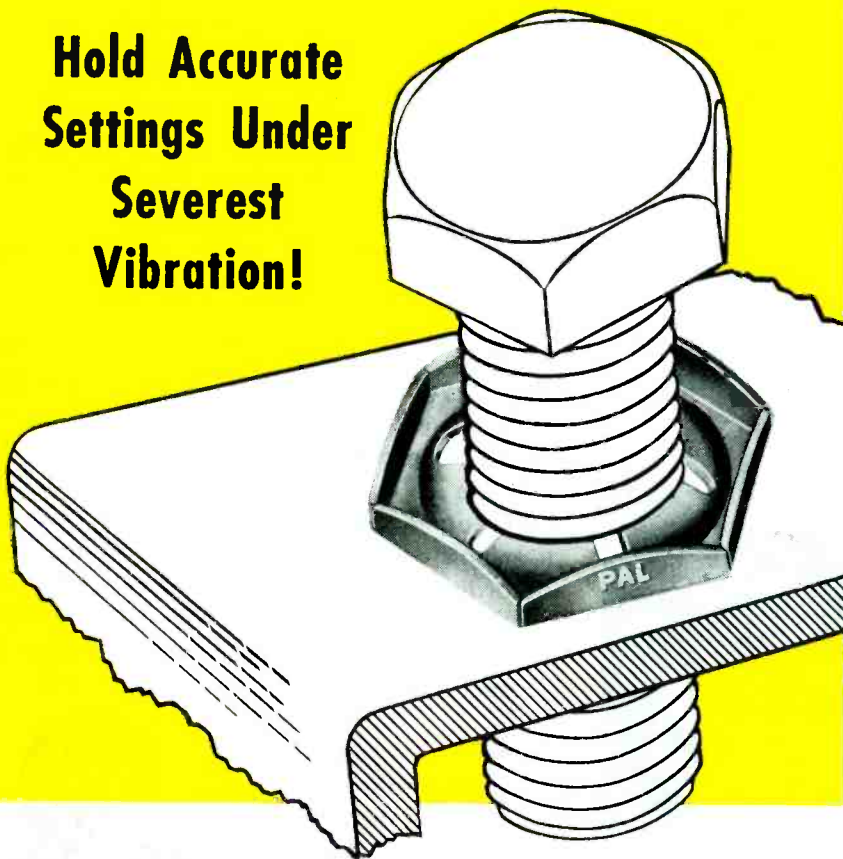

A set screw that won't "stay put" is soon valueless. To maintain accurate set-screw settings, lock them with Palnuts instead of regular hex nuts or jam nuts. This provides a powerful double-locking action* that is unmovable by severe, prolonged vibration.

Single thread, tempered spring steel Palnuts require only 3 bolt threads space. They spin on fast with fingers, lock tight with $\frac{1}{4}$ to $\frac{1}{3}$ turn of wrench. Cost no more, and frequently less, than regular nuts; may be re-used. Full line of sizes in National Coarse and National Fine Threads.

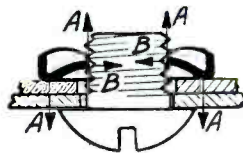

*DOUBLE LOCKING ACTION

When the Palnut is tightened, its arched slotted jaws grip the bolt like a chuck (B-B), while spring tension is exerted upward on the bolt thread and downward on the part (A-A), securely locking both.

WRITE for Palnut No. 2, giving engineering data on Self-locking Palnuts. Outline requirements for samples.

THE PALNUT COMPANY, 77 Cordier St., Irvington 11, N. J.

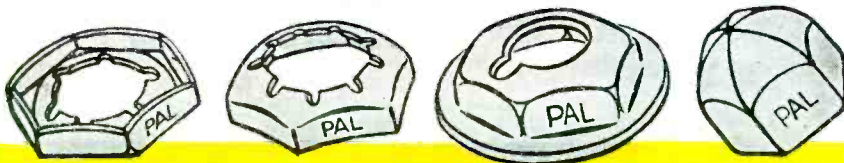

Self-Locking PALNUTS

material and that of tungsten. The radio transmitter consists of a small twin triode located in the space behind the vibrating wire. One element of this triode forms an oscillator, the frequency of the oscillating circuit being largely defined by the capacitance between the vibrating wire itself and a small fixed wire attached to the surface of the Mikroy supporting col-

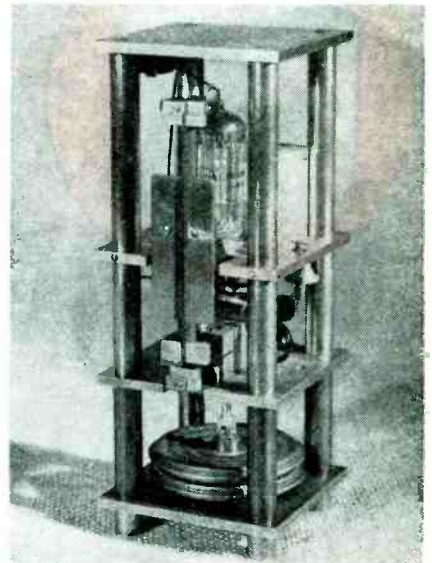

Fig. 5—Compact assembly of the vibrating-wire unit and radio transmitter for radiosonde use

umn. Vibrations of the wire will thus vary this capacitance and alter the frequency of the transmitting oscillator. The second triode element is arranged as a detector responsive to the amplitude of the plate current envelope of the oscillator. The detected current is passed through a transformer and fed into the wire, where it reacts with the surrounding magnetic field to maintain the wire in vibration.

• • •

Turbidity Measurement of Oil in Water

THE STEAM condensates from the reciprocating engines of small aircraft carriers and transports contain some of the lubricating oil in the form of an emulsion. This oil must be removed by filters before the water can be used again in the ship's boilers. Consequently, turbidimeters and turbidity standards are needed for determining the amount of emulsified oil in the

11 REASONS WHY YOU SHOULD USE ZIRMET (FOOTE DUCTILE ZIRCONIUM)

1. ZIRMET may be used in all types of tubes, including mercury rectifiers.
2. ZIRMET is more than 99.9% pure ductile zirconium.
3. ZIRMET is non-volatile, produces clear glass tubes.
4. ZIRMET is a superior getter.
5. ZIRMET is easy to use.
6. Only 1/8 sq. in. of .003" or .005" sheet required for continuous getter in usual tubes, costing but 2¢ to 3¢ per tube.
7. ZIRMET is easily spot welded to tantalum, molybdenum, nickel, etc.
8. ZIRMET is corrosion resistant.
9. Best operating temperature for Zirmet is 400°C. or over.
10. ZIRMET is available in sheet, wire, or rod.
11. ZIRMET NOW REDUCED IN PRICE TO 50% OF 1944 LEVEL!

Telephone (Philadelphia, Pa., RITtenhouse 8722), write or wire for details and quotations.

THIS DIVORCES ORES AND MINERALS

Discharge end of a magnetic separator in one of the Foote plants. This machine, believed to be one of the largest of its type in existence, is typical of the modern equipment spearheading Foote's experience in processing ores, minerals, alloys and chemicals.

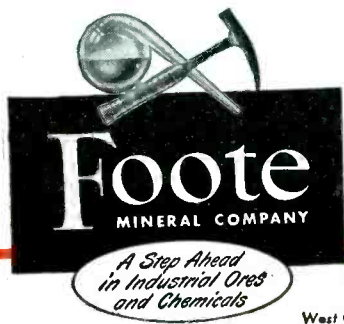
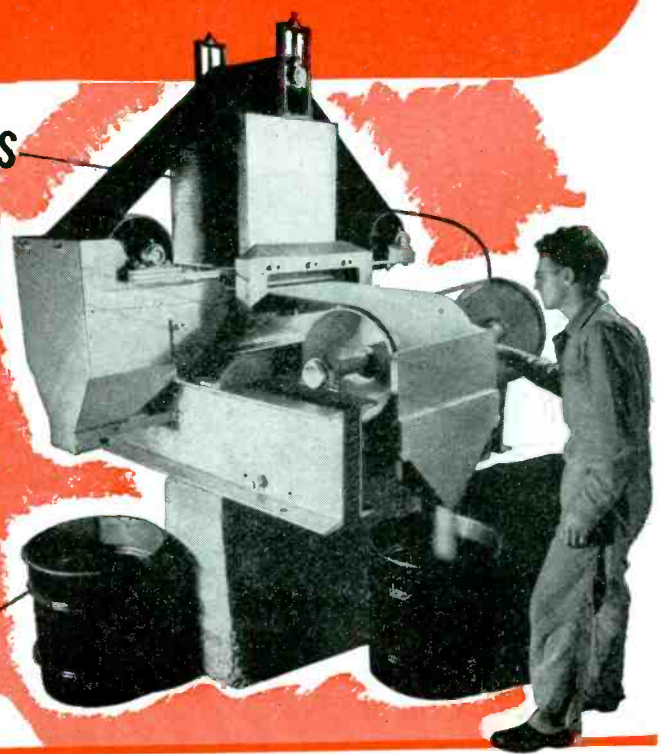

PHILADELPHIA • ASBESTOS • EXTON, PENNSYLVANIA
Home Office: 1617 SUMMER STREET, PHILADELPHIA 3, PA.
West Coast Repr.: Griffin Chemical Co., San Francisco, Calif. • English Repr.: Ernst B. Westman, Ltd., London, Eng.

Metaplate **CONDUCTOR AND NON-CONDUCTOR
IN ONE PIECE**

Commutation
PLATING IN 0.005" GROOVES FOR COMMUTATING SURFACE

CONNECTORS PLATED IN SAME OPERATION

Shielding
MOLDED PLASTIC HOUSING

SHIELDED WITH COPPER AND CADMIUM

Radiation
OVER CAMFIELD'S COMPREG WOOD

ELECTROPLATED WITH COPPER



Since 1941 the Metaplast Company has maintained a 24 hour day schedule producing important war material.

Metaplast **COMPANY** 205 West 19th Street
New York 11, N. Y.

Metaplast Process Patented and Licensed

M E T A L P L A T I N G O N P L A S T I C S

This Oster Motor..

REG. U. S. PAT. OFF.

has the light weight, space-saving size, and dependability that make it ideal for aircraft and blower installations

FEATURES OF TYPE B-6A MOTOR

Here is a dependable fractional-horsepower motor, with maximum ratings from 1/100 to 1/200 H.P., that gives you many quality features resulting from over fifteen years' experience in building this type of motor. It saves weight and space—and performs smoothly and dependably. You can use it with excellent results for operation of blowers, switching arrangements, and for other similar aircraft applications.

Housing: Die cast aluminum, totally enclosed.

Finish: Black anodized.

Weight: 10 oz.

Bearings: Single shielded ball bearings lubricated with grease suited for any specific application. Bearing housings fitted with steel inserts to assure permanent bearing alignment and proper bearing fits.

Mounting: Flange or standard 3/4" dia. air corps rabbet.

Brushes: Metal graphite of ample size to assure unusually long brush life.

Windings: Available in shunt, series, and split series reversible, 12 and 24 volt, intermittent and continuous duty.

Temperature Rise: 55° C. max. frame temp. rise at rated load.

Modifications: Special shaft extensions, mounting arrangements, leads, etc. also furnished for operation in high ambient temperatures and high altitudes.

Applications: Suitable for operation of blowers, switching arrangements and other similar aircraft applications.

All data and ratings are approximate

Wartime performance proves that you can rely on Oster Motors to live up to the worldwide reputation of prewar Oster appliances and to deliver results that add to the prestige of your product. Let us help you fit this or other Oster motors to your requirements.

TYPICAL RATINGS OF B-6A MOTOR, CONTINUOUS DUTY

Maximum H.P.	1/100	1/150	1/200
R.P.M.	7500	5800	3800
Full load amps. at 24 volts	1.00	.70	.55
Starting torque in % of full load torque	200 min.	200 min.	200 min.

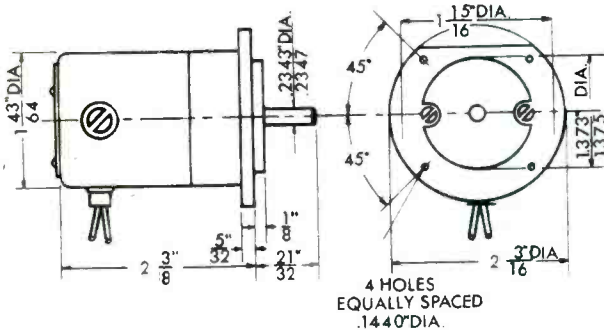

John Oster Manufacturing Company
DEPARTMENT L-26 RACINE, WISCONSIN

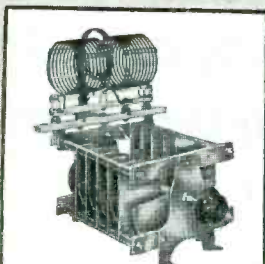
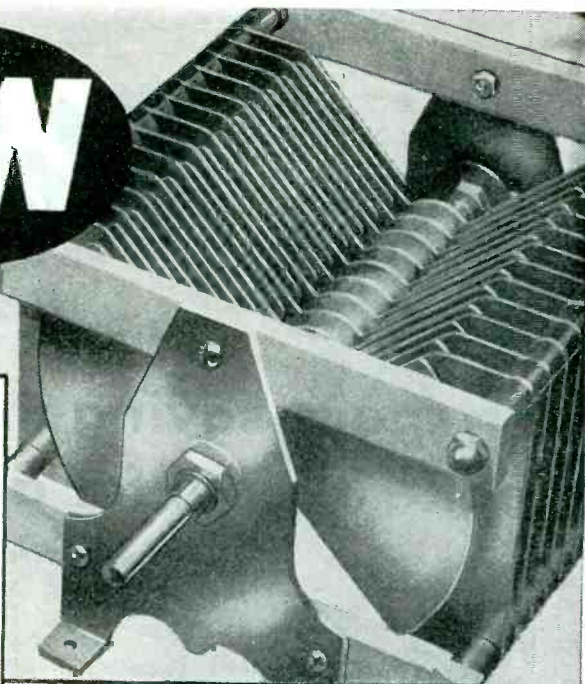

B & W

Tank circuit assembly with B & W condenser and integrally-mounted coil.

REALLY BETTER . . . BECAUSE THEY'RE REALLY DIFFERENT

It pays to plan ahead for real, honest-to-goodness variable condenser efficiency for your product! Because they are half the length of conventional dual units, and because they are designed for built-in neutralization, B & W Type CX Heavy Duty Variable Con-

densers sometimes call for slight changes in the physical design of the product in which they are incorporated—but what a whale of a difference their perfect electrical design symmetry makes in its performance! Write for Variable Condenser Catalog 75-C.



Miniature R-F INDUCTORS

B & W Miniductors in diameters from $\frac{1}{2}$ " to $1\frac{1}{4}$ " are the answer to countless engineering calls for rugged, finely made little coils for all sorts of r-f applications. We can supply them with any type of mounting, in any length, in any winding pitch from 4 to 44 t.p.i., and with either fixed or variable internal or external coupling links, and a large variety of other special features. Q is amazingly high. Write for Miniductor Catalog 78-C.



BARKER & WILLIAMSON

Dept. E-65 235 Fairfield Ave., Upper Darby, Pa.

Exclusive Export Representatives: Lindeteves, Inc., 10 Rockefeller Plaza, New York, N.Y., U.S.A.

steam condensates and clarified filtrates.

At the request of the Research Section of the Navy Bureau of Ships, the National Bureau of Standards undertook the development and production of standards of turbidity for oil-in-water emulsions ranging from 0 to 2 parts per million of oil (ppm) that would deteriorate as little as possible during a 6-month period.

Turbidimeters with photocells and galvanometer or cathode-ray balance detectors were studied, and calibrated with various turbidity standards. In the most successful instrument, two opposing photocells are used to measure the difference in light transmission of the air and of turbidity standards or of a cuvette containing the test sample. A cathode-ray indicator tube serves to detect the balance point.

Accuracy

The meter is insensitive to tilting, vibration, and shock, and may be calibrated readily by any of the types of standards developed at the Bureau. The readings of the instrument are reproducible to 0.05 ppm of oil, and the steadiness appears to be quite satisfactory. The calibration of the scale, which can be graduated to read directly in parts per million, is linear and does not shift with time. Likewise, a humidity of 100 percent does not affect the operation of the electric circuits of the turbidimeter.

Three Standards

Three types of turbidity standards that can be turned out by mass-production methods have been developed. The first consists of films of gelatin in which colloidal carbon is dispersed uniformly in amounts giving decreased transmittancies corresponding to 0.6, 1.6, 1.7, and 2.3 ppm of oil. These films are cemented with Canada balsam between borosilicate glass sheets.

In the second type, rectangular blocks of crown borosilicate glass, with four 25 by 40-mm faces, A, B, C, and D, were polished to give graded light transmittancies. In the standardization, incident light strikes face B, passes through the 40-mm length of glass, through

NOTHING LOCKS LIKE A SPEED NUT

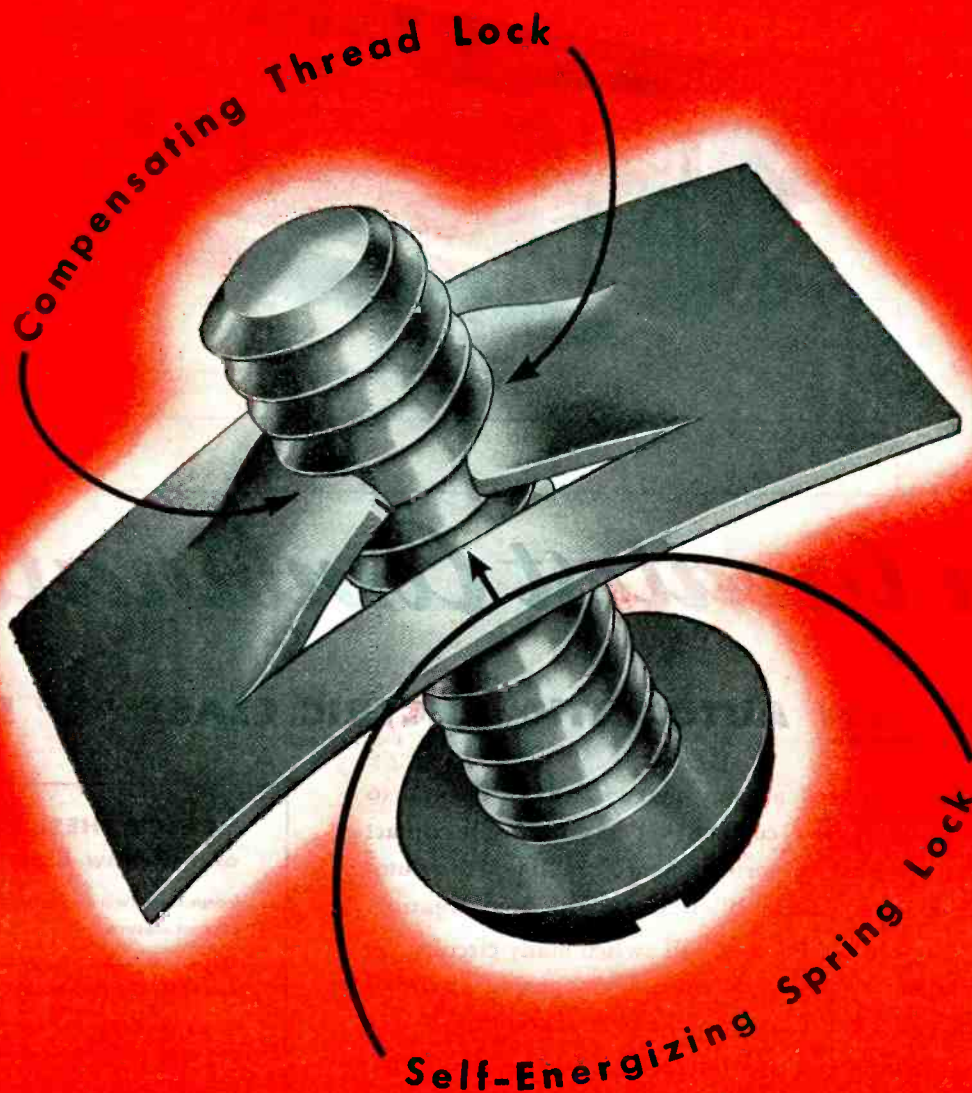

SPEED NUTS are the only fastening devices that provide a **COMPENSATING** thread lock and a **SELF-ENERGIZING** spring lock. **TWO** distinct forces are exerted on the screw, as the **SPEED NUT** is tightened.

First, a compensating thread lock, the two arched prongs moving inward to engage and lock against the root of the screw thread. These free-acting prongs compensate for tolerance variations, and function perfectly on oversize or undersize screw or bolt threads.

Second, a self-energizing spring lock, created by the compression of the arch in both the

prongs and base. The combined forces of the thread lock and spring lock definitely eliminate vibration loosening.

SPEED NUTS, proven in pre-war commercial industry and now boosting the production of military airplanes, are ready to assist you in the assembly of post-war metal, plastic or wood products. Literature is available on over 3000 shapes and sizes, for standard or special assemblies.

TINNERMAN PRODUCTS INC.
2106 Fulton Road Cleveland, Ohio

Speed Nuts

PATENTED

* Trade Mark Reg. U. S. Pat. Off.

FASTEST THING IN FASTENINGS

SENSITIVITY

CONTACT
PRESSURE

DEPENDABILITY

DURABILITY

COMPACTNESS

VERSATILITY

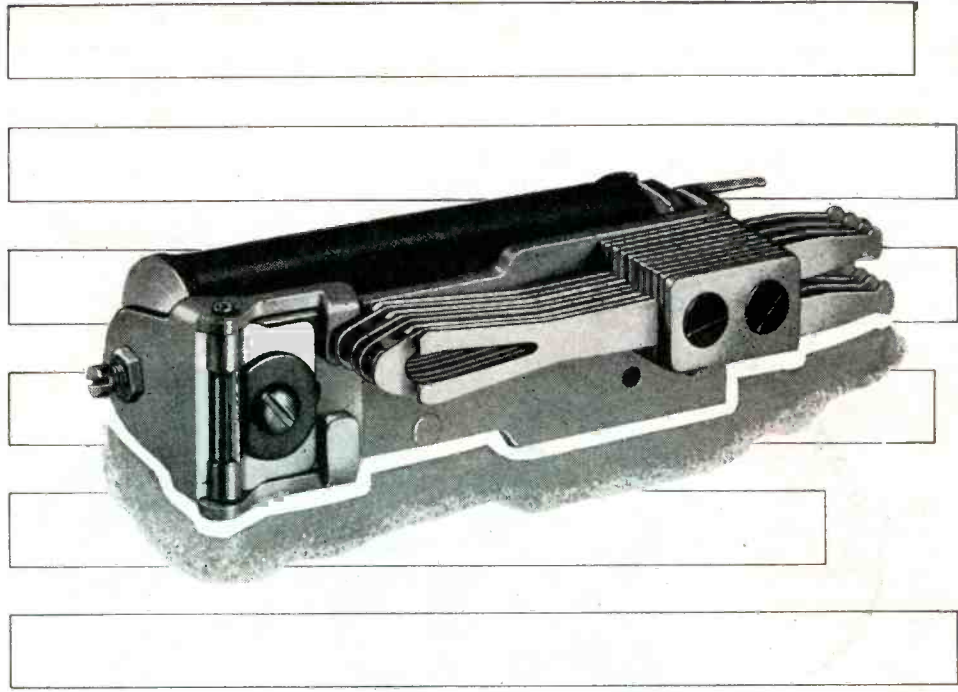

— *in Greatest Combination*

THE NEW AUTOMATIC ELECTRIC CLASS "B" RELAY

● When you need a relay that's sensitive enough to operate on minute current, yet has the high contact pressure needed for perfect closure, you'll find the Automatic Electric Class "B" Relay worth investigating.

If you need a relay that will switch many circuits, yet is compact enough for multiple mounting in small space, you'll find Class "B" the perfect solution.

Or perhaps you are interested in extra durability, for long service under tough conditions. Then you'll need the in-built quality for which Class "B" has become famous.

No other relay—even in the Automatic Electric line—can give you a greater combination of all these essential qualities. Get the full story on Class "B"—one of the forty basic types described in the Automatic Electric catalog. Ask for your copy of Catalog 4071.

CHECK THESE FEATURES of the New Class "B" Relay

Independent Twin Contacts—for dependable contact closure.

Efficient Magnetic Circuit—for sensitivity and high contact pressure.

Unique Armature Bearing—for long wear under severe service conditions.

Compact Design—for important savings in space and weight.

Versatility—Available for coil voltages to 300 volts d-c and 230 volts a-c, and with capacities up to 28 springs; also with magnetic shielding cover, when specified.

**No other relay can give you
a greater combination of
all these essential qualities.**

Relays
AND OTHER CONTROL DEVICES
by **AUTOMATIC
ELECTRIC**



AUTOMATIC ELECTRIC SALES CORPORATION
1033 West Van Buren Street • Chicago 7, Illinois

In Canada: Automatic Electric
(Canada) Limited, Toronto

PARTS AND ASSEMBLIES FOR EVERY ELECTRICAL CONTROL NEED

Another IN-RES-CO scoop!

MOISTURE AND FUNGUS PROOF HERMETICALLY-SEALED RESISTORS for long life, stability and reduced maintenance



TYPE BX

1 watt maximum; 30,000 ohm max. (Manganin); 1 MEG. max. (Nichrome); 1-5/16" long, 9/16" diameter; supplied with 2" #18 copper leads.



TYPE SX

1 watt maximum; 1 MEG. max. (Nichrome); 30,000 ohms max. (Manganin); 1-5/16" long, 3/8" diameter; overall length 2-1/16" including 8/32 studs.



TYPE WX

2 watts maximum; 1 MEG. max. (Nichrome); 0.5 MEG. max. (Manganin); 1 1/2" long, 3/8" diameter; overall length 2 1/4" including 8/32 threaded studs.

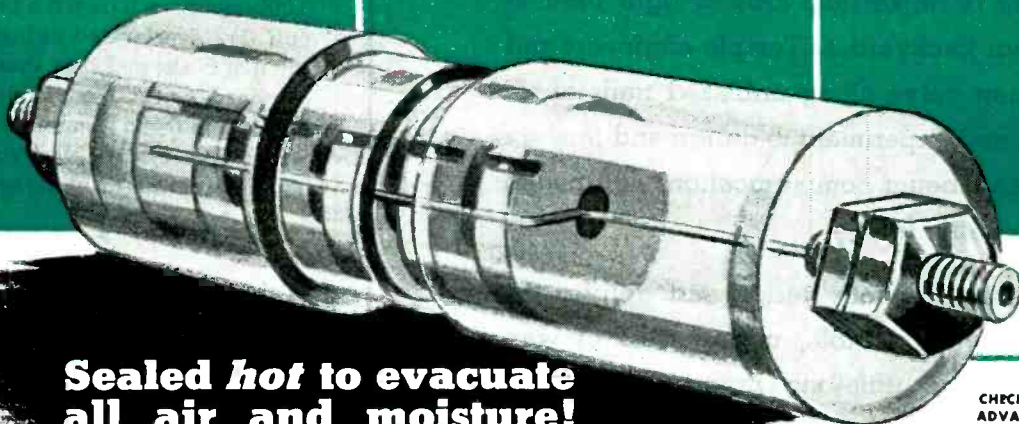

Sealed hot to evacuate all air and moisture!

Four new types of IN-RES-CO hermetically-sealed resistors, now in production, meet a multiplicity of electronic and electrical equipment requirements. Featuring absolute immunity to fungus, moisture and corrosive fumes—free from noise frequently introduced by electrolysis and leakage—each is enclosed in molded bakelite.

An important factor is the sealing-in process, consisting of wax impreg-

nation and oven dehydration, which excludes all possibility of "trapped" moisture or air. Circuit instability and premature breakdown caused by resistor failure are eliminated.

IN-RES-CO Hermetically Sealed Moisture and Fungus Proof Resistors are applicable for all installations—mobile, airborne or tropical—where deteriorating influences are present. Inquiries are invited.

CHECK THESE ADVANTAGES:

- Mechanical protection is provided by rugged, sturdy, telescope-type molded bakelite case which is moisture and fungus proof.
- Resistor element is impregnated with a moisture and fungus proof high temperature compound and then oven dehydrated prior to sealing.
- Mounting—Types BX, SX, and WX have 8-32 threaded studs and two hex. nuts each end.
- Construction—Ceramic spools are non-hygroscopic, leakage and electrolysis effects are eliminated. Nichrome, Advance or Manganin windings are available.
- Accuracy—standard tolerance is 1%; accuracy to 1/10 percent at additional cost. Slight additional cost for Manganin or Advance wound units.



INSTRUMENT RESISTORS COMPANY

25 AMITY STREET, LITTLE FALLS, NEW JERSEY

SUITABLE FOR
A DIVERSITY OF
MOUNTINGS

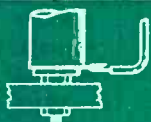

IT CAN'T BE DONE!

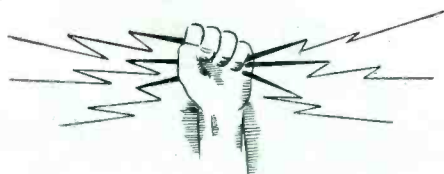

Time and again this war has proved that *nothing is impossible!* Proved right here in our own backyard, as Temple engineers and craftsmen delve along unblazed trails of research and experiment to design and produce more and better communications equipment for the battle fronts.

This ability to both design and deliver the seemingly impossible, under stress of war, has bred an unfailing inventive capacity that should prove invaluable in meeting the vast commercial requirements of peace.

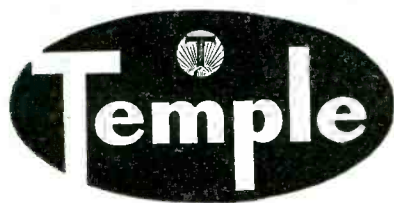

Electronics Division

**TEMPLE TONE
RADIO MFG. CORP.**

New London, Conn.

face A, and then to a photocell. Face A is more highly polished than face B, and the combination gives about 91 percent light transmission—equivalent to that of distilled water (0.0 ppm of oil) in a rectangular glass cuvette with the same light path. By rotating the block 180 deg so that face B is nearest the photocell, the calibration corresponds approximately to 0.3 ppm of emulsified oil in the same cuvette. Faces C and D are slightly rougher than faces A and B. The calibrations of the four faces are linear and correspond to approximately 0.0, 0.3, 0.7, and 1.5 ppm of oil in the cuvettes in two types of turbidimeters.

The third type of turbidity standard consists of colloidal carbon (India ink) in a 0.5-percent solution of Aerosol as dispersing agent, together with 0.1-percent of orthochlorophenol as a preservative, and 0.002-molal phosphate buffer (pH 7). Accelerated aging tests at 140 deg F showed that these carbon standards are reasonably stable. The oil emulsion standards used for calibrations change slowly and must be made up again at intervals.

• • •

Automatic Control of Glazing Furnace

BAKING AND GLAZING of clay models at the Rochester (N. Y.) Memorial Art Gallery posed a problem that was complicated by several factors when the University of Rochester set up classes in modeling and ceramics under the direction of the famous sculptor, William Ehrich.

The use of a flame fired kiln would have necessitated an increase in insurance rates, and extensive alterations to take care of products of combustion. Gas connections were not available inside the building, and oil would have required the installation of a storage tank. No technical men were available to control an electric kiln over the range of temperatures needed over a period of hours.

The problem was solved through the installation of a resistance-type electric furnace equipped with automatic program-type electronic control.

With the automatic program con-

The Test Panel shown here, made by the Standard Electric Time Co. of Springfield, Mass., is equipped with 54 HEINEMANN Panel Type Breakers with INSTANTANEOUS Trip. They are so connected that any single condenser failure will cause the group circuit breaker to open fast enough to avoid creating a voltage surge which might cause failure of the whole group.

HEINEMANN CIRCUIT BREAKERS ARE ENTIRELY MAGNETIC

Instantaneous Action



of

**HEINEMANN
MAGNETIC CIRCUIT BREAKER
Assures Positive Protection
against
Group Condenser Failure**

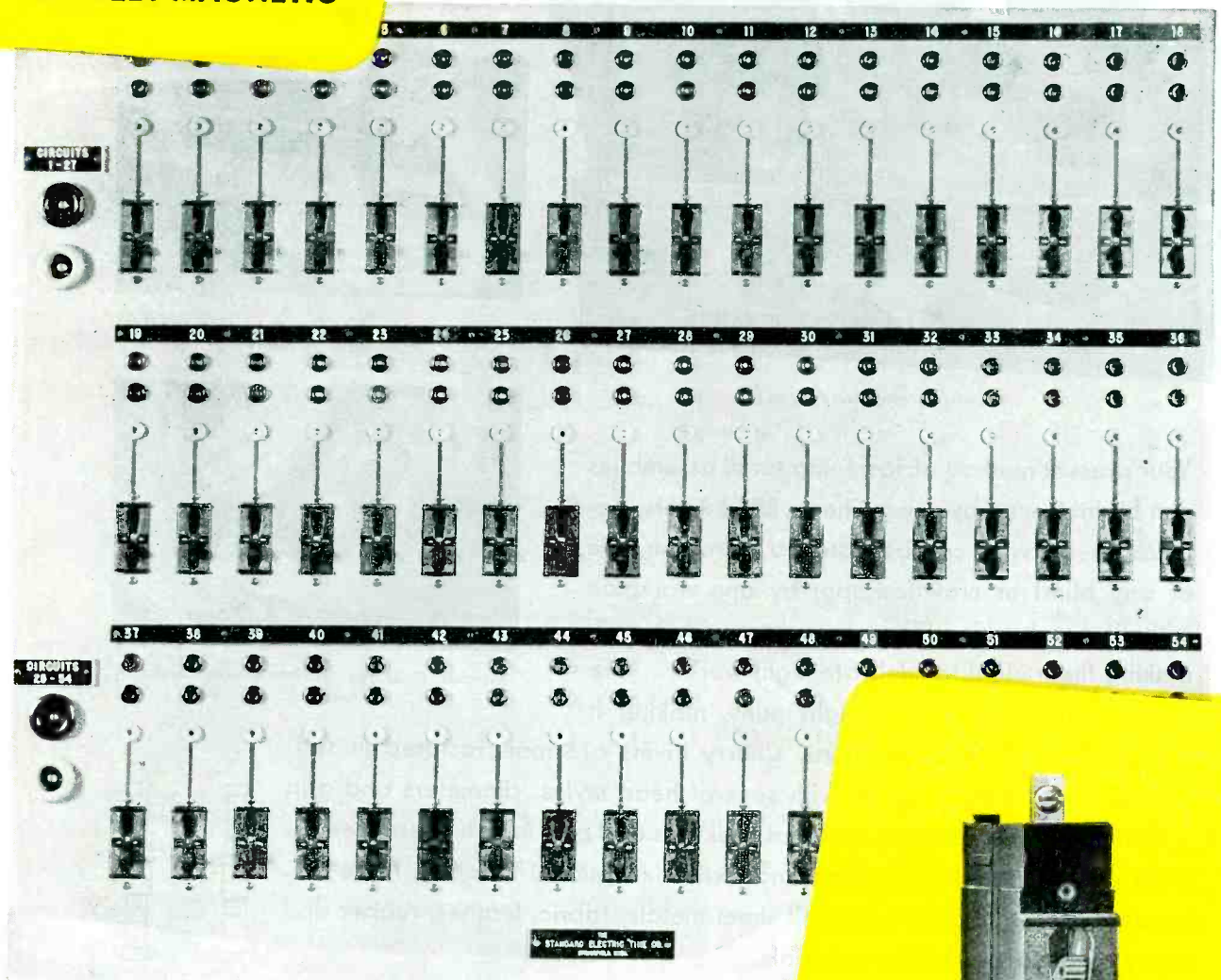

Send for Catalog with Complete Line and Engineering Data

HEINEMANN CIRCUIT BREAKER CO.

Subsidiary of Heinemann Electric Co.

Established 1888

97 PLUM ST.

TRENTON, N. J.

SMALL ASSEMBLY FASTENING *improved* with *Cherry Blind Rivets*

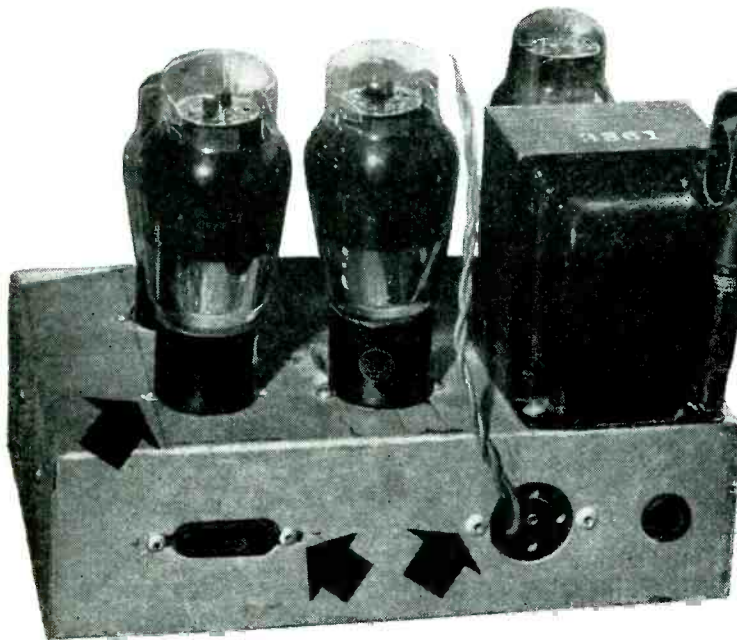

Arrows indicate Cherry Rivets

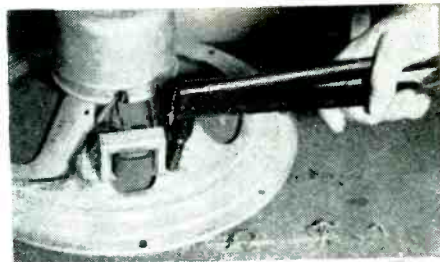

Fastening output transformer to cone speaker with G-25 gun.

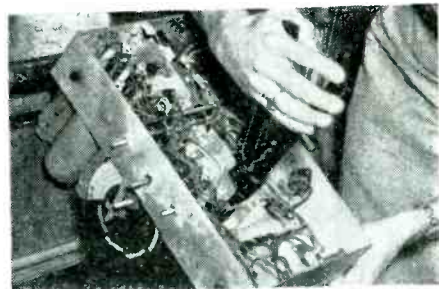

Compact G-35 gun gets into crowded areas easily.

Your present method of fastening small assemblies can be improved by using Cherry Blind Rivets, because these rivets can be installed from one side of any blind or crowded spot by one workman without any bucking. They are upset with a pull, making them ideal for delicate, light work . . . are applied with small, lightweight guns, making it easy to get at tough locations. Cherry Rivets are manufactured in self-plugging and hollow types, with several head styles, diameters and grip lengths . . . have generous material thickness and grip length tolerances . . . have unusual shank expansion and exert exceptional clinching force . . . upset in bends, curves, tubes, all sheet metals, fabric, leather, rubber and many other soft or brittle materials.

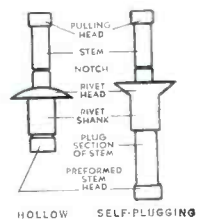

For a quick picture of Cherry Rivet advantages and uses, write for Manual D-45 and metal demonstration panel, Dept. A-120, Cherry Rivet Company, 231 Winston Street, Los Angeles 13, Calif.

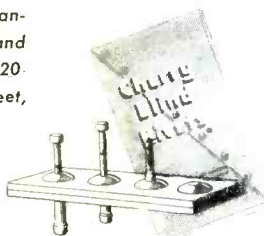

CHERRY RIVETS. THEIR MANUFACTURE & APPLICATION ARE COVERED BY U.S. PATENTS ISSUED & PENDING

Cherry Rivet

Company

LOS ANGELES, CALIFORNIA

Belden CONNECT-A-CORD

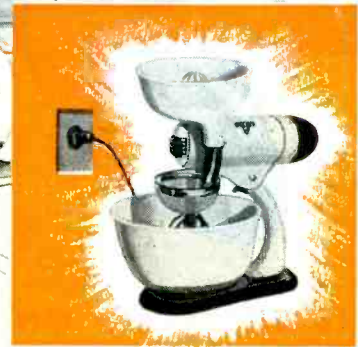

Do cooks have to fight the cord to use your kitchen mixer?

what is the Belden CONNECT-A-CORD?

CONNECTOR + CONDUCTOR + PLUG

Users want this new advantage—

It's a new idea—still, as a result of a recent survey, 50% of the mixer users were already found to be in favor of the advantages of the Belden Connect-A-cord.

This new Belden product is no "postwar dream." It is already engineered—and only offered after a thorough check which has shown conclusively that your customers want the Belden Connect-A-cord on their better electrical equipment.

NOW YOUR NEWLY DESIGNED APPLIANCES CAN ALWAYS HAVE THE CORRECT LENGTH CORD FOR ANY INSTALLATION . . . with the

Belden *CONNECT-A-CORD*

There is something new in electrical cords. The Belden Connect-A-cord makes available the correct length cord for every installation—in matching colors, too. Furthermore, the Connect-A-cord

- 1 Provides a cord for every tool or appliance—detachable at the appliance end as well as the plug end.
- 2 Is easy to replace—eliminates dealer cord repair service.
- 3 Simplifies line assembly operation. Simplifies packing and display.
- 4 Provides a NEW SALES FEATURE.

A worth-while sales feature—promoted by consistent national advertising. Get information on the new Corditis-free Connect-A-cord today.

Belden Manufacturing Company
4625 W. Van Buren Street, Chicago 44, Ill.

Belden

Corditis-free **CORDS**



Chicago, Ill.



Richmond, Ind.

The End RESULT



**IS THE ONLY ONE
THAT COUNTS IN
SOUND**

Regardless of high quality pick-up, amplification, radio broadcast or home reception, the end result is the only one that counts in quality sound reproduction. Perfect sound reproduction from 40 to 15,000 cycles plus is the end result of the Duplex Speaker. That's the end result that counts with top sound engineers and discriminating listeners.

SEND FOR BULLETINS

ALTEC

LANSING CORPORATION

1210 TAFT BLDG., HOLLYWOOD 28, CALIF.
250 WEST 57 STREET, NEW YORK 19, N. Y.
IN CANADA: NORTHERN ELECTRIC CO.

trol, the kiln can be used either day or night, or both, and can be set to operate during off-peak electric demand periods when there is a saving in electric rates. Part of the time the kiln is used by University technicians in optical glass research, and the rest of the time by Gallery students for baking and glazing modelled clay objects.

Heat Cycle

For bisque (clay) baking, the kiln is started at 100 deg and the heat increased over a curve until it reaches 1840 deg in 9½ hours. For glazing, the heat is increased to 1960 deg over a longer period of time. A typical heat cycle for a bisque firing is:

5:00 P. M.	100 deg
9:30	680 deg
10:00	800 deg
11:30	1240 deg
1:15 A. M.	1620 deg
2:30 A. M.	1840 deg

The starting, the time-temperature cycle, and the stopping of the kiln are automatically taken care of in the Wheelco program control by the action of an arm moving along the edge of a contoured disc (or cam) which is rotated by a synchronous motor. This arm is mechanically coupled to the setting lever of the Wheelco Capacitrol instrument, which electronically controls the input to the resistance Glowbars in the electric kiln.

The kiln is a Harper Electric Furnace unit, rated 20 kw at 56 amp, with a maximum temperature of 2250 deg F. Glowbar resistance units are located in compartments at the sides of the furnace chamber, so that there is no direct radiation.

• • •

Electrolysis Prevention on Underground Pipe

By WILLIAM H. STEELE
The Montana Power Company

TO OFFSET CORRODING effects of electrolysis on an underground gas line, an external source of direct current is often used. In a local installation of this type, it was found expedient to use a 3-phase rotary converter with a 5-kw rating. The direct-current output of this converter is connected with the positive terminal to a ground bed and

*Make Plans Now . . .
for the coming . . .*

PLASTIC ERA

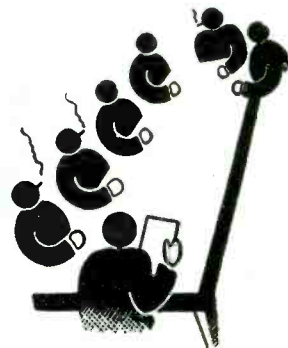

Consult . . .
ROGAN

- Here at Rogan, seasoned engineers are ready and willing to assist you in determining your post-war *Plastic* requirements.

Whether your peacetime products are to include electronic equipment, electrical appliances, stoves or what have you, the Rogan Organization will gladly provide cost-free advice on all phases of plastic production.

*Send us
Your Specifications Today!*

ROGAN BROTHERS

*Compression Molders and Branders
of Plastics*

2005 So. Michigan Avenue
Chicago, Illinois

**a new standard line of
electrode assemblies for
dielectric heating . . .
2, 5, and 10 kw**

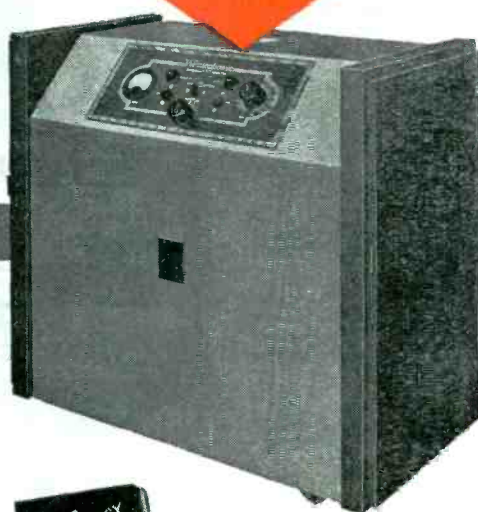

Built in 2, 5 and 10-kw sizes, these Westinghouse electrode assemblies offer new convenience and efficiency for dielectric heating of plastic preforms.

The assemblies may be mounted on standard generators, or matching networks, and the electrodes are interchangeable within the physical limits of the cage.

Top electrode is perforated to minimize moisture condensation. In applications where moisture condensation is unusually severe, warm air from the generator may be bled into the cage. This is easily done with Westinghouse generators using air-cooled tubes. Top electrode's height is easily adjusted by a knob on the cage. Ball joint and spring take-up assure positive contact between preform and electrode regardless of material and heating cycles. Interlock switches remove high voltage from bottom electrode when cage is opened.

Available in electrode diameters from 4" to 15", depending on kw rating, these newest contributions to effective radio frequency heating may also be built in special designs, on order. Ask your nearest Westinghouse office for the facts. Westinghouse Electric Corporation, P.O. Box 868, Pittsburgh 30, Pa. J-08115

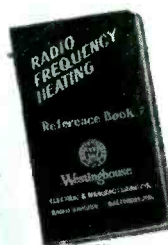

FREE . . . an authoritative, pocket-size reference book on radio frequency heating. Contains extensive tables, charts and formulas on both induction and dielectric heating. Ask for reference book B-3574 on your business letterhead, please.



Westinghouse
PLANTS IN 25 CITIES . . . OFFICES EVERYWHERE

Electronics at Work

RELAYS THAT *"Click"* ON THE JOB!

SIMPLE, DEPENDABLE, POSITIVE ACTION

You can depend on silent Adlake plunger-type Relays to "make good" on every kind of equipment into which you design these modern, hermetically sealed mercury relays for timing, load and control circuits. May we co-operate with your designers by suggesting the type of Adlake Relays best adapted to your product?

Adlake Relays have snap action that stays "snappy." The contact mechanism is hermetically sealed in an armored glass or metal cylinder. No dirt, dust, or moisture can enter . . . there is no danger of oxidation.

The liquid metal mercury contact is instantaneous, positive in action, silent, chatter-free, and cannot burn, pit or stick. No other relays are as simple, rugged and dependable. Write for bulletin.

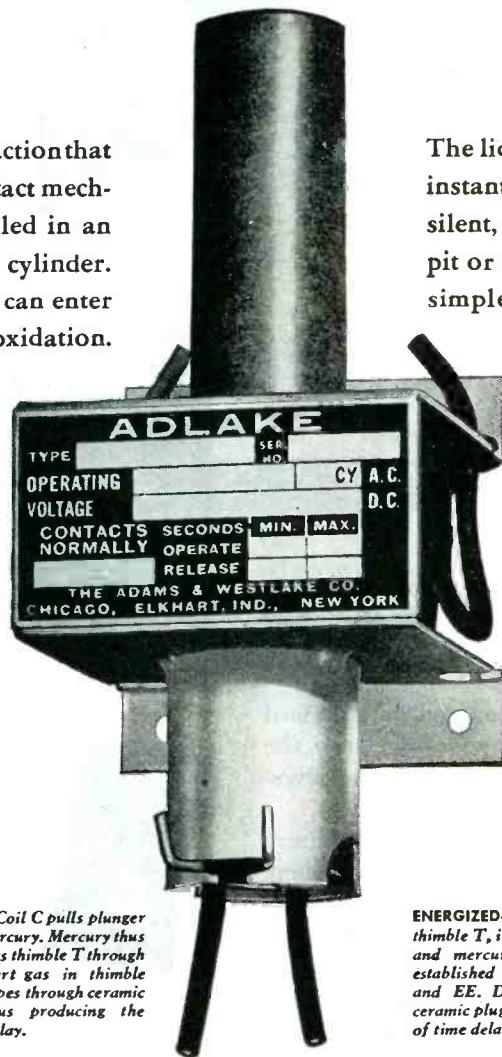

Adlake Model 1040 . . . for panel mounting . . . available with either quick or time delay action, normally open or closed.

Quick acting relays are available with contact ratings up to 50 amperes A.C. with proportional D.C. ratings.

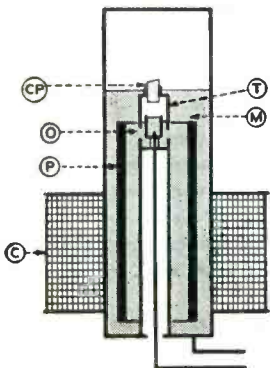

ENERGIZED—Coil C pulls plunger P down into mercury. Mercury thus displaced enters thimble T through orifice O. Inert gas in thimble gradually escapes through ceramic plug CP—thus producing the desired time delay.

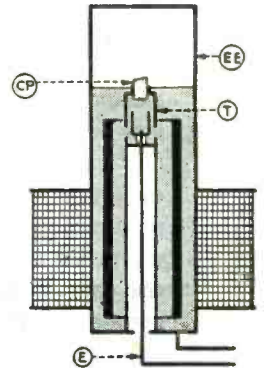

ENERGIZED—Mercury now fills thimble T, is completely leveled off and mercury-to-mercury contact established between electrodes E and EE. Degree of porosity of ceramic plug CP determines length of time delay.



THE ADAMS & WESTLAKE COMPANY

ESTABLISHED IN 1857

ELKHART, INDIANA

NEW YORK · CHICAGO

MANUFACTURERS OF ADLAKE HERMETICALLY SEALED MERCURY RELAYS FOR TIMING, LOAD AND CONTROL CIRCUITS

PICK A CARD



... it's Sure to be a Winner

This is no gamble. Every man whose card you see is a key member of Sickles' Engineering and Co-ordinating Service. All are trained to work with you in meeting your requirements for radio and electronic parts and components.

Their experience is broad and their information is complete. Chances are, they can give you the answer on the spot.

But if your problem is unusual, they'll know what to do. They'll quickly take it to headquarters where Sickles' technical staff and skilled production organization will analyze it and develop a solution to meet your needs for quality, low cost and delivery.

Pick a card — any card — the nearest one to you, for prompt, efficient co-operation whenever you need it.

THE F. W. SICKLES COMPANY

• CHICOPEE, MASS.

SICKLES

Radio and Electronic Specialties for Today and Tomorrow

Unsurpassed QUALITY

• The Industrial Condenser Corporation manufactures a complete line of Oil-filled, Electrolytic, Wax and Special Mica Capacitors for all industrial, communications and signalling applications up to 250,000 volts working. Complete laboratory and engineering facilities available for solution and design of capacitor problems for special applications.

An Industrial Condenser for every industrial application.



.5 MFD. 50,000 VOLTS DC WORKING

(Illustrated above)...28 inches high, weight 175 pounds, built by Industrial Condenser Corporation to meet Navy specifications. Oil-filled, oil impregnated. Built for 24 hour continuous operation and total submersion in salt water.

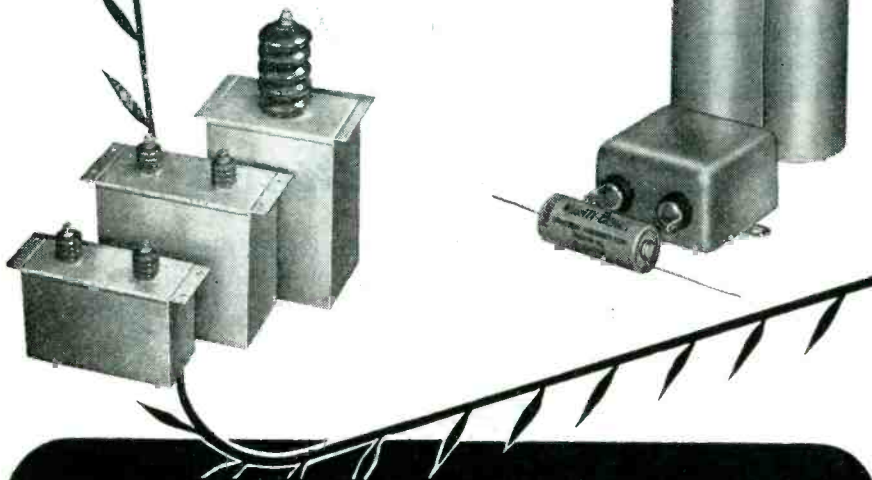

PAPER, OIL AND ELECTROLYTIC CAPACITORS

INDUSTRIAL CONDENSER CORPORATION

3243-65 NORTH CALIFORNIA AVE., CHICAGO 18, U.S.A.

DISTRICT OFFICES IN PRINCIPAL CITIES

the negative to the pipe line. This polarity must never reverse since damage would result from increased electrolysis.

It was necessary to locate the converter where it could not be attended at all times. Since the polarity of the output is not always the same when starting, an across-the-line magnetic starting switch was used. With the power shut down, this magnetic switch falls open. An attendant must then go out and restart the converter so that the proper polarity is maintained.

It was found that with the power shut off, the back emf produced by ensuing rotation of the converter would retain the holding coil closed for about 10 seconds. During this time, the converter would often change its output polarity due to

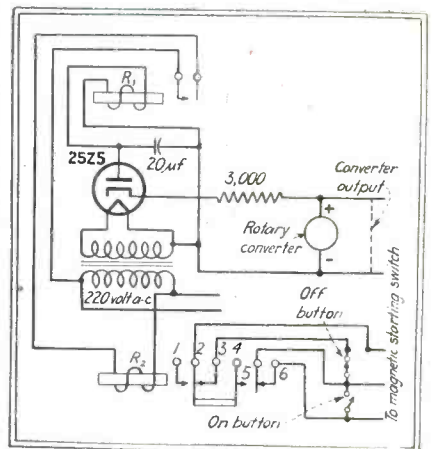

Circuit of electronic unit for correcting the output polarity of a rotary converter used in preventing electrolysis of an underground pipe

the phase relation going out of step with the proper commutator segment at a given instant. An electronic control was installed to overcome this condition and at the same time make the starting-up process automatic and maintain the desired output polarity.

Control Circuit

The circuit diagram above shows the method used. The control tube is a 25Z5 with the two cathodes and plates connected in parallel externally. The filament source can be a transformer or an appropriate heavy-duty resistor in series with the line.

A 2-watt, 3000-ohm resistor was

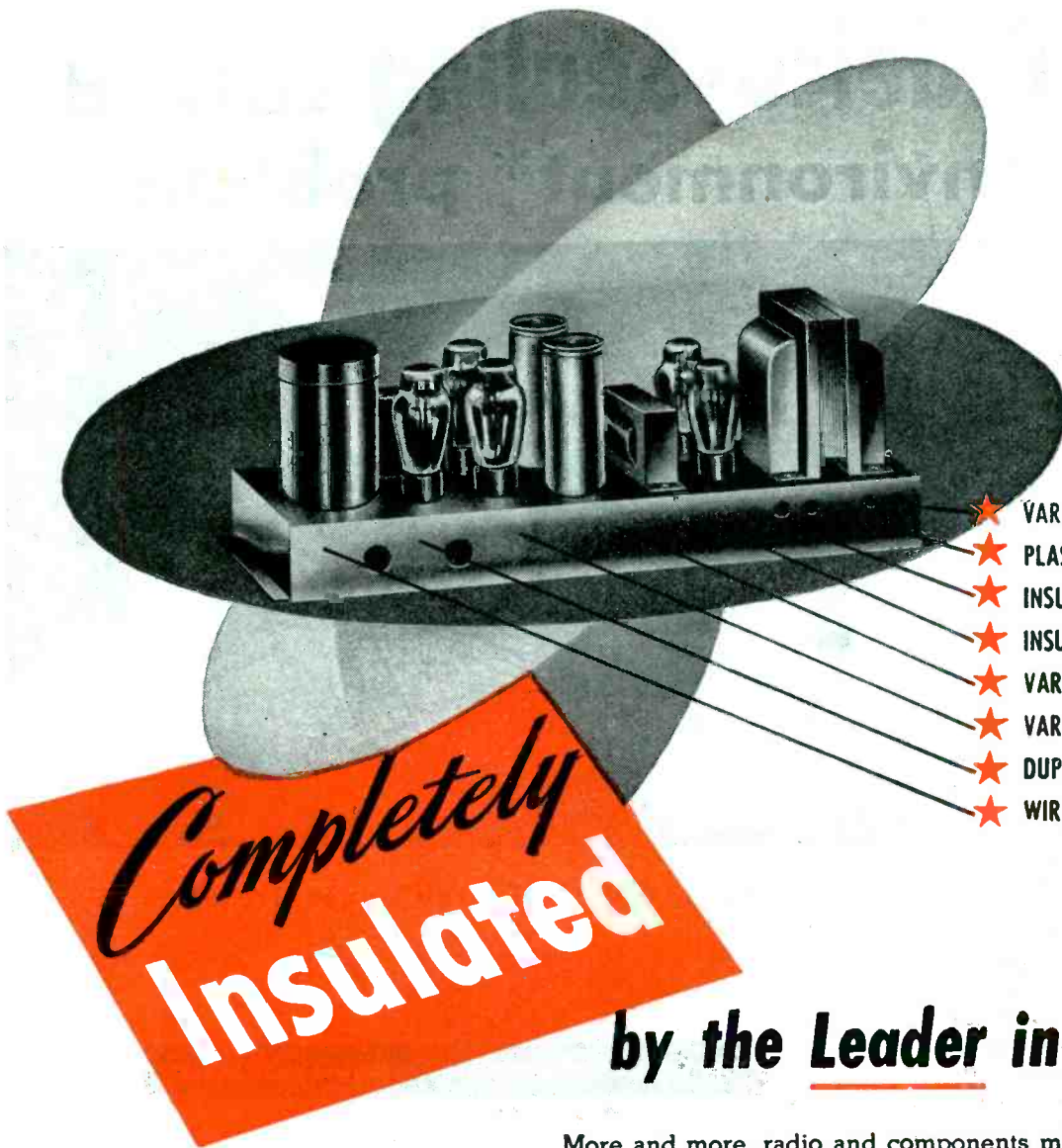

- ★ VARNISHED TUBINGS
- ★ PLASTIC TUBINGS
- ★ INSULATING VARNISHES
- ★ INSULATING PUNCHINGS
- ★ VARNISHED FABRICS AND TAPES
- ★ VARNISHED PAPER
- ★ DUPLEXED INSULATIONS
- ★ WIRE MARKERS

by the Leader in Insulation

More and more, radio and components manufacturers are writing into their specifications "Insulation by IRVINGTON". For IRVINGTON provides every varnished type of insulation required in radio manufacture . . . for all the new needs as well as the old. And each product bearing this outstanding name is formulated and manufactured under exacting IRVINGTON control . . . to assure 'balanced' service when used with others of the same name. Thus this single specification "Insulation by IRVINGTON" assures efficient, long-lasting protection to every part; the kind of service that builds and keeps dealer and user good-will. Complete cooperation on insulating problems involving radio or any other type of electrical circuit is freely offered. Write Dept. 106, or communicate with the IRVINGTON distributor in your territory.

IRVINGTON PRODUCTS include:

- Varnished Cambric and Tape*
- Varnished Fiberglas*
- Varnished Rayon, Nylon and Silk*
- Plastic Tape*
- Cardolite Compounds*

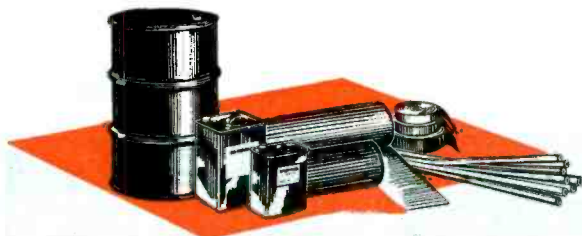

IRVINGTON
VARNISH & INSULATOR COMPANY
 Irvington 11, New Jersey, U. S. A.

How Fedelco-Sealing solved *this environment** problem

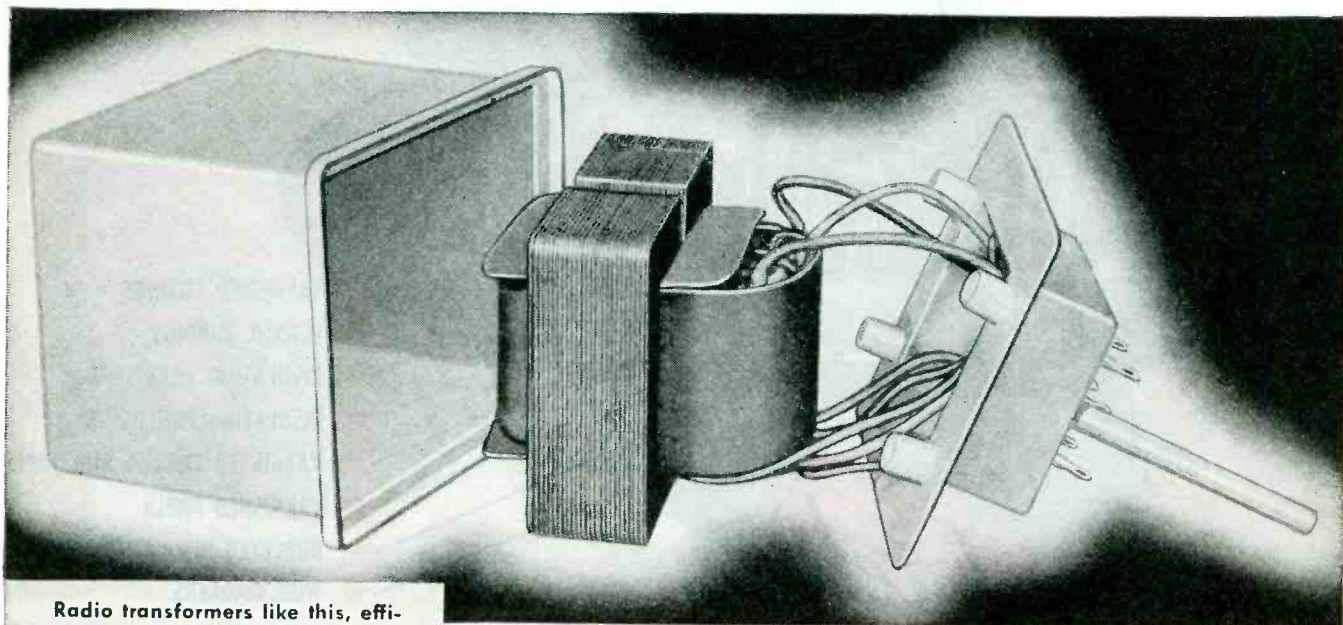

Radio transformers like this, efficient under ordinary conditions, had been going bad in airplanes. The trouble was traced to moisture, condensation being accelerated by changes in altitude and temperature. Fedelco-Sealing solved the problem. A metal case was designed to fit the original mounting—one requirement; leads were brought through sealed terminals in the base, and the cover was sealed on. Then the case was exhausted, refilled with dry air, and sealed permanently, ending moisture troubles.

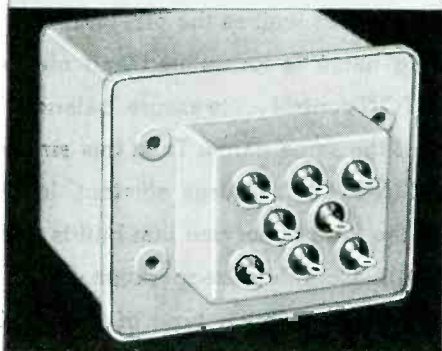

* ENVIRONMENT may cause trouble . . .

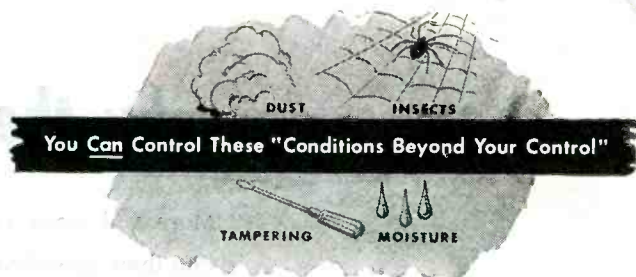

Fedelco-Sealing protects apparatus from environment*

To insure the long life and unflinching performance you build into your product, insure its Environment-Free operation, with Fedelco-Sealing. By this process, an electrical or mechanical device is sealed into an air-tight housing, which can be exhausted, and, if desired, filled with dry air or inert gas, at atmospheric, lower, or higher pressures.

Ship your product to us and we will Fedelco-Seal it for you. Or you can Fedelco-Seal your own products, in your plant, with our methods and our equipment. Get details on this new and progressive method now—from any of the offices listed below.

FEDERAL ELECTRIC COMPANY, INC.

8700 South State Street, Chicago 19, Illinois • Phone: VINcennes 5300



E. B. Mathewson Company, sales agents • 612 North Michigan Avenue, Chicago 11, Illinois • Phone WHItchall 4822
 Sales offices: New York 17, N. Y.—Graybar Bldg. • Chicago 11, Ill.—612 N. Michigan Ave. • Philadelphia 7, Pa.—Real Estate Trust Bldg.
 Kansas City 8, Mo.—2017 Grand Ave. • Atlanta, Ga. • Troy, N. Y.—17 Bank Street

CONVINCING EVIDENCE OF A VERSATILE PLASTIC

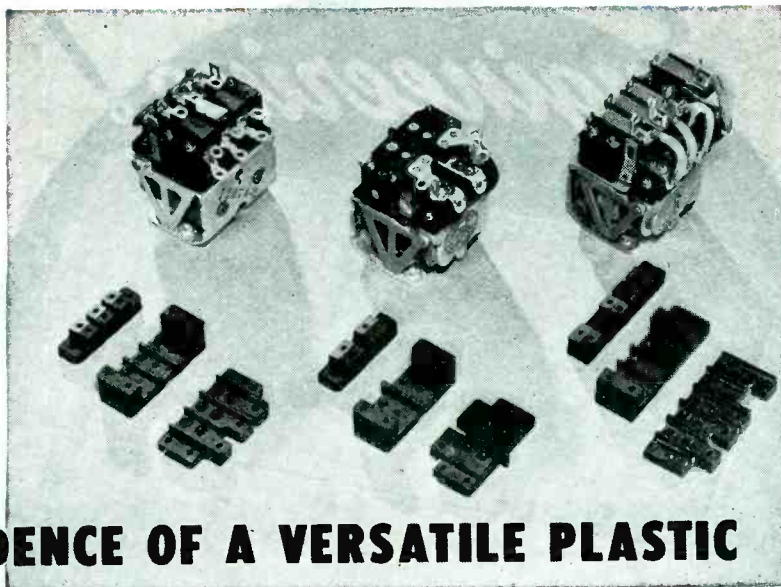

More and more manufacturers are turning to the versatility of Durez phenolics as the ideal solution to their material problems. For these most-versatile-of-all-plastics possess a range of properties so broad that it makes their applications almost limitless... makes them of unusual value to the imaginative design engineer.

Typical of the progress which is being made by manufacturers everywhere in developing new products and improving old ones with Durez phenolic plastics, are the Type 27 relays illustrated above... molded and manufactured by G. M. Laboratories, Inc.

Designed to meet the most severe demands of military mobile and aircraft equipment, these relays pass all the requirements for such service to a degree that exceeds normal specifications. Although they were designed specifically for use on mobile equipment where severe vibration is encountered,

these relays are also highly recommended for communications service and other applications.

Light Weight Yet Rugged

The basic Type 27 design is a rectangular, almost cubic, shape in which great care was taken to utilize all available space, thus insuring compactness. Over-all dimensions of the largest unit shown, the three-pole relay, are 1-13/16" x 2-5/32" high. The outstanding feature of these relays is a combination of light weight, (approximately 5 ounces) and extreme ruggedness. Structural shape rather than mass is the basis of strength, and the manufacturer states that they are immune to severe vibration and sustained acceleration in any direction.

Unusual Versatility

The choice of Durez for the molded parts of these relays was a natural one.

Its high dielectric strength combined with structural rigidity and immunity to atmospheric conditions suits it admirably for the exhaustive tests which the unit must undergo. It easily passes a 200-hour salt-spray test and will withstand 100% humidity in a saline atmosphere. The relay can operate in a temperature range from minus 75° F. to plus 190° F.

Perhaps you are in search of a plastic which must pass rigid tests before it is acceptable. If so, we suggest that you consult your custom molder. Many new molding methods and processes have advanced his techniques by decades... and he is equipped to advise you expertly. Then, we suggest that you take advantage of the broad experience of Durez technicians and the wealth of data in our files. These are available to you and your custom molder at all times. Durez Plastics & Chemicals, Inc., 326 Walck Road, N. Tonawanda, N. Y.

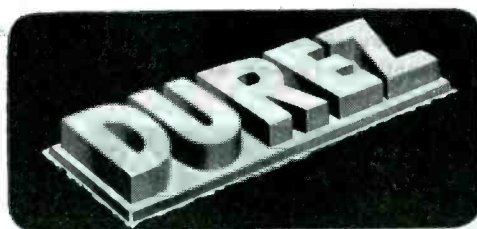

PHENOLIC
RESINS

MOLDING COMPOUNDS

INDUSTRIAL RESINS

OIL SOLUBLE RESINS

PLASTICS THAT FIT THE JOB

A Typical Challenge to ADC

Engineering!

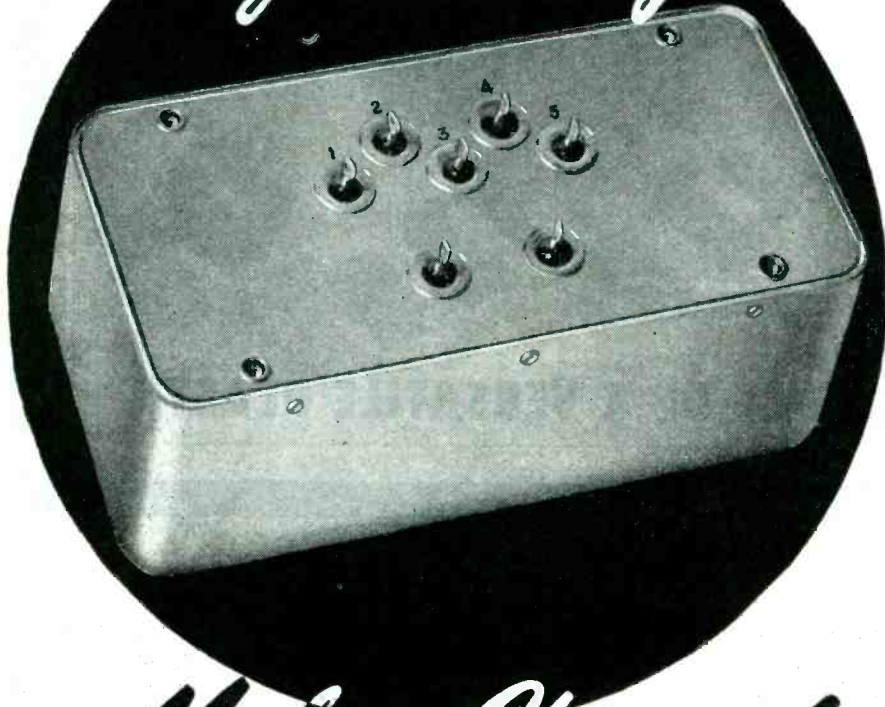

Multi-Channel NARROW BANDPASS FILTER UNITS

● Like many of the problems brought to the Audio Development Company, this one involved a definite performance improvement with reductions in size and weight.

From an originally specified maximum weight of 40 oz. for potted one-channel interstage filters, the weight of this ADC five-channel unit was reduced to less than 10 oz. per section, hermetically sealed. Volume was reduced by over 50%.

Electrical performance was improved to provide a midband gain of $14 \pm 1\frac{1}{2}$ db when the original specifications permitted a loss from 0 to 6 db. In addition, attenuation characteristics were improved to provide approximately 25 db discrimination at $1/3$ octave with bandpass $\pm 1\frac{1}{2}$ db over $\pm 3\%$ of mid-frequency.

These filters are available in single or multi-channel units for frequencies from 200 cps to supersonic and carrier range. Frequencies lower than 200 cps are available with some size increase. Units can also be supplied in combination with high or low pass filters to permit tone channeling on voice circuits, thus allowing several remote control functions to be superimposed on a single voice circuit without interfering in any way with regular service.

We are ready to help with your filter and transformer requirements. Why not consult with us on your specific problem?



Audio Development Co.
2833 13th Ave. S., Minneapolis 7, Minn.

found necessary in the positive lead to the cathode, and a 22- μ f, 150-volt capacitor was used across relay R_1 in order to prevent minute changes in current direction from energizing relay R_1 , until the converter has increased its speed to build up enough potential in one direction or the other. Before the capacitor and resistor were added, considerable chattering of the relays took place.

Relay R_1 is a 5000-ohm d-c relay requiring very little current to operate. Relay R_2 is a quick-acting, double-pole, double-throw a-c relay with contacts 2-3 and 5-6 normally held closed with spring tension. These terminals are connected across the start and stop buttons which operate the holding coil of the magnetic switch.

Operation

When the converter is running with output polarity shown in the circuit nothing happens in the electronic control due to the fact that the negative plate and positive cathode do not pass any current to operate relay R_1 . But should the output of the converter be of opposite and undesired polarity, causing the cathode to be negative and causing the plate (through the relay R_1) to be positive, the resulting current flow in R_1 closes the contacts which energize relay R_2 .

This in turn opens contacts 2-3 and 5-6, shutting off the power to the converter. The unique part is that R_1 will hold open just long enough for the polarity to change due to the loss of speed in the converter. This action is very rapid. In the event of a line change in which the converter holding coil might stay closed momentarily, and if the output changes polarity, the tube and relays would immediately rectify the change.

With different size converters and different output voltages the resistor in the positive lead and the capacitor across R_1 will have to be of different size and ratings and determined by experiment.



JET-PROPELLED PLANES fly so smoothly that a vibrator is necessary on the instrument panels to keep meter pointers from sticking.

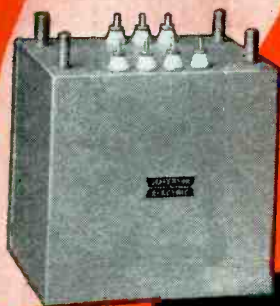
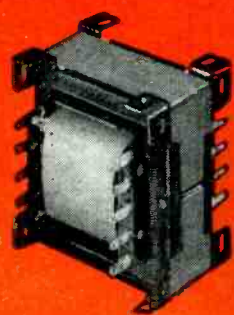

Great Strides Have Been Taken



In **TRANSFORMER** *Development*

Through full utilization of new war-time advancements in production methods, manufacturing facilities, and engineering techniques, Jefferson Electric is prepared to meet tomorrow's transformer needs with a product capable of maximum application to postwar technical developments.

The superiority of Jefferson Transformers will continue to be based on such vital and fundamental quality characteristics as: improved steel to reduce electrical losses; advanced methods of using carefully selected iron for laminations followed by Jefferson's own process of annealing; improved compounds, materials and impregnation methods to provide greater resistance to moisture, extreme heat and cold.

In addition to these features, full control over all methods of manufacture, assembly and inspection insures that every Jefferson Transformer is laboratory correct whether ordered in small lots or hundreds of thousands.

Consult now with Jefferson Electric transformer engineering specialists about your present and anticipated future needs and assure yourself of the ultimate in dependable, reliable transformer service. JEFFERSON ELECTRIC COMPANY, Bellwood (Suburb of Chicago), Illinois. *In Canada:* Canadian Jefferson Electric Co. Ltd., 384 Pape Avenue, Toronto, Ont.

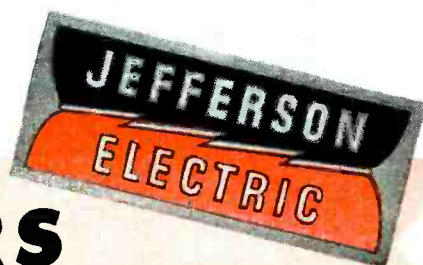

TRANSFORMERS



more efficient
... in miniature



A half century ago, a call to a neighboring city was an adventure filled with uncertainty. Delays, inaudibility, and interrupted connections were accepted characteristics of the telephone. Today we use an instrument to talk across continents and oceans with the ease and assurance of face to face conversation. The development of more efficient equipment in miniature has indeed been remarkable.

So it has been with radio tubes. The new miniature tubes, much smaller than the older receiving tubes, are becoming increasingly important as their advantages are being realized in modern applications. The greater efficiency of TUNG-SOL Miniatures is particularly evident in high-frequency applications. Their lower capacity, their shorter leads with resulting lower inductance and their high mutual

conductance make them ideal for this use.

When planning new or improving existing radio sets and other electronic equipment and controls, consult with a TUNG-SOL Engineer on circuits and tube selection. The use of TUNG-SOL Miniatures may reduce the size, weight and therefore the cost of your product and make it more efficient. Your future plans will be held in strictest confidence, of course.

TUNG-SOL
vibration-tested
ELECTRONIC TUBES



TUNG-SOL LAMP WORKS INC., NEWARK 4, NEW JERSEY
Also Manufacturers of Miniature Incandescent Lamps, All-Glass Sealed Beam Headlight Lamps and Current Intermittors

For precision STAMPINGS...see ADEL

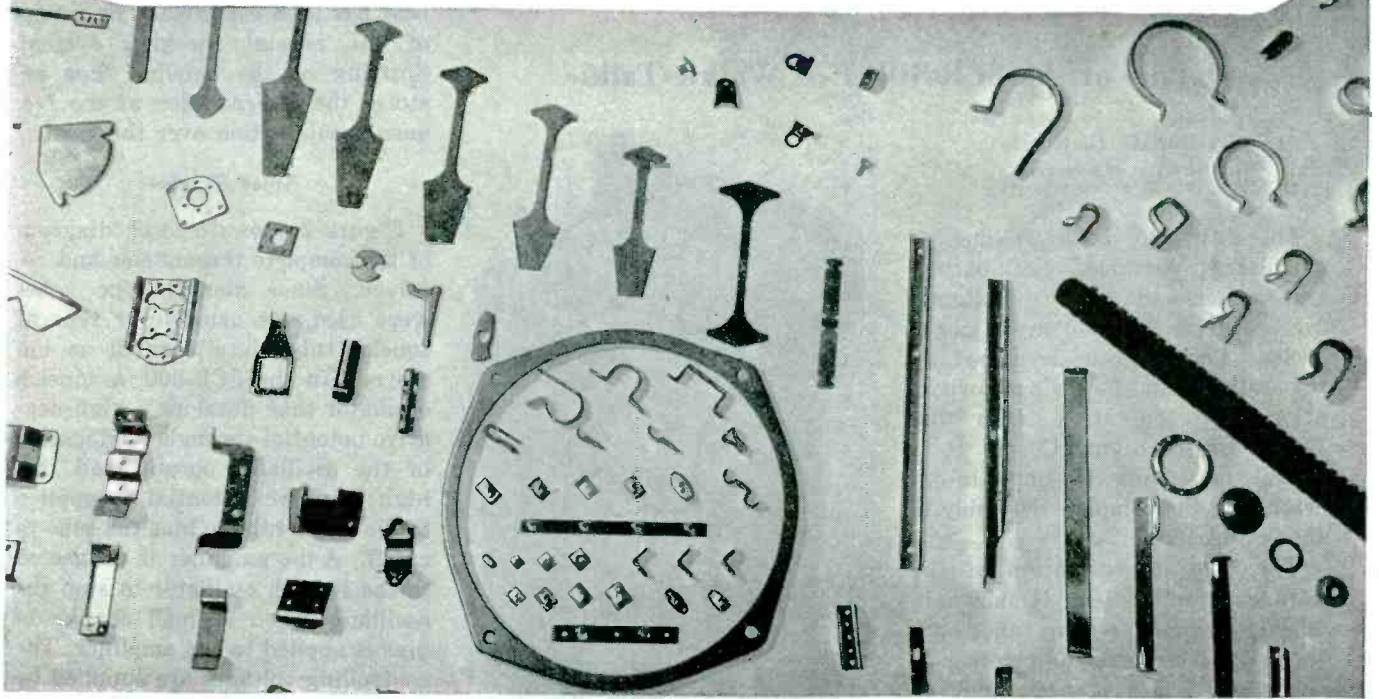

Just furnish the blueprints—and forget it. The job can be tooled, precision-stamped to close tolerances, heat treated, plated—and even assembled—with ADEL techniques which have been war improved to such production speed that your own product-assembly will move at a faster pace because of ADEL's all-around quick stamping service.

ADEL's batteries of punch presses (range up to 110 tons), and ribbon-forming machines

have turned out over 250 million aircraft parts. Use these facilities, and ADEL Design Simplicity Engineering to tool, fabricate, process and assemble your parts all in one shop. ADEL plants are on either side of the country to provide speedy service to industry all over the U. S. A.

For stamping runs that are really fast, call an ADEL engineer at the office nearest you.

It will be the first and only step you'll have to take to solve your stamping problems. Write Dept. E.

ADEL PRECISION PRODUCTS CORP.

ADEL

Trade Mark

Burbank, Calif. • Huntington, W. Va.

Offices: Seattle 1, Washington; Dayton 2, Ohio; Detroit 2, Michigan; Hagerstown, Maryland; Baltimore J, Maryland; New York 20, N. Y.
In Canada: Railway and Power Engineering Corporation, Limited

Copyright 1945—ADEL PRECISION PRODUCTS CORP.

PRODUCTS OF *Design Simplicity* AND *Dependability*



The Aircraft and Transportation Division of ADEL manufactures precision controls for planes, boats, tanks, armament equipment. *Left:* ADEL "Mighty Midget" 4-way hydraulic selector



valve. *Center:* ADEL Series "K" Fluid metering pump—outputs from .05 to 200 G.P.H. *Right:* ADEL *ISOdraulic remote control, remains synchronized from -65°F. to +160°F. *Trade Mark



TUBES AT WORK

Details of the SCR-300 F-M Walkie-Talkie.....	204
German Army Entertainment Receiver.....	216
Voice-Operated Electronic Relay.....	236

Details of the SCR-300 F-M Walkie-Talkie

By DANIEL E. NOBLE
*Director of Research
 Galvin Mfg. Corporation*

The SCR-300 is a frequency-modulated portable, back-packed transmitter and receiver designed for operation from 40 to 48 megacycles. The set was developed by the Galvin Manufacturing Corporation in cooperation with the United States Signal Corps. It is capable of netting, is simple to operate, and the complete assembly is shower-proof.

The final interpretation of the military specifications is shown in Fig. 1. A capacitor gang tunes both the transmitter and the receiver so that the set can be tuned rapidly to any frequency in an eight-megacycle band. The use of separate oscillators for the transmitter and the receiver in a single control system proved impracticable, since the tendency of the two oscillators to drift apart resulted in transmission and reception on different frequencies. To overcome this defect, a circuit was developed in which the single oscillator-modulator circuit was used for both the receiver and the transmitter.

The oscillator was adjusted for the proper operation of the first receiver-converter and with this arrangement the modulator became the automatic frequency control.

For transmission purposes, the afc reactance tube became the modulator, and the modulated output was mixed in a converter circuit with a crystal output whose frequency was equal to the i-f of the receiver. This placed the transmitter output carrier on the same frequency as the receiver.

The i-f crystal serves a dual purpose by tying in with the pushbutton control shown in the upper righthand corner of the control

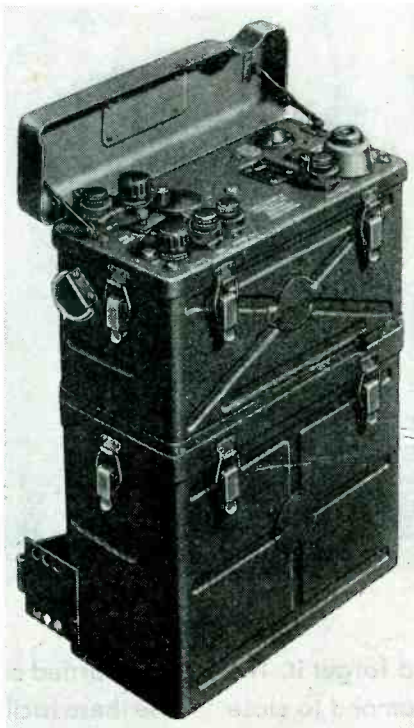

Fig. 1—SCR-300 walkie-talkie. When used by paratroopers, it is harnessed to the trooper's side or thigh. For long hikes, it can be fitted with a packboard

panel. Pressing this button starts the crystal oscillator and provides two check points for the checking of the calibration on the dial.

To make it unnecessary to open the case to adjust the oscillator, a control is attached to the dial hairline so that the hairline can be adjusted to the proper mark after zero beat has been established by means of the crystal checking system. Shifting of the hairline thus restores the interpolation of the frequency calibration over the band.

Noise Squelch

Figure 2 shows a block diagram of the complete transmitter and receiver. Since filament-type tubes were used, the usual lever type of squelch tube circuit cannot be employed. In the SCR-300, a squelch oscillator tube develops a high negative potential through rectification of the oscillator output, and this high negative potential is applied to the audio tube to bias the tube to cutoff. A d-c amplifier is connected to the squelch oscillator to stop the oscillator when a small change in bias is applied to the amplifier. The controlling voltages are supplied by a noise amplifier and rectifier.

In normal operation, the front-end noise of the receiver is amplified and passed on to the noise amplifier. The rectified output voltage of the noise amplifier is sufficient to maintain the d-c amplifier at a potential which insures the continued operation of the squelch

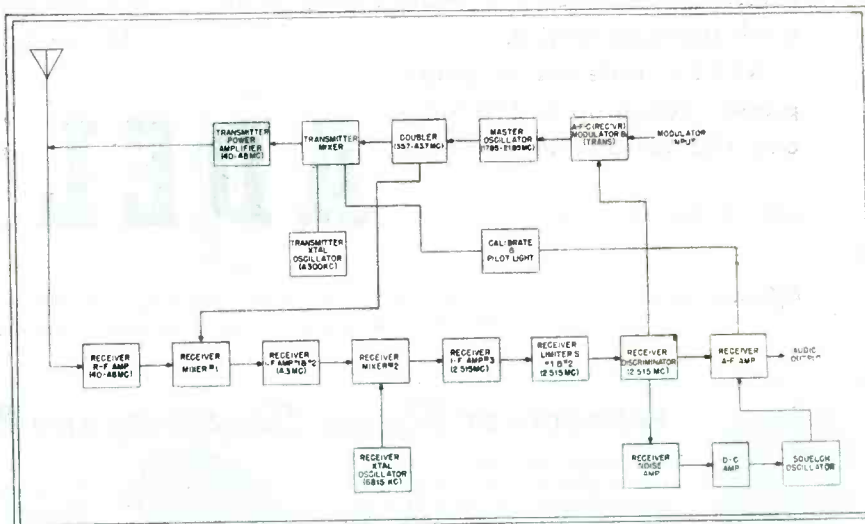

Fig. 2—The complete circuit of the walkie-talkie is illustrated by this block diagram. The transmitter power output is less than a watt; the receiver portion operates on a signal field of less than a microvolt per meter

relays

IN MARINE COMMUNICATIONS

From ship to ship and from ship to shore—whether on war craft or on peacetime boats of commerce and travel—marine radio communications equipment plays a major role. Leading manufacturers of such equipment use Relays by Guardian, two of which are shown installed in the DC power supply unit of the HT-11 Radiophone manufactured by the Hallicrafters Company, Chicago.



hallicrafters
RADIOPHONE

Hallicrafters HT-11 Radiophone
Unit Showing DC Power Supply

for Automatic Control of Electrical Circuits...

THERE'S A *Relay* BY GUARDIAN

In this application one Guardian relay in its normal position feeds the input of the Vibrapack for receiving purposes. On the changeover from receiving to transmitting it disconnects the Vibrapack and simultaneously energizes the other relay. This in turn connects the Dynamotor input and output circuits.

Both relays are Guardian Series 115 with double wound coils for operation on 6 or 12 volts D.C. with the 6 volt winding in parallel and the 12 volt winding in series. It is a small, compact relay, ideal for use where space is limited.

Its use in Marine Radiotelephone is but one illustration of the many applications of relays in radio and electronic equipment. For complete description of numerous types of Relays by Guardian, write for Guardian's new Catalog No. 10.

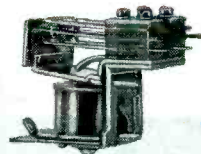

Series 115 DC Relay

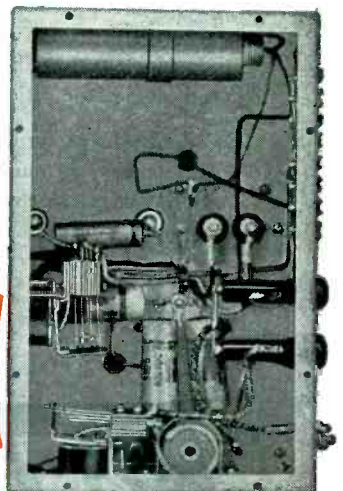

GUARDIAN  **ELECTRIC**
1625-G W. WALNUT STREET CHICAGO 12, ILLINOIS
A COMPLETE LINE OF RELAYS SERVING AMERICAN WAR INDUSTRY

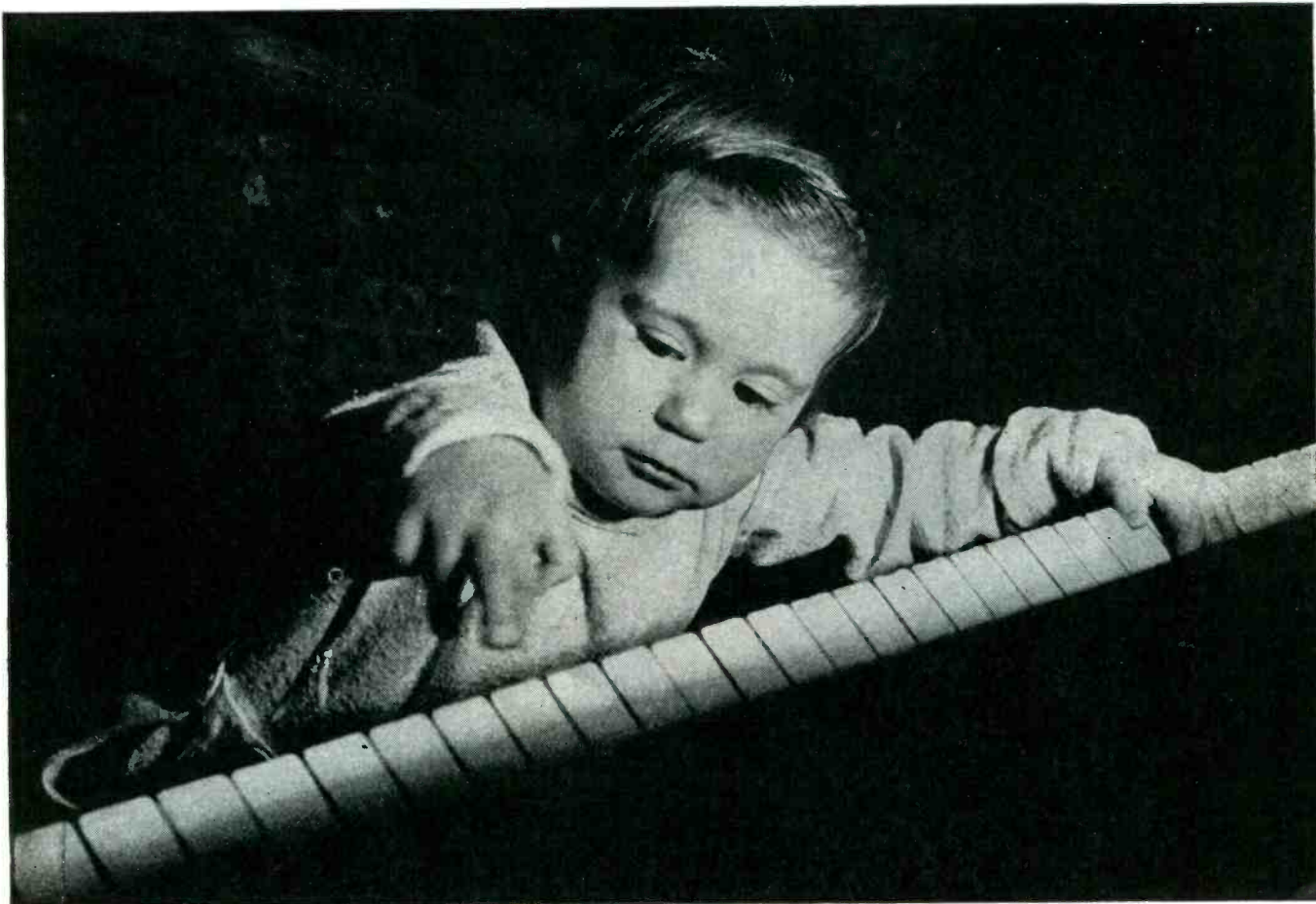

We're Mighty Serious, too!



WAR is a grim business, even on the home front. And we here at Eastern are serious—mighty serious—about the job we are doing for Uncle Sam's fighting men.

Eastern equipment flies the sub-stratosphere gales over Tokyo in American Superfortresses—Eastern equipment rides the surging waves of the Pacific in those valiant little PT boats.

Eastern performance means Eastern leadership in the field of sound and electronic equipment. For we at Eastern are not new hands—we've been in the business since 1921—and some of us even longer

than that. With the coming of peace, Eastern will go further and further into the field of electronics—contributing — *still seriously* — to the development and growth of this, tomorrow's industry.

Our engineers are available for consultation on any amplification problem. Eastern will continue to apply its resources to designing and manufacturing war equipment until the day of Victory. Meanwhile, on request, we will send you the next of a series of articles on peacetime sound and electronic equipment, prepared by our engineering staff. Ask for Brochure 6F.

Buy MORE War Bonds



EASTERN AMPLIFIER
CORPORATION

U. S. Reg'n. Applied For

794 EAST 140th STREET • NEW YORK 54, N. Y.

We take our own Kick in the Pants

—if we earn it!



Maybe you know the plastic molder's best alibi when his shipments to you go astray—"metal insert trouble." Either shipments to him wandering off, or wandering tolerances after they get there—he says. Well, at Kurz-Kasch, we can't pass the buck on your plastic molding schedule! Luckily, we don't have to very often.

We take full responsibility for *all* inserts, most of which are made right in our plant—all kinds, of all metals, by all methods. That means that when you place your molding job with

Kurz-Kasch, you're also placing complete responsibility for that job in full—that engineering, mold-making, insert-making, molding and finishing will mesh together to get out specified quantities at stated times without excuses.

All these facilities are grouped under one roof in one of the largest, best-equipped exclusive custom molding plants in the country—and our Dayton, Ohio, address makes it mighty convenient. We'll let our 28-year-old record of service to Ameri-

can industry speak for the caliber of our work. What *we* want to say is—if you have molded plastics on your mind, talk it over with a Kurz-Kasch engineer. No obligation—just ask.

"A Businessman's Guide to the Molding of Plastics"

Send for your free copy of this illustrated brochure. Just write to Dept. 7 on your letterhead and we'll send it with our compliments.



Kurz-Kasch

For over 28 years Planners and Molders in Plastics

Kurz-Kasch, Inc., 1425 South Broadway, Dayton 1, Ohio. Branch Sales Offices: New York • Chicago • Detroit • Indianapolis • Los Angeles • Dallas • St. Louis • Toronto, Canada. Export Offices: 89 Broad Street, New York City

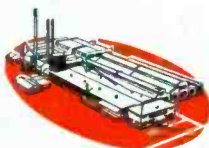

A NEW MINIATURE TUBE— THE RCA-OA2



Actual
Size

**New RCA Miniature Voltage-Regulator Tube Operates at 150 Volts—
Is Practically Equivalent to Standard OD3/VR150**

FOR the first time, equipment designers have available in a miniature envelope a voltage-regulator tube capable of performing the functions previously requiring a standard-size tube. This space-saving feature is especially valuable where compact military equipment is being designed. The OA2 will provide as many hours of service as standard-size tubes.

Like standard-size voltage-regulator tubes, the OA2 is a cold-cathode, glow-discharge tube. It is intended for use as a voltage regulator in applications where it is necessary to maintain a constant d-c output voltage across a load, independent of load-current and moderate line-voltage variations.

The OA2, like other voltage-regulator tubes, can also be used for spark-over protection.

For information on this and other RCA Electron Tubes, mail the coupon or write to RCA, Commercial Engineering Section, Dept. 62-32E, Harrison, N. J.

The Fountainhead of Modern Tube Development is RCA

MAIL THIS TODAY FOR FREE DATA SHEET

RCA, Commercial Engineering Section, Dept. 62-32E, Harrison, New Jersey.

Please send data sheet on RCA's new miniature voltage-regulator tube, the OA2, giving ratings, operating and installation notes, terminal connections, and typical circuits.

Name

Position

Company

Address

City Zone State

TECHNICAL DATA

Maximum Overall Length, Inches.....	2 3/4
Maximum Seated Height, Inches.....	2 3/4
Maximum Diameter, Inches.....	3/4
Bulb.....	T-5 1/2
Base—Miniature Button, 7-Pin	Mounting Position—Any
D-C Anode Supply Voltage, Minimum, Volts*.....	185
D-C Operating Current	
Continuous Maximum, Milliamperes.....	30
Continuous Minimum, Milliamperes.....	5
Ambient Temperature Range, Degrees C.....	-55 to +90
D-C Starting Voltage, Approx. Volts.....	155
D-C Operating Voltage, Approx. Volts.....	150
Regulation (5 to 30 Milliamperes), Volts.....	2

* Not less than indicated supply voltage should be provided to insure "starting" throughout tube life.



62-6136-32

RADIO CORPORATION OF AMERICA

RCA VICTOR DIVISION • CAMDEN, N. J.

oscillator. With no signal input to the receiver, the noise thus effectively maintains the squelch oscillator in operation so that the audio output from the receiver-amplifier is not permitted to reach the earphones. When a carrier is received, the normal reduction in noise which is characteristic of the f-m receiver action results in a reduction of noise at the receiver noise amplifier. The resulting change in the voltage applied to the d-c amplifier stops the squelch oscillator and permits the audio-frequency amplifier of the receiver to assume its normal bias.

Voice Frequencies Filtered

The noise in a band above the voice frequency range is selected for amplification in the receiver noise amplifier with adequate discrimination against the voice frequencies. In practice, headphones are quiet until a transmission is received. The three tubes in the squelch circuit may be removed or their filaments may be turned off

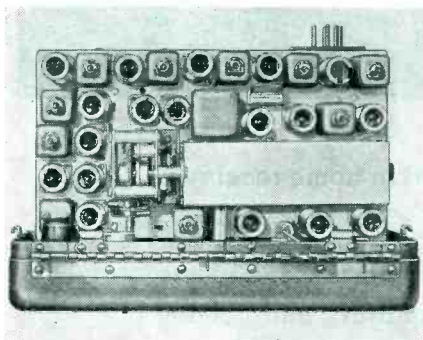

Fig. 3—Compact construction of the SCR-300 walkie-talkie

at the panel squelch control knob without affecting the operation of the receiver, other than to permit the noise to reach the earphones during stand-by periods.

The SCR-300 becomes a transmitter with the addition of two tubes and a crystal. No antenna switch is employed to change from transmit to receive. The single tuned circuit used for the transmitter power amplifier is also employed as the receiver r-f amplifier input circuit.

Waterproofing

Figure 3 shows a top view of the set chassis. This is mounted in the

Unique, simplified, rugged construction

Shallcross Akra-Ohm

HERMETICALLY-SEALED RESISTORS

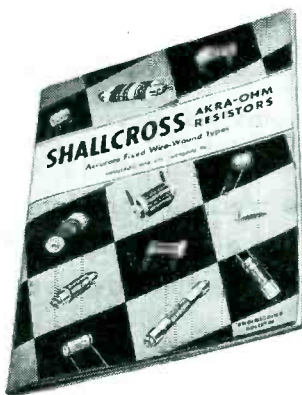

JUST OUT!

This new Shallcross Engineering Bulletin "R" gives full details on Shallcross Akra-Ohm Resistors including styles designed to meet Accurate Fixed Wire Wound Resistor Specifications JAN R93.

- Resistance element entirely sealed.
- No separate lead from resistance element to terminal.
- Standard terminal and mounting arrangements.
- Physical dimensions practically the same as standard impregnated resistors.
- Both resistance form and protective shell are ceramic.
- Resistance element, winding form, and protective shell form one rigid unit.
- Rugged, rigid construction allows rough handling without danger of breaking seal.
- Resistances from 1000 ohms to 10 megohms non-inductively wound can be hermetically sealed without difficulties due to leakage.
- Low tolerances, 1% or less, are standard.

Write for details!

SHALLCROSS MFG. CO.

DEPT. E-65 , COLLINGDALE, PA.

ENGINEERING • DESIGNING • MANUFACTURING

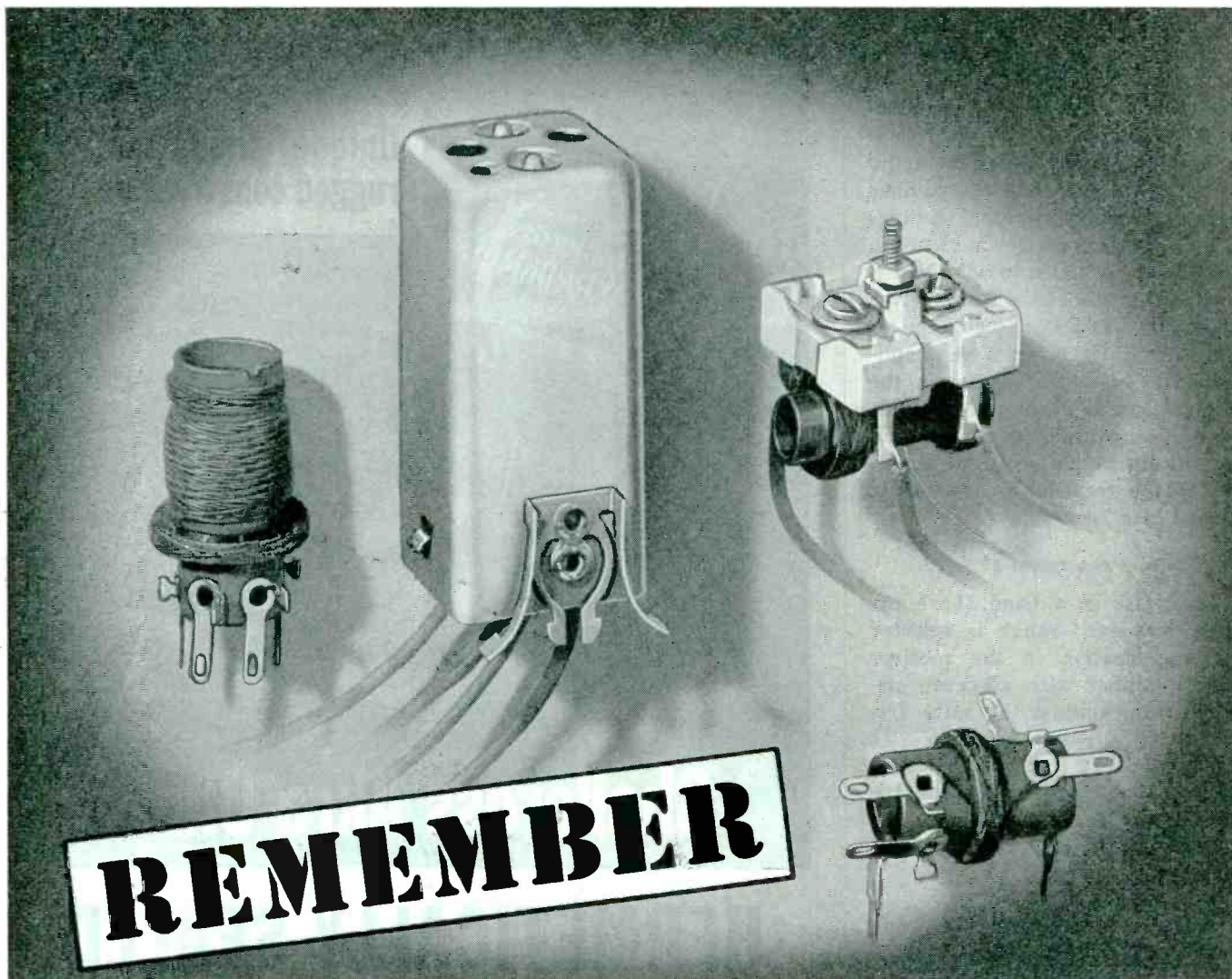

REMEMBER

BEFORE the war, millions of R.F. Coils like these were used in home receivers.

The absolute maximum of economy was necessary.

AUTOMATIC has designed and manufactured R.F. Coils, Trimmer Condensers, Audio and Power Transformers as well as complete Transmitters and related equipment for military service. But—we haven't lost our "know-how" in civilian design and production...now supplemented by new knowledge gained from war work.

All of the key personnel who had years of civilian coil experience are still here. We still remember how to make coils and trimmers for home radios—in quantities, correctly made and at the right prices.

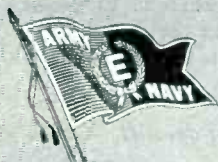

KEEP BACKING
THE ATTACK
BUY MORE
WAR BONDS

COMPLETE ELECTRONIC ASSEMBLIES & COMPONENT PARTS

900 PASSAIC AVE.

EAST NEWARK, N. J.

Now in plant production

STYRAMIC HT

the new thermoplastic

electronic engineers required

Heavy in the scales of Victory, but light and efficient as an insulating material for air-borne electronic equipment . . . that's Styramic HT!

Now in plant production, Styramic HT was developed by Monsanto plastics research specifically to meet the need for a moldable plastic with peak insulating efficiency at super high frequencies *plus* high enough heat resistance to stand up under temperatures generated in electronic equipment.

Styramic HT meets the need . . . with the *best electrical properties ever attained by a rigid plastic*, and with an *ASTM heat distortion point of 236°F*. As a result, many insulating parts can now be designed for maxi-

imum savings in precious weight and bulk.

In addition to these record breaking properties, Styramic HT offers other qualities important to the electronic engineer . . . making a combination entirely unique in the Plastics industry:

- low water absorption
- excellent dimensional stability
- "self-extinguishing" (by ASTM tests for inflammability)
- high heat-resistance without sacrifice of moldability; may be extruded or injected in standard machines
- durability: exceptionally hard surface with Rockwell Hardness value of M103, excellent chemical resistance, and good mechanical strength
- good color range, starting with clear, light yellow transparent

Styramic HT is being produced today for high priority end uses only, in a plant just completed by the DPC and designed and operated by Monsanto's Plastics Division at Springfield, Mass.

For more information on Styramic HT for war or postwar applications, address: MONSANTO CHEMICAL COMPANY, Plastics Division, Springfield, Massachusetts.

CHECK LIST OF STYRAMIC FACTS

Moldability in injection molds	good*
Injection molding temperatures, °F.	475-550
Compression molding temperatures, °F.	360-400
Machining qualities	good
Specific gravity	1.38
Water absorption, 24 hr., percent	0.03
Flammability, in./min.	self-extinguishing
Heat distortion point, °F.	236
Rockwell hardness	M103
Dielectric constant, 1000 cycles	2.62
Power factor, 1000 cycles	0.0002
Dielectric constant, 1000 cycles	2.62
Power factor, 1,000,000 cycles	0.0002

*Moldability in extrusion machines is excellent.

The broad and versatile Family of Monsanto Plastics includes: Lustron polystyrenes • Cerex heat resistant thermoplastics • Vinyl acetals Nitron cellulose nitrates • Fibestos cellulose acetates • Resinox phenolics • Thalid for impression molding • Resimene melamines. Forms in which they are supplied include: Sheets • Rods • Tubes Molding Compounds • Industrial Resins • Coating Compounds Vuepak rigid, transparent packaging materials.



Why

CARDWELL CAPACITORS

mean

"Safety at Sea"

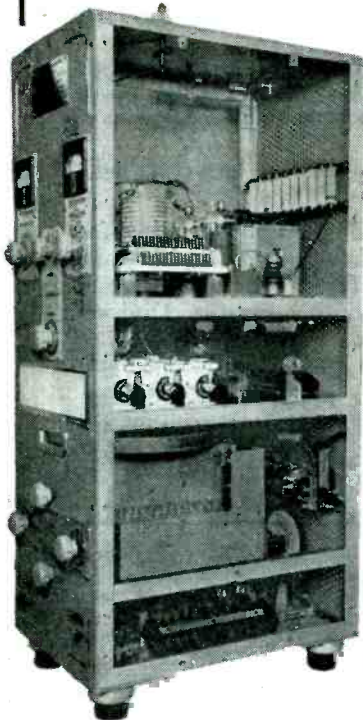

Radiomarine Corp. ET-8019
S.W. Radio Transmitter

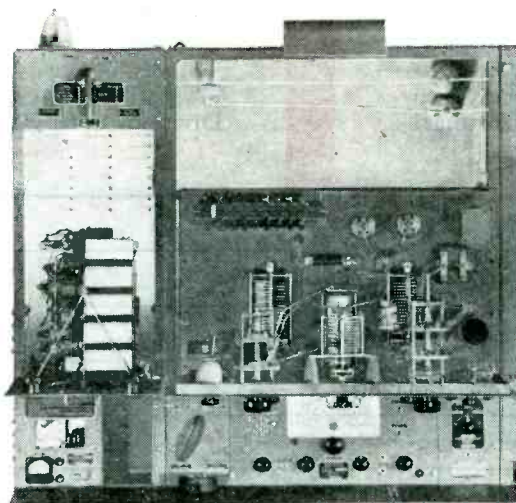

Radiomarine Corp. ET-8023
S.W. Radio Transmitter

Radio communication links our far-flung merchant fleet with all possible protection against disaster. The importance of immediate and reliable contact with protective service facilities of our Navy and Coast Guard, in critical emergencies, is obvious.

The Radiomarine Corporation of America, specialists in building all types of essential marine radio equipment, specified CARDWELL TRANSMITTING CAPACITORS in the two representative designs pictured here. They know that the overall reliability of their products depends on the use of such time and service tested components as

CARDWELL QUALITY PRODUCTS

"Standards of Comparison"

CARDWELL CONDENSERS



THE ALLEN D. CARDWELL MANUFACTURING CORPORATION
81 PROSPECT STREET
BROOKLYN 1, N. Y.

upper housing and the battery is contained in the lower housing. Both cases are waterproofed with rubber gaskets. All jackets on the top panel are equipped with plugs and rubber collars which are effective in keeping out water with the covers in place or with the microphone and headphone plugs in place. It was discovered in tests under showers that it was less difficult to design the set for submersion than it was to design it to withstand the force of a strong shower. A set with gaskets in good condition may be submerged without leakage and will also withstand a hard rain.

Range

Two antennas are supplied with the set. The normal antenna for which the set was designed is a half-wave light steel assembly. A shorter antenna is required for operation in the jungle and over difficult terrain. The short antenna is mounted in place of the long antenna without changing alignment or tuning adjustments. An impedance in the base of the antenna matches the high impedance of the transmitter output to the low impedance of the short antenna.

The nominal range of the set is a conservative three miles. Extreme conditions can be found where the communications distance is less than nominal and other conditions where the range will be far greater. In tests, the sets have been used for communication over forty miles of salt water and fifteen miles over land. In one case, communication was established over three and a half miles of fresh water, with one of the sets submerged in water with only 2/3 of the antenna above the surface.

The use of automatic frequency control with a correction factor of approximately 5 to 1 greatly simplifies the problem of netting sets where frequencies up to 48 megacycles are used with free oscillators.

Sensitivity

The range of communication established by the SCR-300 with the nominal one-half to three-quarter watts of output is possible only by the careful design of the receiver



that assures Balance in High Frequency Lines

PRECISION MANUFACTURE is extremely important in all types of coaxial cables, especially where the success of complex networks depends on perfect balance.

The construction of Anaconda Coaxial Cables provides conductors not only symmetrically accurate, but ruggedly resistant to distortion and mechanical failure. Metal braiding is always substantially woven to prevent fraying and to stand up under continuous flexing.

In view of the rapid advancement in this field we offer engineering service for designing special types of low loss insulation cable.

48291



ANACONDA COAXIAL CABLES

Anaconda coaxial cables are made in many types to Army-Navy specifications.



ANACONDA WIRE & CABLE COMPANY

GENERAL OFFICES: 25 Broadway, New York City 4

CHICAGO OFFICE: 20 North Wacker Drive 6 • Sales Offices in Principal Cities

Subsidiary of Anaconda Copper Mining Company



... a necessity
in every laboratory

THE most annoying and time consuming ordeal confronting the laboratory technician is the task of *setting* and *holding* the input voltage to apparatus undergoing test to a prescribed value. If the voltmeter pointer swings in synchronism with line voltage fluctuations, it is not only impossible to obtain accurate test results but time is wasted in the continual resetting of the voltage. An easy way to eliminate such trouble is to include a SECO REGULATED VOLTBOX as part of your laboratory equipment.

This outstanding instrument consists of a POWER-STAT variable transformer, a voltage stabilizer, and a 1% voltmeter all housed in a self-contained portable cabinet. To insure added convenience, a circuit-breaker, dial light, output receptacles, binding posts, and an input cord and plug are featured.

Designated as type R-500, the REGULATED VOLTBOX provides a constant voltage at any value from 0 to 135 volts when operated from a 115 volt line. The maximum output is 500 watts.

Contact the SECO sales engineers for further information.



Send for Bulletins LE

SUPERIOR ELECTRIC COMPANY
405 LAUREL STREET • **BRISTOL, CONNECTICUT**



**MODEL
204-TC**

DYNAMIC HANDI-MIKE

TECHNICAL DATA MODEL 204-TC

IMPEDANCE: 35-50 Ohms.

FREQUENCY RESPONSE: 200-7500 Cps.

OUTPUT LEVEL: Into 50 ohm input; 44 db below 6 milliwatts for 100 bar signal.

SWITCH: Type "T." Press-to-talk. Vertical toggle with snap action.

COED: 6 feet long. Rubber jacketed. 2 Conductor and shield.

CIRCUIT: Two wires direct to microphone. Switch "makes" independent circuit. For use in connection with control circuit of transmitter or other relay operated device.

DIMENSIONS: Length overall 8 inches, head diameter 2 1/4 inches.

SHIPPING WEIGHT: 2 pounds.

There are seven other dynamic handi-mike models from which to make a selection.

Universal Handi-Mikes have been, through these years of progress in Radio-Electronics, as common a part to specialized sound equipment as the vacuum tube is to your home radio. The same microphone restyled and redesigned progressively has met the wanted need of a rugged hand held microphone. The Handi-Mikes are now available in both carbon and dynamic microphones with a variety of switches and circuits from which to choose.

UNIVERSAL MICROPHONE COMPANY

INGLEWOOD, CALIFORNIA



REPRESENTATIVES: *New York, Chicago, Kansas City, Cleveland, Boston, Tampa, Houston, Philadelphia, Detroit, Seattle, St. Paul, Salt Lake, Los Angeles, San Francisco, and Asheville.*

NEW*Acro Snap***OPEN BLADE SWITCH**

SMALLER SIZE ...
SIMPLER ADAPTATION ...
LONGER LIFE ...

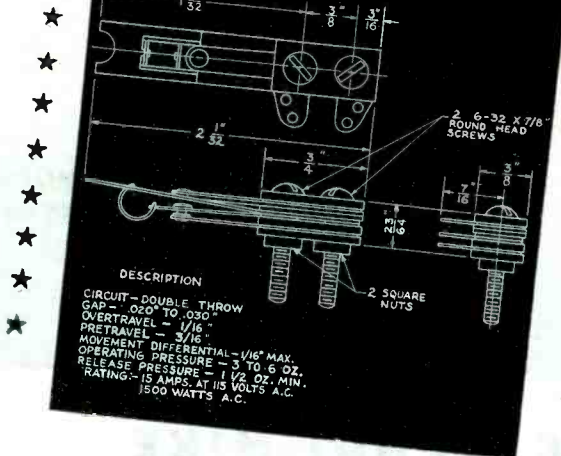
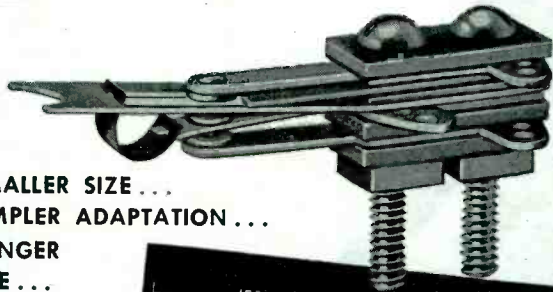

Do you need longer life, open blade switches in smaller sizes to solve many installation problems? If so, you will be delighted with these. Now you can really design for compactness with switches that users' tests have shown well above ten million actuations. They can handle 15 amps. at 115 volts A.C. Made for normally open or normally closed circuits and double throw. Also well adapted to mounting in multiples. Standard pressure range from 3 to 5 oz. Engineered with the

same positive beryllium Rolling Spring action that built the Acro-Snap reputation. (Similar characteristics applicable to vertical mounting model shown below). ACRO basic pin actuator switch code No. HRD7-1A2T approved under spec. AN-S-39 Dwg. AN3210-1. Other ACRO Rolling Spring Switches made to over 1,000 different specifications. Write for further details.

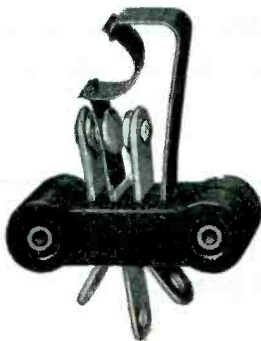
**THE ACRO ELECTRIC COMPANY**

1316 SUPERIOR AVENUE

CLEVELAND 14, OHIO

to a sensitivity which permits the use of signal fields less than a microvolt per meter. Referred to a low-impedance signal generator input, the receiver provides a 20-db noise reduction, with an input of 0.5 microvolt. To maintain this level of sensitivity under adverse weather conditions, care was taken to exclude components which would be adversely effected by high humidity conditions.

Air trimmer capacitors were built into the gang, since it was discovered that air trimmers were less subject to moisture effects than ceramic trimmers. Suitable paper capacitors were developed with molded bakelite housings; i-f coil assemblies were given the most effective wax treatment; and complete chassis units were sprayed with moisture-proofing fungicidal varnish.

The weight of the basic transmitter-receiver unit with top cover but without case is 9 lb, and of the complete station and accessories with large battery is 38.23 lb. Power input to the receiver is 2.25 watts from the B battery and 1.35 watts from the A battery. When transmitting, the respective power inputs are 9 watts and 2.25 watts.

• • •

German Army Entertainment Receiver

By CAPTAIN GIFFORD-HULL
Royal Corps Signals (British Army)

THE RECEIVER provided for the entertainment of the German troops is not on a par mechanically and electrically with that of German military field sets but its operation is very economical and versatile. Outwardly, it resembles the field sets but the chassis reveals commercial technique awkwardly adapted to meet a semi-military requirement.

The receiver has the usual long, medium, and short-wave bands (the latter covering 6 to 15 Mc). It is capable of world-wide reception, but the handbook and cover plate carry a warning of what happens to soldiers who listen to foreign broadcasts. Self-contained dry batteries are provided, but the receiver also works off the a-c or d-c mains,



LOOK TO THE EAST!

For years, set manufacturers have looked to the East as an important source of radio components. We at G. I. have always enjoyed a large share of this business, namely; Condensers, Tuning Mechanisms, Actuators, and associated items.

As a matter of natural development, a few years back we launched the famed and successful G. I. RECORD CHANGER.

Now we have inaugurated a full line of quality SPEAKERS as part of an expanded peacetime program.

Yes, big things are brewing at G. I.—plans that will make us in the peacetime years ahead, eastern headquarters for a complete quality line of major radio components—in volume—thanks to the “know-how”, both physical and creative, vastly increased by the challenge of war needs.

GENERAL INSTRUMENT CORPORATION



829 NEWARK AVENUE • ELIZABETH 3, N. J.

Let **CLAROSTAT**

Solve

**YOUR
RESISTANCE PROBLEMS**

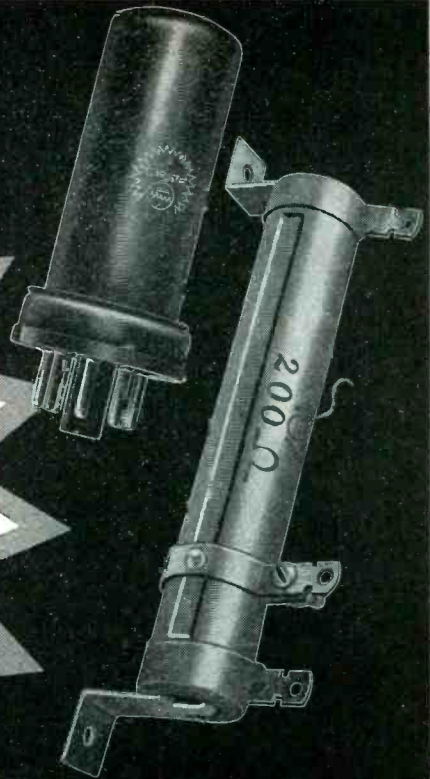

★ And so we enter the home stretch of the long and costly global war. Yet Clarostat's 100% war effort continues. Here the needs of our fighting men on land, on sea and in the air, still come first. So it will be until the final shot on the final front. Later, with the return of peacetime radio and expanded electronics, Clarostat's vastly expanded production facilities, backing an outstanding choice of controls and resistors, will be available in realizing that better world for which we fought. Yes, "Let Clarostat Solve Your Resistance Problems"—today in war, tomorrow in peace.

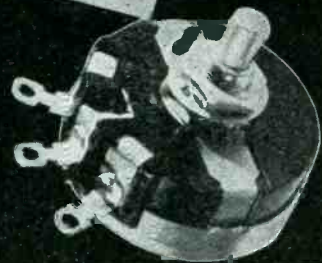
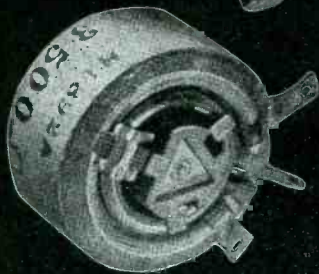

CLAROSTAT



Controls and Resistors

CLAROSTAT MFG. CO., INC., 285-7 N. 6TH ST., BROOKLYN, N. Y.

Export Division: 25 WARREN STREET, NEW YORK 7, N. Y.

Cable Address: SIMONTRICE, NEW YORK



DETROLA RADIO

DIVISION OF INTERNATIONAL DETROLA CORPORATION

DETROIT 9, MICHIGAN

between voltages of 90 and 250.

Provision is made for microphone and gramophone reproduction, and for an additional speaker, and so the public address aspect is not overlooked. However, microphones, speakers, and playback units have not been found with the receivers captured in the African campaigns.

Mechanical Design

Neither German commercial nor military practice are evident in the layout. The horizontal chassis of the commercial set is not employed, neither are the intricate, carefully thought-out, die-cast subchassis assemblies of the military set. Instead, the chassis consists of a number of thin, pressed-steel structures, clumsily bolted together, with odd little brackets stuck on here and there. It seems to be an attempt to make a specialized receiver at a commercial receiver price, in a factory that is used to making intricate unit-constructed military sets.

The accompanying photograph shows a thin steel front panel upon which the sub-assemblies are mounted. When the panel is unscrewed from the box, it flexes, causing the sub-assemblies to twist in an ominous manner. The r-f, i-f and l-f components are mostly located within a framework which is bolted to the bottom of the panel. This framework also carries a verti-

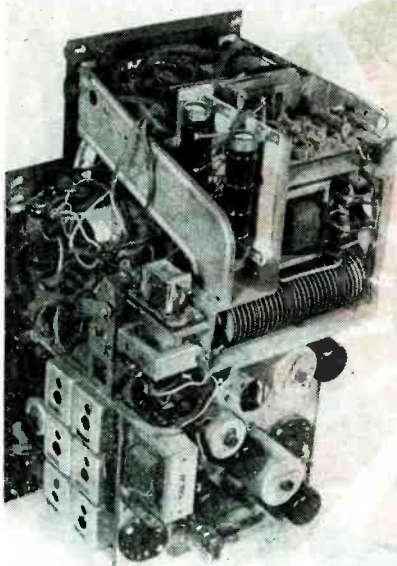

Pressed-steel brackets support most of the components in this German receiver designed for entertaining troops

cal plate upon which the plug-in coil assemblies are mounted. Although these coils are plug-in units, wave bands are changed by switching S_3 . The lower framework also carries a vertical plate at the back, upon which all seven valves are mounted. This plate also carries the i-f transformers and an l-f transformer. An empty socket hole in this plate suggests a change of design at the last moment. Most of the small resistors and capacitors are located on a large paxolin panel, which, being inadequately supported, is unstable.

The top of the set consists of the loudspeaker and the power supply components. These are similarly located on odd pieces of steel sheet, some of which are bolted together and others spot welded. The chief components of the power unit are the voltage selector switch, S_1 , the selenium half-wave rectifier, five electrolytic capacitors, about four l-f chokes, sundry vitreous resistors, two relays and the neon lamp and chemical baretter (which corresponds to the Metrovick Metro-sil).

Components

The valves have continental octal 8-pin bases and metal envelopes. They are heated directly by 1.1 volts, and draw 60 ma. They are very light on plate current, being just over 1 ma. per valve.

The i-f coils are poorly constructed. They are wound on a $\frac{3}{8}$ -inch paxolin tube. Threaded dust cores fit inside the tube, which is not threaded inside. A slot is made in the tube, and a piece of twine wound around the tube and in the slot. Thus, the strands of twine act as a thread which holds the dust core.

The r-f coils are similarly constructed, and have built-in silvered ceramic trimmers.

The line-voltage selector switch consists of two 2-inch diameter Bakelite discs carrying stud contacts. The discs are arranged in the manner of a two-wafer Yaxley

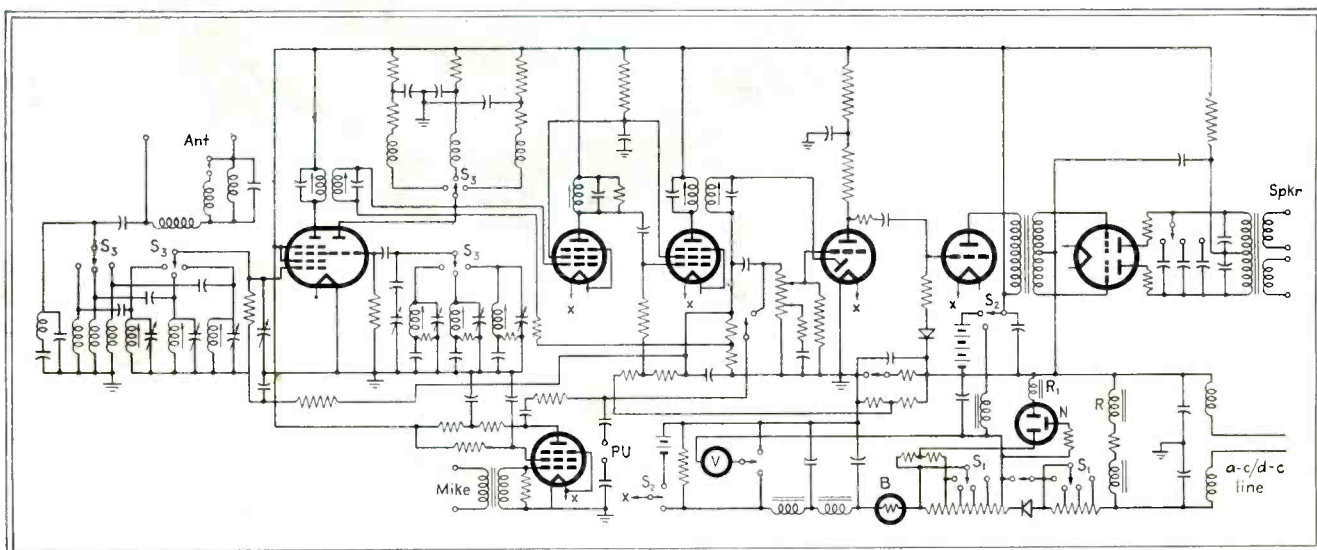

Complete circuit of the receiver supplied to German troops in the field for reception of propaganda programs from the fatherland. It is designed for operation from dry-cell batteries or a-c or d-c lines at voltages from 90 to 250 v

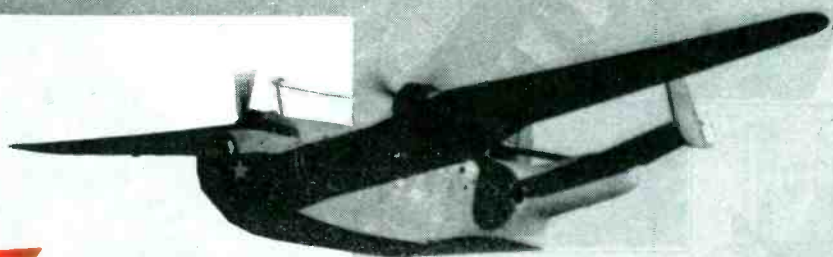

MEC-RAD

ELECTRONIC COMPONENTS ARE VITAL EQUIPMENT ON NAVY PATROL BOMBERS

As a producer of intricate and precise high frequency mechanical and electro-mechanical components for electronic devices, Mec-Rad is today devoted 100% to war production.

Our work includes "fancy brass plumbing" of all types involving soft and hard soldering, close tolerances, precision machining, careful assembly and finishes ranging from lacquered to silver and rhodium plating.

Our organization, with years of experience designing and manufacturing similar products, will make its unusual facilities available to the electronic industry for peacetime needs. Our engineering "know-how" is at your service now to help you with your post-war planning.



Official U. S. Navy Photograph shows a formation of Martin Mariners — able to patrol vast areas and to hit hard when they sight the enemy.



MEC-RAD

DIVISION-BLACK INDUSTRIES

1400 EAST 222ND STREET ☆ CLEVELAND 17, OHIO

LOW FREQUENCIES ACCURACY TO 1/1,000th of 1%

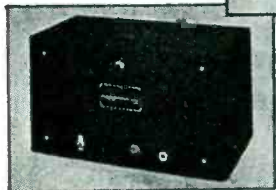
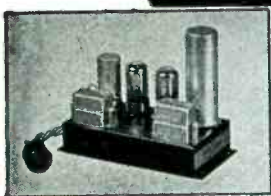
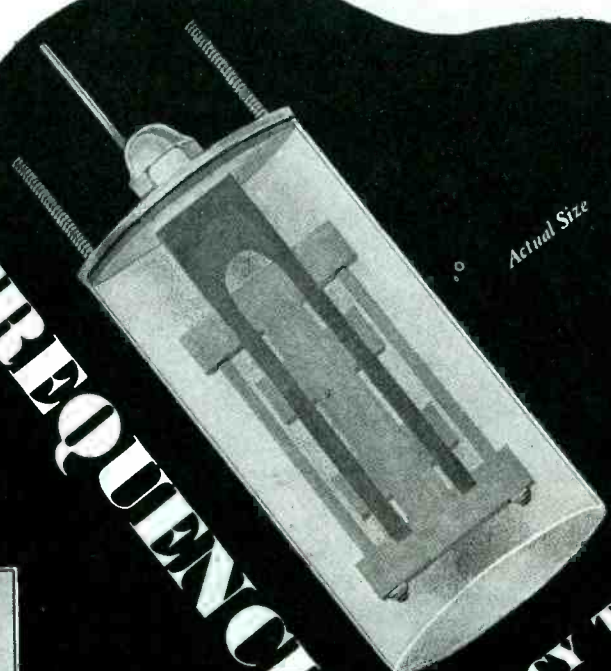

TOP
FREQUENCY STANDARD
(60 cycle) for use with external power supply

CENTER
CHRONOGRAPH
Records time intervals with resolution to .001 second

BOTTOM
FREQUENCY STANDARD
(120 cycles) with self-contained power supply

These tuning forks which include new engineering principles, provide frequencies from 120 to 1,000 cycles directly with an unqualified guarantee of accuracy to 1 part in 100,000 over a wide temperature range. (Better than 1 second in 24 hours). Closer tolerances are obtainable on special order.

These tuning fork assemblies are available only in single or multi-frequency instruments of our own manufacture which are de-

signed to test, measure or control other precision equipment by mechanical, electrical, acoustical or optical means.

The dependability of these frequency standards is being demonstrated for myriad purposes in all climates and under all working conditions.

If you have need for low frequency standards of exceptional accuracy, your inquiries are invited.

American Time Products, Inc.

580 Fifth Ave.

New York, N. Y.

Dist. of Western Electric & **Watch Master** Watch-rate Recorders

OUT OF THE cashew NUT SHELL . . .

Irvington Produces

HARVEL

Insulating Varnishes

TOUGH as the combined strength of Armor Plate, Elephant Hide and Walrus Back.

Irvington's HARVEL Insulating Varnishes, for baking or air drying applications, cure by polymerization to a solid monolithic fused state, will not soften or "throw-out" at high peripheral speeds, have excellent dip-tank stability, exceptional penetrating power, the highest safety factor under excessive heat, heavy overloads and in atmospheres where acids, alkalis and abrasive materials are present . . . and

HARVEL WILL NOT SUPPORT FUNGUS GROWTH

Write for your copy of the "HARVEL INSULATION DATA BOOK" and the MITCHELL-RAND "GUIDE BOOK" OF ELECTRICAL INSULATIONS.



- cures to an infuseable state which is non-thermoplastic
- will not soften or "Throw-out"
- has excellent dip-tank stability
- is stable, insuring constancy of electric properties
- has no objectional solvents that attack enamelled wire
- bonds conductors into a compact unit-acting mass
- has exceptional penetrating power
- has excellent insulation value at high temperatures
- produces firm, tough, mechanically strong coatings
- does not give off corrosive fumes
- resists acids, alkalis, oils and moisture
- imparts high thermal conductivity to finished coils
- is recommended for Fiberglas and Asbestos windings

HARVEL WILL NOT SUPPORT FUNGUS GROWTH

MITCHELL-RAND
for 56 YEARS
THE ELECTRICAL
INSULATION
HEADQUARTERS

EST. 1889

MITCHELL-RAND INSULATION COMPANY, INC.

51 MURRAY STREET

Cortlandt 7-9264

NEW YORK 7, N.Y.

Transformer Compounds
Friction Tape and Splice
Cable Filling and Pothead Compounds
Fiberglas Varnished Tape and Cloth
Insulating Paper and Twines

A PARTIAL LIST OF M-R PRODUCTS

Fiberglas Saturated Sleeving and Varnished Tubing
Asbestos Sleeving and Tape
Varnished Cambric Cloth and Tape
Mica Plate, Tape, Paper, Cloth and Tubing

Fiberglas Braided Sleeving
Cotton Tapes, Webbing and Sleeving
Impregnated Varnish Tubing
Insulating Varnishes of all types
Extruded Plastic Tubing



For more than 10 years

we have been manufacturing crystals. Not only are we crystal manufacturers, but crystal specialists as well. Consult us on your "crystal problems".



PETERSEN RADIO CO.

Council Bluffs, Iowa

CRYSTALS EXCLUSIVELY SINCE 1934

HEXAACON *is helping to do the job at Emerson Radio*

TYPE P-150
for the 24 hour-a-day production schedules

Rugged construction, low power consumption, and the application of "Balanced Heat" principle of construction, actually increases soldering efficiency substantially. Costly tip replacements and element burn-outs are minimized because hexagon-shaped barrels dissipate 20% more excess heat when irons are used intermittently. Literature describing the complete HEXACON line of screw tip and plug tip irons—from 40 to 700 watts, and with tip diameters ranging from 1/4" to 1 3/4"—will be sent on request.

HEXAACON ELECTRIC CO.
130 WEST CLAY AVENUE, ROSELLE PARK, NEW JERSEY

HEXAACON

switch, but the shaft carries wiper arms. The shaft also carries a lever which connects with one of the safety relays. This sets the trip on the relay as soon as the main switch is actuated. The trip is relatively heavy to operate and the relay mounting bracket is flimsy, so when the trip is set, the whole assembly moves. The battery on-off switch S_2 is located close to, and actuated by the main switch shaft. This switch consists of an ersatz circular molding, which carries fixed contact arms. The moving contacts are carried on a laminated Bakelite disc which rotates within the fixed contacts. Connections to moving contacts are accomplished with pig-tails.

The metal rectifier is a selenium half-wave type, and has 30 plates each 1 1/2 inches in diameter.

The remainder of the components are quite straightforward, and of average quality. Seven electrolytic capacitors are used.

Circuit

Provision is made for either ordinary aerial or frame aerial. A tuned circuit is used in the frame aerial circuit to reduce interference. The frame aerial is orientated to give minimum interference, and the tuned circuit is adjusted to bring the undesired signal to minimum.

The antenna circuit is aperiodic, being inductively and capacitance coupled to the frequency-changer input-tuned circuit. This valve is a directly heated triode hexode, the circuit being conventional in every way. Two pentode i-f stages are employed and of the three i-f tuned circuits, two are band-pass coupled transformers, and the other a single tuned circuit.

Next follows a diode-triode working as a signal detector, avc rectifier and first audio. There are two avc lines, one for the frequency converter and second i-f, and the other for the first i-f stage. Three volts fixed bias for the output tube is obtained by the voltage drop across a resistor in the high-voltage lead. The bias for the driver valve is taken from here via a small rectifier of the Westector type. This rectifier appears to reduce the a-c

SINGLE TRANSMITTER CONTROL



for

MULTIPLE OPERATIONS

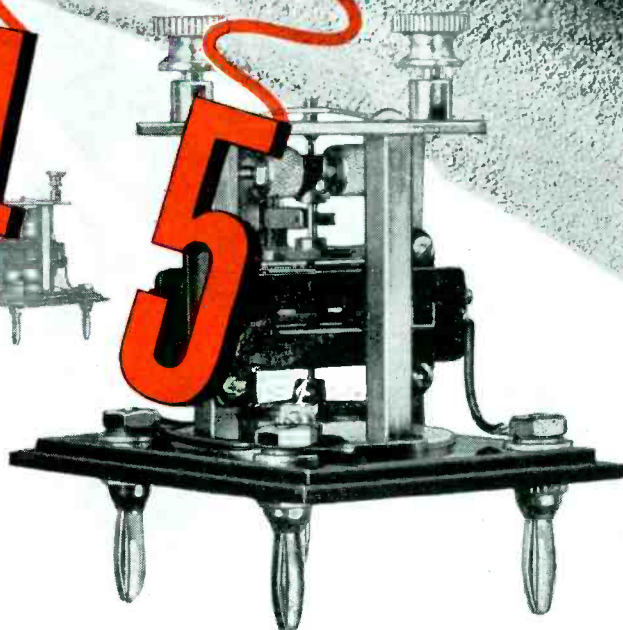

W&T TORSIONAL RELAYS — frequency responsive controllers permitting variable sequence selection of multiple operations — are particularly valuable when single transmitter control is important. For example, as many as eleven W&T equipped remote weather stations, aids to navigation or pumping stations can be operated by one central station transmitter. Installation is economical too, since a single conductor or radio carrier wave from the transmitter is the only circuit required.

Some important design characteristics for such operation are:

RANGE — 10 to 20 cycles per second.

RESPONSE — In less than 3.0 seconds from impression of a 5 volt 0.0012 ampere current pulse of constant amplitude at the resonant frequency.

SELECTIVITY — Resonant frequency plus or minus 2.5% under the above conditions for response.

STABILITY — Excellent over a wide range of ambient temperature and pressure.

CONTACT CAPACITY — 50 milliamperes in the controlled circuit.

Write for Technical Publication 252



WALLACE & TIERNAN PRODUCTS, INC.



BELLEVILLE 9

NEW JERSEY

A-49

"Instant Courier"



SENDING



RECEIVING

In one minute . . . Finch Facsimile will transmit any written, illustrated message, half the size of a letterhead, as far as radio will reach. Transmission by wire, depending upon the frequency characteristic of the line used, is somewhat slower. This is both the most rapid and the most accurate means of long-distance high-speed communication. It provides for 1500 words a minute without one error! It makes practical the first law of efficiency: *Never give or take an oral order — PUT IT IN WRITING!*

FINCH TELECOMMUNICATIONS, INC., PASSAIC, N. J.
N. Y. Office — 10 East 40th Street

Finch Facsimile also makes possible an illustrated, printed newspaper by radio, in homes. Over 80 U. S. Patents have been issued to Finch. At present, facilities are entirely devoted to Victory production.



SELF SYNCHRONIZING

finch facsimile

"BO" POWER RELAY

The "BO" relay is an all-purpose double pole power relay. Like other Allied types it is ruggedly designed yet features compactness and minimum weight. This relay utilizes molded Bakelite insulation throughout. Contact rating is 15 amperes at 24 volts DC or 110 volts AC non-inductive. The "BO" relay can be furnished normally open, normally closed or double throw and is available for either AC or DC service. Weighs 4 ounces.

Height $1\frac{1}{8}$ " ; Length $1\frac{3}{8}$ "
Width $1\frac{13}{32}$ "

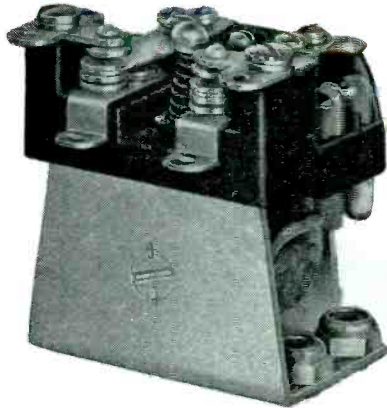

"DO" TYPES 3 and 4 POLE

The "DO" three and four pole relay is similar in function to the "BO" type described above. It supersedes the old three and four pole type and features such modifications as simplified terminal arrangements, adjustable contacts, and improved mechanical structure. By using molded Bakelite insulation throughout, greater electrical clearance is provided. Contacts are rated at 15 amperes at 24 volts DC or 110 volts AC non-inductive. Can be furnished normally open, normally closed, double throw and for AC or DC service as specified. Weight for three pole type 7 oz., four pole $7\frac{1}{2}$ oz.

Three pole Height $2\frac{1}{4}$ " ; Length $1\frac{3}{8}$ " ; Width $1\frac{1}{8}$ " ; Four pole Height $2\frac{1}{4}$ " ; Length $2\frac{1}{16}$ "
Width $1\frac{1}{8}$ "

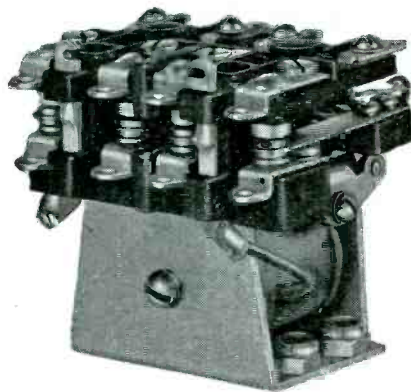
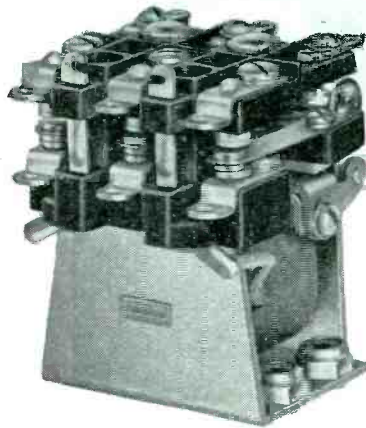

**constant progress
MARKS ALLIED
RELAY DESIGN**

Marking time or "resting on laurels" in no way reflects Allied's engineering and business philosophy. A specific control does a good job . . . but can it be improved? Allied engineers and field staff check its working performance . . . seek possibilities to better or broaden its usefulness.

Thus refinements, revisions and modifications in basic types of relays come about—as in the three and four pole "DO" and the all-purpose double pole "BO" types described herein. Keeping pace with the constant engineering progress of manufacturers whose products require electrical control . . . anticipating their requirements . . . epitomizes Allied's philosophy. Let your control problems become our engineering projects.



ALLIED CONTROL COMPANY, INC.

GENERAL OFFICES: 2 East End Ave. (at 79th St.) New York 21, N. Y. Factories: New York City (2 East End Ave.)—Plantsville, Conn. Chicago—4321 Knox Avenue, Chicago 41, Illinois. In California: Allied Control Co. of California, Inc. 1633 South Hope St., Los Angeles 15, Calif.

HARDWICK, HINDLE PRODUCTS ARE SUBJECT TO HIGH PRIORITY RATINGS



Like many other fine products, they are subject also to first call by Uncle Sam.

We are proud of the service they are performing in so many defense jobs.



HARDWICK, HINDLE, INC.

RHEOSTATS and RESISTORS

DIVISION OF

THE NATIONAL LOCK WASHER COMPANY

ESTABLISHED 1886

Newark 5, N. J., U. S. A.

GERMAN RECEIVER

(continued)

component impressed on the bias line, but more than this, it acts as a relatively high impedance in the bias line to the triode driver valve. Further, by virtue of its lower resistance one way than the other, it ensures that any overload transient passed to the driver grid is not stored up in the 1- μ f decoupling capacitor.

The driver is transformer coupled to the output stage, which is a twin triode working in the region be-

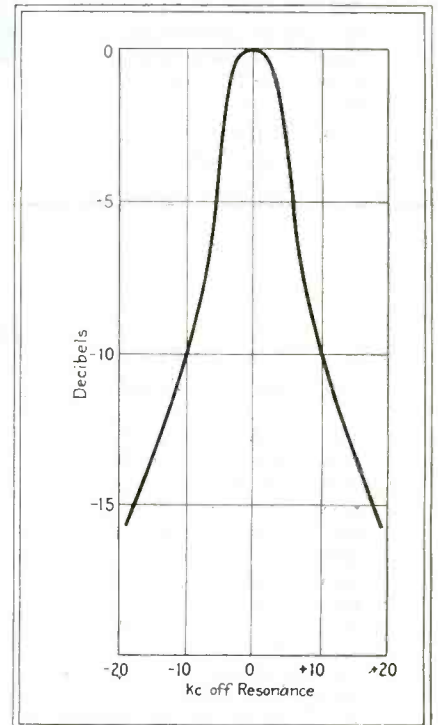

Selectivity curve of the German receiver

tween class AB and class B. On no signal (except for noise) this valve (both triodes together) draws 0.7 ma, which rises to 5 ma on maximum signal.

The output transformer has two secondaries, one for the low-impedance p-m speaker (which has good sensitivity, if a rather indifferent response curve) and one of 25 ohms impedance for a remote speaker.

On microphone operation, a pentode is used as a preamplifier. For gramophone operation, the pickup is connected directly to the first audio valve.

Power Supply

The receiver is intended for a-c/d-c operation but no transformer is used to procure the cor-

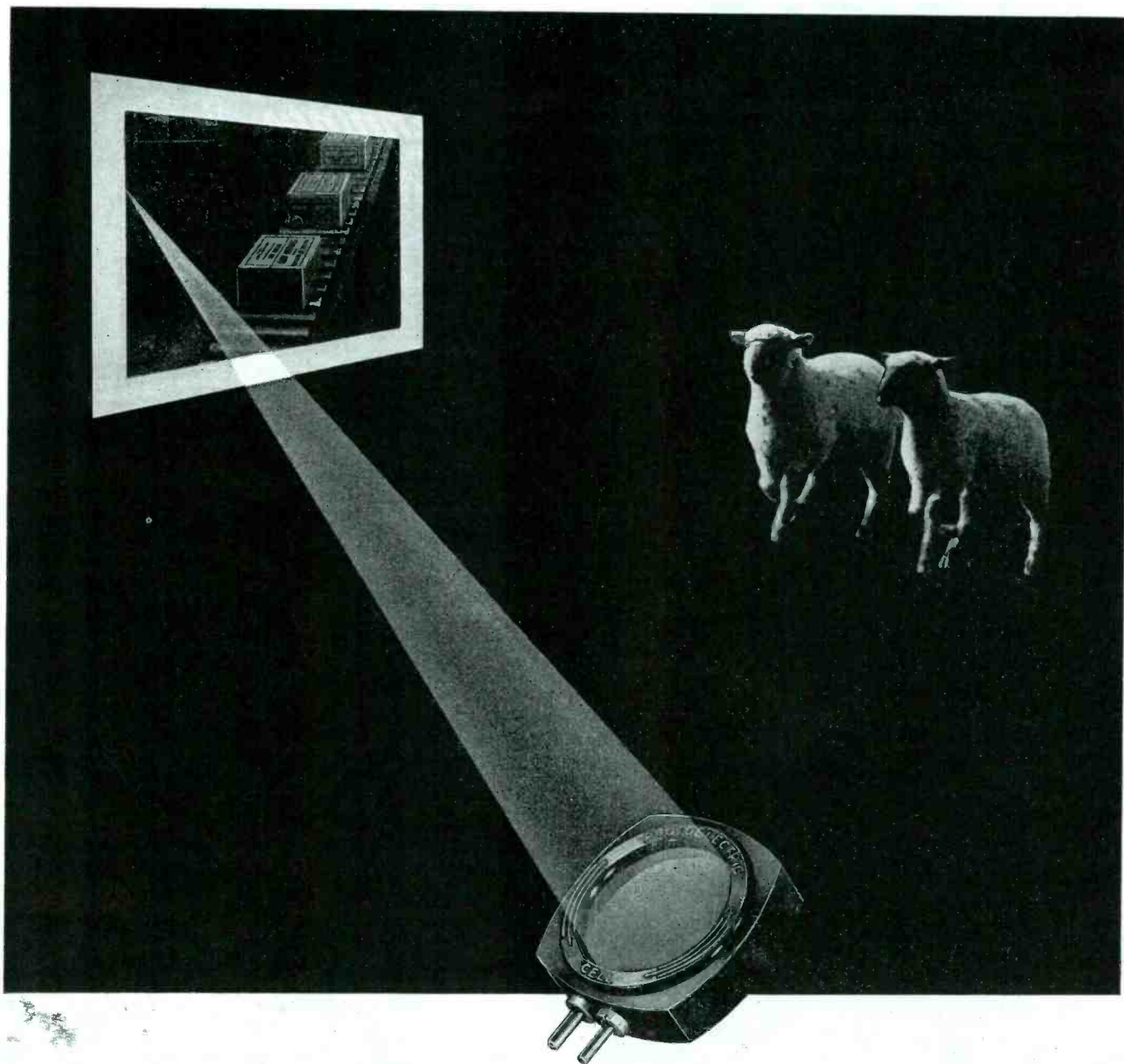

HOW TO COUNT WITHOUT FALLING ASLEEP

From sheep to shoes, the photocell will replace the human eye and never fall asleep or fail on any counting job. Luxtron[®] photocell advantages in counting, and in countless other control and measurement applications, lie in these facts: Luxtron cells transform light into electric energy. They are small and weigh little. Vibration does not

reduce their efficiency or longevity.

Simplicity and stamina typify all Luxtron photocell applications — from matching colors to putting out a fire. The energy they generate requires no amplification to operate meters or meter relays. If you have an idea for putting photocells to work, write Bradley for samples and application help.

Another Bradley Development



Mounted in a tube base and potted in wax, this ring-connected copper oxide rectifier is one of the unique line of "Coprox" rectifiers being produced by Bradley with the same understanding of electrical and plymetallic phenomena exhibited in Luxtron photocells. Write for "Coprox" bulletin.

* TRADE MARK REG. U. S. PAT. OFF.

PHOTOCELLS—MASTERS OF LIGHT

BRADLEY

MASTER OF PHOTOCELLS

BRADLEY LABORATORIES, INC., 82 MEADOW STREET, NEW HAVEN 10, CONNECTICUT

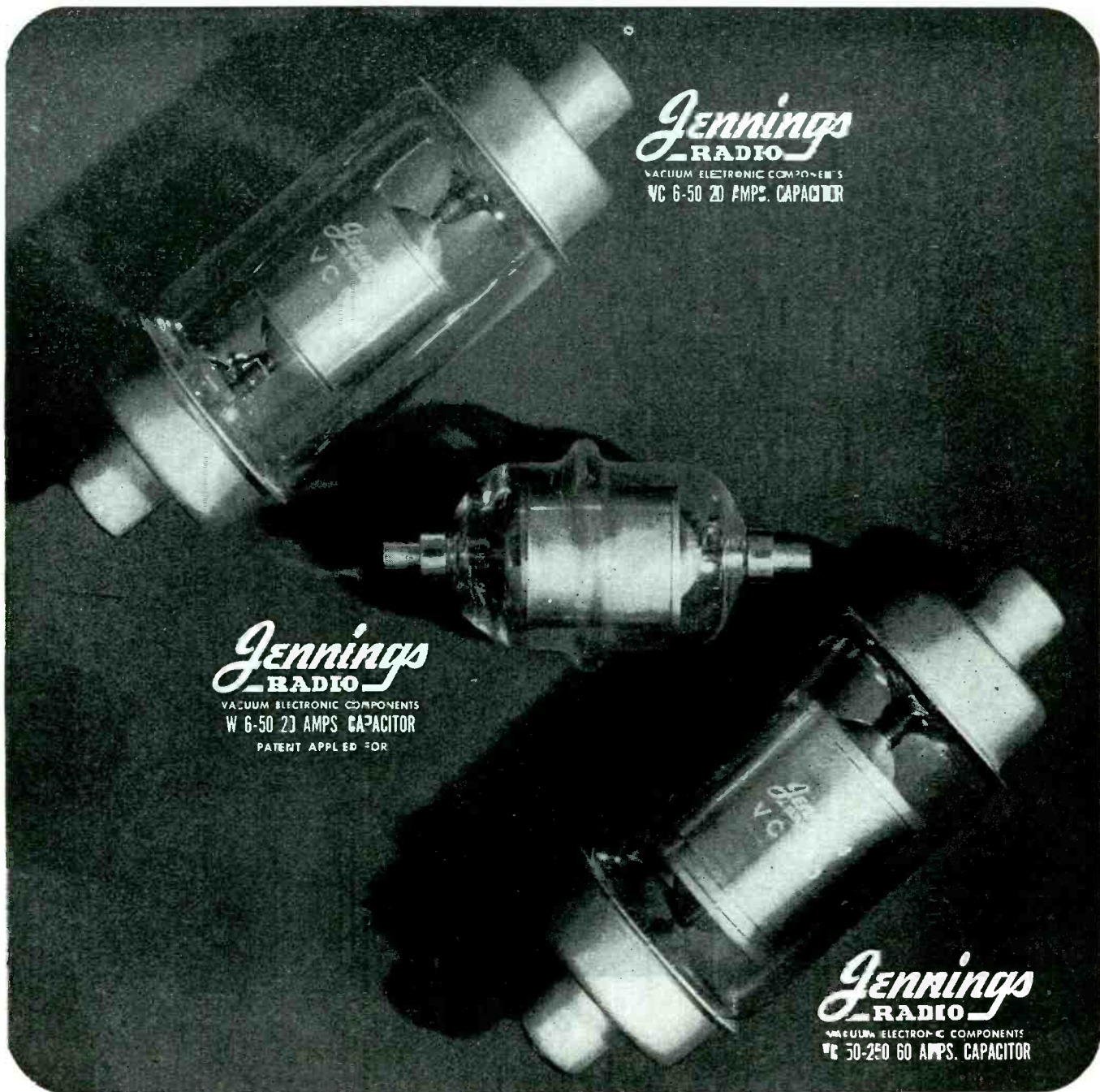

THESE PHOTOGRAPHS ARE REDUCED LESS THAN 1/2 ACTUAL SIZE

JENNINGS LEADERSHIP IN HIGH VOLTAGE VACUUM CAPACITORS *meet urgent need for newly designed electronic equipment*

Jennings research laboratories are constantly developing new and major improvements to help serve the armed forces in their many fields of activity. They also serve the constantly grow-

ing demand for "the unusual" in capacitor usage in the newly designed heating equipment serving the American Electronic Industrial field. We welcome the opportunity to serve you.

Watch Jennings for new developments in the field of Vacuum Electronic Components

WRITE FOR BULLETIN E,

JENNINGS RADIO MANUFACTURING COMPANY • 1098 E. WILLIAM ST. • SAN JOSE 12, CALIFORNIA

Quick as a flash!

DoALL COMPARATOR



Go forward with this remarkable precision inspection device—the quick, easy, electrical way to check all measurements, angles, circles, cylinders, flat surfaces—instruments, gages, tools, delicate dies, machine parts—to tolerances as small as .000001", angles to within a few seconds of arc.

There's no guesswork about the Comparator; it's far more accurate than the human eye, more sensitive than touch. Parts can be checked as rapidly as operator can handle them.

4 COMPARATORS IN 1

The only comparator providing four different magnifications, 10,000-to-1, 5,000-to-1, 1,000-to-1 and 500-to-1 by simply turning a switch. The only comparator with vertical adjustment built right into the spindle. Removable gage head can be used on other machines or fixtures.

QUALITY CONTROL—This book covers the whole interesting subject of Scientific Inspection. 140 pages, profusely illustrated and written for anyone to understand. 6 full pages about the Comparator. Write for copy today.

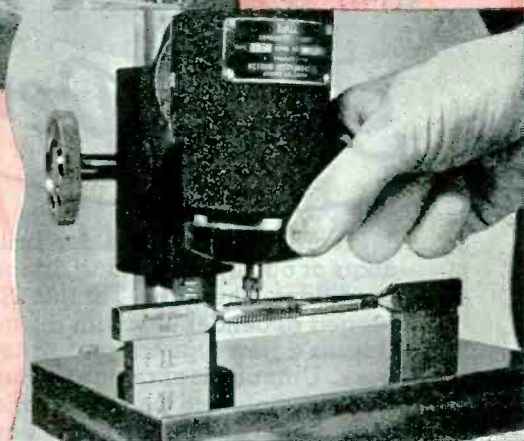

Checking pitch diameter of a 3-fluted tap



The Remote Control Unit in operation on a lathe

DoALL

INDUSTRY'S NEW SET OF TOOLS

CONTINENTAL MACHINES, INC.

1366 S. Washington Ave. • Minneapolis 4, Minn.

Sales & Service Offices: Baltimore, Birmingham, Boston, Buffalo, Chicago, Cincinnati, Cleveland, Dallas, Dayton, Denver, Detroit, El Paso, Erie, Grand Rapids, Hartford, Houston, Indianapolis, Kansas City, Los Angeles, Milwaukee, Minneapolis, New York, Orlando, Philadelphia, Pittsburgh, Providence, Reading, Rochester, Rockford, St. Louis, San Francisco, Seattle, Statesville, Syracuse, Toledo, Tulsa.

Turn to Turner
for *Leadership*



Precision engineered for brilliant performance indoors or out under the most difficult acoustic or climatic conditions, the New Turner 211 Dynamic combines rugged dependability with distinctive, modern styling. Utilizes a new type magnet structure and acoustic network. Unique diaphragm structure results in extremely low harmonic and phase distortion without sacrifice of high output level. Standard equipment with leading electronic communications manufacturers wherever faithful reproduction is paramount. Write for technical data and descriptive literature.



**Turner Performance
for Every Communications Need**

There is a Turner Microphone for every electronic communications application. Get the full story of Turner performance. Write today for illustrated catalog giving descriptive data on all Turner Microphones for Recording, P.A., Call System, and Amateur and Commercial Broadcast work.

The TURNER COMPANY

905 17th St., N.E., Cedar Rapids, Iowa



TURNER -- PIONEERS IN THE COMMUNICATIONS FIELD

Turner
Microphones
CRYSTAL DYNAMIC

Crystals licensed under patents of the Brush Development Co.

rect operating voltage. For operation between 90 and 250 volts, a 14-position switch is used to select various values of series resistance. A meter is provided for the purpose of determining the correct setting and the procedure is to move the switch arm until the meter needle is brought within a red sector on the dial.

Since the filaments have to be in parallel for battery operation, they are left in parallel for line operation. Dropping resistors are employed to cut the 90 volts down to filament voltage. In this circuit, there is a neon tube for voltage stabilizing purposes. At the low-potential end of the dropping resistor is a carbon-type current-stabilizing baretter, similar to the Metrovik Metrosil. The filaments of these valves are very delicate, and the quantity of expensive components is the price paid for operating the filaments directly off the line.

Rectification is effected by a half-wave selenium rectifier, which always operates at 90 volts. It supplies plate current and the 240-ma

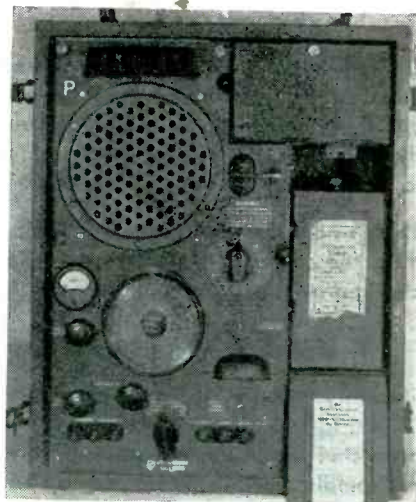

Controls on the front panel of the German receiver. The meter is used when selecting the proper line-switch setting for voltages between 90 and 250 volts

filament current. After rectification, the high-voltage line is stabilized by an anode in the same neon tube mentioned above, and smoothed in the usual way.

Two safety devices are incorporated to prevent overloading the valves. The first one consists of a relay, in series with the neon lamp, which closes if the current becomes too great. This trips the main

Longer life and better performance from vacuum tubes protected with built-in CONSTANT VOLTAGE

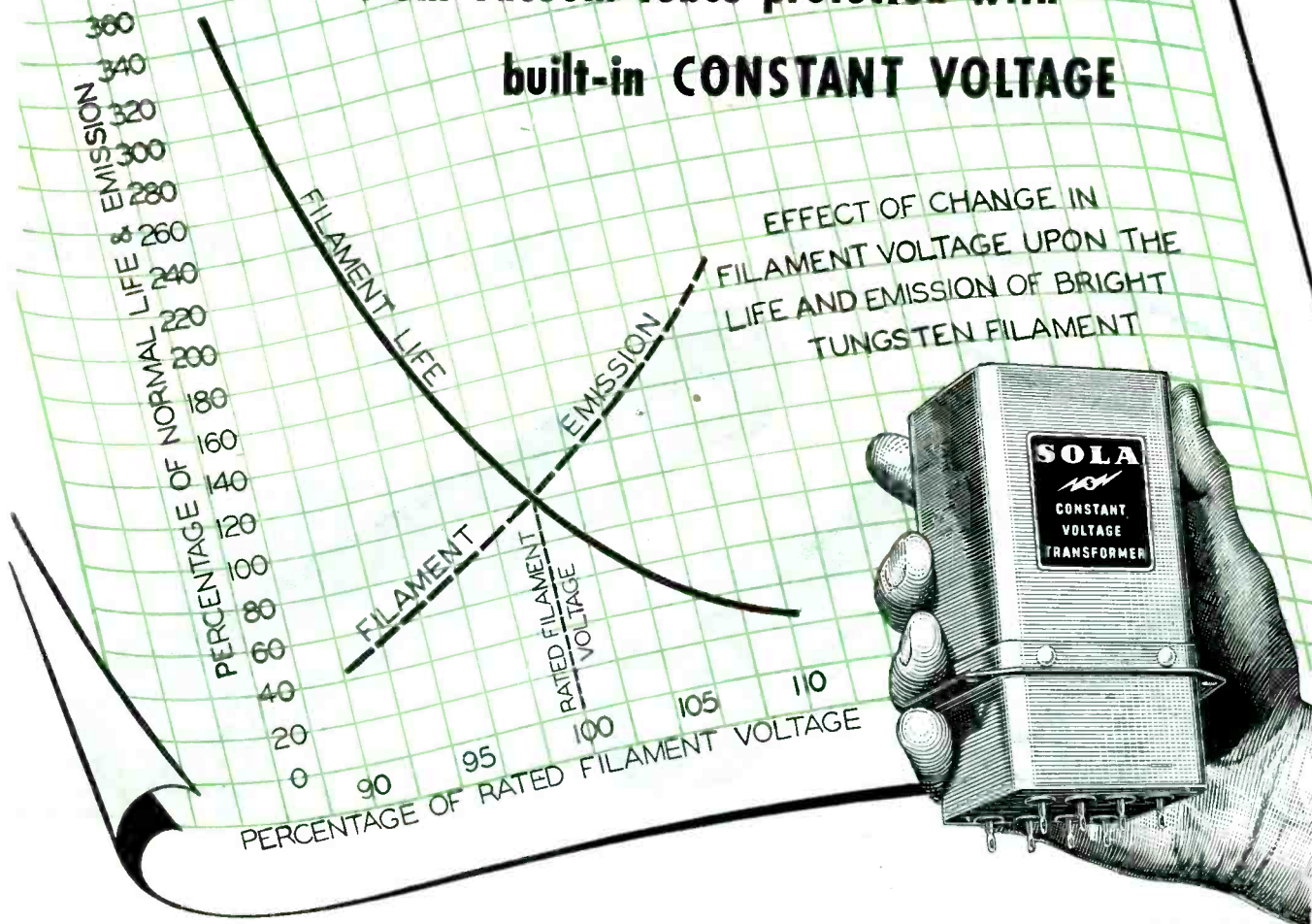

A 5% over-voltage will reduce the life of a tungsten filament by 50%.

A 5% under-voltage will cut filament emission by 33%.

Commercial line voltages today may vary as much as $\pm 20\%$.

With a SOLA Constant Voltage Transformer as a built-in component of your equipment, these line voltage variations can be ignored. No need to depend upon operator adjustments. No need to worry about operator forgetfulness. You

can depend on it—the right voltage is *always* there.

Vacuum tubes protected by SOLA Constant Voltage Filament Transformers require no starting resistors or high reactance transformers. Filaments are automatically and positively protected against damaging inrush currents. Tube life is noticeably prolonged.

SOLA Constant Voltage Transformers require no supervision, or manual adjustments by the oper-

ator. They eliminate the need for voltmeters. They are fully automatic, have no moving parts, tubes or networks, and are self-protecting against short circuit.

Standard units are available in capacities from 10 VA to 15 KVA either for the operation of equipment now in use or as built-in units. Where special problems confront the designer, consultation with SOLA engineers may provide a positive and economical solution.

Constant Voltage Transformers

SOLA

Transformers for: Constant Voltage • Cold Cathode Lighting • Mercury Lamps • Series Lighting • Fluorescent Lighting • X-Ray Equipment • Luminous Tube Signs • Oil Burner Ignition • Radio • Power • Controls • Signal Systems • Door Bells • and Chimes • etc. SOLA ELECTRIC CO., 2525 Clybourn Ave., Chicago 14, Ill.

To Manufacturers:

Built-in voltage control guarantees the voltage called for on your label. Consult our engineers on details of design specifications.

Ask for Bulletin DCV-102

ALL THE

Stability

THE NAME IMPLIES!

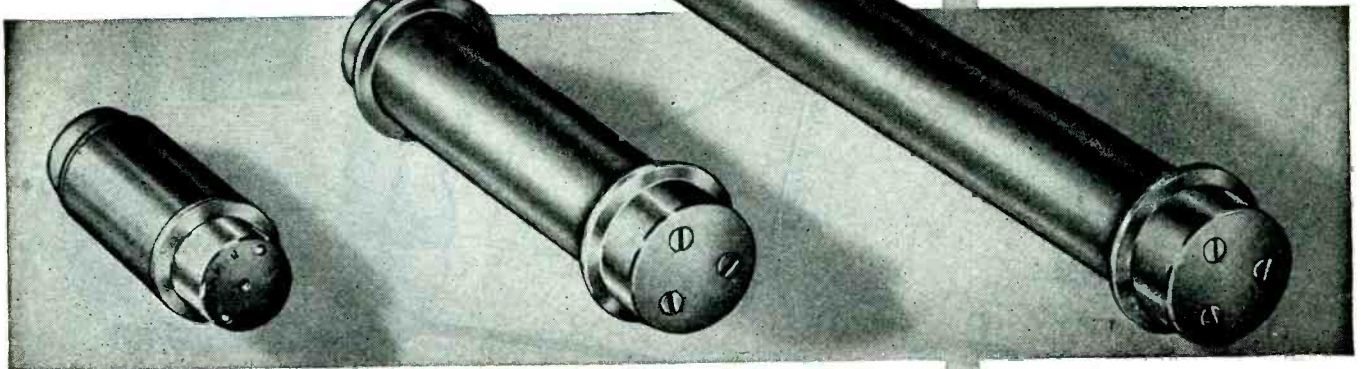

WESTON TUBULAR RESISTORS

WESTON tubular resistors . . . widely used since their introduction over a decade ago . . . furnish another outstanding example of *sound engineering* coupled with *engineering foresight*. For no new 'hurried' resistor design was needed in order to meet exacting military specifications that called for protection against tropical humidity, arctic and high working temperatures, and salt air. The WESTON tubular resistor met these new specifications . . . and in a rugged, non-fragile design *tried and proved* throughout the years. These resistors conform to and are approved under joint Army Navy Spec. JAN-R-29. Bulletin A-12 gives complete specifications. Send for your copy . . . Weston Electrical Instrument Corp., 589 Frelinghuysen Ave., Newark 5, N. J.

Weston
Instruments

ALBANY • ATLANTA • BOSTON • BUFFALO • CHICAGO • CINCINNATI • CLEVELAND • DALLAS • DENVER • DETROIT • JACKSONVILLE • KNOXVILLE • LOS ANGELES • MERIDEN
MINNEAPOLIS • NEWARK • NEW ORLEANS • NEW YORK • PHILADELPHIA • PHOENIX • PITTSBURGH • ROCHESTER • SAN FRANCISCO • SEATTLE • ST. LOUIS • SYRACUSE
In Canada, Northern Electric Co., Ltd., Powerlite Devices, Ltd.

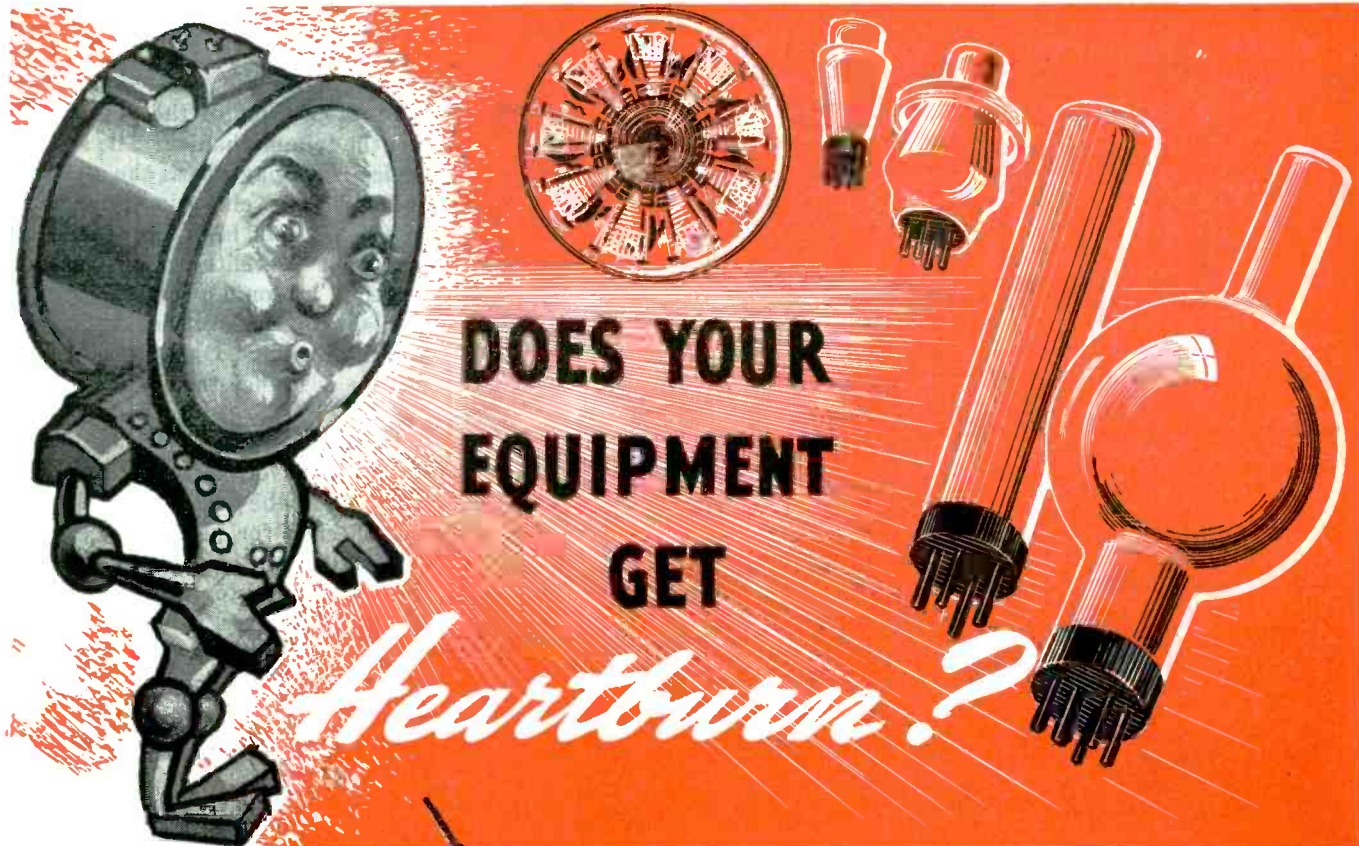

**DOES YOUR
EQUIPMENT
GET**

Heartburn?

...cure it with Dynamic Air Axial Flow Blowers

less weight, space and power input

Are you trying to make old style, heavy, bulky blower equipment meet modern needs?

The advantages of Dynamic Air Axial Flow Blowers may help you solve your problem. Much smaller, lighter, and more economical, they represent over 12 years development of direct air flow for greater air movement efficiency.

Deliver More Air at High Pressures

These advanced type blowers deliver more air against static pressures as high as 10" or more W.G. And they cover a wide field of application. Electronic engineers are enthusiastic over performance of mighty midget models, as illustrated. General industry finds great new possibilities in larger models—up to giants of 60" diameter, delivering as much as 70,000 C.F.M. at 5.0" S. P. or if 2 stages are employed 70,000 C.F.M. at 10" S.P.

All are designed to rigid air delivery and weight specifications. Adaptations can be made to the most precise requirements.

Consult us about your blower problem.

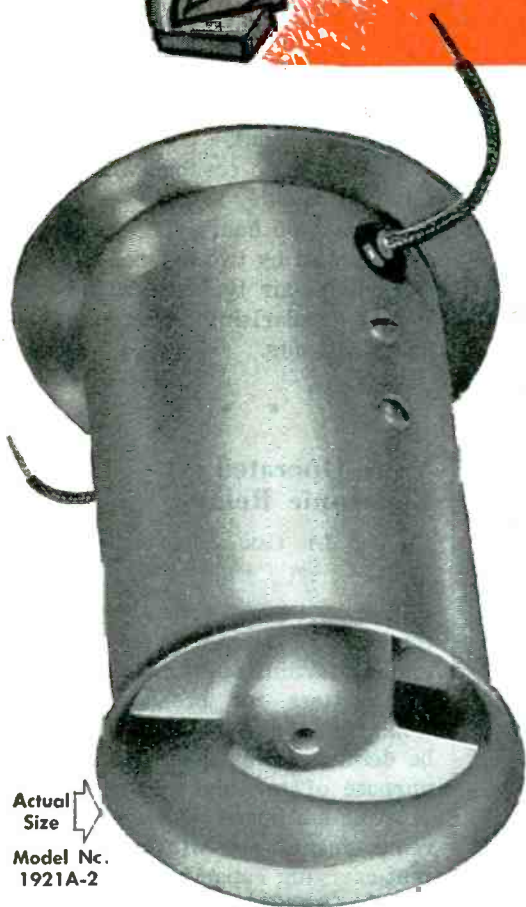

Actual Size
Model No. 1921A-2

**Diameter 2" 25 C.F.M. at .25" S.P.
Length 3 5/8" Weight 5 1/2 oz.**

Revolutionary type designed especially for electronic needs. Many larger sizes available, up to 60" diameter.

**DYNAMIC AIR
ENGINEERING**
LOS ANGELES, U. S. A. *Inc.*

QUICK DELIVERY ON LEADING MAKES OF

Electronic and Electrical

POWER SUPPLIES

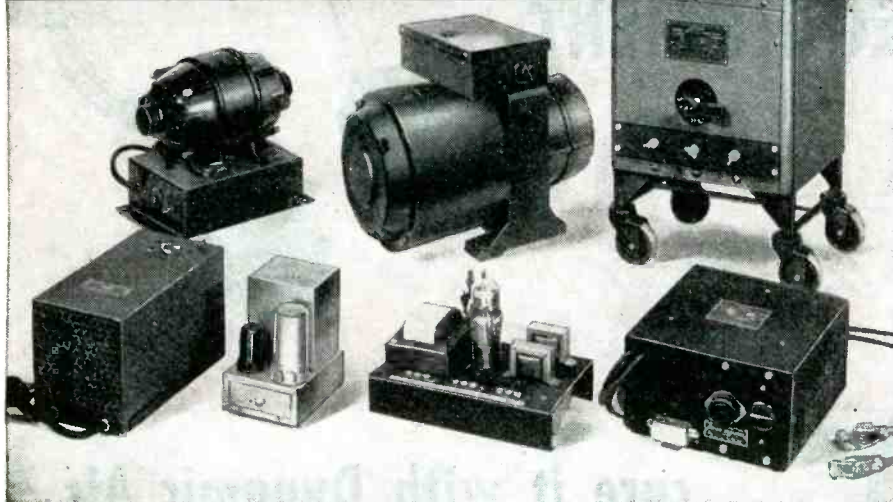

G.E.
MALLORY
ATR
ELECTRONIC LAB.
JANETTE
EICOR
PIONEER
KATO
G.T.C.
STANCOR
KNIGHT
ELECTRO PRODUCTS
WINDCHARGER

*M*ANY types and makes of power supplies are centralized at ALLIED. This enables government and industry to obtain needed units in the shortest time possible. Quite a few types are on hand for *rush delivery*.

Here you find Low Voltage High Current Supplies for aircraft, battery charging, plating, etc.; Vibrator and Rotary-Type Converters and Inverters for frequency changing and for converting A.C. to D.C. and D.C. to A.C.; Gas-Engine, Wind-Driven, and Motor-Driven Generators; Vibrapacks for mobile operation; Dry Batteries; and general utility Power Supplies. Also Dry Disc, Electronic and Vibrator Rectifiers.

*Save time and work . . . call ALLIED First!
Use our complete stock and procurement service.*

WRITE, WIRE, OR PHONE HAYMARKET 6800

Helpful
**BUYING
GUIDE**
Available
on Request
Write for it!

ALLIED RADIO

CORPORATION

833 W. Jackson Blvd. • Dept. 24-F-5 • Chicago 7, Illinois

SUPPLIERS OF ELECTRONIC PARTS AND EQUIPMENT TO INDUSTRIAL AMERICA
Electronic Tubes, Rectifiers, Power Supplies, Intercommunicating Systems, Sound Systems, Photo-Cell Equipment, Batteries, Chargers, Converters, Generators, Supplies for Resistance Welders, Fuses, Test Instruments, Meters, Broadcast Station Equipment, Relays, Condensers, Capacitors, Resistors, Rheostats, Transformers, Switches, Coaxial Cable, Wire, Soldering Irons, Microphones, Speakers, Technical Books, etc.

GERMAN RECEIVER

(continued)

switch. When the set is turned on, the first position of the line switch sets the trip mechanism. The second device is a relay across the a-c line, and this has a choke in series with it. On a-c, the high impedance of the choke prevents the relay from working, but on d-c the relay closes and shorts the rectifier to maintain high voltage. On a-c, the output voltage is higher than rms.

Performance

The receiver tested had weak valves but the set was realigned and checked for performance. The sensitivity, on short waves, was 20 to 90 μ v input for 50 mw output. On medium waves, it was 8 to 10- μ v input for 50- μ v output. Image rejection, on short waves, was 16 to 30 db and on medium waves, 24 to 40 db. The maximum output was about 200 mw.

In view of the trouble taken with the avc circuit, its effectiveness was very disappointing, since an input of 150 μ v was necessary to produce maximum output.

The set is so economical of current that the dry batteries will last for about 500 hours. The filaments are supplied by two dry cells of the carbon-zinc-air type which use air for the depolarizing action and produce 1.25 volts.

• • •

Voice-Operated Electronic Relay

LT. CARL J. QUIRK
North Adams, Mass.

RADIO ENGINEERS often have need for a relay system that permits automatic turning on of recorders and transmitters for break-in operation. The voice-operated relay to be described was designed for the purpose of turning on or off any 115-volt a-c operated device whose requirements are within the current-carrying capacity of the relay contacts and connecting wires. By using a different pair of contact than those used here, any d-c operated device may be controlled in the same manner.

An ordinary magnetic-type earphone was used for the microphone. This necessitated a high-gain amplifier to provide positive control of

CAPACITORS, RESISTORS, CHOKES
...much Better ... much Smaller

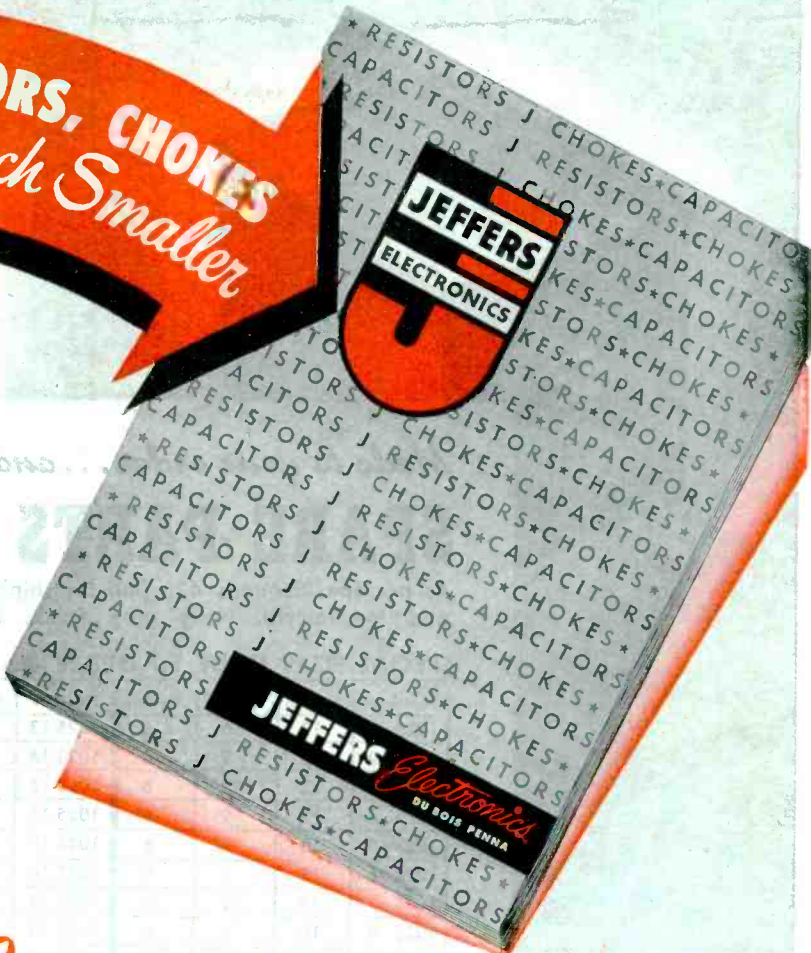
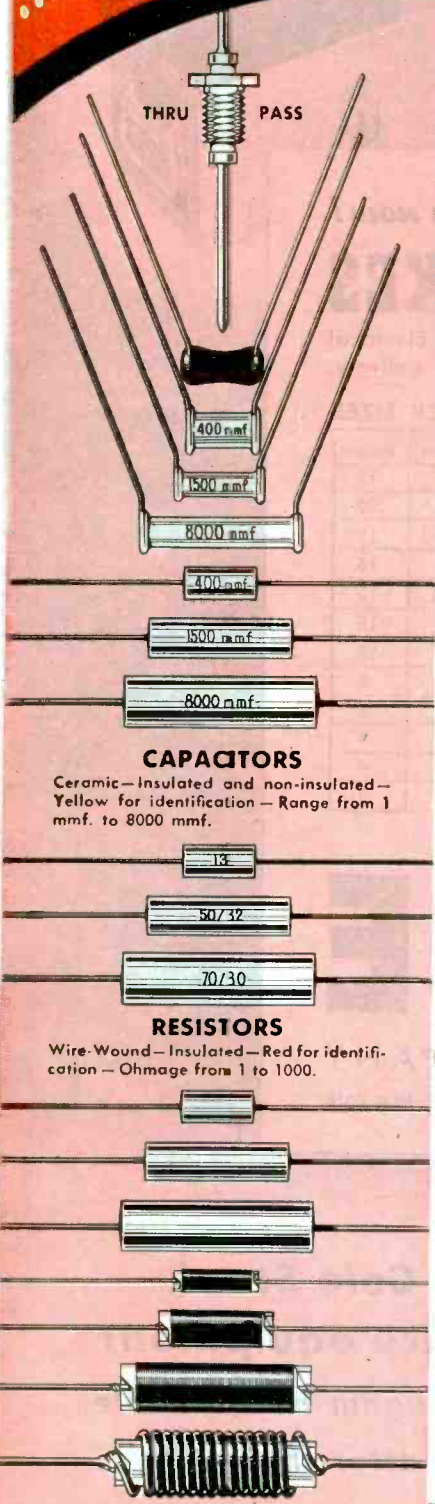

*You'll want a Copy of
 this Valuable Catalog
 for Your Reference Files!*

**COMPLETE INFORMATION ON JEFFERS
 CAPACITORS, RESISTORS AND CHOKES**

The completely dependable, precision-built line of Jeffers Ceramic insulated and non-insulated Capacitors, Low Ohmage, Wire-Wound Resistors and R. F. Chokes, insulated and non-insulated, has been engineered for today's needs—not modified as a compromise to them. Jeffers insulated units are color-molded for your convenience. Chokes are green; resistors, red; and capacitors, yellow. Interesting, too, is the fact that the smallest Jeffers capacitor, resistor and choke unit is also the smallest produced by the entire industry—a point to bear in mind where space is a problem. All connections on insulated resistors and chokes are soldered—a big saving in time and trouble. But you'll want the full details—so why not drop us a line, now? We'll start your catalog on its way.

IN WRITING FOR YOUR COPY PLEASE USE COMPANY
 LETTERHEAD AND INDICATE YOUR TITLE

JEFFERS *Electronics*
 DU BOIS, PENNSYLVANIA



No. 1025-6
8" x 9" x 9"

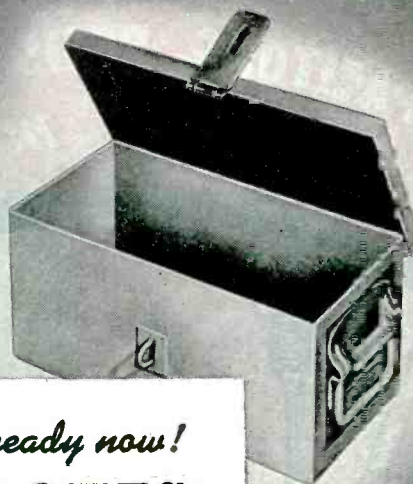

No. 1025-1
12" x 6" x 6"

Made to your order... and ready now!

SPARE PARTS BOXES

As per specifications 42B (Int) for shipboard use. Electrical and Mechanical, Navy grey finish, Immediate delivery.

SPECIAL SIZES MADE TO ORDER . . . 24 STOCK SIZES

Number	Length	Width	Height	Number	Length	Width	Height
1025-1	12	6	6	1025-13	18	18	12
1025-2	12	9	6	1025-14	30	15	12
1025-3	12	12	6	1025-15	24	15	12
1025-4	12	9	9	1025-16	24	15	15
1025-5	18	9	6	1025-17	24	18	12
1025-6	18	9	9	1025-18	24	18	15
1025-7	18	12	9	1025-19	24	18	18
1025-8	18	6	6	1025-20	24	12	9
1025-9	18	15	9	1025-21	42	9	9
1025-10	18	12	6	1025-22	36	12	9
1025-11	18	15	12	1025-23	30	15	9
1025-12	18	12	12	1025-24	42	12	9

WRITE FOR PRICE LIST

COLE

STEEL EQUIPMENT COMPANY

349 Broadway, New York 13, New York • Factory: Brooklyn, New York

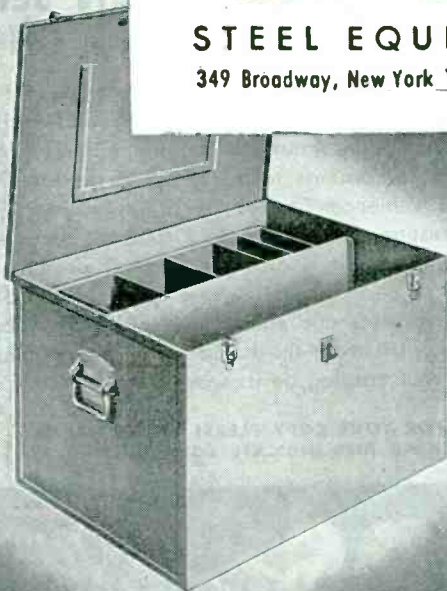

Cole Steel
office equipment
will again be available
after the war

DIRECTIONAL ANTENNA EQUIPMENT

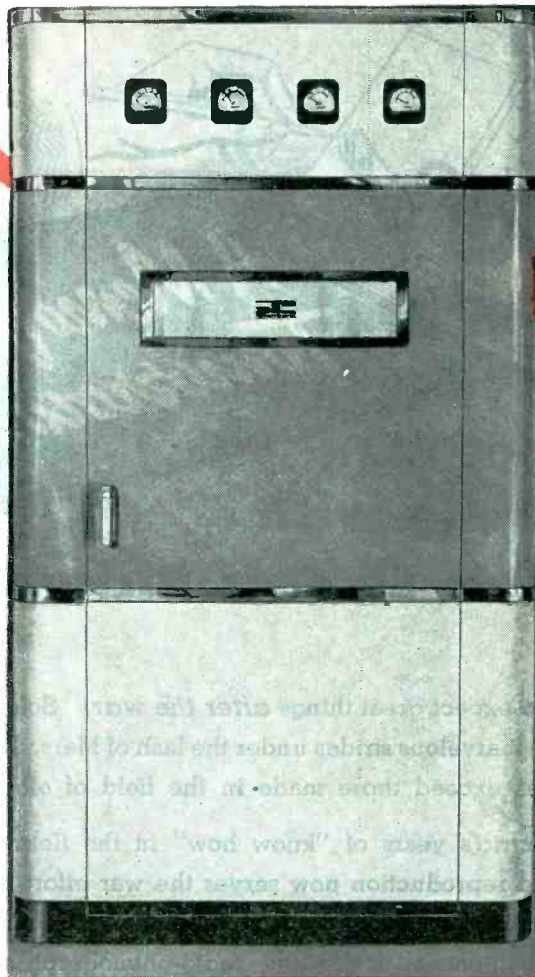
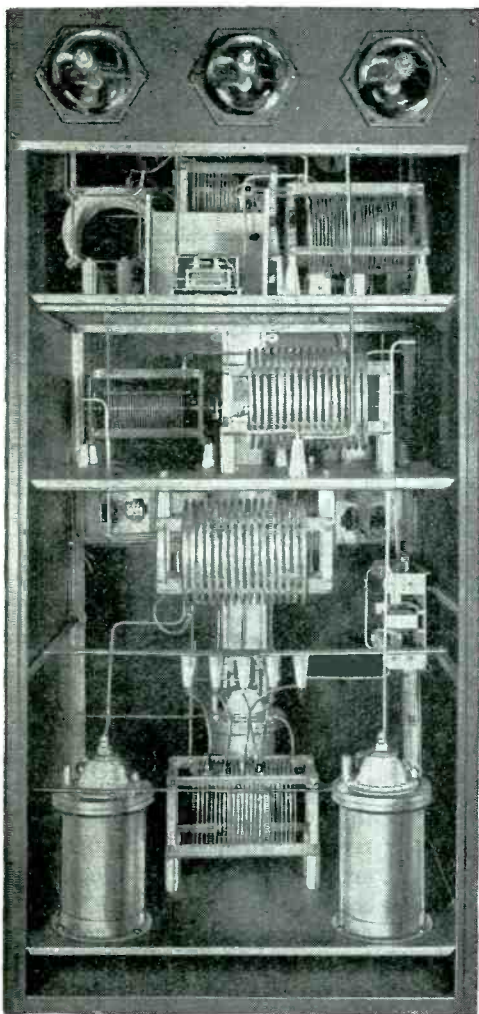

Johnson engineers have designed many highly successful installations of phasing and antenna coupling equipment to individual specifications. These units may be built to match any existing transmitter and thus become an integral part of your station. Let us help you and your consulting engineer plan your transmitting equipment for better market coverage. Orders received now will get first attention when priority restrictions are removed.

Here are two of the many installations of phasing equipment Johnson has furnished for Broadcast Stations, built to match existing equipment. Other items available from Johnson, made to individual specifications, are gas filled pressure condensers, coupling networks, tower lighting filters and special inductors.



JOHNSON
a famous name in Radio

**E. F.
JOHNSON
COMPANY**
WASECA, MINNESOTA



Be Ready with Webster Electric Pickups

We are led to expect great things *after the war*. Science has indeed made marvelous strides under the lash of Mars. Probably few advances exceed those made in the field of electronics.

Webster Electric's years of "know how" in the field of high fidelity sound reproduction now serves the war effort well. In due time many of the things we have learned will become alive as worthy components of the new radio-phonograph sets that many thousand homes are waiting for.

Then, as always, you will want the precisely balanced Webster Electric pickup that practically does away with record wear and needle changing . . . its light weight accurately balanced to give just the right needle pressure . . . its faithful reproduction of the deep tones of the bass, the thrilling soprano of the piccolo and all the colorful tone shadings between.

These, Webster Electric will then have ready for you . . . ready so that the new, streamlined designs for which the public waits will have the clean, high quality tone reproduction that Webster Electric pickups have always given.

To this end we invite you to keep in touch with Webster Electric. Let us cooperate with you in preparing these fine new products for the post-war markets.

Let's All Back the Attack
Buy Extra War Bonds



(Licensed under patents of the Brush Development Company)

WEBSTER ELECTRIC

Racine, Wisconsin, U.S.A. • Established 1909 • Export Dept.: 13 E. 40th Street, New York (16), N.Y. Cable Address "ARLAB" New York City

"Where Quality is a Responsibility and Fair Dealing an Obligation"

VOICE RELAY

(continued)

the relay. A type 6SL7 tube, with both triodes in cascade, provides the necessary gain.

The purpose of the 884 thyatron is to energize or deenergize as desired, the main relay which is designated in the circuit diagram as relay A. Once relay A is energized, the 884 becomes deionized and a pair of holding contacts connects one side of the relay coil to the a-c line; since the other side of the coil is tied directly to the other side of the a-c line, relay A will remain energized.

The current that energizes relay A flows through the normally closed contacts of relay B. Thus, if these contacts become open, relay A will be deenergized and likewise the con-

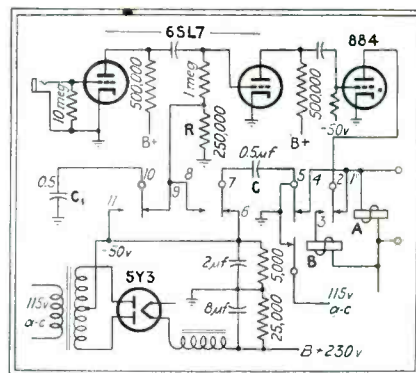

Circuit of electronic relay for actuating equipment by voice signals

trolled equipment will be turned off. To turn off the controlled device, it is necessary to energize relay B, thus opening its contacts. For this reason, when relay A becomes energized, the plate of the 884 is disconnected from the coil of relay A and connected to the coil of relay B, so that when the 884 is fired again, it energizes relay B instantaneously, opening its contacts and deenergizing relay A.

Operation

To turn on the controlled equipment, the following sequence takes place: a single word is spoken into the mike and the resultant voltage is amplified by the 6SL7 and applied to the grid circuit of the normally cut-off 884, overcoming the bias and causing it to fire. Since the plate-cathode circuit of the 884 is in series with the coil of relay A through contacts 1 and 2 of re-

HAVE YOU ANY OF THESE PROBLEMS?

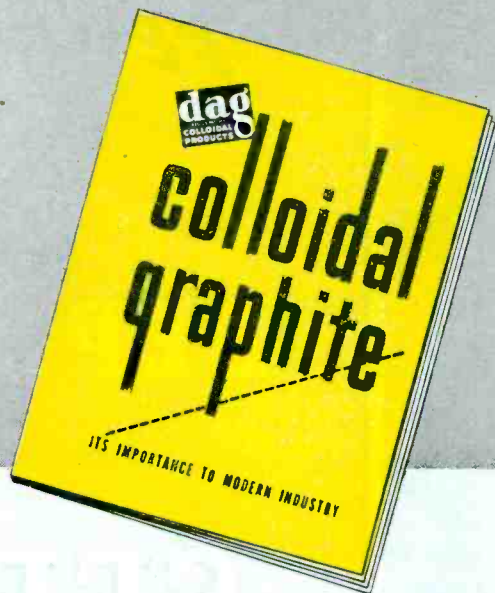

LOOK over the following list of problems common to the electronic industries—then ask yourself this question: "Do I really know how much "dag" dispersions of colloidal graphite can help to cure headaches like these?"

- Minimizing Diamond-die Wear & Wire Breakage
- Production of Special Electrodes — Ionization Chambers, Geiger-Mueller Tubes, Light-Sensitive Cells, Cathode-Ray Tubes, Insulation Tests, etc.
- Electrostatic Shielding
- Aircraft Instrument Lubrication

Use the convenient coupon below and take this opportunity to become better informed about "dag" colloidal graphite. A general booklet (# 430) telling the story of the "dag" products and a full set of specific bulletins are available free on request. Acheson Colloids Corporation also maintains a technical staff ready to study your particular problem.



colloidal graphite

ACHESON COLLOIDS CORPORATION, Port Huron, Michigan

TO GET THESE:

This new literature on "dag" colloidal graphite is yours for the asking:

- 430** A general booklet on the story of "dag" colloidal graphite. 12 pages profusely illustrated.
- 440** A complete list of "dag" colloidal graphite dispersions with applications.
- 421** "dag" colloidal graphite for ASSEMBLING AND RUNNING-IN ENGINES AND MACHINERY.
- 422** "dag" colloidal graphite as a PARTING COMPOUND.
- 423** "dag" colloidal graphite as a HIGH TEMPERATURE LUBRICANT.
- 431** "dag" colloidal graphite for IMPREGNATION AND SURFACE COATINGS.
- 432** "dag" colloidal graphite in the FIELD OF ELECTRONICS.

MAIL THIS:

JML Co. A-FI

ACHESON COLLOIDS CORPORATION
PORT HURON, MICHIGAN DEPT. 5-F

Please send me, without obligation, a copy of each of the bulletins checked:

- No. 430 NAME _____
- No. 440 POSITION _____
- No. 421 FIRM _____
- No. 422 ADDRESS _____
- No. 423 ZONE No. _____ STATE _____
- No. 431 OUR PRESENT OIL SUPPLIER IS _____
- No. 432 (Lubricants containing dag colloidal graphite are available from major oil companies.)

**FEWER
MOVING
PARTS**

assures a more

DEPENDABLE

line of post victory

**SEEBURG
RECORD
CHANGERS**

BUY WAR BONDS

Awarded to the J. P. Seeburg Corporation for outstanding production of war materials in each of its four plants



J. P. SEEBURG CORPORATION · CHICAGO

Seeburg

FINE MUSICAL INSTRUMENTS SINCE 1909

Awarded to the J. P. Seeburg Corporation for outstanding production of war materials in each of its four plants



THIS conversation might easily occur at our reception desk because here under one roof and management we produce both small motors and molded plastics in large quantities for use in widely different products.

YES, YOU CAN BUY *BOTH* AT GENERAL INDUSTRIES



Take small motors. We've built *Smooth Power* units for many years for our own line of velvety operating recorders, record-changers and turntables. We supply standard or designed-to-order *Smooth Power* drives and assemblies for automotive devices, controls and other small electric products. Our customers include leading manufacturers in a wide range of industries.



Now about molded plastic parts. We have the equipment for small and large work in any quantities. Our engineers, mold makers and machine operators have the combined "know-how" to deliver better plastic parts quicker and at prices in line with our established high quality. If you visit our factory (and you'll be welcome) you'll be amazed at the diversity of our work and at the length and quality of our customer list.

Yes, you can buy both small motors and molded plastics for your postwar products from General Industries. We suggest a general discussion now, to be followed by details when our war work has been finished. It will be appreciated if you will address the specific division... *motors or molded plastics.*

THE **GI** GENERAL INDUSTRIES COMPANY
ELYRIA, OHIO



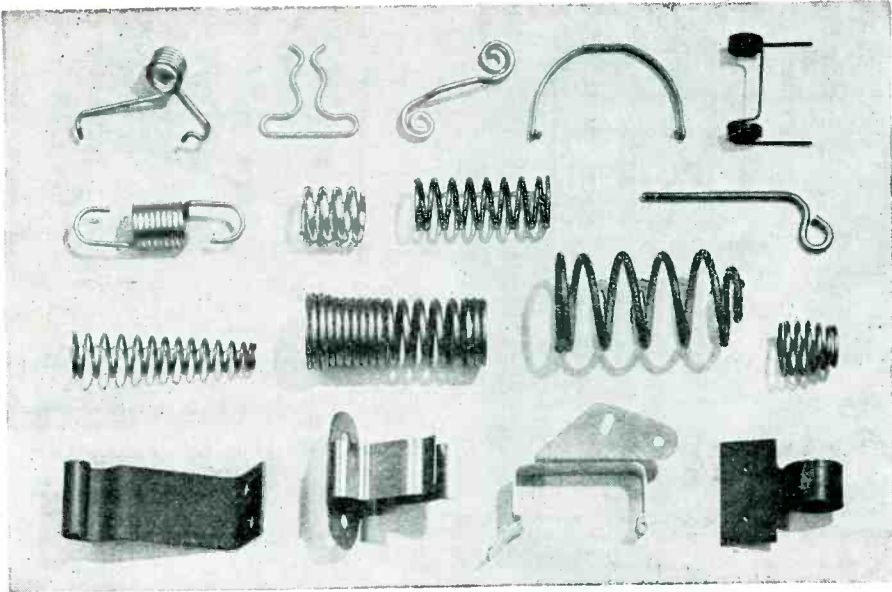

On SPRINGS

We can please
the **HARD-to-PLEASE CUSTOMER**



Spring users whose demands are distinctly above average—who require a degree of quality, precision, and uniformity not available from every spring maker—find Reliable spring service eminently satisfactory. This is proved by a constant flow of business with hundreds of manufacturers whose names would be found in any Blue Book of American firms. These concerns insist on expertness in every detail of spring design and production—and Reliable makes it a matter of policy to adhere to that principle.

We furnish all types of springs of round or square wire, or of strip, of any desired material, to your specifications—also wire forms and light stampings. Our organization is so formed that it is easy for you to lay your specific problem on the desk of the proper key executive—and get prompt and competent cooperation.

For real Spring service—look to Reliable. Catalog 44 on request.

THE RELIABLE SPRING & WIRE FORMS CO.

3167 Fulton Rd., Cleveland 9, Ohio

• Representatives in Principal Cities

YOU CAN RELY ON

Reliable Springs

ROUND AND FLAT
WIRE SPRINGS
CLIPS
HOOKS
BENDS

LIGHT STAMPINGS

lay A, it completes the a-c circuit, thus energizing the relay. When this happens, the holding contacts 4 and 5 replace the circuit of the 884 and thus keep relay A energized. At the same instant, the plate of the 884 is connected to the coil of relay B through contacts 2 and 3 of relay A, but now the tube is no longer ionized since its plate circuit was opened by means of relay contacts 1 and 2. This is the sequence of events that turns on the controlled device and it remains on until another sound is made.

To turn off the controlled equipment, the above sequence of events is repeated, except that this time the 884 plate-cathode circuit is in series with the coil of relay B, so when the 884 is fired, it energizes relay B and opens its normally closed contacts, thus deenergizing the main relay and returning the controlled device to the off position.

In order to stabilize the operation of this circuit, some means must be provided to prevent the 884 from becoming ionized when it is switched from one relay coil to the other. It is very difficult to speak even one syllable before the main relay switches the 884 to relay B or back again, for if sound is still entering the microphone after the 884 is switched, then the 884 would become deionized again and switch the circuit back to the position it maintained before the sound was applied to the mike.

Stabilization Circuit

A "decaying bias" circuit is used to prevent the possibility of the above-mentioned instability from occurring. This circuit consists of two 0.5- μ f capacitors designated C and C₁ and resistor R. One capacitor is used when the controlled equipment is turned on, to prevent the 884 from ionizing twice from one sound impulse and turning the controlled device off again. The other capacitor is used in the same manner, except it is used when the equipment is turned off, to prevent it from being turned back on from the same sound impulse with which it was desired to turn it off.

The circuit works in the following manner: during the period when relay A is deenergized, capacitor C is connected to the minus 50-

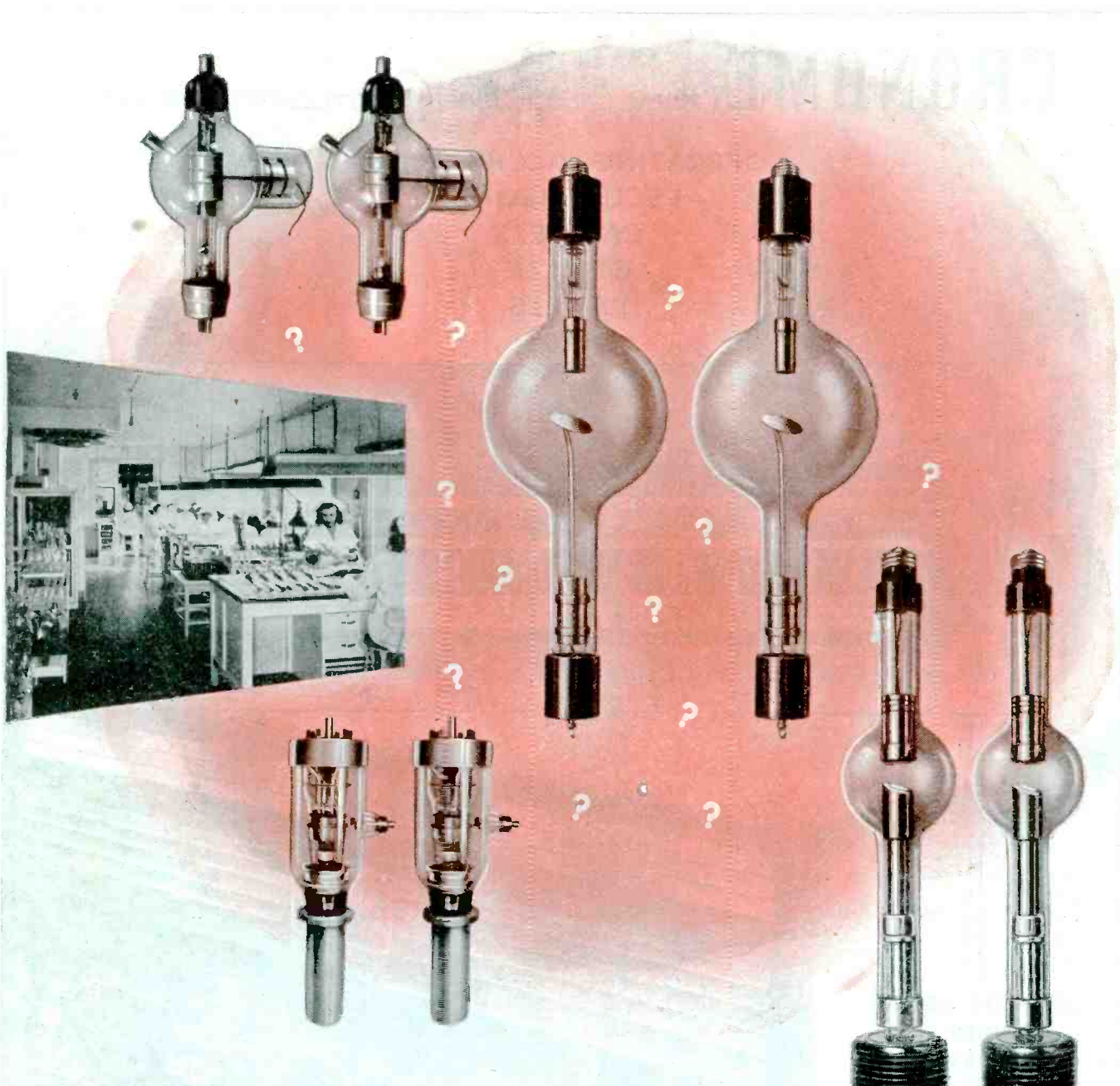

CAN YOU TELL WHICH TUBES ARE BETTER ?

Two tubes of the same type may look exactly alike, but if one was assembled in the Machlett "White Room" while the other was put together under average factory conditions, there would be a considerable difference between them. In lighting, cleanliness and conditioned environment, the "White Room" resembles a hospital operating room, and tubes passing through it remain free of internal contamination that would lessen their stability, shorten their life. Such tubes will give full-rated, predictable performance, and prove uniformly economical and satisfactory. It was to achieve such improved results

that Machlett built the first "White Room" in the industry — subsequently adopted by others. Many still newer Machlett techniques, such as this, continue to improve the quality and performance of our products. In this way, Machlett leadership in the electron tube field is maintained.

When you need a medical or industrial X-ray tube, or an oscillator, amplifier, or rectifier for radio or industrial purposes, select a Machlett. It will pay you in stability of operation and long life. For information as to available tubes, write Machlett Laboratories, Inc., Springdale, Connecticut.

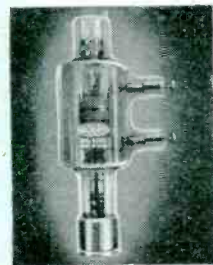

ML-500, a high-frequency triode. Maximum plate dissipation 500 watts with full power input at frequencies up to 50 megacycles.



APPLIES TO RADIO AND INDUSTRIAL USES
ITS 48 YEARS OF ELECTRON-TUBE EXPERIENCE

CRONAME *Electronic Components*

OPERATING MECHANISMS
ESCUTCHEONS
CABINETS
GRILLES
PANELS
DIALS

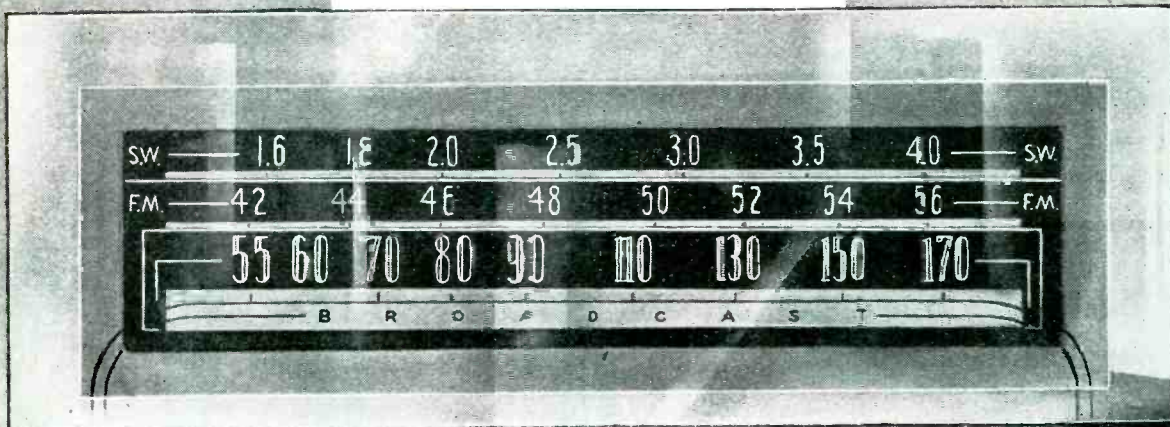

COMPLETE SERVICE
DIES
EMBOSSING
STAMPING
WELDING
PLATING
ETCHING
CERAMIC GLASS
PARTS
AND ASSEMBLING

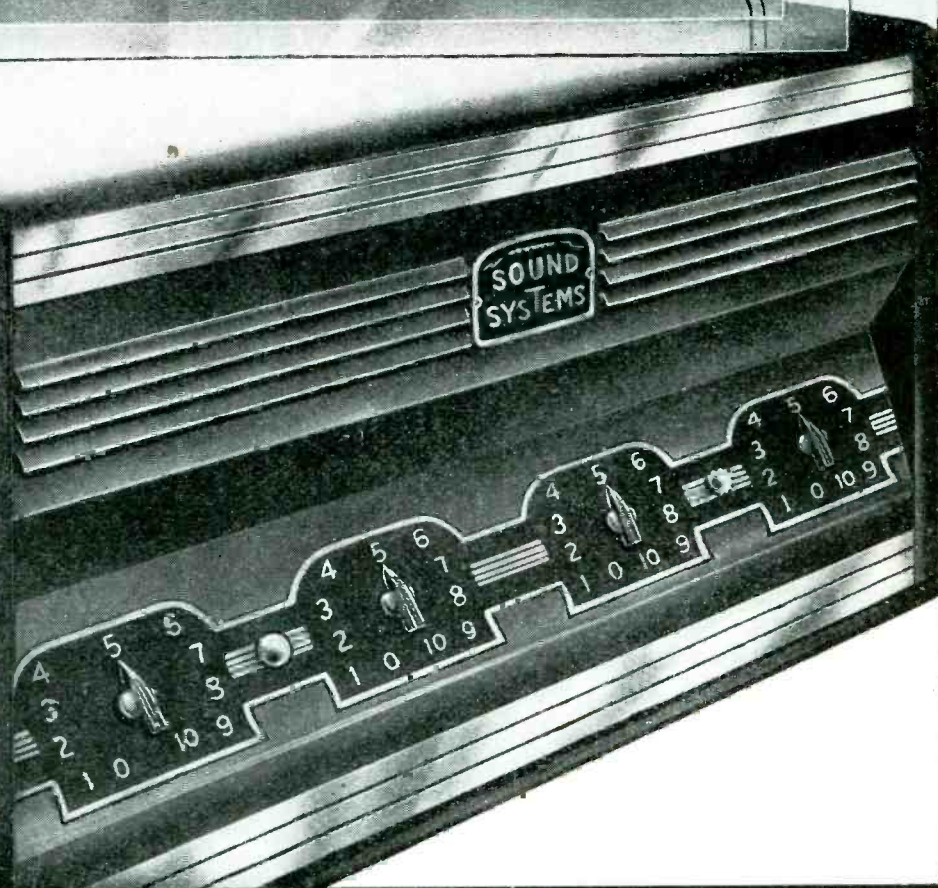

CRONAME

INCORPORATED

3701 RAVENSWOOD AVENUE
CHICAGO 13, ILLINOIS

OVER 40 YEARS EXPERIENCE IN FINE METALCRAFT

HERMETICALLY SEALED

against humidity and fungus

—another G-E "FIRST" in
electric-instrument design

● The Pacific war area is probably the toughest instrument-proving ground in the world. To meet the requirements of such severe service, G-E engineers have designed a 2½-inch panel instrument that *is hermetically sealed*. No detail has been overlooked to make this critical radio component impervious to the tropical conditions of high humidity, extreme temperature, and fungus growth.

Sealed Throughout. Vacuum-tight sealing assures a hermetic enclosure: Thick, strain-free glass is fused to a metal ring by a glass-to-metal seal; then, this assembly is sealed to a steel case. The two terminals are sealed, glass-to-metal; then, this assembly is sealed to a steel base. Lastly, the steel base is sealed to the steel case by a synthetic-rubber gasket, which is treated with a special sealing compound and compressed and secured by a crimped-over metal ring.

Filled with Inert Gas. The final assembly is evacuated, filled with an inert gas through a tube in the base, and is sealed off at a pressure slightly above atmospheric.

Internal-pivot Design. The combination of this hermetic enclosure and the combat-proved G-E internal-pivot element makes an outstanding instrument. It is not only sealed against jungle humidity and fungus, but it is also well able to withstand thermal shock, mechanical shock, and fatigue vibration and still maintain its rated accuracy.

For advance information, ask the nearest G-E office for Booklet GEA-4429, or write to General Electric Co., Schenectady 5, N.Y.



HEADQUARTERS FOR ELECTRICAL MEASUREMENT

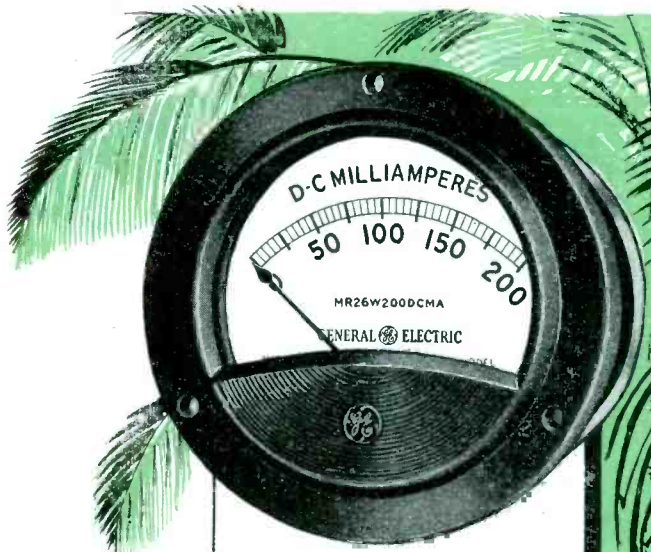

Type DW-61 d-c voltmeters, ammeters, milliammeters, and microammeters

Type DW-62 radio-frequency ammeters and milliammeters

AN INTERNAL-PIVOT DESIGN



External Pivot Internal Pivot

For thinness—pivots are mounted on the *inside* of the armature

For sturdiness—parts that require a definite location in relation to each other are securely fastened together to assure permanent alignment

High factor of merit—resulting from a featherweight moving element and high torque

**Plus Hermetic Sealing—
Another G-E First**

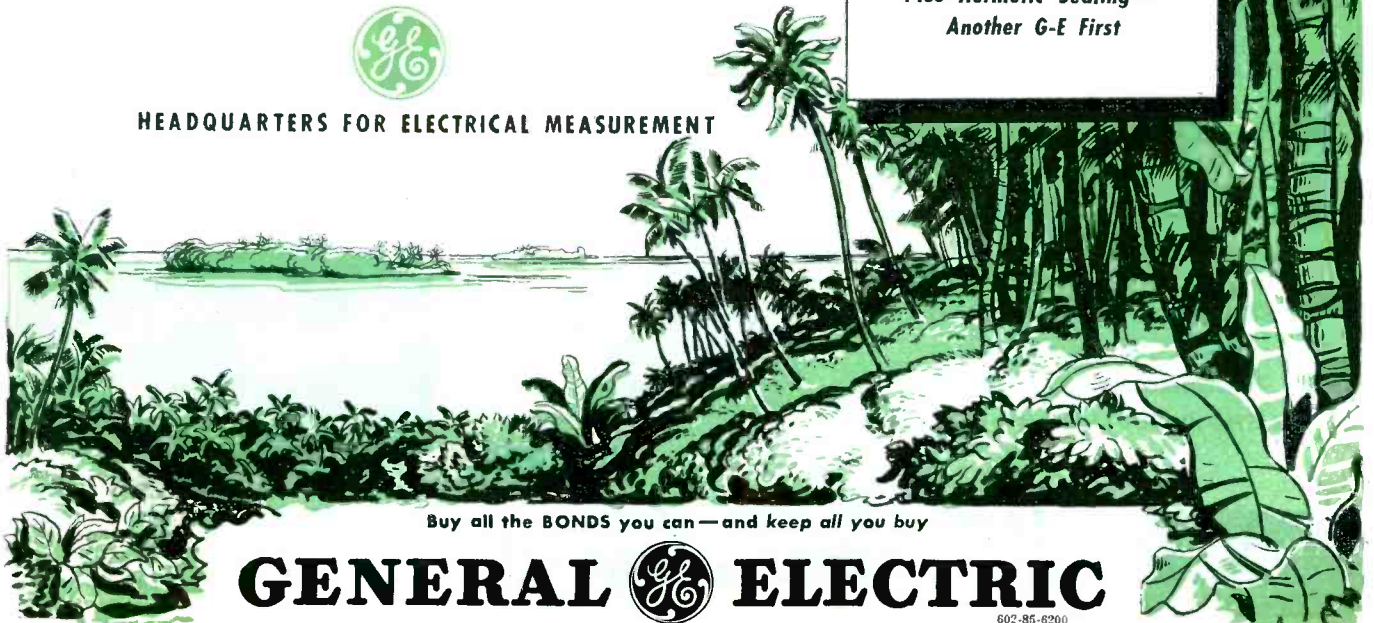

Buy all the BONDS you can — and keep all you buy

GENERAL  ELECTRIC

602-85-6200

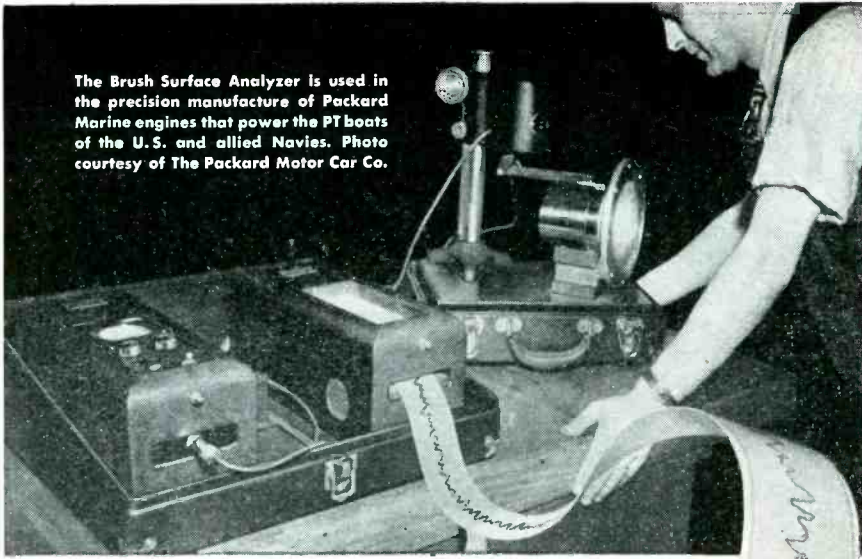

The Brush Surface Analyzer is used in the precision manufacture of Packard Marine engines that power the PT boats of the U.S. and allied Navies. Photo courtesy of The Packard Motor Car Co.

Now!

NO PRIORITIES

...are necessary to purchase a Brush Surface Analyzer...
Approximately two week delivery on unrated orders.

THE BRUSH SURFACE ANALYZER

measures and records the irregularities as shallow as a millionth of an inch on steel...glass...plastics...plated and painted surfaces. Ask for a demonstration at your plant.

An illustrated brochure, *SURFACE FINISH—.000001"*, sent on request

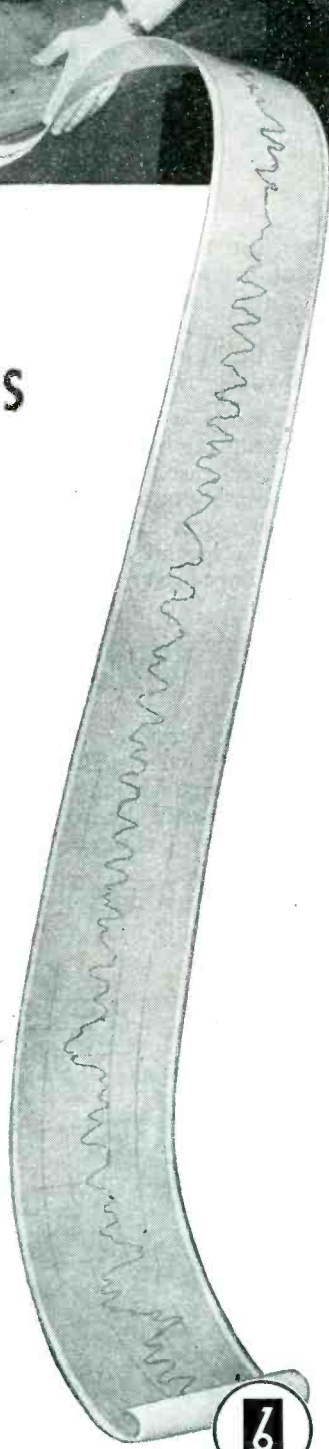

THE BRUSH DEVELOPMENT COMPANY

3428 PERKINS AVENUE

CLEVELAND 14, OHIO

volt bias supply through relay contacts 6 and 7 on relay A. When relay A is energized, the movable contact, 7, disconnects C from the bias supply and connects it through contact 8 to the grid circuit of the second half of the 6SL7 across resistor R.

Since the capacitor was charged up to bias voltage, it will cause the second half of the 6SL7 to be cut off, preventing any signal from getting through and thus preventing the possibility of the 884 becoming ionized and thus deenergizing the main relay. However, since this bias is due solely to the charge on the capacitor, it decays exponentially due to the discharge of the capacitor through R, the time constant of which will be determined by the size of C and R. This time constant may be varied to suit any type of operation.

Capacitor C₁ is charged in the same manner by the bias voltage through the relay contacts of relay A and applied to R when relay A is deenergized, so it will not be turned on again by the same sound impulse. Although a negative 25 volts is sufficient to cut off the 884 when using 115 volts of a.c. on the plate, approximately minus 50 volts was used in this circuit to prevent the possibility of any oscillation that may occur in the 6SL7 from firing the 884.

• • •

INVASION ANTENNAS



Modern warfare requires plenty of communications equipment, as shown by the antennas used by tanks and riflemen in this photo of the invasion of Kwajalein atoll in the heart of the Marshalls

THESE SALES REPRESENTATIVES ARE READY TO SERVE YOU!



DR 869 B



DR 872 A



DR 100 TH



DR 24 G



DR 575A



DR 200



DR 300



DR 8008



DR 17

GERBER SALES CO.

94 Portland St.,—Ph. Lafayette 3484
Boston 14, Mass.
CONN., MAINE, MASS., NEW HAMP., RH. ISL., VT.

S. W. SIMBERKOFF

347 Fifth Ave.,—Ph. Murray Hill 5-7090
New York 16, N. Y.
N. Y., N. J., PENN., DEL., MD., D. C., VA., W. VA.

CHAS. H. DOLFUSS, JR.

Film Exchange Building,—Ph. Prospect 0719
Cleveland 14, Ohio
OHIO, LOUISVILLE AND LEXINGTON, KENTUCKY

FRED J. STEVENS

15126 East Warren,—Ph. Tuxedo 11220
Detroit 24, Michigan
W8KQC MICHIGAN, INDIANA

AL KNODELL

5746 North Artesian Ave.,—Ph. Longbeach 9627
Chicago 45, Ill.
W9TLQ NORTHERN ILLINOIS

CLAIR R. MILLER

Ph. 2-3408
Cedar Rapids, Iowa
SOUTHERN ILL., MO., KANSAS, IOWA, NEB.,
9KFA MINN., WIS.

DALE G. WEBER

7026 S.W. Capitol Highway,—Ph. Cherry 2650
Portland 1, Oregon
WASHINGTON, OREGON, IDAHO, MONTANA

NICKERSON & RUDAT

383 Brannan St.,—Ph. Douglas 8530
San Francisco 7, Calif.
NORTHERN CALIF., RENO AND CARSON CITY, NEVADA

VERN T. RUPP

1150 W. Olympic Blvd.,—Ph. Prospect 9516
Los Angeles 15, Calif.
WGFMK SOUTHERN CALIFORNIA

G. G. WILLISON

West Building,—Ph. M. 2-4553
Houston 2, Texas
TEXAS, OKLAHOMA, SHREVEPORT, LA.

FRANK C. FASSETT

1707 Grand Central Ave.—Ph. H-1976
Tampa, Florida
W4BYR FLORIDA

CAROLINA RADIO EQUIPMENT

105 East Martin St.,—Ph. Raleigh 4842
Raleigh, N. C.
WRAL NORTH CAROLINA

Now—General Electronics is proud to announce nation-wide sales representation on its complete line of electron power tubes—nine of which are illustrated above. These representatives have been appointed because of wide acquaintance in territory, knowledge of products, customers' requirements and ability to render excellent service.

In all phases of electronics—induction heating, broadcasting or medical—General Electronics tubes have earned a reputation for extra-long life—the result of advanced design technique and completely modern production facilities and methods.

Wherever you are—whatever your tube requirements—consult the new General Electronics Catalog . . . then communicate with your nearest representative if you need immediate help.

**GENERAL
ELECTRONICS
INC.**

SALES: 1819 BROADWAY, NEW YORK 23, N. Y.

COMBINING PLASTICS & METALS in Molded **ROTORS**

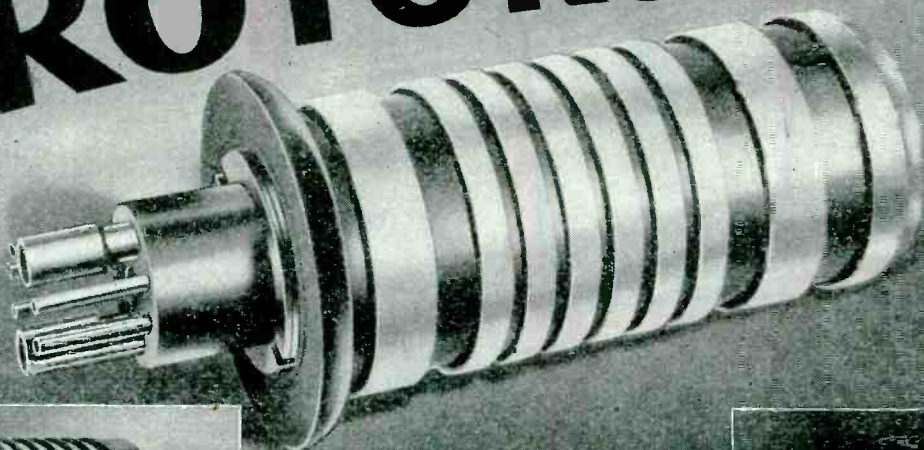

(Above) Rotor designed for top turret of Flying Fortress. Wires are molded in, and covered by at least 3/32" of plastic, providing excellent insulation.

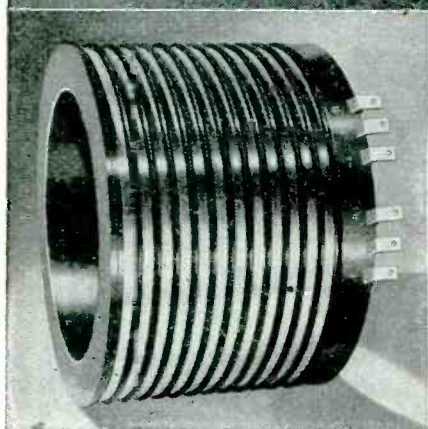

Rotor for shipboard power transmission. Ring, wire and lug assemblies, mounting inserts and steel sleeve at center are molded in position. Transfer molded of high impact macerated fabric material.

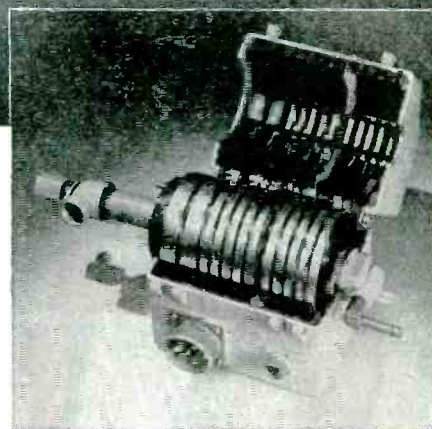

Turret swivel joint for Navy patrol bomber gun turrets. Transmits power, supplies oxygen, connects radio and telephone circuits. Rotor assembly is in two sections—1 5-ring, and 1 7-ring. Housing is transfer molded phenolic piece.

These rotors, or slip ring assemblies, are outstanding examples of the practical value of plastics and metals molded in combination. Rotors are essential requirements for the transmission of power to a revolving part, such as the power operated turrets of military aircraft. Essential operation and life itself depend on smooth, uninterrupted performance from these transmitting units. By transfer-molding the rotors, we save machining and assembly time and incorporate the best features of plastics and complementary metals.

Rings, wire and lug assemblies are combined in single units perfectly aligned. A molded rotor assembly has superior properties as to permanence of alignment, resistance to weather, temperature and vibration. The engineering and molding experience which has produced these improvements will be available for your postwar products.



SEND FOR A COPY OF FOLDER FILE E-6,
OUTLINING OUR PLASTIC SERVICES

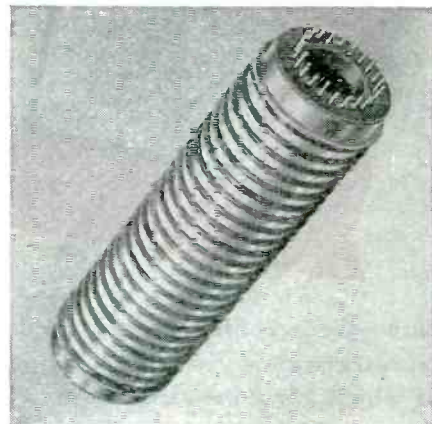

Slip ring assembly designed for aircraft. Transfer-molded with 22 rings of copper alloy, silver finished for improved contact and corrosion resistance.

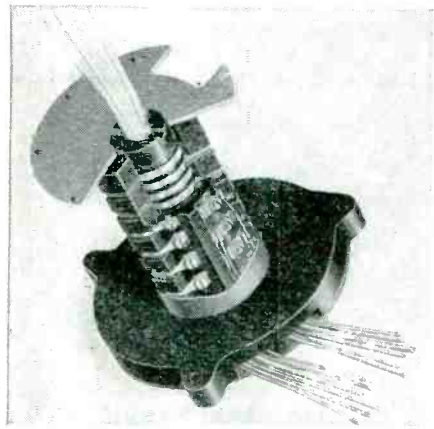

Cut-away view of swivel joint assembly designed for installation in 4 1/2" turret space. The rotor and stator are molded and assembled complete.

PLASTIC MANUFACTURERS

INCORPORATED

STAMFORD, CONNECTICUT

MOLD MAKING • INJECTION & TRANSFER MOLDING • COMPLETE ASSEMBLY

Representatives: DETROIT 2-805-06 New Center Bldg. • LOS ANGELES 35-1440 So. Robertson Blvd.

CANADA—A. & M. Accessories Ltd., 19 Melinda Street, Toronto; 1405 Bishop Street, Montreal; 920 Second Avenue, Seattle

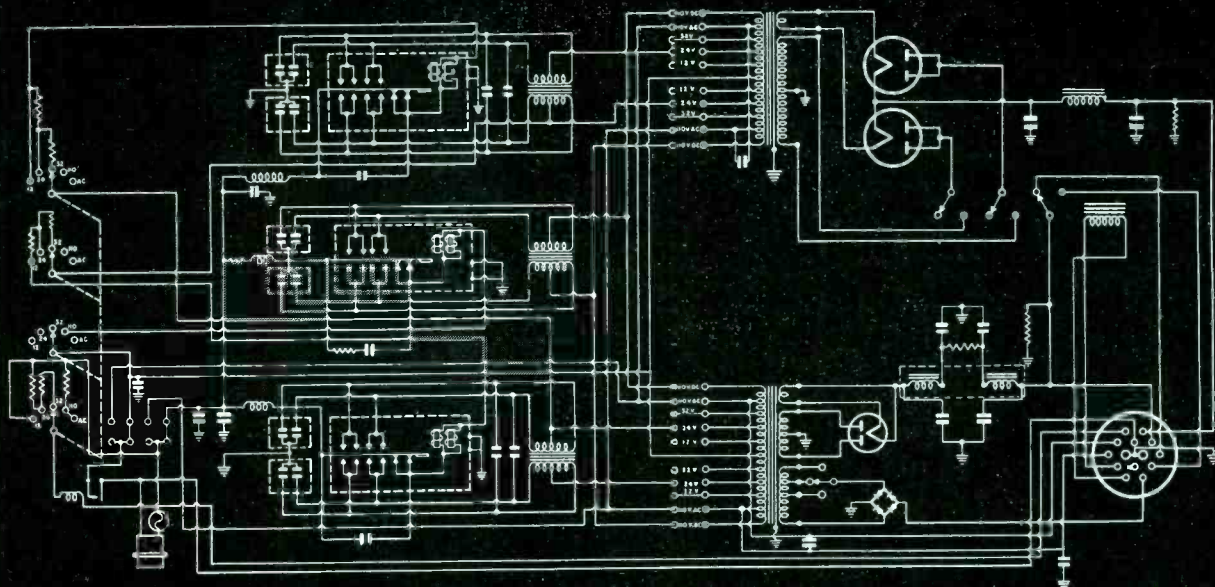

EL DEVELOPMENTS PROVIDE MULTIPLE INPUTS AND OUTPUTS IN VIBRATOR POWER SUPPLIES

● Electronic Laboratories has greatly increased the flexibility of power supply design and versatility of power conversion circuits, through special new developments during the war period. One of these, resulting from intensified research to meet military needs, is vibrator power equipment capable of delivering various voltages, currents and frequencies from a variety of input voltages. This naturally has vastly broadened the field for vibrator power conversion equipment.

The typical circuit diagram shown above illustrates a multiple input and output system. This power unit is designed to be operated from either 12, 24, or 32 volts from storage batteries, or 110 volt DC or AC power lines. Various outputs are available to supply the high voltage plate current required for the grid, and the AC voltages suitable for operation of the filaments. In addition, a source of alternating current power for the operation of the automatic tuning system which is incorporated in this unit, has been provided. There is a current division system associated with the contacts of the vibrators and the circuit is so designed that the phase displacement provides equivalent performance of a two-phase rectifier system, assuring low

hum level with a minimum amount of filter.

During the war period, *EL* has designed many other similar units having a multiplicity of input and output voltages. In addition to DC sources, in many cases, AC sources of any frequency between 18 and 180 cycles have been made available to meet specific engineering problems.

The requirements for power equipment reach into many fields as war born inventions are applied to postwar needs. *EL* Vibrator Power Supplies will have wide application because they are the most economical, efficient and versatile means of solving the many power supply problems that will arise. Electronic engineers will soon be at your service to help meet the power requirements presented by postwar industry.

EL STANDARD POWER SUPPLY MODEL 1200

This EL unit is a typical Vibrator Power Supply with multiple inputs and outputs and was designed for transmitter and receiver use. Inputs: 12 volts DC, 24 volts DC, 32 volts DC, 110 volts DC and 110 volts AC, 50-60 cycles; Outputs: 600 volts DC at 150-250 MA; 300 volts DC at 75-150 MA; 6-8 or 10 volts DC at 1 amp.; and 110 volts AC (50-60 cycles) at 75 watts. Dimensions: 26-1/16" x 15" x 13-9/16". Weight: 160 pounds.



Electronic

LABORATORIES INC.

INDIANAPOLIS



VIBRATOR POWER SUPPLIES FOR LIGHTING, COMMUNICATIONS, ELECTRIC MOTOR OPERATION · ELECTRIC, ELECTRONIC AND OTHER EQUIPMENT

THE ELECTRON ART

Rapid Technique for Measuring Line Characteristics.....	252
Characteristics of Steel During Induction Heating.....	252
Equivalent Series and Parallel Impedances.....	254
Stroboscopic Depiction of Electrons on Transmission Lines....	258

Rapid Technique for Measuring Line Characteristics

A METHOD OF MEASURING u-h-f characteristics of lines which takes only twenty minutes in production testing is described by F. Jones and R. Sear in *Wireless Engineer* (Dorset House, Stamford St., London S.E. 1) for November, 1944.

A test line is brought to resonance. A section of cable in excess of an integral number of half-wavelengths is attached to the test line and brought to resonance by cutting the far end. A meter reading is taken; the test line is then detuned first in one direction, then in the other to the point where the meter

gives half its resonant deflection. From scale readings on the test line and capacitance measurements made at a low frequency, the characteristics of the line under test are calculated.

Special precautions are given for corrections for unbalance in velocity of propagation on dual lines. The method is accurate to 2 percent, and has the added advantage over other systems of using relatively short cable lengths. The paper describes the test line construction, the meter circuit, and wavelength measurements.

Characteristics of Steel During Induction Heating

A DISCUSSION of the peculiar effect of striated heating, produced when steel is heated by induction methods, is given by George I. Babat of Moscow in *Journal of Applied Physics* for December, 1944. The strias appear as bright orange bands against a cherry-red background when a cylinder of magnetic steel is heated by induction means.

The striated heating effect is observed only with materials having high values of permeability. It is most pronounced in the case of soft iron, and appears in carbon steel of the ferrite and pearlite types. Steels with low permeability show a much weaker effect. Moreover, the striated heating effect depends upon the preceding thermal treatment of steel (hardening, annealing). When heating non-magnetic materials such as austenite steel or graphite—the striated heating effect is not observed at all.

The effect described may be explained by the redistribution of current during the heating procedure. A multiturn heating coil produces a non-uniform distribution of currents on the surface of steel. Places under the middle of

the conductors are the first which attain the Curie temperature and the resistance of these places becomes much less than that of the surrounding metal. Currents from the neighboring places gather in these strips so that current density here sharply increases. The specific power in these places may exceed many times that in the surrounding metal. The surface of the steel reflects the luminous pattern of the heating coil.

The power absorbed by the sample is proportional to $(\rho\mu)^{1/2}$, and most of this energy is concentrated in a layer whose thickness is proportional to $(\rho/\mu)^{1/2}$. Because of the change in these parameters the rate and depth of heating are variables depending on the composition of the sample and its temperature. Figure 1 shows these variations.

Resistivity, ρ , increases with temperature, the initial value and rate of increase depending upon the particular iron alloy and composition, until the Curie point is reached. Above this point the resistivity is $(120-130)10^{-6}$ ohms for all alloys of iron.

Permeability, ρ , beside depending upon composition of the sample

and its temperature, depends on field strength, ranging from 100 to 10,000 for low carbon steels at medium field strengths. Permeability decreases with temperature, and above the Curie point iron alloys are non-magnetic.

Current Distribution

As illustrated in Fig. 2, a multilayer coil produces a non-uniform distribution of currents resulting in non-uniform heating. If the power delivered to the work is high so that local heating takes place more rapidly than it can be uniformly distributed by conduction, rings of high current reach the Curie point first. The resistivity of these rings

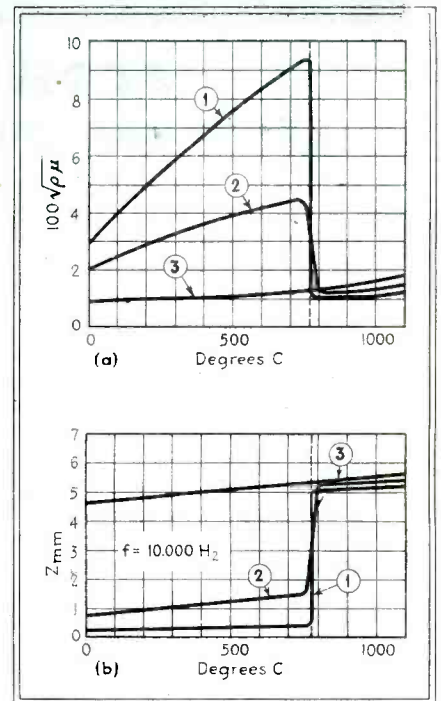

FIG. 1—(a) Relative power absorbed by the work as a function of temperature, and (b) depth of penetration during heating for (1) carbon steel with 0.8-1.2-percent C, (2) chrome steel, and (3) steel containing 18-percent Cr and 8-percent Ni

falls and as a consequence they receive still larger currents. The result is a striated heating effect. Even where the current is uniformly induced into the work, surface irregularities will produce striated heating. Such heating is only observed in materials of high permeability.

Striated heating is apparent by the brighter rings that form. When they first form, they are very bright

OHMITE

Rheostats and Resistors

IN PRODUCTION OF

Penicillin

USED IN
ELECTRONIC POWER GENERATOR
that dries Penicillin 48 times faster

● A new RCA electronic system, using high frequency current for the bulk reduction of purified Penicillin, accomplishes in 30 minutes what formerly took 24 hours.

In the RCA Electronic Power Generator are six Ohmite resistors and two Ohmite rheostats. Circled in the photo above are a 200 watt regulator plate resistor, two 200 watt cathode bias resistors for the two power tubes, and a 50 watt rheostat used as a cathode balancer. Not visible in the photo are two 10 watt Brown Devil resistors used for voltage dropping in the pilot light circuits, one 10 watt Brown Devil in a time delay relay circuit, and a 50 watt rheostat used as the output power control.

The use of Ohmite products in such vital electronic equipment is further proof of their complete reliability.

OHMITE MANUFACTURING COMPANY
 4818 FLOURNOY STREET, CHICAGO 44, U. S. A.

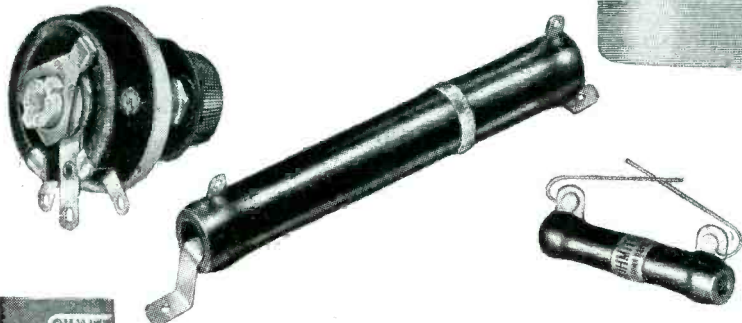

Write on company letterhead for Industrial Catalog and Engineering Manual No. 40. Address Ohmite Mfg. Co., 4818 Flournoy St., Chicago 44

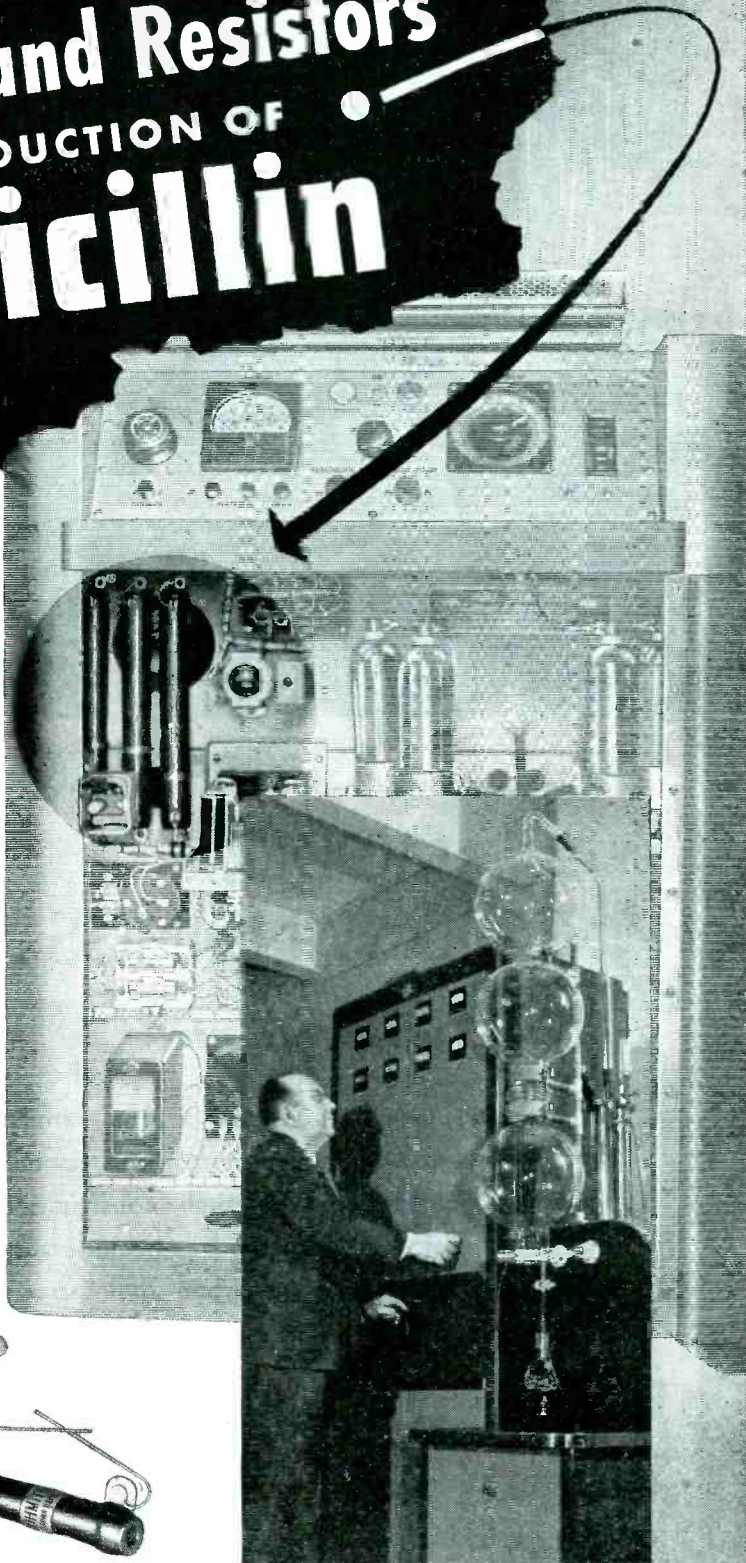

Be Right with **OHMITE**

RHEOSTATS • RESISTORS • TAP SWITCHES

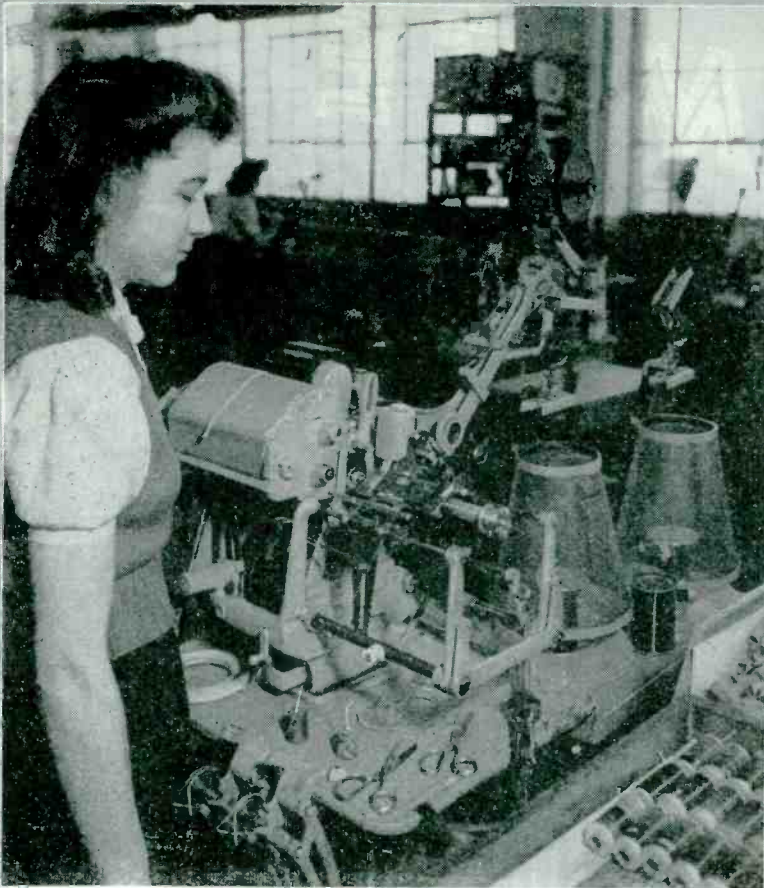

No. 3 of a Series

MODERN COIL WINDINGS

“with yarn”

This machine produces a coil of the familiar "cotton inter-weave" type where appearance or special applications require such construction. Glass or silk yarns are also used as a binder and insulator instead of cotton when their special qualities require it.

Our engineering department will be glad to recommend the type of winding best suited to your requirements.

COTO-COIL CO., INC.
COIL SPECIALISTS SINCE 1917

65 PAVILION AVE.

PROVIDENCE 5, R. I.

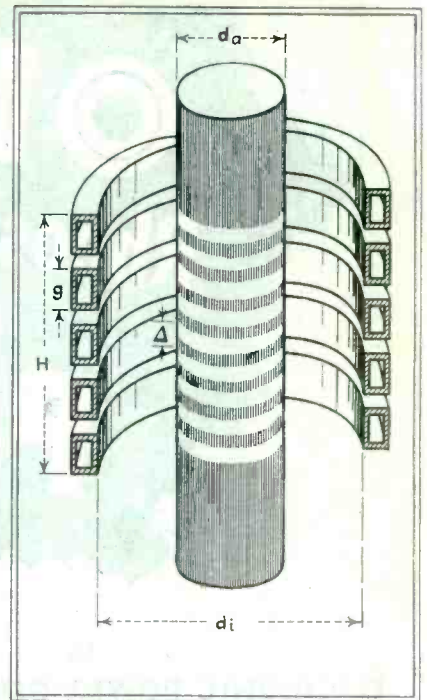

FIG. 2—Multilayer coil used in induction heating produces striated heating at high rates of power delivery

and thin. After formation they spread out, the temperature in the middle falls, while the bands washing out the darker intervals between strias remain bright. Strias are visible while the surface layer having a thickness about twice the depth of penetration is passing through the Curie point.

• • •

Equivalent Series and Parallel Impedances

BY R. L. PEEK, JR.

IN IMPEDANCE computations, it is frequently necessary or convenient to express an impedance $R_s + jX_s$ in terms of a resistance R_p and reactance X_p which have, when connected in parallel, the impedance $R_s + jX_s$. The reverse operation is similarly frequently required. It is the purpose of this note to describe a simple geometrical construction that represents the relation between these impedances. This relation is:

$$X_p = R_s^2 + X_s^2/X_s$$

$$\text{and } R_p = R_s^2 + X_s^2/R_s$$

The corresponding geometrical construction is shown in the illustration. Here R_s and X_s are the sides of a rectangle, of which Z is

N-Y-T

can be your

TRANSFORMER DEPARTMENT, too

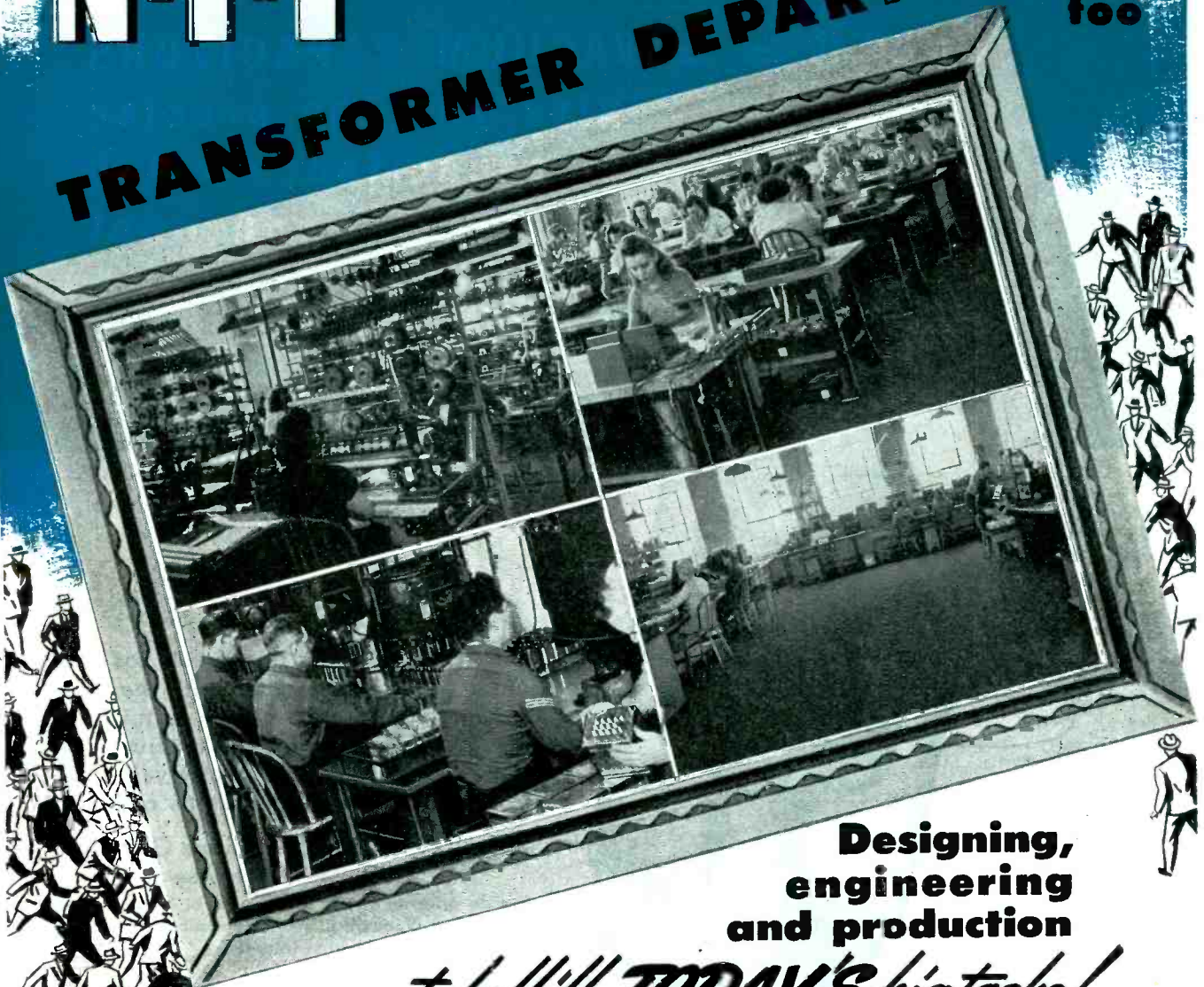

Designing, engineering and production

... to fulfill TODAY'S big tasks!

Now, more than ever, leading electronic and electrical manufacturers are relying on N-Y-T facilities to meet entire transformer, choke and filter requirements. The multiple advantages—release of valuable floor space, reduction in tooling, minimum inventories and alleviation of labor shortages—are vital reasons for this current trend.

More important, however, is N-Y-T specialization in transformers. Emphasizing plant and equipment ap-

plicability — with coordinated tooling, channelized engineering and product design collaboration — transformer solutions are high in efficiency and low in unit cost.

These factors — backed by an enviable record in Army, Navy and Air Corps critical production — justify the acceptance of this "personalized" N-Y-T Transformer Department.

Address inquiries to Department E



NEW YORK TRANSFORMER CO.

26 WAVERLY PLACE, NEW YORK 3, N. Y.

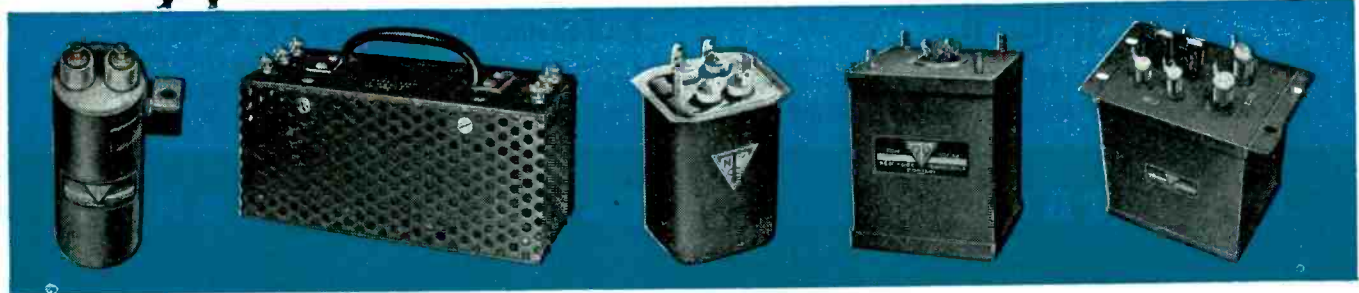

ONLY  VACUUM CAPACITORS
 give you the precise
 capacitance value
 you want

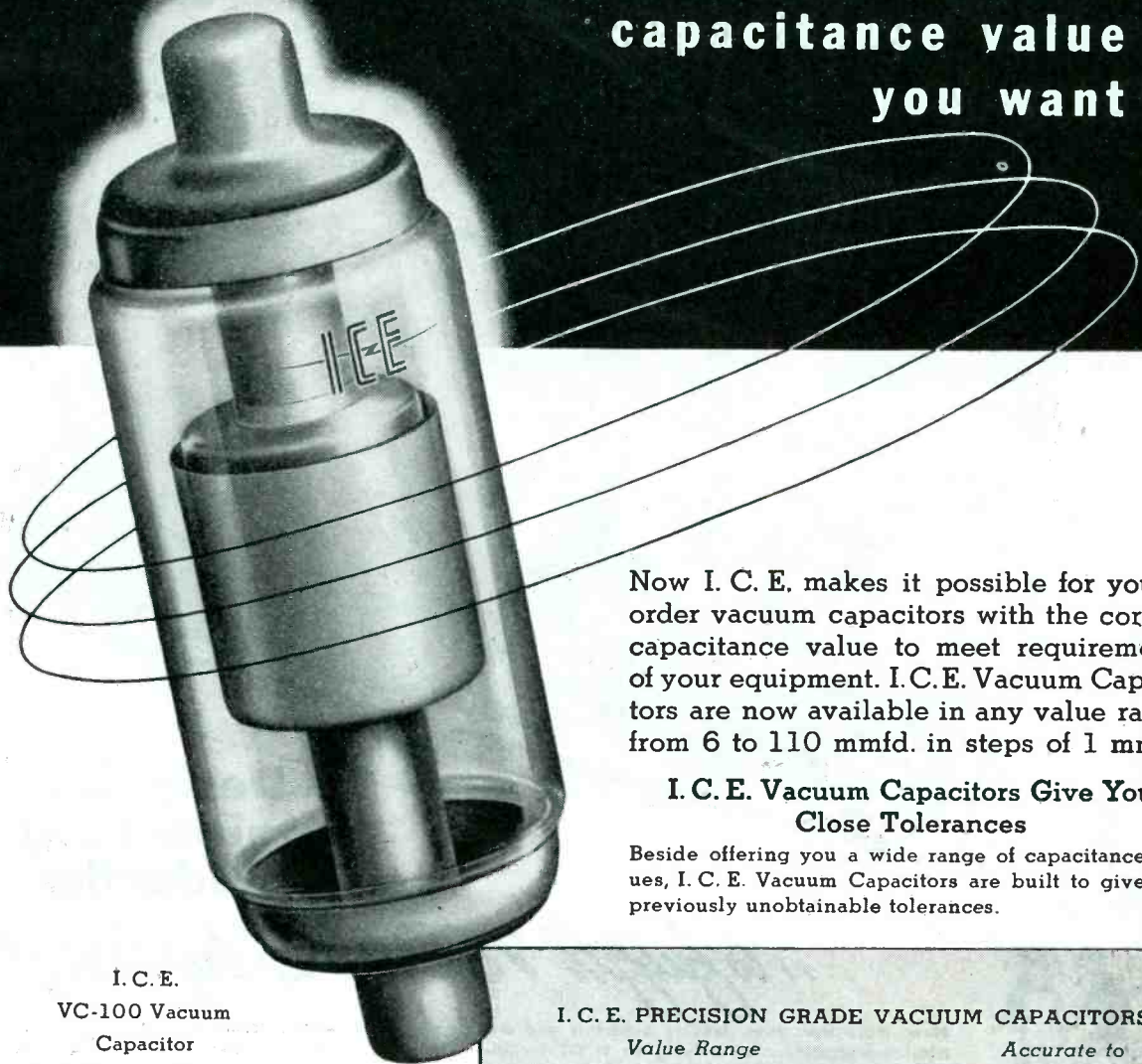

I. C. E.
 VC-100 Vacuum
 Capacitor

Now I. C. E. makes it possible for you to order vacuum capacitors with the correct capacitance value to meet requirements of your equipment. I. C. E. Vacuum Capacitors are now available in any value range from 6 to 110 mmfd. in steps of 1 mmfd.

**I. C. E. Vacuum Capacitors Give You
 Close Tolerances**

Beside offering you a wide range of capacitance values, I. C. E. Vacuum Capacitors are built to give you previously unobtainable tolerances.

I. C. E. PRECISION GRADE VACUUM CAPACITORS

<i>Value Range</i>	<i>Accurate to</i>
6 mmfd. to 25 mmfd.	±0.5 mmfd.
26 mmfd. to 60 mmfd.	±1.0 mmfd.
61 mmfd. to 110 mmfd.	±1.5 mmfd.

I. C. E. XX GRADE VACUUM CAPACITORS

<i>Value Range</i>	<i>Accurate to</i>
6 mmfd. to 25 mmfd.	±0.2 mmfd.
26 mmfd. to 60 mmfd.	±0.3 mmfd.
61 mmfd. to 110 mmfd.	±0.5 mmfd.



ELECTRONIC TUBES
 RESEARCH • DESIGN • PRODUCTION

Full Details in the New I. C. E. Catalog

For full information on these outstanding I. C. E. Vacuum Capacitors, as well as other precision I. C. E. products, write today for the new I. C. E. Catalog.

INDUSTRIAL & COMMERCIAL ELECTRONICS

BELMONT, CALIFORNIA • NEW YORK CITY, N. Y.

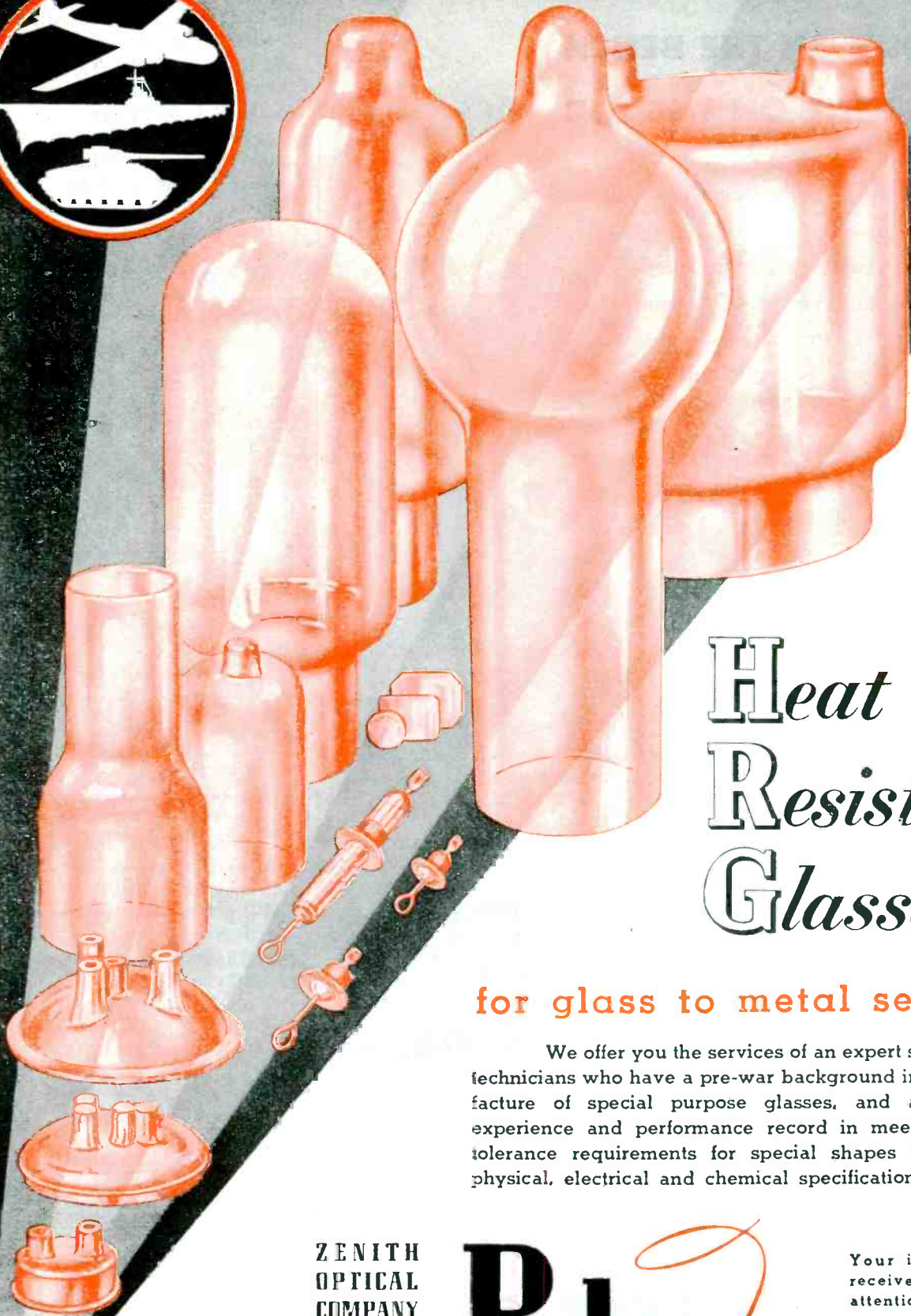

Heat Resistant Glasses

for glass to metal sealing

We offer you the services of an expert staff of glass technicians who have a pre-war background in the manufacture of special purpose glasses, and a war-born experience and performance record in meeting critical tolerance requirements for special shapes to exacting physical, electrical and chemical specifications.

ZENITH
OPTICAL
COMPANY

A unit of

Polan
Industries
HUNTINGTON 19 • WEST VA.

Your inquiry will
receive our prompt
attention.



AN HOUR ON THE BENCH SAVES NINE ON THE JOB

Bench assembly and repair means speed-up in production. The use of Cannon Multi-circuit Connectors in the wiring of electrical equipment is the ultimate in assembly efficiency—time saved on the job, less skilled labor, better critical work under better conditions.

Various parts of electrical assemblies may be manufactured in different factories and put together and into operation simply by inserting a Cannon Plug into a Cannon Receptacle. The connection will be firm, tight and solid—yet quickly disconnected for replacement or repair.

There are more than ten thousand connector sizes, types and kinds listed in the Cannon catalogs. Thousands of special and intricate circuit requirements may be met right from stock with Cannon Plugs.

Wherever quick, complete and sure electric connections must be made—whether for a single element or a maze of circuits—use a Cannon Connector. Nothing less is so surely satisfactory. Nothing better can be had.

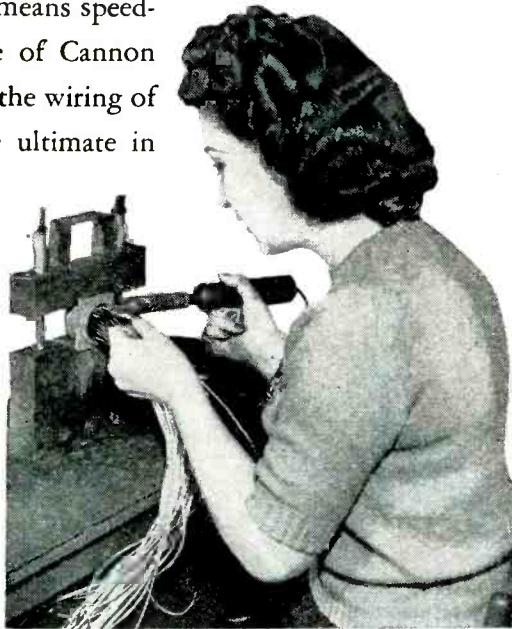

Bench wiring by Jean Wheeling, of the Curtis Wright Corporation Columbus, Ohio



Write for condensed Cannon Catalog. It gives you a general introduction to the Cannon line. Address Department A-120, Cannon Electric Development Co., 3209 Humboldt St., Los Angeles 31, Calif. . . Below is pictured a wall mounting, typical of the famous Cannon AN line of plugs.

CANNON ELECTRIC

Cannon Electric Development Company
Los Angeles 31, California

Canadian Factory and Engineering Office: Cannon Electric Company, Limited, Toronto, Canada



REPRESENTATIVES IN PRINCIPAL CITIES—CONSULT YOUR LOCAL TELEPHONE BOOK

the diagonal. The perpendicular to Z cuts X_p and R_p , prolonged at X_p and R_p , respectively. The proof that the relation between X_p and R_p is that given by the above equations follows from the equal ratios of corresponding sides of similar triangles, as noted in the figure.

By laying off lengths on ordinary

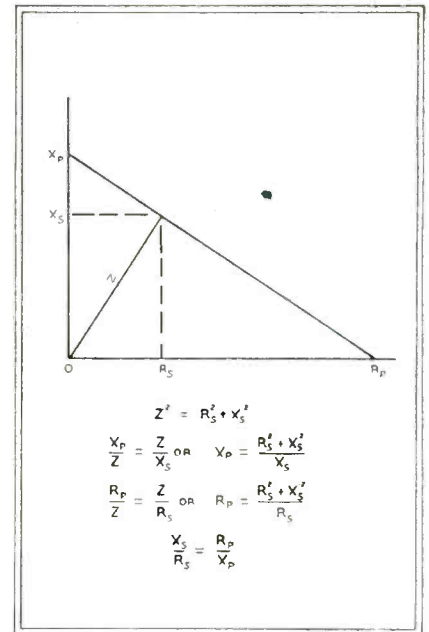

Simple geometrical figure for representing impedance relations

cross-section paper, this construction may be used to determine X_p and R_p when X_s and R_s are given or vice versa. Aside from its utility in computation, the construction permits visualization of the relative magnitude of the four quantities involved, including the useful corollary that $X_p/R_p = R_s/X_s$.

• • •

Stroboscopic Depiction of Electron Motion on Transmission Lines

By J. F. Kline
Instructor, Dept. of Elect. Eng.
University of Michigan
Ann Arbor, Mich.

THE STROBOGRAM shown in Fig. 1 consists of a succession of pictures which depict, in an exaggerated fashion, positions of representative electrons at successive instants of time in standing waves on Lecher wires. This strobogram, when ro-

TELECHRON MOTORS AVAILABLE NOW*

...and at low prices!

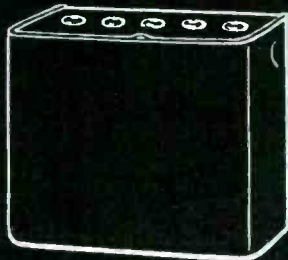

STOKER CONTROLS



INTERVAL
TIMER SWITCHES

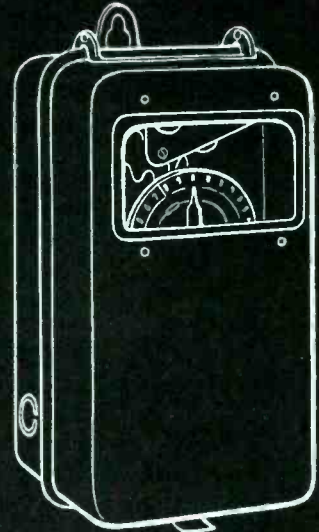

GENERAL PURPOSE
24-HOUR TIME SWITCHES

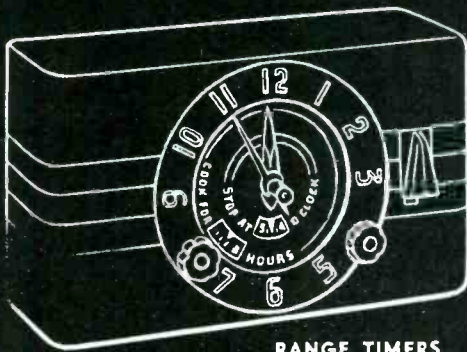

RANGE TIMERS



NIGHT AND DAY
THERMOSTAT SWITCHES

* At present, AA5 priority required

THE things engineers demand in a time switch are absolute accuracy, dependability and long life. You can *guarantee* these advantages if your switch has a Telechron synchronous motor.

Telechron motors, operating in perfect synchronism with all commercial AC frequencies, are 100% accurate. They're self-starting, reach rated speed

almost instantly, take little power. They're light and compact, yet develop many times the power of any spring-driven clock mechanism. Precision building and an exclusive lubrication system assure long, trouble-free life.

Their advantages are the result of Telechron's 25 years' experience in making synchronous motors . . . and of adapting them to the most exacting demands of timing, switching and control instruments.

Our pioneering experience in *application engineering* is at the service of time switch manufacturers who want a better motor for their post-war products. There's no obligation. Just address Motor Advisory Service, Dept. C.

*Here's News
for
Time Switch
Makers*

Telechron

REG. U. S. PAT. OFF.

WARREN TELECHRON COMPANY • ASHLAND, MASS.

Makers of Telechron Electric Clocks and Synchronous Motors

Elastic "GLOBAR" Resistors

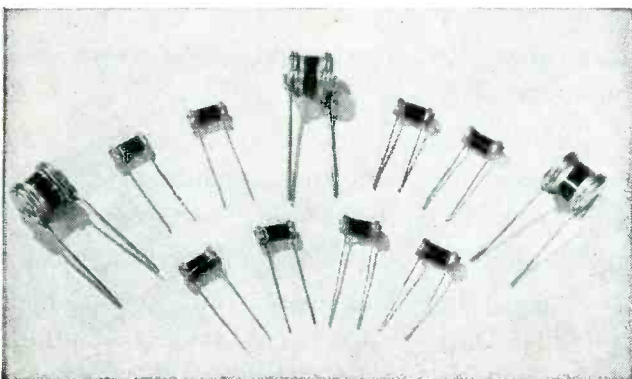
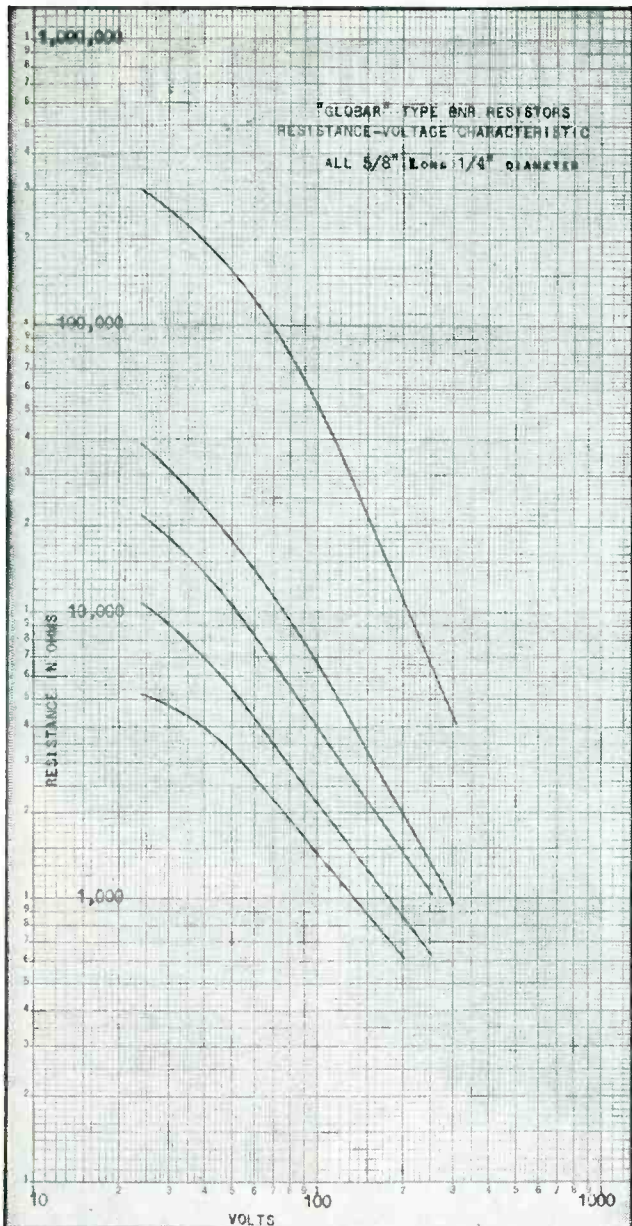

DID you ever hear of an *elastic* resistor? Here is one type—a resistor that springs back when you release the potential or load. Conversely when the potential, or load is applied the resistance decreases. Study these curves, they may suggest a solution to one of your problems.

"GLOBAR" Negative Resistance-Voltage Characteristic Resistors are currently being used in the following typical applications:

- 1 Peak voltage limiters (to limit voltage peaks for protective purposes). For example, they are used in Oil Burner Ignition Transformers to eliminate the inductive kick due to the opening of the electric circuit.
- 2 Stabilizing circuits supplied by Rectifiers to limit the peak voltage.
- 3 For the control of voltage circuits in Electronic devices.
- 4 Protection of Solenoids in direct current circuits.

Resistors of this type must, of necessity, be manufactured to meet the purchaser's needs. Therefore, the following information should be furnished when considering the use of such resistors:

- (a) Type of apparatus in which resistors are to be used.
- (b) Method of mounting and whether they will be mounted in series or in parallel.
- (c) Normal and peak voltage as well as the resistance and inductance of the circuit.
- (d) Ohmic resistance of the resistor and allowable plus or minus tolerance.
- (e) Maximum voltage applied continuously or intermittently.
- (f) Steady or intermittent load.
- (g) Duration of load and elapse of time between its application.

Feel free to write us about your resistor problems. You incur no obligation in doing so.

Working samples for engineering tests are available. The Carborundum Company, Niagara Falls, New York.

"Globar" Ceramic Resistors
by CARBORUNDUM
TRADE MARK

("CARBORUNDUM" and "GLOBAR" are registered trade marks of and indicate manufacture by The Carborundum Company)

PERFORMANCE BEYOND THE CALL OF DUTY
 —ASSURED BY RIGID QUALITY CONTROLS!

Winco

MAGNET WIRE



Above: Continuity Tests
 Below: Resistance Tests

BREAKDOWNS due to faulty magnet wire are virtually "impossible" when you wind with Winco! Laboratory controls and rigid inspection insure these results.

HENCE... a uniformity of product that makes for smooth and fast laying and trouble-free performance. This caution, however! Whatever the type and gauge of wire you specify, make sure that it is chosen with due regard to the conditions of the service for which intended. Winco engineers will gladly assist you in establishing the correct standards for your application.

- ENAMELED COPPER • COTTON COVERED • ENAMELED IRON
- CELANESE COVERED • ENAMELED ALLOY • GLASS FIBRE COVERED
- ENAMELED ALUMINUM • TWISTED MULTIPLES
- SILK COVERED • PARALLEL MULTIPLES • LITZENDRAHT

WINSTED DIVISION
 OF HUDSON WIRE COMPANY
 WINSTED, CONNECTICUT

NOW IT CAN BE TOLD!



**Comco builds
the smallest combat
WALKIE-TALKIES**

Comco Walkie-Talkies are not "war babies." They were first built for *civilian* use . . . for use by mounted policemen . . . *before* the war.

That's why Comco Walkie-Talkies for war boast so many practical superiorities. They are the smallest, most compact of all combat Walkie-Talkies. Their weight complete is *less than eight pounds!*

Comco has built thousands of these remarkably compact units for our fighting forces. And Comco is prepared to build peacetime Walkie-Talkies to meet a wide variety of needs, some of which are suggested in the column at the right.

Comco engineers and craftsmen, in the peacetime ahead, will also produce many other types of radio and electronic equipment—all CUSTOMIZED for dependability and lasting satisfaction.

WRITE! Just a note on your company letterhead outlining your exact requirements. We'll give you the benefit of our specialized experience. We can supply a wide variety of CUSTOMIZED equipment on priority NOW. We are accepting non-priority orders for post-war delivery.

Customized
**FOR MANY
POST-WAR USES**

Fire Fighters

Railroading

Forest Service

Public Utilities

tated and viewed under stroboscopic light, is transformed into a moving picture of the electron motion.

Visual Aid

The device has been used by the author as a visual instruction aid to supplement Lecher wire experiments in the electronics and communications laboratory, where it has helped students to learn and remember the behavior of the currents and voltages in these standing wave phenomena.

Strobograms, of course, may be used to demonstrate other phenomena such as electron flow and space charge in tubes.

This particular strobogram is designed to operate on a standard 78.26-rpm phonograph turntable under a 60-cps stroboscopic light. The strobogram shown in Fig. 2 is for 33.33 rpm and 20-cps-light. If the reader has equipment for both types of operation, he will

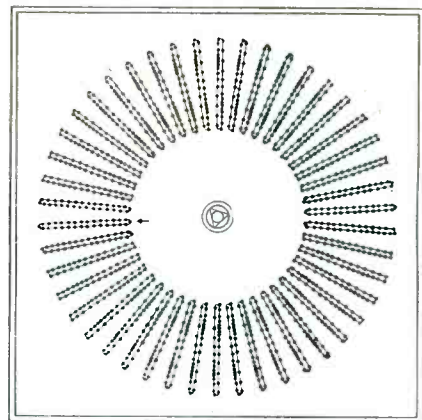

Fig. 1—Strobogram for use on 78.26-rpm phonograph turntable under 60-cps stroboscopic illumination

do well to choose the latter, since the longer period of 1.8 seconds in the 33.33-rpm strobogram is far easier for the eye to follow.

It is suggested that an enlargement of either Fig. 1 or Fig. 2 be stapled to a cardboard disc centered upon the turntable. (It is important that the disc be accurately centered, and in this connection it is easier to cut a triangular center hole than it is to cut a circular one.)

Though at first glance the construction of a strobogram may seem to be a formidable undertak-

MANUFACTURERS OF RADIO  & ELECTRONIC EQUIPMENT

COMMUNICATIONS COMPANY, Inc.
CORAL GABLES 34, FLORIDA

from sand . . .

SILASTIC

the new DOW CORNING SILICONE RUBBER

SILASTIC QUALIFIES EQUIPMENT UNDER GRADE 1, CLASS 1 SPECS.

Resistors coated with SILASTIC SC-75 operate successfully at 275°C. and take the plunge from 275°C. into ice water nine successive times. This seemingly impossible shock performance permits resistors coated with SILASTIC SC-75 to qualify under Grade 1, Class 1 Specifications.

"Newsworthy" is the development by Dow Corning of yet another—and perhaps greater—contribution to the new-day efficiency and resourcefulness of American industry. SILASTIC* is the name of the product and silicone rubber is the achievement.

SILASTIC covers a variety of elastic silicone products made by Dow Corning from sand, modified by chemicals drawn from brine, coal and oil.

Being silicone rubber, SILASTIC exceeds in thermal stability the rubber we've known, whether natural or synthetic. SILASTIC retains complete flexibility—does not harden—in the temperature range—70°F. to 500°F. Its excellent dielectric properties—its arc, corona and oxidation resistance—assure durability of wire insulation under hot, wet service conditions.

For the immediate broad field of its usefulness, SILASTIC stocks are available for application by coating, extruding and molding.

DOW CORNING CORPORATION • MIDLAND, MICHIGAN
ADDRESS ALL INQUIRIES TO BOX 592

*TRADE-MARK DOW CORNING CORPORATION

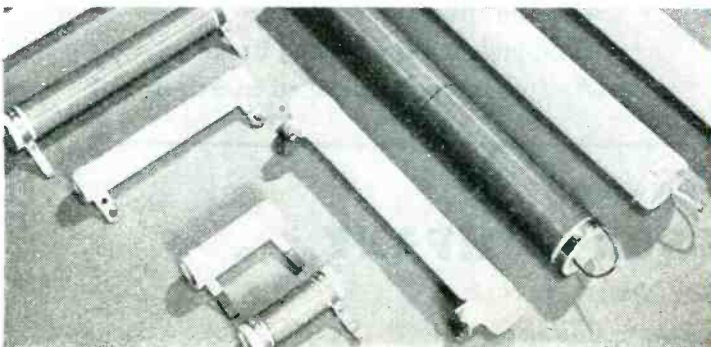

Dow Corning

FIRST IN SILICONES

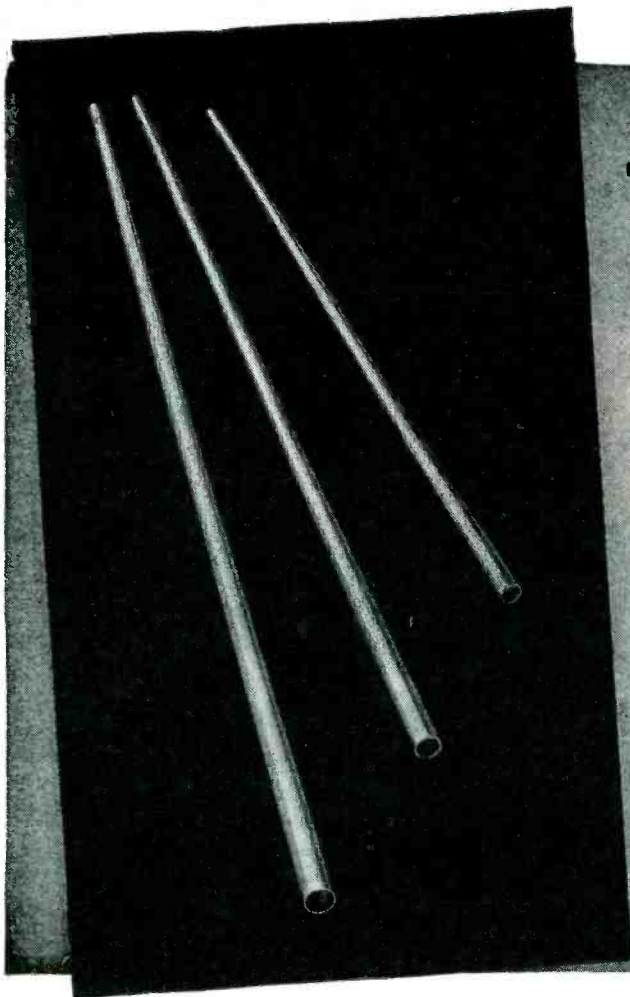

WILCO ANNOUNCES

Larger Plant

New Equipment

Increased Facilities

for producing

TUBING

The demand for Wilco tubing, wire and other products used in various electronic applications for the Army and Navy has caused the H. A. Wilson Company to increase its manufacturing facilities and develop new products and techniques. Both present and future customers will find these new Wilco developments of great advantage.

The H. A. Wilson Company manufactures and is interested in receiving inquiries regarding the following products—

WILCO RADIO TUBING

Silver Tubing (Fine, Coin, Sterling)
Gold Tubing (any karat)
Gold on silver (on one or both sides)
Gold on bronze (on one or both sides)
Silver on copper (on one or both sides)
Tubing made to order from special materials or any combination of materials.

WILCO RADIO WIRE

Silver (Fine, Coin, Sterling)
Silver-jacketed Invar
Silver-jacketed Brass and Bronze
Silver-jacketed Copper
Gold Wire
Gold on silver
Gold-jacketed Bronze and Brass
Any other type of jacketed wire desired

Let us analyze your problems. Write

THE H. A. WILSON COMPANY

105 Chestnut Street, Newark 5, N. J.

Branches: Detroit • Chicago

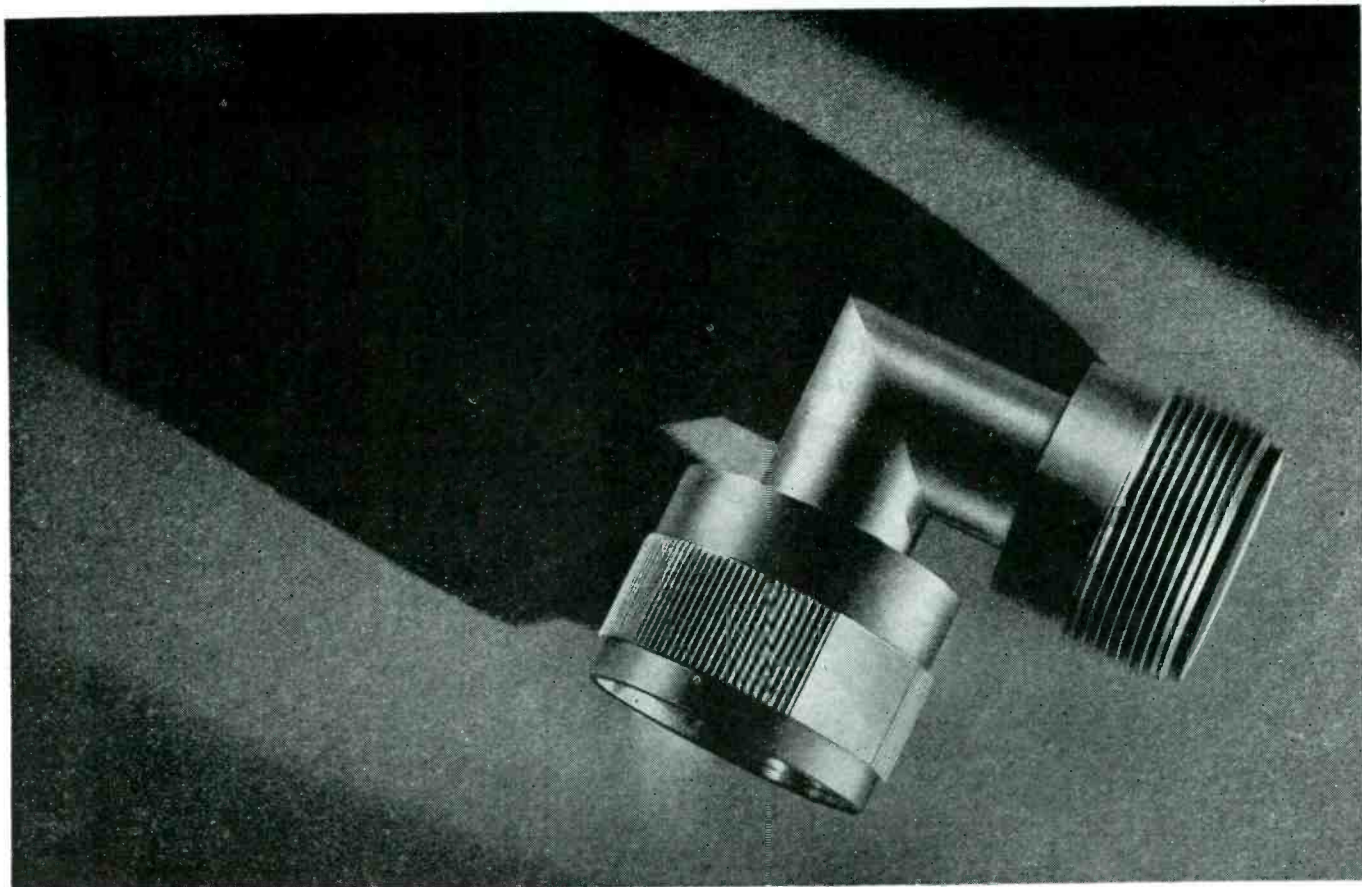

THE IMPOSSIBLE

TAKES A LITTLE LONGER—but if you only want what “can’t be done,”

the first place to come to is DICO. Here you will find product engineering, machining, gold and silver plating, casting, soldering, assembling and finishing, to the most exacting standards. ★ DICO coaxial connectors are an example. They have been developed in accordance with technical and industrial experience of the highest order, through close collaboration with the foremost authorities, both in research and in practice. In design and execution they represent the fullest progress in their field; and they will continue to represent it as further

progress is made. They are a product of precision, based on proof in performance and on supremacy in performance. ★ And connectors are only one example of how DICO can serve you in your readjustment from war to peace. If your product depends on production to rigid specifications, and you are thinking of postwar possibilities for it, you should talk with DICO now.



ELECTRONIC AC VOLTMETER

with Logarithmic Scale

Percentage Accuracy
of reading is uniform
over entire scale!

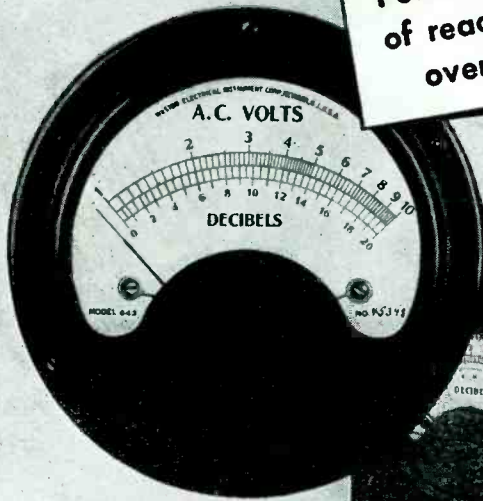

MODEL 300
ELECTRONIC
VOLTMETER

ACCESSORIES

MODEL 220 DECADE AMPLIFIER
MODEL 402 MULTIPLIER



The important feature of logarithmic scale indication in the Ballantine Voltmeter provides the same degree of accuracy at 1 as at 10. Also the simplicity of this scale reduces errors in visual observation, common with most multi-range instruments. Finally, the care taken in overall calibration combined with the inherent stability of the circuits used permits reliable readings within the 2% specified tolerance over the complete range of operation.

Write for technical Bulletin 8



BALLANTINE LABORATORIES, INC.
BOONTON, NEW JERSEY, U. S. A.

ing, it is not as difficult as the preparation of a motion picture film which will do the same work; and when it is finished the strobogram, turntable, and light are somewhat easier to handle than a motion picture projector, film, and screen.

Stroboscope Principle

The illusion of a moving picture is obtained by viewing a series of pictures in rapid succession, each picture being slightly different from its predecessor. In this application, the method used to do this is to rotate the strobogram and flash the light upon each picture as it passes a certain reference point. The synchronizing of

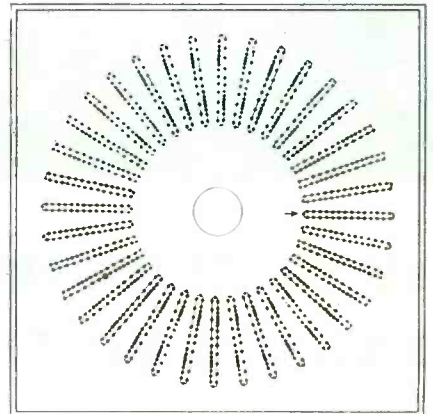

Fig. 2—Strobogram for use at 33.33-rpm rotation under 20-cps illumination

picture and light is accomplished by synchronizing both light and turntable motor with the common line frequency, although direct control which works at any turntable speed can be applied. For example, the author has punched holes in the edge of a strobogram card and, using these to modulate a beam of light directed to a photocell, controlled the stroboscopic light.

There are stroboscopic light sources on the market which are suitable. Fluorescent lamps and thin-filament incandescent lamps, although usable with turntable speed-checking discs, are not at all effective when used with the strobogram. The reason for this is that the light must consist of successive flashes of very short duration compared to the length of the period.

The frequency f of these light



PROGRESS OF THE TIMES - THERMOPLASTIC

As pioneers in the field of thermoplastic insulation, we have acquired engineering experience and production techniques which we believe to be exclusive. These new constructions offer maximum resistance to heat, flame, oxidation, chemical action, oil, grease, moisture, cold, abrasion, fungus growth and other severe conditions. Demand these advantages today . . . write for complete information and samples engineered to your particular requirements. Remember . . . when you're thinking of PLASTIC you're thinking of US!

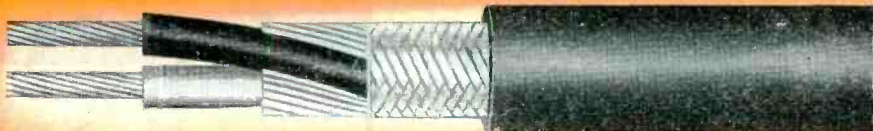
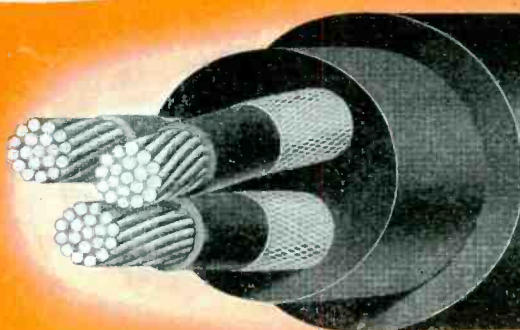

Thermoplastic insulation specialists . . . producing a complete line from fine wires to heavy power cables . . . serving: Public Utilities, Radio, Electronic, Appliance and Instrument Manufacturers, Telephone Companies and Contractors.

PLASTIC

W I R E & C A B L E NORWICH CONN
C O R P O R A T I O N

REMLER SINCE 1918

from WIRELESS to MARINE AMPLIFIED SOUND

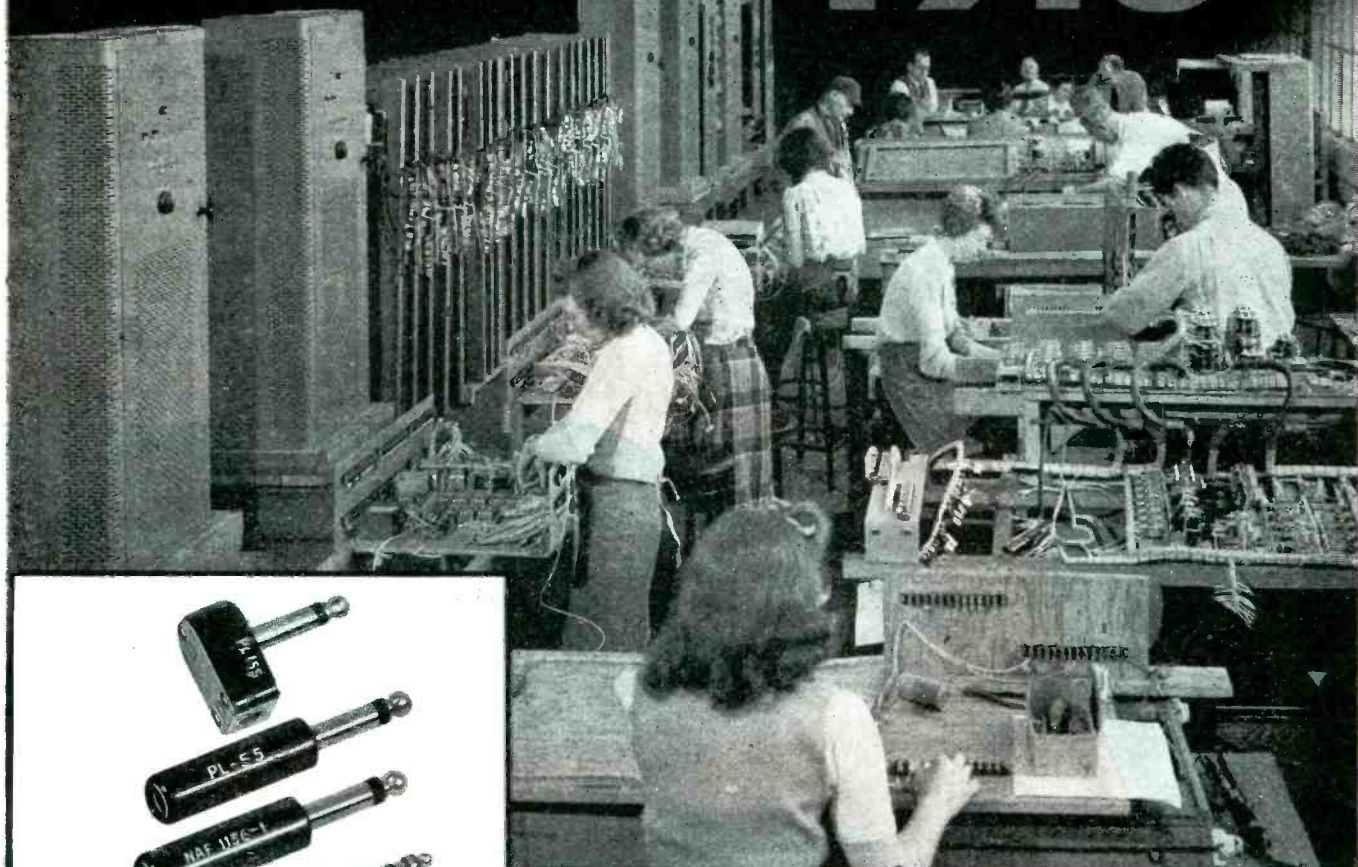

An assembly line in a Remler factory engaged in the manufacture of marine amplified sound systems for U. S. Maritime Commission.



Telephone Type Plugs

Signal Corps • Navy Specifications

PLUG NUMBER	NUMBER CONTACT'S	TYPE SLEEVE	SEE NOTE
PL47	2	Long	
PL54	2	Short	1
PL55	2	Long	2
PL55K	2	Off Set	
PL68	3	Long	3
PL124	2	Short	1
PL125	2	Long	2
PL155	2	Long	2
PL354	2	Short	1
PL540	2	Short	1
B-180207	2	(Lock-Nut)	2
CAU-49109	2	Long	2
CRL-49007A	3	Long	3
NAF-1136-1	2	Long	2
NAF-212938-1	3	Long	3
NAF-215285-2	2	Short	1

Note 1 — Interchangeable with others Note 1.
 Note 2 — Interchangeable with others Note 2.
 Note 3 — Interchangeable with others Note 3.

OTHER DESIGNS TO ORDER

REMLER'S EXPERIENCE in marine sound goes back to 1918; this firm was organized twenty-seven years ago to manufacture ship wireless. For five years before Pearl Harbor a division of Remler Company was busy with the design, manufacture and installation of inter-ship transmitting and amplifying equipment aboard passenger liners and merchant vessels . . . valuable experience for the manufacture of complete marine amplified sound systems for the U. S. Navy—built to withstand the shock and concussion of war as well as the corrosive action of salt air and water.

Further assignments in radio and electronics invited. Consult—

REMLER COMPANY, LTD. • 2101 Bryant St. • San Francisco, 10, Calif.

REMLER

SINCE 1918

Announcing & Communication Equipment

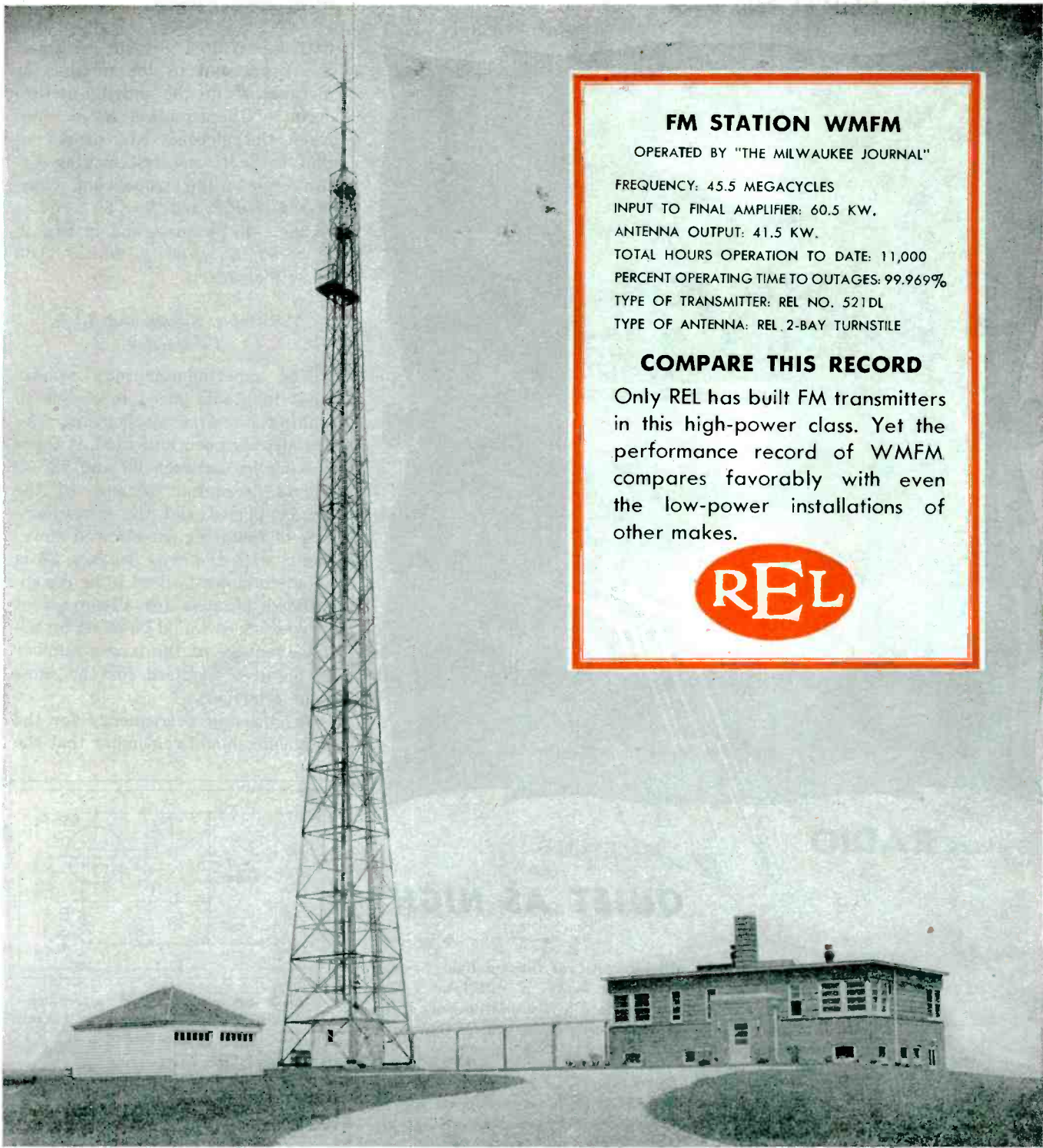

FM STATION WMFM

OPERATED BY "THE MILWAUKEE JOURNAL"

FREQUENCY: 45.5 MEGACYCLES

INPUT TO FINAL AMPLIFIER: 60.5 KW.

ANTENNA OUTPUT: 41.5 KW.

TOTAL HOURS OPERATION TO DATE: 11,000

PERCENT OPERATING TIME TO OUTAGES: 99.969%

TYPE OF TRANSMITTER: REL NO. 521DL

TYPE OF ANTENNA: REL 2-BAY TURNSTILE

COMPARE THIS RECORD

Only REL has built FM transmitters in this high-power class. Yet the performance record of WMFM compares favorably with even the low-power installations of other makes.



Station WMFM is under the management of Walter J. Damm, one of the pioneers of FM broadcasting. This transmitter operates in conjunction with *The Milwaukee Journal's* Radio City which ranks among the finest radio installations in this country.

The demonstrated dependability and efficiency of WMFM and many other REL transmitters definitely establishes the superiority of the Armstrong Phase Shift method of frequency modulation employed in REL transmitters of all power ratings.

Pioneer Manufacturers of FM Transmitters Employing Armstrong Phase-Shift Modulation

RADIO ENGINEERING LABS., INC.

Long Island City, N.Y.



POSTWAR RADIO

QUIET AS NIGHT

The radio the public will buy postwar must deliver Crystal Clear signal—as though heard across a still lake. The precision of Crystal Control is the foundation of radio which pours out of the speaker only those sounds that went into the microphone.

The cutting of Control Crystals, accurate to millionths of an inch, is an art Pan-El Labs have developed into a production operation, with consequent economy, and assurance of scheduled delivery.

Having produced Crystals to the most difficult wartime specifications, we can help you apply them to peacetime electronic uses.



PAN-ELectronic LABoratories, Inc.
500 SPRING STREET, N.W. • ATLANTA, GEORGIA

QUANTITY PRODUCERS OF STANDARD AND SPECIAL

Control Crystals

flashes is related to turntable speed S in rpm and to the number of pictures P in the moving-picture cycle by the equation $SP = 60f$, when the pictures are drawn so that there is one full moving-picture cycle on the strobogram. Thus, in Fig. 1, $P = 60f/S = 60 \times 60 \div 78.26 = 46$ pictures, and in Fig. 2, $P = 60f/S = 60 \times 20 \div 33.33 = 36$ pictures.

Turntable Speed and Light Frequency

The experimenter may wonder what turntable speed to choose in making his first strobogram. As has already been indicated, if there is a choice between 33 and 78, 33 should be chosen because of the longer period and the consequent ease of following the electron movements with the eye. In fact, 33 is about the lowest speed to be recommended, because any advantage of a lower speed would be offset by the disadvantage of the larger number of pictures required for the same light frequency.

In choosing a frequency for the light one should remember that the

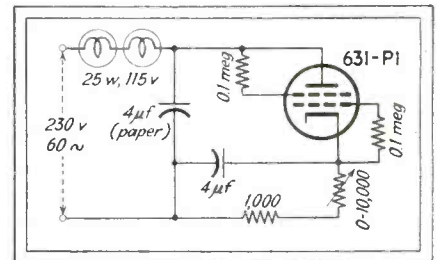

Fig. 3—Stroboscopic light source operates at the line frequency or a sub-harmonic thereof

higher the frequency, the greater the number of pictures that will be required. On the other hand the frequency should be at least 20 and preferably 30 flashes per second in order to avoid flicker. On this basis the 60 cps chosen for Fig. 1 would seem too high; however, at the time this figure was drawn, the author wanted a strobogram which would be useful in experimenting downward through a wide range of continuously varying speed and frequency without encountering the flickering effect.

If the reader follows the instructions given at the end of this article for constructing Fig. 1, he may

THE BLACK HAND OF CORROSION SHACKLED BY LUMARITH^{CA}*



For more effective electrical insulation— typical applications of Lumarith CA:

- Turn insulation for magnet wire
- Major coil insulation
- Coil lead insulation
- Boot and pad insulation
- Layer wound cores for coils
- Slot insulation
- Laminated to paper, cloth, mica, etc.
- Backing for pressure sensitive tape
- Spiral wound for cables and spun-end grommets

EXECUTIVES! Just published, 136 page manual entitled, "FABRICATING METHODS FOR LUMARITH^{CA}* CELLULOID* AND SIMILAR THERMOPLASTIC MATERIALS." Write for complimentary copy on your company letterhead. Additional copies, \$1.00 each.
*Reg. U. S. Pat. Off.

APPLICATIONS of Lumarith CA (cellulose acetate) to fine gauge copper wire—1 and 2 mil—stress the inherent advantages of this cellulosic base insulating material.

Here, where corrosion strikes quickest and hardest, Lumarith CA shows to the greatest advantage its freedom from the tendency to organic decomposition so inherent in many materials.

Rather, this synthetic by its very nature is chemically inert, for example, to transformer oil, and to the electrolytic action of humidity, moisture—even salt water in the presence of direct current.

The in-built dielectric strength and chemical resistance of Lumarith CA, and its physical resistance to abrasion, cracking, crease-breaks, is impressive even with the thinnest foil. Slippage in winding and usage is overcome by a special mat finish (A78) which also increases elongation, requires no lubricants.

Look into Lumarith CA for your electrical needs. In films, foils for winding, laminating. Spiral wound for light yet rugged tubing. Rods, sheets, regular tubes and molding materials. Send for the booklet, "Celanese Synthetics for the Electrical Industry." Celanese Plastics Corporation, a division of Celanese Corporation of America, 180 Madison Avenue, New York 16, N. Y.

A Celanese^{CA} Plastic

It takes more than planes to establish AIR CONTROL

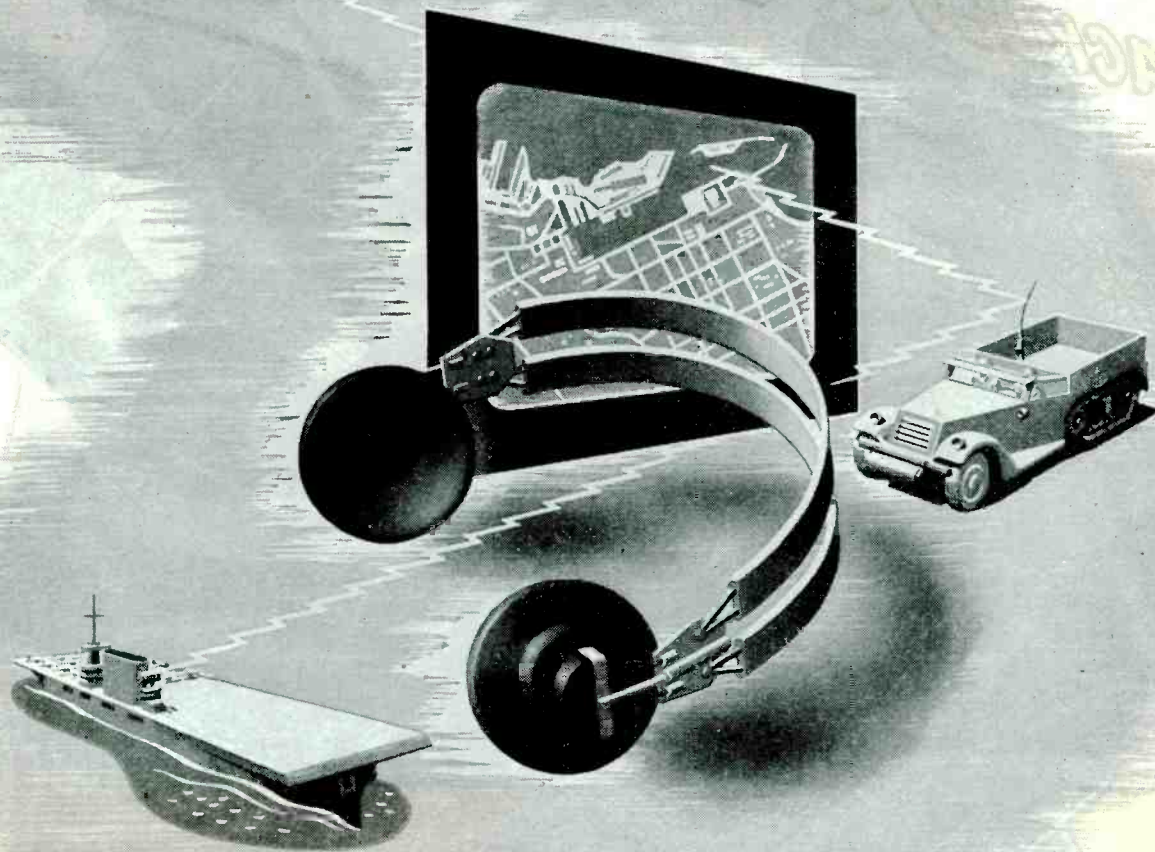

Allied fighters and bombers have established one type of air control. Another type, almost equally important, has been established by Allied radio equipment and electronic devices. For, through the effective application of high-frequency impulses, skilled technicians of the Army and Navy control communication channels—detect and locate enemy planes, ships and submarines—coordinate the movements of aircraft, ships and combat vehicles—direct artillery fire. Delco Radio Division has contributed materially to this air supremacy through the development and production of varied Delco Radio products, ranging from compact mobile radio sets to highly specialized radar equipment still masked in secrecy. Delco Radio Division, General Motors Corporation, Kokomo, Indiana.

Delco Radio
DIVISION OF
GENERAL MOTORS

Keep Buying War Bonds



**"I HAVE AN IMPORTANT ANNOUNCEMENT.
ALBION CAN SHIP ALL THE COILS YOU NEED."**

SUPER-QUALITY COILS AT REASONABLE PRICES

More and more every day, the industry is turning to Albion for fast, quality and quantity production of coils, chokes, and transformers. That's because here you benefit from the unbeatable combination of management "know how," skilled workmanship, streamlined facilities, and central location. Your requirements will be given prompt and thoughtful attention.

**ALBION
COIL COMPANY**

ALBION, ILLINOIS

R. F. AND TRANSMITTING COILS AND CHOKES;
I. F. TRANSFORMERS

save time and effort by omitting every other picture and using 30-cps light.

Stroboscopic Light Source

Those who wish to construct their own light sources may be interested in the circuit in Fig. 3. The two 25-watt lamps serve merely as resistors, and should be covered to prevent their light from interfering with the demonstrations. The type 631-P1 cold-cathode strobotron tube is the same as that used in the General Radio Strobotac.

The strobotron tube emits the flashes of light. The frequency can be made 60, 30, or 20 by adjusting the 10,000-ohm variable resistance. This arrangement has proven especially useful for obtaining subharmonics of the line frequency.

Electron Motion Theory

The brief outline of the theory of electron motion on transmission lines as printed here is from the point of view of the average technician or amateur. This same simple discussion is also presented to college students who have had the customary mathematical background and transmission line theory in order to strengthen their basic conception of the phenomena.

In Fig. 4 the rectangles represent shorted Lecher wires. The electrons are oscillating in a fixed pattern at a frequency such that the corresponding wavelength is equal to the length of the rectangles. The pictures *a*, *b*, *c*, and *d* show, in a very exaggerated fashion, the position of a few representative electrons at four instants during the cycle.

In picture *a*, the electrons have crowded around points 2 and 3, and have moved away from points 1 and 4. Therefore point 2 is negative in potential with respect to point 1 at this instant, and point 3 is negative with respect to point 4. In fact, the entire half wavelength of the lower left-hand wire centering about point 2 is negative with respect to the wire just above, although this difference of potential is greatest between points 1 and 2.

At this instant, all of the electrons are standing still. They have moved to their extreme positions,

NEW ALLOY OPENS ROAD TO IMPROVED DESIGNS

Chace Manganese Alloy No. 772 affords a unique combination of engineering properties that opens the way to many better-designed post-war products.

Briefly, those properties are: an electrical resistivity 60% higher than most commonly used alloys . . . a temperature coefficient of expansion higher than that of any other strong alloy . . . a thermal conductivity only 2% that of copper . . . such strength and ductility that it can readily be machined, stamped, drawn, flanged, or extruded.

Chace Alloy No. 772 is ideally suited for low temperature resistor applications . . . for the reduction of heat losses.

Chace Alloy No. 772 is being produced in sheets, strips and rods. Bulletin No. A-942—detailing physical properties and suggesting applications—is yours for the asking.

W.M. CHACE Co.
Manufacturers of
Thermostatic Bimetals and Special Alloys
1630 BEARD AVE • DETROIT 9, MICH.

NORELCO type 833A tubes undergoing static test—a check that is repeated on each tube after a 6-day holdover. Note mirror behind tube in rack, to show color of plate during test.



How Norelco Tubes Are Quality Controlled

THE ability of North American Philips to produce difficult tube types of consistently uniform characteristics, high performance and long life stems in part from rigid test methods that provide a constant check on manufacturing technique.

A case in point is the 833A transmitting triode, produced in quantity by North American Philips. These tubes are given both static and dynamic runs in special test racks designed by our engineers. Following a holdover period of 6 days, the static and dynamic tests are repeated to spot any deviations from specifications that may have developed during the hold-over period.

This exacting control over quality is one reason why NORELCO electronic tubes hold such high reputation for performance and serviceability—and reason enough why manufacturers look to North American Philips as a reliable source of electronic tubes for their postwar requirements.

Although all the tubes we produce now go to the armed forces, we invite inquiries from prospective users. A list of the tube types we are especially equipped to produce will be sent on request.

Write today for interesting booklet describing the background of North American Philips in the science of electronics.

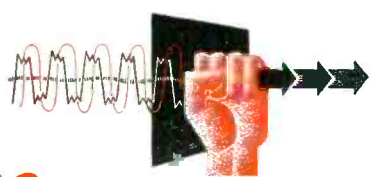

Norelco REG. U.S. PAT. OFF. Electronic Products by

NORELCO PRODUCTS: Quartz Oscillator Plates; Amplifier, Transmitting, Rectifier and Cathode Ray Tubes; Searchray (Industrial X-ray) Apparatus; X-ray Diffraction Apparatus; Medical X-ray Equipment, Tubes and Accessories; Tungsten and Molybdenum products; Fine Wire; Diamond Dies. • We invite you to visit our office and showroom when in New York City

NORTH AMERICAN PHILIPS COMPANY, INC.

Dept. C-6, 100 East 42nd Street, New York 17, N. Y.
Factories in Dobbs Ferry, N. Y.; Mount Vernon, N. Y. (Metalix Div.); Lewiston, Me. (Elmet Div.)

WHISTLER SINGLE HOLE PERFORATOR

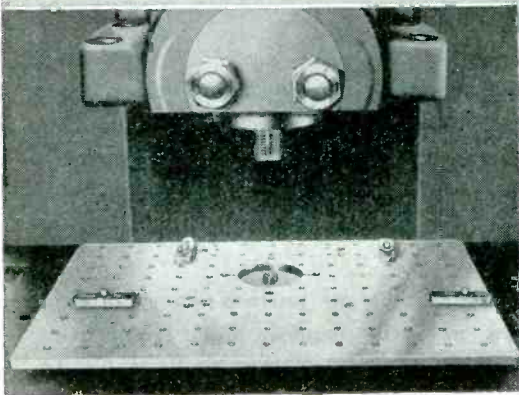
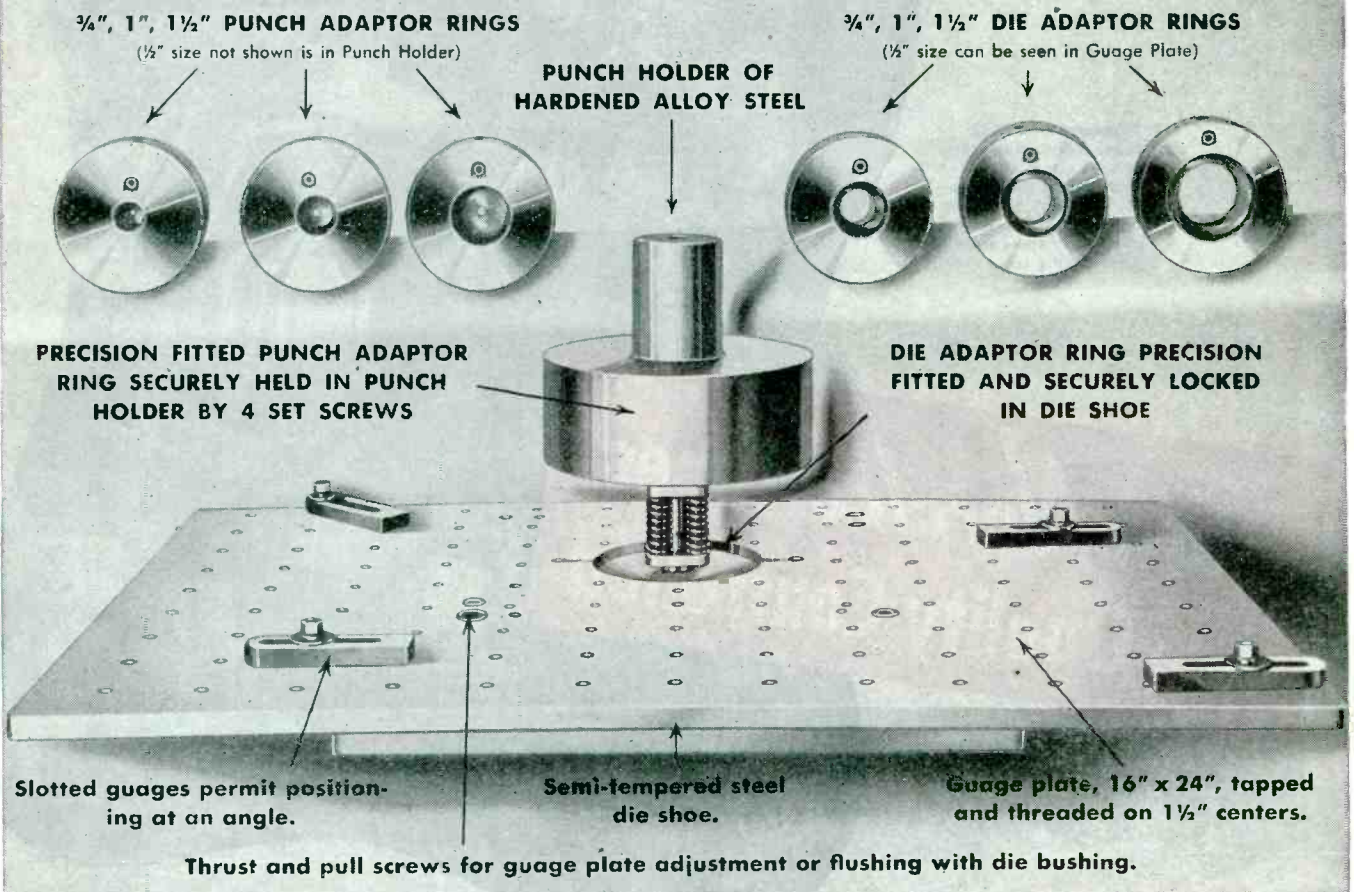

Shown above is the U-5015 Whistler Single Hole Perforator Set complete and at the left, the set on the press ready for production—the answer to quick and economical handling of many perforating jobs. It takes but a few minutes to bolt in the punch holder and position the gauge plate and die shoe which are set on the press as a single unit. Punch and die adaptor rings of the four sizes are changed instantly by loosening then tightening two set screws. The same procedure is followed for changing sizes of punches and dies. Absolute precision is assured. Punches, dies and

strippers are extra. Shipped within a few days in standard sizes from 1/2" to 1 1/2" in round, square, oval and rectangle shapes for perforating materials to 1/4" thick mild steel. Operating satisfaction is guaranteed by Whistler's 28 years of experience in the manufacturing of production perforating equipment. Whistler Single Hole Perforator Unit complete F. O. B. Buffalo **\$465**

S. B. WHISTLER & SONS, Inc. 752-756 Military Road, Buffalo 17, N. Y.
REPRESENTATIVES IN ALL PRINCIPAL CITIES

Get in touch with **WHISTLER** for all types of sheet metal dies!

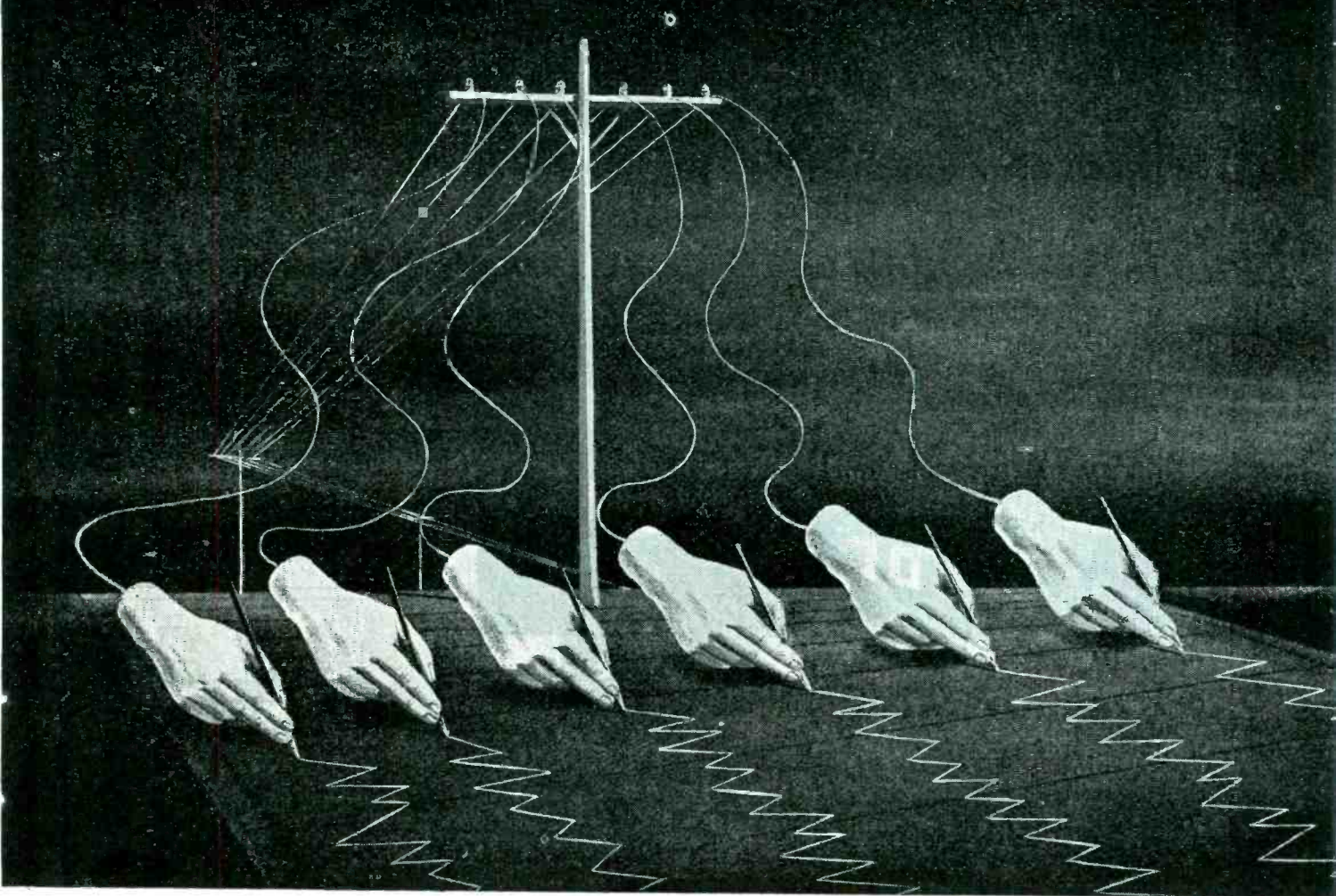

WRITE WITH LIGHT

For recording dynamic strains and vibrations of *aircraft in flight*, we offer an extremely sensitive and accurate six channel Oscillograph, weighing less than 20 lbs., exclusive of battery, occupying less than $\frac{2}{3}$ of a cubic foot of space and selling for only \$1500. Operates from its own or the plane battery. Sensitivity is such that many dynamic strains and vibrations can be recorded directly without amplification. Takes hundred foot roll of paper 2" wide operating at one fixed speed, 3, 6 or 12 inches per second.

Write for further details—Type A401 R.

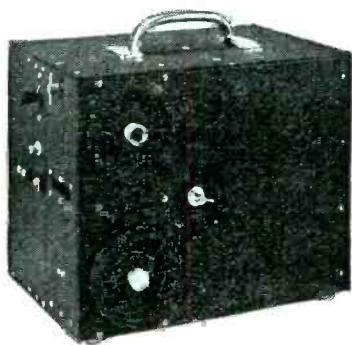

Type A401 R-6 with Battery Case.

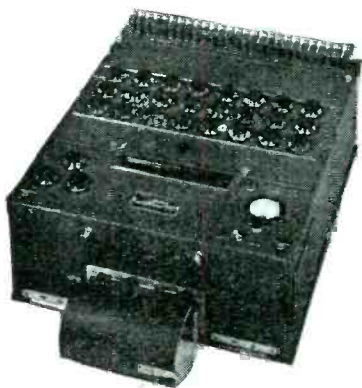

Type S-8-A, B, C: 6, 12, 24 channels
(24 channels illustrated above)
Also S-12-A: 12 channels, portable
5-101-A: 14 channels, portable

WAUGH

Laboratories



Write for Rental
List and Service
Manual on busi-
ness letterhead.

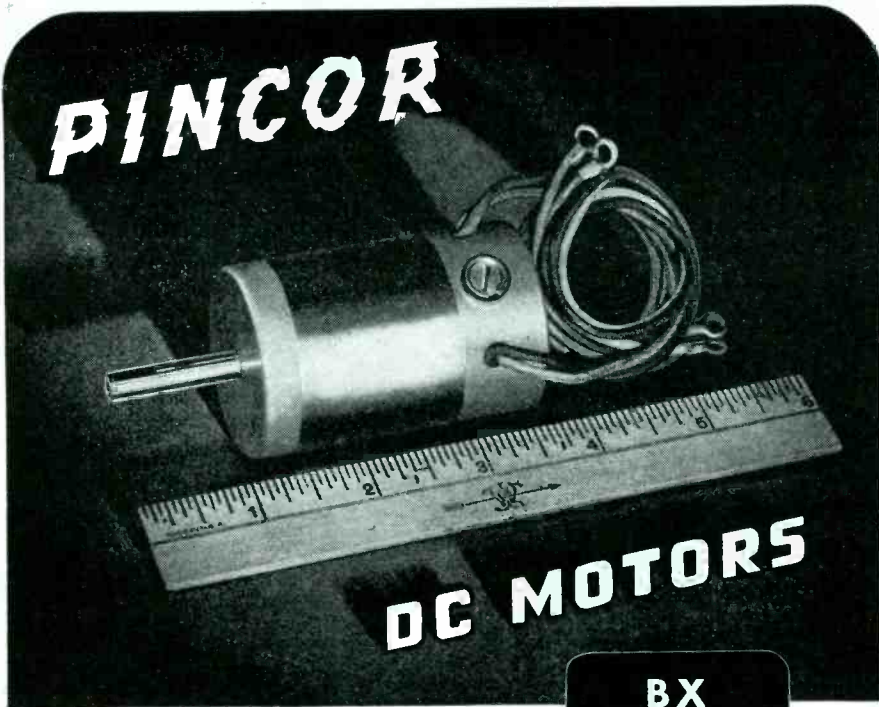

**BX
SERIES**

The urgent demand, in peacetime days, by the aircraft and radio industries for a compact, efficient D.C. motor was the challenge that led Pioneer to develop the Pincor BX series. Today Pincor BX motors flow from our plant in a steady stream to the producers of aircraft and radio equipment for the armed services.

Pincor BX motors, in their classification, meet the varied requirements of aircraft and radio manufacturers that demand light weight, compact motors for efficient and dependable application. Pincor BX motors are direct drive, ball bearing, high speed units wound for continuous or intermittent duty. Shunt, series or split series windings are for operation on 12 to 24 volt battery systems currently used and may be easily modified to meet your product demand.

Depend on these rugged Pincor quality-proven motors in the BX series. Send your problem to Pioneer engineers and let them put their years of experience to work for you. Consultation with these men will not obligate you in the least.

DYNAMOTORS • CONVERTERS
GENERATORS
POWER PLANTS • GEN-E-MOTORS

PINCOR
Products

**PIONEER GEN-E-MOTOR
CORPORATION**

5841-49 DICKENS AVENUE CHICAGO 39, ILLINOIS

BUY MORE BONDS!

Export Office, 25 Warren Street, New York 7, U.S.A.
Cable Address: Simontrice, N. Y.

are now stopped, and will immediately start back toward the opposite extreme shown in picture *c*, where the relative polarities of the charges along the wires have all reversed.

At both time *a* and time *c* there is zero electron motion everywhere, hence zero current everywhere, but there is a maximum of potential difference.

Halfway between the times of pictures *a* and *c* lies time of picture *b* where the electrons are moving rapidly and there is more current than at any other time. This current reaches its maximum at points 5, 6, 7, and 8. These facts will be apparent after a brief examination

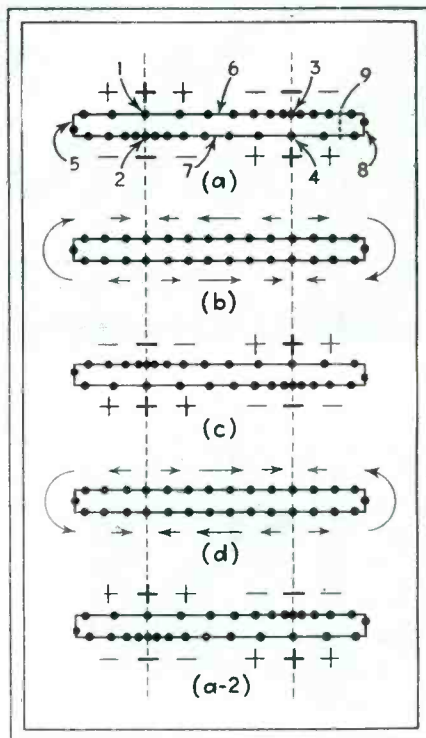
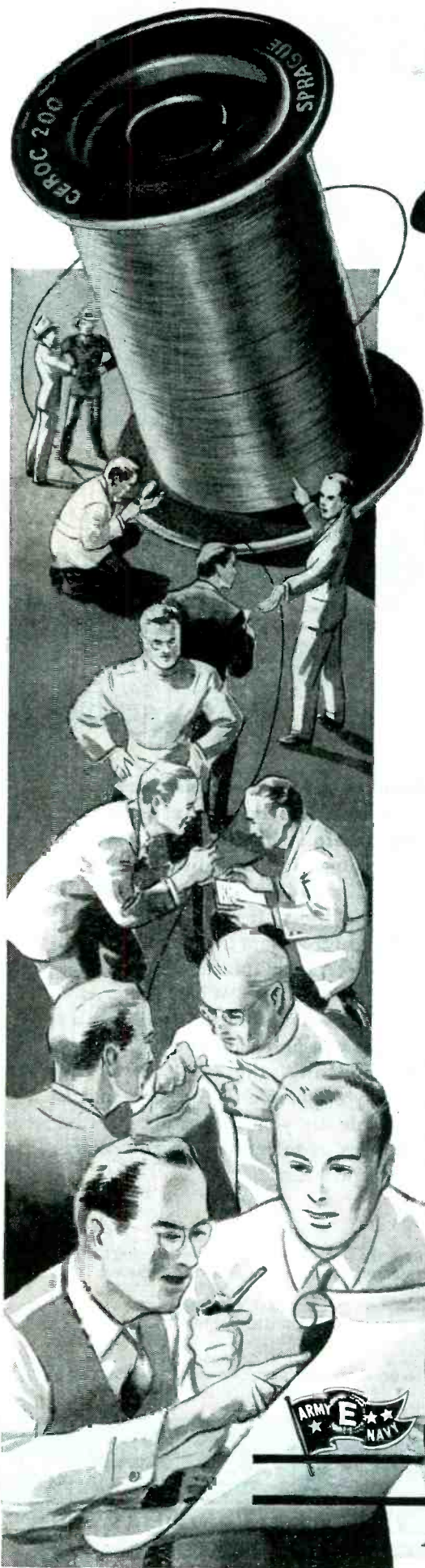

Fig. 4—Electron positions shown at quarter-cycle intervals illustrate the information that can be demonstrated by a strobogram

of the electrons moving on the strobogram. Observe that the single electrons at points 1, 2, 3, and 4 never move. Thus there is never any current at these points, which are $\frac{1}{4}$ wavelengths from the shorted ends of the wires.

In picture *b* the electrons are evenly distributed, hence there are no potential differences anywhere at this instant, the current being at its maximum and therefore having zero rate of change. The same is true in picture *d*, where the elec-



Exclusively

FOR ENGINEERS WHO ARE LOOKING AHEAD!

Where and How Might this Class C High-Temperature Wire Insulation Fit into Your New Product Planning?

Sprague *CEROC 200 is an inorganic wire insulation having outstanding space factor and high-temperature advantages:

- Applied to copper, nickel, or other types of wire, it permits continuous operation at 200°C.
- Wound in coils, the thermal conductivity of *CEROC insulated wire is such that it does not develop hot spots to a point of nullifying much of the high-temperature gain which might otherwise be expected.
- *CEROC 200 has an exceptionally high space factor as the ceramic coating is only one quarter of a mil thick and is uniform for all wire sizes.

Sprague *CEROC 200 is by no means a new or untried development. Pioneered and perfected by Sprague several years ago, it has been supplied exclusively and in large quantities for war applications. Its *proved* advantages are these:

- Substantial volt-ampere rating increases can be obtained.
- Thimble-size coils can be wound to do spool-size coil jobs.
- Throughout the entire field of insulated wire wound electrical devices, countless opportunities exist for re-designing and re-rating products for greater efficiency in smaller sizes and at higher temperature operation.

Wire insulated with *CEROC 200 can normally be supplied in sizes to meet almost any coil, transformer, or motor need. Although practically 100% of the present greatly expanded production is still going for war uses, samples of several popular sizes are available in "engineering" quantities. These represent a real opportunity to those who recognize the tremendous design advantages inherent in this unique insulation development, and who seek to test it, not so much for existing products but in relation to entirely new or re-designed products that look to the future.

Write today for copy of *CEROC 200 Bulletin 505

SPRAGUE ELECTRIC COMPANY
NORTH ADAMS, MASSACHUSETTS

SPRAGUE

PIONEERS IN ELECTRIC-ELECTRONIC PROGRESS

*Trademark Reg. U. S. Pat. Office

**CONTINENTAL
DIAMOND
ENGINEERED**

Plastic Materials

The part illustrated is an airborne radio insulating part . . . made from grade "L" DILECTO . . . a laminated phenolic plastic. It was sawed, milled, drilled, countersunk and tapped. Tolerance requirements were close. DILECTO parts such as this one will be widely used in all branches of air transportation.

Here is a strong, tough plastic . . . with high electrical insulating properties that remain stable under extremes of temperature and humidity. DILECTO is readily fabricated on ordinary metal working tools. It is NON-corrosive and highly resistant to many chemicals.

This versatile plastic may be the answer to your "What Material?" problem. C-D technicians will be glad to help you find out. Their wealth of "Know-How," the result of a half century of service to industry, makes available to you thousands of case histories of solved design and operational problems.

KG-45

C-D PRODUCTS

The Plastics

DILECTO—A Laminated Phenolic.
CELORON—A Molded Phenolic.

DILECTENE—A Pure Resin Plastic Especially Suited to U-H-F Insulation.

HAVEG—Plastic Chemical Equipment, Pipe, Valves and Fittings.

The NON-Metallics

DIAMOND Vulcanized FIBRE
VULCOID—Resin Impregnated Vulcanized Fibre.

MICABOND—Built-Up Mica Electrical Insulation.

Standard and Special Forms

Available in Standard Sheets, Rods and Tubes; and Parts Fabricated, Formed or Molded to Specifications.

Descriptive Literature

Bulletin GF gives Comprehensive Data on all C-D Products. Individual Catalogs are also Available.

Continental - Diamond FIBRE COMPANY

Established 1895.. Manufacturers of Laminated Plastics since 1911—NEWARK 16 • DELAWARE

New **ELCO**
A1-F RESISTOR
38,500 OHMS

its **FUNGUSIZED!**

Temperature coefficient is such that a minus 50° centigrade change in temperature from plus 22° centigrade will produce no greater than plus .01% change in resistance.

A1-F—15/32 long x 1/2" diameter. Mountable with 6-32 flat or filester screw No. 21 Tinned Copper wire leads. 1% standard accuracy. Non-inductive pie wound—1/2 watt, 200 D.C. maximum operating voltage. Fungusized varnish finish.

CAN ALSO BE MADE IN OTHER SIZES
 ACCORDING TO YOUR SPECIFICATIONS

ALL ELCO RESISTORS ARE PRECISION WIRE-WOUND

SPECIFICATIONS:

"A-1"—15/32 long x 1/2" dia.—Mountable with 6-32 flat or filester screw. No. 21 tinned copper wire leads. 1 to 300,000 ohm value—1/2% standard accuracy—non inductive pie wound—1/2 watt, 30° C. temperature rise in free air—100° C. maximum operating temperature—200 D. C. maximum operating voltage. Baked varnish finish.

"A-R"—Same as A-1, with leads reversed.

"B-1"—15/16 long x 1/2" dia.—Mountable with 6-32 flat or filester screw. No. 21 tinned copper wire leads. 1 to 500,000 ohm value—1/2% standard accuracy—non inductive pie wound—1 watt, 30° C. temperature rise in free air—100° C. maximum operating temperature—300 D. C. maximum operating voltage. Baked varnish finish.

"M"—1-13/32 long x 1/4" dia.—Mountable with 6-32 screw—1/4 x .015 thick strap terminals—non inductive wound—1 meg ohm maximum resistance—600 volts maximum operating voltage—100° C. maximum operating temperature—1.5 watts—1% normal accuracy. Baked varnish finish.

"G"—15/32 long x 1/2" dia.—Mountable with 6-32 flat or filester head screw. No. 21 tinned copper wire leads. 1 to 500,000 ohm value. 1/2% standard accuracy—non inductive pie wound .8 watts, 30° temperature rise in free air. 100° C. maximum operating temperature. 200 D. C. maximum operating voltage. Baked varnish finish.

"B-R"—Same as B-1, with leads reversed.

PROMPT DELIVERIES
 on the New A1-F
 and others described
 and illustrated

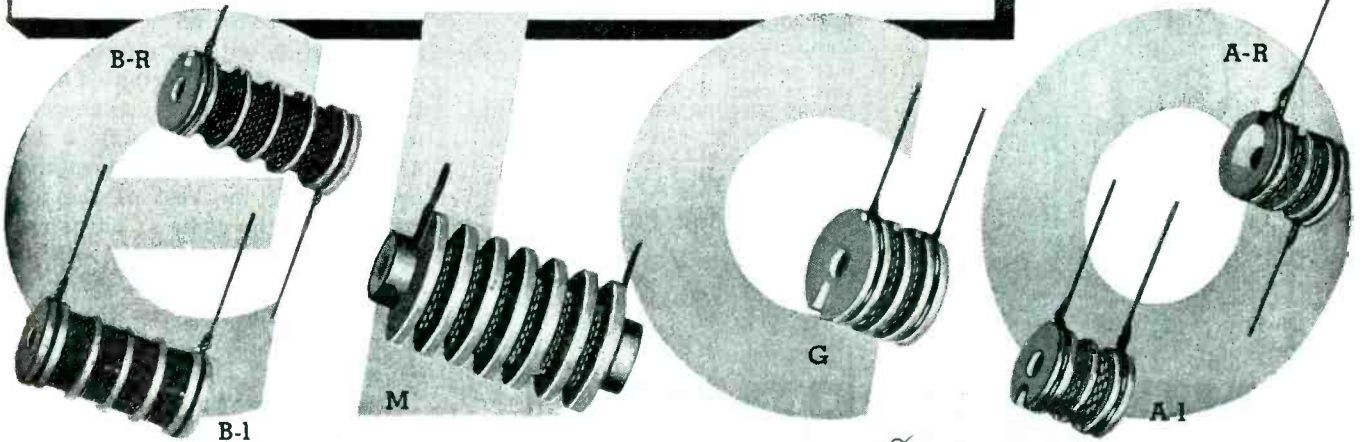

Get to know

ELCO

RESISTORS COMPANY

114 West 18th Street, New York, N. Y.

Telephone - Watkins 9-4774-5

NEW ANGLE CORRECTION CRYSTAL EDGING MACHINE

CORRECTS "X" AXIS IN MINUTES OF A
DEGREE TO MEET SIGNAL CORPS SPECIFICATIONS

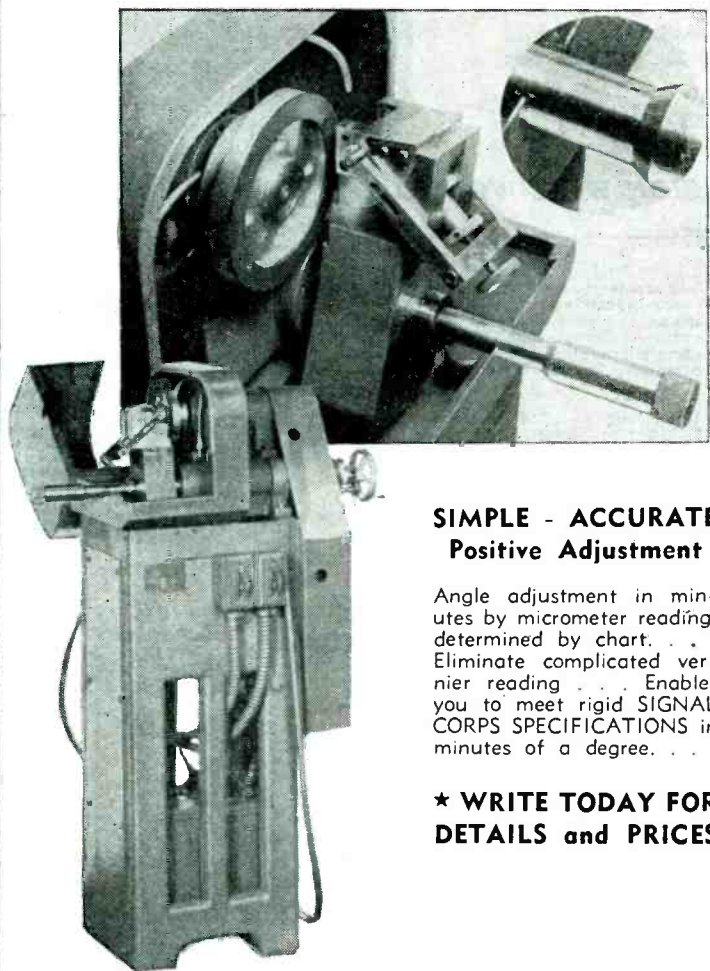

SIMPLE - ACCURATE Positive Adjustment

Angle adjustment in minutes by micrometer reading, determined by chart. . . .
Eliminate complicated vernier reading Enables you to meet rigid SIGNAL CORPS SPECIFICATIONS in minutes of a degree. . . .

*** WRITE TODAY FOR
DETAILS and PRICES**

VOLKEL BROS. MACHINE WORKS

1943 West Manchester - Los Angeles 44, Calif.

Designers and Manufacturers of
SPECIAL DEVICES & EQUIPMENT

trons are halfway back from the condition of picture *c* to the condition of picture *a*. Moreover, it may be seen that in all pictures the average electron density near points 5, 6, 7, and 8 is always the same, hence there is never any potential difference between these points.

Line Impedance

Similarly the impedance at a point along the line can be analyzed. If we break into the line at section 9 of picture *a* in Fig. 4 and look toward the *right*, we see a negative potential on the upper wire with respect to the lower one. At the same place one quarter cycle later, shown in picture *b*, we find a current of electrons flowing into the upper wire and out of the lower one, but no voltage. Thus the current here lags the potential by one quarter cycle; this is the behavior of an inductance.

This behavior is exhibited to greater or lesser extent everywhere between section 3-4 and point 8 and also between sections 1-2 and 6-7, still looking toward the right. By a similar analysis, it can be shown that the behavior in the remaining sections of the line, again looking toward the right, is that of a capacitance.

Furthermore, we can draw conclusions about open-ended lines by reasoning that the right end of this line can be broken off at section 3-4 and removed, without affecting the current or voltage distributed along the rest of the line, since there is never any current at points 3 and 4. The inductive or capacitance properties of the rest of the line will remain the same at all points, and each of these points will be one quarter wavelength closer to the end of the line, but this time the end will be open instead of shorted.

This picture can be shown by means of the strobogram if a card is held over the right-hand quarter section of the line.

Graphical Construction

The procedure used in constructing a strobogram such as that shown in Fig. 1 is first to draw the circle of equally spaced, identical rectangles, 46 of them in this case,

± OR ± QUALITY

It's not wise to think that all Steatite Ceramic Insulators are

equivalent in quality. From selection of materials through the processes of mixing, extrusion or stamping; on through the kiln to final inspection, the production of a high grade Steatite Insulator requires experience, skill, modern tools and machinery, plus the KNOWHOW that comes from extensive research and development.

Inferior Steatite Insulators may be produced. They may be porous or underkilned or overkilned.

Backed by 43 years of Ceramic Leadership, constant research and development, highly trained workers, the most modern machinery and production methods, ALSIMAG has fully earned its reputation as "Tops Among the Steatites". Whatever you are planning in the electrical or electronic field, we believe our specialized knowledge will be helpful.

Let's work together.

AMERICAN LAVA CORPORATION
CHATTANOOGA 5, TENNESSEE

43RD YEAR OF CERAMIC LEADERSHIP

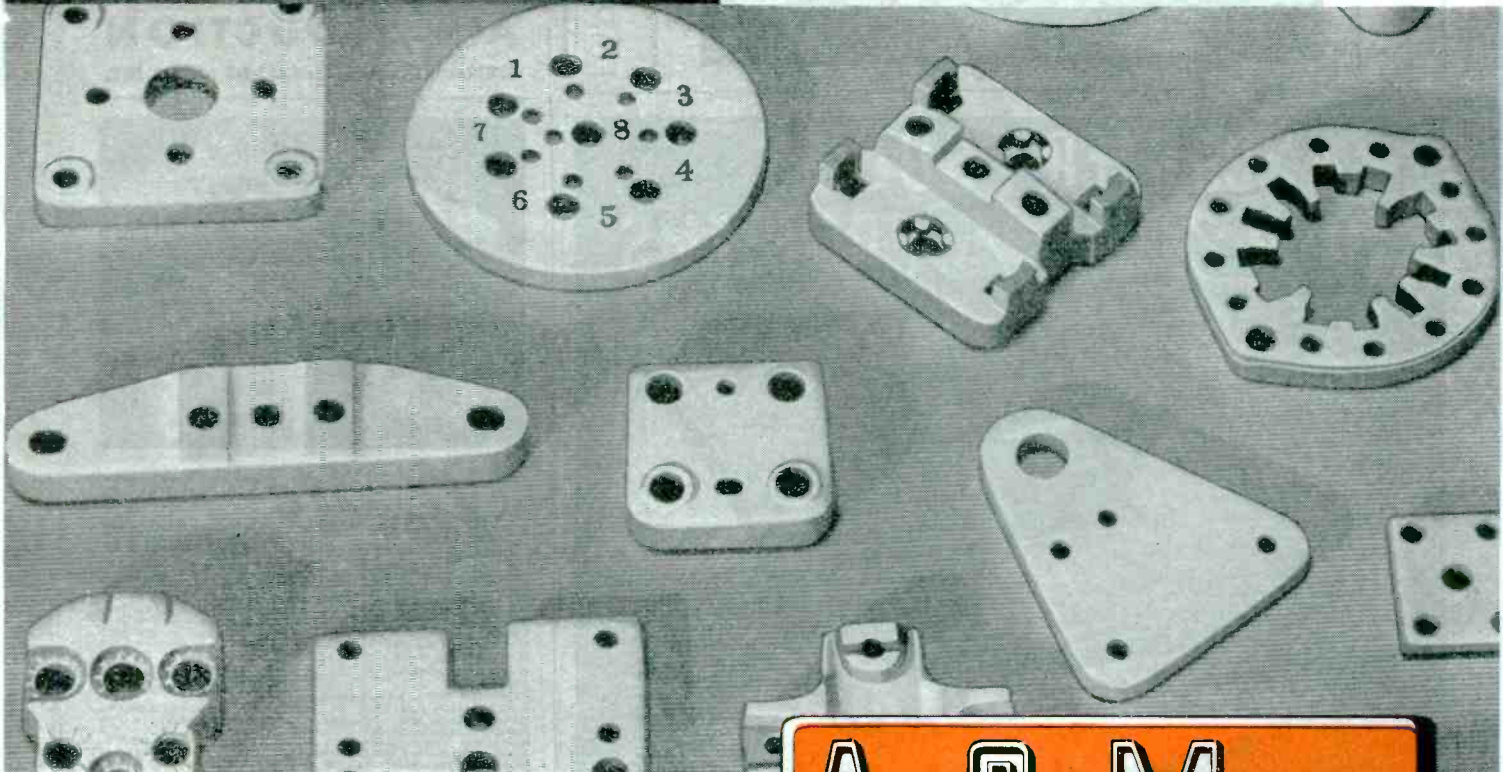
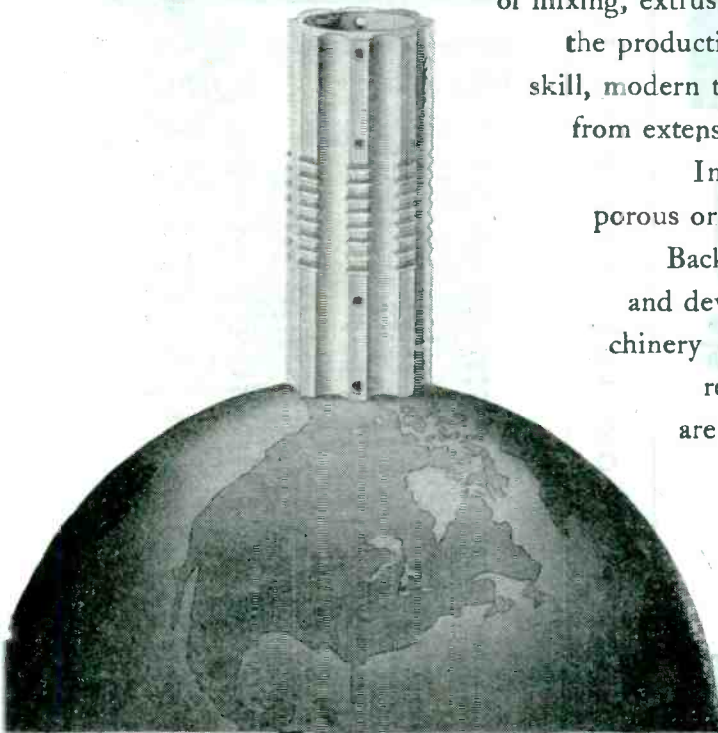

CHARACTERISTICS OF ALSiMAG STEATITE INSULATORS

- Permanent Rigidity
- Cannot Char
- Resistant to Thermal Shock
- Resistant to High Temperatures
- High Mechanical Strength
- Low-Loss
- Does Not Absorb Moisture
- Chemically Inert

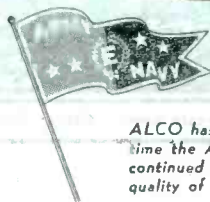

TOPS IN STEATITE CERAMICS

ALCO has been awarded for the fifth time the Army-Navy "E" Award for continued excellence in quantity and quality of essential war production.

BACK THE INVASION — BUY MORE BONDS NOW!

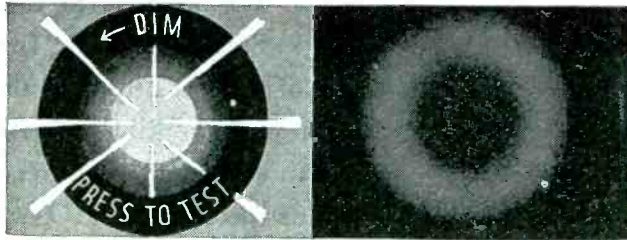

CORRECT LIGHT... DAY or NIGHT ... CORRECT LIGHT

DIALCO "Vari-Dim" PILOT LIGHT #V.M.400

5 DISTINCTIVE FEATURES:—In daytime this unit emits concentrated penetrating light which is visible thru surrounding brightness . . . A turn of the knurled head produces soft diffused light which is ideal for night operation. No effect on operator's vision . . . Field of visibility is a full 150°, 60° more than required minimum . . . Press-to-test — light finger-tip pressure actuates the bulb testing circuit . . . Accommodates screw-base or bayonet base bulbs which can be quickly discharged by finger-tip pressure . . . Assemblies supplied complete with required lamps. Consult us about your problem.

Write for Catalogue



DIAL LIGHT CO. of America, Inc.

900 BROADWAY • NEW YORK 3, N. Y.

Telephone: ALgonquin 4-5180-1-2-3

BACK THE INVASION — BUY MORE BONDS NOW!

**AIRCO ARGON • NEON • HELIUM
XENON • KRYPTON**
Standard and Special Mixtures

Nationwide Distribution through
AIRCO offices

ATLANTA 2, GA.
680 Hamilton Ave., S.E.
(P. O. Box 4176)
BALTIMORE 2, MD.
1310 N. Calvert St.
BIRMINGHAM 3, ALA.
124 So. 16th St.
(P. O. Box 2583)
BOSTON 25, MASS.
122 Mt. Vernon St.
Upham's Corner
BUFFALO 13, N. Y.
730 Grant St.
CHARLOTTE 1, N. C.
Post and McNinch Sts.
(P. O. Box 1147)
CHICAGO 4, ILL.
332 So. Michigan Ave.
Room 604
CINCINNATI 3, OHIO
934 Kenyon Ave.
CLEVELAND 2, OHIO
1112 Williamson Bldg.
DAYTON 1, OHIO
Springboro Pike at
Sellers Road
(P. O. Box 923)
DETROIT 11, MICH.
7991 Hartwick St.
KANSAS CITY 8, MO.
2701 Warwick Trfway
LOS ANGELES 11, CAL.
2423 E. 58th St.
LOUISVILLE 1, KY.
1256 Logan St.
MILWAUKEE 5, WISC.
818 W. Winnebago St.
MINNEAPOLIS 2, MINN.
1111 Nicollet Ave.

NEW ORLEANS 2, LA.
1406 S. Rendon St.
NEW YORK 17, N. Y.
60 East 42nd St.
OKLAHOMA CITY 8,
1521 S. Agnew
(P. O. Box 2457)
PHILADELPHIA 40, PA.
Allegheny Ave. & 17 St.
PITTSBURGH 12, PA.
1116 Ridge Av., N. Side
PORTLAND 10, ORE.
2949 N.W. Front Ave.
RICHMOND 1, VA.
(P. O. Box 1192)
SAN FRANCISCO, CAL.
1280 45th St.
Emeryville 8, Calif.
SEATTLE 4, WASH.
3623 E. Marginal Way
SHREVEPORT, LA.
St. Vincent Ave.
Cedar Grove Station
(P. O. Box 763)
ST. LOUIS 2, MO.
630 So. Second St.
WHEELING, W. VA.
94 - 29th St.
Magnolia Airco Offices
EL PASO, TEXAS
Old Fort Bliss Road
(P. O. Box 64)
HOUSTON 1, TEXAS
2405 Collingsworth Ave.
(P. O. Box 319)
FORT WORTH 1, TEXAS
801 N. Throckmorton
(P. O. Box 996)



AIR REDUCTION

GENERAL OFFICE: 60 E. 42d ST., NEW YORK 17, N.Y.

CARTER SOLVES YOUR *Dynamotor* PROBLEMS

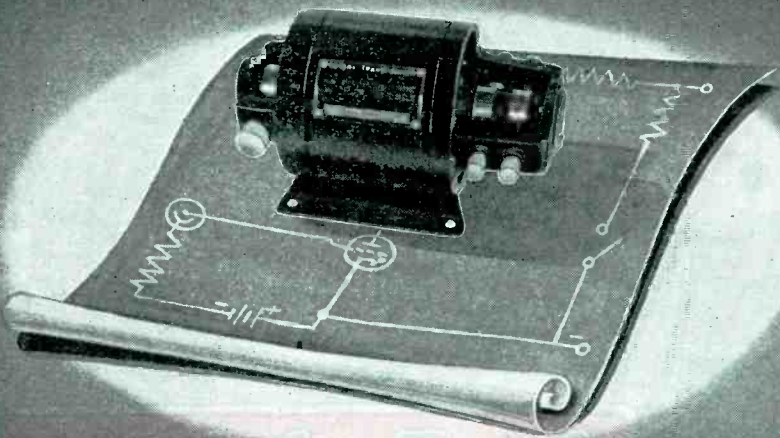

For many years, Carter Dynamotors have been a familiar part of the specifications of leading Communication Equipment Manufacturers, Police Departments, Government Agencies, etc. May we suggest you submit your Dynamotor requirements too, and see for yourself the reason for this recognized preference.

The latest catalog of Carter Dynamotors, Converters, Permanent Magnet Generators and Dynamotors, and special rotary equipment will be sent upon request.

Carter Motor Co.
Chicago, Illinois

1606 Milwaukee Ave. Carter, a well known name in radio for over twenty years. Cable: Genemotor

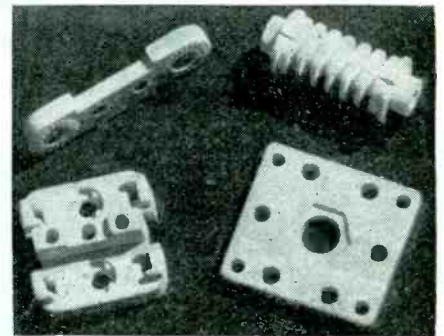

Lavite STEATITE CERAMIC

Properties and Characteristics of Our
LAVITE SI-5 Steatite Ceramic Body

Compressive Strength	95,000 lbs. per square inch	
Tensile Strength	7,200 lbs. per square inch	
Flexural Strength	10,500 lbs. per square inch	
Modulus of Rupture	20,000 lbs. per square inch	
Dielectric Strength	235 volts per mil	
Dielectric Constant	6.42	} Frequency of Loss Factor
Power Factor	2.90	
Bulk Specific Gravity	2.864%	
Density (from above gravity)	0.096 lbs. per cubic inch	
Hardness (Mohr scale)	7.0	
Softening Temperature	2,350°F	
Linear Coefficient of Expansion	8.13x10 ⁻⁶	
Moisture Absorption (ASTM D-116-42-A)	0.009%	

Makers of electrical and radio apparatus destined for war service are finding in LAVITE the precise qualities called for in their specifications . . . high compressive and dielectric strength, low moisture absorption and resistance to rot, fumes, acids, and high heat. The exceedingly low loss-factor of LAVITE plus its excellent workability makes it ideal for all high frequency applications.

We will gladly supply samples for testing.

D. M. STEWARD MFG. COMPANY

Main Office & Works: Chattanooga, Tenn.
Needham, Mass. Chicago Los Angeles

**"precision
control"**

*in electronic equipment
is a certainty with the*

CETRON CE-309 TUBE



Send Quickmail Coupon
No. 34 for catalog of
our COMPLETE LINE
of Rectifiers . . . Photo-
tubes . . . Electronic
Tubes.

Wherever precision control is of prime importance in electronic devices, this CE-309 Thyatron will serve capably and efficiently. It is a mercury vapor filled rectifier designed especially for exceptional service in such operations as handling primary currents of small resistance welders, motor control, etc. It is quick starting, averaging 5 seconds heating time . . . conservatively rated for 2000 hours . . . in every way a tube that reflects Cetron quality engineering and our thorough understanding of the needs and problems of tubes for industrial use.

CONTINENTAL ELECTRIC CO. *Geneva, Ill.*

CHICAGO OFFICE: 903 MERCHANDISE MART • NEW YORK OFFICE: 265 W. 14TH STREET

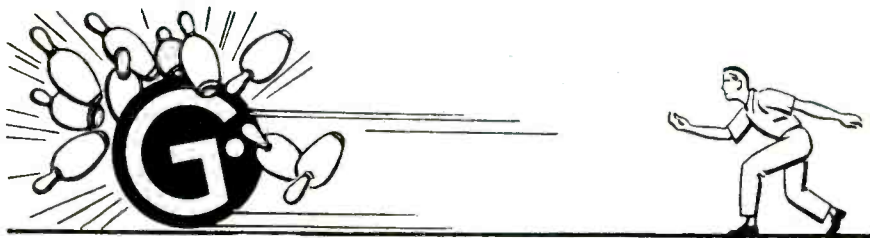

WE'RE BOWLING THEM OVER

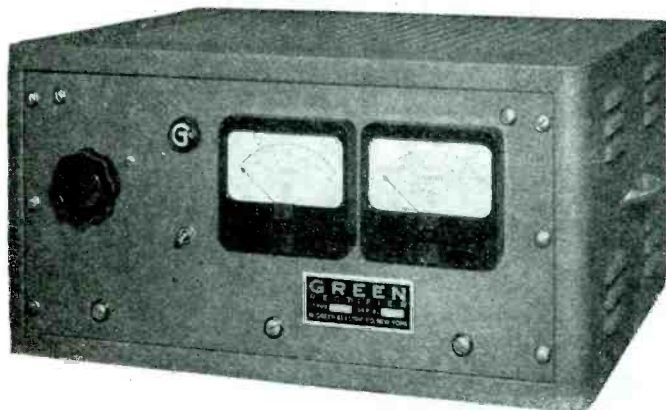

That refers to engineers who have special applications for D.C. power and find that we can design and build **anything** they need.

Metal plate or tubes—high voltage or low—high current or low—filtered or unfiltered—anything that calls for rectifier power is right down our alley.

Talk to Green Electric or to their representatives.

BRUJAC ELECTRONIC CORP.
11 Park Place
New York 7, N. Y.

MUNNING & MUNNING INC.
202 Emmett Street
Newark 5, N. J.

A. J. LYNCH & COMPANY
2424 Enterprise Street
Los Angeles 21, California

**CROWN RHEOSTAT
& SUPPLY COMPANY**
1910 Maypole Avenue
Chicago 12, Illinois

"Rectifier Engineering is our Business"

If you're knitting your brow about DC power, present or post-war, put your problem in the lap of a friendly Green engineer.



SELENIUM • ARGON • MERCURY VAPOR • GRID CONTROL • HIGH VACUUM • XENON

W. GREEN ELECTRIC COMPANY, INC.

SELECTRO PLATERS, AND ALL TYPES OF RECTIFIER EQUIPMENT

GREEN EXCHANGE BUILDING 150 CEDAR STREET NEW YORK 6, N. Y.

RECTIFIER  ENGINEERS

numbered counter-clockwise. The length of each rectangle should be 70 units and the width about 5 units on some convenient scale.

Next, make the drawing shown in Fig. 5. Start with line A, making the solid portion of it 70 units long. Draw lines M and N, perpendicular to A and crossing it 17.5 units from the ends, leaving 35 units between these lines.

Draw the circular arc with some point on A as a center and using

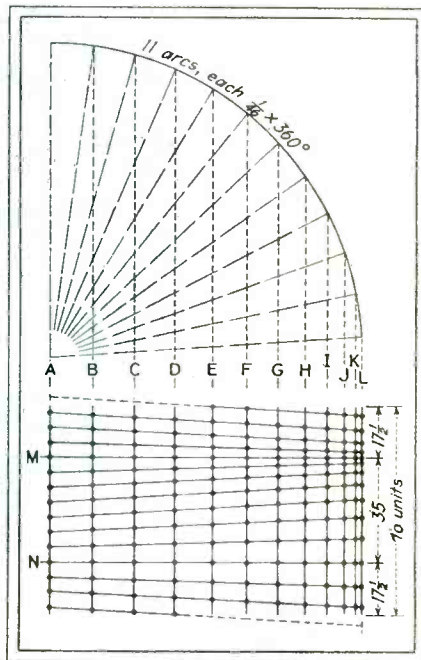

Fig. 5—Graphical construction is used to locate electrons along lines A to L from which the strobogram of Fig. 1 is drawn

any convenient radius. Unfortunately 46 divided by 4 gives a mixed number, therefore take the first whole number less than that value, namely 11. Starting at line A, mark off 11 arcs each $1/46$ of a complete circle. (The pattern for Fig. 2 was made by taking 9 arcs each $1/36$ of a circle.) Then through the endpoints of these arcs, draw the dotted lines B through L parallel to A. Solidify the portions of these lines up to 17.5 units outside of their intersections with M and N. On the last line, L, lay off lengths of 2, 3, 4, 5, 6, 7, and 8 units working away from M, in either direction, or 8, 7, 6, 5, 4, 3, and 2 units working away from N.

Note that these numbers add to 35. They were selected after some trial to give the desired visual effect in the final picture. However,

Eastern Air Devices Announces

another new

400 cycle

blower unit

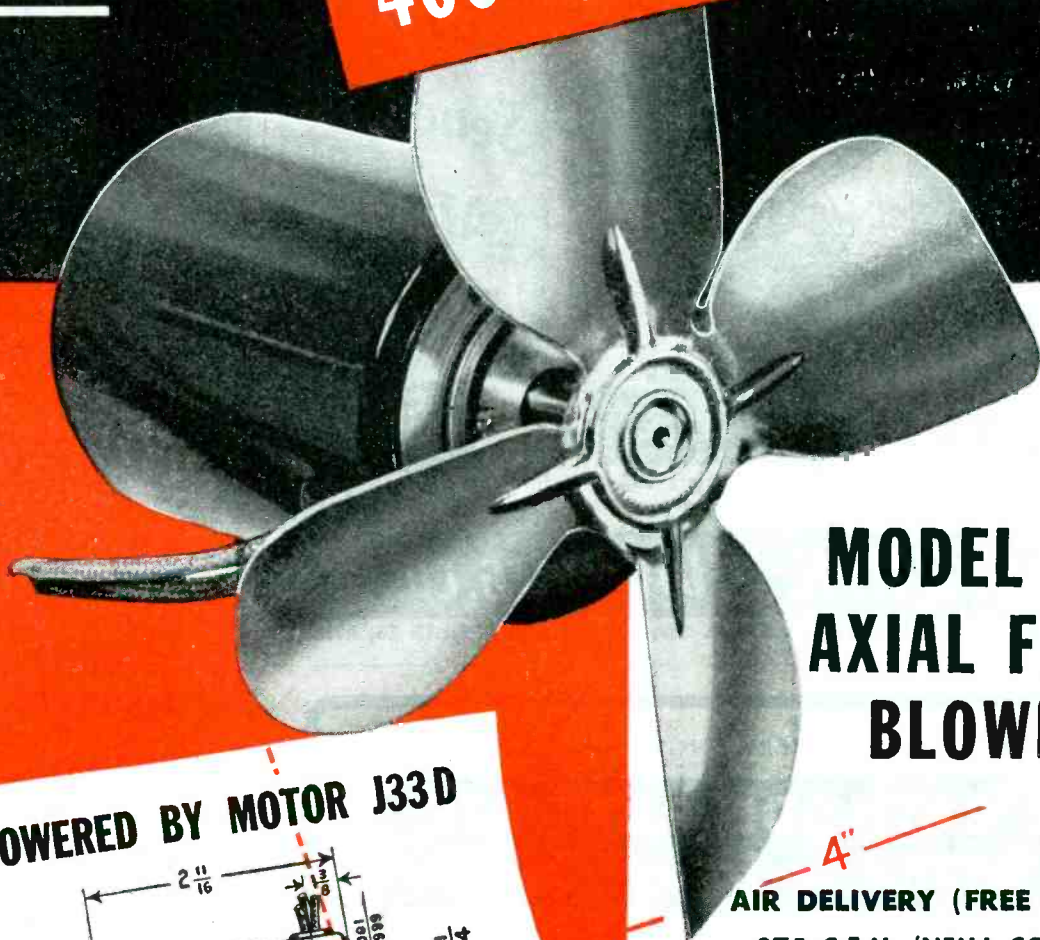

MODEL J81 AXIAL FLOW BLOWER →

POWERED BY MOTOR J33D

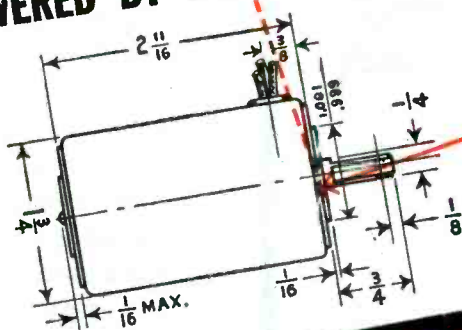

SINGLE PHASE

CAPACITOR INDUCTION MOTOR

1/50 H.P. • 400 cycles • 115 volts • 0.02 rated H.P.
6500 R.P.M. • Continuous duty as axial fan drive.
Intermittent duty for general use • starting torque 2.25
oz. in • 80% power factor • 1.0 mfd. capacitor
required • weight of unit 15 oz.

4"

AIR DELIVERY (FREE AIR)

375 C.F.M. (NEMA CODE)

140 C.F.M. (NAFM CODE)

400 cycles • 115 volts • 6500 RPM
50 watts input • 1.0 mfd. condenser
required • starting torque 2.25 oz.
in • 80% power factor • weight of
unit 16 oz. Fan: 4 blade propeller
type, 4-inch diameter.

We invite inquiry!



EASTERN AIR DEVICES, INC.

585 Dean Street • Brooklyn 17, N. Y.

An Affiliate of The Fred Goat Co., Inc., Est. 1893

MANUFACTURERS OF CONTROL DEVICES AND COMPONENTS FOR ELECTRICAL, ELECTRONIC AND MECHANICAL APPLICATIONS

"DIE-LESS" DUPLICATING

SAVES MAN HOURS AND DELAYS

DIE ACCURACY WITHOUT DIES

Send for CATALOG

BENDER

SHEAR

BRAKE
DI-ACRO is Pronounced "DIE-ACK-RO"

DI-ACRO
PRECISION MACHINES
DIE-LESS DUPLICATING

O'NEIL-IRWIN MFG. CO.

321 EIGHTH AVENUE SO. • MINNEAPOLIS 15, MINN.

DC means SC

DC means SC . . . Selenium Control and Selenium Conversion for the practical, profitable performance planned by top flight design engineers. Selenium provides maximum efficiency . . . unlimited life . . . negative temperature coefficient . . . and other characteristics necessary to solve the electronic problems of tomorrow . . . That's why DC means SC.

SEND FOR BULLETIN

SELENIUM CORPORATION of AMERICA



1719 WEST PICO BOULEVARD
LOS ANGELES 15, CALIFORNIA

EXPORT DIVISION: FRAZAR & HANSEN
301 CLAY STREET, SAN FRANCISCO, CALIFORNIA

IN CANADA: BURLIC LTD., TORONTO 16, ONTARIO, CANADA

TWO BOOKS EVERY ENGINEER NEEDS

THE CATHODE-RAY TUBE AT WORK by John F. Rider



The cathode-ray tube is the most universally used device for research, engineering and maintenance in the radio and electrical fields.

In using this device to its fullest capabilities, it is necessary to understand its theory and functioning. This book presents a complete explanation of the various types and what role each element within the device plays. Different types of cathode-ray oscillographs are discussed.

More than half the book is devoted to the practical applications illustrated with unretouched photographs of actual oscillographs.

338 PAGES . . . 450 ILLUSTRATIONS . . . \$4.00

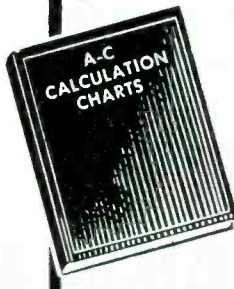

A-C CALCULATION CHARTS

This book is a tremendous time saver for engineers and others who work on electrical communication and electrical power problems. Faster than a slide rule. It covers all alternating current calculations in series circuits, parallel circuits, series-parallel and mesh circuits, at frequencies from 10 cycles to 1000 megacycles. 146 Charts—7" x 11"—Two colors—\$7.50.

JOHN F. RIDER Publisher, Inc.
404 Fourth Avenue, New York 16, N. Y.

Export Division:
Rocke Int. Corp.
13 E. 40th Street
New York City
Cable: ARLAB

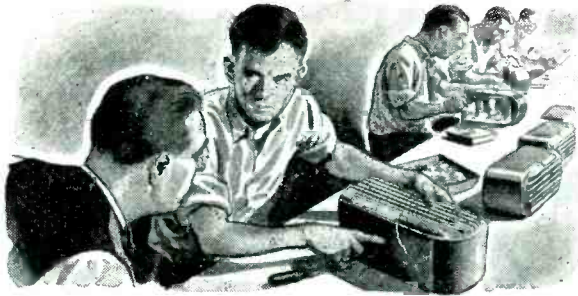

OUT GOES SPOILAGE!

Hamstrung by work-spoiling driver skids while he used slotted screws, a certain radio cabinet manufacturer made a complete switch-over to Phillips Recessed Head Screws. Result: production shot up like a rocket!



DOWN GO COSTS!

With this upward swing in production, there was a consequent downward swing in costs. A downswing that was helped along plenty by the fact that Phillips Screws drive up to 50 percent faster!

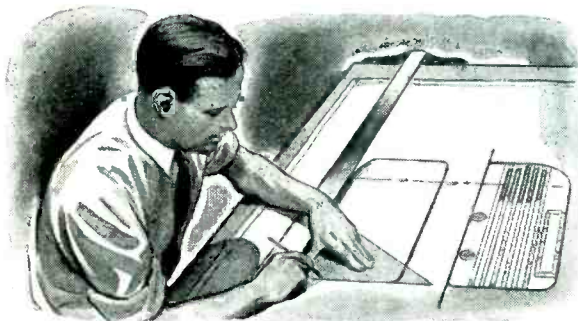

UP GOES STRENGTH!

On production . . . on costs . . . yes, also on design, . . . use of Phillips Screws makes a big difference. Engineered for heaviest driving pressures, they help designers plan exceptional strength and rigidity into products!



AWAY GOES SALES RESISTANCE!

Saleswise, too, use of Phillips Screws pays off. They not only add to a product's strength, smartness, and general good looks. They also banish burrs that snag clothes and sidetrack sales!

It's Phillips *... the engineered recess!*

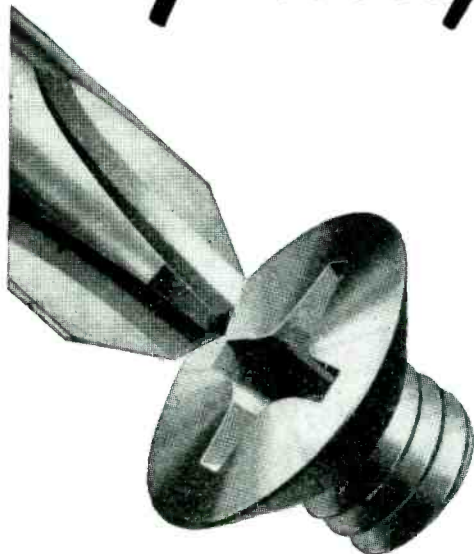

In the Phillips Recess, mechanical principles are so correctly applied that every angle, plane, and dimension contributes fully to screw-driving efficiency.

... It's the exact pitch of the angles that eliminates driver skids.

... It's the engineered design of the 16 planes that makes it easy to apply full turning power - without reaming.

... It's the "just-right" depth of recess that enables Phillips Screw Heads to take heaviest driving pressures.

With such precise engineering, is it any wonder that Phillips Screws speed driving as much as 50% - cut costs correspondingly?

To give workers a chance to do their best, give them faster, easier-driving Phillips Recessed Head Screws. Plan Phillips Screws into your product now.

PHILLIPS *Recessed Head* SCREWS

WOOD SCREWS • MACHINE SCREWS • SELF-TAPPING SCREWS • STOVE BOLTS

Made in all sizes, types and head styles

25 SOURCES

American Screw Co., Providence, R. I.
Atlantic Screw Works, Hartford, Conn.
The Bristol Co., Waterbury, Conn.
Central Screw Co., Chicago, Ill.
Chandler Products Corp., Cleveland, Ohio
Continental Screw Co., New Bedford, Mass.
The Corbin Screw Corp., New Britain, Conn.
General Screw Mfg. Co., Chicago, Ill.

The H. M. Harper Co., Chicago, Ill.
International Screw Co., Detroit, Mich.
The Lamson & Sessions Co., Cleveland, Ohio
Manufacturers Screw Products, Chicago, Ill.
Milford Rivet and Machine Co., Milford, Conn.
The National Screw & Mfg. Co., Cleveland, Ohio
New England Screw Co., Keene, N. H.
Parker-Kalon Corp., New York, N. Y.
Pawtucket Screw Co., Pawtucket, R. I.

Pheoll Manufacturing Co., Chicago, Ill.
Reading Screw Co., Norristown, Pa.
Russell Burdall & Ward Bolt & Nut Co., Port Chester, N. Y.
Seovill Manufacturing Co., Waterville, Conn.
Shakeproof Inc., Chicago, Ill.
The Southington Hardware Mfg. Co., Southington, Conn.
The Steel Company of Canada Ltd., Hamilton, Canada
Wolverine Bolt Co., Detroit, Mich.

as fruitful a land as e'er
 a crow flew over



... and not the least of the fruits of India, are its mica and shellac which, for more than 50 years, have been coming to us for conversion into insulations which have kept pace with technological progress. The dependability of Macallen Mica is never jeopardized by the heavier "loads" placed upon it.



When you think of MICA think of MACALLEN

the Macallen Company
 16 MACALLEN STREET - BOSTON 27
 CHICAGO: 565 W. Washington Blvd. CLEVELAND: 1005 Leader Bldg.

they were in no way derived from the mathematical theory of waves on wires. In fact, they represent an extreme exaggeration of the actual conditions, where these current drifts of electrons are overshadowed even by random motions of the electrons, but they are quite effective in demonstrating qualitatively the motions of the average electron positions.

Transferring Construction to Strobogram

Next, divide line A into sections 5 units long, as shown, and then draw in the straight connecting lines. The intersections of these lines with the parallel lines, A through L, give the patterns for placement of the electrons on the strobogram. The next step is to draw two circles on the strobogram, cutting each rectangle at a point 17.5 units from either end. Then, when transferring from the pattern line to the strobogram itself, keep lines M and N in exact alignment with these circles.

Cut the pattern paper along line L and place the pattern along one side of the rectangle number 11, and transfer the points. Then turn the same pattern line around for the other side of the same rectangle and transfer those points again. The following table indicates the proper pattern for each rectangle. Rectangle No. 0 (or 46) is the one marked with the arrow in Fig. 1. Numbers run counter-clockwise from there.

Pattern Line	Picture Numbers	
A	0	23
B	1	22 24 45
C	2	21 25 44
D	3	20 26 43
E	4	19 27 42
F	5	18 28 41
G	6	17 29 40
H	7	16 30 39
I	8	15 31 38
J	9	14 32 37
K	10	13 33 36
L	11	12 34 35

After all this has been done, the picture will be improved if an extra electron is "faked in" at each end of each rectangle, because the length of each shorting bar is about the same as the average distance between electrons.

The diameter of the dots should be larger than the greatest distance the dots move between pictures.



Photo U. S. Signal Corps.

SPEAKER FOR THE HOUSE

WHEN a battery of "heavies" speaks, the enemy heeds . . . hurries out of range. And as the foe retreats, Spencer precision-made wire goes forward with our fighting men, to direct the inexorable battering of Axis defenses. Battle-tested Spencer steel and alloy wires, serving with distinction in war, will be insurance against wire failure in your peace-time product.



FINE STEEL AND ALLOY WIRE

Spencer Wire Company

WEST BROOKFIELD PLANT

WEST BROOKFIELD • MASS.

ANOTHER
SPECIAL BY
PROGRESSIVE

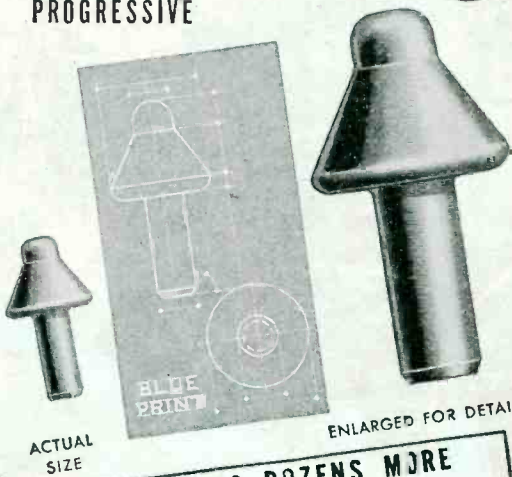

ACTUAL
SIZE

ENLARGED FOR DETAIL

CATALOG SHOWS DOZENS MORE

Special heads, threads and finishes on any metal or alloy adapted to cold upset. Weekly output: 25,000,000 pieces. Many specials, suggesting production savings for you, illustrated in latest catalog. Includes weights per 1M standard pieces, decimals of fractions, other purchasing and engineering helps. Write for Catalog 18.

The **PROGRESSIVE MFG. CO.**
50 NORWOOD ST., TORRINGTON, CONN.

★ **BONDS BUY MORE WAR BONDS** ★

GONE ARE THE DOODABS!
TODAY THE *Accents* ON!

RUGGED CONSTRUCTION

of

- CABINETS
- CHASSIS
- PANELS
- RACKS

for ELECTRONIC APPARATUS

Send specifications; or write for
our Catalog No. 41A.

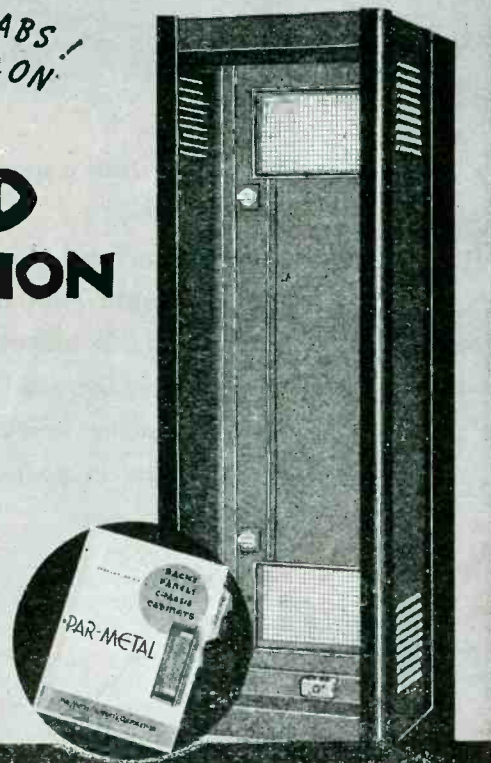

PAR-METAL PRODUCTS CORPORATION

32-62—49th STREET . . . LONG ISLAND CITY, N. Y.
Export Dept. 100 Varick St., N. Y. C.

10,000 PARTS

Ten thousand different
radio and electronic parts immediately
available on priorities

SERVICE

Trained expeditors select
and ship same day your order
is received

EXPERIENCE

Known since 1922 as reliable
jobbers, wholesalers and manufacturers of
radio and electronic equipment

*Radio Wire
Television Inc.*

100 Sixth Ave. Dept. E-6 New York 13, N. Y.
Boston, Mass. Newark, N. J.
World's largest Radio Supply House

Originators and
Peacetime Marketers
of the celebrated

Lafayette Radio

Write today for our bargain
flyers and special bulletins



Brass for variable condensers



... see
REVERE



THE rods, shafts and plates of these variable condensers were made of brass furnished by Revere. We are especially proud of this because orders received for metal for this important purpose reflect our ability to hold gauges to the exceedingly close tolerances that are necessary in order to permit rapid manufacture of uniform units. Thus the critical distances between rotors and stators are maintained on a production basis. Brass is also highly desirable because of its low "creep" or drift with temperature changes, its strength and rigidity, and the ease with which it can be machined, stamped, soldered and plated if necessary.

In addition to various types of brass and bronze, Revere also offers electrolytic copper, Free-Cutting Copper, O.F.H.C. copper, and other copper and copper alloys of special interest to the electronic industry. These may be had

in the usual mill forms of bar and rod, sheet and strip, tube and pipe, and extruded shapes. When you do development work the question is sure to arise as to which material is best, and which form most economical to work. We have assisted a number of electronic manufacturers solve perplexing problems, and will be glad to work with you through the Revere Technical Advisory Service. Write the Revere Executive Offices.

REVERE

COPPER AND BRASS INCORPORATED

Founded by Paul Revere in 1801

Executive Offices: 230 Park Avenue, New York 17, N. Y.

NEWS OF THE INDUSTRY

Network television; society for instrumentation; frequency-modulation publications; Army communications; notes on co-axial cable; meetings; FCC at work

Classified Equipment Shown

RADAR, radio relay systems, and other previously secret equipment was recently shown to members of Congress and the press at Fort Myer. Army Service Forces revealed details of radio relay systems used by the Army to replace wire circuits. These are capable of operating twelve teletypewriter circuits on one channel and 96 simultaneously with a transmission beam width of only $3\frac{1}{2}$ deg. Signals have been relayed as far as 1800 miles

with this particular equipment.

Also at the display was a radar antiaircraft artillery unit weighing 2,800 lb. and a lightweight portable unit capable of locating a medium bomber within a 100-mile range. Other units included a radar-controlled anti-aircraft search light, a radio detonator which sets off land mines 8 to 20 miles away through radio frequencies selected by dialing a 3-digit number on a telephone-type dial.

Moisture-Fungus Specs

THE FAMOUS MOISTURE and fungus treatment Specification 71-2202-A is now superseded by two proposed JAN specifications: T-152 covering treatment of communications, electronic, and associated electrical equipment for moisture and fungus resistance, and C-173, coating materials for the treatment.

Both specifications include the subjects: applicable specifications; classifications; material and workmanship; general requirements; detail requirements; methods of sampling, inspection, and test; and packaging, packing and marking for shipment. Under general requirements, the former specification covers treatment of parts; methods of treatment; non-volatile matter in the coating material; final drying of coating materials; adjusting and final testing; and marking of treated equipment.

Specification JAN-C-173 covers, under the heading "methods of sampling, inspection and tests": classification of tests; type or brand approval tests; submission of sample materials; test routine; failures; inspection tests at a government laboratory; and test methods on drying time, non-volatile matter, viscosity, water-vapor-diffusion constant, dielectric strength, resistance to thermal shock and bending, flam-

mability, porosity, adhesion, fungistatic valve, and effect of coating material on metals.

Copies of both specifications are available through the Army-Navy Electronics Standards Agency at 12 Broad Street, Red Bank, N. J.

Radar Gets the Bird

INSTALLED on a high mountaintop, radar equipment is planned for postwar use in determining height, speed, and flight direction for studying wild geese, hawks, and other birds, according to Professor Maurice Brooks of West Virginia University, writing in *Science*.

The idea came from an ornithologist, presently a naval officer in the Pacific, who noticed that his ship's radar equipment often detected the presence of albatrosses, man-o'-war birds, and other large species.

Electronified Geophysics

DURING APRIL, the Society of Exploration Geophysicists held its Fifteenth Annual and Fourth Wartime Conference, in Tulsa, Okla. This industry, which involves twenty or more research and development laboratories and about 500 field parties utilizing mostly seismic techniques, annually expends about \$35 million.

As an example of the degree to which the elaboration of instrumentation has reached, it was pointed out that a modern seismic recording unit may utilize 72 pickups feeding 24 channels of multiple-

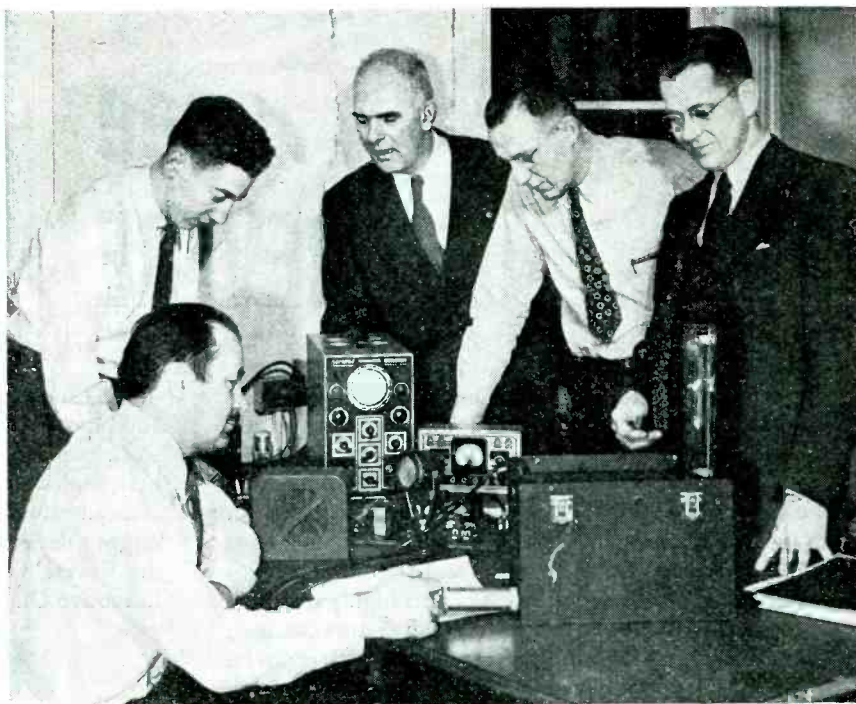

Members of the International Brotherhood of Electrical Workers in the Philadelphia area watch a demonstration by instructor E. C. Hubbert of the Westinghouse Precipitron. Electronics classes are being presented to the union members at Temple University, Philadelphia

UHF PRECISION INSTRUMENTS

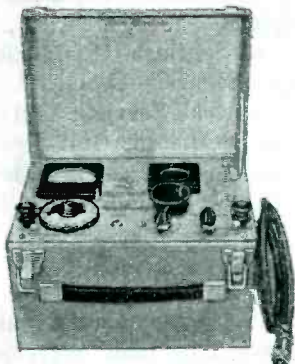

UHF PRECISION FREQUENCY METER

Completely portable Accuracy 0.1%
Battery or AC-Operated

Models available from 100 to 2000 megacycles with 2 to 1 frequency coverage on each model. Available only on high priority.

RECOMMENDED FOR:

- Production testing
- Measurement of oscillator drift
- Independent alignment of transmitters and receivers
- Precise measurements of frequencies

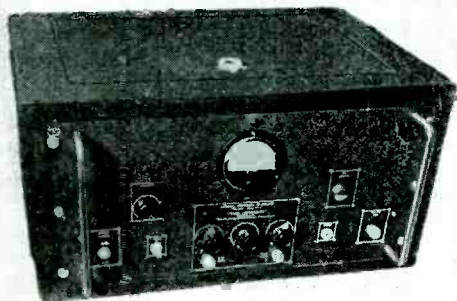

UHF HARMONIC FREQUENCY GENERATOR

PROVIDES output voltages which are multiples of 10 or 40 megacycles with CRYSTAL-CONTROLLED accuracy.

SELECTS 10 or 40 megacycle series and IDENTIFIES any one of these harmonics by means of a Frequency Identifier* which consists of a filter providing high attenuation of all voltages except that of frequency to be identified.

RECOMMENDED FOR:

... the calibration of receivers, wavemeters, or using internal beat detector for calibration of oscillators and signal generators.

*Specify frequency of Identifier wanted.

WRITE FOR FULL DETAILS

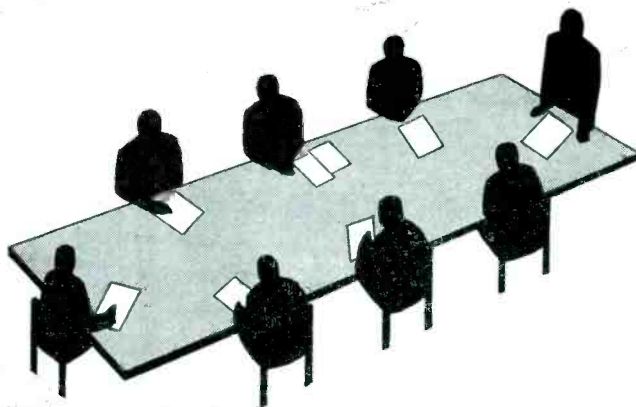

ASSISTANCE WITH YOUR UHF PROBLEMS

If you need assistance in the design, manufacture or improvement of UHF equipment, LAVOIE LABORATORIES can be of real, practical help for two basic reasons:

First, LAVOIE Engineers are specialists in the UHF field.

Second, LAVOIE shop technique and equipment are especially developed for ACCURATE, economical UHF production.

We are prepared to give you the benefit of this service either in the form of technical advice in the improvement of new or old products . . . or in the actual development of new ideas "from the ground up." Your inquiries are solicited.



Lavoie Laboratories

RADIO ENGINEERS AND MANUFACTURERS
MORGANVILLE, N. J.

**Specialists in The Development of UHF Equipment
and in The Manufacture of UHF Antennas**

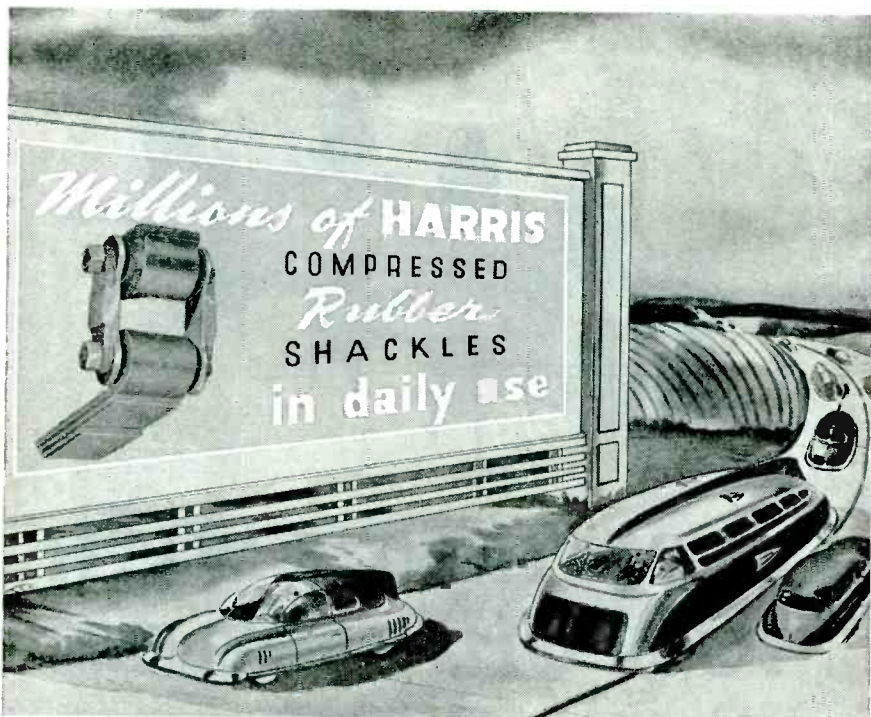

MILLIONS MORE to come on New cars, New models

In prewar days, millions of automobiles were equipped with Harris compressed rubber shackles and bearings* as original equipment. Millions of these automobiles, still in active service, have the same Harris rubber shackles and bearings and will always have them because their span of life is longer than that of the car.

Today, the U. S. armed forces are using mobile units equipped with Harris compressed rubber shackles and bearings.

Tomorrow's new cars and new models will also have Harris rubber shackles and bearings, because they never require lubrication, are low in cost, easy to install, quieter, catch and absorb jolts, jars, and vibrations, and prolong life of the car.

Automobile manufacturers are blue-printing designs for post-war production which will include Harris compressed rubber bearings for the oscillating joints of spring shackles, radius rods, shock absorber links, suspension arms, etc.

Manufacturers in other fields are also equipping their products with Harris compressed rubber bearings, vibration eliminators such as Torflex Bearings, Duflex instrument mounts, engine mounts and Torflex Couplings.

Vibration is death to any and all types of machinery, Harris engineers can correct and eliminate most of that vibration, thereby prolonging the life of machinery and improving the performance of it regardless of shape, size or type.



HARRIS
PRODUCTS COMPANY
 CLEVELAND 4, OHIO, U. S. A.

HARRIS PRODUCTS COMPANY

Specialized Rubber Engineers
 and Sole Manufacturers of
 Duflex VIBRATION INSULATORS (MOUNTS)
 Torflex BEARINGS
 Torflex COUPLINGS
 HARRIS COMPRESSED RUBBER BEARINGS

discrimination a-v-c amplification with recording on a 24-element oscillograph. Between 200 and 300 tubes may be used in a single unit.

Officers elected for 1945-6 included: president—Henry C. Cortes, Magnolia Petroleum; vice-president—J. J. Jakosky, University of Southern California; secretary-treasurer—Cecil H. Green, Geophysical Service; and editor—L. L. Nettleton, Gulf Research & Development. Past president is W. M. Rust Jr., Humble Oil & Refining.

Washington Telecast

A relay system of microwave transmitters and receivers now joins Washington with Philadelphia. Recently, the first television program ever picked up from

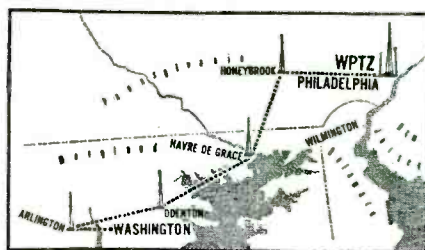

Washington was put on the air by the Philadelphia transmitter of Philco Corp. As shown on the accompanying map, six booster stations were used to carry the pictures from the District of Columbia to WPTZ.

ABC Network

"THIS IS THE Blue Network" as a radio signature will be dropped on June 15 and replaced by the term "American Broadcasting Co." Blue is the oldest network designation now in use and was originated only a few months after NBC formed the first radio network to be known for years as the NBC Red.

Instrument Society

ACCORDING to a declaration of policy issued by the Instrument Society of America, the objective of the new society is to advance the arts and sciences connected with theory, design, manufacture, and use of instruments in the various technologies, to encourage research, to foster education, to advance the standards of science and engineer-

LOUD SPEAKER HEADQUARTERS ... MAGNAVOX

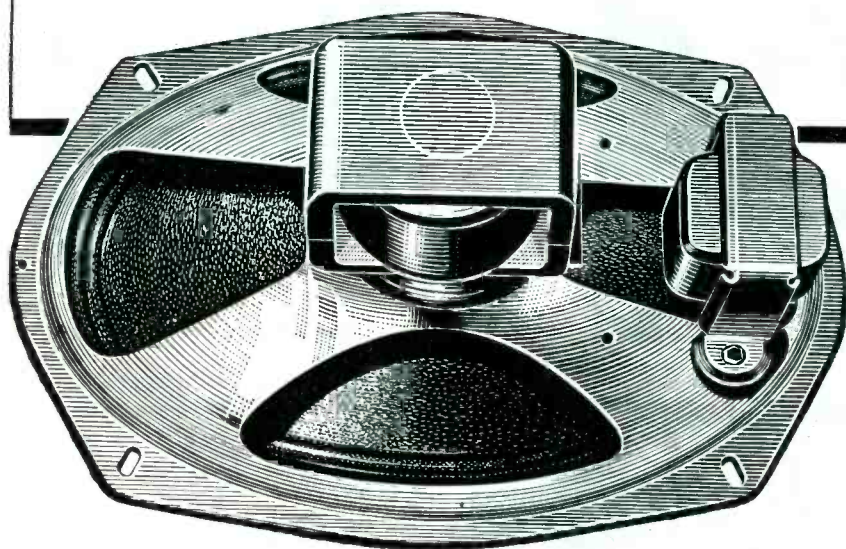

MODEL 69. 118 additional models will be available for the postwar manufacturing trade.

PIONEERING in the production of elliptical speakers, Magnavox filled an important need in receivers for automobiles, as well as for larger model home sets and phonograph combinations.

★★ *The elliptical speaker offers decided acoustical and mechanical advantages . . . desirable frequency response . . . compensation in the speaker for lack of an adequate baffle . . . ideal directional characteristics and small mounting space.*

★★ *Because of the wide popularity of the Magnavox elliptical series, various sizes will be available for postwar radios. Electrodynamic or permanent magnet models will be made to your specifications.*

★★ In your planning, be sure to consult with loud speaker headquarters.



The Magnavox Company,
Components Division,
Fort Wayne 4, Indiana.

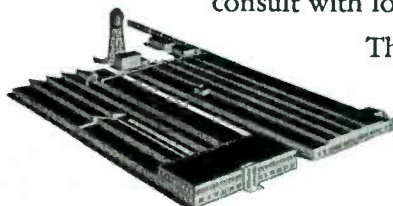

Magnavox

has served the radio industry 34 years

SPEAKERS • CAPACITORS • SOLENOIDS • ELECTRONIC EQUIPMENT

AGASTAT

ELECTRO-PNEUMATIC RELAY

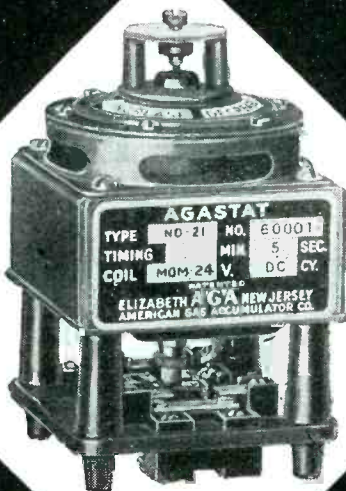

COMPACT:
4 IN HIGH
2 1/2 IN DEEP
2 1/2 IN WIDE

WEIGHT:
1 1/2 POUNDS

ELIZABETH A'G'A NEW JERSEY
AMERICAN GAS ACCUMULATOR COMPANY

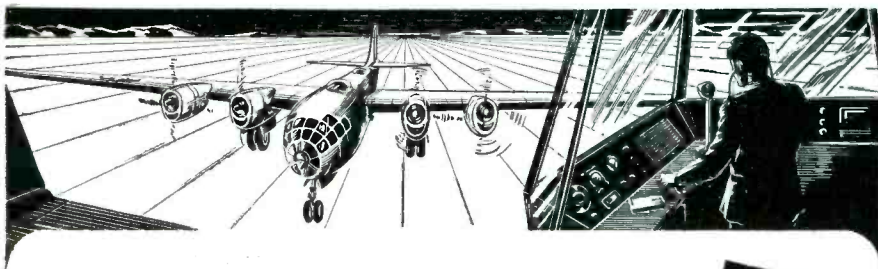

An Invitation to All Electrical Designers to
TRY SILVER GRAPHALLOY

FOR BRUSHES

High current density, low contact drop, low electrical noise, and self-lubrication are characteristics of this silver-impregnated molded graphite that may be the answer to your electrical brush problems.

SAMPLES of Silver Graphalloy will be gladly furnished for test on your applications.

Silver Graphalloy is usually silver plated to permit easy soldering to leaf springs or holders. Why not WRITE NOW for your test samples?

FOR CONTACTS

Low contact resistance and non-welding when breaking surge currents are inherent properties of this unique combination of conductive silver and self-lubricating graphite.

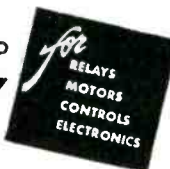

GRAPHITE METALLIZING CORPORATION
1055 NEPPERHAN AVE • YONKERS, NEW YORK



SILIP-RING AND COMMUTATOR BRUSHES AND CONTACTS



- * Design proven by over 5 years production
- * Dual D.C. Sensitivity—25,000 ohms per volt and 1000 ohms per volt.
- * Matched resistors of 1% accuracy
- * Push button operated—no roaming test leads
- * Open face—wide scale 4 1/4" meter. 40 microamperes sensitivity.
- * 1 Microampere first scale division.

SPECIFICATIONS

- D.C. MICROAMPERES: 0-70-700 microamperes
- D.C. MILLIAMMETER: 0-7-35-140-350 milliamperes
- D.C. AMMETER: 0-1-4-14 amperes
- D.C. VOLTS, 25,000 OHMS PER VOLT: 0-3-5-7-35-140-350-700-1400 volts
- D.C. VOLTS, 1000 OHMS PER VOLT: 0-3-5-7-35-140-350-700-1400 volts
- A.C. VOLTS, 1000 OHMS PER VOLT: 0-7-35-140-350-700-1400 volts
- OUTPUT VOLTMETER: 0-7-35-140-350-700-1400 volts
- DECIBEL METER: 0 db to plus 46 db
- OHMMETER: 0-500-5000-50,000-500,000 OHMS 0-5-50 MEGOHMS
- POWER SUPPLY: Battery Operated

With the above specifications the Supreme Model 592 Speed Tester meets today's requirements for general laboratory use, assembly line tests and inspection, radio and other electronic repair and maintenance.

SUPREME

TESTING INSTRUMENTS

SUPREME INSTRUMENTS CORP.
Greenwood, Miss., U. S. A.

COMING HOME TO ROOST

A 1,000-MILE MISSION—safety dependent on recognition by friends and identification of foes. Courage and prayer, skill and a crystal, have brought him back—a crystal that controls communication between our units by means of pre-arranged wavelengths. And protecting this crystal from moist salt air, preventing its clouding or “crazing”—guarding, too, the sensitive metal contacts from corrosion—is a tiny black holder molded from BAKELITE phenolic material BM-7156.

The U. S. Signal Corps found that BAKELITE BM-7156 offered far more resistance to moisture permeation than other molding compounds for this vital application. Designers and product engineers, likewise, will find BM-7156 outstandingly serviceable for instrument housings and covers, wherever delicate electrical conductors must be kept corrosion-free. Besides moisture resistance, BAKELITE BM-7156 provides lightness in weight, chemical resistance, dimensional stability, and good electrical qualities.

Write for copy of Booklet 7P, “A Simplified Guide to BAKELITE and VINYLITE Plastics.” It describes and illustrates the great variety of plastics and resinous products offered by Bakelite Corporation for the solution of diversified product design problems.



BAKELITE CORPORATION

Unit of Union Carbide and Carbon Corporation



30 EAST 42ND STREET, NEW YORK 17, N. Y.

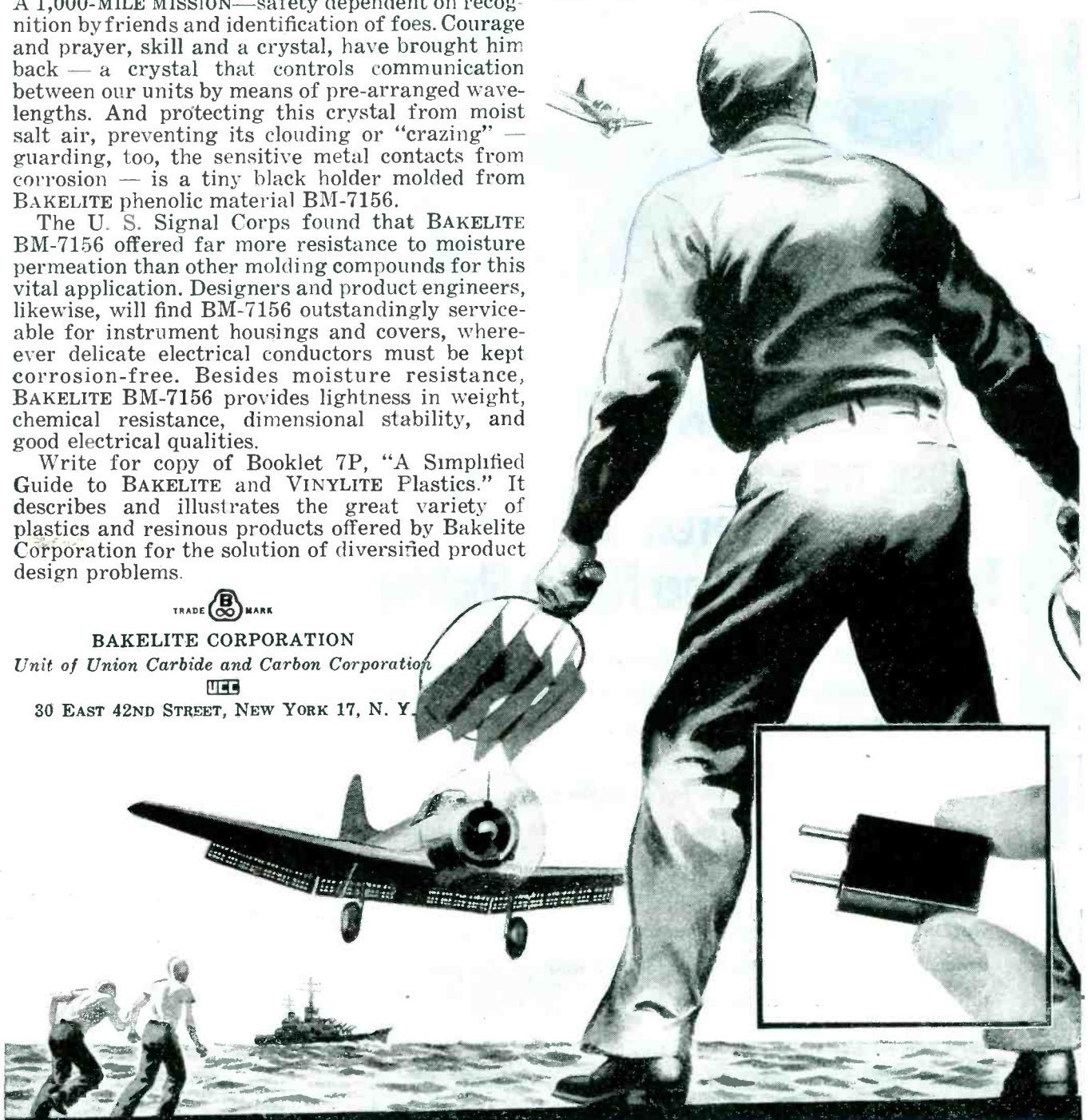

BAKELITE

TRADE MARK

MOLDING PLASTICS

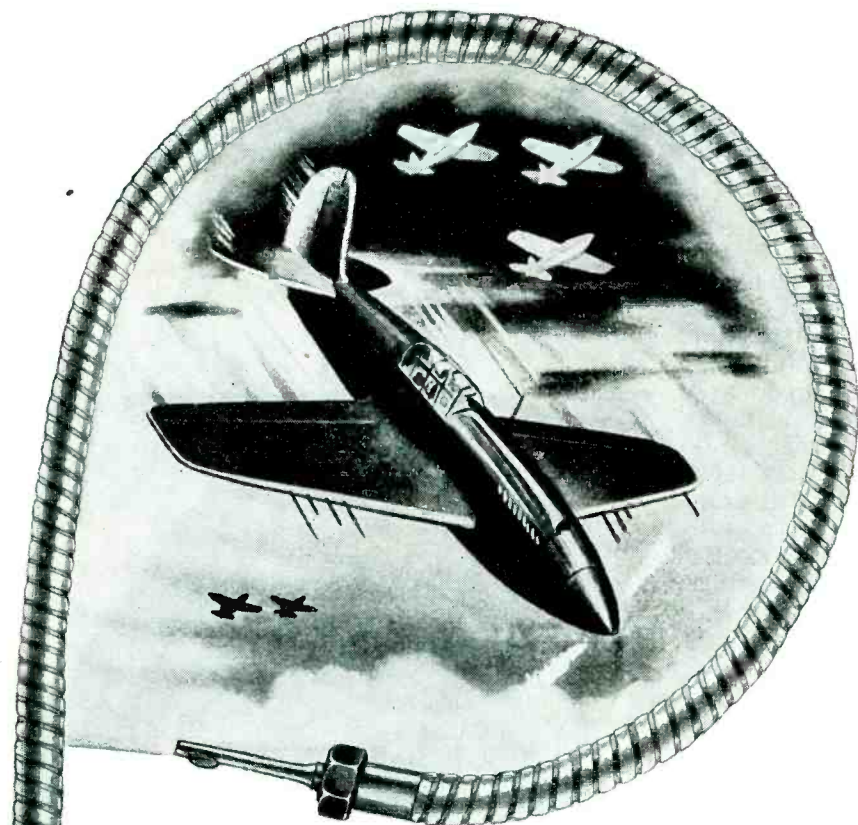

**WHEN THE "LONGEST WAY 'ROUND
IS THE SHORTEST WAY HOME"...
Specify Walker-Turner Flexible Shafting**

In transmitting light power loads between two points, it is often possible to design a simpler, lighter, more compact product with Flexible Shafting than with gears.

You'll find, too, that it pays to specify Walker-Turner Flexible Shafting on jobs like these — for smoother power flow, more sensitive control, trouble-free operation. Into this product, we've packed all the "know-how" picked up in years of manufacturing our own flexible shaft machines . . . in years of working with other manufacturers on problems of power transmission and remote control. Let us know if we can put that experience to work for you!

WALKER - TURNER COMPANY, INC. Plainfield, New Jersey



FLEXIBLE SHAFTING
FOR REMOTE CONTROL AND POWER TRANSMISSION

6-12

ing and to extend and broaden the usefulness of the instrument profession.

Participation will be classified by: honorary members, members, student members, and sustaining members. The organization is to be governed by an executive council consisting of president, vice president, treasurer, executive secretary, and directors—one of which can be elected by a local chapter having 50 or more members. Smaller chapters will be represented by directors-at-large elected on the basis of one per 100 members.

Further details can be secured from Richard Darnell, recording secretary for the organizing activity, Box 4730, Washington, D. C.

IRE-FM Discussion

TRANSCRIPTS are now available of the discussions held in January during the IRE Winter Technical Meeting at which the position of fm in the radio spectrum was considered. Price: \$3.00.

The discussion, which was under the chairmanship of Dr. W. L. Everitt, was participated in by two dozen or so prominent speakers in the field including Major E. H. Armstrong, R. A. Hackbusch, H. H. Beverage, Allen B. DuMont, C. M. Jansky and D. G. Fink, on leave from ELECTRONICS.

Founder Gone

ONE OF THE EARLY names in the radio industry was Thordarson, makers of perhaps the first transformers. The company was founded by Chester H. Thordarson, immigrant to the United States from Iceland. Recently, in Chicago, at the age of 78, Mr. Thordarson died. He had still been acting in an advisory capacity to the company he had launched, and which was, almost simultaneously, being sold to McGuire Industries by its former owners—Burgess Battery Co. The company will continue to operate as a separate entity.

Communications Costs

EXCLUDING LAND, buildings, and installation, the following figures represent estimated costs of the Army communications system which totals \$162 million: radio systems in-



Do YOU Read the G-R EXPERIMENTER?

● SENT WITHOUT CHARGE each month to scientists, engineers, technicians and others interested in communication-frequency measurement and control instruments and problems, the *General Radio Experimenter* has been published continuously since 1926. Each month it contains eight pages of articles describing new G-R instruments, new ways of using G-R equipment, and a number of applications of a general engineering nature not specifically relating to General Radio products.

Included in recent issues have been such articles as: use of the cathode-ray oscillograph in frequency

comparisons; methods of obtaining low distortion at high modulation levels; antenna measurements with the r-f bridge; impedance bridges assembled from laboratory parts; measuring 0.003 horsepower with the Strobotac; a 500-Mc oscillator; the butterfly circuit; a method for measuring small direct capacitances; and many others of similar nature.

To receive the *Experimenter* merely fill-in, clip and mail the coupon below. If you do not want to cut this magazine please supply us with ALL the information requested on the coupon. A postcard will do.

MAIL NOW! PLEASE FILL-IN COMPLETELY.

TO: General Radio EXPERIMENTER, 275 Mass. Ave., Cambridge 39, Mass.

Enter my COMPLIMENTARY subscription to the G-R EXPERIMENTER.

Name (print) Company Name

Company Address
 Street City and Zone No. State

Type of Business Your Title



GENERAL RADIO COMPANY

Cambridge 39,
Massachusetts

90 West St., New York 6 920 S. Michigan Ave., Chicago 5 1000 N. Seward St., Los Angeles 38

"ALNICO" PERMANENT MAGNETS

Specializing in the production of highest quality Alnico Magnets in all grades including new triple strength No. 5.

Production material checked to assure highest uniform quality of product.

Castings made to customer's special order on the basis of sketches or blueprints furnished.

Information and suggestions furnished on request.

**GENERAL MAGNETIC
CORPORATION**
MANUFACTURERS OF HIGH COERCIVE MAGNETIC ALLOYS
2126 E. Fort Street • Detroit 7, Michigan

NEW GUIDE TO PRECISION-MADE PLASTICS

By Sillcocks-Miller



**FREE BOOKLET
PRESENTS 4-POINT
SERVICE TO HELP
DESIGN ENGINEERS**

How the facilities and experience of Sillcocks-Miller specialists can help you solve your problems in precision-fabricated plastics is told in a new illustrated booklet now available.

Designers and manufacturers in need of plastic parts and products made to extremely close tolerances will find the Sillcocks-Miller Company a most dependable source for design and development service and for highest quality production.

Whether you are now using plastics or want to learn why it will pay you to convert to plastics, you should have a copy of this helpful booklet. Write for it today — without obligation.

SILCOCKS-MILLER CO.

Office & Factory

10 W. PARKER AVE., MAPLEWOOD, N. J.

Mailing Address: SOUTH ORANGE, N. J.

**It Costs You Less to Pay a Little
More for Sillcocks-Miller Quality**

EISLER EQUIPMENT

..complete and diversified for every phase
of electronic* manufacture!

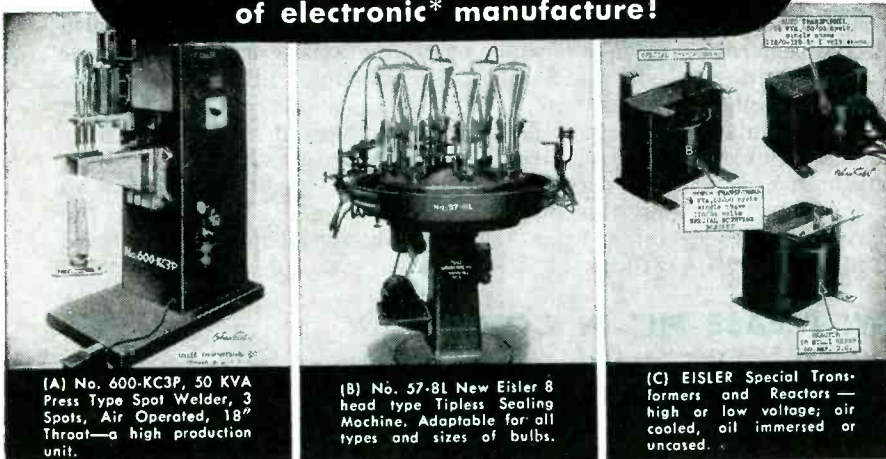

(A) No. 600-KC3P, 50 KVA Press Type Spot Welder, 3 Spots, Air Operated, 18" Throat—a high production unit.

(B) No. 57-8L New Eisler 8 head type Tipless Sealing Machine. Adaptable for all types and sizes of bulbs.

(C) EISLER Special Transformers and Reactors—high or low voltage; air cooled, oil immersed or uncased.

The CHAS. EISLER line of specialized electronic tools, machines and devices is complete and diversified. Included are innumerable types of welders — spot, seam, butt, rocker, arm, pneumatic and special types. Also included are hundreds

of devices for vacuum tube manufacture — glass tube cutters, slicers, stem and sealing machines as well as an all-inclusive line of transformers for every industrial and general need.

* EISLER serves 99% of American vacuum tube producers today. Write for completely illustrated catalog now—you incur no obligation.

Chas. Eisler
Eisler

ENGINEERING COMPANY

751 SO. 13th STREET NEWARK 3, NEW JERSEY



G.H.Q. for Shielding Problems

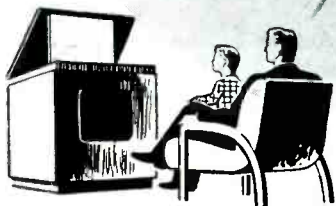

In order to eliminate the radio interference caused by high-frequency impulses radiated from almost every type of electrical apparatus, Breeze pioneered the engineering and manufacture of shielding for aircraft, automotive, marine and industrial engines. Each application presented specialized

problems which Breeze, with its wide background of experience in the field, has been well equipped to overcome. Today Breeze Shielding has stood the tests of 18 years of service, and is constantly being improved to meet new needs.

In the electronic age of tomorrow, the thorough shielding of electrical

equipment of all types will be of even greater importance. To manufacturers or users of such equipment, Breeze engineering and production facilities make it America's Headquarters for Radio Ignition Shielding. For a complete analysis and recommendation, call in a Breeze shielding engineer.



Breeze CORPORATIONS, INC. Newark, New Jersey

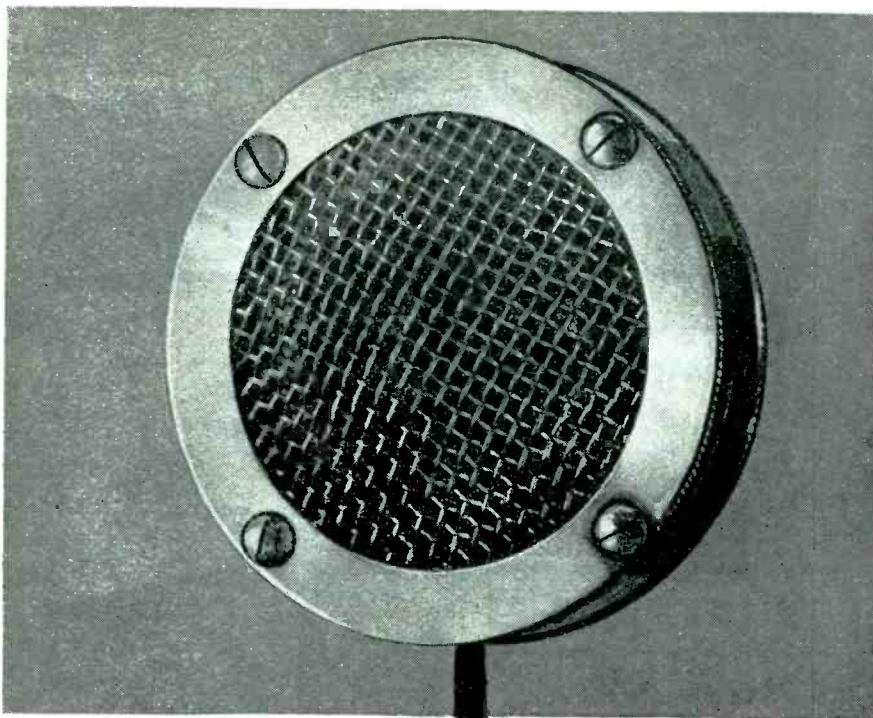

ORIGINAL MODEL D-104 Made in 1933

Away Back in 1933

Astatic PIONEERED Crystal Microphones with Model D-104

EVERY radio engineer will remember this microphone, and although today it is but one of Astatic's extensive line of Crystal and Dynamic Microphones, Model D-104, with but few minor changes, continues in demand and production. It is on performance such as this . . . dependable products rendering long and efficient service . . . that Astatic looks optimistically into the days ahead. Even now, in its modernly equipped laboratories at the new Conneaut (Ohio) plant, Astatic engineers are working on Microphones, Phonograph Pickups and similar devices, new in design and operating efficiency, for a brighter tomorrow.

"You'll **HEAR MORE**
from Astatic"

ASTATIC Crystal Devices
manufactured under Brush
Development Co. patents.

THE
Astatic
ASTATIC CORPORATION
CONNEAUT, OHIO
IN CANADA: CANADIAN ASTATIC LTD., TORONTO, ONTARIO

stalled overseas number 215 estimated at \$17 million, and 38 installed in this country at \$3 million; \$7 million worth of teletype and tape equipment is installed overseas against \$3 million domestically; the Alaskan communication system comes to \$5 million; \$86 million worth of wire systems are installed overseas against \$40 million domestic; \$1 million worth of cables are located overseas; and deep sea cables run to \$1 million.

Ambrose Fleming Dies

IN SIDMOUTH, Devon, England, April 19, Sir Ambrose Fleming died at the age of 95. Inventor of the diode or Fleming valves—based on the Edison effect and later to be evolved into the triode by deForest



—Sir Ambrose was the author of early texts on electromagnetic wave phenomena and radio telephony. He was also a charter contributor to **ELECTRONICS**, writing about transatlantic television possibilities in 1939.

Active to the last, he had been identified with British electronics as president of the Television Society of London.

FM for Education

EXPERIMENTS AND SURVEYS comprise the proposed agenda of a unit on educational use of radio suggested by John W. Studebaker, U. S. Commissioner of Education, reporting on activities during the last fiscal year of the office.

According to his report, there is a lively interest in recorded as well as live radio programs and in the establishment of technical facilities for radio reception and distribution through schools.

A new booklet published by the U. S. Office of Education is entitled "FM for Education" and includes suggestions for planning, licensing, and utilizing educational

**THIS RADIO
RECEIVER
RACK...**

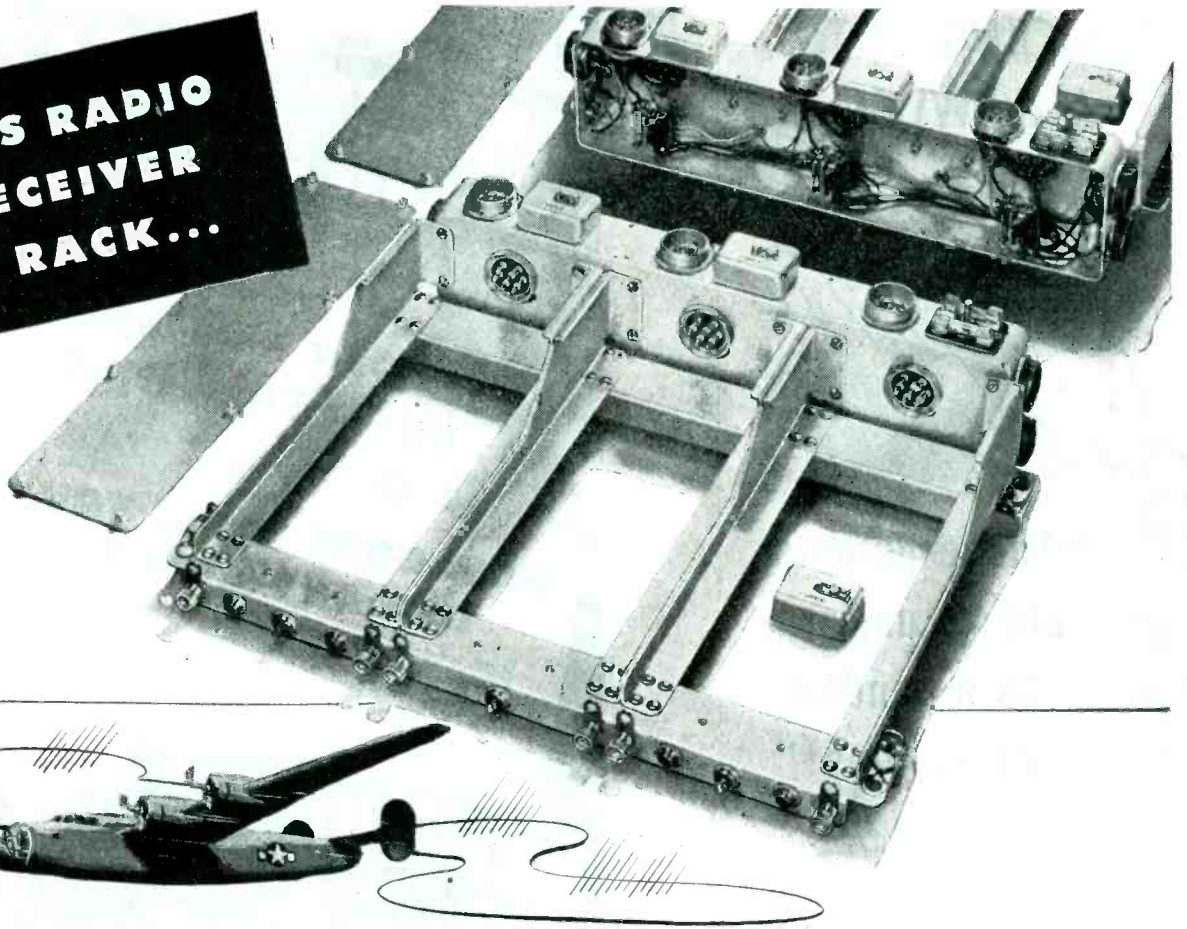

contains more than 500 Electrons
... all made and assembled by Scovill*

This three-position, high-frequency radio receiver rack for big bombers ... one of the most intricate manufacturing and assembling problems ever entrusted to Scovill ... shows how Scovill's versatile production facilities can meet requirements for electronic components or complete assemblies.

More than 500 individual parts are assembled in this rack. Materials used range from plastics to metal alloys in the form of sheet, rod, wire and tubing. Scovill makes all except glass and plastic components. Methods include

forging, stamping, drawing, heading, machining, and wire forming.

Even complicated wiring does not stump Scovill's production engineers. Every wire is cut to length, stripped and soldered into correct position. Relays are manufactured, tested and adjusted by Scovill technicians.

In other words, Scovill engineered the whole job for assembly-line production ... a service that can help you, too, save time, trouble and money on the production of small electronic components as well as large assem-

blies. For further details about the scope of Scovill's ingenuity and facilities, send for literature. Fill in coupon below and mail today.

*Electrons = Electronic Components



Please send me a free copy of "Masters of Metal" booklet describing your facilities. I am interested in the ELECTRONENT* applications checked.

- | | | |
|--|--------------------------------------|--|
| <input type="checkbox"/> Batteries | <input type="checkbox"/> Dials | <input type="checkbox"/> Panels |
| <input type="checkbox"/> Record Changers | <input type="checkbox"/> Escutcheons | <input type="checkbox"/> Sockets |
| <input type="checkbox"/> Clips | <input type="checkbox"/> Jacks | <input type="checkbox"/> Stampings (misc.) |
| <input type="checkbox"/> Condensers | <input type="checkbox"/> Lugs | <input type="checkbox"/> Tubes |

Other applications

SCOVILL MANUFACTURING COMPANY

Electronic Division
22 Mill Street, Waterbury 91, Connecticut

Name

Company

Address

"I'M GOING NUTS!"
I HOWLED



"These pencils
are as uniform
as a handful
of pebbles!"

Take it easy, Bill. Get yourself the right pencils—Typhonite Eldorado. They're honeys! Their leads are dependably true in every degree. The points stand up under pressure, too.

And draw? Boy! Eldorado will give you beautiful lines—dense, clean, sharp and brilliant. Eldorados are made by specialists who know what a draftsman wants. There's a free Comparison Sample waiting for you, Bill—and for all draftsmen who write on their business or professional letterhead to address below.

DIXON'S
TYPHONITE

ELDORADO

Pencil Sales Dept. 59-J6

JOSEPH DIXON CRUCIBLE CO., Jersey City 3, N. J.

**NEED SMALL, INTRICATE
METAL STAMPINGS
TO CLOSE TOLERANCES?**

GOAT *Precise-Formed*
METAL STAMPINGS

**HOW GOAT SAVES YOU
TIME AND MONEY**

Goat specializes in the design and fabrication to close tolerances of small, intricate, drawn, formed, stamped metal and alloy parts. Expert tool design, quality control, and modern manufacturing techniques can save you time and money on parts like those illustrated above.

ENGINEERS
SEND US
YOUR
PROBLEMS

GOAT METAL STAMPINGS, INC.
AN AFFILIATE OF THE FRED GOAT CO., INC.
314 DEAN STREET, BROOKLYN 17, N. Y.



FINE APPLIANCES
deserve the *best* plugs

The continuing performance of your product in the consumer's hands depends upon the plug that transmits the power for its operation. In the competitive post-war market, you can safely use nothing but the best

ELECTRIX
PLUGS

ELECTRIX
Corporation

140-158 MIDDLE STREET
PAWTUCKET • RHODE ISLAND

UNITED STATES RUBBER COMPANY
Exclusive Selling Agents

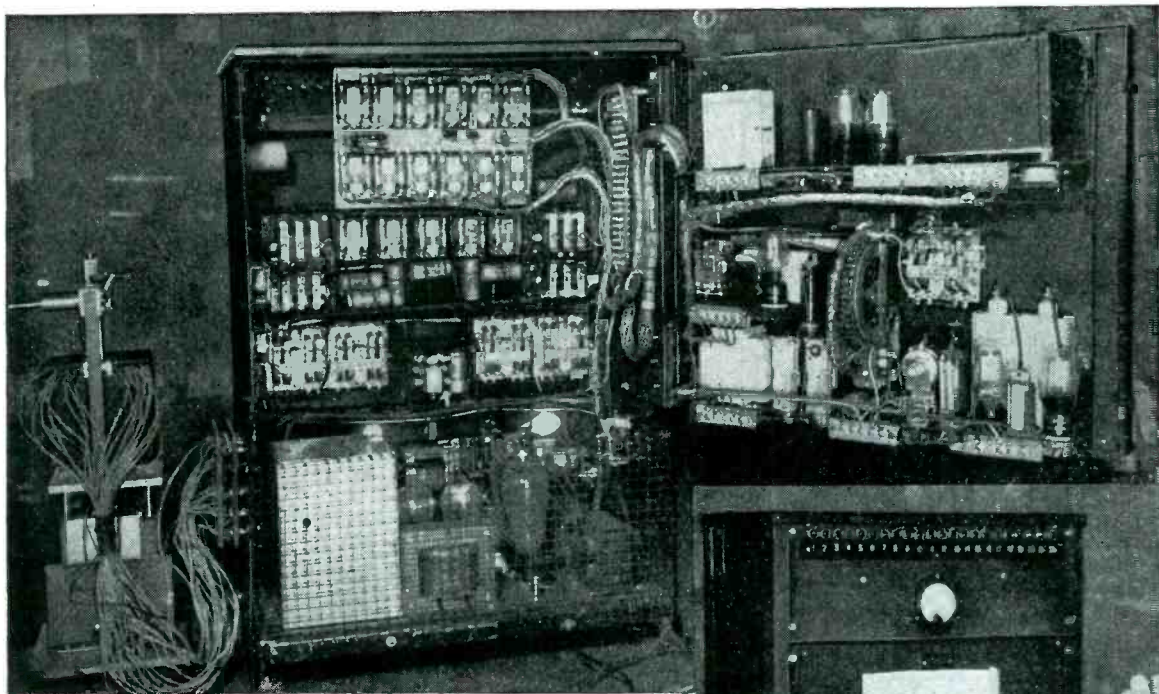

Rear view of new **FOSTER "ROBOT"** TESTING APPARATUS. Open panel reveals complex electrical units.

Front view of "ROBOT." Controls are few and easy to operate. High-precision readings visible at a glance.

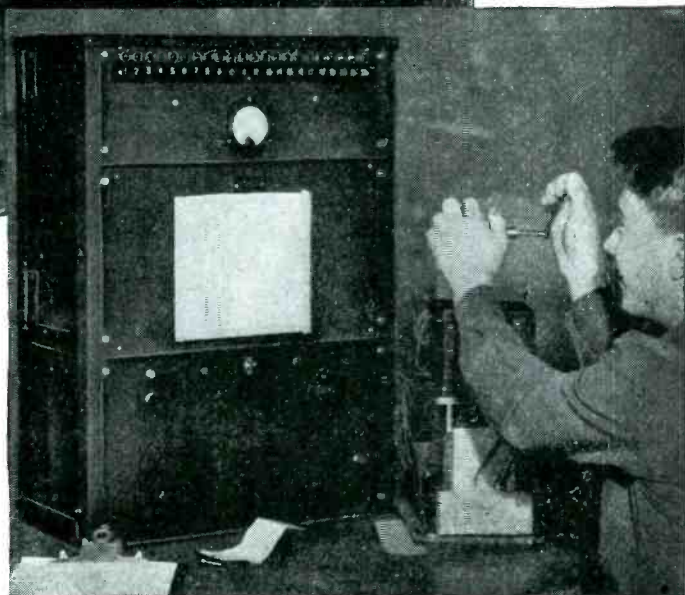

FOSTER AUTOMATIC "ROBOT" ELIMINATES HUMAN ELEMENT IN TRANSFORMER INSPECTION

This is the new Foster "Robot"—an ingenious Foster development designed to eliminate fallible human judgment in the final test and inspection of Foster transformers.

The "Robot" is never tired. Its judgment never fails. It has no memory, and no conscience—it accepts or rejects automatically. All in one operation this stern mechanism tests core loss, turns ratio, leakage resistance and winding resistance. All Foster transformers must meet the "Robot's" requirements, both for usual running conditions as well as a high specified safety margin. And the "Robot" does this vital work faster,

more accurately and more uniformly than was ever possible before.

Designed to meet the heavy demands of Foster's wartime commitments, the new Foster "Robot" will continue as an integral part of Foster testing equipment after the war. It is one more assurance that your peacetime Foster transformers will maintain the highest possible standard of performance. And, because it is a time-saver, the "Robot", together with Foster's other streamlined techniques, will actually save you money.

BOB REID
870 West 57th Street
Indianapolis 5, Ind.
Telephone Broadway 2725

BAUMAN AND BLUZAT
2753 West North Avenue
Chicago 47, Ill.
Telephone Humbolt 6809-10-11-12

THE A. P. FOSTER COMPANY
BARRETT BORDER
11 W. 42nd St., New York 18, N. Y.
Telephone PENnsylvania 6-9133

SPECIALISTS IN BUILDING TRANSFORMERS SINCE 1938

A. P. FOSTER COMPANY

TRANSFORMER ENGINEERS & MANUFACTURERS
719 WYOMING AVENUE, LOCKLAND 15, OHIO

PHASE SHIFT
DEVICES

SPECIAL BRIDGE CIRCUITS

CARRIER SYSTEMS

SUPERSONIC FREQUENCY COMPONENTS

AUDIO SYSTEMS

SUPERSONIC FREQUENCY SYSTEMS

FILTER SYSTEMS



MINDPOWER
at work!

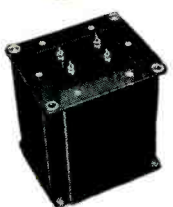

Specialized mindpower — specialized techniques —
at work creating *specialized* products for every application in the electronic and communications fields. Freed's exceptional record for meeting and exceeding the toughest requirements for transformers ordered by the Armed forces was made possible by exclusive laboratory facilities and manufacturing techniques which have developed new and important contributions for peacetime use. If your problems require highly trained mindpower, Freed's facilities are available to you.

FREED TRANSFORMER CO.

72D SPRING STREET
NEW YORK 12, N. Y.

f-m radio stations owned and operated by school systems, colleges, and universities.

As stated in the introduction, this has been prepared to acquaint educators, school board members, and other citizens with the unusual opportunity technological development has brought within the reach of education. The publication is purchasable from the Superintendent of Documents, Government Printing Office, Washington 25, D. C., for 20 cents a copy.

Contents include: FM—An Opportunity for Education, a statement by James Lawrence Fly; FM—What It Is and What It Holds for Education; FM—What It Will Cost, a breakdown of facilities and sample of a station budget; How Can an F-M Educational Station Be Used?; What Audiences Can Educational F-M Stations Serve; Steps to Take to Acquire an F-M Station: an appendix including notes on FCC application forms, a table for computing f-m station service areas and costs, and a sample of FCC form 40, application for new noncommercial educational broadcast station construction permits.

Aeronautical Standardization

UNDER THE AUSPICES of its standards and air transportation committees, AIEE is maintaining activities in standards works of aeronautical electrical equipment. Four subcommittees of the air transportation committee have been recently set up for this purpose. They are: (1) an aircraft electrical systems subcommittee chaired by R. H. Kaufmann and assigned to report on: fundamental electrical problems, ways of finding the abilities and limitations of equipment, procedures for analysis of system performance, and general application practices; (2) an aircraft electrical control and protective devices subcommittee chaired by R. A. Millermaster and assigned to the preparation of standards and codes for the equipment; (3) an aircraft wire and cable subcommittee, chaired by W. S. Hay and assigned to the preparation of standards and codes covering rating, testing and application of wires and cables; and (4) an aircraft electrical rotating machinery subcommittee to prepare standards, codes and defini-

QUESTION:

Why do 100% of the largest
AIRCRAFT COMPANIES use **AMP**
PRE-INSULATED TERMINALS?

ANSWER:

TIME STUDIES showed that
PRE-INSULATION has revolution-
ized the speed and accuracy of
MASS PRODUCTION WIRING!

What does this mean to YOU?

(1) Hundreds of additional productive man hours gained by elimination of buying, stocking, expediting, and installing separate insulation sleeving. With the Pre-Insulated terminal the insulation is permanently bonded to the terminal.

(2) Rejections and costly errors eliminated. No tubing to slip off or be forgotten. The AMP Pre-Insulated terminal is delivered ready to crimp — the only operation necessary.

(3) Every crimped-on terminal a sound connection — mechanically and electrically. The finished connection assures the same maximum service efficiency given by solderless insulation support terminals with separate tubing.

(4) Easy identification. Red insulation for wire sizes 22-16; blue for wire sizes 16-14; yellow for wire sizes 12-10. Press dies and hand tools color-identified to match.

PROVE THE AMP PRE-INSULATED TERMINAL IN YOUR OWN PLANT!

The aircraft industry is but one of many which have proved for themselves that the AMP Pre-Insulated terminal sets new productive standards in solderless wiring.

Write today for Bulletin 29B giving complete information and test data; also for samples and prices.

ONLY AMP makes the PRE-INSULATED TERMINAL!

The cost of applying separate insulation sleeving is approximately the same as for applying the terminal to the wire itself.

AMP

AIRCRAFT-MARINE PRODUCTS INC.
1521-53 NORTH FOURTH ST., HARRISBURG, PENNA.

In Canada: S. F. BOWSER CO. LTD.,
P. O. BOX 370, TORONTO 1, ONTARIO

ELECTRICITY

FOR ANY JOB
—ANYWHERE

★ **ONAN ELECTRIC GENERATING PLANTS** supply reliable, economical electric service for electronics applications as well as for scores of general uses.

Driven by Onan-built, 4-cycle gasoline engines, these power units are of single-unit, compact design and sturdy construction. Suitable for mobile, stationary or emergency service.



"Models range from 350 to 35,000 watts. A.C. types from 115 to 660 volts; 50, 60, 180 cycles, single or three-phase; 400, 500, and 800 cycle, single phase; also special frequencies.

D. C. types range from 6 to 4000 volts.

Dual voltage types available. Write for engineering assistance or detailed literature".

Model shown is from W2C series, 2 and 3-KW, 60-cycle, 115 volt; powered by water-cooled, 2-cylinder engine

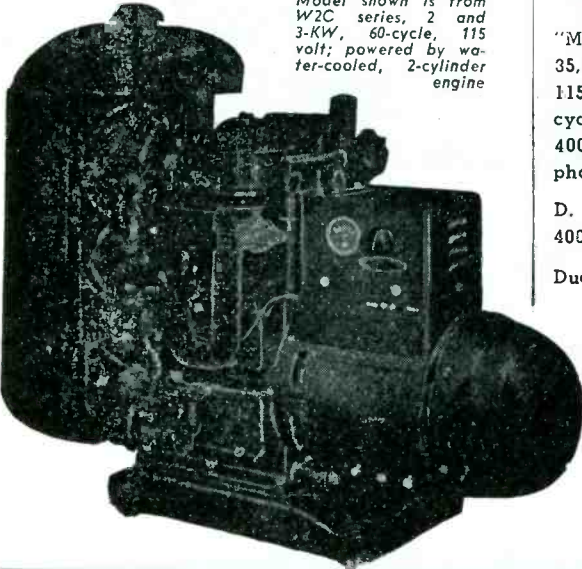

D. W. ONAN & SONS —

3265 Royalston Ave.
Minneapolis 5, Minn.

Toroids..

by

DX

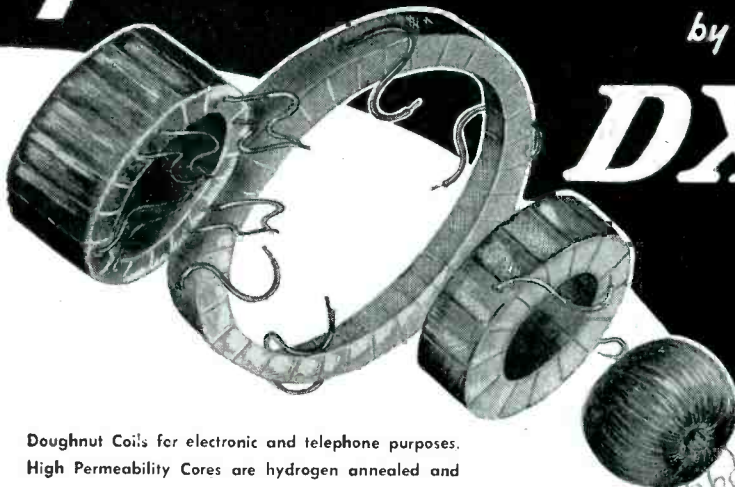

Doughnut Coils for electronic and telephone purposes. High Permeability Cores are hydrogen annealed and heat treated by a special process developed by DX engineers. Send us your "specs" today—ample production facilities for immediate delivery.

DX RADIO PRODUCTS CO.

GENERAL OFFICES 1200 N. CLAREMONT AVE., CHICAGO 22, ILL., U.S.A.



FACTS about

5 Eastern PUMPS FOR VACUUM TUBE COOLING SYSTEMS

These five different models of small centrifugal pumps designed for circulating water through the cooling systems of communications and X-ray tubes are representative of Eastern Pumps. Other pumps for special purposes have been designed. May we have the opportunity to design special pumps for your needs where reasonable quantities are involved?

AIRBORNE MODELS

(Designated as AR Series)

These are designed in conformance with Army-Navy standards.

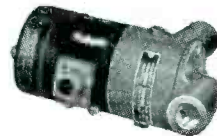

The pump and motor are one integral unit weighing but two and one-third pounds and measuring over-all 5 5/8" x 4 1/2" x 2 1/4".

Performance up to 11 P. S. I. and up to 5 gallons per minute. Models are available in standard 12 and 24 volt D. C. ratings. Shown are performance curves for the AR2, AR3, and AR4. All models have long life and are rated for continuous duty with the exception of model AR4, which under 8 P. S. I. is rated for intermittent duty.

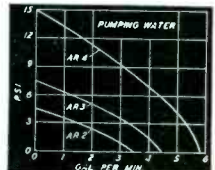

LAND AND SEA MODELS

(Designated as E-1 and E-7)

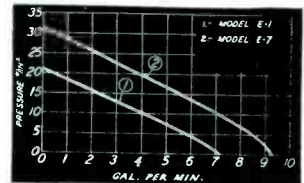

Both are centrifugal pumps, powered by General Electric Universal motors. Model E-1 is 7" x 3 3/8" x 3 9/16", 1/12 H. P., weighs 6 lbs. and has a Maximum Pressure of 20 P. S. I. with a Maximum Capacity of 7 G. P. M. Model E-7 is 9" x 4" x 4", 1/8 H. P., weighs 8 lbs. and has a Maximum Pressure of 30 P. S. I. and a Maximum Capacity of 9 G. P. M. They are equipped with mechanical rotary seals which completely seal the pumps against leakage. Obtainable with motors to meet Navy Specifications.

All five models have the following characteristics:

Extremely light weight, compact, integral pump and motor unit, varied performances available, optional voltages, long life, dependable operation, universal mounting.

The curves shown are those for which production is now standard, it is readily possible to obtain other characteristics where quantity is involved.

Eastern ENGINEERING COMPANY

84 FOX STREET - NEW HAVEN, CONN.

Rubber Mountings —like Electronics— have progressed under the Demands of War

Until the war is *finally* over, the public must wait to share the benefits of recent technical developments in electronics.

It is no secret that under the stimulus of "military necessity", progress has been far greater during the past four years than under any previous periods of much longer duration.

In the production of electronic equipment capable of functioning effectively during violent combat actions, the factor of "cushioning" to reduce vibration, transmitted noise,

and shock, becomes infinitely more important—and more baffling—than under normal conditions.

Rubber, well engineered, has proved the one satisfactory insulating material for this purpose. Fortunately the techniques and skills developed to accomplish this will be invaluable when the electronics industry turns its full effort to the design and manufacture of postwar equipment.

SERVING THROUGH SCIENCE



Listen to "Science Looks Forward"—new series of talks by the great scientists of America—on the Philharmonic-Symphony Program. CBS network, Sunday afternoons, 3:00 to 4:30 E. W. T.

UNITED STATES RUBBER COMPANY

1230 SIXTH AVENUE • ROCKEFELLER CENTER • NEW YORK 20, N. Y. • In Canada: DOMINION RUBBER CO., LTD.

ANDREW *Rhombic Transformers*

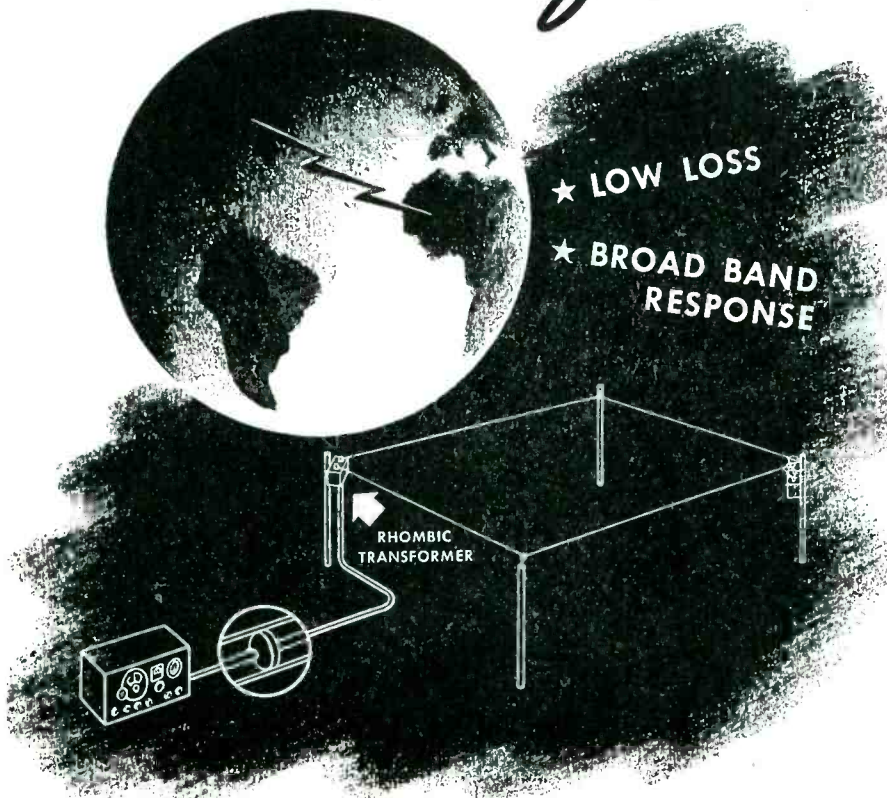

FOR TRANSOCEANIC RADIO COMMUNICATION

★ You need *quality* equipment for reliable, uninterrupted radio communication across oceans and continents. That is why radio engineers specify ANDREW antenna coupling transformers and coaxial transmission lines when designing rhombic antenna systems.

For highest efficiency and most successful rhombic antenna operation, the antenna coupling circuit must have a broad frequency response and low loss. To meet these requirements, ANDREW engineers have developed the type 8646 rhombic antenna coupling transformer, illustrated below, to assure fullest utilization of the advantages of the rhombic type an-

tenna. Losses are less than 2 decibels over a frequency range from 4 to 22 megacycles.

Type 8646 unit transforms the 700 ohm balanced impedance of the antenna to match the 70 ohm unbalanced impedance of the line. Unusually broad band response is achieved by using tightly coupled transformer elements with powdered iron cores of high permeability. This unit is contained in a weatherproof housing which may be mounted close to antenna terminals.

Transformer unit 8646 is another expression of the superior design and careful engineering that has made ANDREW CO. the leader in the field of radio transmission equipment.

WRITE FOR BULLETIN NO. 31 giving complete information on this new radio communication unit.

ANDREW CO.
363 EAST 75th STREET
CHICAGO 19, ILLINOIS

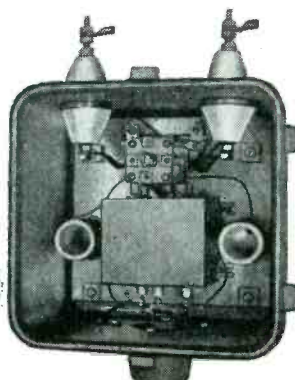

tions with immediate attention to d-c apparatus.

Adopted by the AIEE air transportation committee for one year's trial use is a publication titled "Report on Proposed Standard Voltages for Aircraft Direct-Current Equipment." Copies are available from AIEE headquarters, 33 West 39th St., New York 18, N. Y.

Anniversary Celebration

RADIO STATION WOSU, Ohio State University, Columbus, Ohio, celebrates its silver anniversary this year along with the corresponding observance by the whole broadcast industry. The first experimental license authorized this station to operate for one year on either 200 or 375 meters with a power of 1.8 kw and call letters 8XI. In 1922 a permanent license was given and call letters were changed to WEAO, and again revised to the initials of the institution in 1933.

Films on Plastic Design

RECENTLY RELEASED and previewed in New York by Bakelite Corp. are two sound films planned to aid the engineer designer whose specialty has been other than plastic design. The first is titled, "Selecting the Right Thermosetting Molding Material." It starts by surveying the manufacture of thermosetting material and shows the hundreds of types available, each with specific physical properties and characteristics. It demonstrates how the designer can use a technical data check chart to discover the best material for a given use.

The second film is titled "Product Design and Molding Technique for Thermosetting Plastics." This sequel to the first takes up the problems of the molder after the correct thermosetting material has been selected. It starts with a general outline of molding, surveys the manufacture and use of preforms, touches on the various types of molds, and studies the factors of time, pressure and temperature as they affect the molding art.

Descriptive details are included on preheating methods with emphasis on electronic technique. Among the subjects covered in the ensuing engineering discussion of problems are: shrinkage, undercuts,

WHY DO PROCESSORS MAKE *so many kinds* OF FIBERGLAS* INSULATION MATERIALS?

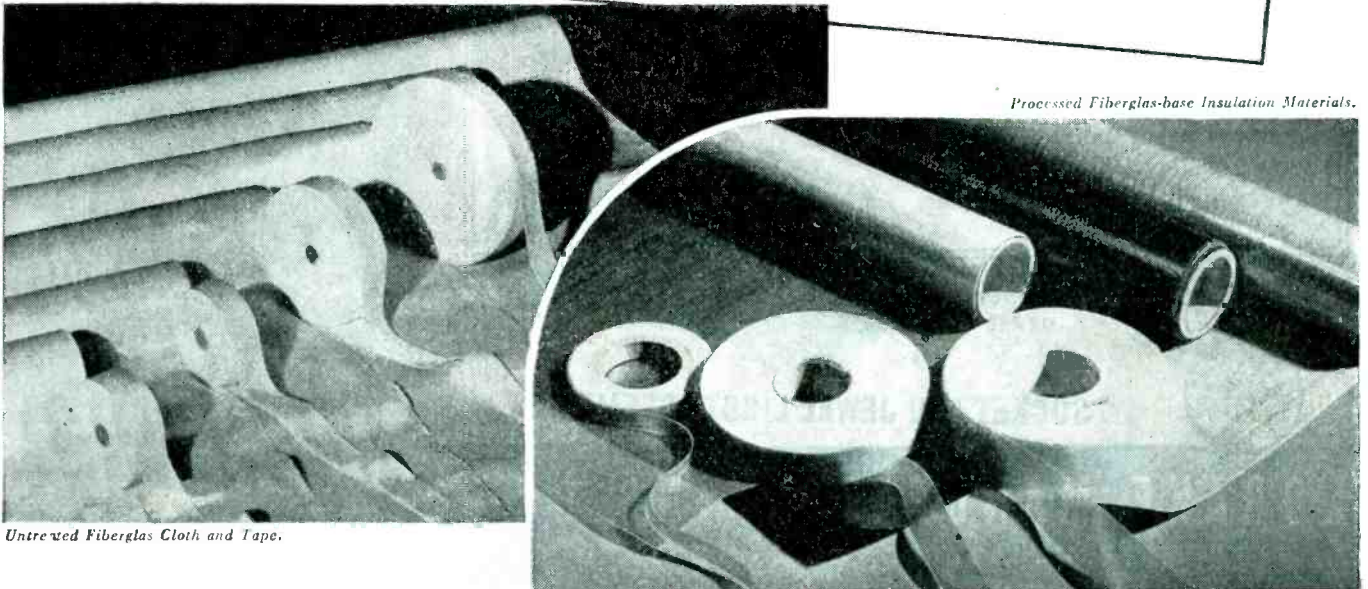

Processed Fiberglas-base Insulation Materials.

Untreated Fiberglas Cloth and Tape.

Designers and manufacturers of innumerable types of electrical equipment recognized the unexcelled advantages which Fiberglas offers as a base for insulation materials. Fiberglas—glass in fiber form, woven into textiles—provides a thin, strong, flexible base for insulating impregnants.

Many electrical engineers saw ways in which Fiberglas insulation materials could solve problems which no other insulation material could solve. Manufacturers recognized it as a means of providing an additional safety factor for their products.

To meet these specifications and the demand for better insulation materials, processors and insulation manufacturers developed a wide range of Fiberglas-base materials. So that, today, there is a Fiberglas Electrical Insulation Material available to meet virtually every insulation need such as:

Fiberglas-insulated Wire and Cable

... Most wire manufacturers are currently manufacturing Fiberglas-insulated wire of many different types for a wide range of applications—magnet wire, single and double covered; lead wire; radio hook-up wire; aircraft ignition cable; neon sign cable; thermocouple wire; communication cables; and wires for special purposes.

Fiberglas Varnished Cloth and Tape

... Made by many manufacturers who impregnate various types of Fiberglas Cloth, in several thicknesses, with several kinds of varnishes specially developed to meet normal or extreme conditions. These products are available in 36" widths or cut to any desired tape width.

Fiberglas-Mica Combinations... The combination of thin, strong glass cloths with mica for ground insulation is not dependent upon impregnating varnish for its electrical characteristics. The mica splittings provide di-

electric strength while Fiberglas gives it a tough, stable inorganic backing.

Fiberglas Laminates... Most manufacturers of electrical laminates make one or more types of Fiberglas-base materials, which are used for panels; in motors and generators as slot sticks; armature or stator end punchings; brush holders; space blocks, etc. Also, Fiberglas-base laminates, having low electrical losses at high frequencies and high humidity, are finding increasingly wide use in radio, radar and other electronic applications.

Write for booklet... EL 44-7, tells what type to use, where and how. Send for your copy today, ask for the name of the Fiberglas Electrical Insulation Materials supplier located nearest to you. *Owens-Corning Fiberglas Corporation, 1860 Nicholas Building, Toledo 1, Ohio.*

*In Canada,
Fiberglas Canada Ltd.,
Oshawa, Ontario.*

Each Distributor of Fiberglas-base Insulation Materials has his own source of supply; none of these processed insulations is made by Owens-Corning Fiberglas Corporation



FIBERGLAS

*T. M. Reg. U. S. Pat. Off.

ELECTRICAL INSULATION MATERIALS

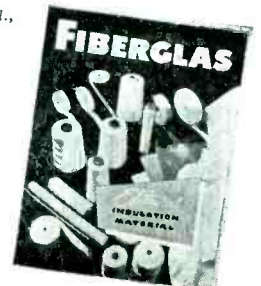

Rugged! NEVER NEEDS REPLACING . . .

The new Drake No. 75AP (Underwriters Approved) is an outstanding addition to the Drake line of better Socket and Jewel Light Assemblies. The No. 75AP is rugged . . . never needs replacement. Solder terminal design makes connections absolutely secure . . . no danger of vibrating loose as with screw type terminals. No parts can rotate with respect to one another, nor can the bakelite housing be pushed or pulled from the mounting

tube. After once being assembled, the whole unit is one rigid piece. Designed for 110 volt circuits, Special Resistor adapts it to 220 volt circuits, if desired.

Write for full details on the No. 75AP, and on the Drake S6 Lamp Remover. Anyone who maintains or installs large numbers of S6 Lamps will find this remover a great convenience.

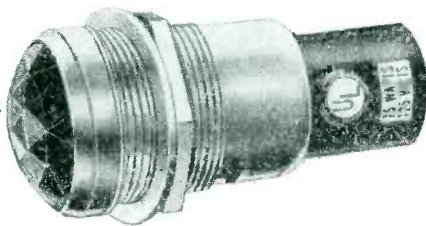

THE NEW
DRAKE
NO. 75AP

SOCKET AND JEWEL LIGHT ASSEMBLIES

DRAKE MANUFACTURING CO.

1713 WEST HUBBARD ST., CHICAGO 22, U. S. A.

New INLAY PROCESS

ELIMINATES NAME PLATES ON FRONT PANELS

A proven method for placing durable characters on metal panels, chassis, etc.

- ★ Inlaid baked enamel characters, protected by background finish; resistant to abrasion and salt spray; guaranteed to pass 50 hour salt spray test. NOW available in luminous characters, if desired, either phosphorescent or fluorescent.
- ★ Front panel will match finish of cabinets.
- ★ Recommended and endorsed by scores of manufacturers of electronic, sound and communication equipment.

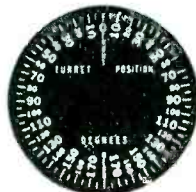
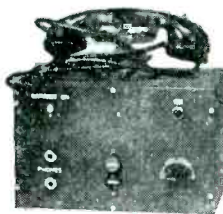

FROMPT DELIVERIES—Send us your bare fabricated steel and within two weeks we will return it finished and marked to your complete satisfaction

SCREENMAKERS

64 FULTON STREET • NEW YORK 7, N. Y.

Tel.: REctor 2-9867

ALSO . . .
SILK SCREENING on front panels and chassis, either metal or plastic. Sharp clear characters durably printed on finished or unfinished surfaces.

Save Money With The RIGHT

Electrical Papers

A laboratory analysis to determine the correct properties of an electrical paper for your job may be the means of saving material and labor costs, as well as product improvement. As experienced designers and builders of papers for electrical applications we are fully equipped to serve you

SEND FOR



Free Book on Technical Applications of Industrial Papers, including Electrical Papers. Write for "Industrial Paper—The New Production Answer."



REG. U. S. PAT. OFF.

**CENTRAL PAPER COMPANY
INCORPORATED**

2442 LAKESHORE DRIVE, MUSKEGON, MICH.

Fairchild
Transcription Turntable

Fairchild Lateral
Dynamic Pickup

25 GRAM 'FLOATING' PRESSURE

Further Reduces Distortion and Record Wear

FAIRCHILD offers an unusually mounted 'floating' design for low-pressure, dynamic pickup. Designed for radio broadcast and other exacting transcription requirements, it reproduces all of the quality and natural beauty of recorded music or speech *with full naturalness*.

All microscopic undulations — that determine the quality of the transcription — are picked up without distortion *even from heavily modulated grooves*.

How? By means of several Fairchild patented design features: Let's start with

the 3 ounce cartridge mounted on a two-point suspension in the pickup head casting. It's the only vertical moving mass in the Fairchild assembly. High and low spots in the record disc need only displace its 3 ounce weight instead of the total weight of the entire mounting arm. This unusual mounting method affords a near-uniform stylus pressure of 25 grams — even under unfavorable playing conditions.

Next, the pickup head is mounted in the famous Fairchild tone arm with cone ball bearings. Lateral drag is reduced. And

still another important source of distortion and record wear is eliminated.

Finally, there is no *overhang* of the tone arm with consequent inertia — another cause of difficulty when playing warped records or on uneven turntables. The tone arm *floats* at any required adjustable height above the disc.

Descriptive and priority data on the newly perfected Fairchild Lateral Dynamic Pickup and Transcription Turntable are now available. Address *New York Office*: 475 - 10th Avenue, New York 18; *Plant*: 88-06 Van Wyck Blvd., Jamaica 1, N. Y.



Fairchild CAMERA
AND INSTRUMENT CORPORATION

SOUND
EQUIPMENT



CHECKS A CIRCUIT A SECOND!

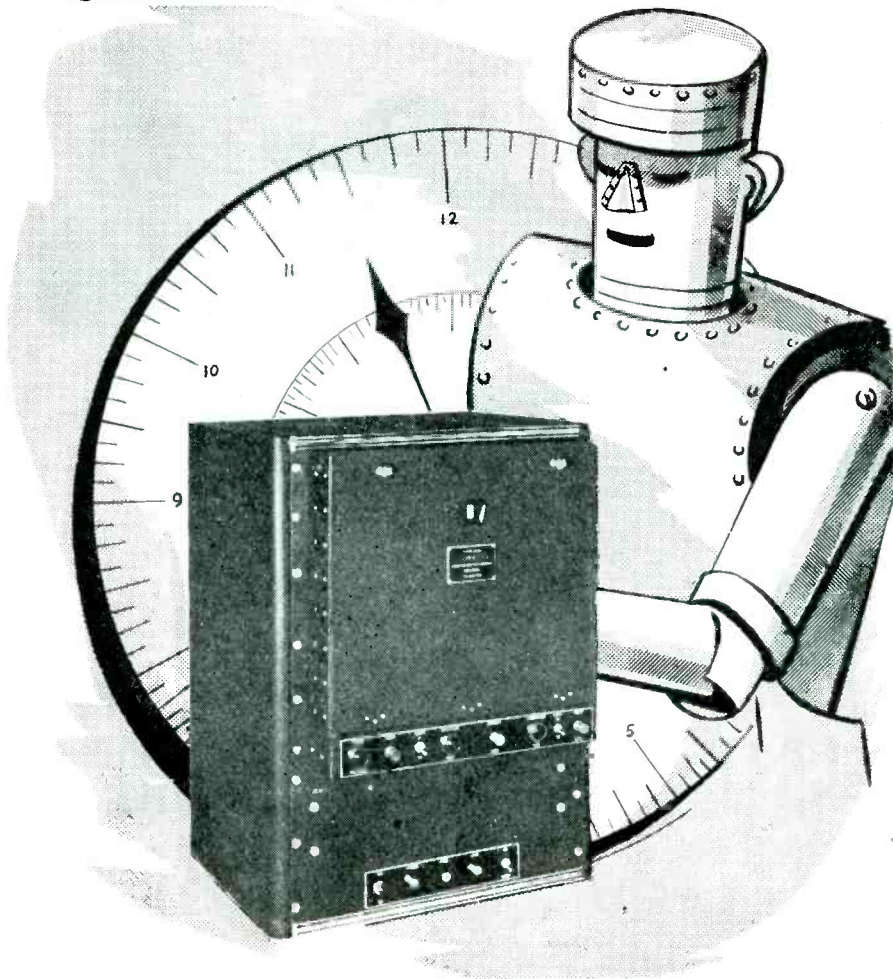

ROTOBRIDGE

The Automatic Robot Inspector

Instantaneous and accurate, the Rotobridge functions with robot-like fidelity in checking wiring errors, resistance and reactance values.

Designed for continuous 24-hour duty, the Rotobridge does your bidding exactly. Do you wish a 10% resistance tolerance at one point? A 25% capacity tolerance at another spot? The Rotobridge gives it to you—automatically and accurately.

An error detected? The Rotobridge stops cold, flashes on a red blinking signal, which winks insistently until the defect is attended to.

The Rotobridge can be put to work on several small sub-assemblies or on a complete set, involving as many as 120 circuits. Want to inspect a 30 or 40 tube set-up? Two or three of these robots, working simultaneously, will do the trick . . . in five minutes flat!

Write for complete details.

Communication Measurements Laboratory

120 Greenwich Street

New York 6, N. Y.

wall thickness, ribbing, tapers, fillets, domed surfaces, effective styling, surface treatments, flash or parting line, holes, bosses, threads in plastic, metal inserts, and tolerance in dimensions.

Both films are particularly well handled from the point of view of combining photography with hand-drawn animation. Things that can be photographed are handled by that method while actions such as those which take place inside a mold are added to clarify the explanation.

So much information is concentrated into these films that special slide-film versions have been produced so that the instruction can be slowed up where necessary. 16-mm prints are available without cost and further information can be obtained from Technical Film Library, Bakelite Corp., Unit of Union Carbide and Carbon Corp., 300 Madison Ave., New York 17, N. Y.

F-M Police Radio

IN KENTUCKY, the city of Louisville has recently installed a completely new f-m police radio system to replace its first police radio installation made more than 18 years ago. Now 60 police cars and 40 miscellaneous units of the fire department, FBI and state and county police are radio-equipped.

Under the old set-up, 15 to 20 percent of the radio coverage was completely dead and 30 percent was by no means dependable. Besides giving 100-percent coverage, the f-m installation permits intercar communication.

Notes on Co-axial Cable

TO INCREASE knowledge among engineers of the characteristics and applications of high-frequency coaxial cable, the Intelin Division of Federal Telephone and Radio Corp. recently conducted a field trip through their laboratory and factory. Several new and not widely known cable properties were illustrated.

Pulse technique and the increasing power used at high frequencies have required a cable with stable high-voltage insulation. Corona, which both decreases the cable power-factor and increases noise level, is especially troublesome. The



P OWER CONVERSION

from AC to DC with **B·L· RECTIFIERS**

B-L SELENIUM AND COPPER SULPHIDE ELECTRICAL RECTIFIERS are used wherever direct current is required from an alternating current source. These rectifiers are compact—durable—silent; have no moving parts; are simple to install, require no maintenance. Ratings from milliwatts to kilowatts.

B-L RECTIFIER TRANSFORMER ASSEMBLIES *are built for many standard applications:*

B-L Laboratory Rectopacs for supplying the required voltage of direct current from the alternating current source.

B-L Heavy Duty Portable Railroad Battery Charger, for use in terminals.

B-L Fast Battery Charger for "no removal" automotive battery service.

B-L Battery Booster for use in charging batteries and keeping them charged.

B-L Cathodic Protection for pipe lines.

B-L Filterpacs, eliminating the need of batteries, in operating 6-volt DC electrical equipment.

Consult us if you have a Power Conversion Problem. Twenty-five years of B-L specialized skill in AC-DC conversion problems is available to you. Address Dept. A.

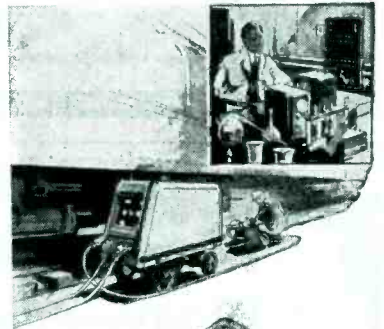

SELENIUM



COPPER
SULPHIDE

THE BENWOOD LINZE COMPANY
1815 Locust Street • • • St. Louis 3, Mo.
Long Distance Telephone CEntral 5830

New York Sales Office:
420 Lexington Ave.
New York 17, N. Y.
Murray Hill 5-5878

Chicago Sales Office:
20 N. Wacker Drive
Chicago 6, Illinois
Telephone CEntral 2379

Designers and Manufacturers of Selenium and Copper Sulphide Rectifiers, Battery Chargers, and DC Power Supplies for practically every requirement.

VANATTA

Kwikheat

THERMOSTATIC SOLDERING IRON

A Division of
Sound Equipment Corp. of Calif. • 3903 San Fernando Rd., Glendale 4, Calif.

America's Only Soldering Iron

WITH BUILT-IN THERMOSTAT

225 WATTS POWER in a Mere 14 ozs.

HOT IN 90 SECONDS

Ready for use 90 seconds after plugging in! The Kwikheat Soldering Iron cannot overheat... adds to life of tips... requires less refinning time, because Kwikheat's built-in patented thermostat maintains proper, even heat for most efficient, economical operation. Powerful—225 watts—yet light weight (14 ozs.). Well balanced with cool, protecting handle. Six interchangeable tip designs adapt the Kwikheat Iron to most any soldering job. Iron with choice of #0, 1, 2 or 3 tip, \$11.00

◀ 6 Interchangeable tip styles

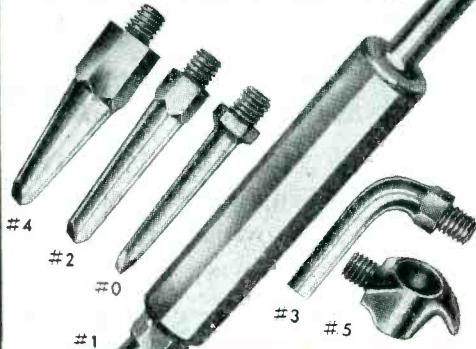

6 TIP STYLES—QUICK-HEATING ELEMENT—BUILT-IN THERMOSTAT—WELL-BALANCED—LIGHT-WEIGHT—COOL, PROTECTING HANDLE.

DESIGNED FOR PEAK PERFORMANCE

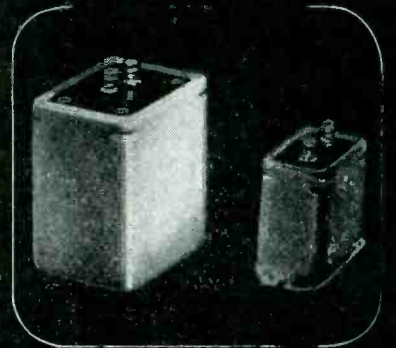

**SEALED, ALUMINUM CASE
AIR-BORNE TRANSFORMERS**

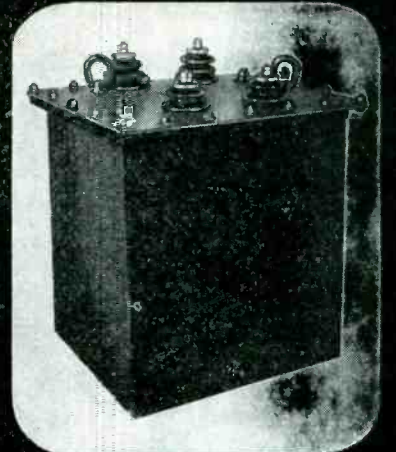

**OIL-COOLED, PLATE SUPPLY
TRANSFORMERS**

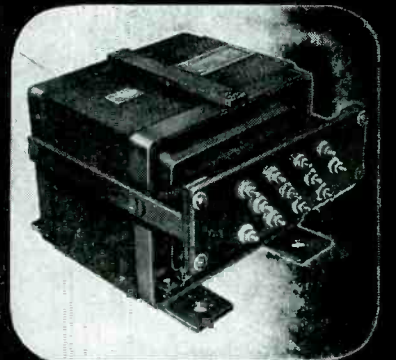

**AIR-COOLED TRANSFORMERS
WITH 10 VOLT SEC. TAPS**

THE ACME ELECTRIC & MFG. CO.
CUBA, NEW YORK • CLYDE, NEW YORK

Aeme Electric
TRANSFORMERS



Fungus-Proofed Waxes

As a vital service to the Armed Forces we now offer Fungus Resistant Materials. These recently developed products are the answer to Communications requirements where the impregnation or coating of radio parts and equipment are concerned.

ZOPHAR waxes and compounds meet every specification of both the Army and Navy for waterproofing and insulating all electrical and radio components. They also have wide application in packaging of every description.

ZOPHAR MILLS INC

112-130—26th STREET
BROOKLYN, N.Y.

ESTABLISHED 1846

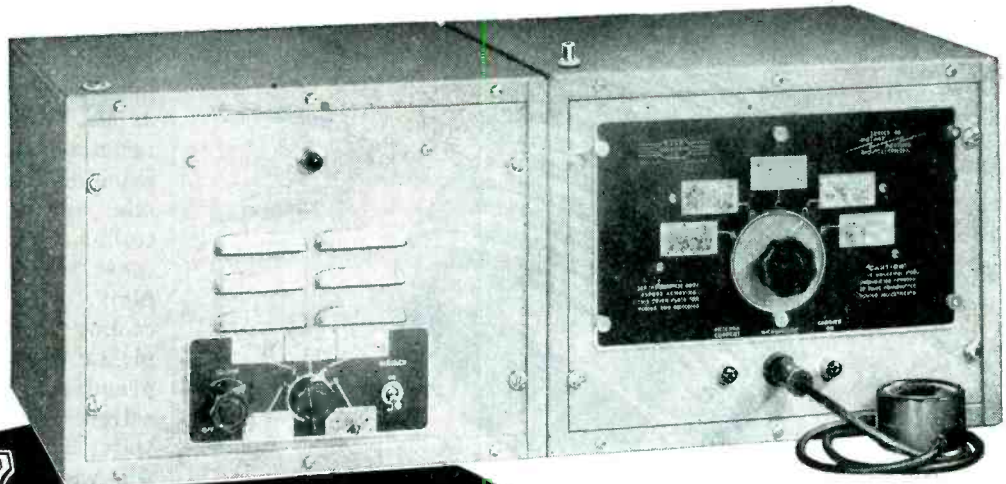

KAAR
Series
46

KAAR

INSTANT
HEATING
RADIOTELEPHONES

ABOVE: Series 46 KAAR radiotelephone, showing 5 channel transmitter and crystal-controlled receiver mounted side by side.

BELOW: Same units mounted in a different manner, and showing how transmitter slides out for servicing.

This new KAAR 50-watt series offers lower battery drain

Low battery drain, obtained through the use of instant-heating tubes, is one of the many special features in the new KAAR Series 46 radiotelephone which make this equipment so popular for police, fire, sheriff, utility, and other emergency use.

Kaar engineers packed years of experience into the development of this new equipment, making it unsurpassed for almost any emergency requirement. The 50-watt transmitter is designed for either five channel or single channel operation—mobile or fixed—with a standard frequency range from 1600 to 6000 Kc. The receiver may be either tuneable or fixed tuned crystal-controlled, as desired. Furnished with separate power supply for operation on 117 volts, 60 cycle AC; or 12, 32, or 110 volts DC.



KAAR ENGINEERING CO.

PALO ALTO, CALIFORNIA, U. S. A.

Export Agents: FRAZAR & HANSEN, 301 Clay St., San Francisco, Calif.

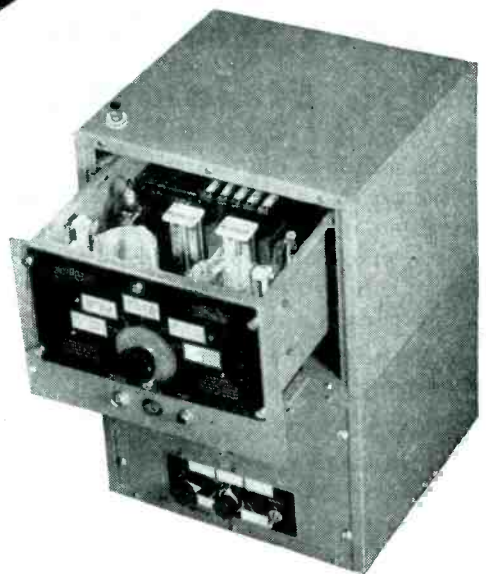

Easily accessible! MANY SPECIAL FEATURES

- **SIMPLE TO SERVICE** . . . when four screws are released, the transmitter slides out like a letter file.
- **ZERO STANDBY CURRENT**, made possible by instant-heating tubes, reduces drain on batteries, yet there is no waiting period for tubes to warm up before sending a message.
- **ONLY ONE TUBE TYPE** is used in the transmitter. This simplifies replacement.
- **FITS ANYWHERE** . . . transmitter may be secured above or below the receiver, or on either side of it. Transmitter and receiver cabinets are 10" high, 13" wide, 13" deep.

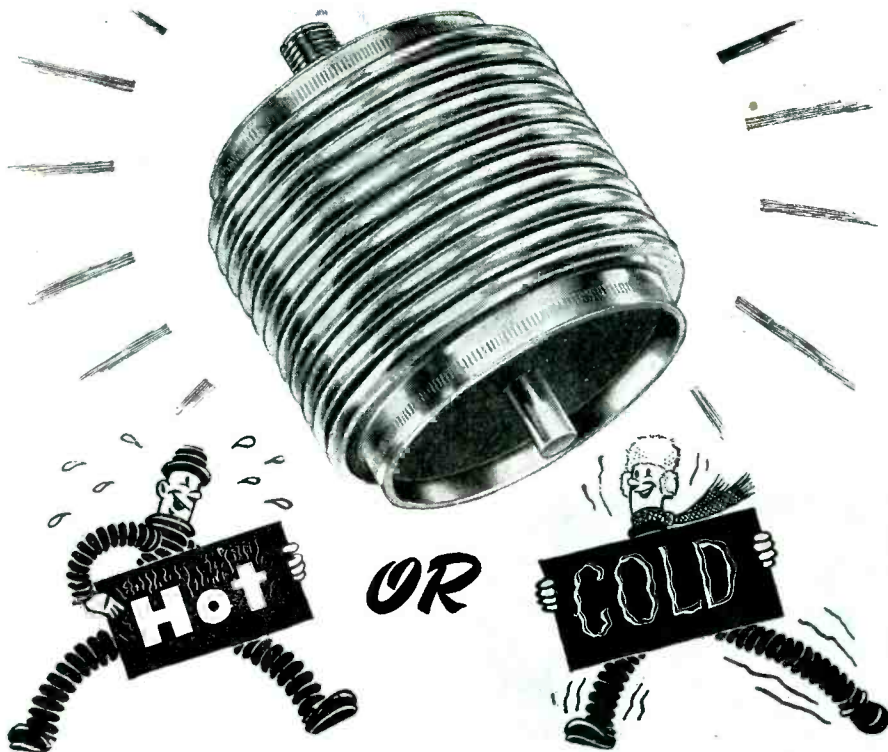

It doesn't matter to C. M. H. Stainless Steel Bellows!

You can't choose the temperatures of each bellows application, but you *can* use a product engineered to perform with equal efficiency . . . at both ends of the thermometer! We mean C.M.H. Bellows, made of 18-8 Austenitic *Stainless Steel*, with a working range of sub-zero to a scaling point of 1800° F.—wide enough to meet practically any heat or cold requirement.

Notice below the other advantages stainless steel and C.M.H. design bring you. Check and compare . . . and we think you'll want the full story of C.M.H. Stainless Steel Bellows!

Ask for Chicago Metal Hose Form SS B 2 on which to submit your bellows requirements. It will save you time . . . assure more accurate transmittal of essential data.

★ Corrosion resistant qualities of stainless steel enable wider application of C.M.H. BELLOWS.

★ Multiple ply construction gives even greater strength factors when needed.

★ Ferrous fittings, attached by Circular Seam Welding, assure permanent, leakproof joints.

★ Uni-metal assemblies avoid the

costly troubles encountered where bi-metal types or solder joints are used.

★ Long lengths are standard production permitting economical use of C.M.H. Stainless Steel BELLOWS for many unusual types of applications.

★ Better delivery schedules are possible because C.M.H. BELLOWS are standard production products.

Flexible Metal Hose for Every Industrial Use



CHICAGO METAL HOSE CORPORATION
MAYWOOD, ILLINOIS

Plants: Maywood and Elgin, Ill.

solid dielectric, polyethylene, extruded onto the inner conductor must be free from air holes which, as Mr. Warner, who conducted the technical discussions of the trip, explained, could set up high electric stresses thereby producing corona. It also must adhere to the inner conductor. Because of the high coefficient of contraction on cooling (12 percent) of the thermoplastic insulation, it must be cooled gradually. This problem has been solved by using a continuous-flow water bath some hundred feet long, the water temperature along the tank being reduced about every six feet.

Cable is tested both continuously in production and by sample for breakdown. Corona can be detected by change in cable loss or by increase in noise of the detected signal received from a cable under high voltage. In both tests, the voltage at which corona sets in is definite and within narrow limits.

A problem not noticeable at low frequencies but which produces irregularities in cable properties at high frequencies is unavoidable periodic variation in the manufacturing process. For example, if there is a slight eccentricity or an irregular tooth in the gear train of a cable drag, the cable will be pulled through a stage in its manufacture with a slight pulsation. This variation in drag will produce a slight change in electrical parameters at regular distances along the cable. If the cable is operated at a wavelength of which this distance is a quarter wave, reflections from the



The magazine being held by William P. Lear, president of Lear Inc., holds pre-loaded spools of wire for the recorder incorporated in the company's postwar home radio receivers. As shown here, the magazine snaps into place on the front panel of the console, does away with threading and handling of the wire

NATIONAL RECEIVERS ARE THE EARS OF THE FLEET

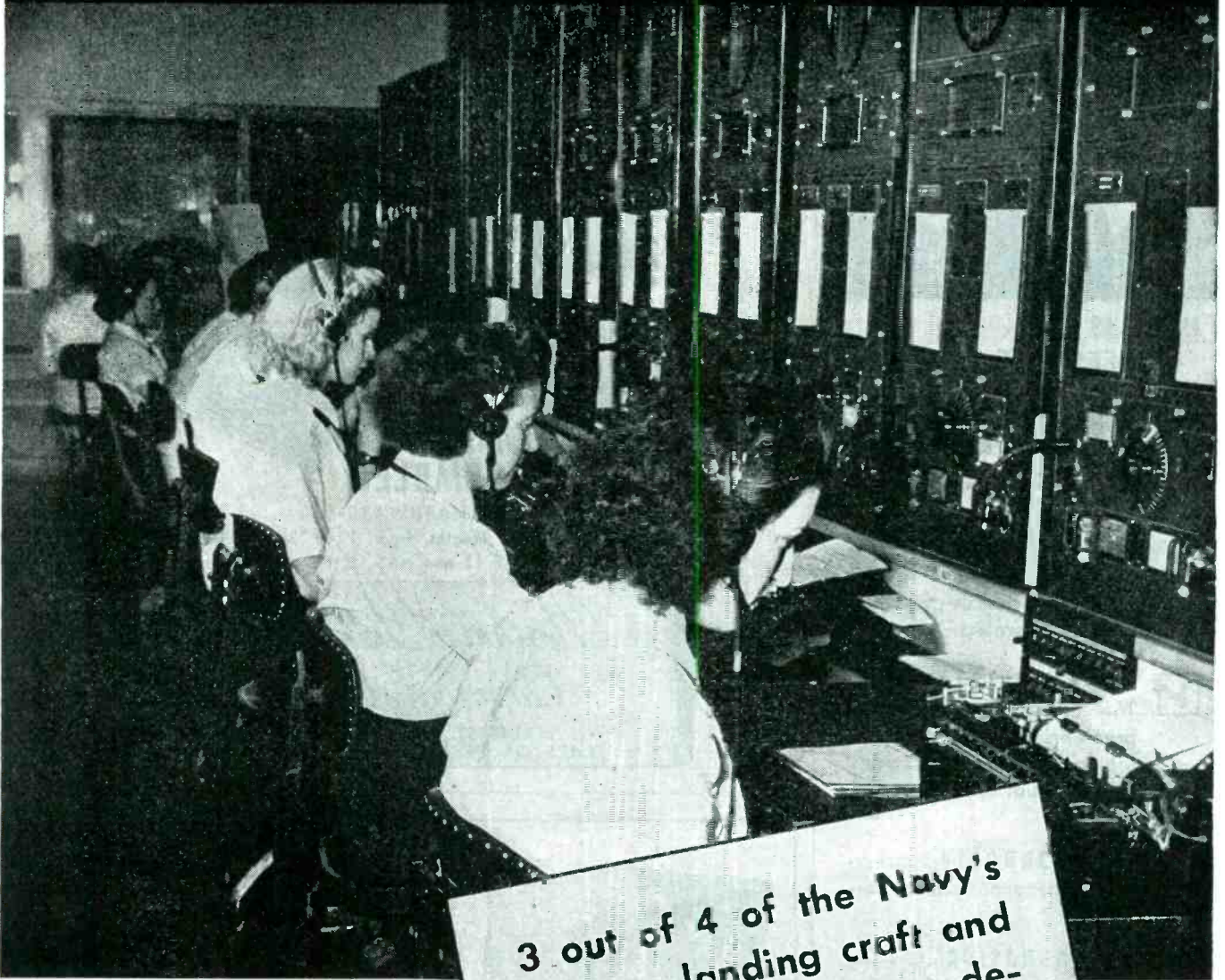

OFFICIAL U. S. NAVY PHOTOGRAPH

3 out of 4 of the Navy's ships — landing craft and larger — use receivers designed by National. Shore stations use them too.

The picture above shows Waves in the radio room of the U. S. Naval Air Station, Floyd Bennet Field, New York.

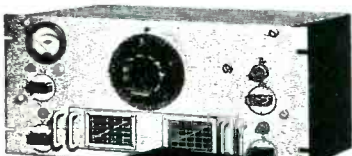

HRO

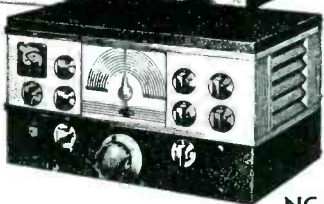

NC-200

NATIONAL COMPANY

MALDEN MASS, U. S. A.



NATIONAL RECEIVERS ARE IN SERVICE THROUGHOUT THE WORLD



HERE IS THE
DIFFERENCE BETWEEN

PERMOPIVOTS^{*} AND ORDINARY PIVOTS

Only PERMOPIVOTS are tipped with Permometal . . . a special alloy of precious metals produced by Permo Incorporated.

- WEAR RESISTANT . . .** The Permometal tip gives precision instruments longer life and greater accuracy under actual operating conditions.
- NON-CORROSIVE . . .** Permopivots cannot rust or corrode.
- NON-ABRASIVE . . .** The satin-smooth tip eliminates abrading particles of wear.
- NON-MAGNETIC . . .** K-monel shank material available.

The two unretouched photos reproduced below show why Permopivots keep precision instruments accurate longer.



Ordinary pivot after test



Permopivot after test

PERMO INCORPORATED
MANUFACTURING METALLURGISTS
6427 RAVENSWOOD AVE.
CHICAGO 26, ILLINOIS

*T. M. Reg. U. S. Pat. Off.

WRITE TODAY FOR DESCRIPTIVE FOLDER
NO OBLIGATION

MOLDED TERMINAL STRIPS



COMPLETELY ASSEMBLED

WITH HARDWARE

Available in lengths from 1 to 20 terminals.
2 Types: NAS 17 and NAS 18. Prompt deliveries.

*Northern Industrial
Chemical Company*

7-11 ELKINS ST., SO. BOSTON 27, MASS.
36 YEARS OF PLASTIC MOLDING EXPERIENCE



Write for this new bulletin
No. 038W

IF YOU USE WAX OR MELTED COMPOUNDS

. . . you'll find a wide variety of efficient low cost equipment for heating, melting, storing, pouring, dispensing and conveying melted compounds of many kinds in Sta-Warm's new and current bulletin 038-W.

Included will be many of the accessory features such as dispensing orifices, valves of various types, agitators, covers, electric currents available, etc.

You probably do not have bulletin 038-W in your files because it is brand new. Why not inquire for it today? It's chock full of specific information about Sta-Warm heating and melting equipment for waxes and compounds.

STA-WARM ELECTRIC CO.
1000 N. CHESTNUT ST. • RAVENNA, OHIO

"CLIENT WILL BUY A BUSINESS"

If some of your War activities cannot be continued profitably in Peacetime, then perhaps a client of ours* can help you.

Our client wishes to buy a going business or a complete department of a permanent organization.

This is to help them in the rapid expansion of a growing concern whose success is due to Electrical and Electronic Engineering talent, backed by proven merchandising ability.

Anything that can be made and sold to any branch of Electrical Communications will interest them; this includes Radio, Telephone, Telegraph, Television, Radar, Wire Photo, Sound on Film, Wire or Disc. An accessory widely used in these fields would be ideal.

Also, any items that would carry their technical ability into Industrial markets or into Air, Ground or Marine Transportation would be attractive.

They are particularly interested in products with protected positions either by virtue of patents, special "know-how" or limited markets; however, they would be glad to consider situations relating to mass markets.

They prefer products whose quality demands Engineering and Manufacturing skill thereby justifying above average sales prices and careful selling attention.

If you will be forced to stop work on any of your projects after V-day, either because they are out of line with your Peacetime activities or because they have insufficient sales volume to be of interest, then our client would like to meet you.

They would like to study your situation with reference to their ability to take over one of your projects, either now or later, and continue it on a mutually profitable basis.

All answers will be held confidential. Please reply to:

Cory Snow, Inc.

• M E R C H A N D I S I N G • A D V E R T I S I N G •
739 BOYLSTON ST. BOSTON 16, MASS.

**We are authorized to furnish the name of our client if requested on your business letterhead.*

Unusual and Vital ELECTRONIC EQUIPMENT

PRODUCED BY

TECH LAB

SUBCONTRACTING DEPT.

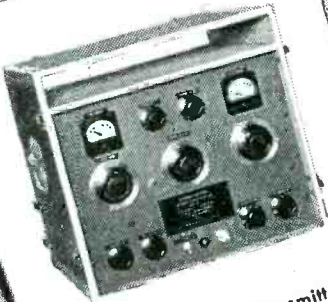

Special Short Wave Transmitter
Range: 1-16 megacycles on
one dial.



Development of special
hearing aid analyzer for
Western Electric Company.

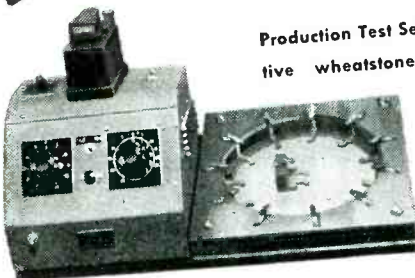

Production Test Set to test varistors. A sensi-
tive wheatstone bridge arranged with
switching means for
quickly checking a
number of varistors
in rapid sequence.

Manufacturers have continually called upon the modern facilities of Tech Lab Subcontracting Department to assist them in the production of unusual and vital electronic equipment. Our Engineering Department is ready to assist you with your production problems.

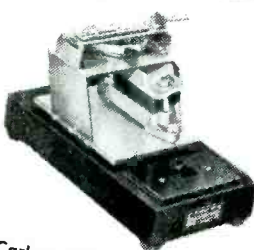

Carbon filling machines for
precision filling of carbon
microphones.



MANUFACTURERS OF PRECISION
ELECTRICAL RESISTANCE INSTRUMENTS

15 LINCOLN STREET, JERSEY CITY 7, N. J.

irregularities will reinforce each other. The effect can take a number of forms—all of which are annoying. The frequencies at which such irregularities become apparent are extremely high and in general can be made to fall outside the operating band of the cable.

Mechanical and chemical properties of cable have been steadily improved. Resistance to moisture absorption of the insulation and sheath have been found to be the best fungus protection. For flexibility a woven outer conductor is best but, not being solid, it permits some field leakage. Double-layer outer conductors eliminate most of the leakage. Additional shielding can only be obtained with a sacrifice in something else—chiefly a disproportional rise in cost.

An interesting side light—quite evident once pointed out but not generally thought of—is that the dielectric loss of the insulation is so low that it cannot be heated by high-frequency dielectric heating techniques. Besides, at about 10 Mc, where dielectric heating equipment usually operates, it is most difficult to heat water so it is not feasible to dry the powders used in cable manufacture by that process either.

Facsimile Radiophotos

ACME NEWSPICTURES, INC. is asking FCC for construction permit to build a Class 2 experimental station in the home of L. A. Thompson, Rocky River, Ohio. Mr. Thompson is chief engineer of the company. Facilities would be used to test facsimile and radiophoto transmission by fm. One-way transmission of signals is proposed to a number of cities on five different frequencies. Power would be 1000 watts.

Electronics of the Future

AN ARTICULATE believer in a tremendously expanded electronic industry after the war is Dr. C. B. Jolliffe, vice-president in charge of RCA Laboratories, who spoke on the subject recently before a joint Indianapolis meeting of AIEE and IRE.

He said that without much imagination it was possible to see a 5- or even 10-billion dollar electronic industry. Speaking about televi-

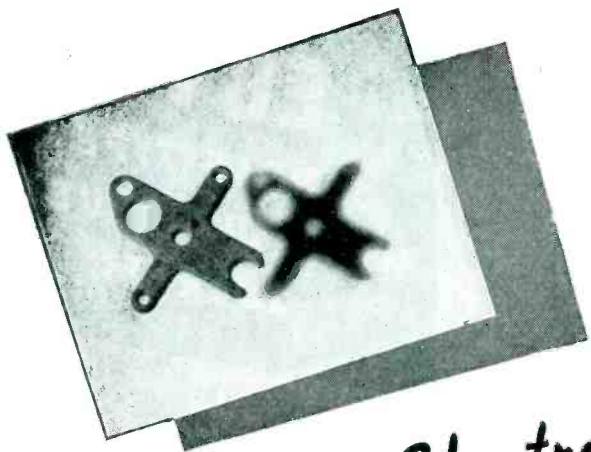

Superior Electronic Components WITH INJECTION MOLDED G-E MYCALEX

G-E Mycalex is doing a big job for the electronic industry. A speedy yet precision type of injection molding developed by the General Electric Company allows intricate shapes to be molded to extremely close tolerances.

G-E Mycalex can be molded with metal inserts, and as a result, the metal and the G-E mycalex are fused into an unusually strong bond.

Having over-all electrical properties superior to porcelain products and refractory qualities superior to organic plastics, G-E mycalex remains the all-purpose, high-heat, high-frequency insulation material for use in the radio and electronic industries.

For further information write Section S-90, General Electric Company, One Plastics Avenue, Pittsfield, Mass.

G-E mycalex has the following properties:

1. High dielectric strength.
2. Low power factor.
3. Prolonged resistance to electric arcs.
4. Chemical stability; no deterioration with age.
5. Dimensional stability; freedom from warpage, shrinkage, etc.
6. Imperviousness to water, oil and gas.
7. Resistance to sudden temperature change.
8. Low co-efficient of thermal expansion.

Hear the General Electric radio programs: "The G-E All-Girl Orchestra" Sunday 10 P.M. EWT, NBC. "The World Today" news every weekday 6:45 P.M. EWT, CBS. "G-E House Party" every weekday 4:00 P.M. EWT, CBS.

Buy War Bonds

GENERAL  ELECTRIC PD-90

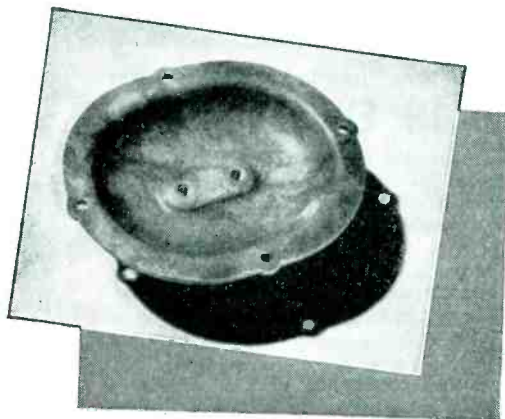
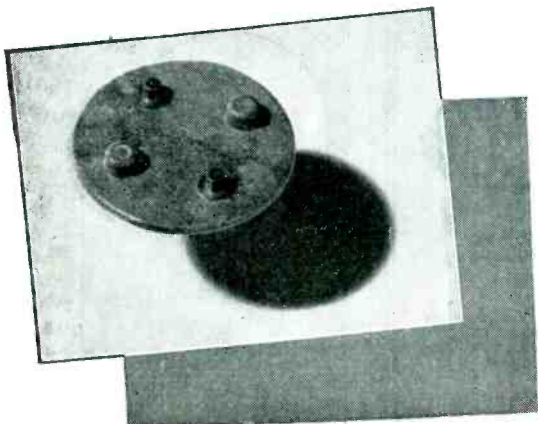
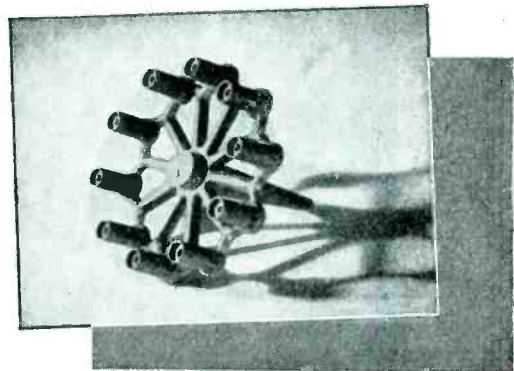
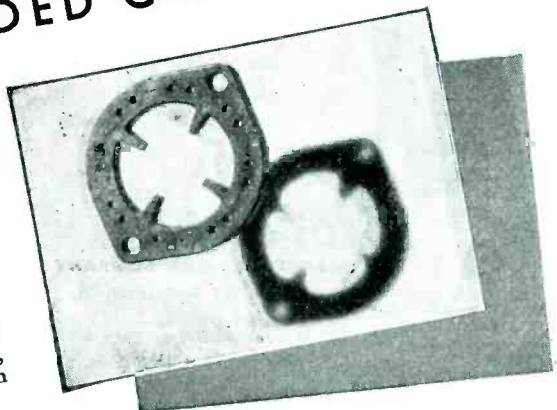

WAR or POSTWAR

Industrial or Consumer Pilot Light Assemblies



Model 1216



for NE45
Neon Lamps

★
Also available
for NE48 & NE51
Neon Lamps

Remember—there are more "UL" Approved Gothard Pilot Light Assemblies than any other make. The broad, precision Gothard Line is equal to practically any need—large or small—high or low voltage. Special engineering service for unusual problems. The Gothard Catalog illustrates and describes all stock models, listing the lamps they take and complete engineering data—write for your copy.

Gothard

MANUFACTURING COMPANY

1310 N. 9th St., Springfield, Ill.

Export Division—
25 Warren St., New York 7
Cables—Simonrice,
New York

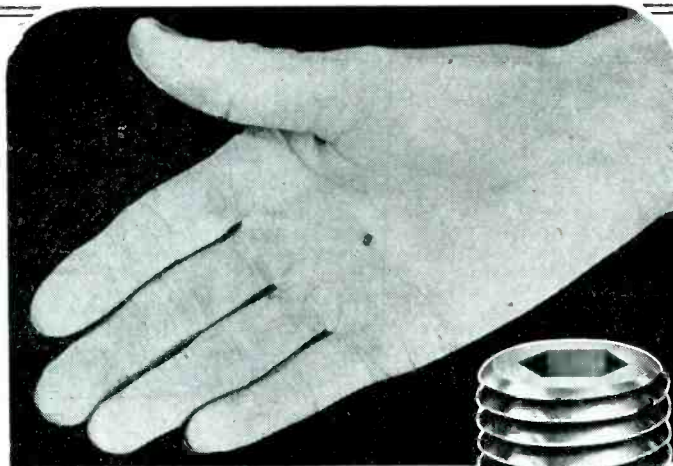
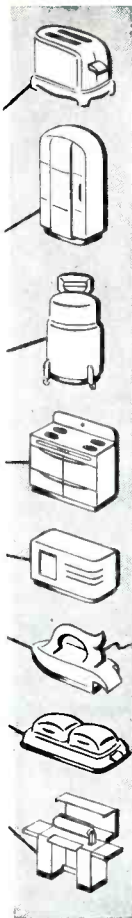

SO SMALL YOU CAN HARDLY SEE THEM, YET PERFECT IN EVERY DETAIL

Now made in extremely small sizes, the "Unbrako" Self-Locking Socket Set Screw is invaluable in the field of radio, electronics and fine instruments. Its knurled cup-point digs in and holds tight—no amount of vibration will cause it to unwind, yet it is easily removed with a wrench and may be used again and again. Sizes from $\frac{1}{16}$ to 1" diameter—all commercial lengths. Send for the "Unbrako" Catalog of Socket Screw Products

THE KNURLING OF SOCKET SCREWS ORIGINATED WITH "UNBRAKO" YEARS AGO.

OVER 40 YEARS IN BUSINESS

STANDARD PRESSED STEEL CO.
JENKINTOWN, PENNA. BOX 596

Boston • Detroit • Indianapolis • Chicago • St. Louis • San Francisco



Pat'd &
Pats. Pend.

UNBRAKO

Reg. U. S. Pat. Off.

SELF - LOCKING
HOLLOW SET SCREW



EBY

SADDLE TYPE MINIATURE TUBE SOCKETS

AVAILABLE IN

GENERAL PURPOSE
PHENOLIC (EBY #8100) →

LOW LOSS PHENOLIC
(EBY #8082) →

STEATITE
(EBY #8083) →

The castings and beryllium copper contacts are identical with JAN 5-28 Types SO 10M and SO 10C except that the shield base is replaced with a saddle. These EBY sockets meet the need for quality replacement of sockets of the saddle type. Write today for prices and samples.

LONG LIFE CONTACTS

The self-aligning beryllium copper contacts have been especially designed and Micro-processed to assure constant, even pressure on all parts of the socket pin without fatigue in contacts after continuous use.

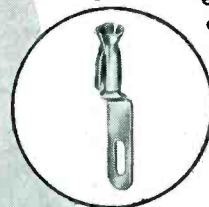

IF IT'S IN A CIRCUIT
... EBY COMPONENTS
AND SERVICES WILL
HELP YOU DO IT BETTER

HUGH H.

EBY

INCORPORATED
18 W. CHELTENAVE.
PHILADELPHIA, PA.



Extra hands

KARP facilities and men, skillful in engineering and fabricating metal parts and products of simple or complex design, are your *extra hands*. In *design*, our engineering department has helped solve the knottiest of problems. In *production and deliveries*, our facilities have been praised for maintaining and beating standards and schedules. In *cost*, KARP extensive stocks of dies have saved thousands of dollars for customers.

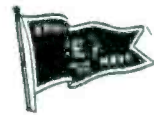

ANY QUANTITIES—ANY METAL—ANY SIZE—ANY FINISH

ARTISANS
IN
SHEET
METAL

KARP METAL PRODUCTS CO., INC.

124 30th STREET • BROOKLYN 32, N. Y.

CABINETS
CHASSIS
RACKS
PANELS

KEEP BACKING THE ATTACK . . . BUY MORE WAR BONDS

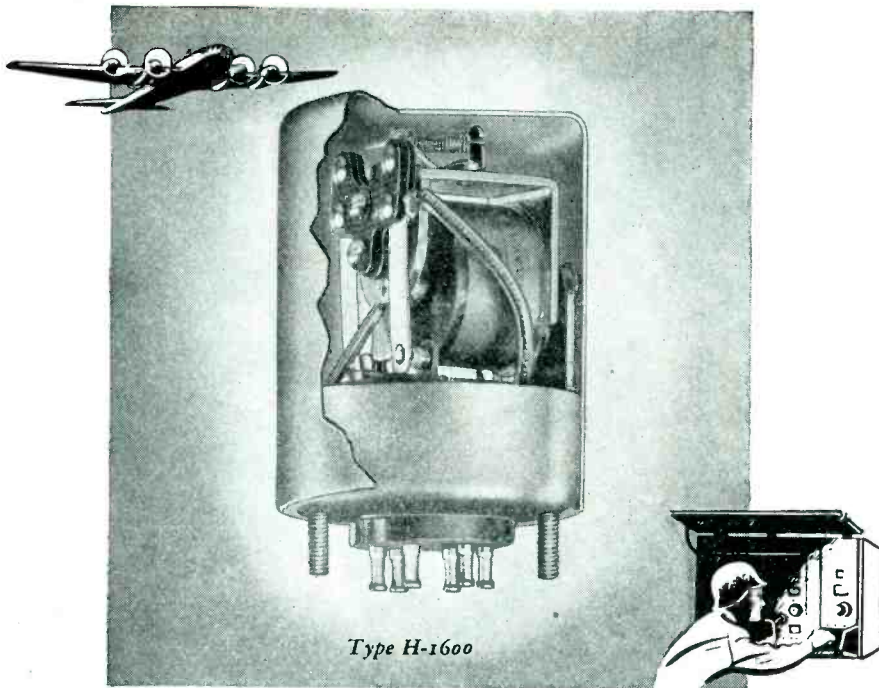

Type H-1600

HERMETICALLY SEALED

HERMETICALLY SEALED Advance Relays maintain their original efficiency under conditions that soon ruin or dangerously impair other types of relays. Dust, moisture, oil or fungus can't reach the precisely adjusted parts. The low atmospheric pressure of high altitudes can't cause failure through arcing or condensation. That these relays are tamper-proof is another advantage. And basically, like all Advance Relays, they have the stamina to resist the severe shock and vibration of battle, as has been so abundantly proved on all war fronts.

TYPE H-1600

Double pole, single throw. (May be had in single pole, double throw.) Full-floating armature suspension minimizes friction between frame and armature. Pure silver contacts are standard, with palladium or platinum alloys on special order. Wiping contacts insure clean contact surfaces. All steel parts cadmium plated to withstand the 200-hour Salt Spray Test. All brass and bronze parts nickel plated. All laminated phenolic parts moisture-and-fungus-proofed. Coil is wound with highest grade enamel wire and insulated with 100% cellulose acetate with a final vacuum varnish impregnation. Dimensions are: height of case only, 2"; diameter 1-5/8". Mounting screws and solder lug terminals project 5/16" below case.

Any Advance Relay can be furnished in hermetically sealed containers on special order. When you select Advance, you will have relays exactly as you want them. Our engineers are at your service. Write today for full information.

Advance Relays

ADVANCE ELECTRIC & RELAY CO.

1260-1262 W. Second Street, Los Angeles 26, Calif.

sion, he pointed out that engineers in that field cannot be satisfied until they have made it possible to project, in the home, pictures of adequate size in color of major happenings wherever they occur in the United States or in any other part of the world.

He also discussed the constructive peacetime aspects of radar and visualized the effect on communication that may result from developments in u-h-f radio relay systems using the techniques of wire communication without many of its limitations.

Rail Radio Test Truck

A HIGHWAY LOCOMOTIVE—a specially fitted truck—is being used by Bendix Radio division of Bendix Aviation Corp. to execute cruising tests on railroad radio equipment under conditions simulating those of actual railroad applications.

Cruising within a 10-mile radius of the radio and electronic laboratories of the company, the unit maintains continuous communication to report location and type of terrain. Information developed has already led to the solution of numerous interference problems.

Plea for Frequencies

IT HAS BEEN SUGGESTED to FCC by Press Wireless, Inc. that not less than 15 frequencies in the range from 5,000 to 20,000 kc be redistributed from other communication companies to PreWi. One of the company's arguments is that it uses only about 20 percent of the frequencies assigned to all the radio telegraph companies but transmitted 44.8 percent of the total wordage of all carriers in the first six months of 1944, as well as 67 percent of the total of radio-photos.

MEETINGS TO COME

JUNE 5; SOCIETY FOR MEASUREMENT & CONTROL, Symposium on Self-Actuated Regulators for Temperature, Pressure, and Liquid Level; Essex House, Newark, N. J.; R. H. Gray, secretary, 1 Whipoorwill Way, Mountainside, N. J.

JUNE 13-14; RADIO MANUFACTURERS ASSOCIATION, Board and Executive Committee Meetings only; Stevens Hotel, Chicago, Ill.; Bond Geddes.

PLASTIC PARTS

... PRODUCED TO YOUR SPECIFICATIONS

PRINTING DIE CUTTING CEMENTING

Wide experience by all known processes in the application of printing, engraving, silk screening, die cutting and cementing of all thermoplastics.

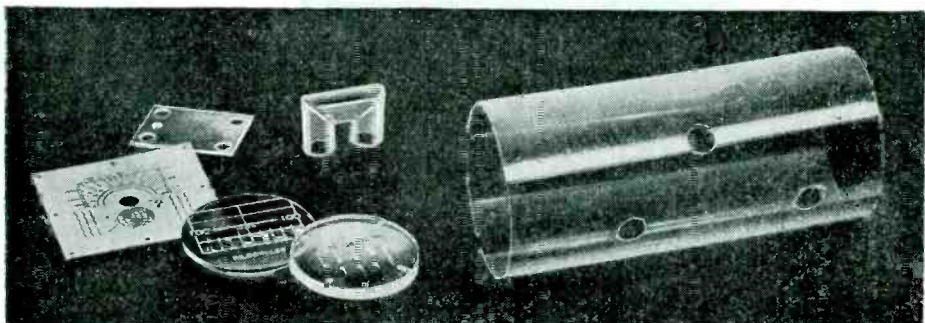

FORMING

Specialists in deep drawing radio dial windows, embossing, swaging and bending in Acetate, Wyalite and Acrylics.

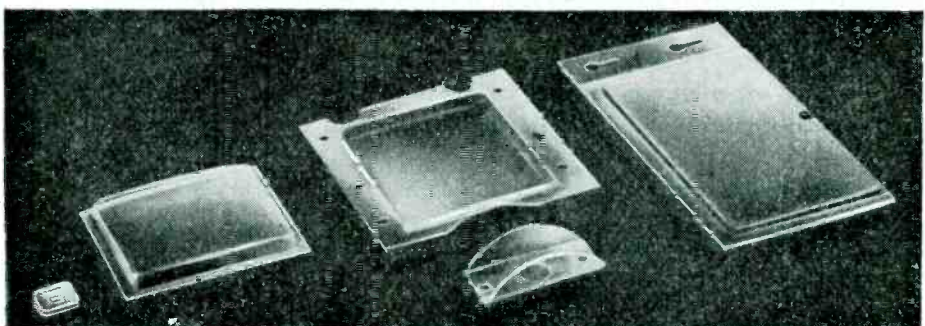

MACHINING

Precision threading, screw machine, milling, drilling, turning of Polystyrene, Acrylics, Phenolics, Nylon, Tenite; sheets, tubes and rods; through spindle capacity up to 2½" rod.

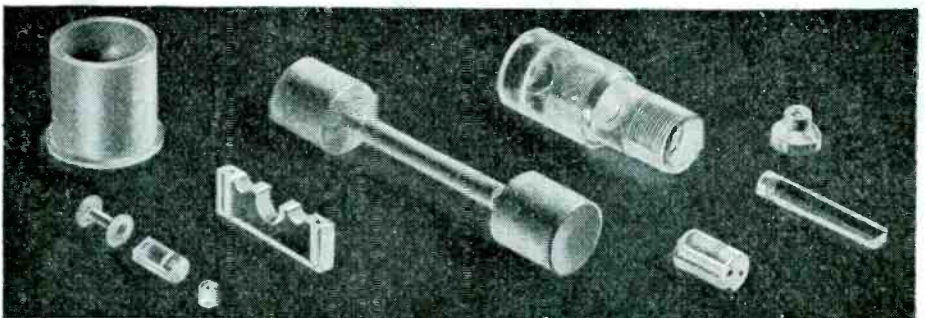

ASSEMBLY

Our engineers can assist you in problems of design and assembly of your plastic units.

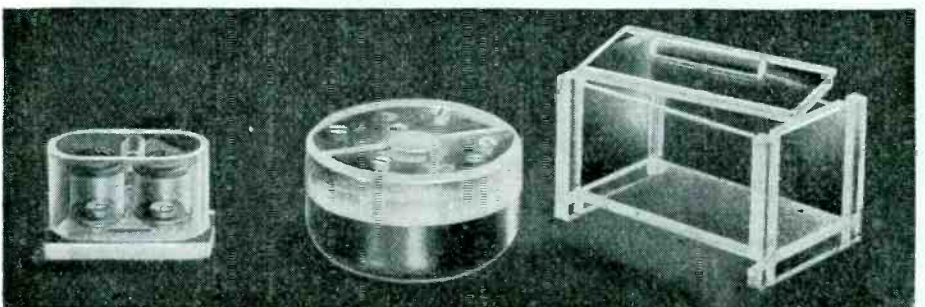

PRINTLOID, Inc.

93 Mercer Street
New York 12, N. Y.



**METAL
STAMPINGS**
IN SMALL LOTS

Die cut metal stampings in limited quantities can be produced to your special requirements at 15% to 20% of the cost of permanent type tools. No matter how small your quantity requirements or how intricate your work, we can show you a definite saving. During our twenty-three years of specialized experience in this service, there has been no other method of producing metal stampings in small lots that can equal the process originated by Dayton Rogers.

Our new, illustrated booklet #176-17 will give you full particulars.

DAYTON ROGERS MFG. CO. 2835 12th Avenue So. Minneapolis, Minnesota

Hercules
TRANSFORMERS and COILS

Standard and CUSTOM CONSTRUCTION to meet all specifications

Prompt engineering service always available

HERCULES ELECTRIC & MFG. CO.
INCORPORATED
2500 ATLANTIC AVENUE • BROOKLYN 7, N. Y.

DC and AC WELDERS • TRANSFORMERS • MAGNETIC CLAMPS • SOLENOIDS • RIVET HEATERS
SPOT WELDERS • FLUORESCENT BALLASTS • SPECIAL CONTROLS

**SPECIAL
PRECISION
FRACTIONAL
HORSE-POWER
MOTORS
AND
GENERATORS**

HOW THEY ARE USED

It was our plan to publish a booklet showing many of the interesting uses for fractional horse-power motors and generators, complete with photographs and schematic drawings—thought-provoking information for engineers planning their post-war products. So, we wrote our many customers and asked for information along those lines. Here is a typical reply:

"I have your letter in which you requested information regarding the use of "ELINCO" products. While I can attest to the excellence and reliability of your products, unfortunately I cannot at this time describe any specific application of such units because of the nature of my work. During the past several years all the work I have done has been of a confidential nature, and one cannot easily describe the application of your products without revealing the nature of the device."

Obviously, we have had to postpone our booklet. However, as soon as official release can be obtained to describe the many fascinating applications of our products, we will publish our booklet, a copy of which will be yours for the asking.

In the meantime, we will welcome descriptions of uses of fractional horse-power motors and generators, if they can be released, and will be delighted to place your name on our mailing list for "Fractional H.P. Motors and Generators . . . and How They Are Used" when we are able to publish it.

the
electric
indicator
CO.

109 Parker Ave. Glenbrook, Conn.
SPECIALISTS IN THE DESIGN AND PRODUCTION OF SPECIAL PRECISION FRACTIONAL HORSE-POWER MOTORS AND GENERATORS

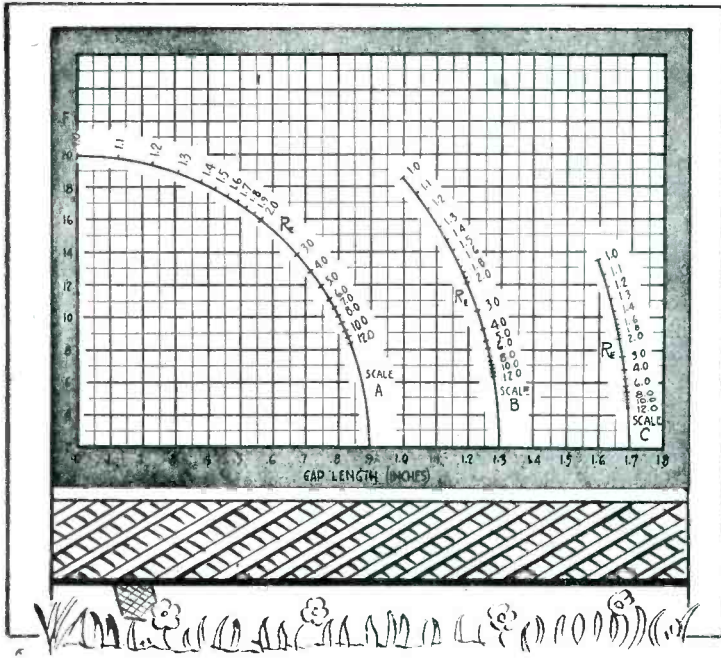

How Much Leakage?

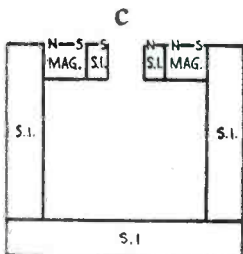
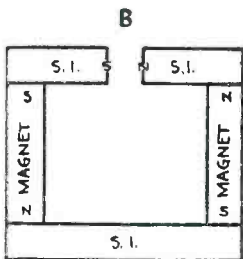
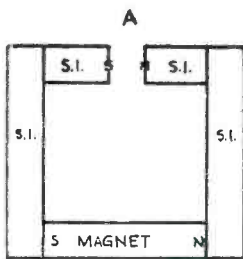

● "Boy, what a sign! Looks like a bunch of destroyers swinging into column. Wonder why they put it up where we can see it every day on our way to the gap where we work." . . . It's meant for you, son, and others like you because it has a lot to do with the leaking from the pails of energy you're carrying. It's your job to deliver a certain amount of magnetic flux at the gap and these curves will help you do just that.

Magnetic systems cannot be made leak-proof. It is possible to compute quite accurately what to allow for leakage in any design but this takes scores of abstruse equations, reams of paper and cups of black coffee. There's a much simpler method, one that is sufficiently accurate, for determining the Leakage Factor F. It can be found from the curves on the billboard using the simple circuit designs on the left. The value of 1.35 can be assumed for Constant f.

With values for constant F and f determined, the energy equation can be solved. Full details are given in our booklet, PERMANENT MAGNET DESIGN. Send for a copy. Study it and if you would like any assistance in designing your magnets, call on us.

CINAUDAGRAPH CORPORATION



2 Selleck Street

Stamford, Connecticut

"Our Staff of Acoustical Engineers is at Your Service"

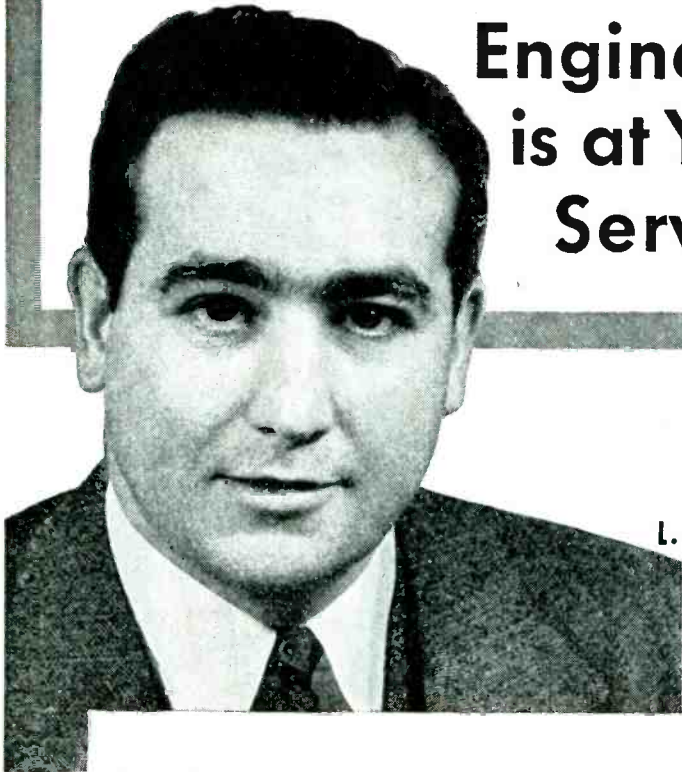

**L. M. Heineman
President
Permoflux
Corporation**

Permoflux engineering is directly responsible for many history-making war communication improvements. Our dynamic headphones, speakers, microphones, midget transformers and other acoustical products have made notable contributions in performance, dependability and progressive design.

If in your development of communication equipment requiring acoustical components, you are interested in availing yourself of exceptional engineering, design and manufacturing talent, we invite you to turn over your problems to us. Our staff of competent acoustical engineering experts is ready and able to give you immediate cooperation.

TRADE MARK
PERMOFLUX
PERMOFLUX CORPORATION
4900 WEST GRAND AVE., CHICAGO 39, ILL.



PIONEER MANUFACTURERS OF PERMANENT MAGNET DYNAMIC TRANSDUCERS

secretary, 1317 F St. N. W., Washington 4, D. C.

JUNE 21; FORT WORTH ELECTRONICS CLUB, High Frequency Heating, by J. L. Caudry, Texas Electric Service Co.; Texas Hotel, Fort Worth; W. H. Farrington, secretary, 3200 Ryan Ave., Fort Worth 4, Tex.

JUNE 25-29; AMERICAN INSTITUTE OF ELECTRICAL ENGINEERS, Summer Technical Meeting; Detroit, Mich.; H. H. Henline, secretary, 33 West 39 St., New York 18, N. Y. . . . Cancelled.

WASHINGTON NEWS

RADIO RECEIVING TUBES. Present production of certain critical types of radio receiving tubes is about 30 percent below both the industry's own forecasts and military requirements. To accommodate Army and Navy needs in excess of production, a plan has been adopted by WPB to shift plant facilities to areas where more labor of the type necessary is available. No immediate improvement in civilian supply is visualized.

ELECTRONIC ENGINEERS. Production of radio, radar and sonar equipment requires that the straight application of induction rules and regulations not be applied to electronic engineers who are, as a group, young men. This is the view of Captain J. B. Dow, USN, Director of Electronics for the Bureau of Ships. He announced that every possible effort is being made to reconcile conflicting demands for manpower as they arise.

LEAD SUPPLY. Further restrictions have been placed on the use of lead since the supply has become increasingly critical. It can be used only for end products that have been investigated thoroughly as to their essentiality in the military program and civilian economy, according to WPB. The amended order lists 64 permissive uses for lead and eliminates previous categories of total restrictions, unrestricted uses, and quota percentage restrictions.

CONSTRUCTION PERMITS. According to a recent action of FCC, the requirement that construction of a station begin within 60 days from the date of grant of the construction permit has been deleted for

WHAT ARE YOU GOING TO DO ABOUT THE NEW ALLOCATIONS?

HERE'S ONE THING YOU CAN DO ABOUT THEM NOW.

Perhaps by the time you read this, all frequency allocations will have been pretty well settled. You'll be thinking about how your present equipment will fit into the future.

Browning Laboratories have always designed and manufactured soundly engineered and ruggedly built equipment for specific services. Right now every available manhour goes into design and manufacture for the Armed Forces. But, looking ahead, if you'd like Browning to have a converter for your specific needs, tell us how you'd like it.

This applies to both AM and FM receiving equipment. Tear out this page now, as a reminder, or write us a letter.



HERE IS A HANDY FORM TO HELP YOU see where you stand. If you mail it to Browning Laboratories, it will give you an opportunity to say exactly what you want by way of conversion equipment.

Browning Laboratories, Inc.
750 Main Street
Winchester, Mass.

Gentlemen:

My present AM receiving equipment has ranges of to to
..... to to to to to

It will be satisfactory in the new allocations without a converter.

It will have to be converted to ranges of to to
..... to to to to to

My present FM receiving equipment has ranges of to to
..... to to to to to

It will be satisfactory in the new allocations without a converter.

It will have to be converted to ranges of to to
..... to to to to to

If a dependable Browning Laboratories converter is available, here are the special features it should have to be most useful to me:

.....
.....
.....

NAME _____

TITLE _____

COMPANY _____

ADDRESS _____

CREI
suggests that you—
Modernize

The Technical
Knowledge of
Your Employees

by means of

CREI
GROUP TRAINING

For Professional
Self-Improvement

★ *Prepare your technical staff to meet the challenge of post-war radio-electronic technological demands.*

• If your organization plans engagement in post-war radio-electronics, your technical personnel must know FM—television—Ultra High Frequency Techniques, and all other phases of war-developed electronics technology; and, of course, a thorough and complete knowledge of the fundamentals of practical radio-electronics engineering.

The CREI
"Employers' Plan"
for group training will:

1. Increase the technical abilities of your radio-electronics personnel.
2. Enable them to perform their duties more efficiently and in less time.
3. Increase the value of their services to your organization.

No company time is required for this training . . . it is accomplished by spare-time, home study.

The CREI "Employers' Plan" is useful for the up-grading of technical personnel in manufacturing, AM, FM, and television broadcasting, communications, industrial electronics, including the following:

Engineers	Testers
Engineering Aides	Technicians
Laboratory Assistants	Field Servicemen
Inspectors	Installers
Maintenance Men	

The CREI "Employers' Plan" for group training is tailored to meet each individual organization's requirements.

Your request will promptly bring an outline of the plan, as now in use with other organizations, and intimate details will follow when your particular needs are known. No obligation or cost, of course.

CAPITOL RADIO
ENGINEERING INSTITUTE

E. H. RIETZKE, President

Home Study Courses in Practical Radio-Electronics Engineering for Professional Self-Improvement

Dept. E-6, 3224-16th St., N.W.
WASHINGTON 10, D. C.

Contractors to the U. S. Navy—U. S. Coast Guard—Canadian Broadcasting Corp.—Producers of Well-trained Technical Radiomen for Industry

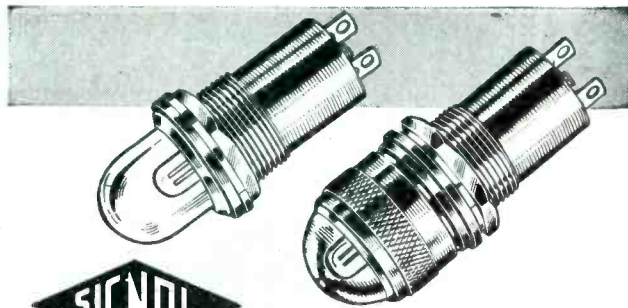

NEON PILOT LIGHTS

EMBODY THESE IMPORTANT FEATURES:

Penetrating orange-red glow . . . Long life . . . Low current consumption . . . Resistance to vibration and shock . . . Operate direct on high voltage circuits . . . Emit practically no heat —

These advantages of Neon Glow Lamps are enhanced by "SIGNAL" Pilot Light Assemblies. We manufacture a complete line, featuring types fitted with Full-View Plastic Heads. Specialists in supplying completely assembled units, housing G.E. or Westinghouse Lamps. Send specifications for prompt estimates and suggestions . . . Write for Catalog.

SIGNAL INDICATOR
Corporation

894 BROADWAY . . . NEW YORK 3, N. Y.

Telephone: ALgonquin 4-4770

BAKELITE SHEETS, RODS AND TUBES



We can furnish Army and Navy specification materials from our representative local stocks. On special mill shipments we can give prompt delivery. Also complete fabrication service backed by 20 years of experience.

ELECTRICAL
INSULATION CO., INC.

12 Vestry St., New York 13, N. Y.

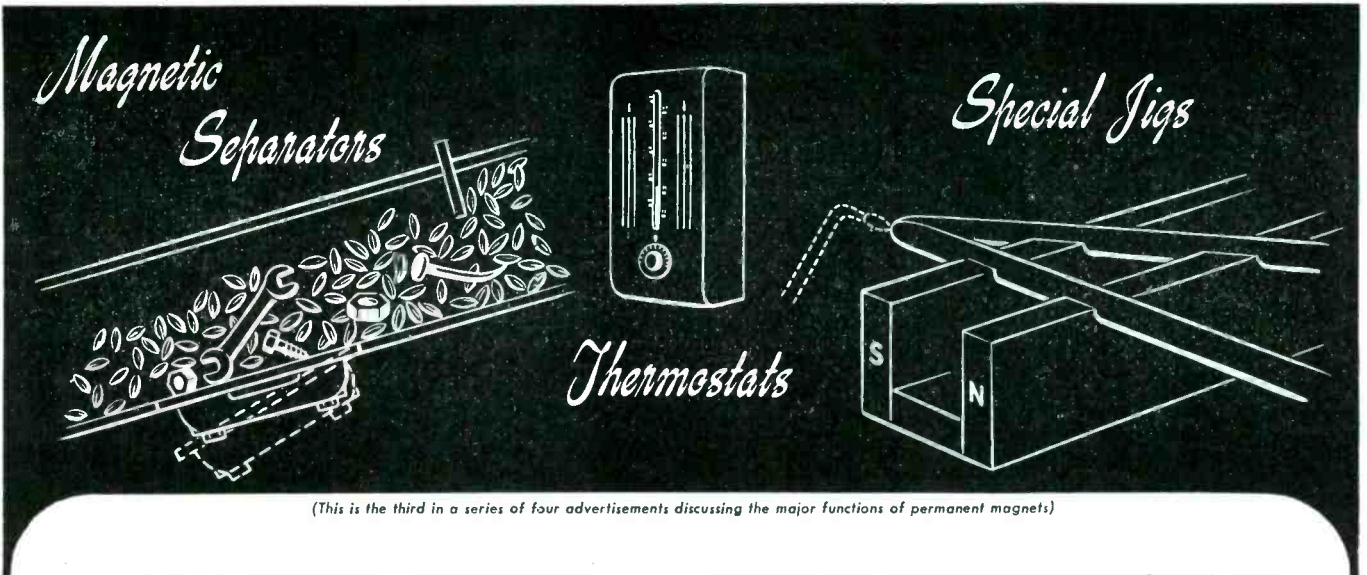

TRACTIVE EFFORT from PERMANENT MAGNETS

The power to attract magnetic materials led to the discovery of the lodestone—the earliest known form of permanent magnet. The same force has served mankind, since antiquity, in the compass. This tractive effort is now employed industrially in three ways.

1. For holding and lifting magnetic materials. Magnetic materials are held in place for assembly or other operations, by means of magnetic chucks or jigs. Magnetic separators extract tramp iron or other magnetic substances from non-magnetic materials. They function in such devices as coin selectors in vending machines.

2. To produce tension—replacing mechanical springs in various applications where tension in another form is required. This principle is

used on thermostats, pressure controls, switches, and similar devices.

3. To transmit motion without mechanical connections. Permanent magnets can reproduce motion from one part to another through a seal—as in the flow meter and other packing-less drives.

Indiana Steel is the largest exclusive manufacturer of permanent magnets, established for over 35 years. Without obligation, our engineers will be pleased to consult with you on any of your problems involving their possible application. Write for copy of technical booklet: "Permanent Magnets Have Four Major Jobs."

★ THE INDIANA STEEL PRODUCTS COMPANY ★

6 NORTH MICHIGAN AVENUE • CHICAGO 2, ILLINOIS



Specialists in Permanent Magnets Since 1910

COPYRIGHT 1945, THE INDIANA STEEL PRODUCTS COMPANY

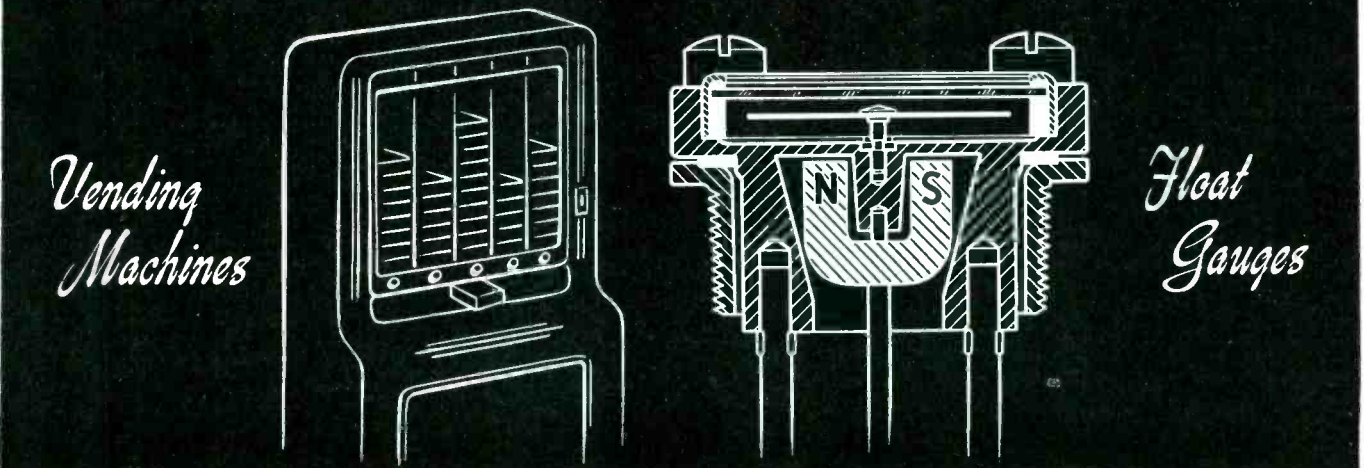

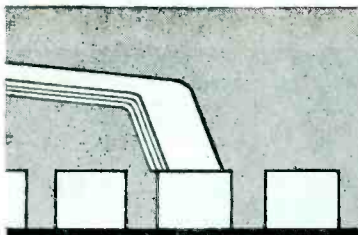

FLAT Contacts

reduce noise, prolong service life

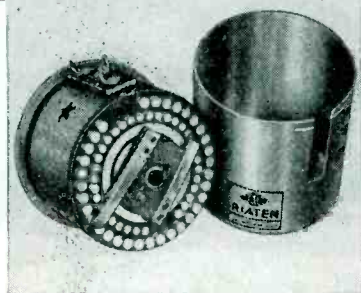

VARIATEN #1218
"T" Circuit—1½ db per step; 30 to 600 ohms impedance. Price, F.O.B...\$17.50

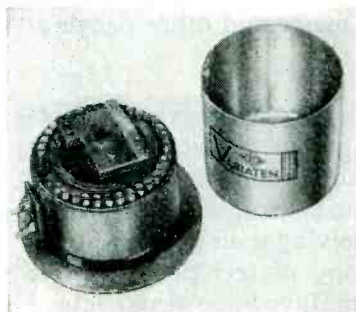

VARIATEN #1156
Ladder Circuit—1½ db per step; 30 to 600 ohms impedance. Price, F.O.B...\$12.50



VARIATEN #1658
Ladder Circuit—2½ db per step; 30 to 600 ohms impedance. Price, F.O.B...\$5.75

VARIATEN contacts and brush surfaces make contact over their entire area because the contacts are ground flat and the brushes stone-lapped, *not* buffed. Buffing produces rounded surfaces and therefore a "point" contact highly susceptible to noise. Variaten brushes move from one contact to the next without rocking motion. The resulting perpendicular spring pressure at all positions allows us to take advantage of the natural resiliency of metals to provide a completely flat contact over the entire brush surface at all times and so reduce noise and lengthen service life.

No carbon resistors are used in any Variaten Mixer...

All are of stable, wire-wound construction. Most are step type. Where quiet operation is the major consideration, we recommend ladder type mixers because the circuit requires only one contact brush operation on the input side of the circuit and any possible brush noise is therefore attenuated along with the signal.

By all means compare circuits, construction and features of these mixers. From the hundreds of Variaten attenuators you may select the attenuators best adapted to your specific needs. Write for the Variaten Catalog today.



CINEMA ENGINEERING CO.
 Established 1935 • Burbank • California

the case of radio stations other than broadcasting. The requirements that construction be completed within eight months after the earliest possible date of commencement is now in force, while the 60-day and six-month limits still apply to broadcast service.

LICENSE RENEWALS. A more detailed review is to be conducted by FCC when passing upon applications for license renewals by broadcast stations. In accordance with this policy, a number of stations have been asked to supply information showing why the percentage of commercial time on their station log is substantially in excess of the percentage projected in the original application made by the station for its construction permit.

MUSICAL INSTRUMENTS. Idle and excess critical materials, subject to certain conditions, can be used by manufacturers of musical instruments to fill military or Veterans Administration orders irrespective of general restrictions, according to WPB. These materials include steel, brass, tin in solder and nickel for plating functional parts. Chromium; copper, except in brass; neoprene; nickel, except for plating functional parts; rubber; tin except in solder; and zinc, except in brass, are still completely prohibited. Methyl methacrylate and phenol formaldehyde plastics previously on the prohibited list have been removed in the amended order. Musical instruments include any electrically-amplified instrument and any amplifier therefor except radios, phonographs and articles designed primarily as toys.

TURNOVER. According to a report from Secretary of Labor Perkins, only 3.3 percent of the workers on payrolls of factories manufacturing radio equipment gave up their jobs, as contrasted to a figure for all 20 major manufacturing groups of 4.3.

REPAIR SERVICE GUIDE. A summary of regulations has been prepared by the Office of Civilian Requirements of WPB to serve as a guide to maintenance and repair personnel. Including all data up to March 23, 1945, the publication includes sections covering controlled materials, motors, solder, radio repair

HOW FUNGUS-PROOFING KEEPS FIELD TELEPHONES FIT FOR COMBAT



In the South Pacific the life of an ordinary field telephone might be measured in hours...were it not for fungus-proofing. Minute organisms, which thrive in the hot, humid islands of the Pacific, strip unprotected wires of their insulation...quickly corrode exposed metals and reduce untreated plastics to a moldy heap of uselessness.

To prevent this costly and dangerous destruction of precision instruments, the EE8-B field telephones we turn out for the U. S. Signal Corps are specially fungus-proofed during their manufacture. There

can be no margin for error in this vital process—because men's lives depend on sure-fire communications.

You may not need fungus protection in the telephone instruments, electrical equipment, or electronic devices you will one day install in your plant. But you *will* be looking for sound, progressive engineering... adaptability to your particular needs... uniform high quality. Ask the returning soldier who has used Connecticut Telephone & Electric Division equipment in the field what he thinks of it. We'll rest our case with him.

INSPECTION IN THE DARK

Fungus-resistant liquid is applied to Army field telephones in the form of an atomized spray. Teil-tale ingredient of the fungus-proofing is a fluorescent dye which glows under "black light" . . . Thus, by means of a final inspection in total darkness, the slightest defect in the continuity of the protective spray coating is instantly detected.

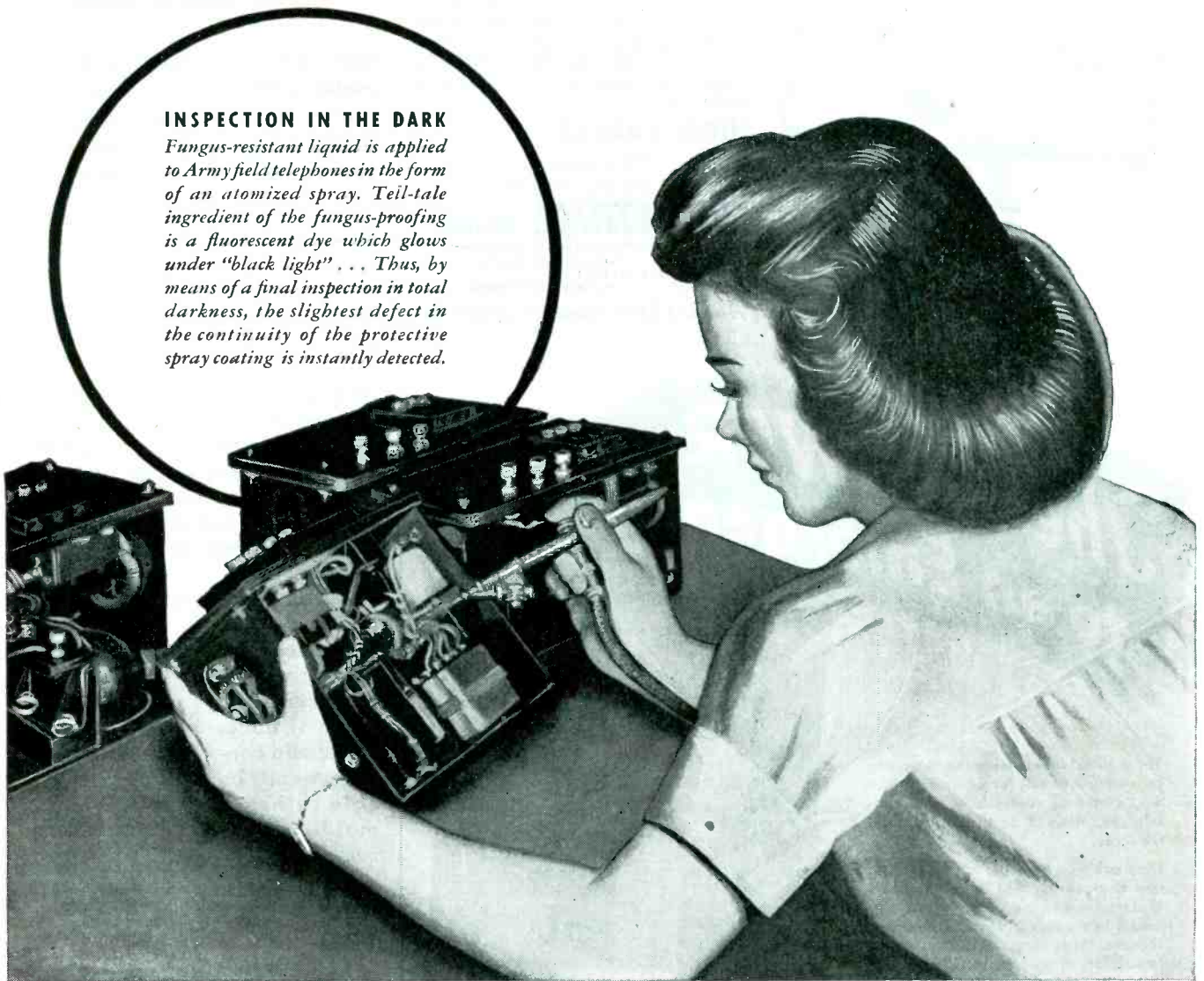

CONNECTICUT TELEPHONE & ELECTRIC DIVISION

GREAT AMERICAN INDUSTRIES, INC. • MERIDEN, CONNECTICUT

TELEPHONIC SYSTEMS • SIGNALLING EQUIPMENT • ELECTRICAL EQUIPMENT • HOSPITAL AND SCHOOL COMMUNICATIONS AND SIGNALLING SYSTEMS • IGNITION SYSTEMS

S.S. White **MOLDED RESISTORS**

The "All-Weather" Resistors

TYPE 65X
Actual Size
Other types available in the lower values

RESISTOR BULLETIN 37 GIVES FULL DETAILS . . .

It shows illustrations of the different types of S. S. White Molded Resistors and gives details about construction, dimensions, etc. A copy, with Price List will be mailed on request. Write for it—today.

WIDELY FAVORED because of **NOISELESS** operation, **DURABILITY** and fine **PERFORMANCE** in all climates . . .

STANDARD RANGE
1000 ohms to 10 megohms

NOISE TESTED

At slight additional cost, resistors in the Standard Range are supplied with each resistor noise tested to the following standard: "For the complete audio frequency range, resistor shall have less noise than corresponds to a change of resistance of 1 part in 1,000,000."

HIGH VALUES

15 megohms to 1,000,000 megohms

S.S. WHITE INDUSTRIAL DIVISION

THE S. S. WHITE DENTAL MFG. CO.

DEPT. R. 10 EAST 40th ST., NEW YORK 18, N. Y.

FLEXIBLE SHAFTS AIRCRAFT ACCESSORIES
MOLDED PLASTIC FLEXIBLE SHAFT 10000

One of America's AAAA Industrial Enterprises

VICTORY* will mold Plastics for you...

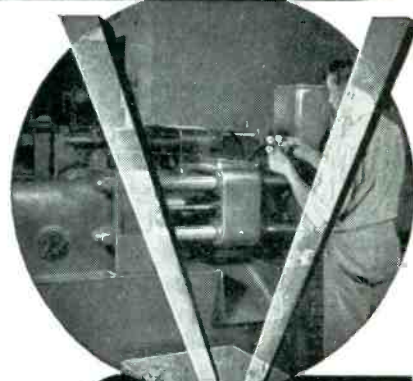

after **VICTORY**

We'll be ready to do a better molding job for you . . . when we've finished supplying the needs of many prime contractors to the Armed Forces.

Molding plastics for War still demands most of our time and equipment . . . it's VICTORY'S* bit toward complete Victory . . . but it's also paving the way for better-molded products for you in the days of Peace.

Wartime lessons in precision molding have sharpened the wits of our engineering staff. Solving tough problems has broadened our knowledge of handling a great variety of thermo-plastics. Our workers are better craftsmen because they have learned the importance of extreme accuracy.

Whatever plastic product you're planning to use, consult with our engineers at once. On certain contracts we may be able to begin molding right now.

Member: Society of the Plastics Industry

Automatic Injection Molding

Small and large parts UP TO 17-OZ. SHOTS

Lumarith, Tenite, Fibestos, Plastacelle, Crystalite, Lucite, Ethyl Cellulose, Polystyrene, Lustron, Styron, Cellulose Acetate and others . . . all molded to your exacting specifications.

The ANSWER to an Emergency

These transformers were the answer to an emergency call for equipment that would operate successfully in the humid conditions of South Pacific jungle warfare.

They are one example of the design and engineering that has established Electronic Engineering Co. as the leader in the field of specialized transformers. Now, all production is going for military applications . . . Tomorrow, this outstanding equipment will be available for civilian applications.

ELECTRONIC ENGINEERING CO.

3223-9 WEST ARMITAGE AVENUE, CHICAGO 47, ILLINOIS

"SPECIALIZED TRANSFORMER ENGINEERS"

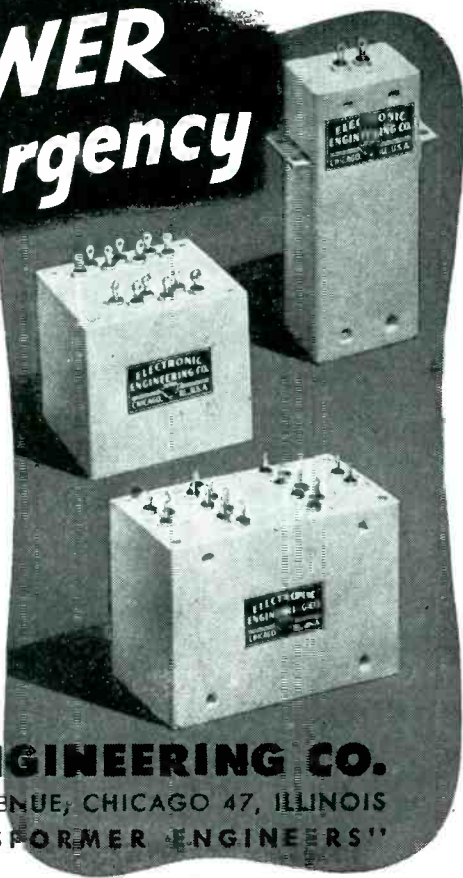

*VICTORY MANUFACTURING COMPANY

1724 W. Arcade Place, Chicago 12, Ill. ESTABLISHED 1930



"I want
**A FLEXIBLE GASKET TO
WITHSTAND 2000° F.**"
said the airplane part maker



"I want
**A RESILIENT
SHIELDING CUSHION**"
said the set manufacturer



"I want
**A FINE TUBE GRID
THAT WON'T SAG**"
said the electronic tube maker



"I want
**A LASTING WICK FOR
AIRPLANE HEATERS**"
said the cabin heater maker

They found what they wanted in

KNIT MESH

made of INCO Nickel Alloys

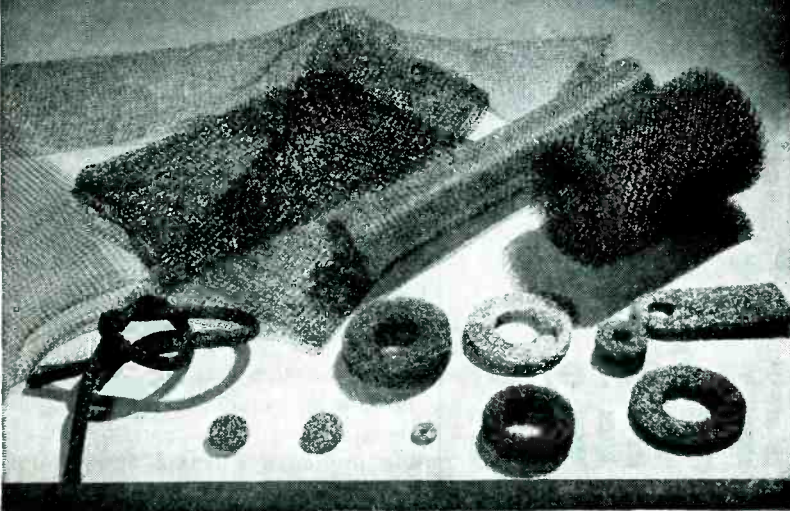

Today, metal mesh knit from INCO Nickel Alloys does *all* these varied jobs.

Tomorrow? Perhaps it's the answer to an electronic problem now on *your* drafting board.

For Knit Metal Mesh, product of the Metal Textile Corp., Orange, N. J., has many properties that point to its wide future use in electronics.

Knit from Monel, Nickel or Inconel, it is rustless corrosion-resistant, tough, strong, able to withstand high temperatures. In addition, its special *linked-loop* design is flexible, highly resistant to breakage, unusually strong on the bias. It offers, for instance, a firm fabric for grids because the linked loops allow normal expansion when the grid is heated, and return the fabric to its original shape as the grid cools.

The knit fabric holds together even when made of very fine wire (.0045 diameter), and with as few as 4 or 5 openings to the inch.

For further information about mesh knit from the INCO Nickel Alloys...and for other technical service on metal problems...address: The International Nickel Company, Inc., 67 Wall Street, New York 5, N. Y.



"I want
**A BETTER
AIR FILTER MEDIUM**"
said the filter manufacturer



"I want
**A FLEXIBLE STRAP THAT
WON'T JIGGLE LOOSE**"
said the magneto maker

NICKEL  ALLOYS

MONEL • "K" MONEL • "S" MONEL • "R" MONEL • "KR" MONEL • INGONEL • "Z" NICKEL • NICKEL • Sheet...Strip...Rod...Tubing...Wire...Castings

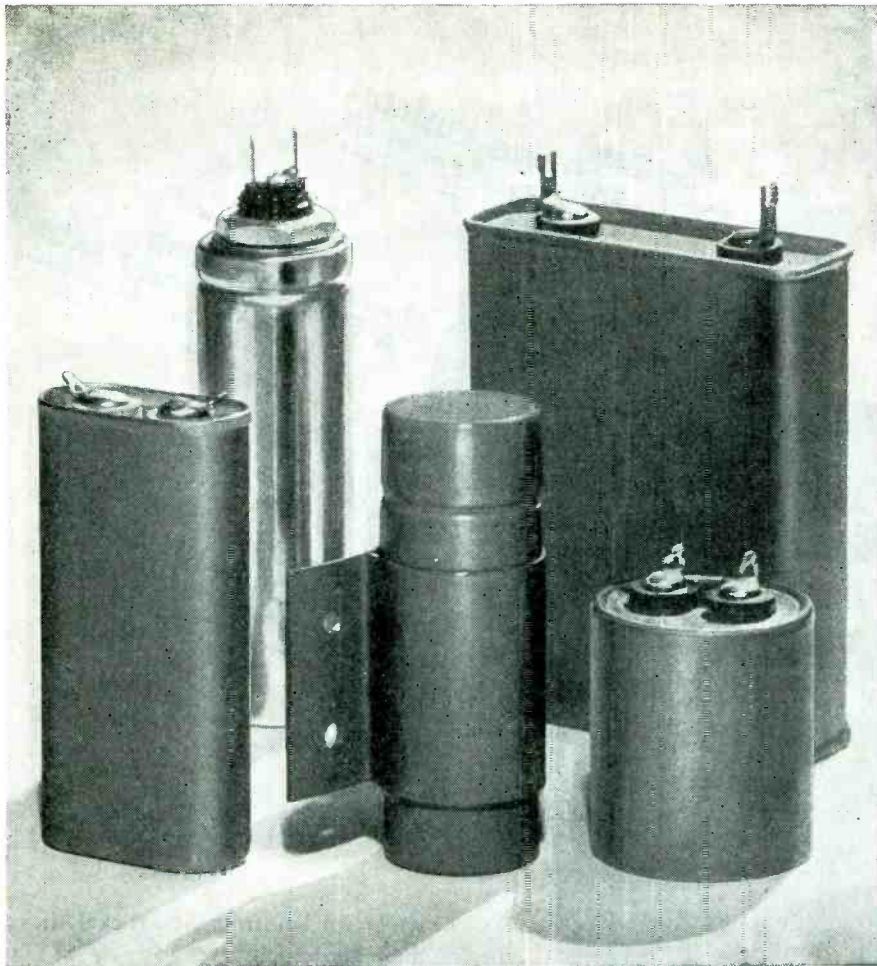

Quality...

A Success Secret of CAPACITRONS

The Capacitron reputation for progressive design, superior craftsmanship and dependable service is backed by a continuous research program covering every capacitor manufacturing operation. No Capacitron production process is ever given a chance to become "standard procedure" — it is always an engineering project — always open for immediate improvement. Through this system of *method control* has come unquestioned leadership for Capacitron Oil, Wax and Electrolytic Capacitors . . . our customers call it Quality.

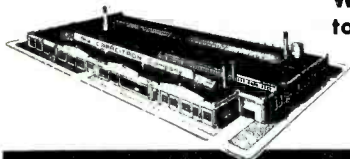

Telephone VAN Buren 3322

The CAPACITRON Company

849 North Kedzie Ave., Chicago 51, Illinois

parts, repair parts and materials in general, tools and special equipment, and procedure to obtain materials.

FCC ACTS

To permit this station	To do this
WSSC Savannah, Ga.	Operate a new relay broadcast station to WTOG on 30,820, 33,740, 35,820, and 37,980 kc at 2 watts.
WFTH Miami, Fla.	Change call letters to WGBS.
WLB Minneapolis, Minn.	Change call letters to KUOM.
KALB Alexandria, La.	Change frequency, increase power, install new transmitter and directional antenna for night use, contingent on non-interference with Mexican Station XEMU.
----- Jersey City, N. J.	Construct a new developmental broadcast station, frequencies to be assigned.
----- Conway, S. C.	Construct a new station to operate on 1490 kc, 250 watts, unlimited time.
KOIN Portland, Ore.	Change transmitting equipment.
KETJ San Francisco, Calif.	Operate new relay broadcast station to KPO on 1,606, 2,074, 2,102 and 2,758 kc, at 100 watts.
WERC Erie, Pa.	Change frequency to 1230 kc.
WKBY Richmond, Ind.	Increase power to 250 watts, change transmitter equipment, and move transmitter and studio.
WFEB Sylacauga, Ala.	Operate new station on 1340 kc 250 watts, unlimited time.
WFVA Fredericksburg, Va.	Operate at change in frequency at 1230 kc, unlimited time.
WHKC Columbus, Ohio	Change frequency to 610 kc, increase power to 1 kw with directional antenna at night.
WHKK Akron, Ohio	Change frequency to 640 kc, increase power to 1 kw with directional antenna for day and night use. Move transmitter and studio, contingent on non-interference with the Bahamas and Newfoundland.
W8XCT Cincinnati, Ohio	Extend completion date of experimental television broadcast station to October 28, 1945.

BUSINESS NEWS

WESTINGHOUSE ELECTRIC CORP. is the new name adopted for simplicity and brevity by stockholders of Westinghouse Electric and Manufacturing Co.

HAZELTINE CORPORATION has abandoned the following trademarks, trade names and any registration thereof: neutrodyne, neutroformer and neutrodon. Trademarks and all rights are dedicated to the public.

PHILCO INTERNATIONAL CORP. discovers that the "Philco" means "flying song" in Chinese.

WESTINGHOUSE ELECTRIC CORP. paid, during 1944, \$186,921 for 14,867 victory-speeding ideas of men and women workers in the company's plants. A total of 38,709 ideas were handed in and labor and material costs to the extent of



laboratory instruments for speed and accuracy

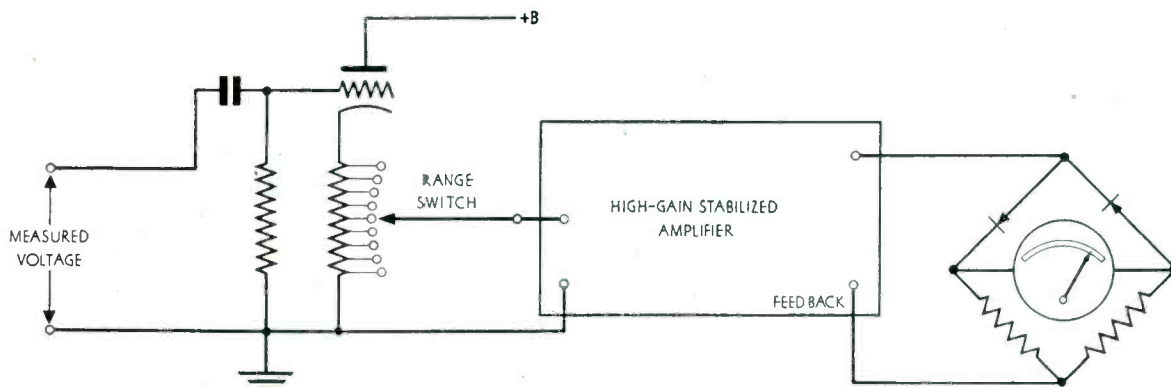

**-hp- Vacuum Tube Voltmeters
Employ This Cathode Follower Circuit**

The advantages are many!

This cathode follower circuit provides an input impedance of 1 megohm and a useful means for varying the meter sensitivity. There are nine ranges, each related to the next by 10 db steps. No adjustment to zero position is required, and the ranges are instantly available by a switch on the panel.



The *-hp-* Model 400A Vacuum Tube Voltmeter consists of the above cathode follower circuit in conjunction with a full wave rectifier and a high gain amplifier. The full wave rectifier actuates a one-mil meter. The amplifier is of the broad band type and is substantially flat from 10 cps to 1 megacycle. Because the amplifier employs inverse feedback, it is extremely stable. Hence the accuracy of meter

readings is independent of line voltage and tube characteristics.

Voltages as small as .005 and as high as 300 can be read with positive accuracy and the wide frequency range makes the instrument suitable for video measurements. The logarithmically related scales are also calibrated in db units. Ordinarily no precautions are necessary—wave form errors and “turn-over” effects are minimized—large overload voltages cause saturation of the amplifier which protects the meter.

The *-hp-* Model 400A is designed for the greatest amount of convenience. Its small physical size and large slanting scale make it desirable to use and easy to read. Power supply is completely contained. All-in-all, the *-hp-* Model 400A is probably one of the most useful, versatile instruments in the field. Write for further details.

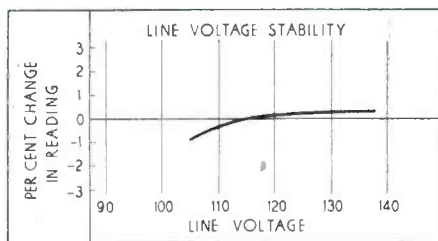

HEWLETT-PACKARD COMPANY

Box 1047A • Station A • Palo Alto, California

- | | | |
|--------------------------------|---------------------|------------------------|
| Audio Frequency Oscillators | Signal Generators | Vacuum Tube Voltmeters |
| Noise and Distortion Analyzers | Wave Analyzers | Frequency Meters |
| Square Wave Generators | Frequency Standards | Attenuators |
| | | Electronic Tachometers |

OTHER -hp- INSTRUMENTS



Noise and Distortion Analyzer
The Model 325B combines a vacuum-tube voltmeter with a set of fundamental elimination filters for general purpose measurements of total harmonic distortion, noise and voltage level.

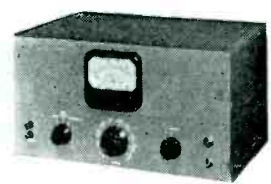

Electronic Frequency Meter
Model 500A Frequency Meter is designed to measure the frequency of an alternating voltage from 10cps to 50kc.

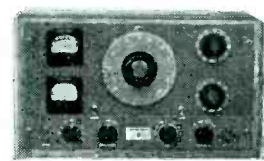

Audio Signal Generator
The Model 205AG consists of a Hewlett-Packard resistance-tuned oscillator in combination with an input and output meter, attenuator and an impedance matching system.



Secondary Frequency Standard
The Model 100B consists of a crystal controlled oscillator and a series of frequency dividers of the regenerative modulator type to provide standard frequencies of 100 kc, 10 kc, 1 kc and 100 cps.



NEED SPECIAL EQUIPMENT FOR SPECIAL REQUIREMENTS?

*To Cool or Ventilate
Electronic Devices?*

Take advantage of 39 years of experience and the wide range of ILG designs made for other manufacturers, the U. S. Signal Corps, Maritime Commission and Navy! Or ask about special equipment to be designed specifically for your needs. In the ILG line you can find practically anything you need in the way of air-moving equipment, ranging from fans you can nestle in the palm of one hand to towering 90" fans. And each fan is available with variations in mounting arrangements to simplify building into *your* product. All ILG products are made to highest quality standards for unfailing duty, quiet operation, efficiency, low power input and long life. Phone Branch Office (consult classified directory) or write us.

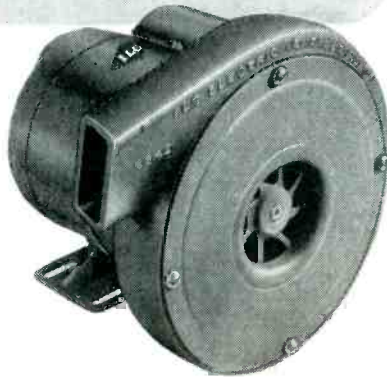

Special ILG unit designed and produced in volume for electronic manufacturer now supplying U. S. Signal Corps.

ILG ELECTRIC VENTILATING CO., CHICAGO 41, ILL.
2882 N. Crawford Ave. • Offices in 40 Principal Cities



VITALIZED VENTILATION
AND AIR CONDITIONING

LET US QUOTE ON YOUR

SMALL STAMPINGS

SPECIAL TERMINALS

SOLDERING LUGS

PRECISION WASHERS up to 5/8" O. D.

Manufactured to Your Specifications

Large Tool Room Facilities plus 20 Years Experience insure

HIGH GRADE STAMPINGS
QUICK DELIVERIES

on Medium and Large Quantities

Let Us Quote on Your Requirements

DIEBEL DIE & MFG. CO.

3658 N. Lincoln Ave., Chicago 13, Ill. Phone WELLington 4202

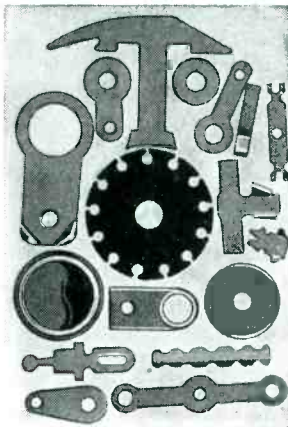

HI-Q
A NEW NAME

**FOR
HIGH QUALITY
CERAMIC
CAPACITORS**

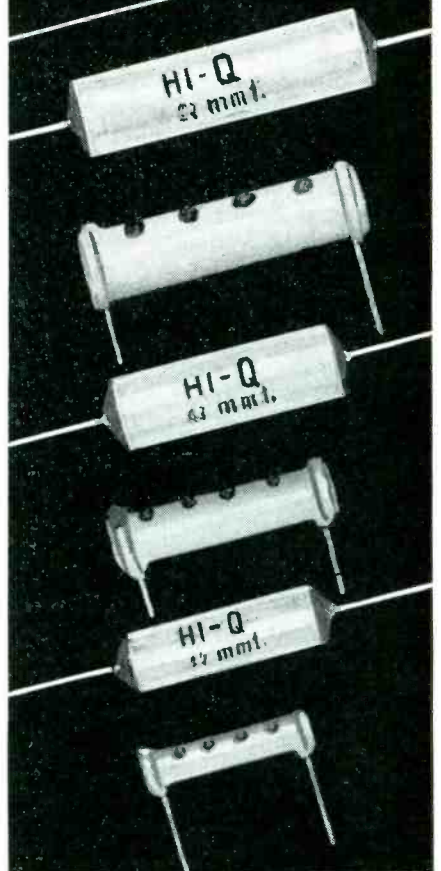

**ELECTRICAL
REACTANCE**
CORPORATION
FRANKLINVILLE, N. Y.

NOW...Broaden Your Duplicating Scope!



Specifications

Here your alternate is dual reading prints and notes. Your printer and notes printer can also be used for printing, tracing and other work. The printer can be used for printing, tracing and other work. The printer can be used for printing, tracing and other work. The printer can be used for printing, tracing and other work.

Typed... **PRINTED** *illustrated*

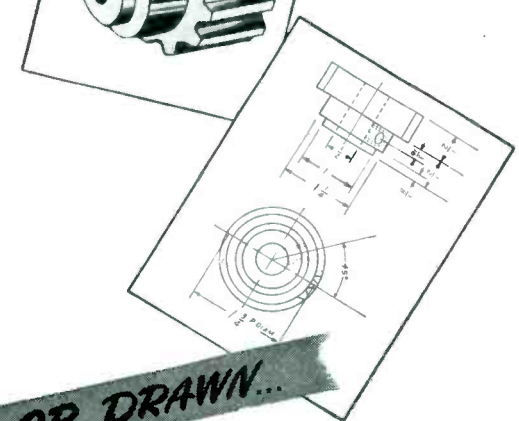
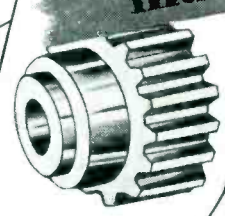

OR DRAWN...

● Here is the quick, easy way to duplicate tracings, line drawings, specifications, black and white prints, Van Dyke negatives or blue prints! The Bruning Model 2 BW—Copyflex Continuous Printer fits into desk-top space—yet gives you the advantages of *continuous* photographic-process production. Do not confuse this Bruning Printer with the less efficient "copy box" type. Used with three trays and a simple drier (readily available), the Model 2 produces Copyflex prints. At the flick of a switch, the Model 2 becomes a BW Printer for producing easy-to-read Black and White Prints—and these prints are developed with an inexpensive BW developing machine. Get all the facts about the versatile Model 2 Continuous Printer—mail the coupon for full information!

CHARLES BRUNING COMPANY, INC.

Since 1897

NEW YORK

Atlanta
Kansas City
St. Louis

CHICAGO

Boston
Milwaukee
San Francisco

LOS ANGELES

Detroit
Newark
Seattle

Houston
Pittsburgh

CHARLES BRUNING COMPANY, INC.,
4712-18 Montrose Avenue, Chicago 41, Illinois

Please send me complete information on your Model 2 BW—Copyflex Continuous Printer—and on other Bruning printing and developing machines for making Bruning Black and White Prints.

Name

Address

City..... State.....



WHAT THE JAPS DON'T KNOW WON'T HURT US

IT'S agreed that recent developments in electronics still must remain closely guarded military secrets. But when the story can be told it will surprise many to learn what an important part Blaw-Knox has had in the advancement of this newest marvel in sciences. More than likely the public announcements of the commercial use of war-born electronic devices will be broadcast from stations equipped to give them effective coverage with Blaw-Knox Vertical Radiators.

BLAW-KNOX DIVISION

of Blaw-Knox Company

2077 Farmers Bank Bldg.
Pittsburgh Penna.

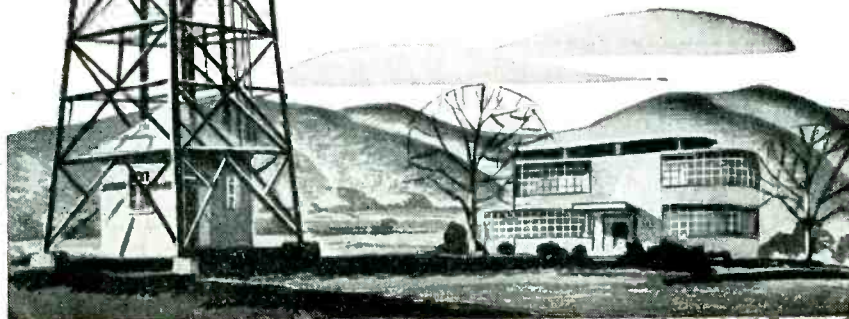

\$1,765,059 were saved by the suggestions used.

TRAV-LER KARENOLA RADIO & TELEVISION CORP. moved its general offices, showrooms and research laboratory to 571 W. Jackson Blvd., Chicago—an entire four-story corner building. Manufacturing continues at Orleans, Indiana.

INTERNATIONAL DETROLA CORP. and ROHR AIRCRAFT CORP. are operating under a postwar plan which will integrate their activities in the aviation, radio and automobile industries. Rohr thus becomes the first of the Pacific Coast aircraft companies to diversify into the electronic industry, while International Detrola becomes the first Eastern radio receiver manufacturer to gain a west coast assembly plant.

BENDIX AVIATION DIVISION OF BENDIX RADIO CORP. looks for a market of 15 million radios and radio-phonograph combinations the first year after resumption of unrestricted manufacture.

NATIONAL RESEARCH CORP., Boston, Mass. establishes a fellowship at MIT. On the graduate level, the grant will be \$2,500 toward research in the field of high vacuum—pressures in the range 10^{-7} to 1 mm of Hg.

SYLVANIA ELECTRIC PRODUCTS announces a new 22,000 sq ft. plant at Marietta, Ohio, in which will be made electronic products. The building, which is a five-story brick unit, has been leased from a furniture company and will be used for production at an early date.

MELCO PRODUCTS, 22 East Hennepin Ave., Minneapolis, Minn., is a newly organized company for the manufacture of radio, radar, and industrial transformer. Present capacity has exceeded 1,000 units per day.

RAYTHEON MFG. Co., Waltham, Mass. lists employees exceeding 20,000 as a result of its recent merger with Belmont Radio Co., Chicago, Ill. Yearly volume has increased to more than \$200,000,000 from a capital beginning in 1922 of \$25,000.

LEAR INC. acquires a seven-floor building in Grand Rapids, Mich.,

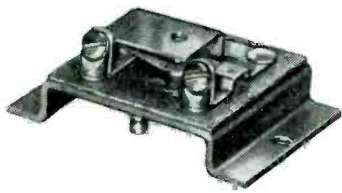

Type C-4351 Thermostat. Used for Tube Warming, Tube Cooling, High Limit Controls, etc.

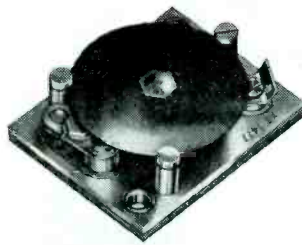

Type B-3120 Thermostat and Heater, Crystal Dew Point Control.



Type C-7220 Precision Snap Switch 12 amps. 30 Volts D. C. 125 Volts A. C.



Your Control or Protection Needs

DESIGNED TO FIT EXACTLY



Type C-2851 Thermostat. For such use as Roughing Controls on Outer Crystal Ovens.

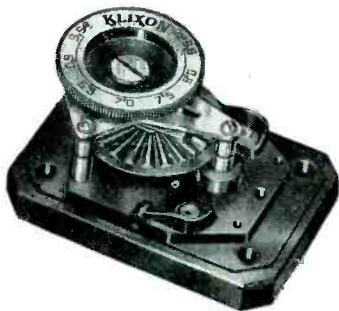

Type RT Thermostat. Adjustable Temperature Control.

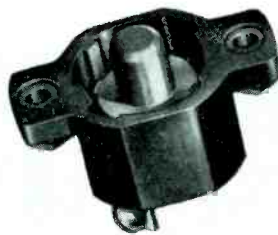

Type PM (NAF-1131) Circuit Breaker.



Type ER Series. Ambient Compensated Time Delay Relays.

KLIXON Snap-Acting CONTROLS

Klixon snap-acting Controls are designed for applications where sure, accurate and reliable operation is a must. Each is specifically designed to perform a specific control or protection job *right*. That's why you'll find them used for such applications as motor and transformer overheat protection, electrical circuit overload protection, thermal time delays and temperature control for radio equipment.

Small, light in weight, compact Klixon Controls are actuated by the simple, snap-acting Spencer thermostatic disc. This foolproof element does away with complicated toggles, magnets and other fussy parts

that tend to wear and get out of adjustment. It always snaps to a quick, clean break or a solid make. Its accurate operation is unaffected by shock, vibration, motion or altitude.

If you have a control or protection problem, investigate Klixon snap-acting Controls. They are available in many standard types, such as those illustrated, for practically every control requirement. Write for complete information today.



SPENCER THERMOSTAT CO., ATTLEBORO, MASS.

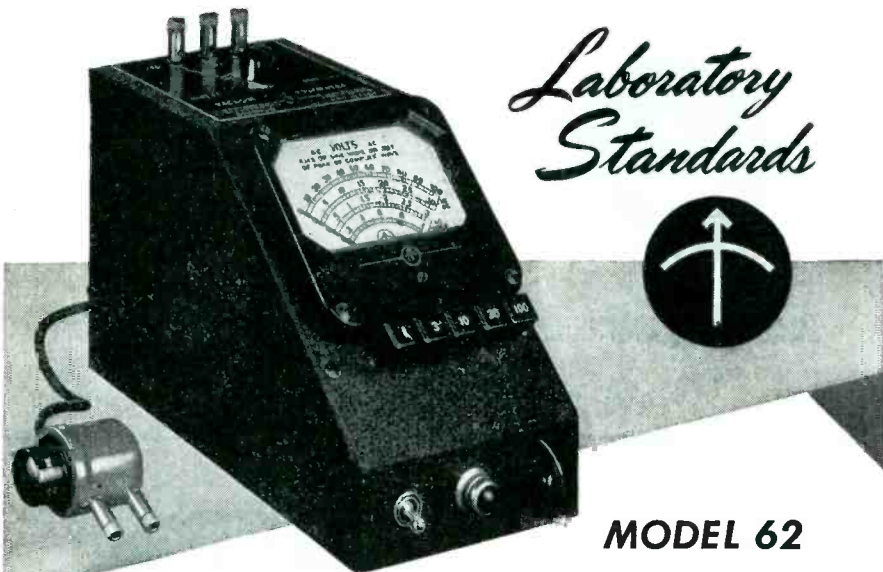

Laboratory Standards



MODEL 62

VACUUM TUBE VOLTMETER

SPECIFICATIONS:

RANGE: Push button selection of five ranges—1, 3, 10, 30 and 100 volts a. c. or d. c.
ACCURACY: 2% of full scale. Useable from 50 cycles to 150 megacycles.
INDICATION: Linear for d. c. and calibrated to indicate r.m.s. values of a sine-wave or 71% of the peak value of a complex wave on a. c.
POWER SUPPLY: 115 volts, 40-60 cycles—no batteries.
DIMENSIONS: 4¾" wide, 6" high, and 8½" deep. **WEIGHT:** Approximately 6 lbs.
PRICE: \$135.00 f.o.b. Boonton, N. J. Immediate Delivery

MEASUREMENTS CORPORATION
BOONTON, NEW JERSEY



Hook Up Those
"LOOSE ENDS"
 in Your
 New Products
 By Specifying

Sherman
Terminals
and Lugs

ONE easy, practical way to speed up development work on your new units, is to turn over your Terminal and Lug problems to Sherman electrical engineers. You'll find that Sherman experience and "know-how" combined with the extensive Sherman production facilities can be extremely helpful to you in getting the right Lug or Terminal for every application.

Sherman can produce practically unlimited quantities of standard or specially designed Lugs and Terminals. Complete facilities are also available for hot tinning, electro-tinning, cad plating, etc. Write today. Let Sherman engineers help you solve your post-war problems NOW.

H. B. SHERMAN MFG. CO.
BATTLE CREEK, MICHIGAN



Sherman Closed Round End Soldering Lugs.

"Uni-Crimp" Solderless (pressure type) Terminals.

Soldering Terminals—hundreds of sizes and styles.

Our specialized business is the production of mica fabricated parts for electronic and electrical use. This includes electronic tube and condenser parts, discs, bridges, supports, all varieties of stampings, condenser films, etc.

One of the most exacting phases of our business is the production of mica parts for radio tube and component manufacturers. Our 27 years of experience enable us to render a quick and understanding service on this and other phases. Hundreds of leading companies rely upon our complete facilities and wide experience to take care of both usual and unusual requirements.

We shall be glad to quote costs or discuss any problems you may have.

FORD RADIO & MICA CORP.
 Joseph J. Long, President
 538 63rd St., Brooklyn 20, N. Y.
 Telephone: Windsor 9-8300
 Established 1917

FOR EVERY RADIO ELECTRICAL AND ELECTRONIC USE

**IT'S
NEW**



**SEND FOR THIS
RESISTOR DATA**

For the convenience of designers of products requiring resistors, Ward Leonard offers this new Resistor Handbook. It describes in detail the full line of wire-wound resistors giving complete information on mountings, enclosures, terminals and resistance values. Write for your copy today.

★ ★
BUY MORE ★
WAR BONDS ★



WARD LEONARD
RELAYS • RESISTORS • RHEOSTATS

Electric control  devices since 1892.

WARD LEONARD ELECTRIC COMPANY • 32 SOUTH ST. • MOUNT VERNON, N. Y.

Here's why SPERTI HERMETIC SEALS are A "MUST" IN THE TROPICALIZATION OF ELECTRONIC MILITARY EQUIPMENT

1. **EFFECTIVELY SEAL OUT DUST**, sand, salt spray, fumes, fungus, injurious atmosphere.
2. **GLASS PATH WILL NOT CARBONIZE**. Have wide thermal operating range and high insulation leakage resistance.
3. **SPECIAL PROCESS** insures maximum acceptability to solder. Simple and easy to attach.

Sperti Hermetic Seals have been an important factor in increasing the life expectancy and usefulness of vital military equipment of many kinds. Write, today. Outline your problems. Let us show you how Sperti Hermetic Seals can help you solve them.

THE HELP YOU'VE BEEN LOOKING FOR!

Now available. Skilled assembly service for soldering terminals into cover plates. Send drawings and specifications for quick quotation. For full information, phone, wire or write.

Sperti

INCORPORATED
Cincinnati, Ohio



RESEARCH • DEVELOPMENT • MANUFACTURING

to house present and future radio production. Containing almost 100,000 sq ft of floor space, the facilities will be used for production of electro-mechanical aircraft accessories as well as radio equipment.

JOHN MECK INDUSTRIES, Plymouth, Ind., now fully occupies all its buildings which had been previously only 60 percent utilized. Facilities will be available for conversion to civilian production within 60 days—capacity being 2,000 receivers per day.

PREMIER ELECTRONIC PRODUCTS INC., Chicago, Ill., is a new company to specialize in the manufacture of radio and radar transformers.

UNGAR ELECTRIC TOOLS, INC. is the new corporate name of the company formerly known as Harry A. Ungar Inc. according to a release signed Ungar Electrical Products Co. Factory and offices are located in Los Angeles, Calif.

HALLICRAFTERS Co., Chicago, Ill., is undertaking new financing to implement its entry into the aircraft, railroad, and two-way mobile equipment field in addition to continued marine and amateur activities.

PHILCO CORP., Philadelphia, Pa. plans to produce television receiving sets for the general public within a few months after the end of the war.

PERSONNEL

GEORGE LEWIS, IT&T representative on numerous technical associations



in the electronic field, is made assistant vice-president of his company.

L. V. BEDELL is appointed manager of the Sperry Gyroscope electronics plant at Garden City, L. I. He was formerly assistant manager at the Nassau plant.

DR. ARTHUR H. COMPTON, dean of

Crystal Gazing

is no way to solve
Wire Problems



Wire-Plan Your Products for Long-lived Performance

Select Permanently Insulated Rockbestos Wires, Cables and Cords for Lasting, Trouble-Free Service

Never let wire get lost in the intricacies of designing if you want to make sure that your product will function dependably under the use and abuse it will get in service.

It isn't enough to select wire by size, diameter and appearance; you want to pick it for *performance!* That calls for *wire-planning* . . . and serious consideration of wire-affecting elements of design, ambient and operating temperatures, exposure to moisture, oil, grease or corrosive fumes, operating voltages and possible overloads, to mention a few factors that shouldn't be overlooked.

Time spent in analyzing wire needs now will pay off later in satisfied customers. Our experience in developing a standard line of 125 *permanently insulated* wires, cables and cords to meet unusual or severe conditions is at your service . . . and Rockbestos Research is always willing to take on new wiring problems. For wire-engineering assistance or information write to the nearest district office or:

ROCKBESTOS PRODUCTS CORPORATION
424 Nicoll St., New Haven 4, Conn.

FOR VICTORY...BUY WAR BONDS

ROCKBESTOS RESEARCH

Solves Difficult Wiring Problems



NEW YORK BUFFALO CLEVELAND CHICAGO PITTSBURGH ST. LOUIS LOS ANGELES SAN FRANCISCO SEATTLE PORTLAND, ORE.

ELECTRONICS — June 1945

A few of the 125 different wires developed by Rockbestos for severe or unusual operating conditions.

ROCKBESTOS FIREWALL RADIO HOOKUP WIRE

Sizes No. 22 to 4 A.W.G. in 1000 volt rating, and No. 12, 14 and 16 A.W.G. in 3000 volt.

The first lightweight, small diameter, flame-resistant hookup wire designed in 1937 and widely used since in airborne and ground communications systems, electronic devices, instruments and apparatus. Operating temperatures range from 125°C. to minus 50°C. Also with tinned copper shielding braid and in twisted pair or tripled construction.



ROCKBESTOS THERMOSTAT CONTROL WIRE

Sizes No. 14, 16 and 18 A.W.G. in two to six conductors with .0125", .025" or (for 115 volt service) .031" of felted asbestos insulation and steel armor.

A multi-conductor control wire for low voltage intercommunicating, signal and temperature control systems. Its life-time heatproof and fireproof insulation and rugged abrasion-resisting steel armor will give you trouble-proof circuits.



ROCKBESTOS A.V.C. 600 VOLT SWITCHBOARD WIRE

Sizes No. 18 to 4/0 A.W.G. with varnished cambric and impregnated asbestos insulation and gray, black, white or colored flameproof cotton braid.

Combine fire insurance and fine appearance in your switchboards with Rockbestos A.V.C. Switchboard Wire. It is fireproof, will not dry out under heat, and sharp clean bends can be made without cracking the braid as the asbestos firewall acts as a cushion. Rockbestos A.V.C. Hinge Cable and Switchboard Bus Cable have the same characteristics.



ROCKBESTOS TYPE CA LEAD WIRE

Has high dielectric strength and moisture resistance for use where heat and humidity are encountered. No. 20 to 8 A.W.G. solid or stranded copper, monel or nickel conductors insulated with synthetic tape and various thicknesses of felted asbestos finished in black, white or colors for coding purposes. Also with All-Asbestos insulation only, where high moisture resistance is not required.

**PRINTERS,
LAMINATORS,
FABRICATORS
OF *Plastics***

INJECTION AND
EXTRUSION
MOLDERS

PLASTIC PRINTING by
special inks and special
methods developed in our
plant.

LAMINATION of printed
sheets on one or both
sides, permanently sealing
the printed surfaces.

SHEET FABRICATION on
even the most complicated
jobs.

Write for Free Booklet E,
"Hopp Plastics Today & Tomorrow"

**THE HOPP PRESS
INCORPORATED**
460 W. 34th St., New York 1, N.Y.

TRADE
CIRCUIT BREAKER
PHILADELPHIA
MADE IN U.S.A.

TYPE
AMPS
VOLTS
FREQ
NO
DATE

HENGAR COMPANY
ALBANY
PHILADELPHIA, U.S.A.

PAT. APPLIED FOR

MAINE COAST BOATS
BOSTON BOAT & ENGINE CO.
270 HANOVER STREET
BOSTON, MASS.

RF
M
FREQ
22
1.8
2
RADIO

THE WILLS
PORT LANT

PRESTO
RECORDING CORP.
NEW YORK, U.S.A.
STROBOSCOPE

If you want

- CRYSTALS
- CABLES
- HARNESSES
- ELECTRONIC ASSEMBLIES
- CABINETS

Telephone Peru, Indiana
151

Serving the Radio and Electronic Industries with precision engineered products.

Wm. T. WALLACE MFG. Co.
General Offices: PERU, INDIANA
Cable Assembly Division: ROCHESTER, INDIANA

American Beauty

ELECTRIC SOLDERING IRONS

are sturdily built for the hard usage of industrial service. Have plug type tips and are constructed on the unit system with each vital part, such as heating element, easily removable and replaceable. In 5 sizes, from 50 watts to 550 watts.

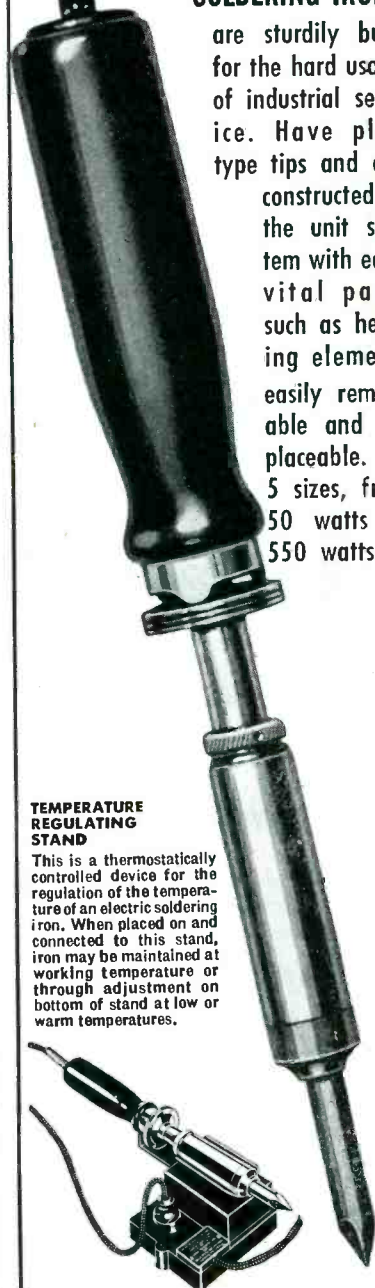

TEMPERATURE REGULATING STAND

This is a thermostatically controlled device for the regulation of the temperature of an electric soldering iron. When placed on and connected to this stand, iron may be maintained at working temperature or through adjustment on bottom of stand at low or warm temperatures.

For further information or descriptive literature, write



107-1

**AMERICAN ELECTRICAL
HEATER COMPANY**
DETROIT 2, MICH., U.S.A.



One operator makes more than 500 sound electrical connections per hour by this simple sure **BURNDY** indenting method

YOU can cut connecting time as much as 50% merely by changing to **HYDENT** (indent type) connectors. These one-piece connectors are *indented* onto the wire or cable by means of the Burndy **HYPRESS**. The operation is fast and sure—no solder—no flame to damage insulation. **HYDENT** connections are strong and highly efficient. The **HYPRESS**—automatic or manually operated—makes a uniformly firm indent that is easily and quickly inspected. Send for literature today, or have Burndy engineers submit costs based on your production needs. Write to Burndy Engineering Co., 107-L Bruckner Blvd., New York 54, N. Y.

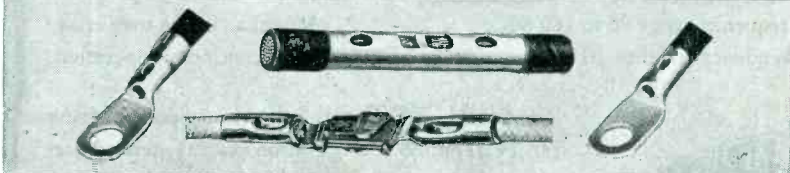

Headquarters for
CONNECTORS
Burndy

ERCO RECEIVERS



For dependable communications



The Model 32 series of fixed frequency, crystal controlled receivers are used as standard ground station and point-to-point receivers by many airlines, public utilities and government agencies. The 32-E, recently added, is intended for exacting VHF applications in the range of 100 to 160 MC. Equipped with carrier-operated audio gate and automatic noise suppressor. All components are designed for continuous operation during wide variations of ambient temperature and humidity. Audio output 2 watts . . . mounting dimension 8¾ inch standard relay rack panel.

A companion transmitter for the very high frequency range is the VF 30:

Carrier power 30 watts.	A3 Telephone emission.
100% modulation.	Push to talk operation.
Frequency range 90 to 160 MC.	Antenna change-over relay.
Frequency stability .01%.	Designed for continuous operation.



The type UHC coaxial half wave dipole antenna can be supplied for operation on any desired frequency between 30 and 500 MC. Skilled engineering, backed by seven years of experience, is incorporated in this new model.



ERCO RADIO LABORATORIES INC

HEMPSTEAD, NEW YORK

Manufacturers of CUSTOM BUILT RADIO APPARATUS

the division of physical science and chairman of the department of physics at the University of Chicago, is given The Washington Award by The Western Society of Engineers.

BRIG. GEN. DAVID SARNOFF, president of RCA, was given the One World award for his leadership and contribution toward strengthening international understanding. The award was a feature of the first annual dinner honoring Wendell Willkie.

GUS L. MYDLIL is made assistant chief engineer of the auto radio di-



vision of the Galvin Mfg. Corp., Chicago, Ill.

G. J. PARKER, chief industrial engineer, becomes assistant plant manager at Nassau Works of Sperry Gyroscope, Great Neck, L. I., N. Y.

HORACE W. ROYER, former quality control engineer with General Electric Co. is made product manager



for home radios in the Bendix Radio Division, Bendix Aviation Corp., Baltimore, Md.

H. Z. BENTON takes charge of design and production on tube sockets and specialty antennas at Amer-





Partner of Good Business

General Plate Laminated Metals

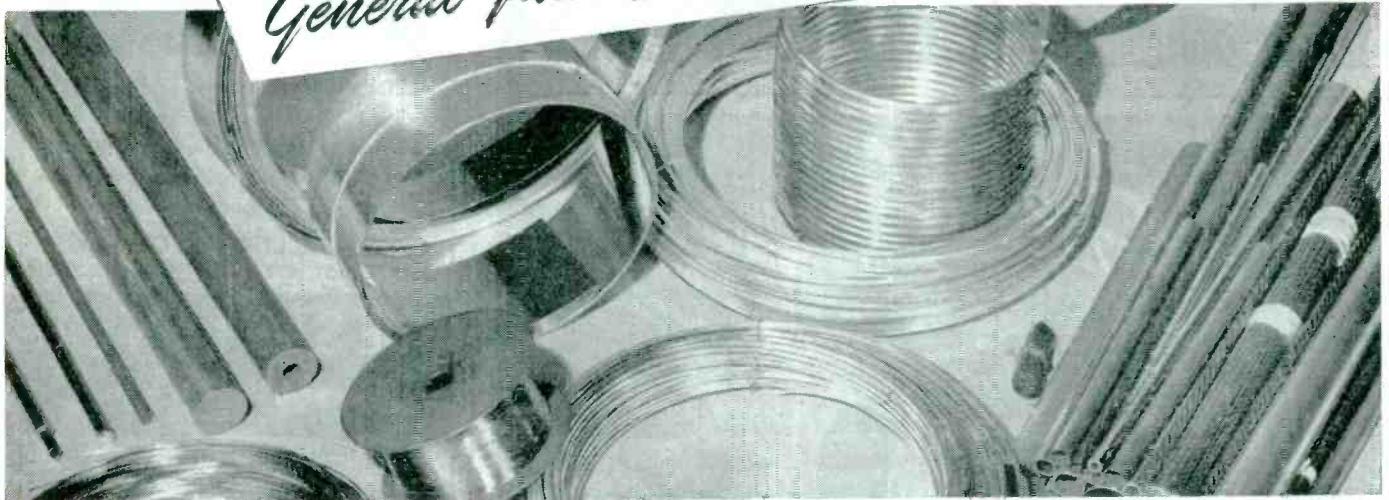

**... For Economy, Performance,
Corrosion Resistance, Electrical
Conductivity, Easy Soldering**

Right now isn't too early to plan and design the products that you'll be selling when war is done. And it is in this designing stage that you should investigate and find out why General Plate Clad Metals are a powerful ally when included into products.

General Plate Clad Metals are permanently bonded laminations of precious metals to base metals or base metal to base metal combinations. Their advantages over solid metals are economy, workability, rigidity and unusual performance requirements not found in solid metals. Here are just a few worthwhile benefits that these clad metals provide in specific applications—in elec-

trical equipment, better electrical performance at a fraction of the cost of solid silver . . . in chemical apparatus, maximum corrosion resistance outside, inside or both . . . while in still other applications, ease of fabrication, low cost and long life. No matter what the products you plan to build—electronic devices, instruments, giant turbines or peanut radar tubes, General Plate Clad Metals will help you get ahead of competition in performance and cost. They are available in sheet, wire and tube . . . inlaid or wholly covered. Write specifying your problems and General Plate engineers will gladly make their recommendations.

General Plate Division
of Metals & Controls Corporation

50 Church St., New York, N. Y.; 205 W. Wacker Drive, Chicago, Ill.; 2635 Page Drive, Altadena, California; Grant Bldg., Rm. 603, Pittsburgh, Pa.
ATTLEBORO, MASSACHUSETTS



Leads the way

New! De Luxe Phone Jacks
Feature Many Special Advantages



**DESIGNED FOR
GREATER EFFICIENCY**

ICA leadership is embodied in these new jacks having the following features: Constructed of an accurate automatic-screw-machine brass body; assembled with molded bakelite separators. Designed to give maximum protection against creepage, moisture and other foreign matter. By use of arch springs, the small size and light weight of the jack enables it to be used in confined spaces, reducing the chances of electrical interaction in critical circuits. Contacts are made of phosphor bronze, silver-plated. Furnished in 3 styles:—No. 1920, Single Open Circuit; No. 1921, Single Closed Circuit; No. 1922, Three-way Microphone Jack.

LEADERSHIP
IN DESIGN AND MANUFACTURE
OF RADIO-ELECTRONIC PRODUCTS

The outstanding production records of Insuline have twice been commended by the Army and Navy. New designs, new products, new manufacturing methods are constantly being devised, so that after V-Day it will still be true that, in the Radio-Electronics field, "ICA Leads the Way."

Write for 48-page Catalogue describing the extensive line of ICA Radio-Electronic Products . . . Also 8-page brochure presenting the ICA Manufacturing facilities.



INSULINE
CORPORATION OF AMERICA



INSULINE BUILDING · LONG ISLAND CITY, N.Y.

PyroFerric

**IRON
CORES**



PyroFerric powdered metal cores have kept apace the vital precision instrument development. They are manufactured to specification:

"Q"

HIGH
as desired FREQUENCY
LOW

HIGH
MEDIUM
LOW

Consult PyroFerric on your Powder Metallurgy requirements

PYROFERRIC Co.

175 VARICK STREET NEW YORK, 14, N. Y.

**RESISTANCE
WIRE**

ALLOY "A": Nickel-chromium alloy, resists oxidation at extreme temperatures. Essential for operating temperatures up to 2100° F. Also used for cold resistance. Resists chemical corrosion by many media. Non-magnetic; specific resistance, 650 ohms/C.M.F.

C. O. JELLIFF MFG. CORP.
123 PEQUOT AVE. · SOUTHPORT, CONN.

**RESISTANCE
WIRE**

ALLOY "C": Nominally contains 60% nickel, 15% chromium, and balance iron. High resistance to oxidation and corrosion. Widely used in resistances for radio and electronics, industrial, and domestic equipment. Operating temperature up to 1700° F. Specific resistance 675 ohms/C.M.F.

C. O. JELLIFF MFG. CORP.
123 PEQUOT AVE. · SOUTHPORT, CONN.

**RESISTANCE
WIRE**

ALLOY "D": Nominally contains 30% nickel, 15% chromium, and balance iron, and has a specific resistance of 600 ohms/C.M.F. Monel and pure nickel resistance wire also obtainable.

C. O. JELLIFF MFG. CORP.
123 PEQUOT AVE. · SOUTHPORT, CONN.

**RESISTANCE
WIRE**

ALLOY "45": Alloy of 55% copper, 45% nickel with a constant electrical resistance over wide range of temperatures. Specific resistance 294 ohms/C.M.F.; temperature coefficient 0.00002 ohms per degree F; 32 to 212 degrees range. Used in winding of precision resistors.

C. O. JELLIFF MFG. CORP.
123 PEQUOT AVE. · SOUTHPORT, CONN.

**RESISTANCE
WIRE**

KANTHAL: Exclusive manufacturers of KANTHAL wire; although unavailable for duration, we will be pleased to supply information for your post-war requirements.

C. O. JELLIFF MFG. CORP.
123 PEQUOT AVE. · SOUTHPORT, CONN.

Note: All alloys are produced in high-frequency type furnaces, and are furnished bright, dull or oxidized finish, also with enamel, silk, or cotton insulation.

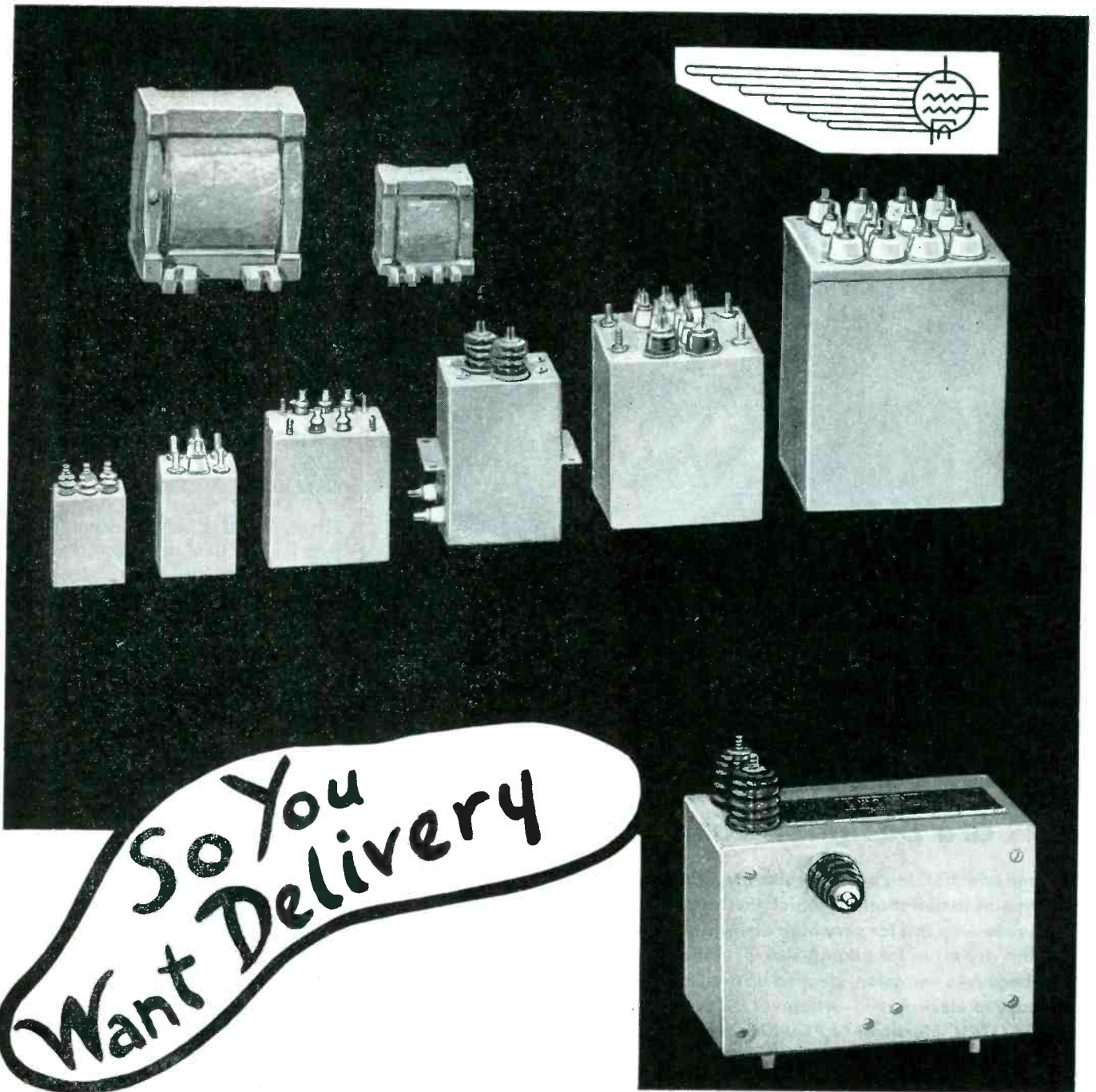

Well — — What do you think of AUGUST, (this year, not next) for open capacity on:
 *POWER TRANSFORMERS, CHOKES AND AUDIO COMPONENTS, ALL FREQUENCIES,
 FOSTERITED, HERMETICALLY SEALED AND OIL FILLED

In spite of the terrific war-time demands for these "Hard to Get" items, Sorensen & Company has steadily gained on delivery dates. Now we are in a position to offer the benefits of this reserve firepower.

All inquiries will be promptly answered whether directly pertaining to the items above or a problem requiring our special engineering facilities. Please address—Dept. A, Sorensen and Company, Stamford, Connecticut.

*Wherever Hi Q is necessary, we will build toroidal, dust core coils for chokes and transformers.

SORENSEN & COMPANY

AIRBORNE ELECTRONICS



STAMFORD, CONN.



**ONLY ONE ELECTRICAL TAPE
CAN BE THE RIGHT ONE-**

SCOTCH BRAND Electrical TAPES *are Designed for Specific Jobs*

and both backing and adhesive are exactly adjusted to the particular type of installation for which the tape is intended. Whether the requirements call for very high dielectric and tensile strength, an extra firm adhesive for edging slot insulation, greater than ordinary resistance to corrosion, stepped up moisture resistance, extreme resistance to electrolysis—whatever the requirements, there is a type of "SCOTCH" Electrical TAPE which has exactly the qualities required.

Our new book on "SCOTCH" Electrical TAPES tells the whole story by word and picture. A copy in your reference file may turn out to be a real lifesaver in an emergency. Why not send for your copy today? Use the coupon below.

★"SCOTCH" is the trade mark for adhesive tapes made in the U. S. A. by Minnesota Mining & Manufacturing Company.



Please send us a copy of your new book on "SCOTCH" Electrical Tapes. E645

Firm _____

Street _____

City _____ Zone _____ State _____

Signed _____ Title _____

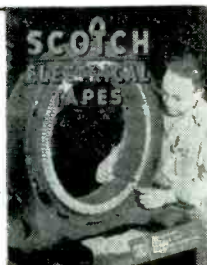

ican Phenolic Corp., Chicago, Ill. He was previously chief engineer at Croname, Inc.

E. F. HERZOG becomes designing engineer of the transmitter division of General Electric Company's elec-



tronics department, Schenectady, N. Y. He has been assistant to the chief engineer.

EMERSON MARKHAM, manager of television, General Electric Co., Schenectady, N. Y., has been named a member of the board of directors of TBA (Television Broadcasters Association). He will fill the vacancy caused by the resignation of Robert L. Gibson, also of GE.

RAYMOND R. MACHLETT, president of Machlett Laboratories Inc., Springdale, Conn., has been presented with the Honor Award



Medallion of Stevens Institute of Technology. The citation refers to such x-ray developments as rotating-anode tubes, malleable beryllium windows, tubes for diffraction analysis, and the new two-million volt tube.

AWARDS

WORKERS of the following concerns in the electronic field have been awarded Army-Navy E burgeses for excellence in production:

- Ansonia Electrical Co.
Ansonia, Conn.
- Hansen Mfg. Co.
Princeton, Ind.
- General Electric Co.
Fort Edward, N. Y.

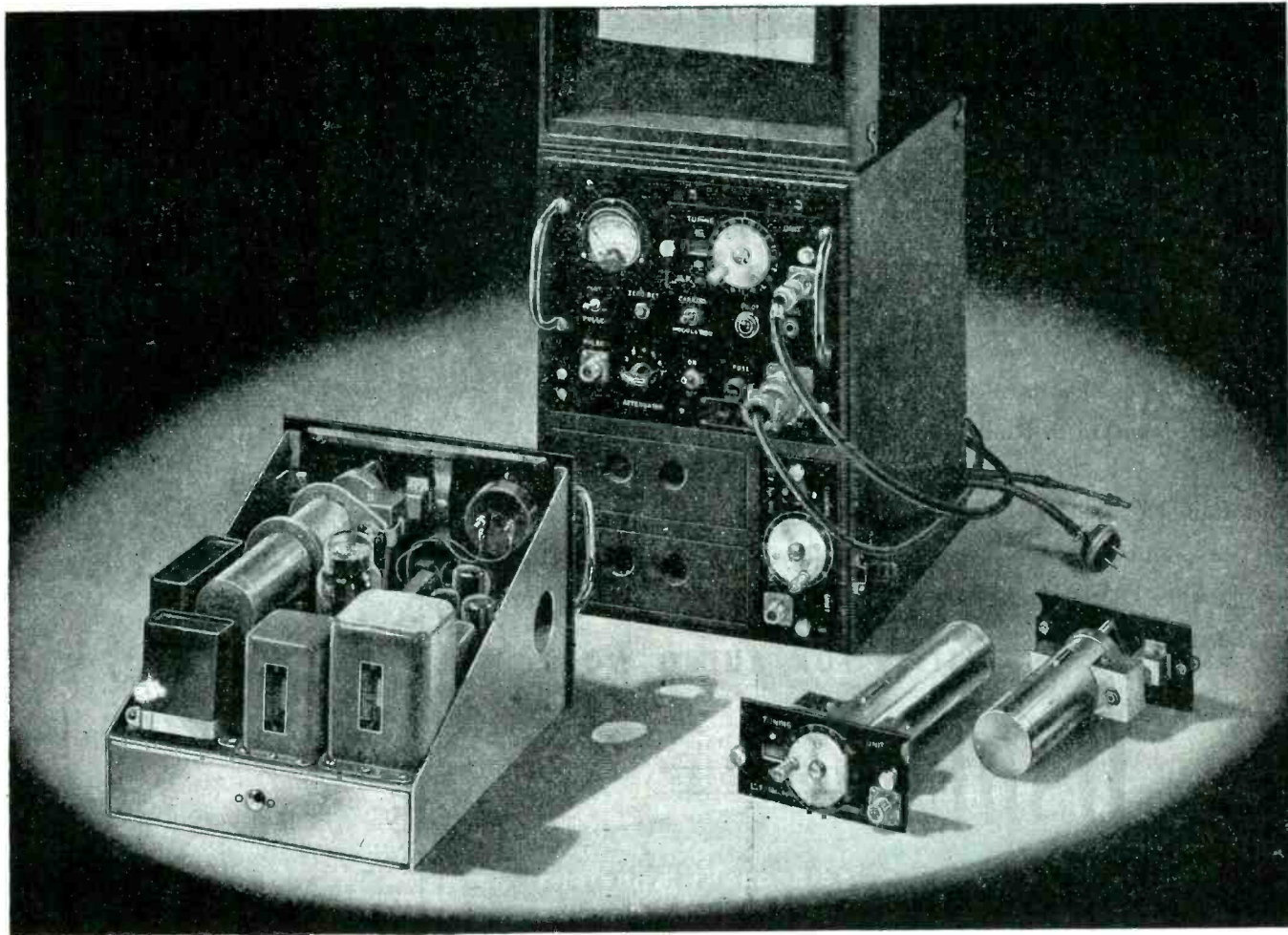

The 90630 ULTRA-HIGH FREQUENCY CALIBRATOR —Cavity Type, With Amplifier—

The 90630 cavity-type frequency calibrator covers the frequency range of 200 to 700 megacycles with a maximum calibration error of not over 0.25%. The range of 200 to 700 megacycles is covered by two plug in cavity-type tuning units which may be interchanged by loosening two thumb screws on the front of the calibrator panel. The calibrator may be used on harmonics up to 1500 megacycles at somewhat reduced sensitivity.

The calibrator consists of an accurately calibrated cavity-type tuning unit, a crystal detector, a two stage video amplifier, and a peak-reading vacuum tube voltmeter.

The video amplifier of the calibrator is provided with a seven-step attenuator and a separate input and crystal detector for measuring the voltage of pulsed or modulated radio-frequency signals without going through the cavity tuning unit. The calibrator will respond to any signal modulated with a negative pulse whose repetition rate is between 250 cycles per second and 3200 cycles per second and whose pulse width is 2 microseconds or greater.

The equipment is provided with a phone jack so that the modulation on the signal may be orally monitored.

The 90630 may be used as a relative power output indicator, a modulation monitor, or an untuned receiver with a crystal detector and a peak reading vacuum tube voltmeter, as well as a frequency calibrator.

The frequency calibrator may be used with or without the video

amplifier. When it is desired to use the frequency calibrator on an unmodulated radio-frequency carrier, the rectified voltage across the detector crystal in the cavity tuning unit is applied directly to the meter on the panel of the calibrator.

The sensitivity of the equipment used as a receiver without the tuning unit is approximately 20 millivolts. The overall sensitivity of the equipment with tuning unit is approximately 100 millivolts r.m.s. for a 30 microampere deflection on a 500 microampere meter on the calibrator at 200 megacycles. This sensitivity increases from 200 to 400 megacycles, and the overall sensitivity from 400 to 700 megacycles is approximately 20 millivolts r.m.s. for a deflection of 30 microamperes on the 500 microampere meter on the panel of the calibrator.

Connectors on the panel of the frequency calibrator are type N connectors.

The 90630 is supplied in a mahogany carrying case complete with two cavity tuning units, complete calibration tables of one megacycle calibration points, from 200 to 700 megacycles, a probe antenna, a power cable, one spare 1N21B crystal detector, and sufficient instructions and precautions for the proper operation of the equipment.

#90630, complete, net \$675.00 Specified type power transformer (ie: 60 cy. or 400-1200 cy.)

JAMES MILLEN

MAIN OFFICE



MFG. CO., INC.

AND FACTORY

MALDEN, MASSACHUSETTS, U. S. A.

FOR **QUALITY**

RADELL-BUILT PRODUCTS

• It is easy to recognize the marks of superior craftsmanship in Radell-built electronic products. With a broad basic knowledge and advanced production skill, Radell Corporation is a versatile organization specializing in the assembly and sub-assembly of highest quality electronic products.

COMPLETE FACILITIES FOR AUDIO WORK

RADELL CORPORATION

6323-37 Guilford Avenue, Indianapolis 5, Indiana

VITREOUS ENAMEL PRECISION WOUND RESISTORS TELEPHONE SWITCH KEYS & JACKS

TELEPHONE COMMUNICATIONS and CABLE ASSEMBLIES

Weather-and-Fungus-Proofed

Backed by 20 years of winding experience. 75 Winding Machines

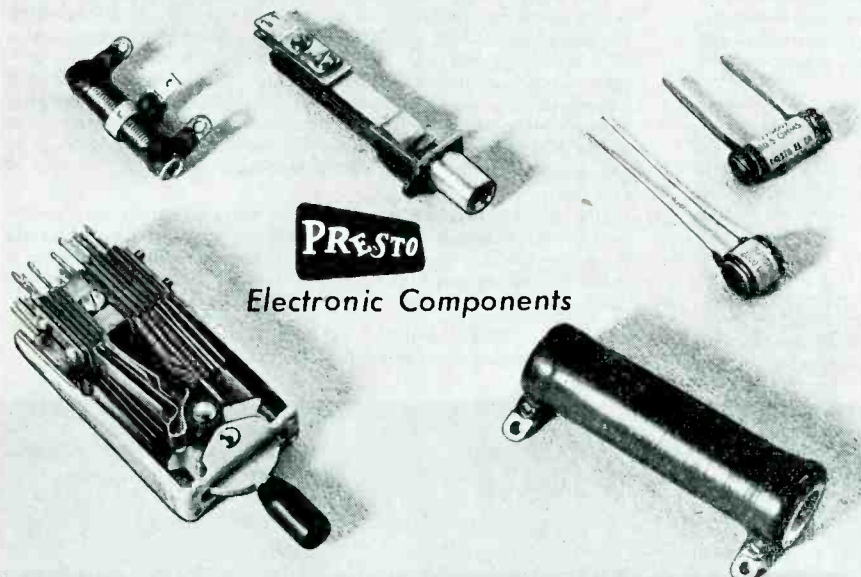

PRESTO ELECTRIC COMPANY
Manufacturers of Signaling Devices
UNION CITY, NEW JERSEY

• M A C O •



CATHODE RAY TUBE SHIELDS...

... to meet your specifications. These are only a few of our many available shields.

• **FABRICATED** from Mu-Metal or Nickelol

• **TESTED** by proven use to meet all requirements

• **DESIGNED** to fit your needs



** Our engineers will design in any metal — shields, chassis, cabinets, etc. for your individual application



METALLIC ARTS COMPANY
243 a Broadway
CAMBRIDGE, MASS.



A RAT ISN'T DEAD WHEN HE'S CORNERED...

That's when he begins to fight—*desperately*.

This war isn't won yet—even though we have the two-legged rats cornered.

It's going to take a lot of hard blows before they're knocked out for keeps.

Our boys aren't letting up over there—Don't let them down over here.

Buy *bonds* and more *bonds*.

Give *blood* and more *blood*.

Stay on your war job—

Until the last shot is fired.

 * Here at Kenyon, we're proud to play *
 * our small role on the stage of a BIG *
 * war. That's why EVERY Kenyon *
 * transformer used by our fighting *
 * forces throughout the world reflects *
 * only the highest precision crafts- *
 * manship. Kenyon workers are doing *
 * their share—bringing Victory closer *
 * by turning out top quality trans- *
 * formers uninterruptedly—and as *
 * fast as possible! *



THE MARK OF

EXCELLENCE

KENYON TRANSFORMER CO., Inc. 840 BARRY STREET
 NEW YORK, U. S. A.

NEW PRODUCTS

Magnetic Wire Sound Recorder and Reproducer

ALTHOUGH THE IDEA of wire recording dates back to Poulsen in 1896, very rapid development of the fundamental principle has taken place recently. At the Armour Institute of Technology, Chicago, for example, a staff of scientists has been at work reducing to practice the earlier work of Marvin Camras, now an associate physicist at that institution. The Armour recorder and reproducer records sound magnetically on a spool of wire nearly as fine as a human hair, and after the wire is rewound the sound record is played back with high fidelity. The recorded wire requires no processing before playback. The record is permanent. Vibration, motion, or position of the recorder or reproducer do not affect the performance.

Modifications of this basic principle result in recording instruments of various kinds, some of which record only, some of which

reproduce only, and others of which both record and play back. Recordings may be made for entertainment and education, communication, dictation and transcription, signal control, proceedings or interviews, or the taking of testimony.

Pictured here is Model 50 which is the original model and which is now being manufactured exclusively for the Armed services. It is a record, playback, and erase unit. Its dimensions are 13 in. wide, 12½ in. high, 9½ in. deep; weight is 35 lbs, complete with accessories; Case, cast aluminum, with carrying handle; The spool contains approximately ½ lb, 11,500 ft, 0.004 in. recording wire; recording time per spool—66 min at a wire speed of 2½ ft per sec, or 33 min at a wire speed of 5 ft per sec. The unit can be adapted for spools containing three times these lengths of recordings; inputs are provided for high impedance dynamic, ribbon, or crystal

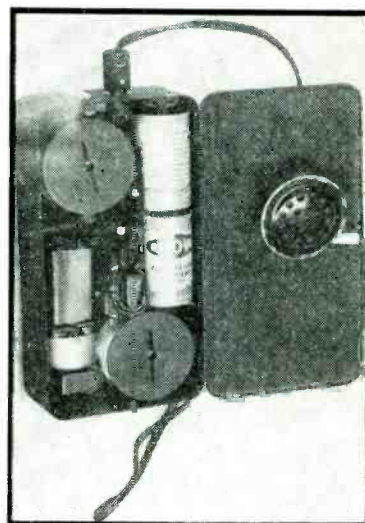

Above, a view of the interior of a pocket model recorder showing the simplicity of the mechanism. Below, an experimental, magazine model with the magazine removed and held above the recorder

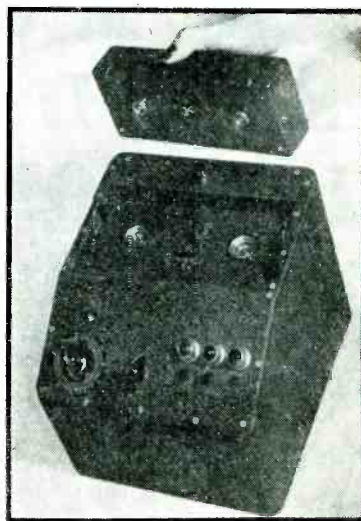

mike; for a-m or f-m tuners, phonopickup, 500-ohm line zero level, outputs are available for 10-ohm speaker voice coil or headphones; monitoring speaker is a 5-inch permanent magnet type. Five receiver-type tubes are used. Dynamic range is 40 db. Frequency response is flat, from 200 cps to 3000 cps for speech only. For music the model could be changed to give a flat response from 75 cps to 10,000 cps. Armour states that frequencies as high as 80,000 cycles (supersonic) have been recorded; Power supply—115 volts, 60 cycles, a.c. Can be used on 50 cycles at slight reduction of speed; on 200 a.c. with a transformer; on 110 d.c. with a converter; or on a storage battery

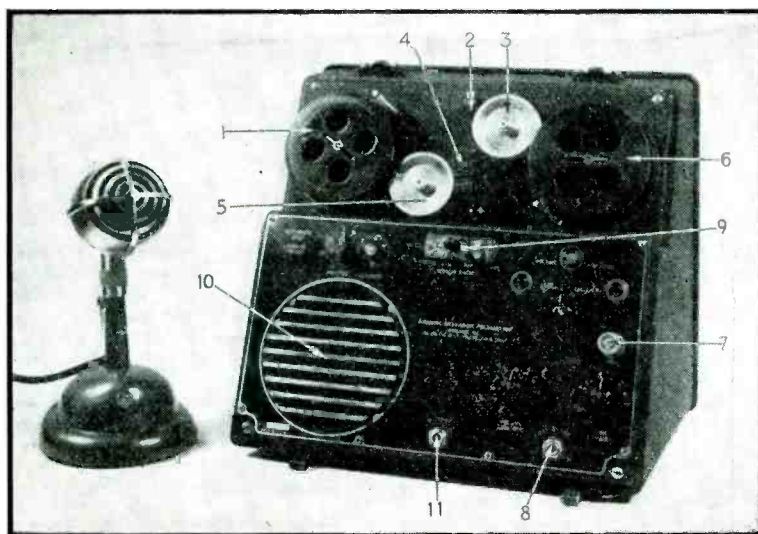

Model 50 Armour wire recorder for both recording and reproducing. Wire travels from spool (1), through a demagnetizing coil (2), around the pulley (3), through the recording or sound head (4), around the lower pulley (5) and finally winds up on the righthand spool (6). Microphone may be attached at (7) or a radio receiver plugged in at (8). The motor switch (9) control the direction of wire travel so that the wire either passes from spool (1) to spool (6) in recording or reproducing or reverses to wind up on spool (1) preparatory to recording or reproducing. (10) is a 5 inch speaker built into the recorder. A larger speaker may be used by connecting it to the jack (11). Volume and tone control and an automatic timing and stop device are also provided

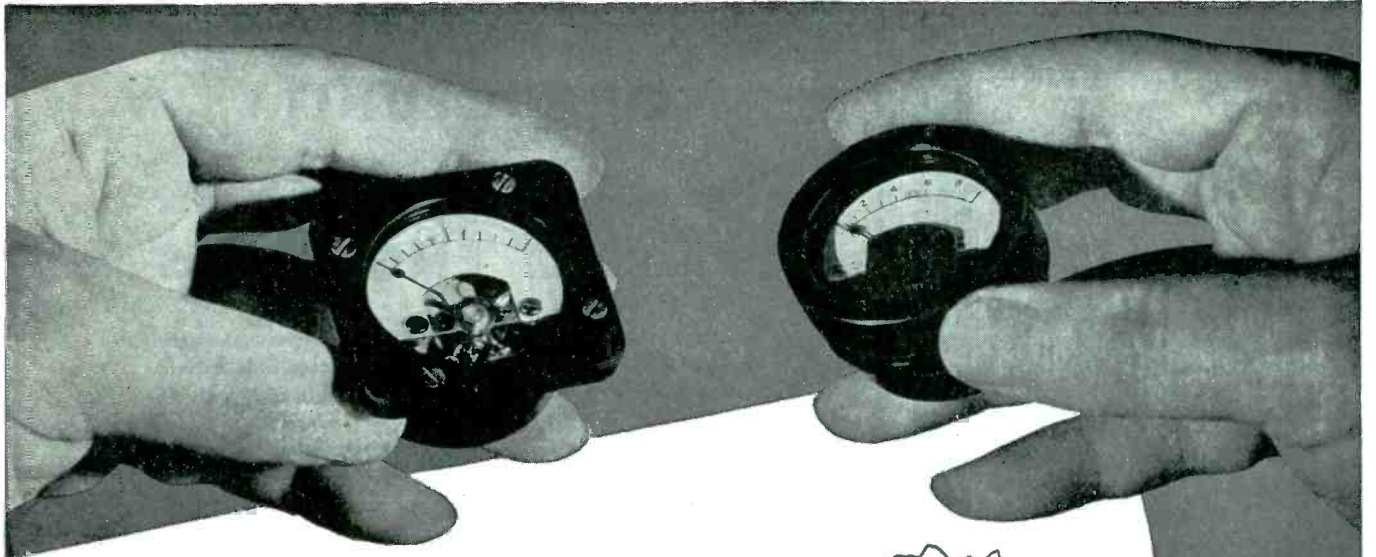

External Pivots

HELP THESE GREAT LITTLE METERS GIVE A LOT OF EXTRA PERFORMANCE!

These two hermetically sealed 1½" DeJur Instruments — the Model 120 (right) and the Model 112 (left) — designed to aid in the development of small equipment for present and post-war applications, combine miniature size with the accuracy resulting from external pivot design.

External pivots used in both models, help provide better all-round performance because: external pivots provide maximum accuracy in mounting the moving element between the jewel bearings . . . prevent rocking of the pointer . . . reduce side friction between jewels and pivots . . . increase the life of bearing surfaces.

Alnico Magnets of the highest grade permit the use of high torque . . . afford instantaneous response under varying loads . . . insure stability . . . and provide protection against the damaging effect of surrounding magnetic fields.

Both Models are available either as D.C. or A.C. Instruments.

We are equipped to work with you on special models of all DeJur Products for present and postwar applications. Write for the latest DeJur catalog.

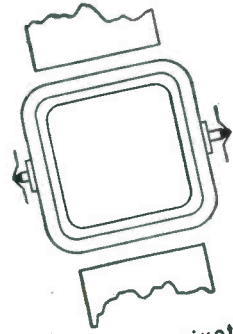

External pivots (above)—used in the design of DeJur 1½" Meters — provide greater accuracy in mounting the moving element between the jewel bearings. For this reason internal pivots (below) are not used in DeJur meters.

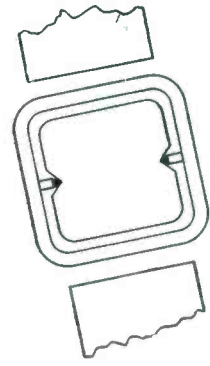

GIVE YOUR FULL SUPPORT TO THE SEVENTH WAR BOND DRIVE



De JUR - AMSCO CORPORATION
 GENERAL OFFICE: NORTHERN BLVD. AT 45th STREET, LONG ISLAND CITY 1, N. Y.



VERSATILITY...
special parts
in any metal

The most efficient functioning of a special part in your product often depends upon the metal used. Our engineers will be glad to help you at no obligation on your part. We are equipped to cold forge special parts in any metal, and in a wide variety of finishes. And costs for cold-forged parts are usually less.

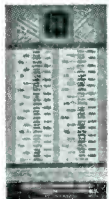

This Decimal Equivalents wall chart is accurate to four places and signalled in three colors. Yours at no cost or obligation. Just send us your name, title and address.

See our Catalog in Sweet's File for Product Designers

JOHN HASSALL
INC.

Specialists in Cold-Forging Since 1850

126 Clay Street
Brooklyn 22, N. Y.



OPPORTUNITY
for
PATENT ENGINEERS

We have openings for two qualified men to investigate patent disclosures. Must be able to recognize inventions by examination of log books and drawings, and by discussion with engineers. Also must be able to write disclosures for the engineers in such form that the patent attorney can make a search and prepare the application. Also must have the personality and ability to work with all engineers.

Top salary and permanent position with unusually good working conditions in modern air-conditioned plant in a residential suburb of Baltimore, Maryland.

W.M.C. regulations apply.

Write to: Director of Engineering and Research

Bendix Radio Division

Bendix Aviation Corporation

Baltimore 4, Maryland

Bendix Radio

C. T. C. TURRET
TERMINAL LUGS



For Firm,
Quick Fastening,
Swift Soldering
Terminal Posts

Just swage them to the terminal board and you have strong, well anchored terminal posts. Two soldering spaces permit wiring of two or more connections without superimposing wires. Soldering is swift because sufficient metal is used in Lugs to provide strength,

but there's no surplus metal which would draw heat and thus slow soldering.

Made of heavily silver plated brass, C. T. C. TURRET TERMINAL LUGS are stocked to fit 1/32", 2/32", 3/32", 4/32", 6/32" and 8/32" terminal boards.



Write for C. T. C. Catalog No. 100



CAMBRIDGE THERMIONIC CORPORATION
 439 Concord Avenue • Cambridge 38, Mass.

Under all temperature and climatic conditions

L-R BLOWERS

give maximum
heat dispersion

LIGHT - COMPACT - EFFICIENT



MODEL 1 1/2

Weight (less motor): 2 oz.
Output: 15 C.F.M. at 8000 R.P.M.

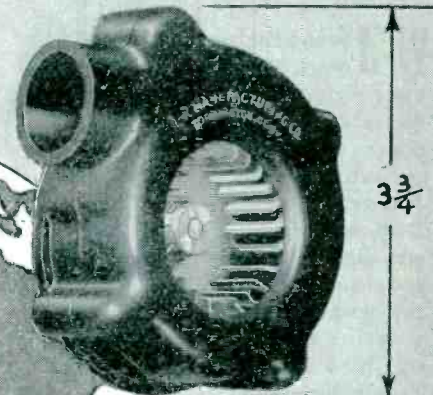

MODEL 2

Weight (less motor): 4 1/2 oz.
Output: 25 C.F.M. at 8000 R.P.M.

It's New!

MODEL 2 1/2

Weight (less motor): 4 oz.
Output: 50 C.F.M. at 8000 R.P.M.
Height: 4 1/2"

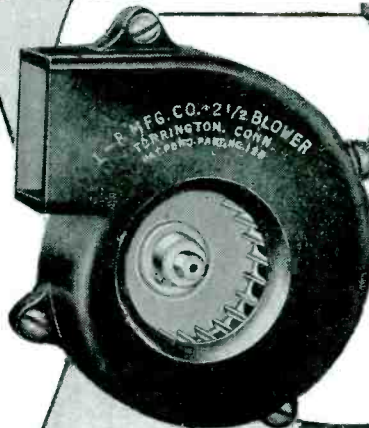

MODEL 3

Weight (less motor): 12 oz.
Output: 260 C.F.M. at 8000 R.P.M.
Height: 6 1/2"

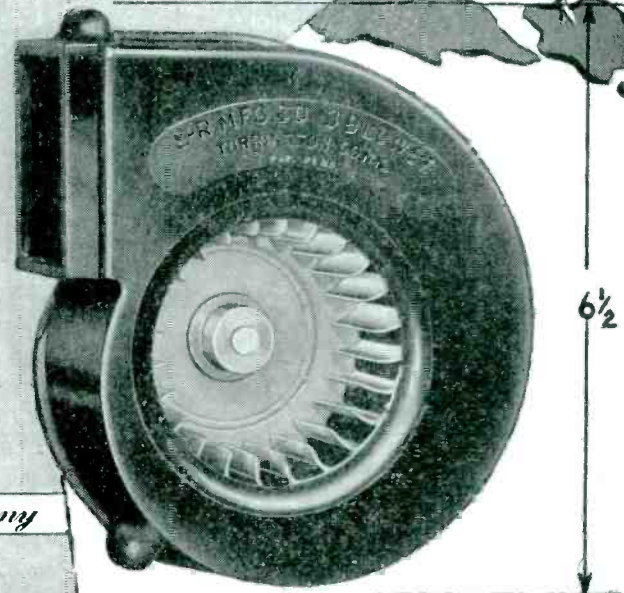

L-R Blowers produce maximum C.F.M. with minimum space and weight. Lightweight, high-impact plastic housings. Turbo-type wheels. Clockwise or counter-clockwise rotation.

L-R MANUFACTURING CO. Division of

The **RIPLLEY** Company

TORRINGTON, CONNECTICUT

INCREASE PRODUCTION

with

SOUND!

LET OUR
ENGINEERS
SHOW YOU
HOW!

W-J Sound Engineers have many successful industrial installations to their credit, at such plants as Johnson & Johnson, Diamond Wire Co. and others. Again and again they have demonstrated the amazing efficiency of W-J Sound Equipment installations to increase production and to promote the safety and happiness of workers. Take advantage of the unusual skill and experience of our sound engineers and our extensive stock which includes all leading, nationally known lines of fine Sound Equipment. Let us show you the need for a Sound System in your plant. Write today. Ask for "Music & Manpower" also the sound brochure, and new catalog.

SEND FOR THIS
NEW BUYER'S
GUIDE TODAY

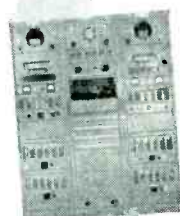
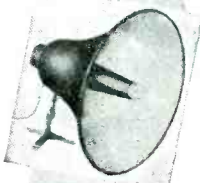
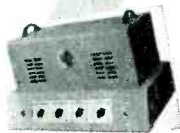

PLANT
BROADCASTER



**WALKER-
JIMIESON, INC.**

311 SOUTH WESTERN AVE., CHICAGO 12, ILL.

Phone CANal 2525



with convertor; Power consumed is 40 to 60 watts.

Production of recorders is done under a license agreement by manufacturers who pay royalties to the Armour Research Foundation. Announced licenses, as of February 1945 include: Automatic Electric Co., Chicago, Boosey & Hawks, Ltd., London, C. G. Conn, Ltd., Elkhart, Ind., E. H. Scott Radio Laboratories, Inc., Chicago, General Electric Co., Bridgeport, Conn., J. P. Seeburg Corp., Chicago, Lewyt Corp., Brooklyn, N. Y., Radiotechnic Laboratory, Evanston, Ill., Raytheon Mfg. Co., Newton, Mass., Stromberg-Carlson Co., Rochester, N. Y., Utah Electronic (Canada) Ltd., Utah Radio Products Corp., Chicago, WiRecorder Corp., Detroit. To expedite the whole program of production, licensing, etc. the Foundation has organized a wholly owned subsidiary named the Wire Recorder Development Corp., 8 South Michigan Ave., Chicago 3, Ill.

Single Crystal Transmitter

A COMPACT, eight-channel, mobile-service transmitter, which can be set for any frequency in the 100-156 Mc band, and which uses but one crystal has been developed by the Bendix Radio Division of Bendix Aviation Corp., Baltimore 4, Md. The transmitter can be quickly converted from amplitude to frequency modulation. A new

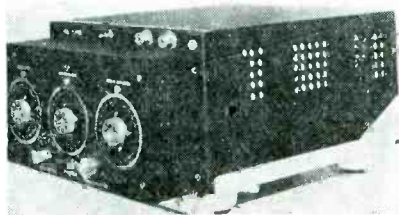

three-dial, eight-channel, automatic frequency shifter used in the unit has possibilities in multi-channel applications. (The number of dials could be varied on the basic design from one to ten, and as many as sixteen channels could ultimately be incorporated into the design.) On any one of the eight channels, frequencies are accurately determined by dial calibration without the use of a crystal-frequency indicator.



REMEMBER

... remember this—when you buy antennae. Snyder offers superior quality (because of controlled manufacture)—better price—prompt delivery. Be certain of customer satisfaction. Recommend Snyder.

ANTENNAE

by

SNYDER

MANUFACTURING CO. • PHILADELPHIA

COMPLETE MANUFACTURERS
FROM START TO FINISH

Another Conant first!

A New Rectifier Assembly
that Eliminates
Temperature Variations

Here's important news for users of rectifier type instruments. Conant has done it again! This new instrument rectifier application makes possible for the first time complete freedom from temperature errors. AC values are read on the same linear scale as DC values.

You'll be amazed at the vastly improved frequency response achieved by this new development. This remarkable assembly can be furnished in any of three Conant series (500, 160 or 160-C).

Available to original purchasers of Conant Instrument Rectifiers *license free*. Write today for details.

Instrument Rectifiers

ELECTRICAL LABORATORIES

6500 O STREET, LINCOLN 5, NEBRASKA, U. S. A.

20 Vesey St., New York 7, New York
85 E. Gay St., Columbus, Ohio
600 S. Michigan Ave., Chicago 5, Ill.
1215 Harmon Pl., Minneapolis 3, Minn.

2017 Grand Ave., Kansas City 8, Mo.
1212 Camp St., Dallas 2, Texas
378 Boulevard N. E., Atlanta, Ga.
4018 Greer Ave., St. Louis, Mo.

1526 Ivy St., Denver, Colo.
4214 Country Club Dr., Long Beach 7, Cal.
Export Div., 89 Broad St., N. Y. 4, N. Y.
50 Yarmouth Rd., Toronto, Canada

Loudspeaker

No. 24-A loudspeaker is designed primarily for outdoor applications. It is weatherproofed with a new type of vitreous finish which retains its non-corrosive qualities. The horn is exponential in form, and has a bell diameter of 25 in.

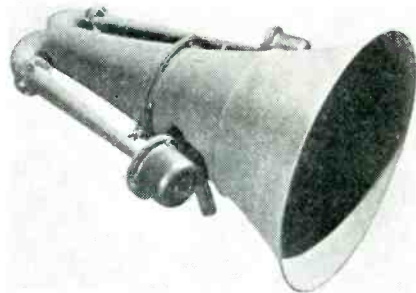

over-all length of 38 in., over-all width of 26 in., and a frequency response of 110 to 6500 cps. Receiver attachments are available for coupling 2 or 4 driver units to make the horn capable of maximum inputs of 50 and 100 watts.

The Langevin Co., 37 West 65th St., New York 23, N. Y.

Transformers

SELF-ALIGNING, detachable mounting studs used in these transformers permit tolerance in mounting dimension that can exceed one-quarter inch and eliminate rejects due to bad threads, leaks around studs, bent or broken studs or changes in length specifications. A simple clip arrangement prevents

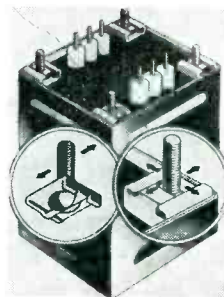

the stud from turning and assures centering in two directions. The stud can be moved (not bent) in four directions to align with irregularly spaced holes. It is replaceable in the field with any round head machine screw available. Transformers equipped with this new mounting feature are available in 15 standard case sizes, either

The bottom of the chassis tells it's own story of Dependability



The type of construction... fungicide treatment... sealing of transformers and components... proper mounting and ready identification of replaceable parts... that "built-to-take-it" look... these are some of the many things that the trained observer notes. These are some of the "musts" when equipment is to be used in hard governmental or commercial services.

Glance at the bottom of any of Techrad's LRR series...

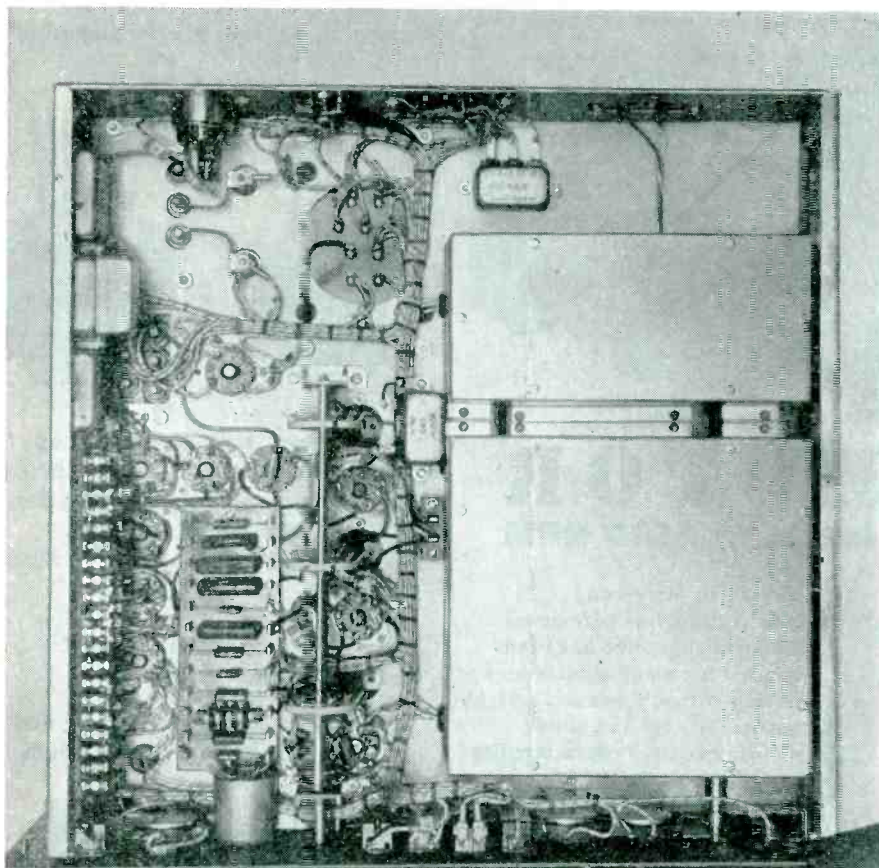

FCC approved

Your receiver problems will receive prompt and thoughtful attention when you consult our engineers. Write now for complete information and data.

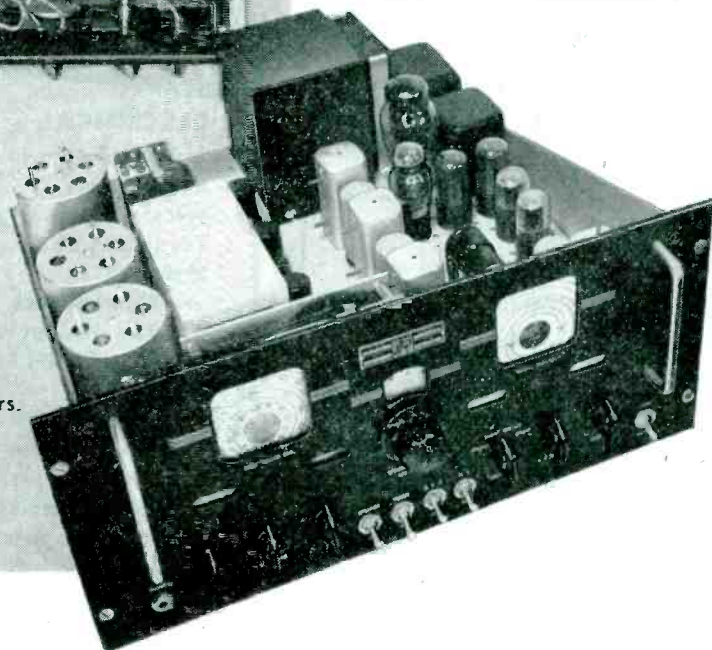

technical radio company

275 NINTH STREET • SAN FRANCISCO 3, CALIFORNIA

EXPORT AGENTS: FRAZAR & HANSEN, 301 CLAY STREET, SAN FRANCISCO 11, CALIFORNIA, U. S. A.

Over a decade of continuous experience

MOTOR DATA No. 124

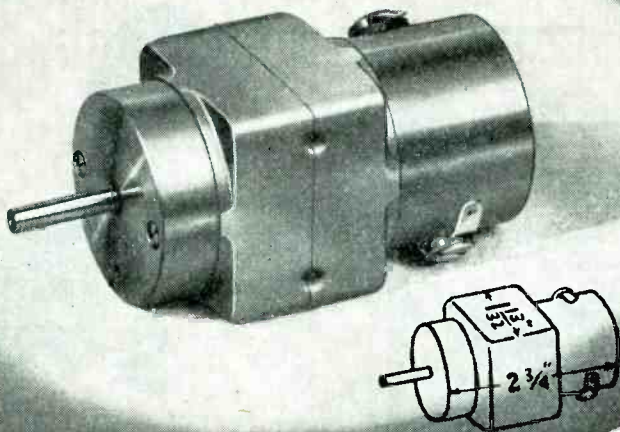

PM MOTOR

Torque 3.5 in. oz. at 4500 RPM

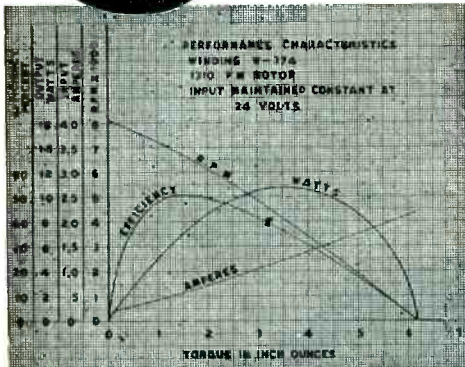

PM MOTOR - 1310

Watts Output Int. (max.)	11
Torque at 7000 RPM (in.oz.)	1
Torque at 4500 RPM (in.oz.)	3.5
Lock Torque (in.oz.)	6
Volts Input (min.)	5
Volts Input (max.)	32
Temperature Rise Int.	50°C
Weight	11 oz.
Shaft Diameter (max.)	.250"
Length less Shaft	2 3/4"
Overall Diameter	1 1/2"

Unique in design and construction, this permanent magnet field motor has been selected for many applications having critical space and weight factors. Wound as a shunt motor, its output characteristics are adaptable for a wide variety of power requirements.

FEATURES

ELECTRICAL

- Alnico field magnets
- No field losses
- Low starting current
- Reversible with change of polarity
- Low RF interference
- Armature windings varnish impregnated and baked

MECHANICAL

- Completely enclosed
- Mounting in any position
- Aluminum end brackets
- Laminated pole pieces
- Stainless steel shaft
- Rotation on ball bearings
- Commutator mica insulated

hermetically or non-hermetically sealed.

Electronic Components Co., 423 N. Western Ave., Los Angeles, Calif.

Dry-Type Transformers

THESE DRY-TYPE F transformers are for indoor use and are built in standard capacities from 100 volt-amps to 7 1/2 kvs, single phase, and

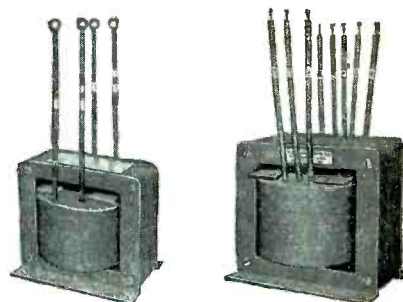

with upper voltage limits up to 2500. Larger capacities can be designed and built to specifications. Bulletin No. 119 is available.

R. E. Uptegraff Mfg. Co., Scottsdale, Pa.

Light Metal Assembly

A NEW PREFABRICATED light metal construction, known as Lindsay

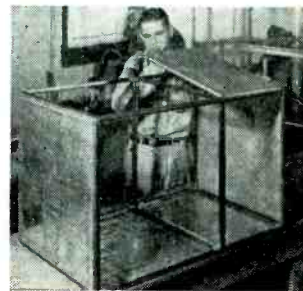

Struc-Lok, provides a simplified method of making enclosures for electrical equipment where lighter weights are necessary and strength requirements are correspondingly lower. All parts are accurately die-formed and can be easily assembled by hand by inexperienced men or women.

Lindsay and Lindsay, 60 East 42 St., New York 17, N. Y.

High-Power Condenser

THIS HIGH-POWER, high-capacitance condenser is available in various spacings up to 1 1/2 in. For a spacing

EICOR INC. 1501 W. Congress St., Chicago, U. S. A.

DYNAMOTORS • D. C. MOTORS • POWER PLANTS • CONVERTERS

Export: Ad Auriema, 89 Broad St., New York, U. S. A. Cable: Auriema, New York

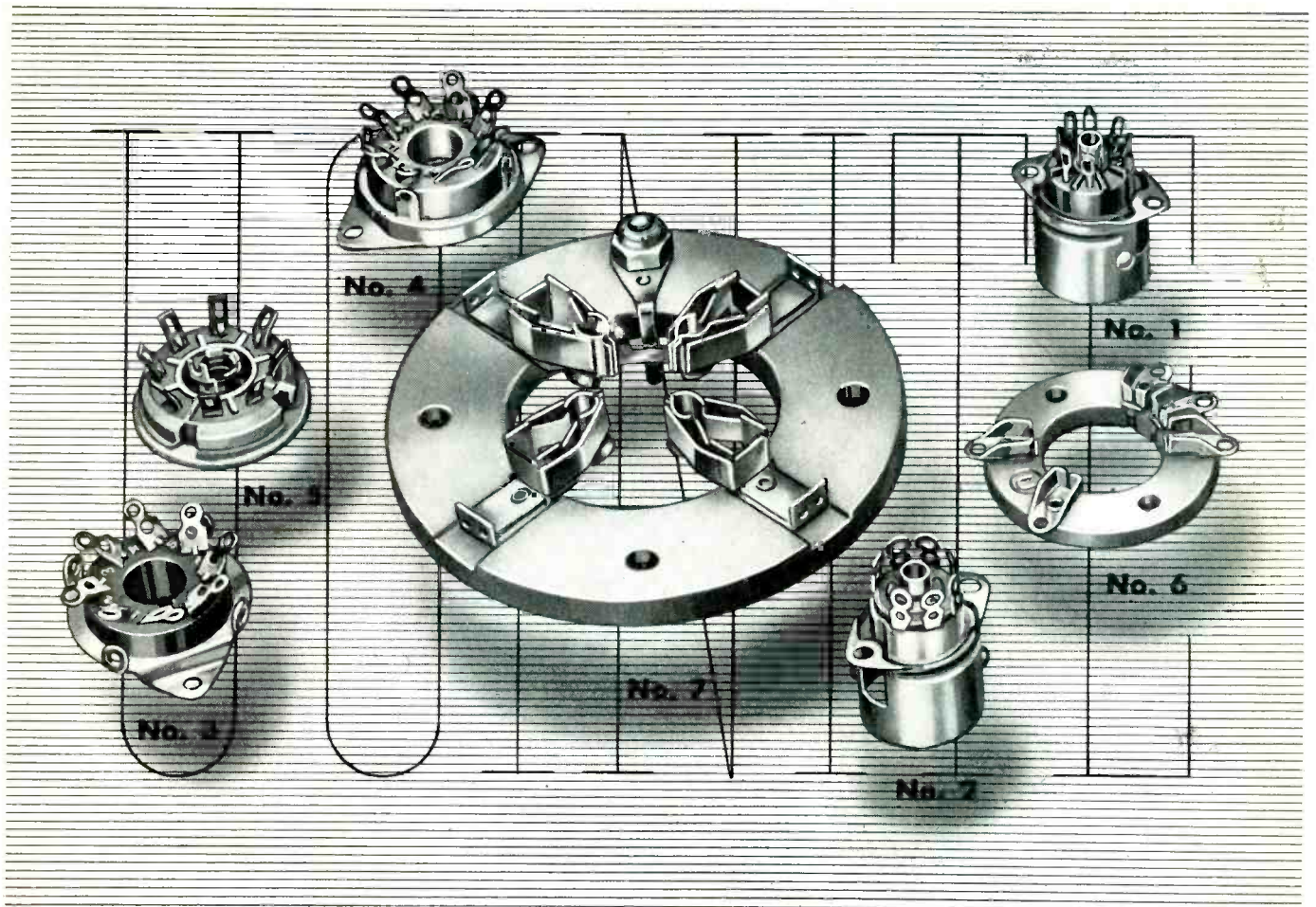

Six Standard Sockets

AND ONE SPECIAL

We make many regular types of socket bases. Here are a few standard items:

No. 1. Miniature 1-Piece, Molded

No. 2. Miniature 2-Piece Ceramic

No. 3. Molded Octal

No. 4. Ceramic Octal

No. 5. Ceramic Loctal

No. 6. Acorn Tube Socket

No. 7 is a special job. But this 705A Tube Socket is a good example of the many departures from standard which we can produce (and design, if need be) without batting an eye. In fact our specialty at Ucinite, these days, is turning out what our customers want . . . not just what would be easiest to make.

The UCINITE CO.

Newtonville 60, Mass.

Division of United-Carr Fastener Corp.

Specialists in RADIO & ELECTRONICS

LAMINATED BAKELITE ASSEMBLIES

CERAMIC SOCKETS • BANANA PINS &

JACKS • PLUGS • CONNECTORS • ETC.



*Higher
and Higher*

Electronic Winding Co. has developed special high quality coils for Ultra High Frequency work. Development of our coils has kept pace constantly with the development of high frequency communications equipment and out of our intensive war experience will come a new and finer product ready to do a new and finer job on the rapidly expanding frontiers of radio communications.

Electronic Winding Co.

5031 BROADWAY
CHICAGO 40, ILL.

★ ★ MANUFACTURERS OF EXTRA
QUALITY COILS FOR PRECISION
COMMUNICATIONS EQUIPMENT

of one inch the breakdown rating is 45,000 peak volts at 2 Mc. Condenser plates are 18-in sq, and are made of fabricated sheet metal. The frame rods are heavy 1½-in copper tubing, and are fitted with heavy strap connectors capable of

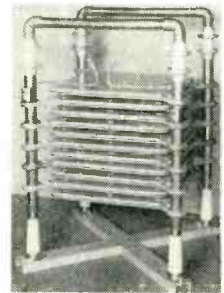

carrying a high current. A tank coil can be mounted on top of the condenser. A protective gap protects plates in the event a flash occurs. Top steatite insulators have corona shields. The condenser illustrated has a capacitance of 1200 mmf and stands 40-in high. Models with higher or lower capacitances at various spacings are available from the manufacturer, E. F. Johnson Co., Waseca, Minn.

Two-Way Connector Cable

THIS COMBINATION two-way connector can accommodate several sizes of wire. High clamping pressure is exerted by the plates, held in place by socket-head cap screws. The connector can also be used as a reducing connector within the wire limitations of each size fitting. O. Z. Electrical Mfg. Co., 262 Bond, Brooklyn, N. Y.

Coating for Resistors

ANNOUNCEMENTS have been made by the War Production Board and O. Hommel Company, Pittsburgh, Pa., that at the Mellon Institute of Industrial Research (under the O. Hommel Fellowship), Dr. E. E. Marbaker carried on the research which resulted in the development of new type of radio resistor coating. The insulating material for the resistors was developed from a new group of resins known as Silicones. Use of the coating material will make possible the production of lower-cost resistors at a more rapid rate with use of fewer man-hours. Resistors coated with the



THE CORRECT ANSWER TO YOUR RECTIFIER PROBLEM IS HERE

GE Builds All Three

Selecting the rectifier best suited for a particular d-c application is not a decision that can be made on a "guess" basis. Construction, basic materials, operating characteristics, weight, size, cost and life expectancy are all factors that should be considered.

G.E. and only G.E. builds the three types of low-voltage rectifiers most generally used—copper-oxide, selenium and Tungar. All three are tops in quality and leaders in their field. To say that one type is better than another is as fatuous as saying a bomber is better than a fighter plane. Each performs best when doing the job for which it was specifically designed.

When blueprints call for rectifiers choose the correct size and type from the G-E line. If you're not sure of what is best for your need let G-E engineers help you. Years of experience qualify them to recommend the rectifier which will give you the most economical, most efficient and most reliable performance. Whether they recommend copper-oxide, selenium or Tungar you can be sure their selection is impartial because G.E. offers all three.

For more information write to Section A656-119, Appliance and Merchandise Dept., General Electric Co., Bridgeport, Conn.

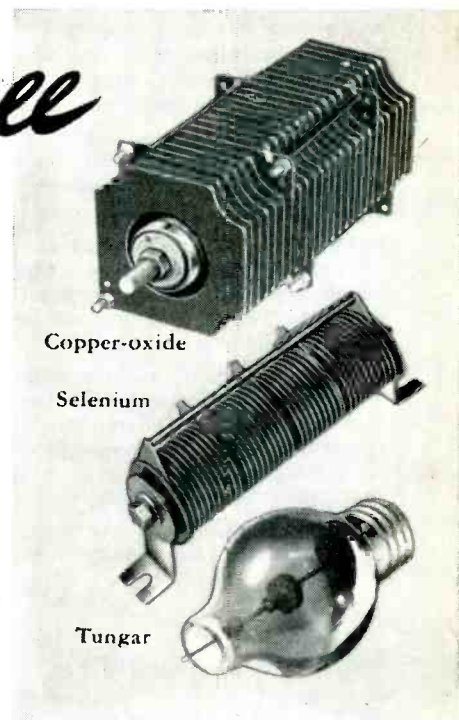

Copper-oxide

Selenium

Tungar

Hear the General Electric radio programs: "The G-E All Girl Orchestra" Sunday 10 p.m. EWT, NBC. "The World Today" news every weekday 6:45 p.m. EWT, CBS. "The G-E House Party" Monday through Friday 4:00 p.m. EWT, CBS.

BUY WAR BONDS AND KEEP THEM

GENERAL ELECTRIC



Photo Courtesy General Electric X-Ray Corporation

be sure . . . consult **KESTER**

- The flux has got to be right if the soldering job is to be right. Take delicate electrical connections for example. A flux that is a poor conductor must be used—a flux that is non-corrosive and that has no tendency to collect moisture, dust or other foreign matter.
- Various types of seams, on the other hand, require different kinds of fluxes. Spot soldering others. Sweating operations still others.
- You'll be freed of all flux doubt if you'll take this simple step: Consult Kester engineers. They'll gladly place at your command their 46 years of practical experience and laboratory research. They'll tell you just which fluxes will best protect the solder-bonds in your products. No obligation, of course.
- Naturally their recommendations can best be carried out if you specify Kester fluxes, because the Kester line is *complete*—all formulas are chemically and physically right for the jobs for which they are compounded—all properly dissolve oxides on metals so that solders can alloy with the metals in a way that prevents reoxidation.
- Why not check the flux formulas you are using, with Kester? A letter will bring expert Kester assistance.

★ BUY WAR BONDS ★

KESTER SOLDER COMPANY
4204 WRIGHTWOOD AVENUE, CHICAGO 39, ILL.
Eastern Plant: Newark, N. J. Canadian Plant: Brantford, Ont.



KESTER

Solder Fluxes

STANDARD FOR INDUSTRY

material will be able to function properly despite moisture conditions and rapid changes in extreme temperatures. The resistors have been tested in conformity with rigid Navy specifications and have been found to meet the requirements for resistors having the highest resistance to moisture penetration and operating at maximum temperatures of 275 deg C. The coating can be applied to any combination of ceramic or metal tubes with high resistance wire of suitable electrical characteristics, or it can be used as windings of electric motors.

Dry-Air Pump

FOR RADAR, radio and other equipment requiring pressurizing there is a new, dry-air pump which measures 6 in. long and 2 in. in diameter and weighs 10 oz. The pump is

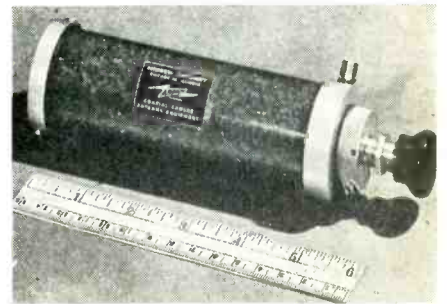

mounted directly on the panel of the apparatus which it pressurizes and therefore is always connected and ready for use. Output is rated 3 cu. in. per stroke. Andrew Co., 363 East 75th St., Chicago 19, Ill.

Multiple-Line Recording

THE ENGINEERING staff of Magno-graph Corporation is actively engaged in developing and improving multiple-line recording on steel tape for industrial, entertainment and home uses after victory. The equipment plays back immediately after recording. All rights to the multiple-line patents and all developments are controlled by Magno-graph but licenses are being negotiated for the manufacture of the various appliances embracing the Magnograph patents. The company is demonstrating its machines at its laboratories at 5800 W. Third St., Los Angeles, Calif.

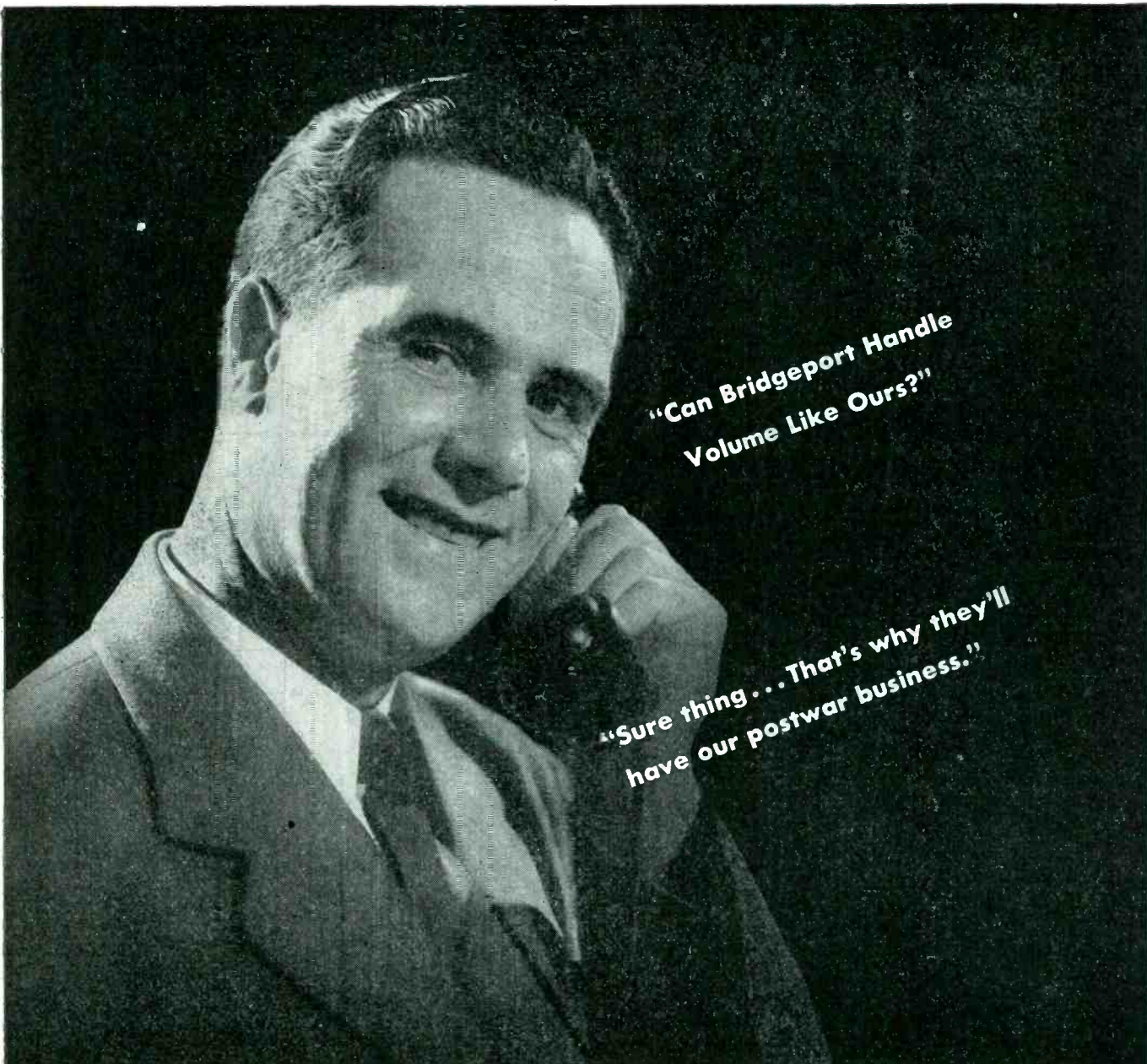

*"Can Bridgeport Handle
Volume Like Ours?"*

*"Sure thing... That's why they'll
have our postwar business."*

**Bridgeport Has
the Personnel and
the Capacity To Handle
Your Order, Too.**



The technicians who are meeting military specifications in the production of search coils and variometers will be available after the war to build equipment for you. The capacity that now enables Bridgeport to ship by the carload will be here, too.



You'll like the fast, trunk line service to any point that is a natural result of Bridgeport's central location. Write to Bridgeport today to insure early postwar delivery of R. F. Coils and Chokes, I. F. Transformers and Transmitting Coils and Chokes.

BRIDGEPORT

MANUFACTURING COMPANY
Bridgeport, Illinois

R. F. Coils • R. F. Chokes • I. F. Transformers
Transmitting Coils • Transmitting Chokes

Precision

QUALITY TUBING

For years we at Precision have been specialists in the small seamless tubing field, from 1/2" O.D. on down to 0.010" O.D. with whatever wall thickness is required, holding to unusual close tolerances. When accuracy and uniformity is the first consideration, we can help you.

We manufacture accurately drawn seamless aluminum, brass, copper and nickel tubing to exact specifications. We also fabricate and form nickel tubing electrode piece parts and various shapes of non-ferrous tubing.



Your inquiries for round tubing in all forms are solicited.

PRECISION TUBE CO.
 SPECIALISTS IN ACCURATELY DRAWN TUBING AND METAL SHIELDED WIRE
 Factory: 3824-26-28 TERRACE STREET • PHILADELPHIA, PA.
 BRANCHES IN ALL PRINCIPAL CITIES SALES DEPT. 215-05 27TH AVE. BAYSIDE, L. I., N. Y.

Low-Loss Plastic

BAKELITE Corporation (300 Madison Ave., New York 17, N. Y.) announces the development of new low-loss phenolic plastic molding material which provides stable electrical insulation values even when used in high temperatures and high relative humidity. Designated as BM-16981, this phenolic, mica-filled molding material is suitable in

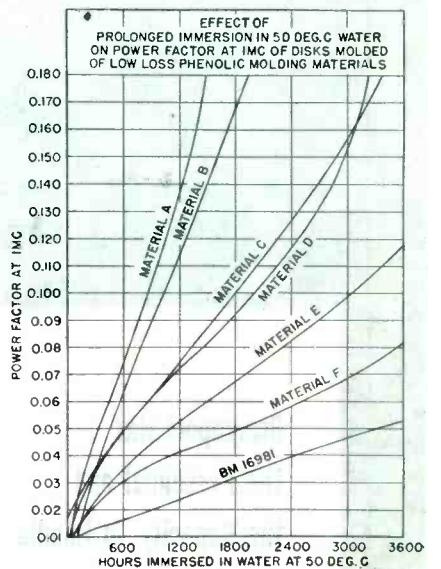
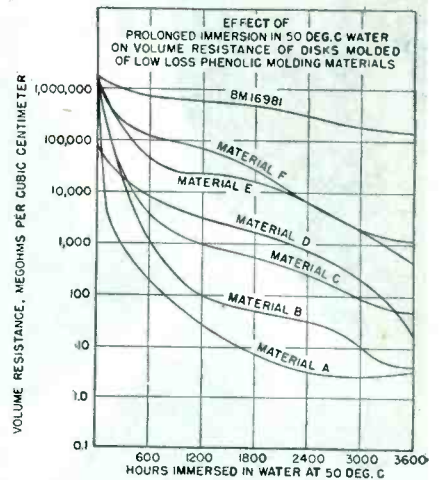

high-frequency circuits. In a recent test conducted by Bakelite, specimens molded of BM-16981 and various other mica-filled phenolic materials were immersed for a period of 3,600 hours in water heated to 50 deg C. Chart I and Chart II illustrate the effects of such immersion on the volume resistivity and power factor of several materials tested.

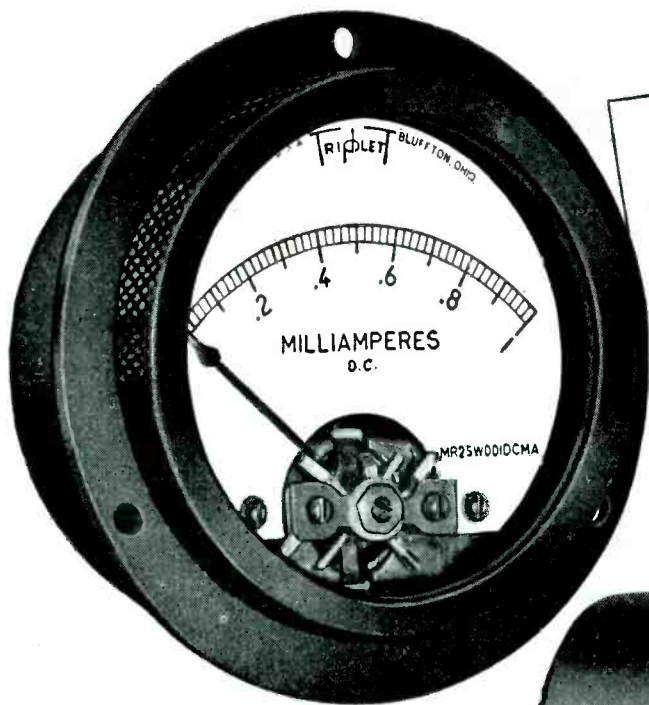

**INTRODUCING THE
NEW TRIPLET LINE
OF
HERMETICALLY SEALED
INSTRUMENTS**

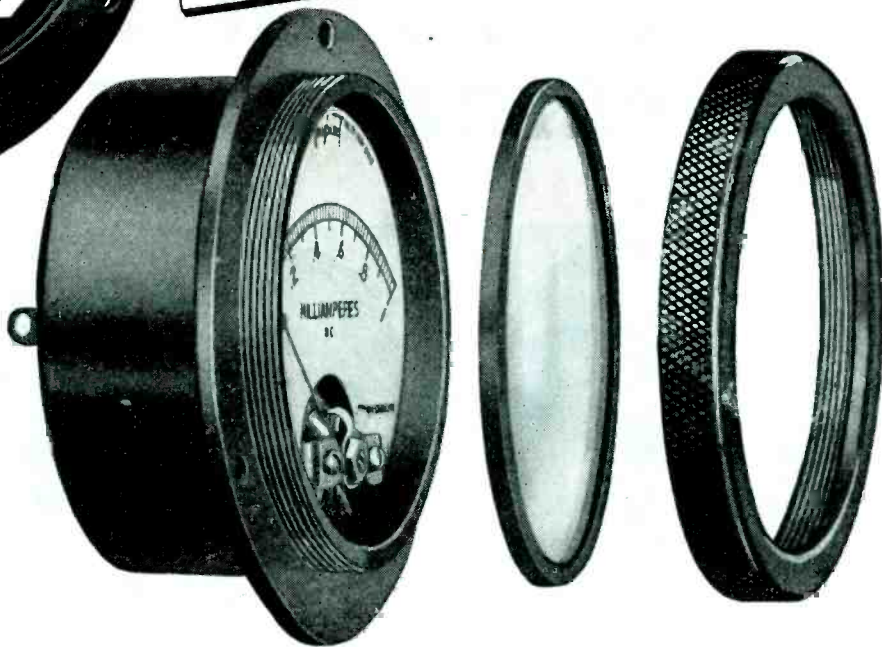
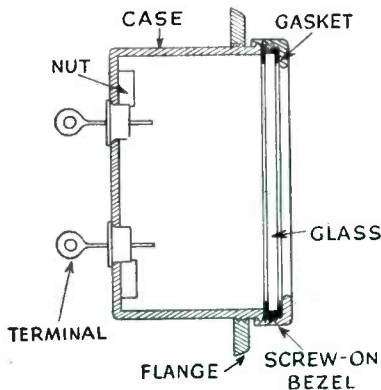

ALL THE FEATURES of STANDARD INSTRUMENTS RETAINED
Withstands submersion tests at 30 feet

A screw-on bezel provides uniform pressure for hermetically sealing the glass to the case. The gasket is pressed into every crevice around the edge of the glass and the top of the case, where the permanent seal is made.

Tempered glass window and ceramic sealed terminals are used.

The knurled screw type bezel permits servicing when necessary and resealing without replacing a single part or the use of special tools or equipment.

Complete dehydration of the interior is readily accomplished by recognized temperature difference

method (the bezel loosely attached for the escape of all moisture, after which the bezel is tightened to make the permanent seal). Interior is completely dry at slightly above atmospheric pressure.

These instruments comply with thermal shock, pressure and vibration tests. They also are resistant to corrosion. Instruments conform to S.C. No. 71-3159 and A.W.S. C-39.2-1944 specifications.

Furnished in 1½", 2½" and 3½" metal cases with 1/16" thick walls, in standard ranges. D.C. moving coil, A.C. moving iron and thermocouple types.

Write for circular

*Precision first
...to last*

Triplet

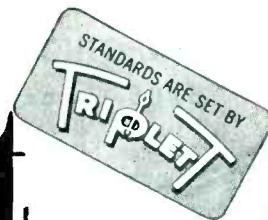

ELECTRICAL INSTRUMENT CO. BLUFFTON, OHIO

OHIO

MOTORS for ELECTRONIC APPLICATIONS

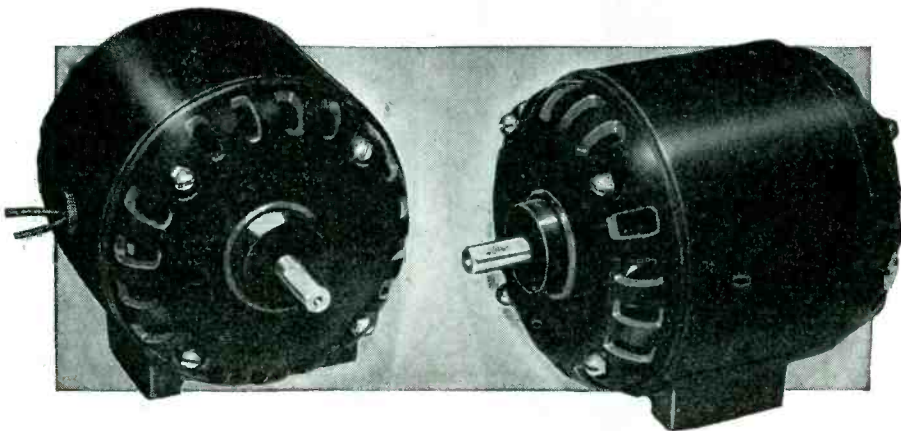

1/2 HP.—115 V.—60 Cy.—1 Ph. 1600 RPM. Reversible—A. C.—Ventilated, ball bearing.

Cut shows one of many types and sizes of Ohio Motors designed for driving Electronic Devices.

RANGE

1/100 to 2 HP.—A.C.

1/100 to 1 HP.—D.C.

1/100 to 1/4 HP.—A.C. Synchronous.

1 to 100 oz. ft. A.C. Torque.

Shell type motors for built-in applications to 4 HP.—D.C. and to 7 1/2 HP.—A.C.

All usual voltages and cycles.

What is your problem?

THE OHIO ELECTRIC MANUFACTURING CO.
5908 Maurice Avenue Cleveland 4, Ohio

Meter Tester, Meter

THE METER TESTER (top illustration) is a multi-range instrument with self-contained regulated power supply and control equipment for use on 110 volts a.c., 60 cycles. It is composed of a stepless vacuum-tube voltage control; an 8 1/2-in. mirror scale and a decade of 0.1 percent accurate wirewound resistors. Range of the unit is 25 microamp full scale, to 10 milliamp full scale, and 0-100 volts full scale. Overall accuracy is rated better than 1/2 of 1 percent (the meter is hand-calibrated by a potentiometer standard-cell method). Sensitivity is 10 milliamp. A simple vacuum tube control, using a type 6N7 as a grid-controlled variable resistor, gives complete and smooth control of the power to the standard 0-100 volts d.c. The power supply is a conventional unit with a 6X5 full-wave rectifier with a type VR150-OD3 voltage regulator to the tubes.

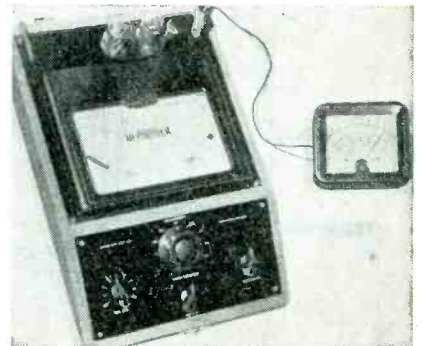

The illustration below shows a type of hermetically-sealed 2 1/2 and 3 1/2-inch meters which are built to ASA specifications and which are available in all d-c ranges. Type HM-2 is directly interchangeable with AWS types MR-24 and 25. Type HM-3 is interchangeable with AWS types MR-34 and 35. Results

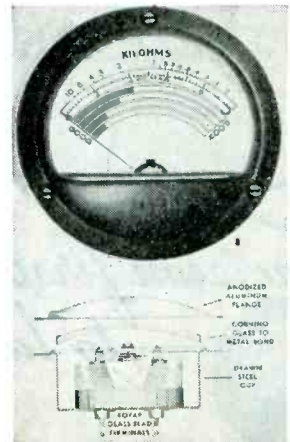



UNIFORM in appearance
UNIFORM in performance
 ...**SPEER GRAPHITE ANODES**



Uniform transmitter and rectifier tube performance depends largely upon the ability of their anodes to withstand rapid bombardment of electrons under high frequencies and high power without warping or unduly increasing the temperature of associated elements. Warping, caused by high temperatures, changes the relative positions of tube elements and hence their operating characteristics.

Because Speer Graphite Anodes will not warp, or soften, and can withstand severe overloads, tube manufacturers specify them with assurance that their tubes will have *uniform characteristics for their entire life*. These anodes, are made of a specially processed, high purity, heat-dissipating, homogeneous graphite. They minimize envelope darkening, withstand severe overloads, prevent hot spots, and improve degassing qualities.

Speer Graphite Anodes can be supplied or made for almost any type or style of electronic tube. For complete information or consultation, without obligation, write today.

Do You Know?

SPEER GRAPHITE ANODES

- Increase allowable plate power dissipation.
- Lower temperatures of associated tube parts
- Withstand severe overloads.
- Defy warping.
- Prevent hot spots or fused holes.
- Minimize bulb darkening and insulator leakage.
- Improve degassing qualities.
- Decrease gas troubles.
- Enhance tube appearance.
- Provide precise anode dimensions.
- Produce uniform tube characteristics.
- Retain original dimensions in service.
- Maintain normal tube characteristics.
- Allow wide latitude of anode design.



SPEER

CARBON COMPANY
ST. MARY'S, PA.

CHICAGO • CLEVELAND • DETROIT
 MILWAUKEE • NEW YORK • PITTSBURGH

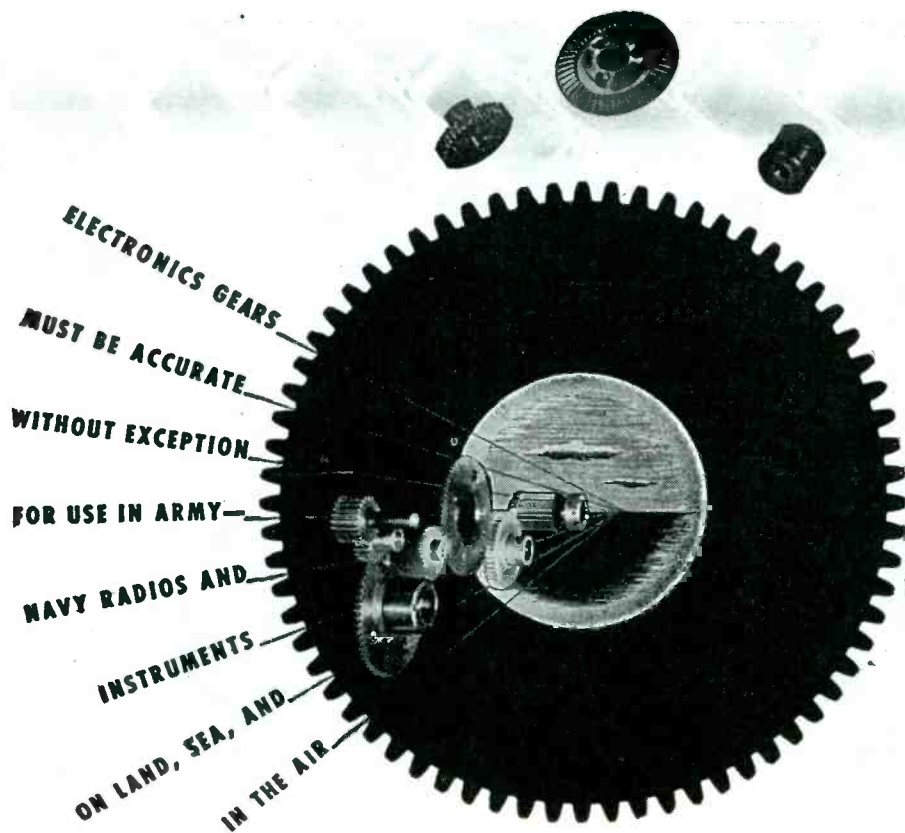

**ACCURACY CANNOT BE COM-
 PROMISED WITH IN THESE WAR
 DAYS OF LIGHTNING SPEEDS AND
 WORLD WIDE COMMUNICATIONS,
 ALL TUNED INTO OUR PRESENT
 TEMPO BY PRECISION GEARS.**



Quaker City Gear Works
 INCORPORATED
 1910-32 North Front Street, Philadelphia, Pennsylvania

of the type of hermetic sealing (glass-to-metal) which this manufacturer uses in these meters are illustrated by this test: "The meter had been boiled and frozen alternately for twelve-hour periods for a total of eight days. Maximum zero shift at any time during these tests was 0.75 percent. Maximum errors in current at full scale reading throughout the tests was 0.5 percent. Throughout this cycling the glass-to-metal seals maintained complete hermetic sealing for the instrument and there was absolutely no moisture penetration.

The instrument was then frozen with dry ice to minus 40 deg. F., and the ice was melted away from the window with a hot soldering iron. The soldering iron barrel was rested on the center of the glass window and the Corning Glass seal and tempering job were such that neither the glass nor the seals were at all disturbed. The instrument continued to function properly with maximum errors no greater than those indicated for the boiling test."

Marion Electrical Instrument Co., Manchester, N. H.

Indicating Instruments

A COMPLETE LINE of voltmeters, ammeters, milliammeters and microammeters measuring one inch in diameter and weighing 1½ ounces (larger sizes measure 1½ inches and weigh 1½ ounces) has been developed by the MB Manufacturing Co.,

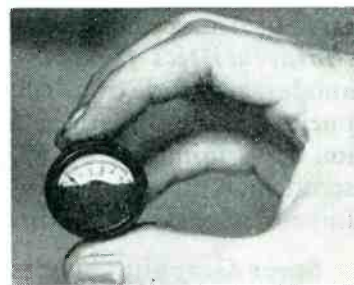

Inc., Instrument Div., East Haven 12, Conn. These moving coil type instruments are hermetically sealed in rugged anodized aluminum cases which can be hermetically sealed to the mounting panel. The instruments are sturdy and maintain a high degree of accuracy and can be used in a multitude of applications in aircraft or portable equipment.

Simplify ELECTRONIC EQUIPMENT DESIGNS WITH S. S. WHITE FLEXIBLE SHAFTS

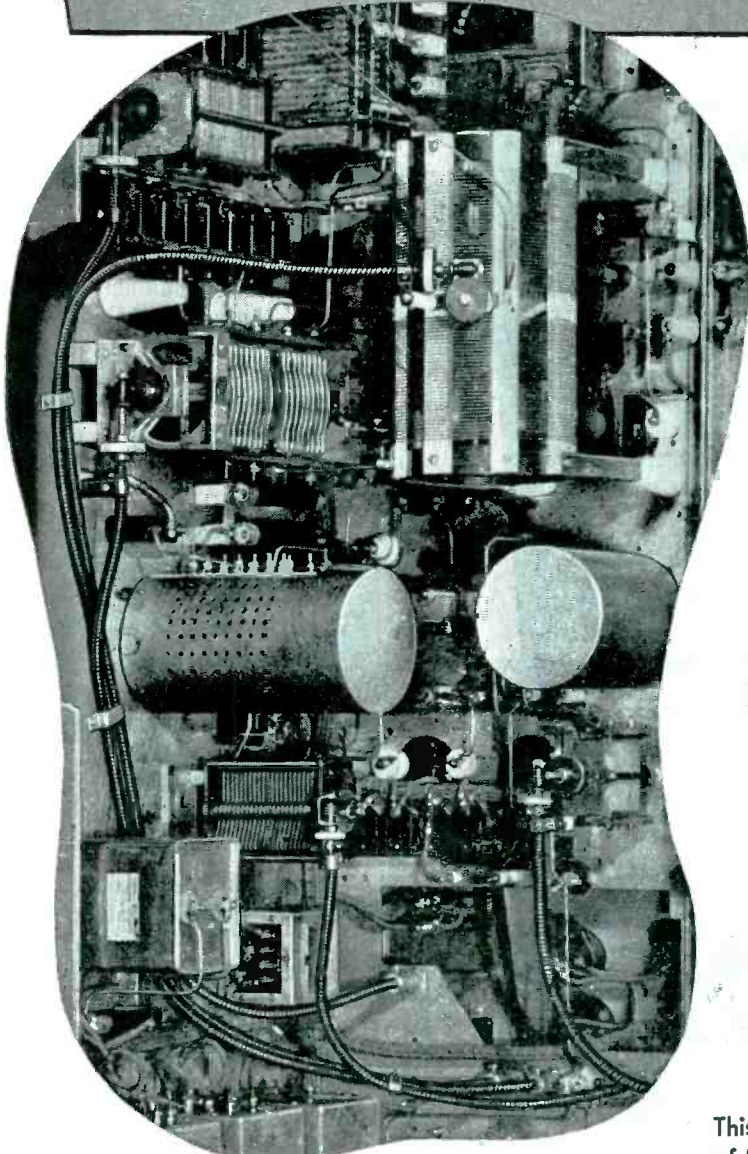

This view inside a large broadcast transmitter, makes clear that coupling with S. S. White flexible shafts gives complete freedom in placing variable elements. Note centralized controls. Note also the simple geared connections of the shafts which make operation smooth and sensitive.

Here's how...

Most electronic circuits include elements such as variable condensers, variable resistors, rotary switches, etc., which require adjustments during operation.

In designing the actual equipment, the *location* of these elements is influenced by considerations of space, circuit efficiency, facility of assembly and wiring, convenience of operation and servicing.

Normally, it would be difficult if not impossible to meet all these requirements. But you can satisfy everyone by using S. S. White Remote Control Flexible Shafts as "couplings" between the variable elements and their respective control knobs or dials. This arrangement enables you to place each and every element wherever desirable to achieve a compact, efficient, easy-to-build unit.

S. S. White Remote Control Flexible Shafts are expressly engineered for such service. They are available in any length in a wide selection of sizes and characteristics, and can be readily applied to function as smoothly and sensitively as a direct connection.

GET FULL DETAILS IN THIS FREE 256-PAGE FLEXIBLE SHAFT HANDBOOK

This book covers the whole subject of flexible shafts. It gives all essential technical data and explains how to select and apply shafts for specific requirements. A copy will be sent free if you will address your request direct to us on your business letterhead and indicate your position. Write for your copy now.



S.S. WHITE

THE S. S. WHITE DENTAL MFG. CO.

INDUSTRIAL DIVISION

DEPT. E, 10 EAST 40th ST., NEW YORK 16, N. Y.

FLEXIBLE SHAFTS

AIRCRAFT ACCESSORIES

MOLDED PLASTICS

MOLDED RESISTORS

FLEXIBLE SHAFT TOOLS



One of America's AAAA Industrial Enterprises

Reliability

*Engineered by Gates
For All-Around
Performance*

NEW *Gates* 1 KW HIGH FREQUENCY TRANSMITTER

Here's evidence of Gates' rugged designing in this extremely large ONE KILOWATT transmitter. Its massive, roomy design expresses quality, and it is full of oversize components for reliable performance in every type of climate. Gates' engineers have paid special attention to the elimination of trouble sources and the saving of maintenance upkeep. For example: Ordinarily a 1 KW capacity band change switch would not be found in a 5 watt R.F. circuit, but it is here in the HF1-2, because it eliminates trouble that might otherwise occur two or three years hence. It has four R.F. stages and three A.F. stages—all self-contained. It operates from 2-22mcs. and can instantly change to any of five pre-set crystal frequencies. The audio response of 30-10,000 cycles is suitable for short-wave broadcasting or communications.* This transmitter deserves your interest. Write for complete technical data and details on low maintenance costs.

*Peaked audio response may be had if desired.

(Also available, is the popular Gates HF1-X Transmitter, identical to the above, but for telegraph service only.)

Wartime restrictions do not allow the sale of new broadcasting equipment without priority therefore, this equipment is presented merely to acquaint you with Gates' current developments.

Ask About Our Priority Plan for Prompt Delivery
When Gates Equipment is Again Available—

Gates

RADIO COMPANY

QUINCY, ILLINOIS, U. S. A.

BROADCAST TRANSMITTERS • STUDIO SPEECH EQUIPMENT • ANTENNA TUNING AND PHASING UNITS • AMPLIFIERS • REMOTE EQUIPMENT • BROADCAST STATION AND TRANSMITTER ACCESSORIES

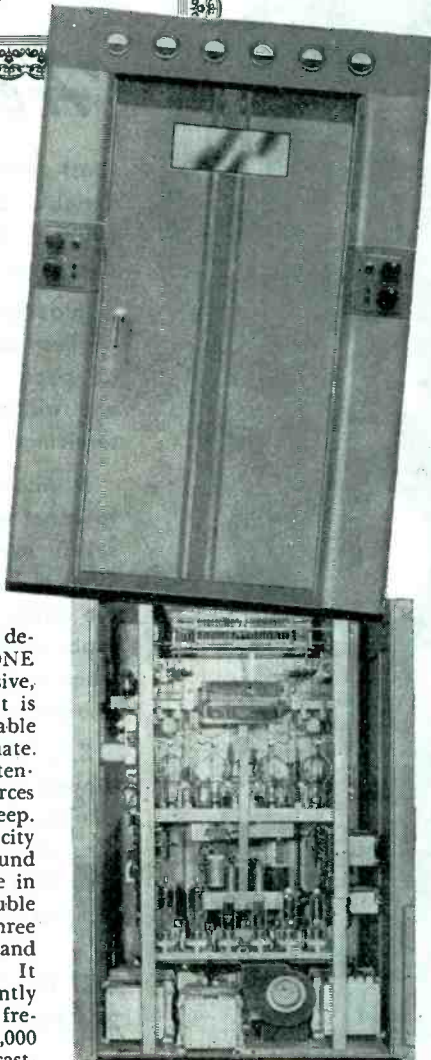

(Top) HF1-2 FRONT VIEW. 78" high, 48" wide and 36" deep—spacious design makes it easy to reach every part, large or small.

(Below) HF1-2 OPEN REAR VIEW. Cabinet is pressure type with complete air change every few seconds. All components are designed for constant operation at low temperature rise.

Coaxial Equalizer

BY USE OF newly developed coaxial equalizer, the Induction Heating Corporation (389 Lafayette St., New York 3, N. Y.) is able to couple two of their standard Model 1070 (rated output of 1070 btu's per minute) so that the full output of both (40 kw) can be obtained from a single set of terminals, for use in any desired application with a single control station operating the tandem generator set-up. Installation of the equalizer (made up of concentric tubular conductors) is simply made by connecting it to the output terminals of the generators. Interconnection between the power sections of the generators is made to give electrical stability. The equipment can be operated single phase, two phase or three phase.

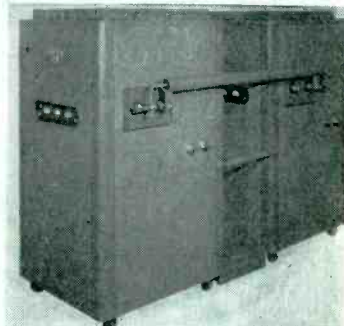

The illustration is of Model 2200 thermionic set-up which has an output of 40 kw, and can surface-harden eight or more square inches of material in a single heating cycle. Its production output is greatly increased by the use of progressive heating methods where small sections are heated and the work progressively moved through the heating coil.

Interelectro Capacitance Meter

THESE CAPACITANCE meters (Model 37-B) are for use in measuring low



HERMETICALLY
SEALED
WEIGHT: 1¼ OUNCES
MOUNTS IN A
1" PANEL OPENING



MB introduces the smallest moving coil type meters available today

MILLIVOLTMETERS—VOLTMETERS—AMMETERS—MILLIAMMETERS—MICROAMMETERS

For Aircraft and Portable Equipment

MANUFACTURERS of Aircraft and Portable Equipment have long been in need of electrical indicating instruments, tiny enough to fit in cramped quarters and yet accurate and durable enough to be *reliable* in every way.

Now the Instrument Division of The MB Manufacturing Company offers a new line of miniature, moving coil, electrical indicating instruments—only one inch in diameter—and which will meet the most rigid tests for accuracy, performance and durability.

These miniature instruments are hermetically sealed in a rugged,

anodized aluminum case, which, in turn, can be sealed to the mounting panel. They offer hundreds of new ways of application in the aircraft and portable equipment fields where economy of space and weight must be kept in mind.

MB also offers a second series of miniature electrical indicating instruments—1½ inches in diameter, weighing 1½ ounces, with the same advantages of the one-inch meter.

Write for new catalogue to Dep't. E, The MB Manufacturing Company, Inc., Instrument Division, 250 Dodge Avenue, East Haven 12, Connecticut.

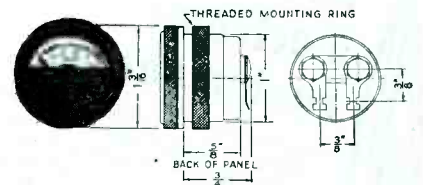

Mounting Dimensions—model 100

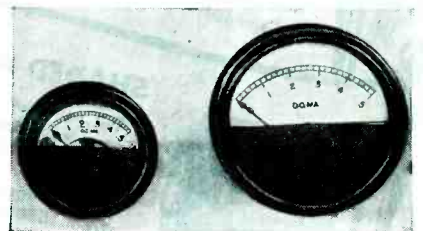

MB Miniature Ammeters
—at left, 1 inch diameter, model 100;
—at right, 1½ inch diameter, model 150.

THE MB MANUFACTURING COMPANY, INC.

INSTRUMENT DIVISION
250 DODGE AVENUE, EAST HAVEN 12, CONN.





Listen, Jim!
ASSOCIATED RESEARCH
 NOT ONLY MAKES
VIBROTESTS

for insulation resistance testing but also VIBROGROUND for ground testing, HYPOT for high voltage breakdown testing, DONUT transformers, SHUNTS, RESISTORS, and many other products.

WHERE CAN I GET ...



VIBROTEST is an outstanding name for easy simplified and accurate insulation resistance testing. Compact, portable, operated in any position, it is in wide use in electrical power fields, industry and all electrical departments. But it is only one of the many products of Associated Research.

BRING YOUR SPECIAL PROBLEMS TO US

The experience of our technicians is at your disposal, with complete facilities for designing, developing and manufacturing to your requirements. We serve organizations and individuals. We produce in large and small quantities. We are equipped for prompt delivery.

Engineering Service Representation in all Principal Cities
 WIRE OR WRITE FOR IMMEDIATE ATTENTION.

*No Cranking
 No Leveling*

Self-contained power source. Easily read scale shows ohms and megohms. Vibrotest Model 201 illustrated. Range 0-200 megohms at 500 V. potential, 0-2,000 ohms, 150-300-600 volts AC or DC. Send for Bulletins on all models.

ASSOCIATED RESEARCH, Incorporated

223 So. Green Street
 Chicago 7, Illinois

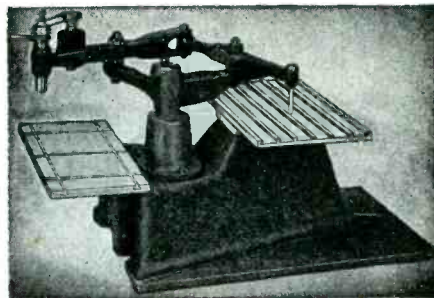

DUPLICATING and PROFILING

AUTO ENGRAVER

*Accurate Engraving
 with Unskilled Operators*

Unskilled operators will profile or accurately reproduce in smooth lines any design, number, letter, emblem, signature; on iron, brass, copper, aluminum, soft steels and all plastics. Here are some of its other uses . . .

- Drills a series of holes, or profiles small parts.
- Cuts an even channel for wiring on panels. Increases accuracy and production.
- Works from original drawing or templates.
- Etches glass and similar items.
- Will not cause distortion.

For complete information on this and other models and prices write Dept. K

AUTO ENGRAVER CO.
 1776 BROADWAY, NEW YORK 19

BLOWERS for Electronic Equipment

Easy-to-install . . . compact . . . quiet-running . . . economical . . . these are the features which make Pilot Blowers ideal for the important job of air circulation and ventilation in Radio Equipment. Available in standard models to move from 15 to 100 C.F.M. Write for Bulletin 507.



SHADED POLE F. H. P. MOTORS

Tell us what your requirements are and we will send you "fact sheets" giving complete specifications on these dependable, efficient, low-cost Motors. For continuous or intermittent duty with H.P. ratings ranging from 1/15 to 1/500 H.P. and from 1550 to 3400 R.P.M. Plain round or with base or resilient mounting . . . open or enclosed cases.



F. A. SMITH MANUFACTURING CO., INC.
 801 DAVIS ST., ROCHESTER 2, N. Y. **FASCO**

SHADED POLE **Pilot** CENTRIFUGAL MOTORS **BLOWERS**

The IMPROVED
KELNOR
 REG. U. S. PAT. OFF.
electric SOLDERING IRON



about 1/4 actual size; weighs 1/2 lb. PATENTS APP. FOR

special designed for most efficient soldering in the

ELECTRONIC, RADIO AND INSTRUMENT manufacturing and repairing fields

Easily solders hard-to-reach connections. Cuts down fatigue, increases accuracy.

ORDER FROM YOUR JOBBER, OR DIRECT. GENERAL OFFICES: CENTRAL TOWER, SAN FRANCISCO 3

KELNOR MANUFACTURING COMPANY

"When Ordering Please Mention Electronics"

values of capacitance, and particularly in the measurement of vacuum-tube interelectrode capacitances. The instrument is direct reading in five steps, through the range of 0.001 to 100 mfd. Socket adapters of the unit accommodate all popular tubes so that measurements in accordance with RMA and JAN standards can be made. Bulletin T-445 available from Technical Apparatus Company (1171 Tremont St., Boston 20, Mass.) gives technical data and application notes.

Accelerometers

THESE accelerometers will drive standard recording galvanometers without amplifiers or electronic-carrier equipment. Natural frequencies of the instruments vary from 100 to 1000 cps, depending upon their acceleration ranges. (The 12-G unit weighs 2 oz and has a natural frequency of 400 cps). Characteristics of units are: sensitivity to transverse acceleration less than 0.1 percent; linear within $\frac{1}{2}$ percent; zero drift with temperature is less than 1 percent between plus 100 deg F and minus 50 deg F; calibration factor changes less than 3 percent within the temperature range mentioned. Excessive acceleration does no damage to the units. The sensitive element of these accelerometers consists of unbonded strain-sensitive filaments which are in grid form, and constitute the sole support for the mass. Filaments are connected in a Wheatstone bridge circuit of which all four arms are active. No external balancing circuits or components are required because the bridge circuit is balanced in assem-

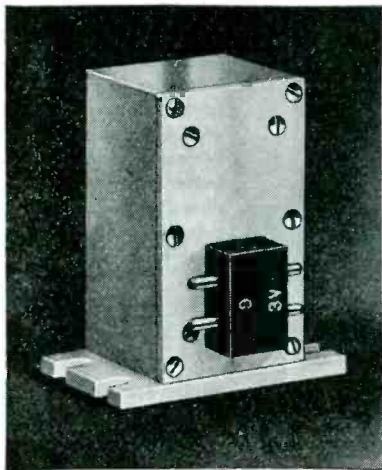

for complete

"EVERY



SYLLABLE"

clarity

equip your postwar products with

TELEX MAGNETIC RECEIVERS

Before war came, TELEX introduced the first wearable Electronic Hearing Aid with Receivers which brought brilliant new clarity in sound reception to sufferers from hearing impairments.

Since Pearl Harbor, TELEX has supplied hundreds of thousands of Midget Magnetic Receivers to the Signal Corps that have met the supreme tests of battle uses.

Today . . . drawing upon this wealth of experience . . . TELEX Engineers continue to pioneer with new and marked advancements in Tiny Magnetic Receivers . . . improvements that set new standards in high fidelity recep-

tion and control of sound communication.

You may need for your own products the high sensitivity and absolute clarity possible under all atmospheric conditions with TELEX Magnetic Receivers . . . for such products as wearable radios, airport and airplane receivers, I C systems for railroads, telephone equipment, dictating equipment, medical equipment, and all types of sound research equipment.

Should you have such a need after V Day, the demonstrated creative ability of TELEX Engineers can be of help to you. Watch TELEX for further new electronic developments.

TELEX INC.

ELECTRONIC PRODUCTS DIVISION
MINNEAPOLIS 1, MINNESOTA

25 YEARS *Specialization in* RELAYS

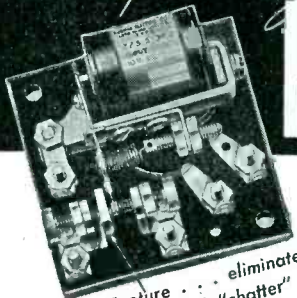

New Feature . . . eliminates "bounce" and "chatter"



Microphone Hummer

Twenty-five years' experience in solving all types of Relay Problems . . . Complete facilities for Designing, Engineering, Manufacturing . . . Specialists in producing Relays of exceptional power and sensitivity for Aircraft, Intercommunications-Systems, Electronic Devices. Exclusive Kurman features provide greater dependability, longer life, more precise performance . . .

Send data for quotations. Write for new descriptive Bulletins.

KURMAN ELECTRIC CO.



35-18 37th STREET • LONG ISLAND CITY 1, N. Y.

Radio-Electronic Materials

• Try us for those items you need in a hurry. Our stocks are big—our service, extra-fast!

We've been at it since 1925—and we know how!

Just Try Us

H. L. DALIS, INC.

Wholesale Distributors

RADIO-ELECTRONIC SUPPLIES & PARTS

17 Union Square

NEW YORK 3, N. Y.

Phones: Algonquin 4-8112-3-4-5-6-7



**FOR POSTWAR
PLANNING
SPECIFY**

NORCO COAXIAL TRANSMISSION LINES AND FITTINGS



NORCO coaxial cables, of the rigid gas filled type, for radio communication, radar, television, and FM. A complete line of fittings, both solder, and improved solderless types can be supplied for NORCO Transmission Lines, including improved End Seals and Junction Boxes. Your inquiry invited.

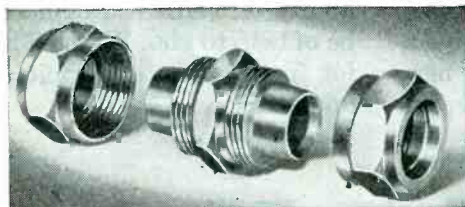

New solderless COUPLING without synthetic gaskets



NORTHERN COMMUNICATIONS MANUFACTURING CO.

210 EAST 40th STREET

NEW YORK 16, N. Y.

Manufacturers of Transformers • Special Coils • Reactors • Sound Systems
Recorders • Equalizers • Full Range Phonograph • Coaxial Transmission Lines

NUMBERALL

MULTI-WHEEL NUMBERING MACHINE • MODEL 70

The Most Efficient Method of
Stamping Numbers into Metal

Adapted for Hand or Press Use

REPEATS THE SAME NUMBERS UNTIL CHANGED

Model 70 NUMBERALL machines are used in all industries to mark various parts. Stamp numbers, etc., quickly . . . neatly. Perfectly aligned. Much better marks are produced by these machines than by single stamps or steel type, and at a far lower cost. Shank for Hand or Press and with any number of wheels from 3 to 20.

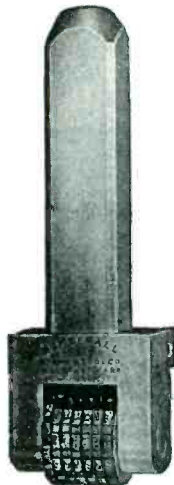

Model No. 70

Write for Bulletin E 70

NUMBERALL STAMP & TOOL CO.
HUGUENOT PARK • STATEN ISLAND 12, N. Y.

bly. Each corner of the bridge has an electrical terminal, two of which are connected to a dry cell battery, while the remaining two terminals are connected directly to the recording galvanometer. This method of supporting strain-sensitive wires makes full use of their strain sensitivity, and results in a high output level. Statham Laboratories, 8222 Beverly Blvd., Los Angeles 36, Calif.

Thyratron

WESTINGHOUSE Electric & Mfg. Co., announces a new 15,000-volt thyratron tube (WL-678) which provides split-cycle control of high power for r-f heating units and radio transmitters. The tube is designed to give smooth and instantaneous power control from zero to 100 percent load; simplified automatic load control; and high speed automatic

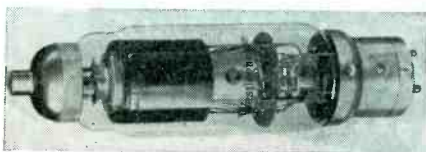

overload protection; General characteristics of the tube are: filament voltage 5.0 volts; filament current 7.5 amp; filament heating time (minimum) 1 min; typical control bias at rated voltage, 50 volts. Maximum ratings: anode voltage (peak forward and peak inverse) 10,000; anode current (average) 1.6 amp; anode current (peak) 6 amp, temperature range (condensed mercury) 25 to 55 deg C. Lamp Division, Bloomfield, N. J.

Automatic Announcer

SPD-33 IS A NEW electronic unit (Automatic Announcer) which consists of a voltage regulated power supply, a d-c amplifier, a lamp and an alarm bell, together with associated operating relays. The unit is adjustable for both sensitivity and for delay action. In practical operation this device, when connected to the proper output of a radio receiver, as an example, will function as a radio-operated switch, whose output is directly connected to either a signal light or an alarm bell, or both, thus giving a visual as well as an audible indication of

RESISTORS

by HANOVIA

GRADE 1 CLASS 1

HERMETICALLY SEALED

Wire Wound

FERRULE TERMINAL TYPE

Power Resistors

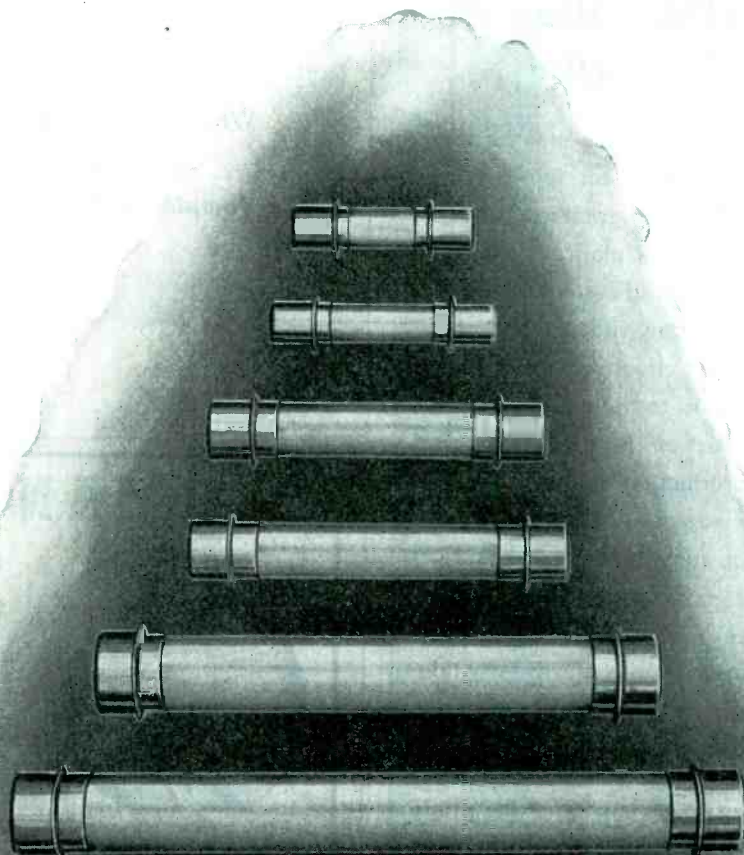

Six Styles Available

Sturdily Built For Dependable Service

Inquiries Invited

HANOVIA Chemical & Mfg. Co.

Dept. E-14

Newark 5, N. J.

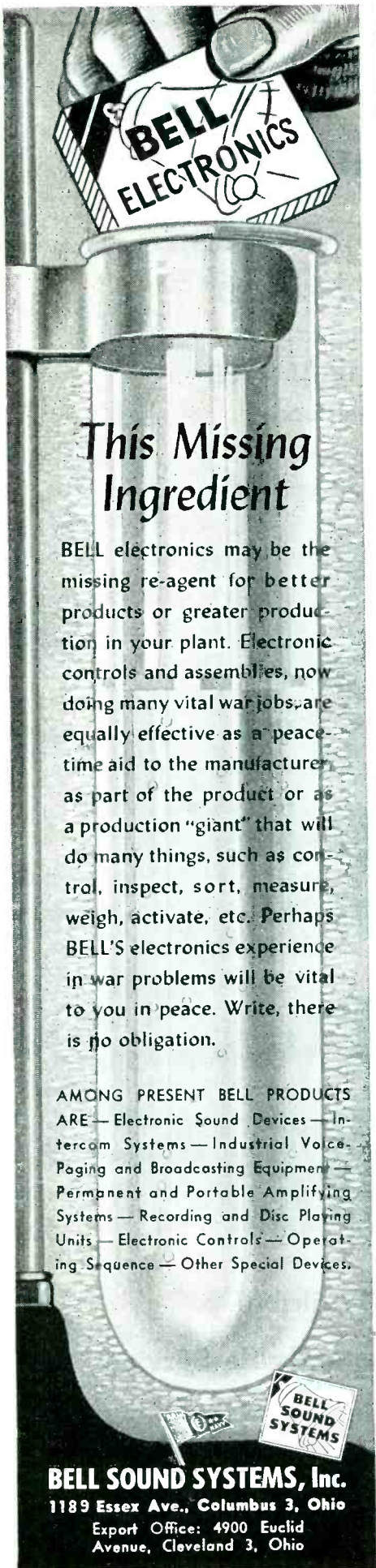

This Missing Ingredient

BELL electronics may be the missing re-agent for better products or greater production in your plant. Electronic controls and assemblies, now doing many vital war jobs, are equally effective as a peacetime aid to the manufacturer as part of the product or as a production "giant" that will do many things, such as control, inspect, sort, measure, weigh, activate, etc. Perhaps BELL'S electronics experience in war problems will be vital to you in peace. Write, there is no obligation.

AMONG PRESENT BELL PRODUCTS ARE—Electronic Sound Devices—Intercom Systems—Industrial Voice-Paging and Broadcasting Equipment—Permanent and Portable Amplifying Systems—Recording and Disc Playing Units—Electronic Controls—Operating Sequence—Other Special Devices.

BELL SOUND SYSTEMS, Inc.
1189 Essex Ave., Columbus 3, Ohio
Export Office: 4900 Euclid Avenue, Cleveland 3, Ohio



Cellusuede FLOCK

HAS MANY USES IN RADIO

Practical, economical Cellusuede Flock is an excellent material for a variety of radio uses. Coat wire grills, cabinet bases, cabinet interiors and phonograph turntables with versatile Cellusuede and note its high acoustical value . . . low cost . . . flattering suede or velvet effect. Rayon or Cotton Flock is furnished in a wide assortment of colors. No rationing . . . no priorities . . . no delay.

Write for Booklet,
Color Card,
Samples and Prices



Cellusuede Products, Inc.
ROCKFORD, ILLINOIS

PERMANENT MAGNETS

All Shapes—All Sizes—for All Purposes
COBALT—CHROME—TUNGSTEN
Stamped, formed and cast
Alnico (*Cast or Sintered under G. E. License*)
Also: Laminations for Radio Transformers
TOOLS—DIES—STAMPINGS
Heat Treating of Metals and Alloys

THOMAS & SKINNER STEEL PRODUCTS COMPANY
1116 EAST 23RD STREET • INDIANAPOLIS 5, INDIANA



- INSTRUMENT HOUSINGS
- PANELS
- CHASSIS
- STAMPINGS
- SCREW MACHINE PARTS

METAL AND PLASTIC SPECIALTIES
Manufactured to your Requirements

Experienced fabrication and dependable service for all types of radio and electronic parts. Send us your drawings and specifications for quotation.

STAMFORD METAL SPECIALTY CO., 428 BROADWAY, N. Y. 13
Metal Work of Every Description



incoming radio signals. Sensitivity and time constant controls, located on the front panel of the instrument, are variable over a considerable range, corresponding to actual operating conditions. Maximum sensitivity of the Announcer is never utilized, and by proper adjustment of the controls trip action of the alarm circuit is had, corresponding to the intensity of the incoming signal and/or the background noise. Delay ranges from zero to over 100 milliseconds and the off-delay action is constant at more than 500 milliseconds. The unit operates on 115 volts a.c. has a power consumption of 34 watts, internally operates a 1-kw switch, and weighs about 40 lbs. It is designed for standard relay rack mounting (panel height is 3½ inches.) Radio Manufacturers Engineers, Inc., Peoria, Ill.

Small Battery

No. 412, "Everyready" Mini-Max B battery is rated at 22½ volts, weighs 2½ oz, and measures 2 x 1½ x 23/32 in. It is for use in hearing aids, pocket-size radios, or certain types of electronic equipment. National Carbon Co., 30 East 42 St., New York 17, N. Y.

Reverse-Current Relay

TYPE 9100 reverse current relay is especially designed for "tough" low voltage d-c applications on either stationary or mobile equipment. An automatic latch on the relay

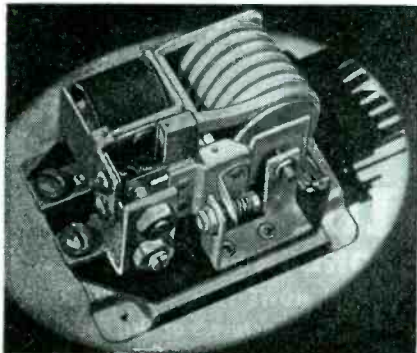

CONCORD

Amplifiers Intercoms and Recorders

FOR EVERY PURPOSE

Concord's full line of Amplifiers range up to sizes covering 200,000 square feet indoors or 75,000 square feet outdoors. A complete line of speakers, microphones, and all essential equipment is also available.

Concord Intercom Units are carried in a variety of master and sub-station units permitting up to 100 stations.

Concord Recording Equipment—professional-type for microphone recording, radio recording, reproduction of transcriptions, public address system.

Mail the coupon below for special folders and literature which picture and describe the complete Concord line of Amplifiers, Intercoms and Recorders.

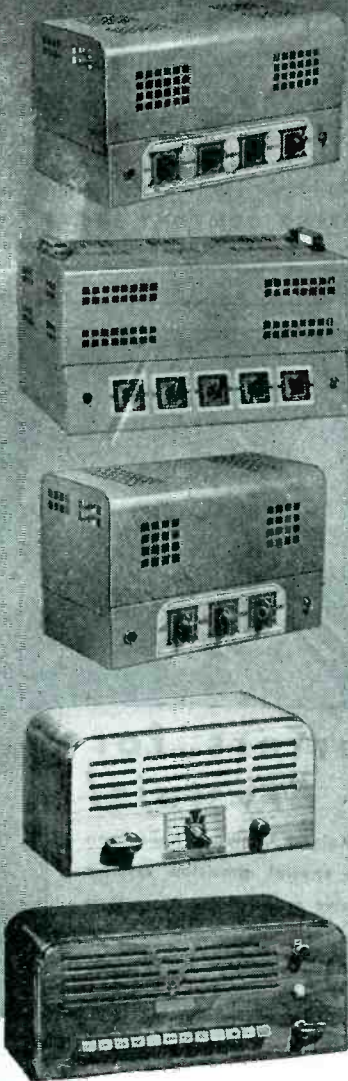

CONCORD RADIO CORPORATION
Lafayette Radio Corporation
CHICAGO 7, ILL. ATLANTA 3, GA.
901 W. Jackson Blvd. 265 Peachtree Street

Concord Radio Corporation
901 W. Jackson Blvd. Dept. G-65
Chicago 7, Illinois

Please send me at once, literature covering your line of Amplifiers, Intercoms and Recorders.

Name.....
Address.....
City..... State.....

A word to radio buyers

... whose annual needs run between 5,000 and 20,000 units, for retail chains, furniture chains and department store buying combines.

We have "ghosted" private label radios for fifteen profitable, pre-war years! When we again turn our resources to civilian production, we plan to make:

- ◆ 5- and 6-tube AC-DC table model radios in bakelite, catalin and wood cabinets
- ◆ Table radio-phonograph combinations
- ◆ Portable phonographs

Our policy has consistently been to keep costs at rock-bottom; to accept orders only when we can fill them and live up to all agreed-on terms. We welcome inquiry.



First of the pre-war radio manufacturers in the New York Metropolitan area to win the Army-Navy "E."

ESPEY MANUFACTURING COMPANY, INC.
33 WEST 46th STREET, NEW YORK 19, N. Y. BRYANT 9-2300

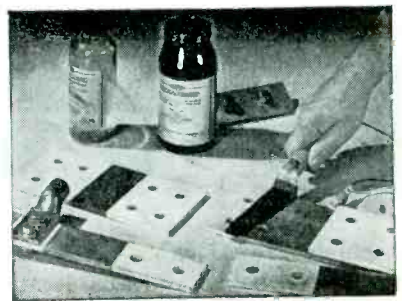

METAL-COATING PROCESS

- FAST AND ECONOMICAL
- FOR HEAVIER COATINGS

REQUIRES ONLY RAPID ELECTROLYTE—RAPID METAL CLEANER—RAPID APPLICATOR

● Plating current is obtained from dry cells, storage battery, or any convenient source of direct current at 3 to 6 V., or use Rapid Plating Rectifier for heavy work.

● For silver surfacing bus bar connections, lugs, switch blades, etc. For plating or touching up miscellaneous surfaces with cadmium, nickel, zinc, copper and gold. Building up limited areas. Hard surfacing with nickel. Used in shop or field. Special applicators designed to speed up production line jobs.

Our laboratory is glad to cooperate. No obligation

Rapid Electroplating Process, Inc.

1414 S. Wabash Ave., Chicago 5, Ill.
621 Graybar Bldg. 237 Rialto Bldg.
New York, N. Y. San Francisco, Calif.

Crystals for the Critical...

Headquarters for SPECIAL Crystals!

The men of The James Knights Company have been designing and making special precision crystals since 1932. Their extensive experience with crystals for every conceivable purpose, coupled with an active participation in Radio dating back to 1913, is available to you. These men are interested in your special crystal problems — they have the knowledge, equipment and research facilities to help you. Why not get them working on your special crystal problem today?

The JAMES KNIGHTS Co.
SANDWICH, ILLINOIS
Sixty Miles Southwest of Chicago

Capacitors
of Time-Tested Quality

Illinois CONDENSER COMPANY
1160 N. HOWE ST. • CHICAGO 10, ILL.
Manufacturers of Oil, Paper and Electrolytic Capacitors

prevents accidental closing of the armature or contacts due to vibration or shock. Contacts are rated 100 amp at 30 volts d.c. maximum. Physical dimensions are $4\frac{1}{4} \times 3\frac{1}{8} \times 2\frac{1}{8}$ inches. Approximate weight is 1.6 lbs. Also available are Type 9000 reverse current relays without the magnetic latch. These units are for use where severe vibration and shock are not encountered. Type 9000 relays are available in sizes as low as 300 watts at 6, 12, 18 and 24-volts d.c. R-B-M Manufacturing Co., Div., of Essex Wire Corp., Logansport, Ind.

Capacitor

ILLUSTRATED IS a capacitor which will operate in u-h-f circuits. It is the size of a walnut and is specially designed for high-frequency operation. Its characteristics are: Capacitance range 6-50 mmfd; maximum voltage 30 kv peak; maximum current 20 amp peak. Units are self-

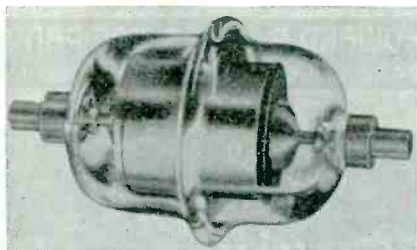

healing in case of overload. Bulletin E available from Jennings Radio Mfg. Co., 1098 E. William St., San Jose 12, Calif., describes the capacitors in more detail.

Power Supply

MODEL FTR-3128-S is a compact, light-weight, many-purpose rectifier unit for use in applications where closely regulated direct current is required. It operates from a single-phase a-c input of 115 volts, 58 to 62 cycles, and provides d-c power up to 10 amp, continuous duty, at any selected voltage between 22 and 30 volts. Output voltage is automatically held constant within plus or minus 0.5 volt regardless of load variation from zero to 10 amp, or a-c line fluctuations of 105 to 125 volts. Ripple voltage is limited to approximately 5 percent. Mounted on the front panel is an on-off switch, 0-30 d-c volt-

PORTABLE POWER PROBLEMS

THIS MONTH—PATHE NEWS RECORDING AMPLIFIER



PORTABLE SOUND EQUIPMENT used by Pathe News' Washington staff must be ready for instant action, rain or shine. To meet all requirements of newsreel work, Pathe News engineers developed a lightweight sound amplifier—powered by a special, flat type 180-volt Burgess Battery—with sufficient output in milli-watts to operate the mirror galvanometer. Burgess engineers worked closely with Pathe sound experts to develop this battery (photo lower right).

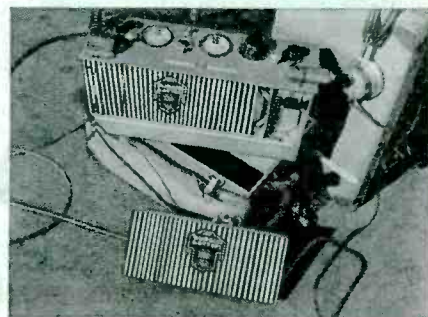

UNUSUAL ELECTRONIC APPLICATIONS for battery power are the specialty of Burgess engineers. Ask for their help on your dry battery problem. In addition to developing batteries for specific needs, Burgess engineers have made a line of Industrial Batteries so complete that one of the standard types may be ideal for your special requirement. For further information on Industrial Batteries, see your Burgess distributor.

Burgess Battery Company, Freeport, Illinois



BURGESS BATTERIES



SAVE MORE PAPER—SEND IT TO WAR

Recognized as the MOST COMPLETE LINE of dry batteries

Shock Proof

Standard Relays

Power

Many jobs can be done easier and better with Potter & Brumfield Standard Relays. Built in a wide range of simplified designs and sizes, these relays give you maximum dependability, longer life and precise performance under most exacting conditions . . . at lower cost.

Sensitive

Latch

Multiple Leaf

Available Standard Types include Power—Shock Proof—Plate Circuit—Sensitive—Latch—Multiple Leaf—

Aircraft

Electrical Reset Latch—Aircraft and Telephone types. Complete range of coil voltages, either AC or DC.

Plate Circuit

Conveniently mounted, varied contact arrangements. IF A STANDARD RELAY WILL DO THE JOB, THAT'S THE ONE TO BUY.

Telephone

Electrical Reset Latch

Potter & Brumfield
Mfg. Co., Inc.

Ask for catalog giving full specifications on all types of Standard Relays.

105 NORTH 10th ST., PRINCETON, INDIANA

JONES 2400 SERIES PLUGS and SOCKETS



P-2406-CCT



S-2406-SB

A new series of Plugs and Sockets designed for highest electrical and mechanical efficiency. Improved Socket Contacts provide 4 individual flexing surfaces which make positive contact over practically their entire length.

The Contacts on both Plugs and Sockets are mounted in recessed pockets greatly increasing leakage distance, increasing voltage rating. Molded BM 120

Bakelite insulation. Plug and Socket contacts are silver plated. The finished appearance of this series will add considerably to your equipment.

The 2400 Series are interchangeable with all units of the corresponding No. 400 Series. Send today for general catalog No. 14 listing and illustrating our complete line of Plugs, Sockets and Terminal Strips.

HOWARD B. JONES COMPANY
2460 W. GEORGE ST. CHICAGO 18

1947 AX*

Dot-I won't be home for dinner. Phone me when you're back

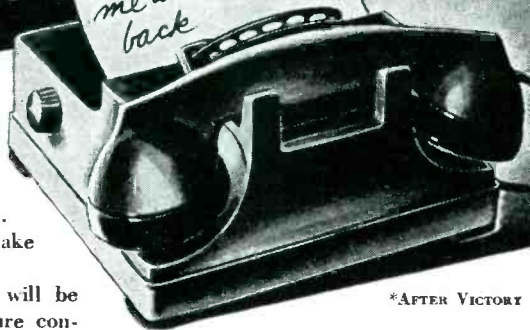

*AFTER VICTORY

Science creates an "ear" for the 'phone that no one answers. The message goes through via electronic writing. Precision manufacturing will make it an actuality.

Millions of precision parts will be necessary to make these future conveniences available to the millions. Precision on a mass-production, low-cost

basis has been our aim and achievement for more than 30 years.

If you have a wartime or a postwar precision problem, you might find it interesting to discuss it with us.

(Below) Some of many thousands of our precision parts that help "Keep 'em flying and fighting."



Let's all back the attack—buy EXTRA War Bonds.

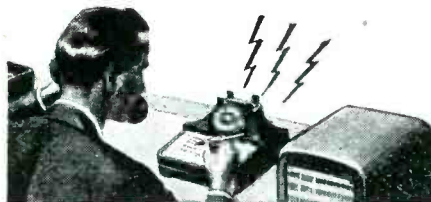

ERICSSON

SCREW MACHINE PRODUCTS CO., INC.

25 LAFAYETTE STREET, BROOKLYN 1, N. Y.



MADE BY
Engineers
FOR
Engineers

it won't
be long
NOW

... and then we'll be able
to sell you these fine

WIRES

cornish
WIRE COMPANY, INC.



15 Park Row,
New York City



meter and d-c output terminals. The equipment weighs approximately 74 lbs, and measures 11½ x 8 x 16 in. Federal Telephone & Radio Corp., Newark, N. J.

Rectifier Tube

TYPE TR-40M high vacuum, half-wave rectifier tube measures 9½ in. high, with a maximum diameter of 3½ in. It is equipped with a 4-pin jumbo (50-watt) base. Glass is Nonex. Filament is thoriated tung-

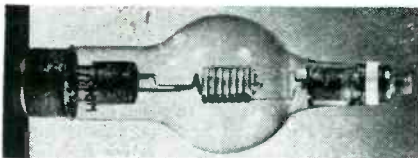

sten. Filament power is 5.0 volts at 10.5 amp; peak forward volts—25,000; peak inverse volts—60,000; average plate current—0.25 amp. Taylor Tubes Inc., 2312 Wabansia Ave., Chicago, Ill.

Resistors, Heaters

REGAN BANK-TYPE resistors come in standard types of 6 resistors to a bank (frame measurement is 23 in. in length 11½-in. in width, and 4½-in. deep) but the units can be built from 2 to 24 resistors to a bank. Resistors are supplied with shock - tested, salt-spray - tested glazed steatite cores. Radiant heaters for temperatures up to 1700 deg F. are also available. A 4-page bulletin describing these pieces of

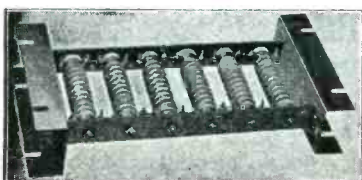

Announcing... a series of High Vacuum Diffusion Pumps for Industrial Use

THE VMF SERIES of all-metal pumps embodies an entirely new application of the fractionating, self-conditioning principle. Six different sizes, varying in their range of pumping speeds, make available a model which will fit your particular problem with maximum efficiency. Sturdy in construction, these pumps meet the exacting demands of industry for compact, reliable units, capable of reaching pressures of 10^{-6} mm. of mercury or lower.

The VMF oil diffusion pumps are suitable for use on automatic exhaust machines, electron microscopes, continuously evacuated X-ray tubes, and a variety of electronic devices and production units. They are also suitable for laboratory and other vacuum systems of moderate size where an inexpensive metal pump may be effectively employed.

CHARACTERISTICS	VMF 2	VMF 5	VMF 10	VMF 20	VMF 50	VMF 100
Speed (L/sec.)	2	5	10	20	50	100
Height	3¾"	5¼"	7"	9¾"	11"	14½"
Width	2½"	2¾"	3¾"	5¼"	6¾"	7¼"
Required fore-pressure, microns . .	100	100	100	100	100	150

Ultimate vacuum 1×10^{-6} mm. Hg with Octoil

For details concerning these pumps, as well as 20 other types of diffusion pumps, low-vapor-pressure fluids, greases, vacuum gauges, control circuits, and other items for high-vacuum technology . . . write Vacuum Equipment Division.

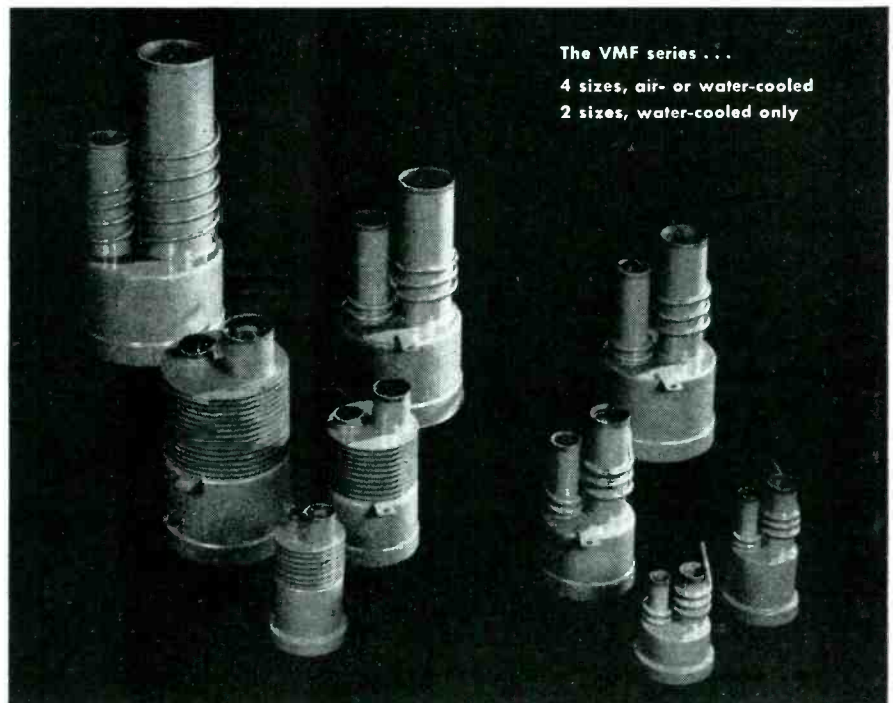

The VMF series . . .
4 sizes, air- or water-cooled
2 sizes, water-cooled only



DISTILLATION PRODUCTS, INC.

Jointly owned by EASTMAN KODAK COMPANY and GENERAL MILLS, INC.

ROCHESTER 13, N. Y.

SPEED IRON

Model B

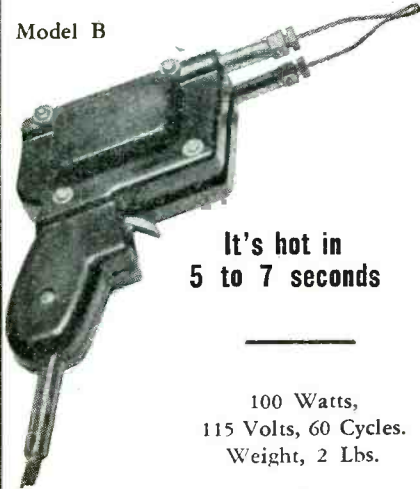

It's hot in
5 to 7 seconds

100 Watts,
115 Volts, 60 Cycles.
Weight, 2 Lbs.

A new development in soldering irons now makes possible great savings in light soldering operations. Rugged, fast, powerful, built to give years of service, it will do soldering jobs that previously were impossible. A tool that is a "must" for your lab and for many special applications in the plant.

It consists of a hi-current, low-voltage transformer with its primary controlled by a trigger switch. To the secondary is connected the soldering tip and heating element, a length of No. 11 copper. The tips are easily replaced and their flexibility permits forming into various shapes to reach difficult connections.

The tool is encased in an attractive plastic housing, comfortable and well balanced.

For More Information Write Dept. E,

WELLER MFG. CO.
EASTON, PA.

TRANSFORMERS FOR ELECTRONIC PURPOSES

We are completely equipped for volume production. Write us concerning your requirements.

**DONGAN
ELECTRIC MFG. CO.**
2977 Franklin Detroit 7, Mich.



The Dongan Line
Since Nineteen-Nine

We Invite
Inquiries

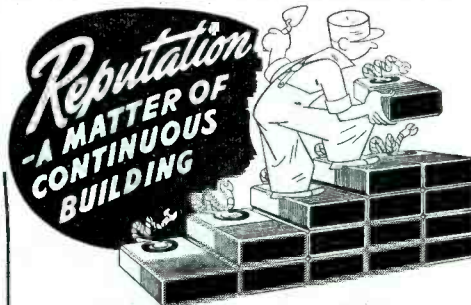

**SUPERIOR CARBON
PRODUCTS, INC.**
9117 GEORGE AVE.
CLEVELAND 5, OHIO



**SUPERIOR CARBON
BRUSHES**

After 25 years we're still at it, and expect always to be. For reputation-building is a job that's never finished . . . Constant change and improvement rule the electrical industry. These advances are steadily making old practices, old viewpoints, old products, obsolete. Good old Superior brush grades, regardless of how good or how old, have to go when they no longer "deliver". New brushes take their place, stemming from consistent laboratory research and a close study of our customers' needs.

Will you outline your problem to us?

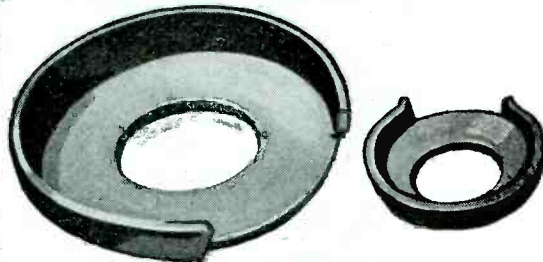

CUP WASHERS
for Binding Screws



WHITEHEAD STAMPING CO.

1691 W. Lafayette Blvd.

Detroit 16, Michigan

Preferred

as a source of precision - made WASHERS and STAMPINGS manufactured to your specifications.

equipment is available from Techt-
mann Industries, Inc., 828 N.
Broadway, Milwaukee 2, Wis.

Automatic Voltage Regulators

VOLTAGE CONTROL for 1 and 2-kva applications is achieved by the use of SECO Models 4101 and 4102 voltage regulators which consist of a thyatron tube circuit which controls the variable transformer and maintains a constant output voltage regardless of variations in input voltage or output load current. These regulators are not affected by changes in the power factor of the load nor is there any distortion in the wave-form of the output. Rack and cabinet mounting types are available and come supplied with a voltmeter, on-off switch, sensitivity control knob and output voltage selector knob. Bulletin No. 164, describing these units more thoroughly, is available from Superior Electric Co., Bristol, Conn.

High-Vacuum Pumping System

TYPE PS HIGH-VACUUM systems are new and complete packaged units (available in various capacities) which are simple to operate and re-

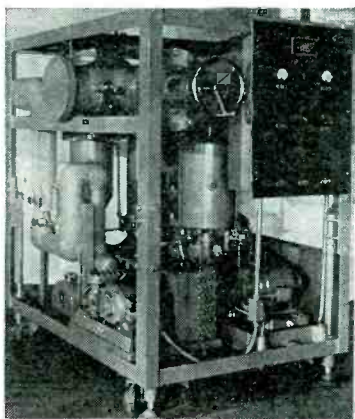

quire only one connection for attachment to whatever is to be vacu-
ated. Casters are used to make units portable. The system is fully automatic and incorporates various safety and protective features. Vacuum conditions are indicated continuously on a control panel, and recorders can be used if desired. Mechanically refrigerated traps are available on special order. National Research Corp., Vacuum Engineering Div., Boston 15, Mass.

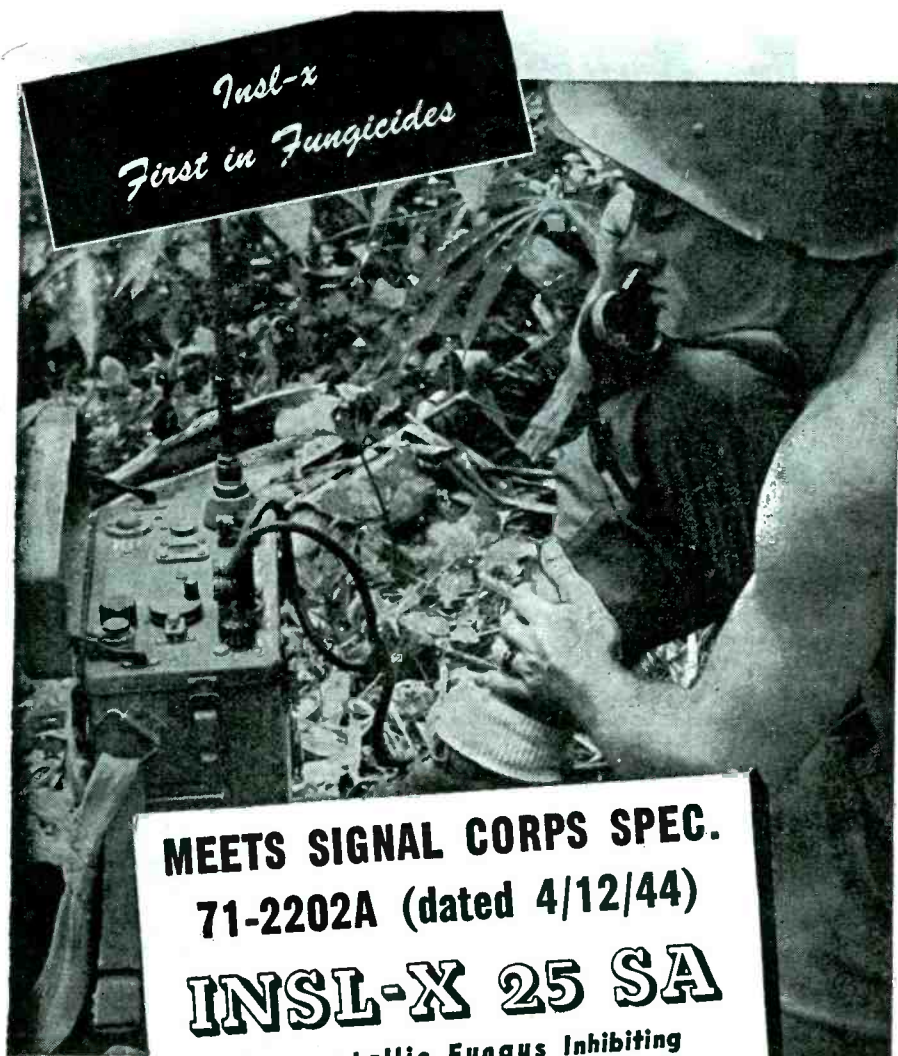

*Insl-x
First in Fungicides*

**MEETS SIGNAL CORPS SPEC.
71-2202A (dated 4/12/44)**

INSL-X 25 SA

**Non-metallic Fungus Inhibiting
Coating for Over-all Treatment
of Assembled Ground Equipment***

- Non-corrosive to copper, 52S aluminum, low carbon steel, cadmium plated steel. No deteriorating effects on coated or adjacent parts.
- The fungicide is completely dissolved thereby eliminating the possibility of settling out.
- Moisture-proof. Non-inflammable, (spec. 71-4943).
- Actually beats specification requirements for insulating properties and drying time . . . tack-free in 8 minutes . . . hard in 45 minutes.
- **NON-TOXIC TO HUMANS**—official tests show *INSL-X will not cause dermatitis.*

*Salicylanilide

LITERATURE ON "27 SERIES" AIR DRY VARNISHES ON REQUEST
27A with Phenyl Mercury • 27PA with Pentachlorophenol • 27SA with Salicylanilide

THE INSL-X CO., Inc. • 857 Meeker Ave. • Brooklyn 22, N. Y.

Chicago • Detroit • Los Angeles • Philadelphia

E-I HERMETICALLY-SEALED MULTIPLE HEADERS

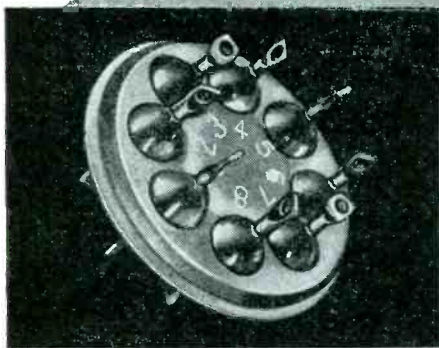

- ★ VACUUM TIGHT SEAL
- ★ KOVAR METAL ELECTRODES
- ★ PYREX GLASS BEAD
- ★ MANY STANDARD TYPES
- ★ ANY TYPE TO SPECIFICATIONS
- ★ SOLDER OR WELD EASILY

A complete and diversified line of E-I 4, 5, 6, 7 and 8 electrode hermetically sealed Multiple Headers are now available as standard stock items. All are supplied at mass production prices—no special tool or die costs involved. Individual sealed terminals are also included in a wide variety of standardized types. All special shapes or forms can be supplied to exact specifications at slightly higher cost.

All include Pyrex glass bead—immune to thermal or electrical shock. Pyrex annealed to eliminate strain. Kovar electrode and shell solders and welds easily and forms absolute vacuum tight chemical bond with glass—lead becomes integral part of housing. Multiple Headers can be fabricated in any form to specification—write today.

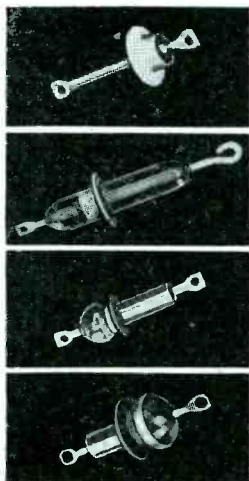

ELECTRICAL INDUSTRIES · INC.

42 SUMMER AVENUE, NEWARK 4, N. J.



SCREWS

All kinds, sizes and shapes, standard and special designs. Contract and engineered screw specialties, precision made, economically produced.



SHEET METAL SCREWS
MACHINE SCREW NUTS
MACHINE SCREWS
PLASTIC INSETS
HOLDING PINS
SPECIAL RIVETS
ALL TYPES OF HEADS
AND THREADS

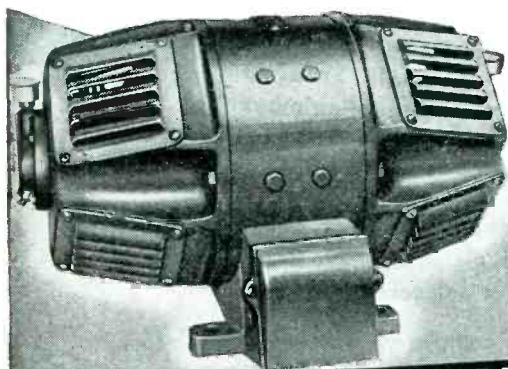

D.C. to A.C.
by JANETTE

UP
TO 3.2
K.V.A.

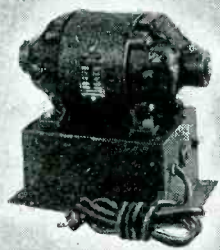

D.C. to A.C. CONVERTERS

Electronic and Gaseous Tube Devices can be operated from direct current power by means of a rugged Janette converter. When used with sound devices, specially designed filters discriminating enough to filter out unwanted noises and to minimize conducted radio noise voltage, can be furnished.

For nearly a quarter of a century Janette converters have given dependable service under varied climatic conditions in all parts of the world.

If you have a D.C. to A.C. requirement and want a reliable, high quality converter you can safely specify a Janette.

Janette

Ask for
Bulletin
13-25

Janette Manufacturing Co. 556 W. Monroe St. Chicago 6, Ill.

RADEX

RADEX

CHICAGO

In future peace-time production, Radex will uphold its war-won reputation by the scope and caliber of its service to the radio and electrical industries.

Radex Corporation

53 W. Jackson Blvd., Chicago 4, Ill.

Literature

ELECTRONICS INDEX. Readers can obtain for 75 cents an offset copy of an index to *ELECTRONICS*, Volumes 1 to XVII (April 1930 to December 1944). Mail requests to *ELECTRONICS*, Editorial Department, 330 West 42nd Street, New York 18, N. Y., together with the money.

ELECTRONIC HEATING. "Electronic Heating for Plastics" is the title of an article on this subject by M. Robert Saslaw, which appears in Vol. 3, No. 3 of a bulletin called *Celanese Plastics*. The author discusses briefly practical methods of heating plastic material, costs and limitations. Celanese Plastics Corp., 180 Madison Ave., New York 16, N. Y.

MICROPHONES. A simplified reference-level conversion chart is contained in a new 36-page catalog which gives basic operating principles of microphones; new and special purpose microphones as well as poly-directional, dynamic, velocity and carbon types. Electro-Voice Corp., 1239 South Bend Ave., South Bend 24, Indiana.

WAR PRODUCTION AND VE-DAY. Is the title of the second report of James F. Byrnes, Director of War Mobilization and Reconversion, to the President, Senate and House of Representatives on the problems of mobilization and reconversion. In the booklet (48 pages) is data on policies of contract curtailment, nonrenewal and termination.

SILICONE PRODUCTS. Four separate pieces of literature from Dow Corning Corp., Midland, Mich., include (1) a booklet on No. DC-993 high temperature Silicone electrical insulation; (2) a booklet on Silicone polymers, a colorless, odorless, inert liquid for use wherever there is a need for a liquid which has a low rate of change of viscosity with temperature, and which will remain fluid at low temperatures, or which will be practically nonvolatile at elevated temperatures; (3) a 4-page bulletin on Silicone lubricants for



A New Impregnating Service

Which . . . **PROTECTS STEATITE CERAMIC PARTS AGAINST MOISTURE ABSORPTION AND FUNGUS ATTACK**

The image shows a black tray containing several white ceramic parts, including a square plate with a central hole and four smaller holes, a circular ring, a small circular disc, and several cylindrical components of different sizes. The tray is set against a dark background.

by the use of **DOW-CORNING FLUID #200**

This new method for waterproofing ceramic surfaces results in increased electrical resistance and improved performance of equipment under conditions of high humidity and condensation. Application of Dow-Corning Fluid No. 200 to ceramic bodies coats them with an extremely thin film of silicone. It will adhere effectively even when immersed for days in sea water and does not collect dust or corrode metals; nor will it react with organic materials. It has a power factor of the order of .005% and is effective up to 150°C. It also acts as a neutral flux for soldering, and is not removed by contact with organic solvents. For further applications and engineering data write or phone.



PRODUCTION ENGINEERING CORP.

666 VAN HOUTEN AVENUE, CLIFTON, N. J. • TEL. PASSAIC 2-5161



Full throw and
(IN NON-LOCK POSITION)
Single Hole Mounting
**BOTH Outstanding FEATURES OF
GENERAL CONTROL COMPANY'S
MODEL MCM "MIDGET" SWITCH**

The Model MCM "Midget" Lever Switch has the unique feature of FULL THROW in both lock and non-lock positions. By means of a stainless steel detent track insert*, the "Midget" may be supplied with (1) lock on each side of neutral; (2) lock one side, non-lock on other; (3) lock one side, no throw on other; (4) non-lock on each side of neutral; (5) non-lock one side, no throw on other; (6) two-position operation.

Conventional switches have reduced spacing between contacts in the non-lock position because of limited travel. The "Midget" completely allows full spacing—and remember, the "Midget" weighs only 3½ ounces with 12 contacts! It is only 2¾" long x 1¼" wide x 1¼" thick.

Another exclusive "Midget" feature is the single hole mounting for which a locating pin can be provided. The "Midget" is compactly constructed for restricted space. Write for further details.

*PATENT PENDING



GENERAL CONTROL COMPANY

1202 SOLDIERS FIELD ROAD, BOSTON 34, MASS.

RADIART VIBRATORS

**INDIVIDUALLY ENGINEERED
for
SPECIFIC REQUIREMENTS**

RADIART VIBRATORS enjoy widespread confidence because they are individually engineered for each job.

Precision manufacturing and inspection guarantee the proper performance of each vibrator.

Consult with our engineers about your electronic and communications vibrator needs.

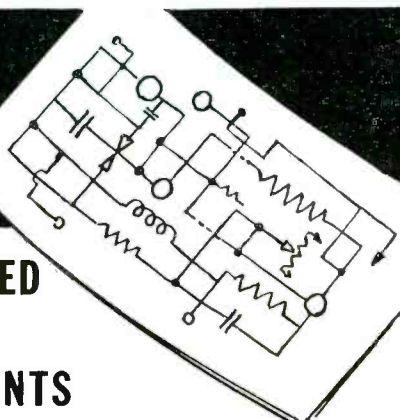

Radiart Corporation

3571 W. 62nd. St.

CLEVELAND 2, OHIO

Star Steatite

has a very desirable low loss factor, making it particularly well suited for radio and television equipment, in addition to which its strength and density make it ideal for many mechanical uses.



The **STAR**
PORCELAIN CO.

Electronics Dept.

Trenton 9, N. J.

**FOR
ELECTRONIC USE**



SILVER

WIRE - SHEET - TUBING
SILVER BRAZING ALLOYS & FLUXES

PLATINUM

WIRE - RIBBON - FOIL
SEAMLESS TUBING

SEND US YOUR INQUIRIES
FOR ALL APPLICATIONS OF
PRECIOUS METALS TO ELECTRONIC PRODUCTS.

PRECIOUS
METALS



SINCE
1875

THE
**AMERICAN PLATINUM
WORKS**

N. J. R. R. AVE. AT OLIVER ST.
NEWARK 5, N. J.

use in automatic control valves, or in applications where extremes of temperature, corrosive chemical or steam make conventional greases ineffective. The grease may also be used as a sealing agent for valves in high pressure or high vacuum systems; and finally (4) there are 6 pages of data on (No. 4) ignition sealing compounds, a new dielectric material for use wherever a corona-resistant filler and moisture-proof compound is needed in sealing ignition junctions or terminals.

PANORAMIC RECEPTION. "From One Ham to Another" is the title of a new book dealing with the techniques of panoramic reception for the amateur radio operator. Panoramic Radio Corp., 242 West 55th St., New York 19, N. Y.

COLUMBIA METAL. "Fansteel Columbium" (Form F-414) is a technical publication on pure columbium which is similar to tantalum in physical and chemical properties. The metal has only recently been prepared on a production basis. The resistivity of columbium at room temperatures is about eight times that of copper. The work function of columbium is 4.01 volts, the lowest of any of the pure refractory metals. Lower values have been reported. Relatively little is known, so far, about the other electrical and electronic properties of columbium. Fansteel Metallurgical Corp., North Chicago, Ill.

FLEXIBLE SHAFTS. Basic data on flexible shafts for remote control and power drives is contained in Bulletin No. 4501 from S. S. White Dental Mfg. Co., Industrial Div., 10 East 40th St., New York 16, N. Y.

LABOR - UTILIZATION PROCEDURES. Written from the standpoint of plant management, Bulletin No. 807 should be of value to employers who are in search of improved labor-utilization procedures. This study is made available at the present time because of the immediate importance of the subject in connection with war production. Superintendent of Documents, U. S. Gov-

QUALITY CONTROL

The Electrical Tests

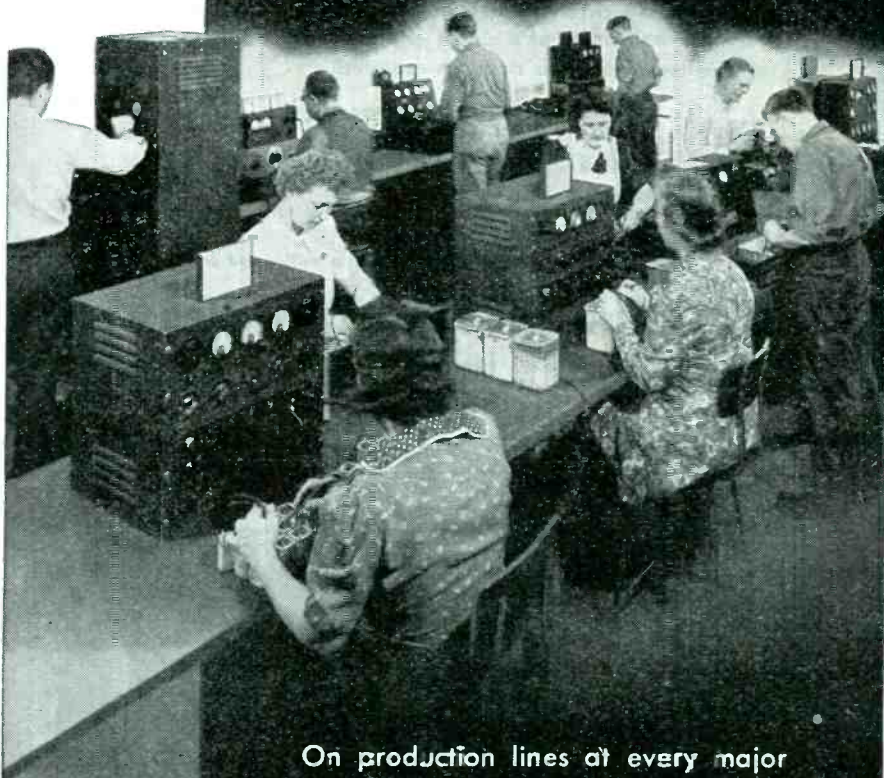

On production lines at every major step in manufacture, Chicago Transformers are checked on modern testing equipment to laboratory — controlled standards. Repeated testing for all important electrical characteristics provides an accurate control of quality — makes certain that every finished Chicago Transformer delivers the exact performance for which it was designed.

CHICAGO TRANSFORMER



DIVISION OF ESSEX WIRE CORPORATION

3501 WEST ADDISON STREET

CHICAGO, ILL.



PRODUCTION PRECISION PROTECTION

Automatic Reset Time Delay Timer

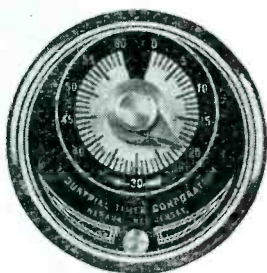

HERE in one Timer are combined all the uses learned on the production fronts of industries engaged in war work. The Automatic Reset Time Delay Timer is designed for application on alternating circuits where an adjustable or fixed time delay between the closing of a circuit and the predetermined closing or opening of another circuit is required.

Some
Typical
Uses

- Control of heat applications
- Conveyors
- X-RAY Timing
- Closing plate circuits (electronic devices)
- Time sequence control for timers in multiple.

Write for bulletin A 12 for complete information and prices

INDUSTRIAL TIMER CORPORATION

110 EDISON PLACE



NEWARK, NEW JERSEY

MICRO-DIMENSIONAL

WIRE & RIBBON
FOR VACUUM TUBES

- Complete range of sizes and alloys for Transmitting, Receiving, Battery and Miniature Tubes . .

- Melted and worked to assured maximum uniformity and strength

WIRES drawn to .0005" diameter
RIBBON rolled to .0001" thick

- SPECIAL ALLOYS made to meet individual specifications. Inquiries invited.

Write for list of stock alloys

SIGMUND COHN & CO.

44 GOLD ST. NEW YORK
SINCE 1901

REGULATED POWER SUPPLY

180-300 volts Type PS-2

For a simple, efficient, economical power supply to replace messy, space-consuming, expensive batteries install a modern G-E Regulated Power Supply. Extremely useful where d-c power is required to operate electronic devices in research or industry. Provides a stable d-c voltage regardless of moderately large or rapid changes in the a-c supply voltage. Other regulated power supplies available in various ranges. Write today: *Electronics Department, General Electric, Schenectady 5, New York.*

Electronic Measuring Instruments

GENERAL ELECTRIC
164-D6

KIRKLAND Pioneer

INDICATING LAMPS

WHERE QUALITY IS THE FOREMOST CONSIDERATION

THE #659 D/E DELUXE-UNIT OF SUPERIOR DESIGN AND CONSTRUCTION

Extremely Shallow in Depth
1 1/4" Behind Front of Panel

Heavy walled glass lens in a screw type lens-cap, 1/8" thickness hex holding lip, 1 3/8" mounting hole, molded socket with 6/32 screw terminals. For S6 lamps up to 120 volts, lamp easily removed from the front without tool. List Price (less bulb) \$2.20.

WRITE FOR CATALOGUE

THE H. R. KIRKLAND CO.
MORRISTOWN, N. J.

ernment Printing Office, Washington 25, D. C. Price 10 cents for single copies.

PLASTIC MOLDING. Comparative physical properties of leading plastic-molding materials is given in a new booklet "The Story of Plastic Molding" available from Chicago Molded Products Corp., 1020 N. Kolmar Ave., Chicago 51, Ill.

DIRECTORY OF MOTOROLA SYSTEMS. This directory contains 72 pages of data of approximately 1000 state, county, and city organizations which use Motorola 2- and 3-way radiotelephone systems. Station call letters, frequency, power rating, type and number of units are included. Galvin Mfg. Corp., 4545 Augusta Blvd., Chicago 51, Ill.

HOUSE ORGAN. "The International Review" is a new publication of International Telephone & Telegraph Corporation (67 Broad Street, New York 4, N. Y.) which gives glimpses of some of the world-wide activities in which I.T.&T. is engaged. Vol. 1, No. 1 is now available.

COMMUNICATION PROBLEMS. "Solving Communication Problems Is Our Business" is the title of an 8-page booklet (Form 193) which illustrates, describes and gives typical installations of Executone Co., 415 Lexington Ave., New York 17, N. Y. Another pamphlet entitled "The Story of Music-At-Work" contains illustrations and brief descriptions of equipment for plant use.

TERMINAL BLOCKS. A new booklet (Bulletin TB-3-2-45-10M) describes ten styles of Controlead terminal blocks for use as junction points in control wiring installations. Cross-section views, dimensions and prices are given. Dept. T.B., Burke Electric Co., Erie, Pa.

GARCEAU PRODUCTS. A 4-page bulletin describes in detail Garceau chronographs; velographs; a single-channel, direct writing, oscillograph with two chronograph channels; and an electroplex key. Technical Products Co., Memphis, Tenn.

IN SENSITIVE RELAYS

MECHANICAL *Ruggedness*

SHOULD NOT BE SACRIFICED

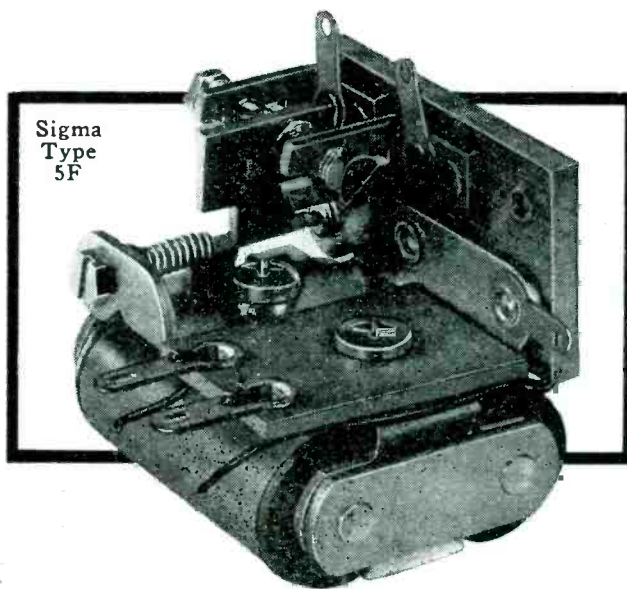

Sigma type 5 relays, with a maximum sensitivity of less than 1 milliwatt, have an ability to stand punishment equalled by very few relays of any type.

At any sensitivity adjustment type 5 relays rigidly mounted, withstand shocks of 500 g's without damage.

A Type 5 relay of 10,000 ohm coil resistance has the following performance:—

Nominal Adjustment		Contact Pressure	
Pull on	Drop out	Normally open	Normally closed
0.3 Ma	0.2 Ma	15 grams	10 grams
0.7 Ma	0.3 Ma	45*-55* grams	20 -30* grams
1.5 Ma	0.7 Ma	60*-80* grams	40*-60* grams

*Adequate for aircraft vibration (10 g's or more)

Sigma Instruments, inc.
Sensitive **RELAYS**

62 CEYLON ST., BOSTON 21, MASS.



... of

HARVEY ORDERS

Many of the radio and electronic components now on the critical list can be obtained without delay at HARVEY. In stock we have an unusually wide assortment of meters, resistors, capacitors, test equipment, transformers, etc. When a specific item is not on our shelves, our trained staff exerts every effort to procure it. Or, if not obtainable quickly, they may suggest an equally effective substitute. Eighteen years of experience have taught us how to handle orders efficiently, and assure prompt deliveries.

The proper priority must accompany each order. If you are uncertain as to your priority, we can supply the information you need.

Telephone orders to LOngacre 3-1800



INDUSTRIAL X-RAY UNITS. Industrial x-ray units (5 to 50 kvp) are described in a new booklet available from Picker X-Ray Corp., 300 Fourth Ave., New York, N. Y.

DETACHABLE TERMINAL CONNECTORS. Literature which describes a method of getting complete speaker connecting assemblies with leads of any and all lengths for any production schedule is available from Alden Products Co., 117 North Main St., Brockton 64, Mass. These sheets tell about detachable terminal connectors (and tuning eye assemblies); speaker cables; detachable terminal connectors (as applied to speakers and mounted with a single screw); multi-wire connectors and plugs; wire specifications and speaker connections.

COMPANY CATALOG. Catalog No. 451-A gives background data on Metallic Arts Company (243 Broadway, Cambridge 39, Mass.) manufacturers of machines and fabricated metals. The catalog also contains descriptions and illustrations of products available from this organization.

HOOK-UP WIRE. Deltabeston radio hook-up wire designed specifically for producers of electronic devices is described and illustrated in a 16-page booklet (No. 59-412). General Electric Co., York Wire and Cable Div., Bridgeport, Conn.

ELECTRIC TIMERS. Timing instruments, including electric stop clocks, stop watch controllers, impulse counters, x-ray timers, and chronoscopes are illustrated and described in Bulletin No. 1100 available from C. H. Stoeltin Co., Industrial Div., 424-P North Homan Ave., Chicago 24, Ill.

GENERAL BULLETIN. An 8-page folder from Industrial & Commercial Electronics, 17 East 42nd St., New York 17, N. Y., describes and illustrates vacuum capacitors for use in radio equipment in military, marine and aviation installations. One page of the folder illustrates and describes briefly the manufacturer's tube types.

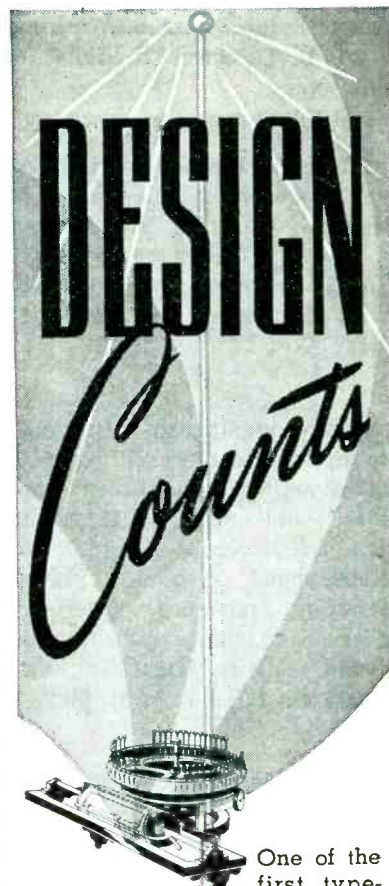

One of the first typewriters developed was that of Thurber in 1843. Then clumsy and slow, it has been brought to its present high level of efficiency and speed by careful application of design.

Here at THE WARD PRODUCTS CORPORATION Design Counts, also; because, it is only through superior design that the benefits of experience and the finest production facilities can best be brought to the user. For the finest antennas for all applications . . . for home and automobile use . . . look to WARD.

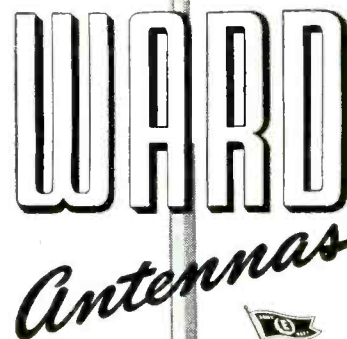

BUY WAR BONDS

BACK AGAIN . . . SOON
WARD AERIALS

"World's Finest for Car & Home"

THE WARD PRODUCTS CORPORATION
1523 EAST 45TH STREET • CLEVELAND 3, OHIO

ARGON HELIUM KRYPTON
NEON XENON MIXTURES

Linde

RARE GASES
AND MIXTURES



- ... Spectroscopically Pure
- ... Easily removed from bulb without contamination

Scientific uses for LINDE rare gases include—

1. The study of electrical discharges.
 2. Work with rectifying and stroboscopic devices.
 3. Metallurgical research.
 4. Work with inert atmospheres, where heat conduction must be increased or decreased.
- Many standard mixtures are available. Special mixtures for experimental purposes can be supplied upon request.

The word "Linde" is a trade-mark of

THE LINDE AIR PRODUCTS COMPANY
Unit of Union Carbide and Carbon Corporation
30 E. 42nd St., New York 17  Offices in Principal Cities
In Canada: Dominion Oxygen Company, Ltd., Toronto

ALDEN

SHIELDED PLUGS & SOCKETS

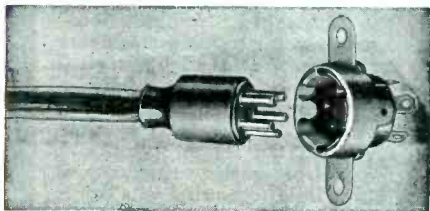

The new automobile set or any commercial requirement for shield grounding socket is going to demand this quality patented socket. Here's what it is and does. It's a metal seal socket that has a rounded edge entrance that grounds the plug upon insertion. The plug has long insulated protection for each lead and was designed to meet all the cable manufacturers' problems of efficient use, as to ease of cutting leads, preparing ends, soldering shield, and applying overbraids. The shield cover seals the plug dust, fungus and moisture tight. Quality—but again, by meeting our design standards, inexpensive with appreciable assembly saving whether supplied by us with the cable or cable is made by others.

Write for the
ALDEN "BLUE-BOOK"
of Electrical Components

ALDEN PRODUCTS COMPANY
BROCKTON (64E) MASS.



OTHER THERMOSTATIC METAL TYPE
DELAY RELAYS
PROVIDE DELAYS RANGING
FROM 1 TO 120 SECONDS

Other important features include:—

1. Compensated for ambient temperature changes from -40° to 110° F.
2. Contact ratings up to 115V-10a AC.
3. Hermetically sealed — not affected by altitude, moisture or other climate changes . . . Explosion-proof.
4. Octal radio base for easy replacement.
5. Compact, light, rugged, inexpensive.
6. Circuits available: SPST Normally Open; SPST Normally Closed.

WHAT'S YOUR PROBLEM? Send for "Special Problem Sheet" and Descriptive Bulletin.

AMPERITE CO. 561 BROADWAY
NEW YORK 12, N. Y.
In Canada: Atlas Radio Corp., Ltd.
560 King St. W., Toronto

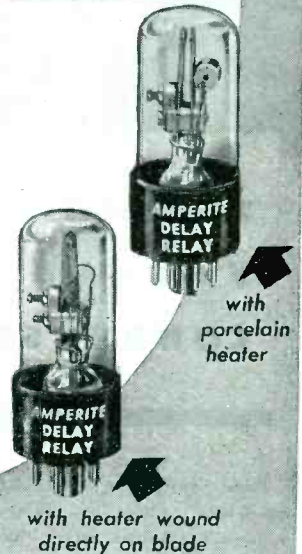

D-C VOLTAGES that "STAY PUT"



CHECK THESE
FEATURES
OF MODEL 1220
EB PACK

- Two Regulated D-C Outputs —
B range — zero to 400 volts
C range — minus 100 to zero
- 1% Regulation — on both outputs at a-c inputs from 105 to 125 volts and any rated current
- Ample Current — up to 40 watts or 250 ma. max. on B range; 2 milliamperes on C range
- Continuously Adjustable — on each range with single rotation of control knob
- Meter Indication — of output voltage and current on B range; C voltage is read directly from panel graduation

PRICE
\$160.00
NET FOB
BOSTON

PROMPT DELIVERY

TECHNICAL APPARATUS CO.
1171 TREMONT ST., BOSTON 20, MASS., U. S. A.

NEW BOOKS

The Radio Amateur's Handbook

Published by The American Radio Relay League, Inc., West Hartford, Conn., 22nd edition, 1945, \$1 in continental United States; \$1.50 elsewhere.

THE LATEST ANNUAL edition of this popular handbook brings chapters on microwaves, wave guides, and new ultrahigh-frequency tubes up to date within the restrictions of military secrecy. The condensed but comprehensive charts and tables of tube characteristics and base diagrams are likewise extended.

Perhaps the most outstanding feature of the new edition, however, is the changeover of all diagrams to the new ASA graphical symbols adopted by the electronic industry in 1944.

As in previous editions, the old and the new are combined in this volume to make a handbook that is useful to a wide group of amateur radio enthusiasts and radio engineers. The book reaches those in the armed services who were amateur operators before the war and are continuing their radio activities as part of their regular duties; those who have suspended amateur activities during the war but are at present rebuilding their equipment or planning new installations when they can again take up their favorite hobby; and those newcomers to amateur radio who want to become thoroughly grounded in this field so that they can take up this absorbing hobby when present restrictions are removed.

To accomplish this purpose the book is divided into two main parts—principles and design, and equipment construction. The former consists of nine chapters of theoretical information that are an education in the principles of radio and the design of amateur equipment. The latter is a ten-chapter practical discussion of what the League headquarters staff regards as the best in all types of amateur equipment for various purposes. The combination of new and old has been achieved by relying on the time-tested basic principles of radio for the foundation and by including the latest information available on technique

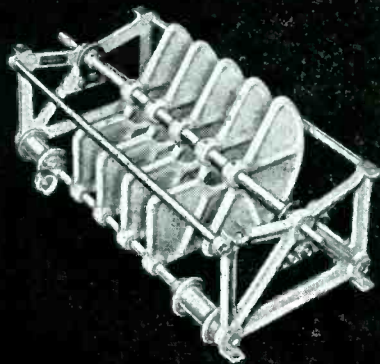

TRANSMITTER VARIABLE CONDENSER

Plate design in this JOHNSON condenser allows a 75% greater voltage breakdown rating than former models having the same spacing. Without increasing the overall size of the condenser JOHNSON engineers have raised the voltage rating by more evenly distributing the electric field, decreasing the tendency to flash over. A substantial saving in weight of plates has been achieved through the use of mechanical design ideas in placing ribs and rounded edges on the plates.

Losses in the insulation have been reduced too, first by using a good low loss material and second by judicious placement of corona shields to distribute the electric field evenly through the insulation. The rotor may be counter-weighted so the shaft will not change its position after an adjustment has been made. Multi-fingered contact brushes bear on a circular rotor contact to provide low resistance, positive contact, to the rotor. A shield is arranged on the stator terminal to nearly enclose the lead wire, resulting in less danger of sparkover at this point.

Definitely a commercial job, this condenser is worthy of consideration in the design of transmitters.

JOHNSON
a famous name in Radio

E. F. Johnson Co. Waseca, Minn.

BROADCASTING STATIONS!
RECORDING STUDIOS!
SCHOOLS!

You Can Get Them
Without Delay!



GOULD-MOODY "Black Seal" GLASS BASE INSTANTANEOUS RECORDING BLANKS

The tributes paid to "Black Seal" discs by many leading engineers have been earned by distinguished service on the turntable. Your ears will recognize the difference in quality of reproduction, and the longer play-back life will prove the superiority of "Black Seal" construction. Choice of two weights—thin, flexible, interchangeable with aluminum, or medium weight—both with four holes.

An AA-2X rating is automatically available to broadcasting stations, recording studios and schools. Enclosure of your priority rating will facilitate delivery. Old Aluminum Blanks Recoated with "Black Seal" Formula on Short Notice

**THE
GOULD-MOODY
COMPANY**

RECORDING BLANK DIVISION
395 BROADWAY • NEW YORK 13, N. Y.

EXPORT DEPT. ROYAL NATIONAL COMPANY, INC.
89 BROAD STREET, N. Y.

CUT HOLES

3/4" TO 3 1/2"

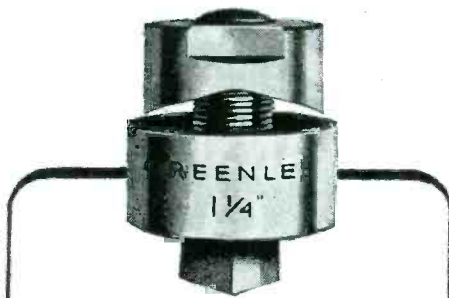

in radio chassis

Punch cuts through chassis, die supports metal to prevent distortion, cap screw is turned with wrench to cut clean, accurate holes for sockets, plugs, and other receptacles. Saves hours of work — no reaming, filing or drilling! 3/4" to 3 1/2" sizes. Get complete data now from Greenlee Tool Co., 1926 Columbia Ave., Rockford, Illinois.

WRITE FOR FREE FOLDER S-119 ♦



Get Ready with Greenlee!



REGISTERED TOOLS

GREENLEE

FOR THE CRAFTSMAN

WANTED

Telephone Engineers and Draftsmen

We have several attractive openings for engineers and draftsmen with experience on central office telephone switchboard equipment, especially Strowger step-by-step systems. Consideration will be given to men without manufacturing-engineering experience who are familiar with dial system principles and operation. College education is desirable but not essential. Plans for widespread postwar adoption of dial equipment in the United States and abroad make this an unusual opportunity for progress with the leading organization in its field. Applications treated in full confidence. Write Mr. E. C. Seepe, Personnel Director.

AUTOMATIC ELECTRIC CO.

Originators of the Dial Telephone

1033 West Van Buren St., Chicago 7, Ill.

ESSENTIAL INSTRUMENTS OF WAR... ESSENTIAL INSTRUMENTS OF PEACE

B. R. C. instruments which are so faithfully serving in the war *today* will be performing the same faithful service in peacetime laboratories and industry *tomorrow*.

These and other new type B. R. C. instruments will be available for the most exacting test and measuring operations in the design, development and production of Communications, Television and Radar equipment . . . after final Victory has come.



BOONTON RADIO

BOONTON, N. J.



DESIGNERS AND MANUFACTURERS OF THE "Q" METER . . . QX-CHECKER
FREQUENCY MODULATED SIGNAL GENERATOR . . . BEAT FREQUENCY GENERATOR
AND OTHER DIRECT READING TEST INSTRUMENTS

INVESTIGATE

Franklin's 39

RADIO SOCKET

The favorite yesterday, the favorite for tomorrow

NORMAN H.

LAWTON

Engineering • Sales • Service
1775 Broadway, New York City, 19
Phone Circle 6-0867

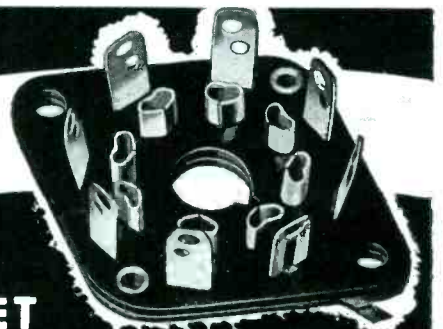

Note—Ground Tab

Illustrating the "U" shaped bow spring action contacts... 39H and 39G sockets in Franklin's series 39 Sockets.

Bow spring action maintains resiliency even after installation of overseas pins. Directly at rear of pin prevents bending and permits rough handling in production.



"U" shaped contact provides separate soldering tabs which prevents solder from flowing into contact body.



The 39G contact has a soldering tab to eliminate wiring to ground... can be inserted in any position where grounding is desired.

- A W FRANKLIN MANUFACTURING CORPORATION Sockets . . . Terminal Strips . . . Plugs . . . Assemblies
- F W SICKLES COMPANY Coils... I. F. Transformers... Antenna Loops... Trimmer Condensers, mica and air dielectric . . . Tuning Units
- ELECTRO MOTIVE MANUFACTURING COMPANY Molded Mica Capacitors... Mica Trimmer Capacitors

Designed for



Application

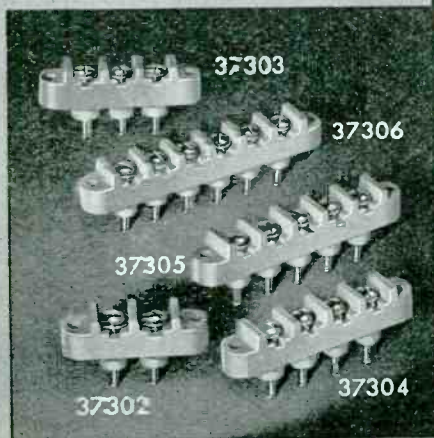

The No. 37300 Series Steatite Terminal Strips

Another exclusive Millen "Designed for Application" product is the series of steatite terminal strips. Terminal and lug are one piece. Lugs are Navy turret type and are free floating so as not to strain steatite during wide temperature variations. Easy to mount with series of round holes for integral chassis bushings. Ideal answer to the "tropicalization" problem.

**JAMES MILLEN
MFG. CO., INC.**

MAIN OFFICE AND FACTORY
MALDEN
MASSACHUSETTS



and equipment where that data is significant.

In addition to these two sections there is a chapter on the history of amateur radio in general and The Amateur Radio Relay League in particular, and a chapter on the fundamentals of radio operating.

This handbook is highly recommended for everyone interested in radio.—K.S.P.

• • •

Introduction to Microwaves

By SIMON RAMO, *Research Laboratory, General Electric Company and Union College, Schenectady, New York. McGraw-Hill Book Company, Inc., New York 18, 1945, 138 pages, \$1.75.*

UNDERSTANDING the origin and significance of microwave concepts is as essential as understanding the concepts themselves. This brief, nonmathematical introduction to microwave concepts was written with this necessity in mind. The book is intended to extend the principles of electricity, which it is assumed are already well understood by the reader, to the microwave region.

Throughout the discussion it is kept constantly before the reader that the author is presenting a complete analysis of electromagnetic behavior, not introducing new theories that apply only to microwaves. With the complete theory understood, it is then possible to isolate the dominant factors in any frequency region. This is just what had been done at the power and low radio frequencies. It is this partial theory with which power and broadcast engineers are familiar. By supplementing their special approach with the remainder of the theory, this book gives them the complete picture.

It is shown that at the microwaves the general theory can be divested of certain particulars of little importance, not because the nature of electricity has been changed by going to short waves, but because important and unimportant factors have become different. The result is what appears on the surface to be an entirely new theory, but which in reality is only an accentuation of different aspects of the same theory.

This is, as was said at the beginning of this review, the approach of this booklet to its subject, and a

OLYMPIC

STANDARD TRANSFORMER CASES



★ Now available in quantity, OLYMPIC standardized transformer cases are specifically designed to meet all normal requirements where standard cases are used. Construction is rigid, with rounded corners, and tight-fitting covers top and bottom. OLYMPIC standard transformer cases can be furnished with pierced covers, studs, brackets or channels. Inquiries are invited—write for illustrated bulletin—no obligation.

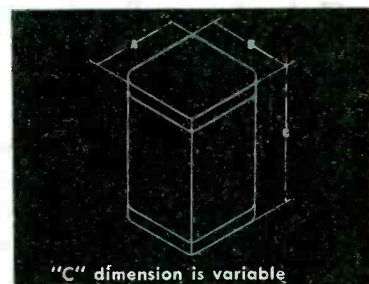

"C" dimension is variable

CORE	CASE	A	B	C
E1-21	1	1 1/4"	1 1/4"	2 1/4"
E1-625	2	1 1/2"	1 1/2"	2 1/4"
E1-75	3	2 1/4"	2 1/4"	2 1/4"
E1-11	4	2 1/4"	2 1/2"	3 1/2"
E1-12	5	3"	2 1/4"	3 1/2"
E1-3A	6	3 1/4"	3"	3 1/2"
E1-112	7	3 3/8"	3 1/4"	4 1/2"
E1-125	8	3 3/4"	3 1/2"	4 1/2"
E1-137	9	3 7/8"	3 3/4"	4 1/2"
E1-13	10	4 1/8"	4 1/4"	5 1/2"
E1-151	11	5"	4 3/8"	5 1/2"
E1-36	12	5 1/4"	4 3/4"	6 1/2"

CRAFTSMANSHIP  IN METAL PARTS

**OLYMPIC
TOOL & MFG. CO., INC.**

39 CHAMBERS ST. NEW YORK 7, N. Y.

CAFETERIA on WHEELS is THERMOSWITCH equipped!

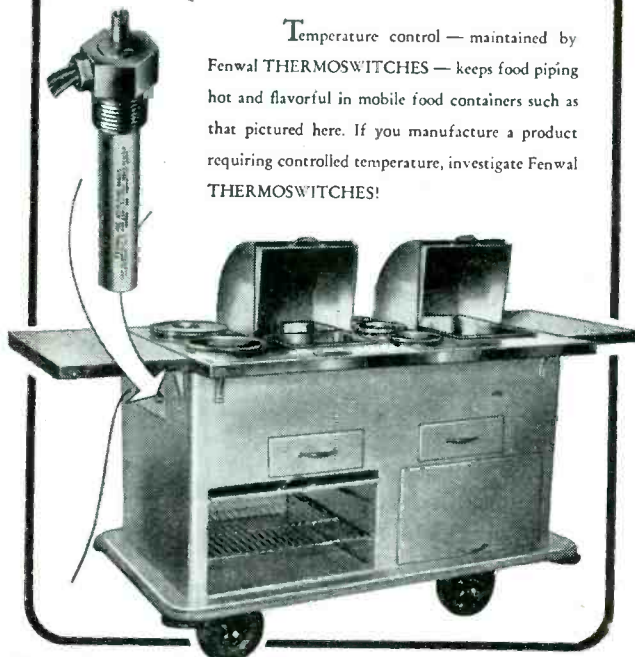

Temperature control — maintained by Fenwal THERMOSWITCHES — keeps food piping hot and flavorful in mobile food containers such as that pictured here. If you manufacture a product requiring controlled temperature, investigate Fenwal THERMOSWITCHES!

Write for catalogue and complete information . . . to

Fenwal INCORPORATED
ASHLAND • MASS.

MANROSS MIGHTY MIDGETS

The Standard for Accuracy and Performance

For instruments, indicators, relays, switches—there are no finer springs than Manross hairsprings. Get the benefits of sound experience in design and modern research in materials.

Send for Brochure of
Specifications and Design



F. N. MANROSS & SONS
DIVISION OF ASSOCIATED SPRING CORPORATION
BRISTOL, CONNECTICUT

Just Published

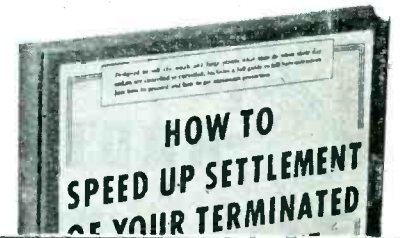

How to SPEED UP SETTLEMENT of Your TERMINATED WAR CONTRACT

By J. K. LASSER.

C.P.A. in New Jersey and California;
Chairman, Institute of Federal Taxation,
New York University

175 pages, 8 1/2 x 11, \$3.50

THIS brand new J. K. Lasser guide-book shows, step by step, what to do, how to do it, when to do it—how to handle your plant operations, inventories, and settlements before and after you receive a termination notice. A boon to every concern, small or large, doing business under a War or Navy Department contract or a subcontract. Written in the same crisp, point-by-point manner as the author's famous tax guides, it actually blueprints a short cut through the seeming maze of procedures, requirements, forms, etc., you face in termination of your war contract. Start using it at once, to pave the way for smoothest, quickest settlement, and to aid in getting the maximum allowable amount

• **COMPLETE:** Covers everything; inventories, costs, how to handle subcontractors, how to make up claims, how to get financing during settlement, how to negotiate a settlement, how to appeal, etc. Includes a full guide for subcontractors.

• **CLEAR:** Covers subject in many detailed sections, fully explaining each step. Gives all necessary forms. Many check lists, section headings, key questions, to help you find answers quickly, make sure nothing is overlooked.

• **AUTHORITATIVE:** The author had all the aid he sought from government officials supervising contract termination; his book gives you informed, dependable instructions.

• **TIMELY:** Tells what you can do NOW, to prepare for quickest, smoothest settlement when termination is in full swing and government agencies are crowded with work.

SEE IT 10 DAYS FREE

Mail Coupon Today

McGraw-Hill Book Co.,
330 W. 42nd St., New York 18

Send me Lasser's How to Speed Up Settlement of Your Terminated War Contract for 10 days' examination on approval. In 10 days I will send \$3.50, plus few cents postage, or return book postpaid. (Postage paid on cash orders.)

Name

Address

City and State

Company

Position L. 6-45

SUN
**BEATING
 A PATH
 TO SUN
 RADIO**

**OVER 10,000
 ITEMS IN STOCK**
RADIO PARTS
TUBES
Electronic Equipment

TO MEET
 URGENT PRIORITY
 REQUIREMENTS

Everything in

**TUBES · METERS · CONDENSERS
 RESISTORS · TRANSFORMERS
 TEST INSTRUMENTS · WIRE
 AMPLIFIERS · SOUND SYSTEMS, etc.**



SUPPLIERS TO

Industrial Manufacturers · Research
 Laboratories · Schools · Colleges
 Government Agencies · Railroads
 Public Utilities · Broadcast Stations
 Hospitals · Shipyards · Police Depts.,

**PURCHASING AGENTS!
 ENGINEERS!**

Send for this
FREE 800 PAGE CATALOG!

Write today on your company letterhead for
 this massive 800 page Buying
 Guide containing everything in
 radio-electronics. Complete
 listings of all standard na-
 tionally known products
 in one handy, bound vol-
 ume! Sent free on request
 by addressing Box 1E



**SUN RADIO
 & ELECTRONICS CO.**
 212 Fulton Street, New York 7, N. Y.

valuable approach it is. The sub-
 ject matter itself centers around
 the concepts of skin effect, induced
 current arising from electrons in
 motion, electron transit time and re-
 tardation of electromagnetic fields,
 displacement current, wave guides,
 and hollow cavities.

For the low-frequency engineer
 looking for the entering wedge into
 an appreciation of microwave con-
 cepts and terminology, this treat-
 ment is especially valuable. As a
 supplement to mathematical discus-
 sions of microwaves, this treatment
 is also useful in that it orients the
 reader as to what is to be done.

A word of caution. Lest it be
 thought that in being nonmathe-
 matical this discussion is nonengi-
 neering, it should be stated that the
 treatment is fundamentally sound
 and presents in unsophisticated
 language a basic philosophical ap-
 proach to microwaves.—F.R.

• • •

**Science Today and
 Tomorrow**

By **WALDEMAR KAEMPFERT**, *Science
 and Engineering Editor, New York
 Times. The Viking Press, 18 E. 48th
 St., New York 17, Second Series, 1945,
 279 pages, \$2.75.*

A LOOK INTO THE FUTURE, in many
 directions, to weigh the impact of
 science on society in the last decade
 and extrapolate the potentialities
 and social implications of newly ac-
 quired knowledge into the years
 ahead. The book is essentially a
 series of articles, first published in
 book form in 1939 and now revised
 in the light of recent advances, cov-
 ering such topics as the relation of
 science to war, electronic frontiers
 of science, the possible sources of
 heat after our coal supply is ex-
 hausted, rocketing through space,
 creation and prolongation of life,
 future trends in medicine, and the
 role of science in world unity.

Of especial interest are the chap-
 ters dealing with the human brain—
 how its performance can now be re-
 corded electronically, and how cer-
 tain sections can be surgically dis-
 connected to restore the balance of
 emotion and reason. More than
 half of the material in this second
 series is new, and all of it ade-
 quately fulfills the author's ex-
 pressed goal of stimulating the
 thinking of technical and nontechni-
 cal readers alike.—J.M.



- ★ NO BLIND OPERATIONS
- ★ AVOID GROUNDS TO CASE
- ★ AVOIDS STRAIN ON SOLDER JOINTS
- ★ REDUCES LABOR COST

DESIGN DATA COURTESY THE
 CAPACITRON COMPANY

The new STRONGHOLD Drilled Ter-
 minal Screw is available drilled in
 No. 12 Diameter; undrilled in No.
 6, 8, 10 and 12 Diameters. Samples
 and Engineering data furnished
 upon request.

**STRONGHOLD COLD
 FORGED TERMINAL STUDS**

All types, lengths, diameters and
 collar styles; all secondary opera-
 tions such as knurling, drilling, slot-
 ting, etc. One piece construction
 —no assembling, no connections to
 work loose, no oil or moisture prob-
 lems. Specials made to meet your
 particular requirements. Send blue
 prints, sketches or description.

MANUFACTURERS SCREW PRODUCTS

270 W. Hubbard St., Chicago 10, Ill.
 It's Faster to Telephone
 Call WHITEHALL 4680

STANDARDS AND SPECIALS

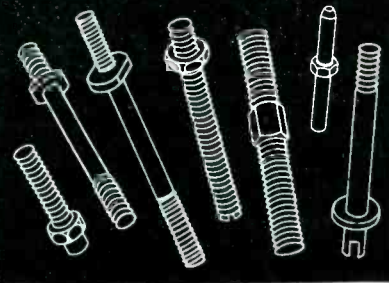

**America's Most
WIDELY USED
Photocopy Equipment
A-PE-CO "Photo-exact"
Photo-Copyer**



Photo-Copyer
\$55
Copies up to
18" x 22"

**"A Business Necessity"
Say Executives**

159 tested uses . . . accuracy . . . operating ease . . . saves time . . . speeds work—these are only a few of the many reasons why A-PE-CO is America's most widely used photo-copy system. And A-PE-CO is lowest in price.

Photo-Copies Made Instantly of:
BLUEPRINTS WIRING & MECHANICAL DIAGRAMS
LETTERS TRACINGS DRAWINGS SPECIFICATIONS
. . . anything written, printed, drawn, or photo-graphed, on one or both sides. Easy to read, per-ma-nent, legally accepted.

Send for This Useful Folder

In your own office or shop, any inexperienced employee can make A-PE-CO photo-copies. No technical training. No darkroom. Needed now for reconversion, new planning, sales development. A-PE-CO folder tells you how you can use this modern method in your office. Send for it—today.

AMERICAN PHOTOCOPY EQUIPMENT CO.
2849 N. Clark St., Dept. AG-65 Chicago 14, Ill.
Representatives in principal cities and Canada

Yesterday **A NEW IDEA**
Today **THE "ACCEPTED" STANDARD**



SCREWDRIVERS

When Xcelite Screwdrivers with transparent plastic (shock-proof) handles appeared on the "tool horizon" a few years ago they were hailed by tool experts as a truly significant advance in screwdriver design.

Their acceptance by men who know, use and buy tools has continued to grow! Today Xcelite Screwdrivers are the stand-ard of comparison—often imitated but never excelled!

In addition to their special plastic handles, Xcelite Screw-drivers are precision manufactured with blades of tough, high quality steel. Here are the ideal tools for all electrical, mechanical and general use. Over 50 sizes and styles, square and round blades, standard and Phillips. Priorities required—sales restricted. Write Dept. C for full details and prices.

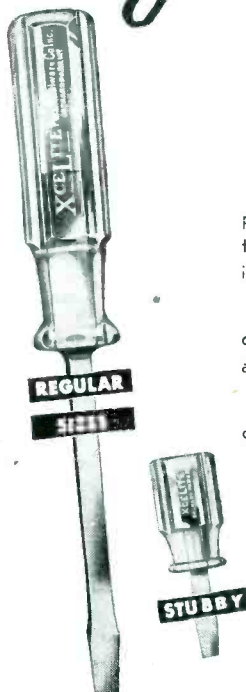

PARK METALWARE CO., Inc.
ORCHARD PARK NEW YORK

Buy More War Bonds . . . Keep the Ones You Own

Need WIRE Now?
COLUMBIA
Has It!

INSULATED ELECTRICAL WIRE

GAUGES
#22
TO
#12

**IMMEDIATE DELIVERY
FROM LARGE STOCK**

- CABLES
- CORD SETS
- We Cut, Strip and Tin, Attach Eyelets, etc.

Inquiries Invited

COLUMBIA WIRE & SUPPLY CO.
4110 N. PULASKI ROAD
CHICAGO 41, ILLINOIS

INDICATOR LAMPS

Indicate and identify circuit operations on radio transmitters and electronic devices. Lock-on caps, available in five different colors, cannot shake loose. Caps and bases of sturdily constructed molded plastic. Easy to mount. With or without "dim-out" feature. For further details write

Electronics Department, General Electric, Schenectady 5, N.Y.

GENERAL ELECTRIC
177-DL-1

"Yes! WASHERS do count in the efficiency of Electronic construction!"

**MAKE SURE WITH
Quadriga Quality WASHERS**

Whatever your requirements, standard or special, Quadriga is equipped to produce to exact specifications. Any quantity, small or large. Prompt delivery: Flat, Tension and Spring, Formed and Drawn, Cupped and Finishing, etc. Wire terminals. Also SMALL STAMPINGS, any design.

Send for Quadriga Catalog
Illustrations and engineering data. Submit Specifications without obligation. Wire or write

THE QUADRIGA MANUFACTURING CO.
Inc. 1894 "Half a Century" 221A W. Grand Ave., Chicago 10, Ill.

"MIGHT" SMALL TOOL SET

A Little Giant For Business!

Saves carrying a lot
of tools

4 Single Hex, 4 Double Hex,
3 Double Square Sockets.
Range 3/16 to 7/16. Uni-
versal Drive with Sliding Bar
a Spintite Straight Drive all
in a pocket size nicely fin-
ished metal box. Ask for . .

WALDEN WORCESTER

Set 3100A
and 3100

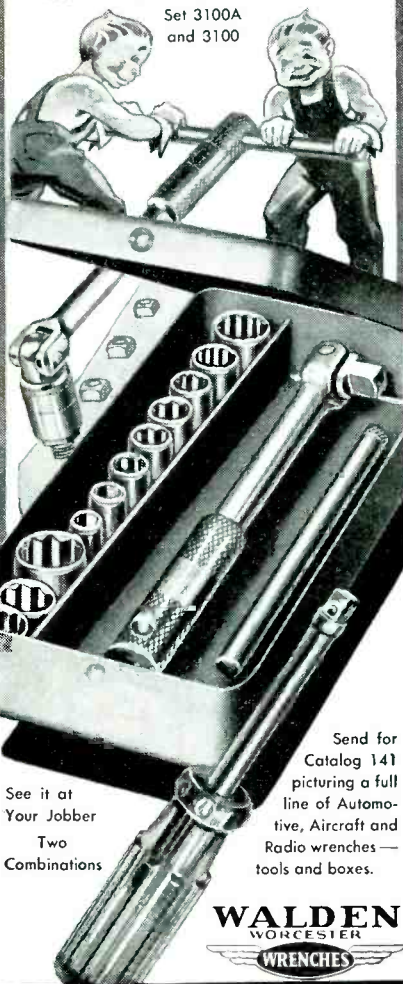

See it at
Your Jobber
Two
Combinations

Send for
Catalog 141
picturing a full
line of Auto-
motive, Aircraft and
Radio wrenches—
tools and boxes.

**WALDEN
WORCESTER
WRENCHES**

STEVENS WALDEN, INC.
468 SHREWSBURY STREET
WORCESTER, MASSACHUSETTS

Backtalk

This department is oper-
ated as an open forum
where our readers may
discuss problems of the
electronics industry or
comment upon articles
which ELECTRONICS
has published

Typographic Revolution

Gentlemen:

BECAUSE of the fact that such ex-
pressions as "100 db below 1 volt"
and "30 db above 1 watt" are un-
wieldy to handle, I propose that
they be written as, $\frac{1v}{100db}$ and $\frac{30db}{1w}$
respectively. The suggestion is of-
fered for comment.

CHARLES E. GARDINER
Hazeltine Electronics Corp.
Little Neck, L. I., N. Y.

That sound we heard, unattended, was
Mergenthaler (inventor of the Linotype ma-
chine) rotating in his grave.—(Ed)

• • •

Labor and the Electron

WE HAVE NOTED with interest the
article under Business News in the
April issue of ELECTRONICS con-
cerning the University of Califor-
nia's offering a free course to mem-
bers of the International Brother-
hood of Electrical Workers.

We believe it may be of interest
to subscribers to ELECTRONICS,
especially in the Philadelphia area,
to know that Temple University
has been running a similar pro-
gram under Engineering, Science,
and Management War Training for
the last six months.

Courses given in the field of elec-
tronics for some 350 IBEW mem-
bers in Philadelphia, Norristown,
and Chester are as follows: Intro-
duction to Electronics, Industrial
Electronics, and Advanced Indus-
trial Electronics.

JAMES J. CRAWFORD
Director, ESMWT
Temple University
Philadelphia, Pa.

• • •

Echo Technique

Dear Mr. Henney

I HAVE NOTED with interest your
editorial comment in the February
issue of ELECTRONICS with refer-
ence to Professor Firestone's develop-
ment, in which you said: "So, elec-
tronics has provided industrial en-
gineers with a new, sensitive, non-
destructive test, a method of meas-

Stokes MICROVAC Pumps

HEART OF HIGH VACUUM SYSTEMS

- Higher Vacuum (in the low micron range)
- High volumetric efficiency
- Low power requirement
- Complete discharge of air—no re-expansion
- Continuous dehydration of oil—no moisture to re-evaporate
- Discharges sudden slugs of liquid without injury
- Easily accessible, non-corrosive discharge valve
- Rugged, compact, simple construction
- Long life . . . negligible maintenance
- Five sizes—from 15 to 225 cu. ft. per min.

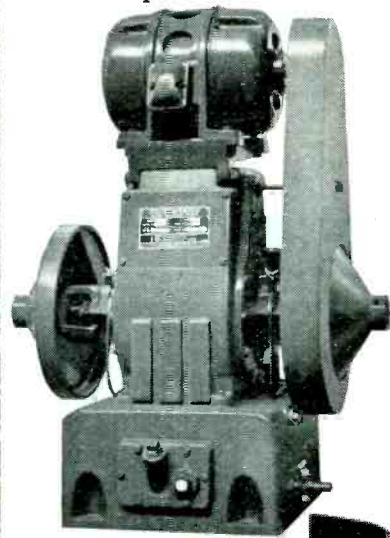

Stokes VACUUM GAUGES
(Patented McLeod Type)
Are Always Accurate

- Require no calibration
- Rapid readings—in 2 to 5 seconds
- Simple to operate—just tip and read

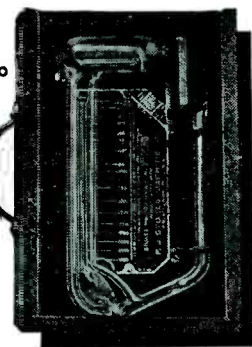

- Two models—(A) 0 to 5000 microns—(B) 0 to 700 microns, with readings to 1/10 micron.

F. J. STOKES MACHINE CO.
6046 Tabor Road Philadelphia 20, Pa.

**Stokes High Vacuum
PUMPS • GAUGES • EQUIPMENT**

SpeedWay

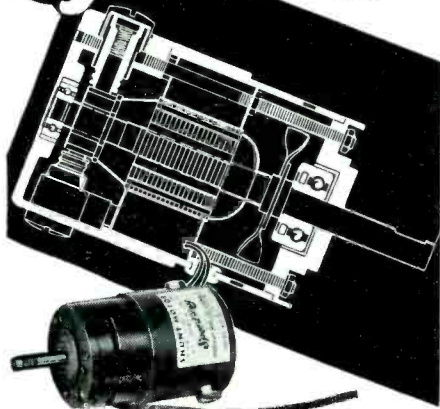

Standardized Special MOTORS and Gear Motors

As a result of 30 years specialization in the design and manufacture of special motors and gear motors of from 1/3000 to 1/2 h.p., SpeedWay has developed not only a vast store of "know how", but innumerable standardized units which can be assembled and wound in varying combinations to give shaded pole, shunt wound or series wound motors, engineered to exactly meet specified requirements of output, torque, space, speed and even cost.

With these standardized parts and units, augmented by over 3000 different gear combinations, SpeedWay can often supply highly special motors and gear motors at standard motor prices.

If you have a war or post-war motor problem, send for the SpeedWay Motor Catalog.

Sample Motors of types now in production delivered promptly.

SPEEDWAY MFG. CO.

1898 South Laramie Ave., Cicero 50, Illinois

You hire an **EXPERT**



---to design the circuits and plan the details of the electronic equipment you are building. But you cannot afford to hire a staff of experts to build the capacitors, inductances, and other critical elements for this equipment. BUD provides this for you! Over eighteen years of experience qualifies BUD for the rating of EXPERT



BUD RADIO, INC.

Cleveland 3, Ohio

Send for Catalog 145

For Radio as you want it!

We're still up to our ears in critical war work but when the war's won we will again be ready

..To DESIGN, DEVELOP and MANUFACTURE..

Radio Receivers and Transmitters
Industrial Electronic Equipment
Airport Radio Control Equipment
Marine Radio Telephone Equipment

Your inquiries will receive immediate action

ISLIP RADIO MFG. CORPORATION

ISLIP, L. I., NEW YORK

NORTON Electrical Instruments

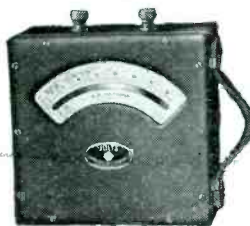
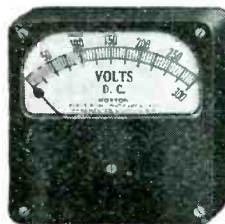

SWITCHBOARD & PORTABLE

•
AMMETERS .
VOLTMETERS

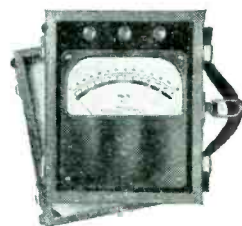

Norton Instruments are precision built to maintain accuracy under exacting conditions. Hand calibrated to meet your specific needs. Widely used in the Electronic Industry for testing and production equipment. Send for complete catalog.

NORTON Electrical Instrument Co.

59 HILLIARD ST., MANCHESTER, CONNECTICUT

ADECO NOZZLE TESTER

Keeps Diesel Engines
Running Efficiently

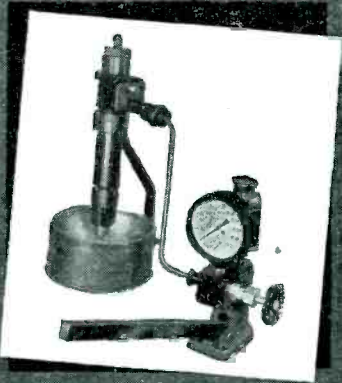

TESTS FUEL INJECTORS
AND HYDRAULIC DEVICES
At Pressures Up To
10,000 p.s.i.

To keep diesel engines operating at peak efficiency, this portable, precision-built Adeco Nozzle Tester is indispensable.

Light in weight yet built for heavy-duty service, it enables any mechanic to make quick, accurate tests on injector opening pressure, spray pattern, etc., and detect stuck needle valves and leakage around valve seats. Tests both large and small injectors, on bench or engine, at pressures up to 10,000 p.s.i. Prevents costly delays and possible damage to engine.

Ideal for testing hydraulic devices.

Write for bulletin on this practical, low-cost unit.



**AIRCRAFT & DIESEL
EQUIPMENT CORP.**

4417 NO. RAVENSWOOD AVE.
CHICAGO 40, ILLINOIS

uring the thickness of a metal plate whose rear surface may be inaccessible, or for exploring the interior for hidden flaws. The wonder is that all of this wasn't done long ago!"

The answer is that an electronic method for this purpose was developed long ago. In fact in 1923 I invented an electronic method of measuring the thickness of lead sheath on lead-covered cable, and also of controlling the thickness in applying the lead sheath.

Patent rights were assigned to the company with whom I was employed at the time but they apparently decided not to file a patent application.

An identical attack on this problem was later made by an English engineer. A write-up appeared in the *Journal of the Institution of Electrical Engineers*, 1938, volume 82, pages 101-104, under the title, Electrical Method of Determining Cable Sheath Uniformity.

My interest in writing this letter is to re-emphasize the fact of which you undoubtedly are already aware, that the lack of a published article along a certain line of activity does not mean that the problem has not already been worked on extensively.

HERMAN E. KRANZ
International Detrola Corp.
Detroit, Mich.

Well, that takes the wonder out of it, anyway.—(Editor)

VIEW OF PORTABLE EQUIPMENT

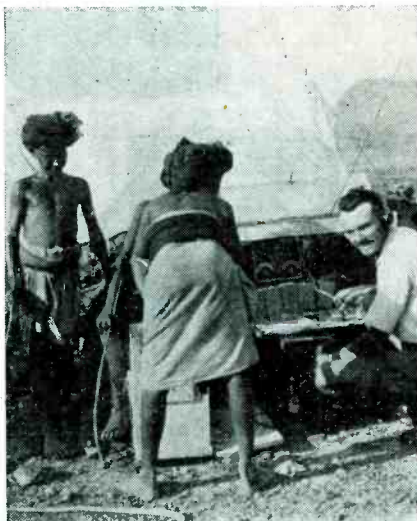

At a British RAF encampment in Arabia, the natives show great curiosity in examining portable radio gear

PROFESSIONAL SERVICES

Research	Production
Design	Management
Development	Sales
Publications	

ASSOCIATED ELECTRONICS CORPORATION, CONSULTING ENGINEERS

Complete Engineering Service for all Industries
RESEARCH DEVELOPMENT DESIGN
MANAGEMENT PRODUCTION PUBLICATIONS
132 Nassau Street, New York, 7, N. Y.
251 Kearney Street, San Francisco, 8, Cal.

WALLACE CLARK & COMPANY

Consulting Management Engineers
25 years Planning in the Fields of Research, Development, Sales, Engineering, Production Finance and Overall Management.
521 Fifth Avenue New York 17, N. Y.

STANLEY D. EILENBERGER

Consulting Engineer
INDUSTRIAL ELECTRONICS
Design—Development—Models
Complete Laboratory and Shop Facilities
6309-13—27th Ave.
Kenosha, Wis. Telephone 2-4213

DON FOSTER

Engineering Consultant
Electrical Specialist in Mechanical
Analysis Sound and Electronics Development
39 Burns Ave., Wyoming 15, Ohio

PAUL E. GERST & CO.

CONSULTING ENGINEERS
Specialists in
Electrical Product Design
El. Machinery, Apparatus & Applications
El. Appliances, Hi-Frequency Apparatus
Electronics, Radio Communication.
205 W. Wacker Dr. Chicago 6, Ill.

HODGSON & ASSOCIATES

Physics, Mathematics, Research, Development & Patent Consultants.
Satisfaction guaranteed. Submit your problem for a preliminary survey without cost.
Box 874 Sherman Oaks, California

JOSEPH RAZEK, Ph.D.

Consulting Physicist
Electrical and Mechanical Engineering Problems
Instruments and control Devices Electronics
Specialists in Colorimetry, Spectrophotometry and
Industrial Color Control
Laboratory and Shop Facilities
202 Darby Road Lancaster, Pa.
Phone Hilltop 6910

ELECTRONIC ENGINEERS

Designers and Consultants
Design for Manufacture—Radio and Electronic products designed to your specifications.
Engineering models Production drawings
Consulting—Radio and Electronic Problems
Complete Development and Research Laboratories
Branch Office Near Chicago
611 E. Garfield Ave. Glendale, California

CONTACTS

FOR THE FIELD OF ELECTRONICS



We manufacture a complete line of equipment

SPOT WELDERS, electric from ¼ to 50 KVA
TRANSFORMERS, special and standard types
INCANDESCENT LAMP manufacturing equipment
FLUORESCENT TUBE MAKING EQUIPMENT
ELECTRONIC EQUIPMENT, vacuum pumps, etc.
WET GLASS slicing and cutting machines for laboratory use
GENERAL GLASS working machines and burners
COLLEGE GLASS working units for students and laboratory

AC ARC
WELDERS
From 100 to
400 Amps

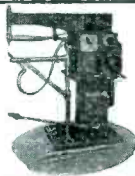

EISLER ENGINEERING CO.
731 So. 13th St. (near Avon Ave.) Newark, New Jersey

**YOUR NEW FREE CATALOG
IS READY FOR YOU!**

Radionic's Catalog No. 26 lists hard-to-get radio parts! Helps you fill your radio and electronic needs. • All parts are available for immediate shipment • All are highest quality. • All are exceptional values.

SEND TODAY FOR YOUR
FREE COPY TO
Dept. 6A

RADIONIC EQUIPMENT CO., Dept. 2A
"CHANCELLOR" PRODUCTS
170 NASSAU STREET, NEW YORK 7, N. Y.

Electron Tube Machinery

of every type,—standard, and special design

Specialists in Equipment for the manufacture of Radio Tubes, Cathode Ray Tubes, Fluorescent Lamps, Incandescent Lamps, Neon Tubes, Photo Cells, X-ray Tubes and other glass or electronic products, on production or laboratory basis.

**Kahle
ENGINEERING COMPANY**

1307-1309 Seventh St., North Bergen, N. J.

NATION-WIDE
MAIL ORDER
DISTRIBUTORS
SINCE 1928



RADIO AND
ELECTRONIC
DEVICES

For...

TRADE... INDUSTRY...
COMMUNICATION...
PUBLIC UTILITY...
VOCATIONAL AND
EXPERIMENTAL
APPLICATIONS

BURSTEIN-APPLEBEE CO.

1012-14 McGEE ST.
KANSAS CITY 6, MISSOURI

Strip Insulated Wires QUICKER... BETTER

with "Speedex"
AUTOMATIC WIRE STRIPPER
... Speeds Production

Strips insulation from all types of wire — instantly, easily, perfectly. Just press the handles and the job is done. Cuts wire too. Strips 800 to 1000 wires per hour. Available for all size solid or stranded wires —No. 8 to No. 30. List Price \$6.00. Write Dept. E for Full Particulars



GENERAL CEMENT MFG. CO.
Rockford, Illinois, U.S.A.

SOMETHING NEW!

Sleeveless type

TUNGSTEN LEADS

PRODUCED FROM CONTINUOUS SPOOLS OF WIRE EITHER STRANDED OR SOLID, ASSURING OVERALL UNIFORMITY. EACH TINY WIRE OF THE STRANDED CABLE IS POSITIVELY FUSED TO THE TUNGSTEN.

Write for details & Samples

GLENDALE VACUUM PRODUCTS CO.
8816-77th Ave. Brooklyn 27, N. Y.

**Your Inquiries to
Advertisers Will
Have Special Value . . .**

—for you—the advertiser—and the publisher, if you mention this publication. Advertisers value highly this evidence of the publication you read. Satisfied advertisers enable the publisher to secure more advertisers and—more advertisers mean more information on more products or better service—more value—to YOU.

FINE RIBBONS
OF
TUNGSTEN and MOLYBDENUM

Quality and accuracy in our fabrication of Tungsten & Molybdenum Ribbons have characterized our service to the Electronic Industry.

A development of
H. CROSS CO.
15 Beekman St., New York 7, N. Y.

BOTTLENECK REMOVER

Have you soldering problems?
Do you use or make hermetic seals?
Does your electro-tin plate
oxidize and refuse to solder?

If so, let me help you. There is a new development in the art of hot tinning. A new development that requires no acid, no alkalin, no corrosive flux. A new development that has undreamed of possibilities.

For further information send your problem and samples, if possible, to

DON FOSTER
30 BURNS AVENUE, WYOMING 15, OHIO

Burned Out or Broken Electric Heating Elements



repaired with NICHRO-CITE PASTE. Simply overlap ends, apply paste, turn on current. Used by utility companies, etc. Family size, \$1.00. 4 oz. size \$2.50. Satisfaction guaranteed.

ADVANCE CO., Box 861E Minneapolis, Minn.

MORE RF KILOWATT HOURS
PER DOLLAR WITH
F & O
TRANSMITTING TUBES

Inquiries Invited—Let us explain how Savings are effected and the F & O greater guarantee.

FREELAND & OLSCHNER PRODUCTS Inc.
611 Baronne St., New Orleans 13, La.
Raymond 4756

High Power Tube Specialists Exclusively
(¼ To 100 KW)

MINIATURE BALL BEARINGS
for precision instruments, electronic devices
RADIAL SERIES (see left) 1/8" to 5/16" outside diameter
PIVOT SERIES 2 to 10 mm. outside diameter
For complete specifications, please write for catalog 431-10

MINIATURE Precision BEARINGS
KEENE, NEW HAMPSHIRE U.S.A.

**MICROMETER
FREQUENCY
METER**

for
checking
Transmitters
from 1.5 to 56 mc.
within 0.01 per cent

LAMPKIN LABORATORIES
Bradenton, Fla., U. S. A.



POSITIONS VACANT

CATHODE RAY Tubes. Old, well-established manufacturer seeks man to head engineering and manufacture of cathode ray tubes. Salary open but will be made attractive to the right man. P-839, Electronics, 330 W. 42nd St., New York 18, N. Y.

WANTED: ELECTRICAL Engineer having some practical experience with radio circuits or vacuum tubes, for war production job in final performance tests of radar. Excellent remuneration and promotion possibilities for right man if available in accord with WMC. Wonderful opportunity for study of amazing future uses for radar while helping to win the war. Write for interview, stating availability, age, education and experience. P-840, Electronics, 330 W. 42nd St., New York 18, N. Y.

WANTED: AN Electrical Engineer for research and development of automotive electrical systems. General knowledge of suppression of electrical interference to radio reception necessary. Give full particulars—background, experience and availability. P-841, Electronics, 520 N. Michigan Ave., Chicago 11, Ill.

WANTED: ELECTRICAL Engineer for electronic tube and lamp production in vital defense plant, good post-war future. P-842, Electronics, 520 N. Michigan Ave., Chicago 11, Ill.

RADIO ENGINEERS: Radio, research and development engineers and draftsmen needed for key positions by manufacturer of diversified line of aircraft accessories, small motors, and aircraft radio who will be in the home radio field post-war. Salaries open. Full compliance with WMC regulations necessary. Confidential inquiries respected. Live in the midst of the best hunting and fishing in Michigan. Our employees know of this ad. P-843, Electronics, 520 N. Michigan Ave., Chicago 11, Ill.

RADIO OR ELECTRONIC Engineers: A commercial airline has immediate openings in midwestern city for engineers interested in development, installation, or maintenance engineering in the fields of aircraft or ground station radio or aircraft electrical or instruments. These are permanent positions. State qualifications in letter. P-845, Electronics, 520 N. Michigan Ave., Chicago 11, Ill.

EMPLOYMENT SERVICE

SALARIED POSITIONS — This advertising service of 35 years recognized standing negotiates for high salaried supervisory technical and executive positions. Procedure will be individualized to your personal requirements and will not conflict with Manpower Commission's. Retaining fee protected by refund provision. Identity covered and present position protected. Send for details. R. W. Bixby, Inc., 278 Delward Bldg., Buffalo 2, N. Y.

POSITIONS WANTED

ELECTRICAL ENGINEER: wishes to make connection where full use can be made of over fifteen years experience in: electrical control, power, industrial electronics, communication, and radio. Will be available after July 1st. PW-846, Electronics, 330 W. 42nd St., New York 18, N. Y.

VACUUM TUBE Engineer: Last five years manufacturing and development of radar, medium and large power tubes. Now supervisory capacity assisting chief engineer. Considerable experience with borosilicate glasses, statistics, quality control. Desire locate N. Y., N. J., Conn. Minimum salary \$5000. Will be in N. Y. City July 9. PW-847, Electronics, 330 W. 42nd St., New York 18, N. Y.

REPRESENTATIVE AVAILABLE

SALES ENGINEER available to represent smaller eastern manufacturers in the Illinois, Indiana, Ohio area. RA-848, Electronics, 520 N. Michigan Ave., Chicago 11, Ill.

ELECTRONICS ENGINEER

Well qualified in electronic musical instrument research, development, and production design.

Working model electronic organ available for examination by reputable manufacturers.

PW-849, Electronics

520 North Michigan Ave., Chicago 11, Ill.

RADIO ENGINEERS WANTED

Top radio design engineer wanted. Also Juniors. War Work-receivers etc. Post war-home radios, radio phones, television, electronic specialties, etc. Prosperous growing medium sized N. Y. radio mfr. Splendid opportunity. Our engineers know about this advertisement. Send complete background, salary earned etc. We pay very highest salaries to good producers.

P-774, Electronics

330 W. 42nd St., New York 18, N. Y.

SURPLUS MATERIAL

TRANSFORMER LAMINATIONS

Large Quantity
Standard Shapes and Sizes

Sealed Bids may be submitted until
June 26, 1945

Ask for Sales Catalog No. B-216E

Navy Material Redistribution and Disposal Office

342 Madison Avenue, New York 17, N. Y.

Murry Hill 2-7600, Extension 72

WANTED

New ideas for musical products, also any other products in the electro mechanical and electronic field.

A reputable established manufacturer is interested to develop new post war products. Suitable arrangements will be made with integrity and confidence, by royalties or purchase, for practical ideas or inventions.

Address: VEGA

155 Columbus Avenue, Boston, Mass.

FOR SALE

ONE Amertran, Class B, Modulation Transformer. Oil filled, Output 64.6 db., .006 W reference (Equiv. to 17.3 kw, capable of modulating 34.6 kw carrier), 6300 volts plate voltage. Total weight 5430 lbs.
ONE Amertran Modulation Reactor, Oil Filled, 16 hrs. at 5.5 amps, 6300 volts. Total weight 5215 lbs.

FS-830, Electronics
330 West 42nd St., New York 18, N. Y.

SALESMAN or SALES MANAGER

wishes to return to Chicago area to sell products of merit. Under 35, well trained in engineering, advertising, factory sales promotion, a successful technical and competitive salesman, ham, college grad. Commission or salary, \$5,000.00.

SA-838, Electronics

520 North Michigan Ave., Chicago 11, Ill.

Are You Looking for
METERS

VOLTMETERS BRIDGES (Wheatstone)
AMMETERS MEGOHMMETERS
INDUSTRIAL RHEOSTATS
ANALYZERS VARIABLE
OHMMETERS TRANSFORMERS
FREQ. METERS RELAYS

Ask for Our Latest Availability List

ELECTRO-TECH

EQUIPMENT COMPANY

329 Canal St., New York 13, N. Y.

BEST QUALITY, USED

ELECTRON TUBE MACHINERY

Equipment for the manufacture of all kinds of electron tubes, radio tubes, incandescent lamps, neon tubes, photo electric cells, X-ray tubes, etc.

AMERICAN ELECTRICAL SALES CO., INC.

65-67 East 8th St. New York, N. Y.

SALES IN CHICAGO

Established Sales and Application Engineering organization in Chicago desires to represent and additional manufacturer. If you make products of merit used by Radio, Electronic and other manufacturers as part of their assemblies our efforts can secure substantial and permanent business for you. Write for details.

RA-782, Electronics

520 N. Michigan Ave., Chicago 11, Ill.

(Additional Employment Ads on pages 362, 403, 413, 414 & 415)



WANTED PRODUCT SALES MANAGER

He should be a graduate electrical or mechanical engineer. Must know switches and be possessed of thorough knowledge of switching circuits and combinations. Should also be familiar with volume controls, rheostats, potentiometers and various types of resistances as used in radio, television and electronics parts market. He should be sales minded, with a proven sales record and possess imagination, foresight and planning capacity. Top executive opportunity with nationally known old established manufacturer. Address

SW-836, Electronics
330 West 42nd St., New York 18, N. Y.

ELECTRICAL ENGINEERS or Men with Technical Sales Experience

Well established Chicago concern will hire qualified men for work as SALES ENGINEERS or DESIGN ENGINEERS. Familiarity with design of transformers or their application in electronic circuits required. Salary plus expenses—a good opportunity. Write qualifications in detail. Address:

SW-826, Electronics
520 No. Michigan Ave., Chicago 11, Ill.

X-RAY

Important manufacturer of dental and medical

EQUIPMENT

expanding medical line, needs

ENGINEERS

with shop practice capable of designing and developing new models of x-ray equipment for medical profession. Permanent position with excellent post-war future.

RITTER COMPANY, INC.
Rochester 3, New York

WANTED ASSISTANT CHIEF ENGINEER

Mid-west radio-electronics manufacturer, engaged exclusively on electronic war projects at present, requires experienced engineer to assume complete supervision of post-war development of household and auto radio receivers. Television receiver experience desirable but not essential. All inquiries confidential. Write

P-814, Electronics
520 N. Michigan Ave., Chicago 11, Ill.

JUNIOR RADIO ENGINEERS

Prefer: drafting, mechanical experience; six years or more practical design experience. Splendid opportunity with growing N. Y. radio manufacturer.

P-792, Electronics
330 W. 42nd St., New York 18, N. Y.

PRODUCTION MANAGER

Experienced in taking charge of production of electrical apparatus. Very good future with growing manufacturing concern.

ADVANCE TRANSFORMER CO.
1161 W. Madison St. Chicago 7, Ill.

Advancement For Electronics or Radio Engineers

Large well-established organization located in New York City wants graduate Engineers with three or more years experience in

ELECTRONICS RADIO RADAR SYNCHRO-MECHANISM

For Present and Post-War research and development on a large variety of electrical products. Give us, in full confidence, your education, resume of experience, and photograph.

P-821, Electronics
330 West 42nd St. New York 18, N. Y.

WANTED Chief ELECTRONICS ENGINEER

With 10 years experience to take full charge of development and Production Engineering for moderate sized company. Excellent postwar opportunities. State age, experience, education and salary requirements in first letter.

P-833, Electronics
520 North Michigan Ave., Chicago 11, Ill.

ELECTRONIC ENGINEERS

SENIOR AND JUNIOR ENGINEERS WANTED FOR DESIGN AND DEVELOPMENT OF TEST EQUIPMENT, PRECISION WIRE WOUND RESISTORS, AND RF COILS. SHOULD HAVE PROVEN BACKGROUND IN THESE SUBJECTS.

EASTERN ELECTRONICS CORP.

41 Chestnut St. New Haven, Conn.

WANTED SENIOR DEVELOPMENT ENGINEER

Large mid-west manufacturer, now exclusively on war radio and radar work, has immediate openings for post-war radio and television development for three senior radio project engineers, two mechanical engineers and one engineer on specifications and standards. Confidential inquiries respected. Write

P-813, Electronics
520 N. Michigan Ave., Chicago 11, Ill.

WAR WORK with a POSITIVE FUTURE

ENGINEERS and PRODUCTION MEN

Electrical Instrument Experience

We think that you'll like working with us. Firstly, we're not asleep—one of our ideas, a truly hermetically sealed electrical indicating instrument, is now the talk of the industry. We have many more. Secondly, ours is a warm and friendly organization, with no limits placed on personal initiative. Thirdly, we're located in a pleasant, thriving community in the heart of New England's vacation playground. It's great for growing children. Starting salary \$4,000, \$5,000—and the rest is up to you. If you have electrical and electronic experience, if you like to roll up your sleeves and get your hands dirty, write immediately. Traveling expenses for a personal interview will be paid.

MARION ELECTRICAL INSTRUMENT CO., MANCHESTER, N. H.

ELECTRONIC CIRCUIT ENGINEERS

Graduate or non-graduate Engineers, with at least two years' experience, needed for application work of hearing aid type tubes, to present and post war small electronic devices. Interviews can be arranged in New York and Chicago after application is submitted. Applicants must comply with all necessary W. M. C. regulations.

Raytheon Manufacturing Co.

55 CHAPEL STREET
NEWTON, MASSACHUSETTS

Wanted

ELECTRONIC ENGINEERS

We are offering permanent positions to a few Electronic Engineers or Physicists. This is an unusual opportunity for men who possess adequate educational background, originality and initiative to join a well established and growing organization engaged in research and development relating to motion picture equipment, television, and marine instruments. Write full particulars relative to education and experience, so that we can arrange an interview for you.

INTERNATIONAL PROJECTOR CORPORATION
 92 Gold Street New York 7, N. Y.

WANTED

Radio or Electronic ENGINEER

For design and development of Army-Navy Electronic Equipment. The position offers an excellent opportunity with a well-established and expanding company in Connecticut, employing over 100 personnel. The company's big postwar program in the industrial electronics, audio and aircraft communication fields assures a continued opportunity to engineering personnel for advancement.

P-794, Electronics
 330 W. 42nd St., New York 18, N. Y.

HELP WANTED TRANSFORMER & SMALL ELECTRIC MOTOR MEN ENGINEERS DESIGNERS DRAFTSMEN TECHNICIANS

For war time and post-war design and development of intricate, specialized, hermetically sealed transformers, and special purpose fractional h.p. motors.

Write giving details about age, experience, past salaries to

SPERRY
 GYROSCOPE COMPANY, INC.
 Research Laboratories
 Stewart Ave. & Clinton Rd.
 Garden City, New York

WANTED

RESEARCH ENGINEERS

Prominent radio and electronics manufacturer located in Midwest has immediate openings for three research men preferably with engineering background, on post-war problems in electrical and electronic fields. Confidential inquiries respected.

P-815, Electronics
 520 N. Michigan Ave., Chicago 11, Ill.

WANTED

Electronic Tube Engineers

Design or production experience. Nationally known Eastern manufacturer has an opening with excellent post-war opportunities for capable engineer with experience in development, design or production of radio receiving or transmitting tubes. Please reply stating age, experience, education and salary.

P-829, Electronics
 330 West 42nd St., New York 18, N. Y.

WANTED—E. E. GRAD

TRANSFORMER DESIGN ENGINEER

FOR ONE OF THE LEADING
 TRANSFORMER MANUFACTURERS
 In the Metropolitan Area of N. Y.

IF YOU ARE AN E. E. GRADUATE & interested in becoming associated with a company which has real Post-War possibilities send us a detailed resume.

P-827, Electronics
 330 West 42nd St., New York 18, N. Y.

Permanent Employment

ELECTRONIC DEVELOP- MENT ENGINEERS

Well-established Eastern Massachusetts concern desires graduate electronic engineers with flair for research and eye to future. Permanent position concerned at present with important development work for government with increased opportunities after the war. Unusual openings for men with capacity and initiative. Must be U. S. Citizens.

P-670, Electronics
 330 W. 42nd St., New York 18, N. Y.

WANTED

ELECTRONICS ENGINEER

with 5 years experience in supervising and installing production set ups for Vacuum Tube Department in progressive concern. Excellent postwar future. State age, experience, education and salary requirements in first letter.

P-834, Electronics
 520 North Michigan Ave., Chicago, 11, Ill.

WANTED

Radio & Electronics ENGINEERS

For research and development in the field of radar, radio communications & electrical test equipment.

Good postwar opportunity.

Also openings available for
**DRAFTSMEN &
 JUNIOR DESIGNERS**

ALLEN D. CARDWELL MFG. CO.
 81 Prospect St., Brooklyn

WANTED

TRANSFORMER Design, Research, Production ENGINEER

- Medium sized, progressive mid-west manufacturer has an opening for an unusual man.
- Knowledge of design and production of transformers for use in electronic applications as well as experience in fluorescent lighting transformers is essential. Ability to conduct research in these fields is also desirable.
- An unusual opportunity for a man with ability and initiative.

P-831, Electronics
 520 North Michigan Ave., Chicago 11, Ill.



OPENINGS FOR RADIO ENGINEERS ELECTRICAL ENGINEERS MECHANICAL ENGINEERS

In the development and production of all types of radio receiving and low-power transmitting tubes. Excellent post-war opportunities with an established company in a field having unlimited post-war possibilities.

Apply in person or in writing to:
Personnel Manager

RAYTHEON
Manufacturing Company
Radio Receiving Tube Div.
55 Chapel St., Newton, Mass.

FIELD SERVICE ENGINEERS FOR DOMESTIC AND FOREIGN SERVICE and INSTRUCTORS

Must Possess Good
Knowledge of Radio
Essential workers need release

HAZELTINE CORPORATION

58-25 Little Neck Parkway
Little Neck, Long Island

ELECTRONIC ENGINEER

With laboratory experience and familiarity with circuit design and development work. Job will be in connection with high frequency heating generators and other industrial applications of electronics. Graduate—Electrical or Radio Engineering.

JUNIOR ENGINEER

Preferably Engineering graduate, with experience in Radio Engineering laboratory, factory or engineering department. Job will be in connection with H.F. and A.F. measurements, and general development work.

JUNIOR RADIO ENGINEER OR PHYSICIST

With good mathematical background.

In replying give complete information as to experience, education, marital, draft status, and salary expected.

Employment Manager

Illinois Tool Works

2501 No. Keeler Ave., Chicago 39, Ill.

Radio Engineers SEVERAL Electronic Engineers

for
Research & Design Dept.

EXPERIENCED
Magnetic Tape Field
Receivers - Transmitters
Knowledge of Manufacture,
Methods &
Procedure Important

A REAL
Post-War Opportunity

With Fast Growing
Progressive N. Y. Manufacturer & Engineering Concern

Established over 10 years

Pioneers in
Magnetic Recording Field

Write resume in detail

P-844, Electronics,
330 West 42nd St., New York 18, N. Y.

Draftsmen

Mechanical layout & detailers for work on transformers & associated equipment, positions are permanent with 40 year old eastern transformer manufacturer. Give full details of experience & salary.

W M C rules observed

Box 116, Suite 617,
1457 Broadway, N. Y. C.

WANTED

V. H. F. or U. H. F. ENGINEER

For design and development of Army-Navy Electronic Equipment. The position offers an excellent opportunity with a well-established and expanding company in Connecticut, employing over 100 personnel. The company's big postwar program in the industrial electronics, audio and aircraft communication fields assures a continued opportunity to engineering personnel for advancement.

P-810, Electronics
330 W. 42nd St., New York 18, N. Y.

Wanted ENGINEERS

Radio
*Electrical
Electronic
*Mechanical
*Factory Planning
Materials Handling
Manufacturing Planning

Work in connection with the manufacture of a wide variety of new and advanced types of communications equipment and special electronic products.

Apply (or write), giving
full qualifications, to:

R.L.D., EMPLOYMENT DEPT.

Western Electric Co.
100 CENTRAL AV., KEARNY, N.J.

*Also: C.A.L.

Locust St., Haverhill, Mass.

Applicants must comply with WMC regulations

RADIO ENGINEERS

Medium-sized, progressive, Midwest manufacturer has openings for one senior and two junior engineers. Desire men for work on military projects now who will be adaptable later to post-war engineering. Prefer men with experience in radio receiver or television laboratory, and with college education in communication engineering.

Our staff knows of this advertisement.

P-825, Electronics

520 No. Michigan Ave.
Chicago 11, Ill.



—and keep out of Enemy Range! That's important! That communicated orders be kept out of enemy range is even more vital. Radio signals are dead giveaways of vulnerable positions. For this reason the highly directional Loud Speaker has become increasingly useful, because it confines signals to a limited area. Loud Speakers used thus must give all out, all-weather, all-the-time performance such as Atlas Sound Instruments have been giving on all Invasion Fronts. Later on Atlas Sound Speakers will again be giving the same fine performance in peace-time pursuits.



Complete Atlas Sound Catalog on request.

ATLAS SOUND

CORPORATION

1449 39th Street

Brooklyn, New York

PREMAX

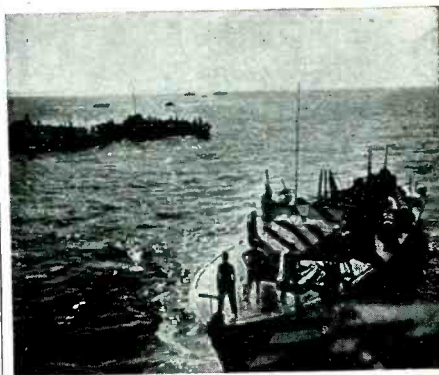

U. S. Navy Photo

**Essential In War—
Necessary In Peace**

Premax Tubular Antennas have done a grand job on the Flat Tops, Battle Wagons, PT and LCT Boats . . . just as they perform in Police, Commercial and Amateur installations.

Premax Products

Division Chisholm-Ryder Co., Inc.
4502 Highland Ave., Niagara Falls, N. Y.

**THERE'S A DRAKE
SOLDERING IRON
FOR EVERY TYPE OF
ELECTRONIC WORK**

From that mighty mite



the Drake No. 400 to the high-speed production "honey"



the Drake No. 600-10 there is a high quality Drake Soldering Iron "just right" for the job.

Drake Heat Controls and the Drake "Magic Cup" Stand are important soldering aids.

SEE
**YOUR RADIO
PARTS JOBBER**

DRAKE ELECTRIC WORKS, INC.
3656 LINCOLN AVE. CHICAGO, ILL.

2 VITAL AIDS

TO THE MANUFACTURER OF
Miniature Tube Radios

★ STAR

DOUBLE-CHECK SYSTEM



#JE-10—Miniature socket wiring plug for accurate alignment of miniature socket contacts during wiring. Precision cast of zinc base alloy—Pins of stainless steel.

#JE-12 — (Hardened tool steel insert) or JE-13 (Stainless steel insert) Miniature tube pin straightener to obtain a perfect fit when the tube is placed in the set.



For complete information and prices—write

RADIO ACCESSORY DIVISION

STAR EXPANSION PRODUCTS CO.
147 Cedar St., New York 6, N. Y.

for dimensional accuracy!

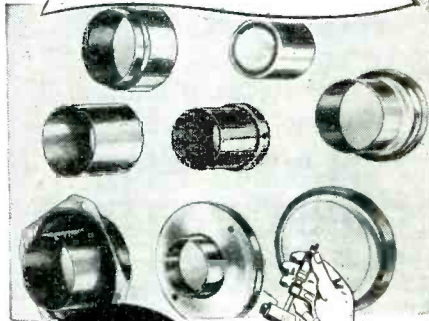

**METAL
STAMPINGS**

DKE

Specialized DKE experience — over 20 years in the field — is now available for the production of stamped metal parts. All types of cups, sleeves, flanged shapes, intricate single pieces or fabricated components are included. High quality workmanship to exacting specifications — with any desired finish — is embodied in every job.

INQUIRIES INVITED

THE ENGINEERING CO.
DANIEL KONDAKJIAN
27 WRIGHT ST., NEWARK, N. J.

INDEX TO ADVERTISERS

	Page		Page
Acheson-Colloids Corporation	241	Continental-Diamond Fibre Co.	280
Acme Electric & Mfg. Co.	318	Continental Electric Co.	285
Acro Electric Co.	216	Continental Machines, Inc.	231
Adams & Westlake Co.	194	Cook Electric Co.	162
Adel Precision Products Corp.	203	Cornell-Dubilier Electric Corp.	85
Advance Co.	411	Corning Glass Works	46
Advance Electric & Relay Co.	328	Cornish Wire Company, Inc.	390
Aerovox Corporation	54	Cory Snow, Inc.	323
Air Reduction	284	Coto-Coil Co., Inc.	254
Aircraft & Diesel Equipment Corp.	410	Croname, Inc.	246
Aircraft-Marine Products, Inc.	309	Cross, H.	411
Aireon Manufacturing Corp.	43		
Albion Coil Co.	273	Dalis, Inc., H. L.	384
Alden Products Co.	401	Daven Company	Inside Back Cover
Allegheny Ludlum Steel Corp.	27	Dayton Rogers Mfg. Co.	350
Allied Control Co., Inc.	227	DeJuro AmSCO Corporation	361
Allied Radio Corp.	236	Delco Radio, Div. of General Motors	272
Altec Lansing Corp.	192	Deutschmann Corp., Tobe	6
Amalgamated Radio Television Corp.	172	Dial Light Co. of America, Inc.	284
American Electrical Heater Co.	350	Diamond Instrument Co.	265
American Gas Accumulator Co.	298	Diebel Die & Mfg. Co.	342
American Lava Corporation	283	Distillation Products, Inc.	391
American Lens Co., Inc.	15	Dixon's Typhonite ELDORADO Pencils	306
American Phenolic Corp.	71	Dobeckmun Company, The	175
American Photocopy Equipment Co.	407	Dongan Electric Mfg. Co.	392
American Platinum Works	396	Dow Chemical Co.	159
American Screw Co.	86	Dow Corning Corporation	263
American Time Products, Inc.	222	Drake Electric Works, Inc.	416
American Transformer Co.	179	Drake Manufacturing Co.	314
Amperex Electronic Corporation	Inside Front Cover	Driver-Harris Co.	41
Amperite Co.	401	Dumont Electric Co.	16
Anaconda Wire & Cable Co.	213	DuMont Laboratories, Inc., Allen B.	38, 60
Andrew Co.	312	Durez Plastics & Chemicals, Inc.	199
Arkwright Finishing Co.	164	DX Radio Products Co.	310
Arnold Engineering Co.	80	Dynamic Air Engineering, Inc.	235
Associated Research, Inc.	382		
Astatic Corporation	304	Eastern Air Devices, Inc.	287
Atlas Sound Corp.	416	Eastern Amplifier Corporation	206
Audak Co.	419	Eastern Engineering Co.	310
Audio Development Co.	200	Eby, Inc., Hugh H.	326
Audio Devices, Inc.	7	Eicor, Inc.	368
Auto Engraver Co.	37	Eisler Engineering Co.	302, 411
Automatic Electric Sales Corp.	186, 403	Eitel-McCullough, Inc.	89
Automatic Mfg. Corporation	210	Elco Resistors Co.	281
		Electric Indicator Co.	330
Bakelite Corporation	299	Electrical Industries, Inc.	394
Ballantine Laboratories, Inc.	266	Electrical Insulation Co., Inc.	334
Barker & Williamson	184	Electrical Reactance Corp.	342
Belden Mfg. Co.	191	Electrix Corporation	306
Bell Sound Systems, Inc.	386	Electronic Engineering Co.	338
Bell Telephone Laboratories	365	Electronic Enterprises, Inc.	40
Bendix Aviation Corp.	362	Electronic Laboratories, Inc.	251
Bentley, Harris Mfg. Co.	64	Electronic Mechanics, Inc.	163
Benwood Linze Co.	317	Electronic Winding Co.	370
Best Manufacturing Co., Inc.	84	Engineering Co.	416
Blaw-Knox Co.	344	Erco Radio Laboratories, Inc.	352
Boonton Radio Corp.	403	Ericsson Screw Machine Products Co., Inc.	390
Bradley Laboratories, Inc.	229	Erie Resistor Corp.	9
Brand & Co., William	79	Espey Mfg. Co., Inc.	388
Breeze Corporations, Inc.	303	Essex Electronics	417
Bridgeport Mfg. Co.	373		
Browning Laboratories, Inc.	333	Fairchild Camera & Instrument Corp.	315
Bruning Co., Inc., Charles	343	Federal Electric Co., Inc.	198
Brush Development Co.	248	Federal Tel. & Radio Corp.	26, 167
Bud Radio, Inc.	409	Fenwal, Inc.	405
Burgess Battery Co.	389	Finch Telecommunications, Inc.	226
Burdny Engineering Co.	351	Follansbee Steel Corp.	160
Burstein-Applebee Co.	411	Footo Mineral Co.	181
		Ford Radio & Mica Corp.	346
Callite Tungsten Corp.	55	Formica Insulation Company	10
Cambridge Thermionic Corporation	362	Foster Company, A. P.	307
Cannon Electric Development Co.	258	Foster, Don	411
Capacitron Company	340	Franklin Mfg. Corp., A. W.	65
Capitol Radio Engineering Institute	334	Freed Transformer Co.	308
Carborundum Company	260	Freeland & Olschner Products, Inc.	411
Cardwell Mfg. Corp., Allen D.	212		
Carter Motor Co.	284	Gates Radio Company	380
Celanese Corp. of America	271	General Cable Corp.	24, 25
Cellusuede Products, Inc.	386	General Cement Mfg. Co.	411
Centralab, Div. of Globe-Union, Inc.	68	General Ceramics & Steatite Corp.	61
Central Paper Co., Inc.	314	General Control Co.	396
Chace Co., W. M.	274	General Electric Co.	11, 12, 13, 14, 44, 45, 247, 325, 371, 398, 407
Cherry Rivet Co.	190	General Electronics, Inc.	249
Chicago Metal Hose Corp.	320	General Industries Company	243
Chicago Telephone Supply Co.	49	General Instrument Corp.	217
Chicago Transformer Corp.	397	General Magnetic Corp.	302
Cinaudagraph Corporation	331	General Plate Div. of Metals & Controls Corp.	353
Cinch Mfg. Corp.	145	General Radio Company	301
Cinema Engineering Co.	336	General Tire & Rubber Co.	63
Clare & Co., C. P.	50	Glendale Vacuum Products Co.	411
Clarostat Mfg. Co., Inc.	218	Goat Metal Stampings, Inc.	306
Cohn & Co., Sigmund	398	Goodrich Chemical Co., B. F.	420
Cole Steel Equipment Co.	238	Gothard Manufacturing Company	326
Collins Radio Co.	51	Gould-Moody Co.	402
Columbia Wire Supply Co.	407	Graphite Metallizing Corp.	298
Communication Measurements Laboratory	316	Green Electric Co., Inc., W.	286
Communications Company, Inc.	262		
Conant Electrical Laboratories	366		
Concord Radio Corporation	387		
Connecticut Telephone & Electric Division of G. A. I.	337		

ONE OF A SERIES...

ESSEX

Showing our complete manufacturing facilities from raw materials to finished product!

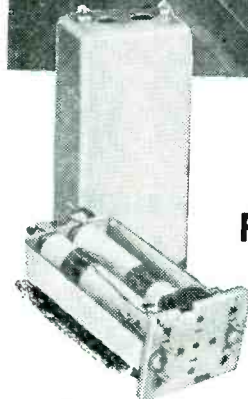
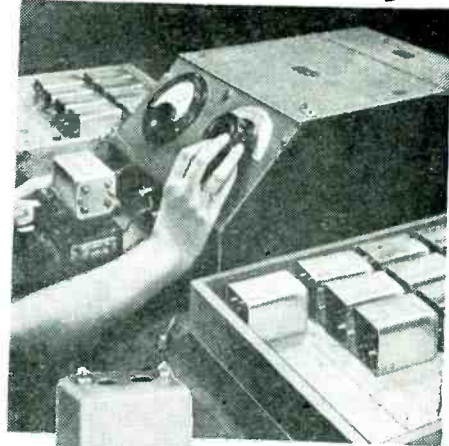

MODERN TESTING FACILITIES for 100% checking "Q" and inductance to close tolerances.

Each ESSEX product must undergo a series of exacting tests before release for final delivery. Measurements for accuracy and performance are made in a complete and modern testing laboratory under the supervision of veteran radio engineers. Careful attention to details of product design and the use of the ultimate in testing equipment has resulted in the development of electronic components which meet the most rigid requirements.

Precision manufacturers of all types of IF and RF coils, chokes, and transformers.

ESSEX ELECTRONICS

1060 Broad St., Newark, N. J.

	Page
Simmons Fastener Corp.	58, 59
Smith Mfg. Co., Inc., F. A.	382
Snyder Mfg. Co.	364
Sola Electric Co.	233
Solar Manufacturing Corp.	88
Sorensen & Co.	355
Sound Equipment Corp. of Calif.	318
Speedway Manufacturing Co.	409
Speer Carbon Co.	377
Spencer Thermostat Company	335
Spencer Wire Co.	291
Sperti, Inc.	348
Sprague Electric Co.	279
Stackpole Carbon Co.	78
Stamford Metal Specialty Co.	386
Standard Pressed Steel Co.	326
Standard Products Co.	87
Standard Transformer Corp.	158
Star Expansion Products Co.	416
Star Porcelain Co.	396
Sta-Warm Electric Co.	322
Stevens Walden, Inc.	408
Steward Mfg. Co., D. M.	284
Stokes Machine Co., F. J.	408
Struthers-Dunn, Inc.	19
Stupakoff Ceramic & Mfg. Co.	33
Sun Radio & Electronics Co.	406
Super Electric Products Corp.	20
Superior Carbon Products, Inc.	392
Superior Electric Co.	214
Supreme Instruments Corp.	298
Sylvania Electric Products, Inc.	170
Taylor Fibre Co.	66
Tech Laboratories	324
Technical Apparatus Co.	401
Technical Radio Company	367
Telex, Inc.	383
Templetone Radio Mfg. Corp.	188
Thermador Electrical Mfg. Co.	171
Thomas & Skinner Steel Products Co.	386
Thordarson Electric Mfg. Co.	47
Tinnerman Products, Inc.	185
Transmitter Equipment Mfg. Co., Inc.	42
Triplet Electrical Instrument Co.	375
Tung-Sol Lamp Works, Inc.	202
Turner Company	232
Ucinite Company	369
Union Carbide & Carbon Corp.	174, 299, 401
United States Rubber Co.	311
United Transformer Corp.	2
Universal Microphone Company	215
Utah Radio Products Company	165
Victory Mfg. Co.	338
Volkel Brothers Machine Works	282
Walker-Jimieson, Inc.	364
Walker-Turner Co., Inc.	300
Wallace Mfg. Co., Wm. T.	350
Wallace & Tiernan Products, Inc.	225
Ward Leonard Electric Co.	347
Ward Products Corporation	400
Warren Telechron Co.	259
Waugh Laboratories	277
Webster Chicago Corp.	72
Webster Electric Co.	240
Weller Mfg. Co.	392
Western Brass Mills, Div. of Olin Industries, Inc.	23
Western Electric Co.	82, 83
Westinghouse Electric Corporation	4, 5, 193
Weston Electrical Instrument Corp.	234
Whistler & Sons, Inc., S. B.	276
Whitaker Cable Corp.	74
White Dental Mfg. Co., S. S.	338, 379
Whitehead Stamping Co.	392
Wilson Co., H. A.	32, 264
Zopbar Mills, Inc.	318
PROFESSIONAL SERVICES	410
SEARCHLIGHT SECTION (Classified Advertising)	
EMPLOYMENT	412, 413, 414, 415
WANTED TO PURCHASE	412
USED EQUIPMENT	
American Electric Sales Co., Inc.	412
Dealers Tool Supply Co.	412
Electro-Tech Equipment Co.	412
Iron & Steel Products Inc.	412
Maritime Switchboard	412
Navy Material & Redistribution & Disposal Office	412

THE IMPORTANCE OF

Specialization

IS FORCEFULLY
DEMONSTRATED BY

Audax



*A*side from outstanding and long-acknowledged technical skill — our “Specialization Formula” is probably as fully responsible for the world-renowned AUDAX quality as any other single factor.

We proudly concentrate all our energies and resources upon producing the finest pick-ups and cutters. Because we are specialists in this field, much more is expected of us. Because the production of fine instruments like MICRODYNE is a full time job, it stands to reason that we could not afford to jeopardize our reputation—EVER—by making pick-ups a side-line.

After Victory, you may expect further AUDAX improvements, refinements . . . master-touches to heighten the marvelous *fac simile* realism of AUDAX reproduction.

AUDAX COMPANY

500E Fifth Avenue, New York 18

“Creators of Fine Electronic-Acoustical Apparatus since 1915”

*“The Standard
by Which Others
Are Judged and Valued”*



Send for complimentary copy of our informative
“PICK-UP FACTS”



From dam site to drawing room...

**with
wire insulation
made from
Geon**

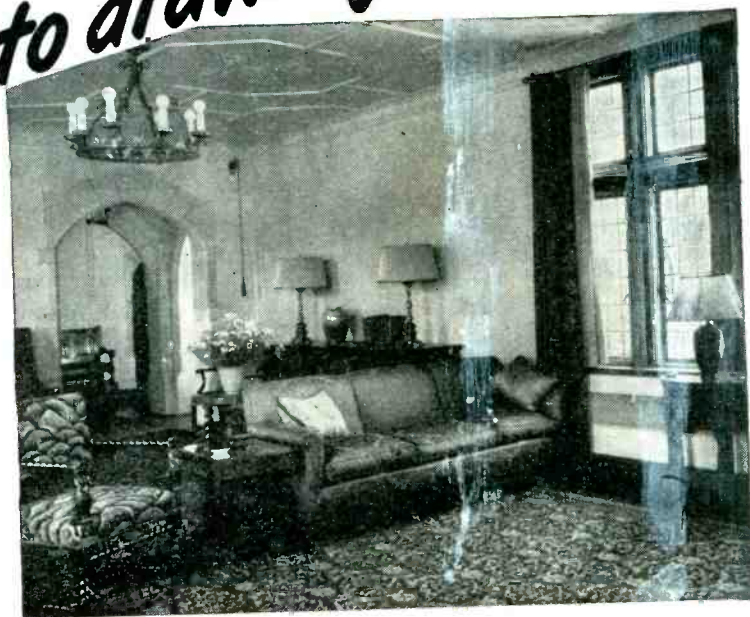

WIRE insulation made from GEON polyvinyl raw materials will have almost universal application just as soon as restrictions on its use are lifted. A greatly expanded knowledge of compounding, derived from a research program accelerated by war needs, has resulted in a large group of special-purpose insulating materials which are being supplied to wire manufacturers for essential applications.

The pictures indicate the wide range of applications—from shot-firing wire to lamp cord. In between there is a long list of uses in industrial and domestic construction, communications, manufacturing of all kinds, transportation, public utilities and every other industry in America.

The list of properties of insulating material made from GEON is headed, of course, by outstanding electrical properties. Following is a long list of normally destructive factors which compounds made from GEON can be designed

to resist; oils and greases, water, air, aging, sun, abrasion, flame, chemicals and many others. GEON has certain limitations, of course. For example, being a thermoplastic material, insulation made from GEON cannot yet be used on wire for certain types of heating units such as toasters, roasters, irons or home heaters. But current research indicates that these applications may soon be included in the list.

Right now all the GEONS are subject to allocation by the War Production Board. Limited quantities may be had for experiment. And our development staff and laboratory facilities are available to help you work out any special problems in connection with essential applications.

For more complete information, write Department FF-6, B. F. Goodrich Chemical Company, Rose Building, East 9th and Prospect, Cleveland 15, O.



B. F. Goodrich Chemical Company A DIVISION OF THE B. F. GOODRICH COMPANY

Presenting the...

DAVEN

WIRE-WOUND
SEALD-OHM

HERMETICALLY-SEALED PRECISION RESISTOR

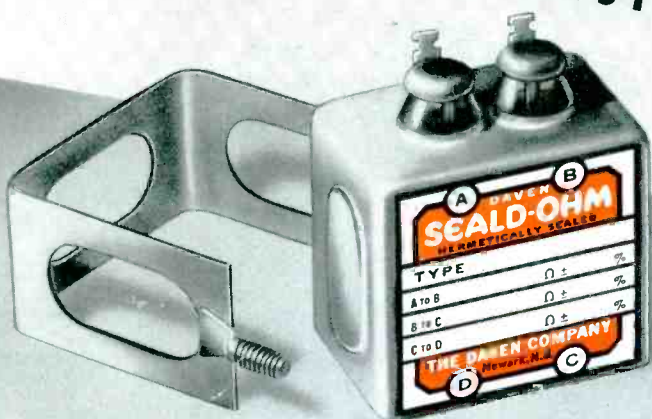

Totally unaffected by extremes of humidity and temperature, highly resistant to vibration and shock, with provision for rigid mounting . . . these were "specs" that could not be met by any resistor on the market. In response to a direct request, DAVEN, applying the know-how of over two decades of precision resistor engineering, carefully designed and built a new, completely hermetically-sealed resistor. DAVEN SEALD-OHMS squarely meet these specifications. This was proven by exhaustive tests conducted by a famous research laboratory.

ELECTRICAL DATA

RESISTOR WINDINGS: Either spool or mica-card type, depending upon engineering requirements. Non-inductively wound and carefully aged to remove strain before final calibration.

RESISTANCE RANGE: Any desired value may be had; maximum 1,600,000 ohms depending upon type of resistance wire employed.

TEMPERATURE CHARACTERISTICS: Four types of resistance wire of different characteristics are available.

ACCURACY: May be had to tolerance as close as $\pm 0.1\%$.

FREQUENCY CHARACTERISTICS: No appreciable effect over the audio range. This range may be exceeded to meet many other applications.

CIRCUIT COMBINATIONS: Resistors available with 2 terminals at one end or 2 terminals at two ends. A single four terminal unit is designed to take up to four separate spool-type resistors of different values and accuracies.

SEALD-OHMS are ruggedly constructed throughout, with special attention given to combining vibration and shock resistance. Their physical design enables the combining of several circuits within a single unit. A unique mounting bracket arrangement adds to the broad adaptability of these resistors. SEALD-OHMS are intended for use in any equipment subjected to humidity and temperature extremes. They fully meet both Army and Navy Specifications. Typical applications include as secondary standards, resistor elements in bridge networks, in voltage divider circuits, in attenuation boxes, etc.

MECHANICAL DATA

SHIELDING: Drawn brass, completely hermetically-sealed. Thermal-shock tested for faulty seals before shipment. Treated to withstand 200 hours salt spray test (f-13 AWS Spec C75.16-1944).

TERMINALS: Electrical connections are brought out through fused glass seals which are soldered in the resistor shield.

MOUNTING: A specially designed steel bracket with spade lugs welded to the sides is supplied with each unit. Cut-outs on this bracket engage with embossings on the side of the brass shielding to enable firm mounting of the unit in a vertical, inverted or horizontal position.

DIMENSIONS: 1-9/16" wide, 1/2" high, 7/8" deep. Add terminal height, 9/16" Studs on mounting bracket, 1-11/16" between centers.

For additional information, write to THE DAVEN CO.,
191 Central Avenue, Newark 4, New Jersey

DAVEN **pioneer** maker of precision resistors



51- Collins TCS ad
177- Rawland SCR-694 ad.

NEITHER STRATOSPHERE COLD NOR DESERT HEAT AFFECT THE RCA-3B25



204- SCR-300 discussion
321- Naval Air Station
HRO receivers

266- German WR-1
Xenon-Filled Rectifier Tube Receiver description

Operates Efficiently Over
165°C Temperature Range

FOR applications in which ambient temperature varies widely, the 3B25 has important advantages over mercury-vapor-type tubes. No temperature-control devices are required, arc-back is minimized, and the tube drop remains constant at approximately 10 volts over the entire temperature range from -75°C to +90°C.

The RCA-3B25 also will carry higher currents than high-vacuum tubes of the same size—and with much lower tube drop.

The Xenon filling permits operation of the tube mounted in any position. Since the 3B25 is ruggedly constructed to

withstand severe shock, it can be mounted near moving mechanisms without being adversely affected by vibration.

TECHNICAL DATA

In single-phase, full-wave operation, a pair of 3B25's will provide 1 ampere d-c output to the filter at 1270 volts. The tube is rated at 4500 peak inverse anode volts and an average anode current of 0.5 ampere.

General: Filament volts (a.c.) 2.5; filament current, 5.0 amperes; tube drop (approx.) 10 volts; overall length, 5 7/8 inches ± 7/16 inch; maximum diameter, 2 1/16 inches; cap, medium; base, medium 4-pin bayonet; mounts in any position.

Maximum Ratings (Absolute Values): Peak inverse anode volts (at 500 cycles or less), 4000; peak anode current, 2 amperes; average anode current, 0.5 ampere; surge anode current for maximum of 0.1 second, 20 amperes; ambient temperature range, -75°C to +90°C.

For more complete data, send for free data-sheet on RCA-3B25. Address: RADIO CORPORATION OF AMERICA, Commercial Engineering Section, Dept. 62-31E, Harrison, New Jersey.

THE FOUNTAINHEAD OF MODERN TUBE
DEVELOPMENT IS RCA

BUY WAR BONDS



62-6136-31

RADIO CORPORATION OF AMERICA

RCA VICTOR DIVISION • CAMDEN, NEW JERSEY