

APRIL • 1943

electronics



Proper maintenance conserves critical materials and minimizes need for new tubes by prolonging tube life. Method of cleaning terminals illustrated above.



For a full measure of service



Not only are men being tried on battlefronts, the equipment that they employ is being subjected to equally critical tests . . . with the lives of the men as the stakes. We at home, entrusted with war contracts, are overcoming serious raw material shortages through laboratory and production developments, making each individual tube that we produce do more than its planned job . . . and do it better.

Through a series of design refinements, Amperex engineers have developed transmitting and rectifying tubes that are being operated for longer periods of time than hitherto had been practical. These new Amperex radio and radar tubes present a dual economy . . . many more hours of uninterrupted service . . . and priceless savings of scarce materials.

AMPEREX ELECTRONIC PRODUCTS
79 WASHINGTON STREET • BROOKLYN, NEW YORK

electronics

APRIL • 1943

RADIO AND ELECTRONICS IN THE NAVY , by S. P. Sashoff.....	72
Brief history of Naval uses of radio plus an outline of how the Navy radio is organized under the Bureau of Ships	
RECORDING UNIT FOR STRAIN AND TIMING FUNCTIONS , by J. H. Meier.....	79
Two strain and twelve timing functions can be permanently recorded to indicate the performance of heavy machinery under conditions actually encountered in the field	
GRAPHICAL SYMBOLS , by B. Dudley.....	84
Compilation of graphical symbols most commonly encountered in electronic circuits is presented for ready reference	
HIGH-CAPACITANCE, LOW-IMPEDANCE ROCHELLE SALT DEVICES , by R. W. Tibbetts.....	88
By bonding a thin gold foil to the surfaces of a Rochelle salt crystal, a low-impedance unit is provided for oscilloscope, microphone or pick-up use. A single crystal is employed	
ADJUSTMENT OF DIRECTIONAL ANTENNAS , by W. S. Duttera.....	91
How impedance measurements can be made at radio frequencies under full load with only a cathode-ray oscilloscope and a ruler, as required for matching an antenna to its transmission line	
FULL-WAVE RECTIFIER WITH CHOKE INPUT , by L. C. Tillotson and C. M. Wallis.....	94
Analysis of the behavior of full wave rectifier for both condition in which current flows continuously, and for intermittent current flow	
WALKIE-TALKIE AT WAR	98
Photos showing some of the practical uses for extremely portable radio transmitter-receiver units in military operations	
PERFORMANCE OF SELF BIASED MODULATED AMPLIFIERS , by R. I. Sarbacher.....	99
Graphical analysis of high efficiency amplifiers with plate modulation. Results show improved operation with grid bias	
ELECTRONIC REGULATORS FOR A-C GENERATORS , by A. Benson.....	104
Two simple electronic control circuits requiring only one thyatron each are described in detail, and advantages over earlier circuits are pointed out	
HIGH FREQUENCY HEATING	108
Four typical examples of ways in which electronic equipment can speed up industrial processes.	
CHART FOR EQUIVALENT SERIES AND PARALLEL CIRCUITS , by R. Toombs.....	109
Location of single point on graph enables conversion from series impedance to parallel impedance values	

KEITH HENNEY, Editor; Beverly Dudley, Managing Editor; Donald G. Fink (on leave); Craig Walsh (on leave); W. W. MacDonald, Associate Editor; John Markus, Assistant Editor; M. L. Matthey, Assistant Editor; J. M. Heron, Assistant Editor; Harry Phillips, Art Director

H. W. MATEER, Publisher; J. E. Blackburn, Jr., Director of Circulation Electronics; Wallace B. Blood, Sales Manager

DISTRICT MANAGERS, D. H. Miller, New York; R. H. Flynn, New England; F. P. Coyle, Philadelphia; L. P. Canty, Cleveland; C. D. Wardner, Chicago

Contents Copyright, 1942, by McGraw-Hill Publishing Company, Inc.
McGRAW-HILL PUBLISHING COMPANY, INCORPORATED
 JAMES H. McGRAW, Founder and Honorary Chairman
 Publication Office 99-129 North Broadway, Albany, N. Y., U. S. A.

EDITORIAL AND EXECUTIVE OFFICES 330 West 42nd St., New York, N. Y., U. S. A.
 James H. McGraw, Jr., President; Howard Ehrlich, Executive Vice President; Mason Britton, Vice President; B. R. Putnam, Treasurer; Joseph A. Gerardi, Secretary. Cable address: MCGRAWHILL, New York. Member A. B. P. Member A. B. C.

ELECTRONICS, April, 1943, Vol. 16; No. 4. Published monthly, price 50c a copy. Allow at least ten days for change of address. All communications about subscriptions should be addressed to the Director of Circulation, 330 West 42nd Street, New York, N. Y.

Subscription rates—United States and possessions, Mexico, Central and South American countries, \$5.00 a year, \$8.00 for two years, \$10.00 for three years. Canada (Canadian funds accepted) \$5.50 a year, \$9.00 for two years, \$11.00 for three years. Great Britain and British possessions 36 shillings for one year, 72 shillings for three years. All other countries, \$6.00 for one year, \$12.00 for three years. Entered as Second Class matter, August 29, 1936, at Post Office, Albany, New York, under the Act of March 3, 1879. **BRANCH OFFICES:** 520 North Michigan Avenue, Chicago; 68 Post Street, San Francisco; Aldwych House, Aldwych, London, W. C. 2; Washington; Philadelphia; Cleveland; Detroit; St. Louis; Boston; Atlanta, Ga.; 601 West Fifth Street, Los Angeles.

A McGRAW-HILL PUBLICATION



DEPARTMENTS

Washington Feedback.....	69
Crosstalk.....	71
Reference Sheet.....	109
Tubes at Work.....	112
Electron Art.....	154
News of the Industry.....	174
New Products.....	192
Backtalk.....	209
New Books.....	216
Index to Advertisers.....	225

CHANGE OF ADDRESS

McGRAW-HILL PUBLISHING COMPANY
 330 West 42nd Street, New York, N. Y.

Director of Circulation:
 Please change my address on Electronics

From

.....

To

.....

Signed

FILTERS— Designed for war



Unique characteristics of many UTC filters are the result of years of research on core materials and filter structures. We are proud of our part in the development of filters for wartime electronics. Here are a few typical elements, based on UTC design, which have led to UTC leadership in this field.

May we design a "Victory" unit to your application?

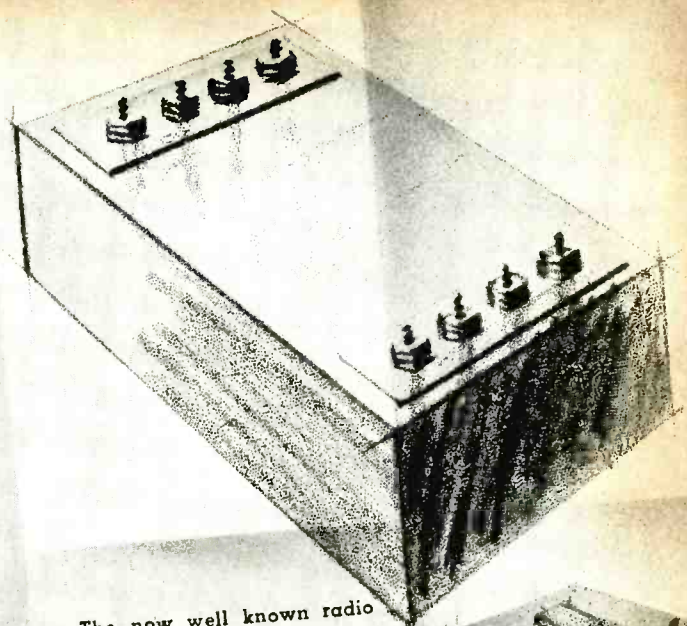

The now well known radio range filter weighed 36 pounds when it originally was submitted to us.

Continuous refinement by UTC has resulted in the modern radio range filter weighing only 1.6 pounds—a weight reduction of 95%.

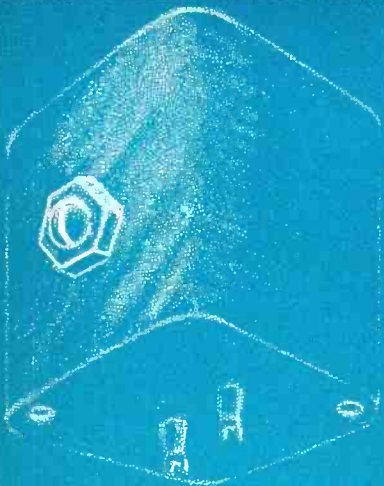
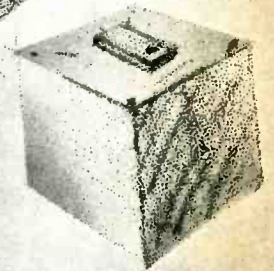

This UTC development is a tunable inductance, adjusted in the same manner as an I.F. trimmer.

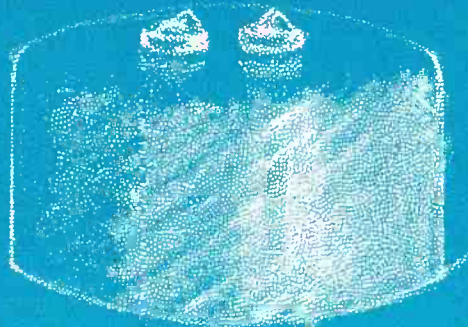

Designed for high frequencies, the Q of this coil is 300 at 20,000 cycles.

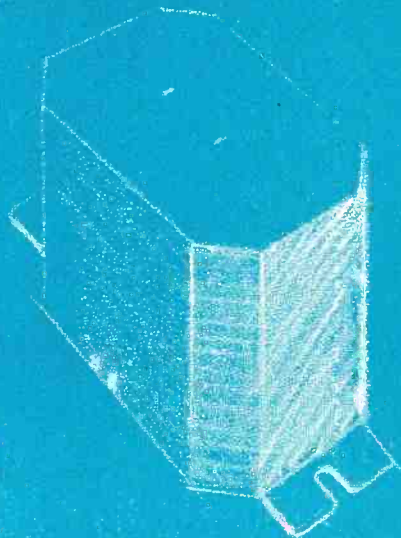

... For medium frequencies, the Q of this coil is 210 at 1,000 cycles.



... For low frequencies, the Q of this coil is 80 at 100 cycles.

UNITED TRANSFORMER CO.

150 VARICK STREET



NEW YORK, N. Y.

EXPORT DIVISION; 100 VARICK STREET NEW YORK, N. Y. CABLES: "ARLAB"



GHOST PROOF



This new tracing cloth defies moisture stains and erasure scars

This new tracing cloth won't show perspiration stains or water marks—*holds pencil smudges and erasure scars at a minimum.* Now you can have clean tracings, in pencil or ink, free from these untidy "ghosts" that reproduce on blueprints!

For PHOENIX is ghost-proofed by a remarkable new process that defies moisture and gives you an unusually durable working surface. You can use harder pencils with this improved cloth and get sharper lines with less tendency to smudge. Even 6H lines show clearly, and reproduce sharply! Erasing does not mar the drawing surface; erased areas take pencil smoothly—and ink without feathering. Its new white color and increased transparency give you excellent drawing contrast and produce strong blueprints.

Put PHOENIX through your own drawing board test. See your K&E dealer, or write for a generous working sample and an illustrated brochure.

K&E
Phoenix
REG. U.S. PAT. OFF.
TRACING CLOTH
for pencil and ink

EST. 1867
KEUFFEL & ESSER CO.
NEW YORK • HOBOKEN, N. J.
CHICAGO • ST. LOUIS • SAN FRANCISCO • LOS ANGELES
DETROIT • MONTREAL



PHOENIX DEFIES MOISTURE GHOSTS . . .

Perspiration and water splashes on ordinary tracing cloth create "ghosts" which reproduce on blueprints. PHOENIX Tracing Cloth withstands actual immersion in water for fully 10 minutes at a time! *Perspiration and water marks will not stain it!*



PHOENIX LESSENS SMUDGE GHOSTS . . .

The new improved surface of PHOENIX Tracing Cloth permits you to use harder pencils (5H and 6H) and to get sharper lines with less tendency to smudge.

Result: Cleaner tracings and blueprints.



PHOENIX REDUCES ERASURE GHOSTS . . .

Ordinary tracing cloths become scarred when erased . . . erased spots produce ghosts on blueprints.

PHOENIX has a durable drawing surface that reduces working scars to a minimum.

Electronics

The Pinhole Detector automatically spots, classifies and marks minute holes smaller than $1/64$ of an inch in tinplate racing through a shearing line at 1,000 ft. per minute. This application shows one of the many ways the photo-electric cell is being applied to heavy industrial processes —to save time and improve products.

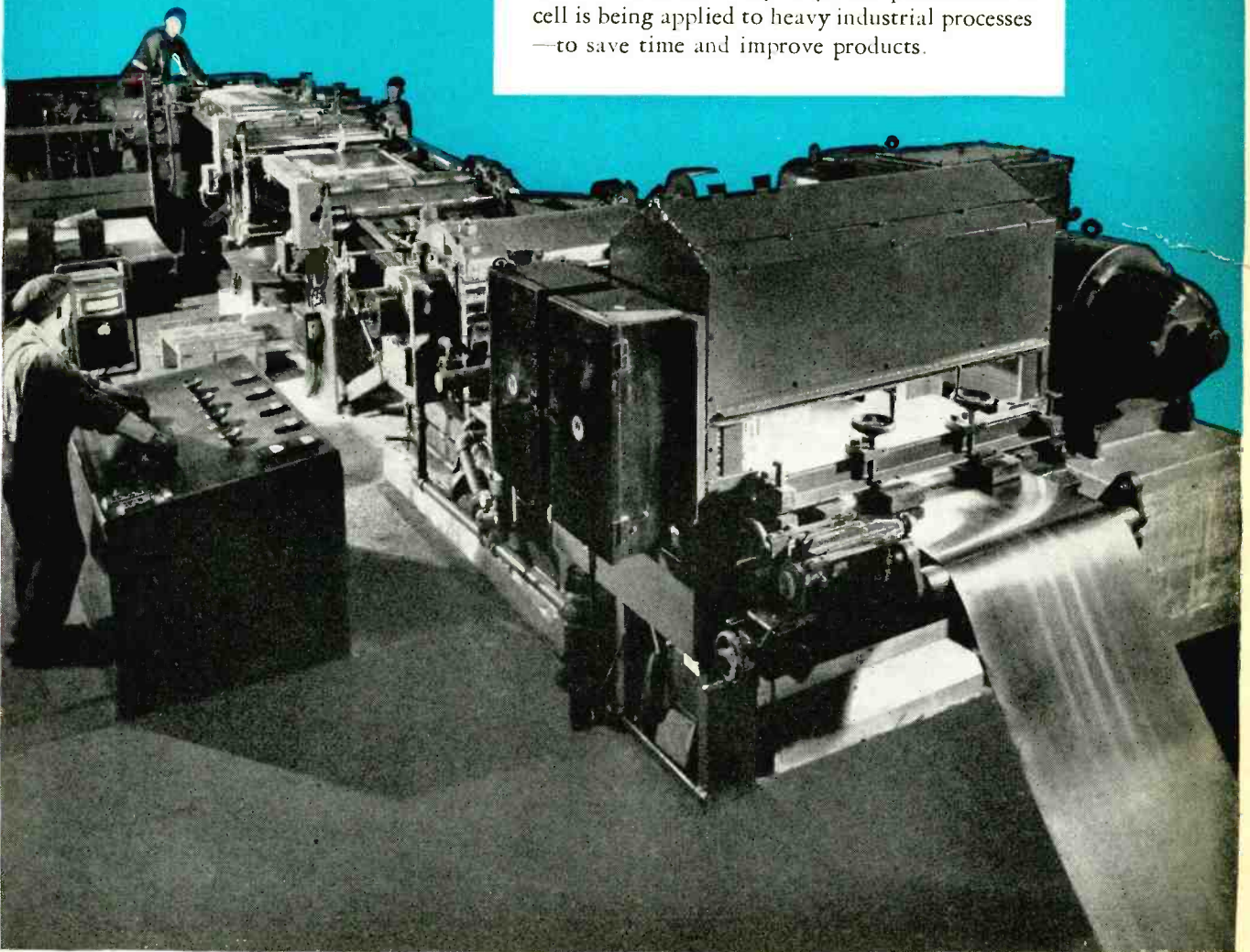

...at Work

Exciting as the future of Electronics may be, it is far more than a "science of tomorrow." Electronic devices are at work *today* in practically every war industry—speeding production, improving products, cutting costs. Here are typical examples of Westinghouse "Electronics at Work."

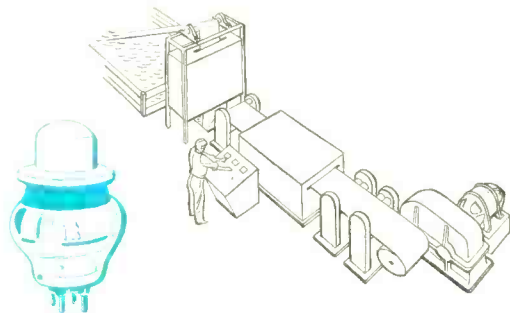

Saving Tons of Tin—Through the use of high-frequency electronic tubes, induction heating at 200,000 cycles per second is used to "flow" tin electrolytically deposited on steel strip. By this means, a coating of tin 1/30,000,000 of an inch thick becomes smooth and corrosion-resistant.

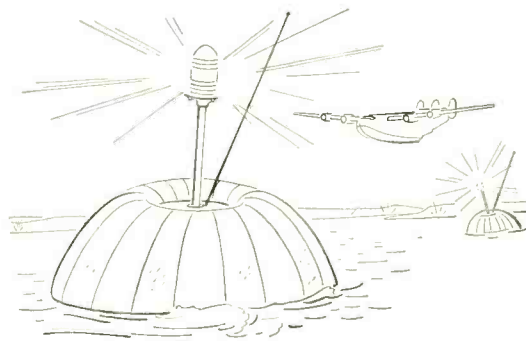

Safe Night Landings for giant clipper planes are made possible by seadrome lights controlled by electronics. An entire landing lane can be turned on by shore radio to meet the arriving plane's requirements and guide it to a safe, sure landing, even in pitch darkness.

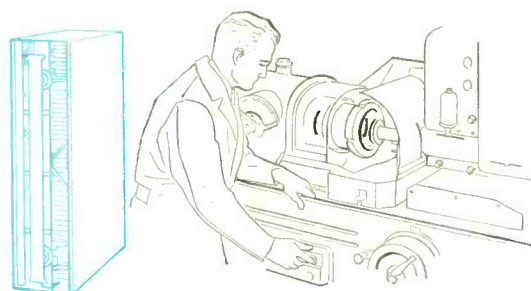

Removing Oil Mist created by gear-grinding and thread-cutting operations is a highly important application of PRECIPITRON—the Westinghouse electric air cleaner. Electronic tubes in the Precipitron's power pack create a 12,000-volt electrostatic field, which draws oil and dust particles irresistibly to charged collector plates.

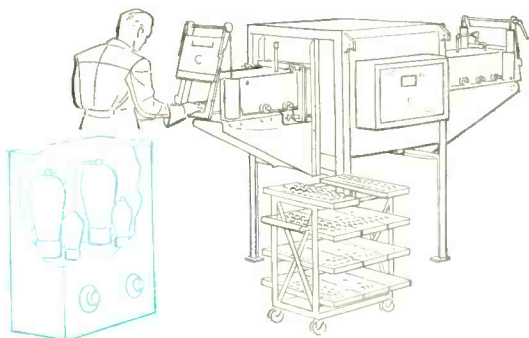

Heat-treating at 2000° C. can now be controlled more precisely than ever before possible. Thyatron tubes, actuated by the temperature recorder, react to minute variations in temperature. They control a saturable reactor, by which current entering the furnace is increased or decreased to maintain a nearly constant temperature.

J-91013-A

For further information on practical applications of Westinghouse Electronic devices, write or phone your nearest Westinghouse office, Westinghouse Electric & Manufacturing Company, East Pittsburgh, Pa.



Westinghouse
PLANTS IN 25 CITIES ... OFFICES EVERYWHERE

ELECTRONICS

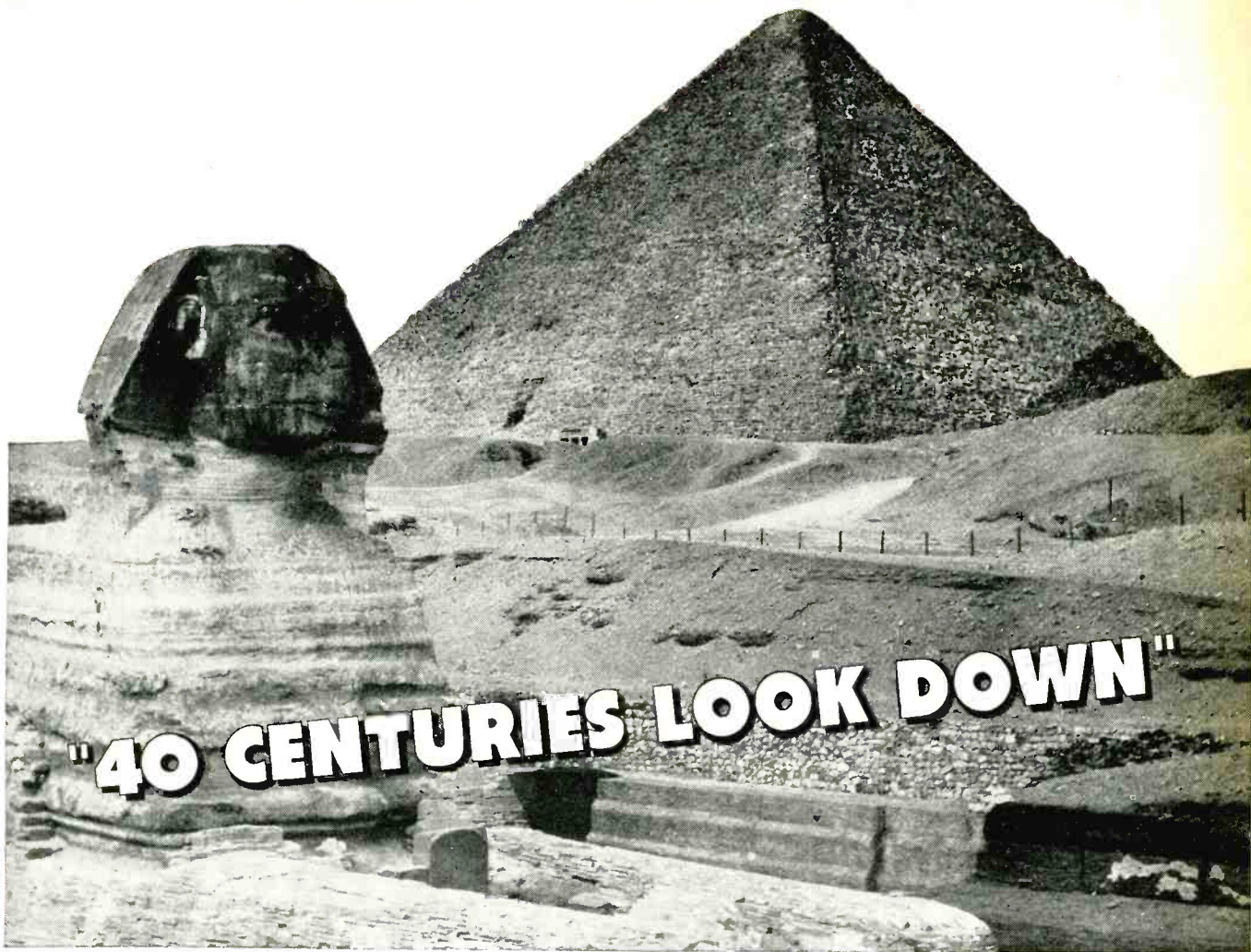

"40 CENTURIES LOOK DOWN"

Long life is the outstanding quality you require in a capacitor. And greatest guarantee of long life is the record of the past.

This record in the case of Tobe Capacitors warrants the fullest confidence . . . a record that is almost completely free of condensers that "couldn't take it".

Tobe's exacting standards mean persistent research and the constant "raising of



sights" in excellence of production.

Typical example is the Tobe Oilmite Capacitor shown below. This capacitor, impregnated and filled with mineral oil, is made with meticulous care and rated with conservatism. It is doing yeoman service as a filter condenser in secret war equipment. We welcome inquiries arising from your condenser problems.

LONG LIFE

ASSURED

CHARACTERISTICS OF TOBE OIL-MITE CAPACITORS

STANDARD CAPACITY TOLERANCE = 10% RATINGS: .05 mfd. to 2.0 mfd. • 600 V.D.C. • .05 mfd. to 1.0 mfd. • 1,000 V.D.C.
 TEST VOLTAGE . . . Twice D. C. rating GROUND TEST . . . 2,500 Volts D. C. POWER FACTOR . . . At 1,000 cycles—.002 to .005
 SHUNT RESISTANCE05 to 0.1 mfd. • 20,000 megohms • .25 to 0.5 mfd. • 12,000 megohms • 1.0 to 2.0 mfd. • 4,000 megohms

Special units can be held to 12,000 megohms per microfad depending solely on terminal construction.

A SMALL PART IN VICTORY TODAY



A BIG PART IN INDUSTRY TOMORROW

QUARTZ MOTHER

THE PREPARATION OF PRECISION CRYSTALS FOR RADIO FREQUENCY CONTROL AS MADE BY CRYSTAL PRODUCTS

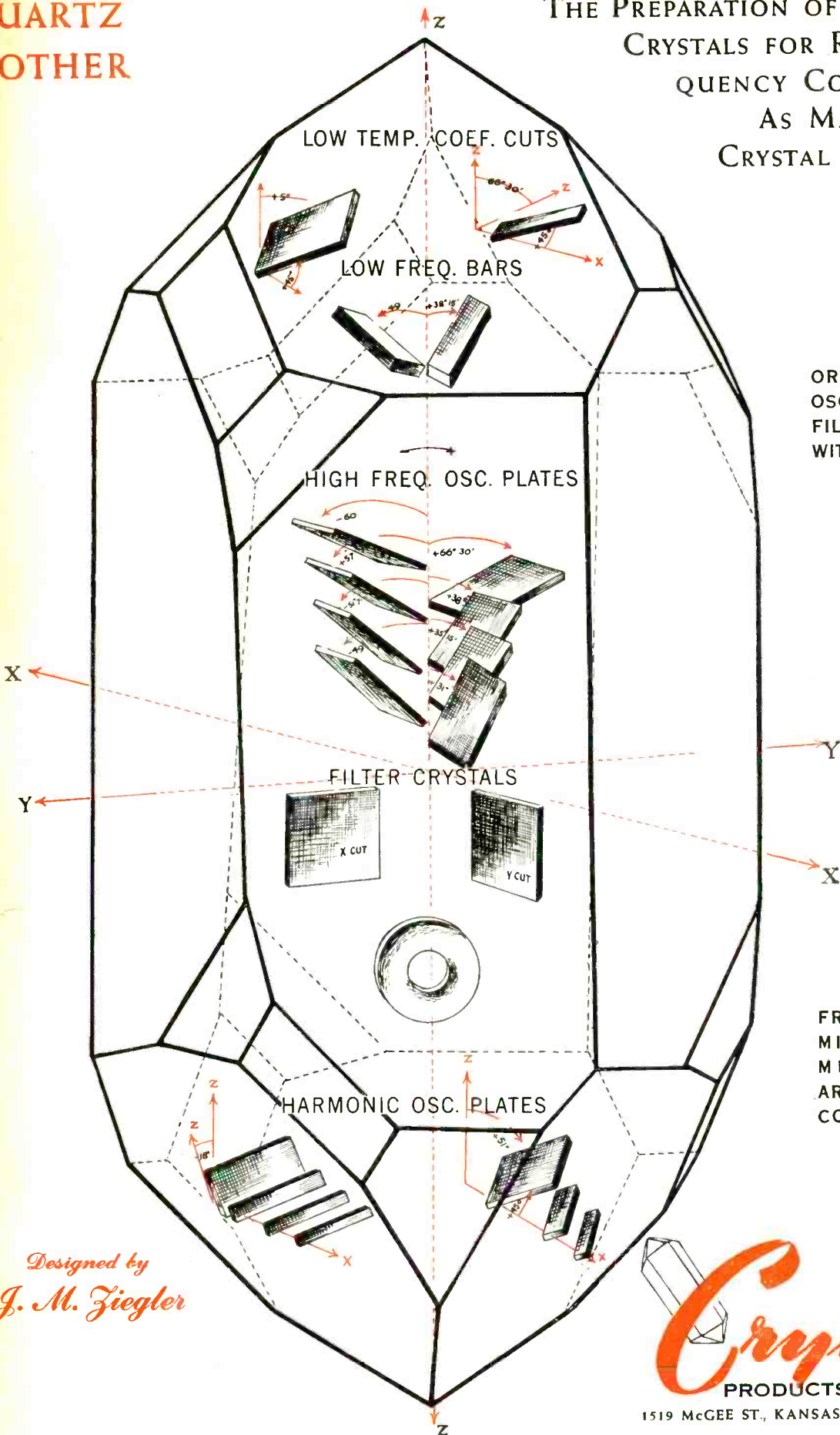

ORIENTATION OF OSCILLATOR AND FILTER CRYSTALS WITH RESPECT TO MOTHER

FREQUENCIES IN MILITARY COMMUNICATIONS ARE ACCURATELY CONTROLLED BY CRYSTALS

Designed by J. M. Ziegler

Crystal
PRODUCTS COMPANY
1519 MCGEE ST., KANSAS CITY, MISSOURI

Producers of Approved Precision Crystals for Radio Frequency Control

**FOR ELECTRONICS
MEASUREMENTS, TOO,**

the Standards are Weston

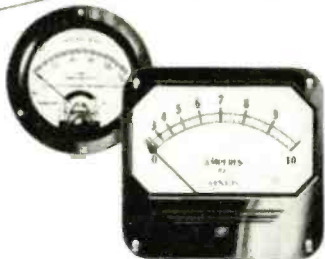

Panel Meters for Electronic applications

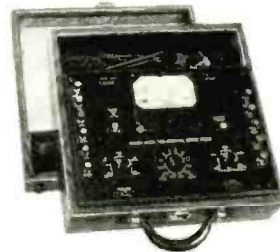

Electronic Circuit Testers



Ultra-Sensitive Laboratory Portables

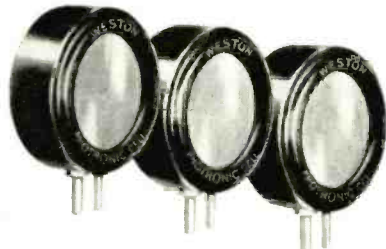

***Photronic (photo-electric) Cells**



Electronic Tube Checkers

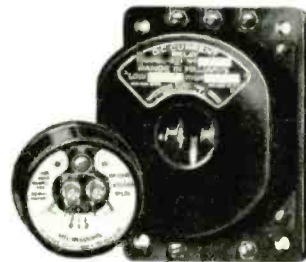

Sensitive Relays

In the field of electronics, too, the measurement tools bear the name most familiar to you. For just as WESTON pioneered fundamental electrical measurement, as well as the special measurement needs of radio, so WESTON has provided simple, precise instruments and devices for the problems encountered in electron-

ics research, production and control. Weston Electrical Instrument Corporation, 597 Frelinghuysen Avenue, Newark, New Jersey.

**PHOTRONIC — A registered trademark designating the photoelectric cells and photoelectric devices manufactured exclusively by the Weston Electrical Instrument Corporation.*

Laboratory Standards . . . Precision DC and AC Portables . . . Instrument Transformers . . . Sensitive Relays . . . DC, AC, and Thermo Switchboard and Panel Instruments.

WESTON

Specialized Test Equipment . . . Light Measurement and Control Devices . . . Exposure Meters . . . Aircraft Instruments . . . Electric Tachometers . . . Dial Thermometers.

FOR OVER 54 YEARS LEADERS IN ELECTRICAL MEASURING INSTRUMENTS

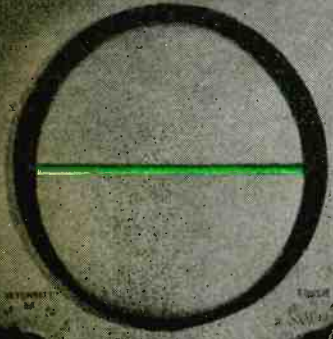

+

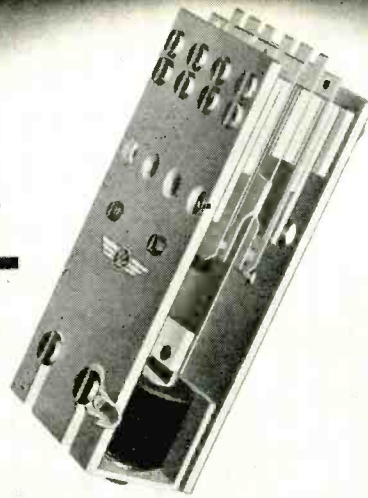

=

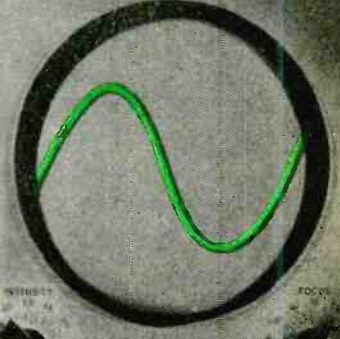

THE VIBRATOR IS THE HEART
OF THE POWER SUPPLY

FROM 6-VOLT DC TO SINE-WAVE 110-VOLT AC!

E·L is the Only Vibrator Converter

That Can Produce This Result

All electrical engineers know that the Sine-Wave current form is more efficient than any other, particularly in the operation of motors and of test equipment.

—But, not all electrical engineers know that it is possible, with an Electronic Vibrator Power Supply, to convert DC current of almost any voltage to AC current of desired voltage and Sine-Wave form.

This is but one of an infinite number of advances which have been made by Electronic Laboratories through intensive development of the principle and technique of *vibrator type* power supplies, coupled with probably the world's most extensive research on power supply circuits. For instance: capacities up to 1,000 Watts—tremendous savings in weight—new output efficiency—close voltage regulation, to name a few.

Wherever electric current must be changed, in voltage, frequency or type—for war or peace—*E·L* Vibrator Converters will do the job more efficiently—more economically—and last longer. Electronic's engineers will be glad to work with you in meeting your current conversion needs.

Electronic
LABORATORIES, INC.

E·L ELECTRICAL PRODUCTS—Vibrator Power Supplies for Communications . . . Lighting . . . Electric Motor Operation . . . Electric and Electronic Equipment on Land, Sea, or in the air.

INDIANAPOLIS



Only *E·L* VIBRATOR POWER SUPPLIES Offer All These Advantages:

1. CONVERSION—DC to AC; DC to DC; AC to DC; AC to AC.

2. CAPACITIES—Up to 1,000 Watts.

3. VARIABLE FREQUENCIES—A power supply may be designed to furnish any frequency from 20 to 280 cycles, or a controlled variable output within a 5% range of the output frequency.

4. MULTIPLE INPUTS—For example, one *E·L* Power Supply, in quantity production today, operates from 6, 12, 24, 110 volts DC or 110 volts AC, and 220 volts AC, with a single stable output of 6 volts DC.

5. MULTIPLE OUTPUTS—Any number of output voltages may be secured from one power supply to suit individual needs.

6. WAVE FORMS—A vibrator power supply can be designed to provide any wave form needed for the equipment to be operated.

7. FLEXIBLE IN SHAPE, SIZE AND WEIGHT—The component parts of a vibrator power supply lend themselves to a variety of assembly arrangements which makes them most flexible in meeting space and weight limitations.

8. HIGHEST EFFICIENCY—*E·L* Vibrator Power Supplies provide the highest degree of efficiency available in any type power supply.

9. COMPLETELY RELIABLE—Use on aircraft, tanks, PT boats, "Walkie-Talkies," jeeps, peeps and other military equipment, under toughest operating conditions has demonstrated that *E·L* units have what it takes!

10. MINIMUM MAINTENANCE—There are no brushes, armatures or bearings requiring lubrication or replacement because of wear. The entire unit may be sealed against dust or moisture.

PERMANENCE

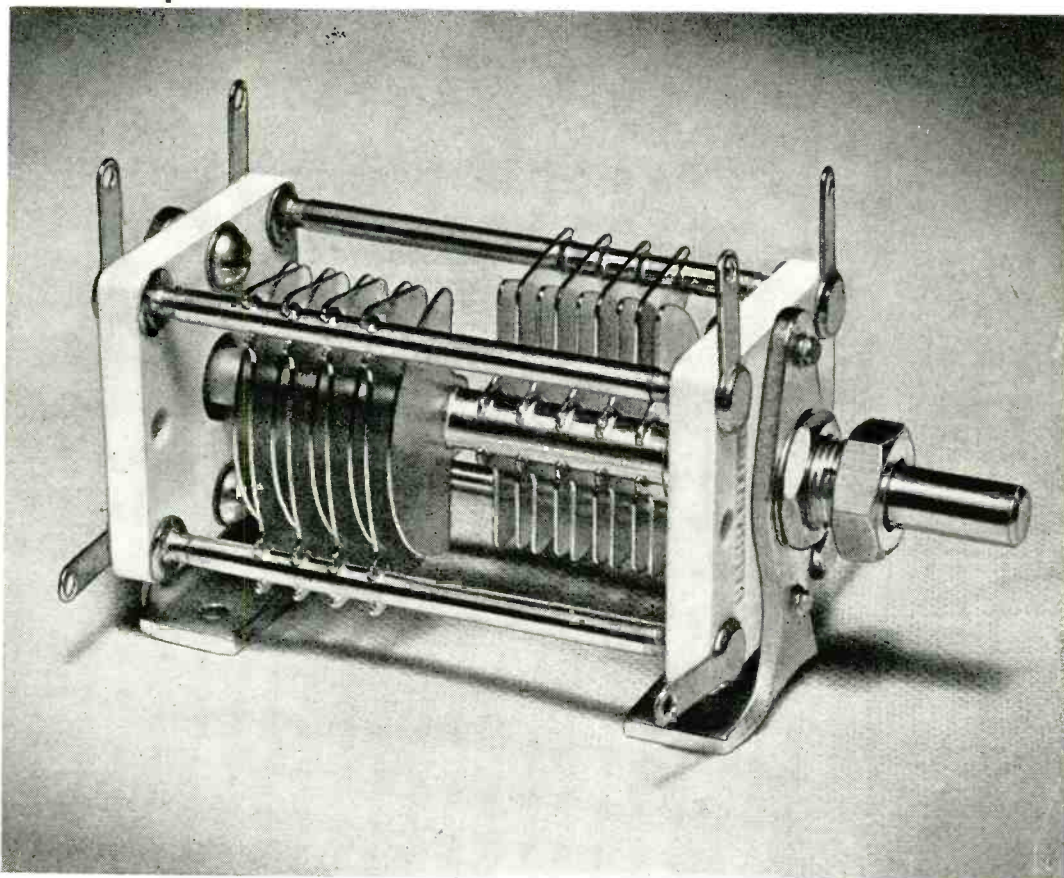

High-stability variable condenser.

MILITARY equipment must perform continuously with a minimum of attention. Permanence of electrical and mechanical characteristics has won a high place for Hammarlund condensers.

THE HAMMARLUND MANUFACTURING CO., INC.
460 West 34th Street, New York, N. Y.



The Acid Test...

WILL IT HELP THE WAR EFFORT
... WILL IT SPEED VICTORY?

● The application of this inflexible test to every management or production action and problem is bearing us fruit in the form of an unprecedented output of special alloys used in their entirety for vital war applications... special alloys that are helping the war effort and speeding VICTORY!



WILBUR B. DRIVER CO.
NEWARK • NEW JERSEY



HT-4B



HERE is that high-powered rig you have always wanted to own . . . one that you can depend upon for peak operating efficiency. Hallicrafters have built into the HT-4B the resultant experience from years of engineering research.

Model HT-4B delivers a carrier output of 325 watts on phone and 450 watts on CW. The preamplifier supplied with the transmitter can be mounted conveniently at the operating position, controlling volume, keying and standby . . . once adjusted to any band the rig may be operated remotely.

When, once again, we are permitted to sell communications equipment for civilian use — your HT-4B will be waiting for you.

hallicrafters

CHICAGO, U. S. A.

World's largest exclusive manufacturer of short wave radio communications equipment.



YOURS FOR THE ASKING . . .

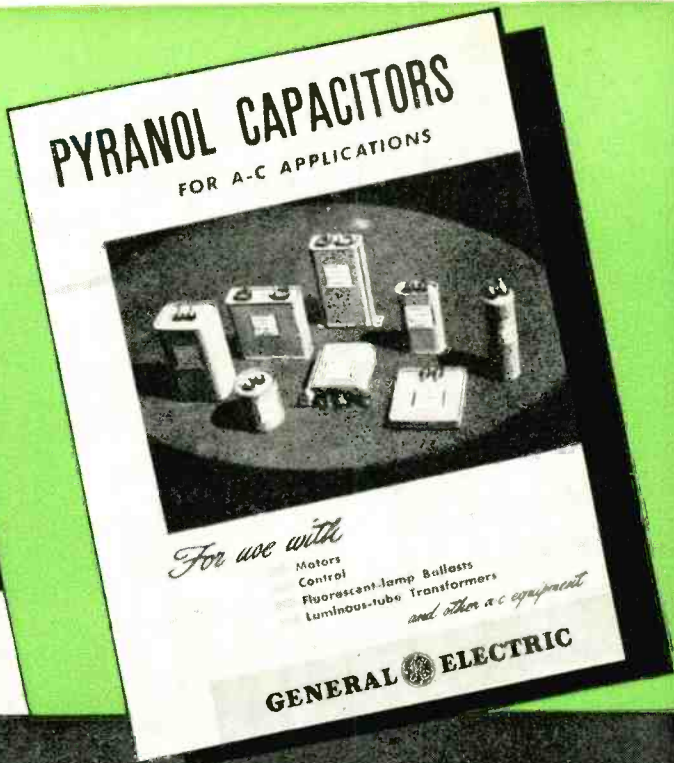
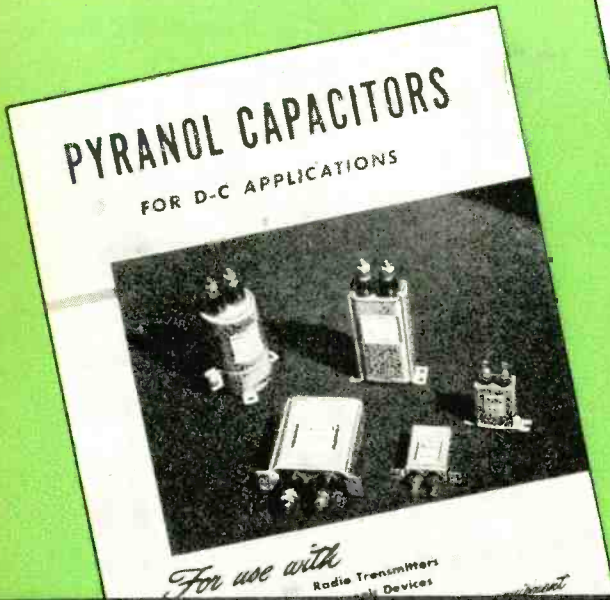

NEW, TIME-SAVING CATALOGS

on Small Pyranol Capacitors
for Built-in Applications

VALUABLE FOR ENGINEERING, DRAFTING,
OR PURCHASING DEPARTMENTS

THESE publications make it easy for you to select Pyranol* capacitors for applications such as electronic devices, communications equipment, control, motors, and transformers.

This technical information is up to the minute, easy to use. Covers all the standard types and sizes generally required—all those that have been found most desirable with respect to ratings and dimensions.

You'll find it's easy to design with G-E capacitors, because: (1) Pyranol, the treating material, makes these units small and compact—often you can reduce the size of your equipment and save critical material; (2) many of the ratings are available in cylindrical, oval, or rectangular cases; and (3) they can be operated in any position.

Get your copies of these comprehensive, time-saving publications.

*Pyranol is the G-E trade name for askarel—a synthetic, noninflammable liquid

- ★ More than 350 standard ratings to choose from
- ★ Easy-to-read, easy-to-use tables and diagrams
- ★ Large photographs of representative types
- ★ Handy thumb index for quick reference

General Electric Company, Section C 407-49
Schenectady, N. Y.

Please send me complete information on small Pyranol capacitors for built-in applications.

For D-c Applications (GEA-2621A)

For A-c Applications (GEA-2027B)

Name

Company

Address

City..... State.....

6708

GENERAL ELECTRIC

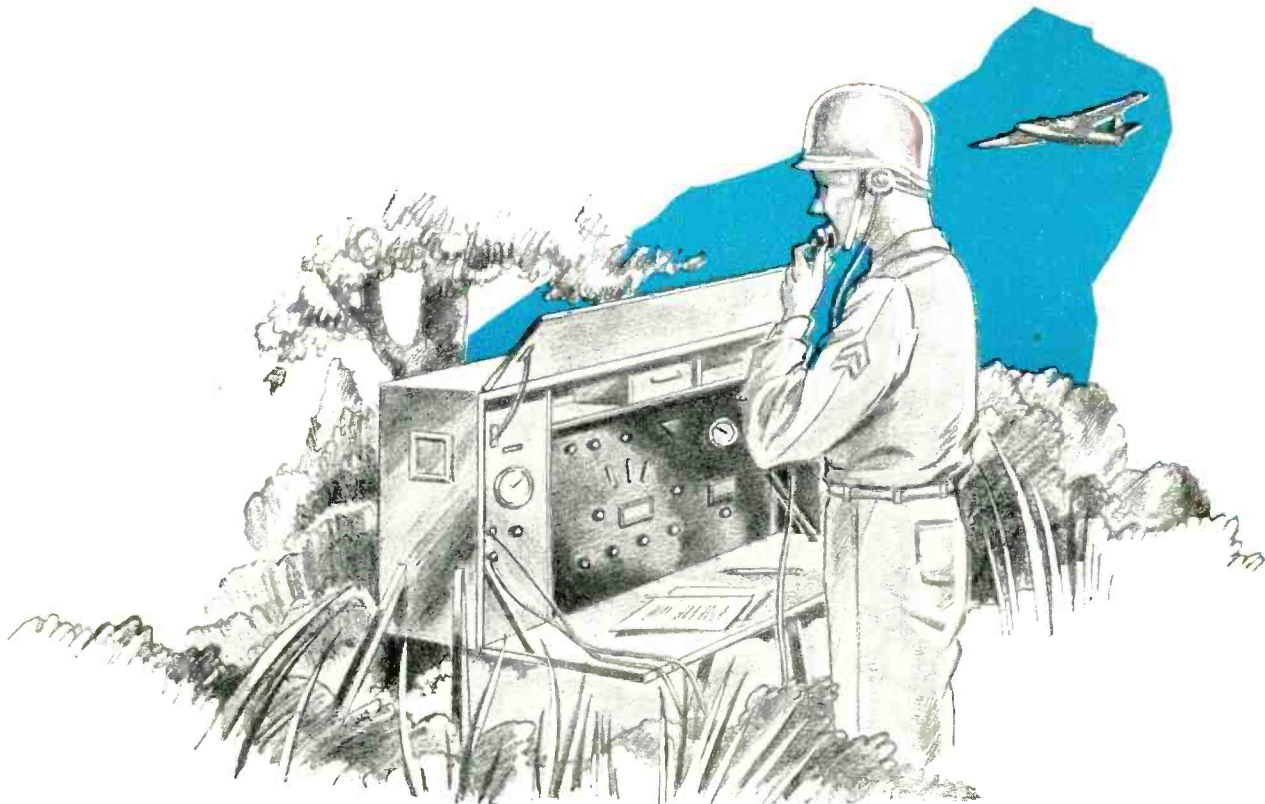

THE **BETTER** INSULATION FOR **BETTER** RADIOS!

THE wartime radios that are now coming through are much better than any similar instruments that have ever been mass-produced. These better devices require better insulation—and wartime developments have enabled Formica to provide it. The new MF grades—glass mat base—are so good that they will do most of the things it was once thought necessary to use ceramics for. Yet they may be machined and worked with ordinary tools providing an adaptability that is impossible in molded forms.

For the television, radar and radio development after the war these new materials—born of new synthetic varnishes and new fibre bases—will be available for the big commercial development which is sure to follow.



THE FORMICA INSULATION COMPANY, 4661 SPRING GROVE AVE., CINCINNATI, OHIO

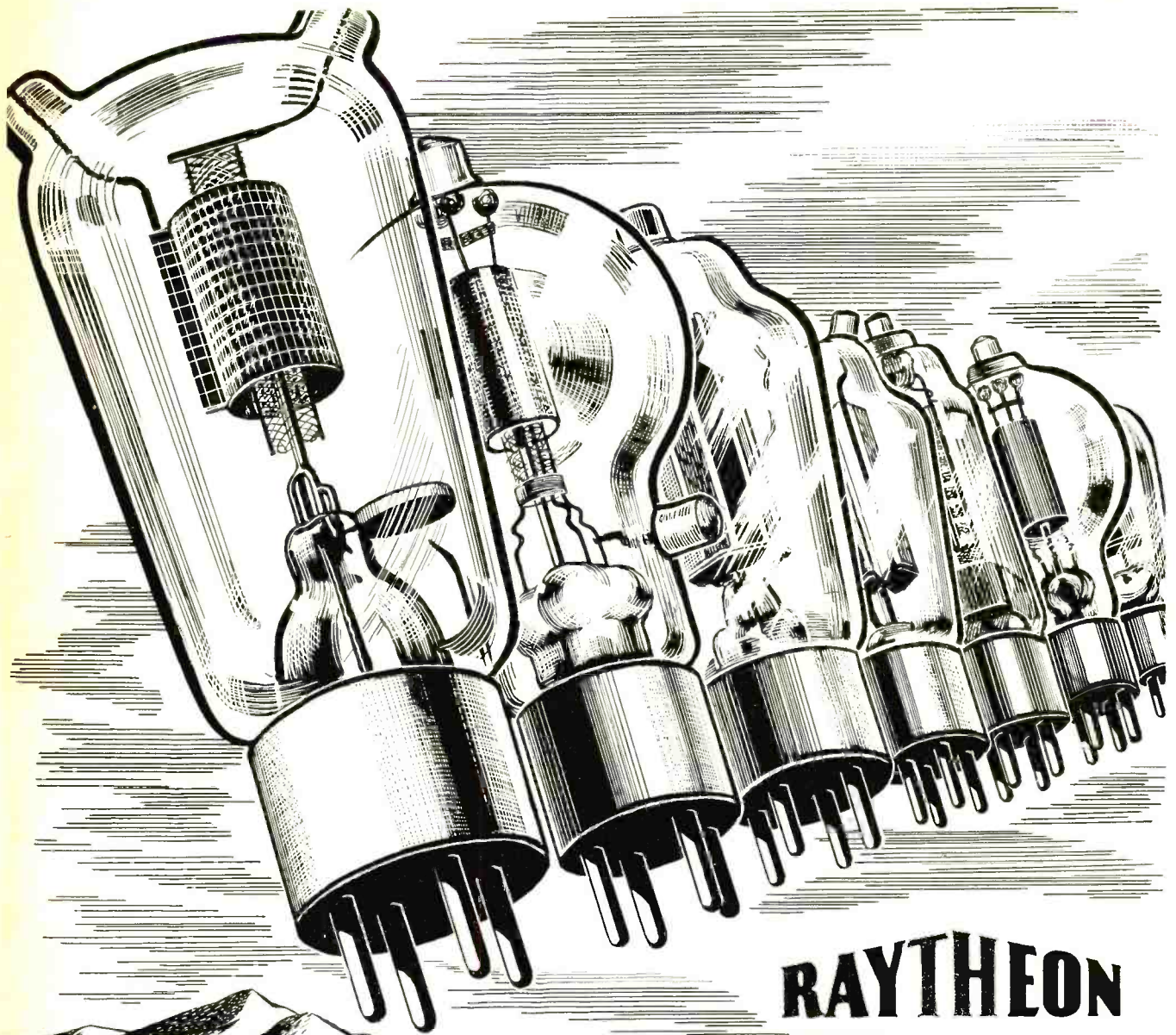

RAYTHEON

M

ILEPOSTS IN THE PROGRESS OF RESEARCH!

RAYTHEON tubes for the peacetime electronic era will incorporate all of the engineering skill gained through scientific accomplishments in wartime.

Your new RAYTHEON tubes will be adaptable to a wide scope of newly developed uses . . . with performance characteristics that have been time-tested through service in stringent military campaigns.

You can look to RAYTHEON leadership when you again purchase tubes . . . no matter what type of function your requirements may be . . . you will find a RAYTHEON tube designed and engineered to faithfully perform its task.

For military reasons tubes illustrated are not a new development.

Raytheon Manufacturing Company

WALTHAM AND NEWTON, MASSACHUSETTS

DEVOTED TO RESEARCH AND THE MANUFACTURE OF TUBES AND EQUIPMENT FOR THE NEW ERA OF ELECTRONICS

THE MARVELOUS LAMP

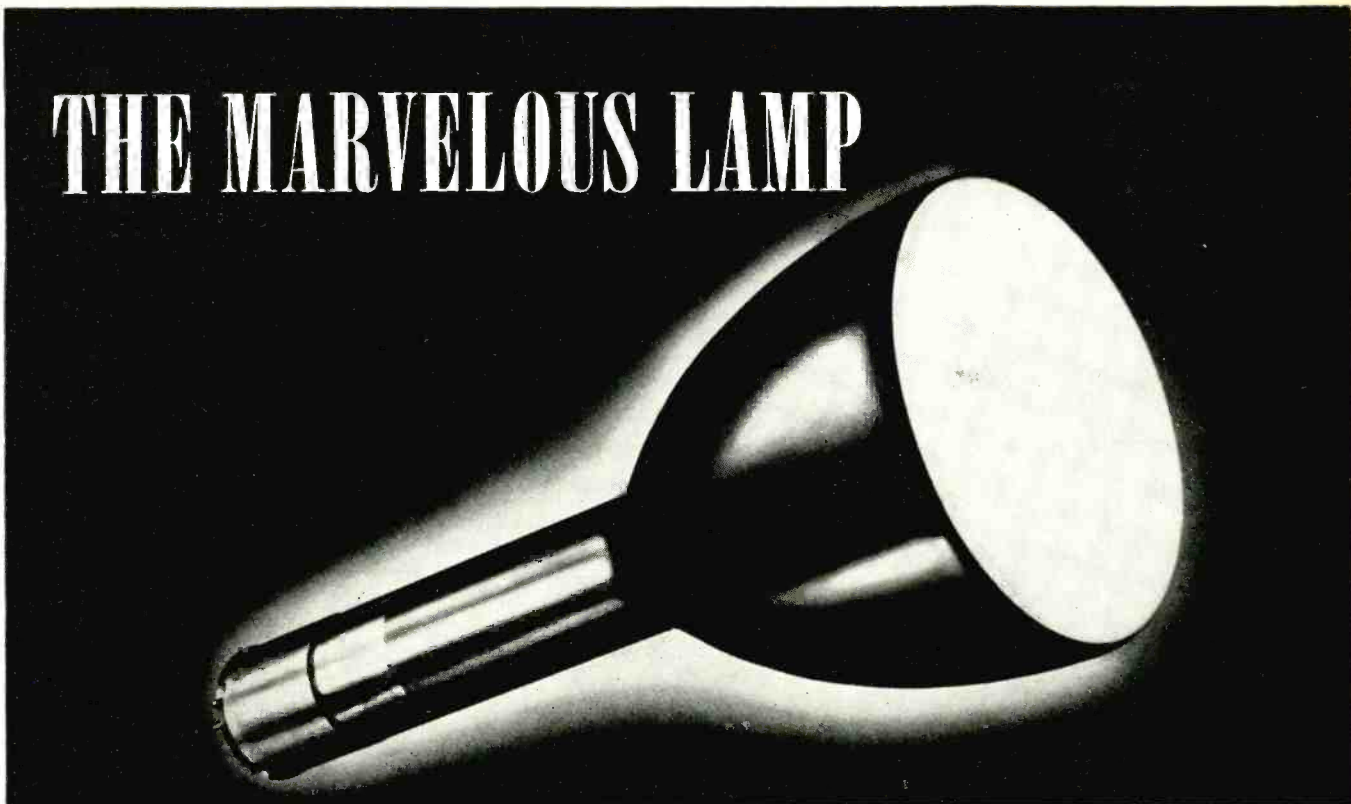

from Genie to Electron

● The fantasy of Aladdin's marvelous genie-commanding lamp—first conceived by the unknown author of "The Arabian Nights' Entertainments"—comes true in the cathode ray tube of today. And there are practical advantages in electrons over genii in modern life and work—in television, for example.

We go back to Aladdin's lamp, because Sylvania has specialized as a maker of

marvelous lamps—and electronic tubes. First it was the incandescent lamp.

Then, in the early days of radio, we put the incandescent "Edison Effect" to work in electronic tubes.

Having attained an electronic reputation in radio research and tube manufacture, Sylvania applied this experience to the making of better artificial light as a fluorescent lamp pioneer.

In our forty years of experience, it has been a far cry from the original incandescent lamp to today's many electronic devices, which have far more possibilities than ever after a year of global war.

Today Sylvania aspires to serve the radio and electronic industries, whose wider destiny is being written in American laboratories, as a supplier of electronic tubes with hundreds of envisioned uses. Ours will be in the role of maker of these marvelous tubes—yours, their application to new products for better life and work in the peace to come.

MAKER OF ELECTRONIC TUBES FOR INDUSTRY



SYLVANIA

ELECTRIC PRODUCTS INC.

Emporium, Pa.

*Incandescent Lamps, Fluorescent
Lamps and Fixtures, Radio Tubes,
Electronic Devices*

April 1943 — ELECTRONICS



Voice of the A. E. F.

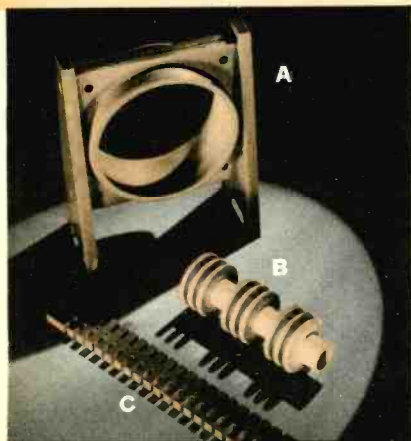

A. Milled, drilled, and turned variometer stator mounting. **B.** Turned high-tension insulator. **C.** Milled and drilled spacing strip.

SECONDS after the U. S. landing in Africa, orders to troops were winging their way by portable radio. There are dozens of applications for Synthane as insulation in radio equipment of this kind. Most important use is to prevent undue loss of minute high-frequency currents.

Long before Synthane entered the armed services it was valued for its many combined properties—resistance to corrosion

from solvents, acids, salts and water . . . structural strength . . . light weight (half that of aluminum) . . . hardness, excellent insulating characteristics, and ease of machining. Some day it will return again to civilian ways, with more uses, it now seems certain, than ever before. Meanwhile, keep posted on Synthane with information such as you will find on the back of this page.

SYNTHANE CORPORATION, OAKS, PENNSYLVANIA

Plan your present and future products with Synthane Technical Plastics

SHEETS • RODS • TUBES • FABRICATED PARTS



SILENT STABILIZED GEAR MATERIAL

Corrosion-Resisting SYNTHANE

SYNTHANE, a laminated phenolic plastic, may be more familiar to you for its physical, mechanical and electrical properties. More recently, through research and development, grades of SYNTHANE have been found of great value as corrosion-resisting materials. Parts made from SYNTHANE have successfully resisted the effects of corrosive waters and atmospheres, chemical salts and solutions, solvents, gasolines, oils, greases, and other petroleum products. The corrosion-resisting possibilities of SYNTHANE for your application may be well worth examining. Only by examination can they be accurately determined.

SYNTHANE is available in sheets, rods, and tubes, fabricated parts, and in parts made by molding the impregnated base materials.

Corrosion-Resistance Factors

The corrosion resistance of any material is usually relative. The degree of corrosion resistance depends generally upon a combination of factors—the nature, concentration, and temperature of the chemical or corrosive agent, time of exposure, degree of agitation, and moisture absorption and chemical reactivity of the material itself.

For example, 10% solutions of either sulphuric acid or potassium dichromate have little effect on SYNTHANE. But if the two are mixed in the presence of organic matter, a vigorous oxidizing action occurs which will destroy any synthetic resin.

Corrosion-Resistance Economics

SYNTHANE is not immune to all corrosion conditions. Nor is any material.

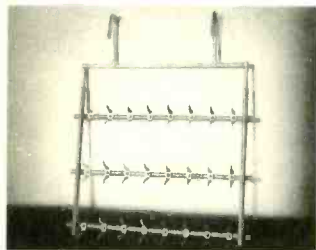

Multiple-type plating rack assembled from SYNTHANE tubing

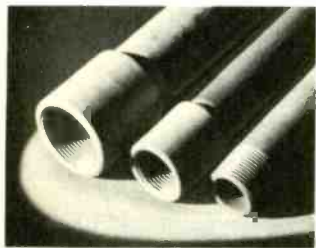

Corrosion-resisting piping and couplings made from SYNTHANE

Yet it need not be 100% corrosion-proof to be economically practical.

In many instances SYNTHANE is used—not because it is completely corrosion-proof—but because it retains its size, shape and strength and has a longer life per dollar invested than other materials, taking into consideration labor and material for the original installation and the cost of replacements.

Base Materials

Selection of the base material must be made with care since in nearly every case it is the base rather than the resin that is first affected.

Cotton cloth base is satisfactory for weak acids, weak bases and low concentrations of salts, or neutral salts in any concentration. Asbestos base is used for strong alkaline conditions or highly concentrated salt solutions which tend to hydrolyze or split into alkaline radicals. Asbestos is not recommended for acids or acid salts even in low concentrations. Glass cloth base is recommended for strong concentrations of acids or acid salts, and is excellent for those conditions. Special corrosion-resisting resins are used for corrosion-resisting SYNTHANE.

When to Use Synthane

We prefer to examine each application individually. If a previous experience does not approximate yours, laboratory and commercial tests will be made to reach a solution profitable and practical in your case.

The Effect of Chemicals

In general, any concentration and temperature up to 180° Fahr. of the salts of the following metals will not affect SYNTHANE except to produce a slight change in its color:

Aluminum	Copper	Mercury
Barium	Iron	Nickel
Bismuth	Lead	Silver
Cadmium	Magnesium	Tin
Cobalt	Manganese	Zinc
Calcium (except hypochlorite)		
Potassium (except hydroxide)		
Sodium (except hydroxide and hypochlorite)		

Synthane Also Resists the Following Solvents:

Aliphatic hydrocarbons	Ketones at room temperature
Aromatic hydrocarbons	Alcohols, esters and ethers

Chlorinated hydrocarbons (except those which have hydrolyzed; for example, carbon tetrachloride in the presence of moisture)

Synthane Will Not Resist:

Chlorine gas, wet or dry
Sodium hypochlorite
Chlorine water
Sodium hydroxide over 2%
Potassium hydroxide over 2%
Calcium hypochlorite
Bromine and bromine water
Pyridine

SYNTHANE will resist the following acids at the concentrations noted at room temperature:

Acetic 50%	Formic conc.
Benzoic conc.	Hydrochloric 10%
Boric conc.	Hydrofluoric 20%
Phenol 10%	Lactic conc.
Chromic 45% (special resin required; intermittent exposure as in plating)	Nitric 2%
	Oleic 5%
	Oxalic conc.
	Phosphoric 10%
	Sulphuric 15%
	Sulphurous 6%
	Citric conc.

Note: The addition of salts such as 20% sodium sulphate to 10% sulphuric acid is known to inhibit the effect of the acid for a long period of time.

A mixture of sodium hydroxide 10% and sodium cyanide 10% also shows this phenomenon. This concentration of sodium hydroxide alone would rapidly attack SYNTHANE.

Standards of Quality Corrosion-Resisting Synthane Sheets

GRADE	C-CR	L-CR	AA-CR	A-CR	GLF
	Coarse Weave Fabric Base	Fine Weave Fabric Base	Asbestos Cloth Base	Asbestos Paper Base	Glass Cloth Base
TENSILE STRENGTH (1) Lbs./Sq. In.	9,500	9,000	10,000	8,000	16,000
TRANSVERSE STRENGTH (1) Lbs./Sq. In.	20,000	20,000	20,000	16,000	20,000
COMPRESSIVE STRENGTH (1) Lbs./Sq. In.	38,000	35,000	38,000	36,000	40,000
DIELECTRIC STRENGTH (2) Volts per mil (.001") Short-Time Test Step-by-Step Test	200	200	50	225	350
	120	120	30	135	250
POWER FACTOR (3) at 1,000,000 Cycles	.10	.10	.15	.10	.026
DIELECTRIC CONSTANT (3) at 1,000,000 Cycles	7.0	7.0	7.5	7.0	5.9
DIELECTRIC LOSS FACTOR (3) at 1,000,000 Cycles	.70	.70	1.12	.70	.10-.25
% WATER ABSORPTION (4)	1.7	1.4	.85	.85	1.2
ROCKWELL HARDNESS	M105	M105	M110	M110	M115

The values above represent average for standard grades.

Methods Used in Testing Synthane

(1) Tests were made on $\frac{1}{8}$ " thickness at room temperature, approximately 25 deg. C., following the American Society for Testing Materials Method D-229-42.

(2) Tests were made under oil on $\frac{1}{8}$ " thickness, according to American Society for Testing Materials Method D-149-40T. (For grade AA-CR, $\frac{1}{8}$ " thickness was used.)

(3) Tests were made on $\frac{1}{16}$ " thick-

ness at a frequency of 1,000,000 cycles, according to American Society for Testing Materials Method D-150-42T.

(4) Tests were made on pieces $3" \times 1" \times \frac{1}{8}"$ thick, according to the American Society for Testing Materials Method D-229-42 after immersion in water for 24 hours at approximately 25 deg. C plus or minus 2 deg. C.

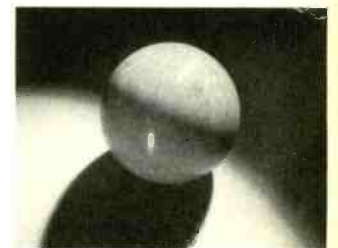

SYNTHANE molded-macerated valve ball for oil well equipment



Washers and molded-macerated gears for rayon machinery

PLAN YOUR PRESENT AND FUTURE PRODUCTS WITH SYNTHANE TECHNICAL PLASTICS

SYNTHANE
Bakelite—laminated

SHEETS—RODS—TUBES—FABRICATED PARTS—SILENT STABILIZED GEAR MATERIAL

SYNTHANE CORPORATION, OAKS, PENNA.

REPRESENTATIVES IN ALL PRINCIPAL CITIES

www.americanradiohistory.com

For cleaning up
the enemy now...



...or cleaning up the
home tomorrow

Coils are one of the tremendous trifles of this war. Many of them, in various designs for all kinds of military purposes, are either manufactured by Anaconda or wound with Anaconda magnet wire. With victory, these important trifles will be eager to fill your urgent peacetime needs.

Make a date with us for the peacetime tomorrow

Perhaps we can talk about a coil problem . . . how thoroughly we're organized to help you on such a problem only military censorship forbids telling now. Or it may be that you manufacture your own coils and will be interested in discussing magnet wire—any shape—any insulation.

As a matter of fact, perhaps we can get together now, but if it happens we can't, remember we have a date in and for the future.

When we both can keep it you can again take advantage of Anaconda service and the benefits derived from the single product control 'from mine to consumer' backed by years of continuous metallurgical experience.

432.10

ANACONDA WIRE & CABLE COMPANY
General Offices: 25 Broadway, New York
Chicago Office: 20 North Wacker Drive
Subsidiary of Anaconda Copper Mining Co.
Sales Offices in Principal Cities

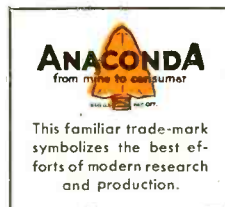

 *Magnet wire and coils*

ANACONDA WIRE & CABLE COMPANY



WOMEN DRIVERS BREAK SPEED RECORDS

... when they drive AMERICAN Phillips Screws

Inspectors hand out no rejection slips on work assembled with American Phillips Screws. These are the screw fastenings that drive straight, keep their heads, and keep the driver from skidding out to spoil work and slash hands. The firm fit between screw and bit permits the use of electric and pneumatic drivers, yet only one hand is needed to drive, so the other can brace the work. Screw sets up uniformly tighter, holds better. Head is unmarred, plumb-level on work surface. This unmatched speed and ease of driving keeps production at maximum levels to the end of the shift . . . enables women to do better work, *and far more of it*, than men could do with slotted-head screws.

American's engineering service, production control, and piece-inspection is so effectively co-ordinated that today scores of plants in every war industry are using millions of standard and special American Phillips Screws.

AMERICAN SCREW COMPANY

PROVIDENCE, RHODE ISLAND

Chicago: 589 E. Illinois Street

Detroit: 5-267 General Motors Bldg.

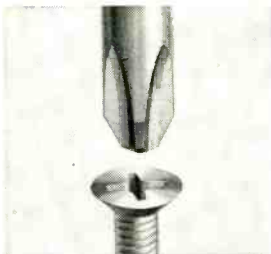

The American Phillips Recess Was Scientifically Engineered . . . The Modern Key To Highest Fastening Speed And Greatest Economy in War-Production Assemblies.

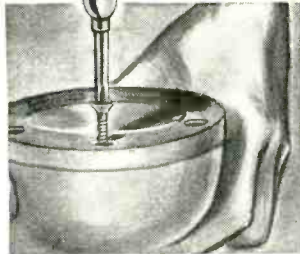

Fast Starting—Driver point automatically centers in the recess . . . fits snugly. Screw and driver "become one unit." Fumbling, wobbly starts are eliminated.

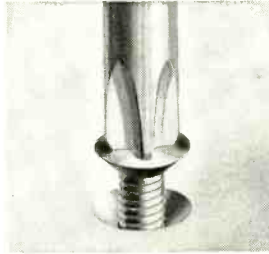

Faster Driving—Spiral and power driving are made practical. Driver won't slip out of recess to injure workers or spoil material. (Average time saving is 50%.)

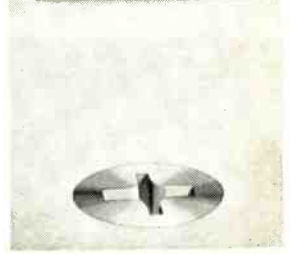

Better Fastenings—Screws are set up uniformly tight, without burring or breaking heads. A stronger, neater job results and there are no gouges on work surface.

On Time!

QUICKER DELIVERY FOR STEATITE INSULATORS



Not so long ago, an order for Steatite Insulators brought a sympathetic shrug of the shoulders and a "Sorry, five to six months delivery." We did not like to tell our customers that. We did not like it because we knew how badly Steatite was needed for the war effort.

This is what we did to quicken deliveries of Steatite Insulators.

- Expanded our plant facilities.
- Enlarged our staff of engineers and technicians.
- Devised improved methods of production.

As a result, there rolls from our kilns every month increasing quantities of insulators. Gradually, but surely the backlog of orders was reduced. Now we can promise our customers deliveries on standard parts from stock in a reasonably short time.

If you have any insulator problem—whether specialized or standard—we would like a shot at it. You can rest assured that your requirements will receive prompt, individual attention.

Above . . . stock insulators such as these are now available in quantity for prompt delivery. Write for data concerning the many different types of Steatite Insulators.

Left . . . these coil forms and insulators were designed and pressed for special applications where stock insulators would not serve. They are working examples of the engineering skill available for your special insulator problem.



General Ceramics

AND STEATITE CORP.
KEASBEY NEW JERSEY





DISTINCTIVE

as a

fingerprint

Wherever terminals and connectors are being attached to small wires, Burndy HYLINE connections, applied with Burndy HYTOOLS, are setting new production records and *slashing costs*. HYTOOLS are specially designed for the application of HYLINE connections . . . and include simple hand tools for rapid, sound application, up to pneumatic and hydraulic presses for *high production* requirements. All tools indent the lug with the distinctive and uniform Burndy indent . . . your assurance of a secure, highly efficient electrical connection. For full facts on lowering connection costs the Burndy way, write connector headquarters today.

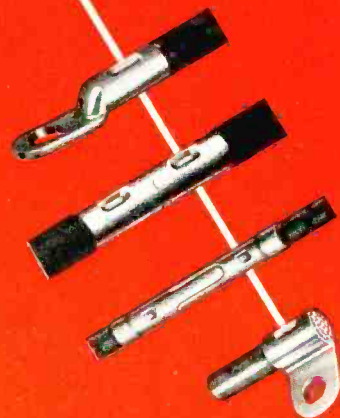

Headquarters for connectors

BURNDY

BURNDY ENGINEERING CO., INC. • 107 EASTERN BOULEVARD, NEW YORK CITY

Some Evening, Spring This on Yourself

*L*IKE brain-twisters? Some evening, then, when you're in the mood, take a crack at this one: Imagine a square plane supported at the corners by equal springs. Place your finger at any point on the board and press downward. For the sake of argument, assume you push with a force of ten pounds, that the springs are centered, a foot apart and the spot you have pressed upon is 3" one way and 2" the other way from the center. Can you figure the proportion

of the load shared by each spring? The practical equivalent of the problem is found, for example, in the design of springs for applications requiring vibration or shock isolation. The answer looks deceptively easy, but it will challenge you, may even plague you. From a spring maker's viewpoint it is a problem of springs working in combination, a worthy example of our experienced knowledge that there is only ONE right spring for your job. We can produce it for you.

WHAT DO YOU NEED? . . . A spring manufacturer with adequate capacity to do your job now? Help in designing springs as well as manufacture? If it's essential for the war, get in touch with us.

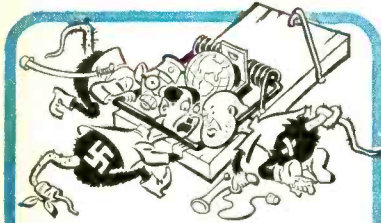

ACH, SCHPRINGTIME!

We don't make the type of spring required above, but we do design and make many another needed for war equipment to catch the Japanazis. Many important curves, charts, and formulas for developing essential springs are contained in our booklet, "Science in Springs." If you do not already have a copy, please write for one on your business letterhead.

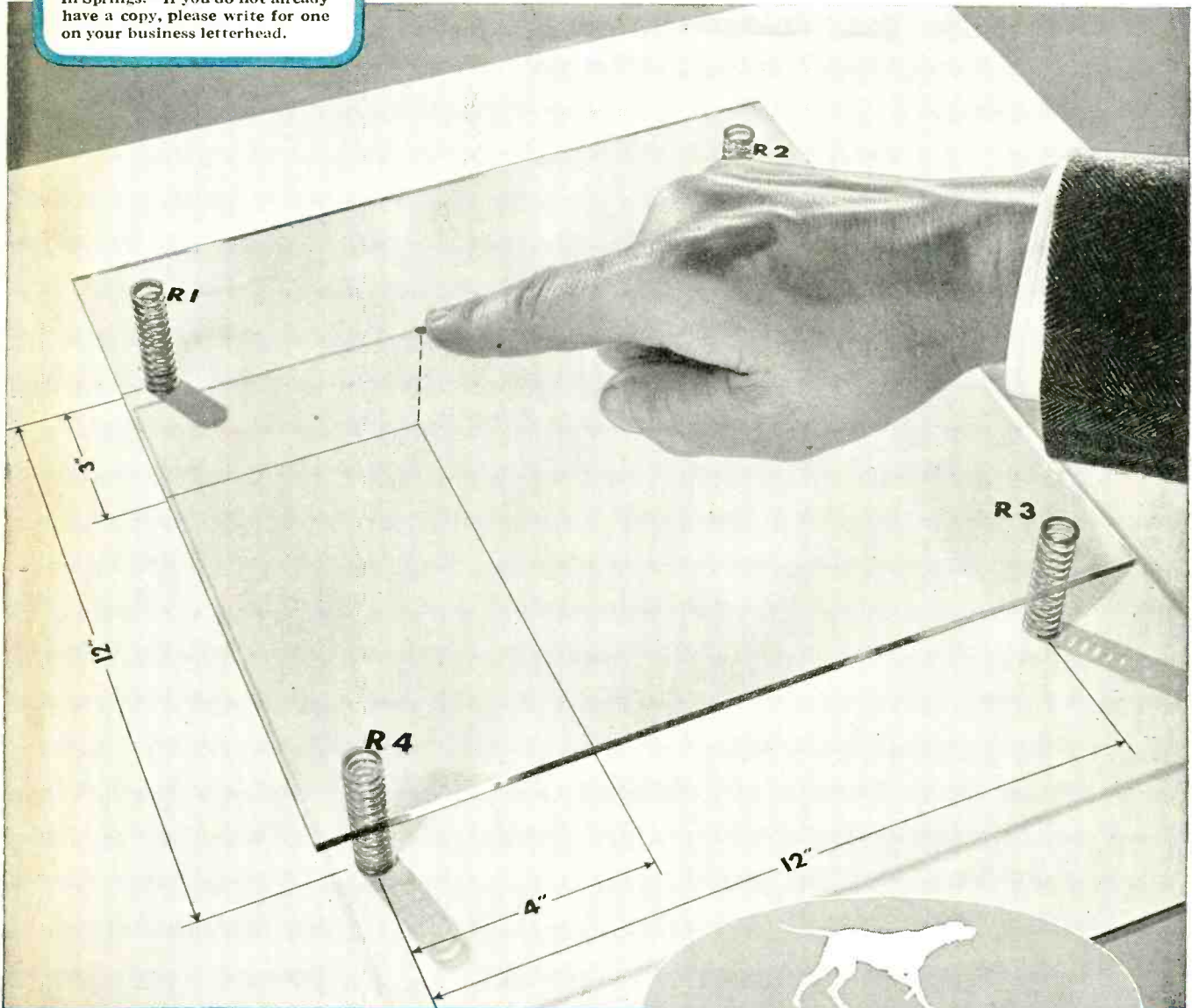

HUNTER
Science in Springs

HUNTER PRESSED STEEL COMPANY, LANSDALE, PENNA.



“Cruiser and transport ahead . . . **LET’S TAKE ’EM!**”

Messages like these “must go through,” and to make certain they do, the communication systems in our Army and Navy aircraft are as sensitive, as rugged, and as trouble-defying as advanced design and precision manufacturing methods can make them.

Producing transformers, headsets and other communications equipment for the Army and Navy Air Forces is ROLA’s present responsibility to the war program. To keep abreast . . . and ahead . . . of demands, new machines have been designed, new methods devised, new tests and inspections applied. Facilities have been

expanded, and production vastly increased.

All this is important to peacetime users of ROLA equipment, for it is only logical to believe that the research and the skill and the equipment inspired by wartime necessity will find important application in the Electronic World of Tomorrow.

The “know how,” gained through twenty years of leadership in the radio field, has enabled ROLA to meet . . . and exceed . . . every war demand made upon it, both as prime and as sub-contractor. We have facilities available for additional contracts. If you are interested, we suggest you write us . . . or ask our representative to call. THE ROLA COMPANY, Inc., 2530 Superior Avenue, Cleveland, Ohio.

★ ROLA ★

MAKERS OF THE FINEST IN SOUND REPRODUCING AND ELECTRONIC EQUIPMENT

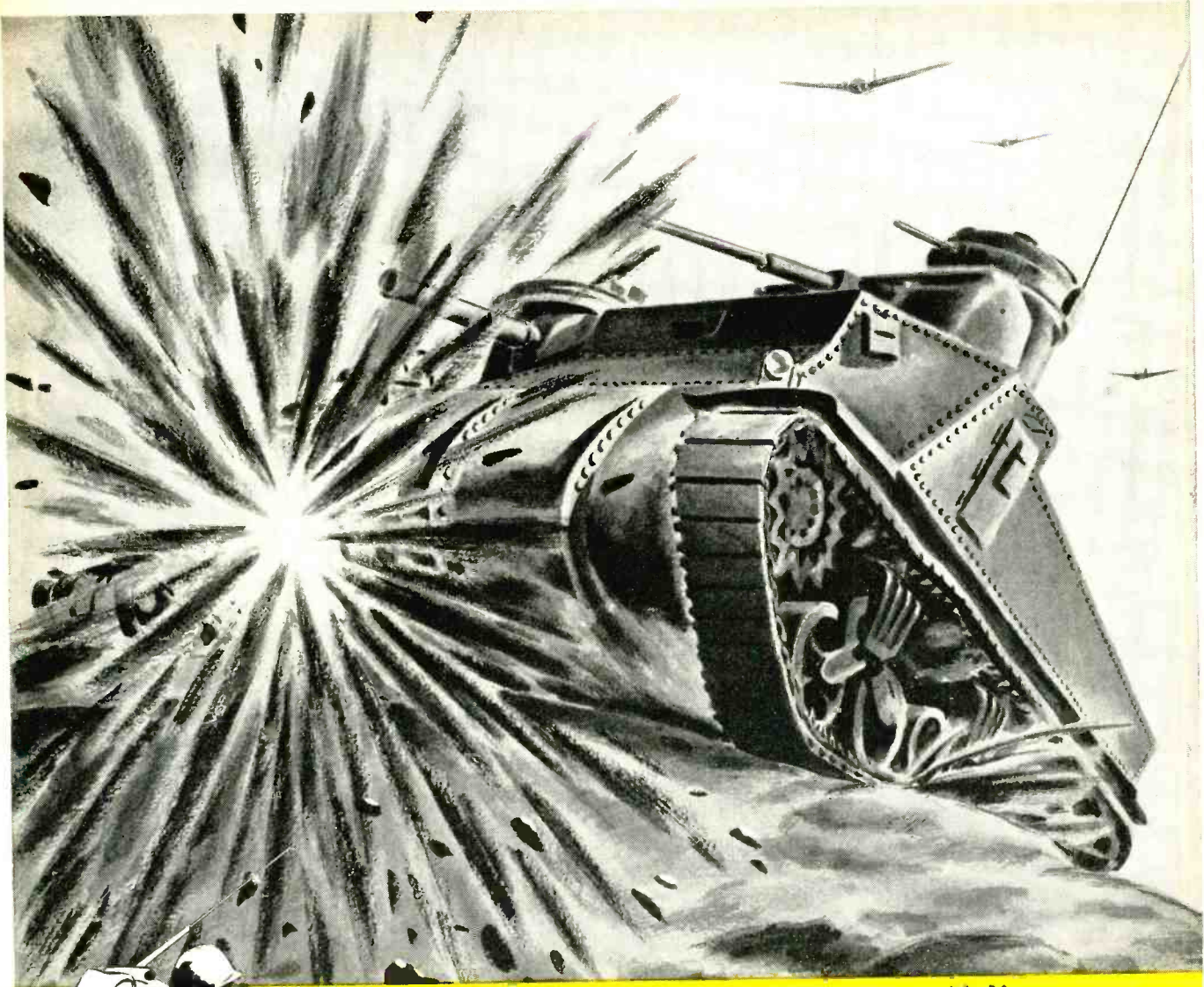

“that darned walkie-talkie S-S-STUTTERED”

Stutterers don't give commands in the Signal Corps. In the stress of battle you can't have a man who stammers. Neither can you have equipment that will fail at the critical moment. Not when seconds mean the difference between success or failure in battle.

With men's lives at stake, you can't afford to use anything less than the best. When a design calls for Capacitors, specify C-Ds. Thirty-three years devoted to the exclusive manufacture of capacitors is your assurance of absolute reliability. Our Engineering department will be glad to cooperate with you. Cornell-Dubilier Electric Corporation, South Plainfield, New Jersey.



**DYKANOL FILTER CAPACITORS
Type TQ**

The Type TQ Dykanol Filter Capacitors have been designed for low power transmitters, high power public address systems and portable power amplifiers. Several of the more important features are listed below:

Impregnated and filled with Dykanol—a non-inflammable, high dielectric impregnant of stable characteristics.

Dried, impregnated and filled under continuous vacuum.

Hermetically sealed—these Capacitors are not affected by moisture, time or temperature up to approximately 200° F.

Conservatively rated—can be safely operated continuously at 10% above rated voltage.

For further details write for Catalog No. 160T.

Cornell-Dubilier capacitors



MICA • DYKANOL • PAPER • WET AND DRY ELECTROLYTICS

**MORE IN USE TODAY
THAN ANY OTHER MAKE.**



IMPACT STRENGTH



FLEXURAL STRENGTH

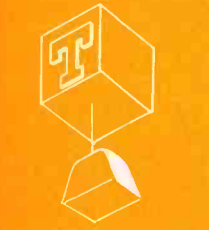

TENSILE STRENGTH



DIMENSIONAL STABILITY

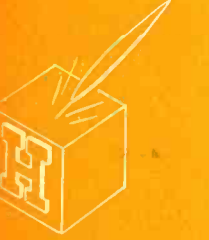

HARDNESS



ABRASION RESISTANCE



PHYSICAL PROPERTIES OF "BAKELITE" PLASTICS

that mean Fighting Strength

THE SEVERE SERVICE under which equipment must operate today puts heavy demands on plastic materials. In many instances, plastic parts must possess not only high tensile strength, but impact resistance and hardness as well. Other parts may require high flexural strength combined with dimensional stability and wear and abrasion resistance. Thus the designer and engineer, in selecting plastics, must constantly keep in mind the correct balance of *all* these physical properties.

The problem may be the selection of a BAKELITE Plastic material possessing high impact resistance, with tensile or flexural strength requirements running a very close second. On the basis of impact resistance alone, it might seem advisable to choose a high-impact BAKELITE Phenolic Molding Material. But such a material might not meet tensile strength requirements! On the other hand, a general-purpose BAKELITE Phenolic that possesses the required tensile strength can have as little as 1/18 the shock resistance of the high-impact material! In such a case, final choice of material may lie between the two extremes.

The design of the part has a lot to do with its ultimate strength characteristics. Frequently, BAKELITE Molding Boards and Blanks are used in conjunction with general-purpose phenolic plastics to provide reinforcement around inserts, and at corners, shoulders, and other points that are

subjected to severe service. Mechanical strength may also be improved by increasing wall thickness, or by making adjustments in fabricating techniques.

Apart from these physical properties, mechanical strength can also be interpreted in terms of *toughness*, particularly with flexible plastics that are not usually tested for impact resistance. *Mechanical fatigue* may also become a major problem where plastics are placed under load, or are subjected to repeated blows, or to continued flexing.

On the facing page are presented the outstanding physical properties of those BAKELITE Plastics of primary importance to war production. Later messages will deal with the chemical, electrical, and thermal properties. For more detailed information write for a copy of Booklet 7—"A Simplified Guide to BAKELITE Plastics."

BAKELITE CORPORATION, 30 E. 42nd St., New York
Unit of Union Carbide and Carbon Corporation



BAKELITE

The word "bakelite" and the  symbol are registered trade-marks of Bakelite Corporation

PLASTICS HEADQUARTERS

Physical Properties of "Bakelite" MOLDING MATERIALS

Thermosetting General-Purpose Phenolics

These materials provide well-balanced combinations of dimensional stability and other physical properties suitable for everyday requirements. *Impact strength*: 0.26 to 0.40 foot-pounds per inch of notch (Izod). *Tensile strength*: 6,500 to 8,500 pounds per square inch. *Flexural strength*: 8,800 to 13,000 pounds per square inch.

Thermosetting Shock-Resistant Phenolics

Four types, offering a wide range of physical properties. All types are dimensionally stable, and resistant to wear and abrasion. Depending upon type, *impact strength*: from 0.46 to 5.4 foot-pounds per inch of notch (Izod); *tensile strength*: from 5,300 to 8,500 pounds per square inch; *flexural strength*: from 6,300 to 11,000 pounds per square inch.

Thermosetting Phenolic Molding Boards and Blanks

These are medium-high, impact materials that may be used in molds built for general-purpose phenolics. Can be used alone, or with other

plastics to provide reinforcement at vital points. Supplied as board stock or as blanks approximating shape of finished part. Also sold in diced form suitable for automatic preforming. Depending upon type, *impact strength*: from 1.6 to 2.0 (with grain) and 0.6 to 0.9 (against grain) foot-pounds per inch of notch (Izod); *tensile strength*: from 3,000 to 11,000 pounds per square inch; *flexural strength*: from 8,400 to 25,000 pounds per square inch.

Special Phenolics

This group comprises a variety of dimensionally stable, thermosetting materials, for special requirements of heat resistance, low power factor, chemical and water resistance, low friction coefficient, opacity to X-rays, and transparency.

Thermosetting Ureas

Most color stable and hardest of all thermosetting plastics. *Impact strength*: from 0.30 to 0.36 foot-pounds per inch of notch (Izod); *tensile strength*: from 9,500 to 12,000 pounds per square inch; *flexural strength*: from 10,000 to 14,000 pounds per square inch.

Physical Properties of Laminated Plastics made with "Bakelite" LAMINATING VARNISHES

BAKELITE Laminating Varnishes are used in the production of paper-base and fabric-base laminated sheets, tubes, and rods. Laminated plastics made from these varnishes possess excellent dimensional stability, high impact, tensile, and flexural strength, and are extremely resistant to wear and abrasion. In addition, they offer an unusual combination of other properties such as high dielectric strength, resistance to corrosion, and immunity to water, brine, oil, ordinary solvents, most acids, and weak alkalis.

Physical Values

Tensile strength of standard paper-base grades ranges from 7,000 to 12,500 pounds per square inch; flexural strength (transverse), from 15,000

to 21,000 pounds per square inch; and compressive strength, from 22,000 to 36,000 pounds per square inch. For standard fabric-base grades, tensile strength ranges from 8,000 to 10,000 pounds per square inch; flexural strength (transverse), from 17,000 to 20,000 pounds per square inch; and compressive strength, from 35,000 to 38,000 pounds per square inch.

Sheets, Rods, Tubes, Special Shapes

Laminated sheet stock and gear stock is supplied by laminators and fabricators in various thicknesses and sizes. Tubing can be obtained in lengths from 36 inches, with I.D. from 3/16 of an inch to 72 inches. Larger tubing can be made for special requirements. Rods come in standard

Thermoplastic Cellulose Acetates

Two types—Class I, general purpose, for compression and injection molding, and Class II, heat- and water-resistant, for injection molding only. Both types noted for high impact strength, toughness, and wide color range. *Impact strength*: from 1.4 to 4.0 foot-pounds per inch of notch (Izod); *tensile strength*: from 2,500 to 9,500 pounds per square inch; *flexural strength*: from 5,000 to 15,000 pounds per square inch.

Thermoplastic Polystyrenes

Outstanding in dimensional stability, chemical resistance, and dielectric qualities. For compression as well as injection molding. Supplied as crystal-clear material, and in transparent and translucent colors. *Impact strength*: from 0.40 to 0.70 (compression-molded), 0.8 to 1.2 (injection-molded) foot-pounds per inch of notch (Izod); *tensile strength*: 5,500 to 6,500 (compression), 6,500 to 7,000 (injection) pounds per square inch; *flexural strength*: 6,500 to 7,500 (compression), 14,000 to 19,000 (injection) pounds per square inch.

lengths up to 48 inches, and in diameters from 1/8 of an inch to 4 inches. Special shapes are made to order.

Special Types

In addition, special laminated plastics have been developed for specific mechanical requirements. Molded-laminated plastics permit the manufacture of such unusually tough and wear-resistant products as heavy-duty bearings. Rubber-laminated plastics combine the rigidity and mechanical strength of laminated plastics with the vibration-absorbing qualities of the rubber interlayer. Tough, densified-laminated woods also are made possible by impregnating wood veneers with a laminating varnish and subsequently applying heat and pressure.

Physical Properties of "Bakelite" BONDING MATERIALS

Phenolic and Urea Resin Wood Glues

For bonding plywood and other wood products. Glue line is dimensionally stable under extreme conditions of heat, cold, moisture, and impact shocks. Bonded woods are resistant to mould growth.

Resin Cements for Lamp Basing

Because of their dimensional stability when subjected to heat, BAKELITE Resin Cements are used widely to set electric light bulbs and radio tubes in their metal or plastic bases. Mechanical shock or vibration does not impair the bond.

Resin Cements for Bristle Setting

A tough, tenacious bond for bristles used in brushes of all types is provided with BAKELITE Resin Cements. The bond obtained is unaffected by constant use, or by frequent cleaning in water or solvents.

Bonding Resins for Glass and Mineral Wool

To form glass, rock, and mineral wool into easily handled, dimensionally stable insulation batts, the fibers are bonded together with BAKELITE Resins. Heat, cold, and moisture do not affect bonding strength.

Bonding Resins for Abrasive Products

Abrasive grit used to form high-speed grinding and cut-off wheels is securely bonded with BAKELITE Resins. This tough, strong bond has made it possible to operate grinding wheels safely, at speeds considerably higher than with other bonds.

Resins for Brake Linings

Both woven and molded brake linings are processed with BAKELITE Resin for greater toughness, dimensional stability, and resistance to wear and heat.

Physical Properties of SURFACE COATINGS made with "Bakelite" Resins

BAKELITE Synthetic Resins, when formulated into protective coatings, provide such properties as durability, faster drying speed, toughness, hardness or flexibility, resistance to wear and abrasion, and resistance to water and chemicals.

Phenolic Resins

For fortifying paints, primers, varnishes, and enamels of all types. Outstanding are the para-phenyl-phenol type of resins BR-17000 and BR-254, which have established new standards of durability for government and industrial specification coatings. Numerous other BAKELITE Phenolic Resins are serving widely diversified coating requirements. Certain types are used to fortify non-phenolic coatings to improve performance.

Dispersion Resins

These resins provide coatings with an unusual combination of properties—extremely fast drying time and maximum resistance to moisture. Such coatings dry as fast as *one minute*, entirely by solvent evaporation, without need of baking treatment. Because they are non-oxidizing, they do not become brittle after long years of service. They are especially useful as primers for ferrous and non-ferrous metals, particularly aluminum and magnesium alloys.

Baking Resins

For hard, abrasion-resistant coatings for lining cans, drums, and tanks. Baked on immediately after application, they provide high resistance

to heat, chemicals, and moisture. Equipment need not be dismantled nor shipped out of the plant; the coatings can be applied, *right on the job*, by means of special, portable baking apparatus.

C-9 Resins

For coatings on cloth, paper, concrete, plaster, brick, plastics, wood, and metal, these versatile resins contribute many unusual physical properties. They are noted for their adhesion and long retention of flexibility. In wet scrub tests, water-emulsion paints made with them far exceed durability required in government specifications. Baking enamels based on them do not blister or flake even when immediately plunged into cold water after long baking.

Calendering Resins for Cloth

Cloth calendered with BAKELITE Resins gains added toughness with little or no sacrifice in flexibility. The resins impart a high order of resistance to water, chemicals, and heat.

Resins for Wood Densifying and Stabilizing

The many important advantages of wood are supplemented by high mechanical strength and excellent resistance properties when impregnated with BAKELITE Resins. In particular, the moisture content of wood veneers can be stabilized by such treatment. Impregnated ve-

neers can be compressed into densified wood, known as "compreg," with specific gravity up to 1.37. On parallel-grained specimens, modulus of rupture can reach 38,000 pounds per square inch (with grain), and compressive strength 25,000 pounds per square inch (with grain). "Compreg" is fire retardant, has excellent aging properties, and is resistant to sulphuric and hydrochloric acid solutions.

Sealing Solutions for Castings

Castings ordinarily rejected for porosity and small blowholes are reclaimed by forcing

BAKELITE Sealing Solutions into the pores under pressure, and then baking. The sealing solution thus becomes exceedingly hard and tough, unaffected by hot or cold water, steam, oils, chemicals, or heat up to 400 deg. F.

Impregnating Varnishes for Windings

As protective coatings and insulating bonds for coils, armatures, and windings, BAKELITE Varnishes remain stable and hard despite elevated operating temperatures and high rotational speeds. Better mechanical strength is also obtained.

For the
Shapes of
Things to
Come -



You'll want this
Information

That answer to "what material?" will be as important to post-war products as it is today. For both immediate and long-range planning avail yourself now of the latest informative data on C-D's wide range of NON-metallics . . . Dilecto laminated and Celoron molded phenolic plastics, Diamond Vulcanized Fibre, Micabond, Vulcoid and Dilectene. Bulletin GF may contain the one and only answer to "What Material?" . . . Write for it today.

Continental = Diamond FIBRE COMPANY

Established 1895 . . . Manufacturers of Laminated Plastics since 1911 — NEWARK • DELAWARE

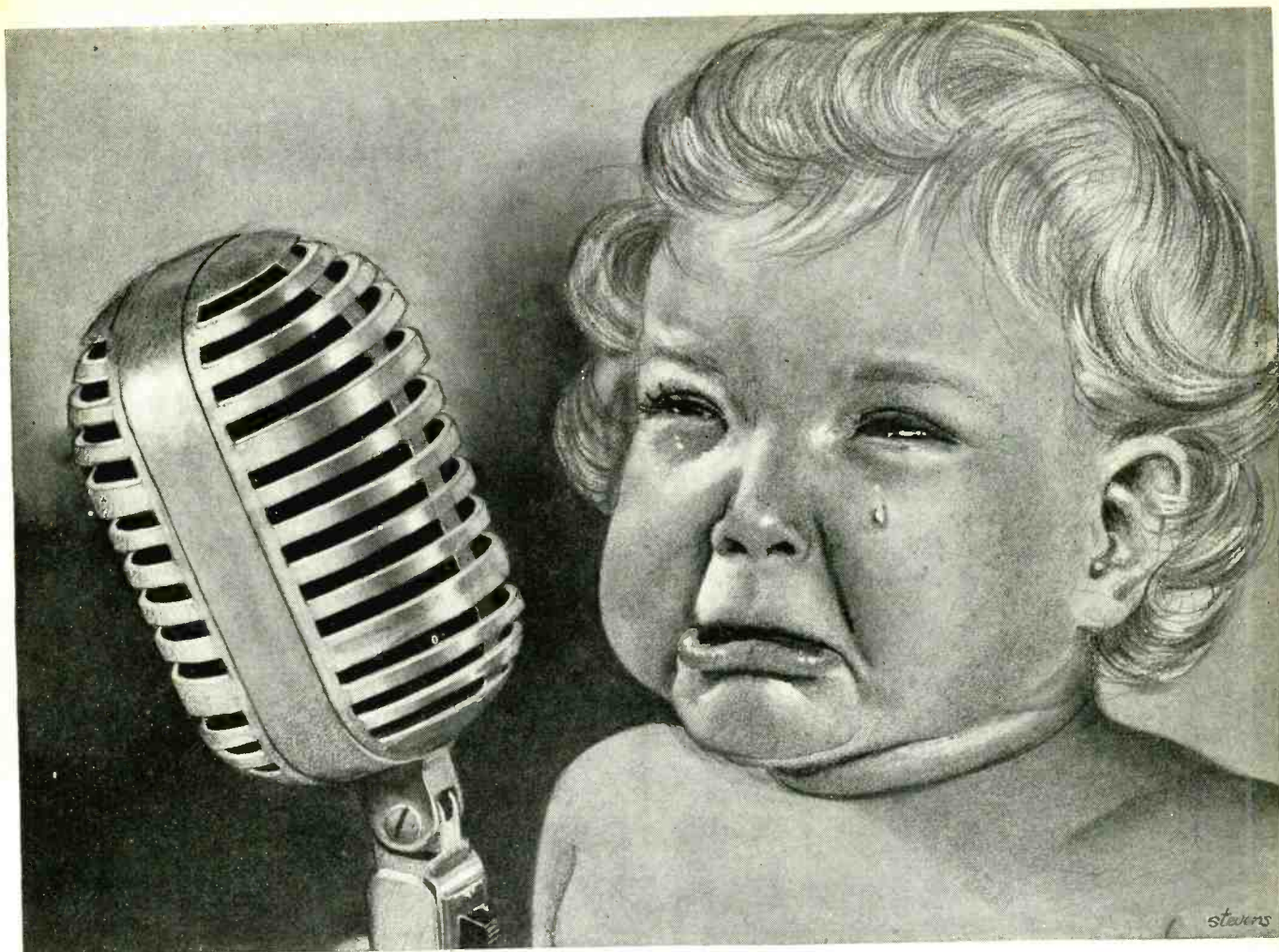

Neither were planned for war

We're not raising new generations to die on battlefields; we're not designing implements for future wars. We Americans are a peace and freedom-loving lot, with an economy that is geared to the home . . . washing machines, automobiles, radio . . .

But we first must finish an unpleasant job of blasting the daylights out of those who deliberately attacked our way of life. For that purpose, we've given our men. And our men are getting the very best tools for that piece of grim business.

We thank heaven that change, progress and mass production are an integral part of a system that enabled us to redesign our products for military applications. True, our new designs were speeded by war necessity—but we like to think of these latest Electro-Voice microphones as no different from the others in our evolutionary scale.

For, as eagerly as any soldier on a fighting front, we retain a vision of returning again to our natural mode of living. We plan to build better microphones for civilian communication . . . for music . . . for laughter . . .



Electro-Voice MICROPHONES

ELECTRO-VOICE MANUFACTURING CO., INC.

1239 SOUTH BEND AVENUE, SOUTH BEND, INDIANA

ELECTRONICS — April 1943

29



Hytron

DEDICATES *the* **PRESENT**

to **PRESERVATION** *of the* **FUTURE**

HYTRON'S SOLE PURPOSE for the duration is to maintain an always-increasing flow of tubes into the radio and electronic equipment which is playing a vital part in winning this Radio War. It is our firm conviction that the torch of Liberty which Hytron is helping to keep burning will light the way to the unconditional surrender of our enemies and to an electronic age which will amaze a freed world.



HYTRON CORP., Salem and Newburyport, Mass.

... Manufacturers of Radio Tubes Since 1921 ...



Dunco Quality

INDUSTRIAL CONTROL RELAYS

Although Struthers Dunn, Inc. makes many more complicated, and therefore more "spectacular," relay types, there are none in which Dunco design and manufacturing care have proved more effective than in these Industrial Control and Power Transfer types commonly used for controlling motors, heats, lights, and for other industrial tasks.

Their success over a long period of time has been largely a matter of refinement of every detail having a bearing on performance and dependability—and top-

ping this off with individual adjustment plus two separate inspections before shipment.

Dunco Industrial Control and Transfer Relays are made in many types and with mounting styles for almost any application.

WRITE for your copy of the Dunco Relay-Timer Catalog and Data Book. Contains details on the largest line of high-quality Relays and Timers, as well as helpful engineering information.

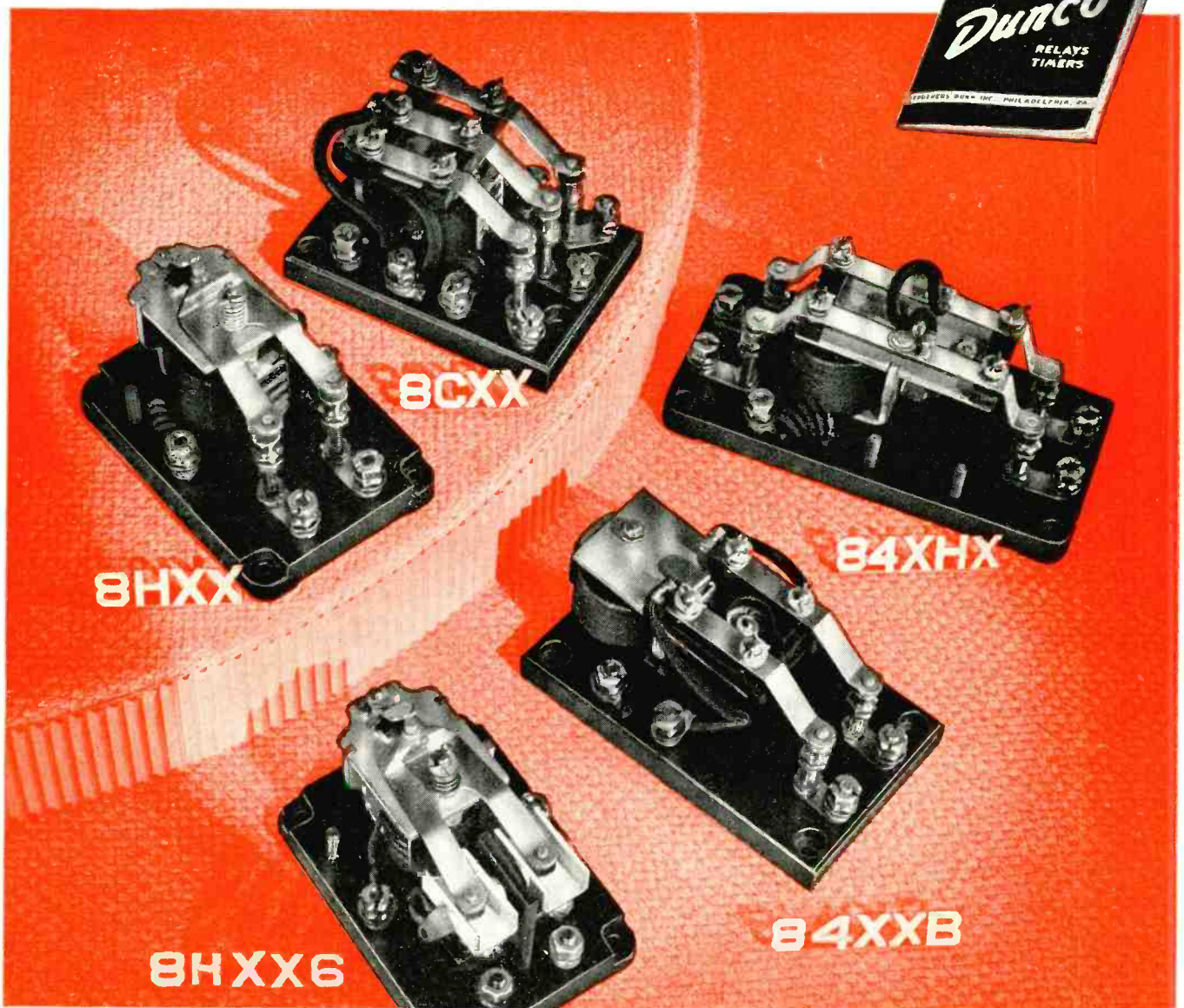

STRUTHERS DUNN, Inc.

1321 ARCH STREET

PHILADELPHIA, PA.

LET DUNCO DISTRICT ENGINEERS IN 28 CITIES HELP SOLVE YOUR RELAY-TIMER PROBLEMS

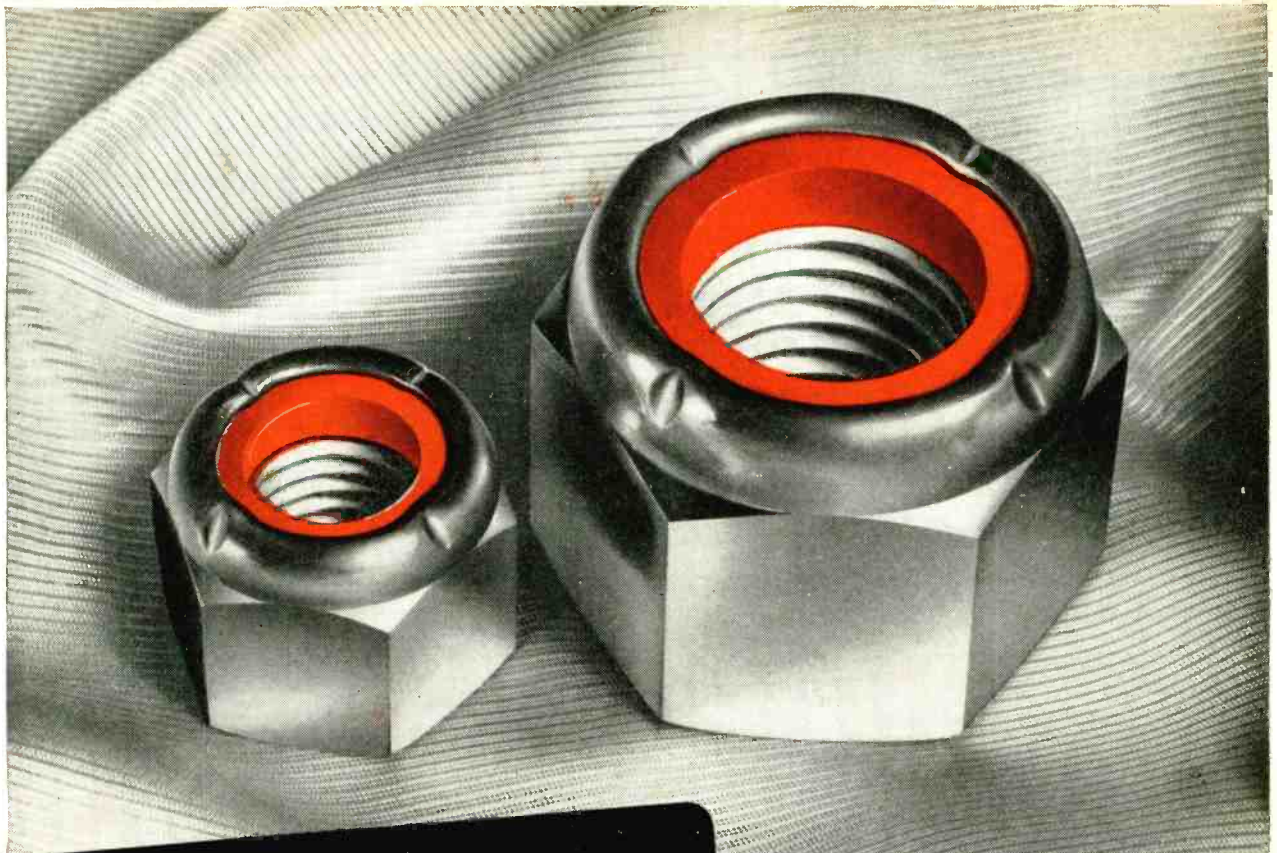

THESE ARE THE NUTS FOR TOUGH JOBS

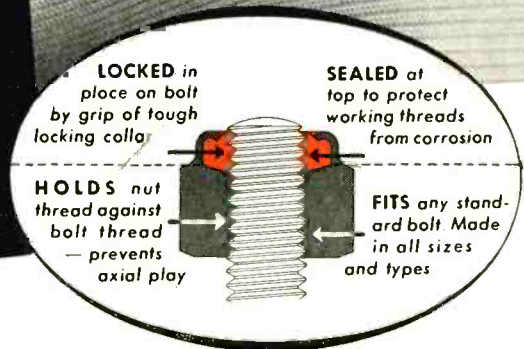

● War jobs have posed infinite production problems.

We know a lot of them that were solved with as simple a thing as a nut.

Because the solution was an Elastic Stop Nut.

For example, aircraft. Their very worth depends upon fastenings that grip sure and won't shake loose under the chatter of machine guns, the impact of cannon fire and the vibration of air combat.

Every plane streaming off America's production lines has Elastic Stop Nuts fastening important structural parts. Several millions of them go into aircraft every day.

And to our knowledge, not one has ever failed to do its job.

With two big plants running full-tilt 24 hours a

day, we can't satisfy all the needs of today's one big customer.

But in the days ahead, with Elastic Stop Nuts generally available, peacetime products and their production are going to be better.

And our engineers schooled in solving the rigorous problems of war production will be at the service of manufacturers with fastening requirements.

Whenever you wish, they will be ready to share their knowledge with you and recommend the desirable Elastic Stop Nut.

ELASTIC STOP NUTS

Lock fast to make things last

ELASTIC STOP NUT CORPORATION OF AMERICA
UNION, NEW JERSEY



SHADOW AND SUBSTANCE

In the highly specialized field of electronics, the question "Who made the tubes?" will always be a matter of vital importance. Power tubes bearing the name "United" are products of original pioneers in the miracle known today as electronics. Step by step these seasoned engineers helped evolve the principles and advance the science of fabricating transmitting tubes which hold a superb record of performance. The early pioneers at United are *still actively pioneering!* The wealth of experience which they have been privileged to accumulate under the demands of war will be available to you when "United" electronic tubes are available again on a peace-time scale for radio and industrial applications.

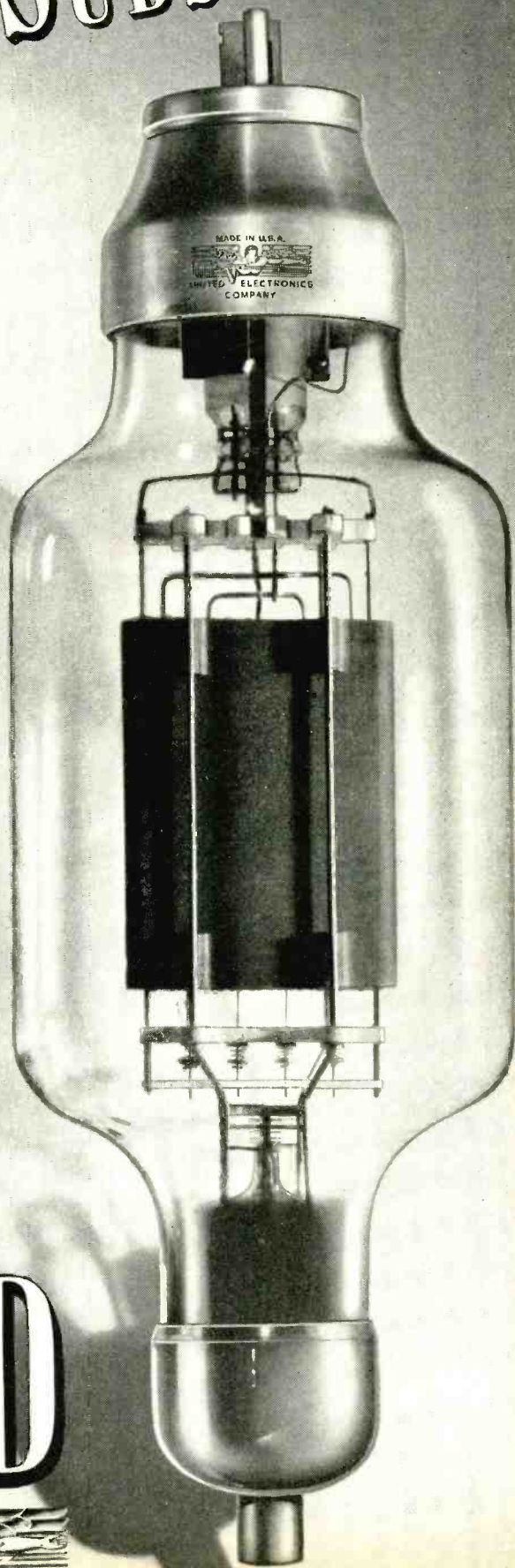

UNITED

ELECTRONICS COMPANY
NEWARK NEW JERSEY



Du MONT Oscillography

...from **A** to **X**, **Y** and **Z**

➔ The new DuMont Type 241 oscillograph is literally an enlarged version of the 3-inch Type 224 already meeting the more critical requirements of oscillograph users.

The 5-inch tube means larger oscillograms for more detailed studies. The added Z-axis amplifier for beam modulation permits use of timing signals or blanking impulses for further applications.

Both instruments—Type 224 (3-inch) and the new Type 241 (5-inch) set new standards for commercial-grade oscillographs. Wide-band Y-axis amplifiers permit study of sig-

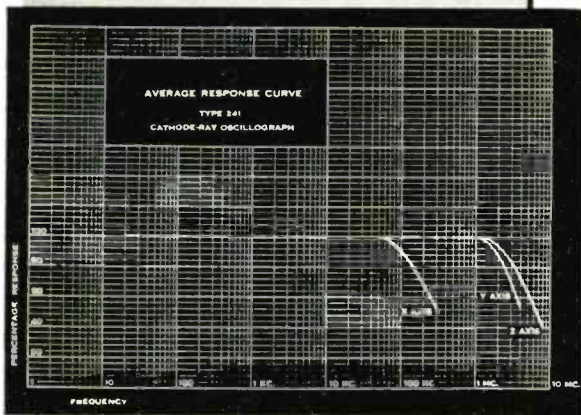

nals of frequencies far beyond the range of usual instruments. Both have a comparably wide-band square and sinusoidal wave response. Both permit a wide choice of panel connections for extreme flexibility in applying signals to the cathode-ray tube. Both are ruggedly housed and supplied with removable front cover for added protection in transit or when not in actual use.

These two expanded-range-expanded-versatility DuMont Oscillographs, along with other DuMont types, round out an outstanding choice of instruments for your particular kind of oscillography.

➔ Write for literature

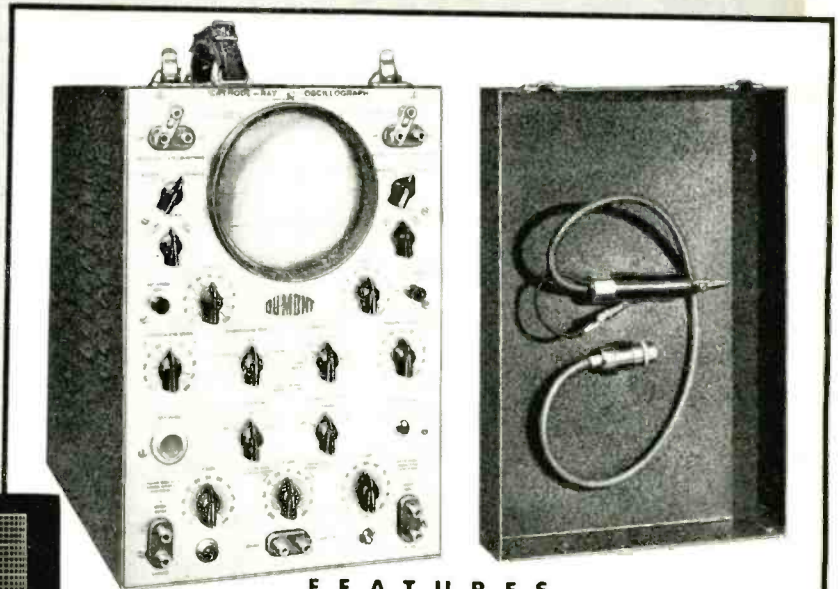

FEATURES

DuMont Type 5JP1 intensifier-type cathode-ray tube for brilliant, easy-reading oscillograms.

Y-axis or vertical deflection response uniform from 20 c.p.s. to 2 mc. Comparable faithful square and sinusoidal wave response.

X-axis or horizontal deflection amplifier with uniform response to 100 kc.

Both amplifiers have input attenuators and distortionless gain controls.

Y-amplifier has input connection for test probe and shielded cable supplied with instrument, reducing input capacitance and eliminating usual stray pickup.

Z-axis amplifier modulates electron beam with any signal applied to input terminal post, or with return trace-blanking pulse produced by linear-time-base generator.

All high-voltage electrolytic capacitors eliminated from circuit. 17½" high; 10¾" wide; 21" deep. 65 lbs.



50 c.p.s.



500 c.p.s.

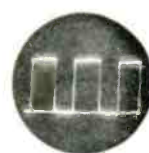

25 KC.



100 KC.

DUMONT

**ALLEN B. DU MONT
LABORATORIES, Inc.**

Passaic • New Jersey
Cable Address: Wespexlin, New York

THERE'S MAGIC IN ELECTRONICS. AND NEW CAREERS!

With electronics man can now see through stone and steel... detect smoke, dust and fog invisible to the eye. He can match colors and finishes... manipulate doors, furnaces, traffic—even make meat tender by means of the science of electronics.

The industrial uses for the magic of electronics appear almost endless. In the 100-1000 kilocycle range of the frequency spectrum, for example, the applications of electronics include operation of electric substations by remote control, more efficient tin plating of steel, maritime direction finding applied even to small pleasure craft.

And almost every day astounding new uses are being recorded—in transportation, food, medicine. With the dawn of peace, the range of useful electronic applications is expected to embrace almost every phase of modern living.

For the electronically-minded, there will be no limit to the opportunities when the war is won. Fascinating new careers, undreamed-of a few years ago, will be waiting—in the service of those who will produce the many electronic devices, as well as in the fields where this new science will be applied in the coming "Era of Electronics."

Isolantite has followed closely the development of science's newest miracle, aware of the possibilities for its commercial application at war's end. Aware, too, of the role *insulation* must play in adapting the electronic principle to new products and uses for peacetime living. The electronic world will not be delayed for want of high-grade insulating materials.

ISOLANTITE

CERAMIC INSULATORS
ISOLANTITE INC., BELLEVILLE, N. J.

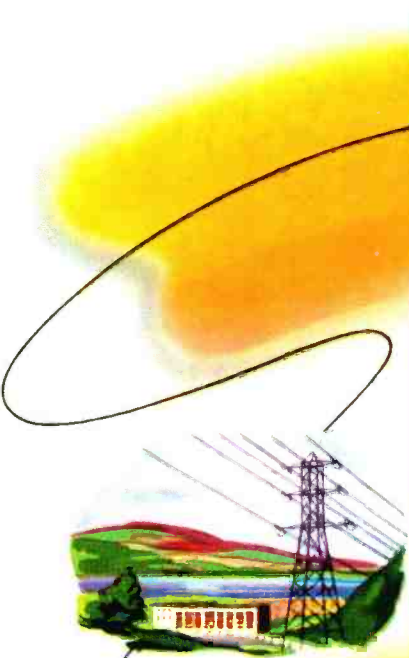

POWER TRANSMISSION
Electronics, science of the future, is used to operate electric sub-stations by remote control.



PROCESSING STEEL
Electronic heating for more efficient tin plating of steel — another electronics application.



DIRECTION FINDING
Even small ships at sea may be guided in future by electronics, newest miracle of science.





MARKS THE SPOT YOU CAN PUT YOUR FINGER ON *Blind!*

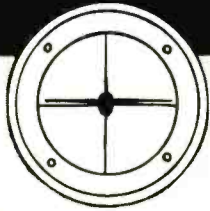

THE VITAL SIXTH SENSE IN INSTRUMENT NAVIGATION

Thanks to the tremendous strides achieved in the field of electronics, a new sixth sense takes the sting out of 'closed' weather—minimizes accidents, permits landings on schedule.

An electric device on an instrument panel registers the gliding path of the craft, vertically and horizontally, in relation to the pre-determined beam of the airport. Safe landings . . . without the pilot ever having seen the field!

The part played by ELECTRONIC ENTERPRISES power and transmitter tubes in furthering aviation progress is but one of the achievements of these highly-sensitive, precision-functioning electronic components.

The complete engineering facilities of ELECTRONIC ENTERPRISES are available to you for collaboration on your problems. Inquiries are invited.

ELECTRONIC ENTERPRISES, INC.

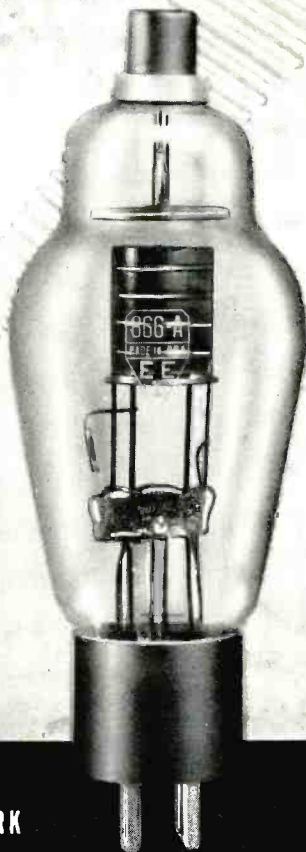

GENERAL OFFICES: 65-67 SEVENTH AVENUE, NEWARK

NEW JERSEY

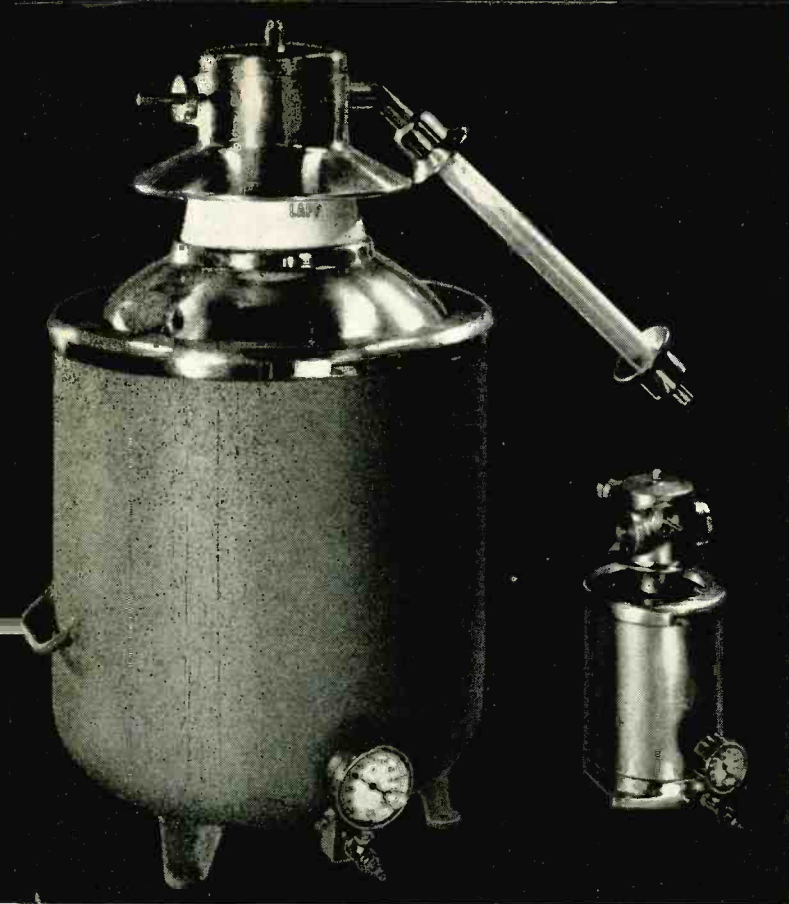

FOR HIGH-FREQUENCY POWER SOURCES

LAPP GAS-FILLED CONDENSERS

In any electronic circuit, wherever lump capacitance is needed, Lapp condensers will save space, save power and save trouble. Available for duty at almost any conceivably-useable voltage rating and capacitance, they bring to any application notable mechanical and electrical advantages: practically zero loss, smallest space requirement, non-failing, puncture-proof design, constant capacitance under temperature variations. *Shown, at left, Unit No. 25934, rated at 200 amp., 6500 volts, capacitance variable 4300 mmf. to 11000 mmf.; right, Unit No. 23722, rated at 50 amp., 7500 volts, capacitance 45 mmf. to 75 mmf.*



STANDOFF, BOWL, ENTRANCE INSULATORS

Standoff, bowl, entrance and other special-purpose insulators are available in wide range as standard Lapp catalog items. Other insulators of special design are easily produced by Lapp methods, either in porcelain or steatite. The wide choice of such insulators available from Lapp simplifies the design of high-frequency equipment. Also, Lapp is equipped for production of many special assemblies, of porcelain or steatite, and the associated metal parts.

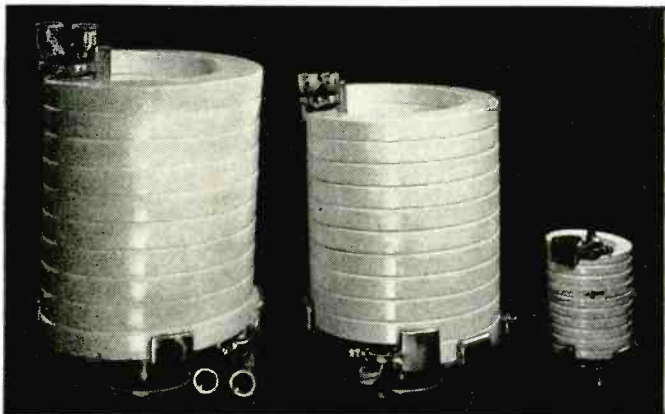

LAPP PORCELAIN WATER COILS

For cooling of high-frequency tubes in radio transmitters and other electronic power sources, Lapp porcelain water coils have been widely used. With nothing about the porcelain to deteriorate, sludging is eliminated, and with it the need for cleaning and water changes. Porcelain pipe and fittings in any needed size are also available as catalog items. We welcome inquiry on any Lapp equipment for experimental or industrial electronic application.

Lapp

INSULATOR CO., INC.

LEROY, N. Y.



"We've been using Wilcox Equipment for two years____ without a single interruption"



*says E. H. Forsman,
Supt. of Communications for
Continental Air Lines*

WILCOX equipment has an important part in the vital communications operations of leading airlines, and uninterrupted service is proving Wilcox dependability. The Wilcox factories have converted their entire facilities and experience to production for military needs...to help keep 'em flying until Peace is assured. But, after the war Wilcox equipment again will be available for the huge expansion in civil air transportation that is certain to come.

**There MUST Be
Dependable Communications**

Communication Receivers
Airline Radio Equipment Aircraft Radio
Transmitting Equipment



**WILCOX ELECTRIC
COMPANY**

Quality Manufacturing of Radio Equipment
14th & Chestnut Kansas City, Mo.

Photo, courtesy
Continental Air Lines

PIONEERS...in war and peace

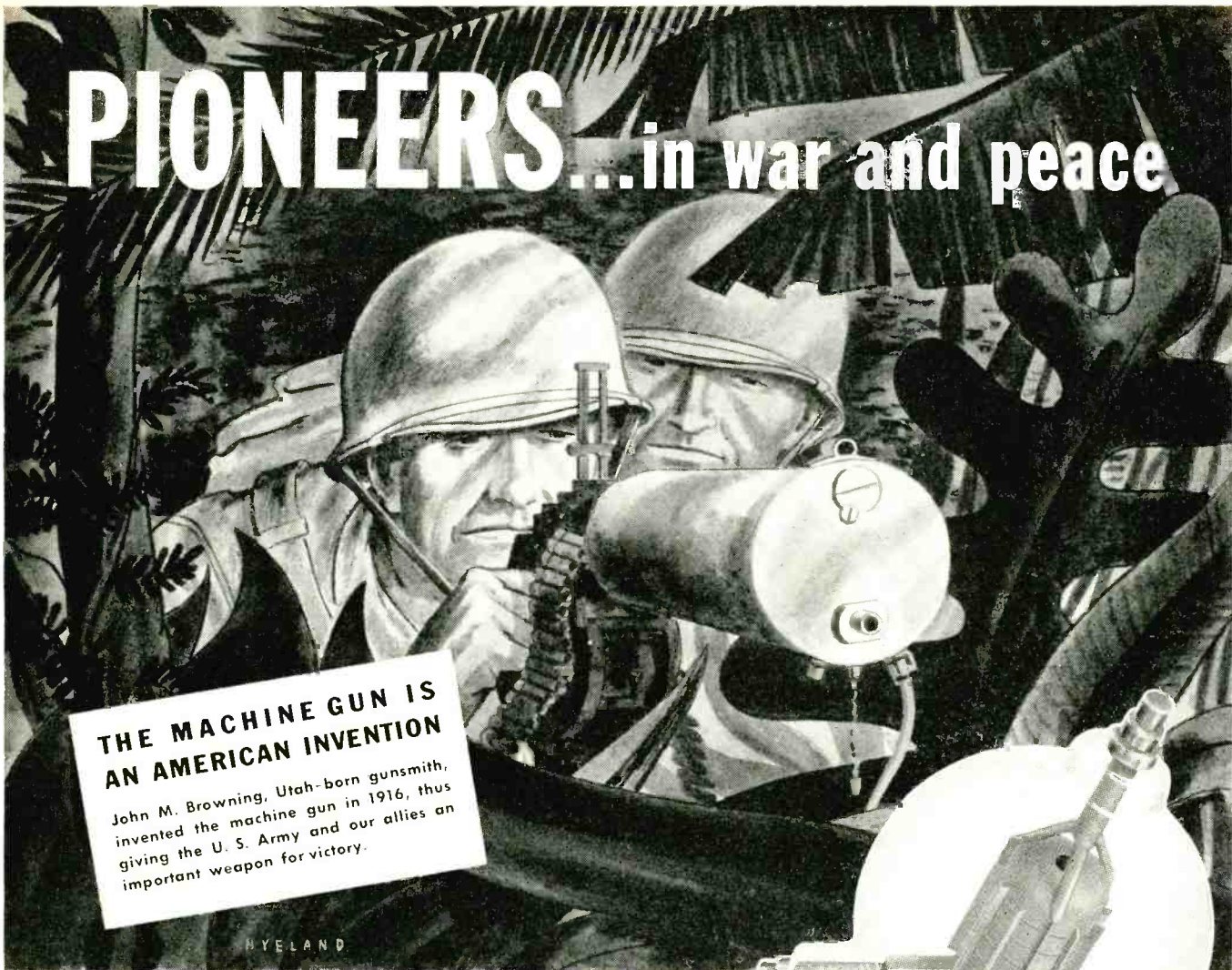

THE MACHINE GUN IS AN AMERICAN INVENTION

John M. Browning, Utah-born gunsmith, invented the machine gun in 1916, thus giving the U. S. Army and our allies an important weapon for victory.

HEINTZ AND KAUFMAN ORIGINATED THE TANTALUM ELECTRON TUBE

GAMMATRON tubes exemplify the ability of Heintz and Kaufman engineers to meet difficult design problems with exceptional skill and ingenuity.

Faced with the need for tubes which can endure great physical and electrical punishment without faltering, our engineers were the first to appreciate the unique advantages of tantalum as a plate and grid material. In addition they pioneered new principles of construction which discarded all internal insulators. As a result, GAMMATRONS are inherently gas-free.

Heintz and Kaufman brought this same pioneering spirit to the UHF band. Some of the accomplishments of GAMMATRONS at high frequencies are well known, but many developments are today classed as restricted information. Until the full story can be told, keep GAMMATRONS in mind for postwar applications... for then as now they will help open new frontiers for electronics.

HEINTZ AND KAUFMAN, LTD.

SOUTH SAN FRANCISCO • CALIFORNIA • U. S. A.

Gammatron Tubes

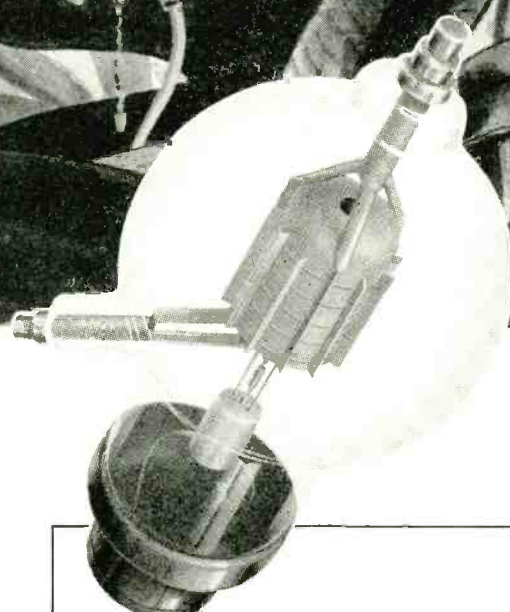

HK-1054 TRIODE

OPERATING DATA

*As an RF Power Amplifier,
Class C, Unmodulated.*

	Typical	Maximum
Power Output	3000 Watts	—
Driving Power	140 Watts	—
DC Plate Voltage	5000 Volts	6000
DC Plate Current	750 M.A.	1000
DC Grid Voltage	-950 Volts	-2000
DC Grid Current	105 M.A.	150
Peak RF Grid Volts	1475 Volts	—
Plate Input	3750 Volts	3750
Plate Dissipation	750 Watts	750

Industry steadies its "nerves"

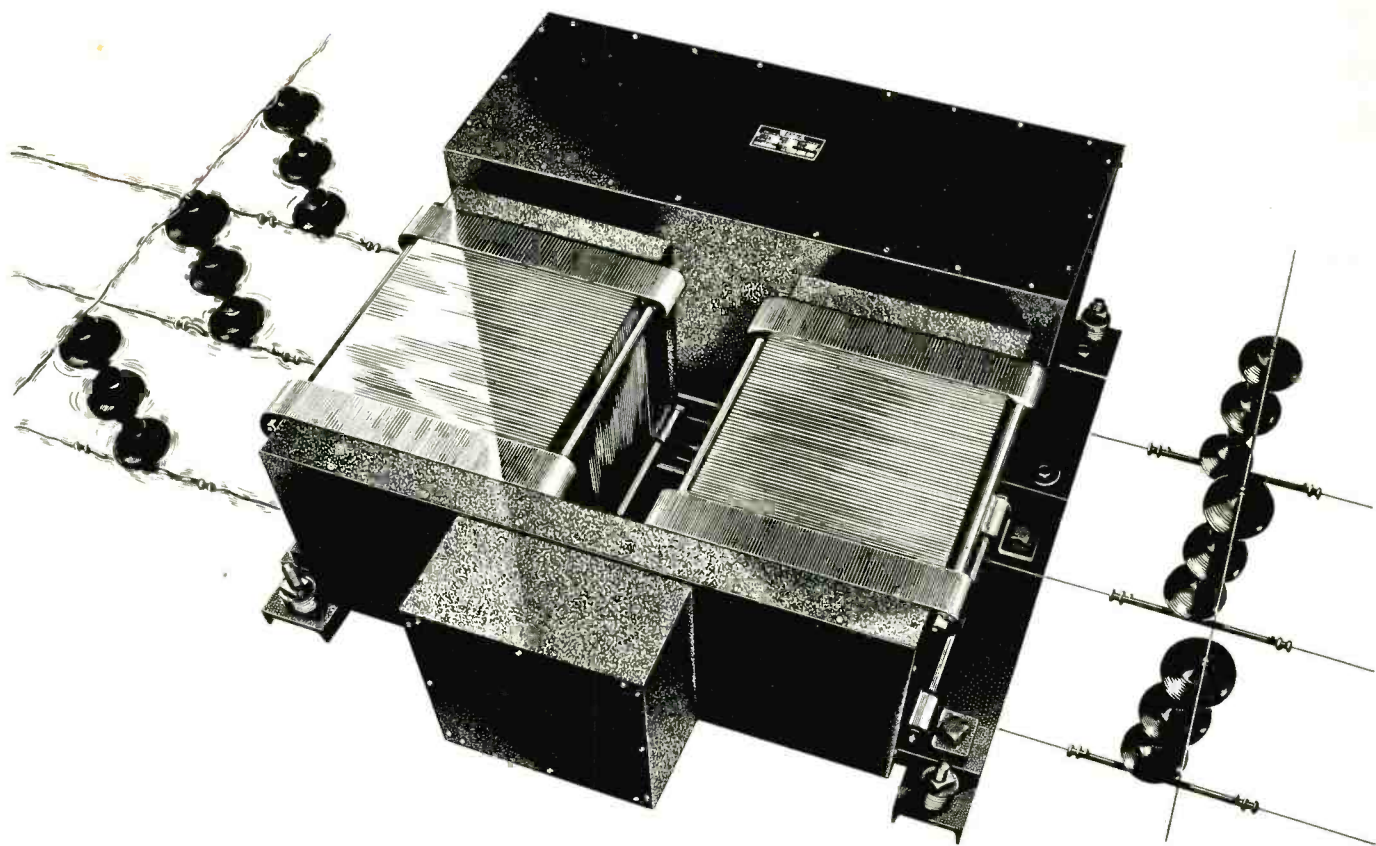

FACED with production schedules that have no precedent in history, American industry finds the fluctuating voltages of its over-loaded power lines wholly inadequate to meet the "deadly" precision demanded for total war.

Vital "nerve centers" of production lines are geared for precise performance when operated at specific line voltages. Any variation from these rated values, and there are many these days, may well mean lagging production schedules and a noticeable lack of uniformity in products.

Fluctuating line voltages are no problem in plants where Sola "CV's" have taken over. Even though the peaks and valleys of power consumption may cause a voltage variation of as much as $\pm 30\%$ —the vital "nerve centers" of their pro-

duction lines continue to operate smoothly and with unerring precision.

Day and night, without care or supervision, Sola Constant Voltage transformers maintain positive control over electrically operated instruments and machines that are indispensable to the nation's war effort. These transformers are available in standard units with capacities ranging from 15 KVA, which might be used for an entire communications system for instance, to the small 10 VA units for vacuum tubes. Special units can be built to specifications.

Note to Industrial Executives: *The problems solved by Sola "CV" transformers in other plants may have an exact counterpart in yours. Find out. Ask for bulletin DCV-74*

Constant Voltage Transformers

SOLA

Transformers for: Constant Voltage • Cold Cathode Lighting • Mercury Lamps • Series Lighting • Fluorescent Lighting • X-ray Equipment • Luminous Tube Signs
Oil Burner Ignition • Radio • Power • Controls • Signal Systems • Door Bells and Chimes • etc. **SOLA ELECTRIC CO., 2525 Clybourn Ave., Chicago, Ill.**

THE ROSÁN

REMOVABLE TERMINAL STUD

**LOCKED IN THE MATERIAL
INSERTED FROM THE FRONT
NO SHIELDING NECESSARY**



THE Rosán Removable Terminal Stud is one of the many applications of the Rosán Locking System designed into our threaded inserts and studs. The red Locking Ring in the illustration broaches its way into the material and locks the stud in place. This is the principle of the Rosán Locking System.

The introduction of this remarkable device has solved one of the most baffling problems with which engineers have been confronted. Ordinary studs or inserts will turn and loosen under vibration. The Rosán Locking System locks our studs and inserts permanently in metals, plastics, wood, or any material which can be threaded.

The Rosán *Removable* Terminal Stud is also locked in the material; but with this difference: By means of the flange above the serrated collar, the locking ring may be removed and the stud replaced. Rosán Removable Terminal Studs are put in from the front of the panel. No counter-boring at the back. No shielding necessary. Effects enormous savings in material and repair time. No special taps or screws required. Standard threads throughout.

The operating principle of the Rosán Threaded Insert is shown in the illustrations below.

Manufacturers are invited to submit their problems to our Engineering Department. The Rosán Locking System has types of inserts and studs for every branch of industry.

BARDWELL & McALISTER, INC.

7638 Santa Monica Blvd., Hollywood, Calif.

DESIGNERS AND MANUFACTURERS

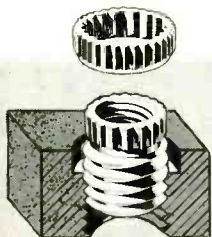

(1) Material has been drilled and tapped. Insert, minus locking ring, has been partly screwed into place.

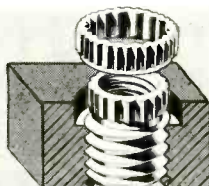

(2) Insert in place. Top flush with surface of material. Note the counter-bored channel for the locking ring.

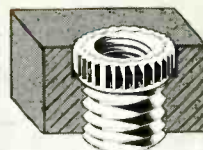

(3) Insert locked in place. Inner serrations engaged with teeth of collar. Outer serrations broached permanently into material.



STEATITE . . .

★ Centralab's Steatite plant can furnish coil forms up to 5" diameter and pressed pieces to approximately 6 inches square. Centralab's engineering, laboratory and production experience in Ceramics extends back to 1930. In addition to Steatite, Centralab also produces other types of Ceramics.* Consult our engineering dept. on your Ceramic problems.

Centralab

Division of GLOBE-UNION INC., Milwaukee

* Cordierite: a low thermal expansion type of ceramic.
Hy Dielectric: a ceramic suitable for capacitors and special application.

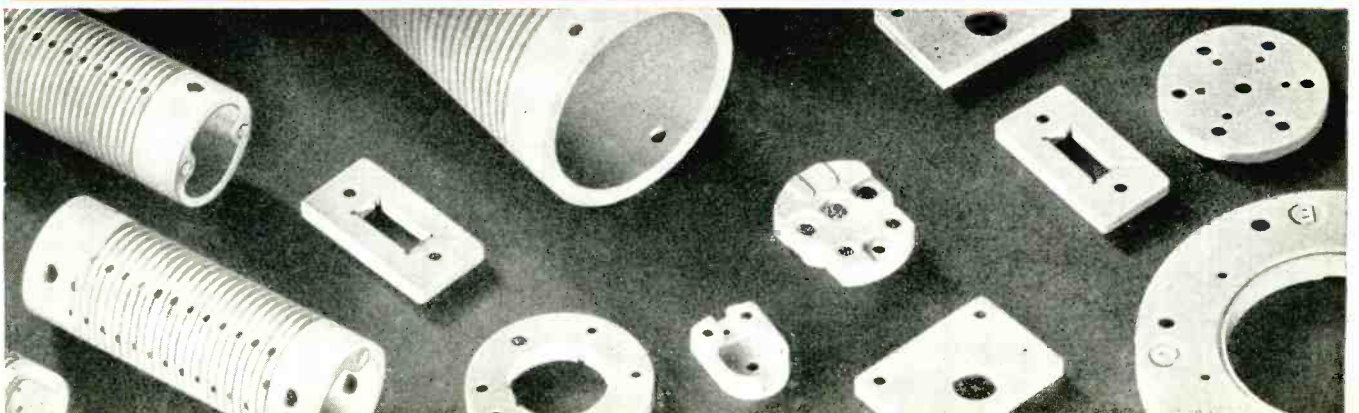

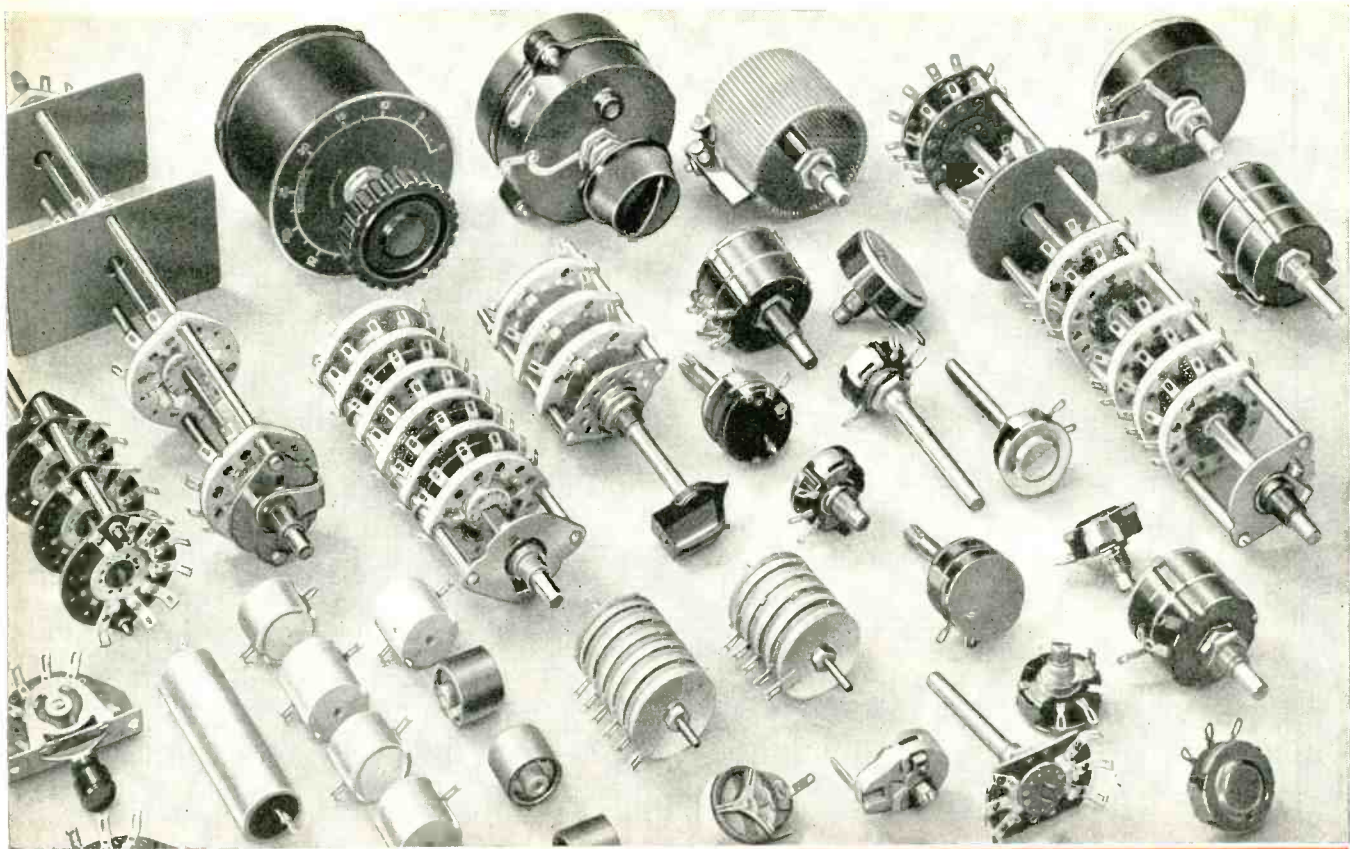

Serving the Electronic Industry since 1922...and now producing the following vital parts:

- CENTRALAB Steatite Insulators
- CENTRALAB Ceramic Trimmers
- CENTRALAB High Frequency Circuit Switches
- CENTRALAB Volume Controls
- CENTRALAB Ceramic Capacitors
- CENTRALAB Wire Wound Controls
- CENTRALAB Sound Projection Controls

Centralab

Division of GLOBE-UNION INC., Milwaukee



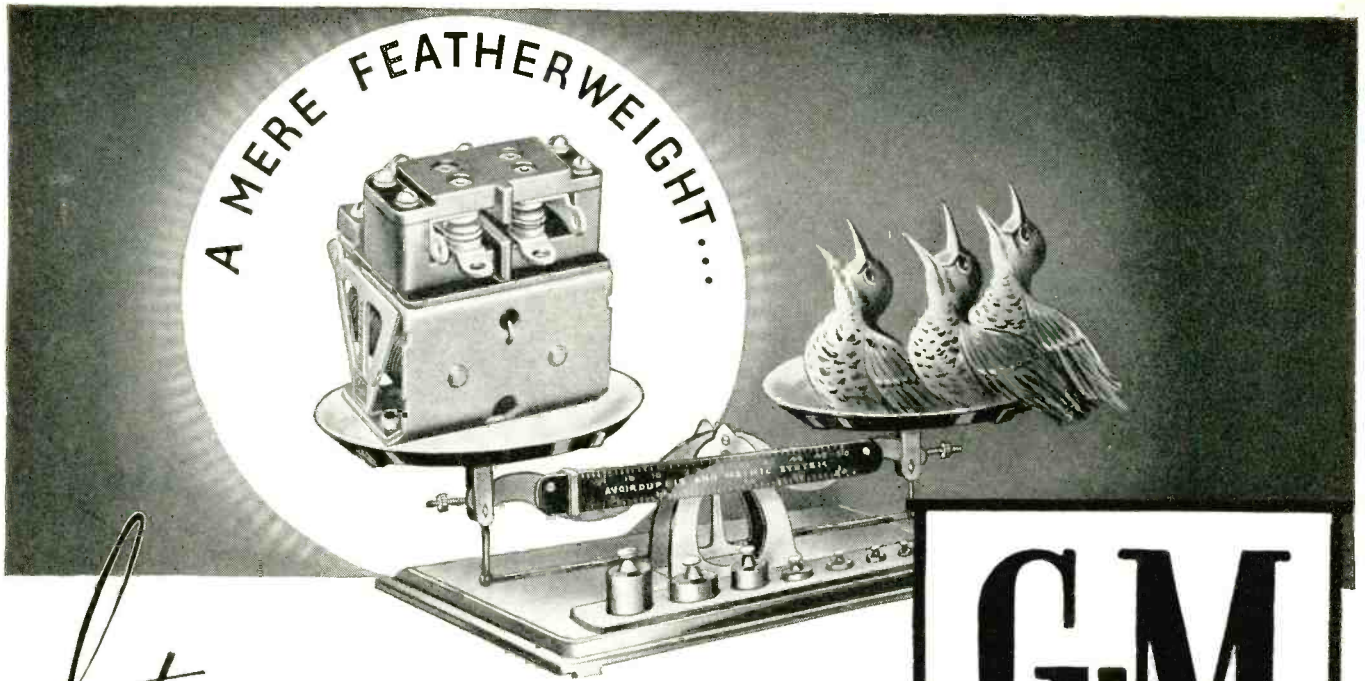

but BUILT TO DO A HERCULEAN JOB

The Type 27
SUPER AIRCRAFT RELAY



Expert design . . . Small size . . . Light Weight . . . yet a powerful Aircraft Relay possessing a number of noteworthy characteristics, which can be varied over a wide range to suit the requirements of different applications.

The box frame construction gives the Type 27 Relay superior strength and sturdiness . . . yet it weighs only 5 ounces. The above illustrated relay is capable of withstanding 15g or more without a tremor . . . has a contact pressure of 60 grams (double make-double break) and a contact capacity of 20 amperes at 30 volts d.c. (100 ampere inrush). The pickup is 6.5 volts (.61 watt) at 20° C. The nominal coil voltage is 12 volts d.c. Coil wattage at 12 volts d.c. is 2.1 watts at 20° C. Temperature range is from -40 to 90° C. Size 1½ x 1¾ x 1⅞".

Free samples of the above Type 27 Relay (SPDT double make-double break in 2 pole construction) are available to relay users if request is accompanied by a priority of AA-4 or better. Write or wire today requesting specification No. 12723.



VISITRON PHOTOTUBES

are available in quantity in numerous sizes. Made by G-M, pioneer in development and manufacture of quality phototubes.

G-M LABORATORIES INC.

4313 NORTH KNOX AVENUE, CHICAGO, ILLINOIS

Buy WAR BONDS & STAMPS

G.E. ANNOUNCES

A NEW VOLTAGE STABILIZER

that is insensitive to load power factor

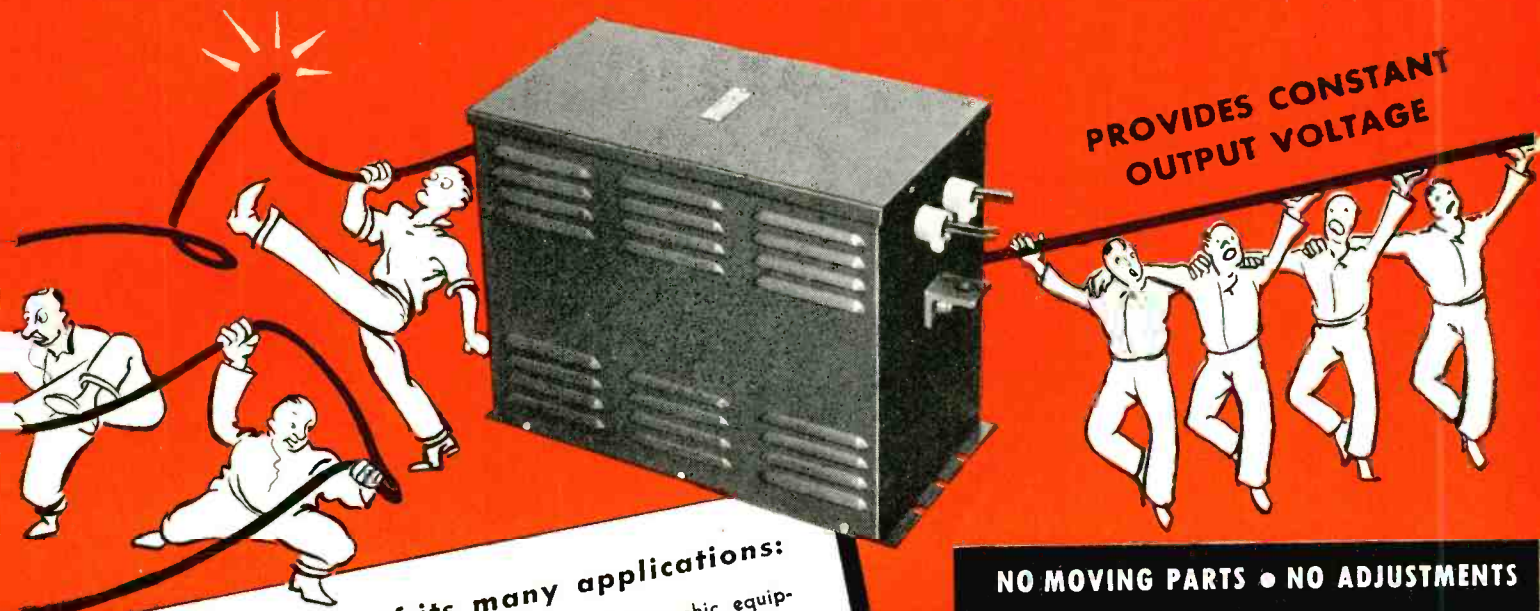

PROVIDES CONSTANT OUTPUT VOLTAGE

NO MOVING PARTS • NO ADJUSTMENTS
NO MAINTENANCE

Here are a few of its many applications:

- 1 Radio transmitters
- 2 Radio testing equipment
- 3 Electronic-tube apparatus
- 4 Motion-picture sound equipment
- 5 Motion-picture projectors
- 6 Telephone apparatus
- 7 X-ray machines
- 8 Photo-cell equipment
- 9 Precision photographic equipment
- 10 Photometers
- 11 Color comparators
- 12 Calibration of meters, instruments, relays
- 13 Laboratory precision processes and testing equipment

Engineers, note these performance features!

WIDE LIMITS FOR INPUT VOLTAGE—95 to 130 volts—ample for all ordinary voltage conditions.

CONSTANT OUTPUT VOLTAGE—For any fixed load, $\pm 1/2$ per cent. For any load that varies between full load and half load, and power factor between unity and 0.8 lagging, the output voltage will not vary more than $\pm 1 1/2$ per cent. For simultaneous variations in input voltage, load, and load power factor—with load between no load and full load, and load power factor between unity and 0.8 lagging—the output voltage will not vary more than $\pm 2 1/2$ per cent.

QUICK RESPONSE—Stabilizing action takes place in less than three cycles.

LEADING INPUT POWER FACTOR—Approximately 20 per cent at no load, and 70 per cent at full load.

CURRENT-LIMITING FEATURE—On short circuit the output is limited to approximately 130 per cent of full load—especially valuable for electronic-tube apparatus during the filament warming-up period.

LOW HARMONIC CONTENT—Only about 6 per cent at or near full load, unity power factor. Only slight variations in harmonic content result from variations in input voltage.

SELF-PROTECTING—Will operate continuously throughout the range from open circuit to short circuit without damage.

HERE is a voltage stabilizer that digests variations in load or power factor, or both, and continues *unaffected* in its smooth, reliable regulation of voltage. Variations in load from no load to full load bother it not a whit. Changes in power factor from unity to 0.8 lagging leave it indifferent.

Electronic-device *manufacturers* who build it into their equipment, or offer it as an accessory, will find that it means better performance and greater salability of their products. Present *users* of electronic devices will likewise find that it can improve the perform-

ance and reliability of their equipment. This stabilizer is ideal for precision control of many laboratory processes.

If *your* problem is one of providing constant voltage for the operation of diversified electric equipment—all or much of which has fluctuating loads and power factor—solve it by installing G-E stabilizers, the only voltage stabilizer on the market that is insensitive to load power factor. Available ratings from 50 va to 5000 va. Ask our local office for Bulletin GEA-3634—the complete story. *General Electric Co., Schenectady, New York.*

GENERAL ELECTRIC

408-87-6205

www.americanradiohistory.com



The Army-Navy "E", for Excellence in the manufacture of war equipment, now flies over six G-E plants employing 100,000 men and women.

CRYSTALS



"SHORT ORDERS" IN A HURRY

If it's a "Rush" phone us, and your order for special crystals will go into work immediately under a competent crystal engineer personally charged with the responsibility for your project.

Our full facilities, including latest electrical and optical equipment, X-ray orientation, etc.—are at your service. John Meck Crystals are "Good Will Ambassadors of the Future" to acquaint you with our Family of Activities in the field of Sound and its Projection. That's why "Short Orders in a Hurry" are welcome.

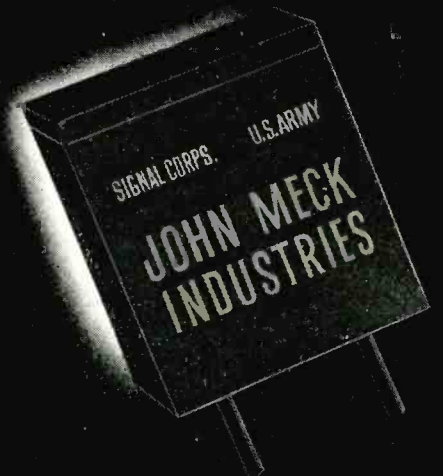

Phone **CRYSTAL SERVICE DIVISION**
PLYMOUTH THREE THREE

JOHN MECK INDUSTRIES
PLYMOUTH, INDIANA





- For lack of a Tube

The Big "B" was limping home over the water with two motors shot away. Too far gone to reach the home field. No visibility for a navigational fix.

Radio Op was trying to locate a closer field when a tube went dead. Which one? No time to test. He yanked out all the tubes. Started putting in a spare set.

But one of the tubes he jerked out was a "special selection." The replacements didn't work. The big bomber never got that bearing. And \$350,000 worth of fighting ship drowned in the Pacific.

The moral? If you are a designer of radio and radio-electronic circuits for our armed forces, you can avoid the use of special selection tubes in 99 cases out of 100.

There's hardly a radio-electronic circuit today that

can't be designed to function perfectly with standard tubes.

You might need two of these in place of one "special selection," but standardization makes it worthwhile.

We can and do supply "special selections" but only when authorized by the Army or Navy. Even then your special selection will interfere with the mass production and delivery of our standard tubes — and today time is the essence.

So why not first find out if the circuit you're working on now, can't be designed without the use of "special selections"? Our staff of application engineers is always ready to help you solve your design and manufacturing problems — and they can help you avoid "special selections"!



RCA RADIO TUBES

RECEIVING TUBES • POWER TUBES • CATHODE-RAY TUBES • SPECIAL-PURPOSE TUBES

RCA Victor Division, RADIO CORPORATION OF AMERICA, Camden, N. J.

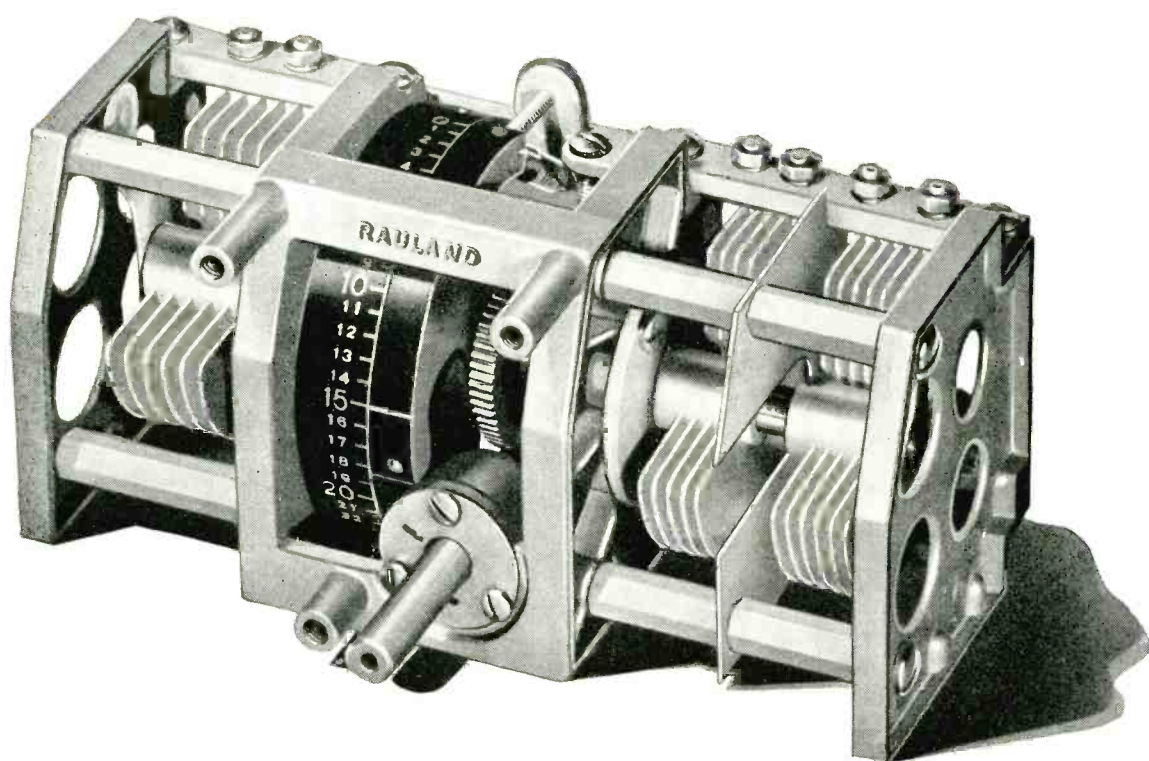

"Condenser by Rauland"

Back of every fine instrument is a combination of wide experience, infinite skill and painstaking care. RAULAND condenser users *know* the utter dependability of these *electroneered* units; how successfully they have met and performed the most difficult tasks demanded of

communications by modern warfare. They are made to "stand the gaff," having battleship toughness, yet blended with a precision accuracy that insures a fine degree of tuning. These are the things you get when you specify "Condenser by RAULAND."

RADIO... SOUND...

Rauland

COMMUNICATIONS

Electroneering is our business

THE RAULAND CORPORATION

» » »

CHICAGO, ILLINOIS

Buy War Bonds and Stamps! Rauland employees are still investing 10% of their salaries in War Bonds



ON THE JOB

Whenever our Flying Fortresses fulfill their missions for victory, AlSiMag ceramic insulators are on the job to help make the flight a success.

AlSiMag steatite insulation can be found in all vital electronic components and is selected by designers of electronic equipment for dependable service.

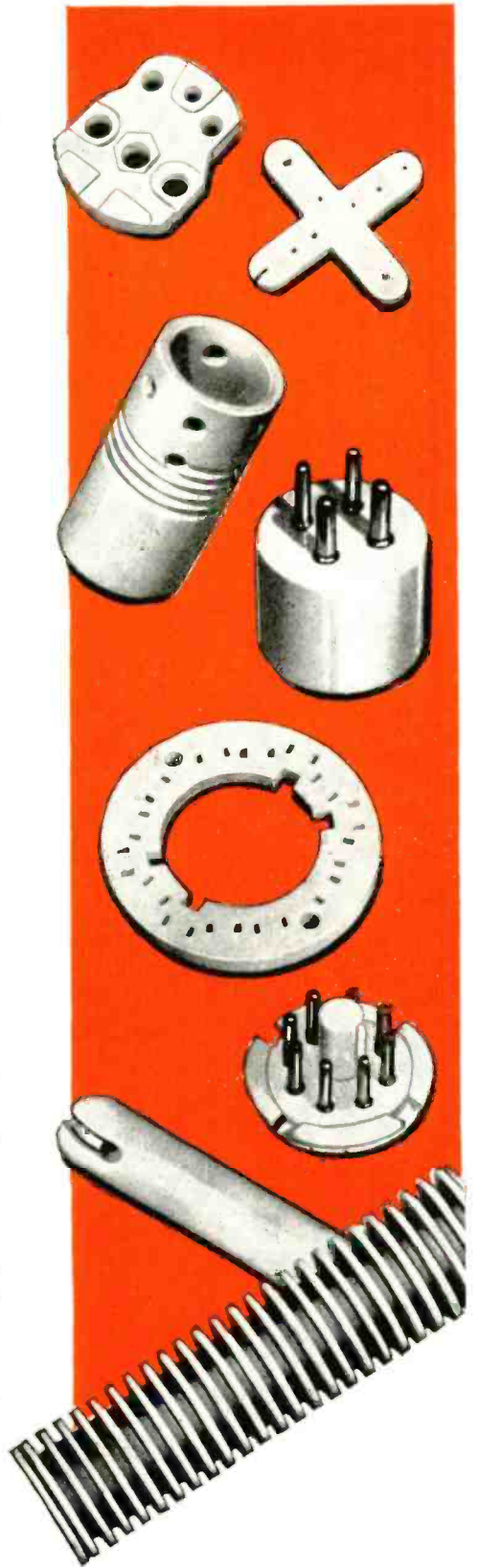

AWARDED JULY 27, 1942

ALSiMAG
TRADE MARK REGISTERED U. S. PATENT OFFICE

AMERICAN LAVA CORPORATION
CHATTANOOGA, TENNESSEE

The N-Y-T Sample Dept.
was established so
that we may have...



MAJOR AIR VICTORIES!



..without the world
ending for Johnny Smith

An eighteen-to-one defeat for the enemy is good reading . . . it's the ratio of advantage that spells ultimate success for the United Nations. However, let's give a thought to Johnny Smith, pilot of the short-end of the score.

For the purpose of making good transformers better, to design and engineer them for more efficient and dependable functioning, the N-Y-T Sample Department was established. By intensive research and laboratory work, new developments are engineered, then made tangible components for ordnance machines and radio equipment.

Which means another day for the Johnny Smiths in our Army, Navy and Air Corps. Translated into post-war practice it will mean better living when they return.

* * *

The N-Y-T Sample Department is prepared to give immediate consideration to your special problems, and make deliveries within a matter of days. Inquiries invited.

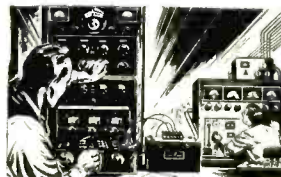

NEW YORK TRANSFORMER CO.



26 WAVERLY PLACE

NEW YORK, N. Y.

HICKOK

33 Years of Progress..

**1910..
1943..**

1 small plant
1 employee
2 styles of meters

2 large plants
Nearly 1000 employees
Hundreds of styles of meters
and test instruments.

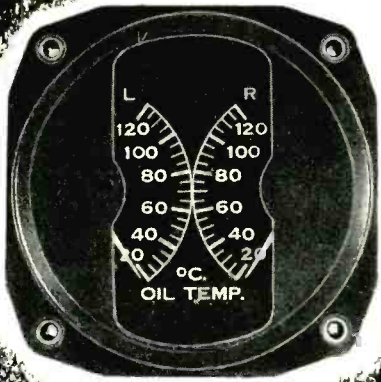

HICKOK METER

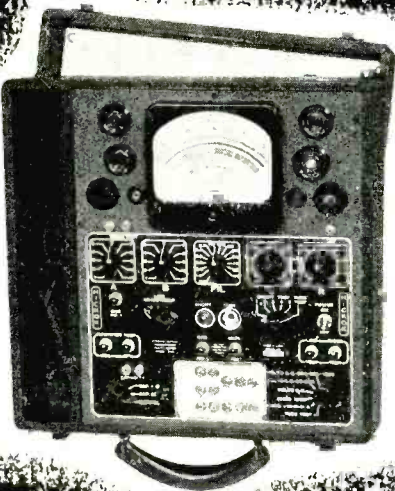

**HICKOK DYNAMIC MUTUAL
CONDUCTANCE TUBE TESTER**

• From its organization in 1910 until now The Hickok Electrical Instrument Co., has always been in the forefront of those companies who have contributed most to Electrical and Radio Instrument progress.

Quality has always predominated over quantity of production—building a reputation for highest grade instruments that is now reflected in the enormous demand for Hickok Meters for Aviation and other War Time uses. The meter illustrated is typical of these War Time Instruments.

The Hickok Dynamic Mutual Conductance Tube Tester, developed soon after the advent of the 3-element radio tube, is the standard instrument for tube testing today.

New Hickok Meters and instruments are being designed or are already in production for the use of our Armed Forces. They will be available for everyone as soon as the present emergency is over.

So keep your eye on Hickok for the newest and best in indicating meters and radio service equipment.

Hickok

ELECTRICAL INSTRUMENT CO.

CLEVELAND, OHIO • U. S. A.

0.00002 to 10,000 VOLTS!

BALLANTINE ELECTRONIC AC VOLTMETER AND ACCESSORIES



MODEL 300
ELECTRONIC
VOLTMETER



MODEL 505
ARTIFICIAL EAR



MODEL 402
MULTIPLIER



MODEL 220
DECADE AMPLIFIER

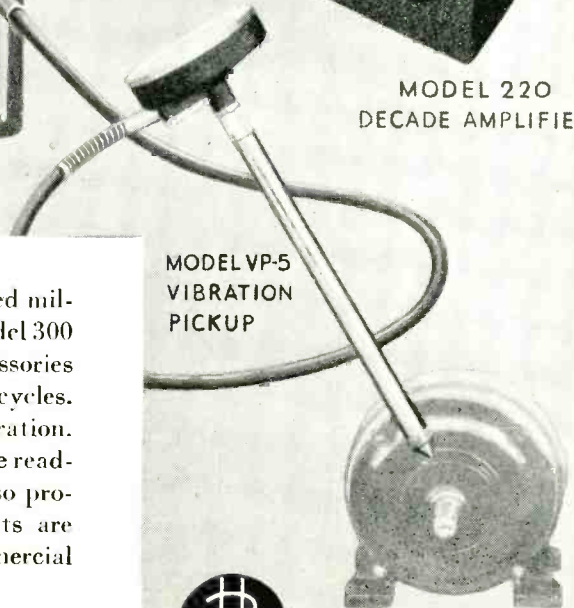

MODEL VP-5
VIBRATION
PICKUP

This enormous range of voltages—five hundred million to one—is accurately covered by our Model 300 Electronic Voltmeter and some of the accessories shown above. Frequency range 10 to 150,000 cycles. Accuracy 2% over most of the range. AC operation. Five decade ranges with logarithmic scale make readings especially easy. Uniform decibel scale also provided. Over a thousand of these instruments are giving excellent service in Government, commercial and university laboratories and factories.

Send for Bulletin 8

BALLANTINE LABORATORIES, INC.
BOONTON, NEW JERSEY, U.S.A.

FABRICATED PARTS IN

MYCALEX

THE INSULATOR

FROM BLUE PRINT SPECIFICATIONS ... TO PRECISION STANDARDS

REAL assistance to manufacturers of communications, high-frequency, electrical and electronic equipment is offered by the announcement of Precision Fabricators, Inc. as a licensed producer of fabricated parts in "LDS" (Leadless) *Mycalex*.

Mycalex as a material has won wide recognition for its high dielectric strength, its low loss even at highest frequencies, its mechanical strength and its stability under pressure, high voltage, heat and humidity.

The *Mycalex* Department of Precision Fabricators is completely equipped with new high-precision equipment, designed especially to the requirements of *Mycalex* for cutting, milling, drilling, thread cutting, grooving, turning, grinding, surfacing and engraving. Already many thousand *Mycalex* parts have been produced by this department—parts turned out on time or ahead of production schedules—parts that pass every inspection.

We solicit the opportunity to figure on your requirements. We think we can tell you a surprising story on precision tolerances—and on delivery schedules.

Precision Fabricators, Inc. have been appointed fabricators by Mycalex Corporation of America who are exclusive licensees under patents of Mycalex (Parent) Co., Ltd., London, England.

PRECISION *Fabricators* INC.

120 NORTH FITZHUGH ST., ROCHESTER, N. Y. • NEW YORK OFFICE: 369 LEXINGTON AVE.

SPECIFICATION FABRICATORS OF MYCALEX ★ PHENOL FIBRE ★

VULCANIZED FIBRE ★ RUBBER ★ ASBESTOS AND OTHER MATERIALS

when Johnny comes marching home again



As a radio technician, Johnny is a vital part of our armed forces. He sees an amazing electronic future in the new devices developed by the urgency of war. No, he can't talk about them now, but as he uses them he dreams of electronic wonders to come.

Someday soon, Johnny and thousands like him will come marching home to take their places in their chosen field. Their vision . . . their plans . . .

their energy will give us those wonders in electronics of which they dreamed.

Wherever Johnny's ambition leads him in electronics, he will find TUNG-SOL ready for the peacetime developments. TUNG-SOL tubes for transmitting, receiving and amplifying, TUNG-SOL research engineering service will be important parts of his future and the future of electronics.

TUNG-SOL

vibration-tested

RADIO TUBES



TUNG-SOL LAMP WORKS INC., NEWARK, N. J., Sales Offices: ATLANTA, CHICAGO, DALLAS, DENVER, DETROIT, LOS ANGELES, NEW YORK
ALSO MANUFACTURERS OF MINIATURE INCANDESCENT LAMPS, ALL-GLASS SEALED BEAM HEADLIGHT LAMPS AND THERMAL SWITCHES

NEW CORNING MULTIFORM GLASSWARE A CHALLENGE TO ENGINEERS!

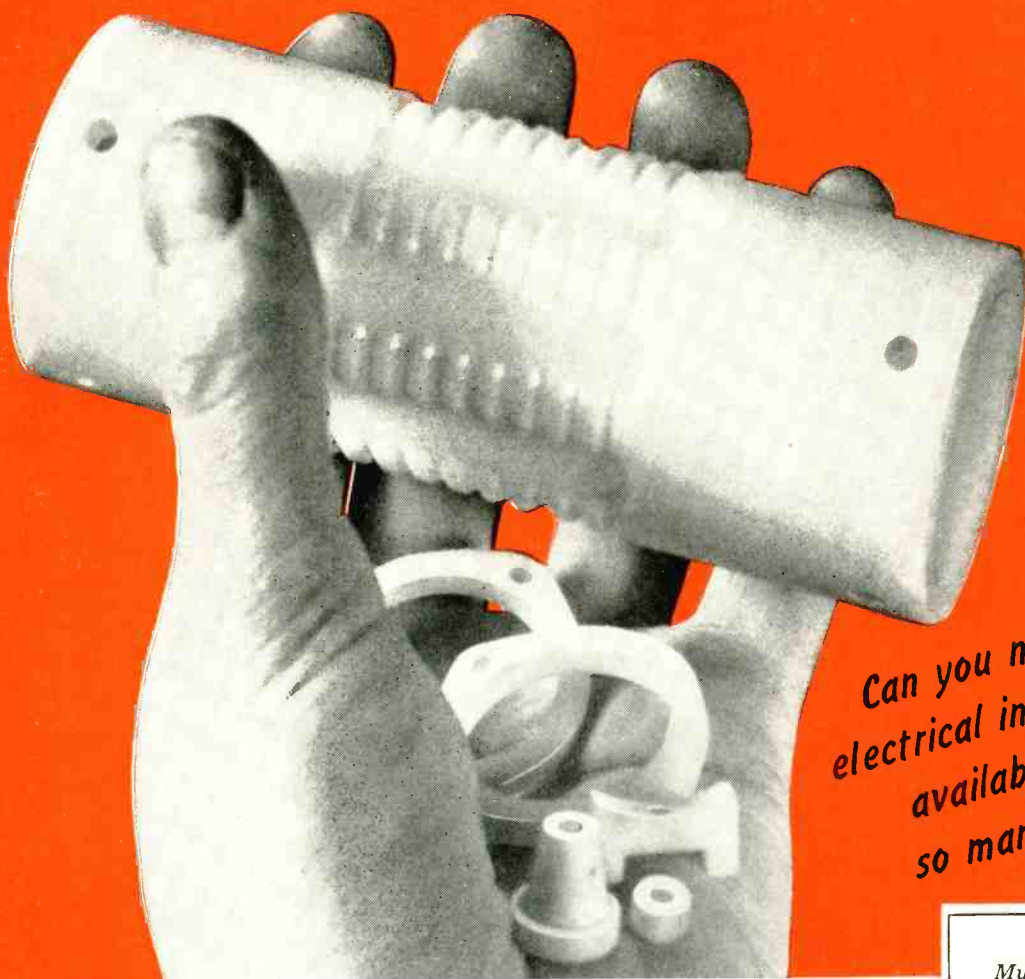

*Can you name another
electrical insulation product
available today with
so many advantages?*

IT'S not only something absolutely new in glass—Pyrex brand Multiform Glassware is an exciting new improvement in electrical insulation!

Multiform Glassware can be made to provide whatever qualities are required. Corning's Glass Number 790, for example, combines the properties of very low thermal expansion, resistance to high temperatures, great chemical durability, and very low dielectric losses. This glass meets all the requirements of U. S. Navy Standard RE-13A-317F, Grade G. Corning Glasses Number 7761 and Number 707, to give further examples, also have very low dielectric

losses and can be used as insulation at extreme frequencies. Laboratory tests have shown that all of these glasses and others will meet the A. S. A. American War Standard on Ceramic Radio Insulating Materials, Grades L-5 and L-6.

Outstanding among the advantages of Multiform Insulators are minimum frequency drift, negligible water absorption, low loss factor, and an unusually wide range of size and shape. If insulator shortages have you worried, take this step now: clip and mail the coupon today for a free sample and complete descriptive booklet on Pyrex brand Multiform Glassware!

Multiform Insulation Products already include radio coil forms, coil form end plates and flanges, capacitor bushings, tube socket bases, rest bar insulators, antenna strain insulators, filament guides, rectifier rings, switch cups, co-axial line spacers, crystal holders, condenser spacers, mounting blocks, various beads and wafers, and many other electrical and industrial parts.

MAIL COUPON FOR FREE SAMPLE AND DATA ➔

Pyrex Insulators

BRAND

"PYREX" is a registered trade-mark and indicates manufacture by Corning Glass Works

Corning Glass Works, Corning, N. Y.
Insulation Division, Dept. E-42

Please send me immediately, without charge, sample and descriptive booklet on new Pyrex brand Multiform Insulators.

Name

Company

Street Address

City State

Excellent examples of QUALITY

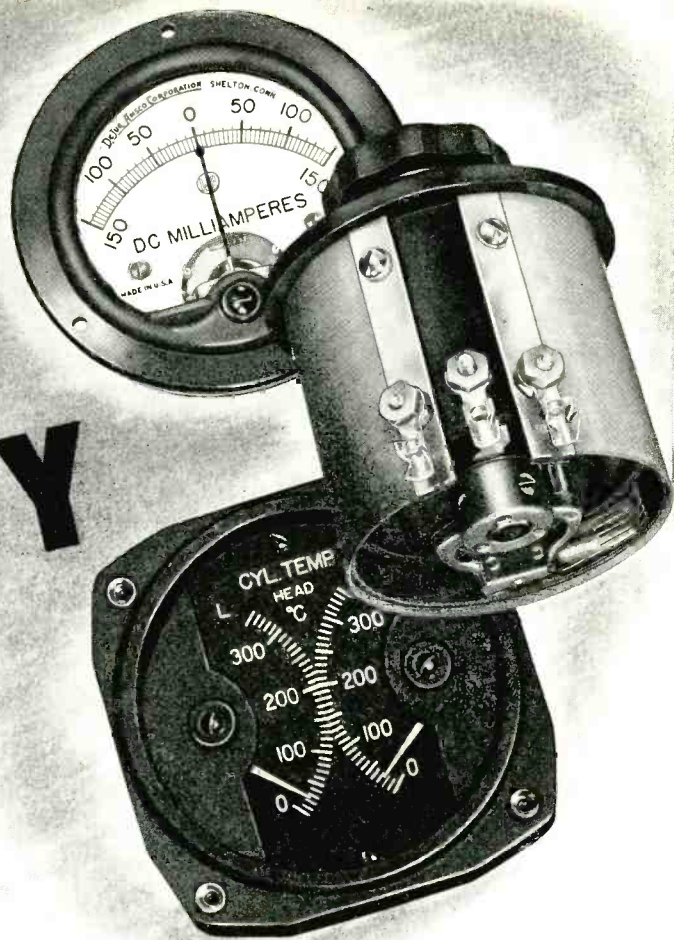

How may quality be recognized? The determining factors are materials, construction and performance . . . plus the ingredients that come from experience and research.

DeJur Aircraft, Electrical Instruments, Potentiometers and Rheostats are backed by more than twenty-five years experience and laboratory research. They are designed and manufactured to conform with the highest standards of war requirements . . . their worth has been demonstrated on both the battle and home fronts.

Awarded for Excellence in Production and Quality of Materiel



DeJUR-AMSCO CORPORATION

Manufacturers of DeJur Meters, Potentiometers, Rheostats and Other Precision, Quality Electrical Instruments

SHELTON, CONNECTICUT

Every Week . . . Everybody . . . 10% in War Bonds and Stamps

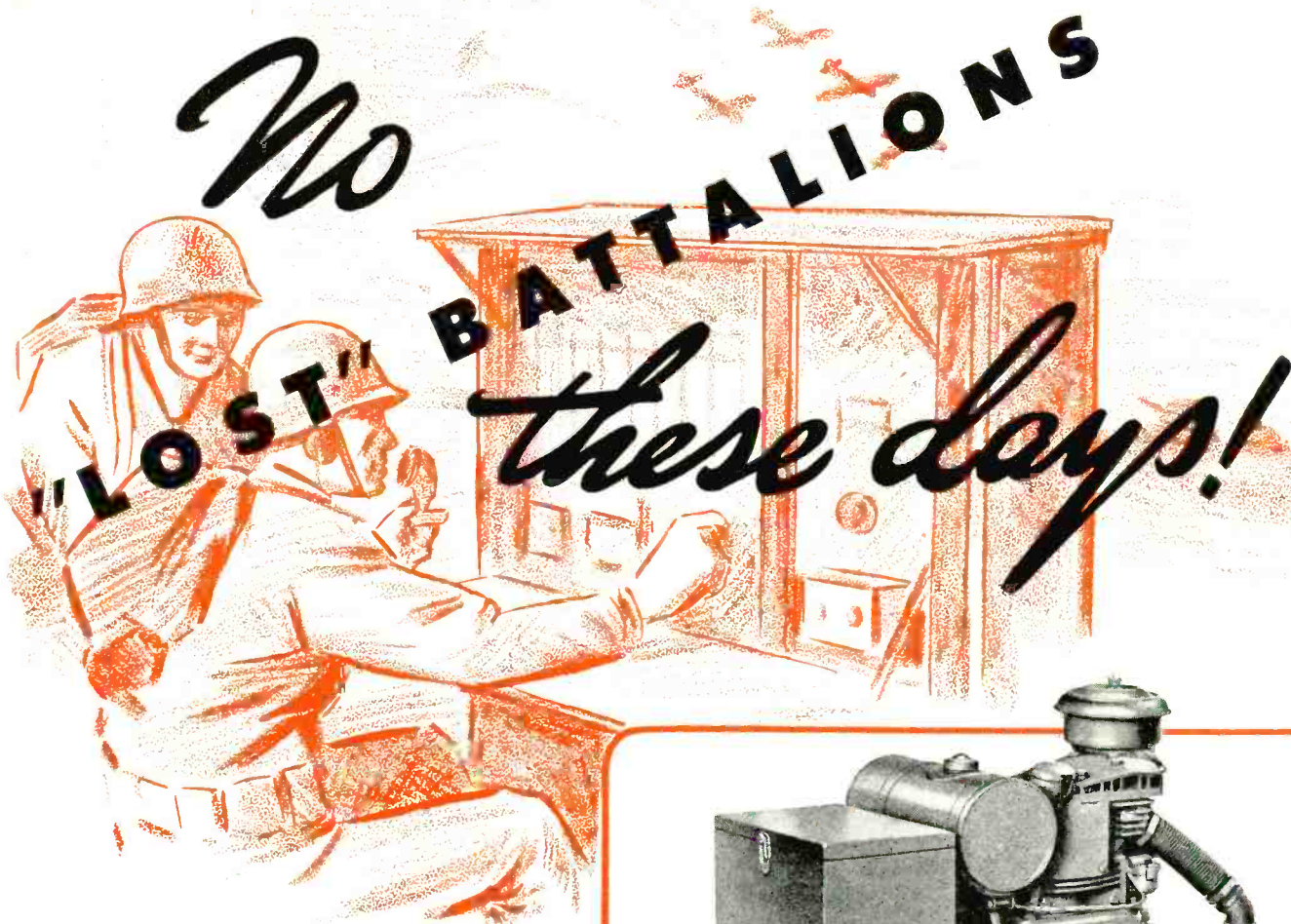

Not when they are equipped with portable gasoline driven power plants for field radio and field service phones. Not when competent sending and receiving equipment is Leland powered.

Here is motor dependability on a life or death assignment, and Leland is proud to be the designer and producer of such critical equipment, just as Leland employees are proud to be the "soldiers" at the machines "in step" with the men at the battle fronts. *Neither shall fail!*

- Power units for aircraft navigation equipment, shipboard transmitters and receivers, and other electronic equipment developed for war use are available to the armed services and essential industries.

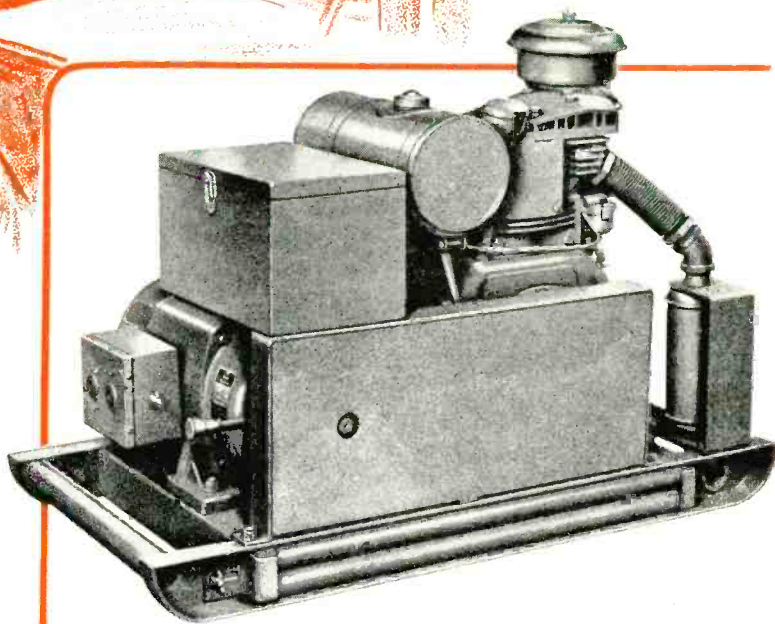

Leland Alternator on Portable Gasoline Field Radio Power Plant. Built for U. S. Signal Corps.

Leland
WAR DUTY MOTORS

THE LELAND ELECTRIC COMPANY • DAYTON, OHIO

ELECTRONICS — April 1943

57



Official U. S. Navy Photograph

I. T. & T. Selenium Rectifiers "Armored" against Salt Sea and Air... as result of New Assembly Method



Special Assembly Method — showing single metal washer which facilitates protective coating against corrosion

Standard Assembly Method — showing conventional petal-shaped brass contact washer

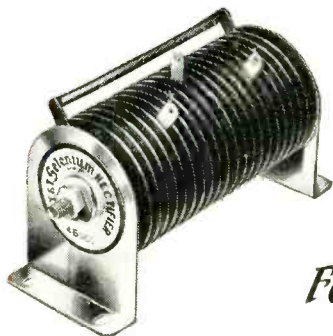

Another I. T. & T. First! Now—in addition to the standard assembly — I. T. & T. Selenium Rectifiers can be supplied with a *special assembly*, coated for protection against the corrosive action of salt spray, moisture and humidity.

Thus the organization which was first to introduce Selenium Rectifiers in the United States is now first to extend their many advantages to marine and other high humidity services.

Compact, light, electrically and mechanically stable—with no moving parts to wear out or cause failure—I. T. & T. Selenium Rectifiers have set a standard for the industry.

Now, on the Fifth Anniversary of their introduction, they are prepared to take on the toughest jobs that weather and war can hand them.

Consulting Engineering Service available for specific requirements. For descriptive bulletins address Department H.

SELENIUM RECTIFIER DIVISION

Federal Telephone and Radio Corporation



1000 Passaic Ave.
East Newark, New Jersey

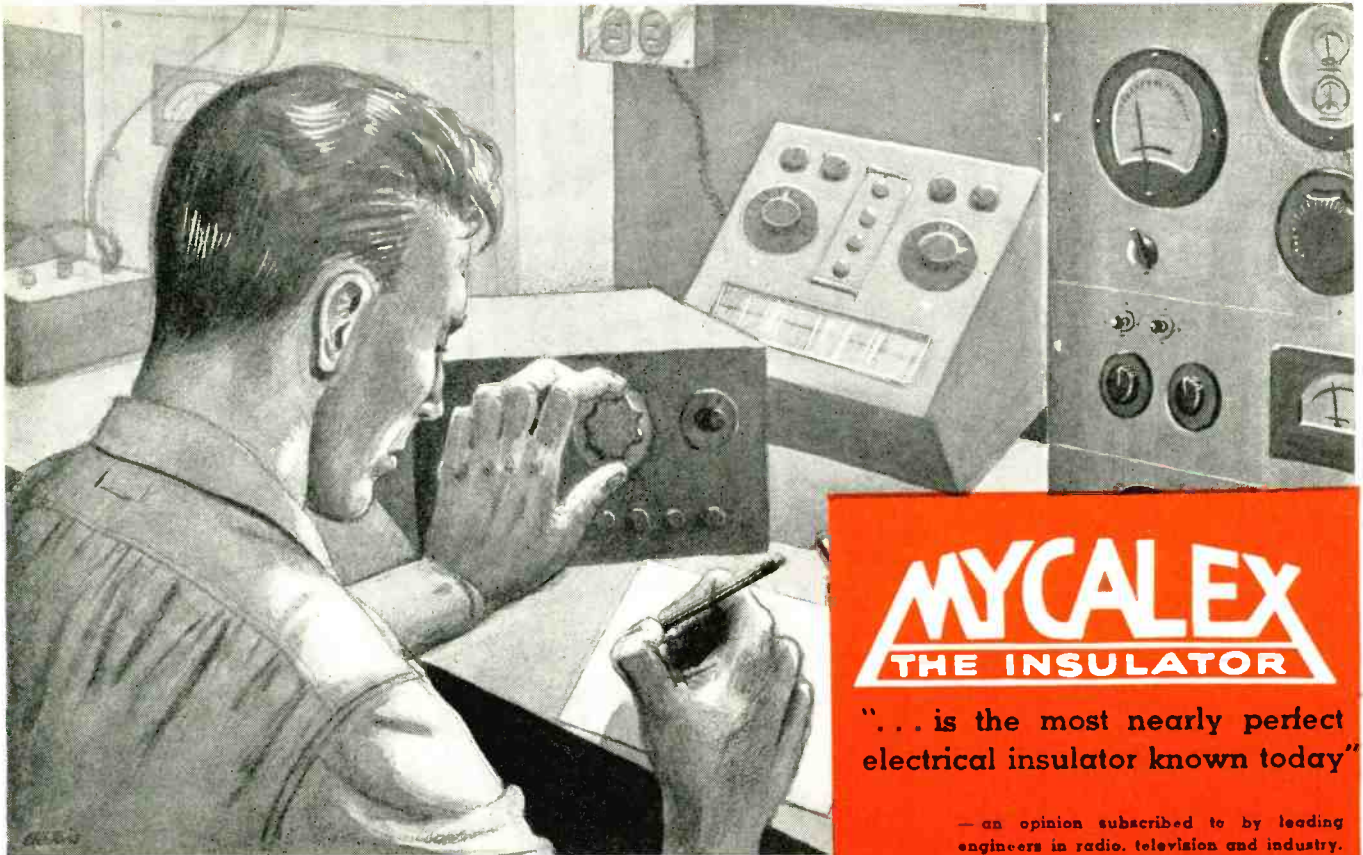

MYCALEX
THE INSULATOR

"... is the most nearly perfect electrical insulator known today"

— an opinion subscribed to by leading engineers in radio, television and industry.

THERE IS ONLY ONE MYCALEX

MYCALEX is not the name of a class of materials. MYCALEX is the registered trade-name for low-loss insulation manufactured only by the Mycalex Corporation of America in the Western Hemisphere. MYCALEX is specified by engineers because MYCALEX is required.

More than a quarter century of extensive application here and abroad has made the name MYCALEX a familiar one in the electrical and communications industries, and we are proud of the important part this versatile insulation is playing today in the military and civil life of the United Nations. The snows of Russia, the sands of Africa, the sweating jungles of New Guinea, the mountains of China—MYCALEX is no stranger to these backgrounds. Unsolicited testimonials to the vital role being performed in the war program by MYCALEX have been given us generously by the Army and the Navy.

If your present insulation fails because of deformation at room temperature or because of failure to withstand elevated temperatures MYCALEX will solve your problem. If you must have hole diameters, hole spacings, or other dimensions with close tolerances, slots, grooves, or accurately tapped holes, combined with low loss at all frequencies, you should bear in mind that MYCALEX has been meeting these requirements for many years. If, on the other hand, dimensions and tolerances are not too critical but ability to withstand high voltages is paramount, MYCALEX is the ideal material for your purpose. The greater machinability of MYCALEX, which is leadless, gives it advantages over any other type of insulation. Our engineering service is available in all cases where the choice of the most reliable insulation is in doubt.

MYCALEX is not available, except in experimental quantities, for other than war applications.

MYCALEX
THE INSULATOR

Trade Mark Reg. U. S. Pat. Off.

MYCALEX CORPORATION OF AMERICA

Exclusive Licensee under all patents of MYCALEX (PARENT) CO. Ltd.

60 CLIFTON BOULEVARD

CLIFTON, NEW JERSEY

ELECTRONICS — April 1943

65

**IF YOU ARE
WORKING ON A WAR APPLICATION**
Start with
IMPACT STRENGTH

IN ALL forms, from sheets to molding materials, LUMARITH'S impact strength is outstanding. (Some indication of its great strength is given by this Gjon Mili repetitive flash photo, showing a 12-lb. iron ball, dropped from a height of 12 ft. on $\frac{1}{8}$ " thick sheet of Aero-Quality LUMARITH, leaving sheet intact.)

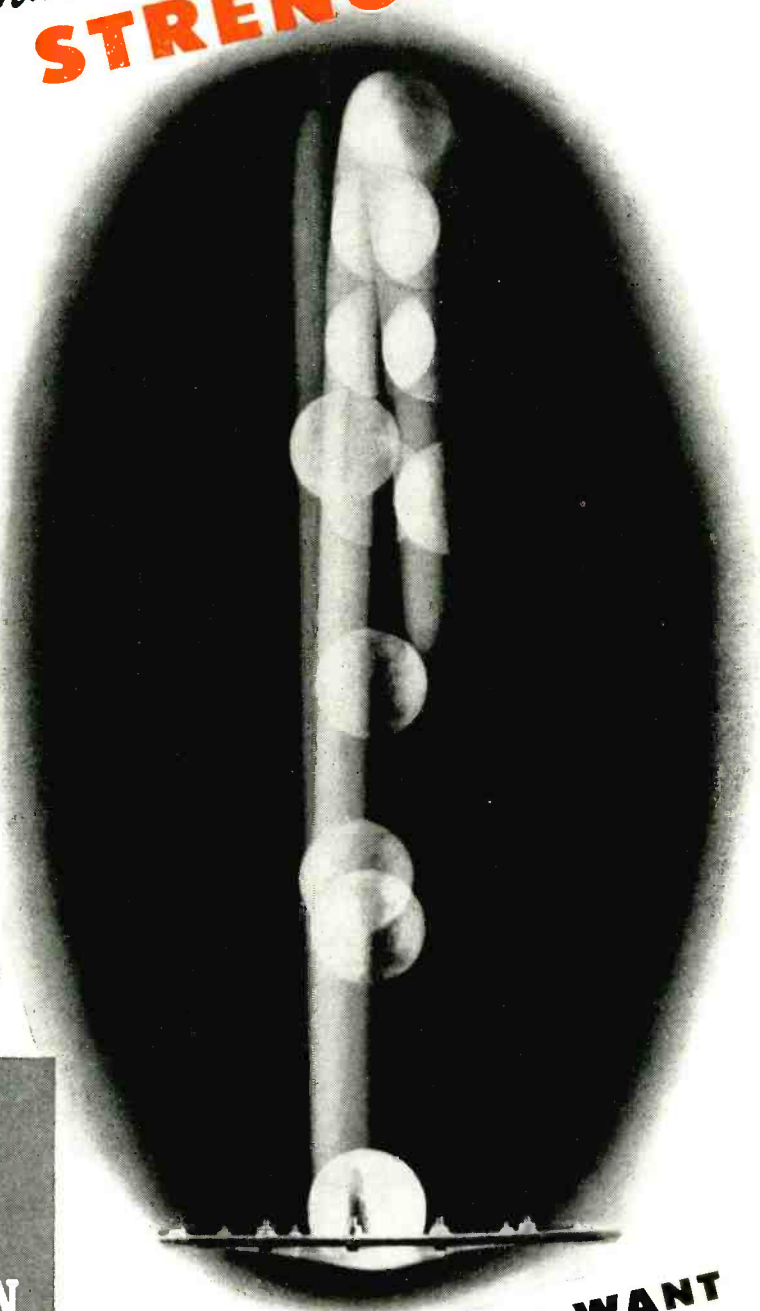

**CELANESE
CELLULOID
CORPORATION**

The first name in plastics

Celanese Celluloid Corporation, a division of Celanese Corporation of America, 180 Madison Ave., New York City. Representatives: Cleveland, St. Louis, Dayton, Chicago, Detroit, San Francisco, Los Angeles, Washington, D. C., Leominster, Montreal, Toronto, Ottawa.

**A DIVISION OF
CELANESE CORPORATION
OF AMERICA**

**IF YOU WANT
IMPACT STRENGTH IN A PLASTIC**
Start with
LUMARITH
MOLDING MATERIALS

LUMARITH, Reg. U. S. Pat. Off.
Copyright, 1943, Celanese Celluloid Corp.

Food—The Deciding Issue

Our food problem remains to be solved

THE first thing the Germans did when they occupied Czecho-Slovakia, Poland, Belgium, France—was to empty all warehouses. Everything went into trucks headed for Germany.

The Nazis knew that this war would be won by the army that had the most supplies and the best supply system.

The Nazis knew that supplies are as essential as guns. They knew that the most essential of all supplies is . . . food.

Being the only people on earth who can watch women and children starve, the Nazis seized upon food as their most powerful instrument for disciplining the masses. They added famine to their arsenal of conquest.

The flocks and herds of Europe are being consumed with alarming rapidity. The desperate shortage of meats and fats is growing steadily worse. Our Allies are short of certain foods that we must supply if we expect them to carry on.

And as we supply them, as our imports are curtailed, as our fighting men consume more than they do in civil life, and as we fail to increase our production rapidly enough . . . we, too, become short of certain foods.

Former President Herbert Hoover, speaking before a conference of the Governors and Representatives of twelve Mid-Western farming states in Des Moines on March 15th, sounded the warning that American agriculture, beset by Washington bungling on manpower, farm machinery and price systems, strangling production and distribution, is facing a deterioration which may bring on a national food shortage such as led to the collapse of Russia, the defeat of Germany in the first World War and the fall of France in the present war. Unless this deterioration is stopped, warns Mr. Hoover, we cannot hope to win the present conflict.

Complications of similar magnitude face the food processor and the distributor.

Never in the history of the world has man's dependence on food been so crucial. Yet it is not easy for us to grasp the full significance of the crisis. We are so accustomed to finding milk, eggs and butter on our doorsteps every morning, we are so used to filling our pantries from the shelves of our grocers and markets that we accept food as something that is due us on demand. We do not stop to think that we never are more than a few meals ahead of famine.

But this picture has changed. Now we are faced with

food rationing, and every day the shelves of our food markets become more bare.

* * *

Let it be noted that the appointment of two Food Administrators has not solved the food problem. It is still with us; daily it becomes more critical. Unless it is solved, and solved quickly, the very food that ex-Food Administrator Wickard said would "win the war and write the peace" may lose the war and lose the peace.

Put very simply and clearly, the food problem amounts to this: we are trying to feed upward of 200 million people. We are trying to do it with the farms and other facilities that heretofore have been capable of feeding about 145 million people (our present population plus a 5% surplus).

Had the Government foreseen the need and planned ahead, we could have begun by 1941 the enlargement of our farm production and food processing capacity. Two irreplaceable years have been lost!

The gravity of the situation becomes apparent when we consider that 50,000 factories are required to process our foods. Food processing not only is America's biggest industry—it is one of America's most important for, without processing, most foods would perish before they could reach the consumer. The term "processing" covers the salting, drying, smoking, pickling, chilling, canning, packing and other methods of preservation that make it possible for us to eat in 1943 food that was produced in 1942. Few realize that most of the food we shall eat in 1943 was produced and processed last year, that most of the seed we plant this spring will grow food for 1944 or perhaps later.

In one important process of preservation, tin and rubber are vital materials. When the Japs captured Malaya and the Netherlands East Indies more than half of the world's tin and nearly all of its rubber fell into their hands. This forced drastic changes upon our entire food economy. The importance of tinned steel containers, tops for glass jars and rubber gaskets is fairly obvious . . . metal food containers alone consume, every year, more than 2,700,000 tons of steel.

The aggression of Japan has snared our whole food industry in a maze of intricate packing problems. It has enforced recognition of a new principle of food technology, i.e., that the *method* of food preservation is determined by the type of container available. The tin, steel and rubber stringency compels many food processors to adopt

unfamiliar methods—methods that call for a great deal of new equipment. This, in turn, involves the use of critical materials that are so urgently needed for other war purposes.

This conversion of the food processing industry to meet these exacting restrictions has been greatly complicated by two factors that have increased its wartime burden. Indeed, it is these that provide the principal reason for civilian food rationing.

The first of these is the task of feeding our armed forces overseas. Allied ships are being sunk at an alarming rate and the loss of cargo is considerable.

The second factor gravely augments the first. Under Lend-Lease our country is undertaking to feed our Allies to the extent of approximately 60 million people.

Types of food required for Lend-Lease and the armed forces are the finest we can produce. They are the high protein foods, especially meats, cheese and milk; and the protective foods which rate high in vitamin content. Peculiarly enough, the more valuable a food is from a nutritive angle, the more specialized is the processing required to preserve it.

The food processing industry, handicapped as it is, is meeting today's challenge with resourcefulness and enthusiasm . . . despite container complications and shipping shortages.

It is accomplishing its Herculean task by resurrecting and modernizing a method of food preservation that is as old as mankind. Probably you have read a great deal about dehydration. You actually may have eaten dehydrated food, but right now nearly every bit of dehydrated food is earmarked for the armed forces or for Lend-Lease.

Food processing never will be as spectacular as the production of bombers or tanks. But under today's conditions, the performance of the food processor is no less important . . . no less inspiring. When we consider that dehydrated food is compressed into solid blocks with a density nearly equal to that of coal, so that almost a whole meal can be carried in a vest pocket, and that half of the shipping space is thereby saved in transportation, we begin to appreciate what the processors have contributed to meet the food problem imposed by the war.

But they have not only contributed new methods, they are achieving new highs in production. And now they are asked to do what borders on the impossible. Consider dehydrated egg powder. Normal production in pre-war

years was about 3,000,000 lbs. In 1940 this was increased two and one-half times, in 1942 it was stepped up again, this time forty-fold. And in 1943 the call is for another 60 per cent boost, to make a total of 480,000,000 lbs. Dried milk powder production of 350,000,000 lbs. in 1940 must be increased to 685,000,000 lbs. in 1943.

Vegetables, which were a small item to the processor before the war, now are dehydrated in enormous quantities. The vegetable dehydration industry has had to grow by leaps and bounds without benefit of the high priorities accorded to arms, ship and aircraft building. Production of dehydrated vegetables in 1942 was four times that of 1941, and 1943 calls for a sixteen-fold increase over 1942.

Total dehydrated food production in 1943 is scheduled at 1,750,000,000 lbs., dry basis . . . all for export. Multiply that by 10 and you have a rough approximation of the astronomical amount of raw materials that will have to be produced.

Many problems remain to be solved in the troublesome days that lie ahead. But with all his resourcefulness, man has little control over the weather. A severe drought could wipe out all of man's carefully laid plans. If we are tempted to reassure ourselves with the thought that the food situation probably is not so serious as it is painted, it will be well to remember that last year's crop increase over 1941 was due to better

than average growing weather.

The war-bred food crisis that now confronts us will be met only by immediate measures to insure a food production ample to allow for adverse weather conditions. The food processing industry is capable, but has not been granted the needed help, in coping with its tasks. The food problem as a whole involves all three functions of production, processing and distribution. And if we are to master the problems that now beset us, all three of them must be coordinated under a single administrative control. "Food will win the war and write the peace". But if American food is to do that double job, we must develop a capacity for food administration comparable with the genius of our food industries.



President, McGraw-Hill Publishing Company, Inc.

This is the tenth of a series of editorials appearing monthly in all McGraw-Hill publications, reaching more than one and one-half million readers, and in daily newspapers in New York, Chicago and Washington, D. C. They are dedicated to the purpose of telling the part that each industry is playing in the war effort and of informing the public on the magnificent war-production accomplishments of America's industries.

electronic briefs: television

To produce a moving picture it becomes necessary to break down the action into a series of still pictures. Each still scene is flashed on the screen individually but done so rapidly that the human eye sees a smooth action. If the motion picture projector is slowed down the action becomes jerky. Each still picture is called a frame. The conventional movie projector flashes between 24 and 30 frames per second on the screen. Television is based upon the same principle but the problems involved are much more complex.

Television, using the same basis for creating picture action as the movies, breaks down the picture or scene to be broadcast into a series of still pictures called frames. But each frame must also be broken down into approximately 200,000 tiny segments, each segment being broadcast separately and reassembled at the receiving end so rapidly that 30 frames can be flashed on the screen every second. Thus some 6,000,000 separate signals must be transmitted per second. Furthermore each of these signals starts as light, is converted into an electrical impulse, broadcast and then reconverted to light again. To make television talk, a conventional sound transmitter must be coordinated and synchronized with the picture broadcast.

As with all things in the field of electronics, vacuum tubes are what make television possible. Remember; Eimac tubes enjoy the enviable distinction of being first choice among leading electronic engineers throughout the world.

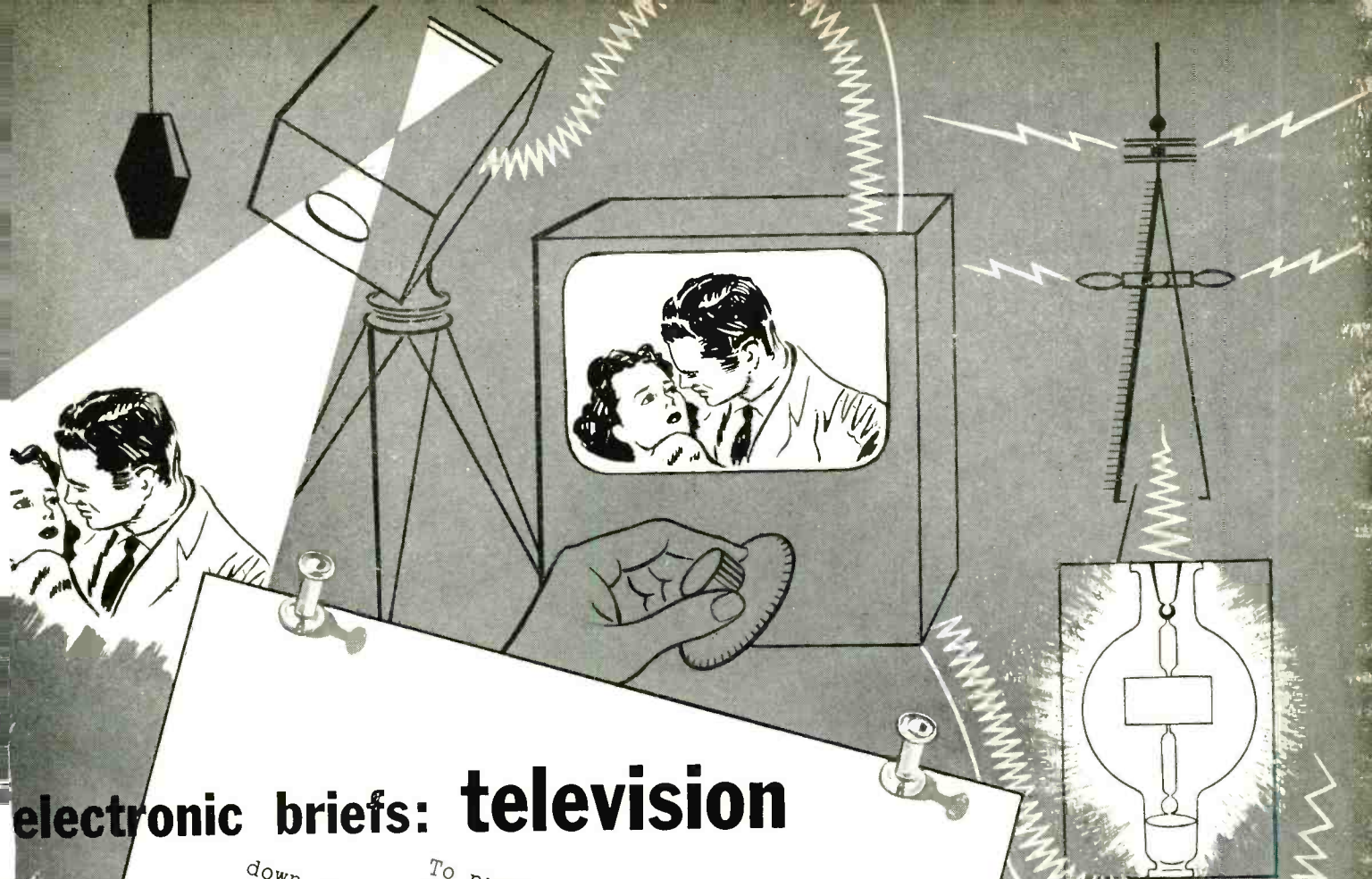

EITEL-McCULLOUGH, INC., SAN BRUNO, CALIFORNIA
EXPORT AGENTS: FRAZAR & HANSEN, 301 CLAY ST., SAN FRANCISCO, CALIF., U. S. A.

Follow the leaders to

Eimac REG. U. S. PAT. OFF.
TUBES



Army-Navy "E" flag awarded for high achievement in the production of war material.

**THIS WORLD OF OURS IS
LITERALLY DOTTED WITH**

TEMCO

EQUIPMENT

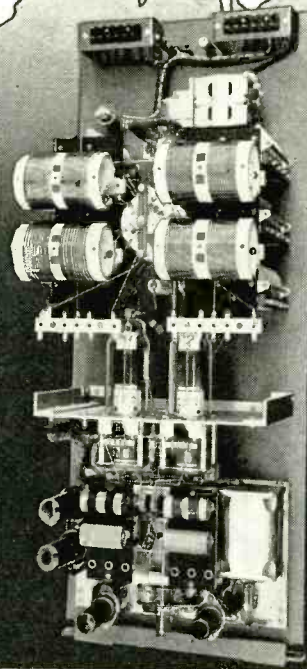
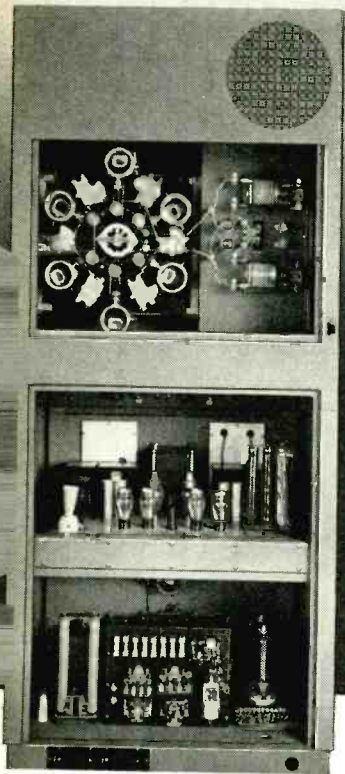
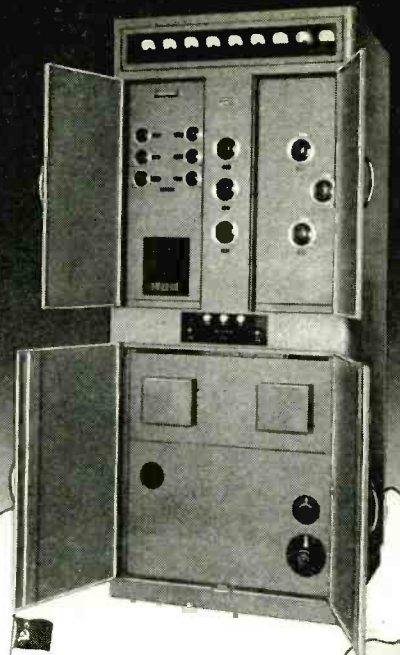
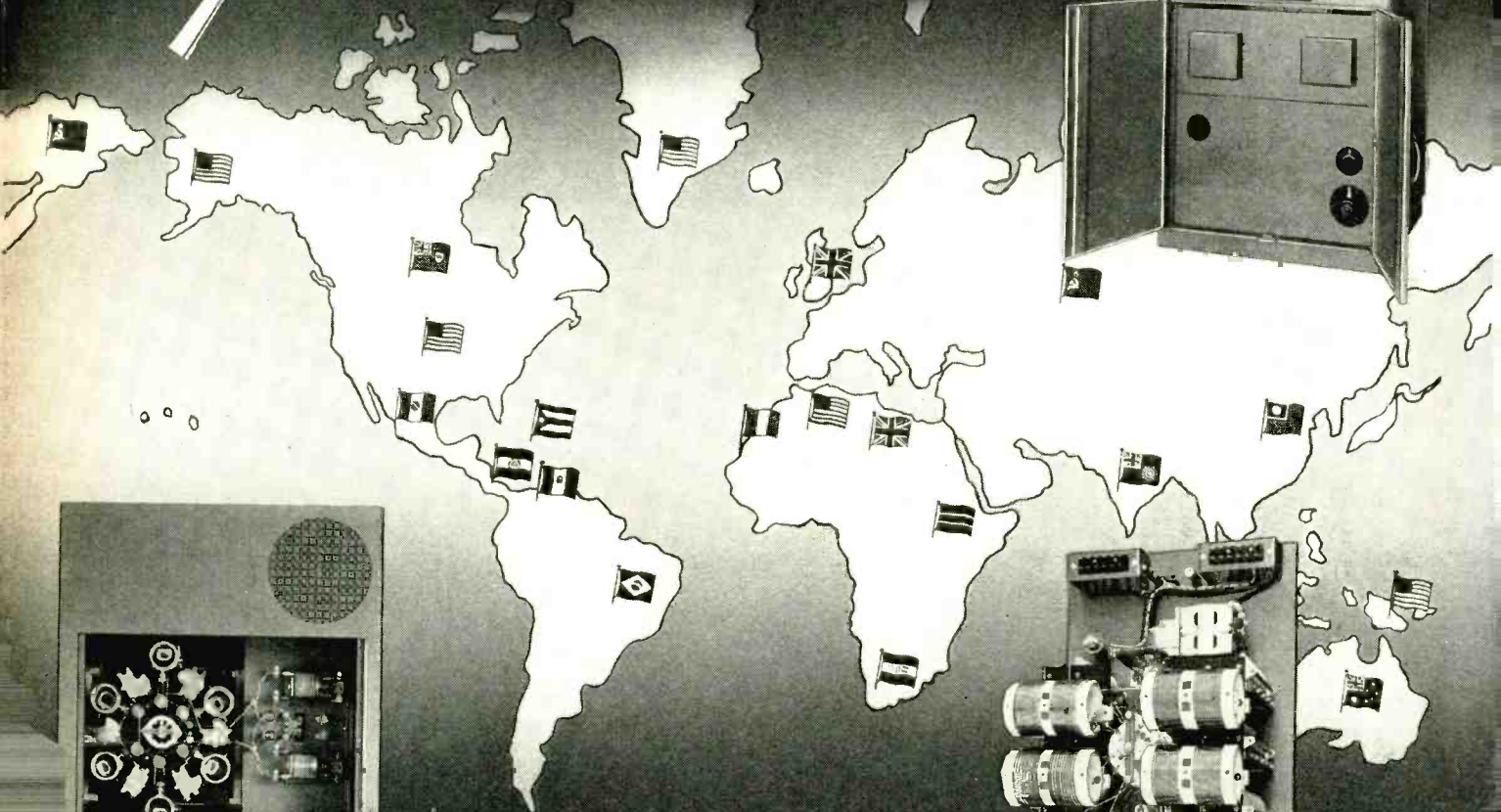

TEMCO IS NOW demonstrating its superb performance in the far flung corners of a mighty global war . . . from Alaska to Madagascar and from Greenland to China . . . for this military conflict has brought about a demand for radio equipment beyond our most far-sighted visualization. The excellence of TEMCO engineering and workmanship is reflected in these units . . . typical of the quality that will again be available for the broad requirements of commercial radio communication.

TEMCO

STANDARD AND CUSTOM-BUILT RADIO COMMUNICATION EQUIPMENT

TRANSMITTER EQUIPMENT MANUFACTURING CO., INC.
345 Hudson Street, New York, N. Y.

WASHINGTON FEEDBACK

When the story of World War II is fully told, the battle of communications will furnish one of the most spectacular chapters. Even today, and despite the atmosphere of hush-hush, one cannot mistake the sense of urgency and expectation back of every phase of the government's radio and radar program.

One day, for instance, Robert P. Patterson, Under Secretary of War, tells a congressional committee that while the War Department has plenty of "inspectors" in production plants, the only "expeditors" are for plants making radio and radar equipment, thus bespeaking the urgency of speeding up those programs and their far-reaching implications.

A few days later, chief analyst of the BEW, Dr. Lyman Chalkley, reports to the American Council of Public Affairs that radar, neglected in time of peace because of the alleged lack of profit motive, is the most dramatic new weapon of this war. It was necessary to start almost from scratch to get radar from the stages of laboratory curiosity to the manufacture of practical instruments, he said.

Dr. Joseph Slepian of Westinghouse goes even further in his address before the Science Talent Institute in referring to electronics as "the fresh and expanding vista that lies before the electrical engineer of today and tomorrow."

It was against this backdrop that the major happenings of the month took place.

WPB—Shake-up in WPB and vesting of control over materials allocation and production in Vice Chairman Charles E. Wilson means more and not less tightening of control over war materials. Wilson stands ready to assume full responsibility for the assignment of orders

for components (see WPB Order M-293). Drastic regulations were set up for a few items of which radio test equipment is one. Lesser controls have been imposed on the rest of the 32 items which are designated as critical, including certain types of tubes, condensers, capacitors and control instruments.

Present setup should cause no upheaval in the R and R Div. of WPB. Mr. Wilson is communications-minded; he knows the industry and its production capacity. The Division has been functioning under his direction for some time. Relations with Army and Navy are friendly and cooperative. An outstanding example is the work of the Standardization Committees under S. K. Wolfe, chief, WPB Resources Branch. When this work is finished, every component used by the Signal Corps will be included. Mr. Wolfe wants all standardization of component parts to be completed in less than a year. About \$160,000 more will be needed for the job.

Resources Branch is also responsible for formation of production integrating committees in the field of resistors, electrical measuring instruments and capacitors. These committees will eventually be extended to all components; will integrate best manufacturing practices throughout each component industry. The work is a continuation of that done by the Industry Advisory and Standardization Committees.

Steatite—An interesting report on Ceramic Capacitors and Steatite has just come from the Industry Advisory Committee, headed by Elmer Crane, Chief of the Component Section of WPB Radio Division. Evidently steatite is no longer a bottleneck in the production of military radio equipment. Producers are able to accept orders for delivery in

from four to eight weeks vs eight months backlog last summer, because facilities constructed to meet war demands are now in operation and because phenol plastics have been substituted for steatite. There is a danger now that the pendulum will swing too far towards phenol and cause a scarcity of it instead of steatite. Producers of ceramic capacitors forecast sharp increase in output within two months because of new facilities now being completed.

Manpower — Recognizing that program objectives hinge as much if not more on adequate manpower as they do on materials and orderly scheduling, the government and industry have moved to solve this No. 1 problem. "Electronics Manpower Advisory Committee" has been organized to prepare recommendations to War Manpower Commission and other government agencies. Formed by the Radio Division of the Bureau of Ships, United States Navy; the Army and Navy Electronic Production Agency and the Radio Division of the War Production Board. Management members are: L. B. Morris, R.C.A. Mfg. Co., Inc., Chairman; J. D. Washburn, Sprague Specialities Co., and W. K. Wiggins, Western Electric Co., Chicago.

Labor members are: Harold Sharpe and James J. Conroy, United Electric, Radio and Machine Workers of America, C.I.O., and Lawson B. Wimberly, International Brotherhood of Electrical Workers, A.F.L.

At the organization meeting, attended by representatives of Armed Services and WPB, a special task committee was set up to summarize electronics manpower problem for presentation to the committee. First subject to be studied is that of absenteeism.

Additional Washington news will be found in Crosstalk and Industry in Review.

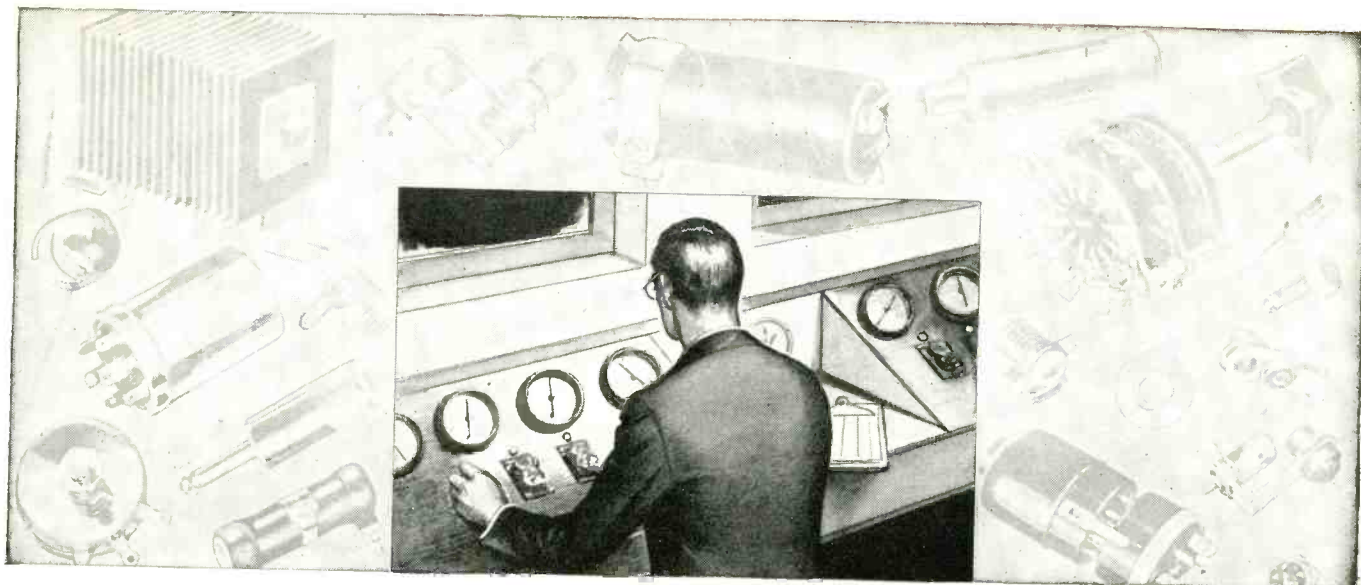

Probably Your Mallory Distributor Can Give You Help Like This—

Somewhere in the Middle West is an aircraft engine manufacturer who uses many Mallory Electronic parts in dynamometer test cells. Recently he sent us a hurry call for some Mallory phone jacks to go in the control panel of a new cell being rushed to completion. He had the right priority, too.

It was a standard jack, but as is so often the case with manufacturers immersed in war production, it was out of stock. To produce it, we would have had to start from scratch—"when, as and if!"

But we referred his request to the local Mallory distributor—who filled his needs from stock.

This is just a sample of how Mallory distributors can help. We do our level best to furnish them with adequate stocks so that essential electronic parts to fill small orders with high priorities may be handled promptly.

It will pay you to maintain a contact with your local Mallory distributor. He will give good service, furnish your purchasing department with complete information and prices; your engineering and design departments with application data; work his head off to get you those parts you need for maintenance, test equipment and pre-production models.

P. R. MALLORY & CO., Inc., INDIANAPOLIS, INDIANA

Cable Address—PELMALLO



Get acquainted with your local Mallory distributor. Or if you do not know who he is, write us and we will put him in touch with you. And, for good measure, we will send along a copy of the Mallory Catalog for ready reference.

P. R. MALLORY & CO. Inc.
MALLORY
APPROVED
PRECISION PRODUCTS



CROSS TALK

► **GARCIAS** . . . At the recent AIEE-IRE meeting in New York City, Brigadier General F. E. Stoner, Director of the Army Communications Division, Signal Corps, paid a fine compliment to the many behind-the-lines communications engineers designing and producing electronic equipment for the armed services. He told of the Army major who got a medal for taking a message to Garcia in another war. "In this war," said the General, "there are thousands of soldiers carrying thousands of messages to thousands of Garcias." After the war some means must be found for letting the rest of the nation know how electronic men in the many laboratories and factories and communications systems have made possible the carrying of these messages with accuracy, speed and security.

► **MARCH 8** . . . As of this date, the President signed the bill merging Western Union and Postal Telegraph. Thus, in time, the United States will have a single integrated land-line communications system for telegraph. Chairman Fly of FCC prophesied that the merger would result in better telegraph service.

"You see," he said, "the great difficulty in having parallel lines under different management is that you can't use vacant capacities as they occur, but where the telegraph is under a single management you can fall back on whatever facilities and personnel you have that can be adapted to the particular need."

► **SYMBOLS** . . . People growing up in different and widely spaced parts of the world developed their own languages. In a smaller way, electrical engineers working in radio and in power fields have developed their own languages, much of which is moderately unintelligible to each other. A generator, for example, means only a piece of rotating equipment to a power man; although to a radio engineer it may mean a tube oscillator. Even the symbols which these two branches of electrical engineering employ in

their blueprints are not alike. A zigzag line to a radio engineer is a resistor; to a power engineer it is an inductor.

In this issue, Mr. Dudley surveys this situation, pointing out the similarities and the differences. Because of the long standing practices to which engineers have become accustomed there is little likelihood that the differences will be reduced during the war. Which proves, probably, nothing but that engineers are people like the rest of us, agreeing on big things, disagreeing on trifles.

► **AMEN** . . . On March 2, FCC announced following terminology defining the bands in the useful radio spectrum.

Frequency in KC	Mc	Designation
10 to 30		Very Low (VLF)
30 to 300		Low (LF)
300 to 3,000	3	Medium (MF)
3,000 to 30,000	30	High (HF)
30,000 to 300,000	300	Very High (VHF)
300,000 to 3,000,000	3,000	Ultra High (UHF)
3,000,000 to 30,000,000	30,000	Super High (SHF)

► **FCC** . . . Narrowly escaping starvation or at least a drastic budget cut when a move was made in the House to eradicate its 1944 fiscal year \$7,609,914 appropriations from the Independent Officers Supply Bill, FCC was saved by Speaker Rayburn in his first speech in this session of Congress.

► **DREAM** . . . We woke up the other night from the damndest dream in which we were saying to someone, whose identity was lost in the shuffle, "It is the strangest thing how the manufacturers who have the best products and the swellest catalogs always get their information to you just after you have been forced, by time limitations, to order your stuff from someone else." We haven't the remotest idea what was going on in our subconscious mind to bring forth such an illuminating statement.

How far the Navy has gone with radio communication may be seen by looking over this NSF-NOF apparatus of 20 years ago. This is an early superheterodyne used for communication with planes. Old timers will recognize on the top shelf the two-stage audio amplifier (SE 1000) which amplified so well at 1000 cycles it wanted to oscillate all the time. Assigned to find out why, Hazeltine started on his way to the Neutrodyne. Lower center is the celebrated SE 1420 designed by Hazeltine

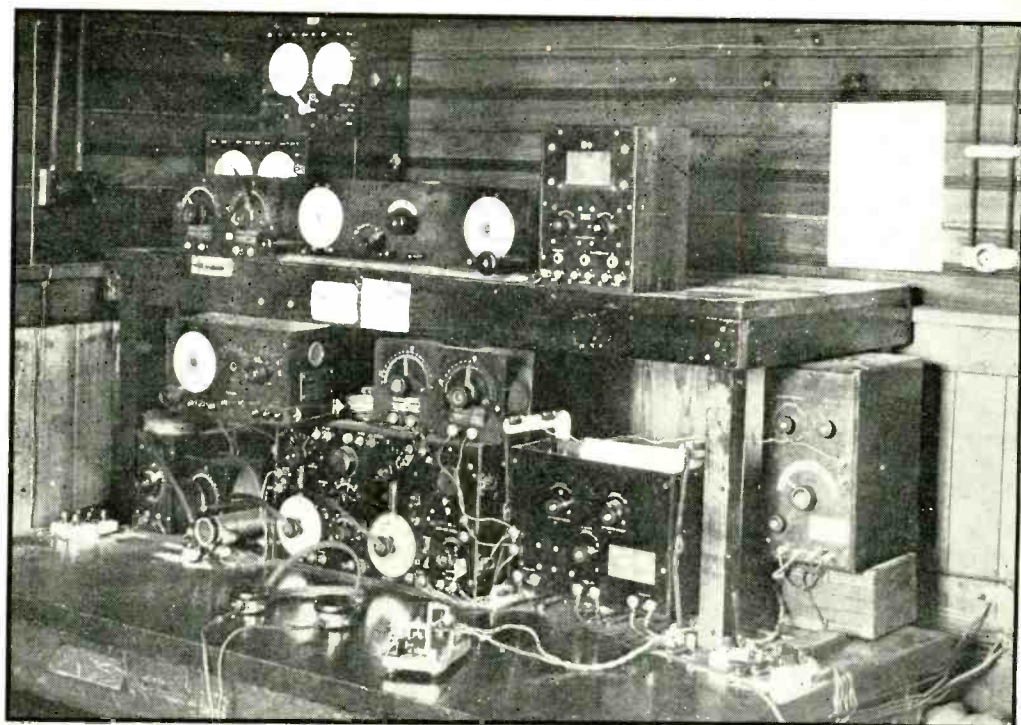

Radio and Electronics in

From the earliest days of "wireless," the United States Navy has made wide use of radio for communication. Through its own research, the Navy has made important contributions to the application of electronics to communication and to other, now secret, uses. A brief history plus details of the present Navy radio organization under the Bureau of Ships

By **S. P. SASHOFF**

*Lt. Comdr. USNR.—Officer in Charge
Training and Publications Section
Radio Division, Bureau of Ships*

THE United States Navy has long recognized the value of electronics in the conduct of warfare. From the earliest days of the science to the present, the attempt has been made to examine and make use of every worthwhile development in the field. In many cases, the advances came from commercial companies. In others, Naval and other government laboratories and activities have made substantial contributions of their own. The result of the progressive policy of past years is that the vacuum tube is now one of the most important weapons our Navy has for winning the war.

A vast amount of coordinated effort is required to meet the present electronic needs of the fleet and air arm. Many thousand men and women, in the Navy and outside of it,

are working on electronic equipment. Hundreds more are administrators, functioning solely to see that the following sequence of events occurs with efficiency and dispatch: to see that a new tool, a good war tool, is designed; that it is carefully built; that men are trained to use it; that, if it breaks, it is repaired.

The guiding agency for the Navy's present radio and electronics program is the Radio Division of the Bureau of Ships in Washington. This Division is responsible for design, procurement, installation, and maintenance of all radio equipment for use on board ship and shore, and, in cooperation with the Bureau of

Aeronautics, for the design and procurement of aircraft radio equipment. The organizational chart serves to give an idea of the complex structure necessary to do the job.

Before the last war, the only Naval use of the vacuum tube was in radio. "Electronic design" meant a new hookup to get the most from a Fleming valve or, better, an audion. Today, though electronics is no longer confined to communications, the need for a dependable fleet radio system continues. It is interesting to note, therefore, that the Navy brought many radio developments into use in this country, was for many years the biggest user of radio gear, and had many skilled radio engineers in the days of the great discoveries of deForest, Fessenden, and Armstrong.

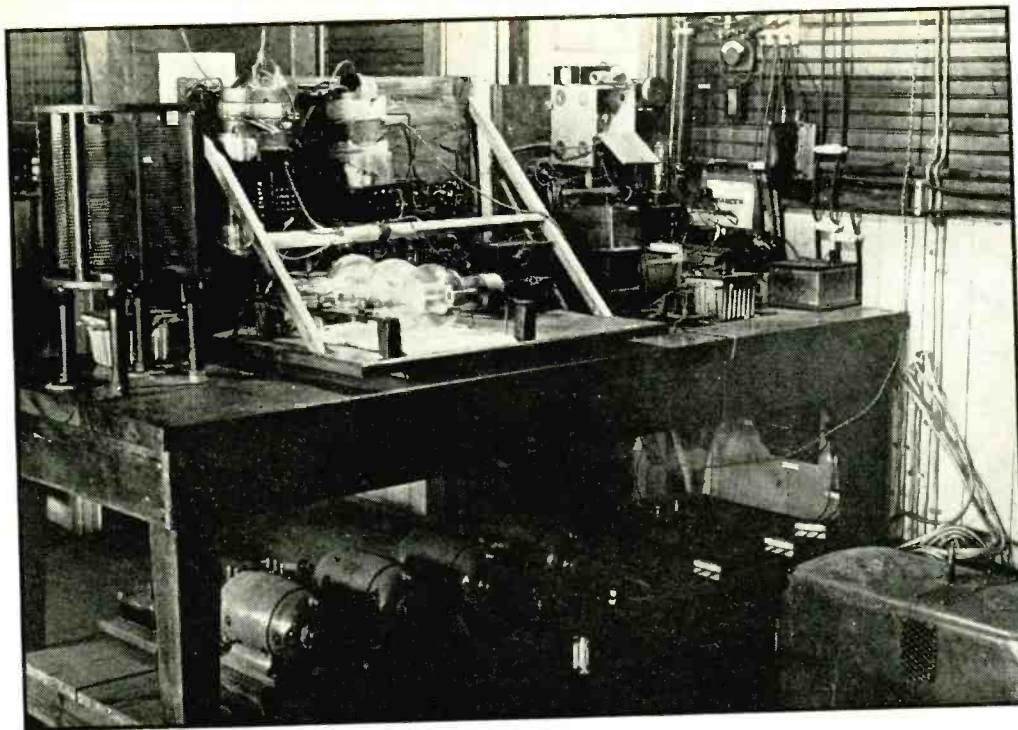

Transmitters weren't so hot in those days either, compared to modern standards. This is rear view of NSF "table model"

An aircraft job. This is the SE 1100 tube transmitter dating back to December 1919

the Navy

The interest of the Navy in radio dates back to 1901, when a proposal was made to replace homing pigeons with wireless telegraphy. In 1902, an offer from the Marconi Company to lease equipment was turned down because the transaction involved disclosure of Naval information to a foreign concern. In 1903, a satisfactory arrangement was made with another company, and work on wireless installations began. By 1912 a number of stations were in operation, the huge Arlington transmitter had been completed and the first Naval purchase of triode vacuum tubes—audions—is recorded.

The early research work in Naval radio was undertaken by a group of Bureau of Standards personnel, headed by Dr. L. W. Austin. Two small rooms at the Washington Navy Yard were taken over, and became the radio test shop. Here trained officer and civilian assistants were assigned special problems in the design, standardization, and testing of communications equipment.

The advent of the first world war brought increased responsibility to these men and the others concerned with Naval radio. Improved equipment and new developments were ur-

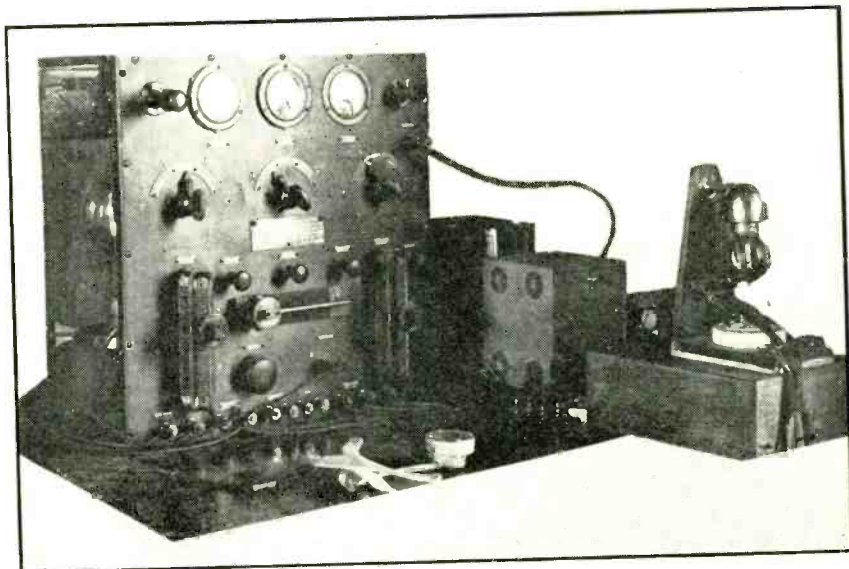

gently needed. Among the achievements to grow out of the cooperative effort of Naval and private research during this first World War were the following:

- Design of radio equipment for aircraft having 100 to 500 miles range.
- Invention of the directional loop antenna by Dr. F. A. Kolster of the Bureau of Standards. This device was manufactured in secrecy and used with notable success as an aid to navigation and to locate enemy stations.
- Invention of acoustic methods of detecting submarines.
- Development of an audion circuit

using both plate and grid tuning.

Development of radio telephone equipment. This was first used in 1916. The original equipment had a range of 30 miles, used three wavelengths, and permitted nine simultaneous conversations.

Design of apparatus for remote control of radio stations, for automatic rebroadcasting.

Investigations into tuned audio frequency amplifiers to reduce static, underground and underwater antennas, and methods of using contact detectors for measurement of small r-f currents.

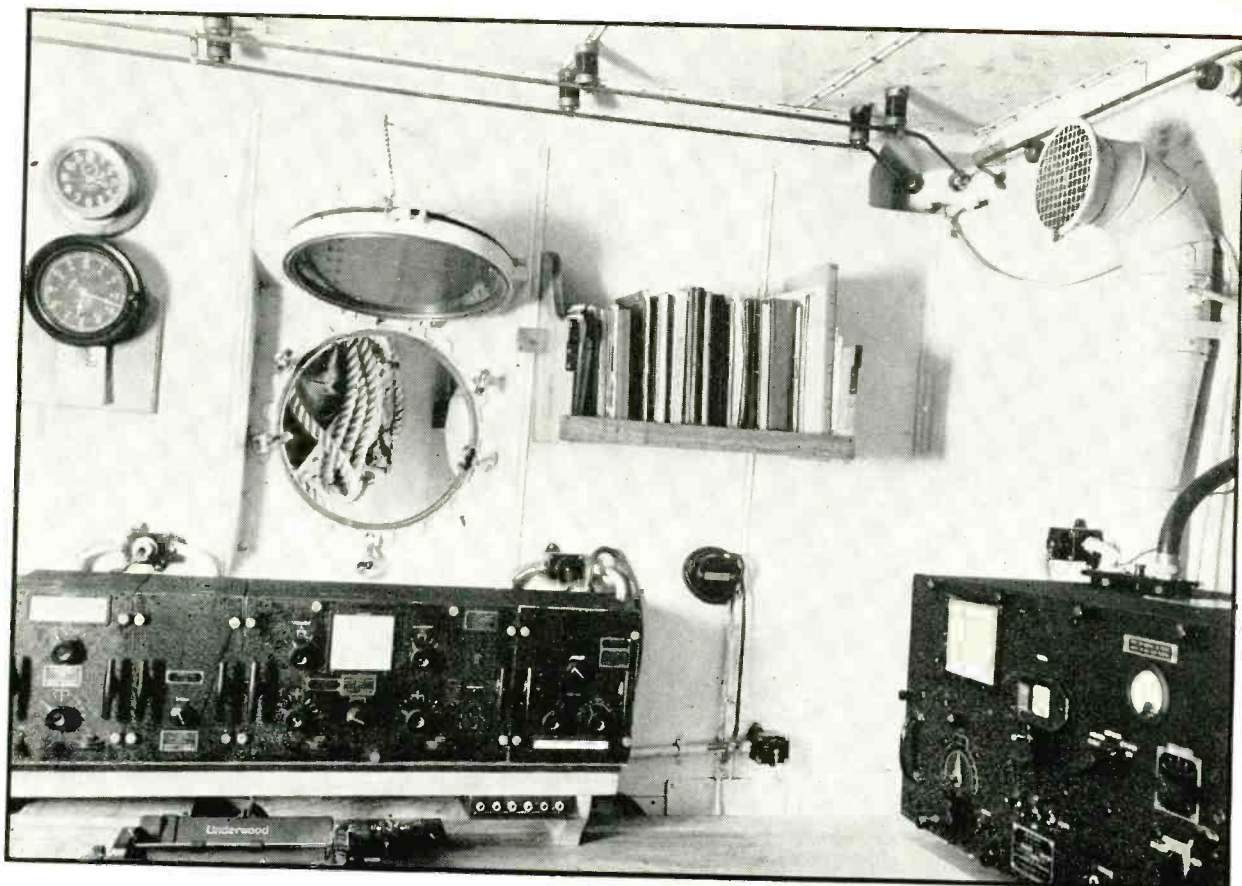

Two views of a 1942 installation aboard ship. Note the individual receivers for the several bands to be covered. This clean-cut layout is in marked contrast to those of the early days

By the end of the war, Naval radio activities had increased to the point that radio materiel officers were required at practically all Navy Yards. Crystal sets had given way to crystal-audion arrangements and finally to straight vacuum tube receivers. Spark was superseded by arc and the Alexanderson alternator. The transmitting tube was coming in, accelerated by a Navy order for a half million dollars worth of 250-watt types in 1919. Progress in electronics went rapidly forward.

Naval Research Laboratory Achievements

The year 1923 was marked by the opening of the Naval Research Laboratory at Anacostia, D.C. This laboratory filled a long felt need for increased facilities to carry on developmental work in electronics and in other fields. This organization, and the two later laboratories at San Diego and New London, are responsible in large measure for the Navy's high degree of preparedness in electronic design before the outbreak of the present war.

The successful history of these Naval laboratories has been largely due

to adherence to certain basic policies. For example, the only projects undertaken are those which have a direct value to the Navy, and which are sponsored by one of the Naval bureaus. The research work is accomplished by eminent scientists from civilian life, working with technically qualified Naval personnel. The officer personnel is changed every two to four years so that men trained in the latest scientific developments may be with the fleet, and so that replacement officers may bring practical service problems back to the laboratories.

Another beneficial policy has been to enlist active cooperation from the research laboratories of universities and industrial plants throughout the country. More than seventy colleges and industries have furnished invaluable technological assistance in electronics.

A listing of a few of the achievements of the Naval Research Laboratory should prove of interest. The laboratory:

Designed and built the first high frequency and the first ultra high-frequency radio sets used by the fleet.

Developed and installed in the fleet the first multiple reception radio system permitting the operation of a large number of receivers from one small antenna.

Developed the technique of producing quartz crystals for the frequency control of radio transmitters, and designed the first crystal controlled high frequency high power transmitters in 1924.

Designed special radio transmitting and receiving equipment for the U.S.S. Shenandoah. This was the first high frequency radio equipment ever used in the air.

Developed the sonic depth finder, the first successful acoustical means for measuring ocean depths from a ship under way.

Was the first to use the hull and other parts of a ship's structure for the radiation of radio energy without a conventional antenna.

Assisted in the development of direction finding units used in all types of ships.

Developed an underwater sonic de-

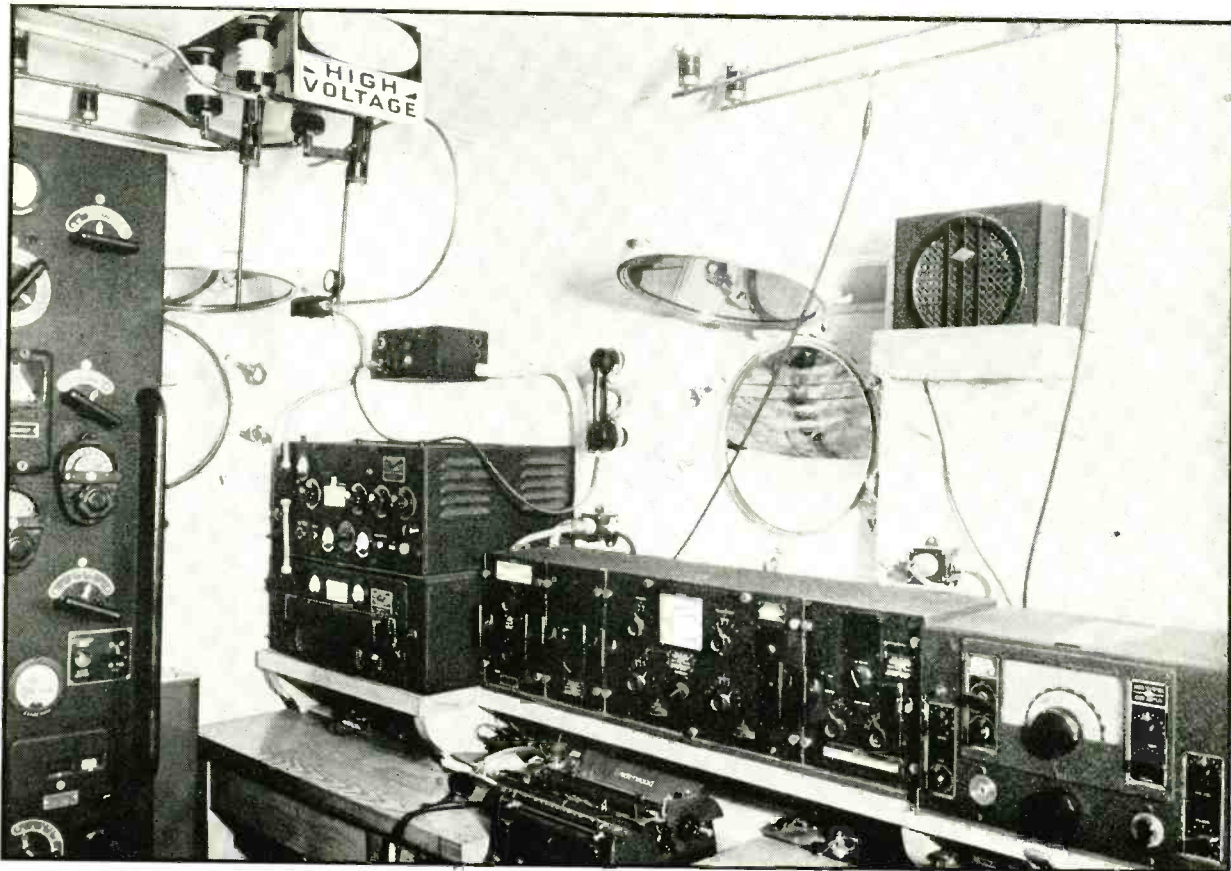

Spark apparatus of the last war has given way to tube transmitters, crystal detectors to highly selective and sensitive tube receivers; long waves to intermediate and short waves

vice by use of which cruisers, destroyers, and other anti-submarine craft are enabled to detect enemy submarines at considerable distances.

Developed a system for the radio control of aircraft in flight, resulting in use of a considerable number of obsolete Naval aircraft as targets for anti-aircraft practice.

Many other research projects have been successfully completed which cannot be discussed here, for reasons of security.

Today electronics means to the Navy—in addition to radio—underwater sound, direction finding, control of electro-mechanical systems, and a host of other non-communication services. In terms of design it means forward-looking ideas—and a good sense of what's practical. This last is important. Service conditions are tough. Temperature variations may be from -40 deg. to $+85$ deg. C, and humidity from low values up to 95 percent. The equipment must be built to withstand the corrosive action of salt spray, constant vibration, and the shock of gunfire. It must be built to take all the rigours

of modern warfare and, if trouble develops, must be capable of speedy repair from the material on hand at distant bases.

The Navy is depending to an ever-increasing extent on radio and electronics. The coordination of inten-

sive research, skillful engineering, and careful manufacture is making the best equipment which can be produced, available to the fleet. The men who design, build, and operate this complex equipment, contribute materially towards winning the war.

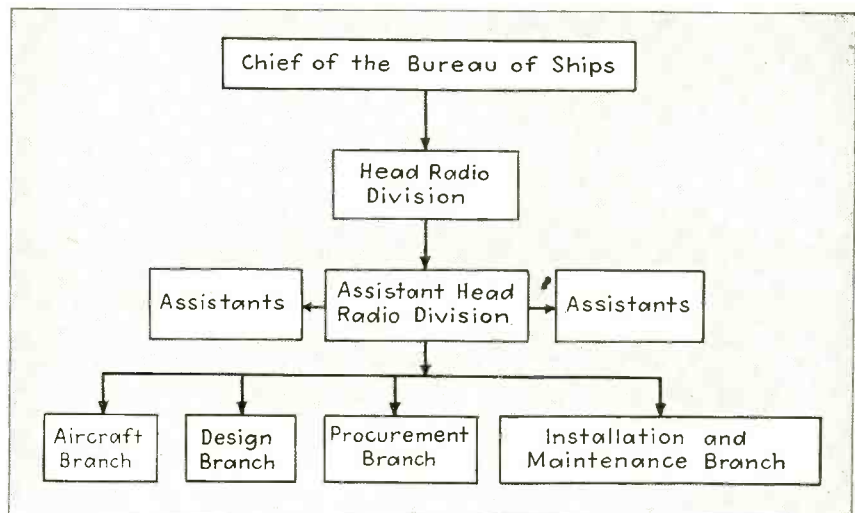

Radio and electronic matters of the U. S. Navy are handled by the Bureau of Ships. At the present time Captain Jennings B. Dow, a contributor to radio technique of long standing, is head of the radio division

RULES FOR

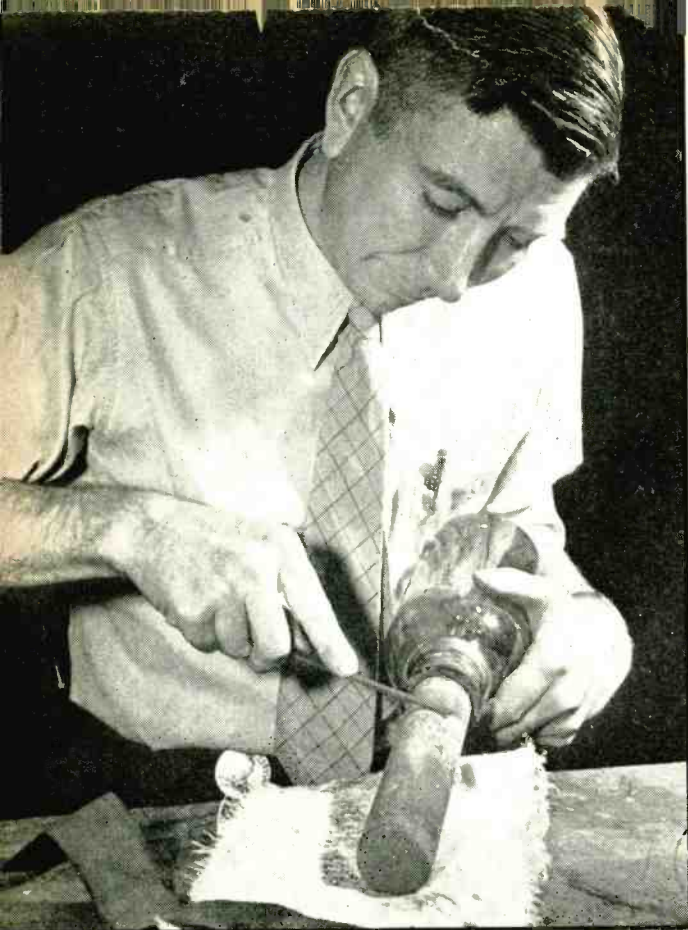

Carl Wirth, test operator at Westinghouse Lamp Division, demonstrates one method of removing hard water precipitates from a rectifier anode

AT this time when the electronic industry is being expanded and pushed for ever-increasing production of tubes vital to our war effort, it is imperative that every possible precaution be taken to prolong the life of our electronic devices. No longer is cost the prime incentive. It is the inability to obtain a replacement for an important tube that now induces us to make every effort to prolong its life.

The observations and experiences of the author on ways and means to prolong the life of electronic devices are given in the belief that this information can contribute to the war effort.

Electronic tubes can be divided into three general classifications, (1) Pure tungsten filament types (2) Thoriated tungsten filament types (3) Oxide coated filament and indirectly heated oxide coated cathode types.

The golden rules of the tube user should be these:

- (1) Use the electronic device within its ratings.
- (2) Operate the tube at the filament voltage recommended by its manufacturer. (Measure it—don't guess).
- (3) Keep the tube clean at all times—contact terminals, glass bulb, and anode (if water cooled.)

- (4) Supply an ample cooling medium when required.
- (5) Neither apply filament voltages suddenly nor remove them suddenly except as permitted by the manufacturers' ratings.
- (6) Do not apply filament and anode voltages simultaneously except as permitted by the manufacturer's ratings.
- (7) Handle this device carefully, as sudden shocks will probably damage it.

The pure tungsten filament types, for example, the 207, 891, 892, 893, 895, 899A and 898, are usually designed for operation at about 2550 deg. Kelvin. At this temperature the evaporation rate of tungsten from the filament is 13.5×10^{-9} gram per square centimeter per second.* If we can reduce this temperature by only 50 deg. and yet get passable performance we can more than double (theoretically) the useful tube life as the evaporation rate is then 6.36×10^{-9} gram per cm^2 per second.

Two curves are shown in the figure. One curve shows the expected tube life expressed as a percentage. It is based on the expected life at rated filament voltage of 100 percent versus rated filament voltage ex-

* Jones and Langmuir—GE Research Lab. Report No. 419.

pressed as a percentage. The other curve shows the expected emission versus filament voltage and again is expressed in percentages.

While pure tungsten filament tubes do have a rated voltage, we may express as a generality that "The most economical filament voltage for a pure tungsten filament tube is the lowest voltage which permits satisfactory operation." This generalization holds true within quite wide limits but it would be wise to point out the restrictions and precautions which should be observed in its application.

When used as an oscillator (class C operation) for induction heating, certain minimum power output requirements are usually necessary. To find this most economical filament voltage we may reduce the filament voltage to the point where a decided rise in either the cooling radiator temperature or cooling water temperature takes place. If the minimum requirements on power are met at this point then that filament voltage will be the most economical.

In water cooled tubes, if the filament voltage is reduced too far the formation of steam bubbles at the anode surface will probably occur and the tube may be permanently damaged or destroyed. The formation of steam bubbles may be detected by placing the end of a piece of long insulating tubing against the tube radiator and listening at the other end. (Caution—A good ground should be used on the end of the tubing next to the ear.) When steam bubbles start, the sound is quite distinctive. The formation of these bubbles may be prevented by a higher velocity water flow and by making certain that the filament voltage is not reduced too far. For radiator cooled tubes, one may observe this minimum permissible filament voltage by reducing the filament voltage slowly thus giving the radiator temperature ample time to reach an equilibrium temperature.

PROLONGING TUBE LIFE

BY HAMPTON J. DAILEY

Electronics Engineer, Westinghouse Electric & Manufacturing Company, Bloomfield, N. J.

This increased anode dissipation is the result of an increased tube voltage drop during the conducting portion of the cycle, that is, during the time the grid is essentially positive with respect to the cathode. If the filament voltage is reduced too far, the tube voltage drop may become a major portion of the total applied voltage and, therefore, the power dissipated in the anode may be sufficient to melt it or heat it to the point where sufficient gas or metallic vapors would be released to permanently damage the tube.

Distortion May be Limiting Factor

For the triodes used to provide the carrier for broadcast stations, another approach is necessary to determine the correct voltage for maximum tube economy. (We may no longer use the same method as that outlined for straight oscillator service as other factors have to be considered.) The filament voltage may be reduced to the point where distortion or harmonic percentage is at the maximum permitted when maximum modulation is being used. The voltage may then be increased just beyond this point.

Let us examine the tabulations given in the table. Under the normal and light load columns for tungsten filament types, we find "100 percent" and "reduce." The 100 percent value may be considered as that filament voltage which satisfies the operating conditions as set forth in the foregoing paragraphs. For conditions of light or reduced load, the filament voltage may be reduced to the point where the same operating conditions are reached for that reduced load.

Where "hard" water is used for cooling tubes, rule 3 should be applied rigorously. With hard water a scale that is essentially lime is formed. This should be removed periodically as it reduces the tube's dissipation capabilities which in turn can cause tube destruction. This scale may be removed by the careful

use of a scraper as shown in the illustration or by immersing the anode (usually copper) in a 10 to 25 percent solution of hydrochloric acid. The acid will remove the lime but does not attack the copper. The anode should then be rinsed thoroughly with tap water to remove all traces of the acid.

Another application of rule 3 is in keeping the tube contacts clean and particularly the filament terminals. As the filament currents are usually quite high, any dirt, lint, or oxidation presents a comparatively high resistance to the filament current with resultant heating at the contacts. This effect becomes cumulative and may permanently ruin the tube. Terminals should be kept tight at all times and occasional polishing with a very fine polishing agent is

desirable. After polishing, the terminals should then be wiped with a cloth dampened with alcohol. The glass surfaces should also be cleaned periodically with an alcohol dampened cloth. This prevents the formation of sufficient dirt or lint on the glass surface which promotes tube punctures.

An insufficient flow of water can contribute to premature tube failure by permitting chronic formation of steam at the anode surface. An interlocking switch on the high pressure side of the water supply will guard against water supply failure while an interlock in the low pressure side will prevent tube damage due to foreign matter clogging up the water jacket. A similar interlock should always be used in the air stream of an air-cooled installation.

The sudden stresses which take place in the filaments and filament leads when the filament voltage is

Percentage of Rated Filament Voltage to be Used Under Operating and Stand-by Conditions to give Maximum Filament Life

Tube type by kind of filament	Operating Conditions		Recommended Stand-by Conditions				Typical tube types
	Normal load operation	Light load may increase life	Under 15 min.	15 min. to 2 hrs.	2 hrs. to 12 hrs.	Over 12 hrs.	
1. Tungsten filament in small & medium sized tubes	100	reduce	80	80	off	off	207, 891R, 892R
2. Tungsten filament in large tubes	100	reduce	80	80	80	off	895R, 899A, 898
3. Thoriated tungsten types	100	95-100	80	off	off	off	211, 803, 851
4. Oxide-coated direct heated filament (gas) (vapor)	100	100	100	100	off	off	866A, 872A
5. Oxide-coated heater cathode types (high vacuum)	100	95-100	100	80	off	off	807, 837
6. Oxide-coated heaters in large tubes (mercury vapor)	100	100	100	100	100	off	857B, 870
7. Oxide-coated quick heater types (high vacuum)	100	95-100	80	off	off	off	1619, 1624, 1616

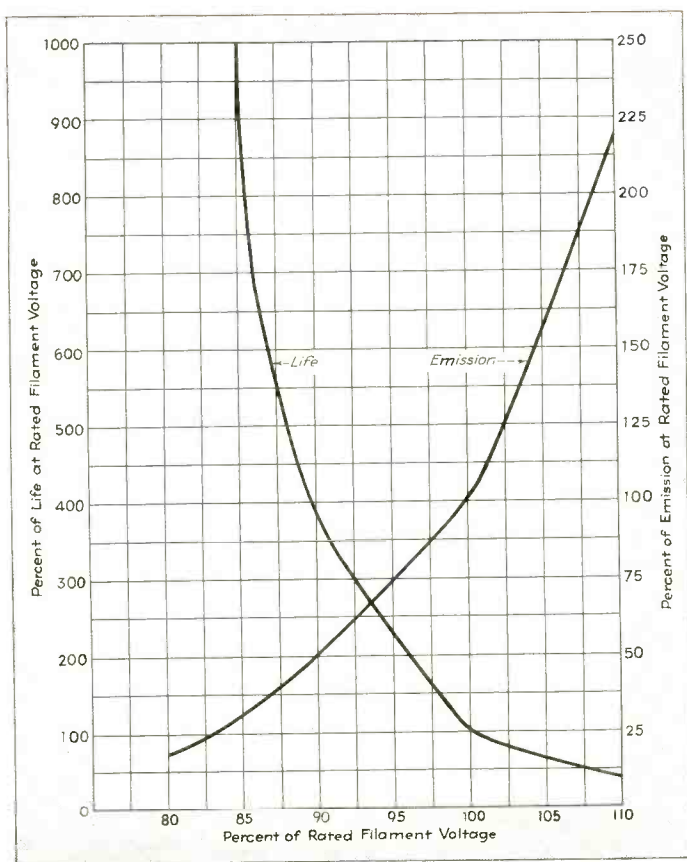

Effect of filament voltage on life and emission from pure tungsten filament. Assumptions are that filament is operated at constant voltage throughout life; that at beginning tube operates at 2550°K with rated voltage; that life is ended when filament current has been reduced 10 percent by evaporation

applied or removed suddenly can lead to premature failure, especially in the larger size tubes. Most manufacturers limit the starting current to 150 percent of the rated current on the larger tubes and it is well to heed this limit by using a starting device. For small size tubes, the filament transformers are usually designed to limit the maximum starting currents to from 200 to 300 percent of the rated filament current.

In the table the recommended filament voltages for stand-by conditions show 80 percent. This value was selected as it reduces the tungsten evaporation to a negligible factor and at the same time reduces to a minimum the number of times the filament and its supports must undergo the stresses of the heating and cooling cycle when reducing the filament voltage to zero or starting up from zero.

Avoid Filament Stresses

For tungsten filament rectifiers we may say that the most economical filament voltage is that minimum voltage which just permits satisfactory operation. The voltage should

not be set at a point which would permit line voltage fluctuations to lower the filament voltage to a point where the rectifier voltage drop would be sufficiently high to cause tube punctures.

Rules for Thoriated Tungsten Filaments

The thoriated tungsten filament types such as the types 803, 833, 211, 810, 806, 849, 860 and 861, require a different handling to obtain an increased useful life. In the table we may note that the recommended filament voltage during operation is never under 95 percent. If a thoriated tungsten filament is operated at too low a filament voltage it may lose its emission rapidly. If operated appreciably beyond its 100 percent rating, the tungsten carbide on the filament surface reduces to pure tungsten at an excessively high rate and the effective life of the tube is shortened. Rule 2 should be applied rigorously.

The tubes should be examined periodically for poor contacts either on the tube itself or its socket. The bulb should be kept clean by wiping with a cloth dampened with alcohol.

The lowest possible anode voltage should be used which will supply the required output. This is always possible when the required power output is less than the tube's maximum ratings. Maximum life will be obtained if the filament voltage is held between 95 and 100 percent of its rated voltage. A violation of this rule is sometimes accomplished unknowingly by users of short-wave diathermy equipment. The voltage fluctuations of well controlled power systems are usually within plus or minus 5 percent but the transformer taps usually provided by the manufacturers of such equipment may not be adjusted or adjustable for the line voltage of the user. Such maladjustments in addition to line voltage fluctuations can easily reduce the tube life appreciably. The users of diathermy equipment can prolong the life of their tubes by observing the rules given. Be sure the output controls are set at their minimum value before turning the equipment on or off. The output control should be advanced slowly from its minimum setting up to that adjustment for the heat required. In this way the tubes will be operating under the best conditions possible. There is a maximum output setting and beyond this point the output again goes down, but the tubes are "over coupled" to the load and thus operate inefficiently and have shorter life.

The care and operation of gaseous tubes was given by D. E. Marshall and W. W. Watrous in the January 1942 issue of *ELECTRONICS* and will not be covered in this paper. If we assume that all of the precautions outlined in that paper are observed, the user of gaseous tubes may further prolong the tube life by observing the recommended filament voltages given in the table.

The high vacuum oxide cathode or filamentary types, such as the 807, 837 and 1616, may be compared quite closely with the thoriated tungsten types in the care required for long life.

As mentioned before, tubes as a rule are quite rugged and will withstand a degree of abuse, but if we develop a healthy respect for their limitations and provide them with suitable working conditions within the limits of their design capabilities, we will be well repaid by a longer trouble-free life.

RECORDING UNIT

For Strain and Timing Functions

Dynamic performance of heavy machines under actual operating conditions in the field can be permanently recorded by combination of electronic and photographic equipment. Method particularly useful where shop tests cannot be made, or where unusual operating conditions occur infrequently. An important application in industrial electronics

By J. H. MEIER

*Bucyrus-Erie Co.,
South Milwaukee, Wisc.*

DYNAMIC strain measurements on machines and structures have long been recognized as an important supplement to design computations. New methods are constantly developed to make dynamic field measurement more accurate, complete, and reliable.

In cases where the designing engineer has no accurate means of estimating the forces acting on his product, it is imperative to check estimates and designs by field measurements when the unit is under actual working conditions. This is, perhaps, particularly true in the case of heavy excavating equipment where the machines are subjected to considerable impact loads and rather complicated dynamic phenomena occur. Shop tests are not possible in many cases because of the size of the machines and because proper test conditions cannot be obtained.

The equipment described in this paper was built to record the performance of machines under actual operating conditions in the field. It lends itself, however, quite readily to laboratory use or to a direct reading instead of a recording unit.

The first requirement is the accurate measurement of strains—be it for determining stresses in structural elements or for the determination of forces by means of calibrated links.

Of almost equal importance is the measurement of instantaneous shaft speeds at the time the strains occur and the recording of the functions the machine is performing.

A typical example is the investigation of the behavior of a fluid drive on an excavator. Load, speed, and slip must be recorded instantly and simultaneously to make possible the analysis of the transient condi-

tion when a heavy load is suddenly applied.

Frequencies of mechanical vibrations on heavy machinery may run as high as 50 to 100 cps and impact features may require the recording

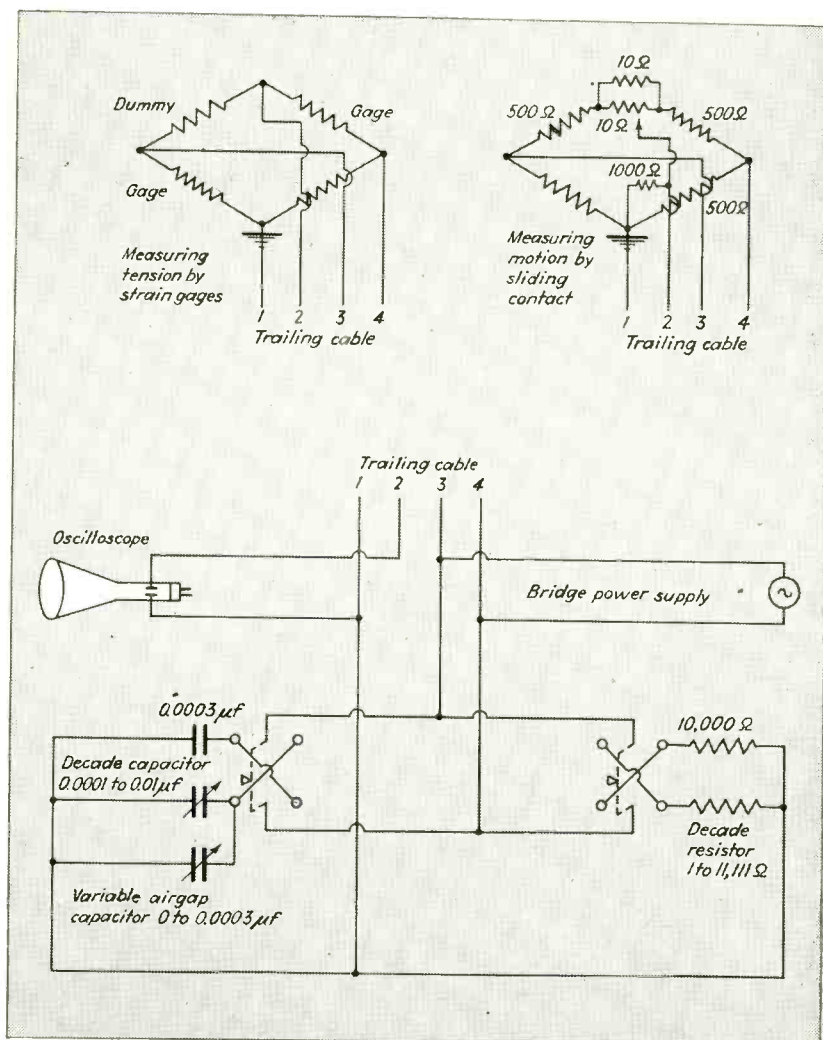

FIG. 1—Schematic wiring diagram of bridge circuits (above) and bridge control circuit (below). Bridge circuit at left is used for recording strain; that at right for recording vibration. Bridge circuits are mounted on machine under test, and connected to control circuit through shielded trailing cable

3000 cps. Gages and dummies are arranged in a Wheatstone bridge and the bridge balance detector is a cathode-ray oscillograph.

The modulation frequency is furnished by a beat frequency oscillator. The 6L6 power stage of a Thordarson T30W08 amplifier is employed to supply the necessary power to the bridge. The output is adjusted for a gage current of about 0.025 ampere. In general, less than one watt is required and this power can be obtained without appreciable distortion.

Usually, two active and two dummy gages make up the bridge. The dummy gages substantially reduce temperature effects, permitting the use of higher sensitivity gages with inherently higher temperature coefficients. The four bridge arms are arranged and almost perfectly balanced near the place of strain measuring. Three leads and a shield establish the connections. Two leads feed the bridge, while one lead and the shield carry the signal. The leads thus do not form integral parts of the bridge arms and difficulties due to distributed capacity are greatly reduced. Since small changes in lead resistance do not affect the signal, plug connections can be used between bridge and control box. The shields are grounded to prevent stray pick-up. Ground is established at one point only, usually near the gages, and ground loops are avoided.

Final balancing is achieved at the control box. Resistance balancing is obtained by a large fixed resistor in shunt with one arm of the bridge and a variable resistor of similar magnitude across the adjoining arm, the common point being ground. To facilitate calibration, a decade box is employed as the variable resistor. A small fixed capacitor across one arm and a variable capacitor across the adjoining arm are provided for the phase balancing. Again ground is the common point of the two ca-

pacitors. Double throw switches are used to reverse the fixed and variable resistors and capacitors with respect to the two bridge arms.

Due to the symmetrical arrangement of the bridge and the control unit, the effect of frequency upon the balance setting is relatively small.

If only one strain function is to be recorded, the bridge signal is fed directly into a cathode-ray oscillograph. The amplitude of the resulting wave is proportional to the strain to which the gages are subjected. Linearity is very good throughout the range of measurements. For calibration purposes the resistance offset on the decade box corresponding to a certain strain is computed and the resistance at balance is changed by this amount. At high frequencies the calibration is made by shunting a dummy gage by a large fixed resistor, and computing the corresponding strain. The amplifier gain is then adjusted so that the deflection on the screen assumes the desired value. The calibration deflection is photographed before the test so that the scale on the film can be determined easily.

Direction of Strain

Where distinction between positive and negative strain is required, an initial deflection is produced by a certain resistance offset. An increase in deflection then indicates a strain of one sign and a decrease a strain of opposite sign.

Without special precautions a sensitivity can be obtained whereby a strain of 7×10^{-6} (corresponding to about 200 pounds per square inch stress in steel) causes 0.1 inch deflection on the oscillograph screen. This deflection produces a trace displacement of 0.01 inch on the film and can be detected without magnification. Tests have shown that the accuracy of recording is very high,

the errors being one to two percent at the maximum loads.

If two strain functions are to be recorded simultaneously, two identical bridge sets and an electronic switch are employed. This switch connects the signals alternately with the input of the cathode-ray oscillograph. The switching frequency is chosen somewhat below one half of the modulation frequency so that at least one full wave of each strain function is recorded. A modulation frequency of 600 cps and a switching rate of 250 double reversals per second make a very good combination for average strain recordings.

The amplification following the electronic switch is limited by the

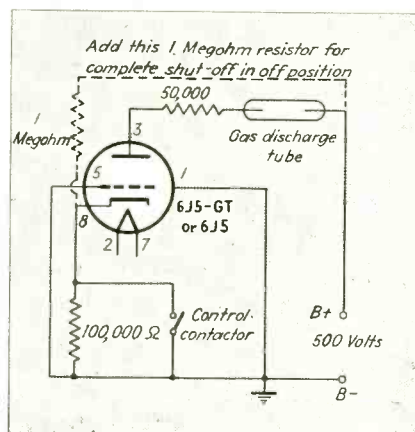

FIG. 4—Electronic relay circuit for control of gas discharge tubes. If several gas tubes are to be controlled, a 6SN7-GT tube may be used to replace two 6J5-GT tubes in the above circuit

permissible tailings. Therefore, the bridge signal must be amplified before reaching the electronic switch. For this purpose the second 6J7 stage of the Thordarson T30W08 amplifier is employed. This stage is available in these amplifiers, but not required for feeding the bridge. Besides the separation of the stages, some measures had to be taken to reduce the 60 cps pick-up in the 6J7 stage. The schematic diagram of the amplifier, as modified for our use, is shown in Fig. 2.

In many cases it is desirable to follow the general trends of the strains while records are being taken. For this purpose the modified first 6J7 stage of the Thordarson amplifier is used in connection with a 6H6 rectifier tube and a spotlight galvanometer. This galvanometer has fast response and while it cannot follow the peaks of short dura-



FIG. 3—Photograph of gas discharge tube used in making timing traces

tion strains, it gives the one second average very closely and thus serves as a good indicator. Any irregularity shows up immediately on the galvanometer and hence the danger of failure in test procedure is greatly reduced. Since the first 6J7 stage is used in cascade with the second, enough sensitivity is available on the galvanometer to balance the bridge. This makes it unnecessary to disturb the light shield arrangement for checks on drift.

Where static or slowly varying strains are to be observed and a photographic record is not required, the galvanometer can be used to great advantage. The a-c modulation bridge supply is then replaced by some dry cell batteries. The amount of equipment is thus greatly reduced and the entire setup is in-

dependent of the 110 volt power supply.

Recording of Timing Functions

Timing functions, such as revolutions or clutch positions, are marked by the light of a special bulb. A very small gas discharge tube, which flashes instantaneously when the voltage is applied, has been developed for this purpose. A photograph of one of these tubes is shown in Fig. 3. Both, argon-mercury and neon tubes proved satisfactory. The argon-mercury type, with blue light, has a somewhat higher actinic value than the neon lamps which emit an orange colored light. Due to difficulties in keeping impurities out of mercury, bulbs containing a small amount of it have a shorter life time than those without it. In general,

neon lamps are preferred, inasmuch as highly sensitive film is used anyway. The tubes can be used for well over one hundred flashes per second, thus fulfilling all practical purposes.

The tubes work from a 500 volt d-c power supply which consists of a transformer, two 816 rectifier tubes, a simple filter, and a bleeder. The light flashes are controlled by an electronic relay circuit, schematic diagram for which is shown in Fig. 4. The voltage across the contactor of this cathode bias control circuit is only 30 volts and since the current flowing is less than 10 milliamperes, the arrangement is entirely harmless and contactors stay perfectly clean. In order to ascertain flashing at low temperatures the circuit is such that the lamps maintain a small glow and intensify their emission when con-

FIG. 5—Typical strain and timing records obtained with the equipment described in this article

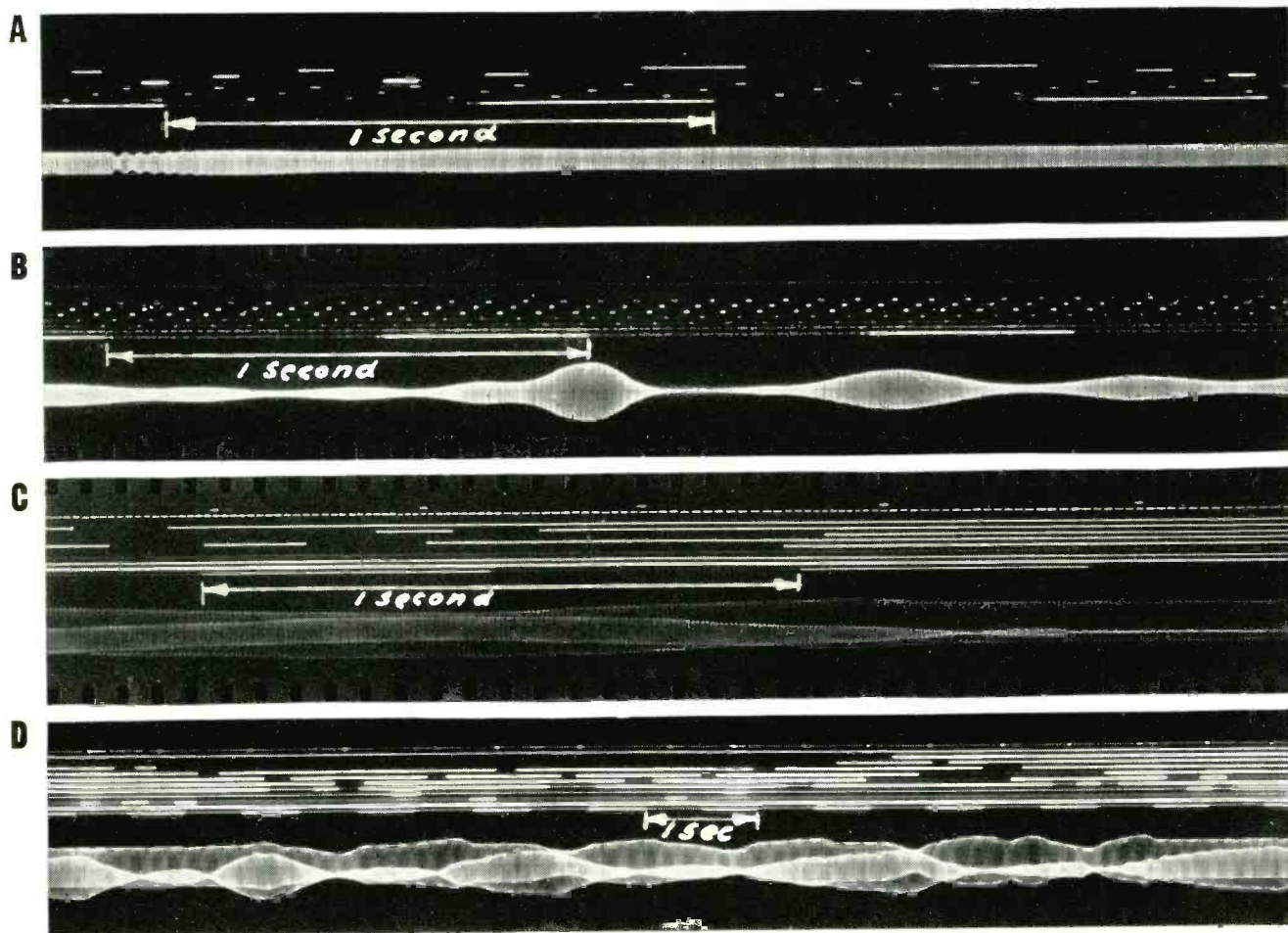

A Timing function provided by three lamps actuated by contacts, 120 deg. apart on same shaft. Reversal of rotation shown in top record. Vibration of rope after it falls over wrap shown in bottom strain function

B Strain function shows impact on rope due to sudden application of brake while lowering. Timing as above

C Two independent strain functions recorded simultaneously with axes displaced, each trace symmetrical about its axis. Normal film speed. Various timing functions at top

D Two independent strain functions recorded at slow film speed. Various timing function at top

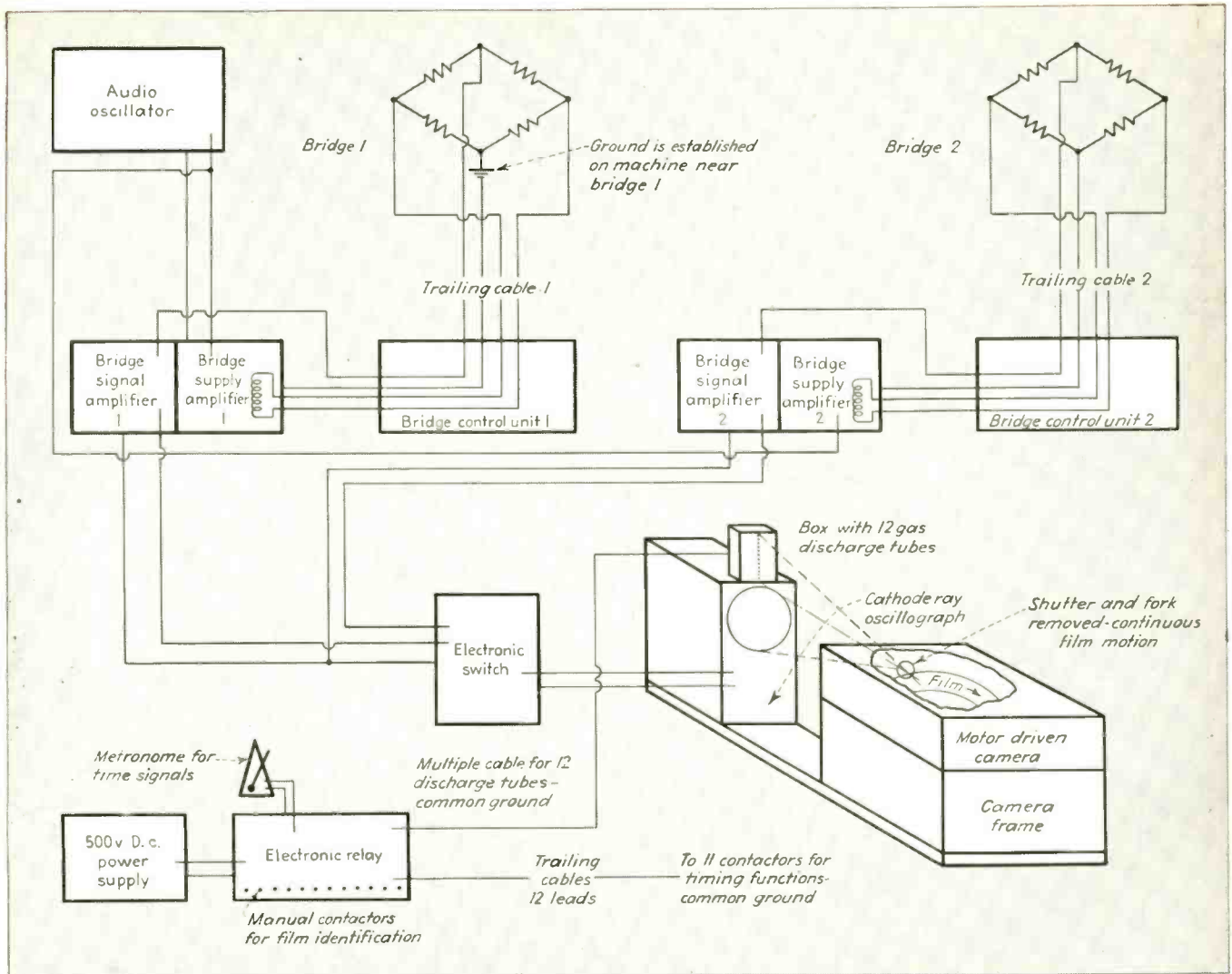

FIG. 6—Block diagram of entire equipment used in making strain and timing analyses of machinery

tact is made. The electronic relay arrangement is also provided with manual contactors so that records can be identified by means of the gas discharge tubes.

Photographing Strain and Timing Functions

For making permanent records of strain and timing functions, the traces of the cathode-ray oscilloscope and the flashes from the timing lamps are recorded simultaneously upon photographic film. The available width of the film is about equally divided between the traces made by the oscilloscope and the traces made by the flashing neon lamps. The images of the two traces due to strain measurements are obtained from alternate traces of the oscilloscope, an electronic switch being used to change from one to the other. The zero lines of the two modulated waves which are obtained in double strain recordings are dis-

placed by only one fifth of the screen width so that even for small amplitudes, the traces from the two functions overlap. However, the two traces are easily identifiable and can be separated from one another since each trace is symmetrical about its zero or reference axis.

Twelve neon lamps of the type already described are arranged in a small box on top of the oscilloscope in such a manner that their traces may be photographed simultaneously with the trace from the oscilloscope. One lamp is used to provide timing marker signals derived from a metronome. The remaining lamps are available for recording as many as eleven various functions, and for identification.

A number of typical strain and timing traces are shown in Fig. 5.

Camera Arrangement

A professional 35-mm camera of 400 ft. film capacity is used for the

recording. The shutter was removed and the driving mechanism was arranged for continuous film propelling. The camera is driven by a governor controlled variable speed motor. Usually a film speed of six inches per second is considered sufficient for recordings of heavy machinery performance. This results in an effective running time of at least twelve minutes per 400 feet of film. An $f/3.5$ lens stop proved to be of ample strength for these recording purposes. The use of Eastman Super XX film permits photographing with a relatively low intensity on the oscillograph screen which is an important factor in increasing the life-time of the tube.

Oscillograph and camera are held in relative position by a wooden frame. A tubular shield between the oscillograph and the camera lens keeps out all outside light. Two slides are provided to facilitate ob-

(Continued on page 114)

GRAPHICAL SYMBOLS

Compilation of the graphical symbols most commonly encountered in the electronics field is presented as a war aid in interpreting schematic wiring diagrams. On the following three pages the symbols used differently in the various fields are indicated

A SCHEMATIC wiring diagram may be thought of as the technician's short-hand method of indicating the inter-relationship of the various elements of an electrical device. The various elements are indicated in the diagram by graphical symbols which, through customary use and widespread adoption became more or less standardized. When such individual symbols are properly coordinated in a schematic drawing, the diagram serves either as (1) a condensed, compact set of instructions, indicating the functional operations which must be carried out to construct the electrical device, or (2) as a record of the electrical design of equipment which has already been fabricated. The schematic diagram is somewhat akin to the musical score which indicates the voices of the various instruments, and therewith, the musical functions to be performed by each musician; the score also serves as a record for the composer. The attainment of a satisfactory result is predicated upon the assumption that the symbolic notation employed means the same thing to all concerned. Disastrous consequences may have to be faced if this condition is not fulfilled.

The development of graphical symbols for use in the various branches of electrical technology has progressed, more or less, independently in each field. While the symbols might be well suited for the particular field for which they were advanced, they are sometimes inconsistent with the symbolic notation employed in other branches. Differences in symbols could be tolerated so long as each specialized field of electrical technology was, more or less, an independent unit. The telephone engineer had little contact or interest in the generation and distribution

of appreciable amounts of electric power, while the engineer in the power plant was seldom, if ever, concerned with electron tubes or communication equipment. But as each field expanded and drew upon the techniques and practices of adjacent fields, it became evident that the various groups of electrical engineers were speaking different dialects. In a few instances, they might even be said to speak in different languages, for the graphical symbols not only lacked consistency, but sometimes the same symbol was used in different branches to represent completely different circuit elements.

The need for a unified system of graphical symbols has been evident for at least a dozen years, but the technological developments under conditions of war have emphasized the existing differences. The need for uniformity and consistency becomes more acute as the various fields coalesce; it is, perhaps, most urgent in electronics, where the same type of tube may be used in the power, communication, traction, or measurement applications where not only different symbols may be used but in which the philosophy underlying the development of graphical symbols is frequently different. Lack of a unified system of symbols may be quite confusing to the engineer who must recognize that a zig-zag line represents a resistance in the communications field but an inductance in the power field.

On the following pages have been tabulated the graphical symbols most frequently encountered in the science of electronics. The list is presented as reference material to aid in determining the intended meaning of a wiring diagram where conflicting symbols must be faced. The compilation is such that where

two or more symbols are commonly encountered as representing the same circuit element, the alternative sketches are indicated. Symbols for electron tubes are fairly well standardized. The only differences normally found are those minor ones indicating the manner in which a grid or filament is drawn. These discrepancies cause no confusion, and could be standardized.

In the preparation of this material, some two dozen associations and organizations most likely to be concerned were asked to indicate the standards they had established or customarily used. Replies indicated that the majority followed the graphical symbols established by the American Standards Association, the American Institute of Electrical Engineers, the Institute of Radio Engineers, and the Radio Manufacturers Association. Certain of the standards on graphical symbols are now undergoing revision and new standards may be available within the next several months. The following standards represent the graphical symbols usually employed in the electrical field:

- Graphical Symbols for Electric Power and Wiring:
 - American Standards Association,—Z10g2
 - American Institute of Electrical Engineers Standard—17g2
- Graphical Symbols for Radio
 - A. S. A. Standard,—Z10g5
 - Institute of Radio Engineers Standard, published in 1941
 - A. I. E. E. Standard,—17g5
- Graphical Symbols for Telephone and Telegraph Use:
 - A. S. A. Standard,—Z10g6
 - A. I. E. E. Standard,—17g6.
- Symbols for electron tubes of the Radio Manufacturers Association.
- Symbols for Metering Diagrams, Edison Electric Institute.

Tabulation of Common Graphical Symbols

Device	Symbol	Device	Symbol	Device	Symbol
Resistor, Fixed*		Inductor or Reactor, Variable*		Twisted Pair	
Resistor, Variable*		Inductor or Reactor, Adjustable (in steps)		Shielded Conductor	
Resistor, Adjustable (in steps)*		Inductor or Reactor, Iron Core		Coaxial Cable	
Rheostat		Inductor or Reactor, Powdered Iron Core		Shielding	
Condenser or Capacitor, Fixed**		Transformer, or Inductors, Coupled; Air Core**		Terminals	
Condenser or Capacitor, Fixed, Shielded		Transformer, or Inductors, Coupled, Air Core, Moving coil indicated**		Antenna	
Condenser or Capacitor, Variable		Transformer, Iron Core		Counterpoise	
Condenser or Capacitor, Variable, with movable plates indicated		Inductors, Link Coupled		Loop Antenna	
Condenser or Capacitor, Variable, Shielded		Tuned Air Core Transformer		Ground	
Condensers or Capacitors, Variable, Ganged		Conductors, or Connecting Wires		Key	
Inductor or Reactor*		Crossed Wires. Top symbol shows wires connected; bottom symbol indicates no connection		Switch, single-pole double throw	

*Upper symbol preferred for radio uses; lower symbol for power applications.

**Symbol at left preferred for radio uses; symbol at right for power applications.

Tabulation of Common Graphical Symbols

Device	Symbol	Device	Symbol	Device	Symbol
Switch, Rotary		Cathode, Photoemissive		Shell, with Contact	
Switch double pole double throw		Cathode, Pool Type		Envelope, Gas Filled	
Jacks		Filament (Thermionic Cathode)		Envelope or Shell, with Shielding indicated by dotted line	
Plug		Grid		Shell or Socket with Alignment Pin Indicated	
Power Switch		Screen Grid		Basing Arrangement for Electron Tubes	
Fuse		Plate or Anode		Cathode Ray Tube	
Dry Cell, or Battery (The positive terminal is represented by the long line)		Plate or Anode		Beam Tube	
A-C Plug for Power Outlet		Target Electrodes		Microphone (Telephone Transmitter)	
A-C Receptacle		Deflecting Plates		Microphone, Single Button Carbon	
Cathode, Thermionic		Beam Forming Electrodes		Microphone, Double Button Carbon	
Cathode, Cold Discharge		Envelope or Shell (General)		Microphone, Ribbon or Velocity	

Tabulation of Common Graphical Symbols

Device	Symbol	Device	Symbol	Device	Symbol
Microphone, Piezoelectric		Frequency Meter		Thermoelement	
Telephone Headset		Power Factor Meter		X-Ray Tube	
Loud Speaker		Watt-Hour Meter		A-C Generator or Motor (Basic Symbol)	
Magnetic Loud Speaker		Graphic Instrument (Basic Symbol)		Induction Motor with Slip Ring Rotor	
Loud Speaker, Permanent Magnet		Synchroscope		Synchronous Generator or Motor with Separately Excited Field	
Loud Speaker, Electrodynamic		Piezoelectric Plate (and mounting)		Synchronous Converter	
Voltmeter		Rectifier Crystal Detector		D-C Generator or Motor (Basic Symbol)	
Galvanometer		Relay (Contact arrangement may be built up as required)		D-C Generator or Motor with Shunt and Series Field	
Ammeter		Lamp		Mercury Arc Rectifier	
Milliammeter		Arc		Delta or Pi Connection	
Wattmeter		Phonograph Pick-up		Wye or Tee Connection	

ROCHELLE SALT CRYSTAL

An outline of experiments leading to the use of a single Rochelle salt crystal, made possible by bonding the surface of the crystal with a thin sheet of gold foil

PIERRE CURIE and his distinguished wife, Marie Sklodowska Curie, world famous co-discoverers of radium, contributed much to the science of electronics by their less known discovery of the piezo-electric effect of certain crystalline substances. Among the crystals having this property are quartz, tourmaline, and Rochelle salt. Long ago it was determined that Rochelle salt had many times the piezo-electric effect of any other crystalline material, and many ideas have been presented, and patented, in an effort to efficiently utilize this phenomenon.

Only one manufacturer has thus far succeeded in making commercially available, suitable piezo-electric units. The unit consists of two crystalline plates having foil or graphite electrodes attached on opposite sides, with the plates cemented together in opposition. The unit assembly is supported on suitable elastic pads in such a way that the saddle warping effect, caused by the mutual constraint of the opposing crystals, may be mechanically utilized for acoustic and other devices.

One system using this unit affixes a perpendicular yoke piece to each corner of a substantially square crystal unit, and supports the other two corners by elastic pads. The diaphragm or other actuating device is

By **RAYMOND W. TIBBETTS**

*Tibbetts Laboratories
Cambridge, Massachusetts.*

connected by pin means to the yoke. In another arrangement, three corners of the crystal unit are cemented to rubber pads, and the fourth corner is actuated. In still another system the crystal unit is supported along one edge and a center shaft is connected at the midpoint of the opposite edge. Due to the twisting effect of the unit when so supported a rotary oscillatory motion is imparted to the shaft, which is used to actuate a stylus, mirror, etc.

Several early attempts were made to adapt a single Rochelle salt crystal plate to a piezo-electric device. All of these gave more or less indifferent results, except for very specific applications. Most of the devices used either a whole homogeneous crystal or an assembly of them, in an effort to secure sufficient mechanical amplitude. The displacement amplitude of the crystal per se is very small even under high electrical stress. Plates of quite some thickness have been suggested but in these cases sufficiently low impedance could not be attained.

In attempting to solve these prob-

lems the author first developed a gold electrode which in effect gives to the crystal unit assembly a capacitance practically equal to the maximum theoretical capacitance of a condenser having Rochelle salt as the dielectric. This in effect reduces the internal capacitive reactance of the crystal generator to a minimum. The gold electrode is applied directly to the crystal surfaces and is in mechanical and molecular bond therewith.

It was found impractical to deposit gold by the electro-deposit or sputtering methods on Rochelle salt crystals, since the material is water soluble and dissolves in its own water of crystallization at about 132 degrees F.

It was discovered that extremely thin gold foil, in the order of 0.000004 inch thick became bonded to the wet surface of the crystal, when dried and recrystallized. It was also determined that thick gold sheet would not adhere in this manner. A patent has been granted the author for this process and the products made thereby.

Tests showed the capacitance of the gold-electroded crystals to be more than twice that for commercially available crystals of the same dimensions. This was indeed a happy discovery, for the gold deposit pro-

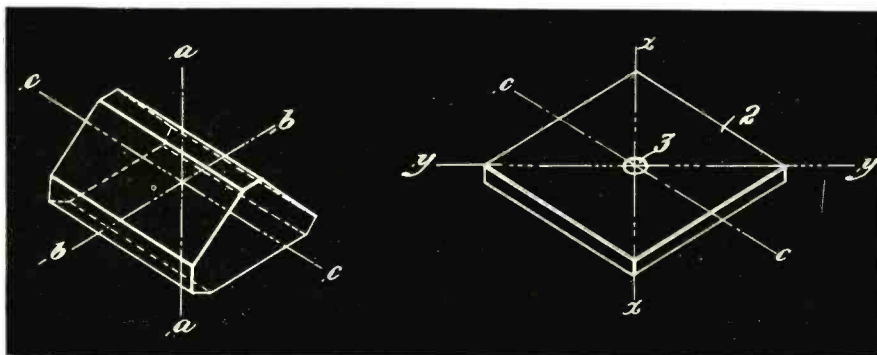

Fig. 1—Longitudinal axis, c-c, electrical axis, a-a, mechanical axes, x-x and y-y. The hole in the Rochelle salt slab provides for the connecting pin between the two toggles

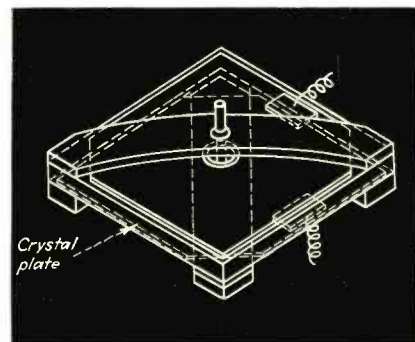
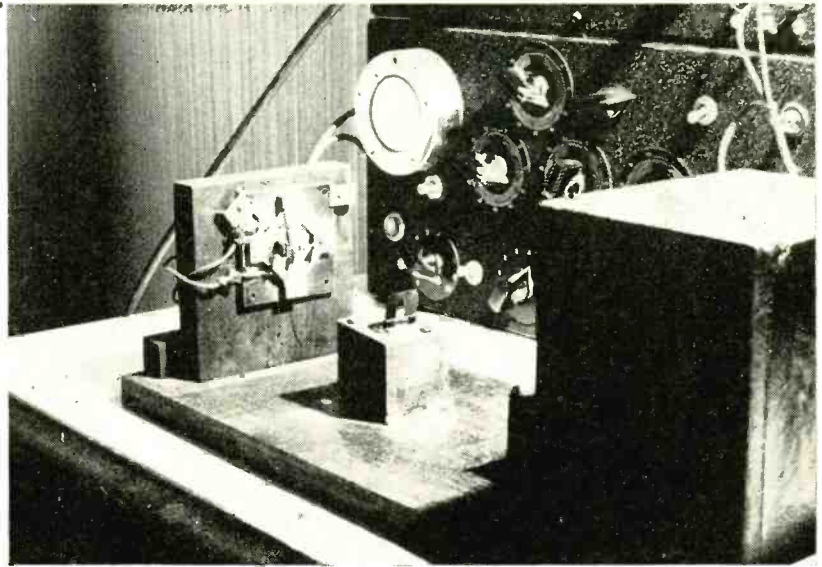

Fig. 2—The complete unit assembly, showing the bow or "toggle" arrangement with connecting pin. The crystal slab has a gold electrode on both surfaces

DEVICES OF LOW IMPEDANCE

The setup using phototube for testing response and waveform of the oscillograph unit



vided an extremely flexible electrode of low specific resistance which was impervious to atmospheric conditions and which was bonded to the surface of the crystal with sufficient adhesion for practically all acoustic applications of Rochelle salt.

The very high capacitance attained has made it possible to make acoustic devices with a relatively low impedance and with a small amount of crystalline material. For example: in one size of the "Monobar" crystal unit adapted for microphones, the single plate used is $20 \times 20 \times \frac{1}{2}$ mm, and has an average capacitance of over 0.007 μ f. From the formula $C = 0.0088 \frac{KA}{d}$, where K is the dielectric constant, A the area in square centimeters and d the thickness of the plate in cm, the value of K will be found to be about 10,000. Capacitance measurements were made at 1000 cps. This high capacity is of extreme importance in a high fidelity acoustic device which must faithfully reproduce very low frequencies or which must have a very long cable.

Means of Utilizing Crystal Deformation

To adapt to best advantage the properties of the gold electroded crystal, a new mechanical system has been developed. This system is based

on two general principles: first, the adaptation of bow or spring toggle devices for the small oscillations of the crystal per se, and second, a frame-like structure within which the crystal slab is cemented, and on the corner portions of which the toggle members are secured.

Since the mechanical axes $x-x$ and $y-y$ of the crystal plate form a 45-deg. angle with the longitudinal axes $c-c$ of the mother crystal, as shown in Fig. 1, the oscillations of the crystal and frame cause a simultaneous bending of the opposed toggles, as these may be secured on opposite sides of the frame and oriented at 90 deg. to each other. This is due to the fact that the crystal under electrical stress contracts along one diagonal and simultaneously expands along the other

diagonal. It will be seen therefore that when the two bows or toggles are interconnected by a pin member, a greatly enlarged version of the crystal and frame oscillations will be obtained. The converse is of course also true—when the pin is mechanically actuated, a greatly increased force with a reduced amplitude will be transmitted to the frame and crystal member. A much greater electrostatic potential will be obtained from the crystal devices than from the crystal itself if actuated by the original force applied to the pin.

Many arrangements and combinations are possible with this new development. For example, when it is desirable to secure a very low impedance or large mechanical output as would be necessary for a loud speaker or a direct-writing pen oscil-

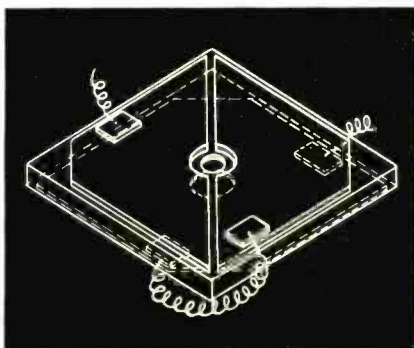

Fig. 3—Arrangement of the electrodes for greater voltage output. Two electrodes are provided on each side of the crystal plate and leads are connected in series

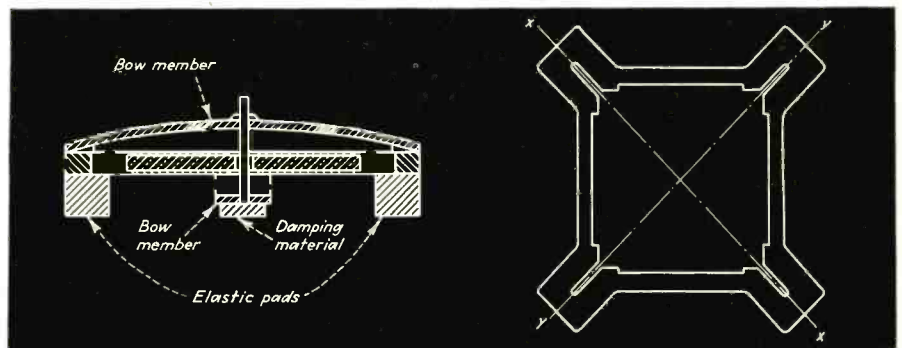
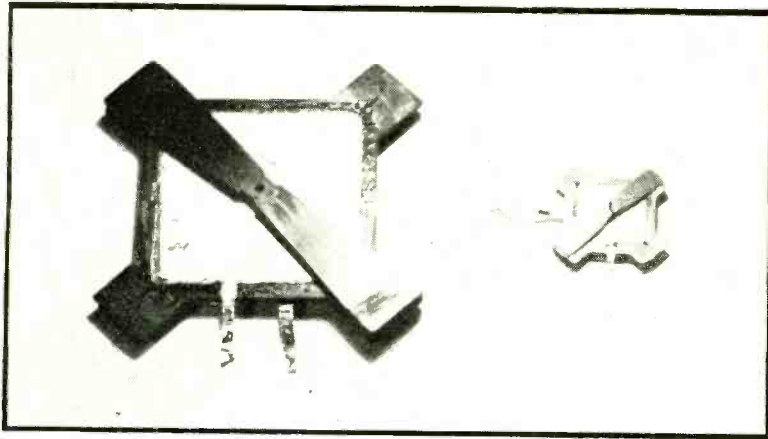

Fig. 4—Cross-sectional view of the framed type of Monobar unit, and a plan view of the frame. The bow members are cemented to the wing portions of the frame



The small unit has a 20 mm x 20 mm crystal suitable for most microphone applications, such as earphones, etc. The large unit has a 57 mm x 57 mm crystal and is particularly suitable for low-frequency devices where low impedance and high power are necessary considerations

lograph, multiple crystal plates may be assembled within the frame structure with their major surfaces parallel, with the leads so connected that all the plates act in unison and in the same directions.

Perhaps one of the most important features is the frame member, which by virtue of its shape and nature adapts itself to the mechanical displacements of the crystal. Under electrical stress the crystal tends to become diamond shaped, to which the frame conforms. By virtue of the frame assembly it is almost impossible to break the crystal, either by mechanical or by electrical shock. So rugged is the unit that a very sensitive microphone or ear piece may be thrown on the floor without in any way damaging the crystal unit. Voltages up to the limit of the dielectric strength of the crystal material have been applied without harm. This lies in the fact that the bows or toggles do the bending while the frame supports the crystal.

One of the outstanding important characteristics of the Monobar type of piezo unit is the fact that cathode-ray oscillograph studies indicate the remarkable freedom from harmonic distortion on sine wave input enjoyed by Monobar microphones. While this type of distortion has not been emphasized very much, most of the emphasis being given to frequency distortion, it is recognized that harmonic distortion undoubtedly plays a most significant part in the thing we call "quality" in acoustic equipment.

It seems to the writer that there are now greater possibilities for the

crystal loud speaker, especially for small, portable radio sets. Already a very satisfactory 5-inch speaker has been developed which uses no critical war materials for its fabrication. The crystal unit weighs less than one ounce, a very desirable feature for portable radios and possibly for certain war communication

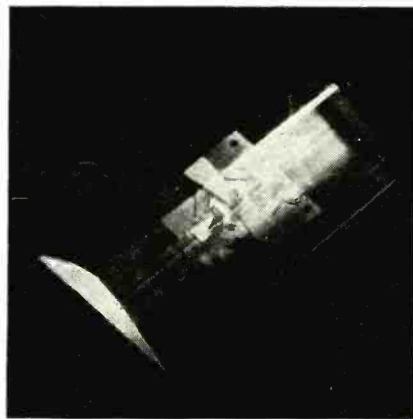

Composite photo of Rochelle salt crystal and the Monobar oscillograph unit

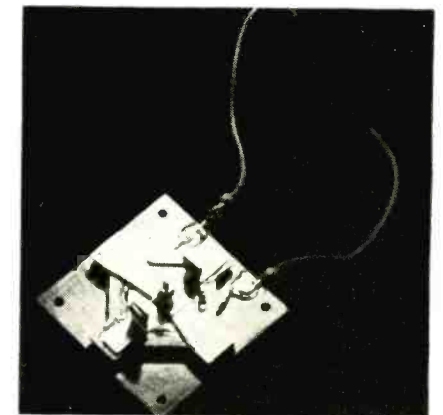

The Monobar unit as used in an oscillograph. Size is 2 1/8 by 2 1/8 by 3/8 inches

equipment. To date the power capabilities of the speaker, over one watt, do not equal the dynamic type. It is expected, however, that this will be increased appreciably.

The crystal speaker should make it possible to eliminate the output transformer, using instead resistance capacity coupling. There will be some loss of course, but this should not be a serious matter in those cases requiring extreme lightness and compactness. The development of a power tube having the proper output characteristics would help greatly in this matter.

opposed electrodes in series. By this method a gain of about 6 db can be obtained without phase shift or harmonic distortion, since the single crystal is the only element involved and the distribution of mechanical and electrical forces is uniform through its mass.

The very high capacity of the crystal makes possible a rising characteristic toward the low end of the spectrum, and by using more flexible toggle elements the highs are greatly attenuated while the output of the low frequencies is actually increased.

(Continued on page 116)

Adjustment of DIRECTIONAL ANTENNAS

A method of measuring resistance and reactance values at radio frequencies with an ordinary 3-inch cathode-ray oscilloscope while full power is being fed to the broadcast antenna. Width and height measurements of an elliptical pattern give the required constants

By **WILLIAM S. DUTTERA**

*Engineering Department
National Broadcasting Company
New York City*

IN the alignment of directional antennas there arise two types of problems. The first is that of securing the proper phase relations and amplitude relations between the various antenna currents. The second is that of tuning each antenna to match its transmission line, so no standing waves exist on the line.

The methods of arriving at proper phasing and current ratios are as varied as the number of engineers engaged in tuning directional antennas. It is not proposed to discuss this subject here, but instead to deal with the second part of the problem. Specifically, this involves determining the resistance and reactance which each transmission line sees at its antenna. The engineer wants to know if the line is "working" into too high or too low resistance, how much reactance is present and

whether this reactance is inductive or capacitive.

In some cases, particularly with antennas less than about 120 degrees high, it is possible to calculate the line termination networks with reasonable accuracy by a combination of ordinary measurements and proper application of circuit theory. With high antennas having distorted current distribution, or with a combination of high and low antennas, accurate calculations are not possible. It has heretofore been necessary in these cases to obtain final circuit adjustment by what almost becomes a trial and error method.

It must be noted that it is impossible to measure, by normal methods, the impedance of an antenna as a working part of a directional system. The measurement must necessarily be made without disturbing the system, under the condition of partial or full power. It is in this manner that the cathode-ray tube measurements to be described are made.

Method Used in 60-cycle Circuits

In 60-cycle single-phase power circuits the load impedance can be found with meters measuring volts, amperes and power factor, connected as shown in Fig. 1. In brief, one

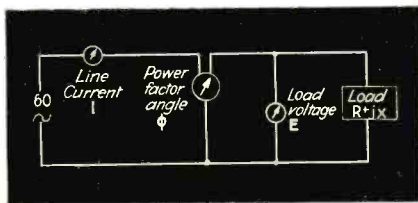
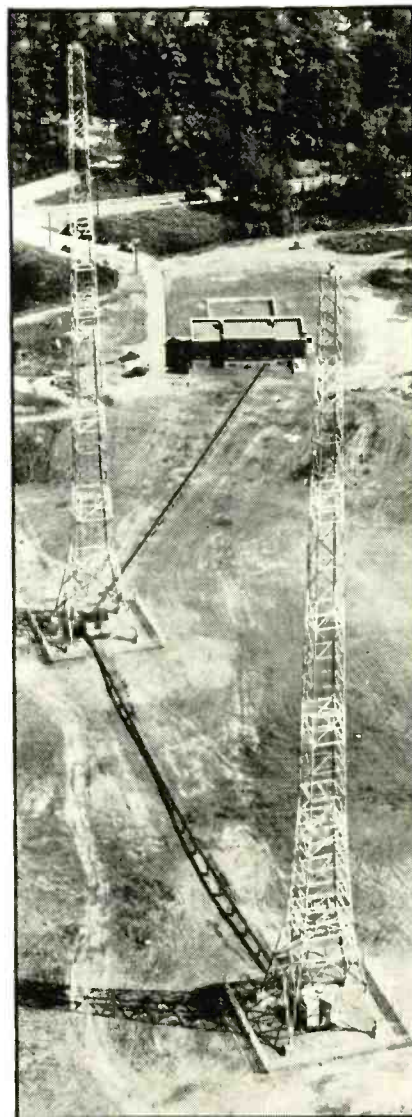

FIG. 1—Standard method of measuring the resistance and reactance of a load at power frequencies, using ordinary meters



This two-tower directional antenna system of station WEAF in Port Washington, Long Island has been adjusted by the cathode-ray method described in this article. Two oscilloscopes were used, one in each under-the-tower tuning house

current flowing in the power factor meter is proportional to the phase and magnitude of the load current, and the other current is proportional to the phase and magnitude of the load voltage. The resultant action of the fields of these two currents upon a vane produces a displacement of the vane. A pointer attached to the vane indicates directly the phase angle between load current and voltage.

With E , I and the phase angle ϕ known, the resistance R and X are obtained from the following basic formulas:

$$R = \frac{E}{I} \cos \phi \quad X = \frac{E}{I} \sin \phi$$

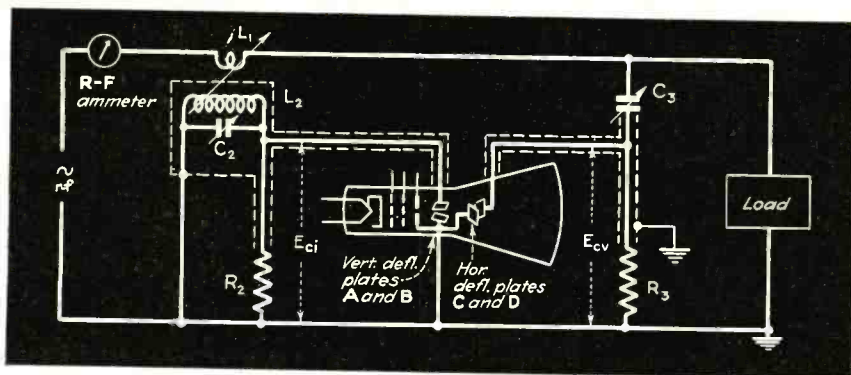

FIG. 2—Circuit for measuring the resistance and reactance of a load at radio frequencies under operating conditions. The cathode-ray tube may be part of an ordinary three-inch cathode-ray oscilloscope

Cathode-ray Tube Method

In the r-f version of the procedure for determining load impedance, a cathode-ray tube is substituted for the voltmeter, ammeter, and power factor meter, as shown in Fig. 2. In this case it is simpler to use voltages instead of currents. A cathode-ray tube with electrostatic deflecting plates is chosen. A voltage proportional to the amplitude and phase of the load voltage is taken from voltage divider C_3R_3 and applied to horizontal deflecting plates *C* and *D*. A voltage proportional to the amplitude and phase of the line current is secured from a well-shielded transformer L_1L_2 and applied to vertical deflecting plates *A* and *B*.

Initially, the voltages applied to the two sets of deflecting plates are adjusted so that when the load is a pure resistance of known value the pattern on the tube is a circle of convenient size. Any other load then gives an ellipse, the orientation and dimensions of which permit calculation of the load constants.

Condenser C_3 permits reducing the r-f voltage applied to the horizontal deflecting plates, and at the same time serves with R_3 to provide approximately 90-deg. phase shift. The voltage due to line current is adjusted by varying the coupling between the primary and secondary of the transformer. It has been found in practice that no coil is necessary in the primary, since sufficient deflection generally can be obtained by coupling to the bus feeding the terminating equipment.

Analysis of Circuit Relations

It can be shown that when secondary circuit L_2C_2 is tuned to resonance, the following relation based on the simplified equivalent circuit in Fig.

3 will provide a sufficiently close approximation to actual conditions:

$$E_{ci} = E'_{ci} = -jI_2 X_2 = I_0 X_1 X'_2 / R_1 \quad (1)$$

Here E_{ci} is the voltage on the cathode-ray tube due to the load current I_0 . This means the cathode-ray tube voltage E_{ci} is in phase with the load current.

The load voltage part of the circuit is as shown in Fig. 4. In this case,

$$E_{cv} = E_0 R_3 \left[\frac{R_3}{R_3^2 + X_c^2} + j \frac{X_c}{R_3^2 + X_c^2} \right] = E_0 R_3 K \angle \theta \quad (2)$$

where E_{cv} is the voltage on the cathode-ray tube due to the load voltage, and

$$\theta = \tan^{-1}(X_c/R_3)$$

In Fig. 5 is a vector representation of the cathode-ray tube voltages resulting from the load current and load voltage when the load is a pure resistance. A circular pattern is obtained on the cathode-ray tube screen when capacity C_2 in Fig. 2 is adjusted until voltage vector E_{ci} takes the position designated as E''_{ci} . This adjustment is necessary for calibration because E_{cv} is not fully 90 deg. ahead of load voltage E_0 (R_3C_3 does not provide a full 90-deg. shift in phase). Adjusting C_2

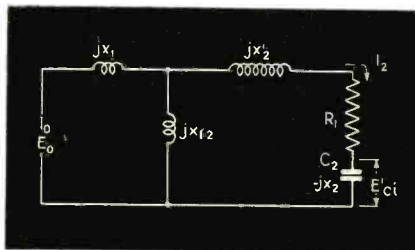

FIG. 3—Equivalent circuit for the current section of the cathode-ray measuring circuit. The voltage drop across the condenser depends on the load current value

makes the vertical deflecting plate voltage E''_{ci} lag E_{cv} by 90 deg., and adjusting the coupling between L_1 and L_2 makes these voltages equal.

Analysis of The Cathode-ray Pattern

It is well known that if equal voltages 90 deg. out of phase are applied to a cathode-ray tube the pattern will be a circle. If the voltages are unequal but 90 deg. out of phase the pattern will be an ellipse with its major axis on either the *x* or *y* axis, depending upon which set of deflection plates has the larger voltage. If the phasing is other than 90 deg., the major axis of the ellipse will assume an intermediate position somewhere between 0 and 90 deg. with respect to the *x* axis.

An example of a general pattern is shown in Fig. 6. It is obtained with voltage E_{ci} (that due to the current) acting on the vertical deflecting plates, and voltage E_{cv} (that due to the load voltage) acting on the horizontal deflecting plates, as is shown in Fig. 2. The center of the ellipse is at 0. The ellipse intercepts the *x* axis at points separated by distance *A*. The total deflection along the *x* axis is *A* and the total deflection along the *y* axis is *B*. It can be shown that when this pattern is obtained from a given load under the operating conditions described above, the impedance of the load is

$$Z = \frac{R A_1}{B} \pm j R \frac{A}{B} \sqrt{1 - \left(\frac{A_1}{B}\right)^2} \quad (3)$$

Here, R is the load resistance which gives a circular pattern. The first term of this equation is the resistance of the load under operating conditions, and the second term is similarly the reactance of the load.

It will be noted that the reactive term has a plus or minus sign. If the cathode-ray tube connections are

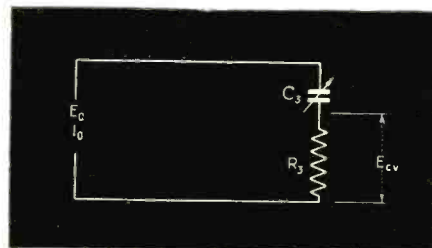

FIG. 4—Equivalent circuit for voltage section is identical to the actual circuit since it is simply an r-f voltage divider connected across the load

so made that with a capacitive load the major axis of the ellipse is in the first and third quadrants, the sign of the reactive term is negative. It will be assumed that this is the case in the following examples. It will also be assumed that R is equal to 75 ohms. Patterns for four different types of loads, with resulting resistance and reactance values based on these assumptions, appear in Fig. 7.

The Practical Application

In a normal application the tuning equipment which matches an antenna to its transmission line corresponds to the load shown in Fig. 2. The simplest method of adjusting L_2C_2 and C_3 involves starting with any one antenna and tuning its matching equipment so that it presents a resistive load R of the correct value for proper termination of the transmission line. This antenna only is then fed from the transmitter with approximately the same power it will carry when it is a part of the directional system. The condenser C_3 is now varied until about half of full-scale deflection is obtained on the screen of the cathode-ray tube. Next, C_2 is adjusted so that the major axis of the ellipse is along either the x or y axis, depending upon the relative voltages. Finally, the coupling between L_1 and L_2 is adjusted so that a circular pattern is obtained. This constitutes the calibration of the equipment. If similar equipment is used at all the radiators, the same procedure is followed at each.

All radiators are now fed together, and the three measurements indicated in Fig. 6 are made on the elliptical pattern of each antenna. From this data, the resistance and reactance of each antenna are calculated as previously explained.

Coil L_2 should be well shielded electrostatically, so it is excited only by the intended field due to line current. Likewise, C_3 and its associated connections should not be subject to extraneous electrostatic fields. In order to assure this result, it is preferable to use coaxial leads for all connections shown with shielding in Fig. 2.

Resistors R_2 and R_3 in Fig. 2 are of arbitrary value. When these resistors are 200 ohms each, the power consumed by the measuring equipment is of the order of 25 watts. This is ordinarily low enough so that the equipment may be removed without any noticeable effect on the directional system. The values of R_2 and R_3 may be increased considerably in order to reduce power consumption.

Some types of cathode-ray oscilloscopes may have to be modified by the installation of r-f jacks on the sides of the unit, to permit short leads directly to the deflecting plates (internal amplifiers in the oscilloscope are not used.) Special provisions may also have to be made for the spot-centering voltages.

Where a cross-ruled scale is not provided with the oscilloscope, transparent graph paper will prove satisfactory and may be fastened to the face of the tube. This permits reading dimensional values directly without a ruler; units of measurement are unimportant so long as all three values are in the same units.

The true r-f power being fed to the antenna or load may readily be determined in this cathode-ray method if an r-f ammeter is inserted in the circuit, as shown in Fig. 2. Multiplying the resistive component of the load impedance by the square of the current reading gives the power.

In this application the degree of

accuracy required is not very great. Consequently, such sources of inaccuracy as non-linear deflection or observational errors in reading the values of A , A_1 and B are not of a serious magnitude. A three-inch tube has been found to be satisfactory, but it is entirely feasible to obtain greater accuracy if needed.

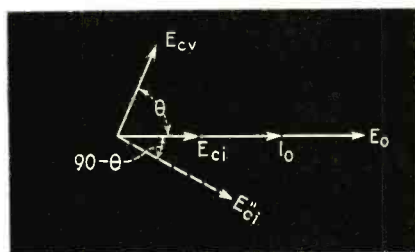

FIG. 5—The circular pattern required for calibration is obtained by detuning L_2C_2 until the deflecting plate voltages are equal and 90 degrees out of phase

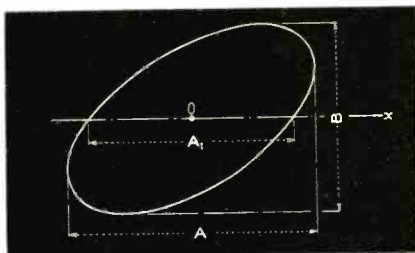

FIG. 6—Typical pattern. Resistance and reactance values are found by measuring lengths A , A_1 and B and substituting the results in equation 3

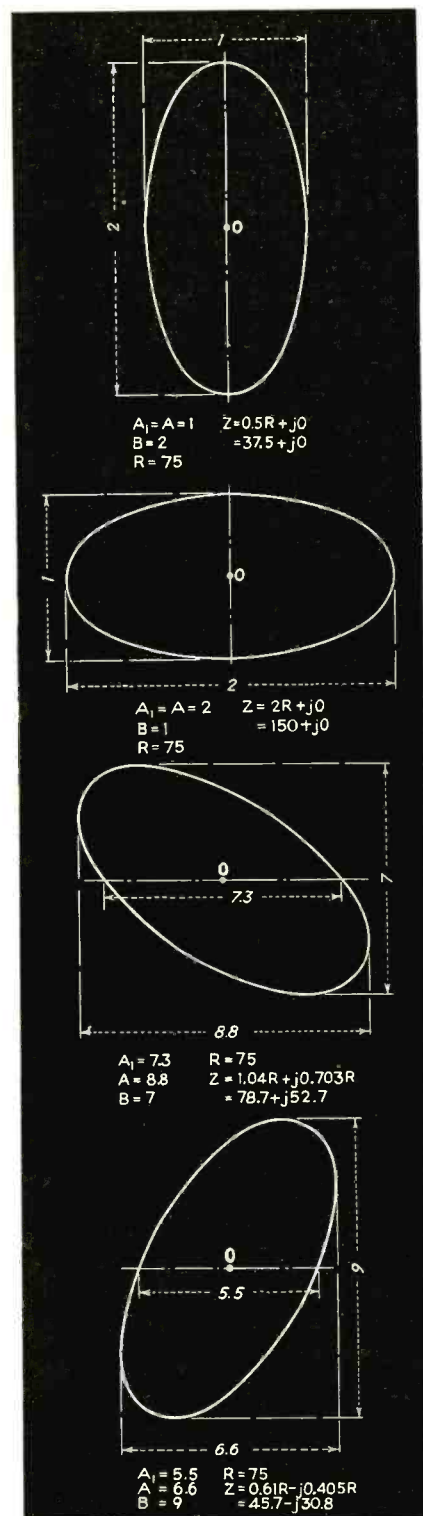

FIG. 7—Examples of cathode-ray patterns and corresponding r-f impedance values

Analysis of FULL WAVE RECTIFIER

An engineering analysis of the behavior of the full wave, single phase rectifier with choke input is given, together with means of determining critical inductance permitting continuous flow of current. Measurements confirm accuracy of theoretical procedure

THE single phase full-wave rectifier, in which is used the so-called "choke input" type of filter, has become popular since the introduction of small capacity mercury vapor tubes. Despite its wide use today, the design is still based to a great extent upon experimental methods. A more exact analysis of the performance of this type of circuit, which is not so tedious as to discourage its use, should help in the understanding of its applications, and permit its characteristics to be more accurately predetermined. Principle emphasis has been placed on the derivation and discussion of the equation for the filter input current, from which expressions for the d-c voltage and current output are determined under two general types of operation. A simple but accurate

expression for the critical choke inductance is also presented.

The specific type of circuit treated in this analysis is shown in Fig. 1. Two basically different types of operation of this circuit may occur. One, where the current through the inductance is continuous, termed "non-cut-off operation", and the other, where the current through the inductance is zero during a period in each half cycle, termed "cut-off operation".

To keep the solution in as simple and usable form as possible certain basic assumptions are made. These are: (1) The circuit parameters are assumed constant and independent of current magnitude. (2) The winding resistance and leakage reactance of the input transformer are assumed to be negligibly small. (3)

The anode-to-cathode voltage drop in the rectifier tube is considered to be constant during the current conduction period. (4) Steady state operation of the rectifier unit is assumed.

The circuit parameters are actually constant with the exception of the inductance of the (iron core) filter choke. This inductance is a function of the current which the choke carries. However, for non-cut-off operation in which the load current is not too small (greater than 25 percent of full load) the inductance of the filter smoothing choke may be considered constant without serious error. For cut-off operation, only those filters which use air-core inductors are capable of simple solution. Analytical treatment of this circuit, on the supposition that the choke inductance is a function of the current, presents a problem whose solution is extremely complicated.

The other assumptions are those which may be made in low power rectifier circuits without serious error.

The following symbols are used throughout the paper.

E_m = Peak value of one half the transformer secondary voltage

E_s = Tube voltage drop during conduction (assumed constant)

e = Instantaneous voltage across input to filter

i_1 = Instantaneous current through filter choke

R_1 = Resistance of filter choke

R_2 = Equivalent load resistance

L = Inductance of filter choke

C = Capacitance of filter condenser

E_{dc} = d-c value of output voltage

I_{dc} = average value of load current

T = complete period of rectifier operation = $1/2f$

f = frequency of a-c supply

p = d/dt = differential operator

$Y \angle \mu$ = vector value of admittance of the filter (and load) looking into its input terminals

TABLE I—CIRCUIT PARAMETERS REQUIRED FOR CRITICAL CUT-OFF OPERATION

No.	Peak Voltage	Voltage Drop Across Tube	Capacitance of Filter	Load Resistance	Critical Inductance
	E_m (Volts)	E_s (Volts)	C (Microfarads)	$R_1 + R_2$ (Ohms)	L_c (Henries)
1	368	13	4.0	11,000	10.5
2	281	13	8.0	11,000	11.0
3	141	13	12.0	9,900	12.0

TABLE II—PERCENT DEVIATION OF ACTUAL CRITICAL INDUCTANCE FROM VALUES CALCULATED BY VARIOUS METHODS

THEORETICAL VALUE OF CRITICAL INDUCTANCE CALCULATED FROM:

No.	Eq. (9)	Eq. (9a)	$L_c = R_1/1130^*$	$L_c = R_1/1000^\dagger$
1	+ 2.0	+4.75	- 7.1	+ 4.8
2	- 3.6	+2.72	-11.4	0.0
3	-11.7	-6.25	-26.7	-17.5

* Dellenbaugh and Quimby, Smoothing Chokes, *QST*, 1932.

† Terman, "Radio Engineering," McGraw-Hill Book Co.

With Choke Input

* Formerly graduate student at the University of Missouri; now with the Bell Telephone Laboratories, New York, N. Y.
† Associate Professor of Electrical Engineering, University of Missouri.

General Solution of Current Equation

Considering the circuit of Fig. 1, the current through the choke may be expressed as

$$i_1 = e/Z(p) \quad (1)$$

where $Z(p)$ is the generalized impedances of the filter and load, looking into the filter input terminals. Thus

$$Z(p) = R_1 + Lp + \frac{R_2 Cp}{R_2 + (1/Cp)} \quad (2)$$

During the period when the upper half of the tube is conducting, the instantaneous voltage across the filter input is

$$e = E_m \sin \omega t - E_o \quad (3)$$

Substituting the values of e and $Z(p)$ into Eq. (1) results in a differential equation, the solution of which (see Appendix I) can be expressed in the form

$$i_1 = YE_m \sin(\omega t + \mu) + \epsilon^{-\alpha t} [A_o \cos \psi t + C_o \sin \psi t] + I_c \quad (4)$$

where

$$Y = \left[\frac{1 + R_2^2 C^2 \omega^2}{(R_1 + R_2 - R_2 LC \omega^2)^2 + (R_1 R_2 C + L)^2 \omega^2} \right];$$

$$\mu = \left\{ \tan^{-1}(R_2 C \omega) - \tan^{-1} \left(\frac{R_1 R_2 C \omega + L \omega}{R_1 + R_2 - R_2 LC \omega^2} \right) \right\};$$

$$\psi = \sqrt{\beta^2 - \alpha^2} \quad ; \quad \beta = \frac{R_1 + R_2}{LCR_2}$$

$$\alpha = \frac{R_1 R_2 + L}{2LCR_2} \quad ; \quad I_c = \frac{-E_o}{R_1 + R_2}$$

In this expression A_o and C_o are arbitrary constants which must be evaluated from a knowledge of the circuit behaviour. If θ_1 is defined as the time angle at which current conduction starts at one anode, and θ_2 as the time angle at which it ceases, then Eq. (4) is valid only within this period. Where non cut-off operation occurs, $\theta_1 = 0$, and $\theta_2 = \pi$.

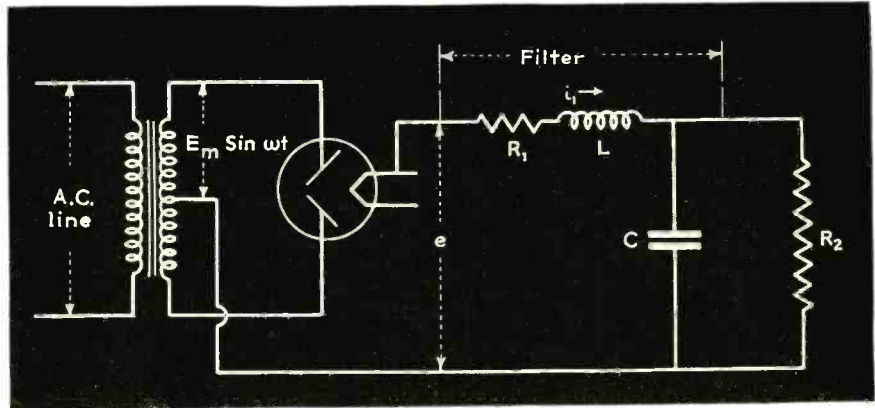

Fig. 1—Schematic wiring diagram of single phase, full wave rectifier circuit with simple choke input filter, and load resistance, R_2 .

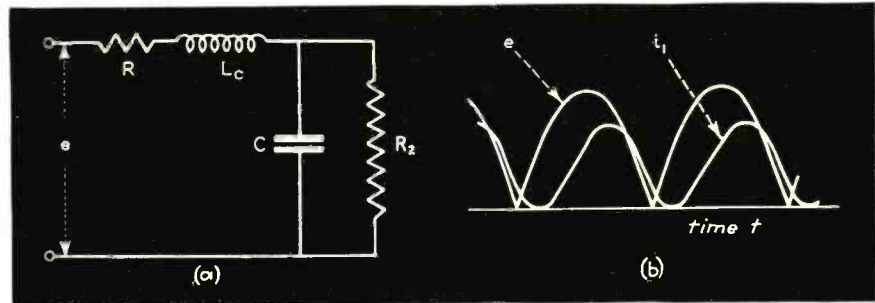

Fig. 2—Equivalent circuit of rectifier filter and load (a), with the resulting voltage and current waveforms (b). The flow of current can be made continuous if the inductance of the choke equals or exceeds the critical value, L_c . Means of calculating the critical inductance are given in the article

Since the rectifier is a full-wave type, a complete period of its operation, T , is half a line voltage cycle.

DC Value of Load Current

The d-c component of the load current is equal to the average value of the current, i_1 , through the filter inductance, and may be expressed as

$$I_{dc} = 2f \int_{\theta_1/\omega}^{\theta_2/\omega} i_1 dt$$

Substituting for i_1 and integrating gives

$$I_{dc} = \frac{YE_m}{\pi} \left[A_1 - A_2 \right] + \frac{2fC_o}{\alpha^2 + \psi^2} \left[S_1(\alpha B_1 + \psi C_1) - S_2(\alpha B_2 + \psi C_2) \right] + \frac{I_c}{\pi} (\theta_2 - \theta_1) + \frac{2fA_o}{\alpha^2 + \psi^2} \left[S_2(\psi B_2 - \alpha C_2) + S_1(\alpha C_1 - \psi B_1) \right] \quad (5)$$

where

$$\begin{aligned} A_1 &= \cos(\theta_1 + \mu) & A_2 &= \cos(\theta_2 + \mu) \\ S_1 &= \epsilon^{-\alpha \theta_1/\omega} & S_2 &= \epsilon^{-\alpha \theta_2/\omega} \\ B_1 &= \sin \psi \frac{\theta_1}{\omega} & B_2 &= \sin \psi \frac{\theta_2}{\omega} \\ C_1 &= \cos \psi \frac{\theta_1}{\omega} & C_2 &= \cos \psi \frac{\theta_2}{\omega} \end{aligned}$$

The d-c value of the voltage is of course the product of the d-c current and load resistance R_2 .

Harmonic Content of Output Voltage

The filter is inserted between the rectifier and the load to smooth out the pulsations in the output voltage and current. The degree to which it accomplishes this objective is a measure of the filter's excellence. To determine ripple content it is necessary to first calculate the harmonic components of the choke current. The current i_1 can be expressed as a

TABLE III—CORRELATION BETWEEN CALCULATED AND EXPERIMENTAL BEHAVIOR OF FULL WAVE RECTIFIER*

Circuit Factor	Calculated Value	Experimentally Observed Value	Deviation in Percent
Output voltage, E_{dc}	178 volts	182 volts	2.3
Load current, I_{dc}	0.248 amp.	0.250 amp.	2.0
120 cps component of i_1	0.0174 amp.	0.0176 amp.	1.2
240 cps component of i_1	0.00212 amp.	0.00218 amp.	2.8
Percent of 120 cps component of output voltage	3.96	3.91	1.3
Percent of 240 cps component of output voltage	0.26	0.28	7.1

* Tabulation determined for the following conditions: $E_m = 324$ volts; $E_o = 12.7$ volts; $L_c = 8.24$ henries; $C = 4.23 \mu f$; $R = 53$ ohms; $R_2 = 728$ ohms; and $\omega = 2\pi f = 377$ radians

Fourier series involving a d-c component, and cosine and sine terms of the harmonic components, the coefficients of these terms for the n th harmonic being evaluated from the expressions

$$I_n = 4f \int_{\theta_1/\omega}^{\theta_2/\omega} i_1 \cos 2n \omega t \cdot dt \quad (6)$$

$$I_n' = 4f \int_{\theta_1/\omega}^{\theta_2/\omega} i_1 \sin 2n \omega t \cdot dt \quad (7)$$

The resulting equations for I_n and I_n' are given in Appendix II. Expressed in literal form, these equations seem rather long and involved. However, using numerical values, their evaluation is not especially tedious. The amplitude of the n th harmonic of the output voltage across the load can be calculated from the equation

$$E_n = Z_n \sqrt{I_n^2 + I_n'^2} \quad (8)$$

where Z_n is the combined impedance of R_2 and C_2 in parallel for the n th harmonic.

Critical Inductance

Whether the current through the choke flows continuously or intermittently depends primarily upon the relative values of the choke inductance L , the capacitance C , and the load resistance R_2 . The limiting value of the inductance above which cut-off does not occur is defined here as the critical inductance and symbolized by the term L_c .

When the inductance of the circuit shown in Fig. 2a has been adjusted to its critical value, the current through the choke has a waveform corresponding to the curve marked i_1 in Fig. 2b. The minimum value of the current just reaches zero, characterising the

border line condition between cut-off and non-cut-off operation. If it be assumed that this current is comprised of only a d-c and a second harmonic component, and that R_1 and R_2 , in comparison to the filter circuit reactance, have negligible effect in determining the magnitude of the second harmonic then the value of the critical inductance can be expressed as

$$L_c = \frac{1}{\omega} \left[\frac{2(R_1 + R_2)}{3K} + \frac{1}{4C\omega} \right] \quad (9)$$

$$\text{where } K = \left[2 - \frac{\pi E_o}{E_m} \right]$$

L_c is the minimum value of the choke inductance which, for given values of R_1 , R_2 , C , and E_o/E_m will cause the current flow through the choke to be continuous. For values of L less than this value the current flow is intermittent. The derivation of the above equation is given in Appendix III.

Neglecting the higher harmonic components of current in arriving at Eq. (9) leads to only small error in final result.¹ For practical filter circuits the critical value of inductance is considerably on the inductive side of resonance (X_L is at least 10 times X_C). Consequently components of current higher than the second harmonic are of relatively small magnitude. Furthermore, the ratio of $2L_c\omega/R_2$ equals 30 or more, and at the critical point the ratio of $2R_2C\omega$ is about 20. Therefore little error is made in considering reactances only in evaluating the second harmonic component.

¹ If the effect of the fourth harmonic along with the second is considered Eq. (9) becomes

$$L_c = \frac{1}{\omega} \left[\frac{0.711(R_1 + R_2)}{K} + \frac{1}{4C\omega} \right] \quad (9a)$$

To indicate the percentage error likely to incur in the use of Eq. (9) and (9a), experimental results on several representative circuits are presented. Table I gives the values of the circuit parameters determined by direct test, necessary to produce the critical condition between cut-off and non-cut-off operation.

Table II gives the percent deviation of calculated values of L_c from those obtained experimentally.

Non-Cut-Off Operation

An oscillogram of the current through the filter choke when non-cut-off operation prevails is shown in Fig. 3. Under these circumstances the constants of integration in Eq. (4) are evaluated from the boundary conditions at $\omega t = 0$ and $\omega t = \pi$. Assuming balanced anode voltages and steady state operation of the circuit, those are

$$(i_1)_0 = (i_1)_\pi$$

$$\left(\frac{di_1}{dt} \right)_0 = \left(\frac{di_1}{dt} \right)_\pi$$

Applying these conditions to Eq. (4) yields the following expressions for A_o and C_o

$$A_o = \frac{D_1(\psi K_1 + \alpha K_2) - D_2 K_2}{K_1(\psi K_1 + \alpha K_2) - K_2(\psi K_2 - \alpha K_1)} \quad (10)$$

and

$$C_o = \frac{D_2 K_1 - D_1(\psi K_2 - \alpha K_1)}{K_1(\psi K_1 + \alpha K_2) - K_2(\psi K_2 - \alpha K_1)} \quad (11)$$

where

$$K_1 = 1 - \epsilon^{-\alpha/2f} \cos \psi/2f$$

$$K_2 = -\epsilon^{-\alpha/2f} \sin \psi/2f$$

$$D_1 = -2Y E_m \sin \mu$$

$$D_2 = -2Y E_m \cos \mu$$

Where the current through the filter choke is continuous it is evident that the d-c component can be expressed directly as

$$I_{dc} = \frac{(2/\pi) E_m - E_o}{R_1 + R_2} \quad (12)$$

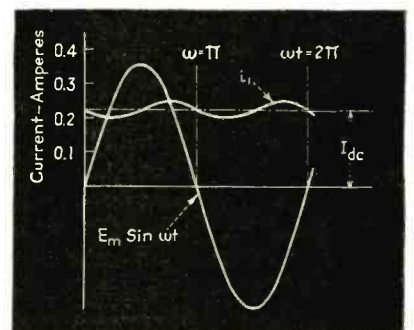

Fig. 3—Applied voltage and rectifier current flowing through filter choke for condition of continuous current flow for non-cut-off operation

the d-c voltage output being merely $I_{dc}R_s$.

The general Fourier series for the choke current is given in Appendix II. Where $\theta_1 = 0$ and $\theta_2 = \pi$, a certain amount of simplification in the coefficients of the sine and cosine terms results, and therefore these expressions are repeated in Appendix IV for reference. Knowing the coefficients, the amplitude of any harmonic of the output voltage can be determined by Eq. (8).

Table III gives comparative results on a rectifier circuit in which $E_m = 324$ volts; $E_o = 12.7$ volts; $L = 8.24$ henrys; $C = 4.23$ μ f; $R = 53$ ohms; $R_s = 728$ ohms, and $\omega = 2\pi f = 377$. The general current equation which is valid from $\omega t = 0$ to $\omega t = \pi$ is

$$i_1 = 0.117 \sin(377t - 82.5) + \epsilon^{-165.3t} [0.375 \cos 58.4t + 0.535 \sin 58.4t] - 0.016 \text{ amperes}$$

Cut-Off Operation

If the circuit parameters have values such that the current flows through the filter in pulses, the arbitrary constants in the general current equation, and the limits of the period of conduction $\omega t = \theta_1$ and $\omega t = \theta_2$ are not so easily determined. Equation (4) is applicable in the cut-off case but it must be restricted by imposing conditions which arise due to fundamental properties of the circuit. At the point of firing, the rising transformer voltage must be equal to the decaying voltage across the filter input since the voltage across the choke is zero at this instant. Therefore at $\omega t = \theta_1$ the following conditions must hold

$$\text{No. 1 } (i_1)_{\theta_1} = 0$$

$$\text{No. 2 } \left(\frac{di_1}{dt} \right)_{\theta_1} = 0$$

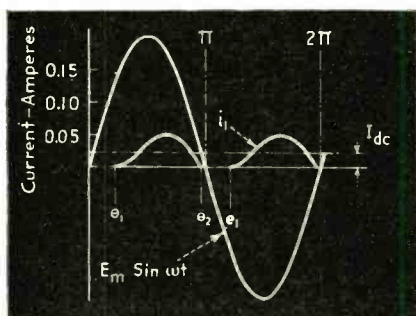

Fig. 4—Waveforms of applied voltage and rectified current output through filter choke for cut-off operation or discontinuous flow of current through choke

TABLE IV—CORRELATION BETWEEN CALCULATED AND EXPERIMENTAL BEHAVIOR OF FULL WAVE RECTIFIER*

Circuit Factor	Calculated Value	Experimentally Observed Value	Deviation in Percent
Output voltage, E_{dc}	195 volts	198.2 volts	1.65
Load current, I_{dc}	0.0250 amp.	0.0254 amp.	1.6
120 cps component of i_1	0.0296 amp.	0.0308 amp.	3.9
240 cps component of i_1	0.00493 amp.	0.00467 amp.	5.45
Percent of 120 cps component of output voltage	5.02	5.15	2.6
Percent of 240 cps component of output voltage	0.42	0.39	7.7

* Tabulation determined for the following conditions: $E_m = 324$ volts; $E_o = 12.7$ volts; $L = 4.0$ henrys (air core); $C = 4.0$ μ f; $R_1 = 900$ ohms; $R_2 = 7800$ ohms; $\omega = 2\pi f = 377$ radians.

$$\text{No. 3 } E_m \sin \theta_1 - E_o = V' \epsilon^{-\frac{\pi - \theta_2 + \theta_1}{R_2 C \omega}}$$

where V' is the voltage across the filter condenser at the instant of cut-off i.e.: $\omega t = \theta_2$. At this latter point two other conditions are true. Namely:

$$\text{No. 4 } (i_1)_{\theta_2} = 0$$

$$\text{No. 5 } E_m \sin \theta_2 - E_o = V' + L \left(\frac{di_1}{dt} \right)_{\theta_2}$$

Condition 4 is in reality a definition of the angle of cut-off. At this point the voltage across the inductance is not zero even though the current is zero.

It is possible to set up four simultaneous equations involving the unknowns A_o , C_o , θ_1 , and θ_2 from the above conditions. However, an explicit solution for any one of these terms is not possible. Consequently trial and error methods must be employed. By applying the first two boundary conditions to Eq. (4) the constants A_o and C_o are evaluated in terms of θ_1 and the known circuit parameters. Applying condition No. 4 to Eq. (4) and substituting in these values of A_o and C_o yields an equation involving the two unknown angles θ_1 and θ_2 . From conditions 3 and 5 a second equation in terms of θ_1 and θ_2 may be evolved. These two equations can be solved only by assuming values of one angle and calculating the other in a trial and error process. Appendix V gives a more detailed discussion of the manner in which this may be carried out.

Once the values of θ_1 and θ_2 are determined the integration constants A_o and C_o can be easily calculated, and thence the d-c load current and the harmonic content in the output voltage by Eq. (5), (6), (7) and (8).

Table IV gives comparative results in a rectifier circuit having the following constants. $E_m = 324$ volts; $E_o = 12.7$ volts; $L = 4.0$ henrys (air core); $C = 4.0$ μ f; $R_1 = 900$ ohms; $R_2 = 7800$ ohms, $\omega = 2\pi f = 377$.

By solution $\theta_1 = 42.1$ deg.; $\theta_2 = 175$ deg.; $A_o = 0.232$; $C_o = -0.480$

The current equation applicable from $\omega t = \theta_1$ to $\omega t = \theta_2$ is

$$i_1 = 0.255 \sin(377t - 41.6^\circ) + \epsilon^{-199t} [0.232 \cos 232t - 0.480 \sin 232t] - 1.46 (10^{-3}) \text{ amperes}$$

Figure (4) illustrates current waveform for this particular circuit.

Appendix I

Substituting in the values of e and $Z(p)$ into Eq. (1) gives the differential equation

$$i_1 [(LCR_2)p^2 + (R_1R_2C + L)p + (R_1 + R_2)] = (1 + R_2C\omega^2)^{1/2} [E_m \sin(\omega t + \phi) - E_o]$$

The complete solution of above equation consists of two parts. The solution of the homogeneous equation plus the particular integrals due to the presence of the two voltage functions $E_m \sin(\omega t + \phi)$ and $-E_o$. Let i_h be the solution of the homogeneous equation, i_p and i_c the particular integrals due to the two voltage functions.

The homogeneous equation is $i_h [(LCR_2)p^2 + (R_1R_2C + L)p + (R_1 + R_2)] = 0$ (13) which has roots $p_1 = -\alpha + \sqrt{\alpha^2 - \beta}$ and $p_2 = -\alpha - \sqrt{\alpha^2 - \beta}$. In all practical filter circuits $\beta > \alpha^2$, hence the roots are complex and may be written as

$$p_1 = -\alpha + j\psi; \text{ and } p_2 = -\alpha - j\psi;$$

where α , β and ψ are constants whose values in terms of the circuit parameters are previously given in the paper. The solution of Eq. (13) is

$$i_h = A_1 e^{p_1 t} + A_2 e^{p_2 t} \quad (2a)$$

where A_1 and A_2 are arbitrary complex constants. Since p_1 and p_2 are complex conjugate roots, Eq. (2a) may be converted into the form

$$i_h = e^{-\alpha t} [A_o \cos \psi t + C_o \sin \psi t] \quad (14)$$

(Continued on page 120)

Walkie-Talkies at War

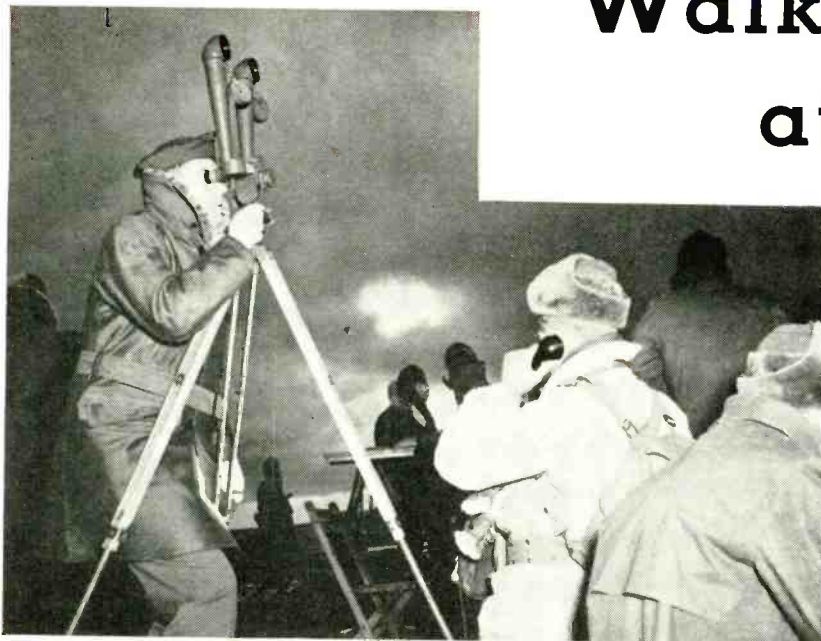

DEFENSE—An officer, watching the movements of a simulated enemy force from a strategic Iceland height, reports to the headquarters command via radiophone operated by an aide



LANDING—Ashore on a hostile coast, watchers may conceal themselves and observe defensive or offensive activities, reporting such preparations via ultrahigh-frequency radio to their own ships or aircraft



Photos by U. S. Army Signal Corps

OBSERVATION—Here a reconnaissance party, high on a hilltop somewhere in the south Pacific, spies out the land ahead. The man in the background reports by means of a walkie-talkie to the main body of troops, safely under cover at the rear

GUNFIRE—The crew in the background blasts away with its 75-mm fieldpiece, receiving range corrections via the foreground pack set from a spotter located at a point from which the effect of the shells may be seen



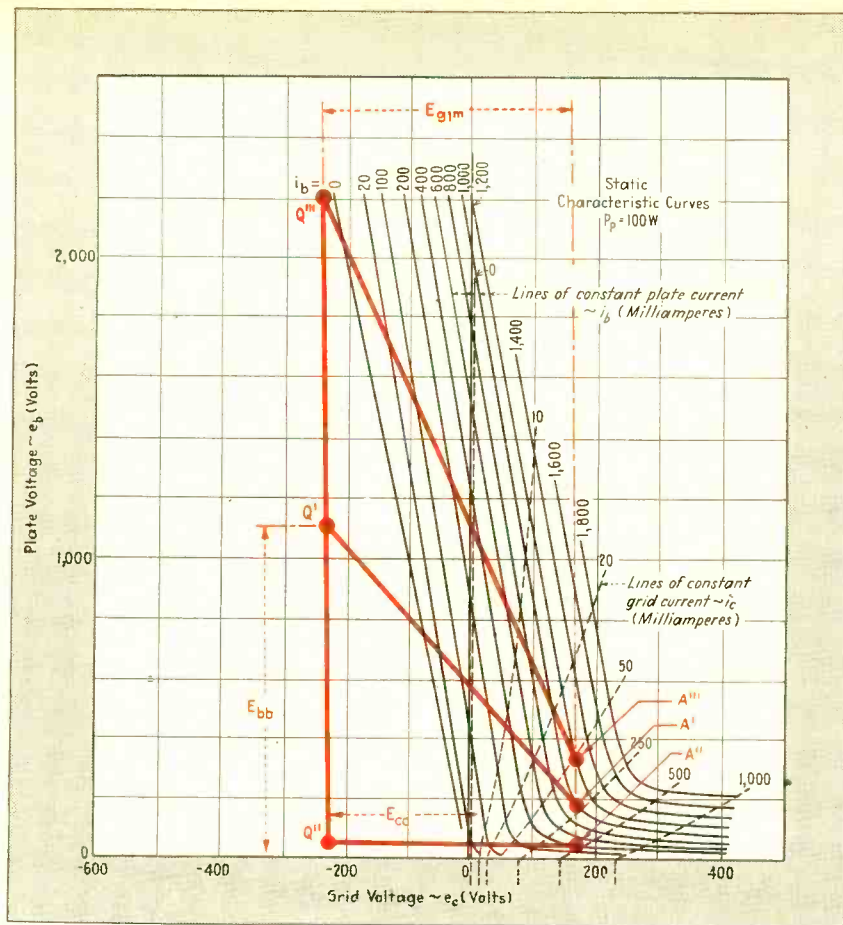

FIG 2.—Constant plate current and constant grid current curves (dotted) of tube whose performance as self-biased plate-modulated amplifier is to be determined. For plate modulated tube with constant bias, the plate operating point varies between Q' and Q'' . Only the power stroke of the path of operation is shown

the path of operation are shown as A and B . In the analysis in this article, we are concerned only with that part of the path of operation between Q and A , called the power stroke, since it is only during this part of the path that plate and grid currents flow.

Plate Modulated Tube with Fixed Bias

As an introduction to this method let us first consider the conditions that exist in the case where fixed bias is employed in the modulated amplifier. The required characteristics of the power tube, plotted on the e_b - e_c diagram are shown in Fig. 2. Under "carrier" conditions, with no modulation voltage applied, the quiescent point established by the application of the polarizing potentials to the tube is located arbitrarily at Q' . During the modulation cycle, when generator bias or battery bias is employed, this Q point is constrained to move vertically up and down as the amplitude of the plate polarizing potential is being changed at an

audio rate. The limiting excursions of Q are Q''' and Q'' when 100 percent modulation is employed. The calculation of the dynamic characteristics under this condition of operation is straightforward. It is necessary to determine only the end point, A , of the path of operation for any given position of the point Q on the line joining Q''' and Q'' . When this information about the position of A is available, the shape of the plate or grid current pulse that exists for this path is known. By the application of any of the harmonic analysis techniques referred to previously, the average or fundamental components of the current pulses may be calculated. The determination of A for any position of Q during the modulation cycle follows from the selection of the grid excitation and the equivalent resistance of the tank circuit. The selection of the grid excitation fixes A in the horizontal direction. The vertical position of A may be found by first assuming three or four possible

vertical positions as indicated by A_1 , A_2 , A_3 and A_4 , as in Fig. 3, for different values of fundamental voltage across the plate tank. For each assumed position of A we may calculate the fundamental plate current, I_{p1m} , by the use of an appropriate harmonic analysis. This may be plotted as a function of E_{p1m} , as indicated in the lower part of Fig. 3. On the I_{b1m} - E_{p1m} diagram, lines of constant equivalent resistance of the tank circuit $(R_b)\omega = L/RC = E_{p1m}/I_{p1m}$ will appear as straight lines. In Fig. 3 is shown the line corresponding to the particular value of $(R_b)\omega = K_1$ chosen for this calculation. The intersection of this line with the curve through the various A points gives the vertical coordinate of the end point, A' of the path of operation for the particular plate load and Q' point chosen, as indicated in Fig. 2. By repeating this procedure, the fundamental and average currents in both plate and grid circuit may be calculated by this method for different positions of Q and the value of A may be determined for each value of Q consistent with the requirements of the grid excitation and equivalent plate resistance. Knowing the fundamental and average currents for any Q and A points, the power output, driving

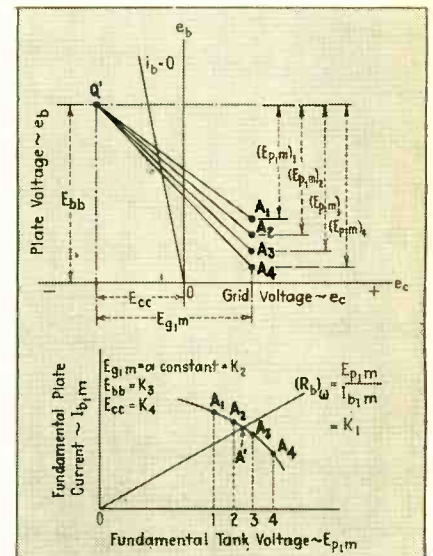

FIG. 3—For specified plate polarizing voltage, grid bias, and grid excitation voltage, the end point of the operating path, A' , is determined by selecting several arbitrary end points, A_1 to A_4 , (above). These points are plotted on the I_{p1m} - E_{p1m} plane and a smooth curve drawn through them. The intersection of this curve with the load line, $(R_b)\omega$, determines the desired end point, A'

power, plate efficiency and other so called dependent variables of the modulating system may be calculated. Hence, the dynamic characteristics may be determined.

Complications of Resistance Bias

When resistance bias is employed the problem is far more complicated, for the path followed by Q during the modulation cycle is no longer known. This is because the average grid current which determines the bias is a function of the position of both Q and A . Since Q is not known, A cannot be determined. For example, if at a given carrier condition (zero modulation) we introduce a resistance of such a value as to replace the generator and supply the same bias as it does, operating conditions at this point will be identical with those obtained with the generator. But if the plate potential is increased or decreased, the movement of the Q point is dependent upon the way the grid current will vary, consistent with the limitations imposed upon the tank circuit equivalent resistance and the excitation. Further, if the bias is supplied by inserting a resistance in the cathode lead, the movement of Q will depend on the variation of the average plate current in addition to the above. Obviously, the path followed by Q will be a complex function of at least four independent variables, E_{bb} , E_{cc} , E_{g1m} and $(R_b)_\omega$, and in the case where the bias, or part of the bias, is furnished by plate current, by five independent variables, the fifth variable being the bias resistor.

The problem then is to determine the locus which the Q point takes during the excursion of the plate voltage in the modulation cycle. Once this locus is determined for the particular grid excitation, equivalent plate resistance, and biasing resistance that are chosen and fixed for this calculation, the position of A could be determined for any Q point along this path in a manner similar to that outlined above. However, in order to find the path which Q follows in the case of resistance biasing, it is necessary first to find the coordinates of A for any likely position of Q during the modulation cycle. The positions that A is likely to take can certainly be restricted to that portion of the e_b-e_c plane to the right of the $e_c = 0$ axis and

above the $e_b = 0$ axis, in Fig. 3. When these coordinates of A are found, the problem is greatly simplified, as will be shown.

Now, for any position of Q on the e_b-e_c plane, (Fig. 2) the horizontal coordinate of A is fixed by the choice of the grid excitation voltage. The

vertical coordinate of A can be determined for any given equivalent plate resistance in the following manner. First we select an arbitrary position for Q for a given value of plate polarizing potential E_{bb} , and a specified value of the grid polarizing potential, E_{cc} , the value of the

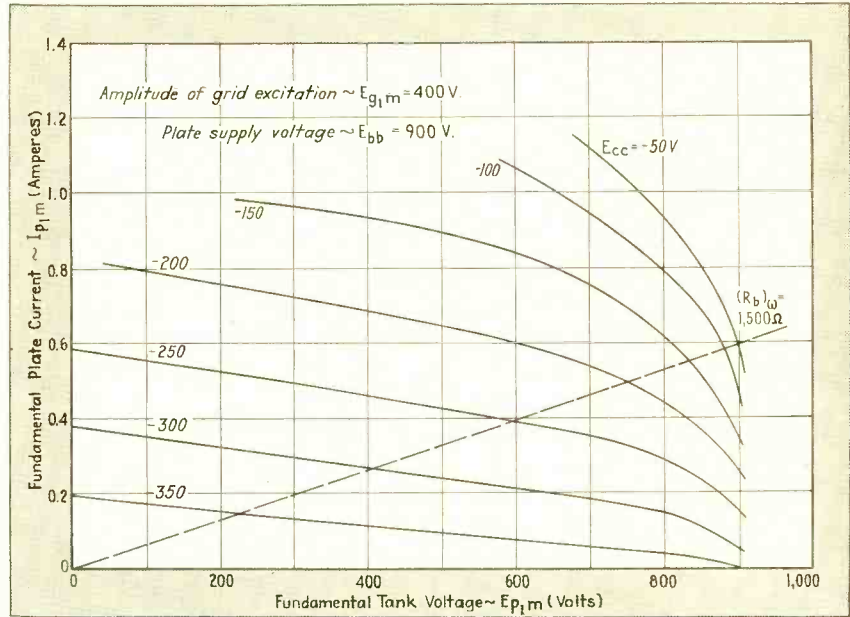
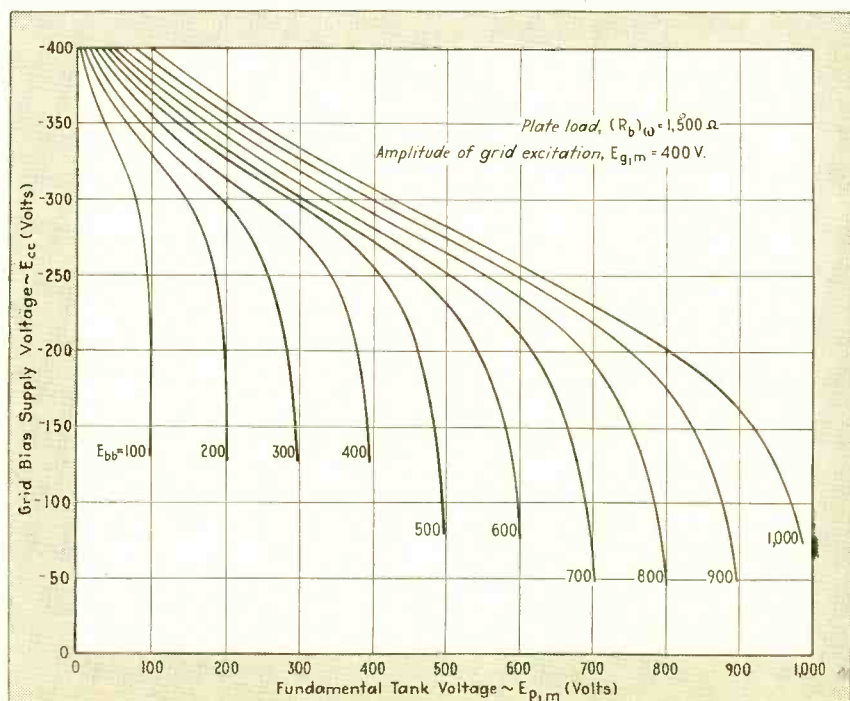

FIG. 4.—Graphical plot of end points of the path of operation. Each curve, for different value of grid bias, is determined in the same manner as the curve in the lower half of Fig. 2. The intersection of the plate load line with the family of curves permits the determination of data for one curve of those shown in Fig. 4. Several such diagrams are required, each for the same grid excitation but for different values of plate voltage

FIG. 5.—For constant plate load and grid excitation, this family of curves (each one of which is derived from a family like those of Fig. 3) shows the relation between grid bias and alternating voltage across the tank circuit



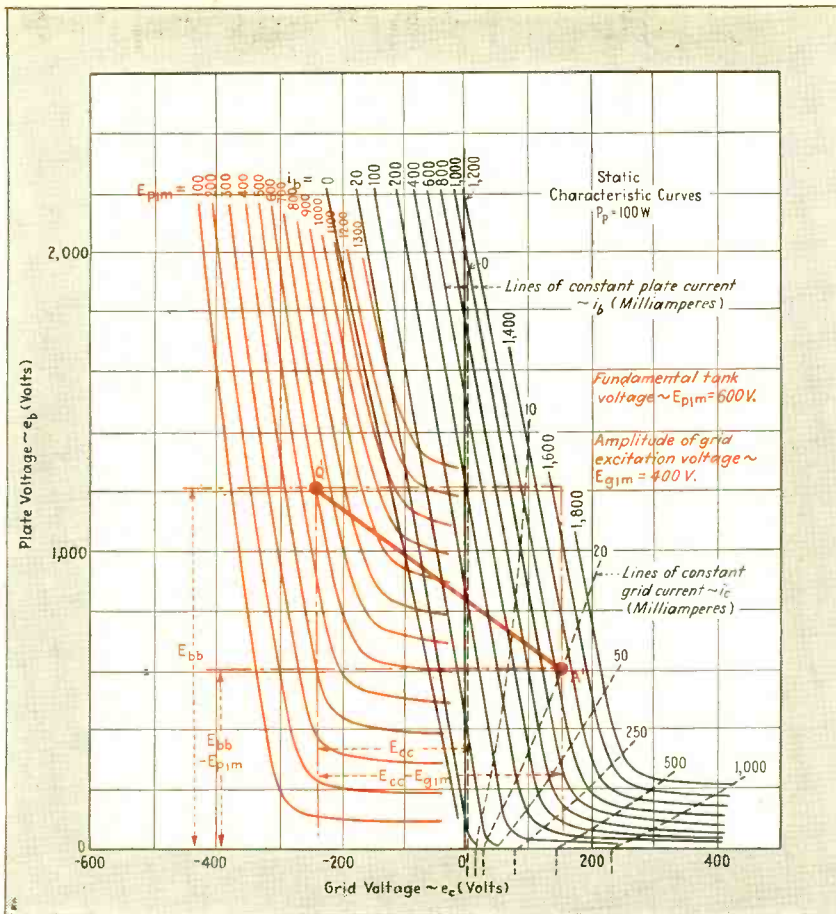

FIG. 6.—Curves of Fig. 4, replotted on the e_b - e_c plane (in red) and super-imposed on the original constant current curves of Fig. 1. The composite set of curves enables the end point A' to be determined for any Q' point, for the grid excitation voltage, constant grid bias, and plate load, $(R_b)_{\omega}$, assumed for this calculation

FIG. 7—Family of curves, for different values of plate polarizing voltage, plotted on grid voltage-average grid current characteristics. From this diagram on which grid resistance R_{cc} appears on a straight line, the paths followed by Q in the e_b - e_c plane can be determined

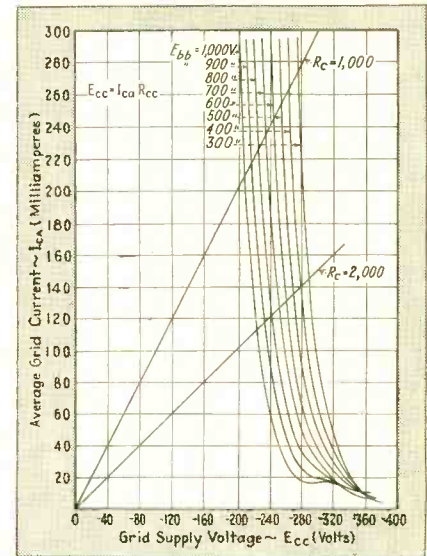
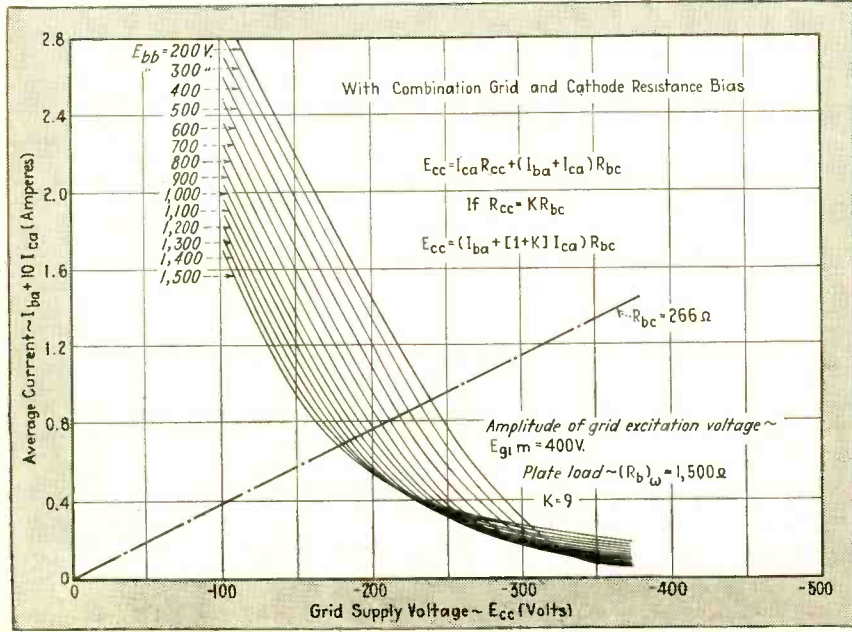

FIG. 8—Family of plate polarizing voltages for combined grid and cathode resistance bias. In this diagram, it has been assumed that $R_{cc} = 9R_{be}$



grid excitation, E_{g1m} , remaining fixed. For this Q -point we may calculate the fundamental plate current amplitude as a function of the fundamental voltage across the plate tank circuit in a manner similar to that employed in the case of generator bias. For the tube whose characteristics are shown in Fig. 2, and for operating voltages $E_{bb} = 900$ v., $E_{cc} = -50$ v., the curve obtained is that labeled $E_{cc} = -50$ volts in Fig. 4. Other curves like this may be obtained by holding the plate polarizing potential E_{bb} fixed at 900 volts and increasing the grid polarizing potential E_{cc} negatively in steps of 50 volts. These curves take the form of the family of curves

shown in Fig. 4. Lines of constant plate resistance may now be drawn on this diagram. For example, the dashed line, Fig. 4, represents a constant equivalent resistance $(R_b)_{\omega} = 1500$ ohms. Diagrams similar to this one are obtained for a number of values of plate polarizing potential, and on each the same line of constant equivalent plate resistance is drawn.

For various values of plate voltage the intersection of the lines of constant grid voltage, E_{cc} with the line of constant plate resistance $(R_b)_{\omega}$ may be plotted on a diagram having the coordinates of Fig. 5. These curves of Fig. 5 may, in turn, be transferred to the e_b - e_c plane. When this is done they take the form indicated by the red curves in Fig. 6. Actually Fig. 5 is only an intermediate diagram which is convenient to

FIG. 9—Characteristic paths of the Q point for various methods of bias. Curve A is for cathode resistance bias, and is the least desirable type of resistance bias. Curve B is for constant grid voltage bias. Curve C, which represents the most desirable type of resistance bias, is for the bias resistance in the grid circuit

use in order to obtain the material represented on Fig. 6.

Tube Operation for Fixed Bias, Plate Modulated Conditions

When the family of curves of Fig. 6 representing lines of constant E_{p1m} have been obtained and plotted on the e_b-e_c diagram, the problem is almost solved. It is convenient to draw the family of curves, $E_{p1m} = \text{constant}$, on transparent or translucent paper rather than to plot them directly on the e_b-e_c diagram so that they may be superimposed on the curves of Fig. 2, as shown in Fig. 6, the superimposed curves being indicated in red. From the superimposed curves we know the value of E_{p1m} that must be used for any arbitrarily chosen Q point. For any Q-point in the region to the left of $e_c = 0$ and above $e_b = 0$, both horizontal and vertical coordinates of A are now determined, since the assumed grid excitation gives the horizontal distance of A from the Q point while the value of E_{p1m} on which the Q point falls as read from the red curves gives the vertical distance.

An example will help clarify the procedure. The derived curves (red) are superimposed on the constant current static curves (black). A point Q' is arbitrarily selected at $E_{bb} = 1200$ volts and $E_{cc} = -250$ volts. This Q' point cuts the derived curves at $E_{p1m} = 600$ volts, and the excitation voltage was taken as $E_{g1m} = 400$ volts. Then, with Q' as the starting point, the coordinates of A' are $e_b = E_{bb} - E_{p1m} = 1200 - 600 = 600$ volts, and $e_c = E_{cc} + E_{g1m} = -250 + 400 = +150$ volts.

Effect of Resistance Bias

We have not yet taken into account the effect of resistance bias, which is
(Continued on page 128)

FIG. 10—Dynamic characteristics for plate modulated amplifier, for three types of biasing conditions. Most desirable characteristic is that for which power output is linearly proportional to d.c. plate voltage, and maximum driving power is a minimum

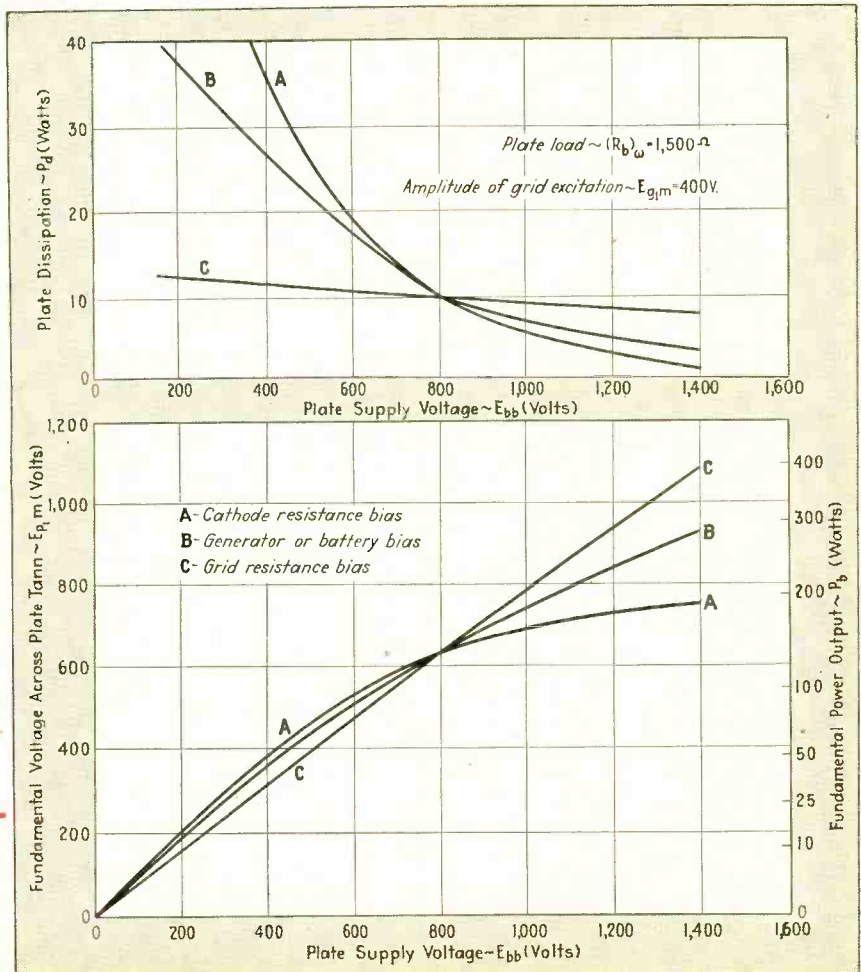
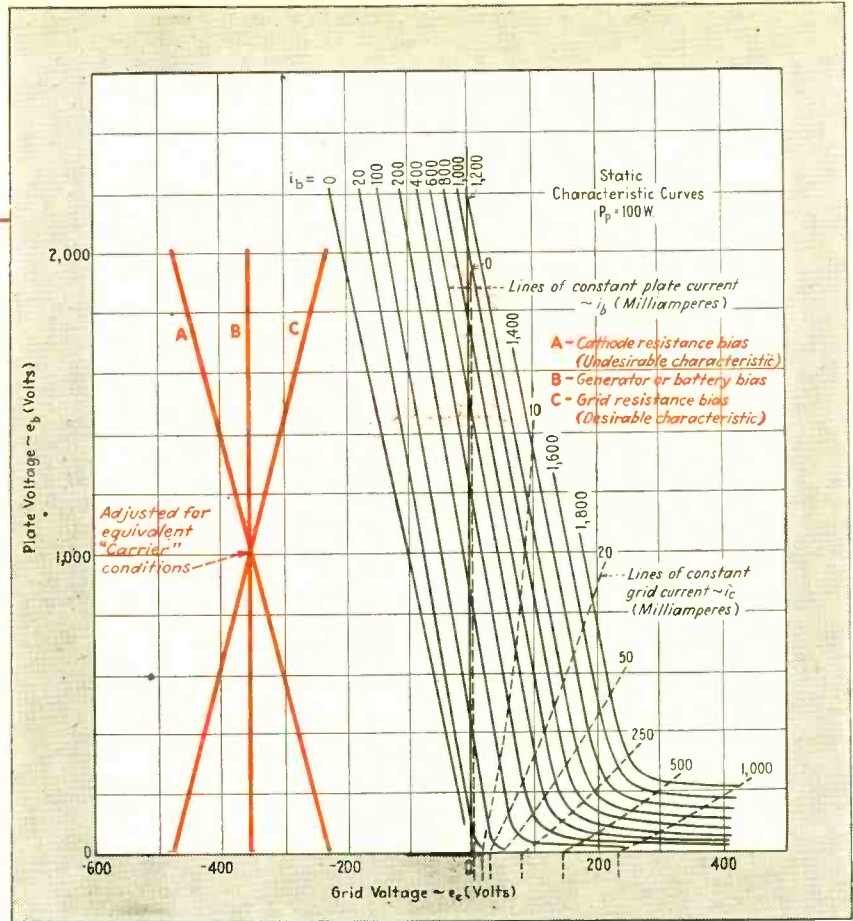

for A-C Generators

Two simple circuits are given. In the first, a single large thyatron handles only the portion of exciter field current needed for control purposes. In the second circuit, for small a-c generators, a thyatron and two 866's furnish all exciter field current

Control of voltage is accomplished manually by means of the exciter field rheostat. The voltage is adjusted to the desired value by hand as load is applied during the first five minutes. A motor-driven time delay switch starts up immediately. After the five-minute delay, during which time the filament is heated, the delay switch energizes the relay. Contacts S_2 then complete the plate circuit of the thyatron and contacts S_1 change from rheostat position 1 to 2. The S_1 contacts are so designed that the circuit is made at 1 before it is broken at 2.

The regulator is now in operation and has full control of the voltage. When the machine is shut down, the time delay relay automatically resets itself, opening S_2 and throwing S_1 from position 1 to position 2.

The reason for using S_1 to change the rheostat from position 2 to 1 when the tube is placed in operation is as follows: The exciter rheostat is initially adjusted to maintain the proper alternating voltage with the thyatron inoperative and S_1 in position 2. When S_2 is closed, the tube is inoperative at the load for which the exciter rheostat was set during the warm-up period. If some load were dropped from the alternator, the voltage would rise above normal. Additional resistance is introduced

by S_1 so that even at no load the voltage will not be too high when the electronic regulator is operating. Best results are usually obtained by a resistance between positions 1 and 2 of at least twice the exciter field resistance, with the optimum value depending on the constants of the machine.

The control of the voltage is accomplished as follows: If the voltage drops below a value determined by the setting of rheostat R in the circuit of secondary No. 2, bridge $R_1R_2R_3R_4$ unbalances in such a direction as to make the grid of the thyatron less negative. The thyatron then becomes operative, rectifying the a-c supply from secondary No. 3 and feeding this rectified pulsating direct current through the exciter field in the same direction as the regular field current flows. The net excitation of the field thereby increases, causing the voltage of the exciter to rise. The current in the alternator field therefore increases and the alternating output voltage rises.

Parenthetically, it should be explained that part of the output of the tube probably flows through the exciter field rheostat and exciter armature, thus reducing the voltage drop in the rheostat. The net result is to raise the exciter field current.

FIG. 2—Method of connecting a thyatron across the field rheostat for voltage control purposes. The necessity for a grid bias battery is one drawback of this previously-used arrangement

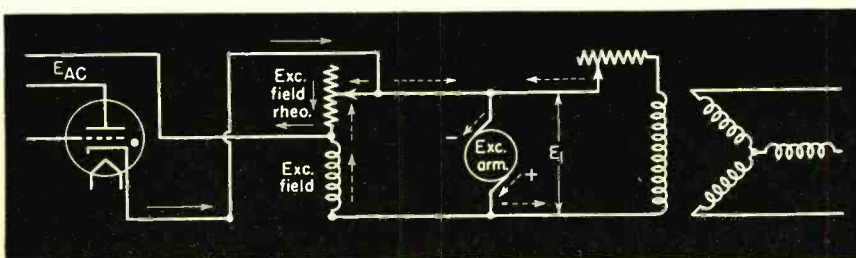

The rising alternating voltage acts through the transformer to make the grid more negative, stopping conduction of the tube. This in turn allows the voltage of the exciter, and thus of the alternator, to decrease until the tube again becomes operative.

To prevent the circuit from surging or hunting, resistors R_5 and R_6 and condenser C_2 are connected across the exciter output as shown.

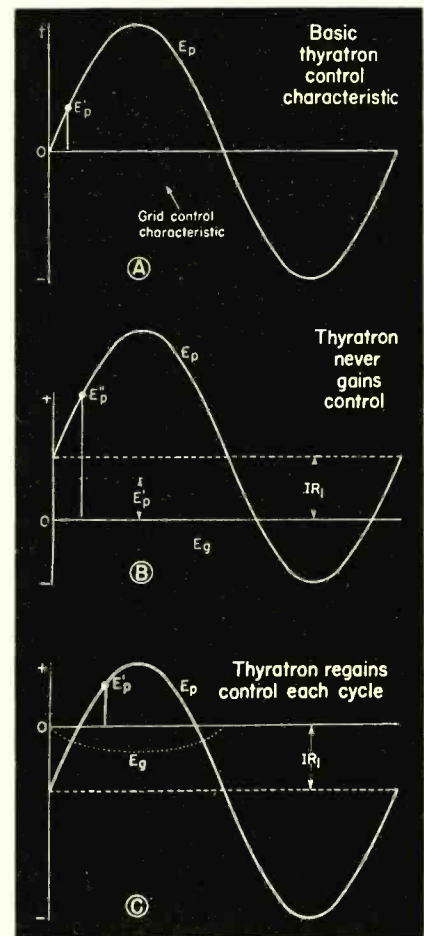

FIG. 3—Diagrams illustrating why a grid bias battery is required in the circuit of Fig. 2 in order for the thyatron grid to regain control each cycle

causes the tube to fire, as shown in Fig. 3C. The critical plate voltage E'_p , always occurs after the grid voltage increases negatively, no grid bias battery is required, and the entire circuit is always stable.

Other Features of New Regulator

With the regulator shown in Fig. 1, the excitation is aided by the tube when the load comes on, thus raising the voltage more rapidly. Also, the tube is only fully conducting during short periods of very heavy loads. Under normal loads it rectifies only a small portion of the time, which results in increased tube life. Some of the required current for the exciter field comes normally from the exciter armature itself, and hence the tube can be much smaller than if it supplied all the field current. No special field winding is required; any standard exciter will work with this arrangement.

The development work on this regulator was done on two different 5-kva, 3-phase, 230-volt alternators, one a sine-wave alternator and the other a salient-pole machine having a very pronounced 19th harmonic due to slot ripple. These machines were driven by 7.5-hp d-c compound motors. As a performance test, each alternator was driven at rated speed at no load, and one and one-half times full balanced 3-phase

load at 100 percent power factor was thrown on the machine. Beyond the momentary dip due to the lag of the machine fields, no change in voltage could be determined on the 300-volt scale of a Weston a-c voltmeter even though the speed of the driving motor decreased about 15 percent.

The same result was obtained with 70 percent power factor balanced load. With single-phase loading the voltage on the regulated phase was constant, although of course the three-phase voltage was unbalanced.

The time delay consists of a clock mechanism manufactured by Hansen Manufacturing Co., and may be obtained on special order with the minute hand making one revolution in five minutes. A small cam placed on this shaft acts on one blade of the relay, closing the contacts. This energizes the relay coil, closing S_2 and changing S_1 from contact 2 to contact 1 and thus putting the regulator in operation. The motor on the clock mechanism is still energized as long as the cam touches the blade, so it runs until the cam is free. The motor then stops, and is ready for another cycle of operation.

Simplified Regulator for Small Generators

Where the maximum field current of the exciter does not exceed 1 amp, the circuit shown in Fig. 4 is just as satisfactory as the previous one, and the cost of the parts is less. Several regulators of this design have been in commercial use over a year on 40-kva, 1200-rpm machines.

The same voltage-sensitive bridge described for the first regulator is used. The plate supply is a center-tapped 500-volt winding which serves a full-wave rectifier circuit feeding the exciter field directly. The response is slightly more rapid than that of the previous regulator, but the adjustment of anti-hunting circuit $R_0R_1C_2$ is more critical. For this reason R_0 is a 1000-ohm fixed resistor in series with a 5000-ohm variable wire-wound resistor which can be adjusted readily to eliminate hunting. Reducing this resistance reduces the sensitivity of the regulator, hence the maximum value which gives stable operation should be used.

The rectifiers are two 866/866A tubes operated in parallel for one half of the cycle, and an FG-17

thyatron for the other half-cycle. As is commonly known, if one half of the cycle of a rectifier feeding an inductance is controlled, the current during the other half of the cycle will necessarily be the same, due to the inductance. Thus only one grid-controlled tube is needed.

Two 866 tubes are used in parallel because they normally carry the greatest part of the current, with the grid-controlled tube operating over a very small portion of the cycle. To make these two 866 tubes divide the current equally, a 50-ohm, 10-watt fixed resistor is connected in series with each plate as shown in Fig. 4.

Figure 5A shows the division of load between the grid-controlled tube and the 866 tubes for light load conditions, while Fig. 5B shows the changed conditions for heavy load. The 866 tubes continue to conduct until the applied voltage E_p on the grid of the control tube becomes less negative than the grid control characteristic, even though these tubes may be conducting in the range where the applied voltage is in the wrong direction. This action is due to the inductance of the exciter field. The grid-control tube cuts off as soon as the applied voltage on the 866 tubes is sufficient to equal the internal tube drop, at which time the pair of tubes again takes over. Voltage E_g is the applied plate voltage for the grid-controlled tube; the plate voltage for the 866 tubes will be inverted, since it is obtained from another half of the transformer secondary.

Since these tubes reach operating filament temperature in 15 to 20 seconds, the time delay device is considerably simplified. A 20-second delay thermal strip which operates on 12 volts is used.

The field rheostat is set by hand to give rated voltage when the machine is brought up to normal speed. At the end of the 20-second time delay interval, contact 4 on the thermal delay closes, energizing the relay coil. Relay contact 1 then connects the exciter field to the regulator. Relay contact 3 closes, providing a holding circuit which keeps the relay energized. Relay contact 2 opens, breaking the circuit through the heater on the thermal delay and allowing this heater to cool down in readiness for another cycle of operation.

FIG. 5—The shaded portions indicate the division of load between the two halves of the rectifier circuit of Fig. 4 under different loads

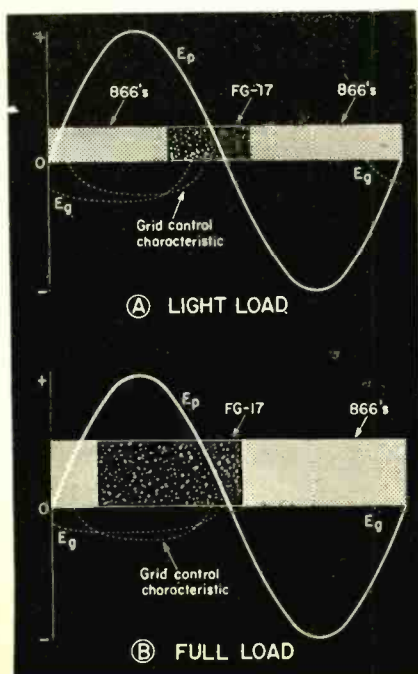



TRANSFORMERS—By wrapping short lengths of solder around terminals and then heating all of them at once by means of power induced from a single-turn coil RCA avoids the necessity for applying a soldering iron to each individual terminal

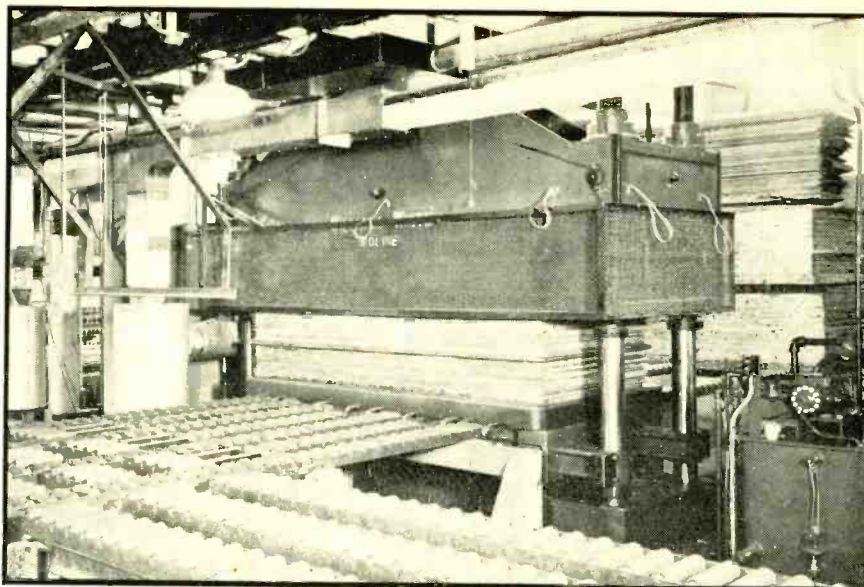

WOOD—Fir veneer bonding is quickly set in this press, bundles 12 inches thick being placed each side of a center electrode. Girdler Corporation high-frequency equipment raises the temperature of the stacks to 160 deg. F in less than five minutes

High-Frequency HEATING

CRYSTALS—Here high frequency heat takes the place of gas heat in a G-E plant, soldering a protective shell to a base without overheating a frequency control unit mounted inside



CRANKSHAFTS—This Ohio Crankshaft Company machine, powered by Westinghouse generators, hardens bearings in four seconds by inducing current into them from a collar constituting a single-turn coil. Distortion of the shaft is minimized as resulting heat is closely confined to the bearings

CHART FOR Equivalent Series and Parallel Circuits

Semi-circle diagram permits rapid conversion of series values of an impedance to the equivalent of an impedance composed of parallel elements, and vice versa. Chart may be applied over wide range of impedance values.

IN dealing with circuits containing resistance and reactance, the need often arises for a quick and easy method of converting the series values of an impedance to the equivalent parallel values. The possibility of a graphical process appeared most useful and the semicircle diagram has been devised as a graphical method of meeting these requirements. This, of course, conforms to a general type of circle diagram which is already quite familiar.

Any point on this diagram represents an impedance whose series resistance and reactance are indicated by its rectangular coordinates, while the equivalent parallel components are given by the values where the corresponding circular coordinates cut the resistance and reactance axes, remote from the origin.

For finding the equivalent series components of an impedance expressed as parallel quantities, the resistance and reactance circles corresponding to the parallel values are followed round to their point of intersection. The rectangular coordinates of this point indicate the equivalent series components of the impedance. As the chart is symmetrical about the diagonal $X_s = R_s$, either axis may be used for resistance as long as the other axis is used for reactance.

Values at which the circles would meet their respective axes have been marked against some of the circles. The range of the diagram may be increased by applying a common multiplication factor to the scales of both axes and the figures marked on the circles.

BY R. TOOMBS

*British Broadcasting Corp.
London, England*

The chart is particularly useful in the design of networks for matching two circuits of different impedances. Where a resistance load of R_A is to be built out to match a circuit of higher resistance R_B without any power loss, this can be done by adding a series reactance $j_s X_A$ and then shunting the combination by a parallel reactance $j_p X_B$ of opposite sign. The resistance circle corresponding to the value of R_B is followed until it cuts the rectangular resistance ordinate of the value of R_A . The other rectangular and circular ordinates of this point immediately give the respective values of the series and parallel reactances, $j_s X_A$ and $j_p X_B$, which are required to effect the matching. These, of course, must be of opposite sign.

Examples: (1) To find the equivalent parallel components of an impedance expressed as 19 ohms resistance in series with 9 ohms positive reactance. The impedance point on the chart is determined by the rectangular coordinates from 19 on the horizontal (resistance) axis and 9 on the vertical (reactance) axis. The circles which intersect at this point would cut these two axes respectively at 23.25 and 49. Therefore, a resistance of 23.25 ohms shunted by a reactance of 49 ohms is equivalent to the given impedance expressed as a resistance of 19 ohms in series with a reactance of 9 ohms.

(2) To match an antenna of 19 ohms resistance and 142 ohms series reactance to a 100 ohm transmission line. For convenience of operation on the chart, half the above values are considered, and an impedance of $9.5 - j_s 71$ converted to a pure resistance of 50 ohms. This is also a case where it is advantageous to use the vertical axis for resistance and the horizontal axis for reactance. The rectangular ordinate from 9.5 on the vertical axis cuts the 50 resistance circle (i.e. which would meet the vertical axis at 50) at the point whose other rectangular and circular ordinates meet the horizontal axis at 19.62 and 24.25 respectively. Thus we have

$$9.5 \pm j_s 19.62 = 50 \pm j_p 24.25$$

and multiplying by 2

$$19 \pm j_s 39.24 = 100 \pm j_p 48.5$$

Therefore, if the antenna reactance of $-j 142$ ohms is reduced to $-j_s 39.24$ ohms by the addition of a series coil having a reactance of 102.8 ohms, the circuit will be equivalent to 100 ohms resistance in parallel with a negative reactance of 48.5 ohms. This reactance is then tuned out by a shunt coil of $+ 48.5$ ohms reactance thus leaving the equivalent pure resistance of 100 ohms to match the feeder.

If the added series coil had a reactance of 181.24 ohms (i.e. $142 + 39.24$) the effective series reactance of this, together with the antenna, would be $+j_s 39.24$ ohms. The equivalent parallel reactance would also be positive and would have to be tuned out by a shunt condenser of 48.5 ohms reactance to leave the same pure resistance of 100 ohms.



Bright but cool lights now simplify live-talent programming at G-E Television Station WRGB

Studio lighting bright as daylight . . . and cool

An Example of General Electric's Complete Service to Radio and Television Broadcasters

Once television actors had to work under hot studio lights that brought beads of perspiration through make-up, wilted costumes, caused discomfort, hindered good production.

Today at General Electric's proving-ground Television Station WRGB, Schenectady, made-up faces stay cool, costumes don't wilt. Excessive studio air conditioning is no longer necessary. For the handicap of high heat from studio lights is on its way to being completely

licked by G-E developed, mercury-filled capillary lamps. They give illumination of daylight intensity with less than half the heat of the noonday sun. Water-cooled, and three to a unit, they have a light efficiency more than double—and heat output one-tenth—that of incandescent lamps. And one control panel aims a dozen of them, noiselessly, independently, anywhere in the studio.

These lamps that give cool studio lighting are another example of the bold

research that will enable G-E electronics engineers to build improved cathode-ray scanning and picture tubes, cameras, transmitters, and other equipment for post-war television.

All this so that television may more quickly find its proper place in the peacetime scheme of things as a vital medium of public entertainment and education. . . . *Electronics Department, General Electric, Schenectady, New York.*

Tune in on Frazier Hunt and the News every Tuesday, Thursday, Saturday evenings over C.B.S. On Sunday night listen to the "Hour of Charm" over N.B.C. See newspapers for time and station.

GENERAL  **ELECTRIC**
160-83-6912

FM RADIO · TELEVISION · AM RADIO

STUDIO EQUIPMENT · TRANSMITTERS · ANTENNAS · ELECTRONIC TUBES · HOME RECEIVERS

TUBES AT WORK

Simple Test Set for Mercury Vapor Rectifiers.....	112
Photoelectric Manometer	112
Navy Buoy Uses 45-volt Fluorescent Lamp.....	142
Large Photos Teach Assembly of Intricate Amplifiers.....	142
Side Shifts of Paper Corrected in Roll-Winding Machine....	144
Pumps Controlled Over Phone Line to Reservoir.....	148

Simple Test Set For Mercury Vapor Rectifiers

By M. J. WEINER

THE USUAL DIFFICULTIES encountered with mercury vapor rectifiers can be held to a minimum if certain operating conditions are maintained. In properly designed equipment the tube temperatures are held within certain prescribed limits to avoid arc-backs. The internal tube drop, however, is a function of the filament emission and load current, and increases with the age of the tube.

Since there has been no readily available measuring equipment to check the filament emission of mercury vapor tubes, it was decided to build one in as simple a form as possible to permit routine tube tests. The test set to be described gives an indication of the tube performance by measuring the tube drop when passing rated current. The parts required are simple and few in number.

The basic circuit is shown in Fig. 1. Being a half-wave rectifier circuit with resistance load, the average voltage drop across the tube and resistor is

$$(E_T + E_{DC}) \text{ av.} = \frac{E_{\text{max}}}{2\pi} \int_0^\pi \sin \omega t \, d\omega t = 0.318 E_{\text{max}}$$

The a-c voltmeter reads the effective value E , however, so the maximum (peak) applied voltage is

$$E_{\text{max}} = 1.414 E$$

Substituting:

$$(E_T + E_{DC}) \text{ av.} = 0.45 E$$

$$E_T = 0.45 E - E_{DC}$$

For the initial calibration procedure, place a new tube in the proper socket for a preliminary warm-up period, with the plate supply off. Next, apply plate voltage and increase it until the d-c ammeter indicates the rated load current for the

particular tube under test. This is 1.25 amp for a type 872 tube, and 0.5 amp for a type 866 tube. Read the d-c voltmeter connected across the resistor to get the value of E_{DC} . Read the a-c voltmeter to get the r.m.s applied voltage E . Now, subtract E_{DC} from $0.45 E$ to get the average tube drop E_T . Repeat for each other type of tube to be tested and record all values. (If it is desired to rate the tube in terms of peak values, multiply this result by π .)

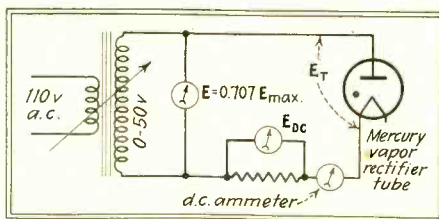

Fig. 1—Basic circuit arrangement for testing a mercury vapor rectifier tube

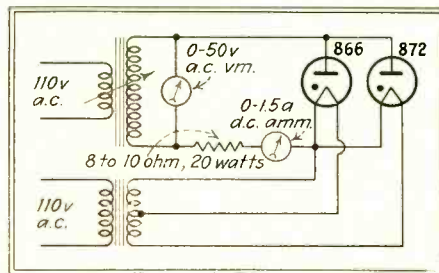

Fig. 2—Schematic circuit diagram of a simple test set for mercury vapor rectifiers. Additional sockets can be provided for other types of tubes if desired

A calibration chart can now be made up, showing the drop across the resistor at rated load current for each type of tube to be tested. The d-c voltmeter across the resistor may then be removed and this chart can be used to find the value of E_{DC} for the tube being tested.

If the tube drop E_T as measured for an old tube exceeds the drop in

a new tube by 5 to 10 volts, erratic operation of the rectifier equipment will follow and the tube should be taken out of service. It may still give many hours of useful service, however, in lower-powered equipment, where the load requirements are less.

The complete schematic circuit of the test set is shown in Fig. 2. The filament voltage at each tube socket must be the exact value required for the tube under test.

The tube to be tested is placed in the correct socket and allowed to warm up with plate supply off. Plate voltage is then adjusted until the ammeter reads rated load current for the tube, and the a-c voltmeter is read to get E . Reference to the calibration chart gives E_{DC} for the rated load current, and this subtracted from $0.45 E$ gives the average tube drop E_T .

The equipment is calibrated in terms of the readings obtained with a new tube because the input voltage required for rated load current will vary according to the position of the d-c return lead with respect to the filament winding. For example, connecting the d-c return to the filament center-tap will not give a value of input voltage which is the means of the values obtained by connecting this lead to either side of the filament.

The variable voltage is obtained from a UTC Varitran, but the same result can of course be obtained with a fixed transformer using a primary rheostat.

Photoelectric Manometer

By W. E. GILSON, M.D.

THE PHOTOELECTRIC membrane manometer described in the article "Applications of Electronics to Physiology" on pages 86-89 of the Jan. 1943 issue of *ELECTRONICS* provided a means for making an accurate record of pressure changes in the cardiovascular systems of animals such as dogs and turtles. It has since become desirable to reduce both the size and weight of the manometer.

The resulting improved manometer is shown in Fig. 1. The lens forms an image of the exciter lamp filament directly above the rubber diaphragm, with the lower part of

(Continued on page 140)

GOES TO SEA...
TO SEE IT THROUGH...



Guardians of the sea—out across the North Atlantic, Coast Guard cutters help guard our life-lines.

WHEREVER and whenever there is a vital message to be sent, CINCH parts are pretty certain to be there to "see it through". In the communication system in every service of land, sea, and air; CINCH parts, sockets, connectors, etc. are used to give dependable service.

CINCH

MANUFACTURING CORPORATION · 2335 WEST VAN BUREN STREET · CHICAGO, ILL.

SUBSIDIARY: UNITED-CARR FASTENER CORP., CAMBRIDGE, MASS.

OPEN SESAME

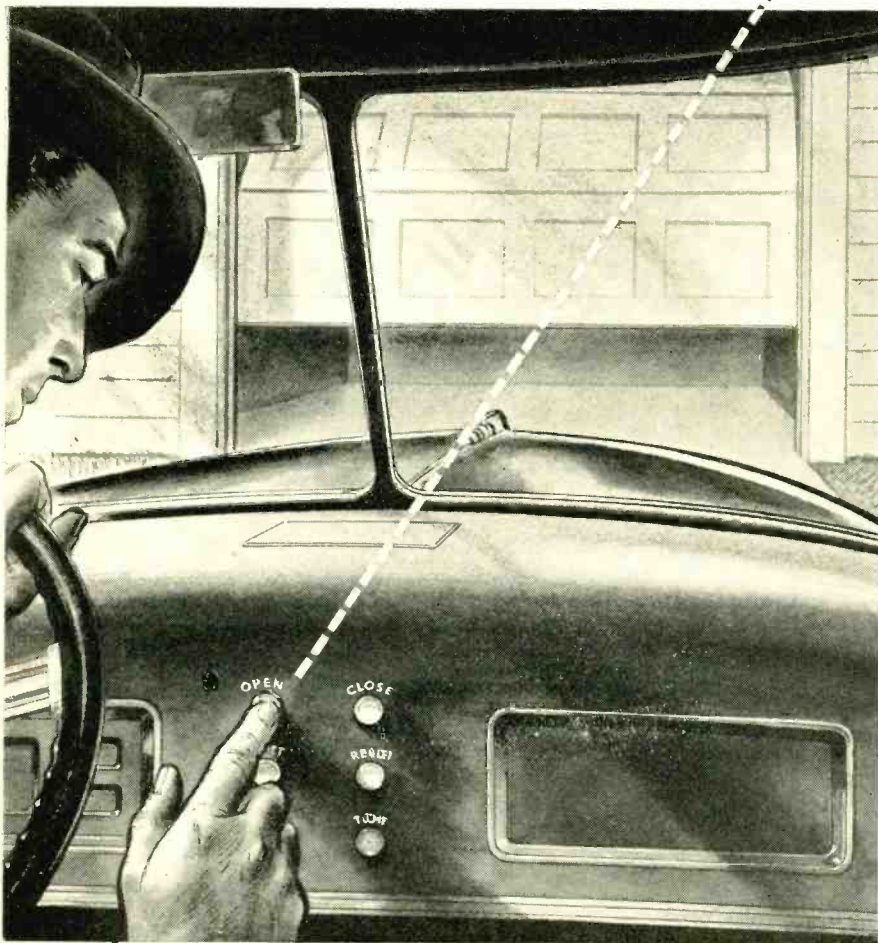

FOR A POST-WAR GARAGE

You push the button in your car as you pull up to your drive and presto the garage door opens. In you go. Press another button and the door closes . . . To put this time and trouble saving device on millions of post-war cars is one of the exciting jobs awaiting the electronic industry when the war is won. No doubt you've thought of others. And when you are thinking ahead, we'd like you

to keep in mind that Jackson electronic test instruments will have a part in this bright future. They'll be used in laboratories where post-war products are designed. They'll be used in service shops where they are repaired and maintained.

Remember: a Jackson instrument—multimeter, tube tester, oscillograph, or whatever—means what it says, within limits established for the job.

All Jackson employees—a full 100%—are buying War Bonds on a payroll deduction plan. Let's ALL go all-out for Victory.

JACKSON

Fine Electrical Testing Instruments

THE JACKSON ELECTRICAL INSTRUMENT COMPANY, DAYTON, OHIO

Recording Unit for Strain and Timing Functions

(Continued from page 83)

servicing of oscillograph screen and lamp box and for focusing the camera.

A diagram of the complete equipment is shown in Fig. 6. The various units are set up at some distance from the machine under observation so that the machine can perform undisturbed and the recording equipment is not affected by too severe vibrations. Five hundred feet of trailing cable is available for each bridge circuit and for the gas discharge lamps. This makes it possible to take recordings from very large machines and from moving units like tractors and scrapers when they are under actual operating conditions.

Remote Control Actuator

Recording is started and stopped by a six volt remote control system. It actuates the camera motor, the power supply for the discharge tubes, and a double pole relay which throws the electron beam on and off the screen of the cathode ray tube. All amplifiers are on all the time to keep filament temperature even and to make recording possible at the instant the machine under observation performs as desired. Yet, no film is wasted and the fluorescent screen of the cathode-ray tube is afforded maximum protection.

Acknowledgement

The interest of Dr. Arnold Peterson of Boston in this recording unit was greatly appreciated. He has suggested the scheme for the electronic relay and recommended changes for adapting the Thordarson amplifier for these special purposes.

The Aladdin Neon Sign Company of Milwaukee deserves thanks for cooperating in the development of the gas discharge tube.

Mr. Harry Halinton of the Electronics Sales Company of Milwaukee (now Chicago) has been very helpful in the selection and the procurement of standard equipment.

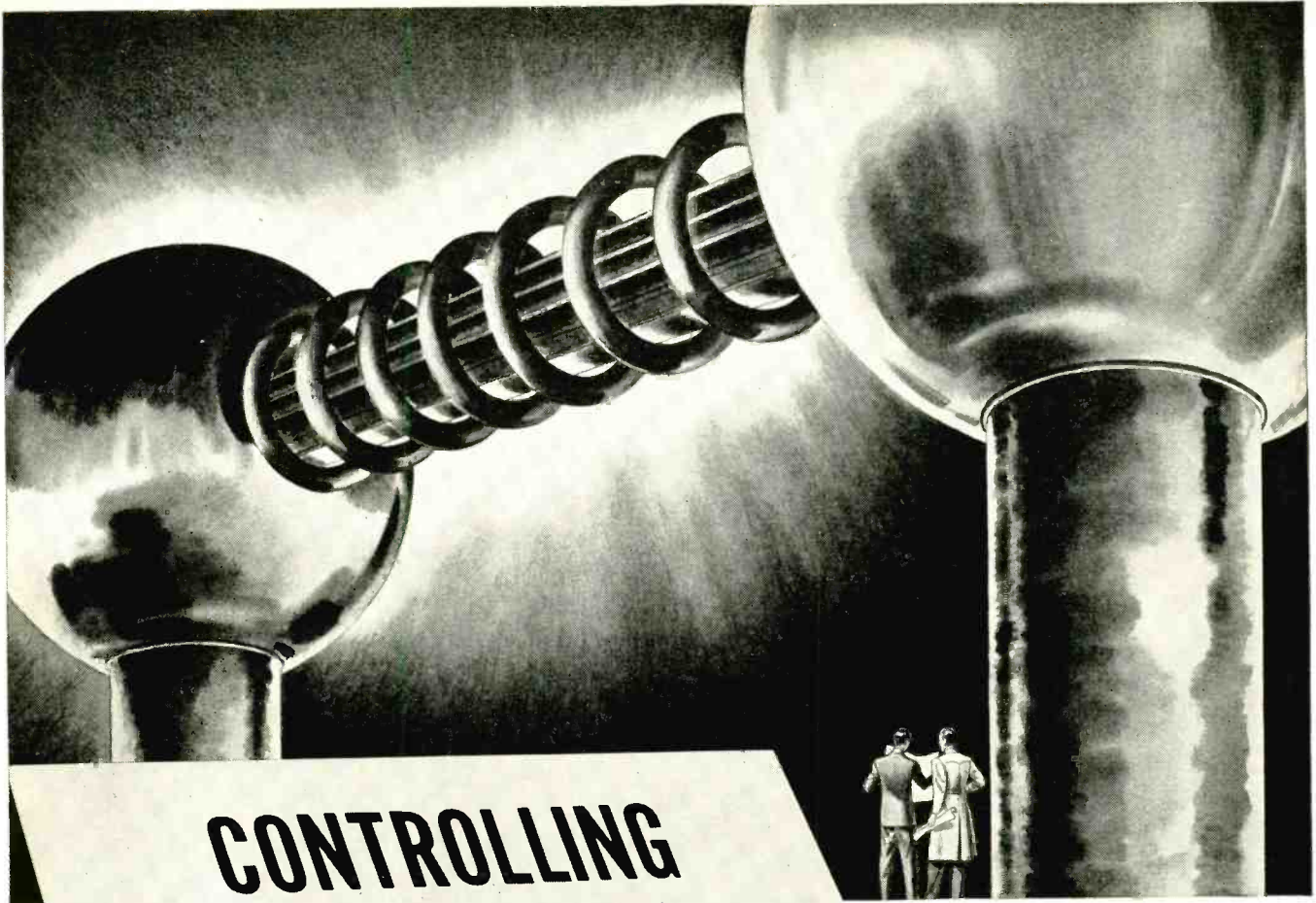

Electron beam tube of atom-smasher.

CONTROLLING MILLIONS OF VOLTS!

In the vast new province of Nuclear Physics the atom-smashing "Big Guns"—the Van de Graaff generators, the cyclotrons and betatrons—are carrying on a campaign of *creative* destruction.

Manned by an army of collaborating specialists, this massive and complex artillery has already achieved spectacular results in the medical, chemical and biological fields and in scientific developments which must remain secret for the duration. The "smashing" of atoms has released new energies, created new atoms.

Despite the tremendous force required to produce high-speed electrons, protons and ions, the controls and measuring devices perform with amazing accuracy.

IRC is proud to have contributed to the development of resistor units, both Wire Wound and Metallized—of fixed and variable types—used in the measuring instruments. And IRC

engineers have produced special resistors used to stabilize corona and other disturbing phenomena in atom-smashers.

If you are confronted with a problem involving resistance devices, we invite your inquiry. Our engineering staff, specialists in the design of all types of resistors, can be depended upon for impartial counsel.



INTERNATIONAL RESISTANCE COMPANY

403 N. BROAD ST., PHILADELPHIA



WE CAN HANDLE SUBCONTRACTS THAT REQUIRE:

- Radio, Electronic or Mechanical Engineering
- Completely Equipped Tool Room
- Automatic Screw Machines
- Hand Screw Machines
- Swaging Operations
- Punch Presses
- Drill Presses
- Threading Operations
- Lathe Operations
- Milling Operations
- Foot Presses
- Wire Braiding
- Light Section Spot Welding
- Intricate Soft and Silver Soldering
- Buffing and Sanding
- Careful Inspection
- Parkerizing
- Plating
- Painting or Spraying
- Infra-red Baking or Air Dried Finishing
- Intricate Mechanical and Electronic Assemblies



We offer the facilities of our two modern plants to any manufacturer faced with production problems. Our equipment is particularly well adapted to turning out intricate mechanical or electronic assemblies, and we would prefer work involving our assembly department. However, we can accept contracts for any one or more of our production units, except that we are not interested in work which involves only our screw machines.

Our two plants comprise 72,000 square feet of floor space, and we have several hundred trained employees on our payroll. Expert engineering and development services are available. Our company

is well financed and now engaged in prime and subcontracts for war production, but is able to take on considerably more.

Address all inquiries to The Ward Products Corporation, 1521 East 45th Street, Cleveland, Ohio.



The WARD PRODUCTS CORP.
CLEVELAND, OHIO

Rochell Salt Crystal Devices

(Continued from page 90)

One unit of this type had an output of -27 db at 5 cps.

Of particular interest is a newly developed mirror oscilloscope. This instrument is very compact and weighs less than one ounce. The unit uses a framed crystal and a novel multiplying system attached to the toggle elements in such a way that effective damping is obtained without loading the device. The high velocity elements are so small and light that virtually no inertia effects are apparent. The units developed to date have a maximum amplitude at 12-inch beam distance of approximately one-half inch, and a substantially uniform response to 5000 cps.

The photograph shows the set-up used to determine the characteristics of the oscilloscope. A conventional phototube having its output fed to the high-gain amplifier of the cathode-ray oscilloscope provides the means to determine the response and waveform characteristics of the crystal oscilloscope. Both modulated and sine-wave inputs to the crystal are provided by the beat-frequency oscillator and an audio amplifier.

Applications to Medicine

In the author's practice of osteopathic medicine he has considered the possibilities of using sound transmission and sound reflection in medical diagnosis. The several types of amplifying and recording apparatus now provided for diagnosis are confined to stethoscopic work.

During tests of the Monobar microphone in stethoscopic investigations, it was noted that the very large low frequency response of the crystal unit rendered the normal thoracic and abdominal sounds extremely clear and distinct. Further work indicated that various types of partial intestinal obstructions could be detected. Investigations also indicated that types of pneumonic consolidations and thoracic cavity complications can be detected and diagnosed. These procedures can be carried out at the bedside with a portable instrument, and if a permanent record of the findings are desirable, they can be made.

The author has made only a be-

one style case...

THE ADVANTAGES OF A COMPLETE LINE HOUSED IN A SINGLE MOUNTING STYLE

STANCOR Professional Series Transformers' case design combines a smart appearance and uniform pattern with rugged mechanical construction. The reversible mounting feature increases the range of application. Uniform mounting centers are maintained for each case size; thus,

accurate chassis punchings may be made with assurance of easy installation or replacement.

This line of Stancor transformers combines sound engineering with highest quality materials and precision manufacturing. No sacrifice of quality is tolerated.

For further information write for catalog No. 240

STANDARD TRANSFORMER CORPORATION

1500 NORTH HALSTED STREET • CHICAGO

D I M E N S I O N S

Professional Series Transformers

Case Type	H	W	L	MW	ML
RA	2 ⁷ / ₈ "	2"	2 ⁷ / ₁₆ "	1 ⁹ / ₁₆ "	2 ¹ / ₃₂ "
RB	3 ¹ / ₁₆ "	2 ³ / ₈ "	2 ³ / ₄ "	1 ¹³ / ₁₆ "	2 ¹ / ₈ "
RC	3 ⁵ / ₈ "	2 ⁹ / ₁₆ "	3 ¹ / ₁₆ "	1 ¹⁵ / ₁₆ "	2 ⁷ / ₁₆ "
RD	3 ⁷ / ₈ "	3"	4 ¹ / ₂ "	2 ⁷ / ₁₆ "	3 ⁷ / ₈ "
RE	5"	3 ⁷ / ₈ "	5"	3 ³ / ₁₆ "	4 ⁵ / ₁₆ "
RF	5"	4 ¹ / ₂ "	5"	3 ²⁷ / ₃₂ "	4 ⁵ / ₁₆ "
RG	5"	5 ¹ / ₈ "	5"	4 ¹ / ₂ "	4 ⁵ / ₁₆ "
RGA	7 ¹ / ₈ "	5 ¹¹ / ₁₆ "	6 ⁹ / ₁₆ "	4 ¹³ / ₁₆ "	5 ³ / ₄ "
RH	9"	7 ¹ / ₂ "	7"	6 ¹ / ₂ "	6"
RJ	9"	8 ³ / ₄ "	7 ¹ / ₂ "	7 ³ / ₄ "	6 ¹ / ₂ "
RK	9"	8 ³ / ₄ "	9"	7 ³ / ₄ "	8"
RL	13"	8 ³ / ₄ "	10"	7 ³ / ₄ "	9"

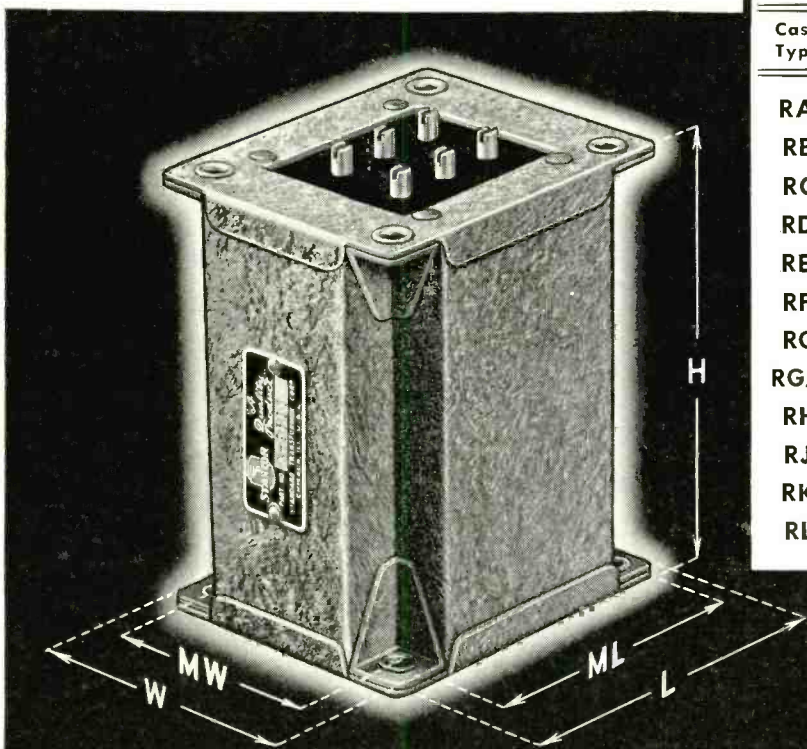

S T A N C O R



MICAH* keeps in Step WITH THE FORWARD MARCH OF ELECTRONICS

**Micah represents the high-grade mica products processed by Macallen.*

While our soldiers of science quietly mould America's postwar future, mica advances to keep sentinel over the volts, ohms and amperes that will control tomorrow's electronic miracles.

For 50 years Macallen Mica has kept pace with electronic advancement, never failing to meet the most exacting specifications. Macallen's specialized skill and experience, in bringing mica's reliability to the greatest possible usefulness, will continue to help shoulder the electrical industry's responsibility for world progress. That we may work together for a mutually bright future, Macallen offers you all its facilities of research.

50th anniversary book — *Macallen & Mica* — yours for the asking.

PRODUCTS

Compressed Sheets — Mica Paper, Cloth, Tape, Heater Plate, Compressed Sheet Tubing—Commutator Insulation — Compressed Sheet Washers — Insulating Joints and Canopy Insulators — Railway Specialties — Domestic and Imported Raw Mica.



THE MACALLEN COMPANY

16 MACALLEN ST., BOSTON

CHICAGO: 565 W. Washington Blvd.

CLEVELAND: 1005 Leader Bldg.

ginning in what appears to be a new approach to the diagnosis of a number of diseases and their complications. Work by another investigator covers a new approach to the diagnosis of disease by the interpretation of pulse wave propagation along an artery. This worker has used two pressure-operated crystal microphones at two points along the course of the artery, feeding the output of the two microphones into suitable recording apparatus.

It is perhaps not too much to say that by the recording of contractions of the various portions of the human body, and by sound transmission and reflections technique, using piezo-electric sound generation and detecting devices, we may be led to a better understanding of certain diseases and their earlier and surer diagnosis and treatment.

Altogether the Monobar developments present a promising picture. The known applications of the new piezo-electric device together with its potential possibilities in new fields, and its many basic points of superiority over other systems, lead us to believe that we really "have something".

SOUND EFFECTS TECHNICIANS



The National Broadcasting Company in Hollywood is training women as sound effects technicians to replace the men who have been called into the Armed forces. Harry Saz is shown explaining the technique of manipulating coconut shells in such a manner that they sound like horses walking, trotting or galloping

ALL-AMERICAN TEAMWORK - 1943



OFFICIAL U. S. NAVY PHOTOGRAPH

SIGNALS are called on a "flat-top" . . . and a smooth-working team of men and equipment swings into action. The hardest game of all begins — War — with death-dealing steel and men's lives at stake.

Networks of communications systems become the nerve center of action. Microphones at battle stations carry the signals to the team. Men rely upon their Microphones in the thick of the fight. They must get the signals through.

Shure Microphones are made to work under fire. They achieve new standards of ruggedness. They will get the signals to the team and help coordi-

nate the efforts of every fighting man for Victory.

SHURE REACTANCE SLIDE RULE



Makes extremely simple the calculation of complicated problems in resonant frequencies. Also helps in the solution of circuit problems involving inductances and condensers. Covers a frequency range of 5 cycles per second to 10,000 megacycles. Indispensable for radio and electrical engineers, technicians and circuit designers. Send 10c in coin to cover mailing costs.

Shure Brothers are supplying Microphones to all of our armed forces. Additional plant capacity is available to Manufacturers who require Microphones for their contracts.

SHURE BROTHERS, Dept. 174M 225 West Huron St., Chicago, U. S. A.
Designers and Manufacturers of Microphones and Acoustic Devices



MICROPHONES

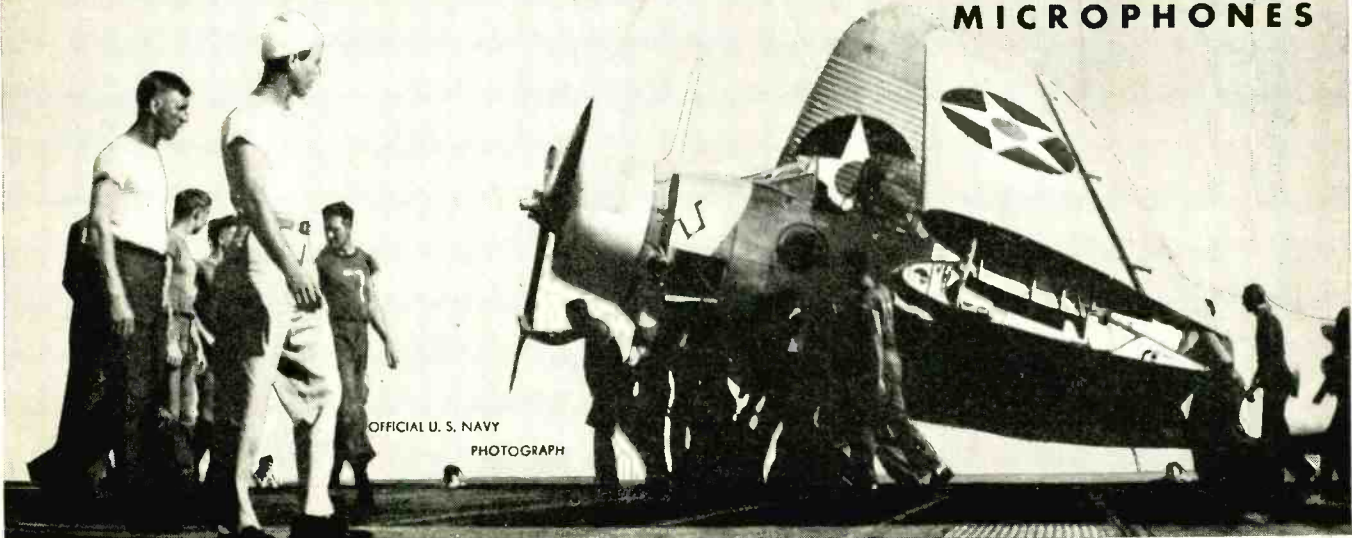

OFFICIAL U. S. NAVY PHOTOGRAPH

... the Highest Standard in Magnetic Measurements



To maintain a high degree of uniform magnetic quality and precision, Arnold engineers use The High II Permeameter (illustrated) ... a duplicate of the Permeameter in use at the National Bureau of Standards ... just one example of the close magnetic control under which the Arnold magnets are manufactured.

All ALNICO types of Permanent Magnets ... including ALNICO V ... are completely fabricated in the Arnold plant under exacting metallurgical, mechanical and magnetic control.

Arnold engineers are available to solve your magnetic design problems ... all inquiries will receive prompt attention.

THE ARNOLD ENGINEERING COMPANY

147 EAST ONTARIO STREET • CHICAGO, ILLINOIS

PRODUCERS OF MAGNETS FOR AIRCRAFT, MARINE, RADIO,
ELECTRICAL AND OTHER TYPES OF MEASURING INSTRUMENTS

* * *

For Victory ... invest at least 10% in War Bonds

Full Wave Rectifier

(Continued from page 97)

where A_0 and C_0 are arbitrary real constants. The particular integral due to the voltage function $E_m \sin(\omega t + \Phi)$ is readily obtained from the equation

$$i_b = \frac{(1 + R_2^2 C^2 \omega^2)^{1/2} E_m \sin(\omega t + \Phi)}{(LcR_2)p^2 + (R_1 R_2 C + L)p + (R_1 + R_2)}$$

by letting $p = j\omega$. This yields the result

$$i_b = Y E_m \sin(\omega t + \mu) \quad (15)$$

where Y and μ are given in the body of the paper. The second particular integral is determined from the equation

$$i_c = \frac{-E_0}{(LcR_2)p^2 + (R_1 R_2 C + L)p + (R_1 + R_2)}$$

by letting $p = 0$. This gives

$$i_c = \frac{-E_0}{R_1 + R_2} = I_c \quad (16)$$

whence the complete solution of the current is

$$i = Y E_m \sin(\omega t + \mu) + e^{-\alpha t} [A_0 \cos \psi t + C_0 \sin \psi t] + I_c \quad (4)$$

Appendix II

The current i , can be expressed by the Fourier series:

$$\begin{aligned} x_t = & I_{ac} + I_1 \cos\left(\frac{2\pi}{T}t\right) + I_2 \cos 2\left(\frac{2\pi}{T}t\right) \\ & + \dots I_n \cos n\left(\frac{2\pi}{T}t\right) \\ & + I'_1 \sin\left(\frac{2\pi}{T}t\right) + I'_2 \sin 2\left(\frac{2\pi}{T}t\right) \\ & + \dots I'_n \sin n\left(\frac{2\pi}{T}t\right) \end{aligned} \quad (17)$$

The value I_n and I'_n resulting from integration of Eq. (6) and (7), and which express the coefficient of the cosine and sine terms in the above equation are as follows:

$$\begin{aligned} I_n = & 4f Y E_m \left\{ \cos \mu [A'_1 + A_1 - A'_2 - A_2] \right. \\ & \left. + \sin \mu [B'_2 + B_2 - B'_1 - B_1] \right\} \\ & + \frac{2f A_0}{\alpha^2 + K^2} \left\{ S_2 [-\alpha C_2 + K D_2] \right. \\ & \left. - S_1 [-\alpha C_1 + K_1 D_1] \right\} \\ & + \frac{2f A_0}{\alpha^2 + K_1^2} \left\{ S_2 [-\alpha C'_2 + K_1 D'_2] \right. \\ & \left. - S_1 [-\alpha C'_1 + K_1 D'_1] \right\} \\ & + \frac{2f C_0}{\alpha^2 + K^2} \left\{ S_2 [-\alpha D_2 - K C_2] \right. \\ & \left. + S_1 [\alpha D_1 + K C_1] \right\} \\ & + \frac{2f C_0}{\alpha^2 + K_1^2} \left\{ S_2 [-\alpha D'_2 - K_1 C'_2] \right. \\ & \left. + S_1 [\alpha D'_1 + K_1 C'_1] \right\} \end{aligned} \quad (18)$$

Technically-informed supplier
of electronic materials . . .

★ ★ ★ ★ ★
★ BUY ★
★ U.S. WAR ★
★ BONDS ★
★ ★ ★ ★ ★



Your local

RCA TUBE and EQUIPMENT DISTRIBUTOR

'ROUND-THE-CORNER SERVICE!

Following are but a few of the electronic items regularly handled by your local RCA Tube and Equipment Distributor:

RCA, CUNNINGHAM, and RCA VICTOR
RADIO TUBES

RCA SPECIAL PURPOSE TUBES

RCA POWER TUBES, PHOTOTUBES,
CATHODE RAY TUBES, etc.

RCA ELECTRONIC TEST EQUIPMENT

. . . also condensers, resistors, rheostats, controls, potentiometers, coils, transformers, wire, and numerous other radio and electronic components produced by many manufacturers.



AN ADVERTISEMENT OF THE RCA TUBE AND EQUIPMENT DIVISION IN THE INTEREST OF
GREATER SERVICE AND EFFICIENCY IN PRIORITY-COVERED WAR MATERIALS BUYING

Making war equipment that necessitates frequent calls for tubes and other electronic components?

Then get acquainted with your *local* RCA Tube and Equipment Distributor today!

He may have just what you need in stock for immediate delivery upon receipt of a suitable priority. If he doesn't, he is well equipped to get it for you as fast as circumstances permit—and to render an intelligent, personalized expediting service all along the line.

Equally important is his technical knowledge. He has been dealing with things electronic since the "knee pants" days of radio. He knows what to use and how to use it. You'll find his technical advice and recommendations a big help.

There are over 300 RCA Tube and Equipment Distributors throughout the country. Write or wire for a list of those nearest you.

RADIO CORPORATION OF AMERICA
RCA Victor Division, Camden, N. J.

WHAT?

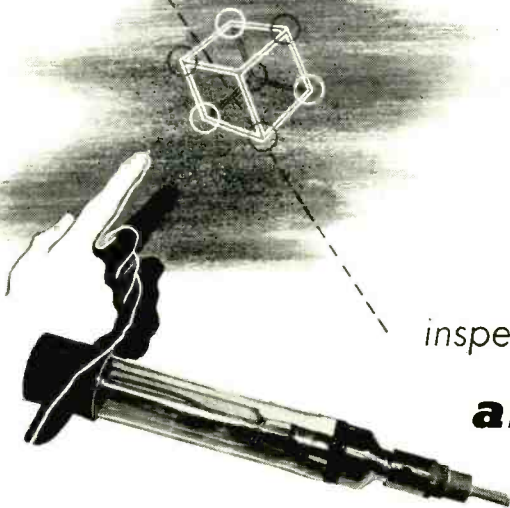

inspect an
atom?

sure thing

With a Machlett Diffraction Tube you can actually inspect the atomic structure of the material under investigation. The x-ray diffraction pattern recorded on a photographic film decisively distinguishes between compounds and mixtures, crystalline and non-crystalline materials. It also points up changes in structure accompanying rolling and annealing by different processes. Today, in these and many other important applications, this improved x-ray tube for diffraction analysis, developed by Machlett Laboratories, is working overtime for Victory.

In designing this efficient x-ray diffraction tube, it is only natural that Machlett should specify Callite wire and formed parts for lead-wires and other tube components. In this unusual application and in many others, where dependability is of utmost importance, Callite products have demonstrated their uniform quality and stamina. If you have a problem involving the use of electronic tube and incandescent bulb components, our engineers will be glad to cooperate in developing the most economical and efficient solution. Why not write today?



Specialists in the manufacture of electrical contacts of refractory and precious metals, bi-metals, lead-in wires, filaments and grids—formed parts and raw materials, for all electronic applications.

CALLITE TUNGSTEN CORPORATION

544 39th STREET



UNION CITY, N. J.

CABLE: "CALLITES" • BRANCH OFFICES: CHICAGO • CLEVELAND

$$\begin{aligned}
 I'_n = & 4fYE_m' \cos \mu [B'_2 - B_2 - B'_1 + B_1] \\
 & + \sin \mu [A'_2 - A_2 + A_1 - A'_1] \left\{ \right. \\
 & + \frac{2fA_o}{\alpha^2 + K^2} \left\{ S_2 [-\alpha D_2 - KC_2] \right. \\
 & \left. - S_1 [-\alpha D_1 - KC_1] \right\} \\
 & + \frac{2fA_o}{\alpha^2 + K_1^2} \left\{ S_2 [\alpha D'_2 + K_1 C'_2] \right. \\
 & \left. - S_1 [\alpha D'_1 + K_1 C'_1] \right\} \\
 & + \frac{2fC_o}{\alpha^2 + K_1^2} \left\{ S_2 [-\alpha C'_2 + K_1 D'_2] \right. \\
 & \left. - S_1 [-\alpha C'_1 + K_1 D'_1] \right\} \\
 & + \frac{2fC_o}{\alpha^2 + K^2} \left\{ S_2 [-\alpha C_2 + KD_2] \right. \\
 & \left. - S_1 [-\alpha C_1 + KD_1] \right\} \quad (19)
 \end{aligned}$$

where

$$\begin{aligned}
 A_1 &= \frac{\cos(1+2n)\theta_1}{2(1+2n)\omega}; \\
 A'_1 &= \frac{\cos(1-2n)\theta_1}{2(1-2n)\omega}; \\
 A_2 &= \frac{\cos(1+2n)\theta_2}{2(1+2n)\omega}; \\
 A'_2 &= \frac{\cos(1-2n)\theta_2}{2(1-2n)\omega}; \\
 B_1 &= \frac{\sin(1+2n)\theta_1}{2(1+2n)\omega_1}; \\
 B'_1 &= \frac{\sin(1-2n)\theta_1}{2(1-2n)\omega_1}; \\
 B_2 &= \frac{\sin(1+2n)\theta_2}{2(1+2n)\omega_2}; \\
 B'_2 &= \frac{\sin(1-2n)\theta_2}{2(1-2n)\omega_2}; \\
 C_1 &= \cos(\psi + 2n\omega) \frac{\theta_1}{\omega}; \\
 C'_1 &= \cos(\psi - 2n\omega) \frac{\theta_1}{\omega}; \\
 C_2 &= \cos(\psi + 2n\omega) \frac{\theta_2}{\omega}; \\
 C'_2 &= \cos(\psi - 2n\omega) \frac{\theta_2}{\omega}; \\
 D_1 &= \sin(\psi + 2n\omega) \frac{\theta_1}{\omega}; \\
 D'_1 &= \sin(\psi - 2n\omega) \frac{\theta_1}{\omega}; \\
 D_2 &= \sin(\psi + 2n\omega) \frac{\theta_2}{\omega}; \\
 D'_2 &= \sin(\psi - 2n\omega) \frac{\theta_2}{\omega}; \\
 S_1 &= \epsilon \frac{-\alpha\theta_1}{\omega}; \\
 S_2 &= \epsilon \frac{-\alpha\theta_2}{\omega}; \\
 K &= (\psi + 2n\omega) \\
 K_1 &= (\psi - 2n\omega)
 \end{aligned}$$

Appendix III

Referring to Fig. 2b, the voltage e across the filter input terminals can be expressed as the Fourier series

FOR QUICK DELIVERIES . . . LONG LIFE . . . HIGH DIELECTRIC STRENGTH . . . SMOOTH INTERIOR

Come to
**MITCHELL-RAND
VARNISHED
TUBING
HEADQUARTERS**

VARNISHED TUBING

FIBREGLAS (INORGANIC) VARNISHED TUBINGS

M-R Fibreglas Varnished Tubings are made in four grades: *Standard; Double Saturated; Triple Strength and Impregnated.*

STANDARD GRADE has maximum flexibility, is treated with a minimum of varnish and recommended for high temperatures where dielectric strength is not a factor.

DOUBLE SATURATED has all qualities of the Standard Grade but with additional coats of varnish to bring the dielectric rating up to 1500 volts.

TRIPLE STRENGTH is built up with coats of especially flexible insulation varnish for dielectric ratings up to 3,000 volts and is particularly suited where assembly operations include the possibility of rough handling.

IMPREGNATED is the Optimum in Superiority for high gloss, non-hydroscopic, resistance to high temperatures, oils, acids, etc. **IMPREGNATED** has a dielectric rating beyond 8,000 volts and is unequalled for Long Life Under Most Severe Conditions. *Write For Samples.*

FOR USERS OF COTTON YARN VARNISHED TUBINGS

The Mitchell-Rand **MIRAC** and **HYGRADE** Varnished Tubings of long staple fibre yarn are comparable to Fibreglas. Tubings in dielectric ratings, tensile strength, flexibility and long life. *Write For Samples.*

Write today for your Free Card of Varnished Tubing with samples ranging from size 0 to 20 to fit wires from .032 to .325 inches . . . other valuable aids, are the M-R Guide Book of Electrical Insulation . . . the Wall Chart with reference tables, dielectric averages, allowable capacities of conductors, dielectric averages, thicknesses of insulating materials and tap drill sizes . . . and the M-R Wax and Compound Guide Book . . . they are full of valuable information . . . write for them on your letterhead.

Some 40 years ago Mitchell-Rand pioneered the Use of Varnished Tubings for Electrical Insulation. M-R in these 40 years developed a consummate knowledge of the requirements for Varnished Tubings in the Electrical and Electronic industries. Based on these many years of experience the M-R line of Varnished Tubings include every essential for Long Life, Flexibility and High Dielectric Strength.

FREE FOR THE ASKING!

THE M-R WALL SHEET

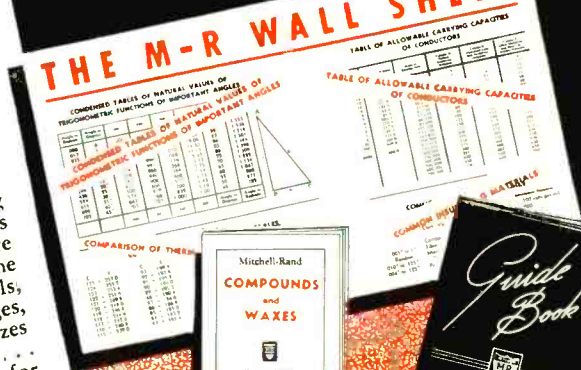

MITCHELL-RAND INSULATION COMPANY, INC.

51-A MURRAY STREET

Cortlandt 7-9264

NEW YORK, N. Y.

Fibreglas Varnished Tape and Cloth
Insulating Papers and Twines
Cable Filling and Pothead Compounds
Friction Tape and Splice
Transformer Compounds

A PARTIAL LIST OF M-R PRODUCTS
Fibreglas Braided Sleeving
Cotton Tapes, Webbing and Sleevings
Impregnated Varnish Tubing
Insulating Varnishes of all types

Fibreglas Saturated Sleeving and Varnished Tubing
Asbestos Sleeving and Tape
Extruded Plastic Tubing
Varnished Cambric Cloth and Tape
Mica Plate, Tape, Paper, Cloth and Tubing

A tricky job,
but-

CLAROSTAT
solved it



Clarostat is now 100% on war production. Greatly expanded plant facilities are keeping pace with rising requirements. An engineering and manufacturing background second to none, is solving many tricky problems these days.

Multiple CONTROLS

★ An entirely new design for tandem controls. New molds provide unit casings that nest and lock together. Metal end pieces and tie rods insure rigid assembly—even up to 20 units in tandem. Single shaft passes through and locks with rotor of each control. Each control accurately

wound to precise circuit requirements — resistance, taper, taps, hop-off. Interlocking resistance ratios provide any desired voltage or current at given degree of rotation. These Multiple Controls are now in regular production and meeting the most rigid multi-control requirements.

★ Send Us Your Problem . . .

No matter how complex or how simple—provided it has to do with control by means of resistance. Let us quote on your high-priority resistance or control requirements. Literature on request.

CLAROSTAT



Controls and Resistors

CLAROSTAT MFG. CO., Inc. • 285-7 N. 6th St., Brooklyn, N. Y.

$$e = \frac{E_m}{\pi} \quad (2)$$

$$\left[1 - \frac{2}{3} \cos 2\omega t - \frac{2}{15} \cos 4\omega t - \frac{2}{35} \cos 6\omega t \dots \right] - E_o \quad (20)$$

Considering only the components of current due to the dc and second harmonic of the voltage e , the current through the choke can be expressed as

$$i = \left[\frac{2/\pi E_m - E_o}{R_1 + R_2} \right] + \left[\frac{4 E_m}{3\pi (X_L - X_C)} \right] \cos 2\omega t + \quad (21)$$

where X_L and X_C are the reactances of the filter choke and condenser to the second harmonic. If the current wave just grazes the zero axis at some point in its period T , then the d-c and peak value of the a-c component must be equal. Equating these two terms given in Eq. (21) and solving for the critical inductance gives

$$L_c = \frac{1}{\omega} \left[\frac{2(R_1 + R_2)}{3K} + \frac{1}{4C\omega} \right] \quad (22)$$

where

$$K = \left(2 - \frac{\pi E_o}{E_m} \right)$$

Appendix IV

For non cut-off operation where $\theta_1 = 0$ and $\theta_2 = \pi$ the value of I_n and I'_n evaluated by Eq. (6) and Eq. (7) are:

$$\begin{aligned} I_n &= 4fYE_m \left\{ \cos \mu [A'_1 + A_1 - A'_2 - A_2] \right\} \\ &+ \frac{2fA_o}{\alpha^2 + K_1^2} \left\{ S_2[-\alpha C'_2 + K_1 D'_2] + \alpha \right\} \\ &+ \frac{2fA_o}{\alpha^2 + K^2} \left\{ S_2[-\alpha C_2 + K D_2] + \alpha \right\} \\ &+ \frac{2fC_o}{\alpha^2 + K^2} \left\{ S_2[-\alpha D_2 - K C_2] + K \right\} \\ &+ \frac{2fC_o}{\alpha^2 + K_1^2} \left\{ S_2[-\alpha D'_2 - K_1 C'_2] + K_1 \right\} \\ I'_n &= -4fYE_m \sin \mu [-A'_2 + A_2 + A'_1 - A_1] \\ &+ \frac{2fA_o}{\alpha^2 + K^2} \left\{ S_2[-\alpha D_2 - K C_2] + K \right\} \\ &+ \frac{2fA_o}{\alpha^2 + K_1^2} \left\{ S_2[\alpha D'_2 + K_1 C'_2] - K_1 \right\} \\ &+ \frac{2fC_o}{\alpha^2 + K_1^2} \left\{ S_2[-\alpha C'_2 - K_1 D'_2] + \alpha \right\} \\ &+ \frac{2fC_o}{\alpha^2 + K^2} \left\{ S_2[-\alpha D_2 - K_1 C_2] + \alpha \right\} \quad (24) \end{aligned}$$

where

$$A_1 = \frac{1}{2(1 + 2n)\omega};$$

$$C_2 = \cos \left(\frac{\psi + 2n\omega}{2f} \right);$$

$$K = (\psi + 2n\omega)$$

$$A'_1 = \frac{1}{2(1 - 2n)\omega};$$

Immediate Conversion

TO

Speed Nuts

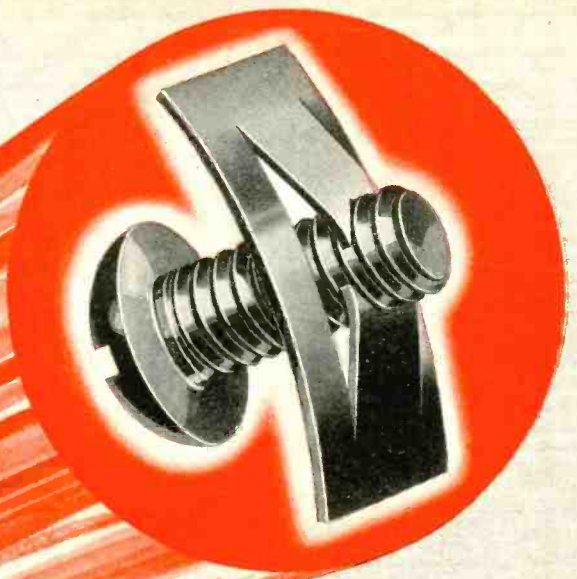

... to meet your production schedules!

You can now convert to SPEED NUTS to help meet your production schedules ON TIME. SPEED NUTS are approved by the U. S. Army Air Forces and the Bureau of Aeronautics for non-structural attachments on military aircraft. They are also used on jeeps, trucks, tanks, P. T. Boats and other war equipment.

This provides a more abundant source of approved self-locking nuts to relieve the present shortage.

Our Engineering Dept. will be glad to assist you in determining the proper approved locations where Speed Nuts may be used. Request for information or assistance will receive immediate attention.

TINNERMAN PRODUCTS, INC. • 2106 FULTON ROAD, CLEVELAND, OHIO

IN CANADA: Wallace Barnes Co., Ltd., Hamilton, Ontario

IN ENGLAND: Simmonds Aerocessories, Ltd., London

Speed Nut System

THE FASTEST THING IN FASTENINGS

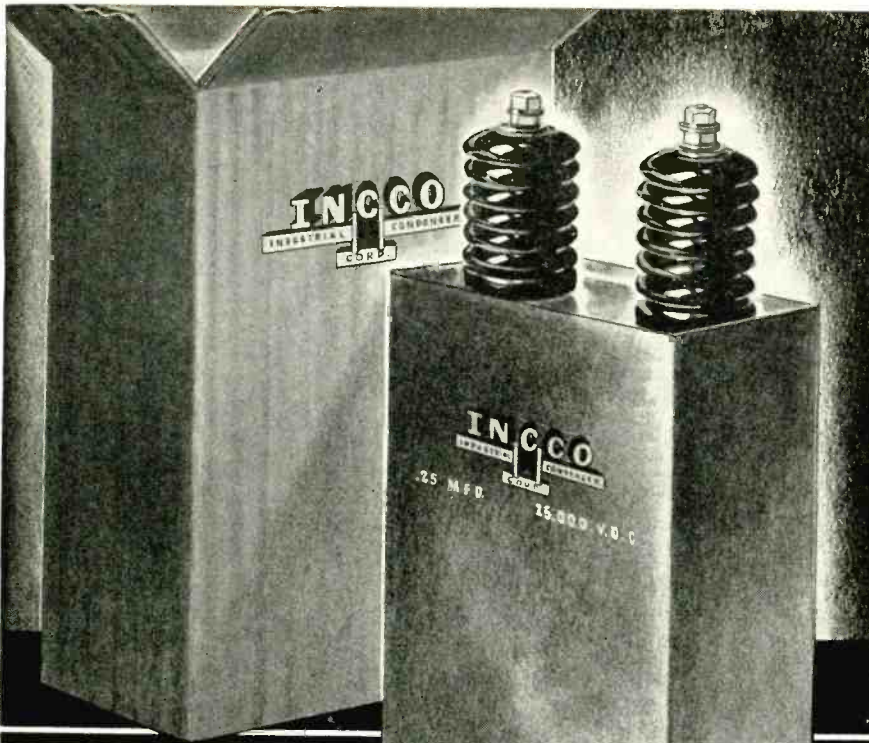

**THE
CONDENSER
LINE OF
UNSURPASSED
QUALITY**

PAPER, OIL, AND ELECTROLYTIC CONDENSERS

**INDUSTRIAL
CONDENSER CORPORATION**
1725 W. NORTH AVE., CHICAGO, U. S. A.

DISTRICT OFFICES IN PRINCIPAL CITIES
QUICK DELIVERY FROM DISTRIBUTOR'S STOCKS

$$C'_2 = \cos \left(\frac{\psi - 2n\omega}{2f} \right);$$

$$K_1 = (\psi - 2n\omega)$$

$$A_2 = \frac{-1}{2(1 + 2n)\omega};$$

$$D_2 = \sin \left(\frac{\psi + 2n\omega}{2f} \right);$$

$$S_2 = e^{-\frac{\alpha}{2f}}$$

$$A'_1 = \frac{-1}{2(1 - 2n)\omega};$$

$$D'_1 = \sin \left(\frac{\psi - 2n\omega}{2f} \right);$$

Appendix V

Applying the first two boundary conditions to Eq. (4) results in the following two equations for i_1 and di_1/dt at $\omega t = \theta_1$

$$i_1 = 0 = Y E_m \sin(\theta_1 + \mu) + I_e + \epsilon^{-\frac{\alpha\theta_1}{\omega}} \left[A_o \cos \frac{\psi\theta_1}{\omega} + C_o \sin \frac{\psi\theta_1}{\omega} \right] \quad (25)$$

$$\frac{di_1}{dt} = 0 = Y \omega E_m \cos(\theta_1 + \mu) + \epsilon^{-\frac{\alpha\theta_1}{\omega}} \left[(C_o \psi - \alpha A_o) \cos \frac{\psi\theta_1}{\omega} - (A_o \psi + \alpha C_o) \sin \frac{\psi\theta_1}{\omega} \right] \quad (26)$$

Solving for A_o and C_o

$$A_o = \frac{D_1(\psi S_2 - \alpha S_1) - D_2 S_1}{S_2(\psi S_2 - \alpha S_1) + S_1(\alpha S_2 + \psi S_1)} \quad (27)$$

$$C_o = \frac{D_2 S_2 + D_1(\alpha S_2 + \psi S_1)}{S_2(\psi S_2 - \alpha S_1) + S_1(\alpha S_2 + \psi S_1)} \quad (28)$$

where

$$S_1 = \epsilon^{-\frac{\alpha\theta_1}{\omega}} \sin \frac{\psi\theta_1}{\omega};$$

$$D_1 = I_e - Y E_m \sin(\theta_1 + \mu)$$

$$S_2 = \epsilon^{-\frac{\alpha\theta_1}{\omega}} \cos \frac{\psi\theta_1}{\omega};$$

$$D_2 = -Y \omega E_m \cos(\theta_1 + \mu)$$

Imposing condition 4 to Eq. (4) gives

$$0 = Y E_m \sin(\theta_2 + \mu) + I_e + \epsilon^{-\frac{\alpha\theta_2}{\omega}} \left[A_o \cos \frac{\psi\theta_2}{\omega} + C_o \sin \frac{\psi\theta_2}{\omega} \right] \quad (29)$$

The value of the (di_1/dt) at $\omega t = \theta_2$ is given by Eq. (26) except that θ_1 is replaced by θ_2 . This is not equal to zero for $\omega t = \theta_2$.

The procedure in solving for θ_1 and θ_2 is as follows. A value of θ_1 is assumed and A_o and C_o are calculated. On the basis of these values, θ_2 is calculated by Eq. (29). A check on the accuracy of the assumed value of θ_1 is condition 3, namely that

$$E_m \sin \theta_1 - E_o = V^1 \epsilon^{-\frac{\pi - \theta_2 + \theta_1}{R_2 C \omega}} \quad (30)$$

where

$$V^1 = E_m \sin \theta_2 - E_o - L' \left(\frac{di}{dt} \right)_{\theta_2}$$

If the right-hand side of Eq. (30) is less than the left-hand side, the assumed value of θ_1 is too large, and vice versa.



DATA AND INFORMATION FOR OVER-WORKED DESIGNERS AND ENGINEERS — REGARDING

TURBO

FLEXIBLE VARNISHED OIL TUBING

Resistant to deteriorating influences and meeting the diversity of requirements essential to withstand general breakdowns, moisture absorption, acids, alkalis, etc.



EXTRUDED PLASTIC TUBING

Incorporating the most advanced developments of the plastic art as applied to electrical insulation. Especially applicable to conditions wherein embrittlement from the effects of sub-zero temperatures must be met.



VARNISHED GLASS TUBING

Resistant to extremely high heat, is perfectly suited for heavy duty operating conditions, confined areas where ventilation is at a minimum, and other similar applications.



WIRE IDENTIFICATION MARKERS

To meet rigid ordnance specifications, are available in any size, length or color, with any marking. Made of standard TURBO tubing, thereby conserving the use of critical materials such as rubber, metal, visilyte, etc. Non-projecting, snug-fitting.



*New advantages...
new applications...new efficiencies!*

With today's vast shift of personnel, the myriad of highly-critical requirements, and the increasing importance of uninterrupted operation of machines and equipment—the need for a brief informative TURBO resumé was emphasized.

The relative advantages and characteristics of TURBO insulation have long

been recognized. Recently—with new additions to the TURBO line, and new or improved features embodied in previous products—it was deemed advisable to acquaint engineers and designers with new TURBO.

Thus the above data and information is made available to those individuals who have either been too busy, or

did not have the facts on hand pertinent to TURBO Saturated Sleeving, Varnished Tubing, Extruded Tubing, Wire Identification Markers, etc.

★ ★ ★

Sample boards, with samples of each TURBO products, together with a list of Standard sizes, will be sent promptly on request.



WILLIAM BRAND & CO.

276 FOURTH AVENUE, NEW YORK, N. Y. 325 W. HURON STREET, CHICAGO, ILL.

Black Mica, Mica Plate & Products — Varnished Oil Tubing, Saturated Sleeving, Varnished Cambric, Tapes, Cloths & Composites

For PROTECTION TODAY...

Today, all our 54 years of craftsmanship in precision manufacturing is concentrated upon war-work—making complete products and vital parts for some very famous companies. Tomorrow, all the new manufacturing techniques originating here will be utilized in peace-time—making many famous products better at less cost.

For PROGRESS TOMORROW...

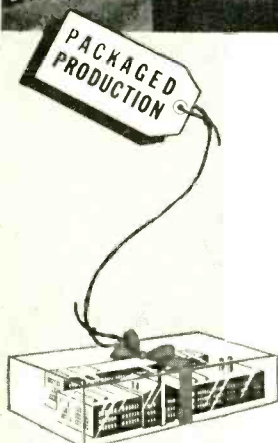
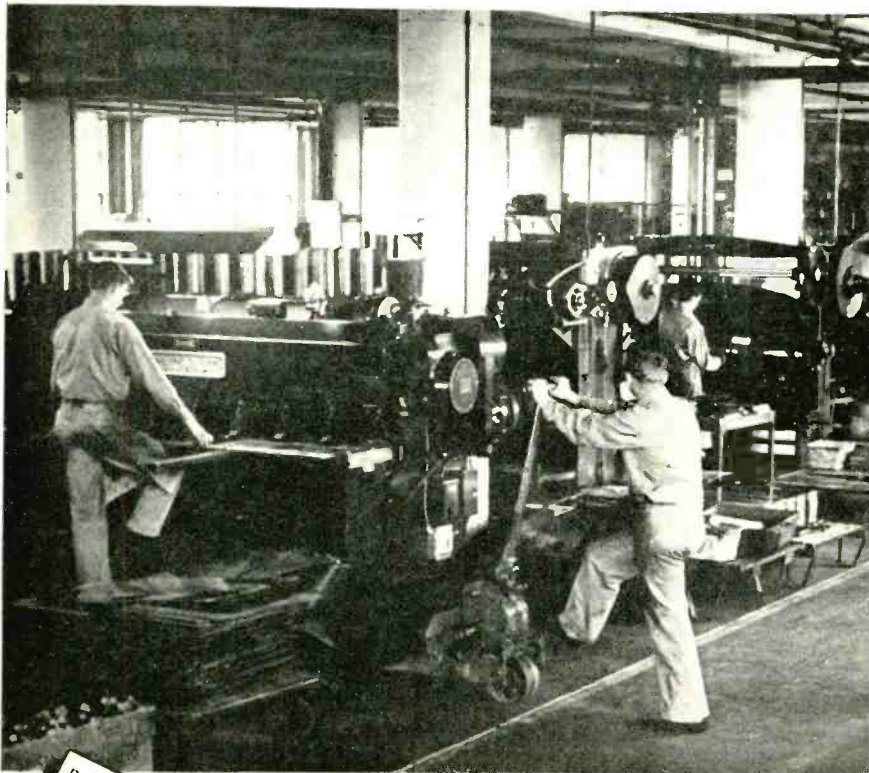

Metal Fabrications: Precision Machine Work: Electrical & Mechanical Assemblies: Plus up-to-date Product Engineering with Facilities, Methods, Controls assuring entire production responsibility—single parts and complete products.

Lewyt
CORPORATION

60 BROADWAY, BROOKLYN, N. Y.

Self Biased Amplifiers

(Continued from page 103)

the final step in the analysis. The value of the bias voltage will depend upon the value of the bias resistor and its location in the circuit. It will also depend upon the average grid current in the case of grid bias or upon the average cathode current in the case of cathode bias. For triodes, the cathode current is the sum of the grid and plate currents. Accordingly, the next step in the analysis is to determine the average value of the grid bias voltage for the possible methods of resistance bias. To determine this bias voltage, we must first determine the average current, flowing through the bias resistance. If it is entirely in the grid circuit we are interested in determining only the grid current whereas if it is in the cathode circuit, both grid and plate current must be known.

To determine the average currents we use paths of operation such as the one mapped out between Q' and A' , Fig. 6. We may select the Q points for these paths at regular intervals in the region defined by the red curves of Fig. 6. In the present calculation these points were selected at the intersection of lines drawn at 50 volt intervals through the grid axis and 100 volt intervals through the plate axis. The paths of operation for each of these Q points were drawn in accordance with the previous discussion. After the paths have been determined, the calculation of the current follows. This calculation is greatly facilitated through the use of a plastic calculating device described in an earlier article.¹⁰ After obtaining the average currents they may be plotted as a function of the grid polarizing voltage for constant values of the plate polarizing potential. These polarizing voltages correspond, of course, to the coordinates of Q for which a given current calculation was made.

Bias Resistance in the Grid Circuit

When the bias resistance is in the grid circuit, it is only necessary to calculate, for the various paths of operation chosen, the average grid current I_{g} . This is plotted as a func-

FROM PHOTO-FINISH SCOREBOARDS

OFFICIAL	
1.	7 12.10
2.	4 9.50
3.	3 2.30

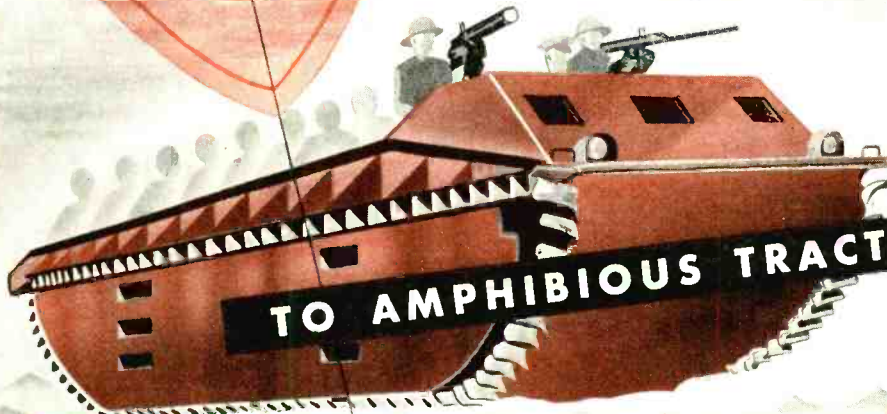

RELAYS BY GUARDIAN MEET ALL CONTROL NEEDS

★ Whether the principle is electronic or magnetic . . . whether the job requires a tiny A.C. relay or a heavy-duty D.C. solenoid . . . whether time delay or instantaneous action . . . there is usually a "Relay by Guardian" to meet the "specs" on most applications . . . from animated electric signs to electric chokes for the Army's amphibious tractors.

SIGNAL CORPS RELAYS—The Signal Corps Relay shown at the right is used for starting dync-motors in portable radio equipment. It is a single pole, double throw relay having contacts rated at 16 amperes at 12 volts D.C. continuous. Coil voltage ranges from 9 to 14 volts D.C. Other Signal Corps "Relays by Guardian" include a relay for change-over from transmitting to receiving and a keying break-in relay for mobile radio equipment.

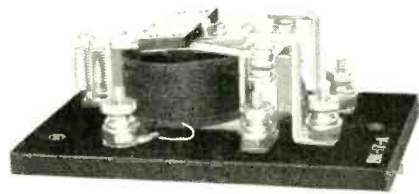

Signal Corps Relay

Write for bulletin 195 describing Signal Corps "Relays by Guardian."

GUARDIAN  **ELECTRIC**
1625-D WEST WALNUT STREET CHICAGO, ILLINOIS

A COMPLETE LINE OF RELAYS SERVING AMERICAN WAR INDUSTRY



It's just good sense to treat your microphone with respect, so it will give you longer, better service. A microphone is a delicate, sensitive instrument and needs protection.

For instance, a fall doesn't have to damage the case to damage the mike. The shock may prove destructive to the interior.

Under no circumstances should you open the mike case and expose the sensitive parts to mechanical and chemical damages which ruin the mike. If the seal is broken on a crystal mike, the crystal absorbs moisture and becomes useless.

Read carefully the instructions which come with your mike, and be certain the circuit is correct for the type mike you are using. Don't use power generating or voltage generating microphones (dynamic, ribbon and crystals) in circuits intended for carbon or condenser mikes. Make sure your mike is made for rough weather before exposing it to the elements. If your mike fails or gives trouble, send it to the factory or its dealer.



THIS FREE BOOK TELLS YOU HOW TO CARE FOR YOUR MIKE

Send NOW for your Free Copy of Turner's new 8-page, fully illustrated, colorful Microphone Catalog. Each unit is engineered for specific jobs and trouble-free performance. Select the one best suited to your needs at the price you want to pay.

Free
THIS NEW TURNER
MICROPHONE CATALOG

The
Turner
Company
Cedar Rapids, Iowa

tion of E_{cc} on Fig. 7, for various values of plate polarizing potential E_{bb} . From this figure we can determine the locus followed by Q on the e_b-e_c diagram for any given grid biasing resistance in the following way. Since the bias resistance is entirely in the grid circuit, the grid polarizing potential is given by

$$E_{cc} = I_{ca} R_{cc}$$

where R_{cc} is the grid resistance. This equation, when plotted on the $I_{ca}-E_{cc}$ diagram, appears as a straight line passing through the origin, having a slope equal to $1/R_{cc}$. Two such lines corresponding to two values of R_{cc} are shown on Fig. 7. The intersections of one of these lines with the lines of constant plate voltage determines the grid polarizing potentials which must be developed across R_{cc} for the given grid excitation voltage, and equivalent plate resistance $(R_b)\omega$ which were chosen and fixed for this calculation. These intersections may be plotted on the e_b-e_c plane, and thus determine the locus of the Q point during the modulation cycle for this value of grid resistance. When this locus has been obtained, the calculation of the complete dynamic characteristics may proceed directly. A number of Q points are selected, evenly spaced, along this locus. For each of these Q points the coordinates of the A points are defined. The horizontal distance from Q to A is given by the grid excitation, the vertical distance from Q down to A is given by the red curves of Fig. 6. Thus the paths of operation for any Q on the locus are obtained. For these paths the average grid current, average plate current, fundamental grid current, and fundamental plate current may be calculated using the plastic device referred to above. Knowing these currents together with E_{bb} , E_{cc} , E_{g1m} , E_{p1m} , and R_{cc} , the power relations in the modulator may be calculated from the relations:

$$\text{Driving power, } P_d = \frac{1}{2} I_{o1m} E_{g1m}$$

$$\text{Power input, } P_B = I_{ba} E_{bb}$$

$$\text{Power output, } P_b = \frac{1}{2} I_{p1m} E_{p1m}$$

$$\text{Power delivered to grid resistor,}$$

$$P_{cc} = I_{ca}^2 R_{cc} = I_{ca} E_{cc}$$

$$\text{Grid dissipation, } P_g^* = P_d - I_{ca} E_{cc}$$

$$\text{Plate dissipation, } P_p = P_B - P_b$$

Determination of these quantities for each of the Q points selected along the locus gives the complete dynamic characteristics of the modulator. Other characteristics may be



To fill a need McElroy Model PFR-443 Wheatstone Code Tape Perforator

Normally, automatic radiotelegraph apparatus is employed by all services, commercial, military or governmental. But despite the present availability of sufficient quantities of this equipment due to McElroy design of simple and rugged units through mass production, communication has been impeded, in many cases, by the lack of simplified, efficient perforating devices. Intricate keyboard perforators, requiring the attention of specialized machinists and skilled operators have restricted quantity production of perforated tape.

Simplified in design, the new PFR-443 will produce tape as cleanly and as accurately as any complex keyboard perforator.

The McElroy Wheatstone Code Tape Perforator is actuated by 110 volt AC or DC current. May be operated with index finger, middlefinger and thumb of the right hand, while unit is in similar position as a hand telegraph key. The feather-light touch on the dot and dash contacts and space bar closes electrical contacts. A powerful die mechanism, driven by a solenoid, perforates and advances the tape through the machine. When this tape, identical in all respects to others prepared by the most complex of keyboard perforators, is passed through any make of automatic transmitter now in existence it will execute signals with the precision characteristic of all professional automatic devices, at any speed for which the transmitter was designed.

Simple and rugged in design and construction, the McElroy perforator requires no critical adjustments. Parts are replaceable by any competent radio technician. Light in weight, it may be carried as a hand semi-automatic transmitting key. When teamed with the McElroy Automatic Transmitter, XTR-442, the combination becomes a manually operated radiotelegraph station that is the equal of any mechanized station.

As creative telegraphic engineers, we are leaders in our field. We are the largest manufacturers in the world devoted exclusively to the production of equipment for the transmission and reception of dots and dashes. We create. We design. We build. We do not imitate and we do not copy. And we can deliver.

The McElroy factory is being tooled for production and orders are being accepted. Moderately priced at \$375. First deliveries may be anticipated by the latter part of May.

McELROY MANUFACTURING CORPORATION

82 BROOKLINE AVENUE

BOSTON, MASSACHUSETTS

ELECTRONICS — April 1943

131



T. R. McElroy, world's champion telegraphist and outstanding wireless operator of all time, operating a development model of the new perforator in conjunction with Tape Transmitter, Model XTR-442.

Unskilled operators have been trained more readily in the use of the perforator, than the standard keyboard of a typewriter. Any station with newly trained personnel may transmit its traffic with absolute accuracy, retaining the tape as a permanent file record of all communications. The McElroy Wheatstone Code Tape Perforator may be operated in conjunction with automatic transmitting equipment at maximum speeds—or with similar efficiency, at speeds of between 25 and 50 words per minute. It may be employed for important communications circuits as readily as for preparation of practice material for radiotelegraph code schools.



Keep your eye on this lad Mr. Manufacturer

A FEW MONTHS AGO he was just a normal, untrained, happy-go-lucky kid. Today he's been well trained by Uncle Sam's Signal Corps into a competent technician, fit to take the responsibility on which hundreds, maybe thousands of lives depend. When he comes marching up Broadway in a shower of ticker tape, be ready to grab him — he'll be a valuable man.

And if he tells you that communications and electrical equipment made here at C. T. & E. is the last word in advanced engineering and rugged dependability, pay heed — you'll be listening to the voice of experience. You see, there's "Connecticut" equipment on the job almost everywhere United Nations forces are fighting.



CONNECTICUT TELEPHONE & ELECTRIC DIVISION



MERIDEN, CONNECTICUT

obtained by selecting a different value of R_{cc} , and a family of dynamic characteristics showing the effect of a variation of this parameter may be calculated.

Bias Resistance in both the Plate and Grid Circuits Cathode Bias

When the bias resistance is in both the plate and grid circuits, it is necessary to calculate both the average grid current I_{ca} and the average plate current I_{ba} for the various paths of operation. The sum of these currents ($I_{ba} + I_{ca}$) may then be plotted as a function of E_{cc} for the various values of E_{bb} selected. Lines of constant cathode resistance $R_{bc} = E_{cc}/(I_{ba} + I_{ca})$ may be drawn on this diagram and will appear as straight lines. The intersection of any one of these straight lines with the lines of constant plate voltage E_{bb} will determine the coordinates of the path followed by Q during the modulation cycle, on the e_b-e_c diagram. When this locus of Q is found for the desired cathode resistance, the remaining problem of obtaining the dynamic characteristics for the modulator is again, straight-forward. With any point on this path as a Q point, the coordinates of the end point for the path of operation passing through this Q are known as in the preceding case. That is, the horizontal coordinate of A is given by the grid excitation, as measured from Q , and the vertical coordinate of A is given by the red curve passing through this Q . This vertical coordinate will be given in terms of the maximum fundamental plate voltage, E_{p1m} , of course, and thus will represent the vertical distance in volts below Q to the point A . Hence we may calculate for the path joining this Q and A the fundamental plate and grid currents from which may be determined, together with the average plate and grid current which we already know, all the dependent variables associated with this condition of operation. By repeating this process for other selected Q points along this locus, the complete dynamic characteristics of the modulator are determined. These dynamic characteristics apply, of course, only for the specific cathode resistance chosen. Families of characteristics may be obtained by choosing other values of cathode resistance, as in the case discussed pre-

You Can Use OUR War-Time Experience
To Improve YOUR Peace-Time Products

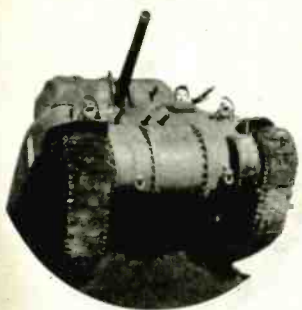

The ingenuity and experience gained by our development and production engineers, in meeting the most rigid Government specifications for exact integral frequency Crystals, can help you provide more accurate selectivity in your post-war units. The precision manufacture maintained by our line production will assure you of an ample volume of uniform high quality. Our use of the latest methods and machines of scientific design will aid you in keeping your products ahead of Electronics developments.



Gentlemen Products Division of HENNEY MOTOR COMPANY

Home Office:—FREEPORT, ILLINOIS - - - Production Office and Factory:—OMAHA, NEBRASKA

WANTED: AN ENGINEER WITH PLENTY OF IMAGINATION

An Out-of-the-Ordinary Opportunity for an Out-of-the-Ordinary Man

• This is an unusual sort of an advertisement. It is unusual because a client of ours has asked us to help them find an unusual sort of a man to fill an unusual sort of a position.

First of all, this man must be an electro-mechanical engineer having both real design imagination and a finger on the pulse of what is going on in the electronic, radio, and electrical industries. Second, he must be the type of fellow who is visionary enough to be constantly alert to new ideas, yet practical enough to understand manufacturing limitations. Third, it would be just fine, if such a man had also had training in the design and development of relays, timers, and solenoids.

The position? Well, primarily it will have to do with helping our client maintain his present leadership in the items that are regularly produced. This activity at present is, of course, 100% devoted to war work. Next, and by no means least, is the task of designing other items to keep one step ahead of the needs which will surely arise with the rapid development of the Electronic art in all of its phases. That's where imagination and a close knowledge of the field come in.

The offer? To the right man is offered a connection with a nationally-known, long-established firm located in Eastern Pennsylvania. It is a firm large enough to afford unlimited opportunity to the right man—yet small enough to assure rapid individual recognition of jobs well done. The engineer selected is assured of free reign to initiative, good working conditions, attractive remuneration, and important war work for the present coupled with future possibilities in full keeping with his abilities.

If you feel that you can fill the position, write in detail. Your correspondence will be treated with strictest confidence. All of our client's employes who might be interested know of this advertisement.

Harry P. Bridge, PRESIDENT

THE HARRY P. BRIDGE CO.

Advertising Counsellors

812 Real Estate Trust Bldg.,

Philadelphia, Pa.

viously. The power relations in the modulator are slightly modified by the cathode resistor. The quantities P_a , P_b , P_g , and P_p are the same but the other relations are

$$\begin{aligned} \text{Power delivered to cathode resistor,} & P_{bc} = (I_{b_a} - I_{c_a})^2 R_{bc} \\ \text{Plate dissipation,} & P_p = P_B - P_b - \\ & I_{b_a}^2 R_{bc} \end{aligned}$$

Bias Resistance partly in the Grid and partly in the Plate Circuits

If the biasing resistance is partly in the cathode circuit and partly in the grid circuit, the calculation is somewhat more involved. For now we are concerned with two resistances R_{cc} and R_{bc} instead of only one. Here the grid polarizing voltage is given by

$$E_{cc} = I_{c_a} R_{cc} + (I_{b_a} + I_{c_a}) R_{bc}$$

Let us set

$$R_{cc} = k R_{bc}$$

where k is a positive constant greater than zero. Then

$$E_{cc} = \{ I_{b_a} + (1 + k) I_{c_a} \} R_{bc}$$

and the polarizing grid voltage is again expressed in terms of only one resistor. It is, therefore, evident that if $I_{b_a} + (1 + k) I_{c_a}$ is plotted as a function of E_{cc} we will be able to determine the path followed by Q in a manner similar to that used in the case of grid bias alone or plate bias alone. An example of this plot when $k = 9$ is shown in Fig. 8. The intersections of line $R_{bc} = 266$ ohms with the lines of constant E_{bc} give the values of E_{cc} which will determine the locus of the Q point under this condition of operation. Families of characteristics may be obtained for various values of k . The power relations under this condition of operation are also modified slightly from those forms as given under grid bias operation. The quantities P_a , P_b , and P_n remain the same, but the other relations are

$$\begin{aligned} \text{Power delivered to grid resistor,} & P_{cc} = I_{c_a}^2 R_{cc} \\ \text{Power delivered to cathode resistor,} & P_{bc} = (I_{c_a} + I_{b_a})^2 R_{bc} \\ \text{Plate dissipation,} & P_p = P_B - P_b - I_{b_a}^2 R_{bc} \\ \text{Grid dissipation,} & P_g = P_d - I_{c_a}^2 R_{cc} - \\ & I_{c_a}^2 R_{bc} \end{aligned}$$

Part Generators and Part Resistance Bias

In the case of part battery and part resistance bias the lines for constant resistance may be drawn on

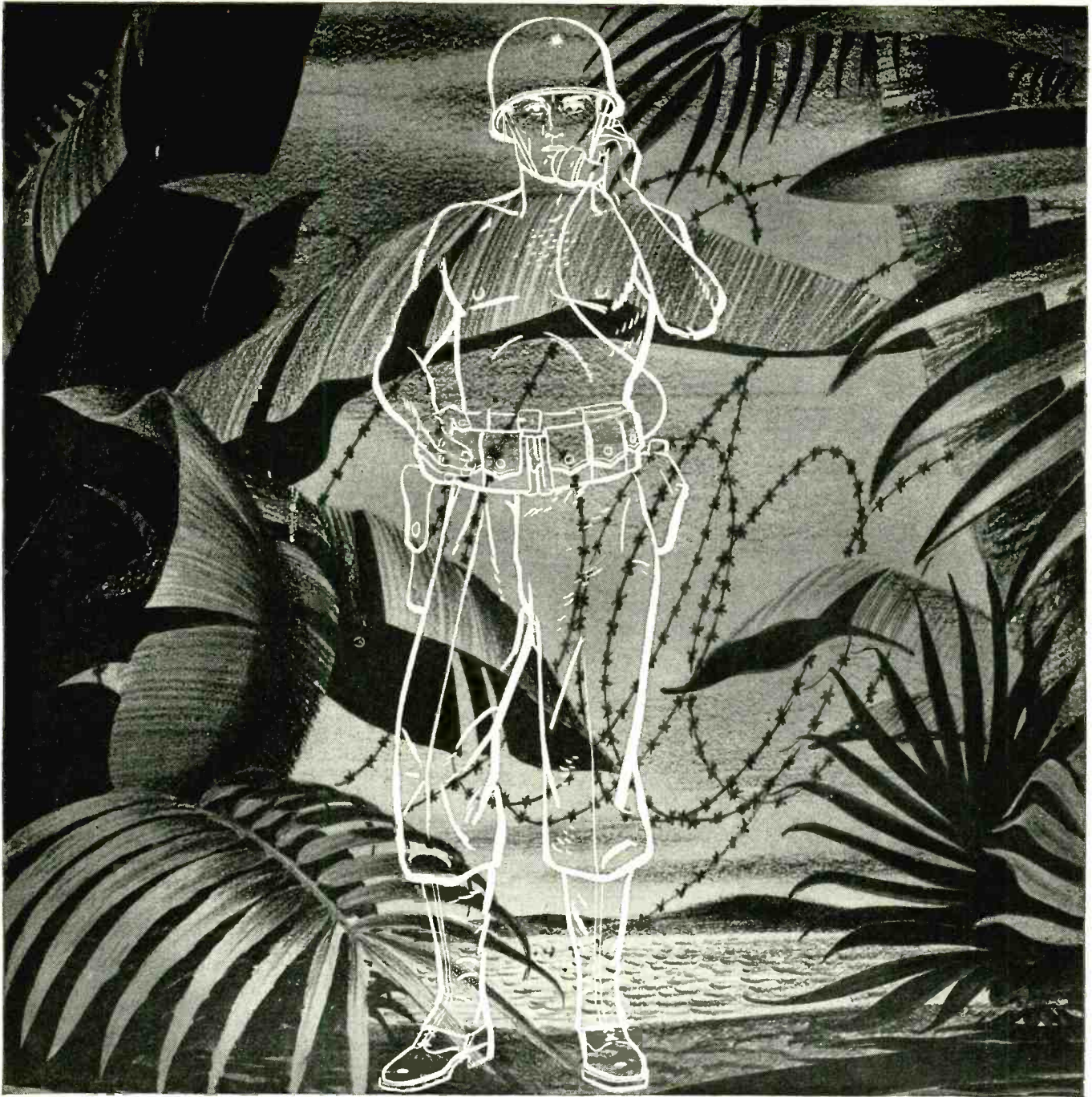

Wherever man goes . . . even when he's slashing through primeval jungle in some remote corner of the South Pacific, he is not alone, thanks to the existence of the two-way radiotelephone. In tomorrow's world, this new medium of communication will become an active part of your business and social life. And when

hostilities cease you can look to Jefferson-Travis for the finest radiotelephone equipment made. As pioneers in this field we have developed new and exclusive improvements for this remarkable electronic achievement. Today they are employed by the United Nations everywhere — tomorrow they will be yours!



JEFFERSON-TRAVIS

RADIOTELEPHONE EQUIPMENT

NEW YORK • WASHINGTON • BOSTON



Shown below is a Utah Potentiometer for power-driven machine gun or cannon aircraft turrets. This gunner has feather-touch control of his guns' position—no matter from which direction the enemy may attack. In this precision operation, the Utah part plays a vital role. It has been fitted for that role by split-hair accuracy in manufacture. This is only one of many Utah products now in service with the armed forces.

When there's a Messerschmitt on his tail, equipment must operate with the precision of a fine watch. That's when a "Fortress" gunner appreciates flawless construction. Precision work, however, is no stranger to the Utah factory. Their outstanding reputation in the radio and electrical industries has been built on precision manufacturing. Advanced Utah engineering has kept ahead of requirements. The dependability of Utah parts—long a by-word among radio men and in industrial plants—is now being proved in all parts of the world.

If you have a problem, calling for precision electrical parts, why not take advantage of Utah's extensive experience? Utah makes a complete line of Potentiometers, Rheostats and Attenuators—as well as other electrical parts. Write today for complete information—and see what Utah precision manufacturing and advanced engineering can do for your product. There is no obligation.

UTAH RADIO PRODUCTS COMPANY
 837 Orleans Street • Chicago, Illinois

Canadian Office: 838 King St., W., Toronto • In Argentina: UCOA Radio Products Co., SRL, Buenos Aires • Cable Address: UTARADIO, Chicago

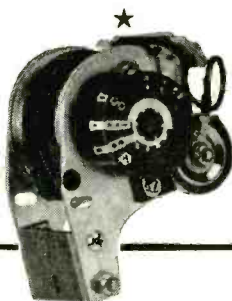

UTAH WIRE-WOUND CONTROLS, RELAYS, JACKS, RESISTORS, PLUGS, SWITCHES, MOTORS

any of these average current versus grid voltage diagrams depending on the location of the bias resistance. The procedure is to draw the lines of constant biasing resistance through the zero current axis at the value of E_{cc} corresponding to the battery voltage. The intersection of this line with the lines of constant plate voltage determine the path, as in the previous cases.

Characteristics of Various Bias Methods

Since the locus of Q can be found for any combination of self biasing or battery and resistance biasing combination, a complete solution of the problem is at hand. The effect on this locus of different conditions of service are shown in Fig. 9. This illustrates the paths followed by the Q point on the e_b - e_c plane during the modulation cycle for three different types of biasing. Curve A is for cathode bias alone, curve B is for battery bias alone, and curve C is for grid resistance bias alone. The system is here adjusted for equivalent carrier conditions in order to make the comparison of the different types of biasing more effective. Curve C , which is shown below to be the most desirable, may be obtained by part battery and part grid resistance bias, or part cathode resistance and part grid resistance bias.

The effect on the dynamic modulation characteristics for these three paths is indicated in Fig. 10. We can see that the path C is by far the most desirable, since it improves the linearity of the modulation process, increases the power output, and reduces the driving power. Further, the driving power is less peaked, while the change in efficiency is but slightly effected. Hence, it is desirable to use grid resistance bias entirely. For tube protection, however, it is sometimes desirable to use a certain amount of generator or cathode resistance bias. Path A , for the case of cathode bias alone, gives most unfavorable results, reducing the linearity while, at the same time, increasing the grid driving power and reducing the power output and efficiency. However, it is found that by using an amount of cathode bias sufficient to protect the tube, and the remaining bias supplied by the grid current alone, it is possible to approximate the condition indicated in C with only a slight sacrifice in efficiency. Or if part battery bias and

Enlist GIRLS for MANpower in Your Screw Driving Army



WOMEN DRIVE PHILLIPS SCREWS EASILY!

Now you can recruit women for your screw driving army and be sure of fast, skilled work from the very start.

Big muscles aren't needed to drive Phillips Recessed Head Screws. Further, it requires no mechanical aptitude... even novices produce without wobbly starts, slant-driven screws and slips that cause accidents or mar work.

Automatic centering of the driver in the Phillips Recess makes such efficient use of turning power that screws set-up uni-

formly tight... with so little effort that workers maintain speed without tiring. Screw and driver "become one unit," making driving so easy and fool-proof that work is greatly speeded up, regardless of the driving method employed. In most cases, power driving becomes practical.

They cost less to use! Compare the cost of driving Phillips and slotted head screws. You'll find that the price of screws is a minor item in your total fastening expense... that it actually costs less to have the many advantages of the Phillips Recess!

KEY TO FASTENING SPEED AND ECONOMY

The Phillips Recessed Head was scientifically engineered to afford:

Fast Starting - Driver point automatically centers in the recess... fits snugly. Screw and driver "become one unit." Fumbling, wobbly starts are eliminated.

Faster Driving - Spiral and power driving are made practical. Driver won't slip out of recess to injure workers or spoil material. (Average time saving is 50%.)

Easier Driving - Turning power is fully utilized by automatic centering of driver in screw head. Workers maintain speed without tiring.

Better Fastenings - Screws are set-up uniformly tight, without burring or breaking heads. A stronger, neater job results.



PHILLIPS *Recessed Head* SCREWS

WOOD SCREWS • MACHINE SCREWS • SELF-TAPPING SCREWS • STOVE BOLTS

21 SOURCES

American Screw Co., Providence, R. I.
The Bristol Co., Waterbury, Conn.
Central Screw Co., Chicago, Ill.
Chandler Products Corp., Cleveland, Ohio
Continental Screw Co., New Bedford, Mass.
The Corbin Screw Corp., New Britain, Conn.
The H. M. Harper Co., Chicago, Ill.

International Screw Co., Detroit, Mich.
The Lamson & Sessions Co., Cleveland, Ohio
The National Screw & Mfg. Co., Cleveland, Ohio
New England Screw Co., Keene, N. H.
The Charles Parker Co., Meriden, Conn.
Parker-Kalon Corp., New York, N. Y.
Pawtucket Screw Co., Pawtucket, R. I.

Russell Burdall & Ward Bolt & Nut Co., Port Chester, N. Y.
Reading Screw Co., Norristown, Pa.
Pheoll Manufacturing Co., Chicago, Ill.
Scovill Manufacturing Co., Waterville, Conn.
Shakeproof Inc., Chicago, Ill.
The Southington Hardware Mfg. Co., Southington, Conn.
Whitney Screw Corp., Nashua, N. H.

WAR EARS

FOR

Uncle Sam!



BUILDING "war ears" for the U. S. Army Air and Signal Corps is our job in this war. We're proud of the famous sensitivity and clear reception of our Radio Phones—proud that Uncle Sam is using so many of them. We're proud, too, that we're beating our war production schedules!

Murdock Radio Phones have solved many civilian communication problems, too. May we help *you*? Write to Dept. 59 for Catalogue.

THE EARS OF A NATION



Murdock

RADIO PHONES

Wm. J. Murdock Co.

Chelsea, Massachusetts

part grid resistance bias are used, these conditions may be approximated more easily. Complete dynamic characteristics for every condition of operation are, therefore, made available.

While the graphical method developed by Dr. Sarbacher may require graphical constructions which are too tedious for use by the operating engineer, nevertheless, a way has been shown by which the performance of self-biased, plate-modulated amplifiers can be accurately determined. It is to be hoped that the derived curves of Fig. 6 can be made available by tube manufacturers for those tubes most likely to be used as plate-modulated self-biased amplifiers.

Acknowledgments

I wish to express my appreciation to Professor E. L. Chaffee for suggesting the problem and to Professor R. P. Siskind and Mr. Beverly Dudley for most helpful criticisms and suggestions in the preparation of the text. I was aided in the calculation by my students and friends Messrs. R. K. Beach, G. G. Carne, W. R. Faust, R. E. Glass, R. M. Soria and H. J. Woll, who also contributed in the calculation of other allied problems and to whom assistance is most gratefully acknowledged.

BIBLIOGRAPHY

- (1) Noyes, A., A Sixty-Cycle Bridge for the Study of Radio Frequency Power Amplifiers, *Proc. I.R.E.*, 23, p. 785, 1935.
- (2) Chaffee, E. L. and Kimball, C. N., A Method of Determining The Operating Characteristics of a Power Oscillator, *J. Frank. Inst.*, 221, p. 237, 1936.
- (3) Chaffee, E. L., Power Tube Characteristics, *ELECTRONICS*, July, p. 30, 1937.
- (4) Chaffee, E. L., The Operating Characteristics of Power Tubes, *Jour. of Applied Physics*, 9, July, 1938.
- (5) Fay, C. E., The Operation of Vacuum Tubes as Class B and Class C amplifiers, *Proc. I.R.E.*, 20, p. 548, 1932.
- (6) Everett, W. L., Optimum Operating Conditions for Class C Amplifiers, *Proc. I.R.E.*, 22, p. 152, 1934.
- (7) Terman, F. E., and Ferns, J. H., The Calculation of Class C Amplifier and Harmonic Generator Performance of Screen-Grid and Similar Tubes, *Proc. I.R.E.*, 22, p. 359, 1934.
- (8) Miller, B. F., An Analysis of Class B and Class C Amplifiers, *Proc. I.R.E.*, 23, p. 496, 1935.
- (9) Babits, V. A., Les Methodes Graphiques pour Determiner les Elements des Amplificateurs de Haute Frequence, Class B et C, *L'onde Electrique*, 14, p. 668, 1935.
- (10) Everett, W. L., Optimum Operating Conditions for Class B Radio-Frequency Amplifiers, *Proc. I.R.E.*, 24, p. 305, 1936.
- (11) Terman, F. E., and Roake, W. C., Calculation and Design of Class C Amplifiers, *Proc. I.R.E.*, 24, p. 620, 1936.
- (12) Wagener, W. G., Simplified Methods for Computing the Performance of Transmitting Tubes, *Proc. I.R.E.*, 25, p. 47, 1937.
- (13) Chaffee, E. L., Power Tube Characteristics, *ELECTRONICS*, July, p. 30, 1937.
- (14) Kozanowski, H. N., and Mourontseff, I. E., Vacuum Tube Characteristics in the Positive Grid Region by an Oscillographic Method, *Proc. I.R.E.*, 21, p. 1082, 1933.
- (15) Chaffee, E. L., A Method of Obtaining the Static Characteristic Curves of Power Tubes, *ELECTRONICS*, June, p. 34, 1938.
- (16) Sarbacher, R. L., A Mechanical Device for Calculation of Class B & C Amplifier Performance, *ELECTRONICS*, Dec., p. 52, 1942.

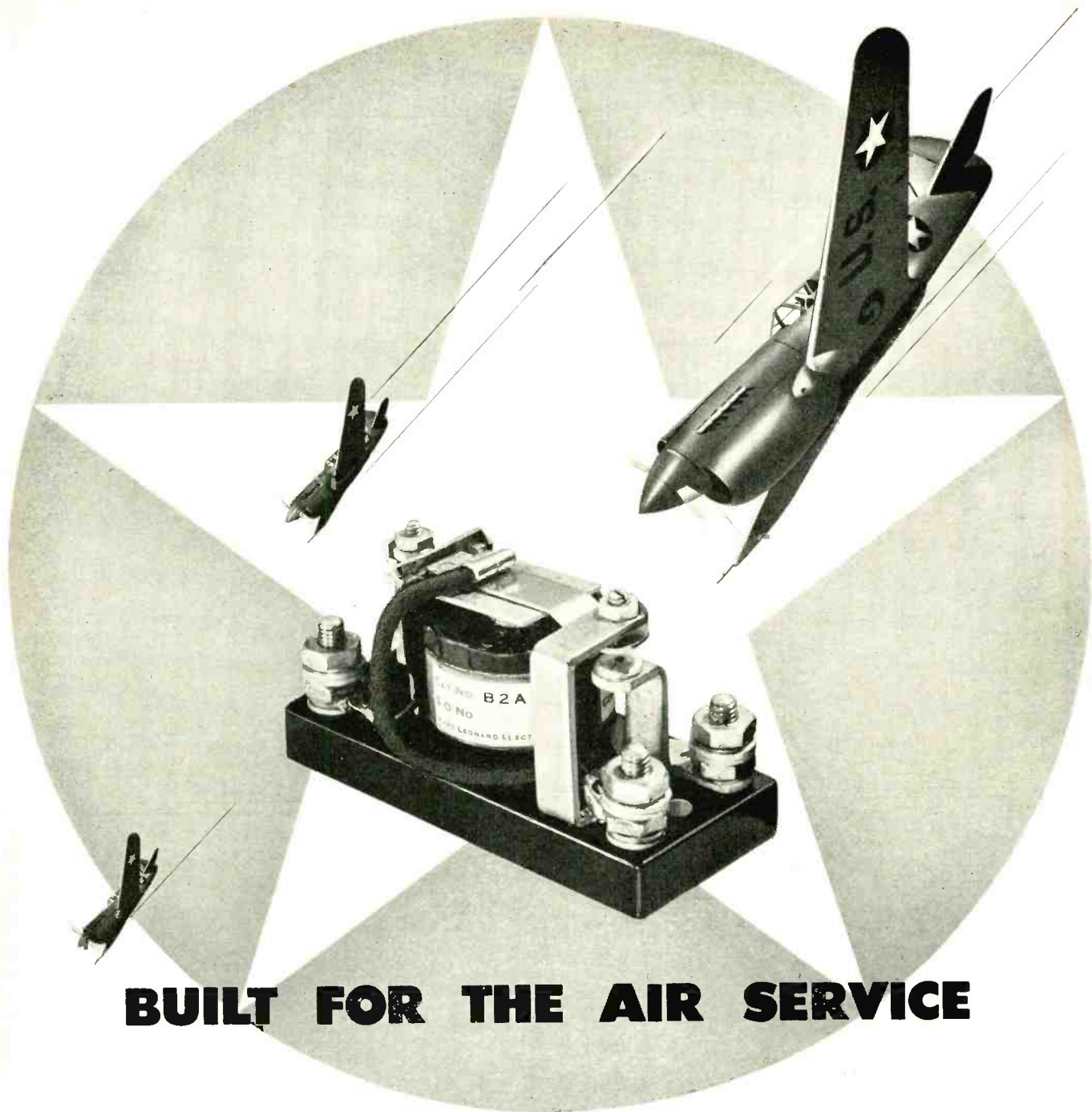

BUILT FOR THE AIR SERVICE



When Ward Leonard developed their B-2A Relay to meet the Army Air Corps tests for vibration and acceleration, they went further than required. They incorporated features in it not found in any other relay.

The layer-wound coils are thoroughly impregnated by a vacuum process that assures better insulation under humid conditions. The tail spring and contact gap are readily adjustable, thus enabling perfect adaptation to the required circuit. The anchorage for the terminal screws molded in the base assures rigidity of the entire relay under vibration.

Yes, this relay is used on aircraft, but the very features that make it desirable for airplane use make it equally

desirable for any purpose when a rugged, positive, crisp-acting relay is required. Send for bulletin.

W. L. B-2A Relay is rated 25 A. at 24V, single pole, single throw, normally open contacts.

WARD LEONARD

RELAYS • RESISTORS • RHEOSTATS

Electric control  devices since 1892.

WARD LEONARD ELECTRIC COMPANY, 32 SOUTH ST., MOUNT VERNON, NEW YORK
ELECTRONICS — April 1943

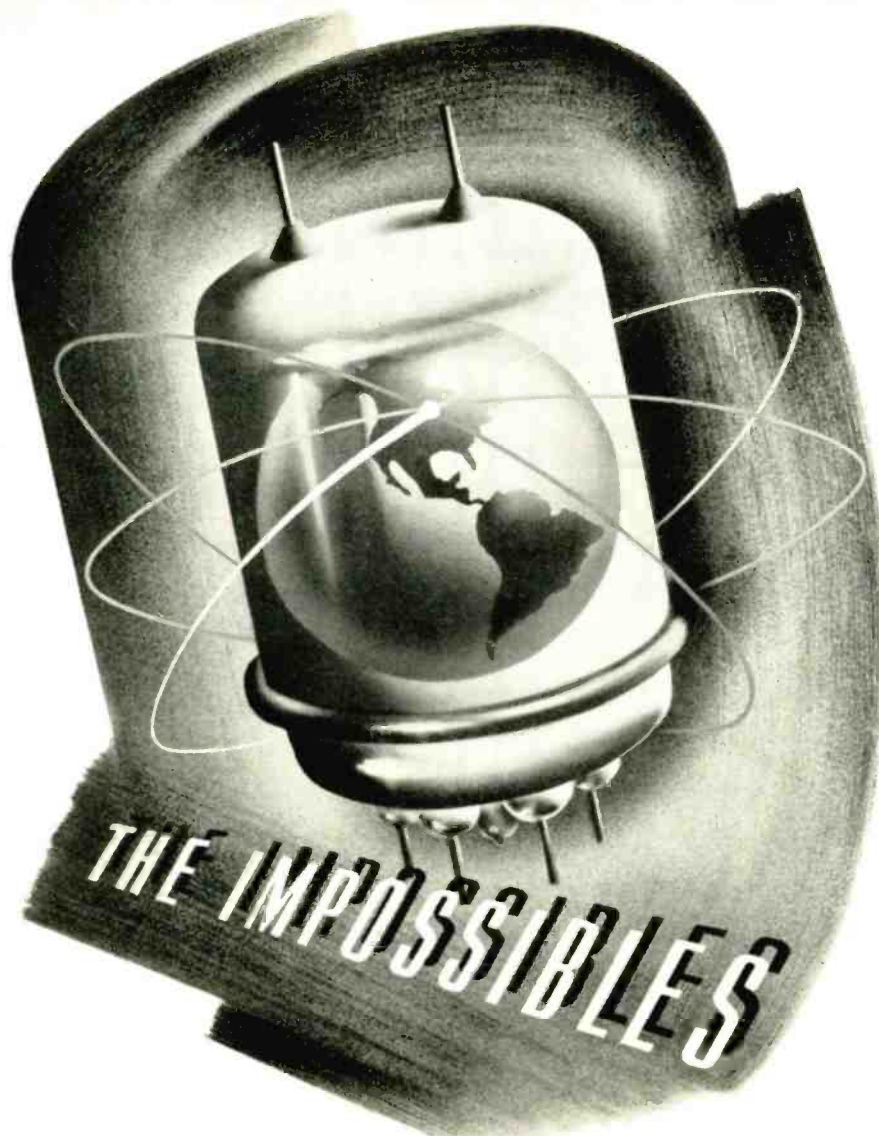

In step with the electronic science of today and tomorrow are the resources skills researches developments and products of Ken-Rad

There is no art of industry or war in which electron tubes cannot be used to accomplish heretofore impossible tasks These impossibles will bring an early Victory followed by peaceful applications of electronic devices to which Ken-Rad will make available its experience and a complete line of dependable electronic tubes

TRANSMITTING TUBES
CATHODE RAY TUBES
SPECIAL PURPOSE TUBES
METAL AND UHF TUBES

KEN-RAD

OWENSBORO KENTUCKY U S A

(Continued from page 112)

the image falling on a small shutter of black paper attached to the diaphragm. That portion of the light beam which gets past this shutter spreads to form a diffuse spot covering practically the entire cathode area of the type CE 20 photocell.

An increase in the pressure being measured forces the diaphragm upward, moving the shutter further into the light beam and thereby darkening the spot on the photocell cathode in an approximately uniform

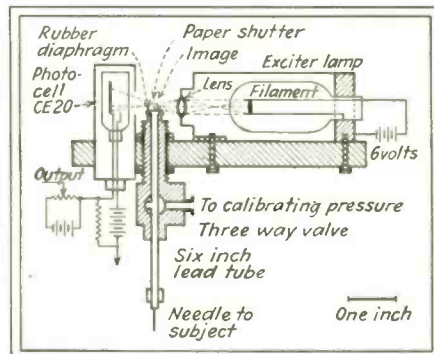

Fig. 1—Circuit and mechanical arrangement of the improved photoelectric manometer developed by Dr. W. E. Gilson for converting small variations in pressure into corresponding electrical values which can be observed on an oscilloscope screen



Fig. 2—Record of calibration, showing the linearity obtained. The pressure was decreased from 150 mm of mercury to 0 mm in 25-mm steps

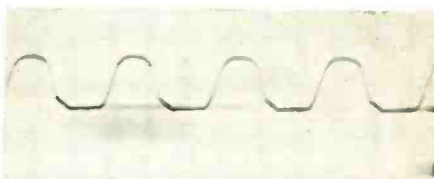
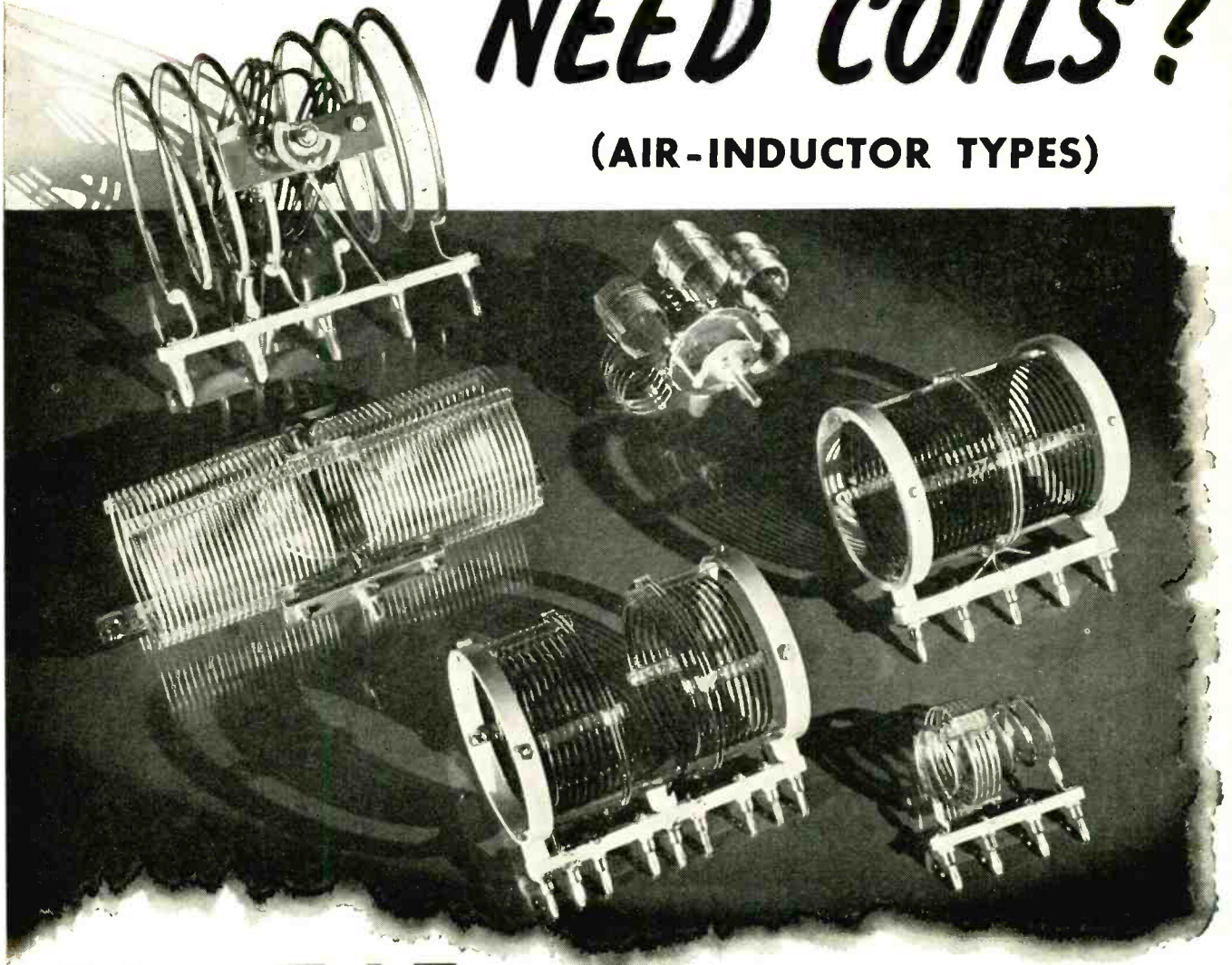

Fig. 3—Oscillogram showing the intra-ventricular pressure in a dog as detected by the improved electronic manometer

manner. Any nonlinearity due to nonuniform sensitivity of the cathode is thus eliminated, giving a linear calibration record as shown in Fig. 2. A comparatively large output is obtained, and is fed into a cathode-ray oscilloscope of the type described on page 22 of the Dec. 1941 issue of *ELECTRONICS*. This oscilloscope is now being manufactured in improved form by Clough-Brengle Co., Chicago. An example of the resulting record is shown in Fig. 3.

NEED COILS?

(AIR-INDUCTOR TYPES)



B & W CAN SUPPLY THEM!

*in large quantities or small
— on line production runs*

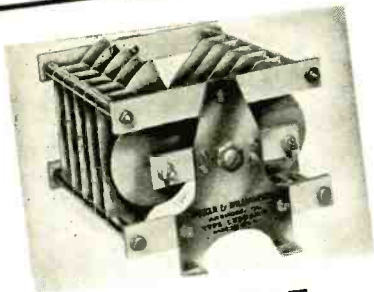

VARIABLE AIR CONDENSERS

The war has meant ten league strides in the production of B & W Variable Air Condensers, too. They're shorter than conventional units, have built-in neutralizers and coil-mounting feature, and are unexcelled for exacting high-power uses. Technical Data Sheet upon request.

It took many years of peace to engineer B & W Air Inductor Coils to their present state of perfection, but . . .

It took less than one year of war to teach us how to produce them by modern line methods—better and faster than coils have ever been made before!

We'd like to stack these expanded facilities against your next coil order—whether it calls for a few coils or a thousand—for relatively common or highly special units—and regardless of any difficult "fixed for fightin'" specifications that may be involved. B & W delivers the goods—and that not only means promptly, but with rigid maintenance of our highest quality standards!

BARKER & WILLIAMSON

Manufacturers of Quality Electronic Components for 10 years
235 FAIRFIELD AVENUE, UPPER DARBY, PA.

Navy Buoy Uses 45-Volt Fluorescent Lamp

A FLUORESCENT LAMP which operates at a voltage of only 45 volts is now being used by the U. S. Navy on doughnut-shaped rubber buoys which mark seaplane landing lanes at night, according to Westinghouse engineers. The low-voltage lamp eliminates the insulation difficulties which had been experienced in salty ocean atmosphere when 3000-volt luminous tubing was used.

• • •

Large Photos Teach Assembly of Intricate Amplifiers

INEXPERIENCED WOMEN are being successfully taught to assemble and wire large amplifiers at the Sound-Scriber Corp., New Haven, Conn., by means of large photographs on which parts and wires involved in only one series of operations are mounted. One giant chassis photograph (19 x 22 inches) mounted on heavy cardboard is used for each of the six consecutive steps in the complete assembly and wiring of an amplifier. Holes are drilled in each photo as required to hold only the parts actually involved in a particular step, and each operation involved in that step is numbered in correct sequence. Explanatory notes are placed alongside the numbers when necessary.

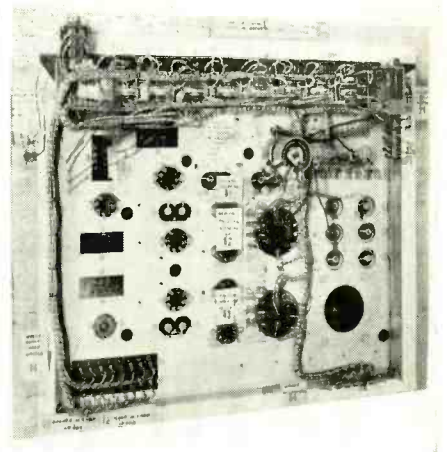

Example of a photo instruction board which shows the parts and wires involved in one sequence of operations for building an intricate amplifier. The tube sockets, T pads and filter condenser terminals are in the original photograph, while the wiring and other parts which cast shadows are mounted on the photograph



Not fulsome promises... but performance!... THAT has been the keynote of

Thordarson's progress through the years.

Whenever, and wherever transformers are

discussed, the reputation for quality leader-

ship enjoyed by Thordarson is invariably

an important part of the conversation.



THORDARSON

ELECTRIC MFG. COMPANY
500 WEST HURON STREET, CHICAGO, ILL

Transformer Specialists Since 1895

Electronic

PRECISION PARTS

TUBE PARTS METAL STAMPINGS
WIRE FORMS

Machined for Accuracy

BURNER TIPS FOR ALL APPLICATIONS



• Perhaps You Have a Problem
Where Haydu Brothers Can Help.
Let Us Know Your Requirements.

HAYDU Brothers have been serving many leading radio and electrical manufacturers for more than 12 years, when the company was originally established in Newark, N. J.

After eight years of growth, we moved to Plainfield, N. J., where we built our present modern and fully equipped factory five years ago.

Our engineers and manufacturing executives understand the requirements of electronic tube and radio manufacturers—due to our experience and close contact with this active and fast moving field.

Enlarged manufacturing facilities now enable us to offer our services to a larger number of customers—including the designing and building of machines for the manufacture of precision electronic parts.

We invite your inquiries regarding our products and services. They will receive prompt and courteous attention.

HAYDU BROTHERS

A member of the Radio Manufacturers Association

PRECISION PRODUCTS FOR RADIO, ELECTRICAL,
AVIATION AND INSTRUMENT MANUFACTURERS

Mt. Bethel Road

PLAINFIELD, NEW JERSEY

Telephone: Plainfield 6-0878

" THE PLACE OF QUALITY AND ECONOMY "

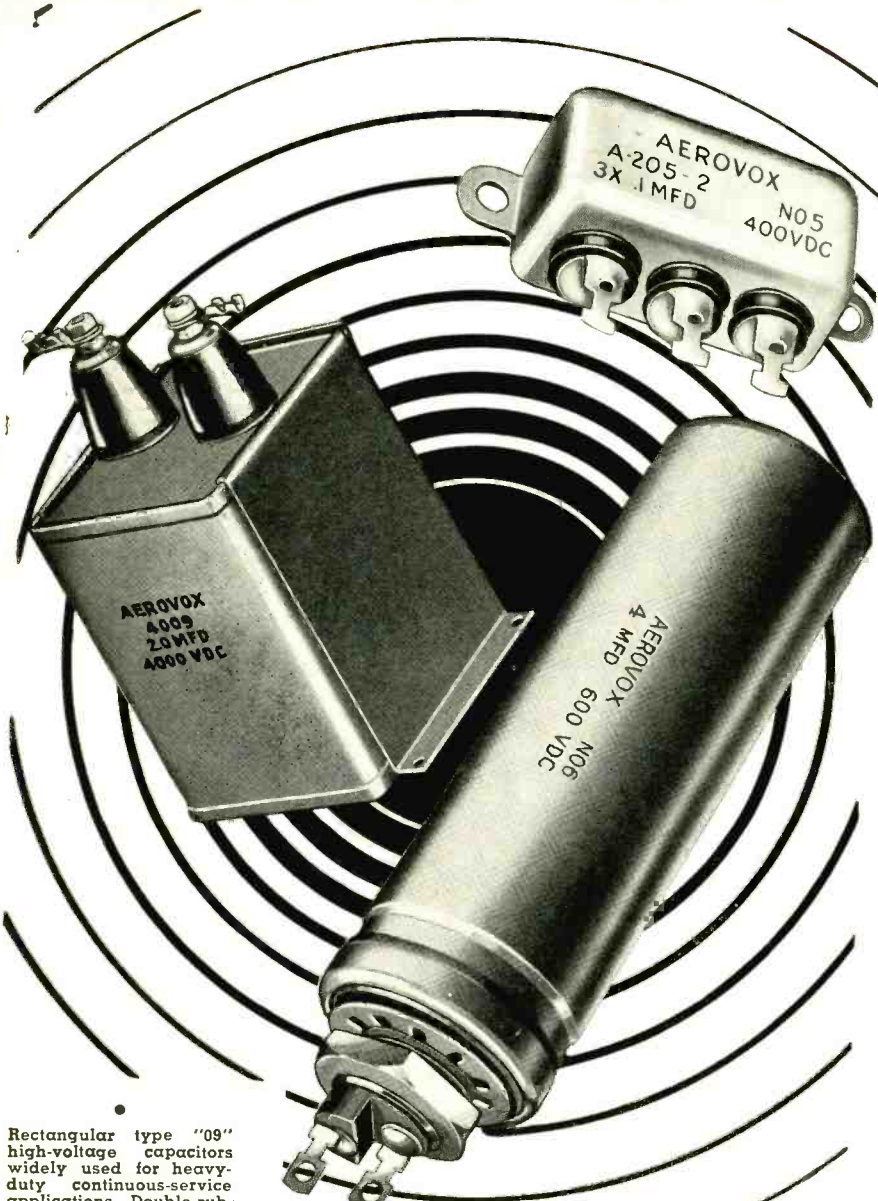

Rectangular type "09" high-voltage capacitors widely used for heavy-duty continuous-service applications. Double rubber bakelite sealed porcelain-pillar terminals. Upright or inverted mounting. 600 to 5000 v. D.C.W. Choice of capacities.

Heavy-duty oil-filled "bathtubs". Logical choice for assemblies subjected to hard usage. One-piece drawn metal case with soldered bottom plate. 400 to 1000 v.

New type "10" Hyvol. Double terminals on stepped bakelite threaded terminal post. Fully insulated can. Insulator washer no longer necessary for non-grounded mounting on metal chassis. 600 to 1500 v.

Aerovox oil-filled high-voltage capacitors Series "20" in voltages up to 50,000 D.C.W.

Drafted...

● For sheer ability "to take it" day after day, month in and month out, year after year, nothing excels the properly engineered and built oil-filled capacitor. Which explains why Aerovox oil-filled capacitors have been drafted for the war effort. Such capacitors, ranging from compact oil-filled tubulars and "bathtubs" and rectangular-can types, to the large-can types and even to the giant Series 20 units in ratings up to 50,000 v., are available on very highest priorities, these days. If your work is of a vital military or war-industry nature, you can count on these Aerovox oil-filled capacitors. ● Write for catalog. ● Submit your requirements.

NEW BEDFORD, MASS.,
U. S. A.
Sales Offices in All
Principal Cities

AEROVOX

CORPORATION

In Canada
AEROVOX CANADA LTD.
Hamilton, Ont.
EXPORT: 100 Varick St., N. Y.
Cable 'ARLAB'

Side Shifts of Paper Corrected in Roll-Winding Machine

PHOTOELECTRIC SIDE REGISTER controls which insure true rewinding of paper rolls at high speeds are now available as commercial units for rewinding machinery in paper mills, for web-operated printing presses, for slitting equipment, and for other types of paper machinery operating from the roll. Crosswise register can be maintained with a high degree of accuracy even though the original roll is telescoped or unevenly wound. With roll-slitting machines trim waste can be avoided by rewinding into rolls having straight ends.

The control system consists essentially of three sections: (1) The scanning head, which converts side-wise shifts of the moving paper or web into electrical impulses, (2) The amplifying system, which rectifies and amplifies the output of the scanning head to provide a suitable register current for operation of the side-shift motor, (3) The side-shifting mechanism, containing a motor, levers and screws which shift the paper and scanning rolls the correct amount in the correct direction to keep the paper running true. These three sections are identified in Fig. 1, which shows a complete installation.

Photoelectric side register controls as manufactured by Cameron Machine Co., Brooklyn, N. Y. employ two distinct types of scanning heads and amplifying sections, but all have same side-shifting mechanism.

Scanning Head

The General Electric scanning system, illustrated in Fig. 2, contains a

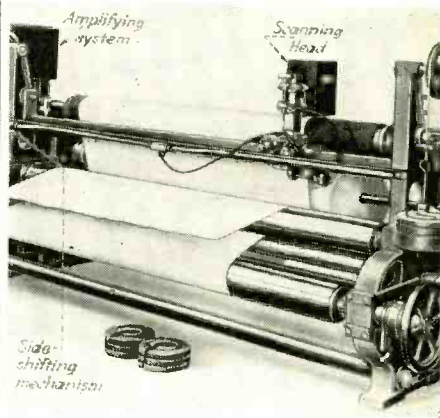
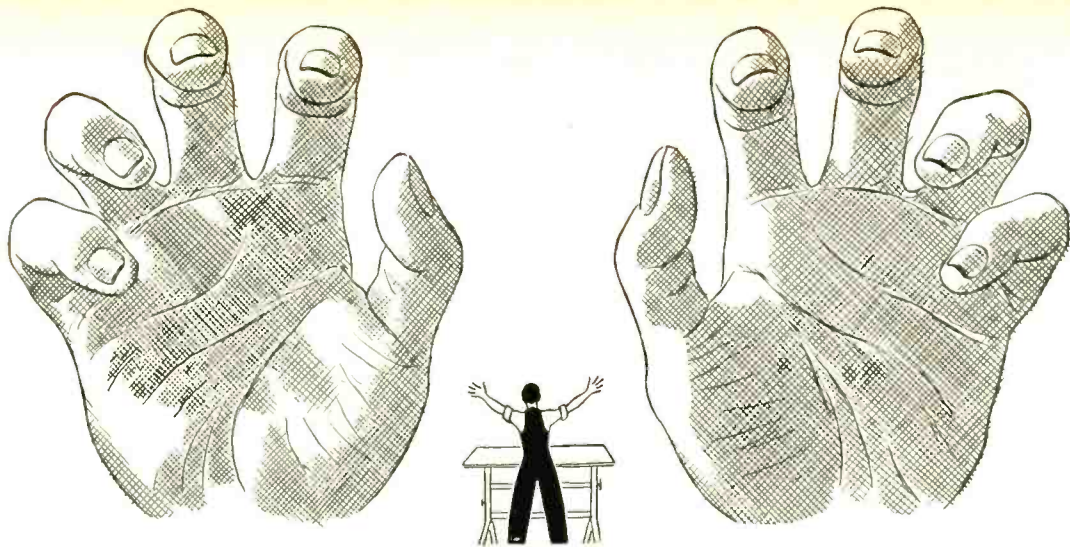

Fig. 1—Cameron photoelectric side register control installed in a web press, with the three basic sections of the control system identified

K & E

REG. U. S. PAT. OFF.



HANDS OFF! Our costly, time-taking original drawings are always

PRESERVED

They stay in safe storage. We make all duplicates from PHOTACT prints — let them take the beating

Today's top-speed production requires as many as a thousand blueprints from one original drawing.

But pencil tracings—which most drafting rooms use today—are not sturdy enough to stand up under too many blueprinting runs, because they become smudged and blurred with handling.

To preserve your original drawings, use the PHOTACT process. After you make the negative, your original drawing may be filed away as a record—preserved from damage. The PHOTACTS made from this negative are used to produce all your blueprints or black line prints.

PHOTACT also restores. Old, smudged, overhandled original drawings come out sharper and cleaner in the PHOTACT reproduction.

PHOTACT duplicates your original drawing as many times as you need. From your negative you make as many PHOTACTS as required for use with government contracts, for sub-contractors or any of the other purposes for which duplicates are necessary.

PHOTACTS, even when made from pencil drawings are equal to fine ink tracings. Therefore, blueprints and black line prints made from them are always sharp and clear.

Pencil or ink originals may be reproduced on either PHOTACT tracing paper or tracing cloth.

For complete information about PHOTACT process write Photact Department, KEUFFEL & ESSER CO., Third & Adams Streets, Hoboken, New Jersey.



EST. 1867

KEUFFEL & ESSER CO.

NEW YORK • HOBOKEN, N. J.

CHICAGO • ST. LOUIS • SAN FRANCISCO • LOS ANGELES
DETROIT • MONTREAL



WHEN YOU
NEED HELP

ON
Electronic

ENGINEERING, DESIGN AND
MANUFACTURING, TURN TO

OPERADIO

MANUFACTURING COMPANY



Here is electronic "know-how" built on 15 years experience as contract manufacturers marked by many significant "firsts." If you have a war or post-war electronic problem involving design, engineering or manufacturing, let us help you with it. Although our laboratory is temporarily working day and night on electronic engineering for the Army and Navy and our production workers are busy on vital equipment for these same government agencies, war has sharpened our ingenuity and taught us many short-cuts to apply on *your* problems.

File a reminder now so you'll know where to go with problems in electronics. Let Operadio supplement your own engineering staff and be your electronics laboratory.



Φ SYMBOL OF ELECTRONIC EXCELLENCE

OPERADIO
MANUFACTURING COMPANY
ST. CHARLES, ILLINOIS

light source which projects a small spot of light onto the edge of the web of paper, in such a way that the web bisects the circle of light when running true. The light reflected from the paper is focussed onto a phototube by a collecting lens. No light is reflected from that part of the spot which falls on the dark rubber idler roll (scanning roll) over which the web passes. Sidewise shifting of the web changes the amount of light falling on the phototube, correspondingly changing its output current.

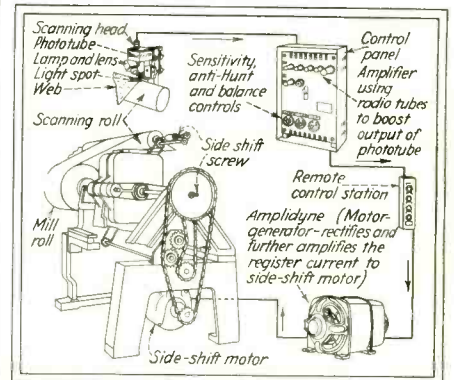

Fig. 2—Photoelectric side register control using G-E scanning and amplifying units. The control panel contains an ordinary audio amplifier as used in radio, along with necessary sensitivity, balancing and anti-hunting controls

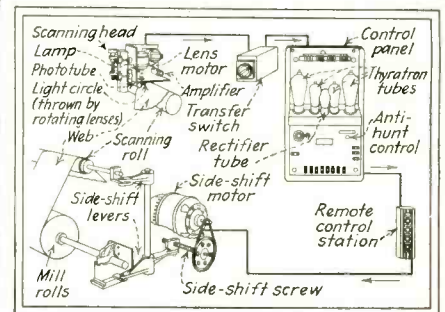
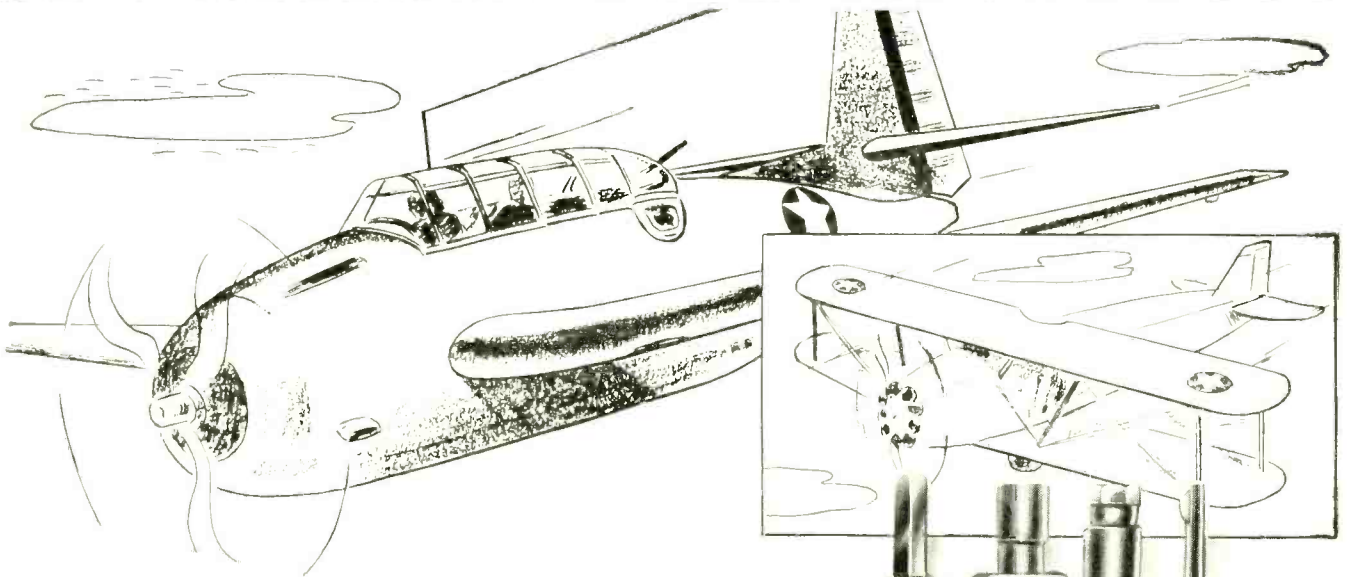

Fig. 3—Equivalent register control system using Westinghouse rotary-lens type scanning unit and thyatron amplifier. This diagram clearly shows the screw-and-lever mechanism used for shifting the rolls sideways

The Westinghouse scanning system, illustrated in Fig. 3, employs a light source and a fixed-focus rotary lens driven by a small electric motor to produce concentric circles of light on the edge of the web. The light reflected from the web is picked up by a phototube, and the output of the phototube is fed through an amplifier stage built into the scanning head.

IT'S SMART TO SIMPLIFY...



Simplify Design with **WALKER-TURNER FLEXIBLE SHAFTING**

IT IS a far cry from the complicated bi-plane of 1917 — with its tangle of struts and wires — to the simple, clean-looking dive-bomber of today. To the engineer, *improvement* and *simplification* are inseparable in most of the machines of war and peace.

WALKER-TURNER FLEXIBLE SHAFTING has made notable contributions to simplification of design — where the problems involved are those of remote control or transmission of light power loads. As one of the largest manufacturers of flexible shaft machines for industry, Walker-Turner has gained wide experience in the design and application of shafting.

This experience we are glad to place at the service of other manufacturers. Perhaps we have the answer to your problem in our files.

WALKER-TURNER COMPANY, INC.
1443 BERCKMAN STREET • PLAINFIELD, NEW JERSEY

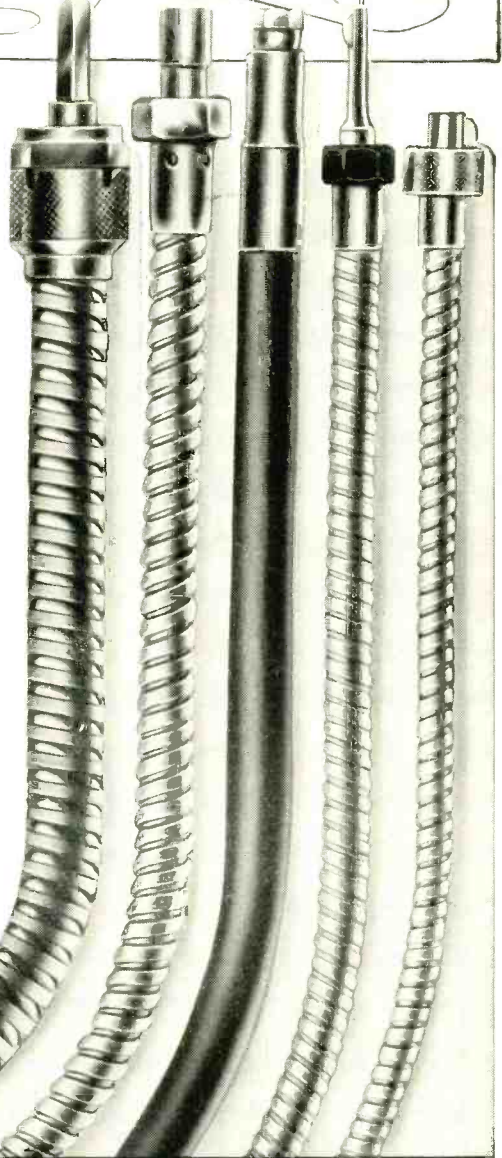

FLEXIBLE SHAFTING

FOR REMOTE CONTROL AND POWER TRANSMISSION

Stamping Grounds

for ELECTRONIC TUBE PARTS AND SHIELDS...

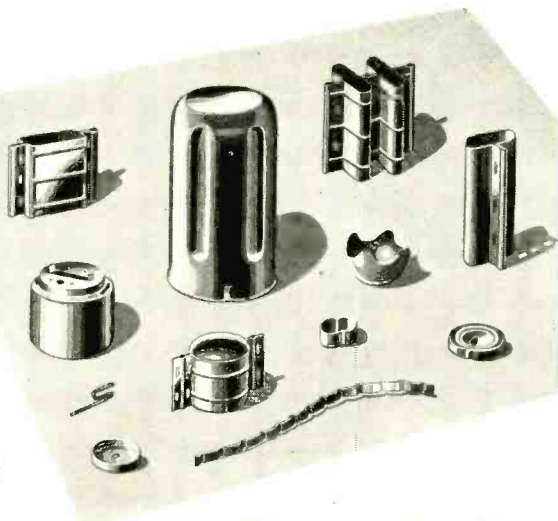

Shown here are just a few typical samples of GOAT Electronic Tube Parts and Shields that have been stamped, drawn and formed on GOAT machines, dies and presses.

SMALL TOUGH JOBS . . . handled with skill, precision and efficiency, are a regular part of GOAT Service. GOAT'S position today, as largest independent manufacturer of electronic tube parts, is due to GOAT'S experience and growth. From the days of radio infancy, GOAT has been able to design and improve the parts needed by this industry as it demanded greater sensitivity and durability as well as quantity production.

Today, GOAT serves almost every electronic tube manufacturer with a tremendous variety of stock parts. Facilities are so complete that GOAT actually can supply any kind of small metal stamping, made in any metal, to any required degree of accuracy.

GOAT

METAL STAMPINGS, Inc.

Division of THE FRED GOAT CO., INC.
314 DEAN STREET, BROOKLYN, N. Y.

Goat has meant Accuracy since 1893

Amplifying System

The General Electric amplifying system uses standard radio receiving tubes to boost the phototube output initially, with this unit feeding into an Amplidyne motor-generator set which rectifies and further amplifies the register current.

In the Westinghouse amplifying system, all amplification is performed by thyatron tubes, which feed the side-shift motor directly.

Side-Shifting Mechanism

The type of mechanism used to correct unevenness in a roll depends upon the size and nature of the machine, but in general consists of a side-shift motor capable of rotating a desired amount in either direction in response to the demands of the scanning head and amplifying system, and a side-shift screw which shifts the printing and scanning rolls either directly or through a lever system.

One requirement for accurate side registry control is constant web tension, which is obtained mechanically in Cameron roll-handling equipment. Under this condition, full correction can be made in a sidewise direction at the rate of 25 inches per minute. Register may be taken either from the right or left edge of the web, or from a printed line having a minimum width of $\frac{1}{8}$ inch anywhere throughout the width of the web.

. . .

Pumps Controlled Automatically Over Phone Line to Reservoir

AUTOMATIC STARTING and stopping of four groups of water pumps in accordance with changes in reservoir water level is provided in the municipal water system of Kalamazoo, Mich. by a system of remote relays connected through a three-mile telephone line to a mercury column and cheostat arrangement at the reservoir. The controls, described in *Water Works Engineering*, were developed by Earl E. Norman, Supt. of Public Utilities of Kalamazoo, to maintain the reservoir level automatically within one foot of any predetermined depth.

In a vault alongside the reservoir



ANOTHER JENSEN WARRIOR!

There is nothing visionary about this product. It is at war every day helping to make our navy the best navy in the world. Many other Jensen loud speakers are at war, too; some of them are standard Jensen prewar products . . . all of which we believe is interesting commentary on the eternal quality and reliability of Jensen products whether in war, prewar or postwar times.

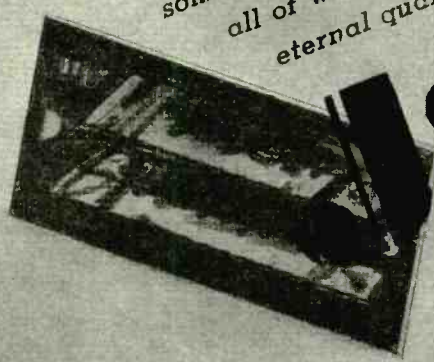

Jensen
RADIO MANUFACTURING CO.,
6601 S. LARAMIE AVENUE, CHICAGO

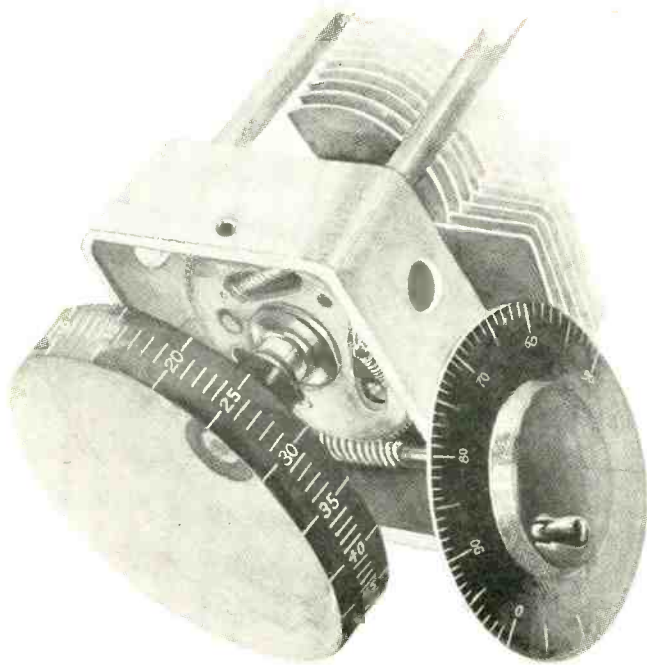

Maybe we're wrong

But we've a few ideas that, we like to think, are clearer realizations of fact. We can't be tempted into soothing self-praise—or boastfulness untrammelled by modesty or ordinary business conservatism.

Frankly, queries about what we are contributing to the nation's effort find us verbally unresponsive. We can't find room for back-slapping when all of our attention is given unreservedly to our small share in the dread realities of this war.

No, The Allen D. Cardwell Manufacturing Corporation is not old-fashioned, static—not standing on a record of past performances, though we have been a military facility ever since the previous war.

Rather, cumulative experience and sound counsel have added impetus and direction to creative ability and production enthusiasm. Our most effective service is being rendered by concentrating solely upon assigned tasks . . . design and construction of more efficient wartime apparatus.

CARDWELL  CONDENSERS

THE ALLEN D. CARDWELL MANUFACTURING CORPORATION

BROOKLYN, NEW YORK

is a mercury U-tube balanced against the head of water in the reservoir. Ten plain wire electrodes are inserted in the atmospheric side of this glass tube as indicated in the diagram, at positions such that movement of the mercury column from one electrode to the next corresponds to a change of one foot in the water level. The electrodes connect through rheostats to one of the telephone wires running to the central pumping station three miles away. An additional electrode contacts the mercury at the bottom of the column at all times, and connects to the other telephone wire. Since each of the ten rheostats is set at a different ohmic value, each one-foot change in water level places a different resistance value across the reservoir end of the telephone line.

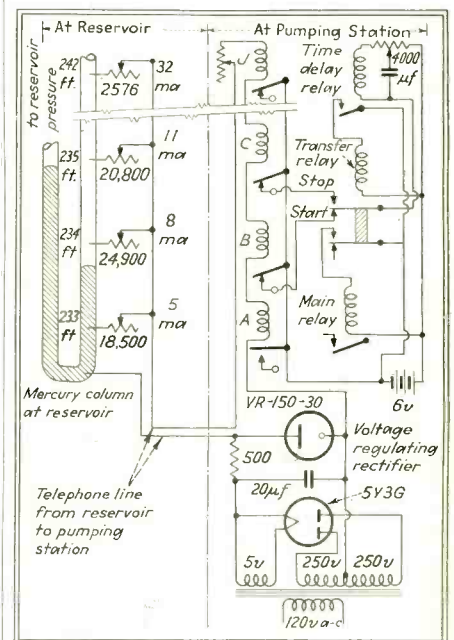

Essential features of the automatic control system used to maintain a desired level of water in the main reservoir at Kalamazoo, Michigan. The electronic voltage-regulating rectifier shown below the relays provides the constant d-c voltage required for the series arrangement of relays

At the central pumping station twelve sensitive relays are connected in series with a voltage source and a rheostat across the telephone line running to the reservoir. Ten of these relays correspond to the ten electrodes in the mercury column at the reservoir, and are adjusted so that each one-foot rise in reservoir level closes one additional relay. Thus, a current of 5 ma flows over the telephone line when the column

This Year Rubber Is Tapped from Test Tubes

Synthetic Rubber Already Is Working for Users of Mechanical Rubber Goods

War production is up threefold. But the vital rubber stock pile is dwindling fast. This is the year of crisis in rubber.

There is only one solution . . . the production of synthetic rubber in steadily increasing tonnages . . . synthetic rubber to take over jobs once handled by natural rubber . . . to perform new tasks, serve in new applications created by wartime need.

One of the first synthetic rubber plants in the Government's program was built and is being operated by United States Rubber Company . . . another soon will be in production.

Our engineers have been working with synthetic rubber since 1921. During this period they have learned that no one synthetic should be used for all types of mechanical rubber goods. They have found where and how synthetic is superior to natural rubber, where it falls short. They know what uses each of the five basic commercial types of synthetic rubber is best suited for — Neoprene, Buna-S, Buna-N, Butyl, or Thiokol—and how to compound the specific synthetic rubber for the specific task. U. S. Rubber has used all five types and knows which one to select for the performance required.

Information based on the results of vast experiments and practical applications of synthetic rubber has been incorporated in a new comprehensive book, *The Five Commercial Types of Synthetic Rubber*.

This informative book traces the history of synthetic rubber from the earliest experiments of Michael Faraday to the present. It discusses each of the basic types of synthetic rubber, tells where it has been used successfully in United States Rubber Company products, and compares its properties with natural rubber. It tells how synthetic rubber is made. It is a detailed answer to the most vital question of the day.

We feel that *The Five Commercial Types of Synthetic Rubber* is a publication of real importance to men of industry. Requests made by them on their company letterhead will be filled promptly.*

The successful use of synthetic rubber in mechanical rubber goods and the insurance of fully dependable service depend largely upon the skill of the manufacturer and compounder. Each of the five basic commercial types of synthetic permits a myriad of variations.

The United States Rubber Company has been developing and improving rubber products for one hundred years. Today, the same vast resources for research and development that resulted in some of the most spectacular achievements in the rubber industry are being devoted to the problem of synthetic rubber. A great backlog of knowledge already has been built. More is being constantly added.

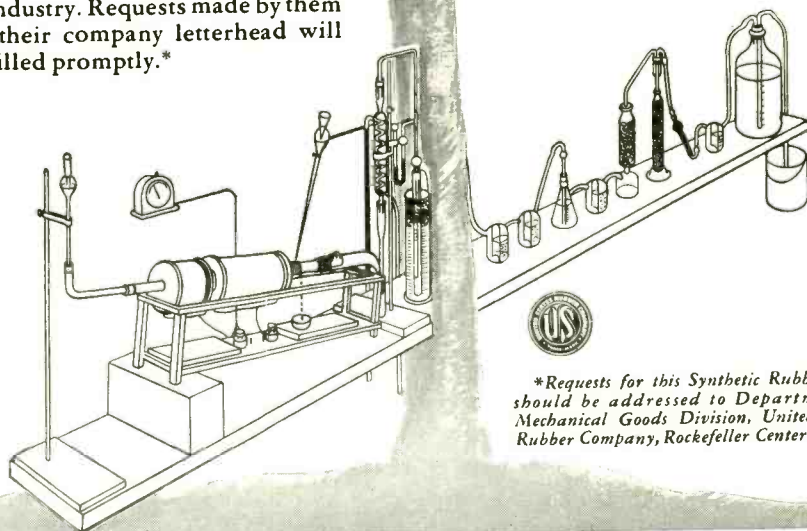

*Requests for this Synthetic Rubber Book should be addressed to Department 10 Mechanical Goods Division, United States Rubber Company, Rockefeller Center, N. Y. C.

UNITED STATES RUBBER COMPANY

Mechanical Rubber Goods Division • Rockefeller Center • New York

In Canada, Dominion Rubber Co., Ltd.

Two Words that Electrified the World

UNCONDITIONAL SURRENDER

Two words that shot terror into the hearts of our enemies. . . .
Two words that foretold the doom of the oppressors. . . .
Two words that lifted the hopes of all the peoples of the world. . . .
And these very same words sounded the Keynote of the policy of American Industry:—

Unconditional Surrender of brain, brawn, and machines to the great job of winning the Battle of Production.

Unconditional Surrender to the mighty task of winning Victory.

To this end the Dial Light Company of America is hard at work. . . . We say this for the record: No problem is too difficult; no delivery schedule is too "impossible" for us to follow-through to a successful conclusion.



DIALCO

PILOT LIGHT ASSEMBLIES

Model illustrated is used with T4½ ¼-Watt Bulb.

We manufacture an extensive line of Warning and Signal Pilot Light Assemblies. If your problem cannot be solved by one of our standard units, we will make one to your exact requirements. Samples and blueprints will be submitted promptly. . . .
Write us today, attention Dept. D.



DIAL LIGHT CO. of America INC.

90 WEST STREET • NEW YORK, N. Y.

rises to the first electrode, corresponding to a water elevation of 233 ft., and relay A is adjusted to pull up at this current. Line current increases to 8 ma when the water level rises one foot, and relay B pulls up at 8 ma. Each additional electrode circuit in parallel with the reservoir end of the phone line increases the current three ma, so that the 32-ma current for the highest electrode pulls up relay J. The two additional relays are for protection, one closing if the telephone line becomes shorted and the other acting if the telephone line breaks and opens the circuit.

A voltage-regulating rectifier circuit fed by a constant-voltage transformer (not shown in the diagram) provides a voltage source for the relays which remains constant within one volt even though the power line voltage drops as low as 55 volts or rises to 130 volts.

The system uses four sets of pumps, each controlled by a group of three relays—a time delay relay, a transfer relay and the main motor-starting relay. One group of these relays is shown in the diagram. The group can be connected between any two of the relays A to J by an arrangement of telephone-type switches, numbered according to the water levels they represent.

When the reservoir is full, 32 ma flows over the telephone line and relays A to J are all closed. With a relay group connected to relays C and B as in the diagram nothing will happen until the water drops to the level which makes relay B drop out. This closes the circuit to the time delay relay, which it closes after a delay of about ten seconds produced by the condenser and potentiometer in its circuit. Closing of the time delay relay energizes the transfer relay, which transfers control of the time delay relay from relay B to relay C and at the same time energizes the main relay controlling the motor-starting mechanism. When the reservoir level has risen one foot, relay C opens and disconnects the time delay relay. After a few seconds delay it drops out, causing the other two relays also to drop out and shut down the pumps. The time delay relay prevents chattering of the main relay contacts if the mercury tends to quiver at one of the electrodes in the U-shaped tube.

TUBING OF DESTINY

We at Precision take justifiable pride in the privilege of contributing in a small way toward our Country's Destiny . . . our Freedom . . . and the Freedom of all men fighting for Liberty and Democracy. Tubing, as used in Instruments, Aircraft and Electronics, is shaping that Destiny, *that Victory which comes to all free men.*

Accurately drawn small Tubing and Metal Shielded Wire are our Specialties. Your inquiry concerning your requirements is invited.

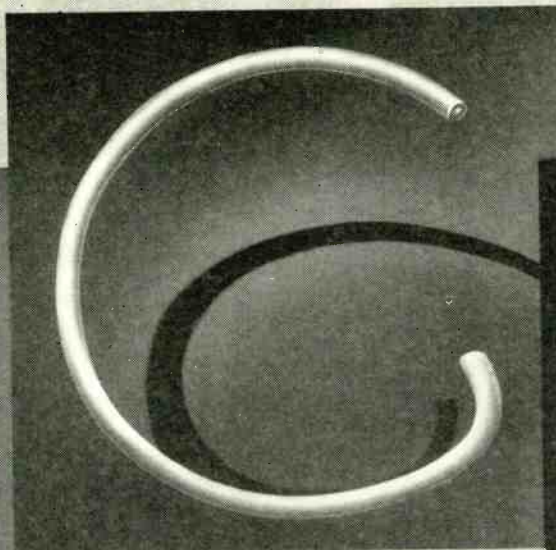
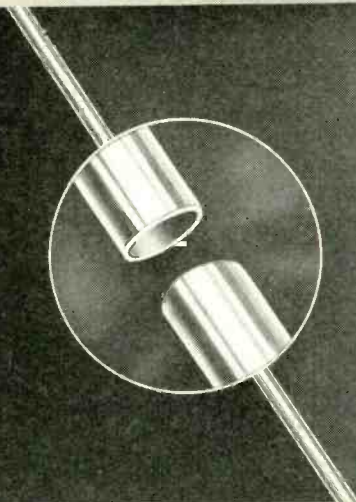

AIRCRAFT

Rate of Climb, Air Speed and similar Aircraft Instruments depend for their accurate measurements upon the amount of air passing through a predetermined length of formed tubing. Precision Tube Company's new method of manufacture steps up production 800%.

INSTRUMENTS

Precise Instruments, vital to all Communications, must depend upon accurately made, positively balanced Pointer Tubing. Today Precision Tube Company supplies this high grade Aluminum Alloy Pointer Tubing to over 80% of the Instrument Manufacturers in this free Land. There *must* be a reason.

ELECTRONICS

Metal Shielded Wire — insulated wires shielded with Seamless Aluminum or Copper Tubing—offers the only positive protection against Moisture, Electrical Interference and Mechanical damage. It is a **MUST** for dependable Electronic Equipment where failure cannot be tolerated. Made in a wide variety of sizes and combinations.



PRECISION TUBE CO.

SPECIALISTS IN ACCURATELY DRAWN TUBING AND METAL SHIELDED WIRE
 Factory: 3824-26-28 TERRACE STREET • PHILADELPHIA, PA.
 BRANCHES IN ALL PRINCIPAL CITIES SALES DEPT. 2957 214TH ST., BAYSIDE, L. I., N. Y.

THE ELECTRON ART

Combining of Phase-Shifted Rectified Sine Waves.....	160
Electromechanical Calculator for Directional Antennas.....	160
Magnetostriction Made Visible.....	162
Method of Predicting A-F Harmonic Distortion.....	164
Measuring Rotational Speeds with Stroboscopic Patterns.....	166
Diodes as Frequency Changers.....	168
Electronic Coil-Turns Counter.....	168
AIEE Bibliography on Automatic Power Stations.....	170
Concentricity Tester for Enamel Film on Wire.....	170
Chemical Analysis with a Cathode-ray Oscilloscope.....	154

Chemical Analysis With A Cathode-ray Oscilloscope

NEWLY-DEVELOPED MEANS for producing current-voltage curves of chemical solutions instantly on the screen of a cathode-ray oscilloscope have brought the polarographic method of chemical analysis within the field of commercial electronics. Speedy identification of as many as half a dozen different substances in a dilute solution is now possible simply by watching the patterns appearing on the oscilloscope screen, once the apparatus has been calibrated with known solutions.

A paper by Tudor S. G. Jones in the Feb. 1943 issue of *Electronic Engineering* (a British publication) gives a comprehensive survey of polarographic methods of analysis. Early history, fundamental explanations, principles underlying each advance in laboratory technique, and the new oscillographic techniques are fully presented.

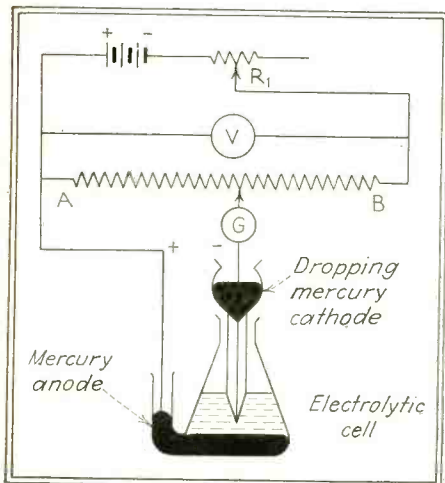

Fig. 1—Basic circuit for polarographic analysis

Basically, the method involves placing the solution to be analyzed in a container or cell having two electrodes. The smaller electrode is usually a capillary tube from which tiny drops of mercury issue every 2 to 4 seconds. The larger electrode is

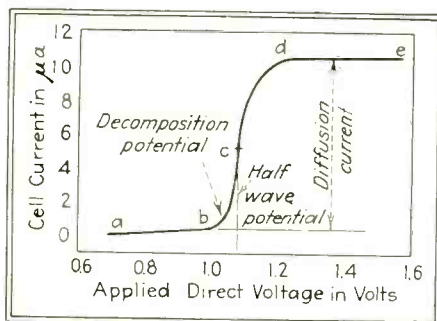

Fig. 2—Example of a current-voltage curve obtained with a polarograph

a pool of mercury in the bottom of the cell. The technique is based upon interpretation of the current-voltage curve obtained for the solution when a direct voltage is applied to the electrodes and gradually increased. Both the nature and the concentration of the substances present can be determined from the resulting curves.

As originally developed about 20 years by Jaroslav Heyrovsky¹ of the Charles University of Prague, the method required tedious manual plotting of the current-voltage curves, and perhaps for this reason received little attention. Nevertheless, it constituted a significant advance in analytical technique, providing a new tool for routine analysis and solving abstract problems immune to conventional methods.

The basic circuit is given in Fig. 1. The direct voltage is applied to the

cell by calibrated potentiometer *AB*, and the current through the cell is measured by galvanometer *G*. When the voltage between the electrodes is increased from zero, the current will increase somewhat in the manner shown by the curve in Fig. 2. From *a* to *b* the current is small and increases but slowly with increases in voltage. At point *b*, the decomposition potential, the current suddenly starts to increase. Eventually, how-

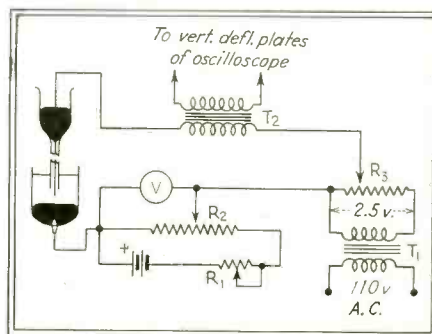

Fig. 3—Polarograph circuit arrangement permitting use of a cathode-ray oscilloscope for identification of ions in a solution

ever, the current reaches a limiting value and follows an almost horizontal curve *d-e* which is parallel to the residual-current portion *a-b*. The paper explains the limiting current in terms of the diffusion of ions in the immediate vicinity of the dropping electrode.

When several different electrolytes are present in the solution, the current-voltage curve will have a number of steps, each similar to that shown in Fig. 2. The decomposition potentials of the several electrolytes will determine the widths of the steps, and the concentrations will determine the heights.

Curves for different concentrations of any given electrolyte are symmetrical about a value of applied voltage at which half the limiting current is flowing. This voltage is known as the half-wave potential, is independent of the concentration and is characteristic of the electrolyte. A determination of the half-wave potential is therefore sufficient to identify an ion, and a determination of the limiting current value gives its concentration.

The development by Heyrovsky and Shikata² of an instrument called the polarograph, which automatically recorded in a few minutes the current-voltage curve for a solution, made polarography of practical use.

for Permanent resistance today and tomorrow...

OHMITE
Resistance Units



Many factors contribute to the permanent performance of Ohmite Units—factors of design and construction that enable them to meet every condition of service . . . to withstand shock, vibration, heat and humidity . . . and keep going. These characteristics make Ohmite Rheostats, Resistors, Chokes and Tap Switches especially well fit for today's critical wartime needs.

What's more . . . Ohmite leadership in developing an extensive range of types and sizes has made it possible to serve innumerable applications. All this, of course, makes them readily applicable for the new peacetime products of tomorrow. Ohmite Engineers are glad to assist on any problem for today . . . or tomorrow. Write on company letterhead for helpful Industrial Catalog and Engineering Manual No. 40.

Send for Handy Ohmite Ohm's Law Calculator. *Thousands of these Ohmite Calculators are in practical use today. Figures ohms, watts, volts, amperes—quickly, easily. Solves any Ohm's Law problem with one setting of the slide. All values are direct reading. Send only 10c in coin to cover handling and mailing. (Also available in quantities.)*



OHMITE MANUFACTURING COMPANY

4816 FLOURNOY STREET, CHICAGO, U. S. A.

Instantaneous and Continuous AUTOMATIC RECORDING of your Electrical MEASUREMENTS

Is the modern way to obtain an absolutely reliable record of your engineering investigation.

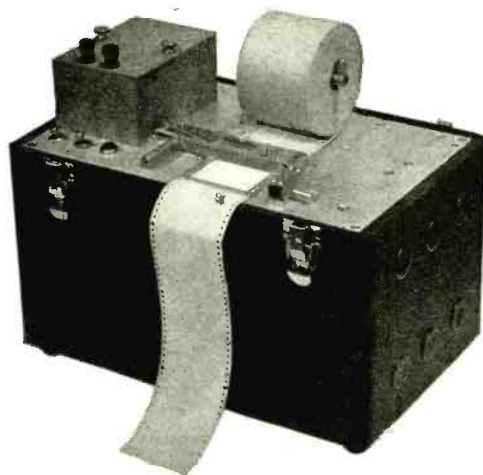

- *If you have to make measurements of: vibration, noise, decay of sound, reverberation, loudness;*
- *or if you want to make frequency response characteristics of: loud speakers, microphones, amplifiers; or in short, measurements of almost any apparatus used in the communications field;*
- *or if you want to make current or voltage measurements, the illustrated AUTOMATIC GRAPHIC RECORDER will execute such measurements in the most rapid manner (either on a linear or logarithmic scale).*

The recorder covers an unusual wide range of intensity with a dependable accuracy over the whole scale (2" wide). The instrument, although light (25 lbs.), and compact, (7" x 10" x 12") contains an AC amplifier, DC amplifier, and a power supply, (Current: 115 volts 60 cycles 150 watts). The sensitivity is extremely high, less than 3 millivolts initial input signal is required to start the scribe moving which means less than 1 volt to cover the full scale if a 50 db input potentiometer is being used. For many measurements additional amplification of the signal is not necessary. The frequency characteristic is essentially flat from 40

to 40,000 cycles.

If you have to deal with measurements as indicated above (and even if you doubt that the instrument will be of any help in your particular problem), please read the discussion about this remarkable recorder in our House Organ "Sound Advances" Volume VII, No. 2. A copy will be mailed to you immediately upon your request.

Our instruments are used by the Armed Forces and the greatest Laboratories in this country for testing vibration and noise, etc., and also for many other applications which we cannot, for obvious reasons, discuss here.

- *The instrument is comparatively low priced and we can guarantee prompt delivery on an agreed schedule.*

SOUND APPARATUS COMPANY

150 West 46th Street

New York City, N. Y.

In this instrument an electric motor simultaneously drives the moving arm of the potentiometer and a drum covered with photographic paper, while a mirror galvanometer with its light source traces the desired curve on the paper. The method has since been modified to permit use of an automatic ink-writing recorder in place of a photographic recorder.

An early attempt to apply the cathode-ray oscilloscope to polarography is that of Matheson and Nichols,⁹ who eventually were able to secure recurrent traces resembling a Heyrovsky polarogram. Their method involved synchronizing a rotating switch with the rate at which the mercury was dropping, this sometimes being quite difficult.

The latest oscilloscope application is based on an entirely new principle of detecting and measuring polarographic waves. When a small alternating voltage is superimposed on the direct voltage during polarographic analysis, the waveform of the resulting current will be the same as that of the applied alternating voltage whenever the current-voltage curve is linear, as at half-wave potential *c* and flat portions *a-b* and *d-e* in Fig. 2. At curved portions *b-c* and *c-d* the distortion will be marked.

Muller, Garman, Droz and Petras based their cathode-ray oscilloscope circuit in Fig. 3 on this principle. The direct potential is applied to the cell by potentiometer R_2 and is measured by voltmeter V . The alternating potential is applied by transformer T_1 and potentiometer R_3 . The resulting cell current is applied to the vertical deflecting plates of an oscilloscope through step-up transformer T_2 , while the horizontal plates are driven by the usual internal synchronized sweep circuit.

The applied direct voltage is varied until the oscilloscope screen shows a trace having the same form as that of the alternating applied voltage (sinusoidal). The half-wave potential is then read on the voltmeter, making due allowance for direct voltage drops in R_2 and the primary of T_2 . The entire pattern disappears as the mercury drop falls, but the interruption is only momentary.

The foregoing circuit arrangement was used with a slight modification by the Dutch workers Boeke and van Suchtelen⁵. By applying the

Communications from Westinghouse

Capacity is available to produce the following products for early delivery to communications equipment manufacturers. Watch this board for latest lists of manufacturing capacities.

PRESTITE—CERAMICS

"Solder-Seal" hermetically tight bushings and terminal boards. Mechanical bushings, standoff insulators, coil forms. Grade "F" characteristics.

BI-METAL THERMOSTATS

Both strip and disc type. Overheating or Temperature Control for cooling systems, crystal ovens, etc.

HIPERSIL TYPE "C" CORES

Three grades of two-piece, laminated steel cores for power, audio, intermediate radio and higher frequencies. Space factors 95%, 92% and 89%. Windows down to $\frac{1}{2}$ " x $\frac{1}{4}$ ". These cores do not require dies or nickel.

AND BLOWERS AND BLOWER MOTORS

400-800 cycle models, 6700 rpm, for cooling radio transmitters, magnesium housings.

RECTOX—RECTIFIERS

Copper oxide rectifiers for power packs, instruments, etc.

MICARTA—PLASTICS

Phenol-formaldehyde, thermosetting. 11-NEMA Grades including XXX, X, P, and LE. Plates, shapes, punchings, moldings.

DYNAMOTORS

Types PE-59, 60, 86; DM-25, 32, 33, 34, 35, 36, 45, 53. Now in production.

TUFFERNELL INSULATING MATERIALS

Varnished cambric and cotton tapes; synthetic, air drying and baking varnishes; thinners; compounds and enamels.

INERTEEN CAPACITORS

Nonflammable, hermetically-sealed, very compact. Ratings from 10,000 to 100,000 volts.

J-94556



For further information on products or deliveries, wire or write Communications Division, Dept. 10-L, Westinghouse Electric and Manufacturing Company, East Pittsburgh, Pennsylvania.

Westinghouse

PLANTS IN 25 CITIES... OFFICES EVERYWHERE

... you've never heard any finer recordings than the results you'll get when using the now famous

GOULD-MOODY "Black Seal" glass base instantaneous RECORDING BLANKS



"Black Seal" Glass Base Instantaneous Recording Blanks have been one of the really outstanding achievements in radio during the year 1942. Broadcasting's keenest ears were given a new delight, a bang-up thrill as they listened to recordings made with these blanks. What are you waiting for? The time is now to install "Black Seal" as a definite, necessary part of your own equipment. Order a trial supply. Try them out under your most exacting conditions. If you're not entirely convinced, not entirely satisfied—we'll stand all the expenses!



Old Aluminum Blanks Recoated with the "Black Seal" Formula in 24 Fast Hours!

Eliminate broken records! Ship with safety in the new Gould-Moody PackARTON,* a perfected, light-weight, corrugated container that not only protects your records but also reduces your shipping costs. Write for details.

No waiting! No delay! Gould-Moody "Black-Seal" Blanks will be shipped immediately. Styli and shipping cartons supplied at actual cost.

*Reg. U.S. Pat. Off.

the GOULD-MOODY company

Recording Blank Division

395 BROADWAY

NEW YORK, N. Y.



alternating potential to the horizontal plates in place of the usual sweep circuit voltage, they secured the traces shown in Fig. 4 as the applied direct voltage was successively increased in steps. Trace *a* is symmetrical, indicating that the voltage is lower than the decomposition potential. Trace *b* is unsymmetrical, corresponding to region *b-c* in Fig. 2. Trace *c* is symmetrical and indicates that the half-wave potential has been reached. Traces *d* and *e* show the effect of changing the direct voltage 0.2 volts higher and lower respectively than that for *c*.

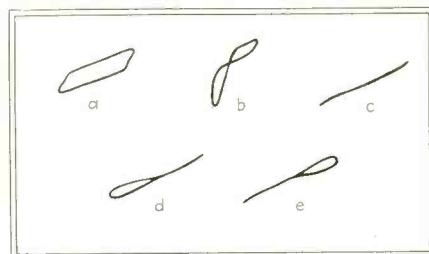

Fig. 4—Traces obtained on an oscilloscope as the direct voltage is increased in steps. The potentiometer is adjusted until the pattern at *c* is obtained, and the direct voltage giving this pattern is then the characteristic half-wave potential of one substance in the solution. Complex solutions containing as many as six different substances may be analyzed in a few minutes by this method

Interest in polarographic methods has lately been stimulated by publication of a comprehensive monograph by Kolthoff and Lingane⁶, two of the leading workers in this field.

In conclusion, the author points out that the polarograph is finding many uses in industry, especially in metallurgy and in the control of processes where even minute traces of metallic contamination are to be avoided. Recent work has been done on the determination of organically bound arsenic used in the treatment of disease, and other applications to biological chemistry are anticipated. The method also makes it possible for the first time to distinguish between tervalent and pentavalent compounds.

REFERENCES

- (1) Heyrovsky, J. *Chem. Listy*, 16, 256, 1922. *Phil. Mag.*, 45, 303, 1923.
- (2) Heyrovsky, J. and Shikata, M., *Rec. trav. chim.*, 44, 496, 1925.
- (3) Matheson, L. A. and Nichols, N., *Trans. Am. Electrochemical Soc.*, 73, 193, 1938.
- (4) Muller, R. H., Garman, R. L., Droz, M. E. and Petras, J. *Ind. Eng. Chem., Anal. Ed.*, 10, 339, 1938.
- (5) Boeke, J. and van Suchtelen, H., *Philips Tech. Rev.*, 4, 213, 1939.
- (6) Kolthoff, I. M. and Lingane, J. J., *Polarography*, Interscience Publishers, Inc., New York, 1941. (This monograph contains numerous additional references.)

LONG LIFE *PROVED*

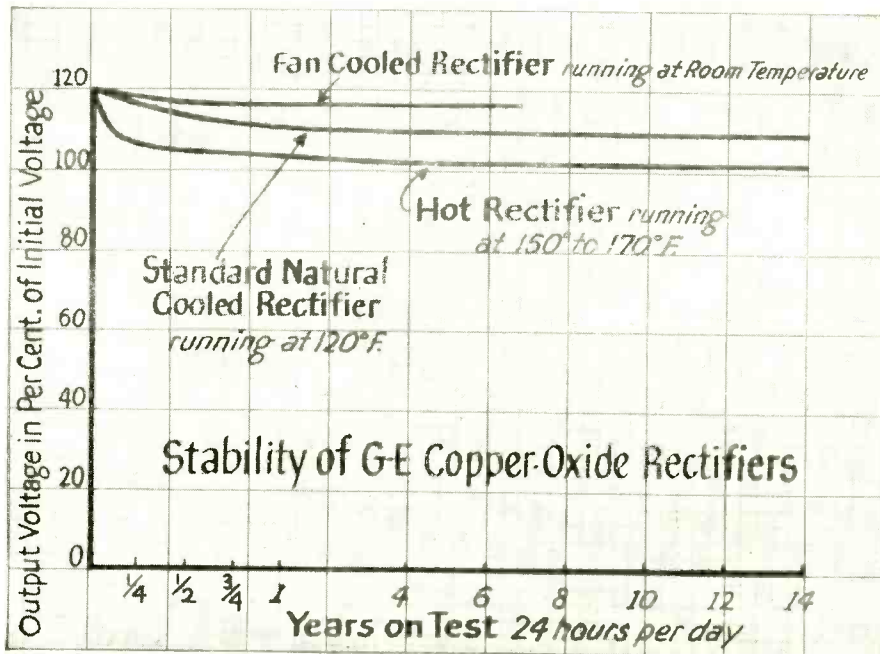

Full rated output is available through entire life of G-E Copper Oxide Rectifiers because of extra conservative initial rating.

For G-E Copper Oxide Rectifier **STACKS**

In 1928 General Electric Company set up operating tests on a group of Copper Oxide Rectifiers. Twenty-four hours a day for fourteen years these tests have continued without interruption. And they're still running.

As a result of this and subsequent tests we know that G-E Copper Oxide Rectifier Stacks have an apparently unlimited life when operated within their rated capacities, in accordance with operating instructions and when given normal care.

Whatever your direct current requirements, you can depend on G-E Copper Oxide Rectifier Stacks. They provide maximum flexibility for high efficiency, and contain no moving parts to wear out and require replacement.

Here are a few typical applications: Electroplating and Anodizing, Battery Charging, Cathodic Protection, Control Circuits, Elevator Control, Field Excitation, Magnetic Clutches, Relays, Signal Circuits, Telegraph & Telephone.

For additional information on how G-E Copper Oxide Rectifiers can be applied to your specific needs, write to Section A436-119, Appliance and Merchandise Dept., General Electric Company, Bridgeport, Conn.

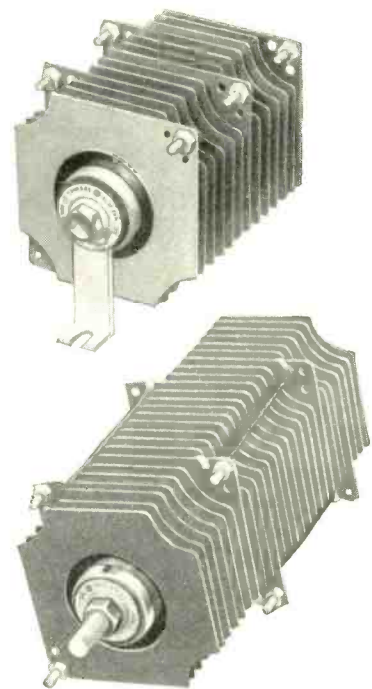

GENERAL ELECTRIC

Right of Way to
AMERICA!

Radio carries to countless homes the urgent war-time messages of war-time America. And Blaw-Knox towers are helping to maintain this great service at maximum dependability and with maximum coverage.

BLAW-KNOX
VERTICAL
RADIATORS
FM & TELEVISION TOWERS

BLAW-KNOX DIVISION
of Blaw-Knox Company
2077 Farmers Bank Building
Pittsburgh, Pa.

DISTRIBUTOR
Graybar
ELECTRIC COMPANY

Combining of Phase-Shifted Rectified Sine Waves

THE RESULTS OBTAINED by combining rectified sine waves in various phase relations are described in a 54-page report by J. T. Tykociner and L. R. Bloom in University of Illinois Engineering Experiment Station bulletin No. 339 (Urbana, Illinois; price 60 cents). The properties of waveforms obtained by subtraction or addition of two phase-shifted rectified

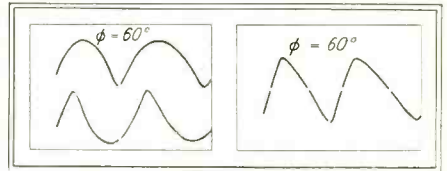

Fig. 1—When rectified pulses differing in phase by 60 deg. are subtracted, the saw-tooth waveform shown at the right is obtained. The greater the phase difference, the sharper the saw-tooth pattern

sine waves are investigated graphically and analytically for various phase angles, and a number of oscillograms are reproduced. One example, in which rectified waves shifted by 60 deg. are subtracted, is shown in Fig. 1. Methods of producing phase-shifted rectified sine waves in various frequency ranges are covered and circuits are given. The waveforms obtained by combining rectified pulses with full sine waves are also considered.

• • •

Electromechanical Calculator for Directional Antennas

RADIATION PATTERNS of a directional antenna array can be drawn with ease for any desired elevation angle by an electromechanical calculator described by Carl E. Smith and Edward L. Gove in the February 1943 issue of *Electrical Engineering*. Once the desired antenna parameters have been set up, the machine draws the field-intensity curve for the desired conditions on polar coordinate paper and indicates the rms value for drawing a circle of the equivalent non-directional pattern. The directional arrays may have any number of antennas. If desired, the pattern can be viewed on an oscilloscope screen, and parameters adjusted until a particular desired pattern is obtained. The whole hemisphere of an array can be explored in a relatively short time, eliminating laborious computations, and the total power radiated by the array can be determined.

★

NORTH AMERICAN PHILIPS COMPANY

★

Electronic Research and Development



PRODUCERS for Victory—of Tungsten and Molybdenum in powder, rod, wire and sheet form; Tungsten Alloys; Fine Wire of all drawable metals: bare, plated and enameled; Diamond Dies; Electronic Test Equipment; Cathode Ray Tubes; Amplifier Tubes, Rectifier Tubes; Transmitting Tubes; Oscillator Plates.

X-Ray Apparatus for industrial, research and medical applications. (Philips Metalix Corp.)

NORTH AMERICAN PHILIPS COMPANY, INC.

Factories in Dobbs Ferry, N. Y., Mount Vernon, N. Y. (Philips Metalix Corp.) Lewiston, Me. (Elmet Division).

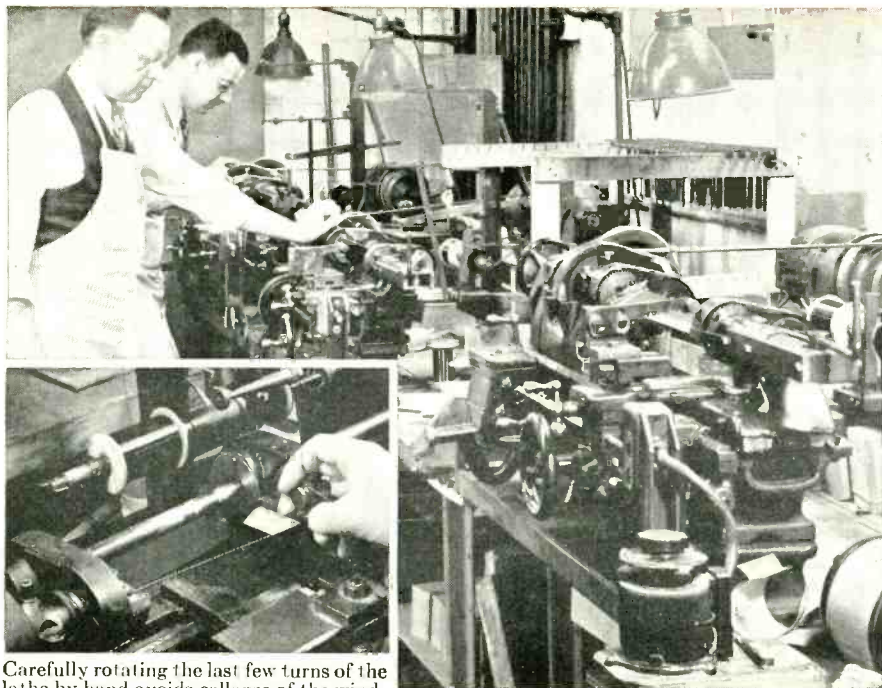

Carefully rotating the last few turns of the lathe by hand avoids collapse of the winding on the steepest slope of cards with a logarithmic taper. These logarithmic units can be used *with* an external series resistor to obtain a truly logarithmic resistance, or *without* the series resistor to give the steepest possible slope to the resistance characteristic.

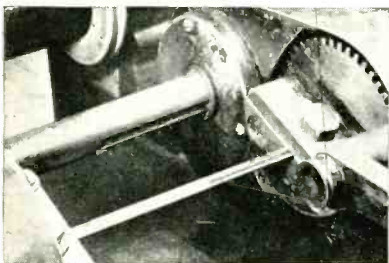

Putting the *second* winding on an Ayrton-Perry, or non-inductive, resistance unit. This unit is used as the output control in a standard-signal generator operating at frequencies up to 50 megacycles.

Although the winding of all resistance cards for General Radio potentiometers is essentially automatic, experienced workmen adapt the winding speed to each particular unit through Variac control of the motor drive.

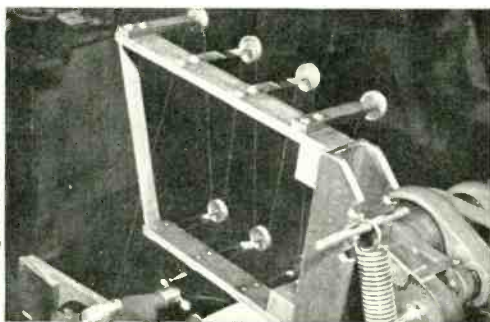

Spring-mounted pulleys absorb variations in wire tension as the card turns. Constant tension is provided by a spring device on the shaft carrying the spool of wire.

How G. R. Rheostat-Potentiometers are Wound

The resistive elements are wound on flat fabric-base phenolic cards, which are then bent around molded cylindrical forms. To achieve definite resistance characteristics — linear, parabolic, or logarithmic — many sizes and shapes of cards are used. More than one size of wire on a single card necessitates abrupt changes in card width. For non-inductive units, two similar windings in opposite directions on a single card are necessary.

General Radio has developed winding methods and adapted standard lathes to produce all these various windings. Constant-tension devices and automatic feed insure precise control of winding. The finished resistance element has turns accurately spaced and presents a smooth uniform surface to the sliding contact. This results in long life and trouble-free operation.



General Radio instruments use a wide variety of these variable wire-wound resistors as calibrated controls in bridge and other measuring circuits. Originally designed for our own use, these rheostat-potentiometers are essential elements in many electronic instruments and are now widely used by other manufacturers of precise electrical equipment.



GENERAL RADIO COMPANY
Cambridge, Massachusetts

NEW YORK

LOS ANGELES

Magnetostriction Made Visible

RAPID MEASUREMENTS of magnetostriction effects in transformer core samples can now be made to a fraction of a millionth of an inch as a routine semi-production procedure, according to Stephen C. Leonard writing in the November 1942 issue of the *General Electric Review*. His article points out that designers of induction apparatus are becoming increasingly aware of possible relations between magnetostriction in core materials and audible sounds such as the hum of a transformer core or a refrigerator motor. The problems involved in developing a satisfactory equipment for routine testing are analyzed, and a successful visual method utilizing a pair of optical flats as the indicating device is described.

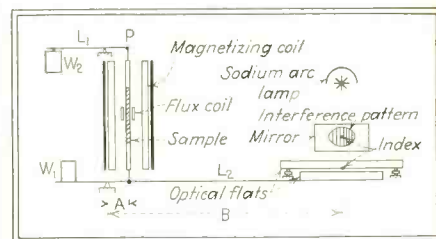

Fig. 1—Schematic diagram of the optical-mechanical system which is capable of magnifying movements due to magnetostriction 500,000 times with an accuracy of 12 percent or better

The arrangement of the optical system is shown in Fig. 1. The sample under test is mounted between lever arms L_1 and L_2 in such a way that any change in the length of the sample will change the spacing between the two optical flats. Sodium light projected normal to the flats produces an interference pattern dependent upon the spacing between the flats. Any change in the spacing can thus be measured directly in terms of the wavelength of sodium light by counting the number of interference lines which appear to pass the reference index mark as the sample is magnetized.

A movement of one light and one dark band across the reference index represents a change in spacing equal to one-half wavelength of sodium length, or 11.6 millionths of an inch. By making the lever-arm ratio (B/A) equal to 11.6 to 1, a direct-reading scale of magnetostriction is obtained in which each division (consisting of one dark and one light line) is equal to a millionth of

WANT TO MEASURE THE INDIVIDUAL COMPONENTS OF A COMPLEX WAVE?



Model 300A will do this and make many another measurement

Variable selectivity feature makes this instrument outstanding . . . permits measurements that would otherwise be impractical. Examples: measuring distortion of sound recordings on film, disc and in other cases where there may be slight frequency modulation; integrating noise spectrum in acoustic measurements or for other purposes where a wider pass band gives a more representative integration. The wider pass band permits more rapid measurement of filter characteristics in the laboratory or in production. The maximum selectivity is sufficient for measurements as low as 30 cycles.

FULL SCALE METER READINGS FROM 1 MV TO 500 VOLTS
The wide voltage range covers the values encountered in nearly

every application. The meter, which is fully protected against overloads, is linear and the various scales have ample overlap for accurate readings. A built-in calibrating system enables you to standardize the voltage measurements. Calibrating controls and meter are at bottom of the panel as can be seen in the illustration.

The overall voltage accuracy is $\pm 5\%$, the input impedance is 200,000 ohms, the voltage regulated power supply operates from 110 volts 60 cycles. Here is an instrument designed throughout for ease of operation and for accuracy which will be maintained over long periods of time. Write for further particulars. A 24-page catalog of *-hp-* instruments contains much valuable information relative to electronic measurement devices. A copy of this fully illustrated catalog will be sent you upon request. No obligation, of course, but mail your request early for the edition is limited.

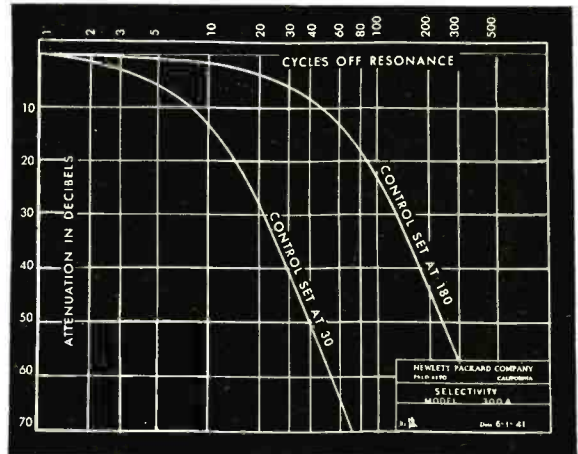
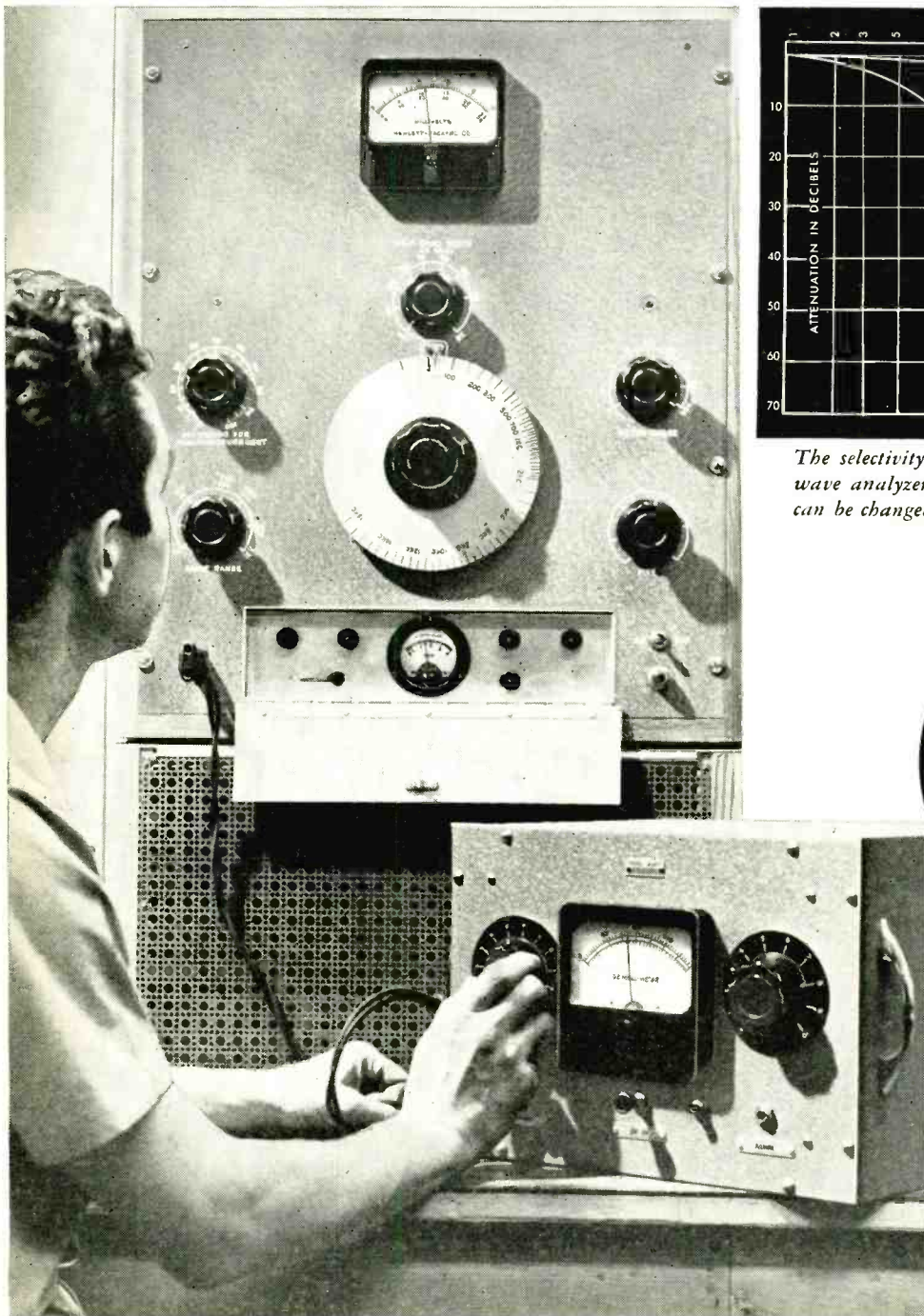

The selectivity characteristic of the Model 300A wave analyzer is shown above. The band width can be changed to any value between these curves by a turn of a knob



**HEWLETT-
PACKARD
COMPANY**

**BOX 135 C STATION A
PALO ALTO, CALIFORNIA**

IMPORTANT Announcement

Our Engineering facilities have been enlarged. The Production Capacity of our plant has been increased. We are now ready to handle additional contracts.

WE MANUFACTURE

Power Transformers—Plate Transformers—Reactors—High Quality Audio & Supersonic Transformers. High Fidelity Transformers. Wave filters—High Q. Chokes.

WE SPECIALIZE

In the development and design of all audio, electronic and supersonic systems.

WE MAKE

Transformers for Air Borne Equipment.

OUR TRANSFORMERS

Can be designed to meet any Temperature or climatic condition.

HERMETICALLY SEALED

To meet any specification.

Inquiries are Cordially Invited

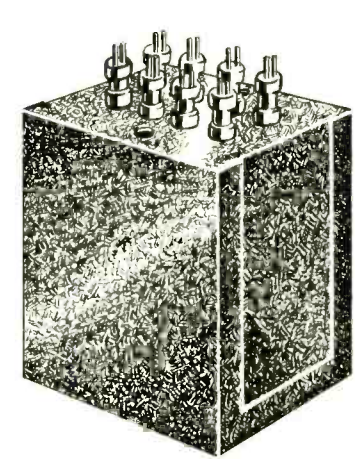

FREED **TRANSFORMER** Company
72 Spring St., New York, N. Y.

an inch. Furthermore, by slightly changing the tilt between the two optical flats, the interference bands can be spread out so that each division covers a distance of half an inch in the mirror mounted above the flats. This is equivalent to an overall magnification of 500,000 times for changes in the length of the sample.

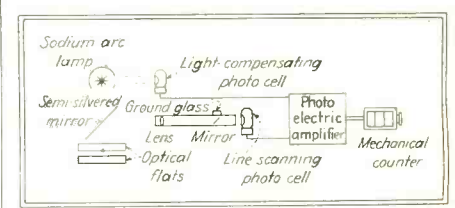

Fig. 2—Photoelectric arrangement for counting moving interference lines. Each number indicated on the mechanical counter represents a change in length of a millionth of an inch

The major portion of the article deals with methods of eliminating temperature effects, adjusting techniques, simultaneous measurements of flux density, and a consideration of practical problems involved in making factory tests. From one to four samples per hour can be tested by a trained operator, depending upon the amount of data desired.

In tests requiring the counting of a large number of moving lines, the interference pattern can be projected optically onto a photoelectric cell connected to a sensitive amplifier and a mechanical counter, as shown in Fig. 2.

• • •

Method of Predicting A-F Harmonic Distortion

A RELIABLE and essentially practical method of estimating the amount of harmonic distortion produced by an a-f transformer from transformer design data, operating conditions and the characteristics of the core material is described in a paper by Norman Partridge entitled "An Introduction to the Study of Harmonic Distortion in Audio Frequency Transformers" in a summer 1942 issue of the *Journal of the British Institution of Radio Engineers*. The author believes this to be the first recognized procedure for predicting harmonic distortion with accuracy. The same subject is treated more formally and at greater length in a series of articles in the British publication *Wireless Engineer*.

TOMORROW'S RADIO

TODAY

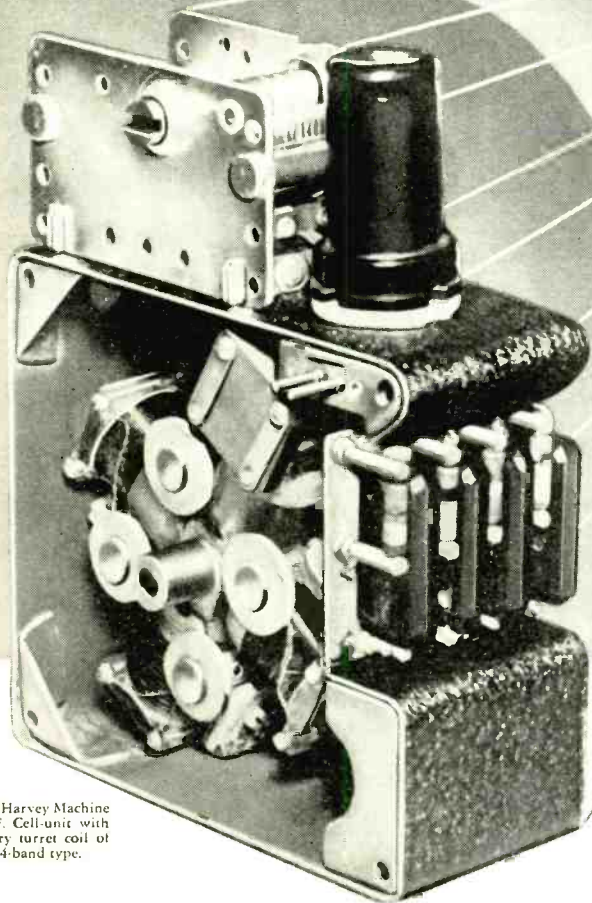

The Harvey Machine R. F. Cell-unit with rotary turret coil of 4-band type.

1 TUBE TYPE, 3 BASIC CELL UNITS, 75% LESS HOOK-UP WIRE

HARVEY "UNITIZED" RECEIVERS

Streamlined Production through use of standardized cell-units requiring only one tube-type, one capacitance of tuning condenser, a minimum of resistor types, and only two values of by-pass condensers.

Streamlined Assembly with standardized R. F., I. F. and Audio cells, which are basic for all electronic assemblies — assembled to provide selectivity, sensitivity, and frequency bands to meet customer requirements.

Streamlined Servicing. In event of damage to a cell-unit, replacement is as simple as tube changing — for quick repair. No solder, special tools, or circuit diagrams needed.

Other Divisions

Aircraft • Ordnance • Special Machinery

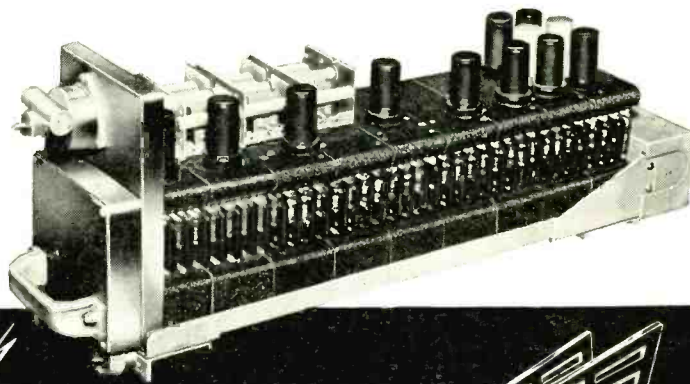

Electronics Division

HARVEY

MACHINE CO., INC. • 6200 Avalon Blvd., Los Angeles, California

for over a quarter century geared for flying production

★
MASS PRODUCTION
★
CUSTOM-BUILT PERFORMANCE

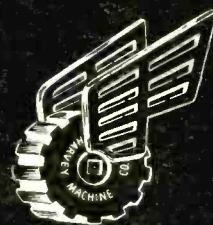

CANNON TYPE "P"



...ideal Connector for Radio and Sound

A connector designed over a decade ago to meet the primary needs of the electronics engineer, it is, today, the recipient of wide acclaim in the fields of radio, sound and television.

It effectively solves the problem of conveying low-level circuits and small power applications, and is dependable under all conditions.

The practical features of the Type P Connector, *the full floating socket and rigid pin insert which serve to eliminate excessive strain on contacts . . .* together with its rugged construction and compactness, make this plug highly desirable wherever there is limited space or need of speedy coupling.

The precision engineering back of the Type P Connector and the features designed to aid the user are typical of every item in the Cannon family of dependable connectors.

The Cannon Catalog Supplement gives data on Type P and seven other types of Connectors. Make request on your business letterhead and we'll send you a copy. Address Department U, Cannon Electric Development Company, Los Angeles, California.



CANNON ELECTRIC

Cannon Electric Development Co., Los Angeles, California
Canadian Factory and Engineering Office: Cannon Electric Co., Ltd., Toronto

REPRESENTATIVES IN PRINCIPAL CITIES—CONSULT YOUR LOCAL TELEPHONE BOOK

Measuring Rotational Speeds With Stroboscopic Patterns

A DISC WITH NINE equally-spaced radial lines can be used in connection with a Strobotron or other modern stroboscopic lamp connected to a 60-cycle a-c line for determination of speeds of rotation between 400 and 7200 rpm. Accuracy is only slightly less than that at which the power line frequency itself is maintained, both for fixed points at which stationary patterns are observed and for intermediate speeds at which the rate of precession or recession of a moving pattern must be considered. The entire speed-measuring procedure is described in detail in an article by D.A. MacInnes entitled "The Use of Stroboscopic Patterns in the Determination of Speeds of Rotation" in the January 1943 issue of *Review of Scientific Instruments*.

Speeds at which stationary patterns are observed when using a 60-cycle source can be determined by the formula: $\text{rpm} = 3600m/n$, in which n is the number of radial lines visible in the pattern and m is the "multiplicity," all values of m being excluded which make m and n have a common factor for a given condition. Thus, a three-line pattern can mean 1200, 2400, 4800 or 6000 rpm, but not 3600 rpm because that gives a single-line pattern.

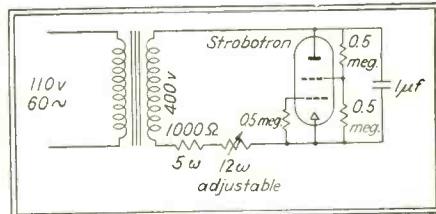
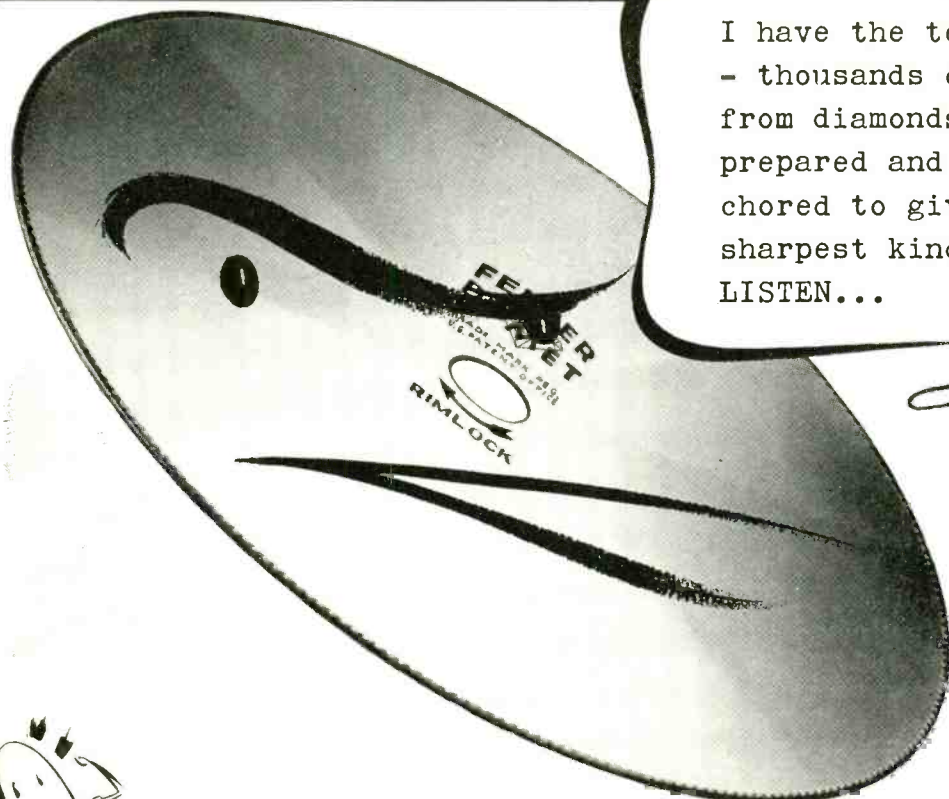

Fig. 1—This simple circuit produces 3600 flashes of intense light per second

To utilize this method, it is necessary to know the approximate speed. This can be determined with an inexpensive speed indicator or other means, or by noting the sequence of patterns observed as speed is changed and comparing with a table based on the foregoing speed formula. Intermediate speeds are determined by the fact that all of the patterns rotate at a rate dependent only upon the difference between the actual speed and the speed at which the pattern is stationary. Thus, if a five-line pattern with a stationary speed of 1440 rpm is turning ten times per minute in the direction of

I PUT TEETH

behind any man's quartz program



I have the teeth, too
- thousands of them - made
from diamonds specially
prepared and an-
chored to give me the
sharpest kind of a bite.
LISTEN...



NEVER A DULL MOMENT!

Stamina? When I leave the factory I'm really in condition - hand straightened, they call it - nicely broken in and waiting for a chance to mow through that quartz. Guess I keep going because I hang on to my teeth and have plenty of 'em to start with.

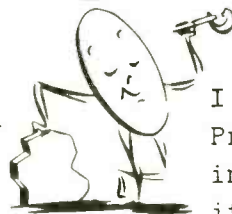

I HOLD 'EM ON THE NOSE, TOO. Precision's the word! I get in the groove and stick to it. No wavering, no runout, but perfectly smooth, parallel cuts morning til night.

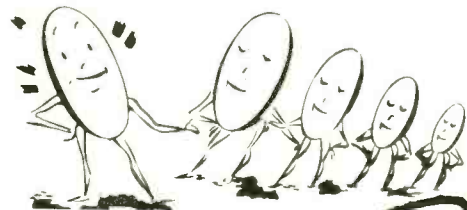

HOW BIG AM I?

Heck, my brothers and I vary from 4" to 24" in diameter. There's a 3" baby in the family, too!

DI-MET

Rimlocks

FOR SPEED...FOR ACCURACY...FOR LONG LIFE

* We're sort of busy now, but if it's more WAR WORK, you can count on us!

FELKER MANUFACTURING CO.
1116 BORDER ST., TORRANCE, CALIF.

MANUFACTURERS OF DIAMOND ABRASIVE WHEELS

1 ROTOBIDGE + 1 Unskilled Girl = 120 Tested Electronic Circuits in 4 Minutes

A practical application of this equation at one of the larger plants produces a result that production wise engineers cannot afford to ignore. Turned loose on a certain complex wire check, resistance and reactance test, the Rotobridge breezes through the same routine in 10 minutes, including handling time. Furthermore better accuracy of measurement is obtained, and errors caused by fatigue or carelessness are eliminated.

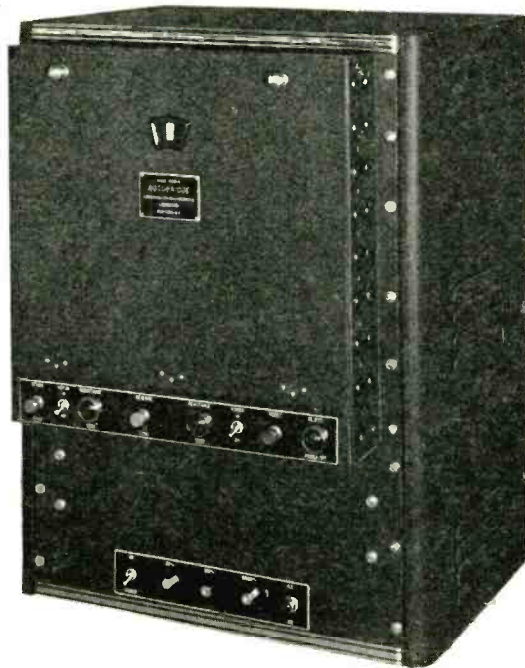

The time for static tests is reduced to less than 10% of that previously required. While the Rotobridge is taking care of this operation, the skilled testers previously employed on this job are devoting their entire time to dynamic testing.

ROTOBRIDGE

**An AUTOMATIC, HIGH SPEED
Mass Production Tester**

Of course there's more to the story—Rotobridges are sprouting all over the place, checking sub assemblies, chassis, and finished equipments ranging in size from "6 tubers" to a 45 tube giant that requires three ROTOBRIDGES to give it a complete test.

Unless you have an oversupply of skilled testers, we believe the Rotobridge can help you too. Complete information on this new testing technique will be mailed on request. Demonstrations for engineers and production men will be made at our plant by appointment.

COMMUNICATIONS MEASUREMENTS LABORATORY

131 LIBERTY ST., N.Y.C.

WHitehall 4-7275

rotation, the actual speed is 1450 rpm.

A simple circuit for operating a stroboscopic lamp at the line frequency is given in Fig. 1. A standard broadcast receiver replacement transformer having a secondary voltage of about 400 volts is used. The tube is a General Radio Strobotron tube.

• • •

Diodes as Frequency Changers

THE MATHEMATICS INVOLVED in using a diode as a frequency-changer for reception of very short wavelengths is covered in two papers appearing in the January 1943 issue of *Wireless Engineer*. This type of converter is often used with the local oscillator set to a sub-multiple of what it would normally be for super-heterodyne reception. A number of theoretical conclusions are presented, some confirmed by measurements at frequencies up to 600 megacycles. The conversion factor is greater than 90 percent for oscillator voltages in excess of 2 or 3 volts, and is essentially independent of the oscillator voltage. With a suitable d-c load resistance, the diode current is of sharply impulsive character, and the local oscillator may be set at half, third or even a fourth of the signal frequency plus or minus the beat frequency with little loss of conversion ratio. Performance formulas are deduced from an equivalent circuit consisting of a pi network of resistances.

• • •

Electronic Coil-Turns Counter

A CIRCUIT CAPABLE OF counting the number of turns in a coil to an accuracy of 1 turn in 500, on coils up to 4½ inches long with minimum inside diameter of ⅜ inch and with up to 111,000 turns, is given in the November 1942 issue of *Electronic Engineering*. The apparatus was developed by the Metropolitan-Vickers Electrical Co. of Great Britain and is sufficiently automatic for routine work. The coil to be tested is placed on an iron core along with a tapped standard coil, and connected in opposition to the standard coil. Decade-type selector switches are then adjusted for zero galvanometer deflection, indicating that both standard and test coils have the same numbers of turns. The decade switches then indicate directly the number of turns in the unknown coil.

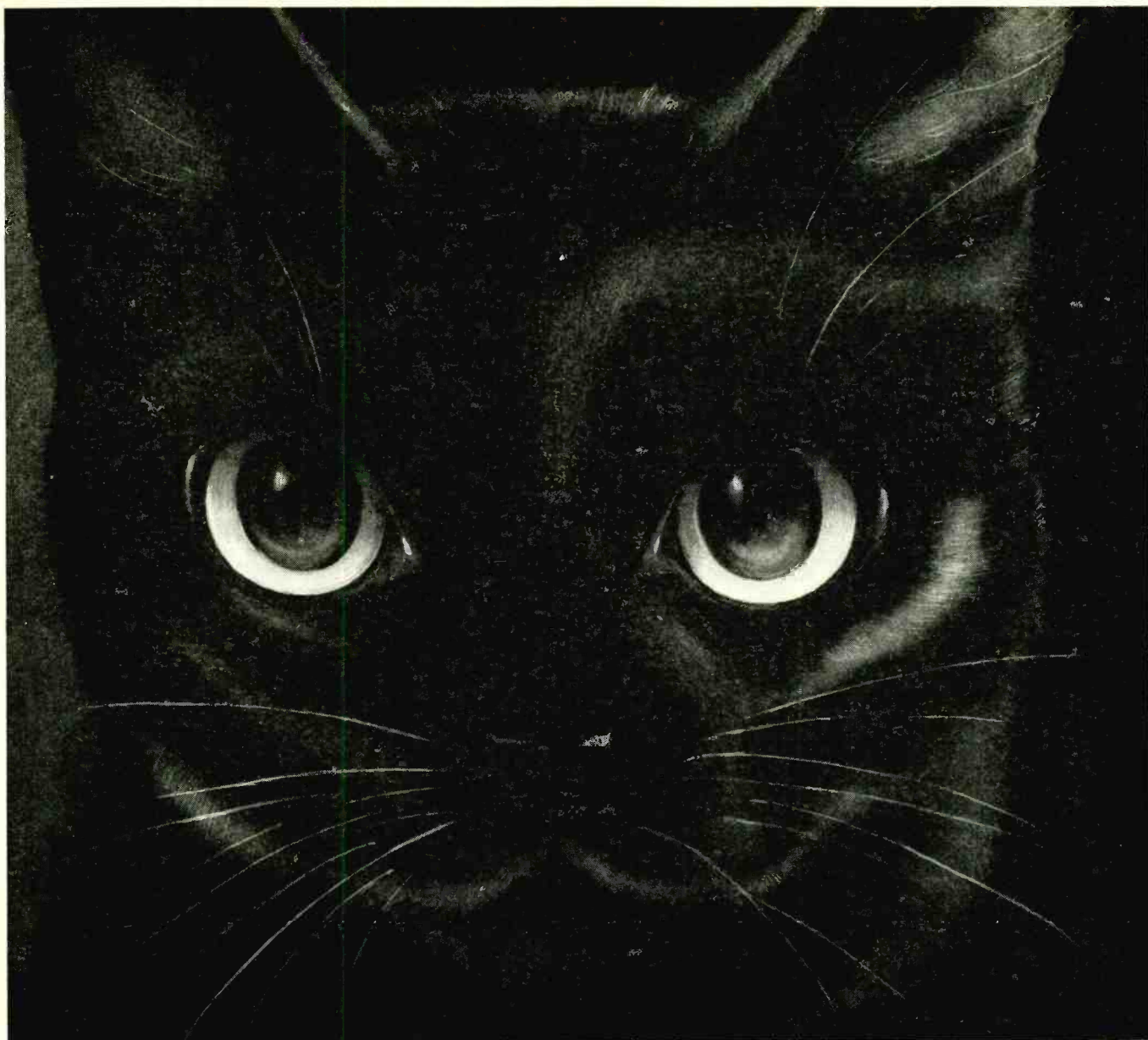

Equipment for Combat

TO see in the dark and to see at a greater distance ...to push back the clouds and fogs of ignorance has been since the beginning of time one of man's greatest aspirations.

Spurred by war, the scientific laboratories of the nation are making tremendous strides toward meeting this aspiration.

In every branch of the services our fighting men are now armed with electrical devices which enable them to pierce the black of night, the depths

of the ocean and the clouded skies. Already much of our success over our enemies on land, sea and in the air has been achieved through the use of these "electrical cats."

The peacetime possibilities of these devices which pierce the darkness are limitless.

In the very forefront in the design and manufacture of these developments stand Western Electric and its engineering organization, the Bell Telephone Laboratories.



Western Electric

ARSENAL OF COMMUNICATIONS EQUIPMENT.



Engineers . . .

A number of interesting, well paid positions open with Fairchild Aircraft



THIS LONG ESTABLISHED major aircraft company now has many positions in its Engineering Department open to engineers with previous aeronautical experience and to engineers who may not have had such experience.

Fairchild needs aeronautical, structural, mechanical and electrical engineers.

It needs architects, draftsmen, machine designers and others similarly qualified.

These positions are highly interesting, confidential, have to do with the unique development of military cargo-carrying aircraft. They offer splendid chances for advancement, financially and otherwise.

Candidates should have at least a high school education and 5 years of actual engineering or drafting experience. Age range 28 to 50. They must be American citizens. Those now employed at their highest skills in war work will not be considered.

In replying please send photo (any kind) and give details of experience, education and general background. Replies will be treated confidentially.

Address: Engineering Department D, Fairchild Aircraft, Hagerstown, Md.

AIEE Bibliography Available on Automatic Power Stations

SUPPLEMENTING earlier bibliographies on the subject, the publication "Bibliography on Automatic Stations, 1930-1941" is now obtainable from AIEE headquarters, 33 W. 39th St., New York City at 25 cents for AIEE members (50 cents to non-members). Entries are arranged alphabetically by years in eight sections: General; supervisory and remote control; telemeter and telemetry; automatic and remote-controlled switches and switchgear; automatic boiler and combustion control; automatic hydroelectric plants; automatic substations.

Concentricity Tester for Enamel Film on Wire

AN ELECTRONIC CIRCUIT which makes it possible to measure the thickness or concentricity of enamel insulation on a sample of magnet wire in about one minute is described by Elmer F. Hansen in the Nov. 1942 issue of *General Electric Review*. The sample of wire is inserted in a turning chuck and placed over two brass plates mounted end to end in the same plane. An insulating block applies pressure to hold the wire flat against the plates. This gives two capacitances in series between the brass plates; the copper wire is the common conductor and each brass plate serves as a conductor, with the film of enamel acting as the principal dielectric for each capacitance. This series connection eliminates the necessity for scraping off insulation.

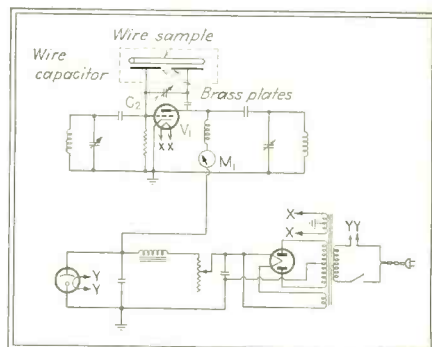

Fig. 1—Basic electronic circuit for measuring the thickness of enamel insulation on wire at production speeds

Changes in film thickness change the capacitance over a range of 5 μf to 7 μf for an average wire samples with varying degrees of concentric-

NOW!

Erie "Hi-K" Ceramicons

REG. U. S. PAT. OFF.

IN CAPACITIES UP TO 16,000 MMF

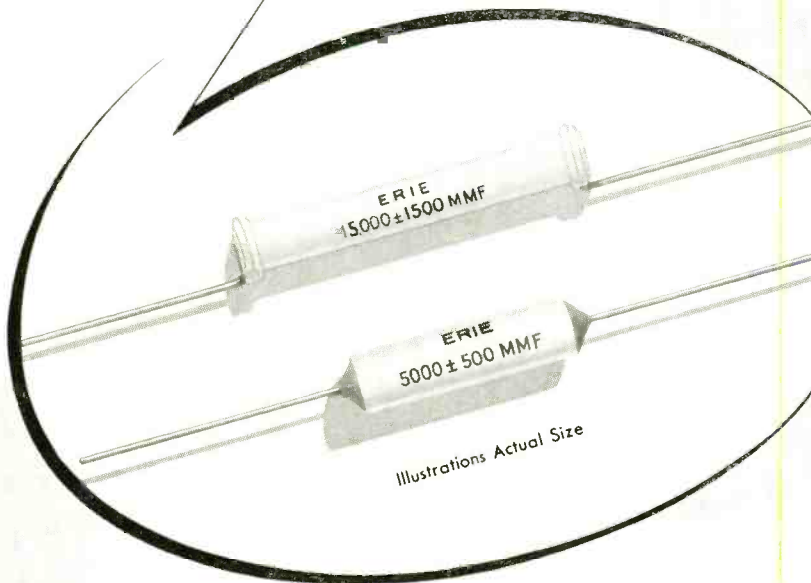

Capacity Range: Maximum capacity, insulated style 5,600 MMF; Non-insulated, 16,000 MMF. Minimum tolerance, $\pm 10\%$.

Working Voltage: 500 volts D.C. up to 60° C. Flash test 1,000 volts D.C.

Maximum Power Factor: 2.5% at 25° C.

Initial Leakage Resistance: Over 5,000 megohms at 1,000 volts D.C. at 25° C.

COMPACT, HIGH CAPACITY, CERAMIC CONDENSERS

ERIE is now in production on a group of new "Hi-K" Ceramicons in capacities up to 16,000 MMF. Behind these units are nearly 7 years of experience in producing silvered-ceramic condensers and over 1½ years of research and development of these high dielectric ceramic units.

Present Erie "Hi-K" Ceramicons have a dielectric constant (K) of 1050 at 25°C, and are available in the capacity range listed above. Insulated units are encased in a sealed ceramic sleeve. Non-insulated units have an extremely hard white protective coating.

The announcement of Erie "Hi-K" Ceramicons has been purposely withheld until they were developed to a point where they would successfully fulfill present day requirements. These units have very high and changing temperature coefficient and are recommended for use as by-pass or blocking condensers where high stability and high leakage resistance is not essential. The ratings of these capacitors, shown in the above panel, are conservative and are indicative of their operating performance.

Interested engineers are invited to write for samples to test in their laboratory.

ERIE RESISTOR CORP., ERIE, PA. LONDON, ENGLAND · TORONTO, CANADA.

Designed for



Application

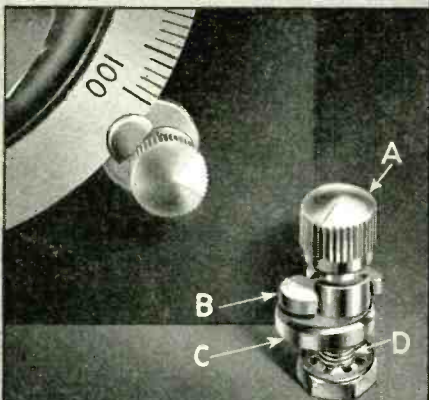

FULL SIZE

The No. 10050 Dial Lock

Designed for application! Compact, easy to mount, positive in action, does not alter dial setting in operation! Rotation of knob "A" depresses finger "B" which firmly pinches dial between "B" and "C" without imparting any rotary motion to Dial. Single hole mounted by means of shank "D". Made of brass —Standard finish Nickel.

**JAMES MILLEN
MFG. CO., INC.**

MAIN OFFICE AND FACTORY
**MALDEN
MASSACHUSETTS**



ity. This change is measured by connecting the brass plates to the grid and plate circuits respectively of an oscillator, as shown in Fig. 1. An increase in film thickness causes a decrease in the connected grid-plate capacitance and an inversely proportionate increase in the d-c plate current of the oscillator. The deflection of the plate current milliammeter M_1 was found by test to be a linear function of film thickness.

A calibration in terms of the ratio of maximum to minimum film thickness was found more suitable for production testing because it remains accurate regardless of normal changes in circuit parameters with age, and is also independent of slight changes in oscillator frequency. In making a test, the wire sample is rotated to get minimum meter deflection, and sensitivity control C_2 is varied until a reading of 1.0 is obtained. The wire is then rotated for maximum deflection, and the ratio of maximum to minimum film thickness is read directly on the meter. The results are accurate to within about 5 percent.

• • •

MINE DETECTOR



This compact case and earphones is a British mine detector used by skillful and courageous engineers who sweep the desert before advancing troops. When the device detects a mine, certain sounds reach the earphones worn by "sappers" who then go about the task of unearthing the deadly mine and rendering it harmless. This detector played a big part in Britain's conquest of Egypt

Lingo

*—a name to remember when
the war is forgotten*

★
**VERTICAL TUBULAR
STEEL RADIATORS**

★
**PATENTED FM
TURNSTILE RADIATORS**

★
*We're "all out" for Victory,
but our engineers are ready
to work with you on
post-war plans.*

★
JOHN E. LINGO & SON, Inc.
CAMDEN, NEW JERSEY



Rare Gases and Mixtures

Airco Rare Gases are pure and free of active gases. Mixtures are blended uniformly and accurately. They are available in lead, glass or pyrex containers.

The individual gases as well as many standard mixtures are available both for production and experimental use. Special mixtures can be supplied to meet any need.

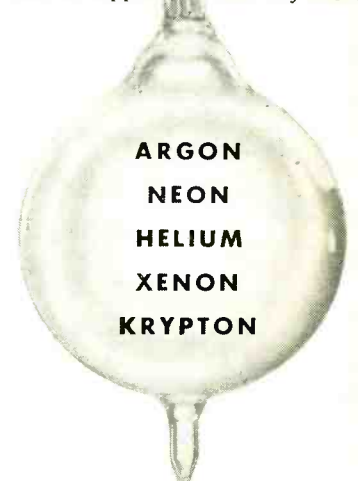

AIR REDUCTION

General Office: 60 E. 42nd ST., NEW YORK, N. Y.

April 1943 — ELECTRONICS

WITH OUR FEET ON THE GROUND

... and our eyes to the future

Today, with our feet firmly planted on the ground, we are producing vital electrical and electronic instruments to help win this war. But we also believe that the time to plan for tomorrow is today. That is why our engineering laboratories are working continuously, developing and designing instruments that will not only keep abreast of war-accelerated radio demands, but will also

meet the requirements of industry after the war.

★ ★ ★ ★

Illustrated are a few of the R.C.P. instruments now available. Others are described in catalog material available on request. If you do not find among these the instrument for your specific needs, our engineers will be glad to cooperate in solving your instrumentation problem.

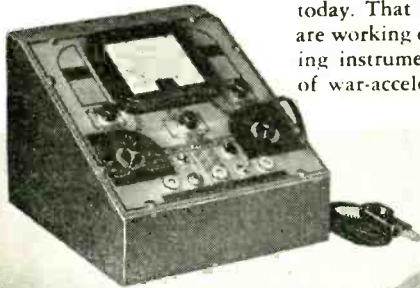

MODEL 662

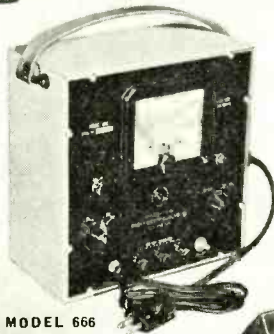

MODEL 666



MODEL 423



MODEL 461

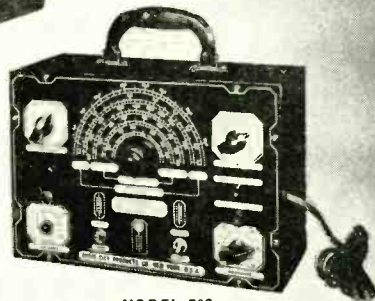

MODEL 703

SIGNAL GENERATOR MODEL 703

A sturdy test oscillator with a range from 95 Kc to 100 Mc. Fundamental frequencies in 5 bands variable from 95 Kc to 25 Mc. Has self contained 300 cycle modulation source.

VOLT-OHM-MILLIAMMETER MODEL 423

A multimeter with a meter movement of 2,500 ohms per volt. Has a uniform A.C.-D.C. voltmeter sensitivity of 1,000 ohms per volt. Voltmeter range to 1,000 volts. All multipliers individually matched to 1%. Suppressor type copper oxide rectifier used on A.C. readings.

VACUUM TUBE VOLTMETER MODEL 666

Essentially a peak voltmeter for accurate measurements over the entire a.f. range. Ranges are 0-3-6-30-150 volts, with meter movement of 0-200 microamperes. Uniform input resistance of 16 megohms for all ranges.

ELECTRONIC VOLT-OHM-CAPACITY METER MODEL 662

A true vacuum tube voltmeter for A.C. and D.C. combining sensitivity, flexibility and utility. Six range D.C. and 7 range A.C. voltmeter to 6,000 volts. Sensitivity 16 megohms on low and 160 megohms on high ranges. Ohmmeter range: 1 ohm to 1,000 megohms. Capacitymeter range from .00005 to 2,000 mfd. All measurements are direct reading.

ULTRA SENSITIVE MULTITESTER MODEL 461

A multimeter with a sensitivity of 20,000 ohms per volt on all D.C. measurements. Uses a wide scale meter with a movement of 50 microamperes. Readings as low as 1 microampere on 100 microampere scale. Six range A.C.-D.C. voltmeter to 5,000 volts.

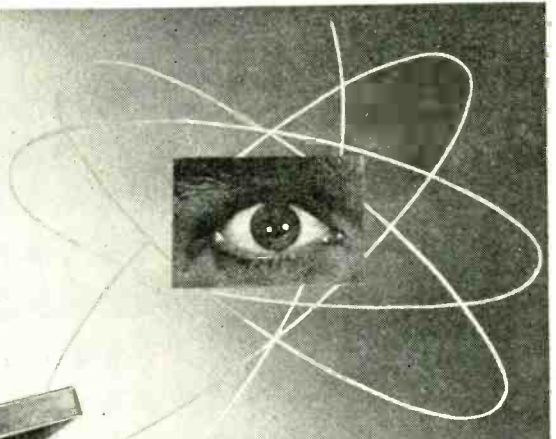

RADIO CITY PRODUCTS COMPANY, INC.

127 WEST 26th STREET



NEW YORK CITY

MANUFACTURERS OF PRECISION ELECTRONIC LIMIT BRIDGES—VACUUM TUBE VOLTMETERS
— VOLT-OHM-MILLIAMMETERS — SIGNAL GENERATORS — ANALYZER UNITS — TUBE TESTERS —
MULTI-TESTERS — OSCILLOSCOPES — AND SPECIAL INSTRUMENTS BUILT TO SPECIFICATIONS.

NEW JOBS IN TRAINED HANDS



**BELL
SOUND
SYSTEMS**

Official
U. S.
Navy
Photo

The electronic miracles that are playing so important a part in the war today were actually born *yesterday*. It was only through years of research and experiment by companies like BELL that they grew into practical realities.

That is why there were so many trained hands here at Bell Sound Systems — experienced hands ready to take over the new jobs that came with the war's sudden demands for all of the things electronics had to offer.

This advanced knowledge, which gave BELL a head start in meeting present-day needs, is being multiplied *many times over* as a result of Bell's vastly expanded production of electronic sound equipment. And although the nature of these war-vital electronic devices must remain secret for the time being, BELL engineers are already thinking in terms of the tremendous new possibilities they hold for a peacetime world. Naturally, BELL will have an even greater head start on *tomorrow's* electronic miracles than they had on today's.

The new BELL system for **INDUSTRIAL VOICE PAGING AND BROADCASTING**, and the new BELfone inter-departmental communication systems are available now for high-priority requirements. Write today for details!

BELL SOUND SYSTEMS,
Incorporated

1189 ESSEX AVE. COLUMBUS, OHIO

Export Office:

5761 EUCLID AVE. CLEVELAND, OHIO

NEWS OF THE INDUSTRY

New Signal Corps radio sets; latest FM log; replacement tubes and parts for civilian sets; technical employment information from the FCC, Navy and industry; data on new tubes; radio industry personnel and business news; how electronics aids in solving heat-transfer problems; new television station; CBC uses relay transmitters in western Canada

Navy Commissions Still Given

OFFICERS TRAINED in electrical engineering are needed by the Navy for work on ultrahigh-frequency electronic apparatus. Men with electrical engineering degrees and experience, or men who have majored in physics, mathematics or other fields dealing with a-c circuits and electronics are technically qualified for commissions. Those accepted as officers are given a three-month Navy u-h-f course either at Harvard or at Bowdoin College, followed by a three-month lab course at MIT. Qualified engineers are urged to apply for a commission at the nearest office of Naval Officer Procurement.

New Shortwave Station at Rio

WITH EQUIPMENT BUILT and installed by RCA Victor Division, a new 50,000-watt shortwave station is on the air at Rio de Janeiro, Brazil. Known as Radio National, it broadcasts nightly to North America on 26.5 meters.

Vital War Jobs Await Retired Skilled Workers

INABILITY OF WAR plants to locate specialists for key jobs has held up employment of many thousands of war workers, according to case histories in the files of the War Manpower Commission. In one case, lack of skilled men prevented the hiring of 3000 workers, and in dozens of other cases vital military orders were held up because of critical shortages of machinists and machine operators.

This situation prompted WMC to begin a nationwide campaign through the U. S. Employment Serv-

ice, aimed at bringing into the war effort as many as possible of the skilled workers who are in retirement or in a non-essential job. One of the 25 skills specifically chosen for this campaign is that of radio chassis assembler.

An example of the type of worker desired is Mrs. D. A. Ausmus, who twenty years ago worked as laboratory assistant in the original radio department of G-E's research lab. Marriage brought retirement to the



Above: Photograph taken 20 years ago, showing Mrs. Ausmus (then Miss Doris Evans) running tests on radio equipment in the General Electric radio research lab. Below: Mrs. Ausmus at her workbench in the G-E general engineering lab today, carrying out experimental work again after almost 20 years as a housewife

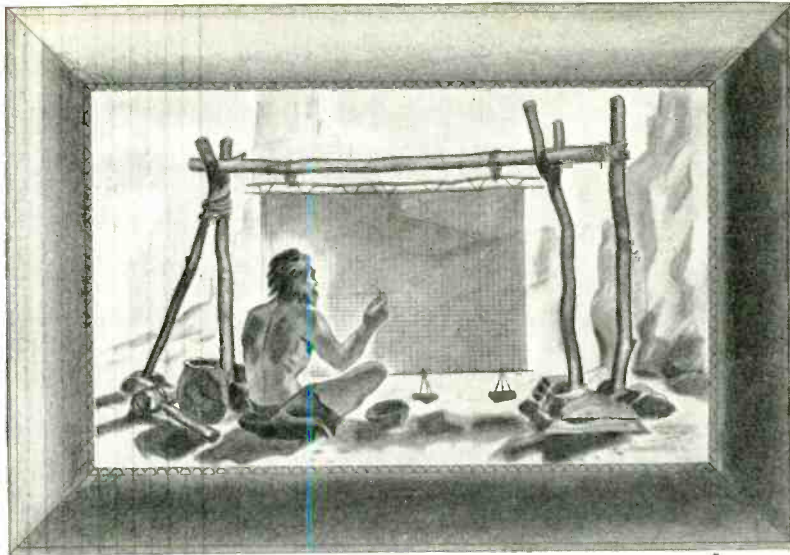

BOOKBINDING FABRICS

(a) Waterproof, full coated, impregnated, linens and vellums; pyroxylin and other synthetic resin coatings and lacquer finishes; embossed, plain, super finished, contrast printing.

(b) Starch filled, coated, impregnated, mottled, linen and vellum; plain or embossed, special glazed and matte finishes; natural, rough and smooth finishes.

SHADE CLOTH

(a) Pyroxylin or resin impregnated waterproof, meeting Government specifications; all weights, widths and colors; print cloths, sheetings and ducks.

(b) Starch filled, water color, and Holland type shades; machine oil, oil tints, oil filled opaques; fast dyed duck shades; light-proof and translucent.

PHOTO CLOTH

Photo Mounting cloth (self adhesive), single and double adhesive.

REINFORCING FABRICS

All types of waterproof and starch-filled reinforcing fabrics and industrial cambrics, for books, file folders, file pockets, box stays; to be combined, gummed and plain. Various weights from the thinnest print cloth to the heaviest drills and twills.

WE GLORIFY AN ANCIENT ART

As We Further Develop the Age of Cloth

The Stone Age and other ages which have marked progress in man's advancement have come and gone. A few persist. Through all ages one alone holds its dominant position. Cloth is of all time, from the earliest to the present. Into the future we see it projected as the structure of many modifications serving many new uses — alone, or in combination with plastics, colors, printings, and finishes. We, at Holliston Mills, continue to pioneer in the development of cloth specialties — cloth finishes, modified and adapted to specific uses.

RESEARCH AND DEVELOPMENT — cloth has a permanent structure combining light weight with strength and flexibility. On or within this structure filling, coating and processing fits cloth for many uses. Consider cloth — consult **HOLLISTON**. In general, **THE HOLLISTON MILLS** can take any type of print cloth, sheeting, drill, twill, duck, in widths from 30" to 80", and can dye; coat with every type of coating, in any color desired; can stiffen fabrics to meet any required pliability, hand, bond, weight of coating, tensile strength, Elmendorf tear strength, for any industrial use.

SIGN, LABEL & TAG CLOTHS

Waterproof and starch filled. Designed for any purpose, for hand lettering, letterpress printing, offset printing. We can design a surface that will take any ink or meet any inking problem.

RUBBER SEPARATOR CLOTHS

Starch filled glazed sheetings and base treated starched fabrics for waterproof separator cloths.

INSULATING CLOTH BASE

Base treated and stiffened fabrics for insulating cloths; all weights, widths and thicknesses.

TRACING & BLUE PRINT CLOTHS

White and blue ink or pencil cloth; map cloth; blue print cloth, thin and regular, all widths.

LINING FABRICS

Shae and drapery linings; starch filled, special filled, mercerized and shreiner finishes; straight backfilled finish; high lustre finish, all colors and widths.

COATED AND IMPREGNATED FABRICS

All widths and colors; synthetic resin, nitro cellulose, thermo plastic and thermo setting coatings; mildew proofing; fire, weather and water resistant finishes; gas impermeable finishes, etc., for war and industrial purposes.

BOOK CLOTHS Holliston cloths for bookbinding are world famous and the line includes a great variety of colors and finishes. Starch filled, Pyroxylin filled or coated. Special embossings. Any book or catalog bound in cloth is bound to be kept. Consider cloth binding for your business literature. Costs but a little more than paper. For attention and retention value cloth binding stands alone. Lesser bindings discount content value. Write for samples of Holliston Bindings. Make your new catalog a cloth bound book.

THE HOLLISTON MILLS, INC.

CONVERTING CLOTHS TO GREATER USE FIELDS
NORWOOD, MASSACHUSETTS

Sales Agents in Principal Cities

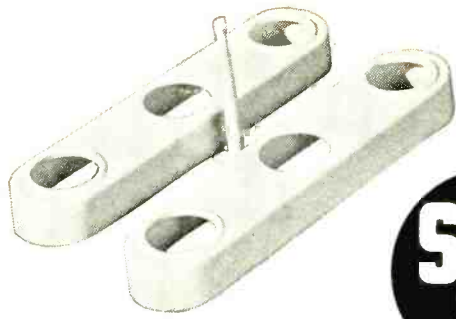

THERMO PLASTIC MOLDING Speeds War Production

This piece of plumbing hardware, formerly made of metal, is now produced by plastic, relieving critical material to help the war effort. These two, 3-hole pieces, were produced in our shop with one injection. Our young, but skilled engineers will gladly discuss with you, your problems upon inquiry.

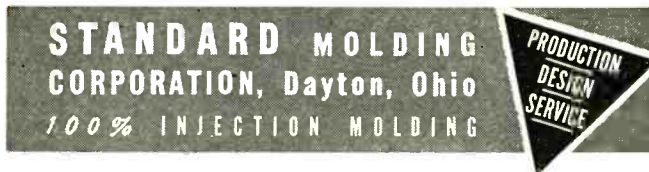

S.S. White MOLDED RESISTORS

The "All-Weather" Resistors.

TYPE 65X
Actual Size
Other types available in the lower values

RESISTOR BULLETIN 37 GIVES FULL DETAILS...

It shows illustrations of the different types of S. S. White Molded Resistors and gives details about construction, dimensions, etc. A copy, with Price List will be mailed on request. Write for it—today.



S. S. WHITE
The S. S. White Dental Mfg. Co.
INDUSTRIAL DIVISION
Department R, 10 East 40th St., New York, N. Y.

THESE widely used Resistors are favored because of their noiseless operation and durability and because they retain their values and characteristics under extremes of temperature, humidity and climatic changes.

STANDARD RANGE
1000 ohms to 10 megohms.

NOISE TESTED

At slight additional cost, resistors in the Standard Range are supplied with each resistor noise tested to the following standard: "For the complete audio frequency range, resistors shall have less noise than corresponds to a change of resistance of 1 part in 1,000,000."

HIGH VALUES

15 megohms to 1,000,000 megohms.

duties of a housewife. When her husband, Col. Delbert Ausmus, was reported as missing on Corregidor and was presumed to be captured, she offered her services once again to General Electric. Mrs. Ausmus is now using her scientific experience in carrying out experimental work on new measuring devices.

In order that workers responding to this campaign can be referred to specific jobs without delay, WMC urges holders of war contracts to make their skilled worker requirements known immediately to the nearest local U. S. Employment Service office.

Separation Process Found For Tin-Tungsten Ores

GREAT AMOUNTS of almost pure tin and tungsten are being recovered from otherwise worthless tailings and complex tinny wolfram ores with a long-sought separation process developed by the Foote Mineral Co. of Philadelphia in cooperation with Brazilian mine operators. Although details are a military secret, the general treatment involves rolling and crushing the mixed ore, then passing it through a series of machines which break the physical bond holding particles of tin and tungsten together. The ores can then be separated and the impurities removed. The entire process recovers 97 percent of the tin and tungsten.

RCA Will Pay Girls to Study Electronics at Purdue

FROM 80 TO 100 GIRLS between the ages of 18 and 22 will be selected from RCA plants and from colleges and universities to take a special electronic training course at Purdue University as employees in training. Those chosen will be paid a salary in addition to all university expenses, and will live on the Purdue campus. The curriculum provides for two terms of 22 weeks each, with classes starting around May 1. Basic requirements are two years of college study with satisfactory grades, some competence in mathematics, good health, and an interest in technical radio work. Those completing the training will be qualified for immediate assignment on test and quality control work on RCA electronic, sound, and radio equipment.

Lever Keys, too, Can be "Custom-Built" by CLARE

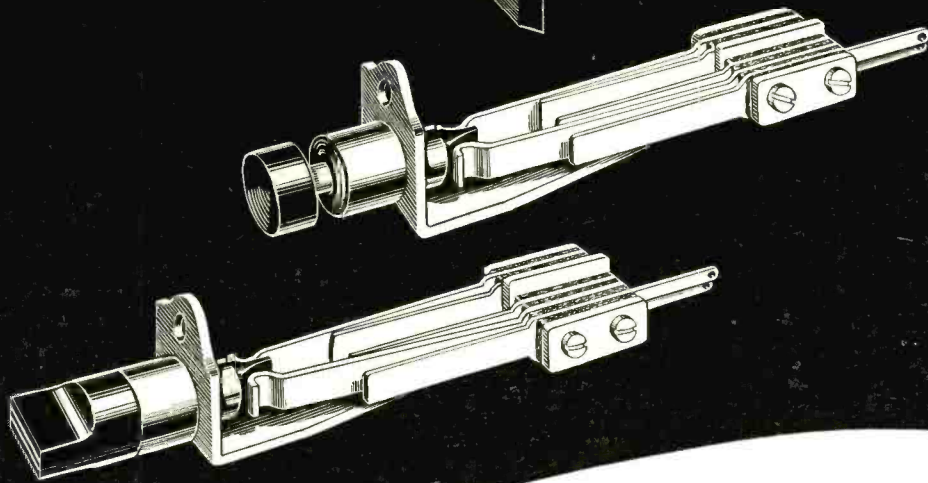
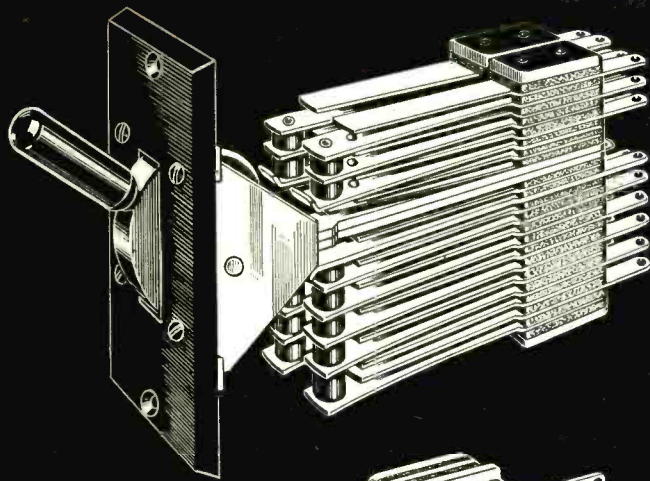

... and so, too, can Push and Turn Keys

The Lever Key illustrated is another example of Clare "custom-building" to meet requirements. Its frame is designed to hold all parts together by their interlocking shapes, then welded to make virtually a "one solid piece frame," to provide maximum rigidity.

The cam assembly is also unique because at the time of manufacture, or at any future time, stops may be provided, added or removed to change the key from locking to non-locking or vice versa. Or it may be changed from one-way to two-way, or vice versa.

The same careful design and construction are typical of the Push Key and Turn Key also illustrated above.

In every feature of design, these keys possess all the construction and design features which make Clare Relays outstanding in performance. Some of these features are listed at the right. Our engineers will be glad to "custom-build" keys to fit your requirements. Write us regarding them. Ask for the Clare catalog and data book. C. P. Clare and Company, 4719 Sunnyside Ave., Chicago, Ill. Sales engineers in all principal cities. Cable Address: "CLARELAY."

- Contact springs are made of nickel silver to exacting specifications.
- Flat or hemispherical contacts of either rare metals or special alloys are "over all" welded to contact springs by a special process which makes them an integral part of the springs, thereby reducing contact resistance to a minimum and providing for rapid heat dissipation.
- Contacts available and their current ratings are as follows:

Contact Ratings: 110 Volt, 60 Cycle, A. C. Non-Inductive

Code No. 1	1 Amp.	50 Watts
Code No. 2	2 Amp.	125 Watts
Code No. 4	3 Amp.	150 Watts
Code No. 5	4 Amp.	175 Watts
Code No. 7	4 Amp.	175 Watts

- Insulation between springs and between springs and frame may be either single, double or special. Single insulation will stand a 500 volt a.c. test, double insulation a 1000 volt a.c. test, and special insulation a 1500 volt a.c. test. These spring insulators are made from special heat-treated Bakelite that permits punching without cracks or checks and possesses minimum cold flow and low moisture absorption properties.

- Contact forms may consist of any one of the five forms shown below, or of any combination of those forms.

- The Lever Key may incorporate as many as 40 springs, whereas the maximum number of springs that may be had on the Push and Turn Keys is 20.
- Spring bushings of Bakelite are designed under a special secret process providing long wearing features.

- The Lever Key handle is made of catalin, in either polished black, red or white. Push Key buttons and Turn Key knobs are of Bakelite, in black only.

- The Lever Key escutcheon is made of Bakelite and is held to the key frame by four oval head No. 3-48 screws; keys may be furnished with or without escutcheon, depending upon the type of mounting to be used.

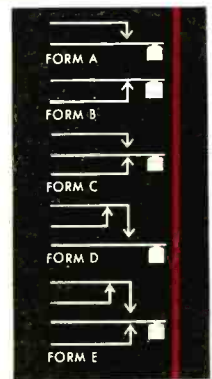

CLARE RELAYS

"Custom-Built" Multiple Contact Relays for Electrical, Electronic and Industrial Use

ELECTRONICS — April 1943

skilled hands and willing hearts . . .

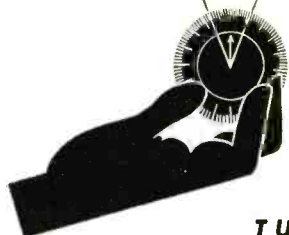

TUNED FOR BATTLE

Advanced developments by *Doolittle* for critical WAR EQUIPMENT today means better communications for your peacetime needs tomorrow.

Doolittle
RADIO, INC.

Builders of Precision Radio Communications Equipment
7421 S. Loomis Blvd., Chicago, U. S. A.

To Assure Victory
Buy More U. S. War
Bonds and Stamps

REMLER

Plugs and Connectors

ARMY
SIGNAL CORPS
SPECIFICATIONS

Quantity Prices Quoted
on receipt of Delivery
Schedules

Manufacturers of Communication Equipment
SINCE 1918

REMLER COMPANY, Ltd. • 2101 Bryant St. • San Francisco, Calif.

FM Log Has Over 50 Stations

FM BROADCASTING enters 1943 with 36 stations throughout the country operating from 6 to 24 hours a day on a regular commercial basis, nine other stations operating with experimental transmitters, and at least seven more operating as non-commercial educational stations.

Call letters of regular f-m stations contain numbers from 31 to 99 which represent the last two figures of the frequency assignment in the f-m band covering 43.1 Mc to 49.9 Mc. The first letter indicates whether the station is east (W) or west (K) of the Mississippi river, just as for regular broadcast stations, and the last letters are the initials of the location whenever possible. Thus, W65H is in Hartford, Conn., and has an assigned frequency of 46.5 Mc. Experimental stations have call letters similar to those of radio amateurs.

COMMERCIAL FM STATIONS

W45RR	Baton Rouge, La.
W49BN	Binghamton, N. Y.
W43B	Boston, Mass.
W67B	Boston, Mass.
W51C	Chicago, Ill.
W59C	Chicago, Ill.
W67C	Chicago, Ill.
W75C	Chicago, Ill.
W41MM	Glingman's Peak, N.C.
W45CM	Columbus, Ohio
W45D	Detroit, Mich.
W49D	Detroit, Mich.
W45V	Evansville, Ind.
W19FW	Fort Wayne, Ind.
W53H	Hartford, Conn.
W65H	Hartford, Conn.
K49KC	Kansas City, Mo.
K45LA	Los Angeles, Calif.
W55M	Milwaukee, Wis.
W39B	Mount Washington, N.H.
W47NV	Nashville, Tenn.
W47NY	New York City
W63NY	New York City
W67NY	New York City
W71NY	New York City
W75NY	New York City
W49PH	Philadelphia, Pa.
W53PH	Philadelphia, Pa.
W57PH	Philadelphia, Pa.
W69PH	Philadelphia, Pa.
W73PH	Philadelphia, Pa.
W47P	Pittsburgh, Pa.
W75P	Pittsburgh, Pa.
W51R	Rochester, N. Y.
W47A	Schenectady, N. Y.
W85A	Schenectady, N. Y.

EXPERIMENTAL FM STATIONS

W1XTG	Worcester, Mass. 43.4 mc
W1XSN	Springfield, Mass. 42.6 mc
W2XMN	Alpine, N. J. 42.8 mc
W2XQR	New York City 45.9 mc
W2XWG	New York City 45.1 mc
W3XO	Washington, D.C. 43.2 mc
W8XAD	Rochester, N. Y. 42.6 mc
W9XER	Kansas City, Mo. 46.5 mc
W9XYH	Superior, Wis. 43.0 mc

EDUCATIONAL FM STATIONS

KALW	San Francisco Schools
KSDS	San Diego Schools
WBEZ	Chicago Public Schools
WBOE	Cleveland Board of Education
WIUC	University of Illinois
WMBE	Memphis Public Schools
WNYE	New York City Board of Education

WBOE is broadcasting eight full hours each school day. Westinghouse's W67B in Boston is now run entirely by women. Eleven Connecticut cities are getting two-way f-m police systems developed by G.-E.

A BIG STEP FORWARD

EVERY TIME our fighting men win a new beach head . . . every time an enemy plane falls from the sky . . . every time the sun sets on a war-torn world . . . America is that much closer to Victory.

No man can know how many days there are between us and peace. We can only do our best to make those days as few as possible.

Hard work is what it takes — good old-fashioned hard work, and sweat, to save us blood and tears. Here at Simpson we hold this as a sacred trust — to send ever more and better Simpson Instruments into battle, and to make each working hour a big step forward toward America's inevitable Victory.

SIMPSON ELECTRIC CO.

5200-5218 Kinzie Street, Chicago, Illinois

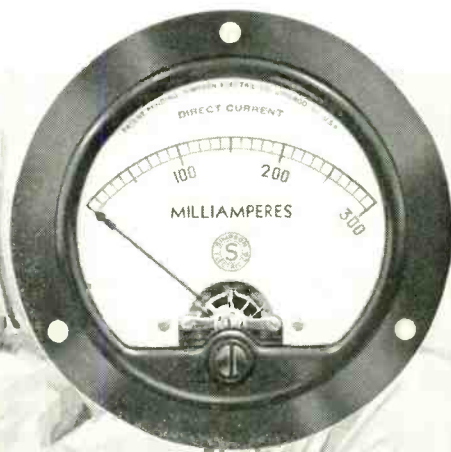

Simpson

INSTRUMENTS THAT STAY ACCURATE

Buy War Bonds and Stamps for Victory

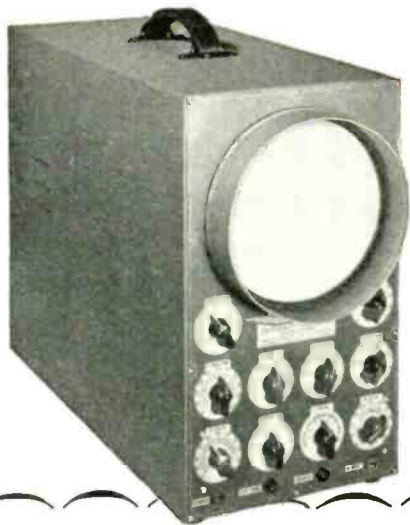

*Immediate
Delivery!*

7 Inch Cathode Ray Oscillograph

\$13950

The 7" tube offers larger, brighter patterns with fine line trace and clean focusing to the very edges of the screen. In addition, this instrument provides all the features of the ordinary five inch oscillograph! A moderate quantity in stock for immediate shipment.

Lafayette carries complete stocks of nationally advertised radio, sound and electronic parts . . . quick deliveries from two big warehouses!

FREE — 130 page illustrated catalog contains thousands of radio, sound and electronic items — indexed for quick reference. Write today to Department 4G3. • 901 West Jackson Boulevard, Chicago, Ill.

LAFAYETTE RADIO CORP.

901 W. JACKSON BLVD., CHICAGO, ILL. • 265 PEACHTREE ST., ATLANTA, GA.

**WHERE PRECISION INSTRUMENTS MUST
"ROUGH IT" YOU CAN DEPEND UPON**

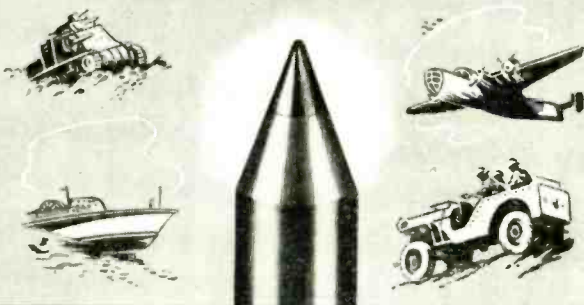

PERMOPIVOTS LONG LIFE PRECISION PIVOTS

PERMOPIVOTS* are tipped with PERMOMETAL* . . . a special alloy of precious metals developed in Permo's own metallurgical laboratories. Permopivots are remarkably wear resistant. They keep precision instruments accurate longer. Permopivots cannot rust or corrode. The satin-smooth Permo metal tip eliminates abrading particles of wear. The extremely low coefficient of friction with Permopivots often makes it possible to eliminate the use of oil.

*Trade Mark Reg.

PERMO PRODUCTS CORPORATION
6427 RAVENSWOOD AVENUE • CHICAGO, ILLINOIS

WRITE FOR FULL INFORMATION

FCC Announces New Position as Radio Intercept Officer

INTERCEPTION OF RADIO messages to insure compliance with radio silence orders of the Army Air Force is one of the duties connected with the newly announced FCC position of Radio Intercept Officer. Other duties involve maintaining a continuous watch on distress channels and carrying out monitoring assignments related to the war effort.

No written tests are required, and the only age qualification is that the applicant must have reached 18. Positions are available throughout the United States. Qualifications for the \$2600 grade are either a full four-year college course in electrical engineering or physics, four years of technical experience in radio, or a time-equivalent combination of education and experience. For the \$2000-a-year grade, less education and experience are required. Ability to send and receive code is essential for both grades. Overtime pay for eight additional hours a week increases the above salary figures about 21 percent. Application forms can be obtained from most post offices or from Civil Service offices.

Infrared Rays Dehydrate Food

THE USE OF INFRARED radiation in a vacuum chamber to dehydrate completely cooked dishes like soups, puddings and pork-and-beans is the subject of U. S. patent No. 2,308,601, issued to J. G. W. Gentele of Stockholm. The infrared rays maintain the food at a temperature above the boiling point of water until the greater part of the contained moisture is driven out.

Heat-Transfer Problems Solved With Roomful of R-C Networks

ALMOST ANY PRACTICAL PROBLEM in heat flow can be duplicated electrically by Dr. Victor Paschkis on the Heat and Mass Flow Analyzer which he developed at Columbia University in New York City. The results are read on meters or recorder charts without the usual expenses for building sample structures and running long heat tests. The procedure, first proposed in Holland by C. L. Beuken, is based upon the similarity between

ARHCO Varieties of 1943

2008 Wartime Essentials

We do stamping, screw machine work, moulding, and general Radio and Radar communications assemblies. Illustrated are but a mere handful of the 2008 wartime essentials which we are now manufacturing. Your inquiries will receive prompt attention.

Now, more than ever, it is important that you keep on buying War Bonds and Stamps.



*American
Radio
Hardware* CO., INC.

476 BROADWAY, NEW YORK, N. Y.

MANUFACTURERS OF SHORT WAVE • TELEVISION • RADIO • SOUND EQUIPMENT



**YOU CAN DEPEND ON
THE UNIFORM QUALITY OF
DOLPH'S
INSULATING VARNISHES**

**1
Testing
Raw
Materials**



**2
With-
drawing
Cups of
Baked
Varnish**

**3
Testing
for
Dielectric
Strength**



When you specify DOLPH'S Insulating Varnishes you get quality products. This is backed by 33 years of specialization in the field of electrical insulating varnishes together with the absolute control of raw materials and plant production. Nothing with DOLPH is left to chance.

All shipments of raw materials are checked carefully and only those which meet the highest standard of quality are accepted.

Further, the DOLPH Laboratories double check the production of the plant. Samples are taken from every batch of varnish and are tested to see that they conform in every way with predetermined characteristics of the varnish.

As a final check, varnish coated paper strips and cups of varnish are baked. These are checked to see that they conform in build up, dielectric strength and possess the maximum acid, alkali, moisture and oil resistance.

The thoroughness of the DOLPH Laboratories is your assurance of the highest quality electrical insulating varnishes. Next time specify DOLPH'S.

JOHN C. DOLPH COMPANY
Insulating Varnish Specialists
168-A Emmet St., Newark, New Jersey

the flow of electricity in a resistance-capacitance circuit and the transient heat flow through walls or other structures. Temperature corresponds to voltage, and heat flow per unit time corresponds to current.

In utilizing this analogy, the structure to be studied is considered to be cut into a number of sections, over 100 sections being possible with the present apparatus. For each section, the capacitance corresponding to the thermal capacity and the resistance commensurate with the thermal conductivity are computed. The resulting electrical values are then set up in the apparatus, and a direct voltage is applied. If the temperature applied to the structure varies under actual conditions, the applied voltage is likewise varied during the test.

Current flowing through the entire circuit along resistive paths corresponds to transmitted heat, and current flowing into capacitors corresponds to heat being stored within the structure during the initial unsteady state.

Voltage values during the test run are measured at carefully selected points with specially-developed electronic voltmeters drawing practically no current, and these values are interpreted in terms of temperature. Two electronic recorders are used to provide continuous records on charts of voltages at four selected points which may be of particular interest.

By appropriate choice of electrical values, the time of a heat cycle can be condensed or stretched as desired. Thus, a heat cycle of 24 hours in a furnace can be condensed to last only 15 minutes in the model, or a fractional-second cycle during welding operations can be stretched to several minutes. Cooling conditions are studied by applying a voltage for a definite time, then removing the voltage and measuring voltage drops across circuit resistors as the capacitors discharge.

Description of Apparatus

The apparatus has 15 condenser sections and 115 resistors sections filling three walls of the room with sufficient resistors, capacitors and plug-board connections to duplicate electrically one section of the heat - transfer structure being

KOLD-HOLD

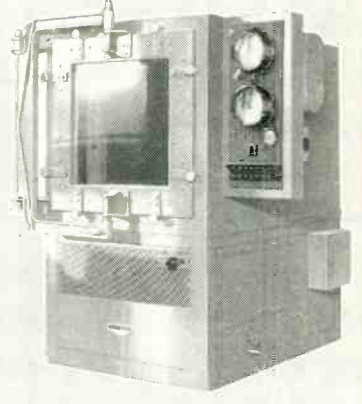

Stratospheres
... for testing

Aircraft instruments, radio receivers, transmitters, batteries, wire, metals and various devices are thoroughly tested under predetermined levels of temperature and pressure with KOLD-HOLD Stratospheres. There is no need to wait for "natural" stratosphere conditions . . . produce them at will in your own plant. Available in six variations of model shown, and in larger sized units. Send for complete details and new Catalog No. 431.

Ball-bearing suspension and guide-arm make doors easy to operate and keep in perfect alignment.

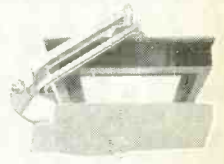

Cold-Elmer interior of KOLD-HOLD Stratosphere, showing rugged, heavy-duty construction.

New York — 354 W. 31st St. — PE 6-1161
Chicago — 201 N. Wells — RAN 3986
Los Angeles — 1015 W. 2nd St. — MI 4989
Philadelphia — 2414 Clover Lane —
Upper Darby — SHERwood 0622

KOLD-HOLD MANUFACTURING CO.
446 N. Grand Ave., LANSING, MICH., U.S.A.

studied. It is possible to secure in each bank a capacity anywhere between 0.1 and 152 μ f in steps of 0.1 μ f. All condensers have an accuracy of 1 percent or better, and a leakage resistance higher than 15,000 megohms per microfarad. Selector switches and jacks provide resistance values ranging from 100 ohms to 1,111,000 ohms for each section. Thirty-six buses run at the tops of the sections, to simplify connecting instruments to sections. The arrangement is such as to permit changing the values during an experiment to duplicate changes in thermal conductivity and thermal capacity with temperature. A motor-driven sequence timer has been constructed to imitate complex processes requiring considerable switching.

The applied d-c voltage is obtained from a 110-volt a-c power pack providing a constant output voltage at any desired value from 286 volts down to zero. An electronic constant-current source is used when it is necessary to duplicate the condition of constant heat input with varying input temperature.

The facilities of the Heat and Mass Flow Analyzer at Columbia University are available to manufacturers for technical investigations on heat flow in solid materials, however complex the shape and however irregular the heating cycle. Dr. Paschkis is in charge of the technical and scientific work of the laboratory, and Prof. C. F. Kayan, as Executive Secretary, is responsible for its administration.

Investigations already carried out with the apparatus include studies of thermal phenomena in the wheel and brakeshoe of an express train locomotive during emergency braking, temperature distribution and heat losses in intermittently operated furnace walls, summer cooling load and heat absorption of building walls under solar radiation, heat loss in intermittently heated steam pipe insulation cooling rates in arc welding, and permissible loading of intermittently operated underground cables.

Standards are Released for Home Radio Parts

SIMPLIFIED STANDARDS for "War Model" home radio replacement parts have been prepared by the

SHALLCROSS ROTARY TAP SWITCHES USE SOLID SILVER CONTACTS, BECAUSE SOLID SILVER . . .

1. Has the highest conductivity of materials available.
2. Is superior to silver-plating which wears off, resulting in high resistance contacts.
3. Should it corrode the sulphide formed does not appreciably increase the contact resistance.

Let Shallcross answer your switch problems
Address Dept. C3

WHY "SHORTING" AND "NON-SHORTING" SWITCHES?

This is the shorting type. As the arm is rotated from one position to another the adjacent contact points are "shorted" (bridged).

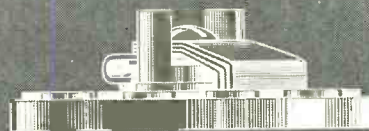

This is the non-shorting type. As the arm is rotated from one position to another, the arm lifts up, and only one contact is touched at a time.

Creators and Makers of

ACCURATE RESISTORS—SWITCHES—SPECIAL EQUIPMENT AND
SPECIAL MEASURING APPARATUS FOR PRODUCTION AND
ROUTINE TESTING OF ELECTRICAL EQUIPMENT ON MILITARY AIR-
CRAFT... SHIPS... VEHICLES... ARMAMENT... AND WEAPONS



SHALLCROSS MFG. CO.

COLLINGDALE, PENNA.

IDEAS WANTED

for Peace-time Products

• If you have an idea for an electronic or radio product which can be placed on the market after the war is over, *we want to hear from you.*

Today our factory is busily engaged in making communications devices for America's armed forces. But we are looking forward to the time when the world will again be at peace and will be in a position to buy a larger number of products than ever before. We believe that *now* is the time to get busy on post-war planning—and we invite you to come along with us.

We will pay a good price for worth while ideas on new products and developments. Please tell us what you have in mind. Send your letter to Max L. Haas, President, Bud Radio, Inc., 2118 East 55th St., Cleveland, Ohio.



BUD RADIO, INC.
CLEVELAND, OHIO

American Standards Association in cooperation with OPA and WPB, and production of these parts is scheduled by manufacturers to start in April. The parts will be covered by price ceilings, will be constructed according to ASA performance and quality standards requiring minimum use of strategic materials, and will carry no private brand names. A special symbol consisting of the letter V above the Morse Code V inside a circle will appear on all parts.

The list of replacement parts constitutes a radical reduction from the thousands of different types of each item made before the war. The ASA list contains but nine paper capacitors ranging from 0.00025 to 0.25 μ f, all with a d-c working voltage of 600 volts. Dry electrolytic capacitors are reduced to seven single units and two dual units, in various voltage ratings. There are eleven volume control values, six power transformers, two chokes, two interstage audio transformers, one driver audio transformer, and three output audio transformers.

Detailed data on "War Model" parts is given in the following three American War Standard bulletins: C16.8-1943—Simplified List of Home Radio Replacement Parts; C16.6-1943—Fixed Paper-Dielectric Capacitors (manufacturing specifications for home receiver replacement types); C16.7-1943—Dry Electrolytic Capacitors (manufacturing specifications). These are available at 20 cents each from American Standards Association, 29 West 39th St., New York City.

New Signal Corps Radio Sets

A COMBINATION WEATHER AND RADIO station no larger than a steamer trunk is one of many Signal Corps radio developments shown to newsmen at Fort Monmouth recently by Major General Dawson Olmstead, Chief Signal Officer. The unit can be buried on a hostile shore where weather observers could not stay, and will transmit reports every few hours on temperature, humidity and barometric pressure. Batteries provide two to three months of operation.

A combination transmitter-receiver weighing only 5½ pounds with batteries is now being furnished to parachutists by the Signal Corps so they can talk to each other while descending or after landing.



GET THE POINT?

Knurling of Socket Screws originated with "Unbrako" years ago.

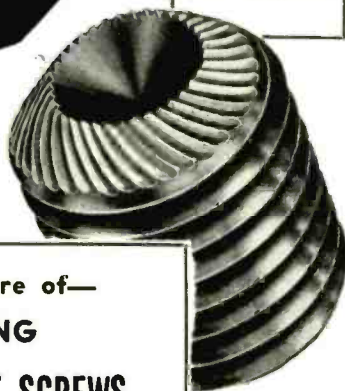

IT'S KNURLED

... an exclusive safety feature of—

UNBRAKO

Reg. U. S. Pat. Off.

SELF-LOCKING

HOLLOW SET SCREWS

When the "Unbrako" (screw) is tightened as usual, the knurled point *digs in* . . . prevents vibration from working it loose. It's easily removed and can be used over and over. So play safe. Order "Unbrako" Self-Lockers.

Sizes: No. 4 to 1½" diameter

WRITE FOR
"UNBRAKO"
CATALOG



STANDARD PRESSED STEEL CO.
JENKINTOWN, PENNA. BOX 596

BRANCHES
BOSTON • DETROIT • INDIANAPOLIS • CHICAGO • ST. LOUIS • SAN FRANCISCO

Another new Signal Corps radio set is designed to be attached to a parachute for the purpose of bringing aid to aircraft personnel in distress. It weighs 23 pounds, is powered by a hand-cranked generator, and is modulated by a code SOS signal recorded on a disc inside. The unit is sealed to the distress frequency to which all receiving stations with direction finders will listen the instant an airplane is reported as missing. Operation of the set requires no knowledge of radio code or theory. The normal coverage is 25 miles, but the signals can be received 500 miles away on favorable nights.

Duplication of Telephones In Philadelphia To Be Ended

TENTATIVE FCC APPROVAL of absorption of properties of the Keystone Telephone System by the Bell Telephone Co. of Pa. and the New Jersey Bell Telephone Co. paves the way for elimination of the last major competitive telephone installation in the United States. The Keystone system operates approximately 50,000 stations and 14 exchanges in Philadelphia and surrounding counties, and approximately 5000 stations in southern New Jersey.

Keystone service has been popular with Philadelphia business concerns because of special rate schedules which permitted unlimited service without message charges. The existence of two telephone systems in the same community made it necessary for many firms to have duplicate telephone service, however.

It is estimated that the merger will release for war use about 1500 tons of copper, 47 tons of zinc, 8 tons of tin and 2.5 tons of aluminum, salvaged from Keystone's underground cable system in Philadelphia and other duplicated facilities.

Telephone Inquiry Service Is Set Up in Washington

TO ELIMINATE CONFUSION and delays when businessmen seek information in Washington on war production problems, WPB has set up a Telephone Inquiry Service. The telephone number is REpublic 7500, Extension 73011, Washington, D. C. Competently trained specialists will answer the questions or refer the caller to the proper WPB official.

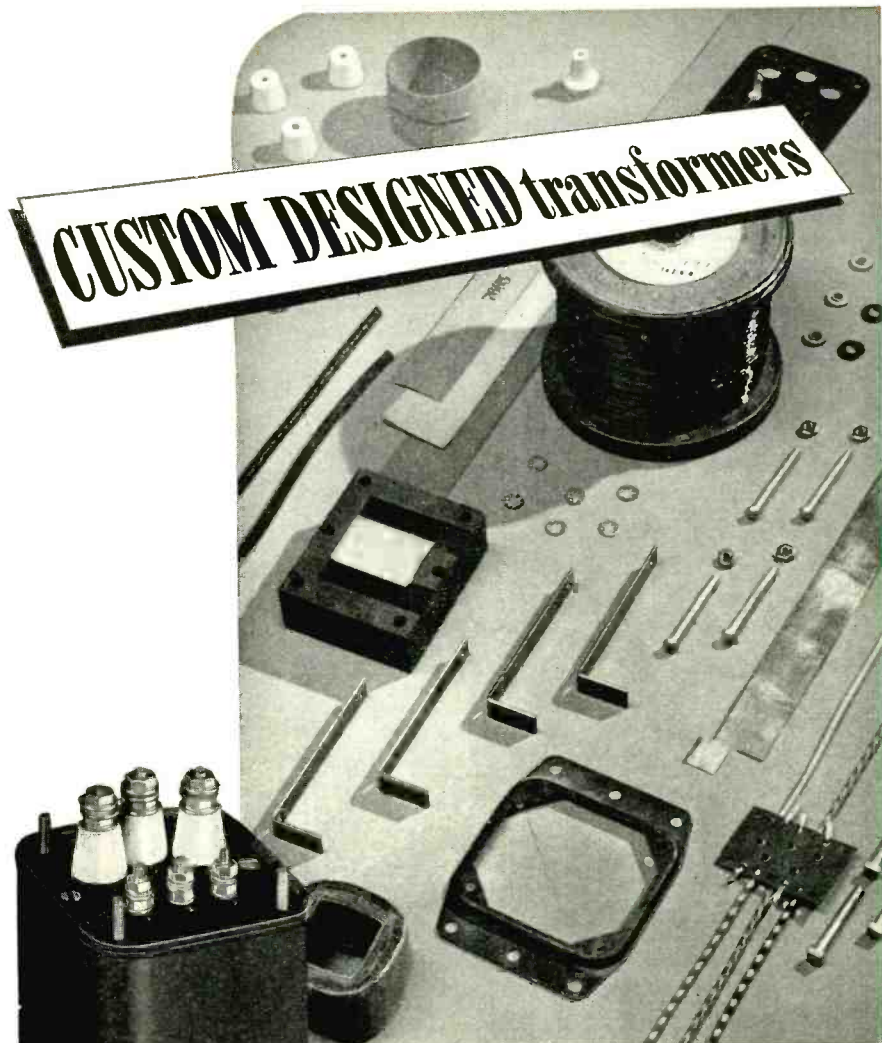

MANUFACTURED FROM STANDARD PARTS . . .

Custom designed transformers can often be assembled from standard parts found in the large variety of types and sizes available to Chicago Transformer's customers.

Where entirely different designs are necessary, its modern and complete plant and laboratory facilities are equipped to handle the most unusual assignments.

Given the application, description and the electrical results desired, the Chicago Transformer organization should best be able to solve your new and difficult transformer problems.

Manufacturers of all types of Transformers up to 10 KVA



CHICAGO TRANSFORMER CORPORATION

3505 WEST ADDISON STREET • CHICAGO

ACME

PRECISION-BUILT TRANSFORMERS

FOR ELECTRONIC PERFORMANCE

Controlling electrons to a useful purpose requires transformers of exact performance characteristics. Acme precision-built transformers for electronic applications, when submitted to unbiased tests, invariably win top honors for performance. If your electronic application is out of the ordinary, let Acme transformer engineers help in its solution.



FOR EXAMPLE

Acme compound-filled transformers for short wave communication, public address systems and other radio applications are preferred for their serviceability under temperature variations from -40° to $+120^{\circ}$.



And preferred for rugged construction, trouble-free long-life. Typical, high voltage plate supply transformer for transmitter. 33,000 volts, 1.8 ampere secondary.



ISOLATING TRANSFORMERS

For use wherever radio, communication, or other electrical equipment must be tested with complete freedom from outside interference. Shielded secondary winding and shielded secondary cable isolate primary fluctuations and interference. Write for details.

THE ACME ELECTRIC & MFG. CO.
31 WATER ST. CUBA, N. Y.



New Television Station Begins in Hollywood

EXPERIMENTAL OPERATION by television station W6XYZ in Hollywood began recently under the direction of Klaus Landsberg. The station uses 100 watts on television channel No. 4 (79.25 Mc) for video, and 200 watts on 83.75 Mc for the audio carrier.

W6XYZ is owned and operated by Television Productions Inc., a subsidiary of Paramount Pictures Inc. DuMont cameras and transmitting equipment are being used with several custom-built units and a special experimental antenna system.

To conserve equipment, only two programs weekly are planned at present. These programs will be confined almost entirely to Civilian Defense activities. Civilian defense workers assembled in Hollywood police stations and some 200 television-equipped homes will receive instruction via television.

WPB Orders 11,000,000 Tubes for Civilian Receivers

A PROGRAM CALLING for the manufacture of eleven million radio tubes in 114 different types by July 1 of this year for home radio receivers is now under way, according to a WPB announcement. The seven tube manufacturers cooperating in the program are: Hytron Corp., Ken-Rad Tube & Lamp Corp., National Union Radio Corp., Raytheon Production Corp., RCA Victor Division,ylvania Electric Products and Tung-Sol Lamp Works. No manufacturer's names will appear on the tubes.

CBC Uses Relay Transmitters

ISOLATED REGIONS in western Canada are being provided with radio service by means of 20-watt relay transmitters connected to railway telegraph repeater stations. Six such low-power transmitters are in operation in British Columbia, and plans are under way to extend the service to all isolated communities on the 3000-mile network system of the Canadian Broadcasting Corporation. CBC field engineers found that the railway telegraph circuits acted as carriers for r-f signals, providing adequate radio reception within a radius of over 15 miles from the relay transmitter.

Global CERAMIC RESISTORS

Be sure your circuit actually requires close tolerance resistors before you specify them

CERAMIC or composition type resistors are not normally supplied as precision devices. So please specify resistance tolerances as wide as possible so that production facilities may be made to yield maximum quantities of acceptable resistors. To do otherwise, lowers production, slows deliveries, wastes critical materials.

Production facilities for Global Brand Ceramic Type Resistors are being utilized to the utmost to maintain deliveries to the most essential Electronic needs. When the present crisis has passed we will be able to serve those industries whose needs at the moment must be subordinated to the war effort.

Today when demands upon us are heavy and deliveries are scheduled according to priority and date of order, your indulgence is appreciated. We pledge our untiring efforts to those who have come to depend upon us as well as others who may need our help.

Below is a condensed table of specifications of the more commonly used types of Global Brand Resistors. Resistors having special characteristics are also available.

Type		A	B	CX
Length	Min.	1 1/4"	1 1/4"	1 1/4"
	Max.	18"	18"	18"
Diameter	Min.	1 1/16"	1 1/16"	1 1/16"
	Max.	1"	1"	1"
Resistance Per Inch Of Length	Min.	25 ohms	5 ohms	1 ohm
	Max.	15 megohms	15 megohms	1000 ohms
*Overall Watt Rating	Min.	1/4 watt	1/4 watt	1/4 watt
	Max.	54 watts	54 watts	150 watts
*Normal Rating W./Sq. In. of Radiating Surface		1 watt	1 watt	2 1/2 watts
Maximum Voltage Per In. of Length		400 V.	400 V.	See Note

*These ratings may be substantially increased by artificial cooling.

Characteristic Coefficients:

Type A: Comparatively Straight Line Temperature and Voltage.

Type B: Negative Temperature and Voltage.

Type CX: Slightly Positive Temperature.

Terminals: All types: Metalized ends for clip mounting or with wire leads.

Type CX Resistors have a low specific resistance and cannot be subjected to voltage stresses permissible with Types A and B. Maximum allowable voltage is that required to yield maximum watt rating.

Global Division

THE CARBORUNDUM COMPANY

REG. U.S. PAT. OFF.

NIAGARA FALLS, N. Y.

(Carborundum and Global are registered trade-marks of and indicate manufacture by The Carborundum Company)

April 1943 — ELECTRONICS

Radio Business News

ELECTRONIC CORPORATION OF AMERICA is the new name of the Transformer Corporation of America. Offices and plant have been moved to 45 West 18th St., New York City.

THE SCOPHONY CORPORATION OF AMERICA, with offices at 527 Fifth Ave., New York City, has been formed by Television Productions Inc., a subsidiary of Paramount Pictures, Inc., and General Precision Equipment Corp. The new enterprise controls the western hemisphere rights for the supersonic system of television developed by the British Scophony company in 14 years of research. Arthur Levey, president and general manager, announces that his new firm will soon make available in this country a large-screen television projection system which is easily adaptable to color.

ADDITIONAL PLANT FACILITIES for Ken-Rad Tube and Lamp Corp. will be constructed in Indiana and Kentucky under a \$1,300,000 Defense Plant Corp. contract.

BUDD INDUCTION HEATING, INC. announces that its new plant in Detroit, Mich. is now at full production, filling war orders for vital induction heating equipment.

FOLLOWING COMPLETION of a program of plant expansion providing additional facilities for electronic research, Hazeltine Service Corporation changed its name to Hazeltine Electronics Corp.

THE G-E RADIO, Television and Electronics Department will henceforth be known simply as the Electronics Department.

RADIO AND DETECTION equipment production for military and civilian use—chiefly military—exceeded \$1,200,000,000 in 1942 according to WPB Chairman Donald M. Nelson. This was more than three times the volume of 1941.

EMBY PRODUCTS Co., INC. announces a change in name to Selenium Corp. of America. The firm manufactures Emby photoelectric cells, selenium rectifiers and other electronic products, and is located at 1800 West Pico Blvd., Los Angeles.

THE **FASTEST** Method of BLACK AND WHITE RECORDING . . .



This Alden recorder was specially designed to produce facsimiles up to 8" width.

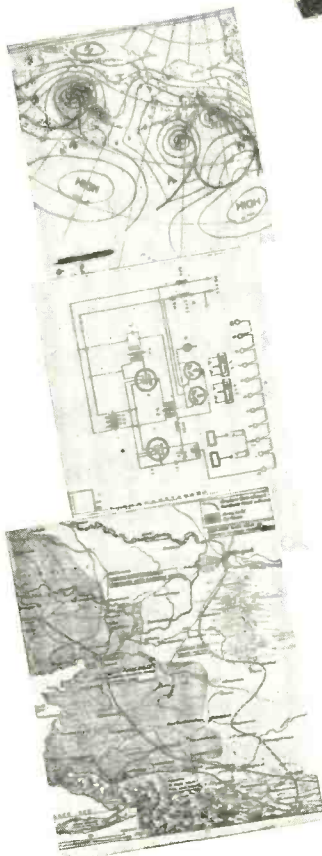

Anything convertible to an electrical impulse may be reproduced by Alden recorders such as these examples shown above.

ALDEN

FACSIMILE RECORDERS

THESE COMPLETE terminal recording units reproduce typed matter, charts, maps, pictures, fingerprints, writing or text of any sort. Speeds of 48 square inches or more per minute are within the recording capabilities of the paper and equipment. Reproduction is crisp and clean and operation of the machine is simple and trouble-free.

Alden facsimile recorders are designed in conjunction with Faximile, Inc., engineers, and built by Alden Products Company. They are based on the *John V. L. Hogan* system, that is proving highly successful on transcontinental and international press circuits.

Alden recording units are custom-built to meet your requirements of speed, width of recording, size and operation with other equipment, or to meet the characteristics of any wire or radio circuit.

For further information, write for booklet A, "The Last Word on Facsimile and Electrolytic Recording". No obligation of course.

ALDEN PRODUCTS CO. INC.

117 NORTH MAIN ST.  BROCKTON, MASS.

Licensees under patents and patent applications of Faximile, Inc.

READY NOW!

NEW ALLIED 1943 BUYING GUIDE

**FOR EVERYTHING IN
ELECTRONICS AND RADIO**



**FREE
SEND FOR
YOURS...
NOW!**

**CENTRALIZE YOUR PROCUREMENT
SAVE TIME... SPEED DELIVERY**

Get this latest Allied Buying Guide for *everything* in Electronics and Radio. Procure all your needs from this ONE central source. Our large complete stocks of over 10,000 items assure you of prompt attention and quick delivery. Our staff is trained to help you with your problems... *write, wire or phone Haymarket 6800, today!*

NEW... ALLIED'S RADIO DATA HANDBOOK

Most essential formulas, charts, tables, standards and technical data on radio and electronics..... **25¢**

ALLIED RADIO CORP.
833 W. Jackson Blvd. Chicago
Dept. 24-D-3



**OVER 10,000
WARTIME ITEMS**

- | | | |
|--------------|----------------|------------|
| Condensers | Switches | Rectifiers |
| Relays | Resistors | Sockets |
| Tubes | Rheostats | Wire |
| Test Equip. | Public Address | Generators |
| Transformers | Coils | Receivers |
| Photo Cells | Tools | Speakers |

ALLIED RADIO

ACRO ELECTRIC Co., manufacturers of Acro snap switches, has moved into a new plant at 1305 Superior Ave. in Cleveland. Manufacturing facilities and space have been enlarged 300 percent for increased production.

INTERNAL REVENUE Tax collections for radio sets, parts, phonographs, manufactured in Jan. 1943 amounted to only \$186,688, as compared with \$2,650,829 for Jan. 1942. Interstate communication revenue for the same periods remained essentially the same, but taxes for local telephone service jumped almost a million dollars, from \$4,280,926 in Jan. 1942 to \$5,033,317 this January.

Data on New Tubes

2C21 High-vacuum heater-type twin triode with small 7-pin base 7BH and ST-12 glass envelope. $E_f = 6.3$ v; $I_f = 0.6$ amp; max $E_b = 250$ v; max power = 2.1 w; $I_b = 8.3$ ma; $r_p = 7600$ ohms; $r_L = 20,000$ ohms; $E_c = -16.5$ v; $\mu = 10.4$; $g_m = 1375$.

3B23 High-vacuum heater-type full-wave rectifier with 4-pin medium bayonet base 4AN and S-19 glass envelope. $E_f = 2.5$ v; $I_f = 8$ amp; max a-c $E_b = 1250$ v per plate; $E_{inv} = 3500$ v; max d-c $I_b = 0.2$ amp; $I_{peak} = 0.6$ amp per plate.

6SH7GT High-vacuum heater-type r-f pentode with 8-pin octal base 8BK and glass envelope. Single-ended, with sharp cut-off. $E_f = 6.3$ v; $I_f = 0.3$ amp; max $E_b = 300$ v; max power = 3 w; $g_m = 4900$; $r_p = 0.9$ meg.

1005 Gaseous ionic-heated-cathode full-wave rectifier with 8-pin octal base 5AQ and MT-8 metal envelope. For starting, $E_f = 11.0$ v and $I_f = 0.125$ amp; continuous, $E_f = 4.0$ or 6.3 v and $I_f = 0.08$ or 0.1 amp. Max peak voltage per anode = 225 v; max peak inverse voltage = 450 v; average tube voltage drop = 20 v; max d-c anode current = 70 ma.

8020 High-vacuum filament-type half-wave rectifier with 4-pin medium bayonet base 4P and T-18 glass envelope. $E_f = 5$ v; $I_f = 6$ amp; $E_{inv} = 40,000$ v; average $I_b = 100$ ma; $I_{peak} = 750$ ma.

0B3/VR90 Gas-filled cold-cathode regulator tube, now assigned a regular RMA number. Double branding is employed in view of long usage of the older designation VR-90-30. The



RUGGED





Accuracy and dependability are built into every Bliley Crystal Unit. Specify BLILEY for assured performance.

BLILEY ELECTRIC COMPANY
ERIE, PENNSYLVANIA

Bliley Crystals

operating voltage drop across the tube is 80 to 100 volts (design center value is 90 volts). ★

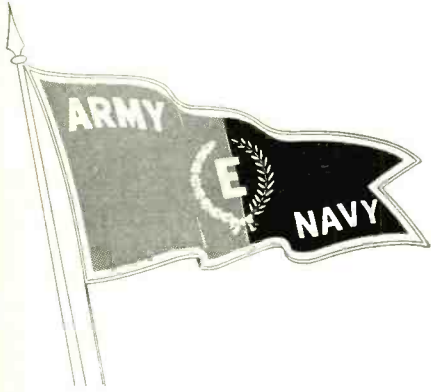
0D3/VR150 Gas-filled cold-cathode regulator tube, now assigned a regular RMA number. The operating voltage drop across the tube is 145 to 160 volts (design center value is 150 volts).



COLONIAL RADIO Co.
Buffalo, N. Y.

CORNING GLASS WORKS
Corning, N. Y.

ELECTRONIC LABORATORIES, INC.
Indianapolis, Ind.

FARNSWORTH TELEVISION & RADIO
CORP.
Marion, Ind.

FORMICA INSULATION Co.
Cincinnati, Ohio

C. O. JELLIFF MFG. CORP.
Southport, Conn.

P. R. MALLORY & Co., INC.
Indianapolis, Ind.

REPUBLIC STEEL CORP.
Cleveland, Ohio.

SOLAR MFG. CORP.
Bayonne, N. J. and West New York,
N. J.

SPRAGUE SPECIALTIES Co.
North Adams, Mass.

WINCHARGER CORP.
Two plants
Sioux City, Iowa

Personnel

Dr. Joseph Slepian, associate director of research at Westinghouse, has been selected by the AIEE to receive the 1942 Lamme Medal. The award is for "contributions to the

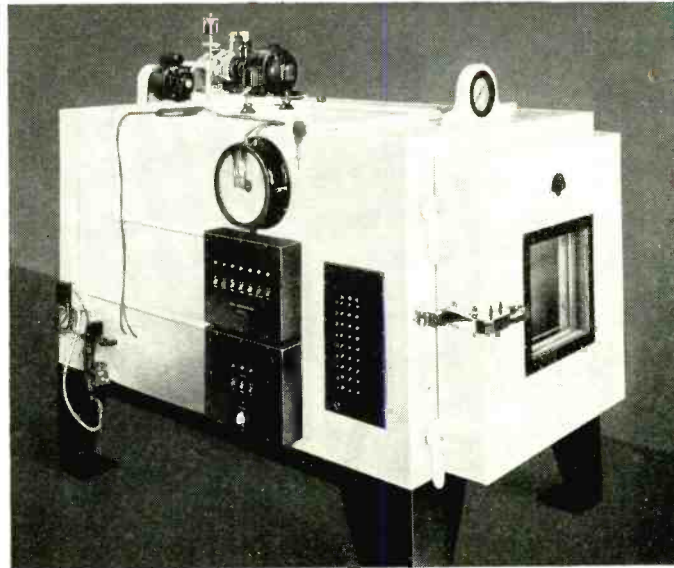

PERFORMANCE

Satisfactory

Radio and Electrical equipment is being tested in Tenney units by leaders throughout the country.

Uncle Sam's Inspectors are passing it after exacting tests with words of highest praise to the Electrical Engineers—

"PERFORMANCE SATISFACTORY"

Tenney units reproduce any atmospheric condition from the ground to Stratosphere.

Tenney Engineering, Inc. equipment is used by the Aviation Industry and the United States Government for all types of test.

Stratosphere Chambers and Rooms to 60,000 feet.

Humidity Chambers to 95%.

Constant and Variable Temperature Baths to $\pm 0.1^\circ$ F.

Temperature Cabinets to -100° F.

Accurately controlled by exterior instruments.

Our Engineering staff is at your service

Illustrated and descriptive booklet on request
For Precision Control, write—

TENNEY ENGINEERING, INC.

Dept. E-4, 8 Elm Street Montclair, N. J.

Telephone: Montclair 2-5535



I'll
VICTORY
and Beyond

You can count on Wincharger Antenna Towers. They combine strong efficient coverage with built to last qualities that insure you years of service.

Add to these advantages their strikingly attractive appearance plus a sensationally low initial cost and it's easy to see why an ever increasing number of Wincharger Antenna Towers are being used for:

Commercial Broadcasting
Police Work
Signal Corps Air Lines
Ordnance Plants

To be sure for years ahead
—be sure to specify Wincharger Antenna Towers.

Makers of
WINCHARGER
FARM ELECTRIC
SYSTEMS
WINCO
DYNAMOTORS
WINCHARGER
VERTICAL
RADIATORS

WINCHARGER VERTICAL RADIATOR
WINCHARGER CORPORATION SIOUX CITY, IOWA

development of circuit-interrupting and current-rectifying apparatus."

I. R. Baker, one of radio's best-liked pioneers, died suddenly of a cerebral hemorrhage on Feb. 19 while at his office at RCA Mfg. Co. in Camden. From 1929 to the outbreak of the war he had been head of broadcast transmitter sales at the Camden plant, and since then had been devoting most of his time to research in applying high-frequency radio current to speed up war production.

T. A. Willard, storage battery inventor and former president of the Willard Storage Battery Co., died Feb. 3 at his home in Beverly Hills, Calif. at the age of 80. After more than 30 years spent in inventing devices for storage batteries, for which 65 patents were awarded, he retired from business and devoted his time to a study of Mayan culture and to frequent trips of exploration to Yucatan. His four books on Mayan culture have made him an authority on the subject.

William Fay and Fred C. Young, vice-president in charge of broadcasting and vice-president in charge of engineering respectively, are among the newly-elected directors of Stromberg-Carlson Tel. Mfg. Co.

Dr. W. R. G. Baker, G-E vice-president, outlined the future of electronics in a talk before a recent New York section meeting of the American Marketing Association.



G-E vice-president Dr. W. R. G. Baker (center), who warned against expecting an overnight flood of new products after the war, is shown here with AMA radio group chairman George H. Allen (left) and Dr. H. S. Hettinger of OWI in Washington, other speakers at the American Marketing Association meeting

tion. He cautioned against expecting f-m and television sets to sell for \$9.95 after the war, and pointed out that it will take time to apply war-acquired knowledge to peacetime practice.

"dag"
COLLOIDAL GRAPHITE

ITS PROPERTIES

- An electrical conductor
- Low in photoelectric sensitivity
- Diamagnetic
- A black body
- Low coefficient of expansion
- Gas absorbent
- Opaque
- Chemically inert
- A conductor of heat

ITS USES IN ELECTRONICS

- Vacuum tubes
- Ray focusing anodes in cathode ray tubes
- Shields
- Grids, radio
- Plates, radio
- Electron guns
- Nonmetallic electrodes
- Glow discharge tubes
- Luminous gaseous discharge lamps
- Experimental cells
- Converter and output tubes
- Electron multipliers
- Half wave rectifiers
- Three element discharge devices
- Photoelectric cells
- Counter electrodes
- Resistances
- Thermopiles

ACHESON COLLOIDS CORPORATION
PORT HURON **dag** MICHIGAN
COLLOIDAL PRODUCTS

W. C. White, engineer in charge of the G-E Electronics Laboratory at Schenectady, has been named a member of the IRE board of directors. He has played a leading part in all G-E radio tube developments, and from 1929 to 1941 was in charge of the Vacuum Tube Engineering Department.

Dr. L. Grant Hector has joined National Union as Director of Engineering, and will direct all electronic tube research and engineering activities for laboratories and



manufacturing plants of the company in Newark, N. J. and Lansdale, Pa. Previously he had been engaged in electronic development work for the Office of Scientific Research and Development.

S. Caplan, after nine years as research chemist with Harvel Research Corp., has become research manager and acting technical director of Irvington Varnish and Insulator Co. of Irvington, N. J. He succeeds C. F. Hanson, who has been appointed chief consulting engineer and will be responsible for expediting technical work on war production.

Radio and Radar Advisory Committee, under the direction of WPB radio and radar officer Ray Ellis, now includes the following members from industry: Max Balcom of Sylvania, M. Cohen of F. W. Sickles Co., W. P. Hilliard of Bendix Radio, W. F. Hosford of Western Electric Mfg. Co., E. E. Lewis of RCA, Percy L. Schonen of Hamilton Radio, and Al Wells of Wells-Gardner Co.

For Finer Co-ordination... remember

ONLY

WINCO GIVES YOU

ALTI-TEMP

The dynamotor specially designed to insure maximum efficiency at all operating altitudes and temperatures.



Quality Built WINCO DYNAMOTORS Insure

- ★ COMPLETE DEPENDABILITY
- ★ PERFECT BALANCE
- ★ MINIMUM A. C. RIPPLE
- ★ LOW VOLTAGE REGULATION
- ★ COMPACTNESS and LIGHT WEIGHT

... And, whatever your power problem, Winco Engineers will be glad to help you solve it. This service is free and without obligation. Why not consult us?

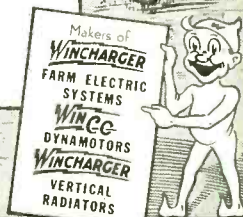

WINCO DYNAMOTORS
WINCHARGER CORPORATION - SIOUX CITY, IOWA

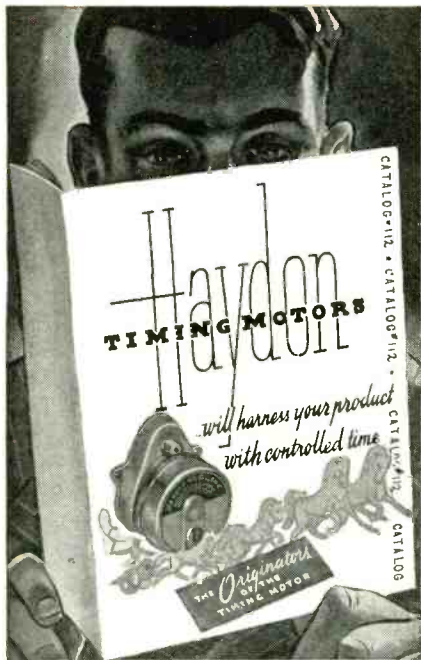

Just off the Press!

**IT'S VALUABLE
IT'S INDISPENSABLE
IT'S TIMELY**

So Send TODAY for Your Copy!

*Complete Information
on Timing Motors*

FOR USE IN:

Automatic Reset Timers
—Time Delay Relays—
Vacuum Tube Circuit—
Controls, etc.

Extensively used in Plate
Circuit Time Delays for
Communication Equip-
ment.

BY

*"The Originators of
the Timing Motor"*

Haydon

Headquarters for
Timing Motors

**MANUFACTURING COMPANY
* INCORPORATED ***

Forestville, Connecticut

NEW PRODUCTS

Month after month, manufacturers develop new materials, new components, new measuring equipment; issue new technical bulletins, new catalogs. Each month descriptions of these new items will be found here

Variation Fatigue Test Equipment

MODEL 25 VIBRATION fatigue testing machine was designed for heavier vibration fatigue testing equipment. Its table load capacity is 25 lbs. and its horizontal table movement frequency range (adjustable) is rated 10 to 60 cps. Table area is 12x15 inches. Total displacement (adjustable) is 0 to 0.125 inches. Maximum acceleration is approximately 14 g. The machine is mounted on a sturdy cast iron base measuring 19x38 inches. Base mounting hole dimensions are 16x25 inches. The table top over all height is 11 inches from the bottom of the base, and provides adequate clearance above the ma-



chine to permit handling of parts larger than the table dimensions. Total net weight of the machine is 365 lbs. It is powered by a 1-hp, 220-volt, a-c motor. No keys or wrenches are needed to make an accurate adjustment of amplitude. Rugged Timken and SFK bearing are used in the machine. The manufacturer states that the machine runs cool, will operate unattended for hours, and will not spill oil. An accurate electric tachometer is provided for frequency readings, and the machine is guaranteed for one year against defective material and workmanship.

All American Tool & Mfg. Co.,
1014 Fullerton Ave., Chicago, Ill.

Kilovoltmeter

SPECIFICATIONS of No. 760 kilovoltmeter include a low current consumption (not more than 1 ma); all multiplier units are an integral part of the self-contained instrument; three ranges are 5, 10 and 20 kv; plus or minus 2 percent accuracy at full scale; and sensitivity of movement, 1000 ohms per volt.

The instrument is rugged and portable and is obtainable from Shallcross Mfg. Co., Collingdale, Pa.

Double Armature Relay

THIS RELAY is a double action interlocking control unit with balanced armature control. It is ruggedly built to withstand vibration and sudden shocks of mobile applications, and can be custom built to fit into designs where light weight and small

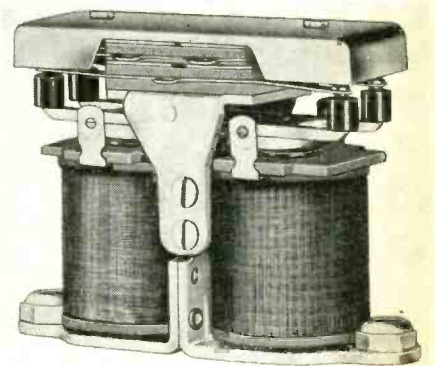

size are essential. It is available in various contact arrangements or with Micro switches (in place of spring pile-ups). Capacities are rated up to 5 amps, 110 volts a.c. Coil resistance is 10,000 ohms. Contact forms or assemblies have up to 12 springs on each side.

Cook Electric Co., Chicago, Ill.

SURE..

PREFERENCE RATINGS DRIVE US NUTS TOO



What with rating requirements and priorities, aspirin has become an important part of our office equipment. But we swallow them cheerfully and tackle our extra work with enthusiasm, for, in spite of the headaches, we've developed a *better* Audiodisc, we're filling more orders than ever before in our history — and Audiodiscs are actively helping the war effort. Naturally, we realize too that these priority restrictions are essential. Audiodiscs do contain some critical materials. Proper control enables us to get these materials and thus maintain the superior quality and dependability found only in Audiodiscs. Recently the preference rating procedure on recording blanks and cutting points has been greatly simplified. So help us speed up your deliveries by sending in your preference rating extensions with your orders. Thanks a lot!

This war may be bringing us headaches, but there is a lot of satisfaction in knowing that Audiodiscs are doing their part for Victory . . . bringing messages and music to boys at the front and training camps . . . reaching millions of our allies and friends in Axis-conquered countries . . . presenting the truth to thousands who listen even in enemy countries . . . recording important speeches and up-to-the-minute news . . . transmitting messages and instructions in war plants . . . releasing wires for wartime communications, and performing many other highly important roles on both the home and fighting fronts.

Whatever your particular application, Audiodiscs will serve you with the same characteristic dependability, under the most exacting conditions, that wins for them universal acclaim, wherever they go on a turntable. Audiodiscs are readily available through a coast-to-coast network of distributors. Call your nearest one — or wire us for complete information today. Audio Devices, Inc., 1600 Broadway, New York City.

AN IMPROVEMENT—NOT A SUBSTITUTE THANKS TO PRIORITIES

With no more aluminum available, Audio's recording engineers stepped in and developed the superior 4-hole, glass base Audiodisc which contains all features essential to high-fidelity recording—superior coating formula and process—flawlessly smooth, non-deteriorating surface—improved tracking—controlled thread action—reduced static—longer playback life—thin, flexible glass base with correct strength-to-weight ratio—center hole and all three drive-pin holes in non-chipping fibre insert (patented)—complete interchangeability with pre-war aluminum-base types—safe, dustproof packing cases—special reshipping cartons.

THERE'S AN AUDIODISC *designed and priced*
FOR YOUR SPECIFIC NEEDS

audiodiscs

—they speak for themselves



RED LABEL • YELLOW LABEL • MASTER
REFERENCE RECORDING AUDIODISCS

G. A. W. CARBONYL IRON POWDER



SETTING A NEW HIGH IN IRON CORE PERFORMANCE

At present available in three types, G. A. W. Carbonyl Powder — combining high effective permeability and highest Q value—is of increasing importance to leading core manufacturers supplying the carrier and high frequency fields where the highest efficiency is required.

Other powders now being developed. We will appreciate your letting us know your requirements.

*Write for further
information*

GENERAL ANILINE WORKS

A DIVISION OF

General Aniline and Film Corp.

435 Hudson St. New York, N. Y.

Manufacturers and sole distributors

Voltage Regulator

A NEW TYPE VOLTAGE regulator controls the voltage delivered to a vibrator used for airplane service, by the use of an automatic thermal switch which automatically turns on any auxiliary circuit ten seconds after the vibrator is started. (Similar regulators can be designed to control the current and voltage applied to any load, providing the total wattage consumed by the regulator itself is not more than 40 watts.) With a battery variation of 20 to 30 volts (50 percent), the voltage on the vibrator is kept between 6.0 and 6.3 volts (5 percent) variation. With a 10 percent change in current through the regulator, the voltage drop increases 200 percent.

Amperite Co., 561 Broadway, New York, N. Y.

Time Delay Relay

IN THE RE-DESIGN of Agastat (an electro-pneumatic time delay relay for making or breaking electrical circuits at pre-determined intervals) the basic design and principle of operation were adhered to, but the newer model weighs 1 lb and 6 ozs less than its predecessor (actual weight being 1 lb and 6 oz) and it is only 4 inches high in comparison to the older model's 5 inch height. An-

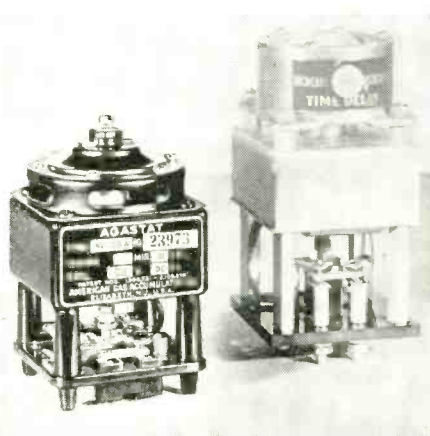

other difference is in the housing and component parts which are made of substitute materials, although heavy brass is used in the operating mechanism. A simple screw adjustment permits a delay ranging from a fraction of a second to several minutes. The relay is unaffected by heat, cold or variations in operating voltage, temperature or humidity.

American Gas Accumulator Co., Elizabeth, N. J.

NOW

a really high-powered

RADIO ENGINEERING LIBRARY

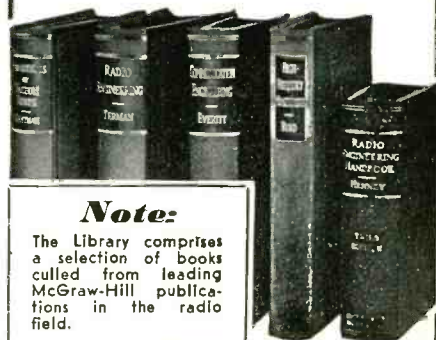

Note:

The Library comprises a selection of books culled from leading McGraw-Hill publications in the radio field.

- ↳ especially selected by radio specialists of McGraw-Hill publications
- ↳ to give most complete, dependable coverage of facts needed by all whose fields are grounded on radio fundamentals
- ↳ available at a special price and terms

These books cover circuit phenomena, tube theory, networks, measurements, and other subjects—give specialized treatments of all fields of practical design and application. They are books of recognized position in the literature—books you will refer to and be referred to often. If you are a practical designer, researcher or engineer in any field based on radio, you want these books for the help they give in hundreds of problems throughout the whole field of radio engineering.

5 volumes, 3559 pages, 2558 illustrations
 Eastman's FUNDAMENTALS OF VACUUM TUBES, 2nd edition
 Ferman's RADIO ENGINEERING, 2nd edition
 Fveritt's COMMUNICATION ENGINEERING, 2nd edition
 Hund's HIGH FREQUENCY MEASUREMENTS
 Henney's RADIO ENGINEERING HANDBOOK, 3rd edition

SPECIAL LOW PRICE • EASY TERMS
 Special price under this offer less than cost of books bought separately. In addition, you have the privilege of paying in easy installments beginning with \$3.00 in 10 days after receipt of books, and \$3.00 monthly thereafter. Already these books are recognized as standard works that you are bound to require sooner or later. Take advantage of these convenient terms to add them to your library now.

FOR 10 DAYS EXAMINATION SEND THIS

-----ON-APPROVAL COUPON-----

McGraw-Hill Book Co., 330 W. 42nd St., N. Y.

Send me Radio Engineering Library for 10 days' examination on approval. In 10 days I will send \$3.00 plus few cents postage, and \$3.00 monthly till \$24 is paid, or return books postpaid. (We pay postage on orders accompanied by remittance of first installment.)

Name

Address

City and State

Position

Company L. 4-43

Mechanic's Protractor

ESPECIALLY DESIGNED for the man on the job is a mechanic's protractor which gives readings for outside angles (such as angles of bend or deflection), or inside (inclusive) angles, or inches-per-foot against degrees up to 24 inches-per-foot (63 deg.—26 inches). All of the above mentioned readings can be taken with one setting. The more difficult angles can be measured by using a bevel in conjunction with the pro-

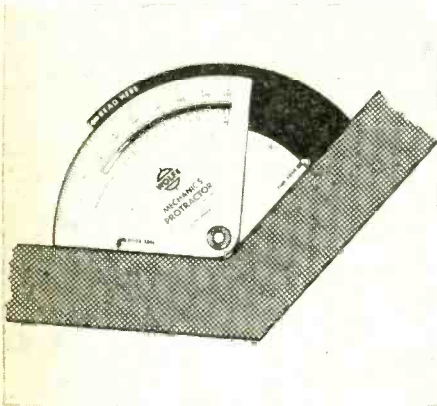

tractor. The calibrations are located at the extreme of the radius, assuring accurate, clear reading to a fraction of a degree. The protractor is printed in red on $\frac{1}{8}$ inch-thick phenol-resin laminated birch. It is light and durable and is unaffected by grease or water. Prices are \$1.00 for one protractor, 90¢ each for two, 85¢ each for three, and 80¢ each for twelve or more, to be remitted when ordering, from the Interstate Sales Co., 1123 Broadway, New York, N. Y.

Pilot Light Assembly

JEWEL LIGHT assembly, No. 675 Type, has a one-inch jewel and is designed for horizontal mounting on panels measuring up to one-half inch thick. Its outstanding features are heavy-duty construction, and double contact candelabra bayonet socket which is housed in a thick black Bakelite base. Any double contact, candelabra-sized bayonet base lamp with C7, G6, S6, or T4 $\frac{1}{2}$ bulb-size can be used. The assembly is available in jewels of smooth, colorless frosted-back glass—with a removable color disc or a diamond-cut (faceted) colored glass. A bezel, which holds the jewel permits easy removal of lamp from panel front.

Drake Mfg. Co., 1731 West Hubbard St., Chicago, Ill.



SHE'S FIGHTING TOO!

Making Parts Without Dies

No delay waiting for dies—parts ready quicker—deliveries speeded up—all to bring the Victory sooner! Women are rapidly taking a major place on the industrial front. DI-ACRO Precision Machines—Shears, Brakes, Benders—are ideally suited for use by women in making duplicated parts accurate to .001" — DIE-LESS DUPLICATING. Thousands of DI-ACRO Machines are now in use in War plants.

Send for Catalog

"METAL DUPLICATING WITHOUT DIES"

It's an eye-opener on what you can do without dies, shows typical parts, and gives sizes and capacities of all models of Di-Acro Shears, Brakes, Benders.



BRAKES

(Illustrated)

Di-Acro Brake forms non-stock angles, channels or "Vees". Right or left hand operation. Folding width—Brake No. 1—6". Brake No. 2—12". Brake No. 3—18".

BENDERS

Di-Acro Bender bends angle, channel, rod, tubing, wire, moulding, strip stock, etc. Capacity—Bender No. 1— $\frac{1}{2}$ " round cold rolled steel bar. Bender No. 2— $\frac{1}{2}$ " cold rolled steel bar.

SHEARS

Di-Acro Shear squares and sizes material, cuts strips, makes slits or notches, trims duplicated stampings. Shearing width—Shear No. 1—6". Shear No. 2—9". Shear No. 3—12".

O'NEIL-IRWIN  **MFG. CO.** 321 8th Avenue So., Minneapolis, Minn.

STABILIZED A. C. VOLTAGE UP TO 25 KVA

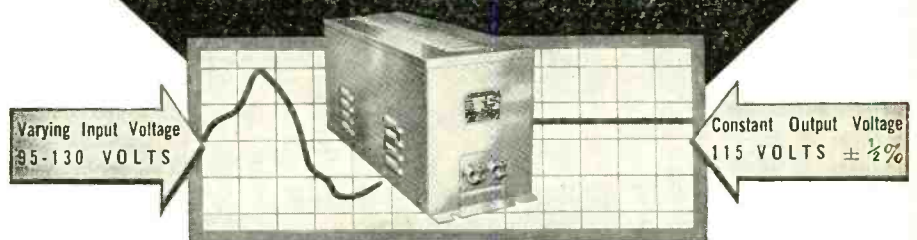

INSTANTANEOUS ACTION

NO MOVING PARTS

When a precision electrical device or a critical process is powered from an AC line, a Raytheon Voltage Stabilizer will permanently eliminate all of the detrimental effects caused by AC line voltage fluctuations. Made for all commercial voltages and frequencies, single or three phase.

Raytheon's twelve years of experience in successfully applying the Stabilizer to hundreds of perplexing voltage fluctuation problems is at your service. It will pay you to take advantage of our engineering skill.

Write for Bulletin DL48-71 JE describing Raytheon Stabilizers.

RAYTHEON MANUFACTURING CO.
100 Willow Street WALTHAM, Massachusetts

2 BOOKS EVERY "WAR-TORN" ENGINEER NEEDS!



A-C CALCULATION CHARTS

By R. LORENZEN

This new Rider Book greatly reduces the time required for alternating current engineering calculations—speeds up the design of apparatus and the progress of engineering students. Two to five times as fast as using a slide rule! Thousands of enthusiastic users.

A-C CALCULATION CHARTS are designed for use by civilian engineers and engineers of the armed forces who operate in the electrical—communication—power—radio—vacuum tube—telephone—and in general, the electronic field. Invaluable for instructors as well as students, and also administrative officers who check engineering calculations.

\$7.50
160 Pgs.
9 1/2 x 12 in.

CATHODE RAY TUBE AT WORK

The Cathode Ray Tube at Work is the accepted authority on the subject. The cathode ray tube in the Oscillograph and its application to electronic and industrial work is fully discussed. Profusely illustrated. 338 pages \$3.00

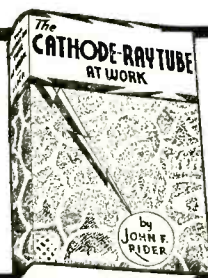

JOHN F. RIDER PUBLISHER, Inc.
404 FOURTH AVENUE, NEW YORK CITY
Export Division: Rocke-International Elec. Corp., 100 Varick St., N. Y. C. • Cable: ARLAB

Vacuum-Creating Outfit

A UNIT WHICH produces and maintains vacuum or pressure needed to test delicate instruments, such as directional gyros, artificial horizon instruments, altimeters, etc., is a motor-driven rotary pumping unit

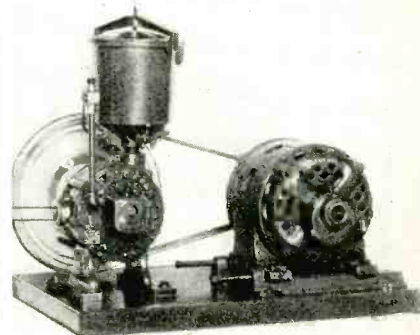

which is furnished with full automatic controls and automatic lubrication. The vacuum or pressure may be adjusted to any degree desired. The machine is slow-running and quiet in operation.

Lieman Bros., Inc., Christie St., Newark, N. J.

Throat Microphone

FOR USE IN AIRCRAFT, submarines, military tanks, defense plants and other noisy places, this is an improved throat microphone which is placed around the neck, over the larynx. Words spoken by the wearer are picked up and may be amplified and transmitted through a PA system. No surrounding noise is transmitted through the microphone. Any standard amplifier designed to use a crystal or other high impedance microphone may be used with the microphone. The microphone is constructed on the inductor-dynamic principle, and is rugged and compact (weighs 2 ounces). It is leather covered and equipped with an adjustable neck strap.

Miles Reproducer Co., Inc., 812 Broadway, New York, N. Y.

Electronic Armament Gauge

AN ELECTRONIC GAUGE capable of indicating differences as small as 0.00002 inch in metal objects up to eight inches in diameter or length is announced by Televiso Products, Inc., 6533 No. Olmsted Ave., Chicago. Indications appear on a four-inch meter scale having ranges of



**THE NEW
AGASTAT**
Unaffected by
variations in voltage
and temperature

...it's smaller!

LIGHTER WEIGHT . . . MINIMUM
APPLICATION AREA . . . GREATER
DURABILITY . . . THESE ARE BUT A
FEW OF THE ADDED ADVANTAGES
OF THE REDESIGNED AGASTAT.
SKILLFULLY ENGINEERED FOR EX-
TREMELY ACCURACY IN TIME DELAY
SWITCHING, THIS ELECTRO-
PNEUMATIC INSTANTANEOUS RE-
CYCLING UNIT OFFERS EVEN
GREATER IMMUNITY TO VARIA-
TIONS IN TEMPERATURE, HUMIDITY
AND VOLTAGE FLUCTUATIONS. FOR
DEPENDABLE, UNINTERRUPTED SER-
VICE, SPECIFY NEW AGASTAT.

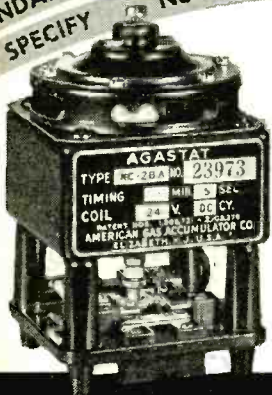

ELIZABETH **AGA** NEW JERSEY
AMERICAN GAS ACCUMULATOR CO.

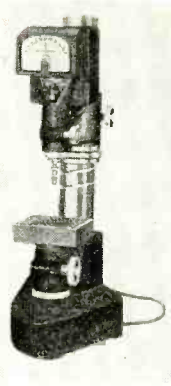

plus or minus 0-0.0005, 0-0.005, and 0-0.05 inches. Ranges are changed by means of a selector switch. In use, a standard work piece is placed under the feeler point and the instrument is adjusted to give a zero reading (at mid-scale). Deviations of production pieces from standard can then be read directly on the scale by unskilled operators as fast as parts can be placed under the feeler point. The instrument is known as the Model 11 Micrometron, and is available on priority only.

Phenolic Plastics

PHENOLIC MOLDING material, BM-13017, is designed especially for the production of aircraft and automotive ignition parts. The material is natural colored and is suitable for extrusion molding around inserts.

Type BM-16034 phenolic molding plastic was developed for long flow extrusion work. It may also be used for transfer molding.

Physical and electrical molded properties are available from the manufacturer, Bakelite Corp., 30 East 42nd St., New York, N. Y.

Screw-On Type Wire-Nuts

NO RUBBER, tin or lead are used in these "Wire-Nuts" (solderless, tapeless wire connectors) which consist of a cone-shaped spiral spring insert which is imbedded in a molded insulation. The nuts utilize insulation which will not melt and is puncture-proof at 10,000 volts. Five sizes are available for making all combination of wires from 2 No. 18 to 3 No. 10, solid or stranded. The nuts are approved by Underwriters' Laboratories, and Factory Mutual Laboratories.

Ideal Commutator Dresser Co., Sycamore, Ill.



a-hunting we will go

With scarcities of critical radio materials developing everywhere, we've become an emergency "procurement" agency for many manufacturers and branches of our military services.

In normal times, we were a distribution channel for radio equipment manufacturers. Today, we still maintain our valuable contacts with practically all reputable suppliers—though our function has changed somewhat. We are trained to locate sources of supply . . . to purchase . . . to speed deliveries of material that you may need urgently.

Let us hunt 'em down. We'll deliver the goods to you.

HARVEY
RADIO COMPANY
103 WEST 43 ST. NEW YORK, N.Y.

★
DeForest's Training, Incorporated
has long used
Potter and Brumfield Relays

Potter & Brumfield
Princeton RELAYS Indiana
THE POSITIVE ACTION RELAY

Voltage Stabilizer

THIS INSTRUMENT provides a constant output of 115 volts from circuits varying between 95 and 130 volts. It is insensitive to load power factor, and is not affected by variations in load from no load to full load, or by changes in power factor from unity to 0.8 lagging. Completely self-protecting, it will operate continuously throughout the range from open circuit to short circuit without damage. Ratings from 50 volt amps to 5000 volt amps are available. The new stabilizer can be applied wherever close voltage regulation is needed, such as in radio transmitters, electron tube apparatus, motion-picture sound equipment and projectors, x-ray machines, etc.

Publication GEA-3634 which describes the stabilizer in detail is available from General Electric Co., Schenectady, N. Y.

Tube Stud Connector

A NEW TUBE STUD connector (called Hystud) has been developed for use in joining flexible leads to filament studs of large electronic tubes. It is

**NEED
DESIGN
WAIT**

On "Critical"
Materials?

One-Piece Rolls
450-2000 Feet
Ready-Slit in
Widths 3/4" to 30"

WANTED . . . New Openings

Highest grade Electrical Insulating Papers combining Toughness, Flexibility, and High Dielectric seek additional applications! Long recommended by the foremost MOTOR and Transformer design engineers! Have you an opening for our well qualified product in your needs of today . . . or tomorrow? Economical in price, Cottrell Papers pave the way to other economies in production time and materials.

Submit Your Insulating Paper Problems
Both Old and New To COTTRELL Engineers.

**COTTRELL
PAPER CO., INC.**

FALL RIVER, MASSACHUSETTS
Factory: Rock City Falls, New York

Order ROLLS or
30x40 SHEETS

COPACO
100% RAG

COPAREX-S
100% RAG

NUNGRA
High RAG Cont.

★

First two guaranteed
300 volts per mil.
NUNGRA usually
tests 300. All tough
yet flexible. Non-
chem. Standard
Thicknesses .005 .007
.010 .015 .020 .025
.030. Others if quan-
tity warrants.
Samples on Request

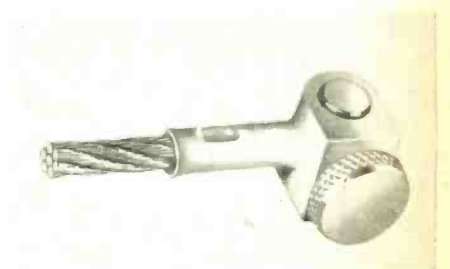

an indent-type of connector and is compact. The connector is assembled to the stud by means of a knurled thumb screw.

Burdny Engineering Co., Inc., 459
East 133rd St., New York, N. Y.

Modern War Sound Effects

AUTHENTIC SOUNDS of warfare such as the sound of Spitfires, Messerschmitts, and other modern fighters and bombers in various flight maneuvers, dogfights, dives, and ground battles with tanks, falling bombs, machine-gunning, etc., are available on Super-Sound Effect records. These sound effects are pressed on Victrolac. A catalog supplement giving descriptions of other effects may be obtained from Standard Radio, 45 West 45th St., New York, N. Y.

Fuse-Bond Process

MACHINE COMPONENTS and similar metal parts may be prepared for metallizing electrically by a new process called "Fuse-Bond". It is claimed that this process affords an adequate bond on the hardest surfaces, and it also simplifies preparation of narrow edges, flat areas, and cylindrical parts having keyways and other interruptions in their surfaces. Available with this process is a unit (Type C is illustrated) which operates on any 110 or 220 volt, single phase power line. The equipment fuses a rough deposit of electrode metal onto a surface to be metallized.

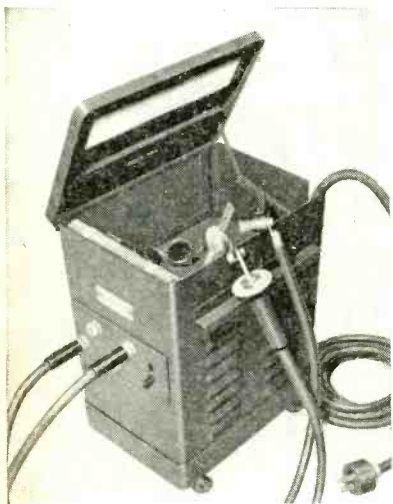

The Unit is compact, and is contained in a cabinet measuring 24 inches high. It weighs, complete, 170 lbs. All cables and attachments fit into a bin in the top of the cabinet. The unit is mounted on casters and can be wheeled right to the job with ease. A complete instruction manual provides all operating data. The manufacturer states unskilled labor can operate the unit efficiently within an hour or so.

Further information on the process and its equipment contained in Bulletin 44, is obtainable from the manufacturer, Metallizing Engineering Co., Inc., Long Island City, N. Y.

Instrument Washer

AN INSTRUMENT WASHER which is electric and portable is available for washing and cleaning aircraft, tank, automobile and navigation instruments, as well as indicating and control units, carburetors, gear trains, mechanism. It may also be used for production cleaning of small parts

AZIMUTH NAVIGATION DIALS



Now Made of Bakelite
Could Not Tolerate Costly
Time-Consuming Engraving!

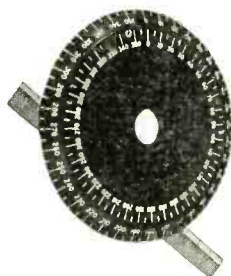

ROGAN

DID THE JOB

- ★ IN RECORD TIME
- ★ ON PLASTIC
- ★ QUICKLY CALIBRATED using the Famous "DEEP RELIEF" BRANDING

★ Months ago, questions arose on how to quickly produce the famous Azimuth Dial from plastic.

A search of the plastic industry brought the problems before Rogan's engineering staff. Then quickly, faster than that, Rogan "deep relief" branding on laminated bakelite provided the solution. As a result, only Rogan . . . Rogan *alone*, has been entrusted with this important job . . . marking the Azimuth Dial accurately, and with a permanence unaffected by salt water, extreme heat or Arctic cold.

BAKELITE PROTRACTOR used with the Azimuth Dial, is also an exclusive Rogan Branding job.



Get details on Rogan's combination Molding and Branding service.

ROGAN BROTHERS

203 South Michigan Ave.

Chicago, Ill.

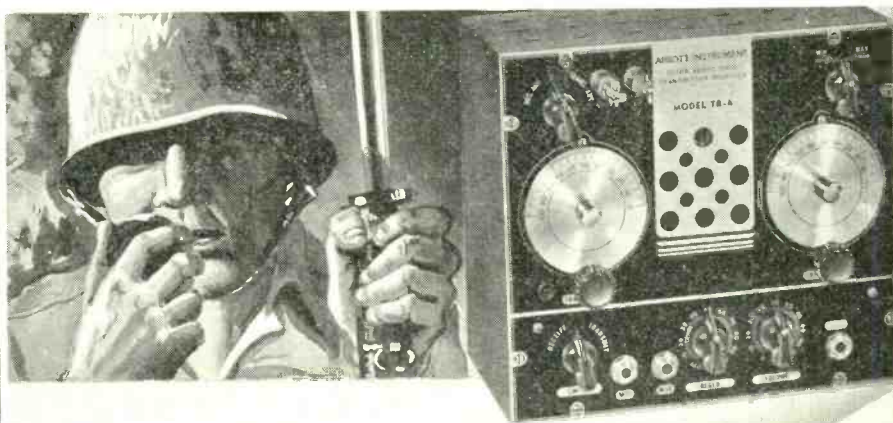

In tough spots

You'll find Abbott equipment in plenty of tough spots, exposed to extreme shock and strain . . . where men and material must possess extra stamina — complete dependability.

This is an ABBOTT TR-4, one of our standard models — a compact and efficient ultra high frequency transmitter and receiver. It is only an indication of the type of apparatus that we can and do produce. Our facilities may be of assistance, if you have a problem within the scope of our activities.

ABBOTT

INSTRUMENT, INC.

8 WEST 18 STREET • NEW YORK, N. Y.



Manross Mighty Midgets

HAIRSPRINGS
FOR
Electrical Equipment
Aircraft Instruments
Speed Indicators
Accurate Gauges

Made from appropriate materials selected for electrical resistance, minimum drift requirements, and endurance life. Furnished with or without collets—and with ends bent as desired.



F. N. BRISTOL **MANROSS & SONS**
DIVISION OF ASSOCIATED SPRING CORPORATION
CONNECTICUT U.S.A.

PROUDLY IN THE
Nation's Service

As in the First World War, BRACH radio and electrical equipment is once again proving its excellence and dependability under the most exacting conditions...the products of 36 years' experience in "QUANTITY-plus-QUALITY" manufacture.

L. S. BRACH MFG. CORP.
World's Oldest and Largest Manufacturers of Radio Aerial Systems
55-65 DICKERSON STREET • NEWARK, N. J.

such as screws, small electrical units, distributor and relay parts, and other odd and complicated shapes of various materials. The material which is to be cleaned is put into any one of the four to six separate trays. The trays (which serve to keep disassembled parts together) remain stationary while a cleansing liquid circulates through the washer. Any of the trays may be removed without stopping or disturbing the other work in the machine. The compartments may be lifted out to accommodate larger parts which may have to be cleaned. A drain well is contained at the bottom of the machine for dirt elimination.

The machine measures 26 inches high x 18 inches in diameter. The weight is 50 lbs.

Naxon Utilities Corp., 2101 Walnut Street, Chicago, Ill., are the manufacturers.

Induction Heating Units

NEW INDUCTION heating units for surface hardening, brazing, soldering, and other heating applications requiring localized heat are available in sizes of 16 kw and 32 kw. Each machine is a completely enclosed unit readily adaptable for low cost hardening and heating of many parts which are manufactured in small lots, or they can be incorporated into any production line. The

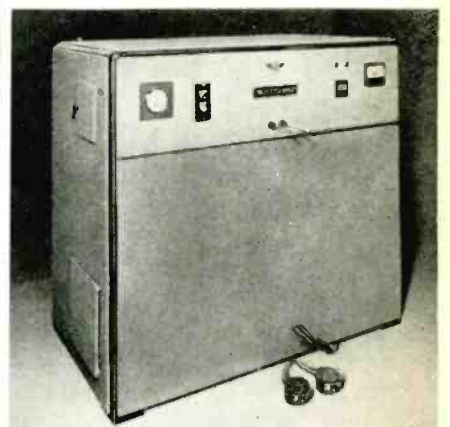

machines are easy to operate and in changing from one job to another, the operator simply changes the work-holding fixture and heating coil and resets the heating cycles to meet the new requirements. The entire heating operation is automatic. Bulletin 2-1-42-5M describes the units in more detail. Quenched spark gaps are used.

Van Norman Machine Tool Co., Springfield, Mass.

Are You Playing

**"BLIND MAN'S
BUFF"**



With Your Future?

GET THE BETTER JOB YOU WANT! CREI technical training enables you to go after—AND GET—the jobs that will mean something when the war is over.

• Are you, like many other professional radiomen, so wrapped up in your present routine work, that you are losing sight of where you will be "tomorrow"? Jobs that provide security—jobs that will mean something when the war is over—must be won and held on ability. Now is the time for you to make your present job an investment in a secure future. Why not investigate what CREI home-study training in Practical Radio Engineering can do for you? This practical course plus the personalized instruction service provide a proven formula for more rapid advancement.

You have a jump on the other fellow because your radio experience is a valuable asset, if supplemented with this modern training. It's worth taking time now to find out how CREI offers you a planned program which will hasten your advancement in radio.

• Write for free 32-page booklet

Let us prove to you we have something you need to qualify for a better radio job. To help us intelligently answer your inquiry—PLEASE STATE BRIEFLY YOUR BACKGROUND OF EXPERIENCE, EDUCATION AND PRESENT POSITION.



CREI Students, Graduates — ATTENTION!

The CREI Placement Bureau is flooded with requests for radiomen. Employers in all branches of radio want trained men. Your Government wants every man to perform his job, or be placed in a job that will allow him to work at maximum productivity. If you are or will be in need of re-employment write your CREI Placement Bureau at once.

CAPITOL RADIO ENGINEERING INSTITUTE

Home Study Courses in Practical Radio Engineering for Professional Self-Improvement
Dept. E-4, 3224 — 16th Street, N.W.
WASHINGTON, D. C.

Contractors to the U.S. Signal Corps—U.S. Coast Guard
Producers of Well-trained Technical Radiomen for Industry

Hole Punching Units

WALES CD UNITS are sets of punch units for use in conventional die sets. The punch half of the unit contains a punch with a pilot, a holder, a stripping spring, and a guide. The die half of this set consists of a holder with a slug clearance chute, and a die. Each unit is self-contained and may be independently mounted to either the punch or the

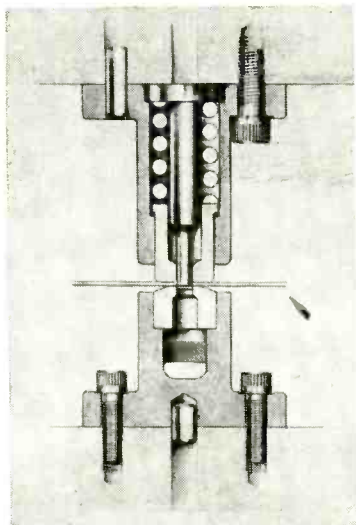

die shoe. Broken or dulled parts may be changed easily without breaking down the entire die set. Punch and die alignment is automatically assured through the use of a pilot pin which is centered on the punch or die.

These units may be used in either punch presses or press brakes to punch holes from $\frac{1}{8}$ to $1\frac{1}{2}$ inches diameter in metal which measures up to 11 gage.

ANOTHER UNIT is the flexible Type E unit designed for punching a ser-

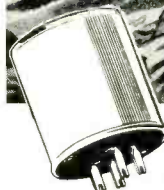
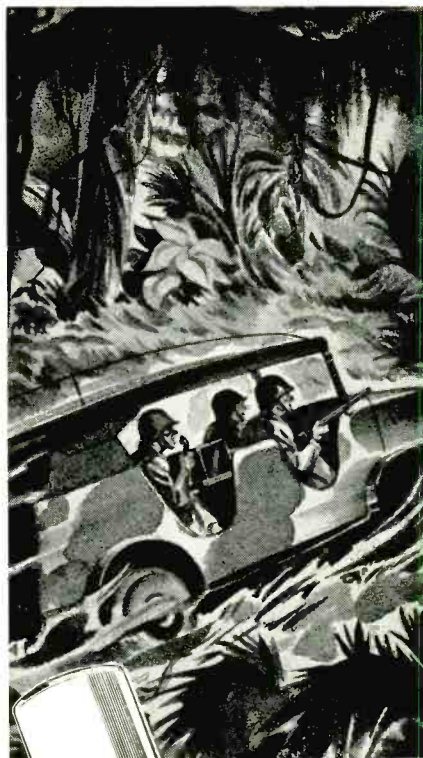
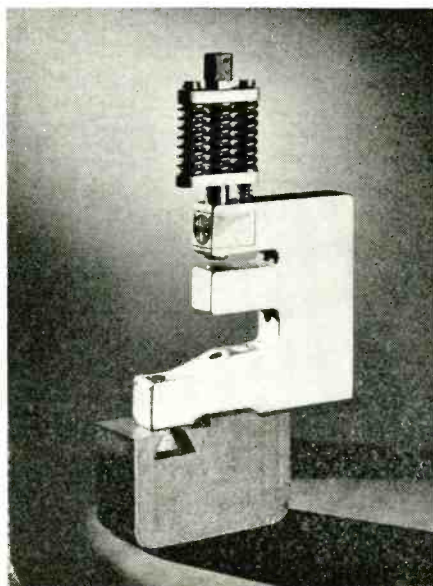

Small and Tough

THERMADOR TRANSFORMERS

THERMATITE TREATED

Engineered to lick extreme temperature and humidity problems on the firing line, Thermador Transformers are effectively *Thermatite treated*. Thermatite is the time tested process of accurate heat-controlled vacuum impregnation, developed and improved exclusively by Thermador during the last decade.

THERMADOR
Electrical Mfg. Co.
5119 S. Riverside Dr.
Los Angeles, Calif.



"Seven Leagues Ahead"

Freedom FROM BOUNCE



SIGMA
Sensitive Relays

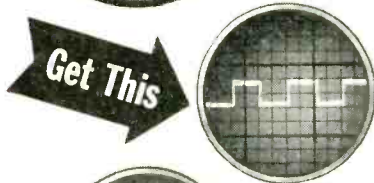

Get This

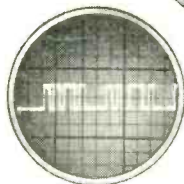

Not This

In high-speed switching, you want sharp, positive action that is free from chatter and bounce . . . that's just what you can get with SIGMA Sensitive Relays.

With total operating delay held in the vicinity of one millisecond, SIGMA relays permit up to 200 contacts per second, even in the presence of severe vibration, and at extremes of temperature and pressure.

We cannot state general conditions under which such results can be attained. Submit your problems to us . . . security of all information—military or commercial—is strictly assured.

SIGMA
Sensitive Relays
INSTRUMENTS INCORPORATED
70 FREEPORT ST.
BOSTON, MASS., U. S. A.

ies of holes in extruded shapes on press brake. Nothing is attached to the press. Each unit is made up of punch, die, holder, stripping spring and guide. The punch and die are held in perfect alignment. A line-up of units may be set up to punch over 200 holes at the same time on a rail.

The Strippit Corp., 345 Payne Ave., North Tonawanda, N. Y.

Gage Blocks

DOALL MASTER GAGE Blocks are available in a standard set (Set 400) and consist of 81 blocks. The 81 individual blocks range in length from 0.050 inches to 4.00 inches. These precision gage blocks are produced in "AA" grade (accuracy 0.000002 inch), "A" grade (accuracy 0.000004 inch), and "B" grade (accuracy 0.000008 inch). Each gage block in addition to being accurate in length, has its measuring surface lapped to a flatness of less than the quarter wavelength of light, and is produced with a mirror finish. These two factors enable the blocks to be wrung together in combination, en-



abling the user to secure practically any dimensions in steps of 0.00001 inches from 0.1000 inches to 12.00 inches.

The illustration shows Doall gage blocks in a mahogany case supplied with the gages. The inspector is checking a 4 inch micrometer. The manufacturer states that precision optical measuring instruments are used to check the accuracy of gage blocks produced, and this equipment is also available to users for re-checking their gage blocks after they have been in use. The used gage blocks sent in will be recalibrated and gages that have been worn beyond tolerance of the original set are replaced to maintain the required standards of accuracy.

Savage Tool Company, Savage, Minn.

"...IN-RES-CO resistors for performance"



★ Engineers, executives, and manufacturers responsible for the design and development of electrical products and equipment, are aware of the numerous electrical and dimensional advantages of these specialized resistors. The performance of all IN-RES-CO units has been proved in actual use, in ordnance and essential industrial applications.

For fixed and adjustable resistors, meter shunts, choke coils, meter multipliers, solenoids and special coils—specify IN-RES-CO.

TYPE LL (at top) stacked as a series multiplier, 1/4 Watt, inductively wound, standard tolerance 1/2%, maximum resistance 200,000 ohms, size 3/8" diam. x 1/4" high.

TYPE ML (center), 1 Watt non-inductive, standard tolerance 1/2%, maximum resistance 500,000 ohms, size 1" diam. x 1/2" high.

TYPE LL (at bottom), shown as a single unit.



**INSTRUMENT
RESISTORS COMPANY**
25 AMITY ST., LITTLE FALLS, N. J.

Stamping Equipment

TWO PRODUCTS AVAILABLE from The Acromark Co. (323 Morrell St. Elizabeth, N. J.) includes a foot-operated stamping machine and a holder for stamping with steel type.



NO. 1-F FOOT-OPERATED name plate and parts stamping machine is a pedal-operated unit which allows an operator's hands to be free for feeding. This pedal feature is available in Models 1, 5 and 7 which may be used to mark steel, brass, bronze, zinc, tin, fibre, celluloid and plastics. The size and height of the machine permit installation in a production line where the machine may be needed. Thickness adjustment ranges from zero to $\frac{1}{4}$ inch. Standard die sizes range from $\frac{1}{8}$ inches to $\frac{3}{8}$ inch in size. Each machine comes with a marking head (any specified size), with a full alphabet and set of figures and punctuation marks.



For marking multiple characters that change, the Heavy Duty Hercules holder is available for stamping with steel type. A holding clip allows type to be quickly changed by thumb pressure on the top of the clip as shown by the illustration. The type used is a heavily built shoulder style type. The holder is made from heavy tool steel bar stock and is available in larger sizes.

Give Message **TO YOU!**

Monarch developments in production and laboratory instruments have performed yeoman service for the leading radio manufacturers of America. Now, in war-time, we are cooperating with these same customers in developing and producing radio and electronic devices used in our war effort all over the globe.

If you need assistance in the field of radio or electronic developments, either for war production or, if you are now thinking of peacetime possibilities, we will be very glad to talk things over with you.



MONARCH MFG. CO.
2014 N. Major Ave. Chicago, Ill.

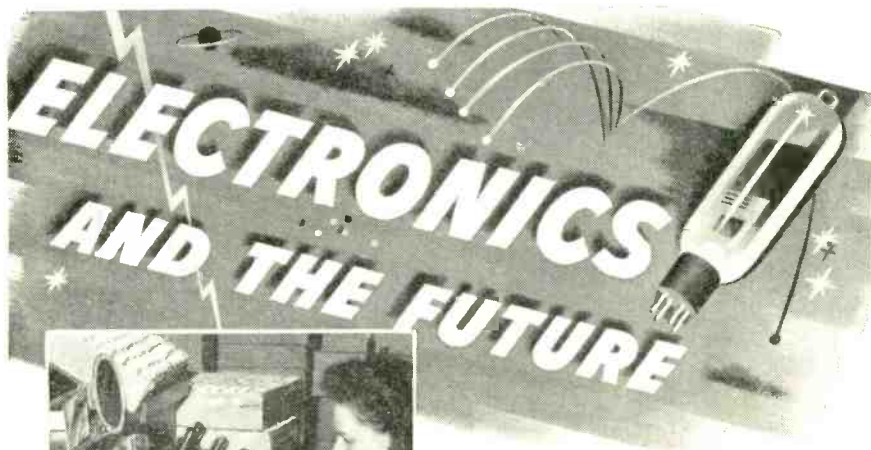

FINAL INSPECTION! Tested at every stage, each National Union Electronic Tube passes a rigid final test before shipment.

With an established reputation for quality and precision, National Union engineers have been in the forefront of electronic tube development in the past. Today, their war research is developing new applications of the electronic tube for the future. Tomorrow, they will be ready to help you apply the new science of electronics to your production problems.

NATIONAL UNION RADIO CORPORATION
NEWARK, N. J. LANSDALE, PA.

NATIONAL UNION ELECTRONIC TUBES

Now a VARIABLE INTENSITY

Shutter Type PILOT LIGHT

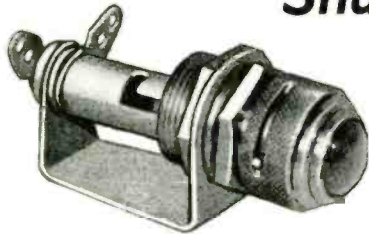

Gothard No. 430 (Faceted Jewel) and No. 431 (Plain Jewel) Pilot Lights are particularly adapted to aircraft, marine, signal and similar applications where various intensities of light are desired under constantly changing conditions. Permits gradation from bright light, thru intermediate glows to total dark within a 90° rotation of the shutters. Also available with polarized lens. Red, green, amber, blue or opal lens.

Gothard

MANUFACTURING COMPANY, 1310 North Ninth Street, Springfield, Illinois

Request complete information and prices.

Standardized Flash-Welders

THE FIRST OF A SERIES of standardized flash-welders, recently announced, further expands the manufacturer's line of products which

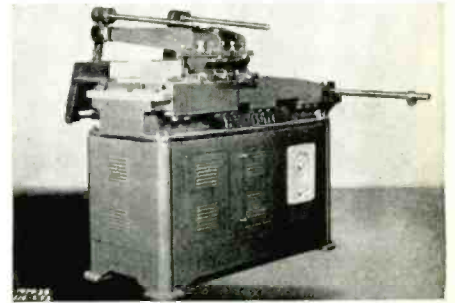

now includes all forms of resistance welding equipment from guns and fixtures to seam, projection, rocker arm and pedestal type welders, etc.

Progressive Welder Co., 3100 Outer Drive, Detroit, Mich.

Inter-communicating System

"CONVERS-O-CALL" is the name of an intercommunicating system which is available for ten to thirty stations. It is designed as an all-in-one master system to facilitate fac-

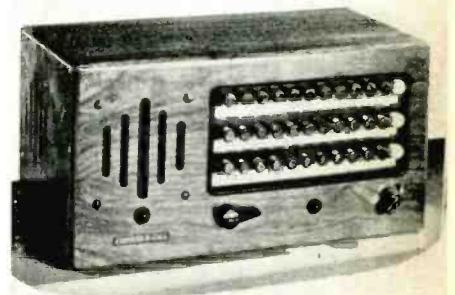

tory and office inter-communications. The system is easy to install and to operate and may be utilized, if necessary, for music transmission to employees.

Fred E. Garner Co., 53 E. Ohio Street, Chicago, Ill.

Liquid Coating Prevents Adhesion of Welding Spatter

A LIQUID COATING called "No-Spat" resists rust, will not freeze, and may be used over the full welding range of amperage and voltage. Adhesion of welding spatter is prevented when the coating is brushed over the seam and area where weld spatter may fall. After welding the spatter may

Solve Voltage Variation PROBLEMS IN AIRCRAFT, TANKS, ETC.

WITH

AMPERITE

BATTERY CURRENT & VOLTAGE REGULATORS

Features:—

1. Amperites cut battery voltage fluctuation from approx. 50% to 2%.
2. Hermetically sealed — not affected by altitude, ambient temperature, or humidity.
3. Compact, light, and inexpensive.

Now used by U. S. Army, Navy, and Air Corps.

Send us your problem.

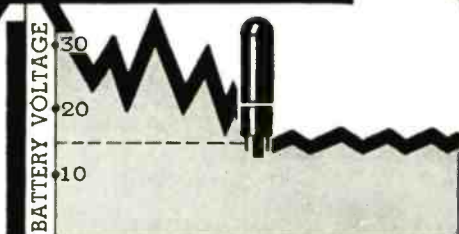

VOLTAGE OF 24V BATTERY & CHARGER VARIES APPROX.

50%

WITH AMPERITE VOLTAGE VARIES ONLY

2%

AMPERITE COMPANY • 561 Broadway, New York, N. Y.

In Canada: Atlas Radio Corp., Ltd., 560 King St. W., Toronto

Cable: Alkem, New York

Lavite STEATITE CERAMIC

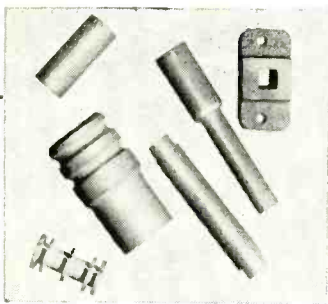

CHARACTERISTICS

Specific gravity of only 2.5 to 2.6.
Water absorption 5, 1.5-0.001 per cent. Per cent power factor.
S. 1.5 to 60 cycles was only 0.0165.
Dielectric constant at 60 cycles was 5.9-1000 KC 5.4.

Makers of electrical and radio apparatus destined for war service are finding in LAVITE the precise qualities called for in their specifications . . . high compressive and dielectric strength, low moisture absorption and resistance to rot fumes, acids, and high heat. The exceedingly low loss-factor of LAVITE plus its excellent workability makes it ideal for all high frequency applications.

We will gladly supply samples for testing.

D. M. STEWARD MFG. COMPANY

Main Office & Works: Chattanooga, Tenn.
New York Needham, Mass. Chicago Los Angeles

be wiped away and no chipping or grinding is necessary. Two other features claimed for the coating is that it fuzes with the molten and maintains maximum tensile strength by floating off impurities and preventing porosity, and that it stabilizes the arc and thus minimizes rod spatter and saves rod metal. Another application suggested by the manufacturer is that of coating the jig to prevent spatter from throwing the production job out of alignment.

The Midland Paint & Varnish Co., Cleveland, Ohio.

Relay

DEVELOPED FOR AIRCRAFT as well as other uses, 3PDT Type 27 relay, No. 12814, measures 2 x 1 $\frac{1}{4}$ x 2 $\frac{1}{8}$ inches and weighs 5 ounces. Its characteristics are as follows: Acceleration, 15 g plus; nominal coil voltage, 12 volts, d-c; pick-up, 6.5 volts (0.92 watt) at 20 deg. C.; coil wattage at 12 volts d-c is 3.2 watts; contact

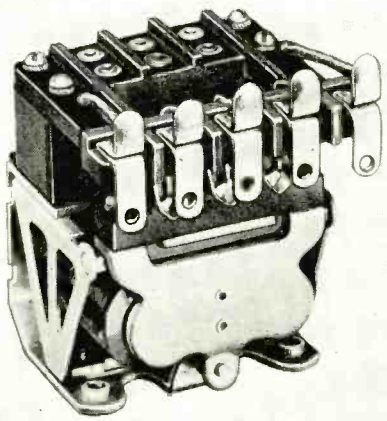

pressure, 60 grams; contact capacity, 10 amps at 30 volts, d-c; and temperature rise 32 deg. C., at 12 volts, d-c. Free samples of this relay may be had if requests designate specification number 12814 and if accompanied by a priority rating of AA-4 or better.

G-M Laboratories, 4326 N. Knox Ave., Chicago, Ill.

Signal Indicator

"SIGNALETTE" is the name of a new signal indicator for use in aircraft or wherever a signal light is used. It is designated as No. 1534. Indication is entirely by reflected light and radio activity. Indications are made in sunlight or daylight, black-light

THE FIRING LINE

..without a dud!

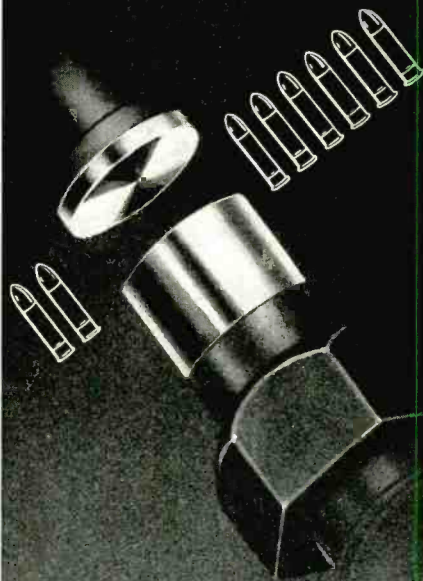

... and every shot a direct hit

There are no near misses with tungsten contacts—aim is true, and every closing and opening is dead center. Outside elements cannot disturb the "bead", because highly-fused pure tungsten eliminates excessive pitting or oxidation.

Where operation is vital, where ordnance and essential industrial equipment must be kept running, tungsten contacts will "carry on".

Take advantage of the perfect firing power of METROLOY contacts when industry resumes its normal occupation. They're proving their worth in all corners of the world. Metroloy Company, 53-57 E. Alpine Street, Newark, N. J.

METROLOY TUNGSTEN PRODUCTS



NEAREST TO RESISTANCE-FREE OPERATION

Jelliff

FINE WIRE SPECIALISTS—
Producing .0009" diameter and larger in Nickel-Chromium, Copper Nickel, and other Wires for Electrical, Chemical, and Mechanical uses.

THE C. O. JELLIFF MFG. CORP.
10 Pequot Ave.
Southport, Conn.
"Wire Products Since 1880"



Photograph by Office of War Information

GLAD HE'S ON OUR SIDE!

Glider pilots have a job to do. They have to set them down at a certain place at a certain time, slug the enemy where it hurts him most, and hold till reinforcements arrive. Coordination with other arms must be perfect, and radio makes this coordination possible. It's a tough job for tough men, and we're glad this Marine Lieutenant is on our side. . . . Wonder where he is now?



NATIONAL COMPANY, INC.
MALDEN, MASS.

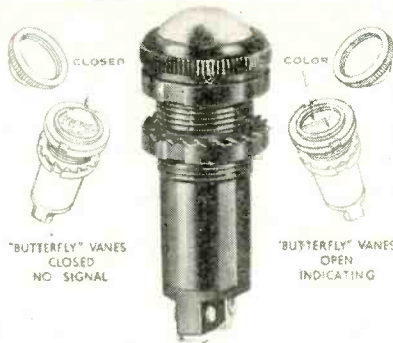

or no light. It is available with red, amber, green or white butterfly vanes. The overall length is $2\frac{3}{4}$ inches and is available for mounting on panels up to $\frac{3}{8}$ inch thickness. The gadget may be interchanged with signal indicator (AC 42B3529) now used in aircraft. The indicator is protected against shattering by the use of a transparent plastic cap which withstands shock or explosion and which permits free penetration by ultraviolet rays.

Littlefuse, Inc., 4757 Ravenswood Ave., Chicago, Ill.

Electronic Control for Resistance Welding of Aluminum

ONE OF THE FEATURES of this welding control is its simple construction which facilitates thorough inspection and servicing. The control utilizes the energy-storage principle, and provides very high currents and short welding time. The control consists of a charging circuit, a discharge circuit, control station, Pyranol capacitors, and sequence control. All this equipment is mounted in one cabinet-type enclosure with full-length front doors and remov-

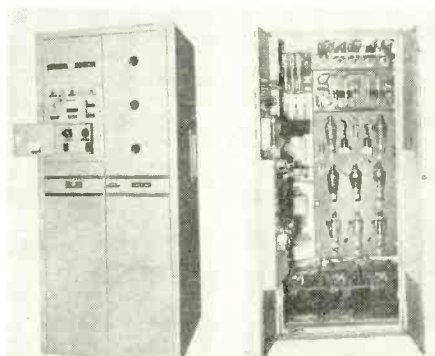

able rear covers. The enclosure is ventilated by filtered air which creates a positive pressure within the cabinet and minimizes the infiltration of dust and dirt. The main



"Demand the Best!"

J. S. STAEDTLER, INC.
53-55 WORTH STREET
NEW YORK, N.Y.

April 1943 — ELECTRONICS

anode transformer and tubes are air-cooled. The charge and discharge tube circuits are mounted on a single base that can be swung out readily for servicing. The control station may be removed from the cabinet and attached to a welding machine at any remote point.

General Electric Co., Schenectady, N. Y.

Literature

Radio Servicing and Buying Guide. A pocket-sized manual, written by Major J. G. Tustison, U. S. Army Signal Corps, describes practical methods for serving electronic and radio devices. This manual includes color code information on resistors, speaker lead and plug connections and a conversion table of fractional inches to decimal and millimeter equivalents. The price of this manual is ten cents, requests on firm letterheads from engineers maintenance and serviceman will be sent free.

A 1943 Buying Guide covering radio and electronic materials and parts includes detailed listings of transformers, resistors, condensers, rheostats, relays, switches, rectifiers, electronic tubes, tools, wire and cable, batteries, sockets, generators, power supplies, converters and other types of equipment in this field. One section is devoted to sound equipment and accessories and another section contains a technical book section on radio, electronics and electricity.

Both the radio servicing manual and buying guide may be obtained from Allied Radio Corp., 833 W. Jackson Blvd., Chicago, Ill.

Solders. In a 6-page folder substitute solders, regular solder and the solving of solder problems is described. A lead-tin fusion graph is included. Among solders described are fusible alloy, or low melting point solder; wire solder, for automatic processes and special operations; ribbon solder, for the sweating of parts; foil, for joining two flat surfaces; acid and rosin cored solders; drop solder and special solders. Alpha Metal Rolling Mills, Inc., 363 Hudson St., Brooklyn, N. Y.

The Widest Selection



OF FLEXIBLE SHAFTS AND ACCESSORIES

In both the power drive and remote control types of flexible shafts, S. S. White offers a large and comprehensive selection of sizes and physical characteristics—a selection that makes it possible to meet a wide range of operating requirements and conditions. The same is true of the selection of flexible casings and shaft and casing end fittings, which are essentials of practically every application.

CONSULT S. S. WHITE when you need flexible shafts or when you have a power drive or remote control shaft application problem. At present, S. S. White products and services are necessarily confined to war production work.

DATA FOR ENGINEERS

BULLETIN 1238—Power Drive Shafts.
BULLETIN 38-42—Remote Control Shafts.
BULLETIN 641—How to Make the Most of Flexible Shafts.

Copies Mailed on Request.



S. S. WHITE

The S. S. White Dental Mfg. Co.

INDUSTRIAL DIVISION

Department E, 10 East 40th St., New York, N. Y.

CARTER SOLVES YOUR *Dynamotor* PROBLEMS

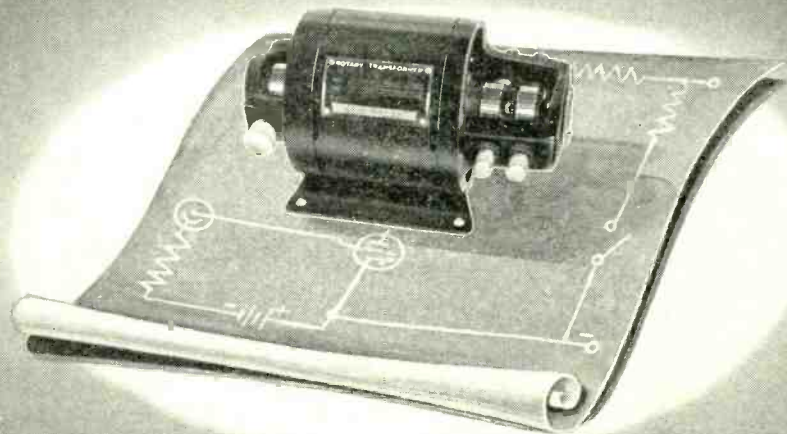

For many years, Carter Dynamotors have been a familiar part of the specifications of leading Communication Equipment Manufacturers, Police Departments, Government Agencies, etc. May we suggest you submit your Dynamotor requirements too, and see for yourself the reason for this recognized preference.

The latest catalog of Carter Dynamotors, Converters, Permanent Magnet Generators and Dynamotors, and special rotary equipment will be sent upon request.

Carter Motor Co.
Chicago, Illinois

1606 Milwaukee Ave. Carter, a well known name in radio for over twenty years. Cable: Genemotor

*By special arrangement with the original makers of the "Megger" Testing Sets, our new instrument carries the U. S. registered trade mark name "MEGGER."

THE NEW "MEGGER" INSULATION TESTER



The first U.S.-made "Megger" Instruments for testing electrical insulation resistance are now being built in our Philadelphia factory and we expect to be in full production by about June 1st of this year.

These new "Megger" testers are of the same hand generator and direct reading ohmmeter type, and the same high quality, as our time-tested "Meg" and "Super-Meg" instruments, which are so well-

known for their great ruggedness and durability. They are housed in molded cases of high impact-strength plastic material.

Our manufacturing facilities are complete, and we now offer these new U.S.-made "Megger" testers for delivery as soon as your priority and our expanding production will permit. We invite your orders for them. Write for new Bulletin Number 1735-E.

**JAMES G. BIDDLE CO. • 1211-13 ARCH STREET
PHILADELPHIA, PENNA.**

VALPEY

VICTORY

**SPLIT SECOND COMMUNICATIONS
ARE VITAL TO OFFENSIVE ACTION
ON THE BATTLE FRONT.**

**VALPEY CRYSTALS
BY THE THOUSANDS ARE
INSURING RELIABLE
TRANSMISSION OF
TACTICAL ORDERS
AT THE BATTLE
FRONTS ALL
OVER THE
WORLD.**

**THE
VALPEY CRYSTALS**

HOLLISTON
MASS.
Established 1931

Crystals
Manufactured
Exclusively
Since 1931

Electrical Connectors. This AN Electrical Connector bulletin contains general information and tabular matter which meets Army and Navy specifications. The following types of AN connectors are shown: AN3100, wall mounting unit; AN3102, box mounting unit; AN3106, straight connector; AN3108, angle 90 deg. connector; AND10066, integral mounting and special plugs adaptable to points of high vibration. 167 insert arrangements with wire data are included. There are also pages on junction shells, AN cable clamps, dust caps, dummy or stowage receptacles and cannon bonding ring. The Cannon catalog condensed supplements are included in a separate section. Copies from Dept. U, Cannon Electric Development Co., 3209 Humboldt St., Los Angeles, Calif.

Pilot Light Assemblies. The pilot light assemblies for marine, aircraft, Signal Corps and industrial applications illustrated in this 8-page catalog are standard items made by this company. A complete range of the various types and sizes are covered; included also are dimensional diagrams and prices. Special assemblies are designed and built for specific requirements. Gothard Mfg. Co., Springfield, Ill.

Transformers. Bulletin 159 lists standard specifications and mounting means of audio, driver, inter-stage and microphone input transformers and reactors for aircraft equipment and transmitter transformers and reactors for mobile equipment. Specifications covering each unit are included. Bulletin 159 available from Acme Electric and Mfg. Co., Cuba, N. Y.

Blind Rivets. A handbook which tells how to save time on difficult riveting jobs. The book tells how rivets are used for airframe construction, field repair and airframe salvage. Methods of specifying rivets, grip length, handling and storing rivets, preparation and drilling material, operation and care of riveting guns, gun accessories and interchangeable pulling heads are given in the handbook. Charts on material thickness and standard rivet sizes are also included. Copies from Dept. 29, Cherry Rivet Co., Los Angeles, Calif.

EXTENDED RANGE SIGNAL SHIFTER!

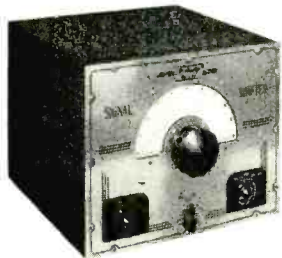

With Meissner's newly developed general coverage series plug-in coils...cover frequencies from 1000 kc. to 16500 kc.

MEISSNER SIGNAL SHIFTER permits instant frequency change in any given band...right from the operating position. Your crystal procurement problems are solved when you install a Meissner Signal Shifter!...provides continuous coverage of a frequency range from 1000 kc. to 16500 kc. without any sacrifice in stability...**NO CRYSTALS REQUIRED!**

The Meissner Signal Shifter is a variable frequency exciter of exceptional stability...may be used alone as an auxiliary or "Short-Haul" C-W transmitter. All tuned circuits are gang-controlled by a high quality precision vernier dial.



TELEGRAPH and RADIO KEYS

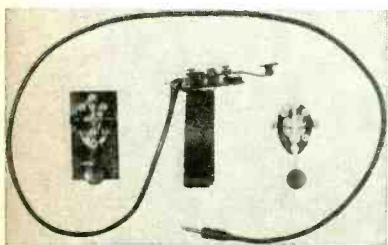

Telegraph Keys to Signal Corps Specifications

Types now in production include

J-12, J-18, J-28, J-29, J-30

J-31, J-37, J-38, J-40, J-41-A

J-44, J-45, J-46, J-47, J-48

Quotations upon request

THE WINSLOW COMPANY
INCORPORATED
9 Liberty Street, Newark, N. J.

Backtalk

This department is operated as an open forum where our readers may discuss problems of the electronic industry or comment on articles which **ELECTRONICS** has published

Stroudsburg, Pa.

Condensers at R.F.

WHY DOES AN electrolytic condenser have a relatively high impedance at r.f.?

✦ An electrolytic capacitor has a relatively high value of impedance at r.f. because at these frequencies it no longer functions as an electrolytic capacitor. Furthermore, the impedance at r.f. is not a function of definite values of capacitive reactance and resistance but rather the impedance of a somewhat complex network containing inductively reactive elements as well as capacitive reactance and resistance.

In the basic construction of an electrolytic capacitor, one conductive surface is metallic and the other conductive surface is an electrolyte. The electrolyte has appreciable resistance and as conduction through such an electrolytic path is by ionization, the resistivity of such a path is subject to considerable change under varying conditions of both frequency and temperature. Under conditions of extremely low temperatures the mobility of the ions is greatly reduced with resultant large increase in resistivity. Also, at high frequencies, the relatively large mass of an ion is too great to permit the requisite speed of movement through the electrolyte path to provide proper conductivity. In other words, the specific resistivity of the electrolyte increases with increase in frequency, until a condition is reached where the electrolyte becomes substantially non-conductive and begins to function as a dielectric.

During this transition there has been an increase in the equivalent series resistance of the electrolytic capacitor structure with proportional increase in power factor and impedance. At the point, however, where the electrolyte becomes effective as a dielectric medium, the normally operative dielectric (the anodic film of aluminum oxide) no longer is effective in determining the capacitance of the structure. Under these new conditions the structure now becomes a purely electrostatic device and the cathode foil, normally employed to only make contact with the electrolyte, becomes the other conduc-

PERMANENT MAGNETS



COOPERATION

**in the Study of Permanent
Magnetism and Its Practical
Application**

WE have been in this business a long time...long enough to realize the industrial possibilities inherent in properly designed and applied permanent magnets.

Today's metals are far superior to yesterday's. Methods for turning these magnet steels into permanent magnets have been greatly improved. Opportunities for utilizing permanent magnets in practical ways are expanding daily.

Our engineers will be glad to cooperate in any study you are making in the field of permanent magnetism. We have extensive laboratory and experimental facilities.

• • •

We are licensed to produce permanent magnets of ALNICO and NIPERMAG, two superior steels.



4-CC-3

**CINAUDAGRAPH
CORPORATION**

STAMFORD, CONNECTICUT

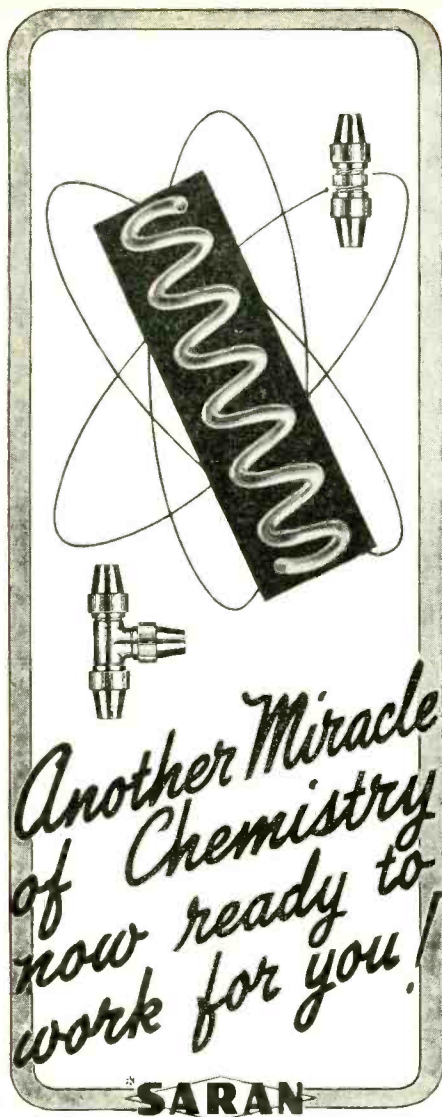

CHEMICALLY RESISTANT PLASTIC TUBINGS AND FITTINGS BY **HODGMAN**

The number of uses to which Hodgman Saran Tubing can be put are limited only by your own requirements. Its electrical properties make it suitable for most insulation work. Its physical properties provide an ease of handling hitherto unknown. Saran is non-corrosive and, being impermeable to water, provides absolute waterproof protection. Available in O.D. sizes from 1/8" to 3/4" with walls of varying thicknesses.

Send for Technical Data Sheet No. P-4 for further information about this remarkable plastic tubing . . . Specify O.D. size of free sample you would like us to send you.



Pat. No. 2160931 *

HODGMAN RUBBER CO.
FRAMINGHAM, MASS.
NEW YORK . . . 261 Fifth Avenue
CHICAGO . . . 412 South Wells St.
SAN FRANCISCO . . . 121 Second St.

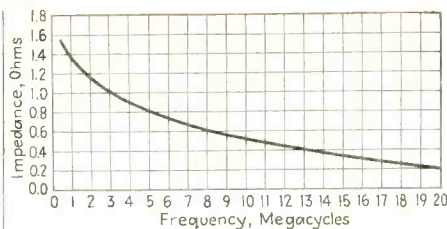

Radio frequency characteristics, dry electrolytic condensers, etched anodes

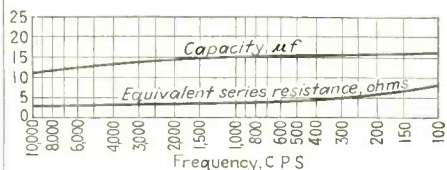

Audio frequency characteristics of dry, etched anode electrolytic condensers

tive surface of the electrostatic structure. This electrostatic structure now consists of: two metallic conducting surfaces separated by two dielectric mediums in series, namely; the aluminum oxide film and the now non-conductive electrolyte. The effective capacity is now determined by the geometry of the structure if other factors do not have to be taken into consideration.

At the higher frequencies, the foil surfaces represent appreciable values of inductive reactance. Also, the now non-conductive electrolyte represents a polar-molecular dielectric structure of extremely poor dielectric properties. These two conditions prevent the capacitive reactance of this electrostatic structure from closely following the requirement that X_c equal $\frac{1}{2}\pi fC$, with the result that a given electrolytic capacitor structure does not appreciably change impedance with change in frequency. The graph of impedance vs frequency illustrates this characteristic.

In almost all filter and by-pass circuit applications, the dry electrolytic capacitor has a sufficiently low value of r-f impedance to meet circuit stability requirements but should the occasion arise where such is not the case then the electrolytic capacitor must be shunted with a mica dielectric or other type of capacitor which will provide the requisite low impedance path.

Circuit instability is frequently encountered in very high gain amplifiers where the r-f impedance of an electrolytic capacitor represents an impedance common to all parts of the circuit and thereby provides sufficient coupling from output to input to cause effective feedback. The correction for this condition has already been mentioned.

Similar conditions of common impedance coupling also sometimes result where three or more capacity sections are concentrically wound with a common cathode foil member in the electrolytic capacitor. In such cases of multiple capacitor structures, the com-



HARVEY - WELLS communications equipment will hold a vital position in the world of tomorrow . . . because we are preparing today.

At the present time, we're doing a tremendous war-time job . . . helping to produce the finest communications instruments in the world. The skill and experience learned through this war production will be reflected in the ultra-modern equipment of tomorrow . . . for police, plane or plant . . . in the home . . . in the auto . . . and on the train.

OUR POLICY

To anticipate the need and keep the lead . . . to develop the finest military communications equipment . . . so that after victory is ours, the Communications fantasy that isn't so today . . . will be so tomorrow!

HARVEY-WELLS COMMUNICATIONS

Are Helping to Win this War

HARVEY-WELLS
Communications inc.

HEADQUARTERS
For Specialized Radio Communications Equipment
SOUTHBRIDGE, MASS.

mon cathode foil itself is the source of common impedance coupling. The corrective measure in such instances is to employ separate electrolytic capacitor sections.

PAUL MCK. DEELEY

• • •

Feedback

IN DERIVING a formula for the improvement in signal-to-noise ratio when negative feedback is applied to an amplifier, it appears that a serious error in logic has been made and as a result the formula generally stated in all the standard texts is entirely erroneous, even though mathematically it may be correct.

The fact is, and mathematical analysis shows, that the application of negative feedback to an amplifier reduces the output signal voltage and the noise, *but it reduces the signal more than it reduces the noise*, and the ratio of the resulting output signal to the resulting noise is *less than without negative feedback*.

The statement that the signal-to-noise ratio in an amplifier is better with negative feedback than it is without it, for the same output voltage, is true but ridiculous. It is exactly the same as saying that the signal-to-noise ratio in an amplifier is improved by increasing the signal, which statement is also true, and equally ridiculous.

In effect, the standard derivation depends upon the comparison of two different amplifiers having two different amplification constants. The output of the amplifier having the greater amplification constant is then reduced by applying negative feedback until the output of both amplifiers is the same for a given input. Now, if a noise voltage is introduced into both amplifiers near the output, it can be shown that the signal-to-noise ratio is better for the amplifier with feedback.

But! Had the output of the amplifier having the greater amplification constant been reduced the same amount by merely putting an attenuator across it, the signal-to-noise ratio would have been still better!

The mathematical demonstration of the above is quite simple and it shows that signal-to-noise ratio is impaired by negative feedback in the proportion,

Signal-to-noise ratio with feedback—
Signal-to-noise ratio without feedback = $(a_o/a_f) (1/1-BM)$

where:—

A is the amplification constant of the whole amplifier.

a_o is the amplification constant of the portion of the amplifier included between the point at which noise is introduced and the output.

a_f is the gain, with feedback, of the same portion of the amplifier.

B is the feedback propagation constant (usually assumed a negative quantity, numerically, for negative feedback).

F. S. MACKLEM

Research Enterprises Limited
Leaside, Ontario

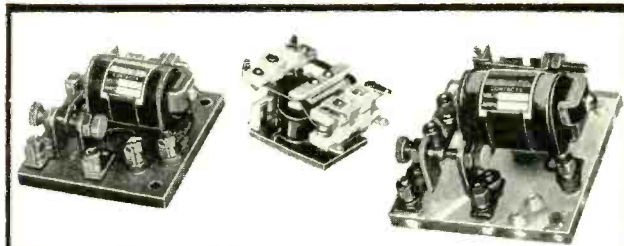

THIS NEW
TRADE MARK
23 YEARS IN
THE MAKING



Here's a simple and direct symbol to know us by! Back of it stands over 23 years of experience in the inventing, designing, manufacturing of relays for every conceivable purpose. But the biggest thing it stands for is confidence. "You can buy a Kurman Relay with your eyes shut," is what many of the biggest relay users will tell you. That—confidence in Kurman—is valuable insurance to safeguard the reputation and performance of your products—be they low cost volume production units or costly experimental developments.

FOR THE BEST RELAYS CONSULT KURMAN

KURMAN ELECTRIC CO.

30-30 NORTHERN BLVD. LONG ISLAND CITY, N. Y.



Quality
AND LOTS OF IT

★
**Transformers
for Combat**

**In Active Service
Over the Entire Globe**

DINION COIL COMPANY
CALEDONIA, N. Y.

WHEN LIVES ARE AT STAKE

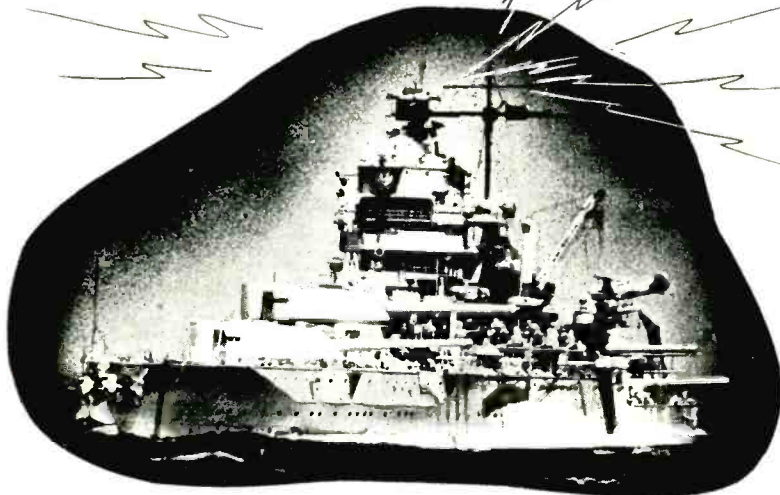

KENYON TRANSFORMERS ARE A "MUST"



KENYON TRANSFORMER CO., INC.

840 BARRY STREET

NEW YORK, N. Y.

WAR PRODUCTION BY
Northern Industrial Chemical Company
7-11 ELKINS STREET SO. BOSTON, MASS.
35 YEARS OF PLASTIC MOLDING EXPERIENCE

Graybar
Distributed by
Graybar
ELECTRIC COMPANY

Radio Parts for Schools

WITH REFERENCE to an item in "Cross-Talk" of the Nov. 1942 issue regarding radio parts desired by schools I would like to offer a suggestion.

This project of supplying representative equipment to the schools would definitely be a war contribution. As you point out, it is desirable not to sidetrack new material nor rely on priorities if possible.

I would suggest that this problem be turned over to the "ham" organizations to carry on. I am not a member of that order myself, but had planned to carry on some development work and do have a number of radio items stored away for the duration that could well be put to use now as you point out. Many of the ham fraternities must also be in the same condition. Therefore, why not call on the radio, amateur organization.

Could there be a more fertile source of miscellaneous and representative radio parts and equipment? Equipment that can be turned over without priorities or red tape and certainly at nominal cost.

S. SOLOMON

Directional Drainage Relay

MR. HAROLD P. HELLER'S letter in *ELECTRONICS* September 1942 issue refers to an error in the application of the directional drainage relay, the article on this subject being previously abstracted in the June and March 1942 issues of *ELECTRONICS*.

I would like to point out that this material was abstracted from the complete article appearing in the *Proceedings of the Pacific Coast Gas Association* (Vol. 30, pp. 163-165) and that the theory advanced in the original article is correctly stated. The authors did not make or edit the abstracts in question, and, therefore, are not responsible for the error which has occurred in stating the direction of current flow. Underground pipes which are electrically positive to rails or to other underground structures will experience a current flow from pipe to rails or to the other structures and, ordinarily, an accelerated corrosion rate. On the other hand, if the pipe system is sufficiently negative to the surrounding medium, current will be accumulated by the pipe system and corrosion will be mitigated.

Mr. Heller states that the application of the directional relay does not constitute cathodic protection. I cannot be in complete agreement with this statement in a practical sense. By the use of the relay a lower resistance path is provided for the return of stray currents to the negative rails, therefore the current pick-up on the pipe system may be increased. Increased cathodic protection will then ensue to areas of negative pipe potentials just as if an additional source of outside power had been provided. Now if the potentials reverse on the pipe system on account of train or street-car movements, the

Radell

Makers of Crystals

Radell CORPORATION

6327 Guilford Avenue
INDIANAPOLIS, IND.

• NUMBERALL •

NUMBERING and LETTERING PRESS

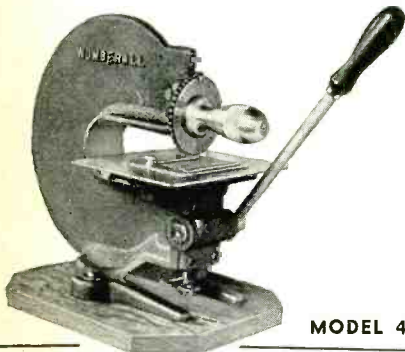

MODEL 40

Quickly stamps serial numbers and other details on name plates, names and numbers on tags, etc. Can also be furnished for HOT stamping. Write for catalog.

NUMBERALL STAMP & TOOL CO.

Huguenot Park Staten Island, N.Y.

area of positive potential may now be negative, and the relay blocks the reverse current flow causing the current to be accumulated via the soil paths. Another relay at the newly positive area will then operate to provide the metallic return path.

It will be noted that more than one relay must be used ordinarily to take advantage of the shifting negative areas. In practice certain areas are found to be predominantly positive for considerable periods, and these locations are then taken as the drainage cable locations. If the pipe potentials merely increase or decrease without change of direction, fixed drainage cables may be installed and the relays eliminated. This is not always the case however.

It is quite possible that, by a properly arranged system of relays and drainage points, cathodic protection can be achieved on a system over a large percentage of the time without the use of additional current sources other than the local electric railway system. However, as Mr. Heller mentions, additional forced drainage using separate ground beds and separate current sources is in many cases desirable inasmuch as railway currents may be insufficient to provide complete protection against corrosion at all times. This presents a problem in economics and engineering which is separate from the problem of controlled pipe system drainage. The latter involves controlling stray soil currents such that (1) they may become less detrimental, and that (2) they may become actually beneficial under certain conditions.

RAY M. WAINWRIGHT,
Engineer

• • •

Toledo, Ohio

Medical Electronics

CERTAIN PHYSICIANS are using electronic machines in an attempt to diagnose diseases. Their contention is that such a machine measures vitality of organs and tissues. The operating physician places an electrode on the leg and another on some other part of the body. With one hand he turns switch after switch. The other hand is used to rub a diaphragm which looks like cellophane.

Is such a machine more or less accurate in diagnosis? If so, what does it actually measure?

C.A.S.
Van Nuys, Calif.

♦ The machine described is undoubtedly effective only in transferring money from the pocket of the patient to the pocket of the quack operating it. I am quite sure that the machine could not effectively differentiate between a live patient and a dead one, although the quacks use some machines which are of value to the physician trained in their use, such as x-ray.

The machine is probably a dummy, in other words is composed of meters

ALMOST LIKE MAGIC!..



The SPEED of W-J INDUSTRIAL EMERGENCY SERVICE ON RADIO AND ELECTRONIC SUPPLIES

• MAGIC could work no greater miracles than our technicians often accomplish in shipping a big variety of sorely needed parts and equipment to buyers who **MUST HAVE THEM NOW!** Urgent war development work can tolerate no delays. That's why we have established a special department and technical staff to give speedy, efficient, emergency service to electrical industries thruout the middle west. Extra large and diversified stocks are constantly maintained. They include thousands of items . . . all of the leading lines. No matter what the items, or who makes them, we'll ship faster than you ever thought possible under trying war conditions

Free



This indispensable reference book and buyer's guide will prove a valuable asset. It's packed with information on Radio and Electronic products. Sent free to Purchasing Agents and others responsible for buying and specifying, who write for a copy on company stationery.

WALKER-JIMIESON, INC. 311 South Western Ave., Chicago, Ill.



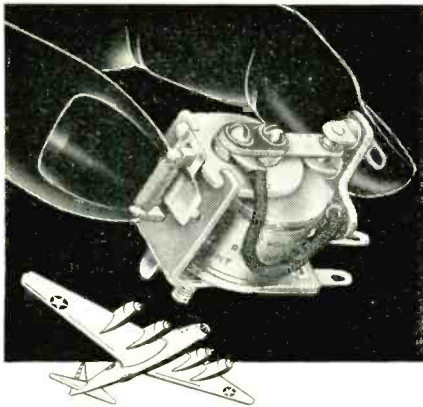

THE ADVANCE MICRO RELAY IS DOING A GREAT JOB ★

TIME-TESTED in hundreds of applications from aircraft to signal-corps communications, the Advance Micro Relay has that vital qualification—RELIABILITY. One of the first small relays on the market, this dependable unit is doing a great job on all fronts. Maybe it is exactly what YOU need.

ADVANCED MICRO RELAY HIGHLIGHTS

- ★ Available from Single Pole, Single Throw to Four Pole, Double Throw. ★ Capacity: 2 to 220 Volts A.C., and 1 to 60 Volts D.C. ★ Stationary Contacts mounted on heavy copper terminals minimize maladjustment. ★ All Contacts insulated, positioned above Ground. ★ Lug Terminals well spaced for easy soldering of connections. ★ Good clearance between Contacts permits control of higher voltages. ★ Weight: 3 oz.; Dimensions: $1\frac{3}{4}'' \times 1\frac{1}{8}'' \times 1''$. ★ All metal parts A & N plated. ★ All Bakelite parts are wax-impregnated to prevent moisture absorption.

OTHER ADVANCE RELAYS

are made for general circuit control applications. They include: Ceramic Insulated Relays (Double Pole, Double Throw, with extra Single Pole, Single Throw if desired) for antenna changeover or other R. F. Circuits.

Each Advance Relay receives individual adjustment and inspection. Close attention is given orders. Write for details today.



Advance Relays

ADVANCE ELECTRIC COMPANY

1260-1262 West Second Street, Los Angeles, California

and dials without function, but may have thermocouples and other devices which will produce a reading which differs on different parts of the body. This reading would be equally meaningless. The business of rubbing the cellophane diaphragm speaks quite eloquently of charlatanry.

The only practical application of recording potentials of the voluntary muscles was described by Jacobson in the Review of Scientific Instruments in the last 3 or 4 years. This or a similar device, would be applicable only where there is a definite disease affecting the muscles, such as infantile paralysis or myasthenia gravis or spasticity, and then it is largely of theoretical interest.

The only electronic devices which can be used safely by the layman for treatment are the ultraviolet generators and hearing aids.

W.E.G.

• • •

Wave Analysis Schedules

SINCE THE SCHEDULES published by Col. Denman in September 1942 ELECTRONICS furnish tools of permanent value for the engineer, they should be free from errors. After hearing from Mr. Corrington (a reader of ELECTRONICS) who has found errors in the article as published, I have found it necessary to rederive the analysis schedules from the beginning. This has been a tedious and time-consuming job, but it is finished and I am ready to report.

The errors, noted below are of three sources: those occurring in typesetting and printing; two errors made by me in redrawing the schedules to fit them into the publication space available; errors which are in Col. Denman's original article. Mr. Corrington's findings are correct at every point, and I think his services in this connection should be publicly noted. He must have done a lot of work on the schedules.

The list of errata follows.

FREDERICK W. GROVER,
Schenectady, N.Y.

Page 44, column 2, in the equation. For y_{13} read y .

Page 45, 36 Ordinate Schedule:

In second row of ordinates y_{33} , y_{35} , y_{34} . . . , y_{33} should be omitted.

At bottom of page, for θ_{10} , read $\theta_{10} = \Sigma_0 + \Sigma_2 + \Sigma_4 + \Sigma_6 + \Sigma_8$.

Page 46, first column:

In equation for d_2 for $+(A_1+A_{17})$, read (A_1-A_{17}) .

Page 46, second column:

Line 2, check for d_9 , for $-(A_{11}+A_{25})$, read $(A_{11}+A_{25})$.

Second line of check for d_{18} , for $(A_{13}-A_{25})$, read $(A_{13}-A_{25})$.

Fifth line of the check for S_0 should read $(B_{12}+B_{21}) + (B_{13}+B_{23}) + (B_{14}+B_{24}) + (B_{15}+B_{21}) + (B_{16}+B_{20})$.

Sixth line of check for S_1 , for $(B_1-B_{25}) \sin 35^\circ$, read $(B_{11}-B_{25}) \sin 35^\circ$.

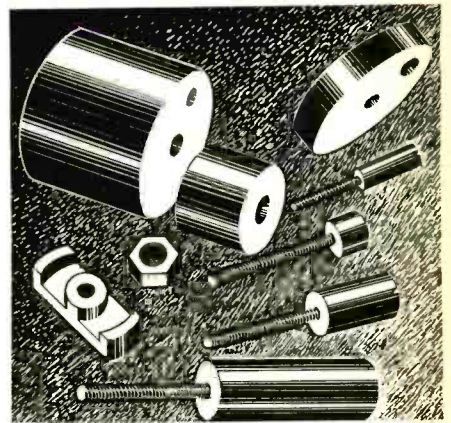

PyroFerric Cores of powdered Iron or Copper have no limitations in size, shape or insert. PyroFerric are specification cores to fit any circuit.

PyroFerric Cores are being made in quantity for the electronic industry's war effort.

If you require Cores to speed the war effort send us your specifications and we will rush samples to you.

PYROFERRIC Co.
175 Varick Street, New York, N. Y.

PHOTOVOLT Electronic Timer for TUBE PROTECTION

- For DC or AC, various voltages and frequencies
- No mechanically moving parts
- Immediate automatic resetting
- Delay periods from 1/10 sec. up
- Standard units can be combined for sequence of several timing periods



Inquiries regarding special timing problems invited. State "g" requirements.

PHOTOVOLT CORP.

95 Madison Ave. New York City

Also: DC Amplifiers
Electronic Photometers

72 Point Schedule, page 46:

Bottom of the page. $\mu_1 = \Delta_1 - \Delta_3 - \Delta_6 + \Delta_7 + \Delta_9 - \Delta_{11} - \Delta_{13} + \Delta_{16} + \Delta_{17}$.
 For $\alpha_1 = R_1 - (R_5 - R_7)$, read $\alpha_1 = R_1 - (R_5 + R_7)$.
 For $\alpha_2 = R_2 - (R_4 - R_8)$, read $\alpha_2 = R_2 - (R_4 + R_8)$.
 For $\gamma_2 = \sigma_1 - \sigma_6 + \sigma_{10} - \sigma_{14} + \sigma_{18}$, read $\gamma_2 = \sigma_2 - \sigma_6 + \sigma_{10} - \sigma_{14} + \sigma_{18}$.

Page 47:

Column for A_{17} and A_{10} in the line for $\sin 80^\circ$, the symbol is not clear. It should read $-\sigma_{18}$.

Table for Cosine Terms:

Column for B_7 and B_{20} , line for $\alpha = 30^\circ$. For $-\Delta_{12}$, read Δ_{12} .

Column for B_8 and B_{23} , line for $\alpha = 50^\circ$. For $-T_8 T_1$, read $T_8 T_1$.

Column for B_8 and B_{23} , line for $\alpha = 70^\circ$, for $T_4 T_5$, read $-T_4 - T_5$.

Column for B_{11} and B_{23} , line for $\alpha = 20^\circ$, for Δ_{21} , read Δ_{21} .

Column for B_{11} and B_{23} , line for $\alpha = 55^\circ$, for Δ_{17} , read $-\Delta_{17}$.

Column for B_{13} and B_{23} , line for 15° , symbol is correct, but not very clear. Read $-\Delta_{16}$.

Column for B_{13} and B_{23} , line for $\alpha = 45^\circ$, for Δ_6 , read $-\Delta_6$.

Editor's Note.—Colonel Denman was killed in active service in November 1941.

• • •

BLIND RADIO OPERATOR



Leo Sadowsky of New York has overcome his physical handicaps to become an amateur radio operator, licensed by the FCC. He was born deaf, and never learned to speak, was blinded by an accident when two years of age. He showed an interest in radio and was encouraged by instructors at the N. Y. Institute for the Education of the Blind. He learned to distinguish radio signals by means of a buzzer, feeling the vibrations through his hands. He is now a licensed ham

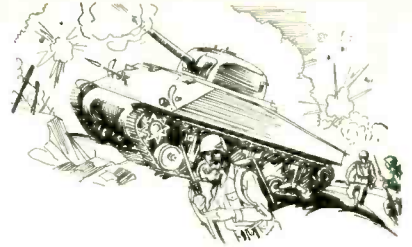

When Every SECOND Counts

• Astatic Multi-contact Plugs and Sockets and Co-axial Cable Connectors not only speed up the operation of connecting and disconnecting electrical circuits for military radio equipment but what is more important, they guarantee positive circuit contacts for uninterrupted radio communications. Government approved, Astatic Plugs, Sockets and Connectors are highly praised by radio manufacturers for uniform quality and expert workmanship.

ASTATIC

IN CANADA:
CANADIAN ASTATIC LTD
TORONTO, ONTARIO

THE ASTATIC CORPORATION
YOUNGSTOWN, OHIO

Leakproof ENAMELED MAGNET WIRE

• Much of the success of this Hudson Wire product is due to a new coating method that gives a smooth, permanently-adherent enameling. Mercury-process tests guarantee perfect uniformity; great tensile strength assures perfect laying even at high winding speeds. Especially adaptable for reduction in coil dimensions without sacrificing electrical values.

Our engineering and design facilities are at your disposal—details and quotations on request.

HUDSON WIRE COMPANY
Winsted Division
WINSTED CONNECTICUT

TRIPLETT

Combat Line INSTRUMENTS

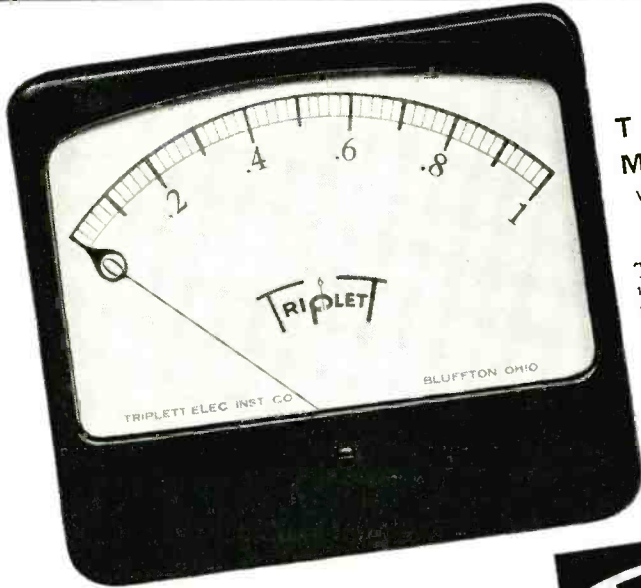

TRIPLET
MODEL 626
with long 5.60 scale

★
This illustration is
1/2 actual size. Note
broad scale and
minimum panel
space required.

A WORD ABOUT DELIVERIES

Naturally deliveries are subject to necessary priority regulations. We urge prompt filing of orders for delivery as expeditiously as may be consistent with America's War effort.

TRIPLET ELECTRICAL INSTRUMENT CO. BLUFFTON, OHIO



WANTED

**RADIO MANUFACTURERS
AND PARTS SUPPLIERS FOR PRESENT AND POST-WAR
EXPORT REPRESENTATION**

Our facilities for handling every type of foreign transaction enable us to offer a superior export service. As specialists in all phases of export, we seek a few well-established radio and radio parts firms interested in present and post-war representation. We invite inquiries regarding our ability to relieve manufacturers of all the intricate details pertaining to the handling of export matters. Reliable radio manufacturers and radio parts suppliers who wish to avail themselves of responsible, efficient and experienced overseas representation are requested
To write

ROBURN AGENCIES, INC.

11-E Warren Street,

New York, N. Y.

PERMANENT MAGNETS

ALL SHAPES — ALL SIZES
FOR ALL PURPOSES

Stamped, Formed, and Cast; Chrome, Tungsten Cobalt and ALNICO** (cast or sintered) under G. E. license.

THOMAS & SKINNER
STEEL PRODUCTS COMPANY
1116 E. 23rd STREET INDIANAPOLIS, INDIANA

Laminations for Radio Transformers — Tools
Dies — Heat Treating — Stampings

42 YEARS EXPERIENCE

NEW BOOKS

Mathematics of Modern Engineering

BY ERNEST G. KELLER. *John Wiley and Sons, New York, 1942, Volume II (mathematical engineering), 309 pages. Price \$4.00.*

WRITTEN IN THE INTEREST of the Advanced Course in Engineering of the General Electric Company this second volume follows by six years the first which was written jointly with R. E. Doherty. Volume II is relatively independent of Volume I and may be read by itself.

The book is divided into three nearly equal length chapters. The first treats the classical methods for setting up the differential equations for studying the dynamics of complicated mechanical systems such as the suspension system of an electric locomotive. The approach is to start with energies and then use Hamilton's principle to derive Lagrange's equations or to use Lagrange's equations directly.

The second chapter is divided into two parts, the first containing an introduction to matrix algebra and tensor analysis, and the second an introduction to the use of these techniques in the formulation of the electromechanical differential equations for rotating electrical machines. The final chapter is concerned principally with methods for solving nonlinear and variable-coefficient linear differential equations analytic in a parameter. Such equations arise in difficult electrical and mechanical problems. A fairly extensive treatment of elliptic and hyperelliptic functions is included.

As this survey of the contents indicates, except for the introductory material in the first part of Chapter 2, the book was not intended for and is not suited to the needs of the beginner. It is essentially written for engineering graduates who are interested in formulating and solving mathematically difficult mechanical and electrical problems associated with lumped-parameter, i.e. discrete physical systems. Volume III, which is yet to appear, will deal with continuous systems.

For Volume II it is presupposed that the reader will be thoroughly familiar with the usual undergraduate mathematics through ordinary differential equations. Volume I,

which assumes a knowledge of calculus, would be appropriate toward the end of such a preparation.

Unfortunately the first printing is full of misprints which even occur in important equations such as (42) on page 44. The necessary corrections are not obvious in some cases. More serious than these are a number of careless and erroneous statements on important points. An indication of the type and distribution of these is as follows.

Chapter 1 is carelessly done in places. For example, the last part of the statement of Rayleigh's Principle on page 87 is vague and misleading if not incorrect.

Chapter 2 is definitely below the level of the other chapters at many points. The following samples will illustrate this. A large number of unsubstantiated claims regarding the contributions of G. Kron and their power, form the introduction to this chapter. The type of coordinate transformation considered, Eq. (13), page 114, is not well defined. The historical remark on page 132 is incorrect. The credit should go to a 1919 paper by Professor Rosebrugh of the University of Toronto. The generalization postulates are too vague to be significant. In obtaining the equations of a stationary network the transformation from branch to loop currents is trivial and unnecessary. These equations may be written down at once in the ordinary way by using the network diagram labeled with loop currents. Consequently matrix transformations are not required for setting up the equations. The network chosen for the main illustrative example, Fig. 2.13, page 143 (also Fig. 2.15, page 148), is found on redrawing to be the trivial five-leaf clover.

Chapter 3 is rather carefully written and is to be recommended to those who wish to solve difficult non-linear and variable-coefficient linear equations of the types which arise in electric control circuits employing iron-core inductors, in the theory of frequency modulation, in the theory of super-regeneration, and in non-linear vacuum tube problems. The book does not mention the last three applications, but stresses applications to electrical rotating machinery.

In general, numerous interesting examples illustrate the text, and

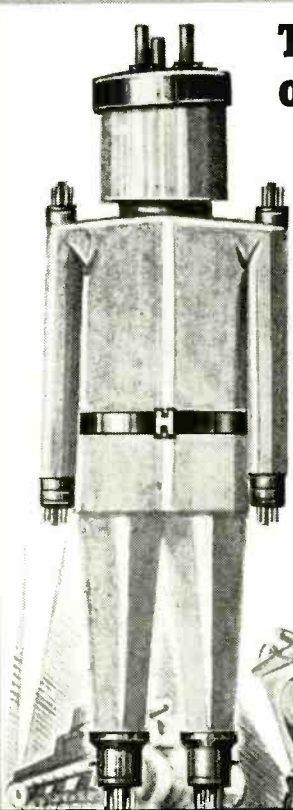

The Eyes and Ears of our Armed Forces

..A ROBOT!

The electronic tube is carving a niche in posterity... its part in achieving victory in World War II has assumed tremendous importance, for the hundreds of military applications are the differential between modern and medieval warfare.

DANIEL KONDAKJIAN tungsten and electronic tube components are prominent in this rapidly expanding field... are being specified in all vital phases.

When the job is done, our engineering experience and facilities will be devoted to human betterment.

THE ENGINEERING CO.
DANIEL KONDAKJIAN
27 Wright Street, Newark, New Jersey

TUNGSTEN LEADS DANIEL KONDAKJIAN BASES AND CAPS



ALLOYS

for

ELECTRONIC APPLICATIONS

D-H Nickel and Nickel alloys have the following advantages:

- Ease of welding and forming
- High emissivity
- Non-corroding
- High strength at elevated temperatures

D-H technical control due to close acquaintance with application assures you of an excellent material.

DRIVER-HARRIS Company
HARRISON, NEW JERSEY

*TRADE MARK REG. U. S. PAT. OFF.



SOUND is the backbone of coordination in this World Wide War. An enemy squadron approaches a battleship... "calling all men to their stations"... and in no time all guns are going full blast. Atlas Sound Equipment... clear, reliable, weather proof... is lending its voice in all theatres of war, doing an exacting task dependably. ★ Our craftsmen and machines can handle minor conversion of our regular precision line... we will be glad to discuss your problems with you.

Complete Atlas Sound Catalog
on request



ATLAS SOUND

CORPORATION

1443 39th Street, Brooklyn, N. Y.

Wonderful things! ... Instruments



They go through thick and thin with our pilots.

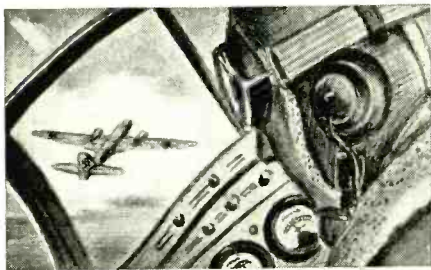

They're shock resisting and highly accurate in all temperatures, altitudes, attitudes.



They've got to be in this man's war. Making them that way is one of the war-time jobs of

The W.W.
BOES
Company, Dayton, Ohio.

Manufacturers of Electrical and Navigational Instruments for Aircraft.

1 1 1

Is there a dollar in your pocket that should be in the fight?
BUY WAR BONDS

many practice problems, with hints for solving the more difficult ones, are placed at the ends of sections. A valuable set of well classified references appears at the end of each chapter.

In brief then, although Volume II cannot be uniformly recommended, its good features constitute a valuable contribution to the literature of advanced mathematical engineering.

—J.L.B.

A-C Calculation Chart

By R. LORENZEN, *John F. Rider, Publisher, New York. (166 pages, price \$7.50.)*

THE CHARTS CONTAINED in this volume have been prepared primarily for increasing speed and minimizing the amount of labor required in making certain types of calculations of alternating current circuits. All except two of the 146 plates make use of the reactance-frequency-inductance-capacitance type of chart originally prepared by the Bell Telephone Laboratories and available as a standard graph sheet from the Keuffel & Esser Company. This type of chart contains four logarithmically ruled scales; values of reactance and frequency being plotted as the ordinates and abscissa, respectively, while another set of logarithmically ruled scales at a 45 deg. angle contain values of inductance and capacitance. Any point on such a graph serves to correlate four factors: X , f , L and C .

In the introduction and also in the explanation of the use of the chart, the author makes a contribution in outlining the history, theory, and development of this type of chart. Several pages are devoted to the use of the charts in convenient form, and illustrating the use of the charts in conditions which are not always realized. Another contribution which has been made is in the inclusion of a number of charts with inverted scales so that values of susceptance rather than reactance are plotted as the ordinates, with the necessary inversion in the logarithmic scales of inductance and capacitance. Two charts at the end of the book deal with Q and phase angle, the latter of which is a double scale device similar to two scales of a slide rule.

In all, there are seventy-two separate charts of frequency against reactance, and seventy-two charts of admittance plotted against reactance. In each case supplementary

TEST with



18A FREQUENCY METER



(Secondary Frequency Standard)

- ★ Transmits EXACT frequency carriers simultaneously every 10 KC and every 100 KC; also marker carriers every 1000 KC between 100 kilocycles and 60 megacycles. 1000 KC carriers usable from 1 megacycle to 150 megacycles, accuracy .05%.
 - ★ The ideal Crystal Controlled Signal Generator for I.F. or R.F. Alignment.
 - ★ Checks Factory or Field Test Oscillator Accuracy.
 - ★ Checks Receiver and Transmitter Calibration. Unexcelled for setting Electron-coupled Oscillator Transmitter Frequency to Close Tolerance, substituting for Spot Frequency Crystals.
 - ★ Modulation "ON-OFF" Switch.
 - ★ No calibration or tuning charts required.
 - ★ Size 5" x 8" x 8 1/2". Weight 12 lbs.
- Operates on 115, 130, 150, 220 and 250 volt 25 to 60 cycle A.C. Supplied complete with Bliley 100 and 1000 K.C. duo-frequency crystal and one 6V6 oscillator, one 6N7 harmonic generator, one 6L7 harmonic amplifier and one 6x5 rectifier.

Manufactured by

FRED E. GARNER CO.
41 E. OHIO ST. CHICAGO, ILL.

Wartime Service



- The country's largest exclusive wholesale distributor of radio and electronic parts offers you the benefit of its well-trained organization, long experience and exceptional factory connections, in filling your PRIORITY requirements.

• Try Dalis — write, wire or 'phone . . .

H. L. DALIS, INC.

Distributors of

RADIO & ELECTRONIC SUPPLIES
17 Union Square • New York, N. Y.

Phones: ALgonquin 4-8112-3-4-5-6-7



scales are printed at the bottom of the sheet giving the relationship between any number and its square root, as well as the reciprocal relationships between ohms and mhos. Each chart is well printed in green and red and is $6\frac{1}{4}$ in. square. This scale size is sufficiently large so that results of engineering precision may be easily achieved. Each of the individual charts is devoted to one decade (a 10 to 1 ratio) of reactance and frequency, and the multiplicity of charts is required to accommodate the wide range of reactance and frequency encountered. In effect, all the information of 144 charts could be placed on two charts, with the exception of the location of the appropriate decimal point. It appears to this reviewer that a single chart with appropriate notation for the location of the decimal point would be as quick to use as 144 separate charts. It would also appear that the price of \$7.50, while a fair price for a book of this size and type of construction, is somewhat high for the convenience of locating a decimal point. Nevertheless, those who have occasion to make frequent use of such calculations of the type for which the book is intended, may not show this point of view. Certainly the charts cover a very wide range of circuit parameters. Conductance from 0.1 micromho to 100 mhos (corresponding to a range of from 0.01 ohms to 10 megohms) may be found on the chart. The frequency range extends from 10 cps to 1,000 megacycles.—B.D.

Principles of Aeronautical Radio Engineering

BY P. C. SANDRETTO. *McGraw-Hill Book Co., Inc., New York, N. Y. 414 pages. Price \$3.50.*

PRIOR TO HIS ENTRY into the Army, Major (now Lieutenant Colonel) Sandretto served as Superintendent of the Communications Laboratory of United Air Lines, and his work in aircraft radio extends over many years. It is not surprising therefore that he has written, in this reviewer's opinion, the best book yet to appear on the engineering applications of radio to flying. The book is well-written and well-arranged; it is complete; the author knows what he is talking about; and it keeps close to the engineering realities of

DYNAMOTORS



...and Dog-fights!



The men in the planes can tell you that it takes perfect coordination of every factor—of manpower, plane and instruments—to come out on top in a dog-fight. Dynamotors don't do the shooting—but they furnish the necessary power for radio communications, direction-finding, radio compass and other instrument controls which enable our men to find the enemy, attack and come back safely. Eicor Engineers are proud of the job Eicor Dynamotors are doing today in fighters, bombers, trainers and transports.



EICOR INC. 1501 W. Congress St., Chicago, U.S.A.
 DYNAMOTORS • D. C. MOTORS • POWER PLANTS • CONVERTERS
 Export: Ad Auriema, 89 Broad St., New York, U. S. A. Cable: Auriema, New York

For VIBRATION FATIGUE TESTING of VITAL AIRCRAFT PARTS

You Can't Go Wrong with the Improved

All-American Portable

MODEL 10

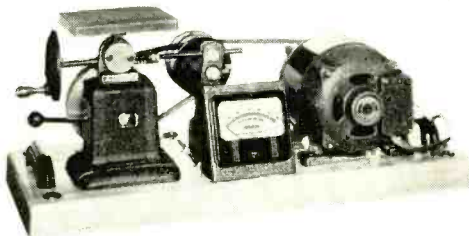

ELECTRIC TACHOMETER assures accurate readings. Model 10 will reproduce vibration conditions exactly as they exist in actual service. Meet Government test requirements with Model 10.

Write for Engineering Data and Quotations

ALL-AMERICAN TOOL & MFG. CO. • 1014 Fullerton Ave. • CHICAGO, ILL.
 DESIGNERS AND SOLE MANUFACTURERS

TAYLOR

LAMINATED PLASTICS
 Vulcanized Fibre • Phenol Fibre

SHEETS, RODS, TUBES, FABRICATED PARTS

TAYLOR FIBRE COMPANY
 NORRISTOWN, PA.

Pacific Coast Headquarters: 544 S. San Pedro St., Los Angeles, Cal.

New and Exclusive!
VINYLINE PLASTIC HAIRLINE INDICATOR
 More accurate than human hair.
 Moisture-proof, won't shrink or warp.

ACETATE SPACING WASHER
 POLYSTYRENE LEAD-THRU BUSHING
 POLYSTYRENE LEAD-THRU BUSHING
 POLYSTYRENE COIL FORM

PLASTIC PARTS
 Supplied Immediately! No Molds! Close Tolerance!

What's your urgent problem? Send specifications—blue-print, if possible—we'll get to work within 24 hours. Printloid experience and research facilities are your guarantee of satisfaction. Literature on Request. Dept. EL-1

PRINTLOID Inc.
 93 Mercer Street
 New York, N. Y.

WE HAVE BUILT:

Integrating Vt. Voltmeters, Vibration Analysis Amplifiers, Multi-stage (bridge stages) D.C. Vt. Voltmeters (.01 v. full scale; 5,000,000 ohms p.v.), Groups of small High-fidelity Amplifiers.

MAYBE WE CAN MAKE SOME INSTRUMENT FOR YOU

We have knowledge, ability and ingenuity. We procure or trouble-shoot equipment. Try us!

HATRY & YOUNG

203 Ann Street

Hartford, Connecticut

WAXES • COMPOUNDS for ELECTRICAL INSULATION

Zophar offers prompt service on Insulating Compounds for a wide variety of electrical applications, including:

... insulation for CONDENSERS, TRANSFORMERS, COILS, power packs, pot heads, sockets, wiring devices, wet and dry batteries, etc. Also WAX SATURATORS for braided wire and tape. WAXES for radio parts.

Special compounds made to your order.

ZOPHAR MILLS INC.

130-26th St.

Brooklyn, N. Y.

FOUNDED 1846

the subject. It is a thoroughly readable book. All of which is fortunate because in this war, as never before, engineers must assimilate quickly what has gone before in engineering radio equipment for aircraft.

The book begins with a chapter on the evident need of radio in aircraft, and then launches into detailed treatments of the low-frequency radio range ("A-N") beacon, (with comments on its shortcomings as well as its capabilities), the u-h-f radio range beacon, aircraft loop direction finders, marker beacons, the various forms of instrument landing developed prior to the war, the absolute altimeter, ground (Adcock) direction finding, medium and ultra-high frequency radio communication. Treated also is that neglected subject, airplane power systems. The concluding chapter treats the system-engineering aspect of aeronautic radio, which is so often neglected by the equipment designer.

Unlike most other books on the subject, this volume does not take a self-consciously elementary approach. It assumes that the reader already has a basic understanding of radio technique and confines itself to the application of this technique to the aircraft problem. Mathematics is used, where needed, but simply so. The author has added to his own authority, by submitting each chapter to a specialist, such as Andrew Alford, Lt. Col. R. R. Brunner, W. E. Jackson, F. C. McMullen, Harry Diamond, Charles R. Burroughs, and A. F. Trumbull, names which are well known in and out of aircraft radio circles.

The book treats all the subjects which military exigencies permit. It is to be hoped that, when censorship is lifted and the behind-the-scenes developments in this field become publishable, the author will not delay in preparing a second, enlarged edition.—D.G.F.

Frequency Modulation

By AUGUST HUND. McGraw-Hill Book Co., Inc., New York, N. Y. 375 pages. Price \$4.00.

THE READER HAS A RIGHT to expect, on the basis of his previous work, that any book by August Hunt should be sound and comprehensive,

(Continued on page 224)

CONTACTS

FOR THE FIELD OF ELECTRONICS

FOUR-RANGE RHEOSTATS

Lubricated Contacts



WRITE FOR CATALOG

FADA SERVICE DEPT.

has replacement parts for all FADA models manufactured during the last 10 years. Call, write, phone or send 10c for our latest Replacement Parts Catalog.

FADA OF NEW YORK
928 Broadway, New York, N. Y.
GRAMERCY 7-0951.

Locking-type
TUBE CLAMPS
for AIRBORNE RADIO & RADAR EQUIPMENT

BIRTCHER Stainless Steel, locking-type tube clamps are flying with Allied Aircraft all over the world. Made in a variety of sizes to fit any size tube base. Precision workmanship.

"You can't pull a tube out of a BIRTCHER clamp!"

PROMPT DELIVERY
SAMPLES AND PRICES UPON REQUEST

The Birtcher Corporation
RADIO & AIRCRAFT SPECIALTIES
PLASTIC FABRICATION & MOULDING
5087 HUNTINGTON DR. • LOS ANGELES, CALIF.



We manufacture a complete line of equipment

SPOT WELDERS, electric from 1/4 to 500 KVA
TRANSFORMERS, special and standard types
INCANDESCENT LAMP manufacturing equipment
FLUORESCENT TUBE MAKING EQUIPMENT
ELECTRONIC EQUIPMENT, vacuum pumps, etc.
WET GLASS slicing and cutting machines for laboratory use
GENERAL GLASS working machines and burners
COLLEGE GLASS working units for students and laboratory

EISLER ENGINEERING CO.
751 So. 13th St. (near Avon Ave.) Newark, New Jersey



KIRKLAND INDICATING LIGHT



#600 Unit

NOTE



The socket is the thing that makes the big difference

A molded bakelite socket, with a 1/4" insulation barrier and two 6-32 terminal screws with cup washers.

Underwriters' Approved

Distributed Nationally By
GRAYBAR ELECTRIC CO.
H. R. KIRKLAND CO. MORRISTOWN, N. J.

PURCHASING AGENTS! EXPEDITERS!

Try **HARRISON first** for your Radio and Electronic Parts requirements.

We are Factory Distributors of all leading manufacturers and we carry

OVER TWO MILLION PARTS IN STOCK!

HARRISON RADIO CORP.
12 West Broadway • New York
Phone WOrth 2-6276

A STEADY SOURCE OF ALL ELECTRONIC EQUIPMENT

TERMINAL RADIO CORP.
Telephone: WOrth 2-4416
85 CORTLAND ST., NEW YORK, N. Y.

Your Plant

FOR ACTION PHONE! WIRE! WRITE!
BULLETINS AND CATALOGS ON REQUEST

FINE RIBBONS of Tungsten and Molybdenum

Molybdenum in widths .006" to 1" in thickness to .0005"

Tungsten Ribbon to specification

H. CROSS

15 Beekman St. New York

ELECTRON TUBE MACHINERY

of every type—standard, and special design

KAHLE ENGINEERING COMPANY

Specialists in Equipment for the Manufacture of Radio Tubes, Cathode Ray Tubes, Fluorescent Lamps, Incandescent Lamps, Neon Tubes, Photo Cells, X-ray Tubes and other glass or electronic products, on production or laboratory basis.

1307-1309 Seventh St., North Bergen, N. J.

MICROMETER FREQUENCY METER

METER

LAMPKIN LABORATORIES

Bradenton, Fla., U. S. A.

HARVEY RADIOLAB'S, Inc.
Manufacturers of Radio Transmitters
ELECTRONIC APPARATUS
447 Concord Ave. Cambridge, Mass.

Make it a HABIT . . . to check this page—EACH ISSUE

THIS WHERE TO BUY SECTION supplements other advertising in this issue with these additional announcements of products and services essential to efficient and economical operation in the field of ELECTRONICS.

CRYSTALS by HIPOWER

Thousands of vital transmitting installations rely on the accuracy and dependability of Hipower Precision Crystal units. With recently enlarged facilities, Hipower is maintaining greatly increased production for all important services. When essential demand begins to return to normal, Hipower will be glad to help with your crystal needs.

HIPOWER CRYSTAL CO.

Sales Division—205 W. Wacker Drive, Chicago
Factory—2035 Charleston Street, Chicago, Ill.

RAPID DEVELOPMENTS in LOUD SPEAKER DESIGN are necessary due to UNCLE SAM'S WAR NEEDS

University Reflex Speakers are being pressed into new and unusual application every day.

UNIVERSITY LABORATORIES
225 Varick Street, N. Y. C.

Bringing you . . .

FM FUNDAMENTALS AND PRACTICES

in a well-organized up-to-date treatment for radio and communication engineers

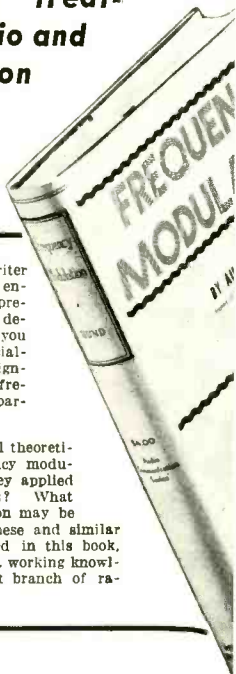

Now August Hund, writer of widely-used radio engineering books, has prepared this thorough, dependable text to aid you in handling the specialized problems of designing and working with frequency modulation apparatus.

What are the special theoretical aspects of frequency modulation? How are they applied in existing apparatus? What short cuts in calculation may be safely employed? These and similar questions are answered in this book, in a way to give you a working knowledge of this important branch of radio technique.

FREQUENCY MODULATION

By August Hund, Consulting Engineer
375 pages, 6x9, 113 illustrations, \$4.00

Radio
Communication
Series

Here is an engineering treatment of frequency modulation, covering both basic principles and the design of commercial apparatus. The phenomena and

features of frequency and phase modulation are described in a thorough approach that included comparison with customary amplitude modulation, following which applications in FM transmitters, receivers, auxiliary apparatus, and antennas are fully discussed. The use of tables and curves to simplify design is emphasized.

THIS NEW BOOK

- demonstrates in numerical and gradual steps how mathematical formulas may be applied readily to engineering solutions by the use of tables or curves.
- gives many explanations directly in the illustrations, so that figures can often be used without consulting the text.
- gives information to help in employing special design formulas in connection with band width characteristics of networks.
- gives methods of testing, useful both in designing and maintaining FM receivers.

10 DAYS' FREE EXAMINATION

McGraw-Hill Book Co., 330 W. 42nd St., N. Y. C.

Send me Hund's Frequency Modulation for 10 days' examination on approval. In 10 days I will send you \$4.00 plus few cents postage or return book postpaid. (We pay postage on cash orders.)

Name

Address

City and State

Position

Company

Professional Services

STANLEY D. EILENBERGER

Consulting Engineer

Complete Laboratory and Shop Facilities
General Electronics Communications
Electro Biology
Patent Development

6309 27th Ave. Kenosha, Wis.
Telephone 2-4213

HAROLD J. McCREARY

Mem. A.I.E.E. & W.S.E.
Consulting Engineer

Laboratory Facilities
Research Electronics
Development Television
Design Radio
Factory Practice Railroads Signalling
Patent Studies Telephone
105 W. Adams St. Phone State 4003 Chicago, Ill.

JOSEPH RAZEK, PH.D.

Consulting Physicist

Electrical and Mechanical Engineering Problems
Instruments and Control Devices Electronics
Specialist in Colorimetry, Spectrophotometry and
Industrial Color Control

Laboratory and Shop Facilities
202 Darby Road Llanerch, Pa.
Phone Hilltop 6910

SEARCHLIGHT SECTION

(Classified Advertising)

EMPLOYMENT : "OPPORTUNITIES" : EQUIPMENT
BUSINESS : USED OR RESALE

UNDISPLAYED — RATES — DISPLAYED

10 CENTS A WORD. MINIMUM CHARGE \$2.00

Positions Wanted (full or part time salaried employment only) ½ the above rates payable in advance.

Box Numbers—Care of publication New York, Chicago or San Francisco offices count as 10 words.

Discount of 10% if full payment is made in advance for 4 consecutive insertions.

Individual Spaces with border rules for prominent display of advertisements.

The advertising rate is \$6.50 per inch for all advertising appearing on other than a contract basis. Contract rates quoted on request.

An advertising inch is measured ¾" vertically on a column—3 columns—30 inches to a page.

POSITIONS VACANT

PRODUCT DEVELOPMENT ENGINEER—Appliance manufacturer has long-tenure opening for man with industrial experience, technical knowledge and creative ability. (J. B.) Swartzbaugh Manufacturing Company, Toledo, Ohio.

ELECTRONIC ENGINEERS—Electrical Engineer to design electronic devices as applied to Industrial Control, welding and similar applications. Also an electrical engineer with knowledge of electronics for application work. Write Westinghouse Electric & Manufacturing Company, Room 1415, Union Bank Building, Pittsburgh, Pennsylvania, for application blank.

(Additional Positions Vacant Advertisements on opposite page)

POSITION WANTED

RADIO ENGINEER, 27, U. S. citizen, married, 1 child. Draft classification 3-A. Seven years experience design special apparatus, communications equipment. Desire position with U. S. firm in South America or Mexico. PW-516, Electronics, 520 N. Michigan Ave., Chicago, Ill.

ENGINEERS WANTED

Electrical, Electronic, and Mechanical Engineers (men or women) with at least some development laboratory experience. Recent graduates also considered.

Old established plant located in Central Indiana, normally manufacturing precision parts for wide range of industries, including aviation, automobile and electrical. At present devoted to developing and producing war equipment.

Excellent post-war opportunities for those who qualify. If not employed in war production to highest skill, write, giving full details of experience, education, age, draft status and salary expected. Address

P-509, Electronics
330 W. 42nd St., New York, N. Y.

PERMANENT POSITION

ELECTRONICS DESIGN ENGINEER
WITH WELL ESTABLISHED,
GROWING CHICAGO COMPANY

Men selected will be trained for important duties on present developments and a far reaching after-the-war program.

In first letter state training, education, experience and age. Salary offered commensurate with ability, experience and performance. Minimum \$250 to start.

P-513, Electronics
520 N. Michigan Ave., Chicago, Ill.

ENGINEERING POSITIONS VACANT

The following engineering positions with Bendix Radio, Division of Bendix Aviation Corporation in Baltimore, Maryland are open. The salary is open and depends only upon the ability and experience of the engineer.

1. Electronic and radio engineers to design electronic navigation and communication equipment for aircraft.
2. Mechanical engineers familiar with and interested in the design of small precision equipment and familiar with shop practice and tools.
3. Engineers familiar with the design of components for electronic equipment.
4. Technical men able to write technical material for instruction books.

These positions are not for the duration only, and can be permanent for the right men. There are excellent opportunities for advancement.

Engineers with experience as outlined are preferred, but the right persons do not need experience if they have the ability to learn and the required aptitude. Applicants may be male or female. Persons already engaged in war work cannot be considered. Write directly to Chief Engineer, Bendix Radio Division, Baltimore, Maryland giving complete details of education and experience.

BENDIX RADIO

DIVISION OF BENDIX AVIATION CORPORATION
BALTIMORE, MD.

WISH TO CONTACT MANUFACTURER interested in acquiring about 25 Patents in the electronic field, some of them basic. Covering grid-controlled gaseous tubes, a Power type of photocell, a new Igniter tube, voltage regulators of several types, basic patents of irradiation of foods, basic patent on present forms of ultra-violet lamps, generator regulators. Many additional patents pending. Some already licensed to leading manufacturers; some in production.

BO-515, Electronics
330 West 42nd St., New York City

ELECTRICAL ENGINEER

preferably some experience or education in

ELECTRONICS

To any one with this experience or educational background we can give an excellent opportunity in research and development in our

TOCCO HEAT TREATING

industry. A satisfactory applicant will have a very good future in work that will probably be in higher demand after the present war effort.

Good salary and future for right party.

APPLY AT ONCE

OHIO CRANKSHAFT COMPANY

3800 Harvard Avenue

Cleveland, Ohio

CONTRACT WORK

Skilled radio man-hours available for the duration

A radio maintenance and rebuild laboratory located within a short distance of Portland, Oregon offers its services and facilities to any radio manufacturer or concern engaged in war production. Competent engineer in charge. Organization is small and flexible. Can set up immediately for most any job of assembly, wiring, rebuild, final testing or maintenance. A large number of unskilled and semiskilled workers available within walking distance of plant. Adequate equipment and plenty of floor space. Special equipment installed if necessary.

A subcontract with this firm will help you maintain your promise to Uncle Sam. Quality of all work guaranteed to exceed your specifications. You furnish us with the materials and specifications and we return a sample of our work at our own expense. Write us your proposition. It will receive prompt and careful attention, and an immediate answer. Business and personal references of firm operators submitted upon request.

CW-514. Electronics

68 Post Street, San Francisco, Calif.

WANTED

SUB-CONTRACTS ON ELECTRONIC DEVICES

Complete Radio Laboratory has facilities to work on electronic devices used in war work.

THE STERLING ELECTRONIC LABORATORY
521 West 131st Street New York, N. Y.

FOR SALE

4 element Oscillograph with two types of photographic attachments, plus concurrent visible traces. Self-contained shunts and multipliers. Cost \$3000; sell for \$2500; good as new. Also 13 tube "Bombarder" for inductive heating of tube or lamp parts; 10 KVA size; cost \$2500; sell for \$2000, with tubes. Never used except for test. Also three 30 KVA distribution Transformers 2400/240,120 volts. Cost about \$800 each; sell for \$150 each.

INVEK CORPORATION
820 Fifth Ave., New York, N. Y.

INSTRUMENTS WANTED

The Signal Corps, Aircraft Radio Laboratory, Wright Field, Dayton, Ohio, and associated critical war industries, have need of meters and test equipment for use in training programs.

Write stating type, condition of equipment, and price desired to

**Director, Aircraft Radio
Laboratory,
WRIGHT FIELD, DAYTON, OHIO**

BEST QUALITY, USED ELECTRON TUBE MACHINERY

Equipment for the manufacture of all kinds of electron tubes, radio tubes, incandescent lamps, neon tubes, photo electric cells, X-ray tubes, etc.

AMERICAN ELECTRICAL SALES CO., INC.
65-67 East 8th St. New York, N. Y.

WANTED ANOTHER POSTWAR PRODUCT

**AND A PRODUCTION
EXPERT TO MAKE IT!**

Before the war halted production of "non-essentials," we manufactured and marketed, for several years, a phenomenally successful line of small electrical household appliances. And we plan to continue as soon as the war is won.

Our customers—electrical and hardware wholesalers, retailers, and four of the largest national chain groups—believe in us. They bought over \$1,500,000 worth of our products yearly, and that volume was increasing by 25% annually when the war hit us.

For the future, we have big plans—and here's why. Our outstanding strength is a sales, promotional and advertising organization that doesn't take its hat off to any other in American business. What we want to do is harness this organization to a bigger job in the postwar years. We have enough money to handle an extra million in sales, and our credit is excellent. We want to branch out by broadening our line and increasing our volume.

That's where you may fit into our picture. Specifically, here's what we're looking for:

1. A new electrical household or hardware product that can add another million or two to our volume. It might be of metal, or it might be of plastic. It should be something for the retailer to sell to the housewife—something for the millions of new homes to be built after the war, as well as for present homes.
2. An outstanding electrical engineering, research, product development, and production expert who can equal, in the calibre of his work, the selling power of our organization. He may even have a plant of his own that would be useful in manufacturing the new product for which we are searching.

In your case, maybe those two points go together. You may have the product we're looking for, and you may be the man, too. Perhaps you just have a product that's a "natural," and that you'd like to sell. Or maybe you're the man we need, but merely have ideas for new products that deserve development.

If this advertisement applies to you in any way, let's talk it over . . . confidentially. What each of us has to offer may make a grand combination that will benefit us both.

**ADDRESS
THE PRESIDENT
P. O. BOX 531
CHICAGO, ILL.**



"O BRAVE NEW WORLD..."

Tomorrow's new world lies in the palms of the draftsmen of today. They are linking country to country, continent to continent. And in this tremendous project, as in every other important blueprinting work, *Typhonite* ELDORADOS lead all other drawing pencils with their decisive clarity, uniform degrees, opacity and speed.

Pencil Sales Dept. 59-J4
Joseph Dixon Crucible Company
Jersey City, N. J.

TYPHONITE
ELDORADO

JONES 500 SERIES PLUGS and SOCKETS

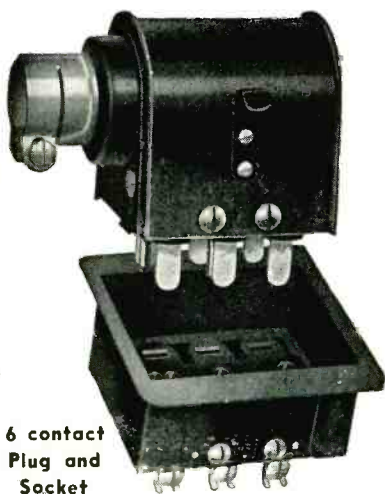

6 contact
Plug and
Socket

5000 volts and 25 amperes. Fulfills every electrical and mechanical requirement. Polarized to prevent incorrect connections. Easy to wire. Sizes: 2, 4, 6, 8, 10 and 12 contacts. Thousands of uses. Write for Bulletin 500 today.

HOWARD B. JONES
2300 WABANSIA AVENUE,
CHICAGO ILLINOIS

useful for obtaining a basic understanding as well as for reference. "Frequency Modulation" is no exception. It is the first thoroughly sound treatment of the subject on the level of the designing engineer. It is not an easy book to read, partly because the concepts on FM are not easy in themselves, and partly because of the author's style. But, hard or easy, it is a book which should be read by every engineer who aspires to a basic understanding of the art and who despairs, as this reviewer does, of obtaining such understanding from periodical publications.

The author wisely adopts the policy of introducing the mathematics of the subject hind-end-to. The analyses of Lord Rayleigh, van der Pol, and Carson are presented in the first chapter as the familiar series of Bessel functions. The derivation of the series is confined to an Appendix, where it rightly belongs. This appendix should not be neglected by the reader. It will serve to disabuse anyone of the idea that the derivation is a simple and logical tracing of cause and effect. It is an adventure in mathematical compromise and judicious simplifying assumptions. It proves what many have already guessed: that the sideband theory of FM is truly abstruse, a delight to the mathematical physicist, but something less than delightful to the practicing radio engineer.

The end result, the Bessel series, is a powerful engineering tool (leading directly to the "zero" method of checking deviation, for example). The author makes immediate use of the series as an engineering tool in the first 25 pages of the book, and it is never completely out of sight for the remaining 325 pages of the text. This does not indicate that the approach is theoretical only. Over 100 pages are given to practical applications, with detailed discussions of transmitters, (which, praise be, are actually identified with the manufacturers' names) receivers and antennas.

The first chapter, which constitutes nearly half of the book, treats the fundamental relationships from the standpoint of the Bessel series, and painstakingly compares amplitude-, phase-, and frequency-modulated waves. A great many numerical examples and basic numerical con-

Now in its 7th
record-smashing year!

MATHEMATICS FOR THE MILLION

By Lancelot Hogben

"I find *MATHEMATICS FOR THE MILLION* superb in laying a foundation for the specialized mathematics of the electronics field. Hogben's handling of trigonometry makes it too easy to believe. The book reads like a novel and is enjoyed in just that way. Both my pupils and my customers have been very appreciative to me of my recommendation of the book."—L. W. Hatry of *Hatry & Young*, Electronics Specialists.

Over 200
illustrations. **\$3.75**

Revised edition with answers

W. W. NORTON
& CO.
70 Fifth Ave.
New York

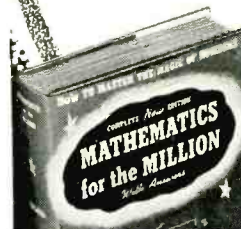

"Books
That Live"

U-H-F TECHNIQUE

TWICE Electronics has reprinted "U-H-F Technique," a series of papers as follows: "Electrical Concepts at Extremely High Frequencies," "Radiating Systems and Wave Propagation," "Generators for U-H-F Waves," "U-H-F Reception and Receivers," "Wide Band Amplifiers and Frequency Multiplication," "Measurements in the U-H-F Spectrum," "Applications of Cathode-Ray Tubes," "Wave Form Circuits for Cathode-Ray Tubes." Stock is running low, and because of paper shortage we do not wish to reprint unless there is sufficient demand. This is a 64-page book—price 50¢ single copies, or 35¢ each for 26 copies or more. Readers are requested to tell us the number of copies of this widely-used symposium on u-h-f they are likely to need during 1943.

P.S. An abbreviated edition of this "U-H-F Technique" reprint containing the articles "Electrical Concepts at Extremely High Frequencies," "Applications of Cathode-Ray Tubes," and "Wave Form Circuits for Cathode-Ray Tubes" (in two parts) are available at 25¢ each, post free.

ELECTRONICS EDITORIAL

330 West 42nd St. New York, N. Y.

IN SELECTIVE SERVICE



“RELAYED-FLUX” Microdyne

*“The Standard by Which Others
Are Judged and Valued”*

EQUIPMENT for the war effort,—

- (1.) **MUST** perform up to highest standards.
- (2.) **MUST** continue to perform irrespective of climatic variations.

That is why AUDAX magnetically powered pickups are selected for war contracts. In building pickups under such contracts, we do not have to change our peacetime specifications because such MUSTS have always been a basic requirement in AUDAX Instruments.

The sharp clean-cut facsimile reproduction of MICRODYNE — regardless of climatic conditions—is a marvel to all who have put it to the only test that really counts . . . the EAR TEST.

WITH OUR COMPLIMENTS

A copy of “PICKUP FACTS” is yours for the asking. It answers many questions concerning record reproduction.

BUY WAR BONDS

*If there is any information
you wish, do not hesitate to
write us.*

AUDAX COMPANY

500 Fifth Ave. New York City

*“Creators of High Grade Electrical
and Acoustical Apparatus since 1915.”*

starts in this section help the reader to link the theory with familiar practice. Every available approach is taken: the series, tables of side-band distributions, vector diagrams. This chapter is truly the work of a scholar and a gentleman. It is worth a solid month of midnight oil.

The second chapter, on auxiliary apparatus, discusses circuits for transmitting (the Armstrong modulator, reactance modulators and center-frequency stabilizers) and receiving (r-f and i-f amplifiers, limiters and frequency detectors). The universally-used Seeley discriminator is given a thorough going over. Frequency pre-emphasis and de-emphasis networks are discussed and typical examples (with circuit constants!) are given. The remaining chapters are devoted to practical embodiments of the circuits in commercial and laboratory equipment.

This book is an exceptionally complete treatment of a most important specialized branch of radio engineering. Its current appearance is fortunate, since it permits engineers to catch up on the subject, while the industry marks time pending the end of the War.—D.G.F.

• • •

A.S.T.M. Standards and Data on Electrical-Heating and Resistance Alloys

By A.S.T.M. COMMITTEE B-4, *American Society for Testing Materials, 260 S. Broad St., Philadelphia, 1942. 160 pages, with heavy paper cover. Price \$1.50.*

TWENTY-THREE SPECIFICATIONS AND TESTS of interest to radio and electronic engineers are here combined with four pertinent technical papers in a single convenient volume. A large portion of the book covers materials used in the manufacture of radio tubes and lamps, such as nickel and nickel-alloy wire and ribbon, mica stampings, grid wires, electrode support wires, strip and sheet metals for tube electrodes, and sleeves and tubing for cathodes. Methods of test and specifications are given for alloy resistance wires, alloy wires used for electric heaters, electric-furnace alloys, heat-resisting alloys, and thermostat metals. The papers cover a contact-testing machine, surge tests on contact materials, design of devices using thermostat metal, and methods of testing thermocouples and thermocouple materials.—J.M.

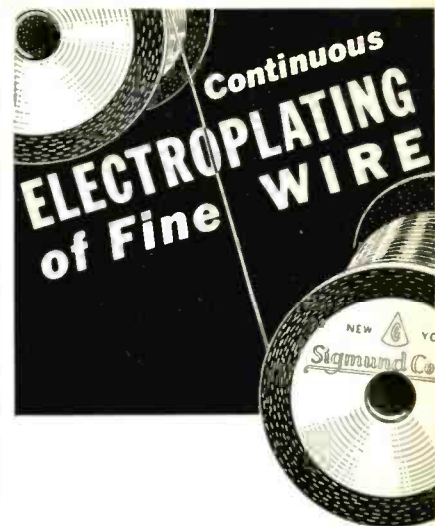

Complete equipment and staff of specialists for the continuous electroplating of fine wire. We can now plate a wide range of metals either on your own wire or on wire supplied by us . . .

Your inquiry is invited

SIGMUND COHN & CO.

44 GOLD ST. NEW YORK
SINCE 1901

ARGON HELIUM KRYPTON
NEON XENON MIXTURES

Linde
RARE GASES
AND MIXTURES

*. . . Spectroscopically Pure
. . . Easily removed from bulb
without contamination*

Scientific uses for Linde rare gases include—

1. The study of electrical discharges.
2. Work with rectifying and stroboscopic devices.
3. Metallurgical research.
4. Work with inert atmospheres, where heat conduction must be increased or decreased.

Many standard mixtures are available. Special mixtures for experimental purposes can be supplied upon request.

The word “Linde” is a trade-mark of

THE LINDE AIR PRODUCTS COMPANY
Unit of Union Carbide and Carbon Corporation
30 E. 42d St., New York **NY** Offices in Principal Cities
In Canada: Dominion Oxygen Company, Ltd., Toronto



**TIME
OUT**

for credit where credit is due

With a brief departure from our customary advertising message, we salute the men and women of our laboratory and our factory. Work clothes are their uniforms.

Their diligent efforts have enabled us to produce the most complete line of precision attenuators in the world . . . in sufficient quantities. They know, and we of the management know, there's only one job that really is important . . . production!

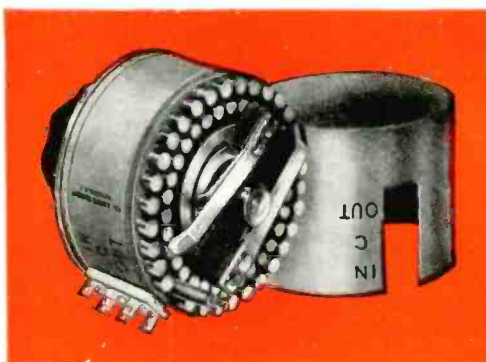

Ordering standard components and equipment may facilitate deliveries.

THE DAVEN COMPANY

158 SUMMIT STREET

NEWARK, NEW JERSEY

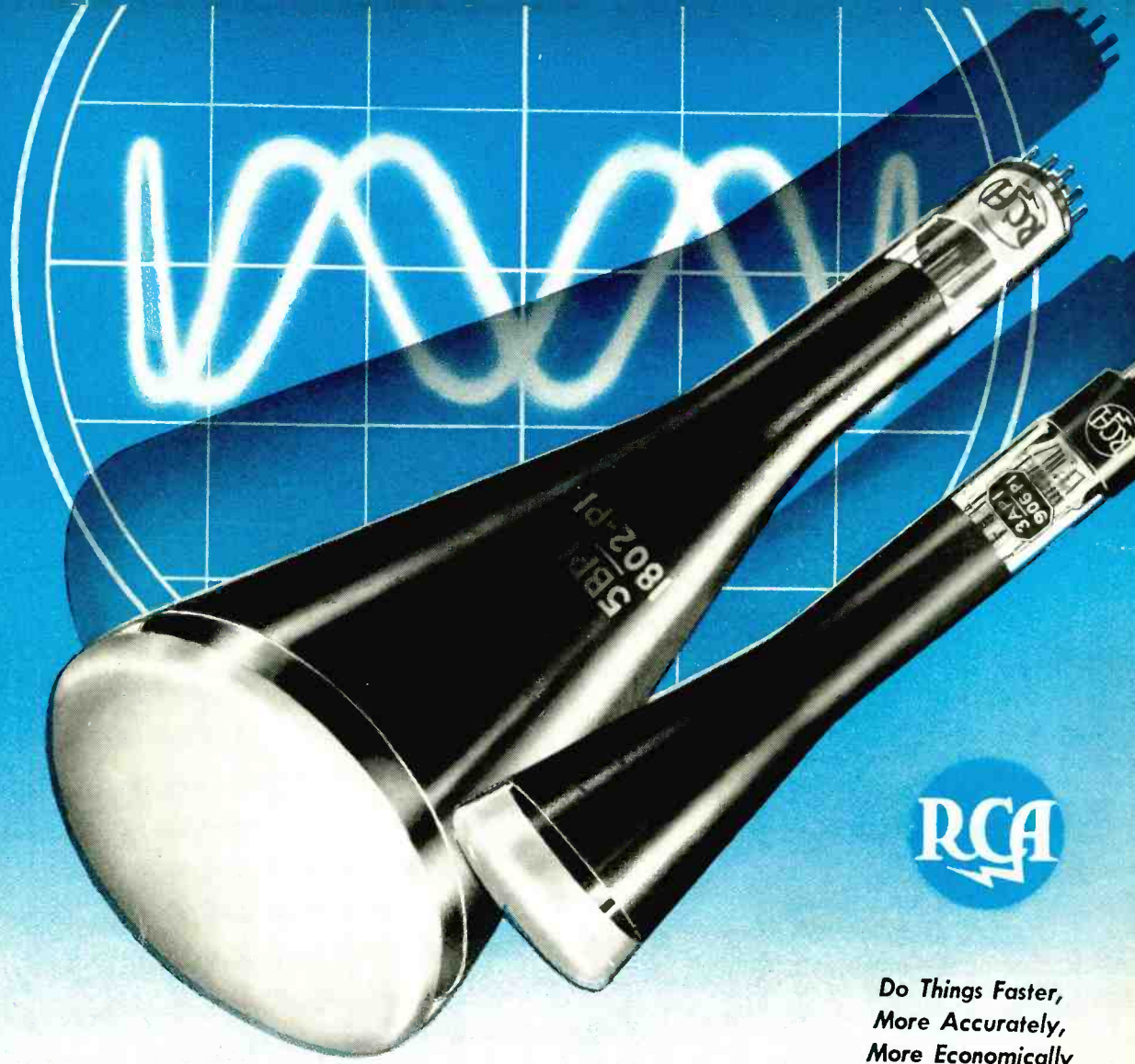

Modern Measurements . . . without mechanical movement or its limitations

Perhaps no single type better illustrates the indispensable nature of the Electronic Vacuum Tube throughout science and industry than RCA Cathode-Ray Tubes.

Used in Oscillographs, these tubes are paving the way to new, higher standards of measuring anything or any phenomena that can be transformed into electrical impulses—and doing it without mechanical movement and the limitations inherent in such movement. Every day, RCA Cathode-Ray Tubes are proving unexcelled in the development and production of war materiel. They are being used in such widely diverse fields as acoustics and vibration studies . . . studies of magnetic phenomena . . . water-leak tests . . . geological and geophysical investigations . . . manufacturing operation tests . . . ignition timing and adjustment work . . . medical and

biological research . . . engine-pressure indications . . . power plant maintenance . . . aeronautical engine synchronization . . . and a host of others, including their better-known applications in communications, radio and servicing.

Other RCA Tube types, from Phototubes to Power Tubes, are doing equally important jobs contributing to the war effort along entirely different lines—and doing them so well that today's "Do It the Electronic Way" becomes far more than a slogan. It stands as a challenge to every civilian and war industry to handle countless tasks faster, more accurately, or more economically than they have ever been handled before!

RADIO CORPORATION OF AMERICA
RCA Victor Division, Camden, N. J.

*Do Things Faster,
More Accurately,
More Economically*

THE ELECTRONIC WAY!

- Communicating • Measuring • Checking
- Analyzing • Actuating • Protecting
- Testing • Detecting • Matching • Sorting
- Controlling • Magnifying • Heating
- Rectifying • Counting • Transforming
- "Seeing" • "Feeling"

The following RCA Tube publications are available from Radio Corporation of America, Commercial Engineering Section, Harrison, N. J.

RCA PHOTOTUBES (booklet on request)

RCA POWER AND SPECIAL PURPOSE TUBES (catalog on request)

RCA TRANSMITTING TUBE GUIDE (Guide 35c net)



RCA TUBES FOR INDUSTRIAL EFFICIENCY

High-vacuum, gas, and vapor tubes . . . voltage amplifiers . . . low-power and medium-power tubes . . . cathode-ray tubes . . . phototubes . . . rectifiers . . . voltage regulators . . . relay tubes