

JANUARY • 1943

electronics

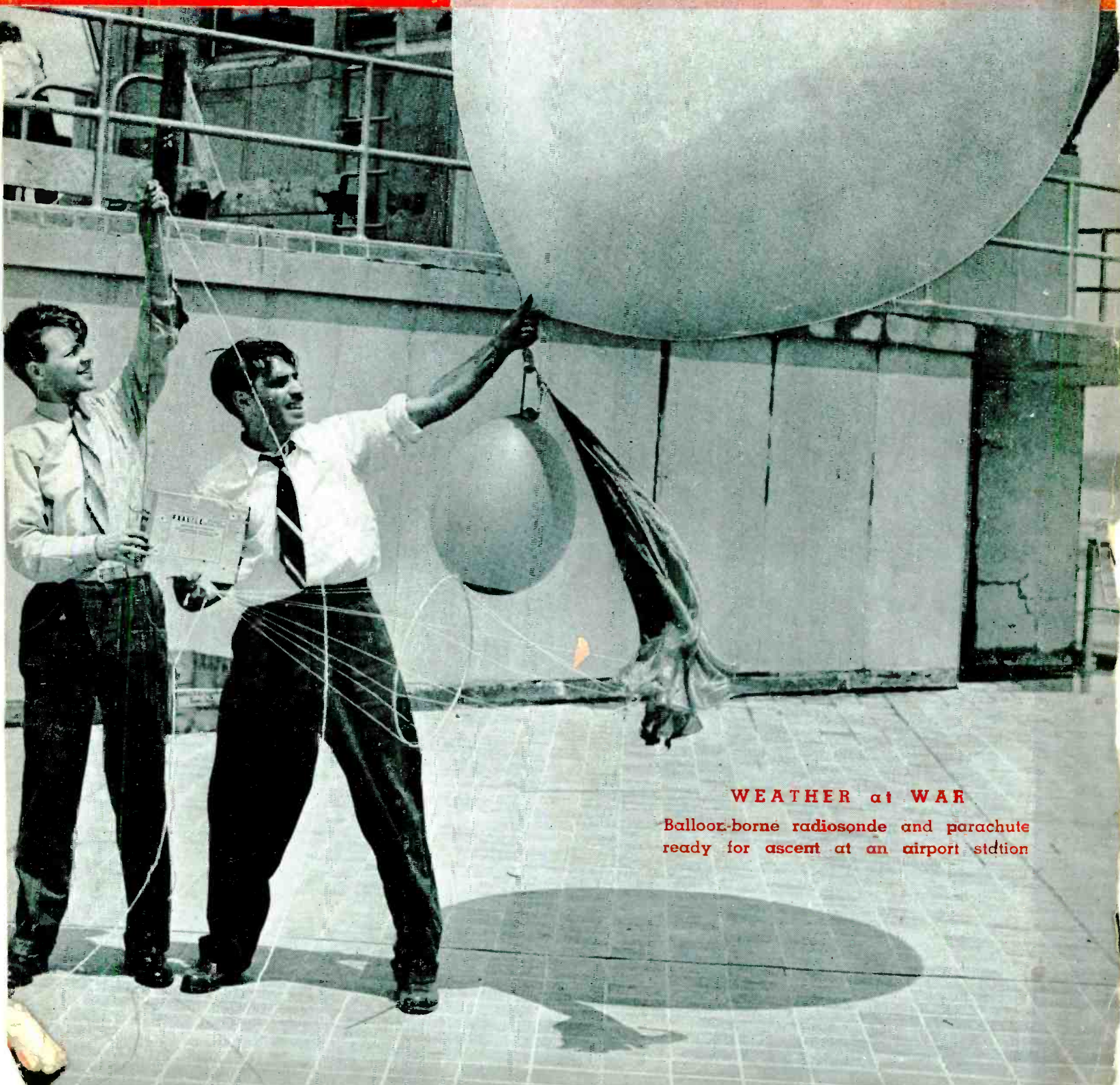

WEATHER at WAR

Balloon-borne radiosonde and parachute ready for ascent at an airport station

In the Battle of Design

A waste of material or machine time in engineering design today is as damnable as sabotage. The battle of design will be won by refinements in existing components as well as by new inventions. Savings in small things add up . . . to big things. Here are some examples:

One of our engineers changed the construction of a plastic assembly from brass insert + lockwasher + brass screw to steel PK screw only. Approved by the Army, the savings represented 1,000,000 inserts and lockwashers.

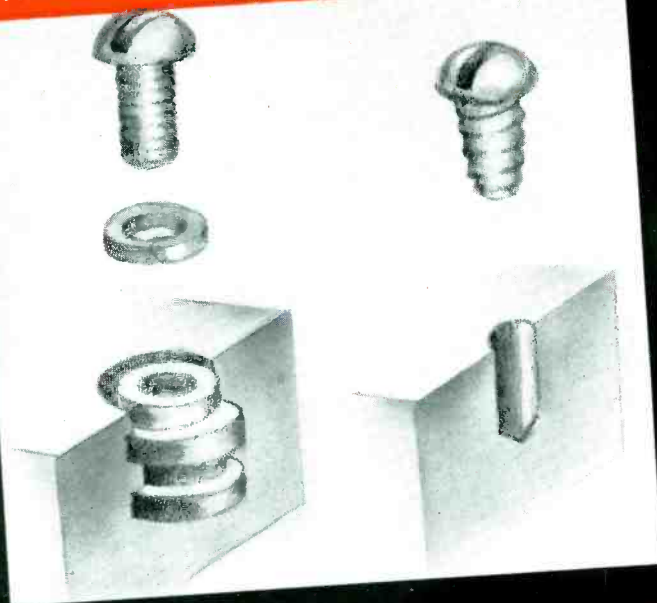

In die cast structures, covers and nameplates were held on by screws. A UTC design modification added a round projection in the casting, which is spur over to hold the plate or cover. Saving: over 2,000,000 screws and lockwashers . . . over 2,000,000 tapping operations.

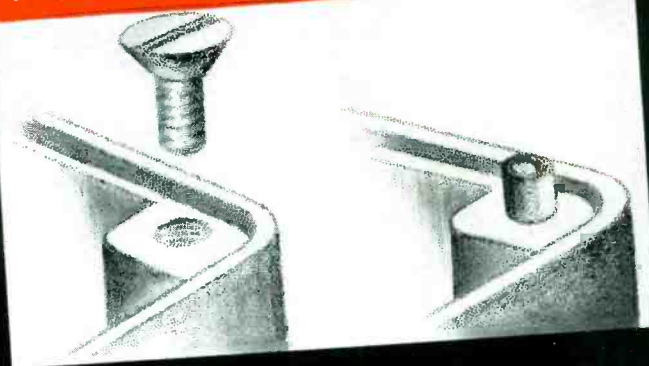

This structure employed a cased transformer fastened to a compartment wall with screws. A changed design permitted potting the transformer directly in the compartment. Saving . . . 1,000,000 terminals . . . 300,000 screws . . . 400,000 aluminum cans . . . plus terminal board saving and reduction in overall size.

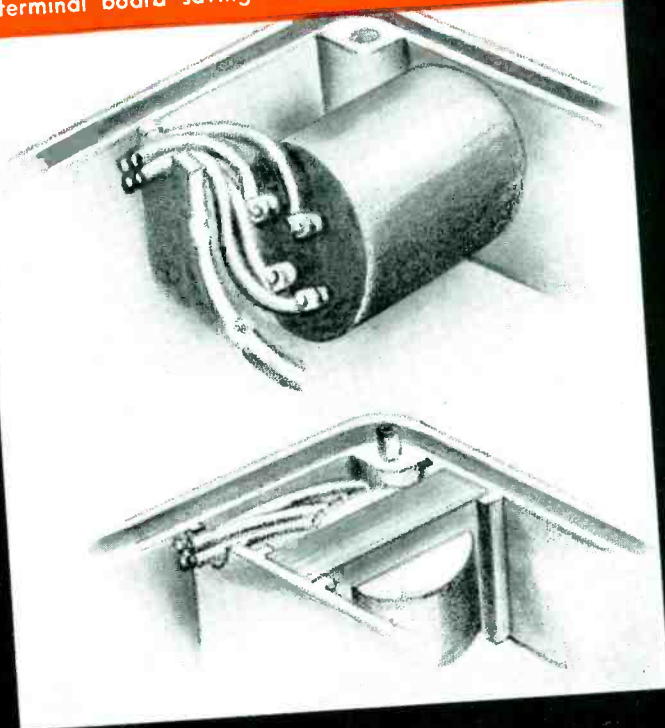

One UTC design eliminated a threaded shank, lockwasher and nut by changing to a spun-over shoulder on the shank. Saving . . . 150,000 lockwashers and nuts . . . 150,000 threading operations.



These savings added up. Small in themselves . . . slight for each individual unit . . . their total is impressive. Today we need all possible savings . . . even those which seem impossible at first. Review your designs for Savings for Victory.

UNITED TRANSFORMER CO.

150 VARICK STREET



NEW YORK, N. Y.

EXPORT DIVISION: 100 VARICK STREET NEW YORK, N. Y. CABLES: 'ARLAB'

electronics

JANUARY • 1943

RADIOSONDE BALLOON AND PARACHUTE	Cover
The small balloon carries sand and decreases the ascensional rate up to the height at which it bursts. Then the hair hygrometer can follow humidity changes in the lower atmosphere	
TINPLATE PRODUCTION AIDED BY ELECTRONIC GENERATORS , by H. C. Humphrey.....	56
Induction heating units producing hundreds of kilowatts of power are used to reflow electrolytically deposited tin. Process saves more than half of tin formerly used	
PLANT PROCEDURE FOR EXPEDITING WAR PRODUCTION	60
War production speeded for Alden Products by adoption of new method of tracing orders, classifying raw materials and sub-assemblies according to priority and ultimate use	
ELECTRON MICROSCOPE IN CHEMISTRY , by V. K. Zworykin.....	64
Applications of the electron microscope to industrial chemical research. Dr. Zworykin describes new table-size microscope at American Chemical Society meeting	
REACTANCE NETWORKS WITH RESISTANCE TERMINATIONS , by E. S. Purington.....	69
A second article by Mr. Purington on a simplified method of analyzing networks, this one on symmetrical reactance networks with equal resistances terminations	
HOW TO GET A PRIORITY	73
Who can get a priority, the forms necessary to be filled out, where the plans known as PRP and CMP fit into the complex picture of critical materials	
WOMEN AT WORK	74
Photographs of feminine design and production workers in the electronic field, helping to win the war	
WARTIME DEVELOPMENTS IN CARRIER CURRENT COMMUNICATION , by G. Abraham.....	76
Description of new broadcast frequency "wired-radio" systems, with particular emphasis upon methods of signal distribution and coupling circuits	
CHECKING RESISTANCE WELDING CONTROLS , Part 6, by Barton L. Weller.....	78
Adapting cathode-ray oscilloscopes to the industrial maintenance job. Photos show typical screen patterns indicating control circuit conditions	
RADIO SOUNDING IN THE UNITED STATES , by C. B. Pear, Jr.....	82
A review of the methods employed to explore conditions of the air over the earth, via radio, as a means of predicting the weather	
APPLICATIONS OF ELECTRONICS TO PHYSIOLOGY , by W. E. Gilson.....	86
Survey of the applications of electron tubes to research in physiology. A manometer, a myograph, temperature control, a precedence indicator	
REDUCTION OF RECORD NOISE BY PICKUP DESIGN , by A. D. Burt.....	90
Design of a record pickup which reduces noise radiated directly into the air. The method of measuring pickup noise is part of this article	
IMPEDANCE MAGNITUDE AND PHASE CHARTS , by T. C. Blow.....	94
Reference sheet and alignment charts permit determination of magnitude and phase of impedance using only straight edge, when resistance and reactance components are given	
A THREE-RESONANT CIRCUIT TRANSFORMER , by Marion R. Winkler.....	96
Uniform gain in pass band obtained by three-circuit tuned transformer, used with its complementary two-circuit transformer. Simple table facilitates design	

KEITH HENNEY, Editor; Beverly Dudley, Managing Editor; Donald G. Fink (on leave); Craig Walsh (on leave); W. W. MacDonald, Associate Editor; M. L. Mathey, Assistant Editor; J. M. Heron, Assistant Editor; Harry Phillips, Art Director

H. W. MATEER, Publisher; J. E. Blackburn, Jr., Director of Circulation Electronics; Wallace B. Blood, Sales Manager

DISTRICT MANAGERS, D. H. Miller, New York; R. H. Flynn, New England; F. P. Coyle, Philadelphia; L. P. Canty, Cleveland; C. D. Wardner, Chicago

Contents Copyright, 1942, by McGraw-Hill Publishing Company, Inc.
McGRAW-HILL PUBLISHING COMPANY, INCORPORATED
 JAMES H. McGRAW, Founder and Honorary Chairman
 Publication Office 99-129 North Broadway, Albany, N. Y., U. S. A.

EDITORIAL AND EXECUTIVE OFFICES 330 West 42nd St., New York, N. Y., U. S. A.
 James H. McGraw, Jr., President; Howard Ehrlich, Executive Vice President; Mason Britton, Vice President; B. R. Putnam, Treasurer; Joseph A. Gerardi, Secretary. Cable Address: MCGRAWHILL, New York. Member A. B. P. Member A. B. C.

ELECTRONICS, January, 1943, Vol. 16; No. 1. Published monthly, price 50c a copy. Allow at least ten days for change of address. All communications about subscriptions should be addressed to the Director of Circulation, 330 West 42nd Street, New York, N. Y.

Subscription rates—United States and possessions, Mexico, Central and South American countries, \$5.00 a year, \$8.00 for two years, \$10.00 for three years. Canada (Canadian funds accepted) \$5.50 a year, \$8.00 for two years, \$11.00 for three years. Great Britain and British possessions 36 shillings for one year, 72 shillings for three years. All other countries, \$6.00 for one year, \$12.00 for three years. Entered as Second Class matter, August 29, 1936, at Post Office, Albany, New York, under the Act of March 3, 1879. **BRANCH OFFICES:** 520 North Michigan Avenue, Chicago; 68 Post Street, San Francisco; Aldwych House, Aldwych, London, W. C. 2; Washington: Philadelphia; Cleveland; Detroit; St. Louis; Boston; Atlanta, Ga.; 601 Fifth Street, Los Angeles.

A McGRAW-HILL PUBLICATION



DEPARTMENTS

Washington Feedback.....	53
Crosstalk.....	55
Reference Sheet.....	94
Tubes at Work.....	101
Electron Art.....	126
News of the Industry.....	146
New Products.....	162
Index to Advertisers.....	205

CHANGE OF ADDRESS

McGRAW-HILL PUBLISHING COMPANY
 330 West 42nd Street, New York, N. Y.

Director of Circulation:
 Please change my address on Electronics

From

To

Signed

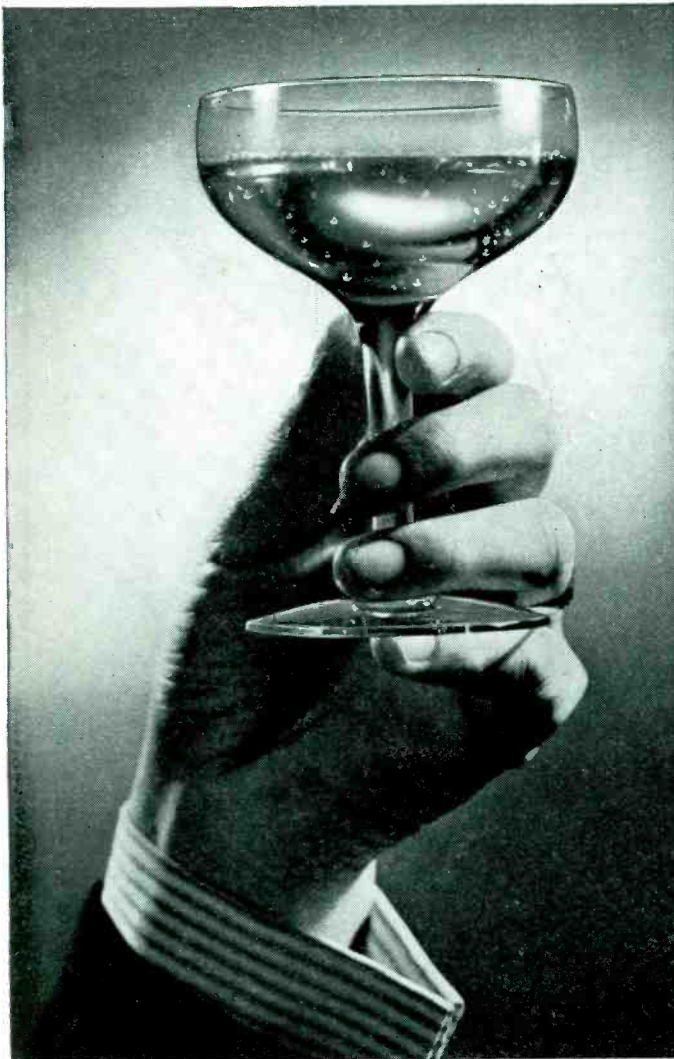

HERE'S TO LONG LIFE!

This TOBE PLUG-IN CAPACITOR — Type PTSC-2—is a refinement of the plug-ins originated over seven years ago by Tobe engineers. It has quite a history—and quite a future, too. In engineering and design, we have one primary objective—to assure *long and satisfactory life* for this and *all* Tobe capacitors under *all* operating conditions. And the testimony of

users of Tobe Capacitors proves that this objective is being reached.

Fortunately, too, to help war production requirements, we now have *additional complete* capacitor manufacturing facilities in operation, meeting urgent production needs. We invite discussion of *your* capacitor problems.

TOBE FILTERMITE (TYPE PTSC-2)

A refinement of early "plug-ins"—wax impregnated, hermetically sealed (also available in oil). Passes all required Army and Navy immersion tests. Low power factor.

CAPACITY: 2 x 8 microfarads

RESISTANCE: 2000 megohms per mfd.

VOLTAGE: 600 volts D.C. continuous working.

Individually tested at 1800 volts D. C.
(Available in 4 and 6-prong base)



THE HOUSE OF "3-PLUS" MANUFACTURE

The quality of Tobe Capacitors is unquestioned; a direct result of...

1. PERSISTENCE in Research
 2. SOUNDNESS in Engineering
 3. EXCELLENCE in Production
- PLUS... 15 years of Condenser Experience.



**NO
MINERAL
OIL**



**NO
VEGETABLE OIL**



**NO
WAX**



MINERAL OIL. Most tracing papers are treated with some kind of oil. Mineral oil is physically unstable, tends to "drift", never dries completely. Papers treated with mineral oil pick up dust, lose transparency with age.



VEGETABLE OIL, chemically unstable, oxidizes easily. Papers treated with vegetable oil become rancid and brittle, turn yellow and opaque with age.



ALBANITE is a crystal-clear synthetic solid, free from oil and wax, physically and chemically inert. Because of this new stabilized transparentizing agent Albanene is unaffected by harsh climates—will not oxidize with age, become brittle or lose transparency.

A new synthetic solid gives you this permanent tracing paper

A remarkable new transparentizing agent developed in the K & E laboratories—produces this truly permanent tracing paper! ALBANENE is made of 100% long fiber pure white rags—treated with *Albanite*—a new crystal clear synthetic solid, physically and chemically inert. ALBANENE will not oxidize, become brittle or lose transparency with age.

Equally important, ALBANENE has an excellent drawing surface that takes ink or pencil beautifully and erases with ease... a high degree of transparency that makes tracing simple and produces

strong sharp blueprints... extra strength to stand up under constant corrections, filing and rough handling. ALBANENE has *all* the working qualities you've always wanted—and *it will retain all these characteristics indefinitely.*

Make ALBANENE "prove it" on your own drawing board. Ask your K & E dealer or write us for an illustrated brochure and generous working sample.

EST. 1867
KEUFFEL & ESSER CO.

NEW YORK - HOBOKEN, N. J.
CHICAGO - ST. LOUIS - SAN FRANCISCO - LOS ANGELES
DETROIT - MONTREAL

K & E Albanene
REG. U. S. PAT. OFF.
THE STABILIZED TRACING PAPER

The **TRIPILETT** ELECTRICAL

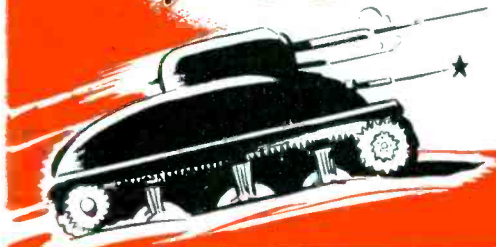

Passing

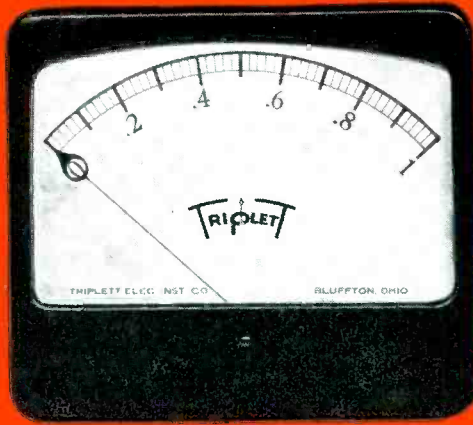
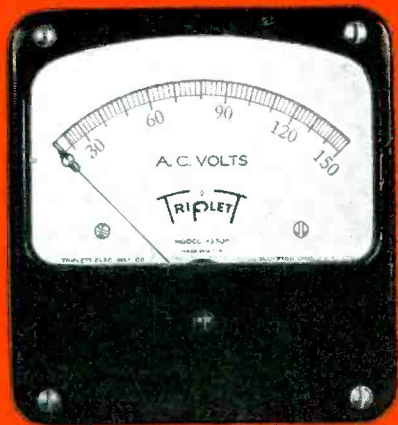
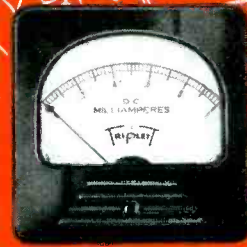
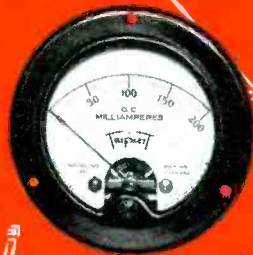
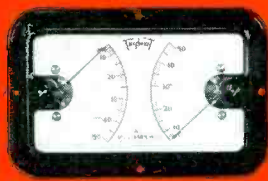

THE TRIPILETT ELECTRICAL INSTRUMENT CO.

A WORD ABOUT DELIVERIES

Naturally deliveries are subject to necessary priority regulations. We urge prompt filing of orders for delivery as may be consistent with America's War effort.

January 1943 — ELECTRONICS

Combat Line

MEASURING INSTRUMENTS



in Review



A Glimpse into the Future

Out of the needs of war; out of tripled production lines and twenty-four hour days; out of the drive for "better performance under spectacular stress and vibration," comes Triplet precision instruments in volumes impossible by now outmoded peacetime methods. Today our country's needs come first—Tomorrow when America again takes up peacetime pursuits, the values of these experiences will be apparent, in savings, in performance, in technical superiority beyond the concepts of yesterday.

BLUFFTON, OHIO ★ ★ ★ ★





Wire Wound Radiohms by Centralab

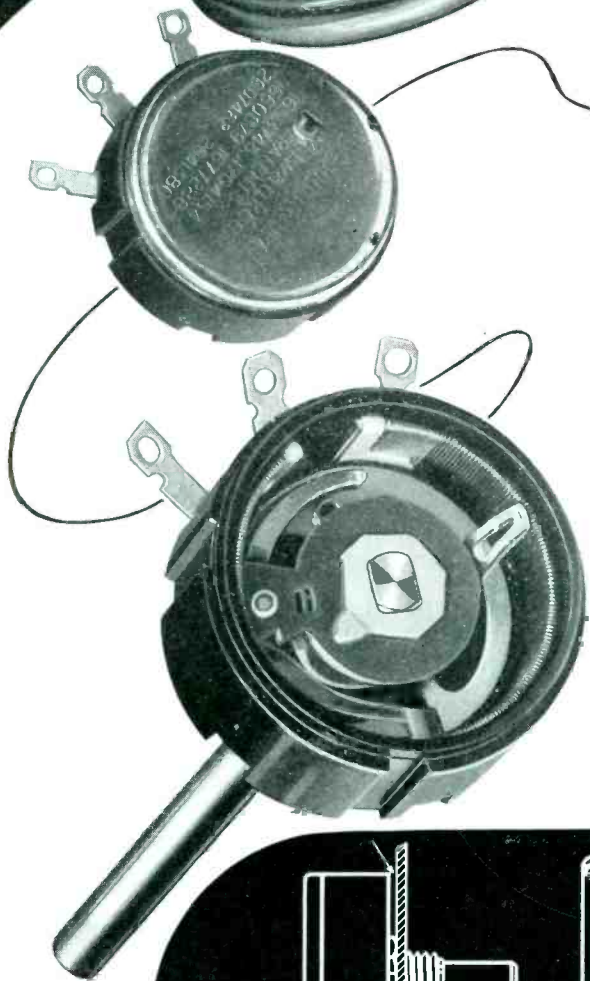

Available in single or tandem type . . . with or without switch . . . for use as a potentiometer or rheostat . . . in resistance values up to 10,000 ohms.

Linear taper only . . . rated conservatively at 3 watts . . . temperature rise of 100 ohm unit is 28° C. at 3 watts, 40° C. at 4 watts with load carried over total resistor.

Total rotation 300°. Switch type requires 40° for switch throw.

Available to Your Specifications

CENTRALAB: DIV. OF GLOBE-UNION, INC., MILWAUKEE, WIS.

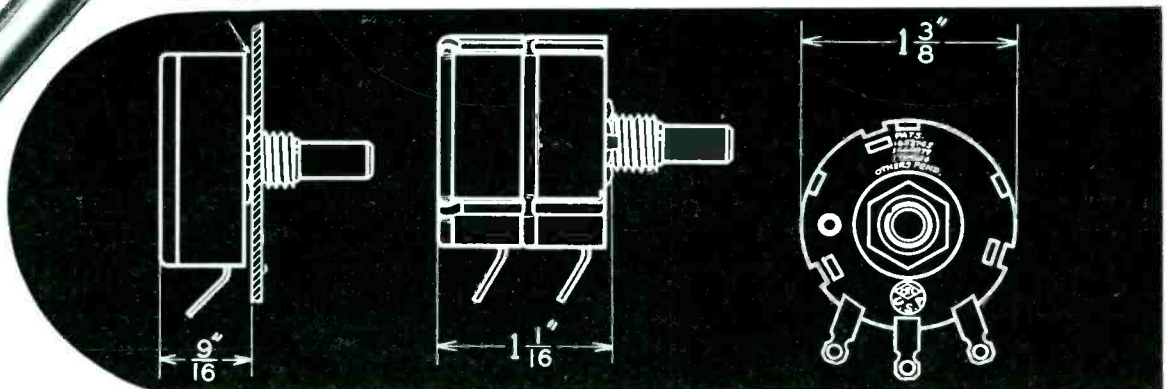

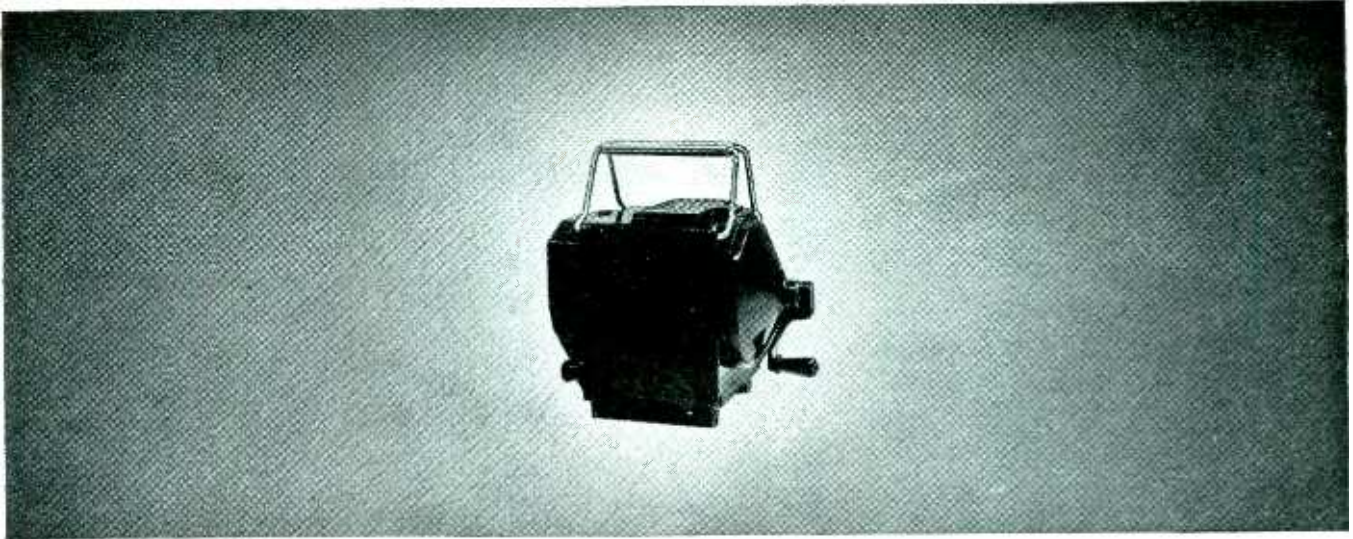

To Our Customers and Friends:

"Megger" Testers are, as you can well imagine, in unusually heavy demand during these strenuous days. Now, if ever, electrical equipment *must not fail*.

Although the demand has been for a quantity of instruments many times larger than our normal pre-war volume, we have so far been able to fill most high priority orders on schedule. Ours is the unique responsibility of supplying America's electrical men who must maintain electrical equipment on land, on the seas and in the air—with a testing device that is a vital necessity.

To this end we are now concentrating on the building of the more generally used types of "Megger" instruments in our Philadelphia factory. We have complete manufacturing facilities, a loyal group of skilled men and women, and above all the *determination* to see that you get all the "Megger" Testers you need—at the earliest possible date.

JAMES G. BIDDLE CO.
January, 1943

P.S.—We urge you to inform us as soon as possible of your requirements for "Megger" instruments, so that we can plan our production to meet your needs.

"MEGGER"

TRADE MARK REGISTERED U.S. PAT. OFF.

INSULATION TESTERS • GROUND TESTERS • OHMMETERS

JAMES G. BIDDLE COMPANY • 1211-13 ARCH STREET • PHILADELPHIA, PENNA.
ELECTRONICS — *January 1943*

ZIP IN EVERY BLADE

FELKER
DI-MET
TRADE MARK REG.
U.S. PATENT OFFICE
RIMLOCK

DI-MET

Rimlocks

**More Speed • More Life • More Production
For All Methods of Quartz Cutting**

WHETHER you use fast through-cutting or the more precise down-feed Rimlocks can speed up your operations! These Di-Met Diamond Abrasive Wheels need no coaxing on quartz, Steatite, or other hard, brittle materials because they're designed for speed. The exclusive Rimlock bonding method anchors the diamonds solidly—yet without additional fracturing, and points the diamonds radially so that their sharpest cutting edges do the work. Graded diamonds and high operating speeds produce excellent, smooth surfaces.

FELKER MANUFACTURING COMPANY
BOX 208, TORRANCE • CALIFORNIA

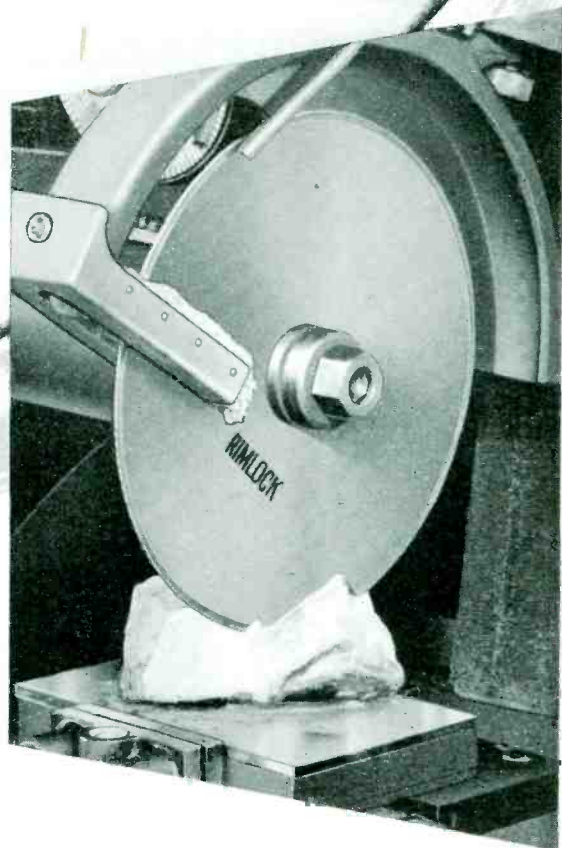

Rimlocks are long lived cutters, too—over 700 quartz wafers, averaging 4 sq. inches of surface area each, have been cut with a single blade.

Let Rimlocks prove their superiority in your own quartz cutting operations. Available in many sizes and in two bonds—steel and copper. Write for our new bulletin.



MANUFACTURERS OF DIAMOND ABRASIVE WHEELS

A NEW AND VITAL SERVICE

**for engineers,
designers and
technicians**

OUR sample department is now delivering highly specialized transformers in a matter of days only. This is a direct result of the increased demands by our customers for greater speed in the development of new designs for military equipment. The establishment of this entirely independent organization was effected

for the sole purpose of delivering engineering service and sample components in the shortest possible time.

The significance of this N-Y-T Service can be stressed when case histories in our files (confidential for the present) show that performance was not merely fulfilled—but surpassed.

That's what we mean by a 'new and vital service' . . . a service which has been personalized to meet your requirements.

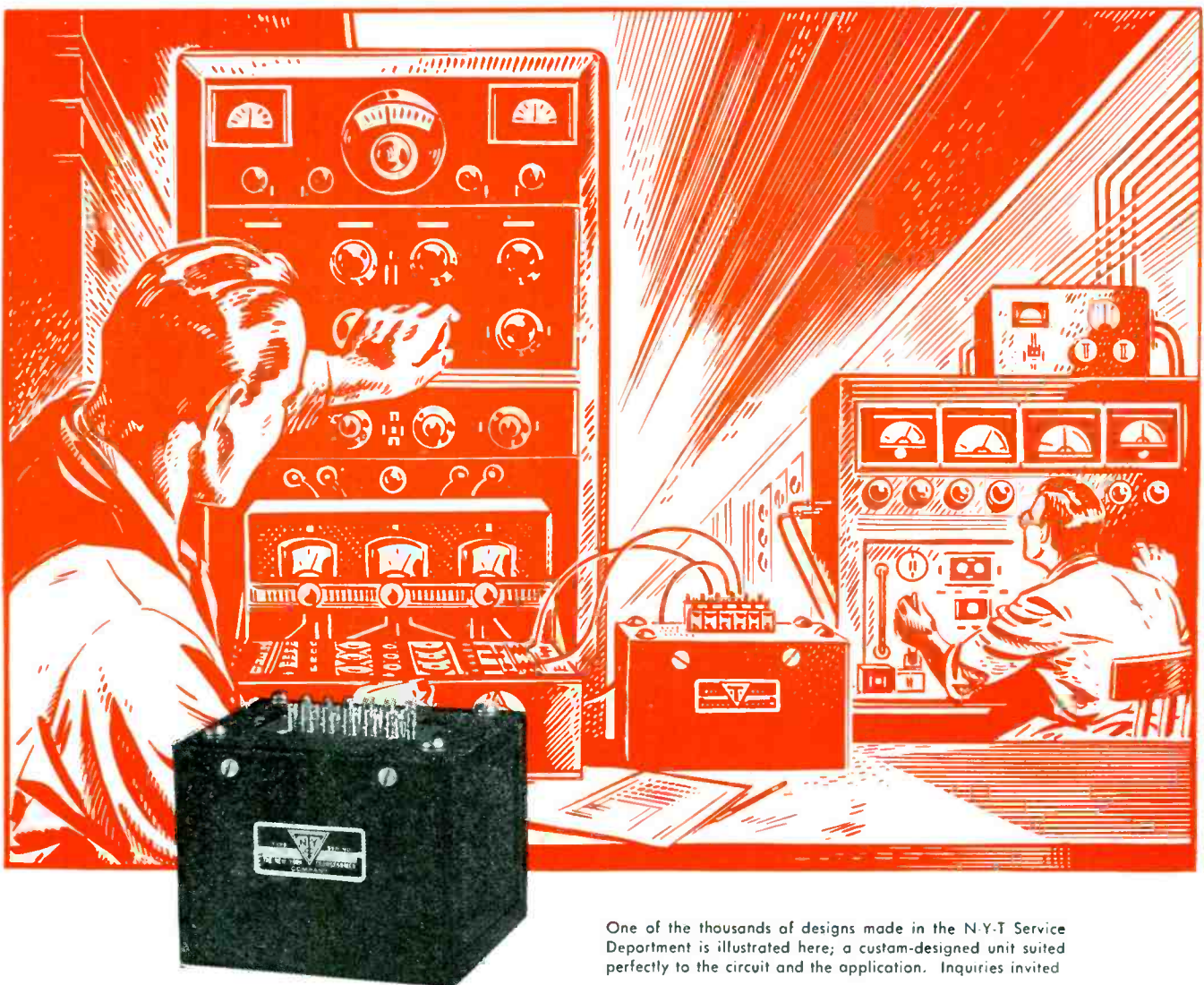

One of the thousands of designs made in the N-Y-T Service Department is illustrated here; a custom-designed unit suited perfectly to the circuit and the application. Inquiries invited

NEW YORK TRANSFORMER COMPANY

26 WAVERLY PLACE



NEW YORK, N. Y.

BUILT TO LAST

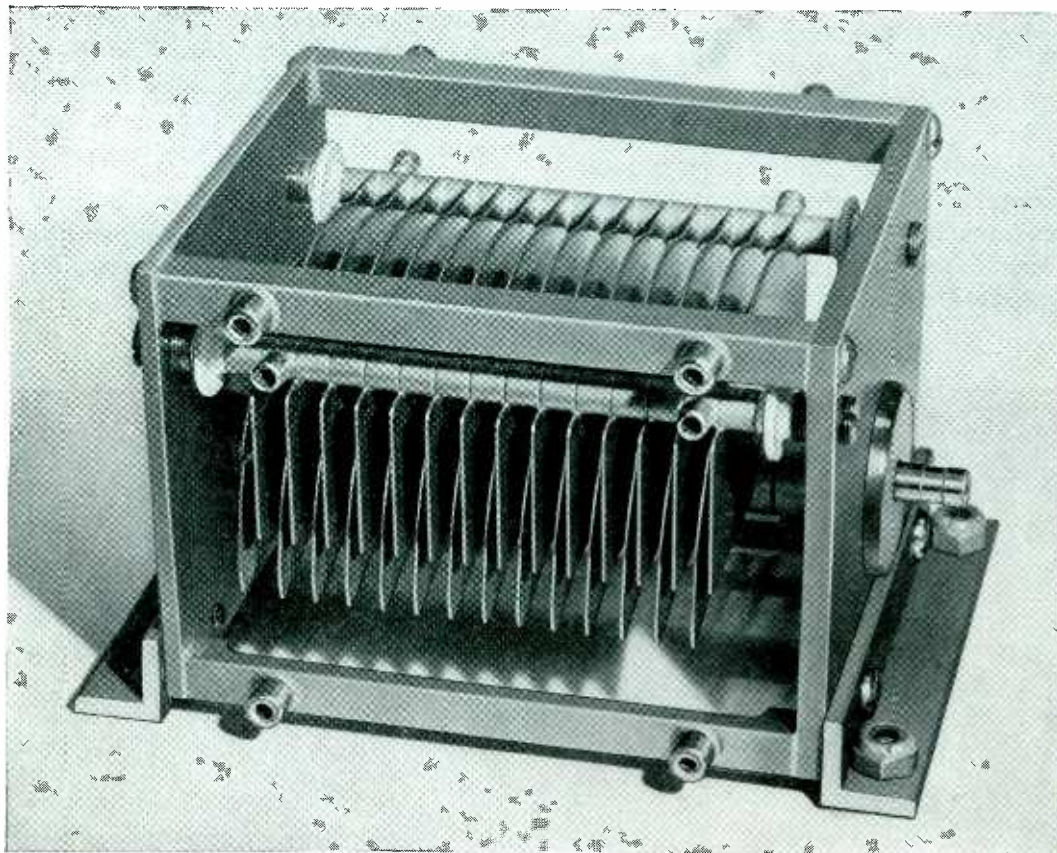

A typical example of rugged construction

THROUGH a combination of bolting, staking, soldering, aging and heat-treating, Hammarlund variable condensers maintain permanent calibration under all sorts of conditions in tanks, airplanes and battle-ships.

THE HAMMARLUND MANUFACTURING CO., INC.
460 West 34th Street, New York, N. Y.

In 194X... a family of electron tubes will go into business for themselves...

A BIG TUBE sat in a neat black box and pushed buttons. Little tubes ran conveyors that brought work to the machines. Others started and stopped lathes and drills and grinders, passed work down the line. Still others peered through holes, squinted along surfaces, probed and measured every piece, moved misfits aside. Others again operated machines that put the pieces together, packaged the product...

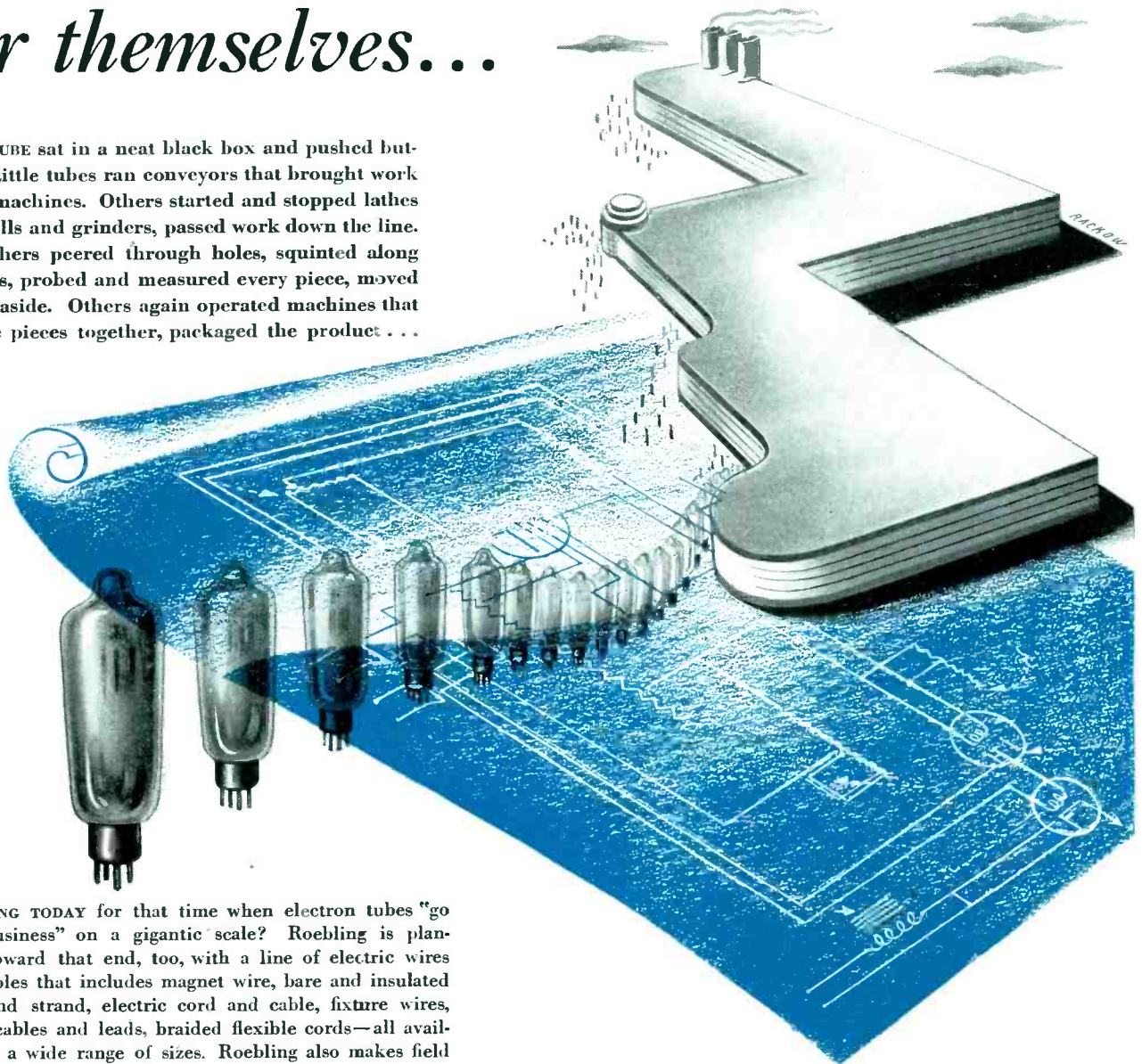

PLANNING TODAY for that time when electron tubes "go into business" on a gigantic scale? Roebing is planning toward that end, too, with a line of electric wires and cables that includes magnet wire, bare and insulated wire and strand, electric cord and cable, fixture wires, brush cables and leads, braided flexible cords—all available in a wide range of sizes. Roebing also makes field coils, armature coils and solenoids.

More than this, though, Roebing is equipping and manning today, toward the production of new types of electric wires and cables as these are required by the growing electronics industry and the electrical industry as a whole. For your needs of today and your plans for tomorrow, you can rely on Roebing as your source for everything in electric wires.

JOHN A. ROEBLING'S SONS COMPANY
TRENTON, NEW JERSEY Branches and Warehouses in Principal Cities

ROEBLING

ELECTRIC WIRES AND CABLES

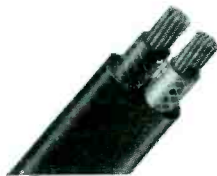
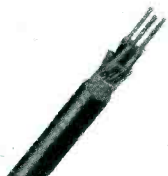

INGENIOUS DESIGN, skilled craftsmanship, and rigid inspection combine in this compact power rheostat to give greater capacity for handling overloads without taking up more space. Among its interesting features are:

25% MORE CAPACITY

Massive ceramic winding core of unusually large cross section for the wattage rating,—more wire, more surface area, less temperature rise.

Copper graphite brush with integral molded pigtail travelling smoothly on inside circumference where wires are closely spaced, each turn a separate step.

Heat treated pressure spring maintains uniform brush pressure, and is entirely independent of electrical circuit.

Mica disk completely encloses brush and pigtail assembly within porcelain contact holder.

Phosphor bronze pigtail eliminates one sliding electrical contact.

Porcelain contact holder insulates contact system from grounded parts.

Thrust spring.

Stop pin acts against heavy boss, an integral part of base.

Large contact surface at end of winding, bolted to screw terminal.

Mounting bushing. Rheostat may also be mounted by tapped holes in base.

Rugged zinc alloy die cast base.

Sturdy central screw terminal,—all terminals are integral with body of rheostat:—another exclusive advantage.

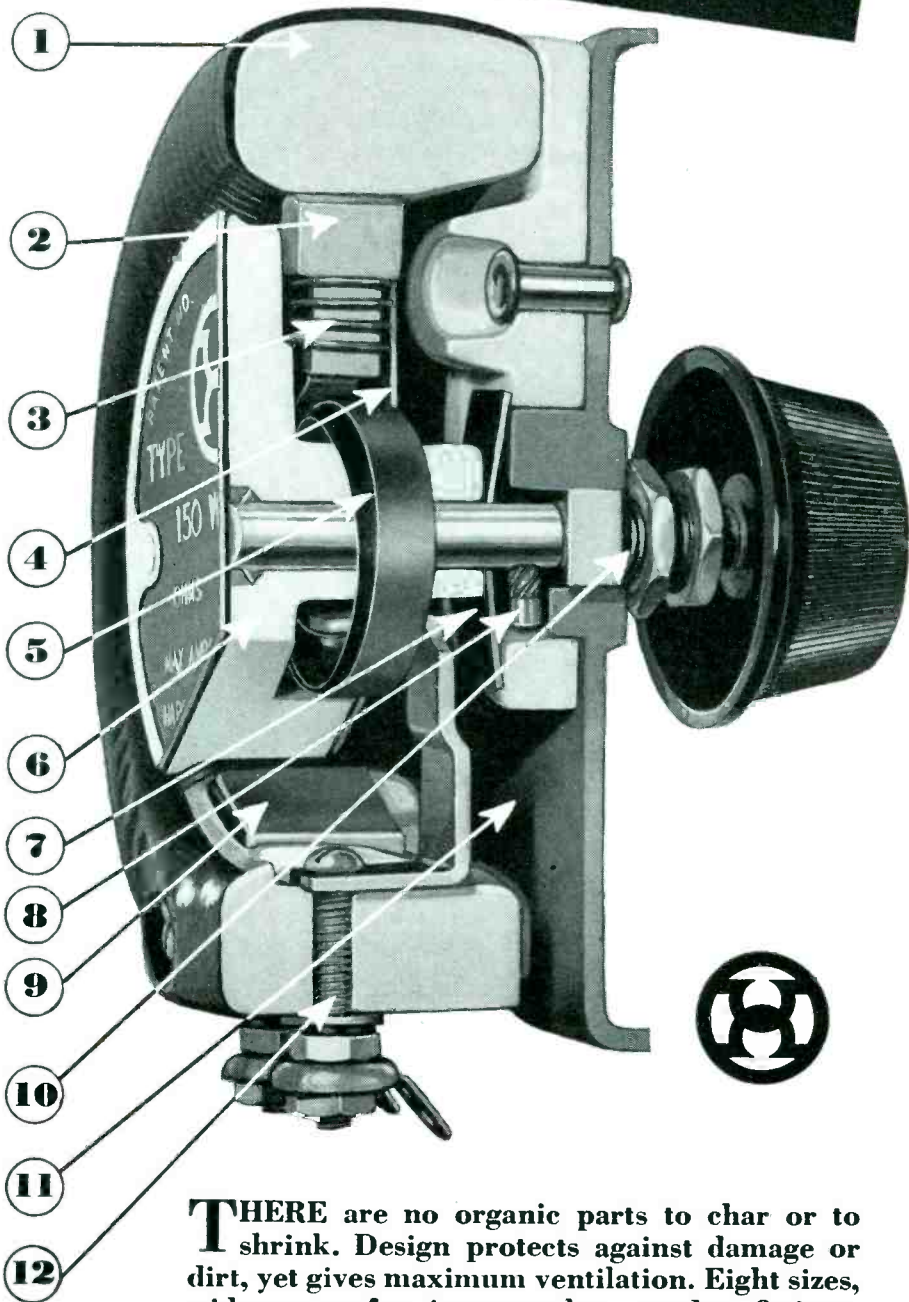

THERE are no organic parts to char or to shrink. Design protects against damage or dirt, yet gives maximum ventilation. Eight sizes, wide range of resistance values, tandem fittings, etc., etc.

HARDWICK HINDLE, INC.
NEWARK, N. J., U. S. A.



EVEN war can bring out much that is good.

The gauging of thin mica sheets threatened to be a production bottleneck. Fingers, highly trained by the Braille system, were called upon to replace mechanical gauges and slower vision. The fingers responded.

Today a group of blind employees at SOLAR are gauging mica quicker and more accurately than ever achieved before. They and their "seeing-eye" dogs bring unusual talents to the production front.

"HANDS THAT SEE"

SOLAR is proud to be a pioneer in drawing upon the untapped reservoir of such able employees. SOLAR "Quality Above All" is well protected by these "hands that see."

Solar **SOLAR**

SOLAR MANUFACTURING CORP., BAYONNE, N. J.
Makers of Capacitors (Mica, Paper and Electrolytic)

|| CAPACITORS ||

IRON CORES *for* 150-175 MEG.

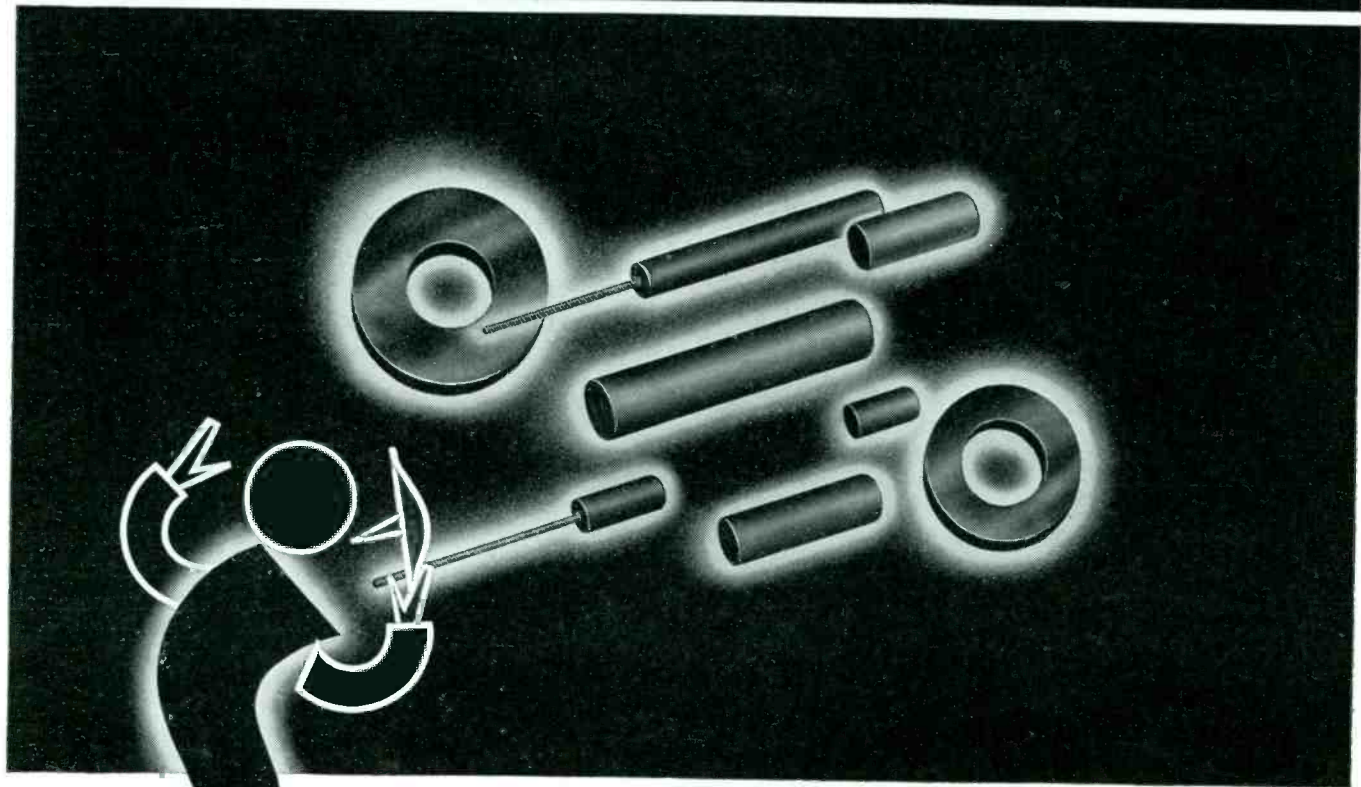

...another example of **Stackpole Engineering Leadership**

Matching the demands of today's exacting applications, Stackpole has developed iron cores which show outstandingly favorable characteristics at frequencies as high as 150 to 175 megacycles. Combining a permeability of approximately 5 with high Q, these cores represent a big forward step in meeting the service requirements of much of the high frequency equipment now coming into widespread use.

Other Stackpole cores for fixed or variable inductance, or for station tuning, are available in a wide variety of grades and sizes for use at any frequency up to 50 megacycles. Molded from powder to match your specifications, they are noted for their uniformity. *All engineering samples are made on actual production equipment.*

Full details on any type will gladly be sent upon request. Where samples are needed, please send complete data as to size and frequency.

STACKPOLE CARBON COMPANY, ST. MARYS, PENNA.
Stackpole Products are Sold to Manufacturers Only

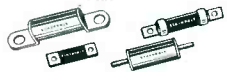

RESISTORS (fixed)
Carbon composition resistors up to 3 watts, all ranges—insulated or molded construction.



RESISTORS (variable)
A wide variety of types for every volume, tone, and sensitivity control need.



SWITCHES
Slide-operated (either indexed or momentary contact)—Rotary Index and Toggle Types.

STACKPOLE

EVERYTHING IN CARBON BUT DIAMONDS — BRUSHES (all types for all rotating machines) — CONTACTS (all carbon, graphite and camposition types — also molded rare metal contacts) — ANODES — ELECTRODES — BRAZING BLOCKS — BEARINGS — WELDING RODS, ELECTRODES AND PLATES — PIPE — PACKING, PISTON AND SEAL RINGS — RHEOSTAT PLATES AND DISCS — BRAKE LINING, etc.

THE FINESSE OF THE

Guild Craftsman

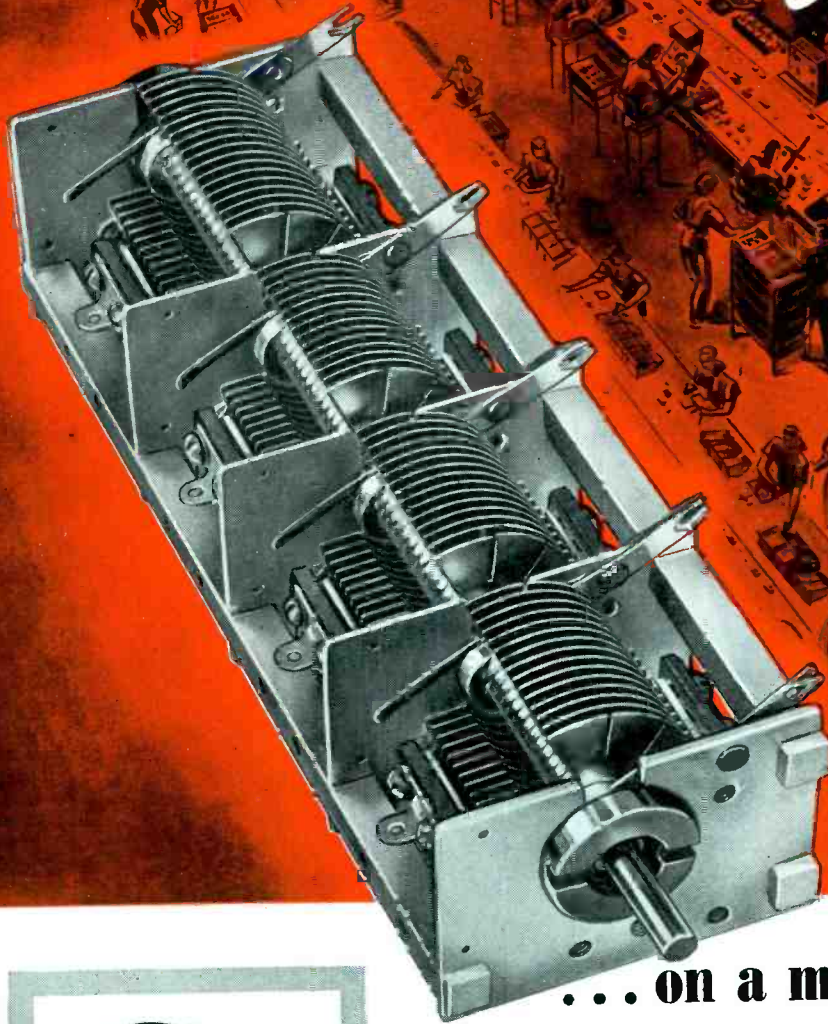

... on a moving-belt basis!

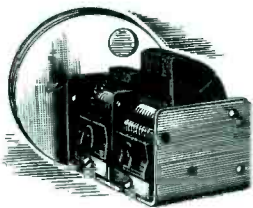

MILLIONS..of home radios are dependent on the performance and permanence of General Instrument Corporation products.

The impossible task of January 1942... a proven fact by August 1942.

The daily shipments of thousands of products—of laboratory-standard quality and military-required ruggedness—are meeting the demands of our fighting forces... and insuring the perfection of communication contacts so vital to modern warfare.

'Guild Craftsman' products adapted to moving-belt production methods, are the answer to this accomplishment.

The manufacturing of precision products by the volume-production assembly line method is a specialty of General Instrument Corp. May we help you by adapting our processes to your problems?



General Instrument Corporation

EXECUTIVE OFFICES:

831 NEWARK AVENUE, ELIZABETH, NEW JERSEY

ELECTRONICS — January 1943

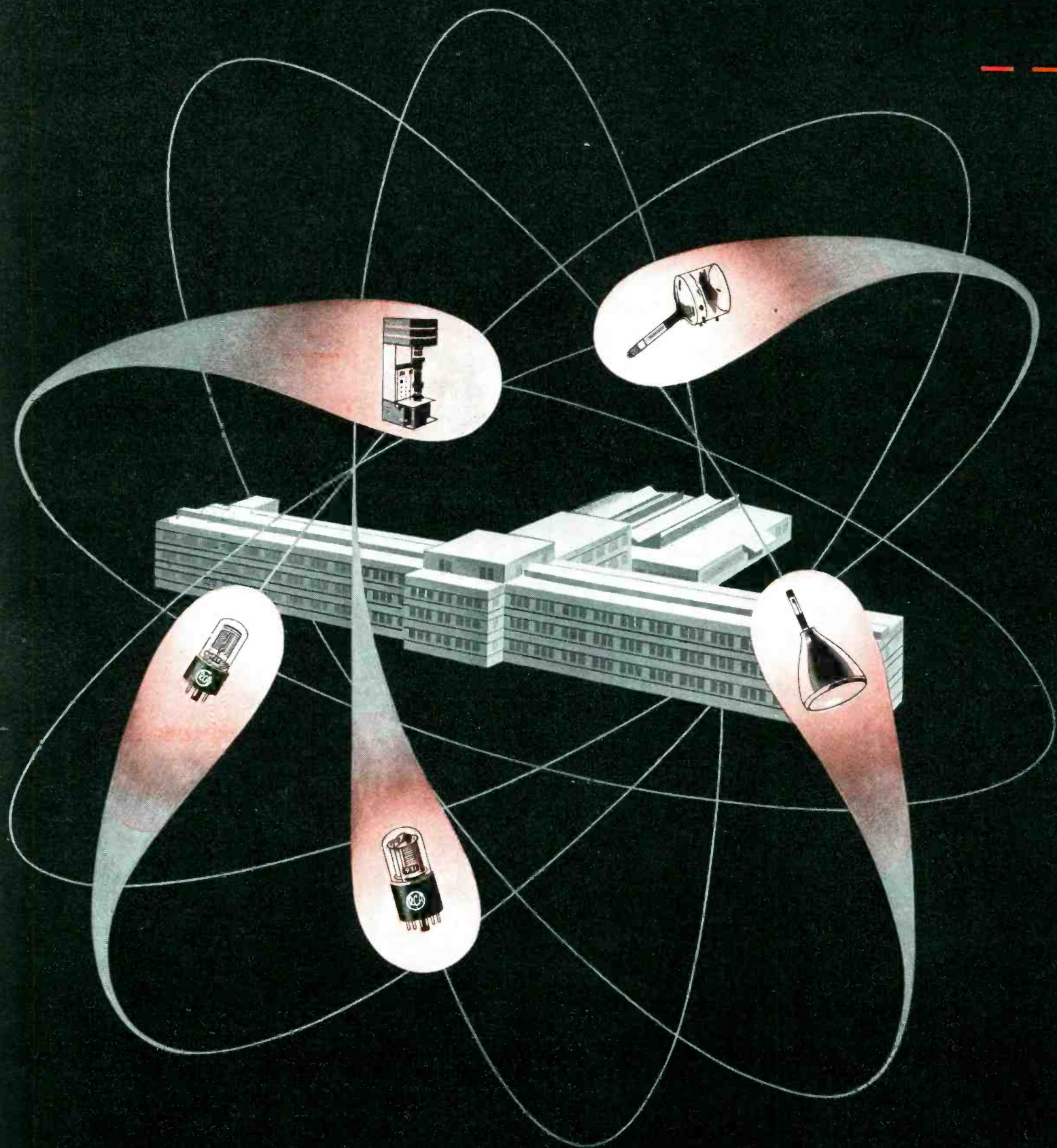

Just as the electrons of an atom are held in their orbits by the mysterious force of the nucleus . . . so the material results of research are controlled and directed by the central force of research exemplified in the new RCA Radio - Electronic Laboratories.

THE HIDDEN BATTLEFRONT

When the RCA Radio-Electronic Laboratories . . . stretching 488 feet from wing to wing . . . were dedicated last November, the Chief Signal Officer of the Army called them the "Hidden Battlefront of Research."

Hidden . . . because from that day to the end of the war, this magnificent new building, housing 150 laboratories, will be closed to all but the scientists and research technicians now working there on a myriad of heretofore unsolved radio-electronic problems . . . many of vital importance to our military effort.

The staff of these laboratories has already produced outstanding developments in new

radio, television and electronic devices, in ultra-short waves, in acoustics and in many other branches of electronic research . . . The skills thus developed before the war are now finding direct use in military applications with our fighting forces.

Out of the ashes of war these scientists will bring forth implements for a new and better civilization to serve the cause of a Victorious peace.

In the meantime . . . while working day and night for Victory . . . they are cooperating with other companies in solving problems that will help the war effort.



RCA LEADS THE WAY

IN RADIO • IN TELEVISION • IN ELECTRONICS

*RCA Manufacturing Company, Inc.
Camden, N. J.*

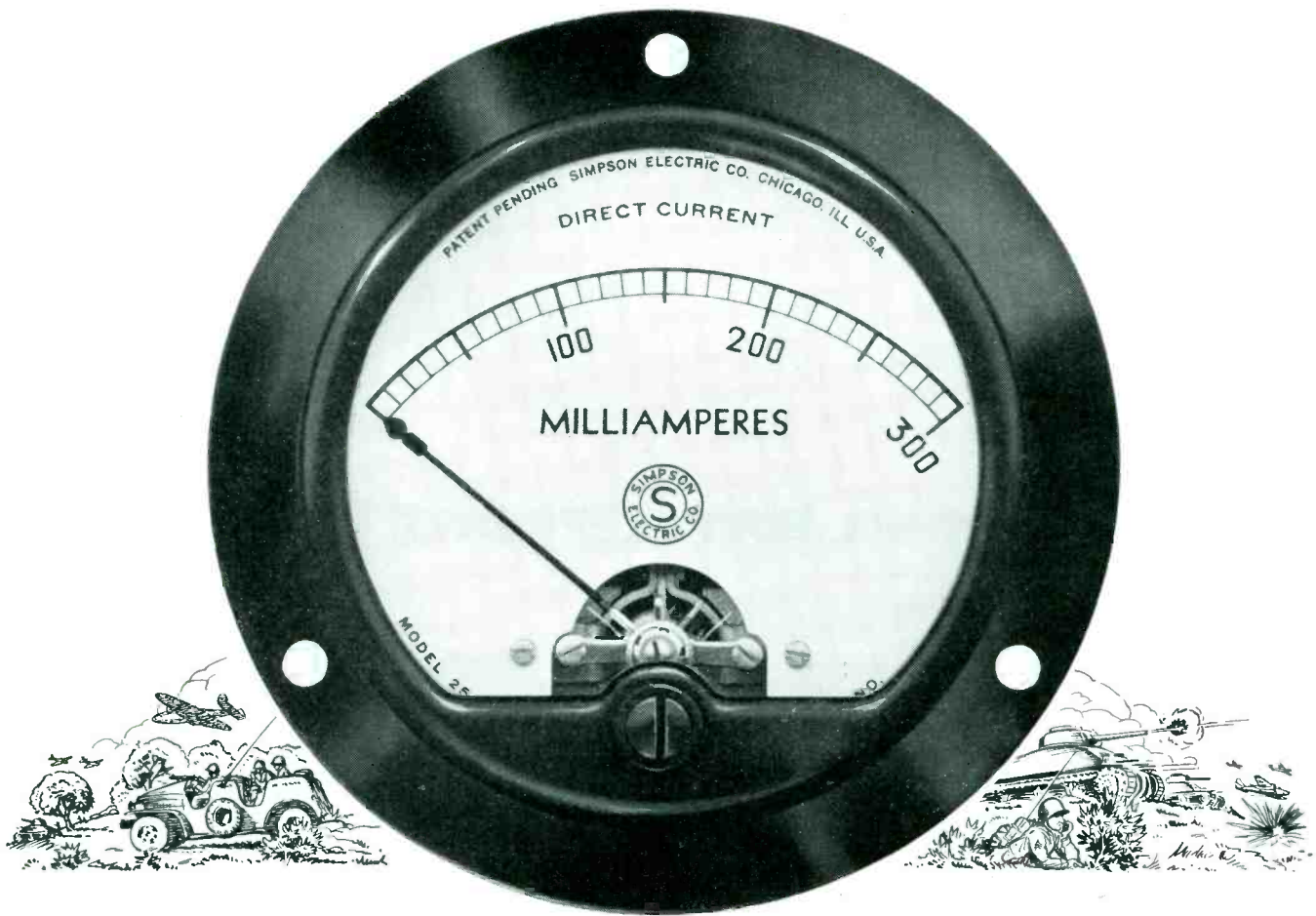

To DO the job . . . and stay ON the job

ORDINARILY we think of the two words, delicate and strong, as direct opposites. Yet for practical, on-the-job performance, an electrical instrument must combine both these characteristics . . . must be sensitive to the most delicate current variation for complete accuracy—rugged and strong for lasting accuracy.

A few years ago the Simpson Electric Company was organized to build these virtues into electrical instruments in fuller measure than ever before. It was founded upon more than 30 years of experience in instrument making. And it introduced an entirely new concept of instrument design—a patented full bridge type movement with soft iron pole pieces, which offers this basically finer movement in its finest form, and which permits substantial economies through straight line production and standardization.

Already the success of these instruments is history. Their outstanding record of service shows plainly their ability to *do* the job and stay *on* the job.

For the job that must be done, only the best electrical instruments are good enough. To those who have searched out the facts, best means Simpson.

SIMPSON ELECTRIC COMPANY, 5200-5218 Kinzie St., Chicago, Ill.

Simpson

INSTRUMENTS THAT STAY ACCURATE

Buy War Bonds and Stamps for Victory

Insulate it Better

with



NOTE THE CHARACTERISTICS:

*Dielectric constant.....	6.4	Dielectric strength.....	640 volts per mil.
*Power factor.....	0.0023	Specific gravity.....	2.5
*Loss factor.....	1.49	Transverse strength.....	13,000 lbs. per sq. in.

*Measured at 300 kilocycles after 96 hours in distilled water according to Navy Specification RE-13A-317F.

IT'S A CERAMIC THAT CAN BE MACHINED!

MACHINEABLE BY WHOM?

By anybody! Your own mechanics can machine MYCALEX Insulating Material to accurate dimensions. Or, send us your specifications and let us quote on machined parts fabricated in our machine shop at our new plant in Clifton, N. J.

REDUCED PRICE?

Yes! After a decade of unchanged prices, we now find that our accelerated production facilities result in lower costs. We feel that vital war materials should be made available as cheaply as possible to all users, to encourage even wider applications. Send for list of new prices, 18% lower in some sizes.

DELIVERIES?

Prompt! THE BOTTLE-NECK HAS BEEN BROKEN. We can supply full sheets of Leadless MYCALEX Insulating Material in large quantities, immediately. If you are using make-shift or substitute materials, change to Leadless MYCALEX Insulating Material.

Write for our free illustrated booklet describing uses, machining technique, etc. Address:

MYCALEX CORPORATION OF AMERICA

Exclusive Licensee under all patents of "MYCALEX" (PARENT) CO., Ltd.

60 CLIFTON BOULEVARD, Dept. 2N, CLIFTON, N. J.



THE SHAPE OF *Things to Come*

● Simply a plug-in capacitor. True. The fact that Aerovox spent months perfecting the corrosion-proof base is beside the point here. Likewise that such capacitors—in the electrolytic, wax-filled and oil-filled types—are standard in essential wartime equipment.

The vital point is that this capacitor symbolizes "The shape of things to come." The plug-in feature denotes ready checkup and replacement. That in turn signifies continuous, gruelling, accelerated-wear service that wears out the best capacitors in months instead of in years under usual operating conditions. Just as the demountable-rim wheel marked the transition of the auto-

mobile from Sunday pleasure rides to everyday essential transportation, so this plug-in capacitor spells an infinitely expanded usage of radio technique, radio components, radio manpower.

Our first job is to win the war. Aerovox is now concentrated on just that. And while tens of thousands of radio men are engaged in waging this war, gaining invaluable training and experience and, indeed, compressing decades of normal progress into as many years, so we at Aerovox are laying the foundation for greatly expanded radio and electronic opportunities in the coming days of peace. Thus "The shape of things to come."

NEW BEDFORD, MASS.,
U. S. A.
Sales Offices in All
Principal Cities

AEROVOX

CORPORATION



In Canada
AEROVOX CANADA LTD.
Hamilton, Ont.
EXPORT: 100 Varick St., N. Y.
Cable 'ARLAB'

Today

CUSTOM MOLDERS DO BIG THINGS

Like this

If you are a manufacturer who has not had experience in securing molded plastic parts, let this advertisement introduce you to the Custom Molder. . . . This miracle man of production takes Lumarith molding powder and with one shot in his injection molding machine produces the top and bottom of this kit—completely finished. It is typical of the jobs being done by Custom Molders. . . . Modern production calls for the fullest use of molded plastics. And so as founder of the plastics industry, we undertake this program to give newcomers to plastics the four steps to plastics molded parts. Here is what to do:

1. Tell us what qualities you want in the molded part—impact strength; resistance to water, acids or solvents; dielectric strength, etc., etc. We recommend the Lumarith Plastic that fits your specifications. . . .
2. We put you in touch with the available custom molders best equipped to mold the piece. . . .
3. The custom molder gives you a quotation. . . .
4. We work with the molder in furnishing the Lumarith formula that suits all factors of the production technique . . . in relation to dies, heat, pressure, etc. . . . We welcome your inquiries.



LUMARITH *Plastics*
REG. U.S. PAT. OFF.
 Lumarith Molding Powders (Cellulose Acetate)
 Lumarith E. C. Molding Powders (Ethyl Cellulose)

CELANESE CELLULOID CORPORATION, a division of Celanese Corporation of America, 180 Madison Avenue, New York City. Representatives: Dayton, Chicago, St. Louis, Detroit, San Francisco, Los Angeles, Washington, D. C., Leominster, Montreal, Toronto.

CELANESE CELLULOID CORPORATION

the first name in plastics

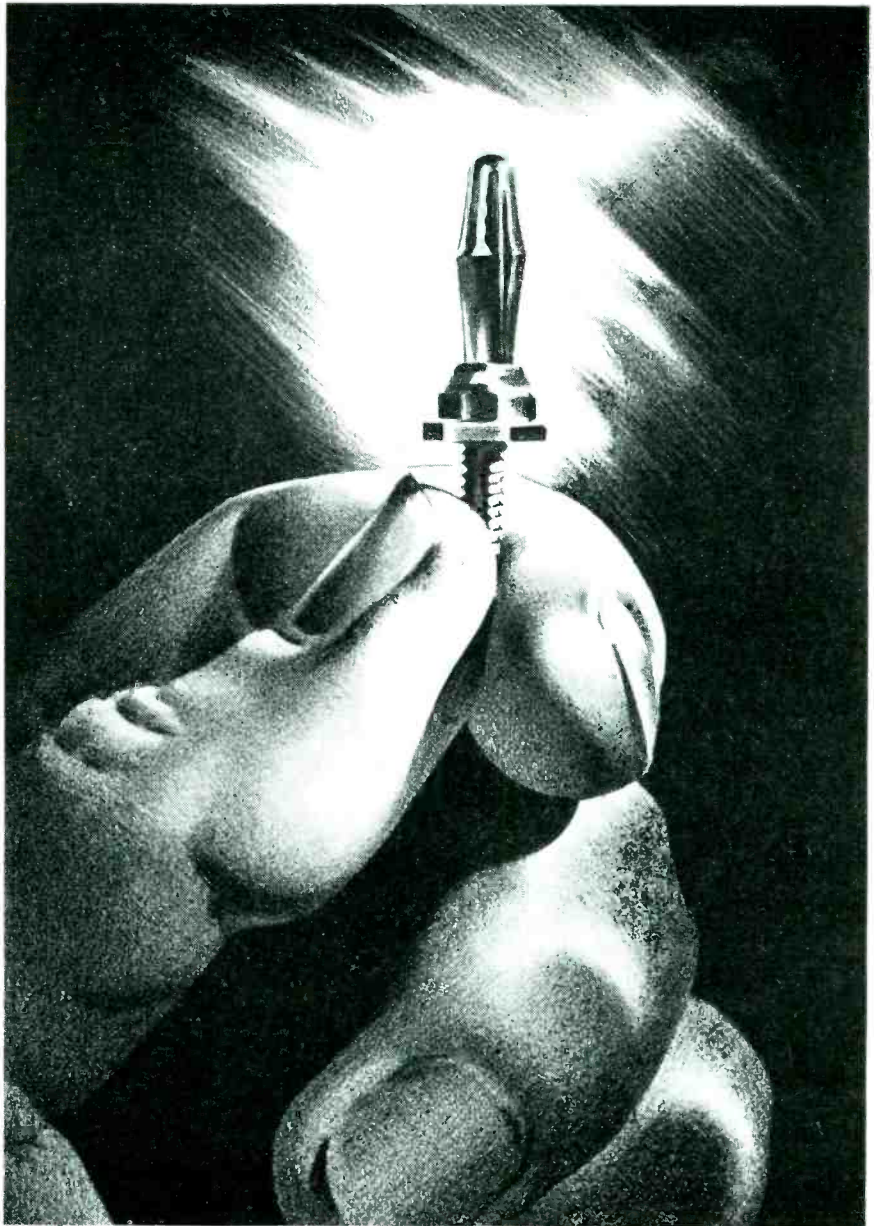

Yes!

WE HAVE

~~NO~~

BANANA *Pins*

Yes! We have plenty of banana pins in many types and sizes. And they are available for prompt delivery. As made by Ucinite these pins protect vital radio connections against the jolts, jars and jounces of mobile units in tanks, jeeps, walkie-talkies, field sets, etc. You can count on them to *keep contact!*

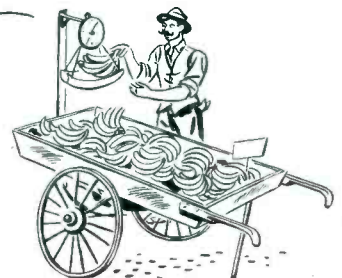

THE UCINITE COMPANY

458 Watertown Street, Newtonville, Mass.

DIVISION OF UNITED-CARR FASTENER CORP.

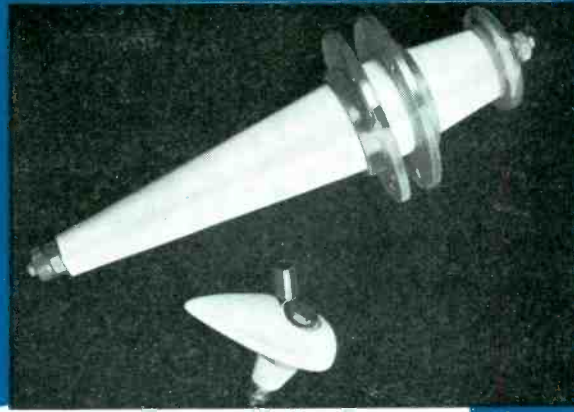

METAL-AND-STEATITE ASSEMBLIES FURNISHED BY ISOLANTITE

*release production facilities
and personnel for major
assembly jobs*

It is the countless minor assembly operations that add to the cost and delay the production of war equipment. By turning over to Isolantite Inc., for assembly, the parts in which steatite is combined with metal in various forms, you release needed production facilities and skilled hands for major assembly tasks. The ability of Isolantite to furnish assemblies that meet the most exacting demands is a matter of record.

In addition to speeding war production, such assemblies give you all the advantages of Isolantite*. Among these

are the extremely close dimensional tolerances Isolantite's manufacturing processes permit... its adaptability to the production of intricate shapes... and a uniformity of product, high mechanical strength, electrical efficiency and non-absorption of moisture which contribute greatly to dependable insulation performance.

If you have a problem in production that is vital to Victory, Isolantite-furnished assemblies might help solve it. War equipment manufacturers taking advantage of this unique service enjoy the benefits of Isolantite high-grade insulation at the same time that they ease the burden of war production.

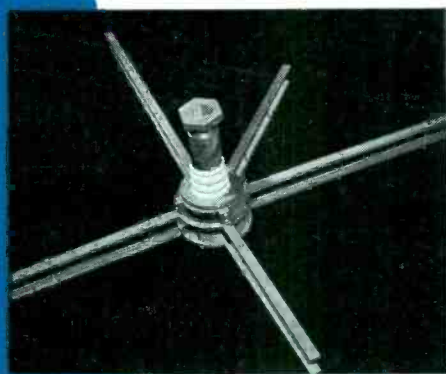

ISOLANTITE

CERAMIC INSULATORS

ISOLANTITE INC., BELLEVILLE, NEW JERSEY

*Registered trade-name for the products of Isolantite Inc.

TURBO takes the bugs out of electrical insulation bugaboos

FLEXIBLE VARNISHED OIL TUBING: resistant to deteriorating influences



● This TURBO insulation meets the diversity of requirements necessary to stand up against general break-downs, impairment through moisture absorption, and the general deteriorating influences caused by acids, alkalis, etc.

WIRE IDENTIFICATION MARKERS: to meet rigid ordnance specifications



● The facilitating of production and assembling operations, with corresponding increases in functional efficiency, are effected with this TURBO insulation product. Available in any size, length or color, these TURBO markers are strictly in accord with Army, Navy and Air Corps

VARNISHED GLASS TUBING: resistant to extremely high heat



● The extensive use of this TURBO product is directly attributable to its excellent characteristics under high heat conditions. Heavy duty operating conditions, confined areas where ventilation is minimized and other similar problems are solved

EXTRUDED TUBING: resistant to sub-zero temperatures

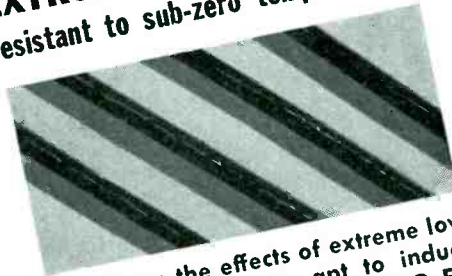

● Where the effects of extreme low temperatures are apt to induce insulation embrittlement, TURBO Extruded Tubing is especially suited. Sudden climatic changes, wide fluctuations in temperature, or refrigerant operating conditions will not effect the dependability

Check the advantageous dielectric and physical properties of the various TURBO insulations today. Samples of each, together with a new specimen board and list of standard sizes, will be sent on request without obligation.



WILLIAM BRAND & COMPANY

276 FOURTH AVE., NEW YORK, N. Y. ● 325 W. HURON ST., CHICAGO, ILL.



YANKS IN AXIS PRISON CAMPS COULD TELL YOU...

how important it is to give war equipment maximum reliability. When blueprints call for capacitors . . . use Cornell-Dubilier.

IS THIS AMERICAN soldier thinking, they let me down? Thinking, I wouldn't be in this place if that stuff hadn't failed. "That stuff" could have been fighting equipment *you* were responsible for. Run no risk in vital war production . . . use C-Ds whenever the design calls for capacitors. Manufactured by specialists, Cornell-Dubilier capacitors have

that *extra* measure of stamina, performance, *reliability* needed in war operations. This capacitor dependability, born of Cornell-Dubilier's 33 years accumulated experience, may mean the difference between victory and — the concentration camp. Cornell-Dubilier Electric Corporation. So. Plainfield, New Jersey.

Since the materials used in the production of capacitors are under control, we are permitted to produce only against those orders carrying the necessary Preference Rating Extensions. Should you be unable to enjoy the finer performance of C-Ds now, we look forward to serving you when Victory has been won.



MICA TRANSMITTER CAPACITORS

The Mica Transmitter Capacitor Type 59, illustrated, is of improved design, extremely adaptable and has been proven dependable under the most severe operating conditions. Enclosed in low-loss, white glazed ceramic cases, with cast, low-resistance, wide-path end terminals. Can be mounted in any position, individually or in groups in series or parallel combinations. Type 59 Capacitors are described in Catalog No. 160T, free on request.

Cornell Dubilier capacitors



Mica • Paper • Dykanol • Wet & Dry Electrolytic Capacitors

M O R E I N U S E T O D A Y T H A N A N Y O T H E R M A K E



I**N EVERY PLANE AND EVERY TANK**
THERE IS WORK FOR FORMICA!

Communications equipment was never before needed in such volume as this war has required. That is one reason why 95 per cent of the Formica output—recently multiplied several times—is currently going to the armed forces.

Instrument dials, panels, tubes, and insulating parts of all kinds are serving on the sea, in the air and on the ground. Formica has a grade for every purpose—including some new ones developed since the war started, such as glass base materials to do some of the work formerly done by scarce ceramics.

For an insulating material that is strong mechanically, resistant to vibration, with high di-electric strength, high insulation resistance, low power factor, and low hysteresis losses—try Formica.

There are punching grades for fast production—instrument panels and dials printed by many processes, some with fluorescent or phosphorescent pigments.

THE FORMICA INSULATION COMPANY
4661 Spring Grove Avenue, Cincinnati, Ohio



IF YOU'RE WORKING WITH ALUMINUM,
you should have this book --

just off the press

WELDING AND BRAZING ALCOA ALUMINUM

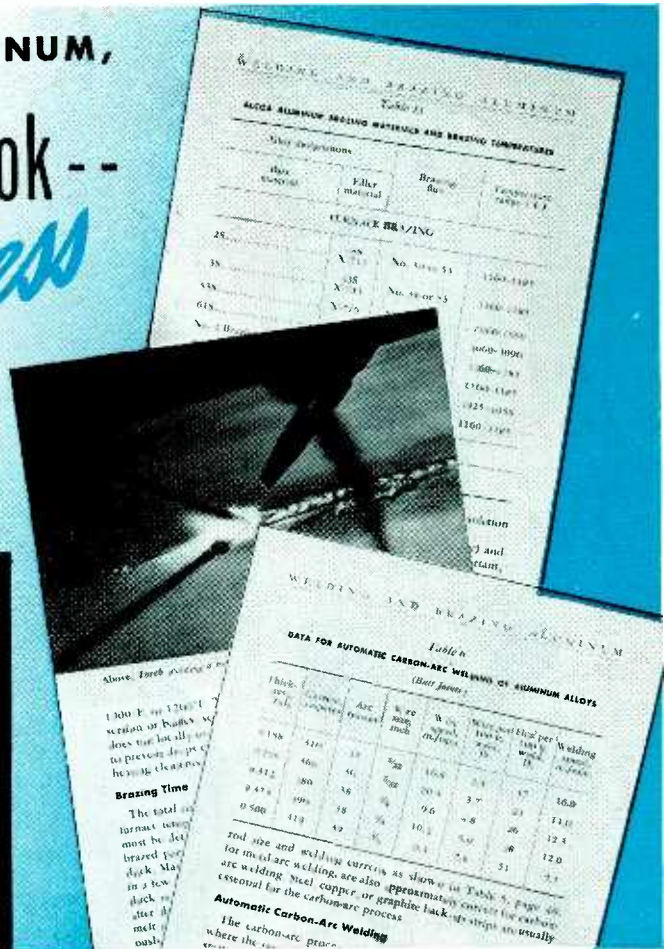

Here's a book of data designed to meet the needs of the practical man—the welder—who is working with Aluminum Alloys. It describes in detail the practices now widely employed for joining Aluminum parts by gas welding, arc and resistance welding, and by brazing.

This book is planned to assist the war effort by making every welder more proficient at his job. Typical subjects covered are: Welded joint

design—preparation of parts—types of welding equipment—electrodes and fluxes—tip selection and flame adjustment—inspection and finishing—strengths of welds.

Joining Aluminum Alloy parts by welding and brazing is readily mastered with knowledge like this at your command, plus a little practice. You may have this book free. Use the coupon to send for your copy today.



ALCOA ALUMINUM

ELECTRONICS — January 1943

ALUMINUM COMPANY OF AMERICA,
2136 Gulf Bldg., Pittsburgh, Pa.

Please send me this new book.

Name _____
Company _____
Street _____
City _____





1776

1898

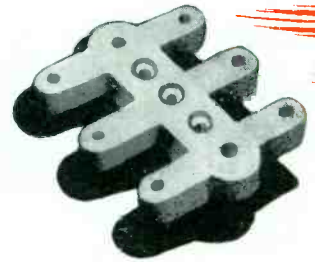
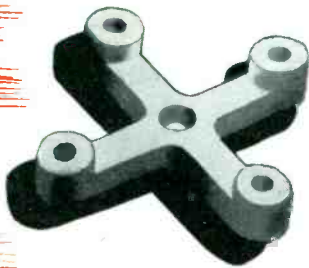

ALSIMAG 1943

Wartime ceramics

Mugs, jugs and goblets were about the only ceramics actively participating in past wars. Spirits were enlivened and convictions reaffirmed by mugs and plates bearing appropriate sentiments. Gay commemorative jugs, fashioned by earlier American ceramists, helped perpetuate the memory of men famed in war and peace.

But today ceramics play an active and vital role in war. Complex electrical mechanisms depend upon ALSIMAG steatite ceramic insulation for unflinching performance.

It was a proud day for American Lava Corporation when it was the first in the land to produce electrical insulators meeting Navy "G" specifications. Since that

time ALSIMAG insulators complying with the toughest specifications of Army and Navy have gone out of this plant in an ever-increasing flood.

The men who make ALSIMAG have only one regret. The all-out efforts of the past two years have forced them to lose touch, for the time being, with many peacetime friends and customers. Every consideration beyond the war effort was proudly and gladly thrust aside. But when peace comes, you will find that the stresses and strains of war have resulted in new and better ALSIMAG products, backed by the same alert organization ready to serve you in the same old spirit of friendly helpfulness.



AWARDED JULY 27, 1942

ALSIMAG
TRADE MARK REGISTERED U. S. PATENT OFFICE

AMERICAN LAVA CORPORATION

CHATTANOOGA, TENNESSEE

An INVITATION to RADIO MANUFACTURERS

THIS firm, actively identified with the aircraft industry, would welcome the opportunity of discussing the manufacture of our UNIONAIR junction boxes and other similar equipment for your specific use. We feel that radio manufacturers can effectively avail themselves of our extensive manufacturing facilities for precision work.

Kindly direct your inquiry for further information to:

Radio Equipment Division
UNION AIRCRAFT PRODUCTS CORP.
380 SECOND AVENUE, NEW YORK CITY

We are in a position to manufacture:

TRANSFORMER CASES SHIELDS BRACKETS CHASSIS CABINETS

N. B. Our experience in producing equipment to the rigid specifications of the Army and Navy qualifies us to manufacture standard and special products to any radio manufacturer's specifications.

He, too, wears
a pair of
Silver Wings*

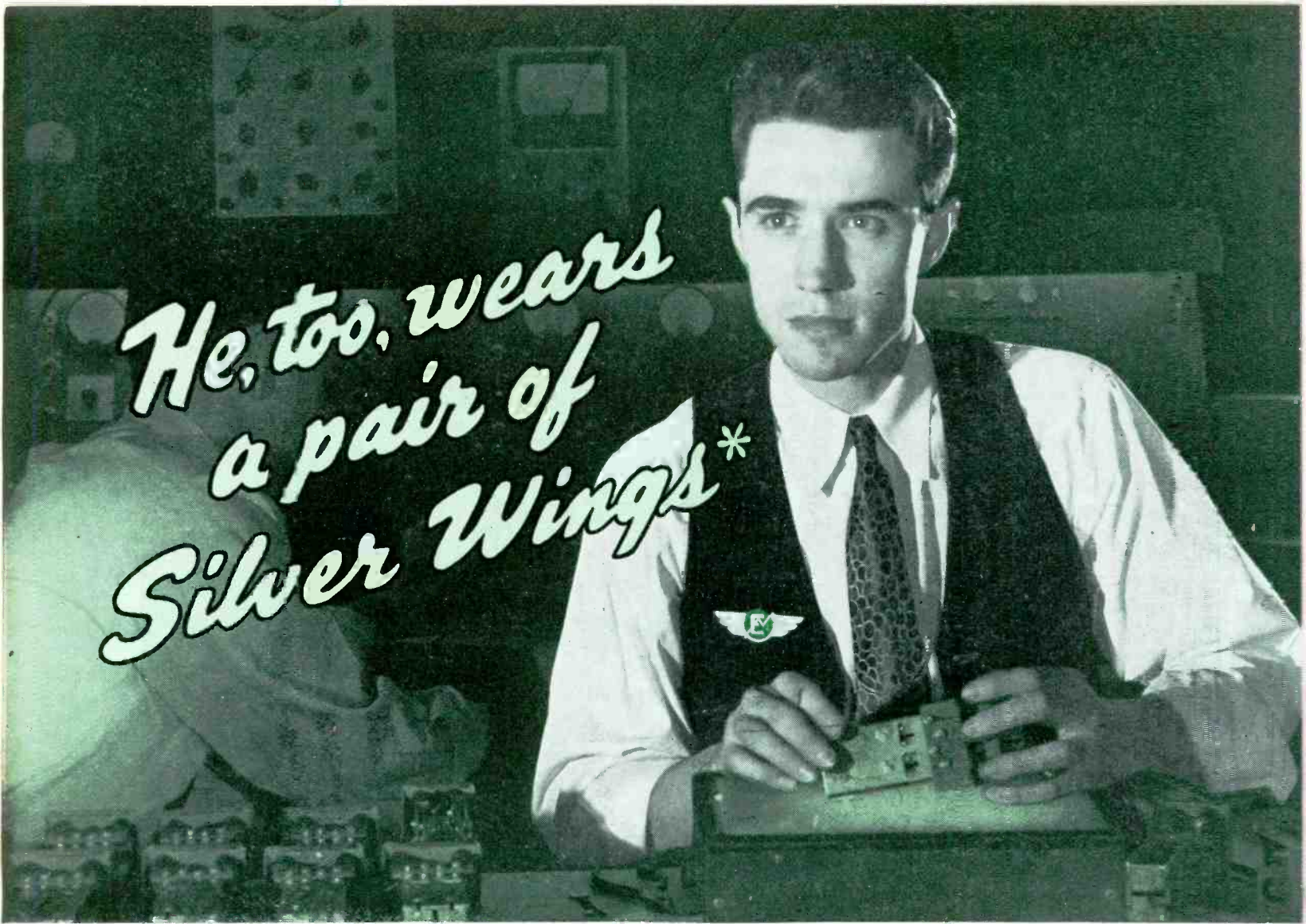

THOUGH he hasn't downed a flock of Jap Zeros — nor led Boeing B-17's on daylight forays over the Nazi-held Continent — he wears his silver wings *with pride!* For, they show he's *servng his country*, meritoriously, at Electronic Laboratories—where, for years, a pair of silver wings has symbolized long, faithful, skilled service.

Day in and day out, without fuss or fanfare, he is producing Electronic Power Supplies for Planes, Tanks, Aircraft Carriers, Jeeps, Walkie-Talkies, P-T Boats, and other military equipment! In short, he's *doing his part* to win battles for America, not only in the air, but on land and sea as well! Little wonder he wears his wings with the pride of an air cadet!

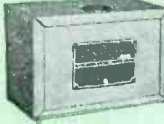

Power Supply using rechargeable non-spill storage battery for operation of "Walkie-Talkie" radio equipment. Input Voltage, 4 Volts; Output, Numerous voltages supplying filament and plate requirements of equipment. Width, 3½"; Length, 6½"; Height, 2½".

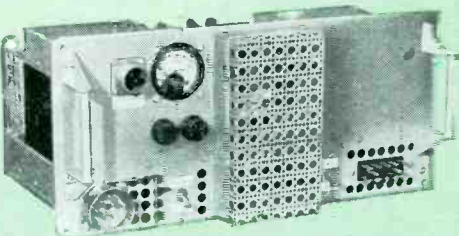

Tough Problem — But Electronic Licked It!

Input: 12 Volts DC or 110 Volts AC	Approximate output wattage 500 watts.
Output: 2000 Volts DC at 200 Ma.	Weight: 56 lbs. Size: 17" x 17" x 8".
450 Volts DC at 70 Ma.	Efficiency: 65%.
+250 Volts at 30 Ma.	Regulation: 13%.
-250 Volts at 25 Ma.	Designed for continuous operation at full load.
10 Volts AC 7 Amperes.	

Electronic

LABORATORIES, INC.



*Electronic's Citation for Excellence

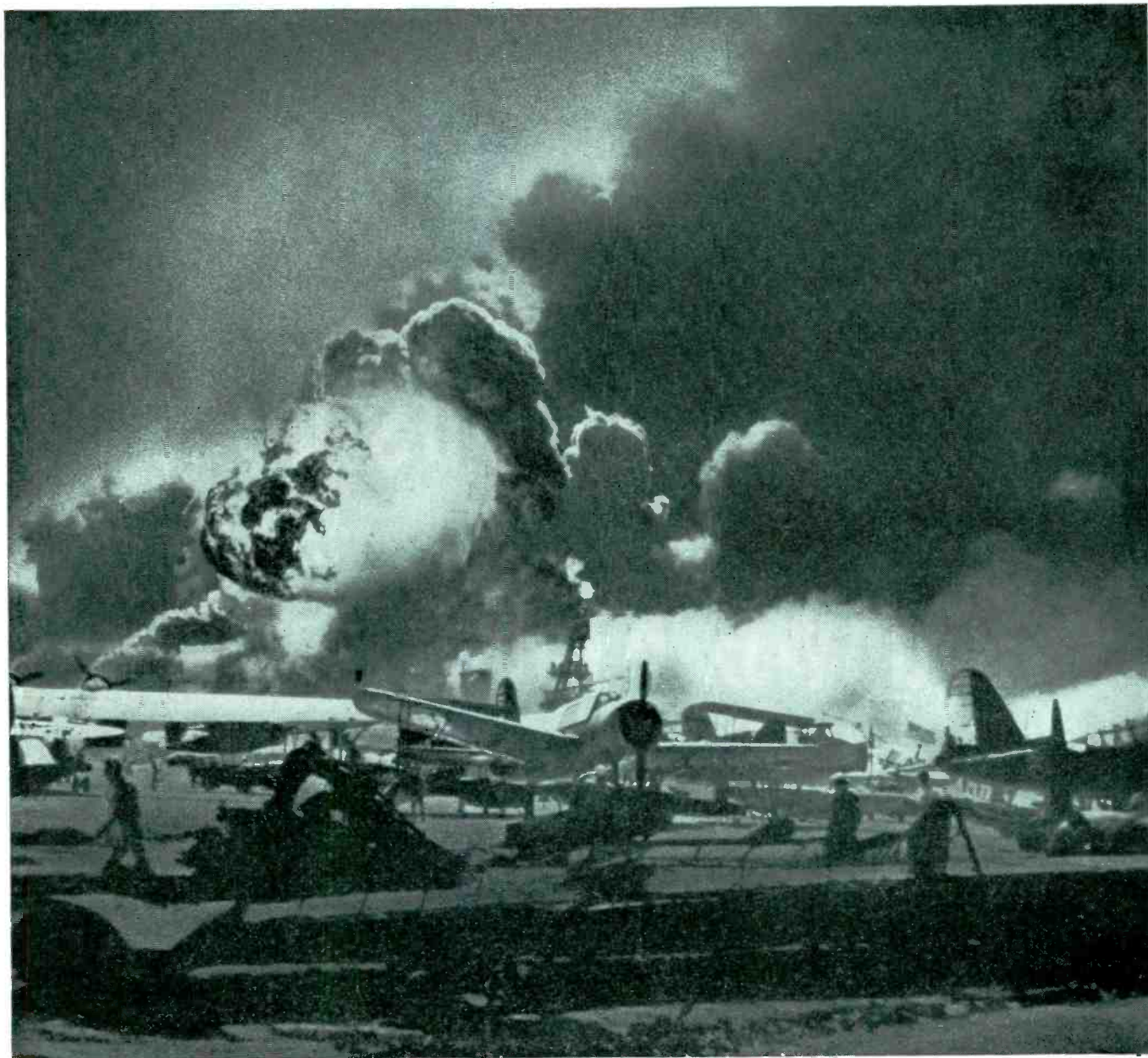

U. S. Navy Official Photo

Minus Sound Effects

If you were receiving radio broadcasts from men in the midst of ear-splitting battle noises, you'd hear crisp speech undistorted by background sound effects.

Electro-Voice Microphones, in military service, are helping to make it possible. Similar microphones, designed to achieve such results, will be available for specific commercial applications . . . after our wartime job is done.

Electro-Voice MICROPHONES

ELECTRO-VOICE MANUFACTURING CO., INC.

1239 SOUTH BEND AVENUE, SOUTH BEND, INDIANA

ELECTRONICS — *January 1943*

31

SMALL METAL TUBING

is Our Only Business

and We Know It . . .

(MAXIMUM O.D. $\frac{5}{8}$ " IN MANY METALS)

SUPERIOR

SUPERIOR TUBE COMPANY, NORRISTOWN, PENNSYLVANIA



The big name in

SMALL TUBING

for Uncle Sam!

FOR EVERY SMALL TUBING APPLICATION

Tubing from $\frac{5}{8}$ " OD down...SUPERIOR  Seamless in various analyses. WELD-DRAWN  Welded and drawn Stainless.

BRAWN  Welded and drawn "Monel" and "Inconel". SEAMLESS and Patented LOCKSEAM Cathode Sleeves.



One Year

We have come a long way since Christmas 1941, all of us. American Amateurs have flocked to the colors — made themselves the backbone of the great Army Signal Corps and Navy Communications. Makers of Amateur equipment have put their entire effort into design and construction of Military communications units. For example, the Hallicrafters have, since Pearl Harbor, turned out production that would normally have taken seven years! ☆ We can all be proud that we have in one short year turned the tide of battle from almost unopposed conquest by the enemy to the first stages of the victory drive on every front. And, let us all fervently hope that another wartime Christmas will be unnecessary.

W. J. Halligan

the hallicrafters co.

CHICAGO, U. S. A.



"PRECISION ENGINEERING..."

THE AMP SYSTEM ASSURES

UNIFORMITY OF APPLICATION!

EVEN BY UNSKILLED OPERATORS

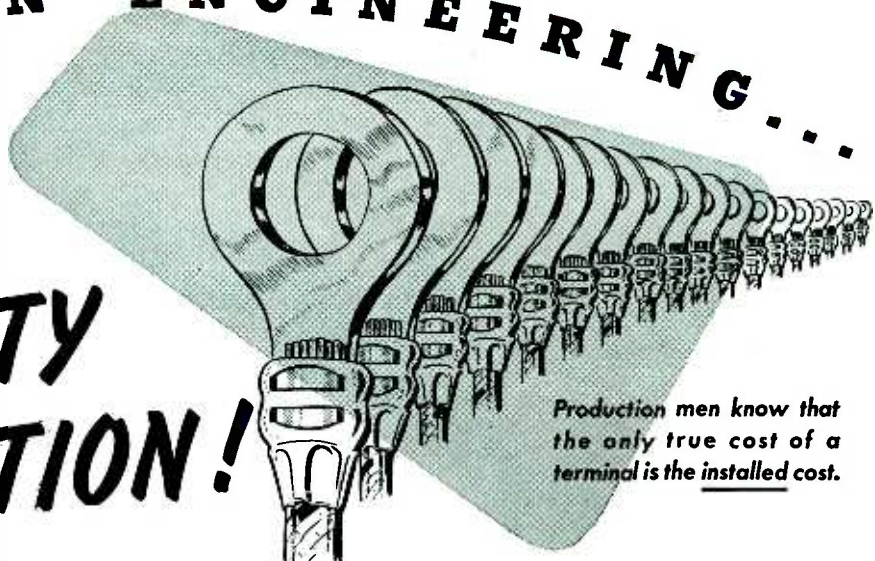

Production men know that the only true cost of a terminal is the installed cost.

The AMP System of Solderless Wiring doubles production and cuts labor costs in half. This System is so simple and so accurate that every terminal connection is exactly like the one before, even when applied by inexperienced operators. Such outstanding assembly performance is the result of two highly coordinated factors: the Diamond Grip Insulation Support Terminal and the AMP Precision Die Hand and Power Installation Tools which make three perfect crimps on the terminal in one application; two on the wire and one on the insulation. (As against two separate crimping operations necessary on conventional insulation support terminals.) Each of these factors in its own right

For
MARINE, AIRCRAFT,
COMMUNICATIONS,
and
COMMERCIAL
USE

is an integral part of a complete production system.

This pure copper terminal is approximately 32% lighter in weight and $\frac{3}{32}$ " shorter in length. It assures high mechanical and electrical efficiency and provides an insulation support which accommodates a wide range of wire and insulation sizes. But this is only half of the story. The self-gauging precision die installation tools developed by AMP engineers represent a new conception of the economics of applying millions of terminals to the ends of millions of wires — without variation.

Write today for comparative test data.

AIRCRAFT-MARINE PRODUCTS INC.
DEPT. B, 286 NORTH BROAD STREET, ELIZABETH, NEW JERSEY

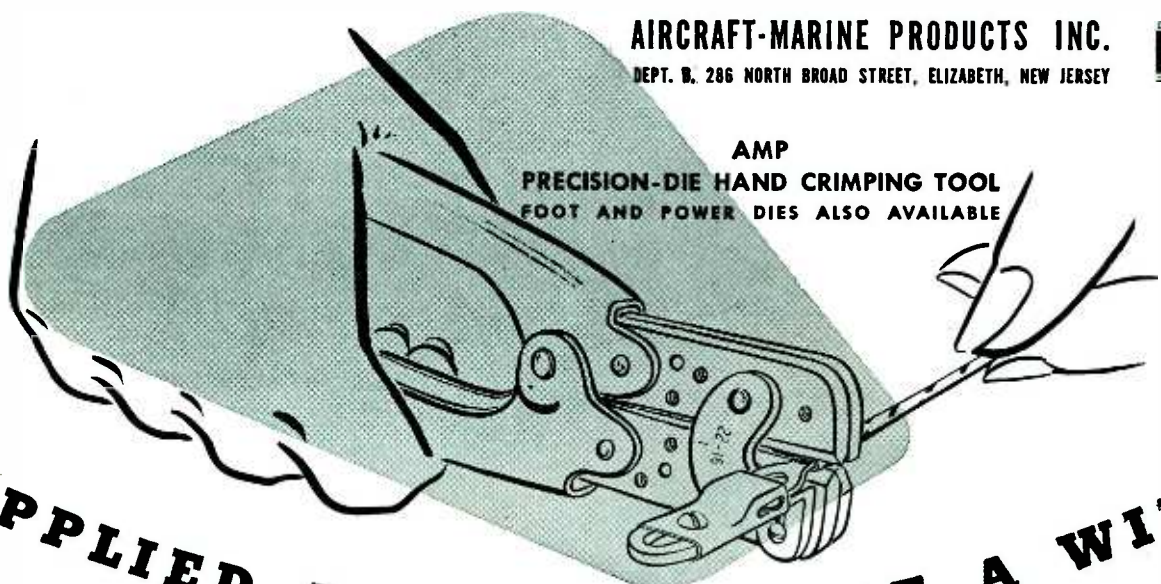

AMP
PRECISION-DIE HAND CRIMPING TOOL
FOOT AND POWER DIES ALSO AVAILABLE

APPLIED TO THE END OF A WIRE"

For Sale—Electronic Production Aids

ELECTRONIC TIMERS

for *SPLIT-SECOND* and
other short-interval
TIMING

Here's the answer to your short-interval-timing problems. Five forms cover range from 0.045 second to 2 minutes. Continuously variable. Knob on front covers full range. Long life, too. Only one moving part—only one tube. Sturdy. Accurate. Times resistance-welding operations, process furnaces, honing machines, molding machines. Warns of tie-ups on conveyors. Controls laboratory tests. Thousands in use. Several timers combine to control series of operations. Priority rating required. Additional information in Bulletin GEA-2902B. Price, \$28 net, up.

ENGINE DESIGNERS!

Measure ignition voltage of gasoline engines with new G-E electronic crest voltmeter. Gives you readings up to 30,000 volts, with accuracy of 3 per cent of full-scale value. Portable. Completely self-contained—needs no outside power supply. No special training required to operate it. Uses standard portable batteries and radio receiver-type tubes. Priority rating required. Cat. No. 5993877G4 (10,000 volts), -G5 (20,000 volts), -G6 (30,000 volts). Price, \$375 net. Ask for Bulletin GEA-3619.

** WEARING OUT* mechanical limit switches too fast? Try photoelectric control. You can't wear out a light beam. Bulletin GEA-1755C for details. Prices, \$18.50 and up. Priority rating required.

SHORT OF INTRA-FACTORY TRUCKS?

Install standard G-E photoelectric control to open and close doors whenever trucks enter and leave buildings frequently. One company with G-E photoelectric control on warehouse doors saves \$30 a day, in truck time, operators' time, and heat. Now its truck drivers come and go without stopping. Easy to install on your motor-operated doors at low cost. Priority rating required. Ask for GEA-1755C.

SAVE
TIN



SAVE
TIME

Are you soldering joints that could be resistance-welded at a saving of both time and solder? Manufacturers tell us resistance welding with G-E electronic control cuts assembly time on such jobs in half; eliminates tin entirely. Ask for GEA-3045A and GEA-2791C on G-E electronic control for resistance welding. Priority rating required.

WIDE-RANGE, STEPLESS speed control is easy when you use Thy-mo-trol—G-E's new electronic motor control. Operates d-c motors from a-c lines. Full speed range of motor covered on a single dial, like a radio volume control. Preset speed before starting, or change speed without stopping. Reversing. A real electronic achievement! Bulletin GED-972A gives more information. Priority rating required.

ARE YOU RIVETING where you should be resistance-welding? Resistance welding is fast, uniform, economical. Speeds production for war. G-E welding engineers will be glad to help you. Write, stating your problem, to General Electric, Industrial Electronic Section, Schenectady, N. Y.

USING CONVEYORS?

Prevent tie-ups easily with G-E photoelectric control. Standard G-E photoelectric relays will warn of "piling up" on conveyors; count fresh-painted or fragile objects on a conveyor without touching them; keep two conveyors in step; stop conveyors at right position for processing; turn on paint sprayer as objects pass; sort objects on conveyor for size. Inexpensive. Low maintenance. Dependable. Frees workers from routine jobs for more production. For indoor or outdoor use. Bulletin GEA-1755C. Priority rating required.

SAVE MAINTENANCE On Resistance-Welder Contactors

G-E electronic contactors eliminate time lost in tip dressing of mechanical contactors. Silent. Fast. Long life. Save factory space because you can mount them overhead. Use long-life G-E ignitron tubes. Range from 11 to 2400 kva. Low cost. Often pay for themselves in short time. Easy to install. Can be used with old or new a-c resistance-welding machines. Available for synchronous or nonsynchronous timing. Bulletin GEA-3058B gives you more details. Priority rating required.

**General Electric, Sec. C645-21
Schenectady, N. Y.**

I'm interested in speeding production electronically. Please send me the bulletins checked:

- GEA-2902B — Electronic timers
- GEA-3619 — Electronic crest voltmeter
- GEA-1755C — Photoelectric relays
- GEA-2791C — Electronic control for resistance welding
- GEA-3045A — Electronic control for resistance welding
- GED-972A — Electronic motor control—Thy-mo-trol
- GEA-3058B — Electronic contactors for resistance welding

Name

Company

Address

City State



Speed Production Electronically

GENERAL ELECTRIC



IN the manufacture of precision instruments for the Armed Forces we strive for short cuts in production—but not in *quality*. There can be no expediency, no compromise, no half-way measures. The success of the bomber's mission depends as much upon the efficiency of the instruments as it does upon the skill of the officers and men.

Meeting the specifications of the United States Armed Forces

is in itself an eloquent testimonial to the *quality* of DeJur meters, potentiometers and rheostats. However, we do not rest upon these laurels alone. Behind DeJur workers is the stern tradition of New England . . . honesty of craftsmanship, pride of skill, the deep, personal delight in doing a job and doing it better than anyone else—anywhere.

in war as in peace . . . nothing takes the place of quality. *Your inquiries are invited.*

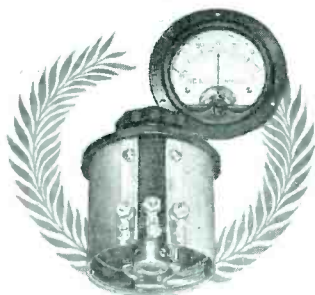

DeJUR-AMSCO CORPORATION

SHELTON, CONNECTICUT

Manufacturers of DeJur Meters, Potentiometers, Rheostats and other Precision, Quality Electrical Instruments

PRECISION
POWER TUBES
FOR EVERY PURPOSE
MADE BY

UNITED

Skills in Electronics

When the war ends, there will be a phenomenal expansion in the peace-time use of electronics. Today—while the war absorbs the tube output—try to fix in your mind this unique source for tubes which you will seek tomorrow:

Its name: **UNITED**. Its organization: a group of eminent engineers and technicians, uniting their highly specialized skills. Its product: power tubes, unsurpassed in precision, for every electronic requirement including radio communication, physiotherapy and industrial control. Its standard: power tubes that consistently attain the highest record in every test of performance. Remember the name "United."



UNITED ELECTRONICS COMPANY

NEWARK, NEW JERSEY



1943 JANUARY 1943

SUN	MON	TUE	WED	THU	FRI	SAT
<i>News of Manpower Importance</i>					1	2
3	4	5	6	7	8	9
10	11	12	13	14	15	16
17	18	19	20	21	22	23
24	25	26	27	28	29	30

DELIVERY IN 20 DAYS!

PHILIPS X-RAY CRYSTAL ANALYSIS APPARATUS

Delivery in 20 days is "headline" news in any industry today. But when delivery can be made in less than 20 days upon Signal Corps authorization — that's a bombshell right in Hitler's face! Mind you — this is delivery of a complete unit — ready for operation. No waiting for parts or supplementary apparatus. Just plug-in and go to work.

But more than that — these advantages now enjoyed by 51 users of approximately 100 Philips X-Ray Crystal Analysis Machines are now available to you:

1. Fast, precise angle measurements of mother quartz, sections, bars, wafers and blanks.

2. Extreme flexibility permitting a wide choice of analysis methods, depending upon the character of the quartz piece to be measured.

3. Maximum simplicity — relatively unskilled personnel can be used on tests previously requiring trained engineers.

4. Speeds testing — tests previously requiring 30 minutes or more, now can be made in one minute.

5. Speeds production — you can predetermine the characteristics of the oscillator by actually maintaining the basic cutting angle.

6. Substantial reduction of rejects — saw tie-ups and elimination of improperly

cut material before expensive finishing operations.

The Philips X-Ray Crystal Apparatus is not a make shift adaptation, but was specifically designed for diffraction testing of crystals. Why not consult with our engineers today? Their wide experience in applying this equipment to a great variety of crystal production problems is at your service. Catalog on request. Philips Metalix Corporation, 419 Fourth Avenue, New York City.



"PHILIPS" is a name with well-earned recognition among engineers the world over. Since the discovery of Roentgen Rays, this organization has pioneered in the development and manufacture of X-Ray apparatus. The vast engineering and laboratory resources of PHILIPS are completely at the service of industry.

PHILIPS METALIX

X-RAY SPECIALISTS FOR OVER 40 YEARS

AT SUB-ZERO TEMPERATURES

*the INCO Nickel Alloys gain strength
without becoming brittle*

MECHANICAL PROPERTIES AT LOW TEMPERATURES								
MATERIAL	Condition	Temperature °F.	Yield Strength (0.20% offset) psi.	Tensile Strength psi.	Elongation in 2 in. per cent	Reduction of Area per cent	Hardness Rockwell C	Charpy Impact Strength ft.-lb.
MONEL	Cold-drawn	Room	93,700	103,800	19.0	71.0	19	181
		-110	100,850	117,450	21.8	70.2	25	178
"K" MONEL	Cold-drawn Age-hardened	Room	125,900	157,300	15.5	37.4	33	27
		-110	134,600	171,550	17.3	41.1	36	27
INCONEL	Annealed	Room	36,800	93,800	37.3	64.1	82B	130
		-110	42,400	106,450	39.8	64.0	87B	134
	Cold-drawn*	Room	147,700	152,100	7.0	49.3	31	54
		-110	154,900	163,900	9.8	51.2	36	60
NICKEL	Cold-drawn	Room	97,400	103,400	16.3	66.9	19	204
		-110	101,800	112,300	21.5	60.9	22	215

* 50 per cent reduction in cross-sectional area by cold drawing.

Selecting the right metal for a given application is today more important than ever.

How drastically the possibilities narrow down is exemplified by *sub-zero* requirements.

At sub-zero temperatures, for example, most ferrous metals become brittle as their strength increases. INCO Nickel Alloys also increase in strength and hardness...but they retain room-temperature ductility and toughness as measured by Charpy impact tests (see table above).

Even at the -328° F. encountered in liquid air compressors, the INCO Nickel Alloys show no appreciable changes in elongation, reduction of area or hardness.

Also, "K" Monel retains another important property, non-magnetism...magnetic transformation point of this age-hardened alloy being -150° F.

A new technical insert, "Mechanical Properties at Low Temperatures" and the booklet "Individualized INCO Nickel Alloys" offer useful information. For copies of each write to:

THE INTERNATIONAL NICKEL COMPANY, INC., 67 WALL STREET, NEW YORK, N. Y.

INCO NICKEL ALLOYS

MONEL • "K" MONEL • "S" MONEL • "R" MONEL • "KR" MONEL • INCONEL • "Z" NICKEL • NICKEL
Sheet... Strip... Rod... Tubing... Wire... Castings

Because WESTON made this tiny element tubular . . . with a paper thin wall . . .

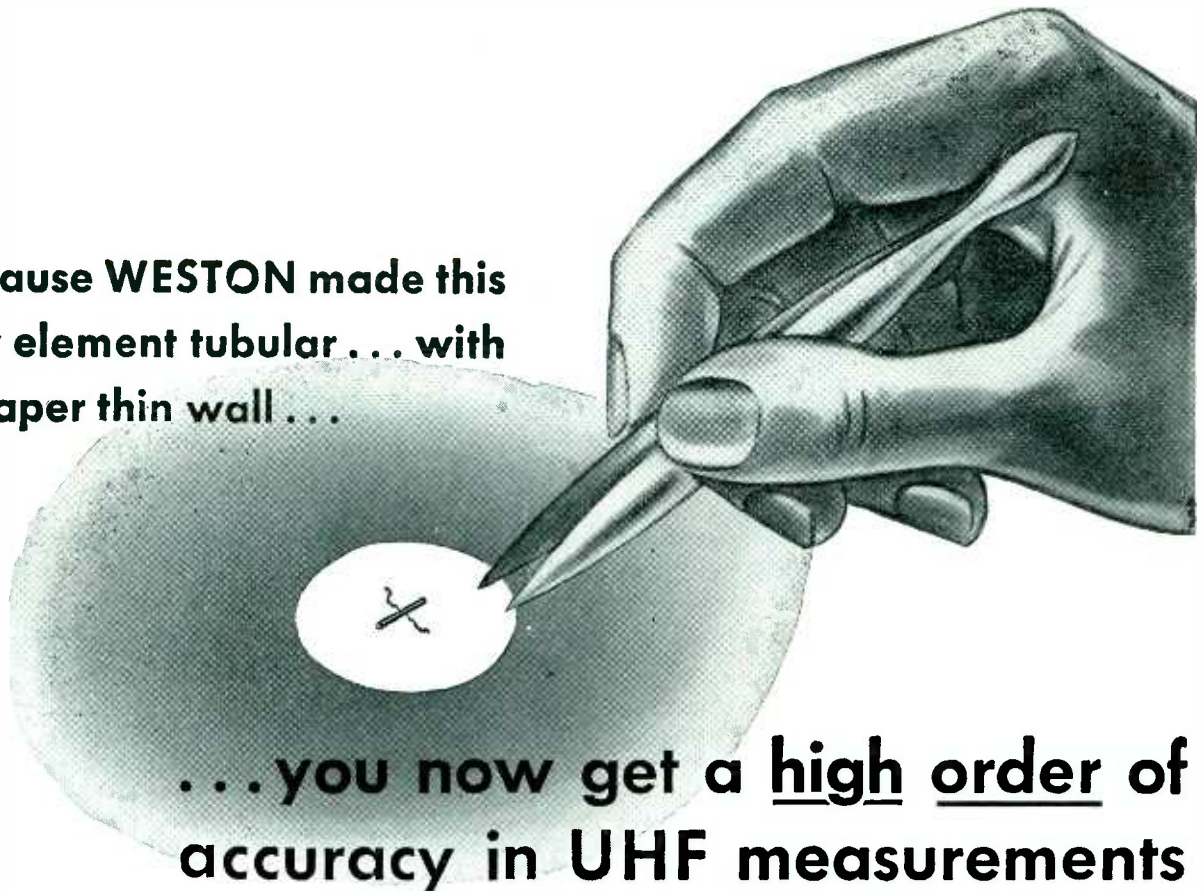

. . . you now get a high order of accuracy in UHF measurements

This tiny heater element in the conventional Thermo-couple Ammeter consists of a small piece of solid wire or a thin strip of noble alloy. It was made in this form when WESTON introduced the first practical Thermo Ammeter in 1915 — back in the days when radio frequency currents were derived from spark gaps and arcs — and was designed to be independent of “skin effects” for frequencies in use until quite recently.

But with the further development of vacuum tube oscillators and the discovery of increased efficiency of ultra high frequency currents, it became evident that the heater element in the conventional Thermo Ammeter would show “skin effect” at frequencies not then in commercial use, but values which WESTON could foresee in the near future.

In line with WESTON’s policy, therefore, research was immediately begun to determine the magnitude of these errors and their possible elimination. For this

time-honored policy dictates that even before a broad commercial measurement need arises, a practical and dependable instrument for that need must be ready.

And the instrument for UHF measurements was ready . . . thanks to this progressive, *continuing* policy. The cause of the errors at ultra high frequencies had been proved to be the skin effect in the strip form of heater. The solution was provided by making this heater tubular, and of correct dimensions. The result was a WESTON Thermo-Ammeter which maintains its accuracy at frequencies up to 60 megacycles, and with only slight deviations above.

Thus we have the same repetition which so constantly appears throughout the history of instrument progress . . . a new and improved measurement standard is created, and it bears the same name as the old. Weston Electrical Instrument Corporation, 618 Frelinghuysen Avenue, Newark, New Jersey.



WESTON
Instruments



LABORATORY STANDARDS • PRECISION D-C AND A-C PORTABLES • D-C, A-C, AND THERMO SWITCHBOARD AND PANEL INSTRUMENTS • INSTRUMENT TRANSFORMERS • SENSITIVE RELAYS • SPECIALIZED TEST EQUIPMENT • LIGHT MEASUREMENT AND CONTROL DEVICES • EXPOSURE METERS • AIRCRAFT INSTRUMENTS • ELECTRIC TACHOMETERS • DIAL THERMOMETERS

PIONEERS...in war and peace



U. S. ARMY ORIGINATED PARATROOPS

Master Sergeant Erwin H. Nichols, U. S. Army, pioneered modern paratrooping. After our Army used our technique, and the Russians borrowed our technique, and the Germans lifted it from the Russians.

THE FIRST TANTALUM TUBE WAS A GAMMATRON

Gammatron engineers, in their constant quest for more rugged and efficient electronic tubes, were first to appreciate the remarkable advantages of tantalum as a plate and grid material.

This unique element has the lowest gas content of any metal. It readily endures high temperatures, and will radiate tremendous amounts of power. Moreover, tantalum has the very desirable characteristic of acting as a sponge with respect to gases: once it is de-gassed by the Heintz and Kaufman process, it eagerly absorbs and retains any gases later released.

Thus tantalum construction and Gammatron design result in electronic tubes which have longer life, and the ability to withstand heavy overloads without freeing destructive gas.

Dozens of Gammatrons, with ratings from 50 to 5000 watts, are now serving the American cause on the r.f. and u.h. frequencies . . . just as many new Gammatrons will serve in the peacetime age of electronics.



HK-257 BEAM PENTODE OPERATING DATA

*RF Power Amplifier,
Class "C" Unmodulated*

	Maximum Rating	Typical Operation
Power Output	—	235 Watts
Driving Power	—	0 Watts
DC Plate Volts	4000	3000 Volts
DC Plate Current	150	100 M.A.
DC Suppressor Voltage	—	60 Volts
DC Suppressor Current	—	3 M.A.
DC Screen Voltage	750	750 Volts
DC Screen Current	30	8 M.A.
DC Control Grid Voltage	-500	-200 Volts
DC Control Grid Current	25	0 M.A.
Peak RF Control Voltage	—	170 Volts
Plate Dissipation	75	65 Watts

GAMMATRONS...OF COURSE!





"Q. E. D."

Television . . . "which was to be proved" . . . *has been proved, decisively.* For British-Gaumont, Ltd., Baird Television and Cinema Television, Ltd., long recognized as leaders in this field, have already thrilled London theatre audiences with televised events projected on regulation 15' x 20' screens, showing such attractions as prize fights, boat races and cricket matches. In view of these world-leading achievements it is of marked significance that RAULAND has been assigned all American rights to patents and processes of these pioneer companies, thus combining proved British technique with the advanced electronic applications of RAULAND research-physicists and engineers; in final perfection of commercial television when conditions permit. RAULAND's full productive facilities are devoted to *one* objective . . . *total allied victory* . . . but developments unfolding at RAULAND laboratories foreshadow complete fulfillment of the promise of television entertainment.

DR. C. S. SZEGHO, Rauland Chief Research-Physicist, has devoted a major part of his scientific career to the development of specialized electron optical devices culminating in the high power cathode ray tube for large screen television. A native of Czechoslovakia, he received his Electrical Engineering degree at Munich Institute of Technology and his Doctorate at Aix La Chapelle, where he became lecturer in Electro-Physics. Eight years ago he was made head of Research for Baird Television of London and New York from which post he joined the Rauland organization.



• *Electroneering is our business* •

Rauland

RADIO—SOUND—COMMUNICATIONS
The Rauland Corporation • Chicago, Illinois

Buy War Bonds and Stamps! . . . Rauland employees are all doing their part as members of the 10% Bond club.

Put Your Screw Driver Army on the **DOUBLE QUICK**

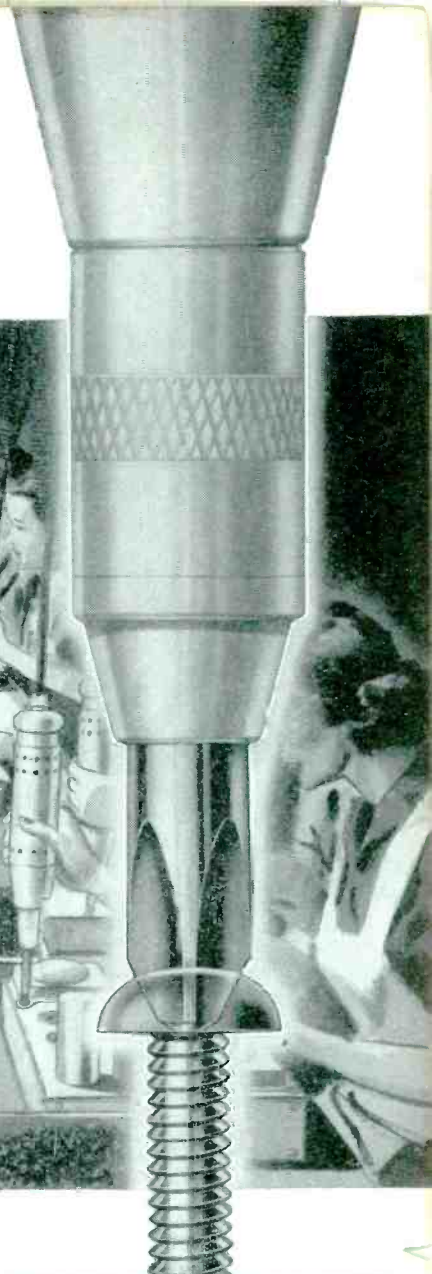
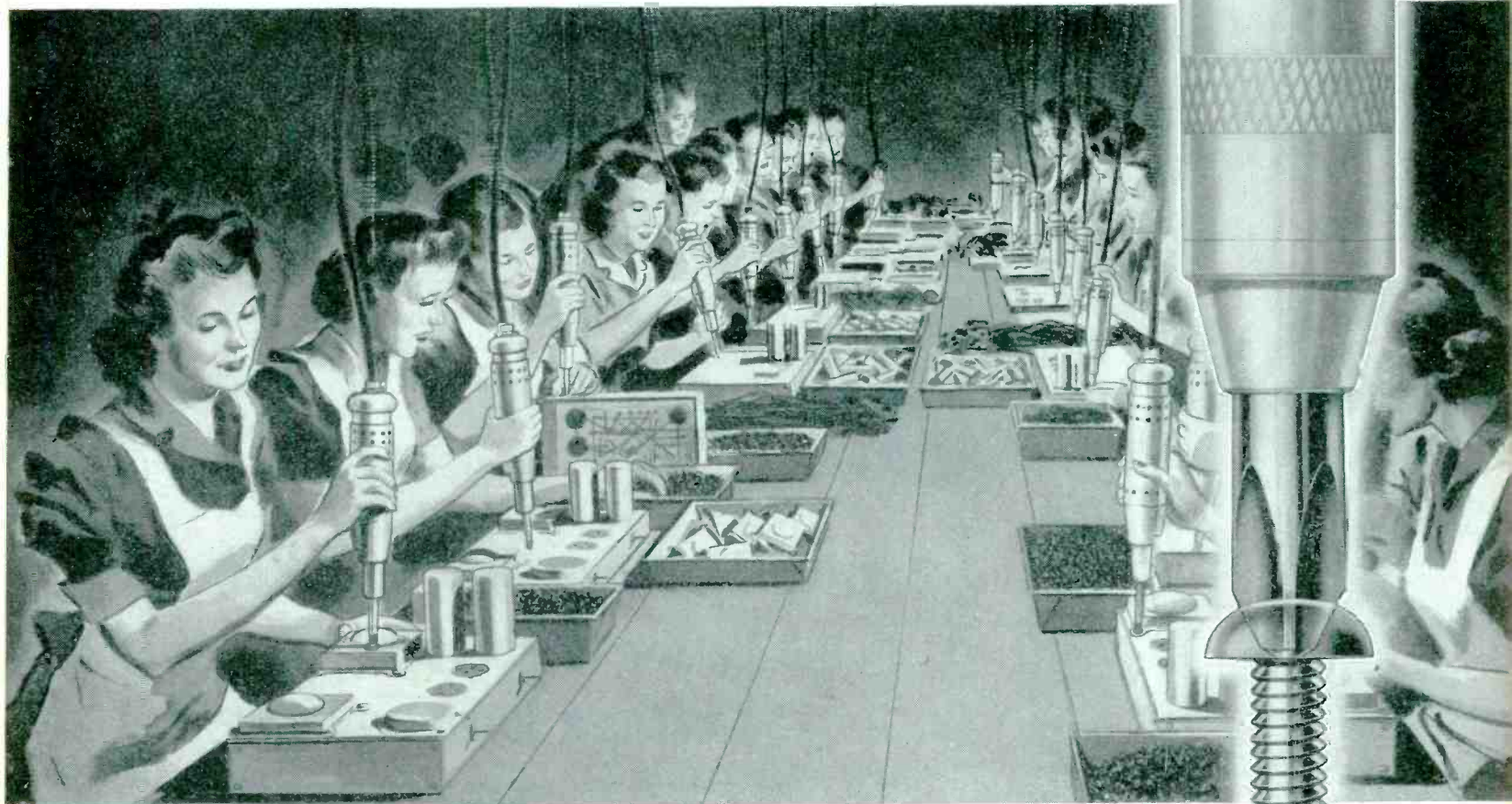

CUT DRIVING TIME IN HALF!

In today's battle of production, probably more workers are armed with screw drivers than with any other single tool.

Think how many workers in YOUR plant are driving screws . . . and how much time and labor would be saved if you could help them to *drive screws twice as fast!* Chances are you CAN! Hundreds of plants have done just that, by switching to Phillips recessed head Screws.

The scientific centering of driving force in the Phillips Recess eliminates all the

handicaps to speed: the fumbling, wobbly starts . . . skidding drivers . . . re-driving of slant-driven screws . . . removal of broken-head screws . . . reclaiming of marred parts. Fast, faultless driving becomes automatic, even for "green hands." Power driving becomes practical for most jobs.

They cost less to use! Compare the cost of driving Phillips and slotted head screws. You'll find that the price of screws is a minor item in your total fastening expense . . . that it actually costs less to have the many advantages of the Phillips Recess.

KEY TO FASTENING SPEED AND ECONOMY

The Phillips Recessed Head was scientifically engineered to afford:

Fast Starting - Driver point automatically centers in the recess . . . fits snugly. Screw and driver "become one unit." Fumbling, wobbly starts are eliminated.

Faster Driving - Spiral and power driving are made practical. Driver won't slip out of recess to injure workers or spoil material. (Average time saving is 50%.)

Easier Driving - Turning power is fully utilized by automatic centering of driver in screw head. Workers maintain speed without tiring.

Better Fastenings - Screws are set-up uniformly tight, without burring or breaking heads. A stronger, neater job results.



PHILLIPS *Recessed Head* **SCREWS**

WOOD SCREWS • MACHINE SCREWS • SELF-TAPPING SCREWS • STOVE BOLTS

20 SOURCES

American Screw Co., Providence, R. I.
The Bristol Co., Waterbury, Conn.
Central Screw Co., Chicago, Ill.
Chandler Products Corp., Cleveland, Ohio
Continental Screw Co., New Bedford, Mass.
The Corbin Screw Corp., New Britain, Conn.

The H. M. Harper Co., Chicago, Ill.
International Screw Co., Detroit, Mich.
The Lamson & Sessions Co., Cleveland, Ohio
The National Screw & Mfg. Co., Cleveland, Ohio
New England Screw Co., Keene, N. H.
The Charles Parker Co., Meriden, Conn.
Parker-Kalon Corp., New York, N. Y.

Pawtucket Screw Co., Pawtucket, R. I.
Pheoil Manufacturing Co., Chicago, Ill.
Russell Burdall & Ward Bdt & Nut Co., Port Chester, N. Y.
Scovill Manufacturing Co., Watervliet, N. Y.
Shakeproof Inc., Chicago, Ill.
The Scunthorpe Hardware Mfg. Co., Southamton, Conn.
Whitney Screw Corp., Nashua, N. H.

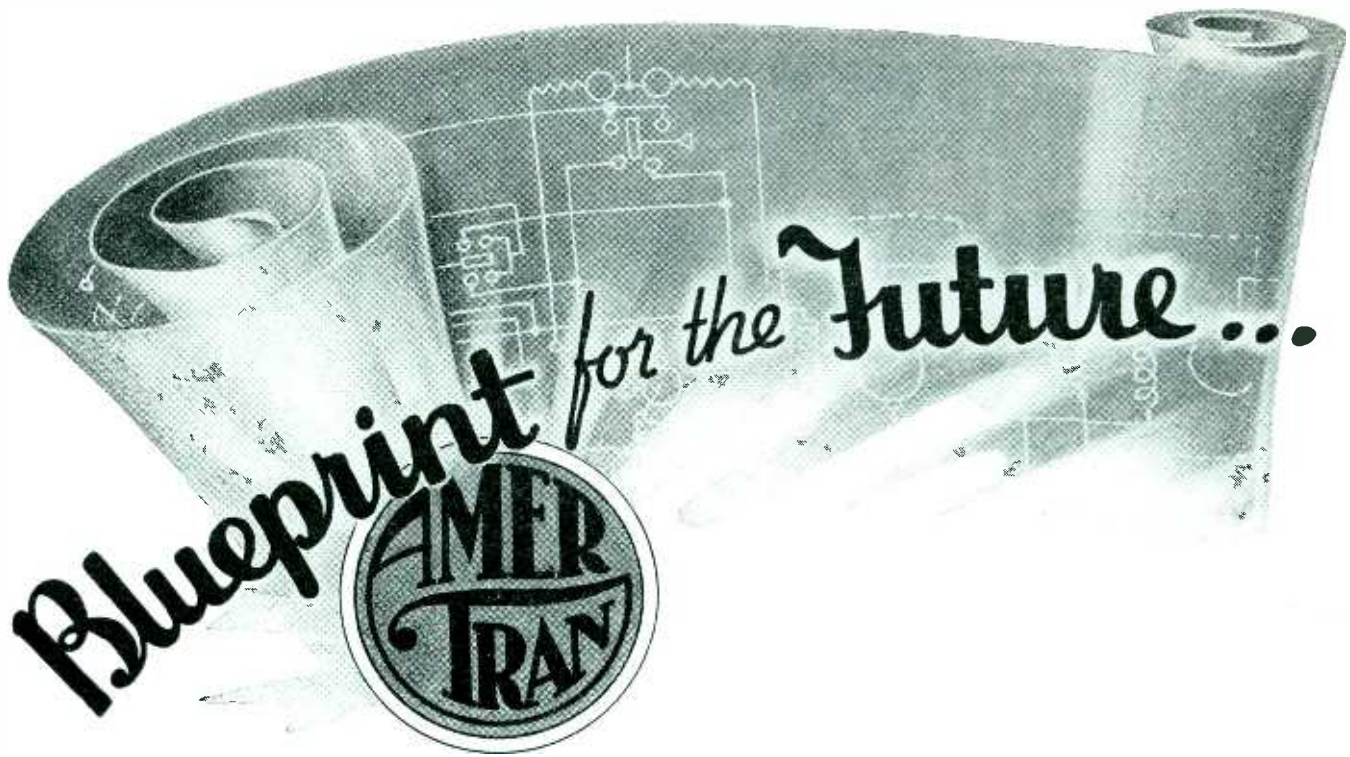

Serving America's War Work Now... the better to serve all American Industry later

Here in AmerTran's factories under the accelerated tempo of war production, we are designing and building better transformers that will help meet the competitive conditions of the general business upswing of the future. Here in blueprint form, and in the shape of refined designs and improved construction, better AmerTran equipment is being produced to serve war-time America now . . . to serve peace-time industry later. Tomorrow these improvements will be available to the whole of the communications field for general electronic and radio applications. The confidence you have placed in the AmerTran pre-war products you are using today—a confidence merited by 41 years of leadership—will be many times justified when the splendid results of the work AmerTran is doing today become generally available to a victorious American industry.

AMERICAN TRANSFORMER COMPANY, 178 Emmet St., Newark, N. J.

Manufactured Since 1901 at Newark, N. J.

AMERTRAN



AmerTran modulation transformers and reactors, oil-immersed type, for large broadcast transmitters.



AmerTran RS plate transformers and reactors, oil-immersed type, for all large installations.



AmerTran W plate transformers and reactors for all small and medium installations.

AmerTran transformers are manufactured to meet your exact electrical and mechanical requirements.

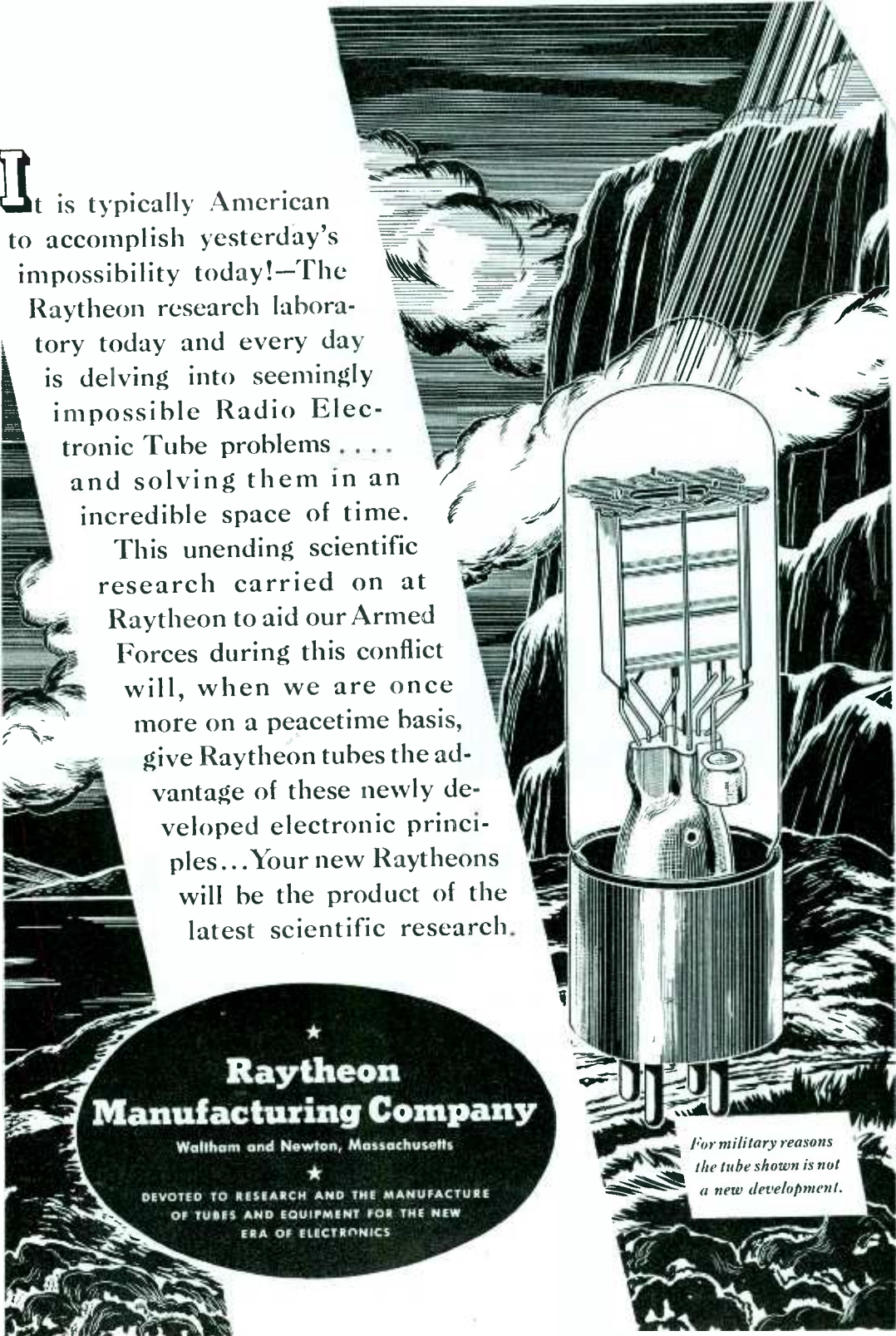

It is typically American to accomplish yesterday's impossibility today!—The Raytheon research laboratory today and every day is delving into seemingly impossible Radio Electronic Tube problems and solving them in an incredible space of time.

This unending scientific research carried on at Raytheon to aid our Armed Forces during this conflict will, when we are once more on a peacetime basis, give Raytheon tubes the advantage of these newly developed electronic principles...Your new Raytheons will be the product of the latest scientific research.

★
**Raytheon
Manufacturing Company**

Waltham and Newton, Massachusetts

★
DEVOTED TO RESEARCH AND THE MANUFACTURE
OF TUBES AND EQUIPMENT FOR THE NEW
ERA OF ELECTRONICS

*For military reasons
the tube shown is not
a new development.*

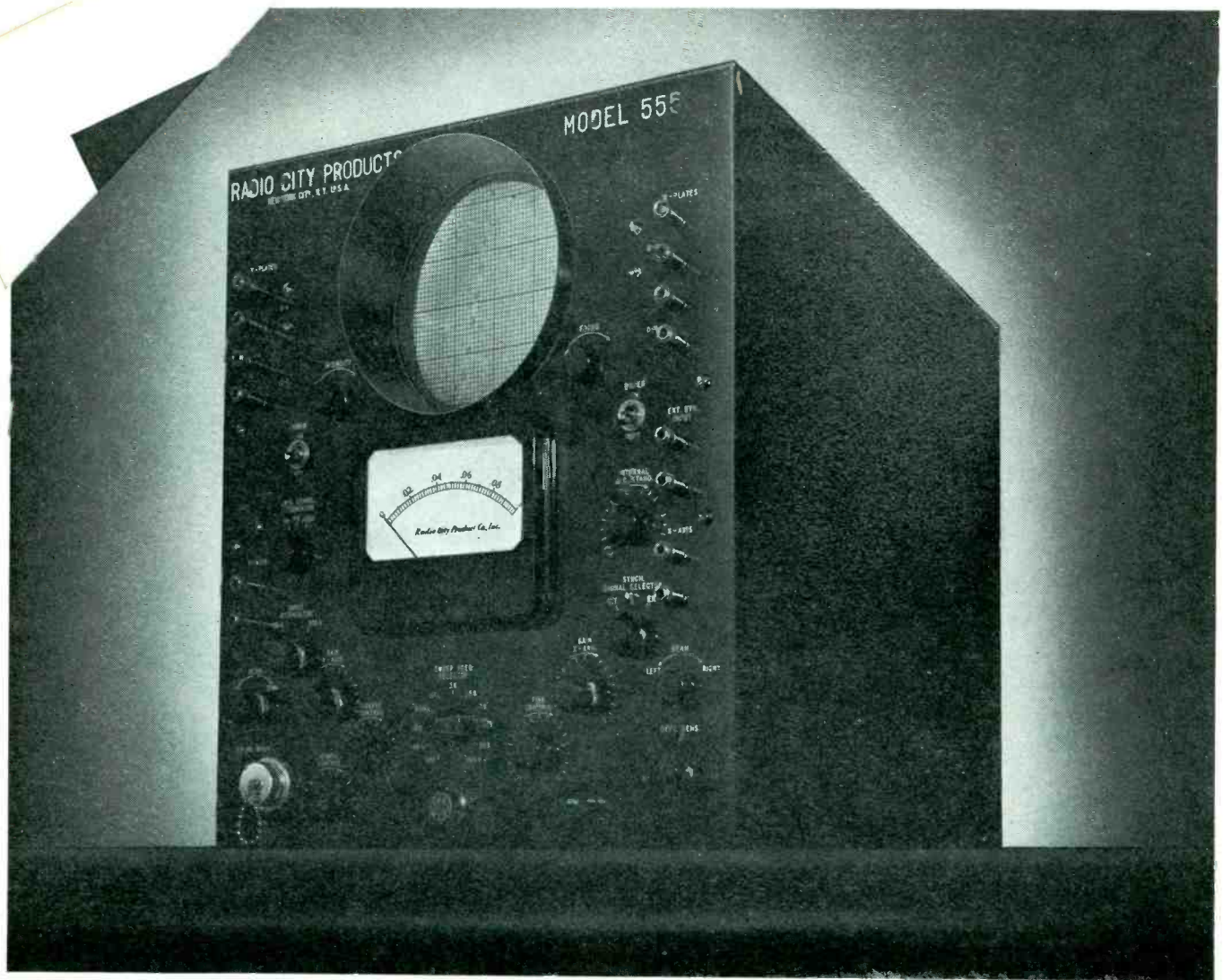

CATHODE RAY OSCILLOSCOPE

This latest addition to the R.C.P. line of electronic and electrical instruments incorporates the most advanced refinements in the field of oscillography. Here are a few of the features of this oscilloscope:

CATHODE RAY TUBE: A 5" tube is used operating on 2,000 volts.

DEFLECTION SENSITIVITY: The deflection sensitivity of the plates is variable in three steps.

AMPLIFIERS: Wide band—uniform response—high gain vertical and horizontal amplifiers, flat within 3 db from 20 cycles to 2 megacycles. Input voltage to amplifiers is 600 volts, rms. Permissible input voltage to deflection plates 500 volts rms. Input impedance is 3 megohms. Voltage gain is approximately 275 times.

SWEEP GENERATOR: Unusually wide range sweep frequency generator from 40 cycles to 750 kilocycles in 10 uniformly linear steps. With fine vernier control.

SINE WAVE STANDARD: Unknown peak input voltage can be read on a direct indicating multirange voltmeter. This is accomplished by a unique comparison method with an internal voltage source.

POWER SUPPLY: Instrument operates from 115-230 volt, 50-60 cycle A C power supply.

The R.C.P. Model 555 Cathode Ray Oscilloscope is supplied in a black crackle, non-corrosive, steel container with convenient carrying handle. 14" high, 12" wide, 19" deep. Complete, ready for operation **\$265.00**

Other instruments in the complete line of R.C.P. electronic and electrical test instruments described in Catalog No. 126. If you have an unusual test problem—either for production line or laboratory work—our engineers will be happy to cooperate in finding the most efficient and economical solution.

RADIO CITY PRODUCTS COMPANY, INC.

127 WEST 26th STREET



NEW YORK CITY

MANUFACTURERS OF PRECISION ELECTRONIC LIMIT BRIDGES — VACUUM TUBE VOLTMETERS
 — VOLT-OHM-MILLIAMMETERS — SIGNAL GENERATORS — ANALYZER UNITS — TUBE TESTERS
 — MULTI-TESTERS — OSCILLOSCOPES — AND SPECIAL INSTRUMENTS BUILT TO SPECIFICATIONS

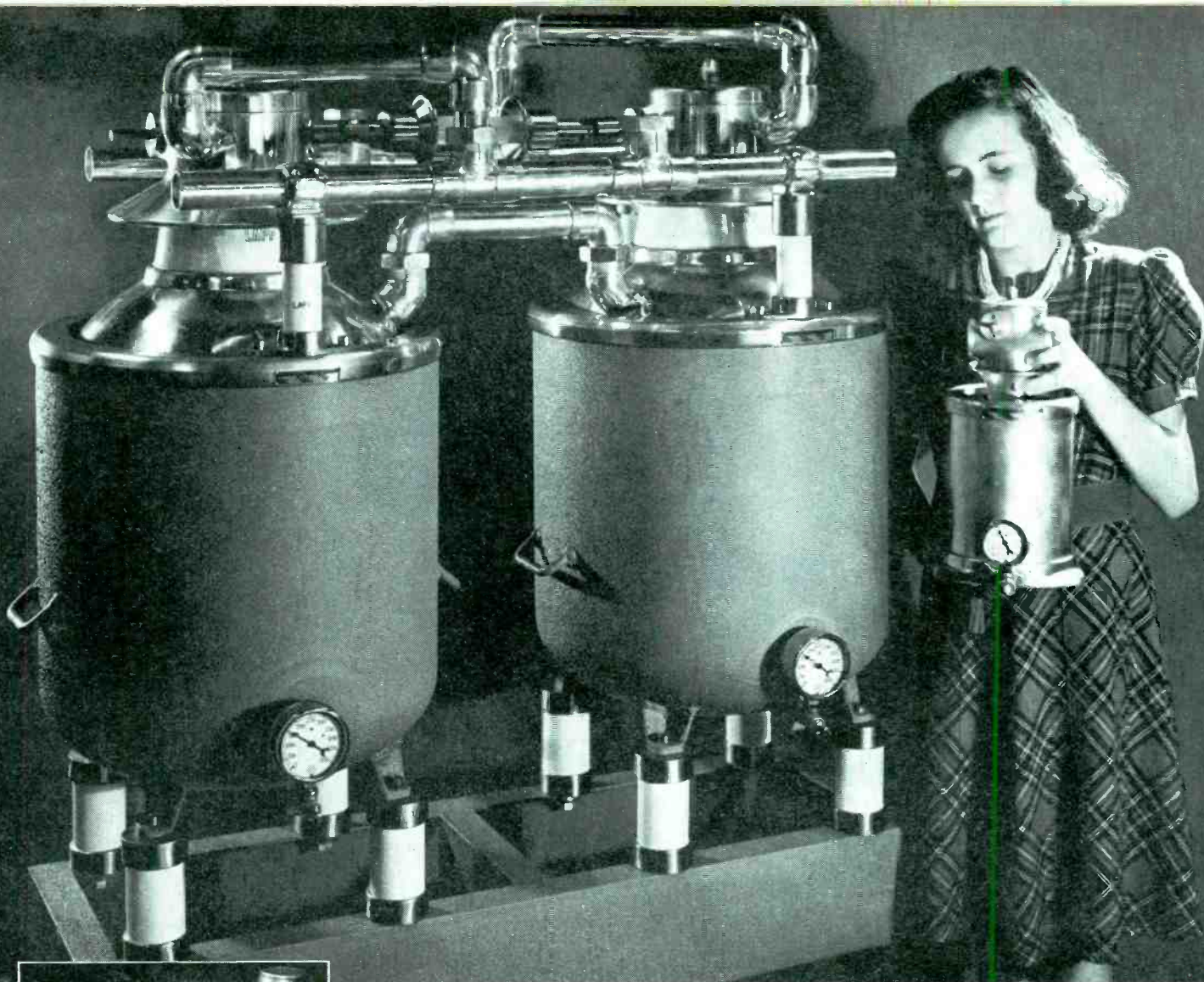

Standoffs, bowls, and other special-purpose insulators are available in wide range. Lapp is also equipped for production of many special assemblies, including porcelain or stearite, with all associated metal parts.

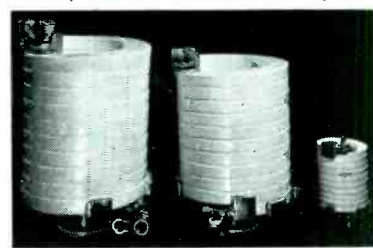

Lapp porcelain water coils, porcelain pipe and fittings provide a means for cooling high-frequency tubes, without sludging, eliminating need for water changing or cleaning.

LAPP *high-capacitance* CONDENSERS FOR INDUSTRIAL ELECTRONIC CIRCUITS

For lump capacitance in any high-frequency circuit, Lapp gas-filled condensers save space, save power, save trouble—and use no mica. Available for use at any needed voltage rating and capacitance, they operate with practically zero loss, are puncture-proof, fail-proof and constant in capacitance under temperature variation.

Above is Unit No. 26541, consisting of two No. 25934 units. The assembly provides pivoting bus conductors, arranged so that the units may be used singly, in series, or in parallel, providing capacitance continuously variable from .0022 mf. to .022 mf. Each unit is rated at 200 amp., 6500 volts, capacitance variable .0043 mf. to .011 mf.; the combination in series, 200 amp., 13,000 volts, .0022 to .0055 mf.; in parallel, 400 amp., 6500 volts, .0086 to .022 mf. In the girl's hands is Unit No. 23722, rated at 50 amp., 7500 volts, capacitance .000045 mf. to .000075 mf.

Lapp

INSULATOR CO., INC.
LEROY, N. Y.

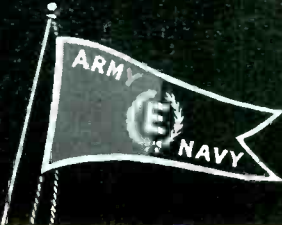

NEW... a compact, high-capacity ceramic condenser

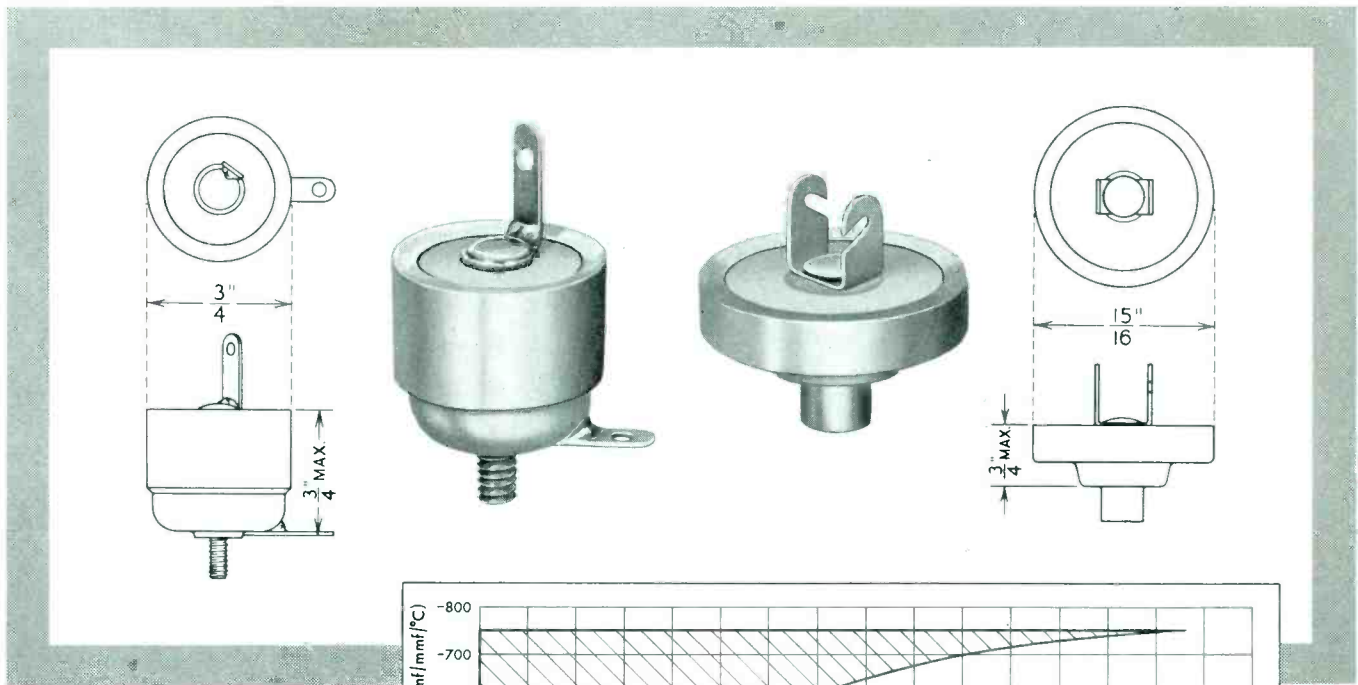

Erie

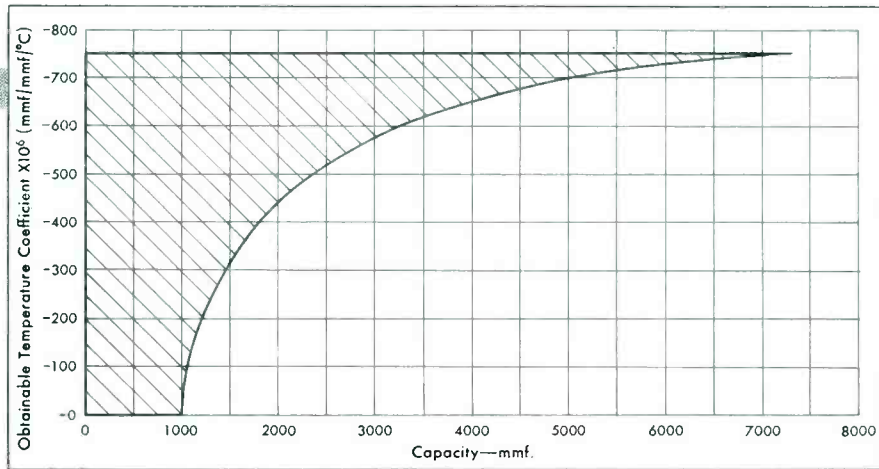

DISC CERAMICONS

REG. U. S. PAT. OFF.

THIS new, compact type of condenser consists essentially of a stack of thin ceramic discs, individually silvered and assembled in a metal cup.

Erie Disc Ceramicons have all the inherent properties of tubular Erie Ceramicons which have been used widely in many types of installations for over 6 years. These capacitors are extremely stable, have low loss and excellent re-trace characteristics. In addition, the units are very stable in humidity, as they are hermetically sealed.

Erie Disc Ceramicons are made in two sizes; $\frac{3}{4}$ " diameter rated at 500 volts D. C. and $\frac{15}{16}$ " diameter, rated at 1,500 volts D. C. The length of each style varies from

$\frac{1}{4}$ " to $\frac{3}{4}$ " depending on the capacity and temperature coefficient desired.

Present maximum available capacity of either type is approximately .007mfd. The accompanying chart shows the temperature coefficients available in various capacities of the $\frac{3}{4}$ " diameter unit.

Erie Disc Ceramicons have many applications in radio transmitters, receivers and other electronic equipment. They can be used as alternates for mica capacitors.

Inquiries for additional information should state: capacity and tolerance, temperature coefficient and tolerance, working voltage and frequency, type of mounting, and style of leads desired.

ERIE RESISTOR CORP., ERIE, PA. LONDON, ENGLAND · TORONTO, CANADA.

Power—Giant Arm of Production

Ninety Per Cent of American Industry Is Electrified

ELECTRICITY is the mainspring that turns the wheels of our factories, mills and mines. It is the tireless arm that grinds our grain, weaves our cloth, pumps our water, builds our planes, our guns, our ships, our cars, our trucks and tanks . . .

The mighty Pharaohs had less energy at their disposal in building their pyramids than is generated today by one single power plant. The combined capacity of America's central power systems is without parallel in the history of the world . . . 46 million kilowatts, i.e., 65 million horsepower in steam turbines, hydro turbines and other prime movers. That is more power, day in and day out, than 650 million slaves could produce—for a limited time—minutes in fact.

The capacity of this vast fountain of energy is beyond the grasp of the average man who flips a switch and sets in motion machines that perform the labor of a thousand man-hours in a matter of minutes. Perhaps only the old time farmer, whose traditional source of power is a team of tired horses and a pair of calloused hands, knows how to appreciate this commodity that is so vital an ingredient of everything we consume and use.

Yes, we take electricity for granted. We expect it to appear in unlimited quantities, like water and air, as we need it. Almost as essential as these two elements in times of peace, it becomes a matter of life and death in times of war. Industry would collapse without it and the nation would quickly perish.

With the catastrophe of Pearl Harbor a little over a year ago, came the realization that we had to out-produce our enemies. To out-produce our enemies, who had a seven year head start, meant to turn more wheels than they were turning and to turn them faster than they were turning them.

New plants sprung up overnight. Production in-

creased beyond our wildest dreams. Aircraft and ship-building surpassed the most daring forecasts. The machine tool industry's output grew to a volume that bordered on the miraculous. Guns, shells, uniforms, shoes, tanks and a thousand other items were being made in hitherto undreamed of quantities. All of them have one common essential ingredient—power. Industry demanded power—more and more power!

It is no small tribute to the power industry that, while other raw materials developed shortages necessitating strict priorities control, electricity remains unrationed—no priorities, no curtailments, no rate increase. Current industrial consumption is running 16 per cent over 1941 and 50 per cent over 1940. Not spectacular perhaps but when we consider that the nation's 26 million domestic consumers utilize only about 14 per cent of the energy output, we begin to get some idea of industry's power consumption.

Our power companies might have been stunned by the prospect of mounting demands for kilowatts. Instead they set about developing and coordinating a multiplicity of relatively small and seemingly unrelated factors. Individually or even collectively, these have not been of a spectacular nature. Certainly they have not inspired the award of the Army-Navy E although they are an essential ingredient in every Army-Navy E that has been

awarded to American industry.

The contribution of the power industry to the winning of the war is not likely to flame forth in newspaper headlines. It takes the more prosaic turn of portraying an industry that is doing wonders quietly, unobtrusively.

At the close of the last war the power at the disposal of the American industrial worker averaged 3½ horsepower. At the beginning of this war, twenty years later,

This is the seventh of a series of editorials appearing monthly in all McGraw-Hill publications, reaching more than one and one-half million readers, and in daily newspapers in New York, Chicago and Washington, D. C. They are dedicated to the purpose of telling the part that each industry is playing in the war effort and of informing the public on the magnificent war-production accomplishments of America's industries.

it had increased to 6½ horsepower. What other nation can even approach that figure? This large provision of power is the achievement of the electric utility industry. For years it had built and applied its equipment to the highest standards of performance and operated its systems to equally high standards of service and dependability. Always recognizing that "public service is a public trust" it had maintained wide margins of security in performance. Today these margins are the source of the power industry's ability to rise to the emergency.

In short, the electric utilities were prepared!

Power men are accustomed to looking ahead, to prepare for growing loads and allow for unforeseen contingencies, for electricity cannot be stored. It is "ordered" by touching a switch. It is delivered and consumed at the same moment.

Months before the actual outbreak of hostilities foresighted power men set to work computing how much life of equipment could be risked in the process of crowding it toward greater output. Generators, boilers, turbines, cables, transformers and even conductors underwent close scrutiny in an effort to increase the load — *safely*. They figured, they experimented, they tried untried measures.

Insulation, for example, is the crux — the least known component of electrical apparatus. When it lets go the service suffers. It is not easy to know how near any bit of crucial insulation is to letting go. It takes courage to work it to a point just short of failure . . . but that is exactly what is being done today.

Technological forcing of equipment, however, is not all of the story. Obsolescent equipment has been rehabilitated; salvage has been intensified; critical metals have been replaced by non-critical materials; water sprays, air-blowers and other cooling methods have been installed to keep over-loaded apparatus from over-heating. Nothing has been overlooked. Ingenuity has contrived the well nigh impossible.

Hand in hand with these measures of expediency have gone measures of intensification. Hydrogen pressure for cooling generators has been stepped up from ounces to pounds taking more heat away from the machines and enabling them to carry greater loads. Capacitors — little more than aluminum foil interleaved with thin paper — have been applied by the carload relieving the systems of that mysterious reactive current which is associated with that equally mysterious power factor. They have performed wonders in avoiding the need for additional generating and transforming equipment. The use of portable sub-stations has averted the otherwise necessary reserve capacity in fixed installations at many points.

When coal was placed on the urgent list last spring

the electric utilities outstripped all other industries in providing storage for the winter. Stocks on hand the first of October were sufficient for 105 days, or more than twice what would be considered adequate in times of peace.

When staff losses to the armed forces became serious power companies contrived measures that enable them to get along without aggravating the national manpower situation by hiring others to replace them. Today meters are being read every two or three months instead of monthly; women are being trained to do drafting, keep the logs in power plants and sub-stations and to test meters in shops and laboratories.

On the summit of "Grandpa's Knob", a mountain overlooking Rutland, Vermont, stands a giant windmill that would have been the delight of Don Quixote. Towering 200 feet above the tree tops its mighty 175 foot propeller turns with the wind and drives a 1,000 kilowatt generator which feeds its output into the Central Vermont Public Service Corporation's power system. The most ambitious wind-turbine generator in the world, and a daring experiment of forward-looking men.

Today everything electrical is being tried; is being worked harder than it has ever been worked before.

Great credit is due the men behind the electric power industry. These men have recognized the responsibility of their jobs — it is a part of their very being. Theirs is the kind of service that must be maintained. No soldier is truer to his trust than is the employee of this great industry.

The service must go on! No matter what happens — acts of God or deeds of men — the service must go on! Labor disturbances may disrupt other industries but there have been no shutdowns due to labor trouble in electric power plants since Pearl Harbor.

And this winter when blizzards pile up drifts and sleet makes pavements slippery there may be absenteeism from other plants but the utility employees will be on the job ready to climb the ice-covered poles and repair the ice-laden lines whenever the call comes.

In this war the least costly yet the most precious element of production — electricity — will be ever ready to "man" the machines that will produce the weapons that will give victory to the forces of freedom.

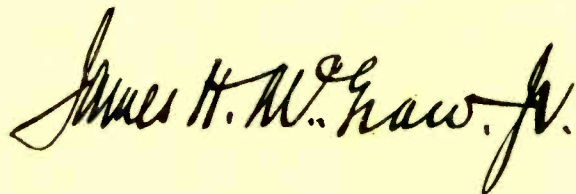

President, McGraw-Hill Publishing Company, Inc.



Proving ground for the future of electronics

On the battlefields, electronics is meeting its extreme test. Failure here means death to men, defeat to armies. Conversely, experience here means vastly broadened knowledge, improved techniques, and progress so rapid as

to be impossible of description.

The collective brains of Eimac engineers are concentrated full tilt on the new knowledge which is coming out of this holocaust. And are consequently still setting the pace in vacuum tube de-

velopments. The fruits of their efforts are going directly to Uncle Sam and our Allies to play a vital role in the war.

When the fighting stops you'll find Eimac still the pre-eminent choice of engineers throughout the world.

Army-Navy "E" awarded for high achievement in production for war.

Follow the leaders to



Eimac
TUBES

EITEL-McCULLOUGH, INC.
SAN BRUNO • CALIFORNIA • U.S.A.

Export Agents: FRAZAR & CO., LTD.
201 Front Street, San Francisco, California, U. S. A.

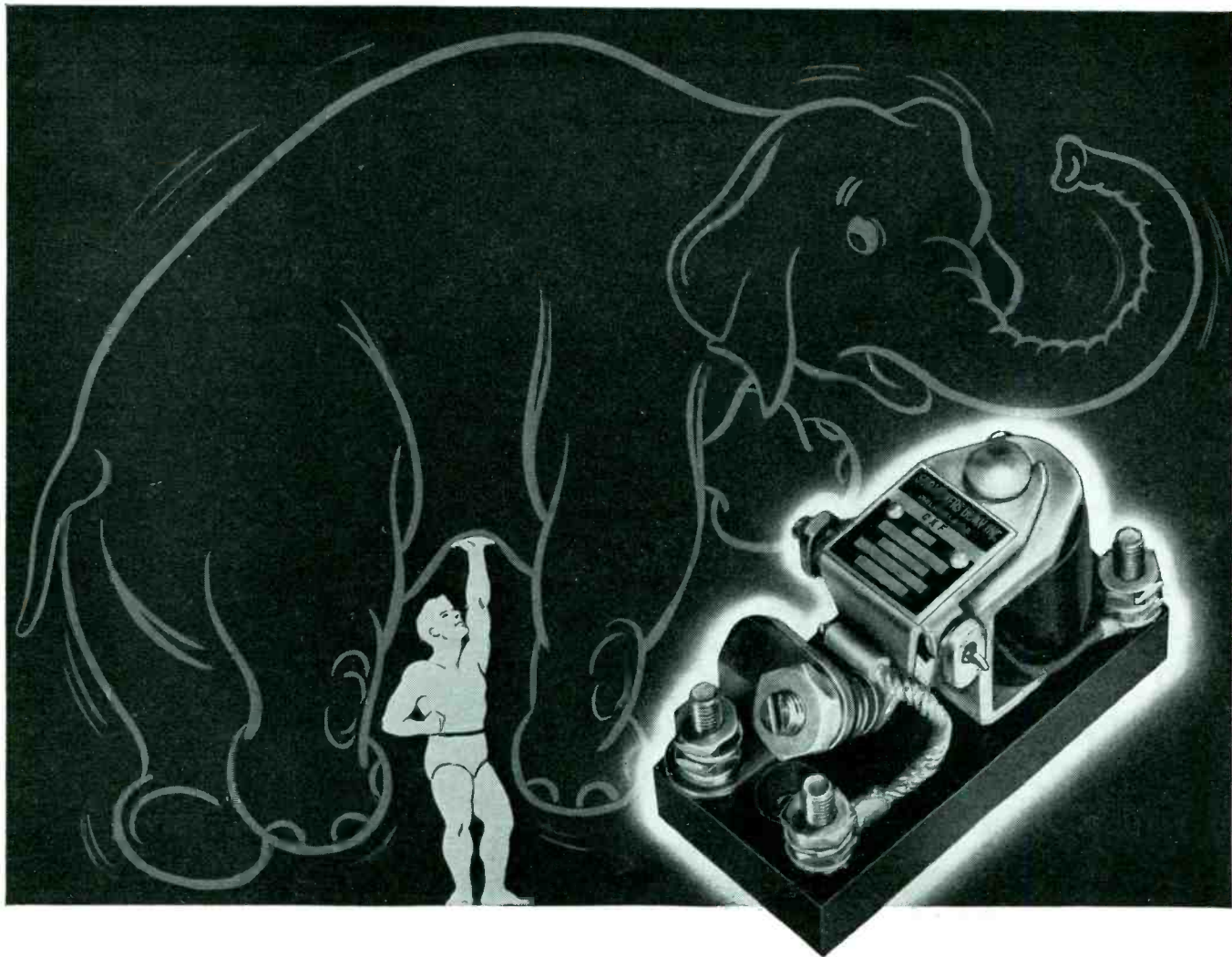

LITTLE GIANT of the RELAY FIELD

Contact Pressure Will Lift 15 Times the Weight of the Unit Itself!



WRITE FOR YOUR COPY!

Get your copy of the new Dunco Catalog and Data Book! Contains design and engineering information on the nation's most complete line of quality relays, timers and solenoids, *plus* helpful data on their selection and use.

Little Giant—Nutcracker—Bulldog...

Such are the names applied to the Dunco Series 61 D.C. Relays in recognition of their remarkable performance in the toughest applications from tanks to airplanes, steel mills or what have you.

For instance, ordinary relays weighing one pound may have a contact pressure of 3 or 4 ounces. This Dunco type gives *7 pounds contact pressure in a unit weighing only 8 ounces*—and is especially designed to withstand intense shocks or vibration and operate faithfully without an enclosure in dirty or dusty places!

Supplied on priority orders in various single and double pole types, these units are designed for D.C. use, although their contacts will also handle A.C. All types are recommended for any low voltage D.C. service where their exceptionally strong contact pressure is desirable for securing maximum resistance to shock.

DUNCO RELAYS AND TIMING DEVICES

STRUTHERS DUNN, INC., 1321 ARCH ST., PHILADELPHIA, PA.

WASHINGTON FEEDBACK

Although the settlement of the controversy between WPB and the Service Chiefs is in the nature of a compromise, with the Service Chiefs retaining their powers to schedule but under supervision of WPB, industries caught in a dead center in this tug of war will now move forward on a chartered course.

The control powers are to be placed with Vice Chairman Wilson, whose primary concern is "to keep our production programs in better internal balance, to prevent waste of resources or reduction of finished output through some parts of the job being done either too early or too late."

Controlled Materials Plan, under Ferdinand Eberstadt, is being worked out and machinery set up so that it can begin to operate by the second quarter of 1943. Carbon and alloy steel, copper and aluminum are the first "controlled materials" to be directly allotted under the plan. Radio and Radar Division of WPB, Deputy Director Ray C. Ellis, will be responsible in its field for correlating the requirements of all claimants adjusting requirements to the productive capacity of the industry; calculating the amount of raw materials required; obtaining raw material allotments; distributing and allotting controlled materials to producers. The office of Civilian Supply is the Claimant Agency for the Division. WPB will function through that channel.

In talking with a representative of **ELECTRONICS** recently, S. K. Wolf, Chief of the Components Section, WPB, stated that emphasis is shifting from the communications field toward radar. The Navy is working on new equipment all the time, and this new equipment requires new components. He believes the industry must remain flexible to meet the changing program, that we are reaching a saturation point in labor, material and facilities, which makes it imperative that we get more out of what we have.

WPB Radio Division has been studying radio manufacturing processes in comparable factories, noting wide differences in production efficiencies. One producer required 70 seconds for a molding operation, another took 7 minutes for the same operation. One plant had an automatic "stacking machine" for mica, another one used the hand method. Estimates indicate there can be a 20 to 30 percent increase in output by requiring that approved methods of efficient production be uniformly used throughout the industry.

WPB, Army and Navy experts and representatives of the ASA are collaborating to bring about simplification of lines and a reduction in the number

of types of components entering into military radio and radar production. In three weeks' time, fixed mica capacitors, now standardized, increased in output almost 100 percent.

Bureau of Ships. Radio and Sound Branch, Navy Department Bureau of Ships, has now been established as the Radio Division, responsible to Rear Admiral E. L. Cochrane, U.S.N., Chief of the Bureau of Ships. Captain Jennings B. Dow is head of the Division and Captain S. F. Patten is Assistant Head.

Four major branches have been organized replacing the previous 10: (1) Design, Commander L. B. Blaylock, all design of radio, radar, and underwater sound equipment except aircraft radio; (2) Procurement and Production Branch, Commander D. F. J. Shea, production and procurement except those which belong in the Design Branch; (3) Installation and Maintenance Branch, combining the previous Marine Corps, Ship and Shore Sections, Commander A. M. Granum, installation and maintenance of all radio, radar and underwater equipment; (4) Aircraft Branch, Commander H. C. Owen, design of all aircraft radio equipment. This branch works closely with the Design Branch and the Bureau of Aeronautics. Under the Design Branch is the Standardization and Coordination Section which works with the Signal Corps and WPB Radio and Radar Section to standardize parts and tubes.

Office of Civilian Defense reports considerable activity in War Emergency Radio Service. Sixty-five blanket licenses have been granted by the FCC for War Emergency Radio Service stations as of November 25, 1942. These licenses cover several hundred individual transmitters to provide supplemental and additional facilities for civilian defense communications. Their use will be essentially local in character, all stations being allocated a band of frequencies from 112 to 116 Mc. In addition to supplementing the basic telephone lines in case of disruption, they will provide communication with mobile units within a damaged area.

OCD proposes the following "Tri-Part" plan, in which communications between the control center and the headquarters of various services, such as fire, police, medical, etc., are divided into three categories, as follows:

1. *The Local-Mobile Band (LM Band).*

One or more channels to be employed only for communication with mobile units in the field. In small communities one channel may be used for all such services. In larger cities, several chan-

nels may be employed to provide greater peak message handling ability, in which case fire, police, medical, etc., may be assigned separate channels. At the control center one transmitter and receiver would be used exclusively for this band. The transmitter should have definite, notched, frequency-changing devices when more than one channel is employed. At the headquarters of the various services would be a transmitter and receiver operating on the channel assigned to that service. The LM band thus provides a means of communication directly to the emergency service headquarters from the field, and also directly to the control center, where an up-to-the-minute picture is maintained for coordinating all activities.

2. *The Local-Fixed Point Band (LF Band).*

A supplemental means of communication between the control center and the headquarters of the various emergency services thus requiring a second transmitter and receiver at control center. In larger communities where more than one channel is employed, frequency change should be definite and by notched control. At the various service headquarters the transmitter and receiver should be permanently tuned to the operating channel. Through these circuits the control center coordinates the activities of the various services throughout the community.

3. *The Local-Warning District Control Center Band (LD Band).*

Supplemental communications to the next higher level of control, i.e., to an outside point from a stricken community. A single channel from each local control center to the warning district control center will usually be sufficient. The cooperation of all communities within a district warning area will be necessary to establish this channel. The same channel should be used by as many communities as possible, and, when more than one channel is used, the channels should be staggered, so that adjacent communities operate on different channels. Staggered channels will provide greater peak message handling ability, since an air raid is more liable to affect two adjacent towns than two separated localities within a district. Transmitters and receivers having fixed tuning should be used on both ends of this channel. Each channel in this band will require a separate transmitter and receiver at the warning district control center, and as few channels as possible should be used to cover all local needs. This circuit is used to call for outside aid and reinforcements for the various services, and to coordinate evacuation procedures in the event of failure of the telephone service.

Even though complete facilities as outlined cannot be provided at the outset, the initial arrangements should be such that gradual expansion without alterations will result in a final network

(See also p. 146, Industry in Review)



Photo by U. S. Army Signal Corps

Mallory Helps Our "Hell Buggies" Kiss The Noise Good-Bye!



Communication between commanders and single units of an attacking column must not be "muddied" by the staccato zip-zip-zip of spark-plugs, electric motors, inverters or other man-made static within the zone of operations. So Mallory Noise Filters step in to suppress static and assure the clear communications that may mean the difference between success and failure . . . life or death.

On battlefronts in the air, on the sea and under the sea, Mallory Noise Filters are equally important . . . helping our fighters kiss the noise good-bye! On the home front, too, where clear radio reception is vital to Civilian Defense . . . and where static might guide enemy bombers to American targets, as has already occurred in Allied countries . . . Mallory Noise Filters help "keep 'em listening" in safety.

Noise filters, however, are just one of the many Mallory Approved Precision Products now serving in both military and industrial applications.

Condensers, rectifiers, Rectostarters, rheostats, volume controls, switches, jacks and plugs, vibrators and Vibrapacks . . . these and other Mallory parts are doing a job where conditions are toughest.

If you need electronic parts . . . for laboratory or test work, for replacements in existing equipment, or as elements in some new device . . . call on your nearest Mallory Distributor. There are 253 Mallory Distributors from coast to coast, ready to serve you promptly. Ask your Mallory Distributor, too, for your free copy of the latest Mallory Catalog . . . used as a buying guide in the aeronautical, automotive, electrical, geophysical, radio and other essential industries.



Write today for your Mallory Distributor's name, and for your copy of this useful catalog.



P. R. MALLORY & CO., Inc.
MALLORY
APPROVED
PRECISION PRODUCTS

P. R. MALLORY & CO., Inc.

INDIANAPOLIS, INDIANA • Cable Address—PELMALLO



CROSS TALK

► **MANPOWER** . . . Even at this early date, the big problem of the new year is going to be manpower. Appointment of a manpower boss in Mr. McNutt comes at a critical time. Already there are more than four and a half million men in the armed services; and it is stated that ultimately—and not so long away—there must be seven and a half million men taken out of productive circulation, demanding more and more equipment with which to do their job all over the world.

At the same time the expanding production needs more man-hours. Agriculture needs more laborers. It is said that the public carriers will need an additional 60,000 workers; that during 1942 approximately 40,000 workers will have lost their lives in one way or another, thus still further depleting the labor pool.

It is hoped that the new top boss of manpower will have an overall picture of what is needed, and not let one service or one industry deplete all others to our overall disadvantage. We must have a figure for the maximum number of armed forces needed that can be equipped and maintained for a long war. Then we must decide how the rest of the manpower is to be employed; for example, what to do about the 2,450,759 civilians on the government payroll as of September; of the thousands of desk jobs now occupied by men in uniform.

Long ago we worked in a place where things were not getting done. We demanded more help. The big boss countered with orders to cut the present staff in two. Then to our complete surprise things began to click; there was a job for everyone, and he did that job and stayed out of other people's hair. Half a staff, in this case, was better than twice the staff.

Are all the civilian jobs in the government, all the desk jobs in the services really necessary?

► **CENSOR** . . . Several months ago, associate editor MacDonald spent quite a bit of his time and that of cooperating components manufacturers gathering data about the parts end of the industry's war effort. A detailed report was written and transmitted to Washington.

Publication of the report in these columns was disapproved on the ground that it contributed an overall picture of the American radio equipment situation which the Axis as well as our own people might find valuable. We found it difficult to disagree with this viewpoint without simultaneously minimizing the usefulness of our own efforts to stimulate production.

Now the Signal Corps has asked *ELECTRONICS* to print the report in booklet form so that it may be distributed privately to a limited list of manufacturers having military equipment contracts. This is being done as a contribution to the war effort. If you do not receive a copy it is because you are not on the Army's list. If you do get a copy, remember that it is *confidential* material and that the penalties for disclosing any of its contents are severe.

This explanation is offered to those who contributed so freely to Mr. MacDonald's report and may be wondering what happened to it.

► **HELP** . . . When we first went to war there was quite a demand on the part of the Navy for "physicists in their undershirts." Some of the scientists who responded were put to work on problems in physics for which they were suited by instinct, training and experience but more of them were flabbergasted to find that they were expected to design, construct and even maintain practical electronic equipment with which they were wholly unfamiliar. Now a story is going the rounds that the mixup was caused by a difference between British and American terminology. It seems that our partners across the water call radio engineers "physicists" and radio servicemen are "wireless engineers." When we started to produce certain highly specialized electronic gear for military use we not only based our work on designs proven in actual service in England but blindly copied British terminology when we advertised for men to handle it. Just how long this curious situation persisted is not known but we can say that for at least three months certain recruiting offices were looking for "physicists", on orders from Washington, and couldn't explain precisely what was meant by the term.

Electronic Generators Extend Induction Heating Field

Electrolytic process of coating sheet steel with tin saves more than half of tin formerly used on tin plate. Induction heating and flowing of tin, using electronic generators, increases corrosion resistance. Electronic generators speed production and can be inserted as part of continuous tin plate process

ELECTRONIC high frequency induction heating is making its contribution to wartime production by helping to save critical tin, speeding production, increasing corrosion resistance, reducing rejects and facilitating the continuous processing of electrolytic tin plate. One unit is already at work in a steel mill, and additional 8600 kw of 200,000 cycle electronic type generators are in process of manufacture for electrolytic tin lines. These lines are designed for operation at speeds of 500 to 1000 feet per minute, which will turn out tin plate in a fraction of the time required by processes using gas furnaces or hot oil baths.

Conventional fuel fired furnaces do not lend themselves readily to high speed heating processes because of the difficulty experienced in forcing heat to flow at a sufficiently rapid rate into the interior of the mass being heated, and because fuel fired furnaces are incapable of sufficiently rapid adjustment of rate of heating to match sudden changes in

By H. C. HUMPHREY

*Radio Division
Westinghouse Electric & Manufacturing Co.
Baltimore, Md.*

processing line speed. Induction heating possesses unique advantages as compared to other heating processes because it develops heat directly within the work itself and eliminates "thermal-inertia" since there is no time lag between application of heat and actual rise in temperature in the work itself. The advantages which derive from these characteristics are:

- (1) Rapid rate of heating.
- (2) Difficulties attendant to methods which require a high temperature gradient between the work and the surrounding medium, in order to force heat from the surface into the interior of the work, are eliminated.
- (3) No physical contact needed between the moving work and the electrical circuit.

- (4) Work may be kept at ground potential.
- (5) Induction heating lends itself to rapid changes in rate of heating such as are required in continuous processes when a line has to be slowed down while the end of one piece of work is welded to the next following.
- (6) Heating may be confined to localized areas. Heating produced may be concentrated in that section of work immediately within the inductor coil.
- (7) Application of heat may be immediately suspended before damage from overheating occurs. Since heat is produced within the work itself, heating will cease immediately when the inductor heating coil circuit is opened. In a continuous process with an oven or furnace which tends to store a large quantity of heat, breakdown in the con-

INDUCTION HEATING AIDS WAR EFFORT

THE role of electronics in aiding our war effort is well illustrated in the application of induction heating to the flowing of tin on sheet steel as an important step in the conservation of tin and the increase of corrosion resistance of tinplate.

The first commercial installation, in a large steel mill, is now producing 60 tons of strip, 14 inches wide, per day. Present lines of electrolytic plating operate at a speed of 500 feet per minute, although this speed is expected to be increased to 1,000 feet per minute in the near future. The 600 kw units now

available are adequate to care for the present rate of production, but 1,200 kw heating units are being built for flowing tin at 1,000 feet per minute by induction heating methods, instead of 150 feet per minute using gas furnaces or 200 feet per minute using hot oil baths.

The commercial utilization of high power induction heating units—of which we may expect additional applications in the future as new fields are developed for this process—introduce new avenues of enterprise for the electronics engineer.

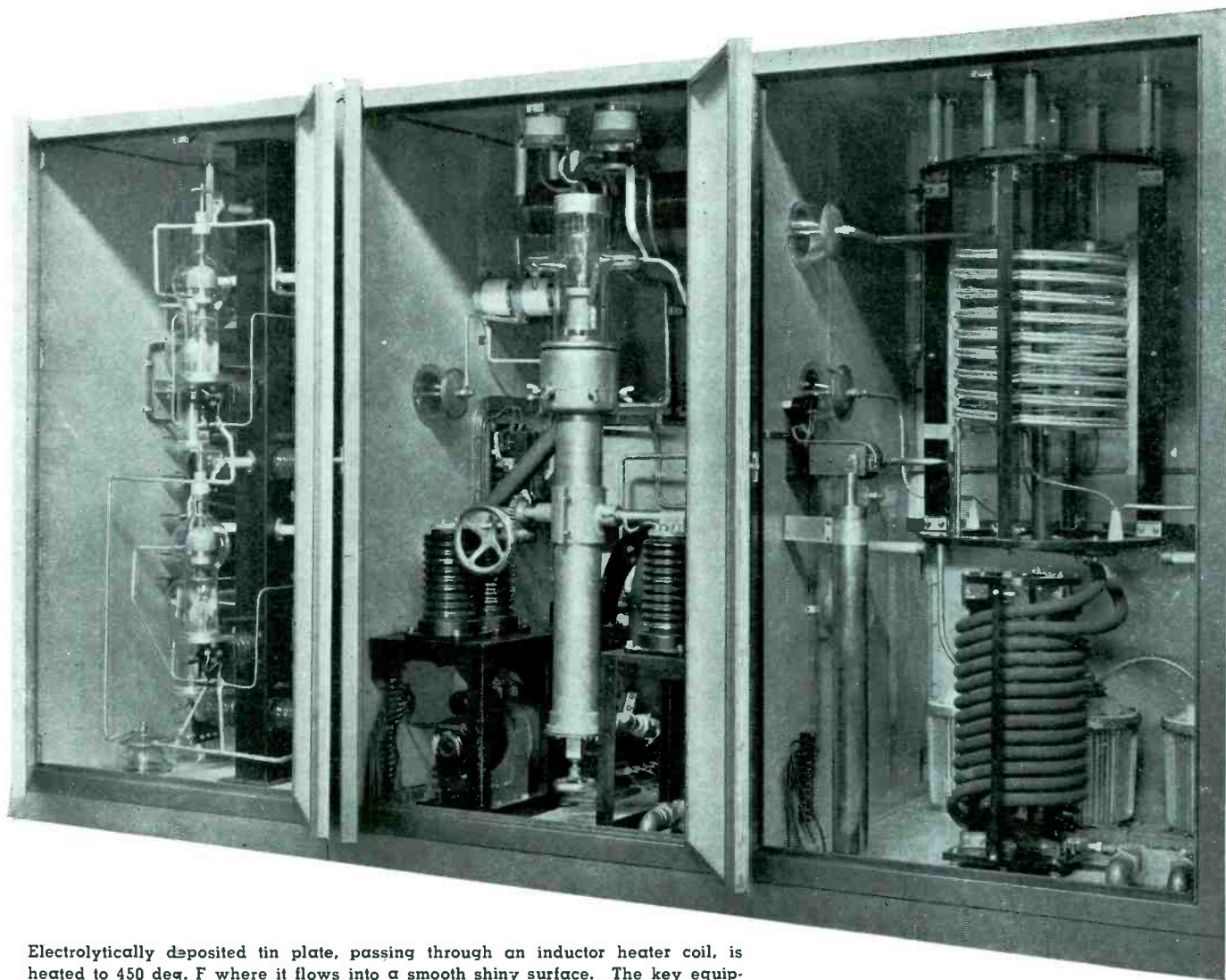

Electrolytically deposited tin plate, passing through an inductor heater coil, is heated to 450 deg. F where it flows into a smooth shiny surface. The key equipment behind the inductor coils is shown above. This three cubicle unit contains electronic rectifier, oscillator tube and oscillator circuit. The d-c power at 17,000 v is fed to the plates of the 100 kw oscillator tube where it is converted into high frequency alternating current, changing direction 400,000 times per second

veyor feed or drive mechanism may be disastrous to the product. This danger may be averted using induction heating.

- (8) Results may be reproduced without variation. Handling operations are reduced and rejects are cut to a minimum. Induction heating lends itself to automatically controlled processes because there is no noticeable time lag between the electrical energy transferred to the work and the heat actually developed as a result thereof.

Basic Principle of Induction Heating

Induction heating is the process of transferring the energy in an alternating magnetic field into metallic work material and there con-

verting this energy into heat. The work is placed within a solenoidal coil or winding (Fig. 2) rectangular or circular in cross-section depending upon whether tubular rods or flat strips constitute the work piece. High frequency alternating current is made to flow through the solenoidal coil winding, usually referred to as the inductor coil, and this inductor coil current sets up a field of varying magnetic flux which links with the work material as in Fig. 2. A voltage is induced in the work and in accordance with Fleming's well-known right hand rule, an electric current tends to flow around the periphery of the work. This current flowing through the resistance of the work produces heating.

Frequency of variation of the alternating magnetic field is importantly related to rate of heating.

According to Faraday's law of induction the voltage around a circuit through which magnetic lines of force vary is equal to the time rate of change of this flux; i.e., the voltage induced in the work is proportional to: (a) frequency of variation; and (b) the total flux from the inductor coil linking with the work.

Frequency Importantly Influences Heating Effects

It is evident that if the total flux through the work were to remain constant an increase in frequency would always produce more voltage and hence more heating current. However, for a given magnetizing force in the inductor coil, the alternating flux density at the center of the work becomes less and less with increase of frequency and the higher the frequency the more pronounced

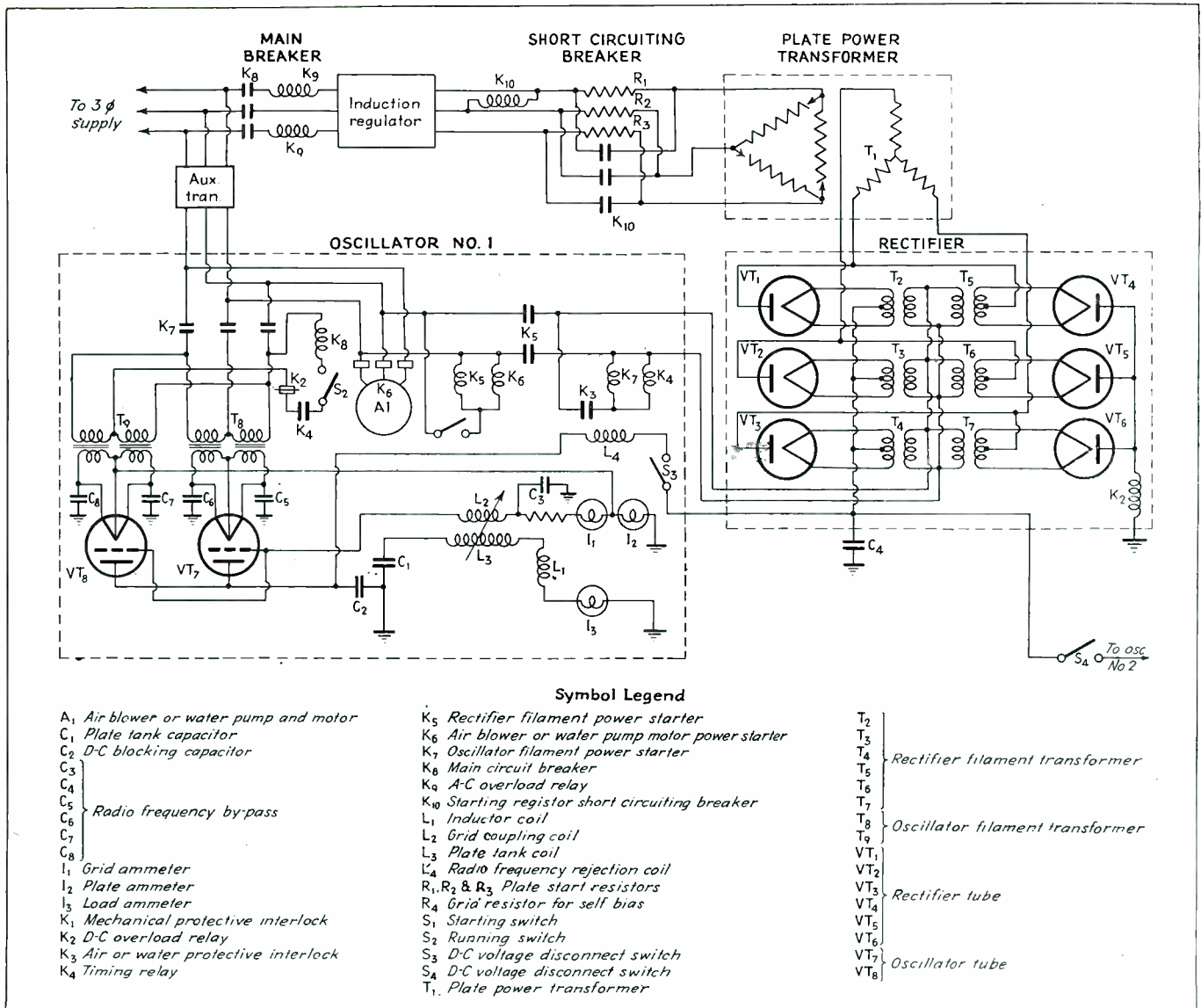

Fig. 1—Schematic diagram of electronic high frequency heating oscillator

this effect until at very high frequencies there is alternating flux only within a skin layer at the surface of the work. At high frequencies this restriction of flux through the work to a thin surface layer tends to offset the advantage otherwise gained by increasing frequency, and for a given size work there is an optimum frequency beyond which the advantage gained from increasing frequency becomes less and less worthwhile. For rigorous mathematical analysis reference should be made to published literature.^(1, 2, 3, 4, 5, 6.)

Optimum Frequency and Rate of Heating

The exact mathematical expression for rate of heating can be stated with the aid of Bessel's functions and hyperbolic functions, but many

practical applications are dealt with using simplifying assumptions. It has been shown⁽²⁾ that to develop the maximum rate of heating for a given frequency the diameter of a long wire or rod must be related to frequency by the expression:

$$f = 1.225 \frac{\rho}{\mu a^2} \times 10^7. \tag{1}$$

where
f = optimum frequency in cycles per second
ρ = resistivity ohm-centimeters

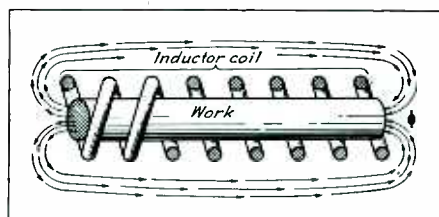

Fig. 2—Diagram of inductor heater coils with lines of magnetic flux

a = radius of wire or rod in inches
μ = effective magnetic permeability

When the foregoing condition is satisfied the expression for rate of heating long wires and cylinders becomes:

$$W = 0.19 H_o^2 \mu f \times 10^{-7} \text{ watts/cm}^3 \tag{2}$$

where
H_o = rms magnetizing force at surface of the wire or rod
f = optimum frequency
μ = effective magnetic permeability

Similar expressions, except for the value of the numerical constant, may be developed for flat strip.

High Frequencies for Thin Sheets, Small Diameter Work

Equation (1) suggests that the smaller the diameter of a rod (and similarly the thinner the sheet) the higher the optimum frequency. The table shows that for an iron rod 1/4 inch in diameter heated to a tem-

perature such that ferromagnetism is no longer detectable (permeability equals unity) optimum frequency is 118,000 cycles and for a wire $\frac{1}{2}$ inch in this increases to 7,550,000 cycles.

It is evident from Eq. (1) that optimum frequency for a non-magnetic material such as copper wire may be several hundred times that for a magnetic material. Also, from Eq. (2) if a magnetic material such as steel strip is heated to a temperature beyond its Curie point* its rate of heating will suddenly and automatically drop because its permeability is reduced to unity. When the permeability drops optimum frequency will be higher.

It is interesting to note from Eq. (2) that the rate of heating strip is independent of its width and if therefore any fractional width strip is substituted for full width sheet of the same thickness the rate of heating when passed through the same inductor coil will be the same in both cases, assuming the inductor coil maintains the same magnetizing force at the strip surface. Even though the high frequency power

of heating but are of doubtful value quantitatively because they are applicable only when optimum frequency is used, and because it is difficult to assign (for magnetic materials below Curie temperature) an appropriate value for μ , which varies with magnetizing force throughout the cross section of the work.

Power Required to Heat Magnetic Materials Below Curie Temperature

For magnetic materials heated below their Curie temperature Rosenberg⁽³⁾ gives an approximate but useful relationship based on the condition that magnetizing force is made considerably in excess of that corresponding to saturation flux density at the surface of the work. For wires and flat sheets it is assumed that the thickness of the skin layer in which most of the magnetic flux will be found is small compared to the radius of the wire or does not exceed half thickness of the strip. It is often possible to fulfill these conditions and power required is:

$$P = 2 \times 10^{-4} \sqrt{\rho f N^2 B} \quad (3)$$

where

- P = watts/cm² of work surface
- ρ = resistivity in ohm-cms
- f = frequency in cycles per second
- N = rms ampere-turns per cm. length of inductor coil
- B = saturation flux density

It is usually of practical interest to determine the rate of heating per unit volume, which is:

For magnetic wire

$$W = \frac{1.575}{a} \sqrt{\rho f N^2 B} \times 10^{-4} \quad (4)$$

For magnetic strip

$$W = \frac{1.575}{t} \sqrt{\rho f N^2 B} \times 10^{-4} \quad (5)$$

where

- W = watts/cm³ = rate of heating
- a = radius of wire in inches
- t = thickness of strip in inches

Electronic Type High Frequency Generators

Although new to induction heating the industrial electronic type generator is actually a variation of the high-power vacuum tube equipment developed for radio communication and radio broadcasting. It is, therefore, already developed to a high state of dependability. It is consistent in performance, stable in operation, capable of remote control and rapid adjustment of power output, with provision for automatic protection against overload or damage to equipment from improper operations. The high frequency elec-

(Continued on page 189)

OPTIMUM FREQUENCY VERSUS DIAMETER FOR IRON WIRE HEATED ABOVE CURIE TEMPERATURE

DIAMETER IN INCHES "2a"	OPTIMUM FREQUENCY CYCLES/SEC. "f"
$f = 1.225 \frac{\rho}{\mu a^2} \times 10^7$ $\mu = 1.$ $\rho = 15 \times 10^{-5} \text{ ohm-cm.}$	
1/4"	118,000.
1/8"	472,000.
1/16"	1,888,000.
1/32"	7,550,000.

source is capable of supplying power for the necessary heating effect, the fractional width strip must be run through the inductor coil at the same speed as the full width strip if the same heating effect is to be obtained.

Equations (1) and (2) are helpful in understanding how frequency, thickness of the work, permeability, and resistivity are related to rate

* By definition Curie temperature is the temperature above which ferromagnetism is no longer detectable.

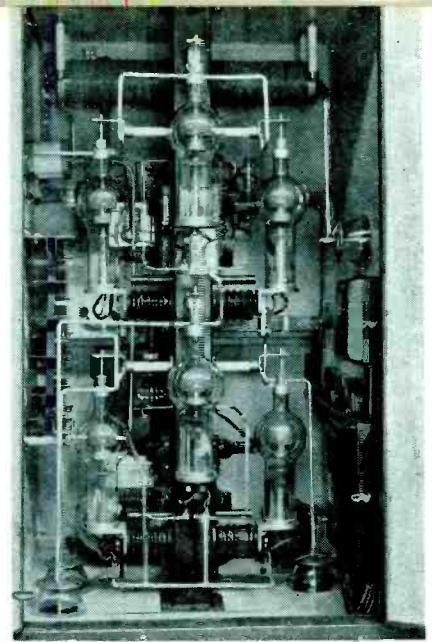

Electronic rectifier in which the alternating current is converted into direct current

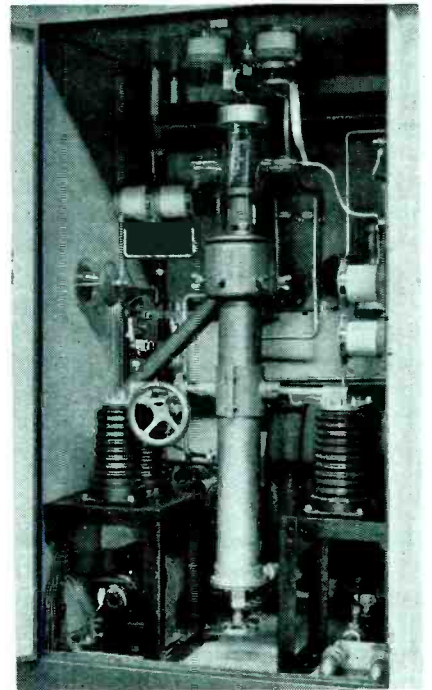

Water cooled oscillator tube (above and tank circuit (below) for generating power at 200 k.c.

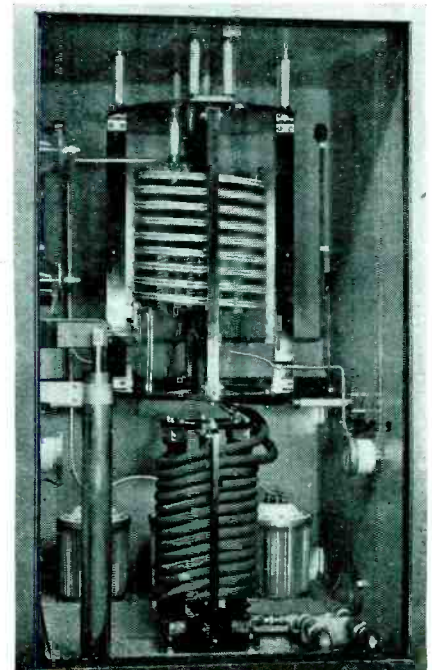

PLANT PROCEDURE

for Expediting War Production

New method of tracing orders, checking production schedules, establishing information center for customers' inquiries, and classification of materials according to priority use, expedite production. Makes available statistical data required for obtaining new raw materials on priority. Method adaptable to use by many medium size plants

IN an industrial nation and having as complex an economic system as that of the United States, total war requires that all available facilities—whether they be manpower, production facilities, or raw materials—be carefully and wisely integrated toward achieving the maximum result with the minimum disruption of ordinary requirements. Increase in individual plant and industry efficiency are goals to be striven for under such circumstances. Still, with reconversion of entire industries, and an exceedingly rapid expansion of all types of production, many of which are more or less foreign in our peace-time requirements, efficiency does not come by itself, nor does it come automatically. Indeed, in many cases the rapid expansions which have been under way, the necessity for employing new personnel, the necessity for training this personnel for the

job at hand, has tended to decrease efficiency rather than increase it. Because of increasingly heavy burdens, plant managers and executives must, therefore, be all the more on the look out for any and all opportunities to operate more effectively and more efficiently than before.

Alden Products Company, Brockton, Mass., have devised record methods and systems which not only check and expedite their production, giving the customer and management a quick and accurate report on the status of any order, but which also are designed to have available at all times statistical information which may be required as a result of priority or other government regulations. The system appears to be adaptable to other manufacturers of relatively small size (employing 50 to 500 persons) who manufacture a wide variety of similar, yet different, items of the same general type. It has the further advantage of being particularly suitable in those plants where the decision of management must be limited

to a few individuals who, in turn, must direct the activities of a rather large group of clerical and factory workers.

The problem of production under present conditions includes the necessity for giving preferential treatment to certain types of orders, at the same time keeping the plant at utmost efficiency for handling other orders of considerable importance. In one way the problem is analagous to the operation of a railroad. The regular passenger and freight trains must be maintained on schedule and with the least possible interruption. At the same time it may be necessary under certain conditions to sidetrack or temporarily slow down such regular services to facilitate the handling of troop or other trains having greater military importance or immediate necessity.

In establishing a system of production control and analysis which meets current day requirements with regard to priorities, end uses, values of product manufactured, units

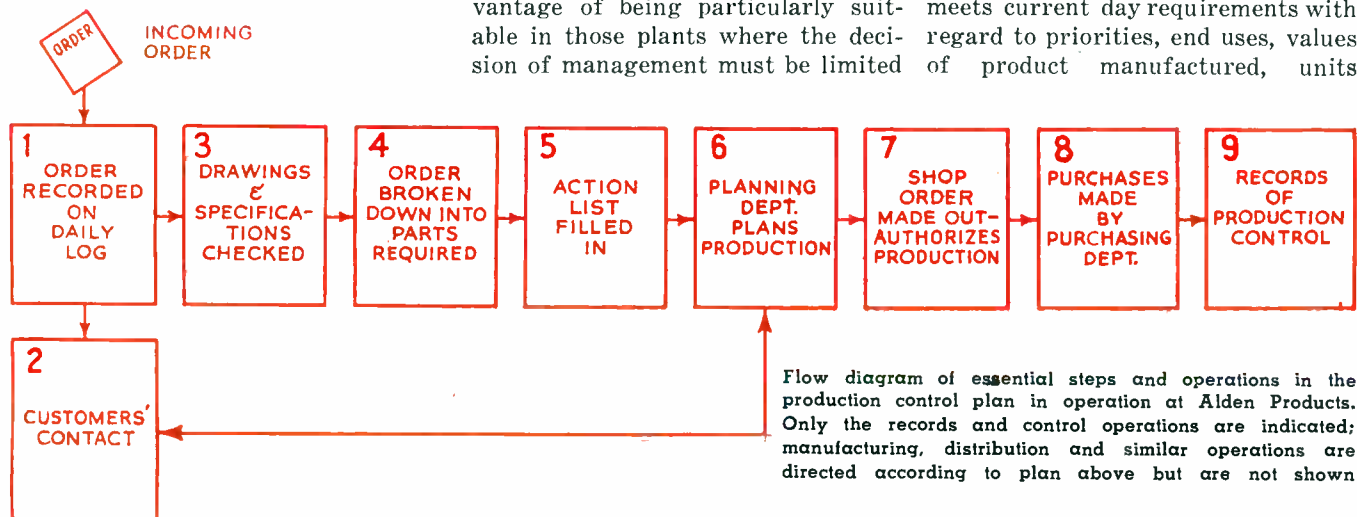

DAY	BALANCE		VALUE		WEEK OF		PERIOD No.		PERIOD No.		PERIOD No.		PERIOD No.		PERIOD No.		BEYOND SIX MONTHS	
	CUSTOMER'S REQUEST	DAILY SHIPMENTS	CUSTOMER'S REQUEST	DAILY SHIPMENTS	WEEK	2 ND MONTH		3 RD MONTH		4 TH MONTH		5 TH MONTH		6 TH MONTH		BEYOND SIX MONTHS		
						CUSTOMER'S REQUEST	PRODUCTION PLAN	CUSTOMER'S REQUEST	PRODUCTION PLAN	CUSTOMER'S REQUEST	PRODUCTION PLAN	CUSTOMER'S REQUEST	PRODUCTION PLAN	CUSTOMER'S REQUEST	PRODUCTION PLAN	CUSTOMER'S REQUEST	PRODUCTION PLAN	
M																		
T																		
W																		
T																		
F																		
S																		
M																		
T																		
W																		
T																		
F																		
S																		

plastic fields, it now is necessary to maintain large inventories and to have quantities of each part coming in on regular schedule.

The clerk then starts to fill in the "Action List", or page 1 of the "Action" form, showing how many of each part is required on the order, how many are in stock, and if necessary how many must be bought or made.

On the basis of the normal or weekly production for such items, an estimate can be made of the length of time required to manufacture or purchase the items required and this also is entered. At this point a tentative planning and production schedule is being set in motion, because the clerk also has shown on the Action List the work to be done on the order by the various shop departments.

The material in the folder then is checked for accuracy and to insure that all the information required by the stockroom, shop and other departments is present.

The folder now goes to the Planning Department (position No. 6), which is concerned with getting the order completed and ready for shipping as quickly as possible. After consultation with shop foremen, the head of the Planning Department must so schedule the work in various departments that the required materials will be manufactured and on hand in each department when it is ready to start on the job. Thus, the Punching Department must be turning out its part of the job at the

right time and in sufficient quantity so as not to hold up the Molding Department when it is ready, and the Molding and Wire Departments must be delivering to the assembly department when the latter is ready. An essential operation here is to see that the various production facilities are utilized so as to keep all of them uniformly loaded in so far as possible, and consequently a card record of the scheduled activity of each machine or unit (which might be a group of assembly employees) in the plant is maintained.

Knowing how and when each department will be able to complete its part of the order, the Planning Department is in a position to fix delivery dates. This information is entered on page 2 of the Action form, and the customers' relations clerk notified. The Planning Department then enters the order and production schedule on the appropriate production planning sheet. There are 25 of these sheets, one for each product classification, and they show the details of the order, the production schedule requested by the customer, the schedule determined by the Planning Department, and the actual shipments made each day, week and month. This latter information, of course, is furnished by the shipping department daily as shipping begins.

Whereas up to this point only the quantities on order have been involved, dollar values now begin to be figured. The price of the product on order is listed on the planning sheet with the value of daily shipments.

The planning operation having been completed and production schedules set, the folder now goes to the Shop Department and shop orders are issued. These indicate the dates when the various parts will be required for production or assembly of the order, and shows each shop department just when and in what quantities it will receive needed sub-assemblies from other departments. It confirms the necessity of making any new part in the shop or of buying materials from the outside.

After the shop order is issued the red folder with its array of sheets goes to the purchasing department who orders the raw materials required, if any. In ordering this raw material the purchasing agent is enabled to charge such items directly against the priority or directive applying to the specific order at hand. To ascertain that the materials which are purchased on the outside will be received in time that they may be processed as required by the order, a shipping material schedule is made out and included with each of the orders for raw material which must be purchased from outside. The information called for on the shipping material schedule is as follows: (1) The deadline date and the unit needed in the processing factory, (2) the date and units of definitely promised delivery from the outside agent from which the material is purchased, and (3) the date and quantity by which the requested dead line might be

(Continued on page 188)

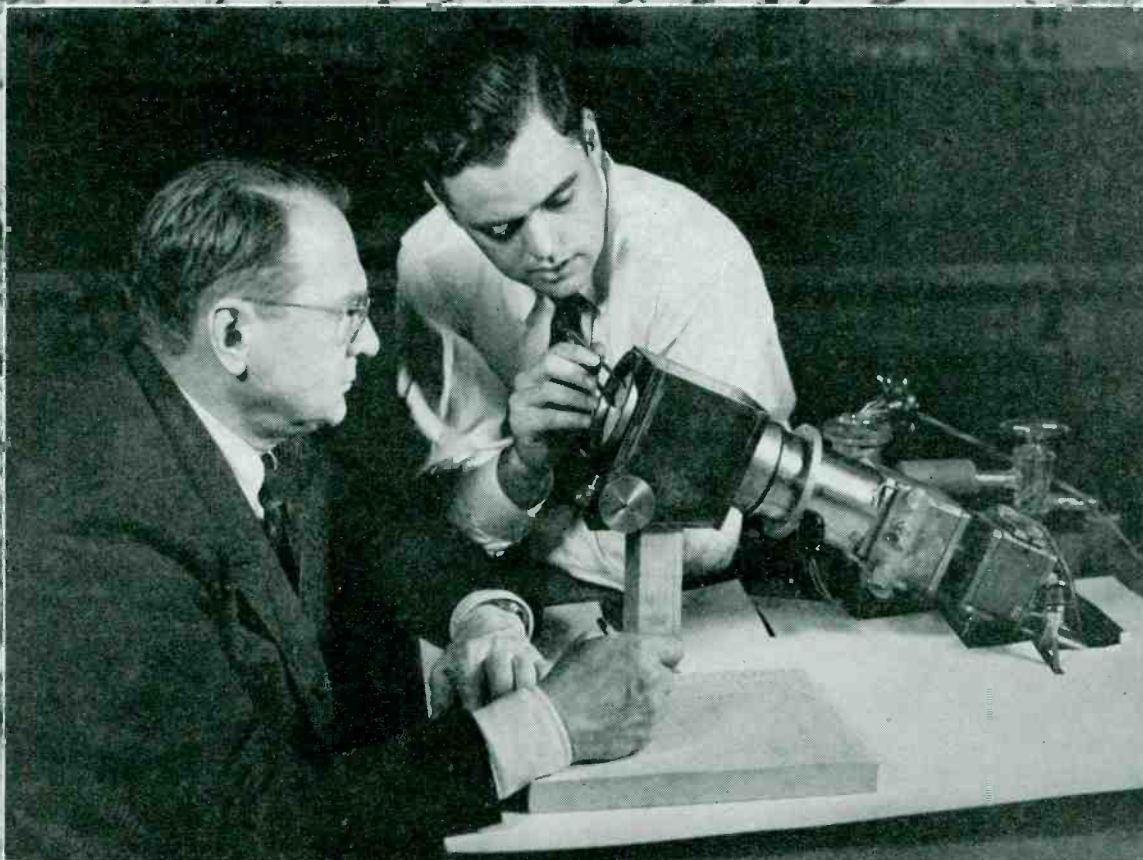

Dr. Zworykin and Dr. James Hillyer, and the new table-model electron microscope. It is 16 inches long and capable of mag-

nification of 100,000 times. The background illustration shows the pearlite structure of steel as seen through the microscope.

IT has often been remarked that progress in science is not uniform and gradual, but takes place, rather, in spurts, initiated by radical new departures in theory or in technique. The electron microscope may well be regarded as a development of this type, exceeding in power, as it does, the familiar light microscope of today by a factor of the same order as that by which good modern light microscopes excel those of three centuries ago.

The natural measure of the performance of any microscope is its resolving power or its capacity to distinguish fine detail in an object; it is normally a minor matter to make the magnification of the instrument large enough that all the detail resolved by it may also become distinguishable by the human eye. The ultimate limit of resolu-

tion of any microscope is set by the wavelength of the radiation employed. Thus, the wavelength of visible light being about a fifty-thousandth of an inch in length, the finest detail resolvable by a light microscope is approximately a hundred-thousandth of an inch. The employment of invisible, ultraviolet, light results in an improvement in resolution by a factor of about two.

On the other hand, fast electrons may be regarded as a radiation with a very much shorter wavelength; if these particles have been accelerated through a potential difference of 50 kv, the wavelength is only a five-billionth of an inch. This might suggest the possibility of attaining a resolving power adequate to distinguish details of single atoms, which are about fifty times as large as this wavelength in diameter. In

fact, however, the peculiarities of the lenses employed to form electron images are such as to limit the resolution to separations of the order of a ten-millionth of an inch, i.e., to detail up to a hundred times as fine as that resolved by a good light microscope. Correspondingly, while light micrographs with a magnification of a thousand may, in general, be expected to reveal all the available detail, ultimate magnifications of a hundred-thousand may be required to accomplish the same purpose in the electron microscope.

Electrons are very readily scattered and absorbed by matter. As a consequence, electron microscopes must be carefully evacuated and the object mounted in an exceedingly thin layer, one hundred-thousandth of an inch or less in thickness, so as to transmit practically all the

ELECTRON MICROSCOPY

in Chemistry

In this paper delivered before a joint meeting of the National Industrial Chemical Conference and the Chicago Section American Chemical Society Dr. Zworykin described the applications of the electron microscope to chemical research. He also described, briefly, a much smaller, less expensive model thus bringing the electron microscope into a new field of usefulness

By **DR. VLADIMIR K. ZWORYKIN**

*Associate Director, RCA Laboratories
Princeton, N. J.*



Diffraction pattern of a single silicon crystal permitting determination of lattice constants to within three-tenths percent

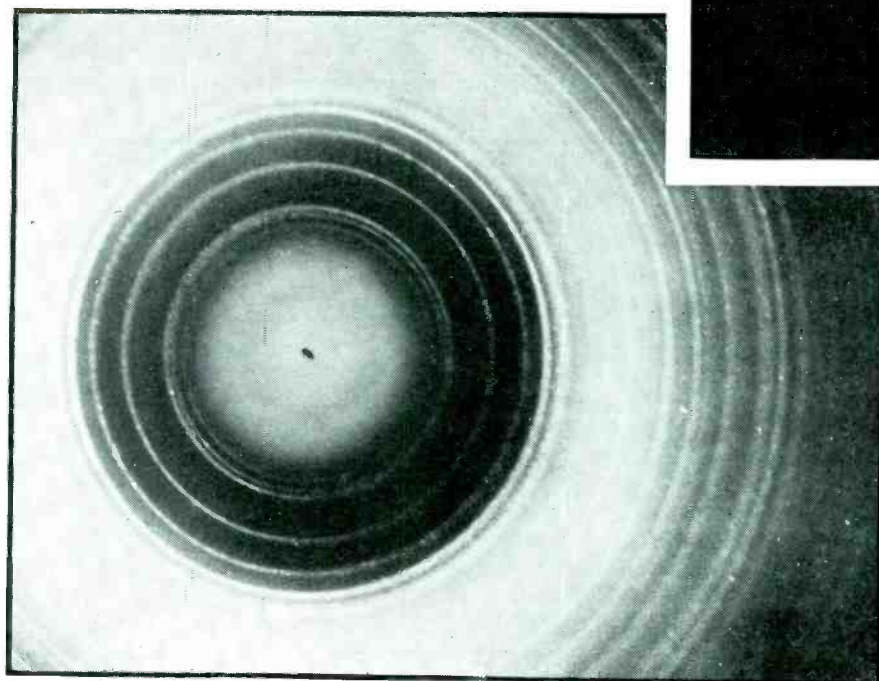

Electron diffraction pattern of zinc oxide smoke ((left)

Method of introducing the object cartridge into the electron microscope (below)

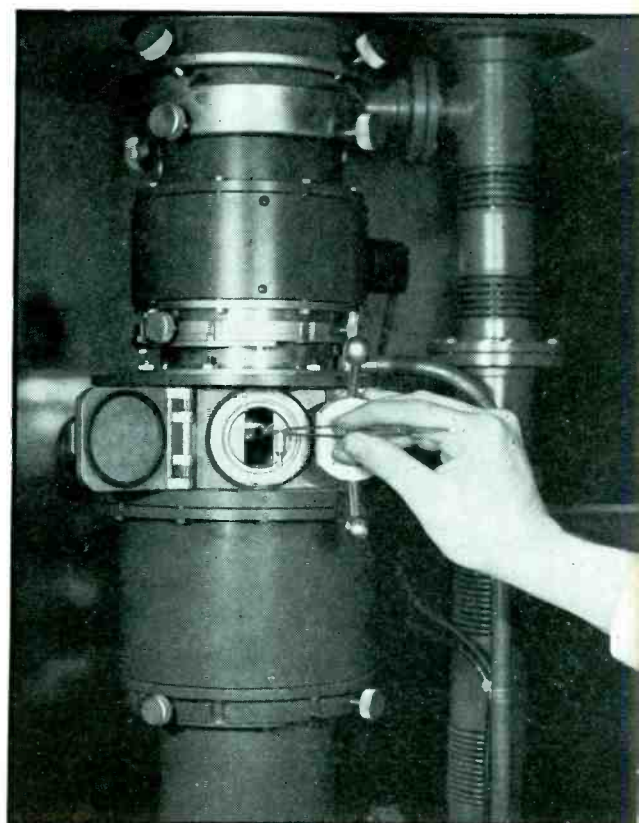

electrons incident on it. It is furthermore obvious that glass lenses cannot serve to focus the electrons. This is accomplished instead by strong axially symmetric magnetic fields formed by suitably designed iron-encased coils carrying electric current. Otherwise the electron microscope closely resembles the light microscope in plan.

Electrons leaving a hot tungsten filament are concentrated by a magnetic condenser lens on the object, placed just above the magnetic objective. The object scatters these electrons, the degree of scattering depending on the thickness and density of the object portion considered. Only the electrons which are either unscattered, or deflected

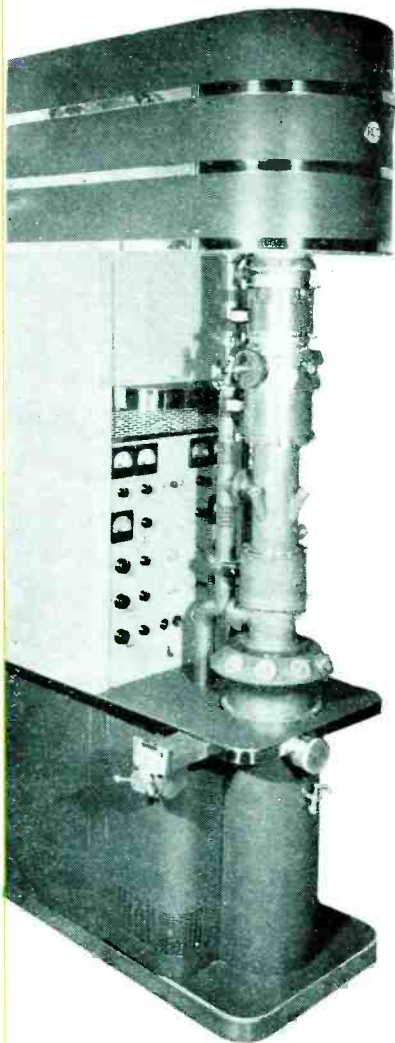

Overall view of the RCA electron microscope

but slightly, are able to pass through the objective and, thus, to contribute to the formation of the intermediate electron image of the object. The electron density distribution in this image is related to the distribution of mass thickness in the original object. A small central section of the intermediate image, which itself has a magnification of the order of a hundred, is magnified by a further, similar factor by the magnetic projector lens, which forms the final image either on a fluorescent screen, for direct viewing, or on a photographic plate, for permanent record. The image on the plate is in general so sharp, that an optical enlargement must be prepared from it to make all of the detail present on it visible to the unaided eye.

The first attempts at realizing instruments of this general character took place about ten years ago.¹ As might be expected, the earlier instruments^{2,3} not only were more lim-

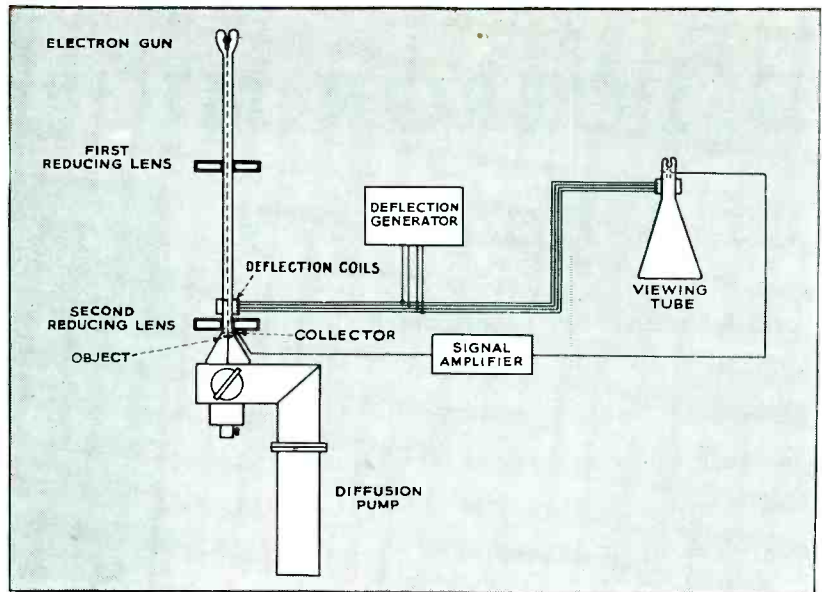

Simple scanning microscope for continuous observation

ited in their performance, but, in addition, required special technical skills for their operation and maintenance. Furthermore, they were exceedingly space-consuming, an extra room being generally needed for the electrical accessory equipment. All these difficulties have been overcome, largely through the application of novel design principles, in the RCA electron microscope.⁴ The

complete instrument stands about 7 feet high and requires about 5 square feet of floor space. All of the power is derived from the 110-volt a-c line, the complete transforming, rectifying and stabilizing equipment being contained in the cabinet at the rear. The most important single factor in the reduction of the bulk of the equipment consists in the employment of radio frequencies

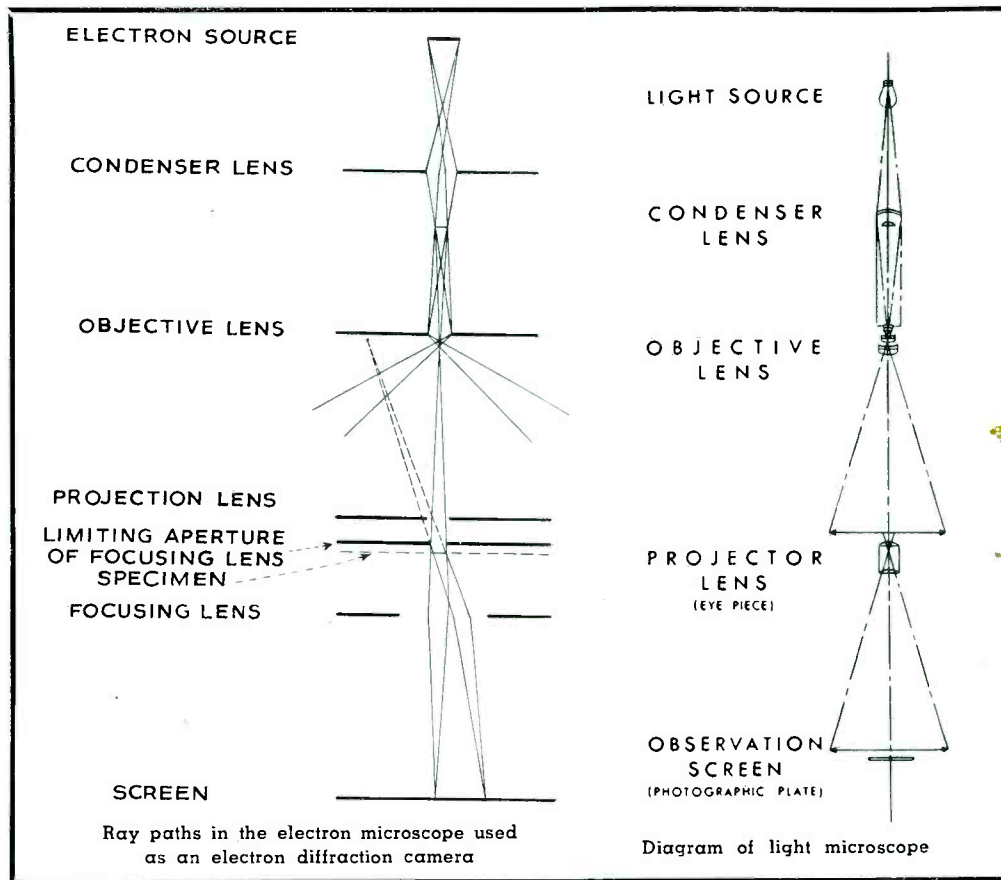

Ray paths in the electron microscope used as an electron diffraction camera

Diagram of light microscope

for the generation of the high voltage, greatly decreasing the size of the transformer and of the filter elements and permitting their placement in the immediate proximity of the microscope column.

All of the electrical controls of the instrument are mounted on a panel behind the microscope proper and may thus be reached by the observer in a seated position. These not only control the voltage and the electron beam current, but also the focusing and the magnification, the latter two quantities being determined by the currents in the objective and projector coils.

At the top of the column is the insulated electron source, to which the high voltage is applied. Sets of adjustment screws permit the perfect alignment of the beam issuing from the source with the optics of the instrument. These are the three magnetic lenses, that is, the condenser, objective, and projector lenses. Between the condenser and objective the object chamber is located. This is provided with an airlock mechanism which permits the introduction of the object, placed in a suitable cartridge, without breaking the vacuum. Just above the projector lens is a small fluorescent

screen, on which the intermediate image may be observed through a port in the microscope column. Below the projector lens is the viewing chamber with six ports for binocular observation of the final image by three persons simultaneously. The fluorescent screen on which the final image is observed serves at the same time as a shutter for exposing a photographic plate placed below it. An airlock is provided for the introduction of photographic plates into the instrument without admitting air into the microscope column.

It is possible, in principle, to replace the magnetic lenses by electrostatic lenses. In fact, microscopes employing such lenses have been constructed and operated.² However, certain serious drawbacks of the electrostatic electron microscope—among them, the extreme sensitivity of the lens action to contaminations of the lens electrodes and the closer limitation of the magnification attainable at a given operating voltage—have given the magnetic microscope preeminence.

The object support normally consists of a disk of fine-meshed wire screen over which a very thin celluloid film, about one two-millionth inch in thickness, is stretched. The

specimen is usually prepared as a suspension in water, a droplet of the suspension being placed on the celluloid film and permitted to dry. If the specimen is in the form of a dust or smoke, it may be caught directly on the wire mesh, even without the celluloid film; the dust particles will then adhere to the edges of the mesh wires and project in part, supporting each other mutually, into the free space. In either case the object-supporting disk is inserted in a small cartridge, which may be introduced into the object chamber. A simple manipulation then brings it into position above the objective lens—the operation of exchanging an object in this manner causes an interruption of the observations by only one minute.

Very extensive research has been carried on with the aid of the electron microscope in bacteriology and related fields in biology and medicine. Yet, the electron microscope has proved quite as effective in many branches of chemistry which are more particularly our present concern.

Consider, first of all, dusts and smokes of various kinds. They may constitute simply a health hazard; on the other hand, they may also

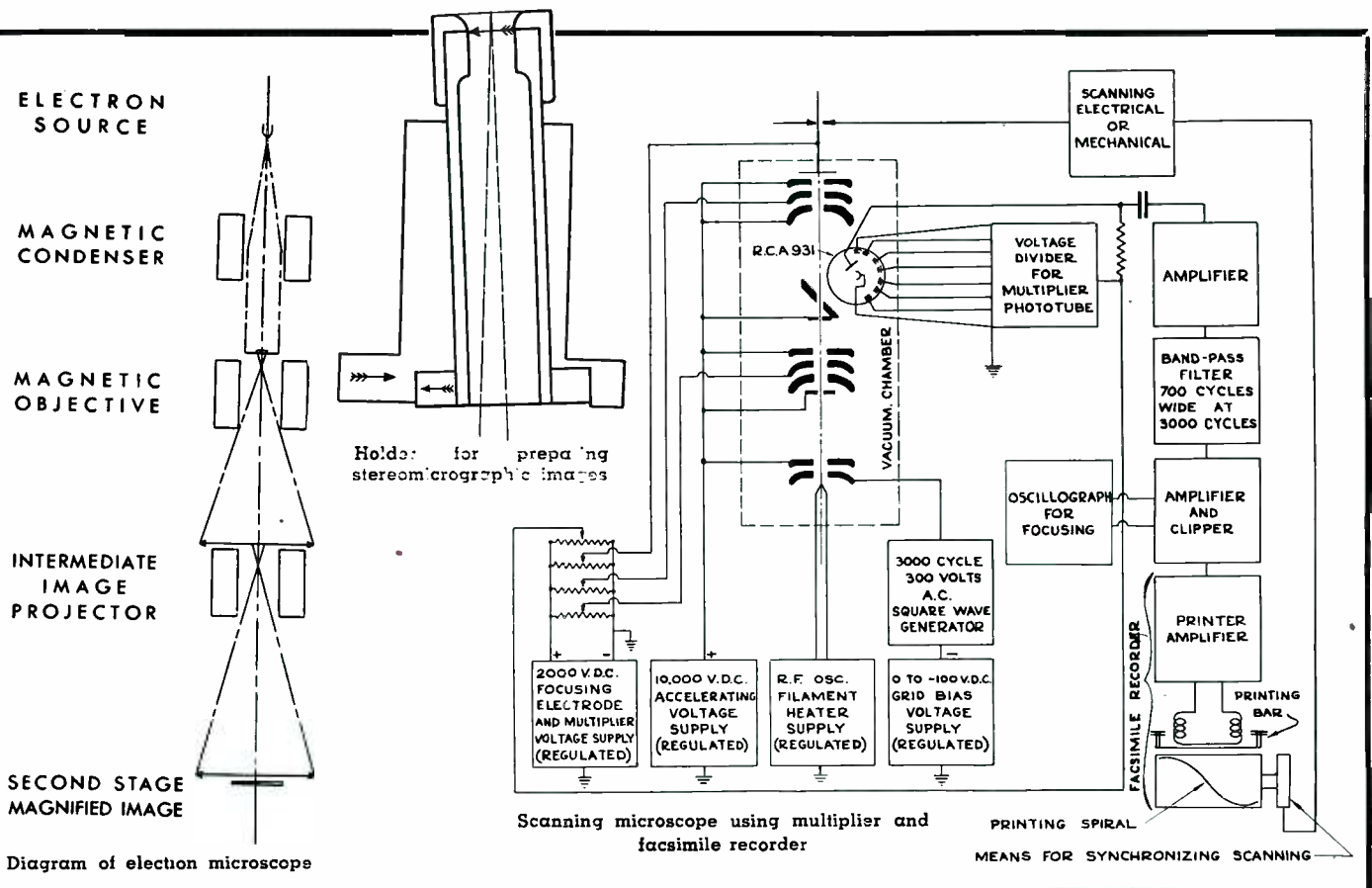

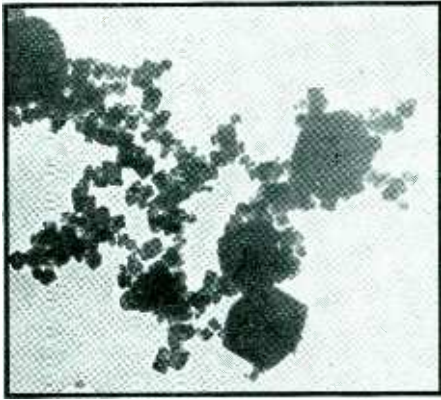

Cube-like particles of magnesium smoke

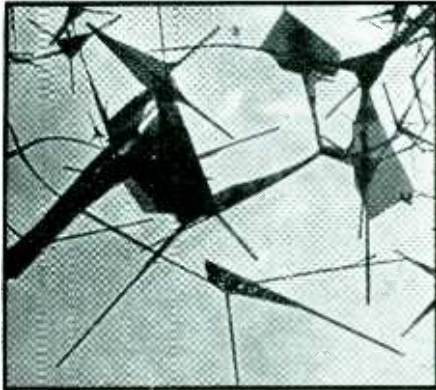

Zinc smoke particles consist of four fine spikes joined together. $\times 10,500$

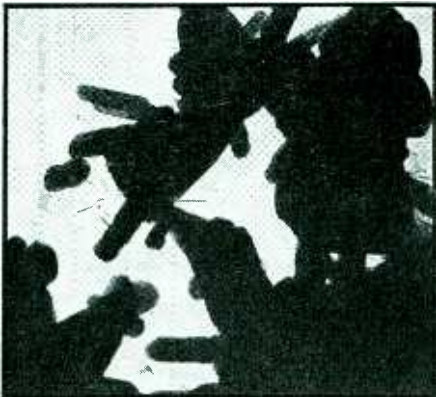

Strongly corrugated and porous particles of calcium carbonate. $\times 30,000$



Lead arsenate. Good insecticide particles are in thin, small plates. $\times 27,500$

find application as preservatives, pigments, insecticides, chemical reagents, and catalysts. In all cases importance attaches to the shape and size distribution of the individual particles which, more commonly than not, are too small to permit a determination of these factors with the light microscope.

One of the most interesting smokes at the present moment is, in view of the rubber situation, carbon black. The effectiveness of finely divided carbon as a reinforcing agent of rubber is known to depend very largely on its fineness of division. Its most important source is the partial combustion of natural gases. It is a highly inhomogeneous collection of particles obtained from a natural gas flame, if no precaution is taken to derive all of the carbon from the same portion of the flame. By contrast the carbon black derived from a camphor flame has a highly homogeneous distribution, the individual particles being approximately spherical and about two millionths of an inch in diameter.

Most metal smokes have very typical particle shapes, characteristic of their crystal structure. A familiar example is magnesium smoke. Here the individual particles are cubes, oriented in all possible ways with respect to the plane of the micrograph. Zinc smoke particles, prepared by burning zinc in an oxidizing flame, on the other hand, consist primarily of four fine spikes joined together at the center.

Frequently an electron micrograph of a sample indicates very directly and convincingly the reason for peculiar physical or chemical properties exhibited by the material in question. Thus, a certain lot of calcium carbonate showed unusual chemical activity. Examined with the electron microscope the individual particles appeared strongly corrugated and even porous, endowing them with an unusually large surface area. Again, two lots of lead arsenate were examined, which differed greatly in their effectiveness. The electron microscope showed that the first of these, which had proved an excellent insecticide of great covering power, was made up of particles in the form of extremely thin, small plates while the less effective material consisted of relatively thick, granular particles.

Fineness of division or surface area are also factors of great importance in many pharmaceutical preparations which are colloidal suspensions. A familiar antiseptic of this type is mercurochrome the individual particles of which are far too small to be distinguished by a light microscope. Another mercurial preparation, merthiolate, exhibits comparably fine dispersion.

The electron microscope has also found application in ceramic research. Thus, it has been used to

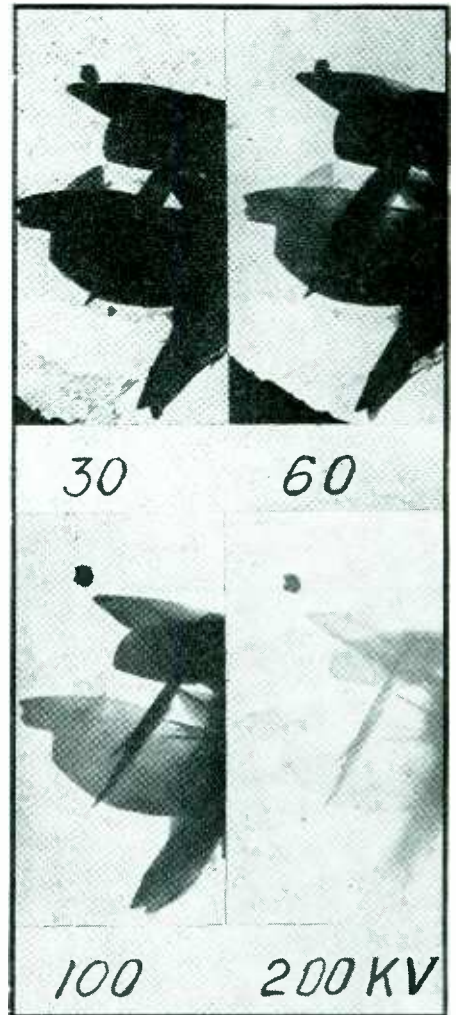

Effect of varying voltage on the electron microscope. Aluminum oxide monohydrate (diaspore) scales taken at 30 to 200 kv. $\times 5500$

study dehydration and disintegration processes of caolin with increasing temperature.

The electron microscope can profitably be utilized in a multiplicity of other branches of chemistry. To mention only mineralogy, it should prove valuable for the surveillance of the grinding of ores as well as of wastes. Its application will explain
(Continued on page 190)

REACTANCE NETWORKS with RESISTANCE TERMINATIONS

A general treatment of bisectable reactance networks with equal resistance terminations, especially with the reactors ideal; illustrated by working out the detailed performance of four-element networks commonly used for simple low-pass purposes. Illustrative curves and numerical examples are given for determining the reactor elements required to produce a specified curve, and for determining the curve corresponding to a given set of elements

By

E. S. PURINGTON

Gloucester, Mass.

MANY electrical circuits consist of a bisectable symmetrical* network of reactor elements inserted between two equal resistance terminations. These are exemplified by the simple but important arrangement of Fig. 1A, where the network comprises the reactor elements L_1 , C_1 , and C_2 , and the driving voltage E in the sending arm R produces an output current I in the receiving arm which is also a resistor R . Also indicated is the first half portion of the system resulting from bisection, and the electrical connectors by which power can be transferred to the second half portion. With the reactor elements dissipative, the insertion properties of the network are most readily derivable from the termination impedance R , and the impedances Z_o and Z_c looking from the termination R into the first half portion, first with the connectors opened, then closed by shorting them together, using

$$\text{Insertion ratio} = \frac{E/2R}{I} = \frac{(1 + Z_o/R)(1 + Z_c/R)}{(Z_o/R - Z_c/R)} = M + jN \quad (1)$$

This equation becomes greatly

simplified if ideal conditions are stipulated, with the terminations R of pure ohmic resistance independent of frequency, with each reactor element free from dissipative loss, and with the numerical impedance of each inductor proportional to frequency and of each capacitor inversely proportional to frequency. By reference to Fig. 1B, Z_o and Z_c become pure reactance impedances jX_o and jX_c , and simple right angle

triangle type vector diagrams result showing the circuit relation for the open and closed conditions. The ratio X_o/R is the tangent of the phase angle by which voltage E leads the current I_o , and X_c/R is the tangent of the angle by which voltage E leads the current I_c . These angles θ_o and θ_c cannot differ from zero by more than 90 electrical deg., but can be positive or negative. For the case illustrated, θ_o is negative for all frequencies, but θ_c is positive for low frequencies and negative for high frequencies. The ratios X_o/R and X_c/R will be here termed q_o and q_c .

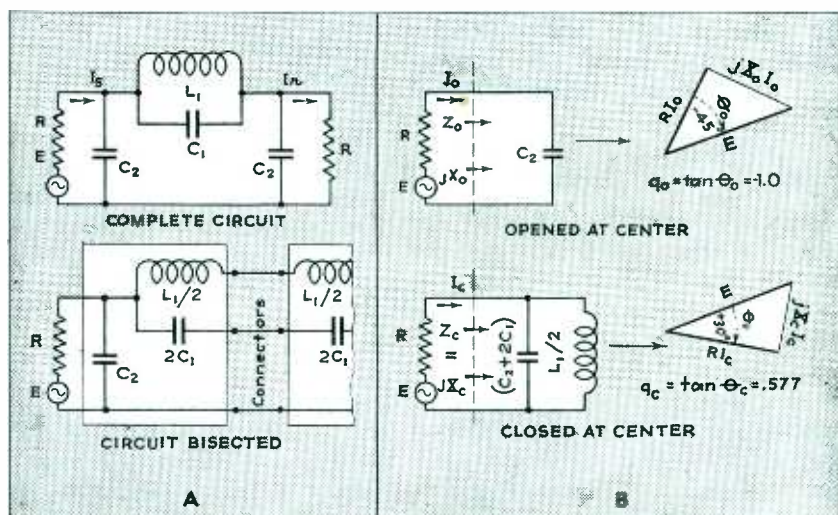

Fig. 1—Bisectable reactance networks with equal resistance terminations

* In November, Mr. Purington discussed a method of analyzing symmetrical networks which possesses some advantage over conventional methods. In this article he applies the analysis to networks made up of reactor elements. Low- and high-pass filters will be covered in a subsequent article.—The Editor.

from analogy to the quality factor Q expressing the reactance-resistance ratio for coils or condensers. These q 's in general are complex functions of frequency, with values ranging from negative infinity to positive infinity. The vector diagrams of Fig. 1B depict conditions for a combination of elements which for some frequency makes $\theta_o = -45$ deg., $\theta_c = 30$ deg., for which the tangents are $q_o = -1.0$ and $q_c = 0.577$.

With this stipulated simplification, Eq. 1 becomes

$$\text{Insertion ratio} = \frac{E/2R}{I_r} = \frac{(1 + jq_o) \sqrt{1 + jq_c}}{j(q_o - q_c)} = M + jN \quad (2)$$

and because the q 's do not involve $j = \sqrt{-1}$, this simplifies to

$$\text{Insertion ratio} = \left[\frac{q_o + q_c}{q_c - q_o} \right] + j \left[\frac{q_o q_c - 1}{q_c - q_o} \right] = M + jN \quad (3)$$

so that M and N are directly computable from the q 's. For the sample values given above, $M = 0.268$, $N = 1.0$, and since M and N are both positive the insertion ratio vector is in the first quadrant, with the termination current I_r lagging behind the reference current $E/2R$ and therefore behind E itself by less than 90 electrical deg. The insertion loss in decibels, $10 \log_{10} (M^2 + N^2)$ is 0.3 db, and the insertion lag, $\tan^{-1} (N/M)$ is $+75^\circ$. In terms of the q 's, in general

$$\text{Loss} = 10 \log_{10} \left\{ 1 + \left[\frac{1 + q_o q_c}{q_c - q_o} \right]^2 \right\} \quad (4)$$

$$\text{Lag} = \tan^{-1} \left[\frac{q_o q_c - 1}{q_c + q_o} \right] \quad (5)$$

These equations are especially useful if the loss and lag are to be computed after expressing the q 's for any specific circuit as algebraic functions of frequency. For single point computations, especially simple equations result by substituting $q_o = \tan \theta_o$ and $q_c = \tan \theta_c$ in Eq. 4 and 5, and simplifying to yield

$$\text{Loss} = 10 \log_{10} \text{cosec}^2 (\theta_o - \theta_c) \quad (6)$$

$$\text{Lag} = (\theta_o + \theta_c) \pm 90 \text{ deg.} \quad (7)$$

In Fig. 2 is given a chart and explanatory matter for quickly evaluating the insertion loss by Eq. 6, applying to any bisectable symmetrical network with equal resistance terminations. By its use the insertion loss for any specific choices of elements such as L_1 , C_1 and C_2 of Fig. 1A inserted between specified resistance terminations R can be most

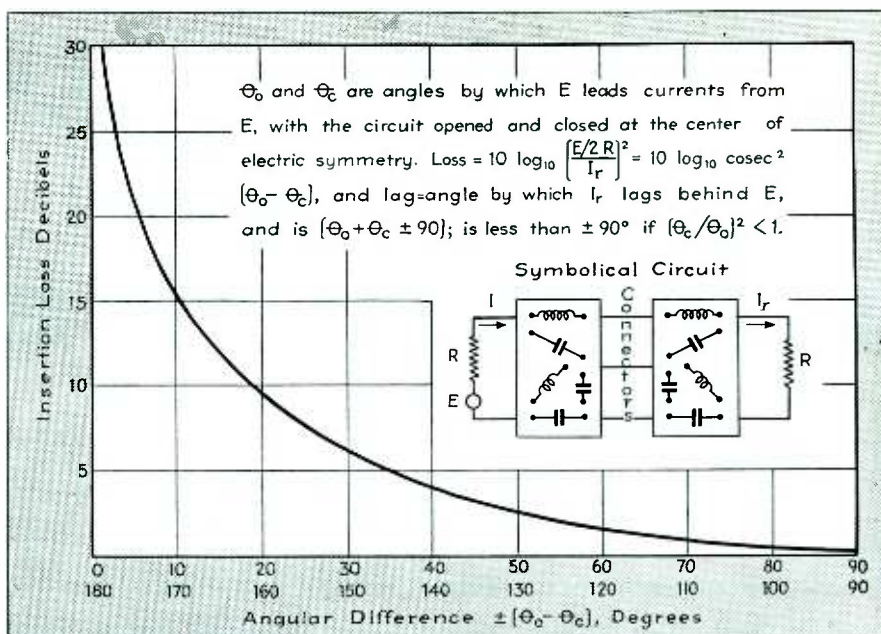

Fig. 2—Loss and lag characteristics for bisectable R - X circuits

rapidly evaluated. Substantially all that is required is computation of the angles θ_o and θ_c by which the driving voltage E leads the current produced by that voltage for the two conditions with the circuit as a whole opened and closed at the center of symmetry.

The more important problem usually is to predetermine what values must be assigned to the elements to be inserted between specified terminations R so that the loss and possibly the lag will be a suitable function of frequency. For this purpose it is desirable to use equations in terms of the q 's, survey the entire possibilities of curve shapes afforded by a given network arrangement, choose the shape that is most satisfactory, and evaluate the reactor elements which for the specified R will yield that shape. Before carrying through the necessary routine using Fig. 1, it will be helpful to study Eq. 4 and 5 in greater detail.

Quick inspection of Eq. 4 shows the loss is zero for any frequency making the product of the q 's negative unity, and the loss is infinite for any frequency making the q 's equal. Less obviously, zero loss is approached for any condition making one of the q 's a very large value and the other a very small value. Such is the case in the cited example of Fig. 1B for frequencies near zero, making q_o highly negative and q_c only slightly positive. Less obviously also the loss is very great for

any condition making both of the q 's very small, as is the case in Fig. 1B for very high frequencies with the q 's only slightly negative. Inspection of the circuit configuration often reveals conditions of zero and infinite loss. In Fig. 1A, the loss is of necessity infinite for the frequency of antiresonance of elements L_1 and C_1 , corresponding in fact to the q 's of Fig. 1B being algebraically equal. Inspection of a circuit configuration will always fail to disclose the condition of zero loss due to the product of the q 's being negative unity, since not all combinations of elements will result in such a condition existing.

It is noteworthy that the loss equation involves the product and the difference of the q 's, while the lag equation involves the product and the sum. The quotient of the q 's is not as yet specifically involved, but for the present has the hidden value of clearing up the equational ambiguity as to the quadrant location of the phase angle. In Eq. 5, if the tangent of the phase lag angle is positive, the angle may be in the first or third quadrant, but if negative, in the second or fourth. Referring back to Eq. 2, $M = (q_o + q_c)/(q_o - q_c)$ is positive provided the quotient (q_c/q_o) is within the limits -1 to 1 . Therefore if $(q_c/q_o)^2$ is less than unity, or correspondingly $(\theta_c/\theta_o)^2$ is less than unity, the lag angle must be located in the first or fourth quadrant for which M is positive, otherwise it must be located in

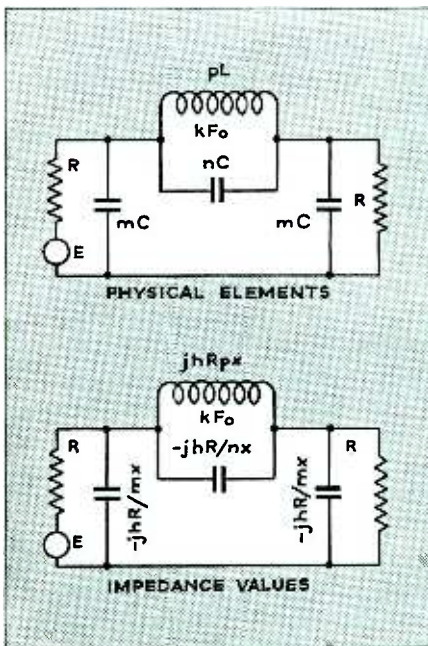

Fig. 3—Circuit designations showing relation between physical elements and impedance values

the second or third quadrant for which M is negative.

Absolute determination of the lag angle must be based upon agreement as to lag for some specified frequency. Since in Fig. 1A all the network currents for very low frequencies are in the inductor L_1 , directly connecting the two terminations, so that the network produces no effect at zero frequency, it will be agreed that the lag is zero at zero frequency, and not, for example 360 deg. But at infinite frequency the loss approaches infinity and the lag angle approaches the boundary between the first and second quadrants. Absolute lag, as for example 90, 450, or—270 deg., can be found only by applying the physical doctrine of continuity and integrating the phase changes as the frequency progresses from zero to infinity. Unfortunately Eq. 3 points out that as frequency changes in such a way as to make $(q_o - q_c)$ change sign, the vector $(M + jN)$ changes by 180 deg. No physical discontinuity is involved because at the same time the insertion loss is infinite. What happens is a reversal of the load current I , as it passes through a condition of zero magnitude, analogous to the change of direction of current in the galvanometer arm of a bridge in passing through a condition of balance. Nevertheless there is no short method of checking whether 180

deg. must be added or subtracted when the frequency passes through the critical value. Apparently the only satisfactory procedure to clear up this point, if important, is to compute the performance at least once with an element such as L_1 of Fig. 1A slightly dissipative, using the more general Eq. 1, useful when Z_c/R is a complex imaginary. The lag performance under this condition will serve as a guide to what should be done in the limiting case with the element L_1 , mathematically free from loss.

Solution of Specific Problem

The procedure necessary to develop loss and lag equations for any network to which the preceding theory applies will be illustrated by working out the complete solution for Fig. 1A. Here is a circuit with four differently choosable electrical elements, the terminations R , and the network reactors L_1 , C_1 and C_2 . It is required to develop the insertion performance equations covering all possible combinations, survey the possible curve shapes and tabulate information as to how any selected curve shape may be realized.

If a set of values is randomly assigned to the circuit elements, the performance as here defined will not be modified by multiplying the impedance of each element by a given factor, as for example by

doubling R , doubling L_1 and halving the capacitances of C_1 and C_2 . But the performance will be altered if the terminations R are held constant while the impedances of the network elements are doubled, since the q 's will be doubled. To provide for various impedance levels of the network elements with respect to the terminations, an impedance level parameter h is introduced to which in the equations the q 's will be proportional.

With a fixed specified value for R , the only way that the elements of the network may be modified without curve shape changes is by multiplying the network reactor values L_1 , C_1 and C_2 all by the same factor, as by doubling. What previously happened at frequency f will subsequently happen at a frequency $f/2$, thereby shrinking the curve if plotted on a frequency basis. If however some significant reference frequency F_0 is set up, as for example the cutoff frequency of the curve shape if used for filtering purposes, and the curve is plotted in terms of the ratio of any frequency to the reference frequency, change of the reference frequency will not change the curve shape. In the present example the significance of F_0 as the cutoff frequency is chosen to give the simplest possible loss equation, but its cutoff significance appears only after specific curve shapes are plotted.

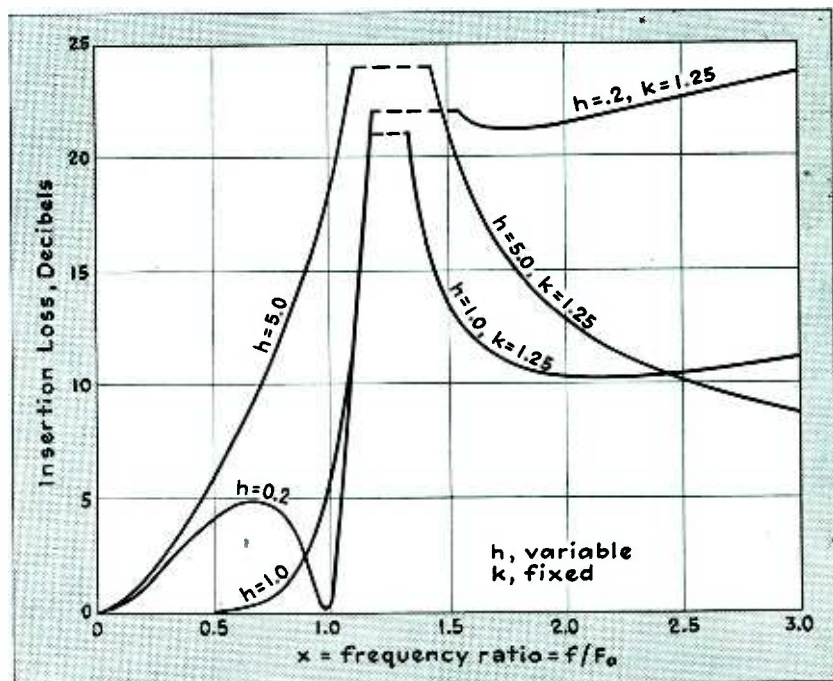

Fig. 4—Low-pass filter characteristics; effect of changing impedance level

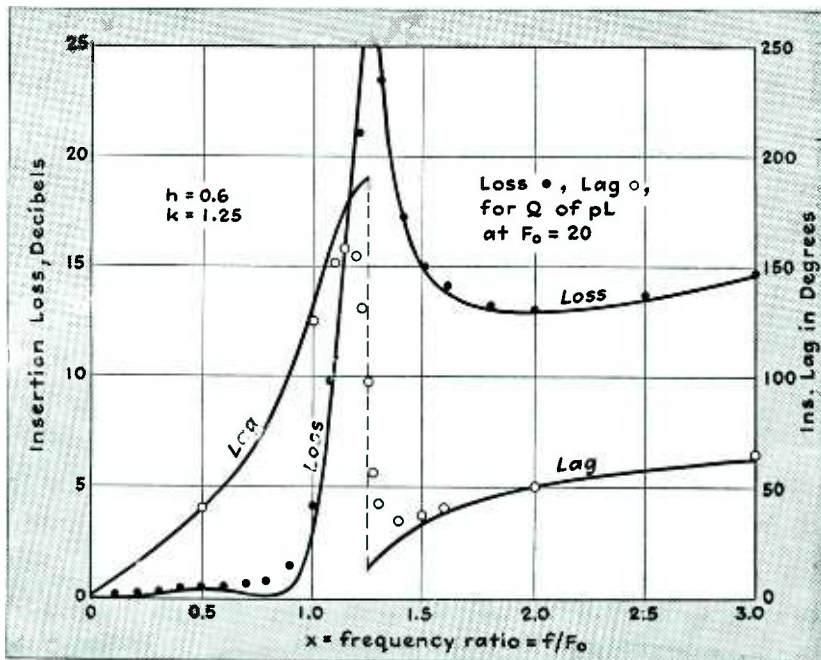
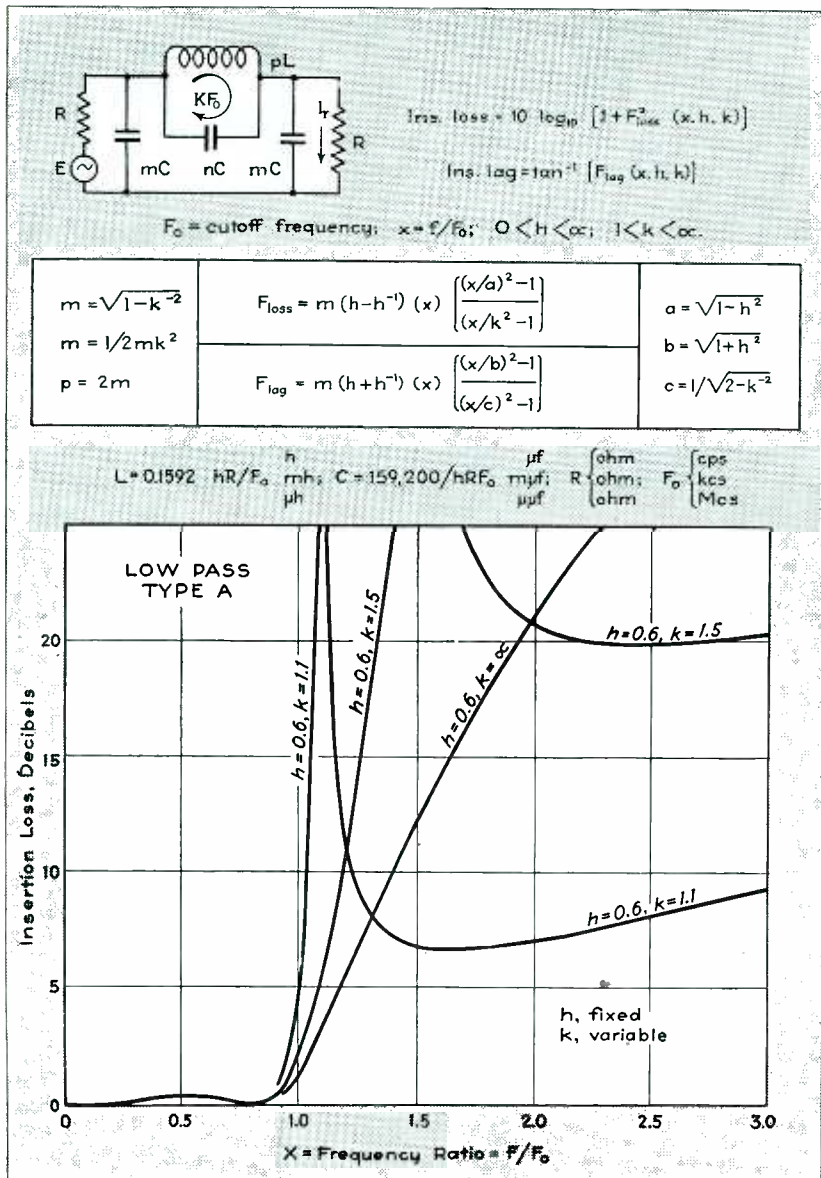

Fig. 5—More detailed data for parameter values $h=0.6$, $k=1.25$

Fig. 6—Characteristics of low-pass filter unit with several values of h



The ratio f/F_0 will be here given the designation x customarily applied to the abscissa in curve plotting.

With a fixed R , and choices of h and F_0 which must be held constant, variations in elements L_1 , C_1 and C_2 are still possible. L_1 and C_1 determine a finite frequency for infinite insertion loss. The ratio of this frequency to F_0 will be termed k , the infinite loss parameter. Changing k requires modification of L_1 , C_1 or of both, and with the requirement that h and F_0 will not be changed, it develops that all three reactor impedances must be altered, but not in a proportionate manner.

In place of the three physical elements L_1 , C_1 and C_2 it becomes necessary, therefore, to deal with three abstract elements F_0 , h and k , to yield performance equations in terms of x , h and k . It must be possible to evaluate the reactors for the specified R , the value desired to represent F_0 corresponding to $x=1$, and the values chosen for the parameters h and k determining and identifying the curve shape to be duplicated.

It works out most advantageously to designate reactor values as functions of R , F_0 , h and k in two steps. Basic values of inductance and capacitance designated L and C are defined as those having numerical impedances hR at F_0 , thereby involving everything except k . The various inductor and capacitor elements in the network are then these basic values multiplied by factors m , n and p , for example, which involve only k . In terms of inductance, element L_1 of Fig. 1A is replaced in Fig. 3 by element pL , for example, but because of the definition of L on an impedance basis, the element is also capable of being assigned an impedance designation $pL = jhRpx$. Similarly for example C_2 can be designated $mC = -jhR/mx$, and $C_1 = -jhR/nx$. Designations here used for basic values of L and C differ from other practices in standard texts, but this seems justifiable because of the greater simplification of results and because of the direct physical significances in terms of impedances. The general equations universally useful for computing basic L and C values, together with the various combinations of units with which they may be used, are

(Continued on page 197)

How to Get A PRIORITY

A priority is a preference rating. A preference rating is the tag on a purchase order which governs the place that order will take in the war economy. It determines the place, both in terms of time and in terms of materials, this order will take among many thousands of orders. The better the rating, the better the treatment, in time and in materials, the order will get. The basic form for a preference rating is Form PD-1A

THIS certificate is used by the War Production Board and by procurement officers of the Army, Navy, and other authorized Government agencies, to assign ratings to orders for specific quantities of material or equipment for a specific purpose. The importance of this certificate is diminishing with the increased scheduling of materials over longer periods of time.

PD-3A, known as the Army-Navy-Government form, is the second of the two individual rating certificates. It is used to assign preference ratings to deliveries under purchase contracts of the Army, Navy and certain government agencies. It is mainly employed by Army and Navy procurement officers in the field. They are authorized to assign ratings on certain direct military contracts and these ratings may be extended. The procurement officers are governed by directives issued by the Army and Navy Munitions Board and approved by WPB. These directives indicate what ratings may be extended on the various types of orders. That is, if a manufacturer has a direct military contract for a completed item (a prime contract) he can go to the procurement officer of the Army or Navy service involved for assistance. This officer can assign a preference rating to the manufacturer's order for materials or parts, if certain routine requirements are met.

The difference between PD-3A and PD-1A is that the former can only be used when there is a clearly defined connection between the need involved and a prime government contract and when the rating is assigned in the field by a procurement

officer. When the work is obviously not going into a prime government contract, then the application for aid should be made to Washington on Form PD-1A.

The first thing to do is to apply to a regional WPB office or the WPB in Washington for an application form to fill out.

Production Requirements Plan

This is a combined preference rating and allocation system. Under it, WPB determines the amount of material available and allots it on the basis of an industry's importance to the war effort. With a few exceptions PRP is mandatory for all concerns using *\$5,000 worth of metal a quarter*. The grade of rating depends on the importance of the product, but the amount of material the manufacturer may obtain with his rating depends also on how much of that material is available. A company operating under PRP is not permitted to use or extend any other form of preference rating for material used in production.

PD-25A is the basic form used under PRP. On this form the manufacturer gives a number of details concerning his business, which are used to determine the preference ratings he will get and the authorization to acquire materials. Instructions accompany the form. PD-25F is used chiefly to apply for interim assistance.

Controlled Materials Plan

Booklets of detailed instructions for filling out the Bills of Materials required by the Controlled Materials Plan will be made available at WPB's field offices.

Prime consumers of controlled materials—aluminum, copper, steel—must submit their requirements for the second quarter of 1943 in the form of bills of materials to the Claimant Agency or Agencies (Army, Navy, Maritime Commission, Civilian Supply, etc.,) from which they will receive their allotments. Secondary consumers must file their bills of materials with their customers who, in turn, are responsible for their accuracy and who will include them in their own bills of materials submitted to the claimant agencies.

For most products, bills of materials will not be required from every producer. No company need prepare a bill of material unless specifically instructed to do so by a claimant agency, a WPB Industry Division, or by another company to which it sells its product and which has been instructed to furnish a bill of material according to WPB officials.

At the present time the Controlled Materials Plan will operate only on the critical materials, aluminum, copper and steel, and, therefore, other materials must be obtained under PRP, which involves priorities, provided the concern uses \$5,000 worth or more of metal a quarter.

CMP is a method designed to see that the right material of the correct quantities get to the correct place at the correct time. This time is determined by officials after having a look at the urgency of certain products, the quantities of materials needed, and the relative order and quantities in which these individual materials must be secured to complete a given project.

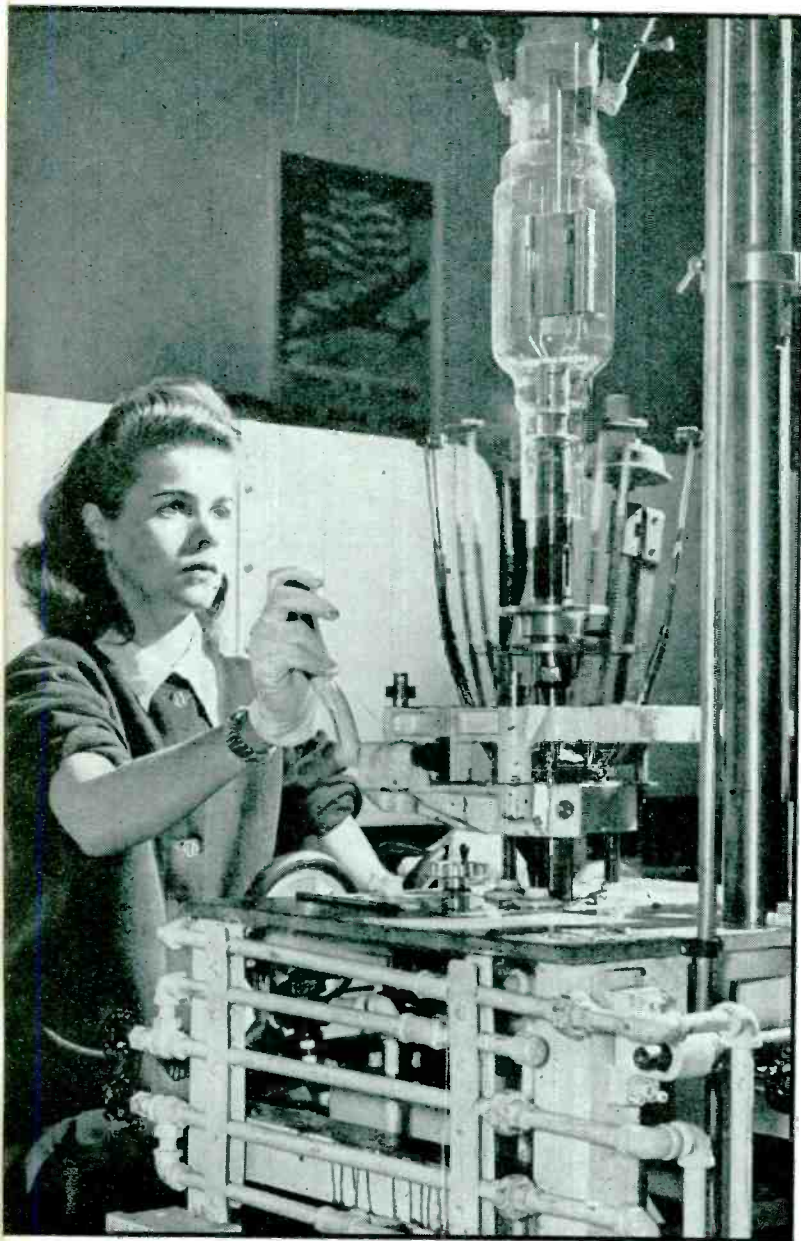

Lavinia Senior seals the end of high power transmitting tube which will ultimately be used by the armed forces



Virginia Potts and daughter Doris Jean constitute an effective production team in an equipment manufacturing plant turning out military communications equipment

WOMEN

WOMEN, for many years important workers on the nation's electronic equipment production lines, are today rendering a vital service to the all-out war effort. Manufacturers who have converted to the limit from male to female help since the initial draft order became effective have found few jobs women can't do well enough, some they can do better.

Women, indeed, are no longer limited in their scope to purely production activities. Many with little or no previous training but with "what it takes" in the way of ability to learn are operating and maintaining

Laura Shumway and Agnes Mack do a fast yet conscientious job assembling radio equipment for war use



Elizabeth LaRocco is an expert inspector of vacuum tubes of vital importance to military communications

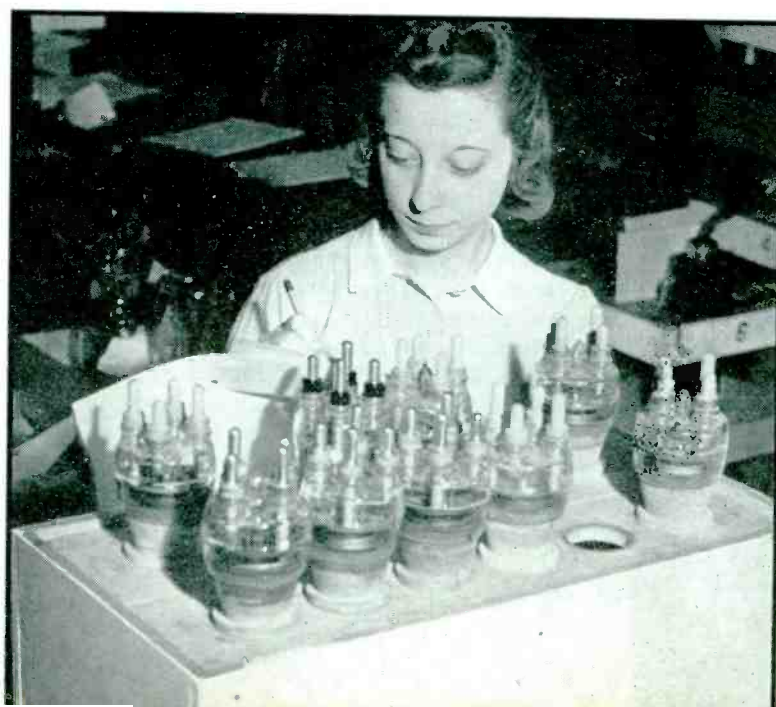

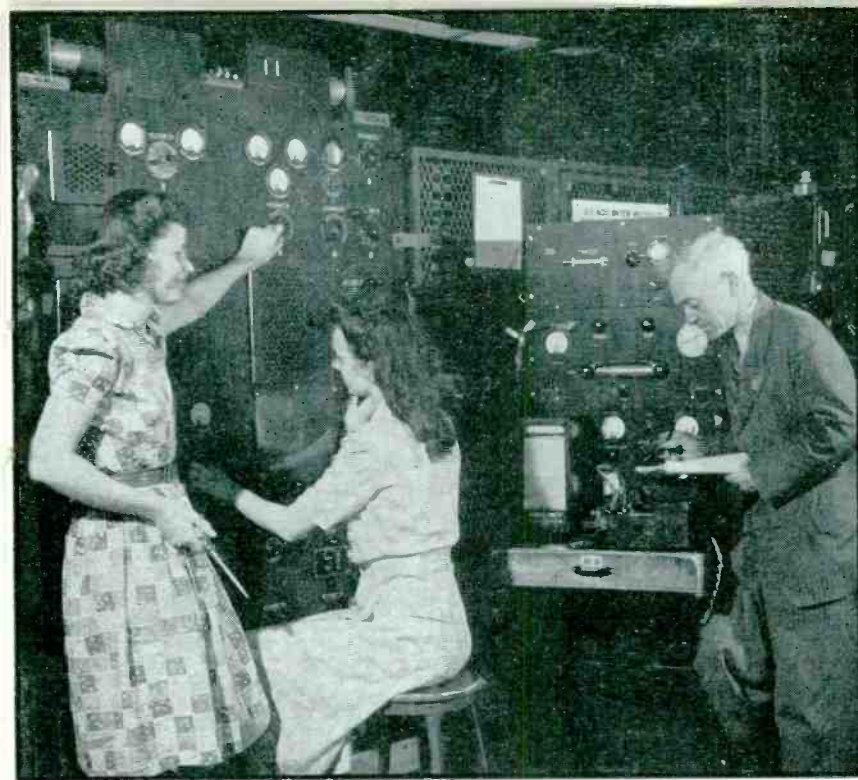

Virginia L. Cassman of Purdue and Josephine Trumbull of N.Y. State College for Teachers learn the fine points of a "heat run" from Navyman R. C. Gray

at WORK

electronic equipment. Some, with academic training in physics, electrical or communication engineering, are moving into laboratories and helping their country win the war by solving problems of research and design.

Women in several branches of the art requiring technical "savvy" and skill are pictured here. To them, war work in the electronic equipment plants of America represents more than a job. It represents a patriotic duty. Photos by *Westinghouse* and *General Electric*.

Billie Evelyn Brooker of Iowa State College calibrates a transmitter which will soon see service in the field

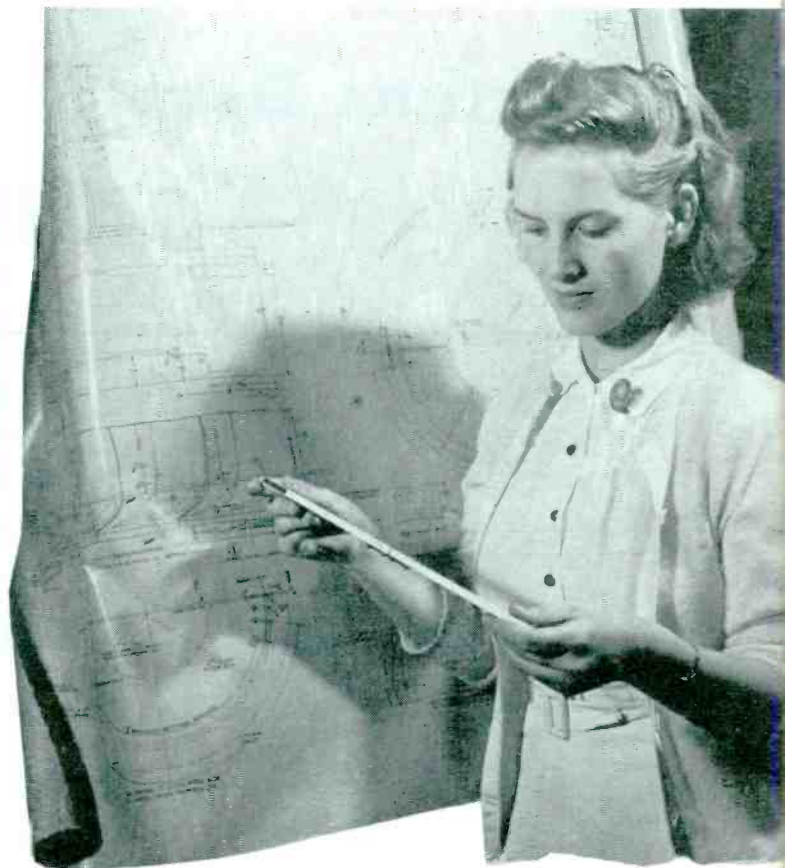
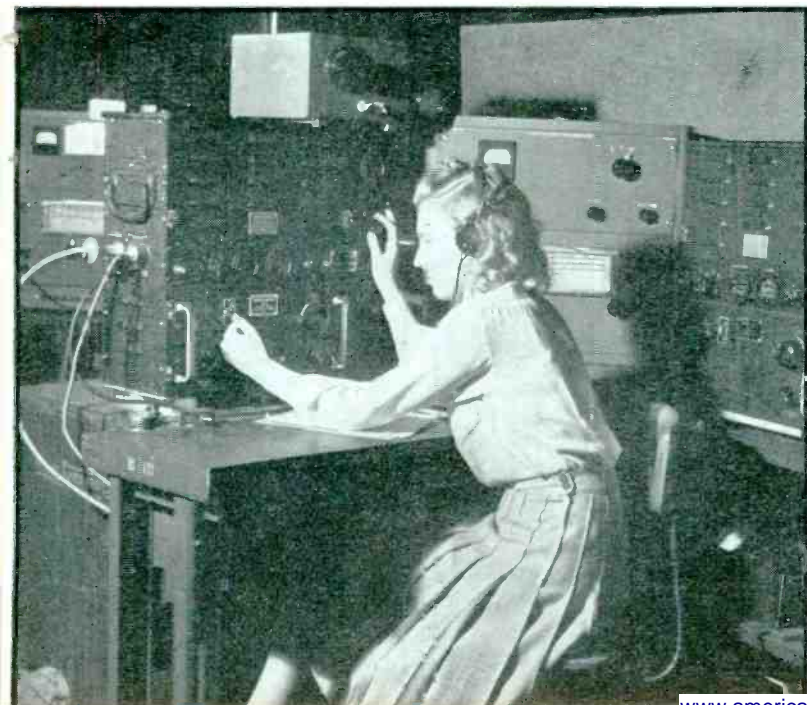

Mary Ellen McClurkin of the University of Colorado works a slip-stick on an engineering job in an eastern plant

Mary Iatesta and Winnie Ferguson check temperature while exhausting transmitting tubes destined for the armed services



Wartime Developments in CARRIER CURRENT

Broadcast frequency signals guided over power lines are attenuated to a greater degree than conventional low frequency transmissions. This disadvantage is counterbalanced by the fact that readily obtainable broadcast tuners are easily adapted to reception of such signals. Four systems of distribution, and coupling considerations, are discussed

FIRST APPLICATIONS of the principle of carrier current transmission date back to the early 1880's, when a method of multiplexing telephone and telegraph lines was attempted. Associated with this study are the names of Gray, Bell, Mercadier, and Edison.

In early work the mechanical resonance of tuned reed instruments was used to generate and select a limited range of carrier frequencies. The next major advance occurred around 1890, when the selection of carrier frequencies by electrical resonance was discovered independently by Leblanc,¹ Pupin, Stone, and Hutin.²

With the advent of wireless telegraphy at the turn of the century, further study of carrier current communication was temporarily neglected. It was not until 1914 that the first commercial carrier current systems were put into service as an auxiliary to existing telephone lines. In the early 1920's³ another application was developed, whereby carrier current transmission was employed for the remote switching of loads at substations as well as for direct communication over power mains. Transmissions of this nature were mainly on a point-to-point basis because of technical and legal limitations. Frequencies selected were below 200 kc. Subsequent development of transmission methods on the low frequency portion of the radio spectrum have been carried out primarily by the telephone and power utilities.⁴

Standard Broadcast Frequencies

It was not until 1937 that successful transmission on standard broad-

By **GEORGE ABRAHAM***

Naval Research Laboratory

cast frequencies via power distribution systems was put into operation at several northeastern colleges. This method of broadcasting is now commonly known as "wired-radio."

Recently, in addition to the many college stations transmitting by wired-radio, there have been other significant outgrowths of carrier current broadcasts on power grids. Carrier current transmission has, for example, been applied to civilian defense. Then, in July, 1942 the War Department took over supervision of the installation and operation of carrier current systems in Army camps. Previously, such installations had been directed by the USO.⁵

Present Army systems are similar technically to the wired-radio stations in colleges. Transmission is on the broadcast band, over 13,000, 4,000, or 2,300 volt, three-phase primaries. Distribution to the listeners is via standard low voltage secondaries. Transmitter output power is of the order of 20 watts. The territory covered is generally several square miles in area.

OC D Tests

The Office of Civilian Defense, in making a survey of the communication systems best qualified to satisfy its requirements, commended the use of broadcast band carrier current

systems in a recent paper.⁶ In the tests described, signals were coupled separately into both overhead and underground 4,000 volt primaries at a frequency of 720 kc, using a 25-watt transmitter modulated at 1,000 cps. Standard broadcast receivers were used for reception. While attenuation by pole type transformers was noted to be substantially greater on broadcast band frequencies than on frequencies below 200 kc it was pointed out that transmissions on frequencies below 200 kc have the disadvantage of requiring special receivers.

A series of tests has also been conducted with the cooperation of the FCC, the OCD and the War Department to ascertain the propagation and radiation characteristics of carrier current radio as a function of frequency, power, coupling, and types of lines.

Transmission Systems

Before the design of a broadcast band carrier current transmission system for a given locality is evolved the physical and electrical aspects of the terrain to be covered should be considered. From past experience it has been found that no one system can be depended upon to perform equally in several different locations.

Four general types of transmission systems for wired-radio are:

- (a) Transmitter coupled to high voltage feeders. Distribution to receivers over 220/110 v. secondaries. (Used in Army camps and on many college campuses.)
- (b) Broadcast over coaxial or parallel wire lines through underground tunnels or conduits in the broadcast area. Lines are terminated locally to steel buildings which serve as an r-f dissipative system or to distribution secondaries. (Used at Brown and Harvard Universities.)

* Formerly at Cruft Laboratory, Harvard University.

COMMUNICATION

A variation of this method was suggested in a paper by Borst⁷, whereby audio and an unmodulated r-f carrier are sent over transmission lines to remote r-f amplifiers which are modulated by the audio signals. Radio frequency driving power for all r-f amplifiers is supplied by one master oscillator, so that all remote amplifiers operate on the same frequency. This eliminates danger of interaction due to heterodyning.

- (c) Audio transmission over telephone wire loops to small transmitters located in the areas to be covered. (Used at Cornell University.)
- (d) Transmission over three-phase primary feeders, on frequencies below 200 kc, to small converter-transmitter units which distribute locally on the broadcast band over low voltage secondaries. (Proposed for use in large Army camps.)

Coupling Considerations

Coupling to and from the transmission system may be accomplished in several ways. Variations of link coupled and tuned L/C matching sections from transmitter to polyphase feeders have been found quite satisfactory.

Due to varying power factors and power system loads, a low-Q coupling network is desirable. Therefore, a compromise between sharpness of resonance and high efficiency of power transfer should be made at the outset. The latter consideration is secondary, as high power is both unnecessary and undesirable in carrier current communication.

Radio frequency power may be fed either in phase or out of phase to the feeders of a polyphase grid. Radiation is less when equiphased coupling systems are used. If the power mains are located under ground most of the space radiation will be eliminated by capacitive shielding of the earth. If r-f power is coupled to underground feeders out of phase a higher field strength along the conductors will be obtained with little or no resulting radiation. For overhead transmission the radiation will be a function of frequency as well as power.

Pole type transformers act essentially as low pass filters to carrier current communication. At the

higher frequencies, above the effective pass band, such transformers may be by-passed capacitively, by induction, or by saturation.

Reception over a properly designed wired-radio system is best in the induction field of all r-f conductors comprising the system.

F-M Applications

Though AM has been used almost without exception in carrier current work to date, F-M transmission has possibilities. Such communication has been attempted at low frequencies and has been described in a recent article.⁸ Though F-M transmission over wire lines is less affected by electrical disturbances than A-M, a greater bandwidth is required. Because of this and due to the lack of available frequencies, the development of F-M carrier current communication has so far been confined to commercial two-way transmission.

There is, however, another application of F-M to the field of carrier current communication; the re-broadcast of F-M over A-M wired radio systems. This may be accomplished with little loss of fidelity. Recently, by arrangement between the Intercollegiate Broadcasting System and an F-M network covering the northeastern states, various member stations of IBS installed F-M translators and have since been regularly rebroadcasting programs from F-M radio stations by carrier current transmission. Accordingly, F-M coverage which would have otherwise remained constant for the duration due to curtailment of receiver production may in this way be considerably extended.

Post-War Possibilities

As evidenced by the use of wired-radio by college stations during the past six years and by departments

of the government more recently, one of its most successful applications has been as a medium for community coverage and interest. Some sections of the country are not in the primary areas of any long-wave stations. Wired-radio, because of its low expense and simplicity of operation, might easily satisfy the needs of many communities so situated. Upward of 40 stations could operate simultaneously on the broadcast band alone in any given locality, without interaction with similar systems nearby.

It has already been demonstrated that wired-radio is well adapted to network operation.

In addition to use on standard broadcast frequencies, carrier-current transmission on frequencies below 200 kc could provide communication for municipal services such as fire and police departments.

Eckersley, in several recent articles⁹, has advanced plans for a post-war system of distribution using low frequency carrier current broadcasts over power mains, with

(Continued on page 187)

In The Army Now

WAR DEPARTMENT personnel has taken over the operation of carrier current communication systems originally installed in several Army camps by the USO. Other training centers are to be similarly equipped

CIVILIAN DEFENSE units in a number of key cities are successfully using "wired-radio." Thus carrier current equipment is playing an important double role in the nation's war effort

Servicing RESISTANCE

Cathode-ray oscilloscopes are ideal tools with which to check the operation of timers and other associated industrial electronic gear. Plant maintenance men can learn to use them by studying instructions furnished with such instruments, data presented here and typical control circuits included in the series which this paper concludes

By **BARTON L. WELLER**

*Electronics Section
Industrial Control Eng. Dept.
General Electric Co.
Schenectady*

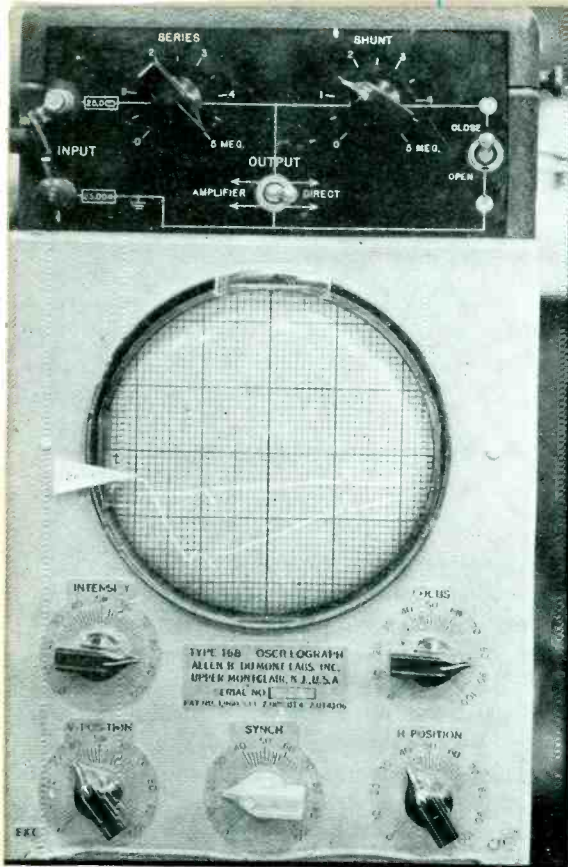
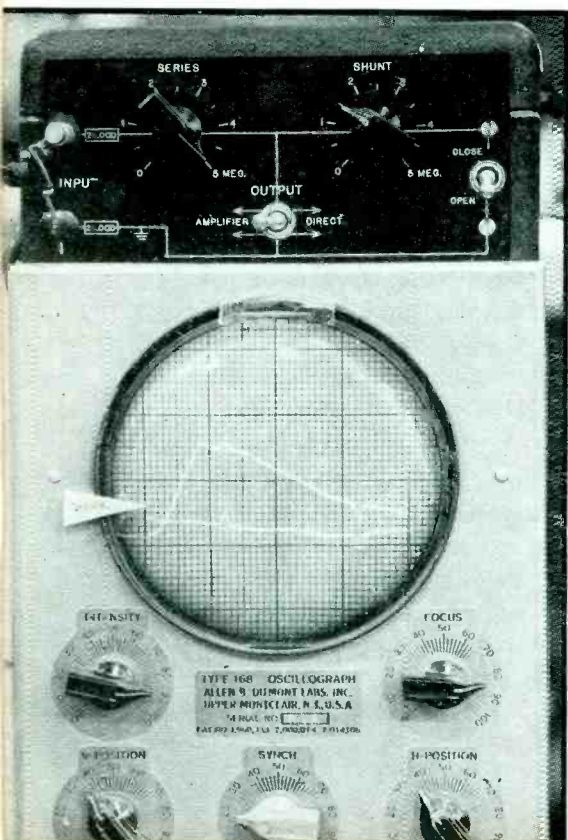

Fig. 1A—Trace showing normal "off" time bias on a typical electronic welding control inverter tube. In this instance, input voltage was correctly applied directly to the vertical deflecting plates of the oscilloscope's cathode-ray tube to accurately picture both a-c and d-c bias components

Fig. 1B—The trace on the screen of the cathode-ray tube in this instance is useful only for determining variation of the "off" time a-c bias. D-c bias component is inaccurately illustrated because, for purposes of illustration, the input voltage was incorrectly applied through the instrument's a-c amplifier



THE WIDESPREAD USE of resistance welding, stimulated by the present production emergency, has largely been made possible by the development of electronic welding controls. The number of industrial plants installing such controls is now increasing at such a rapid rate that it is not always possible for suppliers to render maintenance service with the speed required by urgent manufacturing schedules. Users, therefore, are finding it desirable to supplement the service provided by suppliers by doing some of their own maintenance work.

A knowledge of how electronic welding controls function is, obviously, a prerequisite for intelligent servicing. Discussions of control circuits contained in the series of articles which this paper concludes provide much of the necessary background. Our concern here is the adaptation of the *cathode-ray oscilloscope* to the servicing job. Men who have "lived with" electronic welding controls since their inception consider this instrument virtually indispensable as a maintenance tool.

Visual Curve Tracer

The cathode-ray oscilloscope has proven to be a most useful tool for studying electrical voltages. The radio industry particularly has made available for general use many different types, at prices comparable

to those asked for good indicating voltmeters or ammeters. The majority can be adjusted readily enough to allow even technicians not fully conversant with their theory of operation to use them after studying elemental instruction books.

The heart of the instrument is a cathode-ray tube which is capable of graphically showing on its fluorescent screen the voltages of the circuit to which the instrument is connected. The tube is equipped with electronic circuits which make possible numerous modes of operation, the most common of which is the picturing of variation of voltage with time. Voltages to be viewed are applied to the vertical deflecting plates of the tube so that the amount of vertical cathode-ray or "beam" deflection is proportional to the voltage applied. Horizontal sweep circuits in the oscilloscope produce a time axis of any desired length and allow recurrent phenomena to be seen as stationary images.

When used for servicing electrical equipment the oscilloscope has outstanding advantages. It is invaluable for many applications because it takes only a minute amount of input power to produce full deflection. It can, therefore, be introduced into high impedance circuits without upsetting their operation. Since the cathode-ray does not have inertia, as does a voltmeter, the reading is not distorted by time lag. The device can also take large over-voltage

WELDING CONTROLS... Part 6

for extended lengths of time without harm. Actually, the voltage limitation lies almost entirely in the insulation of the oscilloscope circuits and not in excessive deflection of the beam which produces the graphical trace.

Modifications in General

Oscilloscopes which are primarily made for radio servicing do lack some features which are required for thorough investigation of industrial electronic circuits. The most prominent of these deficiencies are:

- (A) Usually, such oscilloscopes indicate a-c voltages only and do not correctly show d-c components.
- (B) Often the time axis of the oscilloscope (horizontal sweep) cannot be conveniently fixed with respect to the frequency of voltages being observed.
- (C) Electrical insulation is not, in general, up to the standards normally recommended for the voltages which must be applied to the instrument.
- (D) The horizontal sweep frequency cannot always be reduced to a point low enough for the operator to observe more than two cycles.

Relatively simple modifications of oscilloscopes available for general use can overcome these limitations. Those who have used oscilloscopes for servicing electronic welding controls have found it desirable to:

- (1) Modify the oscilloscope so that input voltages can be impressed directly on the vertical deflecting plates, bypassing vertical amplifiers which are sensitive only to a-c.
- (2) Add an input voltage divider to allow a reduction of oscilloscope sensitivity and to increase input resistance so that high impedance grid circuits will not be loaded.
- (3) Add 60-cycle synchronization so that the horizontal sweep frequency can be definitely associated with the frequency of the voltages being studied.
- (4) Insulate the oscilloscope to safeguard the operator from possible contact with the metal case and prevent high short-circuit currents from flowing

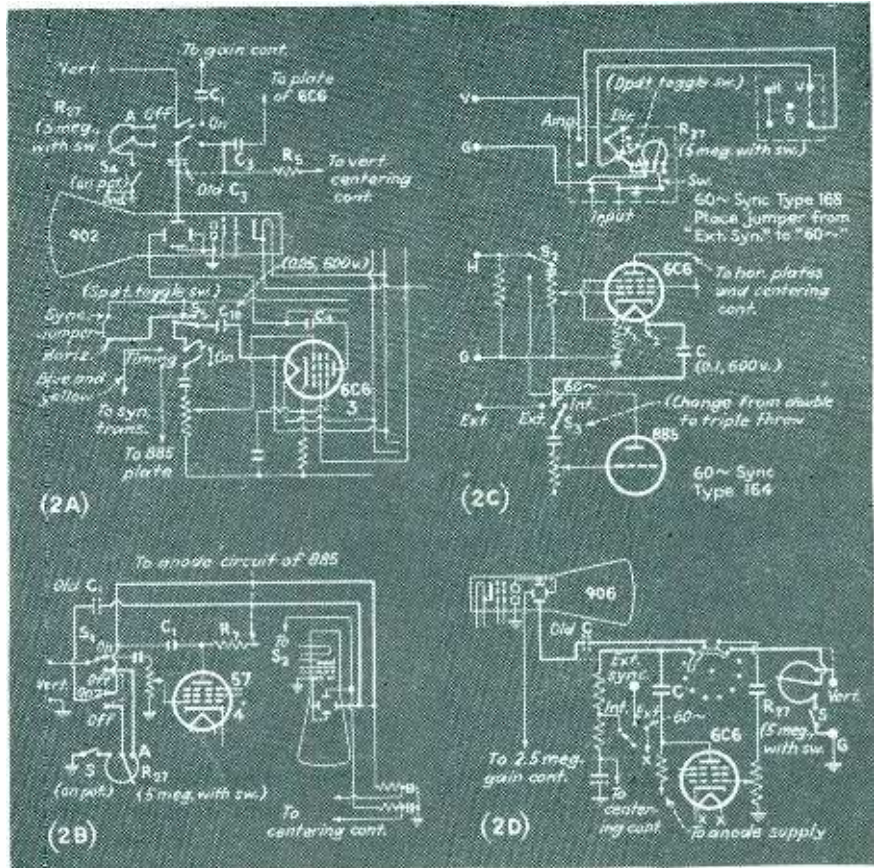

Fig. 2—Oscilloscope circuit modifications suggested for electronic welding control maintenance work. Heavy lines show new connections, light lines show original connections. (2A) RCA types 151, 151A and 151-2. (2B) RCA types TMV-122B and D. (2C) DuMont types 164 and 168. (2D) G.E. type OFM-3

if insulation breakdown occurs.

- (5) Decrease the horizontal sweep frequency so that approximately six cycles can be observed at one time.

The importance of the first feature cannot be overemphasized. Since electronic welding controls usually utilize d-c, sine wave and peaked voltages in various combinations, the waveforms shown by an oscilloscope which does not accurately indicate all of these components will be misleading. Figures 1A and 1B show the difference between traces appearing on the screen of an oscilloscope sensitive to all components will be misleading. Figures 1A and 1B show the difference between traces appearing on the screen of an oscilloscope sensitive to all

components (1A) and one insensitive (1B) to d.c. (In this case, the voltage on the vertical plates of the cathode-ray tubes is the sum of a slowly changing timing voltage and a peaked wave.) It can be seen that the oscilloscope affected only by voltage variation (Fig. 1B) produces a waveform symmetrical about the zero axis even though it may be actually displaced from zero by some constant amount. There is an inversion in Fig. 1B, since the amplifier within the instrument creates a voltage reversal.

Since the usual commercial oscilloscope has a sensitivity of 20 to 30 v per inch, an easily adjustable input voltage divider is a most useful addition so that potentials up to 600 v can be observed. For the ma-

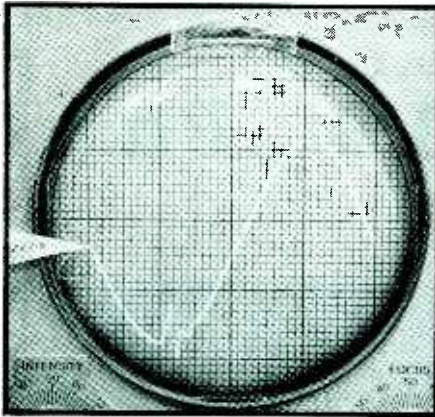

Fig. 3—Firing tube grid voltage when not firing. Self-bias not shown

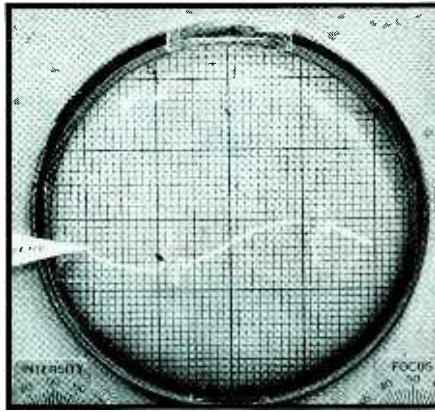

Fig. 4—Firing tube grid voltage while firing. Self-bias not shown

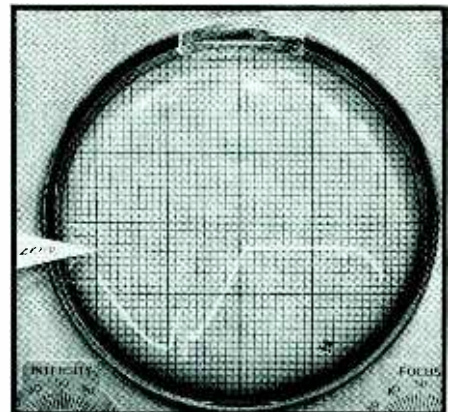

Fig. 5—Firing tube grid voltage when not firing

majority of applications it has been found that a five-megohm potentiometer can be connected to make a convenient variable voltage divider. When used in its low sensitivity position, such a divider places high resistance in series with the oscilloscope leads, thereby insuring a high input impedance and low drain on the circuit being studied. Attenuation of sharp peaked voltages is also minimized. A switch mounted on the potentiometer can be arranged so that when the divider is turned to its maximum sensitivity position the potentiometer is cut out of the circuit and the input voltage is fed directly to the deflecting plates.

Large oscilloscopes frequently incorporate 60 cps synchronization. By turning the synchronization switch to this position the horizontal sweep can be fixed with respect to the 60 cps line frequency. When so adjusted the phase relationship between input voltage and line frequency will always be shown. On those oscilloscopes which are not so equipped a slight addition can easily be made to give 60-cps synchronization.

Since the personal safety of operators using instruments is important, it is necessary to remember that the metal cases of the majority of oscilloscopes made for radio servicing are connected to one of the input leads. When the oscilloscope, therefore, is connected to a power circuit, its case is at the potential of that circuit and can cause severe shocks to one touching it. Experience has shown that operators can be taught to use caution under these circumstances; however, to minimize this hazard one may insulate

this instrument with a wood, plastic, or leather case. It is also advisable, in general, to provide long-handled insulated clip-leads so that it will be unnecessary for an operator to get his hands too close to live parts in welding controls. It should also be remembered that oscilloscopes used for industrial servicing are often connected to lines of relatively high power capacity. When short circuits occur within an instrument, it is possible for arcs of explosive violence to be created. To minimize this hazard, a one-watt, 25,000-ohm resistor can be installed in series with each oscilloscope lead.

In most instruments which do not provide a low enough sweep frequency (10 cps) an additional capacitor can be placed in shunt with the capacitor which is used on the lowest position of the frequency range switch. By trial, this capacitor can be selected to give almost any desired sweep frequency.

Specific CRO Changes

Figures 2A, 2B, 2C and 2D show circuit changes required for adap-

tation of typical oscilloscopes to electronic welding control work. Heavy lines show connections added and dashed lines show connections removed. Circuit elements are shown in the same relative positions as in diagrams provided by the manufacturers of the oscilloscopes. Added controls are usually mounted where they can be conveniently manipulated, on the front panel of the instrument if there is room, or above the instrument as in Figs. 1A and 1B. Modifications involve:

RCA 151, 151A; 151-2 (Fig. 2A)

- (a) Re-locating capacitor C_4 so that the vertical amplifier switch puts the input leads directly on the vertical deflecting plates.
- (b) Re-connecting the vertical centering control so that it is out of the circuit when the oscilloscope is used to check d.c. This change eliminates the shunting effects of the centering control, thereby increasing the input impedance of the instrument.
- (c) Adding divider potentiometer R_{27} , with its accompanying switch S_4 . When R_{27} is rotated to A, S_4 opens, removes the divider from the circuit and puts the input voltage directly on the deflecting plates.
- (d) Introducing switch S_5 and capacitor C_{18} to provide 60-cps synchronization. The heater voltage from the 6C6 is fed into the synchronization transformer when S_5 is as shown. If S_5 is in the upper position and the jumper between terminals "sync" and "horiz" is in place, the horizontal sweep is synchronized with the input to the vertical plates.

RCA Types TMV-122B and D (Fig. 2B)

The same changes are made to obtain d-c operation as on the 151 type of oscilloscope.

PUBLISHED in Electronics 1942

Spot Welding Controls
(August, page 36)

Seam and Pulsation Welding
(September, page 55)

Special Welding Controls
(October, page 62)

Timers for Welding Control
(November, page 65)

Energy Storage Welding
(December, page 63)

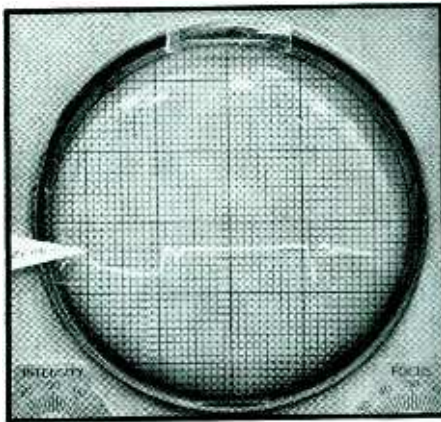

Fig. 6—Firing tube grid voltage while firing

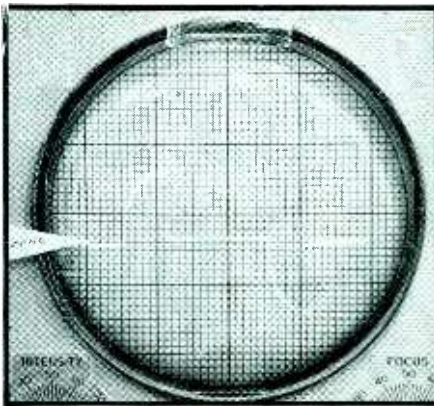

Fig. 7—Voltage on power tubes while firing

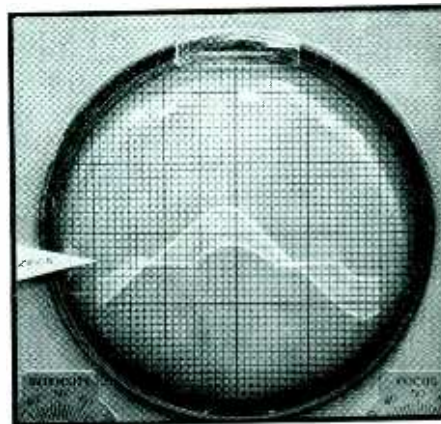

Fig. 8—Welding current as heat control is varied

These oscilloscopes contain 60-cps synchronization circuits, so that no further modification is required.

Du Mont Types 164, 168 (Fig. 2C)

- (a) These oscilloscopes have terminals on the back of the case that allow connection directly to the deflecting plates. The addition shown provides a convenient way to switch from d-c to a-c operation. R_{T1} is again used as a voltage divider and is usable for either a-c or d-c indication. (See also Figs. 1A and 1B.)
- (b) Type 168 oscilloscope already has 60-cps synchronization.
- (c) Add 60-cps synchronization to Type 164 by replacing S_2 with a three-pole switch and adding capacitor C to feed the heater voltage of the 6C6 into the grid circuit of the 885 sweep oscillator.

G.E. Model OFM-3 (Fig. 2D)

- (a) In this oscilloscope, as in the others, the blocking capacitor C must be relocated so that it is out of the circuit when the vertical amplifier switch is in the "off" position, as shown. The voltage divider added at the vertical terminals is usable for either position of the vertical amplifier switch.
- (b) This oscilloscope contains 60-cps synchronization, as manufactured.

These diagrams show examples of how standard oscilloscopes can be altered. Many others can be changed in a similar manner. It should be noted that all of the oscilloscopes thus changed have their vertical deflecting plates at ground potential. This allows input leads which are also at ground to be connected directly to the deflecting plates. Some instruments now available have their deflecting plates at a potential other than ground, thereby requiring ma-

ior circuit changes to allow input directly to the deflecting plates. Standard oscilloscopes can thus be given characteristics necessary for studying welding controls. The only features that cannot be obtained when the input is switched to d-c operation are internal synchronization and vertical centering. Experience has shown that the loss of these qualities is overshadowed by the advantages gained from d-c indication.

Oscilloscope Calibration

The most important properties of an oscilloscope used for studying electronic resistance welding control are its ability to show the magnitude and variation of voltage with time as well as the phase relationships between voltages. Since an oscilloscope of the type described is not direct-indicating, as is a voltmeter, it is necessary that it be calibrated before use. This process requires, first, the establishing of a known horizontal sweep so that images on the screen always appear in correct time relationship, and second, determination of the voltage necessary to make the beam deflect a given distance.

To make these adjustments, assuming that the control to be checked and the oscilloscope operate from a 60-cycle line, connect the oscilloscope leads to a known reference voltage. (This may be the voltage of the "leading" firing or timing tube of the electronic welding control itself, provided the control is known to be operating properly at the time the oscilloscope is calibrated.) Set the 60-cycle oscilloscope synchronization switch in the "on" position, with the synchronization

knob at the full counter-clockwise position. Adjust the oscilloscope range and frequency dials as outlined in the instruction book until the desired image, usually a symmetrical wave of one or more cycles, as shown in Fig. 3, appears on the screen. When the image stands still for observation, advance the synchronization control slightly to lock the image in a fixed position. If this knob is advanced too far, distortion in the waveform will be produced.

With the beam synchronized, one can easily calibrate the deflection where a known voltage is applied to the input leads. For example, the a-c wave in Fig. 3 is 300 volts rms. The crest voltage is 420, therefore the sensitivity of the instrument is about 30 volts per division of the cathode-ray tube screen. This calibration will be maintained as long as the input divider remains fixed and the sweep frequency is not changed.

Typical Traces

A cathode-ray oscilloscope is primarily an indicator of circuit voltages. To diagnose trouble it is necessary that one using the instrument know what voltage should exist if the circuit is functioning correctly. To establish such a background cathode-ray oscilloscope traces produced by a few typical voltages will be presented pictorially. (All photographs were made using an oscilloscope modified as in Fig. 2C, with R_{T1} replaced by two potentiometers. All pictures were taken with one setting of the horizontal sweep circuit, so that the phase relationships between the different voltages could be studied. The sensi-

(Continued on page 200)

RADIO SOUNDING in the United States

Balloon-borne radio transmitters daily explore meteorological conditions over the earth as part of the means of predicting the weather. This paper is a review of this art and science, describing the equipment and methods utilized

By **C. B. PEAR, Jr.**

*Director of Research
Washington Institute of Technology
Washington, D. C.*

IT has been said that war serves to stimulate human progress in scientific matters, and in the case of meteorology this has been especially true. Two developments came out of the last World War that together have served to bring about a minor revolution among weather forecasters.

The first of these came about because wartime restrictions forced Norwegian meteorologists to seek a better approach to weather forecasting in order to protect the fleets of small fishing boats operating along their coast. The result of this search was the development of what is known as "air mass analysis," which differs from the previous methods of analysis principally in that it regards weather as a three dimensional phenomenon rather than as essentially two dimensional. That is, weather phenomena are thought of

as being caused by the movements of large, more or less homogeneous masses of air, whose properties depend on where they came from. Thus, air coming from Northern Canada is cold and dry, while that which has been over the Gulf of Mexico is relatively warm and moist. To know the location of these air masses and to trace their activity, meteorologists needed some means of measuring the properties of the air above the earth. The necessary information were temperature, pressure, moisture-content, wind velocity, and wind direction, all as functions of height, which can be computed from the first three.

The second development which came out of the last war made it possible to obtain at least part of

that information. The above mentioned properties of the air overhead are also of primary importance in firing large guns, for the projectile passes through layers of air having varying densities and motions. In trying to supply their artillery with this data, the Signal Corps of the U. S. Army attempted to follow the course of a balloon-borne radio transmitter with a direction-finder. The method showed promise, and later work led to the addition of devices to transmit measurements of temperature, pressure and relative humidity.

Radio-Sounding Equipment

In the years that followed, many workers in Europe and the United States brought forth a great variety of instruments for radio sounding; from these, there have evolved three principal types.

Photos of clear plastic radiosonde model. Left, pressure switch is at lower right. Above it are the battery and transmitter in an insulated compartment. The hair hygrometer and temperature tube are in the funnel-shaped space at the left. Center, model of radiosonde showing internal components. Production instruments have a metal foil covered corrugated paper housing. Right, end view showing temperature sensitive resistor and hair hygrometer

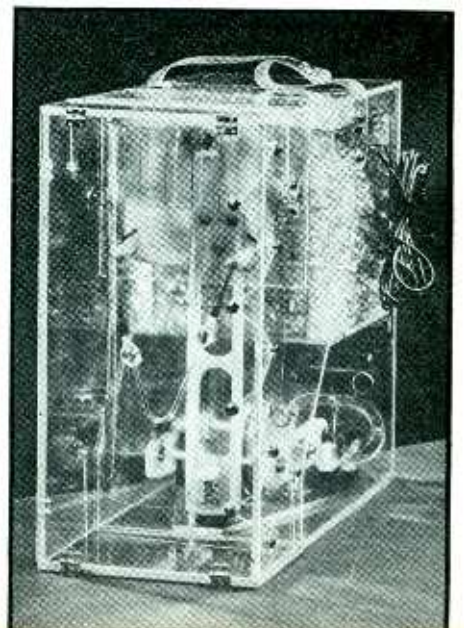
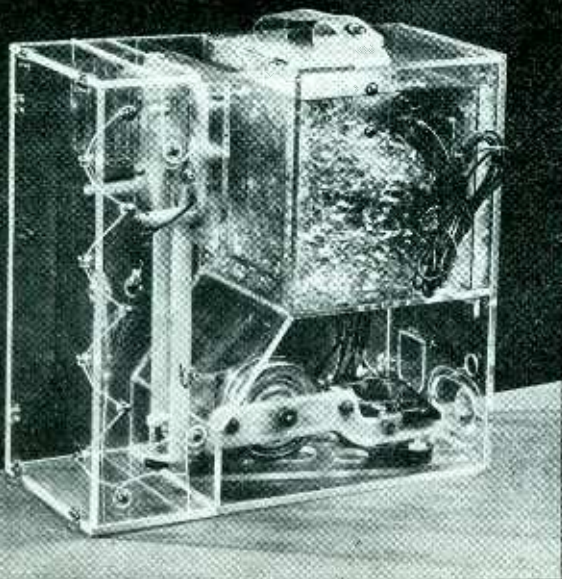

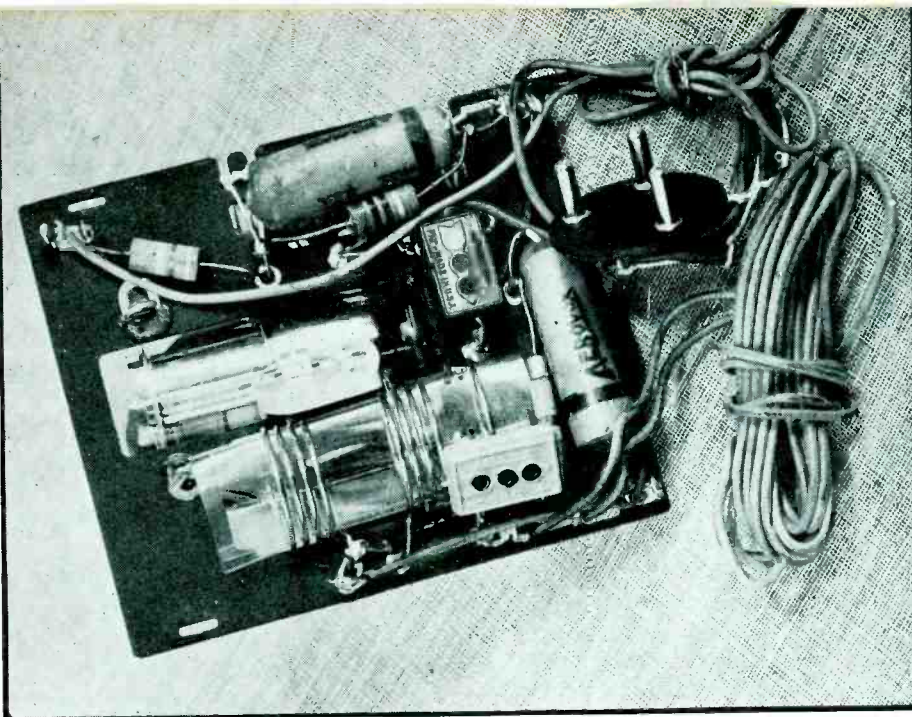

The transmitter. The carrier frequency is 72.2Mc, and the power output about 150 milliwatts

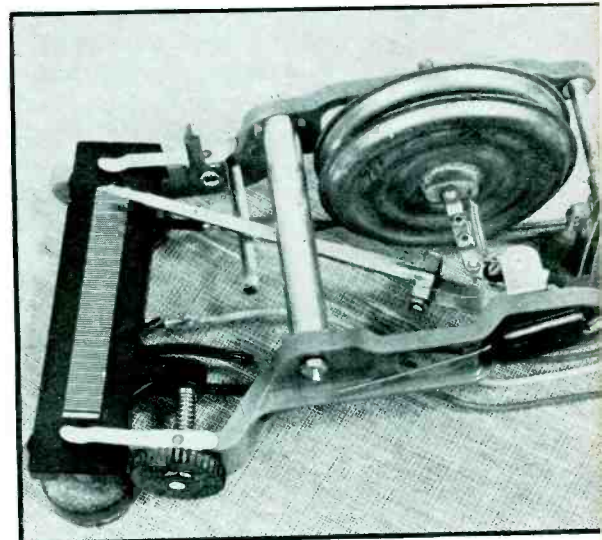

The pressure switch. This connects the transmitter to the temperature tube when the contact rests on an insulator between silver segments; to the humidity potentiometer when the contact is on one of the thin silver segments, or to fixed reference resistors when contact is made with a thick segment

First: The type including those instruments which transmit only a carrier on a single frequency and depend on the arrangement, or timing, of signals to convey their observations. The best known is the chronometric or Olland type, in which the measurements are converted into time intervals between successive signals and their accuracy and reliability depend upon the clock or motor that drives the switching mechanism. This type requires but a single tube of low power and transmits for a very small part of the time. For this reason the battery drain is low. The disadvantages are economic; the clock and other moving parts must be well made to stand shipment and yet remain operative and accurate and each instrument must be individually calibrated for temperature, pressure, and humidity. In general, the problem of con-

structing, at low cost, a delicate mechanical device to operate successfully in the temperature range from +90 deg. F to -95 deg. F is not an easy one.

Second: Those, in which the carrier oscillator frequency is changed by changes in the measured elements. These are simple and highly successful, but require a rather broad band of clear frequencies for their operation and for this reason are not permitted in this country.

Third: Those in which the carrier is modulated at an audible frequency and this frequency is changed by the changes in the measured elements. This is not so simple, calling for an additional tube in the transmitter and complicated receiving equipment, since the frequency of the modulation must be measured quite accurately. A rather high signal level is required to operate the frequency meter and consequently considerable battery power is required for the transmitter. However, one model of this type, developed at the National Bureau of Standards for the U. S. Navy by Harry Diamond, W. S. Hinman, Jr., F. W. Dunmore, and associates, has so many novel and desirable features that it is the one most widely accepted today, and is the one used by the U. S. Weather Bureau.

A brief description of this model follows. Its basic principle is the conversion of temperature and humidity measurements into resistances which determine the frequency of a relaxation oscillator, which in turn modulates the carrier.

The change from temperature resistor to humidity resistor is effected by a switch operated by an aneroid bellows. Each instrument is individually calibrated so that the pressures at which each change takes place are accurately known. As the balloon rises, the pressure decreases, the bellows expand, and a series of alternate temperature and humidity readings are transmitted. Fixed resistors are substituted for every fifth humidity reading so that the frequencies transmitted when these are connected show any change that may be taking place in the characteristic of the modulating oscillator due to diminishing battery voltages or to temperature effects on the transmitter components. By careful design, these effects can be made nearly zero.

For temperature measurements, an entirely new device known as the electrolytic resistor was developed. This is a very fine bore glass tube filled with an electrolyte of hydrochloric acid and alcohol, with a small amount of cuprous chloride. The resistance of this device changes rapidly with temperature; moreover, the slope of the curve of resistance as a function of temperature depends only on the composition of the electrolyte. Hence, it is not necessary to

Temperature tube and hair hygrometer. The radiation shield has been removed. The outer box is covered with metal foil to reduce solar heating

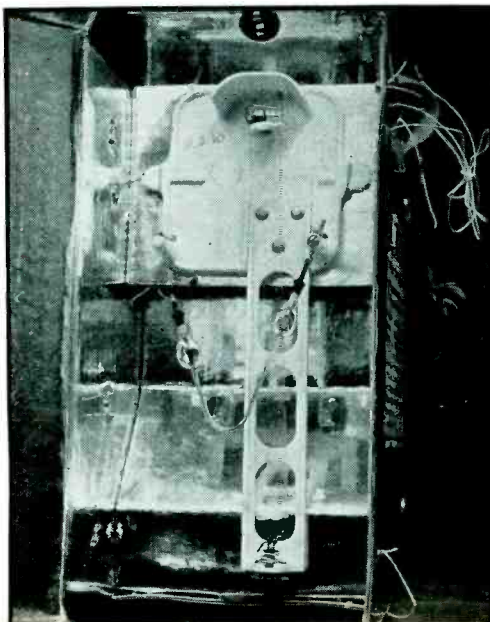

calibrate each resistor separately, an enormous advantage in keeping down the cost of production.

Two methods of converting humidities into resistance are applicable. To date, the most widely used is the well known human hair hygrometer arranged to operate a potentiometer. The principal objection to this is, of course, the slow response of the hair to changes in humidity, especially at low temperature. The indicated humidity does start to change as soon as the instrument passes into air of different humidity, and will arrive at the correct value if the layer is thick enough. It is possible to carry the later reading back to the point where the change began, to correct for the slow response.

The other is an electrical device developed by F. W. Dunmore at the National Bureau of Standards. This consists of two palladium wires wound parallel to each other and

coated with lithium chloride solution. It is necessary to include a small relay in the radiosonde as the resistance variation covers the same range as that of the temperature resistor. The resistance of the device is a function of temperature as well as of humidity, so that a three dimensional chart must be used in evaluating. Its advantages are that it has a very rapid response to changes in humidity, even at low temperatures; it involves no moving parts, and the units can be made sufficiently uniform so that individual calibrations are not required.

Thus, an instrument having an electrical hygrometer requires only one individual calibration; that for pressure, and those having the hair hygrometer require two: for pressure and for relative humidity. Of these individual calibrations, the one for pressure requires the greater accuracy, and to reduce personal errors in reading and to provide re-

corded data, the Washington Institute of Technology has adopted a photographic manometer. This has a moving light carriage which the operator simply keeps centered on the mercury column. The manometer scale is ruled on a transparent plastic and a strip of bromide paper is held firmly against this scale during a calibration. When the contact arm, in moving across the commutator, touches one of the fifth contacts, it operates an electronic timing circuit which causes the light to come on and stay on for a predetermined short interval. Thus, the profile of the top of the mercury column and the scale are printed on the paper, and can be read after development. This method removes what may be a very doubtful step in older methods of calibration, in which an operator had to read the moving column at the sound of a signal; furthermore, it is much less tiring.

A factor of first importance in radio sounding is the cost per observation. To make fullest use of present knowledge, it is desirable to obtain data from as well distributed a network of stations as possible.

In the early history of radio sounding, when airplane flights reached a maximum height of about 3 miles, the cost of each ascent was about \$30, and it was felt that if it were possible to manufacture radiosondes for this price they would be justified, because of their ability to fly in nearly any kind of weather and to return data from heights of about 12 miles. It was once thought

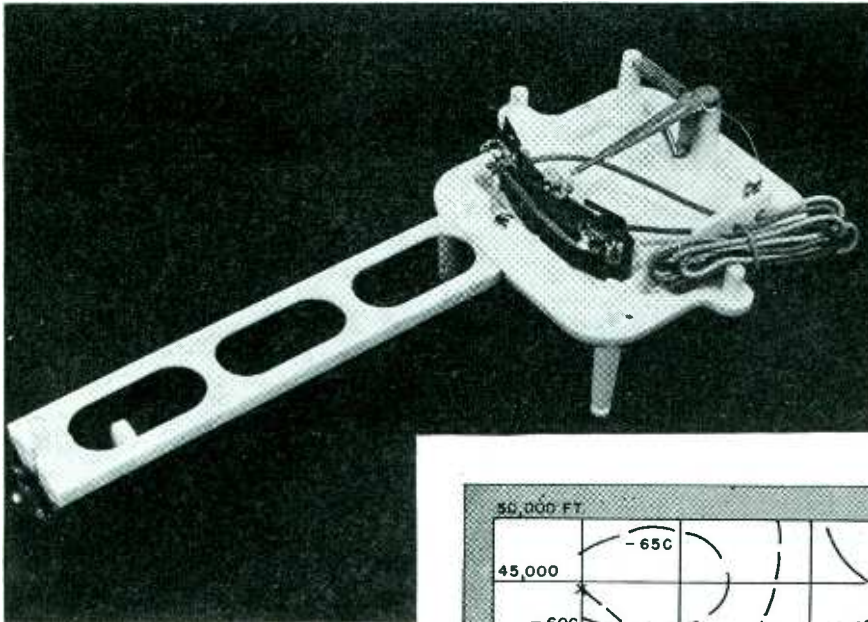

The hair hygrometer before assembly, showing potentiometer. A clear plastic cover that protects the potentiometer from moisture and dirt is not shown

A cross-section through the atmosphere, showing the kind of information that the radiosonde is useful in obtaining. (Taken, in part, from *Meteorology for Pilots* by Haynes)

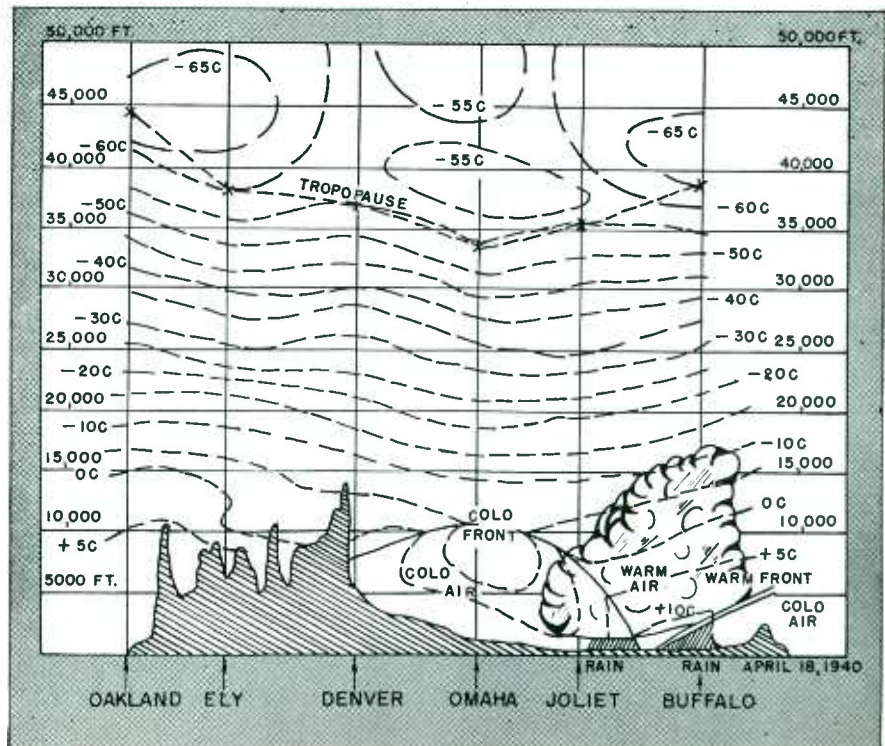

that radiosondes could obtain a record in any kind of weather, and it is possible that by special treatment they might. However, experience has shown that icing forces balloons down just as it does airplanes; in fact, in icing situations the rates of ascent or descent of the balloon, together with its known free lift, can be made to yield important facts about this flying hazard. High winds can also make it impossible to release the balloon without damage to it or to the instrument.

Cost Factor is Important

During the years since 1937, when the Weather Bureau first began radiosonde work, the number flown each year has increased considerably, as shown on the accompanying chart. Until 1940, the Weather Bureau did not buy most of the instruments outright, but leased them and when returned they were again the property of the manufacturer. The figures shown for 1938, 1939, and 1940, include rental and maintenance of ground equipment. It will be noticed that, as the number of instruments bought increased, the price decreased until the price per instrument is now only about \$10.

This low price has been partly brought about by quantity production methods, including the introduction, this year, of molded plastic

frameworks for what were formerly stamped aluminum parts. This use of plastics greatly facilitates manufacture and makes a more rigid assembly than light metal. Besides being a more suitable material for the job, its use releases some six tons of aluminum for other purposes.

A map shows the distribution of radiosonde stations in the United States as of September, 1941. The data obtained by this network of stations represents the most complete information about meteorological phenomena that has ever been assembled in the world. This should not only provide an unusually fine basis for present forecasting but will also provide research workers with excellent material for their studies, so that improvements in future forecasting can be expected.

REFERENCES

Blair, W. R., and Lewis, H. M.: Radio Tracking of Meteorological Balloons, *Proc. I. R. E.*, 19, 9, p. 1531, 1931.
 Lange, K. O.: The Present State of Development of Radio Meteorometric Equipment, *Bulletin, American Meteorological Society*, 16, p. 233, October, 1935.
 Lange, K. O.: The Moltchanoff and Askaniu Radio-Meteorographs (A) the "Kammgerat" of Moltchanoff, *Bulletin, American Meteorological Society*, 16, p. 267, November, 1935.
 Lange, K. O.: Other Radio Meteorographs on the Ollaad Principle, *Bulletin, American Meteorological Society*, 16, p. 297, December, 1935.
 Diamond, H., Hinman, W. S., and Dunmore, F. W.: A Method for the Investigation of Upper-air Phenomena and its Application to Radio Meteorography, *Proc. I. R. E.*, 26, p. 123, 1938.
 Diamond, H., Hinman, W. S., Jr., Dunmore, F. W., and Lapham, E. G.: An Improved Radiosonde and its Performance, *Jour. of Research, National Bureau of Standards*, 25, p. 327, September, 1940.

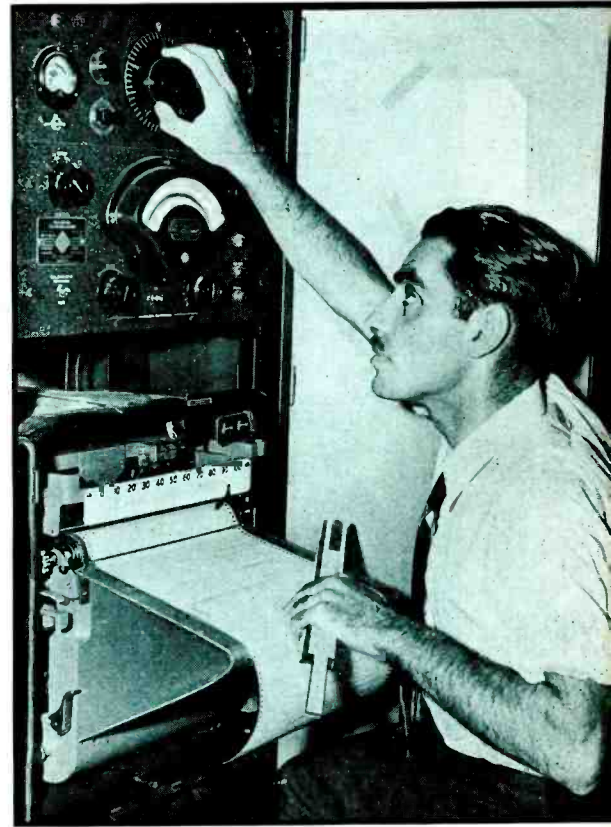

Equipment for receiving and recording the signals from Diamond-Hinman radiosonde. At top is a super-regenerative receiver; below it an electronic audio frequency meter and at the bottom a recorder which makes a record of the frequency meter readings

Locations of radiosonde stations in continental United States in September, 1941. At that time, there were also several stations in Alaska, the West Indies and on ships at sea. (Data taken from the Monthly Weather Review for September, 1941.) The dashed line shows the location of the accompanying cross-section

Chart showing the approximate number of new radiosondes produced by the Weather Bureau, and their average cost. Through 1940, the price was for rental and included rental installation and maintenance of ground equipment. From 1941 on, the instruments were bought outright. The cost trend is downward

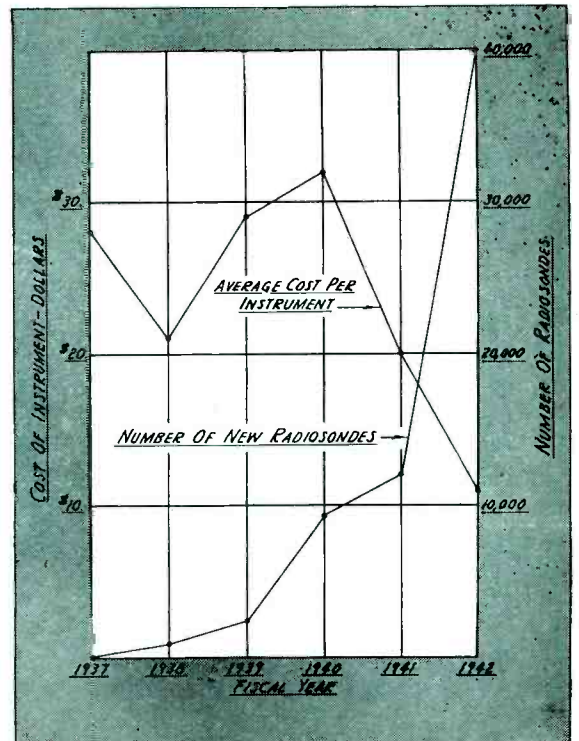
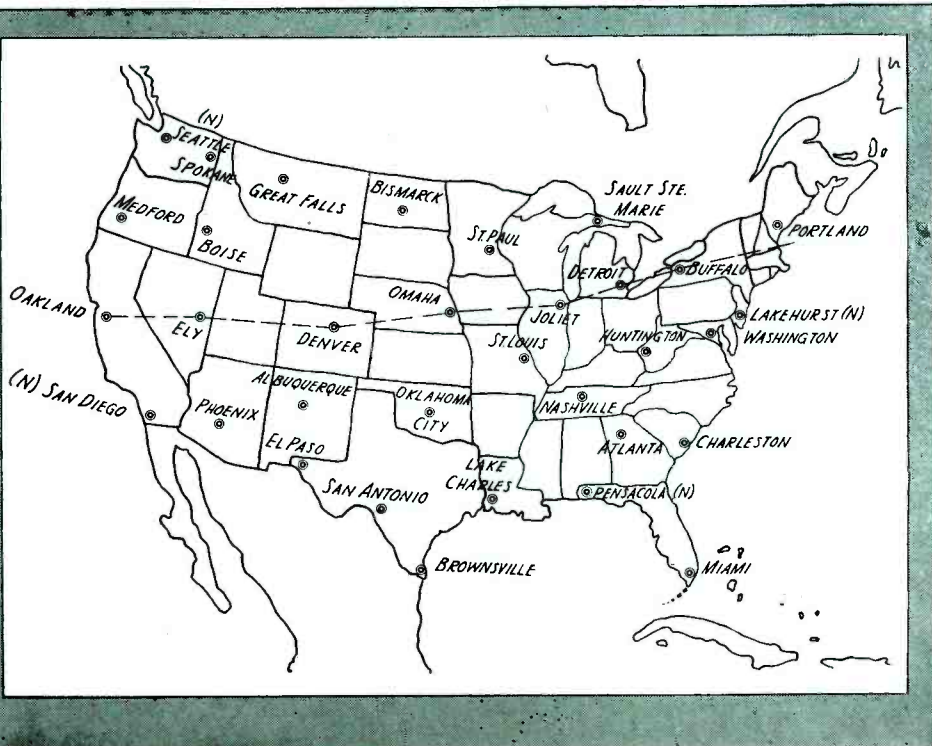

Applications

By **W. E. GILSON, M. D.**
The University of Wisconsin

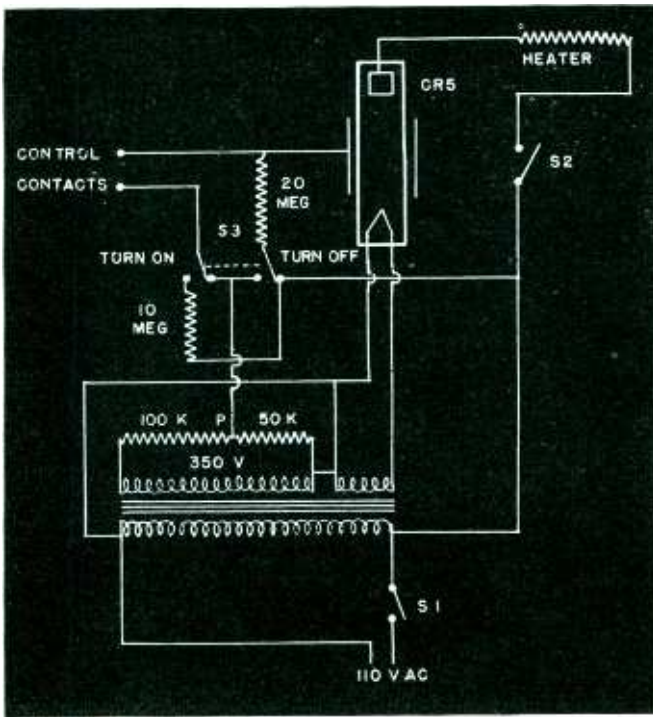

Fig. 1—Electronic relay used for temperature control. Employs a tube with an external control element

BESIDES the automatic blood pressure recorder¹ and oscilloscope² described recently in this journal, several other electronic devices have been developed in this laboratory, some of which should be applicable to other fields than physiology.

A Thyatron Relay for Temperature Control

In recent years many temperature control devices have been described, most of them using relays in connection with vacuum tubes.^{3,4,5} Although the use of more complex circuits permits the use of resistance thermometers and thermocouples for accurate control of temperature,⁶ the more practical circuits for less exacting work operate from a mercury column. If the operating current of a relay passes through the mercury contacts, there is inevitably a considerable amount of sparking and oxidation. This is eliminated by the use of a vacuum tube electronic relay, which is very reliable and inexpensive, but still has relay contacts.⁷ Thyatrons have been used to control small amounts of heating current directly, with satisfactory results.⁸ The limiting factor is the grid current, which increases as larger tubes are used, with a resultant increase in mercury contact oxidation.

The CR-5, made by the Continental Electric Co., uses an external control band and thus virtually eliminates grid current. Although the tube is ideal for phase control of various types, it cannot be controlled by slowly changing voltages applied to its control band. The tube may be used without special ventilation at 1 amp plate current, and will carry 5 amps with a small fan blowing on it, allowing control of power up to 550 watts. The CR-10, a tube twice as

large, may be used in the same circuits.

The operation of the circuit (Fig. 1) is very simple. With switch S_1 in the position shown, the control band voltage is normally in phase with the plate voltage, and the tube fires early in each positive half cycle. When the control contacts are brought together, by a rising column of mercury or other means, the control band is brought to the potential of point P , which is 180 deg. out of phase with the plate, so that the tube can no longer conduct.

Provision has been made for the occasional application where it is necessary to turn the power on rather than off when the controlling contacts are brought together. With S_1 to the left the control band voltage is normally 180 deg. out of

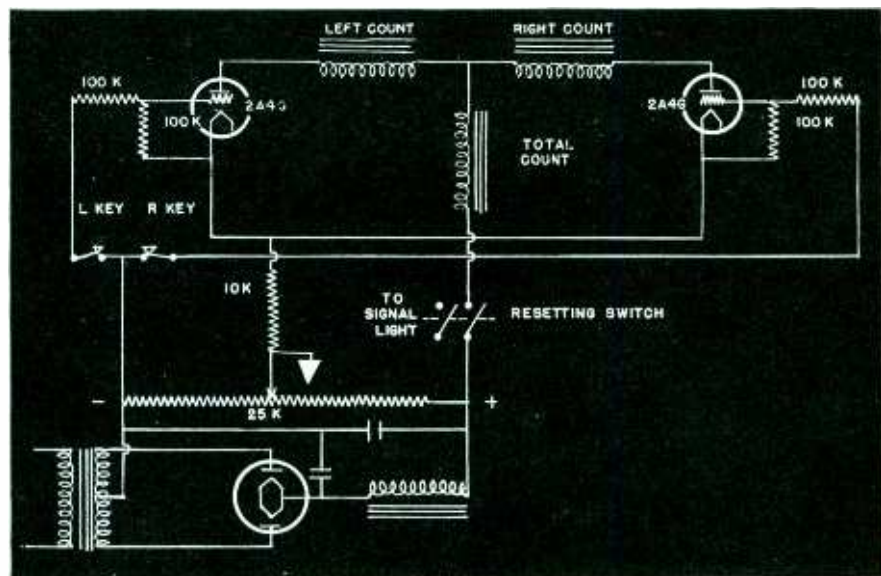

Fig. 2—A precedence indicator tells the investigator which of two contacts opened first

of Electronics to Physiology

Brief survey of the uses to which electron tube circuits have been put in physiological research. A blood pressure recorder and an oscilloscope have already been described. In this article are data on temperature control, an electronic precedence indicator, a phototube myograph and a membrane manometer

phase with the plate voltage, so that the tube does not break down. When the contacts are closed the control band is connected to a point in phase with the plate, causing the tube to conduct.

An Electronic Precedence Indicator

In the course of investigations by Miss Eleanor Larsen concerning intrinsic limb preference, it became necessary to construct a device which would indicate precedence with a high degree of accuracy. The experimental method is quite simple. The subject's hands are placed on two telegraph keys. Four signal lights are used, which may be turned on in any combination. When the two lights on the left are turned on, the subject lifts his hands from the keys as rapidly

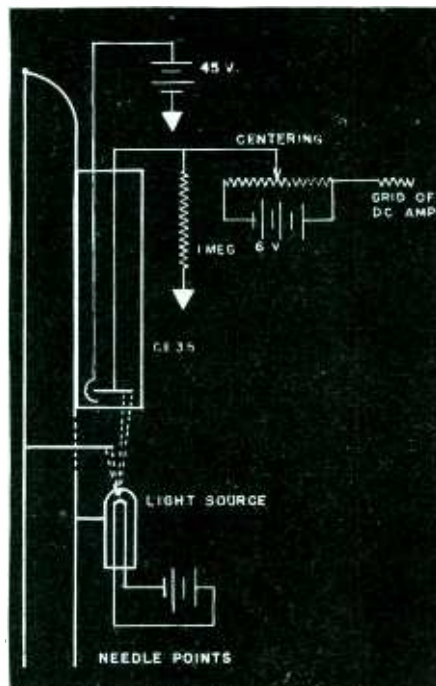

and as nearly simultaneously as possible. In the older methods, the opening of the keys marked a moving strip of paper, and the precedence was determined by measurement. Inasmuch as the degree of precedence is of no importance, a device incorporating relays had been used to indicate which hand lifted first, the opening of one contact actuating a relay which shorted the other contact and made a mark on a paper strip to indicate precedence of right or left hand. The relays had a considerable lag, producing as high as 50 percent simultaneous indications, as well as being somewhat erratic.

It seemed probable that the use of thyratrons rather than mechanical relays would eliminate the simultaneous readings. The 2A4G has an ionization time of about 10 microseconds, and biological variability and human asymmetry being as great as they are, it is seldom indeed that the two hands would be raised within 10 microseconds.

Figure 2 shows the system used, except for the lighting connections. One of 10 combinations of lights is chosen by a 10-point rotary switch. The lights are turned on by the resetting switch, at the same time that plate voltage is applied to the 2A4G's. The weight of the subject's hands holds the telegraph keys closed, providing sufficient negative grid bias so that the thyratrons do not fire. The operator runs through several light combinations, finally turning on the two left lights, at which signal the subject raises his hands. If the right key has opened first, the removal of the grid bias on the right tube allows it to break

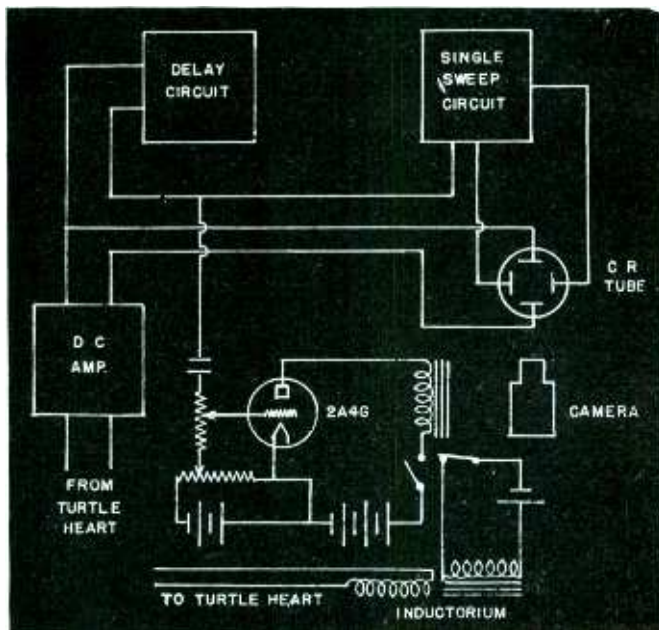

Fig. 3—A phototube myograph, a device for recording muscular contraction

Fig. 4—Circuit of a delayed impulse circuit for sending out a positive impulse at a desired length of time after an actuating signal

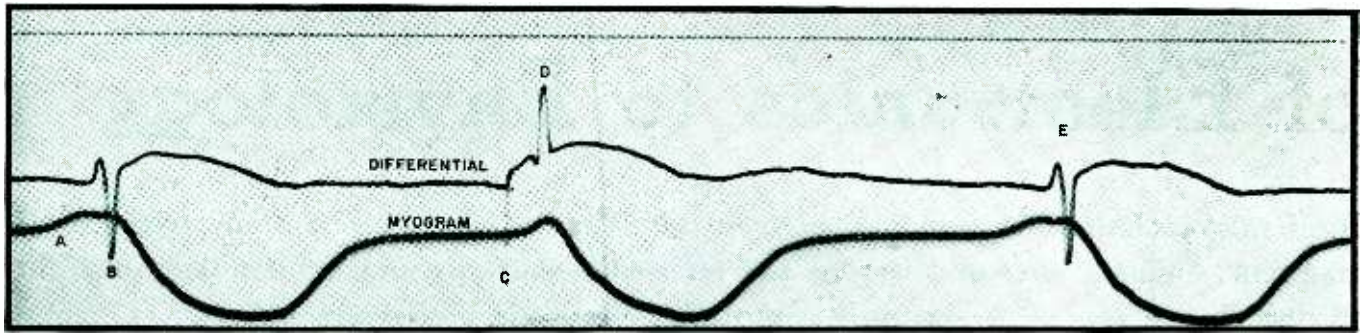

Fig. 5—Typical record made by means of the phototube myograph constructed primarily for use on the heart muscle of the dog or turtle

down. The plate current operates both the right count and total count indicators, and produces a large voltage drop across the 10,000 ohm resistor in the cathode circuit, which is effectively the same as grid bias on the other tube. Thus when the other key opens, sufficient grid bias remains to prevent it from breaking down. If the left key has opened first, the same events take place on the left side of the circuit. One hundred effective stimuli are given, as indicated on the total counter, and the percentage of rights and lefts is given on the respective counters.

Inasmuch as counters are available at present only with a high priority, it might be of interest to mention that excellent counters may be obtained from junked pinball machines, which may be purchased for as little as a dollar each. These counters operate on 12 or 25 volts a.c., and must be operated by a relay.

A Phototube Myograph

A myograph is a device for recording muscular contraction. The myograph to be described was constructed for use primarily on the heart of the turtle or dog. A sketch of the device is shown in Fig. 3. It is constructed of celluloid, the various parts held together by Duco cement. The phototube is a CE-35, made by the Continental Electric Co. It is believed to be the smallest available, and has been very satisfactory. The writer would appreciate information about a still smaller phototube, if there is one on the market.

The light is the standard "grain of wheat" bulb used in bronchoscopes, with the metal base removed. The points of the myograph, which is suspended by three wires, are allowed to rest gently on the surface of the heart. The contraction of the

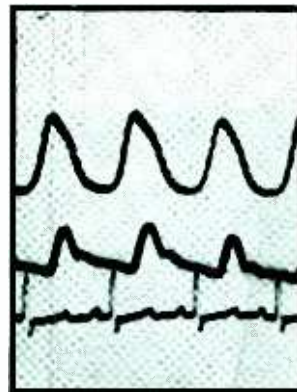

Fig. 6—Record of ventricular and aortic pressures at bottom, electro-cardiogram

heart pulls the points together, which cuts off some of the light falling on the phototube, and the electrical change thus produced is amplified and recorded, using a direct-coupled amplifier* and a three-trace Western Electric cathode-ray tube.

The cardiac muscle does not contract all at once, but the contraction spreads in a complex manner, gradually involving the whole heart.

The "differential" electrogram is obtained from two points on the surface of the heart very close together (1 mm or less), and is so called because it is relatively unaffected by distant potentials. It was desired to relate the onset of contraction at various points on the heart to the potential distribution existing at that moment. Investigation of the relation of the differential record to the myogram shows that the main peak of the differential is synchronous with the beginning of contraction as indicated by the myogram. Such a record is shown in Fig. 5. A downstroke on the myogram indicates contraction. The slight dilation at A is caused by the auricular contraction forcing blood into the

ventricle. The relation of the differential peak to beginning contraction is shown at B. It is thus possible to use the differential peak as a signal of beginning contraction under the differential electrode, which is much more convenient and rapid than using a myograph.

The potential distribution on the surface of the heart is obtained by taking three records simultaneously:

1. A reference curve, the potential between a constant point on the apex of the heart and the hind leg.

2. A differential curve, described above.

3. A unipolar curve, the potential between the hind leg and various spots on the surface of the heart.

From this data it is possible to draw potential maps for various instants of time, each one looking much like a weather map, with areas of positive and negative voltage and isopotential lines. The differential peaks indicate which regions, if any, are beginning to contract on each of these potential maps.

Interpolation of Stimuli into the Cardiac Cycle

Potential mapping of the turtle heart during the normal cycle gave satisfactory results.¹⁰ It then seemed desirable to map the field of the turtle heart during an extrasystole (an abnormal beat, produced in this case by an electrical stimulus applied to the heart). The source of the beat is determined by the position of the stimulating electrodes. For the extrasystoles to be as uniform as possible, the stimulus must be inserted at the same point in the cardiac cycle each time a potential record is made.

To accomplish this we are using a delayed impulse circuit described previously in this journal.¹¹ This device is actuated by a positive signal peak and sends out to the circuit to

be operated a positive impulse at any desired length of time after the actuating signal. It was originally designed to operate a sweep circuit, being actuated by the positive peak of a repeating transient, and tripping the sweep just before the transient next occurs. In this case the peak is shown at *B* in Fig. 5, such a peak occurring at each contraction of the heart. Figure 4 shows the setup diagrammatically. The reader is referred to previous papers for a discussion of the operation of the circuits shown in block diagrams.^{9, 11, 2}

When the effect is to be observed, the sweep circuit is tripped by the output of the delay device, and the same impulse is used to break down a thyratron which has in its plate circuit a relay which opens the primary circuit of an inductorium. The secondary coil is connected to two small clips which fasten to the heart, conducting to it the stimulating impulse. Thus the resulting extrasystole can be observed on the screen of the cathode-ray tube. When a record is to be made, the same procedure can be followed, using a camera with a stationary film, or the sweep can be turned off and the time base provided by a moving film. The latter method is preferable, because the extrasystole can then be observed in relation to preceding and following normal contractions. This is illustrated in Fig. 5 where *B* is the peak of the normal differential (which acts as the actuating impulse), *C* is the stimulus, and *D* is the abnormal curve produced by the extrasystole. *E* is the normal differential curve which follows.

This device, described previously in *Science*,¹³ was designed for the purpose of making an accurate record of the pressure changes in the cardiovascular systems of various animals, especially the dog and turtle. The method previously in most general use has been a combination of a powerful carbon arc and a membrane manometer similar to that shown in Fig. 7. The light is reflected from a mirror on the membrane to a moving strip of photographic paper at a distance of about 10 or 15 feet. The large projection is necessary to provide sufficient optical magnification, even for cardiovascular pressures in the dog. It would be almost impossible to record auricular pressures in the turtle with this instrument.

Because of the inconvenience of the method, its lack of sensitivity, and the difficulty of making simultaneous cathode-ray oscillograms of the potential on the surface of the heart, it was decided to find some electronic means of pressure recording.

A Photoelectric Membrane Manometer

Several methods seemed promising, among them the variable resistance devices, on which Edison took out many interesting patents in his search for a practical microphone. These devices were not sufficiently stable to return to the base line when the pressure was removed, or had some other disadvantage. The piezoelectric pressure recorders will not record accurately a sustained pressure increase. Using a diaphragm as a condenser microphone has the same objection. If, however, the changing capacitance be used to frequency modulate an oscillator tuned to the sharply sloping portion of the selectivity curve of an intermediate-frequency amplifier, and the amplifier output rectified by a diode, the rectified voltage will be in effect a directly-coupled function of the voltage. This method worked quite well in preliminary experiments, but was abandoned because of its needless complexity.

The diaphragm was also used as a condenser to detune a crystal-controlled oscillator, the changing plate current providing the electrical indication of pressure change. The apparatus was quite insensitive, be-

cause the frequency used was too low. This method was perfected by Lilly, whose apparatus is apparently satisfactory in both stability and sensitivity.¹⁴

The method finally used is shown in Fig. 7. The various parts are mounted on a triangular piece of one-half inch steel. The light source is an exciter lamp of the type used in sound-on-film motion picture projectors. A single lens is used to focus the light on a mirror which is mounted off center on the diaphragm. This mirror reflects a cone of light toward the phototube, a CE-23. The apparatus is so adjusted that with zero pressure a small part of the light falls on the phototube. As the pressure applied to the diaphragm increases, the mirror is deflected and more light falls on the phototube. This produces an electrical change which is amplified by a push-pull direct-coupled amplifier⁹ and causes a deflection of the cathode-ray spot, the amplitude of which is controlled by varying the gain of the amplifier. The entire pressure system is filled with Ringer's solution. The three-way valve provides for connection between the diaphragm chamber and the side-arm, for calibration against a mercury column, between the diaphragm chamber and the needle for record taking, and between the side-arm and the needle for washing out the pressure system. Figure 6 shows a record of the ventricular pressure and aortic pressure in the dog, with an accompanying electrocardiogram.

The output is almost exactly linear.
(Continued on page 206)

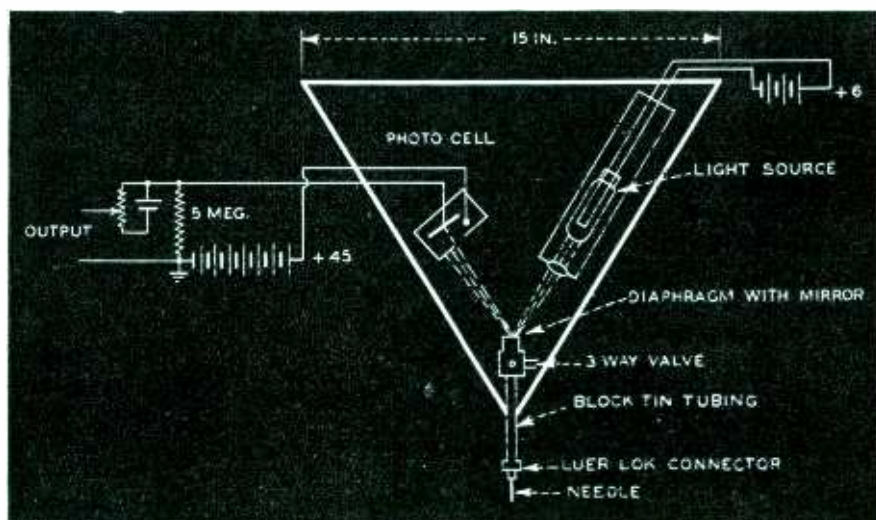

Fig. 7—Circuit of a device for making an accurate record of the pressure changes in the cardiovascular systems of animals such as the dog and turtle

The Reduction of RECORD

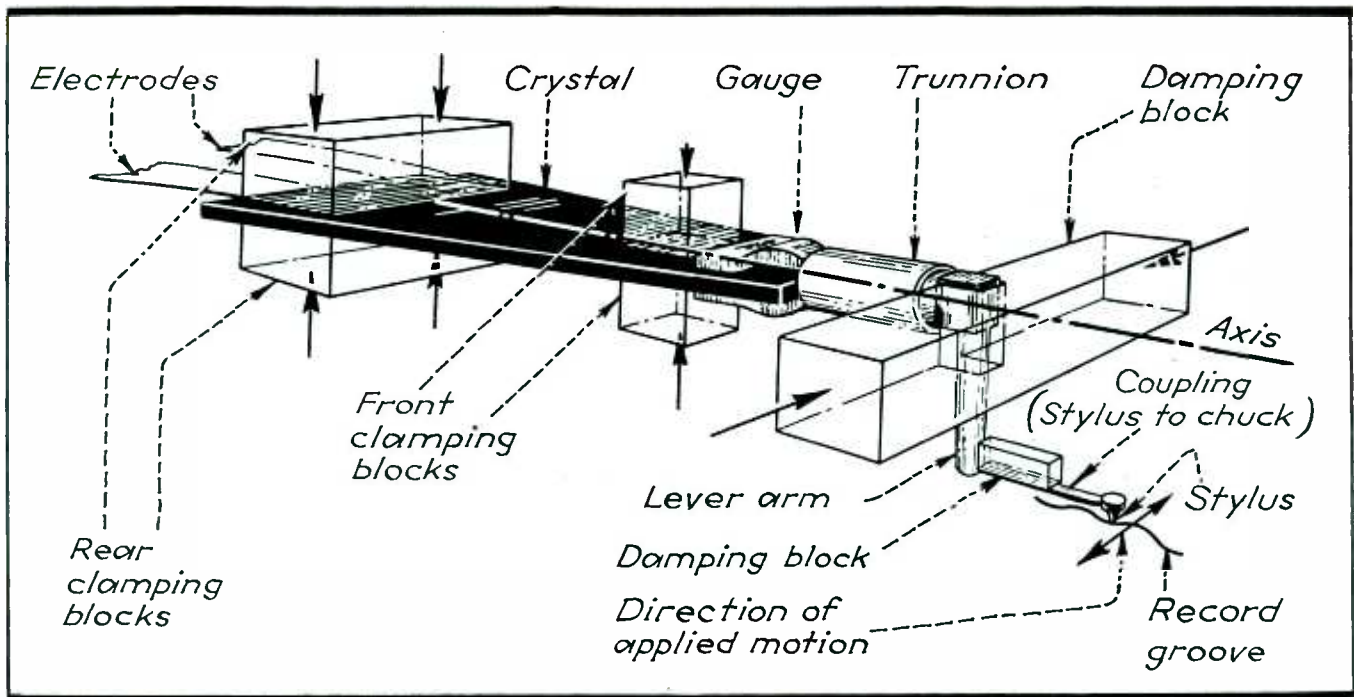

Fig. 1—Schematic illustration of the pickup described in this paper. For clarity, the case and tone arm are omitted

By A. D. BURT

RCA Manufacturing Company, Inc.,
Camden, N. J.

WHEN the stylus of a phonograph pickup is actuated by the groove of a phonograph record, there results a force between the stylus and the walls of the record groove. The value of this force is given by the product of the mechanical impedance of the pickup, referred to its stylus point, and the velocity of the displacement of the record groove. This force causes the record, pickup, and tone arm to vibrate, and as a result, sound is radiated directly into the air. For the lack of a better expression this effect has been termed record noise; other terminologies in use are needle talk and needle chatter. The effect on the listener is that of a highly distorted reproduction of the subject matter on the record, with the low frequencies lacking. The magnitude of this effect is so great as to cause the overall reproduction from many phonograph devices to be very unsatisfactory. Numerous attempts have been made to solve this problem. One practical means is that of an acoustic filter constructed into the lid or door of the cabinet.^{1, 2, 3} Padding the interior of the pickup compartment, while very effective,

detracts from the appearance to the point where it is felt to be unsatisfactory. The development and design of the pickup described in this paper had as its objective the removal of record noise at its source.

Recognizing that the mechanical impedance of the pickup is the one factor relating to record noise which

can be controlled, it is evident that the record noise will be reduced if the mechanical impedance is reduced. The results of an investigation showed that, in general, the disturbing frequencies are confined to the high-frequency range. One of the most important reasons for this condition is the relatively small areas of the vibrating elements. A spherical stylus tracing a laterally cut record groove experiences a vertical motion as a result of the well-known

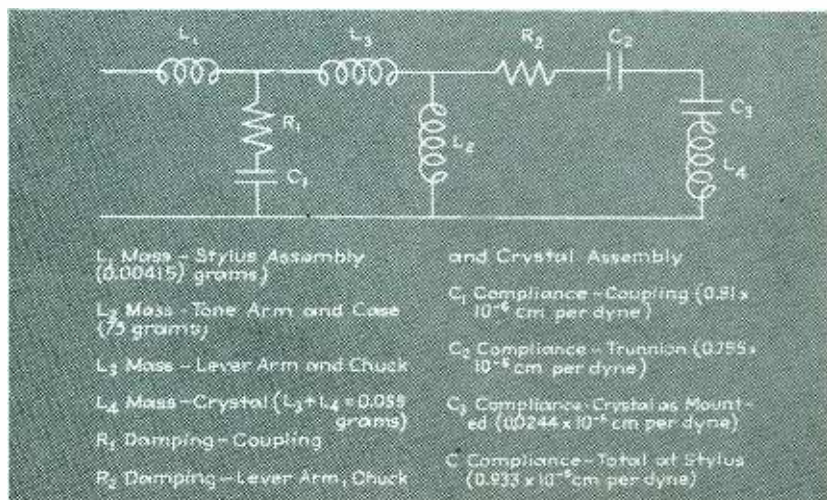

NOISE by Pickup Design

pinch effect.^{4,5} This condition qualitatively demands that the vertical as well as the lateral mechanical impedance be reduced if the record noise is to be reduced.

Description of the Pickup

Figure 1 shows a schematic illustration of the pickup described in this paper.⁶ For clarity the surrounding case and tone arm are omitted. While a crystal type of pickup is illustrated similar construction can be applied to the several other types. In this figure the "free" arrows indicate mounting surfaces supplied by the case. A bearing for the trunnion is also supplied by the case. Lateral motion imparted to the stylus by the action of the record deflects the stylus-to-chuck coupling. The force set up by this deflection is applied to the end of the lever arm and the resultant torque twists the system about its axis. As the crystal is of the "twister" type a voltage is generated. The coupling between the chuck and the crystal is very tight and for all practical purposes can be considered as 100 percent effective. The damping block on the stylus-to-chuck coupling serves to control the free resonance of the coupling as determined by the compliance and inertia of the coupling assembly which includes the stylus. The damping block on the chuck serves to control the resonance of the system as deter-

mined by the compliance of the crystal and trunnion, and the inertia of the crystal, chuck and lever arm. The front clamping blocks serve to support the crystal against bending and, together with the trunnion, to define the axis of rotation. The rear clamping blocks serve to clamp the rear of the crystal and is 100 percent ef-

fective. The clamping and damping blocks are Viscoloid.

Figure 2 shows the equivalent electric circuit of the pickup illustrated by Fig. 1, but includes the pickup case and a rigid tone arm. All values given are for this design and are referred to the stylus point. Figure 3 shows the equivalent electric circuit effective at high frequencies. This simplification is justified in practice as the value of L_2 is many times the value of associated elements. The several circuit elements are defined as shown in Fig. 2. The equivalent electric circuits for vertical motion and for lateral motion are nearly identical except for the actual values of the several circuit elements. For vertical motion the mass of the stylus-to-chuck coupling is the same value, 0.00415 grams, as for lateral motion. For vertical motion the compliance of the stylus-to-chuck coupling is 0.215×10^{-6} cm per dyne.

Neglecting R_1 and R_2 , the impedance looking into this circuit will be

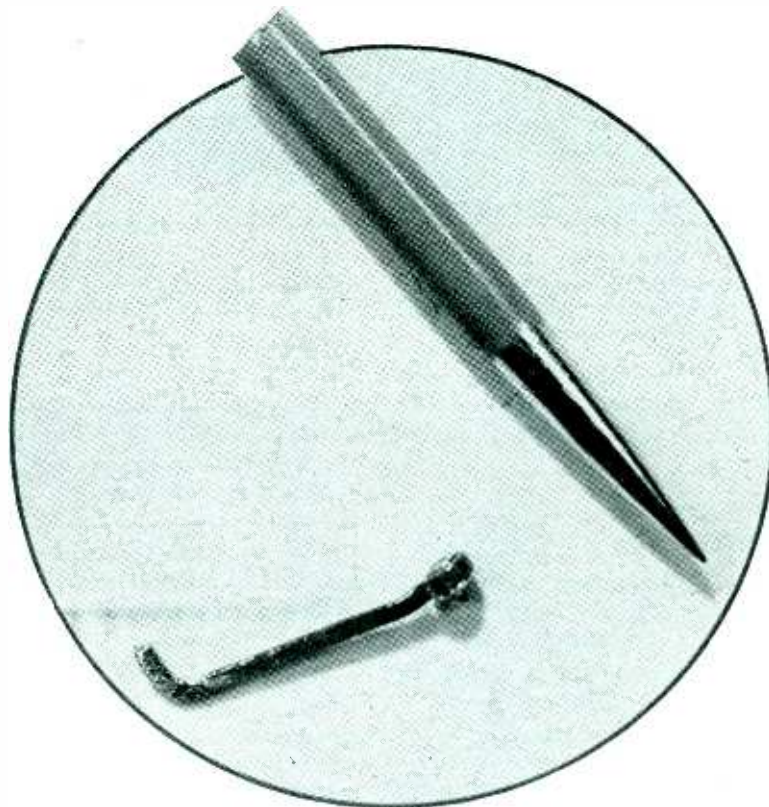
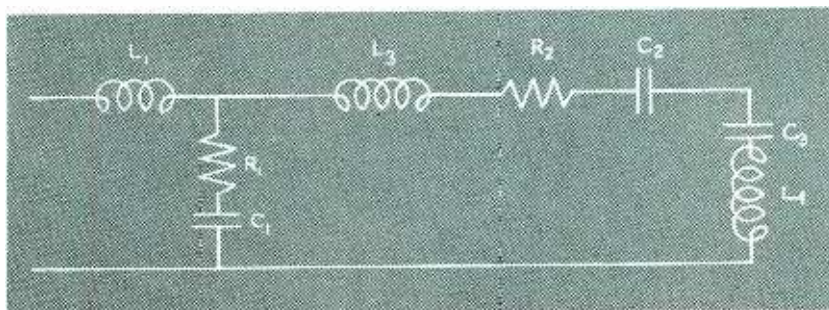

Fig. 4—A comparison of the physical size of the coupling-stylus assembly used in the new pickup with that of a standard needle. The scale is provided by the standard needle which measures 0.068 inches in diameter by 0.625 inches long

Fig. 2—Equivalent electric circuit of the pickup illustrated in Fig. 1. The equivalent inductance of the case and a rigid tone arm L_2 is included

Fig. 3—Equivalent circuit of pickup for high-frequencies. This simplification is justified as the value of L_2 is many times the value of associated elements



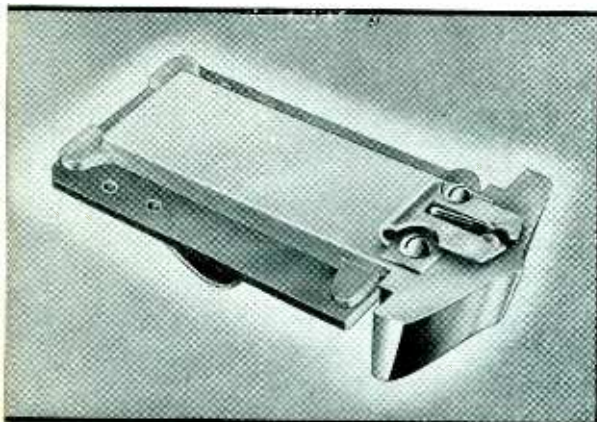

Fig. 5—The bottom view of the complete pickup assembly. A guard will be observed which serves to protect the stylus and coupling against damage



Fig. 6—The complete pickup and tone arm assembly as applied to a commercial model of record changer

infinite at frequency equal to zero, at frequency equal to infinity and at frequency,

$$f_R = \frac{1}{2\pi\sqrt{(L_1 + L_2)\left(\frac{C_1 C_2 C_3}{C_1 C_2 + C_1 C_3 + C_2 C_3}\right)}}$$

This is the frequency of the high-frequency-resonance peak of the pickup. For this design $f_R = 4500$ cps. As this frequency is within the musical range, damping must be added to reduce the mechanical impedance and the response peak of the pickup. The reason for selecting $f_R = 4500$ cps is to provide some effective cutoff of response above that frequency for the purpose of minimizing the reproduction of scratch and distortion.

It is obvious that the addition of damping increases the mechanical impedance at those frequencies below the range of resonance. This leads to the conclusion that if the

scratch and distortion can be reduced, f_R should be increased to a frequency above the musical range. Under this condition no damping will be required.

Neglecting R_1 , the minimum impedance looking into this circuit will occur in the region of,

$$f_z = \frac{1}{2\pi\sqrt{L_1 C_1}}$$

For this design f_z (lateral) is approximately 2500 cps and f_z (vertical) is approximately 5000 cps. These values represent a compromise and were selected after a number of listening tests and measurements of record noise. It is well to point out that the best compromise in this respect is made difficult by the wide variation in magnitude of the high frequencies recorded on records. This condition is a function of many factors, quite apart from the recording characteristic, such as

the acoustics of the recording studio and the placement of the microphone.⁷

Figure 4 shows a comparison of the physical size of the coupling-stylus assembly with that of a standard needle. For the purpose of a scale, the standard needle measures 0.068 inches in diameter by 0.625 inches long. The dimensions of the coupling-stylus assembly measure: coupling, 0.009 inches wide (normal to the paper), by 0.019 inches high, by 0.250 inches long (stylus to bend); stylus, 0.015 inches in diameter by 0.035 inches long. The coupling is steel and the stylus a sapphire. In Fig. 5 it will be observed that a guard is provided to protect the sapphire and coupling against damage.

Vertical Force on Stylus

This unit, as designed, will track satisfactorily with a vertical force (needle force) on the stylus of 15 grams. Record changer design problems resulting from friction and tripping mechanism operation brought about an increase in this force to 28 grams in the commercial design.

Stylus Radius

As a result of an investigation of record groove shape, a stylus radius of 0.003 inches was selected for this pickup. This dimension insures that the stylus will rest on the side wall of the groove in most cases. A 0.0023-inch radius may result in a loose fit of the stylus in the groove

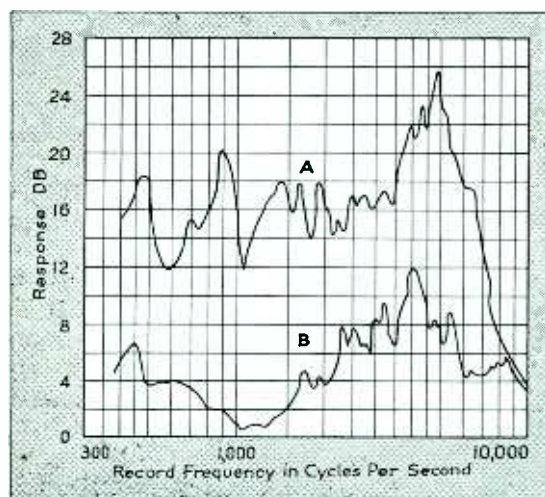

Fig. 7—Characteristic labeled A is record noise from a conventional pickup of the replaceable needle type. Characteristic labeled B represents the new design

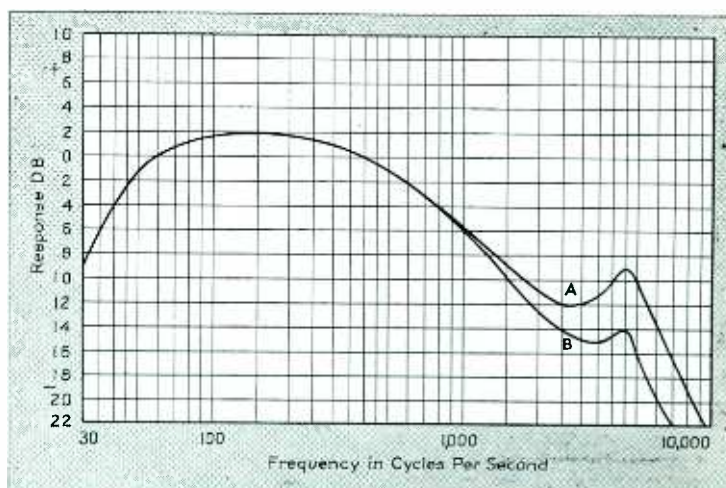

Fig. 8—The voltage-frequency response of the new design. The characteristic labeled A is normal and that labeled B is with the coupling (stylus-to-chuck) damping block removed

and, consequently, the reproduction will be distorted. On the other hand, a 0.004-inch radius may result in the stylus resting on the upper groove edges which are often rough and damaged by scratches on the surface of the record. As a consequence of this condition record scratch and ticks are increased.

Record Noise Checks

Figure 7 shows a comparison between the measured response of record noise from a conventional pickup of the replaceable needle type, labeled *A*, and from the pickup described in this paper, labeled *B*. These characteristics are indicative of the response of record noise. The method used to measure record noise together with a discussion of the results is included in this paper. Tests conducted under actual operating conditions in the home indicate that the performance of this pickup, with respect to record noise, is entirely satisfactory at any practical low level of reproduction. By way of a comparison, tests conducted under the same conditions indicate that the performance of the conventional type of pickup, with respect to record noise, is unsatisfactory even with the level of reproduction increased to the point where it is considerably above an enjoyable level for the average person.

Frequency Response

Figure 8 shows the voltage-frequency response of the pickup and tone-arm assembly as mounted on the record changer. For the purpose of this response the pickup was operated open circuited except for the input circuit of the voltmeter which has a measured d-c resistance of 1 megohm. The frequency record used was cut constant-amplitude from 30 to approximately 800 cps and constant-velocity from the latter value to 10,000 cps. The characteristic labeled *A* is normal and that labeled *B* is with the coupling (stylus-to-chuck) damping block removed. It will be observed that the addition of this damping block serves to increase the amplitude of the high-frequency response of the pickup in addition to the damping effect previously mentioned. The position of this damping block in the equivalent electric circuit (Fig. 2 and 3) illustrates the reason for the increase in re-

sponse. This results in a desirable condition as less electric circuit compensation is required (therefore less loss in gain) to produce the most commonly employed overall fidelity at the voice coil. The voltage output of the pickup referred to 400 cps is 0.7 volt from a record having an amplitude of 0.00102 inches (0.00259 cm.) This voltage value, together with compensation loss, is more than sufficient to overload an amplifier employing a 6R7 preamplifier, a 6SQ7 amplifier, a 6SQ7 phase inverter, and two 6F6 output tubes. The internal electric impedance of the pickup is that of a capacitor having a capacitance of 2000 $\mu\mu\text{f}$; for all practical purposes the series and shunt resistances can be neglected.

Device for Measuring Record Noise

Record noise has been defined as the sounds generated and radiated directly into the air by the vibrating parts of the record, pickup, and tone arm. Under actual conditions of playing a record the record noise is a function of the subject matter as recorded on the record and of the design of the pickup and tone arm. While in the final analysis listening tests are used to demonstrate the reduction of record noise, such tests do not result in data of a permanent nature. Further, the quantitative measure of the result rests solely in the listener's impression of the test. For these reasons it has been found desirable to develop a device which will give a permanent record of the quantitative measure of record noise.

Apparatus Utilized

The device as developed consists of a sound-proof chamber containing a turntable and a microphone. The design of the chamber is such that there are no parallel internal surfaces. This feature tends to result in a uniform distribution of the reflected sound field within the chamber. The inner surfaces of the chamber are covered with a layer of felt and the felt in turn is covered with sheet lead so the actual inner surfaces are lead. The felt and the lead serve to make the chamber sound proof from external sources of noise. In addition, the lead serves as a highly reflective non-resonant interior. All joints and cracks around

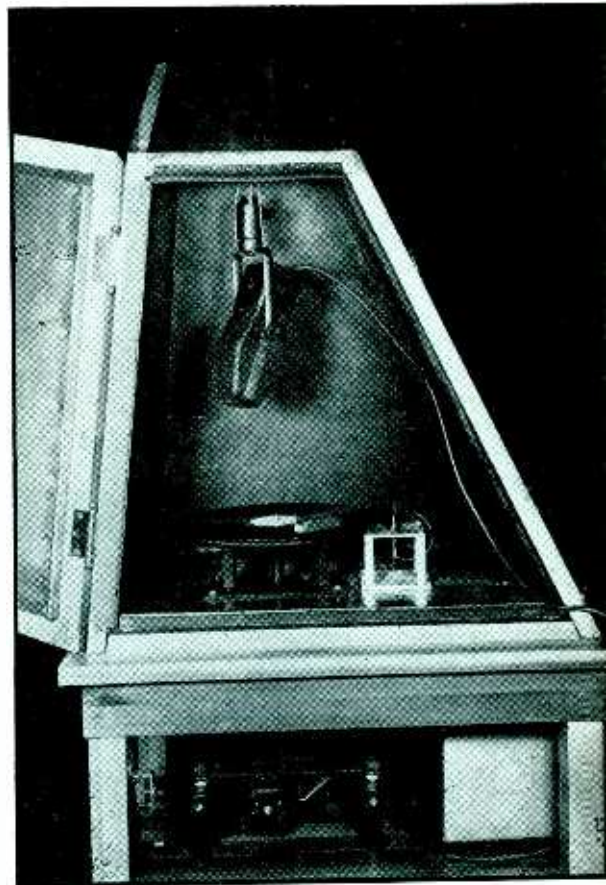

Fig. 9—An internal view of the chamber used to measure the response of record noise

the door are sealed by a rubber gasket. The drive for the turntable is external to the chamber and is mounted by means of a mechanical filter to minimize the transmission of vibrations to the interior of the chamber. Provision is made to mount the pickup and tone arm in the proper manner and position with respect to the turntable. Figure 9 shows a view of the chamber with the door open. The microphone is normally suspended by rubber bands instead of by a wire as illustrated.

The output circuit of the microphone is connected to an amplifier. The output of the amplifier is connected to a db recording type of voltmeter having a motor drive for the paper. Provision is made in the amplifier for the use of a high-pass electric filter to minimize the effect of rumble. The voltmeter is equipped with a damping means which can be controlled. The voltmeter is of the true-average-reading type. The scale is calibrated in terms of the db level of the applied signal above or below an arbitrary zero level. Except for the electric filter

(Continued on page 198)

IMPEDANCE MAGNITUDE and PHASE ANGLE Charts

By T. C. BLOW
Washington, D. C.

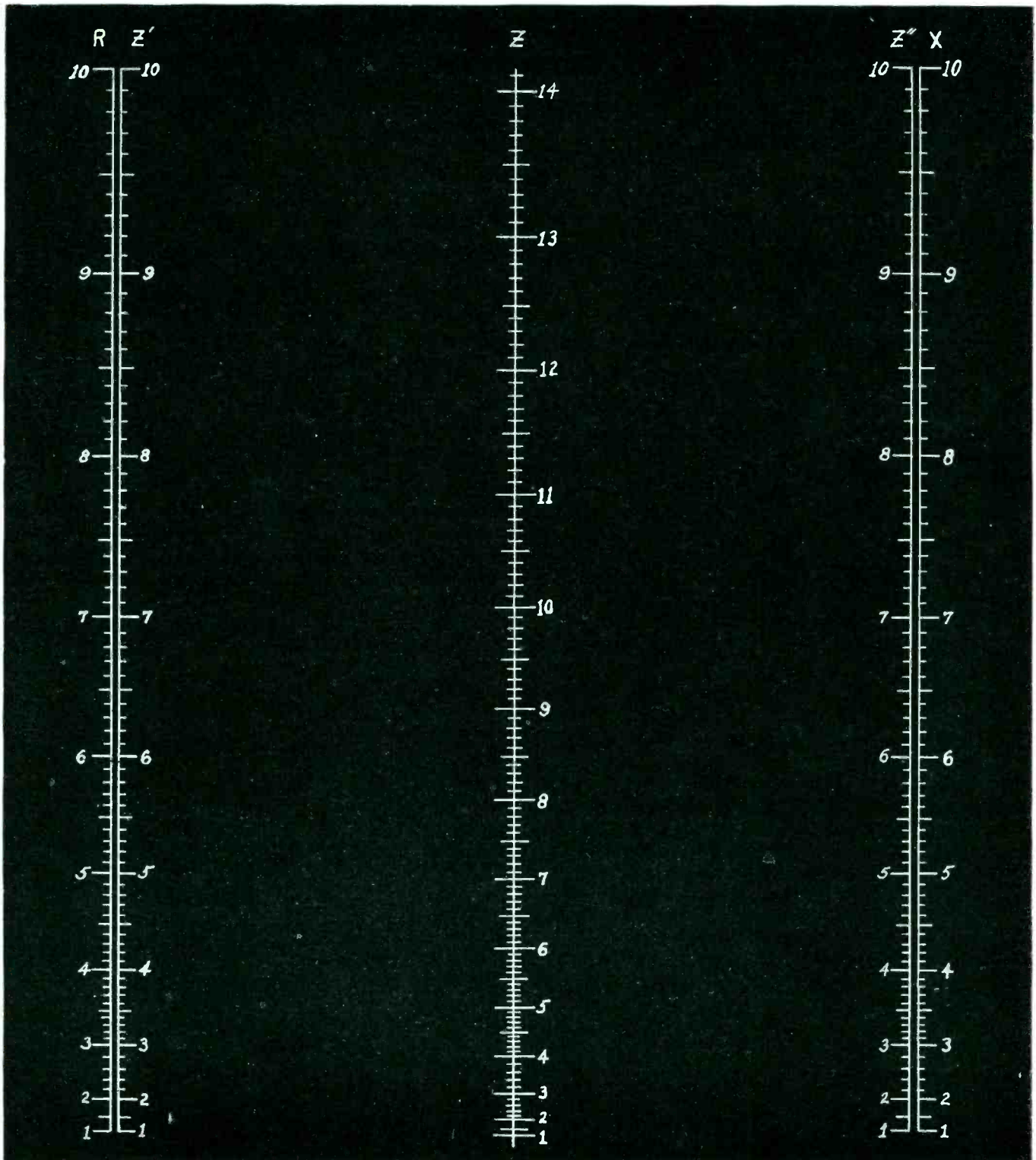

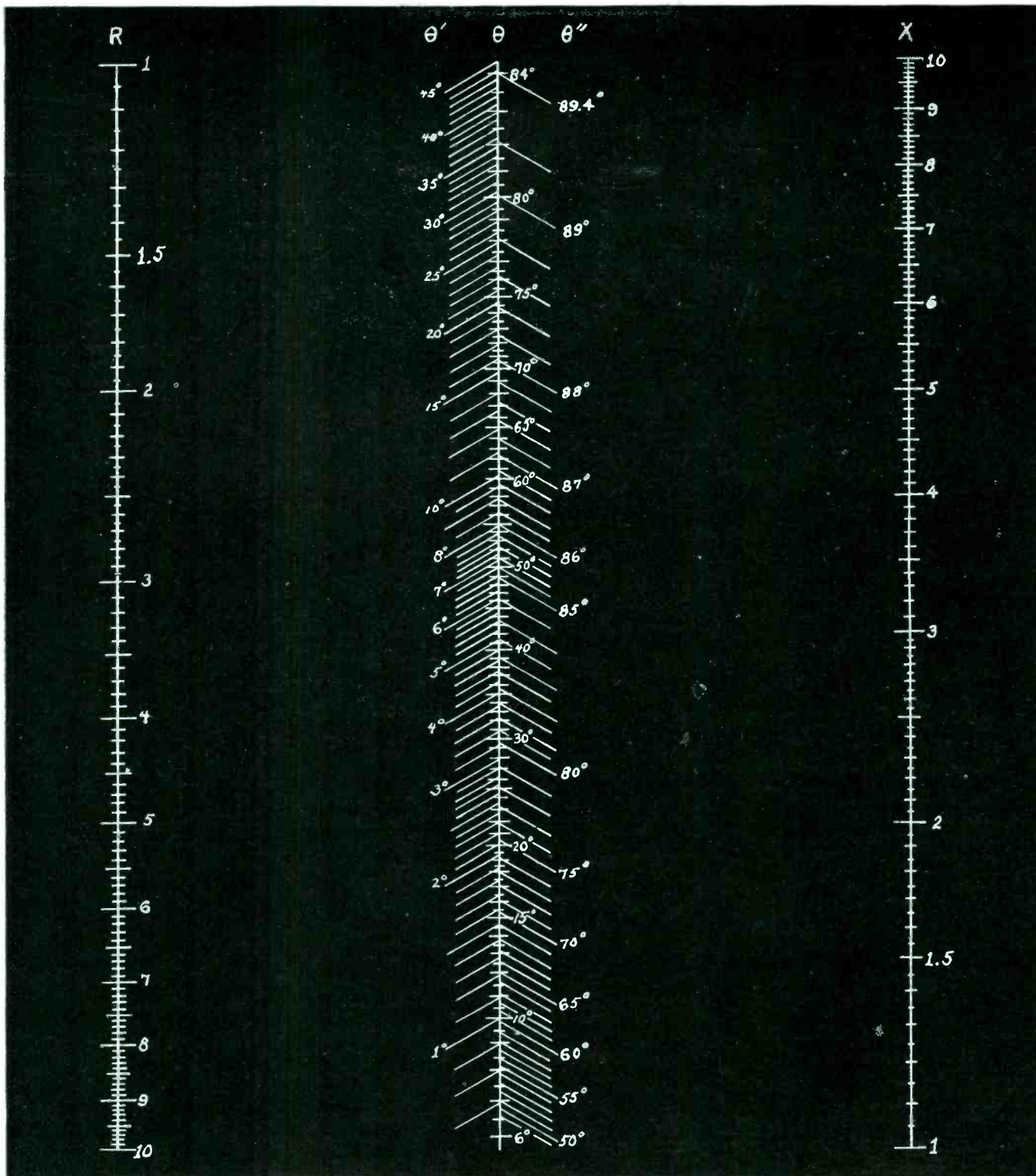

IMPEDANCE MAGNITUDE ALIGNMENT CHART

THIS alignment chart permits graphical solutions of equations of the type represented by the equation, $Z = (R^2 + X^2)^{1/2}$ for values of X/R from 0.1 to 10. It is thus useful for determining the magnitude of an impedance.

To determine the impedance magnitude, connect the selected values of X and R with a straight line and read the impedance on the appropriate Z scale. If the values of R and X are in the same cycle or decade, read the center scale, Z . If R and X are in adjacent cycles, read the Z scale nearest the larger component. Thus, the scale Z' is read if R is larger than X ; the Z'' scale is read if X is larger than R .

Example: To determine $Z = (8.5^2 + 60^2)^{1/2}$, in which X is in the cycle beyond R , connect 8.5 on the R scale with 60 on the X scale and read 60.5 on the Z'' scale, which is nearer the larger component, X .

IMPEDANCE ANGLE ALIGNMENT CHART

THE impedance angle chart is designed to determine the vector angle of any impedance made up of X and R components for values of X/R between 0.01 and 100.

To determine the phase angle, θ , connect the selected values of X and R with a straight edge and read the angle on the proper θ scale. If X and R are in the same cycle or decade, read the center scale, θ . If X and R are in adjacent cycles, read the scale nearest the larger component.

Example: To determine the angle of an impedance composed of $R = 20$ ohms and $X = 50$ ohms, connect 20 on the R scale with 50 on the X scale. The angle is $\theta = 68.2$ degrees, read from the center scale.

Example: To determine the angle of an impedance, $R = 24$, and $X = 850$, connect 24 on the R scale with 850 on the X scale. Since these values are not in the same cycle and since X is larger than R , read $\theta = 88.3$ degrees on the θ'' scale.

A 3 Resonant CIRCUIT TRANSFORMER

A two-stage band-pass amplifier having high and variable selectivity with uniform band pass response uses a three resonant circuit transformer and complementary two circuit transformer. Mr. Winkler provides simplified procedure for designing suitable transformers of optimum performance

IT is often an object in the design of radio frequency amplifiers to obtain a frequency response characteristic which passes all frequencies in a desired band as uniformly as possible, and which greatly attenuates all frequencies outside of this pass band. It is customary to speak of the ideal form of frequency response as a curve which is rectangular in shape. Such a response provides absolutely uniform gain over the pass band (or bandwidth) and has infinite attenuation at all other frequencies. While this ideal type of characteristic cannot be obtained in practice, at least with fairly simple and economically justifiable electrical circuits, this characteristic can be more or less closely approached.

In the past one of the circuits commonly used to achieve an approach to the ideal response curve has been a two resonant circuit network which is sometimes overcoupled.

While a circuit of this type is straightforward, and has been analyzed mathematically, the resultant characteristic often leaves much to be desired.

Other more complicated methods, which are sometimes used, are frequently difficult to analyze mathematically. They often call for circuit construction which is difficult to achieve. Moreover, extensive laboratory equipment for making the desired tuning adjustments are sometimes required.

The method adopted and described in this article provides high selectivity, variable selectivity or variable bandwidth, and essentially flat top response. The interstage coupling circuits used in this system are comparatively easy to construct and adjust.

With the aid of tabulated information given in this article, any competent amateur, laboratory tech-

nician or engineer can design and construct the interstage coupling transformers, which are the primary feature of this article, without having a comprehensive understanding of the theory involved. However, for those who are interested in a more detailed analysis, the theoretical aspects of the coupling network will be found in the appendix to this article.

Essentially, the method outlined in this article* makes use of an amplifier consisting of two stages (or an even number of stages) as shown in Fig. 1. One stage utilizes a coupling network consisting of three resonant circuits. The other stage uses a more or less conventional two resonant circuit network. The essential feature of the amplifier is that the respective networks or transformers are designed such that the gain or voltage amplification of one network is essentially complementary to that of the other over the pass band.

The response curve of each stage is complex, having a multiplicity of peaks or maximums and valleys or minimums. The peaks of one response curve match the valleys of the other and vice-versa. The resultant response of the two stage amplifiers is therefore quite uniform over the entire pass band.

Description of the Three Resonant Circuit Network

The most interesting part of the amplifier circuit, shown in Fig. 1, is the three resonant circuit network and the manner in which it is used.

One form of this circuit, using mutual inductance coupling, is shown

Tabular Data for Designing Three Circuit Transformer and Its Matched Complementary Two Circuit Network

DESIGN DATA FOR CRITICALLY COUPLED THREE RESONANT CIRCUIT TRANSFORMER					DESIGN DATA FOR MATCHED TWO CIRCUIT TRANSFORMER		
h	$g_D = G_D/G_s$	$a_{AD} = Q_A \delta_D$	$a_{BD} = Q_B \delta_D$	$b_s = k_s$ $(Q_A Q_B)^{1/2}$	$g_D = G_D/G_s$	$a_D = Q \delta_D$	$b_s = k_s Q$
0.250	0.235	3.62	0.904	3.30	4.26	4.16	8.38
0.500	0.389	2.11	1.05	3.72	2.57	2.42	4.93
1.00	0.5745	1.323	1.323	2.449	1.741	1.502	3.165
2.00	0.748	0.894	1.79	2.43	1.34	0.994	2.22
4.00	0.872	0.641	2.56	2.64	1.15	0.692	1.71

By
MARION R. WINKLER
 Hicksville, N. Y.

in Fig. 2. Other equivalent forms of coupling which may be used are shown in Fig. 3 and 4.

In all these circuits, the coupling or mutual reactance is zero between the first resonant circuit A and the last resonant circuit C. If the intermediate circuit B is removed, no electrical energy can be transferred from circuit A to circuit C. Under these conditions, the electrical energy must travel through all three high-Q resonant circuits, one at a time, thereby obtaining high selectivity.

Each circuit is individually tuned to the same resonant frequency. Band spread is obtained by increasing the coupling rather than by tuning the individual circuits to different frequencies.

Calculated universal resonance curves of the three resonant circuit network of Fig. 2, are shown in Fig. 5, for the condition that the Q of all the circuits is the same, i.e., $Q_A = Q_B = Q_C$. The curve marked "Maximum Selectivity" is the response obtained as the coupling approaches zero. The curve marked "Desired Band Spread" is the response obtained when the coupling is critical. Critical coupling will be defined as that coupling which produces a flat plateau on each side of the resonant frequency; less coupling causes the flat plateaus to disappear, while greater coupling produces a peak and valley on each side of resonance.

Mathematically, with critical coupling, each plateau contains a maximum and a minimum which coincide. These maxima and minima are real algebraic roots obtained from the equations for resonance. When the coupling is increased, the roots become distinct and of different values, and each plateau resolves itself into a maximum and a

* Historically, one of the earliest applications of a circuit resembling that used in this article was a filter chain network described by Hans Riegger of Berlin, Germany, U. S. Patent No. 1,603,806. German application filed August 31, 1921.

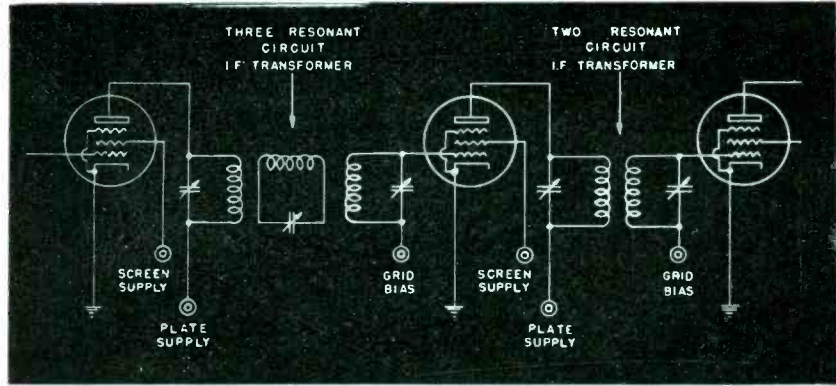

Fig. 1—Schematic wiring diagram of two stage amplifier containing a three resonant circuit network and complementary two circuit network for providing uniform response in the pass band

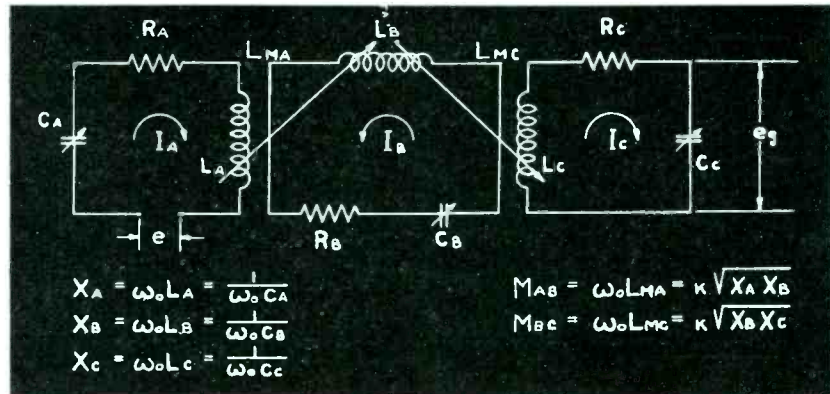

Fig. 2—Three resonant circuit transformer with mutual inductance coupling

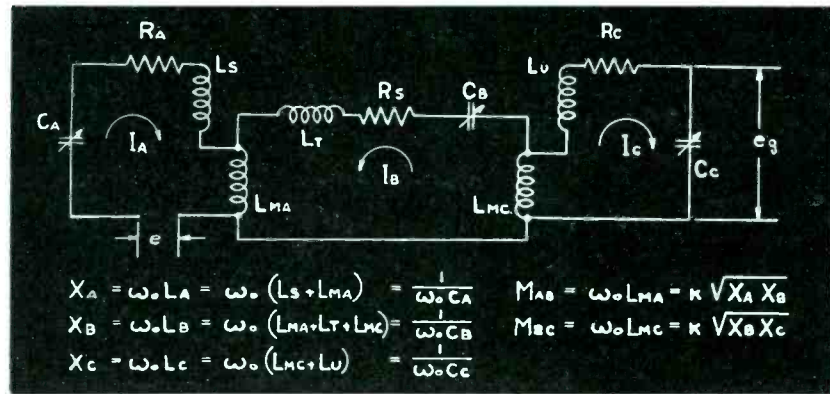

Fig. 3—Three resonant circuit network with common resistance coupling

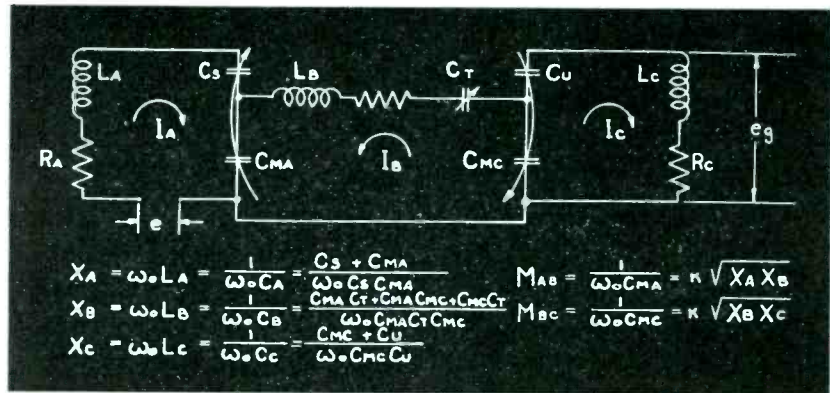

Fig. 4—Three resonant circuit network with common capacitance coupling

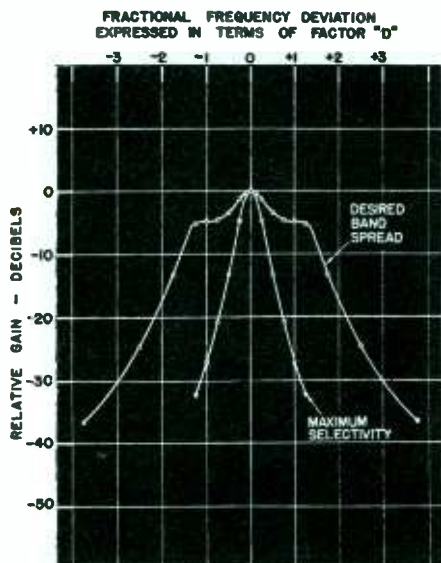

Fig. 5—Calculated universal resonance curve of critically coupled three resonant circuit network

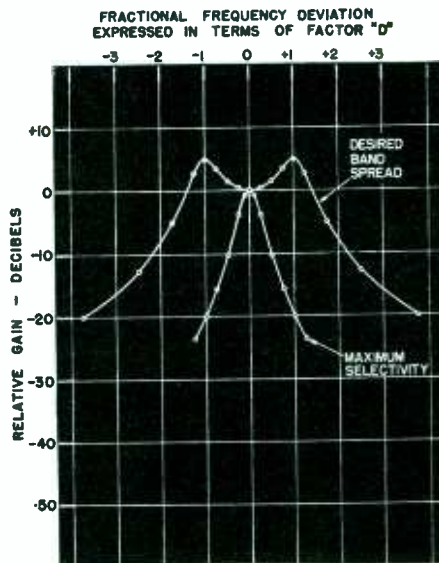

Fig. 6—Calculated universal resonance curve of matched two resonant circuit transformer network

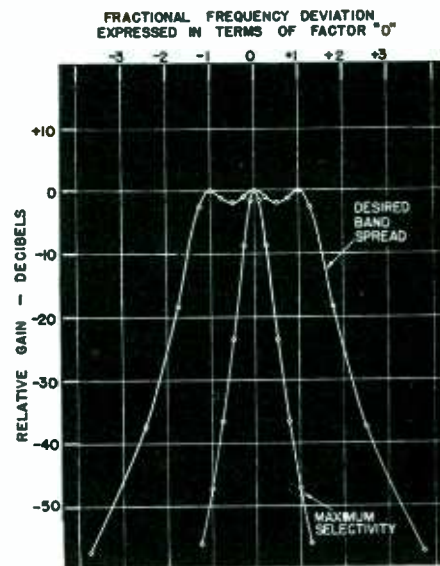

Fig. 7—Calculated resultant universal resonance curve for two and three resonant matched transformer networks

By designing the three resonant transformer for plateaus on each side of resonance, and two resonant transformer to have peaks at these plateaus, the combined overall response, Fig. 7, has only slight ripple in the pass band.

minimum. When the coupling is reduced, these roots become imaginary and the plateaus disappear. In addition to these four roots, there is a fifth root at resonance.

Since the two resonant circuit network has only three distinct roots at most, it is desirable, for purposes of matching, that the three resonant circuit network should have its coupling adjusted so that its response curve will also have just three distinct roots. This is one of the reasons for adopting the critical coupled response curve as the Desired Band Spread curve.

The points on the universal resonance curve of Fig. 5, at which the critical roots occur are at $D = \pm 1$. This is a matter of definition. The term D is only a rationalized measure of bandwidth or fractional frequency deviation. The ratio of the gain at any point of the curve to the gain at resonance is termed the relative gain and is designated by g . The relative gain at the point $D = \pm 1$, where critical roots occur is g_D .

Description of the Complimentary Two Resonant Circuit Network

The two resonant circuit network is used in the second stage of the amplifier shown in Fig. 1, and in the pass band, has a response curve having relative gain complimentary to that of the three resonant circuit network. Also, the frequency of each maximum of the matched two resonant circuit response curve is the

same as the frequency of a plateau of the critically coupled three resonant circuit response curve and vice versa. Mathematically, this is expressed as

$$g_{D2} = 1/g_{D3}$$

The subscripts (2) and (3) are used to differentiate between values corresponding to the two and three resonant circuit networks respectively.

Various forms of coupling can be used in the two resonant circuit transformer as an alternative to mutual inductance coupling as shown.

The solution of the two resonant circuit problem is not new. Calculated universal resonance curves of the matched two resonant circuit network are shown in Fig. 6. The curve Desired Band Spread is the response curve which is complimentary to the response curve of the critically coupled three resonant circuit transformer. The curve Maximum Selectivity is the response obtained as the coupling approaches zero as a limit.

Resultant Response of Two Stage Amplifier

The resultant response of the two stage amplifier, shown in Fig. 1, is given in Fig. 7. These curves are obtained by combining the response curves of Fig. 5 and Fig. 6. The curves in Fig. 7 are for the condition that all resonant circuits, in the three resonant circuit network, have the same Q .

It is observed that although the three circuit and two circuit curves match at the roots ($D = 0$ and $D = \pm 1$), the resultant curve has some "ripple." The actual amount of ripple is small; at the point $D = \pm 0.5$, which is midway between the point of resonance and the critical roots, the relative gain is 0.806. This is less than two decibels below the gain at resonance or at the critical roots.

Tabular Data for Design of Resonant Transformers

The data in Table I contain all the information necessary for the calculation and design of the three resonant and the two resonant networks which, when used in cascade in a two-stage amplifier, will produce substantially uniform gain throughout the pass band.

The symbol h used in the first column represents the ratio of the Q of the central circuit to the Q of the first or third circuits of the three resonant circuit network. That is

$$h = Q_B/Q_A = Q_B/Q_C$$

For each value of h there exists a universal resonance curve of the critically coupled three resonant circuit network. For each of these curves there is a corresponding universal resonance curve of the matched two resonant circuit network.

The factor g_D , listed in the second and sixth columns of the table, fur-

TUBES AT WORK

Electronic Machine Balances Rotating Parts.....	101
Scale Audibly Indicates Standard Weight.....	104
Single Contact Controls Rotation Direction.....	104
Shells Annealed by R.F. Induction Heating.....	110
Electronic Aircraft Wing De-Icer.....	110
Chicago Utility FM Anti-Sabotage System.....	112
Vibrator Operates Aircraft.....	114
Electronics Aids Army Camouflage.....	116
Phototube Coal Car Control.....	116
Simple Pulse-Generating Circuits.....	118

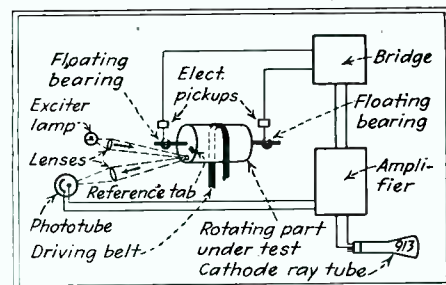

Fig. 1—Block diagram showing principle of operation of electronic balancing machine. Amount and position of unbalance in a rotated part is shown directly on the screen of the cathode-ray tube

Electronic Machine Balances Rotating Parts

A DYNAMIC balancing machine designed by the R. B. Annis Company of Indianapolis determines and indicates the amount and position of unbalance in small rotating parts through a single reading of the trace on the screen of a cathode-ray tube.

The part to be checked is suspended on its own shaft in light-weight, free-floating bearings and is rotated by a driving belt as shown in Fig. 1. A beam of light impinges upon one end of the rotating part and is reflected to a phototube. The light is interrupted once each rotation by a reference tab affixed to the end of the part during the test and from which there is little reflection. Thus a timing pulse rate dependent upon the speed of rotation appears across the output of the phototube and is passed to the cathode-ray tube amplifier.

Voltage proportional to the bearing vibration is generated at each end of the shaft by electrical pickups connected to the cathode-ray tube amplifier through a bridge. Unbalance voltage appearing across the output of the bridge when bearing pressure is unequal is indicated by the height of the cathode-ray tube trace. Position of unbalance is also shown by the trace as the phase relationship between voltage generated by the pickups and voltage generated by the phototube.

The reference tab on the end of the rotated part is set opposite the light spot while the part to be tested is at rest, before the rotating motor is started. The phototube and exciter lamp head are on the same optical axis in a common frame which may be rotated eccentrically around a central pivot by means of a handwheel. A constant correction position may be obtained by turning the handwheel so that zero phase relationship exists between phototube and bridge circuit output voltages. A switch included in the machine permits the operator to determine the extent of unbalance in either of two correction planes.

The largest photograph in Fig. 2 shows the "Dynograph" in use in an industrial plant, with the operator correcting unbalance in a small rotating part under test by adding the weight of solder where it is needed to true up the part. Identifying numerals and letters in the other photographs indicate the location of balancing machine parts, as follows: (1) A-c power switch (3) horizontal gain control (4) vertical gain control (5) left-right unbalance plane selection switch (6) potentiometer dial (7) power cord (10)

cable to electrical pickup number one (14) 913 cathode-ray tube (17) driving motor pulley (18) idler slide bar (21) idler pulley (22) fabric drive belt (23) foot switch (24) vibration isolating mount (H) calibrated handwheel (K) photoelectric optical system (N) carriage base for right and left movement (P) front vertical guard (Q) rear vertical guard and right and left pickup housing (U) connector for pickup number two (Z) belt bracket.

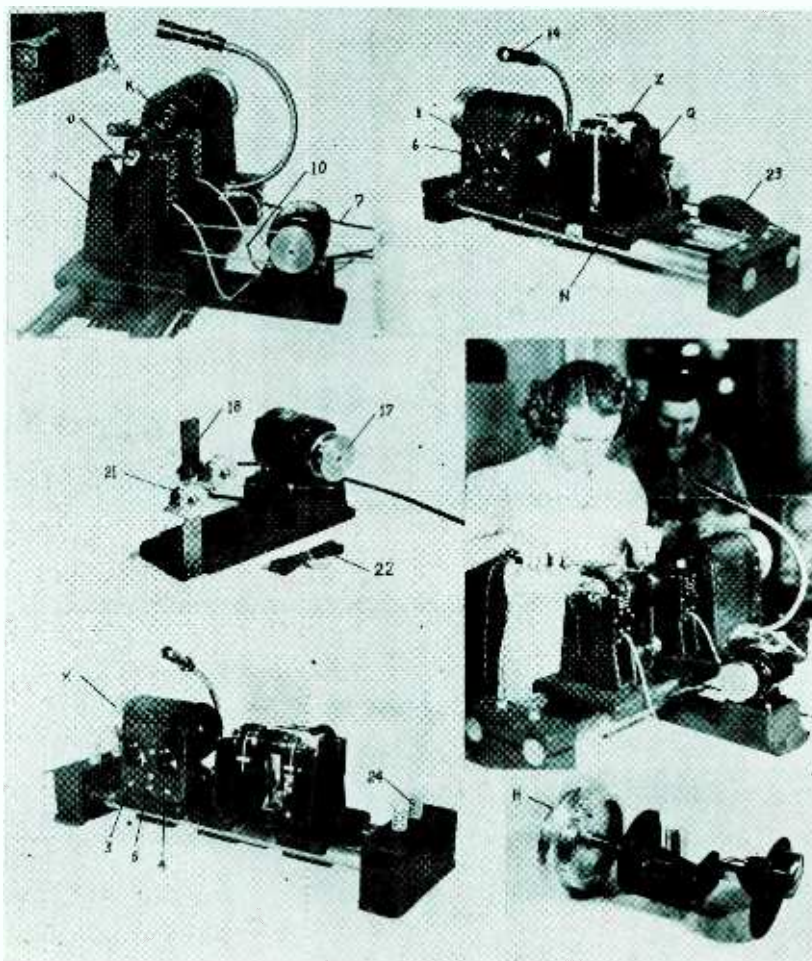
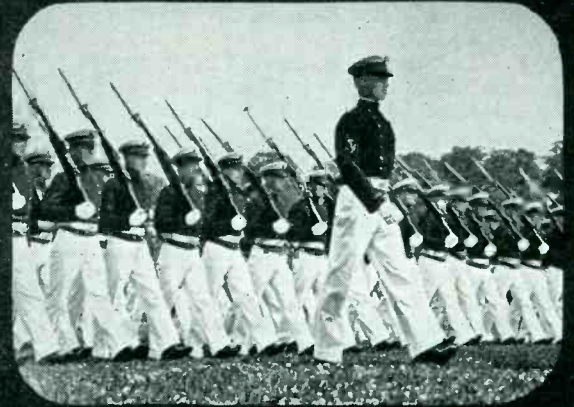
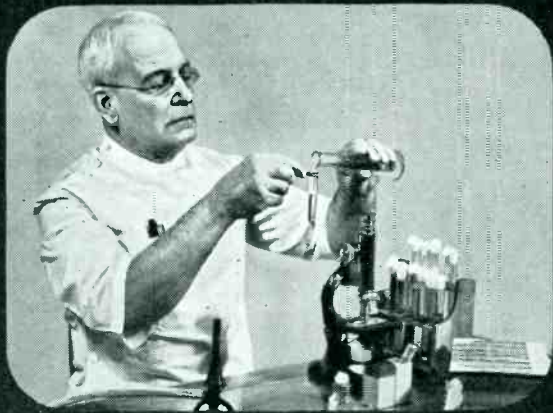

Fig. 2. Photos showing the balancing machine in use and the locations of various component parts. Designating numerals and letters are referred to in the text



**We're experimenting
so you won't have to**

General Electric is operating today one of the world's most complete television stations, WRGB, at Schenectady. There, within the limitations of full-scale war production, G. E. is gaining practical knowledge on which to build a new industry.

For a clear television picture on a fluorescent screen is only the beginning of television. From there on out, problems still loom. What will television offer that movies, theater, concert hall,

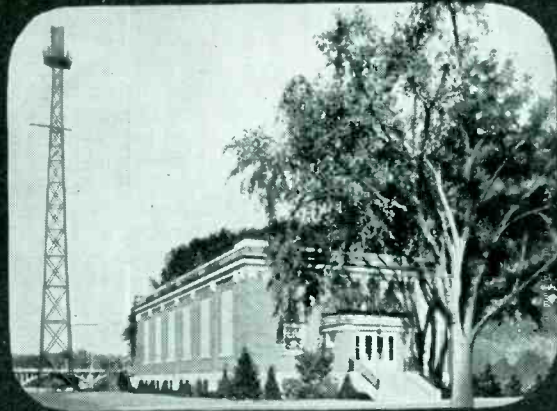

To help you plan for television, visit General Electric's proving-ground station WRGB, shown above

school, and radio cannot offer? Will the television screen make a good teaching platform? Will it further the fine arts, science, industry? What can it offer uniquely to the church?

How, in short, will television best serve the public welfare? How best improve our lives?

General Electric electronic engineers are studying and improving transmission and reception. And studio manager and program staff are urged to give fullest expression to creative

talents and ideas. For the General Electric vision is to make television stand on its own feet as a new cultural and entertainment medium.

In the future, when you are planning your television station, General Electric will be ready with a wealth of experience in television programming and techniques. General Electric today is scanning tomorrow. . . . Radio, Television, and Electronics Department, General Electric Company, Schenectady, New York.

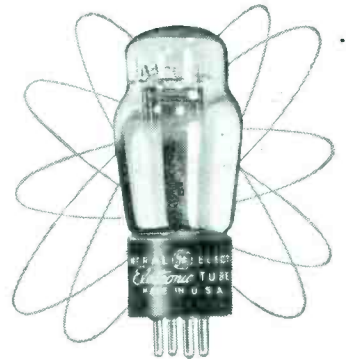

LEADER IN RADIO, TELEVISION, AND ELECTRONIC RESEARCH

GENERAL  **ELECTRIC**

160-A1-6918

TELEVISION

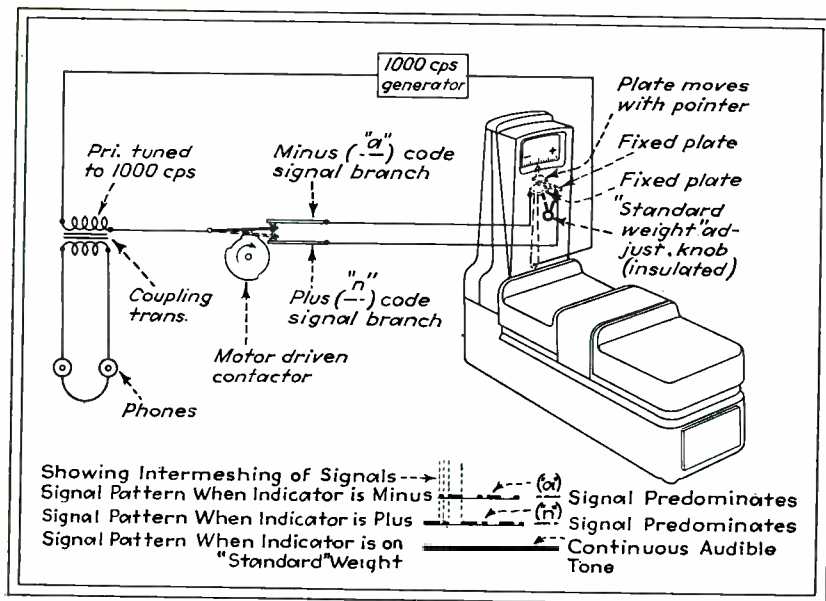

Scale designed to audibly indicate "standard" weight, under-weight and over-weight. A steady tone is heard in the headphones in the first case, the code signal "a" in the second and "n" in the third

Scale Audibly Indicates Selected Standard Weight

A SCALE suggested by a Buffalo blind woman, developed by the Toledo Scale Company and recently demonstrated at the offices of the American Foundation for the Blind transmits a continuous tone to a pair of headphones when the weight of objects placed upon its platform exactly corresponds with any selected standard weight within the range of the scale, sends the code-letter "a" when objects weigh less than the standard and the letter "n" when they weigh more. Obviously invaluable to the blind, the scale should also prove useful to people having normal sight where, for example, an industrial process requires weighing of objects in the dark or where the worker's eyes must simultaneously be used in another operation.

A small, light metal plate is permanently fastened to the pointer of the visual weight indicating device. Two "fixed" plates, insulated from each other and from a knob which permits them to be moved to a position corresponding with the desired standard weight, are positioned in close proximity to the plate fastened on the pointer. The three plates constitute a split-stator capacitor of about 10 μ f maximum capacity, with the pointer plate serving as the rotor.

The capacitor is connected in a series circuit containing a simple 1,000 cps General Radio "hummer" type signal generator, the primary of an audio transformer tuned to 1,000 cps and a contact driven by a motor-operated cam. The cam is cut so that two fixed contacts, connected to the fixed plates of the capacitor in a branch circuit arrangement, are opened and closed in a dot-dash-dot sequence.

It will be seen when examining the accompanying diagram that when the capacitor rotor is exactly centered over the slot between the two fixed plates, so that the capacity from the rotor plate is precisely the same to each stator plate, the amplitude of the radio signal flowing in the primary of the audio transformer through each of the contact circuit branches will be equal. When this condition applies, indicating close agreement between the weight of objects on the scale and the standard weight for which the fixed plate adjustment knob is set, a steady tone will appear in the headphones owing to a merging of "a" and "n" code signals generated by the motor driven disc, in the manner indicated by the notation at the bottom of the diagram.

When the weight of measured objects is less than the standard value the scale pointer and its affiliated capacitor

rotor plate will be off center in a negative direction and when the weight is more than standard value it will be off center in a positive direction. In the first case the amplitude of the audio signal flowing through the larger capacity in series with the minus or "a" branch circuit will be greater than that flowing through the "n" branch, while in the latter case the amplitude of the signal flowing through the "n" branch will be greater than that flowing through the "a". The predominating code signal heard in the headphones will, therefore, indicate whether objects are under or over standard weight. An operator is thus guided by audio signals, in very much the same manner as is the pilot of an airplane following a typical radio beam.

Single Contact Controls Shaft Rotation Direction

A WIDELY USEFUL circuit developed by Hurley Electronic Controls of Chicago permits the direction of rotation of a shaft driven by two opposed a-c motors to be controlled by the opening and closing of a single make-break contact, one motor being energized when the contact is closed and the other motor operating when the contact is open.

The control contact handles little electrical power so it may be a light, sensitive unit susceptible to operation by a small amount of mechanical force. This, plus the fact that the rapidity with which the shaft rotation direction may be reversed depends almost exclusively upon the characteristics of the associated driving motors, admirably adapts the circuit to automatic control of such things as temperature, pressure, gas and liquid flow. The contact may, for example, be adjusted for operation at some critical value by various kinds of thermometers, bellows and valves. Motion of the controlled shaft as temperature, pressure, gas or liquid flow trends above or below the selected value may then be used to effect whatever external equipment

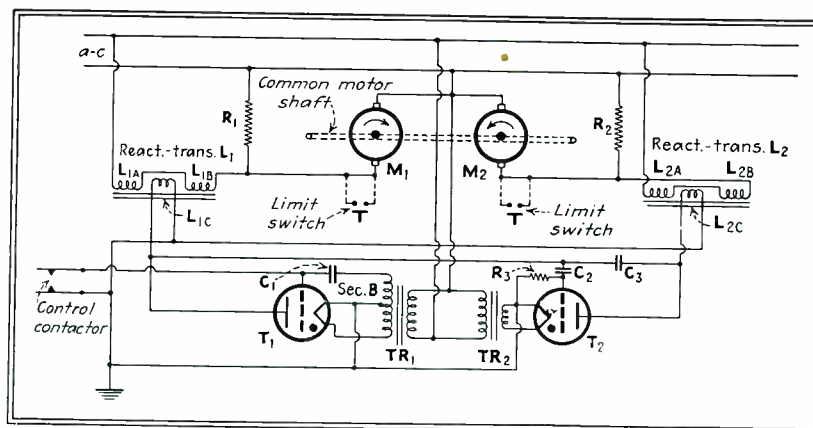
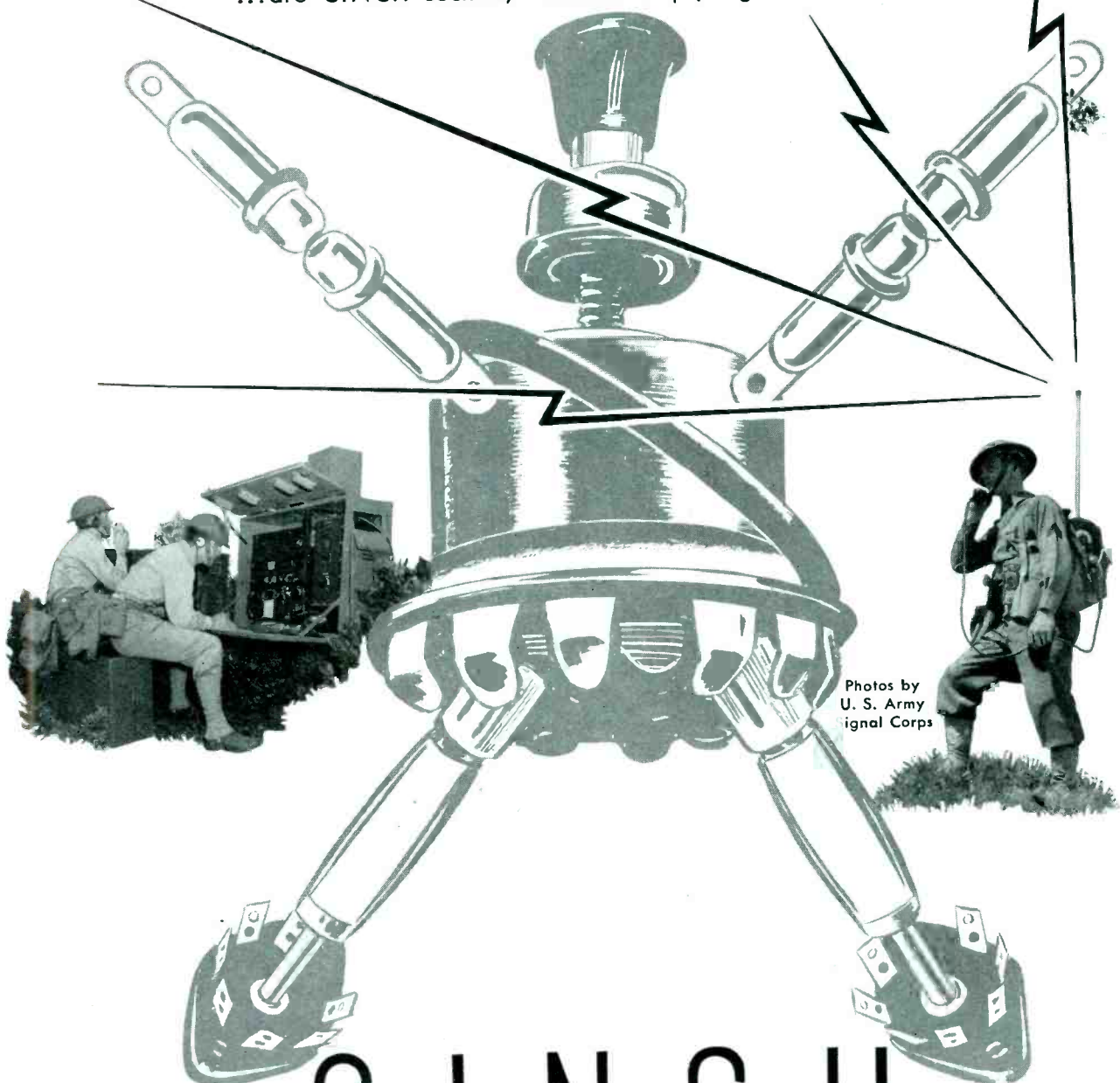

Fig. 1—Schematic of electronic control designed to rotate a shaft in one direction when temperature, pressure, gas or liquid flow falls below a selected critical value and in the other when such factors rise above the critical value. Motors M_1 and M_2 provide the power to operate external corrective equipment

LITTLE . . . BUT THEY REACH . . .

RIGHT UP INTO THE SKY AND SPREAD EVERYWHERE, all the time. In the air . . . on land and sea, "CINCH" parts fit in perfectly in the job to be done. Extensively used . . . serving faithfully in the rapidly extending upward and onward lines . . . are CINCH sockets, terminal strips, lugs and connectors.



Photos by
U. S. Army
Signal Corps

CINCH

MANUFACTURING CORPORATION · 2335 WEST VAN BUREN STREET · CHICAGO, ILL.
SUBSIDIARY: UNITED-CARR FASTENER CORP., CAMBRIDGE, MASS.



**GENIUS
AT
WORK!**

A United Electronic's Contribution to the War Effort

Have you ever contended with the problem of controlling motion, up to and beyond the capabilities of mechanical reaction?

A tube which does just that is the type 967 grid control rectifier. This tube is typical of the many developments United Electronics has contributed to the war effort.

Truly, Genius at Work, the type 967 has stepped up production in a great number of fields. Control of welding operations, control of high speed wrapping machines, counting and sorting of beans to bolts—are just a few of the many applications of this tube.

Callite Tungsten is justly proud that its precision products played a part in the development and production of this truly remarkable tube. Perhaps Callite's extensive metallurgical experience can assist you in improving the quality of your product. Why not consult with our engineers today?

Specialists in the manufacture of welds, lead-in wires, filaments, grids, formed parts, electrical contacts, bi-metals and other metallurgical products. You will greatly facilitate production and expedite deliveries by supplying with your orders properly executed Preference Rating Extensions.

CALLITE TUNGSTEN CORPORATION

544 39th STREET



UNION CITY, N. J.

CABLE: "CALLITES" • BRANCH OFFICES: CHICAGO • CLEVELAND

adjustments are necessary to restore desired conditions.

Circuit Operation Principle

A typical control circuit is shown in Fig. 1. Reactor L_1 is designed to limit current-flow from the a-c line through series-connected windings L_{1A} and L_{1B} so that motor M_1 cannot operate unless the reactor core is saturated by d.c. flowing through winding L_{1C} . Reactor L_2 , controlling motor M_2 , is similarly designed.

Direct current saturating reactor L_1 to operate motor M_1 flows through winding L_{1C} only when thyatron tube T_1 fires and self-rectifies applied a-c anode voltage. Tube T_1 cannot fire unless the control contactor is closed. Similarly, d.c. saturating reactor L_2 to operate motor M_2 flows through winding L_{2C} only when thyatron T_2 fires and self-rectifies applied a-c anode voltage. The circuit of T_2 is arranged so that this tube cannot fire while T_1 is operating. Tube T_2 fires only when the control contactor is open. Both motors obviously, cannot operate at the same time.

(It should be noted that, in addition to their function as motor current control reactors, L_1 and L_2 also serve as a.c. anode supply voltage transformers for tubes T_1 and T_2 . Windings L_{1A} , L_{1B} , L_{2A} , and L_{2B} constitute the primaries and windings L_{1C} and L_{2C} the secondaries. Anode voltage is supplied by these reactor-transformers, even though there may be insufficient primary current flowing to operate the associated motors, due to the completion of primary loops by resistors R_1 and R_2 . These resistors also permit the circuit to function if motor rotation limit switches are included as shown by the dotted lines in the schematic.)

Open Contact Conditions

With the control contactor open, a.c. developed across transformer TR_1 secondary B is rectified in the grid-cathode circuit of tube T_1 and charges capacitor C_1 . Because of the phase relationship of this winding and winding L_{1C} of reactor-transformer L_1 this voltage biases the grid of tube T_1 negatively with respect to the cathode and is of sufficient amplitude to cut off this tube despite the presence of a.c. from winding L_{1C} on its anode. No d.c. anode current flows through winding L_{1C} , therefore motor M_1 cannot operate.

The grid of tube T_2 is connected through capacitor C_2 to one leg of winding L_{1C} and through capacitors C_2 and C_3 to one leg of winding L_{2C} . Phase-shift of potential applied across grid-cathode resistor R_2 by L_{1C} is less than that of the grid potential derived from voltage across L_{2C} since only capacitor C_2 is effective in the circuit under the open control contactor conditions outlined. Thus, if the potential across winding L_{1C} is substantially equal to or greater than the potential across

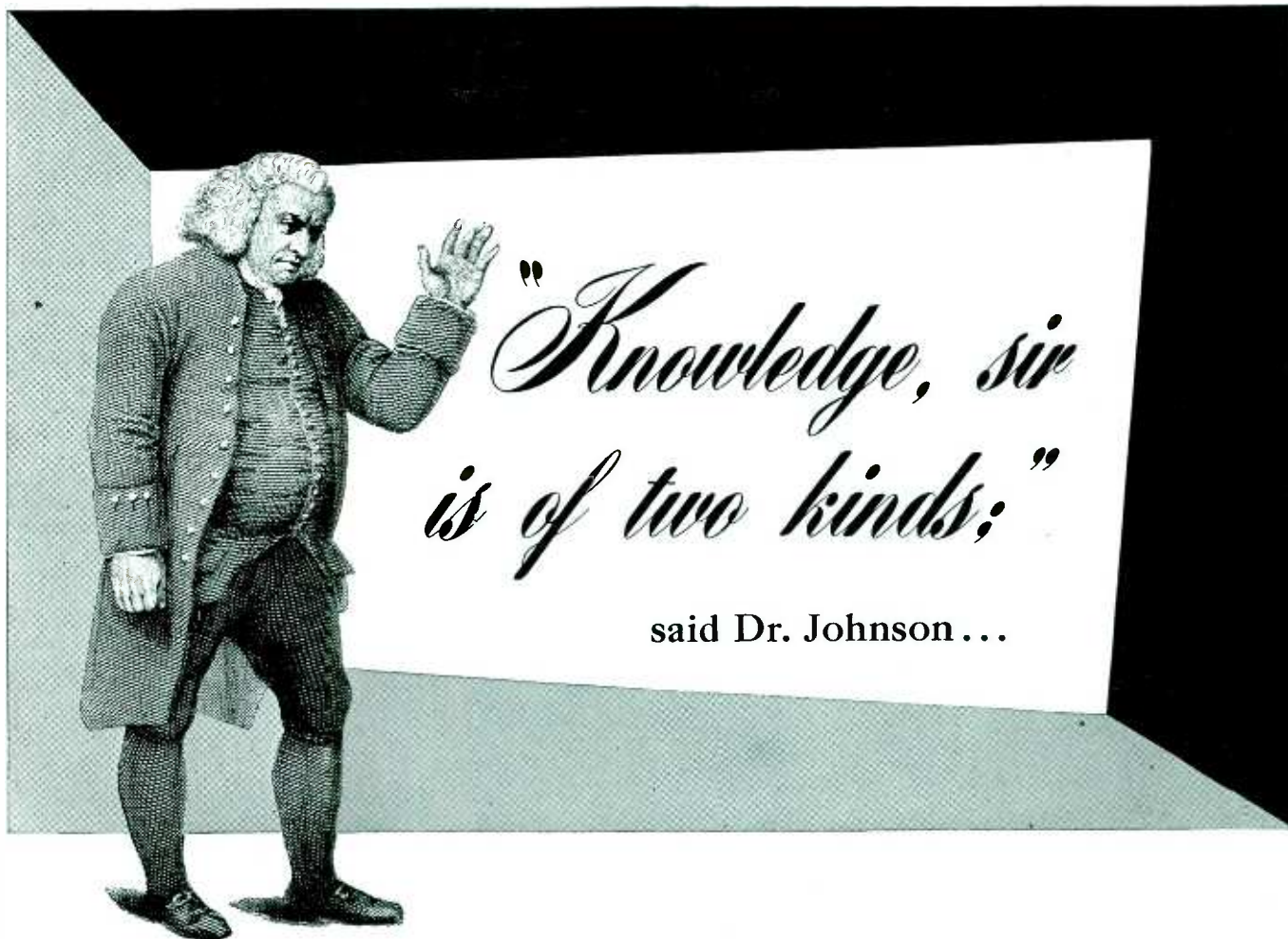

**"We Know a Subject Ourselves or
We Know Where We Can Find Information About It"**

Wise old Samuel Johnson was not, we suspect, talking about the electronics industries . . . But his statement, like most basic truths, applies directly to the increasing search for knowledge among executives and engineers in this field.

Here at IRC you will find a Service and Information Center staffed by electronic engineers of outstanding ability.

Their work has two main purposes: — to design, perfect and maintain the quality of IRC Resistors; to cooperate with you on Resistor applications of every nature. Their counsel is scientifically sound and scientifically impartial whether they recommend IRC units or some other make.

If there is a Resistor problem puzzling you, you can "find information about it" here.

Preferred for Performance  *Fixed & Variable Resistors*

INTERNATIONAL RESISTANCE COMPANY

403 N. BROAD STREET • PHILADELPHIA

"Dispatched on the Double-

...BY RADIO!"

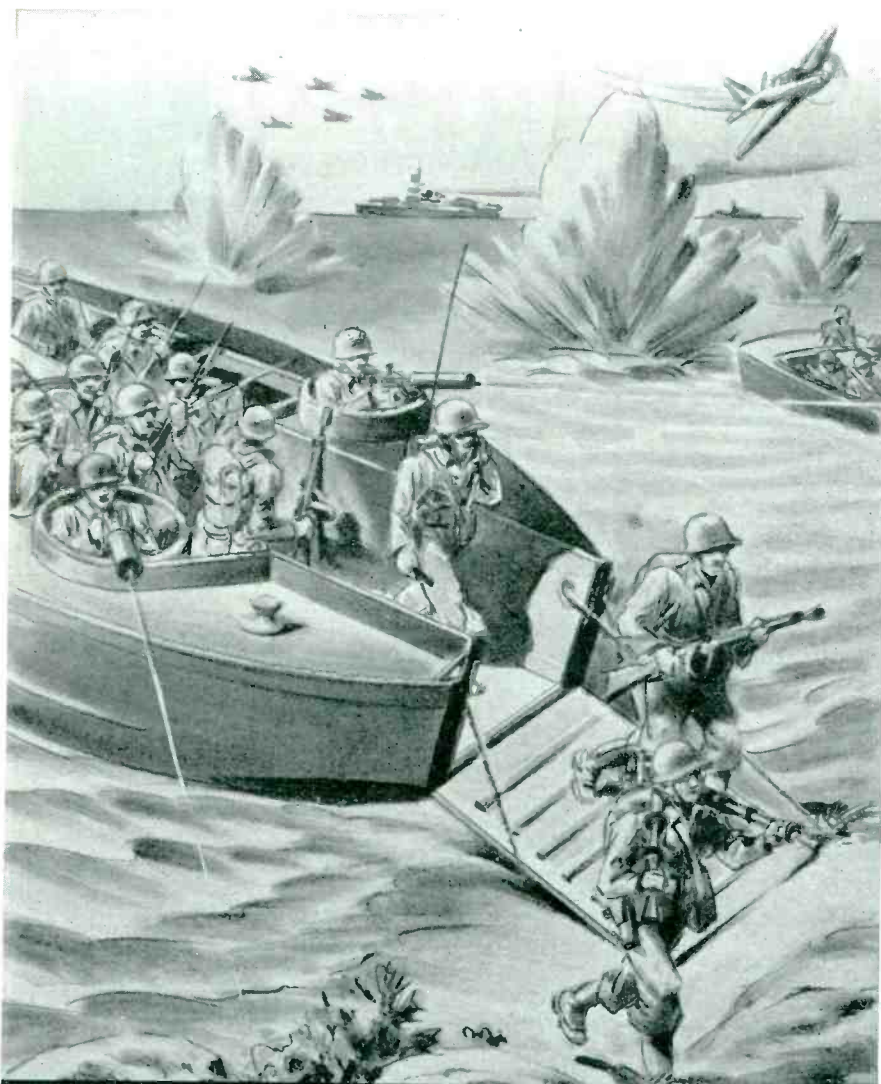

winding L_{2C} it will decrease the effective phase-shift of the potential applied to the grid of T_2 from winding L_{2C} and permit anode current to flow through this tube. Stated in other words, when the grid of tube T_1 is negatively biased because the control contactor is open, flow of d.c. through winding L_{1C} ceases and the potential across this winding increases to its open-circuit value. Open-circuit voltage is approximately equal to the open-circuit potential across winding L_{2C} . When this occurs, and so long as such a condition applies, T_2 passes anode current. Therefore, d.c. flows through winding L_{2C} and motor M_2 operates.

Closed Contact Conditions

When the control contact is closed capacitor C_1 is discharged to ground, negative bias is removed from the grid of thyatron T_1 , anode current flows through winding L_{1C} , reactor L_1 saturates and motor M_1 operates. Potential across winding L_{1C} decreases because of the voltage drop in this winding, bias voltage developed by winding L_{2C} gains control of tube T_2 and cuts off T_2 anode current, stopping motor M_2 .

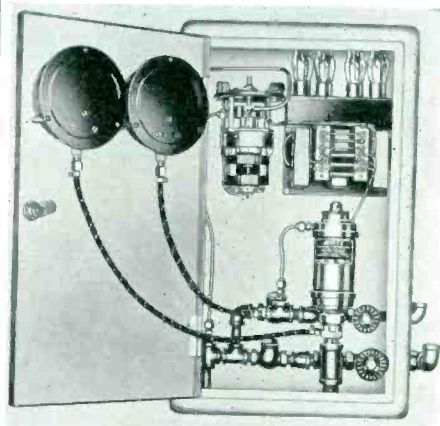
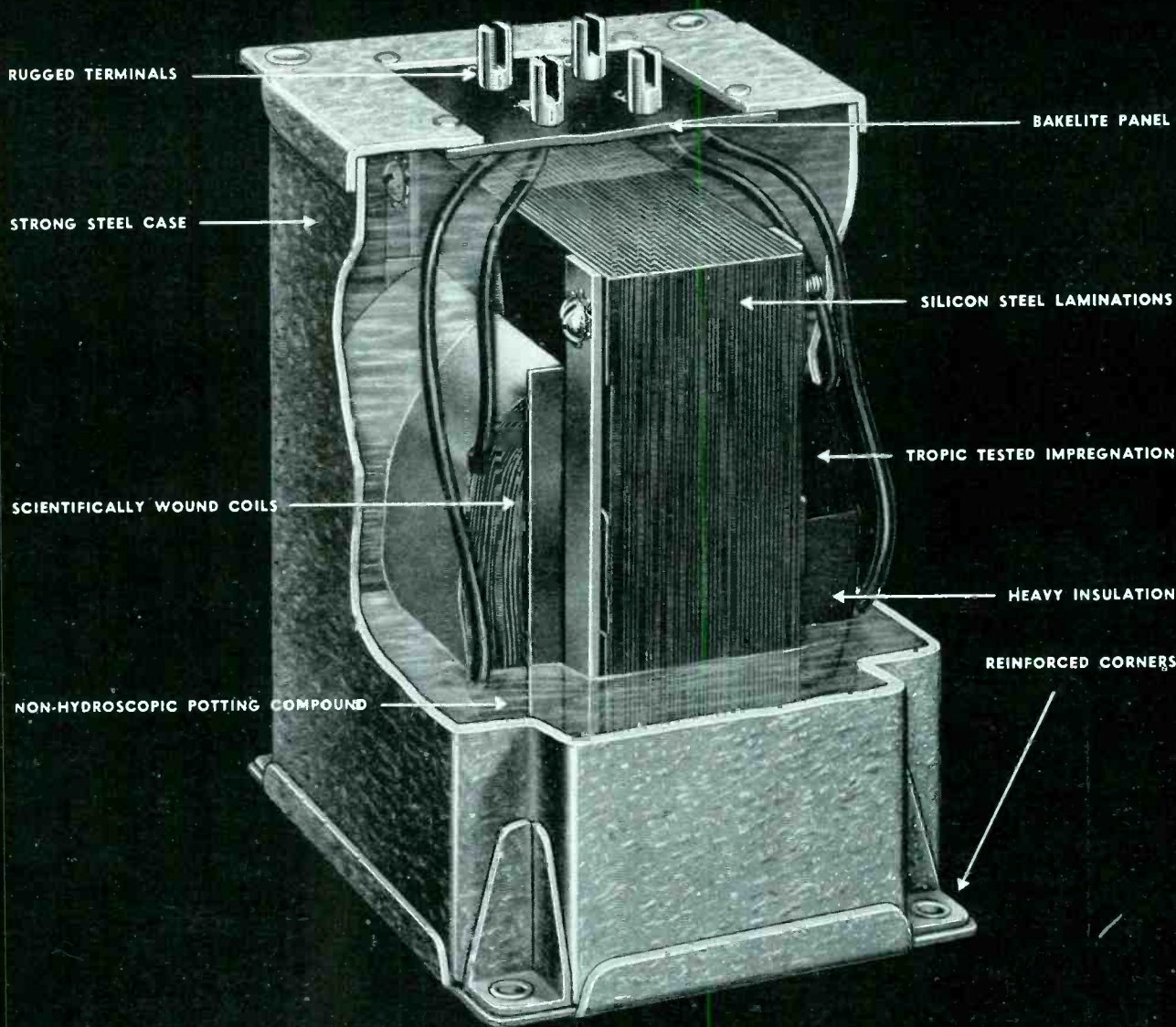

Fig. 2—In this particular control a pressure-sensitive device (lower right), operating a single make-break contact and four thyatron tubes (upper right) operate two a-c motors on a common shaft (upper left) in such a manner that steam pressure is kept at a selected critical value

Figure 2 pictures one specific type of control unit embodying the circuit described. In this instance the equipment was designed to accurately and automatically control steam pressure. There are, of course, many other applications, but these require modifications in the type of gear used to operate the control contact and selection of suitable motors rather than circuit alterations. The single contact control principle described may, of course, be used to operate a plurality of alternating current devices beyond the two diagrammed. Certain applications may dictate the substitution of solenoids or other a.c. operated devices for the motors.

WE ARE THERE WITH
AVIATION RADIO RANGE FILTERS - TRANSMITTERS -
RELAY COILS - TRANSFORMERS -
ELECTRONIC EQUIPMENTS AND TEST UNITS
OXFORD-TARTAK RADIO CORP.
3911 S. Michigan Ave., Chicago, Ill.



For Dependability... Stamina... Adaptability

STANCOR PROFESSIONAL SERIES TRANSFORMERS

BUILT TO MEET STRINGENT WARTIME REQUIREMENTS

THE Stancor Professional Series Transformers are the logical choice of Radio Engineers, Broadcast Engineers, Governmental Agencies, Radio Manufacturers and other equipment designers and users. They are built to meet stringent wartime requirements.

STANCOR quality assures you of sound engineering design, the finest obtainable raw materials, thorough inspections, and high standards of craftsmanship.

★ GENERAL SPECIFICATIONS ★

CASE DESIGN—

A rugged physical construction featuring reversible mounting has been combined with a smart uniform appearance.

INTERNAL MECHANICAL CONSTRUCTION—

Special brackets and/or blocks added in assembly prevent shifting of coil and core inside of case.

IMPREGNATION—

The traditional STANCOR vacuum impregnation provides thorough protection against the effects of humidity and moisture. The special compound, sealing each unit in its case, gives additional protection and adds to the long life and service obtainable from these units.



The Stancor Professional Series Catalog No. 240 lists and thoroughly describes many types of professional series transformers. Also valuable charts to help you. Request your copy today.



STANDARD TRANSFORMER CORPORATION

1500 NORTH HALSTED STREET • CHICAGO

FOR SALE

QUANTITY OF

SEEBURG DE LUXE AUTOMATIC RECORD CHANGER and HOME RECORDER

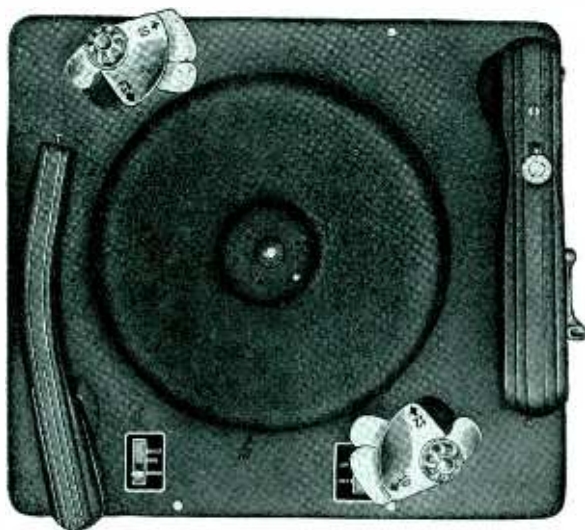

Model No. BR29 (for A.C. only)

These are brand new units in original factory cartons. They are completely equipped including mounting bolts and coil spring supports, and each unit has an elaborate instruction booklet. But the units are minus needles and A.C. and pick-up wires which can be attached quite simply. Terms of payment are by money order or certified check accompanying each order.

This offer is being made subject to prior sale

Price \$32.⁹⁵ ea. net cash

F.O.B. our warehouse in N. Y. City. Approximate Retail Value \$95.00

COLEN-GRUHN CO., Inc.

387 FOURTH AVE. DEPT. E NEW YORK, N. Y.

Shells Annealed By R.F. Induction Heating Machine

A MODIFICATION of shells of a particular calibre required the use of a tap and chaser at the threaded nose fitting. Tool life was exceedingly short and investigation disclosed that the trouble was caused by hardened shot from a blasting operation lodging in the threads and interfering with chaser action.

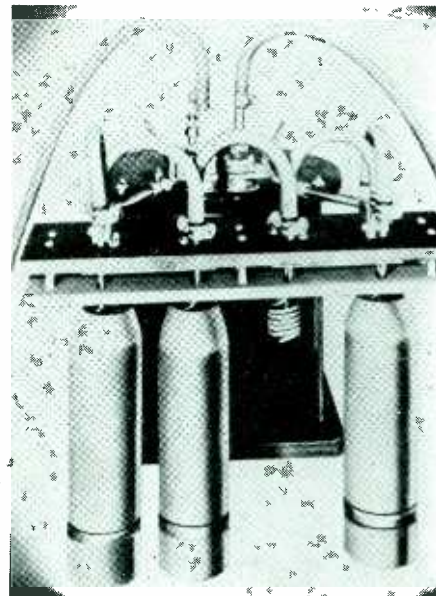

"Business end" of r.f. induction heating unit designed to anneal shell noses. Three shells are shown in place on the four-unit jig. An applicator coil may be seen in the open position

The solution appeared to be to heat the inside of the shell nose to annealing temperature without having the heat penetrate other portions of the shell sufficiently to change the metallurgical characteristics of these portions. The job was done by means of r.f. induction heating, Induction Heating Corporation generator units delivering the required power to special coils designed to fit within the shell nose.

By setting up a multi-unit jig, part of which is shown in the accompanying photograph, relatively unskilled labor found it possible to anneal the noses of approximately 280 shells per hour per machine.

• • •

Electronic Wing De-Icer

DR. WALDO KLIEVER and Richard Franzel of the Minneapolis-Honeywell Regulator Co. have designed an electronic device which indicates the thickness of ice formed on airplane wings at high altitudes, automatically operates air-pulsated "rubber-boot" type de-icing mechanisms (commonly incorporated in the leading edges of wings) when the accumulation reaches a pre-determined thickness.

Weighing less than five pounds and taking up less than 200 square inches of space, the device is normally ad-



MICROPHONES

Yesterday . . . Today . . . Tomorrow

Prewar Microphones. In prewar microphone design, the chief development was in directional pickup. This was a stride forward in the discrimination against unwanted sounds, feedback and background noise. The most efficient directional pickup pattern was the "Super-Cardioid". It effects a 73% reduction in pickup of random noise energy. This was developed by the Shure engineering staff and is being utilized today to good advantage in many wartime applications.

War Microphones. Naturally most improvements are a military secret. It is obvious that service in battle requires—RUGGED construction never before thought possible—CONTROL of frequency response to solve

new and unique acoustic problems. Special applications are being solved for Microphones in masks and on the throat, in tanks, planes, ships and on the battlefield.

Postwar Microphones. New experience in war engineering and war production will provide tomorrow's Microphones with incredible ruggedness—special frequency responses for specific applications—controlled pickup that will permit wider use of sound amplification. When the war for world-wide freedom has been won, Shure Brothers will be ready to make its contribution to *better sound in a better world.*

Shure Brothers • 225 West Huron Street • Chicago, U. S. A.



Designers and Manufacturers of Microphones and Acoustic Devices

ELECTRONICS — January 1943

SAVE TIME SIMPLIFY BUYING

Get ALL your
ELECTRICAL
INSULATING
MATERIALS

FROM ONE
SOURCE
OF SUPPLY



Backed by
53 YEARS
Experience

Send for your FREE personal copy of our new, complete 44 page pocket size Guide Book—containing complete data, specifications and prices on all M-R products. This valuable book is a MUST for every engineer, purchasing agent and manufacturing executive.

Operating on a national scope, Mitchell-Rand has much to offer manufacturers of radio, communication, electrical, aircraft and other equipment and products:— electrical insulation experience of every conceivable nature — 53 years of service to American industry — complete manufacturing and warehousing facilities with ample stocks on hand at all times to render prompt delivery — at present, having definite understanding of war equipment specifications and requirements — in excellent position to help our customers working on Army, Navy and Signal Corps orders; skilled engineering staff and seasoned sales specialists to serve you — promptly, intelligently and courteously. Mitchell-Rand is one of the country's oldest electrical insulation manufacturers and distributors — with the COMPLETE ELECTRICAL INSULATION LINE.

Send for FREE copy
of Guide Book

Inquiries invited on your electrical insulation requirements.



MITCHELL-RAND INSULATION CO., Inc.

51-A MURRAY STREET, NEW YORK, N. Y.

EST. 1889

COrtlandt 7-9264

A PARTIAL LIST OF M-R PRODUCTS:

- Fiberglas Varnished Tape and Cloth
- Fiberglas Braided Sleeving
- Fiberglas Saturated Sleeving and Varnished Tubing
- Insulating Papers and Twines
- Cotton Tapes, Webbing and Sleevings
- Asbestos Sleeving and Tape
- Cable Filling and Pothead Compounds
- Impregnated Varnished Tubing
- Extruded Plastic Tubing
- Varnished Cambric Cloth and Tape
- Friction Tape and Splice
- Transformer Compounds
- Insulating Varnishes of all types
- Mica Plate, Tape, Paper, Cloth and Tubing

justed to function when the ice accumulation reaches a thickness of $\frac{1}{8}$ -inch. Thus de-icing equipment is turned on at the exact instant when it can function efficiently. Less sensitive controls frequently turn on de-icers too soon, with the result thin ice is cracked but still clings to the wing surfaces and provides a matrix for further accumulation, or turn on de-icers too late with the result that these mechanisms cannot readily handle the load.

The equipment comprises three separate units; a sensing element, an amplifier and relay mechanism and a power supply. The sensing element is contained within a small plastic disc which may be set flush with a wing surface to avoid disturbing the air-foil, or may be built within the de-icing boot. (It need not be in actual contact with the ice accumulation to be measured.) A meter, pre-calibrated in terms of ice thickness, is furnished for installation on the plane's instrument panel. Thus the pilot may turn on his de-icers manually at any time after noting the thickness of ice accumulation. The point at which the device functions automatically is adjusted at the amplifier, generally installed within a wing.

• • •

Chicago Utility Sets Up Anti-Sabotage FM System

To PROTECT its extensive and widely scattered properties against sabotage and to provide emergency communications in the event of an air raid, Chicago's Commonwealth Edison Company has set up an elaborate FM radio system.

The city has been divided into four zones. Two battalions of the auxiliary defense corps, each consisting of three platoons containing firemen, policemen and first-aid personnel, are assigned to each zone. Each zone has about 300 officers and men assigned to it.

The company's plant protection organization includes a large force of full-time, uniformed special police engaged in anti-sabotage patrol and watch service. This force is provided with



Transmitter-receiver installation in a Chicago defense corps ambulance. Map on wall shows location of city hospitals

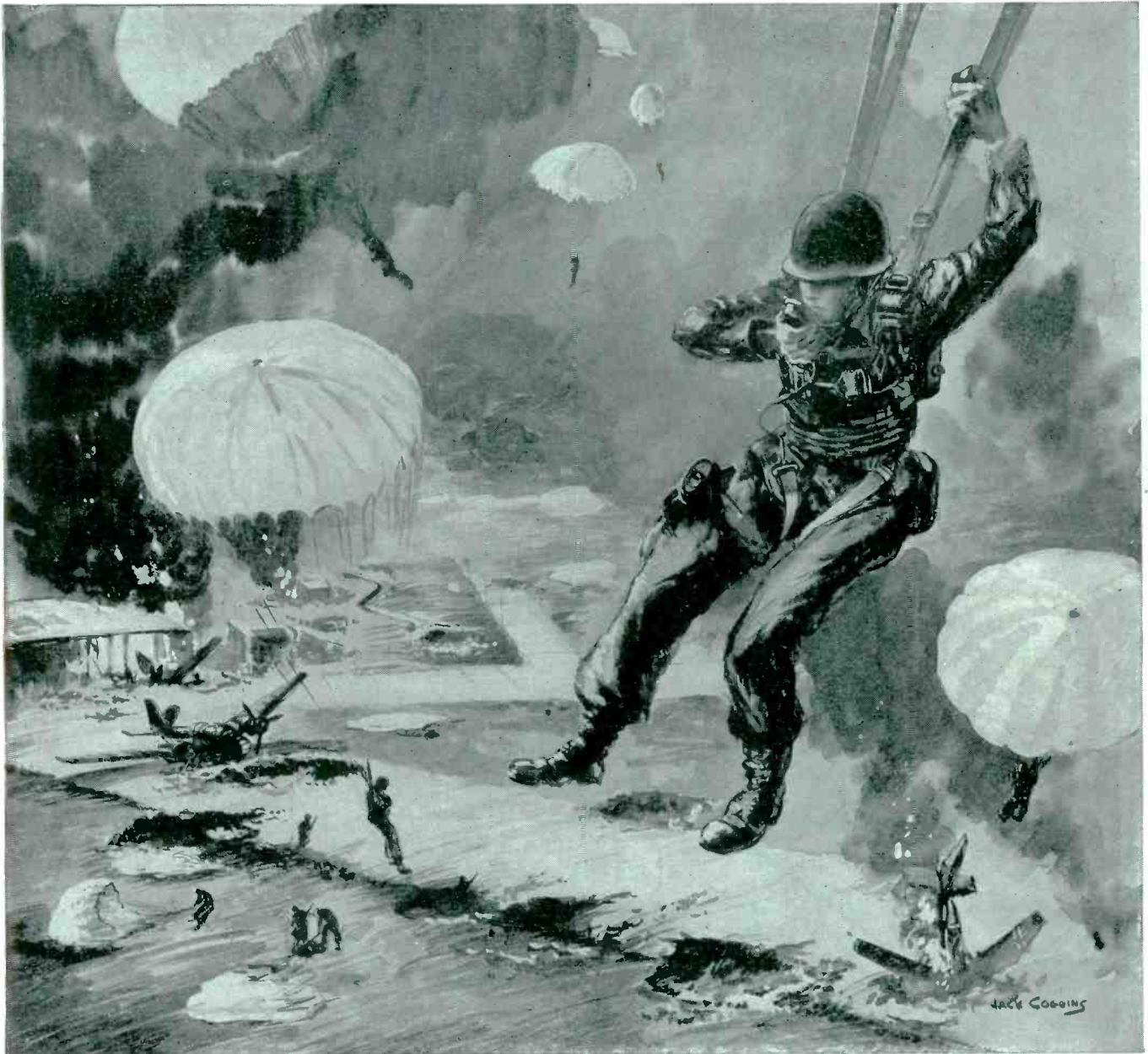

Lifeline

Clear and intelligible directions, spoken over radiotelephone equipment, may mean success or failure to a military operation . . . a soldier's life or death. Our fighting men, though separated by vast distances, are closely linked . . . their actions coordinated by the lifeline of radio communications.

With production racing against time, Jefferson-Travis is developing new engineering designs and advanced manufacturing techniques to speed more improved radiotelephones into front line service with the United Nations. After victory, our equipment will serve the safety and convenience of free men throughout the world.

JEFFERSON-TRAVIS RADIO MFG. CORP.
Manufacturers of Aircraft, Marine and Mobile Radio Communication Equipment

NEW YORK, N. Y.



WASHINGTON, D. C.

This **HEINEMANN**
MAGNETIC
CIRCUIT BREAKER
bares its
Mechanical Heart

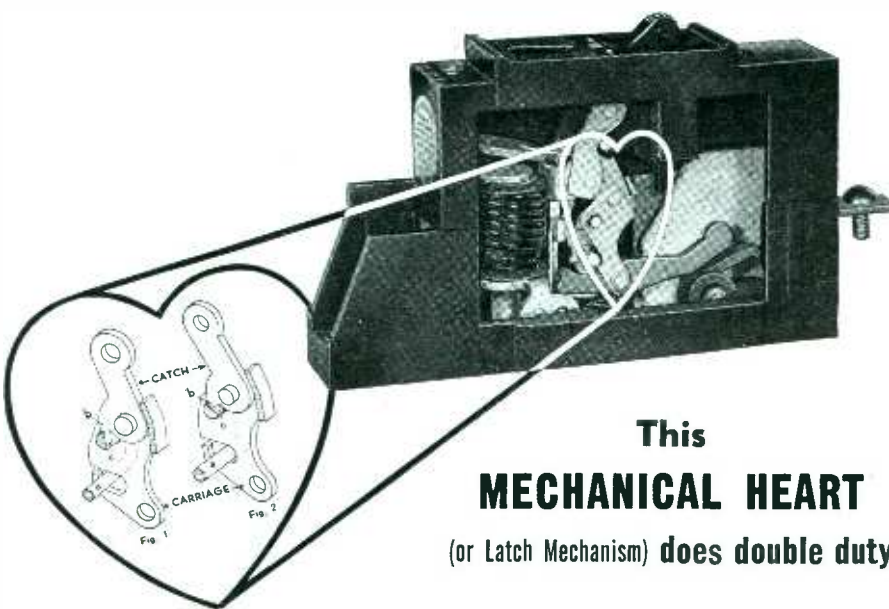

This
MECHANICAL HEART
 (or Latch Mechanism) **does double duty**

No. 1. It opens breaker with least mechanical delay.

When the armature engages the lower leg of the lock (a) it rotates the lock enabling the tooth of the catch (b) to pass through the cut portion of the lock (c), thereby breaking the toggle and releasing the contacts which are under heavy spring pressure. *Of all known latches, this mechanism operates with the least amount of friction.*

No. 2. It opens breaker independent of handle operation.

The relative position of the catch to the carriage remains the same as in Fig. 1 whether the handle is in the "on" position or turned to the "off" position, when the contact is broken manually. The latch collapses only under overload or short circuit conditions—and it does that even if the handle is purposely held in the "on" position. Fig. 2 shows the latch on its way to the collapsed position.

Send for Catalog 40 showing full line

HEINEMANN CIRCUIT BREAKER CO.
 97 PLUM ST. - - - - TRENTON, N. J.



Installation in typical car driven by special Commonwealth Edison anti-sabotage patrolmen

two-way FM radio patrol cars, which makes it possible for guards to reach almost any section of the city in a matter of minutes. Some cars are also provided with receivers tuned to the police frequency. By direct wire to police headquarters company protection authorities can dispatch these cars as well as regular police cars to points where they are needed.

Calls sent out over the company's transmitter are monitored by the state police, permitting incidents outside the city to be handled by sheriffs.



Vibrator Operates Aircraft Fluorescents From Battery

A NOVEL USE for a vibration type d.c. to a.c. inverter is seen in G-E's application of such equipment to the operation of aircraft fluorescent instrument lighting.

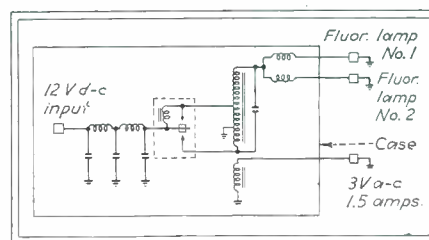

Circuit showing method of using vibrator type d.c. to a.c. inverter for operating aircraft fluorescent instrument lamps

As shown in the accompanying schematic, a-c output from a vibrator driven by the 'plane storage battery is stepped up in an autotransformer to an a-c voltage value sufficient to operate the fluorescent lamps. A typical unit turns out sufficient voltage to operate two 4-watt type T-6 lamps. In addition, a separate secondary winding delivers 1.52 amp at 3 v a.c. with which up to eight type T-1½ lamps may be operated as indicator lights.

Two models are available, one for 12 and one for 24 v d.c. input. Both run at 35 watts maximum input, with approximately 21 watts conversion loss. Net weight is 2½ lbs.

The *First* Real Forward Step
in Radio Design—Since development
of the superheterodyne circuit

**4-cell HARVEY
Scout-car Receiver**

Quickly assembled from standardized cells is this scout-car type receiver; it has two R. F., one I. F., and one Audio units. If greater sensitivity or selectivity were desired, additional cells could be assembled to the basic receiver.

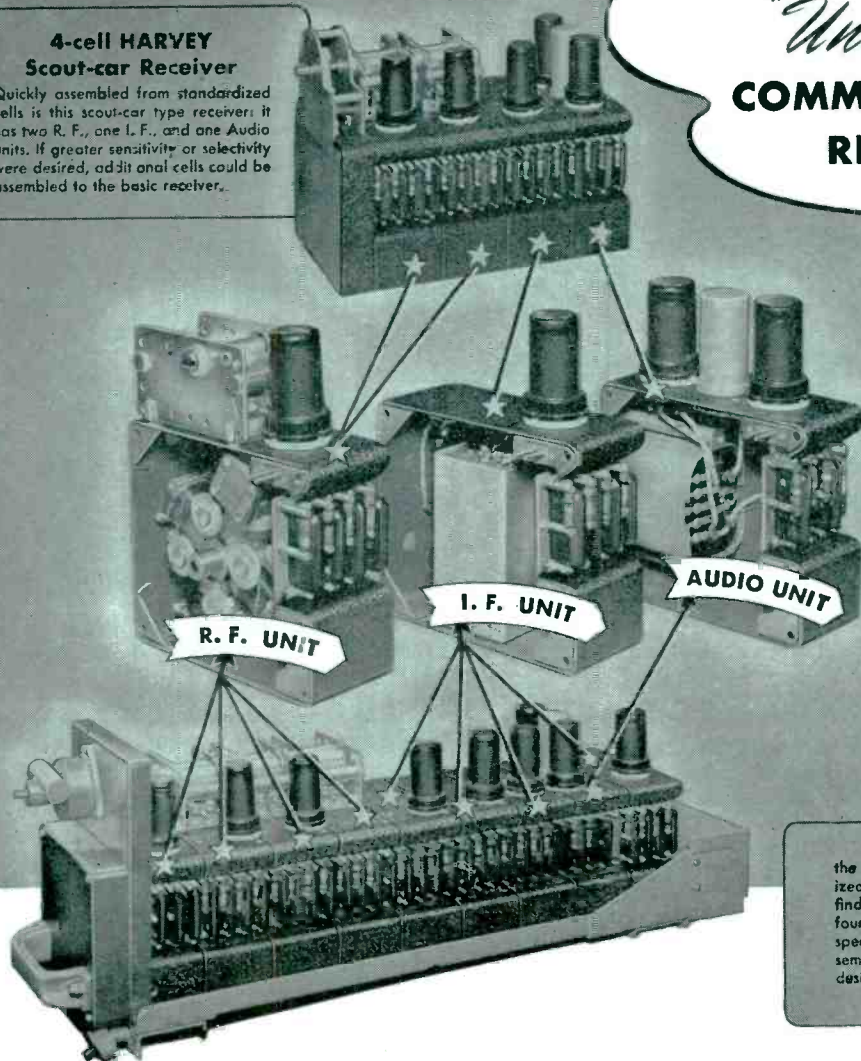

The
HARVEY
"Unitized"
**COMMUNICATION
RECEIVER**

From the
3 Basic Units

the 10-cell HARVEY aircraft receivers of Unitized construction provide automatic direction finding, and loop or antenna reception on four frequency bands; built to Signal Corps specifications. Power supply could also be assembled from standardized Harvey cells, if desired.

REVOLUTIONARY in eliminating critical materials, reducing tube types to only ONE, effecting savings in assembly and servicing time — the HARVEY Unitized construction makes possible custom-built performance by production methods. Among the vitally important features are: reduction of hook-up wire to as little as five feet, in comparison to over one hundred feet commonly used in many communication receivers; reduction in tube types from the usual minimum of six to only ONE; quick assembly and servicing since there are only three basic cell-units; elimination of large spare parts stocks and need for "experts" to make field repairs since complete cells can be as quickly replaced as a tube in ordinary receivers, in event of damage to individual cells.

For the first time, receiver manufacturing is truly put on a production line basis, as a result of *this* Harvey development.

Electronics Division!

HARVEY

MACHINE COMPANY

6200 Avalon Blvd.
Los Angeles, Calif.

OTHER HARVEY DIVISIONS
AIDING THE UNITED NATIONS

**AIRCRAFT DIVISION
ORDNANCE DIVISION
SPECIAL MACHINERY DIVISION**

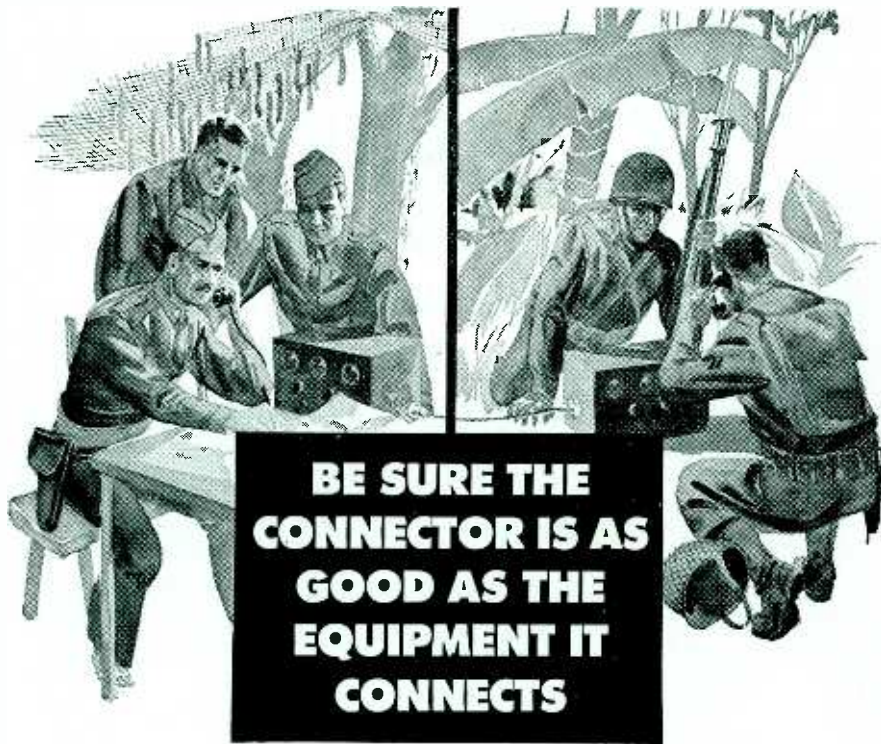

**BE SURE THE
CONNECTOR IS AS
GOOD AS THE
EQUIPMENT IT
CONNECTS**

The best of equipment is no better than the worst if the connections are not dependable. A "cheap" connector may prove to be the most expensive in the long run.

The makers of fine aircraft instruments use Cannon Connectors extensively because they know they can rely upon them to give dependable service under the most severe conditions.

Building quality electrical connectors takes "know-how"... and Cannon Connectors are the result of years of experience in their development and manufacture. That's why you can be *sure* the connector is as good as the equipment it connects when you standardize on standard Cannon Connectors for *your* instruments.

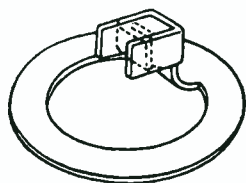

CANNON BONDING RING

For use wherever there is a need for bonding between the plug shell and wire shielding. Can be used with either cable clamp or flexible conduit coupling nut. Write for Bonding Ring Bulletin.

If you would like a copy of our 76-page illustrated manual, "Cannon Plugs for Aircraft Electrical Circuits," drop us a line on your business letterhead and we'll be glad to send you one.

REPRESENTATIVES IN PRINCIPAL CITIES—CONSULT YOUR LOCAL TELEPHONE BOOK

CANNON ELECTRIC



Cannon Electric Development Company, Los Angeles, California

Canadian Factory and Engineering Office: Cannon Electric Co., Ltd., Toronto, Canada

Phototube Coal Car Control

AT A PREPARATION PLANT of the Hanna Coal Company in Ohio loaded cars are automatically emptied by a rotary dump device. They are locked to the tracks immediately over a chute and then the section of track to which they are clamped rolls over, turning the cars

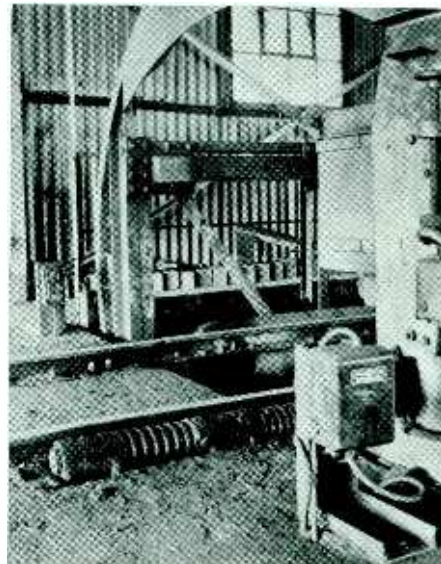

Exit end of rotary dump for coal cars, controlled by a phototube

upside down. When the cars have been emptied and righted again they roll ahead off the track by gravity.

It is important that empty cars be completely clear of the rotated section of track before it rotates again to unload the succeeding full car. Otherwise the empties will be upset on the floor at the exit, a difficulty experienced before the installation of electronic control whenever cars were for any reason sluggish in response to the pull of gravity. Now the dump cannot revolve as long as a beam between a lightsource and a phototube mounted on opposite sides of the exit track is interrupted by an empty car.

Electronics Aids Camouflage

USING A G-E photoelectric spectrophotometer which distinguishes 2,000,000 shades of color, an Army Air Force laboratory is studying the practicability of substituting this electronic instrument for the painted chips ordinarily used as standards for camouflage work. The chips, it seems, fade when exposed to varying temperatures and humidities and, particularly, when frequently handled.

In addition to the possibilities of the photoelectric spectrophotometer in color-matching work, it appears to be distinctly useful in measuring the amount of light reflected and transmitted by plastic materials. Plastics used in the manufacture of aircraft windows or gun-turrets may, for example, be considerably less efficient after exposure to accelerated weathering tests and it is important to know just what their characteristics are.

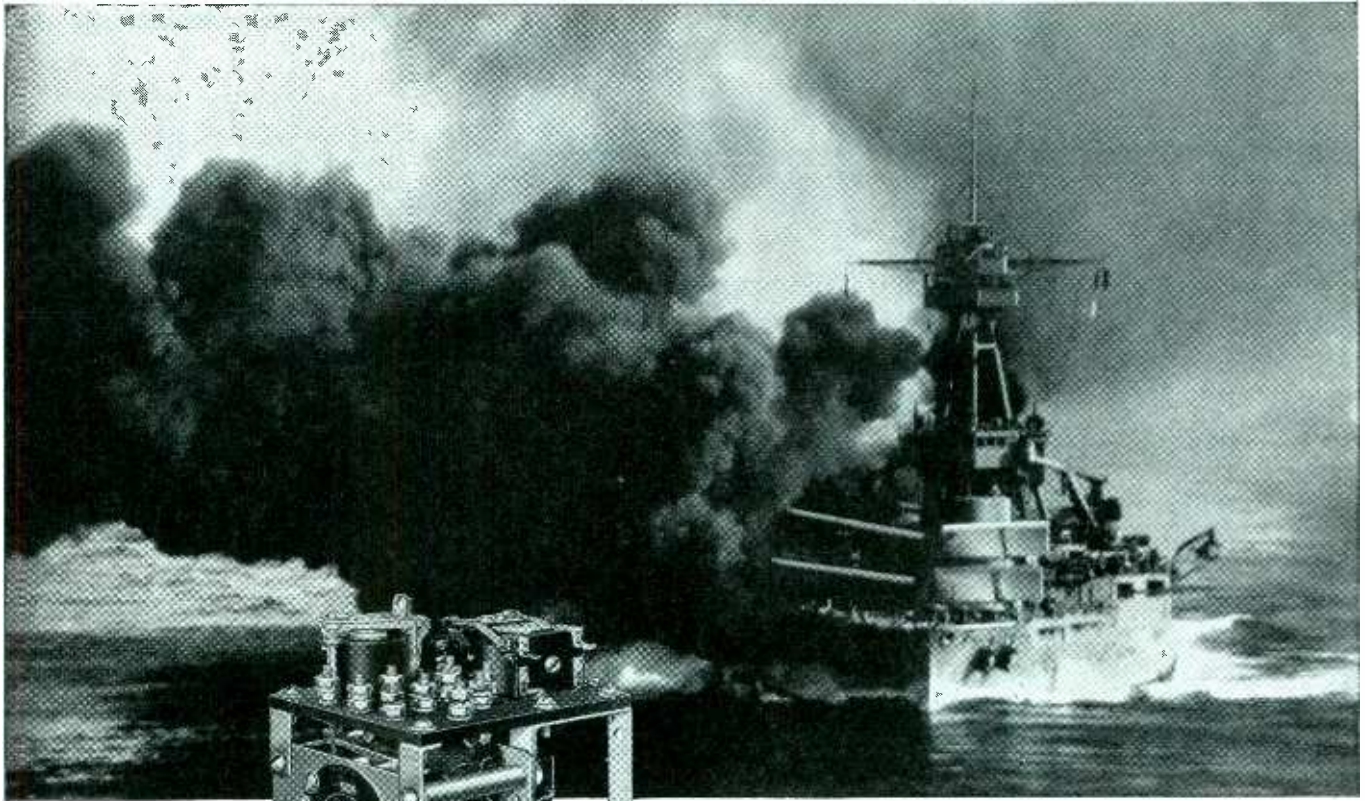

Battleship U.S.S. Texas firing main battery broadside
U.S. Navy Official Photo

IT'S IN THE NAVY NOW

We can tell you about this motor driven, time delay relay because it has been used for years in peace time activities as a time control in drying systems, heat treating ovens, illumination and many other applications.

NOW IT'S IN THE NAVY. The positive action, ruggedness and resistance to shock and vibration of this relay, make it ideal for alarm control, communication circuits and for the protection and timing of many kinds of equipment aboard ship. Manufacturers who are doing essential war production can often find items in the regular line of Ward Leonard Controls that will serve their needs without the delay of extensive redesigning.

WARD LEONARD

RELAYS • RESISTORS • RHEOSTATS

Electric control  devices since 1892.

WARD LEONARD ELECTRIC CO., 32 SOUTH ST., MT. VERNON NEW YORK

ELECTRONICS — January 1943

117

You can still get all replacement parts for your Presto Recorders and Transcription Tables



There is no need to cut down on necessary recording at your station nor to let your recording equipment deteriorate for lack of proper maintenance. All vital replacement parts such as idler wheels, turntable tires, bearings and miscellaneous small parts are on hand for immediate delivery. Cutting heads and pickups are being reconditioned promptly. An A-3 preference rating is sufficient to obtain any parts or factory service. There is no shortage of discs. Your local radio distributor can deliver discs and needles immediately from his stock without requiring a preference rating on your order. But remember, these conditions may not last indefinitely. Wartime demands may at any time prevent our offering this service to Presto owners. We suggest that you recondition your turntable equipment without delay and carry a full stock of discs and needles at your station. Order through Graybar Electric Company or your local radio parts distributor.

PRESTO
RECORDING CORP.
242 WEST 55th ST. N.Y.

In Other Cities, Phone . . . ATLANTA, Jack. 4372 • BOSTON, Bel. 4510
CHICAGO, Har. 4240 • CLEVELAND, Me. 1565 • DALLAS, 37093 • DENVER,
Ch. 4277 • DETROIT, Univ. 1-0180 • HOLLYWOOD, Hll. 9133 • KANSAS
CITY, Vic. 4631 • MINNEAPOLIS, Atlantic 4216 • MONTREAL, Mar. 6368
TORONTO, Hud. 0333 • PHILADELPHIA, Penny. 0543 • ROCHESTER,
Col. 5548 • SAN FRANCISCO, Su. 8854 • SEATTLE, Sen. 2560
WASHINGTON, D. C., Shap. 4003

World's Largest Manufacturers of Instantaneous Sound Recording Equipment and Discs

Simple Pulse-Generating Circuits

By LYMAN E. GREENLEE

SIMPLE pulse-generating circuits are frequently useful to the designer of electronic equipment and there are many such circuits available. Following are typical examples which lend themselves readily to many purposes.

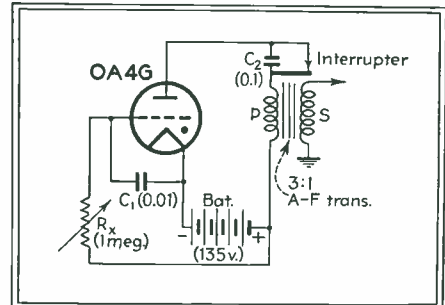

Fig. 1—Simple pulse-generating circuit

When the circuit shown in Fig. 1 is placed in operation the battery voltage charges capacitor C_1 through resistor R_x . As the capacitor charges the voltage drop produced by current flow through R_x decreases and the grid of the cold-cathode, gaseous triode, tube becomes more and more positive with respect to its cathode, eventually firing the tube. When the tube fires, anode current flows through the primary of the output transformer until the anode circuit is opened by the interrupter (operated by magnetic flux generated in the primary of the transformer). Voltage pulses thus appear across the secondary of the transformer and may, for example, be used to energize an "electric fence." The rate at which the pulses are produced may be varied by adjusting the value of R_x and thus changing the time required to charge C_1 and to discharge it through the grid-cathode path when the tube fires. Capacitor C_2 insures proper saturation of the output transformer.

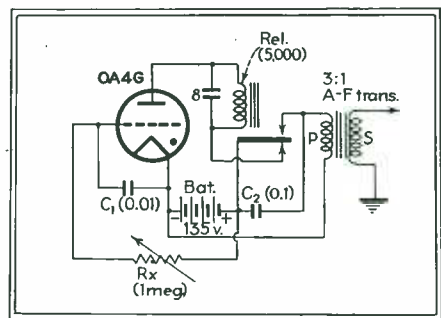

Fig. 2—Arrangement for higher output

The circuit of Fig. 2 is much like that of Fig. 1 except for the fact that the tube carries the initial surge current just long enough to operate the relay. Once the relay operates, the primary of the transformer is connected directly to the battery through



THRU Hell AND High Water!



"War is Hell"—tough on men and equipment. Today, with radio fighting on five fronts, transformers are exposed to every conceivable climatic condition.

Thermador Transformers are Thermatite treated to withstand extreme temperatures and humidity—arid or moist heat—dry or damp cold do not hamper their efficiency. Thermatite is the name of a process of accurate heat controlled vacuum impregnation developed and improved by ten years of daily use by the same personnel and supervision.

Experienced engineers are at your service at Thermador. May we be of assistance in engineering and producing transformers to meet your requirements?

THE THERMADOR TRANSFORMER LINE THERMATITE TREATED

THE THERMADOR TRANSFORMER LINE
Included in the Thermador Transformer line are audio, auto, geophysical, bias supply, bridging, cathode modulation, coupling, driver, field supply, filament, high fidelity audio, input, midjet plug-in audio, mixing and matching, modulation, output, plate, power (combined plate and filament), television, and tube-to-line transformers. Also manufactured are filters, chokes, and reactors (audio and equalizing).

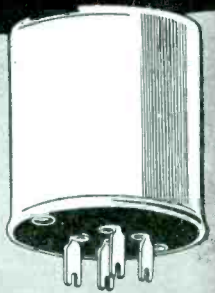

REPRESENTATIVES—Les Logan, 530 Gough St., San Francisco, Calif. • Verner O. Jensen, 2607 Second Avenue, Seattle, Washington • M. J. Klicpera, P. O. Box 3113, Houston, Texas. • FOREIGN DIVISION: Frazar & Co., 301 Clay Street, San Francisco, Calif.



"Seven Leagues Ahead"

THE THERMADOR ELECTRICAL MFG. COMPANY
5119 South Riverside Dr., Los Angeles, California



SWITCHES

to fit your circuit and space requirements



NOTHING TO A GREMLIN— *with dependable Utah Switches*

THOSE mischief-making, invisible little creatures, known among the RAF as Gremlins, can't stir up trouble where Utah Switches are concerned. Like other Utah-Carter parts, Utah Switches are built to give dependable performance—and have proved themselves in hundreds of electrical operations.

Compact size, highest quality and economical price are combined in Utah "Imp" push-button switches. They have the finest nickel silver or

phosphorous bronze springs with integral contacts. Springs are fully insulated in the mounting, bushing and shaft—have high grade phenolic insulation. They are available in three circuit arrangements: "Single-Make"—"Single-Break"—one "Break-Make."

Also available are Utah-Carter Rotary and Push-Button Jack switches, in long and short types. Small and compact in size, they are made to take minimum panel size. Full insulation is provided for all electrical parts.

UTAH VITREOUS ENAMEL RESISTORS—From 5 to 200 watts, they are available either as fixed—tapped or adjustable. Also non-inductive types.

UTAH JACKS—Long and short frame and "Imp" type jacks to meet your requirements. Special Utah jacks to meet Navy and Signal Corps specifications.

UTAH PHONE PLUGS—Two or three conductor types—for practically every type of application.

UTAH TRANSFORMERS are fully guaranteed. Able to meet the requirements in choke, input, output and smaller capacity power transformers.

WRITE FOR FULL DETAILS

UTAH RADIO PRODUCTS COMPANY

General Offices and Factory

837 ORLEANS STREET

CHICAGO, ILLINOIS

the upper relay contact. Output may thus be considerably higher than when current flowing through the transformer primary must be limited to 25 ma or less in order to preserve tube life.

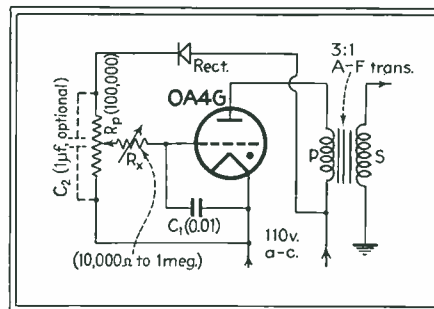

Fig. 3—Pulse generator operated from a-c line

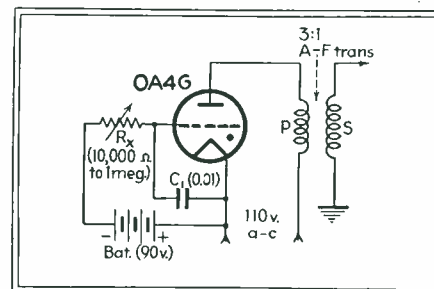

Fig. 4—Modification using battery to avoid timing changes with line voltage variations

Figures 3 and 4 show similar pulse-generating circuits which may be operated from an a-c line. The rectifier included in Fig. 3 may be of the selenium or copper-oxide variety, or may be a tube such as a 117Z6. The use of a battery to charge the timing capacitor C_1 in Fig. 4 provides timing accuracy independent of line-voltage variations. The fact that a-c is applied to the OA4Z anode in both circuits makes it unnecessary to employ an interrupter as the tube extinguishes automatically (like a thyratron) when the phase is such that its anode is negative with respect to the cathode. (Where 60-cps anode supply voltage is used, as in Fig. 3 and Fig. 4, grid circuit timing control is, of course, limited to frequencies less than 60-cps. Anode current will, under any circumstances, cease to flow 60 times per second.) These two circuits usually incorporate a relay in the manner discussed in connection with Fig. 2 in order to avoid overloading the tube. Where a-c anode supply is used extinguishing of the tube is automatically insured as discussed above so a relay with just one set of normally open contacts may be used. The relay coil may be substituted for the transformer primary and the relay armature electrically connected to the a-c line leg of the relay coil. The fixed contact of the relay would then be connected to one leg of the transformer primary, while the other leg of the transformer primary would be connected to the cathode of the tube.

Timing is accomplished in Fig. 5 by

Preview

OF TRIPLE CHECKED ACCURACY

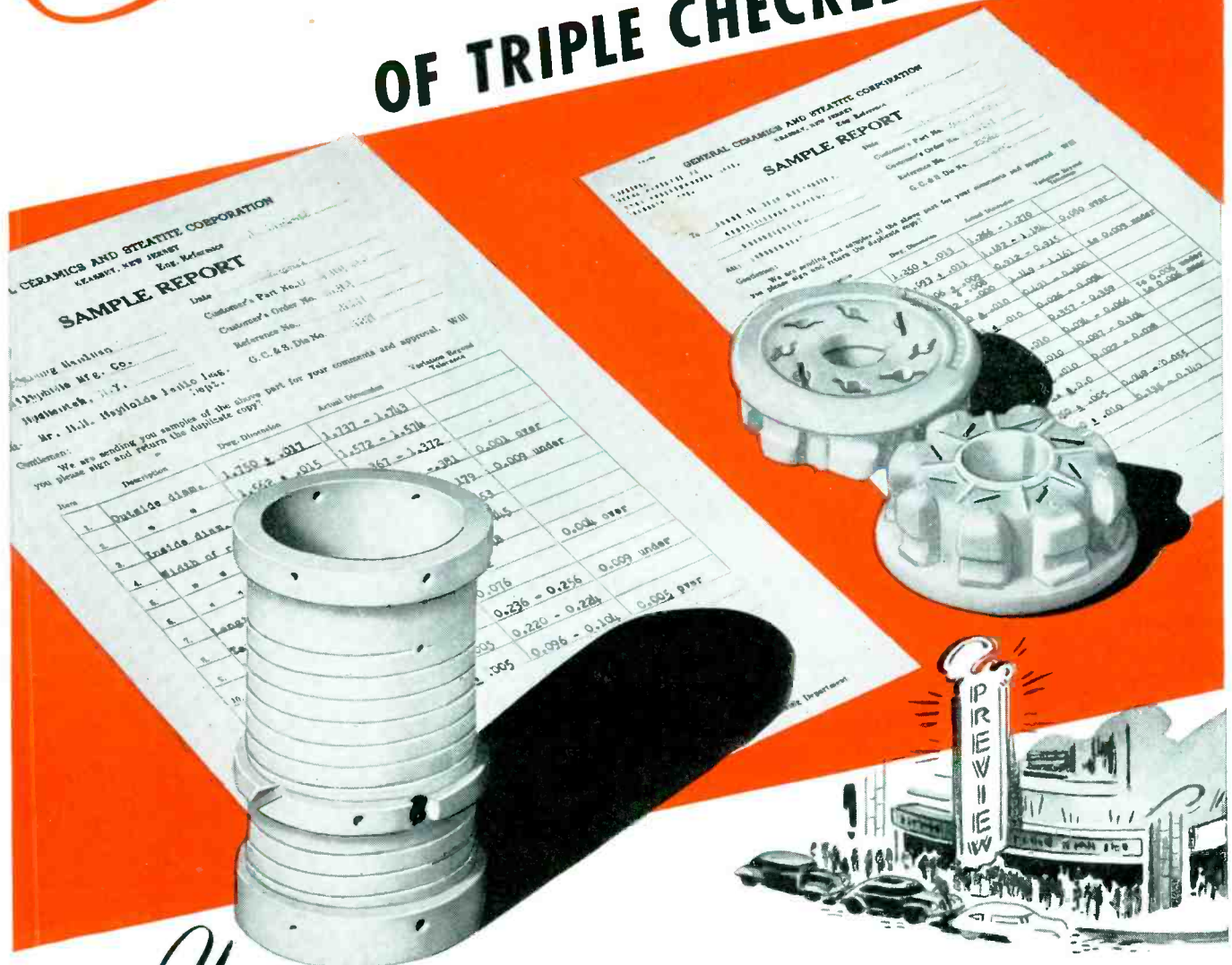

YOU get a preview of your special steatite insulators when we make them — and a triple check on the accurate compliance with your blueprints and specifications.

We make and check the tools for fabricating your order. *Check number one.*

Samples produced for you with these tools get a complete inspection of every detail. *Check number two.*

Inspectors make a "Sample Report" which you

receive with the samples. The report states drawing dimensions, actual dimensions and variations beyond tolerance, if any. Your *check number three* — after a preview of the product.

After your O.K., you can be sure that the rest of the order will conform to your specifications.

To the best of our knowledge, this service is unique in our field. It is one of the factors of our controlled manufacturing technique which assures quality and uniformity of product.

General Ceramics

AND STEATITE CORP.
KEASBEY NEW JERSEY



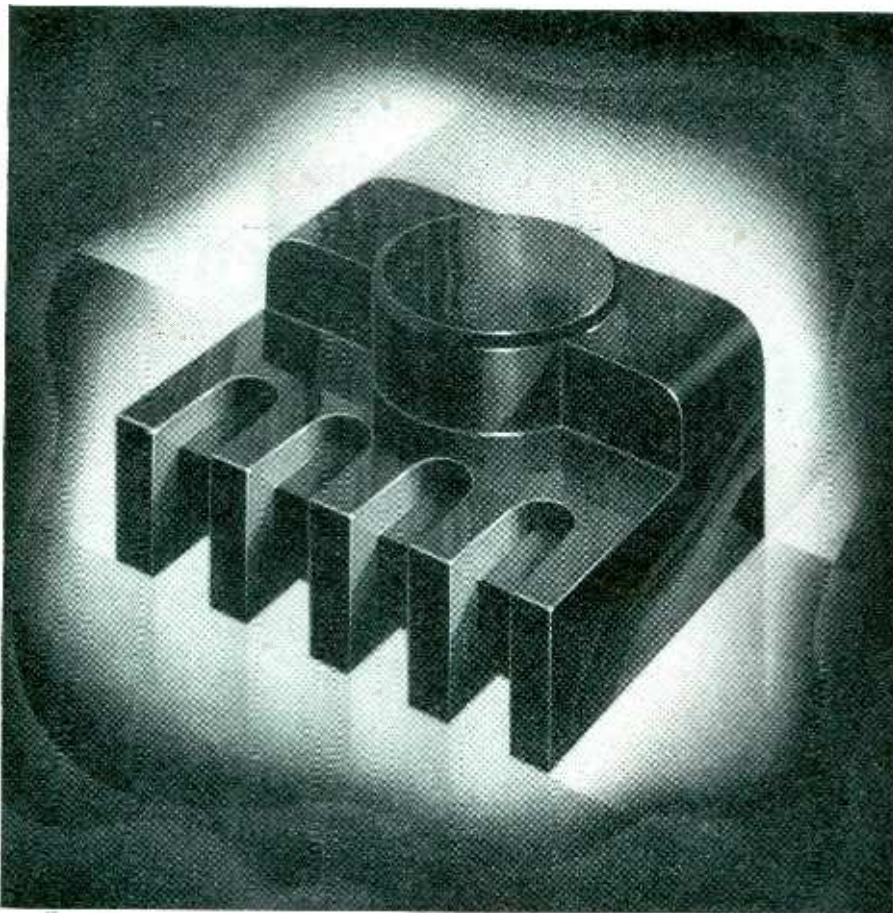

How they simplified the "Life of Inspector Riley"

ONCE he was known as *rejector* Riley and that meant trouble—trouble for him—shut down on the assembly line—and slow down of the company's war effort.

But that was before Richardson Plastics and the contractor's engineers started working together—before the part was made of Molded INSUROK.

In hundreds of ways, Richardson Plastics have helped scores of manufacturers win acceptance and enthusiastic approval for their war products and parts. And INSUROK Precision Plastics have been the means of successfully meeting many a tough specification—of speeding up production that might otherwise be delayed.

If you have a problem which molded or laminated plastics might solve—or a plastics fabrication problem on which years of experience might be beneficial, write us.

INSUROK and the experience of Richardson Plastics are helping war products producers by:

1. Increasing output per machine-hour.
2. Shortening time from blueprint to production.
3. Facilitating sub-contracting.
4. Saving other critical materials for other important jobs.
5. Providing greater latitude for designers.
6. Doing things that "can't be done."
7. Aiding in improved machine and product performance.

The Richardson Company, Melrose Park, Illinois; Lockland, Ohio; New Brunswick, New Jersey; Indianapolis, Indiana; Sales Offices: 75 West Street, New York City; G. M. Building, Detroit, Michigan.

INSUROK

MADE AND SOLD ONLY BY THE RICHARDSON COMPANY

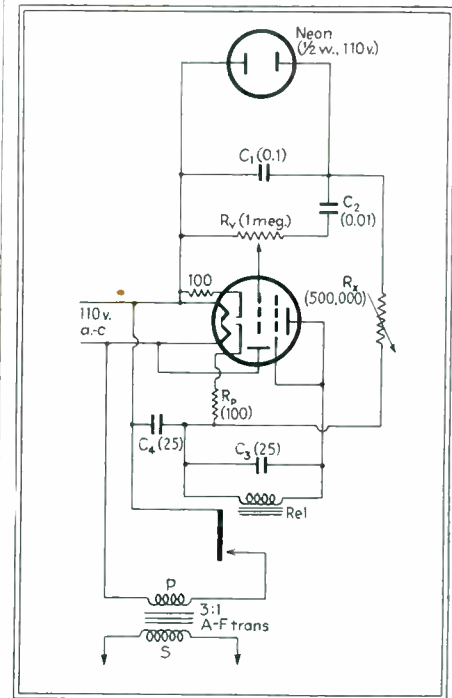

Fig. 5—"Relaxation" type timer using high vacuum tube

means of a grid circuit "relaxation" oscillator. Capacitor C_1 is charged by d-c flowing through resistor R_v and anode current flow in the triode-connected amplifier section of the 117L7GT tube increases to operate the relay as the capacitor approaches full charge and the voltage drop across R_r declines. Inasmuch as the tube is of the high-vacuum type, anode current may then be reduced to a value insufficient to hold the relay closed by swinging the grid more negative and this is accomplished by the neon lamp. As the charge across C_1 builds up it eventually reaches a voltage value sufficient to ionize the neon lamp. When this occurs C_1 discharges through the lamp. The lamp then extinguishes and the capacity starts to charge again repeating the timing cycle.

The diode section of the 117L7GT is used as a half-wave rectifier to provide d-c charging voltage for the timing circuit and also to supply d-c anode voltage for the section of the tube used as a triode amplifier. The frequency of pulsations in the circuit of Fig. 5 may be varied by adjusting R_r . Resistor R_v affords control over the amount of current flowing in the relay coil. The length of the "on" cycle may be varied by using capacitors of other values at C_3 , by varying the resistance of the relay coil or by introducing a variable resistor in series with the relay coil. Capacitor C_1 is a filter capacitor across the d-c output of the rectifier. While it is not critical in value it should be large as compared with C_3 . Resistor R_p is inserted to protect the tube.

Figure 6 shows the schematic of a similar relaxation oscillator driving a battery-operated tube. Circuit constants are similar to those used in the circuits already discussed.

A NEW *Motorola* BUILDING

DEVOTED EXCLUSIVELY TO ELECTRONIC

Research and Engineering



When war came, Motorola research and engineering was already at work around the clock on special assignments for our Armed Forces. Now in its new home, the Motorola staff of engineers and technicians is by specific government assignments at work on problems which embrace many important phases of electronic knowledge. This new Motorola engineering building increases many times our capacity for service of the highest order.

THE ARMY-NAVY "E"
Awarded for excellence in the production of Communications Equipment for America's Armed Forces



Photo Courtesy U. S. Army Signal Corps

Motorola Radio Communication Systems
Designed and Engineered to Fit Special Needs
GALVIN MFG. CORPORATION • CHICAGO



MICAH* fits into the Picture OF THINGS TO COME

*Micah represents the high-grade mica products processed by Macallen.

Where insulation must give permanent satisfaction, mica will be remembered on the drawing boards and in the research laboratories of men who can see today the horizon of a bright new world—through the scientific magic of Electronics. Macallen will be remembered as a dependable source of specialized skill and experience in processing mica to the greatest possible usefulness. Where mica must meet exacting specifications, specify *Macallen Mica*. Macallen in front of the word mica insures dependable insulation.

Macallen has 50 years of insulation experience you can put to work now for post-war production. Our engineering department is at your service.

50th anniversary book—*Macallen & Mica*—yours for the asking.

PRODUCTS

Compressed Sheets — Mica Paper, Cloth, Tape, Heater Plate, Compressed Sheet Tubing—Commutator Insulation — Compressed Sheet Washers — Insulating Joints and Canopy Insulators — Railway Specialties — Domestic and Imported Raw Mica.



THE MACALLEN COMPANY

16 MACALLEN ST., BOSTON

CHICAGO: 565 W. Washington Blvd.

CLEVELAND: 1005 Leader Bldg.

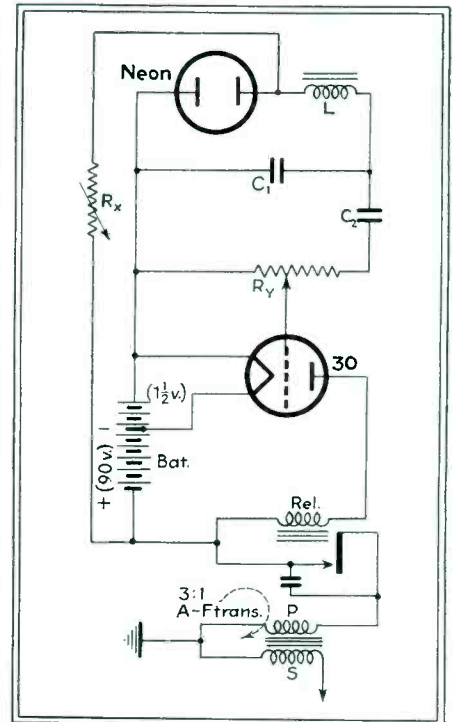

Fig. 6—Battery operated relaxation type timer using high vacuum tube

With proper choice of circuit constants it is possible to secure an extremely wide range of timing pulses with these circuits. Pulsations may vary from several hundred per minute to one or two per hour. It is, of course, essential that capacitor C_1 , particularly, and other associated parts have a minimum of electrical leakage if the timing is to be accurate. Where applications require a high degree of timing accuracy it is also desirable to employ regulated power supplies when operating from power lines. Inasmuch as all of the circuits diagrammed involve grid circuit timing control only grid circuit voltage need be so regulated. Current in the grid circuits is relatively small and this permits the use of small voltage regulating tubes such as the VR-90-30 and the VR-150-30 or small voltage-regulating transformers. For still greater timing accuracy it may in some instances be desirable to include some sort of temperature and humidity control enclosing the entire apparatus.

Interlock Circuit Correction

AN ERROR in circuit 3E on page 59 of the December 1942 issue article "Circuit Elements in Electrical Remote Control" has been called to our attention. In order to obtain the desired interlock operation it is necessary to transpose two leads. Remove the indicated wire between the top of relay coil A and the spring which forms a junction point between contacts 1 and 3. Disconnect the battery series resistor from the two top relay springs. Connect the top of relay coil A to the two top springs. Connect the battery series resistor to the spring forming a junction point between contacts 1 and 3.

RELAYS

FROM GUN BLAST HEAT

TO ARCTIC COLD

★ Smothered in dust... seared by gun blast heat... shrouded in fog... gripped by stratosphere cold... shaken by blasts of bomb and shell... these are daily incidents in the life of a relay. Under these conditions Relays by Guardian have already "proved their metal."

THE SERIES 195 RELAY weighs less than an ounce! But don't let its tiny size fool you. It shrugs off the most severe vibrations likely to be encountered in aircraft. And it's especially adaptable to jobs where space as well as weight is at a premium. It's about wrist watch size in length and width—and not a great deal thicker.

SERIES 345 RELAY. A radio relay for use in aircraft. Maximum contact combination of three pole, double throw, combined with large coil winding area makes this a highly efficient relay in compact space.

While thinking, building and engineering the tools of war today, Guardian is also looking ahead to peacetime applications of Relays, Solenoids, Electrical Controls of all kinds. If you are planning for the future too, write us—our war-time experience can help you build better peacetime products.



Series 195 Relay. One of the smallest relays made. Write for new Bulletin.

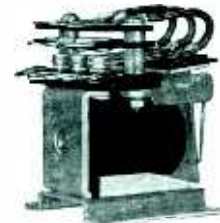

Series 345 Relay. For radio aircraft use. Write for new Bulletin.

GUARDIAN ELECTRIC

1625 WEST WALNUT STREET

CHICAGO, ILLINOIS

A COMPLETE LINE OF RELAYS SERVING AMERICAN WAR INDUSTRY

THE ELECTRON ART

War Radio Conference.....	126
Characteristics of Electron Lenses.....	128
Oxygen Saturation of Arterial Blood in Man.....	130
Notes on Design of German Army Component Parts.....	138

War Radio Conference

APPROXIMATELY 300 radio engineers attended the War Radio Conference on November 19 at the Sagamore Hotel in Rochester, N. Y. At this meeting the wartime needs and obligations of the Institute of Radio Engineers were discussed by Arthur F. Van Dyck, president of the I.R.E., while the activities of the Radio Manufacturers Association in meeting the demands of wartime were discussed by W. R. G. Baker, director of R.M.A. Engineering Department.

In the opening address, delivered by Dr. Baker, it was pointed out that standardization is the problem of principal interest to R.M.A. Engineering Department. Considerable effort in standardization is being made by R.M.A. of which the Data Bureau activities continue to be an outstanding example. Dr. Baker also announced that in June of this year, the Radio Manufacturers Association opened its membership to manufacturers of radio transmitters. Other activities engaged in the active interest of R.M.A. are developments of substitute materials for those not available in sufficient quantity, a consideration of post-war developments, and the close cooperation of the National Television System Committee and the R.M.A. with United States Government for the purpose of devising a basic system of operation for television after the war.

Lieutenant Commander A. B. Chamberlain, Radio Branch, Bureau of Ships, Navy Department, talked at some length on the service requirements of radio equipment. Taking into account the extreme and variable conditions of temperature, humidity, dust, and other conditions under which navy equipment must be operated, the necessity of complete specifications becomes apparent. Military equipment must be in perfect operation under all conditions of roll and pitch of the vessel, gun fire, shock, and vibration, humidity, extreme conditions of sand and dust, and must perform satisfactorily at temperatures from -40 to +85 deg. C.

Some of the problems encountered in the manufacture of mica capacitors

were discussed by Captain Billings McArthur, Army-Navy Communications Expediting Agency. As a means of illustrating what conservation methods could be achieved through intelligent planning and manufacturing, Captain McArthur showed samples of various types of mica capacitors which had been manufactured or were being manufactured under different manufacturing conditions in the United States. In many cases Captain McArthur was able to point out certain economies of time or cost which had been achieved through the employment of certain manufacturing techniques or the availability of suitable standards.

The talk by Mr. F. S. Barton, of the British Air Commission on "Nazi Aircraft Radio Equipment" attracted a

considerable amount of interest. Mr. Barton's talk was similar to that which he delivered before the October meeting of the Institute of Radio Engineers in New York and covered essentially the same type of equipment as that described by Mr. Jupe in the November issue of *ELECTRONICS*.

The afternoon technical session was opened by J. J. Farrell of the General Electric Company who spoke on "Flexibility in Communication Equipment Production." With the potential if not actual limitations of manpower, it was pointed out that a considerable increase in efficiency of manufacture of radio components could be achieved through the use of standardization, design simplification and the most effective production methods. In many cases critical material can be replaced by substitute or alternative materials with little or no sacrifice in essential performance. Such a procedure was recommended wherever it was possible to put into effect, provided the alternate or substitute material permitted the manufacturer to fulfill government specifications.

Radio production test methods was the topic of a talk delivered by Harry Rice, of the Sperry Gyroscope Company. Mr. Rice showed that it was frequently possible to effect economies of material and time by increasing the number of test positions at which inspection operations were carried out. If it is possible to inspect, 100 percent, all of the incoming parts, and to inspect sub-assemblies after each important or essential operation has been completed, the tests of final as-

MICROSCOPISTS STUDY NEW INSTRUMENTS

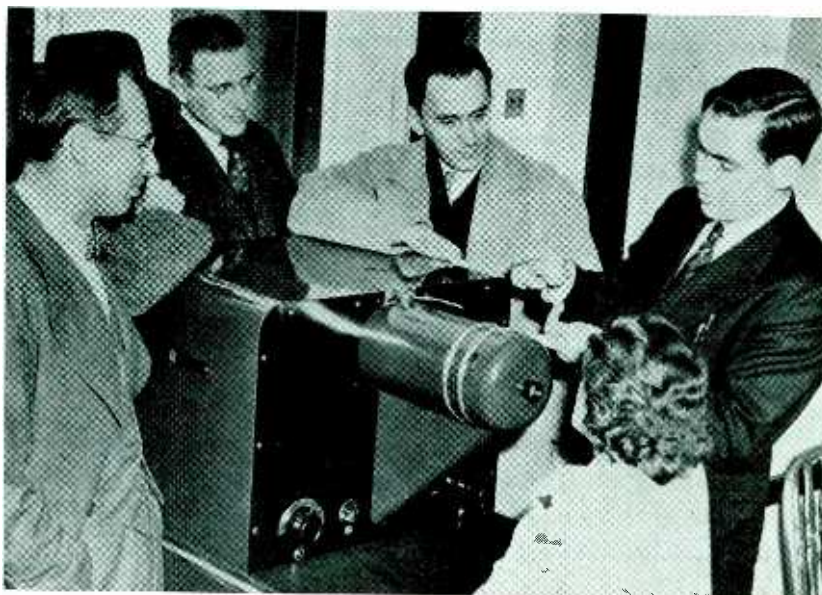

Microscopists and chemists attending the national Chemical Exposition in Chicago had an opportunity to study and operate a new mobile simplified electron microscope developed by Dr. C. H. Bachman and Dr. Simon Ramo, of General Electric's Electronics Laboratory. This picture shows some of the microscopists around the instrument. The image of a specimen can be enlarged 10,000 times with the instrument. Further enlargement of the picture can be made photographically, up to 100,000 times the size of the original specimen

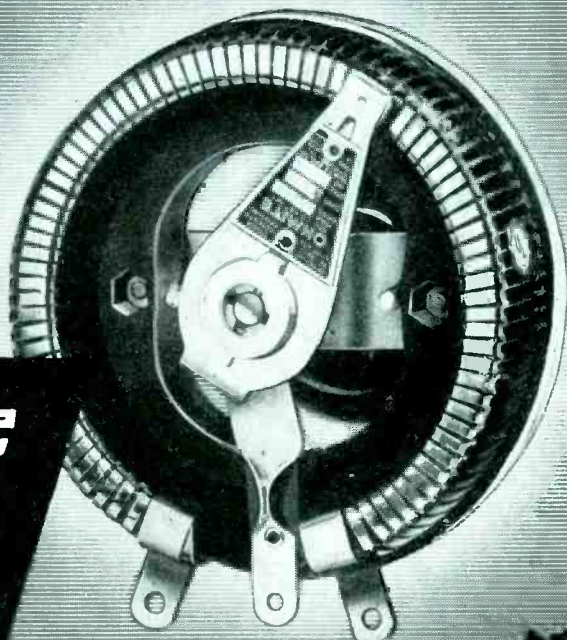
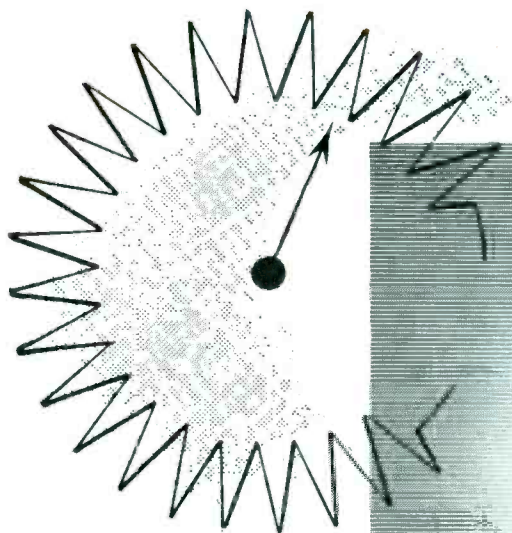

OHMITE

All-Ceramic Vitreous-Enameled

RHEOSTATS

for **PERMANENT** Smooth Control...

There is a basic difference in Ohmite rheostat design that becomes more and more apparent in actual service... a difference in smoothness of action, in long life, in trouble-free performance that means *permanently* smooth, close, electrical control. Every design feature has been time-proved under the most critical conditions, in every climate, on land, at sea and in the air. This soundness of design, plus the wide range of types and sizes, has made Ohmite Rheostats readily applicable to today's vital needs in war and industry. It also makes them ready to serve in the design of new devices to defeat the enemy and build for tomorrow's peace. Many stock types. Special units engineered for you. Approved types for Army and Navy specifications.

Send for Catalog and Engineering Manual No. 40

Write on company letterhead for this helpful 96 page guide in the selection and application of Rheostats, Resistors, Tap Switches.

OHMITE MANUFACTURING CO., 4816 FLOURNOY ST., CHICAGO, U. S. A.

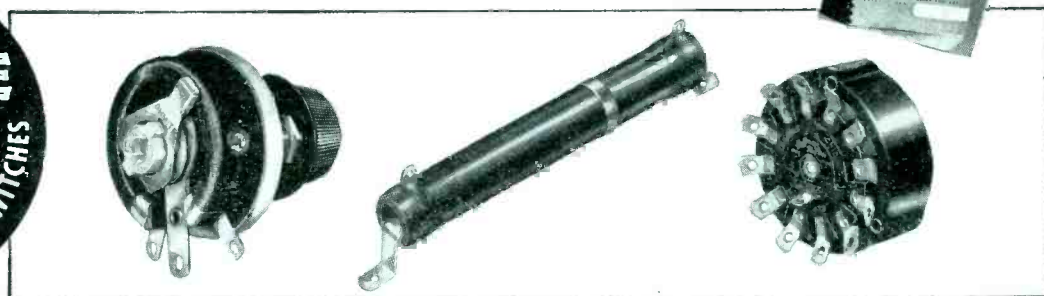

two pioneers!

AR FEATHERWEIGHT RELAY

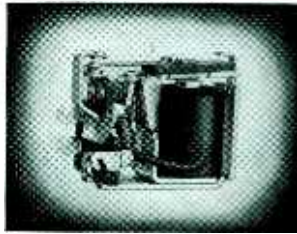

The **AR** Featherweight Relay is a rugged performer despite its low weight of 50 grams and minute dimensions of 15/16 x 1 3/16 x 1 5/8 inches.

Its contacts handle 5 amperes at 24 volts DC or 110 volts AC, single pole double throw.

The **AR** can be furnished with a variety of coils to operate at from 1.5 to 58 volts DC and from 6 to 115 volts AC. Coils are impregnated to withstand humidity and all bakelite parts are wax impregnated. *Model AS when insulated from frame.

The **AR** Featherweight Relay is designed to meet Army, Navy and C A A specifications.

NOW!

A BAKELITE CASE TO ENCLOSE ALLIED'S A3 AND A5 HC SEALED SWITCHES



Bakelite Case for weight saving and greater structural strength no changes were made in either working design or parts.

Thousands of Allied **A3** and **A5** HC Switches (in ceramic cases) are performing their functions in electrical equipment in every part of the world ... their working design and parts have been proven and accepted as standard equipment ... in the engineering and in the designing of the New

Features of the New Bakelite A3 and A5 HC Switches include:

CONTACT

ARRANGEMENT:

A3, single pole single throw ... normally open, double break. **A3**, single pole single throw ... normally closed, double break.

CONTACT RATING:

non inductive; 50 amperes at 12 and 24 volts DC and 110 volts AC.

WEIGHT:

four ounces.

OPERATING PRESSURES:

1 3/4 to 3 1/2 pounds; stainless steel plunger travel differential, **A5**, make to break travel 0.006 to 0.012 of an inch; **A3**, break to make travel 0.006 to 0.012 of an inch.

OVER TRAVEL:

0.050 to 0.070 of an inch at maximum pressure.

VIBRATION:

10 G. for either horizontal or vertical positions.

sembly are considerably simplified. Moreover, the number of rejections of a completed unit will be considerably reduced since any defective component will have been detected in the inspection of sub-assemblies.

After this preliminary discussion, Mr. Rice talked at some length on the measurement of certain components. Resistances are conveniently measured by means of a percent limit bridge for values of resistance less than 100,000 ohms. For resistances greater than this value, a megohm bridge is customarily employed. Capacitors are checked for actual value of capacitance as well as voltage breakdown. In the case of variable condensers, the capacitance is checked at four points of rotation by inserting the condenser in a push-button tuning type of device. Radio frequency chokes and coils are customarily tested by means of a QX checker.

"Photographic Templates" was the topic of a talk by Mr. E. G. Jewett and M. C. Case, who described the method of photographic reproduction developed and employed by the Lockheed Aircraft Company. The application of photographic methods for the duplication of drawing to scale or to full size has been responsible for the saving of much work in the drafting department. At the same time it has reduced the errors to a negligible amount. By coating sheet aluminum with a photosensitive circuit it is impossible to project a drawing onto a sheet of metal and to subsequently process this metal in accordance with the template marking produced thereon by photographic methods. The second method is obviously useful primarily in those cases where flat surfaces, such as the chassis of radio receivers, are encountered.

At the banquet James Lawrence Fly, chairman of the Federal Communications Commission predicted great expansion of radio in all its phases at the conclusion of hostilities. More than ever before this is a people's war, and this state of affairs has been possible largely through extensive use of radio broadcast methods. Commissioner Fly urged that a committee for post-war planning be established for the purpose of solving such problems as: (1) The administrative problem which will be encountered with the increased expansion of television and FM facilities; (2) the surplus of war radio equipment which will have to be disposed of after the war is over; (3) the finding of jobs for men now actively engaged in radio services in the armed forces, and (4) the expansion of radio technique in other fields, such as diathermy, industrial electronic and similar developments.

Characteristics of Electron Lenses

A PAPER by Karl Spangenberg and Lester M. Field presented before the summer convention of the Institute of Radio Engineers, Detroit, Mich. on

**ALLIED
CONTROL** ★
COMPANY, INC.

227 FULTON ST., NEW YORK
Factories
NEW YORK CITY • LONG ISLAND CITY
CHICAGO • PLAINFIELD, TENN.



Wheezes, Wows, Squeaks, Noises,
are out because there are

NO GREMLINS

in GOULD-MOODY'S sensational
"Black Seal" GLASS BASE

Instantaneous
RECORDING BLANKS

Gremlins are those pesky little pixies who annoy pilots of the RAF and the U. S. Air Force. They're also present in many recording blanks, causing wows and rumbles, squeaks and noises. But, there are no Gremlins in "Black Seal" Glass Base Instantaneous Recording Blanks. They're the talk of the industry...giving a wide frequency range, true and beautiful reproductive qualities, and absolute freedom from noises—you hear only the performance itself! Try these Gremlin-free "Black Seal" blanks at our expense —if they don't come up to your expectations, send them back and we'll stand the entire tariff.

Old Aluminum Blanks Recoated with the
"Black Seal" Formula in 24 fast hours.

*Ship and Protect your Records with the
new Gould-Moody PacKARTON light-
weight, corrugated container. Saves time,
saves records and reduces shipping costs.*

THERE ARE HUMAN GREMLINS, TOO!

They're well-meaning, but kind of careless, people who buy things they don't need, who spread rumors, who throw away scrap and rags, who waste fuel, who drive their cars too fast, who aim to but don't invest in War Bonds.

**Help win the war, help spread the word
— DON'T BE A GREMLIN!**



**IMMEDIATE DELIVERY! Styli and
shipping cartons supplied at cost.**

the **GOULD-MOODY** *company*

RECORDING BLANK DIVISION

395 BROADWAY

NEW YORK, N. Y.

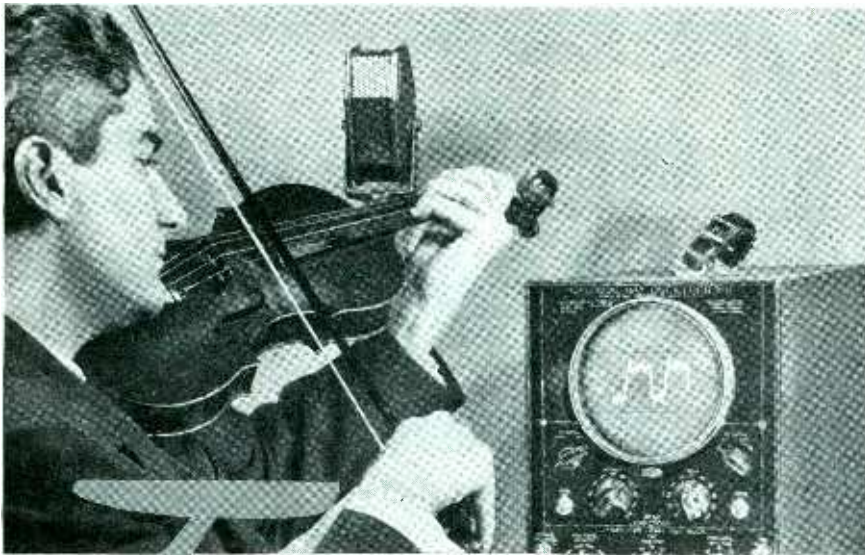

Tone . . .



Sine waves of a tuning fork, A-440 cycles per second. Note the pure wave form absolutely devoid of harmonics. If secondary waves are superimposed on the fundamental wave, we have the harmonics or overtones which distinguish voices or instruments.



G-392 cycles per second as produced by a single reed of an accordion. Complex wave form is the result of reed being driven to a high amplitude, producing many harmonics or overtones.



E-392.6 cycles per second as produced by the D string of a violin, with first finger in position. Since the entire body of the violin resonates, the tone is rich in harmonics and wave form will vary greatly from note to note.

LET'S SEE THE DIFFERENCE BETWEEN A STRADIVARIUS AND A TEN-DOLLAR VIOLIN!

★ Good tone—the average ear demands just that. But how can we describe good tone—in precise terms other than mere personal opinion as to what “listens good?”

The DuMont oscillograph again comes to the rescue. Simply pick up the voice or instrument, and reproduce it as an oscillogram. Here we have a faithful portrayal of fundamental pitch and overtone components. If that voice or instrument is pleasing, then we have a veritable *electronic master blueprint* to be followed and matched in duplicating that desired tone quality.

Thus tone is no longer a matter of personal opinion. It is a precise *quantity* as well as quality to be duplicated. Which represents but another example of how the versatile DuMont oscillograph is employed today.

★ Write for Literature . . .



**ALLEN B. DU MONT
LABORATORIES, Inc.**
Passaic • New Jersey
Cable Address: Wespeilin, New York

June 24, 1941 is contained in Vol. 20, No. 4 of *Electrical Communication*. The title of the article is “Some Simplified Method of Determining the Optical Characteristics of Electron Lenses.” The following material is the author’s abstract.

Some new methods of calculating lens characteristics are proposed which are relatively simpler and more accurate than those previously suggested. The first is an extension of Salinger’s method of joined circular segments applied to paraxial rays in field with a rotational symmetry. This requires as information only the axial potential and derivative thereof. This method is a computational equivalent of the original graphical method. A second method makes use of the action function which is approximated from the potential function. Electron paths are taken as normal to the lines of constant action. A third method replaces the convergent and divergent parts of the usual lens with equivalent thin lenses and then calculates the focal length by means of combination formulas applied to the two thin lenses. All calculating methods are, however, sufficiently long in application and indeterminate in accuracy that experimental methods of finding lens characteristics are preferred.

A new experimental method makes use of a demountable vacuum tube. Lens characteristics are determined from angular magnification measured from the shadows cast by objects illuminated by a point source of electron. No screens are required, nor is it necessary to generate rays parallel to the axis. By observing magnification for all voltage ratios between two positions of the objects screened enough data are available to determine the four cardinal focal distances for all voltage ratios. The results are considered more accurate and cover a greater range of voltage ratios than those reported by previous investigators. Graphical method has been developed for determining the spherical-aberration characteristic of the lens from the curvature of the object-screened images observed on the fluorescent screen.

• • •

Photoelectric Determination Of Oxygen Saturation of Arterial Blood in Man

AN INTERESTING APPLICATION of the barrier layer type of photoelectric cell is described by Dr. E. A. Millikan in the October issue of *The Review of Scientific Instruments*. Dr. Millikan’s article is entitled, “The Oximeter, an Instrument for Measuring Continuously the Oxygen Saturation of Arterial Blood in Man.” It is shown that the oxygen saturation of arterial blood can be measured continuously *in situ* by means of bichromatic photoelectric colorimetry of the fully flushed ear. The accuracy of the photoelectric device has been checked by gas analysis of arterial blood samples and the error is found to be from 3 to 8

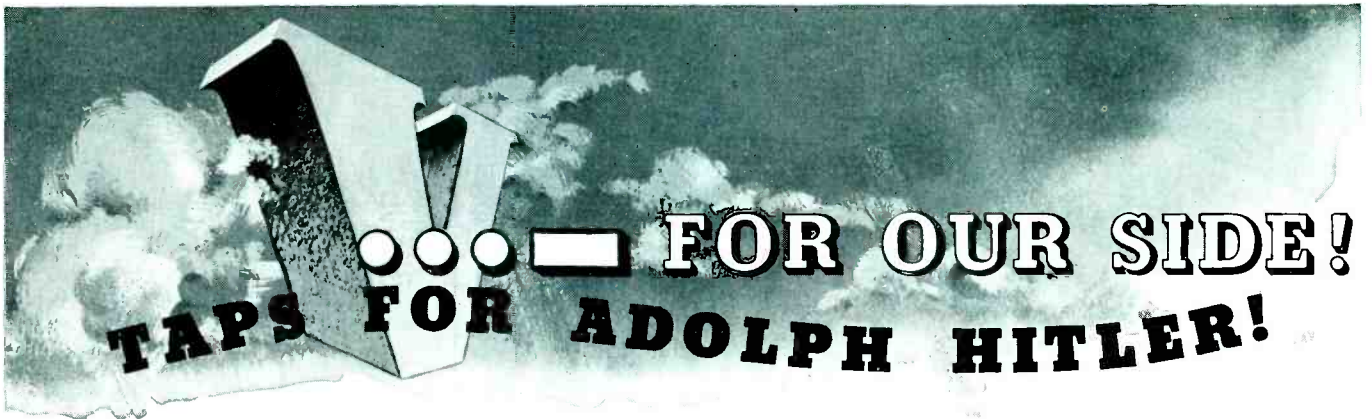

It wasn't so very long ago that they might have gotten their signals from a canny quarterback or the traffic light on the corner. Today, the long, lean fingers of thousands of Americans are tapping out messages in the Signal Corps—the first line at the front line.

Serving with the Signal Corps on all battlefronts, as well as in training schools, are telegraph keys produced by American Radio Hardware. Model J-38 is illustrated . . . other models, and there are many, include the J-37, J-44, J-45. Each one is utilized by both troops and students, helping to hammer home a Tap, tap, tap of victory for our side . . . and sounding taps for Adolph Hitler and his side. It's a beautiful rhythm, this victory tap, and daily it grows louder and louder and more encouraging. Along with you, we're mighty proud to be part of it!

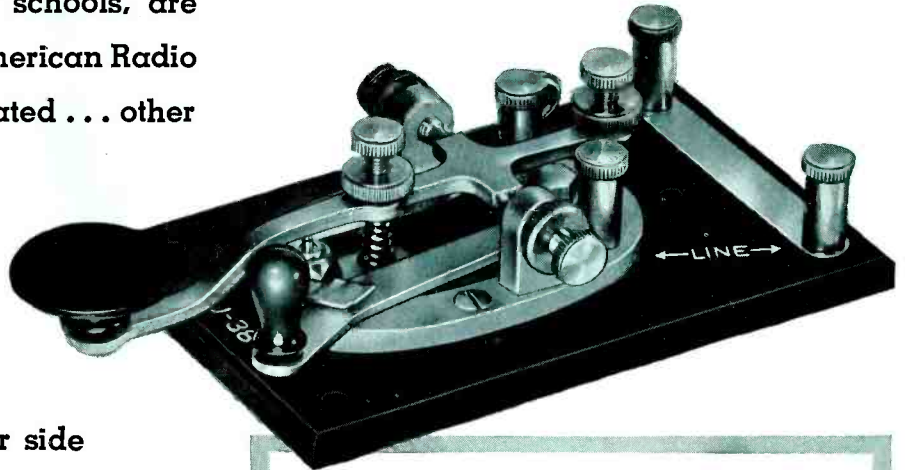

Also in "active service" on our side are our DIM-E-ROID polarized, adjustable panel lamps for bombers and fighter planes . . . and the PHONE-SWITCH aerial communications combination used by Paratroopers. Write for catalogs of all American Radio Hardware products.



★ ★ ★ ★ ★ ★ ★ ★ ★ ★
 100% Behind the Victory Effort
 . . . in production . . . employee
 purchases of War Bonds and
 Stamps . . . and the war on waste.

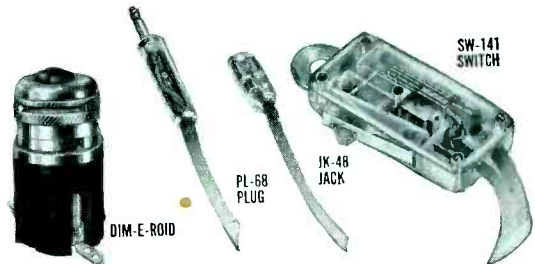

American Radio Hardware Co., Inc.
 476 BROADWAY, NEW YORK, N. Y.

MANUFACTURERS OF SHORT WAVE • TELEVISION • RADIO • SOUND EQUIPMENT

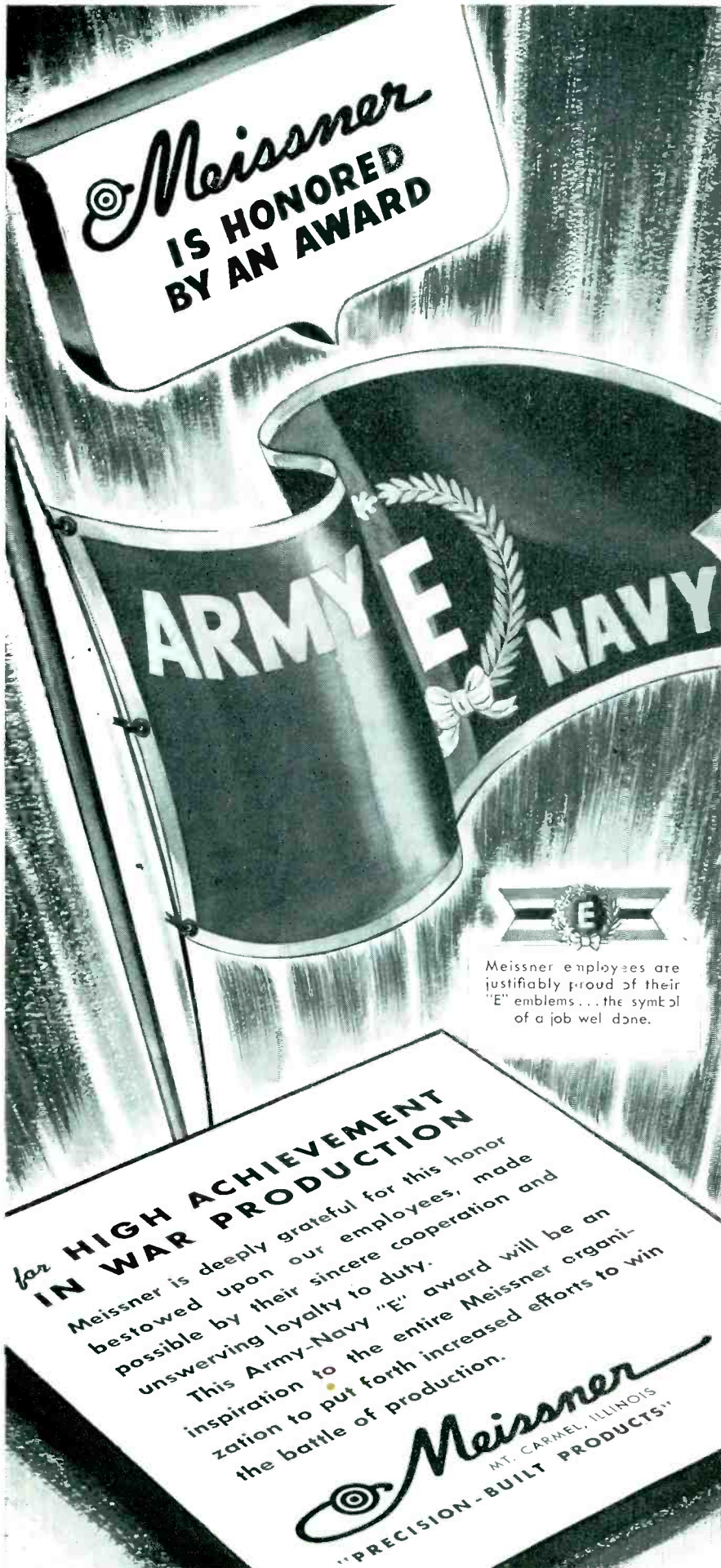

**for HIGH ACHIEVEMENT
IN WAR PRODUCTION**

Meissner is deeply grateful for this honor bestowed upon our employees, made possible by their sincere cooperation and unswerving loyalty to duty. This Army-Navy "E" award will be an inspiration to the entire Meissner organization to put forth increased efforts to win the battle of production.

Meissner
MT. CARMEL, ILLINOIS
"PRECISION-BUILT PRODUCTS"

percent. Features of the system are the small size and weight of the optical and photoelectric system, and the fact that the photoelectric method provides a means of making continuous examinations without the need for taking blood samples with its disadvantage of the possibility of invalidating the results because of anxiety and possible pain which may be produced by such sampling methods.

Essentially the photoelectric element consists of a two-color photoelectric colorimeter, whose entire optical system is contained in a small unit which slips over the shell of the subject's ear. The total weight of this unit is 30 grams. One of the light filters of the optical system transmits a wavelength band which is equally absorbed by oxyhemoglobin and reduced hemoglobin, thus providing a means of measuring the total amount of hemoglobin in the optical path, independent of its degree of oxygen saturation. The other color, transmitted through the alternate filter, is very differently absorbed by the two hemoglobin forms.

The introductory portion of Dr. Millikan's paper deals with the application of two-color photoelectric methods to a clear solution of pigments contained in a parallel sided trough and illuminated by parallel bundles of monochromatic light. This analysis is, of course, a gross over-simplification of the affairs actually encountered in human subjects, but it makes possible a theoretical analysis of the essential method of operation.

On the basis of analysis of this ideal case it has been shown that three simple relationships exists: (1) The oxygen saturation is directly proportional to the logarithm of the transmitted light through the sample. (2) The slope of the lines giving the relationship between oxygen saturation as the ordinate and the logarithm of the light intensity ratio as the abscissa is inversely proportional to the concentration of total hemoglobin and is also a function of the absorption coefficient. If the "oxy-" and "reduced" forms have identical absorption coefficients, or if the total hemoglobin concentration becomes zero, this slope becomes infinite and there is no change in light transmission for varying oxygen saturation.

The system actually employed falls far short of the ideal case in practically every particular. Since it is impossible to predict quantitatively the deviations of actual practice from ideal theory, an extensive experimental investigation was undertaken. The purpose of this investigation was to determine the actual relations between transmission of both "red" and "green" light by the ear, and the arterial saturation, was determined by sampling methods. The results on a number of subjects provided data from which the actual experimental determination could be correlated with the theoretical calculation.

Dr. Millikan describes three forms

Jensen

**SPEECH REPRODUCERS
HAVE GONE TO SEA!**

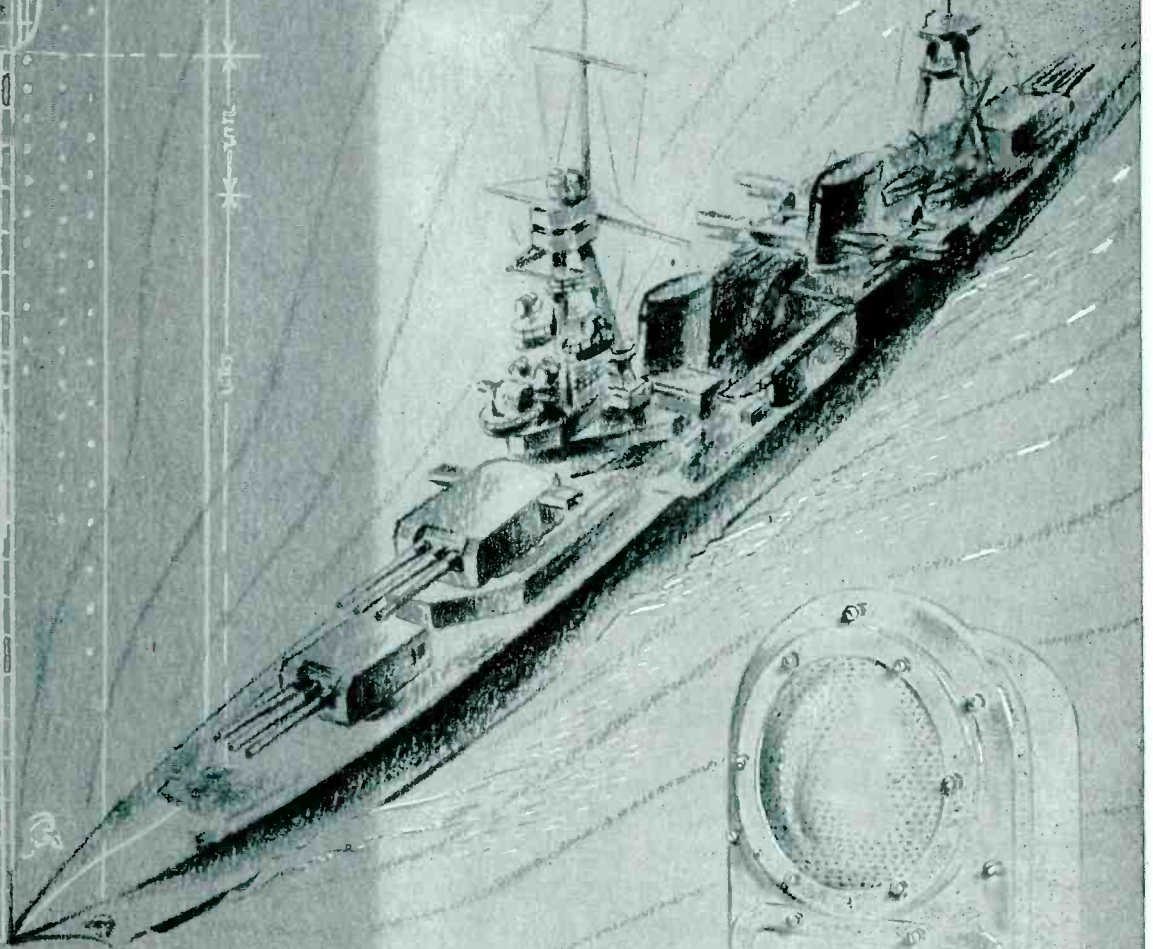

... and they are real seagoing reproducers! ... because each one has been specially constructed and meticulously engineered for perfect performance under the most severe operating conditions.

Jensen
RADIO MANUFACTURING CO.
6601 SO. LARAMIE AVENUE, CHICAGO

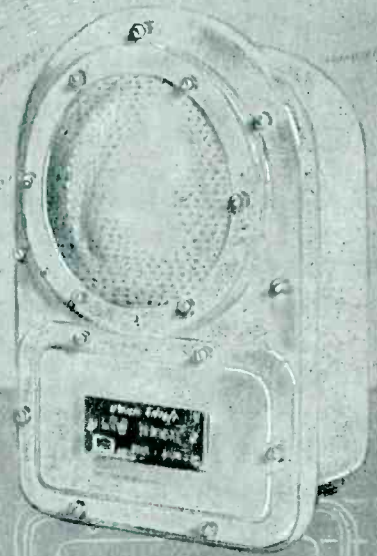



Our Third War!

We are proud that THORDARSON helped win the first two, and now our 47 years of experience has gone "all out" to help win this war! THORDARSON research engineers are working 'round the clock . . . constantly seeking new methods for greater transformer efficiency.

When we have won this war and returned to our normal industrial life . . . THORDARSON engineers will be in possession of priceless knowledge which will be incorporated in THORDARSON products.

Your transformer problems will be welcomed by THORDARSON engineers . . . let them help you!

THORDARSON
ELECTRIC MFG. COMPANY
500 WEST HURON STREET, CHICAGO, ILLINOIS

Transformer Specialists Since 1895



of oximeters. All of them employ the same design of ear units and utilize the same calibration data and standard filter. All require the same constancy of voltage supply to the lamps (plus or minus 0.5 percent). The differences appear only in the means which are used to transform identical combinations of photo current into identical saturation readings. Each of the units has different requirements for galvanometer sensitivity. The three forms of oximeters are shown in schematic wiring diagram found in Figs. 1, 2 and 3.

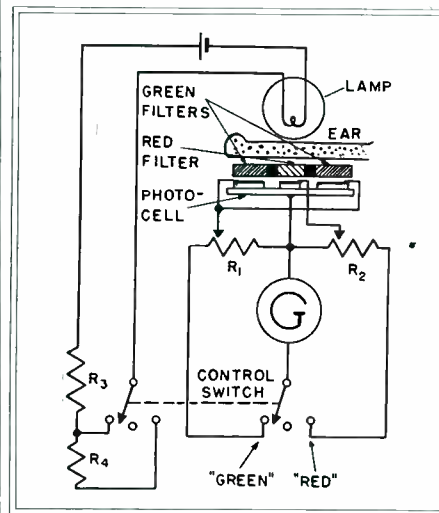

Fig. 1—Schematic wiring diagram for multiple scale oximeter, which, when used multiple scale, permits direct readings to be made of oxygen saturation of the blood

The ear unit consists of a small U-shaped frame, which slips over the shell of the ear. In one leg of this frame is a 6 to 8-volt miniature lamp bulb surrounded by a threaded lead which can be screwed against the ear just tightly enough to prevent the unit from slipping. The other leg of the U-shaped form carries a small bakelite box and contains the filter and barrier layer type of photoelectric cell. These are divided by two parallel grooves in a sensitive surface to form three functionally distinct light sensitive carriers.

A Wratten No. 29 red gelatin filter is cemented over the center strip of photoelectric surface and a Wratten No. 61 green filter is cemented over each of the two outside strips. The two outside strips are connected together so that in effect they form a single green sensitive photoelectric element symmetrically arranged on both sides of the central red element.

Electrically all of the three oximeter circuits are similar and except for the special construction of the barrier layer type of photoelectric element, should introduce no difficulty in construction. In Fig. 1, R_1 and R_2 are equal and represent the critical damping resistance of the galvanometer G . The resistors R_3 and R_4 control the brilliance of the lamp and should be adjusted to fulfill two conditions: (1) The lamp must be

When the shortest distance is *NOT* a straight line

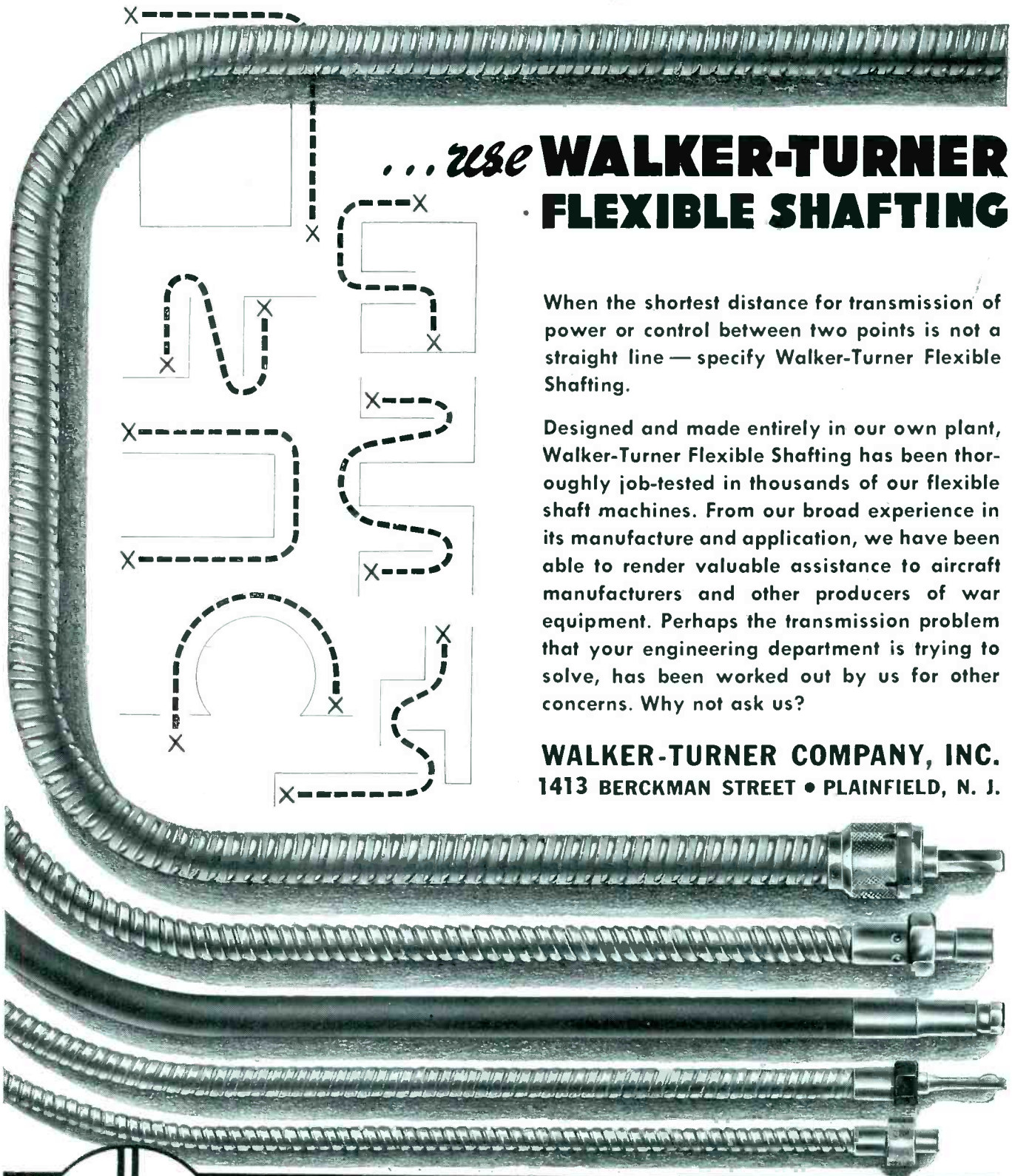

... use **WALKER-TURNER FLEXIBLE SHAFTING**

When the shortest distance for transmission of power or control between two points is not a straight line — specify Walker-Turner Flexible Shafting.

Designed and made entirely in our own plant, Walker-Turner Flexible Shafting has been thoroughly job-tested in thousands of our flexible shaft machines. From our broad experience in its manufacture and application, we have been able to render valuable assistance to aircraft manufacturers and other producers of war equipment. Perhaps the transmission problem that your engineering department is trying to solve, has been worked out by us for other concerns. Why not ask us?

WALKER-TURNER COMPANY, INC.
1413 BERCKMAN STREET • PLAINFIELD, N. J.



walker-turner
COMPANY, INC.
PLAINFIELD, N.J.
U.S.A.

FLEXIBLE SHAFTING

FOR REMOTE CONTROL AND POWER TRANSMISSION



Need
Intelligible
Communications?

Use a

TURNER Microphone



TURNER Microphones are specifically designed and engineered to faithfully reproduce gradations of volume, amplifying only the vibrations received by the diaphragm, without adding any of the harmonics.

A. Turner Cardioid 101

Here's the unit that stymies all background noises. The 2-element generator produces true cardioid characteristics and offers the best features of both the dynamic and velocity. Where the going is tough and acoustic conditions practically impossible, a Turner Cardioid can handle the job. Available in Standard, De Luxe and Broadcast Models.

B. Turner U9-S Multiflex

This ONE Turner unit offers your choice of 4 impedances—50, 200 or 500 ohms or hi-impedance, simply by twisting the switch. A dynamic microphone that's free from peaks and holes from 40 to 9000 cycles. Be sure you can handle ANY job with Turner U9-S.

C. Turner 211 Dynamic

Utilization of a new type magnet structure and acoustic network permits outstanding performance characteristics with the 211. High frequency range has been extended and extreme lows raised, to compensate for over-all deficiencies in loud speaker systems.

D. Turner Han-D

Hold it, hang it, or mount it on standard desk or floor stand, this Turner is HAN-D. Positive contact slide switch permits off-on operation. Will not blast from close speaking. Crystal or Dynamic.

If You Have a Priority Rating

WRITE, explaining your communications problems and we can help you select the Turner Microphone best suited to your needs. Also, information on how to make your present Turner Microphones and Equipment give longer, better service.

FREE Turner Microphone Catalog, with complete information and prices on Turner Microphones and Equipment. Write:

Crystals Licensed Under Patents of The Brush Development Co.

THE TURNER CO.
CEDAR RAPIDS, IOWA

bright enough when the control switch is thrown to "red" to maintain the ear in a fully flushed state. (2) The lamp must be bright enough with the control switch thrown to "green" to give full scale deflection with the standard A filter.

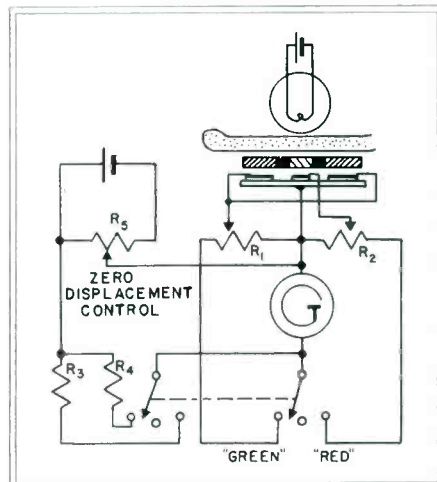
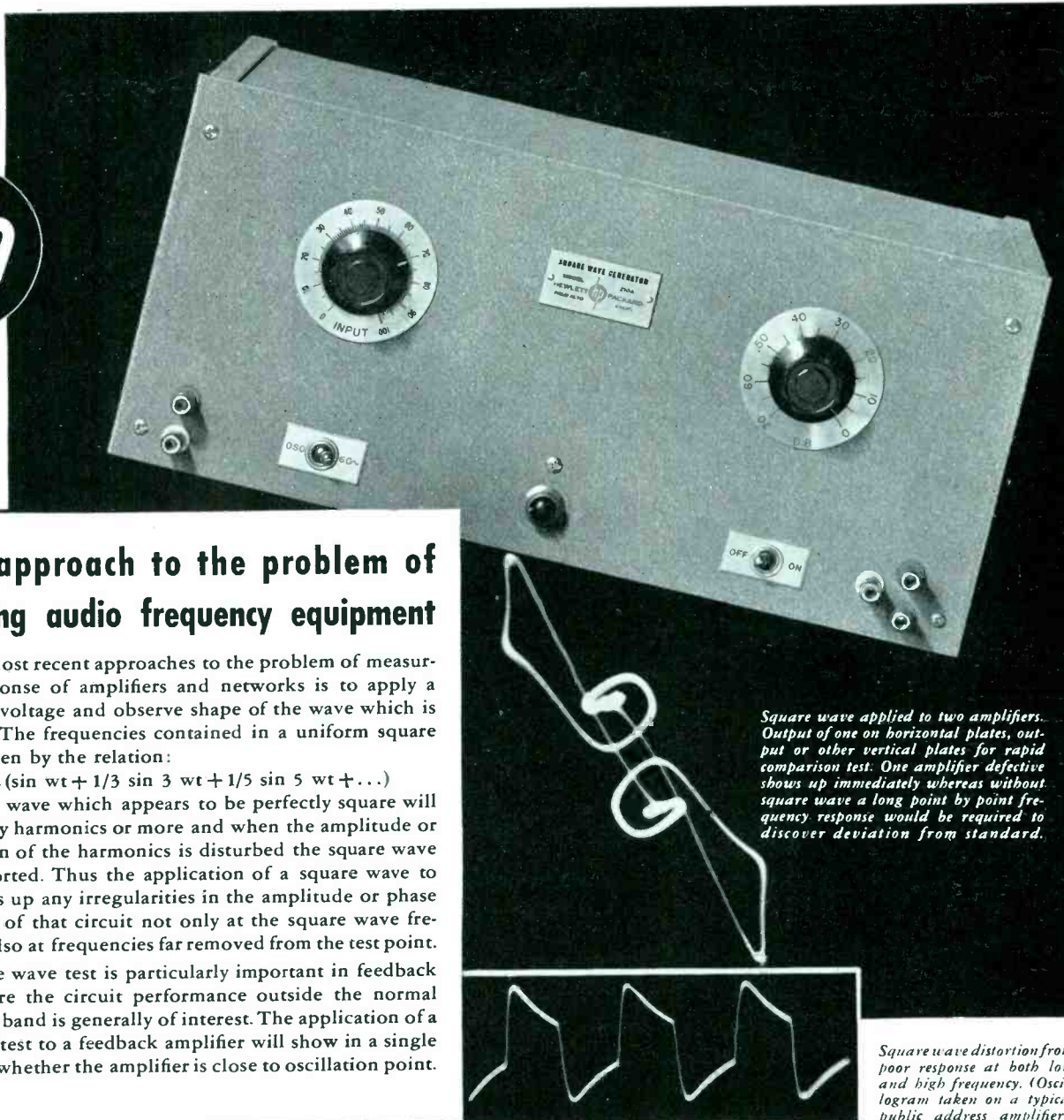

Fig. 2—Schematic wiring diagram of single scale oximeter with manual adjustment

In Fig. 2, the basic circuit is modified only by the addition of an adjustable bias for the galvanometer 0 position, and the substitution of a lamp circuit which provides constant brightness. As before, $R_1 = R_2$ and these represent the critical damping resistances of the galvanometer. The resistor R_3 may be any value, about 200 ohms to 20,000 ohms, while $R_5 = 75,000$ ohms and $R_4 = 1$ megohm. The source of bias potential should be adjusted to give a convenient range of adjustment with R_5 . None of the resistance values need be exact except that the ratio R_4/R_3 which should be 13.3.

The schematic wiring diagram of a single scale oximeter, with automatic adjustment for ear thickness is shown in Fig. 3. The "green" photo current is used to displace the galvanometer zero by an amount determined by the ear thickness. The critical damping resistance galvanometer is designated as R_1 . The resistor $R_2 = R_1/20$, while $R_1 = R_3 + R_4$. None of these values need be exact, but R_3 is accurately adjusted until the "set filter" deflects as 20 percent of the magnitude of the "run" deflection with the red photocell short circuit.

Most of the oximeters now in operation are installed in low pressure chambers and are being used for research in aviation medicine. For experimental purposes it is generally desirable to have at least two ear units operating simultaneously, one on the subject, the other on the control. In some cases it is desired to protect the entire personnel in a chamber. Oximeter installations of 2, 3, 6 and 10 subjects have been constructed by simple repetition of parts, and the addition of a selector switch. The switch can be arranged for automatic selection of subjects and



A new approach to the problem of measuring audio frequency equipment

One of the most recent approaches to the problem of measuring the response of amplifiers and networks is to apply a square wave voltage and observe shape of the wave which is transmitted. The frequencies contained in a uniform square wave are given by the relation:

$$f(t) = \frac{4}{\pi} (\sin wt + 1/3 \sin 3 wt + 1/5 \sin 5 wt + \dots)$$

In practice a wave which appears to be perfectly square will contain thirty harmonics or more and when the amplitude or phase relation of the harmonics is disturbed the square wave will be distorted. Thus the application of a square wave to circuit shows up any irregularities in the amplitude or phase transmission of that circuit not only at the square wave frequency but also at frequencies far removed from the test point.

The square wave test is particularly important in feedback circuits where the circuit performance outside the normal transmission band is generally of interest. The application of a square wave test to a feedback amplifier will show in a single observation whether the amplifier is close to oscillation point.

Square wave applied to two amplifiers. Output of one on horizontal plates, output of other vertical plates for rapid comparison test. One amplifier defective shows up immediately whereas without square wave a long point by point frequency response would be required to discover deviation from standard.

Square wave distortion from poor response at both low and high frequency. (Oscillogram taken on a typical public address amplifier.)

SPEED UP PRODUCTION AND DEVELOPMENT WORK



This Square Wave Generator will help you in Production and development work on A. F. amplifiers. As a general purpose instrument for laboratory work and as a time saver in production testing a square wave generator is an important instrument.

The -hp- model 210 Square Wave Generator provides an excellent square wave and is more useful than other instruments of this type because the frequency can be accurately set for quantitative measurements of decrement factor, time and other quantities to transient analysis. It will save valuable time in production testing because one or two observations will check the frequency response of apparatus where heretofore a large number of observations were necessary. This new instrument is an important tool for development work because it will show up phase shift and transient effects, both of which are rather difficult to study by other methods. In one observation a square wave applied to amplifier will check a wide frequency range, a range of 100 to 1 or

even more. This is extremely important because once the proper criterion has been established a production test can be set up with one or at the most two observations with a square wave.

No priority needed to avail yourself of our engineering help but -hp- instruments are going all-out for war and quick deliveries can be made only to people engaged in the war effort. However, we are making prompt deliveries to war plants and our capacity for fast production is ample. Write today for information.

Square wave test on feedback amplifier showing amplification peak at 9 times square wave frequency. (A normal frequency response measurement shows flat response from 20 cps to 20 ks.)

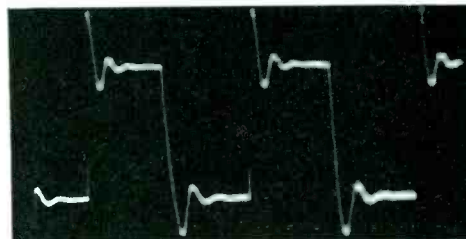

HEWLETT-PACKARD CO.

BOX 135 Y, STATION A · PALO ALTO, CALIF.

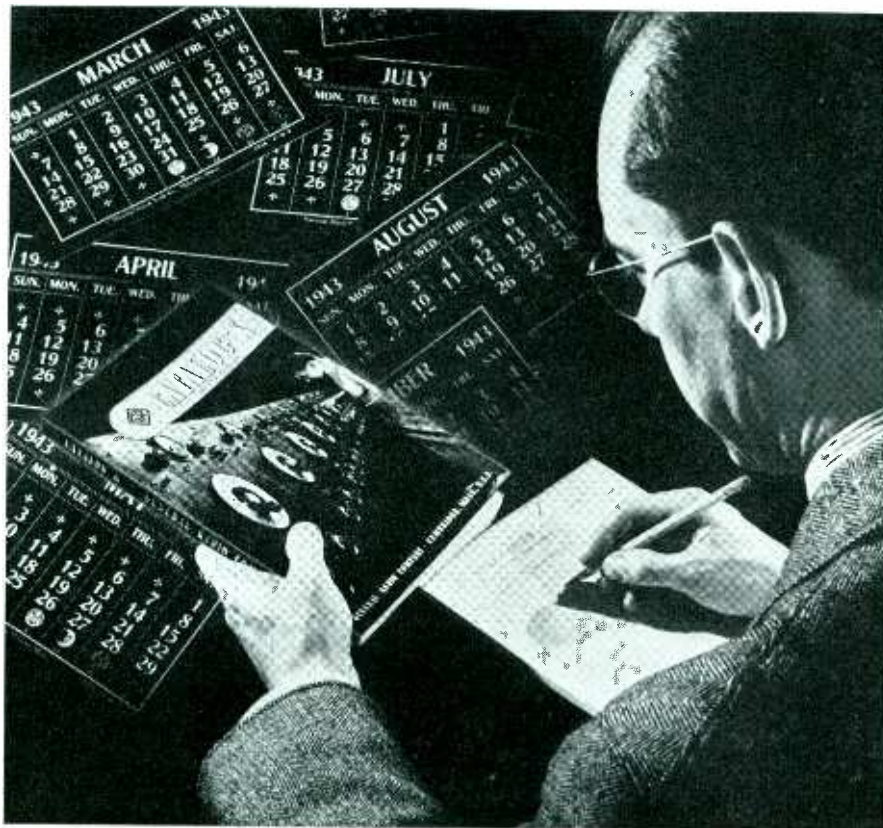

Forecasting Deliveries of TEST EQUIPMENT for 1943

You can help us to schedule production for 1943 more efficiently so that you will be better assured of getting General Radio instruments when you need them. Estimate your test equipment requirements when you plan your own production and place your orders with us well in advance of the desired delivery dates.

Our present plant output is completely allocated, and current orders will be delivered early in 1943. If you will need instruments for use in late spring and summer, order them now, specifying the desired delivery dates. Ordering well in advance will help to assure on-time deliveries. On the other hand, please do not call for delivery ahead of actual needs, and thus prevent someone else from getting urgently needed equipment on time. Your co-operation will help us to deliver what you want, when you need it.



GENERAL RADIO COMPANY
Cambridge, Massachusetts

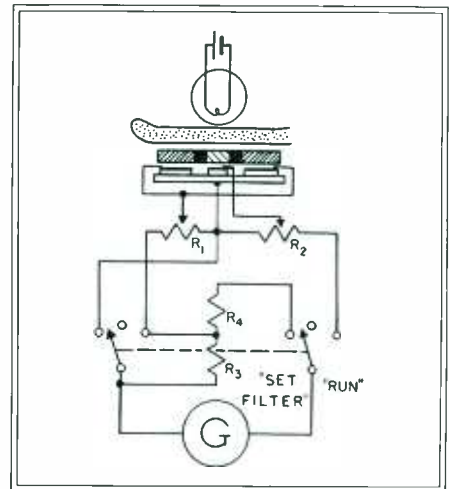

Fig. 3—Circuit diagram of single scale oximeter, with automatic adjustment for ear thickness

it is also possible to have multi-panel recordings by linking the oximeter to a suitable insulating recorder. Projection galvanometers allow everyone in the chamber to observe the saturation value, and signal lamps can be arranged to indicate the subject being measured. Two suggested medical applications may be of considerable value. It should be possible with this device to follow continuously the respiratory condition of the patient during the course of an operation which should be of anesthesiologist. As a second application, the oximeter could be used to determine the effects of oxygen therapy in raising the level of oxygen in the blood.

It should not be forgotten, in considering normal applications of an instrument of this kind, that the oximeter is not a primary measuring instrument, but depends for its reliability upon agreement with measurements made by classical methods. Any new use requires a critical examination of the basic operating principles and a fresh series of calibrations, if there is any doubt as to the applicability of the original calibration data. The attempts which have already been made to apply the method to conditions beyond the range of those described in the paper by Dr. Millikan have, on the whole, been promising.

• • •

Some Notes on the Design of German Army Radio Component Parts

IN SUBMITTING his article, "Nazi Aircraft Radio" which appeared in the November issue of *ELECTRONICS*, Mr. Jupe touched a matter of vital interest to a good many communication engineers in this country. As a result of submitting this material to publication in *ELECTRONICS*, the Program Committee of the Institute of Radio Engineers was instrumental in having a paper on this same topic presented by their president-elect, F. S. Barton of the British

Industry steadies its "nerves"

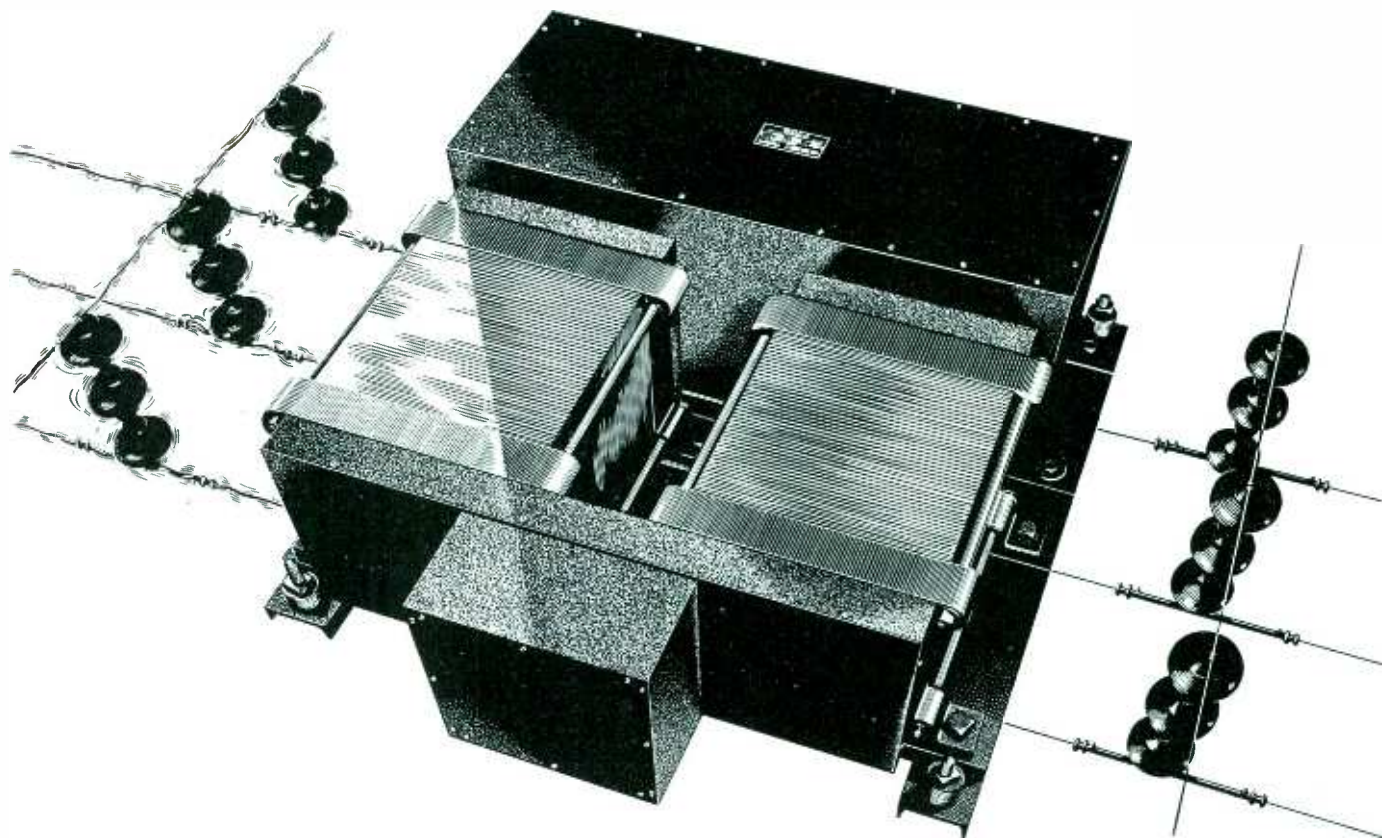

FACED with production schedules that have no precedent in history, American industry finds the fluctuating voltages of its over-loaded power lines wholly inadequate to meet the "deadly" precision demanded for total war.

Vital "nerve centers" of production lines are geared for precise performance when operated at specific line voltages. Any variation from these rated values, and there are many these days, may well mean lagging production schedules and a noticeable lack of uniformity in products.

Fluctuating line voltages are no problem in plants where Sola "CV's" have taken over. Even though the peaks and valleys of power consumption may cause a voltage variation of as much as $\pm 30\%$ —the vital "nerve centers" of their pro-

duction lines continue to operate smoothly and with unerring precision.

Day and night, without care or supervision, Sola Constant Voltage transformers maintain positive control over electrically operated instruments and machines that are indispensable to the nation's war effort. These transformers are available in standard units with capacities ranging from 15 KVA, which might be used for an entire communications system for instance, to the small 10 VA units for vacuum tubes. Special units can be built to specifications.

Note to Industrial Executives: *The problems solved by Sola "CV" transformers in other plants may have an exact counterpart in yours. Find out. Ask for bulletin DCV-74*

Constant Voltage Transformers

SOLA

Transformers for: Constant Voltage • Cold Cathode Lighting • Mercury Lamps • Series Lighting • Fluorescent Lighting • X-ray Equipment • Luminous Tube Signs • Oil Burner Ignition • Radio • Power • Controls • Signal Systems • Door Bells and Chimes • etc. **SOLA ELECTRIC CO., 2525 Clybourn Ave., Chicago, Ill.**

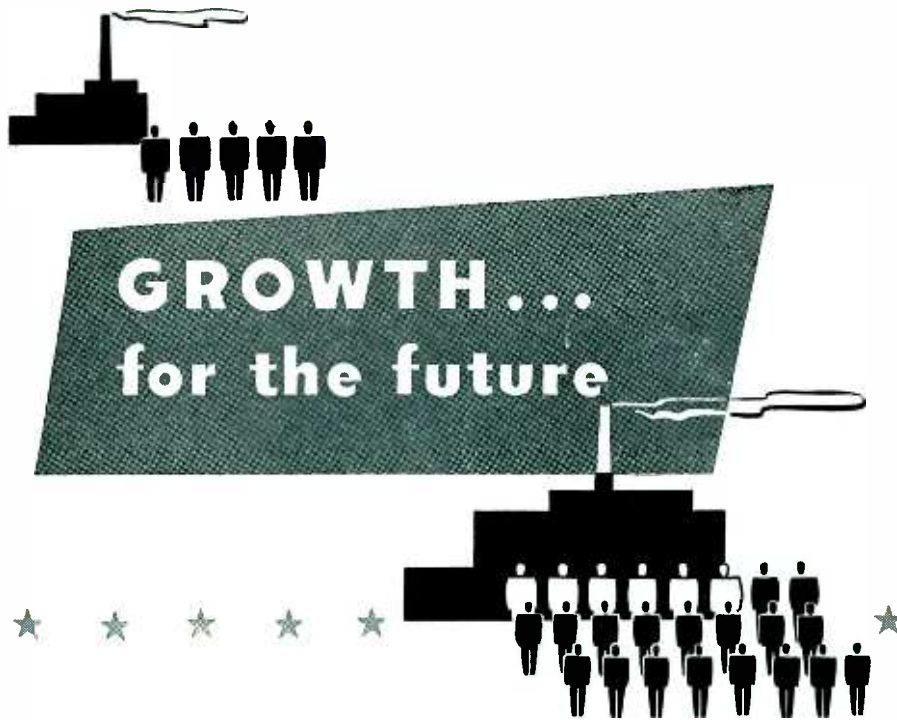

For military reasons, there are many things we cannot tell—facts that would give aid (not comfort) to the enemy—figures from which Schickelgrueber et al could get an idea of American radio and mobile equipment production. We can tell you that in slightly over two years we have expended our floor space to four times the former amount (our own buildings, not rented space), the number of employees to ten times, and dollar production to fifteen times. All of this additional capacity is being used to produce the same type of parts we have always manufactured—tube sockets, insulators, plugs and jacks, inductors, condensers, and similar items. It is being used to produce war material exclusively.

To those now requiring these or similar parts—if they will help win the war, send us your inquiries. Catalog 967 free on request.



JOHNSON
a famous name in Radio

Air Commission. This meeting was attended by a larger group of individuals than perhaps any other similar monthly meeting in the New York metropolitan area.

Our British contemporary, *Electronic Engineering*, presents some additional information not covered in detail in Mr. Jupe's article. This treatment is given in an article entitled "The Mechanical Design of German Army Wireless Components," by D. Gifford Hull, Royal Corps of Signals, in the November issue of *Electronic Engineering*. This article provides a description of some of the more unusual designs found in German army wireless equipment captured during operations in the Middle East.

Supporting the data provided by Mr. Jupe that the Nazi radio equipment is rather heavily built, Lieutenant Hull states that extensive use of aluminum alloy die castings are used for the chassis of radio equipment. In some receivers the chassis consists of an intricate die cast framework, bolted to a panel casting. In certain of the small sub-assemblies, die castings are also used and these may be sufficiently intricate as to include bosses upon which the components are mounted. Recesses in the castings are sometimes provided to make room for certain components, while strengthening ribs are fairly commonplace. In some receivers similar circuits are segregated into individual units. For example, the radio frequency, intermediate frequency and audio frequency circuit may each be built into their own sub-assemblies which are then inserted in the receiver itself.

Tuning condensers of the mica compression type have been almost always replaced by silvered ceramic tuning condensers which are more or less standard for German army receivers. Molded bakelite mica insulation condensers are used in transmitters as

ASSEMBLERS



The girls of Britain's Auxiliary Territorial Service are given a special course on the assembling of radio stations sets which enables them to take over duties at Ordnance Depots. Irence Dilloway and Eve Scott are shown working on radio sets which transmit and receive

to specifications

Test and calibration chambers serve such diversified needs that many of the requirements of instrument manufacturers can be met only by specially designed units. Within the scope indicated, we can build equipment to your individual specifications. All MOBILE units incorporate positive automatic mechanical means of refrigeration and control, plus an indicating recording controller. All sizes of chambers mentioned refer to clear inside test space.

High Altitude Development Chambers

Temperature: -100° F to $+180^{\circ}$ F.
Vacuum: to .5" Hg absolute.
Time: complete cycle within 90 minutes.
Size: minimum of 12" x 12" x 12" to any greater capacity.
Humidity: 20% to 95% R. H. manual or automatic control.

Cold Chambers

Specifications are identical with those listed for altitude chambers, except that cold chambers have no vacuum provision.

Hot and Cold Bath Calibration Stands

Temperature: -85° F. to $+600^{\circ}$ F.
Control: constant temperature control $\pm 1^{\circ}$ F.
Size: 1 pint to 50 gallons; also available with multiple vat units.
Automatic mechanical refrigeration (no dry ice).

Flight Chambers

Temperature: to -100° F, with or without refrigeration.
Vacuum: to 80,000 ft. with automatic control of temperature compared to pressure.
Size: 6' x 4' x 4' to as large as 10' x 10' x 50'.
Humidity: manual or automatic control in range between 20% and 95% R. H.

Accessory Instruments

Special Recording Pyrometers
Manometers and Altimeters
Vertical Speed Indicators
Oximeters
Instrument panels and switchboards

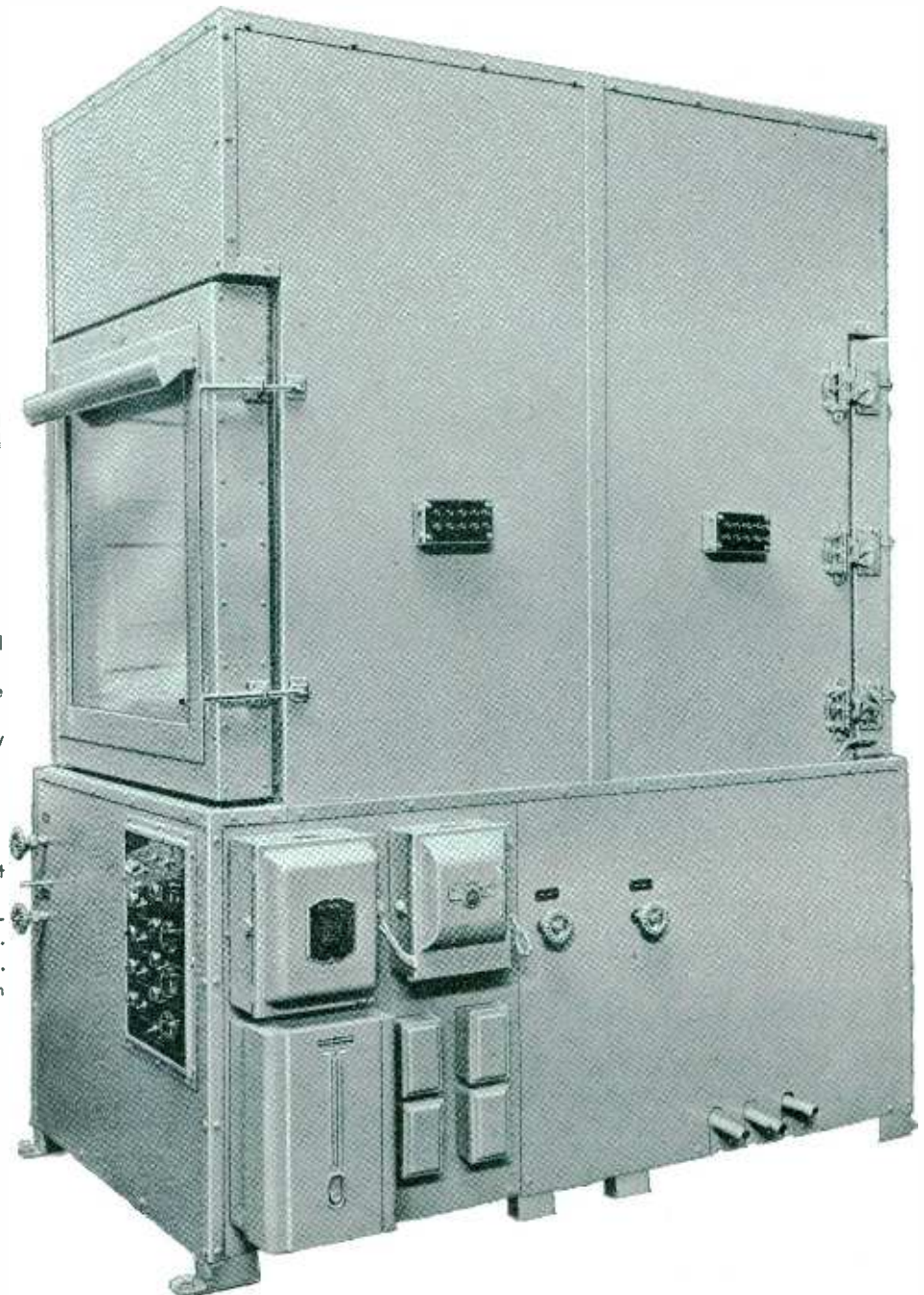

May we assist you with your problem?



MOBILE REFRIGERATION INC.

630 FIFTH AVENUE

NEW YORK, N. Y.

B & W

Variable AIR CONDENSERS

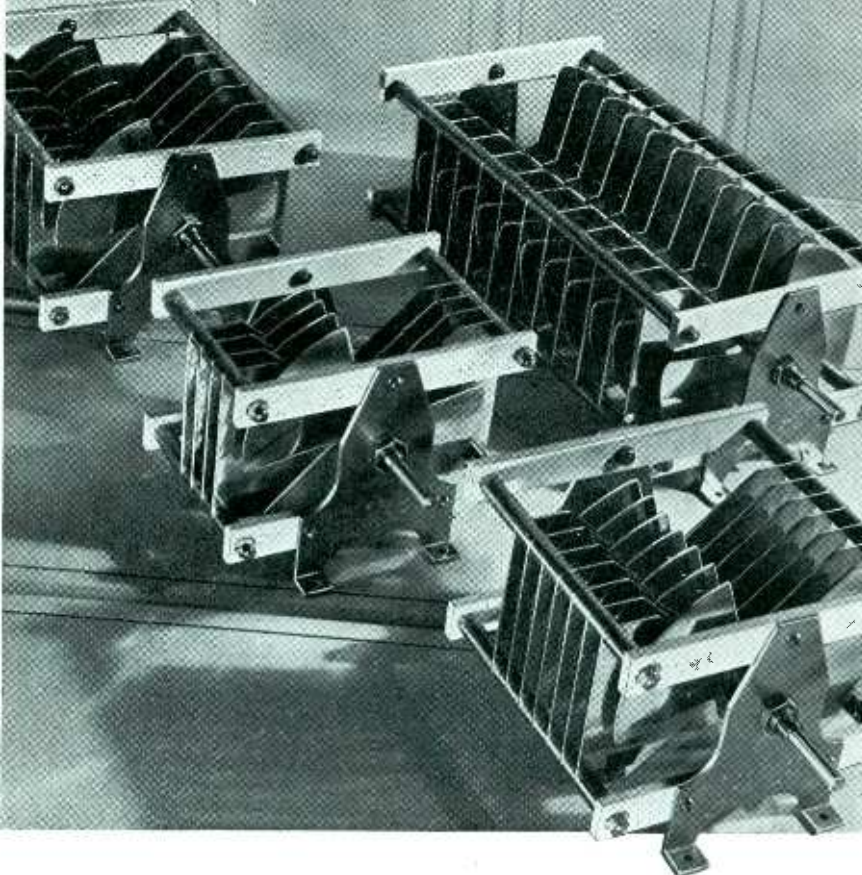

Now Available in GREATLY INCREASED QUANTITY

Production on B & W Variable Air Condensers has now been increased to a point where—well, we won't make any rash promises but, chances are, your order backed by a suitable priority will bring the shipment ahurryin'. And remember: B & W Variable Condensers are designed to combine maximum mechanical ruggedness with electrical performance of a high order—the two factors of utmost importance on today's exacting applications. Literature and full details upon request. Write, wire, or 'phone today!

AIR INDUCTORS!

B & W produces a complete line of Turret Coils and other Air Inductor types for modern requirements. Literature and technical data upon request.

BARKER & WILLIAMSON, Radio Manufacturing Engineers
235 Fairfield Avenue, Upper Darby, Pa.

well as certain very compact wax—paper type.

Tuning condensers are usually constructed of die cast aluminum alloys. The rotor plates are usually die cast, and then machined. Frequently they are mounted on a ceramic shaft. Stator plate assemblies are similarly made and clamped on ceramic rods. The complete set of plates is fixed by clamps in a die cast box which contains a shield between adjacent stator sections which is integrally cast as a part of the box. The condensers may thus be completely shielded by means of this die cast box and the lid which screws onto it.

In many of the condensers the manufacturing process employed is one which makes for mechanical rigidity and electrical stability. At the same time the production operations are intricate and the milling operations involved result in a waste of an appreciable amount of metal.

An interesting condenser of unusual design is found in some of the UHF transmitters. Each section of stator plate consists of a semi-circular alloy block, with grooves filled out to accommodate the rotor plate. The rotor plates are also die cast and machined, and are clamped on to the shaft. The most interesting feature of design is that the stator sections are in no way mounted on the chassis of the transmitter but are affixed to the shaft. They are prevented from rotating with the shaft by the retaining arm, one end of the arm being fixed to the stator section, the other end to the shafting of the transmitter. The purpose of this design is to insure constant juxtaposition of the rotor and the stator plates, should the long ceramic shaft become warped. In such an event, the stator section rides with the rotor being free to turn with respect to the chassis. The retaining arm is constructed to act as a universal joint and is intended only to prevent the stator section from rotating, leaving it free to twist if the shafts twist.

Normal construction is used in some of the inductances used at ultra-high frequencies. A ceramic former $\frac{1}{8}$ in. in diameter has a spiral groove on its surface, and silver is deposited into this groove to form a winding, the turns of which have considerable width but extremely thin depth. The silver appears to be deposited by an electrolytic method rather than by spraying and by means of this construction a high degree of electrical stability and a low distributed capacitance between turns is possible. At the same time a large surface is provided for the conducting of ultra-high frequency current.

One German transmitter employs variometers for tuning the oscillator and amplifier circuit. The design and construction of these variometers is such that the curve relating angle of the rotor with frequency of the circuit is a straight line. In the construction of this variometer, two coaxially mounted cylindrical formers are used, the inner one revolving about a com-

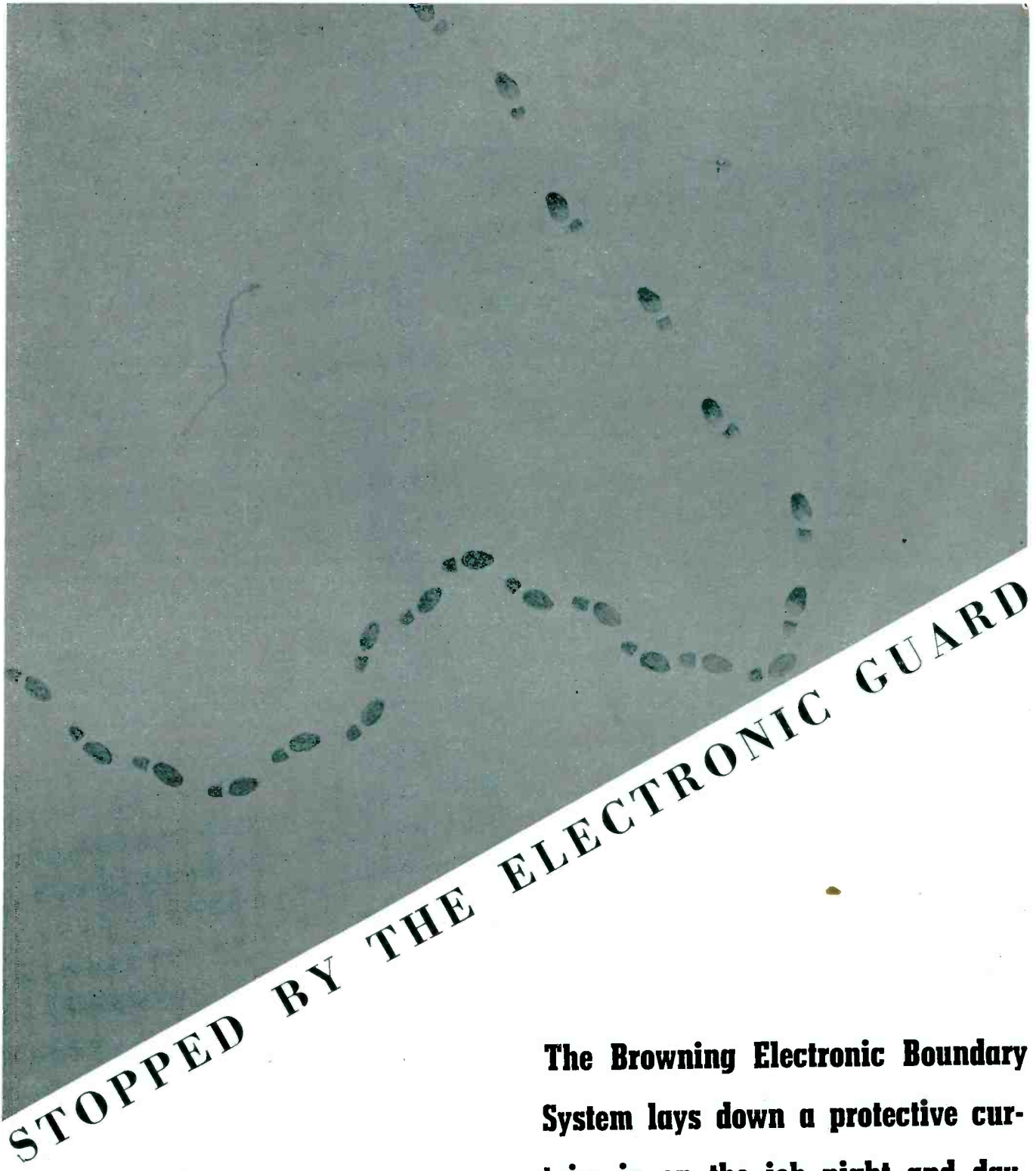

STOPPED BY THE ELECTRONIC GUARD

**BROWNING ELECTRONIC
BOUNDARY PROTECTION**

product of Browning Laboratories research

The Browning Electronic Boundary System lays down a protective curtain, is on the job night and day, reduces guarding personnel, cuts guarding costs. Details on request.

BROWNING LABORATORIES, Inc.
765 MAIN STREET, WINCHESTER, MASSACHUSETTS

ARMY **E** **NAVY**

"FROM that high resolve was born the Army-Navy Production Award which stands today as our fighting forces' joint recognition of exceptional performance on the production front . . . of the determined persevering, unbeatable spirit which can be satisfied only by achieving today what yesterday seemed impossible!"

We're sincerely proud of our award — its significance will always be our goal.

BLILEY
FREQUENCY CONTROL
A10059
7118
MADE IN U.S.A.

BLILEY ELECTRIC COMPANY . . . ERIE, PA.

Bliley Crystals

mon axis. Each coil is wound on a semi-cylindrical surface instead of being wound around the whole circumference of the cylinder. The windings are tapered in shape and are stitched on to the former. While this method of winding does not provide as large a frequency variation as the conventional method, it does permit uniform or linear calibration of the frequency dial.

Piezoelectric crystal resonators mounted in a gas-filled glass envelope are used in certain German field transmitters and also in one Italian transmitter as a calibration check device. At the resonant frequency of the crystal, the crystal is subject to vibration which in turn causes the atmosphere of gas to become ionized and produce a visible indication. A mark on the tuning dial corresponds to the frequency of operation of the crystal and when the tuning control is set to this mark, the crystal should glow to a hole in the panel. If the set is off calibration, the crystal glow will occur at a different dial reading which indicates that the transmitter requires retrimming. In one case three such crystals are mounted in one envelope, and are connected in turn, so that three deck points are provided.

Lieutenant Hull points out that apparatus made in 1940 makes use of pressed aluminum sheets instead of castings for chassis and sub-assemblies in some cases. This receiver is not as rigidly constructed as the earlier models and the assembly work is poorly carried out.

It appears evident that the war has stimulated research in the use of substitute material in Germany since experiments have been carried out with a view to employing cardboard coil cans sprayed with metal to replace the aluminum coil can. In certain cases metal is also being replaced by laminated plastics and ceramics.

. . .

JAP TRANSMITTER

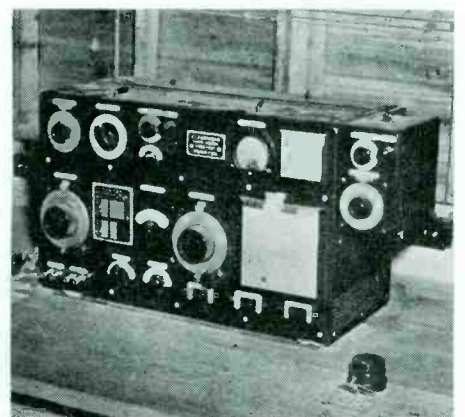

This Japanese short-wave transmitter was found by the U. S. Marines on Guadalcanal in the Solomon Islands after it had been abandoned by the retreating enemy during the early stages of the fighting

FOR VICTORY TODAY AND SOUND BUSINESS TOMORROW

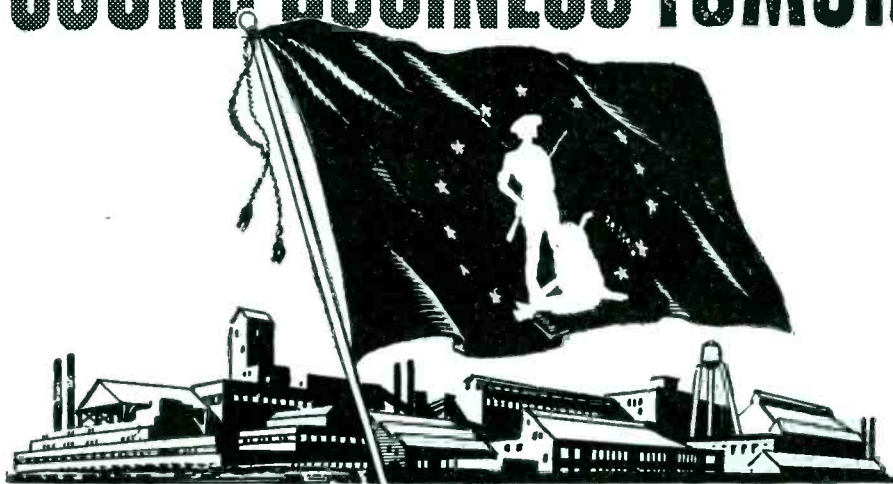

Get This Flag Flying Now!

This War Savings Flag which flies today over companies, large and small, all across the land means *business*. It means, first, that 10% of the company's gross pay roll is being invested in War Bonds by the workers voluntarily.

It also means that the employees of all these companies are doing their part for Victory . . . by helping to buy the guns, tanks, and planes that America and her allies *must* have to win.

It means that billions of dollars are being diverted from "bidding" for the constantly shrinking stock of goods available, thus putting a brake on inflation. And it means that billions of dollars will be held in readiness for post-war readjustment.

Think what 10% of the national income, saved in War Bonds now, month after month, can buy when the war ends!

For Victory today . . . and prosperity *tomorrow*, keep the War Bond Pay-roll Savings Plan rolling in *your* firm. Get that flag flying now! Your State War Savings Staff Administrator will gladly explain how you may do so.

If your firm has not already installed the Pay-roll Savings Plan, *now is the time to do so*. For full details, plus samples of result-getting literature and promotional helps, write or wire War Savings Staff, Section F, Treasury Department, 709 Twelfth Street NW., Washington, D. C.



Save With

War Savings Bonds

This Space Is a Contribution to America's All-Out War Program by

ELECTRONICS

NEWS OF THE INDUSTRY

Elements of the Controlled Materials Plan which is to allocate steel, copper and aluminum; Harold P. Westman leaves Institute of Radio Engineers for American Standards Association; WPB, FCC actions

Controlled Materials Plan

UNDERSTANDING "CMP" (the Controlled Materials Plan) is a must for American industry, because it is going to be the only method under which, within a few months, three essential materials (iron & steel, aluminum, and copper) can be obtained. The plan is described in rather elaborate detail in a 72-page pamphlet entitled, "War Production Board, Controlled Materials Plan," and dated November 2, 1942, and in a further booklet dated November 14.

Without here attempting to describe this plan in detail, a few of its principal characteristics may be mentioned. "Bills of materials" will be made up for each article the armed forces acquire. These "bills" will show the quantity of each material used in a given product. When an order is placed with a prime contractor, all that is necessary is for the allocation authority to multiply the "bill of material" by the quantity ordered. Since production will be carefully scheduled, the quantities of materials thus allocated will also be controlled as to time. Prime contractors will pass material allotments along to secondary contractors.

The salient feature of this process is that demand for materials will be equated to the supply. That is, the WPB Requirements Committee will canvass the quantities of goods asked for by the various "claimant agencies" (Army, Navy, Office of Civilian Supply, etc.) and will weigh the merits of their respective demands, in such measure that the total orders for all products will not call for a supply of material in excess of that available.

Among the advantages of this system over those heretofore in force are: (1) a user will get exactly the quantity of material he needs when he needs it—but no excess quantity; and most of the temptation and all of the opportunity to hoard materials will disappear; (2) there will disappear the condition where holders of high priority ratings get all, and more, of their

requirements, while holders of lower priorities get nothing; (3) since materials will be forthcoming according to production schedules, there will be no holding up of products awaiting a few missing parts. Small quantities of steel will not come under this plan since the volume of clerical work involved would make the system uneconomical of time and effort.

Materials other than Controlled Materials will be distributed through the existing priorities system.

Each claimant agency will break down its submission of requirements into materials for (1) production; (2) construction and facilities; (3) maintenance, repair, and operating supplies. Requirements for construction and facilities, including industrial machinery and equipment, will be channeled through the construction and facilities branch of the office of program determination.

When requirements have been brought into balance with supply and the program of the various claimant agencies are approved, the WPB vice chairman on program determination—who also is chairman of the requirements committee—will allocate with the advice of the requirements committee, authorized quantities of the three Controlled Materials to each.

The claimant agencies, in turn, will distribute these broad allotments among prime contractors by means of "allotment numbers," which will constitute a right to receive delivery. The prime contractors will pass on the allotment numbers as necessary to their subcontractors and suppliers.

Officers Elected for National Conference of Electron Microscopy

AT A JOINT MEETING of the National Industrial Chemical Conference and the Chicago Section of the American Chemical Society recently officers were elected for the National Conference of Electron Microscopy. R. Bowling Barnes of American Cyanamid Co., Stamford, Conn., is President, Albert F. Prebus of Ohio State University is Vice president, M. M. Charles Banca of RCA Labs in Princeton, N. J., was elected secretary-treasurer. The directors include O. S. Duffendack of the University of Michigan, and V. K. Zworykin, Associate Director of RCA Labs. Dr. Zworykin read a paper on the applications of an electron microscope to chemistry, and this appears in this issue of *ELECTRONICS*. Both RCA and the General Electric Company described portable microscopes which will be available for war and industrial work on a large scale.



NATIONAL CONFERENCE OF ELECTRON MICROSCOPY OFFICERS. Left to right, secretary-treasurer, M. Charles Banca; vice president Albert F. Prebus; director, V. K. Zworykin; president, R. Bowling Barnes

NOT A
SUBSTITUTE
AN IM-
PROVEMENT

POLYFLEX

THIS TOUGH & FLEXIBLE
POLYSTYRENE SHEET
OFFERS NEW INSULATION POSSIBILITIES

**EQUALS QUARTZ and
MICA ELECTRICALLY**

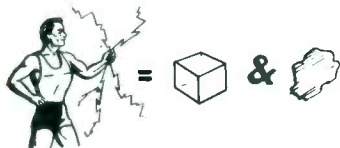

Polyflex has "the dielectric strength of an excellent grade of mica and the low dielectric loss of fused quartz."* (Excepting flexibility, all Polyflex characteristics also apply to Plax polystyrene parts described at right.)

**REALLY TOUGH and
FLEXIBLE**



To polystyrene's startling electrical properties, Polyflex adds *tough* paper-flexibility, adapting it to wide use by condenser, storage battery, cable and other manufacturers.

**UNAFFECTED BY WATER,
ACIDS OR ALCOHOL**



Polyflex's "low water absorption (.00) cannot be approached by any other plastic material."* Weather, acids, alkalis, alcohol, stack gases, etc. . . none of these enemies of electrical equipment affect Polyflex.

**PRODUCED TO YOUR
SPECIFICATIONS**



Tell us what widths, thicknesses, and tolerances interest you. Polyflex is easy to handle in punching and stamping operations. Samples are immediately available. Plax's exclusive Polyflex production is readily adaptable to your needs. Please get in touch with Plax today.

*Modern Plastics, Sept., 1941



**PLAX MACHINED
POLYSTYRENE PARTS
ALSO OPEN
A NEW WORLD**

Engineers are stimulated (and helped) by inspection of Plax parts. From sheets, rods, and tubes, Plax machines special and standard electronic parts in any quantity, to any degree of accuracy . . . on time. They can improve every segment of any circuit, from power supply to antenna. Please ask Plax for details today.

**ELECTRICAL PROPERTIES
OF PLAX POLYSTYRENE**

Arc resistance (ASTMD-495-38T)
sec 240-250. Dielectric strength,
volts/mil:

.005" thick = 3500
.010" thick = 2500
.015" thick = 2200
.125" thick = 500-700

Frequency Cycles	Dielectric Constant	Power Factor
60	2.5-2.6	.0001-.0002
1,000	2.5-2.6	.0001-.0002
1,000,000	2.5-2.7	.0001-.0004

PLAX

CORPORATION

133 WALNUT ST.
HARTFORD, CONN.

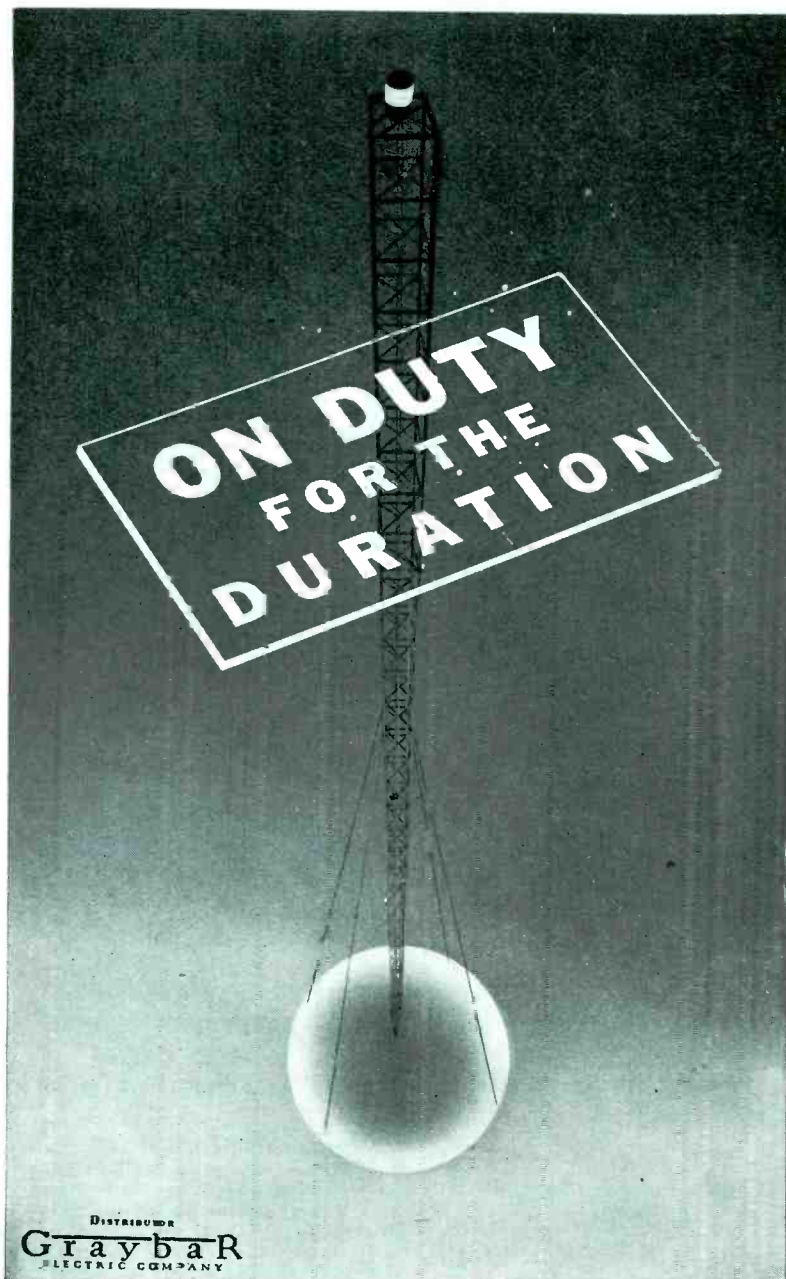

The American broadcasting industry contributes to America's strength by keeping the people informed, by increasing public morale, by promoting national unity. It is a heartwarming fact to every member of the Blaw-Knox organization that more than 70% of the towers in the nation are Blaw-Knox built.

BLAW-KNOX DIVISION of Blaw-Knox Co.

2077 Farmers Bank Bldg.

Pittsburgh, Pa.

BLAW-KNOX
VERTICAL
RADIATORS
 FM AND TELEVISION TOWERS

Westman Leaves IRE

AFTER NEARLY 14 years service at the New York headquarters offices of the Institute of Radio Engineers, Harold Westman resigned on December 15 from the Institute to spend full time with the War Committee on Radio of the American Standards Association. Mr. Westman became assistant secretary of the Institute in July 1929, full secretary in February 1930. During his long association with the IRE he has been very actively engaged in all of the standardization activities of the organization and for all but a half year of this connection has been in charge of the headquarters offices. Last March he was temporarily loaned to

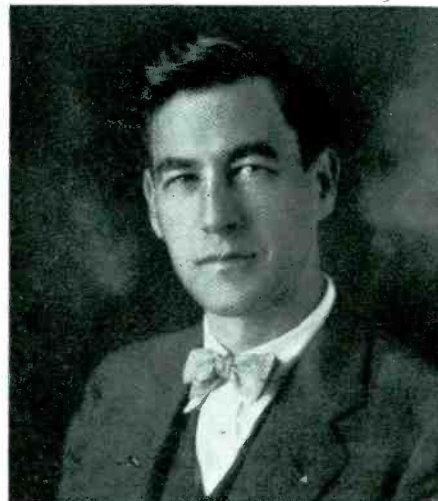

ASA on a part-time basis, becoming secretary of the committee which has been working hard to effect standardization in radio components as a war measure. This work took more and more of his time, and his leaving IRE for ASA enables him to devote his entire time and energy to helping "win the war."

Scientific Personnel

NATIONAL ROSTER of Scientific and Specialized Personnel, War Man Power Commission, now has on record the qualifications of approximately 550,000 persons in more than 60 specialized occupations. These fields cover every technical activity from genetics and geophysics to housing and radio broadcasting. This roster is a compilation of the nation's technical manpower resources, for such use as the war emergency may require.

The Roster is now urging senior and graduate students of chemistry, physics, engineering and other specialized fields to register their skills. Registration is not an application for employment; and it is highly doubtful if many of the skilled workers whose names are in this national pool are out of jobs. In 20 months, 140,000 men and women have been referred from the Roster to prospective employers of specialized personnel, particularly for war production and research.

SPRAGUE

HERMETICALLY SEALED METAL
ENCASED PAPER TUBULARS
TYPES PX-24, -24A, and -24B

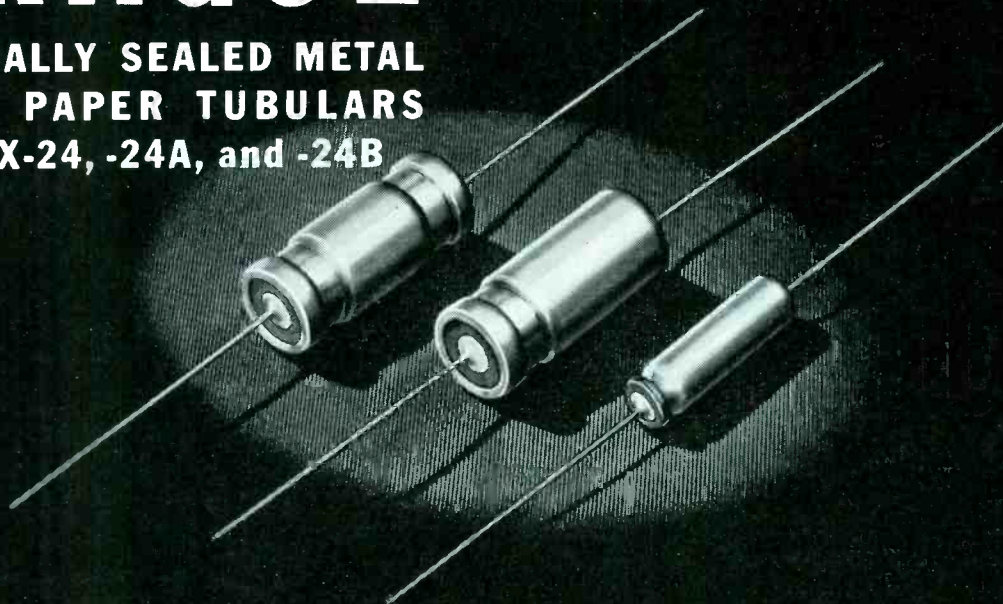

BUILT TO DO MICA CAPACITOR JOBS

... and do them well!

SMALL—light in weight—hermetically sealed, and outstandingly sturdy, these Sprague Metal-Encased Paper Tubular Capacitors have proved eminently satisfactory for numerous blocking and by-pass applications previously assigned exclusively to molded mica units. Not only is this true as regards less critical "mica jobs," but also on more exacting applications where characteristics such as temperature-insulation resistance, voltage-capacitance, or temperature-capacitance are important considerations.

There remain, of course, certain applications where mica capacitors should still be used, and Sprague regularly produces large quantities of transmitting mica capacitors in a complete range of types and sizes.

Deliveries of both types are obviously dependent on prevailing priorities. Production facilities—especially on the Metal-Encased Paper units—are being steadily expanded, and Sprague engineers will gladly cooperate in determining the adaptability of these Capacitors to your requirements.

SPRAGUE SPECIALTIES COMPANY
North Adams, Mass.

MATERIALS WANTED!

Sprague offers a constant market for large quantities of critical materials. Present requirements include: 5/16" 7/16" and 1/4" hex brass rod, free turning; #22 and 1/4" diameter brass rod, free turning; #22 gauge long ternes, 8# to 15# coating; 8/32" standard hex brass nuts; also ferrous and non-ferrous metals. Offers of these items in small lots or large will be reported upon promptly and AA1 Priorities supplied to cover purchases.

F. W. McNAMARA, Purchasing Agent
Telephone: North Adams (Mass.) 804



MANUFACTURERS OF A COMPLETE LINE OF RADIO INDUSTRIAL CAPACITORS AND KOOLOHM RESISTORS



WARD

*Now
Specializing
in*

**TELESCOPING
and
SECTIONAL
ANTENNAE
for
MOBILE
PORTABLE
and
FIXED UNITS
for our
ARMED FORCES**



*Ward can help you with
your antenna problem*

**WARD PRODUCTS
CORPORATION**

1523 East 45th Street
CLEVELAND, OHIO

War Production Board Rulings

ALL SUPPLIES of tungsten wire, rod, sheet, and powder were placed under complete allocation control on Nov. 27 amending Order-29 under which unrestricted deliveries of up to 25 pounds of contained tungsten monthly were permitted.

On Nov. 30 use of stainless steel in several products needed by the armed forces was permitted. Cable boxes and radio antennas were among the list of items which were placed on the exemption list. It is expected that some additional items will be placed on the permitted list as a result of further study.

Under a ruling of Nov. 7, manufacturers who customarily serviced radio receivers with replacement parts are enabled to continue this practice. Under an earlier ruling manufacturers were prohibited from making and delivering electronic devices, including tubes, except to meet ratings of A-3 or higher, but distributors could obtain replacement parts by use of PD 1-X and consumers did not need any preference rating to get these parts to repair receivers or home electronic equipment. This new order requires that manufacturers separate their distribution business from manufacturing and orders manufacturers to keep separate records for each branch. In transferring such parts from the manufacturing to the distributing branch, preference ratings must be obtained.

On January 1 repairs and replacements for broadcasters will secure a rating of AA-1. Plans are under way to provide a sufficient tube-making program to keep in service the vast majority of the nation's home radio receivers, according to reports of late November.

Foreign Patents Reside in Alien Property Custodian

ALL TRANSACTIONS between private persons or companies involving U. S. patents and copyrights in which any foreign country or foreign national has an interest now are subject to control by Leo T. Crowley, Alien Property Custodian. Heretofore, this control has rested in the Treasury Department.

All patent applications, assignments, licenses, and other agreements affecting foreign-owned patents are included in the controls.

The Custodian has issued three general orders and supplementary regulations setting up a complete regulatory system for transactions that are subject to his control.

Copies of the Orders may be obtained from the Alien Property Custodian, Washington, New York, Chicago and San Francisco. Drawings and specifications of foreign-owned patent applications seized by Mr. Crowley's office will be printed and made available to American industry at a nominal price. Printing will begin during December.

War and Business

INDICATIVE OF THE pace of war production is the fact that expenditures for war purposes during October were up 4.8 percent (to a total of \$5,722,000,000) an increase of \$264,000,000 over the previous month, compared to an increase of 5.8 percent amounting to \$300,000,000 in September over August.

Since Pearl Harbor, the Army and Navy have purchased or are in the process of purchasing, land tracts from private property holders equal in size to the combined areas of Massachusetts, Connecticut, Rhode Island, Delaware, the District of Columbia and four-fifths of New Jersey. At the rate at which requests for further sites are being received, it is estimated that before the war is over some 30,000,000 acres, the equivalent of the entire New England group of states, will be taken over by the government. So far, 64,368 tracts have already been acquired and 57,000 more are in process of condemnation. The 121,368 thus affected embrace 12,000,000 acres which, with improvements, are valued at \$284,000,000.

Merger of Telegraph Companies Approved by Commerce Committee

ON NOVEMBER 25, the House Interstate Commerce Committee approved and reported out the Telegraph Merger Bill, with permission for a merger of international cable and radio telegraph companies reinstated in the legislation, also a consolidation of the leading domestic wire telegraph companies. This permission was regarded as a notable victory for FCC-BWC Chairman James Lawrence Fly, who had been the most ardent governmental advocate of merger of international cable and radio telegraph carriers. The Navy Department strongly opposed any international merger during the war.

The Senate Interstate Commerce Committee had not favored the international merger permission because of the disapproval of the Navy. However, it is now believed that some compromise between the two Houses will be evolved. A possible compromise, proposed by one of the international carriers during the House hearings would give the State Department, the Army and the Navy veto power over the FCC findings.

According to FCC officials there are certain definite benefits that will result from the proposed legislation. After this war, a merger will probably open new use for frequencies which heretofore have been part of the point-to-point radio system. There will be more air travel and other increased demands for frequencies. A merger would lead to improvements and progress in the domestic field as competition is wasteful in such companies as these. That there would be better service at a lower cost and more stability of employment, is the contention of the advocates of the bill.



REA

MAGNET WIRE HEADQUARTERS

ALL INSULATIONS

SILK GLASS
PAPER COTTON
NYLON FORMVAR
ENAMELED

REA MAGNET WIRE COMPANY
FORT WAYNE, INDIANA

WITH VICTORY AT STAKE THE BEST IS NONE TOO GOOD!

S.S. White MOLDED RESISTORS

The "All-Weather" Resistors

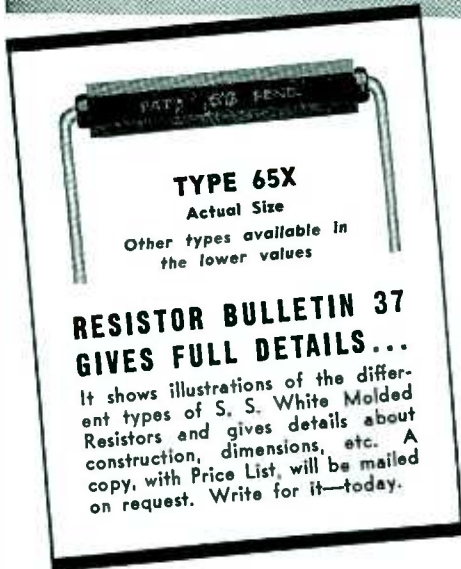

THESE widely used Resistors are favored because of their noiseless operation and durability and because they retain their values and characteristics under extremes of temperature, humidity and climatic changes.

STANDARD RANGE
1000 ohms to 10 megohms.

NOISE TESTED

At slight additional cost, resistors in the Standard Range are supplied with each resistor noise tested to the following standard: "For the complete audio frequency range, resistors shall have less noise than corresponds to a change of resistance of 1 part in 1,000,000."

HIGH VALUES

15 megohms to 1,000,000 megohms.

S. S. WHITE

The S. S. White Dental Mfg. Co.

INDUSTRIAL DIVISION

Department R, 10 East 48th St., New York, N. Y.

STABILIZED A. C. VOLTAGE UP TO 25 KVA

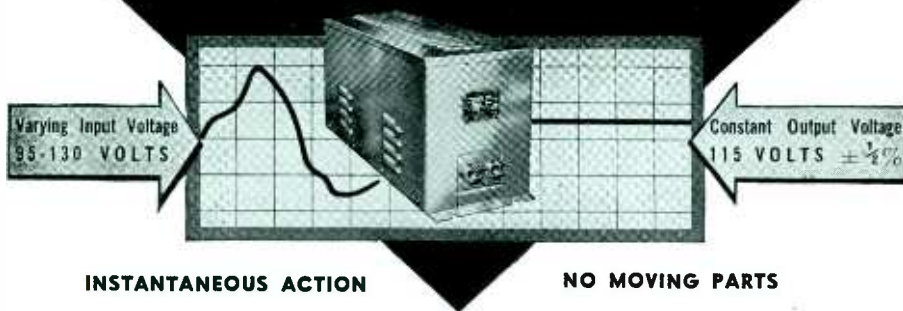

When a precision electrical device or a critical process is powered from an AC line, a Raytheon Voltage Stabilizer will permanently eliminate all of the detrimental effects caused by AC line voltage fluctuations. Made for all commercial voltages and frequencies, single or three phase.

Raytheon's twelve years of experience in successfully applying the Stabilizer to hundreds of perplexing voltage fluctuation problems is at your service. It will pay you to take advantage of our engineering skill.

Write for Bulletin DL48-71 JE describing Raytheon Stabilizers.

RAYTHEON MANUFACTURING CO.
100 Willow Street WALTHAM, Massachusetts

\$115,000 for Ideas

DURING THE FIRST 10 months of 1942, General Electric employees were paid \$115,000 for 12,250 ideas for saving materials or time in war production. This surpasses by a wide margin the best previous annual mark, \$104,000 paid for all suggestions adopted during the full year of 1929. Among suggestions were those by a carpenter who devised a method of saving 647,000 pounds of scarce steel (enough to make 80,000 Garand rifles), an Italian welder whose idea will save 3000 man-hours per month, the suggestion of a radio test man for an improvement in assembling radio equipment for Army and Navy which will save thousands of man-hours and conserve large quantities of scarce materials. Several money-winning suggestions were made by women factory workers.

How to Ship

METHODS OF PROTECTION against moisture and corrosion of machined parts, assemblies and delicate instruments are outlined in a guide book for shippers of war material issued by the War Department. Emphasis also is placed on the most efficient use of common types of containers, the techniques of interior packing, bracing and blocking and selection of the type of packaging which will afford greatest protection while occupying the minimum of shipboard space. The publication is indexed and illustrated. It may be obtained from the office of the Quartermaster General, Washington, D. C.

Tube Registry

DURING THE MONTH of September the following new tube types were registered with the RMA Data Bureau: 5R4GY, full wave rectifier with a rating of 2900 maximum peak inverse voltage and a maximum peak plate current of 650 ma. Under load, the conditions recommended are as follows: condenser-input filter, a-c plate voltage per plate 900 volts rms, output current, 150 ma; choke-input filter, a-c plate voltage per plate, 950 volts, current output, 175 ma.

6J6, miniature double triode, with a maximum plate voltage rating of 150 volts, 1.5 watts dissipation per plate. At 100 volts on the plate, cathode bias resistor of 50 ohms, plate current of 32 ma, the amplification factor is 32, the plate resistance is 6000 ohms and g_m is 5300 micromhos.

6AG5, pentode voltage amplifier, heater type. Under class A₁ amplifier conditions the following typical data holds: plate voltage, 250; screen, 150; cathode bias resistor, 200 ohms; plate resistance, 0.8 megohm; g_m , 5000 micromhos, plate current, 7 ma.

1C21, gas triode, cold cathode. Peak anode breakdown voltage (grid tied to cathode), 180 volts; peak positive grid breakdown voltage, 66 min., 80 max.; d-c anode extinction voltage, 73; a-c

Where corrosion MIGHT LOSE A BATTLE
OR EVEN A WAR....

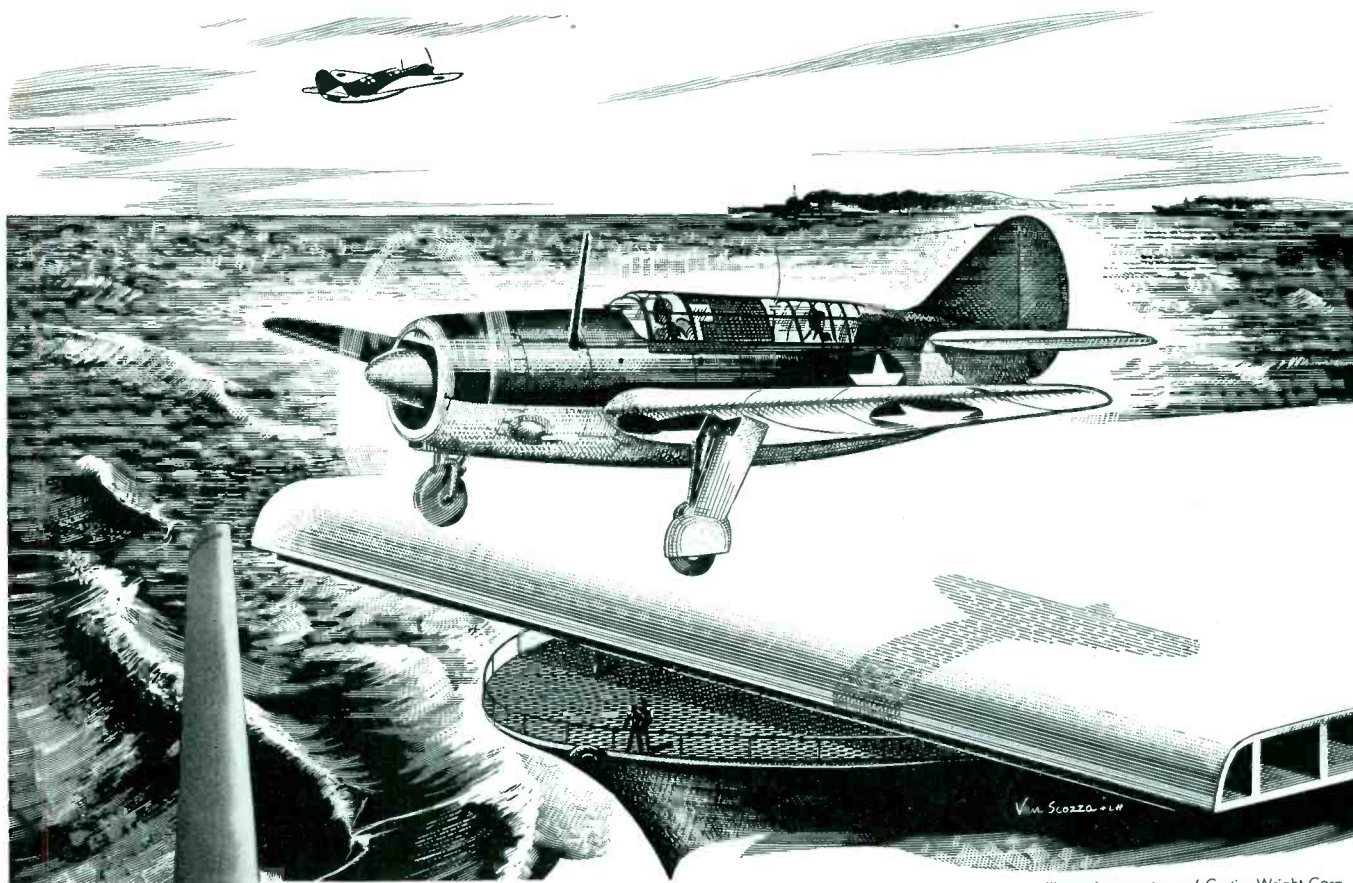

Illustration courtesy of Curtiss-Wright Corp.

CONTINENTAL-DIAMOND
plastics stand guard—

REPLACING an important quantity of a strategic metal, the DILECTO radio antenna mast illustrated also contributes importantly to our war effort by helping insure uninterrupted radio reception under the most severe and adverse conditions.

The properties of Dilecto* (Grade C) which make this antenna mast stand the gaff are:

- 1** Great physical strength—
Tensile Strength 9,500 PSI
Compressive Strength 38,000 PSI
- 2** Adaptability of design—Readily molded or machined.
- 3** High dielectric properties—150 VPM on 1/8" thickness.
- 4** NON-corrosive.
- 5** Light weight—Specific gravity 1.36—about half the weight of aluminum, one-seventh that of steel

Again a C-D replacement material has proved to be a BETTERMENT.

★ Grade C DILECTO is a canvas base laminated plastic, one of many DILECTO Grades. It is a structural material. Other grades excel in dielectric properties; chemical resistance; low dielectric loss. . . . Catalog DO 41 gives complete technical data on all grades. Send for a copy,



Continental - Diamond FIBRE COMPANY

Established 1895 . . Manufacturers of Laminated Plastics since 1911 — NEWARK • DELAWARE

MURDOCK RADIO PHONES

Meet
**EVERY
NEED**



YOU'LL find everything you need for any purpose in Radio Phones built by MURDOCK. Sensitivity, clear reception, reliability,

and durable construction—in all these essentials MURDOCK Radio Phones have been tops for 39 years.

Today these unusual phones are giving real service under tough conditions of warfare, and in all uses of civilian life.

MURDOCK Radio Phones are lightweight, comfortable to wear. Precision-built to Government specifications, they give years of top-notch performance. And they are moderately priced. Before you buy Radio Phones see MURDOCK! Send to Dept. 56 for New Catalogue.



**MURDOCK MANUFACTURING CO.
CHELSEA, MASSACHUSETTS**

anode extinction voltage, (60 cps, rms), 115; anode voltage drop, 73 volts.

OB3/VR90, voltage regulator diode, cold cathode, glow discharge. Minimum starting supply voltage, 150 volts, d.c., operating voltage, 90 volts, d.c., regulation when I_b is varied from 10 to 30 ma = 8 volts.

OD3/VR150. Voltage regulator, cold cathode. Minimum starting supply voltage, 180, d.c., operating voltage, 150, d.c., regulation between I_b current values of 5 and 40 ma = 7.5 volts.

6SR7GT, double diode-triode, heater type.

28D7, double beam power amplifier, heater type. $E_f = 28$, $I_f = 0.4$ amp; $r_p = 3000$ ohms, $g_m = 3000$ micromhos, peak a-f signal voltage = 4.9; PO = 0.1 watts at 7 percent distortion.

28Z5, full-wave rectifier, high vacuum, heater type. $I_f = 0.24$ amps; choke input to filter, a-c voltage per plate, 450, $I_{ac} = 100$ ma; condenser input, a-c plate voltage = 325, plate current = 100 ma.

The following tubes are all full-wave gas rectifiers, with filament voltages of 2.5. 3B21, argon, graphite anode. $I_f = 5.5$ amp. I_b (d.c.) = 1 amp; $E_{drop} = 9$ to 12 volts; $E_{start} = 20$ to 30 volts; $E_{inv} = 500$ volts max.

3B22, Xenon, tantalum anodes, $I_f = 6$ amp; I_b (d.c.) = 1 amp; $E_{drop} = 8$ to 10 volts, $E_{start} = 12$ to 15 volts; $E_{inv} = 725$ max.

4B22, argon graphite anodes, $I_f = 12$ amp; heating time = 20 sec; I_b (d.c.) = 5 amp; $E_{drop} = 9$ to 11 volts; $E_{inv} = 340$ volts per plate; $E_{start} = 16$ to 25 volts.

4B23, argon, graphite anodes, $I_f = 17$ amp; heating time = 2 min; I_b (d.c.) = 5 amp; $E_{drop} = 11$ to 14 volts; $E_{inv} = 425$ max; $E_{start} = 20$ to 50 volts.

4B24, Xenon, tantalum anodes, $I_f = 11.5$ amps; heating time = 30 sec; I_b (d.c.) = 2.5 amp; $E_{inv} = 725$ volts; $E_{drop} = 8$ to 10 volts; $E_{start} = 12$ to 15 volts.

4B25, Xenon, tantalum anodes, $I_f = 17$ amp; $I_b = 6.4$ amp; $E_{inv} = 725$ volts; $E_{drop} = 8$ to 10 volts; $E_{start} = 13$ to 18 volts.

Women Radio Operators Wanted

RADIO JOBS in 8 branches of the government war agencies are waiting for women who know enough radio theory and the code to pass amateur license examinations. The Civil Aeronautics Administration is offering a 6-months course to qualify women as aircraft radio personnel; the Army Air Forces uses women as radio instructors, Signal Corps laboratory at Fort Monmouth, N. J., Navy Radio Section of the Bureau of Ships, the Naval Ordnance Laboratory and the Naval Research Laboratory all are seeking women for radio jobs. Radiation Laboratory at MIT is seeking qualified women as laboratory assistants. WAVES and WAACS are training women in radio work.

Inventions by Enlisted Men

ARMY REGULATION 850-50 permits enlisted men to communicate directly with the Chief Signal Officer concerning unpatented inventions, and many enlisted men have taken advantage of this provision. A number of helpful suggestions have been received from enlisted men, and in some cases new and fundamental principles of new machines proposed by enlisted men have been put to use.

Even in the major commercial development laboratories employing trained engineers an average of 1 invention adopted for every 10 proposed by the engineers employed is a good average. The percentage of good inventions proposed by enlisted men of course falls far short of 10 percent, but, nevertheless, in aggregate the suggestions constitute contributions of value to the war effort.

One enlisted man recently invented a machine which has been adopted and was found to speed up certain field operations fourfold.

A number of suggestions are received for slight structural changes in Signal Corps apparatus, and in some instances these suggestions have been found helpful during redesign of the equipment.—Information Letter No. 11, Office, Chief Signal Officer.

Training in Weather Forecasting

THE WAR DEPARTMENT has announced that an Army Air Forces Weather Training Center, the first installation devoted exclusively to this type of training, will be opened in Grand Rapids, Michigan.

The new training center will have a capacity of 5,000 students, with provisions for expansion as needs arise. The Commanding Officer is Colonel Edward C. Black, Air Corps, formerly commanding officer at Sheppard Field, Wichita Falls, Texas. Weather training will be under the direction of Colonel Don McNeal, Air Corps, one of the more experienced weathermen in the United States Army.

The following types of weather technicians will be trained at the Grand Rapids school: weather observers, weather teletype maintenance men, weather forecasters, and aviation meteorologists.

In the past all Army Air Forces aviation meteorologists have been trained at various universities, and other weather technicians at Chanute Field, Rantoul, Illinois. The training of meteorologists at universities will continue as the demand for these specialists will not be met by the increased training facilities at the new establishment.

It is expected that 60 days will be required to adapt the facilities for occupation. The first classes are scheduled to begin soon after the first of the year.

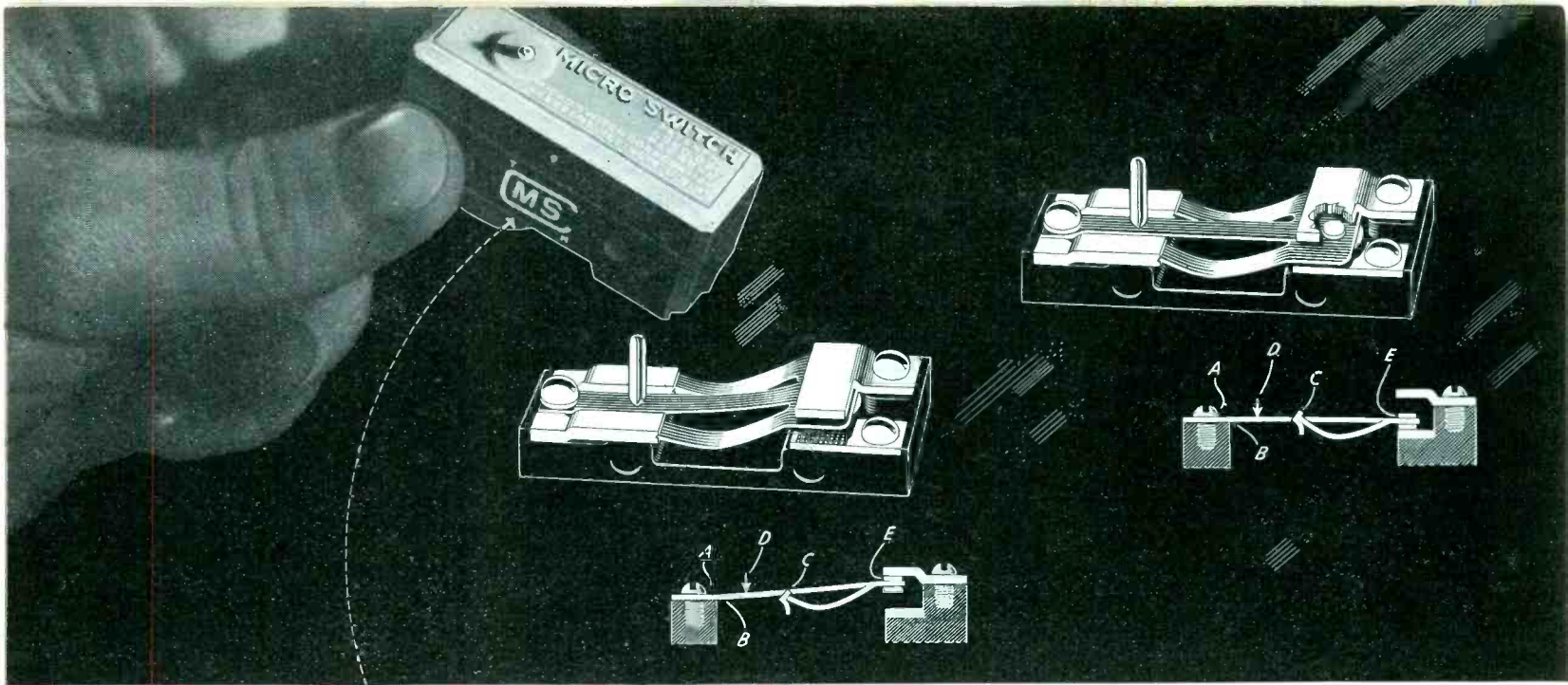

Without This Mark It Isn't a Micro Switch

There is only one micro switch—the MICRO SWITCH—manufactured by this company. When you buy a precision snap-action switch, it is not a MICRO SWITCH unless it has the now familiar trademark shown on the side of the switch as illustrated above.

The MICRO SWITCH is thumb-size, feather-light, and operates precisely at the same point for millions of operations with lightning-fast contact action. It is accurately built to exact standards from precisely made parts. Its performance characteristics can be changed to meet functional requirements. It can be furnished with many types of actuating mechanisms and protective housings. The MICRO SWITCH is the only precision snap-action switch available to you which employs the principles of design illustrated above and described below.

The MICRO SWITCH principle is different. It involves no reverse bends—no buckling "oilcan" action. The long member of the one piece, three bladed, beryllium copper leaf spring "B" is supported in cantilever at "A". The two short members are curved in compression to rest in the notches at "C." These two strut-like springs exert an upward force to hold the electrical contacts "E" together with a force of 40 to 100 grams, depending on the type of switch. The operating force applied at "D" deflects the longer tension member downward in a gentle curve until the upward force of the bowed members is overcome and the contact end of the spring moves downward with the sharp, snap-action which makes clean cut electrical switching. The distance the contacts are separated is controlled to suit the particular problem at hand, and may be as much as .070 inches for high altitude aircraft use. Removal of the force at "D" allows equally fast snap-return

to the original position... The electrical contact moves in the same direction as the operating force. This direct action not only provides accurate performance, time after time, for millions of operations, but should there be a welding or sticking of contacts due to overload, the direct-acting force acts as insurance to break the weld and to put the switch back into service.

On present or future designs it will pay you to consider the many advantages in space saving, accuracy, precision performance, and the dependability of a snap-action switch. But when you do, be sure that you select a MICRO SWITCH for the reasons enumerated above. Shown below are typical applications, and the two catalogs illustrated in the lower left hand corner of these pages will be highly advantageous to you in incorporating the MICRO SWITCH into your design.

SEND FOR THESE CATALOGS

Your up-to-the-minute engineers will thank you for keeping them informed about the Micro Switch. Send for as many of the Handbook-Catalogs illustrated here as you think necessary. No. 60 covers Micro Switches in general; and No. 70 deals with specific Micro Switches for use in aircraft.



Micro Switch is a trade name indicating manufacture by Micro Switch Corporation

How and For What Micro Switches Are Used



This shows an explosion proof Micro Switch used with a spray gun which automatically cuts out the entire operation of the spraying booth when the gun is shut off.

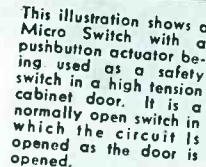

This illustration shows a Micro Switch with a pushbutton actuator being used as a safety switch in a high tension cabinet door. It is a normally open switch in which the circuit is opened as the door is opened.



This illustration shows two steel enclosed Micro Switches which serve as overrun limit switches on a machine tool.



This illustration shows the use of two Micro Switches with spring plungers to insure safe positioning of material in a punch press or a similar tool.



This illustration shows use of a Micro Switch with a spring plunger which is actuated by the pressure of a liquid in a line as the actuating medium.

This illustration shows the Micro Switch with a spring leaf actuator serving as a break indicator as used in textile mills or paper mills.



This illustration shows a Micro Switch enclosed in a die cast housing with a synthetic rubber seal, and is being used as a lathe carriage stop.

MICRO SWITCH

Manufactured in FREEPORT, Illinois, by Micro Switch Corporation

© 1942

Branches: 43 East Ohio St., Chicago • 11 Park Place, New York City • Sales and Engineering Offices: Boston, Hartford, Los Angeles

Quick Delivery ON CAPACITORS!

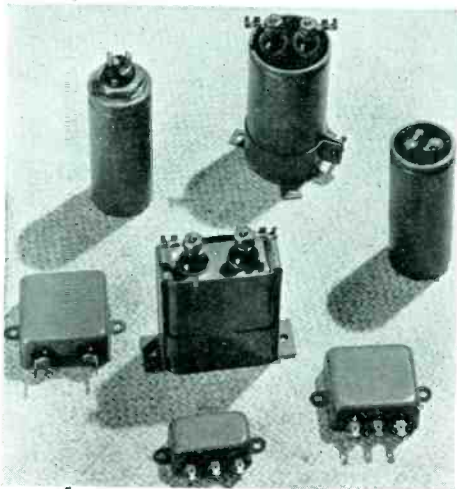

Industrial Condenser Corp. through a new distribution plan enables you to secure small lots of condensers locally. Contact the Industrial Condenser district office nearest you:

ADDRESS	TELEPHONE NO.
Box 1052 Dallas, Texas	Logan 6-1685
117 Water St. Boston, Mass.	Hancock 0200
1406 S. Grand Ave. Los Angeles, Calif.	Richmond 6161
Box 1202 Asheville, N. C.	7149-J
27 Park Place New York, N. Y.	Barclay 7-4977
Rm. 220—Medical Arts Bldg. 34th and Broadway Kansas City, Mo.	Westport 5323
1456 Waterbury Road Lakewood (Cleveland), Ohio	Academy 4932
2434 W. 22nd St. Minneapolis, Minn.	Kenwood 2833
1135 Lincoln Tower Ft. Wayne, Ind.	Anthony 5278
2016 Third Ave. Seattle, Wash.	Seneca 1088
Lutz (Tampa), Florida	99-144
6432 Cass Ave. Detroit, Mich.	Madison 6300
401 N. Broad St. Philadelphia, Pa.	Walnut 4163
235 9th St. San Francisco, Calif.	Market 4166

ENGINEERS ATTENTION! Condensers immediately available from distributor's stocks meet Army and Navy requirements . . . Industrial Condensers are specified where precision is vital . . . Capacitors to 150,000 volts—WRITE FOR COMPLETE NEW CATALOG.

INDUSTRIAL CONDENSER CORP. INCGO

1725 W. North Ave.

Chicago, U. S. A.

Manufacturers of Quality Oil, Wax and Electrolytic Capacitors

Instrument Landing System at LaGuardia Field

AT THE THIRD ANNIVERSARY of the opening of LaGuardia Field, December 2, officials of the Civil Aeronautics Administration and of IT&T demonstrated the new airplane radio instrument landing system now installed at this important eastern airport.

The system, installed at LaGuardia and in the process of installation at other large airports of the country, was developed jointly by the engineers of the C.A.A. and Federal Telephone and Radio Corporation, the I. T. & T. manufacturing subsidiary in the United States, which manufactures and installs the equipment for the C.A.A.

The pilot has in his equipment on the instrument panels of the plane a dial indicator and two small electric lamps. A radio transmitter off the end of the runway actuates the needle of the dial indicator in the airplane by projecting a sharp beam of radio energy which gives the exact line of approach to the runway.

When the pilot flies his plane so that the needle of the indicator is on the exact vertical, the airplane is headed directly for the runway. The two electric lamps are actuated by two marker transmitters, which project radio energy straight upward. One tells the pilot when he is at a certain definite point several miles from the airport. There he checks his line-up with the runway and he checks his altitude which permits him to gauge the correct line of descent for landing. The second marker is at the boundary of the airport where the pilot makes his final, quick instrument check.

FCC Actions

ALL LICENSEES of the FCC are asked to file with that body a statement giving the amount and condition of all surplus equipment the station possesses. A questionnaire requires such matters as size, power, frequency range, type of emission, whether the item is new or used and if the latter an estimate of its serviceability. The information assembled from these returned questionnaires will be analyzed, cataloged and published.

Members of the Armed Forces received a 50 percent reduction in domestic telegraph rates in sending and receiving money by wire on December 1 after a suggestion by the FCC to Western Union and Postal. Reductions had already been in effect on money cables to and from the expeditionary forces.

Conditions under which stations of the War Emergency Radio Service may communicate with each other have been outlined by the FCC. On Wednesdays from 10 to 12 PM and on Sundays from 5 to 7 PM these stations may test. Each time zone west of Eastern may test one hour earlier than the times given above.



For High-Frequency Insulation in Radio Apparatus **USE G-E MYCALEX**

G-E MYCALEX has better over-all electrical properties and mechanical strength than porcelain. It has refractory qualities superior to phenolic resins, gums, pitches, shellacs and other organic materials.

The General Electric Plastics Department has developed facilities for injection molding of mycalex parts, and these can now be produced with the following features:

1. Moderately intricate shapes
2. Close tolerances
3. Molded holes
4. Finishing and machining operations reduced or eliminated.

For a complete technical booklet on G-E mycalex, write Section M-1, One Plastics Ave., Pittsfield, Mass.

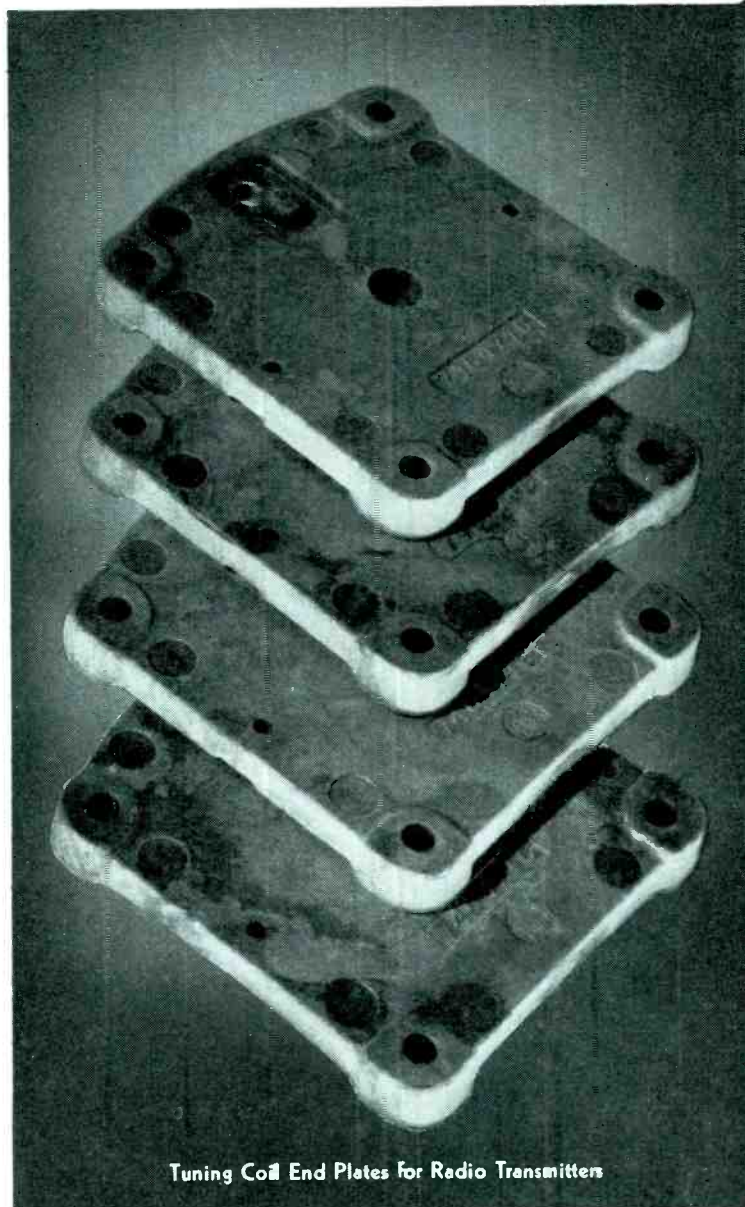

Tuning Coil End Plates for Radio Transmitters

P L A S T I C S D E P A R T M E N T

GENERAL  **ELECTRIC**
PD-81

Theory and Practice "Connect" . . . in . . .



COMMUNICATION CIRCUITS

by LAWRENCE A. WARE, Associate Professor of Electrical Engineering, and HENRY R. REED, Professor of Electrical Engineering; both at The State University of Iowa.

Here is ONE book that clearly and comprehensively presents the relation between the theory of communication and its practice. A concise, authoritative introduction gives the principles of communication transmission lines and their associated networks and attention is concentrated on the essentials of transmission. Logical steps then lead gradually up to a discussion of filters, impedance matching, wave guides, etc.

An introduction to the use of Maxwell's equations and Bessel functions is offered, and numerous illustrative examples are given throughout and at the end of the book. A knowledge of calculus and the elements of alternating current theory are prerequisites to a thorough understanding of the subjects discussed.

287 Pages 116 Illustrations 6x9

\$3.50

JOHN WILEY & SONS, INC.

ON APPROVAL COUPON

John Wiley & Sons, Inc.
440 Fourth Avenue, New York, N. Y.
Please send me a copy of Ware and Reed's COMMUNICATION CIRCUITS on ten days' approval. At the end of that time, if I decide to keep the book, I will remit \$3.50 plus postage; otherwise I will return the book postpaid.

Name

Address

City and State

Employed by.....E. 1-43

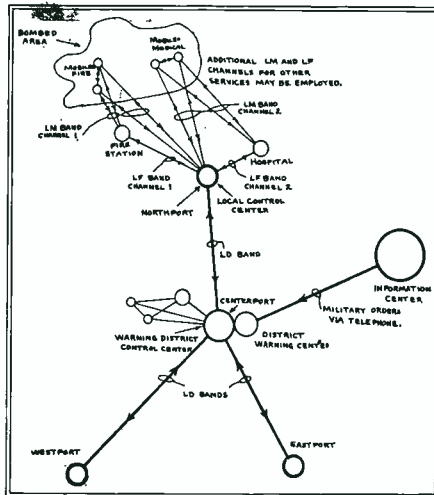

War Emergency Radio Service

METHOD OF OPERATING the tri-part plan for a district warning area as provided under the WERS. For data on this set-up see Washington Feedback, page 53 this issue.

From the Industrial Front

THE OFFICES AND FACTORY of Kurman Electric Co., manufacturers of relays, have been moved from New York City to 30-30 Northern Blvd., Long Island City, N. Y.

Eicor, Inc., manufacturers of rotary electrical apparatus, announced they are moving to a new DPC building at 1501 West Congress St., Chicago.

Sound Apparatus Company, 150 West 46th Street, New York City, has just celebrated its 10th anniversary. The company manufactures automatic high speed power level recorders and automatic frequency response recording equipment.

With construction completed well ahead of schedule, the new Pennsylvania plant of the National Union Radio Corporation was formally opened with impressive ceremonies in which Army and Navy officers participated. The new plant, representing the most advanced design and construction, is 40,000 square feet in area. Included in it are offices, laboratories, and complete manufacturing facilities. All activities are carried out on a single level.

At a banquet and celebration, held November 24th, at the Standard Club, Chicago, Standard Transformer Corporation acted as host to 105 of its employees who have served the corporation for five years or more. The event inaugurated the presentation of honor awards to members of the Stancor family. The honor awards were silver emblems for those who had served five to nine years, and gold emblems for those who had served the company continuously for ten years or more.

Talent Search Aids Careers in Science

THE SECOND science talent search is now being conducted among the country's 1,650,000 high school seniors. The first talent search was conducted last Spring and now nineteen boys and girls are being aided in preparing themselves for careers as future scientists. Westinghouse Science Scholarships ranging in value from \$200 to \$2,400 were awarded to the twenty top-ranking entrants in the first annual science talent search, sponsored by Science Clubs of America and Science Service. One of the recipients of the Westinghouse award was John W. Michener of Pittsburgh whose knowledge of radio has already been put to work in an assignment which he received from the Navy Department to do confidential radio research last summer. He completed the assignment and is now enrolled at Carnegie Institute of Technology.

New Plastic for Telephone Manufacture

LIGNIN IS THE NAME of a new plastic fibre developed by Western Electric engineers to take the place of phenol fibre in many applications. This new insulating material was developed in cooperation with chemists from the paper industry. The word lignin come from the Latin expression "lignum" meaning wood. The development of lignin came about when chemists discovered that a very tasty vanilla extract could be manufactured from the sulphite water waste pollution of the nation's waterways. When lignin paper sheets comes to Western Electric, they are conditioned to a definite moisture content, heated and subjected to high pressures, yielding a tough fibre board which compares in strength to steel. Lignin fibre possesses good electrical characteristics, is less corrosive than phenol fibre, and is readily punchable and has many of the other properties of phenol fibre board. Without this product of engineering ingenuity, the shortage of phenol fibre might have put a serious crimp in WE operations involving this insulating material.

Repairs for Radios

THROUGH A COMMITTEE of the American Standards Association, a program of standardization and simplification of radio replacement parts has been undertaken. A preliminary job of the committee will be to specify a line of Victory parts which will fit most radio sets in use. Dimensions, electrical performance and other essential features will be standardized. Simplification of the replacements parts lines will be another important phase of the committee's work. Thus the number of different volume controls, replacement condensers, etc., will be mate-

Question every fastening job...

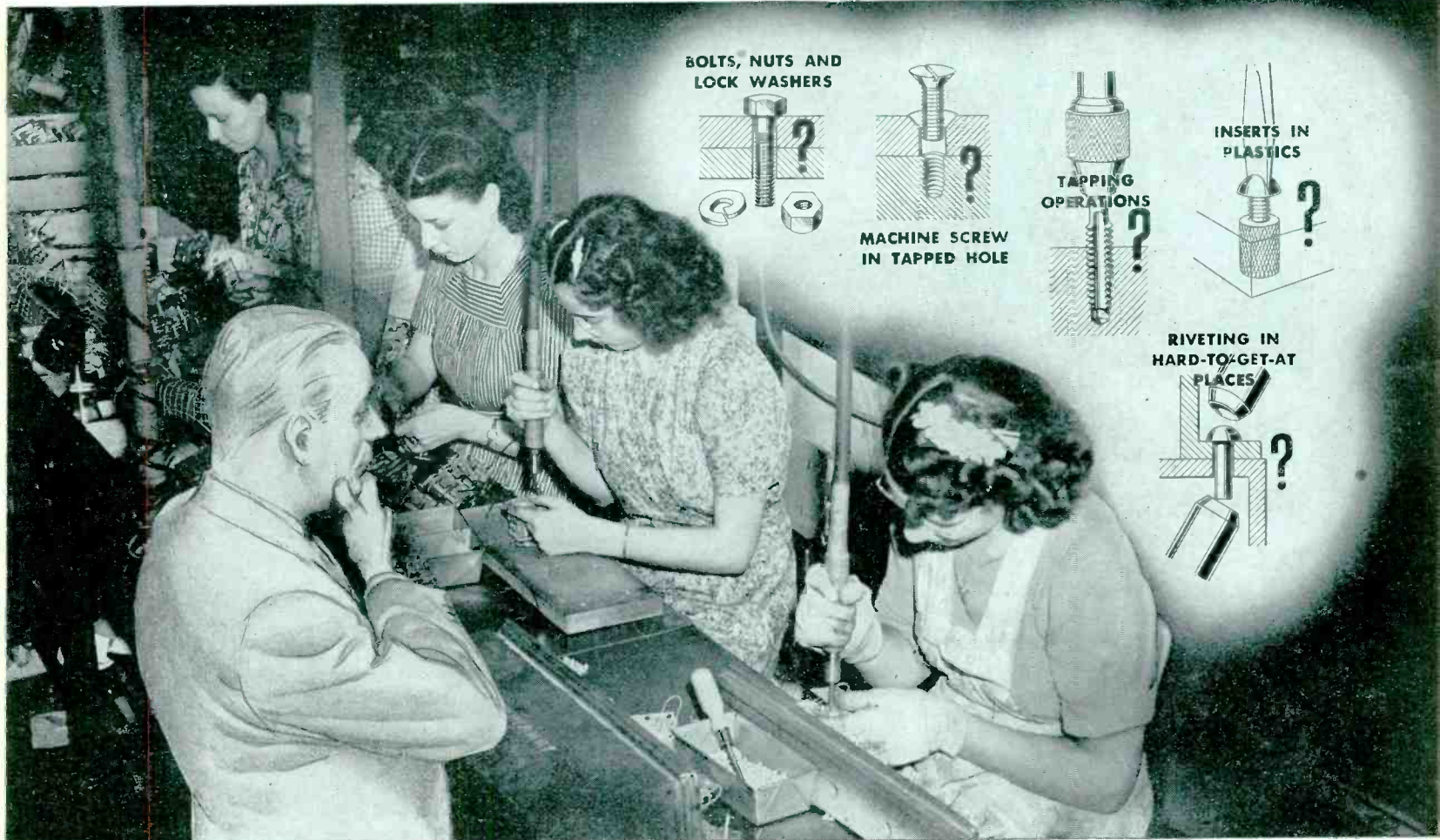

ASK — "Why Can't It Be Done the Simple Way . . . with time-saving P-K Self-tapping Screws?"

That question is standard practise with hundreds of engineers and production men who are trying to conserve vital time and labor. They put it to themselves, and to their associates . . . not only at the drafting board but also on the production line.

They don't expect Parker-Kalon Self-tapping Screws to be the best means of making EVERY fastening under ALL conditions. But they know that, for a *very large percentage* of metal and plastic fastening jobs, these Screws offer a combination of ease, speed and real security that no other fastening device or method can match!

How to Save Operations . . . to Save Vital Time and Labor

Make it *your* practise to see that you can't employ the simple Self-tapping Screw method before you put up with a more difficult one. Wherever P-K Self-tapping Screws can be used, operations will be eliminated, vital time and labor will be saved. You merely drive P-K Self-tapping Screws into plain, untapped holes. Such simplicity eliminates tapping and tap maintenance . . . solves the problem of getting scarce taps . . . stops fumbling with bolts and nuts and placing of lock washers . . . does away with inserts in plastics . . . cuts out riveting and welding in hard-to-get-at places.

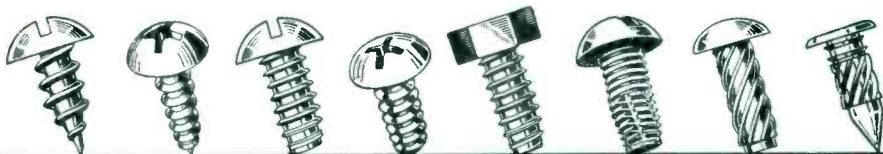

SELF-TAPPING SCREWS FOR EVERY METAL AND PLASTIC ASSEMBLY

Call in a P-K Assembly Engineer to check over fastening jobs with you. He can show you how to search out ALL opportunities to apply P-K Self-tapping Screws. And, he'll recommend them only when they will do the job better and faster. If you prefer, mail in assembly details for recommendations.

Change to Self-tapping Screws Over Night . . .

No matter what material you're working with . . . light or heavy steel, cast iron, aluminum, brass, plastics . . . you can adopt P-K Self-tapping Screws to advantage. And you can make the change-over without interrupting production. No special tools or skilled help are required. Parker-Kalon Corp., 192-194 Varick Street, New York, N. Y.

PARKER-KALON
Quality-Controlled
SELF-TAPPING SCREWS

Give the Green Light to War Assemblies



NEW Black Polymerizing Varnish

Not only does SYNTHITE PX-5 Black Baking Varnish cut baking time to a minimum but it also provides better insulation with less coats.

Curing by heat through chemical polymerization, this varnish will dry even in the deepest interstices of large coils. Then too, shorter baking will permit flexibility, yet cure the varnish evenly throughout. SYNTHITE PX-5 Black Baking Varnish possesses the essential bonding properties which will hold windings intact under the centrifugal force produced by high speed motors. It is ideally suited for use on the modern types of enamelled magnet wire and Class B insulation. This material affords maximum resistance to acids and alkalis and can withstand high temperatures. It can be applied on all types of electrical units and can be baked out by infra-red equipment or the conventional baking oven. Write for specifications.



JOHN C. DOLPH COMPANY

Insulating Varnish Specialists

169-A Emmet St., Newark, New Jersey

rially reduced, thereby limiting the different models that must be manufactured and stocked.

Members of the committee are O. H. Caldwell, Caldwell-Clements Inc., Chairman; John Borst, John F. Rider Publisher, Inc.; M. M. Brandon, Underwriters' Laboratories, Inc.; J. D. Filgate, Hazeltine Service Corp.; Garrard Mountjoy, RCA License Laboratory; M. J. Schinke, Radio Manufacturers Assn., with P. R. Butler, also of the RMA, alternate; K. S. Geiges, of the Simplification Branch, WPB; E. A. Graham, Head of the Consumer Durable Goods Section, Standards Division, OPA; Frank McIntosh, Radio and Radar Branch, WPB, with Samuel Weisbruth of the WPB, alternate; and George F. DuVal, president, Radio Servicemen of America, with Arthur E. Rhine, alternate.

WPB had previously determined to produce 110 types of replacement radio tubes as a Victory model line for the duration. This reduced the number of types to be produced from 350 currently made and from 700 types produced in pre-war days.

Personnel

Irving Berkman has been appointed manager of priorities and expediting for the Radio City Products Co., Inc., New York City, manufacturers of electrical and electronic test instruments.

Dr. Ralph L. Power, Los Angeles radio counsellor and advertising manager of the Universal Microphone Co., Inglewood, Cal., warrant officer overseas in World War I, has become an inspector in the U. S. Army Signal Corps with assignment to a field unit in the west.

George Harrington, formerly field engineer with Lord Mfg. Co., Chicago, is now a Lieutenant in the Navy and is stationed at the U. S. Navy Bureau of Aeronautics, Washington, D. C. Lt. Harrington is being replaced at Lord Mfg. Co. by Gordon E. Graver, who was formerly connected with American Seating Co.

Frederick Van Voorhees Lindsey, Vice President and General Sales Manager of the Driver-Harris Company, Harrison, N. J., manufacturer of special alloys, died November 16th, 1942, after a brief illness.

Emerson Markham, in charge of farm and science broadcasting for General Electric, has also been appointed manager of the FM radio station W85A. Mr. Markham succeeds John R. Sheehan who has assumed duties with the Office of War Information in New York.

Ralph C. Stuart is now manager of manufacturing to supervise production at five plants of the Lamp Division of the Westinghouse Electric and Manufacturing Company, Bloomfield, N. J.

Mr. Stuart will be in charge of the manufacture of all incandescent and fluorescent lamps made by Westinghouse. He will also supervise the Lamp Division's war production which includes radio transmitting tubes, x-ray tubes, and special electronics devices.

Mr. J. A. McCaffry has been appointed technical sales representative of Rowe Radio Research laboratory for the Detroit area and State of Michigan.

Silver Substitutes for Copper

IN TEN WAR PLANTS now being built, 24,000,000 pounds of copper are being saved by substituting silver in electric conductors according to the *Washington War Review* of the Chamber of Commerce of the United States.

Laboratory Equipment Control

ON DECEMBER 5 additional control over purchases of laboratory equipment was put into effect by WPB. The amended order provides that no purchase of laboratory apparatus shall be permitted for more than \$50 unless an authorization is secured from the Director General for Operations.



ALUMINUM COMPANY OF AMERICA
Niagara Falls, N. Y.

BLILEY ELECTRIC CO.
Erie, Pa.

CONNECTICUT TELEPHONE & ELECTRIC
Co.
Meriden, Conn.

FERRIS INSTRUMENT CORP.
Boonton, N. J.

OWENS-CORNING FIBERGLASS CORP.
Newark, Ohio and Ashton, R. I.

SIMPLEX RADIO
Sandusky, Ohio

ZENITH RADIO CORP.
Chicago, Ill.

**For Positive
Snap-Acting
Performance
USE**



**Type B3120
Crystal Dew Point Control**



**Type C4351 Series
Used for Tube Warming
Tube Cooling, and High Limit Controls**

**KLIXON
Disc-Operated
CONTROLS**



**Type C-6363
Switch Circuit Breaker**



**Type PM
(NAF-1131) Circuit Breaker**

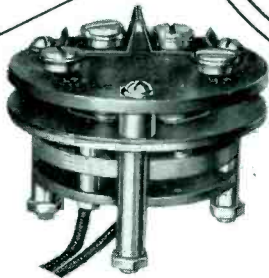

**Type ER SERIES Ambient
Compensated Time
Delay Relays**

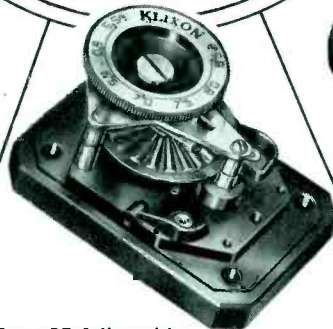

**Type RT Adjustable
Crystal Temp. Oven Control**



**Type C2851 Series, Used as
Roughing Controls on Outer
Crystal Ovens**

Whether you want motor and transformer overheat protection, or electrical circuit overload protection, or temperature control, or controls for radio equipment, the surest, simplest, and most positive-acting controls you can get are Klixon Snap-Acting Thermostats. Operated by a small, snap-acting thermostatic disc, these thermostats eliminate many troubles common to more complicated and more fussy controls.

Because of the snap-acting disc, Klixon Ther-

mostats are not affected by shock, vibration, altitude or position of mounting. Moreover, they are small, compact, light weight, low cost, yet rugged in construction and capable of handling heavy duty electrical loads.

See what our standard controls can do for you — or let our engineering department work out the solutions to your problems.

KLIXON
TRADE MARK REG. U.S. PAT. OFF.
Spencer Thermostat Co.

ATTLEBORO · MASSACHUSETTS · U.S.A.

NEW PRODUCTS

Month after month, manufacturers develop new materials, new components, new measuring equipment; issue new technical bulletins, new catalogs. Each month descriptions of these new items will be found here

New Instruments From General Radio

TWO NEW INSTRUMENTS available from General Radio Co., 30 State Street, Cambridge, Mass., include a standard-signal generator and a beat-frequency oscillator.

Type 805-A standard-signal generator is a new instrument which is designed to meet the need for an all-purpose amplitude-modulated signal



Generator Type 805-A

generator in the frequency range up to 60 Mc for testing both high-fidelity broadcast receivers and specialized military types with the precision and performance required for laboratory measurements and the convenience and speed of operation necessary for production use. The frequency range of 16 kc to 50 Mc is covered in seven ranges, direct-reading to an accuracy of 1 percent. A slow-motion drive is provided, with a dial which indicates frequency increments as small as 0.01 percent.

The output voltage at the end of a 75-ohm cable is continuously adjustable from 0.1 microvolt to 2 volts, and is indicated directly by a panel meter and a multiplier switch. The cable is terminated in its characteristic 75-ohm impedance, so that the generator impedance as seen by the device under test is 37.5 ohms. This impedance is constant for all output voltage settings. Modulation is continuously variable from 0 to 100 percent, and is indicated by a panel meter. Internal modulation is available at 400 cps and 1000 cps. External modulation can also be used. The envelope distortion is less than 5 percent at a modulation level of 80 per-

cent and a carrier frequency of 1 Mc. Carrier noise level is at least 40 db below 80 percent modulation. Frequency modulation and stray fields are negligible. The generator operates from the a-c power line, 115 or 230 volts, 40 to 60 cps. The internal power supply is voltage regulated. Power input is 180 watts, maximum. The overall dimensions are 16 x 33 x 12 inches, and the net weight is approximately 120 pounds. Price: \$850.00, f.o.b., Cambridge.

Type 913-A beat-frequency oscillator is a general-purpose instrument useful as a power source for tests on audio-frequency lines and associated networks. It is also a suitable voltage source for bridge measurements and for

modulating signal generators and test oscillators. The oscillator can be used on either balanced or unbalanced systems.

Constant output, low distortion, and a high degree of frequency stability are

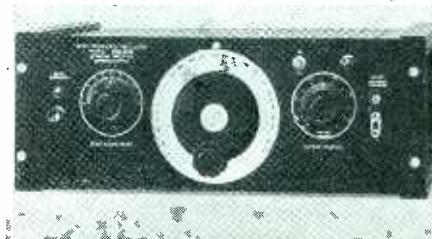

Oscillator Type 913-A

a few of the features. The output is 0.3 watt maximum. Output impedance is 550 ohms, so that the oscillator can be used with either 500 or 600-ohm lines. Open-circuit output voltage is 25 volts. For a matched resistive load, the output voltage varies by less than 0.25 db between 20 and 20,000 cps. With a matched load, total distortion is 0.2 percent between 150 and 7000 cps; at 50 cps it is about 2 percent. Power line hum voltage is less than 0.05 percent on a 60-cps line, and less than 0.1 percent on a 42 cps line. The voltage-regulated a-c power supply operates from a 115 or 230-volt power line, 40 to 60 cps. The oscillator can be used for either relay-rack or table mounting. Dimensions are 19 $\frac{3}{8}$ x 14 $\frac{1}{2}$ x 7 $\frac{1}{2}$ inches, and net weight is 35 pounds. Price: \$260.00.

TRANSPARENT PLASTIC SHIELDS FOR MACHINES AND LATHES

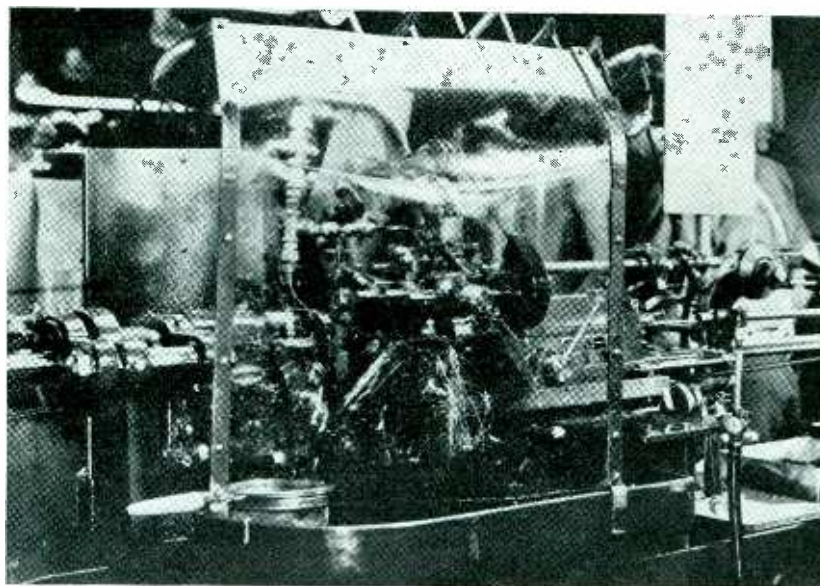

Use of transparent Lumarith plastic shields on automatic screw machines and turret lathes is conserving oil. Without guards, hot oil sprays everywhere—clothing, walls and floors boards. Since Lumarith is crystal clear, the operator can observe the performance with the same vigilance as if the guard were not there

Solenoid Contactor Aircraft Units

FIVE TYPES OF approved solenoid contactor units built to U.S. Army Air Force specification are available for remote control of electrically actuated aircraft armaments, instruments and devices. The manufacturer states these units resist acceleration and vibration over ten times gravity. Metal parts are plated to withstand 200-hour salt spray test. Types B-5 and B-4 both operate in any position and may be disassembled with pliers or screwdriver.



Contactor Unit Type B-4

Type B-4 was originally designed for airplane starting motors, but may be used for other applications of heavy current control. It operates on 24 volts, producing a coil current of 300 milliamps. Contacts are rated at 200 amps at 24 volts d.c. The unit has double pole, single throw, normally open contacts. The weight of the unit is 31 ounces.

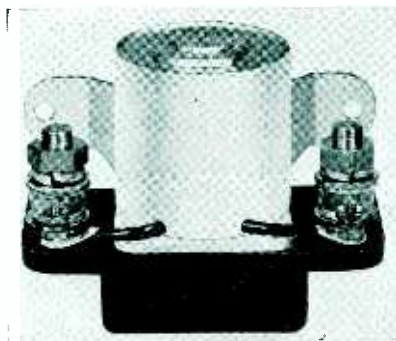

Contactor Unit Type B-5

Type B-5 series has a contact rating of 50 amps continuous and operates on 24 volts, d.c., producing a coil current of 210 milliamps. It has a double pole, single throw, normally open contacts, and weighs 11.2 ounces. It can be adapted for numerous applications of heavy current control in aircraft and other products.

Type B-2-A relay is designed for remote control of aircraft electrical circuits as well as other applications. The unit has a contact rating of 25 amps continuous and 100 amps surge at 24 volts, d.c. It has single pole, single throw, normally open contacts and weighs 6 ounces.

Types A-3 is also for remote control

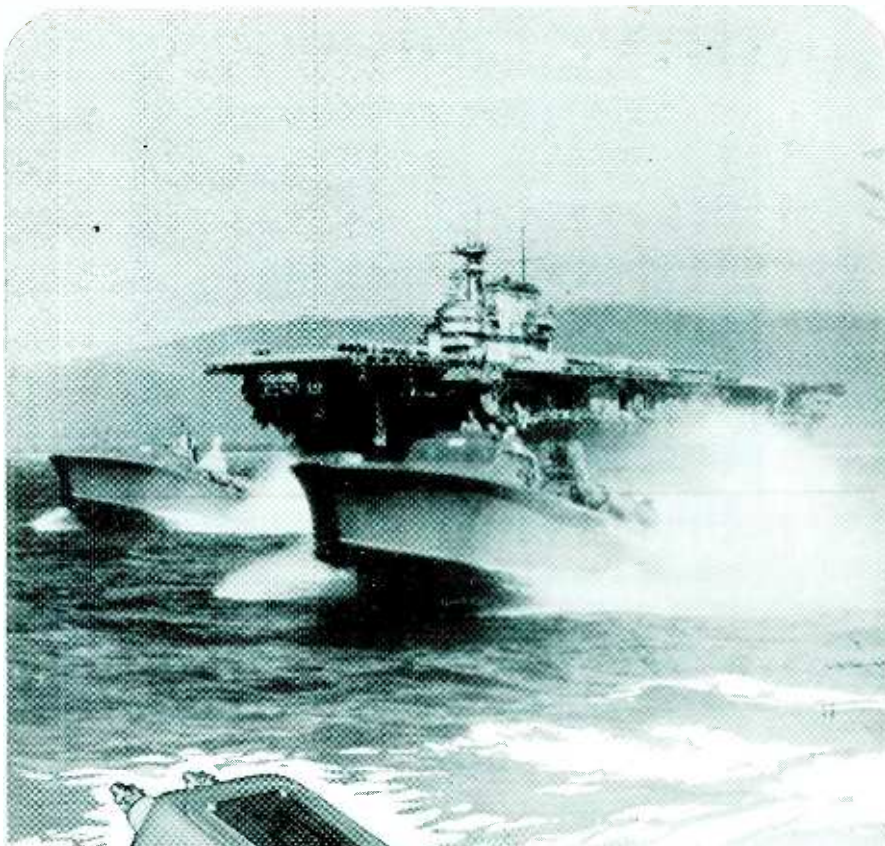

Official
U. S. Navy
photograph

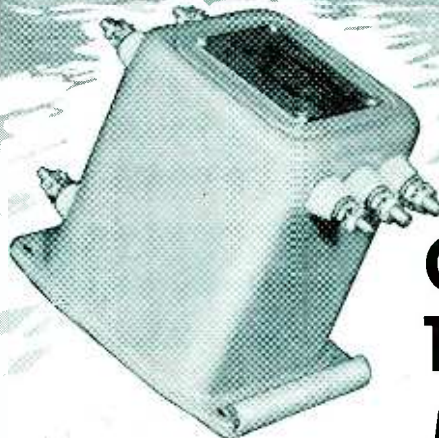

Custom Designed TRANSFORMERS

*Built as well as the ships
on which they serve*

Custom Built Transformers that meet the rigid requirements of the United States Navy have reached a new high in efficient design, sturdy construction and operating accuracy.

Waterproof-Hermetically Sealed Transformers, built to these specifications by the Chicago Transformer Corporation, not only pass the Navy Five-Cycle Salt Water Immersion Test but also other severe operating, temperature and pressure tests set up in our own laboratories.

Manufacturers of all types of Transformers up to 10 KVA.



**CHICAGO TRANSFORMER
CORPORATION**
3501 WEST ADDISON STREET • CHICAGO

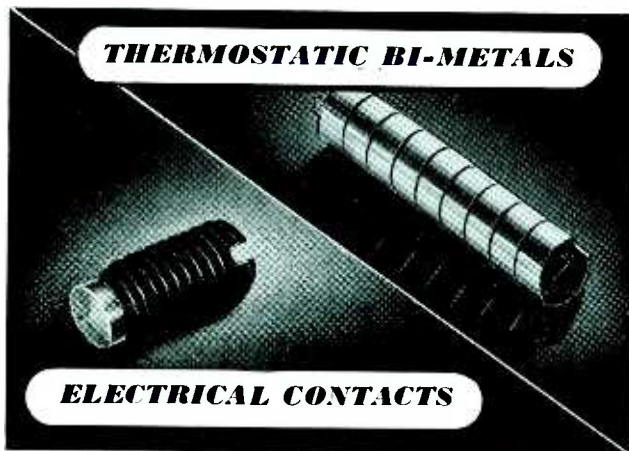

Dryers or Dive Bombers

★ Then in peace-time, and now war, Wilco parts have been meeting the most exacting industrial requirements. The H. A. Wilson Company has specialized in the scientific application of thermostatic bi-metals and electrical contacts to meet specific applications in aviation, automotive, marine and general industrial fields. Thermostatic bi-metals of high and low temperature types are available in wide variety. Also a series of resistance bi-metals (from 24 to 440 ohms per sq. mil. ft.).



of starting motors and other heavy current control applications. It is similar to Type B-4 except that the coil is rated for 12 volts operation. Contact rating is 200 amps continuous, and 800 amps, surge.

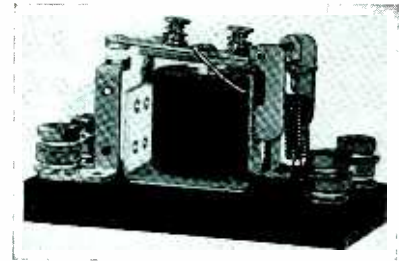

Type B-6 is for use in aircraft for remote control of electrically operated devices. Contact rating is 100 amps continuous and 400 amps surge.

Type B-7 is for remotely making and breaking electrical circuits of aircraft devices. It is practically the same as Type B-4 except for the difference in mounting brackets. Contact rating is 200 amps continuous and 800 amps surge.

Guardian Electric Mfg. Co., 1615 West Walnut Street, Chicago, Ill.

New Tubes

THE FOLLOWING NEW cathode-ray tubes are available to equipment manufacturers for use in connection with WPB rated orders. One of these tubes, the 3BP1 is equipped with the new Di-heptal base which permits wide separation of the low-voltage pins from the high-voltage pins.

3BP1 is a 3-inch, high-vacuum, cathode-ray tube having electrostatic deflection, electrostatic focusing, green fluorescence, and medium persistence. It has a 2-inch diameter bulb neck, separate leads to all deflecting electrodes and the cathode, and an overall length of about 10 inches. All leads terminate in the Diheptal base.

3EP1/1806-P1 is a high-vacuum tube similar to the 3BP1. It has the same ratings as the 3BP1 but a different bulb with 1½ inch diameter neck and a magal base. Separate leads to all deflecting electrodes are provided, but the cathode is connected to the heater within the tube.

7CP1/1811-P1 is a short 7-inch, high-vacuum, cathode-ray tube having magnetic deflection, electrostatic focusing, green fluorescence, and medium persistence. It has a 1½ inch diameter bulb neck and an overall length of about 13½ inches. Except for anode No. 2 which is connected to a snap terminal on the side of the bulb, the other electrodes, including the cathode, all have separate leads terminating in an octal base.

Additional information on these three new cathode-ray tubes is available from the manufacturer, RCA Mfg. Co., Inc., Harrison, N. J.

DIE-LESS DUPLICATING



An almost unlimited variety of work can be rapidly done by the combined use of these 3 Di-Acro units. High hourly production rates can be easily maintained. Multiple units provide large output if desired. All duplicated work is accurate to .001".

Are you in a rush for some duplicated metal parts? Do you have experimental work? In many cases you can make the parts faster with the "Di-Acro" system, and avoid entirely the expense and delay of making dies. You can save valuable man hours and needed critical materials.

In illustration above from left to right: 1st—Di-Acro Shear squares and sizes material, cuts strips, makes slits or notches. 2nd—Di-Acro Brake forms angles, channels or "Vees". 3rd—Di-Acro Bender bends angle, channel, rod, tubing, wire, moulding, strip stock, etc. Send for catalog, "Metal Duplicating Without Dies."

WRITE
FOR
CATALOG



O'NEIL-IRWIN MFG. CO.

321 - 8th Ave. S.,
MINNEAPOLIS, MINN.

Multi-Contact Timers

THE FUNCTION OF these multi-contact timers is to automatically control a sequence of on and off operations of a single or a multiple number of electrical circuits in accordance with a predetermined operating program. The timers may be used to control a series of machine operations in definite order; automatically reverse or alternate in operation a group of motors, machines or devices; operate in a predetermined sequence as well as other applications where sequence operations are of importance. Features of the timer include a self-starting synchronous motor; complete gear trains operating in oil; identical pairs of Bakelite cams which are mounted on a shaft so the on and off increments can be adjusted to the desired operating program; timers can be manually operated; the contacts are in view so that their operations can be observed; timers can be provided with a remote momentary starter.

R. W. Cramer Co., Inc., Centerbrook, Conn.

New Police Radio Equipment

NEW MOBILE FM police radio equipment developed by General Electric electronic engineers and being manufactured for the radio reserve pool established by WPB, incorporates many new features, some of them suggested by police users in many parts of the country. Iron core, or inductive tuning (the closely controlled movement of an iron core in and out of a small form-wound coil) is widely used.

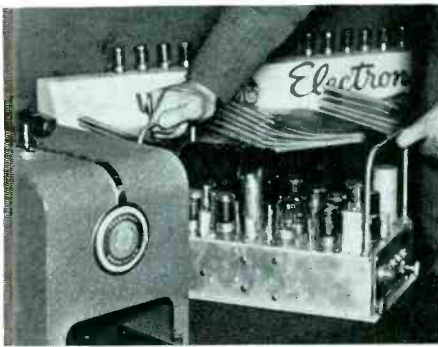

This permits easier and more accurate tuning, and reduces the effects of car vibration on tuning adjustments. Receiver battery drain has been reduced 35 percent and a material improvement made in the effective communication range.

A convenient "work bench" support, which also serves as a part of the cover-latch mechanism of the transmitter and receiving units, provides a rigid support when the chassis is inverted for inspection or repair. A series of test jacks permits direct simultaneous readings of several functions at one time. All tube sockets and tuning controls are clearly stenciled on the top of the chassis.

General Electric Co., Schenectady, N. Y.



New CABINET MAKES ACCURATE TESTS AT *Low AND High* TEMPERATURES!

Delicate precision instruments, like rugged fighting men, are being conditioned today for stratosphere temperatures and blazing desert heat. Predetermined performance is needed to achieve Victory more quickly.

Uniformly accurate tests are made by the Amcoil Model RTC-1, an all-steel test chamber combining mechanical refrigeration and electric heating.

It ranges from minus 55 degrees C. to plus 70 degrees C. Interior content: 28.7 cubic feet. Thermostatic control. Should reach minus 50 de-

grees C. in approximately one hour, without production load. Front panel board accurately controls entire operation. Five thicknesses of glass in door afford clear visibility of instruments under actual test.

Amcoil engineers can help you determine your testing requirements. In addition to the RTC-1, there are other Amcoil chambers with mechanical refrigeration and dry ice, also for altitude testing. Let us advise you on the type of equipment best suited to prove your instruments *under war conditions*.



AMERICAN COILS CO.

25-27 LEXINGTON STREET • NEWARK, N. J.

Ⓜ 3156



The Aviation Industry needs Seed Money

THIS Victory crop is sweet—10,000 planes per month next year seem certain . . . 5,000 per month already passed . . . Worldwide average of four enemy planes knocked down for every American plane lost . . . Jap average five to one . . . Still better planes coming off the line.

And beyond the war, some people see a vast new industrial field opening up for America:

- ▶ Giant freight and passenger airliners, flying the airocean to every part of the globe, linking our cities in a traffic network that will obliterate time.

- Family planes that will jump golfers to far off greens.

What are the chances for this exciting post-war crop of commerce and convenient travel from our aviation industry?

We think the chances are rather slim, and we ask you to take a serious look at the reason.

In our proper anxiety to prevent inflation and control war profits, we have passed tax laws that are taking away most of the "seed money" that aviation companies will need when the time comes to go it on their own in the post-war world.

- ▶ "Seed money" is that part of profit which is held for re-investment in a business to insure its growth.

"Seed money" will pay for research on new and

better products. It will pay for retooling when post-war models are produced. It will pay for the study of methods to get the lower costs that widen markets. It will pay for setting up new distributors and dealers, and for hundreds of other activities that are involved in the *growth* of a business.

- ▶ American industry has grown on "seed money." It has been a national characteristic to re-invest most of our profits in development.

A dangerous confusion between personal profit (salaries and dividends) and re-invested profit (which we have called "seed money") has found its way into our taxing system.

The tax law, and government contracts, should allow American Industry to accumulate funds for the numerous tasks of post-war development.

A sum greater than the total now remaining after taxes will be needed, if we are to take advantage of the new opportunities that will exist after the war.

It is probably the oldest law in economics that enough of each crop must be saved to provide seed for future crops.

Ask your Congressman to see that this economic law is not disregarded in an effort to take excess profits out of war.

Reprints of this advertisement are available in handy booklet form.

McGraw-Hill Publishing Company, Inc.

330 WEST 42ND STREET

NEW YORK

Did you ever try to defend a PROFIT?

EVERY business man knows the difference between profit that is paid out to individuals and profit that is held for re-investment and future growth.

The trouble is that the public thinks of profit in terms of yachts, elaborate homes and costly debutante parties. They have learned to think that way because those things get the headlines.

The public does not know that far more profit money has gone back into American business than has ever been taken out for personal spending.

The McGraw-Hill Publishing Company is going to do its share in the job of explaining the difference between these two kinds of profit.

To be sure that the public does not confuse two different things that have always been called by the same name, we have developed the term "Seed Money."

"Seed Money" is explained in the McGraw-Hill newspaper advertisement reprinted on the opposite page. We urge you to read this

advertisement carefully and apply its message.

There will be other McGraw-Hill advertisements on this vital industrial need. We hope, too, that other advertisers will adopt the term "Seed Money" and help by selling their employees in their own communities on the danger to living standards in taking away industry's ability to improve its plants and techniques.

★ ★ ★

THE MCGRAW-HILL NETWORK OF INDUSTRIAL COMMUNICATION

23 publications, which gather "war-news" from the "war-production-front" through a staff of 153 editors and 725 engineer-correspondents... More than 1,500,000 executives, designers, production men and distributors use the editorial and advertising pages of these magazines to exchange ideas on war-production problems.

THE MCGRAW-HILL BOOKS

Publishers of technical, engineering and business books for colleges, schools, and for business and industrial use.

MCGRAW-HILL PUBLISHING COMPANY, Inc.
330 WEST 42nd STREET • NEW YORK

Aviation—(AMERICA'S OLDEST AERONAUTICAL MAGAZINE)—INFORMATION HEADQUARTERS FOR THE MEN WHO DESIGN, PRODUCE, OPERATE AND MAINTAIN AMERICA'S AIR SUPREMACY.

American Machinist	Construction Methods	Engineering & Mining Journal	Mill Supplies
Bus Transportation	Electrical Contracting	E. & M. J. Metal and Mineral Markets	Power
Business Week	Electrical Merchandising	Engineering News-Record	Product Engineering
Coal Age	Electrical West	Food Industries	Textile World
Chemical & Metallurgical Engineering	Electrical World	Factory Management and Maintenance	Transit Journal
	Electronics		Wholesaler's Salesman

AFFILIATED WITH BUSINESS PUBLISHERS INTERNATIONAL CORPORATION, PUBLISHERS OF BUSINESS AND TECHNICAL MAGAZINES FOR LATIN AMERICA, AND OVERSEAS CIRCULATION.

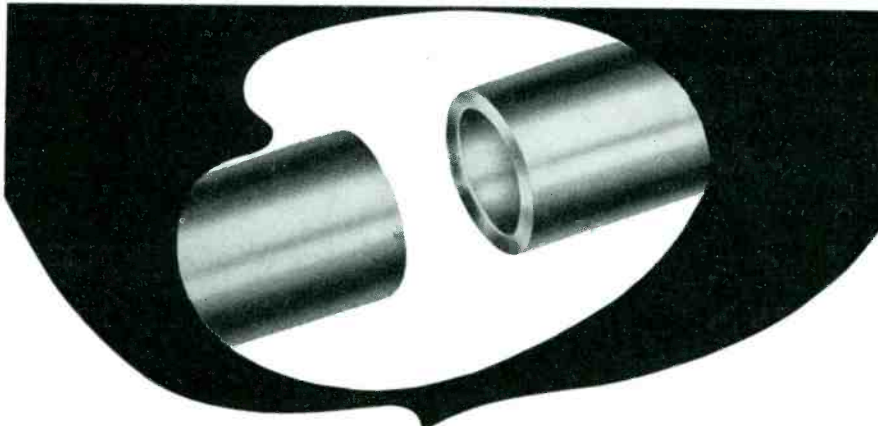

Accurately Drawn TUBING

QUICK DELIVERIES of accurately drawn seamless COPPER, BRASS, and ALUMINUM tubing are today unusual. PRECISION TUBE COMPANY specializes in both promptness and accuracy of finished product.

Write or wire us at once concerning your tubing problems. We are known for our excellent service.

PRECISION TUBE CO.

SPECIALISTS IN ACCURATELY DRAWN TUBING AND METAL SHIELDED WIRE
 Factory: 3824-26-28 TERRACE STREET • PHILADELPHIA, PA.
 BRANCHES IN ALL PRINCIPAL CITIES SALES DEPT. 2957 214th ST., BAYSIDE, L. I., N. Y.

REMOVABLE STICKER SPEEDS ELECTRICAL WAR WORK!

Kum-Kleen labels, with their magic adhesive backing, are applied without moistening... adhere to any smooth surface... never pop off... yet are easily peeled off without leaving a trace. Use them as Identification, Installation, Instruction, and Inspection stickers. Write today for samples and catalog to Avery Adhesives, Dept. E 1, 451 East Third St., Los Angeles, Calif. In Canada, Enterprise Sales & Distributors, Toronto.

KumKleen STICKERS

1-1-1-1
 DUCT THERMO-STAT
 GENUINE EISEMANN
 PART NO. 23736
 Made in U.S.A.

RED ARROW ELECT. CO.
 IRVINGTON, N. J.

SPEC. NO. 0
 SERIAL NO. 2-2-2-2-2-2
 Hercules Electric & Mfg.
 Brooklyn, N. Y.
 A
 R

SIGNAL CORPS
 U. S. A.
 CORD CD-508
 Order No. 215-WFSPD-42
 Universal Microphone Co., Ltd.

F. M. RESEARCH CORP.
 29 West 57th Street
 PLAZA 3-0794 NEW YORK, N. Y.
 DISTRIBUTED IN CANADA
 BY
 CANADIAN MARCONI COMPANY LTD.
 RVL 41
 CTD. IN U.S.A.

TYPE A
 Amp. 10
 Amp. 5
 MATIC
 MEG
 3-3-3-3
 Micro Switch Inspection Dept.

SEE DRAWING NO. 728
 Use this wrench to remove
 mount cover screws marked
 when finished put wrench back
 mounting studs under brass
 (For future use)
 Illinois Testing Laboratories Inc.

Please address
 Industrial Apparatus Plant
 Sylvania Electric
 Products, Inc.
 EMPORIUM, PA.

ACORN INSULATED WIRE CO., BROOKLYN, N. Y.
 DUCT THERMO-STAT
 LOW VOLTAGE
 DATE INSTALLED

GEORGE W. BORG CORP.
 E. Ohio St.
 IMPORTANT: Return ONLY to Factory or Author-
 ized Service Stations for any necessary repairs

AUTOMATIC ELECTRIC
 MFG. CO.
 Mankato, Minn.

ILLINOIS RADIO MANUFACTURING CORP.
 Itaip, L. I., New York
 DATE REMOVED

Oscillograph With Expanded Frequency Range

OSCILLOGRAPH, Type 224 is a standard instrument which features a X-axis vertical deflection response which is uniform from 20 to 2 million cps. It has a comparably faithful square and sinusoidal wave response. The X-axis or horizontal deflection amplifier has a uniform characteristic from 10 to 100 kc. Both amplifiers have distortionless input attenuators and gain controls. A wide variety of signal input connections is available. In addition to the



amplifier connections, signals can be applied directly to the deflection plates of the 3-inch cathode-ray tube, when it is desirable, by means of terminals at the front panel of the unit. The Y amplifier has an input connection for the shielded-cable test probe type 242A, which is supplied with the instrument and which tends to reduce input capacitance and eliminate stray pickup. High-voltage electrolytic condensers are eliminated from the circuit. The oscillograph weighs 49 lbs., and measures 14½ inches high, 8½ inches wide, 15½ inches deep. It operates on 115 volts, 60 cps a.c.

Allen B. DuMont Laboratories, 2 Main Ave., Passaic, N. J.

Portable Measuring Instruments

THREE NEW SMALL laboratory type portable electrical measuring instruments including a voltmeter, ammeter and a wattmeter are offered by this manufacturer. This group of instruments is designated as Model 77-P. The individual instruments are furnished in mahogany cases. They all have electro-dynamometer movements. The scale length is 3½ inches with an accuracy of 1 percent.

Niagara Electrical Instrument Co., 1 W. Genesee St., Buffalo, N. Y.

Aircraft Relays

TYPE 27 AIRCRAFT relays utilize a box frame construction to provide compactness, strength and sturdiness. The contacts are mounted in an open-sided phenolic box for protection against damage and dirt. Electrical characteristics of the relays can be varied over a wide range to suit the requirements of different applications. As an example, the manufacturer cites the following specifications of one relay built to meet the requirements of a specific customer: vibration and acceleration, 15 g; altitude, 40,000 feet; contact pressure for

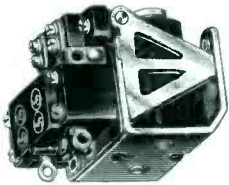

double make, double break contacts, 50 grams; contact capacity at 30 volts d.c., 20 amps (inrush 100 amps); 200-hour salt spray test; pickup, at 20 deg. C., 5 volts (0.36 watt); nominal coil voltage, 14 volts d.c.; coil wattage at 14 volts d.c. at 20 deg., 2.8 watts; temperature range, -40 to +90 deg. C. Dimensions are 1½x1½x1¼ inches high, weight 5 ounces.

Free samples of the relay may be obtained by requesting Specification No. 12723 and supplying a priority of A-1-K or better.

G-M Laboratories Inc., Chicago, Ill.

Phosphorescent Material

THE MANUFACTURER states that a new phosphorescent material has been developed which overcomes certain defects of this type of product which have limited their military and civilian usefulness, especially outdoors. The new phosphorescent material consists of a pre-fabricated paint film in the form of a tape and in large sheets, and is made by laminating under heat and pressure, transparent plastic films on each side of the luminous layer. The film is chemically neutral and is non-absorbing, and will withstand six times the government specification in the weatherometer. The brightness is such that it can be seen after twenty-four hours at 70 deg. F. by the dark-adapted eye, and can be extinguished at will by a red light. The color is blue-green and is peaked at 507 millimicrons. The material can be excited by daylight or photoflood in 20 seconds, or by an ordinary 100-watt lamp in a period from 20 seconds to a minute, depending on the distance from the lamp. It has two peaks of sensitivity in excitation, one at 320 millimicrons and one at 436 millimicrons. The after-glow is accelerated by infrared light and quenched by red light.

FLUORESCENT PIGMENTS CORP., 445 West 41 Street, New York, N. Y.

Creators and Makers of

**ACCURATE RESISTORS—SWITCHES—SPECIAL EQUIPMENT AND
SPECIAL MEASURING APPARATUS FOR PRODUCTION AND
ROUTINE TESTING OF ELECTRICAL EQUIPMENT ON MILITARY AIR-
CRAFT... SHIPS... VEHICLES... ARMAMENT... AND WEAPONS**

SHALLCROSS INSTRUMENTS

are tools of War-Time Production covering a wide range of activity. Shallcross Engineers have much experience in the design and construction of specialized equipment. Submit your problem to Shallcross . . . and if your project is a part of the War Effort we will find time to determine the correct answer. Dept. D 3.

HALLCROSS MFG. CO.

COLLINGDALE, PENNA.

ATR

VIBRATOR POWER SUPPLIES



● ATR VIBRATOR PACKS

For Inverting Low Voltage D.C. to High Voltage D.C.

REPLACES DYNAMOTORS!!



● ATR D.C.-A.C. INVERTERS

For Inverting 6, 12, 32, or 110 Volts D.C. to 110 Volts, 60 Cycle A.C.

REPLACES ROTARY CONVERTERS!!

ATR Vibrator Power supplies have a proven background for performance, reliability and high quality.

AMERICAN TELEVISION & RADIO CO.

St. Paul, Minnesota

Small Power Relays

MODELS BO AND BJ power relays have been redesigned to require minimum mounting space and to permit variation in their mounting bases (Bakelite, screw or Shake-proof nut, etc.) to make them widely interchangeable to meet the individual requirements for tanks, planes and ships. Terminal connections are easily accessible. Semi-balanced armature to withstand vibratory motion with minimum coil power is provided.

The specifications of BO are: contact ratings, non-inductive, 15 amps for 12 and 24 volts d.c. and 110 volts a.c. single or double pole, double throw;



weights, 4 oz. with screw or shake-proof nut mounting or 7 oz. with Bakelite mounting (model BOB in Bakelite); withstands vibratory motion to 12G with 2½ watt operating power; operates at temperatures +70 deg. C., or -50 deg. C; and resists corrosion; dimensions, (screw or shake-proof nut)



1½x1½x1½ inches—(Bakelite mounting, model BOB) 2½x1½x2⅜ inches.

The specifications for BJ are: contact ratings, non-inductive, 5 amps for 12 and 24 volts d.c. and 110 volts a.c.;

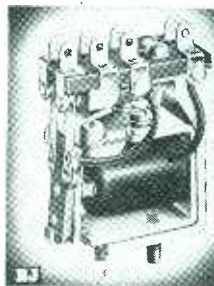

single or double pole, double throw; weights, 2¼ oz. with screw stud mounting or 5¼ oz. with Bakelite mounting (model BJB in Bakelite); withstands vibratory motion to 12 G with 2 watts operating power; operates at tempera-

tures of +70 deg. C. or -50 deg. C.; resists corrosion; dimensions, (screw stud mounting) 2⅝x1½x1⅝ inches—

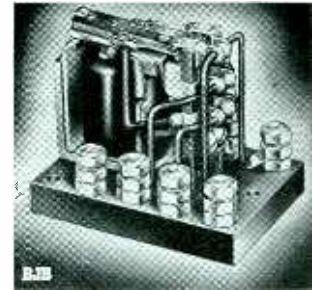

(Bakelite mounting, model BJB) 2⅝x1½x1⅝.

Allied Control Co., Inc., 227 Fulton St., New York, N. Y.

Synthetic White Sapphire

SYNTHETIC WHITE SAPPHIRE (developed to replace synthetic gems no longer available from Europe) is now available in the form of boules. Each boule weighs at least 150 carats and is of a regular cylindrical shape, enabling gem cutters to standardize on cutting and sawing procedures. The manufacturer states that the material is practically perfect (any imperfections being microscopic in size and having no effect whatever on the quality of the material for precision bearing surfaces and other essential industrial parts) and that the hardness of the new syn-

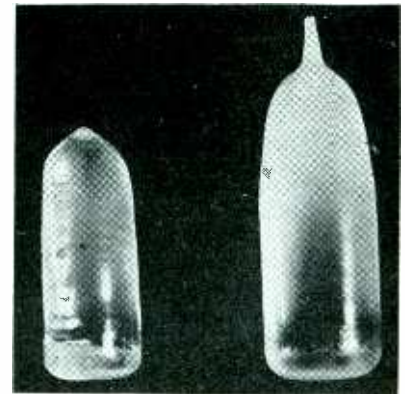

thetic sapphire is exceeded only by the diamond. Once cut, the jewels are resistant to breakage by impact. They are also heat resistant (having a melting point of over 3,700 deg. F.). Other advantages, the manufacturer gives, are the boules' uniformity of size and shape, and their complete chemical inactivity when exposed to all types of corrosion except strong mineral acids and alkalis. The new material is for use in the form of ring bearings or V-type and cup-type end bearings of chronometers, compasses, electrical, and aircraft instruments, or as insulators in gas-filled or vacuum thermionic devices, or for cutting tool tips to perform high speed finishing operation on certain non-ferrous metals.

The Linde Air Products Co., 30 East 42nd Street, New York, N. Y.

Portable Coolant System

MODEL G-10A is a new portable coolant system using a centrifugal pump, designed to deliver controlled coolant flow from 10 to 1000 gallons per hour. It provides large coolant volume and high flushing capacity, making it particularly applicable for multiple spindle and deep drilling work, drill press installations, large cut-off machines, large grinders, large milling machines, large turret lathes, and as a stand-by unit for central systems. The centrifugal pump is a high stress casting,

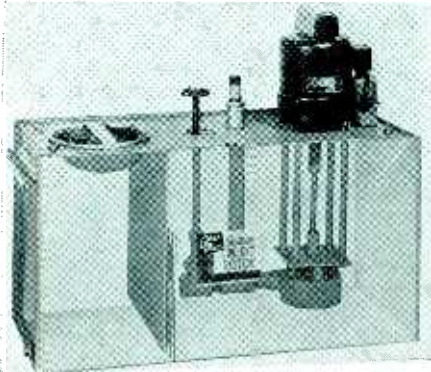

with sleeve bearings. Intake orifice is 1½ inches; discharge 1 inch. Both 1- and 3-phase ½-hp motors, 100/220 or 220/440 volts respectively, are available. The tank, of 40-gallon capacity, is 16 inches deep, 16 inches wide, and 36 inches long. Double baffle plate provides forced settling, and a separate filter screen in the tank cover is easily removed for cleaning. Tank finish is corrosion resistant. Flow control valve is easily accessible.

Gray-Mills Co., 213 W. Ontario St., Chicago, Ill.

Impregnated Transformers

THERMATITE is a new form of impregnation used to treat transformers to make them more adaptable to extreme conditions of humidity and heat. Ther-



matite-treated transformers are also available in very small sizes for radio use.

Thermador Electrical Mfg. Co., Los Angeles, Cal.

Select

How to meet your transformer needs quickly and dependably

Newark

TRANSFORMERS

(Special and Standard Types)



For Control of Motor Speed

Suppose you had spent the last twenty years building transformers. Wouldn't you figure that you had the job licked, pretty thoroughly, too? Wouldn't you conclude that no new transformer problem could be a problem any longer than it took to turn your experience loose on it? That's our story.

We can build Newark dry type transformers to serve your needs, either in standard types or in special types using components of proven correctness. Capacities 1 to 75 kva. And—we may be able to deliver sooner than you expect. Check with us on this. Write for Bulletin A-10.

Do you need SUBCONTRACT help?

Call upon the facilities of our Subcontract Division, established long before Pearl Harbor. Floor space, machines, men available. Also the cooperation of a skilled engineering staff. Our record on this work demonstrates exceptional ingenuity in dealing with a wide variety of difficult manufacturing problems. Production time schedules always met, frequently bettered. Depend upon our production drive to get things done, and upon our 20 years of experience to get them done *right*. Our facilities may be just what you need. Phone or wire

SUBCONTRACT DIVISION
(Phone, Bigelow 3-3577)

Newark

TRANSFORMER CO.
17 FRELINGHUYSEN AVE.
NEWARK, NEW JERSEY

TRANSFORMERS FOR ALL PURPOSES

R **E** **V** **C** **O**

75°F

MEANS LONGER LIFE FOR PRECISION GAUGES
 MEANS MORE ACCURATELY CALIBRATED AVIATION INSTRUMENTS
 MEANS SUPER ALUMINUM SHEETS FOR PLANES



Revco

SUB-ZERO TESTING EQUIPMENT

REVCO engineering insures dependable sub-zero temperatures for electronic equipment manufacturers. Electrical instruments for aircraft must meet the most rigid demands of Sub-Zero temperature conditions. REVCO equipment does this work efficiently and economically. Write for further information.

REVCO, INC., Deerfield, Michigan

R **E** **V** **C** **O**

Steel Substitute Plastic

PLASTIC COMPOSITIONS which can replace steel or other metals in many uses may now be manufactured by incorporating with various cellulosic fibers a resin powder known as Vinsol, extracted by Hercules Power Company, The Patent and Licensing Corp. (30 Rockefeller Plaza, New York, N. Y.) has announced. Vinsol is a thermo-plastic, fibrous-resin composition, hard, dense, stiff but with reasonable toughness. It is described as sturdy but light in weight, and has low water absorption. Fibers used in the production process include such non-critical materials as newsprint, clean cotton rags, sulphite, sulphate, and similar materials. The Vinsol resin is available without priorities, and can be obtained in quantities from the Hercules naval stores plants at Brunswick, Ga., and Hattiesburg, Miss. Existing conventional paper-making machinery may be used to manufacture fiber sheets. Thin sheets for laminating may be made by continuous process on cylinder of fourdrinier paper machines. Thicker sheets for laminating or for homogeneous pressing can be made on wet machines or insulation board machines.

The Patent and Licensing Corp. has under way many types of experimental work with this product. One definite commercial use, however, is in the manufacture, by Federal Electric Co., of Chicago, of a 3-inch diameter plastic tubing to replace steel pipe for shot hole casing in seismograph oil field exploration work. Several other companies interested in the possibilities of Vinsol as a metal substitute, and also for specific uses on its own merits, are working on adaptations of such items as containers for greases and oils, lightweight structural I, U and L or similar members, pipe, wall panels, corrugated sheets, cabinets, boxes, refrigerators, air conditioning ducts, vent pipes, fluorescent lighting fixtures and radio antenna structures.

• • •

Varnished Silk Alternates

VARNISHED RAYON, varnished cotton cloth and varnished nylon have been developed for electrical insulation formerly provided by varnished silk. The manufacturer states that all these materials possess dielectric strength with tensile and tear strengths equal to varnished silk and that they can be punched into special shapes. They are available in thicknesses from 0.003 inch to 0.008 inches in straight-cut rolls or bias cut strips, in 51-inch lengths. Each base material is coated with the manufacturer's special insulating varnish.

High tenacity varnished rayon is suggested as the most suitable alternate for varnished silk, comparing favorably with it in strength and flexibility. It has a dielectric strength of

Solve Voltage Variation
PROBLEMS IN AIRCRAFT, TANKS, ETC.
 WITH

AMPERITE
BATTERY CURRENT & VOLTAGE REGULATORS

Features:—

1. Amperites cut battery voltage fluctuation from approx. 50% to 2%.
2. Hermetically sealed — not affected by altitude, ambient temperature, or humidity.
3. Compact, light, and inexpensive.

Now used by U. S. Army, Navy, and Air Corps.
 Send us your problem.

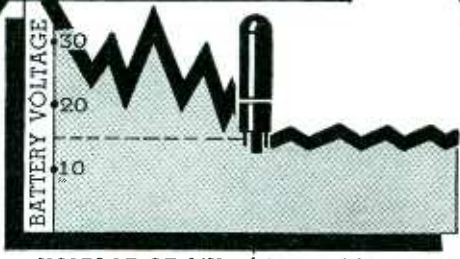

VOLTAGE OF 24V BATTERY & CHARGER VARIES APPROX. **50%**

WITH AMPERITE VOLTAGE VARIES ONLY **2%**

AMPERITE COMPANY • 561 Broadway, New York, N. Y.
 In Canada: Atlas Radio Corp., Ltd., 560 King St. W., Toronto

Cable: Alkom. New York



Put a LITTELFUSE IN A VISE

**TWIST THE CAPS
WITH A WRENCH**

You simply can't detach or even loosen the cap of a

LITTELFUSE

Grip and turn hard! You may shatter the glass—but the cap will stubbornly stick to its end. Reason: Exclusive Littelfuse Patented Locked Cap Assembly.

Littelfuse Caps with their markings will not be lost in any emergency.

Littelfuse process also waterproofs and hermetically seals filament.

Send for Complete Littelfuse Catalog.

Full details on Littelfuses for every instrument purpose. Panels, mountings, Clips including New Beryllium Copper Clips of remarkable strength and resistance characteristics. Write.

LITTELFUSE INC.
4755 Ravenswood Avenue Chicago, Ill.

1200 VPM and is used for wrapping leads, small magnetos and coils. Varnished cotton cloth has greater tensile strength than varnished silk. Its pliability permits application on odd shapes. Dielectric strength is 1200 VPM. Varnished nylon has qualities of flexibility and high tensile strength with dielectric strength of 1200 VPM. Nylon is only available by Government allocation.

Irvington Varnish & Insulator Co.,
24 Argyle Terrace, Irvington, N. J.

Paper Tubing and Cores

THE MANUFACTURER has extended the size ranges of its spirally-wound paper tubing and cores and these may now be had in sizes of $\frac{1}{16}$ inch or of 4

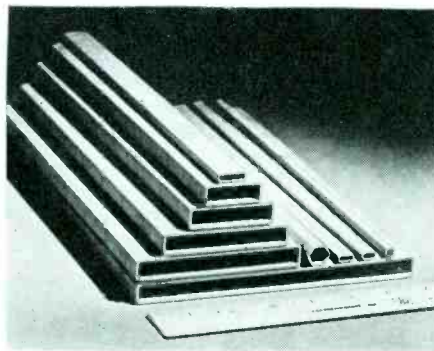

inches square inside with a tolerance of approximately 0.002 inches. The tubes have square corners and straight side walls and are available in continuous lengths in high dielectric kraft, fish paper, red rope, acetate, or combination wound. Shapes which may be had are square, round, or rectangular. The tubing and cores may be used for coil forms as well as other uses.

A list of over 650 sizes, or sample tubes, is available from the manufacturer, Paramount Paper Tube Co., 800 Glasgow Ave., Fort Wayne, Ind.

Dust-tight Aircraft Relay

DESIGNED FOR AIRCRAFT applications which require high current-carrying capacities is a new relay which comes with the coils, contacts, and plunger enclosed in a dust-tight housing. The unit is compact, light-weight and corrosion proof, and can be mounted in any position on a metal or non-metallic base. The relay meets the stipulated 200-hour salt-spray test. It is solenoid-operated with the normally-open contacts rated at 10 amps d.c. These contacts will make or break 30 amps at altitudes up to 40,000 ft. When the relay is in the energized or de-energized state, the contacts will remain in the open or closed position without chattering, even when subjected to mechanical frequencies of from 5 to 55 cps at $\frac{1}{2}$ -inch amplitude ($\frac{1}{16}$ -inch total travel) applied in any direction. The relay is



featuring . . .

- Standard laboratory instrument design and workmanship.
- Wheatstone Bridge Type RN-1. Four resistance dials. Nine positions each. 9 X 1, 9 X 10, 9 X 100, 9 X 1000 ohms, with decade multiplying dials.
- Ratio resistance guaranteed to plus/minus .05%. Resistance coils to .1%.
- Moving coil galvanometer. Sensitivity of 1 microampere per division. 4½ v. internal battery. External battery and galvanometer connections.
- Resistance Decades Type DR. .9 to 999,999 ohms. Accuracy plus/minus .1%.
- Manganin wire coils. Bifilar-wound on ceramic tubes.
- Self-cleaning multi-blade phosphor-bronze spring wiper switches.
- Standard walnut cases.

AVAILABLE:

BRIDGES AND DECADE BOXES

Large-scale requirements on the part of a major Government contractor for equipment "equal to and interchangeable with" present standard D.C. Wheatstone Bridges and Resistance Decades, led us to set up for line production of such instruments. The result is that we can promise prompt delivery because we are in continuous production on such equipment. Also other models, subject to priorities. We suggest that you review your requirements NOW, and take advantage of this favorable situation.

Write for Literature . . .

	PLANT and OFFICES:
	156 CULVER AVENUE,
	JERSEY CITY, N. J.

Goat
ELECTRONIC TUBE
PARTS AND SHIELDS

Small Parts
of the
BIG
WAR
JOB!

Goat Metal Stampings
INC.
Division of THE FRED GOAT CO., INC.
314 DEAN STREET, BROOKLYN, N. Y.
Goat has meant
Accuracy since 1895

ONLY WINCO GIVES YOU ALTI-TEMP DYNAMOTORS

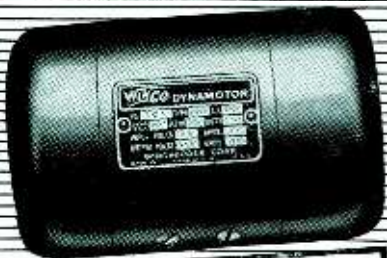

Where complete dependability is essential . . . where efficient electric power is important . . . specify WINCO DYNAMOTORS! WINCO DYNAMOTORS are built for all types of service . . . for operating temperatures ranging from -40° to +65° Centigrade.

**COMPACT
LIGHT WEIGHT
MINIMUM A.C. RIPPLE
LOW VOLTAGE REGULATION**

These are only a few of the quality features in WINCO DYNAMOTORS.

WINCO DYNAMOTORS are regularly available in standard outputs and sizes . . . special WINCO DYNAMOTORS can be designed to meet your exact need. Our complete free Advisory Engineering Service is yours without obligation —why not consult us?

The Dynamotor designed to insure maximum efficiency at all operating altitudes and temperatures.

WINCO DYNAMOTORS
WINCHARGER CORPORATION
SIOUX CITY IOWA

designed for use in an ambient temperature range of from 95 deg. C. to minus 40 deg. C., and will withstand 95 percent humidity at 75 deg. C. on 48-hour tests. The relay is available in a single-pole, single-circuit form with nor-



mally-open contacts or in a single-pole, two-circuit form with one normally-open and one normally-closed contact. The operating coil can be furnished for either 12 or 24 volt d-c operation.

General Electric Co., Schenectady, N. Y.

Generator Equalizing Resistor

GENERATOR EQUALIZING resistors (designated as No. 1011) are light-weight, compact and will withstand extreme temperatures and vibration. Each resistor is individually tested and set to

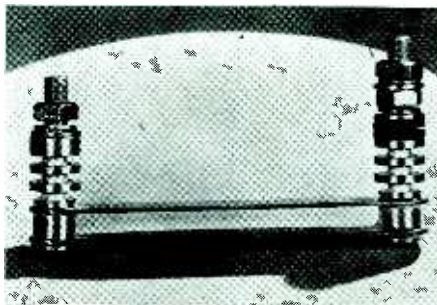

the standard voltage drop desired. The resistors have been approved by Army Corps for use in multi-generator applications.

Avia Products Co., 737 N. Highland Ave., Los Angeles, Cal.

Welding Transformer

SPECIAL WELDING transformers which have been designed for war production jobs are available for operation on primary circuits of 115 volts, single phase, 60 cps. The units have secondary characteristics of 0.75 volts, 1600 amps.

Acme Electric & Mfg. Co., Cuba, N. Y.

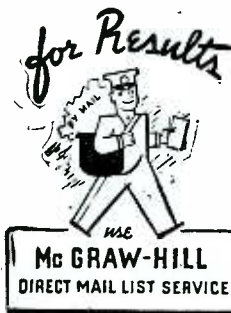

MAILING LISTS THAT WORK...

McGraw-Hill Industrial Mailing Lists are a direct route to today's purchase-controlling executives and technicians in practically every major industry.

These names are of particular value now when most manufacturers are experiencing constantly increasing difficulty in maintaining their own lists.

Probably no other organization is as well equipped as McGraw-Hill to solve the complicated problem of list maintenance during this period of unparalleled changes in industrial personnel. These lists are compiled from exclusive sources, based on hundreds of thousands of mail questionnaires and the reports of a nation-wide field staff, and are maintained on a twenty-four hour basis.

Investigate their tremendous possibilities in relation to your own product or service. Your specifications are our guide in recommending the particular McGraw-Hill lists that best cover your market. When planning your industrial advertising and sales promotional activities, ask for more facts or, better still, write today. No obligation, of course.

McGraw-Hill Publishing Co., Inc.

DIRECT
MAIL
DIVISION

330 WEST 42nd STREET
NEW YORK, N. Y.

Timing Motors for Vacuum Tube Plate Circuits

A NEW TYPE OF CLUTCH mechanism is used in 1600 Series of small self-starting synchronous timing motors which may be used as vacuum tube circuit controls, automatic reset timers, and time delay relays. The rotor in the motor is counter-balanced so that the motor can be operated regardless of the mounting position. Upon interruption

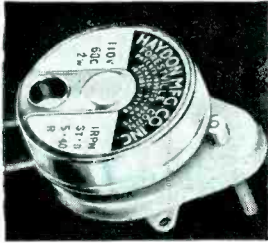

of the current to the motor, the clutch releases the gear train so that the motor shaft can be reset to starting position by means of an external spring. The motors are available in a large variety of output speeds, voltages and frequencies. The units measure $2\frac{1}{2} \times 2\frac{1}{2} \times 1\frac{1}{2}$ inches, and weigh 6 oz.

Haydon Mfg. Co., Inc., Forestville, Conn.

Instrument and Relay Rectifiers

THE UNIPOLAR CONDUCTIVITY of a selenium-to-metal junction is utilized for rectification purposes in these units. Eight standard types are manufactured, ranging in outputs from 8 to 120 ma.

Series L are supplied in insulated metal cases. Series S are supplied in unbreakable, molded plastic enclosures. All types are miniature in outside dimensions and the largest unit weighs

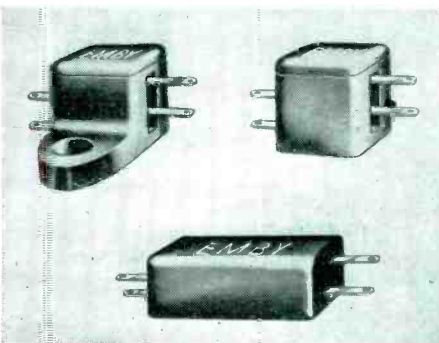

less than $\frac{1}{4}$ oz. The necessity of additional mounting brackets are eliminated because soldering lugs are provided. These rectifiers do not require any warm-up period and are permanently stable. They are rugged in construction, have high overload capacity, can withstand temperatures up to 70 deg. C.

Complete technical data sheet is available on request from Emby Products Co., Inc., 1800 West Pico Blvd., Los Angeles, California.



DELIVERIES are no- a problem at **GOTHARD**. If standard models do not fit your requirements, send your specifications and proposed delivery schedule. You will be answered immediately. Or write for new catalog.

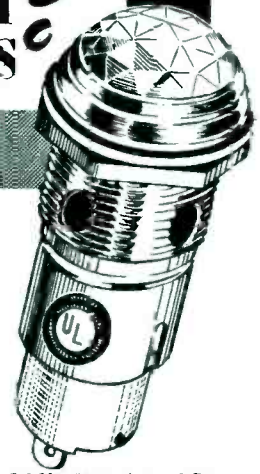

Model No. 1000, Actual Size

Gothard

MANUFACTURING COMPANY
1310 NORTH NINTH STREET
SPRINGFIELD, ILLINOIS

ESPEY MANUFACTURING COMPANY, INC.

SIGNAL GENERATORS - AUDIO OSCILLATORS - TEST EQUIPMENT
RADIO RECEIVERS - TRANSMITTERS - ELECTRONIC DEVICES
Licensed by - RCA - HAZELTINE - WESTINGHOUSE

DOING A WAR JOB!

305 EAST 63rd STREET
NEW YORK CITY, N. Y.
Telephone: REgent 7-3090

**NOW . . . you can secure
the mathematical
background you need
for the solving of everyday
electrical and radio problems**

Radiomen and electricians know that the language and the habit of mathematics are essential to them for real grasp of, and progress in their chosen field. They know that mathematics is a tool for them that they are helpless without.

Now out of the U. S. Navy Radio Materiel School at Anacostia Station comes a complete home-study textbook that is so thorough, so careful in its explanations, so detailed in its examples that any reader "who can perform arithmetical computations rapidly and accurately is capable of mastering the principles laid down in this text."

JUST OUT!



**MATHEMATICS FOR
ELECTRICIANS
AND RADIOMEN**

By **NELSON M. COOKE**
Chief Radio Electrician, U. S. Navy
Member, Institute of Radio Engineers
604 pages, 6 x 9, \$4.00

This book teaches you mathematics from elementary algebra through quadratic equations, logarithms, trigonometry, plane vectors and elementary vector algebra with direct applications to electrical and radio problems. It teaches you how to apply this mathematical knowledge in the solutions of radio and circuit problems. In other words, it gives you the grasp of mathematics you need and then shows you how to use your knowledge.

Keep these 3 points in mind

- gives you 600 illustrative problems worked out in detail;
- gives over 3000 problems for practice, with answers so you can check your work;
- based on more than 8 years' experience teaching mathematics to U. S. Navy electricians and radio operators.

10 DAYS' FREE EXAMINATION

McGraw-Hill Book Co., 330 W. 42nd St., New York
Send me Cooke's Mathematics for Electricians and Radiomen for 10 days' examination on approval. In 10 days I will send you \$1.00 plus few cents postage, or return book postpaid. (We pay postage if remittance accompanies order.)

Name

Address

City and State

Position

Company

Quick-Acting Mercury Relays

NEW QUICK-ACTING mercury relays, designated as BF and CF, are available for blackouts and defense applications. The circuit is made and broken in a hermetically sealed chamber under hydrogen pressure. The relays have low contact resistance, are explosion proof, and are not affected by dust, dirt, moisture, corrosion, or subject to arcing or pitting contacts. When the coil is energized the plunger is pulled down and displaces the mercury, causing the mercury to rise in the steel chamber until contact is made with the electrode.

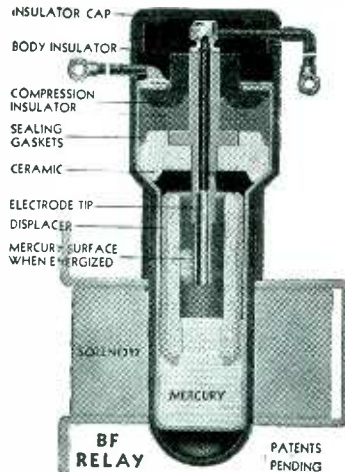

Available in 10-, 30- and 75-amp sizes, the relays are factory-adjusted to fast or slow opening or closing or both; set to normal open or closed, as desired. The relays can be built in any size or kind, including time delays.

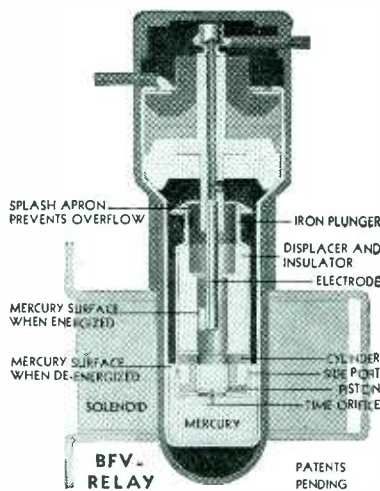

Series BFV time relays can be used in communication systems such as telephone and signal work, or in machines, motors and electrical circuits where a delayed action is required before a secondary or auxiliary circuit is called upon to operate. The relays also may be used in recycling operations and flashing actions. With a single relay unit it is possible to obtain slow closing and quick opening of the contacts,

in addition to slow closing, slow opening contacts and quick closing, slow opening contacts. The tube is filled with an inert gas, which cools and quenches the arcing and therefore is suggested for use where dust and dirt are present and in moist and explosive fumes. The hermetically sealed mercury time relay is unaffected by elements which might oxidize and disintegrate the contacting materials. These relays are available up to 75 amp capacity with solenoids wound for any voltage and frequency.

Durakool, Inc., 1010 North Main St., Elkhart, Ind.

Improved Photoelectric Controls

AN IMPROVED SERIES of photoelectric controls is available for various standard industrial applications such as counting, conveyor control, machinery safeguards, signal and alarm systems, motor or valve control, inspection and break detection, as well as for specialized processes.

The controls embody contacts which are designed to handle heavier loads directly, and are rated at 10 amps a.c., at 115 volts. The output terminals are

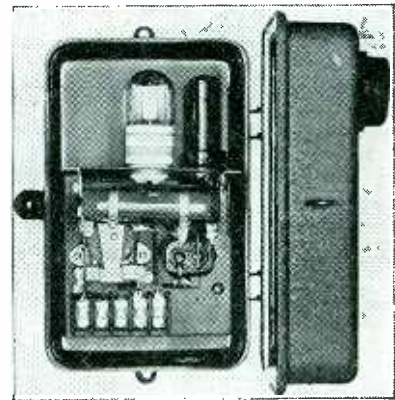

those of a SPDT switch, for either normally closed or normally open operation. This provides for action either when the light beam is broken or when it is made. The operating range of Type A15 is 20 feet with light source L30, and 40 feet with light source L60. (Type A25 is supplied with light source L30 for 50 foot operation, and with light source L60 for 100 foot operation).

Photoswitch Inc., 19 Chestnut St., Cambridge, Mass.

Multiple Track Sound-On-Film Reproducer

A NEWLY DESIGNED reproducer is available for use in studio transcriptions and station record libraries. It simplifies library filing and storage prob-

lens and reduces record scratching, breaking and wear. Duplicate transcriptions can be made on the multiple track which the unit utilizes. The unit has a capacity up to five hours of continuous playing from one 2000-foot, 5-track, 16-mm film recording.

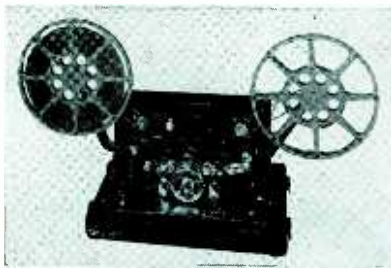

A specially developed film stabilizing mechanism and the use of a synchronous motor assure even sound and tone quality. By replacing the amplifier and the speaker of the reproducer with a photoelectric unit the apparatus works efficiently as a source of



material for broadcasting. A selector dial permits changing to any one of the five different sound tracks, even when the film is in progress. A special optical system coupled with a noiseless source of exciter lamp supply and a special photoelectric cell makes it possible to noiselessly reproduce all types of sound tracks.

Litho Equipment and Supply Co., 215 W. Ohio St., Chicago, Ill.

Electrical Cable Connector

A NEW ELECTRICAL cable connector that eliminates one coupling nut and one barrel, providing a three-piece, split-shell construction is now available to speed up assembly and maintenance work. The connectors are easy to in-

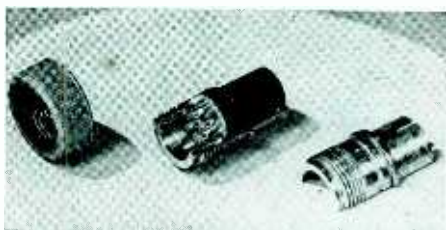

stall, and are made of die cast construction. A complete range of sizes from 10-S to 48 is available. The connectors conform to Army-Navy specifications.

The Harwood Co., 747 N. Highland Ave., Los Angeles, Cal.

Can You Use These Radio Tools?



CREI Technical Training Equips You With The Ability to Hold and Improve Your NEW RADIO JOB!

These "tools" are the symbol of the trained engineer. Knowing how to use and apply them as a radio engineer is an important part of the training you enjoy as a CREI student . . . and an indication that you are equipped for the better-paying jobs that lead to secure futures in all branches of radio.

In our practical radio engineering course, you learn not only *how* . . . but *why!* Your ability to solve tough problems on paper and then follow up with the necessary mechanical operation is a true indication that you have the *confidence* born of *knowledge* . . . confidence in your ability to get and hold the new, better radio jobs that are crying for good, well-trained technical radiomen *today*.

Here's what CREI students say:

"Being employed in the radio industry at the time of my enrollment, I had constant opportunities to apply my training to my daily work, with gratifying results both to myself and my employers."

H. B. Seabrook, Station CJOR—39-29-12

"I have been helped by the course far beyond my expectation and the lessons have been particularly timely for me."

—K. M. Hollingsworth, General Electric Co. —42-9-5

→ SEND FOR THIS FREE BOOKLET

WRITE FOR FACTS TODAY
about CREI Home Study Courses

If you are a professional radioman and want to make more money, let us prove to you that we have something you need to qualify for a better engineering job. To help us intelligently answer your inquiry, please state briefly your background of experience, education and present position.



CREI STUDENTS AND GRADUATES, ATTENTION!

The CREI Placement Bureau is flooded with requests for CREI trained radiomen. Employers in all branches of radio want trained men. Your government wants every man to perform his job, or be placed in a job, that will allow him to work at maximum productivity. If you are or will be in need of re-employment write your CREI Placement Bureau at once.

CAPITOL RADIO ENGINEERING INSTITUTE

E. H. RIETZKE, President

Home Study Courses in Practical Radio Engineering for Professional Self-Improvement.

DEPT. E-1, 3224 16th Street, N. W.

Washington, D. C.

Contractors to the U. S. Signal Corps and U. S. Coast Guard . . . Producers of Well-Trained Technical Radiomen for Industry

PERMANENT MAGNETS

The Arnold Engineering Company produces all **ALNICO** types including **ALNICO V**.

All Magnets are completely manufactured in our own plant under close metallurgical, mechanical and magnetic control.

The Arnold Engineering Company freely offers engineering assistance in the solution of your magnetic design problems.

All inquiries will receive prompt attention.

THE ARNOLD ENGINEERING COMPANY

147 EAST ONTARIO STREET
CHICAGO, ILLINOIS

INVEST 10% IN WAR BONDS AND STAMPS

Pilot Light Assembly

SERIES No. 800 pilot light assembly is for installations where it is desirable to be able to insert a new lamp bulb, at the rear of a switchboard panel, without disturbing the electrical wiring. The lower half of the pilot light snaps apart from the body. Locking pins in the spring member make a secure assembly which is free from rattle, and permit the insertion of a new bulb from the front of the panel. A separate ring

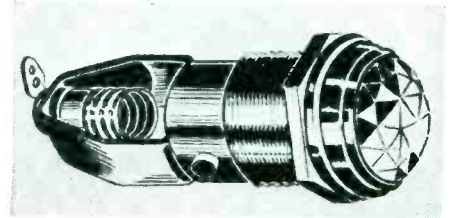

which slips in the tube holds the one-inch jewel. All parts of the assembly are heavily plated and jewel bezel are polished. Pilot lights are available with faceted or plain jewels with either miniature screw sockets, candelabra screw sockets, or miniature bayonet sockets, as well as with frosted jewels with colored discs.

Gothard Mfg. Co., 1300 North 9th Street, Springfield, Ill.

Heavy Duty Safety Switch

NEW WEATHERPROOF, dust-tight heavy-duty switches are available in capacities of from 30 to 1200 amps for operation in hazardous locations or where the use of regular switches is hampered by excessive dust, lint or unfavorable weather conditions. The housing of the unit consists of a heavy rubber gasket, plus a cover-within-a-cover. The box

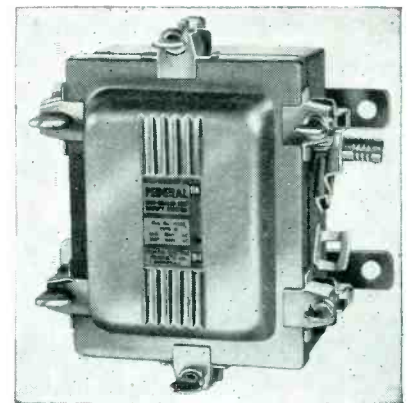

corners are gas welded inside and out. The unit is closed by a simple eyebolt and wing nut arrangement of clamping design which protects the rubber gasket from excessive pressure caused by forcing the wing nuts too tight.

Federal Electric Products Co., 50 Paris St., Newark, N. J.

★ The Holtzer-Cabot
Electric Company
has long used
Potter and Brumfield
Relays

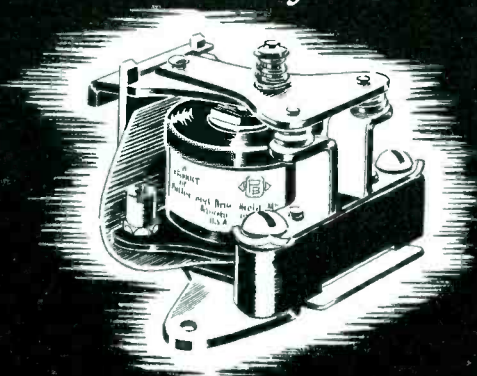

Potter & Brumfield
Princeton RELAYS Indiana

"THE POSITIVE ACTION RELAY"



GREATER POWER BEHIND THE WAR EFFORT!

With enlarged plant and facilities, INSULINE is putting vastly increased effort behind the manufacture of these Electronic Products and Parts for the Armed Services—

- Metal Cabinets, Chassis, Panels • Metal Stampings
- Plugs and Jacks • Completely Assembled Screw Machine Products • Hardware and essentials
- Antennas for "Walkie Talkies", etc.

Mrs. and Contractors, Send specifications for estimates.

Write for this 12-page Industrial Catalog now!



INSULINE

CORPORATION OF AMERICA
INSULINE BUILDING
(36-02 35th AVENUE)
LONG ISLAND CITY, N.Y.

WHAT ARE YOUR INSULATOR SPECIFICATIONS?

DEEP MOULDING

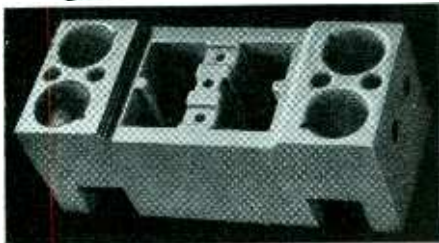

CLOSE DIMENSION TOLERANCE

Universal "dry process" porcelain can be molded to close dimension tolerances. This advantage often permits simplification in design of current carrying elements and parts. Likewise true to dimension porcelain eliminates assembly delays. Have your electrical products been analyzed recently by a porcelain engineer? Send blueprints and specifications to Universal now!

THE UNIVERSAL CLAY PRODUCTS CO.

1535 EAST FIRST ST. SANDUSKY, OHIO

Hot Stamping Outfit For Marking Crystal Holders

A HAND PRESS which can be plugged into a light socket and which can be operated by unskilled help is available for marking crystal holders or small plugs. The machine consists of a powerful arbor press operated by a handwheel. In the ram of this press is assembled a complete automatic stamping unit together with an electronic cartridge heating unit and a thermometer control.

A white or other color transfer tape automatically feeds under the marking type or dies at each stroke of the press, placing a mark in contrasting color on the crystal holder. The hot stamping head may be interchanged for a two-line holder with type for stamping metal name plates. The press outfit is suitable for cold stamping of name plates, plastic name plates, etc., and in switching from hot to cold

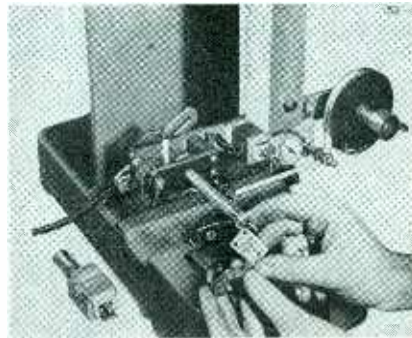

stamping it is only necessary to disconnect the tape feed lever. A depth control plate on the front of the ram enables an operator to set the press for consistently uniform marking. For stamping various sizes of parts or of irregular shapes, special fixtures are available with this outfit which is known as "Hercules" No. 3 Hot Stamping Outfit.

The Acromark Corp., 323 Morrell Street, Elizabeth, N. J.

Molded Iron Cores

NEW MATERIALS recently developed have resulted in the introduction of molded iron cores which show good characteristics at frequencies as high as 150 and 175 Mc. A permeability of approximately 5 is combined with high Q to match the needs of present day high frequency equipment. The units have uniform qualities. Other cores are available for frequencies up to 50 Mc. Engineering details on any type will be sent upon request from Stackpole Carbon Co., St. Marys, Pa.

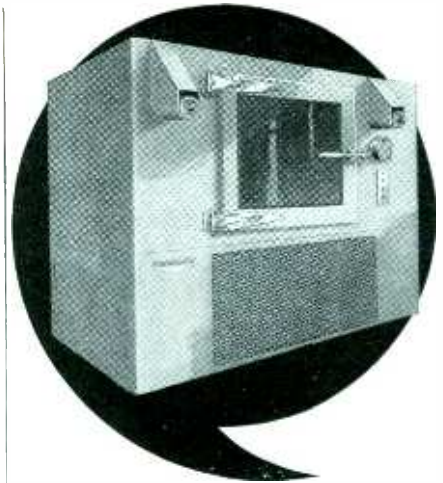

Use . . . KOLD-HOLD "Hi-Low"

for Fast, Accurate, Wide-Range Testing

Test aircraft instruments, radio receivers, transmitters, batteries, wire, metals and various devices over a wide controlled temperature range with the KOLD-HOLD "Hi-Low" machine.

An unusually large working space, combined with a wide Thermopane paneled door, offers maximum workability and visibility. Optional door and hand hole arrangements available.

KOLD-HOLD engineers are ready and willing to show you how to use the "Hi-Low" machine to best advantage in meeting today's demand for speed in production at no sacrifice in precision. Send for complete details, now.

NEW YORK — 1819 Broadway—Circle 63092
CHICAGO — 201 N. Wells — Randolph 3986
LOS ANGELES — 1015 W. Second — Mich. 4989

KOLD-HOLD MANUFACTURING CO.
446 N. Grand Ave., LANSING, MICH., U.S.A.

Custom Made Transformers from ACME STANDARD PARTS

● Are transformers a part of your manufacturing problems? Then get in touch with Acme Electric and free your mind and your plant of transformer production worries. We're transformer specialists. Thousands of special designs have been produced in Acme's three plants for hundreds of transformer users. We offer War Products Manufacturers all facilities and a complete organization to produce quickly to high quality standards. Your special transformers can probably be produced in jiq-quick time by adapting and utilizing tools and dies from the hundreds in stock ready to work for you.

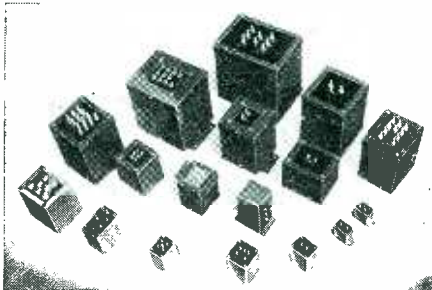

Audio transformers, Driver transformers, Interstage transformers, Reactors, Input transformers, Power transformers, Plate Supply transformers, Filament and Rectifier transformers produced by Acme for prime contractors.

Here's a design

Here's an Acme air-cooled design that can be adapted to a wide range of applications. Maybe the special characteristics of the transformers you need can utilize the tools that build this design.



THIS might be what you need



This compound-filled, high voltage secondary transformer is only one of a series of designs originally built for Luminous Tube sign and Cold Cathode lighting applications. Does your need compare with the serviceability of such applications? Write Acme today.

THE ACME ELECTRIC & MFG CO.
31 Water Street Cuba, New York

Acme Electric
TRANSFORMERS

Exhauster and Blower

A SMALL, PORTABLE unit, designated as "Octopus, Jr." eliminates gasses and fumes from closed-in places such as welding rooms, tunnels, vaults and basements. It is powered by a 3/4-hp ball bearing motor and operates in any position. Its suction and blowing capacity is rated at 2000 CFM. The

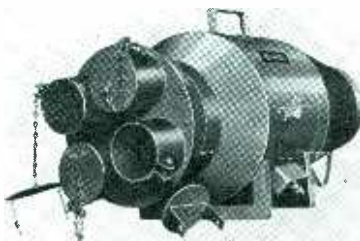

blower has adapters for three 4-inch nozzles or for four 3-inch nozzles of flexible hose. Caps are provided to close nozzles not in use. Each 4-inch hose is of 20-foot length, and will exhaust 250 CFM, and each 3-inch hose will exhaust over 200 CFM. The entire unit can be hung into a small man-hole. Weight of this exhaust-blower is 70 pounds.

Chelsea Fan & Blower Co., Inc., 1206 Grove St., Irvington, N. J.

Products for The Assembly Line

Electric Solder Iron Stand and Accessory

Two ADS to production soldering are Type SS2 electric solder iron stand and Type B background card holder accessory for use with Type SS2 iron. The stand (Type SS2) enables an operator to use both hands, does away with discomfort from fumes and heat by means of a chimney, and gives a clear magnified view of small parts and fine wires which are to be soldered. Rubber bump-

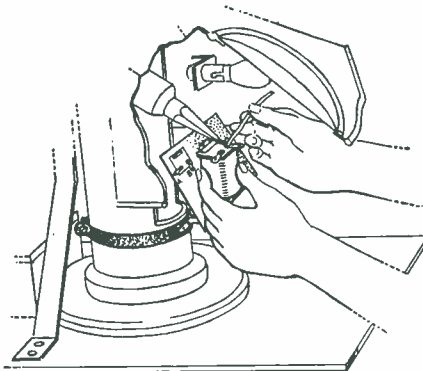

Type SS2 Solder Iron Stand

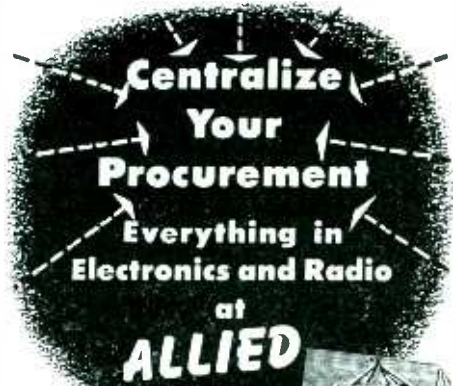

Send for Allied Catalog

Everything you need in Electronics and Radio is available from this one central source. Our large, complete stocks of over 15,000 items speed delivery. Our experienced staff solves your problems. Write, wire, or phone Haymarket 6800.

FREE—New Allied's Radio Formula and Data Book

Pocket sized. Contains essential Formulas, Tables, Data and Standards commonly used in Radio and Electronics. Free to Engineers, Purchasing Agents and Production Men. Write on Company letterhead for your copy.

ALLIED RADIO CORP.

833 W. Jackson Blvd. • Dept. 24-A-3 • Chicago

ALLIED RADIO

FERROCART IRON CORES

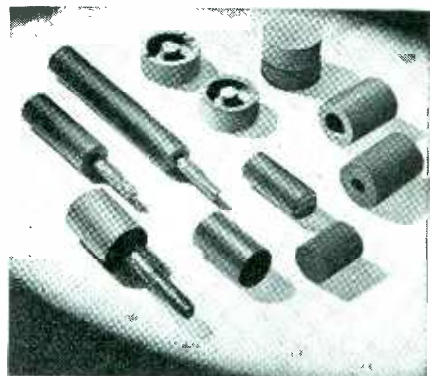

EXCLUSIVELY quality magnetic cores for all radio controlled apparatus—comply with the most rigid U. S. Government specifications; for high "Q", high resistance, and rust-proofing. Submit your R. F. or I. F. coil problems for our engineering collaboration. Samples, quotations, specifications submitted. 100% on victory orders for war equipment contractors.

FERROCART CORP. OF AMERICA

Plant and Laboratory

Hastings-on-Hudson, N. Y.

Chicago: 149 W. Ohio St. Tel: Whitehall 7620
Los Angeles: 1341 S. Hope St. Tel: Richmond 9121

ers are built onto the edge of the hood to protect the operator's wrists. Five-inch diameter magnifiers are available with 2-, 4- or 6-power lenses, or with $\frac{1}{2}$ -inch plate glass if desired. Extra lenses are available at low cost. The work is evenly illuminated by means of two bright lamps and a matte-white reflector surface which are located under the hood.

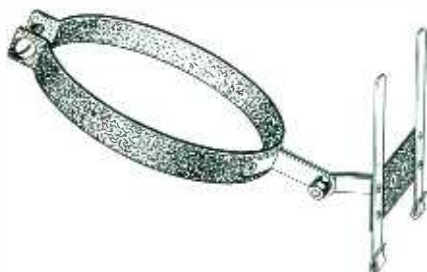

Type B Card holder

Type B card holder accessory simplifies the soldering of small parts by providing a uniformly white background against which the operator views his work. Since the card is placed in a position where the operator can see it continuously, a diagram of connections, or instructions, may be written on the card.

Photobell Corp., 116 Nassau Street, New York, N. Y.

Bonding Rings

NEW BONDING RINGS which have been used mainly in bonding shielded radio and instrument circuits in aircraft applications may be used in other places where a tight bond is required between plug shell and wire shielding. The rings may be used with either a flexible conduit coupling nut or cable clamp. The rings are designed to fit a variety of conduit nuts, and are adaptable to the manufacturer's types AN and K connectors.

The wire shield is separated from the wire by drawing the latter through a

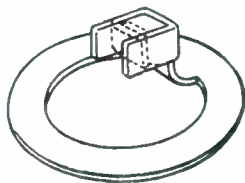

pierced hole in the shielding. The tongues on the bonding ring are then formed around the shielding pigtail and soldered. Since the unit is made of soft copper, all excess lengths of tongue may be cut away. The soldered connection is protected by insulation material (such as plastic tube or friction tape) to prevent any stray wires of the shielding braid from rupturing the insulation of other wires and causing a short circuit.

Cannon Electric Development Co., 3209 Humboldt St., Los Angeles, Cal.

Only SOUNDSCRIBER

SOUND RECORDING and REPRODUCTION

gives you all 5 features:

1. Perfected embossed groove recording.
2. Excellent communications fidelity.
3. Proved constant angular velocity.
4. Thirty minutes on a 7" plastic disc, using both sides.
5. Virtually indestructible discs, only .010" thick . . . mailable, fileable, non-warping.

Thousands of standard units serving industry and the armed forces

Specially designed mobile, aircraft and reference Sound-Scribers now in use by the Army and Navy.

All models exceptionally compact and light in weight. Portable units as light as 12 pounds.

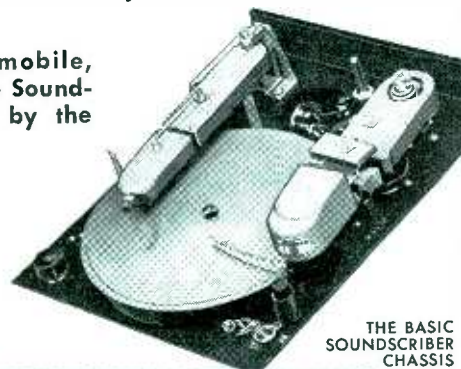

THE BASIC SOUNDSCRIBER CHASSIS

The SOUNDSCRIBER Corporation

82 Audubon Street, New Haven, Conn., U. S. A.

CARTER SOLVES YOUR *Dynamotor* PROBLEMS

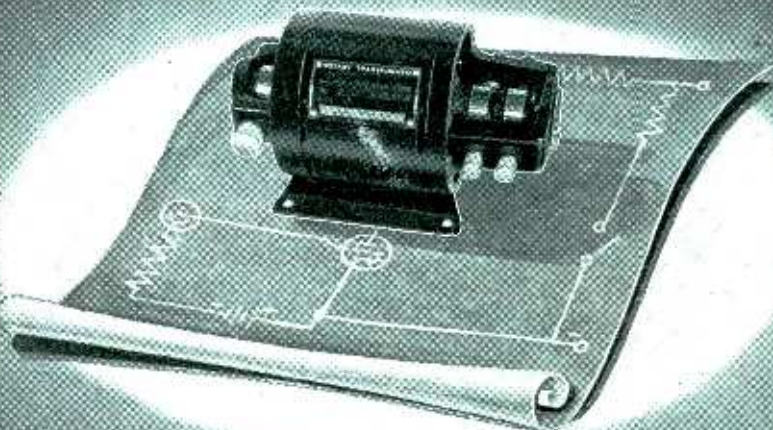

For many years, Carter Dynamotors have been a familiar part of the specifications of leading Communication Equipment Manufacturers, Police Departments, Government Agencies, etc. May we suggest you submit your Dynamotor requirements too, and see for yourself the reason for this recognized preference.

The latest catalog of Carter Dynamotors, Converters, Permanent Magnet Generators and Dynamotors, and special rotary equipment will be sent upon request.

Carter Motor Co.
Chicago, Illinois

1606 Milwaukee Ave. Carter, a well known name in radio for over twenty years. Cable: Genemotor

MANPOWER... and Motor Power!

The number of men in a plane or tank crew is kept to a minimum. Each man has his job to do. This *minimum of manpower* requires a *maximum of motor power*... motor-controlled apparatus that operates at the touch of a finger and functions with utmost accuracy. *Eicor D. C. Motors* have been developed to a high degree of efficiency. They are remarkably light in weight for power output—thoroughly reliable—and are used to actuate instruments, turrets, fire control and other critical equipment. This advanced engineering is your assurance of better motors at lower cost *tomorrow!*

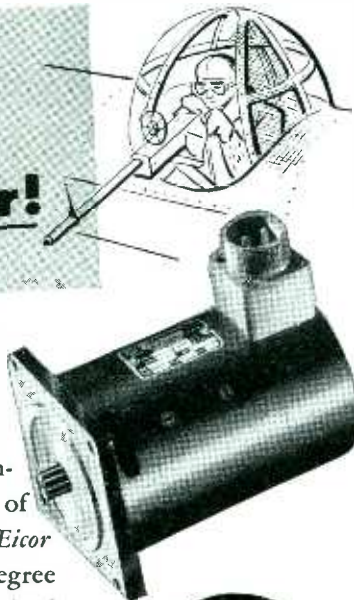

EICOR INC. 1501 W. Congress St., Chicago, U. S. A.
DYNAMOTORS • D. C. MOTORS • POWER PLANTS • CONVERTERS
Export: Ad Auriema, 89 Broad St., New York, U. S. A. Cable: Auriema, New York

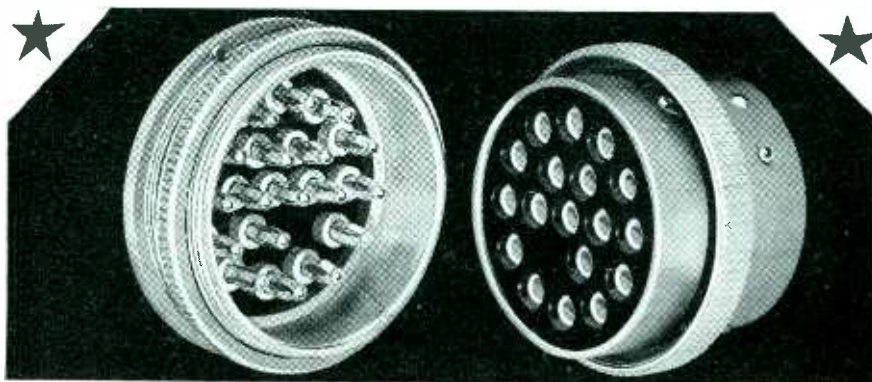

"Right Down Our Alley"

Contributing to the war effort, Astatic Corporation facilities are being utilized today mainly in the manufacture of essential products requiring special engineering skill and precision. Among these are Aircraft Radio Plugs and Sockets, as illustrated,

along with complete Co-axial Cable (concentric) connectors, and similar equipment for the U. S. Army Air Corps and the Navy. The tooling and assembly of delicate, precision products of this type comes naturally to Astatic workers, long experienced in the manufacture of Microphones and Pickups for radio, public address and phonograph equipment. Wartime production of this kind is "right down our alley."

ASTATIC

THE ASTATIC CORPORATION
YOUNGSTOWN, OHIO

Licensed Under Brush
Development Co. Patents

In Canada:
Canadian Astatic Ltd.
Toronto, Ontario

Dust Collecting Bench

NEW HIGH PRESSURE axial flow fan and heavy duty viscous filters are incorporated in the design of a new portable dust collecting bench which comes in sizes as low as 20 inches in height. The bench was designed as an aid to prevent fine abrasive dust from snagging operations or injuring precision machinery or workman, as well as to assist the workman to reach all parts of heavier castings while in a comfortable working position. Castings or parts placed on work surface of the bench are surrounded by a smooth and positive down flow of air which is supplied by a self-contained downdraft unit for carrying away and filtering the dust from the operator and from snagging, polishing,



grinding or any flexible shaft or hand tool operation. Large pieces of the very heaviest particles are collected in the upper tray of the bench, heavy particles in the base, and fine and dangerous dusts in the heavy duty viscous filters. Clean air drawn through the downdraft is returned to the workroom. The bench operates on a single- or three-phase electric line and no piping connections are required to install it. Benches may be furnished with wooden gratings where the softer metals are being worked. The whole unit is completely accessible for cleaning purposes.

Wolverine Equipment Co., Cambridge, Mass.

Soldering Iron

AN IMPROVED SOLDERING iron is available in 80, 100, 150, 175 and 200 watt sizes; tip sizes come in $\frac{3}{8}$, $\frac{1}{2}$ and $\frac{5}{8}$ inches. This hatchet or offset type of iron has all the features of the manufacturer's plug tip irons, and in addition it gives better balance on certain soldering operations, and reduces operator fatigue. The accessory is Underwriter's approved and meets Navy, Air Corps, Signal Corps and Treasury Dept. specifications. The elements of the iron are replaceable.

Hexacon Electric Co., 161 W. Clay Ave., Roselle Park, N. J.

Brake and Shear

NEW AND LARGER MODELS of precision machines for die-less duplicating have been added to the manufacturer's line of such equipment. The first of these is Di-Acro Shear, No. 2, which gives a shearing capacity of 9 inches in width in comparison to the older model, shear No. 1 with a shearing capacity of 6 inches. The second product is Di-Acro brake, No. 3 which has greater capacity than the manufacturer's older models, No. 1 and No. 2, in the 6- and 12-inch sizes. Both the shears and the brake are used mainly for the fabrication of small precisely shaped parts required in the construction of electrical, communication, radio and time control devices for aircraft, tanks and marine equipment.

Shear No. 2 is a rugged unit suitable for precision work on light and medium weight metals and materials that can not otherwise be rapidly worked to

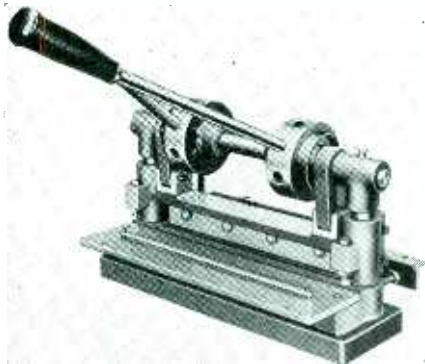

Shear No. 3

accurate tolerances, with a hand-operated scissors-shear, or with a heavy foot operated floor-type shear. It can be quickly arranged for shearing, squaring, slitting, stripping or notching. All ductile and pliable materials and metals (including spring tempered metals, fabrics, plastics, leathers, rubber and very light tissues) can be accurately worked without having to prepare blanking and forming dies. Power driven shears can be furnished as a complete unit with shear, counter-shaft and motor mounted on a rigid floor-type stand. The shear has a guaranteed accuracy to a tolerance of 0.001 inch in all duplicating work.

Di-Acro brake, No. 3, is constructed to allow contact surfaces to be readily removed for changes or replacement. Folding plates of the brake are hardened and heat treated to resist wear. Complete adjustments of all contact surfaces are provided, allowing vertical and horizontal adjustment for accurately duplicating either obtuse or acute angles, as permitted by natural working radii over the entire capacity range of material formed. Precision adjustable stops are provided for holding to die tolerances, the degree of angularity in all duplicated work. Adjustable bolts are provided with lock screws. Forming work involving two or more different operation on a single

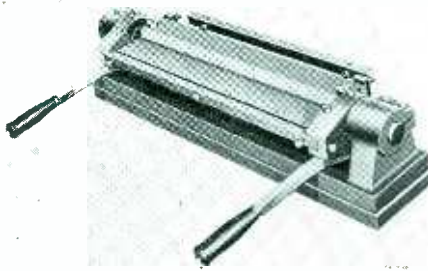

Brake No. 3

part may sometimes be worked in sequence with ample folding surface. Guaranteed accuracy of the brake is also rated at a tolerance of 0.001 inch in all duplicating work.

O'Neil-Irwin Mfg. Co., Minneapolis, Minn.

Torque Wrenches

TORQUE MEASURING wrenches which range in size and capacity from small instrument-building wrenches of a few inch-pound capacity to two-handed torque wrenches of 7200 inch-pound capacity are available for use in manufacturing and inspection departments. These wrenches are for gaging or measuring torsional force, as in equalizing a set of screws, or nuts, by tightening to a predetermined torque; or for measuring the frictional drag in motors or mechanisms. The eight models which are available are of the flat tapered beam type with fixed end and top scales, and are guaranteed by the manufacturer to retain their accuracy.

P. A. Sturtevant Co., Addison, Ill.

Hand-Die Installation Tool

THREE PERFECT CRIMPS can be made at one time by a new "hand-die" installation tool when it is used with the manufacturer's "diamond-grip" solderless insulation support terminal. It was designed to cut down training periods for unskilled workers.

The tool works by means of an insertion guage which automatically positions the terminals. The crimping jaws for both wire and insulation are in reality dies of tool steel which are adjustable to accommodate various insulation and wire diameters. The 15-to-1 leverage on the self-opening handles provides easy operation. When the jaws are closed tightly, a good crimped connection is made and there is no choice of pressure necessary by the operator. Army and Navy wire sizes are marked on the tool, which can be quickly made left or right-handed as needed.

Bulletin No. 18 describes more thoroughly both the insulation support terminal and the hand-die tool.

Aircraft-Marine Products, Inc., Dept. B., 286 North Broad Street, Elizabeth, N. J.



USE THE BEST!

**Lives depend on war jobs...
clean, snappy, no-blot
drawings are vital**

Lives are more important than pennies — the way to save lives in this war is to speed production. Clean, snappy blue-prints help... they keep production going top speed. Use Arkwright Tracing Cloth. This strong, uniform, specially-processed cloth is built for accurate, high-speed production. Run Arkwright through the blue-print machine time after time — it doesn't tear, fray or curl. Don't risk vital war drawings with tracing cloth that may become brittle or opaque with age. Arkwright permanency is an inexpensive guarantee of perfect work. Specify it next time. Arkwright Finishing Co., Providence, R. I.



Arkwright
TRACING CLOTHS

AMERICA'S STANDARD
FOR OVER 20 YEARS

**"...IN-RES-CO
resistors for
high accuracy"**

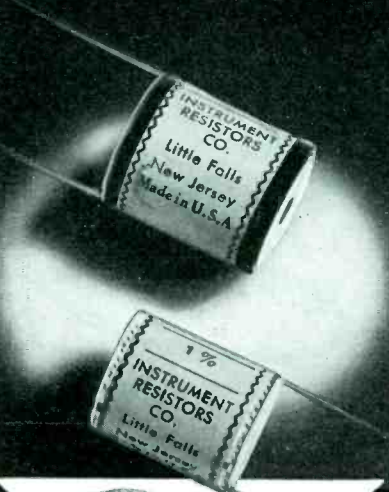

★ The increasing importance of IN-RES-CO resistors in critical ordnance applications, substantiates the great responsibility placed on their proper functioning at all times. Leading engineers emphasize the fact that "a job is being done by IN-RES-CO units where a high degree of accuracy must be maintained.

Write today for illustrated literature describing the complete IN-RES-CO line of specialized resistors — each application designed for a specific requirement.

TYPE DB (at top), 1 Watt, Non-inductive, Standard tolerance 1/2%, Maximum resistance 1 Meg-ohm, Size 11/16" diam. x 13/16" high.

TYPE DL (bottom), 1 Watt, Non-inductive, Standard tolerance 1/2%, Maximum resistance 1 Meg-ohm, Size 5/8" diam. x 3/4" high.



**INSTRUMENT
RESISTORS COMPANY**

25 AMITY ST., LITTLE FALLS, N. J.

Solderless Flag Terminal

SOLDERLESS FLAG type terminals may be used to stack a series of parallel terminal connections on a single stud block without loss of space or electrical conductivity. The manufacturer states this is made possible by a unique design plus a sufficiently flexible tongue to permit multiple stacking after wiring. These terminals may be used for either right or left hand application

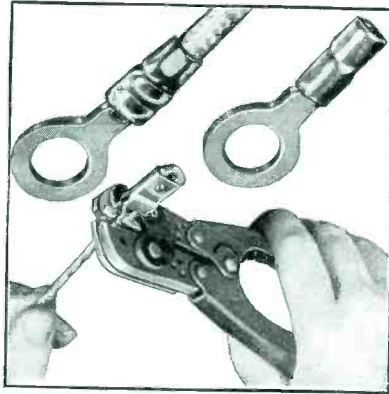

since the terminal barrel is symmetrically located with respect to the plane of the tongue, eliminating the necessity of distinguishing between and stacking two different terminals. These new terminals (for wire sizes 22 to 10) are pure copper and hot electro-tinned for maximum corrosion resistance. The terminals are crimped on the wire with hand, foot or power tools.

Aircraft-Marine Products Inc., Dept. B., 286 N. Broad Street, Elizabeth, N. J.

Diminutive Rings

THESE RINGS are made of sheet stock (to take advantage of proper grain direction) of vulcanized fibre material. The manufacturer states that no burrs or bruised edges occur in their manufacture. In spite of thin walls, these

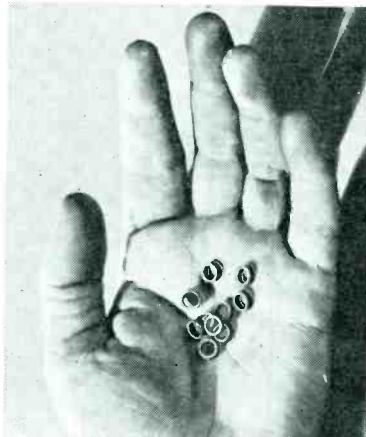

washers retain good structural and tensile strength. The rings are available in a 0.035 inch wall thickness, and in stock thickness of 0.090 inches. N. S. Baer Co., 9 Montgomery St., Hillside, N. J.



An authoritative booklet

... illustrating and describing the latest developments in testing and control equipment for all conditions of temperature, humidity and vacuum.

High Altitude Chambers
Constant and Variable Temperature Baths
Humidity Chambers
All-Weather Rooms

Engineering specifications for more than eighty installations are shown in this Booklet that will be mailed to you on request.

Please address Dept. E-1.



**TENNEY
ENGINEERING, INC.**

8 Elm St. Montclair, N. J.

JONES BARRIER STRIPS SOLVE MOST TERMINAL PROBLEMS

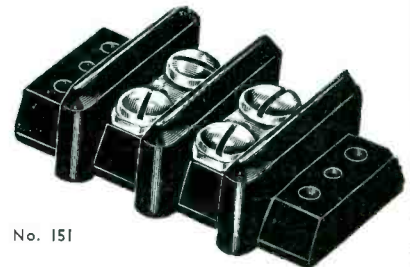

No. 151

A compact, sturdy terminal strip with Bakelite Barriers that provide maximum metal to metal spacing and prevent direct shorts from frayed wires at terminals.

6 SIZES

cover every requirement. From 3/4" wide and 13/32" high with 5-40 screws to 2 1/2" wide and 1/8" high with 1/4"-28 screws.

Jones Barrier Strips will improve as well as simplify your electrical intra-connecting problems. Write today for catalog and prices.

HOWARD B. JONES
2300 WABANSIA AVENUE,
CHICAGO ILLINOIS

Literature

R-F Apparatus. In this booklet standard types of Polyiron components are described. The devices described and illustrated in Inductor Catalog 942 are Type A adjustable coupling, mica tuned i-f transformers, Type G tuned i-f transformers, Type GA air tuned i-f transformers with adjustable coupling, Type GH air tuned i-f transformers with band expansion, permeability tuned transformers, Type C midget i-f transformers, wave traps, choke coils, resonators, acorn tube socket problems. In Core Catalog 1042 small molded cores for fixed inductors, small molded cores for adjustable inductors, small permeability tuning cores, large cylindrical cores, core assemblies for completely enclosed inductors and large toroidal cores are described. Included in Catalog 1042 is a table of comparative data which proves useful in selecting a suitable grade of ferro-magnetic material from which a core is to be molded. Both catalogs may be obtained from Aladdin Radio Industries, Inc., Chicago, Ill.

Dynamotors. Catalog No. 100 describes and illustrates dynamotors, converters and hand generators. Among those described are: "The Super" dynamotor for aircraft, marine, police and all mobile radio equipment, "The High Voltage Super" dynamotor for light weight aircraft, marine, and special communication equipment, "The Multi-Output Super" rotary transformer for light weight aircraft, police, special marine and mobile transmitter and receiver equipment, "The Original Generator" for two-way police radio, amplifiers, FM and small aircraft communications, "The Magmotor" for police radio receivers, small aircraft transmitters, portable life saving device and field communication equipment, "The Magmotor Hand Generator" for portable field communications, emergency aircraft and marine life saving devices and special emergency units and "The Super Converter" for converting d.c. to a.c. for marine radio, testing equipment, small signs, amplifiers and phonographs. Also included in the catalog are performance sheets and the various dimensions of dynamotors. Available from Carter Motor Co., 1603 Milwaukee Ave., Chicago, Ill.

Electric Heat. How various heat problems in industry have been solved by the use of electric heat; described in an 8-page booklet from General Electric Co., Schenectady, N. Y.

Tube Data and Interchangeability Chart. Available now is technical data on F-872-A, F-857-A and F-869-B half-wave rectifier tubes. Also an interchangeability list of transmitting and rectifying tubes. A price list of transmitting and rectifying tubes, which became effective on August 15, 1942, is also available. Federal Telephone and Radio Corp., 200 Mt. Pleasant Ave., Newark, N. J.

You'll find **AUTOMATIC ELECTRIC RELAYS** from SUEZ to the SOLOMONS

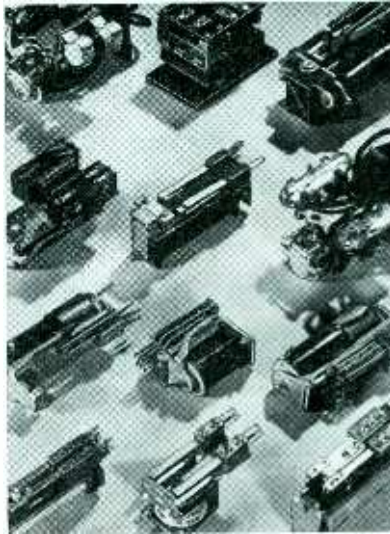

This is a war of electrical control—and we'd like to tell you about the scores of ways in which Automatic Electric Relays are helping the armed forces—in tanks, aircraft, ships and guns. But the telling might give aid to the enemy, so this interesting story will have to wait.

Meanwhile, if you are designing or building war products that use electrical control, you can save time and effort by calling in the Automatic Electric field engineer nearest you. He will be glad to work with you in selecting the apparatus best suited to your needs.

Ask him also for our 80-page catalog describing the complete line of Automatic Electric Relays, Switches and other control apparatus. No other book treats the subject so completely. Or write to us direct; and we'll forward a copy promptly.

AMERICAN AUTOMATIC ELECTRIC SALES COMPANY
1033 West Van Buren St., Chicago, Illinois

RELAYS

AND OTHER CONTROL DEVICES BY

AUTOMATIC ELECTRIC

**ON THE HOME FRONT, TOO,
SPECIALISTS ARE VITAL!**

PAR-METAL
Specializes

IN THE MANUFACTURE OF

**CABINETS
CHASSIS
PANELS
RACKS**

for

**ELECTRONIC
APPARATUS**

Send specifications;
or write for our
Catalog No. 41

U. S. ARMY
BRANCHES

U. S. ARMY
BRANCHES

PAR-METAL PRODUCTS CORPORATION

32-62—49th STREET . . . LONG ISLAND CITY, N. Y.
Export Dept. 100 Varick St., N. Y. C.

KENYON

COMES THRU *Every Time*

WHERE SPECIFICATIONS ARE TOUGH

Navy specifications involving the apparently impossible **censored** have been successfully met by Kenyon's new triumph the **censored**

Kenyon recently responded to the Signal Corps specifications **censored** with a new type **censored** transformer.

. . . Well, after the war you'll hear all about it. Until then, just remember, where specifications are toughest you'll find a Kenyon Transformer.



PLASTIC BRANDING } by ROGAN

PLASTIC MOLDING }

While molding and branding plastics that serve on all battle fronts, Rogan is also preparing for the peace that will follow. Preparing to meet the demand from peacetime industry for the many NEW applications of plastics. And, when Peace does come, get Rogan facts on how you can get faster production of plastic parts at less cost. Write now about your present War plastics and future Peace products.



ROGAN BROTHERS

2003 South Michigan Avenue Chicago, Illinois

Test Equipment and Material. This descriptive catalog gives an idea of the instruments the new Waugh Labs have available. The catalog consists of two sections: pictorial and instrument. The pictorial section shows photographs of the aviation industry, bridge engineering, combat matériel, reinforced concrete, marine engineering, oil industry, railroad field and steel structure. The instruments and testing machines for use in laboratories and field testing operations are described and illustrated in the instrument section. Among the instruments covered are those used for induced vibrations and forces, vibration and noise measuring, strain measuring, auxiliary tools for strain analysis, loads, forces and shocks, time, space and movement recording and heavy testing. From Waugh Laboratories, 420 Lexington Ave., New York, N. Y.

Measuring and Control Instruments. Bulletin Z-6100 gives a condensed listing of measuring and control instruments. Unit construction of temperature controllers and the electronic principles for obtaining control without contact between measuring and control functions of the instrument are described and illustrated. Remote controllers, combustion safeguard equipment and other instruments are presented. A complete price list is also included. Wheelco Instruments Co., Harrison & Peoria St., Chicago, Ill.

Selenium Rectifiers. Bulletin RDP-103 describes and illustrates selenium rectifiers for industry utility and railway service. The bulletin illustrates and describes briefly thirty different types of rectifiers. Among those are selenium rectifiers, Balkite tantalum rectifiers, tantalum capacitor arrester, and electrical contacts. Bulletin RDP-103 available from Fansteel Metallurgical Corp., N. Chicago, Ill.

Training Fire Brigades. "The Organization and Training of Industrial Fire Brigades" is a book which can be used by business and industrial establishments as a safeguard against the hazards of fire and other destructive elements. The price of the book is \$1.00 and a special quantity discount is offered to those organizing private fire brigades among their own employees. Reprints may be obtained for use in connection with large scale training programs. S. C. Toof & Co., 195-201 Madison Ave., P. O. Box 55, Memphis, Tenn.

Circuit Breakers. Bulletin PR-95 covers the PSM circuit breaker or circuit protector; included also are average performance curves on PSM. This device has been approved by the Army Air Force, Bureau of Aeronautics, Navy Dept. and C. A. A. Bulletin PR-95 is obtainable from Spencer Thermostat Co., 34 Forest St., Attleboro, Mass.

Plastics. In a 36-page booklet application data on Micarta is given. Micarta is a plastic which can be used to take the place of many unavailable critical materials. The booklet includes test data obtained by A. S. T. M., tells how Micarta is supplied, how it is graded and how it can be machined or molded. Micarta data book from Westinghouse Electric & Manufacturing Co., E. Pittsburgh, Pa., Dept. 7-N.

Labor Arbitration Rules. A revised edition of Voluntary Labor Arbitration Rules of Procedure, to meet war regulation and conditions, covers such subjects as: Panels of Arbitrators; Summary of Procedure with Respect to Parties, Arbitrators and the Associations; Institution of Proceedings; Appointment of Arbitrators; Hearings and Awards. A special section on the arbitration of wage disputes is included. The rules are accompanied by a manual for using them. Both are available from American Arbitration Assoc., 9 Rockefeller Plaza, New York, N. Y.

Electrical Connectors. This catalog presents engineering data and approved mechanical methods for terminating aircraft wires and cables. All the fittings described in this catalog meet the requirements for quality and performance standards set up by the Army Air Corps and Navy Department, Bureau of Aeronautics. The catalog is broken up into five different sections: Section 1 tells how and why Sta-kon terminals work; Section 2 tells how and why Wedge-on terminals work; Section 3 describes and illustrates Tite-bind terminals; Section 4 describes and illustrates bonding jumpers and Section 5 describes and illustrates some of the specialties manufactured. Included in the catalog is a listing of the various other catalogs available upon request which give descriptive and engineering data on high quality electrical material being made and used in various phases of the War Production Program. T & B Catalog 36 will be sent free to those writing requests on business letterhead and mentioning ELECTRONICS. The Thomas & Betts Co., Elizabeth, N. J.

Stroboscopes. In a booklet entitled "Eyes for Industry" various stroboscopic techniques are covered. In it are covered the types of stroboscopes, qualitative and quantitative measurements, typical uses, operating hints and techniques, photography and specifications. Obtainable from General Radio Co., 30 State St., Cambridge, Mass.

In the October 1942 issue of *The General Radio Experimenter* is an article "Frequency Characteristics of Decade Condensers". The article covers dielectric polarization, residual impedance, and effect of using condensers in parallel. Obtainable from the above address.

Plastics. A 12-page "Vinylite Plastics for Wire and Cable Insulation" reviews the advantages derived from the use of Vinylite resin compounds for wire and cable insulation from the standpoints of installation, service and safety. It points out many instances where it can be used to take the place of rubber. Included also are tables indicating the physical and electrical properties of the compounds and typical applications. Copies obtainable, use business letterheads when writing: Halowax Products Division, 30 E. 42nd St., New York, N. Y.

Tin-Base Bearing Metals. Publication No. 111 presents the factors governing the adhesion of tin-base bearing alloys to various backing metals, including steel, bronze, copper, brass and cast iron. The conditions for obtaining efficient bonds are considered and a large number of tests and the results of individual tests are described. Copies of the paper maybe obtained from the Tin Research Institute, Fraser Rd., Greenford, Middlesex, England or Battelle Memorial Institute, 505 King Ave., Columbus, Ohio.

. . .

Carrier Current Communication

(Continued from page 77)

British domestic radio as ancillary service. According to his proposal, several broadcast program channels would operate concurrently with facsimile transmissions. Whether such a plan would be feasible in this country, where radio and the power utilities are not government operated, is a subject for further speculation and study. Carrier current broadcast, however, has already demonstrated its value for furthering local education and public service. Its future no doubt will be dependent upon subsequent technical developments as well as on the public and federal needs.

REFERENCES

- (1) Leblanc, M.: *Le Telephone Multiplex, La Lumiere Electrique*, p. 97, April 17, 1886.
- (2) U. S. Pat. 596,017 (1897), Fr. Pat. 215,901 (1891), Brit. Pat. 23,892 (1892).
- (3) Colpitts, E. H. and Blackwell, C. B.: *Electrical Engineering*, Vol. 53, p. 205, 1921.
- (4) Loughlin, J. D.: *AIEE Transactions*, p. 147, Vol. 58, April, 1939.
- (5) Frank, E. and Phillips, D.: *Communications*, p. 5, July, 1942.
- (6) ELECTRONICS, p. 59, August, 1942.
- (7) Borst, D. W.: *IBS Publications*, July, 1940.
- (8) Bramhall, F. B. and Broughtwood, J. E.: *AIEE Transactions*, p. 36, Vol. 61, January, 1942.
- (9) Eckersley, P. P.: *Wireless World*, p. 298, December, 1941; p. 7, January, 1942; p. 96, March, 1942.



★ Clarostat reputation is thoroughly tried night after night, in those bombing planes that go out—and come back.

The maker of critical navigational instruments wanted supreme dependability in an illumination control. That control must be absolutely immune to extreme temperature variations, the worst humidity and other climatic trials, intense vibration and all-around rough usage.

And so Clarostat engineers developed this precision dimmer. Tapped winding with silver-soldered connections and rivets. Silver contact points lapped to precise height above bakelite support. Silver contact shoe on phosphor-bronze rotor. Cast-metal frame and snug-fitting bushing with shaft. Corrosion-proof casing. Fussy? Of course; but right down the Clarostat alley!



★ Send Your Problem to . . .



CLAROSTAT MFG. CO., Inc. - 285-7 N. 6th St., Brooklyn, N. Y.

NOW

a really high-powered

RADIO

ENGINEERING

LIBRARY

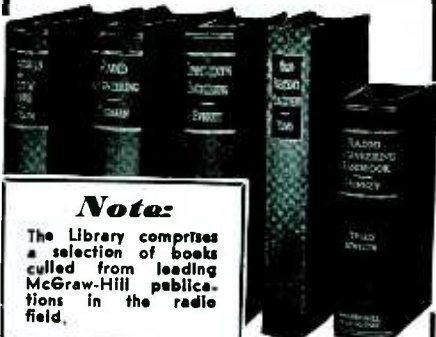

Note:
The library comprises a selection of books culled from leading McGraw-Hill publications in the radio field.

- ↳ especially selected by radio specialists of McGraw-Hill publications
- ↳ to give most complete, dependable coverage of facts needed by all whose fields are grounded on radio fundamentals
- ↳ available at a special price and terms

These books cover circuit phenomena, tube theory, networks, measurements, and other subjects—give specialized treatments of all fields of practical design and application. They are books of recognized position in the literature—books you will prefer to and be referred to often. If you are a practical designer, researcher or engineer in any field based on radio, you want these books for the help they give in hundreds of problems throughout the whole field of radio engineering.

- 5 volumes, 3559 pages, 2558 illustrations**
- Eastman's **FUNDAMENTALS OF VACUUM TUBES**, 2nd edition
 - Terman's **RADIO ENGINEERING**, 2nd edition
 - Everitt's **COMMUNICATION ENGINEERING**, 2nd edition
 - Hund's **HIGH FREQUENCY MEASUREMENTS**
 - Henney's **RADIO ENGINEERING HANDBOOK**, 3rd edition

SPECIAL LOW PRICE • EASY TERMS

Special price under this offer less than cost of books bought separately. In addition, you have the privilege of paying in easy installments beginning with \$3.00 in 10 days after receipt of books, and \$3.00 monthly thereafter. Already these books are recognized as standard works that you are bound to require sooner or later. Take advantage of these convenient terms to add them to your library now.

FOR 10 DAYS EXAMINATION SEND THIS

-----ON-APPROVAL COUPON-----

McGraw-Hill Book Co., 330 W. 42nd St., N. Y.

Send me Radio Engineering Library for 10 days' examination on approval. In 10 days I will send \$3.00 plus few cents postage, and \$3.00 monthly till \$24 is paid, or return books postpaid. (We pay postage on orders accompanied by remittance of first installment.)

Name

Address

City and State

Position

Company L. 1-43

Plant Procedure

(Continued from page 63)

moved up in order to expedite production. This shipping material schedule is a check between the production manufacturing activities of the manufacturing firm and the outside firm from whom materials are purchased.

The folder now goes to active files to await shipping data, or changes, correspondence, etc., cleared through the customers' relations clerk. This clerk, at position No. 2, is the sole liaison between the manufacturer and its customers' expeditors. Upon receiving the 3x5-inch card from the incoming order department, mentioned earlier, he files this under the manufacturer's name and uses it for quick reference to answer telephone and telegraph inquiries regarding the status of the order, the anticipated date of delivery, to discuss changes in design, specifications, etc. When the Planning Department gives him its tentative production schedule on the order, he immediately conveys this information to the customer. If the customer wishes information from a department head, the customers' relations clerk will clear it. Even telephone calls are noted on forms which show the name of the person calling, what the conversation was about, and what the answer was. Such forms go into the job folder.

As mentioned in the discussion of the planning operation, dollar values of the daily shipments of each order are entered on the planning sheets. From the planning sheets for all of the 25 classifications, a final control record is built at position No. 9. This is a daily report of all orders and shipments according to priority, end use, quantity and value. From such a record it is a comparatively simple matter to secure the information necessary concerning any product or material for any given period.

At the present time it is possible for any Alden executive in a moment to tell from these control records what orders are coming in or being shipped on any day, what priorities and end uses are involved, the number of different types of units and their value manufactured during the day, and what materials were used in this production.—B.D. and R.H.F.



Harvey may help to cure those headaches caused by scarcities of certain radio materials. We act as procurement agents for essential manufacturers and military services.

They find that our knowledge of the field and our intimate contact with sources of supply is invaluable in locating material and expediting deliveries. May we take a problem off your hands?

HARVEY RADIO CO.
103 W. 43 St. New York, N. Y.

OK'd

by

ENGINEERS

Wherever installed—Lingo Radiators have exceeded all efficiency expectations. No wonder alert engineers look to Lingo for top efficiency and managers are enthused by the increased sales made possible by increased signal strength and coverage.

Photo shows installation of the 350 ft. Lingo Tubular Steel Radiator at station WBOC, Salisbury, Md.

LINGO

VERTICAL

TUBULAR STEEL

RADIATORS

JOHN E. LINGO & SON, INC., CAMDEN, N. J.

Electronic Generators

(Continued from page 59)

tronic equipment, transmission lines and inductor coil are shielded as a precaution against interference to radio services such as broadcasting, airplane beacons, etc. Controls or switches manipulated during operation are of the dead front or low voltage type. Interlocks are provided on doors to all compartments in which dangerous voltages exist.

A typical circuit schematic for a two tube self-excited oscillator with its associated mercury vapor rectifier is shown in Fig. 2. Once the oscillator and rectifier filaments are energized the main breaker K_8 is used for "on-off" operations. The induction regulator of appropriate percentage buck or boost is used to adjust power output of the electronic generator. Control of power output may be made either manual or automatic. The oscillator tubes may be either water or air cooled. For the larger size generators, such as 100 kw output or more, water cooling of the oscillator tank circuit inductance LT_3 and the inductor coil L_1 is desirable to minimize losses and removing heat dissipated in these coils.

The short circuiting breaker, K_{10} , and associated resistances R_1 , R_2 , and R_3 , function as a step-starting current limiting device. The contacts K_{10} close within a few cycles after the main breaker K_8 . If a-c overload occurs relays K_9 through their contacts act to de-energize the holding coil of the main breaker, thereby removing voltage from the primary of the main plate transformer. The d-c overload protection is by the plate current relay K_2 which acts to de-energize the main breaker K_8 . Starters K_5 and K_7 include thermal overload protection for the oscillator and rectifier filaments. An air (or water) protective interlock K_3 to prevent filament or plate voltage from being applied to the oscillator tubes unless there is proper flow of cooling water or air.

Power Rating of H-F Generator

The power output rating of the oscillator is based on the well known formula for determining quantity of heat which must be added to M pounds of a substance of given specific heat to increase its temperature the desired number of degrees.

$$P = 2.93 MC \Delta T \times 10^{-4} \quad (6)$$

where
 P = power in kilowatt hours
 M = pounds of material to be heated
 C = specific heat
 ΔT = degrees Fahrenheit temperature rise

Knowing the time interval in which the heating must take place and making appropriate allowance for heat losses, the power output rating of the oscillator may be determined.

Future Possibilities

The availability of electronic type high frequency generators offering adequate power capacity for industrial use is a comparatively recent development. New uses for high frequency heating are constantly being discovered as its potential possibilities become more generally appreciated. There are probably many processes where high frequency heating has as yet been unthought of, where, if applied, it would produce a superior product or effect operating economies.

REFERENCES

- (1) Burch, C. R. and Davis, N. Ryland, Theory of Eddy Current Heating. Ernest Benn Lts.—London.
- (2) Warren, A. G., Mathematics Applied to Electrical Engineering. Pages 243 to 264, D. Van Nostrand.
- (3) Rosenberg, Dr. E., Eddy Currents in Iron Masses. *The Electrician*, Aug. 24, 1923.
- (4) Babat, G., and Losinsky, M., Surface Hardening of Steel by Heating Through High Frequency Currents.—*Revue General D'Electricite* Oct. 22, 1938.
- (5) Babat, G., and Losinsky, M., Heat Treatment of Steel by High Frequency Currents. *Journal The Institution of Electrical Engineers*—London. Vol. 86, No. 518.
- (6) Northrup, E. F., Principles of Inductive Heating with High Frequency Currents. *Transactions American Electrochemical Society*.—XXXV pages 69-159 1919.

• • •

TOWER MAN

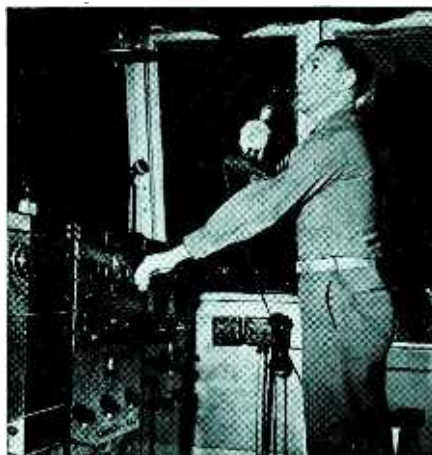

Photo shows a radio tower man at an army base somewhere in the United States talking to pilots in planes overhead



★
★
★

Today, as American military might fans out over the globe, radio becomes an increasingly vital artery of communication. New and astounding developments are being made daily. Tomorrow, after this war has been won, radio communications will revolutionize our present modes of living.

★
★
★

HARVEY-WELLS COMMUNICATIONS

Are Helping to Win the War

★

HARVEY-WELLS Communications inc.

★
HEADQUARTERS

For Specialized Radio Communications Equipment
SOUTHBRIDGE, MASS.

RADIO, ELECTRONIC AND SOUND SUPPLIES AVAILABLE!

Lafayette is your COMPLETE source of supply, especially on those hard to find Electronic, Radio and Sound Equipment parts . . . no order too small or too large for our prompt attention. LAFAYETTE GIVES YOU IMMEDIATE ACTION on deliveries! Lafayette personnel is trained to work with your expeditors.

If quick delivery of engineering samples, or production quantities is your problem, write, wire or phone Lafayette.

FREE Buyers Guide!—130 pages indexed for quick reference . . . Get your copy now! Address Dept. 1G3, 901 W. Jackson Boulevard, Chicago, Ill.

[Camera Fans—Photographic equipment at lowest prices! Write for complete catalog.]

LAFAYETTE RADIO CORP.

901 W. JACKSON BLVD., CHICAGO, ILL. • 265 PEACHTREE ST., ATLANTA, GA.



Electron Microscope

(Continued from page 68)

the peculiar physical properties of very thin metallic films. A micrograph for example of an evaporated silver film indicates a remarkable regularity in the process of formation. Passing over to more elementary matters, the same instrument may be used to demonstrate why face powder sticks.

A field of constantly increasing importance is the chemistry of organic polymers, such as plastics and synthetic rubbers. While not much can be said about developments in this field at the present time, it appears certain that the electron microscope will prove a valuable aid in the study of these materials.

Three-dimensional Micrography

The value of the electron microscope as an instrument for the determination of the shapes and structures of finely divided matter is greatly enhanced by some relatively simple accessory equipment. To begin with, an ordinary micrograph, whether obtained with an electron microscope or with a light microscope, represents the object in two dimensions only, in effect, it shows a projection of the object on a plane normal to the instrument axis. The characteristics of the object in the third dimension, i.e. in a direction along the axis, can be inferred only indirectly. On the other hand, if the object is viewed from a different angle by each eye, the brain fuses the two images, resulting in a perception of the object in all its three dimensions. It is thus merely necessary to obtain two micrographs of the same object inclined by a small angle (e.g. 4 deg.) to the axis of the objective in two opposite directions and to view these in an ordinary stereoscope to obtain the desired three-dimensional representation. In the case of high-power light microscope this is impractical, since their depth of focus is so small that the required inclination of the object would render the image unsharp except in a very narrow range. The electron microscope, on the other hand, having extraordinarily great depth of focus, is ideally adapted for this purpose.

To obtain the two stereo-images,



... Turn 'em
QUICKER
... Turn 'em
FARTHER
— BY HAND!

Knurling of Socket Screws originated with "Unbrako" years ago.

Reg. U. S. Pat. Off.

UNBRAKO KNURLED

Socket Head CAP SCREWS

The hand is quicker than the wrench. That's why the knurled heads of "Unbrako" Cap Screws just naturally speed assembly work . . . make it easy for greasy fingers to grip the head . . . turn it faster and farther before a wrench is needed.

You pay no more for this added time-saving feature when you buy Knurled "Unbrako." Catalog on request.

Sizes: No. 4 to 1/2" diam.

STANDARD PRESSED STEEL CO.
BOX 596 JENKINTOWN, PA.
BOSTON • DETROIT • INDIANAPOLIS • CHICAGO • ST. LOUIS • SAN FRANCISCO

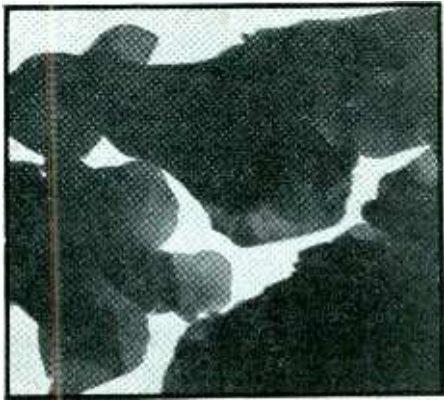

Lead arsenate particles, not so good as an insecticide, are thick and granular. $\times 25,000$

the object disk is inserted at the bottom of a special object holder, the holder is placed in the object chamber, and a first exposure is made. Then the holder is taken out and the central, inclined, portion rotated 180 deg. about its axis. After the holder has been reinserted backwards into the object chamber, the second exposure is made; except for a reversal of its inclination with respect to the optic axis, the object occupies now the same position relative to the objective as in the first exposure. The impression of depth in the resulting stereo pictures is very striking.

Of even greater value, especially for the chemist, is an adapter, which converts the electron microscope into a high-precision electron diffraction camera for the determination of the crystalline structures of materials.⁷ This is accomplished by replacing the usual projector lens by a unit containing, in addition to a magnetic projector lens, a specimen holder and a special focusing lens for the diffraction camera. When the electron microscope is used as a diffraction camera, the specimen is removed from the object chamber and inserted instead above the special focusing lens. The objective serves simply to form an exceedingly fine point image of the source, so that any part of the specimen is struck by electrons coming from one direction only. The projector lens is rendered inoperative. At the object the incident electrons are deflected or "diffracted" through angles which are characteristic of the relative separations and orientations of the atoms in the crystal lattice of the specimen. The focusing lens serves to concentrate all electrons

deflected through a given angle and in a given direction at the same point of the plate.

The specimen holder of the camera is designed for a quick and convenient transfer of a specimen from the object chamber to the camera, so that the diffraction pattern, giving information regarding the crystalline structure of the material, may be compared directly with the micrograph of the same substance. It is also convenient for the study of any other small specimen, be it either transparent or opaque to electrons; in the latter case it must be so oriented, that the electron beam just grazes the surface. Provision is made both for moving the specimen back and forth and for rotating it after it has been introduced into the vacuum.

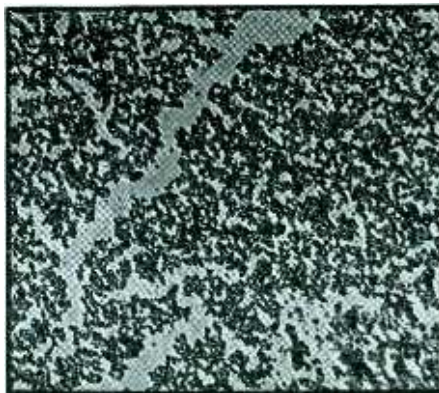

Micrograph of mercurochrome. Individual particles cannot be seen in light microscope. $\times 32,500$

If the substance studies consists of small crystalline particles oriented in random fashion, the deflection of the ray through a given angle may take place with equal probability in any azimuth, so that the diffraction points on the plate arrange themselves in circular rings about the axis, giving rise to a so-called Debye-Scherrer diagram. From the diameters of the rings may be determined the spacings and relative orientation of neighboring atoms in the crystal lattice. Single crystals, on the other hand, give rise to reflection patterns which readily permit the determination of lattice constants within three-tenths of one percent.

Importance of Accelerating Voltage

It has already been mentioned that the scattering and absorption of electrons by matter is such that only very thin specimens can success-

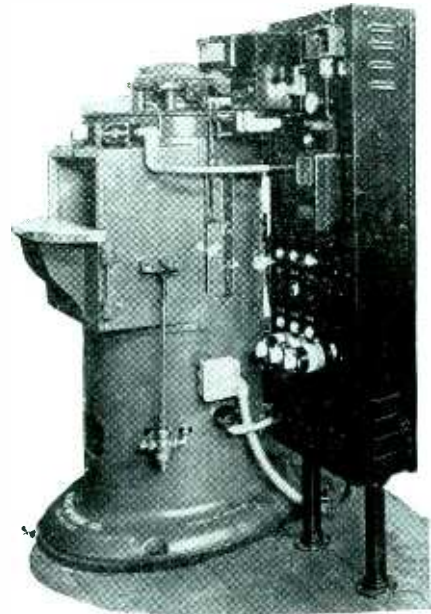

Announcing AUTOMATIC WAX-COATING OF SMALL PARTS!

With this new Dipping,
Impregnating and Centrifuging
Machine

- Incredible economy
- Extreme simplicity
- Elimination of waste
- Faster production
- Finest mechanical design
- Wholly or Semi-automatic
- Safety features—no fire hazard—will pass underwriter's inspection.
- Pilot light and accurate instrument control of wax and air temperatures; and electrical and mechanical operations.
- Absolute coating of surfaces, punch-holes, thin edges, etc.

For the moisture-proofing of small parts, delicate or rugged, at high speed and without breakage—to insure operation and stability under all conditions of dampness or moisture, in the stratosphere or on the ground—this machine has been developed in conjunction with one of the largest government contractors making airplane radio parts and equipment.

Whether it be hot-waxing of mica, plastic or porcelain radio parts, enameling or hot tin dipping, we can furnish you with apparatus designed and developed to do each in the quickest and most economical manner.

Machines now may be leased by government contractors or high priority-rated concerns.

We are prepared to coat your products on an economical contract basis.

Wire or write for full details

**PRODUCTION
ENGINEERING CORP.**
666 VAN HOUTEN AVE.
CLIFTON NEW JERSEY
Telephone: PASSAIC 2-5161



PRIORITY ORDERS

• Dalis Service has meant **SPECIALIZATION** in meeting radio and electronic parts requirements since 1925. The great number of items obtainable from ONE source has saved untold money, time and trouble for thousands of Dalis customers.

That **SPECIALIZATION** is today even more significant in expediting priority orders. Ample stocks on hand provide immediate shipment in many instances. And if items are not in stock Dalis gets them to you in the shortest possible time.

Let Dalis **SPECIALIZED SERVICE** help you fill your urgent priority needs, with maximum efficiency, minimum delay.

• **Write, wire or 'phone**



H. L. DALIS, Inc.

Distributors of
RADIO & ELECTRONIC SUPPLIES
17 Union Square - New York, N.Y.

Phones: ALganquin 4-8112-3-4-5-6-7

fully be examined with the standard electron microscope, which has an accelerating voltage of 60 kv. In many fields of investigation this represents no particular limitation. In particular, in the study of very fine structures and disperse material, the thicknesses being comparable to the widths of the individual entities, the substances are adequately transparent. Not infrequently, the operation at voltages below 60 kv. presents even a definite advantage, leading to greater image contrasts and, hence, easier recognition of very thin structures. However, in a number of other cases, such as the study of the inner structure of large bacteria and that of cut sections, of great importance in many branches of histological research, the thickness of the specimen is such that the field either appears completely opaque or that interesting structures appear only with inadequate definition. Under such



Why face powder sticks—an application of the microscope to the cosmetic chemist.
× 27,000

circumstances the employment of electrons of greater velocity and, hence, greater penetration becomes profitable. With this in mind, an electron microscope operating with electrons accelerated through potential differences up to 300 kv. was constructed.* The principal modification of the instrument rests in the high-voltage equipment, which is now housed in a large separate oil tank, and in the design of the "electron gun," in which the electrons acquire their high velocity. The latter is divided into two sections; the corona ring separating them being maintained at a potential halfway between that of the cathode and of ground.

The effect of the magnitude of the

accelerating voltage on the contrast and the perception of detail in the image of a group of aluminum oxide monohydrate, or diaspor, scales placed on a thin celluloid film is shown. The latter is clearly visible only in the 30-kv. picture. At the same time, all of the oxide scales, with the exception of one very small one, appear completely opaque, making it impossible to distinguish one from another. As the voltage is increased, all of the scales become progressively more transparent, revealing more detail, in particular where they are superposed. At 200 kv. all of the scales are largely transparent, even those which are set practically on edge on the supporting film; at the same time, the thinnest scale has very nearly disappeared. By employing the higher voltages it was found possible, for the first time, to obtain satisfactory pictures of organic sections prepared with a microtome, though these can scarcely be made thinner than a 0.025 inch.

Study of Opaque Specimens

Although the high-voltage microscope extends the range of thicknesses which can be examined with the electron microscope, it does not, any more than the standard instrument, make possible the direct observation of the surfaces of opaque specimens. The utilization of electrons reflected at the surface of the specimen for the formation of the image, analogous to the use of reflected light in the metallographic light microscope, does not solve this problem, since reflected electrons are too inhomogeneous in velocity to lead to satisfactory pictures. Two techniques have been worked out, however, which make use of the high resolving power obtainable with electrons in the study of opaque specimens such as polished and etched metallographic sections.

The first of these⁶ makes use of the standard electron microscope. It involves the preparation of a plastic replica of the surface, thin enough to transmit electrons readily. A procedure which has given very satisfactory results requires an initial evaporation of silver unto the surface in vacuum. The silver coating, bearing the negative imprint of the surface, is then pulled off and a collodion solution flowed over its original surface of contact.

When the collodion has dried, the silver may be dissolved off with nitric acid and the positive collodion replica is left.

The effectiveness of this technique is illustrated as follows. An enlarged oil-immersion light micrograph of fine pearlite structure in steel only partially resolves the structure which to a considerable extent, is beyond the limit of resolution of any light microscope. An electron micrograph of a replica of the same specimen at four times as great magnification, however, shows all the detail sharp and perfectly resolved. The electron microscope, in conjunction with the replica technique, represents a considerable advance over the metallographic microscope in the resolution of fine surface detail.

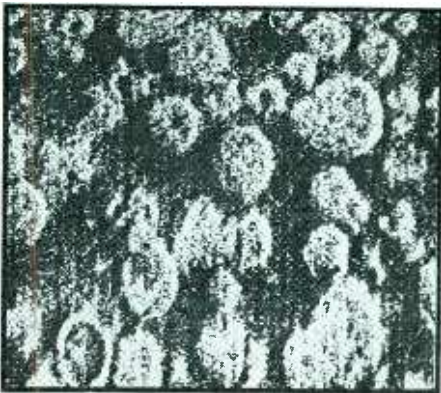

Micrograph of slightly annealed brass made with the scanning microscope. $\times 3500$

A second method of surface investigation prepares a picture of the surface of the opaque specimen directly. The apparatus here utilized, the "scanning electron microscope,"⁷⁰ differs basically both from the standard electron microscope and the conventional light microscope. In place of forming the complete image simultaneously, the intensity of a single minute picture element, corresponding to a halftone dot in the printed reproduction of a photograph, is recorded at any one time; as in electric picture transmission and television, the final picture is built up out of a great number of such elements of different intensity.

The general plan of a successful instrument of this type is as follows. A succession of electrostatic lenses forms a greatly reduced image of an electron source on the object; the diameter of this electron spot is less

Kray Orientation
INSURES HIGH ACTIVITY

CAMBRIDGE THERMIONIC CORP.
447 CONCORD AVE., CAMBRIDGE, MASS.

TAYLOR
LAMINATED PLASTICS
Vulcanized Fibre • Phenol Fibre
SHEETS, RODS, TUBES, FABRICATED PARTS
TAYLOR FIBRE COMPANY
NORRISTOWN, PA.
Pacific Coast Headquarters: 544 S. San Pedro St., Los Angeles, Cal.

Changed Your Address?

• Copies of **ELECTRONICS**, to have their full value, should reach you promptly and with no inconvenience. This we constantly strive to do.

BUT, if you have moved lately and haven't notified us it means a delay in your copy reaching you.

If you are planning to move, why not tell us so we can change your stencil to coincide with your change of address?

Just fill-in this form and mail it to us. We'll do the rest in getting your copies to you promptly.

Your Name

Old Address

City & State

New Address

City & State

Company

Title

ELECTRONICS

330 West 42nd St. New York City

IN THE THICK OF THE ACTION

Where the battle is hottest, there you will find radio communications leading the way to Victory. And there you'll find the reason why BUD Products are in such great demand by America's armed forces.

BUD RADIO, INC. Cleveland, Ohio

REMLER

Plugs and Connectors



ARMY SIGNAL CORPS SPECIFICATIONS

- Also PL—PLP—PLQ and PLS Plugs
- M Type Connectors
- M Type Caps
- FT Type Fittings

Quantity Prices Quoted
on receipt of Delivery
Schedules

*Manufacturers of Communication Equipment
SINCE 1918*

REMLER COMPANY, Ltd. • 2101 Bryant St. • San Francisco, Calif.

than a millionth of an inch, corresponding, in short, to a single picture element of the final image. The secondary electrons given off by the object where struck by the electron beam measure the relative "brightness" of that particular portion of the object. Returning through the last lens, they fall on an inclined fluorescent screen, whose resulting light emission controls the output current of an electron multiplier. This current, after further amplification, ultimately controls the intensity of the halftone lines in the image printed by a facsimile recorder, the image being recorded in synchronism with the displacement of the fine electron spot relative to the specimen surface.

With this instrument numerous pictures have been obtained with resolutions of the order of a five-hundred thousandth of an inch, considerably better than can be obtained with the light microscope.

As may be gathered from the preceding discussion, the design of the RCA electron microscope was guided primarily by two considerations: high performance and great versatility. The first property finds expression in a close approach to the theoretical limit of resolution. It is expected that, with further refinements of technique, the ratio between the practical and theoretical limit, at present equal to 2 or 3, will be reduced very nearly to unity. With this improvement molecules of moderate size will become suitable objects for observation.

The other property, versatility, reveals itself both in the possibility of studying specimens with electrons of different voltages and with magnifications continuously variable in a range of 25:1, and in the adaptation of the instrument for many special techniques. Its employment for obtaining three-dimensional views of specimens and as a precision electron diffraction camera have already been described. Accessory equipment permitting the study of materials in a frozen state and for utilizing the scanning principle in the examination of opaque specimens is being developed. Thus, the user of this electron microscope is certain to benefit by every new advance in electron microscope technique. The instrument may be expected to be sufficiently flexible in design to incorporate even the radical modifica-

tions in operation which will be required to overcome present theoretical limitations in resolution.

A New Microscope, Portable and Less Expensive

It has been found, at the same time, that in numerous electron microscope researches such versatility is unnecessary. In the study of colloids, viruses, and macromolecules, in particular, a fixed magnification and a relatively low operating voltage, giving large contrasts, has proved most satisfactory. Hence a new electron microscope has been developed, distinguished by extraordinary compactness and simplicity of operation. Mounted on an ordinary desk, the microscope column, from electron source to fluorescent screen or plate, measures only 16 inches. The observer, seated at the desk, views the final image on the rear of the fluorescent screen, which is deposited on a plate-glass disk. The magnification of the microscope, which operates with two magnetic lenses of fixed strength, is approximately 5000. Since the grain of the photographic materials normally employed is fine enough to permit twenty-fold enlargement, micrographs with a total magnification of 100,000 may be obtained with the instrument. This is adequate to make use of the full resolving power of the microscope.

The extraordinarily small volume of the instrument makes airlocks unnecessary—its complete evacuation takes only about 2 minutes. Focusing is accomplished by varying the stabilized operating voltage, which, in the model shown, is maintained at about 30 kv. The relatively few controls required to operate it are all within easy reach. Thus, at the sacrifice of versatility, an extremely simple and compact microscope, ideally suited for routine observations, has been created. As such it promises to free the larger instrument for the more exacting researches and the many special uses for which it alone is adapted.

The electron microscopes which have been described may be expected to play an increasing role in the furtherance of chemical research. The few applications which have been demonstrated will suggest others in related fields. In some cases the interpretation of the things observed may, to be sure, not be easy.



How did that get there?

Model RA put it there. In 1-1/5 seconds! And on 2999 other RCA Radiotron bases within the hour!

See how the clear, sharp durable lines match the clarity of hand engraving. Lasting legibility from the RCA monogram to the end of the type-of-tube identification. Years from now, because of the long, satisfying service it gave him, some consumer will want to replace this tube. He'll wipe the grease and dust away and this whole impression will re-appear as clean-cut and easy to read as it is today.

Markem markings assure repeat business from satisfied users. Does your future enjoy this protection?

Why not ask us about marking methods for your products? Whatever the size, shape or substance, we have a method and the machine to mark it quickly, legibly, lastingly and economically.

Marking of parts for war-work production is especially important. It speeds assemblies. Stops mistakes.

Catalog LI on request

MARKEM
VARIABLE DESIGNATION MARKING MACHINES

BOXES, LABELS, TAGS, ENVELOPES, TICKETS, TAGS, LABELS FROM CONTINUOUS ROLLS, COLLARS, SOCKS, STOCKINGS, SHIRTS, SHOE LININGS, TEXTILES, LEATHERS, SYNTHETICS, GLASS, METAL, WOOD, PLASTICS, PRINTED SURFACES, RUBBER SHEETS - ABRASIVES, SHAPE AND SUBSTANCE PRESENT NO PROBLEMS. There's a Markem machine to identify or decorate every part or product known to industry. And out of the Markem laboratories come special process inks, rotatable type wheels, special type bars or master printing plates so that Markem is the only source of supply you need for marking machines, devices and supplementary materials.



You made 'em - Now MARKEM



Government Departments, Universities, Schools and Thousands of Individuals Have Bought this Booklet.

WHY?

Because it is the first up-to-date treatise on the all-important new ultra-high-frequency technique.

In plain, simple, understandable text, the philosophy of ultra-high frequency technique is given to outline the nature of the problems at frequencies for which "line of sight" transmission is of paramount importance.

By means of graphs, tables, and equations, the more important quantitative results are given to familiarize the technician with the general magnitude of the quantities involved—to provide a sense of quantitative proportions and the fitness of things. Finally, since u-h-f technique cannot be treated thoroughly in a 60-page booklet a convenient bibliography is included at the end of each section.

The cost is 50¢ per copy—35¢ each in lots of 26 or more—

The supply is limited—order now.

ELECTRONICS EDITORS

330 West 42nd St. New York, N. Y.



No. 2 BLOWER HOUSING AND WHEEL

Plastic housing designed for operation in restricted spaces. Innumerable mounting possibilities. Motor requirements 1/100 H.P. various voltages. Weight only 4 1/2 ounces.

Compact — Efficient

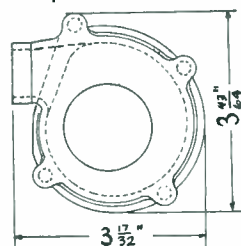

Write for complete specifications
L-R MANUFACTURING COMPANY
Torrington, Connecticut

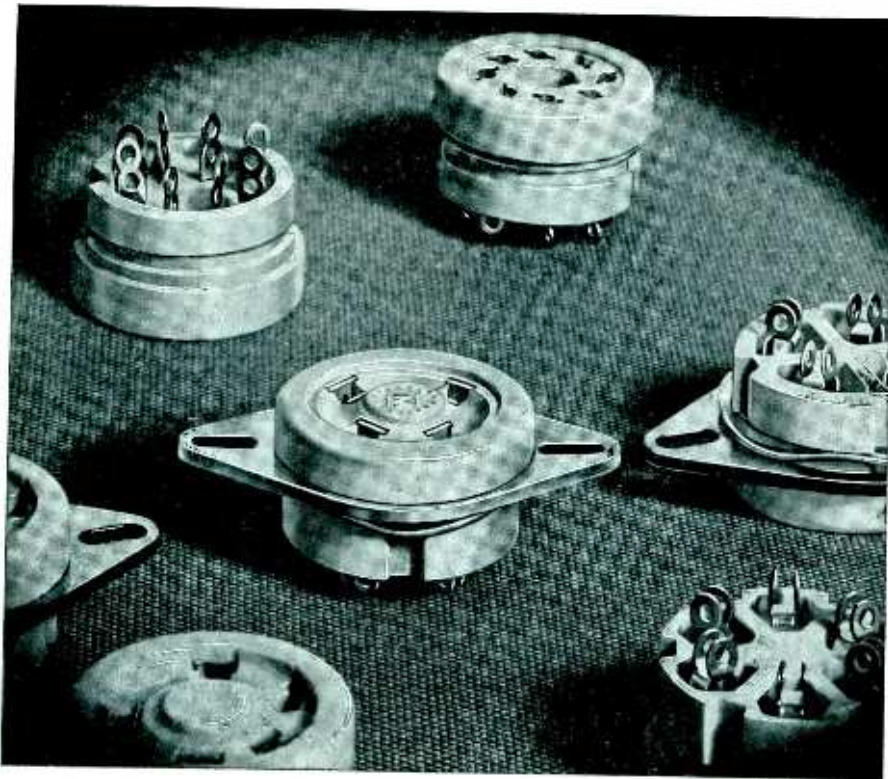

DESIGNED for APPLICATION

MODERN SOCKETS for MODERN TUBES!

JAMES MILLEN
150 EXCHANGE ST.



MFG. CO. INC.
MALDEN, MASS.

KEYSTONE N. T. C. RESISTORS

Compensates
for Resistance Changes
due to Temperature Variations

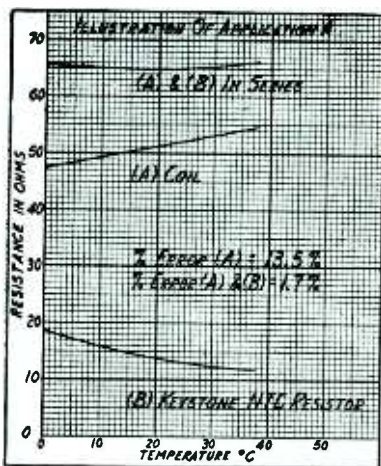
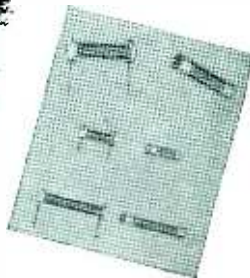

★ Compensation or neutralization of the positive temperature coefficient of electrical components in a circuit is accomplished by using Keystone Negative Temperature Coefficient Resistance Material. The resistors are furnished in a wide range of resistance values so that the proper value may be selected to produce the desired resistance change over the operating range of temperature. Internal resistance changes resulting from current flow are eliminated by selecting the proper physical size of the resistor, so that it will dissipate the required wattage without appreciable self-heating. Write for information or recommendations on your particular application.

KEYSTONE CARBON CO., INC.

Manufacturers of 1935 STATE ST., SAINT MARYS, PA.
Precision Moulded Products

The discovery of the possibility of forming images with electrons has opened up to the eyes of the scientist vast regions which heretofore had only been probed by the cautious groping of ingenious indirect methods. A barrier to vision, regarded as unsurmountable by the optical designer only a decade ago, has fallen.

Many unsolved problems of basic importance to life and work lie hidden in the unexplored realms of biology, physics, and chemistry, and their subdivisions such as medicine, bacteriology, the study of viruses, metallurgy, ceramics, plastics, and synthetics. Society may look forward with assurance to the time in the relatively near future when the researches made possible by the electron microscope will result in discoveries which will greatly enhance our health, efficiency, and comfort.

With the availability of the new and small model of the instrument, and it will be available where necessary to the war effort, the broadest attack in the history of science on the so-called submicroscopic mysteries becomes possible.

Even as scientists and engineers make haste to apply the powerful new tool for extending the mastery over their respective fields, their fellows will be busy adding to its usefulness and searching for means of breaking down new, more distant, barriers. For, though the progress of science is uneven, it will not come to a halt.

REFERENCES

- (1) Knoll, M. and Ruska, E., Electron Microscope. *Zeits. f. Phys.* 78, p. 318-339, Oct. 1934.
- (2) Ruska, E.: On Progress in the Construction and Performance of the Magnetic Electron Microscope, *Zeits. f. Phys.* 87, p. 580-602, Feb. 1934.
- (3) Prebus, A. and Hillier, J., The Construction of a Magnetic Electron Microscope of High Resolving Power, *Canad. Jour. of Research*, 17, p. 49-63, Apr. 1939.
- (4) Hillier, J., and Vance, A. W., Recent Developments in the Electron Microscope, *Proc. I. R. E.*, 29, p. 167-176, Apr. 1941.
- (5) Mahl, H., On the Electrostatic Electron Microscope of High Resolution, *Zeits. f. techn. Phys.* 20, p. 316-317, Nov. 1939.
- (6) Luria, S. E., and Anderson, T. F., The Identification and Characterization of Bacteriophages with the Electron Microscope, *Proc. Nat. Acad. Sci.*, 28, p. 127-130, Apr. 1942.
- (7) Hillier, J., Baker, R. F., and Zworykin, V. K., A Diffraction Adapter for the Electron Microscope, *Jour. Appl. Phys.*, 13, Sept. 1942.
- (8) Zworykin, V. K., Hillier, J., and Vance, A. W., A Preliminary Report on the Development of a 300-Kilovolt Magnetic Electron Microscope, *Jour. Appl. Phys.*, 12, p. 738-742, Oct. 1941.
- (9) Zworykin, V. K., and Ramberg, E. G., Surface Studies with the Electron Microscope, *Jour. Appl. Phys.*, 12, p. 692-695, Sept. 1941.
- (10) Zworykin, V. K., Hillier, J., and Snyder, R. L., A Scanning Electron Microscope, *ASTM Bulletin No. 117*, p. 15-23, Aug. 1942.

Reactance Networks

(Continued from page 72)

$$L = 0.1592 hR/F_0 \quad C = 159,200/hRF_0$$

F	R	L	C
cps.....	ohms.....	henry.....	μ f
kcs.....	ohms.....	mh.....	m μ f
Mcs.....	ohms.....	μ h.....	μ μ f

For example, to be at an impedance level of $h=4$ with respect to a 500-ohm termination at 200 cycles, the basic value of L must be 1.592 henry. Or a 100- μ f condenser operating at $F_0=10$ mc may be considered to be at an impedance level of $h=2.2$ with respect to a 72-ohm resistance impedance.

For determining what functions of k the multiplying factors m , n and p of Fig. 3 must be, one requirement is that pL and nC must be of equal numerical impedance for the special frequency value kF_0 for which $x=k$. This requires the relation $pn=1/k^2$. Two other relations must be found. Inspection of Eq. 4 indicates the desirability of making q_0 as simple an algebraic function as possible. Using the impedance designations of Fig. 3, routine algebraic procedure yields for the q 's and their product

$$q_0 = \frac{-h}{mx}; \quad q_c = \frac{-hpx}{[(m+2n)px-2]};$$

$$q_0 q_c = \frac{h^2}{[m(m+2n)x^2-2m/p]}$$

The product function $q_0 q_c$ will take on the simplest possible form $h^2/(x^2-1)$ provided the relations $m(m+2n)=1$ and $p=2m$ are met as well as the previously established relation $pn=1/k^2$. These three relations are met if m , n and p are the following function of k

$$m = \sqrt{1-k^2}$$

$$n = 1/2k\sqrt{k^2-1} = 1/2mk^2$$

$$p = 2\sqrt{1-k^2} = 2m \quad (8)$$

With these functions of k now replacing m , n and p , the q 's become

$$q_0 = \frac{-h}{\sqrt{1-k^2}(x)}$$

$$q_c = \frac{-h\sqrt{1-k^2}(x)}{(x^2-1)} \quad (9)$$

The four combinations of the q 's which determine the circuit performance are

$$q_0 q_c = \frac{h^2}{(x^2-1)}$$

$$(q_0 - q_c) = \frac{h(k^2 - x^2)}{k\sqrt{(k^2-1)}(x)(x^2-1)} \quad (10)$$

$$q_c/q_0 = \frac{(1-k^2)x^2}{(x^2-1)}$$

$$(q_0 + q_c) = \frac{h[k^2 - (2k^2-1)x^2]}{k\sqrt{k^2-1}(x)(x^2-1)}$$

Substitution of the product, difference and sum functions of the q 's in Eq. 4 and 5 yield the loss and lag equations which when reduced to simplest form are recorded as part of the Chart. These permit loss and lag curve shapes to be computed and plotted as functions of $x = f/F_0$ for all possible combinations of h and k within the allowable ranges of these parameters. The loss is zero db for any condition making F_{loss} zero, including the two conditions $x=0$ and $x=a = \sqrt{1-h^2}$, the latter of which occurs only if h is less than unity for this type of circuit. This condition is a function of the network and of the termination. Infinite loss requires the loss function to be infinite, including the two conditions $x=k$ and $x=\infty$, which are determined by the network only. Information is included also to enable the network elements to be computed corresponding to any specified value of R , any frequency F_0 desired to correspond to $x=1$, and any curve shape specified by numerical values of h and k .

Included with the Chart are loss curves for $h=0.6$ and $k=1.1, 1.5$ and infinity, illustrating choices of parameters which give circuit element values suitable for low-pass filter purposes. With the sharpest cutoff curve ($k=1.1$) there is only 6 db difference between maximum loss in the pass range and the minimum loss in the attenuation range. For higher values of k , greater filtering effect in the two ranges is accompanied by lesser sharpness of cutoff. At $k=\infty$, factor n becomes zero, and the element nC is therefore not required. The other limiting condition with $k=1$ results in the network being entirely absent with the two terminations direct connected to give zero loss and lag at all frequencies.

Fig. 4 shows the effect of changing the impedance level using a fixed value of $k=1.25$, and three choices of h . Values of h less than

A basic "course"
in electronics . . .
in ONE outstanding volume!



PRINCIPLES OF ELECTRONICS

by ROYCE G. KLOEFFLER
Head of the Department of Electrical
Engineering, Kansas State College

Here's a book that has been developed, enlarged, and worked over for almost a decade by Professor Kloeffler, who used the information contained as the basis for an actual course in electronics and then arranged it in book form. It is therefore an up-to-date story of electron theory and the electron tube which begins with the discovery of the electron and carries the subject along to the most modern research in the field.

Clearly and simply this book presents the important facts about electronics, and forms a basis for the study of the more complex problems of electrical engineering. Well illustrated, and comprehensively arranged, it is an ideal text for the student or the practitioner who would have a firmer grasp of the subject.

REVIEWERS SAY:

"... perfectly adapted for use in undergraduate radio defense courses in colleges, and in the Army and Navy communication courses."

"The author has done an excellent job of compiling and arranging the information now scattered in many places, and his explanations are clear and concise."

175 Pages 177 Illustrations 6 x 9
\$2.50

ON APPROVAL COUPON

John Wiley & Sons, Inc.
440 Fourth Avenue, New York, N. Y.

Please send me a copy of Kloeffler's PRINCIPLES OF ELECTRONICS on ten days' approval. At the end of that time, if I decide to keep the book, I will remit \$2.50 plus postage; otherwise I will return the book postpaid.

Name

Address

City and State.....

Employed byE-1-43

EMBODYING A HIGH DEGREE OF

SENSITIVITY

MODEL 300A ELECTRONIC AC VOLTMETER



- 10 to 150,000 cycles.
- 1 millivolt to 100 volts in five ranges (to 1,000 and 10,000 volts with multipliers).
- Logarithmic voltage scale and uniform decibel scale.
- AC Operation, 115 volts, 60 cycles.
- Accurate and stable calibration.
- Can also be used as an amplifier (70 DB gain) flat to 100,000 cycles.

A popular instrument for the measurement of AC voltages, 10 to 150,000 cycles, 1 millivolt to 100 volts (up to 1,000 and 10,000 volts with Model 402 Multipliers). Logarithmic voltage scale and auxiliary uniform decibel scale. AC operated, 115 volts, 60 cycles. By means of special circuits meter indications are independent of line-voltage, tubes, and circuit constants within 3% over entire frequency range. Several accessories are available.

Send for Bulletin 8 for complete data.

**BALLANTINE
LABORATORIES
INCORPORATED**

BOONTON · NEW JERSEY

unity, say in the vicinity of $h = 0.6$ are most desirable if low loss is desired over the greatest possible frequency range.

Figure 5 gives more detailed information for parameter values $h = 0.6$, $k = 1.25$, and includes information for a dissipative case computed by the more complex equations required, based on Eq. 1. Various loss and lag points cover an assumed case with inductor element pL including in series a resistor sufficient to make the Q of the inductor arm the reasonable value of 20. The effect of dissipation is of most importance just below cutoff. Comparison of the loss curve for the dissipative case with the curve of Fig. 4 for $h = 1$ will serve to emphasize that choice of impedance level of the network with respect to the terminations may be of more practical importance than choice of kind and amount of material necessary to give extreme values of quality factors of reactor elements. In Fig. 5, the lag points for the dissipative case justify the phase reversal for the limiting non-dissipative case at $x = k$ being interpreted as a decrease of lag with increasing frequency, thereby making the lag for infinite frequency 90° instead of 450° . This should not be considered to rule out the possibility of other and more complex networks yielding integrated lag changes of more than 360° over the entire frequency range.

The information of the Chart is arranged for ready evaluation of reactor elements corresponding to any curve shape and specified values of terminations and cutoff frequency. For example, for terminations 5000 ohms, impedance level $h = 0.6$, and $F_o = 10$ kc, the basic values of L and C are 47.7 mh and 5.31 μf . Values of the multiplicative factors for values of k greater than unity herein mentioned are given below.

k	m	n	p
1.1	0.416	0.99	0.832
1.25	0.600	0.533	1.200
1.50	0.745	0.298	1.490
Infinite	1.000	0.000	2.000

Noting that the sum of all three capacitors ($n + 2m$) C is practically independent of k , and that over a limited range of inductance the amount of material is practically independent of pL provided the coil quality Q is kept constant, it follows

that economics does not enter into the choice of k . For the choices of R , F_o , and h given above and the additional choice $k = 1.25$, the network is found to require an inductor $pL = 55.3$ mh, two condensers, $mC = 3.19$ μf , and one condenser $nC = 2.84$ μf .

The inverse problem of determining the curve shape and cutoff frequency for a specified set of circuit values is somewhat more complex, but will be carried through to indicate that all combinations are cared for in the general solution here given. Given for example $R = 500$ ohms, $mC = 0.1$ μf , $nC = 0.2$ μf , $pL = 2$ h, it is required to determine R , F_o , h and k . Knowing that pL and nC resonate at kF_o , it follows that $kF_o = 159.2/\sqrt{(pL)(nC)} = 252$ cps. Study of Eq. 8 shows k can be determined from the two condenser values mC and nC , since $k = \sqrt{1 + mC/2nC}$, that is $k = 1.12$. Therefore $F_o = 225$. Also from Eq. 8, values of m , n and p for $k = 1.12$ are 0.447, 0.894 and 0.894 respectively. Therefore from the known values of the circuit elements, $L = 2.24$ h and $C = 0.224$ μf . Using the formulas for L or for C in terms of h , R and F_o , h in either case is 6.31. Therefore, $R = 500$, $F_o = 225$, $h = 6.31$ and $k = 1.12$. For this combination the curves could be plotted if desired, but the loss curve would not be radically different in nature from Fig. 4, $h = 5$, $k = 1.25$.

• • •

Pickup Design

(Continued from page 93)

and the specific value of damping used, the equipment including the microphone, amplifier, and voltmeter is approximately identical with the equipment used to measure loud-speaker response.

The record normally used as a source is a continuously variable frequency record cut constant amplitude from 30 to approximately 800 cps and constant velocity from the latter value to 10,000 cps. Provision is made to synchronize the frequency marks on the paper used with the recording voltmeter with the frequency of the record. Music recordings, and the like, may also be used as a source. With these the abscissa will be in terms of position on

the record. The ordinate will be in terms of the noise resulting from the subject matter as recorded at that position (see discussion of results below).

Method of Test

With the equipment set up as described the pickup and tone arm are placed in playing position on the record. The door of the chamber is closed to exclude external noise. With the synchronization of frequency previously accomplished it is only necessary to start the two drive systems simultaneously and follow the needle of the meter to complete the operation of measuring record noise. Without some previous knowledge as to the level of the noise, it is usually first necessary to make a brief check so that the proper voltmeter setting is established. Sufficient damping is employed to smooth out the response as without any damping the entire response consists of a series of sharp dips and peaks. The microphone placement is held approximately constant although checks indicate that its exact position is not critical.

Discussion of Results

It will be noted that this method gives the abscissa of Fig. 7 in terms of the frequency applied to the pickup stylus by the record. The value of the ordinate at any applied frequency is in terms of the sound pressure of the noise resulting from that applied frequency. To date no attempt has been made to quantitatively evaluate the results of this method in terms of what the ear hears. It can be pointed out, however, that numerous listening tests indicate that this method gives results which are consistent with what the ear hears.

REFERENCES AND FOOTNOTES

- (1) Olson, H. F.: Tone Guard, *J. A. S. A.*, 12, No. 3, p. 374-377, Jan. 1941.
- (2) U. S. Patent 2,247,746.
- (3) U. S. Patent 2,247,731.
- (4) Pierce, J. A. and Hunt, F. V.: Distortion in Sound Reproduction from Phonograph Records, *S. M. P. E.*, 31, p. 157-186, Aug. 1938.
- (5) Fleming, Laurence: Notes on Phonograph Pickup for Lateral Cut Records, *J. A. S. A.*, 12, p. 366-373.
- (6) U. S. Patent 2,280,763.
- (7) Consideration is being given to investigating records by a method similar to that used by Sivian, Dunn and White for the investigation of "Absolute Amplitudes and Spectra of Certain Musical Instruments and Orchestras." With these data in hand, it should be possible to bring about a further improvement.
- (8) Sivian, L. J., Dunn, H. K. and White, S. D.: *J. A. S. A.*, 11, No. 3, p. 330-371, Jan. 1931.

GET THE COMPLETE TECHNICAL RADIO BACKGROUND

most in demand today under this attractive offer



SAVE OVER 10%
in adding these
standard books
to your library

Here is a library of books that brings you advanced radio engineering knowledge in the form in which you can most readily assimilate it and put it to use. The books were carefully selected from among standard McGraw-Hill works to give the most complete, fundamental coverage possible, in a small number of concise, compact, reasonably priced volumes. Use these books to bridge the gap between your own radio training or experience and more advanced, engineering command of the subject—the genuinely technical knowledge that best meets today's practical needs.

The New . . . RADIO TECHNICIANS' LIBRARY

Full of definitions, descriptions, principles, formulas, data, methods, applications, etc., relating to:

- fundamental components of a radio system
- circuit elements
- fundamental properties of vacuum tubes
- thermionic emission
- glow- and arc-discharge tubes
- amplifiers
- modulation
- detection
- electron tube instruments
- rectifiers and filters
- dynamo-electric machinery and meters
- storage batteries
- radio transmitters
- ultra-high-frequency circuits
- marine transmitters
- low-power telephone and telegraph transmitters
- radio receivers
- antennas
- radio aids to navigation
- television
- acoustics
- control-room equipment and operation
- direct-current electricity and magnetism
- alternating-current electricity
- mathematics for electricians and radiomen
- etc., etc.

comprised of these 4 volumes:

- Terman's FUNDAMENTALS OF RADIO
- Reich's PRINCIPLES OF ELECTRON TUBES
- Nilson and Hornung's PRACTICAL RADIO COMMUNICATION
- Cooke's MATHEMATICS FOR ELECTRICIANS AND RADIOMEN

2213 pages, 1332 illustrations

In two of these books widely-used advanced engineering texts have been abridged, to cover the most fundamental aspects of tubes and circuits and their applications, but in the simplified form suited to introduce the man of limited radio and electrical training to these subjects. Another volume further applies these fundamentals to practical communication apparatus, completing a view of radio with which you can solve the technical problems met in a wide variety of situations. The fourth book gives you, at the same time, a progressive command of the radio and electrical mathematics, from arithmetic to advanced principles necessary in using the formulas and computations of advanced technical work.

SPECIAL LOW PRICE EASY INSTALLMENTS

Bought separately, these books would total \$16.25 in price. Under this special Library Offer you save \$1.75 of this amount, get all four books at once, and pay for them over an extended period. Get these advantages by deciding now to add these volumes to your radio library. Mail coupon today for 10 days' free examination.

10 DAYS' FREE EXAMINATION

McGraw-Hill Book Co., 330 W. 42nd St., N. Y.

Send me Radio Technicians' Library for 10 days' examination on approval. In 10 days I will send \$2.50 plus few cents postage, and \$3.00 monthly until \$14.50 is paid, or return books postpaid. (We pay postage if you remit with first installment.)

Name

Address

City and State.....

Position

Company

FL 1-43

Resistance Welding Controls

(Continued from page 81)

tivity of the instrument is the same for all, except in Figs. 1B and 8.)

Figure 1A shows a typical timing curve. It is the voltage that appears on the grid of the thyatron inverter tube in a spot, seam or pulsation welding control. From this waveform, one can deduce a number of facts. It is apparent that the grid is being driven negative every other cycle and that this negative voltage leaks off at a fixed rate. Approximately $1\frac{1}{2}$ cycles after the voltage is applied, the peak which is superimposed on the d-c timing curve rises above the critical grid voltage and the inverter fires to start another weld period. The hold-off bias is again applied approximately $\frac{1}{2}$ cycle later. One can see that at the moment the inverter fires, the grid draws current and thereby limits the rise of the peak. It is obvious from Fig. 1B that these same conclusions could not be drawn if the oscilloscope were not sensitive to d-c voltage.

The firing circuits of phase-controlled electronic welding controls are typical examples of voltage magnitude and phase variation. Figure 3 shows the voltage appearing between the cathode and grid (not including rectified self-bias) of a thyatron firing tube. The grid has an a-c hold-off bias which is shown to be negative during the first half cycle and 180 deg. out of phase with the anode voltage.

Superimposed on this bias is a peaked voltage controlled by the heat control system. This firing tube is non-conductive, since the grid is held negative during the corresponding positive half-cycle of the anode. When the timing circuit of the control dictates that welding current should flow, a third voltage is added. It is of such polarity as to oppose the a-c hold-off bias and produce a resultant wave shape as in Fig. 4. It is apparent that the peak alone rises above the cathode potential and allows the tube to fire. When the phase angle of this peaked voltage is changed by the heat control system, the point in the cycle where the firing tubes conduct is adjusted.

If the oscilloscope is connected directly on the grid of one of the firing tubes, forms shown in Figs. 5 and 6 will result. It should be no-

ticed that the grid does not go more positive than the normal tube drop of about fifteen volts. It can also be seen that the grid conducts current at the moment the peaked voltage attempts to rise above cathode potential. The important function of rectified self-bias can be seen by comparing Figs. 3 and 5. Self-bias on the grid (Fig. 5) makes the grid go negative ahead of the anode voltage zero. If this bias does not exist, the tube may fire because of low bias at the beginning of each positive half-cycle of anode voltage.

Figure 7 is an image of the anode voltage on the firing tubes when the grid voltages are as shown in Figs. 4 and 6. By noting when the anode voltage drops to substantially zero one can tell that the tubes fire at the same time that the peak drives the grids positive. The tubes are phase controlled since they do not fire until late in the cycle. Notice that the length of time during which each tube fires is identical. If this were not the case, a d-c component would exist and the welding transformer would soon become saturated.

A study of welding current itself can be successfully carried on with a cathode-ray oscilloscope. Not only can the operation of phase control be observed, but the presence of transients and d-c components can also be discovered. Figure 8 is a photograph of one cycle of welding current on an oscilloscope screen. The heat control was varied from 100 percent current to approximately 20 percent during the exposure, to show the range of variation of the wave of current. An image lying within the shaded portion of this curve can be obtained if the oscilloscope leads are connected across a low resistance in the secondary circuit of a current transformer placed in the line supplying the welder. It is interesting to note that when ignitron tubes are fired late in the cycle the conduction period terminates sooner than with full sine waves of current. Such an oscilloscope image is used to aid in setting the 100 percent current point of the heat control and to obtain approximations of power factor. Under full-heat conditions the current zero here occurs $7\frac{1}{2}$ screen divisions after the voltage zero. Therefore, the power-

THIS
BOOK



800
Page
Buying
Directory

FREE
TO AUTHORIZED
PURCHASING AGENTS
ENGAGED IN WAR WORK
—YOUR GUIDE TO
IMMEDIATE SERVICE ON
RADIO PARTS
and INDUSTRIAL
ELECTRONIC EQUIPMENT

Here, at SUN, you will find the solution to your urgent needs—a complete, single source of supply under one roof! Thousands of standard electronic parts and equipment in stock for all industrial research, development or production requirements. Save time by coming to SUN first! Write today on your company letterhead for free copy of our 800 page buying directory. Quantity is limited—so hurry! Address Box L-1.

New York's Oldest Radio Supply House
—Telephone BArcley-7-1840—



Protect Priceless
Equipment with the
VIBROTEST



Check the insulation resistance of each piece of electrical equipment in your plant regularly with the VIBROTEST — prevent breakdowns by correcting insulation failures before they happen. Protection for this almost irreplaceable equipment becomes more vital each month the war continues. Write today for the new Engineering Bulletin on the sturdy, accurate, VIBROTEST.

ASSOCIATED RESEARCH
Incorporated

437 So. Dearborn St., Chicago
—**MANUFACTURERS OF
ELECTRICAL INSTRUMENTS**



Premax Gets Orders To the Forces

Premax Metal Antennas are maintaining communications between the armed forces on land and sea. Standard and special designs, complete with mountings, are shown in the Bulletin.

Premax Products

Division Chisholm-Ryder Co., Inc.
4302 Highland Ave., Niagara Falls, N. Y.

Professional Services

STANLEY D. EILENBERGER Consulting Engineer

Complete Laboratory and Shop Facilities
General Electronics Communications Electro Biology Patent Development
6399 27th Ave. Kenosha, Wis.
Telephone 2-4213

HAROLD J. McCREARY Mem. A.I.E.E. & W.S.E. Consulting Engineer

Laboratory Facilities
Research Development Design Factory Practice Patent Studies
Electronics Television Radio Railroads Signaling Telephony
105 W. Adams St. Phone STate 4003 Chicago, Ill.

Consult these SPECIALISTS

Let them save your time by bringing their broad experience in their specialty to bear on your problems.

factor angle is about 68 deg. and the power factor 37 percent.

There are numerous other places in a welding control where an oscilloscope can be connected to indicate whether the control is operating properly. The instrument will indicate incorrect voltages not only by showing their magnitude, but also by revealing the presence of unwanted voltage variation. Sometimes a.c. will appear in the d-c section of the timing circuit of a control. This type of trouble usually is caused by control insulation failure and results in the firing of the control even when the panel is not initiated. An oscilloscope can show the presence of this unwanted voltage and thereby reduce the time of trouble-shooting by more than half.

An important use of an oscilloscope is as a cycle counter. When only a few cycles are required per spot, the number can be observed directly by connecting the oscilloscope input leads from anode to cathode of the power tubes. Set the horizontal sweep to give six or more cycles on the screen. The number of cycles which the power tubes fire will be indicated by the voltage collapsing for that length of time and a straight line appearing on the screen instead of the a-c oscillations.

If one is studying a seam welder rather than a spot welder both the "on" and "off" time can be observed directly on the screen. If the sum of these periods is equal to the number of cycles on the screen a stationary image will exist, with the "on" period being a straight line

• • •

PLANE DETECTOR



Radio location recruits are being trained to use and maintain Britain's radio location plane detector. They are shown looking over some of the complicated radio equipment which is used to locate hostile aircraft and direct anti-aircraft guns at the target



With an APeCO Anyone Can Make Exact Photographic Copies of Blueprints, Letters, Specifications, Orders, Tracings—Anything Typed, Printed, Drawn or Photographed! Easily and Quickly!

Any boy or girl can do all your copying work—better, faster, privately—releasing Typists, Clerks, Draftsmen AND THEIR EQUIPMENT for other work.

APeCO PHOTO COPIES

are identical copies—clear, sharp, durable—legally accepted. No proofreading! No error! No maintenance cost. Foolproof! Nothing to get out of order. Don't be handicapped by using outsiders and their hours.

APeCO makes copies any size up to 18x22". 1st copy in 3 minutes; 120 copies an hour—right in your own place—anytime, day or night. No skill or darkroom needed.

IMMEDIATE DELIVERY on machine and supplies. Learn how others in your field have SAVED MAN-HOURS while speeding production. Write for time-saving facts.

\$55
F.O.B.
CHICAGO

AMERICAN PHOTOCOPIE EQUIPMENT CO.

2849 N. Clark St. Dept. AG-3
Chicago, Illinois

REPRESENTATIVES IN ALL PRINCIPAL CITIES AND CANADA

APeCO SPEEDS YOUR PRODUCTION

Putting 'em Thru the Mill!



Strip for Action! Strip made from Wilbur B. Driver Co. special alloys! Strip that has so many essential war uses! As it is rolled through our mills, day and night, we know it will do its part in flattening the Axis!

Consult us for your special alloy requirements in rod, wire, ribbon and strip—both hot and cold rolled.

WILBUR B. DRIVER CO.
NEWARK, NEW JERSEY



But not now!

Sure we'll fiddle when Tokyo and Berlin burn! For just as surely as good triumphs over evil, that day is coming! Meanwhile there's work to be done! That's where *Typhonite* ELDORADO plays a major role. Because the blueprints of Victory must be unmistakably clear, 100% correct, ELDORADO's incredibly smooth lines, uniform degrees, dustless, stronger points are helping to hasten the day of retribution.

ELDORADO

Pencil Sales Dept. 59-J1
JOSEPH DIXON CRUCIBLE COMPANY
Jersey City, N. J.

CONTROL SPLIT SECONDS

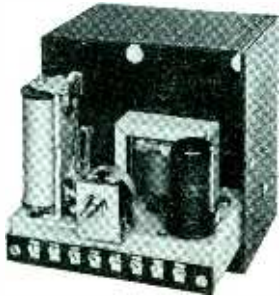

With No Mechanical Lag ELECTRONIC TIMERS

Short interval. Stop or repeat cycle.
Time ranges .05 to .5, .1 to 10, 1 to 100
seconds.

Write for Bulletin C.

COOPERATIVE ENGINEERING
service is available to established
manufacturers with control problems.

UNITED CINEPHONE CORPORATION

Torrington Conn.
Mfgs. of Electronic Controls

for the weld time and a-c voltage appearing for the cool time.

Even when longer timing is required, the oscilloscope can be utilized as a cycle counter. The method can best be stated by giving an example. If the instrument is connected across the power tubes and six cycles appear on the screen, spot welds up to six cycles in length can be seen directly. As the timing dial of the control is advanced, the change in the number of cycles of weld current can be seen. Application of 12, 18, 24, and 30 cycles of current will all cause a uniform collapse of the entire image on the screen. In this way, the weld time of a spot welder can be accurately determined. This method is even more adaptable to seam welding controls. If the sum of the "on" and "off" time is always a multiple of the number of cycles on the screen, the image will stand still. By starting at the lower weld and cool times, one can increase the settings and note the effect of each change of the welding control dials. If the time dial of the welding control is advanced one position and the image on the screen does not change to show that the timing has been changed, the calibration of the control is not correct. When one has acquired experience at using this method of cycle counting an extremely reliable check will be obtained.

Some users place an oscilloscope near the secondary loop of a welder, so that the magnetic field produces a deflection and thereby shows secondary welding current. When used in this manner no vertical input is required. By using external voltage dividers, one can study the extremely high voltages that exist in modern energy-storage type welding-con-

trols. By providing an insulating transformer to isolate the instrument from its power supply, it can be used in circuits that may be displaced from ground potential by high voltage. By connecting an oscilloscope across a load supplied through a contactor, "bouncing" of contacts is easily detected. Often the overlap of relay contacts can be checked with an oscilloscope.

Precautions

Certain precautions should be taken when using an oscilloscope. The instrument is affected by magnetic fields and, therefore, should be removed from regions where high currents are present. Sometimes, when it is fed through high impedance circuits, the instrument will pick up voltages that give an erroneous impression. For example, if the leads to the vertical plates are placed across an open circuit, the leads themselves will often pick up an a-c voltage. This will give the impression that voltage exists in the circuit, whereas actually only the pick-up voltage is present. Such pick-up can be minimized by using shielded leads. Pick-up in the leads from magnetic sources can also be reduced by using two twisted conductors. In general it will be found that unwanted effects can be reduced to negligible proportions with reasonable care.

Success in using a cathode-ray oscilloscope is largely dependent upon the ability of the operator. By studying the instruction booklets supplied with such instruments, and using the examples set forth here maintenance men and other technicians employed in the average plant can in a short time become skillful in its application to the servicing of electronic welding controls.



PERMANENT MAGNETS

ALL SHAPES — ALL SIZES
FOR ALL PURPOSES

Stamped, Formed, and Cast; Chrome, Tungsten Cobalt and ALNICO** (cast or sintered) under G. E. license.

THOMAS & SKINNER
STEEL PRODUCTS COMPANY
1116 E. 23rd STREET INDIANAPOLIS, INDIANA

Laminations for Radio Transformers — Tools
Dies — Heat Treating — Stampings

42 YEARS EXPERIENCE

CONTACTS

FOR THE FIELD OF ELECTRONICS

FOUR-RANGE RHEOSTATS

Lubricated Contacts



WRITE FOR CATALOG

SIGNICO
SIGNAL & INDICATOR PILOT LIGHTS
 for all electrical devices.

WRITE FOR CATALOGUE showing a complete line of assemblies for all purposes.

SIGNAL INDICATOR Corp.
 140 CEDAR ST. NEW YORK, N. Y.

RAPID DEVELOPMENTS
 in
LOUD SPEAKER DESIGN
 are necessary due to
UNCLE SAM'S WAR NEEDS

University Reflex Speakers are being pressed into new and unusual application every day.

UNIVERSITY LABORATORIES
 225 Varick Street, N. Y. C.

We manufacture a complete line of equipment



SPOT WELDERS, electric from ¼ to 500 KVA
 TRANSFORMERS, special and standard types
 INCANDESCENT LAMP manufacturing equipment
 FLUORESCENT TUBE MAKING EQUIPMENT
 ELECTRONIC EQUIPMENT, vacuum pumps, etc.
 WET GLASS slicing and cutting machines for laboratory use
 GENERAL GLASS working machines and burners
 COLLEGE GLASS working units for students and laboratory

AC ARC WELDERS
 From 100 to 400 Amps.

EISLER ENGINEERING CO.
 Newark, New Jersey

751 So. 13th St. (near Avon Ave.)



ELECTRON TUBE MACHINERY

of every type,—standard, and special design

KAHLE ENGINEERING COMPANY
 Specialists in Equipment for the Manufacture of Radio Tubes, Cathode Ray Tubes, Fluorescent Lamps, Incandescent Lamps, Neon Tubes, Photo Cells, X-ray Tubes and other glass or electronic products, on production or laboratory basis.
 1307-1309 Seventh St., North Bergen, N. J.

FINE RIBBONS

of Tungsten and Molybdenum
 Molybdenum in widths .006" to 1"
 in thickness to .0005"
 Tungsten Ribbon to specification

H. CROSS

15 Beekman St. New York

A STEADY SOURCE OF ALL ELECTRONIC EQUIPMENT

TERMINAL RADIO CORP.
 Telephone: WQEd 2-4416
 85 CORTLANDT ST., NEW YORK, N. Y.

FOR ACTION
 PHONE! WIRE! WRITE!
 BULLETINS AND CATALOGS ON REQUEST

We have 37,400 CORNELL-DUBILIER DYKANOL CAPACITORS

in stock for immediate delivery

Try us for all of your Electronic supplies!

HARRISON RADIO CORP.
 12 West Broadway • New York
 Phone WOrth 2-6276

This CONTACTS Section

supplements other advertising in this issue with these additional announcements of products essential to efficient and economical operation and maintenance. Make a habit of checking this page, each issue.

Departmental Staff
ELECTRONICS

CRYSTALS by HIPOWER

Thousands of vital transmitting installations rely on the accuracy and dependability of Hipower Precision Crystal units. With recently enlarged facilities, Hipower is maintaining greatly increased production for all important services. When essential demand begins to return to normal, Hipower will be glad to help with your crystal needs.

HIPOWER CRYSTAL CO.
 Sales Division—205 W. Wacker Drive, Chicago
 Factory—2035 Charleston Street, Chicago, Ill.

HARVEY RADIOLAB'S, Inc.
 Manufacturers of Radio Transmitters
ELECTRONIC APPARATUS
 447 Concord Ave. Cambridge, Mass.

FADA SERVICE DEPT.

has replacement parts for all FADA models manufactured during the last 10 years. Call, write, phone or send 10c for our latest Replacement Parts Catalog.

FADA OF NEW YORK
 30-20 Thomson Ave., L. I. City, N. Y.
 Tel.: transides 6-5400

MICROMETER FREQUENCY METER
 for checking transmitters, from 1.5 to 56 mc., within 0.01 per cent.

LAMPKIN LABORATORIES
 Bradenton, Fla., U. S. A.

ENGINEERS WANTED TRANSFORMER DESIGN ENGINEERS

Unusual opportunity with national manufacturer for several thoroughly experienced Transformer Design Engineers capable of Audio & Power up to 15 K.V.A.

A War Job—Now! A Future—Later!

We are at present manufacturing vital war equipment for our fighting forces and our peace time activities and expansion program should provide steady employment and promotional opportunities to capable men.

Those now employed in war industry at full skill need not apply

Write to Personnel Manager

FEDERAL Telephone & Radio Corp.

Manufacturing unit of the

INTERNATIONAL TELEPHONE
& TELEGRAPH CORP.

1000 Passaic Ave., E. Newark, N. J.

WANTED FOR WAR PRODUCTION HYDROGEN FURNACE FOR BRAZING

ALSO
BOMBARDERS
HIGH FREQUENCY INDUCTION
HEATING INSTALLATIONS

Telegraph or 'Phone

W-356, Electronics

520 No. Michigan Ave., Chicago, Ill.

BEST QUALITY, USED ELECTRON TUBE MACHINERY

Equipment for the manufacture of all kinds of electron tubes, radio tubes, incandescent lamps, neon tubes, photo electric cells, X-ray tubes, etc.

AMERICAN ELECTRICAL SALES CO., INC.

65-67 East 8th St. New York, N. Y.

For Sale BRUSH GALVANOMETER

model OS-3B in new condition, reasonable, write to

PACIFIC NETWORK, INC.
2625 Wilshire Blvd. Los Angeles

SURPLUS EQUIPMENT

50 kw. oscillator parts—3-phase power supply—controls, condensers and accessories. Rectifier tubes, 893 oscillator tube. All brand new.

FS-359, Electronics

330 West 42nd St., New York, N. Y.

Permanent Employment ELECTRONIC DEVELOPMENT ENGINEERS

Well-established Eastern Massachusetts concern desires graduate electronic engineers with flair for research and eye to future. Permanent position concerned at present with important development work for government, with increased opportunities after the war. Unusual openings for men with capacity and initiative. Must be U. S. Citizens.

P-342, Electronics

330 West 42nd St., New York City

WE WANT A MAN WITH VISION TO WORK ON THE FUTURE OF RADIO NOW!

He must be a radio or electronics engineer. He must combine practical ability with a little of the "dreamer." He can have a darn good job now and forever with an alert New York organization, if he "fills the bill."

RADIO RECEPTOR CO., INC.
251 West 19 Street New York City

ELECTRONIC ENGINEER

WANTED

for development of special gas tubes. Experience in gas tubes necessary. Permanent position. Good salary. Location New York.

P-358, Electronics

330 West 42nd St., New York City

POSITION VACANT

CARRIER CURRENT ENGINEERS Wanted—The Department of Power of the Tennessee Valley Authority have open positions for several power line carrier current test and maintenance engineers (junior and assistant grades). The duties will involve initial testing, operating, and maintaining of carrier current telephone, pilot relaying, and telemetering equipment with increasing duties in connection with telemeter transmitters and receivers and load control. Applicants should have graduated from a recognized school of electrical engineering and have some experience in the type of work indicated. Interested candidates are requested to forward complete information regarding their qualifications, including citizenship, age, formal education, and employment record (giving dates, employers, salaries, and descriptions of duties). The Tennessee Valley Authority Act exempted the Authority from civil service regulation, but provided at the same time that all appointments should be made on the basis of merit and efficiency. Persons now employed on war work should not apply. Address all communications to the Employment Division, Tennessee Valley Authority, Knoxville, Tennessee.

WANTED ELECTRICAL ENGINEERS and electrical testers. Electronic engineers, college graduates for test and installation of precision electro-mechanical ordnance apparatus. Electronics or communications experience desirable but not required. Electrical testers, for factory test. Some electrical experience required. Women will be considered. Location Jersey City, New Jersey. Replies should state age, experience, and salary desired. If employed in war industry do not apply. Box 535, Equity, 113 West 42d St., N. Y. C.

POSITION WANTED

RADIO ENGINEER allied national, first papers. 39 years, married, 2 children, draft deferred, 12 years diversified overseas experience. At present in non-essential industry. Available end January. PW-357, Electronics, 330 W. 42nd St., New York City.

The world is waiting until peace comes for the marvels your industry will produce. Complete all necessary patent procedures NOW on your idea to be in a position to negotiate with manufacturers THEN. Write for two free books . . . 68 pages of facts for inventors, immediately! Address: Victor J. Evans and Co., 786-A Merlino Bldg., Washington, D. C.

PATENT YOUR IDEA

Circuit Transformer

(Continued from page 100)

Eliminating I_A and solving for I_B (absolute value)

$$I_B = \frac{Me}{Z_A Z_B + M^2}$$

The method of solution assumes symmetry, so let $Q_A = Q_B$ Then

$$Z_B = lZ_A, M = kX_A \sqrt{l}$$

Solving for gain

$$G = \frac{e_o}{e} = \frac{X_B I_2}{e} = \sqrt{l} \frac{k X_A}{Z_A^2 + k^2 X_A^2} = \frac{\sqrt{l} Q_b}{\sqrt{16\alpha^4 + 8(1-b^2)\alpha^2 + (1+2b^2+b^4)}}$$

Again it is interesting to note that the gain is proportional to the square root of the ratio of the output to input impedance just as it is for low frequency transformers. Remembering α is zero at resonance, the relative gain is

$$g = \frac{G}{G_o} = \frac{1+b^2}{\sqrt{16\alpha^4 + 8(1-b^2)\alpha^2 + (1+2b^2+b^4)}}$$

The roots are found by differentiating and equating to zero. Thus

$$\frac{dg}{d\alpha} = 0; \text{ or } 4\alpha^3 + \alpha(1-b^2) = 0$$

The roots are

$$\alpha = 0 \\ \alpha = \pm \frac{1}{2} \sqrt{b^2 - 1}$$

If the desired relative gain at the roots is known, the factors α_D and b_x can be determined.

$$b_x = g_D + \sqrt{g_D^2 + 1}$$

$$\alpha_D = \sqrt{\frac{1}{2} b^2 - 1}$$

The factor D is

$$D = \frac{\alpha_D}{\frac{1}{2} \sqrt{b^2 - 1}}$$

It is of interest to note that when $b=1$ there is only one distinct root. Under this condition,

$$g_{(b=1)} = \frac{1}{\sqrt{4\alpha^4 + 1}}$$

When the coupling approaches zero, the relative gain approaches

$$\text{Limit } b \rightarrow 0 \quad g = \frac{1}{4\alpha^2 + 1}$$

It is interesting to note that the above relative gain is the square of the relative gain of a single tuned circuit.

REFERENCES

- (1) Purrington, E. S., Single and Coupled-circuit Systems, *Proc. I.R.E.*, 18, p. 983, June 1930.
- (2) Guillemin, *Communication Networks*, 1, p. 335.

Index to Advertisers

	Page		Page		Page
Acme Elec. & Mfg. Co.	180	General Radio Co.	138	Premax Products	201
Aerovox Corp.	20	Goat Metal Stampings, Inc.	173	Presto Recording Corp.	118
Aircraft-Marine Products, Inc.	34	Gothard Mfg. Co.	175	Production Engineering Corp.	191
Allied Control Co.	128	Gould-Moody Co.	129	Radio City Products Co.	46
Allied Radio Corp.	180	Guardian Electric Mfg. Co.	125	Rauland Corp., The	42
Aluminum Company of America	27	Hallcrafters Co.	33	Raytheon Mfg. Co.	45, 152
American Coils, Inc.	165	Hammarlund Mfg. Co., Inc.	10	RCA Mfg. Co., Inc.	16, 17, Back Cover
American Lava Corp.	28	Hardwick-Hindle, Inc.	12	Rea Magnet Wire Co.	151
American Photocopy Equip. Co.	201	Harrison Radio Corp.	203	Remler Co., Ltd.	194
American Radio Hardware Co., Inc.	131	Harvey Machine Co., Inc.	115	Revco, Inc.	172
American Screw Co.	43	Harvey Radio Co.	188	Rex Rheostat Co.	203
American Television & Radio Co.	170	Harvey Radio Lab's, Inc.	203	Richardson Co., The	122
American Transformer Co.	44	Harvey-Wells Communications, Inc.	189	Roebbling's Sons Co., John A.	11
Amperite Co.	172	Heinemann Circuit Breaker Co.	114	Rogan Brothers	186
Arkwright Finishing Co.	183	Heintz & Kaufman, Ltd.	41	Russell, Burdshall & Ward Bolt & Nut Co.	43
Arnold Engineering Co.	178	Hewlett-Packard Co.	137	Scovill Mfg. Co.	43
Associated Research, Inc.	200	Hipower Crystal Co.	203	Shakeproof Lock Washer Co.	43
Astatic Corp.	182	Industrial Condenser Corp.	156	Shallcross Mfg. Co.	169
Audak Co.	206	Industrial Instruments, Inc.	173	Shure Brothers	111
Automatic Electric Co.	185	Instrument Resistors Co.	184	Signal Indicator Corp.	203
Avery Adhesives	168	Insuline Corp. of America	179	Simpson Electric Co.	18
Ballantine Laboratories, Inc.	198	International Nickel Co., Inc., The	39	Sola Electric Co.	139
Barker and Williamson	142	International Resistance Co.	107	Solar Manufacturing Corporation	13
Biddle Co., James G.	7	International Screw Co.	43	Soundscribe Corporation	181
Blaw-Knox Co.	148	Isolantite, Inc.	23	Southington Hardware Mfg. Co.	43
Bliley Electric Co.	144	Jefferson-Travis Radio Mfg. Co.	113	Spencer Thermostat Co.	161
Brand & Co., William	24	Jensen Radio Mfg. Co.	133	Sprague Specialties Co.	149
Bristol Co.	43	Johnson Co., E. F.	140	Stackpole Carbon Co.	14
Browning Laboratories, Inc.	143	Jones, Howard B.	184	Standard Pressed Steel Co.	190
Bud Radio, Inc.	194	Kahle Engineering Co.	203	Standard Transformer Corp.	109
Callite Tungsten Corp.	105	Kenyon Transformer Corp.	186	Sun Radio Co.	200
Cambridge Thermionic Corp.	193	Keuffel & Esser Co.	3	Superior Tube Co.	32
Cannon Electric Development Co.	116	Keystone Carbon Co., Inc.	196	Taylor Fibre Co.	193
Capitol Radio Engineering Institute	177	Kold-Hold Mfg. Co.	179	Tenney Engineering, Inc.	184
Carter Motor Co.	181	Lafayette Radio Corp.	190	Terminal Radio Corp.	203
Celanese Celluloid Corp.	21	Lampkin Laboratories	203	Thermador Electrical Mfg. Co.	119
Centralab Div., Globe Union, Inc.	6	Lamson & Sessions Co.	43	Thomas & Skinner Steel Products Co.	202
Central Screw Co.	43	Lapp Insulator Co.	47	Thordarson Electric Mfg. Co.	134
Chandler Products Corp.	43	Lingo & Son, Inc., John E.	188	Triplet Electrical Instrument Co. 4, 5	5
Chicago Transformer Corp.	163	Littelfuse, Inc.	173	Turner Co., The	136
Cinch Manufacturing Corp.	105	L-R Manufacturing Co.	195	Ucinite Company, The	22
Clarostat Mfg. Co., Inc.	187	Macallen Company, The	124	Union Aircraft Products Corp.	29
Colen Gruhn Co., Inc.	110	Mallory & Co., Inc., P. R.	54	United Cinephone Corporation	202
Continental-Diamond Fibre Co., Inc.	153	Markem Machine Co.	195	United Electronics Co.	37
Continental Screw Co.	43	McGraw-Hill Book Co., Inc.,	176, 188, 199	United Transformer Co.	Inside Front Cover
Corbin Screw Co.	43	Meissner Mfg. Co.	132	Universal Clay Products Co.	179
Cornell-Dubilier Electric Corp.	25	Micro Switch Corp.	155	University Laboratories	203
Cross, H.	203	Millen Mfg. Co., Inc., James	196	Utah Radio Products Company	120
Dalis, Inc., H. L.	192	Mitchell-Rand Insulation Co., Inc.	112	Walker Turner Co., Inc.	135
Daven Co.	Inside Back Cover	Mobile Refrigeration Inc.	141	Ward Leonard Electric Co.	117
De Jur-Amsco Corp.	36	Murdock Mfg. Co.	154	Ward Products Corp.	150
Deutschman Corp., Tobe	2	Mycalex Corporation of America	19	Weston Electrical Instrument Corp.	40
Dixon's Typhonite ELDORADO Pencils	202	National Screw & Mfg. Co.	43	White Dental Mfg. Co., S. S.	152
Dolph Co., John C.	160	Newark Transformer Co.	171	Whitney Screw Corp.	43
Driver Co., Wilbur B.	201	New England Screw Co.	43	Wiley & Sons, Inc., John	158, 197
DuMont Labs., Allen B.	130	New York Transformer Co.	9	Wilson Co., H. A.	164
Dunn, Inc., Struthers	52	Ohmite Mfg. Co.	127	Wincharger Corp.	174
Eicor, Inc.	182	O'Neil-Irwin Mfg. Co.	164		■
Eisler Engineering Co.	203	Oxford-Tartak Radio Corp.	108	PROFESSIONAL SERVICES	201
Eitel-McCullough, Inc.	51	Parker Co., Charles	43		■
Electronic Laboratories, Inc.	30	Parker-Kalon Corp.	43, 159	SEARCHLIGHT SECTION	(Classified Advertising)
Electro-Voice Mfg. Co., Inc.	31	Par-Metal Products Corp.	185	EMPLOYMENT	204
Erie Resistor Corp.	48	Pawtucket Screw Co.	43	PATENTS	204
Espey Mfg. Co., Inc.	175	Pheoll Mfg. Co.	43	USED EQUIPMENTS FOR SALE	204
Fada of New York	203	Phillips Metalix Corp.	38	American Electric Sales Co., Inc.	204
Felker Mfg. Co.	8	Phillips Screw Manufacturers	43	Pacific Network Inc.	204
Ferrocart Corp. of America	180	Pioneer Gen-E-Motor Corp.	156		■
Formica Insulation Co.	26	Plax Corporation	147		■
Galvin Mfg. Co.	123	Potter & Brumfield	178		■
General Ceramics & Steatite Corp.	121	Precision Tube Co.	168		■
General Electric Co.	35, 102, 103, 157				■
General Instrument Corp.	15				■

IN SELECTIVE SERVICE



“RELAYED-FLUX” Microdyne

*“The Standard by Which Others
Are Judged and Valued”*

EQUIPMENT for the war effort,—

- (1.) MUST perform up to highest standards.
- (2.) MUST continue to perform irrespective of climatic variations.

That is why AUDAX magnetically powered pickups are selected for war contracts. In building pickups under such contracts, we do not have to change our peacetime specifications because such MUSTS have always been a basic requirement in AUDAX Instruments.

The sharp clean-cut facsimile reproduction of MICRODYNE — regardless of climatic conditions—is a marvel to all who have put it to the only test that really counts . . . the EAR TEST.

WITH OUR COMPLIMENTS

A copy of “PICKUP FACTS” is yours for the asking. It answers many questions concerning record reproduction.

BUY WAR BONDS

*If there is any information
you wish, do not hesitate to
write us.*

AUDAX COMPANY

500 Fifth Ave. New York City

*“Creators of High Grade Electrical
and Acoustical Apparatus since 1915.”*

Applications of Electronics to Physiology

(Continued from page 89)

ear over a wide range, as determined by accurate calibration. The device is easily adjusted and very flexible. It may be used to record the 160-mm Hg change in the dog ventricle, or the 1-mm Hg change in the turtle auricle, which has not previously been accurately recorded.

The frequency response is good, and entirely dependent on the mechanical design of the membrane manometer. This design is discussed by Wiggers.¹⁵ The first part of this book would be of value to anyone using an instrument of this type.

Rubber diaphragms were originally used on the manometer, and are still to be preferred for small pressure changes, but it has been found that glass membranes are more stable and produce a better frequency response. Of course they are comparatively insensitive. They are made much like the early glass electrodes. A bubble about an inch in diameter is blown on the end of a Pyrex glass tube, and another tube, the end of which is heated to melting, is pressed against the bubble while the bubble is heated to a temperature just under the melting point. The sensitivity of the diaphragm may be tested by changing the pressure applied to it while looking at a light reflected on its surface. The pattern seen should change perceptibly. It is necessary to test the strength of the membrane by applying a pressure about 30 percent greater than the highest pressure which it will be used to record. An hour of glassblowing should enable a novice to make diaphragms of the desired characteristics.

The phototube membrane manometer is not restricted in its application to cardiovascular research, but should be of value in physical and engineering problems.

In summary, its advantages over optical projection are:

1. Greater sensitivity.
2. Variable sensitivity. Pressure changes of any magnitude may be represented by any desired deflection of the cathode-ray spot, simply by changing the amplifier gain.
3. Electrical changes may be more easily recorded simultaneously.
4. Insertion of the needle is easy, because the entire device may be

moved as a unit to any position.

From the few examples given above, which are only part of the developments of one laboratory, the reader may infer the wide and increasing use of electronics in physiological laboratories in general. Many measurements which would be very difficult or impossible otherwise may be made electronically, electronics providing a multiplicity of approaches. A good example is the recording of pressure changes, which may be transformed into electrical changes in a variety of ways, as mentioned above. The problem is merely one of selecting the method which seems simplest, which will work best with the recording equipment available, and which will give the performance required.

Because of the simplicity of changing almost any physiological phenomenon into a varying potential, it seems almost certain that the future trend will be to the use of multiple-trace cathode-ray tubes with direct-coupled amplifiers. In general, such equipment is far superior to the old-fashioned slit type camera.

As is evident from the freedom from complexity of the devices described, imagination is far more needed by the physiologist than a profound theoretical knowledge of electronics. For this reason it seems probable that even more physiologists than at present will find it worth while to provide themselves with the practical electronic training required by the research problems which they undertake.

REFERENCES

- (1) Gilson, W. E.: An Automatic Blood Pressure Recorder, *ELECTRONICS*, May, 1942.
- (2) Gilson, W. E.: A Versatile Oscilloscope, *ELECTRONICS*, Dec. 1941.
- (3) Hawes, R. C.; *Ind. Eng. Chem., Anal. Ed.*, 11:222-3, 1939.
- (4) Rudy, C. E. and P. Fugassi; *Ibid.*, 12:757, 1940.
- (5) Serfass, E. J.; *Ibid.*, 13:262-3, 1941.
- (6) Walsh, C.; Temperature Measurement and Control by Electronics, *ELECTRONICS*, Oct. 1942.
- (7) Cenco-Gilson Electronic Relay, Central Scientific Co., Chicago.
- (8) Gilson, W. E. and H. Wooster; *Journal of Chemical Education*, Nov., 1942.
- (9) Goldberg, H.; *Electrical Engineering*, Trans. p60, Jan. 1940.
- (10) Gilson, W. E.; R. Conklin, and J. A. E. Eyster, *Federation Proceedings*, 1:March 16, 1942.
- (11) Gilson, W. E.; A CRO Delayed Sweep Circuit, *ELECTRONICS*, p. 65, March, 1942.
- (12) Gilson, W. E.; An Electronic Timer, *Photo Technique*, July, 1940.
- (13) Gilson, W. E.; *Science*, 95:513-514, 1942.
- (14) Lilly, J. C.; *Rev. Sci. Inst.*, 13:34-37, 1942.
- (15) Wiggers, C. J.; The Pressure Pulses in the Cardiovascular System, New York, Longmans Green & Co., 1928.

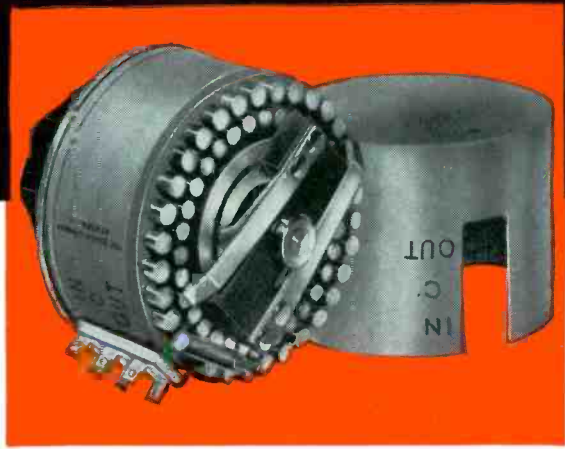
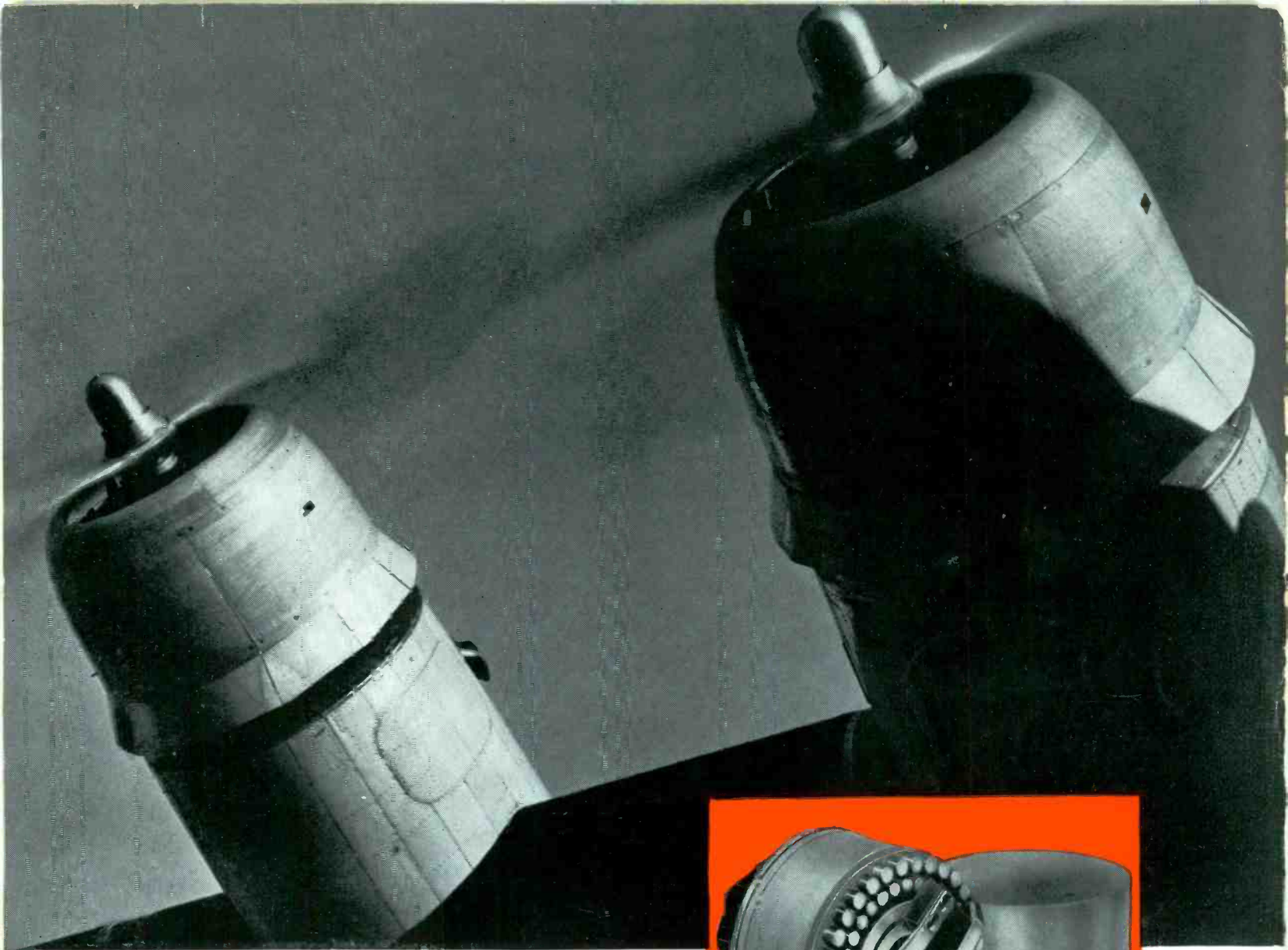

Long-Lasting

Like the giant motors of ocean-spanning Pan American Clippers, Daven products are built for a long haul. Unless Daven components are abused, they invariably outlast the original equipment in which they have been incorporated.

Such durability reduces servicing problems to a minimum and enables us to devote all of our time to the important work of supplying necessary parts and equipment to manufacturers of essential material. And they, in turn, know they can count on Daven for the most complete line of precision attenuators in the world; and for more than eighty models of laboratory test equipment.

THE DAVEN COMPANY

158 SUMMIT STREET

NEWARK, NEW JERSEY



COMMUNICATING ✓
 MEASURING ✓ CHECKING ✓
 ANALYZING ✓ ACTUATING ✓
 PROTECTING ✓ TESTING ✓
 DETECTING ✓ MATCHING ✓
 CONTROLLING ✓ GUIDING ✓
 SORTING ✓ MAGNIFYING ✓
 RECTIFYING ✓ COUNTING ✓
 HEATING ✓ TRANSFORMING ✓
 "SEEING" ✓ "FEELING" ✓

"..do it the *Electronic Way!*"

BETTER . . . FASTER . . . MORE ECONOMICALLY

Every day, throughout industry, RCA Tubes in modern Electronic equipment are helping replace both mechanical and human operations on a wide variety of tasks. Every day, they are making possible new standards of accuracy, efficiency, and economy—higher than are practical or feasible by any other method.

So far-reaching has been this industrial development of the Vacuum Tube, it is now the rare industry which does not already utilize various Electronic methods—or, by the same token, stand to benefit by the adoption of many more.

"Do it the Electronic Way" is far more than a slogan. It is a direct challenge to every business

that has exacting work to be done still more exactly.

The Electronic Way has few or no mechanical limitations, is often more economical, and provides freedom from the annoying element of human error!

As the acknowledged leader in the pioneering of Tubes for Radio, it is only natural that RCA should also lead the way in the design of Tubes for industrial uses. A wide variety of types, each with a background of proved dependability, affords a broad engineering selection. Write for Power and Special Tube Folder TT-100, or Phototube Folder PT-20RI to Commercial Engineering Section, RCA Manufacturing Co., Inc., 5th Street, Harrison, N. J.

RCA Tubes FOR INDUSTRIAL EFFICIENCY

- Low Power • Medium Power • High Power • Cathode Ray • Phototubes
- Thyratrons • Voltage Amplifiers • Rectifiers, etc.