

Ransom

electronics

radio, communication, industrial applications of electron tubes . . . engineering and manufacture

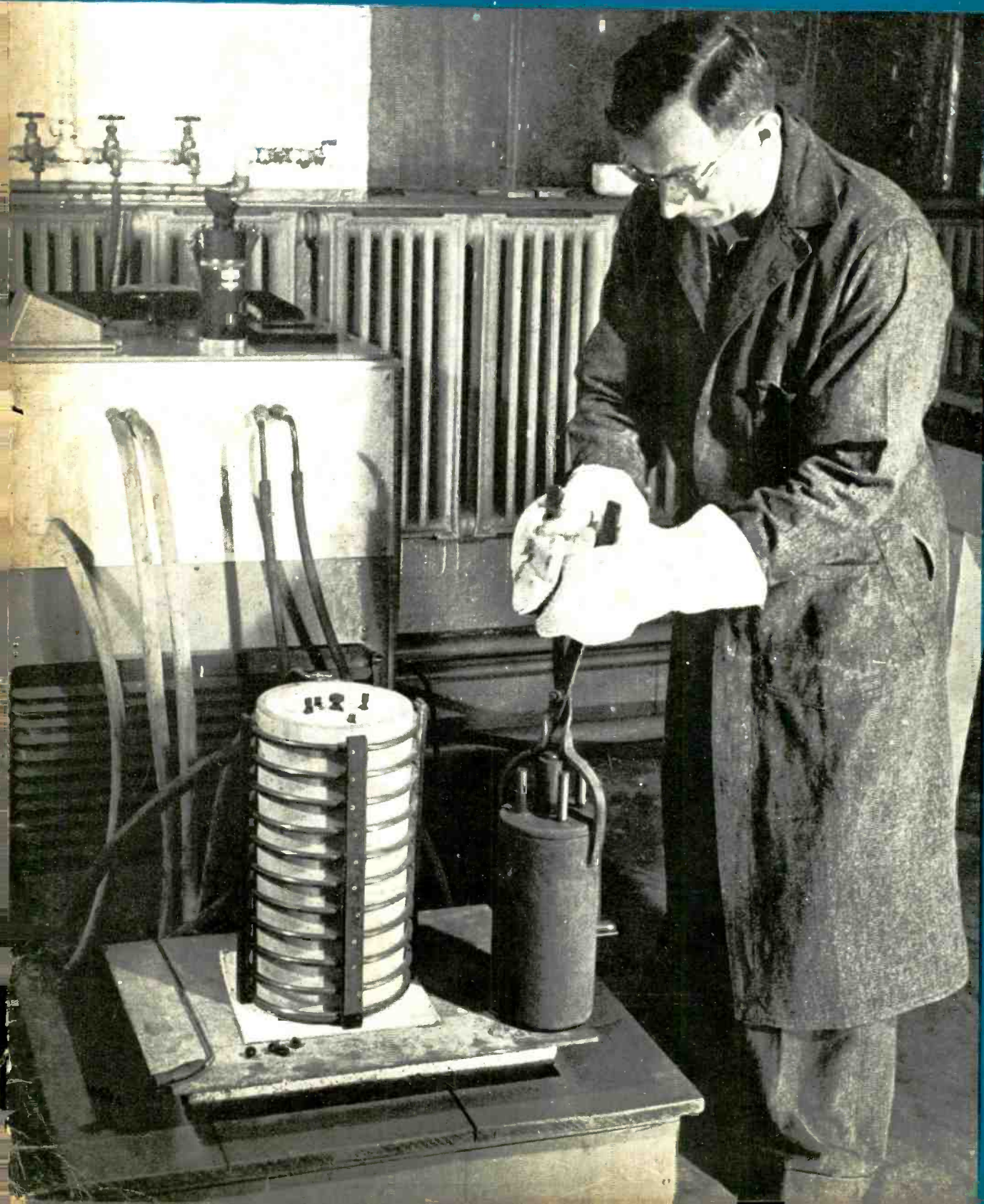

ELECTRONIC FURNACE

(See contents page)

**DECEMBER
1940**

Price
50 Cents

McGRAW-HILL
PUBLISHING
COMPANY, INC.



AMPEREX

AIR RADIATORS FOR WATER COOLED TUBES

AMPEREX engineers have developed a series of Radiators suitable for the forced air cooling of metal anode power tubes which are ordinarily water cooled.

These Radiators are scientifically designed for the greatest transfer of heat to the air stream. Their structures are simple, yet they are remarkably efficient. In fact, for some high frequency uses, they are far more desirable than water cooling systems.

AMPEREX Radiators are available with the 891, 892, 342A, 343A, 232C, 220C, 228A and can be readily manufactured for many other types of tubes.

Because of the technical skill required for imbedding the anode into the radiator well these radiators are only sold as an integral part of the tube.

AMPEREX ELECTRONIC PRODUCTS, Inc.

79 WASHINGTON STREET

BROOKLYN, NEW YORK

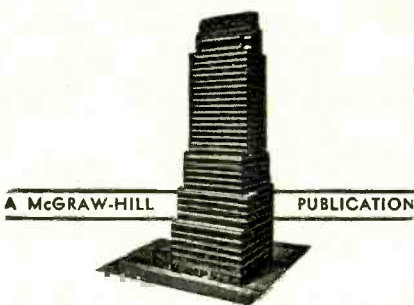

electronics

CONTENTS—DECEMBER, 1940

KEITH HENNEY
Editor

Donald G. Fink
Managing Editor

Beverly Dudley Craig Walsh
Associate Editor Assistant Editor

M. L. Matthey J. M. Heron
Assistant Editor Assistant Editor

Harry Phillips
Art Director

H. W. MATEER
Manager

Wallace B. Blood
Sales Manager

Contents Copyright, 1940, by
McGraw-Hill Publishing Company, Inc.

McGRAW-HILL
PUBLISHING COMPANY, INC.

JAMES H. MCGRAW
Founder and Honorary Chairman

Publication Office
99-129 North Broadway, Albany, N. Y.
U. S. A.

Editorial and Executive Offices
330 West 42nd St., New York, N. Y., U.S.A.

James H. McGraw, Jr., President
Howard Ehrlich, Executive Vice President
Mason Britton, Vice Chairman

B. R. Putnam, Treasurer
D. C. McGraw, Secretary
J. E. Blackburn, Jr., Director of Circulation

Cable Address:
MCGRAWHILL, New York
Member A. B. P. Member A. B. C.

ELECTRONIC FURNACE Cover

High-frequency induction furnace in the laboratory of the American Electro Metal Corp., Yonkers, N. Y., used to sinter compressed metallic powder into the solid form, under more rigid control than is possible with a gas-fuel furnace

G. W. PICKARD AWARDED ARMSTRONG MEDAL Frontispiece

One of radio's most active pioneers honored by the Radio Club of America

MINIATURE RADIOS 17

An investigation of the electrical and mechanical design problems underlying the "personal" radio sets

AN ELECTRICALLY FOCUSED MULTIPLIER PHOTOTUBE, by J. A. Rajchman and R. L. Snyder 20

A secondary emission device that displays an overall current gain up to a million times and a maximum luminous sensitivity of 10 amperes per lumen

THE 1940 ROCHESTER FALL MEETING 24

Reports on the technical papers of the best-attended Fall Meeting in its 12 years' history

A STATE POLICE F-M NETWORK, Part II, by Daniel E. Noble 28

A review of practical experience in two-way communication in the Connecticut system, proving 50 per cent increase in range due to use of fm

AN AUDIO FREQUENCY V-T VOLTMETER, by Harry C. Likel ... 32

A simple circuit to extend the a-c voltage ranges of a typical analyzer test set over the range to 15,000 cps, with high input impedance

NEW FIELDS FOR MAGNETIC RELAYS, by Anthony B. Lamb ... 35

Typical uses of the ultrasensitive type of moving coil relay in industry and commerce

DIATHERMY MEASUREMENT TECHNIQUE, by J. D. Kraus and R. W. Teed 39

A method of calibrating the output of shortwave diathermy equipment by substituting a calorimeter for the patient

SIGNAL RANGE OF HIGH FREQUENCY BROADCAST STATIONS 41

Theoretical range based on antenna height and effective power, for the range from 42 to 50 Mc, particular adaptable to f-m transmissions, compiled by the F.C.C. Engineering Department

ANNUAL INDEX, VOLUME 13 85

DEPARTMENTS

CROSSTALK	15	TUBES	61
REFERENCE SHEET	41	THE ELECTRON ART	67
TUBES AT WORK	42	THE INDUSTRY IN REVIEW	74
INDEX TO ADVERTISERS		88	

ELECTRONICS, December, 1940, Vol. 13, No. 12. Published monthly, price 50c a copy. Allow at least ten days for change of address. All communications about subscriptions should be addressed to the Director of Circulation, 330 West 42nd Street, New York, N. Y.

Subscription rates—United States and possessions, Canada, Mexico, Central and South American countries, \$5.00 a year, \$8.00 for two years, \$10.00 for three years. Great Britain and British Possessions 36 shillings for one year, 72 shillings for three years. All other countries \$6.00 for one year, \$12.00 for three years. Entered as Second Class matter, August 29, 1935, at Post Office, Albany, New York, under the Act of March 3, 1879.

BRANCH OFFICES: 520 North Michigan Avenue, Chicago; 68 Post Street, San Francisco; Aldwych House, Aldwych, London, W.C. 2; Washington; Philadelphia; Cleveland; Detroit; St. Louis; Boston; Atlanta, Ga.



I'm in a jaunty mood as I end the year . . . in the second decade of my life. I still enjoy my reputation as an "old smoothie" and count as my friends the countless servicemen, technicians and set builders the world over who continue to boastfully admit that there is nothing finer than a Centralab part. Thanks.

- Ol' Man Centralab

CENTRALAB • Div. of Globe-Union Inc.
MILWAUKEE, WISCONSIN

Centralab VOLUME CONTROLS

"Standard Equipment" in millions of receivers, Centralab Volume Controls are more than ever on the "MUST" list wherever a dependable control is indicated. For original equipment or replacement. SMOOTH — performs easier and better.

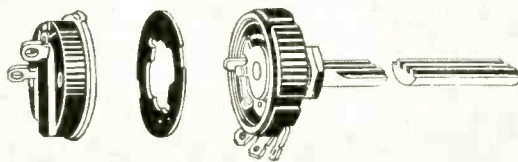

CENTRALAB STANDARD RADIOHM

WALL TYPE RESISTOR hugs inner circumference of black molded bakelite case. Exclusive non-rubbing contact band assures quiet, smooth rotation and long life. Case dimensions: $1\frac{1}{8}$ " diameter x $9/16$ " deep. Soft aluminum shaft extends $3\frac{3}{8}$ " from case; milled full length for push-on or set screw knob.

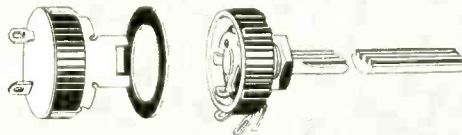

STANDARD MIDGET RADIOHM

Companion to the Standard Radiohm, the Midget is necessary to replace original controls in many current models using small controls for space savers. Molded bakelite case, $1\frac{1}{8}$ " diameter. $\frac{1}{4}$ " soft aluminum shaft $3\frac{3}{8}$ " long, milled for standard push-on or set screw knob.

. . . and the Famous ADASHAFT MIDGET RADIOHM

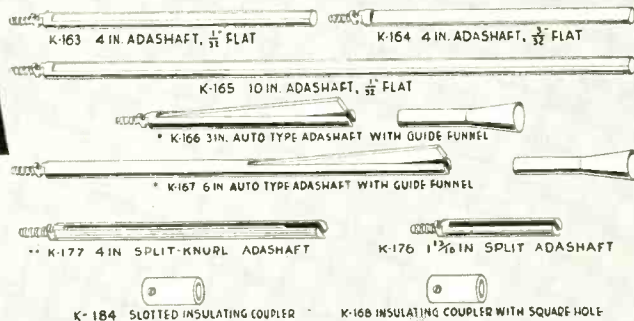
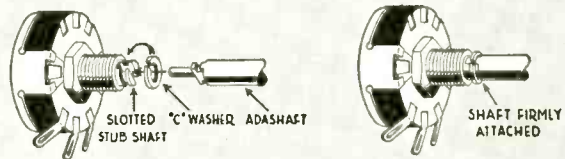



Another Great Step Forward!

PROMISE...PERFORMANCE

and

PROGRESS!

Last year 36... this year only **31**
RCA Preferred Type Tubes!

PROMISE November 1939... Wilderness and confusion in the tube industry—the unregulated evil of "too many tube types." For the first time, a manufacturer points *a way out*. RCA leadership and experience—and months of study—permit the announcement: "Just 36 Preferred Type Tubes cover virtually every requirement in the design of radio receivers—for finest performance at lowest overall cost!"

PERFORMANCE June 1940... In six short months, the RCA Preferred Type Tubes Program has been endorsed and adapted to production by 18 leading manufacturers of radio receivers. Results—? Better, more uniform tubes. Faster deliveries—from *stock*. Lower inventory and warehousing costs. The entire industry has benefited!

PROGRESS November 1940... One year has passed. Manufacturers have announced still more new tube types—and more, and more. There are now *over 500* types on the market! Does RCA *still* say that you can do a complete job with only 36 types—?

RCA goes farther even than that! From the experience and proof-of-performance of the past year, RCA now makes the still more sensational statement: "Only 31 Preferred Types will cover virtually every requirement for modern radio receivers." Another great step!

Increasingly, this Program moves *forward*—to the betterment of manufacturer, distributor, dealer, serviceman and public alike.

Over 380,000,000 RCA Radio Tubes have been purchased by radio users.



**18 LEADING SET MANUFACTURERS
HAVE ENDORSED AND ADOPTED THIS PROGRAM!**

- | | | |
|-------------|---------------------|----------------|
| ★ ADMIRAL | ★ ANDREA | ★ AUTOMATIC |
| ★ DETROLA | ★ DE WILD | ★ EMERSON |
| ★ FADA | ★ FARNSWORTH | ★ GAROD |
| ★ GILFILLAN | ★ HALLICRAFTERS | ★ PACKARD-BELL |
| ★ PILOT | ★ RCA VICTOR | ★ SENTINEL |
| ★ SONORA | ★ STROMBERG-CARLSON | ★ WURLITZER |



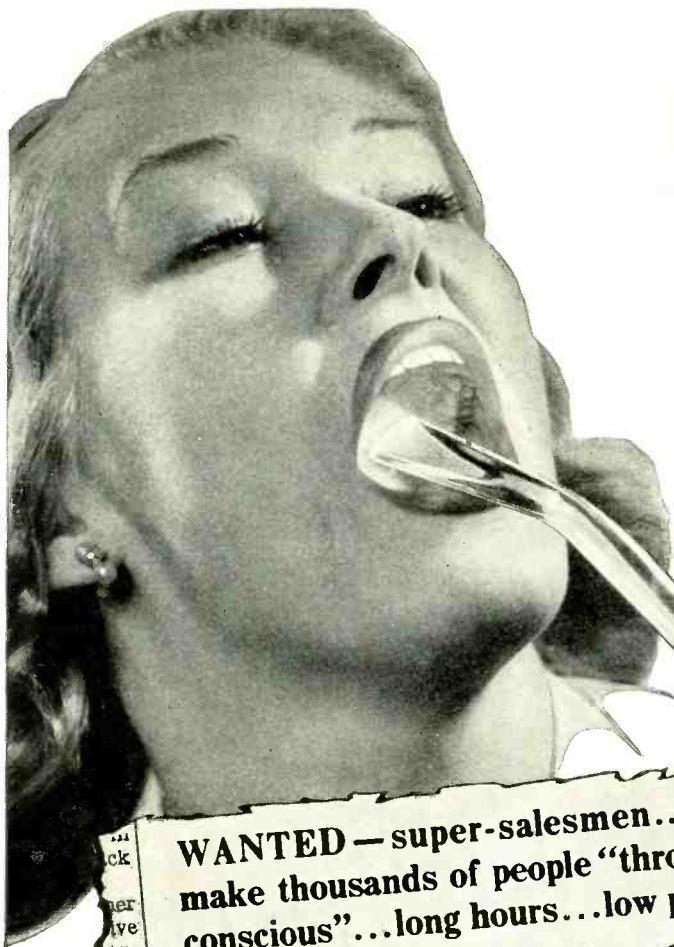

HOW TO SELL A GARGLE

*... with a lively
piece of "LUCITE"!*

**WANTED — super-salesmen... to
make thousands of people "throat-
conscious" ... long hours ... low pay.**

(Below)
Photograph shows tongue
depressors made of molded
"Lucite" after being removed
from the die. Six of them are
quickly and economically
produced at one time with
high luster and flawless body
by the St. Louis Plastic
Molding Co.

TO INCREASE the sales of Listerine antiseptic the Lambert Pharmaceutical Company set about to make America "throat-conscious." More "throat-conscious" people would mean more "gargle-conscious" people . . . and more gargling with Listerine!

But how to get people interested in their own throats? That was a problem . . . until someone remembered that transparent "Lucite" methyl methacrylate resin has the ability to transmit heatless light around curves. Why not let people see their own throats . . . with throat lights made of this versatile plastic? Then sell them in conjunction with the antiseptic.

Here was the answer. Made of clear "Lucite," the throat-light picks up light from a concealed bulb in the handle and flashes it clearly and sharply on throat, teeth or mouth. Moreover, because "Lucite" is so easy to mold, six of these transparent tongue depressors can be produced quickly and cheaply . . . at one injection stroke!

Now "Lucite" is lighting up thousands of throats . . . and more every day. Less than a month after these throat lights had been introduced, the Lambert Company had to triple the original production order for them. During the first 2 weeks after announcement to the trade—orders were booked for more than 1000 tons of Listerine, and sales are still increasing!

"Lucite" is just the thing to solve premium problems. It's strong . . . weather-resistant . . . easy-to-mold . . . clear . . . light . . . and it can be molded in a whole rainbow of colors. Specify "Lucite" for your own products . . . and take advantage of the Du Pont technical service to help solve your design or molding problems. For more information about "Lucite" and other Du Pont plastics, write to E. I. du Pont de Nemours & Co. (Inc.), Plastics Dept., Arlington, N. J.

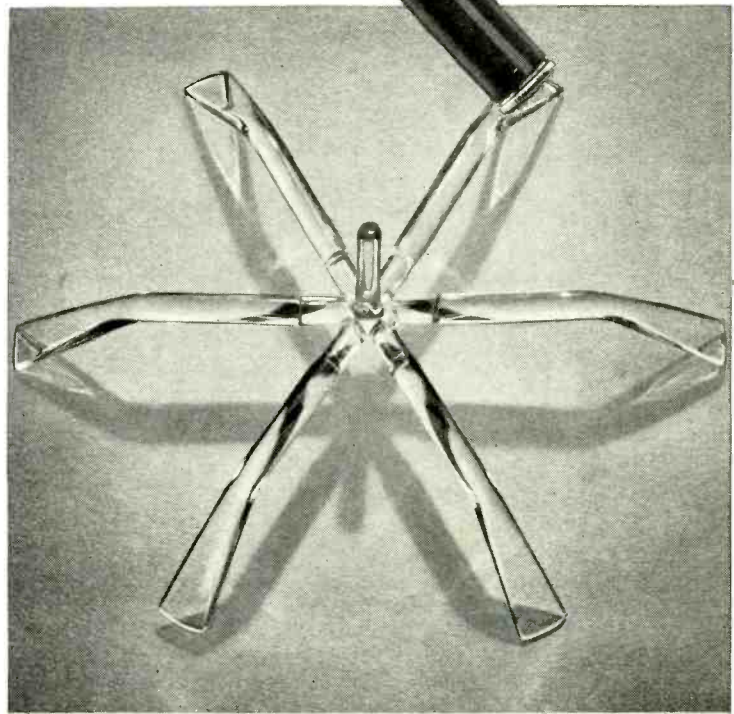

DU PONT **PLASTICS**

Check Before You Choose

SIMPLICITY plus Unexcelled Performance

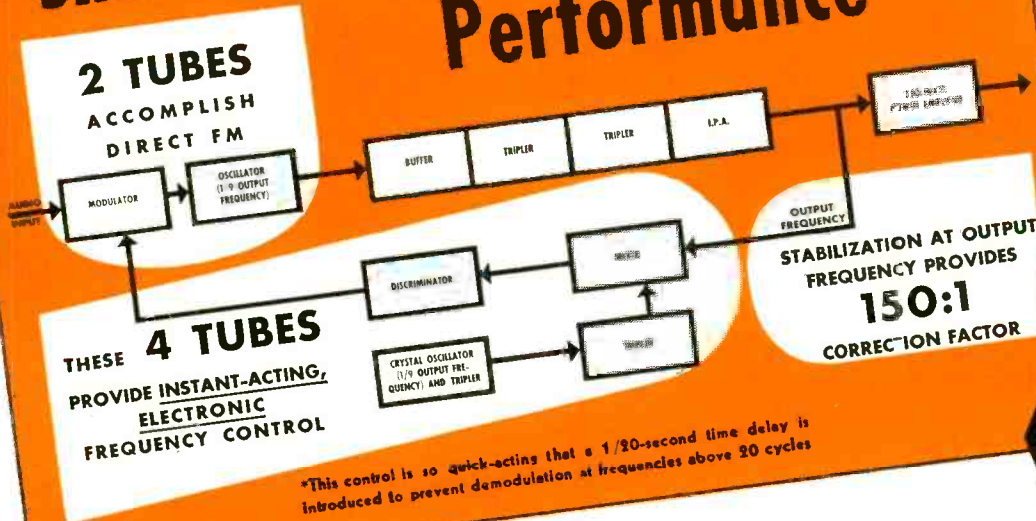

And you'll specify



SIMPLIFIED

FM

CIRCUIT DESIGN

INSIST ON ALL THESE . . .

Continuity of Service

Automatic reclosing overload protection
 Instant access to every tube (no shielding to remove)
 Complete accessibility without disassembly
 Only 2 tubes to produce *direct* FM
 Only 4 tubes in stabilizing circuit
 Single crystal control

Frequency Control

Instant-acting electronic (no moving parts; no overshoot)
 Stabilization at *output* frequency
 Temperature control of crystal only
 ± 1000 cycles stability
 Voltage regulated power supply
 New G-31 crystal unit
 Temperature *compensated* oscillator and discriminator circuits

High Fidelity

Frequency response within ± 1 db of RMA standard, 30 to 16000 cycles
 Full dynamic range—noise level down 70 db
 Linearity within 0.25% up to ± 150 kc carrier swing
 Harmonic distortion less than 1½% (30 to 7500 cycles) up to ± 75 kc carrier swing; less than 2% up to ± 100 kc swing
 Cathode-ray modulation indicator
 Square-wave testing of every transmitter

Economy

Based on G-E 1000-watt Transmitter, Type GF-101-B
 Tube cost—only \$287
 Floor space—only 9.3 square feet
 Ventilation—natural draft (no blower; quiet operation)
 Power consumption only 3.75 kw

FOR CONTINUITY OF SERVICE, G-E design provides a small tube complement, conservatively operated, plus automatic reclosing overload protection and quick accessibility to every part and tube.

The frequency stability of G-E transmitters is maintained at within ± 1000 cycles by *instant-acting* electronic control so sensitive that even abnormal line-voltage fluctuations or *sudden detuning of the oscillator tank* can have no effect on center frequency.

The dependability is equal to that of the finest AM broadcast transmitters. *FM could ask no more.* G-E design centralizes frequency modulation and stabilization in one tube (the modulator), without impeding modulation capabilities or linearity. This fact is proved by performance measurements. No temperature control is necessary or used except within the crystal unit itself.

For true high fidelity—frequency response, linearity, freedom from distortion over wide carrier excursions—G-E transmitters are outstanding. These characteristics—inherent in the G-E simplified circuit—are assured by thorough factory adjustment and testing of every unit.

For economy, G-E simplicity assures low tube cost, ease of maintenance, and small operating expense. Small size and unit construction make installation easy and hold floor space to the minimum.

G-E simplified circuit design offers an unbeatable combination of advantages. Investigate them thoroughly. Your nearby G-E man has the story. Call him in without delay. General Electric, Schenectady, N. Y.

GENERAL  ELECTRIC

IT'S DETOURS LIKE THESE THAT INCREASE YOUR ASSEMBLY COSTS
...BUT DRIVING PHILLIPS SCREWS IS STRAIGHT-LINE DRIVING

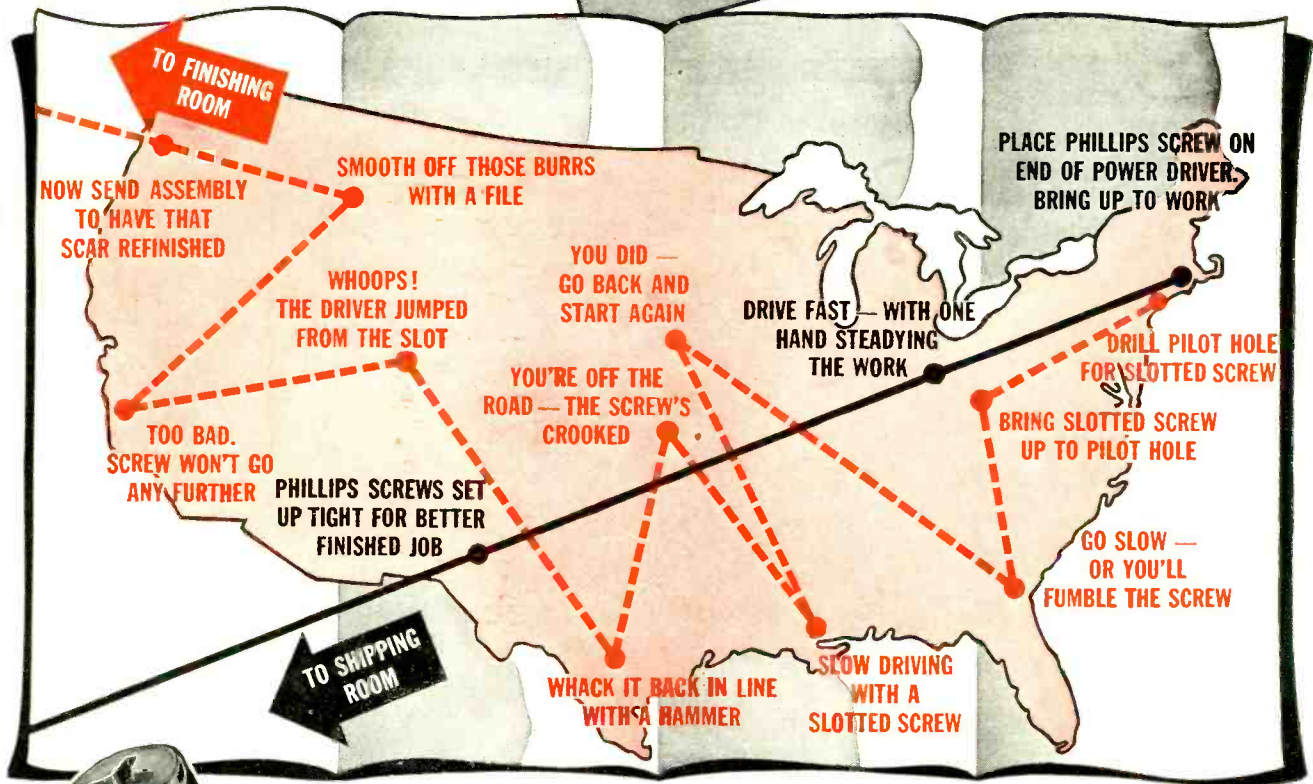

Phillips Recessed Head Screws cut assembly time an average of 50%. Driver and screw fit — no driver slippage with power drivers, more contact for easier turning, no burrs. Phillips Screws set up tighter without pilot holes, and with no danger of split heads.

How much would a 50% saving in assembly time mean in your plant? Add the saving in number of screws used (or smaller, lower-cost sizes), the elimination of expense for locking devices and the freedom from returns due to loosening of the product in use . . . and you'll see why thousands of manufacturers find it costs less in both time and money to use Phillips Screws.

PHILLIPS RECESSED HEAD SCREWS...

WOOD SCREWS • MACHINE SCREWS • SHEET METAL SCREWS • STOVE BOLTS
 SPECIAL THREAD-CUTTING SCREWS • SCREWS WITH LOCK WASHERS

U. S. Patents on Product and Methods Nos. 2,046,343; 2,046,837; 2,046,839; 2,046,840; 2,082,085; 2,084,078; 2,084,079; 2,090,338. Other Domestic and Foreign Patents Allowed and Pending.

American Screw Co., Licensor, Providence, R.I.
 Continental Screw Co., New Bedford, Mass.
 Corbin Screw Corporation, New Britain, Conn.

The Lamson & Sessions Co., Cleveland, Ohio
 National Screw & Mfg. Co., Cleveland, Ohio
 Parker-Kalon Corporation, New York, N. Y.
 Pheoil Manufacturing Company, Chicago, Illinois

Russell, Burdall & Ward Bolt & Nut Co., Port Chester, N. Y.
 Scovill Manufacturing Co., Waterbury, Conn.
 Shakeproof Lock Washer Co., Chicago, Ill.

*Speed Product Deliveries by
 Cutting Assembly Time*

Wherever Lump Capacitance is needed.

LAPP GAS FILLED CONDENSERS WILL SAVE SPACE, SAVE POWER, SAVE MONEY

In any transmitting system, there are numerous places where installation of Lapp gas-filled condensers will improve transmission efficiency with economy of space and security of operation.

Installations now in service include: plate tuning circuits—fixed condensers for coil tuning, variable condensers for condenser tuning; antenna coupling circuits; tuning circuits for directional antenna arrays; filter networks—tuned circuits to eliminate harmonics.

To every application the Lapp condenser brings notable mechanical and electrical advantages: practically zero loss, minimum space requirement, non-failing, puncture-proof design, constant capacitance under varying temperature conditions. Fixed, adjustable and variable types in three voltage ratings and capacitances, 100 to 2000 mmf—54 models in all, price \$75 to \$500. *Descriptive literature is available on request. Want to see it?*

LAPP

INSULATOR CO., INC.

LEROY, N. Y., U. S. A.

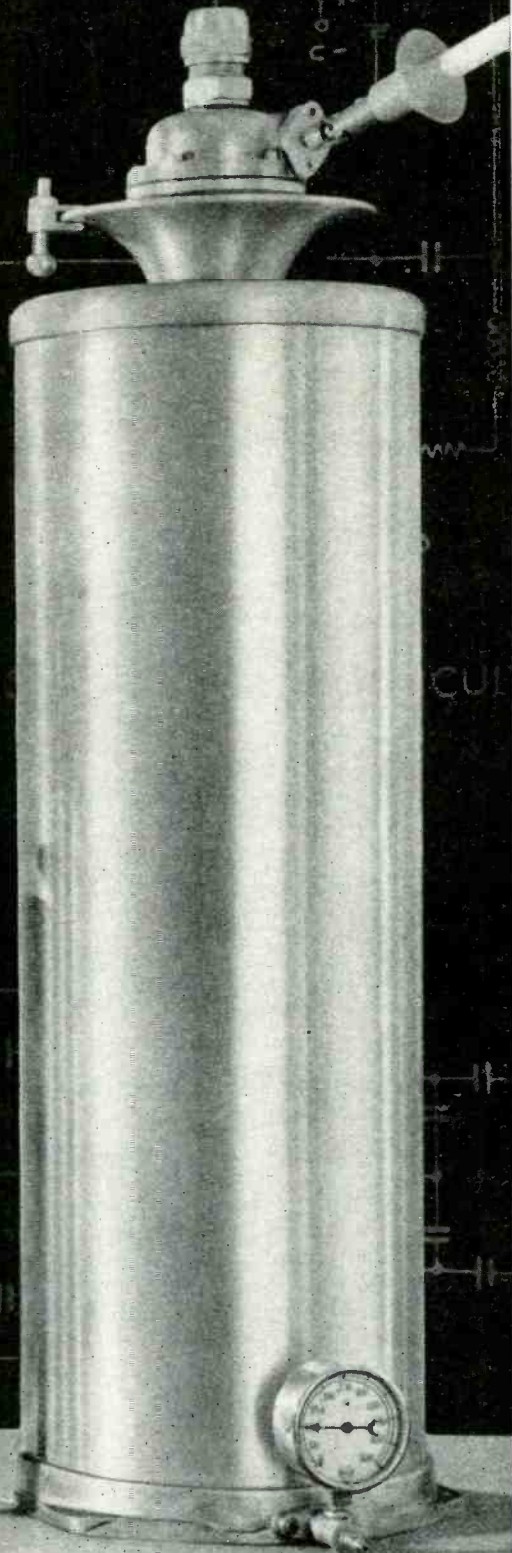
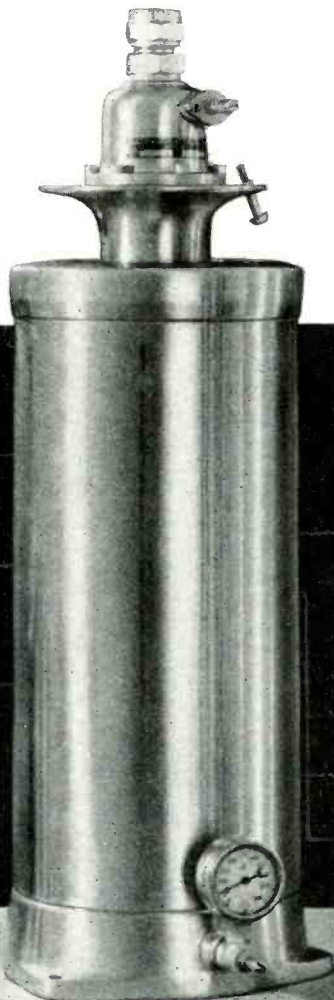

Long Scale

LEGIBILITY

plus

WESTON

DEPENDABILITY



• • • make these DC fan shapes "first choice" for panels and test stands

Especially where repetitive testing is done... such as in the inspection of a wide variety of manufactured or purchased electrical parts... the *extra* scale length of WESTON fan shaped instruments effects an appreciable saving in testing time and assures more accurate readings. The advantages of this extreme legibility is readily apparent, too, for panel requirements of many kinds.

Moreover, there are other advantages which make the use of fan shapes more practical... most economical. Their design provides extreme compactness, with only a slight projection from the panel; as well as savings in weight, and initial cost. And their accuracy is within 1%... ample for most normal test requirements.

Here, again, is further justification for making WESTON your supply source for all instrument needs. While the name WESTON on any instrument assures you of *unquestioned* and *enduring dependability*, WESTON'S design policy supplies this dependability in the form *most practical, most economical*, for each instrument need. Weston Electrical Instrument Corporation, 618 Frelinghuysen Avenue, Newark, N. J.

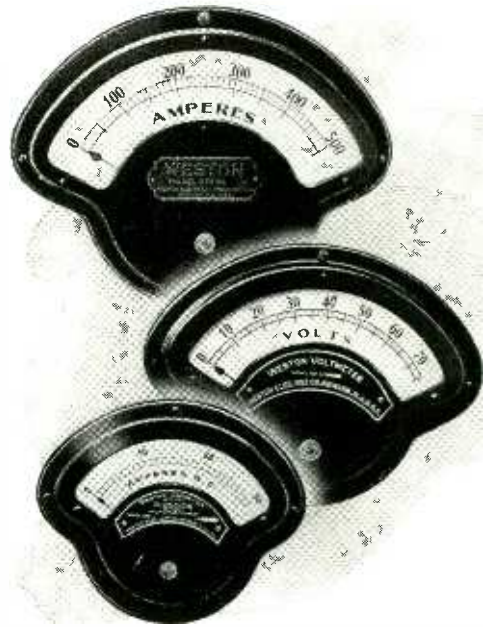

WESTON fan shapes are available as . . .

Voltmeters, Millivoltmeters, Ammeters and Milliammeters, in the following scale lengths . . . 2.6"—4"—5.8"—7.32". Cases and bases are of heavy pressed steel, affording magnetic shielding as well as mechanical protection.

Laboratory Standards . . . Precision DC and AC Portables . . . Instrument Transformers . . . Sensitive Relays . . . DC, AC, and Thermo Switchboard and Panel Instruments.

WESTON

Specialized Test Equipment . . . Light Measurement and Control Devices . . . Exposure Meters . . . Aircraft Instruments . . . Electric Tachometers . . . Dial Thermometers.

FOR OVER 52 YEARS LEADERS IN ELECTRICAL MEASURING INSTRUMENTS

INSULATION

FOR HIGH FREQUENCY CURRENTS!

UNIFORM power factor, high dielectric strength, low hysteresis losses have made Formica a widely used insulation where high frequency alternating currents must be controlled.

There are numerous grades, emphasizing special characteristics, which adapt the material to particular uses. Some of them punch cold and are very easy to machine, so that rapid fabrication at low costs is possible.

Formica specializes on laminated insulation and devotes all its resources to that one product. For more than 25 years it has been recognized as insulation of the first class.

The Formica Insulation Company

4661 Spring Grove Avenue, Cincinnati, Ohio

FORMICA

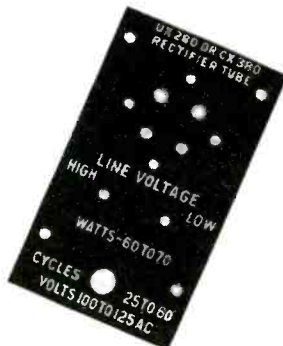
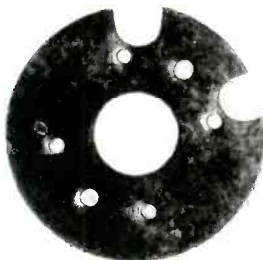
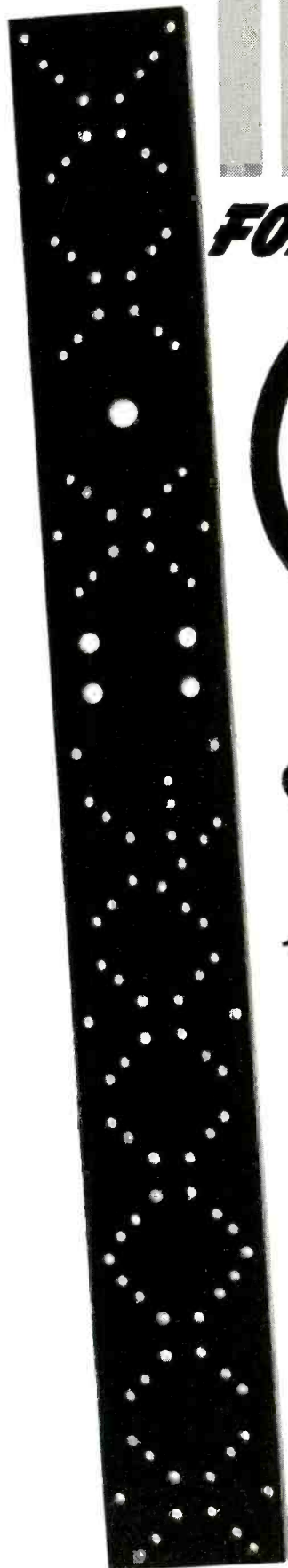



Lumitone Table Lamp Radio manufactured by Sonora Radio & Television Corp. for Mitchell Mfg. Co. Housing molded by Midwest Molders.

STYLING WITH LOW-COST "BAKELITE" PLASTICS

Simplifies Production of Unusual Cabinet for Lumitone Table Lamp Radio

SERVING not only as a cabinet for the receiver, but also as a stand for the lamp, this cylindrical housing for Mitchell Manufacturing Company's new Table Lamp Radio indicates the many opportunities for developing distinctively-styled, yet economically-produced radio cabinets with BAKELITE Plastics.

Molded completely in just two sections from a low-cost BAKELITE Phenolic, the housing interprets faithfully every contour desired by the designer. Fine flutings, deep grooves with through-holes for the speaker, smooth lustrous surfaces—all are obtained in the molding process. Fast assembly with chassis is assured, since positioning lugs, bosses, and threaded metal inserts are integral parts of the interior construction.

BAKELITE Plastics are available in many types, including Phenolics, Ureas, Polystyrenes and Acetates, in a complete range of self-contained, translucent, transparent, and opaque colors. See how these versatile materials can benefit *you* by writing for illustrated booklet 10P, "New Paths to Profits."

BAKELITE CORPORATION, 30 East 42nd Street, New York
Unit of Union Carbide and Carbon Corporation



BAKELITE

TRADE MARKS
The word "Bakelite" and the identifying products  Symbol are registered trademarks of Bakelite Corporation

PLASTICS HEADQUARTERS

RESISTORS *Plus...*

★ Engineering service based on years of specialized resistance manufacturing experience and backed with the most complete line of resistance types, shapes and sizes produced by any manufacturer.

★ Simplification of your own ordering, stock records and engineering by purchasing every needed resistor type from a single, dependable source of supply.

★ Unbiased judgment in helping you select the right resistor type. IRC is not limited in its recommendations to any one type or design. IRC makes them all.

★ "Designed-in" resistors; i.e., inexpensive adaptations of standard resistor

types for your specific application and design for combining different values, for easier mounting or for easier, faster, more economical handling on your assembly line.

★ Proved dependability plus proved acceptability for the most exacting applications, for use under all conditions.

★ Every order backed with all the specialized facilities of a large, internationally known organization that has pioneered the leading fixed and variable resistance developments, and which has made only resistors, researched only resistors and thought only resistors for more than 17 years.

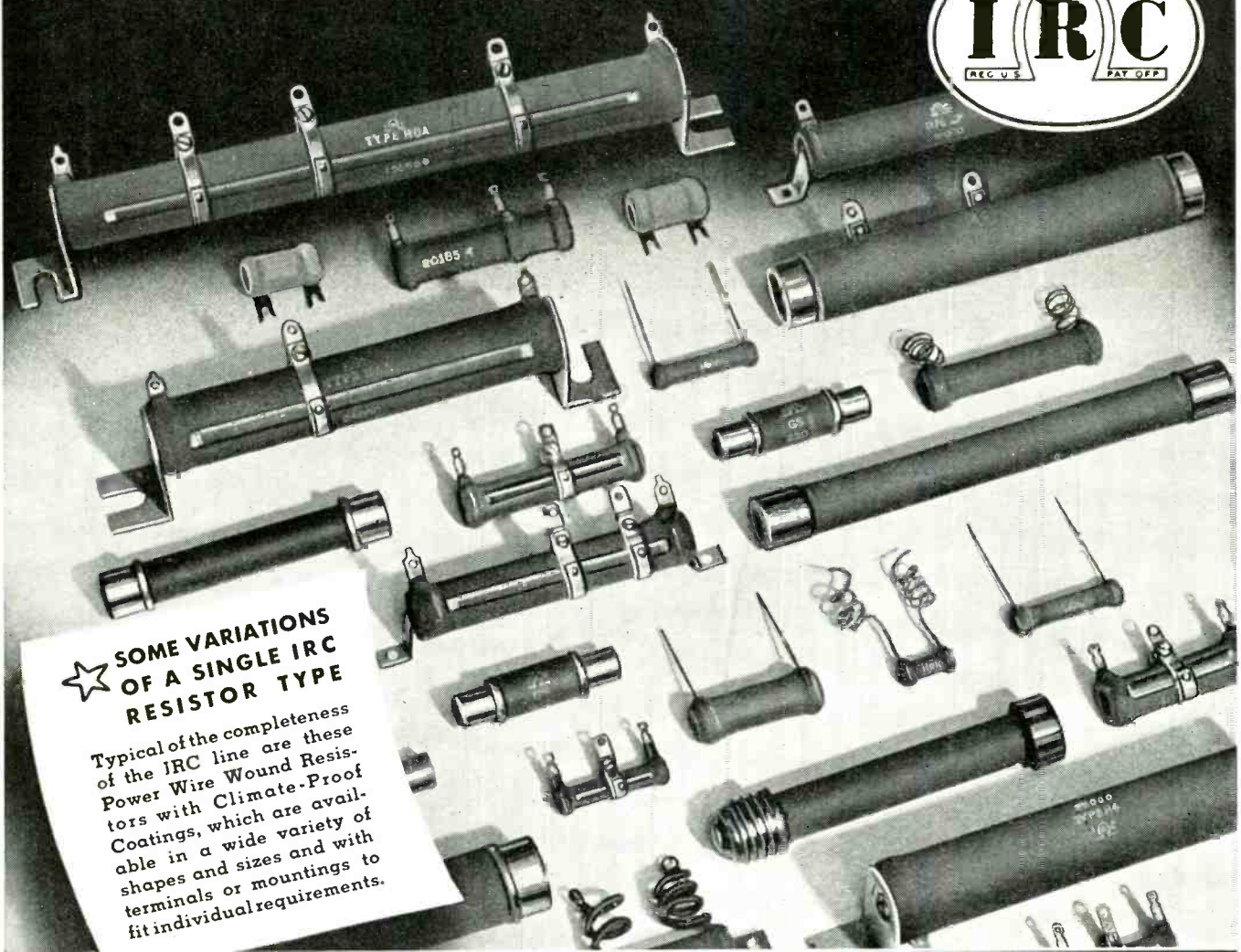

★ **SOME VARIATIONS OF A SINGLE IRC RESISTOR TYPE**

Typical of the completeness of the IRC line are these Power Wire Wound Resistors with Climate-Proof Coatings, which are available in a wide variety of shapes and sizes and with terminals or mountings to fit individual requirements.

INTERNATIONAL RESISTANCE CO.

403 N. BROAD ST., PHILADELPHIA, PA.

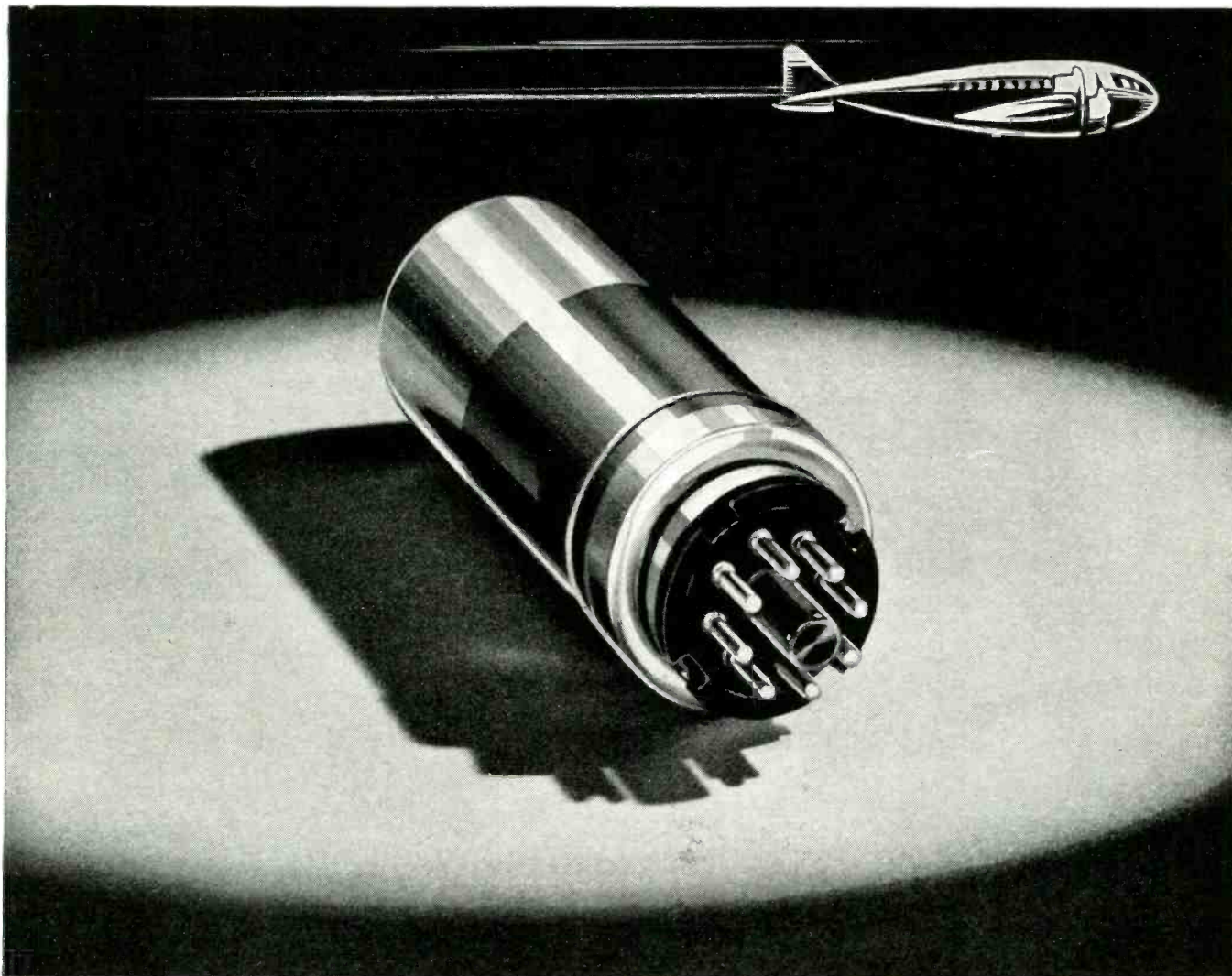

MALLORY *Stratosphere Vibrators*

With the rapid progress of aviation, yesterday's altitude records are quickly becoming today's normal flying levels. But as man reaches higher and higher new problems must be solved... not least among them the problem of reliable radio communications.

From altitudes of 15,000 feet and upwards, for instance, vibrators begin to lose efficiency. At stratosphere altitudes, electrical insulation effectiveness is so greatly reduced as to impair the efficiency of the vibrator or make it completely inoperative. It may even be impossible for the contacts to interrupt an arc. Mallory has solved this problem, however, with the

development of the Stratosphere Vibrator. The Mallory Stratosphere Vibrator is sealed completely airtight at normal pressure of 14.7 lbs. per square inch. Regardless of the altitude or atmospheric pressure, the Vibrator functions with full efficiency. They are available for 6, 12 or 24 volt operation.

If you manufacture receivers or transmitters for aircraft use... or any other battery powered equipment operating under abnormal atmospheric pressure or adverse climatic conditions, be sure to get all the facts about these new Mallory Stratosphere Vibrators.



P. R. MALLORY & CO., Inc., INDIANAPOLIS, INDIANA • Cable Address—PELMALLO

Serves the Aeronautical, Automotive, Electrical, Geophysical, Radio and Industrial Fields with... Electrical Contacts, Welding Electrodes, Non-Ferrous Alloys, Powdered Metal Products and Bi-Metals... Rectifiers, Dry Electrolytic Capacitors, F. P. (Fabricated Plate) Capacitors, Vibrators, Vitreous Resistors, Potentiometers, Rheostats, Rotary Switches, Single and Multiple Push Button Switches, Electronic Hardware.



CROSS TALK

♦ A LETTER...“October ELECTRONICS makes certain suggestions upon which I would like to comment, as they concern some aspects of the profession which interest me greatly.

“One of the suggestions is that the industry arrange public demonstrations of knotty engineering problems to obtain expressions of opinion by laymen, for aid in deciding standardization and design problems. You say that ‘certain matters cannot be explained by the best of mathematicians or scientists or practical engineers. These matters deal with the public taste. No formula has even been worked which will tell a manufacturing company what the public will go for.’ There is some truth in this statement, but not as much as it implies, and I think that the conclusions drawn from it are misleading.

“The situation involved in this matter is an extremely important one with respect to the professional success of engineers, the profit and loss of the radio industry, and the quality and extent of public service afforded by radio. It is quite true that many radio engineers do not take full account of factors affecting a product other than the purely technical ones. This is not true in most engineering professions, and comes about in radio broadcast receiver engineering, I think, because it is difficult for radio engineers to see their product as the ultimate user sees it. In the old days when point-to-point communication was radio’s field, radio engineers were experienced in use of the apparatus, and decided design questions in the light of that experience; they knew what it meant if the receiver failed on a ship at sea, they knew the importance of all the design and operating features involved in the apparatus, and gave them appropriate weight. But in the broadcasting field, the radio engineer does not do a great deal of listening to programs, and what he does do is

highly colored with his technical knowledge. He does not view the apparatus with the eyes of the user.

“This means that he may settle design questions with insufficient weight given to various non-technical factors which are important to the ultimate appeal and success in service of the product. The factors which should be included in the considerations of a practical engineer include technical, physiological, aesthetic, and psychological ones. I maintain that, contrary to your statement, a practical engineer can understand all the factors necessary to successful design of his product.

“There is no mystery about ‘public taste,’ and there is no ‘public demand’ for something which does not exist. The public does not demand improvements in radio, automobiles, or anything else. It accepts improvements when they are provided, and the degree of acceptance will be proportional to the quality of the improvement. In products where the aesthetic and psychological factors have a very large degree of importance in comparison with the technical factors, as for example in clothing, housing, and even books, it is more difficult, and perhaps impossible, to predict unfailingly with respect to any one design. But in a product where the technical factors have the larger importance and the aesthetic and psychological are secondary, it is not very difficult to predict. The practical engineer *can* do it, if he is *really* practical, takes account of all the factors, and uses good judgment.

“If a public demonstration could be counted upon safely to assist in deciding design and standardization questions, it would be the thing to do. However, nearly all radio design and standardization questions are too complex to be so answered. It has been the frequent experience of radio engineers that even such a simple question

as which is the better of two loud speakers cannot be determined by laymen, unless the two speakers are enormously different from each other, because the opinions delivered at one demonstration test will depend upon the particular room, the particular people, what they had been listening to just previously, what their ages were, etc. Furthermore, *proper* sampling of public opinion with regard to even such simple matters as political views, is an enormously difficult job. The distribution of the sample must be selected with regard to many factors, such as age, sex, income group, geographical location, education and so on, if the opinions or responses received are to be regarded as at all representative of the general public. The application of such a control during the preliminary stages of arriving at design decisions would entail impossible expense.

“I would like to see your suggestion turned into a plea to engineers themselves to become more broadminded, and more attentive to the service and operating aspects of their products. Many design questions might be answered from the viewpoint of which way would I rather have it if I were not a radio engineer and were buying it for my own home. The public cannot be used as a proving ground without extra cost and more industry disruption. The design job will be better done, and the public better served, the more the engineer decides himself, and the earlier he decides it. But he must bear in mind *all* the factors involved, and use good judgment in evaluating them and in taking account of them. He should observe more closely the operating habits and desires of public users of his instruments, and in the field of overlapping activities between engineering and sales departments, he should not draw the limit of his own thinking too closely to the purely technical factors.”—ARTHUR VAN DYCK.

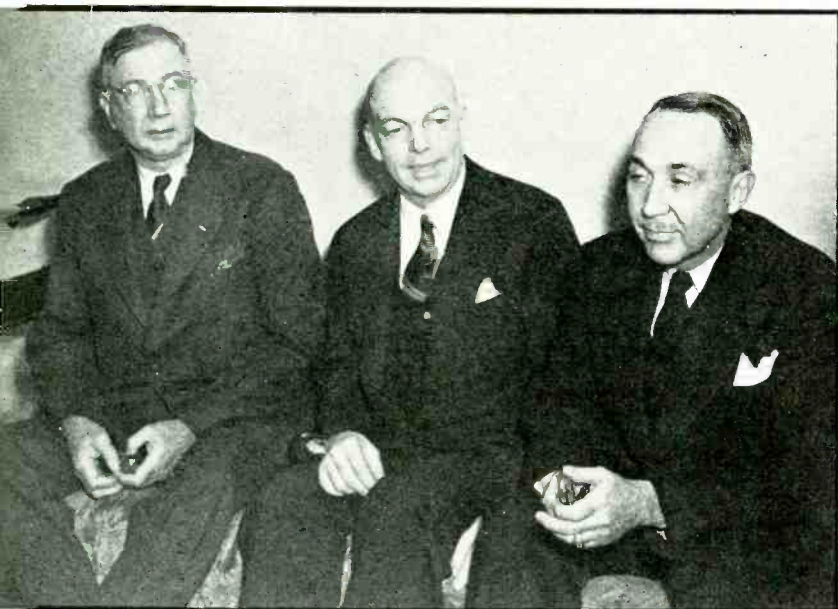

Armstrong Medal Awarded to "Radio's Most Active Pioneer"

Greenleaf Whittier Pickard, at right above, is shown receiving the Armstrong Medal from Keith Henney, President of the Radio Club of America. Dr. Pickard's research spans radio development from the perikon detector, which he patented in 1908, to frequency modulation of the present day, in which he is an authority on field strength surveys and measurements. At the left are Major General J. O. Mauborgne, Chief Signal Officer of the U. S. Army who talked on national defense at the Radio Club Banquet, Major E. H. Armstrong, in whose name the Medal is awarded, and Brigadier General Dawson Olmstead, of the Fort Monmouth Signal Corps Laboratories

MINIATURE RECEIVERS

150,000 miniature receivers have been sold at a list price of about \$20 since early summer. Such a sales record indicates that engineers have designed a product of major significance. Herewith is presented a review of the important characteristics and design features of typical "personal" receivers

SINCE the early days of radio there has been a consistently strong demand for a small radio receiver which could be carried conveniently by a person and which would deliver a reasonable amount of acoustic power under average conditions of reception. Receivers recently placed on the market by a number of manufacturers adequately fill all the requirements of extreme portability. To make the receiver size small enough it was first necessary to design components of small size which would operate on a minimum of power. Tubes have been developed for satisfactory operation with a filament voltage of 1.4 and a B supply of 67.5 volts. With this trend have come very small batteries capable of delivering relatively large amounts of energy, small tube envelopes, miniature i-f transformers, and small tuning condensers. These developments, all maturing at about the same time, have resulted in the design and manufacture of receivers which are portable in the most literal sense of the word. Your editors, taking cognizance of this new development, present herewith a report on the design and characteristics of typical receivers of this type now on the market. While only a few of the current receivers are discussed in this article, it is believed that the important features of the personal type of receiver, common to all the models available, are covered.

The size, weight, shape and method of carrying are important considerations in the design of any instrument intended to be highly portable. The sizes of the receivers investigated vary from about 100 to 180 cubic inches. The average weight is about $4\frac{1}{2}$ pounds. There are two general methods of carrying these receivers, by means of a handle attached to the case, and by means

of a strap slung across the shoulders. RCA, GE and Fada make use of the carrying handle, Philco uses the shoulder strap and Emerson uses both, in different models.

There have been several factors which tended to reduce the use of many radios as portable instruments. One was the relatively large size and weight of available units. If a radio of more than a few pounds in weight is carried very far,

The Fada receiver weighs $4\frac{1}{2}$ pounds and its dimensions are 8 inches by $4\frac{3}{4}$ inches by $4\frac{1}{4}$ inches

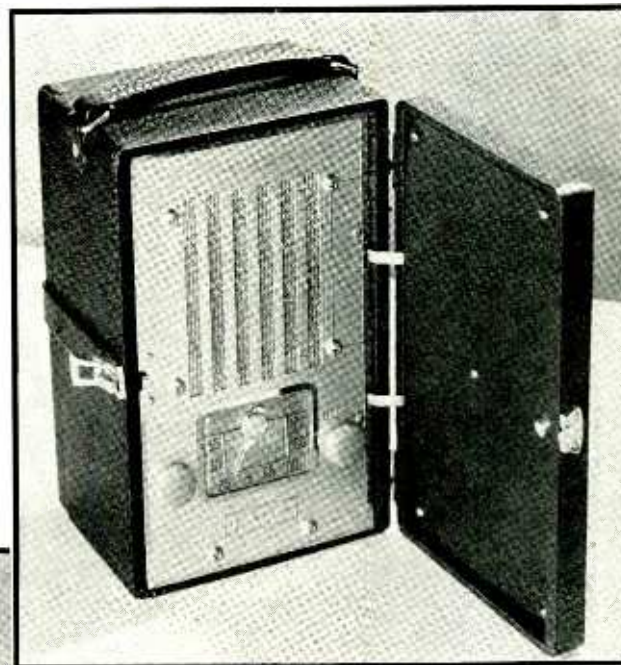

The antenna of the Philco set is contained in the shoulder strap. A low impedance loop is used to avoid dielectric losses in the body of the user

it soon becomes a burden and after the novelty is worn off, it is left at home. On the other hand, if a receiver weighs but a few pounds, the user may be convinced that the effort of carrying it even over considerable distances is well repaid. The average person does not wish to

appear unduly conspicuous in carrying a portable set. This demands that the case be as small a size as is consistent with reasonable operation, and that it be of a conservative design. These precepts have been followed with the results shown in the accompanying photographs. The

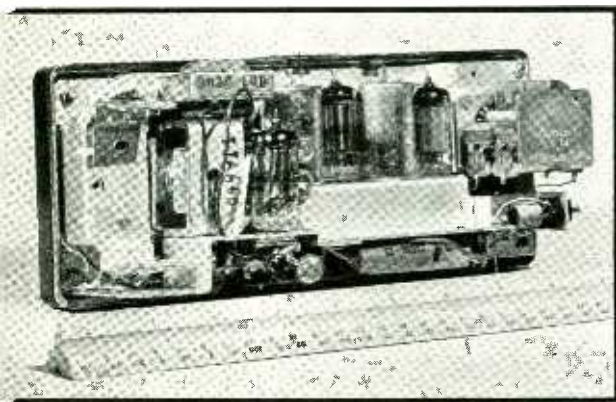

Chassis of the RCA Victor personal receiver. The tube filaments are heated by a single flashlight battery which mounts at the left of the chassis

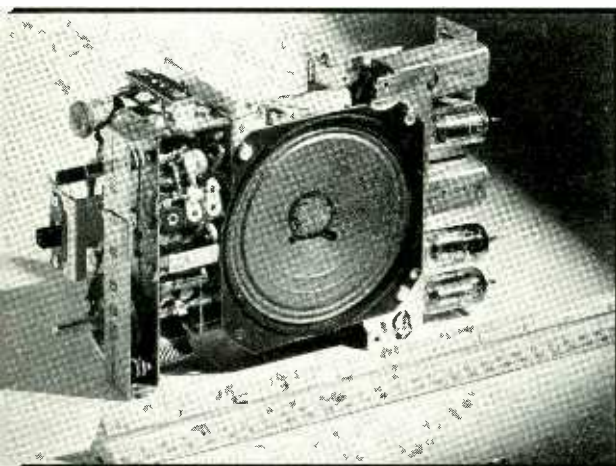

Chassis of the Emerson receiver. An economizer circuit is used in this set to decrease the total current used (see diagram on opposite page)

shape of the Philco set was designed keeping in mind a shape which has been fully accepted by the public for a number of years, the binocular case.

There have been approximately 150,000 of these receivers sold since spring and there are hopes of increasing this figure to 300,000 by the end of the year. There are about eight or ten manufacturers already in the field and several others are planning to enter in the near future.

All of the receivers of this type investigated use superheterodyne circuits, most of them using the line of miniature tubes introduced last year (1R5, 1T4, 1S5 and 1S4). Philco, however, uses loktal tubes in its set. The filaments are powered by one flashlight dry cell (some use two or three in parallel to increase the time between battery renewals. The B battery used is a 67½ volt unit of a small size which was introduced in July of this year. The current from the A battery is 0.25 ampere and from the B battery, about 8 ma.

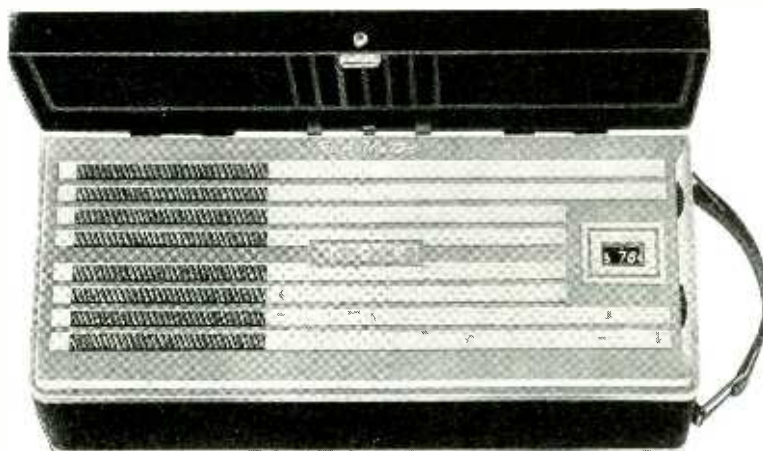

The loop antenna of the RCA Victor set is contained in the polystyrene cover. The on-off switch is operated by opening or closing the cover

An "economizer" circuit in the Emerson set reduces the B current from 7.5 ma under normal operation to 5.5 ma when full volume is not required. This is accomplished by increasing the bias on the power output tube and decreasing screen voltage on the converter 1R5 and the i-f tube 1T4. Thus, the life of the B battery may be increased by a considerable amount.

All of the sets make use of loop antennas, some contained in the cover of the cabinet, others enclosed in the shoulder strap. The "undistorted" power output averages about 50 milliwatts (electrical input to the speaker), which provides a reasonable listening level depending considerably on the efficiency of the loudspeaker. The maximum power output ranges from about 120 to 180 milliwatts.

The problem of sensitivity in a receiver of this type is an important one. The restrictions imposed by the very limited loop area, and the available power from the small batteries are considerable. The extent to which these limitations have been overcome is attested by the sensitivity of a typical set: about 250 microvolts per meter for 15 milliwatts output. This is comparable with the sensitivity of a typical four tube portable receiver of conventional design. The sensitivity decreases slowly during the initial period of battery life and afterwards decreases quite rapidly. Satisfactory operation is maintained with the A battery voltage down to 1.0 volt and B battery voltage down to about 36 volts. Under ordinary conditions of use it can be expected that the B battery will last from two to five months without change. Its life de-

pends largely on the frequency of use as well as the time of use. The A battery will have to be renewed about ten times during the life of the B battery.

To pack all the necessary parts into the small available space, several tricks had to be incorporated into the chassis layout. The chassis is no longer a simple U-shaped piece, but a complicated shape made up of several pieces spot welded together as shown in the accompanying photographs. This is necessary so that all parts, large and small, can be mounted in the most advantageous positions. For instance, the tubes must be mounted in a higher position than the B battery so that the sockets and resistors can be mounted below the chassis. Also, the loudspeaker, because of its relatively large size and its shape requires a rather large opening in the chassis. An interesting feature of the construction is the increasing use of plastic cements instead of screws or eyelets for fastening parts together.

Power Supply

The development of a very efficient and highly compact power supply was essential in the design of the miniature receivers. There has been available since July a B battery which is about half the size of a conventional battery of the same voltage rating and has considerably longer life. The accompanying diagram illustrates the cell construction of the Eveready MiniMax battery. This method of construction makes more effective use of the available space. In this battery, used in these receivers, the carbon electrode has been replaced by a thin layer of carbon placed on the zinc electrode

of the adjacent cell. Thus no connecting wires are necessary from one cell to the next when they are used in series as in a B battery. The yielding mechanical seal wrapped around the edges of each cell provides the necessary expansion for the electrolytic mix in a very small space. Another space saving feature of the miniature battery is the use of connectors which look very much like the ordinary glove snaps. A good contact is provided using only about one-eighth of an inch of length instead of the one-half inch formerly required.

A new line of miniature radio tubes was announced at about the same time as the new B battery. These tubes are much smaller than previous types and their design is such that when used in a radio receiver, the power output is sufficient for reasonable listening level. The operation of the filament on 1.4 volts permits operation on only one standard flashlight cell, which further contributes to the small size of the receiver. The tubes were described in the November, 1939 issue of *ELECTRONICS*.

I-F Transformers

Another contribution to small size is the iron core intermediate-frequency transformer. By the use of iron powder moulded with polystyrene as a binder, used both as a core

Comparison of i-f transformer used in the miniature receiver (RCA) and a conventional transformer. The small unit has powdered iron cores and shields

Circuit diagram of a typical receiver (Emerson). This circuit has a sensitivity of about 250 microvolts per meter for 15 milliwatts output

and as a shield around the coils, and low-loss polystyrene as insulation, it has been possible to decrease greatly the size of the transformers. The spacing between the coils is very small because the proper degree of coupling is obtained at this short separation by the use of the iron powder shielding which increases the permeability of the coils. The shunt condensers are also a factor in decreasing the size of the transformers. A cutaway view of the RCA i-f transformer is shown in comparison with a conventional transformer in the accompanying photograph.

Antenna Systems

All of the miniature receivers under consideration use loop antennas either in the cover of the cabinet or in the shoulder strap. In the case where the loop is contained in the cover, the loop is sandwiched in between two sheets of polystyrene and no evidence of an antenna shows ex-

cept the two lead wires to the set. Polystyrene is used because its very low dielectric losses increase the Q of the loop. Coupling to the first tube is made in the conventional manner. However, in the case of the shoulder strap antennas, it is not possible to use the usual high impedance loop because of the dielectric effect of the body of the user. This problem has been solved by Emerson and Philco by different methods. Philco runs a single piece of heavy copper braid through the shoulder strap to form a low impedance loop. The energy picked up by the loop is transferred by means of an iron-cored r-f current transformer to the first tuned circuit. Emerson's method is to place a low-impedance loop of about eight turns of wire in the shoulder strap and place in series with it an inductance which adds to the impedance of the loop to bring it up to a suitable value to fit the requirements of the tuned circuit.—C.W.

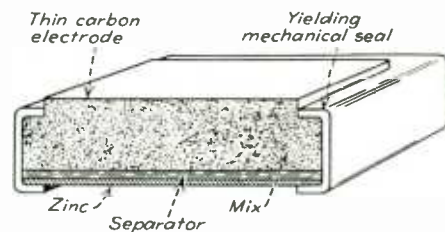
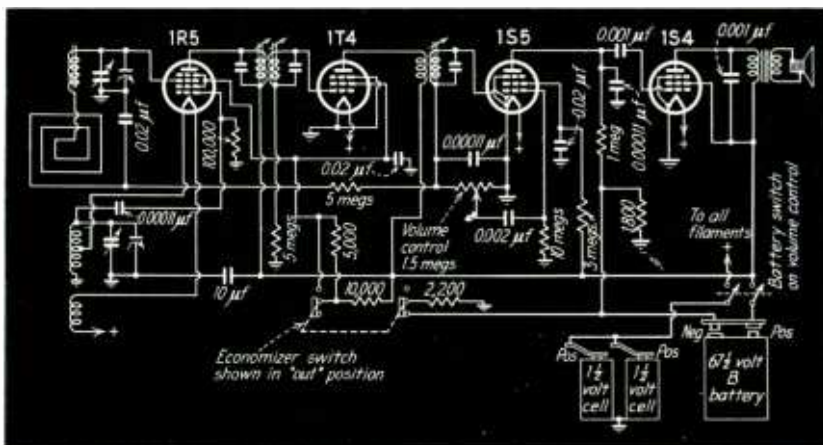
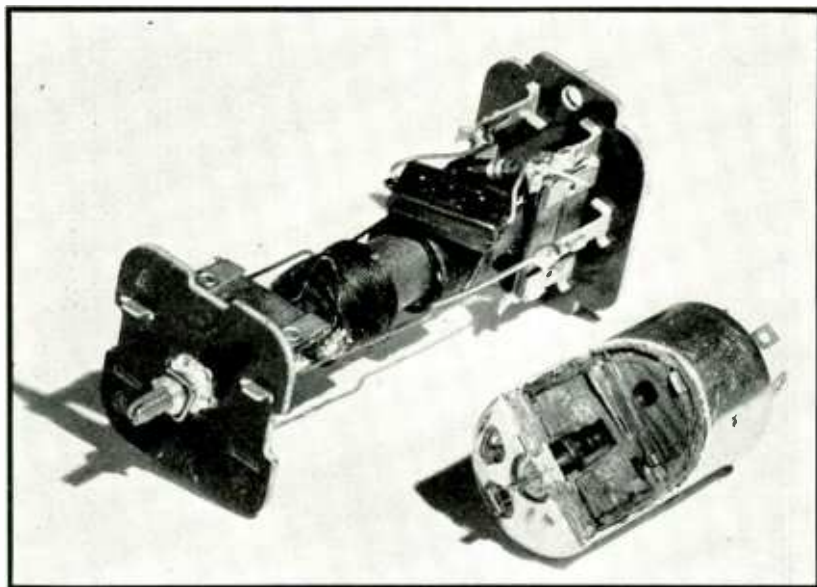

Cross-sectional diagram of one cell of the MiniMax B battery widely used in miniature sets. A smaller battery of longer life results from this method of construction

An Electrically-Focused Multiplier Phototube

A compact secondary-emission multiplier structure using curved targets or "dynodes" develops a maximum current gain of over a million and a luminous sensitivity of over ten amperes per lumen, with signal-to-noise ratio considerably better than conventional phototubes. A practical tube useful in sound-track reproduction, light-operated relays and the like

By J. A. RAJCHMAN and R. L. SNYDER
RCA Manufacturing Company, Camden



Fig. 1—The new phototube structure: A, external appearance; B, section showing glass barrier; C, the element structure viewed from the top

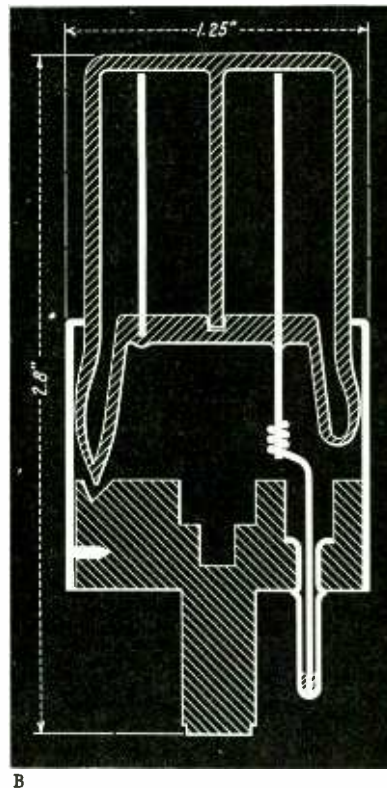

of the impinging primary electrons, are directed in turn to a second dynode, and knock out new electrons. A progressively growing stream of electrons can be created by repeating this process a number of times. For example, in the tube to be described, when the multiplication of every stage has been adjusted to be 5, the nine stages amplify the signal approximately 2,000,000 times. The electrons leaving the last stage flow to the collector or anode, and constitute the current utilized in the output circuit.

As soon as it was realized that this was a practical method of obtaining very sensitive phototubes, many ingenious schemes were devised and used to achieve successful electron multiplication. At first magnetic fields were required to direct the electrons from stage to stage. However, advances in the methods of determining the course of electrons in electric fields made it possible to design purely electrically focused electron multipliers whose geometry could be adapted to almost any specific purpose. This article describes a developmental type of multiplier whose size, sensitivity, and electrical characteristics are adapted to applications in which it may advantageously replace phototubes used at the present time, and to new applications rendered practical by its advent. The design of this tube lends itself to the evolution of a relatively inexpensive manufacturing technique. In this next step such modifications of the design as may be necessary will probably have their chief effect on structural details.

The experimental tube, shown in Fig. 1A, when mounted on an 11-

AS is well known, an electron multiplier is a vacuum tube which uses the phenomenon of secondary emission to amplify signals composed of electron streams. In the photoelectric multiplier, the electrons emitted from an illuminated photocathode are caused to strike an electrode, called a target, or dynode, on whose surface each impinging electron produces the emission of several other electrons. These secondary electrons, whose number depends on the nature of the electrode surface and the energy

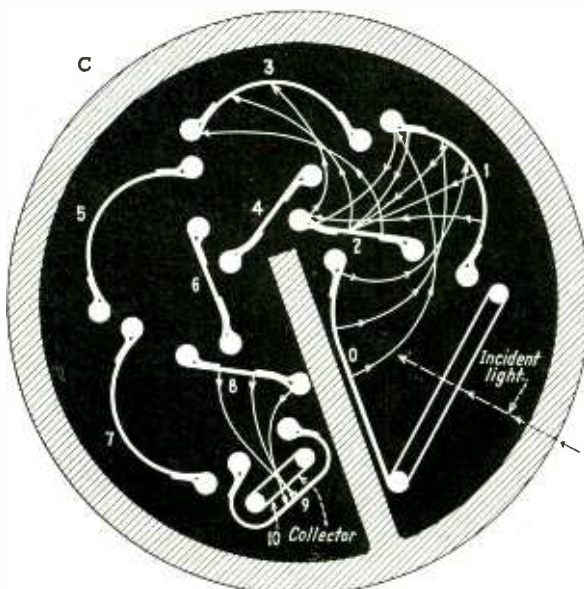

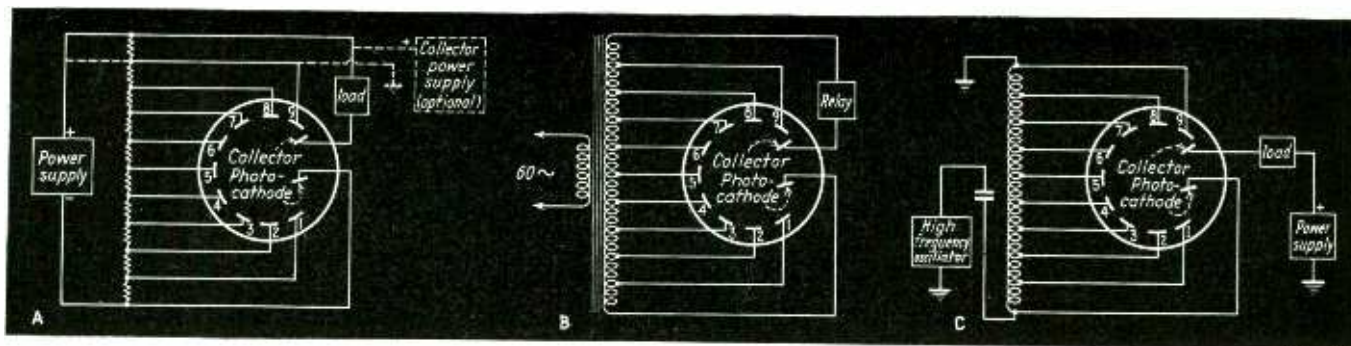

Fig. 6—Several practical circuit connections: A, d-c power supply and bleeder; B, 60-cps a-c self-rectified circuits; C, high-frequency circuit

porting wires, which are molded into the press. Eleven of these wires extend through the glass to serve as leads. Accurate electrodes are formed by simple hand-operated dies, which curl their ends into cylinders fitting the mounting wires. These rounded surfaces also minimize the field emission which would produce an interfering output current.

Operating Characteristics

An outstanding characteristic of the multiplier is that its output is a linear function of a constant or variable (at any frequency up to hundreds of megacycles) illumination of the photocathode, provided the dissipation of the tube does not exceed the safe limit, which is about half a watt. The average multiplication and sensitivity of a series of experimental tubes are shown as a function of the potential applied to the multiplier on the chart of Fig. 2.

This tube is effective at very low illuminations, not only because it is very sensitive, but also because the dark current, or output current without light, is very small, being equivalent to that produced by an illumination of 10^{-7} to 10^{-8} lumens. The effectiveness of the electric focusing is demonstrated by the fact that when cesium-silver oxide targets are used, the average gain per stage (see small graph of Fig. 2) nearly corresponds to the secondary emission to be expected from such a surface.

A convenient control of the multiplication of the tube can be obtained at the expense of a slight loss in sensitivity through deliberately defocusing the electron paths by making the voltage step of one dynode unequal to that of the others. The curves of Fig. 3 show the out-

put as a function of the voltage variation of the initial stage, 1, a typical inside stage, 4, and a typical outside stage, 5.

As was pointed out above, the anode's isolation from the interdynode space and its proximity to the emitting surface of the last stage, make the current it collects

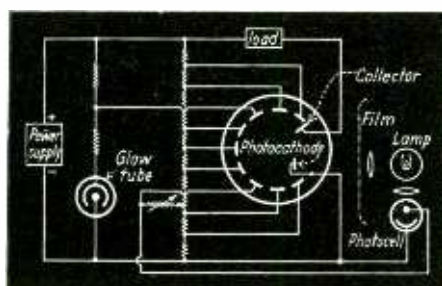

Fig. 7—Circuit combining hum-bucking compensation with optical feedback to reduce effects of power supply and illumination variations

almost independent of its potential over a wide voltage range. This characteristic, shown for various light intensities in Fig. 4, makes it possible to couple the tube to any load impedance, and demonstrates the rather remarkable variation of the plate resistance from a high positive value through infinity to a high negative value.

External Circuits

To maintain the multiplier dynodes at their operating potentials they may be connected to equally-spaced steps of a voltage divider fed by a d-c power supply, as shown in Fig. 6A. The current in the divider should be about ten times the maximum output of the multiplier, a value sufficient to prevent variations of the dynode potentials due to the signal currents.

Due to the critical dependence of the gain of the multiplier on the

voltage (see Fig. 2), rapid changes in the voltage resulting from insufficient filtering of the power supply will introduce considerable hum modulation on the signal. The level of this interference, referred to 100 per cent signal modulation, is shown in Fig. 5A as a function of the percentage of a-c component. For the same reason, slow shifts in the voltage due to poor regulation will cause a change in the level of the output signal, which can be found in Fig. 5B.

The filter and regulation requirements of the power supply can be greatly reduced by utilizing the control exercised by the voltage of individual stages, as shown in Fig. 3. This is done by connecting one dynode to an auxiliary voltage divider which consists in part of a non-ohmic element such as a glow tube, thyrite, etc. (see Fig. 7). Since the potential of the control dynode is no longer proportional to the potentials of the other dynodes, a variation in the supply voltage will cause the output of the multiplier to vary, not only due to the general change in multiplication, as shown in Fig. 2, but also according to the control characteristics of Fig. 3. These two variations can be made to compensate each other, stabilizing the circuit with respect to voltage fluctuations when the value of the resistance and the nature of the non-ohmic element of the auxiliary divider are properly chosen. Since the sensitivity can be considered essentially linear with respect to the voltage over a wide range, the linear section of the control characteristic should be employed. For that range the effects of the voltage fluctuations are reduced by a factor of 200 with respect to an uncompensated circuit, with a loss of only

about 50 per cent in sensitivity for the mean voltage.

The dynode control characteristic can also be utilized in the numerous applications where the signal originates from the reflection or transmission of light, to compensate for the variation in the output due to the fluctuations of the exciting light source. This may be accomplished with the circuit shown in Fig. 7, wherein a phototube, directly illuminated by the exciting light, is resistively coupled to the control dynode in such a way that an increase in light shifts the control voltage in a direction to cause a decrease in gain, and vice-versa. The



Fig. 10 — External view of a self-contained a-c operated phototube relay using the multiplier phototube

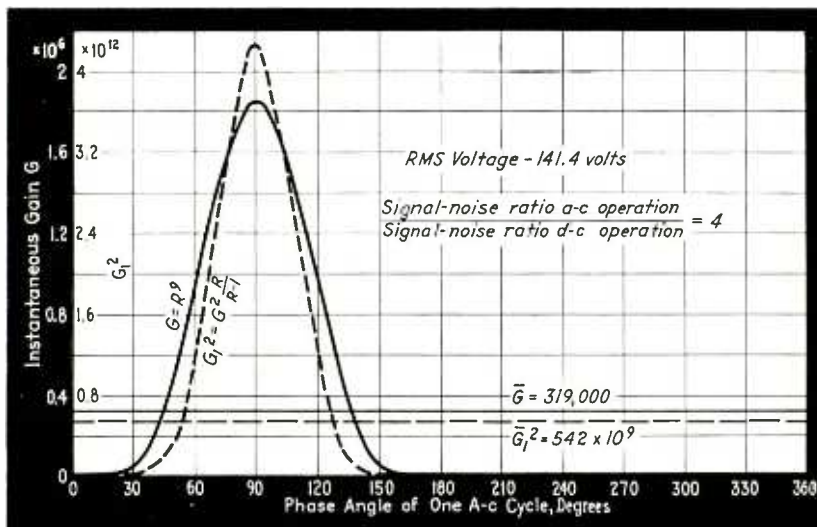
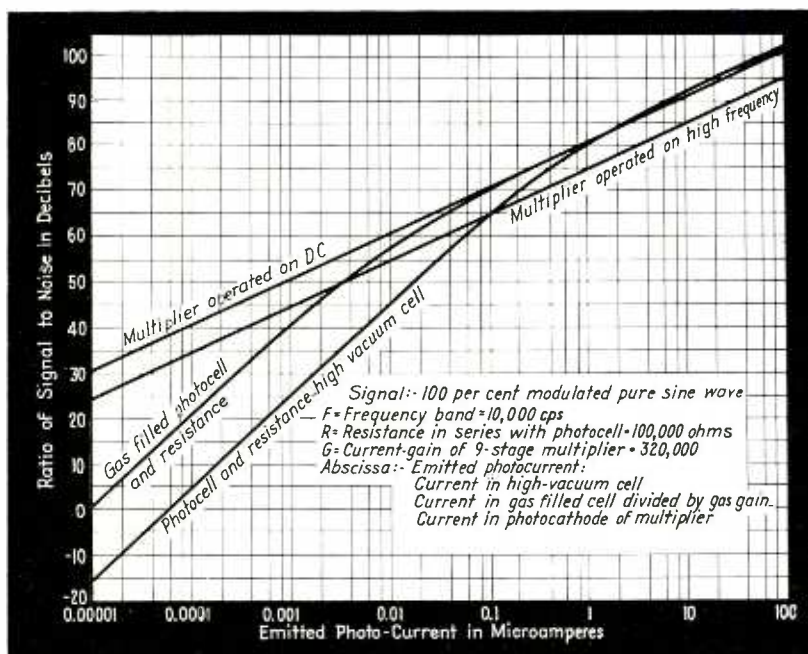

Fig. 8—Gain vs phase angle when multiplier is operated in self-rectified circuit

Fig. 9—Comparison of signal-to-noise ratios of conventional phototubes and the electron multiplier



compensation is perfect when operating on a hyperbolic section of the control characteristics, because then the product of the gain and the light intensity remains constant. Of course, the coupling resistors must be properly chosen and the current in the phototube must be many times that of the control dynode. Combining the light compensation and voltage stabilization, as shown in Fig. 7, it was possible in a sound reproducing system to reduce the fluctuation to within a few decibels of the shot-noise level, with an unregulated power supply and a standard exciter lamp, both operated on an industrial a-c line.

Another practical method of operating the multiplier consists of applying to its electrodes a-c instead of d-c voltages, at a frequency considerably higher than the uppermost signal frequency. The output is then a series of rectified impulses occurring during the positive halves of the cycles. The pulses are effective only after the voltage has risen to a large fraction of its peak value, as can be seen from the solid curve of Fig. 8. However, due to the tremendous increase in the gain during the voltage peaks, the a-c and d-c sensitivities are nearly equal for the same r-m-s values (see dotted line Fig. 2). Two convenient circuits can be used for a-c operation. A tapped transformer, operated on a 60-cycle line as shown in Fig. 6B, is particularly suitable for relay operation. A high-frequency oscillator driving a tapped inductance part of a resonant circuit, as shown

(Continued on page 58)

Rochester 1940

Breaking all previous attendance records, the Rochester Fall Meeting of the I.R.E. and R.M.A. revealed advances in f-m practice and theory, renewed interest in high fidelity amplifiers and acoustics, a new type of metal tube, and direct-pickup color television

FREQUENCY-MODULATION receiver design problems were the subjects of considerable attention at the twelfth annual Rochester Fall Meeting of the Institute of Radio Engineers and the Radio Manufacturers Association on November 11, 12 and 13. Much work on preparing f-m receivers for general public sale is indicated by the nature of the papers delivered and the organizations presenting the papers. This, however, is only one of the subjects which attracted 600 engineers, the largest attendance in the history of the meeting, to the Sagamore Hotel in Rochester. A new coaxial tuning condenser using a new technique, the application of inductive tuning to ultrahigh frequencies, a new cellulose ester dielectric, a new metal tube of unique design, a high quality audio amplifier using automatic bias control on the output tubes, loudspeaker developments, color television and several laboratory instruments for television signal analysis were among the subjects discussed, all of interest to those engineers charged with the responsibility of designing the products of the radio industry so that they will be of better quality or more economical construction. The significance of these papers was discussed by Donald G. Fink, managing editor of *ELECTRONICS*, at the conclusion of the technical sessions.

The program was opened by A. D. Power of the Radiotron Division of RCA Manufacturing Co. who spoke on the measurement of electrode temperatures of tubes during exhaust and operation. Radio tubes must perform in a manner close to the published ratings and such performance depends to a large extent upon the temperature of the electrodes during the processing of the tube. Therefore, some accurate means of measuring such temper-



A. F. Van Dyck, toastmaster of the Fall Meeting Banquet, with his prototype of the 80,000,001st radio set. Before the end of the evening this set had grown to enormous proportions due to the addition of gadgets for f-m, phonograph, recorder, television and color television

atures must be provided. Also, it is desirable to know the temperature of the electrodes under various conditions of operation. For glass tubes it is convenient to measure the temperature of the outermost electrode during processing, providing it is hot enough to be incandescent, with an optical pyrometer. However, it is necessary to measure temperatures below the incandescent point, of inner electrodes, and also of metal tubes. For these purposes, Mr. Power described a technique of using thermocouples with one junction placed at the point whose temperature it is desired to know. It is an easy matter to fasten a thermocouple junction to the metal shell of a tube or to the plate. It is much more difficult to fasten such a junction to a grid wire, although it can be attached to a grid support fairly easily. When it is desired to determine the temperature of a grid wire at a point away from the sup-

port, the following method is used. The grid wire is removed and in its place, a thermo wire with the junction at the proper point is fastened to the support with an insulating cement to avoid short circuiting the junction. The lead wires of such thermocouples are brought outside the glass envelope in a suitable manner for connection to the other junction and the indicating meter. This technique can be used only on experimental tubes.

Frequency Modulation

Frequency modulation was the subject of more attention than any other branch of the industry. No less than four papers were presented, each concerned with the problems of noise or interference. In such a situation it is not surprising that they overlapped each other on certain points. J. A. Worcester of the General Electric Co. noted the need for extremely high gain,

4,000,000 times, previous to limiting and demodulation. For this purpose a double superheterodyne circuit is used in a typical receiver, in which the first two tubes are converters. A single oscillator provides the heterodyne frequency for both converter tubes. The oscillator frequency range is from 18.85 to 22.85 Mc giving a first intermediate frequency in the range from 23.15 to 27.15 Mc for the signal frequency range from 42 to 50 Mc. The first intermediate frequency and the oscillator always differ by 4.3 Mc and when they are mixed in the second converter, the 4.3 Mc becomes the constant second intermediate frequency. The speaker also discussed the cascade limiter used to reduce noise to a very low level, and several other features of the GE JFM-90 Frequency Modulation Translator unit.

After an analytical presentation of the action of the limiter in suppressing noise in an f-m receiver, C. W. Carnahan of Zenith Radio Corp. agreed with Mr. Worcester that the best solution to the noise suppression problem is the use of the cascade limiter. The circuit diagram of such a limiter is shown in the accompanying diagram. With representative conditions for high fidelity broadcasting in the u-h-f range, it was found that the output transient for the same impulse noise was considerably less in frequency modulation than in amplitude modulation.

Interference between two frequency modulated signals on the same channel was discussed in a paper by Harold A. Wheeler of Hazeltine Service Corp. Such interference is of two different types: (1) crosstalk which is simply a combination of the two signals and (2) a beatnote, the frequency of which varies in accordance with the variations of both signals. A lesser difference in signal strength for a given reduction in crosstalk is required in frequency modulation than is required in amplitude modulation, and the same difference is required for different bandwidths in frequency modulation. A limiter in the f-m receiver will reduce crosstalk by a considerable amount but its use also results in slightly higher beatnote interference. This, however, may be reduced by the use of a wider frequency band in f-m.

ELECTRONICS — December 1940

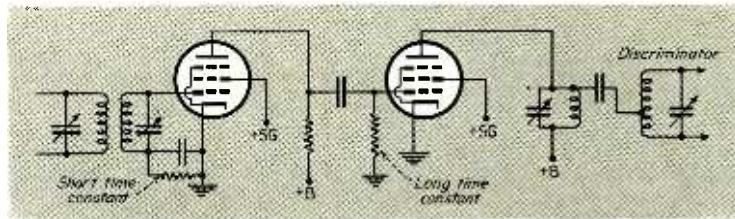

The two-stage cascade limiter employed in a recent G.E. f-m receiver to combine the advantages of a short time constant with those of a long time constant (J. A. Worcester)

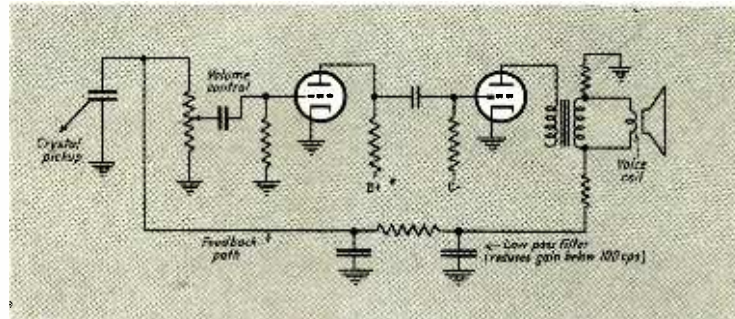

Inverse feedback applied to a phonograph amplifier to reduce the effects of microphonism and motor rumble. Note the filter in the feedback circuit (H. P. Kalmus and D. D. Israel)

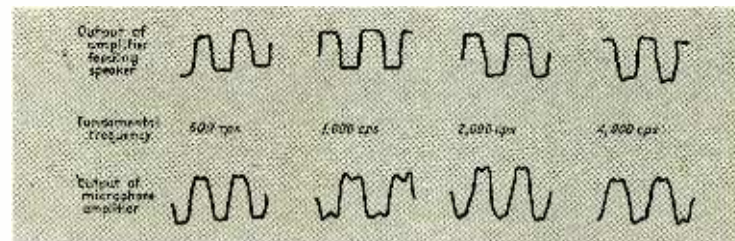

The answer to the question "Can a loudspeaker reproduce square waves?" The lower curves are reproduced from a microphone in front of the speaker (H. F. Olson)

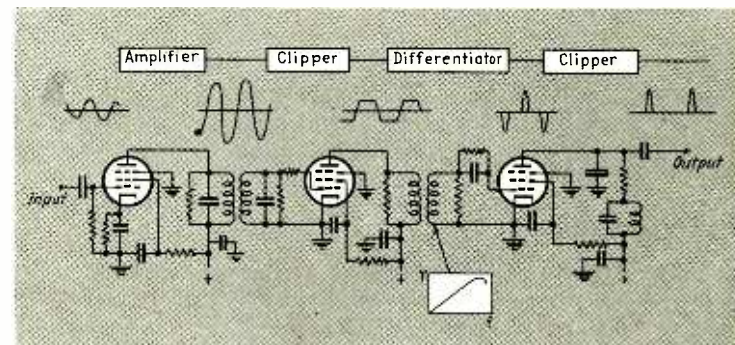

An intercept impulse generator, a part of B. D. Loughlin's phase curve-tracer for television. Timing impulses are generated for each intercept of the measured wave with the time axis

Circuit for producing the "sync cross" on a television picture tube, whereby the blanking intervals and sync pulses may be examined directly on the scanning pattern (Bailey and Loughren)

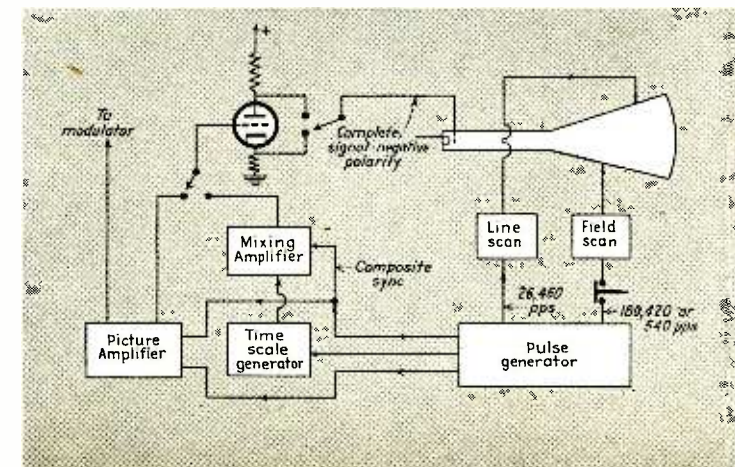

rectly above it by means of an electromagnet. The bell jar is exhausted, the electrodes degassed and the shell dropped in place. The metal header and the bottom of the shell are tinned with solder so that as the shell is dropped in place it is soldered to the header with a vacuum tight seal. Thus, the exhaust tubulation, which has always been the limitation of pumping speed, is eliminated and processing speeded up.

Fluorescent Materials

A discussion of fluorescent materials was presented by B. F. Ellefson of Hygrade Sylvania Corp. One of the points emphasized is that materials used in preparing fluorescent mixtures must be extremely pure. The commercial variety of pure chemicals must be subjected to further purification processes lasting in some cases as long as six weeks to two months. An interesting feature of Mr. Ellefson's talk was the use of diagrams drawn with fluorescent materials and irradiated with invisible light instead of using the usual lantern slides. The use of the chromaticity diagram in determining the proper use of fluorescent materials in obtaining a desired color was explained. Each year sees an increased use of fluorescent materials in the radio industry because of the wide popularity of cathode ray oscilloscopes and will be further increased when television is commercialized. Thus, this paper

by Mr. Ellefson is a timely one on a subject which should not be ignored by radio engineers.

Television

"Special Oscilloscope Tests for Television Waveforms" was presented by A. V. Loughren and W. F. Bailey of Hazeltine Service Corp. In the first of these tests, the synchronizing and blanking pulses are shown on the screen of the cathode ray tube. In the second of the tests, the modulating signal of a single line, or a very few lines adjacent to each other in the same field, was impressed on the deflecting plates of the cathode ray tube to give an indication of the brightness of the line at various points along its length. Also on the screen at the same time is the representation of the brightness of the lines in the same region of the other field. If the timing of the pulses in the two traces are compared, the interlacing can be accurately tested.

Bernard D. Loughlin of Hazeltine Service Corp. described apparatus for tracing on the screen of a cathode ray tube the phase vs frequency curve of television circuits. Sixty-seven tubes are required to perform all of the operations necessary to show on the screen the desired curve plus the coordinates of the graph with each tenth line accentuated. Curves of a number of typical circuits were shown.

P. C. Goldmark of Columbia Broadcasting System reviewed his

method of transmitting and receiving television in color. The method for transmitting pictures from color motion picture film has been described in the October 1940 issue of *ELECTRONICS*. Briefly, it consists rotating in synchronism in front of the camera tube and the picture tube discs containing red, green and blue color filters. The speed of rotation of the discs is such that light during successive fields enters the camera through successive filters. The result is that red, green and blue light is transmitted and presented to the eye successively. The eye sees the three pictures as one with the same color relationships as exist in the original picture. 343 line pictures at 120 fields per second are produced on the standard channel width.

In addition, Dr. Goldmark described a method of transmitting live programs using light levels which are the same as for black and white transmission. It involves the use of an Orthicon camera tube and the three color filters as in film transmission, but with a different mechanical arrangement. The scene to be transmitted is picked up by the usual camera lens and passed through to an inclined mirror which reflects the image through the rotating filter drum to the mosaic of the Orthicon. This is shown in the accompanying diagram. The high sensitivity of the Orthicon permits the use of commonly used light levels.

Roger Wise, chief tube engineer of Hygrade Sylvania Corp. presented a paper entitled "Radio Tubes Today". It was devoted chiefly to the economic aspects of the radio tube industry. Eight companies are engaged in the manufacture of

(Continued on page 72)

By means of this double superheterodyne arrangement, a gain of 4,000,000 may be obtained in four tubes, thus permitting full utilization of a weak f-m signal
(J. A. Worcester)

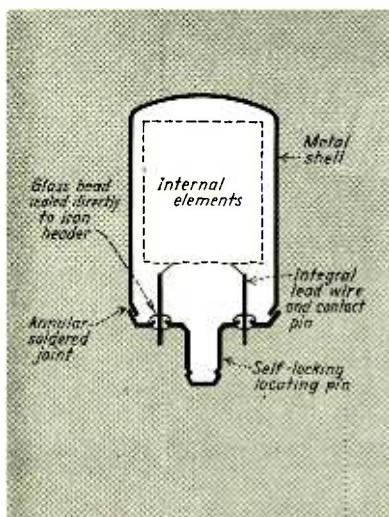

Structure of the newly designed metal tube, pumped under a bell jar and soldered under vacuum (D. W. Jenks)

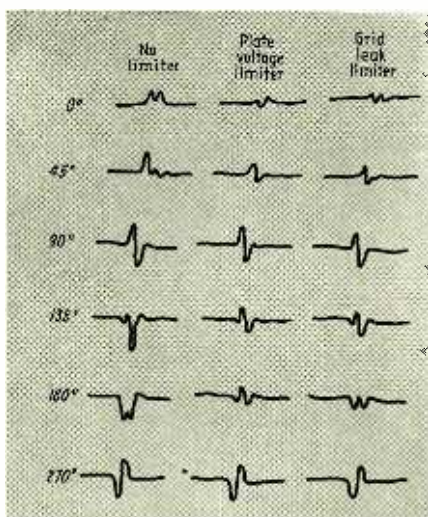

Oscillograms of audio output waveforms resulting from impulse noise excitation in f-m receivers (V. D. Landon)

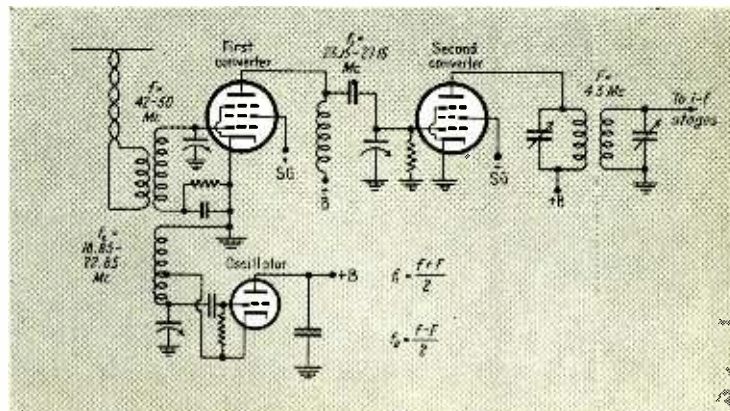

A STATE-WIDE F-M

The second and concluding installment of this article by Dr. Noble describes the mobile receivers and outlines the tests made in the field. Comparative results on am and fm indicate superiority of fm in covering long distances under severe local noise conditions and in hilly terrain

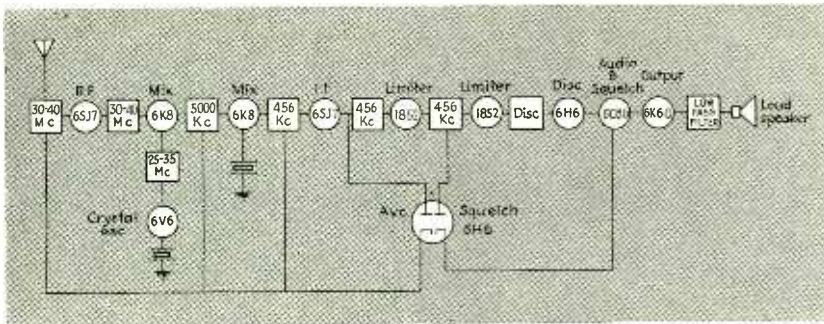

Fig. 1—Block diagram of the mobile f-m receiver installed in the patrol cars. A crystal controlled oscillator in a double conversion superheterodyne, cascaded limiters and a squelch circuit provide steady, noise-free reception

By DANIEL E. NOBLE

Formerly Assistant Professor of Electrical Engineering
University of Connecticut

WHILE the exact sensitivity of the receivers developed for the Connecticut system is not known because of the uncertainty of the calibration of signal generators below one microvolt, the measurements indicate that sensitivities in the order of one-quarter to one-half microvolt are obtained. The block diagram and top view are shown in Figs. 1 and 2. Figure 3 shows a typical car installation with the transmitter at the left and the receiver at the right. The vibrator power supply for the receiver is mounted in back of the receiver in a separate case.

One of the unique features of the Connecticut State Police Radio System is the roof top car antenna shown in Figure 4. A quarter wave tapered rod is mounted on a conical spring and by means of suitable molded bakelite forms fastened to the middle of the car roof section. A thirty-four ohm coaxial cable connects the antenna to the transmitter and receiver. The cable is concealed

between the steel top and the upholstery inside the car. The outer conductor of the cable is soldered to the roof where it passes through the steel and a pigtail connection joins the inner conductor to the antenna.

To check the characteristics of the antenna and to compare the results obtained with those obtained with the conventional rear-of-car antenna mounting, tests were run with the two antenna types. With the car stationed approximately one-half mile across flat land from the field strength measuring equipment, measurements were taken successively while the car was rotated through 360°, first with the roof-top antenna and then with the rear-mounted antenna. Within experimental error the roof-top antenna produced a perfectly circular field pattern. The rear-trunk mounted antenna produced a marked directional pattern, with the signal level in a line from the antenna toward the front of the car approximately four times as great as the signal

level in all other directions. With antennas of the same length, the roof top unit provided greater signal level in all directions than the rear-mounted antenna provided in its best direction. Obviously, the roof-top unit presents a substantial improvement over the conventional type.

Observations and Conclusions

While it is true that the Connecticut System was designed for a deviation ratio of more than four, a value comparable to that used in high fidelity f-m broadcasting, the great degree of noise reduction produced by the large deviation ratio is comparatively unimportant to emergency service applications. The use of such a large deviation ratio with the 40-kc band width is made possible only by the use of a low pass filter at the receiver which limits the high frequency response to three thousand cps. Noise reduction of the type usually associated with f-m reception takes place only when the level of the desired signal exceeds the level of the noise and under this usual condition the reduction in noise is directly proportional to the magnitude of the deviation ratio.

In the emergency service system the mobile unit is frequently operating while in heavy traffic, with the result that the peaks of the ignition noise at the receiver may reach values as high as twenty-five, fifty or even a hundred times the level of the desired signal. Under such conditions the conventional noise suppressing characteristics of f-m do not apply but there is a noise suppressing characteristic which does apply. Since each ignition peak exceeding the signal level will momentarily take control of the limiter, the noise will have the effect

POLICE NETWORK . . . II

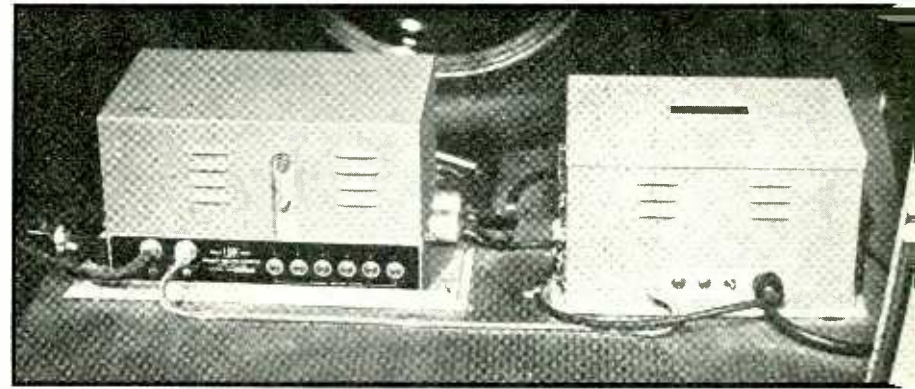
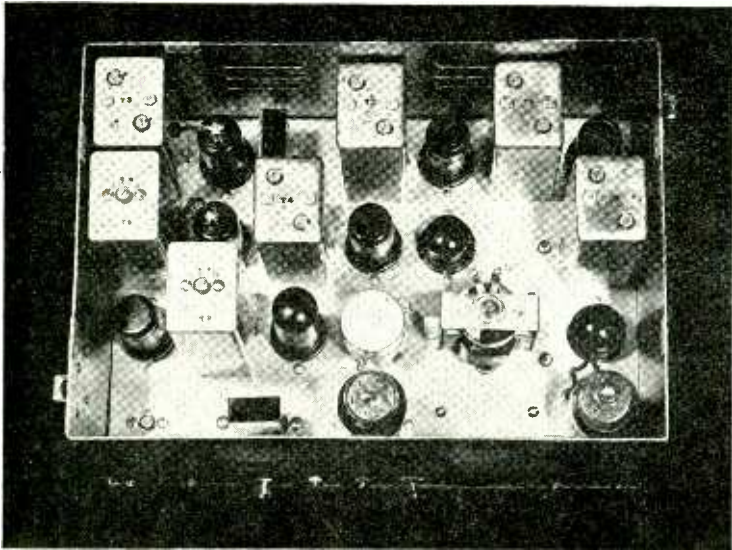

Fig. 2—View of the 11-tube mobile receiver with the cover removed. High sensitivity is necessary to obtain full advantage of the f-m system

Fig. 3—Typical installation of transmitter and receiver in the baggage compartment of a patrol car

of interrupting the signal. With a properly designed detector system the residual noise in the audio output is much less than that found in an amplitude receiver equipped with the best peak noise limiter and operating under similar conditions. In other words one of the important advantages of f-m in emergency service is the noise limiting in the presence of strong impulse noise.

The conventional noise suppression characteristic of f-m is also important in police reception although the importance may be secondary to the impulse noise limiting just described. For the case where the reception is taking place at a quiet location with a very weak signal, the first tube noise or first converter noise, whichever may be the limiting factor, is suppressed by a signal level which is greater than

the tube noise level. Very effective suppression will take place when the signal exceeds the noise by a ratio of two to one. Such suppression permits the reception of f-m signals beyond the range where comparable a-m signals can be heard.

Forty kc was used as the band width in the system described, chiefly because of the stability factors encountered in ultra-high frequency apparatus design. Narrower bands may be used with benefit when improved circuit and tube design solves the drift problem.

Narrowing the band width at the receiver will in general increase the f-m reception range because of the reduction in noise peaks. F-m may therefore be applied to the 8 kc band widths in the comparatively low frequency state police channels where stability problems are more

easily solved. In a project now under way the writer expects to demonstrate the effectiveness of f-m in these low frequency police channels.

One additional characteristic of f-m reception should be emphasized. Since the volume of the received signal depends upon frequency deviation rather than upon carrier level, it is clear that the f-m system possesses the quality of perfect a-v-c action. The observer may travel up hill and down dale and so long as the signal level does not drop below the fluctuation noise level, there will be no noticeable change in the reception accompanying the wide changes in r-f level at the receiver input. This effect alone greatly improves reception over that encountered in the a-m system since the service holds up to a reliable standard over a much greater area than that for an equivalent a-m system. The writer has traveled over the same paths comparing a-m with f-m in reception tests and the f-m signal held perfectly where the avc was entirely inadequate for the a-m audio variations.

Much has been written about the effect of a strong signal wiping out a weak signal in the f-m system.



Fig. 4—One of the patrol cars, showing the antenna protruding through the roof. A circular non-directional radiation pattern is secured, in contrast to the directivity of the rear-mounted antenna

The effect is very marked and may be put to use in police systems. In the Connecticut system, full advantage is taken of this effect to permit simultaneous operation of several fixed stations without interference in the area of the stations. If one frequency had been employed in the system, the operation of a single fixed station would exclude all mobile transmissions to headquarters since the superior fixed station signal would wipe out the mobile signals. By employing two frequencies, 39,180 kc for the mobile units and 39,500 kc for the fixed stations, a fixed transmitter in one area may transmit to its associated mobile units without preventing the reception of mobile transmissions by the other barracks units. Two areas separated by a third patrol area may operate simultaneously and although the first station may be heard in the second station area if the second transmitter is silent, when both transmitters operate simultaneously the mobile units, except in rare circumstances, hear only their home area transmitter. This action greatly increases the available operating time for each station. For car-to-car operation mobile transmitters are equipped with a second crystal for 39,500-kc operation and a relay with dash control permits the switching from 39,180 kc to 39,500 kc without further adjustments. The frequency change is accomplished without retuning circuits and with very little loss of power output. This fact will serve to emphasize the stability of the transmitter and to indicate the complete lack of critical adjustments.

In some cases interference from other stations in a system may be desirable. At least the writer has been informed that interference should permit an emergency signal to break through and that with a signal twice as strong as the interfering signal taking complete control the operator would not know that a second signal was on the air. The writer does not wish to argue the point here but it should be pointed out that this effect may be substantially reduced by use of narrow band and lower deviation ratio. In fact, the effect must be reduced where eight and ten kc bandwidths are used on the lower frequencies.

Any attempt to evaluate the effectiveness of f-m in emergency

service applications by the simple expedient of preparing signal-plus-noise-to-noise ratio measurements would be vain because effects encountered are largely subjective in character where the intelligibility of the received signal is the only important criterion. For this reason the account of the operation of the system is concerned with experiences in the field and will not be an attempt at scientific evaluation. An unqualified statement can be made, however, based upon a-m vs f-m comparisons and upon extended experience with both systems operating in the emergency field that the use of f-m results in service superior to that possible with a-m. The word superior is intended to imply that intelligible reception is possible over greater distances and under more serious impulse noise conditions.

The successful operation of the Connecticut system must be traced to two factors rather than to one. The use of f-m in a conventional installation with the transmitters located at the barracks without regard to the suitability of the location could not have produced a satisfactory system. The engineering layout which specified a high, quiet station location near the center of each patrol area contributed greatly to the effective operation of the system.

Since satisfactory operation can be achieved with very low signal levels where f-m is used, the design of the system must take full advantage of this low level response if extended operating distance is desired. With high, quiet receiving locations, it is possible to maintain signal levels from the distant mobile units great enough to exceed the fluctuation noise threshold of the

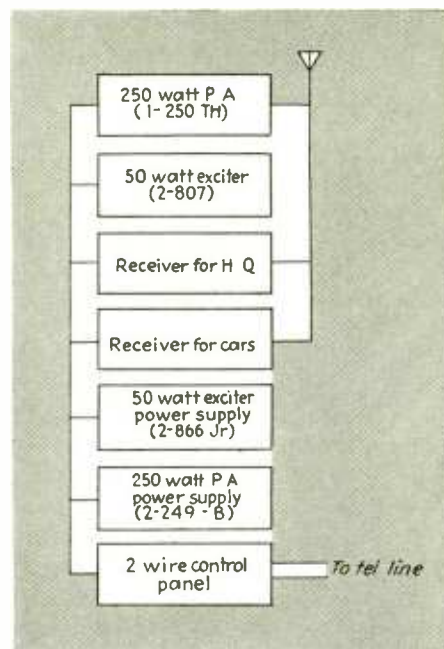
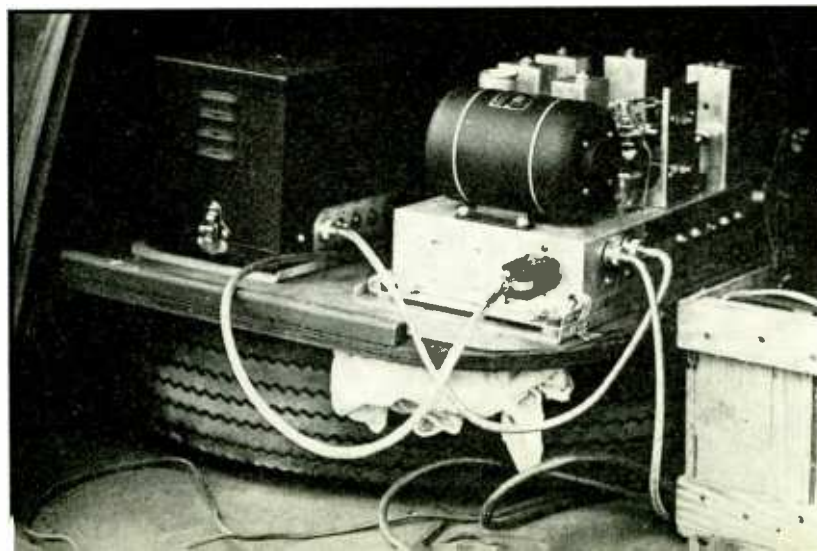

Fig. 5—Block diagram of the fixed station. This equipment is located in high, quiet locations for maximum transmission and reception range, and operated by remote control

receiver and to saturate the limiter properly.

A casual check made to compare a new 250-watt a-m installation with one of the Connecticut State Police 250-watt installations serves to illustrate the overall difference between the conventional a-m installation and the properly engineered f-m installation. A new 250-watt a-m installation had been completed to serve a city in the territory of one of the f-m State Police installations. To run a test, an f-m mobile unit and an a-m mobile unit were operated along a parkway road and their effectiveness checked. At a point on the road approximately seven miles from the a-m transmitter, the a-m mobile unit could not reach the home station until the car was turned and pointed in the direction of the sta-

Fig. 6—One of the early mobile test-car installations with which the superiority of f-m transmission was demonstrated



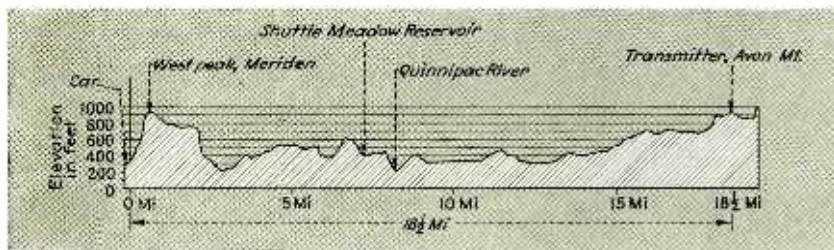

Fig. 7—Profile of terrain between the Avon fixed station and a car location near Meriden (vertical scale exaggerated). Continuous two-way communication was maintained despite the cliff near the patrol car

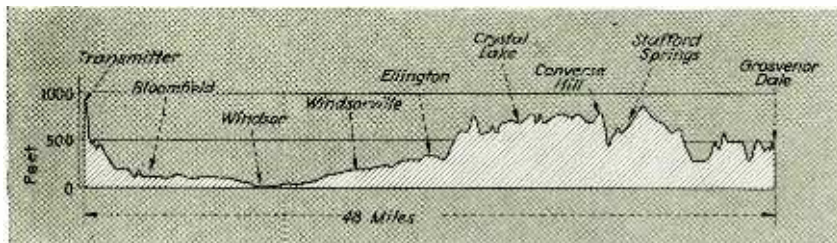

Fig. 8—Profile between Bloomfield and Stafford Springs, distance 48 miles, over which reliable two-way communication is maintained

tion to take advantage of the directional characteristics of the mobile station field pattern. When the a-m headquarters station replied, the reception was seriously handicapped by the strong ignition noise contributed by the high-speed traffic on the parkway.

At this same location the f-m mobile unit was approximately twenty miles from its headquarters fixed installation and the two-way contact was completely satisfactory. In order to check the limit of two-way operation of the f-m unit, the mobile unit was then driven at high speed along the parkway in a direction to increase the distance from the fixed station and two-way contacts were checked every two or three miles of travel. Two-way contacts were maintained consistently under severe noise conditions produced by the high speed of the cars. The test was concluded when the mobile unit reached a point approximately forty miles from the fixed station. The last contact was as good as the contact at twenty miles. During the test the mobile unit failed to get back twice when it was close to high shielding hills but the dead spot in each case was not more than five or six hundred yards along the road. The test was not terminated because the limit of the service was reached but rather because the mobile unit had reached a point opposite the George Washington Bridge in New York City and time did not permit

an extension of the tests. Note that this test was carried on under exceptionally high noise conditions. Experience with a similar amplitude installation indicates that the distances could be duplicated under low noise conditions but even with low noise the reception would be much less consistent because of the great variation in signal level and the service would be very spotty. Service with a-m under the noise conditions described would be completely unsatisfactory.

The original installation of the Connecticut system was made at Hartford to prove out the system. The transmitter is located on Avon Mountain at a point approximately nine hundred feet above sea level. The coaxial antenna is supported by an eighty foot steel pole. For many weeks this installation was the only one in operation in the State and two-way communication was carried on with mobile units over the entire State with this single installation. Secondary two-way coverage over the entire State was possible with this single fixed station at Hartford. By the term secondary the writer means that while two-way communication was actually carried on hundreds of times from all sections and from the extreme distances in the State it was necessary to pick favorable locations to talk back from the mobile unit. Usually a hill or a location free from nearby obstructing hills was satis-

factory. A deep valley or a location behind a shielding ridge would be regarded as unsatisfactory for talk back over great distances. Over short distances, ridges and hills are of no importance.

A profile of the land between the Avon Mountain (Hartford Station) transmitter and a receiving location at Meriden is given in Fig. 7. The curvature of the earth is neglected. Successful two-way communication between the points marked "car" and "transmitter" on the figure has been carried on repeatedly with the mobile unit cruising close to the seven hundred foot granite cliff which shields the car from the fixed station location. The signal level increases as expected when the car moves farther away from the fixed station but out from under the shadow of the cliff. Reliable communication service is maintained over a distance of approximately thirty-five miles in the general direction indicated by Fig. 7. The writer has exchanged messages with Hartford via the Avon transmitter while he was held up in a snarl of traffic in the business section of New Haven. While the distance is approximately 35 miles air line, the significant factor is the high noise level at the mobile receiving location.

Figure 8 shows a second profile covering 48 miles in a Northeast-erly direction from the Avon location. Two-way communication over the total span was successful. At the extreme distance talk-back was interrupted in the deep valleys but service was satisfactory from the hills. Service was continuous for all locations of the mobile unit from about the location marked Stafford Springs along the road all of the way into the transmitter control point. The emphasis intended is not in the matter of the distance covered but rather in the fact that the very low signal levels required by f-m permit reliable service over such distance even with serious impulse noise handicaps.

A-m will cover equivalent distances but the service is subject to wide variations with shadow and noise conditions. During some of the tests conducted, both a-m and f-m modulated waves were used. It was a common experience while listening to a weak a-m signal in a quiet location to have it wiped out

(Continued on page 66)

A V-T VOLTMETER FOR AUDIO FREQUENCIES

Designed as an adjunct to an analyzer test set the instrument described covers the range from 0.05 to 500 volts, 20 to 15,000 cps, with high input impedance, linear scales, with inherent meter protection. May be used with any sensitive d-c moving coil meter

THE vacuum-tube voltmeter described here is intended for operation with, and to round out the usefulness of, an analyzer test kit having a high-sensitivity meter action. When used in conjunction with such a kit it provides a-c voltmeter readings from 0.05 volts to 500 volts. The input impedance is in the megohms at the lower audio frequencies and in the hundreds of thousands of ohms at the upper end of the audio spectrum. With care in calibration an accuracy of ± 5 per cent from 20 to 15,000 cps can be obtained. Line voltage changes of ± 10 per cent from the voltage at which the calibration was made will result in a change in the meter reading of only ± 1.5 per cent. Heavy over-voltage at the input does not harm the indicating instrument as the circuit saturates at about 2.5 times the normal full scale current.

Although modern kits with their sensitive meters make d-c voltage testing a simple matter, they fall down when a-c voltage measurements are to be made on any but low

By **HARRY C. LIKEL**

Pratt Institute

impedance circuits. This is due, of course, to the low resistance of the meter circuits when connected for alternating current.

This addition to an analyzer may be used to measure the magnitude of the signal component at almost all points in an audio amplifier or other circuit, and in general it may be used as freely to measure audio frequency voltages as d-c meters are now used to measure d-c voltages.

Operation of the Circuit

The operation of the circuit is as follows: The voltage to be measured is applied to the input lead and thence to the ends of the voltage divider. When the voltage divider, controlled by the range switch, is set for the 0.5-volt range the full input voltage is applied directly to the grid of the first tube. Under these circumstances the only effect of the tube input capacitance is to add to the input capacitance of the

meter. When the voltage divider is set to the 2.5-volt range, the actual circuit for the voltage divider becomes that shown in Fig. 3A, unless compensation is introduced.

Since the values of the resistors in the circuit are in the ratio of four-to-one the voltage step down should be five to one. However, C_1 is in parallel with the one megohm resistor and this makes Z_1 considerably less than one megohm at the higher frequencies. As the shunting effect of C_1 varies with frequency we must compensate for it in some manner which will also vary with frequency. The simplest thing to do is to shunt the four megohm resistor with a capacitor. If this capacitor is of the correct value it will have the same shunting effect on the four megohm resistor at any frequency as C_1 has on the one megohm resistor. This circuit will keep the step-down ratio constant.

If now we set the switch to the five-volt range, the voltage divider without further compensation would

Top and bottom views of the internal construction of the meter. Note the 6F5 tube, mounted through the chassis as close to the range switch as possible

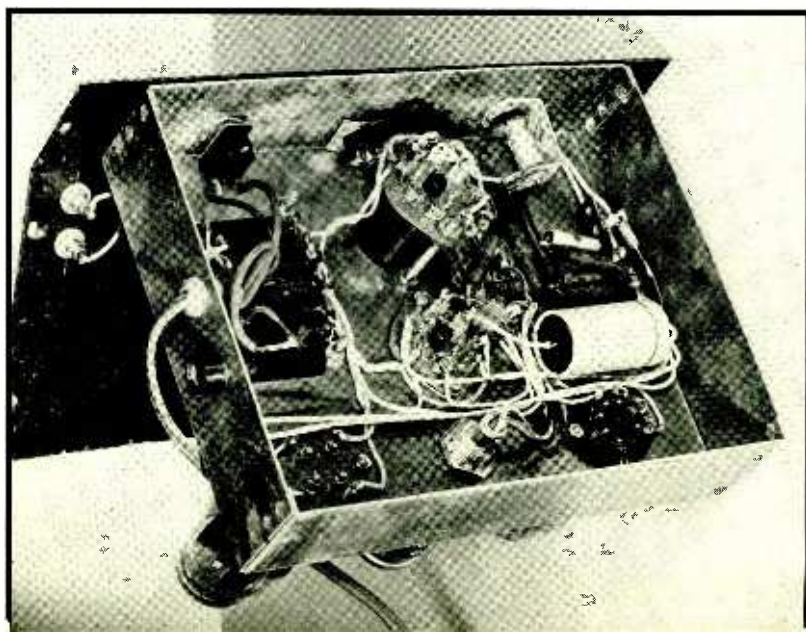
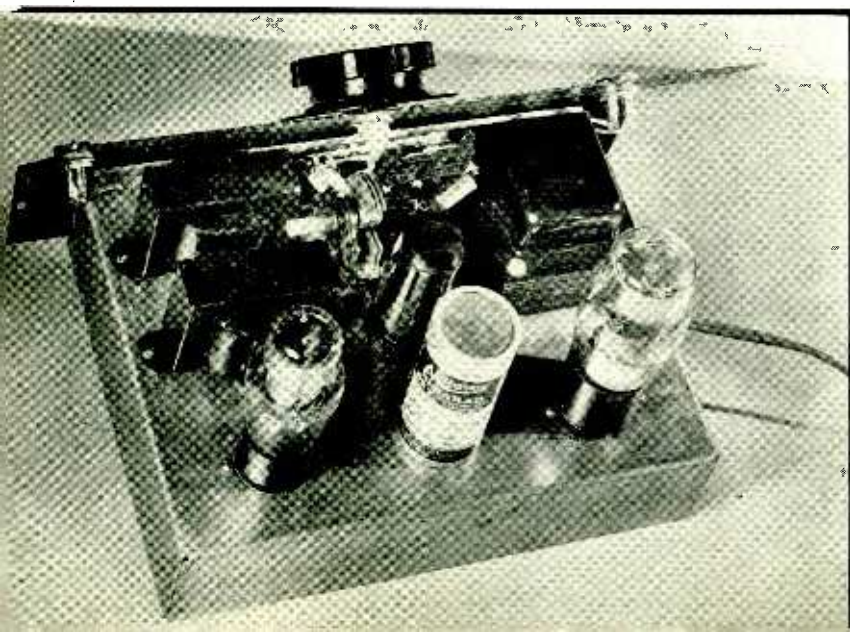

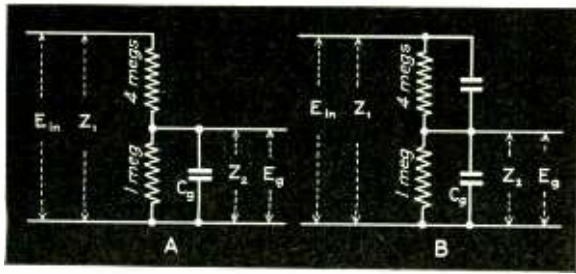

Fig. 3—Uncompensated (A) and compensated (B) voltage divider circuits when two resistance sections are cut in by the range switch

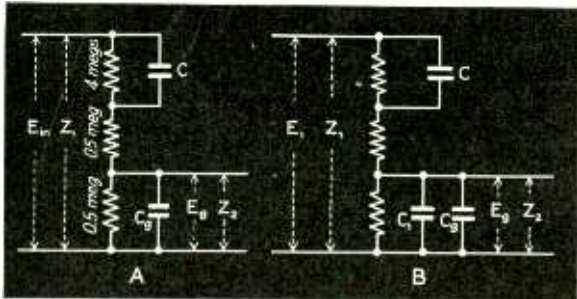

Fig. 4—Uncompensated and compensated voltage divider sections when three resistors are used

of the cycle when no current flows through the rectifier.

Adjustment and Calibration

To adjust the circuit, set the range switch at 0.5 volt and short circuit the input. With the meter turned on the needle will deflect to approximately two per cent of the full scale reading. If the deflection is greater than this, there is a hum voltage in the circuit in spite of the input being shorted, or the 6N7 cathode voltage divider must be adjusted for this individual tube. Shorting the 6N7 first grid should reduce the reading if the trouble is hum which must then be eliminated by a careful search for its point of entry into the circuit. If the voltage divider must be adjusted, this can be accomplished by moving the slider on the 6N7 cathode resistor until the desired deflection is obtained. When this has been done, 0.5 volt at say 500 cps should be applied to the input. If all is well the meter will read full scale and reductions in voltage will give directly proportional reductions in deflection. If the meter reads too high or too low a change in the value of the load resistor of the first section of the 6N7 will give a somewhat proportional change in the indication. Once the meter has been corrected at full scale the relation of input voltage

to scale reading may be made linear by adjusting the values of the 6F5 cathode and load resistors. In general the ratio of these resistors should remain constant as the values are changed. If it becomes necessary to change the ratio in order to get a linear curve it may then be necessary again to adjust the value of the 6N7 first section load resistor or the resistors in series with the meter. In any event a little experimenting should result in a calibration of \pm five per cent at any point within the limits mentioned.

When the above calibration is achieved the meter range should be set at 2.5 volts and C_1 adjusted at 10,000 cps to give correct meter indication at full scale with 2.5 volts applied.

On the 100- and 500-volt scales correcting condensers are not required if a decrease in accuracy to \pm 10 per cent between 4,000 and 8,000 cps can be tolerated. All ranges are adjusted in the same way and a check made on all ranges when the job is completed.

The possibility of using a simple amplifier feeding the a-c meter circuits of the analyser kit was investigated. This makes an extremely simple audio frequency voltmeter. However, it is necessarily subject to all the shortcomings of the a-c meter except its low impedance. The non-linear scales, the shorter scale, aging of the rectifier and lower accuracy of calibration of the meter itself remain. Therefore, the above design was worked out in the belief that the little extra time required to build the meter to operate a d-c instrument would be well worth while.

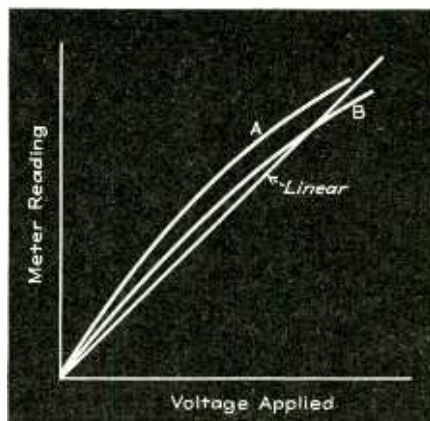

Fig. 5—Relationship between amplitude of input voltage and meter reading, showing non-linearity due to curvature of tube characteristics. Curve B is the best compromise

In building the meter no rigid scheme of construction need be adhered to. In many instances a small amplifier chassis already available can be readily converted, or it may be that the constructor will want to build the circuit into an instrument case similar to that housing the analyser kit. Those who wish to follow the author's arrangement of parts may do so by reference to the data and photographs contained herein. The cabinet shown in the photograph is 9x7x6½ inches with sloping panel. The chassis used was 7x7x2 inches. Pin jacks to take the analyser test prods were installed on both sides of the panel and connected in parallel so that the prods may always be plugged in on the most convenient side.

For connection of the test prods a miniature socket and two plugs were used. To one plug was attached an ordinary set of test leads for use when there is no danger of feedback or induction. To another plug was attached a two foot length of one-half inch diameter beaded type coaxial low capacity cable. At the prod end a test lead pin tip was used. By attaching the shield to the plug at one end and the tip at the other all strain was removed from the center conductor which was then replaced by a very fine wire. Plenty of slack should be left in this wire to prevent its breakage when the lead is bent. To finish off the job a piece of snugly fitting rubber tubing was drawn over its full length.

Because of the high impedance of the grid circuit of the first tube it must be very well shielded, particularly from power circuits, or there will be an induced input voltage which will make it impossible to properly adjust the output circuit for zero reading.

The value of constants shown in the wiring diagram should be adhered to as closely as possible when the circuit is first set up. Later it may prove necessary to adjust some of them slightly to compensate for differences in components, layout and tubes. The exact values needed when they are not on hand can usually be arrived at by using series or parallel combinations of those available. The resistor in the cathode circuit of the 6N7 should be of the wire wound type that has an ad-

(Continued on page 73)

NEW FIELDS FOR MAGNETIC CONTACT RELAYS

The ultrasensitive moving-coil relay, which employs self-attracting magnetic contacts, serves in many industrial control applications not readily handled by vacuum tubes. Hence this review of typical applications should interest control engineers faced by similar problems

IN the extension of automatic means of measurement, signaling or control to new industrial applications, one limiting factor has cropped up with annoying regularity: Many of the chemical, optical and electrical phenomena which are accurate detectors of a significant change in conditions are weak when it comes to providing a positive serviceable basis for response to the change. Frequently, they involve such a minute change in energy level that their "message" has been difficult to translate into a force of a practical order of magnitude for operating signals or controls. Such is the case, for example, with self-generating photocell currents, and with the output of thermocouples.

Although several systems capable of amplifying the effect of a feeble initial impulse are theoretically available, including electronic-tube systems and the "feeler" type of slide-wire potentiometer mechanism used on certain pyrometer-controllers, their application on a wider scale is frequently ruled out by their intricacy, for economic reasons if for no other. In most cases, commercial units for automatic weighing, gas detection, highway signaling, remote control and other automatic-response functions can acquire industrial importance only by proving themselves reliable and economical in competition with existing non-automatic methods.

From the standpoint of future possibilities in the field of automatic control, therefore, it is quite significant to review the more simple manner in which this problem of translating indication into action

BY ANTHONY H. LAMB

Weston Electrical Instrument Corp.

has been met in a considerable group of automatic-response devices which are now on the market. The scope of the industrial services which these devices are now regularly performing in thousands of commercial installations is good evidence of the

economic, as well as the electrical, soundness of the approach.

Although differing widely in function, in the detecting principle employed, and in design, each of these units obtains the necessary power transfer or amplification factor by utilizing sensitive electrical relays of the "magnetic-contact" type. These relays are essentially microammeters or millivoltmeters of the

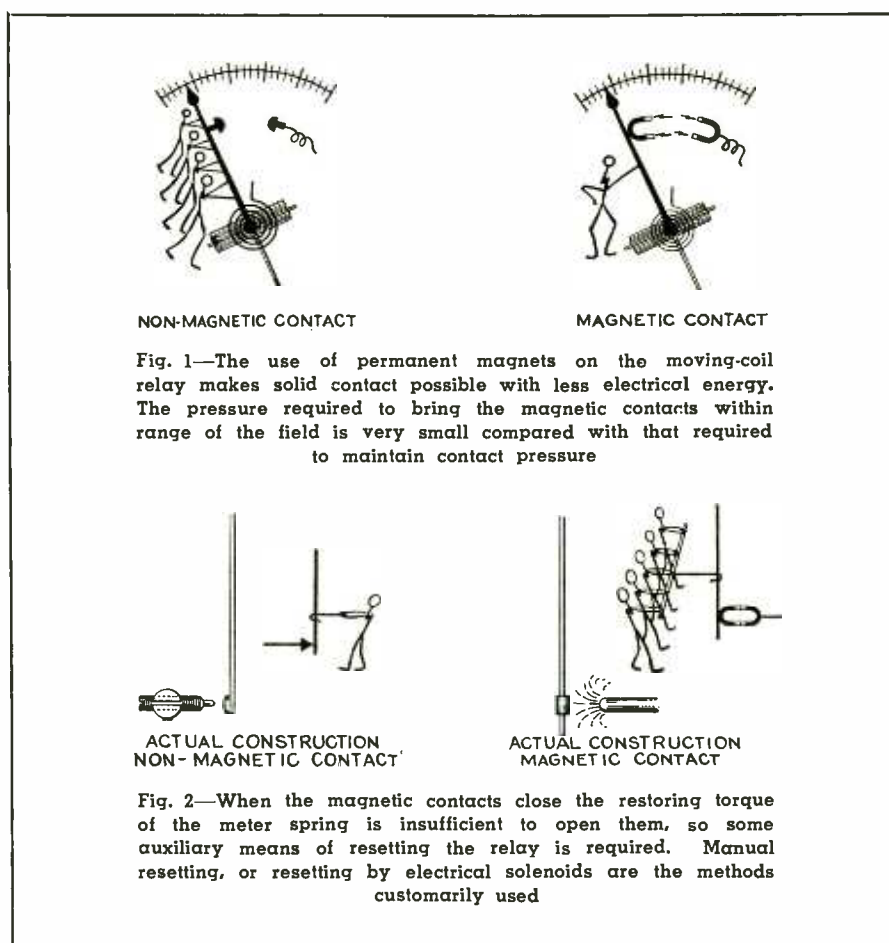

NON-MAGNETIC CONTACT

MAGNETIC CONTACT

Fig. 1—The use of permanent magnets on the moving-coil relay makes solid contact possible with less electrical energy. The pressure required to bring the magnetic contacts within range of the field is very small compared with that required to maintain contact pressure

ACTUAL CONSTRUCTION
NON-MAGNETIC CONTACT

ACTUAL CONSTRUCTION
MAGNETIC CONTACT

Fig. 2—When the magnetic contacts close the restoring torque of the meter spring is insufficient to open them, so some auxiliary means of resetting the relay is required. Manual resetting, or resetting by electrical solenoids are the methods customarily used

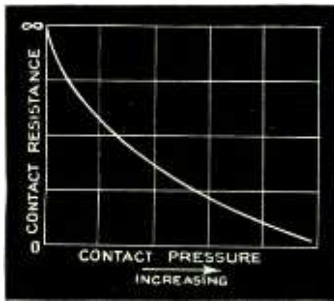

Fig. 3—Even pure platinum contacts can develop contact resistance due to dust and grease films, which can be overcome only by adequate contact pressure

CONCERNING THE LITTLE MEN At the risk of offending the professional dignity of our readers, we are publishing illustrations, drawn from Mr. Lamb's original sketches, complete with a complement of explanatory "little men". Even to those who may doubt their technical significance, they put the point across with directness—and not without humor. Comments from readers are welcome.—The Editors

permanent-magnet, movable-coil type with a contact-making pointer and stop. In place of ordinary contact points which might be brought together by the pointer movement, however, they are built with small "riders" of a magnetic material affixed to the pointer and to adjacent limiting contact or contacts. In operation, the external energy source has only to bring the two magnetic contacts within sufficient proximity to one another to allow the magnetic flux to take effect. Contact is then established with a pressure several thousand times greater than would

entirely clean points are found to have resistances from hundreds of ohms to infinity even though they are in mechanical contact. In each case, mere "touching" is not enough; it requires the application of "follow-up" pressure to reduce the resistance to a value approximating that of a really clean surface (see Fig. 3). Furthermore, since the relay capacity is a function of the cross-sectional area in good electrical contact, adequate unit pressure with contacts of more than needle-like dimensions is essential.

By combining high sensitivity

contact on as little as $\frac{1}{2}$ microampere or $\frac{1}{4}$ millivolt, while the contacts themselves will handle 5 watts at 110 volts regularly.

Explosive and Poisonous Gas Detectors

Important advances in safety engineering at mines, chemical plants, oil refineries, garages, etc., and in dealing with storage tanks, tank cars and the like throughout industry, are being made by various types of automatic gas-alarm units using magnetic contact relays. These devices are arranged to sample the atmosphere subject to danger con-

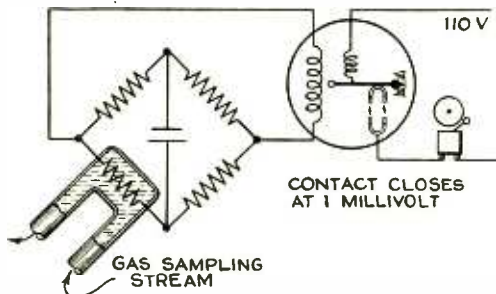

Fig. 4—Wheatstone-bridge method of sampling dangerous gases dissolved in liquid and used as one arm of the bridge

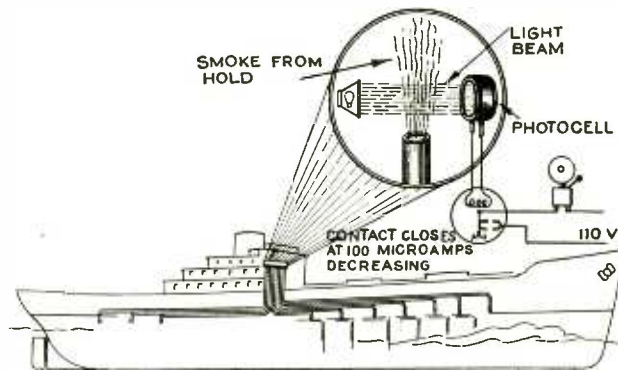

Fig. 5—Where extreme reliability is required, as in fire-detectors aboard ship, the simple self-generating cell and magnetic relay may be preferred to the phototube-and-amplifier system

be obtained with non-magnetic contact points (See Figs. 1 and 2.)

The importance of this extra contact pressure in assuring a sure low-resistance electrical contact will be clear if we realize that, in actual use, there is no such thing as a completely clean contact. Even if we eliminate all possibility of oxidation or corrosion by the use of pure platinum contacts, the accumulation of a film from air-borne grease, dust, moisture, etc. will take place. Even on seemingly mirrorlike surfaces, its existence can be proved by resistance measurements. Appar-

with high contact capacity, a relay having magnetic pull-in contacts is able to provide a power transfer (amplification ratio) of some 2,500,000,000,000 times the energy required to actuate the moving coil of the instrument movement. This is approximately 5,000 times greater than the ratio which can be obtained if contact must be established solely by the pressure arising from the energy-source initiating the closure. It is greater than can be obtained with several stages of a radio amplifier. Indeed, when required, this type of relay can be made to close

continuously at one or more points, and to sound an alarm, start blowers working, or both, within a matter of seconds after a predetermined concentration is found to exist. One such device which has found wide application will detect concentrations of carbon monoxide as low as 2 parts in 10,000. Another detects minute concentrations of hydrogen sulphide. Detection of combustible gas-air or vapor-air mixtures are a major application for still another.

Depending upon the character and concentration of the gases or mixtures which the unit is intended to

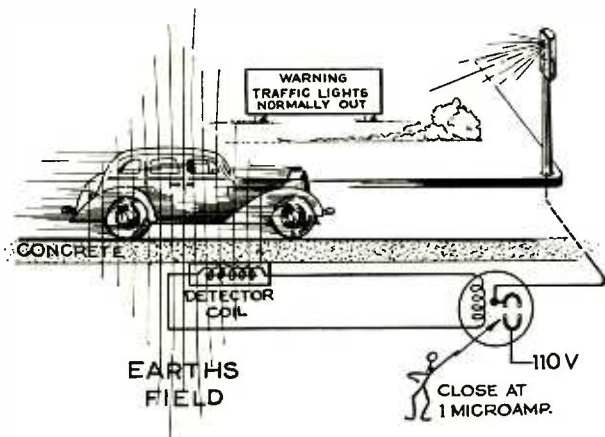

Fig. 6—Distortion of the earth's magnetic field, caused by the passage of a car, may produce sufficient change in energy within a pick-up coil to close a magnetic relay

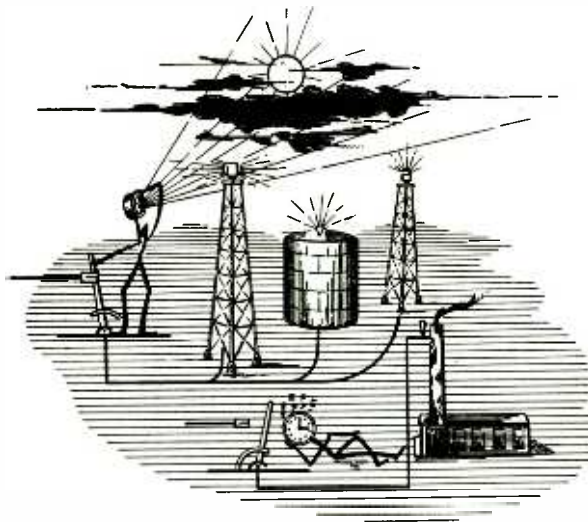

Fig. 7—Control of airway beacon lamps by photocell and relay combinations is now standard practice. The older clock-controlled system may well stay asleep at the switch

reveal, analyzing chambers of various types are employed. Their basic principle ordinarily involves a means of altering the resistance in one leg of a Wheatstone bridge circuit by some chemical or thermal action of the gases (see Fig. 4). In one such unit, the critical level of gas concentration leads to a potential of but one millivolt as a basis for response. In another type of unit using a photocell to determine the extent of a light-interrupting chemical reaction caused by the gas, the zero setting of the relay is 15 microamperes and the working range of the relay is plus or minus 10 microamperes.

Shipboard Fire Detectors

Development of units for assuring safety at sea by the immediate detection of fire in any section of ship's hold has reached a point where they are "required equipment." A type recently installed on important new vessels involves a number of sampling tubes running from various holds to a central control cabinet on the bridge as shown in Fig.

5. A circulating fan draws air continuously through these tubes, and passes it through chambers which lie between a light source and a photocell. The presence of smoke causes a decrease in the current generated by the cell and closes the relay contact to sound an alarm.

Oven or Furnace Protector

Interestingly enough, an automatic unit for detecting the absence of fire is also finding wide application as an industrial safety device. The unit is intended to protect gas-fired ovens against possible failure of the pilot light and against dangerous consequences which might result from the failure of power, fuel supply, or air supply. It also provides an automatic ignition sequence for lighting the oven or furnace.

This device consists of a thermocouple located so as to be influenced by the pilot flame alone, a sensitive magnetic-contact relay set to respond to the significant changes in thermocouple output, and a control circuit involving switching and time-delay features acts to provide the desired

automatic ignition sequence during the lighting and heating-up periods. Fuel supply is immediately shut off and a warning given should any factor contributing to safe operation of the furnace fail to stay in operation.

Vehicle-Actuated Traffic Light

Another highly important safety application requiring positive relay operation from a current of one or two microamperes has developed in the traffic signaling field. At intersections where it is desired that vehicles approaching a main highway from a side road shall provide the impulse for initiating a signal sequence, a buried induction coil is employed. Any automobile or other metallic body passing above the coil upsets its normal relationship to the earth's field, and the resulting impulse closes the contacts of the sensitive relay as illustrated in Fig. 6.

The unit has obvious advantages over mechanical pressure plates in the roadway from the maintenance standpoint, particularly where ice and snow are likely to be encountered. The detector coil is sealed and placed in position under the road-

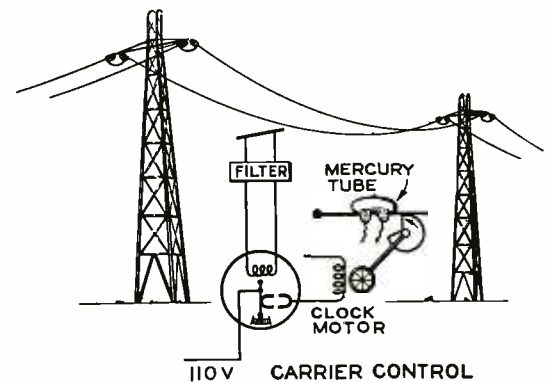

Fig. 8—Carrier current impulses sent over power lines may be used to close a magnetic relay and connect additional load when the system operator finds the demand from other sources falling off

way. A single unit will detect vehicle movement on a traffic lane up to 20 feet in width if required.

A variation of the same principle is also now being employed in a novel safety unit for buses which must make railroad crossings. Here, the detecting coil and relay are located within the bus, being set to respond to the influence of another warning coil located under the pavement adjacent to the tracks. As the bus reaches the crossing, a warning signal visible to the passengers is

flashed, and the driver is reminded that he must bring the bus to a complete stop before proceeding. Here, again, as in many of our previous examples, there are numerous systems by which such a unit could be made to operate, but considerations of simplicity so important to commercial success led to the adoption of the magnetic contact relay.

Airway Beacon and Hazard Marking Control

Every 10 to 20 miles along air line routes throughout the country, light beacons are maintained for the guidance of pilots. Also, there are many smoke stacks, water-towers, power-line towers along the routes on which warning lights are required. These must be lighted at night as darkness levels prescribed by the Civil Aeronautics Authority. An automatic illumination control unit which turns these lights on and off at the required foot-candle levels, regardless of the time of day, has been recognized as providing extra safety in the case of sudden storms, while permitting current saving on bright days. Its use for this purpose has been approved under Government Specifications.

This unit, as well as others applied to airport approach lights, involves the use of the magnetic contact relay in connection with a Photronic cell to determine and act on outdoor light conditions (see Fig. 7).

Carrier Current Remote Control

Although the applications for magnetic contact relays thus far described have involved automatic warning or control for safety purposes, commercial development in other areas has also made rapid progress. One of the more interesting of these is the "wired radio" system of remote control, which provides a simple system for turning on and off electric heaters and other installed equipment direct from the substation thus permitting the sale of excess energy on an "off-peak" basis. These control units (see Fig. 8) are designed to operate for long periods in customers' basements, up the side of line poles, in the bases of street lighting standards and other locations where freedom from frequent servicing is essential.

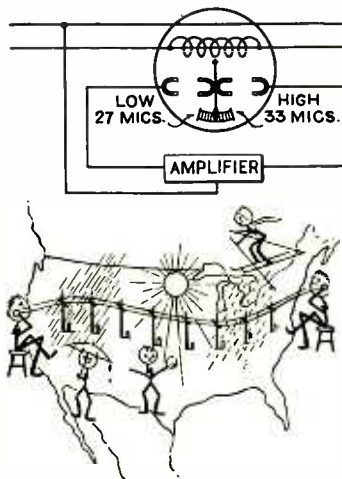

Fig. 9—Automatic adjustment of the gain of repeater amplifiers in telephone service may be obtained by relays having a marginal response between 22 and 33 microamperes

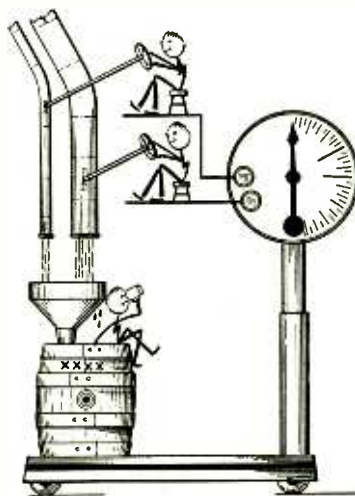

Fig. 10—Automatic weighing may be accomplished by interrupting the light on one of two phototubes, the first cutting off the main supply, the second cutting off a smaller supply at the instant the required weight is reached

In this system, control of the remote loads is accomplished by means of carrier current signals sent out from a substation along the same feeders which carry the 60-cps power that is to be controlled. The relay, in combination with a filter, must respond to a high frequency signal which is a fraction of a milliampere at less than one volt, and yet handle several watts of 110-volt power on its contacts.

High Frequency Telephone Circuit Regulator

Another important application of the magnetic contact relay in connection with so-called "carrier" systems arises in long-lines telephony service, where multi-channel high-frequency transmission over open wire circuits has attained wide usage. One such system comprises six channels—3 in each direction—in the band from 10 to 30 kc.

Because attenuation due to line losses is greatly affected by weather changes and differs on each frequency, some means must be provided for making an automatic adjustment to compensate for the variations taking place and hold the overall transmission uniform. In effect, these changes are compensated for by a regulator circuit which is called to action by a magnetic contact relay set to keep tabs on the variations in attenuation. A change in attenuation of 0.5 db in either direction in a "pilot" signal carried by the line actuates the relay. (See Fig. 9.) A second relay sounds an alarm when large changes in attenuation occur—as when the line is open or short-circuited.

Automatic Weighing

Among the systems of automatic weighing which have acquired industrial importance in recent years, one of the most widely used operates on the light-beam interruption principle: That is, the dial pointer is arranged to interrupt a light beam falling on a photoelectric cell when the desired weight is reached. Larger scales are equipped with a double acting control so arranged that the main feed is closed as the correct weight is approached, and a smaller or dribble feed cuts off at the exact weight (Fig. 10). Use of the magnetic contact relay in connection with photocells of the self-generating type for automatic weighing has found particular favor because of the simplicity of the method of power transfer in comparison to electronic-tube amplifying systems.

As a matter of fact, the single limitation to the use of magnetic contact relays which seems to loom large in the minds of designers contemplating their application is the necessity for resetting the relay (re-separating the magnetic contacts) after each operation. Yet, with the exception of the limited number of applications where power transfer must necessarily be continuous rather than intermittent, the problem is easily overcome.

In a subsequent discussion to be published in an early issue resetting methods employed in the commercial devices here described will be reviewed, along with other factors significant to successful application of relays of this type.

Diathermy Measurement Technique

An accurate method of measuring the r-f power input to a patient undergoing shortwave diathermy treatment is described, and its use outlined in connection with a diathermy machine. Interference with radio services minimized by reducing the possibility of stray radiation

TREATMENT by radio frequency currents constitutes a well established branch of physical therapy. The radio frequencies produce a deep heating within the body tissue which may be of marked therapeutic value. The term "diathermy", commonly employed to describe this effect, means literally "a warming through".

A common mode of application of ultrahigh-frequency diathermy is by two air-spaced electrodes. One is placed on each side of the area under treatment, thus, subjecting it to a radio-frequency electric field. The bony and soft tissues act much like dielectrics shunted by resistances. The therapeutic effects of the diathermy are largely due to heat, the dielectric losses being mainly responsible for the heat produced.

The heat or energy absorbed by the patient equals the average rate of absorption times the length of time of treatment. The length of time can be readily controlled. However, in the ordinary diathermy ma-

chine, the time rate of energy absorption, or power input to the patient, is unknown.

A common disadvantage of present day diathermy equipment is its inability to measure the power actually absorbed by the patient. It is common practice to increase the power input to the patient until a definite sensation of warmth is experienced. However, the reactions of different individuals to the same power input vary widely. A radio-frequency current or voltage measuring device may be provided in the patient circuit of the diathermy machine as a resonance indicator, but due to variations in the "equivalent resistance" of different patients it does not give a significant indication of the power delivered to the patient. Thus, experience gained in treating one patient cannot be fully applied in the treatment of others. Although a measure of the power is

highly desirable in applying diathermy to humans, it is vital to its proper application to animals, since not even the response of the animal can be used as a guide. The power input to the patient can be expressed either in watts or in calories per minute (one watt equals 14.3 gram-calories per minute). This may be designated as the dose-rate. The heat or energy absorbed by the patient is the average dose-rate times the length of time of treatment. This may be spoken of as the dose, and can be expressed in watt-minutes or in calories.

The Diathermic Dosimeter

It is the purpose of this article to describe an ultrahigh-frequency diathermy machine called a "dose-meter-diatherm", which gives a direct reading of the power input or dose-rate to the patient under treatment. The method used for measuring the power follows one described by Mittelmann.² Another

Fig. 1—Right, dosemeter-diathermy as used for treating the sinuses. The dose rate is read on the meter above the patients head

Fig. 2—Below, complete circuit diagram of the diathermy machine and dosimeter

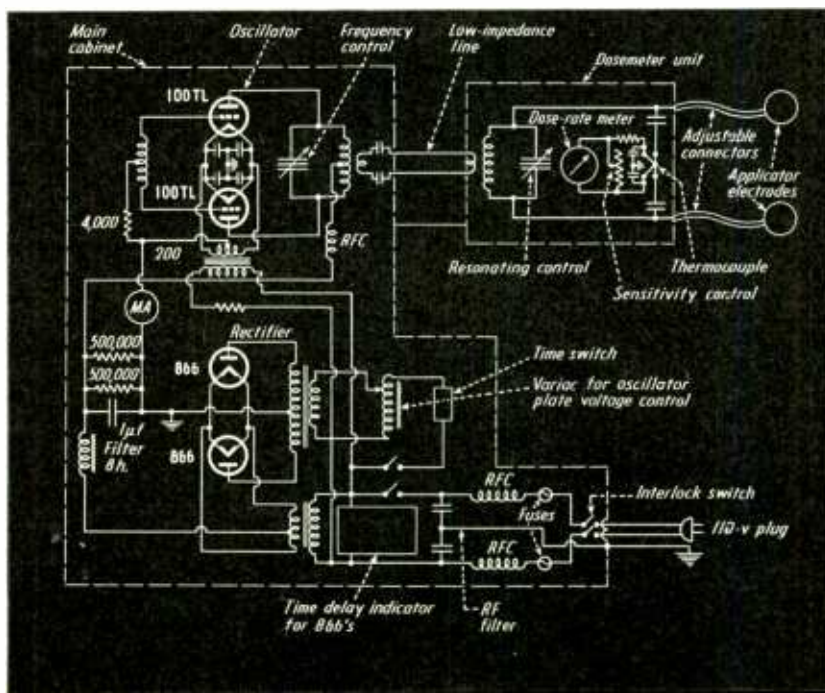

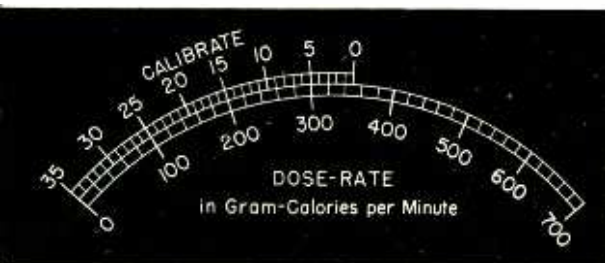

Fig. 3—Scale for meter giving dose rate in calories per minute

feature of the machine is that power losses by radiation are very low.

Figure 1 shows the dosimeter-diatherm in use. It consists of two units of all-metal construction. The larger, castor-equipped unit contains the oscillator and power supply. The smaller unit or dosimeter is supported from the larger cabinet as shown. This unit carries the applicator electrodes and contains a fixed coil and variable condenser for resonating them to the oscillator frequency. The dosimeter unit is situated close to the point of application, short applicator leads being used to reduce both circuit and radiation losses. A low-loss, low-impedance, two wire line with 0.3 inch spacing couples the dosimeter to the oscillator. This line is flexible and enclosed in an insulating sheath.

The oscillator has two 100TL tubes in a conventional push-pull circuit (see Fig. 2). The power supply consists of a full-wave rectifier, using two 866 tubes, and a large filter. Plate voltage and oscillator frequency controls are provided. These are located on the sloping panel at the top. A frequency of about 42 megacycles is normally employed. A time switch for automatically turning off the machine at any time up to 30 minutes is included on the panel. A hinged cover, shown open in Fig. 1, can be lowered over the control panel and locked when the machine is not in use. Windows on the front of the cabinet permit a good view of both oscillator and rectifier tubes. A radio frequency filter is incorporated where the power line enters the cabinet.

The brackets supporting the dosimeter permit both horizontal and vertical adjustments. The insulated gooseneck-type connectors which carry the applicators, allow still further adjustments. The applicator electrodes are disc shaped and are completely enclosed in a plastic housing.

The large meter on the dosimeter unit indicates the dose-rate. The scale for this meter, giving the dose-rate in calories per minute, is shown in Fig. 3.

This machine is designed for use by a practicing otolaryngologist for treatment of conditions of the ear, nose, and throat. Hence, the applicators are arranged for convenient application to the head and neck. In Fig. 1 the machine is being used for treatment of the sinuses. The machine could, however, be readily adapted for treatment of other parts of the body.

Radiation

The patient receives only part of the radio frequency power output from a diathermy machine. The remainder of the power output is either radiated or dissipated as heat in the conductors or dielectrics of the circuits.

The power input to the patient is the effective power. The power

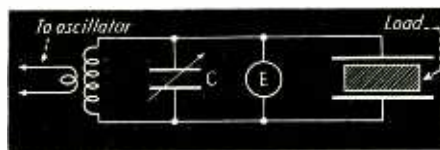

Fig. 4—Schematic diagram of the patient circuit of the dosimeter-diatherm

radiated represents a loss and also constitutes a source of serious radio interference. In ultrahigh-frequency machines having relatively long, widely spaced leads to connect to the applicators, much power may be radiated from the leads themselves. With such leads the system may approach the dimensions of a "flat-top beam" antenna, which consists of two closely-spaced out-of-phase dipoles. It has been shown that even when the radiating efficiency of such an antenna is reduced by the presence of large values of loss resistance, a considerable fraction of the power input to the antenna may, nevertheless, be radiated.³ As an antenna the efficiency may be low, but as a device for transferring power to a patient, it represents excessive radiation. The power dissipated in the loss resistance referred to in the case of the antenna corresponds to the patient power with the diatherm.

By using very short, closely-spaced leads to the applicators on the dosimeter-diatherm, the radia-

tion from this part of the circuit is greatly reduced. At 7 meters the leads are less than 0.05 wavelength long with about 0.03 wavelength spacing. The radiation from the balanced, low-impedance line connecting the dosimeter unit to the oscillator is negligible.

Power Measurement

The patient circuit of the dosimeter-diatherm is shown schematically in Fig. 4. In general, when an object is placed between the applicator plates, both the load resistance and reactance are changed. The latter is compensated by resonating the circuit with condenser, C. The meter E reads values proportional to the voltage across the plates.

The equivalent circuit is shown in Fig. 5. When no object is between the plates, the output is shunted only by the equivalent loss resistance R_L . With the patient between the plates, the effect is equivalent

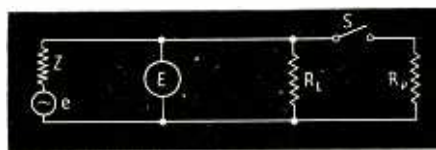

Fig. 5—Equivalent diagram for the patient circuit from which dosage is computed

to closing the switch S putting the equivalent patient resistance R_p in parallel with R_L . Mittelman² has shown that it is possible to express the patient power W_p in terms of the resonant voltage E_1 without a load, and E_2 with the patient or load. In Mittelman's development it is assumed that the generator voltage e is constant.

A more general development can be given in which it is not necessary to assume that the voltage, current, or power output of the generator is constant. Neither need Z be a constant. The loss resistance R_L will be considered constant although this is not necessary. The more general development is as follows:

Let y be a function of the total shunt resistance R_t or $y = f(R_t)$. Then $E_1 = y_1 R_L$ and $E_2 = y_2 \frac{R_L R_p}{R_L + R_p}$. The patient resistance is then,

$$R_p = \frac{E_2 R_L}{\frac{y_2}{y_1} E_1 - E_2}. \quad \text{Since } W_p = \frac{E_2^2}{R_p},$$

we obtain,

(Continued on page 82)

Signal Range of High-Frequency Broadcast Stations

(Prepared by the Engineering Department, Federal Communications Commission)

Distance in Miles or Transmitting Antenna Height in Feet

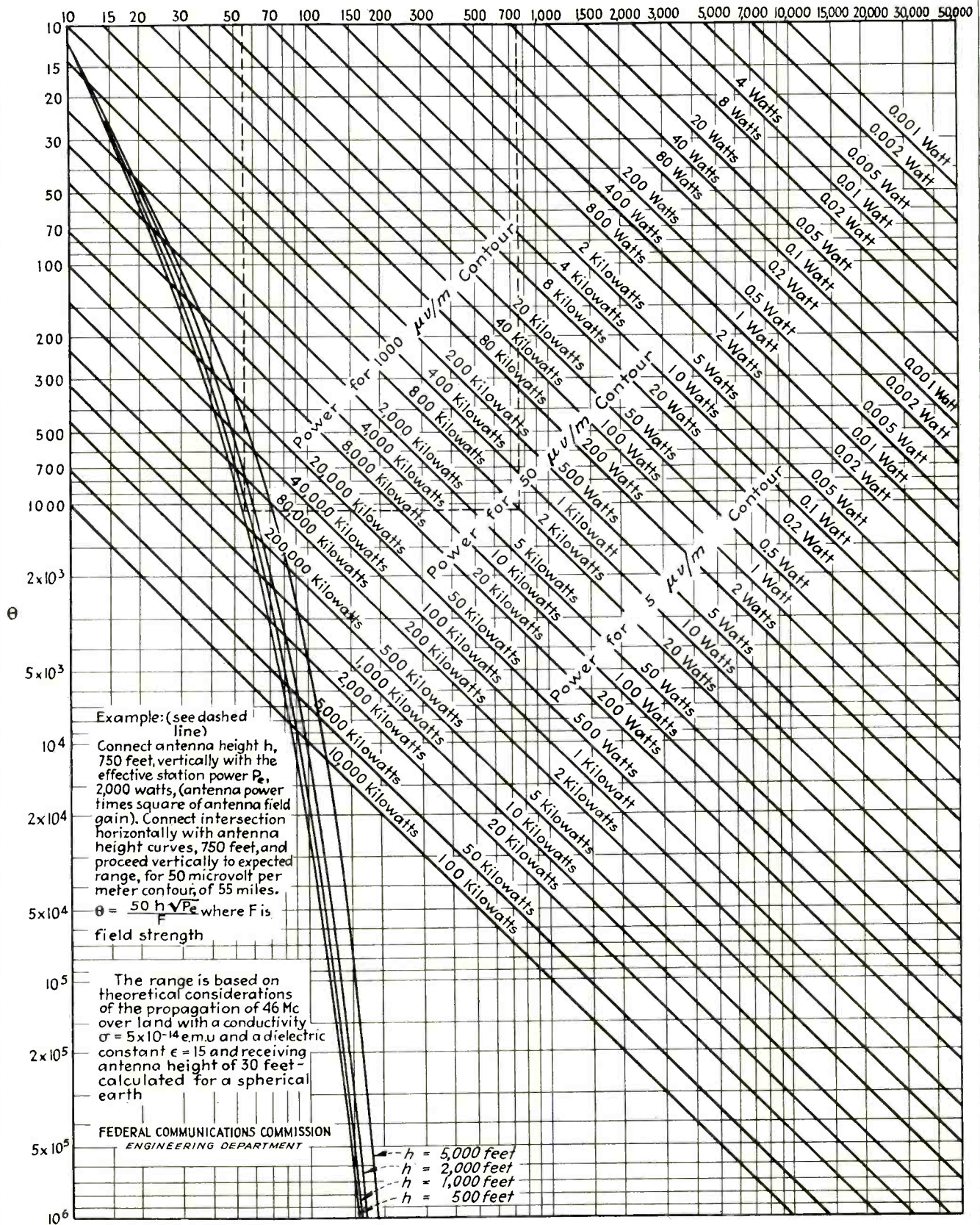

TUBES AT WORK

A transmitter whose frequency is controlled by a barometer for altitude indication, phonograph music transduced from a stylus to a photocell, 4104 phototubes to control a new Broadway sign, and an infrared-sensitive photorelay

Panoramic Reception Applied to Aerial Navigation

AN UNIQUE REFINEMENT of the panoramic reception technique described in the June, 1940 issue of *ELECTRONICS* has been made by its inventor, Marcel Wallace, to the problems of navigation of aircraft. Briefly the system is as follows: the plane is equipped with a panoramic receiver which tunes over a band of frequencies continuously and repeatedly at a rate of from 30 to 150 times per second. The signals received as the tuning passes over the band are indicated on the face of a cathode ray tube, whose vertical deflection is proportional to the frequency and whose horizontal deflection is proportional to the signal strength. A "V" shaped trace appears on the screen for each station received within the tuned band, the axis of symmetry of the V being horizontal. The cathode-ray tube indicator is mounted before the pilot, but the receiving equipment may be mounted wherever convenient in the plane.

Also located in the plane is a transmitter, a low power 5 watt oscillator, whose output frequency is made to correspond to the center frequency of the range swept over by the panoramic receiver. The receiver signal circuit is interrupted momentarily when the tuning passes over this central frequency, so the output of the local transmitter does not affect the receiver.

The unusual application of the system rests in the control of the frequency of the transmitter, as well as the center frequency of the received band of frequencies, by air-pressure controlled elements, of the aneroid barometer cell variety, which causes the frequency to change as the altitude of the plane changes. Thus if the receiver picks up a signal from another plane, the altitude of this plane is indicated by the vertical position of the V-shaped trace on the receiver indicator. At the same time the transmitter in the plane indicated its altitude to all other planes equipped with panoramic receivers. Thus the relative altitudes of several planes may be indicated simultaneously to all the pilots concerned, and the possibility of collision greatly reduced.

The absolute altitude of the plane equipped with the panoramic receiver may also be indicated with reference

to fixed stations on the ground which transmit signals of frequency controlled by the barometric pressure on the ground. Thus the airplane may ascertain its altitude by relative readings of frequency between the ground station frequency control, and the plane's frequency control. Changes in the absolute value of barometric pressure do not influence the system, since both ground transmitter and panoramic receiver shift frequency simultaneously with absolute changes in pressure. The ground stations are identified and distinguished from other airplane transmitters by characteristic keying signals.

The amplitude of the V on the cathode-ray screen indicates the signal strength of the incoming wave, and this may be used to gain an approximate idea of the distance to the ground station or other plane from which the signal is coming. If the signal

strength of all plane transmitters is standardized, and if no directional effects are present, the c-r tube screen may be calibrated horizontally directly in miles. The vertical scale, corresponding to frequency, is calibrated in feet of altitude.

The uses to which the system may be put, according to Mr. Wallace, include the following: anti-collision indication; differentiation between fixed obstacles (such as ground stations) and planes; directional indications by making use of the directional antennas, and determination of absolute altitude. The accuracy with which the aneroid barometer frequency control operates is enhanced by the use of electrical amplification, rather than the mechanical amplification customarily used in barometric instruments.

• • •

A Photoelectric Phonograph Reproducer

A NEW PHOTOELECTRIC PHONOGRAPH reproducing device is available on the larger radio-phonograph combinations manufactured by the Philco Corporation. The reproducer consists of three main elements: an incandescent source of light, a jewel stylus to which is attached a very thin mirror, and a selenium cell. These elements are mounted in the head of the reproducer as shown in the accompanying photograph. Light is reflected from the light source to the surface of the selenium cell by the

RADIO CONTROL OF ANTI-AIRCRAFT



In the Army's anti-aircraft target practice, a sock target is towed at an altitude of from 15,000 to 20,000 feet. The pilot of the towing plane is directed by two-way radio from the Battalion Headquarters Battery truck. When the safety officer gives clearance, anti-aircraft guns fire on the target

PARTS SHOWN TWICE ACTUAL SIZE



IT PAYS...
TO GET A GOOD*
CONNECTION!

*CINCH CONNECTORS ARE *Standard* IN THE INDUSTRY

Get positive constant contact with the "CINCH" all 'round single shielded antenna connectors. Here's the new improved No. 2042 with molded bakelite bushing and a shoulder providing increased insulation. Positive ground connection with complete protection! And

No. 1320 insulated with hard rubber for "low loss"

Even when subjected to the most severe vibrations these connectors provide a constant electrical connection. "CINCH" for a good connection—*always* and all ways.

Cinch and Oak Radio Sockets are licensed under H. H. Eby socket patents.

- ◆ Eight (8) cutting edges to provide positive ground.
 - ◆ Shoulder providing increased insulation.
 - ◆ No. 8323 with flange for screw or rivet.
 - ◆ No. 8307 with flange for spot welding.
- Other types also available, samples and further information on request.*

CINCH

MANUFACTURING CORPORATION

2335 W. VAN BUREN STREET

CHICAGO, ILL.

SUBSIDIARY: UNITED-CARR FASTENER CORP., CAMBRIDGE, MASS.

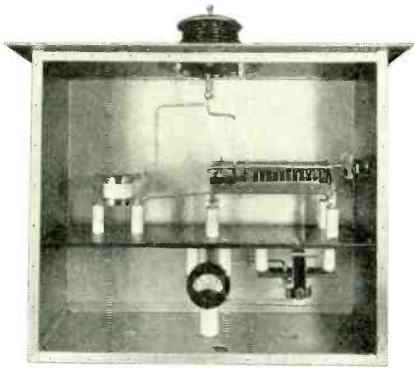

D-99419 (100 to 500 watt) Shunt type Antenna Coupling Unit. (With cover removed.)



D-97008 (100 watt to 1 KW Series Type) Antenna Coupling Unit.

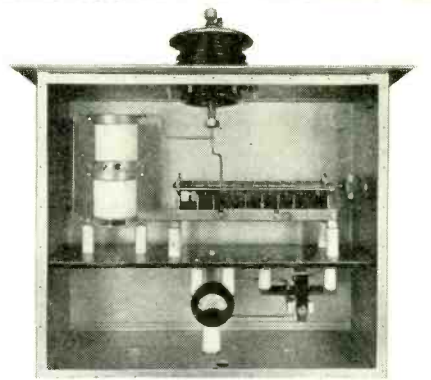

D-99418 (5 KW Shunt Type) Antenna Coupling Unit. (With cover removed.)

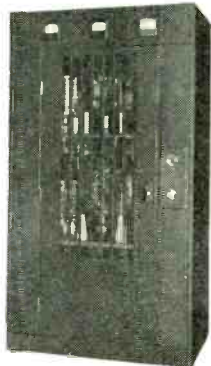

33A Antenna Control Unit, (1 Variable Branching Circuit; 1 Variable, 1 Fixed Phase Shifters.) For powers up to 10 KW.

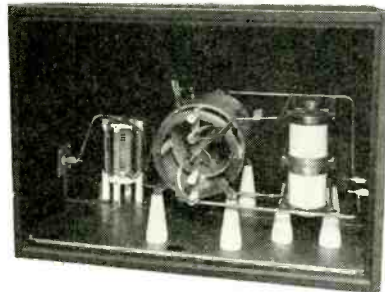

35A Antenna Power Control Unit—Fixed line branching network. For powers up to and including 10 KW.

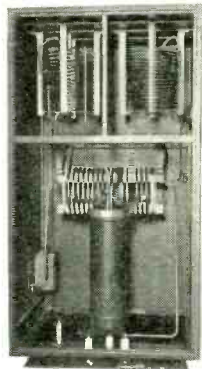

34B (50 KW) Antenna Phase Control Unit.

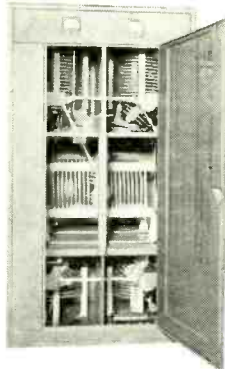

33B (50 KW) Antenna Control Unit (1 Line Branching Network, 1 Phase Shifting Network.)



D-107058 Coaxial Line. (For Phase Monitor Sampling Lines.) Available from stock in single lengths up to 1000 feet—up to 3000 feet on special order.

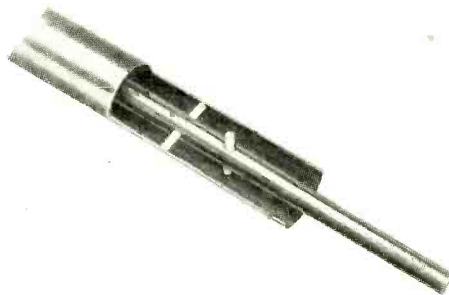

D-151067 (50-100 KW) 2 5/8" Coaxial Transmission Line.

BE UP TO EFF

... with West
Antenna

Whatever your sta
coupling or contr
assures you of up
—not all—is show
50 KW—Graybar
you need—for Be

West

Ask your F



101A (5 KW Series Type) Antenna Coupling Unit, complete in weather-proof housing.

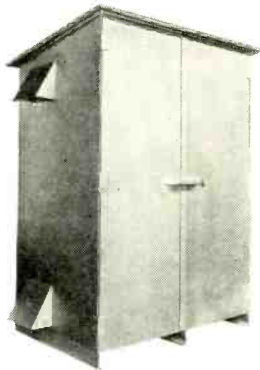

D-151139 (50 KW) Series Excited Antenna Coupling Unit, complete in weatherproof housing.

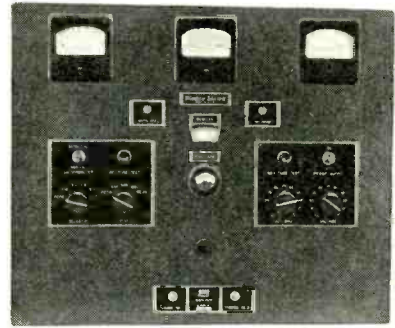

2A Phase Monitor

**DATE
EFFICIENT
ECONOMICAL!**

**Western Electric's complete line of
Coupling and Control Equipment**

ation's power—no matter what your antenna
problem—Western Electric's complete line
to date, efficient, economical equipment. Some
here. Units for all powers from 100 watts to
can give you immediate delivery on everything
ter Broadcasting.

Western Electric

Engineer!



DISTRIBUTORS:
In U. S. A.: Graybar Electric Co., New York,
N. Y. In Canada and Newfoundland:
Northern Electric Co., Ltd. In other coun-
tries: International Standard Electric Corp.



D-151198 (3 wire) Ceramic Core Tower Lighting Choke Coil. (For 1500 Watt Maximum Tower Lighting Load.)

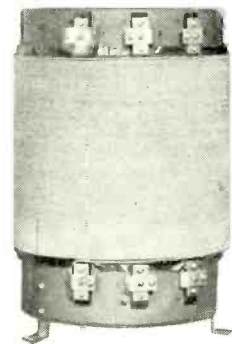

ES-675364 (3 wire) Tower Lighting Choke Coil. (For heavier power require-ments.)



ES-675768 RF Isolation Coil for by-passing phase monitor sampling lines around tower insulator.

“—with little change in temperature”

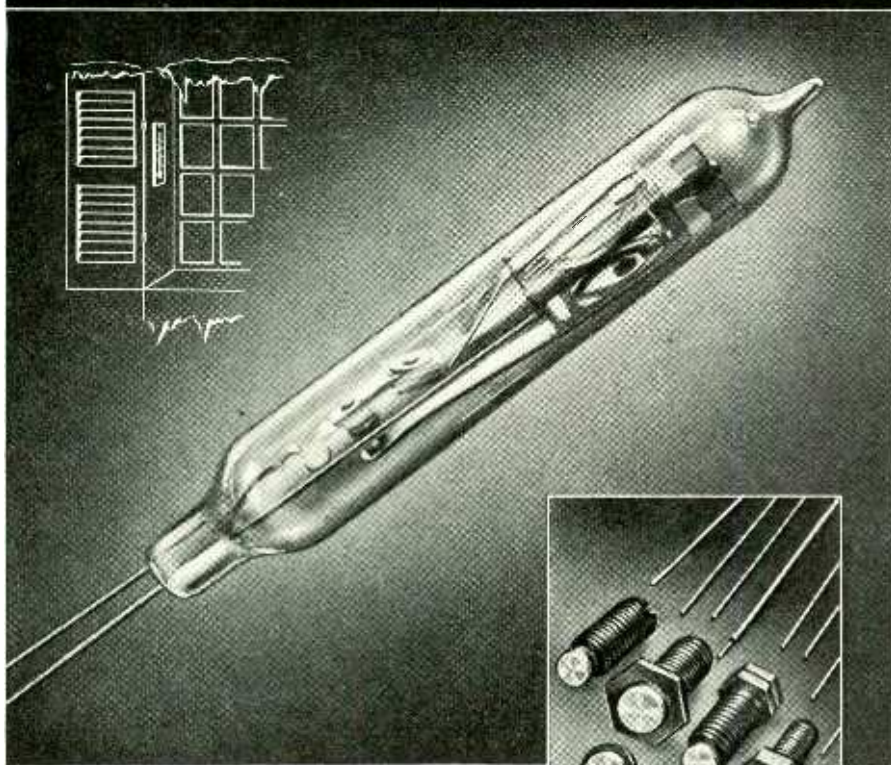

an achievement of
CALLITE LEAD-IN WIRES, WELDS & CONTACTS

Let the thermometer rise or fall 5°—the weather man is safe with his prediction. “little change in temperature”. But to the broadcast engineer, intent on keeping his station carrier “on the nose”, a little change in crystal temperature means a fluctuation in minute fractions of a degree. It took Thomas A. Edison, Incorporated engineers to develop a thermostat that automatically maintains this crystal oven temperature constant within one-tenth of a degree C. of any predetermined value. Today, carrier shift due to crystal temperature variation has been reduced to one part in millions, thanks to the genius of Thomas A. Edison Incorporated engineers.

Development of dependable instruments so sensitive naturally suggests the use of

MANUFACTURERS OF electrical contacts of refractory and precious metals, bi-metals, lead-in wires, filaments and grids—formed parts and raw materials for all electronic applications.

Callite formed parts. Callite lead-in wires, welds and contacts are used by Thomas A. Edison Incorporated in a wide variety of sealed-in-glass thermostats and time delay relays . . . devices famed for precision, ruggedness and ability to stand up under years of continuous operation.

Such instances tell an eloquent story of Callite achievement in electronics. Time after time, Callite recommendations have enabled manufacturers to hurdle discouraging obstacles and realize important production economies. If you are not satisfied with your progress why not consult Callite. Our experience and vast facilities for production may save you time and money. Send for literature.

CALLITE TUNGSTEN

CORPORATION

544 - 39th STREET

CABLE:



UNION CITY, N. J.

“CALLITES”

BRANCHES: CHICAGO • CLEVELAND

small mirror. As the stylus follows the grooves in the record the mirror is vibrated about a vertical axis so that the patch of light falling on the selenium cell surface moves across the boundary of the cell. Accordingly, the resistance of the cell is varied in response to the motion of the mirror, which in turn is made proportional to the lateral displacement of the stylus. The principal advantage of this arrangement lies in the fact that the mechanical impedance at the stylus point is reduced to a very small value, compared with that inherent in crystal and magnetic type pick-ups. Since the stylus and mirror act simply as a control of the light energy, it is possible

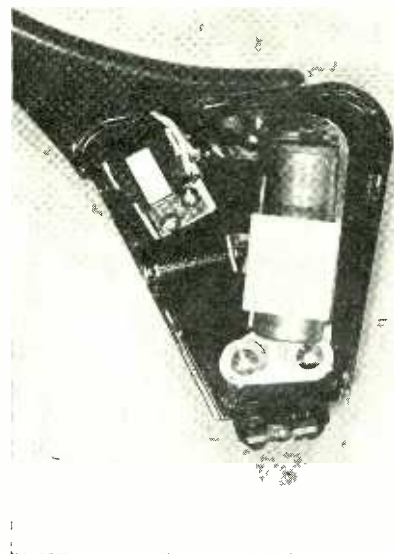

The mechanism of the light-beam phonograph reproducer

to make the mass of the stylus assembly extremely light, and to allow the needle pressure to be reduced proportionately without encountering difficulties due to improper tracking of the stylus in the groove. The net pressure required on the record is accordingly only a fraction of an ounce, and the wear on the record is reduced by a factor measured at approximately ten times. Also, it is claimed that the component of needle hiss due to friction with the sides of the record groove is reduced in about the same proportion.

Several perplexing problems were solved in the design of this reproducer. In the first place, current to light the filament of the lamp could not be obtained from a 60-cps source since this frequency lies in the audible range. Accordingly, the filament is fed from a local radio frequency oscillator, tuned to about 1,800 kc. The lamp filament is connected directly across a portion of the tank inductance of the local oscillator circuit. To obtain the necessary lightness in the moving mechanism, the mirror used is of extremely thin construction, similar to that used in moving coil galvanometers. Another problem involves the

The Ideal Control for A.C. Circuits



TRANSTAT
VOLTAGE REGULATORS

THE Type "TH" Transtat Regulator is being selected for numerous voltage-control applications because of its many advantages over resistive and tap-changing methods. Voltage may be changed gradually, and without circuit interruption, from zero to values considerably higher than line voltage. Moreover, it offers high efficiency, flexibility, good regulation and rugged construction at low cost. All of these features are possible in the Transtat because it is a continuously variable auto-transformer—the ideal voltage control for alternating-current circuits.

● Send for new 20-page bulletin with complete engineering data.



AMERTRAN

Manufacturers
Since 1901
at Newark, N. J.

AMERICAN TRANSFORMER CO.

178 Emmet St., Newark, N. J.

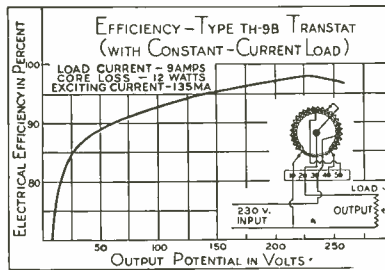

Typical efficiency curve for Type "TH" Transtat Regulator

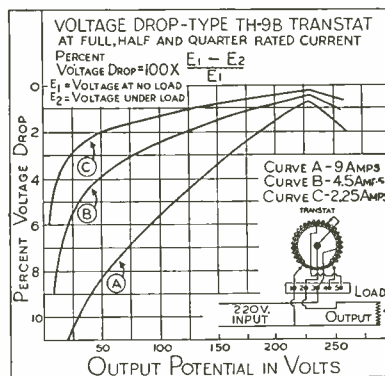

Typical regulation curve for Type "TH" Transtat Regulator.

RATINGS

For loads from 500 Va. to 20 Kva.
For 115-, 230- or 460-volt input.
For single-phase or poly-phase service.
For frequencies of 25, 50 or 60 cycles.
Output range 0 to 113% of input voltage.
Rated current at any output voltage.
Manually operated, air-insulated type.

CHARACTERISTICS

Smooth control without circuit interruption.
High Efficiency* under all operating conditions.
Good regulation*—output voltage practically independent of load.
Low operating temperature —55° C. rise.
Voltage change is at uniform rate.
Practically no effect upon power factor.
Low exciting current—from 1% to 6%.
Does not cause wave-form distortion.

FEATURES

Small size and light weight for power rating.
Mounting is rugged, ventilated and reversible.
Brush is self-aligning and counter-balanced.
Dials are calibrated to indicate output voltage.
Polished Commutator prevents sparking and arcing.
Glass coil insulation prevents damage from heat.
Several units may be ganged on one shaft.

NEW CATALOG

Catalog (20 pages) gives complete data on 63 standard ratings, including 12 pages with 26 diagrams telling "How to use the Transtat."
*See Performance Curves

AMERICAN TRANSFORMER CO.
178 Emmet St., Newark, N. J.

Please send me Bulletin 51-2 with complete data on Type "TH" Transtat Voltage Regulators.

Name

Company

Address

City..... State.....



Integrity

We honestly believe that T R & S Rivets are the best you can specify for your production charts. Because T R & S Rivets are as close to perfection as skill, inspection and processes of manufacture can produce. They are 100% usable, accurately gauged, and are backed by the integrity of the world's oldest and largest Tubular and Split Rivet factory.

Many motorized models of our rivet setting machines are available in single stroke and multiple drive. Inquiries are invited—together with samples of work you wish to do.

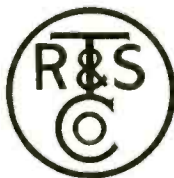

TUBULAR RIVET & STUD CO.

World's Largest Manufacturers of Tubular and Split Rivets

WOLLASTON (Boston) MASSACHUSETTS

New York Chicago Detroit Indianapolis
San Francisco Nashville Dallas St. Louis

tendency of the selenium cell to exhibit a loss of response at the high frequencies above 3,000 or 4,000 cps. This effect has been counteracted by introducing a mechanical resonance in the mounting of the mirror, which emphasizes the upper range and obtains substantially flat output from the selenium cell up to 5,000 cps. Above this range the response drops off rapidly. The output of the selenium cell is amplified in a pre-amplifier stage before being applied to the regular audio frequency circuits of the receiver.

• • •

New Broadway Sign Controlled by Phototubes

THE PRODUCTION BY PHOTOELECTRIC means of moving images on sign boards composed on many incandescent lamps is not new (see *ELECTRONICS*, September 1937, cover and page 21), but refinements in the method have



The phototube-controlled sign, showing three ducklings outlined in lamps

been adopted in recent months. One of the more spectacular examples is the advertising sign recently developed for a distributor of whiskey by Douglas Leigh. The signboard itself consists of 4,104 incandescent lamps, each individually controlled by 4,104 separate thyatron tubes, which are in turn controlled by 4,104 phototubes, arranged in a two-dimensional array. The motion picture to be reproduced



Douglas Leigh and Joan Crawford before the bank of 4104 phototubes

STROMBERG-CARLSON

W3XVB

ZEMITH

YANKEE NETWORK

CONN. STATE POLICE

MILWAUKEE JOURNAL CO.

The PARADE of Leaders in FM

FM and Eimac Tubes have been close companions from the very start. The first public announcement appeared in 1938 when Paul DeMars and the Yankee Network were carrying on their experiments. By the time Major Armstrong had convinced the world that FM was the next great advancement in broadcast transmission, Eimac Tubes were in practically every experimental broadcast station in the country. Stromberg Carlson, REL, Zenith, The Milwaukee Journal Co. and many, many others were the leaders in this field and all use Eimac Tubes. There must be a good reason and there is: Eimac Tubes are the tried and proven tube for use in this service. Their unusual performance capabilities, stamina and complete freedom from premature failures due to gas released internally are a few of the good reasons why Eimac Tubes are FIRST in most of the important NEW developments in radio. Write for information or see the nearest representative.

Eimac TUBES

Eitel-McCullough, Inc.,
Sac. Bruno, California

KSFO-REL
F.M.
DEMONSTRATION

R. E. L.

EIMAC REPRESENTATIVES

California, Nevada
HERB BECKER, 1533 W.
104th St., Los Angeles Cal.
Wash., Ore., Idaho, Mont.
GENERAL SALES CO.,
Verner O. Jensen, 2695-07
Second Ave., Seattle, Wash.
Colo., Wyo., New Mexico,
Arizona, Utah
RICHARD A. HYDE, 4253
Quitman St., Denver, Colo.

Ohio, Mich., Ky., Ind., Minn.
Mo., Kan., Neb., Iowa
PEEL SALES ENGINEER-
ING CO., E. F. Peel, 154
E. Erie St., Chicago, Ill.
N. Y., N. J., Penn., Md., Del.,
Dist. of Col., Maine, N. H.
R. I., Conn., Mass.
ADOLPH SCHWARTZ,
14726 Elm Ave., Flushing,
New York.

N. Caro., S. Caro., Georgia,
Tenn., Flor., Ala., Miss.
JAMES MILLAR, 316 Ninth
St. N. E., Atlanta, Georgia.
Texas, La., Okla., Ark.
J. EARL SMITH, 2821 Live
Oak St., Dallas Texas.
Chicago, Illinois Wisconsin
G. G. RYAN, 549 W.
Washington Bl'., Chicago,
Ill.

HERE'S
RUGGED
DEPENDABILITY
PLUS...

**STUDIO QUALITY
RECORDINGS From
FAIRCHILD
PORTABLE RECORDER**

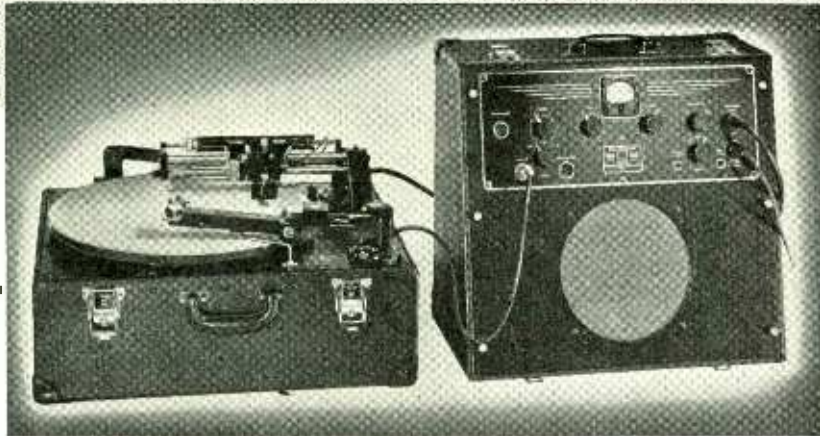

**Why Pamper Your Portable Recorder? Here's
Precision Equipment that Laughs at Trouble!**

Gone is the day when transcriptions cut in the field had to sacrifice tone-quality and brilliance . . . and gone, too, is the superstition that precision construction cannot stand hard use! Better performance has caused dozens of stations to standardize on Fairchild's F-26 Recorders, both for studio and field use. And they've turned in thousands of higher-fidelity transcriptions without repairs! Here's why *station men you know* boast of their Fairchild Recorders:

1. **High Gain Amplifier** permits use of microphone without a pre-amplifier!
2. **Instantaneous Speed Change** (33½ RPM or 78 RPM) through push-button control.
3. **Floating Motor Mount** eliminates all possibility of objectionable motor vibration.
4. **Split-Second Timing** through synchronous speed gear and worm drive at 33½ RPM assures wow-free recordings.
5. **Variations of pitch and direction of cut** provided for in the recorder itself. No expensive, troublesome additional feed screws needed.
6. **Dynamically-Balanced** 16-pound castiron turntable.

Write for illustrated folder today!

"...it had to satisfy Fairchild  first"

FAIRCHILD
Sound Equipment Division
FAIRCHILD
AVIATION CORPORATION
88-06 Van Wyck Boulevard, Jamaica, L. I., N. Y.

is projected onto this bank of phototubes from a motion picture projector running at 20 frames per second. Those phototubes which are illuminated by the image, control the thyratons, which in turn, turn on the associated lamps, thus reproducing the image on the signboard. The principle is essentially the same as that employed in earlier signs installed by Mr. Leigh, but the earlier signs made use of four lamps for each phototube and thyatron. The new sign, using but one lamp to each phototube, produces a smaller but more detailed image.

Three different types of film may be used as program fare. One type is a simple cartoon made up of squares, which when projected cover the individual phototubes. Either positive or negative films may be used, depending on the effect desired. The films are produced by the usual animated-cartoon technique. A second type of film is made from models. The third type of film is made directly from live subjects, such as persons or animals, which are photographed in front of a brightly illuminated screen, producing a silhouette effect. Among the possibilities is the reproduction of lighting effects taken from other Broadway signs, by photographing them and reproducing them on the bank of lamps. The signboard contains, in all, some 10,000 lamps. The 4,104 lamps which make up the animated signboard cover an area of 21 by 31 feet. It is planned to change the program once a month.

• • •

**LONG DISTANCE
MICROPHONE**

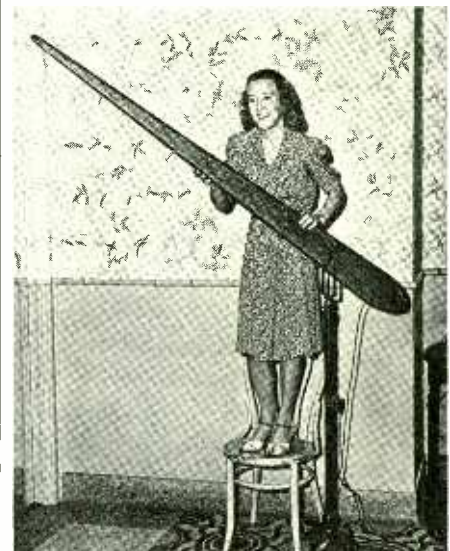

Shown at the recent convention of the Society of Motion Picture Engineers was this "streamlined sausage" microphone, developed by RCA's Dr. Harry F. Olson. The microphone consists of many individual tubes tuned to separate frequencies and was designed to pick up distant sounds



Through the HEAT of the Oven without a CRACK...

*How Monel contributes to economical production
and trouble-free operation of high quality resistors*

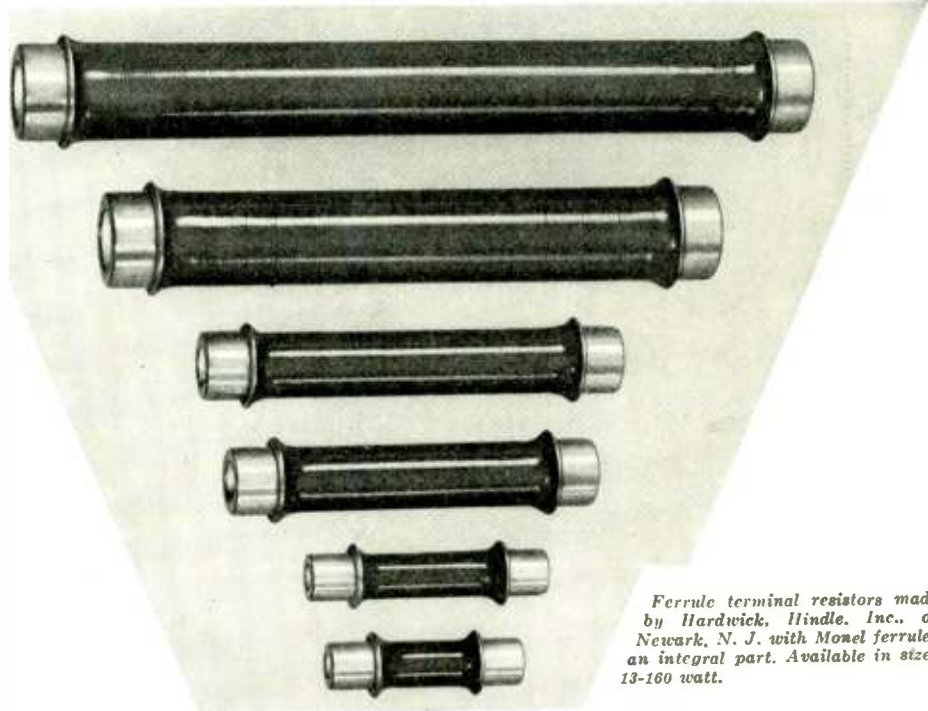

*Ferrule terminal resistors made
by Hardwick, Hindle, Inc., of
Newark, N. J. with Monel ferrules
an integral part. Available in sizes
13-160 watt.*

WIRE wound on a ceramic core...a coating of vitreous enamel...a metal ferrule on each end...that is your ferrule terminal resistor. But what has long puzzled engineers is how to weld these elements into a *solid, durable whole*.

In the Hardwick, Hindle ferrule terminal resistor this problem is solved by the use of Monel. Cracking and breaking during baking at 1300° F., and also during operation at 420° F., have been largely eliminated. A sturdy unit with clean, smooth contacts, no loose parts, and good for long, trouble-free service is the result.

What makes possible this accomplishment? The valuable *combination* of properties offered by Monel:

- 1. COEFFICIENT OF EXPANSION**
similar to that of the ceramic and vitreous enamel.
- 2. RESISTANCE TO OXIDATION**
even during baking at 1300° F.
- 3. RESISTANCE TO CORROSION**
by vitreous enamel during firing, and

by damp atmospheres during operation.

- 4. GOOD FABRICATING QUALITIES**
which permit strong, permanent connections by silver soldering.
- 5. SILVERY RUSTLESS LUSTER**
assuring attractive appearance.

Just as Monel proves an ideal material in this application, so this or another of the Nickel-base alloys—"R" Monel, "K" Monel, "Z" Nickel, Inconel—may prove just the material *you* need. Write for further information on these tough, rust proof metals and on Inco technical service. Ask for the booklet "Tremendous Trifles." Address:

THE INTERNATIONAL NICKEL COMPANY, INC.
67 Wall Street New York, N. Y.



MONEL

"Monel" is a registered trade-mark of The International Nickel Company, Inc., which is applied to a nickel alloy containing approximately two-thirds nickel and one-third copper.



**SAVE TIME AND COST BY USING
S. S. WHITE
FLEXIBLE SHAFT
COMBINATIONS**

If you are planning a flexible shaft application, either for REMOTE CONTROL or POWER TRANSMISSION, it is more than likely that you can save time and money too, by using S. S. WHITE Flexible Shafts. Here's the reason why . . .

The widespread use of S. S. WHITE Shafts in the aircraft, automotive, radio, electronic, machine tool and other fields has made available a large variety of fully developed combinations of flexible shaft, flexible casing and fittings. The chances are good that among these many combinations is one that will fit your particular requirements without modification.

The quickest way to find out is to send us full details of your proposed application and our engineers will do the rest. Their cooperation and recommendations are yours without obligation. We assure you that all information you send us will be held in strictest confidence.

HERE'S VALUABLE INFORMATION FOR YOU



Even if you have no immediate power drive or remote control problem, it's a good idea to have the latest information about flexible shafts handy. So write today for the following Bulletins:

BULLETIN 1238—Flexible Shafts for POWER DRIVES

BULLETIN 38—Flexible Shafts for REMOTE CONTROL

BULLETIN 839—Flexible Shaft Combinations for AIRCRAFT

S. S. WHITE

The S. S. White Dental Mfg. Co.

INDUSTRIAL DIVISION

Department E, 10 East 40th St., New York, N. Y.

FLEXIBLE SHAFTS for POWER DRIVES, REMOTE CONTROL and COUPLING

**Barium Used As Lubricant
in Rotating Targets of
X-Ray Tubes**

IN MODERN X-RAY TUBES, the problem of excessive generation of heat at the target surface has been attacked by using a rotating anode. As the target rotates it continuously presents a new surface to the bombarding electron beam and in this way the heating effect is spread out over a much larger area than would be possible with a fixed anode. One of the problems in such rotating anode tubes is that of lubricating the rotating mechanism. Ordinarily the anode is mounted on the shaft of an induction motor. The rotor part of the motor is suspended within the highly evacuated tube envelope, whereas the stator part of the system, including the field winding, is placed external to the tube envelope. Rotational speeds of the order of 3,000 rpm are attained, but the accompanying noise and friction is excessive because



Messrs Atlee, Wilson and Filmer testing the barium lubricated motor

the ball bearings used cannot be lubricated with any material which would vaporize. If ordinary lubricants are used, it becomes impossible to maintain the extremely high vacuum necessary in X-ray tubes. Recently engineers of the General Electric X-Ray Corporation, Mr. Z. J. Atlee, J. T. Wilson and J. C. Filmer, described the use of a thin film of metallic barium on the steel of the ball bearings. The barium acts as an efficient lubricant, and at the same time does not reduce the vacuum due to vaporization. A reduction of noise of almost 20 db is produced, the speed is increased from 3100 rpm to 3560 rpm, and the coasting time from 12 seconds to 8 minutes. The latter figures indicate a great decrease in friction, and a corresponding increase in the life of the bearing. The life of the bearing under conditions of the new lubrication runs from 50 to 100 hours, corresponding to from 36,000 to 72,000 exposures of 5 seconds each, usual in diagnostic work. It is expected that other metal films such as those in chromium, aluminum, magnesium and zinc may have practical application in rotating devices, not only in vacuum but also in air where organic lubricants may not be desirable.

Checking Station Performance and Maintaining Fidelity



A STORY OF NEW DEVELOPMENTS IN THE COMMUNICATIONS INDUSTRY

By W. J. PURCELL, Chief Engineer, WGY

SQUARE-WAVE testing and standardized volume-level measurement are two of the most useful tools that have come to the broadcasting industry since the absorption wave-meter took a back seat.

The contribution that both can make to more efficient station practices and to high fidelity broadcasting—including FM and television—deserves considerable attention.

Not every piece of equipment in even the most modern station will pass a square wave without adding some identifying hump or depression—or both—to the wave-shape. So square waves must not be taken as a cure-all. What systematic square-wave measurement can do—and very effectively—is to show any tendency toward departure from the “standard pattern” which becomes identified with a given piece of apparatus. It can show both where improvement is needed and how it can be obtained.

The beauty of the square-wave method is that it indicates in one operation what is generally learned only by tedious point-by-point measurement. The square wave, consisting as it does of not only a fundamental frequency but also dozens of harmonics, makes an over-all test possible in one operation. The output of the square-wave generator is merely compared on an oscilloscope with the wave after it has passed through the device being tested. The operation requires only a few seconds.

Thus, this new technique lends itself readily to daily

transmitter and equipment tests which are invaluable in the maintenance of high-fidelity performance, and makes it much easier to check adjustments whenever they become necessary. This is not restricted to audio equipment alone, but can also include the modulation process as an over-all test from a-f to r-f.



G-E square-wave generator. All G-E FM broadcast transmitters receive through square-wave tests

VU Meter Helps to Maintain Fidelity

Then there is another development that has proved to be of great service to radio stations in helping to maintain high fidelity of broadcasts—the VU volume-level indicator. It has brought about a standardization of zero level in db measurements, and has made possible a better correlation of volume-level readings throughout the communications industry—putting “gain cranking” on a more definite basis.



W. J. Purcell

With this instrument, control-room engineers can ride gain with greater accuracy and thus maintain high fidelity more easily. The instrument pointer reaches its peak quickly, with practically no overshoot. This permits the observer to follow the swings with minimum fatigue and eyestrain.

G-E designing engineers have figured prominently in both these developments. For information on the G-E square-wave generator see Bulletin GEA-3442; on the VU volume-level indicator, GEA-3145. Call or write our local representative. General Electric Co., Schenectady, New York.

General Electric VU
Volume-level Indicator



GENERAL ELECTRIC

602-16

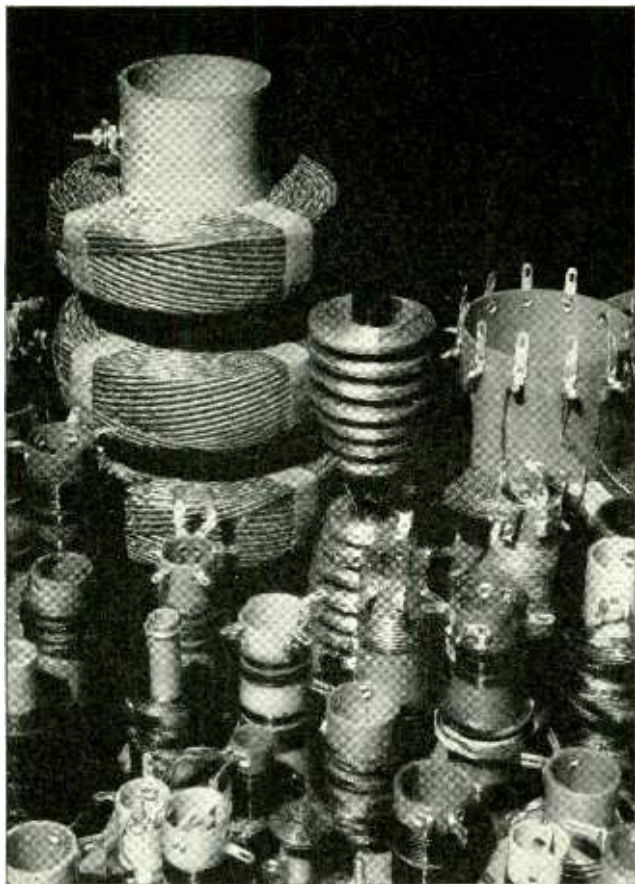

High-Frequency radio coils manufactured by the F. W. Sickles Co., Springfield, Mass. Textolite fabricated tubing is used.

Coil Forms

AND TEXTOLITE MORE THAN MEET THE SPECIAL INSULATION REQUIREMENTS

For any electrical radio or electronic part that requires complete insulation you will find Textolite laminated an excellent material. Its many grades permit a wide selection—you can easily choose the right grade to do the best job for you.

And as for forms, Textolite is available in sheets, rods, tubes, and in fabricated parts no matter how simple or how intricate.

General Electric's newly published price list on Textolite is now available on request. We suggest that you write for your copy now. Address Section G-10, Plastics Department, General Electric Company, One Plastics Avenue, Pittsfield, Massachusetts.

General Electric has recently reorganized its fabricating facilities to assure you of quick and uninterrupted service on fabricated parts. To take advantage of this improved service send inquiries and requests for prices direct to:

IN THE EAST—
Plastics Department, General Electric Co., 44 Cambridge St., Meriden, Conn.

IN THE WEST—
General Laminated Products, Inc., 3123-13 Carroll Ave., Chicago, Illinois.

GENERAL  ELECTRIC

PD-103

A Phototube Relay For Infrared Radiation

By CARL C. SMITH

IT IS THE PURPOSE OF THIS ARTICLE to describe an amplifier developed some time ago by the writer, and recently adapted to a special application having the functions of a burglar-alarm, but with a greatly extended range.

It will be observed from the accompanying schematic diagram that the complete assembly incorporates a direct-current phototube amplifier unit

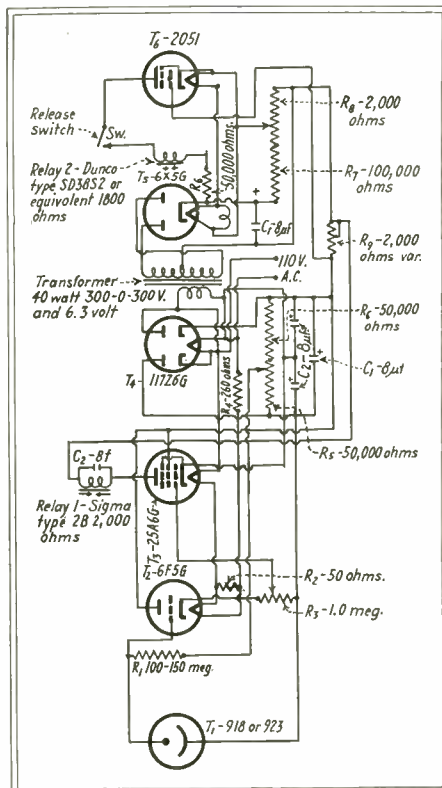

Circuit diagram of a phototube relay particularly adapted to burglar alarm applications

to which is coupled a thyatron lock-in circuit. The purpose of the latter is to provide an extremely rapid locking in of the alarm indicator upon interruption of the infrared beam so that the subsequent removal of the interrupting medium from the path of the beam will not restore the alarm mechanism to normal. The alarm can be reset only by manually operating a release switch situated in the anode circuit of the thyatron.

To avoid disturbance of the amplifier voltage, a separate rectifier system is provided for the lock-in relay circuit. This feature considerably improves the stability of the equipment and materially reduces its sensitivity to line voltage changes.

The control grid bias of the thyatron, which is adjustable by means of potentiometer R_8 , is normally set to a value just sufficient to prevent firing of the tube. An interruption of the beam results in an increase in



Here's the Condition . . .

Push-button-tuned auto radio is set for Station KDKA, 980 KC. Before turning it on, Ambient Temperature is 40° F.

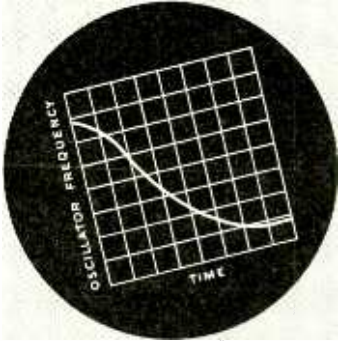

Here's what Happens . . .

As the set warms up, changes in reactance of coils, tuning condensers, sockets, etc. cause the oscillator frequency to drop 2 KC. The result is a distorted signal and a dissatisfied owner.

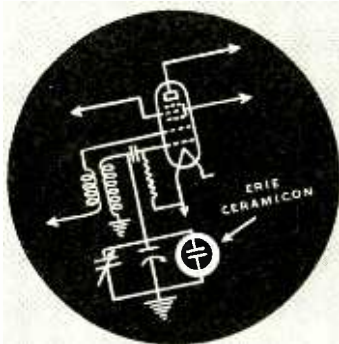

Here's the Solution . . .

Replace a part of the capacitive reactance in the oscillator with an Erie Ceramicon of such a value and temperature coefficient as to compensate for the undesired reactance drift. The oscillator frequency will now remain essentially constant at its correct value over the entire operating temperature range.

TO ELIMINATE UNDESIRABLE FREQUENCY DRIFT USE *Erie Ceramicons*



MANY leading radio manufacturers have found Erie Ceramicons to be the answer to stabilizing the operation of their automatic tuning receivers. Erie Ceramicons are available in insulated and non-insulated styles with compensating temperature coefficient of capacity between $+0.00012$ and -0.00068 per $^{\circ}\text{C}$. The temperature characteristic of Erie Ceramicons does not depend on any mechanical movement of parts, but rather upon the molecular structure of the ceramic dielectric. Thus, with these units, compensation is retraceable and will track faithfully for the life of the set.

RESISTORS
SUPPRESSORS
CERAMICONS
SILVER-MICA
CONDENSERS

Erie RESISTOR CORPORATION, ERIE, PA.
TORONTO, CANADA • LONDON, ENGLAND • PARIS, FRANCE-J.E.CANETTI CO.

MOLDED BEZELS
PUSH BUTTONS
AND KNOBS
POLYSTYRENE
COIL FORMS

THE RELAY

THAT SURPRISED EVEN ITS DESIGNERS

OFFERS 4 DEFINITE BENEFITS TO USERS

1. Reduced user's assembly cost (relays are pre-adjusted)
2. More reliable operation (contacts have heavy pressures—are self-cleaning)
3. More positive action (armature restored by leaf spring)
4. No overheating (coil is self protecting).

You can enjoy these benefits. Write Dept. B for information.

AN OFFER . . .

Tell us (1) Your product or operation (2) Function and performance details (3) Whether chief objective is improved performance or reduced cost. We'll send a helpful recommendation, free. Write Dept. B

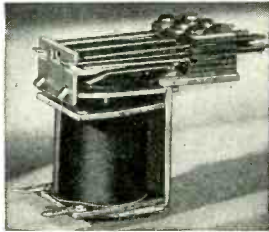

AUTOMATIC ELECTRIC

Relay Makers Since 1898

1033 West Van Buren Street, Chicago

the plate current of the 25A6G tube; this increase of current through coupling resistor R_c results in a decrease in the negative bias of the thyatron, permitting this latter tube to fire and operate its associated relay. Since direct-current excitation of the 2051 is provided, its plate current, once established, is no longer subject to grid control and remains flowing until the circuit is externally interrupted. As it is desirable to obtain indication in case of amplifier tube failure a supervisory relay is included in the 25A6G plate circuit. This relay is adjusted, by means of potentiometers R_1 and R_2 , to remain closed with normal beam intensity on the phototube; an interruption of 25A6G plate current due to tube failure or increased light on the phototube, results in this relay opening and operating the alarm.

As built for practical purposes, the phototube is provided with a 5 or 6 inch lens system which focusses the received beam, through an aperture to reduce the angle of observation of the lens, on to the phototube. The source of infrared radiation may consist of a standard 8 inch automobile spot-light with 50 candlepower lamp and parabolic reflector. The visible radiation is practically eliminated by providing a filter such as the Wratten No. 87, or Corning No. 254.

With the equipment as described, it is quite practicable to obtain definite operation using a beam length of 1200 to 1800 feet. Since most of the visible light is filtered out by the filters mentioned above, the system constitutes an invisible ray burglar alarm operating over considerably greater distances than provided by the ordinary equipment of this type.

ANIMAL X-RAY PHOTOGRAPH



X-ray photograph of a death adder showing the bone structure and the outline of the lung (dark portion). The lower jaw is not joined in the center allowing the mouth to be opened enormously for swallowing large animals

PINCOR FIRST AGAIN!



Again Pincor takes the lead. This time with the new DUAL-VOLTAGE Dynamotors, with double input and double output to permit operation on any one of two specified voltages—6 and 12 volts, 12 and 24 volts, 16 and 32 volts, etc. Transfer from one voltage to the other accomplished by merely changing leads. No other dynamotor affords such flexibility. Built to give thousands of hours of trouble free service in aircraft, mobile and marine use. Information on request.

PIONEER GEN-E-MOTOR CORP.

Dept. R-4, 466 W. SUPERIOR ST., Chicago, Ill.
Export Address: 25 WARREN ST., N. Y., N. Y.
Cable: SIMONTRICE, New York

PINCOR DUAL VOLTAGE DYNAMOTORS



DYNAMOTORS



ROTARY CONVERTERS



HIGH FREQUENCY CONVERTERS



SMALL MOTORS



POWER PLANTS

FOR AIRCRAFT • SOUND • POWER SUPPLY USES

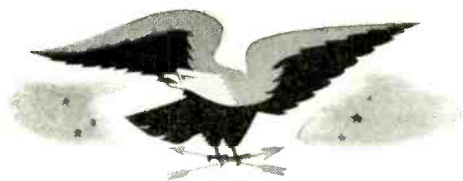

Radio Enlists for National Defense

THE RADIO INDUSTRY has answered the call to national defense with an "all out" acceleration of creative activities. In research, in operation, in production—from blueprint to wavelength—the watchword is Service for the Needs of Uncle Sam!

For radio today has attained front-line rank in the national defense program. Its magic voice keeps our citizens informed, unites our nation as a vast community for free discussion. It links together the 21 republics of our hemisphere in bonds of friendship and mutual interest. It enables us to communicate around the world, to reach out to ships at sea, and to guide our aviators through fog and night.

Whole-hearted Response

As a leader in radio research, as the only company that makes and does everything in radio, the Radio Corporation of America is proud of its call to duty. It eagerly enlists its facilities and personnel in the service of the American people.

The emergency finds RCA fully prepared. Months ago the "must" orders went to every subsidiary of the company, with the result that at the present

moment it is making daily contributions through its great laboratories, ceaselessly active in research—through its manufacturing company, in the production of radio apparatus—through communications, flashing message traffic around the earth—through radiomarine, in all-round communication service at sea—and through the National Broadcasting Company, in nationwide, world-wide broadcasting. To fill the need for men with technical skill, RCA Institutes is training radio operators.

Accepting the Challenge

Using all the resources at its command, the Radio Corporation of America is meeting every demand for service—with expanded facilities, increased production, with smooth functioning speed.

In assuming its vital share in national defense, RCA realizes its opportunity to help preserve the unity and integrity of our national life. Each of its thousands of employees pledges his energies and enthusiasm to producing all needed equipment on schedule, to making America's radio communication system the most efficient on earth.

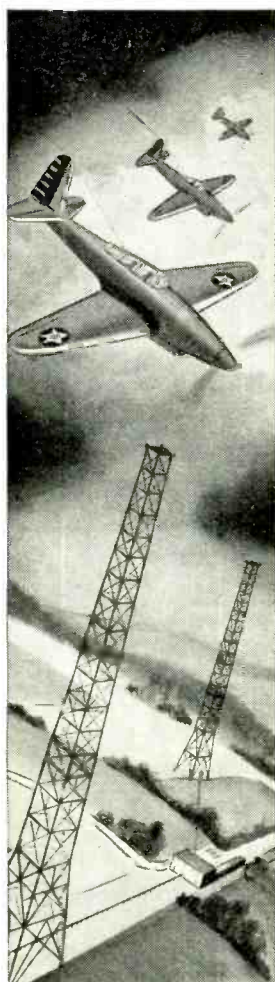

RADIO CORPORATION OF AMERICA
RADIO CITY • NEW YORK

RCA Manufacturing Co., Inc.
National Broadcasting Company

Radiomarine Corporation of America
R.C.A. Communications, Inc.

RCA Laboratories
RCA Institutes, Inc.



"GLOBAL" OFFERS...

MANY SHAPES, SIZES AND TYPES OF CERAMIC RESISTORS



**GLOBAL DIVISION
THE CARBORUNDUM COMPANY**
REG. U. S. PAT. OFF.
NIAGARA FALLS, N. Y.
(Carborundum and Global are registered trade-marks of and indicate manufacture by The Carborundum Company)

Global CERAMIC RESISTORS

INSTANT ACTION!!!

**RUGGED • COMPACT
LOW POWER CONSUMPTION
ALSIMAG INSULATION
COIN SILVER CONTACTS
SELF-CLEANING WIPE**



RELAY

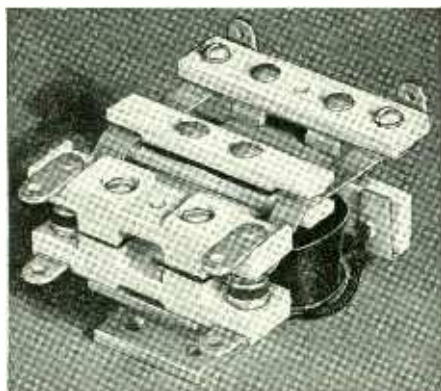

• This instant action relay was designed to meet the need for a quality medium duty unit at low cost. The majority of specifications calling for R.F. insulation and medium contact load, are met with this carefully built unit. Under test, no variations in adjustments were disclosed even after seven million operations. Specification sheet sent on request.

KURMAN ELECTRIC CO.
INCORPORATED
241 LAFAYETTE ST. NEW YORK, N. Y.

Phototube

(Continued from page 23)

in Fig. 5C, is suitable in certain audio-frequency equipment.

Shot Noise Effects

When weak signals are considered, the shot noise caused by the random nature of the electron emission and the resistance noise generated by thermal agitation in the coupling resistance constitute fundamental limitations to the usefulness of photosensitive tubes. For convenient comparison between a high vacuum phototube, a gas filled phototube, and an electron multiplier coupled to the same output resistance, a chart (Fig. 9) showing the signal-to-noise ratio as a function of the pure photoemission has been computed on the basis of the following relations:

High-vacuum phototube

$$s_n^2 = \frac{f m^2 I^2 r}{2 e F I r + 4 k T F}$$

Gas-filled phototube

$$s_n^2 = \frac{f m^2 A^2 I^2 r}{2 e F I r A (A + 1) + 4 k T F}$$

Multiplier operated on dc

$$s_n^2 = \frac{f m^2 G^2 I^2 r}{2 e F R^n \frac{R^{n+1} - 1}{R - 1} r I + 4 k T F}$$

$$\approx \frac{f m^2 (R - 1)}{2 e F R} I$$

It was found that the shot noise in the multiplier was greater when it was operated on ac than when operated on dc. This is due to the fact that all available photoelectrons are not efficiently contributing to the output. Calculations show that noise in that case is given by

Multiplier operated on ac

$$s_n^2 = \frac{f m^2 (\bar{G})^2}{2 e F \bar{G}_i^2} I$$

In all these relations, s_n^2 is the ratio of the averages, over a long time, of the signal and noise powers, I the intrinsic photoemission (= incident light times intrinsic sensitivity of the photocathode), F the frequency band, k Boltzmann's constant, T the temperature of the resistance and r its value, f the a-c form factor, and m the modulation factors of the signal, A the gas amplification, R the average gain per stage of the

*An Announcement to Manufacturers
Regarding the January I.R.E. Convention*

The first annual Winter Convention and Exhibit of the Institute of Radio Engineers will be held at the Hotel Pennsylvania in New York on January 9, 10, and 11, 1941. This supersedes the meeting usually held in June.

As the majority of ELECTRONICS advertisers make plans for extra space or special copy in I.R.E. issues of ELECTRONICS, we want to explain a problem that confronts both of us—i.e., closing dates.

In order to distribute January ELECTRONICS with your advertisement at the Convention we must close all forms by December 27th, right in the middle of the holiday week. In order to avoid the confusion that always accompanies the end of the year, we suggest that advertisements for the January issue be prepared well in advance so that proofs may be okayed before the holidays interfere with both your production schedule and ours.

We are sure that you will not want to miss having your advertisement seen and discussed at this important meeting of the I.R.E. The most effective and economical way to do this is to schedule impressive space in January ELECTRONICS.

electronics, 330 west 42nd st., new york

**SENSITIVE ELECTRONIC
AC VOLTMETER
MODEL 300**



- New operating principle.
- 10-100,000 cycles.
- 1 millivolt to 100 volts in five ranges (to 1,000 and 10,000 volts with multiplier).
- Logarithmic voltage scale and uniform decibel scale.
- A-C operation, 115 or 230 volts, 50-60 cycles (rack mounting and battery-operated models also available).
- Permanent calibration, unaffected by variation in line voltage, tubes, etc. Accuracy 2%.
- Can also be used as an amplifier (70 DB gain) flat to 100,000 cycles.

**MODEL 402
MULTIPLIER**



Newest addition to a line of accessories designed to increase the utility of the Model 300 Voltmeter. This multiplier has two important uses: (1) to provide additional ranges of 1,000 and 10,000 volts full scale, and (2) to increase the input impedance so that, when full sensitivity is not required, measurements may be made on very high impedance circuits. The input impedance on the 1,000-volt range is 4.4 megohms and on the 10,000-volt range 44 megohms.

Send for Bulletin 2E.

Ballantine Laboratories, Inc.
BOONTON NEW JERSEY

multiplier, G the total current gain, n the number of stages, dt an element of time, P the period of an a-c cycle, and

$$\bar{G} = \frac{1}{P} \int_0^P R^n dt \text{ and}$$

$$\bar{G}_v^2 = \frac{1}{P} \int_0^P R^n \frac{R^{n+1} - 1}{R - 1} dt$$

Values indicated in the graphs of Fig. 9 have been confirmed by measurements, within reasonable limits. The values chosen for the various parameters, as indicated on the chart itself, are typical for sound reproduction from a modulated light beam. For other values the general conclusions in the following paragraph remain valid.

The signal-to-noise ratio for low light levels is more favorable for a multiplier than for a phototube, because the high level of the output renders the resistance noise negligible with respect to the shot noise. Similarly, due to its higher output level, the gas-filled tube gives less noise than a vacuum tube for weak lights. This characteristic is of particular importance for sound reproduction from films when, for practical reasons, only small light intensities are available.

Applications

This photoelectric electron multiplier is practical for use in many applications because it is small, simple, and rugged, and because it is free from distortion, has enormous sensitivity, is conveniently controllable to compensate for undesired light and voltage fluctuations, and is amenable to a-c operation.

In scientific research, such as photometry, spectroscopy, astronomy, biology, etc, a multiplier is the best instrument for observing weak illumination. In sound reproduction from films, facsimile transmission, and other operations involving high quality optical signals, this multiplier is practical, not only because it has a low noise level, but also because it can be operated with an unregulated exciter lamp.

The authors wish to express their appreciation to Dr. V. K. Zworykin for his guidance, and to the staff of the electronic research laboratory for their assistance, and regret that space does not allow all specific acknowledgments nor a bibliography of all the works which led to this development.

**BEST IN ITS
CLASS**



MIDGET RF RELAY

That's why many discriminate manufacturers of transmitting equipment have adopted this Relay.

This unit has been approved as a component part of Type Certificated Aircraft Radio.

"Isolantite" insulation throughout. Contact combination Double-Pole, Double-Throw 1/4" Fine Silver Contacts.

Can be furnished with third pole. Special impregnated coils to meet Army or Navy specifications can be supplied.

Write for Bulletin MA-1

**Advance
ELECTRIC COMPANY**
1260 W. 2nd St., Los Angeles, Calif.
Relay Manufacturers

**Automatic
TIME DELAY
CONTROL**

- ★ Synchronous Motor Driven
- ★ Fully Automatic, including instantaneous Automatic Reset
- ★ Different models with Selective Timing over range up to 55 min. SPLIT-SECOND ACCURACY
- ★ Units furnished for flush or panel mounting

SERIES TD-60
in durable metal case
5 1/2" x 7 1/2" x 2 1/2"
Contact rating
1/2 A @ 100 V
watts non-inductive
\$20.00

This is but ONE of THREE important BASIC principles applied to TIME CONTROL by Industrial Timer Corp

1. TIMING cycle Control
2. TIME DELAY Control (TD-60, above)
3. NEW DUPLEX Time Control

• Write today for latest bulletins Model TD-60 (above) now used in Magneto production control Welding Radio Transmitters etc.

**Industrial Timer
CORPORATION**
103 Edison Place NEWARK, N.J.

Tubes Department Index

The *Tubes* department this month is devoted primarily to an index of all the tubes described in it since its inception in November 1939. This index is to appear semi-annually in June and December. Tubes registered with the R. M. A. Data Bureau during October are also included

Filament Types for use with Dry Batteries or Equivalent Power Supply

Type	Structure or Function	Salient Characteristic	Issue	Page
1A4P	Super-control R-F Amplifier	$\mu_m = 725$	Nov 40	64
1A5G	PA Pentode	$P_o = 0.115$	May 40	65
1A5GT	Power Amplifier Pentode	$P_o = 0.1$	Feb 40	52
1A7G	Pentagrid Converter	$g_c = 250$	May 40	62
1A7GT	Pentagrid Converter	$g_c = 250$	Feb 40	53
1B4	R-F Screen Grid Amplifier	$g_m = 650$	Oct 40	68
1B7G	Pentagrid Converter	$g_c = 350$	Feb 40	54
1B7GT	Pentagrid Converter	$g_c = 350$	Nov 39	73
1B8GT	Diode, Triode, Beam PA	$P_o = 0.21$	Nov 39	72
1C5G	PA Pentode	$P_o = 0.240$	May 40	63
1C5GT	Power Amplifier Pentode	$P_o = 0.24$	Feb 40	52
1C6	Pentagrid Converter	$g_c = 325$	Dec 40	65
1D5G	Super-Control r-f Amplifier	$g_m = 625$	Oct 40	68
1D7G	Pentagrid Converter	$g_c = 300$	Oct 40	68
1D8GT	Diode, Triode, Pa Pentode	$P_o = 0.2$	Dec 39	57
1E4G	Triode	$\mu = 14$	Mar 40	65
1E5G	R-F Pentode	$g_m = 650$	Dec 40	65
1E7G	PA Twin Pentode	$P_o = 29$	Nov 40	68
1F5G	PA Pentode	$P_o = 0.31$	Dec 40	65
1F7G (H)	Duo-Diode, Pentode	$g_m = 650$	July 40	57
1F7G (V)	Duo-Diode, Pentode	$g_m = 650$	July 40	60
1G4G	Low-mu Triode	$\mu = 9$	Mar 40	69
1G4GT	Low-mu Triode	$\mu = 9$	Nov 39	69
1G5G	PA Pentode	$P_o = 0.55$	Aug 40	68
1G6G	Twin PA Triode (B)	$P_o = 0.675$	Mar 40	68
1G6GT	Twin PA Triode (B)	$P_o = 0.675$	Nov 39	69
1H5G	Diode, Triode	$\mu = 65$	May 40	62
1H5GT	Diode, High mu Triode	$\mu = 65$	Feb 40	52
1H6G	Double Diode Triode	$g_m = 575$	Nov 40	72
1J5G	PA Pentode	$P_o = 0.45$	Aug 40	69
1J6G	Twin Triode Amplifier	$P_o = 2.1$	Nov 40	72
1LA4 (GL)	PA Pentode	$P_o = 0.115$	Jan 40	66
1LA6 (GL)	Pentagrid Converter	$g_c = 250$	Jan 40	64
1LB4 (GL)	PA Pentode	$P_o = 0.2$	Nov 39	72
1LC5 (GL)	R-F Pentode, sco.	$g_m = 775$	July 40	57
1LC6 (GL)	Heptode Converter	$g_c = 250$	July 40	57
1LD5 (GL)	Diode, Pentode, sco.	$g_m = 575$	Oct 40	65
1LE3 (GL)	Triode	$\mu = 14.5$	June 40	72
1LH4 (GL)	Diode, High-mu Triode	$\mu = 65$	Jan 40	66
1LN5 (GL)	R-F Pentode	$g_m = 800$	Jan 40	64
1N5G	R-F Pentode	$g_m = 750$	May 40	63
1N5GT	R-F Pentode	$g_m = 750$	Feb 40	52
1N6G	Diode PA Pentode	$P_o = 0.1$	Feb 40	50
1N6GT	Diode, PA Pentode	$P_o = 0.1$	Dec 39	57
1P5G	R-F Pentode, reco.	$g_m = 800$	Feb 40	53
1P5GT	R-F Pentode, reco.	$g_m = 800$	Dec 39	55
1Q5G	Beam Power Amplifier	$P_o = 0.27$	Mar 40	66
1Q5GT	Beam Power Amplifier	$P_o = 0.27$	Feb 40	53
1R5 (GB)	Pentagrid Converter	$g_c = 250$	Jan 40	58
1S4 (GB)	Power Amplifier Pentode	$P_o = 0.065$	Jan 40	58
1S5 (GB)	Diode, Pentode	$g_m = 525$	Jan 40	58
1T4 (GB)	R-F Pentode, reco.	$g_m = 750$	Jan 40	58
1T5GT	Beam Power Amplifier	$P_o = 0.17$	Jan 40	62
3A8GT	Diode Triode Pentode	$g_m = 750$	Oct 40	65
3C5GT	Power Amplifier Pentode	$P_o = 0.26$	Dec 39	53
3LE4 (GL)	PA Pentode	$P_o = 0.3$	Sept 40	66
3Q5G	Beam Power Amplifier	$P_o = 0.27$	June 40	72
3Q5GT	Beam Power Amplifier	$P_o = 0.27$	Dec 39	56
4A6G	Twin Triode PA	$P_o = 1.0$	May 40	65

Filament Types for Use with Power Supplies Other Than Dry Batteries

2A4G	Thyratron		May 40	65
2V3G	Half-Wave Rectifier	$I_{dc} = 2$	Mar 40	69
2W3	Half-Wave Rectifier	$I_{dc} = 55$	Apr 40	92
2W3GT	Half-Wave Rectifier	$I_{dc} = 55$	Dec 39	54
2X2/879	Half-Wave Rectifier	$E_{ac} = 4500$	Nov 39	60
2X3G	Half-Wave Rectifier	$I_{dc} = 125$	Aug 40	69
2Y2	Half-Wave Rectifier	$I_{dc} = 5$	Apr 40	94
5T4	Full-Wave Rectifier	$I_{dc} = 225$	Aug 40	69
5U4G	Full-Wave Rectifier	$I_{dc} = 225$	Sept 40	68
5V4G	Full-Wave Rectifier	$I_{dc} = 175$	Nov 40	72
5W4G	Full-Wave Rectifier	$I_{dc} = 100$	Aug 40	68
5W4GT	Full-Wave Rectifier	$I_{dc} = 90$	Nov 39	73
5X3	Full-Wave Rectifier	$I_{dc} = 110$	Apr 40	96
5X4G	Full-Wave Rectifier	$I_{dc} = 225$	Sept 40	71
5Y3	Full-Wave Rectifier	$I_{dc} = 125$	Nov 40	64
5Y4G	Full-Wave Rectifier	$I_{dc} = 125$	Sept 40	71
5Z4	Full-Wave Rectifier	$I_{dc} = 125$	Nov 40	66
5Z4G	Full-Wave Rectifier	$I_{dc} = 125$	Nov 40	66
5Z4GT	Full-Wave Rectifier	$I_{dc} = 125$	Nov 40	64

Unipotential Cathode Types

Type	Structure or Function	Salient Characteristic	Issue	Page
2E5	Tuning Indicator		Nov 40	64
6A3	PA Triode	$P_o = 4.2$	Nov 40	72
6A5G	PA Triode	$P_o = 3.75$	Aug 40	67
6A6	Class B Twin Triode Amplifier	$\mu = 35$	Nov 40	68
6A8	Pentagrid Converter	$g_c = 550$	Nov 40	66
6A8G	Pentagrid Converter	$g_c = 550$	Nov 40	66
6A8GT	Pentagrid Converter	$g_c = 550$	June 40	74
6AB5	Tuning Indicator		July 40	58
6AB6G	Direct-Coupled Power Amplifier	$P_o = 3.5$	Aug 40	70
6AB7 (M)	R-F Pentode, reco.	$g_m = 5000$	Feb 40	55
6AC5G	PA Triode	$P_o = 3.7$	July 40	58
6AC5GT	High-mu PA Triode	$\mu = 125$	June 40	74
6AC6G	Direct-Coupled Power Amplifier	$P_o = 3.8$	Aug 40	67
6AC6GT	Triple-Twin PA	$P_o = 3.6$	June 40	72
6AC7 (M)	R-F Pentode, sco.	$g_m = 9000$	Feb 40	55
6AD5G	High-mu Triode	$\mu = 100$	Apr 40	96
6AD6G	Tuning Indicator		May 40	63
6AD7G	Triode, PA Pentode	$P_o = 3.2$	June 40	72
6AE5G	Triode Amplifier	$\mu = 4.2$	Apr 40	94
6AE5GT	Triode	$\mu = 4.2$	Nov 39	73
6AE6G	Single-Grid, Twin Plate Control Tube		May 40	64
6AE7GT	Double Driver Triode (common plate)	$\mu = 14$	July 40	57
6AF5G	Triode	$\mu = 7.4$	Feb 40	52
6AF6G	Tuning Indicator		May 40	64
6AF7G	Tuning Indicator		Feb 40	51
6AG6G	PA Pentode	$P_o = 3.75$	Apr 40	96
6AG7 (M)	Beam Amplifier	$g_m = 7700$	Feb 40	51
6AL6G	Beam Power Amplifier	$P_o = 6.5$	Nov 39	71
6B4G	Triode Power Amplifier	$P_o = 3.2$	Sept 40	67
6B5	Direct-Coupled PA	$P_o = 4$	Nov 40	64
6B6G	Duplex-Diode High-mu Triode	$\mu = 100$	Oct 40	68
6B8	Duodiode Pentode	$g_m = 1325$	Sept 40	69
6B8G	Duodiode Pentode	$g_m = 1125$	Sept 40	68
6B8GT	Duodiode, Pentode, reco.	$g_m = 1325$	July 40	57
6C5GT	Triode	$\mu = 20$	Dec 39	53
6C8G	Double Triode	$\mu = 36$	Aug 40	69
6D8G	Pentagrid Converter	$g_c = 550$	Sept 40	69
6E5	Electron Ray Tube		Oct 40	66
6E8G fs	Triode-Hexode	$g_c = 630$	Dec 39	53
6F5	High-mu Triode	$\mu = 100$	Nov 40	70
6F5GT (GT)	High-mu Triode	$\mu = 100$	Mar 40	76
6F6	PA Amplifier	$P_o = 3.2$	June 40	62
6F8G	Twin Triode Amplifier	$\mu = 20$	July 40	60
6G6G	PA Pentode	$P_o = 1.1$	July 40	58
6H4GT	Single Diode		Jan 40	66
6H5	Tuning Indicator		Aug 40	70
6H6	Twin Diode		Nov 40	70
6H6G	Twin Diode		Nov 40	70
6H6GT fs	Double Diode		June 40	78
6H8G	Double Diode Pentode	$g_m = 2400$	Dec 39	57
6J5	Detector Amplifier Triode	$\mu = 20$	July 40	57
6J5GT	Detector Triode Amplifier	$\mu = 20$	June 40	78
6J7	Triple-grid Detector Amplifier	$g_m = 1225$	Nov 40	70
6J7G	Triple-grid Detector Amplifier	$g_m = 1225$	Nov 40	70
6J7GT	Triple-grid Detector Amplifier	$g_m = 1225$	June 40	80
6J8G	Triode-Heptode Converter	$g_c = 290$	July 40	58
6K5GT	High-mu Triode	$\mu = 70$	Sept 40	80
6K6G	PA Amplifier Pentode	$P_o = 3.4$	June 40	67
6K6GT (MG)	PA Pentode	$P_o = 3.4$	June 40	80
6K6	Power Amplifier Pentode	$P_o = 3.4$	Oct 40	68
6K7GT	Triple-Grid Super-Control Amplifier reco.	$g_m = 1450$	June 40	80
6K8	Triode-Hexode Converter	$g_c = 350$	July 40	60
6K8G	Triode-Hexode Converter reco.	$g_c = 350$	May 40	64
6K8GT	Triode-Hexode, reco.	$g_c = 350$	Feb 40	55
6L5G	Detector Amplifier Triode	$\mu = 17$	Sept 40	68
6L7	Pentagrid Mixer Converter	$g_c = 375$	Oct 40	66
6M6G fs	PA Pentode	$P_o = 4.4$	Apr 40	96
6M7G fs	R-S Pentode	$g_m = 3400$	Mar 40	62
6M8GT fs	Diode, Triode, Pentode	$g_m = 1900$	Nov 39	72
6N5	Tuning Indicator		Sept 40	67

Explanation of suffixes

G	Glass envelope and octal base
(GB)	Integral T-5½ glass envelope and base
(GL)	Integral T-9 glass envelope and loktal base
(GM)	Metal coated glass envelope with octal base
GT	Short T-9 glass envelope and octal base
LM	MT-8 metal envelope and octalox base
LT	T-9 glass envelope and octalox base
M	Metal envelope and octal base

Type	Structure or Function	Salient Characteristic	Issue	Page
6N6	Dynamic Coupled PA	$P_o = 4$	Sept 40	68
6N6 (MG)	Dynamic Coupled PA	$P_o = 4$	Oct 40	70
6N7GT	Twin-Triode	$\mu = 35$	Nov 40	64
6N7 (MG)	Twin-Triode Amplifier	$P_o = 10$	Oct 40	70
6P5G	Detector Amplifier Triode	$\mu = 13.8$	July 40	57
6P5GT	Triode	$\mu = 14$	Feb 40	54
6P8G	Triode-Hexode Converter	$g_c = 650$	Apr 40	92
6Q6G	Diode, High- μ Triode	$\mu = 65$	Sept 40	67
6Q7GT	Duodiode, High- μ Triode	$\mu = 70$	June 40	80
6Q7 (MG)	Duplex Diode, High- μ Triode	$\mu = 70$	Oct 40	69
6P6G	R-F Pentode, rco	$g_m = 1450$	July 40	59
6R7G	Double Diode, Triode	$\mu = 16$	Nov 40	68
6R7GT	Double Diode, Triode	$\mu = 16$	Dec 39	53
6R7 (M)	Double Diode, Triode	$\mu = 16$	Oct 40	70
6S5	Tuning Indicator		Aug 40	66
6S6GT	R-F Pentode, rco	$g_m = 4000$	Apr 40	88
6S7	Triple-Grid Super-Control Amplifier rco	$g_m = 1750$	July 40	60
6S7G	Triple-Grid, Super-Control Pentode rco	$g_m = 1750$	Sept 40	67
6SA7	Pentagrid Converter	$g_c = 450$	Apr 40	92
6SA7GT	Pentagrid Converter	$g_c = 425$	Feb 40	55
6SC7	Twin Triode Amplifier	$\mu = 70$	Apr 40	93
6SD7GT	R-F Pentode, semi-rco	$g_m = 3600$	June 40	72
6SE7GT	R-F Pentode, sco	$g_m = 3400$	June 40	74
6SF5	High- μ Triode	$\mu = 100$	Apr 40	93
6SF5GT	High- μ Triode	$\mu = 100$	Jan 40	64
6SJ7	R-F Pentode, sco	$g_m = 1650$	Apr 40	93
6SJ7GT	R-F Pentode, sco	$g_m = 1650$	Jan 40	60
6SK7	R-F Pentode, rco	$g_m = 2000$	Apr 40	93
6SK7GT	R-F Pentode, rco	$g_m = 1650$	Jan 40	60
6SQ7	High- μ Triode, Double Diode	$\mu = 100$	Apr 40	93
6SQ7G	Double Diode, High- μ Triode	$\mu = 100$	Nov 39	73
6SQ7GT	Double Diode, High- μ Triode	$\mu = 100$	Jan 40	60
6SR7 (M)	Duodiode, Triode	$\mu = 16$	June 40	72
6T5	Tuning Indicator		July 40	60
6T6 fs (GM)	R-F Pentode	$g_m = 5500$	Nov 39	73
6T7G	Duodiode, High- μ Triode	$\mu = 65$	Aug 40	68
6U5-6G5	Tuning Indicator		Aug 40	66
6U6GT	Beam Power Amplifier	$P_o = 5.5$	Aug 40	65
6U7G	Triple-Grid Super-Control Amplifier	$g_m = 1600$	Sept 40	70
6V6	Beam Power Amplifier	$P_o = 4.5$	July 40	58
6V6G	Beam Power Amplifier	$P_o = 4.5$	Aug 40	68
6V6GT	Beam Power Amplifier	$P_o = 4.25$	Nov 39	69
6V7G	Duodiode Triode	$P_o = 0.350$	Sept 40	70
6W5G	Full-Wave Rectifier	$I_{dc} = 90$	Aug 40	68
6W6GT	Beam Power Amplifier	$P_o = 3.3$	Dec 39	55
6W7G	Triple-Grid Detector-Amplifier-sco	$g_m = 1225$	July 40	60
6X5	Full-Wave Rectifier	$I_{dc} = 70$	Nov 40	72
6X5GT	Full-Wave Rectifier	$I_{dc} = 70$	June 40	76
6X6G	Tuning Indicator		Aug 40	66
6Y6G	Beam Power Amplifier	$P_o = 6.0$	July 40	60
6Y6GT	Beam Power Amplifier	$P_o = 3.6$	Jan 40	62
6Y7G	Double Triode PA	$P_o = 8.0$	Aug 40	67
6Z6 (MG)	Full-Wave Rectifier	$I_{dc} = 50$	Oct 40	68
6Z7G	Twin Triode Power Amplifier	$P_o = 2.2$	July 40	59
6ZY5G	Full-Wave Rectifier	$I_{dc} = 40$	July 40	57
7A4 (GL)	Triode	$\mu = 20$	Feb 40	54
7A5 (GL)	Power Amplifier Pentode	$P_o = 1.9$	Jan 40	66
7A6 (GL)	Duo-diode		May 40	63
7A7 (GL)	R-F Pentode, rco	$g_m = 2000$	Apr 40	95
7A7 (LM)	R-F Pentode, rco	$g_m = 2000$	Nov 39	75
7A8 (GL)	Octode Converter	$g_c = 600$	May 40	63
7B4 (GL)	High- μ Triode	$\mu = 100$	Mar 40	63
7B5 (GL)	Power Amplifier Pentode	$P_o = 3.4$	Mar 40	69
7B5 (LT)	PA Pentode	$P_o = 4.5$	May 40	60
7B6 (GL)	Double Diode, High- μ Triode	$\mu = 100$	Mar 40	67
7B6 (LM)	Duo-Diode, High- μ Triode	$\mu = 100$	May 40	60
7B7 (GL)	R-F Pentode, rco	$g_m = 1700$	Apr 40	95
7B8 (GL)	Pentagrid Converter	$g_c = 550$	Mar 40	66
7B8 (LM)	Pentagrid Converter	$g_c = 550$	May 40	60
7C5 (GL)	Beam Power Amplifier	$P_o = 4.25$	Mar 40	66
7C5 (LT)	Beam Power Amplifier	$P_o = 5.5$	May 40	61
7C6GL	Duo-Diode, Triode	$\mu = 100$	Apr 40	95
7C7 (GL)	R-F Pentode	$g_m = 1300$	Feb 40	56
7D7 fs (GL)	Triode-Hexode Converter	$g_c = 275$	Nov 39	70
7E6 (GL)	Double Diode, Triode	$\mu = 16$	Feb 40	51
7E7 (GL)	Double Diode, Pentode	$g_m = 1300$	Dec 39	55
7F7 (GL)	Double Triode	$g_m = 2(1600)$	Dec 39	55
7G7/1232(GL)	R-F Pentode, sco	$g_m = 4500$	Mar 40	63
7H7 (GL)	R-F Pentode semi-rco	$g_m = 3800$	Oct 40	65
7J7 (GL)	Triode-Hexode Converter	$g_c = 310$	Nov 39	69
7L7 (GL)	R-F Pentode, sco	$g_m = 3100$	May 40	60
7N7 (GL)	Double Triode	$\mu = 20$	June 40	74
7Q7 (GL)	Pentagrid Converter	$g_c = 450$	Nov 39	71
7Y4 (GL)	Full-Wave Rectifier	$I_{dc} = 60$	Apr 40	95
12A6 (M)	Beam Power Amplifier	$P_o = 2.5$	Dec 39	51
12A8G	Pentagrid Converter	$g_c = 550$	Jan 40	62
12A8GT	Pentagrid Converter	$g_c = 500$	Mar 40	69
12B6 (M)	Diode, High- μ Triode	$\mu = 100$	Sept 40	66
12B7 (GL)	R-F Pentode, rco	$g_m = 2000$	Dec 39	55
12B7 (MIL)	R-F Pentode, rco	$g_m = 2000$	Nov 39	71
12B8GT	Triode, Pentode	$g_m = 1800$	Mar 40	65
12C8 (M)	Double Diode Pentode	$g_m = 1325$	Mar 40	65
12E5GT	Triode	$\mu = 14$	Nov 39	70
12F5GT	High- μ Triode	$\mu = 100$	Mar 40	66
12G7G	Double Diode, High- μ Triode	$\mu = 70$	Feb 40	51
12J5G	Triode	$\mu = 20$	Feb 40	53
12J7G	R-F Pentode, sco	$g_m = 1225$	Apr 40	88
12J7GT	R-F Pentode, sco	$g_m = 1225$	Mar 40	67
12K7G	R-F Pentode, rco	$g_m = 1650$	Jan 40	67
12K7GT	R-F Pentode, rco	$g_m = 1450$	Mar 40	67
12K8GT	Triode-Hexode Converter	$g_c = 350$	Nov 39	75
12K8 (M)	Triode-Hexode Converter	$g_c = 350$	Dec 39	52
12Q7GT	Double Diode, High- μ Triode	$\mu = 70$	Mar 40	68
12SA7G	Pentagrid Converter	$g_c = 380$	Apr 40	88
12SA7GT	Pentagrid Converter	$g_c = 450$	Feb 40	51
12SA7 (M)	Pentagrid Converter	$g_c = 450$	Mar 40	64

Type	Structure or Function	Salient Characteristic	Issue	Page
12SC7 (M)	Twin Triode	$\mu = 70$	Mar 40	64
12SF5 (M)	High- μ Triode	$\mu = 100$	Nov 39	75
12SF5GT	High- μ Triode	$\mu = 100$	Jan 40	64
12SJ7GT	R-F Pentode, sco	$g_m = 1650$	Jan 40	60
12SJ7 (M)	R-F Pentode, sco	$g_m = 1650$	Mar 40	64
12SK7GT	R-F Pentode, rco	$g_m = 1650$	Jan 40	64
12SK7 (M)	R-F Pentode, rco	$g_m = 2000$	Mar 40	64
12SQ7GT	Double Diode, High- μ Triode	$\mu = 100$	Jan 40	60
12SQ7 (M)	Double Diode, High- μ Triode	$\mu = 100$	Mar 40	64
12SR7 (M)	Double Diode, Triode	$\mu = 16$	Dec 39	51
14A4 (GL)	Triode	$\mu = 20$	Dec 40	63
14A5 (GL)	Beam Power Amplifier	$P_o = 2.5$	Dec 40	64
14A7/12B7(GL)	R-F Pentode, rco	$g_m = 2000$	Dec 40	65
14B6 (GL)	Duo-Diode, High- μ Triode	$\mu = 100$	May 40	58
14B8 (GL)	Pentagrid Converter	$g_c = 550$	Dec 40	64
14C5 (GL)	Beam Power Amplifier	$P_o = 5.5$	Dec 40	63
14C7 (GL)	R-F Pentode, sco	$g_m = 1575$	Dec 40	64
14F7 (GL)	Double Triode	$\mu = 70$	Dec 40	64
14H7 (GL)	R-F Pentode, semi-rco	$g_m = 3800$	Oct 40	65
14J7 fs (GL)	Triode-Hexode Converter rco	$g_c = 310$	Nov 39	71
14N7 (GL)	Double Triode	$\mu = 20$	Dec 40	63
14Q7 (GL)	Heptode Converter	$g_c = 450$	May 40	58
14Y4 (GL)	Full-Wave Rectifier	$I_{dc} = 70$	Dec 40	63
20G8 fs (GM)	Triode-Heptode Converter	$g_c = 270$	Nov 39	75
21A7 fs (GL)	Triode-Hexode Converter	$g_c = 275$	Nov 39	70
25A6GT	PA Pentode	$P_o = 2.2$	June 40	76
25A6 (M)	PA Pentode	$P_o = 2.2$	Oct 40	70
25A7	PA Pentode	$P_o = 0.77$	Sept 40	69
25A7GT	Half-Wave Rectifier, PA Pentode	$P_o = 0.77$	June 40	92
25AC5G	PA Triode	$P_o = 3.3$	Apr 40	78
25AC5GT	Power Amplifier Triode	$P_o = 2.0$	Nov 39	72
25B5	Dynamic-Coupled PA	$P_o = 3.8$	Sept 40	69
25B6G	PA Pentode	$P_o = 7.1$	Sept 40	68
25B8GT	Triode, Pentode	$g_m = 2000$	Feb 40	54
25C6G	Beam Power Amplifier	$P_o = 6.0$	Jan 40	66
25D8GT	Diode, Triode, Pentode, rco	$g_m = 1900$	Feb 40	56
25L6	Beam Power Amplifier	$P_o = 2.2$	Aug 40	70
25L6G	Beam Power Amplifier	$P_o = 2.2$	Sept 40	69
25L6GT	Beam Power Amplifier	$P_o = 2.2$	June 40	78
25N6G	Dynamic Coupled PA	$P_o = 3.8$	Sept 40	70
25X6GT	Rectifier Doubler	$I_{dc} = 60$	Feb 40	56
25A6GT	Half-Wave Rectifier	$I_{dc} = 75$	Dec 39	54
25Y5	Full-Wave Rectifier Doubler	$I_{dc} = 75$	Nov 40	68
25Z4	Half-Wave Rectifier	$I_{dc} = 125$	Apr 40	96
25Z4GT	Half-Wave Rectifier	$I_{dc} = 125$	Dec 39	54
25Z6GT	Full-Wave Rectifier, Doubler	$I_{dc} = 75$	June 40	78
25Z6 (M)	Full-Wave Rectifier, Doubler	$I_{dc} = 75$	Oct 40	70
32L7GT	Rectifier, Beam PA	$P_o = 1.0$	Mar 40	69
35A5GL	Beam Power Amplifier	$P_o = 1.4$	Apr 40	65
35A5LT	Beam Power Amplifier	$P_o = 1.5$	Nov 39	74
35L6G	Beam Power Amplifier	$P_o = 1.5$	Jan 40	67
35L6GT	Beam Power Amplifier	$P_o = 1.5$	Apr 40	94
35Z3GL	Half-Wave Rectifier	$I_{dc} = 100$	Apr 40	94
35Z3LT	Half-Wave Rectifier	$I_{dc} = 100$	Nov 39	74
35Z4GT	Half-Wave Rectifier	$I_{dc} = 100$	Apr 40	94
35Z5G	Half-Wave Rectifier	$I_{dc} = 100$	Jan 40	62
35Z5GT	Half-Wave Rectifier	$I_{dc} = 100$	Mar 40	66
35Z6G	Rectifier-Doubler	$I_{dc} = 110$	May 40	61
40Z5/45Z5GT	Identical with 45Z5GT		Feb 40	50
43	PA Pentode	$P_o = 2.2$	Oct 40	66
45Z5GT	Half-Wave Rectifier	$I_{dc} = 100$	Feb 40	53
50C6G	Beam Power Amplifier	$P_o = 6$	Dec 39	51
50L6GT	Beam Power Amplifier	$P_o = 1.75$	Feb 40	56
50Y6G	Rectifier-Doubler	$I_{dc} = 75$	Apr 40	90
50Y6GT	Rectifier Doubler	$I_{dc} = 85$	Dec 39	56
50Z6G	Full-Wave Rectifier	$I_{dc} = 250$	June 40	74
50Z7G	Rectifier Doubler	$I_{dc} = 65$	Dec 39	56
70A7GT	Rectifier, Beam PA	$P_o = 1.5$	Dec 39	57
70L7GT	Rectifier, Beam PA	$P_o = 1.8$	Feb 40	56
83V	Full-Wave Rectifier	$I_{dc} = 175$	Nov 40	72
84/6Z4	Full-Wave Rectifier	$I_{dc} = 60$	Oct 40	66
117L7GT	Rectifier, Beam PA	$P_o = 0.55$	Nov 39	74
117M7GT	Rectifier, Beam Power Amplifier	$P_o = 1.3$	May 40	61
117N7GT	Rectifier, Beam Power Amplifier	$P_o = 1.2$	July 40	57
117Z6G	Full-Wave Rectifier	$I_{dc} = 60$	Jan 40	62
117Z6GT	Full-Wave Rectifier, Doubler	$I_{dc} = 60$	May 40	56

Cold Cathode Types (Ionically Heated Cathodes)

0A4G	Cold cathode tube, glow discharge tube	$I_{dc} = 25$	June 40	74
0Z3	Full-Wave Gas-Filled Rectifier	$I_{dc} = 75$	Oct 40	67
0Z4	Full-Wave Gas-Filled Rectifier	$I_{dc} = 75$	Oct 40	67

Picture Tubes

3AP1	Electrostatic	$E = 1500$	Jan 40	67
3AP4	Electrostatic	$E = 1500$	Jan 40	67
5AP1	Electrostatic	$E = 1500$	Feb 40	55
5AP4	Electrostatic	$E = 1500$	Feb 40	55
5BP1	Electrostatic	$E = 2000$	Jan 40	67
5BP4	Electrostatic	$E = 2000$	Jan 40	66
7AP4	Magnetic	$E = 3500$	Dec 39	52
9AP4	Magnetic	$E = 7000$	Jan 40	66
9CP4	Magnetic	$E = 7000$	Oct 40	65
12AP4	Magnetic	$E = 7000$	Jan 40	66
12CP4	Magnetic	$E = 7000$	Oct 40	65

Tube Registry

Tube Types Registered by R.M.A.
Data Bureau During October, 1940

Type 14Y4 (GL)

FULL-WAVE rectifier, heater type; T-9 integral glass envelope-base; seated height 2½ inches (max); 8-pin lock-in base.

$E_f = 12.6$ v
 $I_f = 0.30$ amp
 $E_{in} = 1250$ v (max)
 $E_{bk} = 450$ v (max)
 $I_p = 210$ ma per plate (max)
 E_{drop} (70 ma per plate) = 22 v

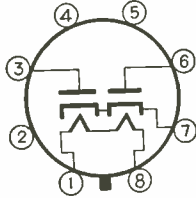

CONDENSER INPUT TO FILTER

$E_p = 325$ v (max)
 $I_b = 70$ ma (max)
Plate supply impedance = 150 ohms (min)

CHOKE INPUT TO FILTER

$E_p = 450$ v (max)
 $I_b = 70$ ma (max)
Basing 5AB-L-O

Type 14N7 (GL)

Prototype 7N7 (GL)

DOUBLE triode, heater type; T-9 integral glass envelope-base; seated height 2½ inches (max); 8-pin lock-in base.

EACH TRIODE SECTION

$E_f = 12.6$ v
 $I_f = 0.30$ amp
 $E_b = 250$ v
 $E_c = -8$ v
 $I_b = 9$ ma
 $\mu = 20$
 $g_m = 7700$ μ mhos
 $C_{in} = 3.4$ and 2.9 μ mf
 $C_{out} = 2.0$ and 2.4 μ mf
 $C_{sp} = 3.0$ and 3.0 μ mf
Basing 8AC-L-O

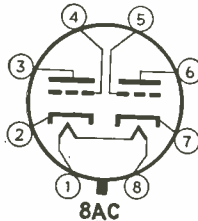

Type 14C5 (GL)

Prototype 7C5 (GL)

BEAM power amplifier, heater type; T-9 integral glass envelope-base; seated height 2½ inches (max); 8-pin lock-in base.

$E_f = 12.6$ v
 $I_f = 0.225$ amp
 $E_b = 315$ v (max)
 $E_{c1} = 225$ v
 $E_{c2} = -13$ v
 $I_{b1} = 34$ ma
 $I_{c2} = 2.2$ ma
 $g_m = 3750$ μ mhos
 $r_p = 77,000$ ohms
 $R_1 = 8500$ ohms
 $P_o = 5.5$ watts (12%)
Basing 6AA-L-O

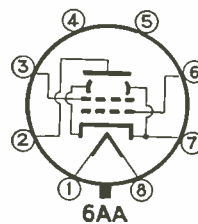

Type 14A4 (GL)

Prototype 7A4 (GL)

TRIODE, heater type; T-9 integral glass envelope-base; seated height 2½ inches (max); 8-pin lock-in base.

$E_f = 12.6$ v
 $I_f = 0.15$ amp
 $E_b = 250$ v (max)
 $E_c = -8$ v
 $g_m = 2600$ μ mhos
 $\mu = 20$
 $r_p = 7700$ ohms
 $C_{ok} = 3.4$ μ mf
 $C_{pk} = 3.0$ μ mf
 $C_{sp} = 4.0$ μ mf
Basing 5AC-L-O

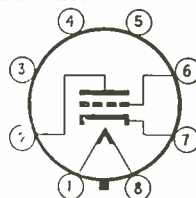

"MOST COMPLETE WASHER STOCK LIST EVER OFFERED"

... say Radio Production and Design Executives who have seen advance copies of this manual.

This new catalog lists complete specifications of

OVER 2200 DIFFERENT WASHER SIZES ON HAND

Send for this handbook showing washers ready for immediate shipment—including a complete range of all standard sizes as well as hundreds of other washers in a great variety of special sizes, materials, and finishes



Sent free to rated firms



SPECIAL WASHERS and STAMPINGS

made up promptly to your individual requirements

SPECIAL NOTE TO DESIGNERS

This catalog keys those sizes which are permanently maintained in stock. Select your new washer specifications from these sizes and thus assure yourself prompt delivery at all times.

WROUGHT WASHER MFG. CO.

"The World's Largest Producer of Washers"

2237 S. Bay St.

Milwaukee, Wis.

Light Beams TO MICROAMPS



THAT'S the job of Luxtron* Photo-Electric Cells, and with Luxtron* you get more current with less light. That's why Luxtron* Cells are extensively used in commercial photometry equipment and exposure meters — and why they are able to operate relays directly, without booster amplifiers or external voltage supply, in many industrial control applications.

In addition to their remarkable current sensitivity, Luxtron* Cells combine sturdiness with stability, long life with low cost, and are substantially unaffected by temperature change.

Luxtron* Cells are manufactured exclusively by the Bradley Laboratories of ALL AMERICAN components, in a variety of sizes and shapes, mounted or unmounted, and in several different terminal arrangements. Write today for Catalog No 101, listing the types available and complete technical data.

Luxtron
PHOTO ELECTRIC CELLS
BRADLEY LABORATORIES, INC.
82 MEADOW ST. • NEW HAVEN, CONN.

BRADLEY LABORATORIES, Inc. Dept. E-3
82 Meadow St., New Haven, Conn.

Please rush copy of Cat. No. 101.

NAME
ADDRESS
CITY STATE

STABILIZED A. C. VOLTAGE UP TO 25 KVA

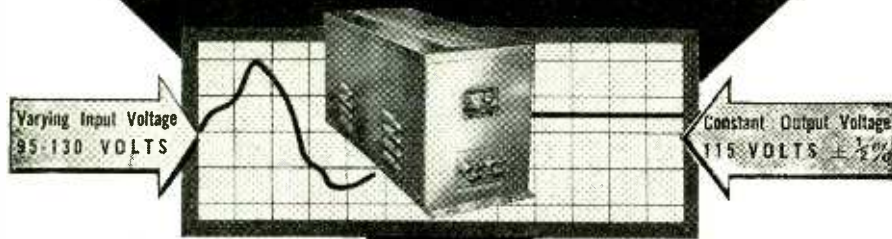

INSTANTANEOUS ACTION

NO MOVING PARTS

When a precision electrical device or a critical process is powered from an AC line, a Raytheon Voltage Stabilizer will permanently eliminate all of the detrimental effects caused by AC line voltage fluctuations. Made for all commercial voltages and frequencies, single or three phase.

Raytheon's twelve years of experience in successfully applying the Stabilizer to hundreds of perplexing voltage fluctuation problems is at your service. It will pay you to take advantage of our engineering skill.

Write for Bulletin DL48-71 JE describing Raytheon Stabilizers.

RAYTHEON MANUFACTURING CO.
100 Willow Street, WALTHAM, Massachusetts

Type 14A5 (GL)

Prototype 12A6

BEAM power amplifier; heater type; T-9 integral glass envelope-base; seated height 2 5/8 inches (max); 8-pin lock-in base.

$E_f = 12.6$ v
 $I_f = 0.15$ amp
 $E_b = E_{c1} = 250$ v.
(max)
 $E_{c1} = -12.5$ v
 $I_{b0} = 30$ ma
 $I_{c20} = 3.5$ ma
 $g_m = 3000$ μ hos
 $r_p = 50,000$ ohms
 $P_t = 7500$ ohms
 $P_o = 2.5$ watts (10%)
Basing 6AA-L-O

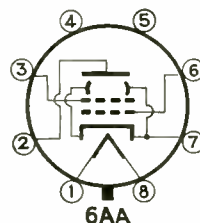

Type 14B8 (GL)

Prototype 7B8 (GL)

Pentagrid converter; heater type; T-9 integral glass envelope-base; seated height 2 1/4 inches (max); lock-in 8-pin base.

$E_f = 12.6$ v
 $I_f = 0.15$ amp
 $E_b = 250$ v
 $E_{c3,5} = 100$ v
 $E_{c1} = -3$ v
 $E_{c2} = 250$ v
 $E_{c1} = (50,000$ ohms \times
 0.4 ma) = -20 v
 $I_b = 3.5$ ma
 $I_{c2} = 4.0$ ma
 $I_{c3,5} = 2.7$ ma
Total cathode current =
10.6 ma
 $g_c = 550$ μ hos
 $r_p = 0.36$ megohm
Basing 8X-L-O

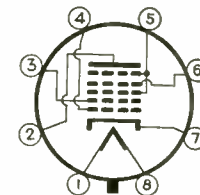

Type 14C7 (GL)

Prototype 7C7 (GL)

R-F PENTODE, sco; heater type; T-9 integral glass envelope-base; seated height 2 1/4 inches (max) lock-in 8-pin base.

$E_f = 12.6$ v
 $I_f = 0.15$ amp
 $E_b = 250$ v
 $E_{c2} = 100$ v
 $E_{c1} = -3$ v
 $I_b = 2.2$ ma
 $I_{c2} = 0.7$ ma
 $g_m = 1575$ μ hos
 $r_p = 1$ megohm
 $C_{in} = 6.0$ μ f
 $C_{out} = 6.5$ μ f
 $C_{cp} = 0.007$ μ f (max)
Basing 8V-L-5

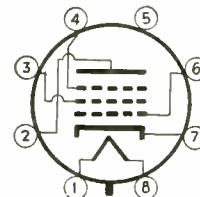

Type 14F7 (GL)

Prototype 7F7 (GL)

DOUBLE triode; heater type; T-9 integral glass envelope-base; seated height 2 1/4 inches (max); 8-pin lock-in base.

EACH TRIODE SECTION

$E_f = 12.6$ v
 $I_f = 0.15$ amp
 $E_b = 250$ v (max)
 $E_c = -2$ v
 $I_b = 2.3$ ma
 $\mu = 70$
 $r_p = 44,000$ ohms
 $g_m = 1600$ μ hos
Basing 8AC-L-O

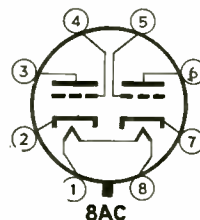

Specifically

FOR THE

ULTRA-HIGH

Yes, there is a complete line of BUD Condensers designed specifically for the Ultra-High Frequencies. They are constructed to meet the particular requirements of high frequency FM or AM transmitter applications.

A four-point wiping contact is placed at the center of the rotor in order to provide an even voltage dis-

tribution on both sections and to allow a symmetrical mechanical design in the amplifier. Tie rods are insulated with Alsimag 196 pillars to eliminate closed inductive loops in the frame.

These condensers are made in three sizes for powers up to 5000 watts. *We invite your inquiries for further information on these and all other Bud Condensers.*

BUD RADIO, INC. • Cleveland, Ohio

New Carter AIRCRAFT TYPE GENEMOTORS



• Here is a new complete line of Genemotors for Aircraft, Police, Marine Radio, and general use, where dependable and efficient service is required. Armatures are wound with double enamel and silk wire, insuring trouble free operation. There is a Carter Genemotor or Converter for every requirement from 5 to 1000 watts output. Write for further information.



1606 Milwaukee Ave. Cable: Genemotor
Carter a well known name in Radio since 1922

**TENSITE
FILAMENT**

"made" the 1.4
volt tube
U.S.A.

**"TENSITE"
made only by**

WILBUR B. DRIVER CO.
NEWARK, NEW JERSEY

Type 14A7/12B7

Prototype 12B7

R-F PENTODE, rco; T-9 integral glass envelope-base; seated height 2 1/4 inches (max); 8-pin lock-in base.

$E_f = 12.6$
 $I_f = 0.15$ amp
 $E_b = 250$ v
 $E_{c2} = 100$ v
 $E_{c1} = -3$ v
 $I_b = 9.2$ ma
 $I_{c2} = 2.6$ ma
 $g_m = 2000$ μ hos
 $r_p = 0.8$ megohm
 $C_{in} = 5.5$ μ uf
 $C_{out} = 7.0$ μ uf
 $C_{sp} = 0.005$ μ uf (max)
Basing 8V-L-5

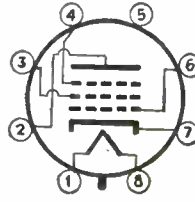

Tube Types Registered By R.M.A.
Data Bureau in 1934, 1935 and 1936

Type 1D5 (G)

Prototype 1A4

SUPER-CONTROL r-f amplifier, filament type, ST-12 glass envelope, seated height 3 3/8 inches, 7-pin octal base.

$E_f = 2.0$ v
 $I_f = 0.06$ amp
 $E_b = 180$ v
 $E_{c2} = 67.5$ v
 $E_{c1} = -3$ v
 $I_b = 2.2$ ma
 $I_{c2} = 0.7$ ma
 $r_p = 0.6$ megohm (approx)
 $g_m = 625$ μ hos
Basing 5Y

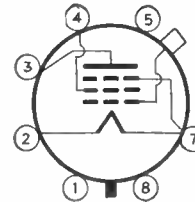

Type 1E5 (G)

Prototype 1B4

R-f PENTODE amplifier, filament type, ST-12 glass envelope, seated height 3 3/8 inches, 7-pin octal base.

$E_f = 2.0$ v
 $I_f = 0.06$ amp
 $E_b = 180$ v (max)
 $E_{c2} = 67.5$ v (max)
 $E_{c1} = -3$ v
 $I_b = 1.7$ ma
 $I_{c2} = 0.6$ ma
 $r_p = 1.5$ megohm (approx)
 $g_m = 650$ μ hos
Basing 5Y

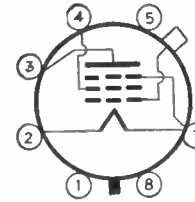

Type 1F5 (G)

Prototype 1F4

POWER amplifier pentode, filament type, ST-14 glass envelope, seated height 4 7/8 inches, 7-pin octal base.

$E_f = 2.0$ v
 $I_f = 0.12$ amp
 $E_b = 135$ v
 $E_{c2} = 135$ v
 $E_{c1} = -4.5$ v
 $I_b = 8.0$ ma
 $I_{c2} = 2.4$ ma
 $R_1 = 16,000$ ohms
 $P_o = 0.310$ watts (5%)
Basing 6X

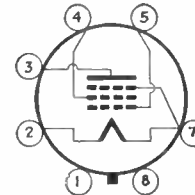

TRIPLET POCKET SIZE

"Little Triplett's"

The Little Testers with the
Big 3-Inch Instruments

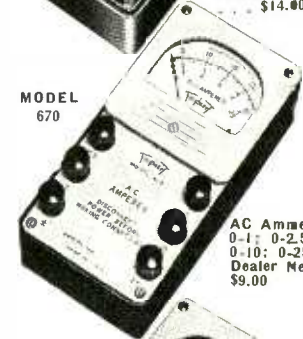

The "Little Triplett's" comprise a series of matched instruments available in single units or in combination to answer every servicing or electrical analyzing problem. Models available in addition to the above are as follows:

Model 672—0-150; 0-300; 0-750 AC Volts . . . \$9.00 Dealer Net

Model 673—0-5; 0-10; 0-25; 0-50; 0-100; 0-250; 0-500; 0-1000 AC Volts (Rectifier type) . . . \$9.00 Dealer Net

Model 674—0-1; 0-2.5; 0-5; 0-10; 0-25 DC Amperes, \$9.00 Dealer Net

Model 675—0-1; 0-5; 0-10; 0-25; 0-100; 0-250; 0-500; 0-1000 DC Milliamperes, \$9.00 Dealer Net

Model 676—0-50; 0-100; 0-250; 0-500; 0-1000 DC Microamperes, \$9.00 Dealer Net

Model 677—0-1; 0-2.5; 0-5; 0-10; 0-25; 0-50; 0-100; 0-250; 0-500; 0-1000 DC Volts at 1000 ohms per volt . . . \$9.00 Dealer Net

Model 678 Ohmmeter, Self-contained batteries for 0-1000 Ohms (10 Ohms Center Scale); 0-10,000 Ohms (100 Ohms Center Scale); 0-100,000 Ohms; 0-1 Megohm; 0-10 Megohms . . . \$9.00 Dealer Net

For full cooperation with the National Defense Program, Triplett engineering and production facilities are being rapidly expanded to continue the service and delivery to which our trade is accustomed.

Write for Catalog—
Section 2312, Harmon Drive

THE TRIPLET ELECTRICAL INSTRUMENT CO.
Bluffton, Ohio



THE BEST SELLING

Quality

**COMMUNICATIONS
RECEIVER**

Here is one of the many reasons for Hallicrafters supremacy in the amateur communications field. The new 1941 SX-28 gives you top quality performance plus the finest precision craftsmanship obtainable.

Check all these improved features! 15 tubes—6 bands—Frequency range 550 kc. to 42 mc.—Two stages preselection—Electrical bandspread on ALL BANDS including international short wave band—Calibrated bandspread inertia controlled—Micrometer scale tuning inertia controlled—Tone and AC On-Off—Beat Frequency Oscillator—AF Gain—RF Gain—Crystal phasing—Adjustable noise limiter—Send-receive switch—80, 40, 20 and 10 meter amateur bands calibrated—Wide angle "S" meter—Band pass audio filter—Improved signal to image and noise ratio—Push-pull high fidelity, audio output—6 step wide range variable selectivity—Phone jack—Improved headphone output. Dimensions 20½" x 10" x 14¾". Model SX-28 with crystal and tubes. \$159.50.

the hallicrafters inc.
CHICAGO, U.S.A.

USED BY 33 GOVERNMENTS
SOLD IN 89 COUNTRIES

F-M Police Network

(Continued from page 31)

by the ignition noise from an approaching car. This happened despite the peak limiter action in the receiver. In a similar situation with f-m, the tick of ignition noise would be heard but the intelligibility of the reception was not destroyed.

The overlapping of the service areas is a very important design factor in the Connecticut system. Since it is true that the operation of the single station at Hartford will provide secondary coverage over the whole State, each of several stations will serve all or a large portion of an adjacent territory with solid coverage. This means that if one or more fixed stations fail for any reason, the areas can be served by the nearest stations available. If all fixed stations were taken out of service, very effective two-way coverage could be maintained by parking mobile units near the fixed station locations and using them to replace the fixed stations. This coverage safety factor insures continuation of service when it is most needed, that is when an emergency prevents the operation of one or more fixed stations. Complete two-way communication between stations is provided for by the fixed-station-frequency receiver mounted at each station.

In conclusion it may be said that the Connecticut State Police Radio system is flexible, that the coverage safety factors are large and that the system provides primary state-wide two-way communication service. The writer wishes to acknowledge the generous assistance contributed by the following men: Colonel Edward J. Hickey, Commissioner of Connecticut State Police for his progressive attitude and whole-hearted support; Sidney Warner, State Supervisor of Radio Maintenance for his effective engineering assistance; Edward Sheeler for his twenty thousand miles of survey activity; Fred M. Link and Fred Budelman for their contributions to the development of the specialized equipment.

JAGABI "LUBRI-TACT" LABORATORY RHEOSTATS

Four Sizes, Seventy-Six
Ratings, Lubricated
Sliding Contact

BULLETIN 1620-E



JAMES G. BIDDLE CO.
Electrical Instruments
1211-13 Arch Street Philadelphia, Pa.

COILS

Electrical Windings



A COMPETENT and experienced organization devoted to the design and manufacture of coil windings. Paper interlayer sections—form wound and bobbin wound coils.

Equipped for prompt production on quantity or small orders.

N. DINIEN, Pres. & Gen.-Mgr.

REPRESENTATIVES

W. A. JORDAN 295 Madison Ave., New York, N. Y.	PARAGON SALES CO. (C. H. Fryburg) 402 Cherry St., Philadelphia, Pa.
GILBERT GISLASON A. 82 St. Paul St., Rochester, N. Y.	J. LOEB SALES CO. 1836 Euclid Ave., Cleveland, Ohio

MAGNETIC WINDINGS COMPANY
Sixteenth and Butler Streets EASTON, PENNA.

THE ELECTRON ART

U-h-f antenna coupling circuits, sound apparatus for the theater, square waves at high frequencies, direct-reading wave meter and a universal phonograph pick-up are reviewed this month

U-H-F Antenna Coupling Circuits

THREE TYPES OF COUPLING circuits for u-h-f receiving antennas when the antenna is mounted on a regular transmitting antenna tower are briefly discussed in the November 1940 issue of the *APCO Bulletin* (Associated Police Communication Officers) by M. M. Lesensky. The illustration shows three of the most popular circuits now in use by the Police Department for such installations. Circuit C is preferred and is recommended in preference to the other two wherever possible. It has the advantage of providing a direct ground for the tower in case of lightning and reduces chances of loss in the matching, which might occur on the other circuits.

Sound Control Apparatus For The Theater

THE SOUND CONTROL apparatus used in the Stevens Theater (Stevens Institute of Technology) is described by Harold Burris-Meyer in the July, 1940 issue of the *Journal of the Acoustical Society of America*. The purpose of sound control apparatus in a theater is to enable the audience to hear any sound from any source and that sound must have the quality, intensity, apparent direction, apparent distance and reverberation requisite to the production. To satisfy these conditions apparatus has been designed and built based on the experience of several years.

The flexibility of the equipment is such that any or all of six sound sources may be used and that any or all of eight loudspeakers may be used. Each input circuit has its own pre-amplifier and remote volume control. The frequency response of each pre-amplifier may be preset to compensate for limitations of the sound sources. Expansion may also be supplied to records on which the dynamic range has been compressed. When expansion is switched out of the circuit, contraction or automatic volume control is switched in. In the operation of certain mechanical sound generators, manipulation of the expansion compression switch results in striking variations in attack and apparent reverberation of the sound. Each loudspeaker has its own flat response power

amplifier. They are individually controlled to provide perspective on the stage, above the audience and alongside of the theater. By using only one speaker per amplifier and by using power amplifiers of good output regulation the problem of impedance matching is avoided. An interesting sidelight on the equipment is that it has been found to be more convenient to use attenuators whose operation is up and down rather than rotary. Provisions are made so that the sound from any source may be connected to any of the speakers.

A frequency discrimination network is used to correct the response of certain mechanical signal generators and to synthesize sound for which special

generators were not available. Also described is a thunder screen which is said to be more useful than a truckload of prop sound machines. It effectively replaces all the rumble, drum, board and sheet mechanisms and all the crashes except glass. The sound as it generates can be controlled as to distance, direction, movement, attack, reverberation, frequency, etc. The electronic and mechanical generators are important not only because the sound produced is susceptible to easy control but also because their operation is silent so far as the operator is concerned, and they can be used out front where the operator can hear and see the show.

Square Waves at High Frequencies

THREE METHODS OF GENERATING SQUARE WAVES over a wide range of frequencies are described in an article entitled "The Generation of Square-Wave Voltages at High Frequencies" by Willard H. Fenn in the November, 1940 issue of *The Review of Scientific Instruments*. The first method

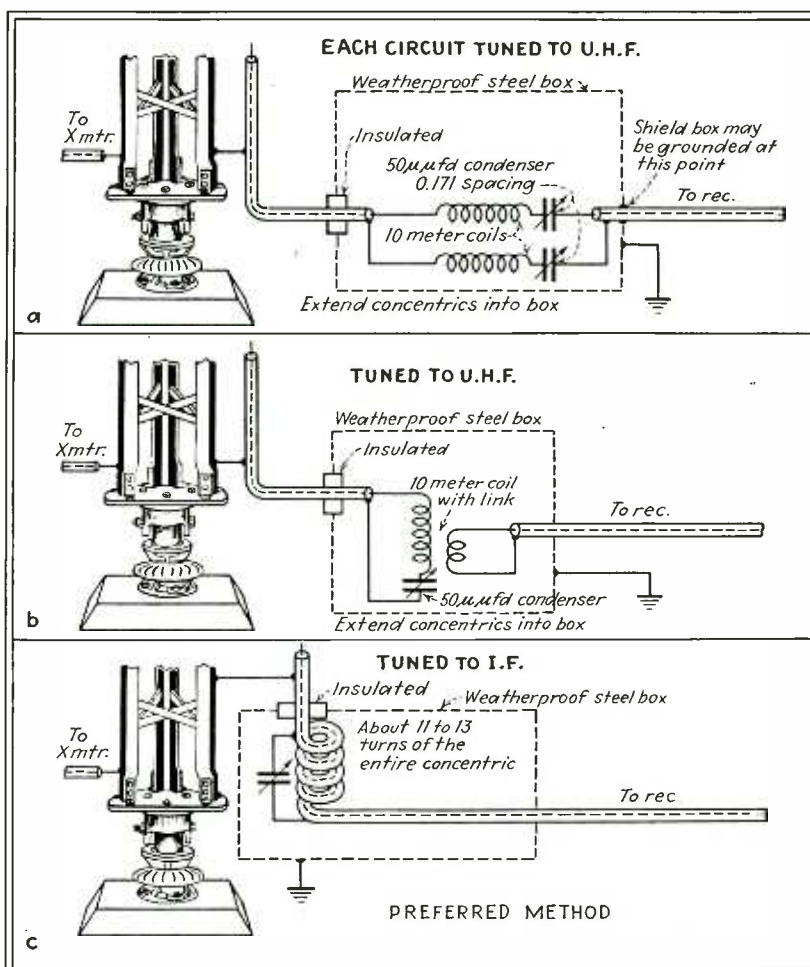

Three coupling circuits for ultrahigh-frequency receiving antennas. Circuit C is preferred because it provides a direct ground for the tower and the chances of losses in matching are less

The RIGHT Product . .

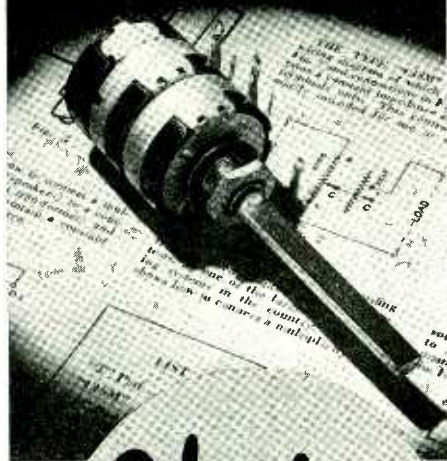

Plus
The RIGHT DATA

★ To save yourself much time, effort, uncertainty, when it comes to the controls and resistors for that radio or electronic assembly, simply specify CLAROSTAT. Here's why . . .

The RIGHT Product . . .

★ Two decades of specialization are behind Clarostat controls, resistors, resistance devices. Constant improvements and refinements make these components as good as they can be made today. We invite you to make any comparative tests you wish between Clarostat and corresponding items of other makes. You are the sole judge, and we rest our case.

The RIGHT Data . . .

★ Along with the right product goes the right data. We invite you to make full use of our vast application-engineering experience and skill. We work with many designers and builders. Our accumulation of data is simply tremendous. Surely such insurance covering satisfactory results, is not to be overlooked by you.

CONSULT US . . .

★ Let us have your control and resistance problems. Our engineers will gladly collaborate. Specifications, samples, quotations, cheerfully submitted to responsible parties writing on their business letterhead.

CLAROSTAT
MANUFACTURING CO.
Incorporated
285 North Sixth St.
Brooklyn, N. Y.

uses an overloaded direct-coupled degenerative vacuum-tube amplifier which makes use of the rectification and cut-off properties of triode tubes to chop off the peaks of a large sinusoidal voltage so as to leave an essentially square wave. The second method uses a special pulse generator followed by a vacuum tube trigger circuit. One form of regenerative square wave generator makes use of the ultrahigh speed switching or trigger action of

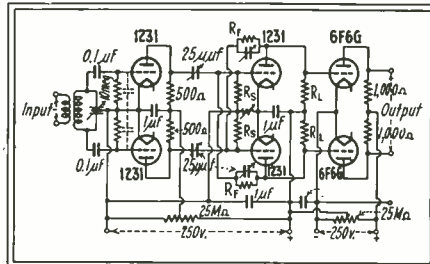

Circuit diagram of high-frequency square-wave generator

the Puckle type of direct-coupled multi-vibrator. This type of square wave generator is essentially temperamental. Adjustment of the input and feedback condensers and of the bias resistor is critical. The main attraction of the circuit lies in the relative simplicity and in the fact that when properly adjusted it represents a counting circuit capable of corresponding to well over half a million positive pulses a second.

The third method is a combination of the first two and produces waves which are squarer than those pro-

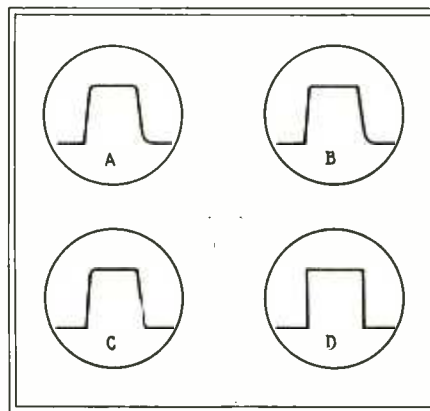

Samples of oscillograms obtained with three different types of square-wave generator. A, B and C are at 200 kc and D is at 2 kc

duced by the individual systems. It consists of a balanced trigger circuit type of square-wave generator followed by a balanced degenerative overloaded amplifier. Slight modification in the trigger circuit results in a generator which is more stable and less critical than the circuit of method two. The maximum squareness that can be expected from a square-wave generator at a given frequency is largely a matter of circuit constants. The vacuum tubes used in these circuits should have

high amplification factors, low plate resistances and the ability to handle large plate currents. This inevitably results in a compromise. The most satisfactory tubes for the experimental work proved to be high-mu power pentodes in triode connection. Type 12Z1's were used as pulse generators and multivibrators and type 6F6G's as amplifiers.

Oscillograms of waves produced by the different systems are shown in the diagram. The wave of A was obtained at 200 kc with the overloaded amplifier. The characteristic sloping sides of a chopped-off sine wave are shown. The wave of B was obtained at 200 kc with the circuit of the second method. The wave of C was obtained at 200 kc and the wave of D approximates a perfect square wave which was obtained at 2 kc with the same generator as used in C. This wave is typical of those obtained with all of the circuits at low frequencies.

Universal Phonograph Reproducer

A PHONOGRAPH REPRODUCER, the Western Electric Model 9A, for both lateral and cylinder recording is described by H. A. Henning in the October, 1940 issue of the *Bell Laboratories Record*. The construction is shown in the accompanying photograph. The moving structure consists of a key lever on the bottom of which is a diamond stylus and at both edges of the cross arm are mounted two very small coils of insulated wire. As the stylus vibrates in the groove of a record these two coils move in a magnetic field. This motion is substantially the same whether the coils are moving vertically or are being rotated from the drive of a lateral cut record. The only difference in the voltage induced in the

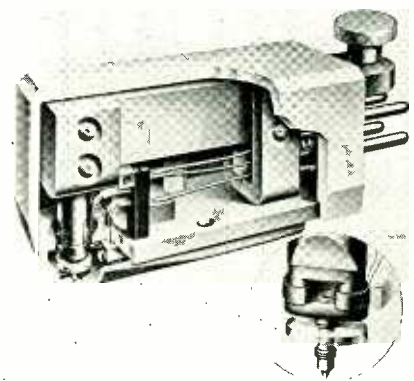

Mechanical layout of universal phonograph reproducer. Both vertical and lateral cut records can be played by throwing a switch

coil is a reversal in phase. If the coils are connected in series aiding the voltages in the two coils will add for vertical motion and cancel for rotary motion (lateral track records). When connected series opposing, the voltages will add for rotary motion and cancel

for vertical motion. A switch placed near the turntable changes the connection. Throwing this switch is the only operation required for the change-over from one type of record to another. If this is overlooked at the moment, it can be put right without stopping the record.

The magnetic circuit consists of a rectangular bar of magnetic material to which is riveted two soft-iron U-

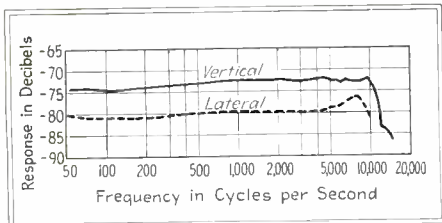

Frequency characteristic of the universal reproducer

shaped yokes, one of which carries the center pole piece. The two yokes are secured directly to the outside pole plate which serves as a mounting for the reproducer and its elements. The frequency response of this reproducing unit is shown in the accompanying diagram. It is essentially flat up to almost 10,000 cps for most types of records. Because most lateral-cut records are intended for acoustic reproduction, they are recorded at a slightly higher level than are vertical-cut records. To compensate for this difference in level, the reproducer is designed to have a greater sensitivity for vertical records and thus the output volume is made approximately the same for both.

BROADCASTING'S TWENTIETH ANNIVERSARY



Three of America's leading radio engineers at the celebration of the twentieth anniversary of broadcasting, in honor of Dr. Frank Conrad (center) Westinghouse engineer who is credited with initiating the first successful broadcasting in the United States. Also shown are O. B. Hanson, NBC vice-president in charge of engineering and Jack R. Poppele, chief engineer of WOR



... Defense Contract

★ Are you working on a negotiated defense contract? Or, a defense contract including government specified equipment designed by other than government engineers?

Guardian Electric will act as a primary and secondary source of supply... ready to furnish Relays that carry U. S. Government approval... solenoids... stepping switches... complete control assemblies that will simplify and speed your defense contract work to a profitable conclusion.

RELAYS by Guardian

Guardian engineers have spent thousands of hours planning, engineering and designing tools, jigs and fixtures that turn out more than 7000 standard Guardian control parts... making it possible to assemble and deliver innumerable varieties of Controls by Guardian, with overnight shipments to every industrial center. Your blue print or sketch will bring cost-free engineering suggestions.

Initial Your Letterhead for Free Catalog "E" Today. Write

GUARDIAN
1625 WEST WALNUT STREET



ELECTRIC
CHICAGO, ILLINOIS

Controls

- Bomb Releases
- Fire Controls
- Communication equipment for tanks and planes.
- Portable Pack
- Radio Remote Controls
- Signal Corps Requirements
- Controls for synchronized and non-synchronized machine gun fire on aircraft
- Anti-Aircraft Gun Control Special Switches and Control Assemblies, complete or in part



Type R Stepping Relay

CONSTANT LABORATORY CHECK on RAW MATERIALS
is only ONE of HUDSON WIRE'S TESTS for QUALITY

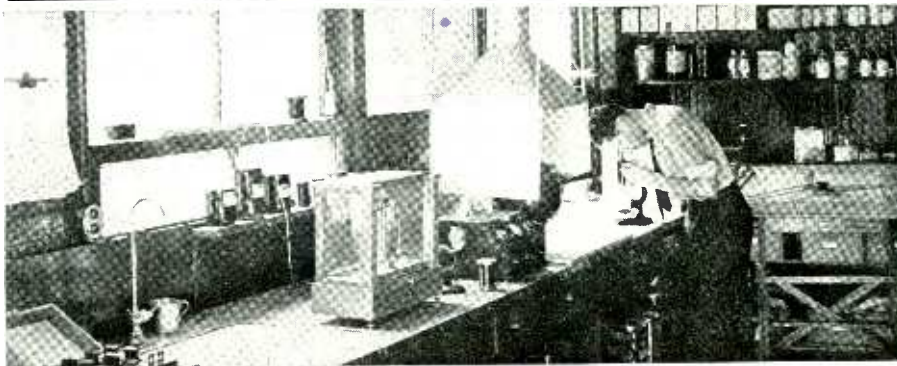

You are assured of a constant source of wire that always meets or exceeds your specifications when it comes from the Winsted Division of Hudson Wire Co. Continual checking and testing from the raw material stage through the exacting control processes guarantee the perfect uniformity you need. And with Hudson Wire's new coating method that adds great dielectric strength you are certain of getting the finest enameled wire available.

Our engineering and design facilities are at your disposal—details and quotations on request.

HUDSON WIRE COMPANY
Winsted Division

WINSTED

CONNECTICUT



Results of recently completed tests reveal a new, improved FM TURN-
STILE ANTENNA . . . surpassing
all previous designs. Those inter-
ested in this newest development in
FM antennas are invited to write us
immediately for facts now available.

JOHN E. LINGO & SON, INC.

Licensed Manufacturers of Patented
Turnstile Antennas for FM

DEPT. E-12

CAMDEN, N. J.



UNBRAKO
REG. U.S. PAT. OFFICE
**SCREW
PRODUCTS**

IF you're careful about the selection of screws for electrical service, you'll compare. And having compared you'll choose "Unbrako" Products for their uniformity and strength; for their unique self-locking feature; for their knurled heads with a non-slip grip that saves assembling time. Complete range of sizes from number 4 up. Write for samples and literature.

STANDARD PRESSED STEEL CO.
Box 596, JENKINTOWN, PENNA.

WAXES • COMPOUNDS for ELECTRICAL INSULATION

Zophar offers prompt service on Insulating Compounds for a wide variety of electrical applications, including:

insulation for CONDENSERS, TRANSFORMERS, COILS, power packs, pot heads, sockets, wiring devices, wet and dry batteries, etc. Also WAX SATURATORS for braided wire and tape. WAXES for radio parts.

Special compounds made to your order.

ZOPHAR MILLS INC.

130-26th St.

Brooklyn, N. Y.

FOUNDED 1846

Direct-Reading Wavemeter

A DIRECT-READING wavemeter of novel design is described by Harald Straubel in the September 1939 issue of *Hochfrequenz and Elektroakustik*. A rotating condenser in a tuned circuit is driven by a synchronous motor which also drives potentiometer controlling the grid voltage of an amplifier tube. Each time the tuned circuit is in resonance with the unknown signal, a high frequency impulse is delivered

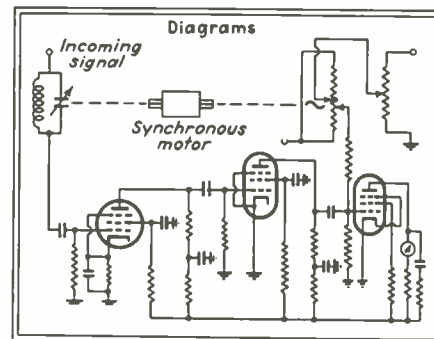

Circuit diagram of the direct-reading wavemeter

to the grid of the amplifier tube. The plate current due to this high frequency impulse is constant above a nominal voltage of four volts. However, at the same time the grid has impressed upon it a voltage varying according to the instantaneous position of the rotating condenser as mentioned above. This voltage alone will not permit current to flow through the tube because it is beyond the cutoff point. At the instant of resonance, the sum of the two voltages on the grid will cause current to flow in an amount depending on the value of the variable voltage. Because the voltage applied to the grid is dependent on the position of the condenser, which in turn de-

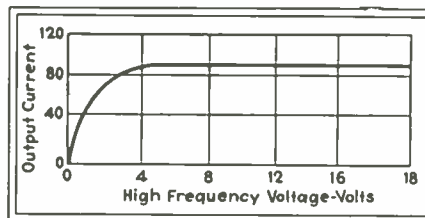

The output current is independent of the signal intensity above 4 volts

pend on the frequency of the signal, the plate current is dependent on the unknown frequency. Therefore, an ammeter in the plate circuit can readily be calibrated in terms of the incoming signal frequency.

In the instrument designed by the author, the speed of rotation of the condenser was 3,000 rpm. At this speed the tuned circuit is in resonance with the incoming signal 100 times per second, which is sufficiently rapid so that the indication of meter will be constant. To provide additional meter damping, a resistor-condenser network whose impedance is approximately equal to the impedance of the meter is placed in parallel with it.

CETRON

- PHOTOCELLS
- MERCURY VAPOR RECTIFIERS
- ULTRA-VIOLET LAMPS
- TRU-VAC VACUUM GAUGES (PIRANI TYPE)

DESIGN AND DEVELOPMENT OF SPECIAL TUBES, ETC.

LITERATURE AND PRICES AT YOUR REQUEST.

CONTINENTAL ELECTRIC CO.

GENEVA ILLINOIS



TWO INSTRUMENTS EVERY LABORATORY NEEDS

The Acme Insulation Breakdown tester not only indicates grounds, shorts or opens but provides for the checking of circuits at approved voltage standards (double the rated voltage plus 1000). Manually adjusted with secondary voltage rating of 500, 1000, 1250, 1500, 1750, 2000 and 2500 volts. Portable and designed with every safety factor.

The Acme Voltrol (made in portable and panel mounting types) gives complete manual control over line voltage in stepless range from 0 to 135 volts. Not a resistance type regulator, output voltage is independent of load.

Acme also manufactures Luminous Tube Transformers, Fluorescent Lamp Ballasts, Radio and Television Transformers, Mercury Vapor Lighting Transformers, Air-Cooled Power Transformers.

THE ACME ELECTRIC & MFG. CO.
31 Water Street • Cuba, N. Y.



New R.M.A. Technical Bulletin

THE ENGINEERING Department of the Radio Manufacturers Association is now publishing a technical bulletin to replace the *RMA Engineer* previously published. Each bulletin is to contain an article on some engineering subject of interest to the Association's members. Bulletin No. 1 contains "The Decibel Scale," by S. V. Perry which is an explanation of the now almost universally used scale in acoustic and communication engineering and allied arts. Bulletin No. 2 contains "Recent Improvements in Frequency Modulation Receiver Design," by J. A. Worcester, Jr. This article discusses certain design features of the General Electric JFM-90 frequency modulation translator which makes use of a double superheterodyne system and a cascade limiter.

• • •

More High Quality Reception Needed

THERE IS A DEFINITE and growing tendency toward turning on radio receivers only during news programs, and playing phonograph records for musical entertainment according to M. B. Sleeper in an article entitled "Red Light Ahead" which appears in the December 1940 issue of *FM*. The author says that while the broadcasters have constantly raised program standards and have developed a national appreciation of good programs the radio manufacturers have lowered their standards of performance in order to engage in price competition. To counteract this tendency the public has bought phonograph turntables either separately or in combination with radio receivers and are now getting into the habit of listening to the records rather than the radio programs. This fact is used as an argument that from a commercial point of view of the program sponsor and of course, the broadcaster, that the quality of the programs as received in the home should be vastly improved so that the public will once more listen to them and to the advertising.

• • •

Erratum

IN THE ARTICLE "A High-Sensitivity Phototube Circuit" by H. S. Bull and J. M. Lafferty there was an omission in the last paragraph on page 32. The first part of the paragraph should read, "This circuit is particularly useful for detecting small changes in light intensity. In Fig. 6 the results of three typical runs are shown. The identifying numbers at the end of each curve indicate the initial value of the light intensity for which the plate milliammeter of the 6C5 was adjusted to zero."



- To meet the ultra-critical requirements of designers and builders of commercial-grade transmitters, television equipment and electronic apparatus, Aerovox now offers the outstanding choice of mica capacitors. All types—cast-aluminum case (shown above), stack-mounting units, bakelite-case units, molded-in-bakelite capacitors, silver mica capacitors, etc.

What were special mica types yesteryear now become standard Aerovox capacitors, for your convenience and economy, when you are building equipment which must last and which must safeguard an enviable reputation.

Ask for Copy . . .



New Aerovox Transmitter Capacitor Catalog lists all heavy-duty mica, paper, oil, and plug-in electrolytics.

Copy available to professional designers and builders of commercial-grade equipment writing on business letterhead.



Detects trouble
BEFORE
a breakdown
Shallcross
Milliohmmeter

.00001 to .5 ohms

Skilled and unskilled operators alike find this rugged, low-cost milliohmmeter easy to operate — accurate — dependable. The actual resistance is read directly from the scale—no reference curves or charts required. Measures low resistances of armatures, field and transformer coils, fuses, relay and switch contacts. Locates oxidized and pitted contacts, weak springs, etc. AN IDEAL PORTABLE BONDING TESTER.

Send for Bulletin #671-KN



Shallcross Mfg. Co.
Collingdale, Pa.

Rochester

(Continued from page 27)

about 100,000,000 radio tubes in 1940. According to Mr. Wise these companies are losing money. For this volume of business there should be room for at least twelve companies, but instead of increasing towards this number, it is decreasing, as two companies have recently failed. Mr. Wise offered no solution to the problem, but merely brought it to the attention of the engineers of the industry. He had one good word for the tube industry, however. The number of new types introduced in a year's time is being reduced. In 1938, 60 new types were introduced; in 1939, a peak of 140 and thus far in 1940, 40 new types.

Tuning Mechanisms

The application of inductive tuning to ultrahigh frequencies was discussed by B. V. K. French of P. R. Mallory Co. A slide wire inductive tuning unit which had a tuning ratio of 6.8 to 1 instead of the usual ratio of 3 to 1 for capacitive tuning devices, was discussed, a further development of the inductive tuning method introduced by Paul Ware several years ago. It is very stable in operation and highly resistant to vibration, both of which character-

istics make it especially suitable for aircraft application.

A new coaxial tuning condenser was described by Dr. Robinson of Sprague Specialties Co. It consists of two coaxial metal tubes upon the inner of which a vitreous enamel dielectric is coated. It is mechanically and electrically strong and is of small size, its dimensions being $\frac{3}{8}$ inch by 1 inch. Variations in capacity from 5 $\mu\mu\text{f}$ to 400 $\mu\mu\text{f}$ are easily attained. Also, the Q of this condenser is very high, about 800 for a thickness of 0.04 inch of dielectric. The vitreous enamel dielectric may be used to advantage as a substitute for mica in small condensers because of its uniformity of characteristics as compared with the great variations in mica which is found in a natural state. Also, a material such as this may be called upon when mica is no longer available because of the political situation throughout the world.

L. L. McGrady of Eastman Kodak Co. presented a paper on the dielectric characteristics of a new cellulose ester sheet plastic which is used instead of paper in small tubular condensers. It is extremely tough and puncture resistant which permits a higher voltage rating on a given condenser. It also has low moisture absorption properties. It can be prepared in sheets as thin as 0.0005 inch and is available in either sheet or flake form.

TELEMOBILE SERVICE INAUGURATED



A specially built motor coach with five sound-proof public telephone booths made its debut recently outside of the Yankee Stadium to supplement regular telephone service. The coach can be connected with either overhead wires or underground cables

VT Voltmeter

(Continued from page 34)

justable slider contact. Carbon or metallized resistors are not satisfactory, as they cause the meter to go off zero as they heat up.

The resistor between the plate supply filter and the voltage regulator tube should be of such value that the current through the regulator tube is about 15 ma at normal line voltage. With such a resistor in place a line voltage change of ± 10 per cent will not cause a change in the meter indication of more than ± 1.5 per cent.

The value of 2,000 ohms in the meter circuit is for use with a 20,000 ohm per volt voltmeter with its range switch set at 2.5 volts. If a 50-microampere meter were to be used in place of the voltmeter, a 52,000 ohm resistance would be used in place of the 2,000 ohm one. If a more sensitive meter is used it will be necessary to add more resistance at this point or to put a shunt across the output. A five plate midget condenser was found to be most satisfactory for C_1 .

The suggestion for this development originated through discussion with the staff of ELECTRONICS. Much of the data necessary for its preparation was obtained in the ELECTRONICS laboratory.

• • •

AGAIN, THE VERSATILE PHOTOTUBE



This time the phototube is put to work by Westinghouse engineers to notify the busy gas station attendant that a prospective customer has just driven up. The car interrupts a light beam entering a phototube

Stand by
All Broadcasters

Vacuum Tube Protection

250 WATT R.C.A. Transmitter Equipped with HEINEMANN CIRCUIT BREAKERS

These accurately calibrated, factory set and adjusted circuit breakers are used in many N.B.C. Studios for the protection of vacuum tubes. They increase tube life, eliminate the need for costly fuses and resultant interruption of broadcasts due to their failure. The device can be reclosed immediately after opening for overload or short circuit. Heinemann Circuit Breakers are made in ratings from 50 milliamperes to 50 amperes.

HEINEMANN CIRCUIT BREAKER CO.
97 PLUM ST. - - - TRENTON, N. J.

for
Dependable
FREQUENCY CONTROL
Use
**BLILEY
CRYSTAL
UNITS**
20 KC TO 30 MC
Write for Catalog G-11

BLILEY ELECTRIC COMPANY
UNION STATION BUILDING
ERIE, PA.

THE INDUSTRY IN REVIEW

Communication Equipment Statistics—1939

IN a preliminary report of the 1939 Census of Manufacturers entitled *Communication Equipment*, embodying figures reported by 227 establishments in the communication equipment industry, the factory value of all products of the industry manufactured last year is given as \$191,326,489. More than one-fourth of this total represents the value of radio apparatus amounting to \$51,485,196. This figure is the sum of the following items in the report: Miscellaneous parts \$45,665,666; Radio transformers for receiving sets, \$5,211,747; and Transformers for transmitting sets, \$607,783. The value given for radio transformers is divided into two parts on the basis of those plants reporting both the value and number of such transformers and of those plants reporting only the value and not the number of individual units produced. In the first category there were reported 6,767,722 transformers valued at \$3,279,936; while the value of the radio transformers on which the number was not reported is given as \$1,931,811.

In addition, the communication equipment report covers telephone and telegraph apparatus, not including wireless, valued at \$94,337,945, audible signals \$4,252,460, electric street traffic signal apparatus and accessories \$1,265,595, fire and police signaling systems \$1,010,865, and railroad highway grade crossing signals \$1,454,244.

In comparison with 1937, the value of products of the industry last year showed a decrease of 15.9 per cent, on the basis of a reported total value for 1937 of \$227,523,931. 1937 production values for radio apparatus also were slightly higher than in 1939.

The wage earners primarily engaged in manufacturing in this industry in 1939 numbered 32,119, a decrease of 21.6 per cent, compared with 40,981 reported for 1937, and their wages \$44,444,379, decreased 19.7 per cent as compared with \$55,326,496, reported for 1937. These decreases may be partially accounted for by the fact that the 1939 Census of Manufacturers questionnaire, for the first time, called for personnel employed in distribution, construction, etc., separately from manufacturing employees of the plants. It is not known how many of the wage earners reported for 1937 were engaged in distribution and construction and how many were engaged in manufacturing. Employees of the plants reported as engaged in distribution and construction activities

Table 1.—Summary for the Industry: 1939 and 1937

(Because they account for a negligible portion of the national output, plants with annual production valued at less than \$5,000 have been excluded since 1919)

	1939	1937	Percent of increase or decrease (-)
Number of establishments.....	227	187	21.4
Salaried personnel ¹	9,305	13,470	-30.9
Salaries ^{1,2}	\$25,325,092	\$29,740,220	-14.8
Wage earners (average for the year) ³ ...	32,119	40,981	-21.6
Wages ^{2,3}	\$44,444,379	\$55,326,496	-19.7
Cost of materials, supplies, fuel, purchased electric energy, and contract work ² ...	\$48,353,690	\$65,180,565	-25.8
Value of products ²	\$191,326,489	\$227,523,931	-15.9
Value added by manufacture ⁴	\$142,972,799	\$162,343,366	-11.9

¹ No data for employees of central administrative offices are included.

² Profits or losses cannot be calculated from the census figures because no data are collected for certain expense items, such as interest, rent, depreciation, taxes, insurance, and advertising.

³ The item for wage earners is an average of the numbers reported for the several months of the year and includes both full-time and part-time workers. The quotient obtained by dividing the amount of wages by the average number of wage earners should not, therefore, be accepted as representing the average wage received by full-time wage earners.

⁴ Value of products less cost of materials, supplies, fuel, purchased electric energy, and contract work.

in 1939 are not included in this preliminary report but will be included in the final report.

This industry, as constituted for census purposes, embraces establishments primarily engaged in the manufacture of electric signaling apparatus

(other than railway); signals and attachments (railway); telephone and telegraph equipment; and miscellaneous radio parts except loud speakers and microphones which are a part of the radio, radio tube, and phonograph industry.

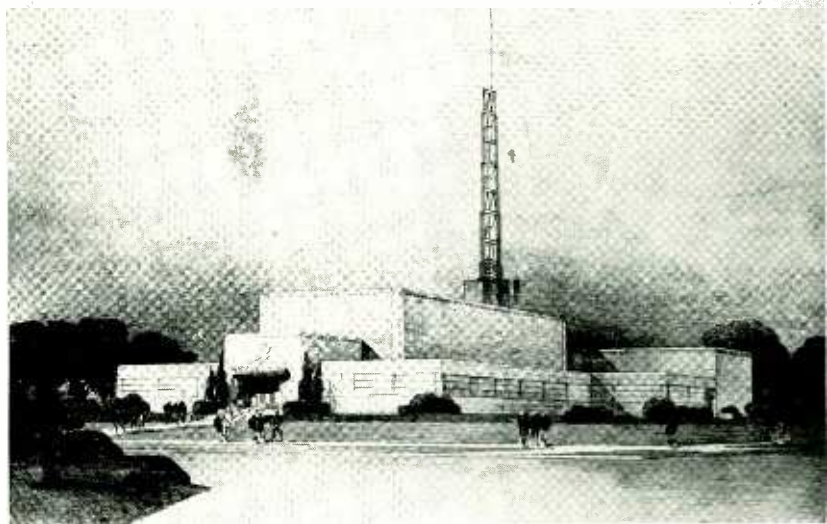

Artists drawing of the new building which is to house the radio stations of The Milwaukee Journal. The stations are WTMJ, a new commercial F-M station and a new experimental television station. The building will contain eight studios, one of which will seat 365 persons, and a large stage for television. This is a part of a half million dollar investment this newspaper is making in radio

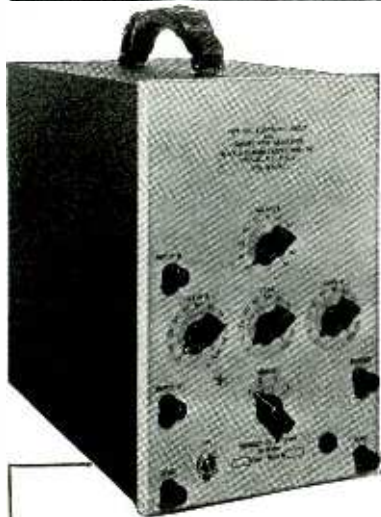

**for
DIRECT-CURRENT
MEASUREMENTS**

• In addition to the well-known application of the DuMont Type 185 Electronic Switch as a switching device for observing two independent alternating-current signals simultaneously on the screen of a single-element cathode-ray oscillograph, this instrument has recently proved itself of great value in the study of direct-current signals.



In such operation it serves as a "chopper" of the direct-current signal, allowing such signal to be passed through the conventional alternating-current amplifier of any good cathode-ray oscillograph. And when the second signal circuit of the Electronic Switch is kept idle, a reliable zero-axis is present for reference purposes. When employed in this manner, Type 185 Electronic Switch is valuable for the study of all types of small d.c. potentials in the range of approximately 0.10 to 250 d.c. volts. It may also be used for modulation studies of radio-frequency transmitters at remote locations by proper connections to the diode detector of a conventional radio receiver.



The DuMont Oscillographer (Vol. 3, Nos. 6-7) describes this application of the Type 185 Electronic Switch. If you do not already have this copy in your reference files, we shall gladly send it on request.

DUMONT
ALLEN B. DU MONT
LABORATORIES, Inc.
Passaic ★ New Jersey
Cable Address: Wesplexin, New York

♦ Frequency Modulation broadcasting was inaugurated Nov. 20 by the General Electric Company when its experimental station, W2XOY, located in the Helderbergs, twelve miles out of Schenectady, began a regular schedule of broadcasts of seven hours daily . . . David Sarnoff, President of the Radio Corp. of America, announced that the research and production facilities of the company are being expanded to speed national defense orders for radio equipment and to accommodate demands of increased business. In order to execute this expansion program, arrangements have been completed to obtain temporary funds (\$15,000,000) from a group of banks . . . Connecticut Telephone & Electric Corp. has installed a new 20 kw electric furnace in its Meriden plant, heat from which is used both for forging and for hardening metal at the same time. The furnace is provided with a gas flame curtain which completely prevents scaling of the magnets and eliminates the necessity for any subsequent cleaning operation . . . The War Department announced, as a general policy that those trainees inducted into the Army of the United States under the Selective Service Act, whose civilian occupations in certain communications companies have qualified them as occupational specialists will be assigned to the Signal Corps of the Army.

♦ RCA Communications, Inc., announced the opening for the first time of a direct radiotelegraph circuit between the United States and Finland. The new circuit operates between the cities of New York and Helsinki . . . The appointment of Dr. W. D. Coolidge and Stuart M. Crocker as vice-presidents has been announced by General Electric Company. Dr. Coolidge will continue as director of the G. E. Research Laboratories in Schenectady. Mr. Crocker will now be located in New York . . . Preliminary test operation of the first air-cooled 50 kw short-wave transmitter in the United States has started at WBOS, the Westinghouse international station at Boston. The new transmitter was expected to enter the European and South American service as of November 30th . . . The standard frequency station WWV of the National Bureau of Standards was destroyed by fire last November 6th. A temporary transmitter was established in another building and is now operating a reduced service . . . American radio broadcasts will, as of January 1, 1941, reach Latin American listeners over local stations in the twenty republics south of the Rio Grande under arrangements announced by NBC.



Who Uses It?

Electronic and Radio Engineers. Designers of electrical appliances. Instrument Makers. Aircraft and Automotive Specialists. Telephone Technicians and others have found this product ideal for many applications.

CHECK THESE ADVANTAGES

1. Seamless ALUMINUM, COPPER or BRASS Tubing is forced over the wire or wires in such a manner that any kind of a bend can be made and the ends easily trimmed.
2. Positive protection to the wire against Corrosion, Abrasion, Acids, Oils, Alkalies, Solvents, etc.
3. It is compact, light in weight and neat in appearance.
4. Tubes made in any required wall thickness.
5. Outside diameter of the tube can be held to close tolerances.
6. Practically any number of wires can be shielded by this method.
7. Armor-like protection gives added stiffness, yet is easily bent.
8. Furnished in exact lengths, multiple lengths or random lengths.
9. Has satisfactorily withstood the severest kind of tests.

SEND FOR FREE SAMPLES

We invite your inquiries and will gladly forward an assortment of samples for your inspection. . . .



PRECISION TUBE CO.

Specialists in accurately drawn Seamless ALUMINUM, COPPER and BRASS Tubing, in the smaller sizes.

200 OSBORN ST. PHILADELPHIA, PA.

Please send samples of your METAL SHIELDED WIRE to

Name

Firm

Address



IT is only fitting that at this season we give pause for a moment to contemplate the many Blessings which are ours and to rejoice with you that of all the places of the Earth, we are fortunate enough to live in a Land of Peace and Promise.

In looking ahead to the New Year, let us more firmly determine to solidify the Partnership ties which bind us together in the common cause to make that Peace secure and long lasting.



If, at times in the past year, you have had to endure delays and tardy delivery schedules, it was because a more pressing and more universal National Duty was ours to fulfill.

The entire Kenyon Organization from President to Watchman are as one man in support of the great cause which will make *this* Holiday Season more secure and to insure for you and for us—for all the future—

*"Peace on Earth
to Men of Good Will"*

KENYON TRANSFORMER CO., Inc.
840 BARRY ST.
NEW YORK

DECEMBER 25, 1940

Literature

Bobbins. Precision Paper Tube Co., 2033 W. Charleston St., Chicago, Ill., has available a new bulletin illustrating and describing a line of dielectric paper coil bobbins available for manufacturers of coils, relays, solenoids, photoelectric devices, etc. A bobbin data sheet is included.

Selenium Rectifiers. International Telephone Development Co., 67 Broad St., New York City, has available four bulletins on selenium rectifiers. One bulletin gives general information on these rectifiers. The other bulletins are reprints and are entitled as follows: *The Selenium Rectifier*, by Dr. Erich Kipphan, Nuremberg, Germany, *The Selenium Rectifier for Signaling* by J. E. Yarmack and C. G. Howard, and *Rectifier Power Plant for Transmission Systems* by R. Kelly of London, England.

Power Plugs and Sockets. Howard B. Jones, 2300 Wabansia Ave., Chicago, has just issued a bulletin on the 500 series power plugs and sockets. These plugs and sockets are designed for 5000 volts and 25 amps, and are made in 2, 4, 6, 8, 10 and 12 contacts.

Radio Capacitors. The 1941 Radio Capacitor Bulletin, No. 185-A, is now available from Cornell-Dubilier Elec. Corp., South Plainfield, N. J. Complete information is given on mica, paper, wet and dry electrolytics, Dykanol, etc., capacitors.

Grid Bias Cells. Load characteristics, illustrations, and descriptive matter make up a bulletin on grid bias cells for receivers, pre-amplifiers, television apparatus, etc., available from P. R. Mallory & Co., Inc., Indianapolis, Ind.

Fluorescent Lamp Ballasts. Last month the editors mentioned that Chicago Transformer Corp., (3501 Addison St., Chicago), had issued a loose leaf binder which would be supplemented with bulletins from time to time on progress being made in small transformer design and construction. The first of these bulletins, just published, is one on fluorescent lamp ballasts for use with replaceable starting switches.

Ceramic Resistors. Bulletin R, available from Global Div., of the Carborundum Co., Niagara Falls, N. Y., contains charts which show the per cent change in resistance of the various types of ceramic resistors available from that company. General information, watt ratings, resistance range per inch of length and voltage specifications are also included in the bulletin.

Speaker Data Sheet. Jensen Radio Mfg. Co., 6601 S. Laramie Ave., Chicago, have just issued a new data sheet (No. 199) fully describing a group of new extended-range high fidelity loudspeakers. The new type "J" dual loudspeakers, the eight-inch and the twelve-inch single speakers are also illustrated and described.

Time Saving Performance with HEWLETT-PACKARD Laboratory Instruments

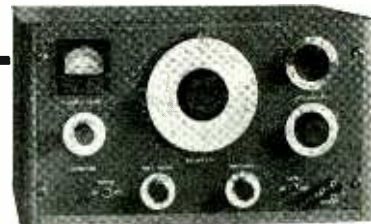

Model 205A

Audio Signal Generator

A known voltage and a known frequency is supplied at the commonly used impedance levels. Frequency stability, low waveform distortion, complete output metering and attenuator system plus many other outstanding features make this instrument an excellent source of audio frequency for any job in the laboratory or field. Write today for information about this and other superior laboratory instruments. You are not obligated in any way.

Write for **FREE literature**

HEWLETT-PACKARD CO.
Laboratory Instruments
481 Page Mill Road • Palo Alto, California



As business paper publishers for over fifty years, McGraw-Hill is uniquely equipped to offer complete, authoritative direct mail coverage of Industry's major markets. Extreme accuracy is maintained (guaranteed to 98%) and through careful analysis of markets, complete classification of companies and personnel, etc., the widest possible selections are available. Send for handy reference folder, "Hundreds of Thousands of Reasons Why" which describes how McGraw-Hill Lists are built and maintained.

What Fields Do You Want to Reach?

Aviation
Bus & Electric Railways
Civil Engineering and Construction
Administrative Executives

Electrical Dealers & Wholesalers
Mill Supply Houses
Power Services

Product Engineering & Design
Production and Maintenance
Radio Dealers & Wholesalers
Radio Engineering & Design

For further details, selections from above basic classifications, counts, prices, etc., or estimates on special lists . . . ask any representative or write to



Complete Lists Covering Industry's Major Markets

New Products

Electronic Welding Timer

WELTRONIC CORP., 2832 East Grand Blvd., Detroit, Mich., announce Model 79 timer which permits control of spot welding of heavy iron and steel sections which require a complicated sequence of accurately timed operations. The timer is capable of providing accurate timing control for low weld current, high weld current, initial (low) welding pressure, impact forging (high) pressure, cool time, hold time, etc. It will also time any combination of functions required in spot welding heavy sections within the scope of the resistance forge welding process. Model 79 can be used with standard or special equipment.

New Recording Improvements

UNIVERSAL MICROPHONE CO., Inglewood, Cal., has introduced a new innovation for its recording machines through the use of fluorescent light over the instruments. Besides dressing up the equipment, the light is useful for the microscope in examining grooves. Fluorescent lighting is available for turntables on professional models at slight extra cost. Also available as standard equipment is a 72 to 150 adjustable-power, rack and pinion microscope for Universal professional recorders. The power rack and pinion microscope has a field of seven lines and is used in conjunction with the fluorescent light.

Tubular Rheostat

Variable contact resistance has been eliminated on the tubular slide-contact rheostats announced by Rex Rheostat Co., 37 West 20th St., New York City. As shown in the illustration the contact brush *B* is attached to a flexible metal cord *C*, shown dotted, which

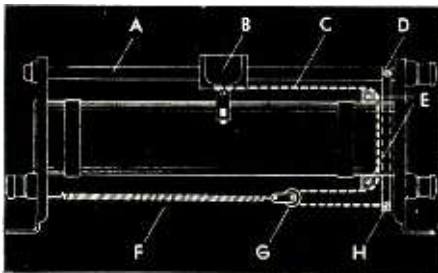

goes over parts of insulated material *E*, and over a wheel *G*. A spring *F* connected to the wheel gives the cord the necessary permanent tension. If the slider knob *B* is moved from right to left, the wheel travels half the distance from left to right, and vice versa. The other end of the cord *C* is directly connected to the slider bar *A* by the rod *D-H*.

LEADERSHIP!

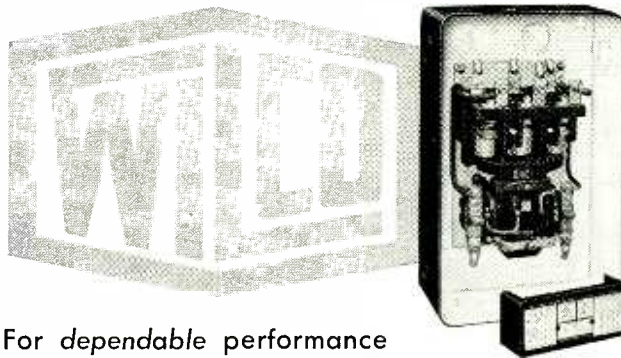

For dependable performance

ALLEN-BRADLEY chooses WILCO

It just doesn't pay to take chances with quality. And Allen-Bradley, famous manufacturer of motor controls proves it by using cadmium silver electrical contacts as manufactured for them exclusively by Wilco!

Pioneer in the development, manufacture and sale of elec-

trical contacts and thermometals, Wilco is the preferred name in temperature control in any industry you can name. Take full advantage of Wilco's experience and research leadership in both of these highly specialized fields.

Outline your particular problem and write Wilco today!

The H. A. Wilson Co., 105 Chestnut St., Newark, N. J. Branches: Detroit & Chicago



Mix with **REMLER** Silver Tap ATTENUATORS

Enjoy the feel of self-cleaning pure silver on silver, ball bearings front and rear, precision machined in every detail. It's smooth. And those are the factors that make the REMLER silver attenuator QUIET—so quiet you can operate it in a low-level circuit in perfect ease and comfort. Standard impedances. Special values to order.

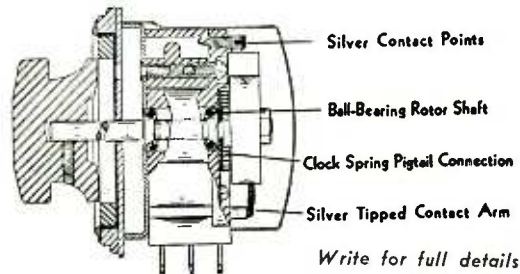

Write for full details.

REMLER COMPANY, Ltd. • 19th at Bryant • SAN FRANCISCO

For Quality Reproduction Use

Oxford Speakers

Precision built to exacting specifications OXFORD Permag and Electro-dynamic speakers ranging in size from 2" to 14" will fill the bill no matter what the application.

Send us your specifications for prompt quotations or write Dept. E7 for further information.

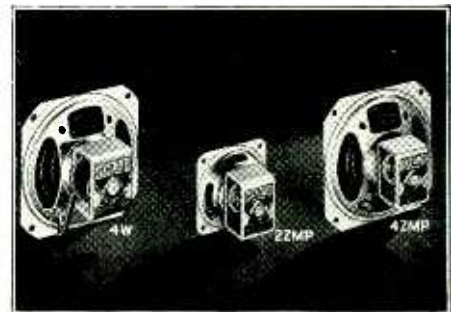

OXFORD-TARTAN
RADIO CORPORATION

915 W. VAN BUREN ST. • CHICAGO, U. S. A.



DAVEN

Precision LEVEL INDICATOR



The Type 910 Volume Level Indicator is an audio level indicator designed for service in broadcasting, sound recording, and allied fields. The meter is sensitive, rugged and correctly damped for program monitoring. The meter multiplier is a heavy duty, step type "T" attenuator designed to offer a constant impedance both to the line, and to the meter at all steps of control. The zero adjustment provides corrections of ± 0.5 Db. in 0.1 Db. steps. The input impedance of the 910 is 7500 ohms. The reference level is 1 mw. into 600 ohms.

WRITE FOR TECHNICAL DESCRIPTIVE LITERATURE

THE DAVEN COMPANY
158 SUMMIT STREET · NEWARK, NEW JERSEY

★ ★ KELLOGG ★ ★

SWITCHBOARD & SUPPLY CO.

THE LOGICAL SOURCE FOR

Aircraft Radio Accessories

★ Complete engineering, laboratory, and manufacturing facilities available for the design and construction of radio accessories and components required by the Aircraft Industry.

★ Manufacturers of Microphones (hand and throat), Headsets, Capacitors and miscellaneous apparatus such as plugs, jacks, keys, switchboard lamps, lamp jacks, lamp caps, multi-conductor plugs and sockets, insulated wire, cords, cord assemblies, etc., etc. Head and chest sets, Control Boxes, Filters built to your specifications. Let us solve your problems.

★ Suppliers to All U. S. Government Departments and Commercial Aviation ★

KELLOGG SWITCHBOARD & SUPPLY COMPANY
6610 SOUTH CICERO AVENUE · CHICAGO, ILLINOIS

PERMANENT MAGNETS

ALL SHAPES — ALL SIZES FOR ALL PURPOSES

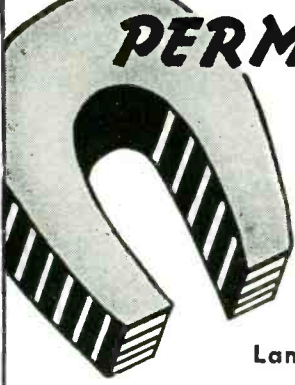

Stamped, Formed, and Cast; Chrome, Tungsten, Cobalt and ALNICO** (cast or sintered) under G. E. license.

THOMAS & SKINNER
STEEL PRODUCTS COMPANY
1116 E. 23rd STREET · INDIANAPOLIS, INDIANA

Laminations for Radio Transformers — Tools
Dies — Heat Treating — Stampings

39 YEARS EXPERIENCE

F-M and Television Cable

A NEW HIGH FREQUENCY transmission cable is announced by Belden Manufacturing Company, 4689 W. Van Buren Street, Chicago. Of the 100 ohm twisted pair type, this new cable is designed for use with television or frequency modulation.

The new 8219 cable consists of 18 gauge stranded tinned copper, celanese braid, rubber covered, color coded, twisted pair with fillers, celanese wrap, tinned copper shield, cotton wrap, and rubber sheath. Outer diameter of the cable is .350 inch. The cable has the following characteristics:

Freq. Kc.	Surge Imp. Ohms	Power Factor	db Loss 100 ft.	Min. Punct. Volts	Max. Cap. Watts
100	90.	2.18	.060	10000	250
40000	92.	2.02	6.180	10000	250

No. 8218 cable is similar in construction, except that it does not have the outer tinned copper shield. Outer diameter is 2.70 inches. This cable has characteristics as follows:

Freq. Kc.	Surge Imp. Ohms	Power Factor	db Loss 100 ft.	Min. Punct. Volts	Max. Cap. Watts
100	105.	1.51	.048	10000	250
40000	92.	2.01	6.180	10000	250

Decade Resistance Box

THE DETERMOHM resistance box, a product of the Ohmite Manufacturing Co. (4835 Flournoy St., Chicago), is now available in two new ranges, one of 1 to 9,999 ohms and the other of 10 to 99,990 ohms. These sizes are in addition to the 100 to 999,900 range box previously available. The Determohm has a ± 5 per cent accuracy for industrial and laboratory uses. One of the chief uses of the Determohm



is in the determination of replacement resistors in radio sets. It may also be used as a voltmeter multiplier, or can be used with auxiliary apparatus in an ohmmeter, resistance bridge circuit or in many other applications. The resistance element is made up of wire wound resistors which are connected to tap switches. The Determohm may be connected directly in radio and electrical circuits which do not cause the instrument to dissipate more than one watt for each tap in the circuit.

U-H-F Transmitter-Receiver

A NEW PORTABLE U-H-F transmitter-receiver having 75 calibrated frequency channels from 28 to 65 Mc has been announced by the Westinghouse Elec. & Mfg. Co., E. Pittsburgh, Pa. Compact and weighing 30 lbs complete with batteries, antenna, microphone, headphones and key, this type HR communicator combines phone or continuous wave operation. It is suitable for communication between scattered field groups, as in traffic, fire, large scale construction, or rescue control work.



A crystal frequency standard permits calibration for accurate adjustment of both transmitter and receiver to the desired frequency. The equipment is designed so that several sets in a small area can operate on the same channel without heterodyne interference. Sending on one channel, receiving on another is accomplished with the push-to-talk send-receive control. The r-f carrier output is 0.5 watt minimum; average receiver sensitivity is 5 microvolts. Power is obtained from a plug-in type dry battery good for ten hours continuous operation, or longer on intermittent service. A four page illustrated folder (85-230) is available.

Ohm's Law Calculator

A CONVENIENT OHM'S LAW calculator has been specially designed for engineers, servicemen, amateurs, experimenters, teachers, etc. It gives the answer to any Ohm's Law problem with one setting of the slide. The calculator has scales on both sides so as to cover the range of currents, resistances, wattages and voltages commonly used in both radio and commercial work. It covers the low current high resistance radio, sound and electronic applications, as well as the commercial higher current range for motors, generators, lamps, electrical appliances, and other applications. The calculator also has a convenient stock unit selector, listing hundreds of stock values, immediately available, in dividohms, fixed resistors (including Ohmite brown devils), and rheostats. A setting of the slide shows the stock number of the resistor or rheostat needed. Simple instructions appear on the calculator. The Ohmite Ohm's Law calculator can be obtained for ten cents from any jobber or from the Ohmite Manufacturing Company, 4835 Flournoy St., Chicago, Ill.

WANT TO SAVE
**TIME...
MONEY...
REJECTS ?**



MAYBE WE CAN HELP YOU! Many production problems are caused by noise and vibration. We've had long experience with noise detection and control in aircraft, refrigerators, automobiles, motors and many other products. We're specialists in practical acoustic methods and equipment for production testing. If you have a problem of this kind, tell us about it. Why not write us today?

Electrical Research Products Inc.

76 Varick Street, New York, N. Y.

A Subsidiary of

Western Electric Company

**5000 RADIOMEN
can't be
wrong!**

**CREI Graduates, as a Group, Are
The Highest Paid in the Industry!**

CREI Provides Advanced Practical Engineering Training for Professional Radiomen to Qualify for Better Jobs in Every Branch of the Industry.

• The success of CREI men in every branch of radio should prove an incentive to investigate thoroughly the opportunities that await you through CREI training in Practical Radio Engineering. We are not interested in bringing "beginners" into the industry, but WE ARE interested in helping professional radiomen NOW in radio to advance to better-paying jobs. 5,000 students and graduates prove we are doing it—surveys show that CREI men, as a group, are the **HIGHEST PAID!** Now is the time for you to advance yourself with advanced practical training.

DO THIS NOW! If you are a professional radioman and want to make more money—write today for facts that prove you can! To help us answer your inquiry intelligently, please state briefly your education, radio experience and present position.



Free Book Sent

**CAPITOL RADIO
ENGINEERING INSTITUTE**

Dept. E-12, 3224-16th St. N.W., Wash., D. C.

**\$ true RELAY
Economy!**

- Each unit specifically engineered for your application ...
- Only highest quality materials used ...
- Rigid tests throughout production ...
- Finished relays are twice-tested ...
- Patented features, precision workmanship, assure quiet operation and long life.

That, in part, is why Dunco Relays spell real economy. First costs are not high, and they actually save you money in the long run.

Catalog on request

STRUTHERS DUNN, Inc.

1326 Cherry St. Philadelphia, Pa.

DUNCO RELAYS

Made right - Priced right - Adapted to your needs



The NEW Series 854 SUPER SENSITIVE TESTER

Especially designed to meet the exacting requirements of Laboratory, Industrial, Television and Radio.

20,000 OHMS PER VOLT D. C.
1,000 OHMS PER VOLT A. C.

● SEVEN D.C. voltage ranges to 6,000 VOLTS ● SEVEN A.C. voltage ranges to 6,000 VOLTS ● SEVEN D.C. current ranges 0-60 MICROAMPERES to 0-12 AMPERES ● THREE resistance ranges to 60 MEG-OHMS (self-contained batteries) ● SIX decibel ranges from -12 to +70 DB ● SEVEN output ranges to 6,000 VOLTS ● 4 1/2" wide-faced, 50 microampere meter ● 1% wire-wound bobbins and matched metallized multipliers, 2% D.C. and 3% A.C. overall accuracy.

SERIES 854P (illustrated) with batteries and high voltage test leads. Net Price..... **\$39.95**



The Series E-200 SIGNAL GENERATOR

It is an unsurpassed, efficient laboratory instrument. Unusual stability and accuracy make the Series E-200 an invaluable aid in Production Alignment, Testing, and Trouble Shooting.

● Designed for lasting, uninterrupted service, the Series E-200 is a rugged A.C. operated SIGNAL GENERATOR ● Large easy reading 6" deeply etched, engine-turned dial with 0-1000 point-reference vernier ● Electron-coupled oscillator circuit with variable 400 cycle modulation (0-100%) accomplished in the buffer-amplifier ● Direct reading accuracy guaranteed within ± 1% on all 6 bands ● Fully licensed by A. T. & T.

PRECISION Series E-200 (illustrated) in heavy gauge steel cabinet and 14 gauge etched aluminum panel. Complete with coaxial output cable. Net Price..... **\$35.95**

Write for the new "PRECISION" 1941 Catalog describing more than 40 test equipment models.

PRECISION TEST EQUIPMENT
Standard of Accuracy SEE THEM AT YOUR JOBBER

PRECISION APPARATUS COMPANY
647 Kent Avenue Brooklyn, N. Y.
Export Div.: 458 Broadway, New York, U. S. A.
Cables: Morhanex

Test Instrument

INDUSTRIAL INSTRUMENTS, INC., 155 Culver Ave., Jersey City, N. J., announce a new model of the type RC conductivity bridge. Model RC-IB is similar in all respects to the earlier models except that it is equipped with a vacuum tube oscillator to supply the bridge source at 1000 cps. Completely self-contained, it operates from 100 to 135 volts on a 50-60 cps line. A companion model is also available for 220 volts 25 cps lines. The RC-IB is a general purpose bridge for electrolyte conductivity measurement from 2 ohms to 2 megohms. Used for determining concentration of electrolytic titrations, testing distilled water and other liquids, it has particularly useful application in chemical laboratories, plants and institutions. This model lists at \$75.00 without test cell. Conductivity cells list at \$7.00 to \$30.00.

Fasteners for Plastics

A NEW "SPEED CLIP" MANUFACTURED BY Tinnerman Products, Inc., Cleveland, Ohio, presents an entirely new method of fastening for plastics. This clip was originally designed by the Tinnerman company to fasten the plastic dial bezels and loud speaker bezels to Philco radio cabinets. Made of high carbon spring steel, the clip is so formed that when it is pressed over a rib, the four sharp points bite into the sides of the rib to hold securely in place. The long retaining arm of the clip is to hold an accompanying object firmly under spring tension.

New RCA Products

A NEWLY-DESIGNED 15-WATT portable PA system for sound reinforcement applications for indoor audiences up to 2000 persons, has been announced by the Commercial Division of RCA Mfg. Co., Camden, N. J. Designated as type PG-180, it is priced at 15 per cent less than the 12-watt system it replaces in the RCA line. The basic unit is the latest RCA amplifier MI-12202. The two loudspeakers are 10 1/4 inch permanent field types, and the microphone is a Junior Velocity type mounted on a table stand. Two separate input circuits with individual volume controls are provided for high impedance inputs. Longer and improved cables are included. The unit packs into one case 21 inches high, 16 3/4 inches wide and 11 inches deep, and weighs 43 lbs.

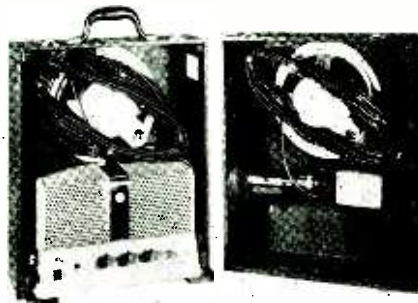

4 NEW BOOKS ON RADIO and TELEVISION

Getting your
RADIO OPERATOR'S LICENSE
made easier

A famous book for those preparing to take radio operator license exams, giving 1297 questions on radio communication—theory, apparatus circuits, laws and regulations, etc.—together with full, correct answers for review and study. Helps beginner and experienced operator seeking advancement to check their training and knowledge and to focus on key points of theory and practice as covered in Government license exams. Now fully revised in accordance with new Government procedure and requirements for exams. Nilson and Hornung's RADIO OPERATING QUESTIONS AND ANSWERS, 7th edition. 415 pages, 87 illustrations. \$2.50.

AN A-B-C BOOK ON RADIO
with a sound technical background

This book covers the radio field from the very beginning—no previous knowledge of radio or electricity is necessary—and gives you a complete basic understanding of radio receivers and transmitters including the ability to construct and test the various types, and a knowledge of the principles that make each part work and how they work together. Has close likeness to personal instruction, combining instructions, construction, experiments, and explanation of results at every step. Watson, Welch and Eby's UNDERSTANDING RADIO. 601 pages, 406 illustrations. \$2.80.

Bringing you an
INSIDE PICTURE of TELEVISION

This unusual manual shows you the results of foremost American experience with television—describes its set-up and methods of operation—discusses the many considerations of putting programs on the air—explains its problems, economical, technical, legal—everything that will give those in the radio, business, advertising and entertainment fields the most authoritative and practical basis for consideration of their many questions relating to television. Lohr's TELEVISION BROADCASTING. Foreword by David Sarnoff. 274 pages, illustrated. \$3.00.

A thorough groundwork in
TUBE AND CIRCUIT DESIGN

Meets the need for a single volume to assemble and coordinate present knowledge of theory and application of electron tubes for use in applying electron tubes to the solution of new problems. While Class C amplification and design of radio transmitters and receivers, adequately treated elsewhere, are not taken up, the basic principles presented are applicable to radio engineering problems, and to industrial electronics, power control, electrical measurements, and other uses. Reich's THEORY AND APPLICATIONS OF ELECTRON TUBES. 670 pages, 512 illustrations. \$5.00.

10 DAYS' FREE EXAMINATION

Mail this coupon

McGraw-Hill Book Co., Inc.
330 West 42nd Street, New York

Send me the books checked below for 10 days' examination on approval. In 10 days I will pay for the books, plus few cents postage, or return them postpaid. (We pay postage on orders accompanied by remittance.)

- Nilson and Hornung—Radio Operating Questions and Answers, \$2.50
 Watson, Welch and Eby—Understanding Radio, \$2.80
 Lohr—Television Broadcasting, \$3.00
 Reich—Theory and Applications of Electron Tubes, \$5.00

Name

Address

City and State

Position

Company L 12-40
(Books sent on approval in U. S. and Canada only.)

MADE BETTER TO
WORK BETTER



• The combination of high tensile strength that assures a lasting bond, and faster, cleaner work made possible by quick-acting flux of pure water-white rosin, has given Gardiner Rosin-Core Solders an outstanding reputation for efficiency and economy on radio work by expert or amateur. Yet, due to modern production methods and big sales, Gardiner Solders cost less than even ordinary kinds. Made in various alloys and core sizes . . . and in gauges as small as 1/32 of an inch . . . in 1, 5 and 20-lb. spools.



4889 S. Campbell Avenue Chicago, Ill.

FOR GREATER flexibility . . .

BRUNO connectors

by *Selectar*

NEW for CO-AXIAL OPERATION

For hi-frequency transmission lines, for aircraft, mobile, stationary installations. Lock nut type—gas and electrical connections made simultaneously. Available in various sizes to accommodate 3/8", 1/2", 3/4" and 7/8" lines. Several types and models for special applications.

Write for Bulletin "C"

SELECTAR
MANUFACTURING CORPORATION
30 WEST 15th STREET NEW YORK, N. Y.

A new 15 1/4 inch high fidelity loudspeaker mechanism, available either separately or with wall housing or console cabinet, has also been announced. Designated as model MI-6237, it is designed for music rooms, audition studios, school auditoriums, etc. It handles 15 watts of power and is suitable for reproducing phonograph recordings or other sound under conditions of high noise level. The voice coil (impedance 8 ohms) is dust proof.

A console cabinet (model MI-6222) designed for the new mechanism has a built-in acoustic phase inverter circuit to extend low frequency response. The cabinet stands 28 inches high, 24 inches wide and 14 inches deep.

The wall housing for the new speaker is of heavy veneer, finished in umber grey or in a neutral color. It measures 28 inches high, 19 inches wide and 13 inches deep. It is designated as Model MI-6223.

The new baffle (MI-6224) is cut to mount four RCA seven inch "accordion edge" loudspeakers (MI-6234) in either the console cabinet or the wall housing mentioned above. Four matching transformers are supplied with and mounted on the baffle.

Precision Tester

THE SERIES 954, combination dynamic mutual conductance type tube tester and thirty-seven range super-sensitive ac-dc multi-range set tester is a complete service laboratory, in one compact unit, available from Precision Apparatus Co., 647 Kent Ave., Brooklyn, N. Y. It provides accurate and reliable tube tests and solves measurement problems arising from a-m and f-m broadcasts, television, industrial and laboratory practice. It is rated at 20,-



000 ohms per volt including ranges of 6,000 volts ac or dc; 60 ma; 12 amps and 60 megohms. The precision tester is available in four models, complete with batteries and extra high voltage test leads. Model 954 MCP is an open type portable tester in a metal case; 954C is a counter type instrument in a metal cabinet; 954PM comes in a standard panel for rack mounting; and the 954P is available in a walnut finish, hardwood, portable type carrying case with removable cover and tool compartment. Literature is available from Precision Apparatus.

For assured stability in your transmitter

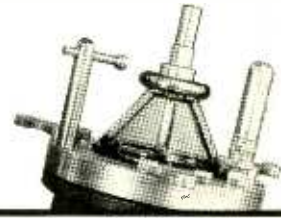

TYPE 174 COMPRESSED GAS CONDENSER

...because it has a proven record of reliability in transmitters everywhere beginning with the first installation at station KDKA over 10 years ago. Write for data.



NEW TERMINALS With Wide Range Utility

No. 140 SERIES



3/4" wide and 13/32" high. 2 to 21 terminals. 5-40 x 3/16" screws.



1 1/4" wide x 1/2" high. 2 to 20 terminals. 6-32 x 1/4" screws.



1-5/16" wide x 5/8" high. 2 to 17 terminals. 8-32 x 5/16" screws.

Made in three sizes as shown above. Barrier strips not only make a long leakage path, but prevent direct shorts from frayed wires at terminals. Molded bakelite insulation.

Terminals, Terminal Panels, Plugs, and Sockets made to your specifications.

Write for prices and samples.

HOWARD B. JONES
2300 WABANSIA AVENUE,
CHICAGO ILLINOIS

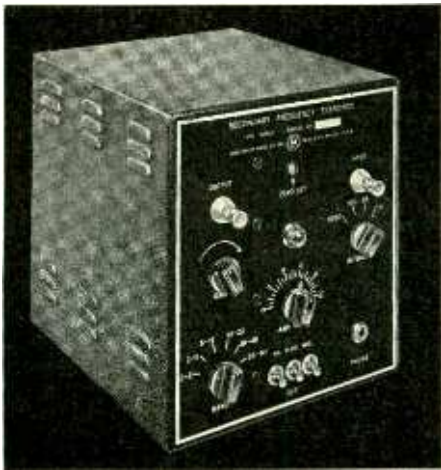

**A NEW Precision Crystal
Secondary
FREQUENCY STANDARD**

THAT HAS BEEN
"Designed for Application"

A precision frequency standard capable of being adjusted to WWV or some other Primary standard and putting out uniformly accurate calibrating signals with 10, 100, 1000 KC intervals. Uses the new GENERAL ELECTRIC No. 18A 1000 KC crystal having a frequency temperature coefficient of less than one cycle /Mc/C°. The crystal is sealed in Helium in a standard metal tube envelope.

The self-contained AC power supply has VR150-30 voltage regulator tube.

In addition to oscillator, multivibrators, and harmonic amplifier, a built-in mixer with phone jack and gain control on panel is incorporated.

JAMES MILLEN MFG. CO. INC.
150 EXCHANGE ST. MALDEN, MASS.

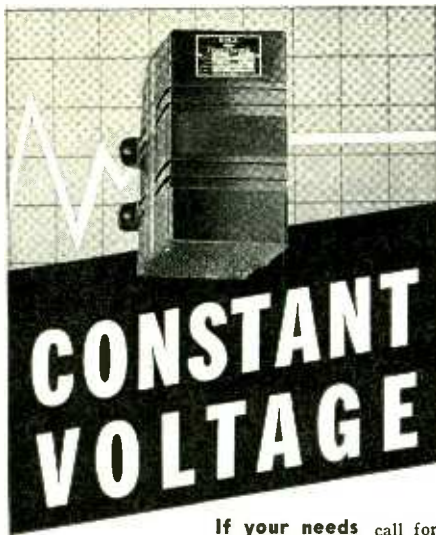

CONSTANT VOLTAGE

If your needs call for stable voltage at all times you can depend on SOLA CONSTANT VOLTAGE TRANSFORMERS to deliver for you, even though the incoming line voltage varies as much as thirty percent. Practical, economical, trouble-free—they can replace non-regulating transformers or perform as auxiliaries to equipment now in use.

WRITE FOR CATALOG
DCV-22

SOLA

SOLA ELECTRIC CO. 2525 Clybourn Chicago, Illinois

Electro-Sensitive Recording Paper

TELEDELTO, A DRY, electro-sensitive recording paper which makes practicable facsimile telegraphy, is now available for public use, the Western Union Telegraph Company (60 Hudson St., New York City) announces. Teledeltos paper requires no developing, processing or fixing, and records made upon it are instantly available. It is an electrically conducting sheet of paper coated with material which shows permanent changes of color at any point where an electric current passes through the sheet. The current is applied to the coated side of the paper through a metal stylus and the circuit is completed to a metal cylinder back of the paper. Neither the coating of the paper nor the record is affected by light or atmospheric conditions.

Diathermy

(Continued from page 40)

$$W_p = E_2 \frac{\left(\frac{y_2}{y_1} E_1 - E_2 \right)}{R_L}$$

Thus, the patient power is expressed in terms of the meter reading E_2 and another factor which can be referred to as the "calibration number." This quantity is a function of the difference between the meter reading without, and with the patient, and is unique for each such set of readings. By providing the meter with a sensitivity control and adjusting the control according to the calibration number, the meter may be caused to read the patient power directly. For large numbers the meter is made more sensitive and vice versa. The sensitivity control is located next to the meter on the dosimeter unit. To read the power, however, it is first necessary that the machine be calibrated by the substitution of a calorimeter as the load.

By using calorimeters of different equivalent resistance, the patient power W_p can be measured for various values of E_2 and calibration number. Then, conversely, when a patient constitutes the load, the power input or dose-rate may be found by observing the calibration number and E_2 . The assumption is made, of course, that y_1 and y_2 vary

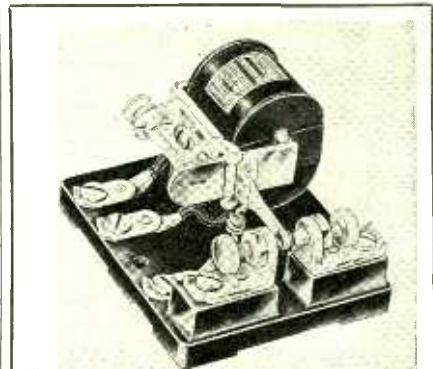

**ALLIED CIRCLE
SENSITIVE RELAY**

The Circle line of relays is a new addition to the growing line of Allied quality relays.

Rugged, precision made, assembled on moulded Bakelite base—has many mechanical and electrical features that assure long life under the most severe operating conditions.

Suitable for thermal regulators, electronic devices, ultra sensitive control circuits; in low current supervised circuits such as burglar and fire alarms, voltage control circuits, keying, tuning devices, etc.

Operating characteristics—for A.C.—as low as one mill at 110 volts, 60 cycles with a 50% drop out value; for D.C.—as low as .012 watts with 80% drop out value.

Dimensions—over-all 2 3/8" wide; 2 3/4" long; 1 3/4" high.

Also manufacturers of a complete line of relays for all communication and electronic uses.

Write for complete descriptive literature and prices.

ALLIED CONTROL CO., INC.
227 FULTON STREET NEW YORK CITY
Export Department:
Pan Mar Corp., 1270 Broadway, New York City

PROFESSIONAL SERVICES

(Rates on Application)

ELECTRICAL TESTING LABORATORIES

Characteristics of Vacuum Tubes
Tests of photo cells, glow lamps, crater lamps.
Tests of electronics and optical devices
East End Avenue and 79th Street
New York, N. Y.
Phone: Butterfield 8-2600

HAROLD J. McCREARY

Mem. A.I.E.E. & W.S.E.
Consulting Engineer
Laboratory Facilities
Research Electronics
Development Television
Design Radio
Factory Practice Railroad Signaling
Patent Studies Telephony
105 W. Adams St. Phone STate 4003 Chicago, Ill.

JOSEPH RAZEK, PH.D.

Consulting Physicist
Electrical and Mechanical Engineering Problems
Instruments and Control Devices Electronics
Specialist in Colorimetry, Spectrophotometry and
Industrial Color Control
Laboratory and Shop Facilities
430 Greenview Lane Llanerch, Pa.

F. H. SHEPARD, JR.

CONSULTING ENGINEER
ELECTRONIC APPLICATIONS
Specializing in:
Industrial Control Special Amplifier Design
Follow-Up Devices Photoelectric Applications
Radio and Carrier Operated Remote Control
6167 Cedar Ave., Merchantville, N. J.
Telephone Merchantville 1111

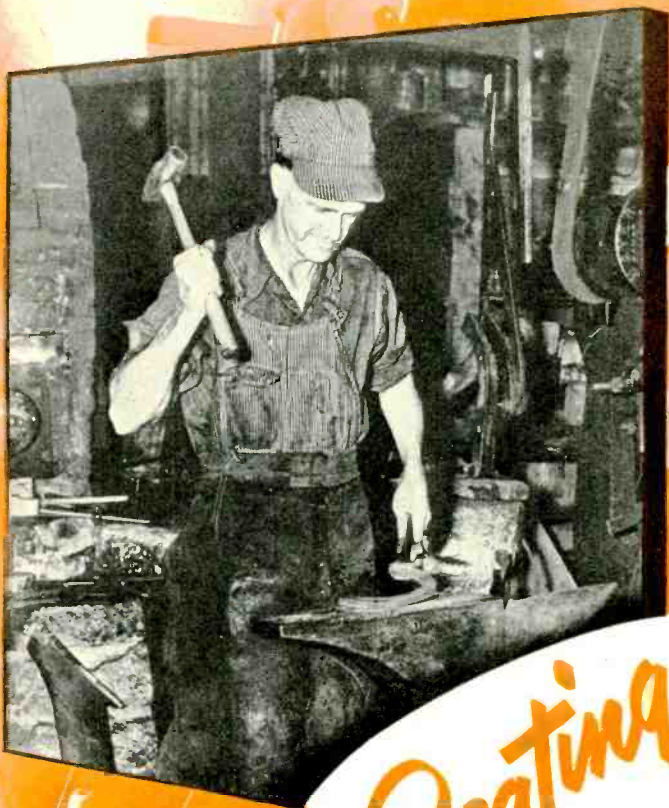

Beating
PLOWSHARES into SWORDS...

Today — is the work of an electronic equipped industry

● The Village Smithy *was* a mighty man, but he's definitely outdated in this era of lightning conquests.

When production for defense is needed today a highly efficient, coordinated group of industries swings into full speed. All the materials so vital for Adequate National Preparedness must be made quickly, efficiently and with no sacrifice of quality. Raw materials, machine tools, manpower — all these are necessary, but not enough. Human beings are not able physically or mentally to control, coordinate or inspect high speed or complicated processing and manufacturing.

Another element must be injected. This is the extraordinary little "master-mind" of industry and communications, the electron tube. As applied in industry for automatic controls and testing equipment it makes practical the mass production of all the necessities of a nation girding itself with arms and material.

For automatic machinery in the machine tool, armament, textile, shipbuilding, aircraft, and practically every other industry—for quick, accurate testing on production lines and in laboratories—for various uses in chemical mining and refining, in the petroleum industry, and naturally in the manufacture of electrical equipment—here the electron tube in one or many hundreds of its industrial applications furthers the productive quality, quantity, and skill of our nation.

The electronic industry has always been ahead of its day, pioneering in research and in the development of its own manufacturing facilities. Fortunately, too, as our nation strives for adequate preparedness with increasing demands on all industries. The manufacturers of electronic equipment are well prepared to meet any demand.

Far-sighted research and organization have made the electronic industry *prepared* for *preparedness*.

An Institutional Message from ELECTRONICS, the authoritative voice of the Electronic and Allied Industries.

THE ELECTRONIC INDUSTRY IS A VITAL ELEMENT IN NATIONAL DEFENSE

with respect to *R*, in the same way for both patient and calorimeter. This appears to be justified, since good agreement was obtained in calibrating the machine with a wide variety of calorimeters. Some were of the liquid filled type, the temperature rise per minute being observed, while others were of the lamp or resistance type. One calibration applies only to one frequency or small range of frequencies. For different frequencies, other calibrations are required.

Procedure

In using the dosimeter-diatherm, the procedure is as follows: With the machine off, the applicators are adjusted to the patient. The geometry of the applicators with respect to the patient is made so that the electric field will be strongest in the anatomical regions where the greatest heating is desired.

The applicators are moved away to remove the patient from the field. On this machine, the bracket supporting the entire dosimeter and applicators swings on a swivel and can be easily and quickly swung away from the patient, and at the

same time the applicator positions with respect to each other remain fixed. This is an important consideration in facilitating the power measurement since the patient is not required to alter his position.

The machine is then turned on and the patient circuit resonated. The sensitivity of the dose-rate meter is adjusted until the pointer gives a designated deflection. This is "0" on the scale marked "calibrate" as shown in Fig. 2. The applicators are then swung back in position on the patient and the circuit again resonated. The new reading on the "calibrate" scale is observed and the meter sensitivity control is set to this value. This control is graduated in arbitrary units which correspond to those on the "calibrate" scale on the meter.

The lower scale on the meter then reads the dose-rate directly in watts or calories per minute. This dose-rate can be adjusted to any desired value at any time during the treatment by changing the plate voltage control. Usually this is carried out at reduced plate voltage, after which the voltage is increased to give the desired dose-rate.

The dosimeter-diatherm has proven to be a very effective and thoroughly practical instrument. The dose-rate can be measured very quickly. An overall absolute accuracy of 10 per cent can be readily obtained. This is adequate for present applications and compares very favorably with the accuracies in x-ray therapy.

By specifying dose-rate, dose, wavelength, and applicator size and positions, a complete description of the treatment conditions is possible. On the basis of such information, significant comparisons with other workers can be made and the application of diathermy becomes a more exact technique.

The authors greatly appreciate the helpful suggestions received from Dr. Robert M. Whitmer of the Department of Physics of Purdue University.

¹E. P. Cumberbatch, "Diathermy", 3rd edition, p. 332.

²E. J. Mittelmann, "Dosimetry in short-wave therapy", *Arch. of Phys. Therapy*, Vol. 18, 1937, p. 613.

Mittelmann and Kobak, "Dosage measurement in short-wave diathermy", *Arch. of Phys. Therapy*, Vol. 19, 1938, p. 725.

E. J. Mittelmann, "Dosimetry in short-wave therapy", *Electronics*, Vol. 12, Nov. 1939, p. 52.

³J. D. Kraus, "Characteristics of Antennas With Closely-Spaced Elements", *Radio*, No. 236, Feb. 1939, p. 9; and "Antenna Arrays With Closely-Spaced Elements", *Proc. I. R. E.*, Vol. 28, Feb. 1940, p. 76.

HIGH GRADE USED
ELECTRON TUBE MACHINERY
Huge Stock of Every Type and Variety
KAHLE ENGINEERING CORPORATION
Specialists in Equipment for the manufacture of Neon Tubes, Radio Tubes, Incandescent Lamps, Photo Cells, X-ray Tubes, etc.
900 DeMott St., North Bergen, N. J.

DEPENDABLE
Used
ELECTRONIC TUBE EQUIPMENT
Complete line of used equipment for the manufacture of Radio Tubes, Neon Tubes, Incandescent Lamps, etc. Write for Bulletin showing 25 to 75% savings.
CALLITE TUNGSTEN CORPORATION
formerly Eisler Electric Corp.
534 39th Street, Union City, N. J.

POSITION VACANT

WANTED—Man experienced in all phases of X-Ray tube manufacture able to take complete charge of production. Position offers exceptional opportunity. Our employees know of this ad and all replies will be held confidential. Give complete information about your ability and experience. P-256, Electronics, 520 N. Michigan Ave., Chicago, Ill.

POSITIONS WANTED

RADIO ENGINEER, Physics Graduate, age 33, 7 1/2 years experience, High Vacuum Practice (experimental and industrial). Radio Tubes and Incandescent Lamps Manufacture. Local references. Available immediately, anywhere. PW-255, Electronics, 330 W. 42nd St., New York, N. Y.

RADIOTELEPHONE first experienced independent radio service man age 30. Anywhere New England, Electronic and public address experience. Desires operating; broadcast, coastal-ship telephone, or other. Pay secondary. R. C. A. Institute trained. Dependable. PW-257, Electronics, 330 W. 42nd St., New York, N. Y.

DEVELOPMENTAL, OR EXECUTIVE position desired by radio engineer and physicist, E. E. and Ph. D. degrees. 15 years experience in radio and industrial electronics. Special experience in development of testing equipments and measuring devices. Numerous scientific publications. PW-259, Electronics, 520 N. Michigan Ave., Chicago, Ill.

SEARCHLIGHT SECTION
(Classified Advertising)

EMPLOYMENT : BUSINESS : EQUIPMENT : USED OR RESALE

UNDISPLAYED	RATES	DISPLAYED
10 CENTS A WORD. MINIMUM CHARGE \$2.00 Positions Wanted (full or part time salaried employment only) 1/2 the above rates payable in advance. Box Numbers—Care of publication New York, Chicago or San Francisco offices count as 10 words. Discount of 10% if full payment is made in advance for 4 consecutive insertions.		Individual Spaces with border rules for prominent display of advertisements. The advertising rate is \$6.00 per inch for all advertising appearing on other than a contract basis. Contract rates quoted on request. An advertising inch is measured 7/8" vertically on a column—3 columns—30 inches to a page.

WANTED

FIELD MAN

Established manufacturer selling radio parts jobbers throughout the United States wants capable assistant to sales manager to aid factory representatives in territories from Coast to Coast. Will necessitate ten months per year in the field. Salary-expenses. Must be experienced—good personality—capable and STABLE. Give the whole story your first letter.

P-254, Electronics

520 No. Michigan Ave., Chicago, Ill.

POSITIONS WANTED

BROADCAST ENGINEER, 20, first class telephone, second class telegraph, two years experience in broadcast field, transmitter, studio control, announcing, regional network. Prefers middle west, but not necessary. Salary reasonable. Immediately available. Details on request. PW-258, Electronics, 520 N. Michigan Ave., Chicago, Ill.

REPRESENTATIVES AVAILABLE

For best informed sales representative in Government contract work write Riddell, 300 B-st., S.E., Washington, D.C.

(POSITIONS VACANT)

THE NATIONAL RESEARCH COUNCIL OF CANADA invites applications from British subjects for positions in the Radio Laboratory, Division of Physics and Electrical Engineering, for

I ENGINEERS

Qualifications—graduation in honours Physics, Engineering Physics or Electrical Engineering from a recognized university. Post-Graduate training and experience in Radio desirable. Experience in the design and operation of radio-frequency equipment. Experience in transmitter design and construction. Mathematical ability in the theoretical type of calculations arising from Radio work.

II RADIO TECHNICIANS

Qualifications—Technical School training or equivalent in Radio Communications, practical machine shop training an asset. Ability to construct transmitters and/or receivers and carry out preliminary tests.

Application forms may be obtained from the Secretary-Treasurer, National Research Council, Ottawa, Ontario, Canada.

Index to electronics—Volume XIII

January to December issues, inclusive, 1940

McGraw-Hill Publishing Company

330 West 42nd St., New York City

Aeronautics:

- Cathode-ray tube used as aircraft instrument indicator.....Mar. *36
- Tests of frequency modulation for aircraft communication. I. R. Weir Nov. *34
- Electro-sonic altimeter for aircraft. J. H. Jupe.....Apr. 54

Amplifiers:

- Amplidyne, a mechanical amplifier Apr. 54
- Amplifier for d-c galvanometers. A. W. Sear.....Jan. *28
- Distortion in compensated amplifiers. Trimmer & Liu.....July *22
- Feedback amplifier. Stewart & Pollock Feb. *19
- High fidelity recording amplifier. I. J. Abend.....Oct. *44
- Inverted amplifier. C. E. Strong.....July *14
- Negative feedback applied to oscillators. Samuel Sabaroff.....May *32
- Shunt-peaking compensation. W. H. Freeman (Ref. Sheets).....Jan. *35
- Volume expansion amplifier. C. G. McProud.....Aug. *17

Antennas:

- Dipoles and reflectors. Stanford Goldman.....May *20
- Directional antenna chart. W. S. Duttera (Ref. Sheets).....Feb. *33
- Double-fed antenna in police service. John Beall.....July *46
- Increasing radiation at low frequencies. M. G. Morgan.....July *33
- Multi-wire dipole antennas. J. D. Kraus.....Jan. *26
- Vertical vs horizontal polarization. G. H. Brown.....Oct. *20

Broadcasting:

- C. B. S. studios in the former Juilliard School.....Sept. *23
- Console for the small station transmitter house. Earl Travis.....July *36
- Differential modulation meter. V. V. Gunsolley.....Jan. *18
- Frequency modulation—a revolution in broadcasting?.....Jan. 10
- High frequency broadcast chart (Ref. Sheets).....Dec. 41
- WEAF, Port Washington station Sept. *20
- WOR's f-m station (on the air 105 hours per week).....Sept. *17

Capacitors:

- Capacitor discharge chart. Louis Hanopol.....June *41
- Testing ceramic capacitors. E. T. Sherwood.....Sept. *26

Cathode Rays:

- Cathode-ray alphabet machine. A. W. Friend.....June *40
- Cathode-ray frequency modulation generator. R. E. Shelby.....Feb. *14
- Improved cathode ray oscilloscope design. W. A. Geohagen.....Nov. *36
- Tube used as aircraft instrument indicator.....Mar. *36

Electron Tubes:

- Air cooling applied to external-anode tubes. E. M. Ostlund.....June *36
- High-sensitivity photosurface. Glover & Jones.....Aug. *26
- Index to list of tubes registered Jan. 1939-Jan. 1940.....Mar. 58
- Index to list of tubes listed, Jan. 1939-Dec. 1940.....Dec. 61
- X-ray tubes—design and application. Z. J. Atlee.....Oct. *26

Electron Tubes—Applications:

- Chronoscope, to test the velocity of rifle bullets. C. I. Bradford...Nov. *28
- Decade of electronics 1930-1940...Apr. 17
- Electron microscope developed at Camden.....May *38
- Electronic flow meter. J. M. Weinberger.....Jan. *30
- Electronic method for determining distribution curves. L. A. Ware...Oct. *36
- Electronic switch for fluorescent lamps. R. F. Hays.....May *14
- Feedback welding timer. J. Kurtz Apr. *47
- High-sensitivity phototube circuit. Bull & Laferty.....Nov. *31
- Indicating system for high voltage power packs. R. L. Hildebrand Oct. *38
- Light regulator. Britton Chance...Feb. *24
- Negative feedback applied to oscillators. Samuel Sabaroff.....May *32
- Operation of a self-excited inverter. F. N. Tompkins.....Sept. *36
- Phase inverter circuits. McProud & Wildermuth.....Oct. *50
- Quartz... from raw stock to finished crystal (picture feature).....Nov. *26
- Remote control of a model boat. W. P. West.....Aug. *19
- Simple pulse-generating circuits. Sashoff & Roberts.....Sept. *40
- Tubes and toothpaste. Craig Walsh Oct. *16
- Water level indicator. L. A. Ware Mar. *23

Electronics:

- Decade of electronics 1930-1940...Apr. 17
- Federal Communications Commission defense activities.....Nov. *16

Frequency Modulation:

- Cathode-ray frequency modulation generator. R. E. Shelby.....Feb. *14
- Design and performance of frequency modulation receivers. Marvin Hobbs Aug. *22
- Federal Communications Commission holds frequency modulation hearing.....Apr. *14
- Frequency modulation applied to a television system. C. W. Carnahan Feb. *26
- Interspersed frequency modulation and amplitude modulation in a television signal. A. V. Loughren Feb. *27
- Modulation limits in frequency modulation. Black & Scott.....Sept. *30
- Narrow band vs wide band in frequency modulation reception. M. L. Levy.....June *26
- Review of frequency modulation. Jan. 10
- State-wide f-m police network. D. E. Noble pt 1 Nov. *18, pt 2.....Dec. *28
- Tests of frequency modulation for aircraft communication. I. R. Weir Nov. *34
- Transmitting antenna is iced at Alpine. N. J.....May *19
- WOR's f-m station (on the air 105 hours per week).....Sept. *17

High Frequency:

- High frequency broadcast chart (Ref. Sheets).....Dec. 41
- Short wave inductance chart. F. C. Everett.....Mar. *33

Institute of Radio Engineers:

- Program for convention.....June *25
- Program of Fourth Pacific Coast convention.....Aug. 29
- Report of meeting.....July *17
- Rochester meeting report.....Dec. *24
- Program of Rochester fall meeting Oct. 35

Loudspeakers:

- Acoustic line loudspeakers. W. D. Phelps.....Mar. *30
- Coaxial loudspeaker. Benjamin Olney Apr. *32
- 27-in. loudspeaker at N. Y. World's Fair. R. T. Bozak.....June *22
- Vented speaker enclosure. C. E. Hoekstra.....Mar. *34

Measurements:

- Amplifier for d-c galvanometers. A. W. Sear.....Jan. *28
- Audio-frequency voltmeter. H. C. Likel.....Dec. *32
- Band-operative oscillator. Alan Bloch July *36
- Differential modulation meter. V. V. Gunsolley.....Jan. *18
- Dosemeter—diatherm measurements. Kraus & Teed.....Dec. *39
- Electronic flow meter. J. M. Weinberger.....Jan. *30
- Electronic method for determining distribution curves. L. A. Ware Oct. *36
- Logarithmic electronic voltmeter. P. J. Selgin.....Nov. *40
- Multi-frequency oscillator for audio testing. Jack Quinn.....May *23
- Radio-frequency power measurement. P. M. Honnell.....Jan. *21
- Stroboscope circuit. C. C. Street...Apr. *36
- Testing ceramic capacitors. E. T. Sherwood.....Sept. *26
- Tuning fork stabilization. Ernst Norrman.....Jan. *15
- Vacuum tube voltmeter for coaxial line measurements. G. L. Usselman July *32
- Visual alignment generator. H. F. Mayer.....Apr. *39
- Voltage control with non-linear Wheatstone bridge. Walther Richter June *20

Music:

- Artificial reverberation for electronic organ music.....Mar. *42
- Bell Laboratories demonstrates enhanced stereophonic recordings. May *30
- Electronic reed organ. F. D. Merrill, Jr.Apr. *42

Networks:

- Forty commonly used pads. Aaron Shelton (Ref. Sheets).....Apr. *53

Patents:

- How to write and understand patents. T. R. Goldsborough.....Feb. *10

Phonographs:

- Embossing at constant groove speed—a new recording technique. E. E. Griffin.....July *26
- Photoelectric tape recording.....May *16

Physics:

- Facts about atomic power.....July *12

Radio:

- Frequency assignments for the operation of radio (chart).....Sept.
- Highway radio on George Washington bridge.....Sept. *32
- State-wide f-m police network. D. E. Noble pt 1 Nov. *18, pt 2.....Dec. *28

* Illustrated

Receivers:

- Artificial ear for receiver testing. Stuart BallantineJune *34
- Frequency modulation receivers—design and performance. Marvin HobbsAug. *22
- Narrow band vs wide band in frequency modulation reception. M. L. LevyJune *26
- Panoramic reception.....June *14

Recording:

- High fidelity recording amplifier. I. J. Abend.....Oct. *44
- Recent improvements in recording. C. J. Lebel.....Sept. *33

Rectifiers:

- Full wave rectifier analysis. C. M. WallisMar. *19

Reference Sheets:

- Capacitor discharge chart. Louis HanopolJune *41
- Directional antenna chart. W. S. DutteraFeb. 33
- Filter design charts. John Borst pt 1 Aug. *35; pt 2 Oct. *39; pt 3 Nov. *41
- Forty commonly used pads. Aaron SheltonApr. *53
- High frequency broadcast chart. Dec. 41
- Short wave inductance chart. E. C. EverettMar. *33
- Shunt peaking compensation. W. H. FreemanJan. *35
- Square wave harmonics. D. L. Herr May *34

Relays:

- Electronic relay tester. S. Bagno Sept. *44
- For electronic circuits.....Aug. *13
- Magnetic relays. A. B. Lamb.....Dec. *35

Telephony, narrow-band carrier. J. A. CsepelyMar. *14

Television:

- British vision receivers. W. J. Brown Mar. *26
- Business side of television. N. E. KerstaMar. *10
- Color television demonstrated by CBS engineersOct. *32
- DuMont proposals.....Feb. *22
- Federal Communications Commission and television.....May *11
- Frequency modulation applied to a television system. C. W. Carnahan Feb. *26
- Interspersed frequency modulation and amplitude modulation in a television signal. A. V. Loughren Feb. *27
- National Television Systems Committee organizes.....Aug. *34
- Picture signal generator. Wilder & Brustman pt 1 Apr. *25; pt 2 May *26; pt 3 June *30; pt 4 July *28; pt 5 Aug. *30
- Pre-selector circuit for television receivers. B. F. Tyson.....Nov. *23
- Receivers for television using electrostatic deflection. T. T. Goldsmith, Jr.June *16
- Shunt-peaking compensation. W. H. Freeman (Ref. Sheets)Jan. *35
- Square wave harmonics. D. L. Herr (Ref. Sheets)May *34
- Television changeoverOct. *24
- Television technique adopted in photographing sun's corona.....Feb. *34

Timer:

- Chronoscope, to test the velocity of rifle bullets. C. I. Bradford...Nov. *23

Transmitters:

- Flexible beam power transmitter. E. F. Klernan.....Aug. *40

War:

- Defense set-up for the communications industry.....Nov. *16
- Industry organizes for national defense. J. H. McGraw, Jr.June 24a

AUTHORS INDEX

Authors:

- ABEND, I. J. High fidelity recording amplifierOct. *44
- Atlee, Zed J. Design and application of x-ray tubes.....Oct. *26

- BAGNO, S. Electronic relay tester..Sept. *44
- Ballantine, Stuart. Receiver testing with an "artificial ear".....June *34
- Barcus, L. M. Bass compensation by screen-grid injection.....June *44
- Beall, John. Double-fed antenna in police serviceJuly *46
- Bissmire, H. T. & T. J. Rehfisch. Calibration circuit for audio oscillators June 48
- Black, L. J. & H. J. Scott. Modulation limits in frequency modulation Sept. *30
- Bloch, Alan. Band-operative oscillator July *36
- Borst, John. Filter design charts pt 1 Aug. *35; pt 2 Oct. *39; pt 3 Nov. *41
- Bozak, R. T. Design of a 27-inch loud-speakerJune *22
- Bradford, C. I. Chronoscope.....Nov. *28
- Brown, George H. Vertical vs horizontal polarizationOct. *20
- Brown, W. J. British vision receivers Mar. *26
- Brustman, J. A. & M. P. Wilder. Picture signal generator pt 1 Apr. *25; pt 2 May *26; pt 3 June *30; pt 4 July *28; pt 5Aug. *30
- Bull, H. S. & J. M. Lafferty. High sensitivity phototube circuit..Nov. *31

- CARNAHAN, C. W. Frequency modulation applied to a television systemFeb. *26
- Chance, Britton. Light regulator..Feb. *24
- Csepely, John A. Narrow-band carrier telephonyMar. *14

- DUTTERA, WILLIAM S. Directional antenna chart.....Feb. 33

- EVERETT, FREDERICK C. Short wave inductance chart.....Mar. *33

- FREEMAN, WILLIAM H. Shunt-peaking compensationJan. *35
- Friend, Albert W. Cathode-ray alphabet machineJune *40

- GEOHAGEN, WILLIAM A. An improved c-r oscilloscope design.....Nov. *36
- Glover, A. M. & R. B. James. New high-sensitivity photosurface.....Aug. *26
- Goldman, Stanford. Dipoles and reflectors May *20
- Goldsborough, Thad R. Patents—how to write and understand them..Feb. *10
- Goldsmith, Thomas T. Jr. Television receivers using electrostatic deflectionJune *16
- Griffin, E. E. Embossing at constant groove speed—a new recording techniqueJuly *26
- Gunsolley, Verne V. Differential modulation meterJan. *18

- HANOPOL, LOUIS. Capacitor discharge chartJune *41
- Hays, R. F. Electronic switch for fluorescent lamps.....May *14
- Herr, Donald L. Square wave harmonics May *34
- Hildebrand, R. L. Indicating system for high voltage power packs..Oct. *38
- Hobbs, Marvin. F-M receivers—design and performance.....Aug. *22
- Hoekstra, C. E. Vented speaker enclosure Mar. *34
- Honnell, P. M. Radio-frequency power measurementJan. *21

- JANES, R. B. & A. M. GLOVER. New High sensitivity photosurfaceAug. *26
- Jupe, John H. Electro-sonic altimeter for aircraft.....Apr. 54

- KERSTA, NORAN E. Business side of televisionMar. *10
- Klernan, E. F. Flexible beam power transmitterAug. *40
- Kraus, John D. Multi-wire dipole antennasJan. *26
- Kraus, J. D. & Dr. R. W. Teed. Dose meter—diatherm measurements Dec. *29
- Kurtz, J. Feedback welding timer..Apr. *47

- L AFFERTY, J. M. & H. S. BULL. High-sensitivity phototube circuit Nov. *31
- Lamb, Anthony B. Magnetic relays..Dec. *35
- Lebel, C. J. Recent improvements in recordingSept. *33
- Likel, Henry C. Audio-frequency voltmeterDec. *32
- Loughren, A. V. Interspersed frequency modulation and amplitude modulation in a television signal..Feb. *27

- Levy, M. L. Narrow band vs wide band in f-m reception.....June *26
- Liu, Y. J. & J. D. Trimmer. Distortion in compensated amplifiers..July *22

- MAYER, H. F. Visual alignment generatorApr. *39
- McGraw, James H. Jr. Challenge to industry's patriotism.....Sept. 22a
- Industry organizes for national defenseJune 24a
- McProud, C. G. Volume expansion with a triode.....Aug. *17
- McProud, C. G. & R. T. Wildermuth. Phase inverter circuits.....Oct. *50
- Merrill, Frederic D. Jr. Design for an electronic reed organ.....Apr. *42
- Morgan, Millett G. Increasing radiator at low frequencies.....July *33

- NOBLE, DANIEL E. State-wide f-m police network pt 1 Nov. *18; pt 2Dec. *28
- Norrman, Ernst. Tuning fork stabilization Jan. *15

- OLNEY, BENJAMIN. Coaxial loud-speakerApr. *32
- Ostlund, E. M. Air cooling applied to external-anode tubes.....June *36

- PHELPS, WILLIAM D. Acoustic line loudspeakersMar. *30
- Pollock, H. S. & H. H. Stewart. Compression with feedback.....Feb. *19

- QUINN, JACK. Multi-frequency oscillator for audio testing.....May *23

- RAJCHMAN, J. A. & R. L. SNYDER. Electron multiplier.....Dec. *20
- Rehfisch, T. J. & H. T. Bissmire. Calibration circuit for audio oscillatorsJune 48
- Richter, Walther. Voltage control with a non-linear Wheatstone bridge June *20
- Roberts, W. K. & S. P. Sashoff. Simple pulse generating circuits....Sept. *40

- SABAROFF, SAMUEL. Negative feedback applied to oscillators..May *32
- Sashoff, S. P. & W. K. Roberts. Simple pulse generating circuits...Sept. *40
- Scott, H. J. & L. J. Black. Modulation limits in frequency modulation Sept. *30
- Sear, Arthur W. An amplifier for d-c galvanometersJan. *28
- Selgin, Paul J. New logarithmic electronic voltmeter.....Nov. *40
- Shelby, Robert E. Cathod-ray frequency modulation generator.....Feb. *14
- Shelton, Aaron. Forty commonly used padsApr. *53
- Sherwood, E. T. Testing ceramic capacitorsSept. *20
- Snyder, R. L. & J. A. Rajchman. Electron multiplierDec. *20
- Stewart, H. H. & H. S. Pollock. Compression with feedback.....Feb. *19
- Street, C. C. Practical stroboscope circuit Apr. *36
- Strong, C. E. Inverted amplifier.....July *14

- TEED, DR. R. WALLACE & J. D. KRAUS. Dosimeter—diatherm measurementsDec. *39
- Tompkins, Frederick N. Operation of a self-excited inverter.....Sept. *36
- Travis, Earl. Console for the small station transmitter house.....July *36
- Trimmer, J. D. & Y. J. Liu. Distortion in compensated amplifiers...July *22
- Tyson, Benjamin F. Pre-selector circuit for television receivers.....Nov. *23

- USSELMAN, G. L. Vacuum tube voltmeter for coaxial line measurementsJuly *32

- WALLIS, C. M. Full wave rectifier analysisMar. *19
- Walsh, Craig. Tubes and toothpaste..Oct. *16
- Ware, L. A. Electronic method for determining distribution curves..Oct. *36
- Water level indicator.....Mar. *23
- Weinberger, Joseph M. Electronic flow meterJan. *30
- Weir, I. R. Tests of f-m for aircraft communicationNov. *34
- West, William P. Remote control of a model boat.....Aug. *19
- Wilder, M. P. & J. A. Brustman. Picture signal generator pt 1 Apr. *25; pt 2 May *26; pt 3 June *30; pt 4 July *28; pt 5Aug. *30
- Wildermuth, R. T. & C. G. McProud. Phase inverter circuits.....Oct. *50

CONTACTS

FOR THE FIELD OF ELECTRONICS



SEASONS GREETINGS AND BEST WISHES

from CHARLES EISLER, President

EISLER ENGINEERING COMPANY

751 So. 13th St. (near Avon Ave.)

Newark, New Jersey



RELAYS

AND

CONTROL ACCESSORIES

- POWER
 - LATCHING
 - TELEPHONE
 - TIME DELAY
 - PLATE CIRCUIT
 - PHOTO CELLS
 - CAPACITY RELAYS
 - COUNTERS
- IN STOCK

TECHNICAL ASSISTANCE AND LAB. FACILITIES AT YOUR DISPOSAL . . .

DOUGLAS RADIO

89 Cortlandt St.

New York, N. Y.

BA. 7-3956

TOM WAITE

ROS. AMMON

A C T O N E

CUTTING STYLI

For recording direct on all coated aluminum or paper base discs. Individually lapped for a quiet, high quality cut.

H. W. ACTON CO., Inc., 370 7th Ave., New York

SIGNICO

SIGNAL & INDICATOR PILOT LIGHTS

for all electrical devices.

WRITE FOR CATALOGUE showing a complete line of assemblies for all purposes.

SIGNAL INDICATOR Corp.
140 CEDAR ST. NEW YORK, N. Y.

TRANSMITTING TUBE PARTS

"The Engineering Co." of Newark, N. J., Inc.

SPECIALISTS IN TUNGSTEN AND MOLYBDENUM WELDS—LEAD-IN WIRES MATERIAL AND WORKMANSHIP GUARANTEED—WE USE THE BEST ALWAYS.

59 Branford Street Newark, N. J. D. Kondakjian, Pres. Est. 18 Years

CONSOLIDATED ENGINEERING CORPORATION

ELECTRONIC ★ OPTICAL ★ VIBRATION ENGINEERING AND RESEARCH

INSTRUMENT DEVELOPMENT AND MANUFACTURE ★ PATENT STUDIES

1255 EAST GREEN STREET - PASADENA, CALIFORNIA

? Find what you are looking for? **?**
If this or other advertising in this issue does not supply the information of products wanted write

Electronics
330 West 42nd St., New York City

MICROMETER

for checking transmitters, from 1.5 to 56 mc., within 0.01 per cent.

LAMPKIN LABORATORIES
—Bradenton, Fla., U. S. A.—

With Offices in 80 Cities

GRAYBAR ELECTRIC COMPANY

DISTRIBUTES HIGH GRADE KIRKLAND PILOT-LIGHTS

To manufacturers of high grade apparatus, who cannot afford to be judged by the standards of the retail bargain counters. Underwriter's Approved Units in three lens sizes, 2", 1 1/16", 11/16", for Tungsten or Neon lamps.

WRITE FOR TEN PAGE CATALOGUE

MFGD BY H. R. KIRKLAND CO., MORRISTOWN, N. J.

"What Can It Do For Me?"

Advertising that is read with this thought in mind, may provide the solution to a problem that has kept you awake nights for weeks.

Remember, back of the signature of every Electronics advertiser is another organization, whose members have thought long and hard about your business in the course of introducing and applying their products or services to your industry.

If their offerings can improve the quality of your company's product . . . or save your company's money . . . they can contribute to your company's income.

We all know, "It pays to advertise." It pays just as big to investigate what is advertised!

Each month, Electronics advertisers, old and new, invite you and over 14,000 other subscribers to investigate further the advantages they can provide.

**Departmental Staff
ELECTRONICS**

FINE RIBBONS

of Tungsten, Molybdenum and Special Alloys

To your specifications

H. CROSS
15 BEEKMAN ST. NEW YORK

FILTERS—EQUALIZERS

Lattice Bridged-T Paralleled-T etc. Designed and manufactured

Submit your filter problem

HOLLYWOOD TRANSFORMER CO.
7364 Melrose Ave. Hollywood, Calif.

QUALITY ABOVE ALL

SOLAR

CAPACITORS

Write for Catalog
SOLAR MFG. CORP.
BAYONNE, N. J.

"RELAYED-FLUX"

Microdyne



MOST important wide range development since the advent of the pick-up in 1926. The "RELAYED-FLUX" principle makes possible a moving system, far beyond anything yet devised . . . a system that actually approaches the theoretical ideal of zero mass . . . a system capable of reproducing all the fine detail engraved at the original recording.

- Flat within $\pm 1\frac{1}{2}$ db to over 10,000 cycles.
- Delivers consistently uniform response, with the sharp, clean-cut definition of the finest Moving-Inductor system.
- Vibratory - Momentum near vanishing point.
- Absence of distortion.
- Free-floating stylus.
- Designed for and equipped with Jewel-Point
- Point-pressure about 18 grams.
- Immune to climatic changes.
- Complete with arm.

With Our Compliments

A revised copy of "PICKUP FACTS" is yours for the asking. It answers many of the questions you want to know on record reproduction.

Also write for details on the NEW AUDAX HIGH FIDELITY CUTTERS.

Microdyne models for every purpose.

AUDAK COMPANY
500 Fifth Avenue New York City
"Creators of High Grade Electrical and Acoustical Apparatus Since 1915"

INDEX TO ADVERTISERS

A		K	
Acme Electric & Mfg. Co.	71	Kellogg Switchboard & Supply Co.	78
Acton Co., Inc., H. W.	87	Kenyon Transformer Co.	76
Advance Electric Co.	60	Kirkland Co., H. R.	87
Aerovox Corp.	71	Kurman Electric Co.	58
Allied Control Co.	82		
American Lava Corp.	6	L	
American Screw Co.	8	Lampkin Laboratories	87
American Transformer Co.	47	Lamson & Sessions Co.	8
Amperex Electronic Products, Inc.	Inside Front Cover	Lapp Insulator Co.	9
Audak Company	88	Lingo & Son, Inc., John E.	70
Automatic Electric Co.	56	M	
		Magnetic Windings Co.	66
B		Mallory & Co., Inc., P. R.	14
Bakelite Corp.	12	McGraw-Hill Book Co., Inc.	80
Ballantine Laboratories, Inc.	60	Millen Mfg. Co., Inc., James	82
Biddle Co., James G.	66	N	
Bliley Electric Co.	73	National Screw & Mfg. Co.	8
Bradley Laboratories	63	O	
Bud Radio, Inc.	64	Oxford-Tartak Radio Corp.	77
		P	
C		Parker-Kalon Corp.	8
Callite Tungsten Corp.	46	Pheoll Mfg. Co.	8
Capitol Radio Engineering Institute.	79	Phillips Screws	8
Carborundum Co.	58	Pioneer Gen-E-Motor Corp.	56
Carter Motor Co.	65	Precision Apparatus Co.	80
Centralab Div., Globe-Union, Inc.	2	Precision Tube Co.	75
Cinch Manufacturing Corp.	43	R	
Clark Controller Co.	5	Radio Corp. of America	57
Clarostat Mfg. Co.	68	RCA Mfg. Co.	3, Back Cover
Consolidated Engineering Corp.	87	Raytheon Mfg. Co.	64
Continental Electric Co.	71	Remler Co., Ltd.	77
Continental Screw Co.	8	Russell, Burdsall & Ward Bolt & Nut Co.	8
Corbin Screw Corp.	8	S	
Cornell-Dubilier Electric Corp.	Inside Back Cover	Scovill Mfg. Co.	8
Cross, H.	87	Selectar Mfg. Corp.	81
		Shakeproof Lock Washer Co.	8
D		Shallcross Mfg. Co.	72
Daven Co.	78	Signal Indicator Corp.	87
Driver Co., Wilbur B.	65	Sola Electric Co.	82
Du Mont Labs., Allen B.	75	Solar Mfg. Corp.	87
Du Pont de Nemours & Co., E. I.	4	Standard Pressed Steel Co.	70
Dunn, Inc., Struthers	79	T	
Douglas Radio	87	Thomas & Skinner Steel Pds. Co.	78
		Triplett Electrical Instrument Co.	65
E		Tubular Rivet & Stud Co.	48
Eisler Engineering Co.	87	U	
Eitel-McCullough, Inc.	49	Union Carbide & Carbon Corp.	12
Electrical Research Products, Inc.	79	W	
Engineering Co. of Newark, N. J.	87	Western Electric Co.	44, 45
The Erie Resistor Corp.	55	Weston Electrical Instrument Corp.	10
		White Dental Mfg. Co., S. S.	52
F		Wilson Co., H. A.	77
Fairchild Aviation Corp.	50	Wrought Washer Mfg. Co.	63
Formica Insulation Co.	11	Z	
		Zophar Mills, Inc.	70
G			
Gardiner Metal Co.	81	Professional Services	82
General Electric Co.	7, 53, 54		
Guardian Electric Mfg. Co.	69	SEARCHLIGHT SECTION	
		(Classified Advertising)	
H		EMPLOYMENT	84
Hallicrafters, Inc.	66	USED EQUIPMENT FOR SALE	
Heinemann Circuit Breaker Co.	73	Callite Tungsten Corp.	84
Heintz & Kaufman Ltd.	81	Kahle Engineering Corp.	84
Hewlett-Packard Co.	76		
Hollywood Transformer Co.	87		
Hudson Wire Co.	69		
I			
Industrial Timer Corp.	60		
International Nickel Co.	51		
International Resistance Co.	13		
J			
Jones, Howard B.	81		

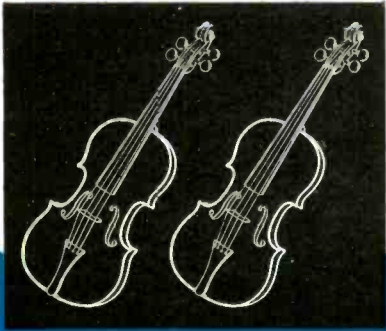

ONE VIOLIN looks like another. It takes a skilled musician to recognize the Stradivarius. He sees the *hidden* quality. In capacitors, too, *quality* lies hidden. The thing that gives you extra service is found in capacitor ingredients.

EXTRA SERVICE!

That's the reason..

THERE ARE MORE CORNELL-DUBILIER CAPACITORS IN USE THAN ANY OTHER MAKE

YOU get more for your money when you specify Cornell-Dubilier capacitors. An extra measure of value that's hidden in C-D ingredients. Thirty years of experience put it there. And the longer these capacitors remain in service, the more you realize how much Cornell-Dubilier experience means—in extra performance, extra long life and extra savings. Next time, don't be fooled by "looks" . . . demand the capacitor that's different where difference counts—and get the extra service built into modern C-D's.

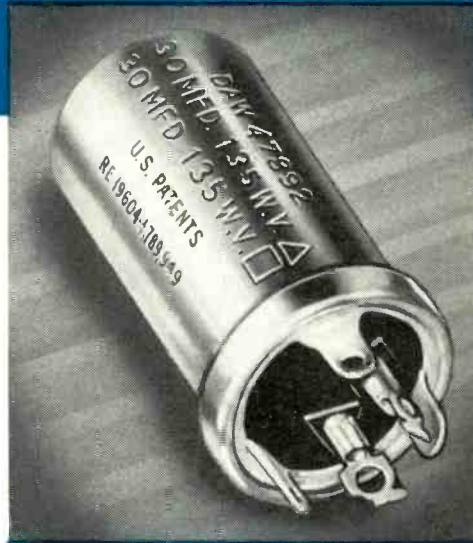

Only Cornell-Dubilier Electrolytics offer all these **EXTRA FEATURES!**

- Special high voltage paper separator
- C-D etched plate
- Special C-D electrolyte
- Special high formation process



For complete technical information, write for engineering bulletin 170.

**CORNELL-DUBILIER
ELECTRIC CORPORATION**

1006 HAMILTON BLVD. • 50 PLAINFIELD, N. J.

REMEMBER! Only C-D union-made capacitors give you the EXTRAS at no extra cost.

Get the extras

— WITH CORNELL-DUBILIER CAPACITORS!

for SOUND ECONOMY

...RCA AIR-RADIATOR TRANSMITTING TRIODES

Hundreds of RCA-891-R's and 892-R's in daily service in leading broadcast stations testify to the sound economy of operation made possible by these popular RCA Air-Radiator Transmitting Triodes. Lower first cost—simplified installation—no water-cooling worries—ample output for general broadcast requirements!

Similar in construction to water-cooled units, these tubes are equipped with highly efficient air radiators which provide great cooling areas in a minimum of space. Anode heat is dissipated quickly and efficiently.

Double-unit filaments permit operation from two-phase a.c., thus minimizing hum. Filaments used in these types operate at lower-than-ordinary temperatures and contribute materially to exceptionally long tube life. Ask the station that uses these tubes!

Both the RCA-891-R and 892-R are designed for class B and class C services. The 891-R may also be used in class A. Amplification factor of the 891-R is 8; the 892-R, 50. Maximum ratings of the 891-R for plate modulated class C telephone service are: d-c plate voltage, 8500 volts; d-c plate current, 1 ampere; plate input, 8 kw; plate dissipation, 2.5 kw. Typical power output is 3.5 kw. Net replacement costs compare favorably with water-cooled tubes of equal size.

Complete technical information gladly sent upon request. Write to RCA Mfg. Co., Commercial Engineering Section, RCA Manufacturing Company, Inc., Harrison, N. J.

NEW!

This Triode Takes its Full Rated
Input of 50 Watts up to 500 Mc.

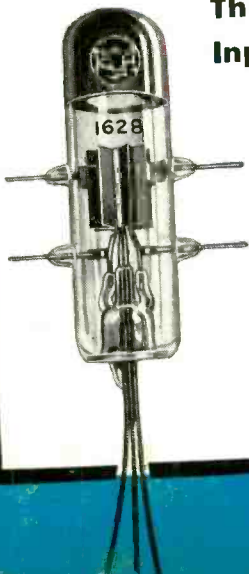

Outstanding engineering features make the new RCA-1628 Transmitting Triode unexcelled in its class. A double-helical filament has a center-tap lead that is brought out of the bulb through a separate seal. By connecting the three filament leads in parallel through r-f by-pass condensers, it is now practical to minimize the effect of filament lead inductance at ultra-high frequencies. Double grid and plate leads, also brought out through separate seals, simplify neutralization in r-f amplifier service at the ultra highs by eliminating common impedances between tank and neutralizing circuits within the tube. Close spacing of grid and plate decreases electron transit time, thereby improving efficiency at high frequencies.

Data bulletin on request



No Experiments Here!

As essential to the operation of Air-Radiator tubes as good tube construction itself, is the design of the finned radiator with which they are equipped. Pioneered and perfected by RCA, each radiator supplied with RCA-891-R's and 892-R's carries the fine reputation which has been established through more than four years of extensive use in many of the country's leading high-power broadcasting stations. Exceptionally low operating temperatures are assured at all times. For real economy, it pays to invest in experience—*not* experiments!

Radio Tubes

FIRST IN METAL—FOREMOST IN CLASS—FINEST IN PERFORMANCE

RCA MANUFACTURING CO., INC., CAMDEN, N. J.

A Service of The Radio Corporation of America