

electronics

radio, communication, industrial applications of electron tubes . . . engineering and manufacture



**JANUARY
1940**

**Price
50 Cents**

**McGRAW-HILL
PUBLISHING
COMPANY, INC.**



For HIGHER FIDELITY



● UTC MODEL 3A EQUALIZER

The UTC 3A equalizer is an ideal universal equalizer for broadcast and recording service. It combines tap switches and pad controls permitting accurately controlled equalization up to 25 DB at both low and high frequencies. This unit will equalize telephone lines, pickups, cutting heads, sound on film, and other applications of similar nature. Net price to broadcast stations \$85

● MODEL 3D UNIVERSAL ATTENUATOR

The UTC model 3D attenuator is similar to the 3A equalizer, but is designed to ATTENUATE the low or high frequencies. The low frequency control consists of a switch for adjusting the point at which cutoff starts to 100, 175 or 250 cycles, and a calibrated pad control to adjust the slope of the attenuation curve. The high frequency portion is tapped at 4,000, 6,000, 8,000 and 10,000 cycles with a similar attenuation control. This type of equalizer finds many applications in recording, dialogue equalization, and P. A.—theatre applications. Net price to broadcast stations \$75

● MODEL 4B SOUND EFFECTS FILTER

The UTC model 4B filter is an improved design based on the sound effects filter developed by UTC for the Columbia Broadcasting System. The low pass control has cutoff frequencies of 500, 1,000, 2,000, and 3,000 cycles and incorporates a pad control to govern the rapidity of attenuation. The high pass section has a switch for cutoff frequencies of 500, 1,000, 2,000, and 4,000 cycles, with a calibrated attenuator. Net price to broadcast stations \$70

It is significant, that on the whole, difficult transformer jobs find their way to UTC — jobs requiring unusual engineering ingenuity; improved design methods; advanced production technique and equipment.

These typically UTC features, augmented by continuous research, are incorporated in both standard and special products.

Each of the UTC lines is distinguished by individual characteristics ideally suiting the items to the specific applications intended.

LINEAR STANDARD TRANSFORMERS

UTC linear standard transformers are available in sizes from minus 130 DB operating level to 50 kw. All standard units are guaranteed to be ± 1 DB from 30 to 20,000 cycles. The UTC LS-10 input transformer illustrated above incorporates trialloy magnetic filtering, which, combined with the UTC hum balanced coil structure, assures lowest hum pickup ever attained in a standard input transformer.

Write for Bulletin BC-1

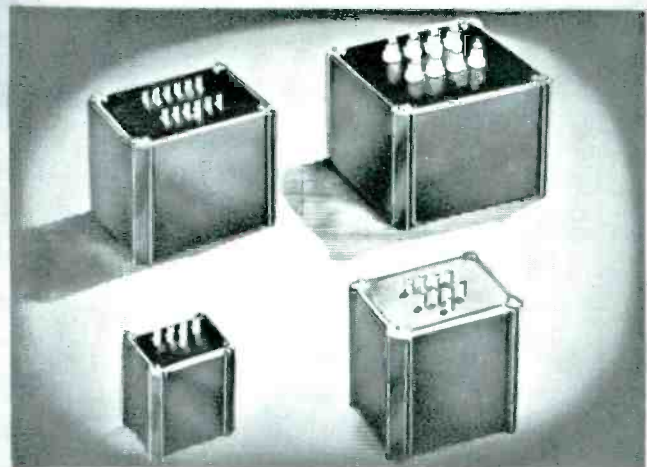

UNITED TRANSFORMER CORP.

Write: ENGINEERING DIV. ★ 150 VARICK ST. ★ NEW YORK, N. Y.
EXPORT DIVISION: 100 VARICK STREET NEW YORK, N. Y. CABLES: "ARLAB"

A McGRAW-HILL PUBLICATION

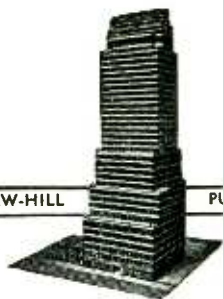

electronics

CONTENTS—JANUARY, 1940

RADIO . . . COMMUNICATION AND
INDUSTRIAL APPLICATIONS OF
ELECTRON TUBES . . . DESIGN . . .
ENGINEERING . . . MANUFACTURE

KEITH HENNEY
Editor

DONALD G. FINK
Managing Editor

BEVERLY DUDLEY
Associate Editor

CRAIG WALSH
Assistant Editor

M. L. MATTEY
Assistant Editor

J. M. HERON
Assistant Editor

HARRY PHILLIPS
Art Director

H. W. MATEER
Manager

ELECTRONICS, January, 1940, Vol. 13, No. 1.
Published monthly, price 50c a copy. Subscription
rates—United States and possessions, Canada,
Mexico and Central American countries, \$5.00 a
year. All other countries, \$6.00 a year or 36
shillings. Entered as Second Class matter, August
29, 1936, at Post Office, Albany, N. Y., under
the Act of March 3, 1879.
Branch Offices: 520 North Michigan Ave., Chicago;
68 Post Street, San Francisco; Aldwych House,
Aldwych, London, W. C. 2; Washington; Phila-
delphia; Cleveland; Detroit; St. Louis; Boston;
Atlanta, Ga.

Contents Copyright, 1940, by
McGraw-Hill Publishing Company, Inc.

McGRAW-HILL
PUBLISHING COMPANY, INC.

JAMES H. MCGRAW
Founder and Honorary Chairman

Publication Office
99-129 North Broadway, Albany, N. Y.
U. S. A.

Editorial and Executive Offices
330 West 42nd St., New York, N. Y., U. S. A.

James H. McGraw, Jr., President
Howard Ehrlich, Executive Vice President
Mason Britton, Vice Chairman
B. R. Putnam, Treasurer
D. C. McGraw, Secretary
J. E. Blackburn, Jr., Director of Circulation

Cable Address:
MCGRAWHILL, New York
Member A.B.P. Member A.B.C.

THE PIT AND THE PENDULUM Cover

Sound test chamber at Johns-Manville Laboratories. A loudspeaker swinging on a pendulum, to avoid standing waves, is used to test sound-proofing of a section of airplane fuselage

FREQUENCY MODULATION—A REVOLUTION IN BROADCAST- ING? 10

A review of the facts and conjectures concerning the most-talked-of topic in radio engineering at present

TUNING FORK STABILIZATION, by Ernst Norrman 15

Two methods of increasing frequency stability of tuning forks by tempering and by driving circuit design

A DIFFERENTIAL MODULATOR METER, by Verne V. Gunsolley . . 18

A means of balancing a-c and d-c components in the cathode circuit of the measuring tube

R-F POWER MEASUREMENTS, by P. M. Honnell 21

Use of a diode rectifier and wattmeter combination to measure r-f power simply, either directly or by the "loading-back" method

KLYSTRONS 25

Two forms of the new centimeter-wave tubes, for receiving as well as transmitting. Photographs by Thurlow M. Gordon, Jr.

MULTI-WIRE ANTENNAS, by John D. Kraus 26

High frequency dipole structures having high impedance termination points to which open-wire lines may be connected without a transformer

AMPLIFIER FOR A D-C GALVANOMETER, by Arthur W. Sear . . . 28

A tube circuit for permitting use of rapidly-moving meters in galvanometer measurements

AN ELECTRONIC FLOW METER, by Joseph M. Weinberger 30

Application of a photoelectric indicator to a Venturi-tube flow meter

SHUNT-PEAKING COMPENSATION, by William H. Freeman . . . 35

A chart for computing the shunt compensation inductance in a video amplifier, in terms of circuit elements and frequency range

DEPARTMENTS

CROSSTALK	9
TUBES AT WORK	32
REFERENCE SHEET	35
TUBES	56
THE ELECTRON ART	68
THE INDUSTRY IN REVIEW	75
PATENTS	84
INDEX TO ADVERTISERS	84

FIXED RESISTOR

CERAMIC CAPACITOR

WAVE BAND SWITCH

RADIOHM

"FOUR". MOST

FAMOUS MEMBERS OF A FAMOUS FAMILY

Numerology plays no part in our business . . . but we can't refrain from admitting that this foursome is so superior that we simply must "play on words" in this advertisement.

Individually, or collectively they represent the ultimate in **QUALITY**, workmanship, and precision engineering.

In the serviceman's shop, or on the block-long production line . . . It pays to **SPECIFY CENTRALAB.**

RADIOHM
In standard or midget . . . low noise level . . . long life.

FIXED RESISTOR
Insulating and conducting area baked together into one . . . copper sprayed end connection.

CERAMIC CAPACITOR
Where permanence or temperature compensation is important.

WAVE BAND SWITCHES
In Isolantite or Bakelite . . . available in various combinations.

Centralab
CRL

Division of **GLOBE-UNION, Inc.**, Milwaukee, Wis.
August 1939 — **ELECTRONICS**

In '40 as in '39.

36

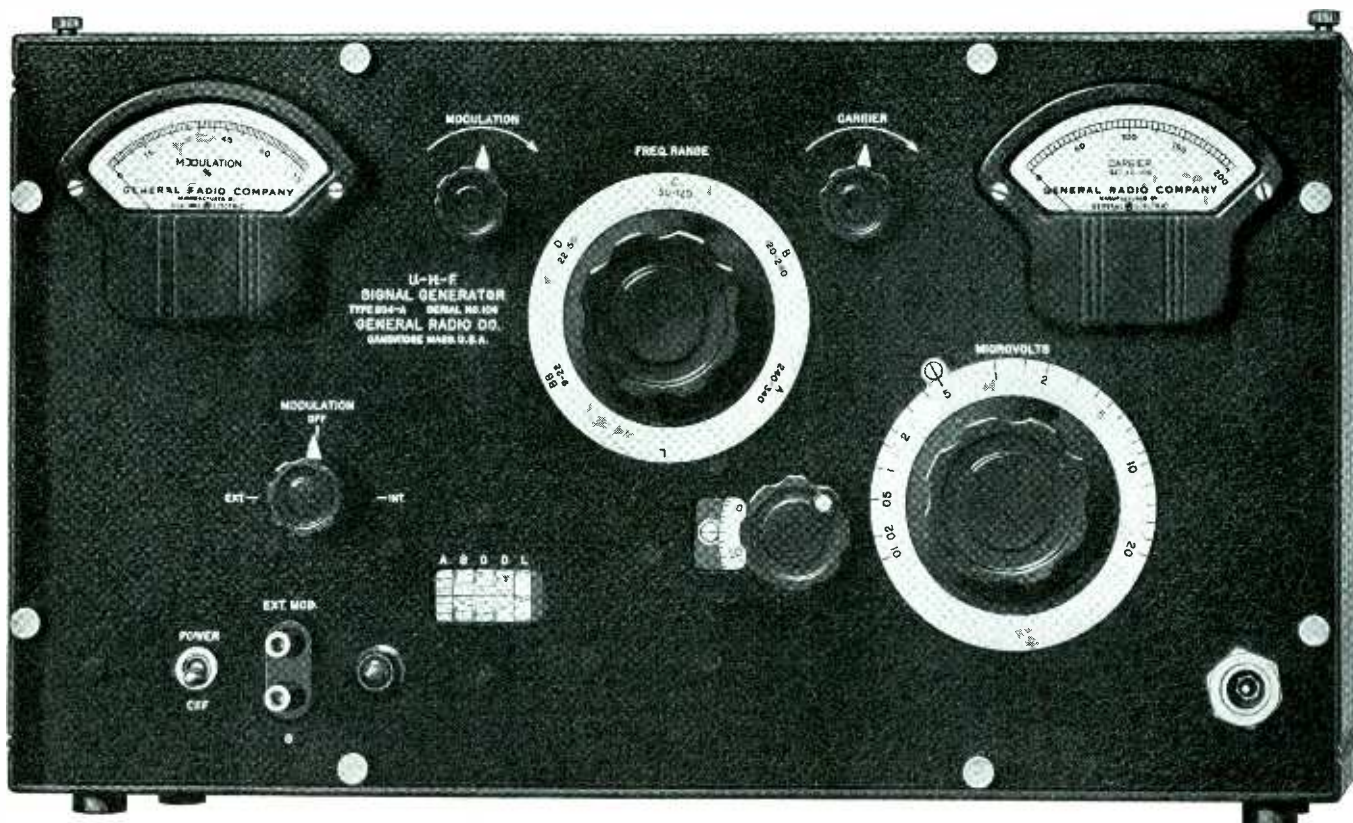

NEW ULTRA-HIGH-FREQUENCY SIGNAL GENERATOR

THE development of ultra-high-frequency communication equipment for frequencies up to 300 Mc has been seriously retarded by the lack of satisfactory test equipment.

General Radio announces a new signal generator for use at frequencies between 7.5 Mc and 320 Mc. This signal generator has a number of unique mechanical and electrical features which include very compact oscillator circuit; unique rotatable coil system; new capacitive attenuator with alignment plates to present constant capacitance to the oscillator and eliminate changes in frequency with attenuator setting; very careful mechanical design and construction to obviate changes in calibration from mechanical shock.

The new signal generator features:

- WIDE FREQUENCY RANGE:** in five steps from 7.5 to 320 Mc; unwound plug-in coil provided for any additional frequency range desired by user
- CONTINUOUSLY VARIABLE MODULATION:** from 0 to 60%. Internal modulation at 400 cycles $\pm 5\%$; external flat to 2 db from 200 to 20,000 cycles
- ADEQUATE OUTPUT VOLTAGE:** 10 microvolts to 20 millivolts between 7.5 and 120 Mc
- COMPENSATED CAPACITIVE OUTPUT SYSTEM:** 100 $\mu\mu\text{f}$ capacitance with no attenuator effect on frequency; 90-ohm cable with 90-ohm termination supplied
- NEGLECTIBLE STRAY FIELD:** not noticeable with receivers of less than 10 μv sensitivity

Type 804-A Ultra-High-Frequency Signal Generator.....\$350.00

● WRITE FOR BULLETIN 532

GENERAL RADIO COMPANY
30 STATE STREET CAMBRIDGE, MASSACHUSETTS

Branches in New York and Los Angeles

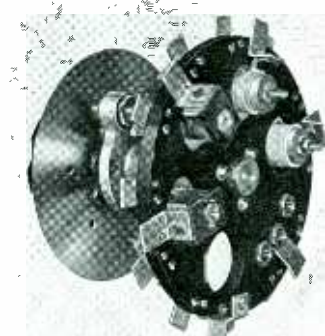

Coil assembly mounted on mycalex disc attached to switch system. Polystyrene coil insulation with unwound plug-in coil form for any additional frequency range desired; excellent electrical contact between silver-plated switch blades and contact springs.

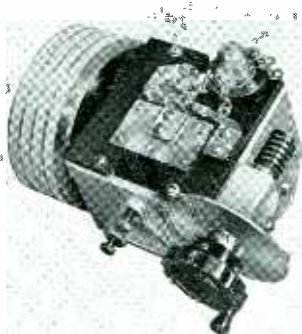

Oscillator circuit built on Type 755-A high-frequency condenser; coil switch contacts mounted directly on condenser; 30 to 1 precision worm drive on condenser with 1500 divisions on main frequency dial; accuracy of setting better than 0.1%.



G. Hamilton Beasley
President



Peter L. Jensen
Vice-President

UTAH PLUS PETER L. JENSEN

COMBINING TWO OF THE MOST OUTSTANDING NAMES IN SPEAKER HISTORY



J. W. Caswell
Vice-President



W. Durke
V.P. in charge of prod.



H. S. Newman
Secretary & Treasurer



D. F. Jester
Gen'l Sales Manager

In announcing the association of Peter L. Jensen with the time-proved Utah organization, the consequent benefits to manufacturers, sound-men and service-men are undoubtedly obvious. Users of all types of speakers for original equipment or replacement requirements have long recognized the respective advantages and superiority of speakers bearing the Utah trademark and those carrying the name of this speaker pioneer.

Utah's background of 18 years of speaker designing, engineering and manufacturing skill will be reinforced by the experience in speaker development and improvement which has won world-wide acclaim for this radio speaker authority, now a member of the Utah staff.

It is a foregone conclusion that Utah's policy of aggressive research and product development will be maintained—that Utah products will continue to keep abreast of all industry developments—that *Utah will serve you better than ever before.*

(Signed)
G. Hamilton Beasley
President Utah Radio Products Company



F. E. Elithorpe
Sales



P. H. Heckendorn
Sales



R. H. Mutmacher
Sales

ENLARGING THE ORGANIZATION WHICH FURNISHED
THE **RADIO** INDUSTRY 5,963,621 PARTS DURING 1939



W. A. Ellmore
Chief Engineer



J. M. Hume
Sales Engineering



F. H. Wilke
Sales Engineering



R. M. Karet
Sales



D. H. Coswell
Sales

UTAH RADIO PRODUCTS COMPANY

820 ORLEANS STREET, CHICAGO, ILLINOIS

Canadian Sales Office—414 Bay St., Toronto, Canada

Cable Address: Utaradio Chicago

VIBRATORS • TRANSFORMERS • SPEAKERS • UTAH-CARTER PARTS

HOW LAPP DOUBLED THE STRENGTH OF THE PORCELAIN COMPRESSION CONE, WITHOUT CHANGING DIMENSIONS, WALL THICKNESS OR WEIGHT

The advance of modern industrial science has been achieved largely through making minute changes in physical or chemical form to effect tremendous changes in performance character-

istics. Consider the matter of steel. *If you know how*, you can take a pound of common nails, add about $\frac{1}{8}$ ounce of carbon and make tool steel with double the tensile strength and five times the hardness.

*** As pioneers in radio tower insulation, Lapp men had to develop whole new engineering conceptions. Recognizing early that the tremendous mechanical loads could be carried by porcelain loaded only in compression, they developed the porcelain compression cone



Left, early Lapp Compression Cone. Right, curved side compression cone—same dimensions, wall thickness and weight—twice the compression strength of the straight side cone—the design used in all footing and guy insulators (see below) since 1932.

for use in all types of footing and guy insulators. And, then, not content with their first efforts along these lines, they set out to improve the design—

with the result that by changing slightly the contour of the cone, they *doubled the strength of the insulators*. *** It's the *know-how* of Lapp engineers that has kept Lapp the dominant force in insulation for radio broadcast. Today, if you

contemplate installation of a new transmitter, or modernization of present equipment, you can't afford not to consider Lapp for tower footing and guy insulators, for porcelain water cooling systems, for pressure gas-filled condensers.



LAPP

INSULATOR CO., INC., LE ROY, N. Y., U. S. A.

**I never worry over
an insulation problem**

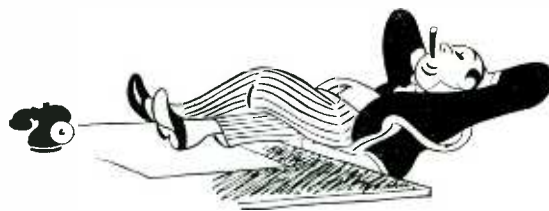

Boon to engineers is AlSiMag's demonstrated ability to lick high frequency insulation problems.

Thirty-seven years of leadership, a laboratory and engineering staff constantly at work on problems vital to every industry using ceramics,— here is convincing proof that we are ably

equipped to meet *your* insulator requirements. For the economy that experience alone can achieve, bring your insulator problems to American Lava Corporation.

• • •

There is an AlSiMag body to meet your insulator requirements.

ALSiMAG

FROM CERAMIC HEADQUARTERS

AMERICAN LAVA CORPORATION • CHATTANOOGA • TENNESSEE

CHICAGO • CLEVELAND • NEW YORK • ST. LOUIS • LOS ANGELES • SAN FRANCISCO • BOSTON • PHILADELPHIA • WASHINGTON, D. C.



DISC AND CAM OPERATED— Program control by means of a roller-leaf actuator Micro Switch following strips on a driven drum.

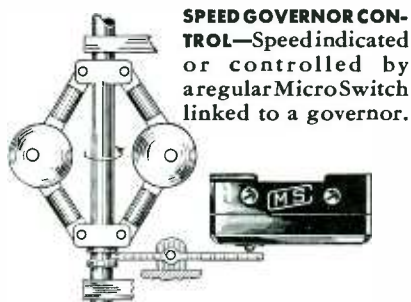

SPEED GOVERNOR CONTROL—Speed indicated or controlled by a regular Micro Switch linked to a governor.

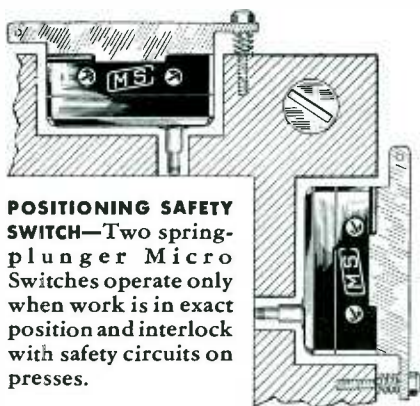

POSITIONING SAFETY SWITCH—Two spring-plunger Micro Switches operate only when work is in exact position and interlock with safety circuits on presses.

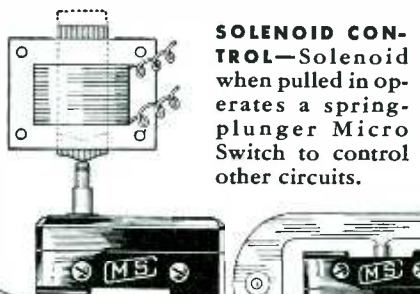

SOLENOID CONTROL—Solenoid when pulled in operates a spring-plunger Micro Switch to control other circuits.

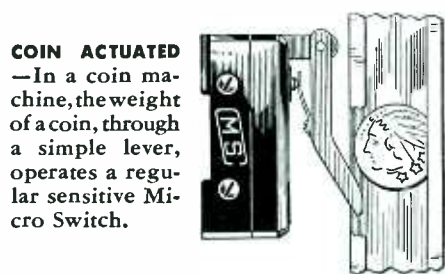

COIN ACTUATED—In a coin machine, the weight of a coin, through a simple lever, operates a regular sensitive Micro Switch.

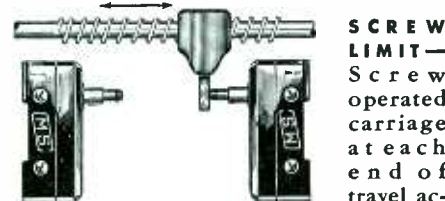

SCREW LIMIT—Screw operated carriage at each end of travel actuates a spring-plunger Micro Switch which reverses or stops motor drive.

actuates a spring-plunger Micro Switch which reverses or stops motor drive.

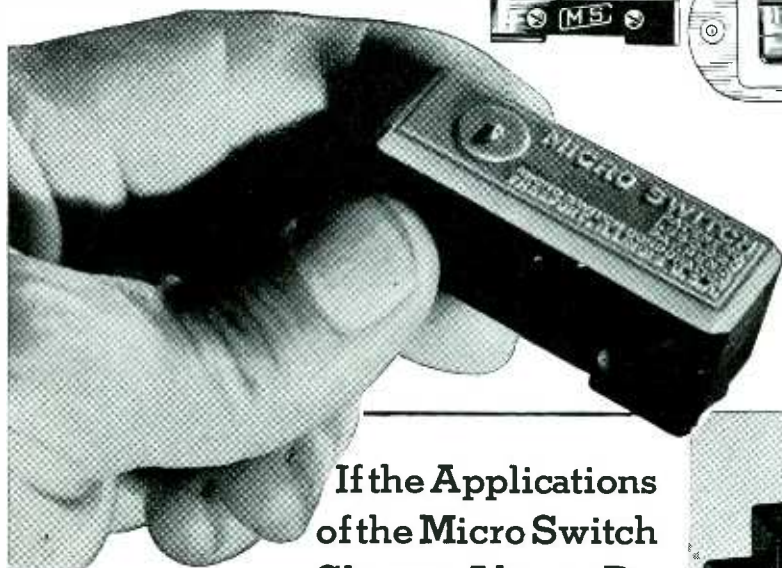

If the Applications of the Micro Switch Shown Above Do Not Meet Your Design Requirements, Write Us for Complete Data

The design possibilities of this small, compact, sensitive precision snap-action switch are so broad that we cannot begin to illustrate all of them. Write for a complete set of data for your files. . . . The Micro Switch is 1 15/16" long, weighs 1 ounce, operates precisely on small energy, small force and small movements at speeds as high as 600 times per minute and endures millions of operations. It's listed by Underwriters' Laboratories and has the approval of the Hydro-Electric Power Commission of Ontario.

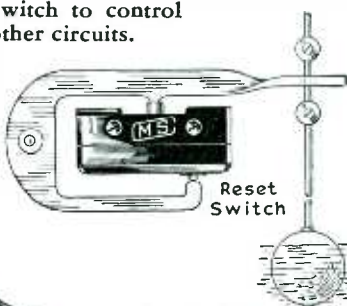

DOUBLE ACTION FLOAT—Liquid level control through the use of a reset Micro Switch and a lever operated by stops on the stem of a float.

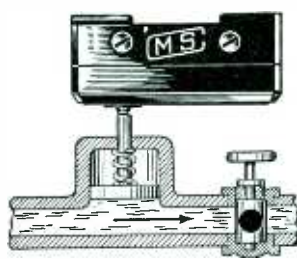

PRESSURE ACTUATED—Pressure switch is made by combining a regular Micro Switch and a pressure operated plunger. The electrical circuit is thereby controlled by the opening and closing of the valve.



Also New!

A Streamlined Die-Cast Housing with Many Features

A sturdy and attractive die casting for enclosing all types of Micro Switches . . . Rugged terminals for No. 14 wire well supported on the switch



and arranged for easy field connection . . . Underwriters' listed construction throughout . . . No pigtailed or sealing pitch necessary . . . Micro Switch readily replaceable . . . Hub takes 1/2" standard conduit . . . Available in normally open, normally closed, or double throw circuits. Write for data sheet No. 5.

MICRO MS SWITCH

MANUFACTURED IN FREPORT, ILLINOIS BY
MICRO SWITCH CORPORATION

New York

Chicago

Boston

Copyright 1939, Micro Switch Corporation

MICRO MS SWITCH



Don't fall for a Stand-in

Only *FP (Fabricated Plate) CAPACITORS
TRADE MARK
 REG. U. S. PAT. OFF.
can give you fabricated plate performance!

A stand-in may even *look* like the star in every respect. But when it comes to *acting* only the star will do. And that's the way it is with capacitors. On the basis of *appearance* you may get by with a condenser that just *looks* like an FP Capacitor. But when it comes to actual performance... there is no substitute for a genuine FP Capacitor.

The design of FP Capacitors is so practical and their success so outstanding that attempted imitation was to be expected. But the *real* differences... the operating characteristics... cannot be imitated. FP Capacitors are constructed by a patented process that involved great investments of time and money to develop. The result is a capacitor that sets a new high in efficiency and performance. Low R. F. Impedance... better filtering efficiency... surge proof construction... smaller sizes without a sacrifice of safety or efficiency... freedom from corrosion... these are just a few of the revolutionary features of FP Capacitors.

There are already over five million in use as original equipment. Every one of them is a reason for you to fully investigate the advantages offered exclusively by FP Capacitors.

**NOT etched construction*

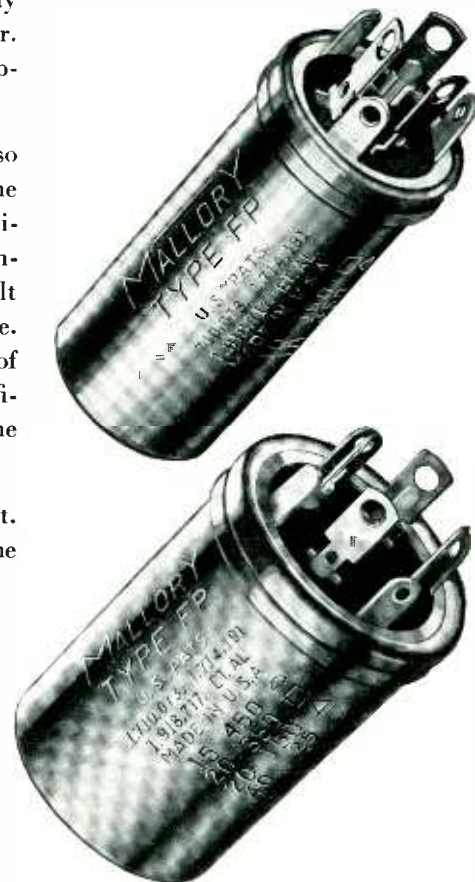

P. R. MALLORY & CO., Inc.
 INDIANAPOLIS INDIANA
 Cable Address — PELMALLO





CROSS TALK

► XMAS . . . Although this issue of *Electronics* gets to the readers after New Years, much of it is being written the day before Christmas; and our hearts are full of good cheer for all of you who read, month after month, what all of us manage to wangle from our typewriters.

At the year-end certain pleasant occurrences stick in our mind. For example; a certain well known radio engineer whose name we don't have permission to reveal, suffered rather badly in an auto accident a few months ago. Associates were concerned because his spirit seemed to be broken. Then they took heart. He was raising hob in the hospital because the doctors were talking of tying his broken legs together with sections of piano wire. He demanded (and got) catgut because he still had much research to perform on high frequencies and he wanted no open-ended conductors in his legs to soak up h-f energy.

And at the other end of the spectrum is the letter from J. R. Tate who complains because he can't keep up with the new tubes. "I bought a new tester three months ago and now it's out of date. I've been trying to keep up on testers for the last 16 years. When will this outrage stop?"

► ARGUMENT . . . We have already commented on the present excitement about frequency modulation. In this issue will be found a summary of the situation as we now see it. It is an attempt to sift facts from rumors. It is an appraisal of what we now know and of what must soon be found out. In this summary we are fighting no one's battles; we take no sides unless

there is an industry side. We are for better and better broadcasting and for more business for those who design, engineer and manufacture the parts that make up the communications business. We are unbelievers when anyone states that the public does not want high fidelity; or that the poor farmer remote from a transmitter must take his poor signals as his medicine for not working in a crowded city. We believe that high frequency broadcasting will provide a superior broadcasting service whether it is by amplitude or frequency modulation. And we want a better broadcasting service.

It is rumored that the F.C.C. will begin informal talks to sift the wheat from the chaff on frequency modulation late in February. Some of this sifting will be found in this issue.

► CENSUS . . . This month the United States Bureau of the Census begins to take the count—of business and manufactures. All those who make, sell, or service radios, phonographs and other sound apparatus will be covered. In April the Population Census begins. Every one of some 33 million homes will be visited, and one inquiry will be "Is it equipped with a radio?" Much data of value to the industry will be uncovered, assembled and finally made available to those who can use it. And, best of all perhaps, will be data which will show not only the numbers of sets in use but the number that can be sold. One of the angles of research will be on the relation between the number of persons employed in any locality to the number of radios in that place.

FREQUENCY MODULATION

A Revolution in Broadcasting?

A survey of the facts, as well as of matters requiring further investigation, gathered from engineers in whose hands rests a new medium for an improved broadcast service

THIS article is based on the investigations of the editors, who assume responsibility for the statements made. As a background, interviews were held with the inventor of the wideband system, with a Commissioner of the Federal Communications Commission, with the chief engineers of the three major broadcasting systems in the United States, and with engineers active in the radio receiver business. Expecting a wide diversity of opinion in these men, the editors were surprised to find considerable unanimity on the merits of the system as well as on the subjects requiring the presentation of further evidence. This report represents, insofar as it is possible to do so, a digest of all points of view, with particular reference to the good of the industry, rather than in the interests of taking sides.

CONTROVERSY, a word not altogether unfamiliar in the history of radio, has dogged the footsteps of frequency modulation almost from the first announcement of the wideband system in 1935. Today a veritable storm center of discussion revolves about it, not only in engineering circles but in the commercial sphere, and even in sight of the body politic. Engineers and salesmen have been asking each other: Is it really as good as it seems? Can it be promoted to commercial success? And if so, how will it affect the radio business? Is there danger in overenthusiasm which may ruin what little prosperity the radio business now enjoys? Does the public really want high fidelity, or

will it be as apathetic to a better service as it is to attempts to improve the present broadcast service? These and a hundred similar questions seem to be on the lips of nearly every one who has a stake in radio. Unfortunately the answers to these questions lie buried deep beneath a fog of misinformation and contention based on ignorance or self-interest. There has been too much said on the basis of too little knowledge, too many claims and counter-claims, too much acrimony and suspicion to allow a clear view. In short there has been, not too far behind the scenes, a tidy little fight concerning the merits of the system and the advisability of promoting it to the public.

In the face of such a situation it behoves the editors of a technical publication to maintain as benevolent a neutrality as possible. The editors of *Electronics* hope they have done so, although they have been flatly accused of taking the side of the inventor in reporting demonstrations enthusiastically. But this accusation is not widely made, because if there is one thing clear about frequency modulation, it is that the system as demonstrated really does perform with startling high fidelity and with startling freedom from noise.

The questions arise only on the interpretation: Is the improvement due to the use of frequency modulation, itself (and if so, how much does the wideband contribute to it); or does the improvement in noise reside in the use of the ultrahigh frequencies; and is the high fidelity

due mostly to the painstaking care with which distortion and other technical aberrations have been removed from the equipment demonstrated. These are burning questions, but they are ones for which good first-approximation answers have been available for some time.

The present article represents as honest an attempt as the editors can make to reveal what matters are known facts and what ones still require investigation, and to elucidate principles on which economic considerations and the public interest can best be decided. This is a large order, and one of your editors would hesitate to undertake if they did not sincerely believe that the situation demands a thorough review, not only in the interest of the technical fraternity, but for the broader group of executives and members of the lay public on whom so many important decisions depend.

What is the Situation Today?

Two facts stand out in the national situation: first there is a very large and growing number of broadcasters who have applied for permits to erect and operate frequency-modulated stations, and second that there are very few receiver manufacturers offering receivers to the public. On November 27th, 1939, when the last available recapitulation prior to going to press, was made by the F.C.C., there were five frequency modulated stations operating under F.C.C. license and 15 stations operating (or about to operate) under F.C.C. construction permits, making 20 f-m authoriza-

tions in all. The total installed power represented by these authorizations was 108,550 watts, including one 40 kw and one 50 kw authorization. Most of the authorizations are for 1000 watts. As early as December first, f-m stations were operating on regular schedule in Paxton, Mass., Alpine, N. J., Meriden, Conn., Springfield, Mass., New York, N. Y., and Rochester, N. Y.

On November 27th, there were 31 amplitude modulated stations authorized to operate on the u-h-f broadcast bands under license, and three under construction permits, making 34 in all. The total installed power of these 34 authorizations was 11,950 watts, including no power higher than 1000 watts. (This list omits television sound transmitters.)

As of the same date there were 17 applications for new f-m stations, total installed power 72,350 watts, including one 50 kw application. There was, as of the same date, one new a-m application for 500 watts. There were also several reapplications for changes in both systems which do not affect the number or power of the stations. The present investment (assuming the applications are granted) in u-h-f amplitude modulation broadcasting is accordingly 35 stations and 12,450 watts, in u-h-f frequency modulation broadcasting, 37 stations and 180,900 watts. Since November 27th, and up to the date of going to press, approximately 15 more applications for f-m stations were received. These figures are of interest because they reveal that broadcasters are

interested in frequency modulation to the extent of investment (actual or as soon as permission is granted) based on power only, of nearly 20 times the total investment in amplitude modulation on the same bands of ultrahigh frequencies. All f-m stations are experimental (except one or two relay stations). No doubt many of the stations represent investment truly in the interests of experimental research. But equally without doubt some of them have been installed to stake a claim on a frequency. No further proof of this is needed than the fact that there are *two* experimental f-m stations in prospect for Rochester, N. Y., Hartford, Conn., Boston, New York, each a pair of stations which may eventually be in competitive commercial relationship.

The availability of commercial receivers, however, presents a somewhat different picture. At the time of writing nine manufacturers are licensed to manufacture frequency modulated receivers under the Armstrong patents: General Electric, Stromberg-Carlson, Scott Radio, Radio Engineering Laboratories, National Company, Hammarlund, Hallicrafters, and two others not yet ready to offer receivers to the public. These organizations have agreed to pay three per cent of the manufacturer's selling price to the inventor, but the license agreement permits deductions which bring the net royalty payment to a minimum of 1.8 per cent. The base rate of payment of an RCA receiver license including

rights to patents of other companies is roughly five per cent with deductions to approximately three per cent. For a Hazeltine license it is three per cent with deductions to approximately 1.5 per cent.

Exact figures of frequency-modulated receiver distribution have not been released, but the number may surely be placed at not lower than 2000 sets and not higher than 5000 sets, installed mostly in the New England and New York City areas. This distribution establishes the fact that no commercial audience of any significance is available for frequency-modulated broadcasts as yet.

Is All the Credit Due to Frequency Modulation?

The foregoing evidence of economic activity in frequency modulation indicates clearly the faith now held in it by those individuals willing to spend money on it (or to spend money on the chance of gaining a valuable foothold, in the event their faith is justified). But it does not prove, by any means, that frequency modulation is all it's cracked up to be. For proof of this, resort must be made to the engineering evidence, and at once the three questions arise: How much due to frequency modulation? How much due to use of u-h-f waves? How much due to painstaking removal of technical aberrations?

In the first place, let it be stated for the record, so that question never need be answered again: The observable natural static on the

ESTABLISHED OR SUBSTANTIATED MATTERS OF FACT:

Channels available for frequency modulation, each 200 kc wide, number 13 in all, four from 26,300 to 26,900; five from 42,600 to 43,400; and four from 117,190 to 117,910 kc.

As of November 27, 20 authorizations were issued by the F.C.C. for frequency modulation stations, covering a total installed power of 108,550 watts.

As of November 27, 16 additional applications had been made for new authorizations for frequency modulation stations, representing total requested power of 72,350 watts.

As of November 27, 31 authorizations were issued for amplitude modulation u-h-f stations, covering total installed power of 11,950 watts.

As of November 27, one additional application had been made for authorization of an amplitude modulation u-h-f station, power 500 watts.

Man-made static is a factor on the ultrahigh frequencies to be considered in comparing a-m and f-m, with an advantage of 10 to 30 db in favor of frequency modulation at 5-to-1 deviation.

Tube and circuit noise is a factor for consideration, assuming equal degrees of fidelity in the two systems, with an advantage of 30 db in favor of frequency modulation.

Quality of transmission may be achieved in either system, if power is disregarded. With a given expenditure of peak power, however,

a program of given quality may be sent by frequency modulation over an area some 10 to 30 times as great as that covered by amplitude modulation on the same frequency band.

A frequency modulated station occupies from two to five times the ether space required by double-sideband amplitude-modulated signal of the same quality.

The established desired-to-undesired signal ratio, below which interference on amplitude modulation is said to be negligible, is 40 db (F.C.C. regulation).

The established desired-to-undesired signal ratio, below which interference is negligible on frequency modulation, is 6 db.

ultrahigh frequencies is very much less than that existing on the lower frequencies. On wideband amplitude modulated receivers operating with high sensitivity at about 40 Mc, during the summer, natural static is in evidence, but it is very much weaker than on the lower frequencies. Amplitude modulation is powerless against whatever natural static exists, except by reducing the bandwidth of the received signal (and thus lowering the fidelity of reception), or by raising the power of the transmitter. The frequency modulated receiver is highly effective in discriminating against whatever natural static does exist. Were it not for this fact, since very low field strengths are useful in frequency modulation, the natural static problem might be serious at times.

Man-made static is, of course, a horse of a very different hue. Noise from ignition systems, diathermy apparatus, and the like is much more pronounced on the ultrahigh frequencies than on the low. Amplitude modulation and frequency modulation must contend with it equally. With amplitude modulation, in urban areas, such man-made noise may be the limiting factor in reception, especially if the transmitter power is low, which has been true of virtually all a-m broadcasting on the u-h-f bands up to the present, except in a few television sound transmitters. But if sufficient power were available, amplitude modulation can overcome the noise and, in fact, has been proved to do so many times.

The important fact is that frequency modulation is more effective against this man-made noise than is amplitude modulation, and this means that less power is required to overcome the noise than is necessary with amplitude modulation. The advantage, for this type of noise, is generally agreed to be in the neighborhood of 10 to 30 db, or a power ratio of 10 to 1000 times. While the exact value of this figure is not agreed upon by every one, and is therefore a subject of further investigation, practically no one now doubts that there is *some* advantage and most agree it is not less than ten times in power.

So much for the matter of noise on ultrahigh frequencies. Now what about the fidelity of the system? Again let it be stated for the record that any degree of fidelity which

may be built into a frequency-modulated transmitter may also be built into an amplitude-modulated transmitter, *provided* that power is not a factor. The only question at issue is whether or not the fidelity so built into the transmitters may be utilized, which means brought out of a loudspeaker unimpaired. It may be said that *if* transmitter power were not a limiting factor, amplitude modulation could provide as much realizable fidelity as can frequency modulation, although this might require the use of very low modulation percentages.

Unfortunately, in most cases power is a very definite limiting factor, and especially so on the ultrahigh frequency bands. The power factor is therefore basic to the argument. And it may be stated, again for the record, that a program of given quality can be transmitted to a given receiver with less power on frequency modulation than on amplitude modulation. The magnitude of the power advantage is from 10 to 100 times or more.

The statement that amplitude modulation and frequency modulation are capable of equivalent quality, provided that power is not a factor, requires considerable qualification, however, when harmonic distortion is considered. It is still true that if unlimited power is available in an amplitude modulated transmitter, and if therefore the percentage modulation may be kept low, and the range of operation over the dynamic characteristics of the tubes may be restricted, then harmonic distortion may be kept within any assigned limit we may choose. But in amplitude modulation, the nonlinear harmonic distortion introduced is caused principally by the nonlinearity of tube characteristics. If tubes are to be used economically in amplitude modulated transmitters, therefore, harmonic distortion becomes a problem.

In frequency modulation a quite different situation exists. The harmonic distortion does not depend on tube characteristics, but rather on the characteristics of the tuned circuits used. In general it seems to be easier to design a linear circuit than a linear tube, and still maintain operating economy. This accounts for the phenomenally low values of harmonic distortion commonly quoted for frequency modu-

lated stations, compared with those of amplitude-modulated stations.

The advantage of frequency modulation in providing low harmonic distortion without sacrificing operating economy has an important bearing on the whole high fidelity problem, because high fidelity depends not only on a high upper frequency limit, but on a low value of distortion. In fact it is claimed that the reason why the public has not taken to high fidelity reception is that harmonic distortion has not been sufficiently reduced, either in the transmitters or in the receivers to allow completely natural reproduction. That there may be some merit in this claim is indicated by the direct experience of the editors in demonstrating their own frequency modulated receivers to people who have had previous exposure to high fidelity, but have been unconvinced. Many of these observers, including men who have no connection with the radio industry, have commented on the difference between f-m high fidelity and previous examples of a-m high fidelity. This difference is, apparently, a difference in distortion.

But even if high fidelity is discounted, for the moment, the advantage of frequency modulation with respect to noise still remains. The improved signal-to-noise ratio is *not* a matter of conjecture. It has been proved practically and mathematically, and no informed person gives this particular aspect of the question any serious thought. The main question, right now uppermost, is how to use the advantage. Shall it be used to provide a high quality program of transmission over a given number of stations, or shall it be used to provide a lower quality over a greater number of stations. It is generally agreed that frequency modulation, in one form or another, can do a better job on ultrahigh frequencies, both as to quality and range, than can amplitude modulation. If transmission of the highest possible quality has no social or economic value (as is firmly held by some of our outstanding broadcasters), and if the increased range in prospect provides radio service to an area not inhabited by any one at all, then there is no economic justification for frequency modulation because these are the only two advantages it

can give: better quality and more range for a given expenditure of power. But if quality has economic value and if increased service area is inhabited, then some economic value accrues and this economic value must be balanced against other economic values, particularly those related to the status quo and the maintenance of a sound industry structure.

Thus far, the comparisons have been strictly on a basis of a-m vs f-m on the same ultrahigh frequencies, and the discussion is of interest, therefore, only if the use of the ultrahigh frequencies for broadcasting is a foregone conclusion. If u-h-f is surely in the cards for broadcasting in the future, then frequency modulation has very little opposition, and the only questions are subsidiary ones; that is, whether quality or number of stations shall predominate, and in what proportion.

What then is the case for the ultrahigh frequencies in the future of broadcasting? Here is perhaps the most basic consideration of all. Unless the u-h-f band is to be used, the present controversy is a lot of thermal agitation and nothing more. But if the u-h-f is the next step, then the a-m vs f-m question is very quickly decided on its merits, and the subsidiary questions of how best to use the advantages gained must be left to the engineers and executives who guide the industry.

No one can deny that most 50-kw broadcast stations in the standard band do a very good job of putting out a 5000-cps program (when they get one to put out) to about 95 per cent of their audience within service range. The less powerful stations (whom God loves best because there are so many of them) are of course equally well placed because their service range is less. But fidelity to 10,000 cps is virtually impossible, because of heterodyning and the increase in noise, in any but favorable locations close to the transmitter. In fact, due to the pressure of many stations and little space for them, when the present allocation for 550 to 1600 kc was drawn up, fidelity above 5000 cps was made impossible for the great majority of all listeners. Fidelity within that limit was taken care of, and at the time seemed plenty adequate enough. But today every engineer knows that 5000 cps is not enough and surprisingly

enough, a great many plain ordinary people know it's not enough. If we want high fidelity, above 5000 cps and below 20,000 cps, then the ultrahigh frequencies are the prescrip-

Matters of conjecture

requiring further evidence and industry agreement:

Whether or not a higher fidelity service can be sold to the public.

Whether or not broadcasting should undergo a transition from the standard broadcast band to the ultrahigh frequencies.

Whether or not a greatly increased number of broadcast stations (made possible by u-h-f allocation) is in the public interest.

The standards for frequency modulation, particularly regarding total frequency deviation, maximum modulating frequency, and total bandwidth occupied by the sidebands of the signal.

Whether frequency modulation standards on the u-h-f bands should include facilities for binaural reception, multiplexing of facsimile and other service requiring a wider band than that required for a single high fidelity program.

If frequency modulation is widely adopted, how many channels are required for a national allocation and where can ether space be obtained for additional channels in the present allocation structure?

Quantitative indices of u-h-f coverage vs antenna height vs power over different types of terrain in territory other than New York and New England, particularly for frequency modulated waves.

tion. The question is then, do we want such high fidelity?

Your editors have encountered a surprising amount of resistance in interviews with broadcasters to the idea of higher fidelity. The reason given is plausible enough: The transmitting stations of today are at least 2000 cps wider than the best receivers listening to them, and maybe 6000 cps wider than the worst receivers listening to them. The public apparently doesn't give a hoot. But there are other broadcasters who argue that the public

objects not to the high frequency range but to the increased noise and harmonic distortion which go with it.

There is no doubt that high fidelity cannot be exploited without a well conceived selling plan based on education. But it is equally agreed that there is no agency better equipped to do such a selling and educating job than radio, itself. Suppose, for example, that all the broadcasters espoused higher fidelity with the enthusiasm they now seem to show for an independent source of copyrighted music. Suppose that more engineering ingenuity, as part of the same concerted effort, were exerted on making real high fidelity cheap than on making tubes more numerous. Suppose, in short, that the radio industry showed the same acumen in selling the public as has the automobile industry. High fidelity would be with us almost overnight, and whole industry would benefit, not only because initial equipment was being sold, but because radio would take a more important place in the national life.

Perhaps all this is too optimistic, but it makes much more sense to us than the standpat attitude of letting the public be blissfully ignorant of a service they *could* value a lot higher than they now value the present radio service. Certainly this is not the attitude for a young and progressive industry to take.

This line of reasoning leads directly to the ultrahigh frequencies, not that high fidelity broadcasting is impossible in the standard band, but simply that it is too generally unrealizable. The ultrahigh frequencies are not a perfect solution either, but in our opinion they offer a far higher prospect of wide realization of high fidelity than any other.

Suppose we admit for the present that ultrahigh frequency broadcasting is a desirable step, and that eventually it will be taken in the industry stride. Then we come to the question of which path to follow. Shall it be amplitude modulation, wideband frequency modulation, narrowband frequency modulation? Now is the time to make that choice, because there is no status quo. The public has practically no equipment for the ultrahigh frequencies. It will buy what is offered, when properly convinced of its merits. The broadcasters have substantially

no investment in any system for the ultrahigh frequencies, although the investment is growing apace. We are free to choose. The choice must be made on its merits, technical, economic and social.

What are the factors which should influence the decision? The range and quality available from a given expenditure of power, are certainly such factors, and there seems to be no doubt that frequency modulation can do a conspicuously better job in this respect.

Another factor not to be overlooked is prospective shortage of space in the ether spectrum. This factor seems of less importance on the u-h-f bands than on the lower frequencies, because there is so much more space on the high frequencies. But this is an illusory argument. We never shall have too much space in the ether for the demands put on it, certainly not if previous experience is any guide, and certainly not if we have any faith in the future of radio. Here lies the one advantage which u-h-f amplitude modulation may safely be accorded. It requires less space in the ether for a given program quality than does frequency modulation.

On the face of it, this is a very serious matter, and one which no one, particularly those charged with regulating the industry, can overlook. It is safe to say that if there were no extenuating circumstances, frequency modulation might not be worth it on this score alone. But there are extenuating circumstances. The principal one is the fact that the interference between two frequency modulated stations, operating on the same carrier frequency, is a vastly less serious problem than that between two amplitude modulation stations on the same frequency. In the amplitude modulation case the limit is heterodyning and crosstalk due to beating of sideband components. The established ratio between the desired and undesired signal used by the F.C.C. in this case is 40 db. For a high fidelity service, the system is proportionately more open to interference, and the 40 db ratio should no doubt be raised to 50 db, or possibly higher. In frequency modulation, the necessary ratio between desired and undesired signal is only 6 db. The problem of allocating stations

is thus very greatly simplified. Because of this fact alone, it is argued, it is possible to allocate more f-m stations in a given region than a-m stations, despite the increased space required by the f-m stations. If this argument holds water, it puts a different construction on the bandwidth problem. It makes frequency modulation distinctly feasible from the ether conservation point of view.

How Much Ether Space?

But the bandwidth problem, while answered for the most part, is not completely disposed of. The question still remains, How much space in the ether shall be given to frequency modulated stations? The frequency may be swung over a wide range or over a narrow range, and in general the wide swing occupies more space (though not in strict proportion) than does the narrow swing. The relative merits of the wide swing (say a deviation from the carrier five times as great as the maximum modulating frequency) and a narrower swing (deviation two or three times the modulating frequency) are at present the chief concern of engineers charged with gathering evidence for the industry. Much evidence has already been gathered, some of it has been known for many years, but before standards for frequency modulation can be set up, as much evidence as has been adduced must be forthcoming and it must be presented for analysis. As editors, we are not prepared to take a stand on the relative merits. What information we have been able to pick up points to a definite desirability of wide band frequency modulation for close range service. Elementary considerations point to a higher signal-to-noise ratio, better dynamic range and more freedom from interference, in the wideband case. At the fringe of the service area, near the discontinuity of limiter action below which noise is apparent, narrowband modulation has been shown in some experiments to offer a better signal-to-noise ratio, and hence better service in that part of the area. But the difference between a deviation of five to one and a deviation of two or three to one is a matter of degree only. While important, and of necessity a matter requiring stand-

ardization, the choice between the two can be decided readily.

The choice seems to have little to do with patents, despite rumors to the contrary. It is rather a matter of deciding whether the new service shall be restricted to the transmission of a program of given quality over a given number of stations, or allowed to offer a better and more flexible service to a smaller number of stations. In particular, and in addition to the advantages of higher fidelity, better dynamic range and greater freedom from interference, the wide band system permits a highly flexible system, whereby two programs might be multiplexed on the same channel for binaural reception, and in which facsimile might be multiplexed to carry a printed record of events. But these advantages may not outweigh the requirement of minimum ether space. In any event there seems to be very little disposition on the part of anyone to reduce the effective fidelity of the system much below 15,000 cps, and this augurs well for the high fidelity aspect, whether the deviation ratio adopted is five-to-one or three-to-one.

The main reason for the discussion at present is the fact that the 13 channels now available are not sufficient for a national allocation using a 5-to-1 deviation, not only because they do not contain sufficient space, but also because they are not arranged in a continuous band (although conceivably push-button control may overcome the last objection, as it has in television.) The problem then is to find the space required, and the obvious suggestion is to take it from services which do not offer so good a case for using them as does the proposed system or, alternatively, pushing the whole u-h-f allocation higher in the spectrum.

As this issue goes to press, word has been received that an informal public hearing is to be held in Washington before the F.C.C. on February 28th, 1940, at which all interested parties will be invited to present evidence bearing on the future of frequency modulation service. That meeting will be reported in full in these pages and the report should make interesting reading compared with the informal survey here presented.—D.G.F.

Tuning Fork Stabilization

Two methods to improve the stability of operation of tuning forks are presented. One deals with the tempering of the forks during manufacture and the other with an improved driving circuit. The various causes of erratic operation of tuning forks are also discussed

By ERNST NORRMAN

TUNING forks are an important source of audio frequencies for a wide variety of applications where accuracy is a requirement, but where the cost of a crystal controlled electronic audio oscillator is not justified. However, the frequency of vibration of tuning forks is subject to variation for several reasons, one of which is change in temperature. In an effort to reduce as much as possible the effects of temperature change, the writer has developed a method of treating tuning forks so that the coefficient of temperature may be made very close to zero. Because tuning forks do not sustain themselves in vibration, a means of driving them must be used. In the interests of stable operation, an improved driving circuit has been developed which delivers to the tuning fork a definite amount of driving energy during each cycle. In addition to these two means of stabilizing the operation of tuning forks, there is presented here a discussion of the various other factors which affect their operation.

Method of Tempering

It has been found that by proper tempering the coefficient of temperature could be controlled to a considerable degree. The forks used in these tests had a temperature coefficient of about ten parts per million, negative, per degree C. If the forks are heated to an orange red color and cooled in oil bath, the coefficient can be made substantially zero or even positive. If the action is not carried far enough, the process may be repeated or if it is carried too far the fork may be hammered or

rolled to reduce the effect of tempering.

Improved Drive Circuit

If an ordinary amplifier circuit is used to drive the fork any slight change in the amplification constants of the circuits or any increase in the pickup voltage will cause a reactive buildup of the amplitude of the oscillations of the circuits and of the mechanical amplitude of vibration of the tuning fork. This buildup will continue until the increased losses in the circuits and particularly the increased mechanical losses in the fork balance the cause for the change of amplification.

Various methods have been employed to counteract this action. The circuit shown in Fig. 1 prevents this reactive buildup. The capacity of condenser A and the voltage to which it is charged are the only

factors that have any appreciable influence on the driving power delivered to the drive coil B.

Condenser A should be of a small enough capacity so that it will be properly discharged during part of the time that the grid of the 6C5 swings in a positive direction. Resistor B should have a very large resistance value compared to the impedance of the 6C5 and the drive coil. The 6C5 should be biased to, or near, plate current cutoff.

The action of the circuit is as follows: When the tuning fork is in vibration a voltage is generated in the pickup coil. This voltage, amplified by the 6J7, swings the grid of the 6C5. When the grid of this tube is positive the condenser A discharges through the tube and through the drive coil. Thus the fork receives a drive impulse. The power of the drive impulse is dependent only on the capacity of the condenser

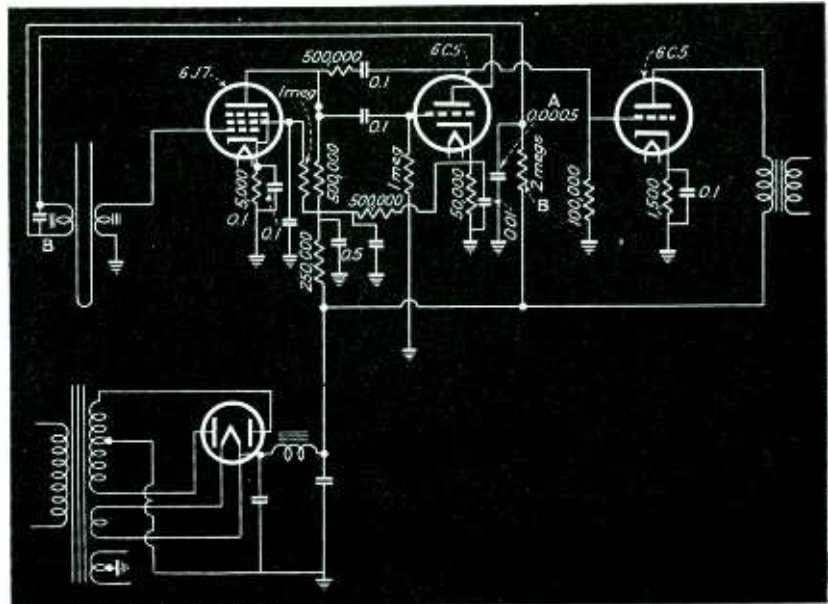

Fig. 1—Circuit diagram of the driving unit. The condenser A provides a fixed amount of driving energy during each cycle and is discharged by the trigger action of the 6C5 tube

and the voltage to which it is charged. As the grid voltage of the 6C5 falls back in a negative direction the condenser charges through resistor *B*. In this way a constant quantity of energy is delivered to the drive coil during each half cycle of vibration.

The action of the amplifier is such that the 6C5 acts as a trigger for the condenser charge and it would operate as well if a gaseous discharge tube such as the 884 were substituted for the 6C5.

This circuit is much less affected by varying line voltages than is an ordinary amplifier circuit. This is because the line voltage influences the driving power only in such a way that it increases the charging voltage of condenser *A*. The change of the amplification constant of the 6C5, which in an ordinary circuit would cause a reactive build-up, has no effect on the driving power in this circuit.

A line voltage change of ten per cent caused a change of the frequency of the fork of about one part per million. By using a neon-lamp voltage regulator, the plate voltage variations and the frequency changes are considerably decreased.

In order to determine whether temperature would influence the frequency of the generator, several fork units (including the amplifiers) were placed in a temperature controlled chamber and the frequencies of the various units were measured at different temperatures from fifteen degrees C. to 55 degrees C. The change of frequency for this entire temperature range was less than one part per million in most of the tests and never as high as two parts per million.

Methods of Checking

Most of the tests were made by exciting one pair of plates of a cathode ray oscilloscope by the frequency of a standard fork and the other pair of plates by the output voltage from the fork unit under test. Several forks accurate within a few parts in ten million were available. A 3600 cycle fork unit was used as a standard most of the time, because the checking against a high frequency source gives speedier results than checking against a low frequency fork. A drift of one "wave space" of the oscilloscope pattern in

one minute when a frequency of 60 cycles is compared with a frequency of 3600 cycles represents a frequency drift of one part in 216,000. By using a graded screen in front of the pattern a fraction of a wave space drift could be estimated.

Another method of checking was the use of a graded stroboscopic dial operated by a synchronous motor driven by the output current of one fork unit. A neon lamp mounted under the dial was operated through a cam mechanism operated by the output current of another fork unit.

In order to check the standards one 440 cycle fork and one 1000

It was found that the magnetic fields of the pickup magnets and the drive magnets have a considerable influence on the temperature coefficient of a tuning fork. Bringing the magnets closer to the tines of the fork or increasing the strength of the magnets changes the temperature coefficient in a positive direction. This causes the temperature coefficient to vary with the amplitude of the fork. Thus a negative temperature coefficient in a fork will decrease with increased amplitude, whereas the reverse is true with a positive coefficient.

In commercial use it is sometimes

Fig. 2—The change of frequency of a tuning fork is very rapid during the first few days of operation and gradually tapers off

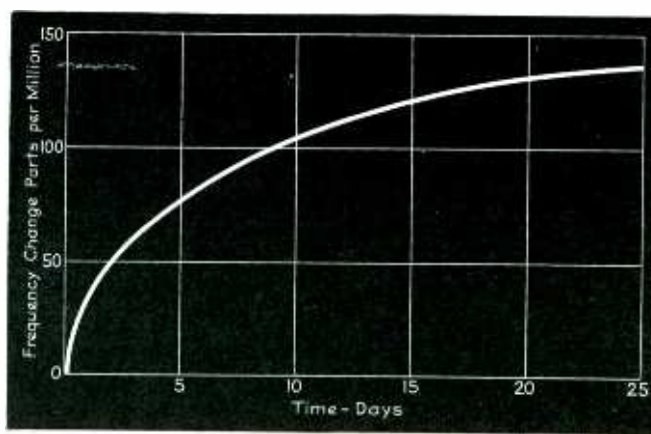

cycle fork were driven as slave forks by the Bureau of Standards frequency transmissions and then the standards were checked against these slave forks which would keep exactly the frequency of the transmitted signal. The 1000 cycle signal always came in very well through the radio receiver. The 440 cycle signal was very poor most of the time, but it was on nearly all day so there was nearly always a chance of getting a check every day.

Clocks were run from several 60 cycle forks, so that the frequency of these forks could be checked against the time signals.

Most of the tests described in this paper would give fairly accurate results even if considerable errors had been made in the checkings. For example, at the temperature tests the temperature was changed 30 degrees C. or more; thus if an error as great as one part in 100,000 were made in a checking, the error in the temperature coefficient measured would be only one part in three million per degree C.

desirable to vary the frequency over a considerable range. This can be done by changing the amplitude of the forks by means of a rheostat either in series or in parallel with the driving coil. In most cases the amplitude variations of the fork, even with allowance for some frequency adjustment, can be kept so low that the change of the temperature coefficient is of little importance. However, this effect of the pickup and driving magnets and the amplitude of the fork seems to make it impractical to supply a fork with a very low temperature coefficient separate from its amplifier and driving system. The final temperature coefficient should be given of the fork, properly aged, mounted with its magnet system, driven at a certain amplitude by a certain amplifier.

Effect of Changes of Atmospheric Pressure

In order to determine the effects of changes of the atmospheric pressure on the frequency of a tuning

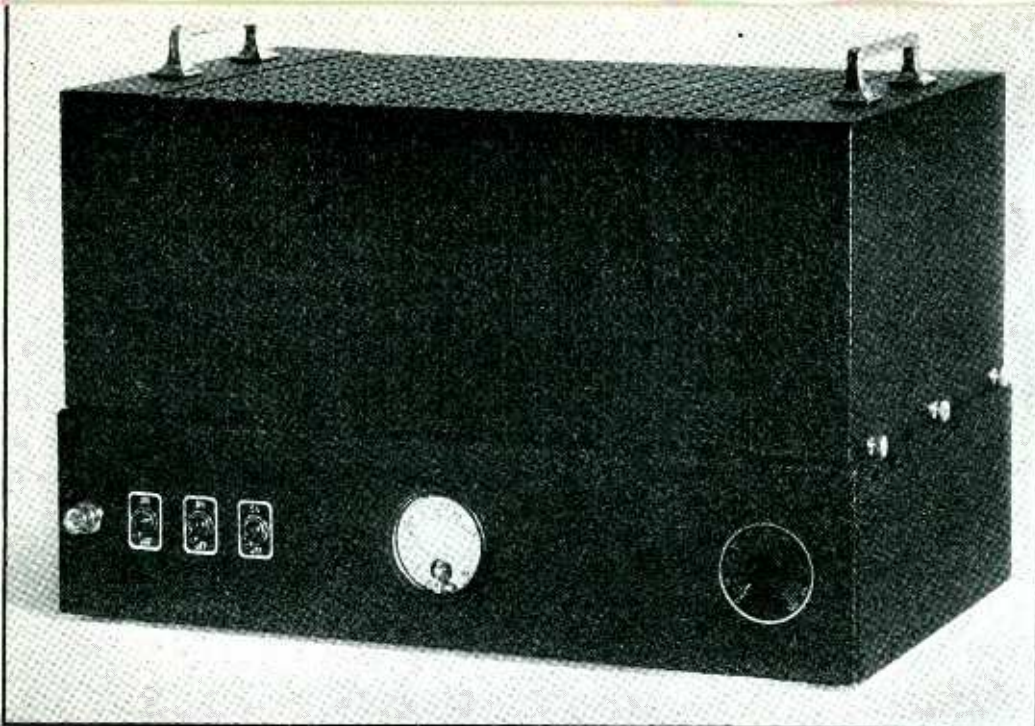

Fig. 3—The temperature coefficient of the tuning fork and its associated drive unit, pictured above, is of the order of one part per million per degree C

fork the complete fork units were placed in an airtight box which was then partly evacuated. It was found that the frequency increased 24 parts in 100,000,000 per millimeter decrease in the atmospheric pressure.

The pressure was changed from normal atmospheric pressure (760 millimeters) to 150 millimeters less than normal and measurements were made at intermediate points.

For this range of atmospheric pressure and at the various amplitudes of the forks tested the frequency changes are linear with the changes of pressure and independent of the frequency and of the amplitude of the forks.

Low frequency forks are greatly influenced by the position of the tines as referred to the horizontal plane; for high frequency forks the influence of the position of the tines to the horizontal plane is small. A 60 cycle fork was adjusted to zero rate with its tines parallel to the horizontal plane. Then the position of the fork was changed gradually to the vertical and measurements were made at various angles.

Effect of Position With Respect to the Horizontal Plane

It was found that the total change of frequency from the horizontal to the vertical position was -0.0002763 . It was also found that the change of frequency for any angle of the tines counted from the horizontal plane equals the maximum change (in this

case 0.0002763) times the sine of the angle.

A deflection of two degrees from the horizontal causes a change of frequency nearly as large as that caused by a deflection of fifteen degrees from the vertical plane. This shows that a fork should be mounted in a vertical position whenever practicable.

Rotating the fork around its longitudinal axis showed no effect on the frequency. This appears self-evident when the tines are mounted in a vertical position, but it also holds true when the tines are mounted horizontally.

Effect of aging on frequency

It was found that the frequency of steel forks as well as of alloy forks increases with time. This process is called aging. Two kinds of steel and three kinds of elinvar alloy were used in the forks tested. The difference in aging of the forks made from these five kinds of material was not enough to be clearly determined. The frequency of the steel forks seemed to settle down to its final value somewhat sooner than the frequency of the alloy forks, but the difference was not enough to warrant the use of steel for making of tuning forks. It is of theoretical interest, however, to know that the frequency of a steel fork increases with age as well as that of an alloy fork.

An aging process will take place whether the fork is in operation or

not, but it is much faster when the fork is in vibration and it is believed that no matter how long a fork has been stored after it was made, it will age considerably when put in operation. After a fork has been sufficiently aged in operation it will either not change at all in frequency or by an insignificant amount while in storage. The same seems to be true of a fork in operation as long as the amplitude is not increased.

When a fork is first put in operation its frequency will increase at a considerable rate at first and the rate of increase will gradually drop to an negligible amount.

The curve illustrated shows the rate of a fork from the first day in operation to the 25th day in operation. The increase in rate for the first day was 35 parts per million and for the 25th day it was about one part per million. During the following months few measurements were made until the sixth month when careful measurements were resumed. During this month no increase in rate was observed. Then this fork was kept idle (not running) for a month, and when it was put in operation again (eight months after it was first started) it had the same rate as it had when it was shut off at the end of six months' running.

This fork has now been in constant operation for nearly two years, and no increase in rate that can be definitely attributed to aging of the fork has been measured. The increase in rate from any and all causes is known to be less than ten parts per million for one and a half years.

A fork that had been run for a month from the time it was first put in operation was put in storage. It was run for a day or two every four months. The increase in frequency at each of three tests was about six parts per million. This test shows that a fork that is not aged while in operation will age slowly while at rest. Tests show that if the amplitude of a perfectly aged fork is increased it will start to age again to a lesser degree. If an aged fork is heat treated the aging will start all over, but it seems to reach an equilibrium sooner than it would if it had not been run at all. The amount and the time of the aging depends on the heat treatment it was given.

DIFFERENTIAL MODULATION METER

By VERNE V. GUNSOLLEY

THE customary form of modulation meter when reduced to its simplest terms is little other than an ordinary level indicator that has been definitely calibrated under fixed operating conditions to read the percentage modulation predetermined by measurement. In such a meter no provision is made for a change in carrier strength and so such a level indicator is valueless when used on any other carrier wave, the relative amplitude of which is undetermined.

The principle on which the differential meter is based is as follows: If, as shown in Fig. 1, the grid is returned to the center of the resistor R , the bias on the triode, and consequently the indication of the meter M , will be purely a function of the bias and plate voltage. If, with conditions remaining as in Fig. 1, we now insert a negative voltage in the left end of the resistor R as shown in Fig. 2, the potential on the grid relative to ground will be one half the applied voltage and this bias will cause the meter to indicate a lower plate current. Further, with conditions as shown in Fig. 2, if an equal positive voltage is applied to the right end of the resistor, the voltage of the grid return will be restored to zero, as in Fig. 1, and the meter will have its original indication restored. It is upon this differential principle that the modulation meter to be described is based.

We may apply the negative bias to the left end of resistor R in Fig. 3, from the diodes of an r-f rectifier in a conventional receiver as shown in Fig. 4. In such event the arrival of a carrier alone, without modulation, would cause the 6H6 to deliver negative bias to the left end of the resistor and so reduce the indication of the modulation meter.

On the other hand, we can pro-

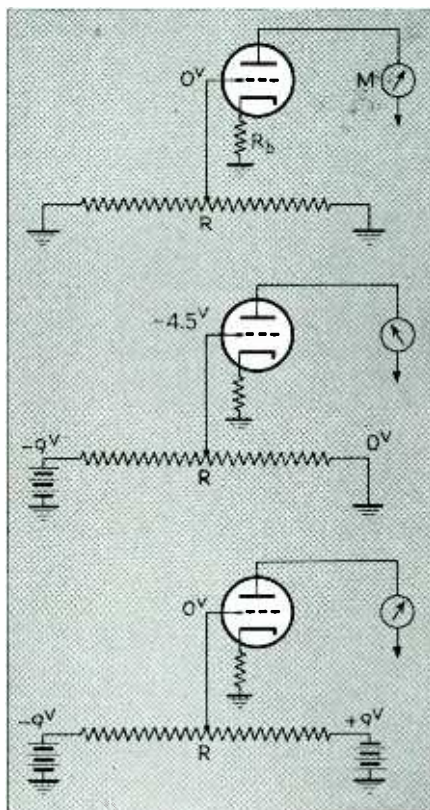

Illustration of the principle of the differential modulation meter. Fig. 1—Top, both ends of the resistor are grounded and the grid bias is zero. Fig. 2—Center, a negative voltage is applied to the left end of the resistor and the bias is one-half the applied value. Fig. 3—Bottom, a positive voltage is applied to the right end of the resistor and the bias is returned to zero

duce the positive bias on the right end of the resistor as in Figs. 3 and 4, by applying the rectified audio component of the modulated carrier.

The circuit shown in Fig. 4 is a schematic diagram of the differential principle involved, which is based on the fact that for any given percentage of modulation there is a definite relation between the r-f component and the a-f component; that is, at 100 per cent modulation, the a-f component is equal to the r-f component; at 50 per cent modulation the a-f component is half of the r-f component, etc. Thus when a 100 per cent modulated carrier is

impressed upon the r-f rectifier, and the circuit components of Fig. 4 are properly chosen to compensate for various indeterminate losses in rectification, the positive voltage applied to the right end of resistor R by the audio rectifier will be equal to the negative voltage applied to the left end by the r-f rectifier, the differential will be zero, and the modulation meter in the plate circuit of the triode will not change its indication from that corresponding to Fig. 1, or that shown in Fig. 3; that is to say, 100 per cent modulation on the meter face corresponds to the position of no signal.

It follows, therefore, that if only the carrier is impressed on the receiver, the differential will be maximum, and the meter indication will decrease a maximum, due to the negative bias supplied to resistor R . Therefore, we calibrate the meter at this point as for zero per cent modulation.

When the carrier is modulated 100 per cent, the positive bias delivered to the resistor, R , by the audio rectifier cancels the negative bias and restores the meter reading to 100 per cent, and this point is calibrated as being 100 per cent modulation. With the carrier level maintained constant, various percentages of modulation are then impressed upon it and the meter calibrated accordingly.

It is obvious from the foregoing that any change in carrier strength will change the zero per cent point on the meter scale, but will not change the point corresponding to 100 per cent modulation; since it coincides with the point of zero signal. A fading of the signal, therefore, only serves to compress the scale on the zero end, while an increasing of the signal causes it to expand. To be able to use such a monitor on various carriers, therefore, it becomes necessary to introduce automatic volume control to such a degree as will hold the zero point reasonably steady.

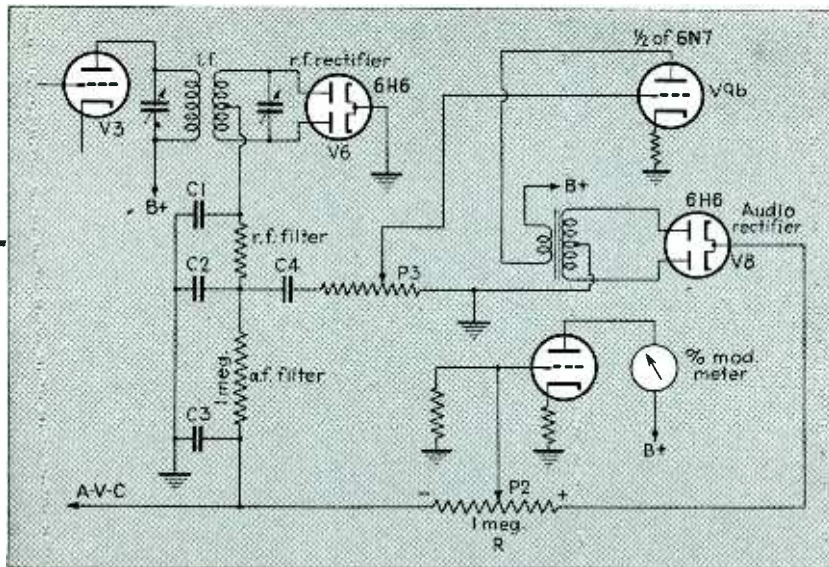

Fig. 4—Schematic diagram of the differential modulation meter. The outputs of the r-f and a-f rectifiers are applied to the opposite ends of the resistor R

Since fading does not change the calibration point indicating 100 per cent modulation, and since it does not appreciably affect the accuracy of calibration on values above 50 per cent, and further, since on rapidly varying modulation the pointer of the meter can indicate the instantaneous modulation only approximately, the practical value of the meter for indicating modulation values between 50 per cent and 100 per cent is not impaired by the usual extreme variations of carrier strength that can be leveled by the conventional a-v-c.

In the circuit diagram of the complete modulation monitor, shown in Fig. 6, the meter used has an 0-1 ma range; that is, an 0-1000 μ a range. With the monitor set up for regular operation and connected to the final i-f stage of a type HRO communication receiver, the signal strength from a modulated oscillator was varied from R3 to R12, by steps, and the following readings taken:

Signal Strength	Meter Reading	Per cent Zero-Error
R3	480 μ a	57.
R4	190 μ a	57.7
R5	160 μ a	11.4
R6	125 μ a	6.43
R7	100 μ a	2.9
R8	80 μ a	0.
R9	65 μ a	2.1
R10	40 μ a	5.7
R11	20 μ a	8.6
R12	0 μ a	11.4

(Note: At 50 per cent modulation the percentage of error is $\frac{1}{2}$ the values given above, and at 100 per cent modulation the error is zero.)

A study of these readings shows plainly that the a-v-c circuit lost

control somewhere between the R4 and the R5 signal. The important thing to note is that there is negligible shift in the zero modulation point between an R6 and an R12 signal; that is, a negligible shift either way from the average signal of R8 at which the monitor is calibrated.

When the monitor is permanently connected into the final i-f stage of the receiver, and the i-f stage re-

aligned to offset any slight detuning that may occur, the i-f stages of the monitor are tuned to the same frequency as those of the receiver, and all other adjustments made.

These adjustments are not independent, so the initial set-up of the monitor needs to be carefully made in order that the various functions may operate in the middle of their ranges when operating on an average signal of the same strength as that at which the meter was calibrated; in this case R8. When this is done, the meter will handle a maximum of signal variation either way from the average.

The procedure is as follows: First; when a signal of average strength, (R8), arrives at the grid of the first i-f amplifier, V_1 in Fig. 6, it is amplified in the conventional manner and passed on through V_2 , to V_3 , where it meets with full-wave rectification. Full-wave rectification is chosen for obvious reasons.

The i-f is filtered from the rectified carrier in the usual manner and the audio component passed to both P_1 and P_2 , which are in parallel, while the d-c component is freed of audio components by the audio filter and supplied to P_3 . This puts negative bias on the grids of V_4 and V_5 , thereby making V_4 inoperable, and

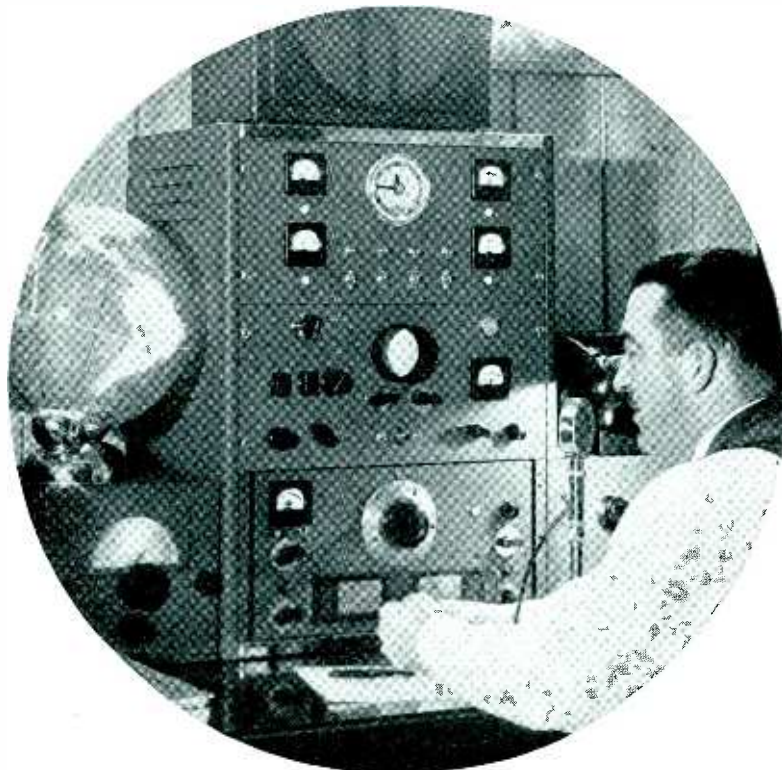

Fig. 5—The differential modulation meter in use at the controls of W9BRK, contained in the center panel

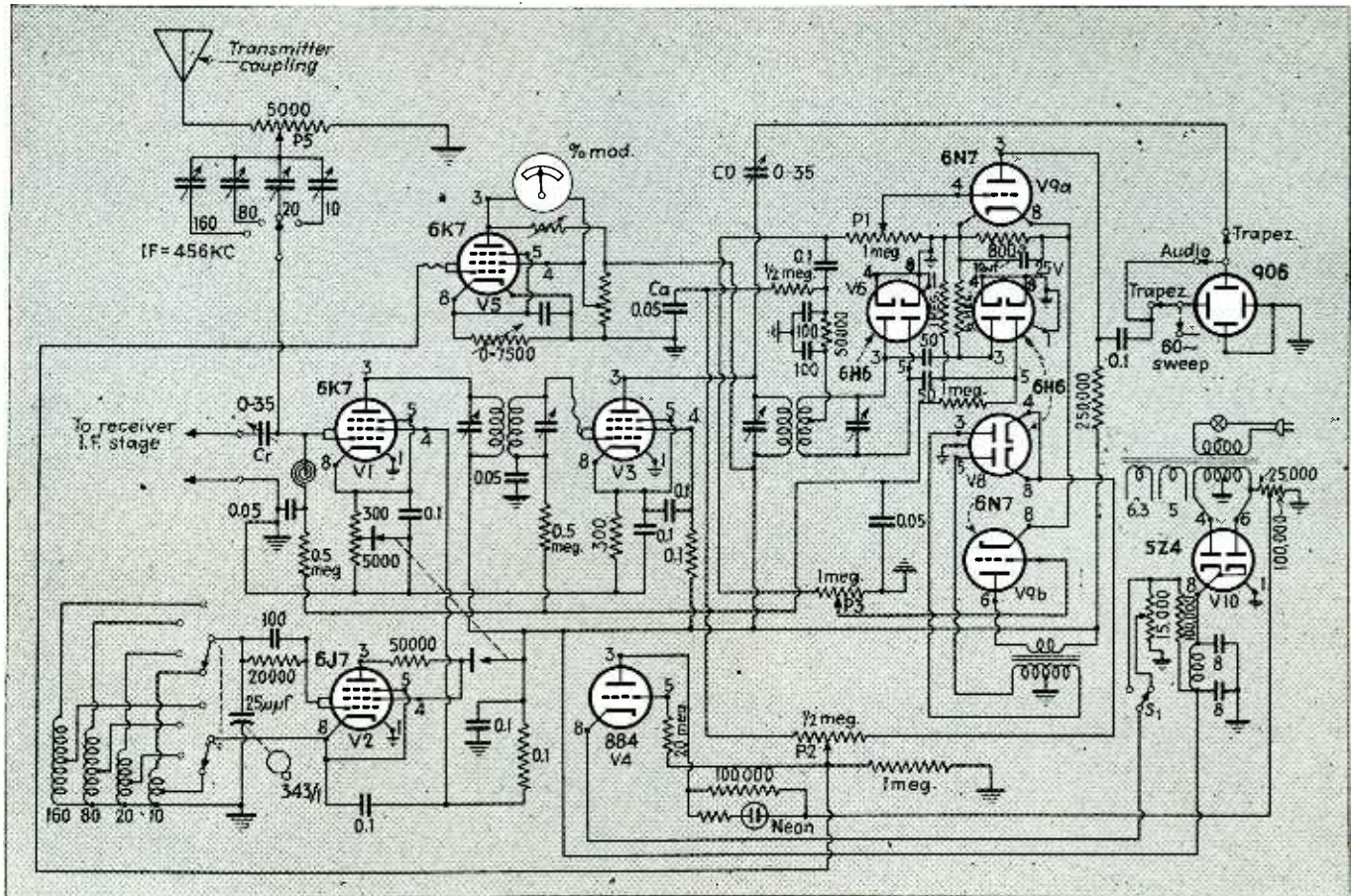

Fig. 6—Circuit diagram of the complete modulation monitor. It is connected to the final i-f stage of a receiver. For measuring a transmitted signal, the 5000-ohm portion of the V_1 cathode resistor is cut in and the plate and screen circuits of V_2 are closed

causing the pointer of the meter in the plate circuit of V_5 to fall back to 0 per cent modulation (provided the carrier is unmodulated).

With the monitor operating in this condition, the potentiometer P_3 is adjusted so that when the signal is modulated 100 per cent, the output of the full-wave audio rectifier V_8 will just cancel the output of the i-f rectifier, V_6 . This can be done by increasing the drive on the V_6 grid, by the use of P_3 , until the meter of V_5 goes back to the position it had before the signal was impressed on the monitor. This is the point of 100 per cent modulation. Various percentages of modulation may be given the carrier and the differential of the two rectifier outputs will operate the plate meter of V_5 proportionately, and the meter may be calibrated accordingly.

As P_3 is turned toward the left end, the capacitor C_a becomes more effective on the grid of V_5 , tending to smooth the rectified audio waves, and thereby to integrate the audio power in the carrier. Turning the control to the right end will, there-

fore, cause the meter to indicate more alertly the peaks of audio power, and thus show the instantaneous values of modulation percentage.

The percentage of modulation at which the type 884 thyratron fires, and causes the neon tube to flash, is determined by the setting of the potentiometer, P_1 . For 100 per cent modulation it is set so that the neon bulb flashes, or is on the verge of flashing when no signal is on the monitor; that is, when the meter is indicating 100 per cent modulation. If desired, the control may be equipped with a calibrated dial, so that it may be set to flash on peaks of any desired percentage. When thus set to 80 per cent or 90 per cent, the operator is forewarned against peaks running into and over 100 per cent.

The a-v-c voltage must be obtained from a separate rectifier, and this purpose is served by V_7 . The a-v-c voltage is supplied by the diode connected to prong 5. In order not to unbalance the i-f full-wave rectifier V_6 , prong 3 of V_7 is supplied

with a dummy load equal to the load imposed on the prong-5 diode by the a-v-c network, $\frac{1}{2}$ megohm.

When the monitor is operating properly on reception, it is a relatively simple matter to put it in operation on transmission. When the transmitting key is switched to the "transmit" position, a relay cuts in the 5000-ohm portion of the cathode resistor in V_1 , by opening, thereby converting the first amplifier, V_1 , into a first detector. At the same time the relay closes the plate and screen circuit of the 6J7 oscillator, V_2 , the frequency of which depends upon what position the band switch is set.

The band-switch is ganged with the antenna gang-switch. The adjustable condensers in the antenna gang, together with the potentiometer, P_5 , are preset to give the equivalent of an R8 signal to the grid of V_1 , on each band. The oscillator tuning condenser is equipped with a ratio of 343-to-1 in order to make correction of the warm-up drift an easy procedure, not in the least critical.

R-F Power Measurement

A simple and direct method of measuring power independently of frequency, using a diode rectifier and a wattmeter as the indicating instrument. A thorough treatment of the theory and practice involved, for direct and load-back methods

By P. M. HONNELL

The A. and M. College of Texas

NUMEROUS schemes for measuring radio-frequency power output are in common use, but none is preeminently superior from the standpoint of simplicity of apparatus, ease of calibration or of minimum high-frequency errors. As these considerations are intimately dependent upon the measurement frequency, a technique inherently independent of frequency is indicated. Such a technique is made possible by the application of thermionic diode rectifiers to power measurements.

The circuit for the thermionic rectifier determination of radio-frequency power is shown in Fig. 1. The output of the device under test is converted to direct-current power by the diode rectifier and dissipated in the load resistance. The power output is indicated directly by a wattmeter. Since there is a small power loss in the diode rectifier, precise measurements require a slight correction of the wattmeter reading. This correction can most conveniently be made by calibrating the wattmeter directly at 60 cycles per second, quite analogously to the similar calibration of vacuum-tube voltmeters at commercial frequencies.

Since it is usually necessary, particularly at high-frequencies, to utilize a suitable coupling line between the transmitter under test and the power measuring rectifier, a tuned circuit for impedance transformation is highly advantageous. A suitable rectifier circuit, together with a diode peak voltmeter, is shown in Fig. 2. The tuned circuit shown in this figure should be resonant to the radio-frequency of measurement.

Desirable features introduced by

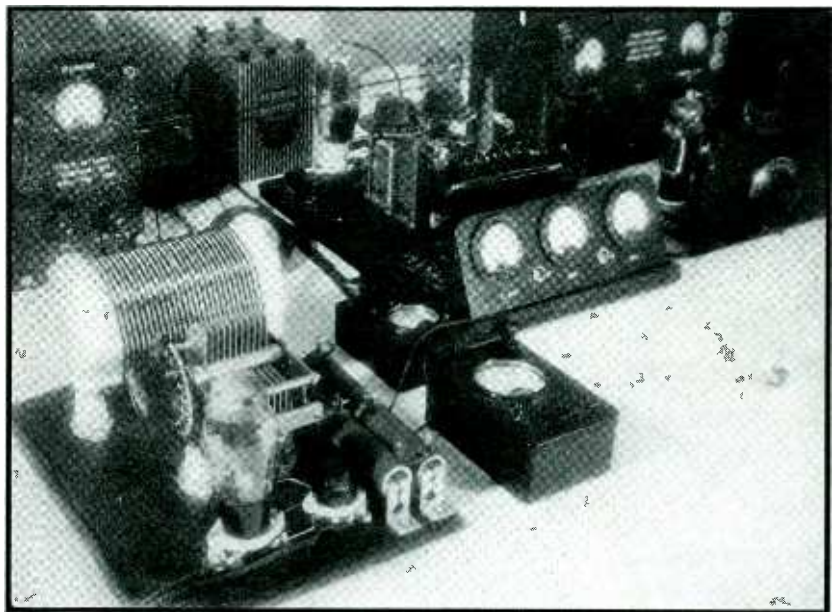

Experimental equipment used in checking the method on a practical basis, using a 25-watt oscillator as the power source

the tuned circuit, in addition to impedance transformation, are: the suppression of all voltages differing appreciably from the carrier frequency, and the possibility of increasing the power rectification efficiency by making feasible higher ratios of R_L/R_p for a given power output. A further consideration involves the fundamental assumption of linearity of the i_p-e_p characteristic of the rectifier. Considerable experimental data obtained to confirm the theoretical power rectification efficiency at 60 cycles per second—making possible the actual measurement of both input power and rectified power with low-frequency instruments—showed that the least error results when the peak rectifier anode current is well up in the linear range of the i_p-e_p characteristics. Observed discrepancies between measured and calculated rectification efficiencies

were less than five per cent under these circumstances. This again indicates the desirability of high voltage—and resulting high peak current—operation, which is made possible by the voltage transformation introduced by the tuned circuit.

The peak radio frequency voltages applied to the rectifier can be measured with a diode-type vacuum tube voltmeter which is also illustrated in Fig. 2. Although not recommended by manufacturer's ratings, a type 6H6 diode can be pressed into service and will function quite well with peak input voltages of five hundred to one thousand volts.

Radio-Frequency Loading-Back Test Methods

The cost of electric energy for testing power apparatus of high ratings often justifies the use of load-

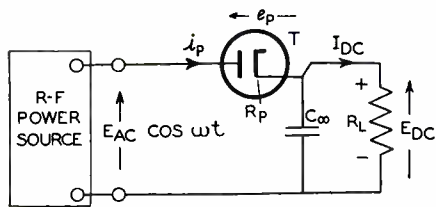

Fig. 1—Fundamental circuit of rectifier for measurement of r-f power using direct current instruments

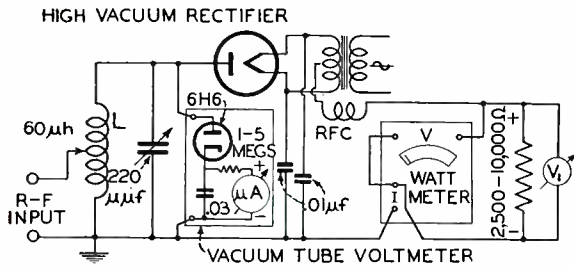

Fig. 2—Practical rectifier circuit for r-f power measurement

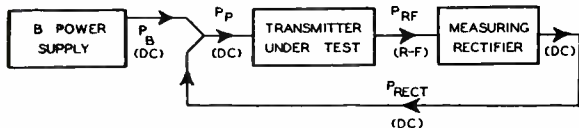

Fig. 3—Block diagram of loading-back circuit

ing-back circuits. In these circuits, a pair of machines are connected in such a manner that there is an interchange of power between them sufficient to load each apparatus to the desired level; at the same time, the net energy consumed is only that required to supply losses in both machines. Similarly, the difficulties of testing high-power radio transmitters, or other sources of radio-frequency power, are in a large measure due to the facilities required for the dissipation of the power output, to say nothing of its measurement. Loading-back circuits functioning at radio frequencies are made feasible by the rectifier method of measuring power, and offer definite advantages.

Before discussing actual circuits it is interesting to consider the flow of power in possible loading-back circuits. This is indicated by the block diagram of Fig. 3 which shows that the power from the anode B supply flows through the transmitter or oscillator under test where it is converted to radio-frequency power, then through the power measuring rectifier which converts it to direct current; thence the power is looped

back to the anode B supply of the transmitter.

If we denote by ϵ the ratio of power output to power input of the transmitter under test, we have

$$\epsilon = \frac{P_{RF}}{P_p} \quad (1)$$

where P_p is the total direct-current power input to the plates of the output stage of the transmitter, and P_{RF} is its radio-frequency power output. The total plate power input to the last stage of the transmitter under test, P_p , is the sum of the power from the measuring rectifier P_{RF} and the B supply, P_B . That is,

$$P_p = P_B + P_{RF} \quad (2)$$

The power rectification efficiency of the measuring rectifier τ_r is defined as before, namely,

$$\eta = \frac{P_{Rect}}{P_{RF}} = \frac{P_{DC}}{P_{AC}} \quad (3)$$

From (1), (2) and (3) it is a simple matter to show that

$$P_p = \frac{1}{1 - \eta\epsilon} P_B \quad (4)$$

$$P_{RF} = \frac{\epsilon}{1 - \eta\epsilon} P_B \quad (5)$$

Thus we see from (4) that whenever the product $\tau_r\epsilon > 0$, the power through the transmitter actually exceeds the power furnished by the B supply. Likewise equation (5) shows that if $(\tau_r + 1) > 1/\epsilon$, the radio-frequency power output of the transmitter will exceed the power supplied to the entire system by the B supply.

Loading-Back Circuits

There are two fundamental loading-back circuits: the series and the parallel, the designation indicating the disposition of the anode supply circuit. The series loading-back circuit has the B supply, measuring rectifier output, and transmitter plate input connected in series and the parallel loading-back circuit has the B supply source, the measuring rectifier output and the transmitter plate circuit in parallel.

Experimental Results

As an example of loading-back methods the table summarizes the results of such tests. Data were obtained with type 5Z3 and 80 power measuring rectifiers in both the series and parallel loading-back circuits. The transmitter utilized a Type 830B tube as a neutralized Class

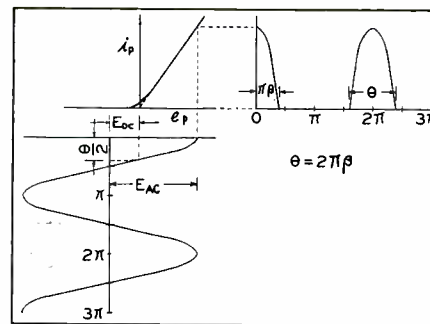

Fig. 4—Voltage and current relationships in the rectifier. θ represents the time of current flow in the rectifier

C radio-frequency amplifier. The operation of the transmitter was found to be quite normal; no instabilities or spurious oscillations of any sort could be detected.

The ratio of P_p/P_B , Equation (4), shows that the plate power input exceeded the B supply power by factors ranging from 1.52 to 1.85, depending upon the adjustments. In other words, the input to the transmitter actually exceeded the power from the B supply by fifty to eighty per cent.

This shows clearly the savings in energy costs made possible by loading-back circuits. Furthermore, the radio-frequency power outputs are accurately measurable. Thus the radio-frequency loading-back circuits parallel the performance and exhibit the same advantages presented by their low-frequency counterpart.

Theory of Operation

Many thermionic rectifiers exhibit a linear relation between anode voltage and current in their useful operating range—types 5Z3 and 80 are examples for smaller tubes—except for the small curvature of the characteristic in the vicinity of the origin, which can usually be neglected. Under such circumstances the power conversion efficiency of a linear rectifier (and thus its loss) is computable from the angular period of flow of the diode space current pulse, which is itself directly related to measurable quantities. It is therefore advantageous to derive the equations of rectifier efficiency. At the same time, a more fundamental understanding of the operation of the power rectifier action is made evident.

The power output of a device un-

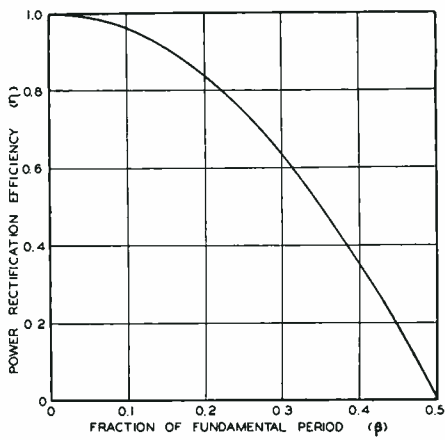

Fig. 5—Theoretical curve of power rectification efficiency versus the fraction of the fundamental period of flow during which current flows

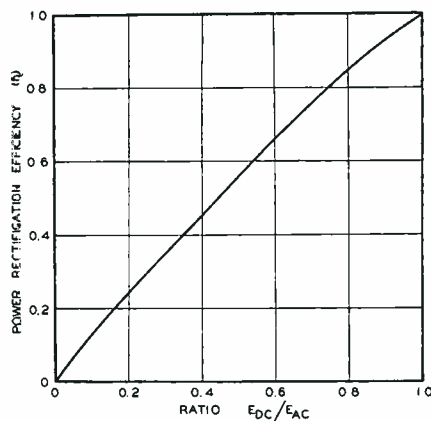

Fig. 6—Curve showing that the relation between power rectification efficiency and the ratio of d-c voltage to a-c voltage is nearly linear

der measurement by this method is

$$P_{AC} = \frac{P_{DC}}{\eta}, \quad (6)$$

where P_{AC} is the radio-frequency power supplied by the source under test, P_{DC} is the rectified power in the load resistance and η , the power rectification efficiency of the rectifier, is defined as

$$\eta = \frac{P_{DC}}{P_{AC}}. \quad (7)$$

In the circuit diagram shown in Fig. 1, the directions are positive for current and voltage. The condenser C is assumed as having no internal loss and negligible reactance at the operating frequency. The instantaneous applied radio-frequency voltage is $E_{AC} \cos \omega t$. In the steady-state, the rectified current I_{DC} flowing through the load resistance R_L produces a constant bias on the tube which acts as an equivalent electromotive force E_{DC} in opposition to the positive cycle of the applied sinu-

soidal alternating voltage E_{AD} . This follows from the fact that the condenser C is assumed as having zero reactance. At radio frequencies the reactance of a 0.01 to 0.05 μf condenser will have but a small fraction of the magnitude of the rectifier tube plate resistance. Consequently the diode plate current i_p flows in pulses during the fraction of the positive half cycle during which the applied alternating voltage E_{AC} exceeds the equivalent biasing voltage E_{DC} . These relations are depicted graphically in the usual manner in Fig. 6.

The space current-plate voltage

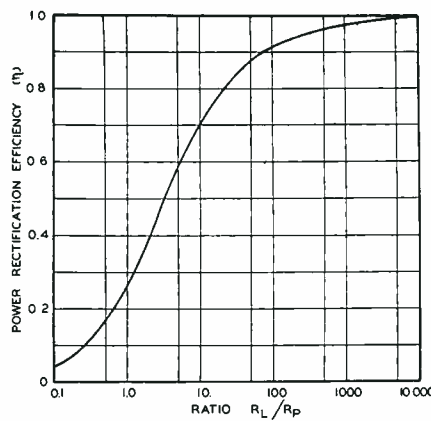

Fig. 7—Theoretical curve of the power rectification efficiency versus the ratio of the rectifier load resistance to internal plate resistance of the rectifier

relation in a two-element tube having a linear characteristic can be expressed as,

$$i_p = \frac{e_p}{R_p} \quad (8)$$

where i_p is the instantaneous plate current, e_p is the instantaneous positive plate voltage

R_p is the constant internal resistance of the tube while conducting.

From Fig. 1 it is evident that the numerator of (8), by Kirchoff's law, can be replaced by $(E_{AC} \cos \omega t - E_{DC})$. Equation (8) then reads

$$i_p = \frac{E_{AC} \cos \omega t - E_{DC}}{R_p}, \quad (9)$$

and is valid when the numerator is positive.

It now becomes advantageous to express the period during which the space current pulse flows—that is, θ —in general terms. This is done by defining a numeric β , which is the

fraction of the radio-frequency cycle during which the rectifier space current flows. Thus from Fig. 4 we have

$$\beta = \frac{\theta}{2\pi}, \quad (10)$$

where θ is the total angular period in radians during which the anode current pulse flows.

Another important relation evident from Fig. 4 pertains to the instant at which the space current pulse just begins (or just ceases) to flow. At this instant the applied carrier voltage just equals the rectified voltage, so that

$$E_{AC} \cos \theta/2 = E_{DC},$$

or, by virtue of (10),

$$\frac{E_{DC}}{E_{AC}} = \cos \theta/2 = \cos \pi\beta. \quad (11)$$

The input and rectified power can now be obtained from (9), and the efficiency η determined. To obtain the rectified power we note that the rectified load current I_{DC} is equal to the average value of the current pulse over a complete cycle; this is obtained by integrating (9),

$$I_{DC} = \frac{1}{2\pi} \int_{-\pi\beta}^{\pi\beta} \frac{E_{AC} \cos \omega t - E_{DC}}{R_p} d\omega t,$$

which yields

$$I_{DC} = \frac{E_{AC}}{\pi R_p} \left[\sin \pi\beta - \frac{E_{DC}}{E_{AC}} \pi\beta \right].$$

Substituting $\cos \pi\beta$ for E_{DC}/E_{AC} by virtue of (11), this can be written as

$$I_{DC} = \frac{E_{AC}}{\pi R_p} \left[\sin \pi\beta - \pi\beta \cos \pi\beta \right]. \quad (12)$$

The rectified direct-current power output

$$P_{DC} = E_{DC} I_{DC}.$$

Substituting in this expression the value of E_{DC} from (11) and the value of I_{DC} from (12), we have after some reduction

$$P_{DC} = \frac{E_{AC}^2}{2\pi R_p} (\sin 2\pi\beta - \pi\beta \cos 2\pi\beta - \pi\beta). \quad (13)$$

The average alternating-current power from the source under measurement can be written as

$$P_{AC} = \frac{1}{2\pi} \int_{-\pi\beta}^{\pi\beta} e i d\omega t.$$

in which $e = E_{AC} \cos \omega t$ is the applied voltage and i is identical with the plate current i_p from (9). Substituting these equivalences we obtain

$$P_{AC} = \frac{1}{2\pi} \int_{-\pi\beta}^{\pi\beta} (E_{AC} \cos \omega t) \frac{(E_{AC} \cos \omega t - E_{DC})}{R_p} d\omega t.$$

Upon integration and evaluation of limits, this expression finally reduces to

$$P_{AC} = \frac{E_A c^2}{2\pi R_p} (\pi\beta - \sin \pi\beta \cos \pi\beta). \quad (14)$$

The power rectification efficiency can therefore be obtained from the ratio of (13) to (14). This fundamental ratio becomes, after simplification,

$$\eta = \frac{2 \sin 2\pi\beta - 2\pi\beta \cos 2\pi\beta - 2\pi\beta}{2\pi\beta - \sin 2\pi\beta} \quad (15)$$

It should be noted from equation (15) that the power rectification efficiency η is independent of both the magnitude of the applied carrier voltage and its frequency. This is in accord with usual concepts, for it is well known that the operation of rectifiers is independent of frequency up to the range in which electron-transit time effects become important.¹ This should be of the order of twenty to thirty megacycles per second for the smaller rectifier tubes.

The tacit assumption has been made throughout that the applied radio-frequency voltage is strictly sinusoidal even in the presence of current flow in short pulses of a fraction of a cycle duration. This is, however, entirely justifiable since tuned-circuits are universally used in radio-transmitters and other sources of high-frequency energy. Furthermore, it is most practical to employ a tuned circuit at the power measuring rectifier itself. The applied voltage will therefore in all useful cases be sinusoidal to the required extent.

Application of Equation (15)

It is of course hardly practicable to determine with sufficient accuracy the rectification efficiency η by the direct measurement of the fractional period of flow of the space current pulse at radio-frequencies. However, two methods of solving for the flow angle are possible from the fundamental relation of equation (11):

1. The most obvious method is to actually measure the rectified direct-current voltage E_{DC} appearing across the load and the peak value of the applied radio-frequency voltage. The quotient of these two quantities, according to (11), gives the cosine of the angular period of flow, from which β , and finally η , is readily obtained.
2. The second method is

based upon the fact that the flow angle is uniquely determined by the ratio of the direct-current load resistance to the resistance of the thermionic rectifier, R_L/R_p .

Efficiency Based Upon E_{DC}/E_{AC}

Considering first the determination of the rectification efficiency by the direct measurement of E_{DC} and E_{AC} , considerable simplification results if we plot η from equation (15) not as a function of the fractional period of flow β , but instead directly as a function of the ratio E_{DC}/E_{AC} . This can be accomplished by means of (11) and the graph of η in Fig. 5. The resulting curve relating the efficiency η , as a function of the ratio E_{DC}/E_{AC} is plotted in Fig. 6, and shows the interesting fact that the power rectification efficiency approximates a linear function of the fractional period of flow of the space current pulse.

Since the peak value of the applied radio-frequency voltage can be obtained by means of a vacuum-tube voltmeter with nearly the same accuracy² and almost the simplicity of measurement of the direct-voltage E_{DC} across the load resistance, this provides a most practical method of determining the efficiency.

from equation (12), the relation

$$\cos \pi\beta = \frac{R_L E_{AC} (\sin \pi\beta - \pi\beta \cos \pi\beta)}{E_{AC} \pi R_p}$$

is obtained. Solved for the ratio of resistances, this gives

$$\frac{R_L}{R_p} = \frac{\pi \cos \pi\beta}{\sin \pi\beta - \pi\beta \cos \pi\beta}. \quad (16)$$

While not solvable directly, β can be obtained as a function of R_L/R_p from a graphical plot of (16). For our purpose, it is more desirable to plot the rectification efficiency η directly as a function of R_L/R_p ; this is again accomplished graphically and leads to Fig. 7.

The value of R_L is easily determined while R_p can be closely approximated from a plot of the i_p-e_p characteristic of the rectifier tube. The corresponding power rectification efficiency for a given rectifier tube and load is then obtained from Fig. 7. Finally, power output measurements are corrected for this efficiency by use of equation (6), as in Method 1.

The equations leading to Fig. 9 are the theoretical justification for the statement previously made that the wattmeter could be calibrated at 60 cycles per second, since it is evident from these equations that the efficiency can be expressed implicitly

TABLE OF RESULTS
Radio-Frequency Loading-Back Tests

Rectifier Tube Type	P_R Watts	P_p Watts	P_{RF} Watts Computed	P_{Rect} Watts Measured	$\frac{P_p}{P_R}$
Series Circuit					
80	61	101	60	40	1.66
80	200	316	171	116	1.58
5Z3	65	119	71	54	1.83
5Z3	108	196	116	88	1.81
Parallel Circuit					
80	14	26	15	12	1.85
80	84	128	55	44	1.52
5Z3	13	24	13	11	1.85
5Z3	100	172	86	72	1.72

The final result is obtained by dividing the wattmeter reading P_{DC} by the efficiency η , as given by equation (6),

$$P_{AC} = \frac{P_{DC}}{\eta}. \quad (6)$$

Efficiency Based Upon R_L/R_p

If we substitute $I_{DC}R_L$ for E_{DC} in equation (11) we obtain

$$\cos \pi\beta = \frac{I_{DC}R_L}{E_{AC}}$$

and substituting for I_{DC} its value

in terms of the circuit resistances. The calibration need be made only for the several values of R_L which it may be desirable to use. For a valid low-frequency calibration, the size of the by-pass capacitance C must be greatly increased over the value suitable for radio-frequency operation, to insure that the reactance of the condenser is negligibly small in comparison to the rectifier tube resistance.

^{1, 2} Nergaard, L. S., "Electrical measurements at less than two meters," *Proc. I.R.E.*, Vol. 24, pp. 1207-1229; September, (1936).

KLYSTRONS

In operation at Stanford University. These tubes generate sizeable amounts of radio frequency power at a wave length of ten centimeters (3000 Mc). They show great promise for the future of very high frequencies

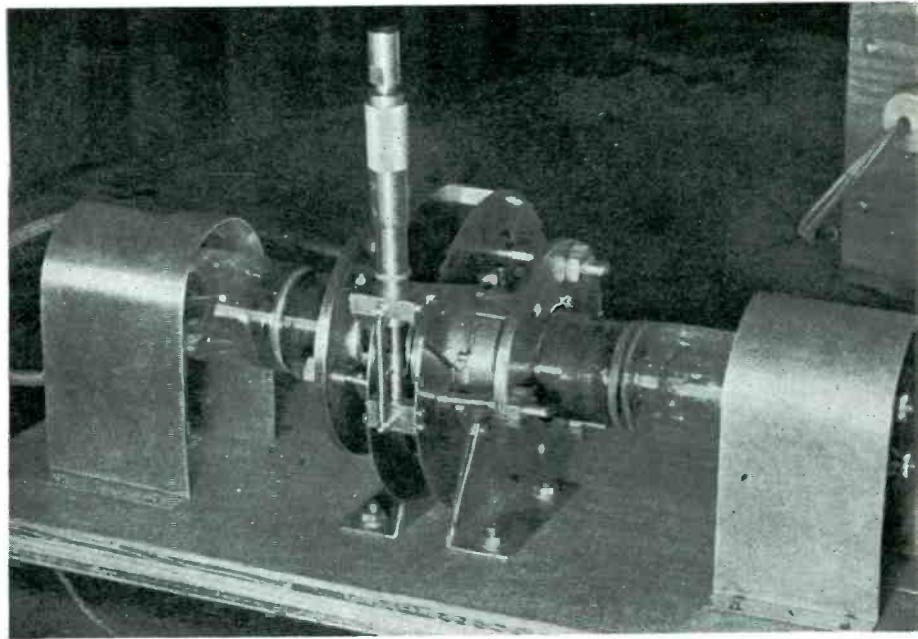

Receiver tube. Tuning (the range is about 9 to 11 cm) is accomplished by compressing the thin walls of the resonating chambers with the micrometer adjuster until the greatest sensitivity is obtained

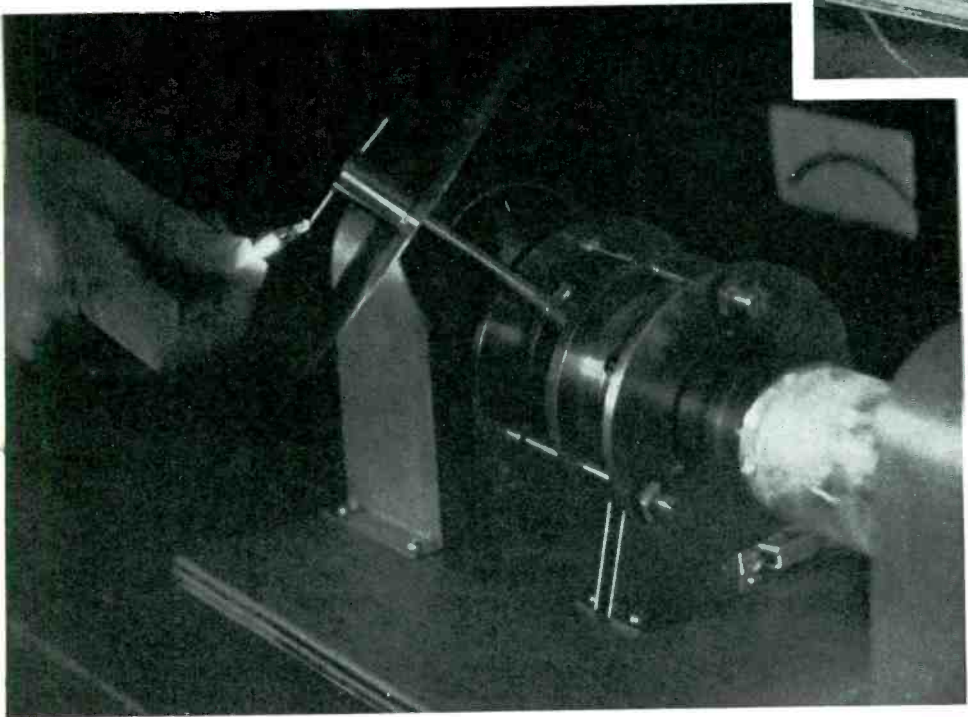

A neon lamp in contact with the radiating antenna of the transmitting tube glows not with the usual neon red, but with a weird reddish purple which seems to be a characteristic color of such ultra-high-frequency ionization

Transmitting tube. The antenna (projecting wires above disc) is a half-wave dipole coupled to the "catcher" rhumbatron (resonating chamber where the electron groups deliver their energy)

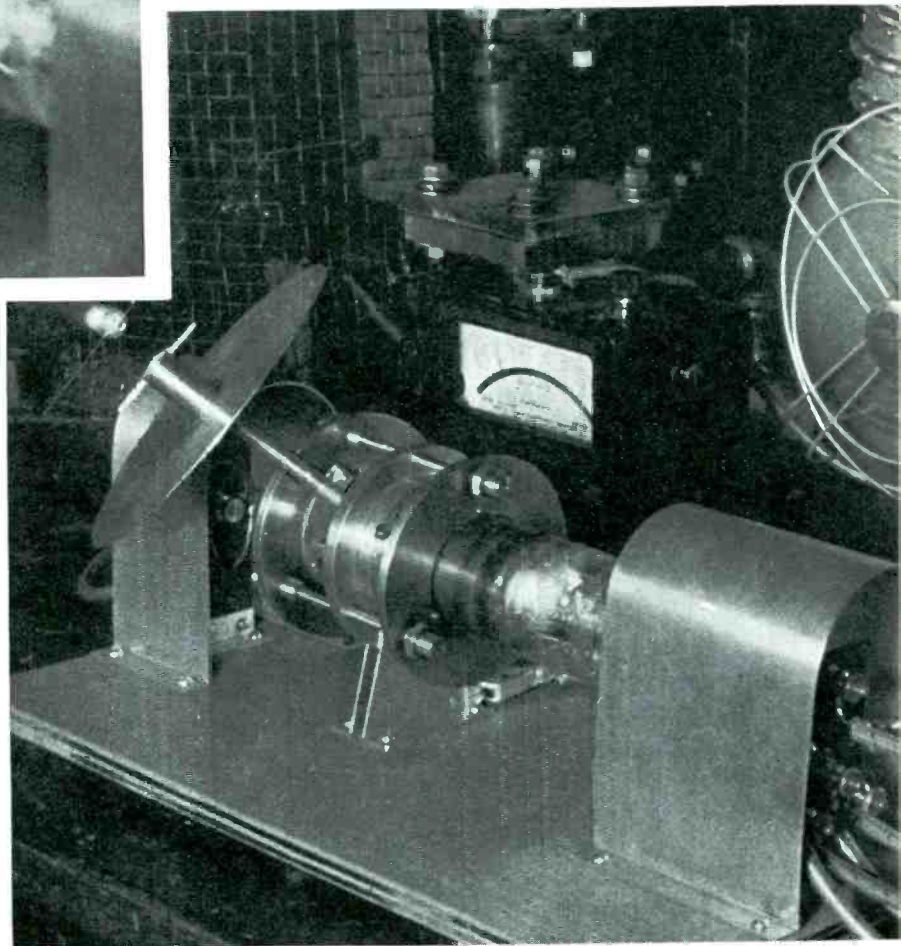

MULTI-WIRE

High-frequency antennas to which transmission lines of high impedance (of the order of 500 ohms) may be directly coupled, without the use of matching transformers, and which use several wires in the dipole, are here described

THE single-wire half-wave doublet is a common form of short-wave antenna. When operated at its fundamental frequency there is a maximum of current, or current loop, at the center of the antenna and a minimum of current at the ends. The resistance, as measured at the current loop point of this antenna, is about 70 ohms when the antenna is in free space. Thus, a transmission line connecting a transmitter to the current loop point of a single-wire half-wave doublet should have a characteristic impedance of about 70 ohms if a minimum of reflection on the line is desired.

A line of this relatively low characteristic impedance may be convenient in some cases. In other cases, a higher impedance line may be preferable. Such lines, having a characteristic impedance of 300 to 600 ohms and constructed of parallel open wires, are commonly used in short-wave practice. To terminate such an open wire line at the current loop point of a single-wire half-wave doublet with a minimum of reflection requires the use of some type of matching transformer. Quarterwave transformers, building-out sections, and delta matching systems are often used for this purpose.

This article describes a number of new antennas of the multi-wire type¹. Three of the multi-wire doublets discussed are one-half wavelength long and a number of other types both longer and shorter than a half-wave are also treated. Several of these antennas have terminal resistances which are suitable for the direct connection of an open wire transmission line. For this reason they may be more convenient in certain cases in place of a single-wire doublet which requires some

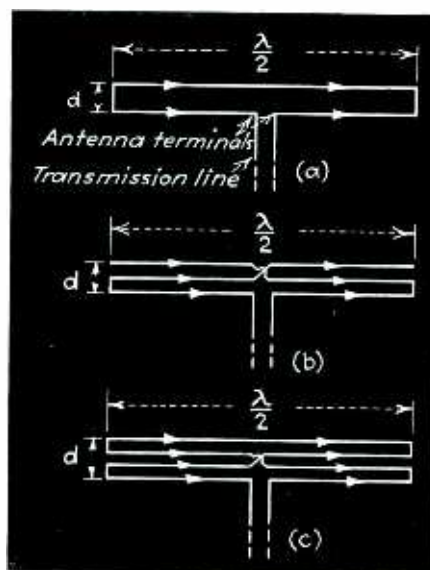

Fig. 1—Two, three and four wire half-wave antennas. The instantaneous currents are in phase with each other and their directions are indicated by the arrows

form of matching transformer. The transmission line terminals of all of the types described are located at a current loop point. Lindenblad² has recently described a folded antenna, which might be called a 2-wire quarter-wave doublet, in which the terminals are located at a current node.

Multi-Wire Half-Wave Doublets

Figure 1 shows multi-wire half-wave antennas employing two, three, and four parallel in-phase wires. The current distribution at a given instant is indicated by the arrows on the wires. The two-wire half-wave doublet at *a* consists of two parallel closely-spaced half-wave wires connected together at the ends. Very small spacing *d* between the wires of the order of 0.01 wavelength can be used. With the antenna in free space

By JOHN D. KRAUS

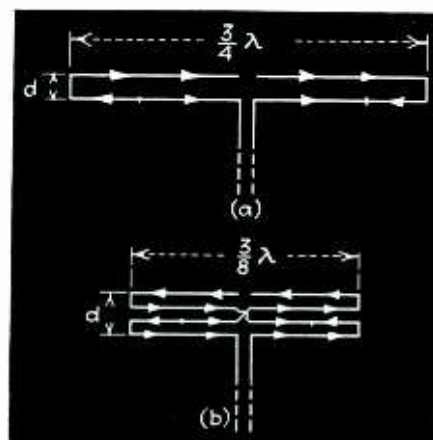

Fig. 2—Two wire, three-quarter wave antenna (terminal resistance 450 ohms) and four-wire, three-eighths wave antenna (terminal resistance 230 ohms)

the feed point radiation resistance is about 350 ohms. Thus, it is practical to connect an open wire transmission line of this characteristic impedance directly to the terminals of the antenna and no matching transformer is required.

By using a larger number of parallel in-phase half-wave wires the feed point resistance can be further increased. Thus, Figs. 1b and 1c show three- and four-wire half-wave doublets which have terminal resistances of approximately 875 and 1500 ohms respectively. It is not practical to build open wire lines of sufficiently high characteristic impedance to directly match these three- and four-wire doublets. However, these doublets can be applied to beam antenna systems where an increased feed point resistance is desired. Several beam antenna systems using multi-wire doublets have recently been described.³

¹ J. D. Kraus, Multi-Wire Doublet Antennas, *Radio*, No. 239, p. 24, May 1939; also *Radio*, No. 240, p. 21, June 1939.

² N. E. Lindenblad, Television Transmitting Antenna for Empire State Building, *RCA Review*, vol. 3, no. 4, p. 400, April 1939.

DIPOLE ANTENNAS

Although the feed point resistance of the multi-wire doublets is much higher than for the single-wire half-wave doublet, the radiation characteristics of both types are very similar.

Additional Types

Another type of multi-wire antenna called a two-wire three-quarter

The standing waves on the transmission line were used as an indication of the condition of match.

The measured variation in the standing wave ratio versus length of the antenna for the multi-wire antennas described is given in Fig. 3. The lengths are plotted in terms of the optimum length, that is, the length resulting in the smallest terminal reactance. The antennas

were found to be approximately as follows: Two-wire half-wave, 0.49λ ; three-wire, 0.46λ ; four-wire, 0.47λ ; two-wire three-quarter wave, 0.71λ ; and four-wire three-eighths wave, 0.38λ .

Using these optimum lengths, the variation of standing wave ratio with frequency was measured. The results are shown in Fig. 4. A 570-ohm line was directly connected to the antenna terminals in each case. Some mismatch is to be expected for certain of the antennas such as the four-wire doublets. However, it is significant that over the frequency range measured (amateur 14.0 to 14.4 Mc band) the standing wave ratios remained very constant.

In the frequency test all of the antennas were suspended in a horizontal position and at a height of about 25 feet above ground except the four-wire half-wave which was about 30 feet above ground. The height of an antenna above ground has, of course, an important effect on its terminal resistance and reactance.

The antennas were constructed of number twelve (B. & S. gauge) wire and the overall spacing d was of the order of 0.015 wavelength or less. Thus, for example, the two-wire half-wave doublet designed for 14 Mc was 34 feet long and had a wire spacing of one foot.

Three-Eighths Wave Vertical

Although the multi-wire antennas described may be used in either a horizontal or a vertical position, a purely vertical type can be constructed by using one-half of the two-wire three-quarter wave antenna and working it against ground. The arrangement for such an antenna is shown in Fig. 5a. The total current distribution (vector sum of currents in both wires) is given in Fig. 5b. The terminal resistance of the antenna is about 250 ohms. An interesting property of this antenna is that due to the multi-wire construction, a current distribution is produced which is similar to that of a vertical top-loaded single-conductor antenna.

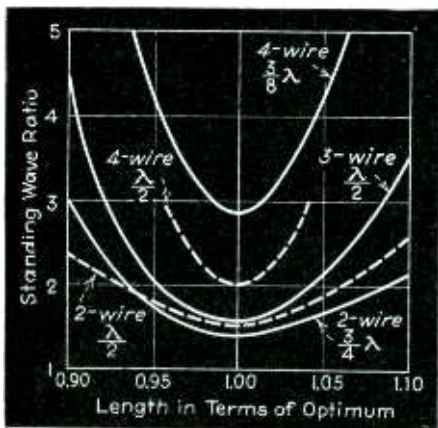

Fig. 3—The length of the antenna becomes more critical as the number of wires is increased. Also, the standing wave ratio increases

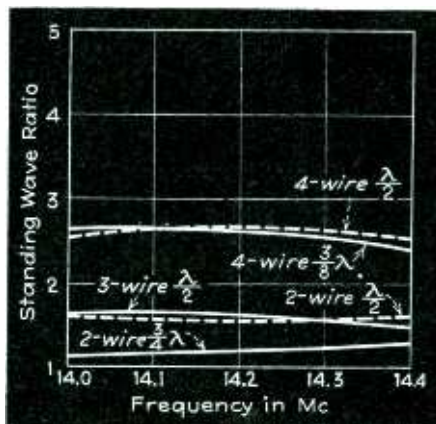

Fig. 4—The standing wave ratio is quite constant over the operating range from 14.0 to 14.4 Mc. A 570 ohm line was used

wave doublet is shown in Fig. 2a. This antenna is approximately three-quarters wavelength long overall. The resistance at the terminals is about 450 ohms with the antenna in free space and thus, a 450-ohm open-wire line can be directly connected to the terminals of this antenna.

Figure 2b shows a four-wire three-eighths wave doublet. This antenna has four parallel wires and is three-eighths of a wavelength long overall. The terminal resistance is about 230 ohms when the antenna is in free space.

Tests

Tests were made on the multi-wire antennas described to determine the effect of antenna length and frequency on the impedance match of the antenna to the transmission line.

³ J. D. Kraus and H. E. Taylor, Compact-H Beam Antenna, *Radio*, no. 242, p. 34, Oct. 1939; also J. D. Kraus, Twin-3 Flat-Top Beam Antenna, *Radio*, no. 243, Nov. 1939.

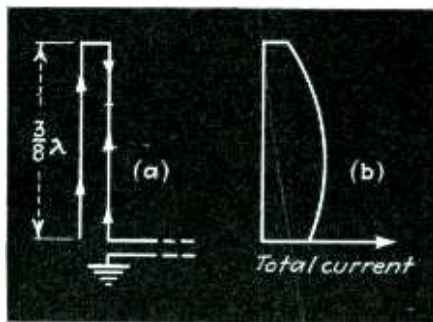

Fig. 5—A three-eighths wave vertical antenna working against ground and its total current distribution curve

were tested in a horizontal position. A frequency of about fourteen Mc was used and the frequency, height above ground and spacing between the wires were maintained constant. A 570-ohm transmission line was used in each case and was connected directly to the antenna terminals. The optimum lengths expressed in wavelengths for the various an-

AN AMPLIFIER

By
ARTHUR W. SEAR

Armour Institute of Technology

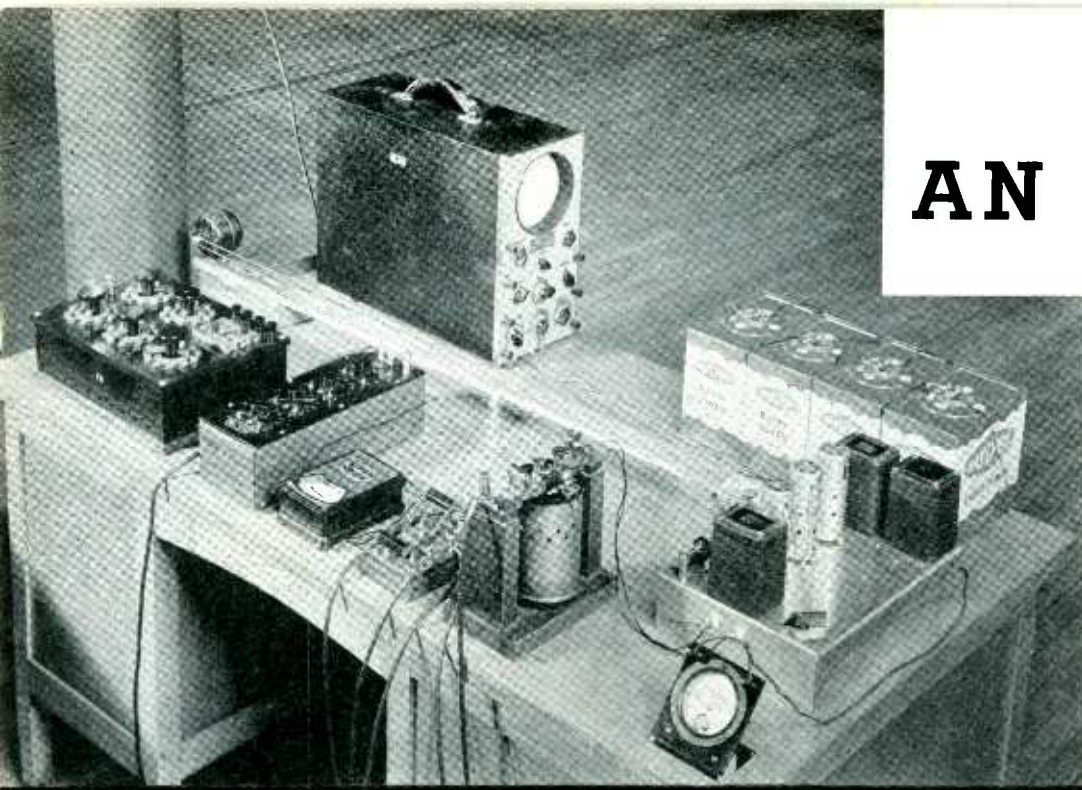

The experimental model with which it is possible to estimate the value of a resistance to six significant figures

THE use of vacuum tubes to increase the sensitivity of portable instruments in the measurement of very small direct current potentials has not been satisfactory due to drift of the tube characteristics which mask the effect of voltages being measured. In order to balance direct current bridges and potentiometers with high precision it is necessary to detect potential differences of a microvolt or less, and the sensitive D'Arsonval type galvanometer has been used in this service.

The use of sensitive galvanometers require a mounting which eliminates vibration and the use of an optical

system to read the small deflections which are obtained. The rather slow response of sensitive instruments consumes time and reduces the speed with which measurements can be made. This may be a serious handicap in determining temperatures or other measurements where changes occur.

An amplifier with a portable galvanometer of relatively low sensitivity would obviate the use of special mountings and speed up the measurements. Right and left indication as the polarity of the direct current potential reverses is necessary for use in conjunction with

bridge and potentiometer measurements.

The above requirements are met in an amplifier and associated apparatus which has been developed in the communication laboratory of Armour Institute of Technology. As indicated in the circuit diagram, the device consists of a high-gain amplifier with a transformer input. The input transformer has a low impedance primary which is in series with a motor driven switch. If a small direct current potential is impressed across the input terminals a transient current will flow in the primary when the motor driven switch closes. The secondary voltage caused by the current transient in the primary is amplified by the high-gain amplifier and impressed on the grid of the output tube. The switch in the output circuit is closed at the instant the input switch closes so that a current impulse flows in the galvanometer due to the voltage transient. The switch in the output circuit opens before the input switch. Consequently, the combination rectifies a series of half wave impulses. The transient which occurs when the input switch opens could be used instead. The current and voltage waves are shown in the accompanying diagram.

The speed at which the input switch is operated depends somewhat upon the time constant of the transformer circuit. The switch in the output circuit should not open until

Transient voltages and currents from a direct current input

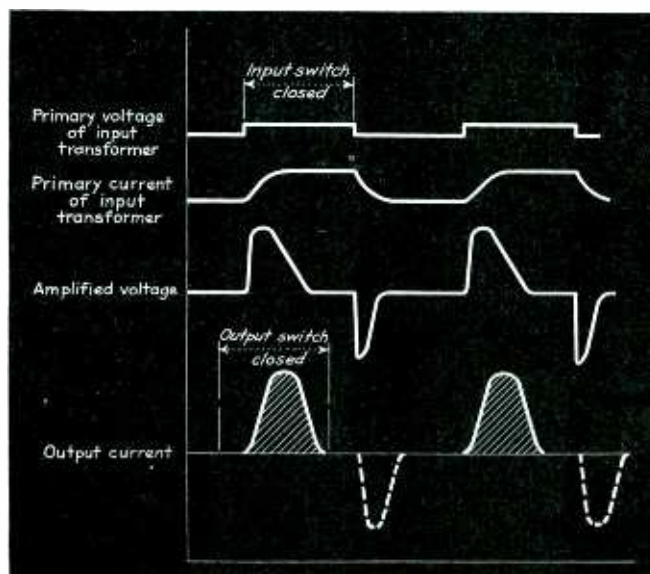

FOR D-C GALVANOMETERS

A means by which a vacuum tube amplifier may be used to increase the sensitivity of portable instruments to such a degree that it is comparable with the sensitivity of a permanently mounted D'Arsonval galvanometer, with the speed of a less sensitive instrument

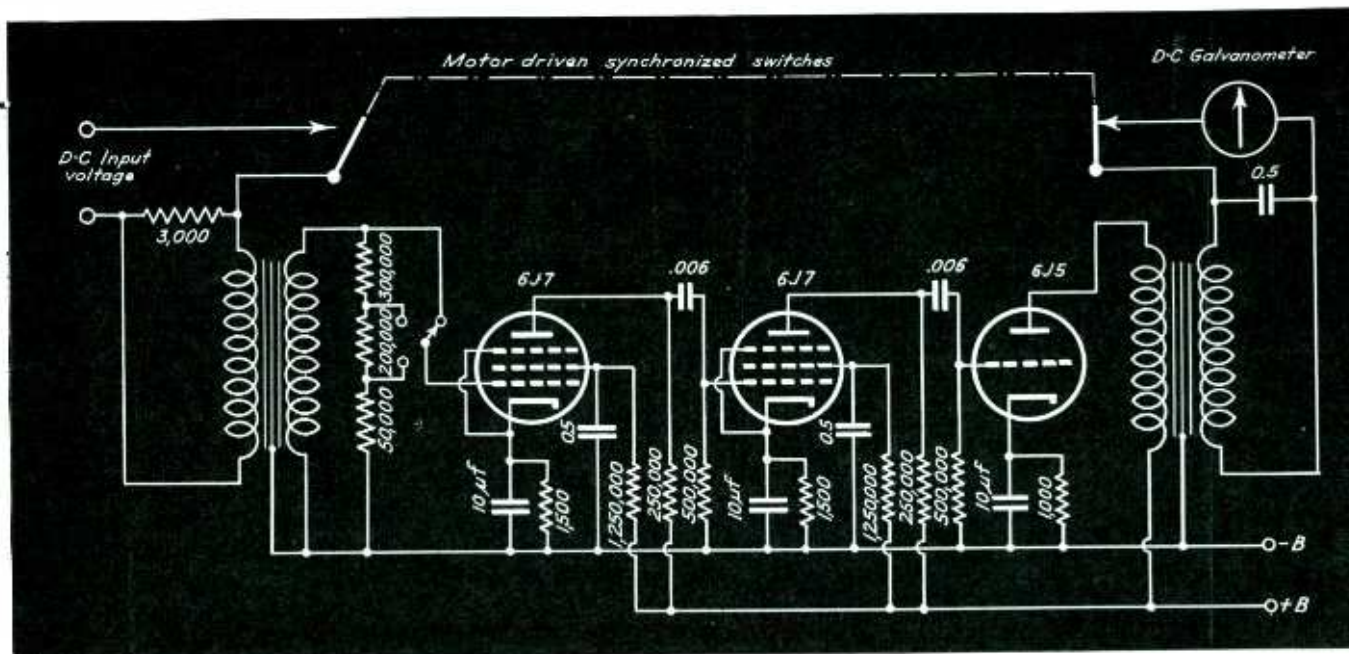

Circuit diagram of amplifier and switches. The combination of the switches and the circuit rectifies a series of half wave impulses to deflect the meter

the transient has passed and there is no current flowing in the galvanometer circuit. Up to the limitation of the time constant the output current increases as the switching speed increases.

In the experimental model shown in the photograph, a direct current potential of one-half microvolt, due to the flow of fifty microamperes through a standard resistance of one hundredth of an ohm, produced a deflection of two divisions on the output galvanometer. The meter used has a one milliamperere movement with zero center. The right and left deflection of the galvanometer was symmetrical about the zero position as the current through the standard resistance was reversed. There was a shift of the zero position of the galvanometer of approximately three divisions when the motor was started caused by contact potentials in the input circuit. The use of a more sensitive galvanometer produced a greater deflection,

but since the zero shift was also greater, the increase in sensitivity of the complete unit was not appreciable.

A stable and quiet amplifier is necessary in order to prevent flutter of the galvanometer. The presence of hum or noise in the amplifier produces a random shifting of the galvanometer zero due to indiscriminate rectification of noise currents by the output switch. Since the magnetic shielding in the experimental model was inadequate, it was necessary to place the motor some distance from the amplifier to avoid magnetic pick-up. Filtering in the output circuit prevents vibration of the galvanometer pointer which would otherwise result from the pulsations of output current.

When using the unit to balance a Leeds and Northrup Wheatstone bridge the galvanometer deflection due to change of the fifth dial, one tenth ohm per step, was quite large. When the tenth ohm dial was set at

six the deflection was four divisions to the right, and at seven the deflection was six divisions to the left, so that it was possible to estimate the value of the unknown resistance to six significant figures by using the relative deflection of the galvanometer. This was, of course, beyond the guaranteed accuracy of the bridge but it serves to illustrate the sensitivity of the method. Under the above conditions the reading of the meter was immediate and readings could be repeated.

With careful design and adequate shielding of the amplifier, together with input and output transformers designed for the service, it appears that a compact and portable unit can be constructed which will be equal in sensitivity to delicate and permanently mounted D'Arsonval type galvanometers while retaining the indication speed of the less sensitive instruments. With slight modification the device can be adapted for use with control apparatus.

ELECTRONIC FLOW METER

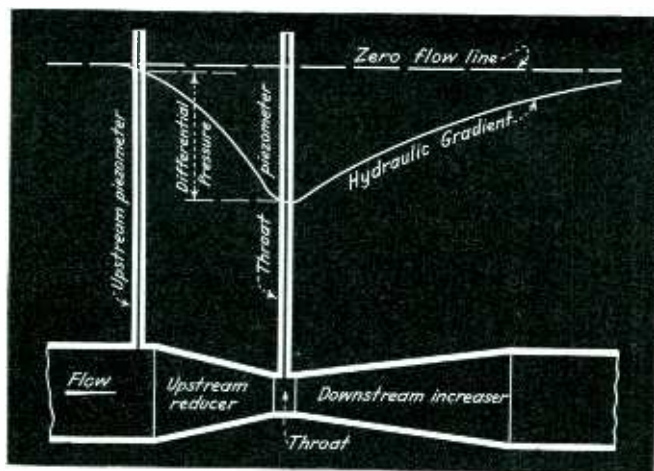

Fig. 1—Venturi tube, in which the hydraulic pressure at the throat is less than at other points

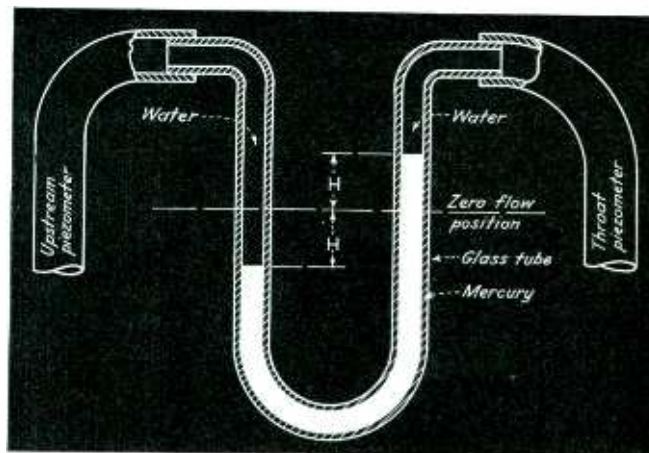

Fig. 2—Mercury-filled U-tube, connected to the throat an upstream point on the Venturi tube

By JOSEPH M. WEINBERGER

THE fundamental device for the measurement of flow of water in pipes is the Venturi tube (Fig. 1). This tube consists of a restricted portion of pipe called the throat, a short upstream reducer and a long downstream increaser. A vertical pipe or piezometer is inserted a short distance upstream from the short reducer and another piezometer is inserted at the throat. Under a condition of zero flow, water will rise in the respective piezometers and find a common level. As the water begins to flow through the Venturi tube, the levels of water in the piezometers change, the level in the upstream piezometer being higher than that at the throat.

If a section of glass tubing, bent into the shape of a U, (Fig. 2) be partly filled with mercury and connected to the piezometers so that the mercury will move due to the difference in pressures in the piezometers, the change of level of the mercury from the zero flow position in one leg of the U-tube will be proportional to the quantity of water flowing through the Venturi tube, or

$$Q = K \sqrt{H} \dots \dots (1)$$

Q is the quantity of water flowing through the Venturi tube.

K is a constant depending on the

areas of throat and upstream sections, on the specific gravities of mercury and water and on the acceleration of gravity.

H is the amount of displacement of mercury from the zero flow position.

The U-tube may be calibrated in

cubic feet per second or, in large installations, gallons per 24 hours.

The meter as described could be considered complete for visual reading of flow at the U-tube. However, to keep a permanent record at a remote point of the rate of flow throughout a period of time, some

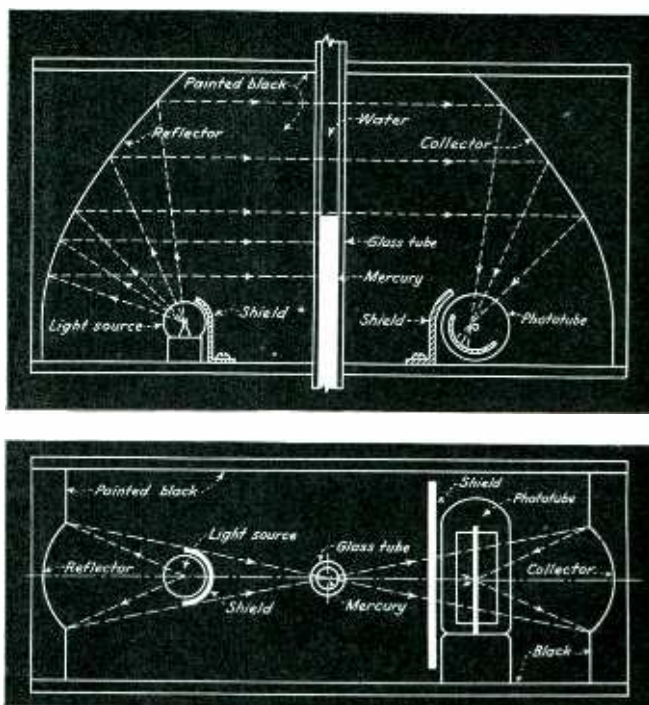

Figs. 3 and 4—Vertical and horizontal sections of the measuring unit. The height of the mercury column determines the amount of light reaching the phototube

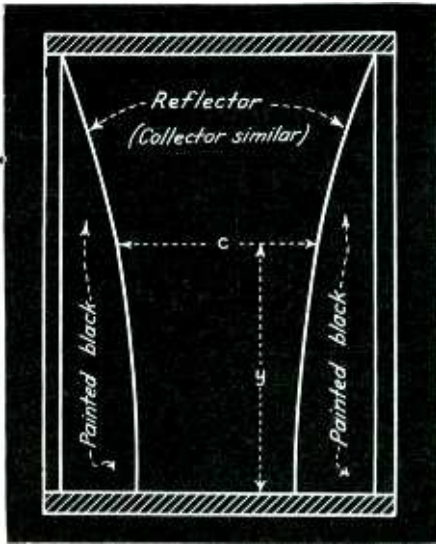

Fig. 5—The width of the reflector varies so as to give a light beam of uniform intensity through the mercury column

means must be employed for converting the displacement of mercury or the difference of water pressures in the two piezometers into a displacement of a pen or stylus.

The device to be described is a photoelectric means of recording a continuously varying level of an opaque (or semi-opaque) liquid in a transparent tube as applied to the measurement of the flow of water.

Figure 3 shows a longitudinal section of the device which consists of a light source, two opaque shields, a reflector, a transparent tube or manometer, a collector and a photoelectric cell.

The function of the reflector is to collect light from the source and concentrate it in a narrow beam along the axis of the manometer. In the longitudinal section the reflector has a parabolic shape with its focus in the light source. Any ray of light leaving the source will be reflected in a horizontal plane parallel to the axis of the parabola. An interesting feature of the parabola is the fact that all rays of light from the light source, reflected toward and reaching the manometer are of the same length.

In a horizontal section, (Fig. 4) the reflector is curved to concentrate the light on the axis of the manometer. The accuracy of this curvature need not be very great for flow measurements since the glass tube will have a diameter of about one-quarter inch.

The mercury in the manometer will prevent all the light which im-

pings on it from reaching the collector while the transparent portion of the tube will allow the light to pass through to the collecting reflector and thence to the photocell.

The opaque shields at the light source and photocell prevent any but the horizontal rays from reaching the manometer tube.

If it is desired to make the band of light at the manometer of uniform intensity throughout the length of travel of the mercury level, it is necessary for the reflector to intercept a constant angle of light. This means that the horizontal width of the reflector must vary (Fig. 5) since the reflector is at a varying distance from the light source. The chord width of the reflector (Fig. 6) may be computed from the equation:

$$c = 2 \left(\frac{y^2}{4a} + a \right) \tan \phi \dots \dots \dots (2)$$

where

a is the distance from the vertex of the parabola to the focus.

y is the height of the mercury column above the axis of the parabola.

ϕ is one-half the angle of light intercepted by the reflector.

c is the chord width of the reflector.

Since the intensity of light at any point on the manometer is a function of the angle ϕ a beam of varying intensity involves a varying angle ϕ , which may be computed by equating ϕ to the quantity to be measured and substituting in equation (2).

With the photocell connected through a linear d-c amplifier to a recording voltmeter, a permanent record may be kept of the rate of flow. A block diagram of the complete unit is shown in Fig. 7.

When this device is used with a constant angle ϕ for the measurement of the flow of water, it will be seen from equation (1) that the

quantity of water varies as the square root of the change in level of the mercury column. This would result in a crowded scale at one end of the voltmeter.

To eliminate the crowding of the scale, (i.e., to have uniform spacing on the meter) the width of the reflector must be so designed as to intercept a varying angle of light (ϕ) which will make the band of light at the manometer varying in intensity. The result will be that *H* will vary as the square of the photocell current and hence as the square of *Q*. Thus, *Q* will vary linearly with the photocell current and the scale will be uniformly spaced.

The advantages of this system are quite numerous. The use of a photocell provides a practically frictionless and inertialess means of measurement with none of the attendant losses inherent in mechanical apparatus. The threshold of operation is much lower than in any mechanical system. The accuracy is dependent only upon the electrical system which may be kept within close limits for long periods of time.

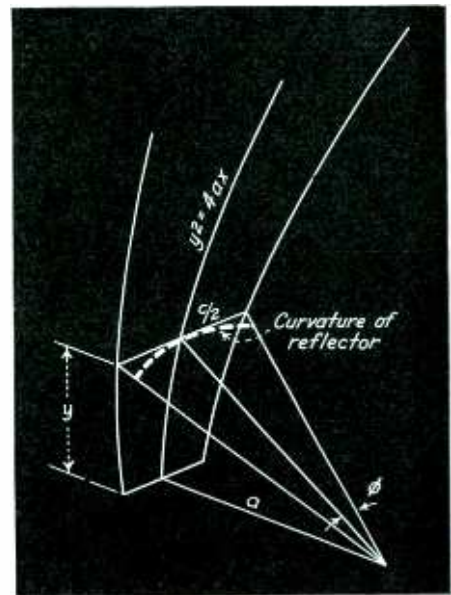
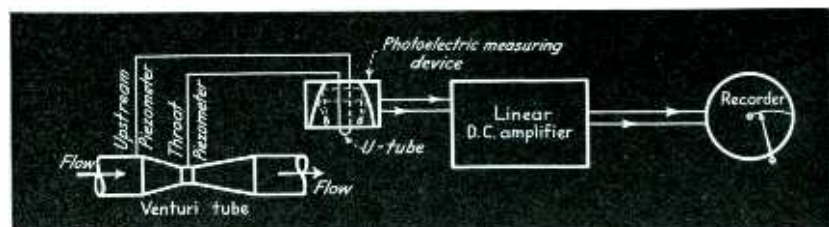

Fig. 6—Mathematical construction diagram of the parabolic reflector and collector

Fig. 7—Block diagram of the electronic flow meter. An indicating or recording meter may be used



TUBES AT WORK

A triple-condenser band-spread system, an inductance measurement method, a voltage regulator of 5 amperes capacity, a handy telephone set for the broadcast engineer, and an electronic timing control

Calibrated Constant Bandspread System

By FRANCIS KING

IN SHORT WAVE AND communications types of radio receivers, many devices, both mechanical and electrical have been resorted to, to obtain a satisfactory solution to the problem of separating signals. Generally the result has been, that a tuning device has been used in conjunction with the main tuning system to obtain the desired band spreading. The usual electrical system heretofore developed produces unequal band spreading over several different bands or for that matter over different portions of the same band.

As an example consider LC circuits which will cover the amateur communication bands, such as the 3500 to 4000 kilocycle band and the 7000 to 7300 kilocycle band. For our purpose a 12.5 μ h inductance is chosen and capacity of 126.4 μ mf will make a LC circuit resonant at 4000 kilocycles. Leaving these units at these values, if we wish to bring the circuit to resonance at 3500 kc we will have to add parallel capacity to the value of 38.6 μ mf which gives a total of 165 μ mf. The 38.6 μ mf parallel capacity will be the band-spread value for that tuning condenser.

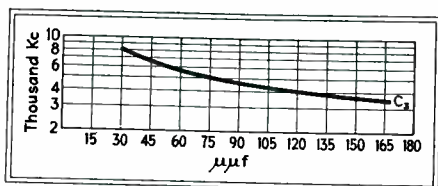

Fig. 1—Typical variation of band-spread range with frequency

Using the same inductance and desiring to tune to 7300 kc, the total capacity must be reduced to 38 μ mf for resonance. However we note that if we wish to have a band spread of 500 kc as was the case in the foregoing case it is necessary only to increase the total capacity 5.5 μ mf, raising it to 43.5 μ mf for resonance at 6800 kc giving equivalent bandspread over slightly more than the "forty meter" band. Hence, 38.6 μ mf variation of capacity gives 500 kc change in frequency on the first band while only 5.5 μ mf variation of capacity gives the same amount of frequency change on the latter band.

If the original 38.6 μ mf variable condenser is used on this higher fre-

quency, with the band set at 7300 kc, the addition of the 38.6 μ mf will reduce the resonant frequency to 5140 kc and the desired 500 kc spread will cover less than one-fourth of the bandspread dial.

In answer to this problem, a variable condenser unit or group has been developed as shown schematically in Fig. 2. There are three variable con-

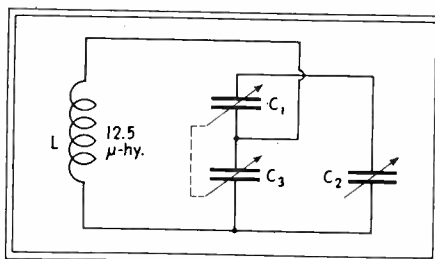

Fig. 2—Series-parallel method of tuning to insure constant band-spread

densers in the tuning unit for one LC circuit, designated as C_1 , C_2 and C_3 . The capacity is, in effect a lump capacity for tuning to resonance, dependent upon the setting of the capacity values. Condensers C_1 and C_3 are mounted tandem, but could be mounted in any other manner whereby both can be turned and tuned together. C_2 is separately mounted or may be mounted on the side of the C_1, C_3 unit, so that it may be adjusted independently from C_1, C_3 , which is the main tuning or band set condenser. C_3 is actually the main tuning condenser and C_1 is the "equalizing" capacity and is in series with C_2 and both are parallel to C_3 . C_2 is the band-spreading condenser and may be calibrated directly in terms of frequency or may be in units of rotation, degrees, etc.

When C_3 is tuned to decrease its capacity and increase frequency, C_1 also turns with it in a like manner and also reduces in capacity and therefore since it is in series with C_2 , the bandspread condenser the total bandspread capacity is reduced proportionately and gives equivalent spread for all frequencies.

If the plates are properly shaped, the series value of C_1 and C_2 will always be such, that no matter what frequency is tuned to, whether high or low on any band, the bandspread will always be the same. If the bandspread dial is calibrated in kilocycles it would add algebraically to the frequency reading, on the band set dial and the

value of such a system is obvious. In such devices as wavemeters, frequency meters and on receivers it will be most convenient.

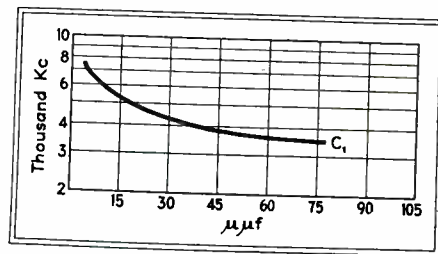

Fig. 3—Values of C_1 required for constant 500-kc bandspread

Fig. 3 shows a graph on which is plotted a curve giving series value of C_1 for the above bands, to obtain 500 kc bandspread, with the 12.5 μ h inductance.

Measurement of Incremental Inductance

By H. D. SHORT

THE INDUCTANCE OF AN iron-cored filter choke coil or audio transformer through which a direct current and a superposed alternating current flow is called the incremental inductance. This incremental inductance varies, for a given core material, with the value of the direct current component flowing through the coil and the magnitude of the air gap employed in the core. It is quite well understood, of course, that different core materials possess different core and hysteresis losses and hence affect, to a marked degree, the incremental inductance of a particular coil.

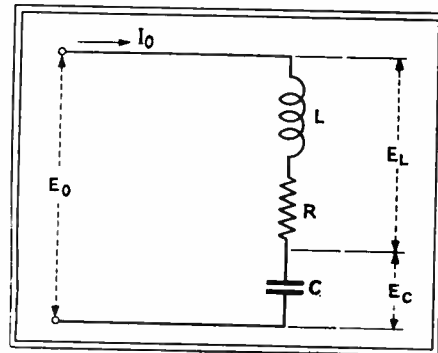

Fig. 1—Basic series circuit used for inductance measurement

Consider the circuit of Fig. 1 where L = inductance of choke coil, R = resistance of choke coil, C = capacity in series with L . In the vector diagram (Fig. 2) the components are in polar co-ordinates.

$$\text{Let } \phi_L = \tan^{-1} \frac{\omega L}{R}$$

$$\therefore E_L = |E_L| e^{i\phi}$$

$$\text{and } \phi_C = \tan^{-1} \frac{1}{\omega C} / O = \tan^{-1} \omega$$

assuming C has a power factor = 0

(Continued on page 38)

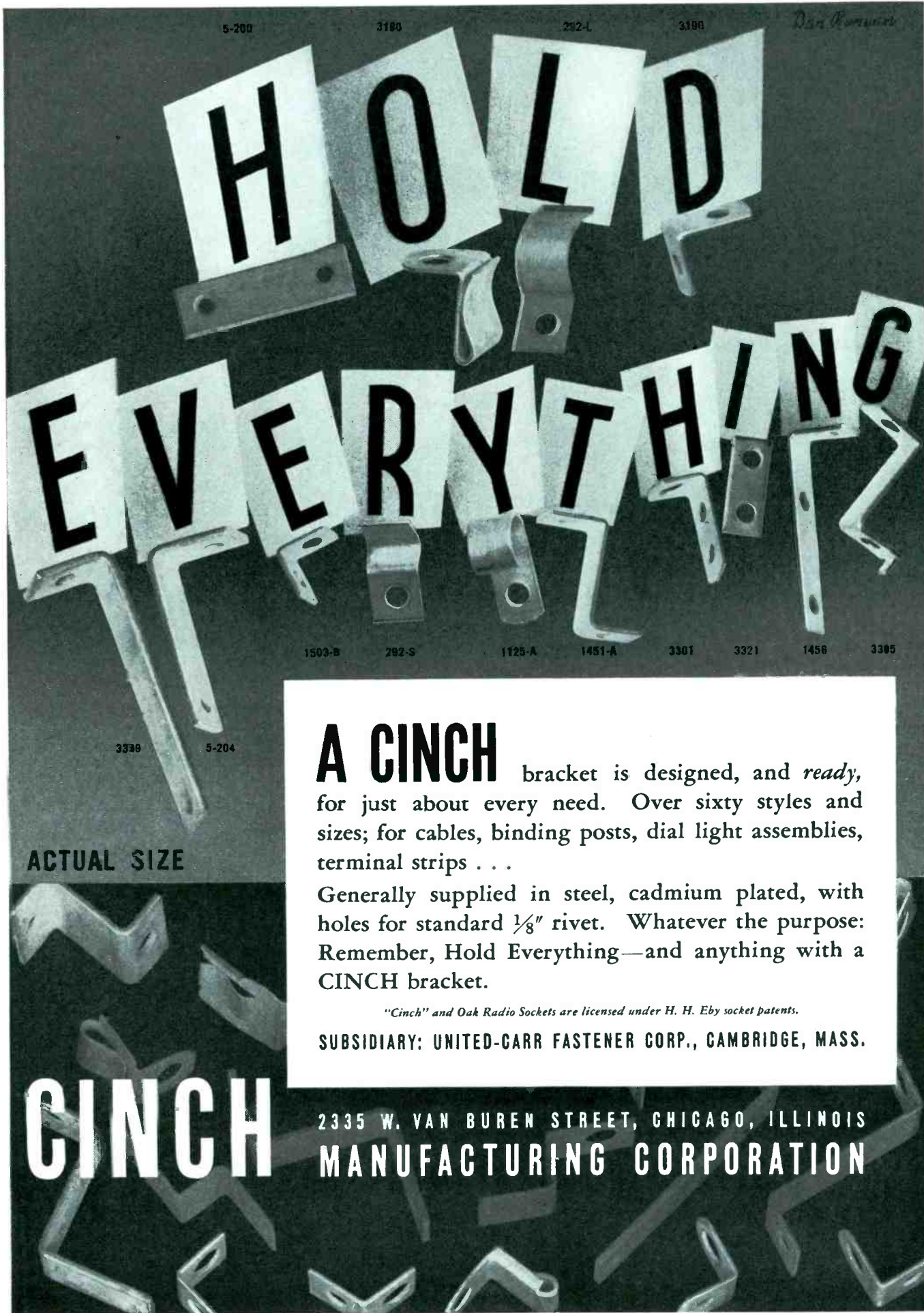

A CINCH

bracket is designed, and *ready*, for just about every need. Over sixty styles and sizes; for cables, binding posts, dial light assemblies, terminal strips . . .

Generally supplied in steel, cadmium plated, with holes for standard $\frac{1}{8}$ " rivet. Whatever the purpose: Remember, Hold Everything—and anything with a CINCH bracket.

"Cinch" and Oak Radio Sockets are licensed under H. H. Eby socket patents.

SUBSIDIARY: UNITED-CARR FASTENER CORP., CAMBRIDGE, MASS.

CINCH

2335 W. VAN BUREN STREET, CHICAGO, ILLINOIS
MANUFACTURING CORPORATION

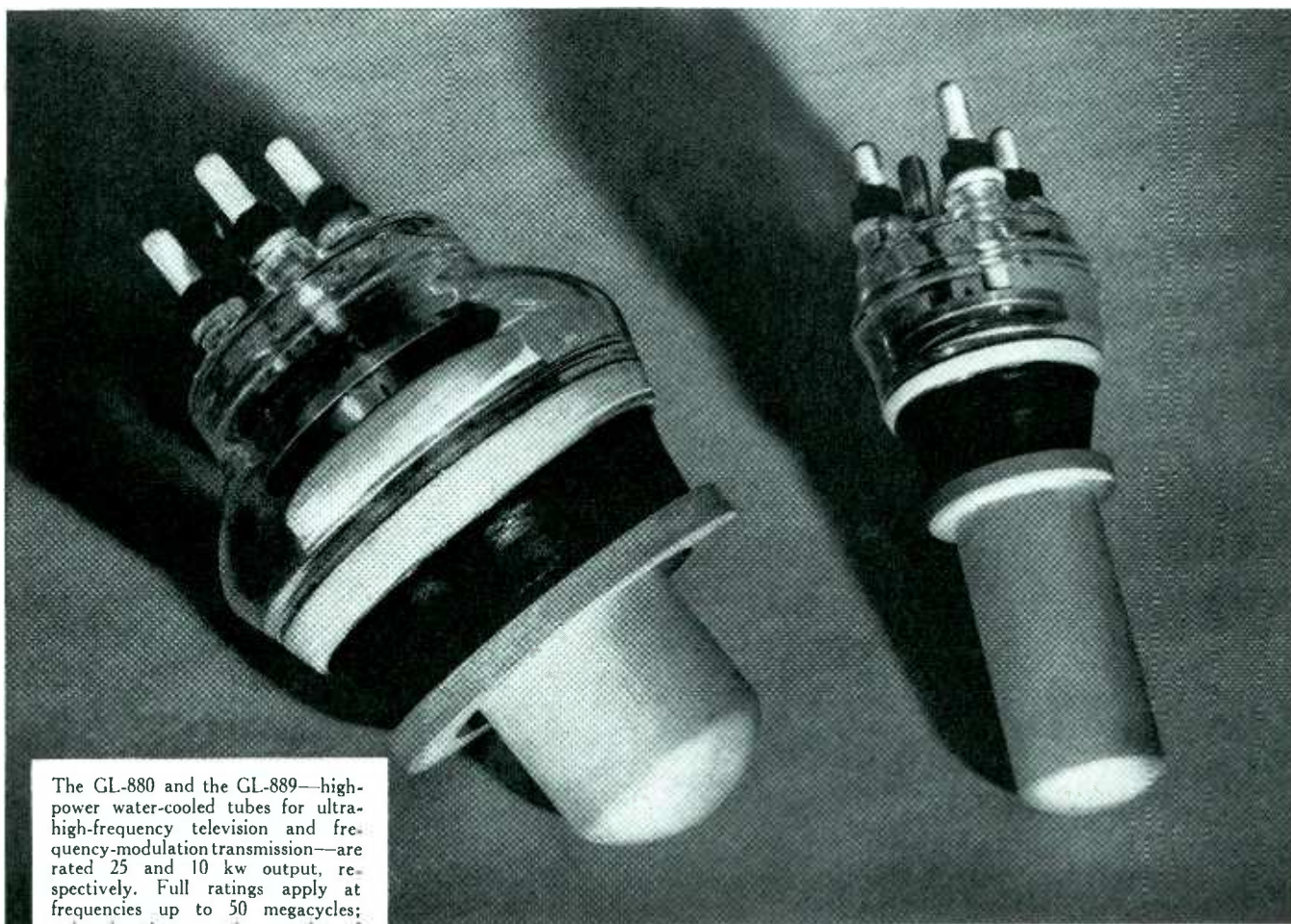

The GL-880 and the GL-889—high-power water-cooled tubes for ultra-high-frequency television and frequency-modulation transmission—are rated 25 and 10 kw output, respectively. Full ratings apply at frequencies up to 50 megacycles; reduced ratings permit operation of these tubes at well over 100 megacycles.

These 27 Years ... G-E Leadership in Radio-Tube Design Has Brought Many Major Advancements

Such as:

- thoriated tungsten filaments
- high-power water-cooled tubes
- the screen-grid tube
- hot-cathode mercury-vapor rectifiers
- metal tubes

Tubes built by General Electric have for years given outstanding performance in every kind of application, including broadcast service. G-E tubes are built by highly skilled workmen, with modern machinery and

the latest manufacturing methods. Their uniformly high quality assures you of getting the most for your tube dollar—in dependability, in service life, and in over-all economy of operation.

G-E warehouses, conveniently located, render prompt service in all parts of the country.

Bulletin GEA-3315 lists the complete line, including technical information and prices. Write for a copy, or get one through your dealer. General Electric, Radio and Television Department, Schenectady, N. Y.

GENERAL  **ELECTRIC**

400-22

FRIGID OR TORRID

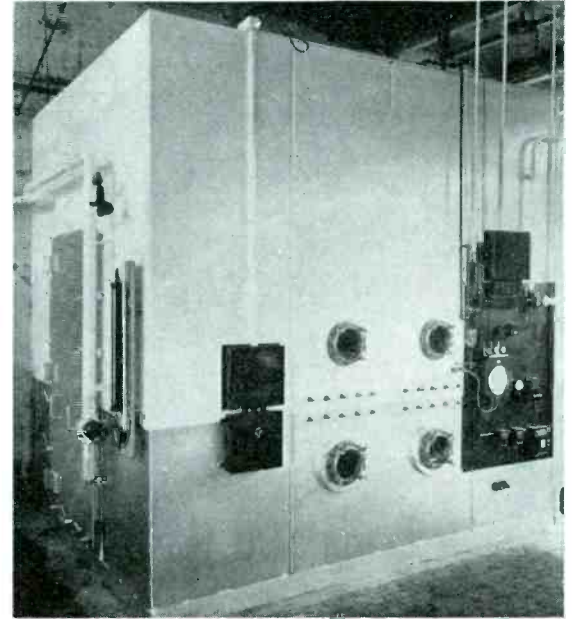
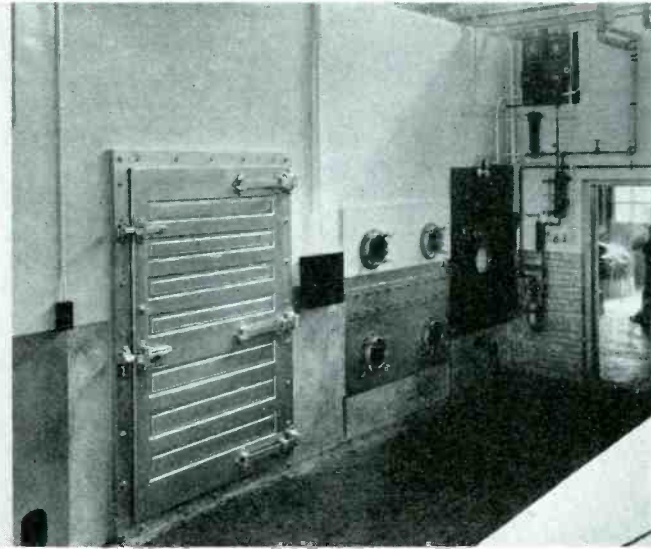

Grueling Climatic Tests Prove Isolantite Insulators Can Take It

NEITHER snow nor rain nor heat nor gloom of night stays these couriers..." might well be suggested as a slogan for Isolantite* by manufacturers of radio and television equipment who take advantage of its indifference to every conceivable type of severe weather.

Isolantite proves its qualities through daily use in every part of the world. And at General Electric's Radio Engineering Laboratories, it is subjected to the extremes of weather encountered in military and commercial flying: temperatures from tropic heat to sub-zero arctic cold... barometric pressures from below sea level to those found in the stratosphere... humidities from 0-100%—all under accurate control from an outside panel. Actual service conditions with adequate safety factors are thus applied to complete aircraft transmitters and receivers.

Under these arduous conditions, does Isolantite retain all its advantages? Indeed it *does*. While in these torture chambers, it still maintains its unusually low dielectric loss, high surface resistivity, and great mechanical strength. All its characteristics as a superb insulator remain unimpaired.

This remarkable material is adaptable in many other ways, too. New and precise forms and unusually-shaped parts may be economically manufactured to meet requirements—whether in the widely used Isolantite body or in Iso-Q, a ceramic with still lower losses. The Isolantite engineering staff, with long, specialized insulation experience, will be glad to cooperate with you in their design. For *your* requirements in high-efficiency, rugged and thrifty insulators, consult us at all times.

* Registered Trade-name for the products of Isolantite, Inc.

ISOLANTITE

CERAMIC INSULATORS

ISOLANTITE INC., FACTORY: BELLEVILLE, NEW JERSEY • SALES OFFICE: 233 BROADWAY, NEW YORK, N. Y.

RELAYS



The conciseness, characteristic of all Ward Leonard Relays, is due to sound engineering and careful workmanship. The very attributes that impart precision assure ruggedness and long life. Ward Leonard Relays are made in a wide variety of sizes, types and contact arrangements. Send for Bulletins describing relays of interest to you.

LIST OF BULLETINS

- Light Duty Relays.....Bulletin No. 106
- Intermediate Duty Relays.....Bulletin No. 81
- Heavy Duty Relays.....Bulletins Nos. 131 and 132
- Sensitive Relays.....Bulletin No. 251
- Time Delay Relays.....Bulletins Nos. 351 and 362

WARD LEONARD ELECTRIC COMPANY

32 South Street

Mount Vernon, N. Y.

Electric Control Devices Since 1892

Ward Leonard Electric Company, 32 South Street, Mount Vernon, N. Y.

Please send me Relay Bulletins Nos.

Name

Firm

Address

City..... State.....



$\therefore \phi_c = 90^\circ$
hence $E_c = |E_c| e^{-j90}$
the vector E_o in polar co-ordinate form is:

$$E_o = |E_o| e^{-j\beta}$$

$$= |E_o| \cos \beta - j |E_o| \sin \beta$$

where $|E_o| \cos \beta = I_o R$

and $|E_o| \sin \beta = I_o \left(\omega L - \frac{1}{\omega C} \right)$

$$\text{Hence: } L = \frac{E_o}{\omega I_o} \sin \beta + \frac{1}{\omega^2 C}$$

$$\text{and } \frac{E_o}{I_o} = \frac{R}{\cos \beta}$$

$$\text{Then: } L = \frac{R}{\omega} \frac{\sin \beta}{\cos \beta} + \frac{1}{\omega^2 C}$$

$$= \frac{R}{\omega} \tan \beta + \frac{1}{\omega^2 C}$$

Using this equation the procedure to be followed in ascertaining the incremental inductance of a coil, which we shall term coil (1), is to connect this coil in parallel with an exactly similar coil (2), as shown in Fig. 3. The bat-

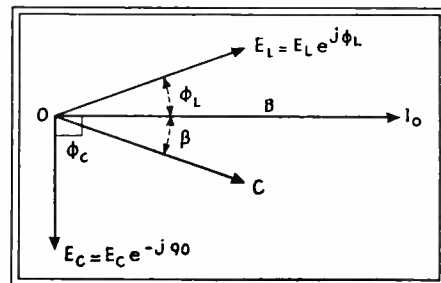

Fig. 2—Vector diagram of circuit in Fig. 1

tery supplies the direct current to the two coils which flows through these coils when under actual working conditions. An alternating voltage E_o is applied to the circuit through two blocking condensers, which should have power factor angles not greater than nine minutes to insure accuracy.

After measuring the direct current resistance of the coils, they are connected in the circuit and the direct current voltage so adjusted that the proper direct current flows through them as indicated on meter (I_{dc}). By means of the switch this meter is cut out of the circuit and the voltage E_o , and current I_o measured on the meters E_{ac} and I_{ac} respectively.

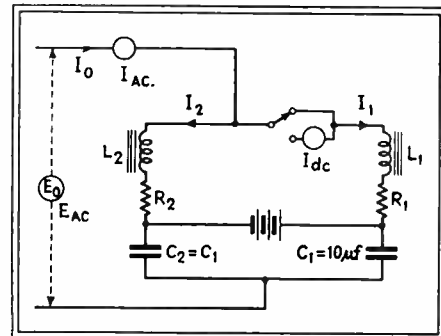

Fig. 3—Working circuit diagram for inductance measurement

One Way to STOP FAILURE of SPRINGS



Use a metal that provides greater strength and stiffness and also assures longer life

WHEN a spring persistently fails what do you do? Replace it with a longer one or a spring of heavier gauge? Here's a way to overcome such difficulties... and at the same time *keep size of spring to a minimum*: Use "Z" Nickel*.

This material is a heat treatable alloy of 98% Nickel. Its strength after heat treatment is $2\frac{1}{2}$ to 4 times that of structural carbon steel. That is why "Z" Nickel springs are so exceptionally strong and stiff for their size and weight.

Because "Z" Nickel is readily fabricated prior to heat treatment, it can be readily formed into all manner of strong, stiff, long-life springs.

Equally important, "Z" Nickel springs *retain* their strength. For "Z" Nickel cannot rust, and it stoutly resists corrosion, also oxidation and scaling at high temperatures. In addition, "Z" Nickel has good electrical conductivity.

Other Nickel-base alloys such as Monel* and "K" Monel* also make excellent springs. Which to use depends on individual requirements in each application. In this connection INCO Technical Service is available without cost or obligation. For help or further information simply write to:

THE INTERNATIONAL NICKEL COMPANY, INC., 67 Wall St., New York, N. Y.

"Z" NICKEL

*"Monel" and other trade-marks which have an asterisk associated with them are trade-marks of The International Nickel Company, Inc.

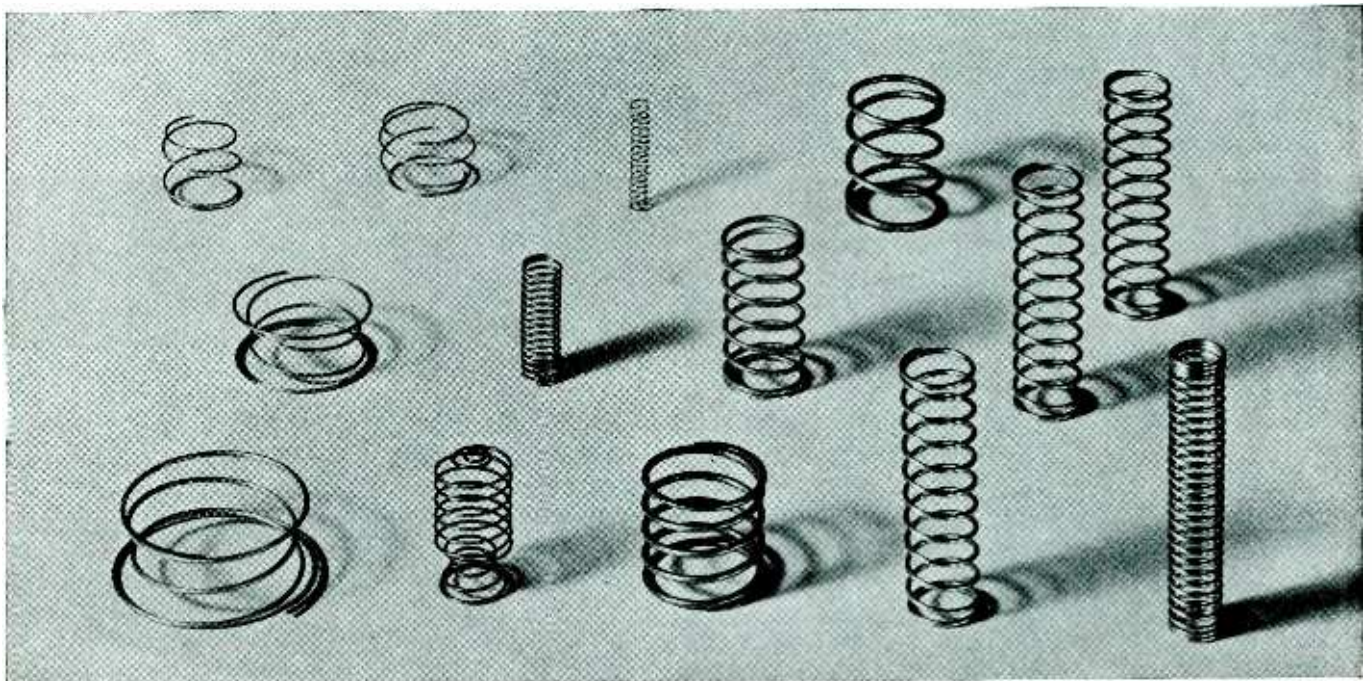

Ferranti QUALITY Products

<p>PLATE-FILAMENT TRANSFORMERS</p>  <p>High Efficiency. Low Regulation. Reversible Mounting. Maximum Safety Factor. Conservation Design. Extremely Low Temperature Rise.</p>	<p>HIGH FIDELITY TRANSFORMERS</p>  <p>Hum-Bucking Windings. High Fidelity. Every Unit Completely Reversible. Electrostatic Shields between Windings. Small. Light. Low in cost.</p>
<p>New ELECTRO STATIC VOLTMETERS</p>  <p>Zero current consumption. Reading from 20 to 25,000 volts, A.C. or D.C. up to 3,500 volts. Self contained over-voltage protection. 2 1/2" Dials. Single, Dual, Triple Ranges. Magnetic Damping.</p>	<p>HUM-FREE TRANSFORMERS</p>  <p>Hum-bucking windings. High efficiency. Low regulation and low case and copper losses. New completely reversible cases.</p>
<p>AIR-COOLED INDUSTRIAL TRANSFORMERS</p>  <p>For industrial applications. 1 V.A. to 10 K.V.A. Made in many different types, either standard or to suit your particular requirements. Consult our Engineers.</p>	<p>AERO TRANSFORMERS</p>  <p>For Aircraft and Portable Work. Low Cost. Broad frequency response. Exceptionally low insertion loss. Small, compact-rectangular cases, with completely reversible mountings.</p>

• You will be interested in the above brief review of some of the more outstanding Ferranti Quality Products . . . among them you may find exactly the answer to your specific problems . . . there are separate Bulletins ready on each product . . . and remember, "What Ferranti Builds, Ferranti Builds Better"

1882
1940



Ferranti
ELECTRIC
INCORPORATED
RCA BUILDING
NEW YORK, N.Y.

FOR VALUE RECEIVED

Upon raising the direct current resistance R_1 of coil 1 to R_{H1} , the resistance at the hot or "running" temperature we are able to find the inductance of 1 coil, thus:

$$\text{find } \cos \beta = \frac{I_1 R_{H1}}{E_o}$$

$$\text{where } I_1 = \frac{I_o}{2}$$

Knowing $\cos \beta$
 $\tan \beta$ is known; also $\omega = 2\pi f$ is known, and C_1 is known prior to measurement.

$$\text{Hence: } L_1 = \frac{R_{H1}}{\omega} \tan \beta + \frac{1}{\omega^2 C_1}$$

can be readily calculated in henrys when C_1 is in farads and R_{H1} in ohms.

By changing the direct current or the air gap it is possible to determine the variation of the incremental inductance with either the direct current or the air gap length held constant.

Example:—

Circuit set up as in Fig. 4.

$$R_{H1} = 50 \text{ ohms at } 40^\circ\text{C}$$

$$C_1 = 10 \mu\text{f}$$

$$f = 60 \text{ cycles}$$

$$E_o = 124 \text{ volts}$$

$$I_o = 0.080 \text{ amps.}$$

$$\omega = 2\pi 60 = 377$$

$$\cos \beta = \frac{I_1 R_{H1}}{E_o} = \frac{0.080 \times 50}{2 \times 124} = 0.0161$$

$$\therefore \beta = 89^\circ 05' \quad \therefore \tan \beta = 62.499$$

$$\text{hence } L_1 = \frac{R_{H1}}{\omega} \tan \beta + \frac{1}{\omega^2 C_1}$$

$$= \frac{50 \times 62.499}{377} + \frac{1}{(377)^2 \times 10 \times 10^{-6}}$$

$$= 9.004 \text{ henrys}$$

• • •

A 5-Ampere Electronic D-C Regulator

By J. N. COOMBS & P. T. NIMS

IN ANY TYPE OF PRECISE photoelectric measuring device constancy of the light source is of great importance. This is especially true of the Cinema Integrator¹, developed at the Massachusetts Institute of Technology by Professors H. L. Hazen and G. S. Brown. The machine is a device for integrating the product of two functions by measuring the quantity of light passing through two masks representing the functions. Any variation in the light source appears as a variation in the answer. This is true even though the machine is operated as a null device by balancing one light magnitude against another, as the color temperatures of the two lamps must remain constant if the photocells are to give reproducible results.

The main light source consists of a straight tungsten filament, 12 inches long, enclosed in a cylindrical envelope, this length being needed for optical reasons. To produce adequate surface

¹To be described in a forthcoming issue of the *Journal of the Franklin Institute*.

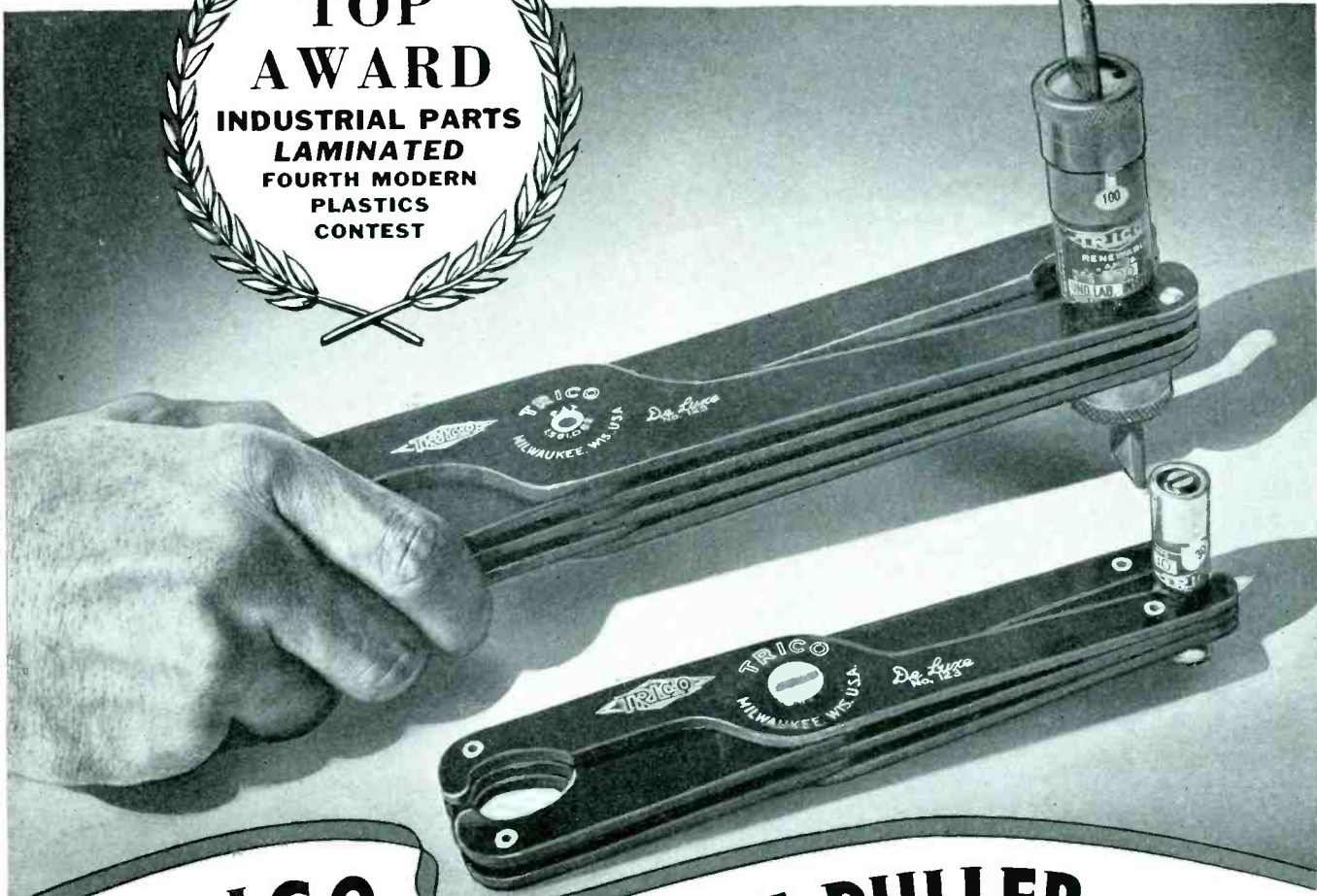

to **TRICO**
FUSE MFG. CO. for **FUSE PULLER** made of
PHENOLITE LAMINATED
 BAKELITE

Here's the INSIDE Story

"We decided to use PHENOLITE - Laminated Bakelite - in our fuse pullers to improve the appearance . . . to obtain a dielectric strength between the point where the fuse is gripped and the closest point at which the hand touches, when holding the puller, of not less than 4000 volts after a 24 hour immersion in an 80% synthetic sea water solution - also to obtain an insulation resistance of more than 3 megohms between these two points.
 Phenolite - Laminated Bake-

lite was the solution to our problem as it enabled us to produce a fuse puller that we know is 100% safe to use under any and all atmospheric conditions. Its beautiful black finish contrasting with the cadmium plated metallic parts - plus the improvements in dielectric characteristics justified us in calling this our De Luxe line.
 This line has just been introduced and sales are steadily increasing despite the fact that the price is higher than our standard line of fibre fuse pullers."

IF you can use Phenolite, the material of outstanding beauty that possesses excellent electrical, mechanical and chemical properties - that can be fabricated into countless forms and shapes - and is obtainable in over a hundred standard grades, write or call us. Our trained technicians gladly will study your problem - with no obligation on your part.

FOUNDED  1873
 TRADE MARK
NATIONAL
VULCANIZED FIBRE CO.
 WILMINGTON · DELAWARE

WESTINGHOUSE

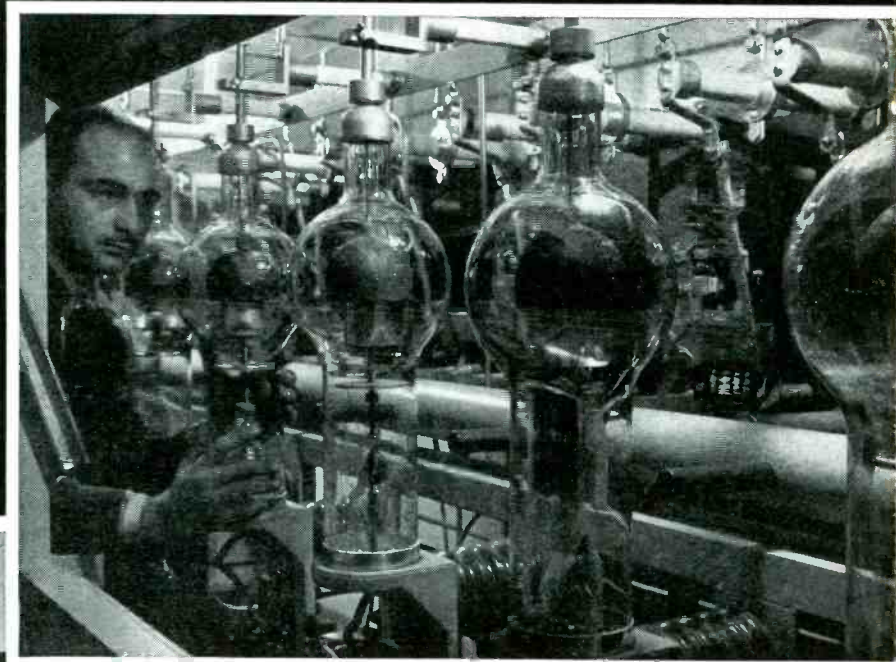
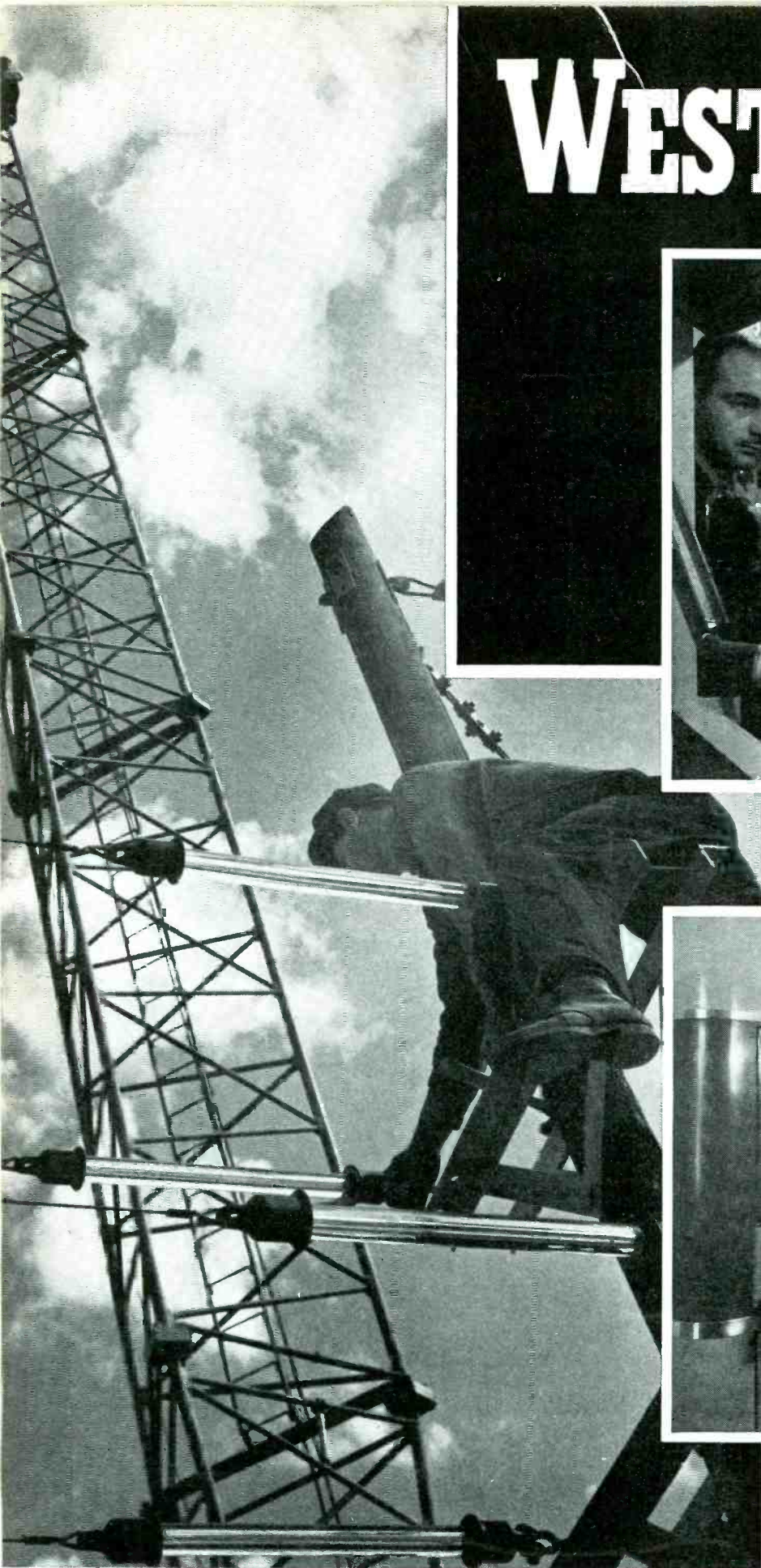

High-voltage rectifier arrangement which obviates manual changing of tubes during broadcast periods. In the background are relays for electrical changing of tubes.

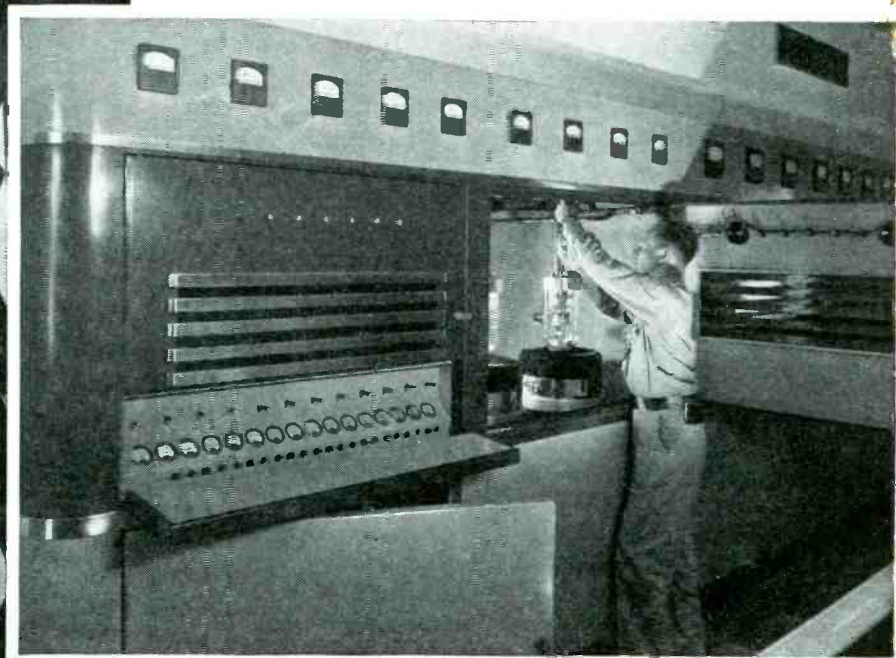

Streamlined front of the new 50,000-watt Westinghouse transmitter at KDKA. Air-cooled tube in the modulator unit being connected at the front panel of the transmitter.



Westinghouse

ANNOUNCES *New* LINE OF BROADCAST EQUIPMENT

Westinghouse, operator of the nation's first broadcasting station, presents to radio a new line of broadcasting equipment.

First of the new equipment, a 50,000-watt transmitter, has given a new voice to Westinghouse KDKA just as the station entered its 20th year.

The KDKA 50,000-watt equipment steps far ahead of conventional design in many improvements and refinements among which are:

- 1 Air cooling of all tubes, eliminating all water cooling and permitting utilization of exhaust air for heating the building.
- 2 Replacement of rectifier tubes by electrical remote control.
- 3 New Standard of Efficiency—50 kilowatts output with average program modulation for 115 kw from the power line.
- 4 Clean cut modern design with every part readily accessible.

To operators of stations everywhere, this Westinghouse announcement signals availability of proved equipment that contains all the practical features Westinghouse has learned in 19

years of operating some of the nation's foremost stations. Call the nearest Westinghouse office for further information.

WESTINGHOUSE TRANSMITTING TUBES

Such milestones in the radio broadcast industry as are represented by the new KDKA transmitter are made possible when backed by radio tube development and manufacturing experience.

In the Westinghouse manufacturing, as well as operating departments, this tube experience extends in an unbroken line from the development and manufacturing of those tubes used in the first broadcast. A complete line of Westinghouse transmitting tubes for broadcast and other uses will be announced shortly.

J-08005-A

Broadcast Equipment

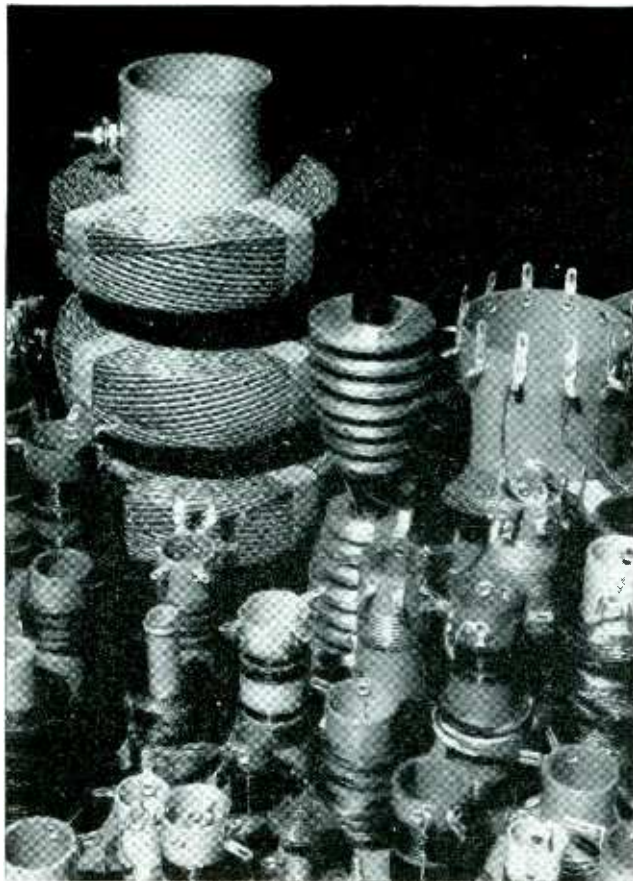

High-Frequency radio coils manufactured by the F. W. Sickles Co., Springfield, Mass. Textolite fabricated tubing is used.

Coil Forms

AND TEXTOLITE MORE THAN MEET THE SPECIAL INSULATION REQUIREMENTS

For any electrical radio or electronic part that requires complete insulation you will find Textolite laminated an excellent material. Its many grades permit a wide selection—you can easily choose the right grade to do the best job for you.

And as for forms, Textolite is available in sheets, rods, tubes, and in fabricated parts no matter how simple or how intricate.

General Electric's newly published price list on Textolite is now available on request. We suggest that you write for your copy now. Address Section G-10, Plastics Department, General Electric Company, One Plastics Avenue, Pittsfield, Massachusetts.

General Electric has recently reorganized its fabricating facilities to assure you of quick and uninterrupted service on fabricated parts. To take advantage of this improved service send inquiries and requests for prices direct to:

IN THE EAST —
Plastics Department, General Electric Co., 44 Cambridge St., Meriden, Conn.

IN THE WEST —
General Laminated Products, Inc., 3123-13 Carroll Ave., Chicago, Illinois.

GENERAL  ELECTRIC
PD-103

brightness the current through the lamp is 5 amperes, which must be direct current to prevent vibration. If the light source is to be constant within a third of one per cent, the voltage across the lamp must be held constant to within a tenth of one per cent. This requirement is difficult to fulfill because the current through the lamp is so large and the drop across the lamp is only 20 volts.

Recently it was decided to replace the original battery supply by some type of regulated supply. Several methods were tested before the circuit shown in Fig. 1 was adopted. This circuit, as may be seen, is an adaptation of the vacuum tube regulator commonly used for a plate supply for communication receivers^{2, 3}.

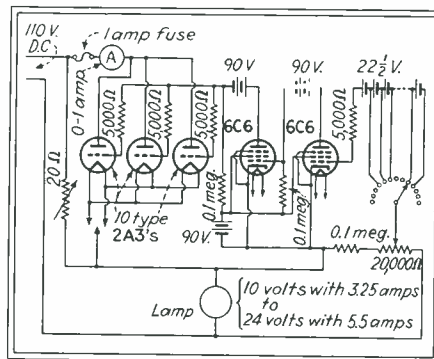

Fig. 1—Circuit of 5-ampere voltage regulator

In this type of regulator the 2A3's act as a variable resistor in series with the load. For this application the ten 2A3's used were shunted with a wire wound variable resistor to help them carry the load, the tubes carrying $\frac{2}{3}$ ampere and the resistor the remainder. When the circuit is operating the grid of the first control tube (a 6C6) measures the change in lamp voltage; this change is amplified and applied to the grids of the 2A3's to change the current and bring the voltage across the lamp back to its original value.

The load being fixed, the regulator has to compensate only for changes in line voltage. It will make a ten volt swing in line voltage appear to the lamp as a change of less than .01 volt or 1/20 of 1 per cent.

To be satisfactory the regulator must not only compensate for line voltage swings but must drift very little during the time of operation. This requirement is more severe than it is in most regulators of the same type because of the small changes of voltage that must be detected. However, due to the feedback in the circuit most of the components are not critical. For example the circuit is so insensitive to the tube constants that one of the 2A3's may be removed from its socket while the regulator is operating without producing a measurable change in the output voltage.

² A. C. Bousquet, "Improved Regulator Performance," *Electronics*, 11, 26-27, July, 1938.

³ G. Grammer, "Battery Performance from the R. A. C. Power Supply," *QST*, August, 1937.



a great PAST is desirable
a hopeful FUTURE makes life endurable
... but
a policy of assurance in the PRESENT
after all is what counts

Superior, as we speak of time, has too short a history to say much of its PAST, but its entire organization looks into the FUTURE with confidence, and as for the PRESENT, well . . . we make each and every day one of joy and pride—fun in our occupation and glory in the achievement. We still make only Small Tubing, which we define as “Fine Tubing”, and it is produced in many Metals . . . Our doors are open to those who have tubing problems.

SUPERIOR TUBE CO.
[THE BIG NAME IN SMALL TUBING]
NORRISTOWN, PENNSYLVANIA

Tubing from $\frac{5}{8}$ " OD down . . . SUPERIOR  Seamless in various analyses. WELDRAWN  welded Stainless. BRAUN  Welded “Monel” and “Inconel”. Patented LOCKSEAM and SEAMLESS Cathode Sleeves.

“ F O R F I N E S M A L L T U B I N G ”

*Here Beauty is
more than Skin deep*

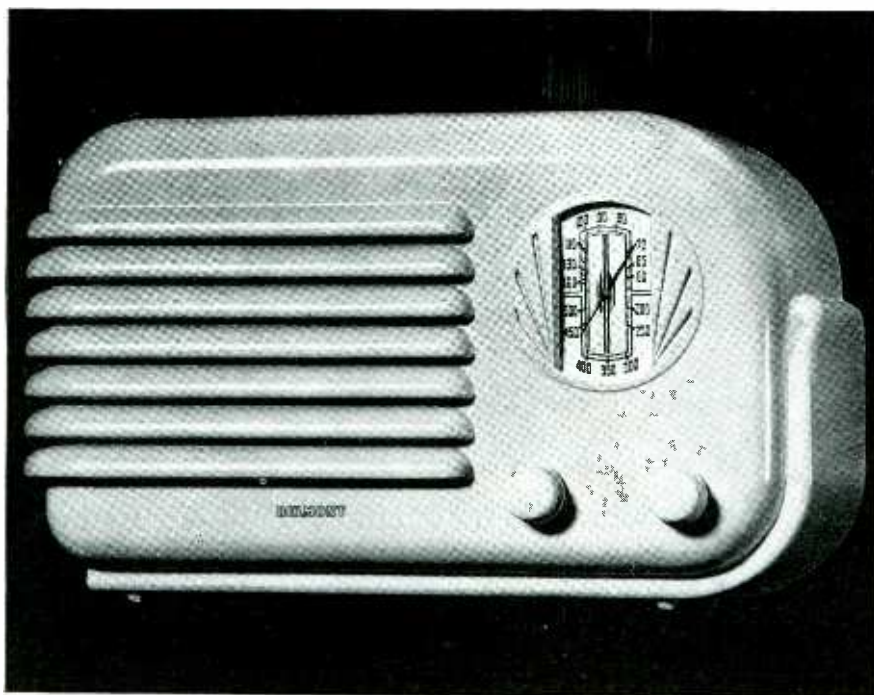

INSUROK

The Precision Plastic

Surface beauty is not enough—it must be backed by performance. For that reason every INSUROK precision molded part or product not only possesses pleasing appearance but delivers the utmost in utility and dependability. Manufacturers are quick to appreciate these advantages. More and more Richardson facilities are called upon to assist in adding eye appeal, greater salability, and improved performance to numerous diversified products. Quite likely you're missing something by not availing yourself of this service. Why not investigate?

The **RICHARDSON COMPANY**

Melrose Park, (Chicago) Ill. Founded 1838 Lockland, (Cincinnati) Ohio
New Brunswick, N. J. Indianapolis, Ind.
Detroit Office: 4-352 G. M. Building, Phone Madison 9386
New York Office: 75 West Street, Phone Whitehall 4-4487

The only parts of the circuit requiring unusual care are the reference voltage and the heater supply of the first tube. In place of the conventional neon bulb, a bank of dry cells is used as reference voltage with a tap switch to adjust the operating voltage. The heater of the first tube was supplied through a regulated a-c supply of the magnetic type to keep variations of the cathode temperature small, as this was a source of drift.

This circuit represents another case where small electronic tubes, cheap and plentiful because of their use in the radio industry, have invaded the domain of power equipment and done a better job than could be done with conventional apparatus.

A Compact Telephone and V. I. Set

By GERALD CHINSKI,
Chief Engineer, KXYZ

THE EQUIPMENT HERE described is a very compact and complete telephone extension set. It contains also a volume indicator with multiplier in 2 db steps to provide a maximum level measurement of plus 16 db (at .006 watt equal 0 db) and a minimum of minus 10 db. A key switch and 500 ohm dummy load resistor are provided. This is included because it provides a quick and accurate termination of either an open ended line or the output of an otherwise unloaded amplifier. Complete binding post and jack arrangements are included for quick connection as is also a line reversal switch for quick reversing of program and order wires.



External appearance of telephone set

The indicating instrument itself is a compromise for monitoring service but is rugged and capable of a very good job if the operator properly allows for the overshoot and somewhat fast return. The entire assembly is on an aluminum panel 11½ inches x 9¾ inches x ¾. It mounts in a very light reinforced wood case 15 inches x 10½ x 5½. These dimensions allow for a net open space inside the case to the left of the panel of 9¾ inches x 3½ inches x 2. This recess is used to store the "push talk" hand set and ringer crank. The ringer crank screws on the ringer shaft and protrudes through a bushed hole at the right edge of the case. The

Maintained Leadership in Resistors Since 1921



"Grid Leak"



Type F

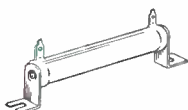

Power Wire Wound
Type "A" Coating



Type "A"
Volume Control



Type BT



Type "B"
Volume Control

1921 The advent of commercial broadcasting—the first dependable "grid leak" is produced, the forerunner of the now-famous metallized filament-type resistance element.

1925 A radical improvement in the filament type resistor—new stable filament embedded in ceramic form with molded metal terminals—the recognized standard of quality for many years.

1932 IRC announces the first moisture-proof cement coating for power wire wound resistors—a coating that, today, remains the standard for difficult applications.

1932 Bakelite resistance element for volume controls—durable and moisture proof—first made commercially available for the industry.

1933 IRC introduces the first bakelite-insulated resistor. This principle has since been adopted almost universally by the resistor industry. Today, IRC is still the only firm making a complete line of insulated low-wattage units.

1934 Multiple Finger Contactor for volume controls—each finger independently acting—resulting in quieter and more uniform controls—first introduced. This principle gradually being adopted by other manufacturers of controls.

1936 Departing from conventional designs, IRC produces the first medium-power wire wound resistors with high temperature, molded bakelite insulation—also a complete line of low-power insulated wire wounds.

1937 The Spiral Spring Connector—replacing sliding metal-to-metal contact—is developed to eliminate the last major source of noise in volume controls.

1937 IRC introduces cement coating affording maximum protection against excessive humidity conditions. It withstands the standard U. S. Navy salt immersion cycling tests.

1938 IRC introduces a new type all-metal power rheostat, having practically the same temperature rise with full load across small sections as across entire unit.

1938 IRC announces the first Attenuators with commutator switching device and Spiral Spring Connectors.

1939 The metallized filament principle is applied to large resistor forms. IRC makes commercially available high voltage resistors, for use up to 100 kilovolts, and power resistors for use at high frequencies.

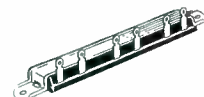

Type MW



Type BW



Type "CS"
Volume Control

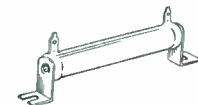

Power Wire Wound
Type "C" Coating



Type PR



Type A-21



Type MV



Type MP

1940 The increased scope of IRC specialized engineering activity insures continued leadership as expressed in further important fixed and variable resistor developments.

INTERNATIONAL  **RESISTANCE CO.**

403 NORTH BROAD ST., PHILADELPHIA, PA.

Makers of Resistance Units of More Types, in More Shapes, for More Applications, Than Any Other Manufacturer in the World

This **MOVIE PROJECTOR** is focused with an **S. S. WHITE** REMOTE CONTROL FLEXIBLE SHAFT

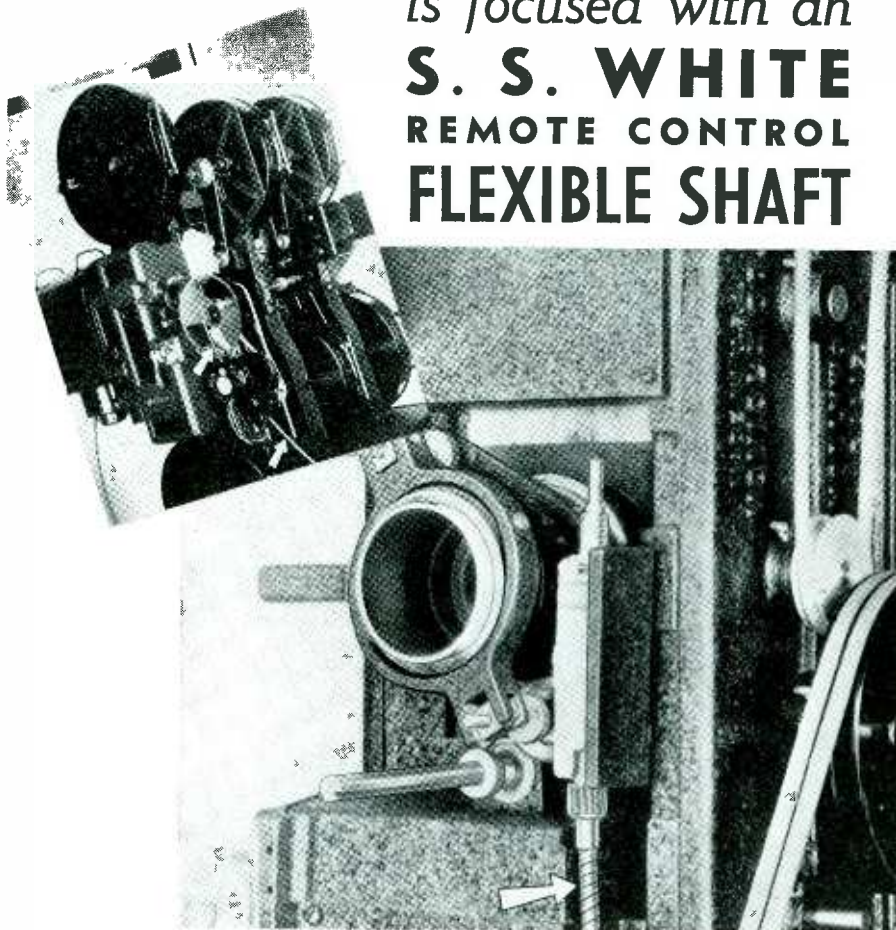

This projector is one of eight in the studios of Walt Disney, equipped with S. S. WHITE Flexible Shafts for focusing. The shafts are of the type specially developed by S. S. WHITE for remote control.

The Moviola Company of Hollywood, manufacturer of the projectors, and the studio technicians state they are "very satisfied" with the way the flexible shafts perform the focusing operation.

This application once again demonstrates that where close, accurate mechanical adjustment from a remote point is required, an S. S. WHITE Remote Control Flexible Shaft is the simple, effective way to provide it.

Designing engineers will find it helpful to have up-to-date information about S. S. WHITE Flexible Shafts handy. Write, today, for the FLEXIBLE SHAFT BULLETINS.

S. S. WHITE

The S. S. White Dental Mfg. Co.
INDUSTRIAL DIVISION

Department E, 10 East 40th St., New York, N. Y.

FLEXIBLE SHAFTS for POWER DRIVES, REMOTE CONTROL and COUPLING

hand set is a conventional W. E. Type D 14842 field unit. It is connected at will by a standard 601 plug. A two bar ringer appropriated from an old W. E. field telephone is used and has proved entirely adequate for the job. It has been used to operate a standard drop signal at the station over a regular telephone circuit (without coils) of as much as 50 miles. No greater distance has been encountered. Local battery is used in the set, of course, because we always want to be able to talk over a dry loop. The battery is a small $4\frac{1}{2}$ volt unit and is replaced about every six to eight months.

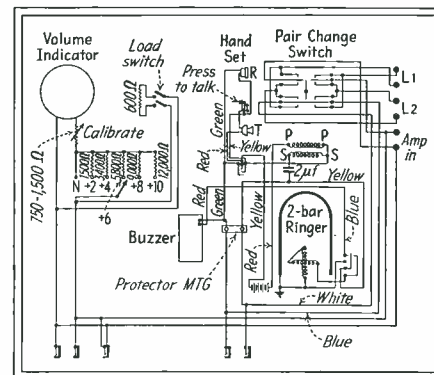

Connections of volume indicator and telephone set

Checking equalization and loss on local loops is carried out extensively at KXYZ. So the meter section of the set sees quite an amount of service in addition to regular monitoring service. One way to accomplish nemo pick-ups with minimum personnel overload with no loss in efficiency is to arrange equipment and routine in such a manner that in 90 per cent of the pickups only one operator will be necessary. This makes it essential to transport to the job what is required and nothing more. If the pickup is of sufficient importance to insure against the small chance of failure, this may be done by duplicating the feed in its entirety on the order wire.

The space on the inside of the cover of the telephone and meter set is utilized to keep several hand tools, grey tape, scotch tape and sufficient twisted pair to avoid the necessity of carrying these items on the person or in an additional tool bag.

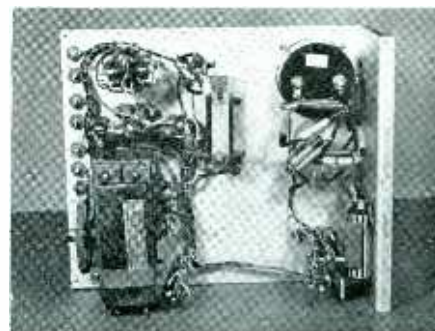

Back-of-panel construction details

FORMICA TUBING

*PRINTED IN
GOLD OR SILVER*



FORMICA

TUBING as well as panels may be printed in gold and silver where Formica tubing is used as an exterior part and appearance is important or the surface of the tubing is to be used to identify the product.

The illustration shows tubing produced in this way for the United Motors Service.

There are grades of Formica tubing and sheet with a wide variety of characteristics to serve a wide variety of purposes. These may be purchased in standard lengths and sizes to be machined by you or completely machined to your blue prints in the Formica plant.

THE FORMICA INSULATION CO.
4638 Spring Grove Ave., Cincinnati, O.

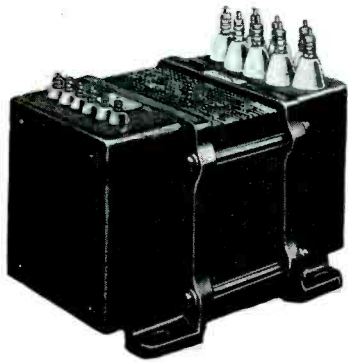

Left: AmerTran Type W air-cooled plate transformer, sizes to 5 Kva. at 17.5 Kv.

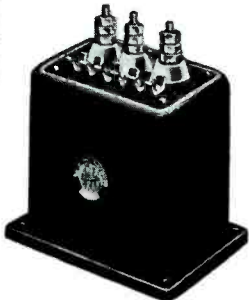

Right: AmerTran Type H air-cooled filament transformer, sizes to 300 Va.

Transformer Components For all Requirements in Electronic Tube Circuits

HAVE you been designing electronic tube equipment, such as rectifiers, radio transmitters, amplifiers, etc., around specifications of standard transformer and reactor components? With the large assortment available, this is possible in many cases, but the practise frequently leaves something to be desired from the viewpoint of either performance or efficiency.

AmerTran engineers are open minded on this question and will gladly discuss problems of this nature with you as they come up. We manufacture both standard and special transformers of all types used in electronic tube circuits and will recommend the particular equipment best suited for your needs. Furthermore, our set-up is such that, if special units are desirable, they can be produced economically in either small or large quantities and in mountings similar to standard parts.

Let us have data on your transformer requirements so that we can submit complete information on AmerTran Transformers.

AMERICAN TRANSFORMER CO.

178 Emmet St.



Newark, N. J.

AMERTRAN

AMERTRAN ELECTRONIC PRODUCTS

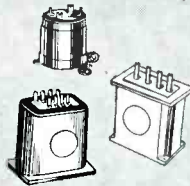

AUDIO FREQUENCY COMPONENTS

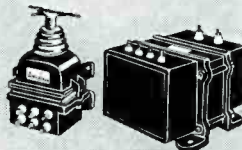

AIR INSULATED RECTIFIER COMPONENTS



MANUALLY OPERATED VOLTAGE REGULATORS

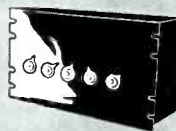

LINE EQUALIZERS

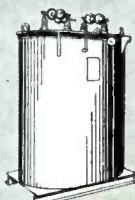

OIL IMMERSED TRANSFORMERS



RECTIFIERS

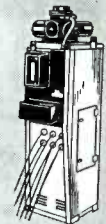

AUTOMATIC VOLTAGE REGULATORS

The set described weighs 14.8 pounds. Total weight that one operator will carry to the average job will not exceed 53 pounds, including inductor microphone, mike cable, extensions and duraluminum program stand together with one channel amplifier, which he can distribute evenly between two hands.

In equalizing a local loop it is only necessary for the operator at the remote end to connect the set to the order wire and terminate the program line in the 500 ohm dummy load. Upon call, the operator at the control room sends him a reference tone followed by a frequency glide. The operator at the remote sets reference and measures loop loss on the reference tone. Occasionally, it is necessary (where the loop loss runs over 4 or 5 db) for the control room operator to over feed the line for short duration of the run. On the glide the remote operator can tell if there are any unusual peaks or valleys. If the attenuation increases uniformly with frequency the line is assumed to be normal. He reports the difference between reference (in our case 1000 cps) and 7000 cps to the control room operator who sets equalization accordingly. Occasionally more elaborate runs are made on local loops here but in the main they are found to be pretty close, in so far as their general curves are concerned. Noise levels are consistently -50 db (below 0 = .006 watt) or better.

• • •

An Electronic Time Control

By E. A. MILLIGAN

IN COLOR PHOTOGRAPHY, enlarging, and other light exposures, the amount of time, the light energy, or time control is a most important consideration. This is usually done by manual operation of a hand switch, while watching the start and stop of a time interval of a clock. This is subject to an error when starting and stopping the switch, especially in the case of short time intervals, and much costly material may be wasted.

Three or four negatives are made of each subject for the color process, each through a different color filter, and a different length of time. If the time of exposure is not correct the final result will have the colors out of balance, or a general distortion of color in the shadows and other parts of the picture. The correct ratio between the exposures is determined by test, using a strip of paper or film that is graduated in squares, dark at one end and light at the other, the squares in between vary in a log ratio.

Commercial photographers often must produce many photos uniform in brightness, and this electronic device should prove of great benefit to them. The time control is also useful to a great many fields other than photography, as in chemical, and mechanical operations that have use for accurate, flexible units.

GOING GREAT!

...is "Lucite" Molding Powder. More and more designers go for it. How about your molded parts for '40?

Not yet three years old... "Lucite" molding powder has grown fast. Sales charts for the powder show amazing increases. And that means sales right down the line — for molder and manufacturer. The unusual combination of properties in "Lucite" meet practically any molding requirement. Makers of automobiles, radios and refrigerators are using it more than ever — with even greater increases to come.

"Lucite" is a natural for lenses, electrical shields, insulating parts, radio and refrigerator panels

It's clear—weather resistant, stable in color (two-year test shows no apparent change)

It's beautiful—soft in lustre, pleasant to touch (low heat transmission)

It "edge-lights"—for illuminated fixtures and numerals (no glare)

It's safe—breaks without sharp, jagged edges or fragments.

It's strong—tensile strength 7,000 to 10,000 lbs. per sq. inch; flexural strength 14,000 to 17,000 lbs. per sq. inch.

It's easily molded—for instance, one

job consists of five dissimilar pieces (from ½" to 3" in size) molded in one shot.

It's chemical resistant—to dilute alcohols, dilute alkalis and dilute mineral salt solutions.

It has low specific gravity—1.16 to 1.20

It has high dielectric strength—

Dielectric constant:

60 cycles, 3.5-4.5

106 cycles, 2.5-3.0

Power Factor:

60 cycles, 0.06-0.08

106 cycles, 0.01-0.03

For modern functional applications you can depend on Du Pont "Lucite" methyl methacrylate molding powder. Write Du Pont, Plastics Department, Arlington, N. J.



PLASTICS

DU PONT ON THE AIR — Listen to "The Cavalcade of America" Tuesdays, 9 p.m., E. S. T. over NBC Networks.

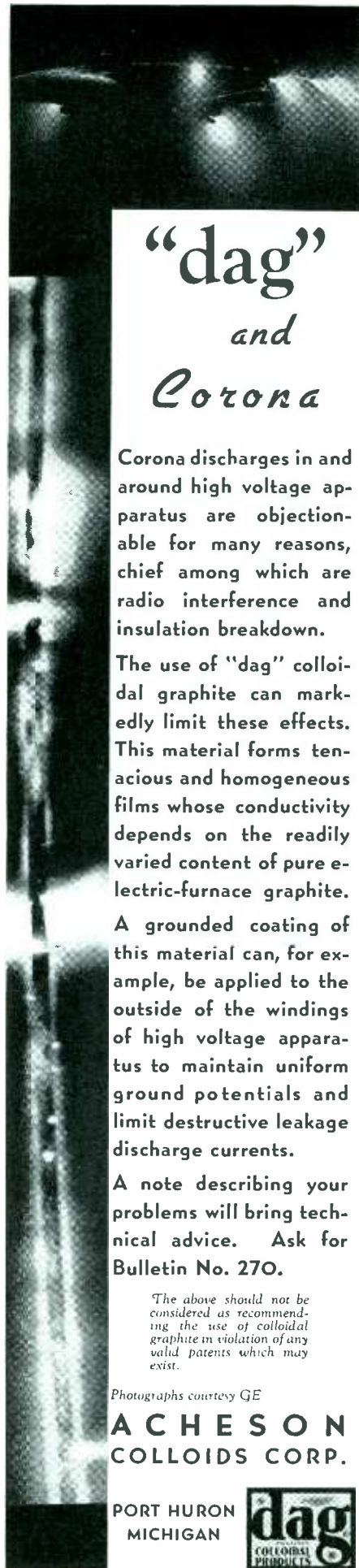

“dag” and Corona

Corona discharges in and around high voltage apparatus are objectionable for many reasons, chief among which are radio interference and insulation breakdown.

The use of “dag” colloidal graphite can markedly limit these effects. This material forms tenacious and homogeneous films whose conductivity depends on the readily varied content of pure electric-furnace graphite.

A grounded coating of this material can, for example, be applied to the outside of the windings of high voltage apparatus to maintain uniform ground potentials and limit destructive leakage discharge currents.

A note describing your problems will bring technical advice. Ask for Bulletin No. 270.

The above should not be considered as recommending the use of colloidal graphite in violation of any valid patents which may exist.

Photographs courtesy GE

**ACHESON
COLLOIDS CORP.**

PORT HURON
MICHIGAN



The accuracy of the resistors is important, also the 43 tube has to be quite free from gas, and the grid control condenser must be free from leakage currents. This is important as the resistors cannot then be combined to add their effect on the total timing.

The line voltage regulator and meter may be omitted if a high degree of accuracy is not needed. A change in line voltage of five per cent changes timing about seven per cent, which is usually not noticed.

The relay is chosen to stand the full plate current of the 43 tube, and open at about 2.5 ma.

The principle of operation is based upon the change of the plate current of the 43 tube, which operates the relay. Bias is supplied from one side of a 25Z5 rectifier tube, which passes through the time control resistors to the grid of the 43 tube. The condenser being in parallel with the bias circuit next to the 43 tube, will have a charging time, in this case one second for a half megohm of resistance, other values of capacitance will change the time also, as may be desired in some cases. The other side of the 25Z5 rectifier tube supplies the plate voltage. A simple filter circuit is all that is needed, a dual eight μ f condenser, as the current requirements are small. The line ballast resistor is chosen for

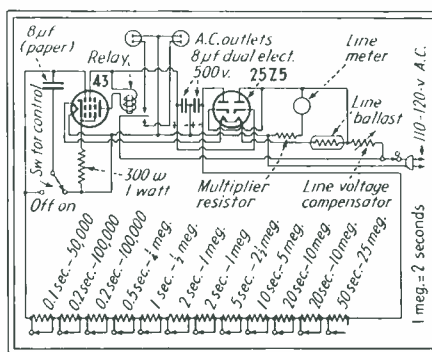

Timing circuit based on capacitor charge through adjustable resistance

the two tubes used and the line voltage encountered. The cathode resistor is used to protect the control tube from excessive plate current.

Switch S is the control switch for operating the relay, in the off position the condenser is discharged, and the grid goes to a high negative potential, this opens the relay, then, when this switch is turned on, with one or more of the time control resistors in the circuit, the bias is low, causing the plate current to close the relay, while the condenser charges and the plate current lessens. The relay will open when its current reaches 2.5 ma. The time interval switches can be labeled so as to be used in addition. In this case a system was used requiring a minimum number of units, .1-2-2-5-1-2-2-5-10-20-20-50. These may be used in combinations to produce steps of .1 from .1 to 111. A variable resistor could be used instead of the fixed units,

DRAKE

WORLD'S LARGEST EXCLUSIVE MANUFACTURERS

Dial Jewel
PILOT LIGHT ASSEMBLIES



Wherever extreme dependability is required, DRAKE Pilot Light Assemblies are usually specified. They will be found on aircraft instrument panels, practically all leading radios, and many electrical devices. Among the prominent users are R.C.A., Zenith, Emerson, Scott, General Elec., Western Elec., Bendix, Western Union, U. S. Navy, and many others. High speed precision methods assure quick service, low cost. Stock units in big variety or special assemblies developed for any Pilot Light Problem. Get full particulars. Write today.

SEND for FREE BOOK

DRAKE MANUFACTURING CO.
1713 W. HUBBARD ST. • CHICAGO, U. S. A.

GOAT TUBE SHIELD FEATURES
that Simplify the Set Manufacturer's Problems

3-EYE-VALUE



Appearance Values swing many a set sale. For the buyer who insists upon neatness as well as sound engineering, Goat form-fitting tube shields will contribute much to his projected ownership through High Eye value. And, of course, they add materially to the set's performance values, too.

GOAT TUBE SHIELD FEATURES:

- | | |
|-----------------------|-------------------------|
| 1 Variety | 3 High Appearance Value |
| 2 Maximum Compactness | 4 Tested Performance |
| | 5 Quick Service |



Send for Bulletins

GOAT RADIO TUBE PARTS, INC.

[A DIVISION OF THE FRED GOAT CO., EST. 1892]
314 DEAN ST., BROOKLYN, N. Y.

ONE COMPONENT CHANGE SOLVES A NASTY TEMPERATURE PROBLEM



SALES MANAGER: "Jim, here is another batch of jobber's complaints from Northern Minnesota. All on our push-button sets. Seems as though they won't stay calibrated once the automatic tuning has been adjusted."



CHIEF ENGINEER: "Looks like the cold weather up there might be affecting the capacity of the fixed tuning condensers. It's possible for that to happen even in shipment, if the temperature drops suddenly."

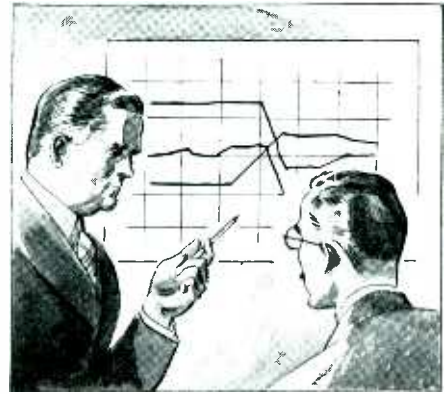

CHIEF ENGINEER: "Here's the results of accelerated heat and cold tests we made on five of our push-button models. It shows that wide fluctuations in oscillator condenser capacities take place with large temperature changes."



CHIEF ENGINEER: "The logical way to get around this is to use a dependable silver mica condenser. I noticed Erie Resistor advertises that their units will withstand wide changes of temperature and humidity without appreciable capacity change. We'd better get some samples in and put them on test."

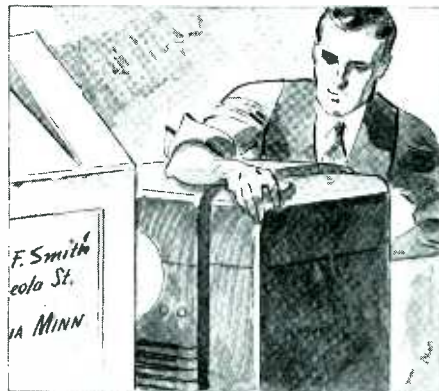

RETAILER: "No more kick-backs on the automatic tuning since they substituted Erie Silver Micras for the regular mica condensers in the oscillator circuit! Once I set up the push-button system, it stays tuned on the nose."

The inherently low temperature coefficient of Erie Silver Mica Condensers (0 to + .00004 per °C depending on capacity) makes them ideal for obtaining automatic tuning stability under all conditions of temperature. Even after 5 complete cycles of 5 hours at -30°F. and 15 hours at 180°F., capacity change is less than .135%. In addition, the molded-case Erie Silver Micras will vary less than .05% in capacity after being subject to 100% relative humidity at 104°F. for 100 hours. Such excellent operating characteristics will provide dependable condenser stability for your automatic tuning sets.

ERIE
TYPE M 4F
825 ± 25 MMF

Type F Erie Silver Mica
Ceramic Case
15-2500 MMF

ERIE
SILVER MICA

Type J Erie Silver Mica
Molded Case
15-1000 MMF

ERIE
SILVER MICA

Type K Erie Silver Mica
Molded Case
15-500 MMF

RESISTORS
SUPPRESSORS
CERAMICONS
SILVER-MICA
CONDENSERS

Erie RESISTOR CORPORATION, ERIE, PA.

MOLDED BEZELS
PUSH BUTTONS
AND KNOBS
POLYSTYRENE
COIL FORMS

Vacuum Tube Protection

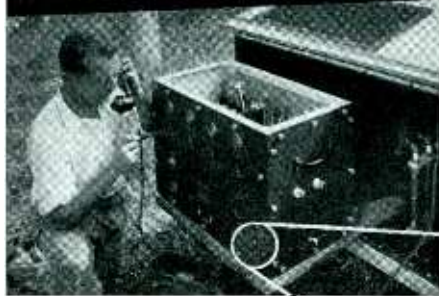

HIGHLY EFFECTIVE
in
Temperature Ranges
from -40° C. to $+75^{\circ}$ C.

HEINEMANN Circuit Breakers

Now Operating Satisfactorily in
Instrument Landing Equipment for Airports
made by International Telephone Development Co., Inc.

They say, "These were the only breakers we could obtain for operation in temperatures between -40° and $+75^{\circ}$ C." Fully electro magnetic and small in size, they give positive built-in protection at low cost. Write for full information.



Any rating or split rating from 250 milliamperes to 35 amperes • Instantaneous operation on short circuits and dangerous overloads • Immediate re-closing after device has opened on overload or short circuit • Increases life of tubes • Reduces expensive replacements.

HEINEMANN CIRCUIT BREAKER CO.
97 PLUM ST. - - - - TRENTON, N. J.

DIRECT READING FREQUENCY MONITOR

MODEL FD8 BY

Doolittle



FEATURES:

- Provides direct reading of frequency deviation.
- Temperature controlled crystal chamber.
- Monitors four frequencies.
- Operates on any frequency—1500 to 50,000 KC
- Accuracy of the monitoring frequency is .002 per cent
- Three ranges of measurement—1000, 5000, and 10,000 cycles

For further details write

DOOLITTLE & FALKNOR, Inc. 7421 S. LOOMIS BLVD.
CHICAGO, ILLINOIS

but would be harder to set to duplicate positions.

Editor's note: The circuit shown is very similar to that published in "For Photographers Only" in the June 1937 issue of *Electronics*, except that the light integration function is not employed. The device as described by Mr. Milligan is simpler and perhaps easier to construct than the circuit described previously.

Automatic Volume Expander Compensator

CONTRIBUTION FROM MAJESTIC RADIO
AND TELEVISION CORP.

IN PRINCIPLE THE AUTOMATIC volume expander and bass compensation consists of a regular audio amplifier and output stage consisting, in the accompanying diagram, of a 6F5 amplifier and a 6K6 output tube. The emf appearing across the voice coil of the speaker is applied to the grid of a variable- μ tube such as the 6U7 shown below. The output of the 6U7 is fed to the input of the 6K6 in such polarity that all frequencies above the resonant period of the speaker are degenerated while those below that resonant period are regenerated. The amount of emf fed back to the 6K6 depends on the bias of the 6U7 which is applied, through resistance capacity filter R_1, C_1 , by the diode of the 6Q7 tube.

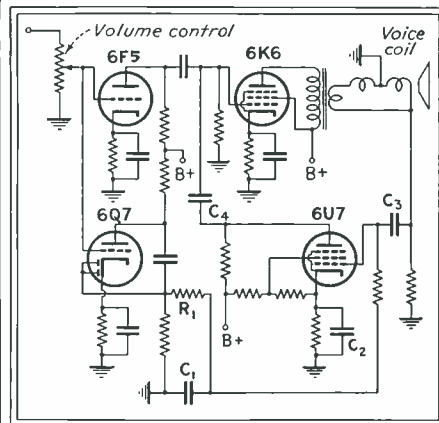

Practical expander-compensator circuit

If a small audio emf is impressed on the volume control, of frequency higher than the resonant frequency of the speaker, the degenerative action of the 6U7 tube will decrease the emf eventually appearing across the voice coil because the bias on the 6U7 is small. As the emf across the volume control gradually increases, the diode in the 6Q7 impresses a greater negative bias on the 6U7 which degenerates less and less. Thus, small emfs are decreased more than large ones giving rise to automatic volume expansion.

Since the frequencies below the speaker resonance are regenerative, the opposite will take place and the bass will be boosted at low levels more than at high levels. The nature of the bass compensation can be varied by changing the values of C_2, C_3, C_4 , or by altering the speaker resonance.

27 ranges

...for measurements
in signal, control and
electronic circuits . . .

THE NEW WESTON industrial CIRCUIT TESTER (Model 785)

VOLTAGE RANGES

DC Volts—0-1/10/50/200/500/1000 volts—20,000
ohms per volt

AC Volts — 0-5/15/30/150/300/500 volts — 1000
ohms per volt

CURRENT RANGES

DC Current—0-50 microamperes, 1/10/100 milli-
amperes, 1 ampere and 10 amperes

AC Current — 0-.5/1/5/10 amperes (available
through self-contained current transformer)

OHMMETER RANGES

0-3000, 0-30,000, 0-300,000 ohms

0-3 megohms, 0 to 30 megohms
(self-contained batteries)

Compactness and light weight
provide extreme portability.
Sturdy oak carrying case mea-
sures only 13 x 12½ x 5½ in.
Weight 13½ lbs.



The Model 785 Industrial Circuit Tester brings new convenience, new economy to production and maintenance testing. This compact, self-contained unit provides all the ranges necessary for voltage, current and resistance measurements wherever high sensitivity is a factor . . . including all types of signal systems, telephone circuits, photo-cell circuits, oscilloscope circuits, and for servicing network protectors, etc. . . . checking the electrical

values in sensitive relays, cathode ray tubes, public address systems and amplifiers, thyratron tubes, etc. . . . as well as for many other plant production and maintenance requirements. Complete data on this new, relatively inexpensive test unit will gladly be sent on request. Weston Electrical Instrument Corp., 618 Frelinghuysen Avenue, Newark, N. J.

WESTON *Instruments*

TUBES

Registry of tubes issued in November, as well as those of May, 1939. Simple method of measuring tube capacitances, and a list of preferred tube types

Measuring Tube Capacities With a Signal Generator

SINCE THE INTRODUCTION of the loktal tube and other single-ended tube types, a convenient means of measuring minute capacitances of the order of a few thousandths of a micromicrofarad is frequently desirable. Few laboratories possess a low range capacity bridge, or suitable standard capacities, required for the measurement of an unknown capacitance by direct comparison methods. The method described herein, published through the courtesy of Hygrade Sylvania Corp., Emporium, Pa., employs equipment found in most radio laboratories. It may be used to measure capacitances of a few thousandths of a micromicrofarad between two terminals which are both above ground potential, and it is fast enough for production testing.

The essential pieces of apparatus which are required include a good standard signal generator, a sensitive well shielded radio chassis and a means of measuring input capacities of the order of 10 to 30 micromicrofarads (a Q meter or ordinary capacity bridge).

The following description of a set-up for measuring grid-plate capacitances of pentode type loktal tubes will serve to illustrate the method. The test socket is mounted in a shielded compartment placed as near to the r-f tube of the radio chassis as is feasible. The grid of the r-f tube is disconnected from the antenna circuit and wired to the test socket as shown in the diagram. The tube under test is then made to serve as a capacity attenuator, and the grid-

plate capacity is calculated from two values of input microvolts and the total input capacity of the radio chassis and the tube under test. The signal generator is connected to the test socket with a shielded cable and additional shielding fins are wired to the socket to reduce the stray capacity between plate and grid prongs to a negligible value. All elements of the tube except the plate and grid are, of course, grounded. The input capacity of the test set-up (C_{IN1}) and the input capacity of the tube under test (C_{IN2}) are then measured on a Q meter or ordinary capacity bridge. For production tests C_{IN1} may be measured and the published value of the input capacity of the tube taken for C_{IN2} . Set sensitivity (μV_G) is obtained by feeding the signal generator direct to the grid of the r-f stage, and this is most conveniently done by connecting the plate and grid prongs together through a large condenser of about 0.05 μf . The condenser is then removed and the tube to be measured is inserted in the socket and the microvolts input (μV_P) required for standard output again determined. It can be readily shown that for C_{OP} very much smaller than $C_{IN1} + C_{IN2}$

$$\text{the value of } C_{OP} = \frac{\mu V_G}{\mu V_P} (C_{IN1} + C_{IN2})$$

With a well shielded set-up, accuracies as good as that of the signal generator attenuator and the input capacity measurement may be obtained. The method is not confined to tubes, but may be applied to various other measurements such as the capacity between the control element and a-c switch of vol-

ume controls, stray capacities between various parts of any chassis or any three terminal networks whose two points in question are above ground.

• • •

Tube Standardization

A NEW PLAN for the standardization of radio tubes is presented by the Radio Tube Division of the RCA Manufacturing Co. Although there are more than 450 different tube types currently manufactured, 90 types constitute 90 per cent of all tube sales. Also for these 90 types there are only twenty basic functions. In an effort to ease the situation a preference list of 36 tube types has been built up which fills the need of the great majority of tube applications, and design engineers are encouraged to use these types. This list is not intended to be inflexible over a long period, but as new tubes of superior performance are developed they will be substituted for the older types. It is not expected that the plan presented will be a cure-all, but that it is a step in the right direction and will serve as a starting point for further efforts of standardization of radio tubes. The list of preferred types is presented here.

PREFERRED TUBE LIST

METAL TYPES

6H6	Twin Diode
6J5	Detector Amplifier Triode
6SA7	Single Ended Pentagrid Converter
6SC7	Single Ended Twin Triode Amplifier
6SF5	Single Ended High Mu Triode
6SJ7	Single Ended Triple-Grid Detector Amplifier
6SK7	Single Ended Triple-Grid Super-Control Amplifier
6SQ7	Single Ended Duplex-Diode High Mu Triode
12SA7	Single Ended Pentagrid Converter
12SC7	Single Ended Twin Triode Amplifier
12SJ7	Single Ended Triple-Grid Detector Amplifier
12SK7	Single Ended Triple-Grid Super-Control Amplifier
12SQ7	Single Ended Duplex-Diode High Mu Triode
12C8	Duplex-Diode Pentode

GLASS TYPES

2A3	Power Amplifier Triode
6U5/6G5	Electron Ray Tube
6J5-GT	Detector Amplifier Triode
6K6-GT	Power Amplifier Pentode
35L6-GT	Beam Power Amplifier
35Z5-GT	Half-Wave High-Vacuum Rectifier
50L6-GT	Beam Power Amplifier
1A7-GT	Pentagrid Converter
1D8-GT	Diode-Triode-Power Amplifier Pentode
1G4-G	Detector Amplifier Triode
1G6-G	Class B Twin Amplifier
1H5-GT	Diode High Mu Triode
1N5-GT	R-F Amplifier Pentode
3Q5-GT	Beam Power Amplifier
5U4-G	Full-Wave High-Vacuum Rectifier
5Y3-G	Full-Wave High-Vacuum Rectifier
6B8-G	Duplex-Diode Pentode
6F6-G	Power Amplifier Pentode
6N7-G	Class B Twin Amplifier
6R7-G	Duplex-Diode Triode
6V6-G	Beam Power Amplifier
6X5-G	Full-Wave High-Vacuum Rectifier

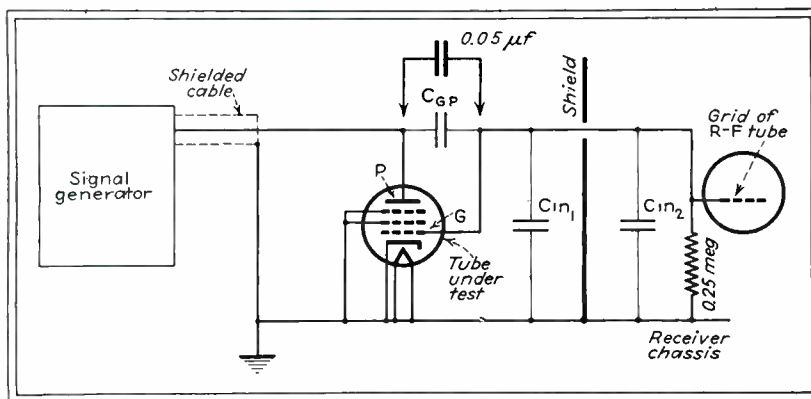

Circuit for determining tube capacitances with a signal generator and radio receiver as measuring equipment

Another Satisfied Eimac user



BRANIFF
THE B LINE
Airways

BRANIFF BUILDING,
OKLAHOMA CITY
OKLAHOMA.

Dallas, Texas
Dec. 20th, of
Braniff's 12th Year
1939

Eitel-McCullough Corporation
San Bruno, California

Gentlemen:

Last June we installed at Kansas City, Missouri, a three kilowatt, non-attentive, remotely controlled transmitter. Since that time we have purchased an additional transmitter for installation at Dallas. At the time these transmitters were ordered we contemplated specifying a number of different makes of tubes on the as modulators for use in the final amplifier. After running light tests on the various tubes under consideration, we finally specified Eimac 750TL tubes for use in the final amplifier and 450TL tubes for use as modulators. In view of our experience with these tubes we feel that we made a very wise choice.

The transmitter at Kansas City has been running continuously since approximately June 1, and to date there has been no failure because of your tubes. In fact, after 5000 hours of service we can see no evidence to indicate that the tubes are not as good as the day they were installed in the transmitter. Every indication is that we will have at least another five or ten thousand hours of service from these tubes.

These transmitters as originally manufactured call for a power output of three kilowatts. After six months of service we felt that as far as the 750TL tubes were concerned they were fully capable of delivering five kilowatts of power to the antenna, and that the 450TL tubes were capable of modulating the plate input required for this output. Accordingly we made recommendations to the manufacturer, which he approved, and approval has been granted by the Federal Communications Commission to increase the power output to five kilowatts.

Needless to say, we are well pleased with the performance of our Eimac tubes.

Yours very truly
BRANIFF AIRWAYS, INC.

F. C. Dyer
F. C. Dyer
Communications Engineer

Collins Radio Co.
is the Manufacturer responsible for this outstanding 10 channel, non-attentive, remotely controlled, multifrequency transmitter.

Eimac
TUBES

In use by practically every major Air Line

EITEL-McCULLOUGH, INC. • SAN BRUNO, CALIFORNIA

HEADQUARTERS FOR
ELECTRICAL CONTROL DEVICES

RELAYS
SOLENOIDS
STEPPING SWITCHES
ELECTRIC COUNTERS
SIGNAL LAMPS
SWITCHING KEYS
PLUGS AND JACKS

★ For 50 years, we have specialized in the manufacture and application of these devices. May we apply our experience to your problems? American Automatic Electric Sales Co., 1033 W. Van Buren St., Chicago.

AUTOMATIC ELECTRIC

MAKERS OF TELEPHONE AND SIGNALING APPARATUS
ELECTRICAL ENGINEERS, DESIGNERS & CONSULTANTS

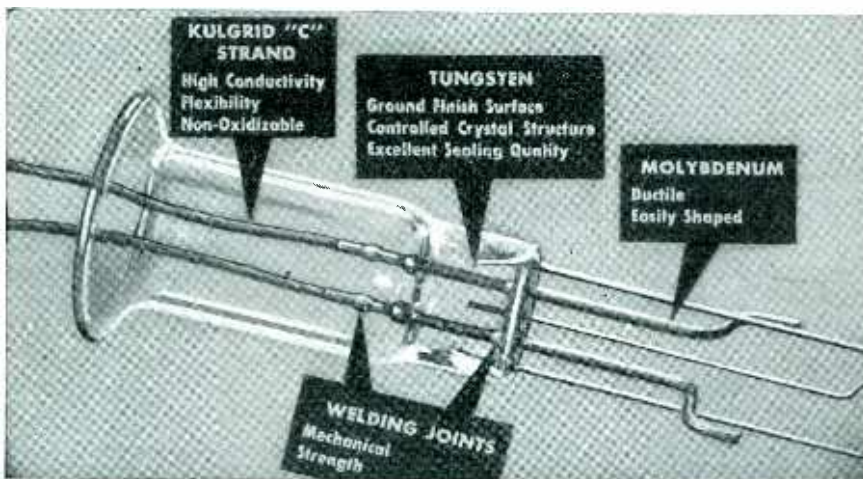

HARD GLASS STEM
MADE WITH
CALLITE LEAD-IN WIRES
of Tungsten • Molybdenum • Kulgrid

The TUNGSTEN in Callite Hard Glass Welds is specially processed to give a compact fibrous structure, free from longitudinal cracks and is centerless ground to eliminate surface imperfections.

The KULGRID "C" STRAND has none of the objectionable features of regular copper strand. Kulgrid "C" does not oxidize. There-

fore, no oxide flakes off to deposit in the tube press as is the case with copper strand. Kulgrid "C" is flexible and does not become brittle. It welds more readily to tungsten than ordinary copper strand and forms a strong joint. *Accept no inferior substitutes.*

Pure metals of best quality are used for any third component part.

CALLITE PRODUCTS
DIVISION

EISLER ELECTRIC CORP. • 544 39th ST. • UNION CITY, N. J.

Tube Registry

Tube Types Registered by R.M.A. Data Bureau During November 1939

Type 1S4 (GB)

POWER amplifier pentode; filament type; (T-5½) glass envelope base; seated height 1½ inches (max) 7 pin button base.

$e_f = 1.4$ v
 $i_f = 0.1$ amps
 $e_p = 45$ v (max)
 $e_s = 45$ v (max)
 $e_g = -4.5$
 $i_{p0} = 3.8$ ma
 $i_{s0} = 0.8$ ma
 $R_p = 0.25$ megohms (approx)
 $G_m = 1250$ μ mhos
 $R_i = 8000$ ohms
 $PO = 0.065$ watts (12%)
Basing 7-AV

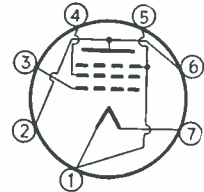

Type 1T4 (GB)

R-F PENTODE, remote cutoff; filament type; (T-5½) glass envelope base; seated height 1½ inches (max) 7 pin button base.

$e_f = 1.4$ v
 $i_f = 0.05$ amps
 $e_p = 90$ v (max)
 $e_s = 45$ v (max)
 $e_g = 0$ (min)
 $i_p = 2$ ma
 $R_p = 0.8$ megohms
 $G_m = 750$ μ mhos
 $C_{in} = 3.5$ μ mf
 $C_{out} = 7.3$ μ mf
 $C_{sp} = 0.01$ μ mf (max)
Basing 6-AR

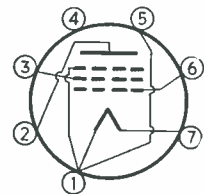

Type 1R5 (GB)

CONVERTER; filament type; (T-5½) glass envelope base; seated height 1½ inches (max) 7 pin button base.

$e_f = 1.4$ v
 $i_f = 0.05$ amps
 $e_p = 90$ v (max)
 $e_{s1} = 45$ v (max)
 $e_{s2} = 0$ v
 G_1 resistor = 0.1 megohms
 $i_p = 0.8$ ma
total cathode current = 2.75 ma
 $G_c = 250$ μ mhos
 $R_p = 0.75$ megohms

With no external shield

$C_{rin} = 7.0$ μ mf
 $C_{rout} = 7.0$ μ mf
Basing, 7-AT

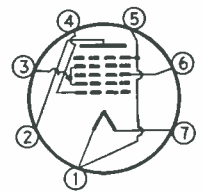

Type 1S5 (GB)

DIODE-PENTODE; filament type; (T-5½) glass envelope base; seated height 1½ inches (max) 7 pin button base.

$e_f = 1.4$ v
 $i_f = 0.05$ amps
 $e_p = e_s = 45$ v
 $e_g = 0$ v
 $i_p = 1.2$ ma
 $i_s = 0.3$ ma
 $G_m = 525$ μ mhos
 $R_p = 0.5$ megohms (approx)
Basing 6-AU

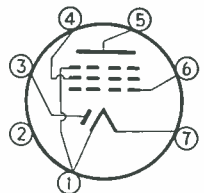



Western Electric 1A Radio Altimeter instantly indicates the distance of an airplane above the terrain underneath by timing an ultra high frequency wave sent straight down from the plane and reflected by the ground.

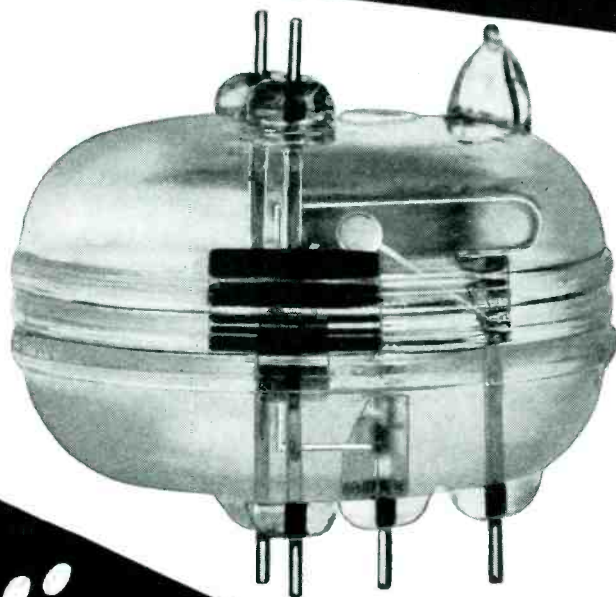

New Triode...

... developed for use in Western Electric Radio Altimeter

Generates 5 watts at 750 mc.

This new transmitter tube has greater power output than the famous Western Electric 316A, even at frequencies 30% higher than maximum for the latter.

Some of the outstanding features are: (1) molded glass envelope, (2) graphite anode which permits 50 watts plate dissipation, (3) plate and grid leads from both ends of envelope, giving effectively lower inductance leads when built into a double Lecher wire circuit, (4)

fin grid construction providing more effective grid cooling and limiting primary emission, (5) heavy thoriated tungsten filament.

Also developed for use in the 1A Radio Altimeter — the small diode D-157653.

For information on Western Electric Vacuum Tubes, write to Western Electric Company, Specialty Products Division, Dept. 9640, 300 Central Avenue, Kearny, New Jersey.

CHARACTERISTICS of D156548 Tube

Filament voltage 1.5 volts
 Filament current 9.0 amps.

Interelectrode Capacitances

Plate to filament or cathode . . 1.0 mmf.
 Grid to plate 1.5 mmf.
 Grid to filament 1.5 mmf.

Average Characteristics

(With a plate voltage of 500 v. and a plate current of 50 ma.)

Amplification factor 7
 Plate Resistance 3500 ohms
 Grid to plate transconductance . . . 2000 micromhos

Maximum Ratings

Max. direct plate voltage . . . 500 volts
 Max. direct plate current . . . 125 ma.
 Max. direct grid current 20 ma.
 Max. plate dissipation 50 watts

Western Electric
 ELECTRONIC EQUIPMENT

You HELPED US PERFECT THIS NEW RECORDER..!

The new F-26-3, just out, was perfected on the firing line. It meets the demands of engineers for a precision instrument, simpler to operate and easier to service:

Amazing new cutterhead and network with a frequency response flat to 8,000 cycles (also available to fit Unit 199 and 220 Recorders, Model 2)

- Instantaneous variation of pitch and direction of cut eliminate expensive feed screws—a Fairchild exclusive
- 16" dynamically balanced turntable with direct synchronous drive assures split-second timing
- Instant change from 78 to 33 1/3 r.p.m.
- New recording scale in minutes for all pitches and both OUT-IN and IN-OUT
- Floating motor mount eliminates all vibration.

SEND TODAY FOR LITERATURE

"... it had to satisfy Fairchild first"

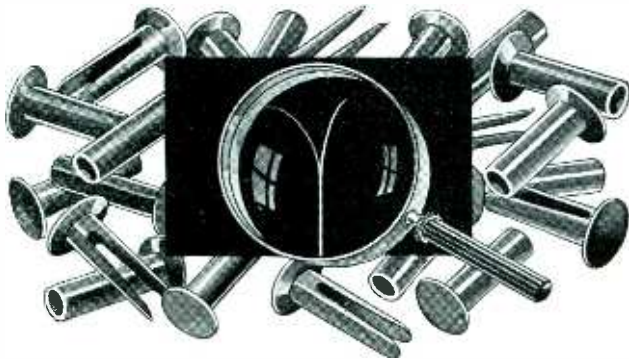

When PRECISION Counts

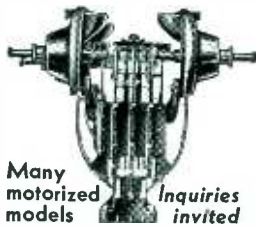

Many motorized models available in single stroke and multiple drive

Inquiries invited with samples of work you wish to do

There is one item in your specifications you can decide upon without hesitation—T R & S Rivets. T R & S quality means every rivet, no matter how many thousands you need, is usable; rivets of uniform preciseness, accurately gauged to drive with smoothness, to clinch with non-brittle efficiency.

We have solved the riveting problems of America's leading industrial concerns.

TUBULAR RIVET & STUD CO.

World's Foremost Producers of Rivets

WOLLASTON

MASSACHUSETTS

Type 1T5 (GT)

BEAM power amplifier; filament type; (T-9) glass envelope; 8 pin octal base.

$E_f = 1.4$ v
 $I_f = 0.05$ amps
 $G_m = 1150$ micromhos
 $e_p = 90$ v
 $e_g = -6$ v
 $R_1 = 14,000$ ohms
 $PO = 170$ milliwatts (7.5%)

Basing 6-AF

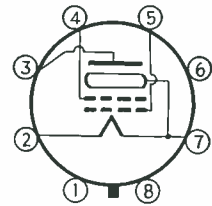

Type 117Z6 (G)

FULL wave rectifier; center tapped; heater type; (T-9) glass envelope; 7 pin octal base.

$E_A = 117$ or 58.5 v
 $I_A = 0.150$ or 0.075 amps
 $e_{ac} = 117$ v (max)
 $i_{dc} = 60$ ma (max)

Basing 7-AR

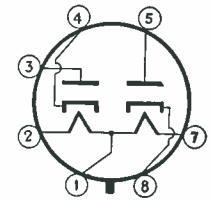

Type 6Y6 (GT)

Prototype 6Y6 (G)

BEAM power amplifier; heater type; (T-9) glass envelope; 7 pin octal base.

$E_A = 6.3$ v
 $I_A = 1.25$ amps
 $e_p = 135$ v
 $e_g = -13.5$ v
 $G_m = 7000$ micromhos
 $R_1 = 2000$ ohms
 $PO = 3.6$ watts

Basing 7-AC

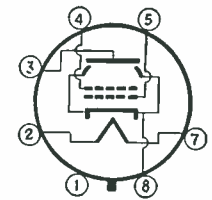

Type 35Z5 (G)

Prototype 35Z5 (GT)

BALLAST-HALF wave rectifier; tapped heater type; (ST-12) glass envelope; 6 pin octal base.

$E_A = 35$ v
 $e_{tap} = 7.5$ v
 $I_A = 0.15$ amps
 $e_{ac} = 125$ v (max)
 $i_{dc} = 100$ ma

Basing 6-AD

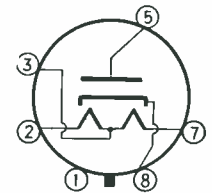

Type 12A8 (G)

Prototype 12A8 (GT)

PENTAGRID converter, remote cutoff; heater type; (ST-12) glass envelope; 8 pin octal base.

$E_A = 12.5$ v
 $I_A = 0.15$ amps
 $e_p = 250$ v
 $G_r = 550$ micromhos
 $R_p = .36$ megohms

Basing 8-A

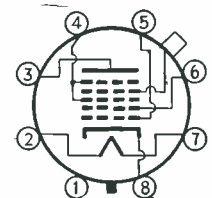



Years of intensive laboratory research is the secret of the advanced engineering design you will find in these new Cornell-Dubilier Type BR Etched Foil Dry Electrolytics. Credit C-D research for:—

- Exclusive electro-chemical etching process —eliminating corrosion.
- Hi-pressure centrifuge impregnation — resulting in better impregnation and lower power-factor.
- Special C-D super-purity cellulose separator—makes possible longer life expectancy.
- Double ageing — assures uniform and stable electrical characteristics.
- Special safety vent—eliminates the danger of destructive high internal pressures.
- Hermetically sealed aluminum container—ideally suited for operation under conditions of high relative humidity.

The Type BR electrolytics are available in both single and dual capacity combinations. In the smaller diameters the dual capacity unit is supplied with two positive leads extending from the opposite ends of the tube. The container is negative. In larger diameters dual section units can be supplied with both positive terminals on the same end. In this construction a common negative lead is supplied. In the smaller diameters a mounting strap acts as the negative terminal. In all cases the container is negative. Complete technical and physical data supplied on request. Your inquiries are invited.

PRODUCT OF THE WORLD'S OLDEST AND LARGEST MANUFACTURER OF CAPACITORS

CONSTRUCTION DETAILS OF TYPE BR CAPACITORS

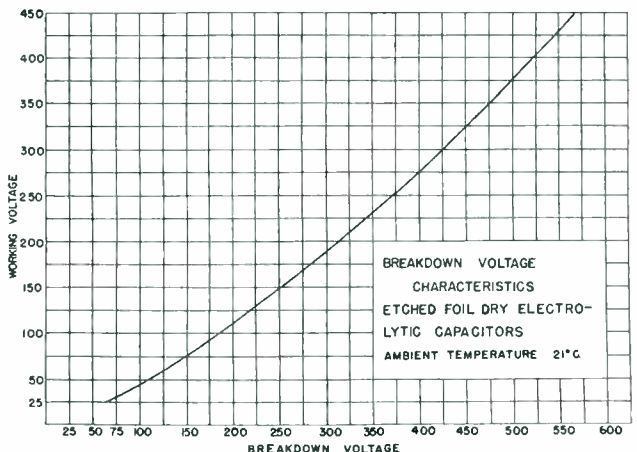
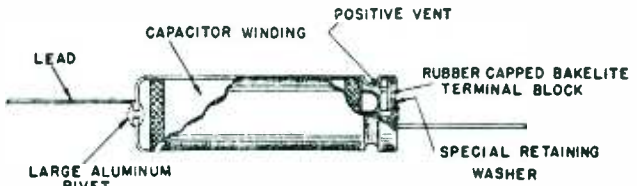
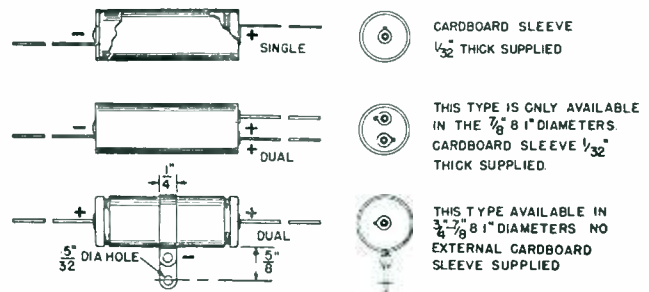

CORNELL-DUBILIER

ELECTRIC CORPORATION

1006 Hamilton Boulevard, South Plainfield, New Jersey

Cable Address: CORDU

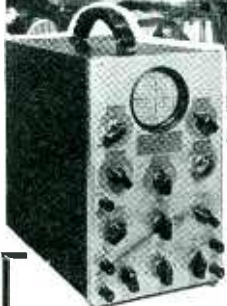
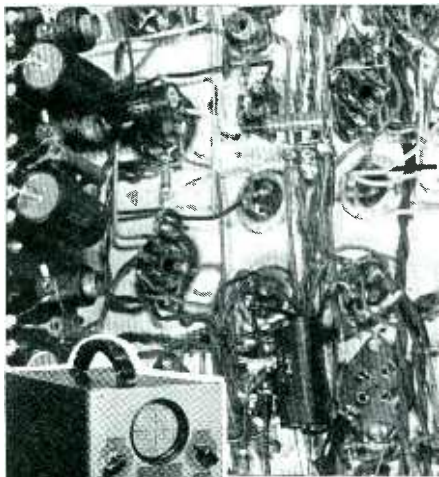

BEAUTY
is only skin deep

★ We believe we are justifiably proud of the appearance of DuMont instruments. Their appearance will never disgrace any laboratory where they are used. BUT . . .

★ We also ask you to consider what lies behind the pretty front panel. DuMont instruments are designed and built with that care and skill arising out of years of specialized experience with cathode-ray equipment. Between the lines of DuMont specifications, there can be read a hidden quality which assures the engineer that what he sees on the cathode-ray screen is a true and dependable reproduction of the signal he applies.

★ It is this hidden quality in DuMont instruments, speaking for itself, which accounts for their ever-increasing application in industrial laboratories, schools, production lines and elsewhere throughout the world.

Write for DATA . . .



Cable Address: Wespexlin, New York

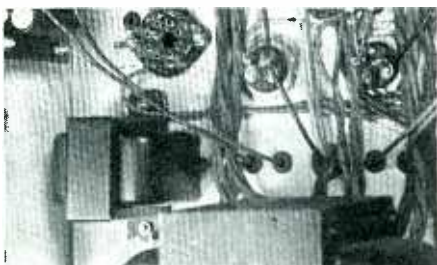

Type 12SK7 (GT)

R-F pentode, remote cutoff; heater type; (T-9) glass envelope; 8 pin octal base.

$E_h = 12.6$ v
 $I_h = 0.15$ amps
 $E_p = 250$ v (max)
 $E_c = 100$ v
 $E_c = -3$ v
 $I_p = 9.2$ ma
 $G_m = 1650$ micromhos
 $R_p = 1.5$ megohms
Basing 8-N

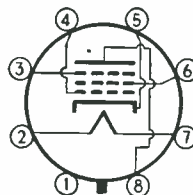

Type 6SF5 (GT)

HIGH mu triode; heater type; (T-9) glass envelope; 6 pin octal base.

$E_h = 6.3$ v
 $I_h = 0.3$ amps
 $E_p = 250$ v (max)
 $E_c = -2$ v
 $I_p = 0.9$ ma
 $\mu = 100$
 $G_m = 1500$ micromhos
 $R_p = 66,000$ ohms
Basing 8-P

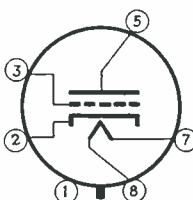

Type 12SF5 (GT)

HIGH mu triode; heater type; (T-9) glass envelope; 6 pin octal base.

$E_h = 12.6$ v
 $I_h = 0.15$ amps
 $E_p = 250$ v (max)
 $E_c = -2$ v
 $I_p = 0.9$ ma
 $\mu = 100$
 $G_m = 1500$ micromhos
 $R_p = 66,000$ ohms
Basing 8-P

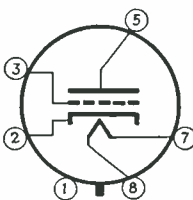

Type 1LA6 (GL)

Prototype 1A6 (G)

PENTAGRID converter, sharp cutoff, filament type; (T-9) all-glass envelope base; 8 pin Loktal base.

$E_f = 1.4$ v
 $I_f = 0.05$ amps
 $e_p = 90$ v
 $e_g = 0$ v
 $G_c = 250$ micromhos
 $R_p = .75$ megohms
Basing 7-AK

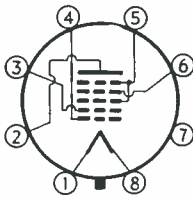

Type 1LN5 (GL)

Prototype 1N5 (G)

R-F pentode; filament type; (T-9) all-glass envelope-base; 8 pin Loktal base.

$E_f = 1.4$ v
 $I_f = 0.05$ amps
 $e_p = 90$ v
 $e_g = 0$ v
 $G_m = 800$ micromhos
 $R_p = 1.1$ megohms
Basing 7-AM

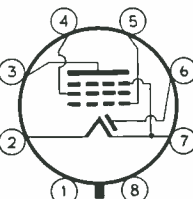

PREVENTS
NEEDLESS
BLOWS!

SLO-BLO
LITTELFUSE
250 VOLTS
170/100 AMP.
RATING

HAS A
HIGH TIME
LAG!

© SPRING © RESISTOR © FUSE LINK

Helps equipment do a better job! Fuses power packs, relays, B+ lines, motors, magnets, solenoids, having inductive or capacitive surges. Useful on intermittent duty circuits. Good on electric fences, portable tools, vibrator circuits, etc. Eliminates blown fuses due to crystallization of the fuse element. Multiplies the life of the equipment it protects. These are a few of the cost reducing reasons why the SLO-BLO Littelfuse will do a good job for you. Can we send you a sample test fuse? Please make request on your company letterhead. Write today.

LITTELFUSE INC.
4755 RAVENSWOOD AVE. CHICAGO, ILL.

NEW TERMINALS

With Wide Range Utility

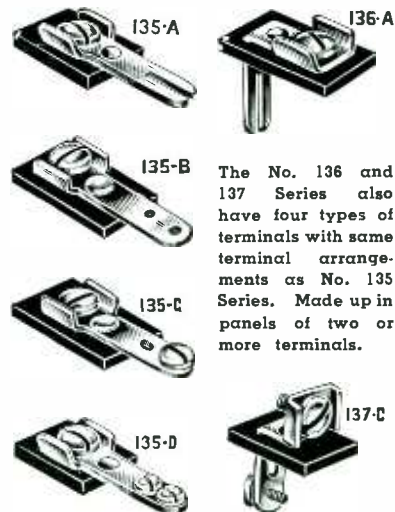

The No. 136 and 137 Series also have four types of terminals with same terminal arrangements as No. 135 Series. Made up in panels of two or more terminals.

Our line of standard parts is constantly being increased to give you the most complete service for Terminal Panels, Terminals, Plugs, Sockets, etc. Specials also made to your blue print. Write for new catalog today. Address Dept. 10.

HOWARD B. JONES
2300 WABANSIA AVENUE,
CHICAGO ILLINOIS

These Manufacturers Know Business will be Good in 1940— *and they're going out to get it!*

ELECTRONICS

begins its 10th Anniversary Year with the
biggest January issue in its history

47% Ahead of 1939.

Here are the manufacturers who are starting off
the new, bigger, electronic decade in Electronics

Acheson Colloids Corp.	Heintz & Kaufman, Ltd.
Acme Electric & Mfg. Co.	Hudson Wire Co.
Aerovox Corp.	Hunter Pressed Steel Co.
Amer. Automatic Elec. Sales Co.	Indiana Steel Products Co.
American Lava Corp.	International Nickel Co.
American Transformer Co.	International Resistance Corp.
Astatic Microphone Lab., Inc.	Isolantite, Inc.
Audak Co.	Jones, Howard B.
Autocall Co.	Lapp Insulator Co.
Bakelite Corp.	Lingo & Son, Inc., John E. Littlefuse Labs.
Biddle Co., James G.	Mallory & Co., Inc., P. R.
Bliley Electric Co.	McGraw-Hill Book Co.
Bud Radio, Inc.	Micro Switch Corp.
Callite Products Div.	Millen Mfg. Co., Inc., James Millen Volcanized Fibre Co.
Carborundum Co., Globar Div.	Obmite Mfg. Co.
Carrier Microphone Co.	Permo Products Corp.
Centralab Division	Pioneer Gen-E-Motor Corp.
Chicago Molded Products Co.	Presto Recording Corp.
Cinch Mfg. Co.	R.C.A. Mfg. Co. (Radiotron Division)
Cornell Dubilier Elec. Corp.	(Test Equipment Div.)
Doolittle & Falknor	Radio City Products Co.
Drake Mfg. Co.	Radio Wire Telev. Inc.
Driver Co., Wilbur B.	Richardson Co.
DuMont Labs., Inc., Allen B.	Shallcross Mfg. Co.
DuPont Plastics	Simpson Electric Co.
Eitel-McCullough, Inc.	Superior Tube Co.
Erie Resistor Corp.	Thomas & Skinner Steel Products Co.
Fairchild Aerial Camera Corp.	Triplett Elec. Instr. Co.
Farnsworth Telev. & Radio Corp.	Tubular Rivet & Stud Co.
Ferranti Elec., Inc.	United Transformer Corp.
Ferris Instrument Corp.	Utah Radio Prds. Co.
Formica Insulation Co.	Ward Leonard Electric Co.
General Electric Co.	Webster Elec. Co.
General Radio Co.	Western Electric Co.
Goat Radio Tube Parts, Inc.	Westinghouse Elec. & Mfg. Co.
Guardian Elec. Mfg. Co.	Weston Elec. Instr. Corp.
Hammarlund Mfg. Co.	White, S.S., Industrial Div.
Heinemann Circuit Breaker Co.	Wincharger Corp.

58% more advertising contracts in our hands by January 1st 1940 than at the same date last year—226% more advertising pages scheduled in advance for this year than were planned ahead for 1939. 47% more advertising in this issue than in January 1939. That is the business forecast for 1940 from most of the leading manufacturers in the electronic industry.

These top manufacturers are showing you through their advertising appropriations and schedules, that 1940 is going to be a big year. Concentration of these important names in ELECTRONICS is their word that this publication, carrying a consistent schedule of sales messages, is the one medium that will get you your share of this business.

Each of these companies is recording in black and white on the dotted lines of contracts and schedules the definite evidence of its confidence in 1940. These manufacturers are not fooling. Their confidence is being expressed, not in idle speech, but in contracts for cash expenditure, wisely considered, thoughtfully planned.

These manufacturers know why they are planning for all this business through ELECTRONICS. They're not gambling with untried media. 41% of the space in this issue was purchased by advertisers who have been in ELECTRONICS for *ten years*, since the first year of publication. Every dollar they spend for advertising must produce business more than sufficient to justify the outlay. ELECTRONICS produces this business for them, does it consistently month after month, year upon year.

These manufacturers have pointed out the way for 1940—a good year for your business, a good year to use ELECTRONICS as the primary advertising force for your products. Now it's your move. You must make the next step—a consistent program of sales messages designed to present your products through ELECTRONICS to this active market.

electronics

radio, communication, and sound
design, engineering



industrial uses of electron tubes
and manufacture

Place **ELECTRONICS** on your sales staff in 1940

BLILEY CRYSTALS



HOLDERS OVENS

for ...
BROADCAST SERVICE

for ...
GENERAL SERVICE

for ...
HIGH AND ULTRA-HIGH FREQUENCIES

for ...
FREQUENCY STANDARDS

Catalog G-11 contains complete information.
Ask for your copy.

BLILEY ELECTRIC CO.
UNION STATION BUILDING ERIE, PA.

Type 5BP4

PICTURE tube; electrostatic deflection; max. dia. $5\frac{5}{8}$ inches; No. 4 phosphor (white); 11 pin base.

$E_h = 6.3$ v
 $I_h = 0.6$ amps
 $e_{anode 2} = 2000$ v (max)
Deflection sensitivity =
0.33 mm/volts dc
Screen input power = 10
milliwatts/sq cm
(max)
Basing 10-A

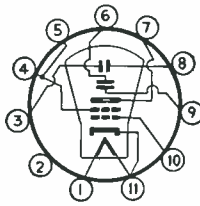

Type 9AP4

PICTURE tube; magnetic deflection; max. dia. $9\frac{1}{8}$ inches; No. 4 phosphor (white); 6-pin base.

$E_h = 2.5$ v
 $I_h = 2.1$ amps
 $e_{anode 2} = 7000$ v (max)
Screen input power = 10
milliwatts/sq cm
(max)
Basing 6-AL

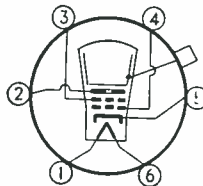

Type 12AP4

PICTURE tube; magnetic deflection; max. dia. $12\frac{3}{8}$ inches; No. 4 phosphor (white); 6 pin base.

$E_h = 2.5$ v
 $I_h = 2.1$ amps
 $e_{anode 2} = 7000$ v (max)
Screen input power = 10
milliwatts/sq cm
(max)
Basing 6-AL

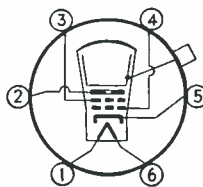

STUDYING LIGHTNING



G. D. McCann sets into trial operation one of the fifty fulchronograph surge recorders which have been installed to study lightning. The fulchronograph makes a record of current in a natural lightning stroke throughout its entire duration

Type 6H4 (GT)

SINGLE diode; heater type; (T-9) glass-envelope 5 pin octal base.

$E_h = 6.3$ v
 $I_h = 0.15$ amps
 $e_{ac} = 100$ v (max)
 $i_{dc} = 4$ ma (max)
Basing 5-AF

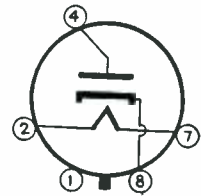

Type 7A5 (GL)

POWER amplifier pentode; heater type; (T-9) all-glass envelope base; 8 pin Loktal base.

$E_h = 7.0$ v
 $I_h = 0.75$ amps
 $G_m = 6100$ micromhos
 $R_i = 2700$ ohms
 $e_{c1} = -9$ v
PO = 1.9 watts (11%)
Basing 6-AA

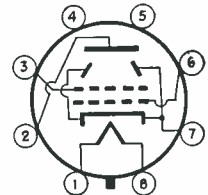

Type 25C6 (G)

Prototype 6Y6 (G)

BEAM power amplifier, heater type; (ST-14) glass envelope; 7 pin octal base.

$E_h = 25$ v
 $I_h = 0.3$ amps
 $G_m = 7100$ micromhos
 $R_i = 2600$ ohms
PO = 6 v (10%)
Basing 7-AC

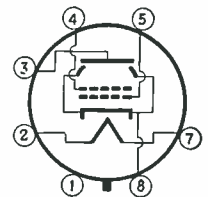

Type 1LH4 (GL)

Prototype 1H5 (G)

DIODE triode; filament type; (T-9) all-glass envelope-base; 8 pin Loktal base.

$E_f = 1.4$ v
 $I_f = 0.05$ amps;
 $e_p = 90$ v
 $e_g = 0$ v
 $\mu = 65$
 $G_m = 275$ micromhos
 $R_p = .24$ megohms
Basing 5-AG



Type 1LA4 (GL)

Prototype 1A5 (G)

POWER amplifier pentode; filament type; (T-9) all-glass envelope-base; 8 pin Loktal base.

$E_f = 1.4$ v
 $I_f = 0.05$ amps
 $e_p = 90$ v
 $e_g = -4.5$ v
 $G_m = 800$ micromhos
 $R_i = 25,000$ ohms
PO = 115 milliwatts
(10%)
Basing 5-AD

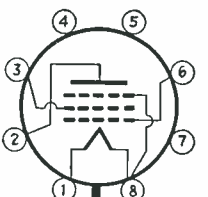

Type 3AP4

PICTURE tube; electrostatic deflection; max. dia.- $3\frac{1}{8}$ inches No. 4 phosphor (white); 7 pin base.

$E_A = 2.5$ v
 $I_A = 2.1$ amps
 $e_{\text{anode 2}} = 1500$ v
 Deflection sensitivity = 0.23 mm/volt, dc
 Screen input power = 10 milliwatts/sq cm (max)
 Basing 7-AN

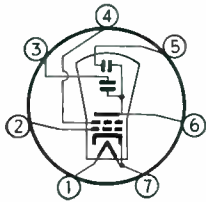

Type 3AP1

PICTURE tube, electrostatic deflection; max. dia.- $3\frac{1}{8}$ inches No. 1 phosphor (green); 7 pin base.

$E_A = 2.5$ v
 $I_A = 2.1$ amps
 $e_{\text{anode 2}} = 1500$ volts
 Deflection sensitivity = 0.23 mm/volt, dc
 Screen input power = 10 milliwatts/sq cm (max)
 Basing 7-AN

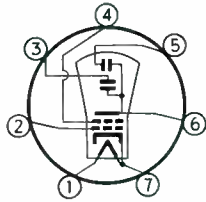

Type 5BP1

PICTURE tube; electrostatic deflection; max. dia.- $5\frac{5}{8}$ inches; No. 1 phosphor (green); 11 pin base.

$e_{\text{anode 2}} = 2000$ v (max)
 Deflection sensitivity = 0.33 mm/volt, dc
 Screen input power = 10 milliwatts/sq cm (max)
 Basing 10-A



Type 12K7 (G)

Prototype 12K7 (GT)

R-F pentode, remote cutoff; heater type; (ST-12) glass envelope; 7 pin octal base.

$E_A = 12.5$ v
 $I_A = 0.15$ amps
 $e_p = 250$ v
 $G_m = 1650$ micromhos
 $R_p = .6$ megohms
 Basing 7-R

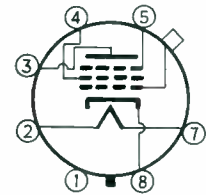

Type 35L6 (G)

Prototype 35L6 (GT)

BEAM power amplifier; heater type; (ST-12) glass envelope; 7 pin octal base.

$E_A = 35$ v
 $I_A = 0.15$ amps
 $e_p = 110$ v
 $e_o = -7.5$ v
 $G_m = 5800$ micromhos
 $R_i = 2500$ ohms
 $PO = 1.5$ watts (6.5%)
 Basing 7-AC

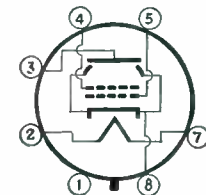



TRANSMITTING CONDENSERS

DESIGNED FOR EXACTING SERVICE



Here is a BUD Junior Transmitting Condenser (No. JC-1569) as installed in a special amplifier designed to operate from 2 to 32 megacycles. This particular unit was selected because it has the valuable Maximum-to-Minimum Capacity ratio of **OVER 22-to-1** in addition to many other outstanding BUD features including Center-of-Rod Rotor Contact, Ceramic Insulated Tie Rods, Fitted Cone Bearings, Alsimag 196 Stator Insulation, and many others.

No matter how exacting your requirements are for variable capacitors, our competent engineering staff is always ready to give valuable assistance in meeting your problems.

We invite your inquiry

BUD RADIO, INC., Cleveland, Ohio



PERMANENT MAGNETS

ALL SHAPES — ALL SIZES FOR ALL PURPOSES

Stamped, Formed, and Cast; Chrome, Tungsten, Cobalt and **ALNICO**** (cast or sintered) under G. E. license.

THOMAS & SKINNER

STEEL PRODUCTS COMPANY
 1116 E. 23rd STREET INDIANAPOLIS, INDIANA

Laminations for Radio Transformers — Tools Dies — Heat Treating — Stampings

38 YEARS EXPERIENCE



Note These Features of This New Webster Electric Crystal Pick-up!

Moisture-proofed crystal element . . . Frequency response range from 50 to 8500 cycles . . . Rubber cushioned arm assembly . . . Needle pressure of only 2.5 ounces . . . Convenient single hole mounting for motor boards from 1/16" to 1/2" thick . . . Write for technical details.

Licensed under patents of the
 Brush Development Company

WEBSTER ELECTRIC COMPANY
 RACINE, WISCONSIN, U.S.A. Est. 1909
 Export Dept.: 100 Varick Street, New York City. Cable Address: "ARLAB" New York

Webster Electric

"Where Quality is a Responsibility and Fair Dealing an Obligation"

THE ELECTRON ART

The subjects reviewed this month include ultra-high frequency oscillation, antenna array adjustment, hearing tests at the World's Fairs and the input resistance of feedback amplifiers

Ultra-High Frequency Oscillation with the Beam Tube

THE OPERATION of beam power tubes in regenerative ultra-high frequency oscillators has been investigated experimentally and is reported in an article "Beam Tubes as Ultra-High Frequency Generators" by Ronold King in the September issue of the *Journal of Applied Physics*. As a result of the occurrence of high frequency parasitic oscillation in circuits employing beam power tubes, an investigation was conducted into the mode of generation of ultra-high frequency oscillation and methods of enhancing as well as of eliminating such oscillation were studied.

Early in the program of investigation it was quickly disproved that the oscillations, which occurred primarily in the screen-plate circuit, might be explained in terms of base oscillation of the Barkhausen and Kurz types. Preliminary investigations showed that the beam tube oscillator was of the simple regenerative type similar to that in triode circuits, but with the screen taking the part of the grid in the triode. This conclusion was completely verified when it was found that the wavelength characteristics of the beam tetrode, as a function of the tank circuit dimensions were precisely like those of the triode in a simple regenerative circuit.

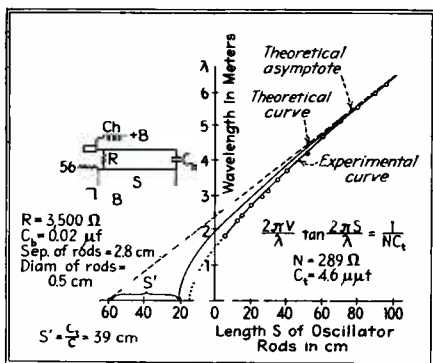

Fig. 1—Diagram showing the experimental and theoretical relations between the length of the oscillator rods and the wavelength of the generated oscillations for triodes

The fundamental frequency equation of a regenerative oscillatory circuit consisting of a section of parallel rods bridged at one end by a large capacitance and connected at the other end to the plate and grid of a triode

are developed. The theoretical and experimental wavelength characteristics of the triode oscillator of this type are given in Fig. 1. The discrepancy between the theoretical and the experimental curve is attributed to the fact that the capacitances used for determining the theoretical curve are made from measurements with the tube cold and for no space current of electrons between the cathode and anode. The effect of a stream of free electrons between the electrodes decreases the effective capacitance thereby permitting the tube to oscillate at higher frequencies as is found, in fact, to be the case. The effect of space charge in increasing the generated frequency by effectively decreasing the inter-electrode capacitance is also verified in another illustration of the original paper in which the generated wavelength of a triode oscillator is plotted as a function of the plate current. It is clear from this curve that as the space current increases the generated wavelength diminishes just as would be predicted in terms of a decreasing capacitance between grid and plate as the base charge density increases.

In order to obtain experimentally the wavelength characteristics of beam tubes, similar to the triode curve of Fig. 1, the oscillating circuit shown in Fig. 2 was used. The tank circuit consists of a length of parallel rods connected at one end of the plate and screen terminals of the beam tubes, and bridged at the other end by a large blocking condenser, C_1 . A second condenser, C_2 , serves to detune the length of rod extending beyond C_1 . All battery connections to the control grid, the cathode, the heater and the tank circuit are provided with adjustable coils which are kept arranged to act as parallel resonance wave traps. For operation with plate and screen at the same potential, the blocking condenser, C_1 is dispensed with. For the shortest possible wavelength, a piece of heavy wire is connected directly across the screen and plate terminals of the tube socket, and the brass rods and grid condensers are not used. The generated wavelength was measured on a parallel wire system loosely coupled to the tank circuit. The wavelength and current characteristics of the 6Y6-G are shown in Fig. 3. For this diagram, the plate and screen were operated at the same potential and this voltage was well below the maximum rated value for the particular tube in question.

A comparison with the wavelength

curve of the beam tube plotted in Fig. 3, with the triode curve shown in Fig. 1, indicates that they are entirely alike. From Fig. 3 it is clear that oscillation may be obtained over a wide range of potentials, except at the lowest generated wavelength. In spite of the relatively large size of the electrodes in the beam tube, the upper frequency limit for both the 6Y6-G and the 6V6-G is about the same as that of the small triode such as the type 56. The lower wavelength limit of the 6L6-G is about $4\frac{1}{2}$ meters, which is considerably in excess of that for the other varieties of beam tubes. The author explains this as a result of shielding of the beam-forming plate between the plate and the screen, the area of the plate ex-

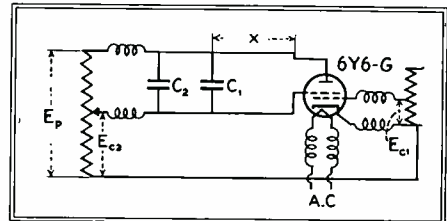
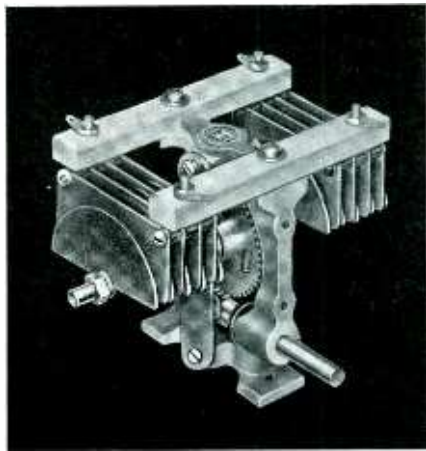

Fig. 2—Schematic wiring diagram of the 6Y6-G ultra high frequency generator

posed to the screen in the 6Y6-G is not much greater than the plate area exposed to the grid in the cylindrical 56. Since the average distance between the plate and screen in the beam tube is nearly double that of the triode, the effective plate-screen capacitance of the former cannot be larger than the plate-grid capacitance of the latter.

Additional curves given in the original article as the result of experimental measurements, show that the frequency of oscillation increases with rising space current, much as in the case of the triode characteristic. This increase in generated frequency may be explained in terms of lowering of the effective plate-screen capacitance as a result of increasing space charge density. If the plate voltage of the 6Y6-G is maintained constant and the screen voltage is varied, the wavelength of generated oscillations decreases as the screen potential varies from zero to a value equal to that of the plate voltage. The wavelength rises abruptly as the screen voltage exceeds the plate voltage and this effect may be ascribed to a decrease in space current density in the plate-screen space as the plate current diminishes and the screen begins to take an increasing portion of the space current.

A discussion of the power output and efficiency of the beam tube oscillator is given and a distinction is made between the efficiency of the circuit in terms of high frequency power developed in the entire tank circuit or radiated from it, and the efficiency in terms of the high frequency power supplied to that part of the tank circuit which is outside of the tube envelope. Under the latter consideration it is noted that by changing the design of the tube, especially for use at



★ NEW ★

Safety Terminals, Insulated Rectifier and Thyatron Connectors, High Voltage Tube Sockets, Iron Core RF Chokes, Quartz Polystyrene Insulation, High Frequency Variable Condensers, Meter Type Dials, Cast Aluminum Chassis, etc.

Catalogue Upon Request

JAMES MILLEN MFG. CO. INC. 150 EXCHANGE ST. MALDEN, MASS.

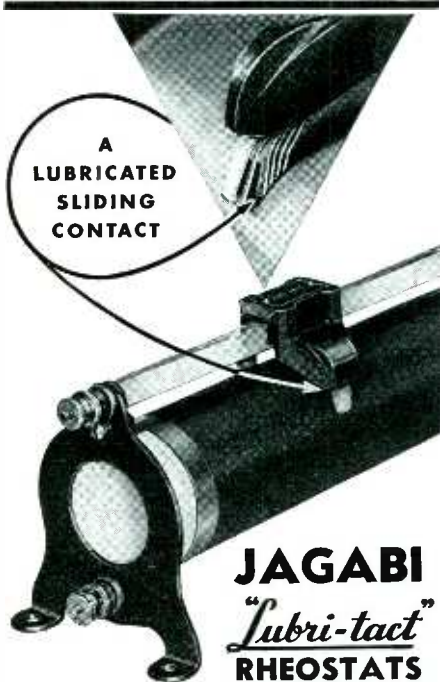

JAGABI
"Lubri-tact"
RHEOSTATS

have a graphited carbon lubricator associated with the contact brushes. Eliminates scratching and abrasion—gives smoother operation and a better contact. Makes Jagabi Rheostats better rheostats.

Write for Bulletin 1620-E which lists new lower prices.

JAMES G. BIDDLE CO.
ELECTRICAL AND SCIENTIFIC INSTRUMENTS
1211-13 ARCH ST. PHILADELPHIA, PA.

ultra-high frequencies, a considerable shortening of the lead within the bulb is possible, and the wire size of the lead (which is entirely too small for high frequency current of several amperes) can be very much increased. If these changes were made in the structure of the tube, the major part of the power converted to the ultra-high frequency formed should be available in an external circuit.

Methods of measuring the power output are discussed as well as the total tank circuit efficiency. It is concluded that by reducing the resistance of the circuit within the tube by shortening and thickening the plate and screen leads, efficiencies approaching a total power conversion efficiency of 25 per cent may be obtained in the external part at a frequency as high as 150 Mc. With the 6Y6-G in its present design, a maximum efficiency of only 7 per cent is obtained in terms of the external part of the circuit.

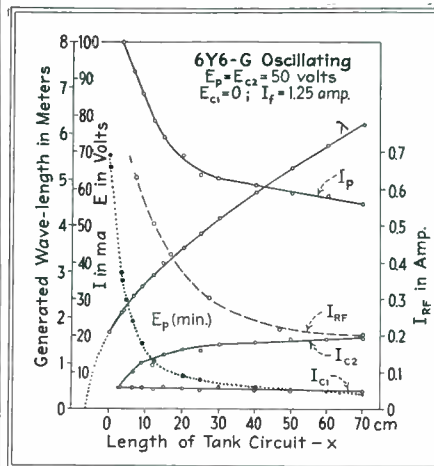

Fig. 3—Oscillation characteristics of the 6Y6-G tube at high frequencies when used in the circuit of Fig. 2

After demonstrating that the beam tube generates ultra-high frequency oscillations in circuits of almost any length, the author describes preventive measures for eliminating such high frequency oscillations. It is pointed out that an attempt to suppress the high frequency current by connecting blocking condensers across the socket terminals will tend to enhance rather than reduce the tendency to oscillate. An alternative method of reducing parasitic oscillations is to use chokes in the plate, screen and grid connections. Since it is difficult to make chokes which are effective over a wide range of frequencies, a simpler and more effective way is to connect small resistors in the screen and grid circuits only. Experiments show that the ultra-high frequency oscillations will not be maintained if a resistor of more than 10 ohms is inserted in the screen lead at the socket, although resistors of even as much as 100 ohms may be used without altering the characteristics in any significant way.

GAMMATRON TANTALUM ANODE TYPE 2054A

*For Broadcast Service**

*COMPLETELY INTERCHANGEABLE WITH THE TYPE 279A

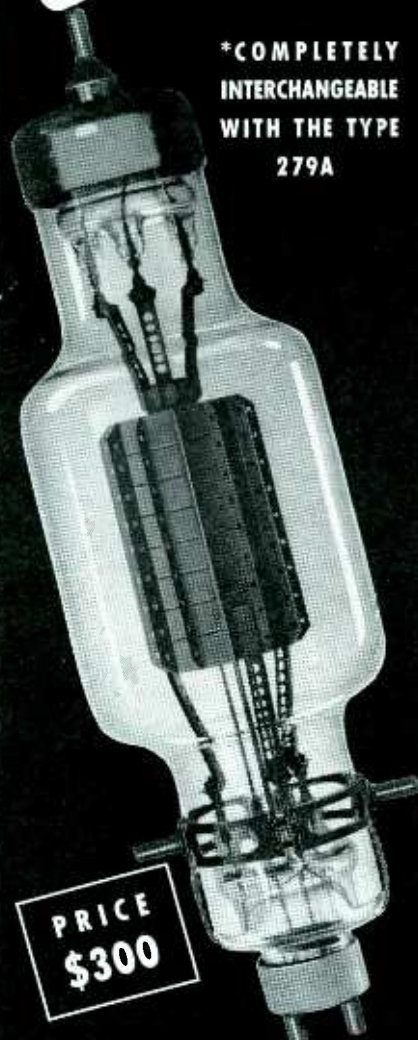

PRICE \$300

1. LONGER LIFE
2. DECREASED AUDIO DISTORTION
3. NO INSULATORS
4. COMPLETE TANTALUM CONSTRUCTION

HEINTZ AND KAUFMAN
SOUTH SAN FRANCISCO LTD. CALIFORNIA U.S.A.



BEAUTY that's more than skin deep—

• Too often eye appeal is obtained at the expense of basic construction—but not in Simpson Panel Instruments. Their outward beauty is only the start of the story. The real story is that Simpson bridge type movement with soft iron pole pieces—the sturdy, precision movement that makes them accurate and keeps them accurate.

You pay no more for this finer construction. That is why Simpson Instruments represent today's greatest buy in electrical metering devices. Typical panel instruments are illustrated above and opposite. Ask for bulletin describing ten models covering all requirements.



Know SIMPSON Testing Instruments

• The Simpson Movement is also the basic feature of a complete line of testing instruments, equally advanced in every detail. A recent addition to the line is this new Model 260 High Sensitivity Tester for television and radio servicing. It has A.C. and D.C. ranges to 5,000 volts at 20,000 ohms per volt D.C. and 1,000 ohms per volt A.C. Also resistance ranges from 1/2 ohm to 10 megohms and decibel ranges from -10 to +52 D.B. Ask for catalog describing a wide range of testing equipment.

SIMPSON ELECTRIC CO.
5212 Kinzie Street, Chicago

SIMPSON
Instruments that STAY accurate

Antenna Adjustment

AN ARTICLE OF INTEREST to broadcast engineers is contained in the August 1939 issue of the *Bell Laboratories Record*. It is "Simplifying Adjustments of Antenna Arrays", by J. F. Morrison. In order to make the most effective use of their licensed power, broadcasters have resorted to antennas which allow a directional control of the radiated power, thus permitting a reduction in interference from stations operating on the same or on an adjacent channel and with an increase in signal strength in closely populated areas where high noise conditions generally prevail. Such antenna arrays usually consist of two or more vertical antennas. In the method of adjusting such antenna arrays described in this article all measurements are made at the broadcast station eliminating the necessity of making tedious field-strength measurements except as a final check.

The radiation patterns depend on the distance between the individual towers and on the relative magnitudes and phase angles of the currents in them. It is a simple enough matter to calculate and inject into each tower current of the proper magnitude and phase. But currents are also induced in each tower for the current flowing in the other towers, thus making the resultant current and phase in each tower unpredictable. The usual method to obtain the desired pattern has been to make an approximate adjustment and then to make field intensity measurements around the array. Changes can then be made to produce more nearly the desired results.

In the new method a sampling loop is fastened to each antenna tower at a point sufficiently high above the ground to assure an accurate sample of the

• • •

SCHOOL BOYS INSPECT TELEVISION



London school boys take a close look at the large screen E. M. I. television cinema projector recently exhibited at Radiolympia

30 ohms list \$60.00
200-500 ohms list \$68.50

Carrier *@mike you'll like*

because it has the looks and the QUALITY. Shown above, dynamic No. 702 D, with exclusive CARRIER "Acoustic Equalizer" that insures amazingly wide range; Hepco locking type cable connector; magnetic shielding; sealed; response $\pm 2\frac{1}{2}$ db. 30 to 10,000 cycles, output level—60 db.

Other models, professional in looks and performance, widely preferred by veterans in broadcasting, recording, re-inforcing. Truly any CARRIER model's a mike you'll like!

Send for complete catalog 10 B

CARRIER MICROPHONE CO.
439 So. LaBrea Avenue
Inglewood, Cal.
15 East 26th St., N. Y. City



0 to 135
VOLTS
stepless

VOLTAGE REGULATION

No laboratory is complete without a means of stepless voltage control such as provided by the Acme Voltrol. Manually operated, the Acme Voltrol provides for stepless regulation of A. C. voltage from 0 to 135 volts. For production line testing this unit has no comparison. Put voltage control on all test boards and discover the performance characteristics of your product under all voltage conditions. The NEW Voltrol is lower priced than ever.

Inquiries invited from manufacturers who use small, special characteristic transformers in quantity.

THE ACME ELECTRIC & MFG. CO.
31 Water Street • Cuba, New York

Acme Electric
TRANSFORMERS

current flowing in the antenna. Each sampling loop is connected by a transmission line to the measuring equipment inside the station. The block diagram is shown below. Radio frequency thermal milliammeters indicate the magnitude of the two currents supplied to the input of a vacuum-tube galvanometer or voltmeter. Between the milliammeter M_2 and the galvanometer is a phase shifting network which permits the phase of the current in that circuit to be shifted until it is the same as that supplied by the other line. The circuit is arranged so that when this condition is reached the galvanometer will give minimum

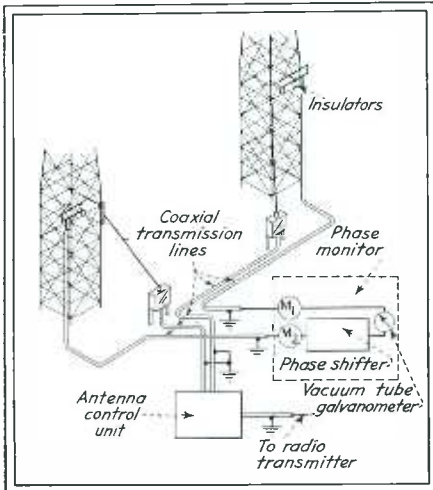

Block diagram of method of directly measuring antenna currents by means of a phase monitor

reading and the amount of phase shift required to bring the two circuits into phase is indicated by the dial controlling the phase shifting network. Since the magnitude and phase of the current required to give the desired radiation distribution pattern is known, it is necessary only to adjust the line and phase shifting network in the main line to the antenna until those known values are indicated.

The transmission lines may be made interchangeable at the monitor so that the phase angle may be re-measured to obtain a check upon the accuracy of the original measurement.

• • •

World's Fairs Hearing Tests

AT THE NEW YORK and San Francisco World's Fairs of 1939, the Bell System conducted in their exhibits a series of hearing tests. About three-quarters of a million records are available from these tests and an analysis is given by H. C. Montgomery in the December 1939 issue of the *Bell Laboratories Record*. The tests covered the frequency range from 440 to 7040 cycles per second at intervals of one octave. The results were recorded along with information to indicate whether the person tested was male or female, colored or white, and to which of five age groups the person belonged. The age groups were 10 to 19, 20 to 29, 30 to 39, 40 to 49 and 50 to 59. The results

DESIGNED FOR DISCRIMINATING MANUFACTURERS

Leakproof
ENAMELED
MAGNET
WIRE

A product, resulting from many years of research in the field of fine wire manufacture, that meets the most rigid requirements of radio and ignition coils. A new coating method gives a smooth, permanently-adherent enamelling, and mercury-process tests guarantee perfect uniformity. Great flexibility and tensile strength assure perfect laying, even at high winding speeds. If you want reduction in coil dimensions without sacrificing electrical values, or seek a uniform, leakproof wire that will deliver extra years of service, this Hudson Wire product is the answer.

Also manufacturers of high grade cotton and silk covered wires, cotton and silk coverings over enamel coated wires, and all constructions of Litz wires. A variety of coverings made to customers' specifications, or to requirements determined by our engineers. Complete design and engineering facilities are at your disposal; details and quotations on request.

Winsted
HUDSON WIRE CO.
Division
WINSTED • CONNECTICUT

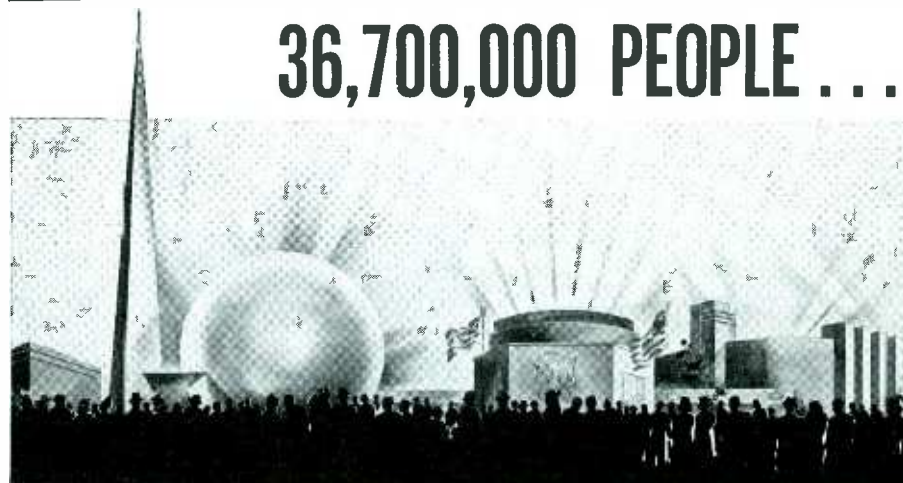

36,700,000 PEOPLE . . .

★ Surging crowds . . . approximately 25,800,000 paid admissions at the New York Fair *plus* another 10,900,000 through the Golden Gate turnstiles. All *Troutman Totalizer counting mechanisms used Relays by Guardian, exclusively, and never missed once!

No interruptions in service from opening to closing, for a total of 439 eighteen-hour days. Moreover, Relays by Guardian were in steady operation 7 days per week, withstanding one of the severest, large scale tests ever made.

*Certified Correct—F. B. Troutman, Pres., Troutman Totalizer Co.



RELAYS by GUARDIAN

Solenoids • Stepping Switches • Time Delay • AC • DC singly, or in COMPLETE CONTROL UNIT form, have answered thousands of problems. They answer yours, too, with a quick solution and a delivery date a lot closer than you'd ever expect.

Write for Catalog "E" Today!

GUARDIAN  **ELECTRIC**
1625 W. Walnut Street Chicago, Illinois



More **HIGHER**
LOWER Ranges

it's the new
ELECTRONIC MULTITESTER



Engineers will appreciate RCP Multitester Model 660's twelve ranges, all on direct reading master scales. Resistance is from 0.1 ohm to one billion ohms. Voltages from 0.1 volt to 6000 volts—ranges unusually wide even for laboratory instruments costing two to four times as much. An input resistance of 200,000,000 ohms accounts for this instrument's super sensitivity. The 6 volt range is 40,000,000 ohms—practically no load whatsoever. Here is the perfect instrument for all high resistance measurements. Readings very clear on extra long scale. Extreme tolerance limits of 2% for all circuit components insure a high degree of accuracy. Net..... **\$18.85**

**DYNOPTIMUM
TEST TUBE
CHECKER**

**NEW
MINIATURE
7 PRONG
TUBE
TEST.**

Tests all new and old tubes, ballast tubes, all filaments or heaters up to full line voltage. Line voltage control, direct reading on meter. New miniature tubes. Audible test of noisy tubes. Model 308, Net..... **\$16.95**



SEND FOR THE NEW 1940 catalog of Quality RCP Test Equipment. Get full details on these and other instruments in the RCP Dependable line.



RADIO CITY

PRODUCTS CO. INC.
88 PARK PLACE, N. Y. C.

We take pleasure in Announcing

MR. W. E. McKIBBEN

formerly of the Research Laboratory of General Electric Company, Schenectady, N. Y., has joined our organization and will specialize in research and development of Permanent Magnet Materials.

THE INDIANA STEEL PRODUCTS COMPANY

135 SOUTH LA SALLE STREET CHICAGO, ILLINOIS

Plant: Valparaiso, Indiana

McGraw-Hill

DIRECT MAIL



As business paper publishers for over fifty years, McGraw-Hill is uniquely equipped to offer complete, authoritative direct mail coverage of Industry's major markets. Extreme accuracy is maintained (guaranteed to 98%) and through careful analysis of markets, complete classification of companies and personnel, etc., the widest possible selections are available. Send for handy reference folder, "Hundreds of Thousands of Reasons Why" which describes how McGraw-Hill Lists are built and maintained.

What Fields Do You Want to Reach?

Aviation
Bus & Electric Railways
Civil Engineering and Construction
Administrative Executives

Electrical Dealers & Wholesalers
Mill Supply Houses
Power Services
Product Engineering & Design
Production and Maintenance
Radio Dealers & Wholesalers
Radio Engineering & Design

For further details, selections from above basic classifications, counts, prices, etc., or estimates on special lists . . . ask any representative or write to



DIRECT MAIL DIVISION
McGraw-Hill Publishing Co.
330 W. 42nd Street NEW YORK, N. Y.

Complete Lists Covering Industry's Major Markets

of this survey, in harmony with previous data, indicate a definite falling off in hearing acuity with age. This is particularly noticeable at the higher frequencies. A rather remarkable fact is that at the low frequencies the falling off with age was less for men than for women, whereas at the higher frequency it is less for women than for men. For a frequency of 880 cycles per second the loss for women in the oldest age group is about 3 db greater than for men, where at the higher frequencies it is about 7 db less. For the youngest group the difference between men and women nearly disappears at the low frequency and is only about 2 or 3 db at the highest.

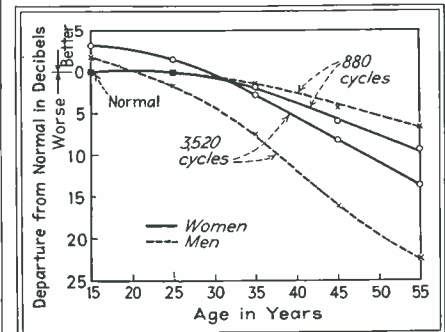

Fig. 1—Variation in hearing loss with age for men and women at 880 and 3520 cps

The curves of Figs. 1 and 2 represent the averages of both men and women and the extent of deviation from the averages is given in the distribution curves of Fig. 3. These are plotted from the data for men, but the use of the data for women would not essentially change their characteristics. The abscissa scale represents hearing loss in db from the average for the age group from 20 to 29 years. A minus loss indicates a hearing better than average. The small arrows along the scale indicate the average for that particular age group and frequency.

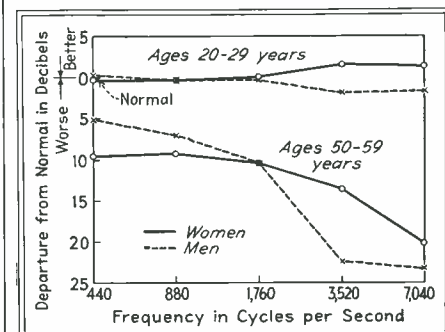
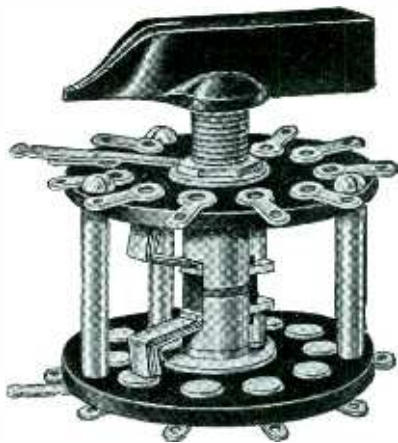

Fig. 2—Variation in hearing loss with frequency for men and women in the age groups 20-29 and 50-59

It has been found that one's ability to understand speech can be determined from the average of the hearing losses at 440, 880 and 1760 cycles per second as compared to good "young" ears. If this average is 25 db there may be some difficulty in hearing in auditoriums and churches, while if it is 45 db there may be difficulty in hearing a direct conversation. Only if the hear-

SHALLCROSS SOLID SILVER SWITCHES



for jobs which mean accuracy—

The Shallcross Superior Solid Silver—one of two section—Switch utilizes ceramic switch plates with high surface leakage; designed to withstand high voltage and maintain extremely low contact resistance.

High grade insulation—easily mounted—shorting or non-shorting contact arms—continuous operation through 360°—low contact resistance.

Write today for complete information in Bulletin No. KK.

SHALLCROSS MFG. COMPANY
Electrical Measuring Instruments
and Accurate Resistors
COLLINGDALE, PA.

A CONTINUOUS WORLD'S PAIR:

A 280 Tube
and
"Sylvaloy"
Filament



WILBUR B. DRIVER CO.
NEWARK, NEW JERSEY

ing loss is as much as 65 db will there ordinarily be much difficulty in hearing over the telephone.

By the analysis of these figures, the tests indicate that about one out of twenty-five persons have difficulty in hearing in auditoriums; one in 125 have some difficulty in direct conversation and one in 400 over the telephone. Two out of five men between 50 and 59 will have a loss of at least 25 db at 3520 cycles per second, while only one in five women or half as many will have as great a loss at this frequency. It was found also that about one in

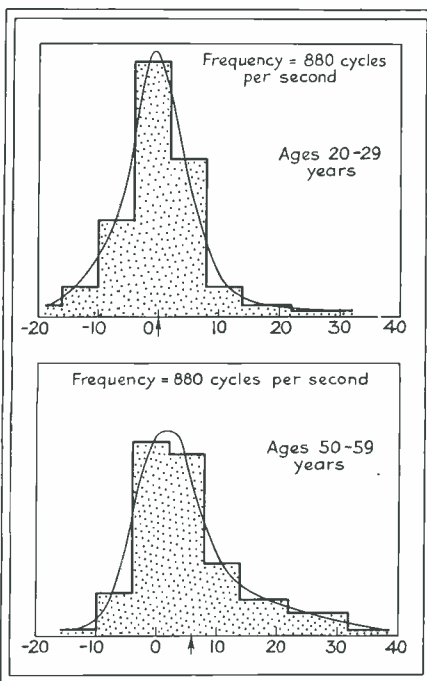

Fig. 3—Distribution curves for hearing loss at 880 cps

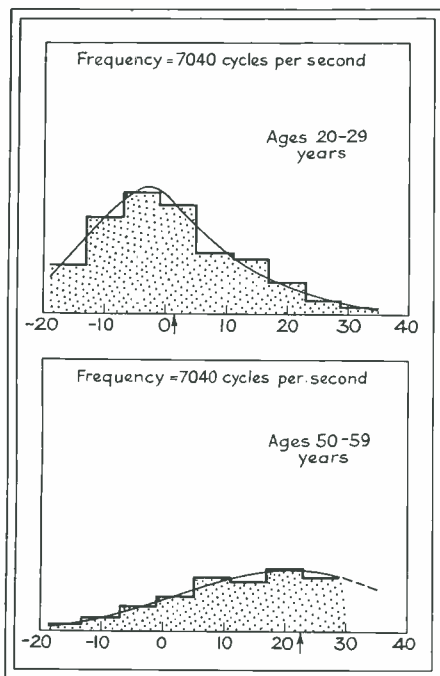

Fig. 4—Distribution curves for hearing loss at 7040 cps

LINGO

has met every demand!

- Efficiency
- Construction
- Stability
- Maintenance
- Economy

■ Every radio engineer gets "tough" when buying equipment. With claims and promises coming in every direction—only facts and results are important to him. The ever-increasing number of station installations is significant progress of Lingo Vertical Tubular Steel Radiators. In every case Lingo Radiators have more than met each demand—whether it be for increased efficiency, lower maintenance, stormproof stability. One engineer writes: "The remarkable signal we are putting out should be reported to you because your Lingo radiator is doing the biggest job of any radiator that I know of. . . ." Get our complete story at once—it should be on every alert engineer's desk.

Complete Details Sent on Request

Write today for complete technical data and cost chart. Please include location, power, and frequency of your station. No obligation, of course.

JOHN E. LINGO & SON, INC.

Dept. E-1, CAMDEN, N. J.

LINGO

VERTICAL
TUBULAR STEEL
RADIATORS



● For those applications requiring paper type condensers, be sure to check with the new 1940 AEROVOX catalog.



Despite the preponderant use of electrolytics, AEROVOX maintains a wide choice of paper condensers to meet those needs where only paper dielectric can be safely and satisfactorily used. You can have uncased units for your own grouping and container; inexpensive paper tubulars; various types of metal-can jobs; bakelite-case paper units; oil-filled high-voltage condensers, etc., etc.



All of which is typical of the AEROVOX aim to provide condensers that fit into your exact needs, rather than expecting you to improvise or warp your requirements to an otherwise limited choice of condensers.

Have You Our New CATALOG?

Contains more pages, more items, more choice. Copy gladly sent on request. Meanwhile, submit your problems for A.A.E. (Aerovox Application Engineering) which considers your problem in terms of entire circuits and other components, as well as condensers.



twenty-five of the group from 10 to 19 had a loss of at least 25 db at 7040 cycles per second.

It is also indicated that there is no significant difference between the populations of New York and San Francisco. Also, no consistent difference was found in tests made at various parts of the day, indicating that there is no effect of fatigue on hearing.

• • •

Input Resistance of Feedback Amplifiers

PREVIOUS TREATMENTS of the variation of input resistance of a feedback amplifier have been more or less restricted to the case of a tube whose grid-anode capacitance has been used for this purpose. In an article entitled "The Input-Resistance of Feedback Amplifiers" in the *Elektrische Nachrichten Technik* of June 1939, H. Bartels treats this subject in a more general sense than attempted before.

The diagram shows the circuit relations of the amplifier under discussion. R_p is the input resistance of the amplifier and R_o is its output resistance, e_1 and e_2 are input and output voltages respectively and the feedback voltage is proportional to e_2 and is designated by βe_2 . The input voltage is now composed of two voltages which may be called e_1' . With opposition coupling the relation is:

$$e_1' = e_1 - \beta e_2 = e_1 (1 - \mu\beta)$$

where μ is the amplifier gain. The input resistance of the amplifier under these conditions is:

$$R - e_1'/i_1 = R_p (1 - \mu\beta)$$

Geometrical construction for the input-resistance is possible when the vector v is known. This is the vector determined by the equation:

$$v = R_o/R_i + R_o$$

The author describes and illustrates various geometrical constructions of the vector v for different conditions, i.e. for constant values of ϕ_a and for $|R_o|$ constant. The vector diagrams show the input resistance variations with positive and negative feedback for various magnitudes of R_o .

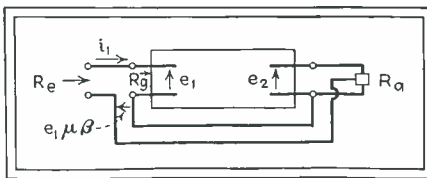

Feedback connection of amplifier

By a variation of the amplifier constants, namely, μ_o , R_p , G_p , R_k and β a new kind of input resistance change can be had. Instead of the characteristic change incurred by varying R_o , the input resistance can be made to be a function of the frequency and a vector construction for this condition is also included in the article. The conditions for stability or instability of negative resistances are discussed at the conclusion of the paper.

LOWER COST

WINCHARGER

NEW GUYED

VERTICAL RADIATOR

A new and improved guyed tower designed for commercial radio stations. Uniform cross section. Liberal safety factor. Low erection cost. Wincharger tower now used and endorsed by numerous commercial and government stations.

★

APPROXIMATE COSTS

Following prices include towers furnished with pre-fixed guy sockets (except 200 foot tower), Lapp base insulators, high strength guys, guy insulators, turn-buckles, and paint:

200 FT. TOWER	*\$67500
240 FT. TOWER	*\$152500
300 FT. TOWER	*\$210000

* F. O. B. Sioux City, Iowa, less lighting and erection costs.

WRITE for Complete Details Including Stress Analysis on Towers

WINCHARGER CORPORATION

SIOUX CITY IOWA

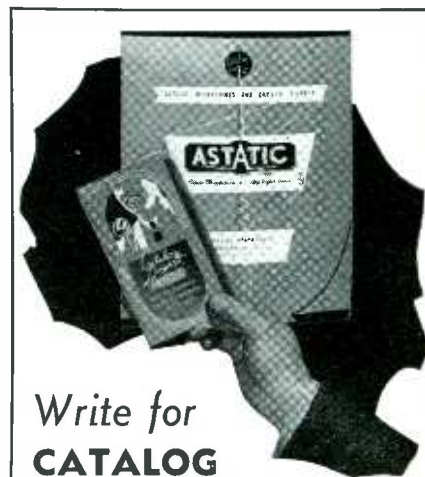

Write for CATALOG

Complete line of Astatic Microphones, Pickups, Stands and accessories. Description and prices. Your name and address on blank lines below will bring you one of these new Astatic Catalogs.



ASTATIC MICROPHONE LABORATORY, INC.
YOUNGSTOWN, OHIO

THE INDUSTRY IN REVIEW

News

THE Hammarlund Mfg. Co. announces a new and improved "Super-Pro" receiver available in two tuning ranges, 15 to 560 meters and $7\frac{1}{2}$ to 240 meters. The improvements include the variable selectivity crystal filter introduced in the Hammarlund "HQ-120-X"; a new noise limiter designed to provide maximum suppression without affecting the normal performance of the receiver; and a new "S" meter which makes possible reporting signal strength under almost any conditions. It has a single variable control. With the Super-Pro the operator picks up an "average" loud signal and adjusts the control so that the "S" meter reads whatever he is accustomed to reporting that type of signal and from there on, all other signals are read in proportion to the strength of the signal on which the meter was set.

There are five ranges of selectivity available. Three are for reception of voice and music, and the remaining two are for CW or code reception.

The new Super-Pro uses two 6K7's as first and second t-r-f amplifiers; 6L7 first detector; 6J7 h-f oscillator; 6K7 first i-f amplifier; two 6SK7's as second and third i-f amplifiers; 6H6 second detector; 6N7 noise limiter; 6SJ7 beat frequency oscillator; 6SK7 a-v-c amplifier; 6H6 a-v-c and meter rectifier; 6C5 first a-f amplifier; 6F6 second a-f amplifier; and two 6G6's

as push-pull output audio. The power supply has two rectifiers, one 5Z3 high voltage rectifier, and one 80 low voltage rectifier for the C-bias supply.

The two carefully designed tuned r-f stages result in high sensitivity with a very low background noise level. The gain in the first stage is sufficient to override noises originating in the tubes that follow, and the gain in the antenna circuit, or first tuned circuit, is great enough to definitely establish a high signal-to-noise ratio even on the weakest signals. The antenna coil is designed to operate with a low impedance feeder or lead-in system. The use of low impedance lead-ins greatly reduces possibility of noise pick-up and provides a simple means for using resonant and directional antenna systems.

Band changing is accomplished by a multi-section cam-operated knife switch with silver plated contacts. No moving parts in this switch carry current, and therefore, there is little danger of this switch becoming noisy or introducing instability. Changes in i-f band width are accomplished by mechanically varying the coupling between the primary and secondary of the i-f transformers. By means of a control knob on the panel, the operator can adjust the band width of the receiver to provide highest possible fidelity with a minimum of interference.



The new and improved Hammarlund Super-Pro Receiver. New features include a variable-selectivity crystal filter, a noise limiter and an "S" meter

◆ RCA Laboratories recently demonstrated its newly developed light-weight portable television field pick-up equipment before members of the F.C.C. in Washington. The apparatus was developed to meet the demand for television field stations comparable in compactness to present-day sound broadcasting units. To make the equipment highly portable, engineers have assembled the various components in small carrying cases varying in weight from 35 to 72 pounds each. The complete unit is more efficient, and is approximately one tenth the weight and one sixth the cost of the only other unit ever designed in this country for the same purpose. . . . Raymond Stevens, Vice President of Arthur D. Little Inc., Cambridge, Mass., was appointed Director of the National Research Council's nation-wide survey of research in industry as a natural resource. Mr. Stevens, a widely known authority on organization of research, will direct the survey from headquarters in Washington. The announcement followed the first meeting of a special committee held at the Engineers' Club in New York to formulate initial plans. . . . For the fifth time in twelve years, Littelfuse, Inc., has had to enlarge its manufacturing facilities, increase its plant capacity, and move to enlarged quarters. The new plant address is 4757 Ravenswood Avenue, Chicago. . . . Mr. George L. Crosby, Vice President and General Sales Manager of Roller-Smith Co., died recently at his home in Bethlehem, Pa. . . . An agreement between the Apex Electrical Mfg. Co., of Cleveland, and the RCA Mfg. Co., for the sale of Apex products in the world-wide export market, has been announced simultaneously by the two companies. Under the agreement, RCA Victor will act as exclusive Apex distributor in all foreign markets except Canada. . . . The first major attempt to light a broadcasting studio with Zeon fluorescent tubing was recently made by Federal Electric Co., Chicago, in Studio "D" of station WLS. The outstanding features of this Zeon installation is its ability to light a room directly and indirectly without casting troublesome script shadow. WLS claims that broadcasting seems to run smoother in the studio due to the fact that announcers and dramatists feel properly relaxed in the warm atmospheric light. . . . Clarence G. Stoll was elected President of the Western Electric Company at a meeting of the Company's directors recently. He succeeds Edgar S. Bloom who joins the new British purchasing commission. . . . The Norman B. Neely Company, Cali-



New
The Library now comprises a revised selection of books culled from leading McGraw-Hill publications in the radio field.

McGraw-Hill RADIO ENGINEERING LIBRARY

— especially selected by radio specialists of McGraw-Hill publications

— to give most complete, dependable coverage of facts needed by all whose fields are grounded on radio fundamentals.

— available at a special price and terms

These books cover circuit phenomena, tube theory, networks, measurements, and other subjects—give specialized treatment of all fields of practical design and application. They are books of recognized position in the literature—books you will refer to and be referred to often. If you are a researcher or experimenter—if your interest in radio is deep-set and based on a real desire to go further in this field—you want these books for the help they give in hundreds of problems throughout the whole field of radio engineering.

5 volumes 3319 pages, 2298 illustrations

1. Eastman's FUNDAMENTALS OF VACUUM TUBES
2. Terman's RADIO ENGINEERING
3. Everitt's COMMUNICATION ENGINEERING
4. Hund's HIGH-FREQUENCY MEASUREMENTS
5. Henney's RADIO ENGINEERING HANDBOOK

Special Low Price and Easy Terms

Bought singly, the five volumes comprising this library would cost you more. Under this offer you save money and, in addition, have the privilege of paying in easy installments beginning with \$2.50, 10 days after receipt of the books, and \$3.00 monthly thereafter. Already these books are recognized as standard works that you are bound to require sooner or later. Take advantage of these convenient terms to add them to your library now.

SEND THIS ON APPROVAL COUPON

McGraw-Hill Book Co., Inc.
330 W. 42nd St., New York, N. Y.

Send me the McGraw-Hill Radio Engineering Library 5 vols., for 10 days' examination on approval. In 10 days I will send \$2.50, plus few cents postage, and \$3.00 monthly till \$23.50 is paid, or return books post-paid. (We pay postage on orders accompanied by remittance of first installment.)

Name

Address

City and State

Position

CompanyL-1-40

(Books sent on approval in U. S. and Canada only.)

California agents for Jefferson-Travis marine radio telephone, has been working with the J. W. Miller Company on the problem of interference in relation to radio marine telephone communication. This experience has permitted the development of a definite interference elimination technique for marine radio telephone installations. One important feature is that no spark plug suppressors are used, so that motor efficiency and dependability are not jeopardized.

Dr. Arthur Korn has been appointed a member of the Faculty of Stevens Institute of Technology as Professor of Electrical Engineering. Dr. Korn attended the Universities of Leipzig and Freiburg and received his doctorate in 1890. He resigned from the Faculty of the Berlin-Charlottenburg Technische Hochschule in 1935. He will offer two evening graduate courses at Stevens during the second semester, beginning February 5, 1940. His subjects are "Picture Transmission Engineering" and "Introduction to Electromagnetic Theory."

Literature

Monthly Technical Service. The first three issues of the Mallory Supplemental MYE Monthly Technical Service are available for the use of radio service engineers, amateurs, experimenters, and others interested in the radio trade. Supplement No. 1 treats the subject of "Receiving Tube Characteristics", Supplement No. 2 tells about "Dry Electrolytic Capacitors", and Supplement No. 3 deals with "Useful Servicing Information."

The MYE Supplemental Service may be subscribed to in conjunction with the 3rd Edition Mallory-Yaxley Radio Service Encyclopedia, or separately. In either case, the price of the full-year's subscription is well worth what it costs.

For those interested in the Technical Service, it may be obtained from P. R. Mallory & Co., Inc., Indianapolis, Ind.

Ceramic Products. A booklet prepared by the technical staff of the Star Porcelain Co., Trenton, N. J., contains a brief survey of technical characteristics of molded ceramic products for electrical wiring and heating and special applications.

Transmitting Equipment. Catalog No. 966 is a new catalog which includes detailed descriptions of radio transmitting equipment manufactured by E. F. Johnson Co., Waseca, Minn.

Remote Amplifier. Model 12Z remote amplifier is described and illustrated in a bulletin from Collins Radio Co., Cedar Rapids, Iowa.

"K" Monel. Bulletin T-9, revised recently, gives technical information on monel, nickel and nickel alloys. International Nickel Co., 67 Wall St., New York City.

Rotary Converter. Heavy duty rotary converters for changing d.c. to a.c. are described in Form No. 1050K available from Carter Motor Co., Chicago.

Servicing. "Ideas for Profitable Servicing" is a new 8-page bulletin issued by Weston Electrical Instruments Corp., Newark, N. J. Besides offering helpful hints to the servicemen, it also includes specifications, and ranges of prices of Weston servicing instruments.

Measuring Instruments. Electrical measuring instruments manufactured by Leeds & Northrup Co., Philadelphia, Pa., for research, teaching and testing are described and illustrated in a nicely covered and well edited catalog E, which contains 66 pages.

Portable Instruments. General Electric Co., Schenectady, N. Y. have available a bulletin No. GEA-1784B which describes a-c and d-c portable instruments.

Condenser Manual. "Industrial Capacitors Manual" issued by Aerovox Corp., New Bedford, Mass., devotes several pages to pertinent information on motor-starting capacitors, including diagrams, curves, formulas, specifications, etc.

Capacitor Catalog. "Replacement Motor Starting Capacitors" 1939-40 edition is available from Cornell-Dubilier Electric Corp., S. Plainfield, N. J. The book lists exact duplicate replacement capacitors for all types of a-c motor driven equipment.

Frequency Modulation Receiver. Bulletin 258 describes a receiver for laboratory and monitoring service. Frequency range is 40 to 44 Mc. Output is 12 watts—500 and 8 ohms. Bulletin 257 describes a 250 watt radio telephone transmitter. Both bulletins are available from Radio Engineering Laboratories, Long Island City, N. Y.

General Products. A wide range of products such as Thermo-Grip electrical soldering irons, fuse pullers, etc., is listed and described in a 12-page leaflet available from the manufacturers, Ideal Commutator Dresser Co., Sycamore, Ill.

Catalog. Laboratory thermometers and hydrometers are described in Catalog No. 1100B of C. J. Tagliabue Mfg. Co., Park and Nostrand Aves., Brooklyn, N. Y. Two pages of the catalog are devoted to Fahrenheit-Centigrade conversion tables and Baume-Specific gravity conversion tables.

New Stock List. A new publication lists thousands of washer specifications in various materials, including steel, brass, copper, aluminum, fiber, etc. available from Wrought Washer Mfg. Co., 2100 S. Bay St., Milwaukee, Wis.

CONTACTS

FOR THE FIELD OF ELECTRONICS

B-L RECTIFIERS



CHANGE AC TO DC WITHOUT MOVING PARTS, GLASS BULBS, LIQUIDS, OR SPARKING CONTACTS.

DRY—DURABLE

COMPACT—ECONOMICAL

SPECIAL RECTIFIERS AND COMPLETE ASSEMBLIES

THE BENWOOD LINZE CO.
ST. LOUIS, MO.
ELECTRICAL RECTIFIERS
MANUFACTURERS ENGINEERS

ELECTRON TUBE PARTS

QUALITY All Types EST. 18 YEARS

Seal Finish Tungsten Welds
Tungar Welds Coil Springs
Filament Hooks Bases
Spot Welders Caps
Stem Wire Cutting & Forming Machines

"The Engineering Co." of Newark, N.J., Inc.
Daniel Kondakjian, Pres.
59 Branford Street Newark, N. J.

VACUUM TUBES AND ELECTRONIC DEVICES

Design, Development and Construction of tubes and circuits.

VACUTRON, INC.
2819 12 St. South Arlington, Va.

We manufacture a complete line of equipment

SPOT WELDERS, electric, from ¼ to 500 KVA A.C. ARC WELDERS
TRANSFORMERS, special and standard types
INCANDESCENT LAMP manufacturing equipment From 100 to 400 Amps.
RADIO TUBES, ex-ray, cathode ray, photo cells
ELECTRONIC EQUIPMENT, vacuum pumps, etc.
TUNGSTEN SLUGS, rod and wire manufacturing equipment
GENERAL GLASS working machines and burners
COLLEGE GLASS working units for students and laboratory

EISLER ENGINEERING COMPANY, CHAS. EISLER, Pres.
751 So. 13th St. (near Avon Ave.) Newark, New Jersey

MICROMETER FREQUENCY METER

for checking transmitters, from 1.5 to 56 mc., within 0.01 per cent.

LAMPKIN LABORATORIES
— Bradenton, Fla., U. S. A. —



UNIVERSAL 15MM. "Streamliner"
Highest quality sound pickup for p. a. recording and amateur. Crystal or dynamic in any impedance. Modern in design. Incl. loop, flex tube, screw plug and 25 ft. cable. In De Luxe package. At your jobber's now.

UNIVERSAL MICROPHONE CO., LTD.
424 Warren Lane Inglewood, Calif.

ACTONE CUTTING STYLI

For recording direct on all coated aluminum or paper base discs. Individually lapped for a quiet, high quality cut.

H.W. ACTON CO., Inc., 370 7th Ave., New York

FINE RIBBONS

of Tungsten, Molybdenum and Special Alloys

To your specifications

H. CROSS
15 BEEKMAN ST. NEW YORK

PILOT LIGHTS

UNDERWRITERS APPROVED MODEL 100

Write for **DIALCO** 1940 8-Page CATALOG



DIAL LIGHT CO. OF AMERICA, INC.
National Sales Agents
F. EDWIN SCHMITT SALES CO.
134 Liberty Street, New York, N. Y.

"What Can It Do For Me?"

Advertising that is read with this thought in mind, may provide the solution to a problem that has kept you awake nights for weeks. Remember, back of the signature of every Electronics advertiser is another organization, whose members have thought long and hard about your business in the course of introducing and applying their products or services to your industry. If their offerings can improve the quality of your company's product . . . or save your company's money . . . they can contribute to your company's income. We all know, "It pays to advertise." It pays just as big to investigate what is advertised! Each month, Electronics advertisers, old and new, invite you and over 13,600 other subscribers to investigate further the advantages they can provide.

Departmental Staff
ELECTRONICS

Portable Drawing Machine

THE AUTODRAFT PORTABLE drawing machine, manufactured by Eugene Dietzgen Co., Chicago, provides a drawing board, a T-square, a scale, a protractor



and paper clamps, all in one, and the size is about the same as a brief case. The entire drafting mechanism is precision engineered of non-reflecting metal. Angles from 0 to 360° are available.

Tubes

THREE NEW TUBE types introduced by Arcturus Radio Tube Co., Newark, N. J. are: Type 3A8GT diode-triode pentode detector amplifier, filament type, designed for use in receivers operating from a low voltage battery filament supply; Type 117Z6GT is a midget high vacuum full-wave rectifier, heater type, designed for operation directly across a 117 volt line; and Type 117L7GT midget rectifier-beam power amplifier designed primarily for output-half wave rectifier service in a-c d-c battery receiver combinations as a source of filament current and plate supply for lighting line operation.

Crystal Microphone

THE NEW MODEL 44X crystal microphone of the Turner Co. of Cedar Rapids, Iowa, gives selective directional pick-up of sound, and allows the operator to choose the sound he wishes to amplify. The 13-15 db differential between front and rear pick-up allows the back to be considered dead. It has a 90° tilting operation. The level is 58 db, with 25 ft. cable line. 50 ft.-lines can be used with no frequency discrimination and with minimum loss of level. Response is quite smooth from 30-10,000 cycles.

Graph Papers

A BROAD and comprehensive line of graph papers for mathematical, commercial, and industrial use has been announced by Eugene Dietzgen Co., Chicago. The line includes "same division" and "different division" sheets, with a wide range of divisions; security price sheets; logarithmic and semi-logarithmic sheets in varying divisions, sizes and weights; mathematical sheets in circular percentage, isometric, polar and triangular coordinates; time element sheets for periods from one day to 5 years.

Soldering Irons

THREE NEW types of electric soldering irons have been added to the line of Hexacon Electric Appliance Corp., 161 W. Clay Ave., Roselle Park, N. J. They are: 60, 120, and 170 watts, screw type tip with diameters of $\frac{1}{8}$, $\frac{5}{16}$, and 1 inch respectively. The irons were built for hard service and speedy production, being of the constant duty type for industrial use.

Amplifiers

ERWOOD SOUND Equipment Co., 224 W. Huron St., Chicago, announce two new products. The first is Model 3428 amplifier with a power output of 28 watts. The distortion capacity is given as less than 5%. Two frequency characteristic controls, a high and a low, are provided to adapt reproduction to the particular acoustical conditions encountered. Output impedance is variable. Provision has been made for use of a remote control unit to adjust the volume. Ample ventilation is provided



and tubes are readily accessible through a hinged door. The other item is Model 1420 combination 6 volt d.c.—115 volt a.c. PA system. The power output of 20 watts is obtained at a distortion of less than 5% total harmonic content. When used on a 115 volt line, the circuit is of conventional design. A plug arrangement permits operation on a 6 volt storage battery and a heavy duty vibrator changes the d.c. to a.c. Provision is made for either microphone or phonograph reproduction.

**OHMITE RESISTANCE UNITS
Give You The Exact Answer!**

Don't worry about resistance problems! Let the experienced Ohmite Application Engineers help you get the *exact* units you need—quickly, economically, dependably! Remember, Ohmite has the largest, most complete stock of close-control Rheostats, wire-wound Resistors, and high-current Tap Switches available anywhere. Special units will be designed promptly for your specific application.

Write Today for Ohmite Catalog 17

OHMITE MANUFACTURING COMPANY
4816 FLOURNOY STREET ★ CHICAGO, U.S.A.

Be Right with **OHMITE**
RHEOSTATS • RESISTORS • TAP SWITCHES

FOR LABORATORY • COMMERCIAL AND INDUSTRIAL TESTING

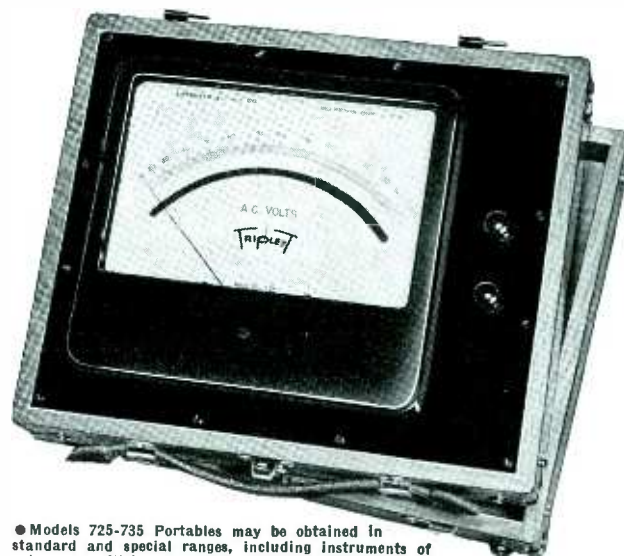

- 7-Inch Instrument with 6-Inch Scale.
- Standard and Special Ranges.
- Mirror Scale Avoids Parallax in Readings.
- Oak Carrying Case with Detachable Cover.
- Special Design to Assure Quick, Accurate Readings.

● Models 725-735 Portables may be obtained in standard and special ranges, including instruments of extreme sensitivity for laboratory use—as well as those for general commercial and industrial testing purposes. The large 7-inch instrument has a long six-inch mirror scale, maximum dial opening, and knife-edge pointer to assure quick accurate readings. Accuracy within 1% ($\frac{1}{2}$ % for many ranges). Mirror scale eliminates parallax in readings. Available in microammeters, milliammeters, ammeters, voltmeters, millivoltmeters, thermo-ammeters—multiple or single ranges. Case is quarter-sawn golden oak, 11"x9"x4", with handle and detachable cover. Black bakelite panel.

FOR MORE INFORMATION WRITE—Section 231, Harmon Drive

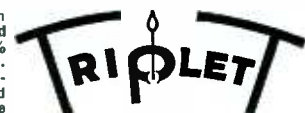

Write for details on your needs.

THE TRIPL'ETT ELECTRICAL INSTRUMENT CO., Bluffton, Ohio
NEW 7-INCH PORTABLES

Wire Stripper

A POWER-DRIVEN, brush-type wire stripper (Model 9-C) is available from Ideal Commutator Dresser Co., 1631 Park Ave., Sycamore, Ill. It cleans enamel wire rapidly. It also cleanly strips cotton and enamel, silk and enamel, string asbestos and similar types of light insulations from round wire, flat or rectangular wire, solid or stranded wire. It is also effective in cleaning "Litz" and "Formex" wires, and in removing gummy insulation imbedded in stranded wires.

Directional Television Antenna

"VERTI-FLEX" television antenna was designed by K. W. Jarvis for the Illinois Seating Co., 2138 N. Racine Ave., Chicago. It consists of crossed dipoles, with convenient switching means at the television receiver for choosing either dipole. The switching means allows alternate halves of the dipoles to be connected together so as to receive from the 45 degree directions also, thereby allowing the adjustment of the receiving direction to a maximum or minimum of 22½ degrees of the best receiving point. The antenna was designed to make television reception available at distances greater than 50 miles. The antenna comes in an assembly kit with directions on how to install it.

Attachable Actuator

MICRO SWITCH CORP., Freeport, Ill., announce a complete roller level Type J Actuator which can be sold as an attachment to be used in conjunction with Regular and Metal-Clad switches. It has two mounting holes which register with the mounting holes on the switch. The lever arm of this Actuator rides on an oilless bronze bearing,

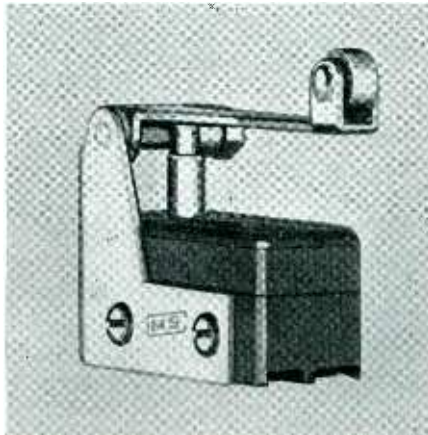

which rests on the plunger of the switch. A case hardened roller is mounted on the end of the lever arm. An 0.008 inch movement at the end of the lever arm moves the switch plunger 0.001 inch and a pressure of 2 ounces at the end of the arm will exert a pressure of 16 ounces at the actuator point. Minor adjustments can be made by slightly bending the lever arm.

Molded Socket

AMERICAN PHENOLIC Corp., 1250 W. Van Buren St., Chicago, announce a new molded socket designed to fit the new all-glass tubes announced by RCA. The socket is of molded high-dielectric black bakelite with seven contacts arranged in a ⅜ inch diameter circle. It mounts on a plain ⅝ inch diameter clearance hole, and is held in place with a spring steel retainer ring. Floating contacts can't break the seal between the glass and 0.040 inch tube prongs. Center sleeve shields contacts from each other, and has a hole in the lower end for grounding. Overall diameter of socket is no greater than that of the tube. Adapters for these tubes for use with tube testers and analyzers are also available.

Exciter Transmitter

ELECTRON-COUPLED, band-switch exciter-transmitter and voltage regulated power supply has been developed by the Browning Labs., Winchester, Mass. This apparatus is cooperatively sponsored by Amphenol, Cardwell, Cornell-Dubilier, Kenyon, Ohmite, Par-metal, and Raytheon. Careful electrical and mechanical designs have been coordinated to make the unit's stability comparable to the better grade X-cut crystals. It allows operation in any portion of any amateur band from 10 to 160 meters inclusive. The circuit is arranged so that crystals may be used if desired. A circuit diagram is available.

SEARCHLIGHT SECTION

EMPLOYMENT : BUSINESS : OPPORTUNITIES : EQUIPMENT—USED or RESALE

UNDISPLAYED RATE:

10 cents a word, minimum charge \$2.00.

Position Wanted, (full or part-time salaried employment only). ½ the above rates, payable in advance.

Proposals, 40 cents a line an insertion.

INFORMATION:

Box Numbers in care of our New York, Chicago, or San Francisco offices count 10 words additional in undisplayed ads. Replies forwarded without extra charge.

Discount of 10% if full payment is made in advance for four consecutive insertions of undisplayed ads (not including proposals).

DISPLAYED—RATE PER INCH:

The advertising rate is \$6.00 per inch for all advertising appearing on other than a contract basis. Contract rates quoted on request.

An advertising inch is measured ⅜" vertically on one column, 3 columns—30 inches—to a page.

Copy for new advertisements must be received by January 29th for the February issue

POSITION WANTED

RESEARCH ENGINEER, PhD 1936 Physics and Physical Chemistry. Fellowship original research, publications. Constantly employed since 1937 as research physicist in industrial laboratories. Experience in Applied Electronics, Spectroscopy, Radiography and Photographic Engineering. PW-225, Electronics, 330 W. 42nd St., New York, N. Y.

POSITION VACANT

YOUR ORGANIZATION is it complete? Are you expanding or making replacements? Naturally you are anxious to secure the most suitable man or men available. You can contact such men through a Position Vacant advertisement in Electronics.

WANTED

ANYTHING within reason that is wanted in the field served by Electronics can be quickly located through bringing it to the attention of thousands of men whose interest is assured because this is the business paper they read.

DEPENDABLE

Used

ELECTRONIC TUBE EQUIPMENT

A complete line of used equipment for the manufacture of Radio Tubes, Neon Tubes, Incandescent Lamps, etc.

Write for Bulletin showing savings from 25 to 75%

EISLER ELECTRIC CORP.

534 39th Street, Union City, N. J.

HIGH GRADE USED

ELECTRON TUBE MACHINERY

Huge Stock of Every Type and Variety

KAHLE ENGINEERING CORPORATION
Specialists in Equipment for the manufacture of Neon Tubes, Radio Tubes, Incandescent Lamps, Photo Cells, X-ray Tubes, etc.

900 DeMott St., North Bergen, N. J.

TO HELP YOU

SELL WHAT YOU NO LONGER NEED

"Searchlight" Advertising

YOUR ORGANIZATION

Is it complete?

Are you expanding it?

Making replacements?

Naturally, you are anxious to secure the most suitable man or men available. You want men with the special training that will make them an asset to your organization. You can contact such men through a Position Vacant advertisement in the Searchlight Section of ELECTRONICS

FERRIS



Model 22-A Signal Generator

A versatile instrument for general laboratory use

Output continuously variable to 1 volt

Individually calibrated direct reading dial

Direct reading modulation system

Write for bulletin E22
for full details

Ferris Instrument Corporation

Boonton, N. J.

PROFESSIONAL SERVICES

(Rates on Application)

ELECTRICAL TESTING LABORATORIES

Characteristics of Vacuum Tubes
Tests of photo cells, glow lamps, crater lamps.
Tests of electronic and optical devices
East End Avenue and 79th Street
New York, N. Y.
Phone: Butterfield 8-2600

INTERNATIONAL ELECTRONICS, INC.

DESIGN AND DEVELOPMENT

Radio Television
Sound Electronics
MANUFACTURING METHODS
Condensers Tubes Resistors
Vibrators Lamps Speakers
630 Fifth Avenue New York, N. Y.
Cable: Interengin, New York

HAROLD J. McCREARY

Mem. A.I.E.E. & W.S.E.

Consulting Engineer

Laboratory Facilities
Research Development Design Factory Practise Patent Studies
Electronics Television Radio Railroad Signaling T-lephony
105 W. Adams St. Phone STate 4003 Chicago, Ill.

F. H. SHEPARD, JR.

CONSULTING ENGINEER
ELECTRONIC APPLICATIONS

Specializing In:
Industrial Control Follow-Up Devices Radio and Carrier Operated Remote Control
Special Amplifier Design Photoelectric Applications
6167 Cedar Ave., Merchantville, N. J.
Telephone Merchantville 1111

Photoelectric Door Attendant

ANOTHER item has been added to the phototube line of Photobell Corp. (123 Liberty St., New York City). This is the "Sentinel" door attendant. It provides a protecting wall of light across any door, entrance, or open space and no one can enter without being announced immediately. The unit comes in an ivory case. An adjustable bracket holds it, and screws easily to any surface. It's an "all in one" unit, including the adjustable mirror. No wiring is necessary since it is simply plugged into an a-c outlet. A receptacle on the back of the Sentinel will accommodate an extra chime or buzzer away from the unit itself (about 50 to 100 ft.) which will operate together with the internal chime. A counting attachment can also be used.

Frequency Modulation Receiver

FREQUENCY MODULATION receiver with a frequency range of 40 to 44 Mc and outputs of 500 and 8 ohms is available from Radio Engineering Labs, Long Island City, N. Y. One microvolt signal will impress two volts on the limiter grid. The adjacent channel selectivity and the image ratio have been carried to the degree necessary to assure good quality frequency modulation broadcast reception. It operates on 115 volts, 60 cycles and consumes 100 watts power supply. Catalog 517 describes the receiver.

A radio telephone transmitter (250 watts) also available from REL is complete and self-contained affording instantaneous operation on any one of five pre-determined frequencies. The component parts are specially treated to resist high humidity and varying temperatures. Catalog 516-5 describes the unit in detail.

Recording Frequency Analyzer

AN INDUSTRIAL "STETHOSCOPE" for use of acoustic engineers engaged in the diagnosis and checking of running machinery has been announced by Electrical Research Products Inc., 195 Broadway, New York City. The Recording Frequency Analyzer discloses the "sound" condition of motors undergoing test, and records the results on a graph automatically.

The equipment employs frequency analysis by the sweep method, using a small drive motor to actuate the frequency dial which sweeps the whole range of frequencies from 30 to 10,000 cps. With this motor is synchronized another motor driving a band of graph paper on which a stylus traces the sound level at each frequency passed. Sharpness of frequency selection from the great variety of sound that the microphone picks up from a whirring machine is assured by available crystal filters.

A VALUABLE AID FOR YOUR LABORATORY

...and an unusual value!
RCA 5-inch Oscillograph



You'll call this RCA 5-inch oscillograph a worth-while addition to your laboratory.

It embodies all of RCA's skill and experience in oscillograph manufacture. And in addition to performing all the laboratory functions of other RCA Oscillographs, it may also be used for engine pressure measurements and similar applications.

It offers you unusually wide amplifier ranges and its 5-inch screen is easy to read. All controls are conveniently located on front panel. Compact construction assures easy portability. An unusual value at its moderate price. Stock No. 160, net price \$130.

Over 335 million RCA radio tubes have been purchased by radio users... in tubes, as in parts and test equipment, it pays to go RCA All the Way.



NOW!
A Complete Line
of
**PERMO POINT
PHONOGRAPH NEEDLES**



PERMO Recording NEEDLES



—a new stylus equalling ability of sapphire on nitrate coated blanks. Cuts clean grooves, free from surface noises. Records entire frequency range. Minimum loss of high frequencies—no "peaks". Permo Metal point gives long life. MICRO-SPECTED for uniformity, packed in special protective metal container.

Every Permo Point Needle sold subjected to rigid Permo MICRO-SPECTION process before it leaves the Permo Laboratories. This process is a positive check on the precious Permo Metal point for perfect uniformity and performance.

**Transcrip-tone
PERMO POINT NEEDLE**



—gives even response over entire audio frequency range—constant at over 10,000 cycles. Specially designed to transmit all frequencies useful in modern broadcasting and recording work. Fits standard groove. Valuable in play-back and dubbing work. Permo Metal tip gives 35-50 hours service. Won't

wear acetate, nitrate coated, commercial records—prolongs life with self-lubricating Permo Metal Point.

**Fidelitone
PERMO POINT NEEDLES**



—for home record players and changers. Keeps surface noise at minimum. Permo Metal point assures finest full range reproduction. Record wear negligible with self-lubricating action of Permo Metal. Up to 50 hours service on standard recordings. Long play for use in home, salon, sound distributing systems, schools, etc.



The above and other Permo Point Needles for professional and home use are available at all leading suppliers.

PERMO PRODUCTS CORP.

Manufacturing Metallurgists
6415 Ravenswood Ave. Chicago, Illinois
Gentlemen:

Please send me your free booklet on Needles and Records, and full information on Permo Point Needles.

Name

Address

Spray Tank

THE VORTEXEDDY spray tank designed especially for racked parts rinsing in electroplating departments has been announced by Storts Welding Co., 108 Stone St., Meriden, Conn. The rinsing operation is performed by alternate vortexes of spray streams circulating clockwise and anti-clockwise and interrupted by other straight line spray streams which produce a multiplicity of eddies moving in many directions. Provision is made for turning the work so that every portion of the surface is subjected to the impact of the high velocity atomized rinse water from numerous angles. In the operation of this new tank, water flows only while the work is in rinsing position and a spray of great fineness and density at high speed replaces the greater mass of quiet water in the conventional still rinse tank. Considerable water and time are saved in this tank.

Relays

TYPE K relays were designed to make available multiple contact assemblies operating from a single coil. Standard pile-up assemblies up to 6-p.d.t. have been designed. The springs are all tinned phosphor bronze with fine silver rivets. The bakelite insulator carrying the movement on the end of the springs is slotted so that the spring is always held positively, and so that it shields the contact points at the end of the springs. Standard contacts are rated at 1 amp at 110 volts a.c. non-inductive. Higher ratings can be had by using special springs and contacts. Coils are layer wound and impregnated and can be supplied for 6 to 125 volts ac or dc. The relay is available from Allied Control Co., Inc., 227 Fulton St., New York City.

Resistors

A NEW PRODUCT of Instrument Resistors, Inc., 375 Main St., Little Falls, N. J. is the type AL and BL inductively wound resistors of standard tolerance of 1%. The rating (4 watt) for Type AL is: maximum resistance 80,000 ohms; mounting by terminals or center hole; terminals are No. 18 tinned copper wire 1½ inches long; and the size is 7/16 inch in diameter and 1 inch long. Type BL (6 watt) characteristics are: maximum resistance 150,000 ohms; mounting is by terminals or center hole; terminals are No. 18 tinned copper wire 1½ inches long; the size is 7/16 inches in diameter and 1½ inches long.

Pilot Light Assembly

THE DIAL LIGHT Co. of America, 136 Liberty St., New York City, announces its new Series 100 pilot light assemblies which accommodate a ¼ watt neon candelabra screw base lamp or a ½ watt

New...

PRESTO TURNTABLE

*gives perfect reproduction
of all makes of
transcriptions*



Here is a turntable designed for practical operating conditions in broadcasting stations where from two to five different makes of recordings are used daily. In place of the ordinary tone controls this Presto turntable is equipped with a compensating network accurately calibrated to reproduce the full range of NBC-ORTHACOUSTIC, WORLD, A.M.P. and R.C.A. transcriptions, COLUMBIA, DECCA and R.C.A.-VICTOR phonograph records.

A definite setting of the compensator is specified to take care of the individual characteristics of each of these makes of recordings as well as PRESTO instantaneous recordings. Thus you obtain a perfect, uniform reproduction of the full range (50-9,000 cycles) of the finest lateral recordings.

In addition to this valuable feature the Presto 62-A turntable employs a radically new drive system. The turntable rim is equipped with a heavy, live-rubber tire driven by a steel pulley on the motor shaft. With this design vibration is negligible and the speed is as steady as the finest Presto recording turntables. Speed may be changed instantly from 78 to 33⅓ RPM.

The pickup is equipped with a permanent diamond stylus which may be removed if damaged by accident and replaced for a few dollars.

Attractively finished in two tones of gray and chromium, the Presto 62-A turntable will improve both the appearance and performance of your station.

Write today for descriptive folder.

PRESTO RECORDING CORPORATION

242 West 55th Street, New York, N. Y.

double contact bayonet base neon lamp. The same assembly can be furnished for 6, 12, and 110 volt double contact bayonet base lamps to be used in applications where vibration might have a tendency to loosen the lamp.

Recording Machine

UNIVERSAL MICROPHONE Co., Inglewood, Cal., is now manufacturing and distributing its Unicord recording machine in a new model with portable carrying case. The equipment is a complete professional machine in a miniature size with recording at 78 rpm which makes it possible to record a seven minute program on a 12 inch blank disc. The manufacturers claim that it reproduces piano and other difficult music with perfect fidelity. The 100% synchronous motor is a feature of the assembly. Monitoring is through the use of earphones. A new development is that the weight in the center automatically lifts the cutting head out of the acetate at the completion of the recording process. The recorder is adaptable for use in radio stations, advertising agencies, music studios, etc.

Fasteners

ELASTIC STOP NUT Corp., 1015 Newark Ave., Elizabeth, N. J. have added nine new types of nuts all of which embody the basic self-locking element, a resilient non-metallic collar which is built into the head of the nut. The collar, in resisting the entrance of the bolt or screw, forces the thread faces into a pressure-contact which is maintained after the nut is tightened. With thread play thus eliminated, the nut cannot work loose under vibration, operating stresses, or wear of surrounding parts. These fasteners are available in a variety of sizes, thread systems and materials.

SPEED CLIPS announced by the Tinnerman Speed Nut plant of Cleveland, have been developed to fasten metal parts together without the need of gaining access to the opposite side of the assembly as is required with nuts, bolts or threaded studs. It is an assembly device which first locks itself firmly in place and also firmly locks the stud of the name plate in assembled position.

Radio Telephone

MULTI-CHANNEL radio telephone for aircraft, which provides for dial-switch selection of any one of ten pre-tuned frequencies, has been announced by the Western Electric Co., 195 Broadway, New York City. The new transmitter develops more than twice the power of conventional equipment. It was designed primarily for use by airlines and private planes. Descriptive literature is available from the manufacturers.

LET US DESIGN YOUR RADIO CABINET



Our merchandising and engineering staffs will design for you, or cooperate with your engineers in developing a Plastic Molded Radio Cabinet that will have strong sales appeal and low production costs.

We have, perhaps, developed and molded more radio cabinets than any other custom molder, and this broad experience is at your service.

Write us regarding your 1940 problem, addressing Radio Design Department.

CHICAGO MOLDED PRODUCTS CORP.
1029 NORTH KOLMAR AVENUE, CHICAGO, ILLINOIS



HQ-120-X *variable* SELECTIVITY

The selectivity curves above indicate overall selectivity at six different positions of the crystal selectivity switch. This feature allows the operator to adjust selectivity to conform with various degrees of interference. Uniform output is maintained throughout the entire selectivity range. Details of circuit are contained in a 16-page booklet.

THE "HQ-120-X" was designed for operation in narrow, crowded bands where selectivity, sensitivity and noise level become extremely important. Selectivity is controlled by a variable crystal filter, an antenna compensator permits adjustment for peak sensitivity, and a noise limiter takes care of auto ignition interference and many other disturbances.

WRITE DEPT. E-1 FOR 16-PAGE "HQ-120-X" BOOKLET

HAMMARLUND MFG. CO., INC.
424-438 WEST 33rd ST., NEW YORK
CANADIAN OFFICE: 41 WEST AVE., NO., HAMILTON, ONT.

**Maybe AUDAX
was too good
but now see
what happens!**



Throughout the engineering field the superb quality of MICRODYNE is unquestioned—universally accepted as

**"The Standard by Which
Others Are Judged
and Valued"**

Here and there are those who, in the past, held that AUDAX was better than was necessary for present recordings . . . However, with the advent of the new recording technique comes the realization that MICRODYNE has really been one step ahead of the industry.

For OPTIMUM results with this new type record, the quality of the pickup is vitally important, demanding unequivocally:

- flat to 8,000*
- low needle impedance*
- absence of distortion*
- low point pressure*

Here is a virtual synopsis of the very properties which AUDAX pickups demonstrate day in and day out on the finest sound equipment in the land!

MICRODYNE—regardless of climatic conditions—delivers consistently uniform response to 8,000 cycles and beyond, with the sharp, clean-cut definition of the finest Magneto-Inductive Pickup . . . yet for all its superlative quality, COSTS NO MORE THAN THE ORDINARY PICKUP.

List prices from

\$12.50 to \$125.00

Write for Latest Literature

AUDAX COMPANY
500 Fifth Avenue New York City

"Creators of High Grade Electrical and Acoustical Apparatus Since 1915"

INDEX TO ADVERTISERS

Acheson Colloids Corp.	52
Acme Electric & Mfg. Co.	70
Aerovox Corp.	74
American Automatic Electric Sales Co.	58
American Lava Corp.	6
American Transformer Co.	50
Astatic Microphone Laboratory, Inc.	74
Audak Co.	84
Autocall Co.	60
Bakelite Corp.	Third Cover
Benwood Linze Co.	78
Biddle Co., James G.	69
Bliley Electric Co.	66
Bud Radio, Inc.	67
Callite Products Division	58
Carborundum Co., Global Div.	77
Carrier Microphone Co.	70
Centralab Div., Globe Union, Inc.	2
Chicago Molded Products Corp.	83
Cinch Manufacturing Co.	33
Cornell-Dubilier Elec. Corp.	63
Dial Light Co. of America	78
Doolittle & Falknor	54
Drake Mfg. Co.	52
Driver Co., Wilbur B.	73
Du Mont Laboratories, Inc., Allen, B.	64
Du Pont Plastics	51
Eisler Engineering Co.	78
Eitel-McCullough, Inc.	57
Engineering Co. of Newark, N. J., Inc.	78
Erie Resistor Corp.	53
Fairchild Aerial Camera Corp.	62
Farnsworth Television & Radio Corp.	59
Ferranti Electric, Inc.	40
Ferris Instrument Corp.	81
Formica Insulation Co.	49
General Electric Co.	34, 44
General Laminated Products, Inc.	44
General Radio Co.	3
Goat Radio Tube Parts, Inc.	52
Guardian Electric Mfg. Co.	71
Hammarlund Mfg. Co.	83
Heinemann Circuit Breaker Co.	54
Heintz & Kaufman, Ltd.	69
Hudson Wire Co.	71
Hunter Pressed Steel Co.	77
Indiana Steel Products Co.	72
International Nickel Co.	39
International Resistance Co.	47
Isolantite, Inc.	37
Jones, Howard B.	64
Lampkin Laboratories	78
Lapp Insulator Co.	5
Lingo & Son, Inc., John E.	73
Littelfuse, Inc.	64
Mallory & Sons, P. R.	8
McGraw-Hill Book Co.	76
Micro Switch Corp.	7
Millen Mfg. Co., Inc., James	69
National Vulcanized Fibre Co.	41
Ohmite Manufacturing Co.	79
Permo Products Corp.	82
Pioneer Gen-E-Motor Corp.	60
Presto Recording Corp.	82
Radio City Products Co.	72
Radio Wire Television Inc.	60
RCA Manufacturing Co.	81, Fourth Cover
Richardson Co.	46
Shallcross Mfg. Co.	73
Simpson Electric Co.	70
Superior Tube Co.	45
Thomas & Skinner Steel Pds. Co.	67
Triplet Electrical Instrument Co.	79
Tubular Rivet & Stud Co.	62
United Transformer Corp.	Second Cover
Universal Microphone Co.	78
Utah Radio Products Co.	4
Vacutron, Inc.	78
Ward Leonard Electric Co.	38
Webster Electric Co.	67
Western Electric Co.	61
Westinghouse Electric & Mfg. Co.	42, 43
Weston Electrical Instrument Corp.	55
White Dental Mfg. Co., S. S.	48
Wincharger Corp.	74
Professional Services	81
SEARCHLIGHT SECTION (Classified Advertising)	
EMPLOYMENT	80
EQUIPMENT FOR SALE	
Eisler Electric Corp.	80
Kahle Engineering Corp.	80

British Patents

Electron Tube Applications

Photo Tube Control. This patent relates to phototube devices for controlling feed-screws. According to the present invention, the screw controlling the phototube device is replaced by a cylinder marked with a helical line. No. 507,536. H. Lindner.

Atomic Disintegration. In a method of carrying out nuclear reactions, the energy requisite for activating the elementary particles participating is produced in a gas discharge under a mean gas concentration of more than 10^{10} molecules per cc, in which energies of 100 watt-seconds and more are dissipated during intervals of 10^6 second and less, corresponding to momentary outputs of 10^6 kilowatts and more. The concentration is preferably that corresponding to a pressure of one atmosphere at 18° C. The discharges are obtained from condensers and may be repeated at a rate of five per second. Neutrons are produced by a discharge in heavy hydrogen, alone or mixed with light hydrogen. Helium is produced by a discharge in lithium vapour mixed with light hydrogen; two isotopes are produced. Alternatively, a neutron-producing reaction may take place in a vessel lined with a boron compound, for example $B(OCH_3)_3$. No. 508,233. Degea Akt.-Ges.

Phototube Gage. Apparatus for sorting sheets by gaging their thickness in which the sheet is passed between rollers, the upper roller being pressed towards the lower by a spring and being connected to a phototube adapted to energize a relay to move a deflector determining the subsequent course of a gaged sheet. J. O. Farrer, No. 508,786.

Colorimeter. A method of determining the color of a light comprises exposing directly to the light two phototubes connected in opposition to each other with a galvanometer, inserting two differently colored filters successively in front of one of the phototubes, obtaining a balance with both filters respectively, for example by varying the total intensity of illumination of one or both tubes, and comparing the conditions of balance in the two cases. The light filters may allow the passage of two regions of the spectrum which do not or only to a small extent overlap, while preventing the passage of a third spectral region either intermediate or at the end of the spectrum. Or the light filters may pass a common spectral region and two different other regions. No. 508,802. I. G. Farbenindustrie.

Hydrogen Ion Meter. D. H. Cameron, B. D. Eisendrath Tanning Co., No. 2,181,866. (U. S. Patent.)



GIVE YOUR TABLE MODELS

Increased Consumer-Acceptance

WITH COLORFUL BAKELITE MOLDED CABINETS

IN CREATING new cabinet designs, assure enthusiastic consumer acceptance by employing versatile Bakelite Plastics. These materials are supplied in an extremely wide range of colors—colors that are integral with the material, and, therefore, will not wear off or wash off. Cabinets molded from Bakelite Plastics permanently retain their smooth, lustrous appearance. When soiled, they may be easily restored to their original brilliance by wiping with a damp cloth.

Bakelite Plastics, in addition to unlimited styling possibilities, offer practical production economies as well. They are adaptable to quantity production at low manufacturing costs, in line with current pricing trends. They are available in several types, including *thermosetting* ureas and

phenolics for compression molding, and *thermoplastic* polystyrenes, and cellulose-acetates for injection molding—in transparent, translucent and opaque effects.

For further information on the many types of Bakelite Plastics now available, write for booklet 13P, "New Paths to Profits", which describes in simple terms their distinctive properties and advantages.

BAKELITE CORPORATION, 247 PARK AVE., NEW YORK
 Chicago: 43 East Ohio Street
 BAKELITE CORPORATION OF CANADA, LTD., 163 Dufferin St., Toronto
 West Coast: Electrical Specialty Co., Inc., San Francisco, Los Angeles and Seattle

BAKELITE

The registered trade name of Bakelite Plastics, developed by Dr. Leo Baekeland, is a trademark of the Bakelite Corporation. Under the name "B" is the symbol of Bakelite Plastics.

PLASTICS HEADQUARTERS

ELECTRONICS — January 1940



PREFERRED TYPES of RADIO TUBES

...a Suggestion to Simplify the Tube Picture for
Manufacturers of Radio Sets and Electronic Devices

You may need only one type in ten!



As you know there are 453 types of tubes for radio receivers and electronic devices on the market. A careful study by RCA over a period of months has revealed that 36 preferred types can

meet the requirements of virtually every kind of radio receiver and electronic device being manufactured today. This is less than one-tenth the number of tube types now being used.



Your company and ours face a situation in regard to radio tubes that parallels an interesting episode which occurred in the French Army back in 1870. A Colonel, with a taste for efficiency, discovered to his utter amazement that somehow the army had amassed a total of 425 different types of cables for the simple purpose of mooring captive balloons. Analysis showed that the job could be done with just 17 preferred types!

If you think the French Army was up in the air in this situation... just consider the facts about radio tubes. Four hundred and fifty-three types of tubes for radio receivers clutter the industry's warehouses. Four hundred and fifty-three types... and just 36 preferred types are necessary to meet all the

requirements of practically all radio receivers and electronic devices.

We believe that the RCA "Preferred Types" concentration program will act as a stabilizing influence on the industry and will be helpful to all manufacturers. In spite of the fact that we suggest discarding 9 out of 10 tube types, your engineers are in no way hampered in designing the best radio receivers their ingenuity can contrive—at competitive costs.

This program permits RCA to do more manufacturing for stock with obvious benefits to you. Your inventory of tubes and component parts will be simplified. Deliveries will be speeded up. The whole industry will be benefited. We shall be glad to discuss complete details and point out the specific advantages of the "Preferred Types" plan to you.

MANAGER, RADIO TUBE DIVISION, RCA MANUFACTURING COMPANY, INC.