

electronics

radio, communication, industrial applications of electron tubes... engineering and manufacture

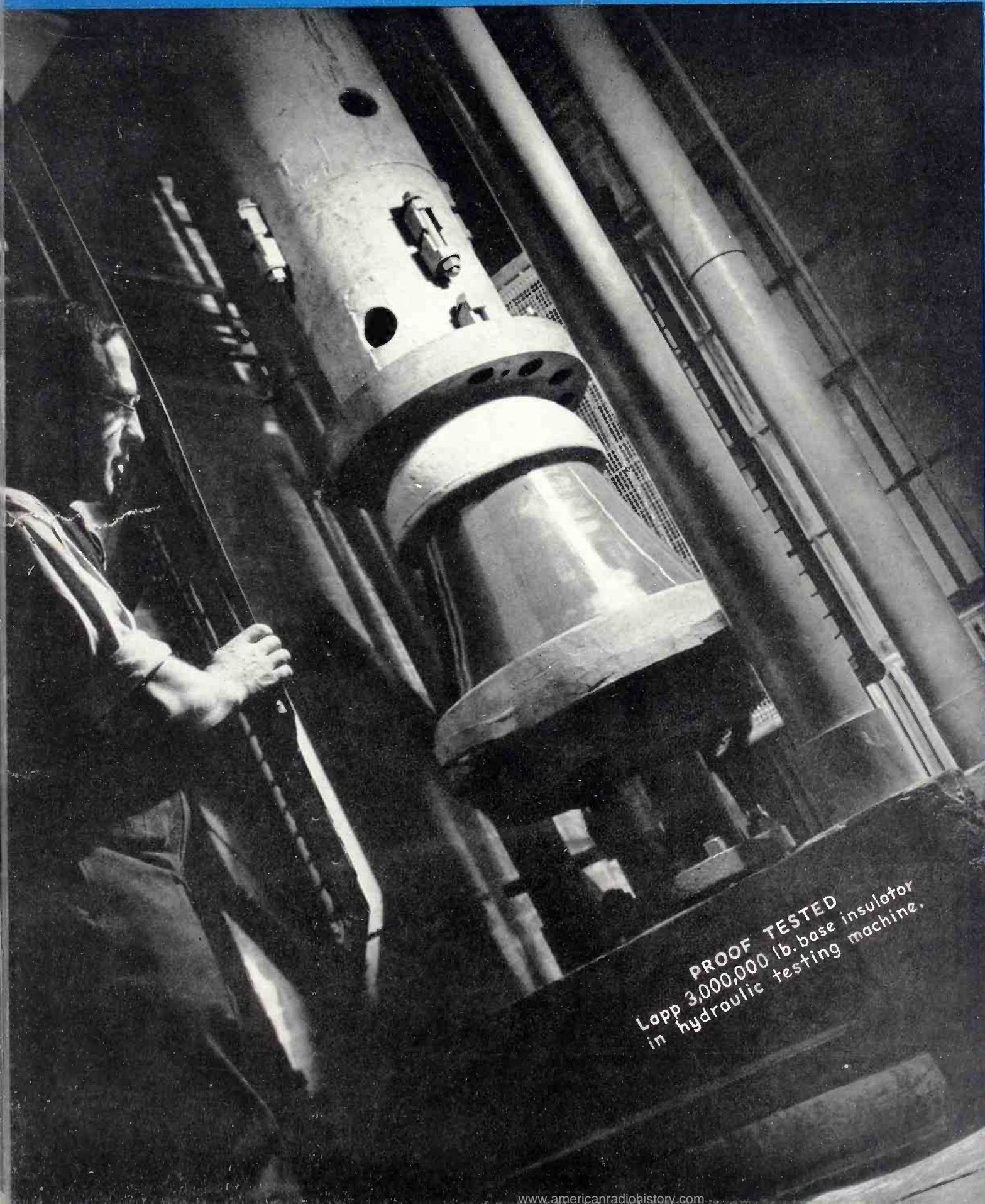

PROOF TESTED
Lapp 3,000,000 lb. base insulator
in hydraulic testing machine.

**AUGUST
1938**

**Price
50 Cents**

**McGRAW-HILL
PUBLISHING
COMPANY, INC.**

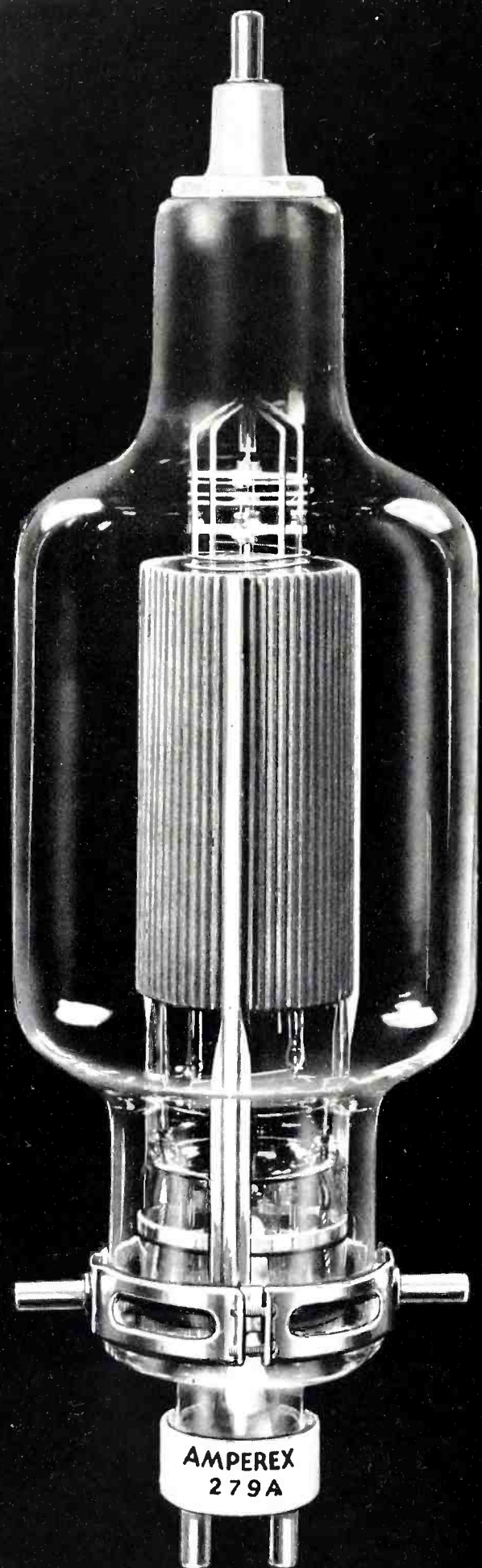

AMPEREX GRAPHITE ANODE 279-A and 251-A

Amperex has redesigned the 279-A and 251-A. Their structures have been simplified and their element anchored with greater rigidity.

The merit of these two excellent tubes is further enhanced by the incorporation in their design of graphite anodes:

*LONGER LIFE
COOLER OPERATION
GREATER EFFICIENCY
NO CHANGE OF INTERELEMENT
SPACING DURING LIFE*

279-A...\$350 251-A...\$300

OUTSTANDING FEATURES of all AMPEREX GRAPHITE ANODE TUBES are NOW PROPERTIES of the REDESIGNED AMPEREX 279-A and 251-A.

AMPEREX ELECTRONIC PRODUCTS, Inc.
79 WASHINGTON STREET
BROOKLYN, NEW YORK

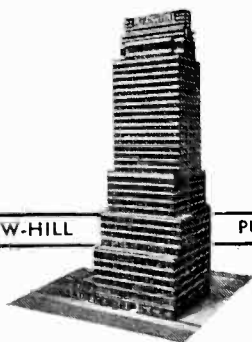

A McGRAW-HILL

PUBLICATION

electronics

RADIO . . . COMMUNICATION AND
INDUSTRIAL APPLICATIONS OF
ELECTRON TUBES . . . DESIGN . . .
ENGINEERING . . . MANUFACTURE

KEITH HENNEY
Editor

DONALD G. FINK
Managing Editor

BEVERLY DUDLEY
Associate Editor

HARRY PHILLIPS
Art Director

H. W. MATEER
Manager

ELECTRONICS, August, 1938, Vol. 11, No. 8.
Published monthly, price 50c a copy. Subscription
rates—United States and possessions, Canada,
Mexico and Central American countries, \$5.00 a
year. All other countries, \$6.00 a year or 24
shillings. Entered as Second Class matter, August
29, 1936, at Post Office, Albany, N. Y., under
the Act of March 3, 1879.

Branch Offices: 520 North Michigan Ave., Chicago;
883 Mission St., San Francisco; Aldwych House,
Aldwych, London, W. C. 2; Washington; Phila-
delphia; Cleveland; Detroit; St. Louis; Boston;
Atlanta, Ga.

Contents Copyright, 1938, by
McGraw-Hill Publishing Company, Inc.

McGRAW-HILL
PUBLISHING COMPANY, INC.

JAMES H. MCGRAW
Founder and Honorary Chairman

Publication Office
99-129 North Broadway, Albany, N. Y.
Editorial and Executive Offices
330 West 42nd Street, New York, N. Y.

James H. McGraw, Jr., President
Howard Ehrlich, Executive Vice President
Mason Britton, Vice Chairman
B. R. Putnam, Treasurer
D. C. McGraw, Secretary
A. W. Morrison, Circulation Manager

Cable Address:
MCGRAWHILL, New York
Member A.B.P. Member A.B.C.

CONTENTS—AUGUST, 1938

PROOF TESTED.....Cover

A Lapp antenna base insulator being tested in the Lapp laboratory on hydraulic testing equipment

1939 RADIO RECEIVERS..... 8

Technical details of certain of the models now being introduced to the trade for sale this Fall. Higher fidelity, program presetting system, triple cone speakers, push-button tuning are features

AN ELECTRONIC CARDIOTACHOMETER, by J. W. Horton..... 14

Low frequency amplifier and counter indicator for observing heart beats

TELEVISION VIDEO AMPLIFIERS, by E. W. Engstrom and R. S. Holmes..... 18

Third of a series of articles on aspects of television receivers, this portion dealing with the video if amplifiers, detector and automatic volume control problems

FREQUENCY CHARACTERISTICS OF QUARTZ OSCILLATORS, by J. E. Anderson..... 22

Equivalent circuits of Pierce and Miller piezo oscillators and a discussion of the factors affecting their frequency stability

PRACTICAL REMOTE AMPLIFIERS, by Robert W. Carlson..... 25

Description of remote pick-up amplifiers designed and built at WBNY

A LABORATORY TELEVISION RECEIVER, PART II, by Donald G. Fink..... 26

The second article on *Electronics'* television receiver describes construction of kinescope mounting, bleeder circuits, and horizontal deflection circuits

EQUIVALENT RESISTANCE CHART, by Alfred E. Teachman.... 31

Alignment chart for determining equivalent parallel resistance of circuits containing reactance and series resistance

DEPARTMENTS

CROSSTALK.....	7
NEW BOOKS.....	30
REFERENCE SHEET.....	31
TUBES AT WORK.....	33
ELECTRON ART.....	44
THE INDUSTRY IN REVIEW.....	56
INDEX TO ADVERTISERS.....	64

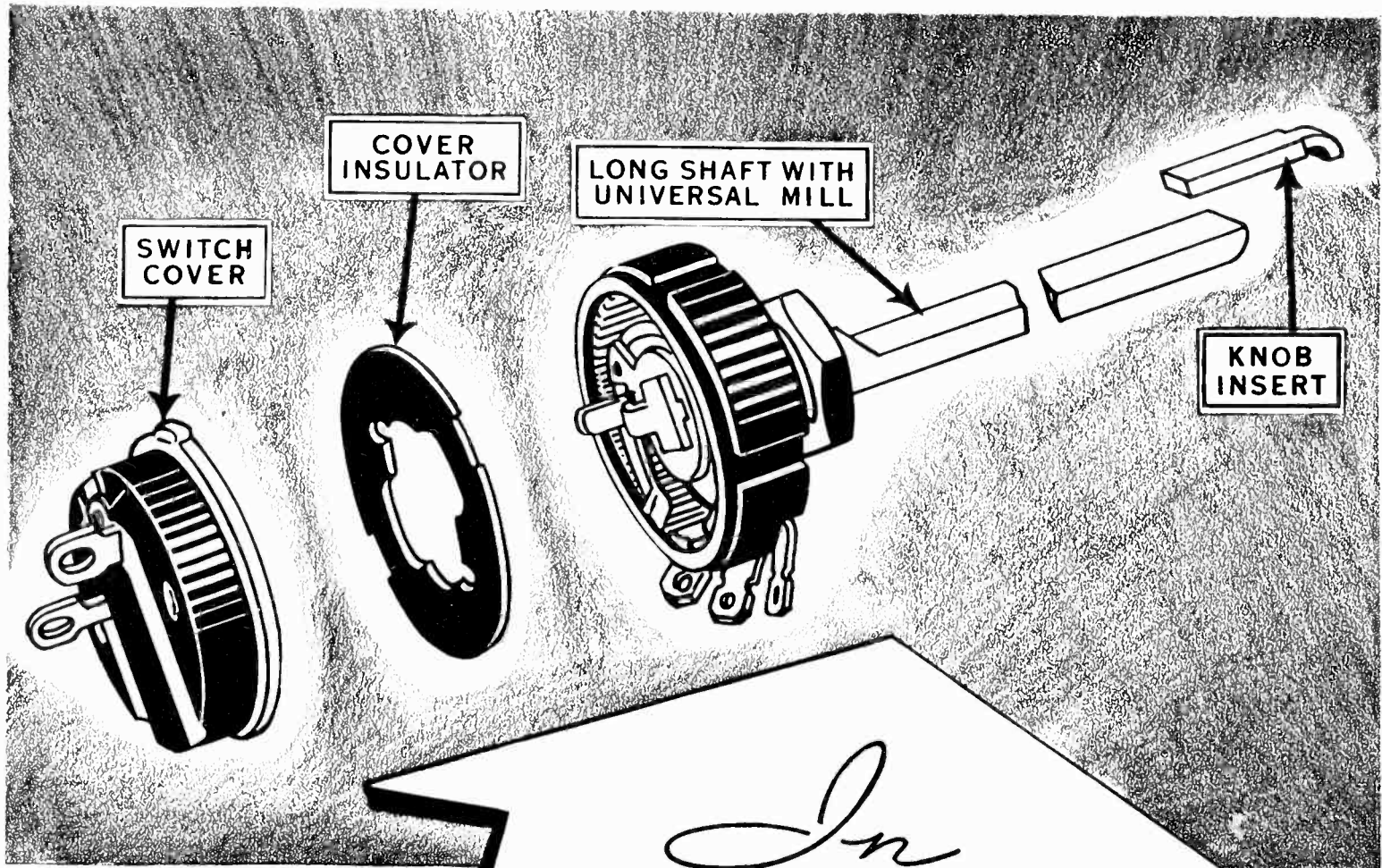

In
ANSWER
to a
DEFINITE DEMAND

"Build us a wire wound resistor that's as good as your other products" . . . they asked us time and again. And so we "gave in", with the result that where circuit requirements call for "wire wound", service men have been using the new Centralab Wire Wound Radiohm with remarkable success.

Available at your jobber . . . in dimensions identical with the Standard Radiohm. Be sure to specify Centralab.

Features:

Small size. Bakelite case is $1\frac{3}{8}$ " in. diameter x $\frac{9}{16}$ " deep. Available in values from 2 to 10,000 ohms.

Insulated construction—no washers required in mounting. Regular Radiohm switch covers can be attached.

Dissipates up to 4 watts without damage or change.

Universal shaft for all replacement work.

Close tolerance — $\pm 5\%$.

CHIEF APPLICATIONS:

1. Instruments
2. In radio receivers where very heavy bleeder current passes through unit in cathode and screen circuits.
3. Filament control.
4. Hum control.

In linear curve only

CENTRALAB
Wire Wound
RADIOHM

CENTRALAB: Div. of Globe Union Inc., Milwaukee

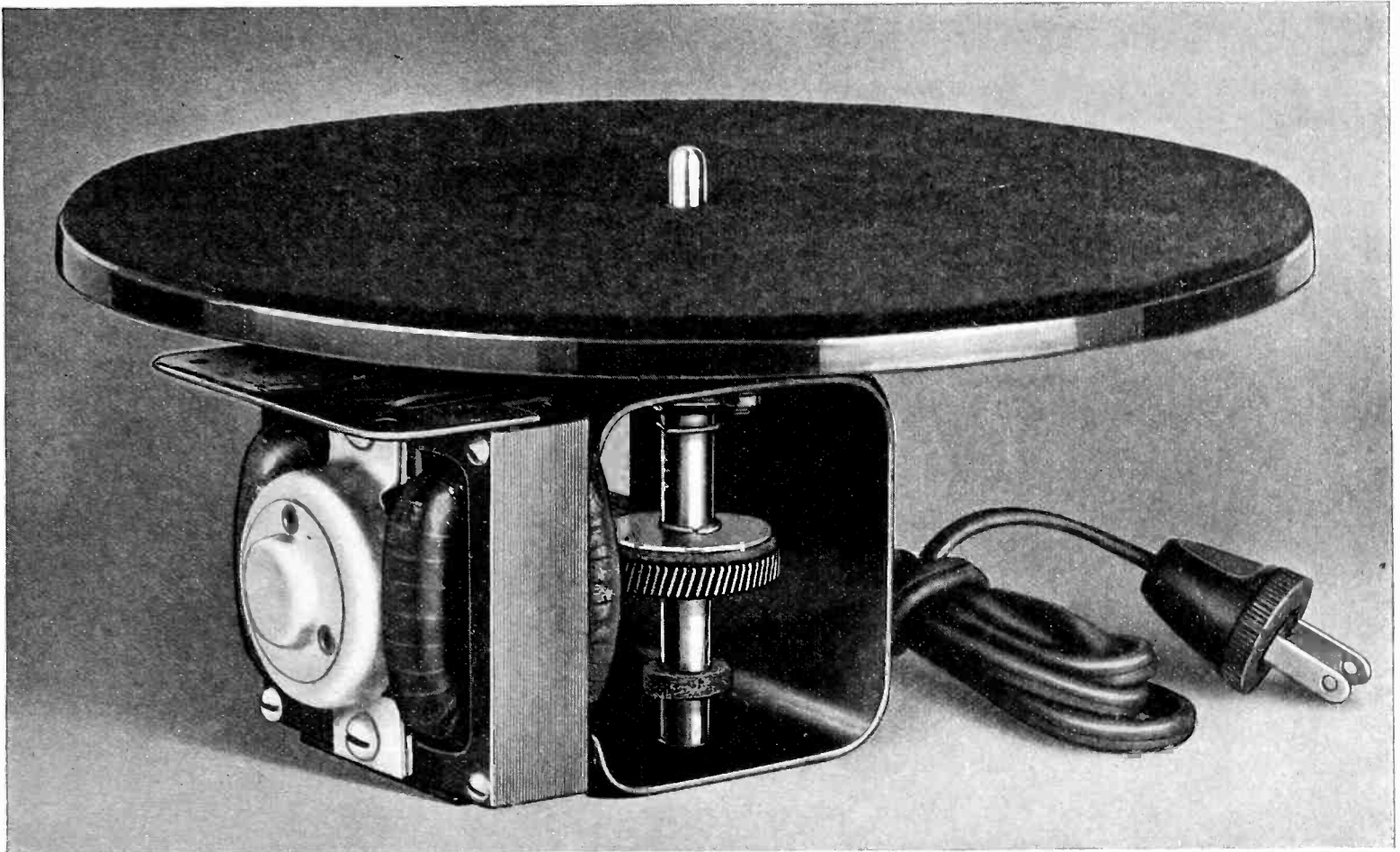

Introducing THE NEW "EVEN SPEED" SELF-STARTING PHONOGRAPH MOTOR . . .

• The turn-table shown above is driven by the new Alliance "Even Speed" motor. This new Alliance engineering achievement eliminates the need of a governor, yet maintains uniform speed through all variations of record drag. The "Even Speed" Self-Starting motor maintains proper record speed regardless of variations in line voltage or operating temperature and it's built to last for years.

Large bearings with ample oil reserves and laminated bakelite helical cut gears assure smooth, silent operation and long life. Motor design allows free ventilation and cooler operation. Motor dimensions are: Length 4-7/16"; Width 3 1/4"; Depth to bottom of motor board—2-13/16"; bottom of motor to top of spindle 4-11/32". Turn-table and motor (110 volt—60 cycle) furnished complete with 5' cord and rubber spools for mounting. Available with 9"—10" or 12" turn-tables.

For full information and prices write

Alliance

MINIATURE MOTORS

The Alliance "Even Speed" motor that drives the turn-table illustrated above is just one of the many engineering achievements by Alliance in the field of fractional horse power motors.

Today, in thousands of homes, Alliance Miniature motors are tuning radios, driving fans, movie projectors, food mixers and many other products. In industry, too, Alliance motors have earned a permanent place for their lasting dependability.

Alliance miniature motors can be furnished with or without gear reduction assemblies, and the Alliance Engineering Department is always ready to help you work out difficult drive problems.

ALLIANCE MANUFACTURING CO., ALLIANCE, O.

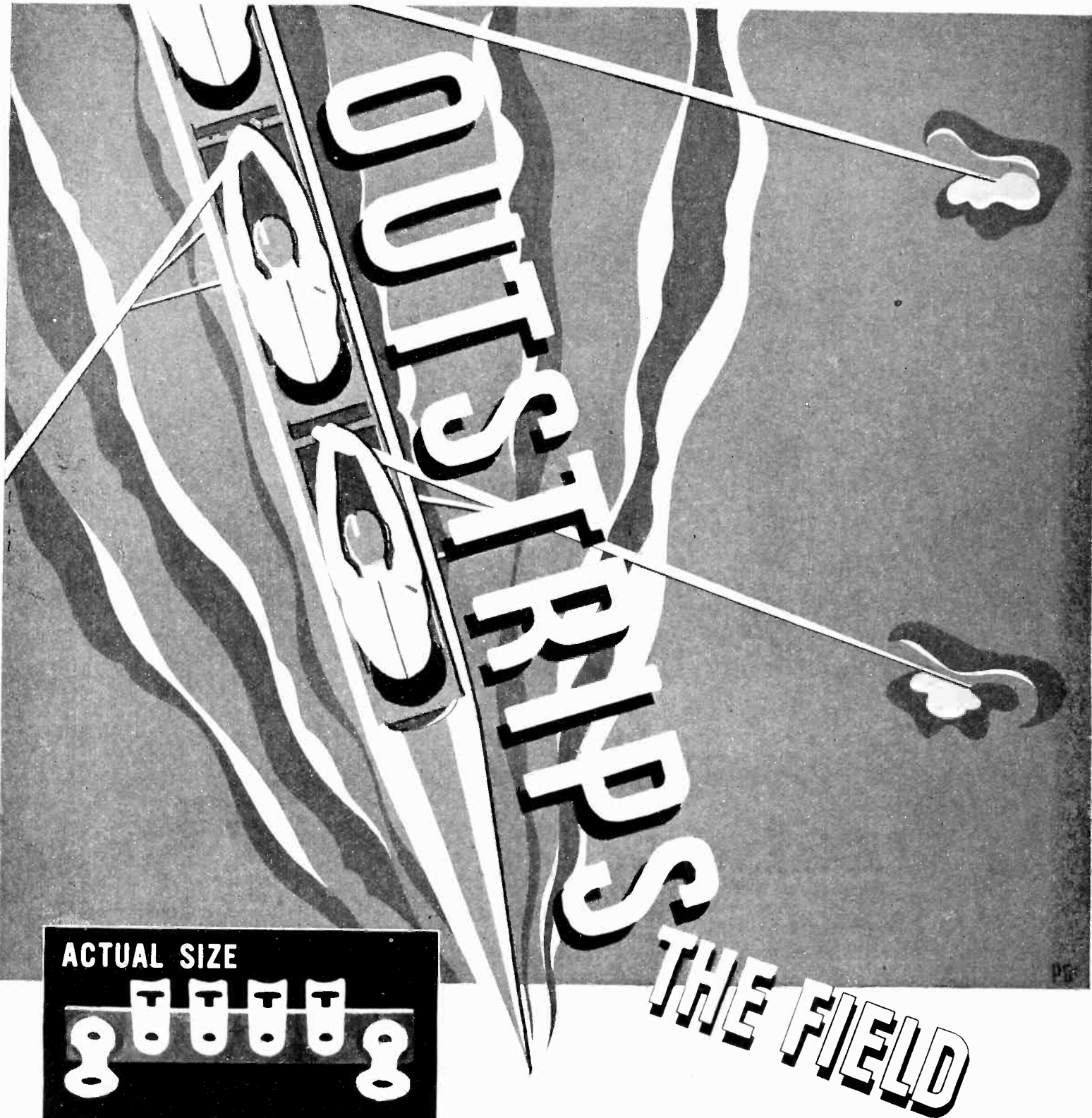

ACTUAL SIZE

TAKES LESS SPACE IN THE SET—GIVES MORE SPACE FOR WIRES

AS MANY AS SIX WIRES AT ONE "SPOT"

TWICE ACTUAL SIZE

THESE POPULAR CINCH TERMINAL STRIPS

Originated and designed by "CINCH" for maximum efficiency—rigid assembly—these mounting strips actually *save time and labor costs*. Each component part is fabricated and each strip is assembled entirely by "CINCH" under the most careful supervision. Ease of soldering. Satisfactory performance. May be had with one to 14 lugs, $\frac{3}{8}$ " or $\frac{1}{2}$ " centers. Note particularly T slotted concave top lug providing space for maximum number of wires. Hundreds of variations, all styles *in stock* give you prompt action on your needs. Prompt delivery, quality parts and expert workmanship have made these terminal strips the choice of set manufacturers.

Cinch and Oak Radio Sockets are licensed under H. H. Eby socket patents

CINCH MANUFACTURING CORPORATION
 2335 West Van Buren Street, Chicago, Ill.
 Subsidiary: United-Carr Fastener Corporation, Cambridge, Mass.

THIS IS HEADLINE NEWS FOR RECORDING ENGINEERS

PRESTO

HAS DEVELOPED A
COMPLETELY NEW DISC

FOR
*Instantaneous
Recording*

FOR years we have been looking for the formula that would produce the perfect disc for instantaneous recording. Six months ago we discovered a new manufacturing process. We made over 1,000 experimental discs by this process, each slightly different.

Some were too soft. They cut quietly but they wouldn't reproduce the higher frequencies. Their playing life was limited. The thread would not clear the cutting needle. It stuck in the groove. Some were too hard. They required a ticklish needle adjustment to cut properly.

Some of the experimental discs changed their characteristics after a few months exposure*to open air making them unsuitable for many important uses.

One day we found the answer to our problem. We discovered a composition in which we could cut a smooth shiny groove without critical needle adjustments. The surface noise was unbelievably low, at least 15 db less than any disc we had produced in the past.

Yet the new material was amazingly durable. We tested the playing life by recording a 1,000 cycle tone in a single circular groove. After 500 consecutive playings the signal level had decreased only 2 db. The noise level had increased only 5 db.

Baking the new disc at 150° F. . . . exposure to direct sunlight for several weeks had no perceptible effect on its quality. The new discs reach their maximum hardness during the manufacturing process.

**AT LAST WE HAVE A DISC THAT
SATISFIES US IN EVERY RESPECT**

PRESTO RECORDING CORPORATION
143 W. 19th ST.



Look for the "Q" at the center of the seal. This identifies the New Presto Green Seal Disc.

**NOW WE WANT YOUR OPINION.
WE ASK THAT YOU TRY ONE OF THESE
NEW DISCS AT OUR EXPENSE.**

At the request of any radio station, advertising agency or other commercial user of instantaneous recording equipment, we will send, free of charge, a sample 12" Presto Green Seal disc made by our new process. Test it thoroughly, then let us know how you like it. We think you'll agree with the engineers who tried the first samples.

• • • *We've really got something!*

New Process Presto Discs are now available only in 12", 16" and oversized masters. Other sizes will be available shortly.

**THE PRICES ARE THE SAME AS YOU
NOW PAY FOR GREEN SEAL DISCS**

FEATURES OF THE NEW "Q" DISC.

1. Surface noise 15 db lower than any previous Presto disc. No hiss, no crackles, no ticks, no surface irregularities.
2. Clean, crisp, high frequency response.
3. Thread clears the needle $\frac{1}{2}$ to 1 inch, reducing danger of tangling, simplifying outside-in cutting.
4. Thread is slow burning. Only an open flame will ignite it.
5. Long playing life, the toughest disc we've ever produced.
6. Long shelf life. All volatile substances are driven out in the final stages of manufacture.
7. Quick delivery by air express anywhere in the U. S. within 24 hours.

The Most Flexible Multiple Circuit Push Button Switch Ever Offered

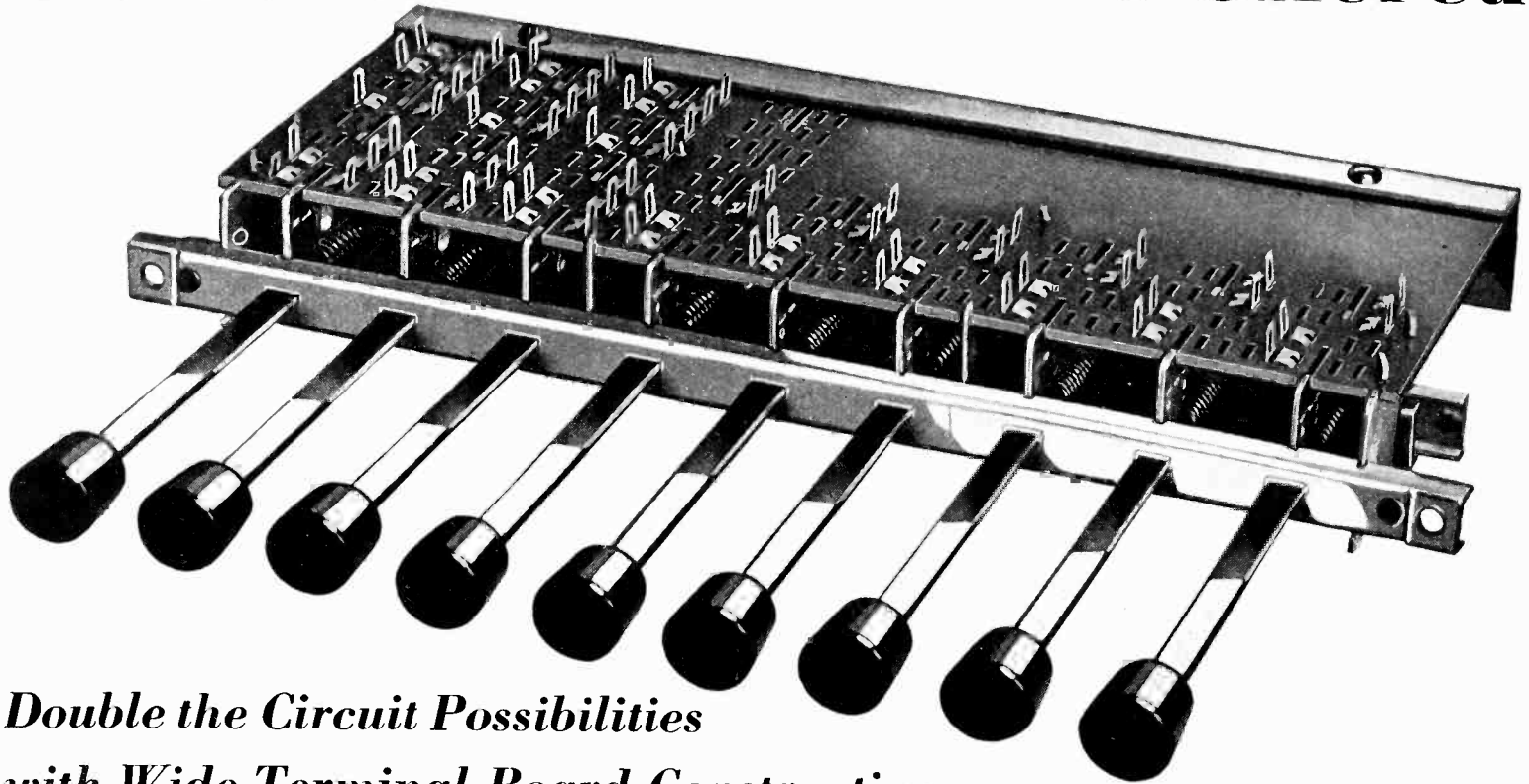

Double the Circuit Possibilities with Wide Terminal Board Construction

Mallory-Yaxley Type MC Push Button Switches —now offer circuit combinations not previously available in a latching push button switch. Terminal boards accommodating 4, 5, 6 or 8 rows of terminals may be specified. The maximum of 32 terminals per plunger provides an endless combination of switching combinations by suitable arrangement of sliding contact shoes.

Double board construction permits 3-band, 3-gang switching, the flat plunger and spring providing shielding directly between terminals on opposite sides of the board. Top and bottom boards may be specified with different construction such as 8-terminal board on top and 4-terminal board on bottom. Either top or bottom board may be omitted.

The new construction makes possible the switching of many circuits with only one terminal board. It permits narrower construction with more circuits and more accessible wiring.

Provision may be made to actuate an AC line switch on both end plungers. It may be either "off" or "on" when depressed, as desired. When AC line switch is used, 4 rows of terminals may be specified on the plunger actuating the AC switch.

You may use as many as 13 buttons on Type MC Switches. Two plunger center spacings are available— $\frac{3}{4}$ inch and $\frac{5}{8}$ inch.

A side action latch bar allows mechanical inter-connection of two switches.

Sliding contact shoes may be specified to accomplish either shorting or non-shorting sequence.

All strain of mechanism when mounted is relieved by embossed mounting pads. Mounting holes are in line with plungers. Front mounting plate is available for iron core tuning units.

Write for specification sheet (shown below) and additional information.

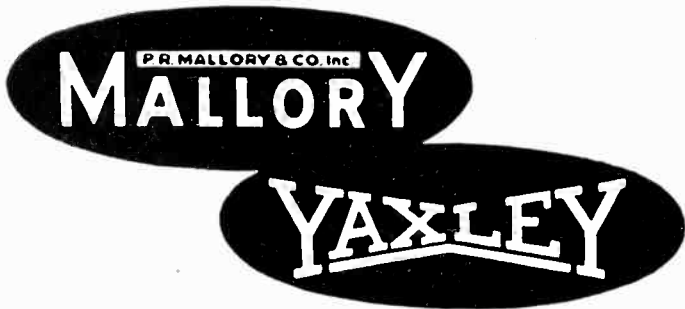

YAXLEY MANUFACTURING DIVISION
of **P. R. MALLORY & CO., Inc.**
INDIANAPOLIS INDIANA
Cable Address—PELMALLO

YAXLEY TYPE MC MULTIPLE CIRCUIT PUSH BUTTON SWITCH—SPECIFICATION

TOP VIEW

BOTTOM VIEW

NOTES: The type MC switch is available with standard banks accommodating 4, 5, 6 or 8 rows of terminals. Top and bottom boards may be specified with different construction such as 8-terminal board on top and 4-terminal board on bottom. Either top or bottom board may be omitted. Indicator is on hand of 4" four pronged plungers by some types of plunger construction.

No. of Buttons: _____ Code No. _____
Species of Buttons ("A") _____ "B" _____
Check Spacing Desired

AC Line Switch Indicator Plunger No. _____
AC Line Switch is Available Actuated by Other End Plunger and is "OFF" When Plunger is Actuated

EXAMPLE OF LAYOUT: This is based on the above and assumes a 4" spacing. Also it is not a standard model. Layout should be based on the type of switch to be used. It is not intended to specify a standard layout. The number of rows and columns is limited by the type of switch used.

For other quantities of this type switch contact your nearest Yaxley office or write to Yaxley Manufacturing Division, P. R. Mallory & Co., Inc., Indianapolis, Indiana.

PLEASE DISREGARD—FOR FACTORY LAYOUT ONLY

Customer _____
Customer's Part No. _____
Yaxley IPO No. _____
Date _____

ELECTRONICS

AUGUST
1938

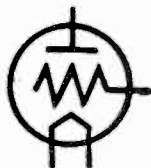

KEITH HENNEY
Editor

Crosstalk

► **J. C. . . .** On the morning of July 21, J. C. Warner, vice-president of RCA Manufacturing Co., in charge of the Harrison, N. J. Radiotron plant, died on his way to work. At the moment of writing this note, it is uncertain whether Mr. Warner suffered a heart attack, or was forced off the road in his automobile. Known to many as "J. C." and to many as "Jack", Mr. Warner was one of the radio industry's best and most favorably known young men. Coming to Radiotron from W. C. White's group at Schenectady he brought to his executive position a vitality that was youthful and vigorous, an experience in engineering and manufacturing that was mature and solid, and above all, a friendly spirit that makes his loss great, not only to his associates at Harrison but to those of us on the outside who liked him so much.

► **OLD STUFF . . .** Philco has conducted a nation-wide survey of electrified farms to determine the farm market for radio sets. 200,000 farms were surveyed, to discover that 93.7 percent of such farms had one or more radio receivers. But of these, almost one third were over six years old. More than half were over 3 years old.

► **HALLUCINATIONS . . .** We are sorry to say that if we are to believe at least one reader of *Electronics* Einstein is not only "suffering from hallucinations but is crazy on mathematics." Furthermore, Dr. W. B. Cartmel of the University of Montreal, according to the newspapers, has not fallen for the Einstein-Ives business (see *Electronics* June). Dr. Cartmel and Dr. Einstein use non-Euclidian mathematics but one believes that space at infinity becomes Euclidian and the other thinks space

at infinity becomes non-Euclidian. Our reader feels that the editors should be more careful in making statements of the character of the Ives material published in June because we are dealing "with a very confused subject." This reader sends us many pages of refutation of the Einstein relativity, the Lorentz contraction theory etc., which we have not read. One of the stock arguments of relativity is that a clock on a fast train, for example, runs slow and therefore that the train would go farther in unit time. But, this reader states, this is the bunk because the train will go a long mile in an equally

long second and therefore the velocity is the same.

It is a confusing subject and some day we are going to try to read both Einstein and this critic of *Electronics* who thinks there is a lot of bum reasoning on the part of mathematicians and physicists.

► **KUNZ . . .** Professor Jakob Kunz of the University of Illinois died on July 18. Known as the "father of the electric eye" he was, for many years, almost the only producer of photoelectric cells. The literature is replete with references to his work which began at an early date and which continued to his death. The patent (U. S. No. 1,381,474) which described methods of degassing elements and glass walls of tubes by means of eddy currents and which also described the methods of distilling alkali metals onto the inner surface of the tube was sold by him to the General Electric company.

► **HELP WANTED . . .** Educational Broadcasting, Lakewood, Ohio, has been sending us postcards with questions on them. For example on June 20 came a card with this question, to which the answer is "no". "Do you supply white robes of purity for radio artists and announcers to wear while broadcasting purse cathartics for tricky advertisers?" Some of the questions asked by this group, however, have not been answered by us, and that is not good service.

Another reader thanks us for defining "perveance" (page 60, June,) and asks us to continue the good work by defining the crime of "contumacy" of which Dr. Arthur Morgan was accused. We don't go in for these non-technical problems much, but if anyone has a good definition, we shall pass it along.

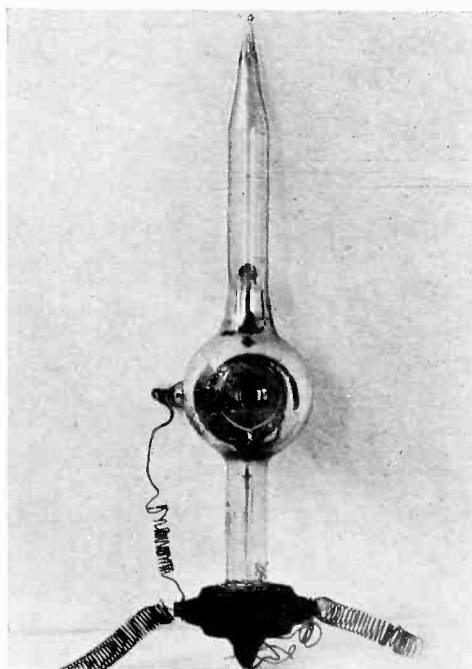

An early neon-filled, potassium hydride Kunz cell (photograph from Samuel Wein). Construction prevented current leakage across the glass seal

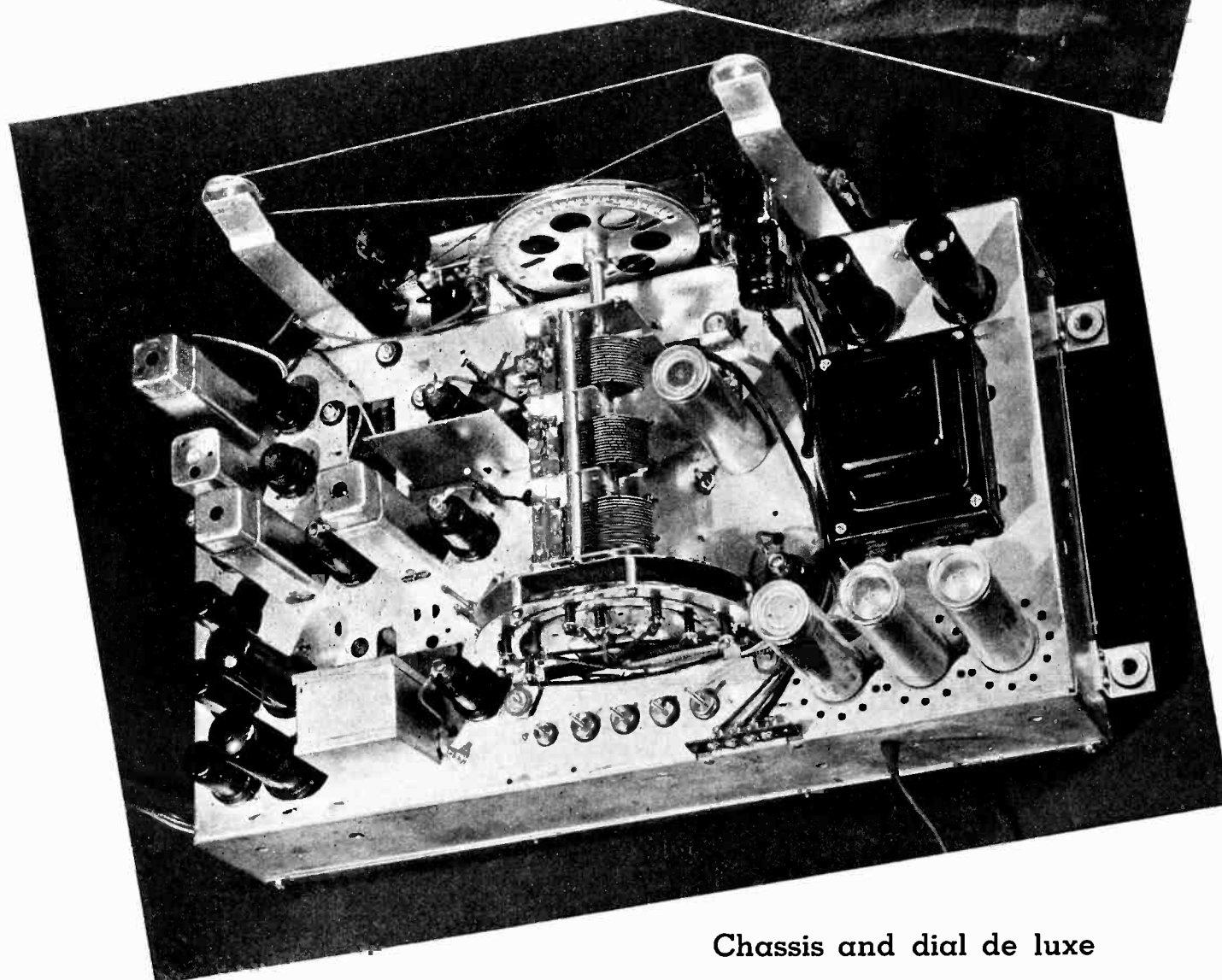
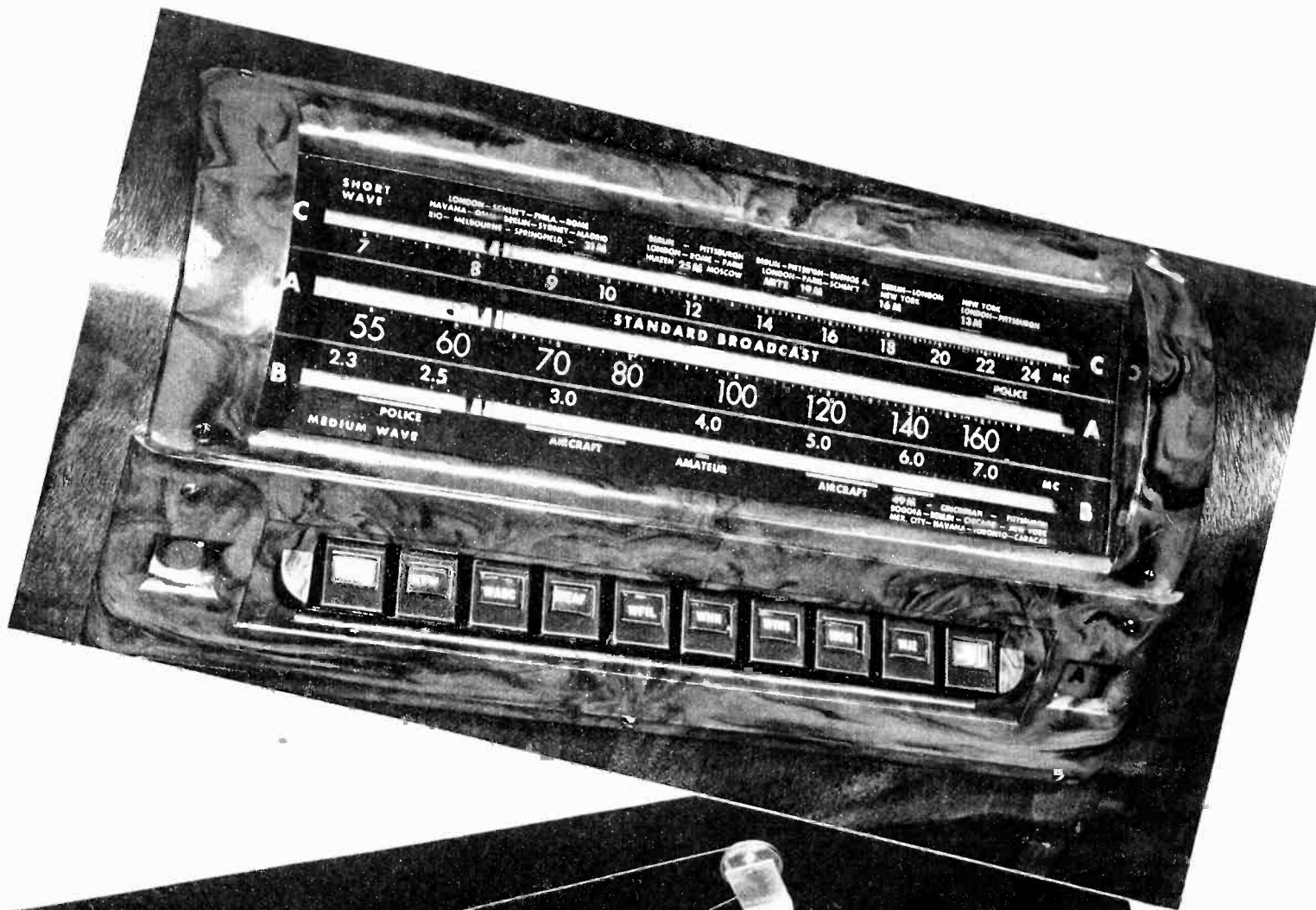

Chassis and dial de luxe

Slowly, radio receivers become musical instruments. Ease of tuning is one more step toward this goal. Dial and chassis are representative of 1939 RCA Victor line

What's New in Radio Sets

Circuit and mechanical features of receivers now being shown to the trade for sale this fall and during 1939. Even low-priced sets have phonographs and push button tuning; new stabilized components make AFC less necessary

ANNUALLY the radio set manufacturers display to distributors during the summer their new wares; annually these sets get to the dealers' floors and, during the following season, several millions of them are moved into the homes of listeners. Annually, too, the editors of *Electronics* approach these set manufacturers for details of the new technical and mechanical features; and, as usual, very few of the set manufacturers bother to deliver many of these details. The following story, therefore, is made of what information the few manufacturers have revealed plus what data can be picked up here and there from unofficial sources of information.

Even a casual perusal of the dealer helps and other general information supplied by the manufacturers discloses a remarkable swing toward push button receivers. "Lazy" tuning now finds its way into the simplest and least expensive of the new receivers. Recent development of a new line of tubes operating on 1.4 volts has enlivened the battery set business. These tubes, operating from the 1.5 volt dry cell will probably attract considerable attention on the rural and portable radio markets. The increase in combination radio and phonograph models is striking and encouraging.

In the following description of certain of the new lines, no attention should be paid to the order of appearance as it does not imply that the first mentioned products are more meritorious or interesting than those discussed later, but only that this happens to be the order in which the material was received.

Offerings by General Electric

Engineering developments designed to remove both human and

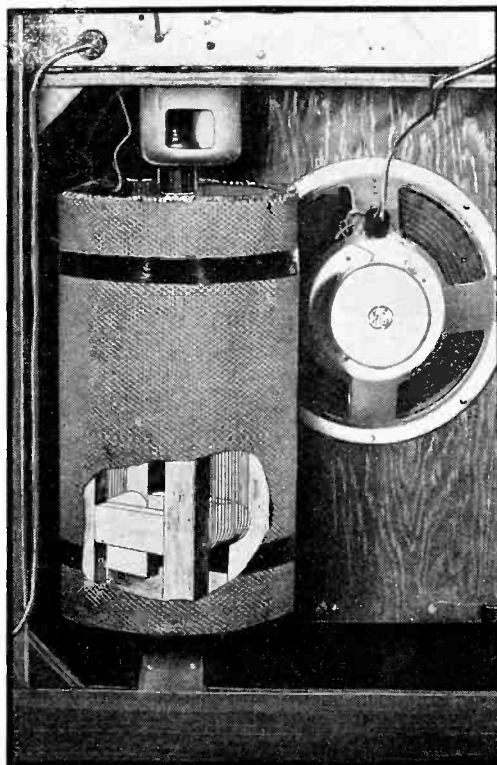

Beamscope of G.E. with cut-away portion showing location in cabinet

mechanical obstacles to better reception of broadcast programs, are the distinguishing mark of the G.E. line of radio receivers for 1939.

On the human side, a development characterized as "time-tuning," making it possible to preselect any one of five stations for any 15-minute period over a full 24-hour span, tends to make ability to read newspaper program schedules the sole qualification for any one who wants perfectly tuned broadcast reception. Once the day's and night's programs have been chosen and set up in advance, it is not necessary to go near the receiver. It will turn on and off, change stations, and perform manual functions, automatically.

The preselector used in a few of the new G.E. models was worked out cooperatively by the radio engineers at G.E. and the engineering department of the Warren Telechron Company. While a full description of this interesting device will be found in a later issue of *Electronics*, the

following data will suffice to describe it now. There are 96 sliders arranged for each 15 minute period of a 24-hour day. They are in two horizontal rows corresponding to AM and PM. Each slider may be set to one of 7 positions, corresponding to 5 different stations, "OFF" and "NEUTRAL." Inactive sliders are in the "neutral" position.

The clock contacts are plugged into the station key assembly and, therefore, the pre-timer clock simply amounts to another push button assembly in parallel to station keys. The pre-timer clock has a disabling switch which prevents the clock from operating the tuning motor. This switch is used whenever clock operation is not desired. The pre-timer clock is arranged so that contacts are closed for only 7 seconds. This means that motor must complete tuning operation in less than 7 seconds. The normal time required for pointer to travel full length of dial scale is $3\frac{1}{2}$ seconds.

Since the clock contacts are in parallel to push button key assembly, the clock will always take over the operation of the receiver unless disabling switch is operated. Should a station key be depressed while clock is tuning the motor, nothing serious will happen. The contact that is depressed the longest will actually tune in the station. If the two contacts which are depressed fall on opposite sides of the commutator, then the motor will stall until one or the other contacts are released. If both contacts are effective for five minutes, the motor will overheat. This is one reason why clock contact is not effective for a period longer than seven seconds.

Of greater interest to radio engineers, however, is the "beamscope," a built-in shielded loop antenna that

eliminates the nuisance of outside antenna and ground connections. Models equipped with the beamscope may be moved about a room or home at will and plugged into a socket in the same manner as a floor lamp. The loop reduces local noise interference. The electrostatic shield used consists of a weave of wires and fabric. The wires running up and down are insulated from each other by the fabric weave except at the top end where all the wires are soldered to the top plate. The bottom contains a shield plate exactly like that used at the top except that only one wire connects to the bottom shield. A high-Q coil is mounted within the electrostatic screen and the connections for this coil are brought out through the top with the high potential connection at the center so as to reduce the capacity effects of shield to coil to a minimum.

Where local interference noise is encountered, the beamscope is able to improve the reception obtained. This is accomplished by rotating the beamscope so as to balance out the electro-magnetic field of the noise sources. The electrostatic field of the noise source is avoided due to the shielding employed. The electrostatic shield does not interfere with the signal pickup as the latter works entirely on electro-magnetic component. Most noise signals originate close to the receiver as compared to the station signals. Close to any signal source the electrostatic component is stronger than the electro-magnetic and therefore the shield is important in reducing the noise to a minimum. A more adequate description of this loop will be published in *Electronics* soon.

Several interesting circuit, rather than mechanical, features are to be found in the new G.E. line. For example the figure indicates the i-f amplifier of the RG-61, 66 showing the band expansion and neutralizing

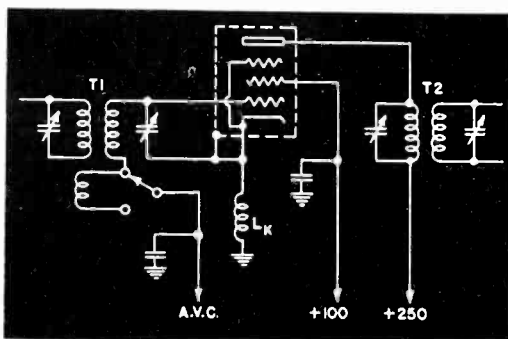

Band expander and neutralizing circuit found in G.E. sets

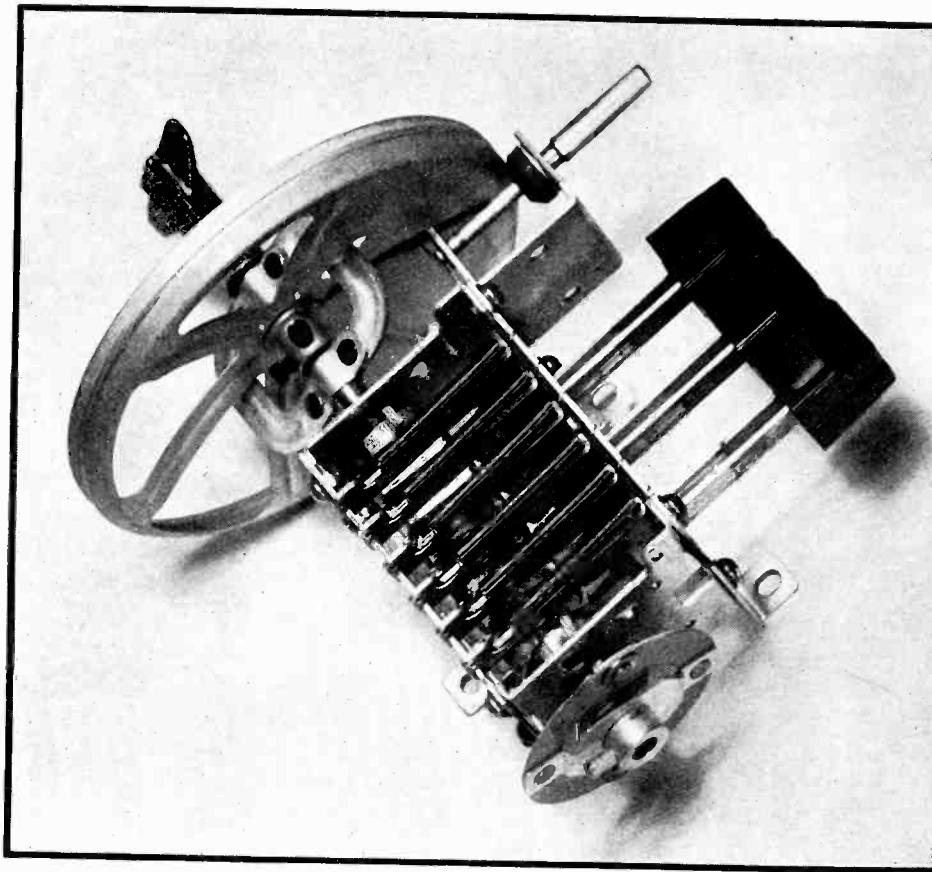

Button tuning mechanism used in the 1939 line of Colonial radio receivers

circuits. Band expansion is automatically provided in the push-button positions to minimize the effects of oscillator drift and improve the fidelity of selected stations.

Neutralization of the amplifier is found desirable to provide symmetrical band expansion when alignment is performed in the sharp position. Essentially this comprises returning the trimmer of the first i-f transformer to cathode and inserting the neutralization inductance, L_x , between cathode and ground. This inductance is quite small and consists of about 18 in. of rubber-covered connection wire hand-wound in a small bundle. The resulting circuit produces a network effecting substantially zero transfer of i-f plate potential to the grid circuit.

Audio Compensation

The audio degeneration and compensation circuit is also shown. The degenerating voltage is fed from the voice coil into the low end of the volume control providing a degree of degeneration which varies with the position of the volume control slider; thus in the normal working range of the control, the degeneration is large (of the order of ten to one) in order to provide low hum and low audio harmonic distortion as well as increased frequency range and im-

proved loudspeaker damping.

At maximum volume the degeneration is greatly reduced by the voltage divider action of the volume control resistance and diode load resistance R-6. The remaining degeneration in this position is removed, to restore maximum sensitivity, by introducing regeneration from the other side of the voice coil to the top of the volume control through the resistor R-3. Thus the benefits of degeneration are provided in the working range of the control with no reduction in maximum sensitivity. A four-position tone control is provided which acts independently of the degeneration circuit.

Every receiver in the new G.E. line, with one exception, features automatic tuning and most are equipped with keyboard (push-button) tuning. Certain of the new sets have a remote keyboard control which will not only change stations but regulate volume. A simplified version of the "time-tuning" feature will be found in a 9-tube model. It will make it possible to tune any one station to any of its varied programs over a 12-hour period.

Features of the 1939 RCA-Victor Line

In the new line of RCA Victor receivers separate oscillator coils are used for each push button and they

are adjusted by moving the magnetic core in the field of the coil. Each coil covers a range of about 500 kc and three coil groups are used to cover the band of 550 to 1,550 kc with sufficient overlapping of the ranges to meet any ordinary requirements. The coils parallel the conventional oscillator coil to simplify the winding and switching arrangements. The frequency stability of the circuits is such that oscillator drift is less than 1,500 cycles for a temperature rise of 50° F. at 1,500 kc.

The antenna circuits, which are not so critical to capacity variation, use conventional compression mica trimmers switched across the normal antenna coil. The i-f amplifier stability is assured by use of permeability tuned coils with stabilized fixed tuning condensers.

RCA engineers feel that motor

in series type which eliminates the possibility of overheating the motor in case more than one station button is pressed in at the same time. Contact positions 1 to 8 inclusive represent push buttons for 8 different stations. Position 9 is for "dial tuning" and removes the motor voltage from the 8 station buttons. When a station is to be set up, the "dial tuning" button is pressed in and all of the station buttons are energized through one of the pilot lamps from a 6 volt transformer winding. The return circuit for the pilot lamp is through the selector and motor windings to ground. When a station button and the "dial tuning" button are both latched in, the pilot light will go out only when the station contact is directly over the insulator, thus indicating proper set up.

The high fidelity chasses in the

When the motor armature is energized it engages the star wheel and pinion by means of the crank pin and drives the gear train which in turn drives the tuning shaft. The time required to tune from one end of the broadcast band to the other is approximately 3 seconds. The motor armature when de-energized is thrown clear of the star wheel and pinion by means of a spring, the armature itself having axial movement.

A flywheel is mounted on the motor shaft but is not rigidly connected to it. The torque is transmitted to the flywheel through an adjustable leather friction pad. It is the action of this flywheel which controls the overtravel of the motor and the accuracy of stopping the system.

When a station button is pressed, the motor tends to pick up speed and rotate the selector disc in the direction of the corresponding station contact. The motor cannot come up to speed immediately due to the friction drag of the slipping flywheel. When the insulator on the selector disc has reached the station contact, both the motor and flywheel are rotating at the same speed and their combined inertias carry the insulator beyond the station contact and the motor reverses. Because of the momentum of the flywheel which is still rotating in the original direction, the motor speed in reverse is reduced. While the motor is rotating at low speed in the reverse direction the station contact is again reached at which time the motor current is broken and the condenser stops within the limits of the insulator. In actual operation, the system hunts only once, returning to the proper setting after one overtravel. The receiver is silenced during the period of motor tuning by biasing off the audio tubes by means of a muting circuit.

Inverse feed-back is used over the last two stages of the wide band sets, the feedback loop including the output transformer. The 1st a-f tube is operated outside of the feed-back loop and the 10 kc filter and audio tone control are inserted in this circuit.

For wide range of control of fidelity the selectivity is varied by switching coupling coils in the 1st and 2nd i-f stages. The selectivity from the 2nd i-f tube to the 2nd detector is relatively sharp and flattens out the valley of the double humped selec-

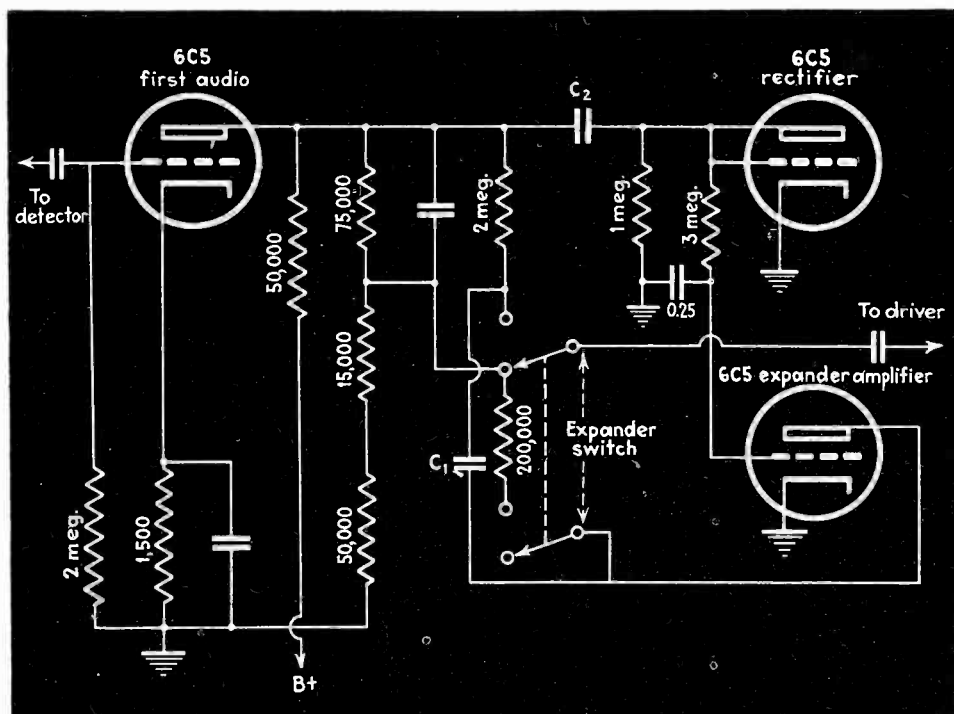

Emerson "Symphonizer" volume expander. Switch thrown upward, signal is amplified and rectified current increases gain of the 6C5 expander tube

tuned receivers have the advantage over the pre-set electrical type of greater ease in setting up stations for push button operation—particularly with receivers using 3 gang condensers—and the possibility of attachment of a remote tuning device if so desired. The motor tuning system used in the 1939 Victor receivers is greatly improved over previous types. It is of the "homing" type, that is, the motor seeks the station directly without the necessity of throwing a reversing switch at the end of the condenser travel. The station selector switch is of the latch-

line are provided with afc. Accuracy of tuning is assured in others using motor tuning through the use of frequency stabilized components and a highly accurate motor drive and stopping system.

The accuracy of stopping depends on the width of the insulator in the selector disc and the diameter of the station contacts. A small amount of overtravel with the ordinary motor drive, even with an armature of low inertia would be very difficult to control, without excessive oscillation or hunting. A type of drive with very little overtravel has been developed.

tivity characteristic of the 1st two i-f transformers in the broader selectivity positions. The use of magnetite core adjusted i-f transformers tuned with zero temperature coefficient mica condensers assures constancy of i-f alignment and assures correct tuning to the center of the pass band.

Fidelity and Tuning Controls

The tuning control is arranged

coupling in the large cone allows the small cone to be driven independently at high a-f frequencies by the voice coil to which it is attached at its small end. Loading the apex of the inner diaphragm with sufficient mass to resonate with the stiffness between the apex and the voice coil increased the response from 4,000 to 7,500 cycles without increasing the 10,000 cycle response. This required mass was furnished by a small inverted

automatically, the records being placed on top of the record holder post supports. From here they are dropped gently down the center spindle one after the other after the completion of playing of the previous record. A lever is provided to give manual, 10-in., 12 in. and record reject operation. After all of the records have been dropped to the turntable the machine will repeat the last record as long as desired.

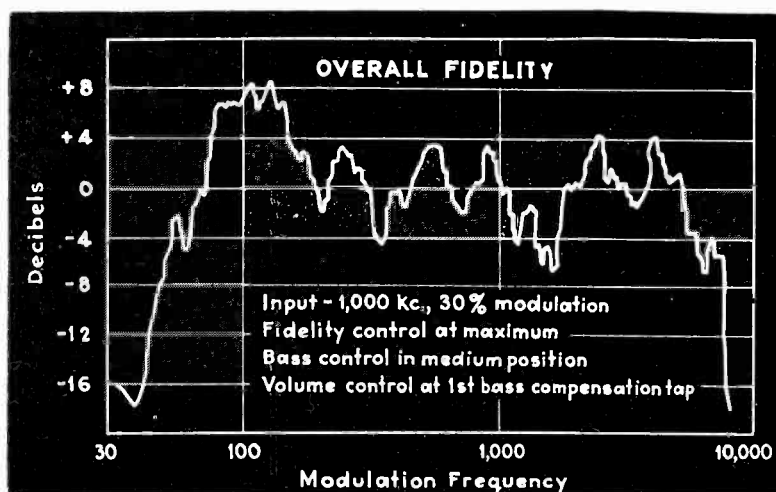

Overall fidelity characteristics of wide-band 1939 RCA Victor receivers

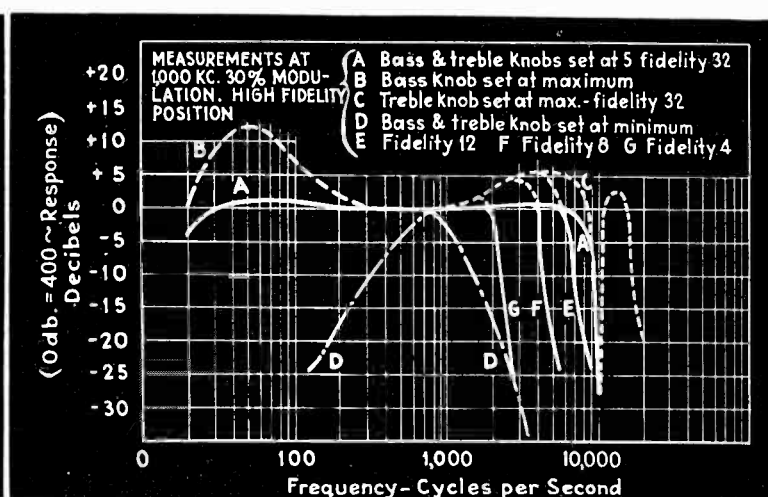

Various degrees of audio response possible in McMurdo-Silver Masterpiece VI

with a push action for manual operation on the high fidelity chassis. Pushing in the knob while tuning removes afe and narrows selectivity. Releasing the knob automatically reconnects afe and returns the selectivity to that for which the fidelity control was set. The fidelity control is a seven point switch. It was not considered desirable to use afe on weak distant stations subject to fading; therefore, the first two positions of the fidelity control are labeled "Distance" and in these positions afe and electric tuning are made inoperative. In the remaining five positions afe and electric tuning are reconnected.

Triple-cone Speaker

To realize the full capabilities of the high fidelity receivers, a new speaker was designed having substantially flat response from 50 cycles to 7,500 cycles but with high attenuation of 10,000 cycles. To handle high power input a relatively heavy cone was necessary but this inherently limited the high frequency response. To overcome this difficulty a smaller and lighter auxiliary diaphragm was placed inside the larger cone and fastened to it by a flexible base support at about half way out. Compliant

metal dome which, by its motion, also contributes to the high frequency radiation.

Spread Band Short Waves

The four principal entertainment bands on short waves are each spread across the entire tuning scale on those receivers using the Overseas Dial. The actual spread is such that the 300 kc band covers the 8 in. scale with 10 kc calibration points almost $\frac{3}{16}$ in. apart.

To accomplish this the oscillator is tuned by means of a standard 11 to 530 $\mu\mu\text{f}$ variable capacitor but the circuit constants are such that the effective change across the inductance is from 44 to 58 $\mu\mu\text{f}$. A combination of series and parallel capacitors are used with one of the units designed to have temperature compensation. The oscillator drift with temperature is less than 4 kc at 15 Mc for a temperature rise of 50° F.

New Automatic Record Changer

The chief features of this record changer are its ability to handle either 10 or 12 inch records and the simplicity of its construction which results in freedom from service trouble in the field. It will handle eight 10 in. or seven 12 in. records

The automatic record changer employs a new crystal pickup with a top loading needle socket making change of needles much more convenient. The pickup is so placed in the tone arm that the needle exerts uniform pressure on the walls of the record grooves at all parts of the record surface from the inner to the outer groove. A very light pressure of only 3.1 ounces at the point of the needle, together with low stiffness of the mechanism contributes to greatly decrease the record wear using this pickup and tone arm. Response of the pickup is essentially flat from 70 to 7,000 cycles.

Every model in the new RCA Victor line which has 10 tubes or more has in it the "master antenna" described at the recent IRE convention by V. D. Landon and J. D. Reid and reported, briefly, in July *Electronics*. It involves a master noise eliminator adjustment at the rear of the chassis which can be easily performed by the owner of the receiver.

Higher Fidelity Marks Stromberg Receivers

New and improved labyrinths are to be found in the new Stromberg-Carlson receivers, still further improving fidelity of reproduction. Use

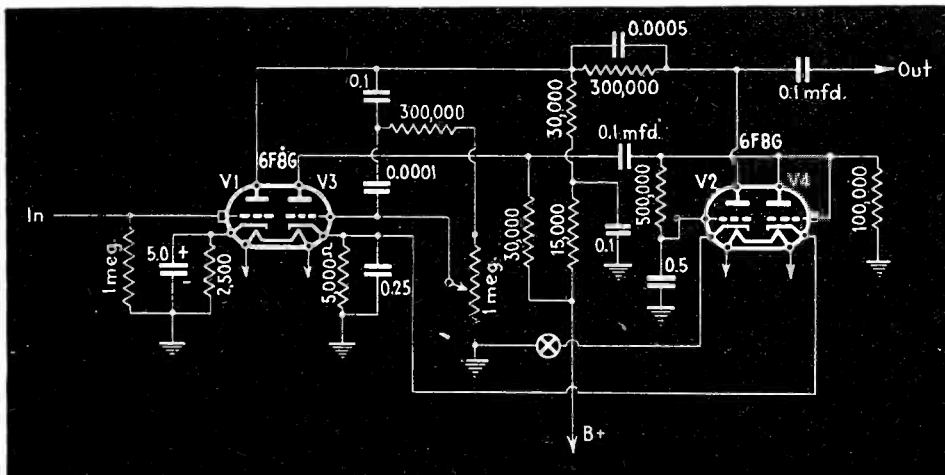
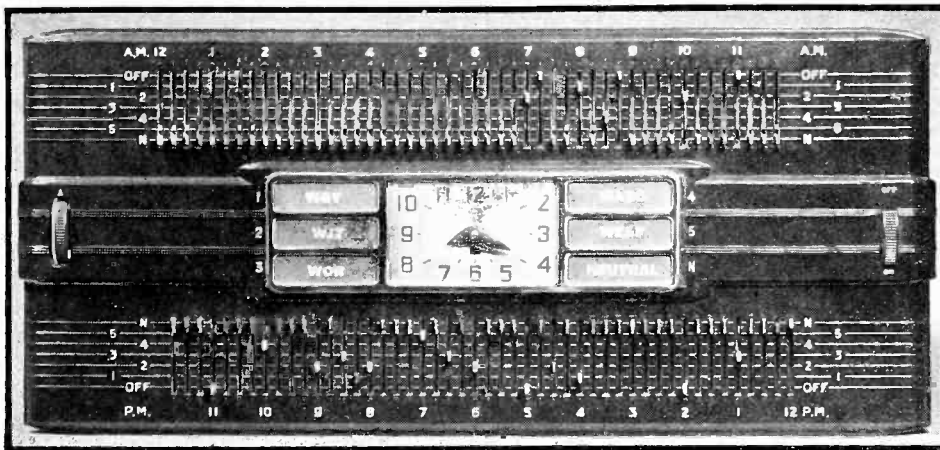
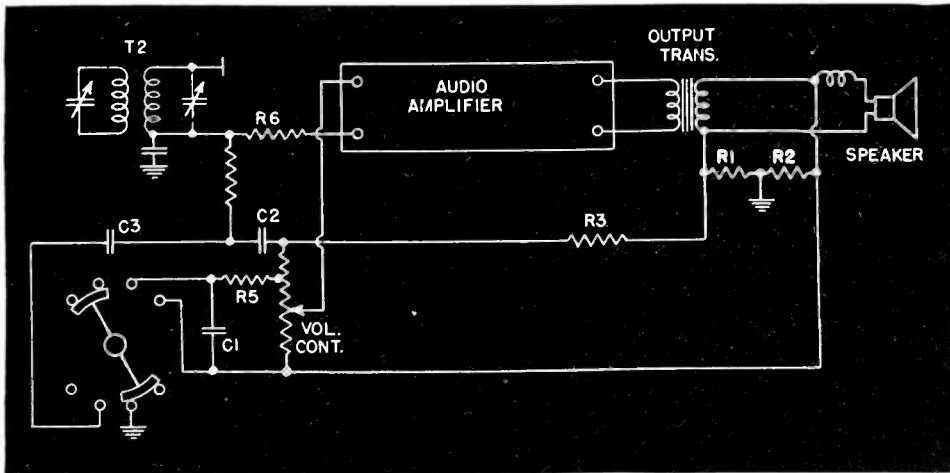

Degeneration circuit in General Electric receiver; also G.E. pre-setting tuning system. Silver attachable volume expander. V4 rectifier changes bias of V2 and controls expansion of 23 db

is made of acoustic materials recently developed which are self-supporting and which do away with the rather involved pressed metal construction used in the earlier labyrinths. Great care has been exercised in the furniture cabinet designs to see that nothing enters which might affect the quality of reproduction. Several of the new Stromberg models are corner cabinets, and the labyrinth has been found to be the only way in which high-grade reproduction has been possible in the restricted space available in these cabinets.

A new design of labyrinth is to be found in the 340-P radio-phonograph combination, where the dimensions of

the cabinet are restricted. Made of a two-piece construction it is designed to work with a speaker smaller than any used in labyrinth application up to the present time. In chairside models in which the speaker is necessarily close to the bottom of the cabinet, a speaker of better-than-usual high frequency response is used to compensate the absorption of high frequencies by rugs and heavily upholstered furniture.

Chassis Design Features

In the new chassis, a protecting framework and reinforced base has been incorporated. It serves to protect the chassis in the production

department, during shipping, and subsequent use in the field. The framework serves as considerable assistance to the worker, in that it is possible for him to place the chassis in any one of four positions without danger of damage to delicate mechanical and electrical parts.

Wide use is made of bronze in the construction of dial plates in many of the new models. This gives a permanent type of dial material, and allows a variety of interesting designs to be obtained through etching processes.

In push button operation there is incorporated in connection with the push button unit a type of compensator which has novel features. This compensator employs the usual capacitor to balance electrical circuit drift, but, in addition, it has built into it an electrical heating unit which serves to control closely the amount of compensation which is derived through the use of the compensator unit. For the service man's convenience, the push button electric tuning unit is provided with front adjustment. The adjustment screws are accessible on removing an escutcheon plate which is part of the main dial assembly. In this position, the tuning eye is immediately visible for use in obtaining accurate setting of the push button tuning units.

In the larger models provision is made for adequate low frequency response by building a separate channel designed for amplification of the frequencies below 200 cycles.

McMurdo Silver in his Masterpiece receivers seems to include all that one could wish for. Taking advantage of recent work on cabinet design to eliminate boom (the peri-dynamic and bass-reflex principles of Jensen) the new receivers comprise a chassis and a loud speaker cabinet properly designed to reproduce the lower frequencies with great fervor down to 30 cycles. An 18 in. speaker aids in this extension of the range. At the higher end the receiver is good to 9000 cycles in the extended band region and by providing various degrees of selectivity and audio cut-off, reception limited to a very narrow band for tuning is possible. Both treble and bass ends of the scale may be adjusted to suit the user's requirements. Incidentally the treble adjustment extends from "bright" to

(Continued on page 55)

An Electronic

By J. Warren Horton

Biological Research Laboratories
Massachusetts Institute of Technology

DEVELOPMENTS in the vacuum tube art, particularly in recent years, act like a swiftly rushing stream, carrying a thousand and one other development problems along on their current. The cardiometer has shared in the progress thus made. Modern electronic techniques have not only made it possible to meet the requirements which should be imposed on a practical cardiometer; they have been instrumental in accurately specifying these requirements.

Since the early work of Dr. Ernst P. Boaz¹ and Dr. Benjamin Liebowitz, at the Montefiore Hospital in New York, instruments controlled by the electrical impulses accompanying muscular action of the heart have been used for observing and recording the heart rate. In general these instruments involve a circuit for amplifying the electric pulses and a mechanism for recording the time of occurrence of these pulses on a moving tape. The instrument here described differs from earlier types mainly in respect to details of construction which give it a simplicity and reliability of operation not heretofore available.

The present cardiometer is operated by power received wholly from the alternating current lighting circuit. Connection to the body is made by flexible electrodes which may be applied to almost any conveniently accessible parts, such as arms or legs. Observations are made by noting the deflection of a meter calibrated directly in beats per minute. Readings may be made while the patient is at rest or moderately active. They may also be made during the progress of

¹ *Archives of Internal Medicine*, March 1928.

anaesthesia and operation. The apparatus as finally developed contains a number of circuit arrangements which are believed to be novel and which may well have utility in other applications. In general these arrangements will find greatest use in vacuum tube circuits in which, as in the cardiometer, the frequencies of the signal waves are lower than those of the power supply or of the interference. This situation is often encountered in biophysical studies.

Operating Conditions

The form of the electric wave from the heart, as picked up by the body electrodes, has been made familiar through the cardiogram². It has a peak amplitude of the order of 1 millivolt. Recent analyses of such waves, made possible by modern electronic techniques, yield essential information as to the energy distribution among the components. The frequency of the fundamental component of the cardiac wave is, of course, determined directly by the heart rate itself. With human sub-

² *Electronics*, January, 1938, page 29.

jects the frequency of this component may be considered to lie between 0.5 and 4 cycles per second. With small animals such as mice the fundamental frequency may be as high as 10 cycles per second.

Harmonic analysis shows that the cardiac wave contains components corresponding to all multiples of the fundamental up to very high values. The greater portion of the energy of the wave is, however, contained in the first 15 or 20 components. This is important in view of the fact that in the voltage picked up by the electrodes there are components due to body muscles other than the heart. Voltages due to the diaphragm muscles are always present, and any sudden motion of the body produces voltages which may have several times the magnitude of the heart voltage. These interfering voltages are made up largely of components having frequencies above those of the important energy components of the heart voltage.

On the basis of the present quantitative knowledge of the energy distribution in the cardiac wave it is now clear that these amplifiers should

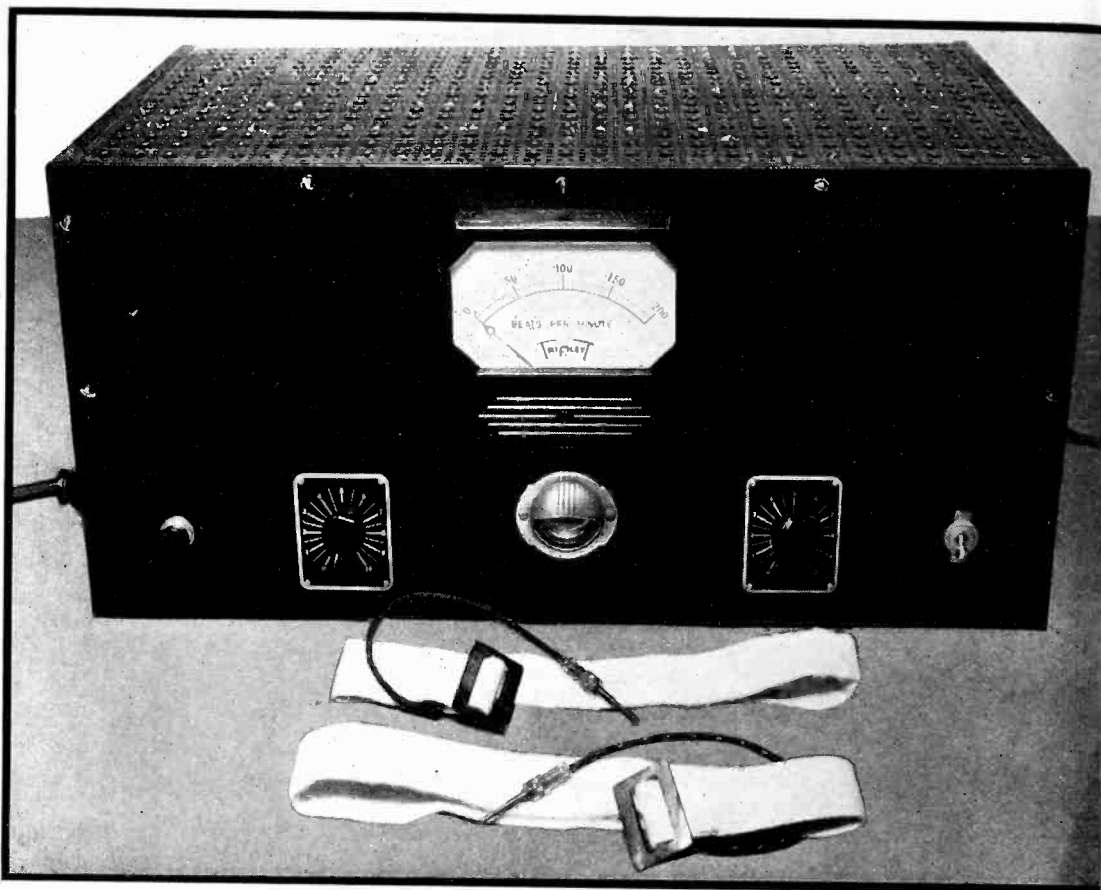

Fig. 2—Front view of electronic cardiometer and electrodes

Cardiotachometer

R1	1,250 ohms	R36	Depends upon meter constants
R2	200,000 "	R41	50,000 ohms
R3, R6, R12	1 meg	R42	Half of R41
R4, R7	300 ohms	R43	8,000 ohms
R5, R9	20,000 "	C1, C8	25 μ f
R8	100 "	C2, C15, C20	0.1 "
R10	250,000 "	C3, C6, C10, C31, C32	1 "
R11	1,000 "	C5, C9	0.25 "
R13	2,500 "	C16, C18	.8 "
R14	50,000 "	C33, C34	1,000 "
R15, R20	100,000 "	C41, C43	16 "
R16, R18, R19, R30	5,000 "	L41, L42	15 h
R17	2,000 "	Relay	500 ohms, max.
R33, R34, R35	2,500 "	T40	Power supply transformer

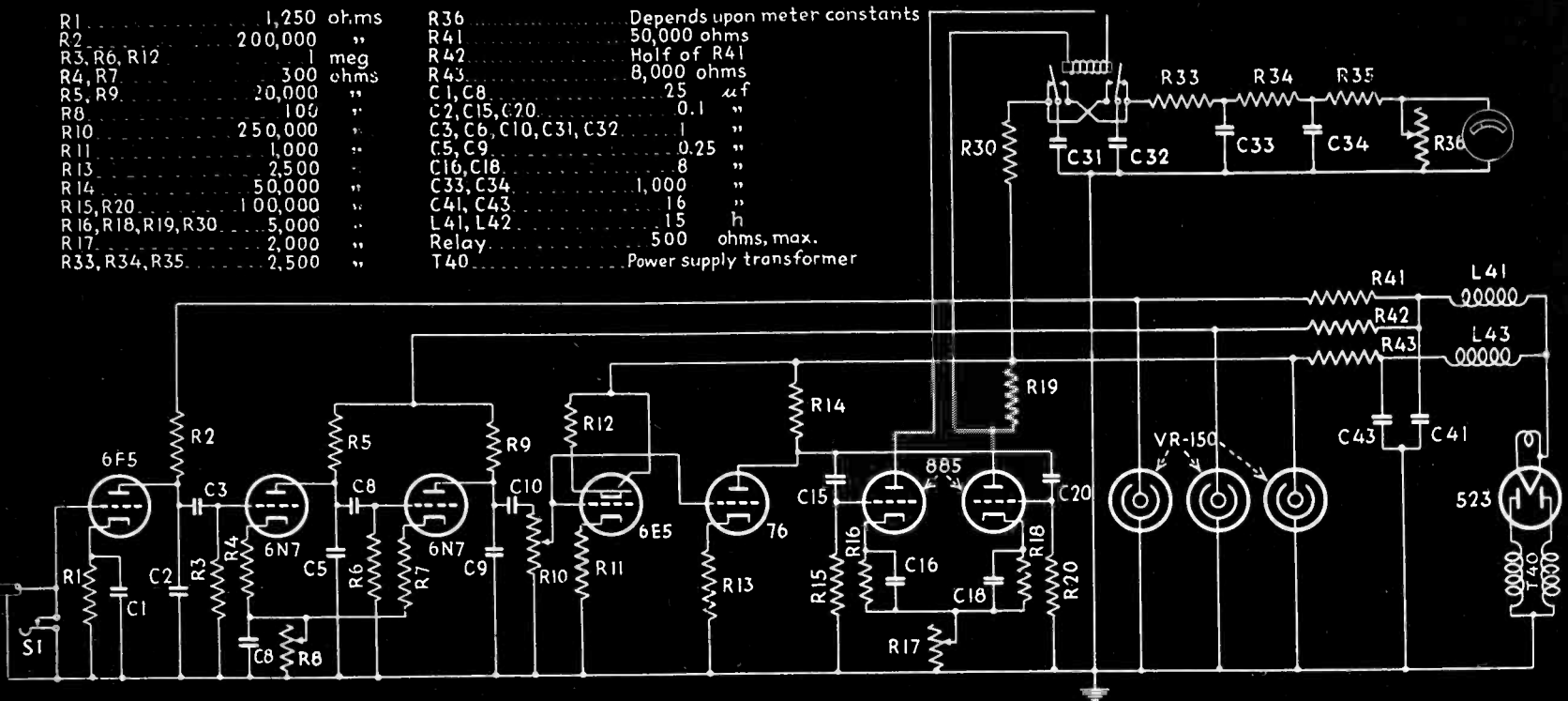

Fig. 1—Schematic wiring diagram of electronic cardiotachometer

have the characteristics of a low-pass filter rather than that of a tuned circuit. They should transmit with high efficiency all components between about 0.5 and 40 cycles per second and should discriminate against higher frequencies. For cardiotachometers to be used with small animals the cut-off frequency should be set considerably higher; a value from 15 to 20 times the fundamental frequency will in most cases be found satisfactory.

Functional Arrangement

A schematic diagram of the complete circuit of the cardiotachometer is shown in Figure 1. The first three vacuum tubes are conventional triodes used as amplifiers. The electrodes are connected to the first triode through a shielded cable, the shield being used for one lead. When in use there is no impedance between the grid of the first triode and ground other than the impedance of the subject between the electrodes. When not in use, or when the electrodes are being adjusted, the grid is shorted to ground by the switch S1. The next two tubes are both driven by a common connection to the adjustable gain-control in the output of the third triode. The control is located at this point because the amplification is

so great that were it located earlier there would be violent disturbances following any adjustment. These result, largely, from thermal potentials between resistor and sliding contact. Of these two tubes the first, 6E5, is an indicating tube, of the "magic eye" type. Its function is essentially that of a peak voltmeter, showing the magnitude of any signal impressed upon the grid of the final amplifier tube.

The type 885 tubes are gas triodes. Their function is to cause current to pass through the windings of a relay during alternate intervals between pulses. The arrangement of these gas triodes is one commonly used for this and similar purposes. At any instant one tube is conducting and the other is non-conducting. With the circuit in this condition the voltage relations are such that an impulse impressed on the grid circuits will cause the break-down of the non-conducting tube. This, in turn, causes the extinction of the conducting tube and the re-establishment of a stable condition in which the relations between the two tubes are interchanged. The relay, being connected in series with one of these tubes, thus carries current when that tube is operated, or during every other pulse interval. The remaining tubes are voltage regulator and rectifier tubes associated with the power-supply portion of the system.

The circuit associated directly with the relay develops a direct current pro-

portional to the rate of relay operation. The relay performs a double transfer, a pair of condensers, C31 and C32, being connected alternately and in turn to a source of fixed potential and to a discharge circuit. The current in the discharge circuit is thus proportional to the quantity of electricity constituting the charge on one condenser and to the rate at which this quantity is delivered to the discharge circuit by the relay. The resistance-capacitance network is used to prevent varying components of the discharge current from appearing in the meter. The deflection is, therefore, virtually steady and proportional to the original pulse rate.

Electrodes

A remarkably satisfactory type of electrode may be made by covering a piece of fine phosphor bronze gauze with a snugly fitting jacket of soft cloth. When moistened with a strong solution of common salt and placed in contact with the body an electrical connection of good stability is established. The shape and method of affixing the electrodes depends upon the portion of the body to which contact is to be made. For studies of changes in heart rate during exercise it is desirable to place them as near the heart as possible. Rectangu-

lar or oval electrodes, backed by a thin pad of some soft material, may be fastened directly upon the back and chest by adhesive tape. For the majority of purposes, however, a simple band electrode such as shown in Figure 2, on each arm, is equally satisfactory and more convenient.

Power Supply System

The discrimination of the amplifier against frequencies of 60 cycles a second and higher is an important factor in the design of the power supply system. In view of the high gain necessary in the amplifier the requirements on hum elimination would be almost prohibitive without this discrimination. The major problem in connection with the power supply thus becomes the prevention of feed-back resulting from the coupling impedance of this system. This effect may be so serious here that even with battery operated amplifiers it has been customary to use independent batteries for the several stages. The low frequencies of the signal components bring in an added difficulty, inasmuch as they make the usual type of decoupling filter quite ineffective.

Power for the entire circuit is supplied by the transformer T40 and the rectifier 5Z3. Current for the high level portion of the circuit, which includes both the final amplifier stage, the gas triodes, and the condenser charging circuit, is delivered through a network having as series elements the inductance L43 and the resistance R43, and as shunt elements the condenser C43 and the third voltage regulator tube. This network constitutes a simple form of hum elimination filter. Current for the first, or low level, stage is taken from the common rectifier through a similar network. In any multi-stage amplifier it is necessary to prevent current changes in the high level stages from affecting the voltage of the power supply to the low level stages. In the present case this situation is intensified because of the considerable magnitude of the current changes accompanying the operation of the gas triodes and the charging of the rate indicating condensers. Unless these are effectively prevented from affecting the supply voltage on the first stage there will be not only the usual tendency to self oscillation but an actual overloading of the low level stages which would result in a paralysis of the entire system. With the arrangement shown any current surges in the gas triodes or charging circuit produce a small potential change across the third regulator. The regulator tube is more effective in reducing this change than the usual filter condenser would be as it is virtually independent

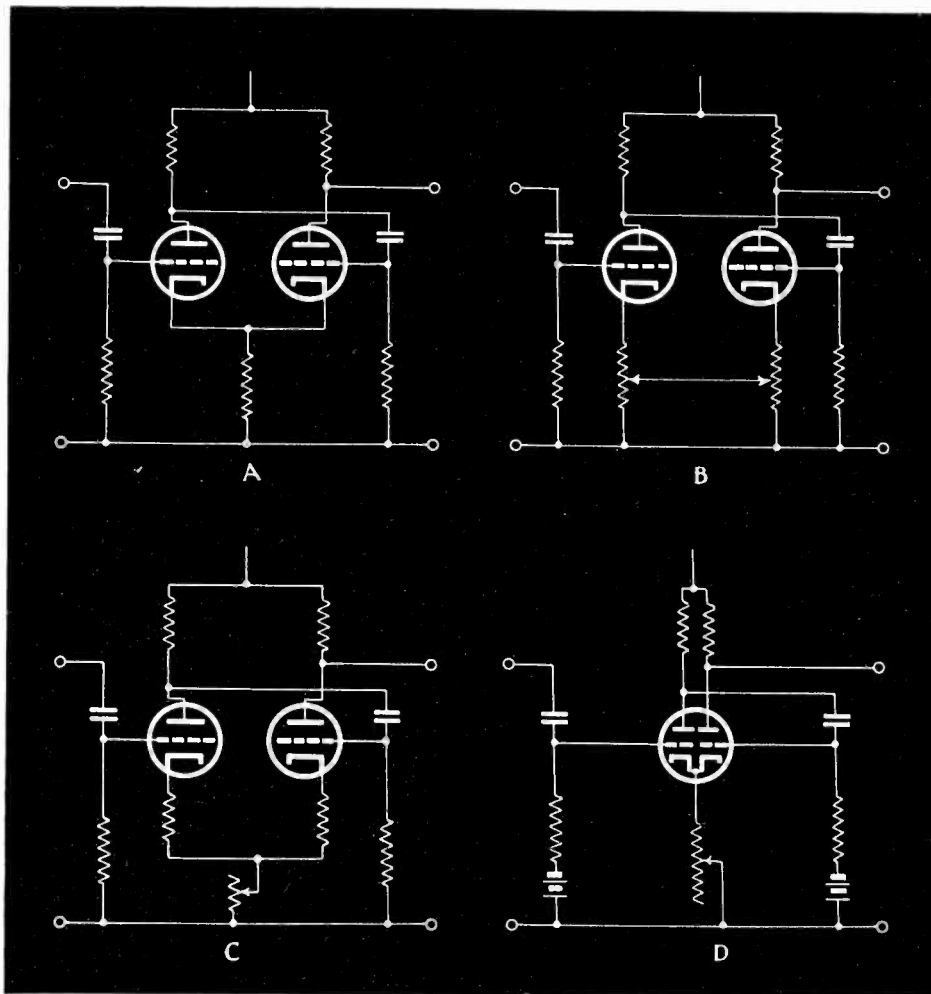

Fig. 3—Cathode resistance used for regeneration in two stage amplifier. A, theoretical arrangement of circuit. B, ideal arrangement of circuit. C, practical working circuit. D, circuit arrangement with duplex-triodes

of the rate at which the change takes place. From this point in the circuit the disturbance has to pass through *both* of the power supply networks in tandem in order to reach the first stage. The final element in this combined network, the first voltage regulator, is again a very effective means of reducing the magnitude of such voltage change as remains.

The network supplying plate power to the intermediate stages has the inductance L41 and the condenser C41 in common with the network for the first stage. It has the separate resistance R42 and the separate voltage regulator tube. Those portions of the two networks which are not common, together with the common capacitance C41, form a single network for suppressing the interchange of voltage variations between stages. This network, though less effective than that between the first and last stages, is entirely adequate for this purpose.

Regenerative Amplification

Because of the low frequency of the signal it is possible to utilize a form of regeneration which is effective for the signal but not for power supply interference.

As is well known the use of a resistance in the cathode lead of a triode for obtaining the required biasing potential between grid and cathode has a degenerative effect. Suppose, how-

ever, that the cathodes of two similar triodes are connected together, as in Figure 3-A, and that the combined plate-currents flow to ground through a common resistance. Let these triodes be connected as two stages of a resistance-capacity coupled amplifier. A voltage introduced into the grid-circuit of the first triode will cause changes in the plate-currents of both tubes. The change in the plate-current of the second tube will be greater than in that of the first and will be of opposite sign. The net change will be, in consequence, of opposite sign to that which would take place in the cathode resistor of a single tube. The voltage across the cathode resistor will appear in the grid-circuit of the first tube, therefore, with the same sign as the impressed voltage which originally produced the change. It will appear in the grid-circuit of the second tube as of opposite sign from the amplified voltage impressed by the first tube. The effect of this voltage will be greater in the first tube than in the second, because of the amplification. The net result, therefore, is that the common cathode resistance produces a regenerative effect.

In practice the regeneration result-

ing from connecting in parallel the cathode resistances of two successive stages would be so great that the circuit would be unstable. The effect may be reduced in a number of ways. (1) A variable resistance, of proper value may be connected in the cathode lead of each tube, as in Figure 3-B, so that the total resistance is always between the cathode and ground. If the sliders of these two resistances are connected together, both electrically and mechanically, the amount of resistance common to the two stages may be adjusted as desired. This is the ideal arrangement, inasmuch as it does not disturb the normal operating points of the tubes. (2) In general the amount of common resistance will be small as compared to the total resistance in either lead. It is entirely practicable, therefore, to use individual fixed resistances, of somewhat less than the usual amount, in each lead and to combine the plate currents in a single small variable resistance between the common point of these fixed resistors and ground.

because it may be made selective for the signal components. With the conventional cathode resistance *degeneration* is reduced by by-passing the resistance with a condenser which offers a path of low impedance to the signal waves. With cathode coupling regeneration may obviously be reduced by the same means. In the cardiometer the frequencies of desired signal components are below those of interference, hence a condenser may be chosen which offers a path of low impedance to the interference but not to the signal. It consequently prevents regeneration of the interference without impairing that effective for the signal.

It should be noted that in general there is almost no value in attempting to prevent degeneration in the cathode circuits of those tubes not involved in regeneration. The condensers which would be needed to produce any appreciable effect would be of prohibitive capacitance. There is, however, a substantial reduction in hum level if a condenser is shunted across the cathode resistance of the first stage. Such a condenser reduces any hum voltage which may be set up in the grid-circuit as a result of ripple in the supply voltage, and thereby reduces its effect by an amount proportional to the amplification of the tube.

tube and any impedance there may be in the power supply system. The use of the voltage regulator tube has the advantage of making the power supply, in effect, a low impedance generator. It may, therefore, be neglected in computing the value of the condenser.

The discrimination obtained by the use of a condenser in shunt with the plate-feed resistance does not increase linearly with frequency. It shows, in fact, a characteristic which resembles that of a conventional low-pass filter. This characteristic may be computed directly from the familiar impedance relations of a shunted condenser. The curves shown in Figure 4 are the frequency-amplification characteristics obtained with one, two, and three stages of amplification each having a fixed condenser in shunt with the plate-feed resistance. The point marked as unity on the frequency scale corresponds to that frequency at which the magnitudes of the resistive and reactive components of the equivalent impedances of the parallel branch circuits are equal. Other frequencies are plotted in terms of this reference frequency as direct ratios. By choosing the absolute value of frequency for any significant point on one of these characteristics the frequency at which the resistance and reactance components are to be made equal is at once obtained. At this reference point the magnitudes of the actual resistance and reactance of the parallel branches are also equal and are twice the magnitude of the equivalent series components. Knowing the magnitude of the plate-feed resistance the value of the capacitance to give the same magnitude at the reference frequency may be readily computed.

Rate Indicating Circuit

The circuit by which is developed a current proportional to the pulse rate is similar in principle to the familiar condenser charge-and-discharge circuit. It does, however, have some changes in detail which make it more suitable for the operating conditions which exist in the cardiometer. The conventional arrangement has been modified so that one condenser remains on charge and a second condenser on discharge for one entire interval. During the succeeding interval the condensers are interchanged, the fully charged unit being connected to the discharge circuit and the fully discharged unit to the source of charging potential. To insure that each condenser delivers a full charge every time it is transferred it has been found that relays making positive contacts must be used. Thyatron relays have been tried but do not give as linear a calibration as that obtained with a mechanical relay. By

(Continued on page 55)

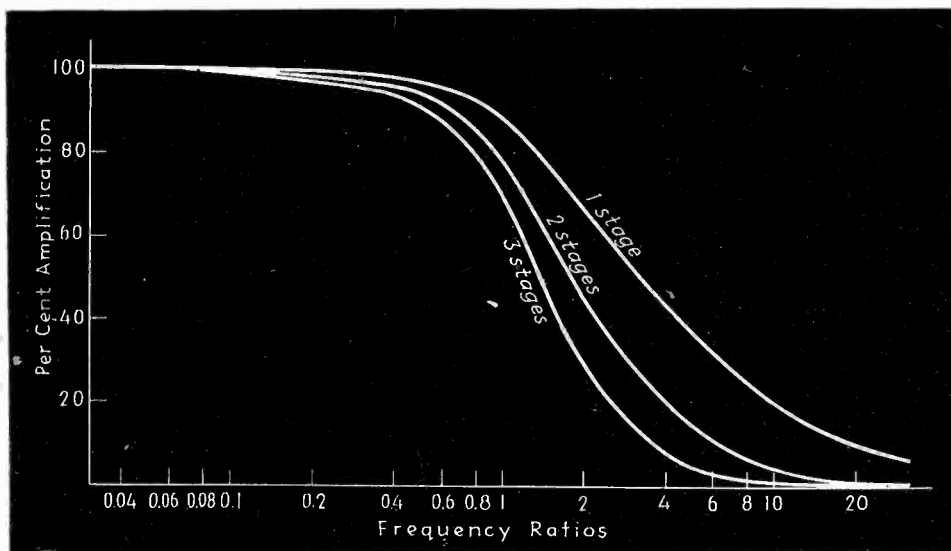

Fig. 4—Transmission characteristics of amplifier having a fixed condenser in shunt with the plate-feed resistance. Unit frequency is taken as that frequency at which the magnitude of the shunt resistance is equal to the magnitudes of the plate feed resistance and of the internal tube impedance

This arrangement is used in the cardiometer. It is shown in Figure 3-C. (3) In case the two triodes are in a single bulb and have a common cathode a resistance may be used in the cathode lead for regeneration. A single battery in this lead or, as shown in Figure 3-D, individual batteries in the separate grid-leads, will then be required to bring the total grid-bias potential to the proper value.

This regeneration through cathode coupling is of distinct advantage in the cardiometer, not only because of the increased gain which it provides, but

As in all resistance-capacitance coupled amplifiers the low frequency end of the transmission characteristic of the cardiometer is controlled by the values of the interstage blocking condensers and of the grid-leak resistors. It has been found that the high frequency end may be controlled with equal simplicity. The amplifier may be given the desired characteristic by shunting a condenser of the proper value between the plate of each tube and ground. This condenser is thus in parallel with the plate-feed resistance of the

By E. W. ENGSTROM and
R. S. HOLMES

RCA Manufacturing Co., Inc.
Camden, N. J.

Television V-F Circuits

Third of a series of articles dealing with the general problems of television receiver design. Antenna, r-f selector, oscillator, first detector and i-f amplifiers have been covered. This paper deals with v-f detector and amplifier and avc for picture

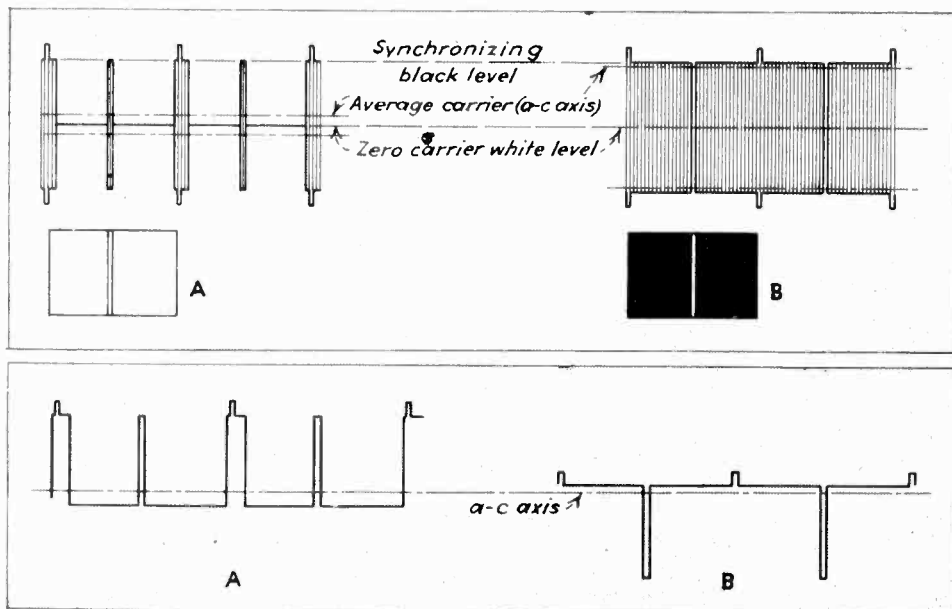

Fig. 1—Carrier envelope for two conditions of black and white in the transmitted picture

Fig. 2—The video signal as it appears with reference to the a-c axis

IN the first two articles of this series we reviewed the requirements to be met in the radio and intermediate frequency amplifiers and in the audio frequency amplifier. This article deals with the video frequency detector, automatic volume control for picture, and video frequency amplifier.

The polarity of the transmitted signal has been tentatively stand-

ardized so that for conditions representative of black in the picture, the carrier is of nearly maximum amplitude and of a constant level. Thus maximum white is represented by minimum carrier amplitude. This is called negative transmission. The synchronizing signals are transmitted in the region of "blacker than black" picture, i.e., maximum carrier amplitude. This is illus-

trated in Fig. 1 where Section A represents the variations in carrier amplitude during the transmission of two successive horizontal lines. The picture being scanned in this case is a white field with a single narrow vertical black line. Fig. 1B represents the variations during the transmission of a picture of a black field with a single narrow vertical white line. These two conditions of picture are chosen for analysis because they represent the extremes of average brightness that the television system is required to handle; other conditions of brightness will be intermediate. So far as the performance of the video amplifier is concerned, the exact wave shape of the synchronizing pulses is relatively unimportant, and will not be discussed in this article.

The variations in carrier amplitude of Fig. 1 are also the variations in i-f signal applied to the video detector in the receiver, since the r-f and i-f portions of the receiver do not materially alter the form of this signal. The video detector might be either a plate circuit rectifier or a diode rectifier. Because of its simplicity we will consider the detector to be a full wave diode

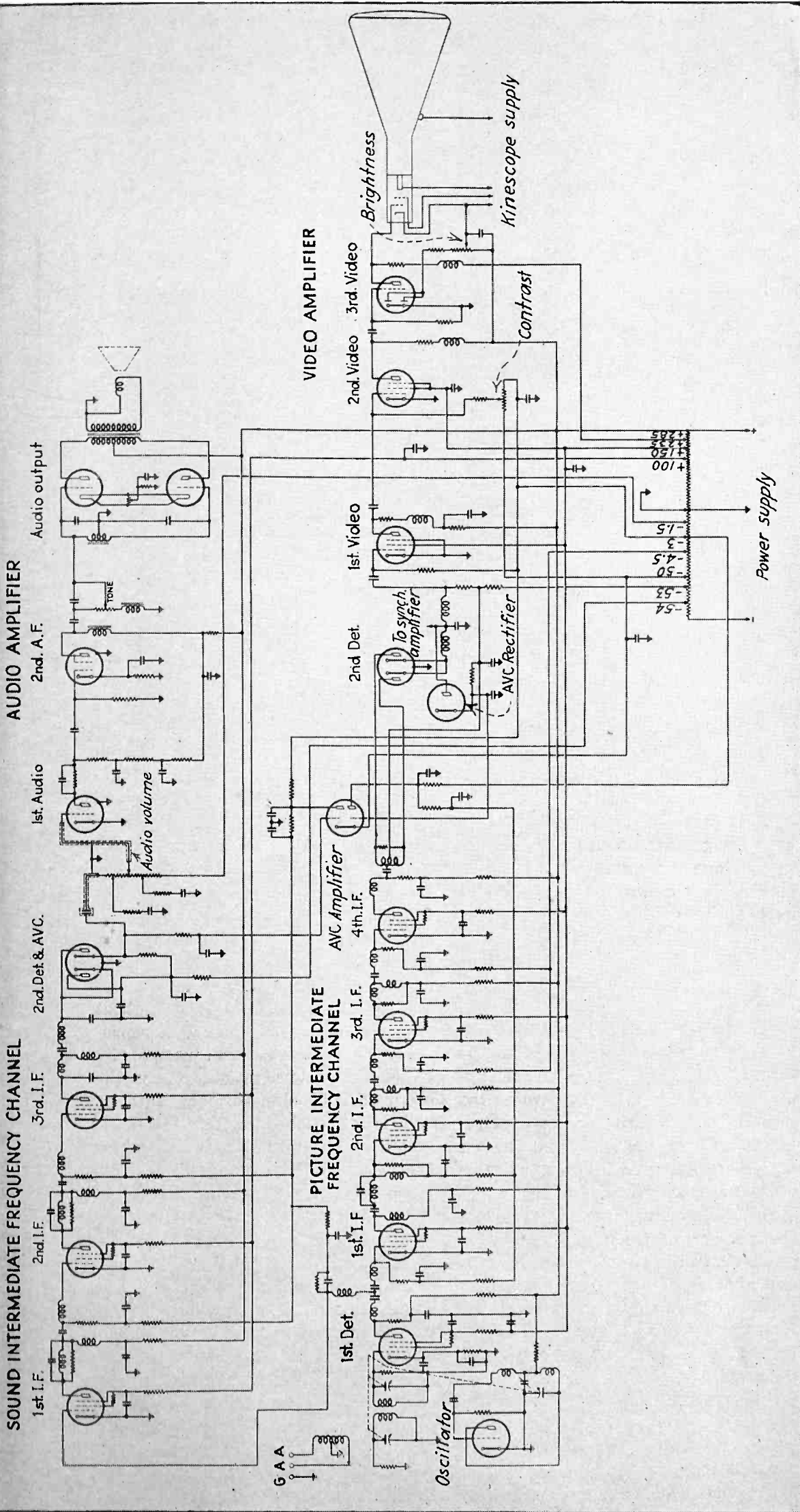

Fig. 3—Circuit diagram showing the portions of the receiver thus far described

as shown in the circuit diagram of Fig. 3. The principal difference between this circuit and the diode detector circuit normally used for sound is that in order to maintain the proper video fidelity the diode load resistance must be very much smaller, usually of the order of 2500 ohms or less. It is not necessary that the diode be full wave, but with a full wave diode the intermediate frequency appearing across the diode load resistance is doubled, and is consequently more easily eliminated from the v-f amplifier.

When the i-f signals of Fig. 1 are impressed on the diode the signal appearing across the diode load resistance will be essentially the same as one-half of the input wave. There will be some distortion due to diode curvature near zero, but this will have a negligible effect on the reproduced picture if the peak signal impressed on the diode is of the order of 5 volts or more. The d-c component of the signal present in the modulated wave will also be present in the signal across the diode load. Thus, white in the picture is represented by minimum voltage across the diode resistor, while synchronizing occupies the upper 20% of the voltage range.

There are several distinct advantages obtained from the use of an automatic volume control on the picture channel of a television receiver. Only a few of these advantages will be mentioned. An AVC will maintain the signal level at the second detector constant for wide variations in input signal. While the signal from a given transmitter may not vary greatly within its service area due to natural fading, the signal will sometimes vary considerably because of a swinging receiving antenna or transmission line and because of moving conductors and objects nearby. When tuning from one station to another an AVC again maintains proper signal levels without manual readjustment of other controls. Again, with a constant signal level at the second detector the problems of synchronizing pulse separation and gain control are simplified

and operation is made more reliable. In field testing television receivers, AVC has been found to be a very desirable part of the system.

In sound broadcast receivers it is customary to use the filtered d-c drop across the diode resistor as the source of the AVC voltage. This is satisfactory because the d-c voltage thus obtained is directly proportional to the *average* carrier amplitude at the diode. If it maintains the average carrier amplitude constant then the AVC operates as it should.

For television signals, however, this is not the case. When the d-c component of the picture is transmitted, the average carrier does not remain constant for varying pictures, but is rather a function of the relative amount of black and white in the scene. An AVC operating on average carrier is not satisfactory for television. Figure 1 shows the carrier characteristics for conditions of a white picture with a narrow vertical black line, and a black picture with a narrow vertical white line. The average carrier level varies approximately 5 to 1 between these two conditions. However, for d-c negative transmission the *peak* value of the carrier always remains constant—that is, the peaks of the synchronizing pulses always rise to the same amplitude. Since the synchronizing pulses are transmitted continually (at the end of each line and at the end of each field) they form a continual reference for operating an AVC.

On the circuit diagram of Fig. 3, the tube marked "AVC rectifier" furnishes the AVC control voltage for the receiver. It is connected across the diode load resistor in such a manner that it draws current on the positive excursion of voltage across the resistor—that is, on synchronizing pulse peaks. This current charges the capacitor in the cathode of the rectifier to a d-c potential equal to the peak of the television signal. The time constant of the circuit consisting of the cathode capacitor and the resistor across it is such that the capacitor does not appreciably discharge between successive line synchronizing pulses. This d-c voltage is then proportional to the *peak* value of the i-f signal at the second detector. It is amplified in a d-c amplifier having the customary AVC delay and impressed on the grid re-

turns of two of the picture i-f amplifier tubes to control i-f gain.

It is obvious that this AVC circuit is suitable only for negative transmission, which is the tentative standard. It would not be suitable for positive transmission. An AVC for positive transmission is more complicated in its circuit arrangement and operation.

With the circuit just described, the

will be described later.

The video signal is applied to the first v-f tube through a low pass filter. This filter has a cut-off somewhat above the highest video frequency it is desired to pass. It not only improves the response but it also eliminates the i-f voltage from the v-f amplifier.

The signal on the grid of the first v-f amplifier does not contain the d-c

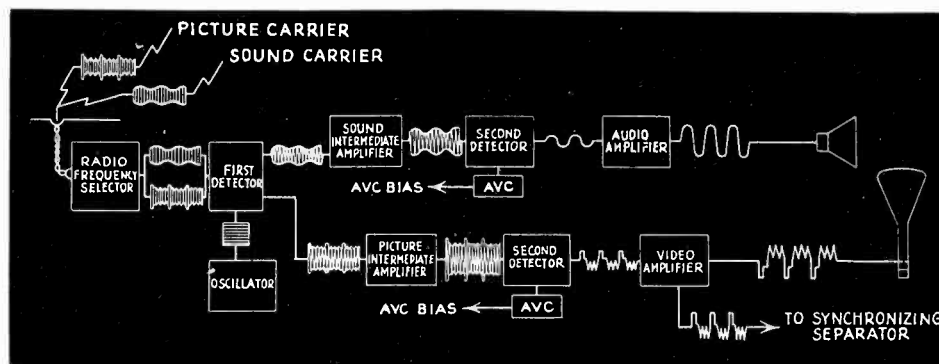

Fig. 4—Block diagram showing the portions of the receiver thus far described

video signal appearing across the diode resistor will remain substantially constant in amplitude and will contain the d-c component—that is, black level will always be represented by a certain definite voltage across the resistor within the limits of AVC performance and receiver sensitivity. If the voltage at this point were sufficiently great in amplitude only a single stage of v-f amplification would be necessary before applying the signal to the grid of the Kinescope. This stage could be arranged to amplify the d-c component as well as the a-c components of the video signal—that is, it could be a d-c amplifier. There are, however, several limitations to using only a single stage d-c video amplifier, such as supplying suitable voltage from the power supply to satisfy the requirements both of the AVC and the v-f amplifier, and providing a suitable video gain control.

In some experimental receivers three stages of video have been used as shown in the circuit diagram. (An odd number of stages is required to obtain correct signal polarity at the Kinescope grid.) Since it is difficult to handle a three-stage d-c coupled v-f amplifier, the d-c and low video frequencies are removed by using RC coupling between the v-f amplifier tubes, and the d-c and low frequency components are reinserted at the grid of the third v-f amplifier tube, as

component. In other words, black level no longer occurs at a fixed voltage in this grid circuit; instead, the tube operates about the a-c axis of the signal. The signals of Fig. 1 as they appear with reference to the a-c axis are shown in Fig. 2. The transition from one condition to the other is not shown, but it takes place at a rate determined by the low frequency response of the circuits, in this case the RC circuit in the grid of the first v-f amplifier tube.

The first v-f amplifier tube has a resistor and a peaking coil in its plate circuit of such values that the response will be flat to the highest video frequency it is desired to reproduce. The resistor will necessarily be of fairly low resistance, in the order of 2500 ohms or less, and the coil is of such inductance that it resonates the circuit at a frequency somewhat higher than the highest video frequency. The RC in the plate circuit is simply a filter to eliminate hum.

The amplifying tube should have fairly high transconductance and should be capable of handling the input grid swing without distortion.

The second v-f amplifier tube may be a remote cut-off tube of high transconductance. The gain of the v-f amplifier is controlled by varying the bias on this tube. This method of varying the gain has the advantages that the frequency-amplitude char-

acteristic of the amplifier is very little affected by the control, and that the control may be mounted wherever it is convenient on the chassis with little regard to lead lengths. This control is known as the "contrast" control.

The v-f signal appearing at the plate of the second v-f amplifier tube of course does not contain the d-c component. Consequently the height

rent small the grid resistor should be large—a half megohm or more, depending on the tube used. The bias generated by the grid current which flows during the occurrence of the synchronizing pulses is maintained by the charge on the grid coupling capacitor. The time constant of the grid resistance-grid capacitor should be sufficiently long to maintain the bias substantially constant during the

hum, low frequency instability, etc.

The signal appearing on the grid of the third v-f amplifier tube is then the same as that across the diode resistor, except that it has been amplified and its polarity reversed. This tube may be a triode, the most important characteristic required is that the plate current be rather high and that it be able to operate at zero bias without being damaged. The plate current must be high enough so that sufficient swing is available for the Kinescope grid with the low plate resistor required for good fidelity. The grid swing required on the Kinescope is of the order of 25 volts peak to peak or more. To retain the d-c component which has been reestablished the grid of the Kinescope must be directly (d-c) connected to the plate of the third v-f amplifier tube.

Bias for the Kinescope is supplied by a potentiometer between the plus B supply and ground, with the Kinescope cathode connected to the arm of the potentiometer. This control is known as the "brightness" control.

To protect the Kinescope against operation with positive bias while other tubes are warming up, one end of the "brightness" potentiometer circuit is returned to ground through the diodes in the third v-f amplifier tube. When power is first turned on, this diode path is an open circuit, and the Kinescope cathode is at full plus B potential (285 volts) regardless of the brightness control setting. The grid of the Kinescope is returned to a slightly lower positive voltage (235 volts), so that the net grid bias is negative (about 50 volts), independent of the brightness control setting. Of course, when the tubes are warm, the Kinescope bias is determined by the setting of the brightness control. The advantage of using diodes in the third v-f amplifier tube rather than in some separate tube is that should this tube be removed from the circuit or fail, the Kinescope bias returns to 50 volts negative automatically, and thus the Kinescope cannot be damaged.

In this article we have discussed the v-f detector, AVC and v-f amplifier. We have not discussed synchronizing wave shapes or methods of separating the synchronizing pulses from the composite television signal. These phases of the television receiver will be discussed in the next article of the series.

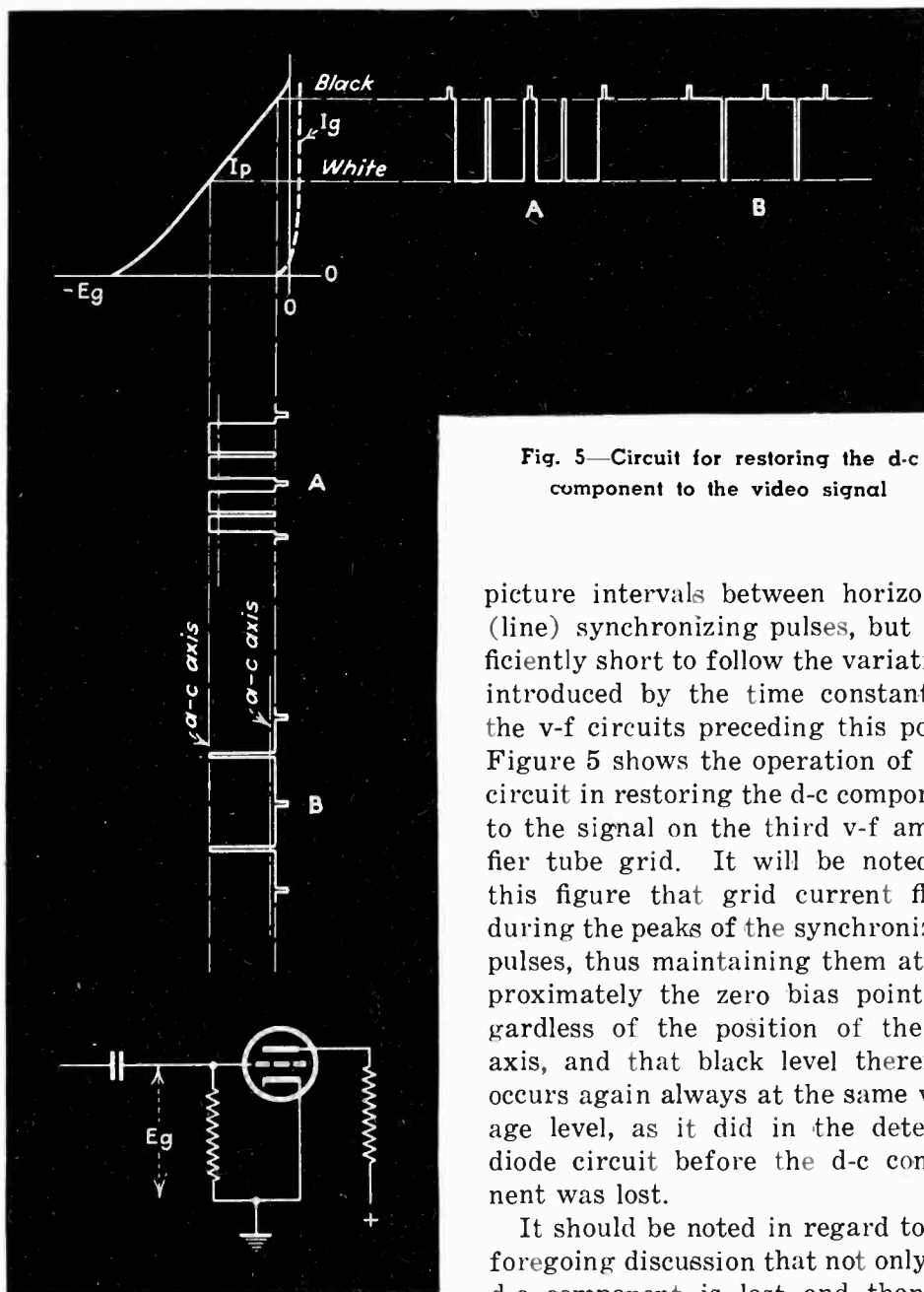

Fig. 5—Circuit for restoring the d-c component to the video signal

picture intervals between horizontal (line) synchronizing pulses, but sufficiently short to follow the variations introduced by the time constant of the v-f circuits preceding this point. Figure 5 shows the operation of this circuit in restoring the d-c component to the signal on the third v-f amplifier tube grid. It will be noted in this figure that grid current flows during the peaks of the synchronizing pulses, thus maintaining them at approximately the zero bias point regardless of the position of the a-c axis, and that black level therefore occurs again always at the same voltage level, as it did in the detector diode circuit before the d-c component was lost.

It should be noted in regard to the foregoing discussion that not only the d-c component is lost and then restored, but some of the extremely low video frequencies are likewise lost and restored. This is important in that the process restores those low frequencies, and only those, which were lost, while the unwanted effects of hum, etc., unavoidably introduced in the v-f amplifier are eliminated because the v-f coupling circuits will not pass them. This permits economies in the v-f amplifier which would not otherwise be possible because of the difficulties with

of the top of the synchronizing above the a-c axis is not constant, but varies in proportion to the average amount of white in the picture being transmitted. The d-c component may therefore be easily reinserted in the signal at the grid of the third v-f amplifier by operating the tube at zero fixed bias. The operating bias is then determined by the d-c drop across the grid resistor caused by the grid current. To keep the grid cur-

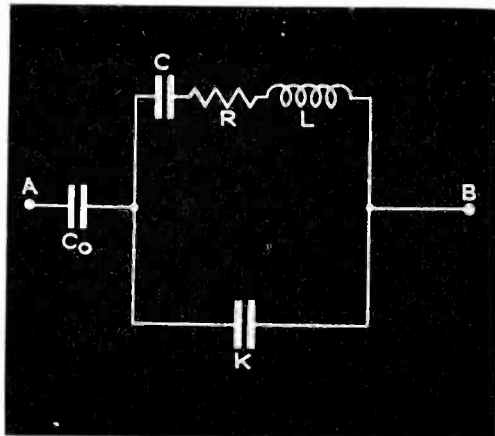

FIG. 1

The equivalent network of a piezo-electric crystal and its holder

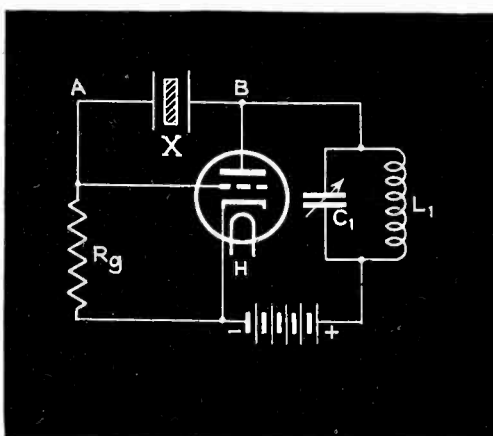

FIG. 2

The Pierce piezo-electric oscillator, in which the crystal, X, is placed between the grid and the plate.

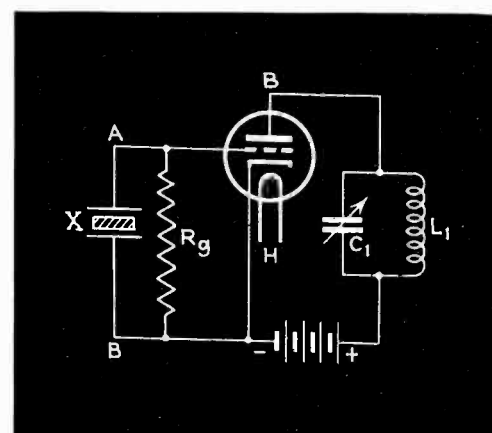

FIG. 3

The Miller piezo-electric oscillator, in which the crystal, X, is placed between the grid and the cathode

Frequency Characteristics

AS IS well known, the frequency generated by a piezo-electric oscillator is not entirely determined by the mechanical properties of the crystal, but is affected, in a small degree, by the characteristics of the associated circuit. In particular, the frequency is affected by the grid and plate resistances of the driving tube, and by the coupling reactances in the circuit. In other words, a crystal oscillator behaves, qualitatively, in exactly the same way as an ordinary oscillator having a coil and condenser resonator. Its frequency, for example, depends on the operating voltages on the tube, and on the intensity of oscillation. The high relative constancy of the frequency of a piezo-electric oscillator is due in part to the high selectivity of the resonator and in part to the fact that the crystal is shunted by a condenser. The primary function of the of the crystal is to supply inductance. In the ordinary crystal oscillator the crystal vibrates off resonance as much as 87 degrees.

The piezo-electric crystal, with its holder, can be treated as an electrical network such as that shown in Fig. 1, in which L , C , and R represent, respectively, the equivalent inductance, capacitance, and resistance of the crystal, regarded as a series circuit, K is the capacitance of the condenser formed by the two exciting electrodes separated by the crystal as dielectric, and C_0 is the

By J. E. ANDERSON

New York, N. Y.

capacitance of the air gap between the upper electrode and the upper surface of the crystal. The resistance term has a negligible effect on the impedance, and therefore the reactance between the points A and B can be written

$$X_e \frac{X}{1 - X\omega(C_0 + K)} \dots \dots (1)$$

in which $X = L\omega - 1/C\omega$. This reactance enters into the networks of all the usual piezo-electric oscillators.

Two Piezo-Electric Oscillators

There are two piezo-electric oscillators in common use, the Pierce circuit, shown in Fig. 2, and the Miller circuit, shown in Fig. 3. Although these oscillators appear to differ only in the connection of the crystal, they are really opposite in kind, for the Pierce circuit is properly classed as a Colpitts and the Miller, as a Hartley. The basis for this classification will be brought out in the analysis.

The filter network equivalent of the Pierce oscillator is given in Fig. 4. In this, C_0 represents the grid-cathode capacitance of the tube and is an essential element for oscillation. C_m represents the grid-plate capacitance. While it is not essential for oscillation, it plays an important role

in the oscillator. Obviously, one of the shunt elements in this network is a capacitance. Hence the other shunt element must also have the reactance of a capacitance, for both reactances must have the same sign. In order for the L_1C_1 circuit to have a negative reactance it is necessary that its natural frequency be less than the frequency of oscillation. That this is true is an experimental fact. Further, since both the shunt elements are capacitances, the series element must be an inductance, or the circuit cannot oscillate. It follows that the crystal must vibrate considerably above its series natural frequency. Since this circuit has shunt capacitances and a series inductance, it partakes of the distinguishing features of the Colpitts.

The filter network equivalent of the Miller circuit is given in Fig. 5. In this oscillator C_m , the grid-plate capacitance, is essential for oscillation. C_g , the grid-cathode capacitance, is not essential, yet plays an important role. Obviously, the series element, C_m , in this circuit has negative reactance. Therefore if the circuit is to oscillate at all, both the shunt elements must have positive reactance. The L_1C_1 circuit will be positive if its natural frequency of resonance is greater than the frequency of oscillation. That this is the case for this oscillator is an observed fact. The other shunt reactance, that between the points A

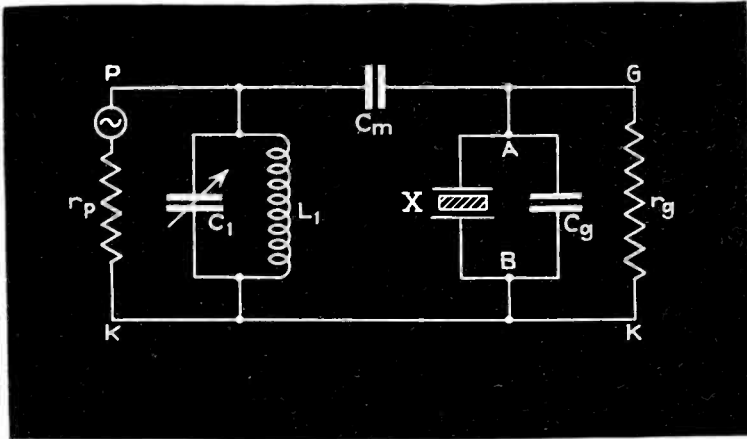

FIG. 4

The filter network equivalent of the Pierce oscillator, showing that it has the characteristics of a Colpitts oscillator

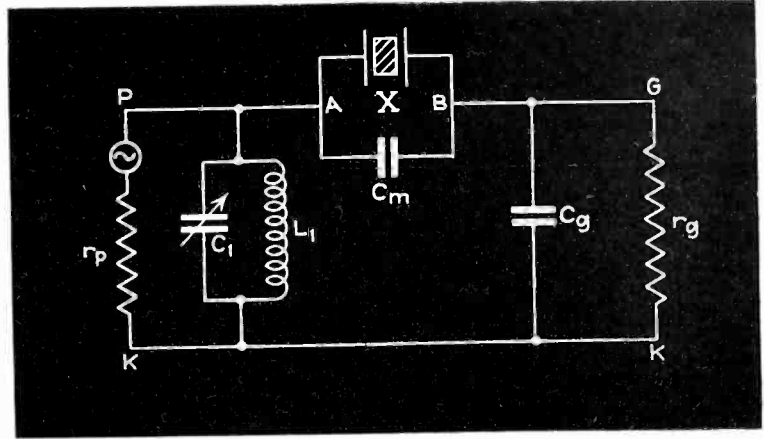

FIG. 5

The filter network equivalent of the Miller oscillator, showing that it has the characteristics of a Hartley oscillator

of Piezo-electric Oscillators

and B , will be positive if the crystal vibrates slightly above its series natural frequency. Since this circuit has two shunt inductances and a series capacitance, it has the distinguishing features of the Hartley. It is to be noticed that in this oscillator, as in the Pierce circuit, the crystal is forced to vibrate at a frequency higher than its own series natural frequency.

When a condenser of capacitance C_n is connected across the crystal,

as is done in both oscillators, the reactance of the new combination is

$$X_{AB} = \frac{X\omega(K + C_0) = 1}{\omega(C_0 + C_n)[1 - X\omega(K + C^1)]} \quad (2)$$

in which $C^1 = C_0 C_n / (C_0 + C_n)$. Since X_{AB} must be positive, oscillation is possible only within the band of frequencies determined by

$$\frac{1}{K + C_0} < X\omega < \frac{1}{K + C^1} \quad (3)$$

These inequalities can be written in a more useful form in terms of f_0 , the series natural frequency of the

crystal, and Δf , the amount by which the frequency of oscillation exceeds f_0 . If $\Delta f \ll f_0$, (3) become

$$\frac{C f_0}{2(K + C_0)} < \Delta f < \frac{C f_0}{2(K + C^1)} \quad (4)$$

since $X\omega = L\omega^2 - 1/C = 2\Delta f / C f_0$.

Inequalities (4) show under what conditions the crystal will oscillate near its natural frequency. For a crystal of fixed dimensions, C , f_0 , and K are fixed, and only C_0 and C_n are subject to variation. Both should be large if the crystal is to vibrate near resonance. C_0 can be made infinite by letting the upper electrode rest firmly on the crystal. If that be done (4) become

$$\Delta f < \frac{C f_0}{2(K + C_n)} \quad (5)$$

For practical purposes this may be taken as the limitations on the frequency, unless C_0 is made intentionally small. According to (5), the oscillator will vibrate near the natural frequency of the crystal if C_n is large.

It is interesting to apply the results in (4) to a particular case. A certain crystal had the following values: $L = 162.5 \text{ h.}$, $C = 0.044 \mu\text{mf.}$, $f_0 = 59,521 \text{ cycles/sec.}$, $R = 6,500 \text{ ohms.}$, $K = 8 \mu\text{mf.}$, and $C_0 = 278.5 \mu\text{mf.}$ If C_n is assumed to be $10 \mu\text{mf.}$, the frequency limits are 4.6 and 74.2 cycles/sec. above the crystal resonance frequency. Oscillation occurs, as a rule, within a few cycles of the upper limit.

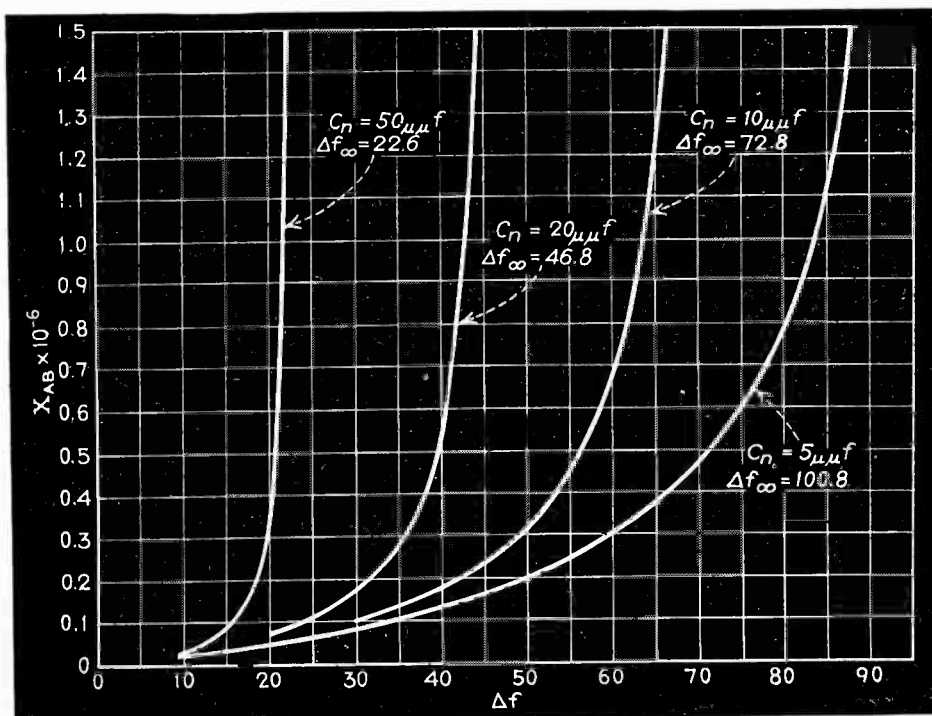

FIG. 6

Curves showing the variation in the reactance of a crystal for small changes in frequency above resonance and for four different values of shunting condenser

When C_o is infinite, equation (2) reduces to

$$X_{AB} = \frac{X}{1 - X\omega(K + C_n)} = \frac{2\Delta f}{2\pi f_0[Cf_0 - 2\Delta f(K + C_n)]} \quad (6)$$

This function of Δf has been plotted in Fig. 6 for four different values of C_n . It will be noticed that the larger C_n is the narrower is the band in which the reactance is positive. For each value of C_n the oscillation will be in the region where the curve is steep. Therefore only a minute change in the frequency is necessary to offset any given small change in the reactances in the remainder of the circuit. It would seem that the frequency would be more stable the closer the operating point is to the point at which the reactance X_{AB} becomes infinite, but common experience indicates that the contrary is the fact. One reason for this discrepancy undoubtedly is that the point of discontinuity shifts. If C_n is one of the inter-electrode capacitances, either C_m or C_g , changes in the location of the point of discontinuity can be expected. Another reason for the instability when X_{AB} is large relates to the effect of the tube resistances on the frequency. This will be discussed later.

The course of the curves in Fig. 6 suggests a possible way of improving the stability of a piezo oscillator. It is to use a large value of C_n and to include the larger part of it in the constant temperature oven. To avoid an excessive value, a tube could be chosen which contributes as little to C_n as possible.

Expressions for Frequency

The two oscillators are too complex for complete analysis. However, useful approximate expressions for the frequency can be obtained. Thus in Fig. 4 let the tank circuit be equivalent to a condenser of capacitance C_p and let $C_2 = C_p C_g / (C_p + C_g)$. Then if the resistance effects be neglected, the frequency may be obtained by letting $X_{AB} = 1/C_2\omega$, X_{AB} being taken from (2). Simplification leads to

$$\Delta f = \frac{f_0 C (C_0 + C_n + C_2)}{2[C_2(K + C_0) + (C_0 + C_n)(K + C^1)]} \quad (7)$$

Let the $L_1 C_1$ be tuned so close to f_0 that its reactance is that of a condenser of $2 \mu\mu\text{f}$ and also let $C_g = 5 \mu\mu\text{f}$. These values make $C_2 =$

$1.43 \mu\mu\text{f}$. If this be inserted in (7), together with the values already given for the other factors, $\Delta f = 69$ cycles/sec., and the upper frequency limit, as given by (4), is 72.8 cycles/sec.

An expression similar to (7) can be found for the Miller circuit in Fig. 5 by letting the equivalent inductance of the $L_1 C_1$ be L_p at the frequency of oscillation. Then the equation for the frequency can be obtained from $L_p\omega + X_{AB} = 1/C_m\omega$. Simplification leads to the approximate expression

$$\Delta f = \frac{f_0 C [C_m + (C_0 + C_n)\Omega]}{2[(K + C_0)C_m + (C_0 + C_n)(K + C^1)\Omega]} \quad (8)$$

in which $\Omega = 1 - L_p C_m \omega^2$. In this case let $C_m = 5 \mu\mu\text{f}$ and let $L_p = 3.575$ h., an inductance which has the same absolute value of reactance at f_0 as $2 \mu\mu\text{f}$. Substitution of these values, together with those previously given, yields $\Delta f = 69$ cycles/sec. That is, for similar conditions, the amount of detuning is the same for both oscillators.

When the detuning is $\Delta\omega$ radians and the phase angle is ϕ , $\tan \phi = 2L\Delta\omega/R$, provided that $\Delta\omega \ll \omega_0$. Thus when $\Delta f = 69$ cycles/sec, $\tan \phi = 21.7$, and $\phi = 87.4$ degrees. Therefore even when the crystal vibrates

as close as 69 cycles to resonance the detuning is almost complete.

Because the oscillators are so complex, explicit expressions for the frequency cannot be found, but useful, implicit relations are easily obtained. For the Pierce circuit, let the reactance of the $L_1 C_1$ circuit be equal to that of a condenser C_p , and let the reactance of the crystal be that of an inductance L_x . With these values the solution of the circuit yields

$$\omega^2 = \frac{1}{L_x} \left[\frac{1}{C_p} \left(1 + \frac{R}{r_p} \right) + \frac{1}{C_g} \left(1 + \frac{R}{r_g} \right) \right] + \frac{1}{C_p C_g r_p r_g} \dots \dots \dots (9)$$

For the Miller circuit, let the reactance of the tank be that of an inductance L_p and let the reactance of the crystal be that of another inductance L_x . With these assumptions the solution of the circuit gives

$$\omega^2 = C_m \left[L_p \left(1 + \frac{R}{r_p} \right) + L_x \left(1 + \frac{R}{r_g} \right) \right] + \frac{L_p L_x}{r_p r_g} \dots \dots \dots (10)$$

In these equations, (9) and (10), r_g and r_p are the grid and plate resistances, respectively, and R is the resistance in the resonator mesh.

In equation (9) the bracketed quantity is subject to little variation because the terms involving resistances are small. Most of the variation in the frequency is due to the last term. All the factors are variables to some extent, and when C_p is very small the term is large. Hence the percentage variation is larger the nearer the tank circuit is to resonance. It will be noticed that the frequency increases as the tank circuit is tuned toward resonance.

In equation (10) also there is little variation in the bracketed quantity because the terms involving resistances are small. And again most of the variation is due to the last term, for it becomes relatively large as L_p increases, and hence as the tank circuit is tuned toward resonance. In this case the frequency decreases as resonance is approached.

Both formulas show that the frequency stability can be improved by making the grid and plate resistances high. It is, of course, not possible to make r_p infinite, but this limitation is not imposed on r_g . It is possible to make it very large, and when this is done most of the frequency variation with changes in operating voltages is eliminated.

CARRIER TELEGRAPH BY ELECTRONIC ORGAN



To illustrate the principle of carrier telegraph using audio frequency carriers, a Hammond Electronic organ was recently employed by Western Union as the carrier generator. New equipment now carries 96 telegraph messages on a single pair, using audio tone generators as the carrier sources

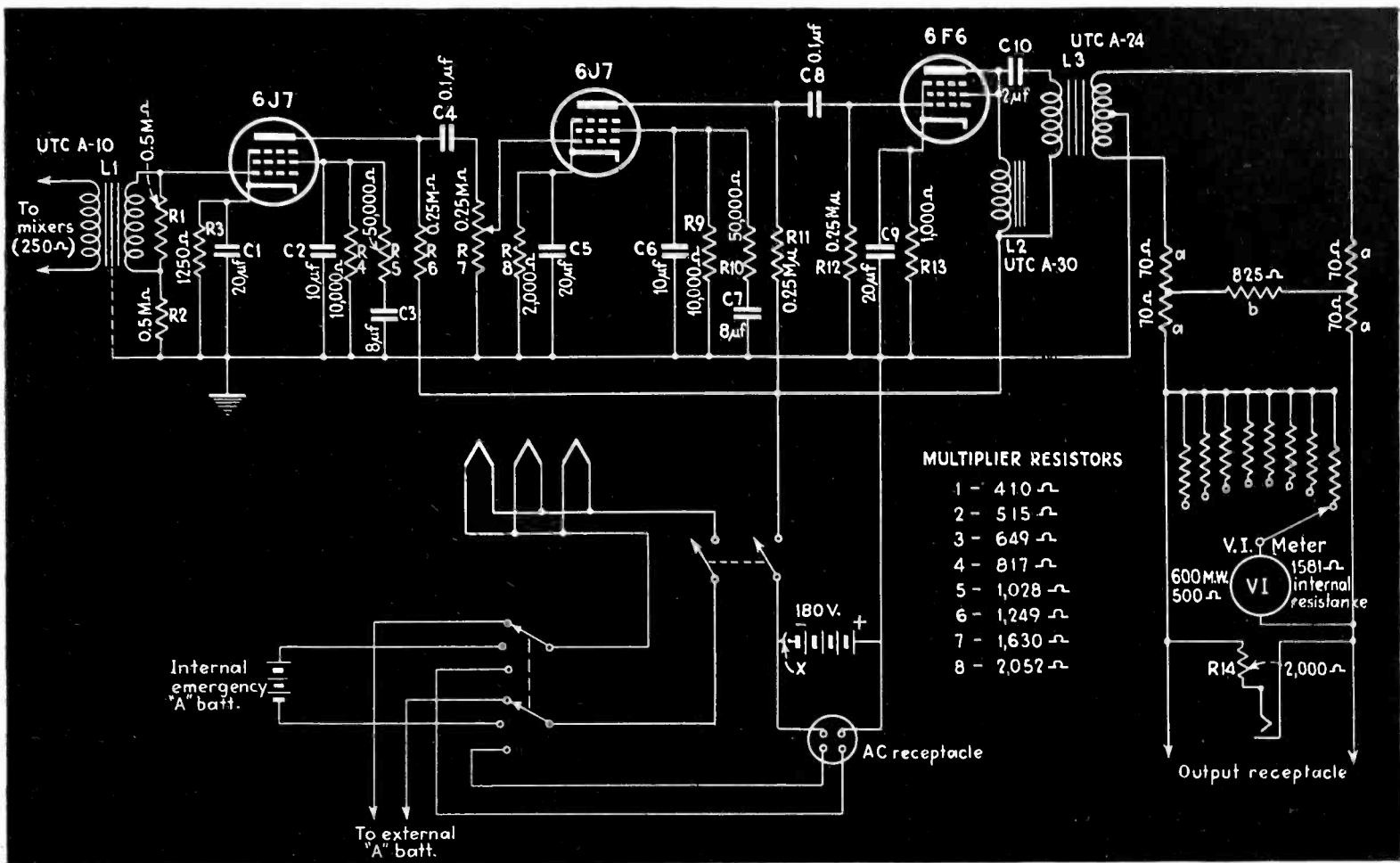

Schematic wiring diagram of remote amplifier at WBNY

THE radio station, where a great number of outside pickups form a large part of the daily operations schedule, must be equipped with a sufficient quantity of high quality amplifiers. Commercial amplifiers meet practically every broadcast demand but are often rather costly. The amplifiers described in this article have been constructed at moderate cost and have given faultless service at WBNY for over one year. They compare favorably with and in some aspects exceed, the characteristics of commercial amplifiers.

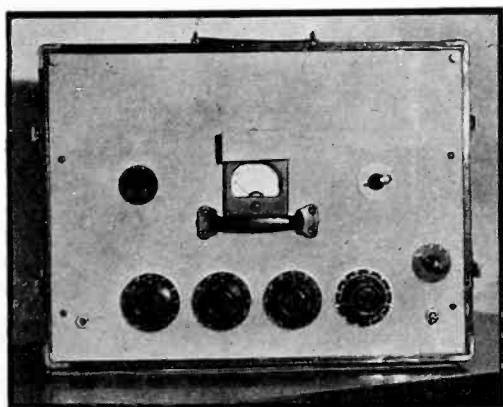

Front panel of large amplifier unit.

Practical Remote Amplifiers

By **ROBERT W. CARLSON**
WBNY, Buffalo

Amplifiers of two sizes have been built and the circuit shown is essentially the same for both. The first two stages use 6J7's as pentodes. A 6F6 in the output stage is operated as a triode. The gain in the first stage of the larger amplifier was increased to compensate for the larger loss in the three-channel mixer. Both amplifiers are nineteen inches wide and six inches deep; one is nine inches high, the other fourteen inches. The panels and chassis are constructed of 16 gauge sheet aluminum. The front lay-outs were made as symmetrical as

possible, and with panels finished in a grey crackle, they present a fairly professional appearance.

The frequency response is plus or minus 1 db from 40 to 10,000 c.p.s. The overall gain is about 105 db including mixers and output pad. The hum level is down 50 db at zero level. Total filament current is 0.9 amperes and the "B" battery drain is 25 milliamperes. Input channels have an impedance of 250 ohms. The output transformer works into a 5 db pad, having 500-ohm input and 500-ohm

(Continued on page 55)

A Laboratory Television Receiver—II

Second in the series of articles describing *Electronics'* television equipment, designed for professional use. Details of the construction of the cathode-ray tube mount, bleeder circuits, and horizontal scanning current generator

By DONALD G. FINK
Managing Editor, Electronics

THE problem of mounting a cathode ray tube for television is complicated by the length of the tube, with the result that vertical mounting has been adopted in most instances. In a rack-and-panel assembly, however, horizontal mounting is to be preferred for structural reasons, and in addition it permits viewing the image directly from the end of the tube. Accordingly the arrangement shown in Fig. 1 was adopted. It consists of a 23-inch chassis, made of non-magnetic material, supported by brackets from a standard rack panel. A square panel of plywood in which a 9½-inch circular opening is cut, receives the face of the tube. A flat brass strip is screwed against the rim of the opening, and covered with a layer of felt weather-stripping to protect the edge of the tube. The plywood panel is supported from the chassis by angles made of brass strip. The socket for the kinescope is supported from the chassis by stand-off insulators, although metal construction can be used equally well. The scanning yoke is supported from the chassis (to remove its weight from the tube, not strictly necessary) by a fiber rod fitted into a brass tube. The connection to the second anode terminal (at right, Fig. 1) is made through a piece of hollow fiber tubing, cut obliquely at the top to fit the tube surface, and supported at the chassis by a collar, similar to those used for mounting electrolytic condensers. The tube slides through

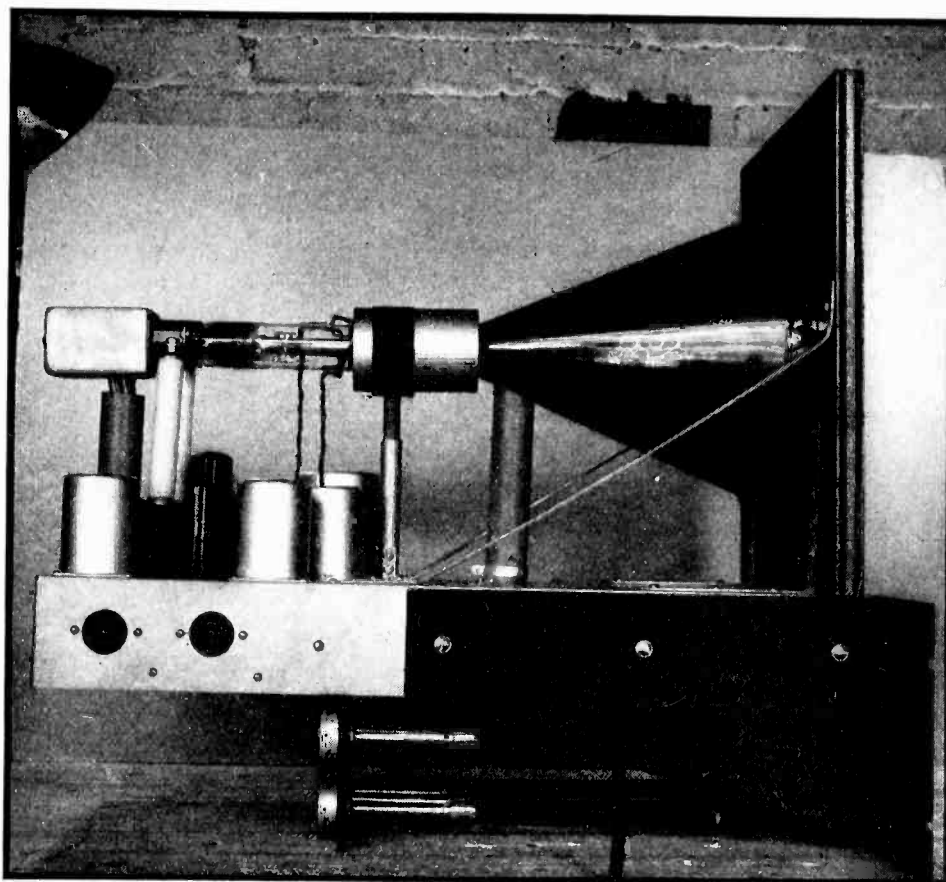

Fig. 1—Side view of the cathode-ray tube mount. The scanning current generators are at the rear of the chassis

this collar into a hole in the chassis, thus giving access to the second anode terminal for disconnecting the clip.

The front panel, through which the tube face is viewed (top, Fig. 2), is a standard loudspeaker panel, having a ten-inch hole. Over the opening is mounted a piece of duplate shatterproof glass, one foot square, drilled at the corners and fitted over bolts tapped into the panel. Cork washers and thumb screws fasten the glass securely. The purpose of the shatterproof plate is protection against flying glass in the event that the tube "implodes". It is wise to handle the kinescope only when wearing shatterproof goggles, for the same reason. The total air pressure on the tube, it must be remembered, is about 3 tons.

The connections to the cathode-ray

tube itself are shown in Fig. 3 and the arrangement of the various circuit parts is shown in Fig. 4. Referring to Fig. 3, it will be seen that the bleeder resistor consists of five separate parts. About 70 per cent of the voltage is taken by the fixed resistor R_1 , which in the present case consists of 15 70,000-ohm units mounted on a laminated bakelite strip and connected in series, the whole having a resistance of about 1.08 megohms. This resistor has never given trouble, and since resistor units are cheap, it is advised that 15 units be employed. Ten units of 110,000 each will serve, but fewer than ten is apt to impose too high a voltage on each unit. The wattage dissipation of R_1 is about 15 watts at maximum voltage, so that one-watt units will suffice if 15 units are employed. If

a tuned filter (see Part I, July issue) is used in the high-voltage power supply, all the resistance values in Fig. 3 should be multiplied by a factor of 5, thus reducing the bleeder current, and avoiding hum difficulties. With the $2\ \mu\text{f}$ capacitor filter described in the previous article, the values shown in Fig. 3 give highly satisfactory performance.

The potentiometer R_5 , the focus control, is a conventional carbon-element 100,000 ohm linear volume control; R_3 is three 50,000-ohm 1-watt units in series, R_4 one 75,000 ohm unit, and R_6 , the brightness control, is a 20,000-ohm wire-wound linear volume control.

The arrangement of the circuit parts is shown in Fig. 4. Resistors R_2 , R_3 , R_4 , and R_6 are mounted on a laminated bakelite strip, with a minimum spacing of $\frac{3}{4}$ inch to the chassis ground. R_2 and R_6 are controlled through six-inch lengths of bakelite rod, which provide the necessary insulation. The resistor R_1 is mounted on 2-inch porcelain stand-off insulators, the high potential end being separated by at least $1\frac{1}{2}$ inches from ground at all points. The lead to the second anode terminal of the tube travels directly from the high potential end of the bleeder through the fiber tubing at the right in Fig. 1.

The leads from the bleed resistors to the socket terminals of the kine-scope are conducted through fiber tubes, one shown vertically to the left of the center in Fig. 4, the other at the left in Fig. 1. The first anode lead is further encased in a sheath of "spaghetti" tubing. The fiber tubing passes directly through the bakelite panel, shown edgewise in

Fig. 4, on which the scanning generator controls are mounted. The heater current is obtained from the scanning power supply chassis.

The cost of parts, including all mounting members, bleeder circuit components, and the cathode ray tube itself, was \$84.54, at customary trade discounts. The cost of the tubes and components in the two scanning current generators, including the yoke, was \$44.33, making a cost of about \$129 for all parts in Figs. 1, 2 and 4.

The cathode-ray tube and bleeder circuits may be tested before the scanning circuits are built, if desired, by the following procedure: The power supply, including the heater current, is turned on with the high voltage auto-transformer control set at about 2500 volts. The brightness control R_6 (Fig. 3) is set with the potentiometer slider at its most negative position (making contact with the ground terminal). The focus control is set at the middle of its range. The brightness control is then advanced slowly from its most negative position. The fluorescent spot should not appear until the brightness control reaches nearly midscale position. The spot should be kept at a brilliance just visible in a dimly lighted room, to avoid burning the screen. Adjustment of the focussing control may then be made to bring the spot into sharpest focus. The procedure may then be repeated, using the full second anode voltage of 5500 volts, taking care to reduce the brightness control to produce a barely visible spot. The sharpness of focus should be appreciably better with the full high voltage than with one-half the full value. The

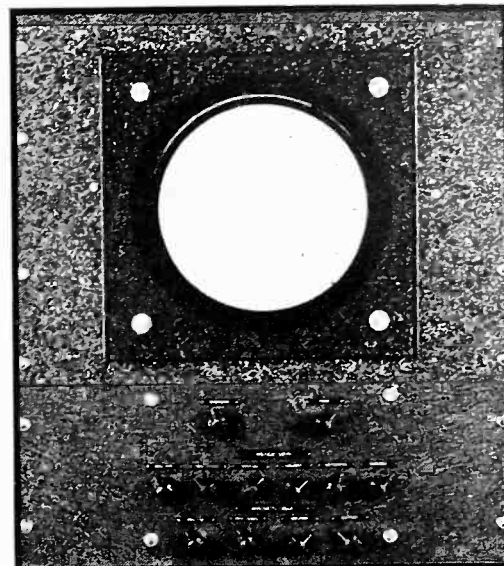

Fig. 2—Front view of the two panels comprising the cathode-ray tube mount. The tube is protected by a plate of shatterproof glass. The brightness and focus controls are at the top, the four horizontal sweep controls at the bottom

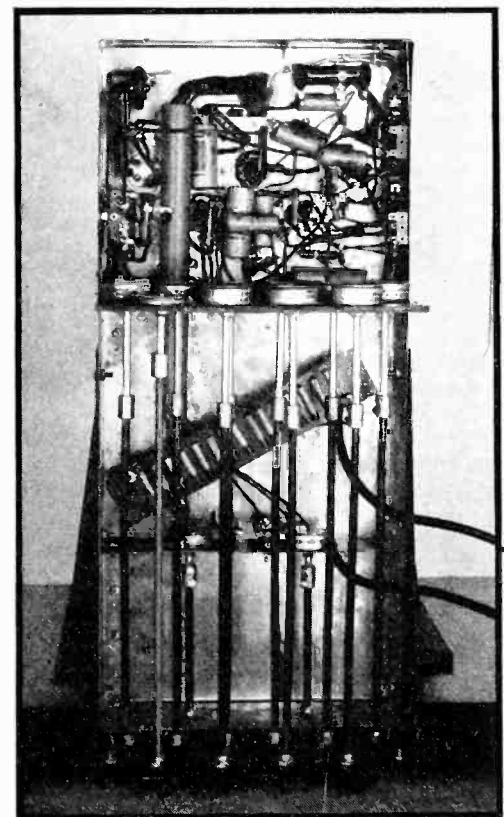

Fig. 4—Bottom view of the chassis. The bleeder components are behind the bakelite extension shafts. The scanning circuits, above, are controlled by ten potentiometers grouped on a bakelite panel

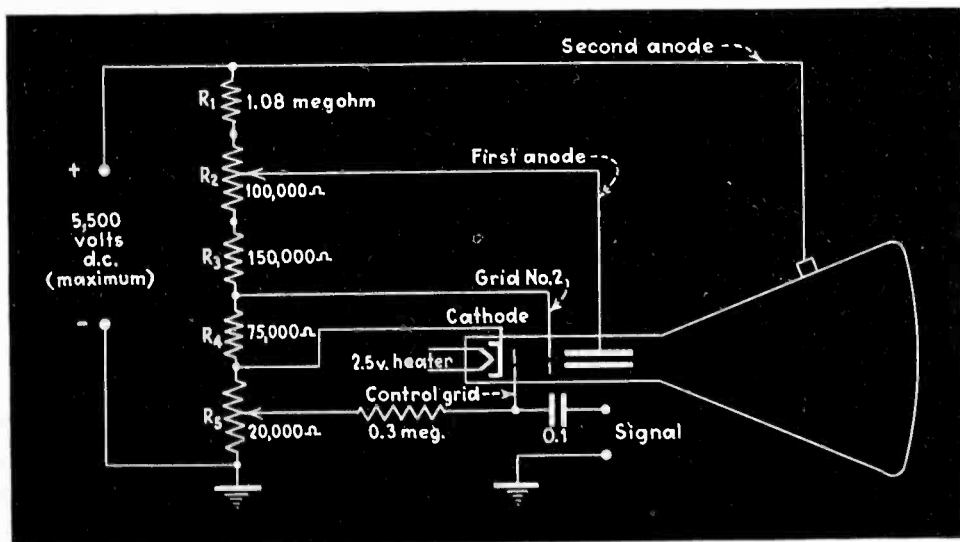

Fig. 3—Bleeder circuit connections. R_5 is the focus control, R_6 the brightness control

spot should be from $\frac{1}{8}$ to $\frac{1}{4}$ inch in diameter at sharpest focus, and its position should not be further than $\frac{1}{2}$ inch from the center of the screen, measured horizontally, otherwise the picture will be off center by an amount which cannot be corrected by the centering control. If the focus control does not bring the spot into focus, it may be necessary

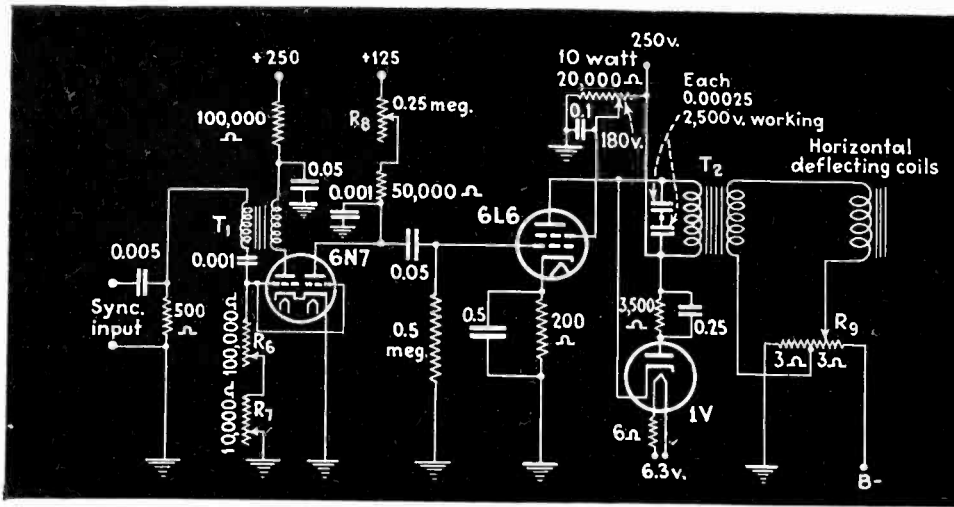

Fig 6—Horizontal scanning generator diagram

to raise or lower the position of R_2 in the bleeder by adding resistance to R_1 and subtracting the same amount from R_3 , or vice versa.

Details of the horizontal scanning generator

Of the two scanning generators, the simplest from the standpoint of controls is the horizontal generator. This generator is intended to produce a current of saw-tooth waveform, at a frequency of 13,230 cps, and of a peak amplitude at maximum operating conditions, of about 200 milliamperes. This current passes through the horizontal deflecting coils of the scanning yoke, and causes the fluorescent spot to scan the horizontal lines in the image.

The connections of the horizontal generator are shown in Fig. 6, while the arrangement of parts, including the vertical generator, is shown in Figs. 4 and 5. Referring to Fig. 6, the circuit consists of two basic parts, a blocking oscillator utilizing a 6N7 twin-triode, and a power amplifier using a 6L6. The latter tube seems to satisfy the problem most satisfactorily from the standpoint of economy. Two type 42 tubes connected in parallel might be used, and a type 807 gives highly satisfactory performance but is considerably more expensive than the 6L6. A third tube, a type 1V rectifier, is used to modify the wave shape of the output current of the 6L6, as illustrated in Figs. 7 and 8.

The blocking oscillator functions as follows: one triode of the 6N7 is connected as a feedback oscillator, the feedback energy being carried through the transformer T_1 . This transformer must allow a high frequency of oscillation, several hun-

dred thousand cycles per second. The transformer used is manufactured by the RCA Manufacturing Company especially for the purpose, under the number 9835. The grid of the oscillator triode is in series with a condenser which is charged by the first few oscillations, thus blocking the tube. The charge from the condenser leaks off through resistors R_6 and R_7 , at a rate determined by the R and C values, thus gradually restoring the amplitude of oscillation. The envelope of these oscillations is thereby given an approximately saw-tooth shape. The oscillations are then demodulated in the other triode of the 6N7, and the envelope is emphasized, relative to the oscillations themselves, by the $0.001 \mu\text{f}$ shunting condenser between plate and ground. As an alternative to the blocking oscillator, a multivibrator may be used. Such a circuit has been described by Wilder in *QST*, page 26, April, 1938.

The envelope is thereafter amplified by the resistance-capacitance coupled 6L6, and applied to the output transformer T_2 . The transformer used depends upon the scanning yoke employed. Two magnetic deflecting yokes are available on the market, those manufactured by the Kenyon Transformer Company and the RCA Manufacturing Company. These companies manufacture a transformer T_2 for use with the corresponding yoke.

In the circuit shown in Fig. 6, four variable controls are shown. R_6 and R_7 , in the blocking-oscillator grid circuit, control the grid discharge rate and, consequently, the frequency of the envelope of the oscillations. By varying R_6 and R_7 from minimum to maximum resistance, the frequency of the output saw-tooth current can be

adjusted from 34,000 cps to 3600 cps. The proper adjustment, 13,230 cps, occurs near the midscale position of the control. The control R_8 , in the plate circuit of the triode section of the 6N7, controls the amplitude of the output by adjusting the plate load and the plate voltage. By adjusting this control, with the power supply voltages shown, the voltage across the horizontal deflecting coils may be adjusted from about 190 volts to 230 volts, measured from peak to peak of the output voltage waveform (Fig. 7). A value of about 200 volts, peak to peak, suffices to deflect the kinescope spot from edge to edge of the

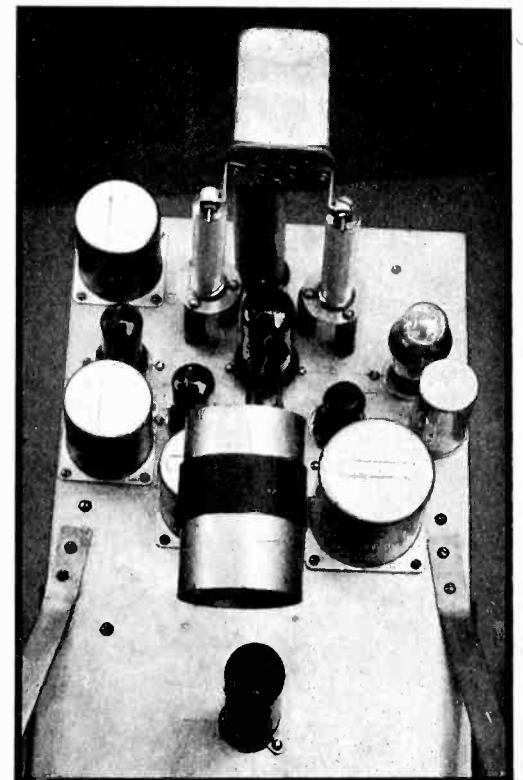

Fig. 5—Scanning-generator tubes, transformers, and yoke. The tubes are, rear row, 6N7 horizontal blocking oscillator, 6L6 horizontal amplifier, 1V damping tube; front row, 6N7 vertical blocking oscillator, 6C5 vertical amplifier

screen when the second anode voltage is 5500 volts.

The fourth control is the centering control, R_9 , shown connected to the output transformer secondary and the deflecting coils. The entire plate current supply of the generator is caused to pass through this resistor. The deflecting coil and transformer secondary, in series, are shunted across part of the resistor, to the left or right of the center-tap as shown. Consequently a direct current is passed through the yoke, sufficient to displace the center of the scanning mo-

tion left or right by about one-half inch, when the second anode voltage is 5500 volts. A further shift, if necessary, may be obtained by shunting a resistance from the terminal marked B— to +250 volts, thereby increasing the current through R_s , and incidentally increasing the load on the power supply.

An essential part of the circuit shown in Fig. 6 is the damping circuit consisting of a 1V rectifier (with 5 volts on the heater) in series with a shunt combination of 3500 ohms and 0.25 μ f. The use of the damping circuit is illustrated in Figs. 7 and 8. With the rectifier out of the socket,

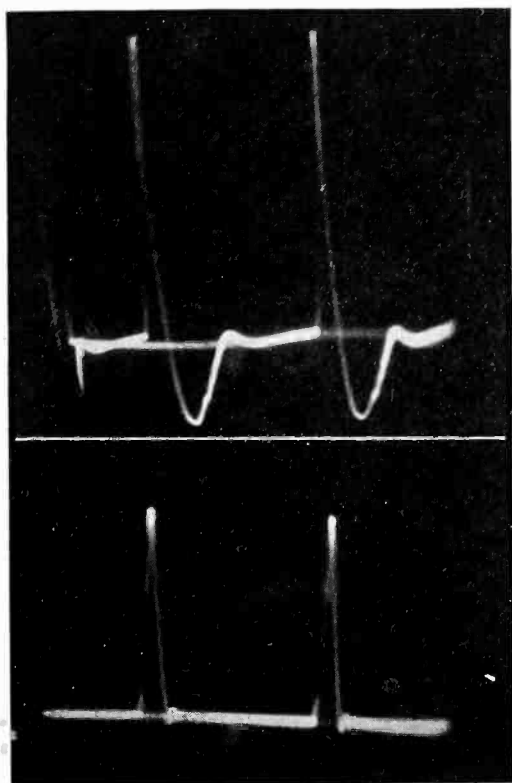

Fig. 7—Oscillograms, taken on test oscilloscope, of voltage appearing across horizontal deflecting-coil terminals. Above, with 1V damping rectifier removed, serious "overshooting" occurs below time axis. Below, with 1V in place, the undesired oscillation is reduced to a negligible amount

the inductance reflected by the transformer T_2 and the deflecting coils to the plate circuit of the 6L6 is sufficient to cause a spurious oscillation at the base of each voltage pulse. The rectifier and RC combination absorb this unwanted "overshoot" to the extent shown in Fig. 7. The slight residual oscillation at the base of the pulse is of no consequence. Adjustment of the value of the resistor in the RC combination may be desirable to obtain optimum absorption. It is not worth while, however, to bring this resistor out to a control on the

front panel. The 1V tube is subjected to considerable voltage stress, since the voltage induced in the output transformer primary by the sudden changes in current may reach very high values on peaks. The voltage also subjects the tube elements to considerable mechanical vibration, which may be audible as a 13,000-cycle hiss. The same peak voltage stresses are applied to the 6L6, but apparently do not cause trouble. In this connection it is wise to use one of the newer 6L6 tubes which have a "button-press" stem in the base.

Due to the inductance present in the deflecting coil, the voltage waveform is appreciably different from the current waveform. Consequently the voltage waveform taken directly from the deflecting coil terminals does not have a saw-tooth form, and is of interest only because it is easy to obtain by connecting terminals of an oscilloscope directly to the coil. To obtain some idea of the saw-tooth wave itself, it is necessary to measure the voltage drop across a resistance in series with the deflecting coil. In obtaining Fig. 8, a resistance of 100 ohms was used, to provide sufficient voltage (about 25 volts) for direct deflection of the oscilloscope. This resistance disturbs the deflecting circuit considerably, but allows some idea of the wave-form to be obtained.

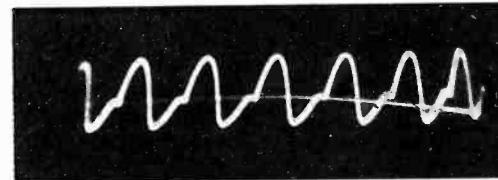
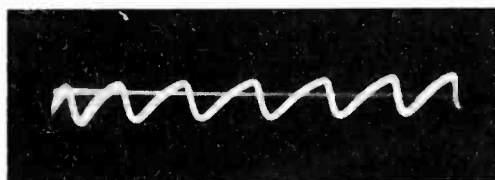

Fig. 8—Oscillograms of the scanning current, taken across 100 ohms resistance in series with horizontal deflecting coil. Right, without rectifier, left with 1V in circuit. Slight non-linearity in curve at left due to presence of measuring resistance

The effect of omitting the rectifier damping circuit is to place a small plateau about half-wave up the forward slope of each saw-tooth, as shown in Fig. 8. The effect of this plateau is seen as a bright vertical line in the middle of the image, accompanied by serious geometrical distortion on either side.

The horizontal generator may be tested by following the procedure previously given for obtaining the fluorescent spot, and by applying the deflecting current to the proper coil in the yoke. The spot should assume the form of a straight line when the scanning generator is turned on. The

length of line should be about equal to the diameter of the kinescope screen when scanning at 13,230 cps (with 5500 volts on the kinescope), and its width should be about 1/50 of an inch at sharpest focus.

To test the synchronizing of the scanning generator circuit, the output of a beat frequency oscillator is connected to the sync input terminals shown in Fig. 6. The beat oscillator is adjusted to 20 volts output at about 13,200 cps, and the frequency controls, R_6 and R_7 , adjusted until the scanning generator locks in with the beat oscillator.

The action of the control grid of the kinescope may also be tested by connecting the output of the beat oscillator, operated at 13,200 cycles, to the terminals marked "signal" in Fig. 3. The synchronizing input is fed simultaneously from the beat oscillator. When so connected, the kinescope should produce a fluorescent line whose length is approximately one half the full length of the line when no signal is applied to the control grid. This follows from the fact that the 20 volt signal is sufficient to blank out the line during the negative half-cycle, while maintaining synchronism with the scanning current. Loss of synchronism in the scanning circuit is very easily determined by noting the length of the

fluorescent line which is produced.

The wave-form of the output of the scanning generator may be easily checked by connecting the test oscilloscope to the deflecting coil terminals, or to a resistance in series with the deflecting coils. The beat oscillator may be used to synchronize the oscilloscope and the scanning generator simultaneously. In that event, the pattern on the oscilloscope will remain stationary, so long as the scanning generator is in synchronism with the beat oscillator.

The next article in this series will describe the vertical scanning generator and sync separator circuits.

NEW BOOKS

Engineering Electronics

By DONALD G. FINK, *Managing Editor McGraw-Hill Book Co., Inc., N. Y., 1938* (358 pages, 216 illustrations, Price \$3.50).

IN THE WORDS of the author "this book has been written to meet the needs of the practicing engineer who has a good foundation in electricity, but who has no specific training in electronic concepts and methods—the author has attempted to steer a course between simple descriptions of equipment on the one hand and elaborate technicalities on the other. It is hoped that the book will serve not only for the practicing engineer but also for the student who wishes to orient himself in the field before undertaking advanced courses. For such purposes the book is adaptable to an introductory course for junior or senior college students in general electrical engineering curricula."

The subject matter of the book is very well organized and presented in such a logical manner that, although intended primarily for use in advanced courses in Engineering or Physics, it could, the reviewer believes, very well be used as a text even in the sophomore year. Since no advanced mathematical treatment is employed, the student who understands high-school algebra and trigonometry will have no difficulty in following the explanations and arguments. He must, however, either have or acquire an un-

PHOTOTUBE CONTROLS MILLING MACHINE

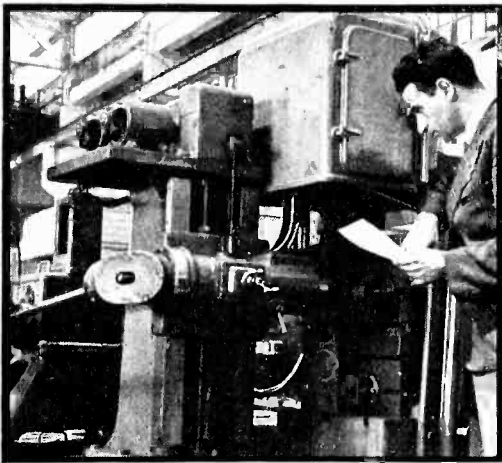

This milling machine, invented by a Russian engineer, machines stock in accordance with a drawing placed in a photo-electric control mechanism. Tests have shown that complicated contours may be milled accurately entirely without the aid of an operator

derstanding of curves plotted on logarithmic scales as such are quite commonly used.

Part I consists of about 90 pages devoted to what the author terms "Physical Electronics", more commonly known as electron physics. This section gives a very clear description of such fundamentals as are necessary for proper understanding of what is to follow in Parts II and III. For example, such subjects as the properties of the electron, the various types of electron emission from solids, the different means and methods of controlling electron flow in a vacuum and, in the final chapter of this section, the more elementary factors of gaseous conduction of electricity are discussed.

Part II—"Electron Tubes" (approximately 130 pages) is devoted, as the name implies, to a description of the structure and essential characteristics of the various types of electron tubes, including thermionic vacuum tubes, gas-filled thermionic tubes, photosensitive tubes and cells, electronic sources of light, and specialized electron tubes. The chapters covering the first three of the above types of tubes are well illustrated with diagrams, curves, and circuits and are sufficiently complete to give the reader a reasonable working knowledge, at least, to the extent and for the purpose intended as indicated in the preface. The other two general types are not treated in similar detail, and properly so, since the subjects are of less general application but enough is given to afford the reader a general knowledge of what the various specific types are and, very briefly, the principles involved in their operation. To do more would obviously require going beyond the scope which the author set for himself.

In Part III "Electron Tube Applications" (approximately 100 pages) the author deals in four chapters with the elements of circuit theory as applied to electron tubes, power transformation circuits, electronic communication circuits, and industrial control and measurement circuits. The first three of these are treated with the clarity and consciousness consistent with that of foregoing sections of the book, but it is the reviewer's opinion that, in view of the diversity of application of electron tubes in the industrial field and of the tendency toward rapid growth in this direction, justice is scarcely done to the subject of the final chapter.

At the end of each chapter is given a fairly complete bibliography insofar as published books are available. There are relatively few references to publications in other form.

Each chapter is also supplemented

with a list of problems which, though, in general, are scarcely of the type to be met in practice by the engineer, do nevertheless illustrate the fundamental principles involved quite well.

A desirable feature in one of the Appendices at the end of the book is a list of all the definitions of electronic terms which have been standardized by sectional committees of the American Standards Association and which are now awaiting final approval by that body. These definitions are also now under consideration for international standardization.

Objection may be raised to the statement that the "accepted names" for gas diodes and triodes are respectively "phanotrons" and "thyratrons", since these terms have not been accepted by any standardizing body. In fact, this statement seems to be refuted by a rather general use of the more descriptive terms, "gas diode", "gas triode", etc., throughout the text.

Some fault, aside from several obvious typographical errors, may also be found with the book by practical engineers and by physicists, the former in that discussion of many practical methods and processes are either incomplete or not entirely correct, (such as the statements with reference to the action of barium-strontium oxide on page 97) and the latter in that a number of statements, though not usually ambiguous, are not exact. There are a few cases where the explanation appears to be questionable as, for example, in Chapter V in the discussion of grid control in a gas triode. In general, however, the book is accurate, is quite readable and should be very useful as a text in engineering schools.

—DAYTON ULREY

• • •

National Union Quick Reference Radio Tube Manual

National Union Radio Corp., Newark, N. J. (Price, \$1.00, 169 pages).

THIS NEW ADDITION to the existing data manuals on receiving tubes gives the operating electrode voltages, capacitances, physical dimensions, socket connections and similar data for the complete line of National Union tubes. No characteristic curves are shown, however.

The book is spiral bound so that it lies flat wherever opened, and is divided into nine groups. The first seven groups deal, respectively, with rectifiers, triode voltage amplifiers, pentode voltage amplifiers, power amplifiers, frequency converters, duplex tubes, and tuning indicators. The eighth section gives data on methods of measuring interelectrode capacitances, contact potential, design of resistance coupled amplifiers, and inherent noises in vacuum tubes. The last section gives a numerical-alphabetical classification together with the equivalent tubes of other manufacture.

—B.D.

Equivalent Resistance Chart

An alignment chart for computing equivalent parallel resistances in circuits containing reactance and series resistance. Applicable also for determining the impedance of tuned circuits at resonance and the Q values of reactive elements

By ALFRED E. TEACHMAN

Woonsocket, R. I.

AN IMPERFECT condenser may be represented by a perfect condenser having a series or shunt resistance producing equivalent losses. The relationship of the equivalent series or shunt resistance is expressed by the formula

$$\text{shunt resistance} = \frac{(\text{Cap. react})^2}{(\text{series resis.})}$$

Thus it is possible to have an imperfect condenser with internal series resistance shunted by an external resistance and by easy computation combine and express the resultant as the equivalent series or shunt resistance. This simplification is a great aid in the solution of many problems. The same proposition, though not so commonly noted, applies equally well to coils having series or shunt resistance. In the formula given above the capacitive reactance is replaced by the inductive reactance.

The alignment chart printed on the reverse side of this sheet makes easy work of conversions. For problems of

are equal. Were these elements without losses the circuit would possess the properties of infinite impedance and zero phase angle. However, series resistance is usually present in one or both arms of the circuit and as a result the circuit behaves as though consisting of a perfect coil and condenser shunted by a high resistance which is the equivalent resistance of the parallel circuit. At resonance the resultant current is in phase with the supply voltage and behaves as a pure resistance.

By use of the conversion scales A and B of the alignment chart, the series resistance of the branch arms may be converted to the equivalent parallel resistances as illustrated by Fig. 2 and by combining these resistances, in parallel, we derive the parallel resistance of the circuit as in Fig. 3.

Most often the condenser used in a parallel tuned circuit has so little loss that it is neglected and the principal resistance residing in the coil determines

and condensers. Since resistance is more commonly associated with coils the term generally refers to them, although the Q of a tuned circuit may be given as the ratio of reactance in one arm to the total series resistance in the circuit. When so used, the quantity of Q also represents the voltage gain of the circuit which means that a voltage induced in the circuit will appear across the coil or condenser terminals multiplied Q times due to the resonance properties of the circuit. The Q of a coil does not vary directly with frequency as might be expected from inspection, but changes rather slowly with frequency due to the compensating effect of the coil resistance which generally increases with frequency. Coils are often rated as having an average Q for a band of frequencies and when used with a nearly perfect condenser the circuit Q is approximately the same as the coil.

When working with Q , X , and R the

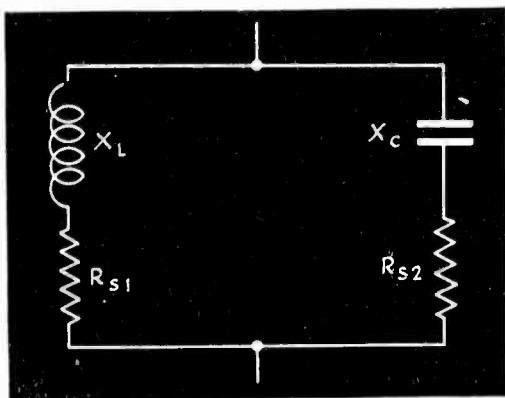

Fig. 1—Parallel tuned circuit containing resistance in each arm

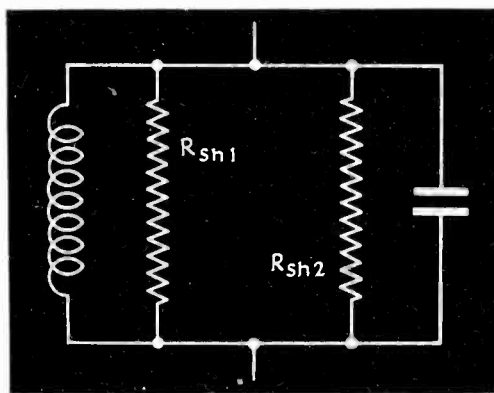

Fig. 2—Series resistances of Fig. 1 converted to equivalent shunt resistances

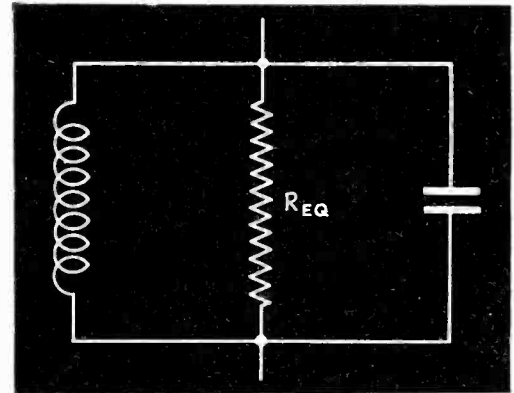

Fig. 3—Shunt resistances of Fig. 2 combined to give equivalent resistance of circuit

this type, the scales A , B , and X are used. As an example, take the dotted line (A). This represents a condenser or coil having a reactance of 2000 ohms with a shunt resistance of 1,000,000 ohms across the terminals. The intercept on scale A gives an equivalent series resistance of 4 ohms which may be added to the known series resistance and the combined value is then carried through the problem as a single term.

Of particular interest are the applications which may be made to parallel tuned circuit calculations at resonance. Most simple parallel tuned circuits may be represented by the equivalent circuit of Fig. 1 in which X_L and X_C

the parallel resistance. When making such an assumption it is only necessary to convert the series coil resistance to the equivalent shunt resistance which becomes the parallel resistance of the tuned circuit. The results obtained by this method are exactly the same as by the formula: $Z_o = X_L^2/R$

As an example: the dotted line (B) is for a coil having a reactance of 1000 ohms and a series resistance of 5 ohms. The equivalent parallel resistance is 200,000 ohms which is also the resistance of the parallel tuned circuit.

The term Q , the ratio, X/R represents a very convenient factor which may be used as a figure of merit in rating coils

corresponding lettered scales are to be used. The dotted line (C) shows that a coil or tuned circuit having a series resistance of 5 ohms and a reactance of 1000 ohms will have a Q of 200. Using a coil having a known average Q value in conjunction with a good condenser, the average parallel resistance of the circuit can be found by placing a straight edge intercepting the Q and reactance values and reading series resistance on the R scale. Then, by transferring the R scale value to scale A and retaining the reactance value, a straight line passing through these points will give the parallel resistance of the tuned circuit as read on the B scale.

Equivalent Resistance Chart

BY ALFRED E. TEACHMAN

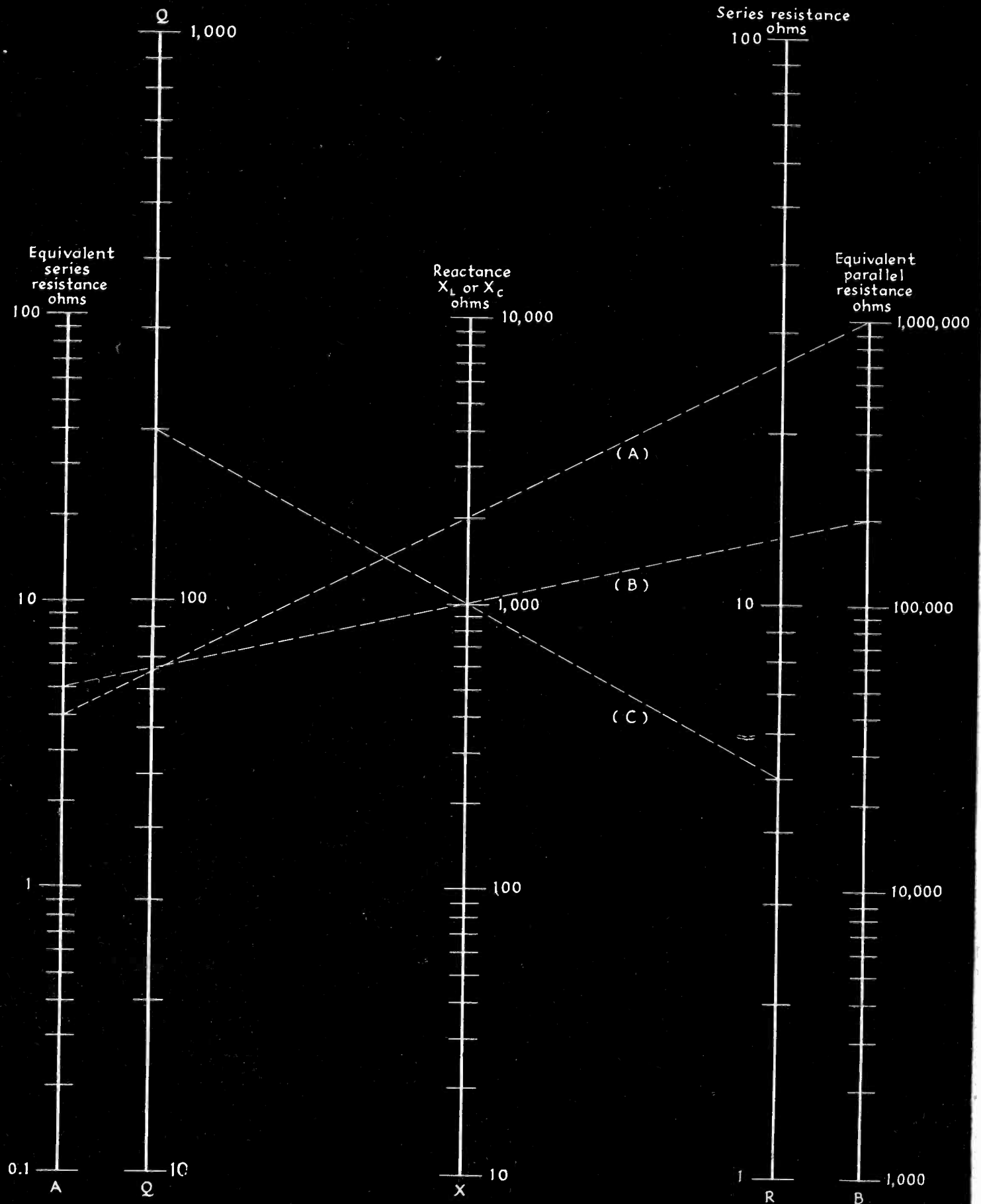

ELECTRONICS REFERENCE SHEET

TUBES AT WORK

Phototubes aid in setting printer's type directly from telegraph signals, and maintain constant temperature in new alloy furnaces. Tube circuits for volume indication and peak metering

Automatic Type-Setting Machine Employs Photoelectric Translation Device

THE FIRST TEST of the Semagraph, an automatic type setting device which permits operating a linotype machine from telegraph signals, was made on June 8 between the offices of the Associated Press in New York and the New York Times. A long-distance test between Charlotte, N. C. and New York was conducted a few days later.

The apparatus consists of four units. The first is similar to a typewriter in form, and is operated by the transmitting operator. It prepares the typewritten copy in lines of equal length, each line in the copy corresponding to one line in the type which is to be set at the receiving end. Under each letter in the copy, the typewriter prints a small code signal, consisting of a combination of six dots. The type bars in

the typewriter mechanism are similar to those of an ordinary typewriter, except that the semagraph signals are added to them. Copy prepared on this typewriter is placed in a transmitting unit, which contains a photoelectric tube and a source of light. The dot signals under each character in the copy are caused to pass between the light source and the phototube, thereby setting up a signal which is transmitted over the telegraph circuit. These signals at the receiving end actuate an ordinary telegraph printer, which has been modified to respond to a 6-unit code signal rather than the ordinary 5-unit code. The telegraph printer has type bars which correspond with those of the original typewriter used at the transmitter. As a consequence, the copy received has exactly the same form as that sent out from the transmitter, including the semagraph signals under each character. The copy is then edited, a line at a time, by the editors at the receiving end of the circuit. After editing, the copy is put in a control unit for the type setting machine. A phototube and light source are used to scan the dot signals under each character in the copy. These dot signals are then amplified and used to vibrate a magnetic armature which releases the proper mechanism in the linotype machine to set the type characters required for that line. This magnetic selector mechanism takes the place of the manually operated keyboard of the ordinary linotype. The tests made by the inventor, Buford L. Green, of Charlotte, N. C., have indicated that speed of operation of the entire system is limited only by the speed of the linotype machine.

SELECTS PROGRAMS A WEEK IN ADVANCE



Harold Kaye with his clock-driven automatic program changer on which he can set up 672 program changes, at 15 minute intervals, throughout the week. According to Mr. Kaye, it has not failed once in more than a year of operation

Electronic Timer Announced for Photographic Purposes

AN ELECTRONIC TIMER, similar in operating principle to that described in the June, 1937 issue of *Electronics* has been recently put on the market. The timer is plugged into a light socket, while the device to be controlled is plugged into an outlet appearing on the timer itself. The timing dial is then set to the required number of seconds, and the control button is pressed down momentarily. Power is thereby applied from the power circuit to the device being controlled, and is



Electronic timing control for photographers

continued for a length of time equal to the setting of the timing dial. At the end of this time the power is automatically removed from the circuit. The total range of timing available is from 0.2 sec. minimum to 100 sec. maximum. A logarithmic timing control is employed which allows all of the time intervals to be included in a single dial. Other ranges are available from 0.2 to 20 sec. and from $\frac{1}{2}$ to 80 sec., the latter being recommended for general use. The power which can be controlled is limited to 800 watts incandescent lamp load, although a special model is available to control up to 1500 watts. The dimensions of the device are 6 $\frac{1}{4}$ in. long, 3 $\frac{1}{2}$ in. wide, 4 $\frac{1}{2}$ in. high.

• • •

Elaborate Temperature Monitoring Equipment Installed in New Alloy Furnace

THREE UNUSUAL ELECTRIC furnaces are nearing completion at the Westinghouse Research Laboratories, to be used

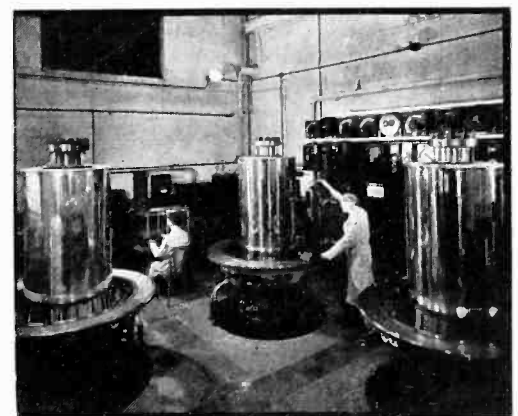

P. G. McVetty, right, with the photo-tube controlled electric furnaces recently installed at the Westinghouse Research Laboratories

for the study of metal alloys used in turbine construction. Temperatures up

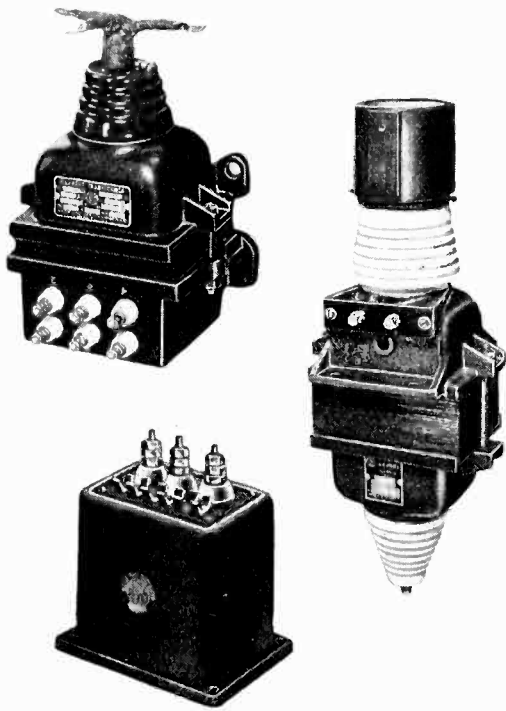

Thinking About FILAMENT TRANSFORMERS?

FILAMENT transformers can do more than provide a source of low voltage for your tube filaments—use of the proper type for each application permits simplifying the construction of your apparatus, improving its appearance, increasing the efficiency and safety factor and reducing the cost. Investigate the possibilities offered by AmerTran's new line which contains nearly 200 standard listings for popular tubes from which to make a selection. Conventional types for all tubes are available in seven different test voltage ratings. The line also includes scott-connected units for three-phase circuits and transformers with the tube socket mounted on the high-voltage bushing to simplify your wiring. All types are vacuum-varnish impregnated and have compound-filled mountings, ceramic terminals and primary taps. May we send Bulletin 1005?

AMERICAN TRANSFORMER CO.

178 Emmet St.,



Newark, N. J.

AMERTRAN

AMERTRAN ELECTRONIC PRODUCTS

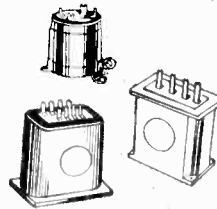

AUDIO FREQUENCY
COMPONENTS

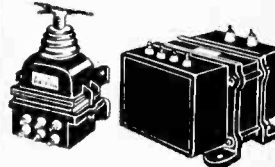

AIR INSULATED
RECTIFIER COMPONENTS



MANUALLY OPERATED
VOLTAGE REGULATORS



LINE EQUALIZERS

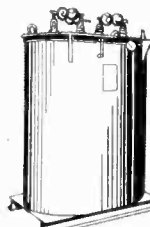

OIL IMMERSED
TRANSFORMERS



RECTIFIERS

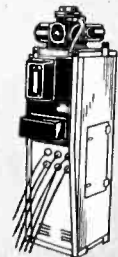

AUTOMATIC
VOLTAGE REGULATORS

to 1,000 deg. F. are to be obtained and maintained within 10 deg. or less. Phototube control of the heating current will be used for this purpose. In the walls of each of the furnaces a total of 125 thermocouples have been installed for monitoring the distribution of temperature. Individual wires connected with thermocouples are used for indication. Tests to be conducted involve the measurement of "creep" or deformation of steel alloys under high temperatures. In turbine operation, such deformation is apt to result in collision between the turbine blades and the outer frame, since the spacing between the two must be kept to a few thousandths of an inch for efficient operation. Each of the furnaces will accommodate twelve 20-in. test samples of alloy, each of which is subdivided into five sections, making 60 tests simultaneously.

"Ticker Tape" Records Eye Movements

H. H. SLAWSON

USING THE MINUTE electrical energy developed by the moving eye itself, Dr. Ward C. Halstead of the University of Chicago has developed a new "ticker tape" method for recording eye movements of a person while his eyelids are closed. The method is used to facilitate analysis of brain lesions in mental cases.

The eye acts like a miniature battery with a strength of a few microvolts. Every time the eye moves

SHIELD CAGE USED IN STUDY OF BRAIN ELECTRICITY



At the exhibit of the American Psychiatric Association in San Francisco, this bio-electrical potential measuring equipment was shown. The minute potentials are measured within a wire cage, eventually record themselves on the tape at the left

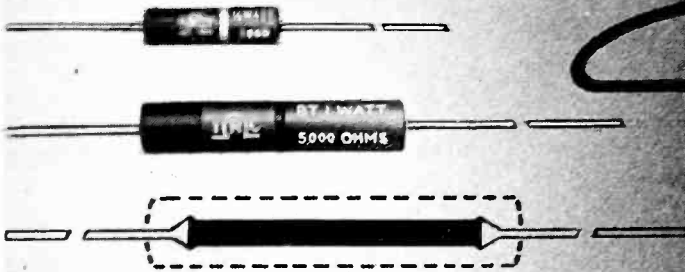

This Type BT Resistor is an example of the homogeneous "Metallized" resistance material bonded to the outer surface of a sturdy glass tube and encased in a protective covering.

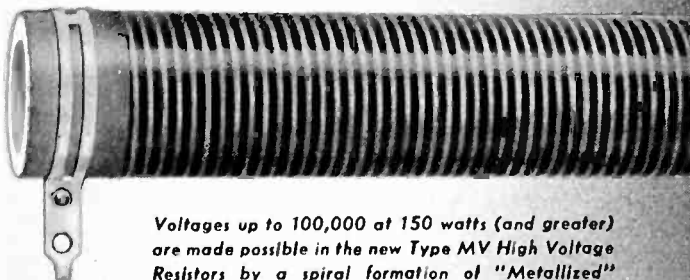

Voltages up to 100,000 at 150 watts (and greater) are made possible in the new Type MV High Voltage Resistors by a spiral formation of "Metallized" resistance element on a ceramic base.

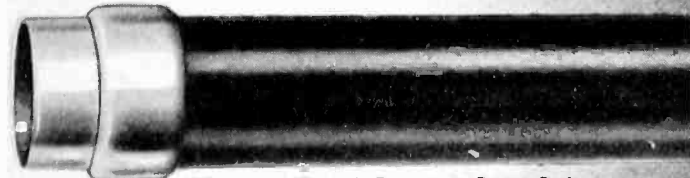

In IRC Type MP High Frequency Power Resistors, the "Metallized" element is applied solidly over a ceramic surface. Excellent characteristics at ultra-high frequencies of more than 75 megohms result.

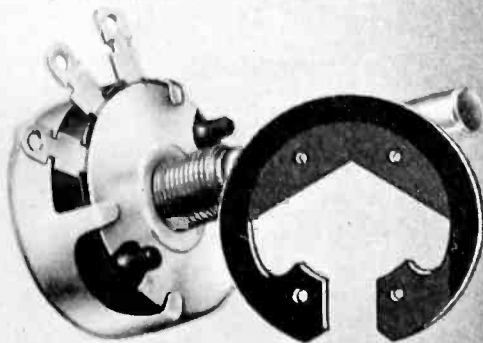

Bonded to a phenolic base in IRC Controls, the "Metallized" element set new standards for quietness, smoothness and protection against moisture.

WHAT ARE "Metallized" RESISTORS?

"Metallized" Resistors differ from conventional units in that a homogeneous film of high resistance material is applied and bonded at high temperatures to insulating bases of various types. The result of this process is a resistance element of predetermined resistance value and accuracy. This process, time-tested throughout 16 years, has been utilized and perfected for seven distinctive types of resistors, each one internationally known for its exceptional quality:

The Type BT "Metallized" Resistors, completely insulated in phenolic, and the Type F protected by ceramic, are perhaps the best known for radio and high frequency service.

Types FH and MG, protected by ceramic or glass, are made from 100 to 100,000 megohms and have long been standard for certain kinds of scientific apparatus.

The Types C and CS (Silent Spiral Connector) "Metallized" Controls have established new standards for volume control, tone, and potentiometer applications wherever radios are made.

Type MP — a recently developed resistor for high frequency needs—is rapidly solving dummy load and rhombic problems for transmitting engineers in the ultra high frequency field.

The New Type MV, a high voltage "Metallized" Resistor, is capable of carrying 50,000 volts on a 10 1/2" x 1 1/8" tube with characteristics similar to that of a standard BT unit of low value. It opens new possibilities for the design of high voltage equipment.

The inherent characteristics of "Metallized" Resistors are stability, low noise level, uniformity, non-ageing, low voltage and temperature coefficient and freedom from major humidity effects.

No other type of resistance material holds such an outstanding record of success. None holds such broad possibilities for future development.

Write for new IRC Engineering Data Bulletins Nos. 1 and 2.

INTERNATIONAL RESISTANCE COMPANY

401 NORTH BROAD STREET, PHILADELPHIA, PA.

Factories or Licensees in Canada, England, France, Germany, Italy, Denmark and Australia

MAKERS OF RESISTANCE UNITS OF MORE TYPES, IN MORE SHAPES, FOR MORE APPLICATIONS THAN ANY OTHER MANUFACTURER IN THE WORLD

GLOBALBAR OFFERS MANY

REG. U. S. PAT. OFF.

SHAPES, SIZES AND TYPES OF CERAMIC RESISTORS

*Write us concerning
your difficult
resistance problems*

THEY ARE OUR SPECIALTY

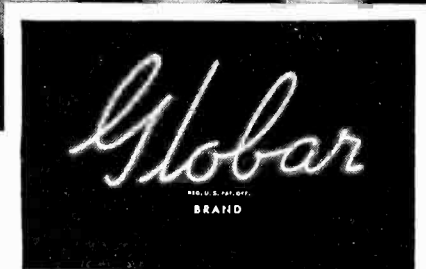
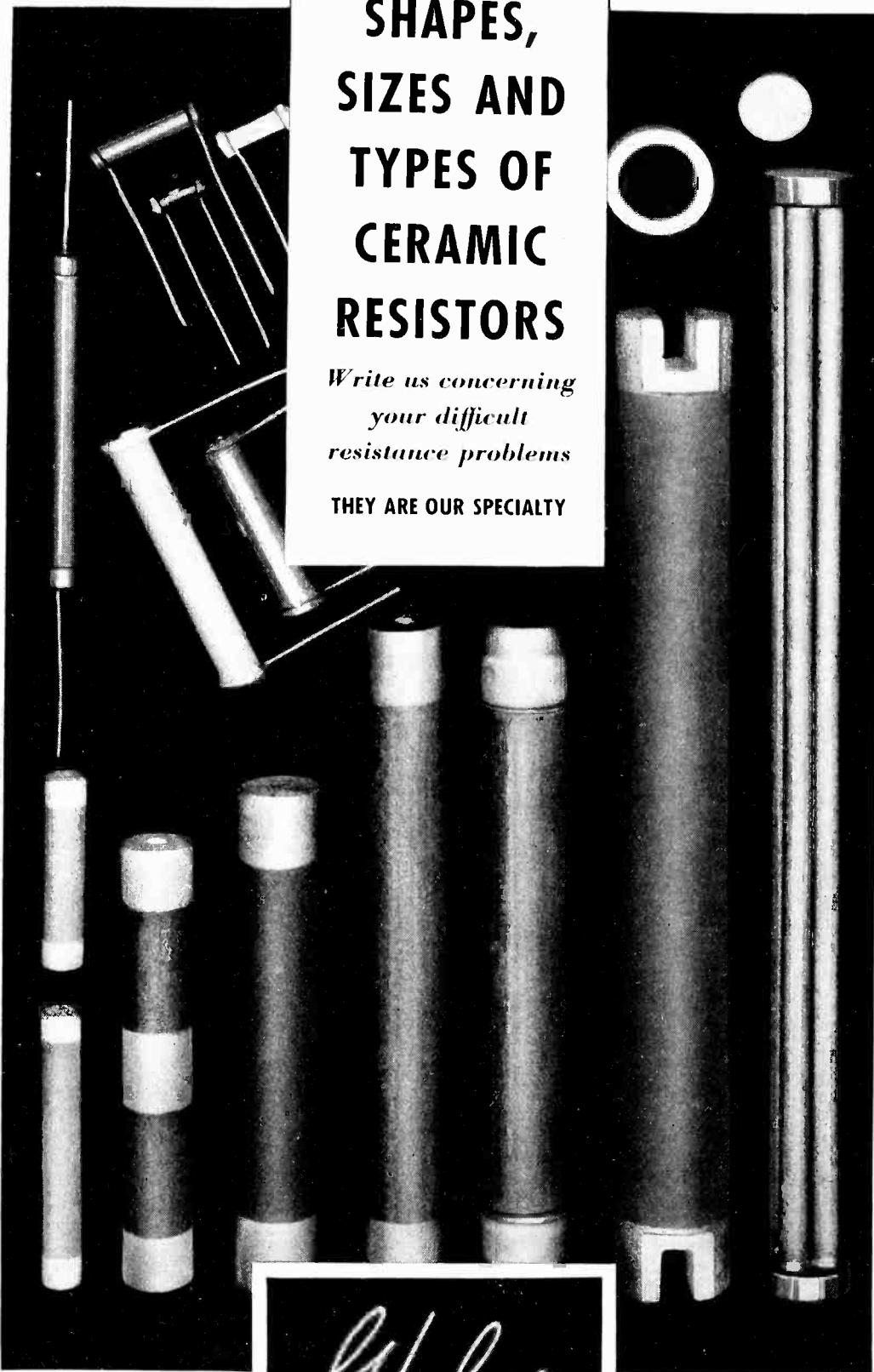

GLOBAR DIVISION
THE CARBORUNDUM COMPANY • NIAGARA FALLS, N. Y.

REG. U. S. PAT. OFF.

Sales Offices and Warehouses in New York, Chicago, Philadelphia, Detroit, Cleveland, Boston,
Pittsburgh, Cincinnati, Grand Rapids
(Carborundum and Globar are registered trade-marks of The Carborundum Company)

is detectable by the new device. On each side of the eye electrodes are placed to pick up the tiny current and carry it to a specially constructed amplifier. The amplifier manipulates a recording pen on waxed ticker tape paper, making a graph of the eye movement.

In a statement issued by the University announcing the new apparatus, Dr. Halstead said that reliable records of the direction and extent of eye movements are possible while the subject is walking around a room, an achievement important in mental cases and not possible with other methods of recording eye movements. While the technique has been used successfully on subjects with eyelids closed, he stated, further experimentation is in progress. The interesting possibility of recording eye movements while the subject is asleep is still to be explored.

With the new device the operator can directly control the extent to which the subject can hold his eyes still during examination. The device is also used in recording eye movements of patients with aphasia, that is, those suffering from loss of language, stuttering, stammering or amnesia and in studies of pseudo-hallucination, fantasy and imagination.

Dr. Halstead is a member of the staff of the Otho S. A. Sprague Memorial Institute in the Division of Psychiatry of the University of Chicago clinics. It was the involuntary movement of the eyes in a brain case he was studying two years ago, he said, which led to development of the method.

VARIABLE FREQUENCY TRANSMITTER FOR IONOSPHERE STUDIES

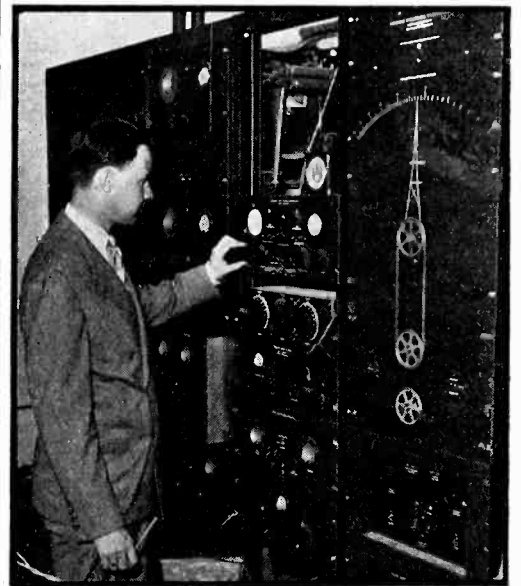

The pointer at the right is the tuning dial of the ionosphere transmitter at Harvard University used to obtain wave-reflection data at different frequencies. At the left is H. R. Mimno, Director of the Ionosphere Observatory

Announcing the
QUAM PERMANIC

Patents Pending

DYNAMIC PERFORMANCE
at 70% of Dynamic Cost!

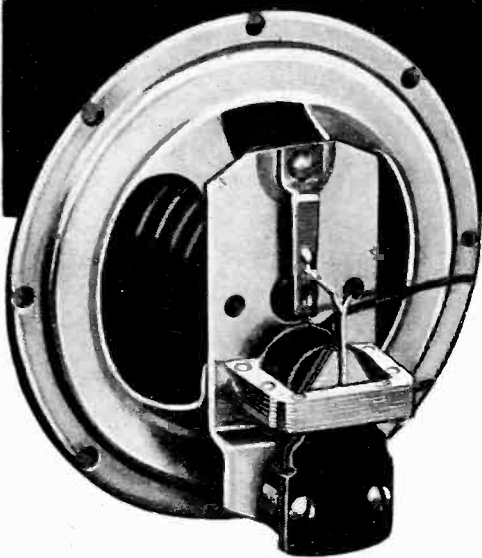

EXAMINE THIS
 COMPARATIVE
 RESPONSE CURVE

Built in
 5", 5½", 6½"
 and 8" sizes

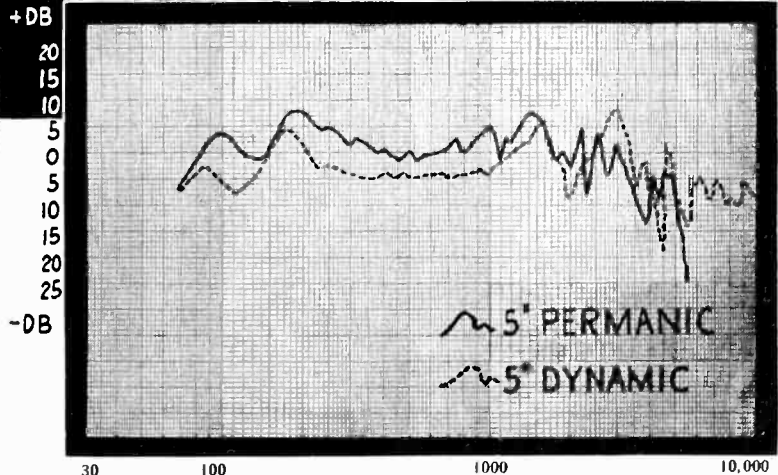

Not just another speaker, but one that is absolutely new and revolutionary in design and construction, with amazingly good performance characteristics that equal and exceed those of a large percentage of dynamics used today at only 70% of the cost. With better sensitivity and

Bass Response than these Dynamics, it has equivalent Power Output, cuts down Rectifier Drain and offers the added advantage of light weight and more compact design. It is the ideal speaker for moderately priced receivers. Mail the coupon today for complete details on the new QUAM PERMANIC!

Perfectly Suited for use as Microphone-Speaker in Inter-Office Communication Systems



MAIL THIS COUPON!

QUAM-NICHOLS CO.

Cottage Grove at 33rd Place, Chicago

Please send me complete details of new Quam PERMANIC Speaker.

Name

Company

Address

FOR Beauty IN APPEARANCE

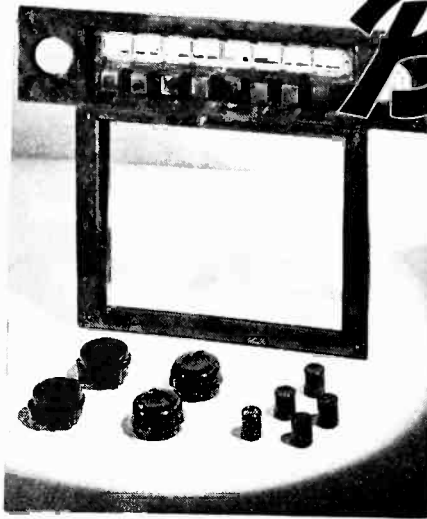

Plastics and push-button tuning go hand in hand. For outright beauty nothing can equal Erie Custom Molded Bezels, originated and perfected by Erie Plastics Engineers. Either flat or curved glass and metal inserts for holding the push buttons are injection molded into a colorful plastic frame in one operation. Erie molded push-buttons, designed to fit any standard switch, can be supplied from either a stock mold or one of custom design.

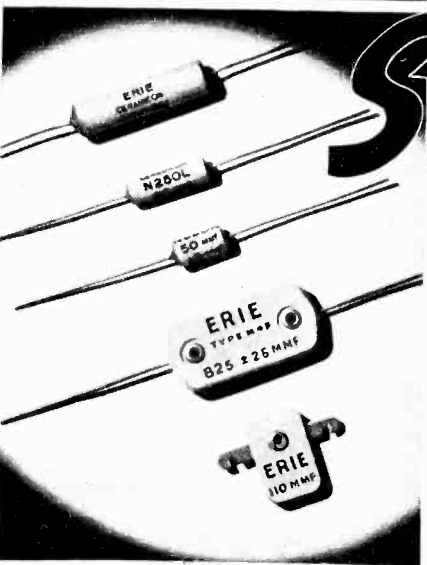

Stability IN TUNING

Whether you use electric motor or condenser type tuning, there's one way to keep the LxC product constant. Use Erie Compensating Ceramicons, the new silver-ceramic fixed condensers, or Erie Silver-Mica Condensers in your tuned oscillator circuits. Erie Ceramicons have a definite, linear and reproducible temperature coefficient which can be supplied in any specified value between $-.00068$ and $+.00012$ mmf/mm $^{\circ}$ C. Erie Silver-Mica Condensers have a temperature coefficient of only $+.000025$ mmf/mm $^{\circ}$ C.

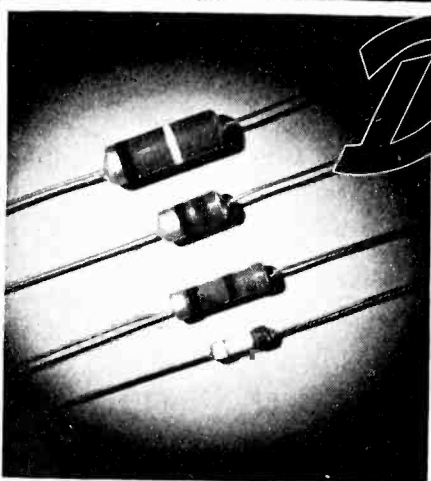

Dependability IN OPERATION

Erie Resistors give uniformly superior results in all standard tests for load, voltage, humidity and noise. That's why they can be used in any part of the circuit without changing excessively in value. Erie Resistors are made in both plain and insulated types in four sizes that will cover practically all resistor requirements.

Use
ERIE PLASTICS • ERIE CERAMICONS
ERIE SILVER-MICA CONDENSERS
ERIE RESISTORS
In Push-Button Tuned Receivers

ERIE RESISTOR CORPORATION, Erie, Pa.

TORONTO, CANADA • LONDON, ENGLAND • PARIS, FRANCE - J. E. CANETTI CO.

RESISTORS • SUPPRESSORS • CERAMICONS • INJECTION MOLDED PLASTICS

A Single-tube "Floating Needle" Volume Indicator

H. C. LIKEL
Chief Engineer
Pacent Engineering Corporation

THE VOLUME INDICATOR described herein was developed to produce an instrument free from the usual defects, such as sluggish response on the one hand or too rapid response on the other, and at the same time to keep cost at a minimum. Experience indicates that the meter type of indicator with "floating needle" action is desirable, that is, an indicator in which the meter needle rises rapidly in response to increases in the volume level and then returns at a slower rate. This type of indication gives good dynamic response but at the same time allows opportunity for the eye to register the peak values.

Although a variety of tubes could be used, the tube shown in the circuits given is a double-triode, such as the 6N7, one set of elements being connected as a diode, the other as a direct coupled amplifier. In the circuit of Figure 1a, which cannot be used on a grounded line, the meter reading decreases as the volume increases, thus preventing burnout on overloads. The

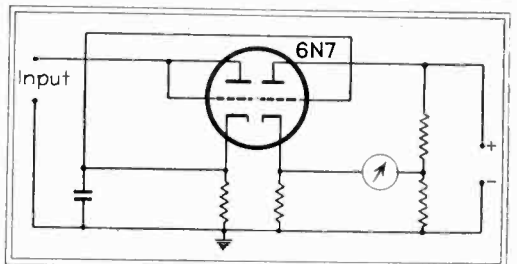
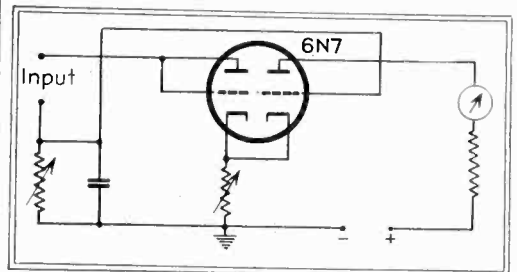

Fig. 1-(a), above, "floating needle" indicator for use with ungrounded line. Below (b), circuit suitable for grounded line, giving left-to-right indications

cathode and plate resistors are adjusted to give full scale reading with no signal. The main disadvantage is the fact that increases in volume are indicated from right to left. By adjusting the torsion spring of the meter action so that the needle normally (at no current) rests at full scale and by reversing the polarity, the indications may be made left-to-right.

The circuit in Fig. 1b has left-to-right indication and can be operated on a grounded line. However, it is subject to burnout due to overload or failure of the tube and the circuit constants must be adjusted if the plate current of the tube changes, and when a new tube replaces an old one.

The circuit in Fig. 2, while not so

NEW

LOW-DRAIN BATTERY TUBES!

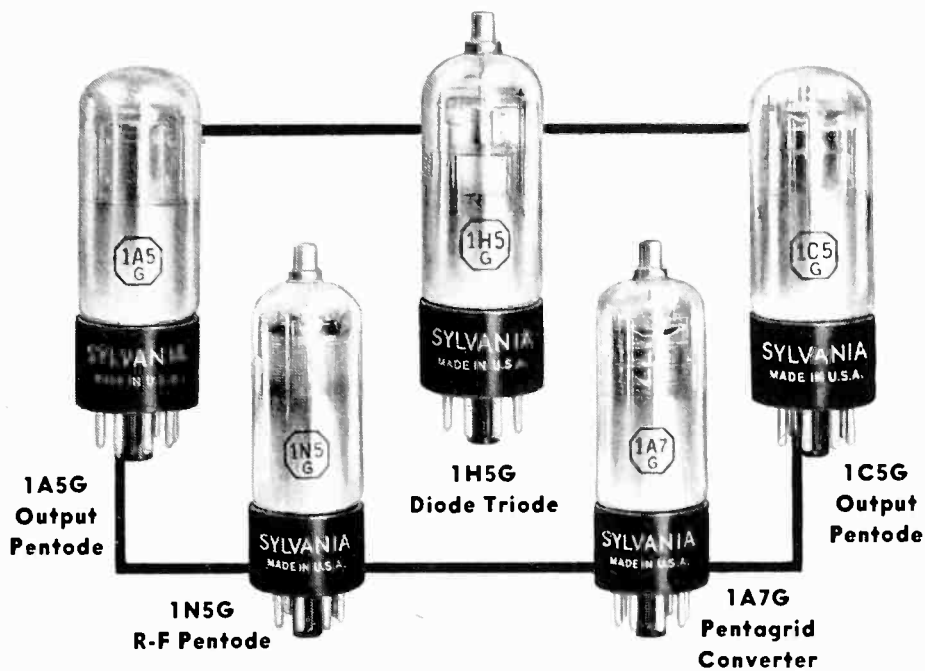

Sylvania presents an important contribution to the radio industry

A new and completely different line of tubes for battery radios has been perfected in our engineering laboratories. These new tubes are conspicuous for features embodying a highly desirable combination of both operation and space economy in battery radio sets.

Note these characteristics:

- Low current drain—.05 ampere at 1.4 volts on all types except 1C5G, .10 ampere.
- Twice normal battery life.
- Less battery space—only 90 volt B battery

- required—no C battery needed.
- Less tube space—T.9 envelope used.

These five Sylvania low current drain tubes are a complete complement for the design of any type of battery receiver. To the farm market, to the extra set and portable set market which reaches into every family, this new development is most significant. Write today to the Hygrade Sylvania Corporation, Emporium, Pa., for complete technical information.

SYLVANIA

SET-TESTED RADIO TUBES

LEAR AIRCRAFT Radio Equipment

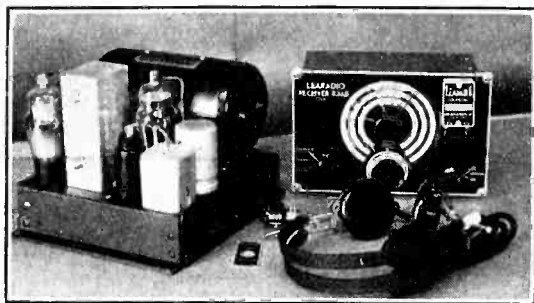

Sensitivity: 2 microvolts or less.
Signal to noise ratio: 4 to 1 or better.
Selectivity: 10 to 15 KC wide at 60 db. down.
500 to 1000 milliwatts output. No overload.

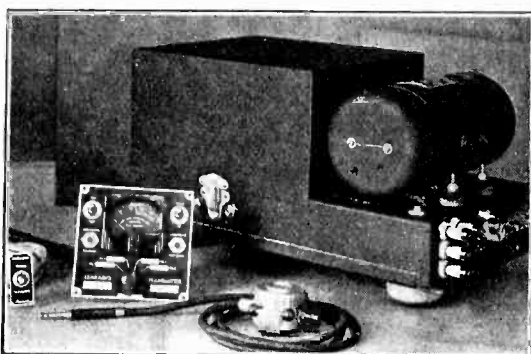

● CRYSTAL CONTROLLED RECEIVER

The R-3-AB is the first receiver with crystal holder plug provided on face of receiver with a crystal switch, allowing crystal locked reception of any frequency on any of the three bands—Beacon Broadcast and Communication.

The tuning section, separated from amplifier section, reduces size and weight of tuning unit, eliminates remote control apparatus, tuning heads, mechanical shafts, etc. This reduces weight, bulk, cost and insures better resettability.

● LEARADIO UT-6 SIX-FREQUENCY TRANSMITTER

Furnishes pilot almost instantaneous choice of transmission on six frequencies. No adjustments—simple to operate and install. 30 to 40 watts. Compact and light-weight (28 lbs.).

Interphone, sidetone. Excellent voice and MCW. Built to meet Army, Navy and Department of Commerce specifications.

● LEARADIO T-30-AB TRANSMITTER

Remote, crystal controlled. 30 watts on phone or MCW. Weighs 19 lbs. A complementary unit to the R-3-AB receiver, the combination of which weighs only 28 pounds, complete with cables. Advanced performance, minimum weight and low price.

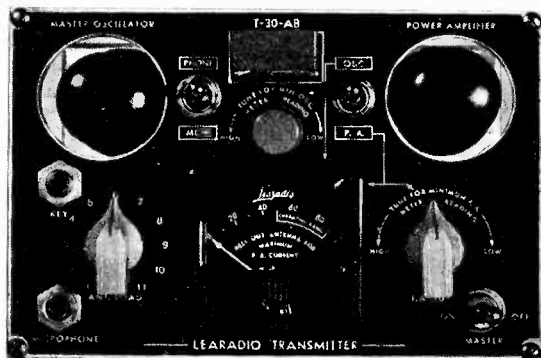

● LEARADIO UNIHAND REEL AN AUTOMATIC SPRING LOADED FAIRLEAD

Entirely new in antenna systems for aircraft—designed to meet operating problems involved—can be operated with one hand. Simple, foolproof, reliable. Prevents loss of weights, insure better transmitting range, improved reception. Fixed antenna may be automatically connected to transmitter through loading coil when trailing antenna is fully retracted, providing excellent transmission for takeoff, landings.

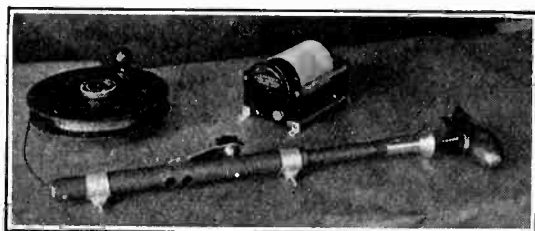

● NEW LEARADIO COMPASS

New Learadio ARC-6 Radio Compass and Direction Finder. Low weight, small size. New dynamotor power. New efficiency and automatic action. Ask for further data. Whatever your requirements for aircraft communication or direction finding equipment, investigate LEARADIO before deciding. We carry a complete line of tuning units, insulators, wire, switches, relays, etc.

Engineering, Installation and Service on All Types of Aircraft Radio

**GROUND STATIONS
ULTRA HIGH FREQUENCY
DIRECTION FINDERS
AUXILIARY POWER PLANTS
Aircraft Radio Compasses
Aircraft Radio Transmitters
Aircraft Radio Receivers
Portable Radios**

LEAR DEVELOPMENTS

INCORPORATED

ROOSEVELT FIELD

MINEOLA, L. I., N. Y.

Export Dept., 17 State Street, New York, N. Y. Cable Address: LEARVELOP
Telephones: GARDEN CITY 2840—VIGILANT 4-6380 (Direct N. Y. Wire)

versatile as those in Fig. 1, is very simple and has excellent "floating needle" action. As in all the circuits, the rate at which the needle returns from a volume peak is determined by the values of the resistor and capacitor used in the diode circuit. Since the R. and C. values also determine to a great extent the input impedance of the circuit, it is necessary to select them with this requirement in mind. A resistor in series with the meter is used to limit the meter reading to full scale at no signal. If a high plate voltage is used, the difference between new and replaced tubes may be minimized, since the series resistor then has a large value relative to the D.C. plate resistance of the tube. The volume increase indications, as in the circuit of Fig. 1a, are normally right-to-left, but may be reversed in direction by adjustment of the meter action as outlined above.

In operation then, the meter indicates maximum volume when the amplifier is turned off. When turned on the pointer

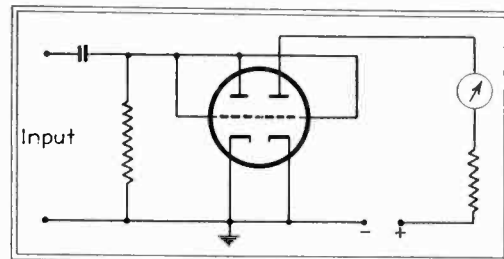

Fig. 2—Simple circuit using double triode, two resistors and a capacitor

gradually returns to the "zero" volume point as the associated tube warms up. Thereafter a signal will cause variations in the indicated level. The initial motion of the pointer in dropping to zero indicates the proper operation of the instrument, and if it draws its potentials from the associated amplifier indicates in a general way that it is operating properly, as well.

Any d'Arsonval type meter may be used, even the most inexpensive giving satisfactory service. For best results a meter having a high speed action and good damping should be used. Proper selection of circuit constants will result in the instrument responding over the range desired. It would be difficult to suggest constants, however, as the combinations of input voltages, plate voltages and spread of scale are so great as to be almost infinite and a proper set of constants must be found for each application.

Automatic Adjustment for Modulation Indicator

ROBERT W. CARLSON

IN A TRANSMITTER designed for a change of power from day to night ratings, the use of a modulation indicator, must entail some provision for the change of input to the modulation indicator. This provision can be made in any transmitter using a dropping re-

NEW LENZ SHIELDED AUTO RADIO LEAD-IN

**KNOCKS CAPACITY
TO A NEW LOW!**

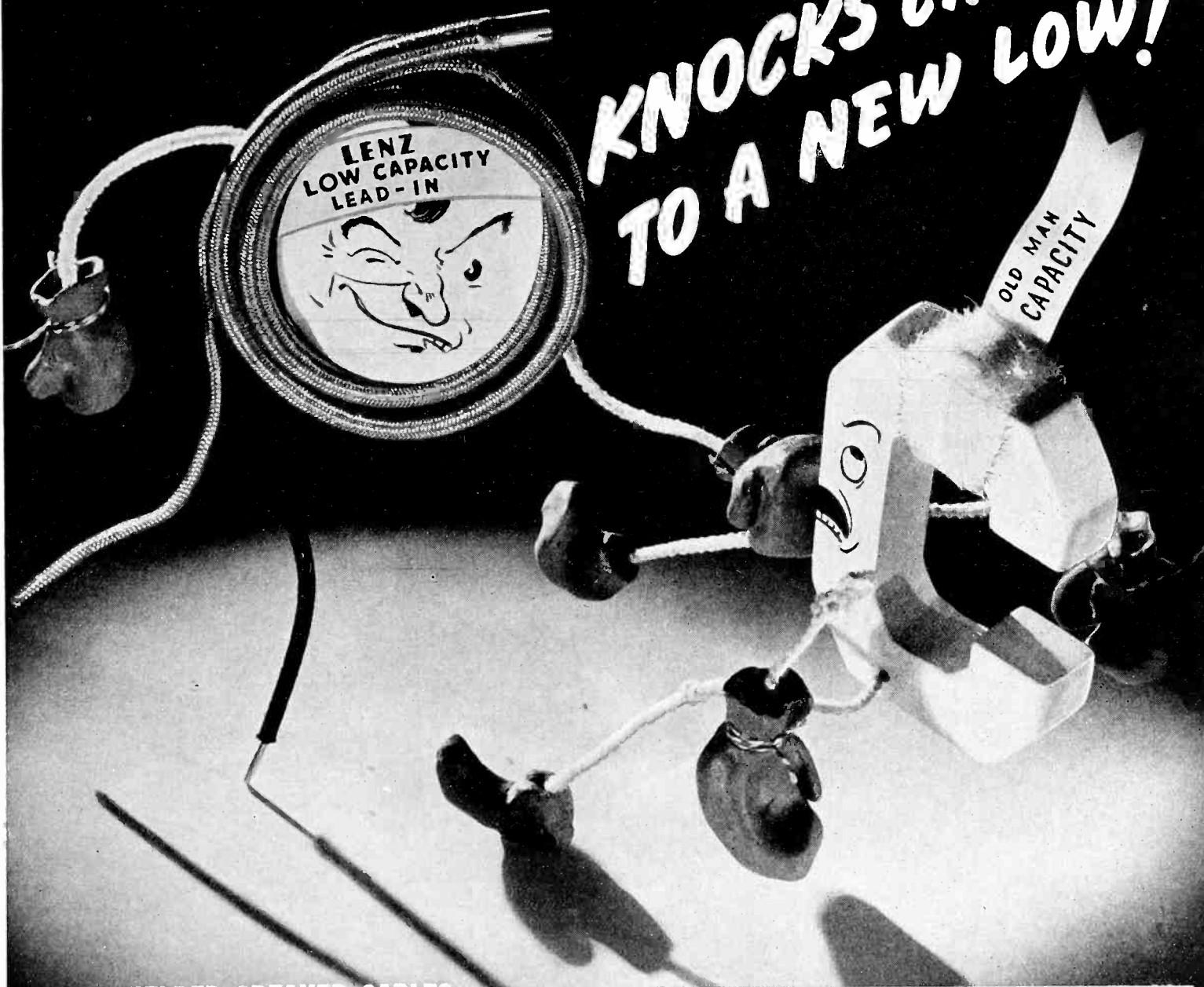

**SHIELDED SPEAKER CABLES
SHIELDED BATTERY CABLES
CHASSIS HOOK-UP WIRE
COPPER BONDING BRAID**

- ★ Mistracking reduced due to minimum capacity
- ★ Higher Antenna Gain
- ★ Better Signal-to-Noise Ratio
- ★ Excellent Mechanical Properties



"In Business Since 1904"
**LENZ ELECTRIC
MANUFACTURING CO.**
1751 NORTH WESTERN AVE., CHICAGO, ILL.

LENZ ELECTRIC MANUFACTURING CO.
1751 No. Western Ave., Chicago

Gentlemen: Please send me FREE
.....ft. sample of Lenz Shielded
Low Capacity Auto Radio Lead-in.

Name
Position
Company
Address



sistor to accomplish the change in power as shown in diagram.

Since a wide variation of voltages can usually be found by tapping off the inserted resistance, as shown, almost any relay on hand can be used successfully. If the parallel resistance of the relay coil causes any appreciable drop in the total resistance, it can be compensated by re-adjusting the resistance of the entire circuit. The diagram shows power switch at full power

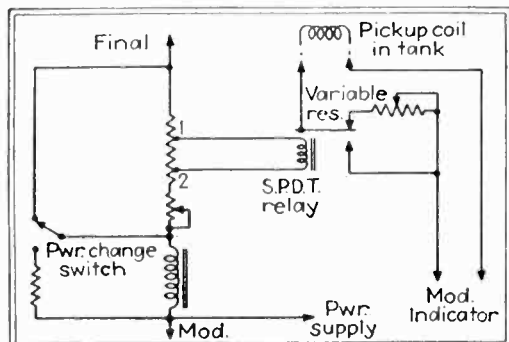

Circuit for adjusting input to modulation monitor

position, shorting out the inserted resistance. The relay in this position is not energized. One side of the pickup coil, coupled in final tank circuit, is brought out to relay arm. In the position shown, the circuit is made with the modulation indicator through the variable series resistance, and upper contact of relay. When the power change switch is thrown to low power, the relay is energized by the voltage across a portion of inserted resistance, and the circuit to modulation indicator is made through the lower relay contact direct to the pickup coil. After adjusting the modulation indicator to read proper deflection at low power, the variable resistance in series with the relay can then be adjusted to proper deflection at high power.

TABLE-MODEL TELEVISION



American Television Corporation's 3-inch tube television receiver sells for \$125, is mounted in a table cabinet 26 inches high. A console model sells for \$250

ELECTRONIC NIGHTMARE

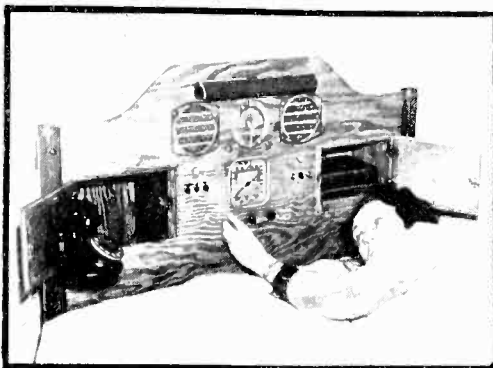

Frank Hasencamp of Chattanooga contrived this bed-room brainstorm. The radio, mounted in the headboard (above), plays in 12-minute intervals, turns itself off if the occupant falls asleep. Thermostats controlling window-openers and fans, and a loudspeaking communication system are included. The alarm clock cannot be turned off until the sleeper rises, goes off if he gets in bed again within a half-hour

A Peak Voltmeter Useful for Sound Recording

THE EDITORS ARE indebted to Mr. Henry Loughnane of Germantown, Pa. for the following information concerning a slow-return peak voltmeter used by him for sound recording work. The meter will read peak voltages with very quick dynamic action, but has a very slow return to zero. The time constant is adjusted by the use of a bleeder circuit, the resistor R_3 in the diode ground lead. When this bleeder resistor is removed the time of return is approximately 5 seconds. However, when a re-

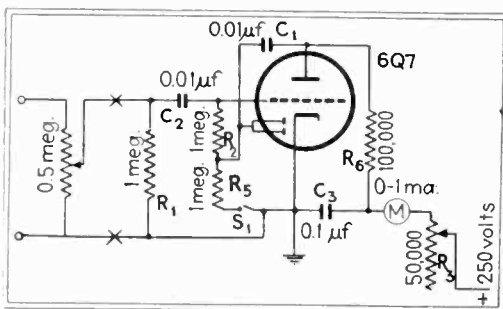

Peak voltmeter circuit connections

sistor of about 1 megohm is inserted as a bleeder, the meter follows the envelope of the sound voltages. As shown in the diagram, a 6Q7 duo diode triode is used in conjunction with a 0-to-1 milliammeter. The signal is applied through a coupling circuit to the grid of the triode section of the tube. From the plate circuit of the triode the signal is passed on to the diode plate through the condenser C_1 . The meter is inverted, and R_3 is adjusted so that the meter reads 1 ma. with no input. A 1 volt signal will cause full scale deflection. The voltage divider R_4 is indicated for use on higher voltage ranges than 1 volt.

Bringing
engineers
up to date
on current

electronic engineering
practice

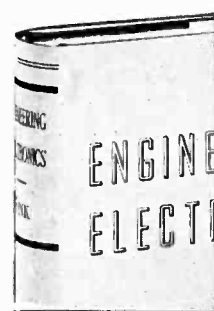

HERE is a new book to meet the engineer's need for a working introduction to electron tubes and the design of circuits for their application. In a practical treatment it brings you the information you need to understand the present status of electronic science, to handle its engineering applications, to keep abreast of progress and meet the increasing demands and opportunities in this field.

Just Published

ENGINEERING ELECTRONICS

By Donald G. Fink

Managing Editor, *Electronics*

358 pages, 6 x 9, 217 illustrations, \$3.50

THIS book presents a quantitative treatment of electronic engineering, on a level commensurate with the engineer's average use of mathematics and physics and correlated with general electrical engineering practice.

This book gives you:

- an introductory working knowledge of electron physics; the electron, its properties, methods of production in the free state, control by electric and magnetic forces, etc.
- an understanding of practically all modern types of electron tubes, their construction, principles of operation, and characteristics
- a working knowledge of the application of these characteristics to electronic circuit design
- an understanding of many practical applications of electronic circuits

In addition to the standard electron tube structures and their uses, a large number of special types such as electron multipliers, electron microscopes and telescopes, electron image tubes, television tubes, etc., are covered.

The circuits described and illustrated have to do with power transformation, electrical communication, and industrial control and measurement problems.

10 days' examination — Send this coupon

McGraw-Hill ON-APPROVAL COUPON

McGraw-Hill Book Company Inc.
330 W. 42nd St., New York, N. Y.

Send me Fink's Engineering Electronics for 10 days' examination on approval. In 10 days I will send \$3.50, plus few cents' postage, or return book, postpaid. (Postage paid on orders accompanied by remittance.)

Name

Address

City and State

Position

Company FL-8-38
(Books sent on approval in U. S. and Canada only.)



“8-BALL”

AND

“SALT-SHAKER”

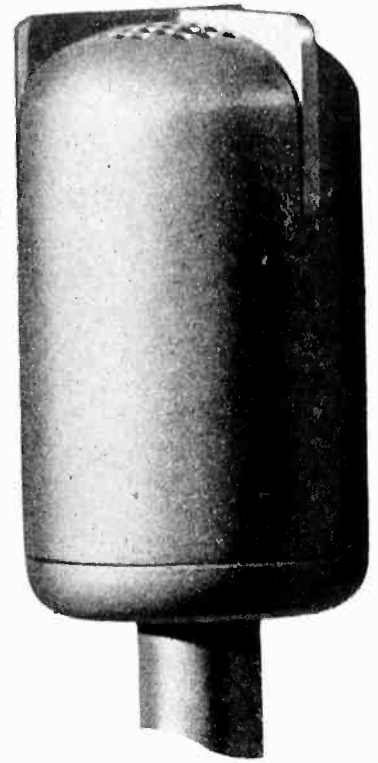

... now give you still greater value!

These two mikes have won wide popularity with broadcasters because they've always given *value*—high quality at low cost!

Now they give you still more for your money. The price of the famous “8-Ball” has been reduced. And the “Salt-Shaker” is given new flexibility by means of the new 311A plug. This permits quick removal from, or attachment to the 442A Jack—just like the “8-Ball.”

Between them, these two Western Electric mikes meet practically every broadcasting need. Can you afford to get along without their quality pick-up?



DISTRIBUTORS

Graybar Electric Co., Graybar Bldg., N. Y. In Canada and Newfoundland: Northern Electric Co., Ltd. In other countries: International Standard Electric Corp.

Western Electric



NEW CONVENIENCE

The 311A plug (center) makes the “Salt-Shaker” as flexible as the “8-Ball.” It fits the 442A Jack (bottom).

RADIO TELEPHONE BROADCASTING EQUIPMENT

ELECTRONICS — August 1938

THE ELECTRON ART

Articles on electricity in medicine, characteristics of glow discharge lamps and magnetrons, and measurement of small voltages reviewed this month

Electricity in Medicine

AN EXCELLENT SUMMARY outlining the role which electricity is playing in the diagnosis, prevention and remedy of physical ailments and diseases appears under the title "Electricity in Medicine," by R. Williams, in the June issue of *Electrical Engineering*. While this article will probably prove of little value to the practicing physician as a means of improving his technical knowledge of the curative properties of electricity in its various applications, the article does much to consolidate and summarize knowledge on this subject. It concludes with a plea for cooperation between physicians and electrical engineers, the necessity of which will undoubtedly be evident to any engineer who may have listened to the sales talks used by some manufacturers of electro-medical equipment when dealing with physicians and surgeons whose technical knowledge of physics and electricity is rather limited.

As an aid to diagnosis, x-rays, the electrocardiograph, and the incandescent lamp are mentioned as the most important. The first and third of these are generally well known and the author disposes of them with comparatively little comment. The electrocardiograph is an instrument used for detecting and recording the minute electrical voltage variations within the heart. Through the use of the string galvanometer type, the amplifier type, and the cathode ray type of electrocardiograph, all of which are comparatively recent developments, considerable progress has been made in the diagnosis of heart ailments.

Of the possible relation existing between the body impedance and disease, it is pointed out that the method is not yet sufficiently developed to become generally valuable in diagnosis. Recognition is made of the experimental work done in England, and at Harvard University and Johns

Hopkins University in the United States. However, no mention is made of the important work which has been carried on at the Massachusetts General Hospital in collaboration with engineers of the Massachusetts Institute of Technology.

In speaking of electricity in therapy and surgery, the following quotation undoubtedly speaks for itself: "Many formidable looking machines without any scientific justification, but apparently with much psychological and 'box-office' appeal, have been used for years by quacks and charlatans, the modern versions of the medieval mystics. One of these electrical gadgets supposedly was based upon a theory that every dis-

TELEVISION STATION OPENS IN PARIS

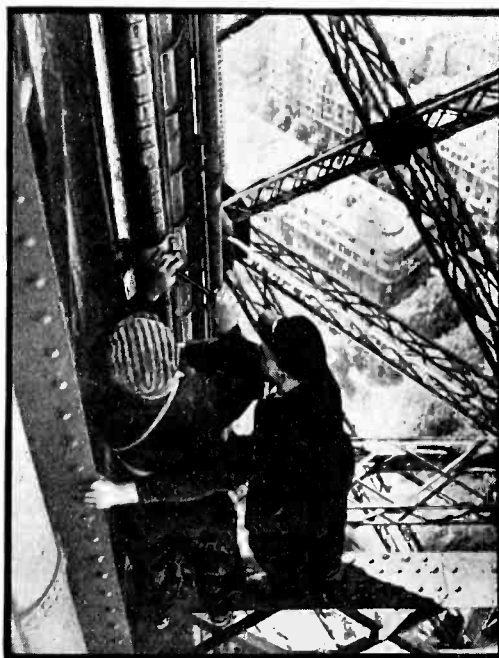

The world's most powerful television transmitter, 30 kw. at 46 Mc., has recently gone into service in Paris. The antenna, atop the Eiffel Tower, is fed through a coaxial cable 1000 feet long, 5 inches in diameter and weighing 12 tons. At the top of the tower, the grounded cable is terminated in a balanced-to-ground cable which in turn feeds the antenna

ease causes the body to radiate electrical energy at some specific frequency peculiar to that disease. The same machine diagnosed and likewise treated all diseases, each malady having its own colored light on the front of an impressive control panel. As the specific frequency of the patient was discovered the proper colored lamp flashed, thus 'informing' the operator of an actually predetermined treatment. The treatment, the same for tonsillitis or gallstones, consisted of some sort of electric shock that never failed to impress the patient; and sometimes it effected a complete cure—at least psychologically. Most ethical physicians merely looked askance at this remarkable machine, but a few crusaders succeeded in making it look so ridiculous that it retired from the scene hastily and confusedly."

According to the author, the legitimate and accepted division of medical treatment known as physical therapy may be divided into five main branches:

- (1) Light therapy, the treatment of disease by means of "light" rays.
- (2) Heat therapy, employing various types of heating devices.
- (3) Electrotherapy, using electricity.
- (4) Hydrotherapy, the employment of various water applications.
- (5) Methanotherapy, treatment by massage, corrective exercise, and mechanical devices.

Of these, electrotherapy will probably be of most interest to readers of *Electronics*, especially since two of the principal branches of electrotherapy are diathermy and electro surgery, both of which employ high frequency alternating currents which are usually most conveniently produced through the use of electron tubes and their associated oscillating circuits. (An article on diathermy and its relation to the field of electronics was published in the November, 1936 issue of *Electronics*, together with a brief bibliography.)

"Even a casual survey of the literature available on the subject shows that but few physicians have any great familiarity with the physics of electrical apparatus, and perhaps fewer engineers have any conception of the physiological significance of the process served by the machines they create. The sciences of both electricity and medicine are still im-

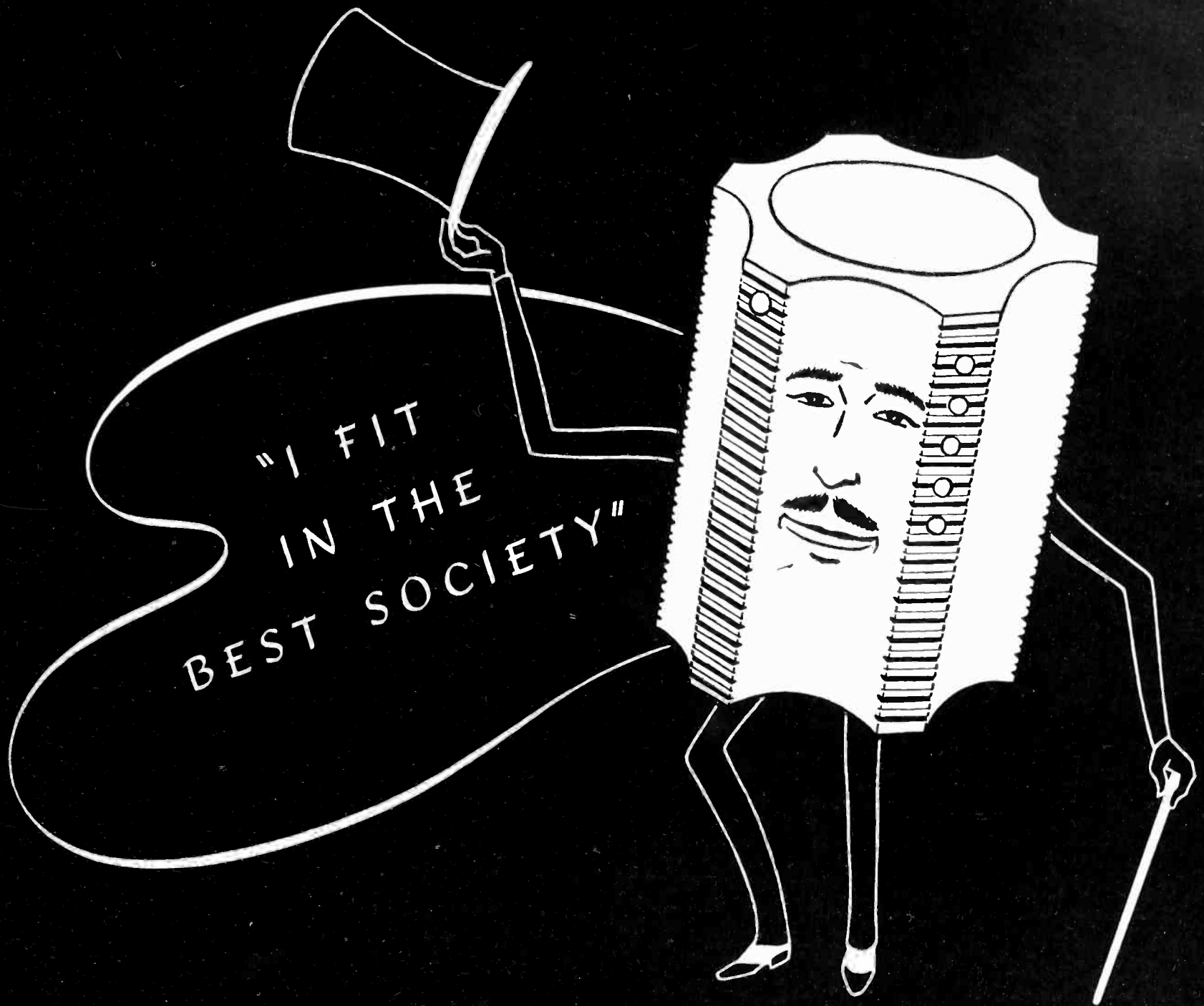

ISOLANTITE* coil forms are always socially eligible; they fit in with their neighbors quickly and easily, without any need for troublesome adjustments.

Accurate dimensions are highly important in inductance coil forms. Mounting holes must be correctly spaced for quick, easy assembly. Diameters must be precise, to give the desired inductance values with the minimum need for adjustment.

The attractive appearance provided by the smooth, glazed surface of Isolantite is an added asset, particularly when insulators are mounted in full view.

Extremely low dimensional tolerances in all Isolantite insulators are the result of careful design and manufac-

turing processes. These manufacturing processes are also readily adaptable to the economical production of special forms for applications in which standard insulators cannot conveniently be used. Isolantite engineers will gladly cooperate in the design of special insulators.

*Registered Trade-name for the products of Isolantite Inc.

ISOLANTITE INC.

CERAMIC INSULATORS

Factory: Belleville, N. J. • Sales Office: 233 Broadway, New York, N. Y.

AUTOMATIC ELECTRIC

makes **MORE** relays
 makes **BETTER** relays
 makes **MORE VARIETIES** of relays

**THAN ANY OTHER
 MANUFACTURER!**

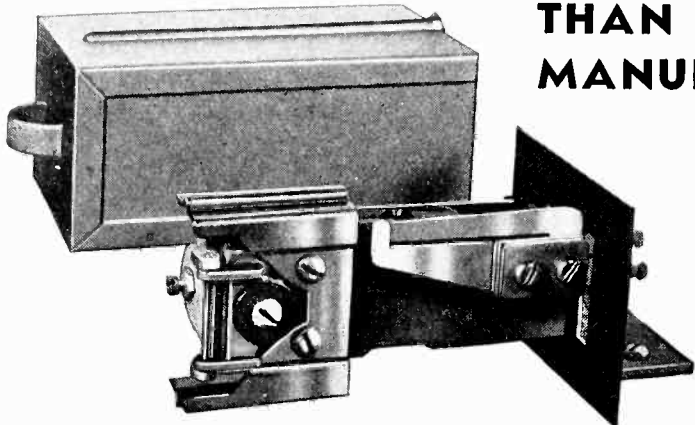

AND—when you buy an Automatic Electric Relay you get a precision product designed and constructed by an experienced company—for Automatic Electric has been making relays **LONGER** than any other manufacturer!

Relays for EVERY INDUSTRIAL Need

- The Automatic Electric line of relays includes quick and delayed action types, sensitive and heavy duty types, mechanical locking types, polarized relays, etc. Available with any contact combination and for operation on D. C. or A. C. circuits of any voltage.
- Write for complete illustrated catalog of relays, stepping switches, electric counters, solenoids, keys, and other electrical control accessories. Address American Automatic Electric Sales Company, 1033 W. Van Buren St., Chicago.

AUTOMATIC ELECTRIC

MAKERS OF TELEPHONE AND SIGNALING APPARATUS
 ELECTRICAL ENGINEERS, DESIGNERS AND CONSULTANTS

CALLITE TUNGSTEN — MOLYBDENUM

- Grids
- Plates
- Cathodes
- Copper-clad
- Formed Parts
- Hooks and Pigtails
- Trimet Lead-in Wire
- Tungsten Filament Wire
- Molybdenum Anchor Wire
- Special Filament Springs
- Two and Three-Piece Welds for Hard and Soft Glass

We maintain a competent staff of engineers ever at your service to assist you. Write for additional information and let us help you with your problems.

CALLITE PRODUCTS DIVISION

EISLER ELECTRIC CORPORATION

544-39th STREET

UNION CITY, N. J.

mature, but the rapid advances they have made in combination suggest that more concerted efforts might result in a new hope for the annihilation of human disease." Already a concerted effort has been made to secure the cooperation between physicians and physicists and electrical engineers. Not only has an effort been made to obtain cooperation between medical and electrical men, but, with the beginning of the 1937-38 school year, the Massachusetts Institute of Technology inaugurated a new course on biological engineering which gives the students extensive training in physics, chemistry, biology, and engineering. It is anticipated that this new course will not only prepare students for graduate work in medicine and surgery, but will prepare them to fill industrial positions where it is necessary to pay attention to the health and comfort of human beings.

Ultra High Frequency Oscillators

A COAXIAL LINE stabilized oscillator that is easily and rapidly adjustable only the frequency range of from 70 to 700 mc. per second, is described by W. L. Barrow in the June issue of the *Review of Scientific Instruments*. Rugged mechanical construction, substantially completes shielding and coaxial line output connections are features of this oscillator which has a power output of several watts throughout its entire frequency range. For best stability it was found necessary to tune precisely both element leads, and to provide high Q tank circuits. It was found that the frequency stability decreases as the frequency increases.

Electronic Switching

IN THE MAY ISSUE of *Electrical Engineering*, B. E. Schumard has an article "Some Electronic Switching Circuits," in which it is shown that by means of electronic devices, circuits may be made operative or inoperative by a change of polarity or magnitude, or both. Switching by means of the mechanically operated circuits is, of course, a more familiar type of switching. In this article, a number of circuits and applications are given which should provide a foundation for accomplishing a wide variety of switching arrangements.

ARE YOUR SPECIFICATIONS

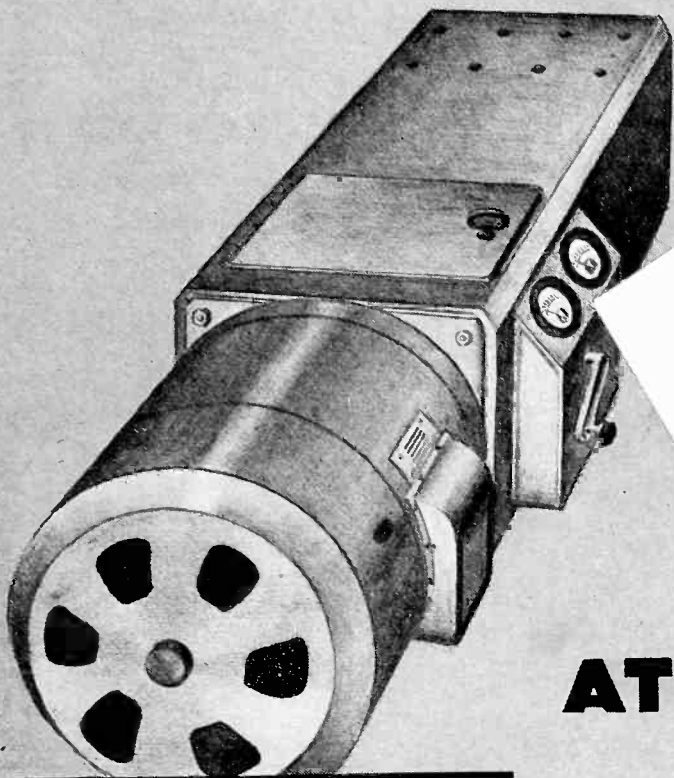

RIGID

AT THIS VITAL POINT

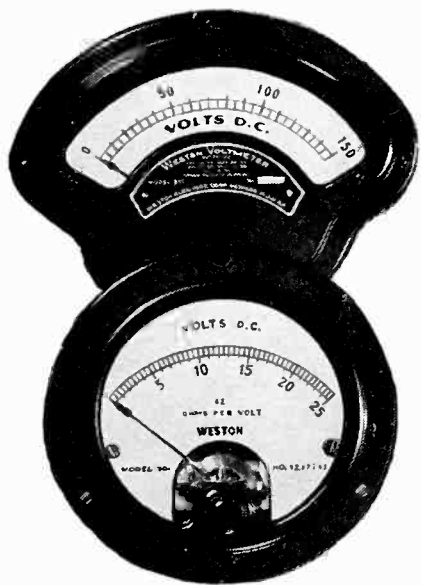

Build-in WESTONS

A wide range of WESTON instruments are now being "built-in" on machine tools, rectifiers, welding machines, radio transmitters, alarm systems, therapeutic and scientific apparatus, and wherever a close check on electrical quantities is vital to operation and control. There is also a WESTON instrument available for your built-in requirements. Let us send full details.

Today, when keen-minded equipment buyers make *exacting* point-by-point comparisons, there's a big point in favor of the equipment which has WESTON instruments standing guard at the controls.

Buyers know they will benefit when the machine is WESTON equipped at this vital point. They know that WESTON dependability will assure a *true* check on operating conditions . . . *safe-guard* the machine against inexact operation and interruptions for costly servicing . . . constantly *protect* the machine, and the work the machine performs. They *trust* a machine which shows this evidence of rigid specifications and sound engineering sense.

To assist you in obtaining these and other benefits of WESTON instrumentation, the services of the WESTON engineer in your vicinity are freely offered. Call on him for assistance on all instrument problems, or write direct to . . . Weston Electrical Instrument Corporation, 618 Frelinghuysen Ave., Newark, N. J.

WESTON

Instruments

**FOR ULTRA
MEASUREMENTS**

Use...



MODEL
1252
DEALER
PRICE

\$48.33

MODEL 1252 VACUUM TUBE VOLTMETER

Has an Outstanding Patented Circuit Recommended by the Best Laboratories and Technicians

Tube on Cable . . . Particularly Desirable for High Frequency Work . . . Ranges: 3-15-75-300 Volts.

This model is self-calibrating, same as other Triplett Vacuum Tube Voltmeters, the self-calibrating feature being automatic with the highly developed tube bridge circuit. It has the exclusive feature for indicating above, below and at the null point. The initial operation of adjusting the bridge at the zero level cancels out error independent of the tube emission values or when replacing tubes.

Model 1252 is furnished with the exclusive Triplett tilting type twin instrument. One instrument indicates when bridge is in balance—the other is direct reading in peak volts. Furnished complete with all necessary accessories including 1-84, 1-6P5, 1-76. Case is metal with black wrinkle finish. Etched panel is silver and red on black. DEALER PRICE, \$48.33.

Model 1251 same as 1252 but with test tube located inside case. . . . DEALER PRICE, \$47.67.

Model 1250 same as 1251 except ranges are 2.5, 10, 50 volts. DEALER PRICE, \$36.67.



The Triplett Electrical Instrument Co.
238 Harmon Dr., Bluffton, Ohio

Please send me more information on

Model 1252; Model 1251;
 Model 1250.

Name

Address

City..... State.....

Glow Discharge Tube Curves

A METHOD for determining the dynamic current-voltage characteristic curves of glow discharge tubes is described in an article "Dynamic Characteristics of Glow Discharge Tubes," by Reich and Depp in the June issue of the *Journal of Applied Physics*.

Static characteristic curves of glow discharge tubes are readily made and the factors which determine the form of these curves have been satisfactorily explained. The static curves do not, however, indicate the behavior of the tubes under dynamic operating conditions. Because of the time required for ionization and deionization to take place, the voltage under changing conditions depends not only upon the current flowing at any instant, but also upon the current which has flowed previously and upon the rate of change of current. While some information regarding the dynamic behavior of glow discharge tubes may be determined by making oscillographic studies of the relation between current and voltage when relaxation oscillations are taking place, the authors have undertaken to study the dynamic characteristics by using a technique and circuit in which the current varies with time under controlled conditions. This is accomplished by the use of a vacuum tube to limit the current passed by the glow tube. A schematic wiring diagram of the basic circuit is shown in Fig. 1.

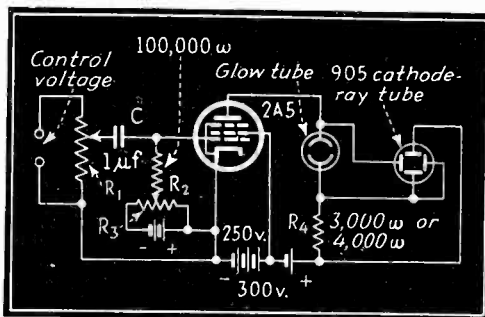

Fig. 1—Schematic wiring diagram of cathode ray tube circuit for determining the dynamic characteristics of glow discharge tubes

The glow tube, whose characteristics are to be studied, in series with a power pentode, is connected to a source of voltage considerably higher than the ignition voltage of the tube. The pentode acts as a high resistance load, the magnitude of which may be controlled, within limits, to any desired value by means of the voltage applied to the control grid.



**Self-Locking
TILTING
HEAD**

★
**Cannot be
Acoustically
Overloaded**

NEW MULTI-UNIT Dual Diaphragm Crystal Microphone

An outstanding achievement in microphone construction for night club and public address installations. Maximum amplification without feedback. Cannot be acoustically overloaded. Made in two models. MU-2 constructed with two dual diaphragm crystal units using four small diaphragms. MU-4 uses four dual diaphragm crystal units and eight diaphragms. Black and chrome. Complete with three-prong interchangeable locking connector and 25-ft. cable.

List Prices

MU-2 \$29.50 : MU-4 \$39.50

ASTATIC

Astatic Microphone Laboratory, Inc.

Dept. A-4, Youngstown, Ohio

Licensed Under Brush Development Co. Patents

"JAGABI" RHEOSTATS

- SMOOTH
- POSITIVE
- RUGGED
- DURABLE

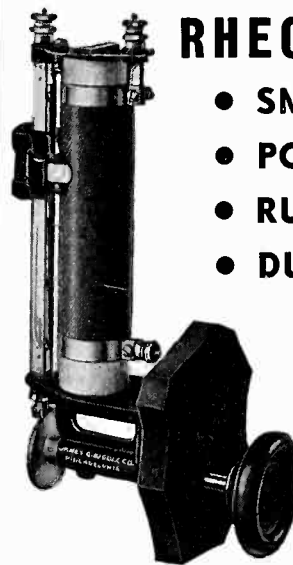

A Jagabi
Switchboard
Type Rheostat

FOR fine adjustment and control of electric current, Jagabi Sliding-Contact Porcelain Tube Rheostats have been, for many years, first choice of engineers and research workers in many fields. Stock sizes, types and ratings for most requirements. Special Rheostats if you need them. Write for descriptive Bulletin 1515-E.

JAMES G. BIDDLE CO.

ELECTRICAL INSTRUMENTS
1211-13 ARCH STREET PHILADELPHIA, PA.



QUICK SERVICE!

GOOD INSULATION!

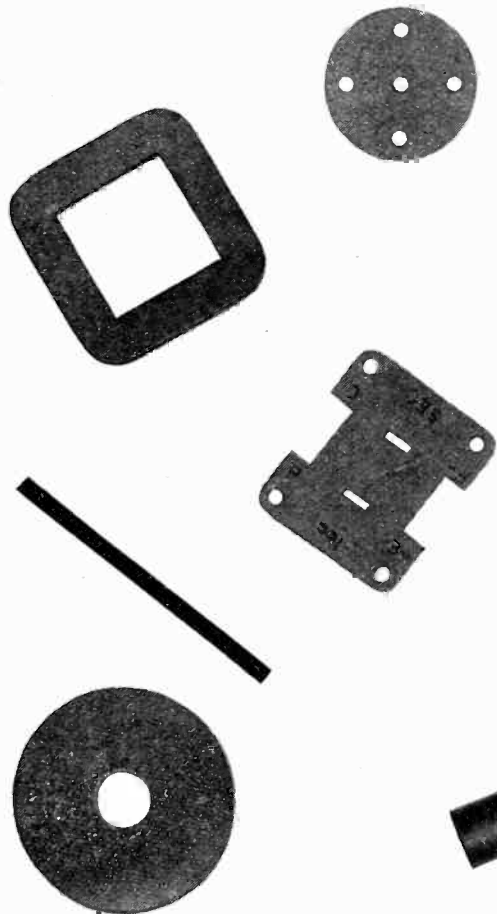

FORMICA offers good service on insulating parts because it has one of the largest equipments in the industry for producing laminated insulating sheet, and also for machining it to your dimensions. Twenty-five years of concentrating on just one product has provided grades and variants suitable for any requirement. Careful laboratory control of manufacturing processes assures high quality and uniformity. Send us your blue prints for quotations.

THE FORMICA INSULATION COMPANY
4638 Spring Grove Ave. • Cincinnati, O.



FORMICA

QUALITY-BUILT ANTENNA COUPLING EQUIPMENT By JOHNSON

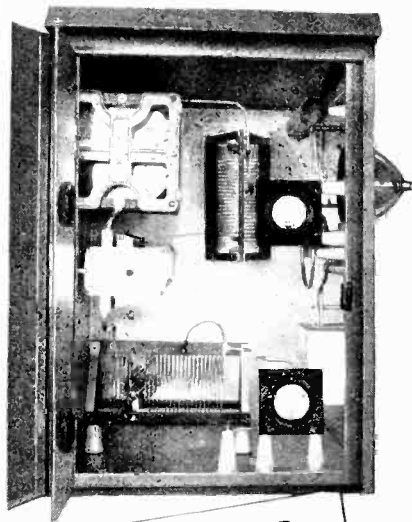

WRITE FOR
CATALOG
301D

KEEP your Antenna Coupling Equipment of the same standard of quality as your transmitters! Equipment of this kind is built by Johnson for practically any type of antenna and transmitter line—for directional antenna arrays,—for use with two transmitters and a single antenna and for many other antenna combinations.

ALL parts used in these Antenna Couplers are of the same high quality identified with other Johnson products,—the same precision-built inductors, fixed and variable condensers and other Johnson parts are assembled and mounted in a sturdy, weather-proof cabinet with a protective inner door.

JOHNSON equipment is fully guaranteed, designed according to the latest engineering practice and complies with FCC rules and regulations.

YOUR engineers or consultants will find this organization glad to cooperate in supplying your exact requirements. Write for Catalog 301D covering Antenna Coupling equipment and other Johnson products.

• **E. F. JOHNSON CO.**
WASECA, MINN.



Frequency Measuring Service



Many stations find this exact measuring service of great value for routine observation of transmitter performance and for accurately calibrating their own monitors.

MEASUREMENTS WHEN YOU NEED THEM MOST
at any hour every day in the year

R.C.A. COMMUNICATIONS, Inc.

Commercial Dept.

A RADIO CORPORATION OF AMERICA SERVICE

66 BROAD STREET

NEW YORK, N. Y.

LEACH LR RELAYS

you can depend upon their
OPERATING RELIABILITY

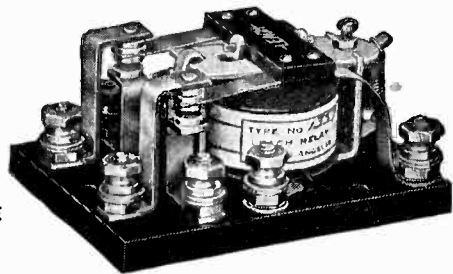

TYPE
NO.
1357

Leach small size circuit control relay, type No. 1357 is a compact, rugged and reliable control relay ideal for your control circuit. These relays have solid cores, positive contact and low current consumption—built so that you can depend upon them!

LEACH RELAY COMPANY

5915 Avalon Boulevard, LOS ANGELES, CALIF
15 E. 26th St., New York City

LEACH RELAY COMPANY, 5915 Avalon Boulevard, Los Angeles, Calif.

Please send your catalog. I am interested in.....type relay.

Name

Company

Address

City

With this arrangement, the manner in which the current varies with time can be made to conform to any desired wave form. As shown in the diagram, the voltage across the discharge tube is applied to one set of deflecting plates of a cathode ray oscilloscope, whereas the second set of plates of the oscilloscope are connected across a resistance in series with a discharge tube. The image trace formed on the cathode ray tube screen is a dynamic curve showing the relation between the current and the voltage across the tube.

In preliminary experiments with glow discharge tubes of various sizes and makes, it was found that the characteristics of all of the tubes tried were sufficiently similar so that a study of one type of tube would provide useful information concerning all tubes. Accordingly, experiments were confined to an early form of type 874 voltage regulator tube containing argon and to the two watt neon filled glow tubes manufactured by the General Electric Company. Dynamic characteristics of both of these tubes for frequencies ranging from 60 to 8,000 cycles per second, and operated at constant current, are given by the authors. Static as well as dynamic characteristics are given.

The most outstanding features of the characteristics observed by the authors are summarized from their paper as follows:

1. When the current rises abruptly, the ignition potential is considerably higher than the static ignition potential.

2. When the current is decreased abruptly, it does not follow the static characteristic but follows a slightly curved line to the origin.

3. When the current rises abruptly, or, in any case, when the frequency is high, the portion of the characteristic corresponding to increasing current lies to the right of the static characteristics.

4. The ignition potential falls with an increase of frequency of the current wave and with an increase of current amplitude.

5. The characteristics obtained with gradually increasing current appear to indicate that if the current should be held constant after ignition, at the value prevailing at the time of ignition, the voltage would fall abruptly to a value not greatly in excess of the static extinction potential.

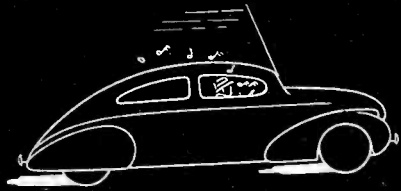

AN automobile radio antenna made of Superior Seamless or "Brawn" Monel Tubing is admittedly the most satisfactory device of its kind. Likewise, a thousand-and-one other products in varied fields owe their improved performance, appearance and value to this better tubing. Engineers whose plans for product improvement have been shelved by a restricted budget will find Superior not just willing, but able to assist them. Samples and quotations by return mail.

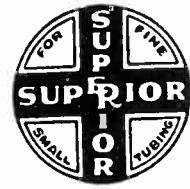

SUPERIOR TUBE CO.

Norristown

Pennsylvania

Manufacturers of Lockseam Cathode Sleeves under U. S. Patent • Fine small seamless tubing in various metals and alloys • Brawn Monel Tubing — a new development for those who want the advantages of Seamless Tubing at a lower price.

SUPERIOR TUBING

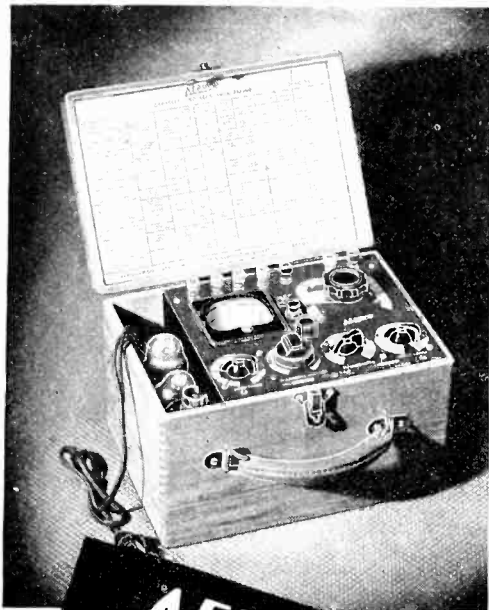

AEROVOX CAPACITY and RESISTANCE Bridge

● Users of condensers are now offered a more critical and conclusive yardstick of condenser quality, in the AEROVOX Capacity and Resistance Bridge. Combines, in a single, portable instrument, the following:

CAPACITY BRIDGE

Measures capacity 100 mmfd. (.0001)—100 mfd. in 6 ranges; leakage; power factor to 50%, etc. of condensers under actual working conditions.

RESISTANCE BRIDGE

Measures resistance values of resistors and electrical equipment and circuits. 10 ohms to 1 megohm in 5 ranges.

INSULATION RESISTANCE

Measures this important factor in condensers and other devices. Meter calibrated directly in megohms. Reads up to 10,000 megohms.

VACUUM-TUBE VOLTMETER

Consists of amplifier stage and gridleak detector. Measures minute values 0—2 volts.

PRECISION METERS

Voltmeter, also for external uses, provides 0—60, 0—300 and 0—600 v. meter at 1000 ohms per volt. Also a 60 mv. at 60 ohms milli-voltmeter; and milliammeter 0—6 ma., 0—60 ma.

VARIABLE POWER SUPPLY

Available directly at terminals. 15 to 600 volts continuously variable over entire range.

Ask to See It . . .

Your local AEROVOX jobber can show you this indispensable instrument. Or write us direct for descriptive literature.



Measurement of Small Voltages

ELECTRONIC APPARATUS for measuring direct current potentials smaller than 20 microvolts with an accuracy of 10^{-6} volt is described by I. Amdur and H. Pearlman in the June issue of the *Review of Scientific Instruments*, under the title "Potentiometric Measurements of Extremely Small Voltages."

As shown in the diagram, the null

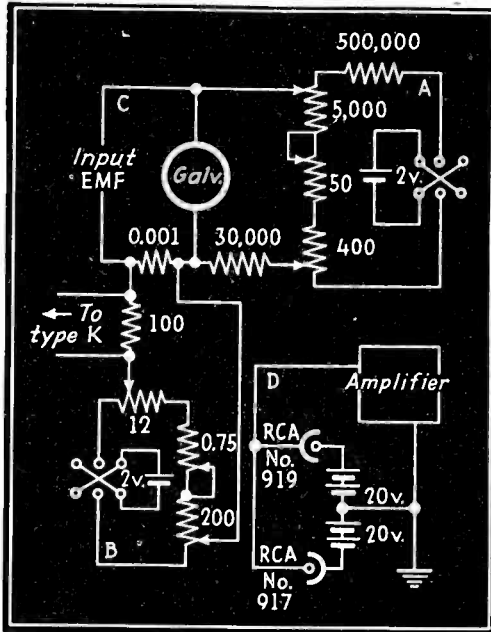

Phototube circuit for determining magnitude of small voltages

method is used. The potential to be measured is applied across a shielded galvanometer which reflects a light beam from the original source to the two phototubes where, the deflection of the galvanometer is effectively amplified. The deflection of the galvanometer is balanced out by an auxiliary circuit and the voltage drop produced by the balancing current passing through a known resistance is measured by means of a potentiometer. The potentiometrically measured drop is related to the unknown potential under measurement. The amplifier used in connection with the phototube is a negative feedback device similar to that described by Vance in the *Review of Scientific Instruments* for July, 1936.

Operating Characteristics of Power Tubes

Under the title "The Operating Characteristics of Power Tubes," E. L. Chaffee describes in the *July Journal of Applied Physics* a new method of calculating the performance of a power tube from a set of static curves. A 60-cycle test method is also



● Cinaudagraph permanent magnet speakers need no special introduction. America's foremost engineers in radio and sound long recognized the precision engineering and superior workmanship of these speakers. Now YOU can enjoy Cinaudagraph's famed true-fidelity performance at no extra cost. For today, these speakers are competitively priced. Complete details on request.

CINAUDAGRAPH CORPORATION
Speaker Division
STAMFORD CONNECTICUT
EXPORT DEPT., 100 VARICK ST., N. Y. C.

The ultimate in Radiation 
WILBUR B. DRIVER CO.
NEWARK, NEW JERSEY

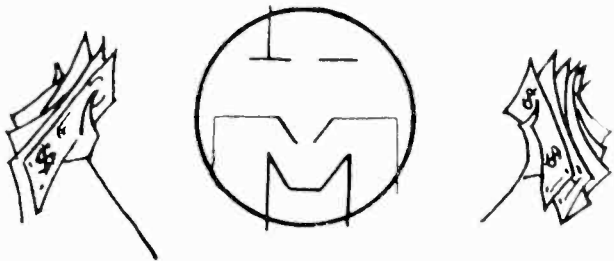

BUSINESS WITH US

isn't bad at all!

New business — that's what we get for our advertisers — and as a consequence we get a sizeable amount for ourselves. In the last year (through June) fifty-four new advertisers joined with the long-time advertisers in realizing the sales and research value of ELECTRONICS.

In spite of curtailed advertising budgets, ELECTRONICS shows an increase of 1.4% in advertising space used in that period. The circulation keeps right on with its steady increase, too, 12.1% (at \$5.00 a head, mind you) over the previous twelve months' period.

Look at the record!

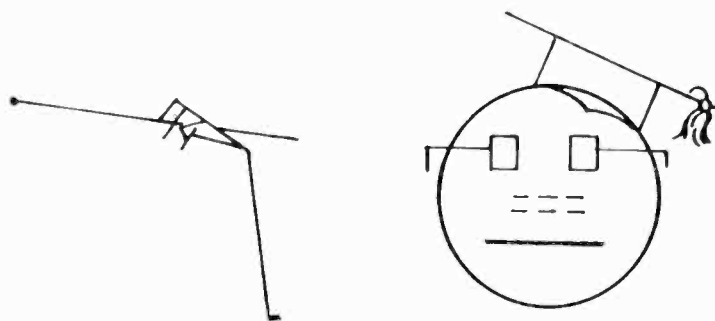

And Here's Why!

ELECTRONICS keeps going forward because advertisers realize that it is the only medium which can penetrate into design, research and production headquarters of the electronic arts and come up with orders. The market research value of ELECTRONICS actually increases in importance during quiet periods of business, because that's when new designs are made and when engineers and research men scan this magazine for new products and new ideas that will soon go into the production line.

Regardless of the speed of business, the cycle in the electronic field starts up rapidly in September. Your sales message in that issue is a reminder to buyers that you're ready to sell.

electronics



radio, sound, communications, industrial applications
of electron tubes... design, engineering, manufacture

330 WEST 42ND STREET
NEW YORK, N.Y.

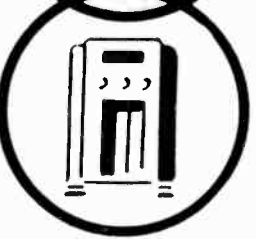
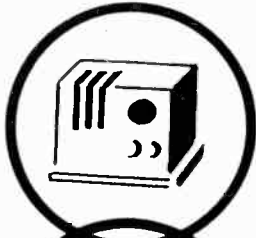

GOOD SETS Made Better

LEADING set manufacturers cooperated in creating the design for the new improved 1100 series Goat Form Fitting Tube Shields. They are made for every type of radio set . . . and are contributing their share towards the greater superiority of 1939 sets over all previous models.

Send for Bulletin TS-5, samples and prices.

FEATURES:

Sturdy Construction
Greater Stability
Improved Grounding
Complete Shielding
Better Appearance

Magnetic Shielding
Easy Assembly
Space Saving
Beaded Top
Economy

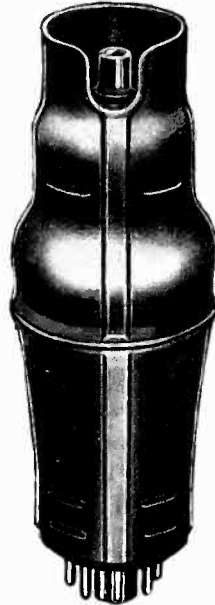

THE NEW IMPROVED
1100 SERIES GOAT
FORM-FITTING
TUBE SHIELD



GOAT RADIO TUBE PARTS, INC.

(A DIVISION OF THE FRED GOAT CO., EST. 1893)

314 DEAN ST., BROOKLYN, N. Y.

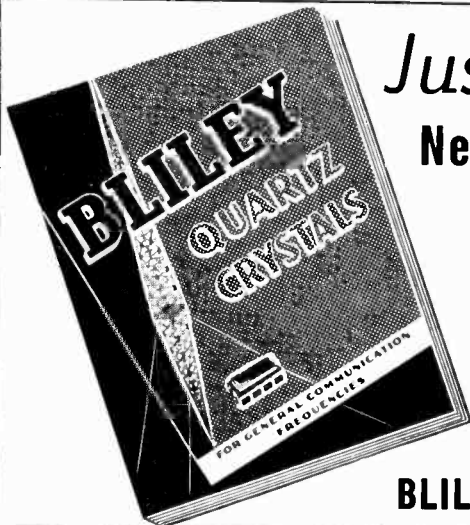

Just off the press! New Products! New Prices!

Your files of radio communication components will not be up to date without a copy of the 1938 Bliley Catalog which describes the line of Bliley Crystals, Holders and Ovens for all frequencies from 20kc. to 30mc.

Of special interest are the high frequency crystal units, types MO2 and MO3, for frequencies above 7500kc. Designed to provide greater stability and reliability under severe conditions, they are particularly adapted for mobile and portable applications.

Write for your copy today—just ask for Bulletin G10.

BLILEY ELECTRIC CO., Erie, Pa.

WAXES • COMPOUNDS • VARNISHES for ELECTRICAL INSULATION

Zophar offers prompt service on Insulating Compounds for a wide variety of electrical applications, including:

. . . insulation for CONDENSERS, TRANSFORMERS, COILS, power packs, pot heads, sockets, wiring devices, wet and dry batteries, etc. Also WAX SATURATORS for braided wire and tape. WAXES for radio parts.

Special compounds made to your order.

ZOPHAR MILLS INC.

130-26th St.

Brooklyn, N. Y.

FOUNDED 1846

briefly outlined and the results of the new method compared and discussed. The effects of secondary emission from the plate and grid and primary emission from the grid on the performance of the tube are discussed in an appendix.

Thyratron Arc Extinction

A NEW CIRCUIT which has applications for operating high speed electric counters by gaseous triodes is described by W. H. Pickering, in his article "A Circuit for the Rapid Extinction of the Arc in a Thyratron" appearing in the June issue of the *Review of Scientific Instruments*. No auxiliary contacts are necessary, and the circuit resets itself in a period which is so short that most counters will operate near their maximum speed. The circuit thus has the advantage that it utilizes the relay action of the gas tube to operate with a very short initiating impulse, and yet does not involve any auxiliary relays or contacts to open the arc circuit after the count has been registered.

The basic principle underlying the operation of this circuit, shown in

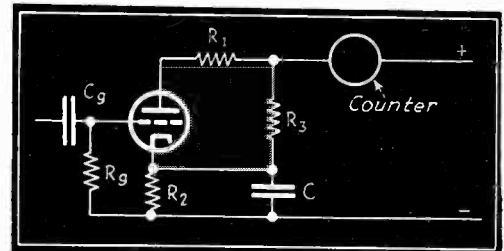

the figure, is that if the grid of a gas tube is strongly negative with respect to the cathode, and if the current through the tube is small, the grid will regain control and extinguish the arc. The operation of the circuit now becomes clear; the grid receives a positive pulse. An arc is established and a current flows through the counter, and the resistance R_1 and the condenser C . This flows long enough to operate the counter. The condenser C now becomes charged to practically the full plate voltage, and the arc current drops to a value determined by R_1 , R_2 and the resistance of the counter. The cathode is now at a high positive potential with respect to the grid and thus the condition for the extinction of the arc is obtained. After this occurs, the condenser C discharges through R_2 and the circuit is ready to operate again.

Practical Remote Amplifiers

(Continued from page 25)

output impedances, to eliminate line reflection. The main control varies the gain in steps of 2 db, from 0-40 db. The volume indicator can be attenuated from minus 10 db to plus 6 db, also in steps of 2 db.

The larger amplifier, a front view of which is shown in Fig. 1, has a

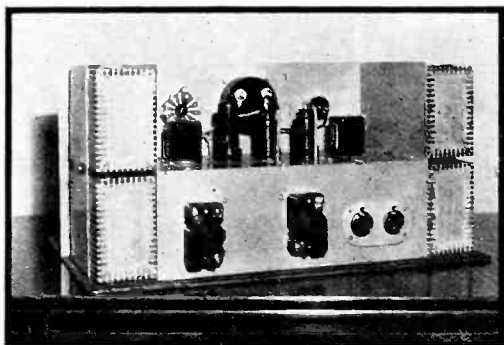

One of the amplifiers at WBNY for remote pick-up service

two-pole, three-way switch in the filament circuit, which allows the technician to select any one of the three

filament supplies, i.e.: external battery connected by polarized plug in rear, internal battery, used only in emergencies or on pickups of short duration, or heater supply from external power pack. The third filament supply can be switched in only when using an a-c power supply, connecting by a four pole receptacle. In this case, the switch puts a-c on the filaments. The internal batteries have saved a lot of sore muscles on short pickups where ordinarily two heavy units would have to be lugged for operation.

This amplifier can be built for a cost slightly over eighty dollars. For the amateur or public address operator man, who would have need for a high gain voltage amplifier and not necessarily need the mixing channels or volume indicator, it can be constructed for much less, since these two big items make up about half the cost of the amplifier.

What's New in Sets

(Continued from page 13)

"B.O." which means "beat oscillator" and not what you might think.

The Masterpiece VI contains a volume expander circuit, covers frequencies as high as 70 Mc, delivers 34 watts, has a feedback amplifier, two AVC systems and in general seems to be the answer to the deluxe listeners' prayer.

The Emerson line for the new season will include a \$19.95 radio phonograph combination. Its dimensions are 7½ in. by 8½ in. by 10½ in. A built-in antenna makes this miniature combination truly portable. A battery operated (2 volts) portable superhet is equipped with an extra antenna roll. Using two No. 6 drycells and three 45-volt B batteries, 250 hours of service may be expected. Emerson sets continue to

use the "miracle tone chamber" introduced in June, a device to reduce the beam effect at the higher audio frequencies. In a walloping large radio-phonograph, known as the Aristocrat (15 tubes, 15 watts, \$750) volume expansion is used, known as the "symphonizer."

Almost by the time these lines are being read, the secret about Philco's mystery box will be out and copies will be well on the way. Jealously guarded have been its inner workings. In demonstration, several receivers, each sympathetic to the output of a single remote tuning box respond when that remote unit is adjusted and not to any other. Convincing demonstrations are being made over the country. Much speculation exists as to the attitude

of the FCC on this device which must radiate to produce results. Its radius of activity is limited to 100 feet; there is no danger of unwanted control of sets other than the one to which the tuning unit is adjusted—such are Philco's claims. On or about August 15th, dealers over the country will have models, but until that date each mystery box is carefully put to bed each night surrounded by all the Philco brass hats.

Cardio-tachometer

(Continued from page 17)

inserting a moderate amount of resistance in series with each condenser quantities of electricity of adequate magnitude may be handled without incurring any risk of fusing the contacts. In fact, there is no evidence of sparking. This is a feature of the utmost importance with instruments which may be used in operating rooms. It is recommended that if mechanical relays are included the instrument be not in close proximity to the operating table.

With this circuit, provided the condensers are of good quality, the calibration of the instrument is linear within the accuracy of the meter scale. The voltage regulator tube, G10, plays an additional role here in that it provides a source of charging potential which is constant and thus gives the instrument a permanent calibration. With 150 volts charging potential and condensers of 1 microfarad capacitance the current at full scale, or at 200 beats per minute, is 0.5 milliamperes.

Mechanical Arrangement

The arrangement and mounting of the circuit elements is shown in Figure 5. The only precautions which need be observed are to keep the low level stages as far as possible from the power supply coils. Although the low signal frequencies reduce difficulties resulting from wiring pick-up this is somewhat offset by the high gain. It is therefore desirable to observe the usual rules as to grounding and as to keeping wires short.

For an instrument designed primarily for operating room use the first three stages might well be mounted separately. This would permit the power supply and the counting circuit to be kept outside of the operating room entirely.

THE INDUSTRY IN REVIEW

News

♦ The Annual Report of April 30, 1938, of the National Union Radio Corporation and its subsidiaries shows a net loss of \$59,196.80, before a special charge covering the writeoff of investment in and advances to an affiliated company considered worthless amounting to \$36,934.52. Depreciation in the amount of \$71,804.05, figured on the same basis and at the same rates as for the fiscal year ended April 30, 1938, has been charged against operations, and deducted from income in arriving at the net loss shown. The radio tube business was considerably under normal for the year according to the report.

♦ Dr. E. F. W. Alexanderson, radio inventor and consulting engineer of the General Elec. Co., has been awarded the honorary degree of doctor of philosophy "in absentia" by the Royal University of Uppsala, Sweden.

Two other Americans of Swedish descent were also honored by the university, Prof. Amandus Johnson of Philadelphia and Prof. C. M. Stephenson of Minneapolis. The degrees were conferred by the university in recognition of the Swedish cultural work that had been done in America by these three men.

♦ There has been recently established in Toronto, Can., an organization designed to assist industrial companies to overcome difficulties or develop new and improved products. The Canadian Research Institute, located at 709 Spadina Ave., has divisions devoted to chemical, electrical and mechanical work, and specialize particularly in the design and fabrication of laboratory and industrial equipment for testing and manufacturing along lines slightly out of the ordinary. The Director is R. S. Soanes.

♦ The Society for the Promotion of Engineering Education recently presented the Lamme Medal to Robert Lemuel Sackett, dean of the school of engineering at Pennsylvania State College from 1915 to 1937.

♦ Station WGAL, located in Lancaster, Pa., on July 1, joined the National Broadcasting Company as its 153rd affiliate.

♦ For the purpose of testing the efficacy of duplex transmission and reception of regular broadcast and facsimile programs on a single channel, Finch Telecommunications, New York City, has announced that its duplex transmitter, call letters W2XBF, is the first to be licensed by the FCC.

♦ Electronic Laboratories, Inc., of Indianapolis sold its Auto Radio Replacements Vibrator Div. to the Meissner Mfg. Co. of Mt. Carmel, Ill., and will concentrate on the production and sale of heavy duty vibrators, converters, and power supplies for all types of applications.

♦ Radio Engineering Labs, Long Island City, N. Y., signed an agreement with AT&T permitting them to continue with the development and manufacture of two-way communication equipment. In addition to police and fire radio, Radio Engineering Labs is also licensed to build radio telephone sets for use on aircraft, and radio telephone or radio telegraph sets for use on ships and boats of all kinds.

♦ Edward F. McGrady was elected a vice president of RCA at a regular meeting of the Board of Directors on June 24th.

♦ Resinox Corporation has moved to 17 Battery Place from 230 Park Avenue, New York City.

♦ In his high voltage laboratory, Mr. P. L. Bellaschi, research engineer of Westinghouse bested nature's record by sending his quarter millionth successful reproduction of a natural lightning stroke crashing into a transmission pole with a pressure of more than 3,000,000 volts.

♦ Malcolm P. Hanson, Navy's aircraft radio expert, left Government Service to become vice-president of Radio Navigational Instrument Corp., in New York.

♦ Associated Research, Inc., with quarters at 16 N. May St., has become affiliated with the J. W. Murphy Co., 431 S. Dearborn St., Chicago. Associated Research will continue to devote its efforts to the repair and testing of all types of electrical indicating, recording, and controlling instruments, including thermometers and pyrometers, to load surveys in industrial plants and the design and manufacture of special testing equipment for industrial concerns. The J. W. Murphy organization will continue to specialize in the sale of new metering equipment, power plant measuring devices and combustion control.

50,000 VOLTS ON TEST

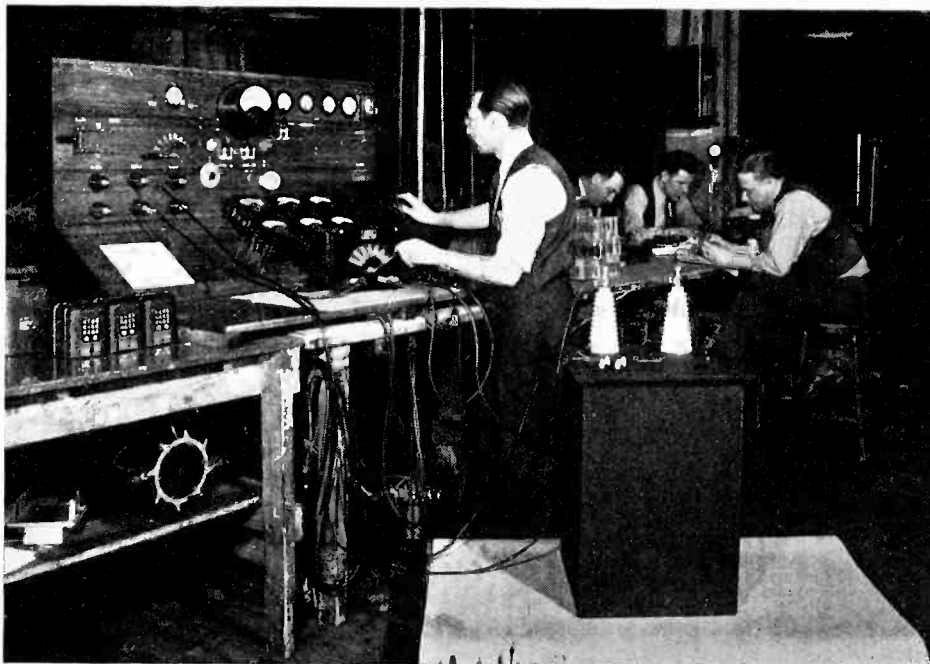

Tests being conducted on an oil-filled bombarder built by Thordarson for laboratory use with X-ray equipment. It is a 2¼ KVA, 110-220 volt primary, 50,000 volt secondary bombarder with separate reactor to vary secondary voltage from 25,000 V. to 50,000 V. in 5,000 volt steps

Literature

Transmitting Equipment. Catalog 301 lists and describes equipment for broadcast and commercial radio. E. F. Johnson Co., Waseca, Minn.

Volume Level Indicators. Pamphlet also includes useful technical db data. Circular R-1006-A. Weston Electrical Instrument Corp., Newark, N. J.

1938 Catalog. 42-pages. Lists the products of Meissner Mfg. Co., Mt. Carmel, Ill.

Monel "The Third Essential" is a booklet outlining the use of monel for mechanical accuracy. Also available is "Nickel Cast Iron Data," a guide to engineering specifications for grey cast iron. International Nickel Co., Inc., 67 Wall St., New York.

Radio Electrical Apparatus. Catalog No. 939 includes inductance-capacity chart and describes a number of products of F. W. Sickles Co., 300 Main St., Springfield, Mass.

Microphones. 1939 microphones and also sound recording equipment listed in two separate booklets. Universal Microphone Co., Ltd., Inglewood, Cal.

Resistors. And other products are listed in Bulletin 140. Shallcross Mfg. Co., 10 Jackson Ave., Collingdale, Pa.

Condensers. Five colors are used in No. 9-S catalog which includes new line of Minicap dry electrolytic condensers and also new CC analyzer. Rating data and illustrations. Solar Mfg. Corp., 599 Broadway, New York.

Controls. Thyatron resistance-welder controls described and KVA ratings of ignitron tubes given. Bulletin GEA-2791A. General Electric Co., Schenectady, N. Y.

Electron-ray Tube. Application note on operation of the 6AF6-G. RCA Mfg. Co., Harrison, N. J.

Radio Coils and Allied Products. Catalog No. 39. 32-page book giving circuit diagrams, prices, descriptions. J. W. Miller Co., 5917 S. Main St., Los Angeles, Cal.

Graphic Instruments. "Solving Industrial Crimes" Case No. 19 describes instruments for improving research, design, tests and operation in industry. Esterline-Angus Co., Indianapolis, Ind.

Broadcast Transmitters. Folder on 20H-20J improved 1000-watt broadcast transmitters. Collins Radio Co., Cedar Rapids, Iowa.

Handbook of Amateur Tube Uses. Listed last month with no mention that the book costs 50¢. Raytheon Production Corp., 55 Chapel St., Newton, Mass.

Radio Products. Bulletin No. 280 gives complete information on various products of National Company, Inc., 61 Sherman St., Malden, Mass.

Radio Servicing Guide. No. 342-C, 32-page manual gives many helpful servicing and constructional hints. Price 15¢. Other free catalogues available are: Amplifier Catalogue No. 600-C, which illustrates six models with outputs ranging from 8 to 60 watts; a booklet of radio and amplifier transformers, chokes, etc., covers each item with complete electrical characteristics, prices, etc.; Bulletin SD-378 describes foundation units for: band-switching transmitter, 6L6 plate modulator and speech amplifier. Thordarson Electric Mfg. Co., 500 W. Huron, Chicago, Ill.

Transmitting Tubes. Bulletin No. TT-100 lists various types of air-cooled type tubes. Also Bulletin 1275B which gives characteristic chart and socket connections for receiving tubes. RCA Manufacturing Co., Harrison, N. J.

Pumps. No. 38-D is a well edited, profusely illustrated, well printed catalog on high vacuum pumps giving data on units from 10 cu. ft. to 225 cu. ft. capacity and in vacuum ranges from around 28 in. up to within a few microns. Vacuum practice in the electrical field is described, and types of equipment are illustrated. F. J. Stokes Machine Co., Olney, P. O., Philadelphia.

Audio and Power Components. T-Line catalog of amateur transmitter and public address systems. Kenyon Transformer Co., 840 Barry St., New York.

Electrical Measurements. Lists and describes precision electrical instruments of Sensitive Research Instrument Corp., 4545 Bronx Blvd., New York.

Reflexed Loud Speakers. Bulletin issued by University Laboratories, 191 Canal Street, New York.

Silverstat Regulators. Designed for automatic voltage control of small a-c and d-c generators. 12-page illustrated pamphlet, Catalog Section 31-260. Westinghouse Electric & Mfg. Co., E. Pittsburgh, Pa.

Symbol Chart. For engineers and architects 249 drafting symbols have been assembled in a single chart, known as "2E." Frederick Post Co., Box 803, Chicago.

Television Picture Tube. 5-in. deflection, Type 2005 Videotron. In addition to data relating to this tube, practical television receiver circuits are described and illustrated with a complete listing of the necessary parts for construction.

Also, complete information is given in another bulletin on Type 2203 Monotron, a 3-in. electrostatic deflection picture signal generator tube. National Union Radio Corp., Newark, N. J.

They ASKED for it!

THE PROBLEM:
A Radiator to offer suitable performance at a frequency of 930 KC—fulfilling Canadian government requirements—at a minimum of cost.

They GOT it!

THE RESULT:
"I am satisfied that a more efficient and economical Radiator could not be obtained", writes R. A. ERICKSON, Chief Engineer, Station CFAC.

Today it's Lingo
for the utmost in
Antenna performance

● Lingo has introduced new standards for Vertical Radiators. From installations already made, and from field tests conducted by outstanding authorities, come remarkable facts of superior performance. Lingo Tubular Radiators offer a new high in efficiency never before attained by any other type of antenna. We'll be glad to show you complete cost and performance charts without obligation.

Engineers—write today for your free copy—"New Standards for Vertical Radiators"

Be sure to read this interesting story. Mail your request now and be sure to state location, frequency and power of station.

JOHN E. LINGO & SON, INC.
Dept. E8, Camden, N. J.

LINGO
VERTICAL
TUBULAR STEEL
RADIATORS

DUMONT NEW LABORATORY OSCILLOGRAPH

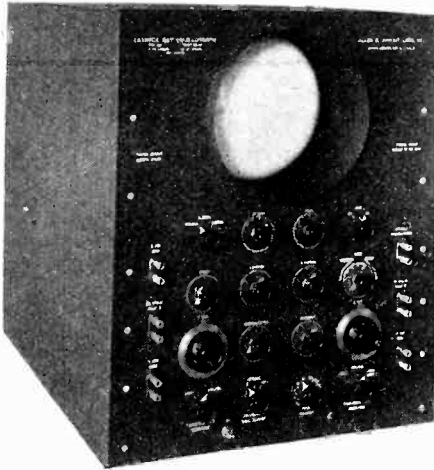

The Type 169 Nine Inch Laboratory Oscillograph was designed to meet the requirements of the research worker for a precision oscillograph of many applications. The new instrument incorporates many advanced and exclusive features of design.

Features

- Du Mont Type 94-9-H nine inch Cathode Ray Tube with vastly improved uniformity of focus over entire screen area.
- High intensity of trace—3000 volt Cathode Ray Tube Power Supply permits studies with long persistence screens.
- Exclusive Du Mont single sweep circuit greatly aids the study of transient phenomena.
- Linear frequency response as low as 3 cycles per second.
- Push-pull symmetrical deflection of Cathode Ray Tube including Du Mont wave expanding feature.
- Linear sweep frequency range 4—30,000 cycles per second.
- Separate grid modulation amplifier allows simultaneous writing and timing of transients.
- Beam Switch greatly facilitates photography.
- Controlled return trace elimination.
- Convenient Direct connection to all four deflection plates.

Write For Complete Specifications

ALLEN B. DU MONT LABORATORIES, INC.
 PASSAIC Cable Address: WESPEXLIN, NEW YORK NEW JERSEY

A NEW STUDIO RECORDER RADIOTONE PR-20

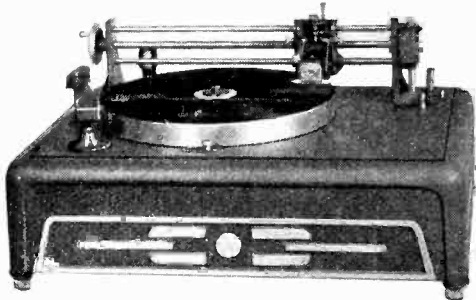

As streamlined in action as appearance, the RADIOTONE PR-20 allows every changeover at the flick of a finger—inside-out to outside-in, change from 78 to 33 1/3 RPM, lines-per-inch from 90 to 125. Line-Spreader, and micrometer adjustment of cutting-head are extra values. The PR-20 is vibration-free and "wow"-free, because of heavy construction, specially-balanced synchronous motor, and live-rubber drive. This 16-inch Studio Recorder offers the maximum of operating-ease plus unbelievable fidelity, at a moderate price.

★ Write for complete information on RADIOTONE PR-20; or if you are interested in portable or console models, mention that, too! ★

Radiotone, Inc.

7356 Melrose Ave., Hollywood, Cal.
 620 N. Michigan Blvd., Chicago, Ill.

MICROHM WIRE WOUND RESISTORS

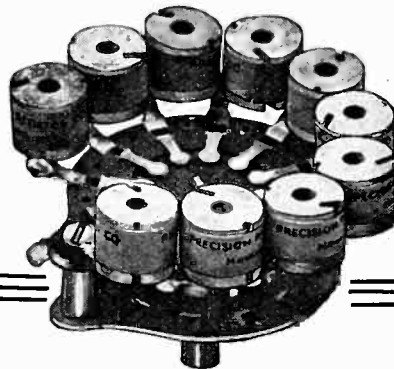

TYPE R Non-Inductive facilitate DECADE and OTHER ASSEMBLIES

Midgets in size but high in quality and accuracy. Diam. 1/2" x 7/16" long. Accuracy 1%. Available in a resistance range from 1 to 500,000 Ohms. Standard mounting with center hole to clear 6/32" screw. Designed for mounting by their terminals, making them adaptable for meter multipliers, decade and bridge assemblies. Small size recommends them for other uses. Accuracy of 1/10 of 1% available at slight extra cost.

Write for catalog and prices of Microhm PRECISION AND WIRE WOUND RESISTORS.

PRECISION RESISTOR CO.
 332 Badger Avenue
 NEWARK NEW JERSEY

New Products

New Tubes

KEN-RAD: Models 7000 and 7700 useful in applications where the elimination of hum and microphonics is important. Electrical characteristics are similar to types 6C6 and 6J7.

SYLVANIA: Type 906 high vacuum cathode ray picture tube suitable for use in small television receivers, etc. It has a 3 inch screen.

RCA: Type 1619 for transmitting beam power amplifier. Delivering 20 watts at 45 Mc Class C; 35 watts in push-pull AB. Type 1852 and 1853 television amplifier pentodes of high mutual conductance and type 832, a push pull, R-F beam power amplifier useful at ultra high frequencies.

RAYTHEON: Types 1A5G, 1A7G, 1C5G, 1H5G, 1N5G, 6AD6G, 6AE6G, 6AF6G, and 4A6G.

NATIONAL UNION: Monotron, Type 2203, a 3 inch electrostatic deflection type picture signal generator tube. Videotron, type 2005, a 5 inch electrostatic deflection type television picture tube.

Hamband Switches

TO PROVIDE AMATEURS with a convenient method of transmitter band switching, Mallory-Yaxley's new "HamBand" offers several features: Low-loss impregnated magnesium-silicate ceramic insulation; heavy silver plating on all current carrying parts insuring permanent low resistance; convenient contact spacing permitting short, direct leads; continuous rotation. Switch can be mounted

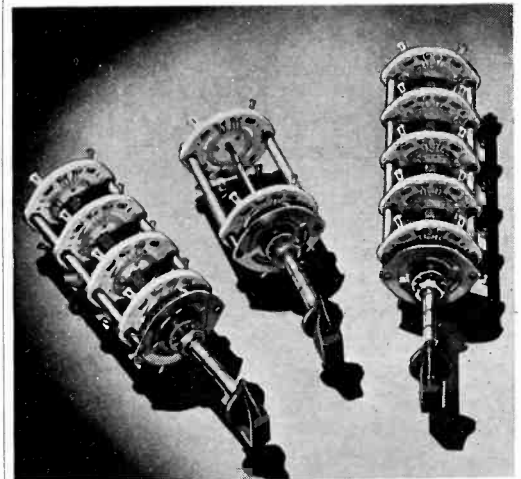

in any position. Design provides a smooth wiping action, keeping the contacts bright and clean without cutting away the silver.

A new line of dry disc rectifiers for servicemen, amateurs and experimenters have also been announced. Types are available for outputs from 1 to 20 volts, and 1/2 to 20 amps. Higher outputs may be obtained by series or parallel connection.

Rheostat

SAFE OPERATION at 25 watts down to 25 percent of full rotation with a temperature rise of 160° is possible with the new IRC all metal 25 watt rheostats (International Resistance Co.), Philadelphia. These rheostats have a die cast aluminum case. The resistance element is a low temperature, coefficient wire wound on a strip of heat dissipating aluminum core insulated by asbestos.

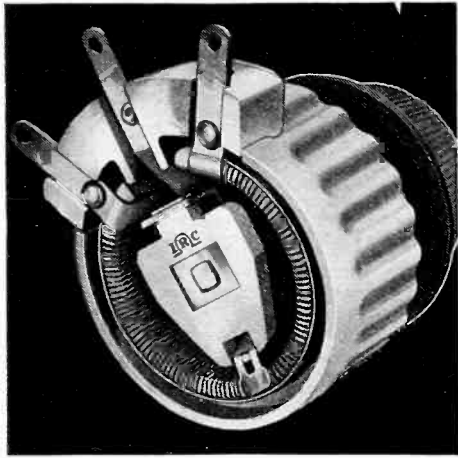

IRC also announced an attenuator, Type A-21, which features a unique switching mechanism. Instead of the usual stud type switch, this unit utilizes a molded motor commutator with conducting segments of polished, hard-drawn copper molded in phenolic. This new design with a multi-finger beryllium copper contact, which operates independently, and a flat, spiral spring connector will maintain its initial low noise level of -150 db in service.

Running Time Meter

DRIVEN BY A SLOW speed, self starting synchronous motor with enclosed gear train operating in oil, this unit which employs a 5 dial counter will automatically register the operating time of the circuit, apparatus or system to which it is connected. Types for registering total hours and tenths of hours, or total minutes and tenths of minutes are available from R. W. Cramer & Co., 67 Irving Place, New York.

Auto Radio Cable

STABILITY UNDER ALL weather conditions, a new type of insulation with extremely high "Q" and low capacity, and a weather-proof braid are characteristics of the new cable of Lenz Electric Mfg. Co., Chicago. Any number of conductors may be used, including r-f and control leads.

Multiple Recording Unit

AN ACHIEVEMENT in instantaneous recording is this multiple unit which combines a recorder, an electric phonograph, a radio and a public address system is announced by Federal Recorder Co., 1775 Broadway, New York. It operates on 110 or 220 volts 60 cycles.

Resistors

A NEW SERIES of Erie resistors has the leads in line with the axis of the body. They are identical in construction with the Erie insulated resistors without the insulated sleeve. The tinned copper wire and metal cap assembly is rigidly attached to each end of the unit by a special process.

Attenuator

TYPE T-330 for use as mixing or master gain control in broadcast speech input equipment, public address systems, sound recording studios and sound projection systems.

This unit made by The Daven Company, 158 Summit St., Newark, N. J., is a 30 step "T" pad with physical dimensions of 2 3/4 in. overall diameter, and a back-of-panel depth of 2 1/8 in. Insertion loss, zero; accuracy of calibration is within 5% at any or all steps, measured at 1,000 cycles; no frequency discrimination over the range of 30 to 17,000 cycles; the standard range of control is tapered from 1 1/2 db to a total loss of 60 db on the next to the last step and approximately 128 db on the last contact.

Hand Tachometer

EXCEEDINGLY wide range of speed with only three tachometer ranges accomplished by allowing the pointer to make two turns around the dial for each

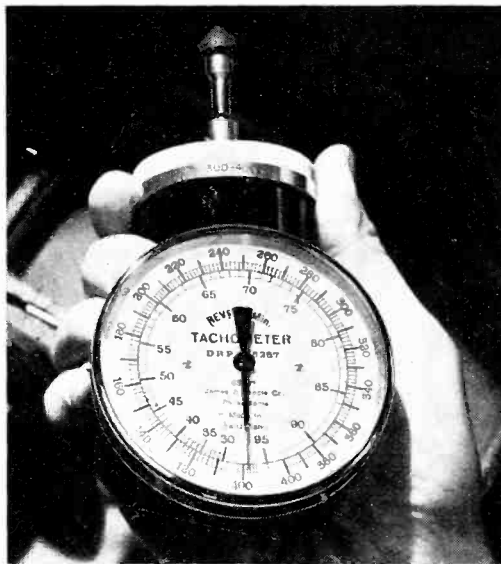

range instead of only one is the main feature of this new "Jagabi" universal unit of Jas. G. Bidle Co., 1211 Arch St., Philadelphia. Bulletin 1575 describes the unit.

Generator

A PORTABLE POWER supply suitable for PA systems, radio communication, etc., has been developed by D. W. Onan & Sons, Minneapolis. The lightest model weighs 71 lbs. net and delivers 600 watts at 115 volts. A pneumatic-tired dolly is available for moving these portable plants around with greater ease.

"PINCOR" SILVER BAND DYNAMOTORS

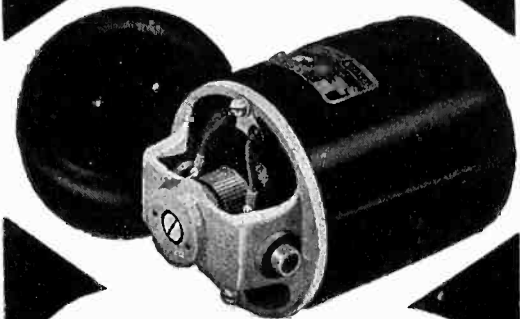

Now..Choose the Unit that Fits the Job..

★ "PINCOR" offers the only complete line of "B" power supply equipment for police units, aircraft and radio broadcast service and sound systems. Available in a wide range of frames, sizes and capacities to fit any particular requirement.

★ "PINCOR" dynamotors are the last word in efficiency and regulation. Deliver high voltage current for proper operation of your apparatus with a minimum of A.C. ripple. These units will give years of smooth, quiet, satisfactory service. They are compact, light weight. Available with or without filter.

NEW CATALOGUE FREE

Send for the latest "PINCOR" dynamotor catalogue and data sheets which includes description of the new types, "PS," "CS," and "TS" dynamotors. Mail coupon below.

PIONEER GEN-E-MOTOR CORPORATION
466 W. SUPERIOR ST., CHICAGO, ILL.
Export Address: 25 Warren St., N. Y., N. Y.
Cable: Simontrice, New York

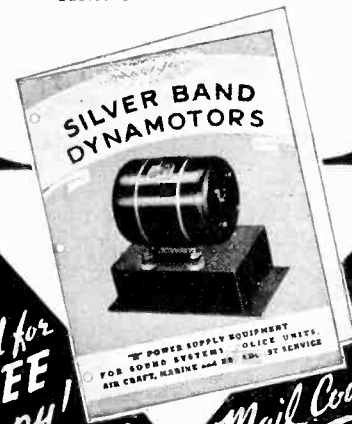

Send for
FREE
Copy!

Mail Coupon
Today

PIONEER GEN-E-MOTOR CORPORATION
Dept. R-4-H, 466 West Superior Street, Chicago, Illinois
Without obligation kindly send me "PINCOR" Silver Band Dynamotor catalogue and data sheets.

Name
Address
City State



WHERE DEMANDS
ARE
Most Exacting

INSUROK

LAMINATED AND
MOLDED PLASTIC

EVERY day the increasing use of INSUROK for electrical requirements gives further proof of the superiority of this Richardson plastic, and its adaptability to countless products and insulating needs. Your own interests can be most profitably served by standardizing on INSUROK, the superior plastic, thus adding its own value to the excellence of your product.

The **RICHARDSON COMPANY**
MELROSE PARK, CHICAGO, ILL. FOUNDED 1898 LOCKLAND, CINCINNATI, OHIO
NEW BRUNSWICK, N. J. INDIANAPOLIS, IND.
DETROIT OFFICE: 4-282 C. M. BUILDING, PHONE MADISON 9246
NEW YORK OFFICE: 75 WEST STREET, PHONE WHITEHALL 4-4487

Voltmeters

PORTABLE MULTI-RANGE Model 433 a-c voltmeters with improved temperature compensation are now being offered by the Weston Electrical Instrument Corp. The improvement will be of particular benefit in field test work where temperatures ranging from -20 deg. to 120 deg. F. may be encountered.

Rheostat

A 225 WATT, Model P unit has been added to the Ohmite (4835 W. Flournoy St., Chicago) line of vitreous enameled rheostats which may be secured in

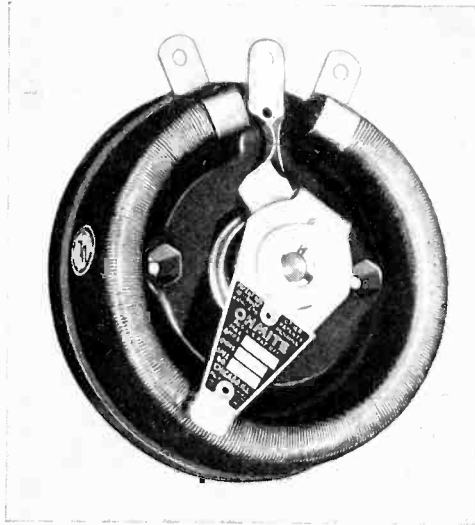

single or tandem assemblies. Cages can be furnished if desired. These rheostats are now available in several models handling from 25 up to 1000 watts.

Recorder

A RECORDER for dictation, recording telephone and verbal orders as well as conversations, conferences, etc., using blank or developed film 8 or 16 mm. is available from Miles Reproducer, Inc., 812 Broadway, New York City. It reproduces immediately after recording without processing. By means of an electro mechanical head with sapphire point, sound tracks are visibly indented into the film. They may be played back two thousand times and 80 minutes of dictation may be placed on 100 feet of 16 mm. film, costing 80c. Model D is equipped with microphone, amplifier, headphone, etc.

Industrial Socket

A NEW HEAVY DUTY wafer socket is designed by Hammarlund Mfg. Co. especially for use in sound equipment and other similar apparatus where a great many tube changes cause socket failure. Featuring two-piece construction, this socket is built of low loss natural color bakelized canvas. Contacts are heavy, non-corrosive metal reinforced with sturdy steel clamps to insure perfect electrical contact and long life.

PROFESSIONAL SERVICES

(Rates on Application)

ELECTRICAL TESTING LABORATORIES

Characteristics and
Life Tests of Vacuum Tubes
Tests of photo cells, glow lamps, crater lamps.
Tests of electronic and optical devices.
80th Street and East End Avenue
New York, N. Y.
Phone: Butterfield 8-2600

INTERNATIONAL ELECTRONICS, INC. AMERICAN CONSULTING ENGINEERS TO FOREIGN MANUFACTURERS

Designs Specifications
Electrolytics Tubes Resistors
Transmitters Receivers
630 Fifth Avenue New York, N. Y.
Cable:—Interengin, New York

HAROLD J. McCREARY

Mem. A.I.E.E. & W.S.E.

Consulting Engineer

Research. Electronics
Development Television
Design Radio
Factory Practice Railroad Signaling
Patent Studies Telephony
105 W. Adams St. Phone STAt 4003 Chicago, Ill.

RADIO DEVELOPMENT & RESEARCH CORP.

CONSULTANTS AND DESIGNERS

Including
Amplifiers—Antennas—Transmitters
Receivers—Laboratory Equipment
Special equipment designed and constructed
145 West 45th Street, New York, N. Y.
Tel. BRyant 9-6898

ROWE RADIO RESEARCH LABORATORY CO.

DOMESTIC SECTION

Development Engineers of Radio Receivers.
Allied Apparatus and Components.
Designers and Constructors of Special Equipment.
Complete Laboratory Facilities.
1103 Bryn Mawr Ave. Chicago, Illinois.
Telephones—Longbeach 3163—3164

ROWE RADIO RESEARCH LABORATORY CO.

FOREIGN SECTION

Engineering Information Specialists and
Consultants.
Complete Laboratory at Disposal of Clients.
Current Radio Receiver Characteristics Available.
Sales, Patent, and License Negotiation
Intermediaries.
1103 Bryn Mawr Ave. Chicago, Illinois, U.S.A.
Cable Address—RORADLAB CHICAGO

THE SOLUTION OF YOUR PROBLEM

in the field of Electronic devices may be found through enlisting the services of the Consultants whose cards appear on this page.

This is a highly specialized field and specialists are therefore better able to undertake the rapid developments necessary to keep in step with modern manufacturing progress.

Turn Table

SUITABLE FOR radio-phonographs, phonographs and play-back units is the "Even Speed" motor developed by Alliance Mfg. Co., Alliance, Ohio. The motor design is such as to allow free ventilation and cool operation and

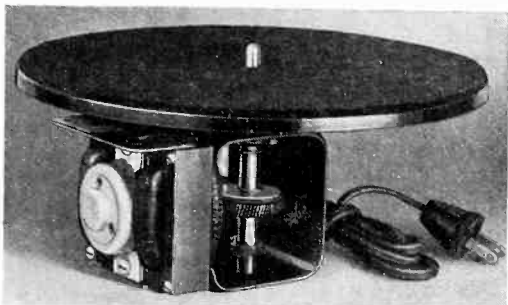

maintenance of proper speed regardless of variations in line voltage or operating temperature. Turntable and motor (110 volt—60 cycles) furnished complete with 5 ft. cord and rubber spools for mounting. Available with 9, 10 or 12 in. turntable.

Transmitting Condensers

ONE OF THE IMPORTANT qualities of the Atkins & Brown Co., 215 14th St., Oakland, Cal., A&B type condensers is their short length for the capacity and plate spacing involved, made possible by mounting the two stator sections opposite each other across the shaft. A compact 90° construction makes possible the elimination of the rear end plate and assuring lower minimum capacities. The condensers may be mounted directly to the panel at a suitable height in regard to the tube elements, or they may be mounted vertically on the sub-panel.

Signal Generators

MODELS 17 AND 18 of Hickok Electrical Instruments, Cleveland, have five output selections: frequency modulated r-f output, amplitude modulated r-f output, unmodulated r-f output, 100 to 10,000 cycles continuously variable a-f output, and 400 cycle fixed audio output. All ranges are controlled by output attenuator. Both models provide synchronized horizontal sweep voltage for oscillograph and the frequency modulated output (30 kc sweep) is available over entire range of signal generator for visual alignment and trouble shooting, and is automatically disconnected when using amplitude modulation.

Relay

WARD LEONARD Electric, Mt. Vernon, N. Y. announces a new Break-In or Push-to-Talk relay especially suitable on 'phone transmitters where the operator merely presses a button while transmitting and releases while receiving. There are two types, each having 4 poles. The types are heavy duty and midget, both using Micalax insulation in their construction.

Doherty Transmitter

A 5-KW RADIO broadcast transmitter on circuits which won its inventor the I. R. E. Morris Liebman Memorial Award. It raises the efficiency of the power amplifier stage approximately 100% thus effecting a saving in power and a reduction in plate dissipation. A-C operated its output power is 5,000 watts and may be changed to either 2,500 watts or 1,000 watts by means of a push-button. Connections are provided for cathode ray oscillograph in all important circuits. Western Electric also announce that it is designed to accommodate expansions to 10, 50 or 500 kw by the addition of units available.

Crystal Unit

WITH A CRYSTAL ground so that it can be made to oscillate at either 100 or 1000 kc by placing the proper tank in the circuit, type SMC100, standard frequency unit, Bliley Electric Co., Erie, Pa., is dual-frequency mounted for use in secondary standards of frequency. Calibration accuracy is 0.01% at 100 kc, and 0.05% at 1000 kc and can be applied to any conventional oscillator

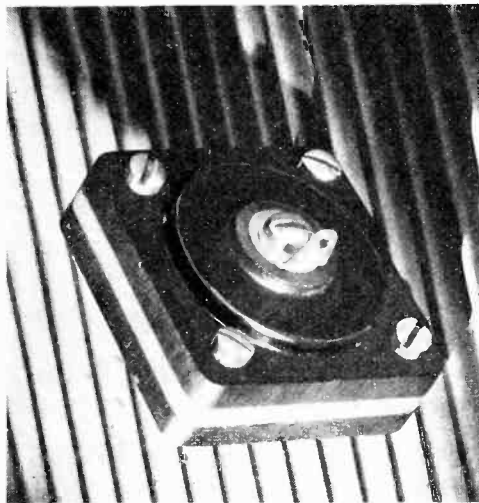

circuit. A 6F6 tube is used with a screen-grid serving as the tuned plate of a triode crystal oscillator. Output is obtained by electronic coupling between the oscillating portion of the circuit and the plate circuit of the tube, and is rich in harmonics. Usable frequencies can be obtained up to 20,000 kc from 100 kc and up to 60,000 kc from 1000 kc.

Solder

AN INCREASE in tensile strength amounting to 33% is an important characteristic of "Hi-Tensile" solder made by the National Cable & Metal Co., 1727 Standard Ave., Glendale, Cal. Other characteristics are: Low melting point which means that less heat is required to flow and to sweat these solders; good bonding ability, and increased conductivity for electrical jobs. They are also cleaner to work with and may be purchased in bar, pig or plain wire form.

Compressed Nitrogen Condenser

TYPE

174

IMPROVED

Neoprene gaskets
Corona shields
Safety gap
Increased break-down voltage



RATINGS: (at 1 mc.)
PEAK VOLTS 40,000
R. M. S. AMPERES 80

HEINTZ AND KAUFMAN
SOUTH CALIFORNIA
SAN FRANCISCO LTD U. S. A.

SIGMA RELAY

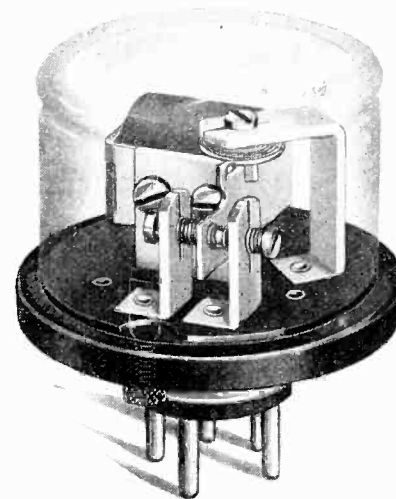

TYPE 2-A

- 6 to 12 milliwatt operation
- Single pole, double throw contact circuit
- Handles 150 watts non-inductive load at 110 volts A.C.
- Field resistances 100 to 8,000 ohms
- Plug-in mounting in standard tube socket.

In similar construction, Sigma relay type 2-B operates at 4 milliwatts to control 50 watts non-inductive load.
Write for data sheet giving detailed information.

SIGMA INSTRUMENTS, Inc.
388 Trapelo Road
BELMONT MASSACHUSETTS

ALLIED

"CLEEN CUT" RECORDING BLANKS

Meet the Critical Requirements of Professional Recording. A GOOD BLANK IS THE FOUNDATION OF GOOD RECORDING.

PROMPT DELIVERIES

Our new enlarged manufacturing facilities permit us to fill and ship all blank orders the *same day* of receipt of order.

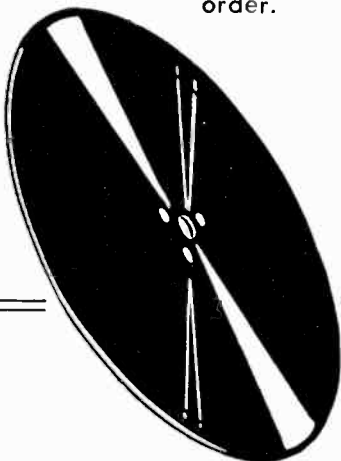

Also manufacturers of quality fixed and portable recording equipment. Write for 8 page bulletin, "Fine Points in Recording".

ALLIED RECORDING PRODUCTS COMPANY

126 W. 46th St.
New York City

Cable Address: Allrecord

Phone: Bryant 9-1435



ENCLOSED RELAYS That Operate in Any Position

Available in Power, Vacuum Tube and Radio Frequency Types.

Especially adaptable for mobile, marine, aircraft and police installations. AC and DC.

ALLIED CONTROL CO., INC.
95 Liberty St. New York, N. Y.

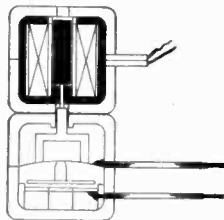

McGraw-Hill

DIRECT MAIL LISTS

As business paper publishers for over fifty years, McGraw-Hill is uniquely equipped to offer complete, authoritative direct mail coverage of Industry's major markets. Extreme accuracy is maintained (guaranteed to 98%) and through careful analysis of markets, complete classification of companies and personnel, etc., the widest possible selections are available. Send for handy reference folder, "Hundreds of Thousands of Reasons Why" which describes how McGraw-Hill Lists are built and maintained.

What Fields Do You Want to Reach?

Aviation
Bus & Electric Railways
Civil Engineering and Construction
Administrative Executives

Electrical Dealers & Wholesalers
Mill Supply Houses
Power Services
Product Engineering & Design
Production and Maintenance
Radio Dealers & Wholesalers
Radio Engineering & Design

For further details, selections from above basic classifications, counts, prices, etc., or estimates on special lists . . . ask any representative or write to



Complete Lists Covering Industry's Major Markets

Wax

FLEXO WAX C introduced recently by Glyco Products Co., 148 Lafayette St., New York, has the property of being sticky or adhesive and can be used on glass or metals. It is amorphous or non-crystalline and will blend easily with resins, oils and other waxes and can be used for coatings or laminated work of all kinds.

Relay

TWIN-LATCH RELAYS known as Type L have been released by G-M Laboratories Inc., Chicago. The relay consists of two coils and two hinged armatures each of which carries a latch arm. The

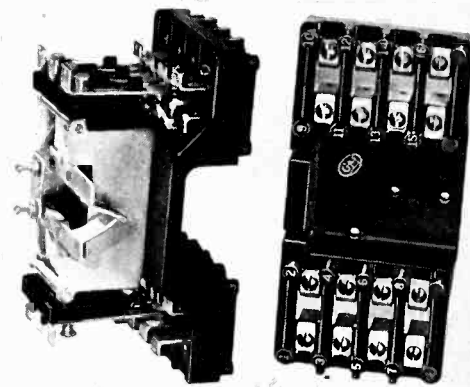

latched arms interlock, thereby mechanically holding one armature in the energized position until the other armature operates.

Late News

SPRAGUE announces silver mica condensers in 4 sizes and in capacity from 5 to 500 mfd. Also a plug-in type noise filter . . . A non-skid screw driver is announced by the Bridgeport Hardware Mfg. Corp., of Bridgeport, Conn, which is particularly useful for radio mechanics . . . A thermostatic controlled stand for maintaining constant temperature of electric soldering iron is a new item of the Electric Soldering Co., Inc., Deep River, Conn. . . . A 30-watt portable sound unit with remote control and remote mixing is available from Operadio. It is known as Model 425-GG . . . Clarostat has a complete listing of interchangeable tube type resistors in wall chart form . . . G.E. announces a new photoelectric control for removing skew from cotton cloth. Also a new high voltage power fuse known as Type EJ-1 described at the AIEE, Washington, June 23 . . . Received from Spaulding Fibre Co., a booklet on recent test specifications issued by the ASTM covering phenolic sheet for use in radio application . . . Recent bulletins on electrical measuring instruments are from Weston: Panel Instruments, Industrial Control Relays, Test Equipment, Contact Making Instruments and Illumination Control Relays . . . Bulletins on Rotary Switches and 3-in. sq. flush Mounting Panel Instruments from Roller-Smith Co.

SEARCHLIGHT SECTION

(Classified Advertising)
 EMPLOYMENT: "OPPORTUNITIES": EQUIPMENT
 BUSINESS: USED OR RESALE

UNDISPLAYED — RATES — DISPLAYED

10 CRTS A WORD. MINIMUM CHARGE \$2.00
 Positions Wanted (full or part time salaried employment only), 1/2 the above rates payable in advance.

Box Numbers—Care of publication New York, Chicago or San Francisco offices count as 10 words. Discount of 10% if full payment is made in advance for 4 consecutive insertions.

Individual Spaces with border rules for prominent display of advertisements.

1 inch \$6.00
 2 or 3 inches 5.75 per inch
 4 to 7 inches 5.50 per inch

An advertising inch is measured vertically on a column—3 columns—30 inches to a page. Contract rates on request.

New advertisements must be received not later than August 30th for the September issue

WANTED

The names and addresses of the following box number advertisers in the July 1938 issue of ELECTRONICS

PW150 — P151 — RA152

The above information is required due to the loss of our office records on these advertisers. Address Departmental Advertising Staff, ELECTRONICS, 330 West 42nd St., New York City.

POSITION VACANT

WANTED—ELECTRONICS RESEARCH ENGINEER, college graduate, experienced in the design and use of cathode ray, ultra high frequency amplifier, and oscillator circuits, wave filters, short wave receivers and transmitters, measuring equipment, etc. State experience, salary expected, and full particulars. P-154, Electronics, 330 West 42nd Street, New York City.

HIGH GRADE SALES ENGINEER wanted by progressive manufacturer. Salary basis. P-156, Electronics, 330 West 42nd Street, New York City.

POSITIONS WANTED

YOUNG MAN, now employed, desires permanent connection with midwestern industrial control firm for administrative, laboratory, or sales work. I have ideas that will be profitable to any industrial electronic control company. 3 years college, Physics major. Only inquiries with request for interview will be answered. PV-153, Electronics, 520 North Michigan Ave., Chicago, Ill.

ELECTRICAL ENGINEER, 35, Vienna, Berlin graduate. Sound film, acoustics, facsimile and related fields; patents; research and development. Creative ideas, languages. 12 years' European experience. Some own laboratory equipment. PW-155, Electronics, 330 West 42nd Street, New York City.

SELLING OPPORTUNITIES OFFERED—WANTED

Selling Agencies—Sales Executives
 Salesmen—Additional Lines

OPPORTUNITY WANTED

WANTED: Communication from firms desiring sales representation in Metropolitan New York. Experienced sales engineer, Buchann's Engineering Sales, 210 Fifth Avenue, New York City.

MICROMETER FREQUENCY METER for checking transmitters, up to 56 megacycles
LAMPKIN LABORATORIES
 BRADENTON, FLORIDA

CHAS. EISLER'S
 Equipment
 Has Produced
MILLIONS

750 S. 13th St. (Near Avon Ave.)

FOREMOST IN THE ELECTRONICS FIELD FOR OVER 20 YEARS!

Charles Eisler's equipment for the production of radio and electronic tubes, incandescent lamps, X-ray and cathode ray tubes, photo-electric cells, mercury switches, and neon signs has met the severest demands of industry in operating at the lowest cost and highest efficiency. If you are in the market for any of this or allied equipment including electric spot welders up to 250 KVA. butt, and arc welders, get in touch with us. Write for our "college and glass working laboratory units" catalog if interested in equipment for instruction purposes.

EISLER ENGINEERING CO. Newark, N. J.

IRC RESISTORS

- Insulated Metallized and Wire Wound Resistors
- Precision Resistors
- Cement Coated Power Wire Wound Resistors

We stock all types for Laboratory and Industrial Applications
 WRITE FOR OUR 1938 CATALOG

CAMERADIO

963 LIBERTY AVE. PITTSBURGH PA. 30 TWELFTH ST. WHEELING, W. VA.

Established 1919

DEPENDABLE

New and Used

ELECTRONIC TUBE EQUIPMENT

A complete line of equipment for the manufacture of Radio Tubes, Neon Tubes, Incandescent Lamps, etc.

Write for Bulletin showing savings from 25 to 75%
EISLER ELECTRIC CORP.
 534 39th Street, Union City, N. J.

Meters repaired, made more serviceable. Conversion to higher sensitivity as high as 10 microamperes for Weston type I or 24-57.

Sensitive vacuum thermo-couples For Sale used Weston panel meters. Rawson microammeters, Brown pyrometers.

Reasonable Prices
Precision Electrical Instrument Co.
 561 Broadway, N. Y. C.

HIGH GRADE NEW AND USED ELECTRON TUBE EQUIPMENT

Huge Stock of Equipment of Every Type and Variety

KAHLE ENGINEERING CORPORATION
 Specialists in Equipment and Methods for the Manufacture of Neon Tubes, Radio Tubes, Incandescent Lamps, Photo Cells, X-ray Tubes, etc.
 941 DeMott St., North Berger, N. J.

VACUUM THERMOCOUPLES

Separate Heater and Contact Types. Mounted and Unmounted

Ranges from 1 Milliamp and up
 Write for Bulletin "A"

American Electrical Sales Co., Inc.

65-67 E. 8th St., New York, N. Y.

75 Kilowatt Power Supply

- 3—25 K.W. Transformers, Double Secondaries of 13,500 Volts.
- 2—Auto-Transformers, 10% Steps.
- 1—15 Henry, 20,000 Volt Choke.
- 1—Interphase Reactor.
- Westinghouse Equipment. Condition A-1.

Priced low for quick sale
MILLER WATKINS, Wlac Nashville, Tenn.



"BUT

—What Can CREI Training Do For Me?"

● CREI offers a complete course in Practical Radio Engineering, written for the man who is serious about getting ahead in Radio. Over 260 U. S. stations employ CREI men—proof that our training pays dividends in better jobs and more pay. We offer advanced home-study for experienced radio men who know that new developments are creating new opportunities for trained men. If you realize the importance of training for success, send for our Free Booklet "A TESTED PLAN" that describes our courses and your future in detail.

CAPITOL RADIO ENGINEERING INSTITUTE
 Dept. E-8 3224—16th St., N. W.
 WASHINGTON, D. C.

MAIL THIS COUPON TODAY!

Please send me complete details and FREE illustrated 48-page booklet—"A Tested Plan for A Future in PRACTICAL RADIO ENGINEERING."

Name

Address

City

E-8

radio equipment . . .

for Broadcasting Stations
 Engineers • Laboratories

We carry at all times a most complete line of
PUBLIC ADDRESS EQUIPMENT

Call or Write

TERMINAL

Radio Corporation

80 Cortlandt Street, New York, N. Y.

Want only a FEW?

We specialize in small quantities—as few as 50.
 R.F. COILS (Duo-lateral and Solenoid)
 AMPLIFIERS (Audio and Radio Frequency)
 Mechanical Design, Assembly and Electrical Development

Get our prices—no matter how many you need. Let us work with you.

• ALESI & FENER •

132 Nassau St., N. Y.

BEekman 3-2063

FOR SALE

One Ferris Microvolter, model #10B, serial #528, brand new, used only once for 15 minutes. Will sell for \$200.00 cash.

REGEL MFG. CO., INC.

14-16 W. 17th St.

New York, N. Y.

PILOT LIGHTS

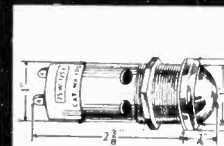

NEW TYPE No. 100
 1-inch Jewel Assembly

Uses Mazda S6 lamp removable from front of assembly. Can be furnished with smooth or faceted jewels. — Colors optional. Extremely low price.

Write for complete catalogue and prices

DIAL LIGHT CO. OF AMERICA

F. EDWIN SCHMITT SALES CO.

National Sales Agents

136A Liberty Street, New York, N. Y.

NOW —

**Electronics theory
and applications
at your fingertips**

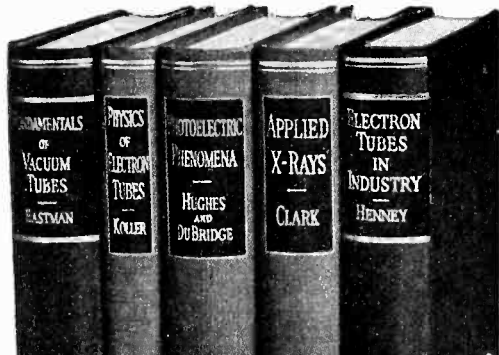

The Library of ELECTRONICS

FUNDAMENTAL laws and principles—**F**—theoretical discussions—tube and circuit descriptions—diagrams and data—design information—practical applications—a modern reference and special-study library of electronics for the industrial engineer, communications man, and physicist—brought to you in this newly assembled group of five authoritative and detailed volumes.

5 volumes, 2212 pp., 1406 illustrations

1. *Eastman's* FUNDAMENTALS OF VACUUM TUBES
2. *Koller's* PHYSICS OF ELECTRON TUBES
3. *Hughes and DuBridge's* PHOTOELECTRIC PHENOMENA
4. *Clark's* APPLIED X-RAYS
5. *Henney's* ELECTRON TUBES IN INDUSTRY

Books selected by specialists of the McGraw-Hill Publications to give the broadest view, a detailed coverage, of advanced electronics engineering. Replete with the sort of information to which you will refer often in both ordinary and special work. A thousand pages on electronics applications in industry and technology.

Special Low Price and Easy Terms

Bought singly, the five volumes comprising this library would cost you \$22.00. Under this offer you save \$2.50 and, in addition, have the privilege of paying in easy installments beginning with \$3.50, 10 days after receipt of the books, and \$4.00 monthly thereafter. Already these books are recognized as standard works that you are bound to require sooner or later. Take advantage of these convenient terms to add them to your library now.

SEND THIS ON-APPROVAL COUPON
McGraw-Hill Book Co., Inc.
330 W. 42nd St., New York, N. Y.

Send me The Library of Electronics 5 vols., for 10 days' examination on approval. In 10 days I will send \$3.50, plus few cents postage, and \$4.00 monthly till \$19.50 is paid, or return books post-paid. (We pay postage on orders accompanied by remittance of first installment.)

Name

Address

City and State

Position

Company L 3-38
(Books sent on approval in U.S. and Canada only.)

INDEX TO ADVERTISERS

Aerovox Corp.	52
Alliance Manufacturing Co.	3
Allied Controls, Inc.	62
Allied Recording Products Co.	62
American Automatic Elec. Co.	46
American Transformer Co.	34
Amperex Electronic Products, Inc.	Inside Front Cover
Astatic Microphone Laboratory, Inc.	48
Biddle Co., James G.	48
Bliley Electric Corp.	54
Callite Products Division	46
Centralab Div., Globe-Union Co.	2
Cinaudagraph Corp.	52
Cinch Manufacturing Co.	4
Driver Co., Wilbur B.	52
Du Mont Laboratories, Inc., Allen B.	58
Erie Resistor Corp.	38
Formica Insulation Co.	49
Goat Radio Tube Parts, Inc.	54
Globar Div., Carborundum Co.	36
Heintz & Kaufman, Ltd.	61
Hygrade-Sylvania Corp.	39
International Resistance Co.	35
Isolantite, Inc.	45
Johnson Co., E. F.	50
Jones, Howard B.	64
Leach Relay Co.	50
Leac Developments, Inc.	40
Lenz Electric Co.	41
Lingo & Sons Inc., John E.	57
Mallory & Sons, P. R.	6
McGraw-Hill Book Co.	64
Pioneer Gen-E-Motor Corp.	59
Post Co., Frederick	42
Precision Resistor Co.	58
Presto Recording Corp.	5
Quam-Nichols Co.	37
Radiotone, Inc.	58
RCA Communications, Inc.	50
RCA Manufacturing Co.	Back Cover
Richardson Co., The.	60
Shallcross Mfg. Co.	64
Sigma Instruments, Inc.	61
Superior Tube Co.	51
Synthane Corp.	Inside Back Cover
Triplet Electrical Instrument Co.	48
Western Electric Company	43
Weston Elec'l Instrument Corp.	47
Zophar Mills	54
Professional Services	60

SEARCHLIGHT SECTION

Classified Advertising

EDUCATIONAL COURSES	
Capitol Radio Engineering Institute.	63
EMPLOYMENT	63
EQUIPMENT FOR SALE	
Alesi & Fener.	63
American Electrical Sales Co., Inc.	63
CameRadio Co.	63
Dial Light Co. of America.	63
Ducommun, M.	63
Eisler Electric Corp.	63
Eisler Engineering Co.	63
Kahle Engineering Corp.	63
Lampkin Laboratories.	63
Precision Electrical Instrument Co.	63
Regel Mfg. Co., Inc.	63
Terminal Radio Corp.	63
Watkins, Miller.	63

PLUGS — SOCKETS TERMINAL PANELS, ETC.



ILLUSTRATED
PLUG: P-6-CCT—SOCKET: S-6-AB

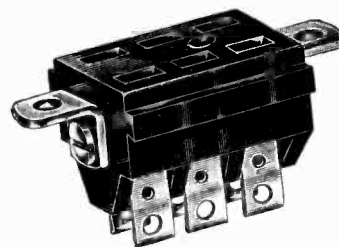

**HUNDREDS OF STANDARD ITEMS
OR SPECIALS TO YOUR BLUE-
PRINTS.**

WRITE FOR BULLETINS.

HOWARD B. JONES
2300 Wabansia Avenue
CHICAGO ILL.

SHALLCROSS Akra-OHM Wire Wound PERMANENT VALUE RESISTORS

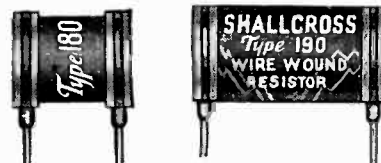

Developed for use in scientific and industrial control equipment and measurements. Also for use in laboratory and experimental instruments.

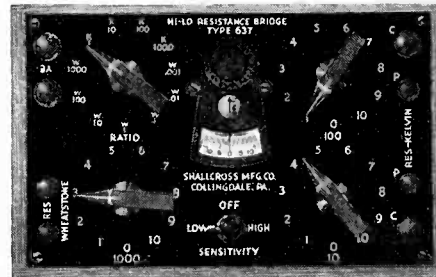

We manufacture resistance boxes, decade potentiometers, Wheatstone Bridges, resistance standards up to 100 megohm all wire wound.

Send for Bulletin 140KC

SHALLCROSS MFG. CO.
COLLINGDALE, PA.

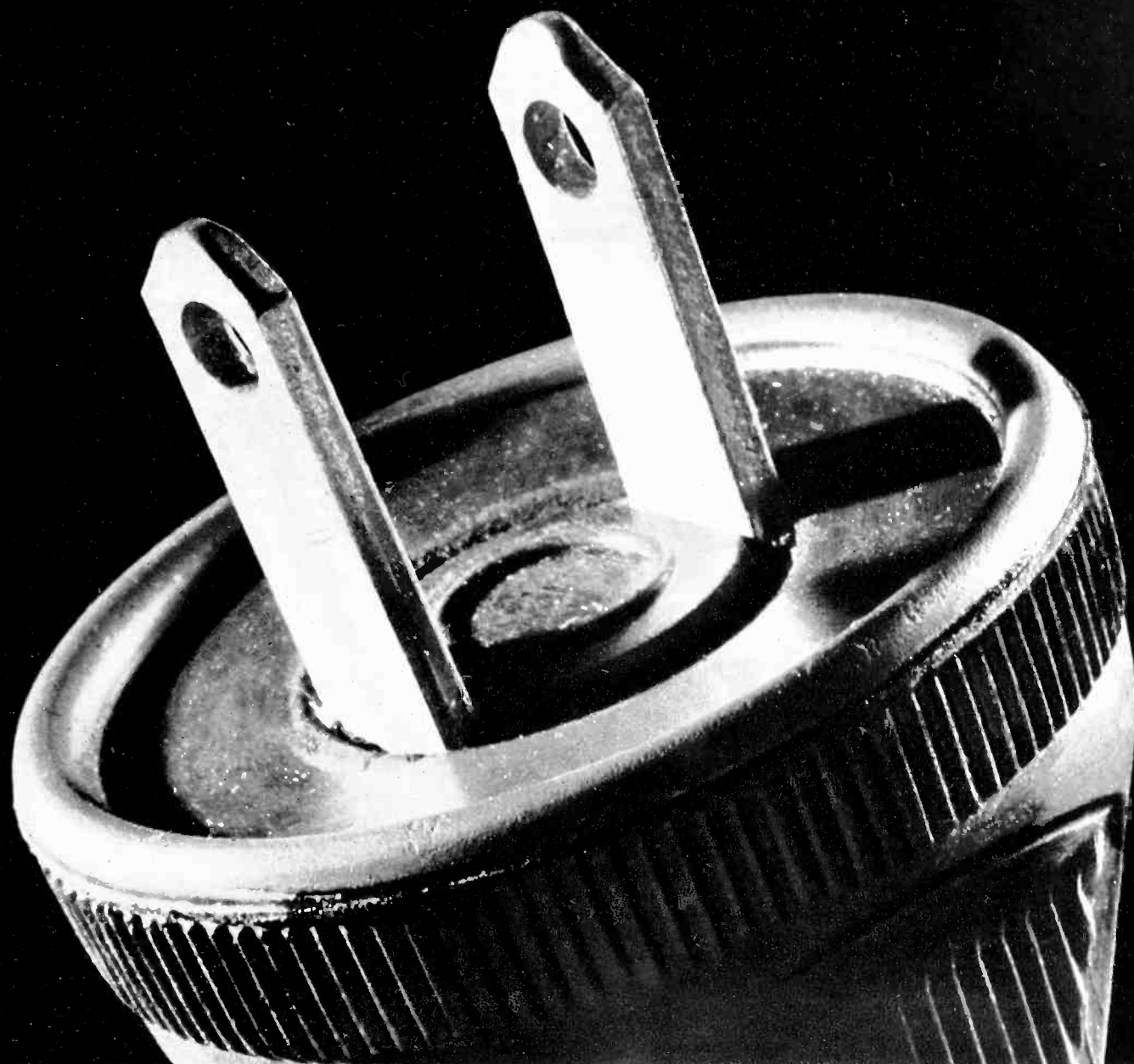

What This Connects, SYNTHANE Protects

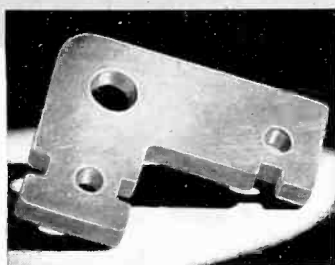

PLU^G-in appliances use the protection of Synthane electrical insulation—Familiar kinds do—from the meticulously accurate electric clock to the conveniences that brighten every hour of its dial—radios, ranges and telephones, fruit juicers, pianos and heat regulators, sun lamps, refrigerators and toasters—devices for home, office, factory. These are the reasons . . .

Synthane has what electrical manufacturers want—what *you* may want—an unusually broad *combination* of physical, electrical, chemical and mechanical properties. Synthane is a dense, solid material, tough, strong, and light in weight—an excellent insulator—with a low power factor, low moisture absorption, high di-

electric strength, low dielectric constant.

It's chemically inert and corrosion resistant. It machines easily. Synthane is often the most *economical* material to use because of lowered production costs, better product performance, dependable adherence to standards. Why not write for data on Synthane, giving us your requirements? We might help you make more money.

SYNTHANE
Bakelite —  *laminated*

SYNTHANE CORPORATION, OAKS, PENNSYLVANIA

SHEETS • RODS • TUBES • FABRICATED PARTS • SILENT STABILIZED GEAR MATERIAL

Good things come in small Packages
**AND NEW RCA VISUAL
TUNING TUBE IS TRULY SMALL!**

6AF6-G is a twin indicator type of electron-ray tube that radio set manufacturers will find ideal—especially for table sets.

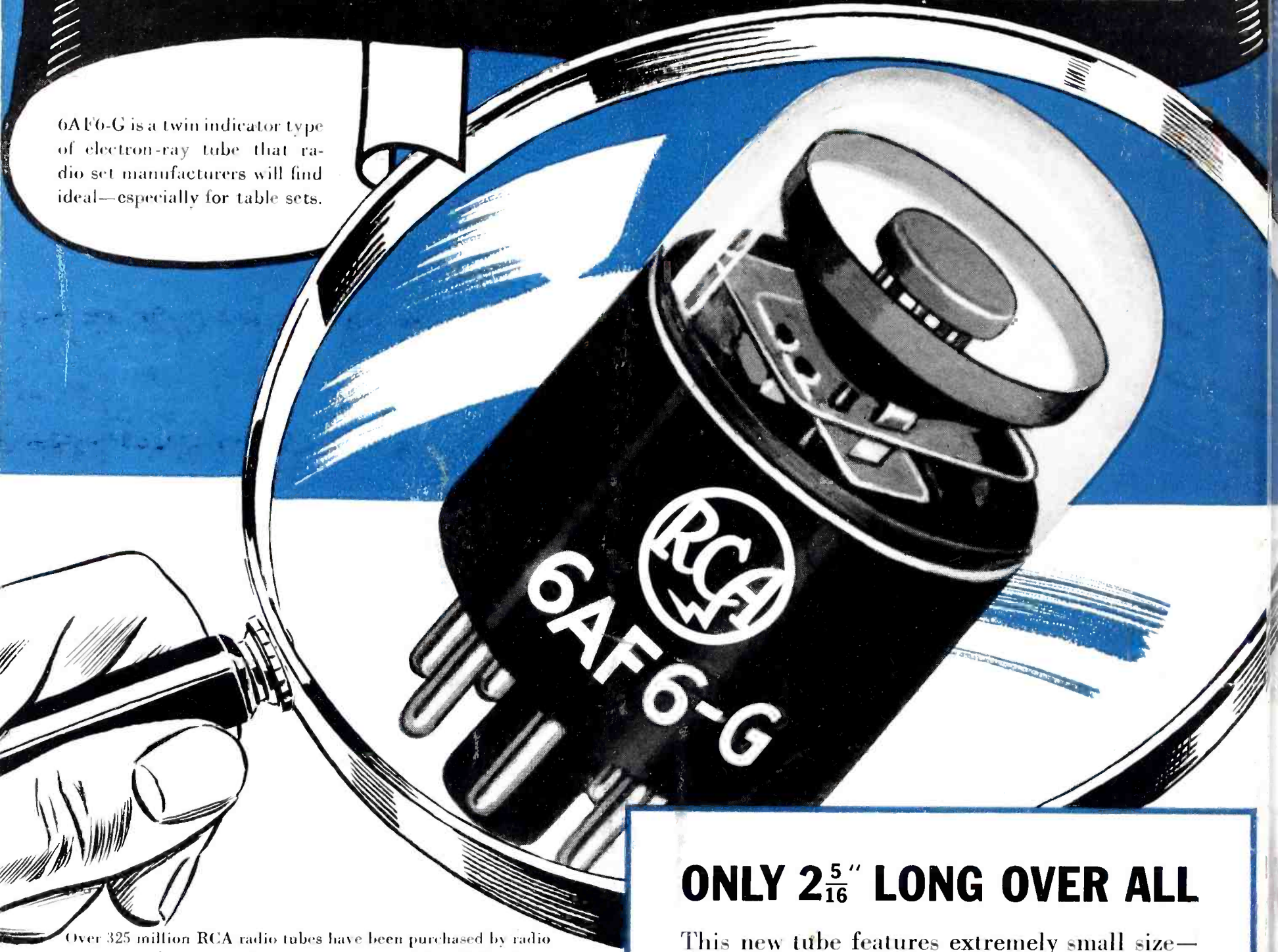

Over 325 million RCA radio tubes have been purchased by radio users... in tubes, as in radio sets, it pays to go RCA All The Way.

RCA presents the Magic Key every Sunday, 2 to 3 P.M., E. D. S. T., on the NBC Blue Network.



Radio Tubes

RCA MANUFACTURING CO., INC., HARRISON, N. J.

A SERVICE OF THE RADIO CORPORATION OF AMERICA

ONLY 2 $\frac{5}{16}$ " LONG OVER ALL

This new tube features extremely small size—a size made practical by a special construction which eliminates the conventional stem. It can be used on any size radio panel.

TWO INDEPENDENT SHADOWS

The new tube has two controlling electrodes. As a result, two shadow angles are produced in one bulb—and may be used independently or together.

Full details and the surprisingly low price of this tube are available on request.