

electronics

radio, communication, industrial applications of electron tubes . . . engineering and manufacture

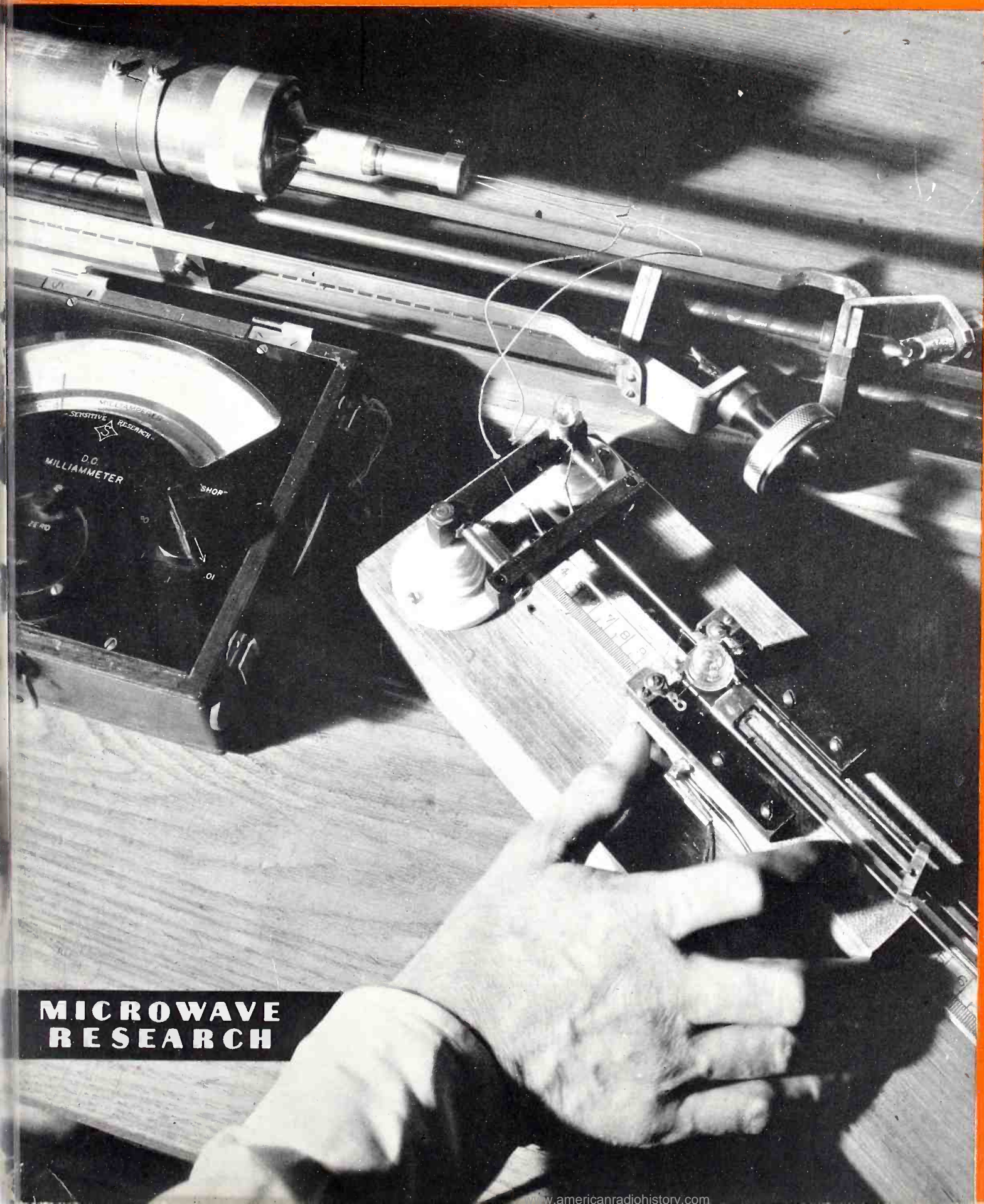

**MICROWAVE
RESEARCH**

**OCTOBER
1937**

**Price
50 Cents**

**MCGRAW-HILL
PUBLISHING
COMPANY, INC.**

the New

AMPEREX

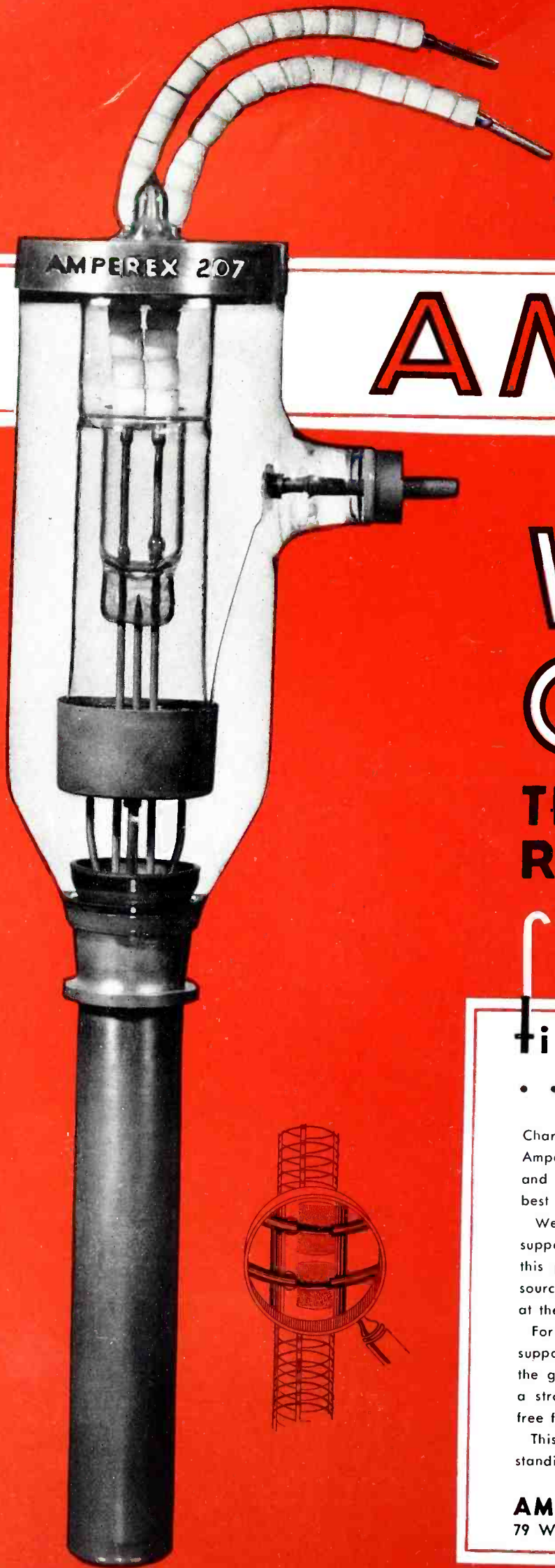

**WATER
COOLED
TRANSMITTING and
RECTIFYING TUBES**

**fine craftsmanship . . .
. . . expert workmanship**

Characterize every element which enters into the construction of Amperex Water Cooled tubes. The painstaking thoroughness, precision and skill with which these elements are designed and engineered is best illustrated by the grid.

Welding, the customary method of attaching the fine grid wire to the supporting rods, is entirely eliminated. The intense heat developed in this process results in the formation of oxide films on the wires (a source of grid emission) and in the crystallization of grid wire and rod at the point of junction.

For the Amperex grids, a machine was developed which slots the supporting moly rods at accurate intervals determined by the pitch of the grid. The grid wire is securely swaged into these notches, forming a strong rugged grid free from brittleness due to crystallization and free from surface contamination because of any oxidation.

This minute attention to detail is a contributing factor to the outstanding performance of Amperex tubes.

AMPEREX ELECTRONIC PRODUCTS, INC.
79 WASHINGTON STREET
BROOKLYN, NEW YORK

electronics



RADIO . . . COMMUNICATION AND
INDUSTRIAL APPLICATIONS OF
ELECTRON TUBES . . . DESIGN . . .
ENGINEERING . . . MANUFACTURE

HOWARD EHRLICH
Executive Vice-President

H. W. MATEER
Manager

KEITH HENNEY
Editor

DONALD G. FINK
Managing Editor

BEVERLY DUDLEY
Associate Editor

HARRY PHILLIPS
Art Director

ELECTRONICS, October, 1937. Vol. 10, No. 10.
Published monthly, price 50c a copy. Subscription
rates—United States and possessions, Canada,
Mexico and Central American countries, \$5.00 a
year. All other countries, \$6.00 a year or 24
shillings. Entered as Second Class matter, August
29, 1936, at Post Office, Albany, N. Y., under
the Act of March 3, 1879.
Branch Offices: 520 North Michigan Ave., Chicago;
883 Mission St., San Francisco; Aldwych House,
Aldwych, London, W. C. 2; Washington; Phila-
delphia; Cleveland; Detroit; St. Louis; Boston;
Atlanta, Ga.

Contents Copyright, 1937, by
McGraw-Hill Publishing Company, Inc.

McGRAW-HILL
PUBLISHING COMPANY, INC

Publication Office

99-129 North Broadway, Albany, N. Y.

Editorial and Executive Offices

330 West 42nd Street, New York, N. Y.

James H. McGraw, Jr., President

Howard Ehrlich, Executive Vice President

James H. McGraw, Honorary Chairman

B. R. Putnam, Treasurer

D. C. McGraw, Secretary

A. W. Morrison, Circulation Manager

Cable Address:

McGrawHill, New York

Member A.B.P. Member A.B.C.

CONTENTS, OCTOBER, 1937

MICROWAVE RESEARCH	Cover
Acorn tube and Lecher wire measuring system in the laboratories of the Radiotron Division, RCA Manufacturing Co.	
METALS IN RADIO, By Herbert Chase	13
The latest method of fabrication for mechanized radio receivers with special emphasis on die-casting.	
SCANNING IN TELEVISION RECEIVERS, By Frank J. Somers	18
Practical data on a subject not too well understood by radio engineers.	
APPLYING POLICE RADIO, By R. N. Harmon	22
Designing police radio communications to fit the requirements of the community.	
QUALITY IN DISC REPRODUCTION, By C. J. LeBel	25
How broadcasters (and others) may get the maximum return for their transcription dollar.	
REACTANCE AMPLIFIERS	28
Recent developments in saturated iron core reactor circuits enables amplifying and control operations to be carried out with simple, rugged equipment.	
PROGRAM OF ROCHESTER FALL I.R.E. MEETING	31
Informal papers at Rochester Annual Fall Meeting feature television as leading topic; session for physicists planned.	
TELEVISION IN GREAT BRITAIN By H. M. Lewis and A. V. Loughren	32
Application of British experiments to the American problem of television communication.	
BASS COMPENSATION CHARTS, By P. A. D'Orio and R. De Cola	37
Capacity and resistance values for maximum compensation easily computed by graphical methods.	

DEPARTMENTS

CROSSTALK	11
TUBES AT WORK	36
REFERENCE SHEET	37
ELECTRON ART	50
MANUFACTURING REVIEW	63
PATENTS	78
INDEX TO ADVERTISERS	84

Automotive applications demonstrate ...the utility and reliability of **S. S. WHITE FLEXIBLE SHAFTS**

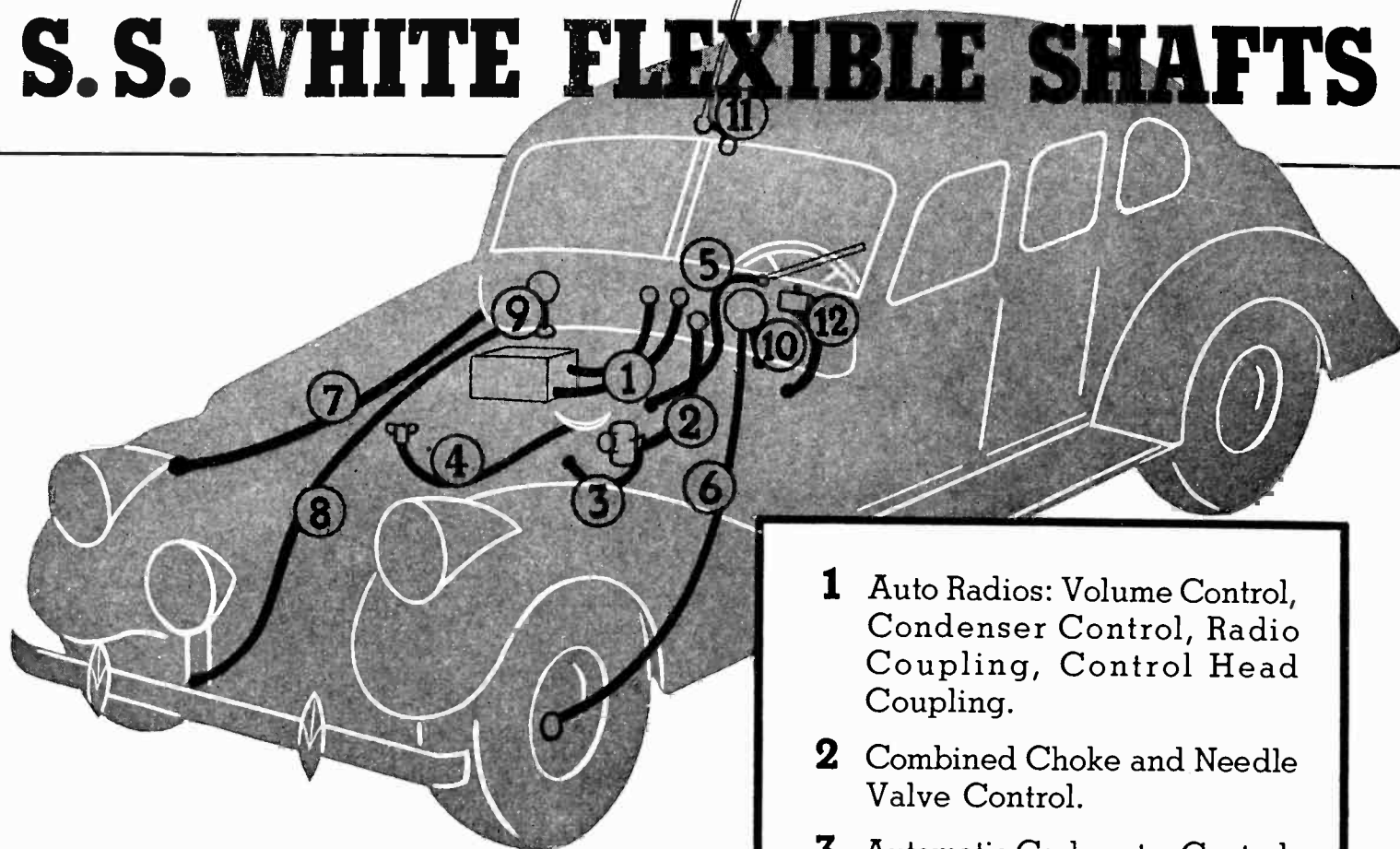

- 1** Auto Radios: Volume Control, Condenser Control, Radio Coupling, Control Head Coupling.
- 2** Combined Choke and Needle Valve Control.
- 3** Automatic Carburetor Control.
- 4** Crank Case Drain.
- 5** Windshield Wiper.
- 6** Speedometers.
- 7** Retractable Head Lights.
- 8** Spot Light Control.
- 9** Clock Setting Device.
- 10** Trip Mileage Setting Device.
- 11** Antenna Adjustment.
- 12** Gear Shift Control.

AUTOMOTIVE Engineers know that when it comes to the mechanical transmission of power or control movement between two points, the flexible shaft is the simple, effective way to do it, regardless of the relative positions of the two points.

Tangible evidence of this is provided by the illustration, in which the various automotive applications of S. S. WHITE Power Drive and Remote Control Flexible Shafts have been consolidated.

Flexible Shafts for Remote Control for Coupling or for Power Drives are available in a wide range of diameters and physical characteristics. Our engineers will be glad to cooperate on any power drive or remote control problem . . . no obligation . . . send us the details.

**The S. S. WHITE Dental Mfg. Co.
INDUSTRIAL DIVISION**

10 East 40th St., Room 2310E, New York, N. Y.

FLEXIBLE SHAFTS for POWER DRIVES, REMOTE CONTROLS and COUPLINGS

Leadership

... AN OBLIGATION

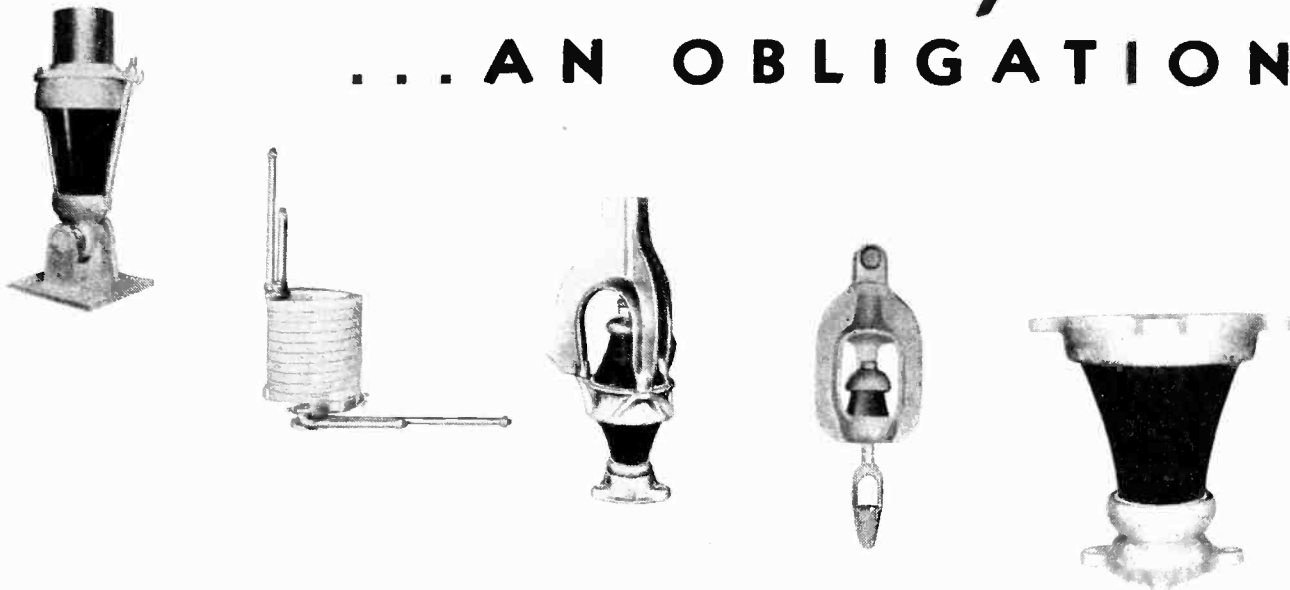

To attain foremost place in its industry, an institution serves its period of apprenticeship. Step by step it builds public confidence by supplying advantages in design, in dependable product, thus meeting in creditable manner the requirements of the field it serves. With accepted leadership comes a new obligation . . . the necessity of forecasting future needs, and of being prepared to satisfy them as rapidly as constant progress in usage may demand.

Such is Lapp's position in radio insulation today. With the growth of radio transmission, amazingly rapid as that has been, Lapp has kept pace to the consistent satisfaction of radio engineers. Lapp still sets the pace . . . an obligation imposed by Lapp's unquestioned leadership. In constant touch with technical progress, Lapp foresees the problems of tomorrow, provides solutions as comprehensively adequate as those already provided for the problems of today.

**BULLETIN 137 TELLS THE STORY OF LAPP WATER COILS
AND TOWER FOOTING INSULATORS. WRITE FOR YOUR COPY.**

LAPP INSULATOR CO., INC.

**LAPP
INSULATORS**

LE ROY - N.Y. - U.S.A.



PUNCHABLE FORMICA TUBING FOR INDUCTANCES!

AMONG the wide variety of materials which Formica has developed to meet the requirements of specific uses are grades of tubing that punch well in production operations, can be threaded accurately, and that have

a uniform and attractive color. The electrical efficiency of this tubing is high. It has been worked out to meet the requirements of the manufacturer who uses tubing in quantity, by production methods, to produce a high quality product.

• *Let us quote on your requirements*

THE FORMICA INSULATION COMPANY
4638 SPRING GROVE AVENUE, CINCINNATI, OHIO

FORMICA

FERRANTI

announces

the *New* AERO SERIES

...a complete line of Miniature Aero Transformers!

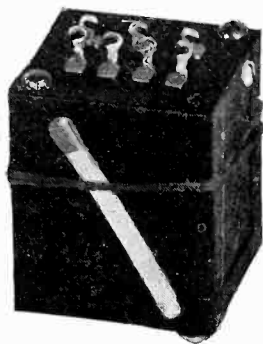

*"Small as a Match
but Matchless as
a Transformer."*

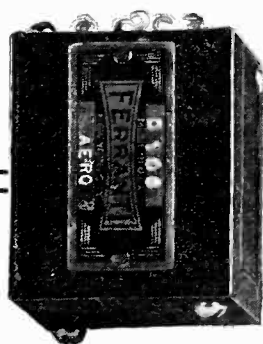

1 1/4" x 1 1/4" x 1 1/2" — including completely reversible mounting.

4 1/2 ounces.

Mixing, Input, Interstage and Output Types.
Electrostatic and Magnetic Shielding.

Usable Range: 20 — 20,000 c.p.s.

Many units are designed to carry D.C. plate current.

New Low Prices.

Available immediately from stock.

Operating level ranging from -80 to +20 db.

FERRANTI ELECTRIC, INC.

RCA BUILDING, NEW YORK, N. Y.

LINKING THE SHIP AND THE SHORE

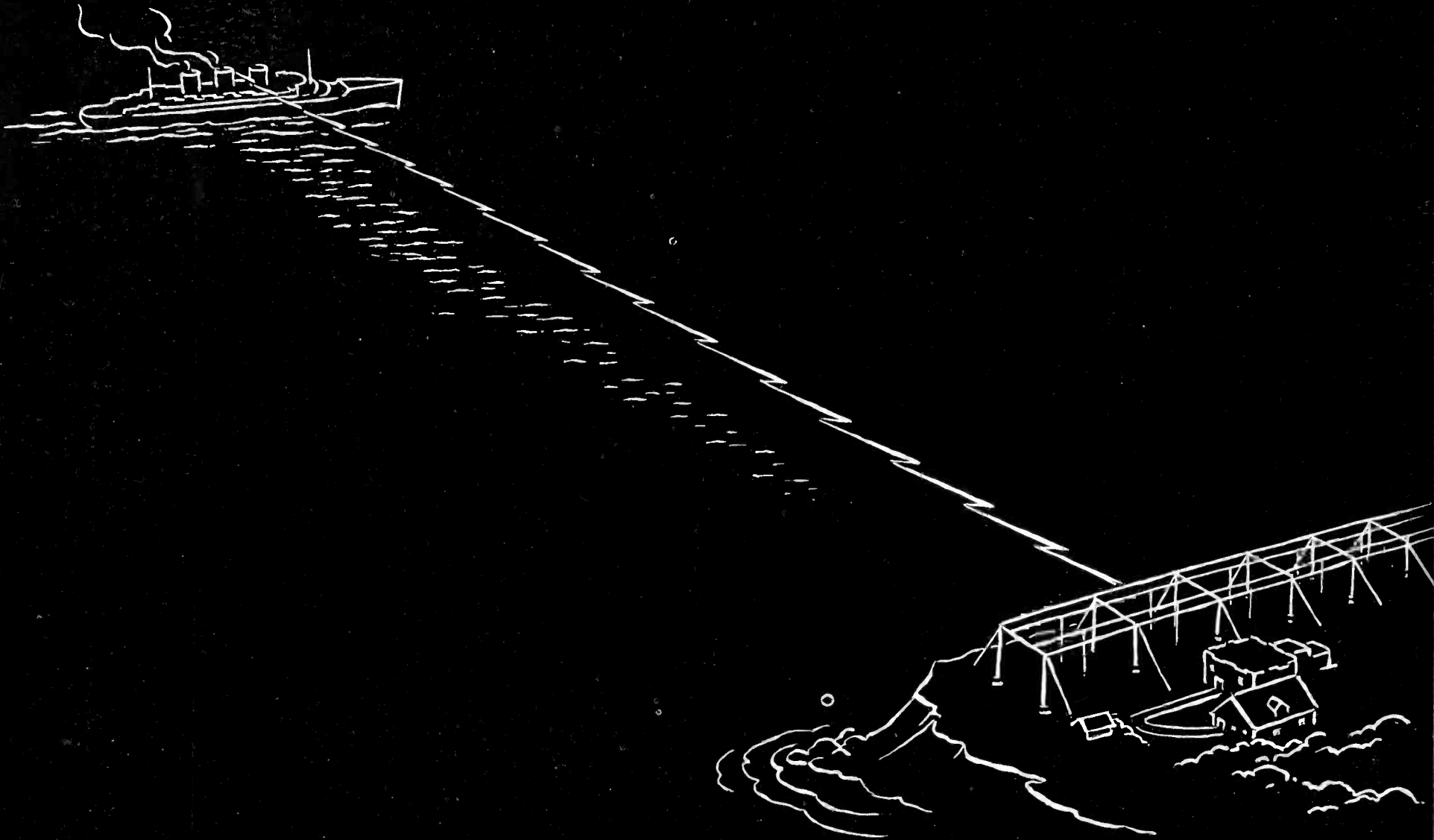

ON ocean liners, thousands of miles from land, passengers maintain constant contact with friends and business associates through ship-to-shore radio. And when danger from the sea threatens liner or freighter, the piercing note of a ship's distress signal brings swift aid from Coast Guard Station or nearby steamers. In normal routine or moment of peril, radio keeps ship and shore safely linked by its invisible waves. Only the finest quality of equipment can maintain that link — and Isolantite* ceramic insulators are an important part of this equipment.

On ship and ashore, Isolantite insulators insure maximum operating efficiency of both transmitter and receiver. Isolantite Coaxial transmission lines reduce interference

between sending and receiving equipment. Antenna systems insulated with Isolantite decrease the hazards of salt spray, ice and wind.

Consult Isolantite engineers on insulator design problems. Their judgment is the result of long experience in the manufacture and application of ceramic insulation.

**Registered Trade-name for the products of Isolantite Inc.*

ISOLANTITE INC.

CERAMIC INSULATORS

Factory: Belleville, N. J. • Sales Office: 233 Broadway, New York, N. Y.



"Sorry, but we're too busy"

We would like to take time out to write an advertisement about the recent activities here at Superior Tube. They would interest you because they affect our ability to serve you quicker, better, cheaper. But the work in progress requires "peak performance" from every member of our staff, so we will ask those who have followed the growth of this young concern kindly to wait for the announcement of our Third Anniversary in the November issue of this Magazine.

A. Label

SUPERIOR TUBE COMPANY, NORRISTOWN, PENNA. MANUFACTURERS OF SEAMLESS & LOCKSEAM CATHODE SLEEVES AND FINE SEAMLESS TUBING IN VARIOUS METALS AND ALLOYS.

SUPERIOR TUBING

ELECTRONICS — October 1937

7

DIRECT READING—300 KC to 300 Mc

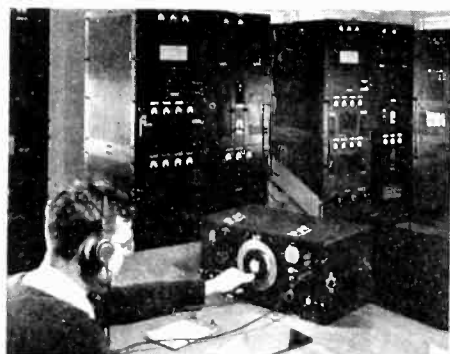
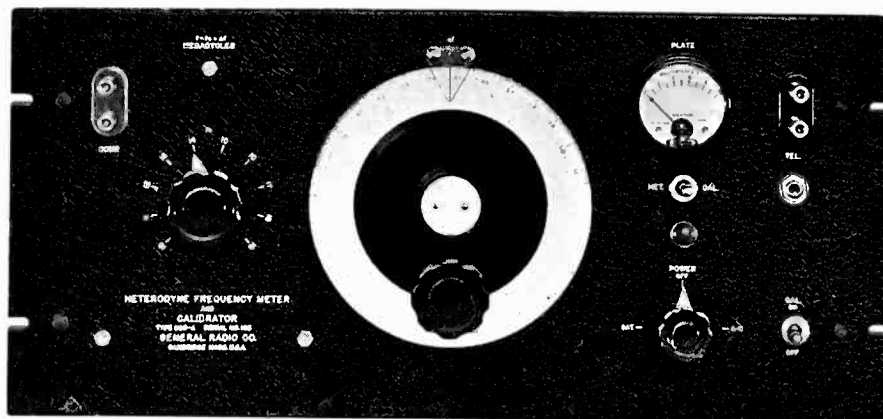

DESIGNED for use by the operating staff . . . for routine hourly or daily frequency checks or for continuous monitoring . . . the new G-R Type 620-A Frequency Meter-Monitor and Calibrator has a number of features which appeal to all operators.

- 1 DIRECT READING**—No calibration charts, curves or plug-in coils.
- 2 EXCEPTIONALLY WIDE FREQUENCY RANGE**—Continuous from 300 kc to 300 Mc.
- 3 EXCELLENT ACCURACY**—0.01% or better; suitable for practically all classes of service throughout the range of the instrument.
- 4 SELF-CALIBRATING**—Calibration may be checked quickly against the built-in low-temperature-coefficient quartz plate.
- 5 PORTABLE**—The portable model weighs only 45 pounds; either model may be used on d-c or a-c.
- 6 RUGGED CONSTRUCTION**—Unique electrical and mechanical design insure trouble-free operation.

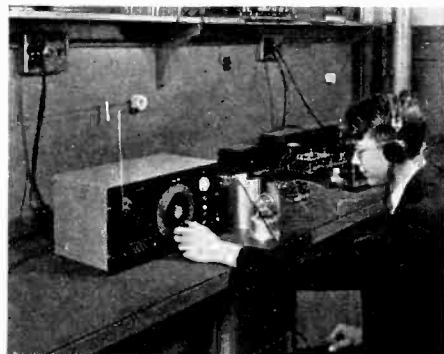
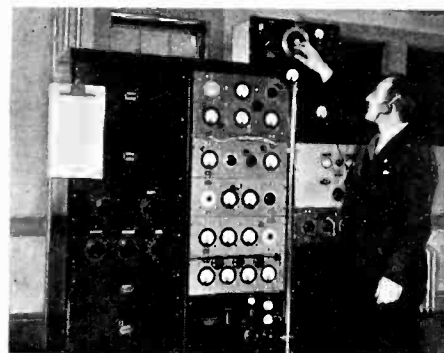

Designed for the man who has to use it, you don't have to be a radio engineer to operate this new G-R frequency meter.

Type 620-A Heterodyne Frequency Meter & Calibrator

Relay Rack Model \$490.00
Portable Model \$555.00

GENERAL Radio manufactures a number of instruments and accessories of interest to the engineering and operating staff of all communication organizations. This apparatus includes standard-frequency assemblies, interpolation and auxiliary equipment, secondary standards, piezo-electric oscillators, multivibrators, visual-type broadcast monitors, frequency deviation meters, heterodyne frequency meters, quartz plates and bars, temperature control boxes, precision tuning forks, audio-frequency meters, precision and general-purpose wavemeters, beat-frequency oscillators, amplifiers, r-f, d-c and a-c bridges, line voltage controls and an exceptionally complete line of laboratory standards and parts for experimental work.



WRITE FOR CATALOG 179 FOR COMPLETE DATA
GENERAL RADIO COMPANY • CAMBRIDGE, MASSACHUSETTS

AND NOW! *Light Up Your Panels...*

WITH **TRIPIELET** FRONT ILLUMINATION

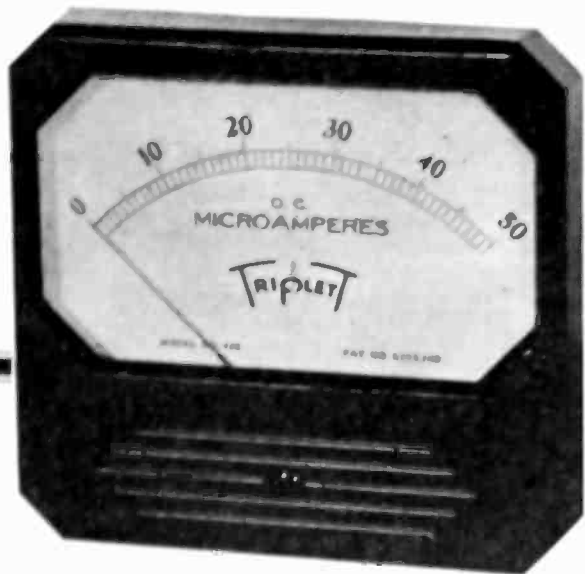

Model 426 Without Front Illumination

A new highly attractive four-inch square modernistic design featuring extra long scale length. Front illumination available in 3" and larger cases.

Stocked in all popular ranges.

NOTE
LIGHTING
ATTACHMENT
IS ENTIRELY
EXTERNAL

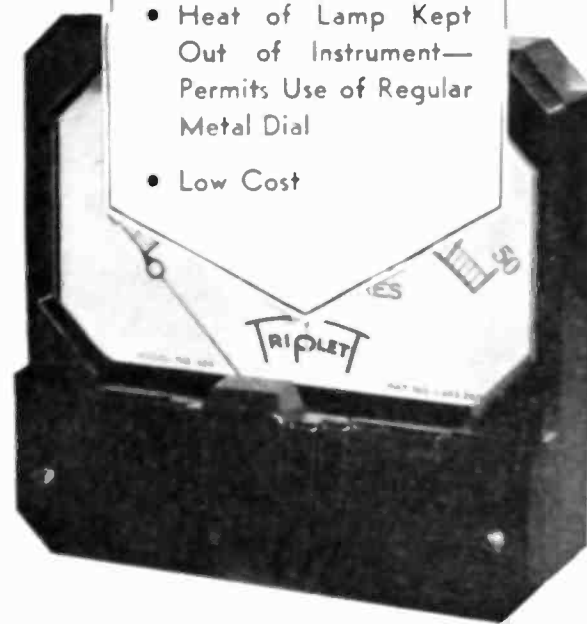

Model 426, showing Front Illumination attachment

This is an exclusive Triplet development. Fits on front of case and is entirely external to instrument itself.

Front illumination also available in other models.

Rear illumination with lamp inside the case, also can be supplied, preferably in the smaller size cases.

- Perfect Distribution of Light—No Glare
- Does Not Affect Operation of Instrument
- Bulb Can Be Replaced Without Opening Sealed Instrument
- Heat of Lamp Kept Out of Instrument—Permits Use of Regular Metal Dial
- Low Cost

Triplet instruments are noted for:

Highest Quality

1. Bar-Bridge Construction.
2. Magnet pole pieces are continuous . . . gauged to precision accuracy.
3. Fewer magnetic parts . . . greater initial and lasting accuracy.
4. Fully aged to relieve strains and unnecessary adjustments.
5. Unsurpassed for ruggedness and wearing qualities.

Low Cost

1. Recognized in industry for simplified construction.
2. Produced on quantity production basis.
3. Manufactured by highly skilled workers.

Triplet manufactures a complete line of electrical measuring instruments embracing round, square, rectangular; molded and metal cases and twin meters for radio, electrical and general industrial applications.

If you have an Electrical Instrument Problem . . . Write to Triplet

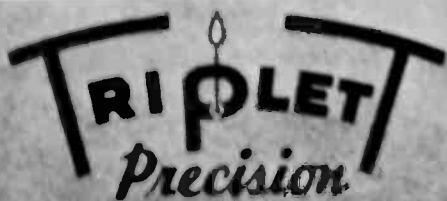

ELECTRICAL INSTRUMENTS

The Triplet Electrical Instrument Co.
2310 Harmon Ave., Bluffton, Ohio.

Please send me more information on Model 426; I am also interested in . . .

Name
Address
City State

**For automatic tuning
without costly changes in chassis design**

YAXLEY

JUNIOR TYPE STATION SELECTOR SWITCH

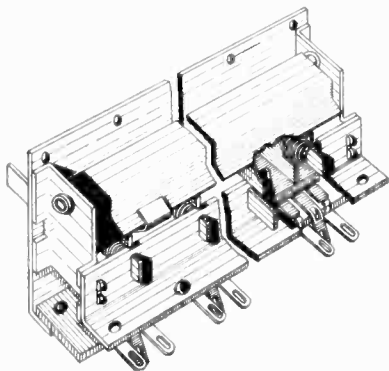
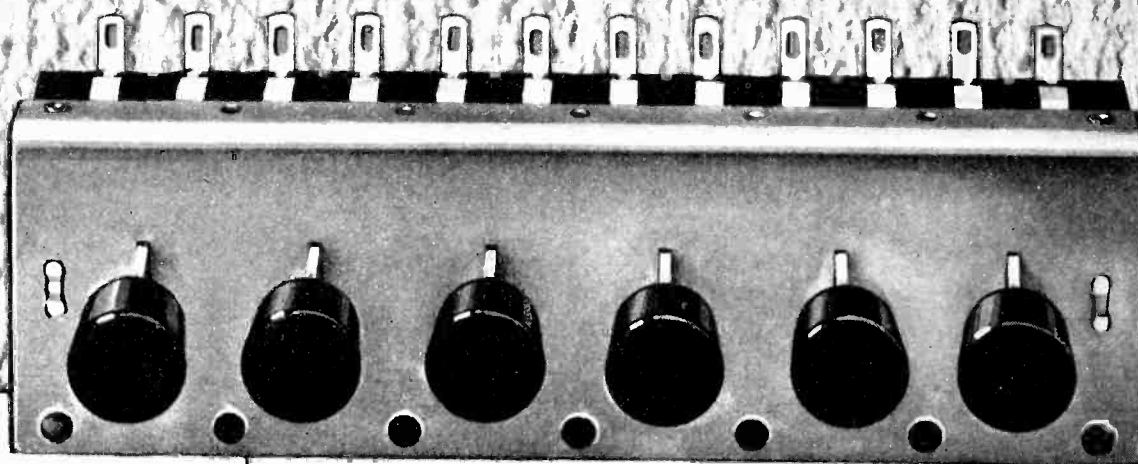

The Yaxley Junior Type Station Selector Switch has been developed in response to the demand for a unit which will occupy a minimum of depth behind the front panel. Engineers contemplating the conversion of current models to automatic tuning without change of expensive chassis dies will appreciate the necessity of this conservation of space between the front of the sub-panel and the cabinet.

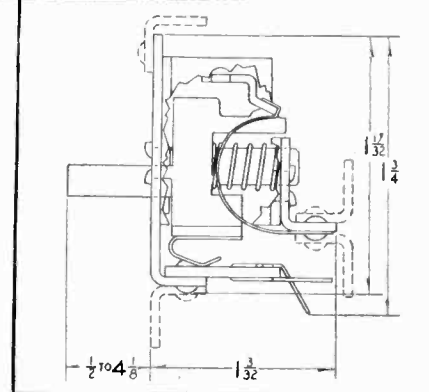

The unit incorporates the same features of dependable mechanical action, quiet operation and long satisfactory life found in the original Yaxley Station Selector Switch and is available with the same terminal arrangements. Flexible tooling permits rapid delivery of units in multiples of from 2 to 12 buttons in a single frame and with variable lengths of actuating

plungers to fit individual requirements.

A newly developed "L" terminal allows series type connection of Yaxley Push Button Station Selector Switches and results in considerable economy of wiring and simplicity of operation.

Write for complete mechanical and electrical specifications covering Yaxley 3-S and 3-SJ Station Selector Switches.



YAXLEY MANUFACTURING DIVISION OF P. R. MALLORY & CO., INC.
INDIANAPOLIS . . . INDIANA . . . CABLE ADDRESS—PELMALLO

ELECTRONICS

OCTOBER
1937

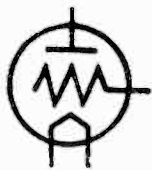

KEITH HENNEY
Editor

Crosstalk

► **MORE RIVALRY . . .** Visitors returning from Europe report enthusiastically about the status of television there; not about the number of sets sold but of the technical quality of the German and English systems. These visitors incline one to believe that America may be a bit behind Europe in television; not commercially, but technically. This may not be so of course. But the very fact that television has come out of the laboratory in England indicates that it forces more people to work on its problems, not in numbers, perhaps, but more different groups of people. More ideas are thereby produced.

Nothing is so stimulating as intellectual competition. Is it, perhaps, true that there has been too little rivalry of this sort in our television research? Have the groups working on the subject been too few?

In this connection it is worth noting that the number of patents being issued to British radio manufacturers on radio subjects, such as AFC, seems to be much greater than the number seen in our own Official Gazette. There are several companies getting patents in England; only one or two in America. Is this another sign of too little intellectual competition? Are manufacturers depending too much upon one or two sources of new ideas?

► **WHITHER: METAL TUBES . . .** Survey of some 1,000 set models produced during the first six months of 1937 indicates that the metal tube is running far behind other types of tubes in both home and auto radio set complements. Glass tubes for home sets are about four times as plentiful as metal. Glass tubes with octal bases, however, are used to a very great extent in auto sets, and hold second place in the home sets.

This survey has no bearing on the number of sets sold, or does not show the public preference among the

models examined. It does show, however, the low usage to which metal tubes are being put by set manufacturers. If they should be used still less, and that is always possible, tube manufacturers would not be encouraged to continue their manufacture. Perhaps the metal tube's big contribution has been the octal base.

► **PATENT POOL . . .** In *Electrical World*, August 28, appeared a most interesting discussion of the inhibiting influences at work in the field of electronics. The writer believes that if permission to use electron tubes without liability of patent infringement suits was increased, the usage of such tubes would multiply appreciably. He feels that power engineers, particularly, are somewhat afraid of tubes because one can never be sure who owns the patents or whether use will make one liable for damages.

Situations have come up in which a company wished to make and sell a device using an electron tube. Inquiry of the possible holders of patents covering portions of the device brought the answer that licenses would be issued but on the basis that the patent-holder would do the manufacturing with the inventor doing the selling. So high was the price to be charged for manufacturing that sales would have been nil.

The editors would be glad for *Electronics'* readers to note the *Electrical World* article, to set down in confidence difficulties they may have had in exploiting electronic circuits they have worked out.

► **Q AND A . . .** For several months readers of *Electronics* have been given a look-see into the correspondence of Mr. Samuel Wein, to whom many people write about their troubles, and send their queries on all sorts of matters. Many of the questions do not relate

directly to electron tubes; but they have been published for their intrinsic interest. Some evidence that such a department should be continued in *Electronics* has been shown; the Editors would like other expressions of opinion. Obviously the Q and A department should be broadened to take in questions from all its readers and not be confined to those queries which come to but one member of its circulation.

A patent attorney of long service to inventors in electronic fields suggests that a somewhat similar service might be offered to include answers to simple questions regarding inventions and patents. "Such a service should be open to subscribers only" and the number of queries should be limited. "If they asked over this number of questions, they should be charged or obliged to turn in a new subscriber, or something of that sort."

Is there a need for this kind of service?

► **FCC . . .** Appointment and confirmation of T. A. M. Craven, former chief engineer of the Federal Communications Commission and Frank R. McNinch, former chairman of the Federal Power Commission to the FCC fill two commission vacancies. Readers of *Electronics* are probably unfamiliar with Mr. McNinch's background, but they know quite well the qualifications of Commander Craven to be full member of the group. He has served well as technical adviser; his appointment is a well deserved step forward. The Commission will benefit by his closer attachment to the communications group as a whole.

► **P.S. . . .** Mr. McNinch has become Chairman of the FCC and E. K. Jett has been made acting chief engineer. Mr. Jett has been assistant chief engineer in charge of telegraph.

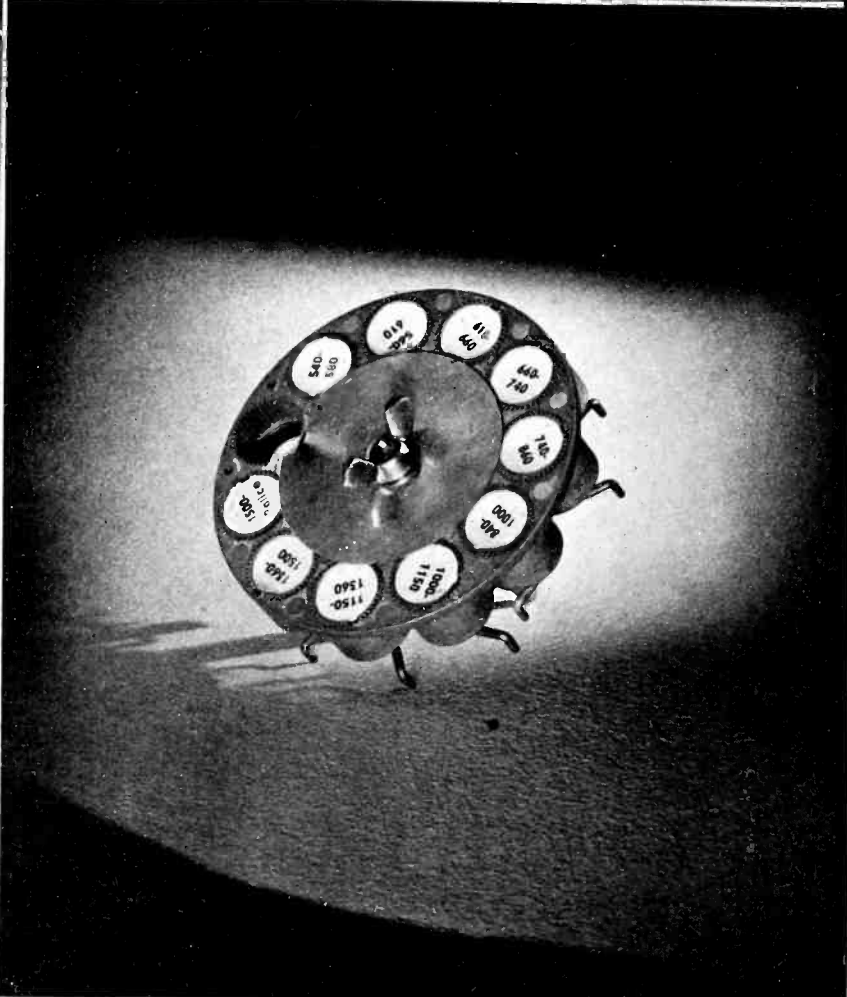
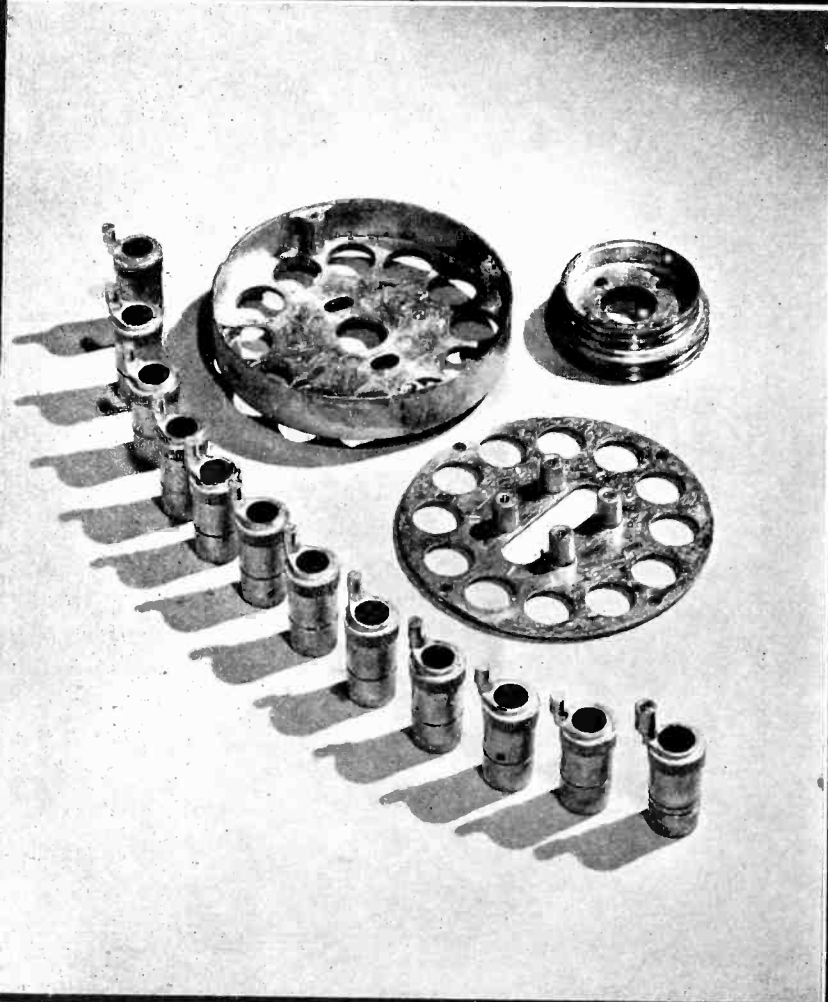
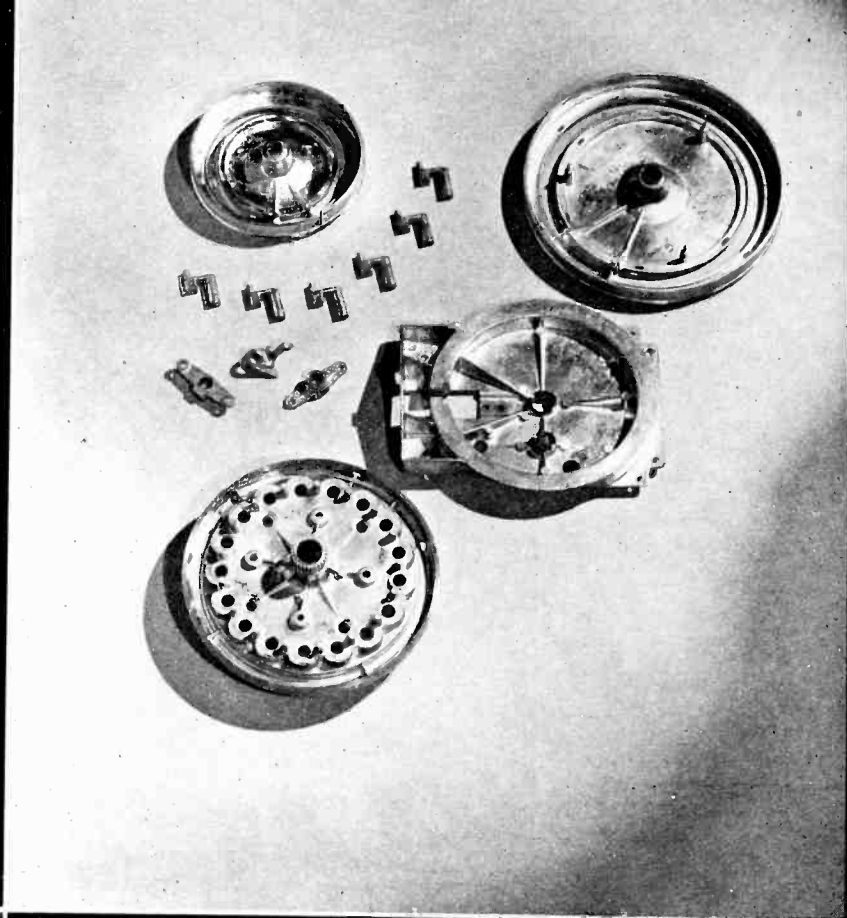
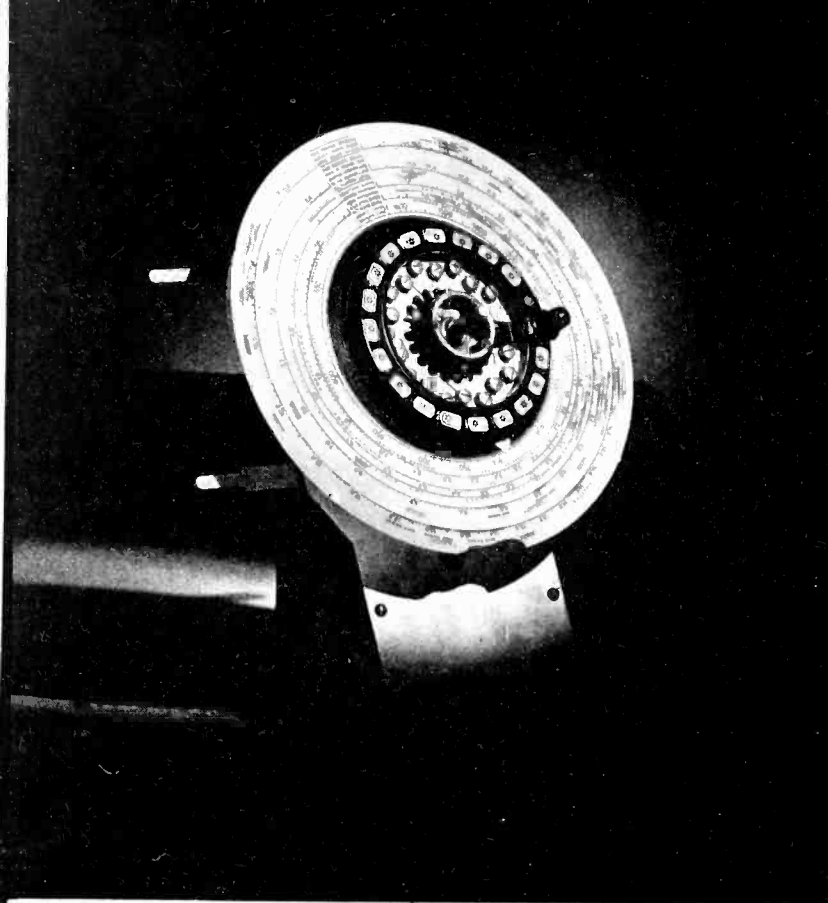

DIE CASTINGS FOR AUTOMATIC TUNING

Close-fitting parts are necessary for accurate automatic tuning. Above, left, a Philco assembly; right, parts for the Grunow tuning control. Below, left, parts for the Colonial dial; right, the Emerson assembly, in which small wire "cranks" have been inset into the castings.

Metals in Radio

Each refinement in radio equipment makes new demands on metals and metal-working technique. Herewith is a review of the present situation, with particular emphasis on die-castings, which are finding much use in the new mechanisms of radio receivers.

OF the many basic materials used in the radio and electronic arts the most widely misunderstood are the metals. For many years metal was used in radio as a conductor only, in wires and binding posts; the structure of the equipment was almost universally an insulating material. With the coming of the metal chassis and the rack and panel assembly, metal as a structural element in electronic equipment assumed importance, but its mechanical properties were more or less taken for granted, and the relative suitability of different materials and fabrication processes were not studied. Recently much more attention has been paid to these subjects, partly because radio receivers have employed more and more complex mechanisms for tuning, both manual and automatic. The more recent of the automatic tuning mechanisms are the result of considerable research into alloys and fabrication methods, an important result of which is the "discovery" by radio design engineers of the art of die casting. This subject, being newest to the art, is one of great practical interest at present, consequently in what follows, major attention is devoted to die casting methods. The latter part of the article is concerned with the uses of stamped steel, surface treatments, stamped and extruded aluminum, and the many other metals and alloys employed in modern electronic equipment.

Die-Castings: Advantages and Uses

Die castings have assumed increasing importance in the construction of receiving sets within the past few years and are used to advantage also in combination sets

By HERBERT CHASE

involving reproduction from phonographic records, not to mention other equipment in which electronic elements are employed. Reasons for these applications are not hard to find. The principal ones are that such castings are low in cost, accurate in dimensions, require little or no machining, lend themselves to production on a rapid repetitive basis in either simple or complex forms, are non-rusting and so require no applied finish except for exposed parts (and are then readily and inexpensively finished) and fulfill all the physical and structural requirements to which they are normally subjected. This is an imposing list of advantages and one

meriting consideration by all designers and production men not already familiar with die castings and their possibilities.

Die castings rank more or less on a par with stamped and drawn parts in respect to low production cost, especially where non-ferrous metals are desired. Often the stamped or drawn part can be produced somewhat more rapidly, but the cost of blanking and drawing dies is likely to exceed that of die-casting dies and complex die castings made in one piece sometimes take the place of two or more stampings requiring assembly operations. In addition, the die casting can have almost any variation in section thickness and can be made in many shapes not feasible in stamping. In many instances,

Zinc die-castings for automotive control units, illustrating the variety of shapes which can be produced



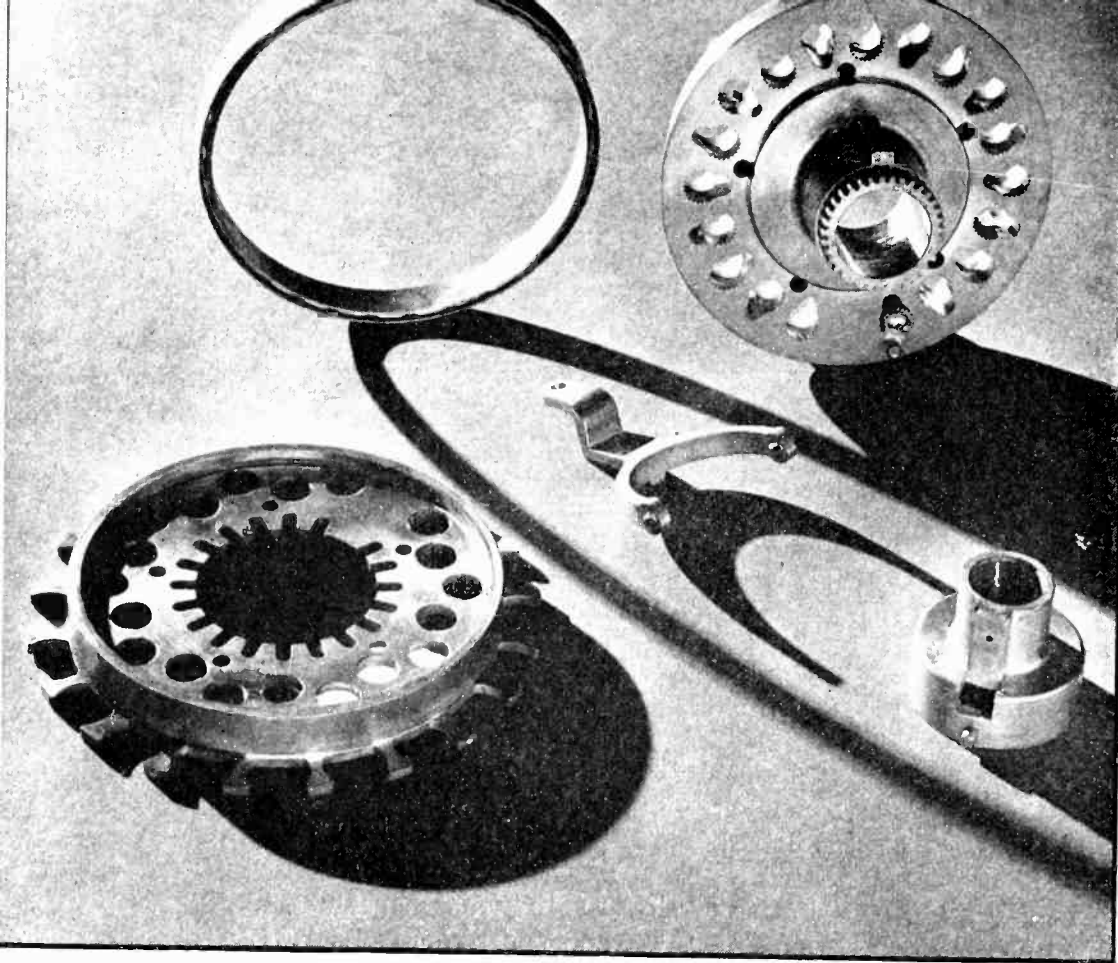

Parts of the Philco automatic tuning device, all zinc alloy die castings.
Note the serrated hole contours in the piece at the upper right

however, it is economical to combine stampings and die castings and each type of parts has some advantage not matched in the other.

Before considering specific designs of die castings, some particulars concerning the alloys available deserve mention. Of the several types produced, only those based respectively on zinc and aluminum need be given more than passing attention, as they are the only types which have seen any considerable use in the electronic field. Even the aluminum type, which is excellent in many respects, has found far less use than the zinc-alloy type, largely because the castings themselves are usually somewhat more expensive than the zinc type and involve higher die costs. The chief advantage of aluminum is light weight, and as the sets in which this is an important consideration are not very numerous, the investment for casting dies is not often justified by production requirements. In high-production sets, such as those for home and automobile applications, where the zinc alloys are advantageously employed, investments in dies are not only justified but pay a handsome return.

Of the zinc alloys for die casting, the patented grades known as Zamak No. 2 and No. 3, corresponding respectively to A.S.T.M. specifications No. XXI and No. XXIII (B 86-34 T) are much the most widely used. Both are made from high-purity (99.99+ per cent) zinc—a highly important requirement—alloyed with 4.1 per cent of aluminum, but the No. 2 contains about 2.7 per cent of copper, whereas the No. 3 is practically copper free. The No. 2 alloy has a somewhat higher tensile strength and is somewhat harder than the No. 3, but the No. 3 type has a higher impact strength and retains it through long periods of aging, whereas the No. 2 alloy decreases in impact strength with aging and is subject to somewhat greater dimensional change than No. 3. In neither case, however, is the dimensional change great enough to be of practical significance except in unusual cases where extremely close dimensions must be retained.

All the zinc die-casting alloys are characterized by toughness (high impact strength) greater than for most of the commoner cast metals and are rarely subject to breakage in service. Castings can

be made in remarkably thin sections (0.040 in. or less for small castings) and are often produced with a surface so smooth that only buffing is required before plating. Dimensions can also be held within remarkably close limits and, when machining is required, only a very small amount of metal need be removed. The metal machines readily and often the only operations required—if any machining is needed—are drilling, tapping or reaming of holes or the external threading of a projecting part.

Aluminum Alloys

Several aluminum die-casting alloys are available and the choice between them is sometimes left to the die caster, as casting properties are often more important than the variations in physical properties which, generally speaking, do not differ very widely. The tensile strength of the aluminum alloys is somewhat below that for the zinc alloys and impact strength is materially lower. There is, however, no dimensional change with aging and the castings take and hold a polish for considerable periods of normal exposure under which zinc alloys tarnish. Both classes of castings are quite resistant to any but surface oxidation, but in the applications considered here this oxidation is usually negligible. One large producer of receiving and transmitting sets includes in its material specifications one covering aluminum die-casting alloy No. XII (A.S.T.M. designation B 85-33 T). This alloy has a nominal composition of: copper 8 per cent, silicon 1.5 per cent and the remainder aluminum, and, for aluminum, is a low cost, general-purpose alloy suitable for many applications though not extensively used in the electronic field.*

Applications to Radio Receivers

Reference to accompanying illustrations gives an excellent idea as to the practical applications of die castings in receiving sets. Many

* For details as to the composition, physical properties and general application of all die casting alloys and notes on the design, finishing, testing, etc. of die castings, see the author's book, "Die Castings." Data on composition and some on physical properties are found in the A.S.T.M. and S.A.E. specifications and are available also from The New Jersey Zinc Company and the Aluminum Company of America.

of these are for mechanical parts, such as are employed in automatic tuning devices, but at least one cabinet for an automobile receiver has been produced commercially in die-cast form, and the complex case with thin-wall partitions (illustrated), which presumably act in part as shields, is an excellent example of what can be done in the way of compact castings in which one or two parts serve functions which would require many parts and several assembly operations were the units to be built up from stampings. It is significant also that, unless exposed to view, such parts require no applied finish, as a rule, whereas, if stamped or drawn from steel, some finish to avoid rusting is necessary

Another type of part which is often die cast in zinc alloy is the remote control case employed in automotive radio sets. Today, this is usually designed as a unit arranged to fit on the instrument panel of the car, but for older cars, without provision for instrument panel mounting, the control unit may be mounted on the steering column. In either case, the die casting is usually provided with integral lugs or mounting brackets, such as would require extra parts on a stamped or drawn unit. Bearings for shafts and control knobs and supports for internal parts are often made integral with the die casting, and the latter may have projecting lugs for riveting to other parts in assembly or for fastening

by so-called "speed nuts," (page 16).

Examination of some of the die castings used in tuning devices illustrates immediately the intricacies possible at low cost in the die casting and not commercially available otherwise without much greater expense. Small holes of irregular shape and with serrated contours accurately fitting mating die-cast parts, hubs with gear teeth and projecting key, small gears formed on integral shafts having, perhaps more than one diameter and a forked coupling at one end, levers, cranks and yokes of irregular shape and many similar parts are often ideal for die casting. In general they cost less in this form than if made by other means. Frequently, one part in die-cast form

Top, left, ornamental die castings in zinc alloy used as control panel and escutcheon by General Electric, and speaker grilles for International, and Colonial. Right, an RCA microphone casing cast entirely in zinc. Below, left, off-set type phonograph

pick-up housing. Right, assembly of die-cast and stamped-steel parts in Philco's automatic tuning device. The parts marked A are of steel, assembled by tubular brass rivets. Bezel B is of drawn brass. Parts C are die castings.

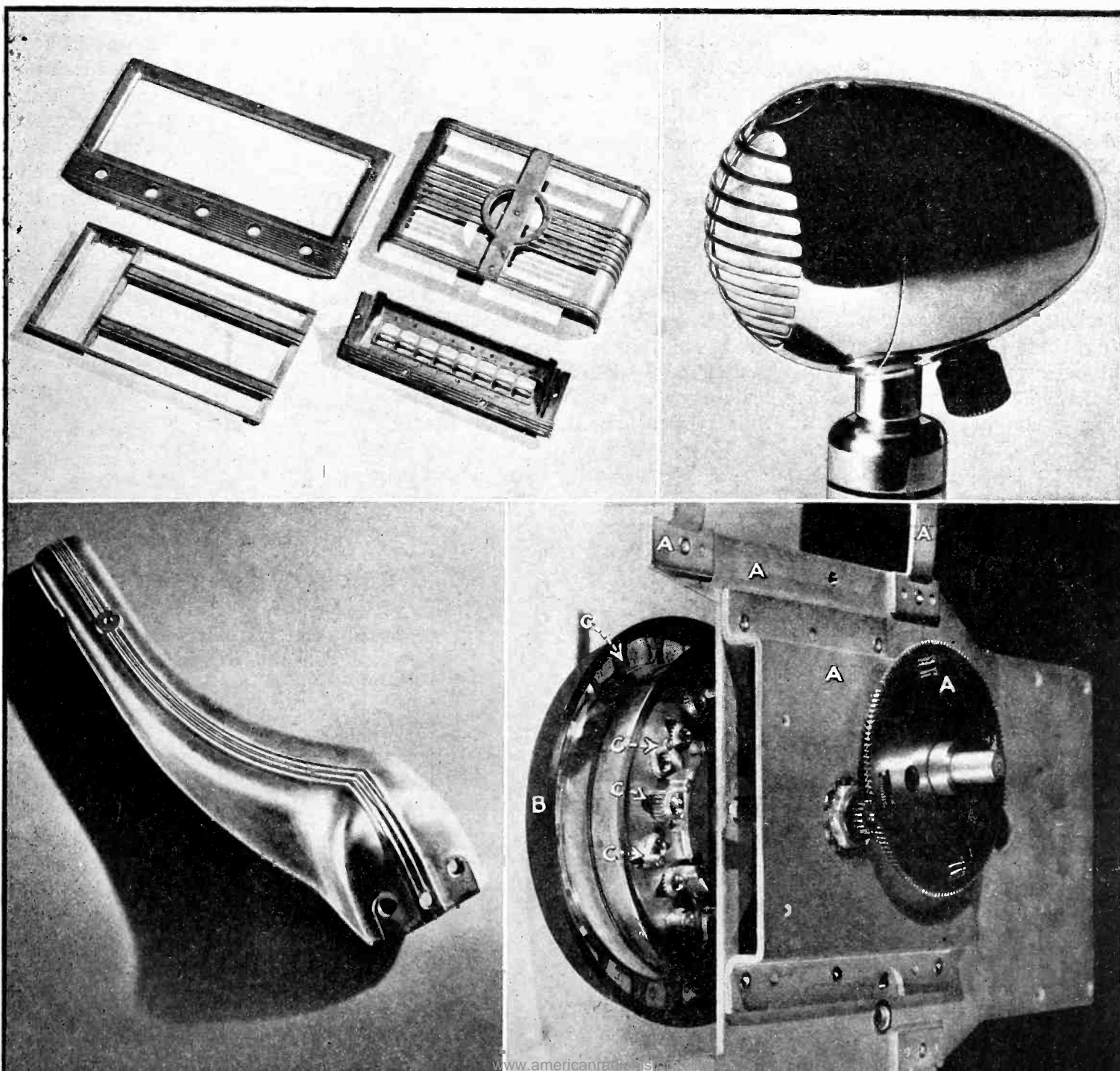

takes the place of several required when production is by some other method, and this avoids unnecessary handling and assembly costs.

To date, so far as the writer is aware, no separate chassis in die-cast form has been produced in quantity as yet, unless the complex case, shown in the illustration, may be so considered. Chassis are, in general, stamped from steel and often require, besides the initial blanking and piercing, the forming of separate feet and brackets, the insertion of gromets and rivets and separate plating and handling of the several elements forming the assembly. It would certainly be possible to die-cast a chassis in one piece with all the elements named integral, without assembly operations and without requiring an applied finish, holding some dimensions closer than in stamping, with as many holes or other openings as required and perhaps with a considerable saving in cost. In some instances, parts of the housing and some of the shielding might be made integral, and the mounting of certain units at different levels, if this were advantageous, could be facilitated. As against this, the higher cost of zinc alloy as compared with steel would have to be considered, but whether this would offset the other gains is a matter which would require consideration of specific designs preferably laid down with a view to maximum economy in both instances. Die cost might be lower with the die casting, but the production rate might be lower, perhaps offsetting the gain. The subject is one deserving study, however, especially

as off-hand conclusions may prove misleading.

It is worth remembering that, in certain instances, the die-cast part may include an insert of some other metal or even of plastic or non-metallic substance. Such inserts frequently make die castings feasible where they would not be otherwise. The cost of the insert itself and its effect on slowing the casting cycle are not to be overlooked, but there are many instances in which the benefits gained warrant the extra cost.

The possibilities of die castings for decorative purposes on cabinets of other materials is another phase of design deserving study. Automotive manufacturers have gone a long way in this direction and every car has exposed parts die cast and applied partly or wholly for decorative effect. This applies also to some of the radio control units on the instrument panel and also to grilles over speaker openings. Somewhat similar uses in sets for household applications are now gaining acceptance. Bezels are combined with control units in a single die casting, much as has been done with some molded parts, and with contrasts of metal against other materials which prove highly attractive, especially as a wide range of finishes for die castings is available.

Sheet Steel and Strip

Steel sheet or strip stock, either cold rolled or hot rolled, is the metal most widely employed in receiving sets for home and automobile applications. Chassis are nearly

always of these materials, primarily because they are low in cost, relatively easy to work and yield a product which meets all requirements as to strength, stiffness and other physical properties. The chief disadvantage of steel is its tendency to rust, but rusting is minimized or rendered negligible for most applications by plating, usually with cadmium or zinc. Sometimes additional protection is afforded by organic or synthetic finishes which, in some cases, improve appearance at the same time. Steel is employed also for the cases of small sets, especially for the automobile type; for speaker housings when these are separate; and for many other supplementary parts, including fastening screws and bolts, brackets, some forms of shields, certain shafts and for a large variety of small parts in which low cost and adequate strength are usually the primary requisites.

There is, of course, a wide variety of grades of steel to choose from, but in most instances, the matter of finish and ease of forming are primary considerations. Some companies employ chiefly half-hard cold-rolled automobile sheet, because of its excellent finish. One large user buys cold rolled sheet and strip to A.S.T.M. specification A 109-35 T but uses chiefly hot-rolled sheet and strip for chassis and for automobile radio cases, the composition requirements (in percentages) being as follows:

Carbon	0.05 to 0.12 (for annealed temper) 0.05 to 0.15 (for unannealed temper)
Manganese	0.30 to 0.60
Phosphorus	0.100 max. (for material less than 0.0625 in. thick) 0.050 max. (for material 0.0625 in. thick and heavier)
Sulphur	0.060 max.
Iron	balance

Policy in respect to purchasing steel as well as other metals varies greatly with different manufacturers and is not the same in respect to all metals purchased even within the same company. In general, however, companies which fabricate their own metal products follow one of two general policies. They either purchase by generally accepted names or classes of material, leaving details as to composition and other factors more or less up to the suppliers with the provision that the material must be suitable

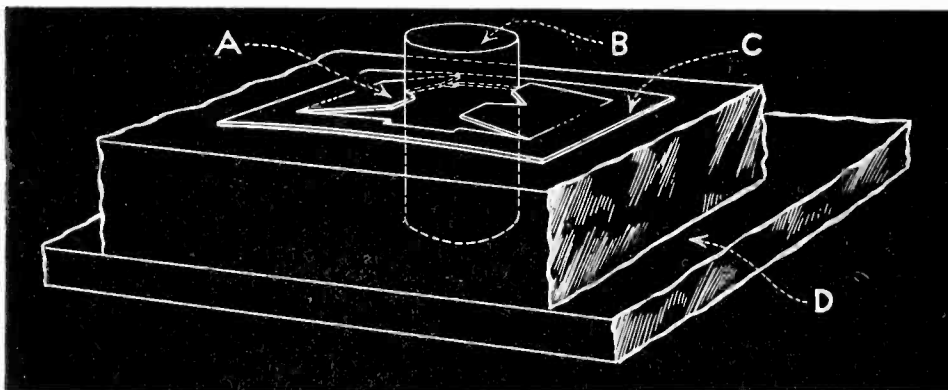

Typical "speed nut" assembly. The spring-steel ears A, of the nut grip pin B, which may be a projecting pin, screw or rivet. The flat surface of the nut holds the two pieces D in close contact

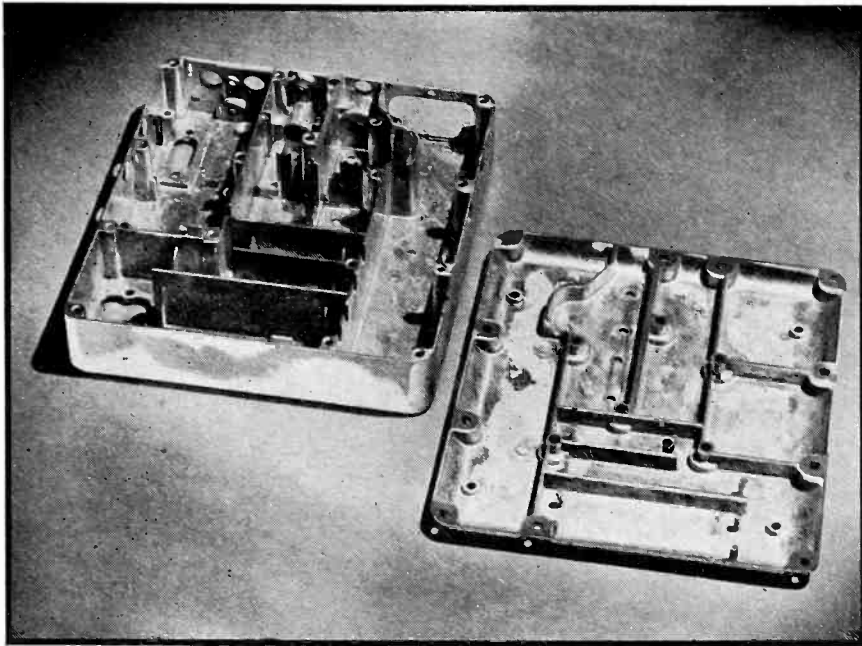

Above, die-cast chassis and case for Motorola auto radio, all partitions lugs and openings produced in one operation

for conversion into specific parts about which the suppliers are informed; or they employ somewhat detailed and exacting specifications, especially as to critical properties, and may also specify suitability for specific uses, thus having more or less of a double guarantee that the materials will meet requirements.

In the case of units purchased ready fabricated, the specification as to materials used may be left, so far as the assembler is concerned, wholly or largely to the supplier on the theory that he will use suitable judgment in selecting materials to meet service requirements, as, of course, he must do if he is to retain the account. For certain elements, however, the gage of metal and the nature of finish applied to it may be specified and a certain standard of appearance insisted upon to insure a salable product.

The Radio Corporation of America employs quite detailed specifications for some metals but makes a point of following A.S.T.M. or other recognized standard specifications wherever these meet requirements, partly because this encourages standardization within the industry and presumably also because departure from recognized standards, when they meet requirements, serves no very good purpose and may result in unnecessary increases in cost.

Matters of applied finish vary greatly with different parts and sometimes with different applications of the same part, but the use

of cadmium and zinc plating for many home and automobile receiver chassis and other steel parts is quite general, a coating approximating 0.0002 in. in thickness being considered adequate as a rule. Cadmium plating is sometimes preferred to zinc on the ground of somewhat better appearance and ease of soldering, but the relatively high price of cadmium in recent months, as well as the development of new and brighter zinc coatings which are still quite low in cost, is leading to more extensive use of zinc, despite some tendency to tarnish or become dull with prolonged exposure. Either type of finish appears to be adequate in protection against rust. Some inexpensive but adequate shields for tubes are produced in tinned steel sheet, the tin being bright and of excellent appearance. Such sheet costs less than aluminum shields and meets requirements where non-magnetic properties and high conductivity are not essential.

Aluminum sheet finds extensive use for coil shields and for con-

denser plates and is an excellent material for these purposes, being quite high in conductivity, non-magnetic, quite corrosion resistant and light in weight as well as excellent in appearance. It is available in thin gages and shields can be drawn from sheet or produced by impact extrusion from slugs at quite low cost. For variable condenser plates, aluminum has the advantage of light weight and so requires little or no counterbalancing to avoid undesired changes in setting. Aluminum is employed also for the cans of electrolytic condensers, especially of the wet type.

Zinc

Zinc finds its primary use in die casting alloys, considered previously. It is employed for plating, as already mentioned and also for fabricating cans for dry electrolytic condensers and for vibrator cases. Zinc is heavier than aluminum, of course, but item for item may be

(Continued on page 76)

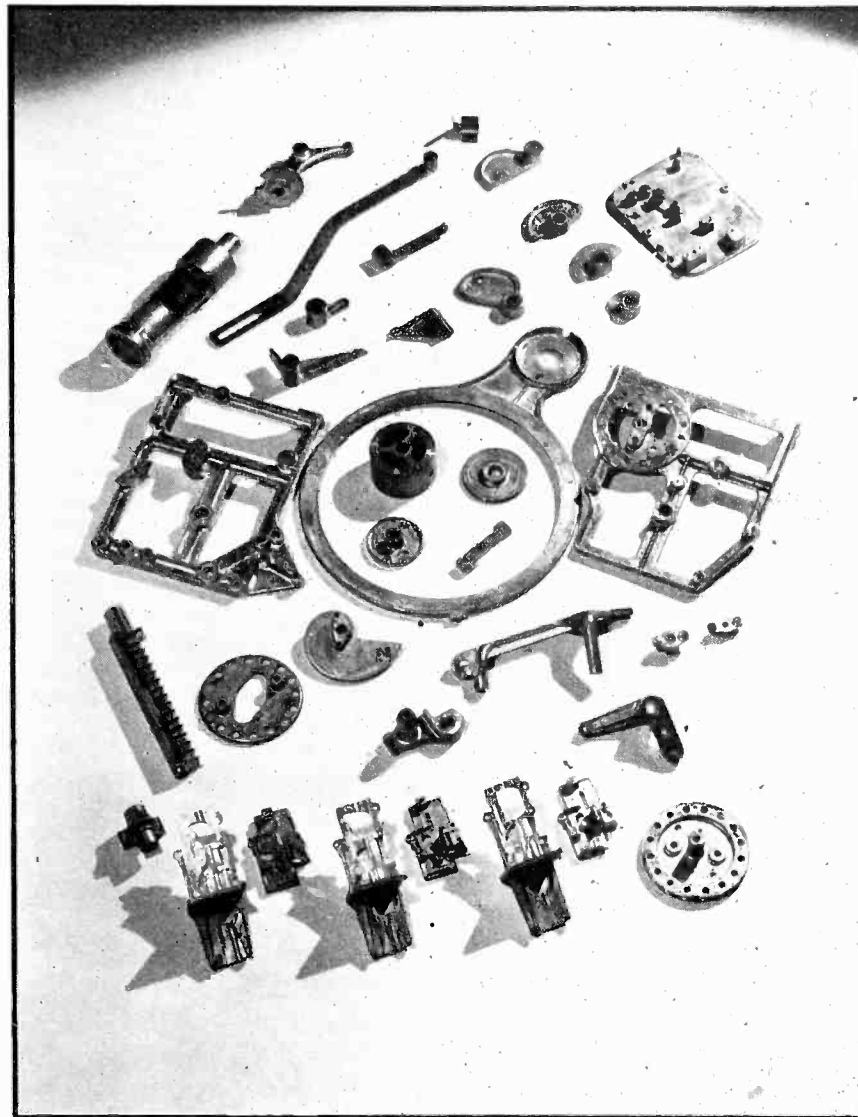

Right, zinc-alloy die castings for a Wurlitzer coin-operated switch mechanism, total weight 34 pounds

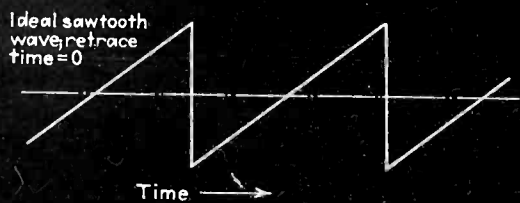

FIG. 1A

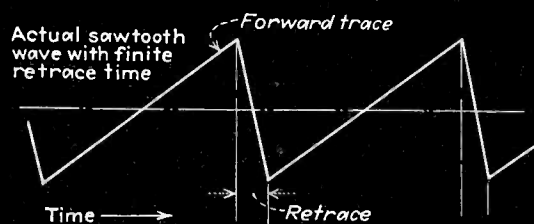

FIG. 1B

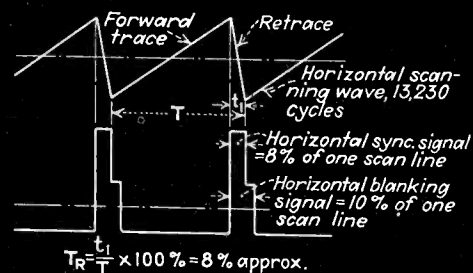

FIG. 2

Scanning in Television Receivers

Scanning-circuit design has no counterpart in present broadcast receiver practice, a fact which makes it an important subject for radio engineers who may soon be faced with the problems of television receiver development

By FRANK J. SOMERS

Farnsworth Television, Inc.
Philadelphia

THE scanning circuits of a television receiver present problems which are radically different from anything to be found in present broadcast set design. The purpose of this article is to outline some of the more important features of television receiver scanning and to show why certain precautions should be taken in the design of the scanning circuits to avoid image distortion and loss of picture detail.

The nature of a television receiver is such that it operates at its greatest efficiency when it is designed to work on a predetermined set of picture fidelity standards, since the efficiency of the scanning circuits and their ability to synchronize accurately with the transmitter is greatly affected by changes in picture repetition rate, or number of scanning lines. Consequently, a set designed for 441-line/30 picture transmissions will operate only poorly, if at all, on 300 or 500 lines.

We must, therefore, concentrate our attention on those of the R.M.A. standards which have particular bearing on television receiver scanning. These are listed below:

1. Aspect Ratio = Ratio of picture width to picture height = 1.33
2. Frame Frequency = 30 complete pictures per second
3. Field Frequency = 60 half-frames per second
4. Type of Interlace = "Odd-line" (odd number of lines per frame)
5. Interlace Ratio = $\frac{\text{field frequency}}{\text{frame frequency}} = 2:1$
6. Lines Per Frame = 441
7. Line Frequency = (frame frequency) x (lines/frame) = 13,230
8. Time Devoted to Blanking Signals = 10% of one line and 10% of one frame

9. Time Devoted to Horizontal Synchronizing Signals = Not standardized. A value of 8% of one line is usually used.

10. Type of Vertical Sync. Signal = $\left\{ \begin{array}{l} \text{Narrow Vertical} \\ \text{or} \\ \text{Serrated Vertical} \end{array} \right\}$
= Not standardized at present.

Regardless of which method of deflection, the electrostatic or the magnetic, is used, it is required that the scanning spot move with uniform velocity from left to right and from top to bottom of the picture frame area and that the time consumed in retracing the scanning path be as short as possible. This requires that the voltage applied to the deflector plates in the case of electrostatic deflection, or the currents flowing in the scanning coils in the case of magnetic deflection, shall be essentially straight-line functions of time. This would require scanning waveforms of the type shown in Fig. 1, which shows a "sawtooth" scanning wave. Since the production of a sawtooth wave of zero retrace time is a practical impossibility, it is necessary to allow an appreciable portion of the scanning time for the retrace portion of the cycle. This is illustrated by Fig. 1-B.

Since the scanning spot does not retrace its pattern in zero time, blanking signals are arranged to drive the grid of the cathode ray tube to cut-off during the retrace to erase the retrace lines so that they

do not appear in the final image.

The relation between the sawtooth wave and the blanking and synchronizing signals for scanning in the horizontal direction is shown in Fig. 2. It is important to note that the duration of the synchronizing signal is approximately equal to the retrace time of the scanning wave. A synchronizing signal of much longer duration than this tends to allow shifts in phase of synchronization between adjacent scanning lines. The length of the blanking signal, however, has no effect on accuracy of synchronization, and usually has a slightly longer period than the synchronizing signal. This is done to insure adequate blanking in all receivers, since the actual horizontal retrace time is bound to vary slightly from set to set even when they are manufactured only in small quantities. It should also be noted in Fig. 2 that the horizontal retrace time T_R is expressed in per cent of the total period of the wave. Thus—

$$T_R = \frac{t_1}{T} \times 100\% \quad (1)$$

Similarly for the vertical scanning wave—

$$T_R' = \frac{t_1'}{T'} \times 100\% \quad (2)$$

The relation of the vertical scanning wave to its corresponding blanking and synchronizing signals is similar to Fig. 2, except that here a value of T_R' of the order of 2 per cent or 3 per cent of the frame period and a synchronizing signal of correspondingly short duration is

¹P. T. Farnsworth, U. S. Pats. # 1,773,980, 2,051,372, 2,059,219, 1,844,949

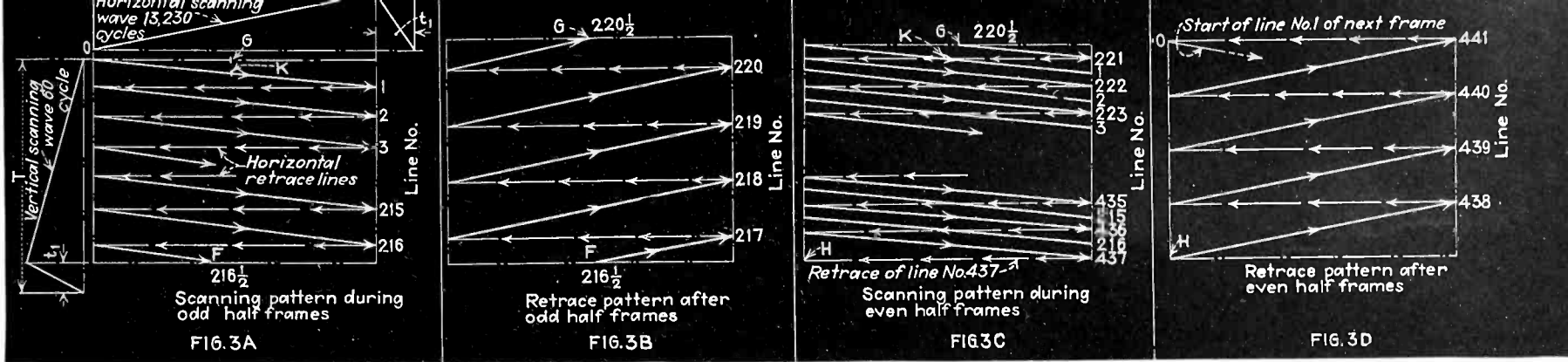

needed to provide the accuracy of synchronization necessary to preserve the interlaced scanning pattern.

The actual motion of the scanning spot for the duration of a single picture frame may be seen by reference to Fig. 3. Here the scanning process starts at point zero of Fig. 3-A, and continues to point "F" at the end of $216\frac{1}{2}$ lines, thence to the retrace pattern in Fig. 1-B from point "F" to point "G" at $220\frac{1}{2}$ lines. In Fig. 3-C, which is the second half-frame, the point "G" is exactly a half-line pitch above point "K" on line No. 1. This causes the second set of scanning lines to fall evenly between those traced on the first scan, and an "odd-line" interlaced scanning field is the result. In drawing diagrams 3-A, B, C and D, the vertical retrace time T_r' was taken exactly equal to the period of four horizontal scanning waves. However, in actual practice the vertical retrace time need not be an integral number of horizontal scanning periods, as changing the value of T_r' serves only to shift the position of point "F" on Figs. 1-A and 1-B. T_r' must, never-

theless, remain sensibly constant over a reasonable period as otherwise the resulting "jitter" of the scan lines will tend to destroy the effect of interlacing. The slightest variation in the ratio between T and T' on the other hand, will shift the relation of "G" and "K" and cause "pairing-off" of the scanning lines. Pairing of the scanning lines becomes objectionable if the period T' varies more than $\pm 1/10$ scan line from the correct value. The correct value of the ratio T/T' is maintained in the synchronizing impulses supplied from the incoming signal. It is, therefore, apparent that a high degree of accuracy of synchronization is needed to provide a satisfactory interlaced scanning pattern at the receiver.

Since the blanking signals occupy 10 per cent of the total scanning time, the actual number of lines visible in the received image is 397, although the rate of scanning is 441-lines per frame.

Magnetic Deflection

Magnetic deflection of the cathode ray beam is accomplished by means of two sets of electromagnets ar-

ranged for vertical and horizontal scanning. The vertical deflection coil carries a sawtooth current having the waveform of Fig. 1-B and a frequency of 60 cycles. The horizontal deflection coils carry a sawtooth wave current, also having the form of Fig. 1-B, and a frequency of 13,230 cycles. The deflecting magnets are positioned about the cathode ray tube in such a way that the desired scanning pattern is obtained on the fluorescent screen.

In the present state of the art, the design of a deflecting coil system for a particular cathode ray tube is done largely on an experimental basis. This is necessary because the deflecting coils and magnet yokes must be placed outside the glass envelope of the tube and the magnetic circuits, therefore, involve large air gaps and leakage flux paths which are hard to evaluate. However, there are certain definitely established principles which should be followed in the design:

1. The deflecting coils should be so placed that there is no de-focusing effect on the electron beam.
2. Deflecting coils should be placed far enough away from the electron gun so that the beam is not intercepted by the walls of the neck of the tube before striking the fluorescent screen.
3. The deflecting coils must produce magnetic fields having uniform intensity throughout that portion of the cross-section through which the electron beam travels.
4. Coupling between vertical and horizontal deflecting fields should be avoided.

A laminated magnet yoke is usually used in connection with the vertical scanning coil to improve the deflection sensitivity. There is little to be gained in using iron pole pieces for the horizontal deflection, however, due to the high frequency components present in the sawtooth wave. Horizontal deflection fields are, therefore, usually obtained by means of air-core coils. These are used in pairs placed parallel to each other on opposite sides of the neck of the tube. One type of coil system which fulfills the requirements is shown in Fig. 4.

The next step is to investigate the type of scanning circuit which will produce the desired results. The

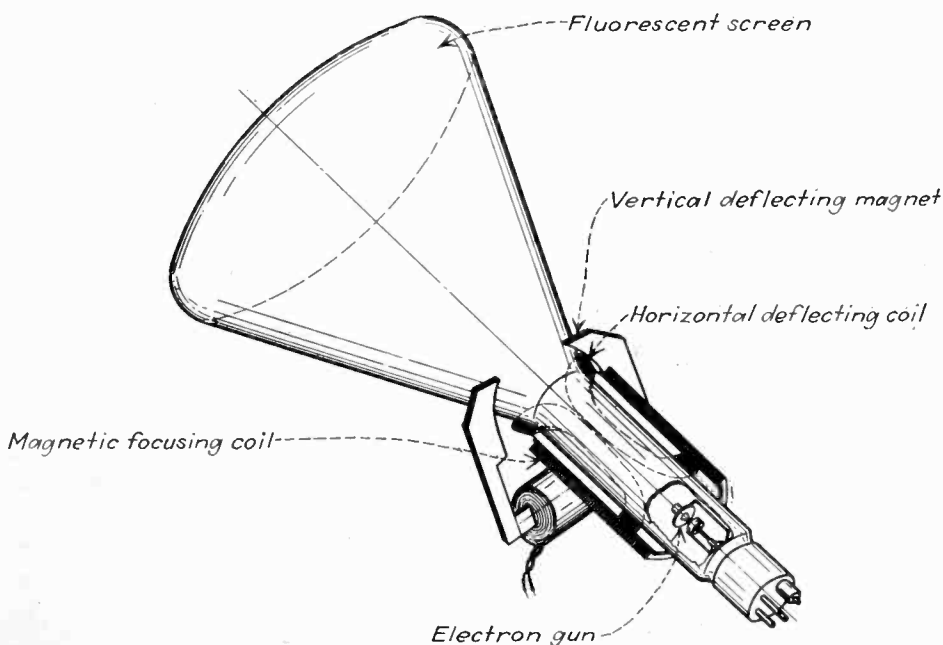

FIG. 4

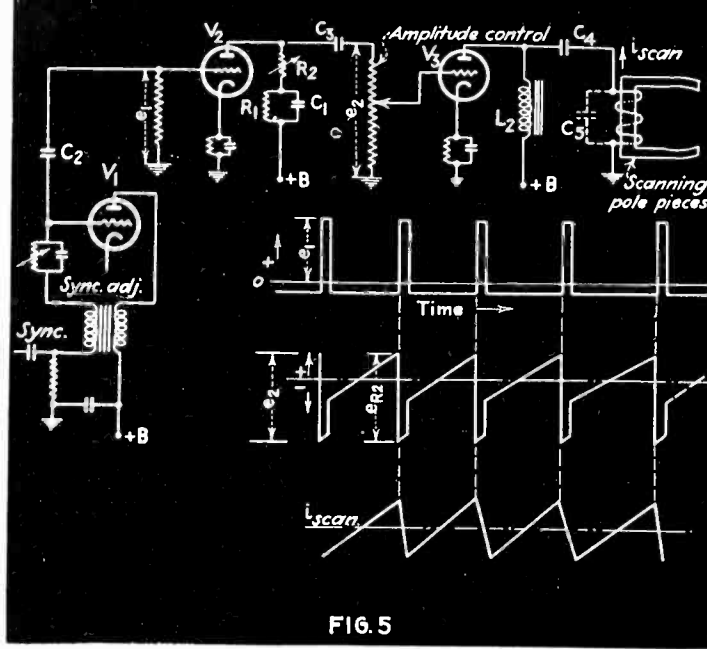

Fig. 5. Blocking oscillator circuit used for magnetic scanning in either vertical or horizontal direction

general requirements for either vertical or horizontal scan circuits are:

1. The scanning wave must be linear. Any rounding off of the sawtooth wave current fed to the scanning coils causes distortion of the shape of objects in the received image.
2. The sawtooth wave current must have the proper value of I_m .
3. The scanning circuit must have sufficient stability and be capable of being synchronized accurately enough to produce a satisfactory interlaced scanning pattern. This practically eliminates sweep circuits employing gaseous discharge tubes, thyratrons, etc., as tubes of this type, as used in ordinary sweep circuits, are too much affected by temperature, supply voltage and ageing effects for reliable operation.
4. Means should be provided so that the amplitudes of both horizontal and vertical scanning may be adjusted to obtain the required 1.33 aspect ratio for the image.

There are a number of circuits, all utilizing high vacuum rather than gaseous tubes, which possess sufficient stability and can be synchronized accurately enough for interlaced scanning.

One circuit commonly used for either vertical or horizontal deflection is shown in Fig. 5. This is similar to the scanning generator described by Holmes, Carlson and Tolson². In Fig. 5 V_1 is a "blocking oscillator" which applies a series of

²Holmes, Carlson & Tolson, "Experimental Television System" *Proc. I.R.E.*—Nov., 1934.

positive pulses e_1 to the grid of tube V_2 . Tube V_2 is normally biased to cut-off, but the arrival of a positive pulse causes plate current to flow, charging C_1 and causing a voltage drop e_2 across the grid leak of tube V_3 . The negative pulse in e_2 is due to the voltage drop across R_2 during the time C_1 is charging. The sawtooth portion of e_2 occurs due to C_1 discharging through R_1 when the positive pulse is removed from the grid of V_2 . In order that the sawtooth portion of e_2 be reasonably linear the time constant $R_1 C_1$ should be made large compared to the period of the scanning wave.

The negative pulse e_{n2} is utilized to drive the grid of tube V_3 to cut-off during the retrace portion of the scanning wave. If this is not done the high voltage induced in the scanning coil during the retrace period will place a positive potential on the plate of V_3 and the resultant low plate resistance shunting the coil makes it impossible for the current to decay rapidly. The value of R_2 is made adjustable so that the proper amount of negative pulse for good

waveform may be readily obtained. The circuit of Fig. 5 illustrates several design features which are common to scanning arrangements where an amplifier tube is used to feed the deflection coils. Usually the required deflecting ampere turns are known or can be measured for a particular cathode ray tube and coil system. The question is then to determine the maximum allowable turns for the deflection coil for a given peak plate current $2I_m$. The maximum number of turns that can be used in any case is limited by the distributed capacity C_s of the deflecting coil since this capacity tends to discriminate against the higher harmonics present in the sawtooth output current.

Harmonic Content of Sawtooth Wave

It is well to point out here that the sawtooth wave equation which has heretofore appeared in the literature assumes a zero retrace time as in the wave of Fig. 1-A. This equation is of the form:

$$i = a \left(\sin \omega t - \frac{1}{2} \sin 2\omega t + \frac{1}{3} \sin 3\omega t - \frac{1}{4} \sin 4\omega t + \dots \pm \frac{1}{n} \sin n\omega t \right) \quad (3)$$

This is misleading because the amplitude of the higher order harmonics decreases more rapidly when a finite retrace time is allowed. The correct equation is given below in connection with Fig. 6.

$$i = a_1 \sin \omega t + a_2 \sin 2\omega t + a_3 \sin 3\omega t + a_4 \sin 4\omega t + \dots \quad (4)$$

$$\text{Where } a_m = \frac{-2I_m(-1)^m \left(\frac{\sin mK}{mK} \right)}{(\pi - K)m}$$

and $m = \text{order of harmonic}$
 $I_m = \text{peak sawtooth current}$

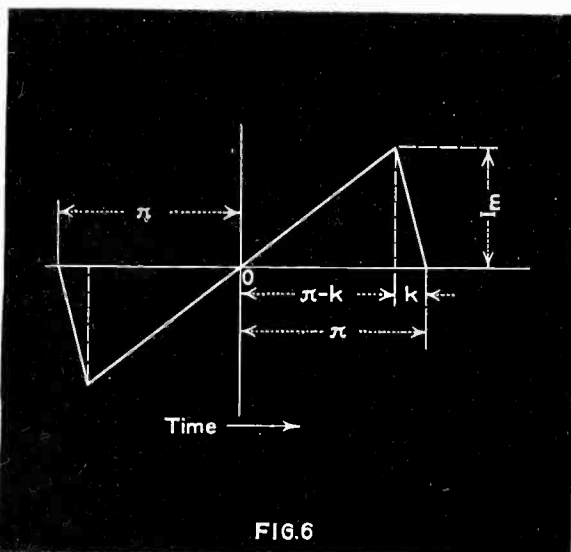

FIG. 6

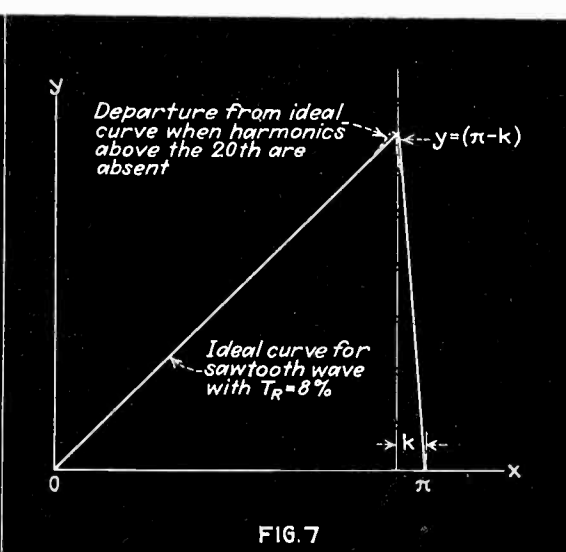

FIG. 7

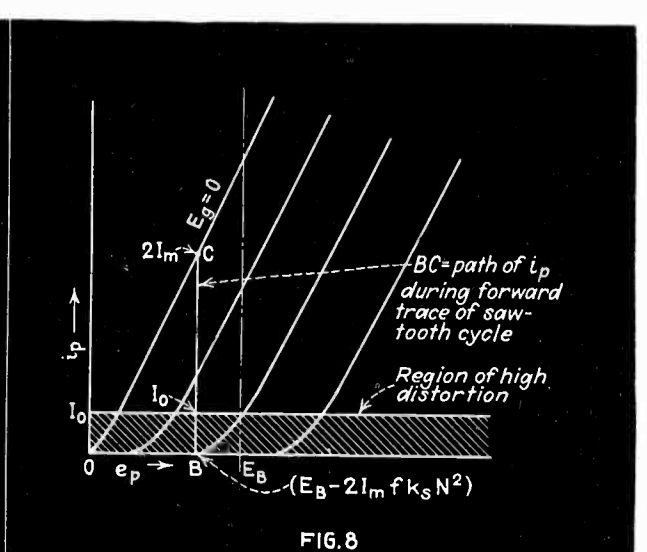

FIG. 8

and $K = \frac{l_1 \pi}{T}$ radians.

This equation together with the constants for all harmonics up to the 20th of a sawtooth wave of $T_r = 8$ per cent have been calculated by Mr. J. D. Schantz, of Farnsworth Television Incorporated, and Fig. 7 prepared from these values. This figure indicates that the value of C_s must be kept low enough for the vertical direction of scanning to allow at least the 20th harmonic to flow in the deflection coil. This means that the amplifier circuit must pass frequencies at least as high as 1,200 cycles. For the horizontal direction of scanning distortion is not so readily noticeable and inclusion of the 12th harmonic gives sufficiently a linear sweep. This means that the amplifier must pass frequencies at least as high as $12 \times 13,230 = 159$ KC and C_s must be kept correspondingly low.

Another factor which limits the number of turns that can be used in the deflection coils is the magnitude of the peak induced voltage which appears across the coil when the current is suddenly reversed at the end of the sawtooth cycle. In the case of the vertical deflection coil this may easily amount to 1,000 volts or more. The value of the peak retrace voltage can be readily calculated from equation

$$E_{RETRACE} = \frac{2I_m}{t_1} L \text{ Volts} \quad (5)$$

Where L = inductance of deflection coil

I_m = peak scanning current amps

t_1 = retrace period in seconds.

In the circuit of Fig. 5, the inductance of the choke coil L_s is always

made large compared to the inductance L of the scanning coil. Also C_s is chosen to have negligible reactance for the fundamental sawtooth frequency. We may, therefore, write the following equation for i_p of tube V_3 ,

$$i_p = \frac{\mu}{R_p} \left[E_0 + \frac{1}{\mu} \left(E_B - L \frac{di}{dt} \right) \right] \quad (6)$$

Due to the complex nature of the sawtooth wave a rigorous analysis of plate circuit conditions based on equation (6) is rather involved. However, by making certain simplifying assumptions we can readily derive equations for the optimum number of deflection coil turns and the maximum ampere turns that can be supplied by a given tube operating at a given plate voltage. It should be kept in mind that the values thus obtained are maximum values and that the actual deflection coil turns must later be modified in order to avoid too high a value of e_{r1} and to keep C_s sufficiently small.

By assuming a straight-line E_0-I_p characteristic and a constant R_p for V_3 we get for the forward part of the cycle at $E_0 = 0$,

$$NI_m = \frac{NE_B}{2R_p + 2fK_s N^2} \quad (7)$$

- where E_B = Applied plate voltage
- N = Deflecting coil turns
- R_p = Plate resistance of V_3
- f = Fundamental frequency of sawtooth wave
- K_s = Inductance per turn of deflection coil
- and $I_m = \frac{1}{2}$ Peak plate current.

Differentiating with respect to N we get for the optimum coil turns N_o ,

$$N_o = \sqrt{\frac{R_p}{fK_s}} \quad (8)$$

Substituting (8) in (7) we get for the optimum peak ampere turns

$$N_o I_m = \frac{E_B}{4} \sqrt{\frac{1}{R_p f K_s}} \quad (9)$$

In applying equation (9) we cannot swing the plate current from $2I_m$ to cut-off as this would introduce considerable distortion and we are forced to limit the minimum plate current to a value I_0 obtained from the tube characteristic curves as shown in Fig. 8. Hence, the actual peak to peak ampere-turns are $N_o(2I_m - I_0)$ and the peak ampere turns are $N_o(I_m - 1/2 I_0)$.

Another type of circuit³ which possesses sufficient stability and accuracy of synchronization for interlaced scanning is shown in Fig. 9. This circuit operates more efficiently than the amplifier type scanning generator already described because it works with positive grid during most of the sawtooth cycle. In operation the currents in the grid and plate windings of the "Kipp" transformer and in the output winding are as shown in Fig. 9. Synchronization of the oscillator is obtained through the action of a second grid G_2 as shown in the diagram is usually maintained at a low positive potential with respect to the cathode. In using this circuit, best results are obtained if the second grid G_2 in the oscillator tube selected exerts only a very small control on the plate current. For this reason, tubes specially designed for the Kipp oscillator give the best results. However, a type 802 tube is a standard tube which may be used. In using the 802 the suppressor is used for G_2 and the screen is connected to the plate. A detailed analysis of the mode of operation of this circuit is too involved and lengthy to be included in the present article. However, by proper design of the transformer and selection of a suitable oscillator tube, the output scanning currents have excellent linearity and a T_r of 8 per cent at 13,230 cycles. The Kipp oscillator is not used for vertical scanning at 60 cycles because the transformer becomes too bulky when designed for low frequency operation.

³ P. T. Farnsworth, U. S. Pats. # 2,059,683, 1,758,359.

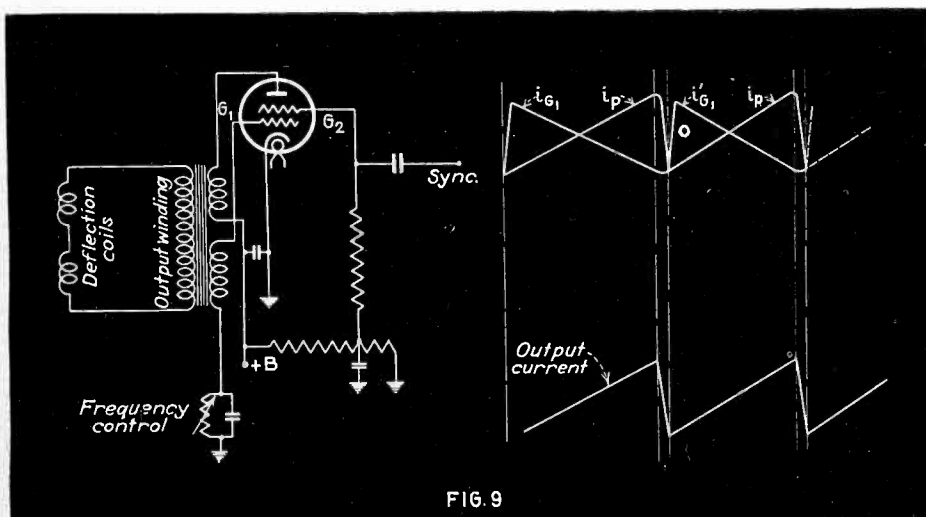
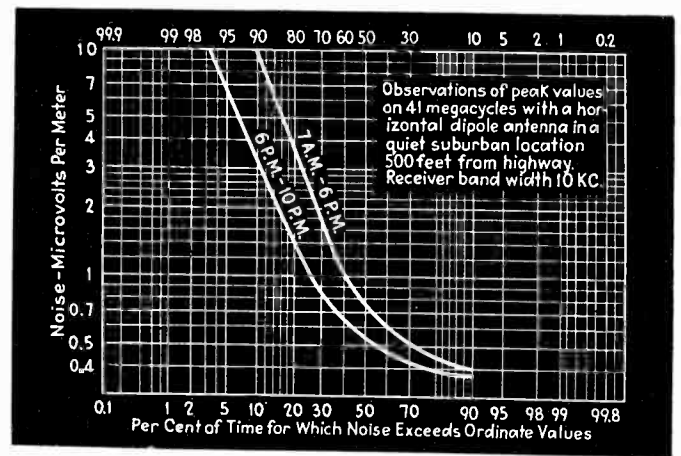

FIG. 9

Applying Police Radio



—to the varying needs of different communities requires a careful analysis of the terrain, the noise level, and the type of service expected. Methods of performing this study are here presented as well as the results, useful to engineers planning police radio installation.

By R. N. HARMON

Radio Division, Westinghouse E. and M. Co.
Chicopee Falls, Mass.

IN CONSIDERING the installation of a police radio communicating system, it is essential that an analysis be made of the area to be served to provide accurate operating specifications and estimate of costs. An accurate engineering analysis should include a study of the following to determine the best site and accurate equipment and installation expense:

- 1.—Size and shape of the area to be served.
- 2.—Character of the soil (sandy, marshy, level, hilly, and so forth).
- 3.—Character of the settlement (manufacturing, business, residential or rural).
- 4.—Electrical noises present, (automobile, trolley car, x-ray, diathermy, neon signs, and atmospheric static).
- 5.—Chances of interference from other stations with similar services.
- 6.—Charting of a map of the area to be served in order to show the field strengths required for satisfactory service. In preparing this chart the following must be known:
 - (a) Noise intensity present on the frequency used at various points throughout the area.
 - (b) Type of service desired (just barely satisfactory or entirely satisfactory.)

Considerable material has been prepared from studies of the above subject. A recent investigation by the C.C.I.R. entitled, "Study of Question No. 9", and submitted for

the Fourth Meeting of that Committee in May 1936, contains this data:

MEDIUM HIGH FREQUENCIES 1500-3000 KCS

Microvolts Per Meter Required	Barely Satisfactory	Entirely Satisfactory
Concentrated Business District	707	5012
Residential	251	1778
Rural	.63	4.5

ULTRA HIGH FREQUENCIES 30-42 MEGACYCLES

Microvolts Per Meter Required:	Barely Satisfactory	Entirely Satisfactory
Concentrated Business District	50	355
Residential	10	79
Rural	Receiver Noise Only	10

Man-Made Noise a Large Factor

Operation in the medium high frequency band, 1500 to 3000 kcs., is limited by man-made noise in the concentrated business districts where the electrical noise level is extremely high. The same is true, but to a lesser extent, in the residential areas. In rural areas the degree of service is limited mainly by atmospherics and receiver noise, plus possible adjacent channel interference.

In the ultra high frequency range, 30 to 42 megacycles, the degree of service is again limited by man-made noise in the concentrated business and residential areas. However, the type of electrical noises that interfere with this service are usually found to originate in an electrical discharge, such as automobile ignition, leaky power lines, defective neon signs, and so forth.

Curves K and L (Figures 1 and 2) of the C.C.I.R. paper previously referred to show clearly the advantage to be gained by locating ultra high frequency receiving antennae in quiet locations. Referring to Fig. 2 which gives noise levels received by a receiver located 150 feet from a road, it may be seen that 10 per cent of the time noise peaks exceed 115 microvolts per meter, whereas 50 per cent of the time they are below 34 microvolts per meter. On the other hand, Fig. 1, which gives noise levels received by a receiver located 500 feet from a road in a quiet, suburban area, indicates that 10 per cent of the time noise peaks are in excess of 10 microvolts per meter, while 50 per cent of the time noise peaks will be below 0.8 microvolt per meter.

Determining Power Requirements

Having charted the area to be served, with the signal strength required for the type of service desired, the next step is to determine the transmitter power to produce those signal strengths in the area of interest.

For medium high frequencies there is available a wealth of material which will enable practically anyone to determine the type of antenna and the power of the transmitter required to produce a given signal strength at any given distance over different types of soil. Particular reference is made to the National Association of Broadcasters' engineering manual, which is complete on this subject. Figure 1D (Fig. 3) of this manual shows the increase in signal to be obtained as

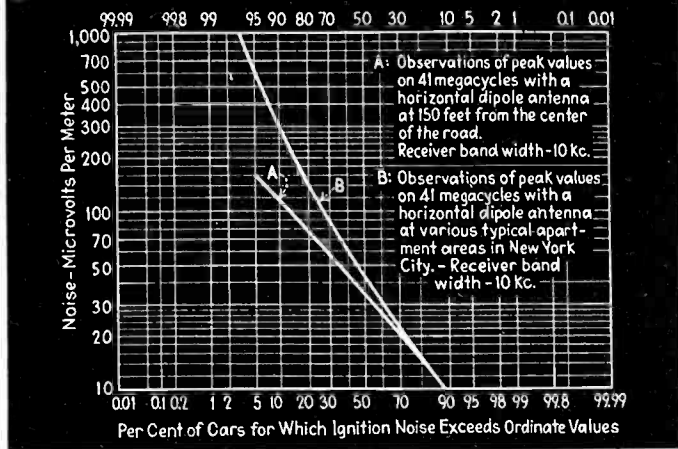

Fig. 1—(opposite page) Noise levels encountered 500 feet from road in quiet suburban areas

Fig. 2—(left) Noise levels (A) 150 feet from road (B) in apartment areas in New York City

the antenna length is increased. That figure indicates an antenna 1/10 of a wave length long should produce a field strength of 3.5 millivolts per meter per watt, while a quarter wave antenna should produce 5.4 millivolts per meter per watt, and a half wave antenna 7.5 millivolts per meter per watt.

Numerous formulae have been developed to predict the field strength which can be expected at various distances from a given transmitting antenna but development of these equations is beyond the scope of this paper. A bibliography is given at the end of the paper for those who may be interested in such equations. Other curves on this same subject have been prepared by the Federal Communications Commission engineers and are available to the public. These curves indicate that the limit of useful service in a residential area for a 50 watt transmitter with a short antenna, operating on 2500 kcs., for ground of excellent conductivity, is thirteen miles; and for ground of poor conductivity, five miles, (see Figs. 4 and 5). For a 500 watt transmitter under similar conditions, the distances are twenty-five miles and eight miles respectively.

Data on Ultra High Frequencies

In the ultra high frequency range there is at present only a moderate amount of literature available to the public and its accuracy has not been proven. This is due mainly to the youthfulness of the development of ultra high frequency equipment and its application. In general, the field strength received from a given transmitter is a function of the product of the transmitting and receiving antenna heights above ground, the square root of the transmitter power, and the square root of the antenna length, all divided by the wave length and the square of the distance between the transmitting and receiving antennae.

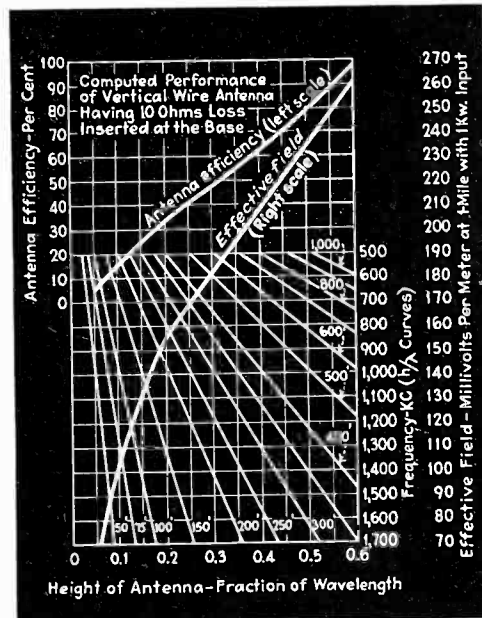

Fig. 3—Antenna efficiencies and field strengths vs. antenna height and length

Two curves, (Fig. 6), show the field strength to be expected at distances from one to six miles from both a 50 watt and 15 watt ultra high frequency transmitter when the antenna heights are 150 feet and 3 feet respectively for the fixed and mobile units. These curves show that the range for the 50 watt transmitter is limited to three miles for an entirely satisfactory signal and seven miles for a barely satisfactory signal in residential areas. The limit of range of the 15 watt mobile unit will depend upon the quietness of the remote receiver location and should be two and a half miles for the average residential location and five or six miles for the best possible location.

In the medium frequency range moderate hills and irregularities of the ground have little effect on the transmission, while serious shadows are cast by even moderate hills when ultra high frequencies are employed. Thus, considerable caution must be used in locating ultra high frequency antennae to minimize the chance of such shadows.

Considerable time may be ex-

pected in developing a logical choice of equipment and data to enable the proper location of that equipment within a given area. These data must be used in conjunction with other factors which are mainly economic or political. In deciding upon the location for the headquarters transmitter, these data must be considered along with the fact that it usually must be located on city property, preferably at police headquarters, although this should not exert too much weight as remote control may be used if the headquarters building is unsuitable to give a practical antenna location. A suitable room for the transmitting equipment, proper telephone and power facilities must be provided.

The installation costs of various heights of antennae should be weighed against the probable gain in signal as indicated in Fig. 4. For installations employing lower powered transmitters the cost of the antenna and transmitter is a large percentage of the entire cost and special care should be taken to obtain the most efficient installation for the least expense. New and novel developments, such as the shunt excited antenna, which is merely a steel pipe of proper length grounded directly at the base, are helpful in reducing installation costs.

Care Needed With "Talk-Back" System

If the installation is to employ mobile "talk-back" transmitters, the receiver locations must be carefully picked. Reference to Figs. 1 and 2 showing probable noise level existing in different types of areas, together with Fig. 6, of signal strength received at different distances from the mobile unit, will be helpful in locating these receivers. Too much importance cannot be placed upon the necessity of selecting a location which is both quiet and high above the surrounding territory. Other factors which must be considered are buildings suitable for antenna

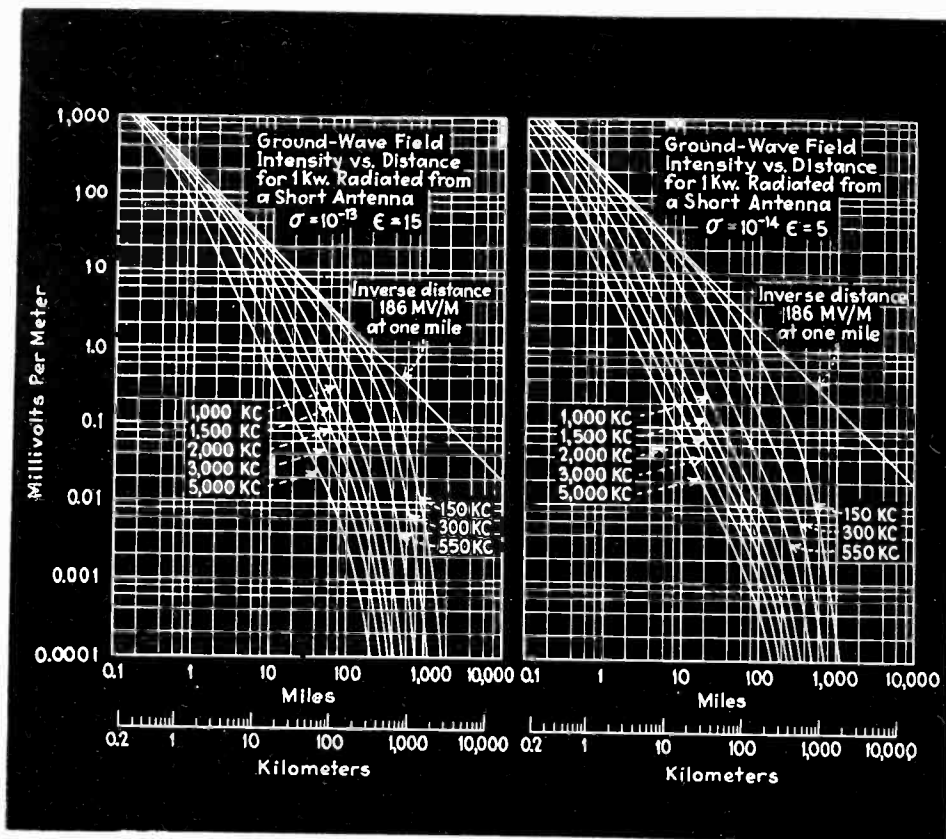

Figs. 4 and 5—Field strength intensity as a function of distance, ground conductivity and dielectric coefficient, for frequencies from 550 to 5000 kc.

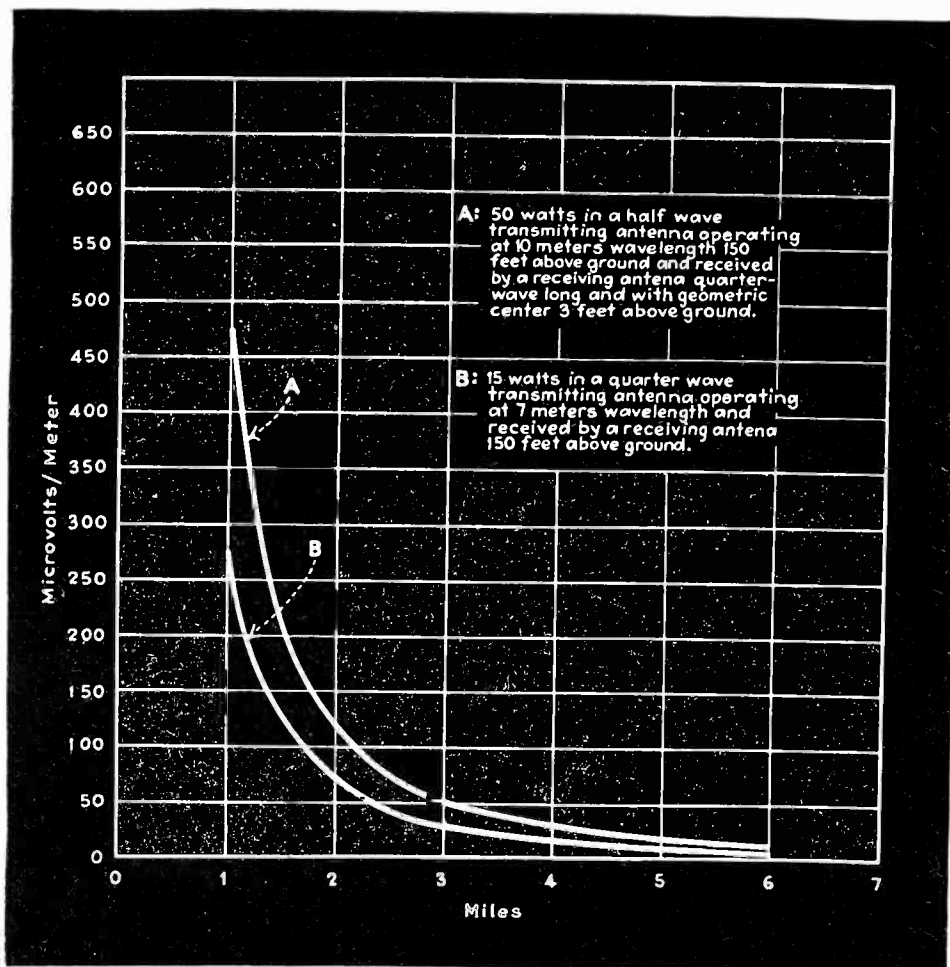

Fig. 6—Field strength at ultra-high frequencies (10 and 7 meters) as a function of distance from transmitting antenna

installation, telephone and power facilities, accessibility to the operator, and control from headquarters.

The installation of medium high

frequency receivers in mobile equipment is relatively simple and will not be discussed other than to indicate that most of what applies to

ultra high frequency installations also applies to installations of this type.

In any mobile installation great care must be exercised to make the installation as mechanically sound as possible. Even with the best care, the constant excessive vibration and shock will eventually loosen or break various parts which are not fastened securely to the automobile. Care should be used to also make the installation in such a manner and with such proper materials that the equipment may be removed and re-installed where the cost of the transmitting and receiving equipments is usually a large percentage of the cost of the car. The life of the automobile itself is much less than that of the radio equipment.

Hints on Mechanical and Electrical Maintenance

The maintenance of any police radio equipment may be divided into two main divisions, one mechanical and the other electrical. The mechanical maintenance will consist in a regular and careful check and cleaning of all mechanical parts of the equipment. Particular care should be given all mobile equipment, rotating equipment, and contactors. A regular periodic check should be the rule and complete records should be kept of all the checks and work done on individual units.

The electrical maintenance should consist of proper checks to see that the equipment is operated in accordance with the rules of the Federal Communications Commission regarding frequency, power, modulation, and radiations. These checks should be made with sufficient instruments to show that all parts of the circuits of each piece of apparatus are properly and efficiently operating. Other checks should include measurement of filament voltage, plate and grid voltages and currents, antenna current, microphone current, percentage modulation, and so forth. Here, as in the mechanical maintenance, a regular systematic schedule with complete records of adjustments made and results obtained is of the utmost importance.

BIBLIOGRAPHY

- I.R.E.—Oct. 1936—Norton—"Propagation of Radio Waves."
- NATURE—Vol. 135, p. 954—June 8 (1935).
- I.R.E.—Vol. 20, pp. 1555-1579—Oct. 1932.
- I.R.E.—Vol. 19, pp. 1150-1165—July, 1931.

Fig. 1—Buchman-Meyer pattern on a glide-type audio test record. The width of the "Christmas tree" is proportional to the recorded volume

Quality in Disc Reproduction

According to Mr. LeBel, a specialist in the field, many broadcast stations are obtaining 1926 results from 1937 equipment. Broadcast engineers (and others) will gain much from his practical advice on turntables and pickups

A SHORT session with a good radio receiver will soon convince anyone that many radio stations do not have satisfactory equipment for record reproduction. A few talks with broadcast engineers have revealed the causes: Confused by misleading advertising, unfamiliar with the peculiarities of the recording art, consequently unable to apply proper corrections, and with insufficient money and time for development work, many organizations are getting 1926 results from 1937 records. This article attempts to outline a remedy and to answer common questions.

The first question, of course, is whether to buy a complete assembly or build it. The answer is not too easy, since it involves chiefly the character and anticipated character of program material, standards of the station, and its listeners. From an engineering point of view the question becomes one of speed range, speed stability, and durability in relation to price.

This point may be enlarged upon. A station using, for example, only "swing-music" 78 rpm. records, and the like, would be foolish to invest

By C. J. LeBEL

much money in an expensive turntable mechanism. Music of that type is not sensitive to variation in speed. On the other hand, a station which runs many classical or semi-classical records—even if at 78 rpm.—must have the driving speed steady to a far higher degree. This does not imply a far higher cost, but it does

imply greater care in design, construction and maintenance.

The larger station may prefer to spend more money and get a complete manufactured job. The small station will get quite satisfactory results from equipment of its own assembly. While the following discussion is directed at the latter group, the points and tests are also of interest in choosing a complete unit.

The mounting for the motor should be adequate in stiffness and weight. Excessive vibration produces hum in the pickup output, and a light flimsy motor mount is the best encouragement for excessive vibration. Some provision for leveling should be included; a level record will enable the needle to track at a definitely lower pressure. Finally, the mounting should include definite means of guarding the pickup from motor vibration, although a heavy motor board may do this as well.

Turntable and Drive

The turntable and its drive are the most expensive and most critical parts of a reproducing assembly. In choosing or designing a turn-

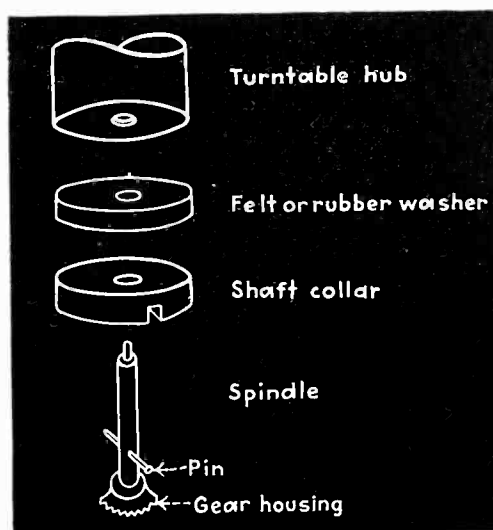
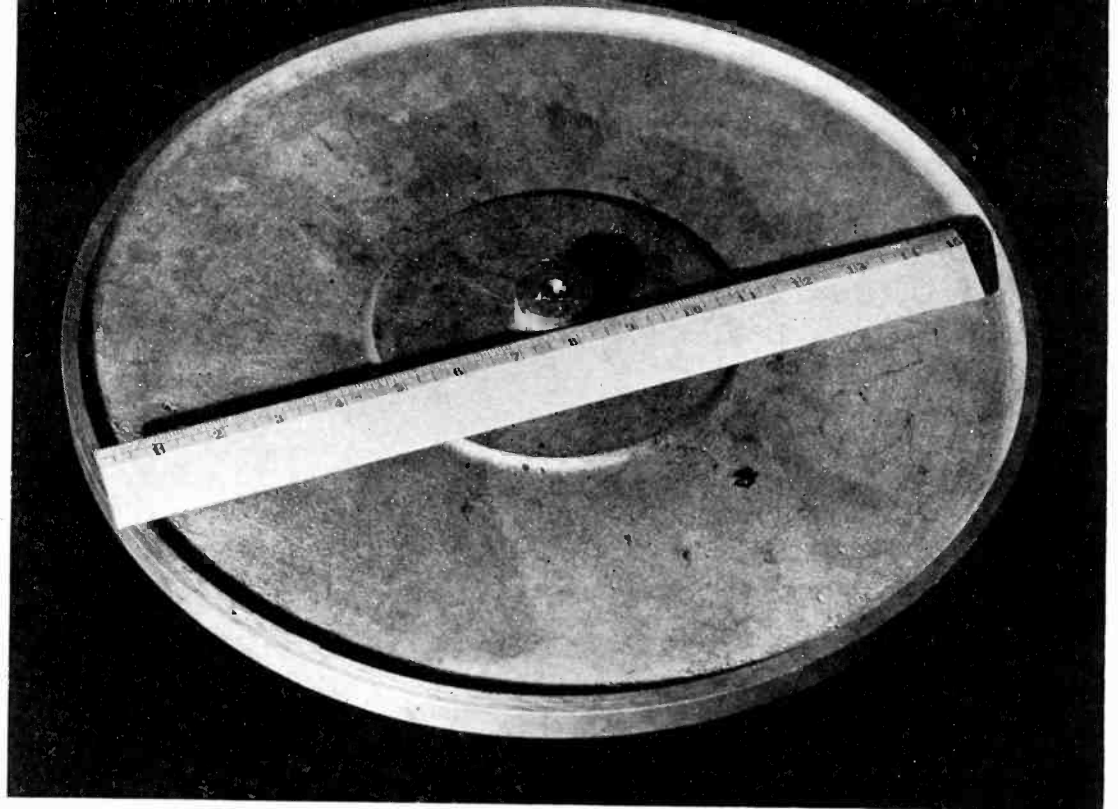

Fig. 2—A friction drive for the turntable will reduce gear "hum"

Fig. 3—Cast aluminum turntable, referred to in the text. Extra weight at the rim adds to stability



table, remember that what counts in achieving speed stability is not weight, but moment of inertia. The writer has seen several turntables weighted down with twenty pounds of lead,—at the center. The only effect was to ruin the thrust bearing. A few pounds at the rim would have had far greater effect on stability.

When we come to the driving mechanism we come to a wide range of price and not so wide a range in quality. As a matter of fact, durability is even more important than initial quality. Many of the small stations have found this out after a trial of the light governor-controlled phonograph motors used in home phonographs. These are all right when first bought but a few months of heavy service generally creates very annoying governor trouble.

A similar trouble (to the ear) may be caused by gears. Here the difficulty is seldom wear; if the

justment. Periodic wows at some multiple or sub-multiple of $33\frac{1}{3}$ or 78 rpm. per minute indicate defective gear teeth. This is a very common manufacturing difficulty, easily and cheerfully remedied by the manufacturer, and very unlikely to re-occur if once a good set of gears is secured.

While some manufacturers claim

The writer's personal preference is a small phonograph unit with synchronous motor and a special 16" turned aluminum table, friction driven from the spindle. Speed reduction is by worm gear to 78 rpm., with a friction drive down to $33\frac{1}{3}$ rpm. The entire unit is carried on a three spring suspension from the motorboard. The cost of this type

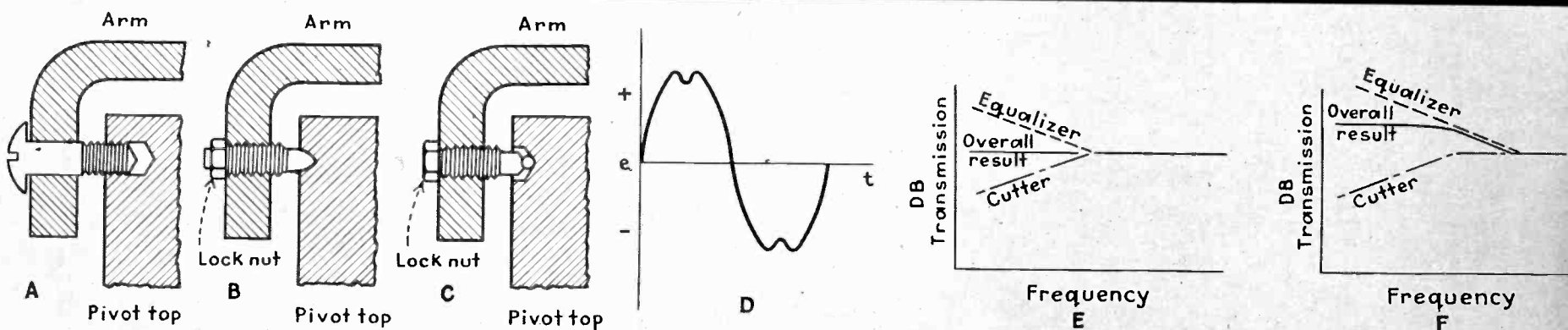

Fig. 4—A, B, C, Types of pick-up trunnion bearings: sleeve, cone, and ball-cone respectively. D, Wave-form of pickup output due to defective damping. E, F, Curves showing necessity of matching

initial quality is satisfactory, it is likely to remain so. A similar situation exists with the steel ball friction drive used in some machines for the 78 to $33\frac{1}{3}$ rpm. stepdown.

Tests for stability of speed should be applied to every new drive mechanism, and reapplied periodically. The conventional method is to play a piano record of known stability. This is the most sensitive practical way. A continuous series of wows without exact periodicity indicates governor trouble or a motor rotor oscillating longitudinally because of improper motor thrust bearing ad-

that the small phonograph motor does not have proper bearings or lubrication for continuous service, this does not check with the writer's experience. Such motors in transcription sales agencies often operate eight hours a day, yet the writer has encountered no sign of bearing trouble. The lubricant does have a tendency to drip out, but a felt pad wired under the gear box will catch the drops before they deface the studio rug. Regreasing every two or three months is quite ample. In the above mentioned agencies regreasing at yearly intervals was adequate.

of unit is low and the results have been quite satisfactory.

Pickups

Pickups display an even greater disparity between prices and results. The first question is naturally one of crystal vs. magnetic type. This is solely a question of cost and convenience, except in a very few tropical locations. The writer had several crystals deliver temporarily reduced output when the temperature rose above 110° during last year's hot spell. The quality was unaffected and the volume rose to nor-

mal when the temperature dropped slightly.

For 10-12" records it is possible to secure magnetic pickups with response uniform (± 1 db) from 50 to 5500 or 7000 cycles, as desired, at under \$10. This makes it unsound to trifle with the cost of a one stage amplifier or a special coupling transformer for the crystal. On the other hand, good magnetic pickups for 16" records cost so much more that it becomes profitable to use a crystal with a one stage amplifier.

In judging pickup quality, many things must be considered. No one make has all the desired features; the ideal unit would be composite. In inspecting a pickup we come first to the trunnion and pivot bearings. Good bearings will enable operation at decidedly lower needle pressure—minimizing scratch. Poor ball bearings at this point can be worse than none. Both sets of bearings should be fairly free from play. Incidentally, many manufacturers fail to grease the bearings. A speck of petroleum jelly applied with a toothpick will work wonders in reducing friction. Cone bearing trun-

Record wear is enhanced tremendously and the pickup will not track properly on bass notes. A station using a given record many times for theme music will find such a pickup an expensive luxury.

The only fundamental improvement in pickup arms to appear in a long while is the use of the bent arm. This has been standard practice in England for some time. A consideration of the theory, as given by Wilson and Webb,¹ shows that the reduction of needle tracking error is very great, i. e., that the needle stays much closer to tangential to the groove center line thruout the record. Practical test bears them out completely. The effect is to make reproduction near the inside of a record much cleaner without at the same time injuring the reproduction elsewhere on the record. American manufacturers will undoubtedly change over as their dies wear out. A very handy device for checking needle tracking error is the Wilson Alignment Protractor.²

The rigorous testing of a pickup is so simple that there is no excuse for omitting it:

lars' worth of the writer's records is a living disproof of this assertion.

2. Put the pickup on a good frequency record and plot the response as indicated on a meter in the amplifier output with the needle recommended by the pickup maker. Repeat, using other needles. Pick the best curve. If the response rises appreciably in the bass, reject the unit if a magnetic. Other grounds for a rejection are a deep valley or strong peak around 250-300 cycles (excessive arm resonance) or a strong resonance peak between 3000 and 6000 cycles (armature or crystal resonance). Rising bass response (in a magnetic pickup) indicates probability of rapid record wear; the excessive arm resonance, muddy tone in the upper bass register; and the excessive upper peak causes too much scratch. If the upper peak frequency is between 3000 and 4000 cycles, a strong peak will cause a peculiar form of distortion in upper treble tones.

A distinction has been made between magnetic and crystal units with regard to desirability of built-in bass boost. In a magnetic unit

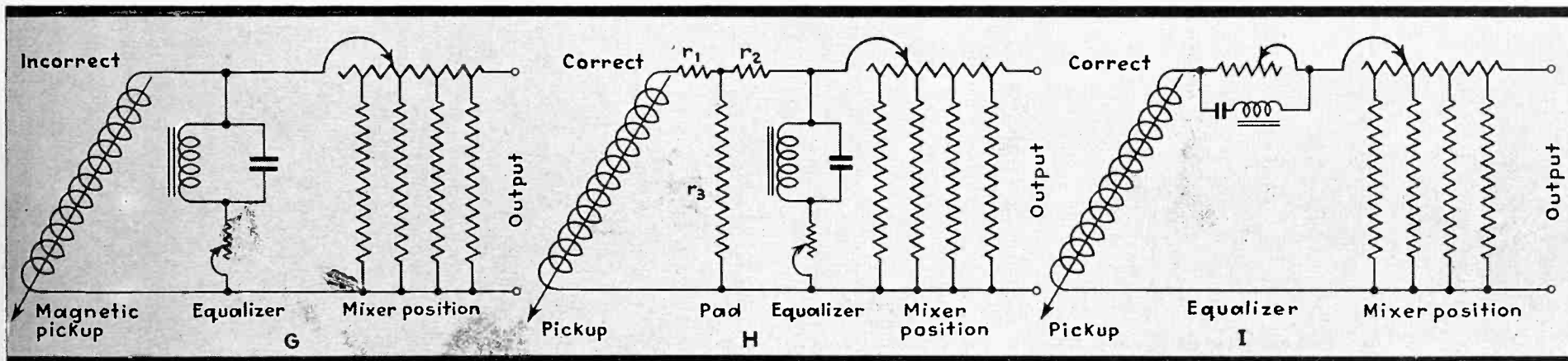

equalizer curve to recording cutter characteristic. G, H, I, Bass compensation circuits: G, incorrect, high frequencies are cut off; H, correct, using an isolating pad; I, correct, series compensator

nions are particularly in need of this slight lubrication.

The arm is another part which has been badly misused. Many pickup arms, being too light, have a resonance and antiresonance at 250-300 cycles, producing a peak and valley in the response. A far worse condition is caused by certain manufacturers of magnetic pickups, who resonate their tone arms with the pickup mass to produce a mechanical resonance at 65 to 90 cycles. This does bring up the bass in the same fashion as an equalizer but has an additional very undesirable result.

1. Test for tracking at low frequencies: Try a 60 cycle test record, then a record with very heavy bass, such as the Götterdämmerung Siegfried Funeral March (Columbia 6844D or preferably the corresponding British pressing which is quieter). The tone should be smooth, with practically no chatter. If there is decided chatter or the needle utterly fails to track, the pickup will cause too much record wear, and is hence unsuitable. Some makers claim that there is not enough bass on a normal record to make this test worth while. A ruined hundred dol-

this is caused by mechanical resonance, and the writer's practical experience has found it detrimental to record life. In a crystal unit this rise is produced by the electrical nature of the crystal, is non-resonant, not harmful to record life, and can be controlled by a circuit of proper design. The bass boost built into some crystal pickups is both too much and of the wrong shape, but fortunately inexpensive networks will correct this.

3. Put the pickup on a good heterodyne frequency record with
(Continued on page 77)

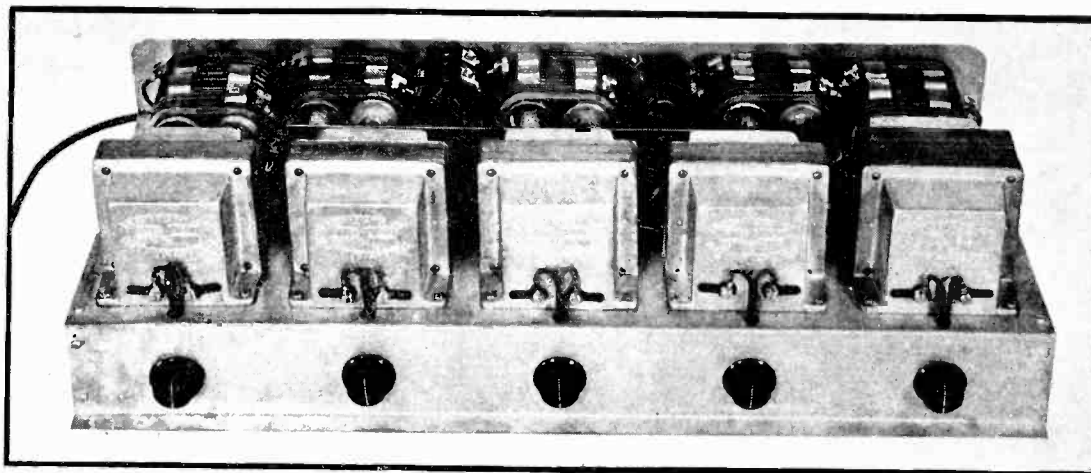

Reactance Amplifiers

Recent developments in circuits using iron core reactors, saturated by d.c. from copper oxide rectifiers, provide stable magnetic amplifiers and control circuits for industrial purposes. Saturated reactors used for sequence and tuning operations

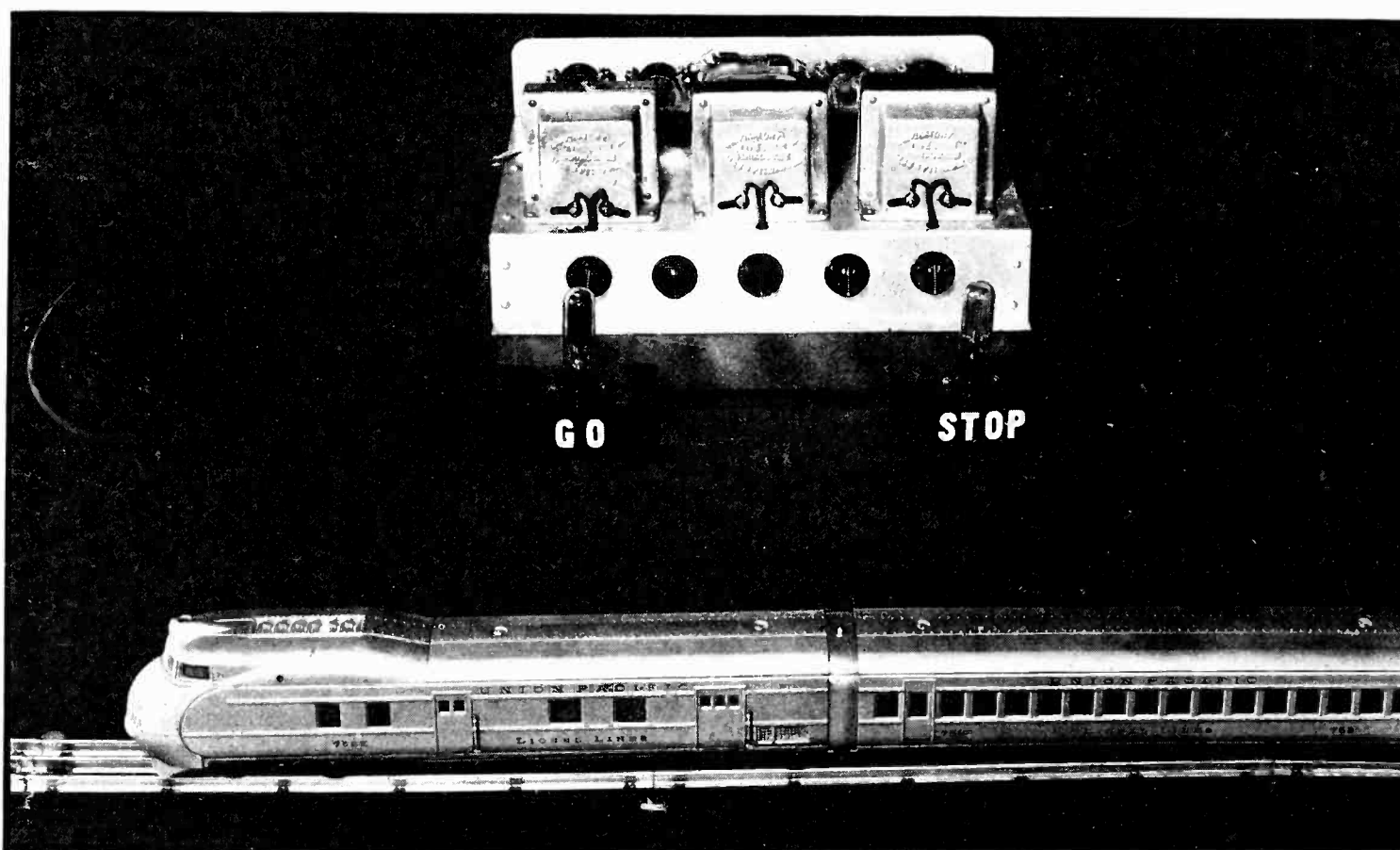

THE use of iron core reactors for purposes of electrical control and for regulation is beginning to become of commercial importance^{1,2}. At least within certain ranges of available control power, and especially for certain applications, magnetic amplifiers using saturated reactors are entering the field which

has been the exclusive domain of electron tube circuits. It is still too early to say just to what extent, if any, magnetic amplifiers will displace vacuum tube equipment. It seems likely that saturated reactor amplifiers will supplement rather than replace electron tube amplifiers. At present magnetic ampli-

fiers operating on the principle of a saturated inductance are not suitable for communication applications, nor do they seem well suited to those applications where the power available for control purposes is extremely minute. But for those industrial applications where the power available for control purposes

Left—Five stage magnetic amplifier using iron core reactors and copper oxide rectifiers. Center—opposite page. Through the use of two phototubes and a three stage magnetic amplifier, the miniature train is made to demonstrate the operation of a magnetic amplifier—and polarity indicating circuit. Below—Four stage amplifier with input controlled by phototube. Right—Three stage magnetic amplifier

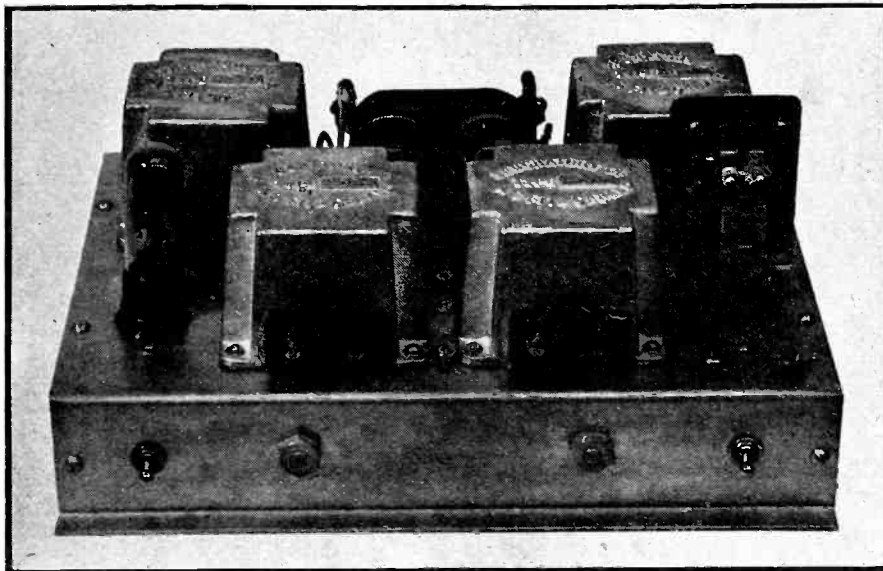

is between one microwatt and one watt, magnetic amplifiers have been made to perform a number of useful and ingenious control functions, and do so with simple equipment which easily surpasses electron tube equipment in sturdiness, simplicity, and the ability to function under unfavorable operating conditions.

In brief, the "saturex" principle—as it is called by Alan S. Fitzgerald in whose laboratory at Haverford College, Haverford, Pa., saturated reactors are made to do many interesting control jobs—makes use of the change in inductance of an iron core reactor as the d-c saturation through one of the windings is made to vary. The saturation current is provided by copper oxide rectifiers. Through the proper combination of several reactors and rectifiers a great number of interesting controls can be effected, including proper detection of polarity, sequence, and timing operations, and d-c as well as a-c amplification. And all of this is accomplished without the use of any moving parts, except perhaps a power relay in the output circuit of the control equipment.

The use of iron core transformers as the saturable inductors, and copper-oxide rectifiers for providing the saturating current—both units

of which are highly stable, sturdy, and simple in themselves—makes possible a complete, integrated control unit which is silent in operation, simple, reliable, and so free from operating and maintenance troubles as to be very well suited to industrial applications where temperature, humidity, or vibration extremes are often encountered.

Complete three, four and five stage magnetic amplifiers made by Mr. Fitzgerald are illustrated in this article. These exterior views indicate comparative simplicity in construction; a view of the interior of these amplifiers would substantiate this conception further. Terminals for the input and output are provided as well as for the 110 volt a-c power sources. Sometimes phototubes may be used as the input energy convertor and not infrequently a relay will appear in the output circuit. Otherwise the magnetic amplifier contains no fragile or moving parts and consists only of iron core reactors, copper oxide rectifiers, fixed or variable resistors, and the necessary electrical wiring.

The four stage amplifier shown operates directly from the phototube in its input circuit which provides about 10 microwatts of power for control purposes. The output

circuit actuates a small relay requiring about half a watt for positive action. Thus this four stage magnetic amplifier has a power amplification of approximately 50,000 or a gain of about 47 db. The five stage amplifier delivers an output of 20 watts to an industrial type contactor and is controlled by an input power of approximately one microwatt. This represents a gain of about 73 db. From these two examples, it is evident that magnetic amplifiers can be built having a gain per stage of about 12 db.

One of the advantages of the saturated core magnetic amplifiers which is not obtained in the case of d-c amplifiers using electron tubes is the ease with which the input winding of the amplifier can be matched to the resistance of the circuit from which the input power is derived; it is just as easy to furnish a magnetic amplifier wound to operate with an input of microvolts as it is to make one which corresponds to microamperes. Another advantage of these amplifiers is that troubles from feedback have been found to be negligible, even with high gain amplifiers.

One application of the saturex principle combines in a single circuit the functions of both a polarized relay and a stick or latched-in relay. With this circuit arrangement it is possible to determine the polarity or direction of current flow

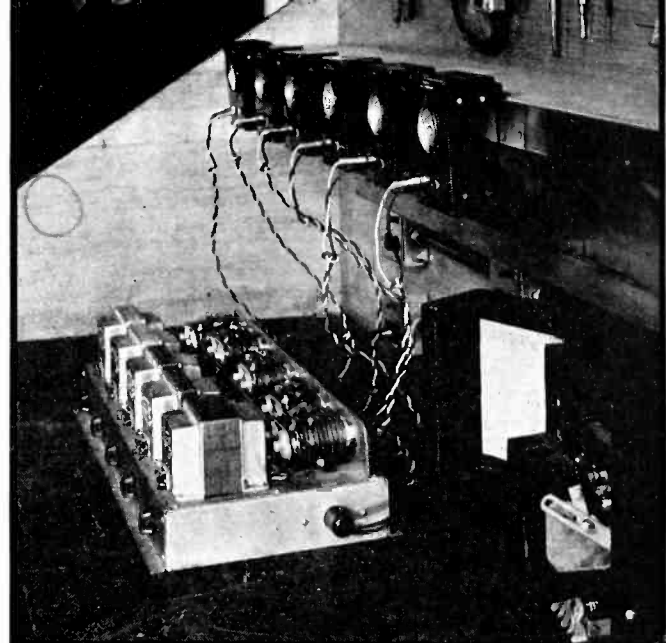
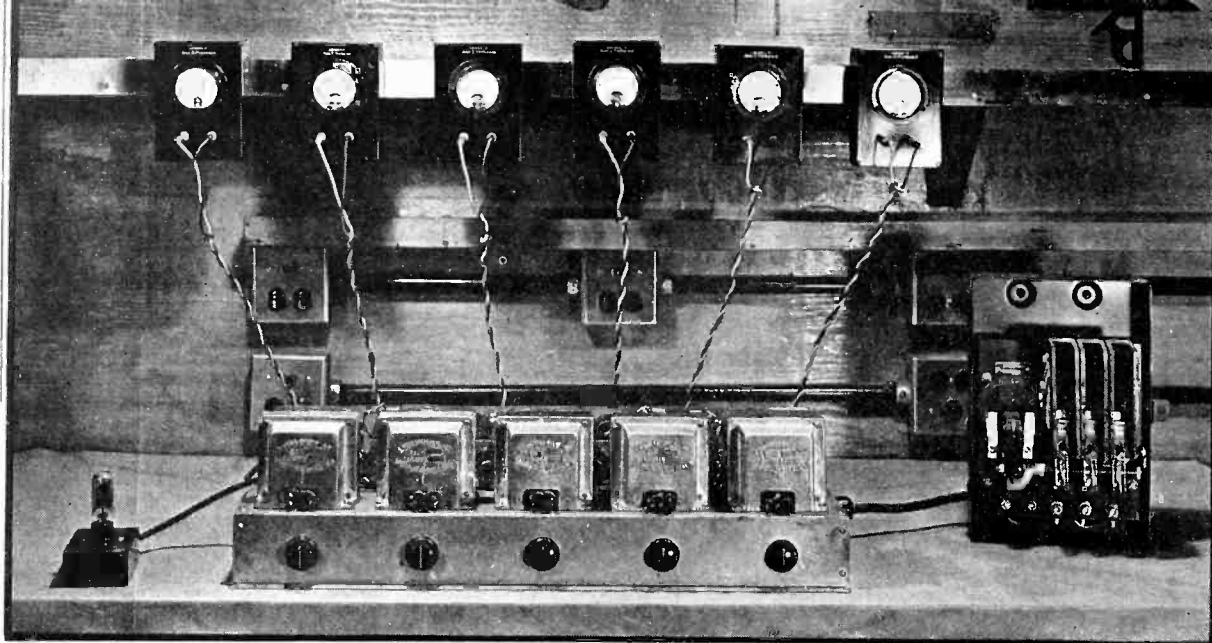

Laboratory arrangement for determining the characteristics of a five stage magnetic amplifier which operates an industrial contactor from the phototube control unit

in a circuit, even though only two wires are required between the transmitting or control position and the remote or controlled station. Because the response, in this application, is related to the direction of current flow, it has been possible to set up demonstration equipment in which a lamp at the remote end of a circuit was turned on or off by pressing the corresponding button at the local or transmitting station. Only two wires carry the control current, the direction of current in which actuates the equipment at the remote station to operate the lamp in the desired manner. Of course in so simple an application as this, the desirable properties of the saturex principle do not show up to maximum advantage, especially when a lamp can be controlled by two switches in a much simpler manner. But the demonstration equipment is constructed primarily to illustrate principles of operation.

The lamp at the remote end draws its power from a local source of

power; if this source of power fails, the lamp will of course go out. But when the power is again restored to the lamp, the lamp will continue to burn, if none of the buttons at the control position have been touched. If, during the interruption of power at the remote end, the buttons on the control panel have been pressed, the lamp will burn if the "on" button has been touched last, or will remain extinguished if the "off" button was pushed last.

This control of a lamp at some remote position by means of reactors and rectifiers, and without the use of relays provides an effective demonstration of possibilities of the saturex principle.

Another application of the saturex principle combines the action of a magnetic amplifier with the ability of saturated reactors to indicate the direction of current flow in a circuit. For purposes of demonstration, this system is applied to the running of a toy train, whose control is effected by light sources impinging on one or the other of

two phototubes, which act as the control elements. The output of the saturated reactor polarity determining device and magnetic amplifier controls the power applied to the track circuit of the model streamline train and supplies the running current. Two phototubes, connected to give currents of opposite polarity, furnish the input, which is of the order of 5 microwatts.

When a flash of light is momentarily directed on the "go" phototube, the train starts, and continues in operation until the beam of light is directed on the "stop" phototube, or until the power feeding the track circuit is interrupted. If the power is interrupted the train will start running upon resumption of power if the light beam was last flashed on the "go" phototube; if the light was last directed to the "stop" phototube, resumption of power will not start the train.

In another but similar application of the saturex principle, any one of ten lamps, in a demonstration circuit, may be lighted to full brilliance at will by turning a small knob which controls the arm on a variable resistor. By replacing the variable resistor with ten "off" and ten "on" push buttons, any one or more of the ten lamps at the remote position can be made to light in any desired combination or sequence, from the local control panel.

General view of part of the laboratory at Haverford College, where applications of saturated reactors are being investigated



¹ Reactors in D-C Service, by Reuben Lee, *Electronics*, Sept. 1936.

² Voltage Regulators Using Magnetic Saturation, by K. J. Way, *Electronics*, July, 1937.

Rochester Fall Meeting Program

Twenty papers, with television as the leading topic, to be presented November 8, 9 and 10 at Sagamore Hotel under auspices of I.R.E. and Engineering Division of R.M.A. "Quarantine session" for physicists planned

WITH the announcement of the program of the Rochester Fall Meeting held annually by the I.R.E. and the engineers of the R.M.A., the program committee reveals that this year, more than in any previous, television will be the subject of many papers. Of the twenty papers in the program, nine deal directly with, or are related to, television development. Other topics in the list include inverse feed-back amplifiers, auto radio antennas, measurements at ultra-high frequencies, high efficiency modulation, oscillator stability, and "teledynamic control by selective ionization", a mysterious but very intriguing subject to be dealt with by engineers of the RCA License Laboratory. One departure from the usual practice of Rochester Meetings is the holding of a double technical session on the afternoon of the second day of the convention, Tuesday, November 9. One of these is labelled "Physicists' Session" apparently to make a distinction between their interests and those of ordinary mortals. A battle for first place in attendance will be staged between L.C.F. Horle of the "Ordinaries" and B. J. Thompson and L. B. Headrick of the Physicists.

The convention will be held November 8, 9 and 10 in the Hotel Sagamore, where a large number of manufacturers' exhibits will be on display. A record attendance is expected.

PROGRAM

Monday, November 8

9:00 A. M.

Registration Inspection of Exhibits

10:00 A. M.

Technical Session
Parallel Resonance Methods for Measurement of High Impedances at

High Frequencies—D. B. SINCLAIR, *General Radio Company.*

Report of R.M.A. Television Transmission Frequencies and Standards—A. F. MURRAY, *Philco Radio & Television Corp.*

Vibrational Tube Analysis (with demonstration)—A. B. OXLEY, *RCA Victor Company, Limited.*

2:00 P. M.

Technical Session

The Problem of Synchronization in Cathode Ray Television—F. J. BINGLEY, *Philco Radio & Television Corp.*

New High Efficiency Modulation System—R. B. DOME, *General Electric Company.*

7:45 P. M.

Technical Session

Specifications of Screen Color of Cathode Ray Tubes—G. A. FINK and R. M. BOWIE, *Hygrade Sylvania Corporation.*

Figure of Merit for Television Performance—A. V. BEDFORD, *RCA Mfg. Co., Victor Division.*

Tuesday, November 9

9:30 A. M.

Technical Session

Direct Viewing Type Cathode Ray Tube for Large Television Images—I. G. MALOFF, *RCA Mfg. Co., Victor Division*

Stabilization of Oscillators—C. E. GRANQVIST, *Stockholm, Sweden.*

A Unique Method of Modulation for High Fidelity Television Transmitters (with demonstration)—WILLIAM N. PARKER, *Philco Radio & Television Corp.*

2:00 P. M.

Technical Session

New Projects of the RMA Engineering Division—L. C. F. HORLE, *RMA Engineering Division.*

Measurement of Characteristics of Automobile Antennas—H. LYMAN, *Philco Radio & Television Corp.*

Discussion by H. C. FORBES, *Colonial Radio Corp.* and D. E. FOSTER, *RCA License Laboratory*

2:00 P. M.

Physicists' Session

Space Charge Limitation on the Focus of Electron Beams—B. J. THOMPSON and L. B. HEADRICK, *RCA Mfg. Co., Radiotron Division.*

Negative Ion Components of the Cathode Ray—C. H. BACHMAN and C. W. CARNAHAN, *Hygrade Sylvania Corporation.*

4:00 P. M.

Inspection of Exhibits
RMA Committee Meetings

6:30 P. M.

Stag Banquet

Wednesday, November 10

9:00 A. M.

Exhibits Open

9:30 A. M.

Technical Session

The Monoscope—C. E. BURNETT, *RCA Mfg. Co., Radiotron Division*

Further Data on Inverse Feedback Amplifiers—C. B. FISHER, *Northern Electric Company.*

Teledynamic Control by Selective Ionization and the Application to Radio Receivers (with demonstration)—S. W. SEELEY, H. B. DEAL, and C. W. KIMBALL, *RCA License Laboratory.*

2:00 P. M.

Technical Session

Stability of Wide Band Amplifiers—E. H. B. BARTELINK, *General Electric Company.*

An Audio Curve Tracer (with demonstration)—J. B. SHERMAN, *RCA Mfg. Co., Radiotron Division.*

4:00 P. M.

Exhibits Close
RMA Committee Meetings

Television in Great Britain

Is British television further advanced technically than American? Evidence on this pertinent question is supplied by two Hazeltine engineers who set up a laboratory in London to study the situation at first hand.

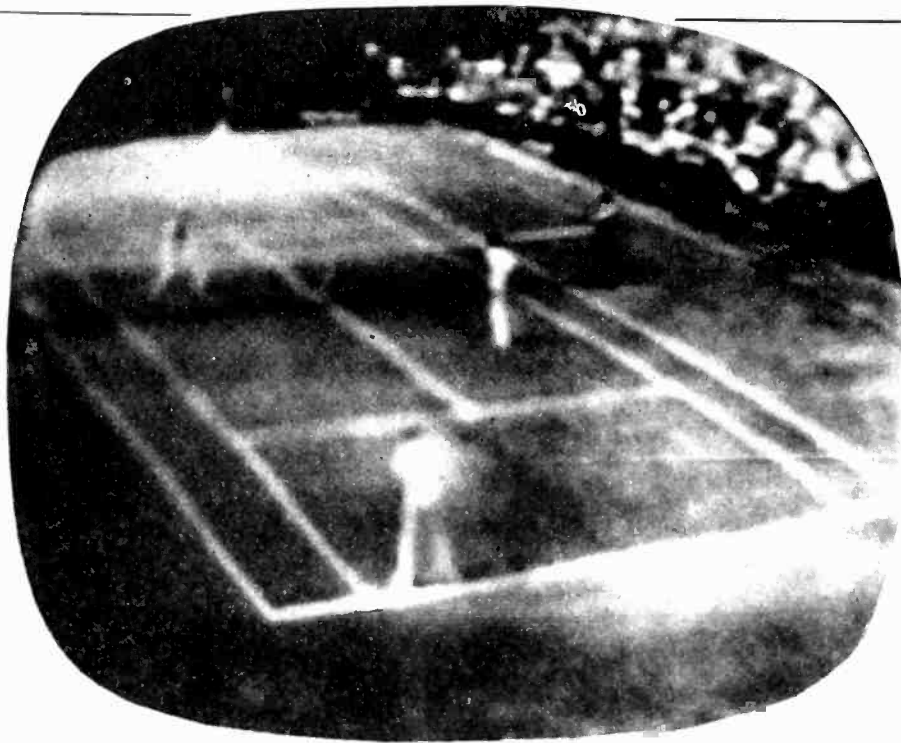

Fig. 1—The Wimbledon Tennis Matches, as received on a standard British receiver. A remote pick-up transmitted the picture via u-h-f link to Alexandra Palace

THE question was raised, in the article entitled "Television Standards" (*Electronics*, July 1937), whether certain of the present practices and proposed standards in the United States are wise. The principle items there discussed were three:—the polarity of transmission, the transmission of the d-c or background components and the shape, amplitude and duration of the synchronizing pulses.

This article aims to describe cathode ray television as it exists in England, where the standards of operation on these three items in question are the exact reverse of United States practice.* The picture of British television, here presented as it appears to American engineers, is that of an operative system giving good stable pictures of acceptable detail, brilliance and interest. Some of the defects and the lines of future improvement are touched upon. That considerable improvement is possible within the band width available is evidenced. Some technical points of interest in the British system are described to point out wherein they differ from the United States proposals and practices. The nature of these differences in standardization is illustrated by explaining certain fea-

* The U. S. practices and standards referred to are those which (a) employ negative modulation of the carrier wave, (b) radiate a carrier which, through omission of the "d.c.", has no definite level for black, and (c) employ synchronizing pulses which are inadequate in amplitude and duration. Recent information shows that not all U. S. stations employ these features.

By H. M. LEWIS and
A. V. LOUGHREN

Engineers, Hazeltine Service Corp.

tures of operation which give improved performance through their use.

That these British standards constitute a major improvement over present American practices is an inescapable conclusion, because television is technically successful and an accomplished fact in England. Radiolympia, the annual radio exhibition, opened August 25th to celebrate a year of television service. At one section, National Hall, were television demonstrations by fourteen representative British manufacturers.

For some time prior to Radiolympia a daily free exhibition has been showing at the Science Museum at South Kensington, London, where eight different makes of cathode ray television receivers are in steady operation in adjacent booths. These receivers show the afternoon program from the B.B.C. transmitter at Alexandra Palace and at other times operate on signals from a local film transmitter.

During this past year actual production and marketing of receivers was carried on by four companies. Not a large number of receivers was sold because in spite of one price reduction, the cost is high and also the time during which programs may be received is limited. There is some adverse criticism of the character of

programs and the fact that there is often repetition.

The amazing thing is that the criticism is not related to any inability to receive clear steady pictures of good brilliance. It sums up to this:—completely operative television receivers may be purchased in England and a regular program of good pictures and accompanying sound received. During the coming year nearly every large radio manufacturer will be producing television receivers as well as the regular quota of sound broadcast receivers.

Why this is possible only in Great Britain cannot be answered by simply referring to the government subsidy of the British Broadcasting Company. In the United States the fact that television is still around the corner cannot be excused merely by asserting that we really are ahead but that we prefer to wait and be sure; and then we will provide a superior system.

Britain has been fortunate in government sponsorship but they have also been fortunate, or wise, in their choice of standards. We, in this country, may have been equally fortunate in not having government help, particularly if such help would have left us fixed with a less fortunate choice of standards.

We cannot avoid the fact that the situation in the United States is much less favorable. Unless changes are made in the type of signal which is now being used for experimental transmitters, American receivers will be more expensive, more difficult to service and will give performance inferior to British receivers. The bad performance will not be lack of detail in the transmitted picture, since, with its slightly greater number of lines the American picture can be provided with

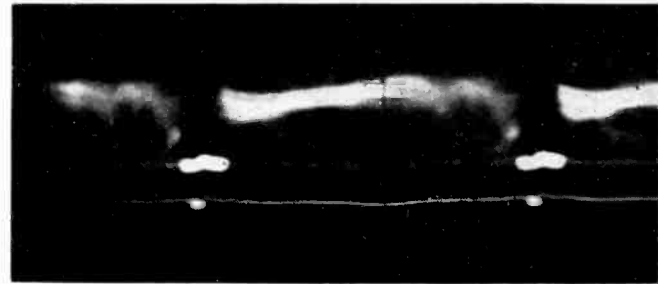

Fig. 2—Wave-form oscillograph of the British video signal

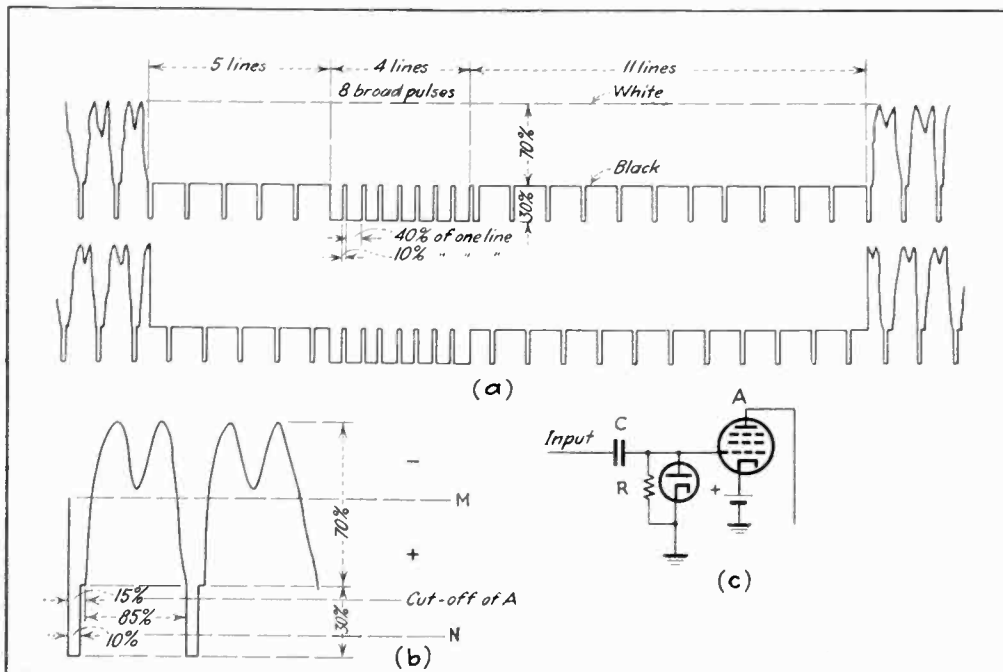

Fig. 3 (a)—The transmitted signal in the region of the frame-retrace interval, showing broad pulses delayed five lines from the leading edge of the interval. (b) Signal applied to the circuit shown in (c). (c) Simple amplitude separator circuit

more detail than the British picture. It will be in steadiness and contrast that the American picture will suffer. Even with a more complex receiver the picture may show the fluctuations and loss of synchronism which has been noted in various American demonstrations. In this respect the situation is markedly different from the British where the criticisms are directed to picture detail and program contents.

To know with certainty how British television does operate in its first commercial setting, the authors established for the Hazeltine Service Corporation a temporary laboratory this summer in England for the purpose of making a survey. This survey included observing the transmissions and making measurements of the received signals with special equipment designed for the purpose. A major part of the survey called for visits to the transmitting station and contacts with receiver manufacturers and engineers. Such a study could not have been made but for the cordial and open-minded hospitality of the British radio industry.

First let it be said that the British pictures are remarkably good. They are steady; they are brilliant; they have an exceptional amount of detail. A typical program includes a short dramatic skit, generally comedy but often more serious; a lecture or a series of short subjects such as their Picture Page; a newsreel and sometimes a film cartoon. Scenes having a large number of actors on the stage come over clearly. Dancing and ballet subjects are very effective. Close-ups of the stars are, however, still the most effective shots since they emphasize the detail that the scene conveys by allowing careful scrutiny of the details of the face. For such scenes the detail in the highlights of the

eyes, lashes, teeth and hair is particularly remarkable.

There is reason to believe that there is more detail in the British transmitted signal than the present receivers can utilize. Improved cathode ray tubes having better spot size and modulation characteristics are one avenue of development. However, in spite of the excellence of the present signal there is also room for much improvement in the transmission within the standards which have been set.

Description of British Receivers

First, as to reception, the available receivers are of the cathode ray type having white screens observable directly or via a surface mirror. The tubes are generally 12 inches in diameter though some are as large as 16 inches. Generally, the scanning is beyond the edges of the tube, to cut the corners. A relatively large picture (8½ x 11") is realized. The white screens are quite brilliant and the level of black in the transmitted signal is so well maintained that excellent contrast and brilliance results. The resulting black and white picture is easily viewed in an average living room without drawing the shades, provided the receiver is placed to avoid direct reflection of sunlight (or lamp light in the evening) from the face of the tube. In this respect extraneous light seems less objectionable in the case of cathode ray television than it is in the case of projected pictures such as home-movies.

In viewing the Alexandra Palace transmissions on a large variety of different receivers there were practically no cases of faulty synchronization. In general, a receiver, after being switched on, is in a sufficiently steady state in the short time required for the voltages to rise so that the pic-

ture lights up on the screen locked in steady synchronism without any tearing of the lines or edges. There is no upset of synchronism when large changes in average lighting occur such as is often the case in transmitting film. The fact that the British pictures are remarkably good should not be forgotten in reading the following critical comments.

Now, as to defects: Motor car static, when excessive, results in a decided snowstorm on the screen. The accompanying noise on the sound channel is, however, much more irritating than the effect on the eye. Even the most excessive disturbances of this type apparently fail to have any disturbing effect on synchronization. It is of interest that one disturbance which has been known to completely destroy signal and synchronism is the passing of an airplane directly overhead.

An example of the extreme in steady synchronization was the reception of the Alexandra Palace signal at eighty miles distance with a standard receiver. In this beyond-line-of-sight reception the signal was not visible except as a hazy movement of light on a grille of noise. Yet it was easily demonstrated that the grille was synchronized by throwing out the synchronizing controls, in which case the horizontal and vertical bars of the framing signals were visible traveling across the screen.

The most frequently observed defect in receiver performance was failure of interlace. Examples of this ranged from no interlace to perfect interlace and included pairing of the lines and in some cases a slow weaving in and out of interlace. Such faults cannot be blamed upon the character of the transmitted signal since there are receivers that give perfect and steady interlace. Possibly the transmitted signal could be modified as to components which could make this problem easier in the receiver design. However, good engineering in the receiver design does solve the problem and without adding to receiver cost.

For the Alexandra Palace transmissions the "Emitron" tube is used for both the direct vision and film pick-up. This is a camera tube of the electron-gun mosaic type and possesses remarkable sensitivity. For studio shots, four cameras are in operation and the average illumination employed on the subject is only 200 foot-candles. Although these tubes are probably the most sensitive and reliable pick-up devices which have been produced they are subject to the inherent defect of shading troubles. In the June and July issues of *Electronics* the shading effect and its correction has been discussed. In the B.B.C. system, "tilt and bend" generators supply correcting signals to an illumination control unit. These controls require constant adjustment as the program continues. The result is that two complete rehearsals are required, one of which is before the cameras. This enables the operators to know the corrections to be expected by viewing the program on the monitors

before going on the air. Where a program is repeated, the improvement of illumination in the second showing is evident. The shading corrections are more difficult for film where the change of scene is more rapid and film subjects are conceded to be inferior to studio shots. The improvement in the successive showings of newsreels is very evident.

Titles on black or white backgrounds are difficult because of the shading effect which is here evidenced in streaking shadows which follow the individual letters or words. There is remarkably little of this streaking in the Alexandra Palace signal but it is frequently evident in the received image.

The contribution of the receivers to such shadows, is due generally to phase distortion. In the better designed receivers such effects seem to have been entirely eliminated and the receiver circuits apparently take advantage of all the frequency spectrum available. The cathode ray tubes do not in all cases take full advantage of the signal since some may not have as fine a focus of the spot on the screen as others.

In connection with detail as represented by band-width the Alexandra Palace station transmits the carrier and both side bands to three megacycles; a flat band of six megacycles varying less than a decibel is claimed. The wave is vertically polarized.

Since there is but the one transmitter and no additional ones contemplated in the London area the receivers are of fixed frequency with only a vernier tuning adjustment. Our American problem of tuning over a band to select one of several stations, therefore, has not been faced. Otherwise, England is a wonderful proving ground for all varieties of receivers and there is no tendency to follow the leader into any rut of design. We find t-r-f receivers and superheterodynes, quasi-single side band reception and full side

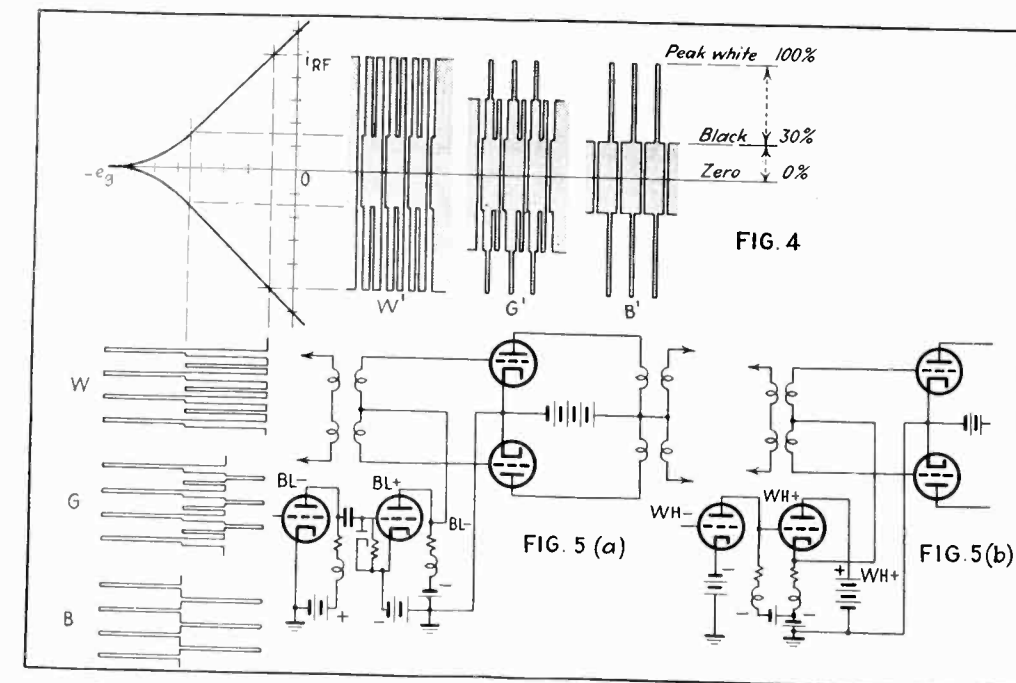

Fig. 4—When positive modulation is used in transmission, the curvature of the tube characteristics falls in the region of the synchronizing pulses, hence the amplitude of the video modulation is preserved without distortion. Fig. 5—Two circuits for modulating with the d.c. included in the signal

band acceptance. The detector output is generally poled to feed the cathode ray tube grid via one video stage. The video voltage required in such designs is about 25 volts for the change from black to peak white. One design employs no video amplification, the detector output being directly connected to the cathode ray tube grid which requires only a ten volt swing.

The cathode ray tubes are of all varieties as to structure, shape, scanning and focus. Generally they operate at about 6000 volts. The so-called "onion" shape as against the "funnel" shaped tube appears to be favored because of safety which the curved surfaces give to the design. With the safety factor which properly curved surfaces will give, the use of soft glass

envelopes is increasing. At first glance these appear awkward but through good design these tubes of enormous size are completely housed in most presentable cabinets.

Scanning and Focusing Methods

Engineering opinion is apparently well divided on scanning and focus, and during the past year models in these types were available:

(a) Electrostatic focus—full electrostatic scanning, (b) Electrostatic focus—full magnetic scanning, (c) Magnetic focus—full magnetic scanning.

All three types are continued and represented in the new models this year. A fourth type is also announced comprising electrostatic focus—electrostatic horizontal scan—magnetic vertical scan.

A minimum of four tubes, a maximum of eight, are employed for the functions of synchronizing separation and scanning. In this connection and also due to the wide band amplification problem in general a variety of new tubes is appearing—particularly high slope valves having mutual conductance of the order of 7 to 10 ma. per volt.

The scanning of the various receivers, as evidenced by the picture on the screen, is not always perfectly linear. The transmitted signal gives a blanking interval for the line flyback or retrace which is 15% of the total line time. This is much longer than the 10% interval proposed for the United States. In micro-seconds the British standard allows for retrace a total of 15 micro-seconds. Since the U. S. system employs a higher line frequency our allowed retrace time is actually $7\frac{1}{2}$ micro-seconds. Nevertheless the achievement of a good linear line trace and a perfect return during the 15 micro-seconds blanking interval is not always accomplished. Some receivers

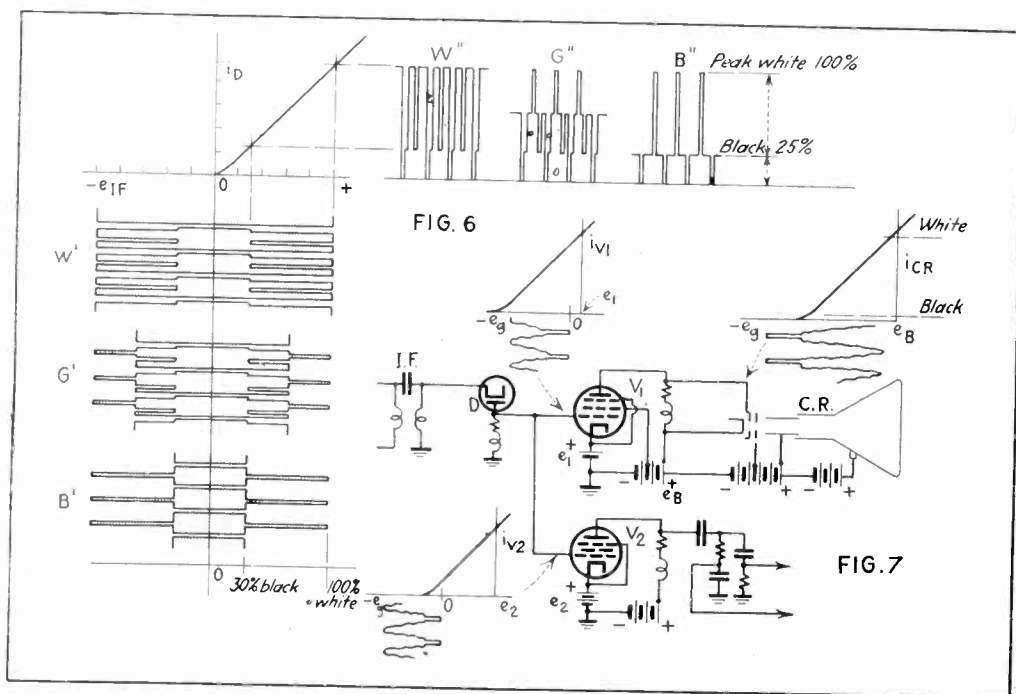

Fig. 6—In detection, the curvature affects only the synchronizing impulses, not the video. Fig. 7—Receiver circuits, showing limiter action of tube characteristics employed for amplification and sync pulse separation

may evidence a lighting on the left side of the picture due to a slow retrace. A slight crowding or narrowing of objects, also generally at the left side of the picture, frequently gives evidence of imperfect line linearity. Frame linearity is generally good and there is little or no evidence of hum troubles from the 50 cycle mains.

It is rather evident that many of the defects discussed are rapidly being ironed out by experience. Such progress can, of course, only be realized where a standard and regular transmission is available.

The photograph of Fig. 1 may not appear to be a triumph of television in view of various television pictures which have been published. It does, however, tell a different story from that of the usual television picture which is circulated.

The subject is the tennis matches at Wimbledon, an outside sport pick-up comparable with the famous coronation broadcast. In this case the relay from location to Alexandra Palace was via an ultra-high-frequency radio link. Incidentally, the power supply to the television truck at Wimbledon was of slightly lower frequency than the London 50 cycle supply. The receiver, the screen of which gave the image here photographed, was a standard model of a well-known make which was taken from stock—unselected and installed in a London hotel apartment by the service men trained to make such installations. A vertical di-pole on the roof supplied the signal to the receiver via a two-wire cable or transmission line, all as a part of their standard installation. The location was on Oxford Street approximately 5 miles from Alexandra Palace.

Although test equipment for measuring the received signals was also located in this apartment laboratory, this equipment was not in use at the time the photograph was taken and the receiver was operating without any changes in the adjustments made by the service men during installation. A two-second exposure was used during which time the players had moved. The picture shown is unretouched and is decidedly average and representative of slightly less than the best that any buyer would expect to see.

The fact that careful engineering is required to achieve good line scanning with the 15% blanking interval has already been discussed. It seems clear that the art is much too young to reduce this interval and be fair to set manufacturers. Similarly adequate duration and amplitude of synchronizing pulses is essential to set manufacturers for tolerance in design.

Since the British system employs positive modulation and "d-c working" a graphic view of some points of merit in the production and utilization of such a signal will be of interest. "D-c working" means that the background illumination is transmitted directly instead of by a variation in the height of the blanking pulses from the a-c axis. As has been pointed out in the article in July *Electronics*, this results

in a constant level for black and the synchronizing pulses. Furthermore, the synchronizing pulse level corresponds to zero radiated power from the transmitter. Consequently the tops of the synchronizing pulses are always at a definite voltage level in the output of the receiver's detector. As a result the simplest type of amplitude filter will operate to separate the synchronizing pulses from the picture components of the signal.

Technical Details of the System

The wave-form photograph, Fig. 2, is an oscillograph of the signal at the control grid of the cathode ray tube of the standard receiver to which reference has been made. The oscillograph sweep was at 25 cycles and hence two frame-scanning cycles are pictured. The line intervals and pulses are too closely packed at this sweep frequency to be defined but the synchronizing pulse amplitude as distinct from the video signal is evident. The 30-70 ratio is clearly shown—that is, the 70 per cent amplitude devoted to video (black to peak white) and the 30 per cent amplitude of synchronizing pulses may be scaled from the oscillograph. The 10% frame blanking interval and the occurrence of the broad pulses for frame synchronization are also evident.

The equipment previously mentioned for measurements of the British wave included a special sweep circuit, for showing alternate 50 cycle traces, thereby permitting inspection of any definite group of lines and the related group with which they interlace on the receiver screen. This arrangement is similar to the equipment used to give the interlace patterns, as pictured on the April 1937 cover of *Electronics*. Fig. 3 gives an accurate showing of the transmitted signal in the region of the frame retrace interval as revealed by this equipment. This is essentially the same as shown in the *Electronics* article for July, the only difference being that the broad pulses for frame synchronization are delayed by five lines from the leading edge of the frame blanking interval. Fig. 3(b) gives an accurate drawing of the line synchronizing pulse.

The fact that the line pulse endures as it does, for 10 micro-seconds, is important in giving tolerance in receiver design. Although the d-c is directly transmitted synchronizing-separators frequently are employed which use an a-c coupling and hence reinsert the d-c by peak detector operation as explained in the July *Electronics* article. In any event the utilization of the synchronizing pulse generally is associated with the charging of a condenser by the pulse and its discharge through high resistance circuits. A long duration of the synchronizing-pulse permits reasonable values of capacity and resistance in such circuits. The importance of this width of pulse will be apparent in the following approximate analysis.

In the circuit diagram (Fig. 3(b)) a simple form of amplitude separator is

shown. A signal such as that of Fig. 3(a) is applied in the polarity shown. In the absence of any conduction in the diode the wave center M would be at ground potential, on the right hand side of the condenser C . But the diode anode does draw current and C will be charged to such a value that the wave center will be made negative by an amount MN ; if the condenser is large, the potential across it will be substantially constant during the line cycle as shown. The condenser is being charged for 1/10 of the time, and discharged for 9/10; the instantaneous charging voltage is of the order of 1/5 or 1/10 of the discharging voltage. If the charging and discharging currents—averaged over the total time—are to be equal, the charging resistance must be 1/50 to 1/100 of the discharging resistance. Now, the charging resistance is the internal resistance of the diode—say 20,000 ohms. The discharging resistance is the leak R , which should be one hundred times the diode resistance, or 2 megohms. These values of circuit coefficients will maintain the condenser charge at a sufficient amount to keep all the video portion of the signal wave below negative cutoff of the amplifier A , thus making the latter responsive only to synchronizing pulses.

Now, if the synchronizing pulse duration be decreased, the time ratio becomes less favorable and the value of R must be increased to maintain correct operation. A 5 per cent pulse width seems to be the minimum for stable amplitude separation, as it requires a leak of about 5 megohms. The use of 10 per cent wide pulses provides a useful tolerance above the bare minimum requirement, with no attendant disadvantages.

Virtues of Positive Modulation

Certain factors which result in good modulation at the transmitter are due to the positive polarity of transmission and "d-c working". These are pictured in Fig. 4. Two methods of applying the modulation signal with the d-c included, to the grids of the final balanced r-f stages of the transmitter are indicated schematically in Fig. 5(a) and 5(b). For both cases Fig. 4 illustrates the operation. The modulation voltage contains the video and synchronizing pulses in equal amplitude; a 50-50 ratio of synchronizing to video. The curvature of each tube characteristic falls in the region of the synchronizing pulses and the video signal is in the region where the relation between grid voltage and r-f current is linear. It will be clear that the curvature of the characteristics is effective to shorten the synchronizing amplitude and not otherwise distort the signal. The result is that the 70 per cent video—30 per cent synchronizing ratio is obtained. Furthermore, the carrier is zero during the peak of each synchronizing pulse.

The illustration here given is for the three representative cases of a bright

(Continued on page 60)

TUBES AT WORK

AN audio level indicator for broadcasters, an oscillographic method of balancing shaded pole motors, a photoelectric weighing-machine limiter are among this month's new tube applications.

An Automatic Line-Level Indicator

By E. G. ODELL

A DEVICE OF CONSIDERABLE use in calling the operator's attention to the fact that the program from the studio has stopped or that the modulation has dropped below a predetermined value, has been in use at KTRH for some time.

If the program is discontinued for more than twenty-five seconds or if the modulation falls below thirty per cent due to the neglect of the control operator, a buzzer sounds accompanied by a light indicator. Of course the operator is constantly on duty at the trans-

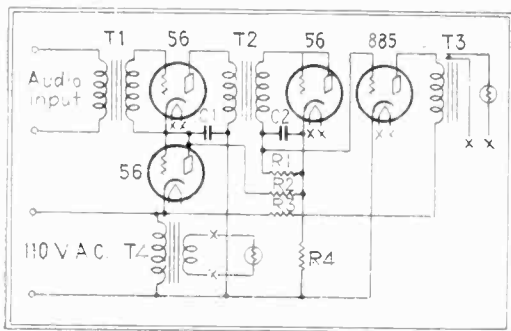

Fig. 1—Diagram of the line-level indicator

mitter and listens to the monitor speaker most of the time, but there are times when he answers the telephone, inspects the pumps, or makes switching arrangements in the adjoining room that such a watchdog is useful.

Effort was made to make the circuit (Figure 1) as simple as possible. A plate-to-grid input transformer was used to avoid mismatching the 500 ohm monitor rectifier line. Following this comes an amplifier tube with its half-wave power supply, the rectifier tube, and the 885 grid glow tube. The pre-amplifier was found necessary to raise the level to assure proper operation. The indicator is a telephone relay which gives a loud buzzing noise and lights the indicator lamp when the 885 flashes.

A time delay of 25 seconds seems to be about right since it allows for the 20-second breaks between announcements and chain programs. This time constant is determined by the values of condenser C_2 and resistor R_1 . Resistors R_2 and R_4 set the fixed bias on the 885 and determines the percent-

Balancing Shaded Pole Motors

By E. V. SUNDT
Sundt Engineering Co.

THE BALANCING of the magnetic field in small shaded pole motors is sometimes a problem, particularly when it is essential that the motor operate at synchronous speed as is necessary in self-starting clock motors. The method described here is relatively simple and inexpensive and well adapted to production needs.

To obtain maximum efficiency and torque in small motors such as illustrated in Fig. 1, the coil "A" must be in the exact magnetic center of the field reacting on the rotor "B." Normally this position would be in the center of the yoke "C" but variations in production and materials may necessitate the coil being finally fixed in position. In the present method, this position can be located quickly to less than plus or minus .010 limits, which is usually sufficiently accurate for practical purposes.

The basic principle employed is that the E. M. F. picked up by two identical coils placed at opposite poles and connected to buck each other, cancel each other out when the magnetic field is in perfect balance. Since the voltage differences are of a very low value, a sensitive instrument is required to indicate an out of balance condition. A neobeam oscilloscope is used for this purpose and the field is in balance when

(Continued on page 40)

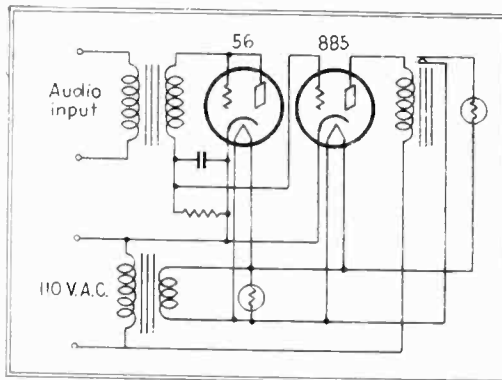

Fig. 2—If a line-match transformer is available, this simpler circuit may be used

age of modulation below which the device will sound off.

If the input transformer can be matched to the line, the construction is considerably simplified since the amplifier and power supply tube can be dispensed with. This circuit is shown in Figure 2.

For installation in a relay rack a subpanel was used mounted behind a standard 5½-inch panel and covered with a shielding can. The "off-on" switch was mounted in the center of the panel with indicator lamp on one side and "on" lamp on the other.

DIRECT COMPARISON TUBE-TESTING

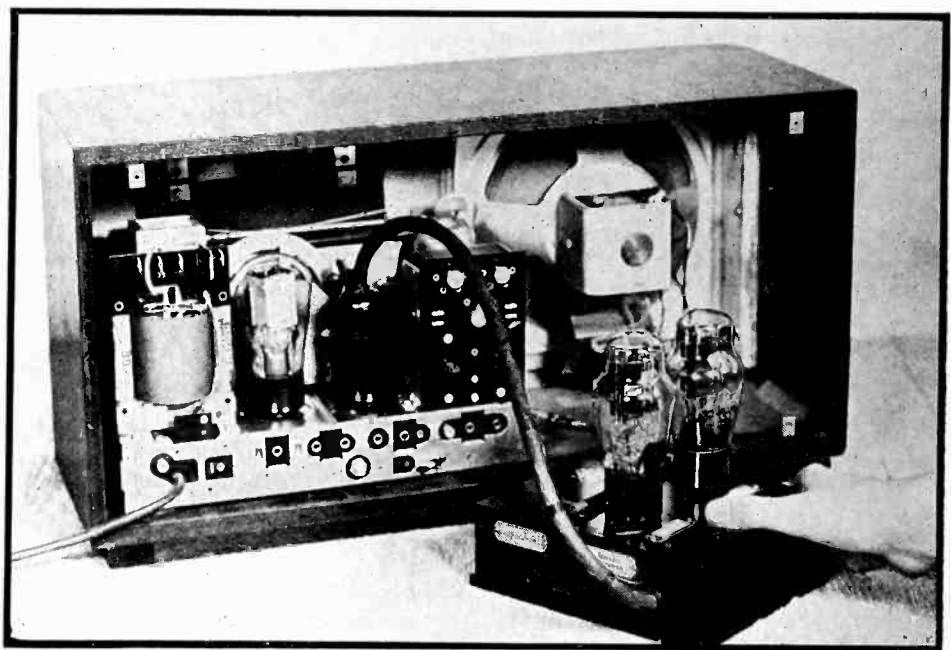

This Telefunken tube tester plugs into the set, providing power for two sockets, containing the old tube and the replacement tube. Switching from one to the other convinces the customer

Bass Compensation Design Chart

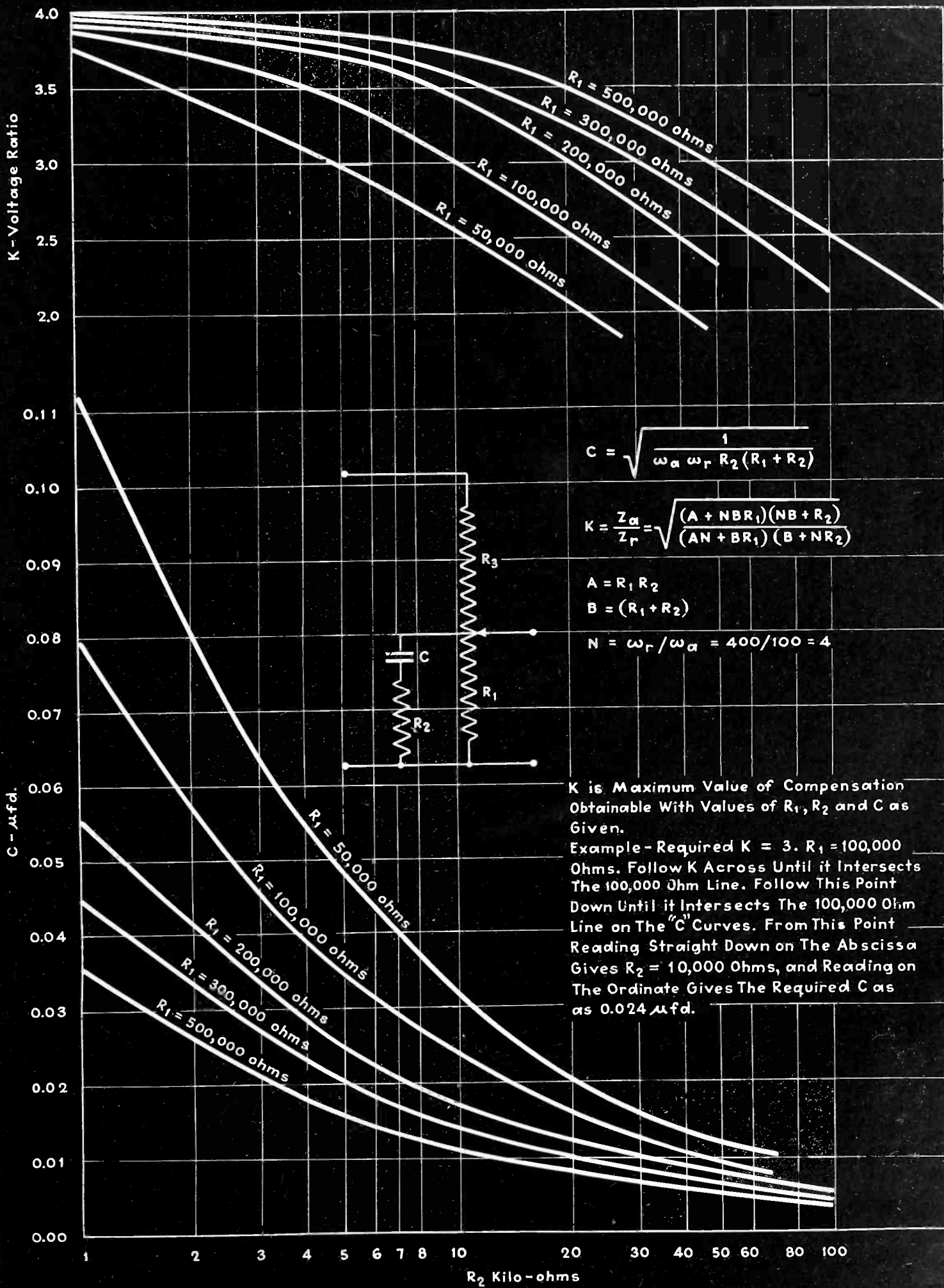

Bass Compensation Design Chart

A direct method of choosing the proper condenser and series resistance values in tapped-volume-control bass compensators to obtain the maximum degree of compensation between 100 and 400 cycles

By P. A. D'ORIO and
RINALDO De COLA
Belmont Radio Corp., Chicago

TO achieve the necessary bass response in radio receivers, resort is frequently made to bass-boost circuits. The most popular by far of these circuits is shown in Fig. 1. Resistors R_3 and R_1 constitute the usual tapped volume control. The resistor R_2 is inserted in the circuit in order that there will not be too great a loss in the higher audio-frequencies, and also to fix the output level of the receiver, when the volume control arm is set at the tap, at which point maximum compensation occurs. The problem arises of finding the proper value for C which will give the greatest attenuation ratio between two arbitrarily chosen frequencies. In most development laboratories these frequencies are usually chosen as 400 and 100 cycles.

In Fig. 1 looking into the network between points A and B, (considering R_3 open.) the impedance between these two points will, at two different frequencies, reach a maximum ratio for a certain combination of R_1 , R_2 , and C . Now if terminals A and B are fed from a high impedance source, say through R_3 , the ratio of voltages across A and B, for two different impressed frequencies, will have the same ratio as the impedances at these two same frequencies. Of course, if the impedance across A and B were a pure capacitive reactance the ratio of reactances at 400 and 100 cycles would be 4 and there would be no point to our analysis. However, R_2 is always required to prevent the higher audio frequencies from being entirely lost, hence there will be a certain value of C which will yield the maximum impedance or voltage ratio across the terminals.

Developing the basic equation

If we then write the equation for the impedance at any arbitrary fre-

quency f_a , across terminals A and B,

$$Z_a = \frac{R_1(R_2 - j \frac{1}{\omega_a C})}{R_1 + R_2 - j \frac{1}{\omega_a C}}$$

and the equation for a certain reference frequency, f_r

$$Z_r = \frac{R_1(R_2 - j \frac{1}{\omega_r C})}{R_1 + R_2 - j \frac{1}{\omega_r C}}$$

where $\omega_a = 2\pi f_a$ and $\omega_r = 2\pi f_r$.

If we now write Z_a/Z_r and maximize with respect to C , set the resulting equation to zero and solve for C , we obtain,

$$C = \sqrt{\frac{1}{\omega_a \omega_r R_2 (R_1 + R_2)}} \quad (1)$$

This value of C gives, therefore, a maximum ratio of the impedances at f_a and f_r .

Writing Eq. 1 for C in equations for Z_a and Z_r , we obtain,

$$Z_a = \sqrt{\frac{A^2 + R_1 A B N}{B^2 + N B R_2}} \quad (2)$$

and

$$Z_r = \sqrt{\frac{N A^2 + R_1 B A}{B^2 N + R_2 B}} \quad (3)$$

then,

$$K = \frac{E_a}{E_r} = \frac{Z_a}{Z_r} = \sqrt{\frac{(A + N B R_1)(N B + R_2)}{(A N + B R_1)(B + N R_2)}} \quad (4)$$

where A is $R_1 R_2$, B is $(R_1 + R_2)$ and N is f_r/f_a . These equations are perfectly general. However because they are somewhat cumbersome the chart shown on the reverse side has been constructed, for a range of values which covers most practical cases. The frequency ratio, N was taken as 400 cycles/100 cycles. K is the ratio of the voltages at these two frequencies. Say that K is chosen at 3, and that R_1 (one of the resistors must be known or assumed) is 100,000 ohms. Then on Fig. 2 follow K over parallel to the abscissa, until it intersects R_1 at 100,000 ohms, then follow this point down, until it again intersects the R_1 line at 100,000 ohms, on the "C" curves, then reading straight down from this point, R_2 is given as 10,000 ohms and reading straight across toward C , gives C as .024 μ fd. The values of C and R_2 thus derived will give maximum value for compensation with the chosen value of R_1 . Increasing or decreasing either R_1 or R_2 will require a new value of C for maximum compensation to be attained. Experimental checks of values derived from the chart show a high order of accuracy. It will be found that the use of the chart will save considerable effort and at the same time yield circuit constants of which one can be sure gives the maximum compensation. The addition of high frequency compensation networks across the volume control will not affect the values of R_1 , R_2 and C for maximum compensation.

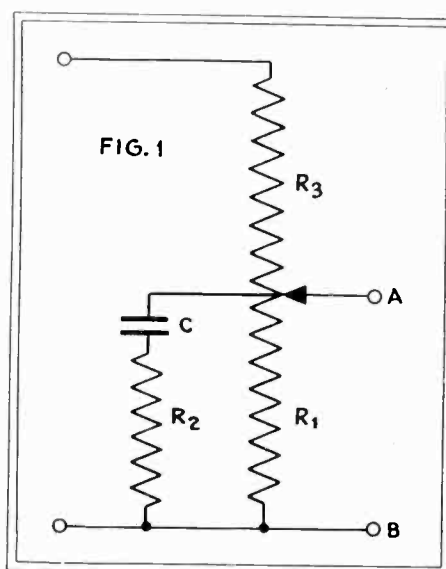

Fig. 1—Tapped-control bass-boost circuit

YOU PAY FOR INSULATED RESISTORS

*... Whether You
Use Them or Not!*



.... For engineers, Insulated Resistors pave the way to more efficient modern design. No lost time, wasted effort or engineering "detours."

.... From a manufacturing standpoint they simplify production—do away with extra testing—avoid assembly line rejects. Fewer sizes meet every need.

.... From a service and maintenance standpoint they are more reliable—easier to use—eliminate danger of failure to a minimum.

In brief, Insulated Resistors pay dividends in a dozen different ways. It actually costs money NOT to use them!

INTERNATIONAL RESISTANCE COMPANY

401 NORTH BROAD STREET, PHILADELPHIA, PA.

Factories or Licensees in Canada, England, France, Germany, Italy, Denmark and Australia

MAKERS OF RESISTANCE UNITS OF MORE TYPES, IN MORE SHAPES, FOR MORE APPLICATIONS THAN ANY OTHER MANUFACTURER IN THE WORLD

VOLTAGE REGULATORS

for Radio Transmitters

ACCURATE control of voltage to all plate, filament and bias circuits is now possible at lower cost and with greater efficiency through the use of Transtat Voltage Regulators. This new AmerTran product is a commutator-type, continuously variable auto-transformer regulator which offers both the smoothness of control of a potentiometer and the high efficiency, good regulation and flexibility of a transformer. Single-phase and polyphase types for either manual or automatic control are available for loads from 0.5 to 150 Kva. May we send complete data? Ask for Bulletin No. 51-1.



Above—Type "FH" Transtat Voltage Regulators of encased and open construction. These units are manufactured under U. S. Patents 1,993,007, 2,014,570, 2,085,255 and 2,089,434; also licensed under U. S. Patent 2,009,013.

APPLICATIONS

Master voltage control: Where the line voltage fluctuates throughout the day a Transtat Regulator in the main power line permits application of normal voltage to all equipment.

Rectifier output control: The d.c. output voltage from a rectifier may be controlled smoothly and efficiently over a wide range without sacrifice of voltage regulation by means of a Transtat Regulator connected in the primary circuit of the plate transformer. Power may be reduced without shutting down.

Filament control: Smooth, continuous control of filament voltage to insure efficient operation under all conditions and maximum tube life may be provided by a Transtat Regulator connected in the primary circuit of the filament transformer. Failure of one filament will not appreciably increase the voltage applied to the others.

AMERICAN
TRANSFORMER
COMPANY

178 Emmet St.
Newark, N. J.

AMERTRAN

Manufactured
Since 1901 at
Newark, N. J.

TRANSFORMERS

(Continued from page 36)

the minimum modulation is shown on the pattern portrayed by the oscilloscope. The oscilloscope has a built in high gain amplifier with external connections, and in production work it is usually easier to have the operator observe the point of minimum reading in a 0-3 volt meter, which also is an indication of perfect balance.

The circuit diagram of the pick-up used is shown in Fig. 2. The two pickup coils *a* and *a'* are air core coils of about 85 millihenrys inductance and can be almost any kind of coil with 500 to 1,000 turns as long as both coils are matched in characteristics. Air core coils are used in order not to distort the magnetic field of the motor. A potentiometer "b" is provided to balance out small variations in coil resistance.

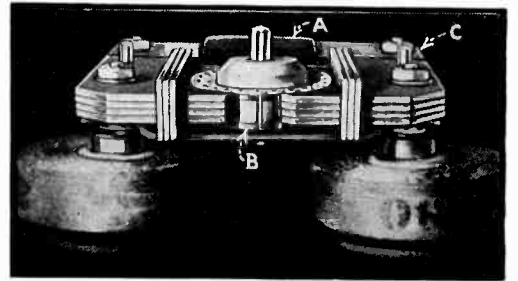

Fig. 1—Shaded-pole motor parts

It is preferable, though not essential that the leads to the oscilloscope be shielded to avoid extraneous pick-up from near-by power lines. A fixture for holding the motor should be provided to insure the coils being always in the same position with respect to the magnetic field.

In operation the motor is placed in

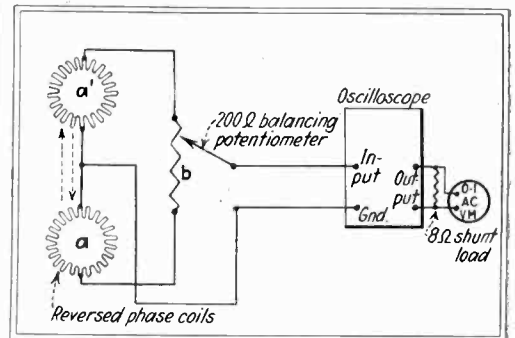

Fig. 2—Test diagram

the jig and started with the output of the coils fed into the oscilloscope. The coil "A" is shifted until the modulation is reduced to the minimum point and or meter reading, as the case may be, the coil is then wedged fast. A stroboscopic check reveals that at this point slippage, if any, is reduced to the minimum.

Phototube Limit Relay Applied to Weighing Problems

AN INGENUOUS APPLICATION of the phototube relay has been made by Mr. L. C. Barnes of Los Angeles to

New!

LEV-O-MATIC

Tuning Unit — Latest Yet!

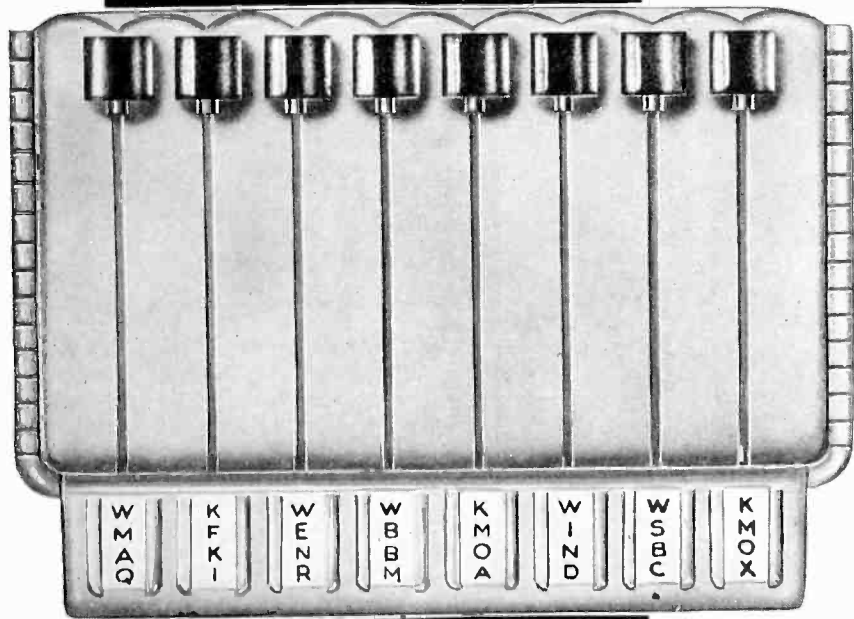
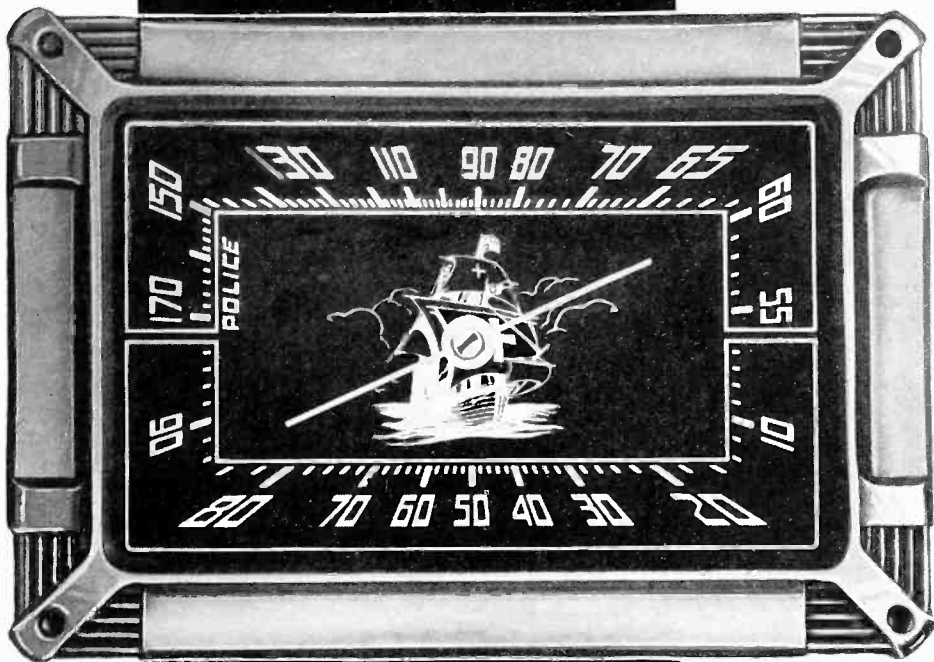

Typical unit shown.
Can be changed to
suit specific needs.

THE LEV-O-MATIC is a quick-acting mechanical tuning control, with all the advantages of an automatic unit—yet has greater convenience.

Lev-O-Matic Operation

Its operation is instantaneous. Simply by pulling down a lever, it instantly tunes in the stations designated on the labels. It is from 2 to 9 times faster than any automatic tuner, and operates so rapidly that intervening station noises are unnoticeable, as no muting is necessary.

Any Number of Stations Arranged in Desired Sequence

Although the No. 801 unit shown is typical, yet the Lev-O-Matic can be made for any number of stations ranging from 6 to 15. These can be arranged in any sequence preferred, such as types of programs or stations in alphabetical order.

Easy, Accurate Adjustment

Any lever of the unit can be set with absolute accuracy for tuning into any desired station, and once the lever is set and secured in position it assures precision tuning, bringing the dial exactly on the signal. Automatic frequency control may not be required on smaller receivers.

A Highly Flexible Unit

It can be adapted to many different types of dials or special escutcheons.

Send for Details

No. 801 Lev-O-Matic Tuning Unit shown. All Lev-O-Matic units are licensed under Leishman Patent No. 2,084,851, and Leishman patents pending.

CROWE NAME PLATE & MFG. CO.
1741 Grace Street — CHICAGO, ILL., U.S.A.

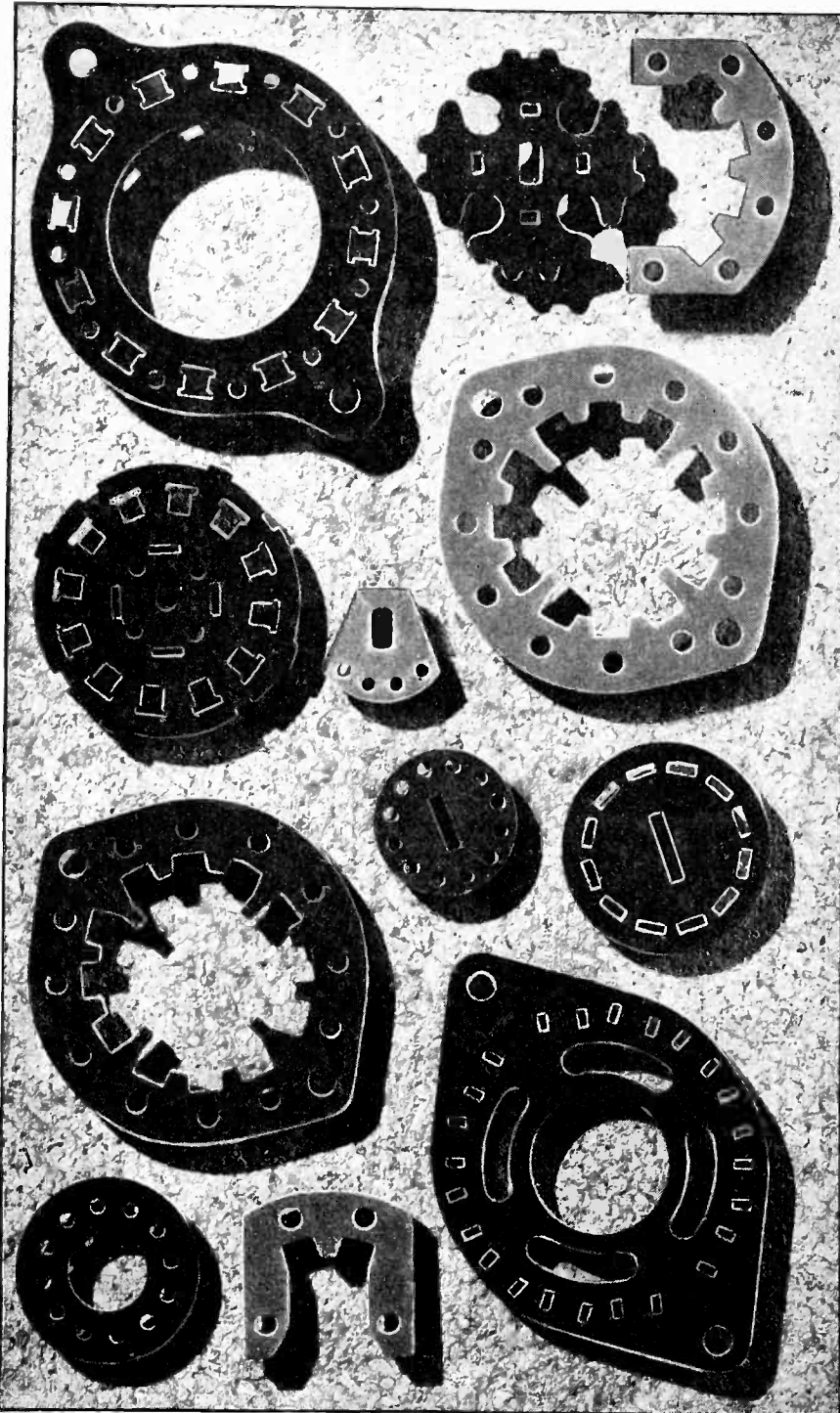

SAVE WITH TEXTOLITE ROTORS AND STATORS

For accurate punchings, toughness and complete electrical insulation, specify General Electric Textolite — made to meet your most exacting requirements.

Write to our nearest Textolite distributor, listed below, for complete information and prices, or to Section P-424, Plastics Department, General Electric Company, Pittsfield, Massachusetts.

GENERAL LAMINATED PRODUCTS, INC.

233 Spring St., NEW YORK, N. Y.

3113-3123 Carroll Ave., CHICAGO, ILL.

GENERAL ELECTRIC

Plastics

GENERAL ELECTRIC COMPANY

PITTSFIELD, MASSACHUSETTS

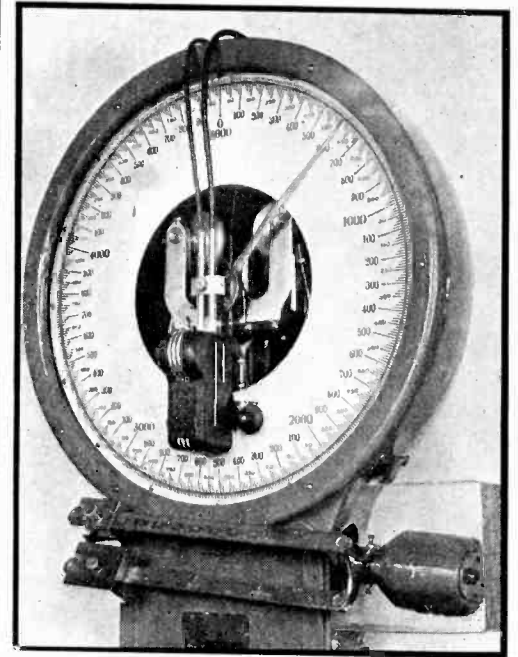

Phototube limiter attached to face of weighing machine, for automatic batching

the problem of automatic weighing. As shown in the illustration the phototube and lamp housing is attached directly to the glass face of the weighing machine by means of suction cups. The housing contains a 3,000-hour lamp and a lens which focuses the image of the filament upon the scale surface, which reflects the light to the phototube. A vacuum type phototube having an automobile headlight type base is used. The output of the phototube is coupled to the grid circuit of

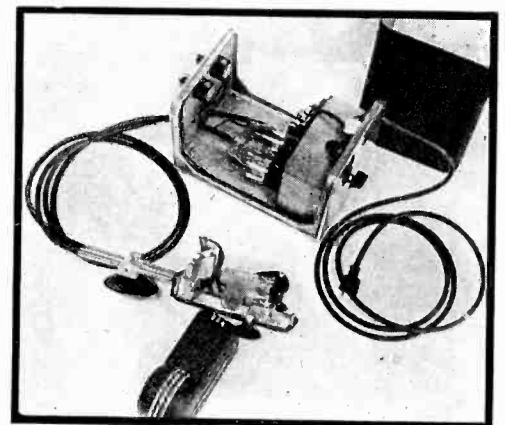

Limiting unit with housing covers removed. The knob is a bias control to compensate for line-voltage variations.

a 43 tube, the plate circuit of which is a relay having 300-watt contacts. The plate power and bias voltages are supplied by a 25Z5 rectifier, while a ballast tube is used for series-filament operation. In the main control unit two convenience outlets are provided, for "on" and "off" applications. Supervisory pilot lamps indicate the operation of the relay and show which circuit ("on" or "off") is energized.

The entire unit may be applied to any type of indicating instrument, but has thus far found its principal application in connection with weighing machines. By placing the suction cups (which may be cemented per-

CENTRALAB WILL STAY QUIET

U. Elgin Chandler

U. Elgin Chandler
Radio Sales and Service
Louisville, Ky.

U. ELGIN CHANDLER

Radio Sales and Service

1332 94 BARDSTOWN ROAD
LOUISVILLE KY

June 9th, 1937

CENTRALAB,
Milwaukee, Wis.

Gentlemen:

The writer first became acquainted with your Volume Controls in 1925, and since that time has used them almost exclusively.

Each time, I have gone back to Centralab, because it is the only control that I have ever found that will stay quiet.

Here in our shop we make every effort to avoid "call backs", and we have found that the use of your volume controls means one hundred percent satisfaction.

Both yourselves and the local service men are fortunate in having a distributor who promotes your merchandise as does P. I. Burks & Co., of Louisville.

U. Elgin Chandler

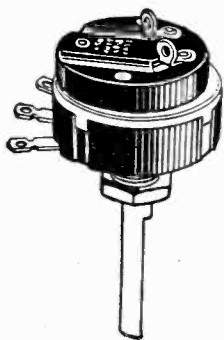
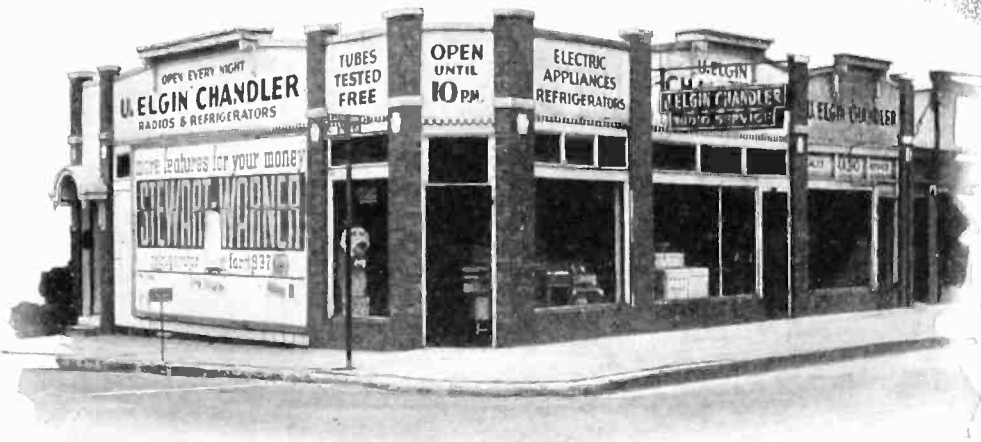

THE QUIET CENTRALAB CONTROL

offers maximum resistor length for case diameter . . . close uniformity between resistors . . . accurate tapers . . . uniform current distribution . . . better power dissipation and longer life

Fine phrases seldom fool a radio man. Graphs, curves and self-praise may read well . . . but customer complaints put a "negative-bias" on such bouquets.

So, when an "old timer" like Mr. Chandler writes . . . "Since 1925 I've used your controls almost exclusively, in fact each time I have gone back to Centralab, because it is the only control that I have ever found that will stay quiet." . . .

Here's proof for manufacturer . . . for experimenter and for the serviceman. Specify Centralab.

CENTRALAB DIV. OF GLOBE-UNION INC., Milwaukee, Wisc.
Canterbury Rd., Kilburn, London N. W., England 118 Ave., Ledru-Rollin, Paris

Centralab

CRL

Multi Connector Plug

BY GUARDIAN

BUILT TO STANDARD DIMENSIONS
WITH SUPER STANDARD FEATURES

*Designed for the
Wear and Tear of
Heavy Duty Service*



★ Plugs mounted on bakelite strip are readily "peeled" away from the clips without danger of breakage. No prying or forcing. Entire unit is easily placed in any assembly.

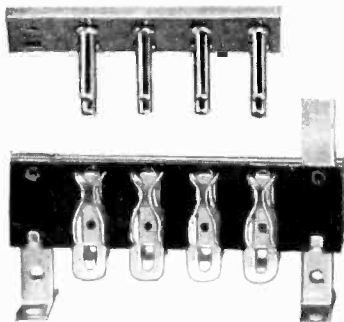

A TOUGH, rugged, economical plug, designed to permit rapid insertion and easy removal, affording firm and positive contacts for every circuit. Oversize soldering lugs for rapid wiring. Style illustrated is designed for direct connection to the plug, but side lugs will be furnished to order.

Notice the open construction of the spring clips, avoiding any possibility of dirt collection to break the circuit or interrupt play of machine. Fool proof construction makes it impossible to reverse circuits, as the plugs can be inserted only when in correct position. Built in any size from two connections up. Bakelite construction with metal parts cadmium plated. Will stand heavy use without breakage of plugs or clips.

*Write for Full Details
and Catalog "E"*

GUARDIAN  **ELECTRIC**

1625 W. WALNUT STREET

CHICAGO, ILLINOIS

manently if desired) on the glass in the proper position the phototube and lamp can be situated at any desired point on the scale. In automatic weighing operations the device is used to shut off the feed on the material being weighed when the pointer intercepts the light beam. Two modes of operation are possible. In the one shown in the illustration the light spot is focused not on the white scale but on the interior mechanism so that practically no light is reflected to the phototube. When the pointer intercepts the beam it reflects some of the light into the phototube, thus actuating the relay. The other mode of operation consists in allowing the light to fall directly on the white face of the scale and using the pointer to reduce the light when it reaches the control position. In the control unit a plug is provided to reverse the connections to the phototube so that the proper polarity of bias is obtained in each of these two cases. The construction of the device permits its application on a wide variety of indicating instruments. The center suction cup is attached to the phototube housing through a flexible grip so that it may be adapted to the radius of any size scale. By using several suction cups (of the smaller variety shown) at different points on the scale the device may be used for control at any one of several positions throughout 360 degrees. In the applications of the scale, shown in the illustration, the amplifier unit is mounted directly on the rear of the scale housing. The accuracy of operation is within one scale division (as showing 1 pound in 2,500).

WESTINGHOUSE PLANS ATOM SMASHER



This unusual tank at the Pittsburgh Research Laboratories of Westinghouse will house the new generator (of the Van der Graff type) which will develop d.c. at 5,000,000 volts and higher for atomic structure studies.

History speaks for itself. It shows unmistakably that Sprague Condensers have always led in quality because they have always been the first to be improved. Constant, far-reaching engineering research is a Sprague tradition.

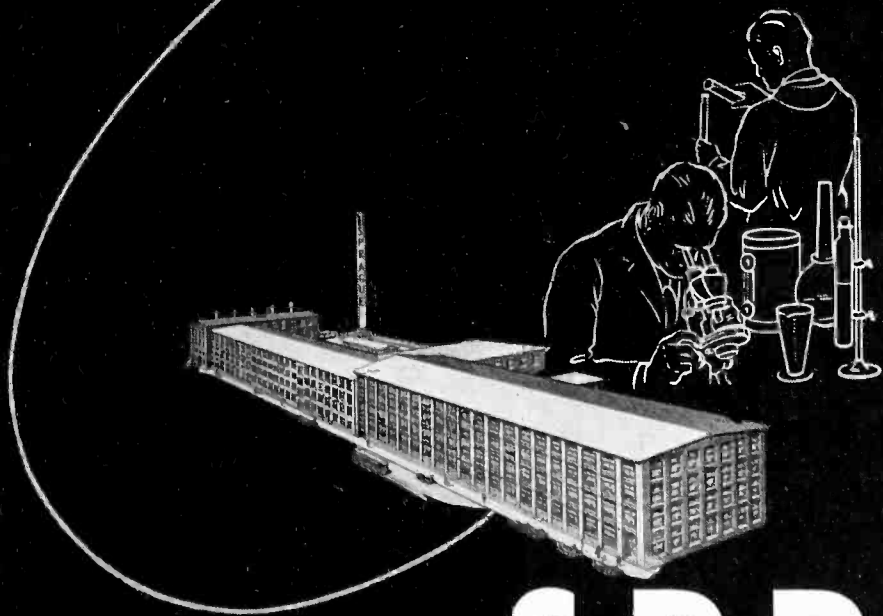

SPRAGUE

**GOOD CONDENSERS—EXPERTLY ENGINEERED—
COMPETENTLY PRODUCED**

SPRAGUE SPECIALTIES COMPANY, NORTH ADAMS, MASS.

MORE and MORE IN IMPORTANT PLACES



Since the beginning of this year alone, UNITED Type 966 rectifiers have been purchased by thousands of new users. The obviously better design of this tube is rapidly attracting favorable attention everywhere.

The main reasons are:

1. QUICK STARTING: A few seconds initial preheating vs. full 15 minutes stipulated for other makes. Also, specially designed filament comes up to full emitting temperature instantly, resulting in negligible time delay in routine operation.
2. CONTROLLED MERCURY: Measured pellet exploded after exhaust prevents excess mercury amalgams with elements and getter, hence longer filament life.
3. DEFLECTING BAFFLE: Large Svea metal baffle to deflect heat, tends to keep condensed mercury temperature in proper relation to ambient temperature.

Interchangeable with 866 tubes of all makes

Please address Department B

UNITED ELECTRONICS CO.
42 SPRING STREET
NEWARK NEW JERSEY

Metal Tube Used to Measure Diffusion of Hydrogen

THE DIFFUSION OF HYDROGEN through solid metal has been investigated by Dr. Francis J. Norton, of the G. E. Research Laboratory, using an ordinary metal tube for the purpose. In his experiment the protective coat of paint on the tube was sandblasted off. The tube was then dipped into water at different temperatures for different lengths of time, and the grid current measured. It was found that at 78 deg. F., the rate of diffusion was $\frac{1}{10}$ of a micron per hour through 30-mil steel. The gas which entered was analyzed

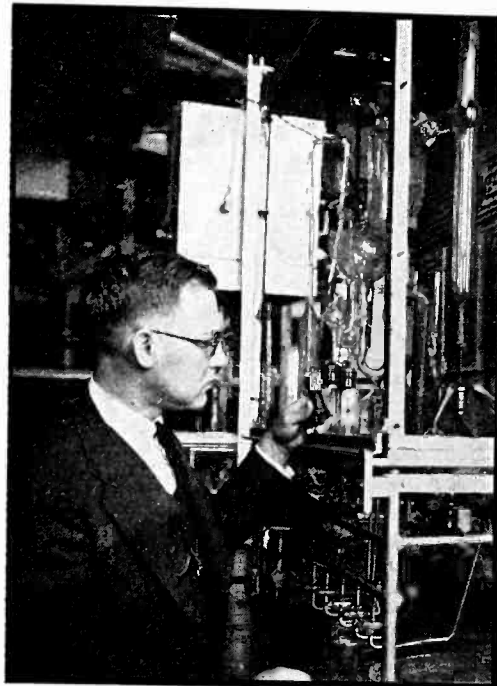

Dr. Norton with his diffusion apparatus

and found to be very pure hydrogen. It was found that by adding one-tenth of 1 per cent of sodium chromate to the water the penetration of hydrogen was completely stopped. Various coatings of paint on the metal were also tested, and it was found that the regular paint applied to the tubes was the best protection against hydrogen diffusion. Other coatings, notably zinc and porous copper, caused the rate of hydrogen diffusion to increase. Stainless steel was found to have very much better resistance to diffusion than ordinary steel. It was found that tubes do not admit hydrogen from the air in appreciable amounts.

• • •

Spherical Reflectometer for Light Transmission and Reflection Measurements

A NEW REFLECTOMETER which uses self-generating cells has been developed by the General Electric Co. in Nela Park. The device consists of two spheres, one of which is fitted with two barrier cells (self-generating type) on opposite sides. These cells are con-



LUGS

ANY SHAPE
EVERY USE

TWICE ACTUAL SIZE

Here are a few useful and popular lugs. Many others in stock. Cards of 50 or more sample lugs sent you on request.

hundreds of types and sizes in stock—all designed for a specific purpose—many now serving in a variety of uses—all available for prompt delivery—all of the best material and workmanship—with "CINCH" special solder coating. Maybe small parts, but sure to do a big service.

Cinch and Oak Radio Sockets are licensed under H. H. Eby socket patents.

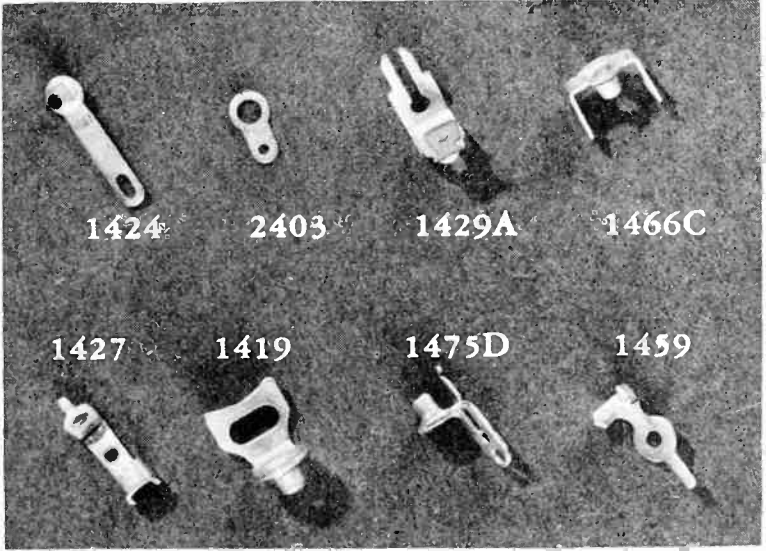

CINCH

MANUFACTURING CORPORATION
2335 WEST VAN BUREN STREET
CHICAGO, ILLINOIS

SUBSIDIARY OF UNITED-CARR FASTENER CORP., CAMBRIDGE, MASS.

A MILLION DOLLARS hung on a *Single* blow



ON THE light tap of the diamond cleaver's mallet hangs the destiny of one of the world's fabulous diamonds. There can be no middle ground . . . for it will be either a perfect stroke or utter destruction.

Only one diamond man . . . the industry's foremost expert . . . has the skill and training to attempt such a task. He spent a whole year in careful study and scrutiny to determine the planes of cleavage and prepare a groove. Finally the blow is struck! A perfect cleave! . . . and the beauty falls into eager hands.

The destiny of a new electrical development may hang on its being properly insulated. That, too, is a job for unusual experience and ability. Mica's 42 years of specialized experience and its complete research facilities are available to work out your own insulation problem.

200 Varick St., New York; 542 S. Dearborn St., Chicago; 1276 W. 3d St., Cleveland. Birmingham, Boston, Cincinnati, Los Angeles, San Francisco, Seattle. Montreal, Toronto

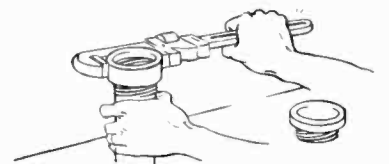

NEW FIELD OF INSULATING BUSHINGS DEVELOPED WITH LAMICOID

To find a shock-proof, oil-proof conduit insulating bushing which would prevent current surge was the problem which faced a manufacturer recently.

They required a tubing with steel-like threading qualities . . . combined with high insulating strength.

By a combination of resin characteristics and modified rolling process our engineers produced a tubing to meet the required specifications—a unique Lamicoid development, opening up new possibilities in the field of insulating bushings.

MICA
*Insulator
Company*

OVER 40 YEARS OF SPECIALIZATION MAKES THE DIFFERENCE!

MICANITE . . . EMPIRE VARNISHED INSULATIONS . . . LAMICOID LAMINATED PLASTIC MATERIALS

announcing...

THE *NEW* Lansing *Iconic*

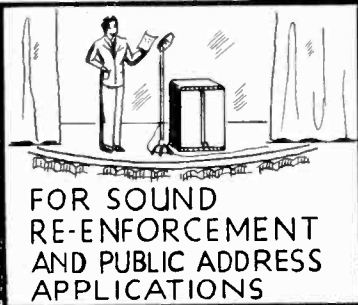

FOR SOUND
RE-ENFORCEMENT
AND PUBLIC ADDRESS
APPLICATIONS



FOR THEATRE QUALITY
REPRODUCTION
IN THE HOME-RADIO
OR PHONOGRAPH

The new Lansing ICONIC high-quality loudspeaker system has been developed for a class of applications for which there has previously been no equipment available.

It includes a new high frequency unit with constant efficiency up to 10,000 cycles or above, a new multicellular horn which gives uniform coverage over an angle of 80°, even at the highest frequencies, and a new low frequency unit with very low distortion, all especially developed for the ICONIC.

Its performance is exceedingly good, being surpassed only by the well-known Lansing-Shearer theater horn systems. It is very flexible in application and can be altered in size and shape within very wide limits to suit particular conditions without affecting its performance. Its efficiency is very high which assures a high acoustic output with less amplifier power—in itself a considerable saving. It is comparatively unaffected by local acoustic conditions. And finally its low price makes it practicable for many applications which hitherto had to be satisfied with cheap radio speakers of greatly inferior performance.

NEW components NEW performance NEW economy

For complete information, ASK YOUR DISTRIBUTOR, or write to

LANSING MANUFACTURING CO.
6900 SOUTH MCKINLEY AVENUE
LOS ANGELES, CALIFORNIA

nected to a microammeter which is mounted on the sphere. Light is directed into the sphere through a projecting tubular arm at the end of which is a projection lamp, whose light output is adjustable by means of a rheostat attached to the housing. The inside surface of the sphere is painted white. At the bottom of the sphere is a circular opening against which the sample is placed. Light reflected from the sample is received by the photo-cells, which register the current that can be translated into reflection factor. By means of various adjustments it is possible to take readings with the light falling on the sample at any de-



Spherical photoelectric reflectometer in use

sired angle. For measuring transmission, a second integrating sphere is used containing a source of light. The sample is placed between the two spheres so that light passes from the lamp source to the sample through the integrating sphere containing the measuring cells. The size of the sample may have any value up to the circular area 3 in. in diameter.

• • •

Supersonic Horn Used On German Highways

IT IS REPORTED that a new supersonic horn is being used by autos and trucks in Germany for signaling purposes. The noiseless high frequency horn is used as a signal to the driver of a truck. The waves are picked up and actuate a relay which in turn connects an electric buzzer in the truck cab. A red tail light on the truck indicates to the driver behind that the signal has been received. The truck driver presses a button when it is safe for the car behind him to pass, thus changing the red light to green.

THE ELECTRON ART

EACH month the world's technical literature is scanned to see what physicists and engineers are doing with tubes, for presentation in tabloid form to Electronics' readers.

Tracing Electron Paths In Electric Fields

By H. SALINGER
Farnsworth Television Incorporated

IN PRACTICALLY EVERY KIND of high-vacuum apparatus, whether it be an amplifying or transmitting tube, a cathode-ray oscillograph or an electron multiplier, a television pick-up tube or a photocell, the fundamental question is the paths the electrons follow. Strangely enough little attention is usually paid to this problem, and in the majority of cases a rough mental picture of the general behavior of the electrons is relied upon. It is only in the recently developed theory of electron-optics that more elaborate methods have been worked out to calculate the motion of electrons, especially for electrostatic fields of rotational symmetry. They are, however, by no means simple, and moreover confined to rays in the neighborhood of the axis; thus, they seem to justify the general dislike toward dealing with this subject on an exact basis.

A rather elementary and yet perfectly rigorous method of attacking the problem given in this paper, should therefore prove helpful, even though it applies only to purely electric fields where no magnetic forces are present.

Consider an electrostatic potential distribution V , which may be any function of the coordinates x, y, z . The acceleration a of the electron is given by

$$(1) \quad a = \frac{-e}{m} \text{grad } V,$$

where e/m is the charge to mass ratio of the electron (e is negative) and $\text{grad } V$ is the vector with components $\frac{\partial V}{\partial x}, \frac{\partial V}{\partial y}, \frac{\partial V}{\partial z}$. Now it is a well-known

theorem of kinematics that a can be resolved into two components, one parallel to the motion of electrons,

which is $\frac{dv}{dt}$, and one normal to it,

which equals $\frac{v^2}{R}$. Here v is the instantaneous velocity, and R the radius of

curvature. It is this latter component which is of interest to us, and we may write

$$(2) \quad \frac{v^2}{R} = -\frac{e}{m} \text{grad}_n V;$$

in which $\text{grad}_n V = \delta V / \delta n$ is the component of the potential gradient normal to the instantaneous electron velocity. On the other hand, the energy equation reads

$$(3) \quad v^2 = \frac{2e}{m} (V - V_0)$$

where V_0 is the value of the potential at a point where the electron velocity is zero. As an arbitrary constant may always be added to the potential without changing the physical conditions, we shall take $V_0 = 0$ for the sake of simplicity. Then (2) and (3) may be combined to give

$$(4) \quad R = \frac{2V}{\delta V / 2m}$$

To show the use of this equation, consider the field of equipotential lines drawn in Fig. 1. Let an electron ar-

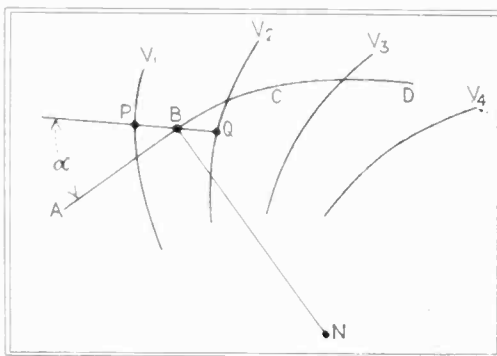

Fig. 1. Equipotential lines illustrating method

rive along AB ; the potential at B is $V = \frac{V_1 + V_2}{2}$. The gradient at B has

the value $\frac{V_2 - V_1}{PQ}$; therefore, $\frac{\delta V}{\delta n} =$

$\frac{V_2 - V_1}{PQ} \cdot \sin \alpha$. Thus, from (4) the

radius R can be computed. If we make $R = BN$, a subsequent element BC of the path can at once be drawn, BC be-

ing a circular arc around the center N . At the point C the operation has to be repeated, rendering CD , and so on.

Fig. 2 has been prepared to give an example of the usefulness of this procedure. This figure is, except for the electron paths, taken from an article of H. C. Thompson² and shows the potential distribution in an experimental tube as determined by the model

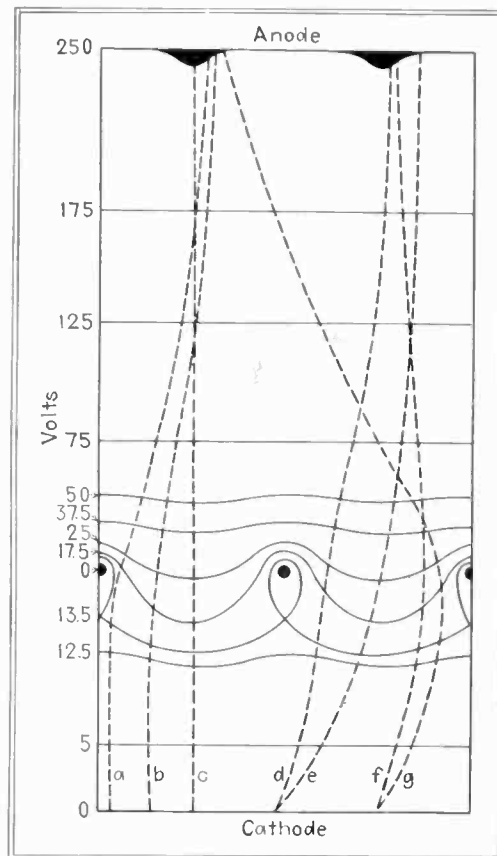

Fig. 2. Potential lines in an electron tube

method. The grid is kept at zero potential. By coating the electrodes with Willemite, it was observed that the electrons hit only on certain regions of the anode, as indicated by the black spots in Fig. 2. The rays a, b, c , have been calculated from the potential field; they are supposed to start with zero velocity. For the traces d, e, f, g , certain initial directions but negligible initial velocities were assumed. d and e start opposite a grid wire, e and f halfway in between.

It is remarkable how well experiment and theory check, although the discharge was space-limited according to H. C. Thompson's statement, and thus the actual potential curves must have been somewhat different from the one found by the model method.

In going through the actual graphical process as described, care must be exercised. The radius of curvature varies rapidly from point to point, especially so near the cathode and near the grid wires, where the velocities are small. This means that the construction in these regions has to be executed in rather small steps. On the other hand, there are regions where the radius of curvature becomes so great that a compass of ordinary size

(Continued on page 52)



Why
"CRIME DOESN'T PAY"
in Illinois



Let bandits beware Illinois! That state is now a model of broadcasting efficiency for the detection and prevention of crime . . . location of missing persons . . . and the many other activities of state police.

Seven strategically located broadcasting stations . . . equipped with Truscon Vertical Radiators . . . provide a state-wide hookup. (A typical station is illustrated). Every state-police cruiser or motorcycle is equipped with a radio. When the Illinois State Police go into action, an *actual* . . . not theoretical . . . *net* blankets the entire state instantly!

A rapidly growing list of Truscon Vertical Radiator installations for commercial and non-commercial radio stations is definite proof of the outstanding advantages of these modern antenna towers.

Truscon offers expert cooperation in assisting you to determine the most efficient and economical application of Truscon Vertical Radiators to meet *YOUR* requirements.

TRUSCON VERTICAL RADIATORS

TRUSCON STEEL COMPANY • YOUNGSTOWN, OHIO

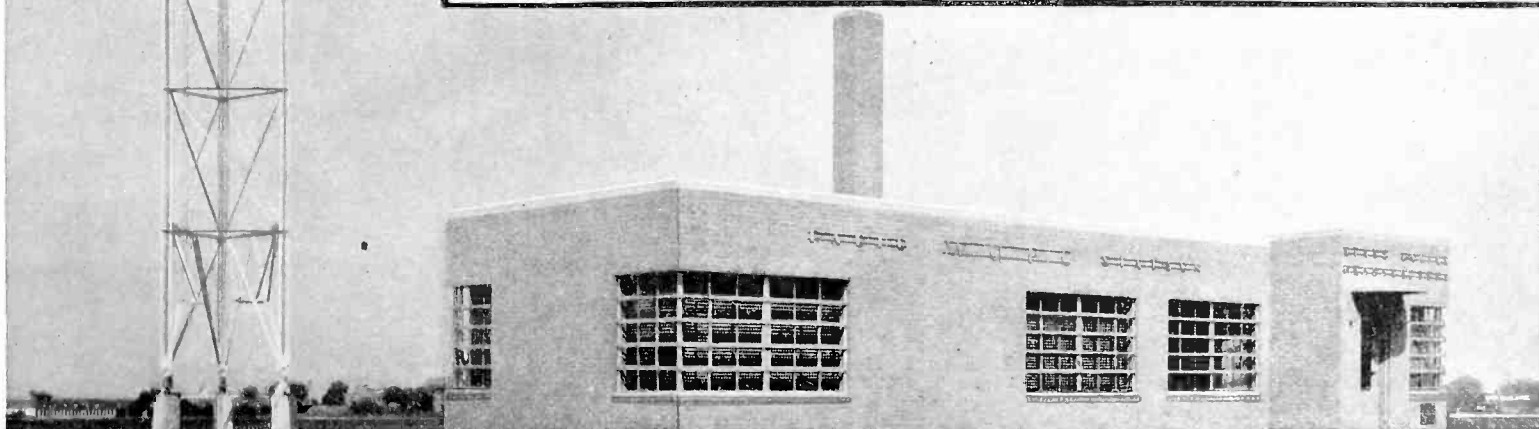

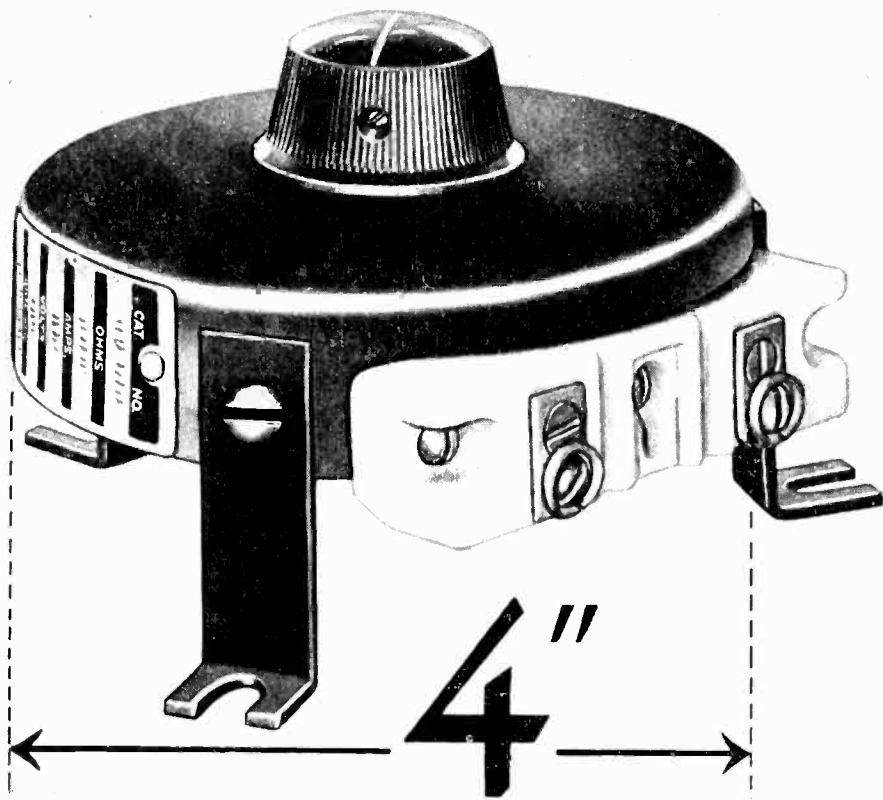

PRESSED STEEL POWER RHEOSTAT

*Solves the Problem of Multi-
Plate and Dead Shaft Mounting*

This new Ward Leonard design includes features of compactness and sturdiness that are of interest to you. It is built on the lines of the 6", 8" and 13" Vitrohm Pressed Steel Rheostats and includes the same flexibility of mounting arrangements. New descriptive bulletins give full information. Send for them.

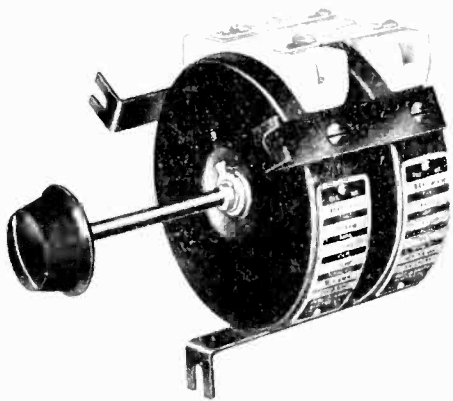

The 4" Rheostat is available for front or back of board mounting. In multi-plate arrangement design assures the contact arms always in step.

Bulletin 69 is just off the press. It is devoted entirely to the 4" Vitrohm Pressed Steel Rheostat.

Bulletin 60 describes the large sized Vitrohm Rheostat that has served industry for nearly half a century.

WARD LEONARD

RHEOSTATS • RELAYS • RESISTORS

Electric Control Devices Since 1892



WARD LEONARD ELECTRIC COMPANY, 32 South Street, Mount Vernon, N. Y.

Please send me bulletin Nos.

Firm

Address

City State

can no longer be used. Amazingly large errors would, however, be encountered if the paths were replaced by straight lines. One has to use a larger compass or else apply a graphical correction, as shown in Fig. 3. If the arc AC is replaced by the straight

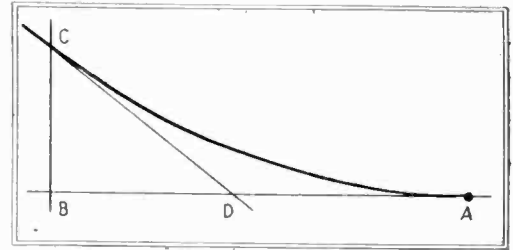

Fig. 3—Curve of graphical corrections

line AB, C may be found from B as $BC = \text{approx. } \frac{(AB)^2}{2R}$. Moreover, $CD =$

$AD = \text{approx. } \frac{AB}{2}$, hence CD (which

is the tangent of the circle at point C) can be drawn at once.

Thus, it is seen that electron paths can easily be drawn once the equipotential surfaces are known. They may either be calculated or found experimentally by a model method. In our opinion, much is yet to be done to improve and apply the methods of measuring potential fields. E.g., equation (4) applies to any field, whether or not space charge is present. But no simple procedure exists for finding the field under space-charge conditions; hence our method cannot be applied to these cases.

Again, equation (4) is valid for any tridimensional potential distribution. There is no ambiguity as to the position of the center of curvature (N in Fig. 1), as in any moment the plane of motion is given by the directions of the electron velocity and the potential gradient, and the center of curvature must be chosen so as to bend the electron beam towards increasing V (in Fig. 1, $V_1 > V_2 > V_3 > V_4$ has been assumed, else N would have to lie on the other side of AB). Yet to carry out the graphical construction described above, the equipotential lines must be available in the plane of motion. Therefore, the method becomes rather cumbersome if the electrons do not move in one plane. This confines its use somewhat to plane fields or to fields of rotational symmetry, where the electron remains in a meridional plane provided its initial velocity lies in that plane.

The same limitation, by the way, applies to the method of electron optics as now in use. This method also is in itself general, but for the sake of convenience usually only paths in the meridional plane are considered. In order to compare the two methods more closely, we might add that the usual

MAKE YOUR TABLE -
TALK WIN YOU
FURTHER
INVITATIONS

DO YOU HAVE TO TALK
ABOUT THE
WEATHER?

DOES YOUR BOSS
DRUM ON THE TABLE
WHEN YOU TALK
IN MEETINGS?

Make them say
"You said it!"

HOW'S YOUR
COME-BACK?

CAN YOU SAY IT
WITH GRACE
AS WELL AS
TO GRACE?

DO YOUR
BUSINESS ASSOCIATES
THINK OF YOU
AS A GOOD TALKER?

HAVE YOU
A GOOD LINE?

How often do you gain heart-felt approval of what you say? How effective is your everyday conversation? Are people won over to you when you talk?

Because relations with people are so large a part of your daily life, in business and social activities, the ability to talk is your most important asset in keeping these relations smooth and in winning people over to your ideas. And the better you talk, the greater will be your success.

"I say without hesitation, this is the best book on conversation ever written." — ALBERT EDWARD WIGGAM

"Will help all who wish to be able to carry on an interesting conversation."
—Liberty

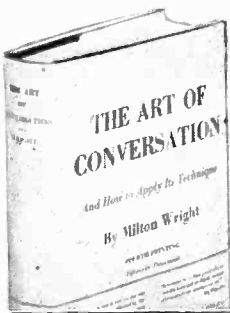

How to acquire the ability to talk—
readily
entertainingly
convincingly



Are people won over to you when you talk? They will be if you understand and apply the technique of conversation. This book is a brass-tack analysis of talk today—its principles—its techniques. It is a fascinating, practical discussion of simple exercises which will improve everyday conversation.

How would you work out these problems?

- How would you keep up the interest of a group for fifteen minutes in a topic selected by you? (See page 28)
- How would you discover a special interest of a person you have met for the first time? (See page 74)
- What steps would you take in a talk with just one other person to insure his wanting to talk with you again? (See page 111)
- How would you start, keep moving, and control the conversation at a dinner party of six? (See page 149)

10 days' Examination

Send this Coupon

Milton Wright's **THE ART OF CONVERSATION**

And How to Apply Its Technique

Already in its fourth big printing—\$2.50

IF you would win an argument or win a wife, cultivate a friend or humble an enemy, get information or give it, ask a favor or deny one, land a job, sell a bill of goods, be elected to office—if you would accomplish anything, at work or at play, where you are in the presence of other human beings, then you must talk.

So that you may learn how to talk to the best advantage in any situation, Milton Wright has written this book. He shows you—not merely tells you, but *shows* you—how to start a conversation, how to keep it going, how to direct it the way you want it to go,

how to make precisely the impression you want to make and get exactly the result you want. He analyzes repartee and shows you how to develop facility in using it. He takes actual conversations apart and shows you what makes them tick.

Mr. Wright's book is firmly grounded in psychology and is written in his easy-to-read style. You can't help setting yourself in the places of the people who do the talking, and when you've laid down the book, you want to go out and practice on your friends. It's a fascinating book—interesting, practical, and really helpful.

TRY WRIGHT'S METHODS FREE

Check the list of conversational offenses on page 320; see how plainly Wright shows how to overcome these faults. You can make this test, read Wright's book, put his method right into practice, without obligation, simply by mailing the coupon. Take this practical way to see just what the book offers you. Mail the coupon today.

McGraw-Hill Book Co., Inc., 330 W. 42nd St., N. Y. C.

Send me Wright's The Art of Conversation for 10 days' examination on approval. In 10 days I will send \$2.50, plus few cents postage, or return book postpaid. (Postage paid on orders accompanied by remittance.)

Name

Address Position

City and State Company

(Books sent on approval in U. S. and Canada only.)

L.10-37

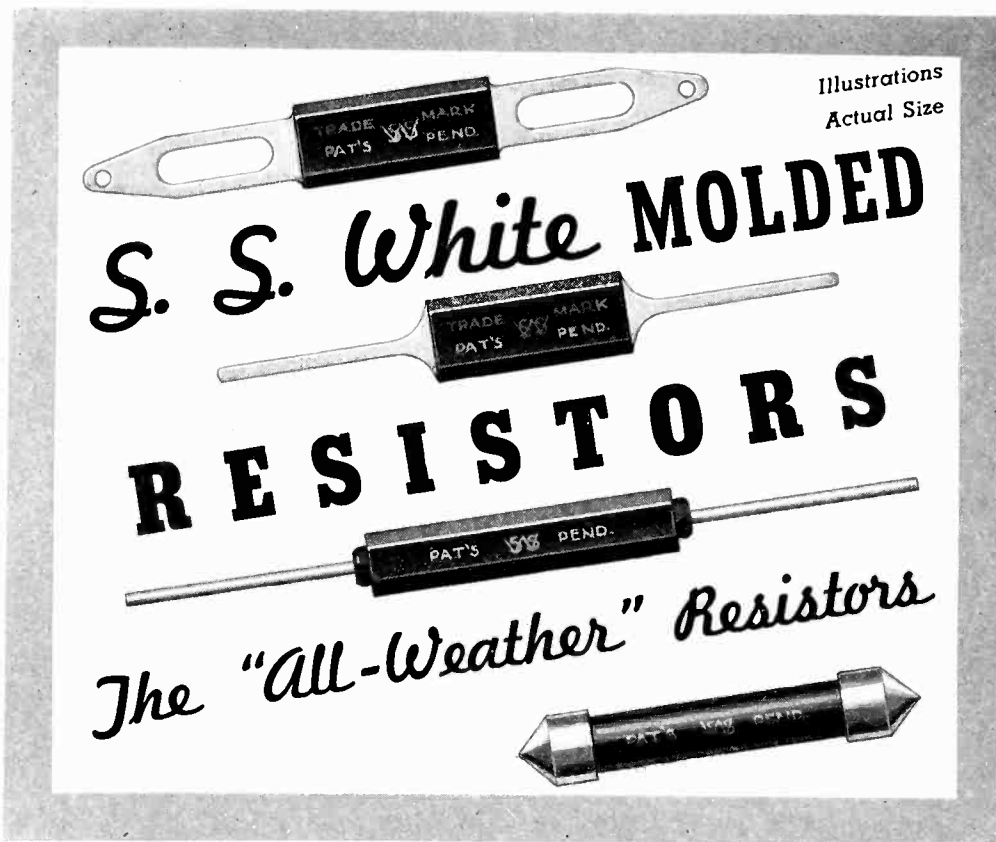

STANDARD RANGE

1000 OHMS to 10 MEGOHMS

Standard Tolerance: Plus or Minus 10%

NOISE TESTED

1000 OHMS to 10 MEGOHMS

At slight additional cost, any of the resistors in the Standard Range will be supplied individually "noise-tested" and guaranteed to conform to the following standard:

"For the complete audio frequency range, resistors shall have less noise than corresponds to a change of resistance of 1 part in 1,000,000."

HIGH VALUES

15 MEGOHMS to 1,000,000 MEGOHMS

Standard Tolerance: Plus or Minus 10%

MAIL THE COUPON for your copy of the new Bulletin No. 37 which gives full details about S. S. White Molded Resistors

The S. S. WHITE Dental Mfg. Co.
Industrial Division

10 East 40th St., Room 2310E, New York, N. Y.

Send me a copy of the new RESISTOR BULLETIN No. 37 with Price List

NAME

COMPANY

ADDRESS

CITY

STATE

method demands only the knowledge of the potential along the axis. In this regard it possesses some advantage over ours, which requires the total field of equipotentials. On the other hand, the old method is more complicated and restricted to the so-called paraxial rays, a restriction altogether foreign to the new procedure.

In conclusion, the principal fields of application of this method may be indicated. They are:

(a) Electron paths in cathode-ray tubes, image amplifiers and electron multipliers, as long as no magnetic fields are present; focusing conditions of electrostatic lenses.

(b) Electron motion in triodes and multigrad structures; grid current problems.

References:

(1) D. W. Epstein. *Proc. Inst. Radio Engineers*, Vol. 24, page 1095, 1936.

(2) H. C. Thompson. *Proc. Inst. Radio Engineers*, Vol. 24, page 1276, 1936.

• • •

Definitions of Electrical Terms

THE COMPLETE and finally revised report on "Definitions of Electrical Terms," prepared by the Sectional Committee on Definitions of Electrical Terms of the American Standards Association, is being circulated for final approval. Originally published as a printed report in August, 1932, these definitions have enjoyed a wide circulation in which many suggestions for improvements and revisions were made.

The present report is considerably enlarged over the 1932 report. Two new sections have been included, one on "Switching Equipment" and the other on "Electronics." The sections on "Wire Communication" and "Radio Communication" have been consolidated into a new section on "Electro-Communication."

The section on Electronics includes fifteen pages of definitions on tubes, tube electrode components, voltages, current, impedances, operations and accessories associated with electron tubes. Included in the section on Electronics is a sub-section on cathode ray oscillograph tubes and another on X-ray tubes.

In a work as extensive as the report of the Committee on Definitions of Electrical Terms, many conflicting interests and divergent viewpoints must be correlated. Obviously, such a report cannot always please everyone in every detail, but the vast amount of work which has gone into the compilation of this set of definitions makes available to those in the electrical field a very extensive and important group of terms bearing the stamp of approval of the American Institute of Electrical Engineers, sponsors of this program.

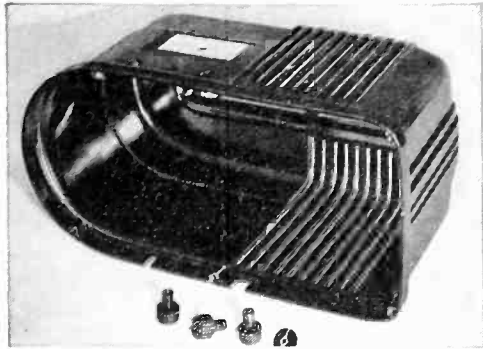

The 1938 Coronet Model "Silvertone" Radio is completely housed in a lustrous black one-piece Bakelite Molded cabinet. Product of Sears Roebuck & Co. Molder, American Insulator Corp.

STYLING THAT KEEPS PACE with Technical Advances



AS EACH year's improved models are brought out by leading radio manufacturers, an increasing number are housed in up-to-the-minute cabinets of lustrous Bakelite Molded. Every advance in technical design finds this material fully competent to express equal progress in styling.

One reason for this, is that the lustre, self-contained color, fine texture, and moldability of Bakelite Molded offer unlimited opportunity for originality in styling. Another, is that the use of this material affords important simplifications and economies in the production and assembly of sets.

Bakelite Molded cabinets for either large or small table radios may be completely formed in a single molding operation. In the same operation, all lugs, bosses and through-holes are formed; metal inserts are permanently embedded; and the final lustrous finish is imparted to all surfaces.

Radio engineers and designers are urged to consider the outstanding merits of Bakelite Molded for electrical parts as well as cabinets. Special types of this material offer special advantages such as low power loss, high impact strength, or unusual heat resistance. Write for comprehensive reference booklet 13M, "Bakelite Molded".

BAKELITE CORPORATION, 247 PARK AVENUE, NEW YORK, N.Y.
BAKELITE CORPORATION OF CANADA, LIMITED, 163 Dufferin Street, Toronto, Canada West Coast: Electrical Specialty Co., Inc., 316 Eleventh Street, San Francisco, Cal.

BAKELITE

REGISTERED U.S. PAT. OFF.
"The registered trade marks shown above distinguish materials manufactured by Bakelite Corporation. Under the capital 'B' is the numerical sign for infinity, or unlimited quantity. It symbolizes the infinite number of present and future uses of Bakelite Corporation's products"

THE MATERIAL OF A THOUSAND USES

ELECTRONICS — October 1937

55

IT'S

GETTING CLOSE

Publication date for the 1937 set of Electronics Reference Sheets is scheduled for December 1, 1937.

Only enough sets will be printed for the orders on hand at that time. There isn't much time left—so don't delay.

Many subscribers have placed their order with payment—insuring them of a set of charts and at the same time saving the delivery costs.

Electronics Yearly Service was inaugurated at the request of subscribers for an opportunity to secure an extra set of the Reference Sheets that had appeared in all the issues during the current year. These will be printed on heavy stock, punched and ready for insertion in the notebook. Only bona fide subscribers as of publication date—December 1, 1937 are entitled to secure this extra service.

If you haven't placed your order yet DO SO AT ONCE. The handy coupon below is for your convenience.

Enter my order for a complete set of 1937 Electronics Reference Sheets for \$1.00.

- Here is my check. Send sheets postpaid.
- Bill me \$1.00 plus small delivery charge.

Name

Address

City State

11-37

Impedance Measurements

A BRIDGE for making direct impedance measurements and designed for the purpose of measuring quickly and conveniently, especially by semi-skilled operators, the characteristics of telephone apparatus, is described by D. W. Sutton in the September issue of the *Wireless Engineer*.

For the range of impedances for which this bridge was designed (100

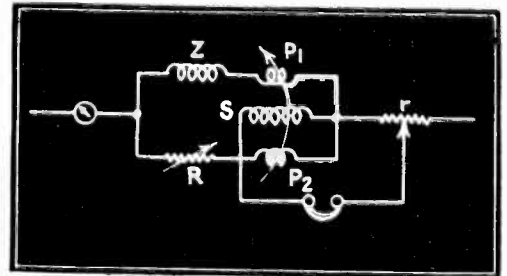

Simple impedance bridge

ohms to about 20,000 ohms) an accuracy of about 2 per cent may be obtained. P_1 and P_2 are the equal primary windings of a mutual inductance, of which S is the secondary. The stray and mutual capacitances of this transformer should be reduced to a minimum. The impedance to be measured is given at Z and the two resistance boxes, R and r , determine the magnitude of the real and reactive components of the impedance under measurement when the bridge is balanced.

Engineers and Government

LATELY IT HAS BECOME the custom of certain engineers to discuss the social effects of engineering advances and the relation of the engineers to society to such a point of exhaustion that the subject is frequently hackneyed and motheaten. Perhaps because of this very reason an address delivered at the summer convention of the American Institute of Electrical Engineers and published in the August issue of *Electrical Engineering* is all the more refreshing. This article, by Dr. Vannevar Bush is entitled "The Engineer and His Relation to Government."

Failure on the part of the Government to request and utilize sound technical engineering information rather than political expediency, the need for an integration of all of the engineering societies in order that the engineer as a professional man may make his voice more readily heard in the world, and a real need for the close association of management and engineers with the legal system, (especially in the patent system) are among some of the engineer's problems which Dr. Bush discusses. Although there is an enormously complex system of organization of scientists and engineers in the United States, this mechanism is not utilized to the full in expressing the viewpoint of engineers generally, especially when public questions are involved.

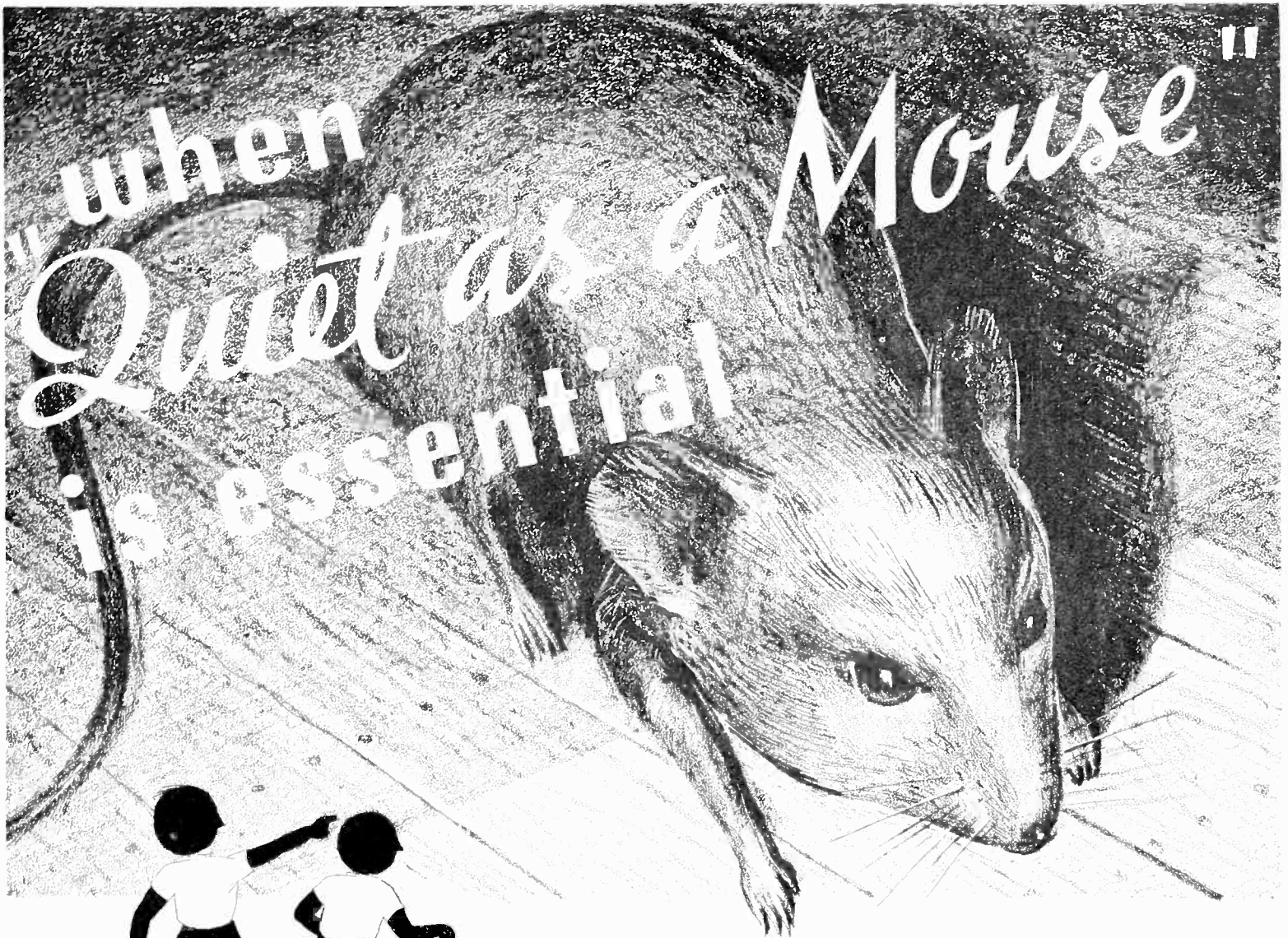

"When Quiet as a Mouse is essential"



WHEN selecting component parts no factor is too small to overlook. In recently conducted noise tests different makes of insulated resistors showed a spread of almost 10 to 1 in microvolts of noise per volt of applied D. C.

In Erie Insulated Resistors not only is the noise extremely low, but the other characteristics; load, voltage coefficient, humidity characteristic and mechanical strength, are all uniformly good. It is this all-round superior operating performance that makes these units the outstanding carbon resistors available today.

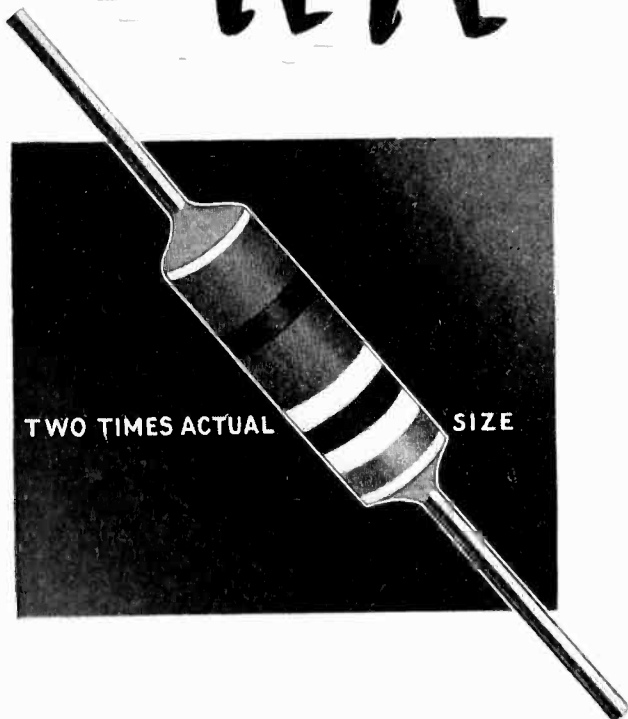

ERIE RESISTOR CORPORATION
 CARBON RESISTORS AND SUPPRESSORS AUTOMATIC INJECTION MOLDING
 TORONTO ERIE, PENNSYLVANIA LONDON

Announcing

a

NEW OUTPUT POWER METER by DAVEN

featuring:

- ... 40 STEPS ON 1 KNOB
- ... COMPLETE CONTROL ON 2 KNOBS
- ... IMPEDANCE VARIATION *less than 5%* from 20 to 10,000 cycles.

Sound laboratories, broadcasting studios, industrial and other technical laboratories, will find the NEW DAVEN TYPE "OP-182" OUTPUT POWER METER a valuable and useful instrument for rapid measuring purposes.

This instrument, the primary purpose of which is to terminate a source of audio frequency power—performs functions which ordinarily require a complicated set of apparatus. It is calibrated in milliwatts, has an overall range of 0.1 to 5000 milliwatts, and reads directly the amount of power delivered to the termination. Calibration is also provided in decibels, permitting its use as a power (or volume) level indicator.

Other features of this outstanding development by Daven in measuring instruments include:

- ... 40 step adjustment over a range from 2.5 ohms to 20,000 ohms.
- ... not subject to power factor corrections from generating sources.
- ... meter element calibrated to read from 1 to 50 milliwatts or from 0 to 17 decibels with 1 milliwatt as a reference level.
- ... meter control extends range from 0.1 to 5,000 milliwatts or from minus 10 to plus 37 decibels.

ACCURACY . . .

The New Type "OP-182" OUTPUT POWER METER has a frequency correction of less than 0.5 db. from 20 to 10,000 cycles and a restricted impedance variation of less than 5% for the same frequency range. SIZE: 6" x 12" x 6½"; WEIGHT: 11¾ lbs.

Further details
available on
request.

THE DAVEN CO.

158 SUMMIT ST., NEWARK, N. J.

MANUFACTURERS OF

Single and Dual Potentiometers
Special Rotary Switches
Filament Rheostats
Mixer Panels
Variable and Fixed Attenuators
Faders

Volume Indicators
Output Meters
Line Equalizers
Attenuation Boxes
Multipliers

Super Davohms
Laboratory Equipment
Speech Input Control Apparatus
Decade Resistances
Resistances Davohms

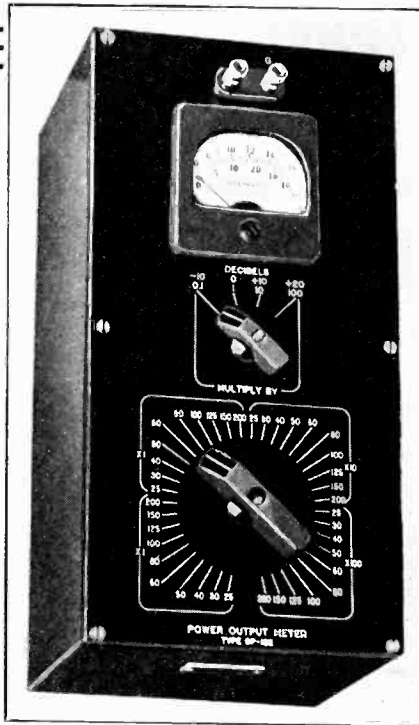

Ratings for Power Output Tubes

IN THE INTEREST of enabling the user to obtain better operation and longer life from vacuum tubes the Radiotron Division of the RCA Manufacturing Company, Harrison, N. J., has issued its application note No. 79 on "The Significance of Ratings for Power Output Stage." It is the purpose of this note to discuss the significance of output tube ratings, to show how certain maximum ratings may be unintentionally exceeded in practice, and to suggest means for reducing the possibility of exceeding maximum ratings.

Prizes for Best French Radio Receivers

THE DIRECTOR of the Central Radio College, Mr. Eugene Poirot, has decided to award each year prizes for the best radio receiver designed and built by radio engineers having obtained their education in France. Radio receivers put on the market before the annual competition are not admissible. Two classes of receivers will be distinguished: the highly refined receiver and the receiver for everybody. Prizes to the amount of 15,000 French francs will be awarded by the jury. The performance of the receiver will be studied at the National Radio Laboratory, Paris.

Phase Inversion Circuits

WITHIN THE PAST several years an increasingly large number of phase inversion systems have been introduced and an appreciable amount of data has been published for many of them. The Hygrade Sylvania Corp., Emporium, Pa., have recently made available their Engineering News Letter No. 41, dealing with "Performance Characteristics of Phase Inversion Circuits." It is the purpose of this letter to present briefly a comparison of the performance characteristics of a number of the different systems of phase inversion circuits, so that the advantages and disadvantages of each may be summarized and made available in useful form. The characteristics of seven typical circuits are presented graphically for comparative purposes.

Modern Marvel

THE ELECTRON TUBE has been credited with accomplishing many astonishing operations. It is now proposed to put the tubes to use to record non-existent entities.

Free radio sets are to be distributed to families of Japanese soldiers in North China by the Communications Ministry, according to an official Domei News Agency report. The object of the move is to make it possible for soldiers' families to hear the government's official broadcast on the situation at the front—of a war, which we are told, does not exist.

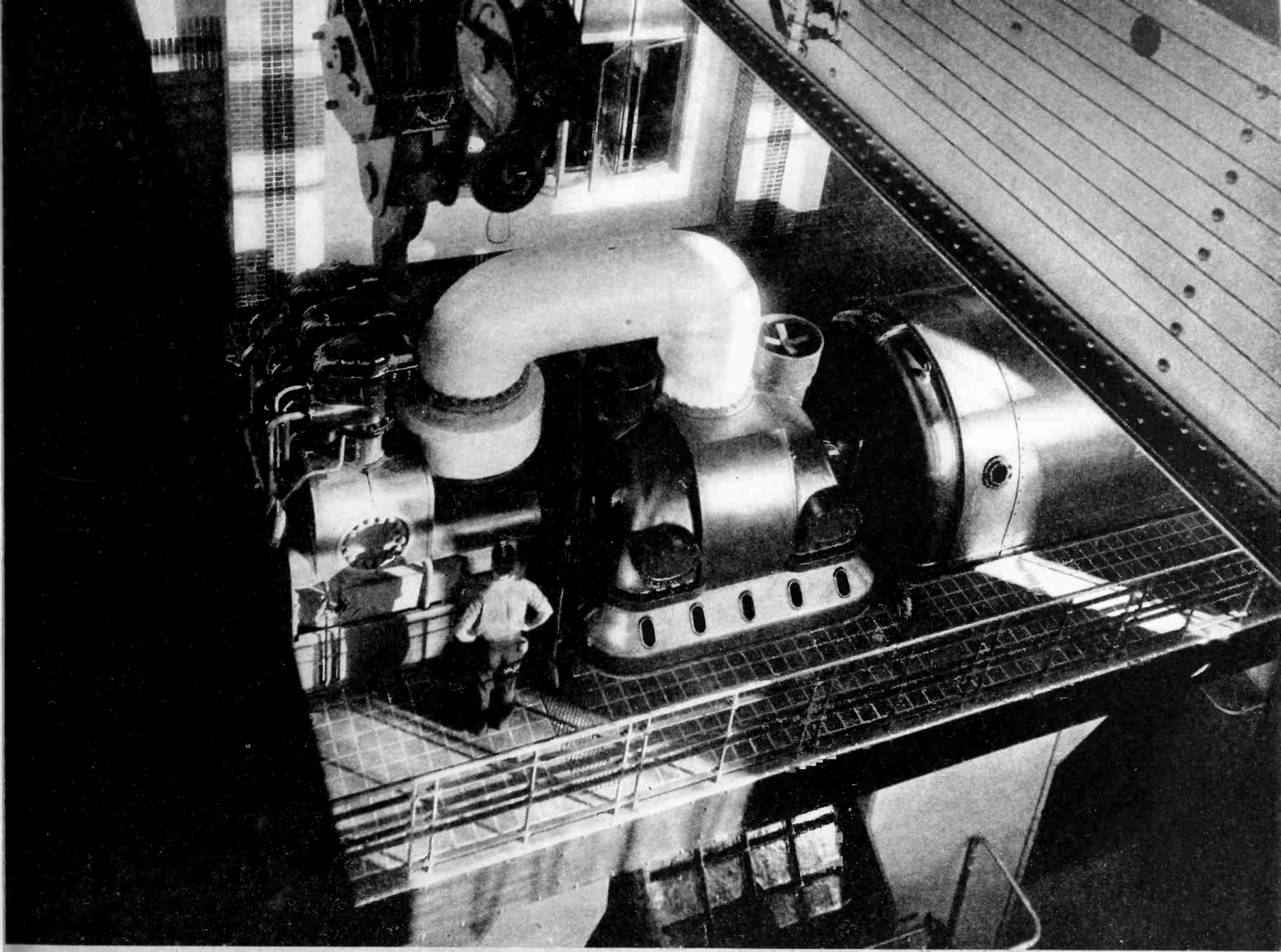

POWER NEEDS PROTECTION

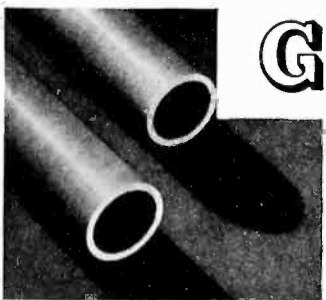

GENERATORS, great sources of electrical energy, would work in vain without adequate insula-

tion. *Synthane* plays its part. *Synthane* protects—protects the flow of energy from generator to bus bar to substation to point of use. . . . *Synthane* has many other applica-

tions. . . . *Synthane* Bakelite-laminated is a uniformly dense, solid material possessing a combination of useful physical, chemical, mechanical and electrical characteristics. It is tough, strong and light in weight; one of the most effective dielectric materials; chemically inert and corrosion resistant. It is easy to machine. The uses for *Synthane* are countless. . . . *Synthane* is a type of

material indispensable in insulating electrical products. It may similarly be of material assistance in the manufacture of your product. Write for "*Synthane* for Mechanical Applications". (Please indicate your requirements in your request) . . . *Synthane* gives you *Material Satisfaction*.

SYNTHANE CORPORATION, OAKS, PENNSYLVANIA

SHEETS • RODS • TUBES • FABRICATED PARTS • SILENT STABILIZED GEAR MATERIAL

SYNTHANE
Bakelite —  laminated

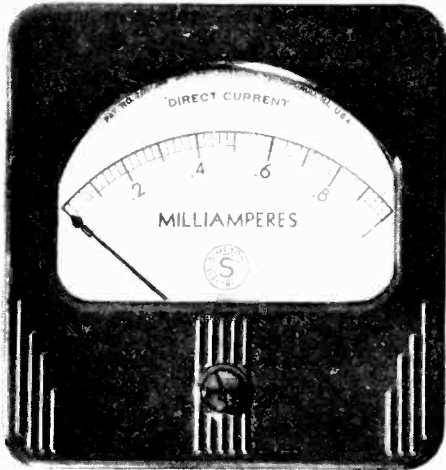

This handsome, streamlined instrument is available with translucent dial illuminated from the rear by a built-in 6-volt lamp.

"You've GOT something there!"

THAT is the verdict of men who know panel meters when they examine the design and construction of this new line of Simpson Meters.

The movement was developed by Ray R. Simpson, formerly president of Jewell Electrical Instrument Company, in collaboration with some of the same engineers who once took part in building the Jewell reputation for accuracy and ruggedness. It has the "bridge-type" construction and soft iron pole pieces which are the recognized prerequisite of accuracy and permanency in a meter movement.

As important as this better type of construction is the workmanlike way in which it is carried out in these meters. The trim design that you see in the illustrations is merely the outward evidence of refinement that is found in every detail of the movement dial and case.

Still more remarkable is the fact that this premium quality asks no premium price. This should be your final reason for investigating the new Simpson line. Whether you need meters for original equipment in electrical devices you manufacture, or for testing in production work, there is a Simpson instrument that will fill the requirement. Ask for complete description and prices.

SIMPSON ELECTRIC CO.
5218 W. Kinzie Street, Chicago

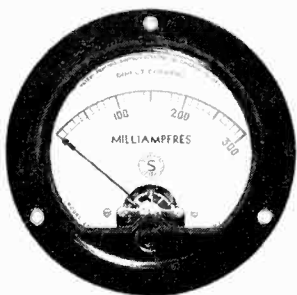

A typical round case instrument, made in many types and ranges.

SIMPSON

Instruments that STAY accurate



G.E.C. vision-only receiver which sells for \$175, shown at the Radio-lympia Exhibit, London

British Television

(Continued from Page 35)

scene represented by a white field having a vertical black bar; a grey scene represented by a grey field having a white vertical bar followed by a black bar, and a black scene represented by a black field having a vertical white bar.

In the case of *continuous scanning of such fields*, a few adjacent lines from the bright scene would (in voltage variation) be as shown at *W*; from the grey scene as shown in *G*; from the black scene as shown in *B*. The voltage changes are here shown as variations from a fixed level, i.e., the d-c components are present. It is evident then that for all types of scenes the amplitude level of the carrier wave is defined and is zero for synchronizing peak 30 per cent for black and 100 per cent for peak white. We understand that the system of modulation employed at Alexandra Palace is similar to that here illustrated. The black level is always definite and is said to be 3 kw. The value of peak white may be set as high as 17 kw.

The story for positive modulation and "d-c working" at the receiver has similar points of interest. Demodula-

tion of the carrier is represented graphically in Fig. 6 for the case of an average detector. Here, as in the transmitter story, curvature of the detector is made to fall in the region of the synchronizing peaks. The result is that, in the illustration, the synchronizing peaks are slightly shortened to give a signal of 75 per cent video, 25 per cent synchronizing. There is, however, no distortion of the signal.

In practice, the tendency is to employ a diode detector as shown in Fig. 7 where operation is preferably as a peak detector. This operation is more difficult to illustrate but it is well known that with such detectors the distortions occur on the "inward modulation" in the region of zero carrier. Hence the diagram of Fig. 6, is suffi-



As business paper publishers for over fifty years, McGraw-Hill is uniquely equipped to offer complete, authoritative direct mail coverage of industry's major markets. Extreme accuracy is maintained (guaranteed to 98%) and thorough careful analysis of markets, complete classification of companies and personnel, etc., the widest possible selections are available. Send for handy reference folder "Hundreds of Thousands of Reasons Why" which describes how McGraw-Hill Lists are built and maintained.

What Fields Do You Want to Reach?

- Aviation
- Bus & Electric Railways
- Civil Engineering and Construction
- Administrative Executives
- Electrical Dealers & Wholesalers
- Mill Supply Houses
- Power Services
- Product Engineering & Design
- Production and Maintenance
- Radio Dealers & Wholesalers
- Radio Engineering & Design

For further details, selections from above basic classifications, counts, prices, etc., or estimates on special lists ask any representative or write to



Complete Lists Covering Industry's Major Markets

LEACH LR RELAYS

ALWAYS ON THE JOB GIVING DEPENDABLE OPERATION

The new Leach Impulse Relays make possible many new developments such as new circuits, new lock-out schemes—alarm systems and safety devices. Operation is dependable, absolutely quiet, and fast . . . time required to shift from one position to the other is approximately 1/60 second.

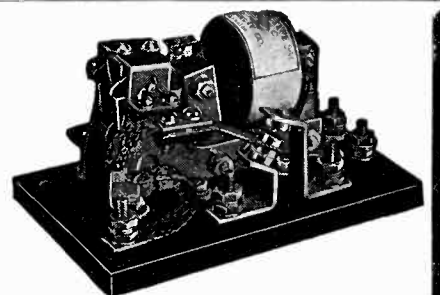

LEACH RELAY COMPANY
5915 Avalon Boulevard, Los Angeles, Calif.
15 E. 26th St., New York City

LEACH RELAY CO., 5915 AVALON BOULEVARD, LOS ANGELES, CALIF.

Please send me your new catalog. I am interested in . . . relay.
Name
Company
Address City



*The Men Who MAKE
the Radio Industry*
THEY'LL ALL BE THERE!
*AND in their hands will be
the great November I. R. E.*
CONVENTION ISSUE OF
electronics

*Here is the opportunity to reach every important man—
every company of importance in the radio industry—*

When they are **thinking in terms of new design—
searching collectively for new pro-
ducts—open minded to sales approach
—standing in groups around the
ELECTRONICS booth to get a look at
their convention issue.**

**EVERY MAN AT THE CONVENTION + 12,000 MORE — THE ENTIRE
LIST OF THE KEY MEN OF THE ELECTRONICS INDUSTRY WILL
READ YOUR SALES MESSAGE IN THIS NOVEMBER ISSUE. YOU
CAN'T AFFORD TO MISS IT— FORMS CLOSE OCTOBER 25**

While It's Still On the Board

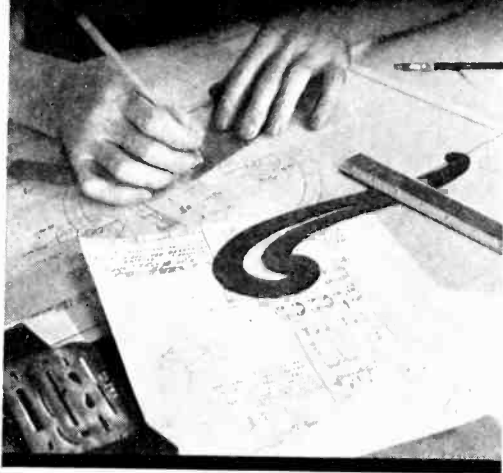

Consider the Contacts!

Too often are electrical contacts slighted until changes in plans become costly. Much difficulty can be avoided by deciding your contact requirements *before* your new product goes into manufacture. And substantial savings often can be made by adapting your design to use standard materials and dimensions.

Fansteel engineers will be glad to examine your prints or sketches and recommend the right contacts—tungsten, molybdenum, platinum, silver or one of our special alloys. From their broad experience they may be able to suggest cost and trouble saving short cuts in design. Entirely confidential, of course.

FANSTEEL

METALLURGICAL CORPORATION
NORTH CHICAGO, ILLINOIS

TANTALUM	COLUMBIUM
TUNGSTEN	MOLYBDENUM
ELECTRICAL CONTACTS	

ciently illustrative of that case also since for both types of detection, the distortions of tube curvature will affect only the amplitude of the synchronizing peaks.

The schematic circuit of Fig. 7 is intended as an illustration of "d-c working". As was pointed out in the Electronics July article, the d-c component must be present prior to application of the signal to the cathode ray tube grid and to the synchronizing separation circuits. In the circuit of Fig. 7 the detector develops the signal plus the d-c component and the d-c is not lost in the following circuits. The small graphs indicate the signal in its correct polarity and potential as applied to the video amplifier tube V_1 , as applied to the synchronizing separator V_2 , and as applied to the cathode ray tube grid. The example shown is an entirely acceptable and efficient circuit.

Practice as it exists in England varies more in the way of utilization of the detector's output than would seem possible. There are various practices relative to retaining the d-c component. To avoid direct coupled stages it is the practice of some to capacity couple the video stage to the cathode ray tube grid and then reinsert the d-c. The practice of others is to lose and reinsert the d-c in coupling to the synchronizing separator.

It might appear that this is an argument for not directly modulating the carrier with the d-c. It appears, however, that all British engineers would oppose such a change. The loss of the d-c in the carrier can cause all manner of overloads in the i-f and carrier channels. It sums up to this:—the d-c may be dropped for the sake of a coupling connection but it must be immediately restored—"else the black level will wander". From that point in the transmitter where d-c is established, its presence and relative level is maintained religiously until utilized at the receiver. It would not be putting it too strongly to say that the level of black is a definite foundation upon which the structure of British television is built.

A final confirmation of the practical nature of the British standard is that the other European countries are adopting its principal feature of "d-c working" and positive modulation.

German television as demonstrated by the various companies showing at the Berlin exhibit of July 30 to August 8, was briefly surveyed. As in the United States they have no high definition television on the air as a regular program. There is no final agreement among the various companies to a standard frame synchronizing signal and each company demonstrates its receivers with its own transmitters. The results are, however, comparable with the British system and it is evident that the principal British standards will be closely adhered to.

It is gratifying to have had the opportunity to make a close study of British television and to have enjoyed the hospitality of the engineers of various British companies during this work.



ULTRA-SENSITIVE DC METER

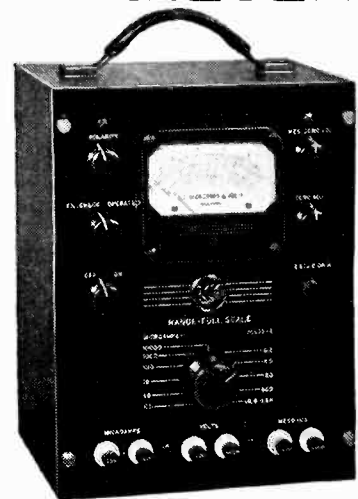

RCA TMV-178-A

Range of Measurements
.02 to 10,000 MICROAMPERES
0.1 to 500 VOLTS
0.1 to 10,000 MEGOHMS
AVERAGE ACCURACY—2%

**Specially practical
for measuring Ion, Electron,
and Galvanic currents
of very low values**

EMPLOYING a new and novel application of electronic circuits for accurate and sensitive DC measurements.

The RCA Ultra-Sensitive Meter is a convenient, compact and completely self-contained precision instrument. Can not be easily damaged or burned out by overloads. Does not require any special set-up or balancing. Portable, excellent for field measurements as well as laboratory use. Contains all necessary batteries for long and continuous operation.



*Test
Equipment*

RCA Manufacturing Co., Inc., Camden, N. J.
A Service of Radio Corporation of America

MANUFACTURING REVIEW

News

◆ The appointment of Alfred Crossley as special consulting engineer to its engineering staff is announced by the Belden Manufacturing Co., 4689 West Van Buren St., Chicago.

Mr. Crossley has been active in the radio field for many years and is well-known for his past activities as chief engineer of a number of prominent radio manufacturers. In his new capacity as radio consultant, Mr. Crossley will work in close cooperation with the Belden Manufacturing Co.'s engineering department. Investigations now being made by Mr. Crossley cover the design and production of advanced types of antenna systems and transmission lines.

◆ An ultra short-wave radio telephone circuit which transmits nine completely segregated two-way telephone conversations simultaneously, has been established by the British Post Office between Ireland and Scotland according to an announcement by the International Telephone & Telegraph Corp.

Communication is carried on with waves 10 cm. long.

◆ Equipment sales are opening the fall season at a brisk rate, according to an announcement made by the Electrical Research Products, Inc. Contracts for the beginning of the third quarter are keeping pace with last year's business and have more than doubled the summer business. Installation in the mid-western areas has been most active and may easily be accounted for by optimism resulting from the prospects of a boom harvest.

◆ Harold J. McCreary, formerly chief engineer of the Leigh Electric Co., Genoa, Ill., manufacturers of a complete line of telephone equipment, has recently established his own consulting practice at 105 West Adams St., Chicago, Ill. Mr. McCreary will be engaged in consulting work in the electrical communication field where he has had considerable experience with a number of large companies.

◆ The Stupakoff Laboratories, Inc. of Pittsburgh have just completed a plant modernizing program for increased and improved facilities for handling ceramic products. These additions and improvements enable the Stupakoff Laboratories to expand their activities in the production of quality insulators in the radio, appliance, and electronic tube fields.

◆ Mr. M. N. Breitman, author of articles and booklets on sound systems, has been added to the engineering staff of the Chicago branch of the Wholesale Radio Service Co.

◆ Hazeltine Service Corporation has opened a Chicago office at 325 West Huron Street where J. Kelley Johnson will be in charge. Mr. Johnson is an engineer of wide acquaintance in the radio industry. The new office will enable middle western licensees to have closer contact with Hazeltine engineers.

New Products

Small Speaker

THE INTRODUCTION of a 3-in. permanent magnetic dynamic speaker is announced by the Oxford Tartak Radio Corp., 915 West Van Buren St., Chicago.

Soldering Outfit

AN ELECTRIC soldering outfit, different from the conventional soldering iron and using a small arc for the heat production, instead of the wire heating unit has been made available by the Cole Radio Works, Caldwell, N. J.

Tri-Polar Microphone

ACCORDING TO an announcement released by Shure Bros., 225 West Huron St., Chicago, a new crystal microphone having interesting directional characteristics has been devel-



oped. The microphone consists of two essential parts, a velocity actuated element and a pressure actuated ele-

ment. The microphone may be used as a uni-directional, bi-directional or non-directional microphone.

Megohm Bridge

TYPE 544-B megohm bridge manufactured by the General Radio Co., Cambridge, Mass. is an improved version of this company's Type 544-A Megohm Meter. The circuit is that of a conventional Wheatstone bridge with a vacuum-tube voltmeter used as the de-

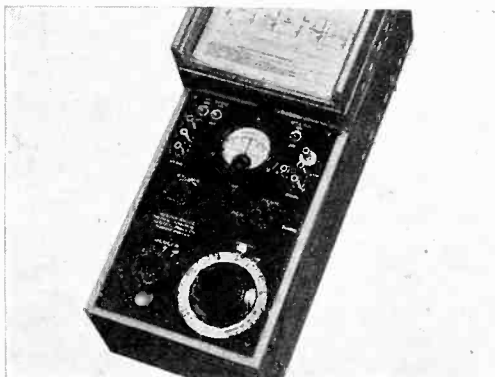

tector. The bridge is balanced by means of a logarithmic dial and a multiplier switch. A micro-ammeter in the plate circuit of the vacuum tube detector serves as a null indicator.

The useful range of measurement is 0.1 megohm to 10,000 megohms, which is covered by an effective scale length

of 35 inches. Resistances up to one-mega-megohm (10^{12} ohms) can be detected. Provision is made for the measurement of 3-terminal samples using guard electrodes. The voltage across the sample is 90 volts and is practically constant during balance. up to 500 volts to the bridge from an external source.

This bridge is useful in measuring the insulation resistance of cables and electrical machinery, the leakage resistance of condensers, and the volume resistivity of insulating materials. Since volume resistivity is sensitive to small traces of moisture, measurements with this bridge can be used as a measure of moisture content.

The accuracy of measurement is $\pm 3\%$ between 0.1 megohm and 100 megohms, and is $\pm 6\%$ between 100 megohms and 10,000 megohms. Accuracies of better than 1% can be obtained by using an external decade-resistance box. The bridge is supplied for either a-c or battery operation. It weighs approximately 30 pounds and is $22\frac{1}{2} \times 8\frac{1}{2} \times 8$ inches over-all.

Microphone

A COMMUNICATION type microphone incorporating a "grip-to-talk" switch is announced by the Astatic Microphone Laboratory, Inc., 830 Market St., Youngstown, Ohio.

electronics

Catalog & Literature Service

Manufacturers' literature constitutes a useful source of information. To make it easy to keep up to date, "Electronics" will request manufacturers to send readers literature in which they are interested.

1. **Amperex Catalog.** A catalog of 28 loose-leaf sheets and printed in two colors is available from the Amperex Electronic Products, Inc., 79 Washington St., Brooklyn, N. Y. This catalog describes the complete line of Amperex transmitting power tubes with technical data relative to the operation of these electron devices.

2. **Multiple Scale.** A folder describing revolving multiple scales for measuring instruments is available from H. A. Allison, 19411 Woodstock Road, Detroit, Mich., U. S. representatives for Robert Abrahamsohn, originator of this ingenious scale.

3. **Headsets.** Copies of catalog pages describing headsets and other electric acoustic devices and accessories manufactured by the Trimm Radio Manufacturing Co., 1770 West Berteau Ave., Chicago, is available from that company.

4. **Record Prices.** A new price list, effective September 1 and covering their line of recording accessories is available from the Mirror Record Corp., 58 West 25th St., New York City.

5. **Gasoline Electric Plant.** Bulletin 23-25 describes a-c and d-c gasoline electric plants manufactured by the Janette Manufacturing Co., 556 West Monroe St., Chicago, Ill.

6. **Resistor Catalog.** A new 12-page catalog covering their complete line of volume controls, fixed resistors, selector switches and auto radio noise suppressors has just been issued by Centralab, 900 East Keefe Ave., Milwaukee, Wis.

7. **Transformers.** Two folders covering transformers are available from Ferranti Electric, Inc., 30 Rockefeller Plaza, New York City. One of these describes audio receiving and similar transformers whereas the other describes plate and filament transformers as well as filter chokes.

8. **Mercury Contacts.** Catalog No. C 71-MB illustrating and describing ferro-tube mercury contacts is available from the Jefferson Electric Co., Bellwood, Ill.

9. **Science in Music.** A 4-page folder describing the use of the DuMont Resonoscope in determining the pitch of musical instruments is available from Epiphone, Inc., 142 West 14th St., New York City.

10. **Overhead Conductor.** A 38-page bulletin printed for loose-leaf binding and describing flexible and mobile electrical distribution systems designed to meet varying light and power demands has been published by the Bulldog Electric Products Co., Detroit, Mich.

11. **Service Equipment.** An 8-page folder issued by the Supreme Instrument Co., Greenwood, Miss., lists a complete line of new equipment for the service man.

12. **Mercury Switches.** A 12-page bulletin, designated as catalog 603, describing the complete line of Kon-nec-tor mercury switches has just been issued by the General Electric Vapor Lamp Co., Hoboken, N. J. A 4-page section is devoted to desirable applications of mercury switches.

13. **Tube Bulletin.** Technical bulletins covering vacuum tube characteristics have recently been issued by the Raytheon Production Corp., 55 Chapel St., Newton, Mass. These new bulletins cover the K49C-B resistance tubes, and the NB1-NB8 resistance tubes for battery operated 2-volt receivers.

14. **Test Speaker.** A single sheet folder describes the multi-test speaker recently introduced by Wright-DeCoster, Inc., St. Paul, Minn. The unit is intended to test all a-c and d-c radio receivers and requires no field excitation.

15. **Phototube Control.** A bulletin issued by the Electronics Control Division of the United Cinephone Corp., Long Island City, N. Y., gives a brief description of various types of phototube controls for industrial applications and allied uses. In all, nineteen different models are available from stock or on short notice and will operate at an illumination of 1 ft. candle or more. The various models are available with different types of make and break relay contacts in the output circuit and suitable for operation on power circuits of various voltage ratings. The units are complete rather than designed specifically for each individual job and are moderately priced.

16. **Rotating Machinery.** A small 16-page brochure issued by the Janette Manufacturing Co., 556 West Monroe St., Chicago, describes a complete line of custom-built motors, generators, speed reducers, and similar rotating electrical machinery.

17. **Motor Slot Insulation.** A 4-page folder issued by the Spaulding Fibre Co., Inc., 310 Wheeler St., Tonawanda, N. Y., describes technical characteristics and engineering data on improved motor slot insulation of high dielectric strength.

18. **Photoelectric Potentiometer.** Circular B-501-A issued by the Weston Electrical Instrument Corp., Newark, N. J., describes the model 721 photoelectric potentiometer employing a new method of potentiometric control and measurement featuring high speed and sensitivity combined with permanently stable calibration.

19. **Aircraft Communication Equipment.** Lear Development, Inc., 121 W. 17th St. New York City, have recently issued a 4-page bulletin describing two-way aircraft communication equipment and antenna reel.

(Continued on Page 66)

ELECTRONICS

October

Please request manufacturers to send me, without obligation, literature identified by numbers circled below.

1	2	3	4	5	6	7	8	9	10	11	12	13	14
15	16	17	18	19	20	21	22	23	24	25	26	27	28
29	30	31	32	33	34	35	36	37	38	39	40	41	42
43	44	45	46	47	48	49	50	51	52	53	54	55	56

NAME..... TITLE.....

COMPANY.....

ADDRESS.....

CITY..... STATE.....

**Just try to find a program
you can't pick-up better with
the "8-Ball" or the "Salt-Shaker"**

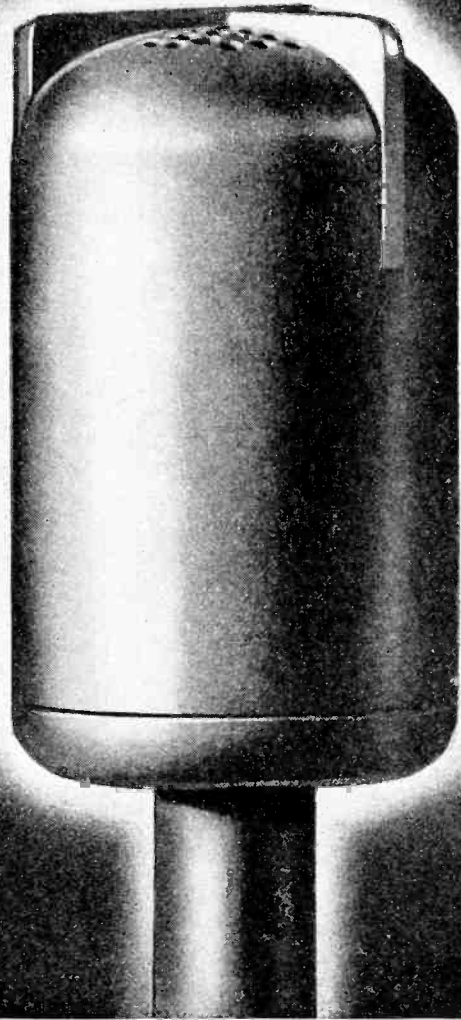
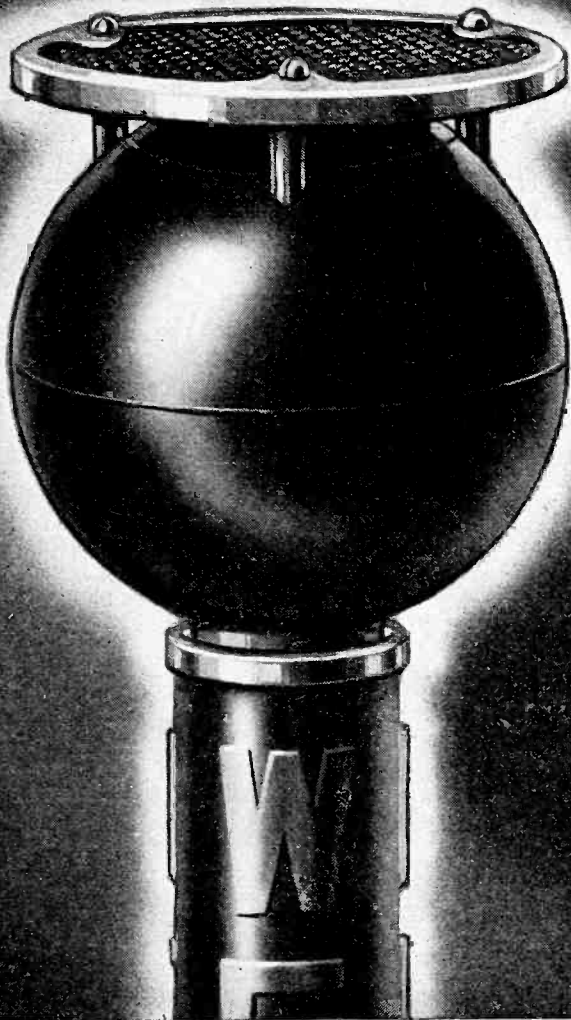

Between them, these two famous Western Electric mikes meet every broadcasting need. Both can be used for non-directional pickups—both can be transformed quickly for directional work by simply putting on their acoustic baffles.

The "8-Ball," which jumped into immediate popularity two years ago, is still being bought in bunches. And

orders for the newer "Salt-Shaker" keep pouring in from broadcasters—and from Public Address operators who find it ideal for their work, too.

At the low prices, you can't afford anything less than the true Western Electric quality these two mikes will give you! For full details: Graybar Electric Co., Graybar Bldg., New York.



Western Electric

Distributed by GRAYBAR Electric Co. In Canada: Northern Electric Co., Ltd.

RADIO TELEPHONE BROADCASTING EQUIPMENT

**GET FREE
YOUR COPY OF
CATALOG
DESCRIBING
THESE BETTER
RHEOSTATS**

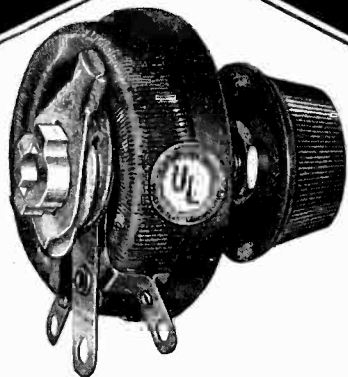

**OHMITE
VITREOUS ENAMELED
RHEOSTATS**

*No other type of
power rheostat
made can give you
the close gradua-
tion of control
which these rheo-
stats afford.*

Please send OHMITE catalog:
NAME:
COMPANY:
ADDRESS:
TITLE:

OHMITE
MANUFACTURING COMPANY
4825 W. FLOURNOY ST.
CHICAGO, U.S.A.

20. **Intercommunicating System.** A 6-page folder (Form 1652G67) from the Operadio Manufacturing Co., St. Charles, Ill., describes communicating equipment made by this company.

21. **Automobile Antenna.** A folder describing an automobile antenna that extends above the car roof just the required distance for best reception is available from Hugh H. Eby, 2066 Hunting Park Ave., Philadelphia.

22. **Police Radio Equipment.** Bulletin GEA-2660 describes transmitting and receiving equipment and accessories designed by the General Electric Co., Schenectady, N. Y., for police radios.

23. **Panel Instruments.** Bulletin GEA-2645 describes modern small panel instruments with two per cent accuracy and suitable for equipment manufacturers. The meters are manufactured by the General Electric Co., Schenectady, N. Y.

24. **Recording Instruments.** Presto Recording Corp., 139 W. 19th St., New York, has released a brochure describing their Junior sound recorder.

25. **Recording Equipment.** A catalog issued by the Universal Signal Appliances, 64 W. 22nd St., New York City, describes this company's line of automatic recording and keying equipment for recording telegraph messages and similar applications.

26. **Plastic.** "Molding with Lumarith" is the title of a 24-page booklet describing some of the applications and uses of this material. The booklet is issued by the Celluloid Corp., 10 E. 40th St., New York City.

27. **Resistant Finishes.** "Chemical Resistant Finishes" and "High Resistance to Spots and Tarnish" are the subjects covered in two bulletins recently released by the Roxalin Flexible Lacquer Co., Elizabeth, N. J.

28. **Capacity Relay.** A capacity-operated relay that closes a circuit when approached and which may be used for protective purposes is described in a single page data sheet issued by the Luxtrol Company, 205 West 19th St., New York, N. Y.

29. **Record Prices.** A price list of recording discs and accessory equipment of their manufacture is available from the Mirror Recording Corp., 58 West 25th St., New York, N. Y.

30. **Shakeproof Engineer.** Vol. 1, No. 1 of the "Shakeproof Engineer", a new house publication of the Shakeproof Lock Washer Co., 2501 N. Keeler Ave., Chicago, Ill.

31. **Replacement Transformers.** Catalog R-2 lists a complete line of replacement transformers manufactured by the Kenyon Transformer Co., Inc., 840 Barry St., New York, N. Y.

32. **Antenna Manual.** An antenna system manual just issued by the Technical Appliance Corp. may be obtained from this company at 17 E. 16th St., New York, N. Y.

33. **Magnetic Blowout.** An 8-page folder on facts worth knowing regarding electrical protection is obtainable from the Heinemann Electric Co., Trenton, N. J.

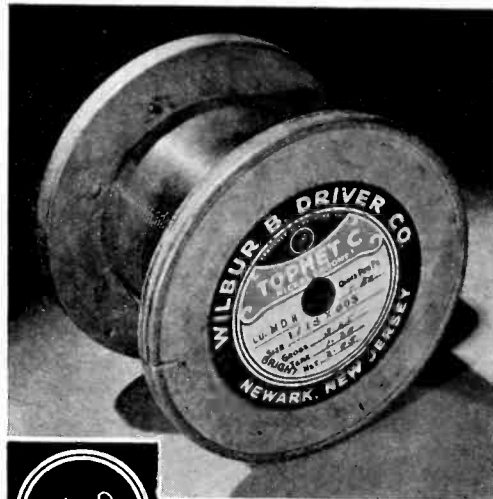

Critical resistance-wire users seeking dependable performance and uniformity, choose

Topnet

The nickel-chrome alloy made and endorsed by the pioneer. Hard or soft tempers, wire or ribbon, bare or insulated.

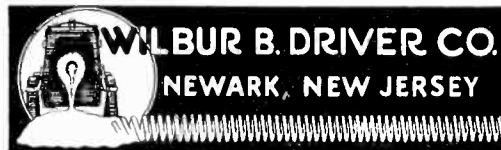

Callite Products

HAVE TESTED, PROVEN
QUALITY

TUNGSTEN

... Rod, Sheet, Wire and Special Shapes
... Hard Glass Welds

MOLYBDENUM

... Rod, Sheet, Wire and Special Shapes
... For Grids, Round or Flat
... For Grids, Supports, Heating Elements
... Hard Glass Welds

KULGRID

... For Grids, Round or Flat
... Kulgrid "C" Tungsten Welds

CONTACTS

All Sizes and Shapes For All Applications

... Tungsten - Molybdenum
... Silver and Platinum
... Special Alloys
... For High Conductivity
... Precious Metal Laminated
... Silver and Platinum on Base Metals

CAL-LUX
FLUORESCENT MATERIALS

- WITH -
Measured Characteristics
... For All Applications

Callite Products

Division of EISLER ELECTRIC CORP.
544 - 39th STREET • UNION CITY, N. J.

The Company We KEEP

**A business magazine is known by the company it keeps —
the companies it maintains as advertisers, year after year.**

FORTY-FIVE organizations who advertised in **ELECTRONICS** in our charter year, 1930-1 continue to be with us now. Their success is ours.

Much water has gone over the dam since the introduction of this magazine seven years ago. The prolonged depression levelled off the industry — the weaker organizations dropping out; consolidations strengthening others; solid, well-managed companies holding their own.

Through this period, **ELECTRONICS**, with these early advertisers, has held its head high. It has maintained its editorial policy as originally conceived, serving a constantly broadening field as the use of the electron tube has spread with progress.

In volume 1, number 1, of **ELECTRONICS**, April, 1930, our editors said:

"The art of the electron tubes goes forward to great and greater achievements. To the engineers and executives in all the ramified branches of electronics, the editors and publishers pledge a service worthy of this field of unparalleled opportunity."

That Was the Dream—The Big Idea

This issue of **ELECTRONICS**, its predecessors,

and the issues to come are the successful fulfilment of that pledge.

The Reward of Consistency

The consistency with which we have maintained our original policy has brought us success — has created a magazine without competition which is bought by over 12,000 subscribers and read by four times more — every company — every man of importance in this amazing industry.

We feel strongly that the same consistency, shown by these 45 charter advertisers in utilizing the pages of **ELECTRONICS** to keep their products and their abilities constantly before the important companies and men, has contributed no little to their success.

We are proud that we have walked with them through the lean years and come out into the radiance of what promises to be one of the greatest industrial strides in American history — the pace of advance of the electron tube.

A great many other companies have become consistent advertisers in **ELECTRONICS** since this first year. They are finding—as have the original 45 — that regular use of **ELECTRONICS** is as important as regular routing of salesmen.

ELECTRONICS Salutes the Following 45, Who Have Been With Us Since Our First Year

Acme Wire Company
Allen-Bradley Company
American Lava Corporation
American Transformer Company
Arcturus Radio Tube Company
Bakelite Corporation
Allen B. Cardwell Manufacturing Company
Central Radio Laboratories
Central Scientific Company
Clarostat Manufacturing Company
Continental Diamond Fibre Company
Daven Corporation
Dubilier Condenser Corporation
Electrad, Incorporated
Erie Resistor Corporation

Fansteel Products Company
Ferranti, Incorporated
The Formica Insulation Company
General Electric Company
General Radio Company
Goat Radio Tube Company
Hardwick-Hindle, Incorporated
Hammarlund Manufacturing Company
Hygrade-Sylvania Corporation
International Resistance Company
Isolantite Company
Leach Relay Company
Littlefuse Laboratories
Electro Acoustic Products Company
P. R. Mallory, Incorporated
Micra Insulator Company
The Muter Company

Ohmite Manufacturing Company
Radio Corporation of America
Shakeproof Lock Washer Company
Shallcross Manufacturing Company
Sprague Specialties Company
Synthane Corporation
Thordarson Electric Manufacturing Company
Universal Microphone Company
Universal Winding Company
Ward Leonard Electric Company
Weston Electrical Instrument Company
S. S. White Dental Manufacturing Company
Yaxley Manufacturing Company (Mallory)

**It is not too early to think of your new appropriations.
Make ELECTRONICS a profitable member of your sales force.**

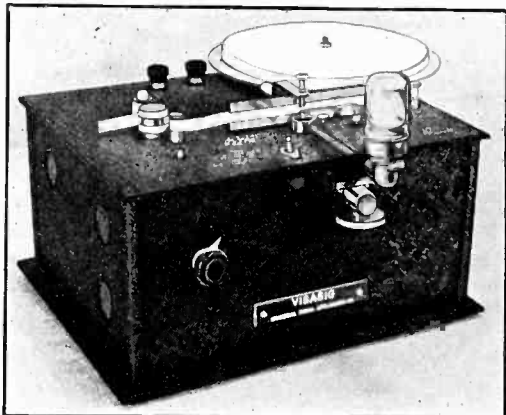

VISASIG

full automatic siphon tape recorder

FOR COMMERCIAL AND AMATEUR USE

1 cent's worth tape records over 3,000 words

Model VI-B — Semi-Professional

List \$75.00

Model V-5 — Professional High Speed

List \$175.00

Prices FOB New York City

Export Department 116 Broad St., N. Y. C., U. S. A.

Cable Address: Auriema, N. Y.

Write for full particulars

UNIVERSAL SIGNAL APPLIANCES

Department E

64 West 22nd Street

New York City

Multivibrator

DESIGNED TO SIMPLIFY the alignment of radio receivers, especially the recent models covering a wide range of frequencies, the Monarch Manufacturing Co., 3341 Belmont Ave., Chicago, has introduced their model 20 multivibrator. Frequencies from the multivibrator are available up to 20 mc. or more, and enable the test operator to determine the operation of the receiver in each band almost as rapidly as the receiver can be tuned.

Coaxial Cable

THE TRANSDUCER CORP., RCA Building, New York City, announces a new coaxial cable known as CO-X which is recommended for use for antenna leads, antenna transmission lines and feeders and lines between photoelectric cells and amplifiers, and numerous similar applications.

Test Bench Panels

LABORATORY TEST bench panels, in three cabinet styles, and offering facilities for complete service of radio equipment have recently been announced by

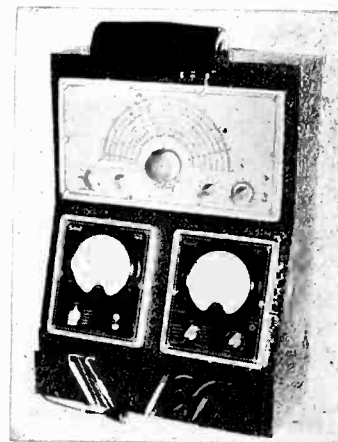

the Triplett Electrical Instrument Co., Bluffton, Ohio. The model illustrated accommodates three test units. Any two or more cabinets can be bolted together to form a continuous panel in which Triplett standardized units may be fitted.

New Tubes

ANNOUNCEMENT COMES from the Radiotron Division, RCA Manufacturing Co., of Harrison, N. J. of the introduction of the 6Y6-G beam power tube, which is intended for use in the output stage of a-c receivers, particularly those in which the plate voltage for the output stage is relatively low. With 135 volts on the plate and screen, this tube is capable of giving an output of 3.6 watts with a maximum signal input of 13.5 volts. Under these conditions, the total distortion is about 9½ per cent.

STABILIZED VOLTAGE

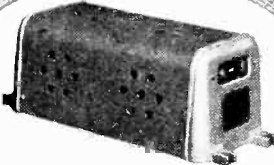

RAYTHEON VOLTAGE REGULATORS
U. S. Patents 1,913,334 and 1,913,335

are magnetic devices without moving parts or adjustments which automatically stabilize AC voltages to plus or minus 1%

SOME BENEFITS OF STABILIZED VOLTAGE

- Factory Test Equipment—eliminates manual voltage adjustments
- Amplifiers and Rectifiers—makes AC fluctuations unimportant
- Laboratories — holds AC voltage constant during tests
- Photo-cell Light sources — stabilizes illumination
- X-ray Tubes—holds filament emission constant
- Pirani Gauges—permits AC operation

WRITE FOR
Bulletin DL48-7110E

RAYTHEON MFG. CO.

WALTHAM, MASS.

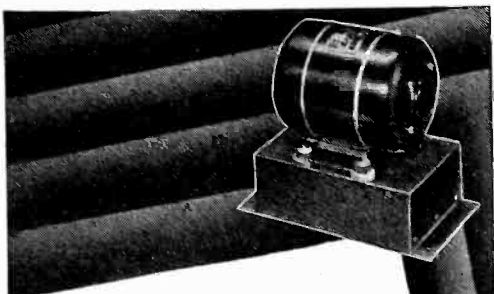

"PINCO"
DYNAMOTORS
CONVERTERS
GEN-E-MOTORS

Radio engineers have learned from experience that Pioneer Gen-E-Motor Corporation's dynamotors, gen-e-motors and converters provide the last word in dependable power supply units for air craft, police, marine and auto radios and public address systems. They are available in a wide range of capacities for every requirement. Designed and constructed to give maximum long life and service. Light weight and compact. For complete information write Dept. No. R-4J
 466 West Superior St.
 CHICAGO, ILL.

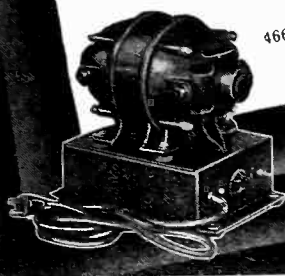
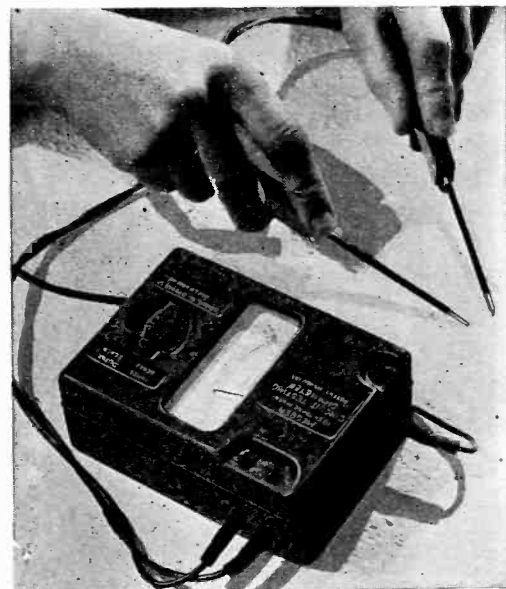
"MEGGER" Presents

a new and unusual type of portable ohmmeter for the man who needs something definitely better than instruments heretofore available—something more dependable and more accurate, with which to measure resistance of coils, contacts, circuits, relays and other equipment.

THE MIDGET "MEGGER" CIRCUIT TESTING OHMMETER is a true "Megger" Cross-Coil Ohmmeter (not just a voltmeter calibrated in ohms). It requires no adjustment for battery voltage. Has remarkably wide ranges—from .1 ohm to 200,000 ohms. Has remarkably low ranges—0 to 3 ohms full scale, reading to .02 ohm. Built to "Megger" standards of accuracy, ruggedness and durability.

Write for descriptive Bulletin 1495-E.

JAMES G. BIDDLE CO.
 ELECTRICAL AND
 SCIENTIFIC INSTRUMENTS
 1211-13 ARCH ST. PHILADELPHIA, PA.

Panel Instrument

THE Sensitive Research Instrument Corp., 4545 Bronx Blvd., New York City, announces the release of their line of 4½-in. panel type instrument. These instruments have been specifically designed and used for vacuum tube production test sets. The designs



are new in that any instrument can be mounted either flush or projection mounting by the user on any panel thickness, and multiranges up to four internal ranges, entirely switch controlled, are available. Microammeters are available down to 10 microamperes and millivoltmeters down to two millivolts full scale deflection.

Multi-connector Plug

THE Guardian Electric & Manufacturing Co., 1621 West Walnut St., Chicago, offers manufacturers a multi-connector plug that may be disconnected by merely lifting cable lacing extension on the end of the plug strip. This feature is made possible by spring tension clips having cutting edges which insure good contact with the plug at all times. Standard plugs of two, four, six, eight, ten, twelve and fourteen points are carried in stock at all times.

Improved Sound Apparatus

A NEW LINE of improved public address and sound reinforcement equipment, which includes among other technical developments a unique electric mixing unit for remote control of

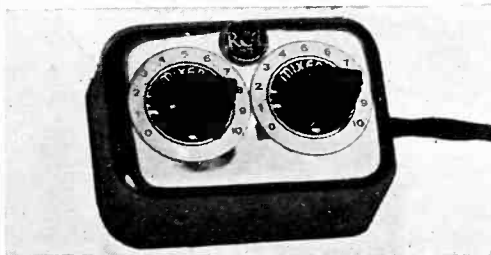

sound distribution has been announced by the Commercial Sound Section, RCA Manufacturing Co., Camden, N. J. Included in this line are three improved power amplifiers rated at 6, 12 and 24 watts. The electric mixing unit is illustrated.

Let this Great Book Save You Time and Money

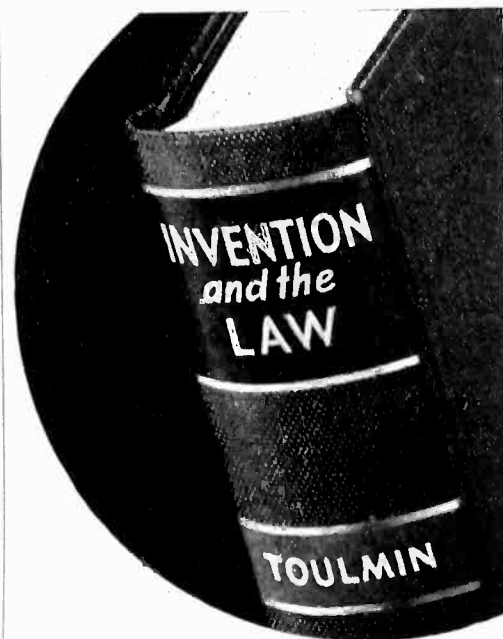

EVERY DAY this Toulmin book can help you. Don't just **THINK** you have a patentable invention . . . **KNOW!** Learn when Design is **NOT** Invention.

An opportunity is lost—because somebody lacked clear understanding of the true characteristics of Invention. Time and money are wasted—on an "invention" which could never satisfy the legal definition of the term. EVERY manufacturer might profitably know MORE about the essential principles of Patentable Invention. **INVENTION AND THE LAW** answers the various perplexing questions as to what is, and what is not—patentable invention.

Complete, Clear, Accurate

Gives you a clear statement of the RULES on each invention question. It summarizes the findings of the Federal courts—classified for ready reference. Two outstanding sections in particular: What Is Invention and What is Not Invention make the work invaluable.

The author presents the Background of Invention, the Characteristics of Invention, How Invention Is Determined, what you must do to determine the patentability of inventions, invention rules in other countries, etc., etc.

5 Days Free Approval

Let us send you a copy of **INVENTION AND THE LAW** and decide its value for yourself. No obligation to buy unless you want to keep it—after examination. The price postpaid is only \$5.00.

PRENTICE-HALL, Inc.

Dept. 1P-7

70 Fifth Ave.

New York, N. Y.

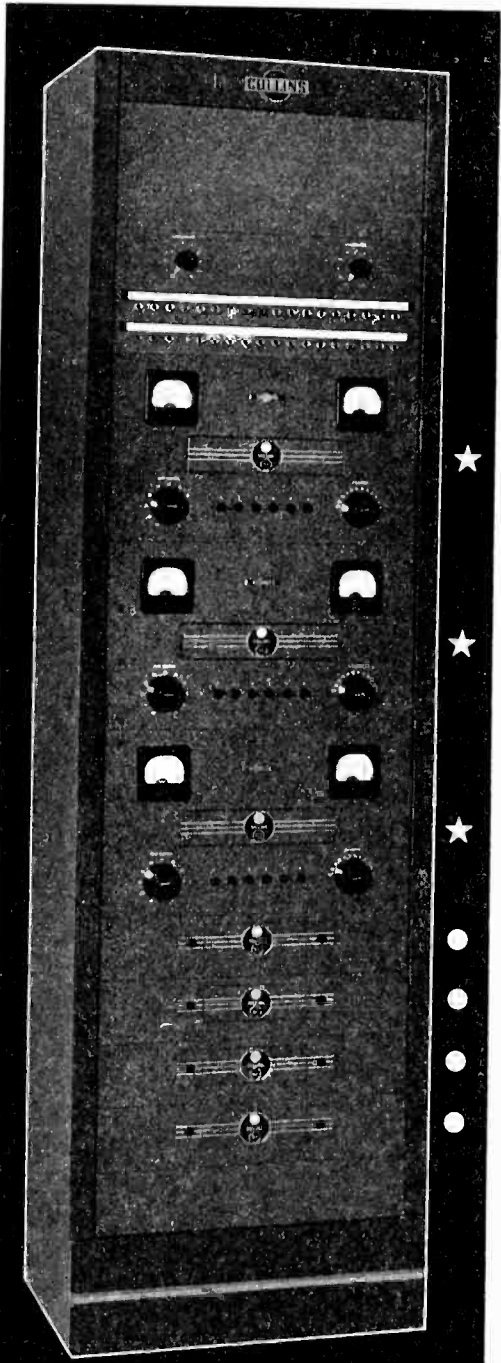

• **6F** PRE-AMPLIFIERS
AND
★ **7S** MAIN AMPLIFIERS

are built for stations who use the best equipment obtainable. Their design includes every desirable electrical feature, complete metering, tube access doors, modern styling, easily removable inspection plates.

Technical data sent on request.

COLLINS
RADIO COMPANY

CEDAR RAPIDS IOWA
NEW YORK, N. Y.: 11 WEST 42 STREET

Audio Frequency Amplifiers

TWO NEW AUDIO frequency amplifiers have been introduced in the broadcast transmitting field by the Western Electric Co., 195 Broadway, New York City, for use in operating monitors and loudspeakers. Designed as the 94-C and 94-D they provide flexibility of application and a large power output at low cost. The gain of these units is approximately 45 db., the frequency response is essentially flat from 40 to 10,000 cycles and either design is such that glass or metal tubes may be used. The single frequency power output is approximately 12 watts distortion.

Sound Recorder

PLAYING ANY PHONOGRAPH RECORD, recording voice and music, and connecting to any radio receiver for recording programs off the air, the Junior Recorder of the Presto Recording Cor-

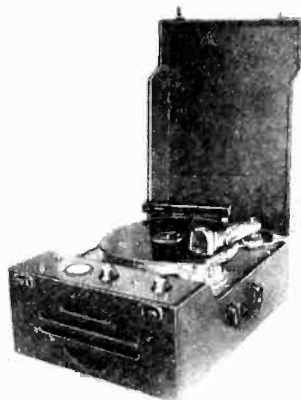

poration, 139 W. 19th St., New York City, has recently been announced. It uses standard radio tubes, is portable, operates on 110 volts, a-c, and comes complete with microphone, ready for operation.

Antenna System

AN ANTENNA SYSTEM packed in handy kit form is realized in this season's offering by the Technical Appliance Corp., 17 E. 16th St., New York City.

Antenna

A NEW, efficient antenna, which is factory assembled and easy to install has been announced by the Parts Division of the RCA Manufacturing Co., Camden, N. J. Known as the RCA 395, the new antenna will operate with receivers of all types and manufacture. Three supports 40 ft. apart are all that is required for the installation. All the parts, Antenna wires, strain insulators, junction box, and transmission line have been assembled and soldered at the factory. The antenna is effective as a pick-up device from 140 kc. to 22,000 kc.

Takes the Sock!



- Porcelain-case mica capacitor. For those high-frequency high-voltage applications.
- Minimum metal in high-frequency field.
- In capacities of .00005 to .1 mfd. 2000 to 12500 volts D.C. Test.
- **New CATALOG:** Big, Startling, 32-page book. Just issued. Write for your copy.



CINAUDAGRAPH

Speaker

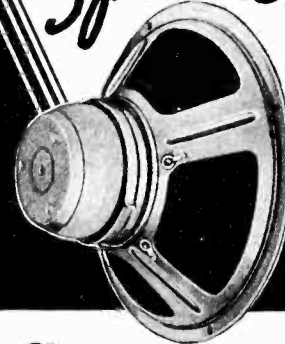

CINAUDAGRAPH
Magic Magnet Speakers

—extensively utilized by all leading radio receiver and P. A. equipment manufacturers—are available in a complete range of sizes from 5½ to 18 inches, to meet your every radio requirement.

If you demand utmost dependability and fidelity of reproduction from your equipment—insist on Cinaudagraph P. M. speakers. Carried in stock by all progressive distributors. Free descriptive literature on request.



CINAUDAGRAPH
CORPORATION

Speaker Division • Stamford, Conn.

NEW

U.S. PATENT OFFICE

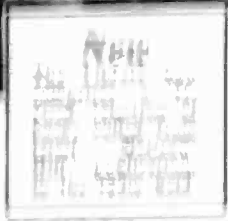

RADIO ENGINEERING LIBRARY

— specially selected by radio specialists of R.F. SHAW Publications

— is the most complete, dependable source of facts needed by all those who are engaged in radio engineering

— available at a special price and terms

These books are...
1. SHAW'S PRINCIPLES OF RADIO ENGINEERING
2. FETTER'S MEASUREMENTS IN RADIO ENGINEERING
3. GUNTER'S THEORY OF THERMIONIC VACUUM TUBES
4. HUNT'S PHENOMENA IN HIGH FREQUENCY MEASUREMENTS
5. HENNESSY'S RADIO ENGINEERING HANDBOOK

- 3 volumes 300 pages, 3000 illustrations
- 1. SHAW'S PRINCIPLES OF RADIO ENGINEERING
- 2. FETTER'S MEASUREMENTS IN RADIO ENGINEERING
- 3. GUNTER'S THEORY OF THERMIONIC VACUUM TUBES
- 4. HUNT'S PHENOMENA IN HIGH FREQUENCY MEASUREMENTS
- 5. HENNESSY'S RADIO ENGINEERING HANDBOOK

Special Low Price and Easy Terms

Months ago, the five volumes comprising this library...
Name _____
Address _____
City and State _____
Position _____
Company _____

SEND THIS ON APPROVAL BASIS

Name _____
Address _____
City and State _____
Position _____
Company _____

Books sent on approval to U.S. and Canada only

50 Watt Amplifier

Development of a new 50 watt class A amplifier with built-in expansion and...
This amplifier consists of a voltage amplifier and power amplifier which...
The amplifier consists of a voltage amplifier and power amplifier which...
The amplifier consists of a voltage amplifier and power amplifier which...



This amplifier consists of a voltage amplifier and power amplifier which...
The amplifier consists of a voltage amplifier and power amplifier which...
The amplifier consists of a voltage amplifier and power amplifier which...

500 Watt Amplifier

A high sensitivity 500 watt amplifier has been recently announced by the...
The amplifier consists of a voltage amplifier and power amplifier which...
The amplifier consists of a voltage amplifier and power amplifier which...

Power Unit

The new power units are announced by the...
The power unit consists of a transformer and a power supply...
The power unit consists of a transformer and a power supply...

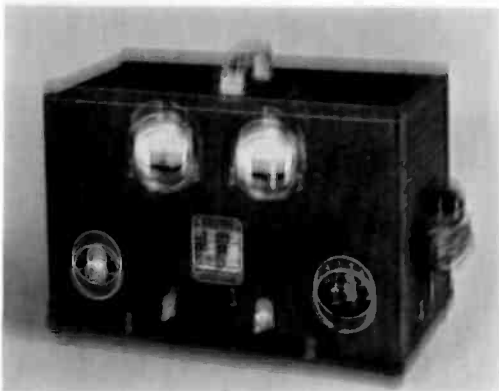

Intended for portable radio...
The power unit consists of a transformer and a power supply...
The power unit consists of a transformer and a power supply...

Amplifying Station

The first of a series of amplifying stations...
The amplifying station consists of a transformer and a power supply...
The amplifying station consists of a transformer and a power supply...

EVERYBODY SAYS:

"It's a Honey"

THIS REMARKABLE NEW MOTOR

By

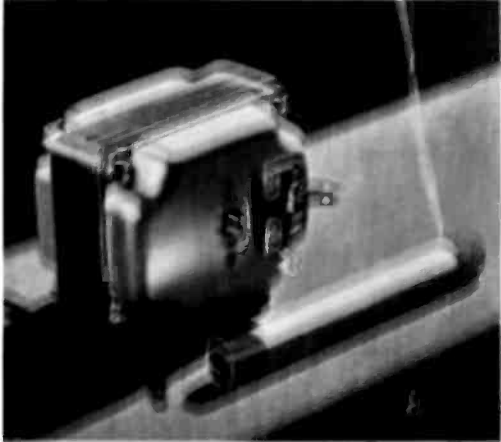

FOR ELECTRIC TUNING and MANY OTHER APPLICATIONS!

UTAH RADIO PRODUCTS CO.

CHICAGO, U.S.A.

TORONTO ONTARIO CANADA

BIENNA AIRS

UTAH RADIO PRODUCTS CO.

15 YEARS OF LEADERSHIP!!

SCREW MACHINE PARTS of **AMEROID**—a high dielectric casein product

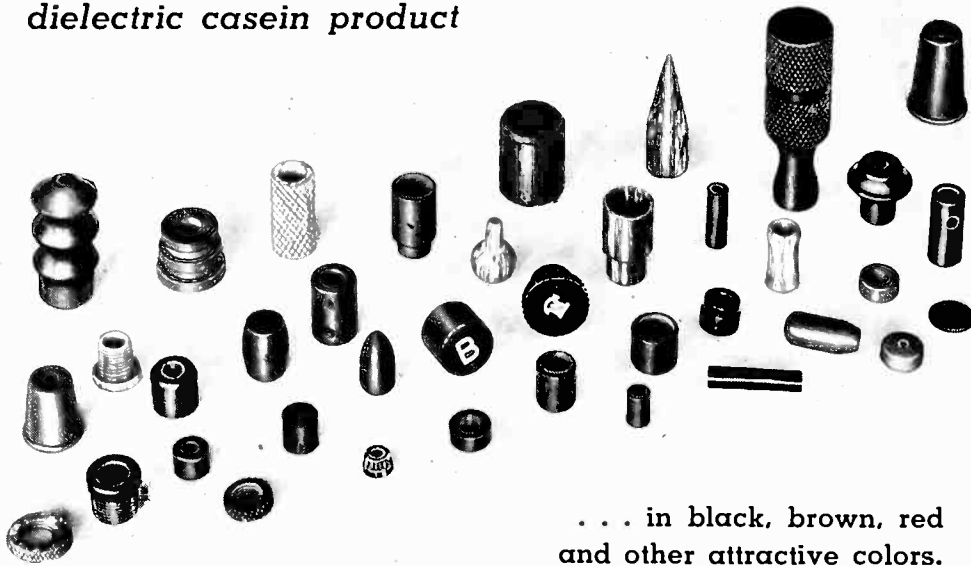

... in black, brown, red
and other attractive colors.

We manufacture standard parts for the radio and allied industries, and also special parts of any size or shape.

For parts made to your specification, there is no mould or tool charge if the maximum dimension does not exceed one inch.

Our Ameroid Parts are made with the same unusual degree of accuracy that characterizes metal parts made by

AMERICAN RADIO HARDWARE CO., INC.

476 Broadway

New York, N. Y.

MICROHM WIRE WOUND RESISTORS

MICROHM WIRE WOUND RESISTORS are built on the foundation of a QUALITY PRODUCT and can be used as a component with the finest of precision instruments. Manufacturers interested in maintaining the QUALITY of their apparatus recognize this merit of QUALITY, demand and use only MICROHM WIRE WOUND RESISTORS. Precision Resistor Company manufactures a complete line of all types of wire wound resistors and is equipped to meet the most rigid specifications.

Write for catalog and prices

PRECISION RESISTOR COMPANY

332 Badger Ave.

Newark, N. J.

Manufacturers of custom built PRECISION and INDUSTRIAL WIRE WOUND RESISTORS.



TYPE R 1/2
Watt (Actual
Size) Res. 5
to 50000 ohms.
Accuracies as
close as 1/10
of 1%.



Frequency Measuring Service



Many stations find this exact measuring service of great value for routine observation of transmitter performance and for accurately calibrating their own monitors.

MEASUREMENTS WHEN YOU NEED THEM MOST
at any hour every day in the year

R.C.A. COMMUNICATIONS, Inc.

Commercial Dept.

A RADIO CORPORATION OF AMERICA SERVICE

66 BROAD STREET

NEW YORK, N. Y.

Precision Circuit Breaker

A PRECISION circuit breaker manufactured by the Heinemann Electric Co., Trenton, N. J., is suggested as a means of eliminating the danger of overdosage or injuries from shortwave diathermy or high frequency heat treatment.

Paging System

THE Operadio Manufacturing Co., St. Charles, Ill., announce their type BH high powered intercommunicating and

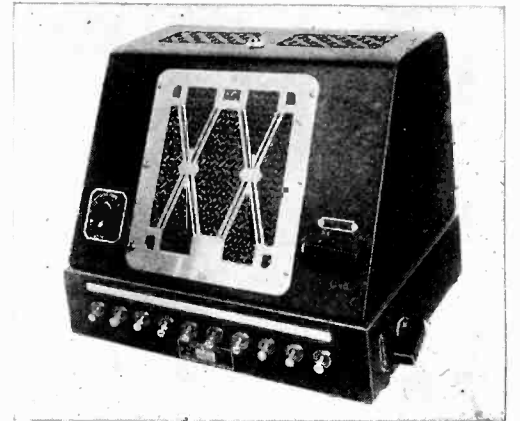

paging system embodying the feature of return speech. Several models of this equipment are available, depending upon the specific requirements of the user.

Multi-Range Analyzer

THE MODEL 320 multi-range analyzers recently announced by the Triumph Manufacturing Co., 4017 West Lake

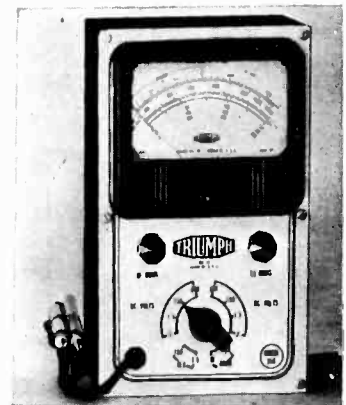

St., Chicago, contain a foundation meter having a 50 microampere movement, which provides seven voltage scales each, a-c or d-c, four direct current scales, and three resistance scales.

Contact Microphone

A CONTACT MICROPHONE intended for use on vibration instruments such as the guitar and violin and which is claimed to be flat between 40 and 9000 cycles is announced by the Amperite Corp., 561 Broadway, New York, N. Y.

Now—
a high-powered—

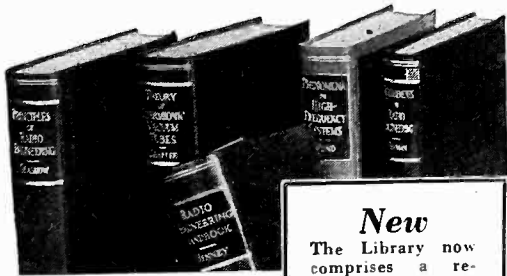

New
The Library now comprises a revised selection of books culled from latest McGraw-Hill publications in the radio field.

RADIO ENGINEERING LIBRARY

- especially selected by radio specialists of McGraw-Hill publications
- to give most complete, dependable coverage of facts needed by all whose fields are grounded on radio fundamentals
- available at a special price and terms

These books cover circuit phenomena, tube theory, networks, measurements, and other subjects—give specialized treatment of all fields of practical design and application. They are books of recognized position in the literature—books you will refer to and be referred to often. If you are a researcher or experimenter—if your interest in radio is deep-set and based on a real desire to go further in this field—you want these books for the help they give in hundreds of problems throughout the whole field of radio engineering.

5 volumes 3064 pages, 2000 illustrations

1. GLASGOW'S PRINCIPLES OF RADIO ENGINEERING
2. Terman's MEASUREMENTS IN RADIO ENGINEERING
3. Chaffee's THEORY OF THERMIONIC VACUUM TUBES
4. Hund's PHENOMENA IN HIGH-FREQUENCY MEASUREMENTS
5. Henney's RADIO ENGINEERING HANDBOOK

Special Low Price and Easy Terms

Bought singly, the five volumes comprising this library would cost you \$26.00. Under this offer you save \$2.50 and, in addition, have the privilege of paying in easy installments beginning with \$2.50, 10 days after receipt of the books, and \$3.00 monthly thereafter. Already these books are recognized as standard works that you are bound to require sooner or later. Take advantage of these convenient terms to add them to your library now.

SEND THIS ON-APPROVAL COUPON

McGraw-Hill Book Co., Inc.
330 W. 42nd St., New York, N. Y.

Send me Radio Engineering Library 5 vols., for 10 days' examination on approval. In 10 days I will send \$2.50, plus few cents postage, and \$3.00 monthly till \$23.50 is paid, or return books postpaid. (We pay postage on orders accompanied by remittance of first installment.)

Name

Address

City and State.....

Position

Company..... L-10-37

(Books sent on approval in U. S. and Canada only.)

50 Watt Amplifier

DEVELOPMENT OF A NEW 50-watt class A amplifier with built-in expander and suppressor circuit to enhance musical reproduction and prevent blasting and overloading in large scale public address and sound reinforcement installations, has been announced by the RCA Manufacturing Co., Camden, N. J.

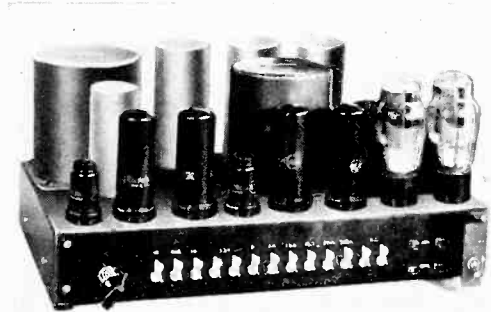

This amplifier consists of a voltage amplifier and power amplifier which together make up an advanced amplifier system for sound reinforcement work, particularly adapted to large outdoor and indoor installations such as auditorium, ballrooms, beach controls, race-tracks, etc.

Set Analyzer

A HIGH SENSITIVITY test analyzer has been recently announced by the Simpson Electric Co., 5216 West Kinzie St., Chicago. The meter has a resistance of 10,000 ohms per volt for the d-c scale. Five direct voltage scales and four alternating voltage scales (at 1,000 ohms per volt) together with three resistance scales are available.

Power Unit

TWO NEW POWER units are announced by the B-L Manufacturing Co., St. Louis, Mo. One of these is a 3 ampere, 32 volt device, operating from the 110 volt a-c line, and is especially suitable for farm installations. The other is

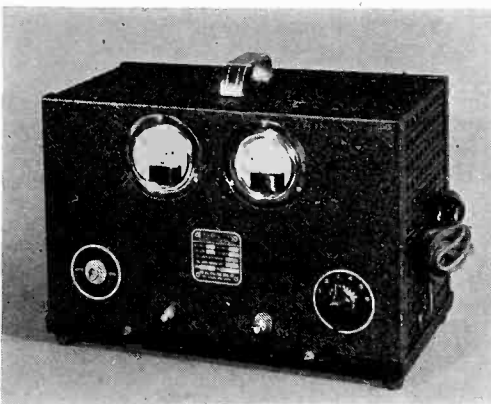

intended for portable brush electroplating work and delivers 7 amperes at 10 to 24 volts. This latter unit is illustrated.

Amplifying System

THE FIRST of a series of amplifying systems, a 15 watt unit, is announced by the Regal Amplifier Corp., 14 W. 17th St., New York, N. Y.

EVERYBODY SAYS:

"It's a Honey"

THIS REMARKABLE
NEW MOTOR

by

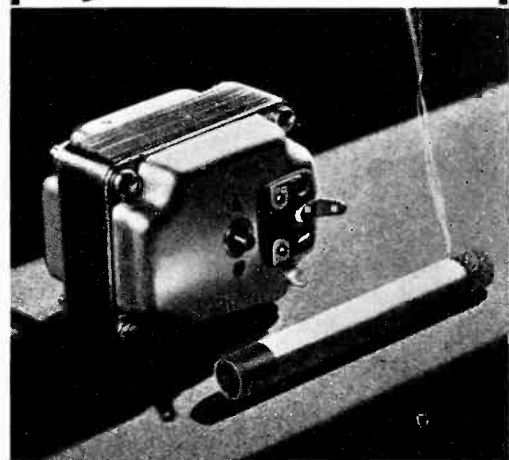

for ELECTRIC TUNING and MANY OTHER APPLICATIONS!

Just imagine a tiny motor you could hide in the palm of your hand. A motor scarcely larger than two packages of cigarettes. That's the new UTAH motor!

And it's a little giant! It's got power . . . starting torque . . . stamina. It equals—even surpasses—the performance of motors almost twice its size. Although ideally adapted for Electric Tuning Purposes, this motor has countless other possibilities.

It is a shaded pole induction motor of the three wire brushless reversible type. Starting torque is one and one half ounces. Rotor diameter is 3/4". Can be supplied for any AC power supply from 6 to 110 volts. Requires no field current when inoperative, and is free from radio interference. Here is an exceptionally compact motor built to take the rigorous starting, stopping and reversing required by many applications. Let us tell you more about this remarkable new UTAH motor! Write department E-10.

UTAH RADIO PRODUCTS CO.
CHICAGO, U. S. A.

TORONTO
ONTARIO, CANADA

BUENOS AIRES
(UCOA RADIO PRODUCTS CO.)

"16 YEARS OF LEADERSHIP"



**Greater Microphone
PERFORMANCE**



**Acorn Model T-3
Has What it Takes**

Beautiful, heavily chrome plated, acorn shaped microphone with new tilting swivel mount for directional or non-directional pick-up. Designed for high class P.A., Broadcast, Recording and Amateur use. Acoustic feedback definitely reduced. Complete with interchangeable plug and socket connector, 8-ft. cable and spring cable protector. Fully LIST PRICE **\$25.00** guaranteed.

**Handy Grip-to-Talk
Microphone CD-104**



Unique grip-operated switch, attached to standard, cuts microphone in or out. Ideal for airway ground stations, inter-office, inter-factory and similar communicating systems. Chrome plated, with black base. Complete with 8-ft. cable.

LIST PRICE
\$27.50

See Your Astatic Jobber



MICROPHONE LABORATORY, Inc.

Dept. A-4, Youngstown, Ohio
Licensed under Brush Development Co. Patents

Bridge Analyzer

A NEW LABORATORY TYPE condenser bridge and analyzer manufactured by the Tobe Deutschmann Corp., Canton, Mass., makes available for servicemen, engineering laboratories, and production engineers, a quick and accurate means of testing resistors and of determining characteristics of paper dielectrics and electrolytic condensers. Measurements of resistors between 1 ohm and 1,000,000 ohms capacitance between 10 microfarads and 100 microfarads may be made. This bridge employs an "electronic eye" to indicate balance. The main control dial is linearly graduated and all adjustments may be made by means of switches mounted on the slanting panel.

Multirange Meter

A NEW MULTIRANGE METER for the radio and appliance trade using a highly sensitive meter with 50 microampere full scale deflection is announced by the Triumph Mfg. Co., 4017 W. Lake St., Chicago. The d-c and a-c voltage ranges of 3, 15, 150, and 600 are available as well as current ranges of 15 and 150 ma. and resistance ranges of 5,000 ohms and 1.5 megohms.

High Frequency Receiver

THE NATIONAL COMPANY, Malden, Mass., announce the new type NC-80X communication receiver available with continuous tuning range between 550 kc. and 30 mc. or with tuning especially adapted for use in the amateur fre-

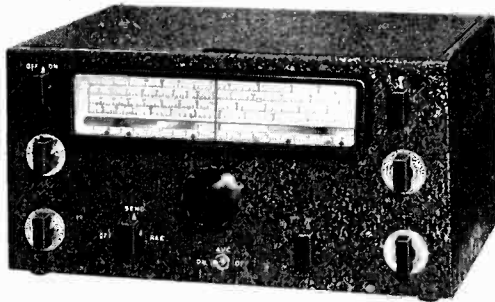

quency bands. A number of new features providing for simplicity and ease of operation are provided.

Polarized Light Analyzer

THE MARKS POLARIZER and analyzer, which slips into place on any microscope for instant use, enables the ready detection of strains, irregularities, and other defects in transparent materials as well as in thin sections of opaque materials. The unit is available from the Laboratory Equipment Co., 148 Lafayette St., New York, N. Y.

PLUGS—SOCKETS

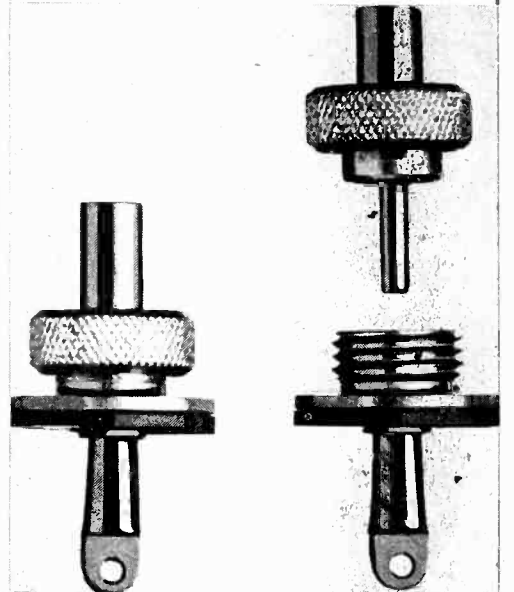

Type No. 101 shielded single contact plug and socket.

One type from our line of several hundred electrical plugs and sockets. We also supply manufacturers with terminal panels, standard or to blue print.

Write for bulletins on complete line

HOWARD B. JONES

2300 Wabansia Ave.,
Chicago, Ill.

**LEPEL
SPARK-GAP CONVERTERS**



Model C-4
the 5 K.V.A. Converter

FOR BOMBARDING
PHOTO-ELECTRIC CELLS
COATED ELECTRODES
RADIO TUBES
CATHODE RAY TUBES, ETC.

WRITE FOR BULLETIN 401

LEPEL

HIGH FREQUENCY LABORATORIES
39 W. 60th St., New York, N. Y.
Cable address LEPELSPARK

Aircraft Transmitter

AN IMPROVED AIRCRAFT transmitter operating on four crystals with two crystals, with either CW or phone transmission available at will, and with a power output of 20 watts which may be 100% modulated for phone, is announced by the Victor Division of the RCA Mfg. Co., Hamden, N. J.

Coil Comparator

IN ADDITION TO its use as a coil comparator, direct measurements can be made of inductance and resistance on the type 721-A coil comparator manufactured by the General Radio Co. of Cambridge, Mass. Capacitance can also

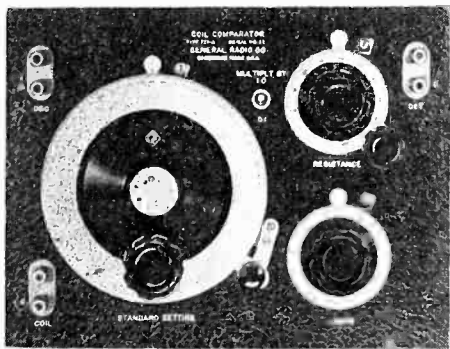

be measured if an external coil is used to obtain a balance. The comparator uses a circuit which combines the precision of the null method with the simplicity of the resonance method of measurement. The reactance and resistance adjustments are entirely independent. The unit is intended for use in the production testing of radio frequency coils, such as those used in radio receivers. The test is made by comparing the coil with a standard sample.

30 Mc. Tube

A THREE ELECTRODE transmitting tube capable of operation at maximum rated conditions up to 30 megacycles, or up to 100 megacycles with reduced input has been released by the Radiotron Di-

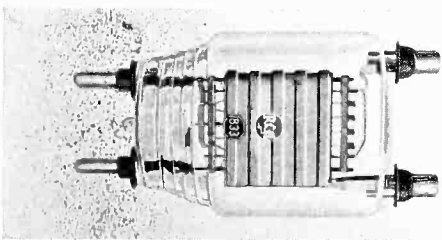

vision of RCA Mfg. Co., Harrison, N. J. The plate dissipation is 300 watts, and the maximum power output is rated as 1 kw. when used as an oscillator or r.f. amplifier. The tube is known as the RCA-833 r-f power amplifier and oscillator.

Automatic Plastics Molding

A COMPLETELY AUTOMATIC molding machine or press, to mold thermo-setting plastics materials of the phenol base and urea compound types is announced by the F. J. Stokes Machine Co., Philadelphia.



IT'S THE SONG OF THE ASSEMBLY

Deft fingers assembling radio and other parts move more swiftly and accurately when **LINE** TURBO Oil Tubing and Saturated Sleeving are used to encase the conductors, lead-ins, etc. Aside from being flame-proof, tough and resilient these products have the exclusive characteristics, smooth inside walls and freedom from inside obstructions.

We ship all orders—regardless of quantities—on the day received.

Send for standard, full length strands of TURBO Products for trial or test in your own plant.

WILLIAM BRAND & CO.
268 FOURTH AVE., NEW YORK
In Chicago—217 N. Desplains St.

TURBO OIL TUBING and SATURATED SLEEVING

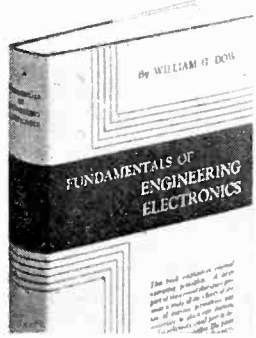

Now Available—An Up-to-date Working Manual

FUNDAMENTALS OF ENGINEERING ELECTRONICS

By **WILLIAM G. DOW**, Assistant Professor of Electrical Engineering, University of Michigan

"Fundamentals of Engineering Electronics" gives the reader a realistic and quantitatively usable conception of the principles that govern the internal behavior of electronic devices. To illustrate these principles the book discusses methods of circuit analysis customarily employed in connection with the most common engineering applications of electronic devices. An indispensable reference book on present-day theory and practice.

604 pages; 207 illus.; 6 by 9; \$5.00

"The author has done an excellent piece of work in bringing together the fundamental ideas of physics in a manner suitable for the engineer. And I agree with him that emphasis should be placed on this aspect of engineering electronics. The book should certainly fill a unique and important place in the field."

—TRUMAN S. GRAY, Assistant Professor of Engineering Electronics, Massachusetts Institute of Technology

ON APPROVAL COUPON

John Wiley & Sons, Inc.
440 Fourth Avenue, New York, N. Y.

Kindly send me a copy of Dow's "Fundamentals of Engineering Electronics," on ten days' approval. If at the end of that time I decide to keep the book I will remit \$5.00 plus postage; otherwise, I will return the book postpaid.

Name
Address
City and State
Employed by

EL10-37

Study Construction—
 Test Performance—
 Consider Costs—



... and you, too, will standardize on
GOAT FORM-FITTING TUBE SHIELDS
 in your 1938
AUTO-RADIOS



GOAT RADIO TUBE PARTS, INC.

314 Dean Street, Brooklyn, N. Y.

(A Division of THE FRED GOAT CO., INC., Est. 1893)

Metals in Radio

(Continued from page 17)

somewhat lower in cost, especially under normal conditions in the metal market. Like aluminum, it is non-rusting and quite resistant to harmful corrosion, although it tarnishes more readily and may lack the luster of aluminum in some forms. It can be drawn or impact extruded in much the same way as aluminum, but is more readily soldered than the latter. In addition, it is a relatively "dead" or non-resonant metal, which is considered an advantage in vibrator cases where noise must be minimized. Zinc is, of course, the required material in the common form of dry cell can, extensively used in certain classes of radio work, and finds very wide use in this field.

Brass

Brass finds important uses for springs, contacts and terminals, certain items produced on screw machines, as shafts for variable condensers and where non-magnetic or non-rusting properties are required. It is also employed, of course, for escutcheons and bezels, where decorative considerations and corrosion resistance are important, as well as for some drawn parts, grommets and the like. Ease of working, resistance to corrosion, color and hardness are among the qualities desired and found in brass parts for electronic products. Cost is higher than for some other metals and tends to prevent wider use. Copper is employed chiefly for electrical conductors, as in wiring and coil windings. Phosphor bronze finds some use for springs and other small parts, and some similar elements are made occasionally from nickel silver, which is highly corrosion resistant.

About the only other metal finding extensive use in home and automobile receivers and not mentioned above is the special grade of silicon steel employed for laminations for transformer cores. This is a common type of steel for electrical uses where good magnetic properties are important and is designed for fabrication by stamping.



SIGMA RELAYS

MODEL 2-A

A 12 milliwatt, D. C., semi-sensitive instrument for general electronic and industrial uses.
 Controls 150 watts, noninductive load, at 115 volts, A. C., on single-pole double-throw silver contacts.

With coil resistances up to 2,000 ohms.....	List Price
With higher coil resistances.....	\$5.00
	5.50

MODEL M

Embodies Tobe Mu-Switch. Input, 50 milliwatts, D. C., Controls 1 kilowatt, noninductive load, at 115 volts, A. C., on single-pole double-throw contacts.

With coil resistances up to 2,000 ohms.....	List Price
With higher resistances.....	\$7.00
	7.50

Both models are mounted on 5-prong base to plug into standard tube socket.

SIGMA INSTRUMENTS, INC.

388 TRAPELO ROAD

BELMONT, MASS.



UNIVERSAL CRYSTAL MICROPHONES

Hand Model Crystal

New hand-type for p.a., amateur, sports events, etc. Output —65 db. [Desk holder \$2.50]

Crystal Stand Model

For stage or orch. where mike should be mounted on floor or desk stand. Output —65 db. [Desk mount \$3.50.]

All crystal models under patent
 of Brush Development Company.

MICROPHONE DIVISION

UNIVERSAL MICROPHONE CO. LTD.

424 Warren Lane,

Inglewood, Calif., U. S. A.



List \$22.50
 with
 10 ft. cable

List \$22.50
 with
 10 ft. cable

Disc Reproduction

(Continued from page 27)

known good wave form, and feed the output into a cathode ray oscillograph. Some pickups will develop non-linearity, showing a wave somewhat like that shown in the Figure in a band of frequencies a few hundred cycles wide, usually somewhere between 2000 and 5000 cycles. Such a pickup has defective damping and will usually get progressively worse, till the reproduction all over the upper treble becomes very "wooly."

4. Listen to the pickup on a wide range of records.

The first reaction of many salesmen to the above four tests is that the tester is "curve crazy." Nevertheless they should be regarded with some respect. After listening to an old pickup for months any new unit sounds good. The tests given do not in themselves constitute infallible evidence, but some years' experience has shown that the symptoms given invariably precede a growing dissatisfaction with a unit, for the reason given. While it might be quite possible to have a unit check out all right in these tests and fail to satisfy the ear; nevertheless a unit which fails to pass these tests will never, in the long run, continue to be satisfactory.

5. Durability can not be revealed by a short test. Only experience can show whether a unit will stand an announcer's treatment.

From the preceding it may be judged that the writer favors the use of electrical networks rather than attempt to get perfect uniformity of response by tinkering with the pickup itself.

This network should be variable in two respects: amount of bass boost, and amount of high frequency cut-off. The bass boost is varied to compensate for three things, viz., recording cutter characteristic, orchestral balance in the recording, and station policy on tonal balance. The amount of high cutoff is varied to limit scratch in accordance with station policy.

In Fig. 4-G is a simple single circuit equalizer used to boost bass, as recommended by network manufacturers. Now such an equalizer will present a very low impedance to the pickup at the higher frequencies. This, interacting with the pickup

leakage reactance, will cut the high frequencies,—the amount of cut increasing as the bass boost is increased. The simple remedy is to use either of the circuits shown in Fig. 4-H or 4-I.

After a system is set up, how should it be tested? For the initial run a heterodyne or glide type record is best.

How may the record characteristics be checked before use, without elaborate measurements? Fortunately we have the simple yet accurate optical method of Buchman and Meyer. The record is examined in a beam of parallel light rays. A Christmas tree pattern appears. The width of this pattern, measured at right angles to the radius, denotes the velocity or volume. The point of dropoff can be accurately located and marked with white China marking crayon. Electrical test will then measure the frequency at that point. Interpreting such a pattern, however, is another article in itself.

A second test is, of course, playing music records of known good quality. They should be free from wows and recorder peaks, and should be of as wide range as records in current use. Pains should be taken with the choice of these records. They should not only be free from harmonic distortion but should include enough instruments to cover the audible range fairly completely.

Daily or weekly routine tests of course include listening to a music record for wows and harmonic distortion, and a check of output level at 1000 cycles, using a record like Victor No. XL81 or No. 84522B. The output reading should be logged, and a steady change week by week calls for investigation and replacement.

Finally, are all of these tests and precautions necessary? The best answer is to invite the reader to compare lateral disc reproduction in various stations. In a big city it is even possible to compare the same record. In one station you have an acceptable counterfeit of a studio program, in the other a typical "phonograph" sound.

REFERENCES

¹ Modern Gramophones and Electrical Reproducers—P. Wilson and G. W. Webb, Cassell & Co., Ltd., London, 1929. P. 121-132.

² The Wilson Alignment Protractor is sold by The Gramophone, London.

Compressed Gas Condenser TYPE 174

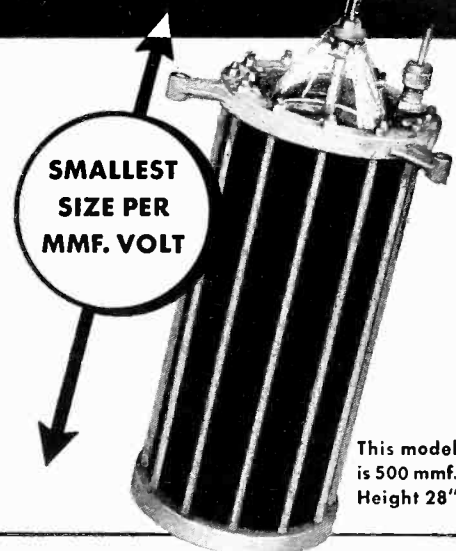

INVESTIGATE these UNIQUE compressed gas condenser ADVANTAGES

FOUR CAPACITIES: 250, 500, 1000 and 1500 mmf.
TWO RATINGS . . . 40,000 and 32,000 rms working volts.

CONTROL External, continuously variable.

LOSSES Lower than equivalent air condensers.

ALSO Lower distributed inductance, complete shielding.

HEINTZ AND KAUFMAN
SOUTH CALIFORNIA
SAN FRANCISCO U. S. A.

MONARCH MULTIVIBRATOR

A COMPLETELY NEW DEVELOPMENT



- The most important development in factory receiver alignment since the Signal Generator.
- Now used by leading set manufacturers—Multivibrators afford faster and more accurate alignment . . . instantly show weak or dead spots on any band . . . eliminates need for rocking gang condensers.
- Operators become quickly proficient in using Multivibrators and they pay for themselves by speeding up production line tests, insuring accuracy, and avoiding rejects or returns. Complete technical data and prices on request.

MONARCH MFG. CO.

3341 BELMONT AVE. CHICAGO, ILL.

PROFESSIONAL SERVICES

Rates on Application

BLILEY ELECTRIC CO.

Designers—Manufacturers

Quartz Crystals for standard or special radio frequency applications.

Inquiries Invited.

200 Union Station Bldg.
Erie, Penna.

CHARLES EISLER

EISLER ENGINEERING CO.
Consulting and Designing Engineer

Electric Welding Machines for Metal Tubes
Electric Welding Problems, High Vacuum
Compound Pumps, Soft and Hard
Glass Working Equipment, Radio and
Electronic Tube Machinery

753 So. 13th St. Newark, N. J.

ELECTRICAL TESTING LABORATORIES

Characteristics and Life Tests of Vacuum Tubes
Tests of photo cells, glow lamps, crater lamps.
Tests of electronic and optical devices.
30th Street and East End Avenue
New York, N. Y.
Phone: Butterfield 8-2600

THAD. R. GOLDSBOROUGH

REGISTERED PATENT ATTORNEY
Patent and Trademark Soliciting
Consulting Service

Patent Sale and License Negotiations
201 205 McLauchlen Building
Washington, D. C.

INTERNATIONAL ELECTRONICS, INC.

AMERICAN CONSULTING ENGINEERS TO
FOREIGN MANUFACTURERS

Designs Specifications
Electrolytics Tubes Resistors
Transmitters Receivers

145 W. 45th Street New York, N. Y.

HAROLD J. McCREARY

Mem. A.I.E.E. & W.S.E.

Consulting Engineer

Research Electronics
Development Television
Design Radio
Factory Practise Railroad Signaling
Patent Studies Telephony

105 W. Adams St. Chicago, Ill.

THE SOLUTION OF YOUR PROBLEM

in the field of Electronic devices may be found through enlisting the services of the Consultants whose cards appear on this page.

This is a highly specialized field and specialists are therefore better able to undertake the rapid developments necessary to keep in step with modern manufacturing progress.

British Patents

Photo Cells and Applications

Barrier cell. Phototube of the barrier layer type or of the type having electrically separate anode and cathode, has a light-sensitive layer formed by vaporizing caesium or rubidium onto antimony or bismuth, and then causing the two metals to alloy by heat treatment. The layer of antimony or bismuth is formed by vaporizing the metal onto a base and is preferably treated with oxygen or its homologues prior to the deposition of the caesium or rubidium. Zeiss Ikon. No. 460,012.

Control apparatus. System for transmitting, indicating or recording the movements of a compass card, the variation of light falling on a phototube controlled in accordance with the movements of the card throughout the whole 360 deg. of movement. In one arrangement, the light may be passed through or reflected from a screen bearing different colors, the amount

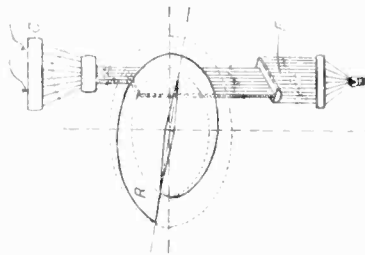

of absorption or reflection depending upon the angular position of the member. In another arrangement the width of a band of light falling on a cell varies by a screen having a periphery in the form of a spiral. C. Tutino, No. 460,162.

Light control. A photo-electric control, for turning a gas valve, ringing a bell, or operating a locking device, comprises a clockwork motor which is adapted to be started as a result of an increase above a pre-determined upper limit or a decrease below a pre-determined lower limit of the amount of light falling upon a phototube. The motor stops automatically when its function is at an end and is then ready to be restarted when the intensity of the illumination again varies in the opposite sense. South Metropolitan Gas Co. No. 460,155.

Biological tests. A method of testing a subject, particularly an egg, for determining whether a living organism is present and for determining the sex of the organism, consists in directing upon the subject a beam of light of wave-lengths from the violet end of the spectrum and a high-frequency oscillatory electrical field, detecting the electrical effects produced by the subject under the action of the beam and/or field by means of electrodes disposed adjacently to the subject, and indicating the effects produced, for example by a Lindemann electrometer. C. R. A. Chadfield, 462,237.

SOUND RECORDING EQUIPMENT

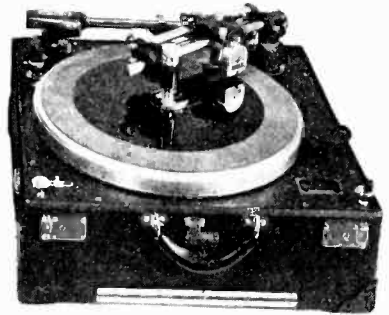

Designed, engineered and manufactured with laboratory precision by men with long recording experience who understand recording problems—these instruments will meet the most exacting professional requirements—yet they are priced within the range of every potential user.

Sturdy in construction—simple in operation—with many NEW and EXCLUSIVE mechanical and electrical features.

We invite you to consult us freely concerning your recording problems. Write for photos, including complete descriptive literature, data and prices.

Also manufacturers of the famous ALLIED blanks for instantaneous recording. Literature and price list sent upon request.

Allied Recording Products Co.
126 West 46th St., New York, N. Y.

Cable Address: Allrecord

SHALLCROSS RESISTORS, SWITCHES and INSTRUMENTS

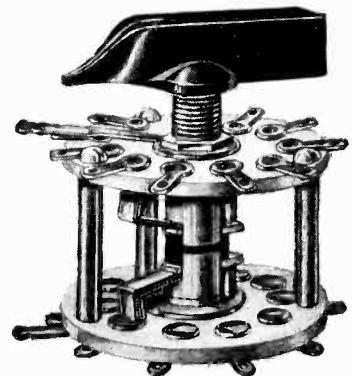

Our products have established an enviable reputation in many of the industrial and college laboratories in this country and abroad.

Write for Bulletin 140-KA

SHALLCROSS MFG. CO.
COLLINGDALE, PA.

Photometric apparatus. Apparatus for measuring the color density of liquids. H. L. Marriott, 464,001.

Recording. In a system for sound-recording on a groove record without excessive groove curvature, the sound-modulated voltage is first converted to a voltage substantially proportional to

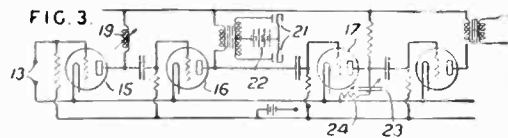

the curvature by an operation representing a differentiation with respect to time and this converted voltage is then subjected to peak-suppression. RCA. No. 464,173.

Electron multiplier. This device is composed of (a) a primary source emitting electrons which strike an emitter surface to liberate a larger number of secondary electrons, this process being repeated to produce secondary electrons from surfaces at progressively increasing positive potentials; (b) a field electrode maintained at a uniform positive potential and producing a field normal to the emitter surfaces; and (c) means for producing a magnetic field parallel to the emitter surfaces and transverse to the electron paths, the arrangement being such that when the potential on the field electrode is higher than that on any of the emitter surface, the field strength is the same at each surface. Marconi Co. No. 460,356.

Weighing apparatus. An indicating or recording mechanism for weighing apparatus embodies a light-projecting system, a light-sensitive unit, a member which is displaceable with the load and provided with transparent and non-transparent portions arranged to correspond to weight values of several orders of weight. W. & T. Avery, Ltd. No. 461,651.

Indicating circuit. A circuit in which the period of oscillation is determined mainly by the values of resistance and capacity has at least a part of the capacity in the form of an element adapted to change its capacity in response to movements of a body in its vicinity so as to cause a change in the current in the oscillator circuit, thereby operating a relay. A. C. Alexandra. No. 460,297. See also 460,298. A. C.

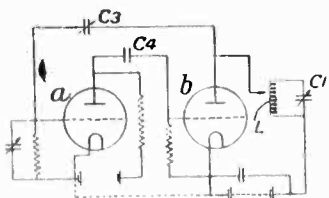

Alexandra, on a capacity-controlled system for switching, indicating, controlling, signalling, alarm, lighting and other installations adapted to be actuated by capacity variation caused by the approach of a body or person.

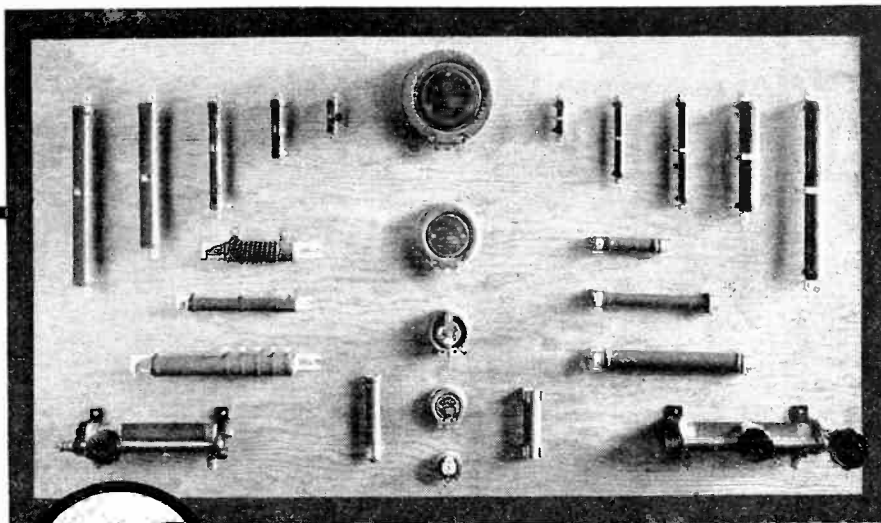

Rugged, Long-Lived

RHEOSTATS AND RESISTORS

12 years specialization in this field enable us to offer complete service in special applications. Vitreous enamel resistors—fixed, tapped, adjustable—with various accessories for any conceivable requirement. Porcelain-vitreous enamel rheostats with exclusive fully inclosed positive contact system—covered by patents.

Let us send literature on our complete line of control devices . . . and remember the mark (H) means reliable rheostats and resistors.

HARDWICK, HINDLE • Inc.

136 PENNINGTON STREET—NEWARK, N. J.



HANDBOOK OF BROADCASTING

By WALDO ABBOT

Director of Broadcasting Service, University of Michigan, Federal Radio Education Committee, Vice-President, Ann Arbor Broadcasting Company

424 pages, 6 x 9, \$3.50

Just Published

—the modern broadcasting system set-up; —how programs are developed and produced; —radio announcing, speaking, and acting; —how to write for radio; —opportunities in the business end of radio; —radio singing; —serving the sponsor; —training for radio; —etc.

Look up in this book:

- station staffs
- how electrical transcriptions are used
- basic problems of radio speaking
- interpretation in radio reading
- radio play requirements
- staging the radio play
- suggestions for singers
- preparing children's and educational programs
- building commercial and sustaining programs
- free-lance opportunities in radio
- the service of the advertising agency
- advertising or sales department requirements
- women in radio
- glossary
- radio practice in pronunciation
- studio musical practice
- etc., etc.

A complete guidebook of broadcasting for those in the radio profession, those who hope to be announcers, actors, or writers, or to fill other positions in radio producing agencies, and those who are, or may be, called upon to deliver addresses or make special appearances before the microphone. Covers educational, commercial, legal, public service, and other aspects of radio, but gives major attention to practical pointers on vocational opportunities and requirements both in the before-the-mike and backstage positions of broadcasting.

10 DAYS' FREE EXAMINATION—SEND COUPON

McGraw-Hill Book Co., Inc., 330 W. 42nd St., N. Y. C.
Send me Abbot's Handbook of Broadcasting for 10 days' examination on approval. In 10 days I will send \$3.50, plus few cents postage, or return book postpaid. (Postage paid on orders accompanied by remittance.)

Name

Address

City and State

Position

Company

L-10-37
(Books sent on approval in U. S. and Canada only.)

New
1937

REMLER ATTENUATORS

New Features • Same Price

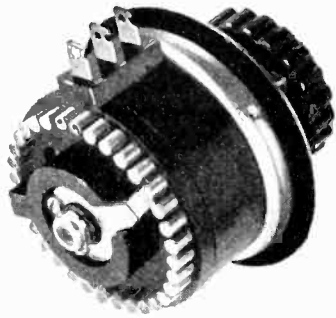

Improvements provide unequalled ease of operation and long life. Attenuation variable in 27 steps of 1-2/3 db. per step up to 45 db. fading in 3 additional increasing steps from 45 db. to infinity. Attenuation change halved as switch arm spans adjacent contacts resulting in attenuation of 5/6 db. per step. Impedance practically constant over entire range of the pad. Standard impedances of 50, 200, 250 and 500 ohms. Special values to order.

- BALL BEARING ROTOR SHAFT.
- CLOCK SPRING PIGTAIL CONNECTIONS.

LA-5 LADDER
TYPE—NET

\$10.80

REMLER COMPANY, LTD., 19th at Bryant, San Francisco

REMLER—THE RADIO FIRM AS OLD AS RADIO

CANNON SECTIONAL CABLE TERMINALS

By using CANNON Sections you can build Cable Terminals of any size by adding center sections of 5 pairs each. Designed primarily for telephone use, these sectional terminals suggest many other applications.

(The two end sections form an 11-pair strip)

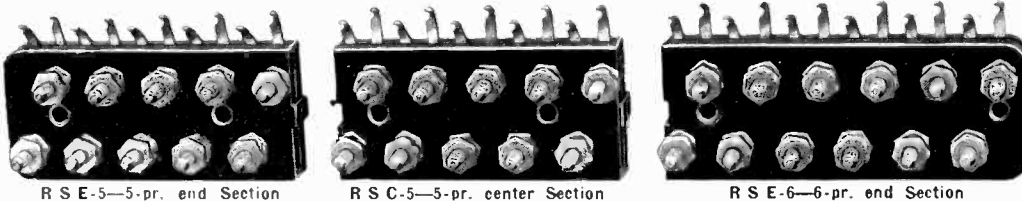

RSE-5—5-pr. end Section

RSC-5—5-pr. center Section

RSE-6—6-pr. end Section

Features: All bakelite insulation; tinned solder lugs; 3-nut, 8-32 binding posts; exceptional compactness—pairs are on 5/8" longitudinal centers. Three stock pieces make any size terminal in multiples of 5 pairs.



CANNON ELECTRIC DEVELOPMENT CO.
420 WEST AVENUE 33, LOS ANGELES, CALIFORNIA

WAXES • COMPOUNDS • VARNISHES for ELECTRICAL INSULATION

Zophar offers prompt service on Insulating Compounds for a wide variety of electrical applications, including:

... insulation for CONDENSERS, TRANSFORMERS, COILS, power packs, pot heads, sockets, wiring devices, wet and dry batteries, etc. Also WAX SATURATORS for braided wire and tape. WAXES for radio parts.

Special compounds made to your order.

ZOPHAR MILLS INC.

130-26th St.

Brooklyn, N. Y.

FOUNDED 1846

Telemetering. In a system for transmitting meter readings to a distance by modulated carrier current, the modulations are produced by a phototube subjected to a beam of light which is interrupted by two disks. No. 460,997.

Photometric apparatus. A device for measuring light quanta for use as an exposure meter comprises a tube system adapted to operate a counter which records the number of impulses

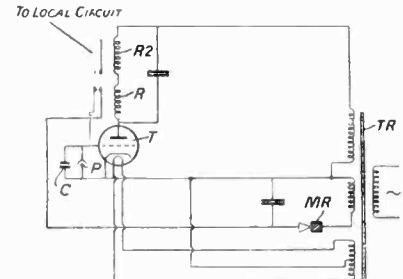

or surges in a circuit, the rate of production of impulses being controlled by the intensity of light falling on a phototube. True-Colour Film, Ltd. No. 460,452.

Piezo crystal manufacture. A method of making piezo-electric devices comprising bodies formed of water-soluble crystalline material of high specific inductive capacity and having electrodes on one or more surfaces, consisting in applying directly to the body surface to be electroded a thin coating of conducting material in a wet state and sufficiently finely divided to be adapted when dry to adhere to the photoelectric material in intimate contact therewith, causing the wet coated surface to dry and thereafter applying additional conductive material to the coating to increase its conductivity. Specifically, the patent shows construction of elements using Rochelle salt clamped between masks and the application of "Aquadag" by means of an atomizer. Brush Development Co. No. 454,595.

Control apparatus. An apparatus for checking the output of a cigarette-making machine and regulating the tobacco supply by photo-electric means controlled by a weighing device, the completed cigarettes being received from the machine by a trough chain and are carried forward to a packing machine. The cigarettes pass under an optical projector cooperating with a phototube for counting the cigarettes. A rotating segment takes off a number of cigarettes and delivers them by way of a shoot to a scale pan. The balance beam carries a shutter movable in front of a screen pierced by two apertures through which beams of light from projectors pass to phototubes, shutter moves from normal position and cuts off either of the light beams, electric devices are set in operation to increase or decrease the supply of tobacco to the machine. Brinkmann Akt.-Ges. No. 461,100.

Patent Suits

1,573,374 (a), P. A. Chamberlain; 1,707,617, 1,795,214, E. W. Kellogg; 1,894,197, Rice & Kellogg; 1,728,879, same, D. C., S. D. Calif. (Los Angeles), Doc. E 895-J, *R. C. A. et al. v. E. Spigel*. Decree pro confesso holding patents valid and infringed, injunction Feb. 25, 1937. Doc. E 1079-H, *R. C. A. et al. v. J. Forbes*. Decree pro confesso against defendant, injunction Feb. 26, 1937. Doc. E 1081-Y, *R. C. A. et al. v. O. J. Bates*. Decree pro confesso, in junction Feb. 25, 1937. Filed Feb. 26, 1937. Doc. E 1127-M, *R. C. A. et al. v. G. Deutch et al. (Radio Accessories Co.)* Doc. E 1083-C, *R. C. A. et al. v. F. Sage*. Decree pro confesso, injunction Feb. 25, 1937. Same, D. C., N. D. Calif. (San Francisco), Doc. E 4104-L, *R. C. A. et al. v. O. S. Grove*. Decree pro confesso holding patents valid and infringed as to certain claims, injunction Mar. 4, 1937.

1,573,374 (b), P. A. Chamberlain; 1,707,617, 1,795,214, E. W. Kellogg; 1,894,197, Rice & Kellogg; 2,052,316, R. E. Sagle, D. C., S. D. N. Y., Doc. E 84/302, *R. C. A. et al. v. Ampex Radio Corp. et al.* Consent decree for plaintiff (notice Mar. 17, 1937).

1,466,701, L. de Forest, Method of and means for controlling electric currents by and in accordance with light variations; 1,693,071, same, Sound recording attachment for motion picture cameras; 1,695,414, same, Talking moving picture machine; 1,473,976, E. E. Ries, Sound recording method; 1,607,480, same, Method of reproducing photographic sound records; 1,701,911, De Forest & Reynolds, Acoustic apparatus; 1,203,190, C. E. Fritts, Recording and reproducing of pulsations or variations in sound and other phenomena, D. C. Del., Doc. E 808, *General Talking Pictures Corp. v. R. C. A. Photophone, Inc.* Dismissed for want of prosecution Mar. 9, 1937.

1,473,976, E. E. Ries, Sound recording method; 1,607,480, same, Method of reproducing photographic sound records; 1,489,314, L. de Forest, Recording sound; 1,653,155, same, Talking moving picture equipment; 1,693,071, same, Sound recording attachment for motion picture camera; 1,693,072, same, Means for shielding sound detector and amplifier apparatus; 1,695,414, same, Talking moving picture machine; 1,695,415, same, Talking motion picture records; 1,716,033, same, Method of producing talking motion picture film and apparatus used therefor; 1,764,938, same, Method of producing talking motion picture films, D. C. Del., Doc. E 809, *General Talking Pictures Corp. v. R. K. O. Radio Pictures, Inc.* Dismissed for want of prosecution Mar. 9, 1937.

1,815,768, A. Georgiev, Electrolyte, filed May 11, 1927, D. C., N. D. Ill. (Chicago), Doc. 15639. *Aerovox Corp. v. S. P. Levenberg et al.*

A MINIATURE
REVERSIBLE
Power plant

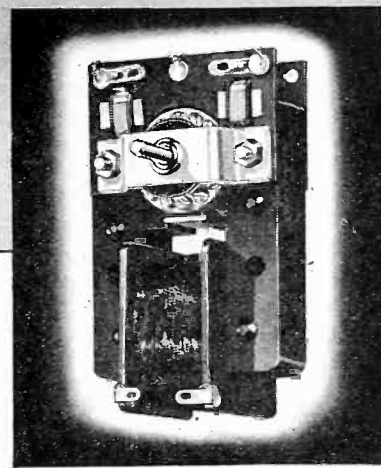

Featuring:
compact power
positive control
universal application

Unusually high starting torque in both directions is now obtainable in this new midget motor.

Dynamic braking and reversal of rotation are easily accomplished by simply switching in a low voltage circuit.

Recent developments make it possible to announce the addition of small gear reduction assemblies, integral with the motor, enormously extending the range of applications.

Both reversible and unidirectional models may now be mounted in any position, with or without speed reduction assemblies.

For additional information address your inquiries to

THE ALLIANCE MANUFACTURING CO., ALLIANCE, OHIO
South Mahoning Avenue

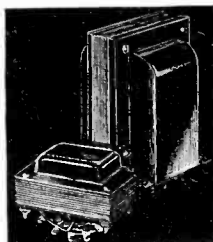

DEVELOPMENT

Rapid increase in the application of electronic principles to industry requires constant development of transformers having new characteristics for new services.

STANCOR today, as in the past, is eager to offer its facilities and experience to any manufacturer of electronic equipment who requires economical solution of his transformer problems.

STANCOR

STANDARD TRANSFORMER CORPORATION
850 BLACKHAWK STREET, CHICAGO

**AUTOMATIC
ELECTRIC**

RELAYS

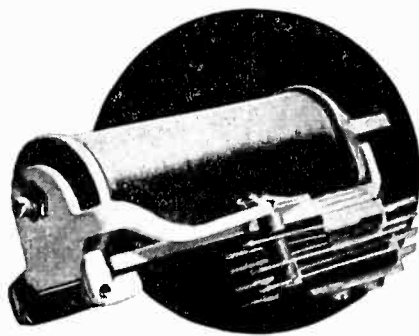

**A WIDE VARIETY OF TYPES
FOR EVERY INDUSTRIAL USE**

The Automatic Electric line of relays includes quick and delayed action types, sensitive and heavy duty types, mechanical locking types, polarized relays, etc., etc. Available for operation on D.C. or A.C. circuits, any voltage, any contact combination.

Also stepping switches, electric counters, solenoids, keys and other electric control accessories. Write for complete illustrated catalogs.

AMERICAN AUTOMATIC ELECTRIC SALES COMPANY
1019 WEST VAN BUREN STREET CHICAGO

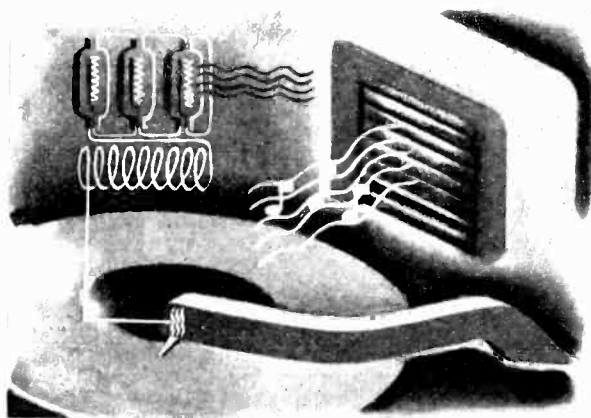

There's a

New Pick-Up Coming!

Webster Electric announces a new electric phonograph Pick-up that will be unlike any other ever developed. New in design. New in principle. New in performance characteristics. Write for information as to how you can profit by the increasing replacement demand.

WEBSTER ELECTRIC COMPANY • RACINE, WISCONSIN, U. S. A.
Established 1909 • Export Department—100 Varick Street, New York City
Cable Address "ARLAB" New York



Webster Electric

PORTABLE AND SEMI-PORTABLE SOUND SYSTEMS • ELECTRONIC
INTER-COMMUNICATING SYSTEMS • ELECTRIC PHONOGRAPH PICK-
UPS • TRANSFORMERS AND FUEL UNITS FOR OIL BURNERS

1,141,402, R. D. Mershon, Electrolytic apparatus employing filmed electrodes; 1,784,674, same, Film formation and operation of electrolytic condenser and other apparatus, appeal filed Mar. 17, 1937, C. C. A., 1st Cir., Doc. 3233. *R. D. Mershon et al. v. Sprague Specialties Co.*

1,977,271, P. K. Giddens, Radio antenna circuit, filed Feb. 5, 1937, D. C., W. D. Mo. (Kansas City), Doc. 2889. *The Zodyne Corp. v. G. B. Steele*. Dismissed Feb. 22, 1937. Doc. 2891. *The Zodyne Corp. v. W. C. Hemingway*. Dismissed Feb. 22, 1937.

1,922,162, A. J. King, Evacuation of electronic devices, D. C., S. D. N. Y., Doc. E 79/30, *King Laboratories, Inc. v. Kemet Laboratories Co., Inc.* Discontinued without prejudice (notice Jan. 21, 1937).

1,573,374, P. A. Chamberlain, 1,707,617, 1,795,214, E. W. Kellogg; 1,894,197, Rice & Kellogg; 1,728,879, same; D. C., S. D. Calif. (Los Angeles), Doc.

E 1127-M, *R.C.A. et al. v. G. Deutch (Radio Accessories Co.)*. Consent decree for injunction May 4, 1937. Same, D. C., W. D. Wash., N. Div., Doc. 1150, *R.C.A. et al. v. F. V. Buckley*. Decree as above May 19, 1937.

1,403,475 (a), H. D. Arnold; 1,403,932, R. H. Wilson; 1,507,016, L. de Forest; 1,507,017, same; 1,811,095, H. J. Round, D. C., S. D. Calif. (Los Angeles), Doc. E 1126-C, *R.C.A. et al. v. G. Deutch et al. (Radio Accessories Co.)*. Consent decree for injunction May 4, 1937.

1,403,475 (b), H. D. Arnold; 1,403,932, R. H. Wilson; 1,507,016, L. de Forest; 1,507,017, same; 1,811,095, H. J. Round; Re. 18,579, Ballantine & Hull, D. C., W. D. Wash. (Seattle). Doc. 1149, *R.C.A. et al. v. F. V. Buckley (Buckley Radio Co.)*. Injunction May 19, 1937.

1,755,114, L. A. Hazeltine, Uni-control signaling system; 1,755,115, same. Variable condenser, D. C., S. D. N. Y., Doc. E 80/195, *Hazeltine Corp. v. Chevrolet Motor Co. et al.* Dismissed without prejudice (notice May 16, 1937).

1,879,863, H. A. Wheeler, Volume control; 1,951,685, same, Peak detector, D. C., S. D. N. Y., Doc. E 80/192, *Hazeltine Corp. v. Chevrolet Motor Co. et al.* Dismissed without prejudice (notice Apr. 16, 1937).

1,573,374, P. A. Chamberlain; 1,707,617, 1,795,214, E. W. Kellogg; 1,894,197, Rice & Kellogg; 1,728,879, same; 2,052,316, R. E. Sagle, Variable condenser, filed Apr. 12, 1937, D. C., N. D. Calif. (San Francisco), Doc. F. 4167-R, *R.C.A. et al. v. Cavalcade Radio Corp. et al.*

1,329,283, H. D. Arnold; 1,448,550, same; 1,520,994, same; 1,403,475, same; 1,465,332, same; 1,231,764, F. Lowenstein; 1,426,754, R. C. Mathes, appeal filed Apr. 14, 1937, C. C. A., 2d Cir., Doc. —, *Western Electric Co. et al. v. General Talking Pictures*.

SEARCHLIGHT SECTION

EMPLOYMENT : BUSINESS : OPPORTUNITIES : EQUIPMENT—USED or RESALE

UNDISPLAYED RATE:
10 cents a word, minimum charge \$2.00.

Position Wanted, (full or part-time salaried employment only), ½ the above rates, payable in advance.

Proposals, 40 cents a line an insertion.

(Copy for new advertisements must be received by the 26th of the month to appear in the issue out the following month)

INFORMATION:

Box Numbers in care of our New York, Chicago or San Francisco offices count 10 words additional in undisplayed ads. Replies forwarded without extra charge.

Discount of 10% if full payment is made in advance for four consecutive insertions of undisplayed ads (not including proposals).

DISPLAYED—RATE PER INCH

1 inch\$6.00
2 to 3 inches..... 5.75 an inch
4 to 7 inches..... 5.50 an inch

An advertising inch is measured vertically on one column. 3 columns—30 inches—to a page. Contract rates on request.

POSITIONS WANTED

TESTING DESIGN ENGINEER, E.E. Graduate. Age 30. Married. Mature training. Five years' experience in design of testing equipment and production supervision. Desire relative connection. Will work from bottom up. References. Any location. PW-121, Electronics, 520 No. Michigan Ave., Chicago, Ill.

LICENSED OPERATOR, radio telephone first class, desires permanent position in East preferably. Married, 30, Protestant; salary secondary to securing work. Go anywhere on reasonable notice. Some experience. Education two and a half years university. References furnished. Have had instruction in television. PW-122, Electronics, 330 West 42nd Street, New York City.

FOR SALE

COLLINS 202A Broadcast Transmitter, built for export. 500 to 700 Watts. Can be analyzed for any frequency. Reasonable. FS-123, Electronics, 330 West 42nd Street, New York City.

WANTED

ANYTHING within reason that is wanted in the field served by Electronics can be quickly located through bringing it to the attention of thousands of men whose interest is assured because this is the business paper they read.

PRACTICAL HOME STUDY COURSE FOR RADIO AND COMMUNICATION ENGINEERS

Primarily for men who have completed High School or equivalent education and wish to grow with their profession. Consists of over 50 lessons in book form, each with exercises, exercise answers, and examinations to be graded. Course covers elementary mathematics necessary to handle alternating current circuit theory, a general treatment of bilateral networks and of unilateral networks. Very reasonable—payable monthly. Write for the information booklet.

CARL E. SMITH
Radio Sta. WHK Cleve., Ohio

YOUR ORGANIZATION

*Is it complete?
Are you expanding it?
Making replacements?*

Naturally, you are anxious to secure the most suitable man or men available. You want men with the special training that will make them an asset to your organization. You can contact such men through a Position Vacant advertisement in the Searchlight Section of ELECTRONICS

REBUILT INSTRUMENTS of GUARANTEED ACCURACY

We Believe

No Instrument is BETTER than its CALIBRATION

Therefore

We maintain a STANDARDS laboratory, where every instrument is checked before shipment, and guaranteed to be accurate within the original makers specifications.

New Bulletin Now Ready

LOUIS J. WINSLOW

200 Pennsylvania Ave., Hillside, N. J.

VACUUM TUBE EQUIPMENT

Formerly Production Units of
JOHNSONBURG RADIO CORPORATION

Including:

Power Transformers
Motor Generator Units
Hydrogen Furnaces
Filament Coating Units
Hofmann Exhaust Units
Lepel Bombarders
Weston & Rawson Meters
Biddle Slide Wire Rheostats
International & Elsler Pumps
York Soldering Machine
York Base Brander

PRICES ON INQUIRY

A. E. LYLE, Box 567, Newark, N. J.

DEPENDABLE

New and Used

ELECTRONIC TUBE EQUIPMENT

A complete line of equipment for the manufacture of Radio Tubes, Neon Tubes, Incandescent Lamps, etc.

Write for Bulletin showing savings from 25 to 75%

EISLER ELECTRIC CORP.
534 39th Street, Union City, N. J.

WANTED

CASH WAITING

We pay highest prices for your surplus laboratory equipment as meters, rheostats, bridges, decade boxes, etc. Submit your lists of what you have to offer.

AMERICAN ELECTRICAL SALES CO.
65-67 E. 8th St. New York, N. Y.

New "SEARCHLIGHT" Advertisements

must be received by the 26th of the month to appear in the issue out the following month.

Address copy to the
Departmental Advertising Staff
Electronics

330 West 42d St., New York City

REAL THRIFT

Our reconditioned 49 and 04A type tubes, have lasting qualities that make them an outstanding value. Save half on your replacement cost.

49 type—\$75 04A type—\$45

Our work fully Guaranteed.

We solicit a trial order.

National Radio Tube Co., Inc.

3420 18th St. San Francisco, Calif.

Meters repaired, made more serviceable. Conversion to higher sensitivity as high as 10 microamperes for Weston type I or 24-57.

Sensitive vacuum thermo couples For Sale used Weston panel meters, Rawson microammeters, Brown pyrometers.

Reasonable Prices
Precision Electrical Instrument Co.
561 Broadway, N. Y. C.

BUY • EXCHANGE • SELL Electronic Equipment

Rheostats—Pumps—Solenoids—Relays
PHOTO CELLS, \$1.00 & Up
ELECTRO-TECH TRADING CO.
321 CANAL ST., N.Y.C., N.Y.
Tel—CAnal 6-8661

HIGH GRADE NEW AND USED ELECTRON TUBE EQUIPMENT

Huge Stock of Equipment of Every Type and Variety
KAHLE ENGINEERING CORPORATION
Specialists in Equipment and Methods for the Manufacture of Neon Tubes, Radio Tubes, Incandescent Lamps, Photo Cells, X-ray Tubes, etc.
941 DeMott St., North Bergen, N. J.

MAGNET WIRE

All Insulations
**BRAIDS AND CABLES—RUBBER COVERED
WIRE—LAMP AND HEATER CORDS.
JOB LOTS OUR SPECIALTY
WIRE MACHINERY
B. D. LAND**
37 GRAND ST., NEW YORK CITY
Walker 5-4687

ELECTRONIC TUBE

NEW • EQUIPMENT • USED
For the manufacture of Electronic, X-Ray, Power, and Radio Tubes, Incandescent Lamps, Neon Signs, etc.

Write for full information
ELECTRONICS MACHINE CO.
751 13th Street, Newark, N. J.

Now!

You too, can build amplifiers with 70 db. volume range!



A new line of INCA transformers featuring:

Sextuple Shielding—Hunt and noise pickup 90 db. less than unshielded transformers; 80 db. less than transformers in high-permeability cast-iron cases.

Wide Frequency Range—20 to 20,000 cycles ± 1 db.

Reversible Mounting—4 bolt mounting from either end of case with circular cutout for sub base mounting.

"Climate" Treatment—An improved vacuum treatment. Improved engineering makes it unnecessary to resort to "flash-dipping" in order to keep internal capacity low.

Wide Range Midget Transformers—(Illustrated above), with frequency range from 20 to 20,000 cycles ± 1 db. and shielding 30 db. more effective than that obtained with heavy cast iron cases.

Liberal Power Equipment—Power transformers and chokes designed for cool operation at high ambient temperatures. Low flux density, low copper density, high insulation safety factors.

All above are described in bulletin L-33, obtainable from your jobber or from:

The Phelps Dodge Copper Products Corporation

2375 East 27th Street — Dept. E
Los Angeles, California

INDEX TO ADVERTISERS

Aerovox Corporation	70
Alliance Manufacturing Co.	81
Allied Recording Products Co.	78
American Automatic Electric Co.	82
American Emblem Co.	70
American Radio Hardware Co.	72
American Transformer Co.	40
Amperex Electronic Products, Inc.	40
Inside Front Cover	
Ariston Manufacturing Corp.	50
Astatic Microphone Laboratory, Inc.	74
Audak Company	69
Bakelite Corporation	55
Biddle Co., James G.	69
Brand & Co., William	75
Callite Products Division	66
Cannon Electric Development Co.	66
Centralab Div. Globe-Union Co.	43
Cinaudagraph Corp.	70
Cinema Engineering Co.	71
Cinch Manufacturing Co.	47
Collins Radio Co.	70
Cornell Dubilier Corp.	57
Crowe Nameplate & Mfg. Co.	41
Daven Company	58
Driver Co., Wilbur B.	66
Du Mont Laboratories, Inc., Allen B.	71
Erie Resistor Corporation	57
Fansteel Metallurgical Corp.	62
Ferranti Electric, Inc.	5
Formica Insulation Co.	4
General Ceramics Co.	4
General Electric Co.	42
General Radio Co.	8
Goat Radio Tube Parts, Inc.	76
Guardian Electric	44
Hardwick-Hindle, Inc.	79
Heintz & Kaufman, Ltd.	77
International Resistance Co.	39
Isolantite, Inc.	6
Jones, Howard	74
King Laboratories, Inc.	50
Lansing Mfg. Co.	49
Lapp Insulator Corp.	3
Leach Relay Co.	60
Lepel High Frequency Labs.	60
Mallory & Co., P. R.	10
McGraw-Hill Book Co.	53, 73, 79
Mica Insulator Co.	48
Monark Mfg. Co.	77
Newark Transformer Co.	71
Ohmite Manufacturing Co.	66
Phelps-Dodge Copper Products Co.	84
Pioneer Gen-E-Motor Corp.	69
Precision Resistor Co.	72
Prentice Hall Publ. Co.	69
Presto Recording Corp.	84
Raytheon Manufacturing Co.	68
RCA Communications, Inc.	72
RCA Manufacturing Co.	Back Cover, 62
Remler Co., Ltd.	46
Shakeproof Lock Washer Co.	Inside Back Cover
Sigma Instruments, Inc.	76
Simpson Electric Co.	60
Standard Transformer Corp.	81
Superior Tube Co.	7
Synthane Corp.	59
Teleso Company	54
Terminal Radio Corporation	67
Triplett Electrical Instrument Co.	9
Truscon Steel Co.	51
United Electronics, Inc.	46
United Sound Engineering Co.	63
United Transformer Corp.	66
Universal Microphone Co., Ltd.	76
Universal Signal Appliances	68
Utah Radio Products Co.	73
Ward Leonard Electric Co.	52
Webster Electric Co.	82
Western Electric Company	65
Wiley, John & Sons	75
White Dental Mfg. Co., S. S.	2, 54
Zophar Mills	52

Professional Services 78

SEARCHLIGHT SECTION

Classified Advertising

EMPLOYMENT	83
HOME STUDY COURSE	83
WANTED TO PURCHASE	83
EQUIPMENT FOR SALE	
American Electrical Sales Co.	83
Eisler Electric Corp.	83
Electronics Machine Co.	83
Electro-Tech Trading Co.	83
Kahle Engineering Corp.	83
Land, B. D.	83
Lyle, A. E.	83
National Radio Tube Co., Inc.	83
Precision Electrical Instrument Co.	83
Winslow, Louis J.	83

BUY PRESTO

Get These Exclusive Features

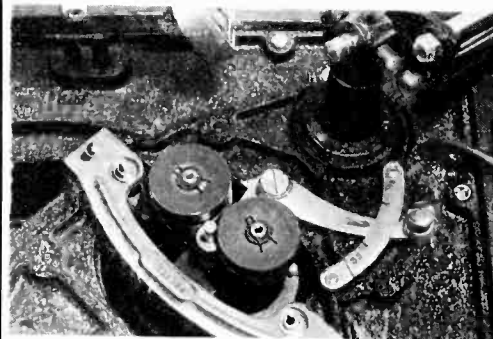

Presto, 2 second, speed shift—changes instantly from 78 to 33 and back—no need to stop the motor or turntable or lift the record. Simply move the lever. Standard equipment on all Presto recording and transcription turntables.



Presto high fidelity cutting head (and mounting). A sturdy magnetic movement of hardened steel, hand polished and assembled with watchmakers' precision. No rubber to age or deteriorate. No delicate parts to fracture or fail without warning. And a perfectly controlled frequency characteristic hand-tailored to fit the peculiarities of lateral cut cellulose coated discs. Input required + 20 D.B. (Ref. .006W=0 db.)



Presto recording amplifier, combined with Presto high fidelity cutting head, gives you 78 RPM records a flat response on playback from 50 to 6600 cycles. A built-in adjustable equalizer compensates for additional high frequency losses at 33 1/3 RPM. Power output 10 watts with one per cent total harmonics—gain 95 DB—self-contained power supply.

Special prices quoted to Presto owners who want to add these improvements to their equipment.

Write for catalog describing the latest Presto equipment in detail.

PRESTO RECORDING CORPORATION

143 WEST 19th STREET, N. Y. C.

SHAKEPROOF

External
Type

TRIPLE-ACTION LOCK WASHERS

Internal
Type

A LOCK SO POWERFUL IT ACTUALLY DEFIES VIBRATION

● Nuts and screws can't shake loose when locked with Shakeproof Triple-Action Lock Washers. First, there's *Strut-Action*—the powerful locking force which is set up when the tapered-twisted teeth bite into both nut and work surfaces. Next, *Spring-Tension*—produced by the special design of the teeth to keep the locking action constantly at work. And, third, there's *Line-Bite*—which assures a tight lock with only a quarter turn of the wrench after initial contact. Send today for a free test ring of Shakeproof Lock Washers—contains assorted sizes of both external and internal types—write for yours, now!



U. S. Patent Nos. 1,419,564; 1,604,122; 1,782,387;
1,963,800; 1,862,486; 1,909,476; 1,909,477. Other
Patents. Patents Pending. Foreign Patents.

The automobile industry has proved that Shakeproof's Triple-Action locking principle gives perfect protection against the damaging action of vibration. The vital connections of most leading cars are kept tight with Shakeproof Lock Washers!

Thread-Cutting
SCREWS
with Standard Machine
Screw Thread



**TAP
AND
FASTEN
IN ONE
OPERATION**

Here's a screw that actually cuts its own thread. Patented thread-cutting slot eliminates tapping—cuts costs—speeds up production—assures a perfect fastening! Write today for free demonstration kit of Shakeproof Thread-Cutting Screws!

SHAKEPROOF LOCK WASHER COMPANY

Distributor of Shakeproof Products Manufactured by Illinois Tool Works
2539 North Keeler Avenue Chicago, Illinois

IN CANADA: Canada Illinois Tools, Ltd., Toronto, Ont.
Copr. 1937 Illinois Tool Works

THE NEW
**RCA
833**

**A UNIQUE DESIGN—
A NEW STANDARD OF
TUBE PERFORMANCE**

FOR BROADCASTING:

Low-Price + Conservative Rating
= ECONOMY



RATED AT 500 WATTS per tube by FCC for high-level service, two RCA-833's can be used as final RF stage in 1 KW Transmitters.

Its low cost and extra performance suggest the RCA-833 as an economical replacement tube. Note the radical new features which will make the RCA-833 of interest to every radio engineer.

FOR SHORT-WAVE AND UHF RADIO SERVICES:

The unique features of the new RCA-833, which include low driving power, high efficiency and ease of neutralization, insure stable, economical operation at the higher frequencies.

RCA-833 FEATURES*

HIGH EFFICIENCY AT HIGH FREQUENCIES
HIGH INSULATION
SHORT, HEAVY LEADS
LOW DRIVING POWER
COMPACT DESIGN
TANTALUM ANODE
MODERATE PLATE VOLTAGE REQUIREMENTS
EXTRA EMISSION FROM 100-WATT
THORIATED-TUNGSTEN FILAMENT

*Technical bulletin available on request.



Radiotrons

RCA MANUFACTURING COMPANY, INC. • CAMDEN, NEW JERSEY
A SERVICE OF THE RADIO CORPORATION OF AMERICA