

electronics

radio, sound, communications and industrial applications
of electron tubes • • • design, engineering, manufacture

This new radio
prosperity?

♦
Iron core
i-f coils

♦
Design of
dual-band
receivers

♦
Litz-wire
transformers

♦
At right—3-cm. waves
at California Tech.
See page 316



McGRAW-HILL PUBLISHING COMPANY, INC.

Price 35 Cents

NOVEMBER, 1933

ALSIMAG

for
RADIO and TELEVISION

ALSIMAG incorporates in a quality ceramic the desired characteristics of high dielectric strength—low losses at all frequencies—rigidity—permanence—beauty and unsurpassed strength against mechanical shock—heavy loads—and heat.

Your product needs this better insulation.
Our new low cost production methods permit its use at a definite saving.

Use ALSIMAG
for
broadcasting
or
receiving
sets.

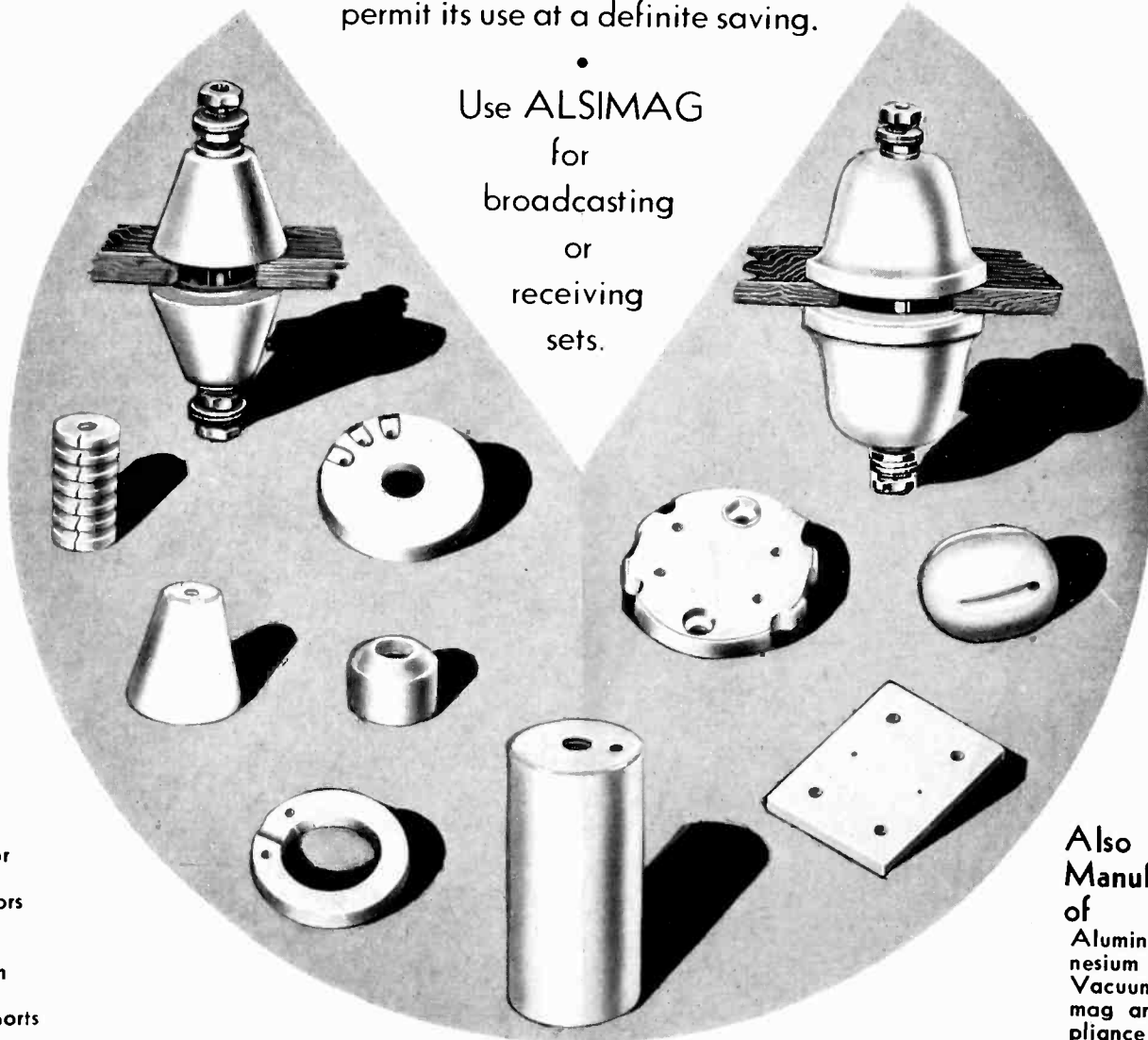

A Few Uses

Support Insulator
Coil Forms
Lead-in Insulators
Strain Insulators
Resistor Spools
Inductance Form
Spacer Bars
Condenser Supports
Sockets

Also Manufacturers of

Aluminum and Magnesium Oxide for Vacuum Tubes, Alsimag and Lava Appliance and Specialty Insulators.

AMERICAN LAVA CORPORATION

1430 Williams Street
Chattanooga Tennessee

SALES OFFICES

Boston—No. 80 Federal Street, Room 223
Chicago—1112 Merchandise Mart
Cleveland—Newman Stearns Building

Washington—Room 441, Evening Star Building

Newark—Globe Indemnity Bldg.
St. Louis—1623 Locust Street
San Francisco—163 Second Street

ELECTRONICS, November, 1933. Vol. 6, No. 11. Published monthly, price 35c. a copy. Subscription rates—United States, Mexico, and Central and South American countries, \$3.00 a year. Canada, including duty, \$3.50 a year. All other countries, \$4.00 a year or 20 shillings. Entered as second class matter April 4, 1930, at Post Office at New York, N. Y., under the Act of March 3rd, 1879. Printed in U. S. A. Cable address "McGrawhill, New York." Member of A.B.P. Member of A.B.C. Copyright 1933 by McGraw-Hill Publishing Co., Inc., 330 West 42d Street, New York, N. Y.

Printed by The Schweinler Press, N. Y.

IN THIS GREAT MARKET FOR BATTERY RADIO

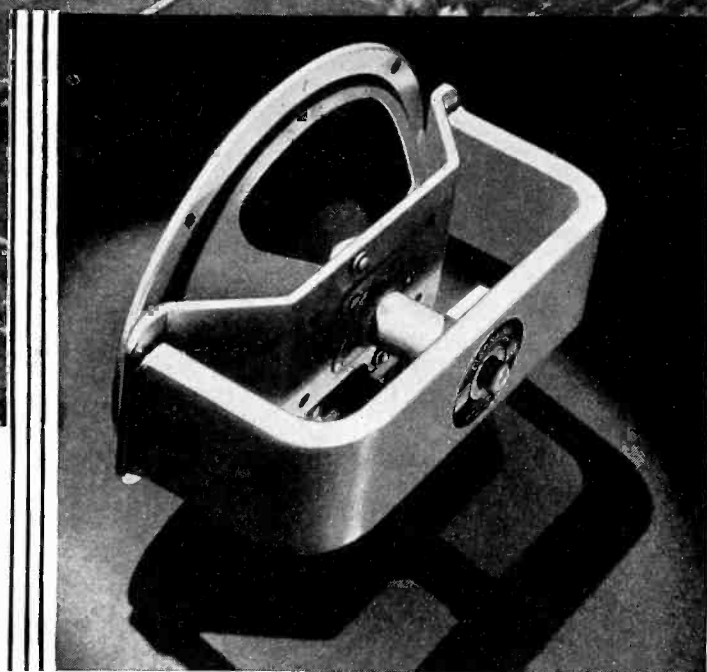
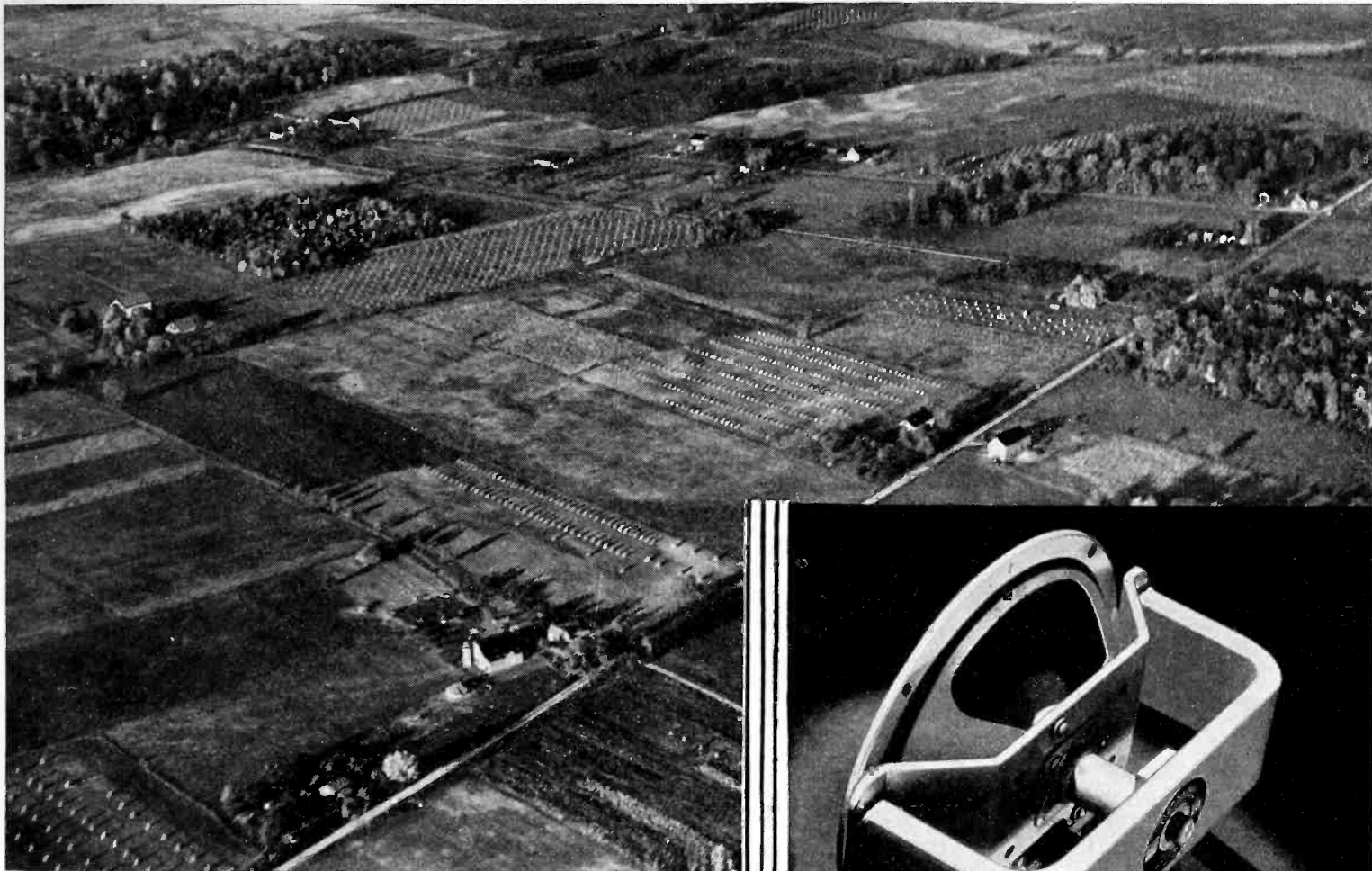

USE
MAGNAVOX
P. M. SPEAKERS
for Dynamic Performance

ONE vast undeveloped market for radio lies ahead... *the Farm Market*. Hundreds of thousands of American families living in isolated homes not connected with electric service *need* the best modern radio for business, culture and entertainment. Rising prices have increased their income. *At last they have the money to buy!* And they can now enjoy radio as rich, true and delightful as the A. C. set provides in the city home.

The Magnavox Permanent Magnet Speaker *gives genuine dynamic performance to battery operated radio sets*—with complete frequency range and entire freedom from distortion. Write for P. M. Speaker Bulletin. Our engineers are at your service.

This Magnavox Permanent Magnet Speaker makes possible the development of the great farm market because it provides dynamic performance for battery operated radio sets.



The Magnavox Company

FORT WAYNE, INDIANA



STANDARDS of SERVICE

There is no logical reason for using test equipment below proved Weston standards — since the long, dependable service which these thoroughly engineered test units give makes them cost far less in the end. Bulletin RA tells the whole story. Send for a copy . . . Weston Electrical Instrument Corp., Newark, N. J.



WESTON

Radio Instruments

WESTON ELECTRICAL INSTRUMENT CORPORATION
618 Frelinghuysen Avenue, Newark, New Jersey
Send Bulletin RA on Weston Radio Instruments.

Name _____

Address _____

JOBS FOR ELECTRON TUBES

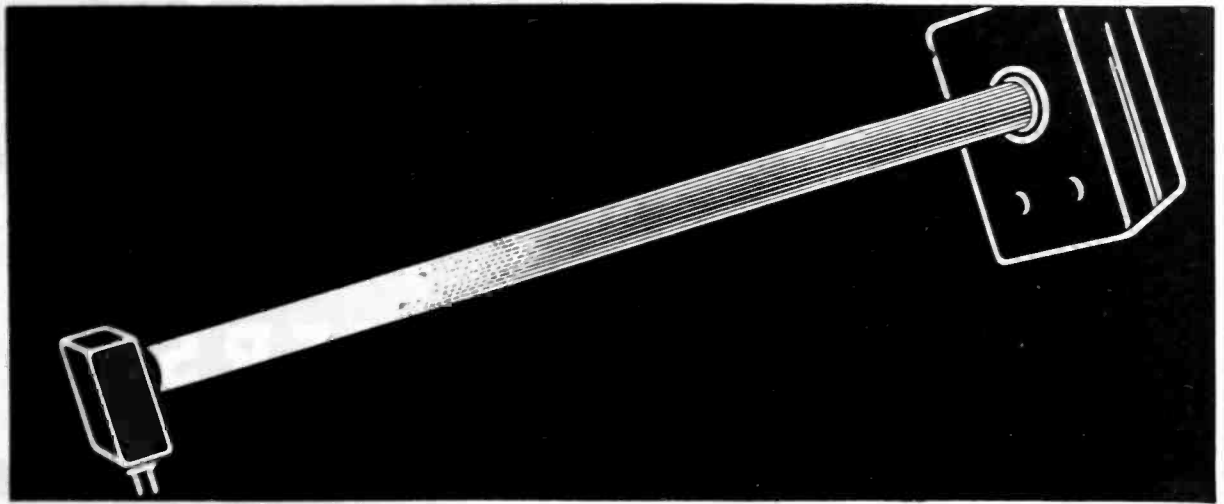

LIGHT-SENSITIVE DEVICES

FOR engineers and scientists interested in the application of light-sensitive tubes to industrial and experimental problems, General Electric offers a complete line.

Each of the types available is designed for long, trouble-free service, and high, uniform sensitivity. With G-E tubes, successful performance is assured, for they are built to meet the most exacting requirements of laboratory or factory.

For details on these G-E light-sensitive tubes, simply check and mail the coupon below. At the same time, if you desire information regarding other G-E tubes for rectification, control, conversion, amplification, etc., please attach a list of the types of service for which you wish to use them. Our specialists will gladly assist you. General Electric, Dept. 6-201, Schenectady, N. Y.



- Standard G-E Tubes
For Light-Sensitive Devices**
- General-purpose high-vacuum phototube — PJ-22
 - General-purpose gas-filled phototube — PJ-23
 - Variable-resistance, selenium, light-sensitive tube — FJ-31
 - Ultra-violet, quartz-bulb, high-vacuum phototube — FJ-76
 - Small, high-sensitivity, vacuum phototube — FJ-114

GENERAL ELECTRIC COMPANY,
DEPT. 6-201, SCHENECTADY, N. Y.

() Please send me further details on G-E electron tubes for light-sensitive devices.

NAME

FIRM

ADDRESS

301-143

GENERAL ELECTRIC

MALLORY DRY DISC RECTIFIERS

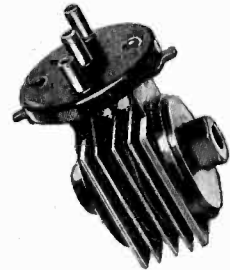
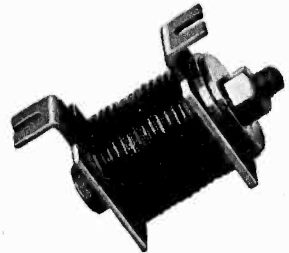
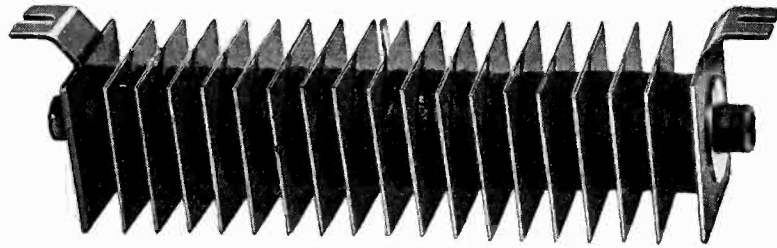
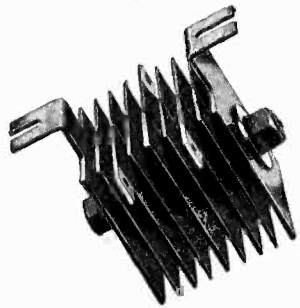
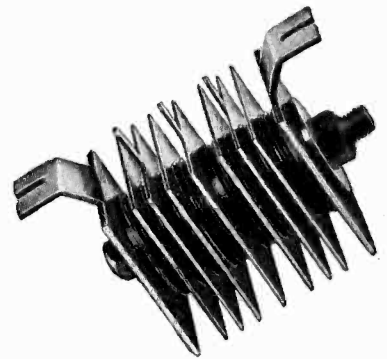
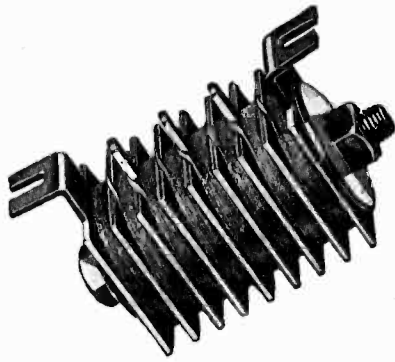

**Checked... on a basis of size...
or a basis of cost... you'll find they
lead the field for efficiency and economy**

Here are dry disc rectifiers of obvious compactness and demonstrated dependability, durability and economy. Mallory engineers designed them for battery chargers and other applications in which high currents and small size are essential requirements. Engineers generally are according them the same enthusiastic reception which has greeted the appearance of so many Mallory major contributions to the electrical industry.

Mallory Dry Disc Rectifiers are unusually efficient for relays and magnetic devices such as clutches, brakes, chucks and separators. You'll be equally impressed with their standard of performance on solenoids, motors, signaling devices and electroplating units.

In connection with Mallory High Capacity Dry Electrolytic Condensers, the Mallory Rectifier unit is available as an A Power in capacities of the order of 2 Amp. 6 volts to 6 Amp. 6 volts.

You'll appreciate the correctness of Mallory principles. You'll be quick to see the advantage offered by *sealing for protection against atmospheric conditions*. You'll value the longer life of service that Mallory Dry Disc Rectifiers provide.

You can depend upon Mallory Dry Disc Rectifiers to meet your most exacting requirements. And you can depend on Mallory engineers to assist you in the solution of any problem involving the use of rectifiers.

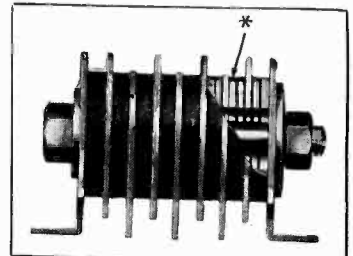

** Fabric impregnated with compound which is unaffected by moisture and does not harden after being subjected to temperature encountered on surface of rectifier.*

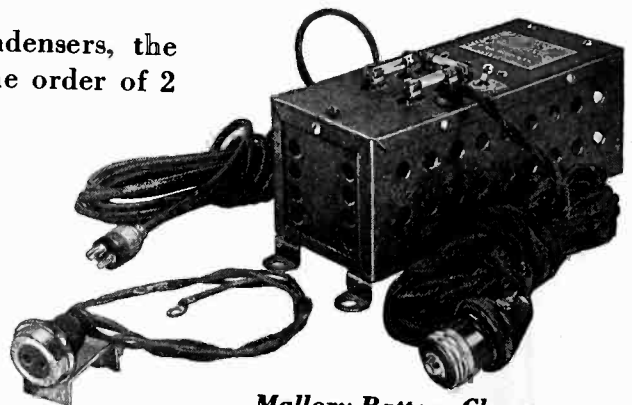

Mallory Battery Charger
Available in standard capacities from 2 Amp. 6 volts to 12 Amp. 12 volts. Other capacities available upon request.

MALLORY



in RADIO, ELECTRICAL,
AUTOMOTIVE AND
INDUSTRIAL FIELD

P. R. MALLORY & CO., Incorporated
Indianapolis Indiana



November, 1933 — ELECTRONICS

electronics

O. H. CALDWELL
Editor
KEITH HENNEY
Associate Editor

McGRAW-HILL PUBLISHING COMPANY, INC.

New York, November, 1933



radio
sound
pictures
telephony
broadcasting
telegraphy
counting
grading
carrier
systems
beam
transmission
photo
cells
facsimile
electric
recording
amplifiers
phonographs
measurements
receivers
therapeutics
traffic
control
musical
instruments
machine
control
television
metering
analysis
aviation
metallurgy
beacons
compasses
automatic
processing
crime
detection
geophysics

Steadying radio parts production

THE past few weeks have witnessed a surprising turn in the tables, in the radio industry.

Only a little while ago, the parts manufacturers and parts suppliers were wringing their hands, seeking buyers for their products.

Then with Indian summer, came the sudden demand for radio sets from the public. Set manufacturers' stock-rooms were soon bare; their supplies of parts and raw materials were overnight exhausted. The parts makers found themselves in a seller's market, but with demands for goods far outrunning any possibility of supply.

* * *

THIS experience, topping all the other jolts of the economic whirligig of radio, has cost both sides real money, and must be enlightening to both sides. Both the parts suppliers and the set makers should come to realize how they depend upon each other. It would seem to be the essence of good industry planning to set up some inter-group basis of production which will keep both groups busy and prosperous. The world as a whole is now beginning to learn that forced idleness and localized prosperity cannot go along together.

The old opportunism of "feast or famine" will have to be eliminated from radio, also. It is time the parts producers and the set makers sat down together and figured out the basis for a sound, steady-going radio-set production.

THIS NEW RADIO

Is it sound? Will it last? Can the NRA NEMA-RMA Code supervisors effect stabilization of radio industry?

THE whole radio industry has been enjoying sudden prosperity.

Set manufacturers have fallen far behind in their orders, and have been working their plants overtime.

Parts manufacturers in some cases have had to go on double and triple shifts. One plant has multiplied its payroll employees by six times, as compared with the number employed a year ago at this period.

Even for the radio engineer, the employment stringency has lightened somewhat, as manufacturers are building back their organizations, particularly on the production side.

There is no doubt about it, that for the present, at least, the whole radio production industry is bathed in the warm sunshine of prosperity and customer orders. Manufacturing activity is feverish, and once again the lights burn in radio plants long into the night.

But will it last?

But is all this demand for radio sets and radio parts to be regarded as permanent? Will this unique revival of past prosperity last beyond the next month or two? Will manufacturing plants be speeded up and output multiplied, only to build up a tremendous overstock, which eventually will have to be liquidated, at tremendous losses, with "dumping" and destruction to retail businesses? Will January and February see a return of the disastrous practices of a few years ago?

There is plenty of evidence to be had that the radio industry is already accelerated to a pretty excessive pace. Surveys of retail dealers indicate that these front lines of radio selling have not felt the new sunshine and "new deal" in such poignant fullness as have the manufacturers who are shipping them the goods. The dealers' stocks have been sadly depleted this past year, and so they are

just beginning to be replenished. These stocks are being built up, and customers are buying some sets and taking them away. But the time at which the slack is going to be absorbed, and equilibrium established, will depend upon a lot of external factors, beyond the control of radio. The advance of farm price-levels, the further restoration of industrial employment, the release of money from closed banks, are all conditions which can extend and protract the rate of consumer buying of radio sets, possibly even into a permanently prosperous activity for the whole radio industry.

The new factor of industry control

But another new element that can make for stability of the radio industry has come into the 1933 picture, a force that was not available in previous periods of radio optimism. Now, thanks to the new Administration at Washington and to General Johnson and the NRA, supervisory agencies have been set up for radio as well as for other manufacturing groups, and between these Supervisors and NRA headquarters there will be available full and immediate knowledge of employment enrollment, set prices, and inferentially, set production.

Arthur T. Murray, of Springfield, Mass., chairman of the radio-set division of the Radio Manufacturers Association, is Supervisory Agent for radio-set makers under the NEMA Electrical Code, which was accepted by the radio manufacturers. Leslie F. Muter, Chicago, chairman of the parts division RMA, is Supervisory Agent with jurisdiction over parts, cabinets and accessories. The radio-tube makers, who joined the National Electrical Manufacturers Association directly, as individual members, with their own section, have chosen as tube supervisors a committee made up of E. T. Cunningham, B. G. Erskine, and H. W. Harper.

Supervisory agencies administrating radio under NEMA-RMA NRA Code



ARTHUR T. MURRAY,
United American Bosch,
Springfield, Mass.
Receiving Sets



LESLIE F. MUTER,
The Muter Company,
Chicago, Ill.
Parts and Accessories



E. T. CUNNINGHAM,
RCA-Radiotron,
Harrison, N. J.
Tubes



B. G. ERSKINE,
Hygrade-Sylvania,
Emporium, Pa.
Tubes

The radio-tube industry, represented by a special section of the NEMA, is supervised by a committee comprising Messrs. Cunningham, Erskine, and Harvey W. Harper, Tungsol Radio Tubes, Inc., Newark, N. J.

P R O S P E R I T Y —

Receiver, parts and tube manufacturers are busy. Retail dealers not so sure of continuance of public demand

Supervisor Murray is initiating in radio the "open price" provisions of the NRA-NEMA Electrical Code, and has already required the filing by radio manufacturers of their net sales prices or their list prices, with maximum discounts, and terms of payment. This will apply to all types of radio receiving sets. These prices and discounts will then be made known by Mr. Murray's office to all competitors producing similar items.

This "open price" plan is regarded as an important step toward market stabilization and toward the disappearance of unfair and undesirable practices in radio set manufacturing. Set makers will be required to adhere to their officially filed prices and discounts, and to advise the supervisory agency of any changes. In addition to the price reports, three labor reports are being asked for, by the supervisors, to be transmitted to NEMA headquarters and Washington. These will give complete statistical information regarding seasonal peak overtime employment, labor employed in emergencies, and adjustment of wage rates under the NRA Code. Such labor reports will be required monthly by the supervisory agencies.

Thus the offices of the NRA authorities become centers of all basic information relating to the production of radio sets. It is apparent then, that the NRA Code machinery provides the means for applying the brakes against the radio industry again "running away with itself" as has happened in previous periods of prosperity.

Set and parts manufacturers busy

But the increased production schedules and increased numbers of workers and payrolls, throughout the radio industry give very tangible evidence that a sudden new demand for radio productions has come all along the line.

One large manufacturer of nationally known sets is understood to be able to deliver hardly one in ten of the sets ordered for Christmas business. Inability to get raw materials and parts, has held up his production in the face of overwhelming orders. Other set people have found that their shipments are falling far behind the requirements of their distributors.

Upon the parts suppliers came a sudden and unexpected demand that has overtaxed their depleted facilities, following upon a long period of sales at prices dictated by chiselers and price cutters, with production cut to almost nothing.

But the parts people have met the new demands with surprising facility, and have speeded up their plants, restored employment, added extra shifts, and kept production pouring out. The Summerill tubing plant, for instance, has increased its payroll 570 per cent, compared with a year ago, while the number of workers is sixfold. With three shifts, production is unbroken 24 hours a day!

In an effort to find out conditions in the local distribution of radio sets and tubes, the editors of *Electronics* and *Radio Retailing* collaborated in a survey of jobbers

and dealers throughout the United States, requesting telegraphic replies indicating whether consumer buying at this season is exceptional, and whether present activity may be looked to continue.

Responses indicate that while in some sections, like New England, there is very real demand from the public, yet in other districts like the Middle West, extensive customer sales still wait on increases in the prices of hogs and farm products. In other communities which suffered most from the bank closings of last Spring, active radio purchasing is expected as soon as the government thaws out the frozen assets and releases a substantial proportion of the depositors' funds.

Here are replies from the front-line trenches of radio selling:

OHIO—October demand much less than in September. November outlook not as good as last year, unless entire change can be effected by administration and fear of higher prices again be instilled into public. Would caution manufacturers against overstock, as we don't want dumping in January this season.

IOWA—Believe there is greater consumer interest in radio this year. Consumer buying has declined past month, on account of the decline in farm prices. Believe that if hog and corn prices advance materially will have much better business for November than last year. Certainly until dealers begin to accumulate inventory, they can't move to consumers.

MICHIGAN—Too much price rise since September 1. Over-production may result, as rural buying is very light due to low price of farm products. Too much price differential on competitive lines. Radio here had a spurt the first of October, dull latter part. November outlook about same as last year, due to strikes in cities and rural attitude.

ALABAMA—Retail orders for radio placed fifty-fifty for stock and customers. Expect hundred per cent increase this year. Believe manufacturers should be cautioned as over-production will cause dumping.

NEW JERSEY—Will need all factories can make. We are waiting for banks to open for record business. Urge avoid multi-prong tubes and tuning meters in sets as much as possible.

WISCONSIN—Requirements being bought mostly for stock. Consumers not buying high-priced radios as yet. Outlook for November not so rosy. Look forward to less business this year. Manufacturers should be cautioned not to go wild on price increases nor on production, as lull will follow stock requirements.

LOUISIANA—Fifty per cent of our orders are for immediate requirements. The future looks 25 per cent better than last year. Urge that manufacturers not over-produce.

CONNECTICUT—Strong public demand for radio sets here. Believe most Massachusetts and Connecticut dealers way behind orders. General business much improved.

Iron core intermediate frequency transformers

By ALFRED CROSSLEY
Consulting Engineer

THE use of iron cores in radio frequency transformers is old, but recently a radical improvement has been made in such transformer design, in the interest of obtaining higher gain and greater selectivity. These features greatly surpass those obtained in the past with iron core systems, and in their present state, the new transformers or tuning systems are superior to air core systems.

During the period from 1919 to 1926, iron was employed in radio frequency transformers for the purpose of obtaining a flat amplification characteristic over a broad band of frequencies. The introduction of the iron into the radio frequency field introduced losses, and reduced to a minimum the selectivity of the transformer, and to a marked degree the gain. In other words, iron was used as a means for broadening the selectivity characteristics of the transformers, and in addition eliminating the tendency toward self-oscillation in circuits, due to additional load placed on the tube circuit by the insertion of the iron in the radio frequency field.

The original application of iron in transformer design in this country comprised a development of four broad-band transformers covering selective ranges from fifteen to fifteen hundred kilocycles. These transformers were housed in one unit, and resort was made to the use of a switching arrangement to change from one transformer to another. The results were applied later commercially by such companies as General Electric, Remler, Murad, and other companies in their tuned radio frequency receivers, and later, the early model superheterodynes.

In these receivers, one and one-half mil silicon steel, or its equivalent, with a heavy coating of enamel was employed, and reliable operation was obtained over the broad band of frequencies necessary to cover the broadcast band. The advent of the superheterodyne receiver, which required a definite intermediate frequency soon indicated that the iron core type of transformer was not

satisfactory from a gain and selectivity standpoint, and this type of transformer was abandoned in favor of the air core transformer, which showed greater gain and selectivity for a specified frequency. It is to be noted that the iron core transformers used in these early superheterodyne receivers were not designed to resonate at frequencies higher than sixty kilocycles.

In 1931, there was brought to the attention of commercial radio engineers the fact that iron cores were again being considered in radio frequency tuning circuits. W. J. Polydoroff, of the Johnson Laboratories, Chicago, had developed a new type of iron core employing finely divided iron, assembled in a special core form, the particles being insulated one from another by the use of suitable plastics. Polydoroff's work was confined to the broadcast band, and he definitely proved

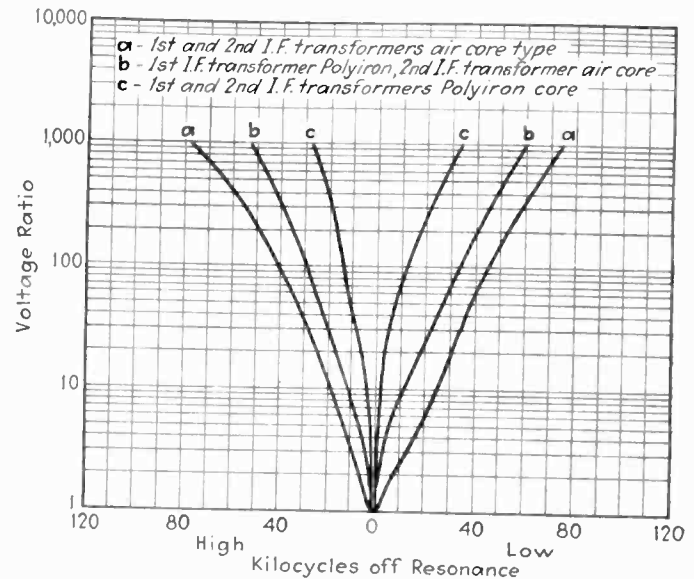

Effect of using iron core in 456 kc. a.c.-d.c. receiver with composite oscillator, single i-f stage and diode a.v.c.

that this material could produce better results from a gain and selectivity standpoint, than that of air core tuning devices in the same frequency range. This work is very completely covered in Mr. Polydoroff's paper in the *Proceedings of The Institute of Radio Engineers* for May, 1933. (See also *Electronics*, July, 1931, "Tuning by permeability variation," Ralph H. Langley.)

It is the object of this article to describe certain phases of the application of the special iron developed by Polydoroff to intermediate frequency transformer design.

Use of iron in intermediate transformers

The development of intermediate frequency transformers first has to be considered from a coil design standpoint, and secondly from an iron content standpoint. Various forms of coils were tested. These coils were of the cylindrical, toroid, bank wound, and Universal type of winding. Of these various types, the Universal type of coil was found to be most efficient, and also the most economical. It has less distributed capacity, and greater inductance per foot of wire than any other type known. In view of the coil design, it became necessary to change the iron core features from the conventional iron enclosed type to that of the open end cylindrical type. The coil is wound directly on the core, and an optimum coil form size has been developed, which is a compromise between distributed capacity, and iron core dimensions. An ideal coil form, having minimum distributed capacity is best from an air core standpoint, but when we desire to take advantages of the iron core, it is

necessary to have the turns closer to the iron core, thus reducing the amount of copper used in the coil, and in view of this fact, a compromise must be made in the coil design.

Due to the peculiar and intense field produced by the primary and secondary iron core tuning units and also due to their low resistance, it was found that optimum coupling from a magnetic standpoint required considerable separation between the units. This did not produce a practical type of transformer, and in the interest of compactness, and with no loss in gain or selectivity, a special construction was employed in which the tuning units were placed in such a position that their magnetic fields were nearly at right angles to each other. This construction is worthy of mention in view of the fact that the coupling can be either magnetic or magnetic and capacitive, by movement of one coil to either side of the zero coupling position. It was found, however, that the introduction of magnetic coupling was detrimental, in view of the fact that the stray capacitive coupling produced a condition of over-coupling, and for best results, it was necessary to introduce a counter-magnetic coupling, in order to reduce the total coupling to a condition of optimum or less than optimum, for best transformer efficiency.

Comparative measurements on efficiency of air and iron core transformers were made by employing a standard stage-gain setup. This consisted of a type 78 pentode r-f amplifier stage feeding a type 77 detector with a type 41 audio output tube. The transformer to be tested was interposed between the plate of the 78 tube and the grid of the 77 detector tube. This setup simulates actual practice inasmuch as we are interested only in gain versus selectivity. Information on the Q of transformers is of value, and was obtained by other methods, but in the final analysis, we are primarily interested in gain versus selectivity, and, therefore, these latter values will be quoted in this paper.

To express in a simple way the efficiency of the new type of transformer, it is convenient to use a "figure of merit," taken as the product of the stage gain, or amplification obtained by the transformer, and the ratio of the input at ten kilocycles off resonance to that obtained at resonance. In other words, if the transformer had a gain of three hundred, and a ratio of five between ten kilocycles off resonance and resonance, then the "figure of merit" is 1500. Working from this standpoint, it may be stated that measurements on a good air core type of transformer in a $\frac{1}{2}$ in. aluminum can, similar dimensions to that employed in the iron core transformer, has a figure of merit of 1260. The gain obtained with the air core transformer is 200, while the selectivity ratio is 6.3. The iron core transformer showed a gain of 282, with a selectivity ratio of 11.7, or a figure of merit of 3300. Both transformers were adjusted to have identical inductance in order that the comparison would be valid. These data cover results obtained with a 456 kilocycle transformer, having an inductance of 1.5 millihenrys. This value is close to that employed in the present day superheterodyne receivers.

The effect of the can or metal container on the figure of merit of iron core transformers is very marked, more so than in the case of air core transformers. An increase in can diameter from $1\frac{1}{2}$ inches to $2\frac{3}{4}$ inches diameter increases the figure of merit from 3300 to 4800, while if the transformer is removed from the container, the figure of merit increases to 5180. These data were obtained with containers averaging 4 inches in length, and the shielding

of the transformer was completed by proper fastening to a metal base plate.

Measurements conducted at various intermediate frequencies indicate conservatively that the iron core transformer can be designed to produce either double the gain or double the selectivity obtainable with the better type air core transformers of today. This figure can be improved upon, as the frequency requirement of the transformer is decreased. When we consider that the gain obtained in a radio frequency amplifier is a square law function, it can be readily noted the substitution of iron core in place of air core transformers in a receiver employing two tuned stages, the gain is quadrupled for equal selectivity. A check on this condition in practice was made on a commercial five-tube superheterodyne, which with air core transformers had a sensitivity of 100 microvolts, and a band width of 120 kilocycles, at one thousand to one ratio, at one thousand kilocycles. When the two air core intermediate frequency transformers were replaced by the iron core type, the receiver showed a sensitivity of 24 microvolts, with a selectivity of 41 kilocycles.

The iron core type of intermediate frequency transformer has shown such marked superiority over the air core type, that it seems to be only a matter of time before this type of transformer will be accepted commercially in the interest of greater selectivity or reduction in the number of tubes employed. The iron core having many times the permeability of air, and low losses, permits a large reduction in copper or turns with the consequent all-around improvement of transformer or tuning unit efficiency. This condition is obtained at frequencies as high as fifteen hundred kilocycles, and when used at lower frequencies, the saving in copper and the increase in efficiency becomes increasingly marked. The capacitive type of coupling for transformers produces equivalent results to that of the magnetic type, but is more economical, due to the smaller space required, and the less expensive mounting form.

The writer wishes to express his appreciation for assistance in the investigation to H. E. Meinema and C. C. Neighbors.

AIR CORE VERSUS IRON CORE I. F. TRANSFORMERS (456 Kc.)

| Type | 1 | 2 | 3 | 4 | 5 | 6 | 7 | 8* |
|-----------------|-----|-----|------|------|-------|-------|-------|------|
| Air core..... | 500 | 200 | 1900 | 4400 | 3.8 | 8.8 | 6.3 | 1260 |
| Iron core.....1 | 400 | 250 | 4000 | 6900 | 10.00 | 17.25 | 13.63 | 3410 |
| " ".....2 | 385 | 260 | 3800 | 6450 | 9.88 | 16.75 | 13.32 | 3470 |
| " ".....3 | 370 | 271 | 3400 | 5750 | 9.2 | 15.50 | 12.35 | 3350 |
| " ".....4 | 380 | 263 | 3800 | 5850 | 10.0 | 15.40 | 12.70 | 3340 |
| " ".....5 | 400 | 250 | 4300 | 6500 | 10.75 | 16.25 | 13.50 | 3380 |
| " ".....6 | 365 | 274 | 3250 | 5800 | 8.9 | 15.9 | 12.40 | 3400 |
| " ".....7 | 380 | 263 | 3700 | 6100 | 9.73 | 16.0 | 12.86 | 3380 |

- *1. Microvolts at resonance.
- 2. Gain.
- 3. Microvolts at plus 10kc.
- 4. Microvolts at minus 10kc.
- 5. Ratio microvolts resonance versus plus 10kc.
- 6. Microvolts resonance versus minus 10kc.
- 7. Average ratio.
- 8. Figure of merit.

EFFECT OF CONTAINER Aluminum—4 inches high

| Container diameter | Gain | Selectivity Ratio | Figure of merit |
|--------------------|------|-------------------|-----------------|
| $1\frac{1}{2}$ | 143 | 16.18 | 2318 |
| $1\frac{3}{4}$ | 159 | 18.17 | 2890 |
| $1\frac{7}{8}$ | 167 | 20.07 | 3340 |
| 2 | 185 | 18.75 | 3470 |
| $2\frac{1}{4}$ | 204 | 20.05 | 4008 |
| $2\frac{1}{2}$ | 238 | 17.97 | 4280 |
| $2\frac{3}{4}$ | 247 | 19.40 | 4800 |
| In Air | 290 | 17.85 | 5180 |

Photoelectric control on packaging machines

By E. LOVELL SMITH

Package Machinery Company,
Springfield, Mass.

IN many applications of photoelectric control to automatic machinery, the control supplies an impulse that initiates or performs a particular operation. If only a momentary impulse is required from the cell, the speed of response usually imposes restriction in the selection of the photocell and its amplifier and relay. An example of such an application is found in packaging or wrapping machinery for applying wrappers of printed cellophane to cigars, candy bars or packages of chewing gum. The roll of cellophane is printed with the design properly spaced to provide the right length of wrapper for one package.

In each cycle of operation the machines feed a length of paper, cut it off, and wrap it around a package. Thus, the paper feed is intermittent, and the position of the printing on the wrapped article depends on the position of the printing in relation to the cutter. This relation must be corrected constantly when the machine is running, because of the effect of variation in temperature and humidity on the cellophane strip. When a manual control on an adjustable paper feed mechanism is used, the full time of an operator is required to keep the paper in register, and corrections can be made only after a properly wrapped package has been delivered by the machine.

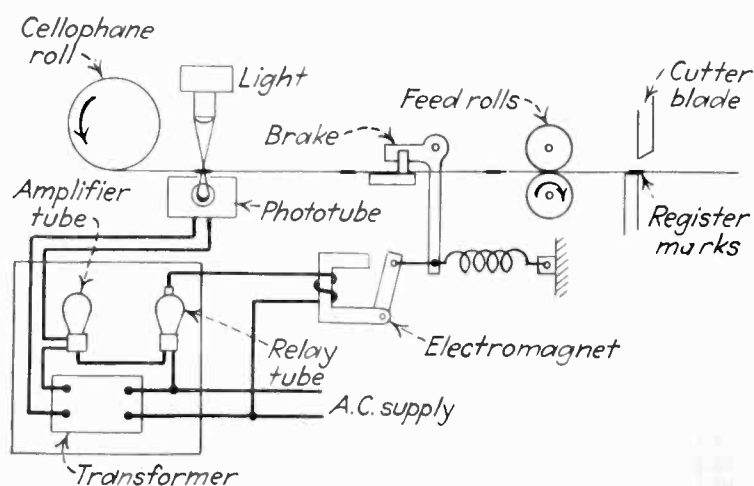

Fig. 1—Showing how paper-feed rolls are geared to supply slightly-excess amount of paper

In a wrapping machine developed by the Package Machinery Company, illustrated in Fig. 1, the paper feed rolls are geared to supply slightly more than the required length of paper. A clapper-type magnetic brake, released by the photo-cell, as shown in the diagram Fig. 2, stops the paper at the proper point. A cam operated by the machine then releases the brake for the next cycle of operation. To obtain more accurate timing of the operation of the brake, mechanical relays are placed by a grid control, rectifier or relay tube, and to match the speed

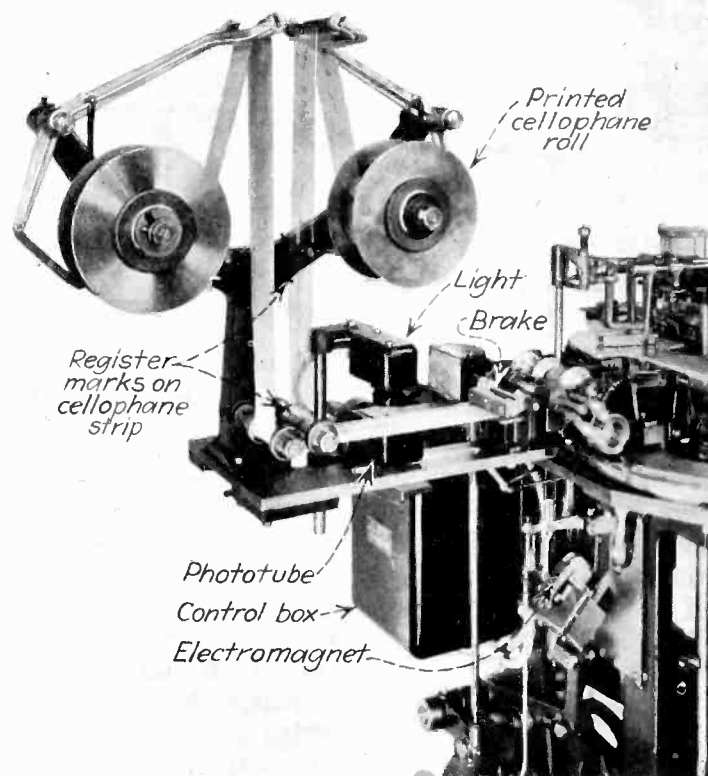

Fig. 2—How clapper-type magnetic brake stops paper at proper point, when brake is released by photocell

of the relay tube it is necessary to use the photo-emissive cell.

Voltage for the phototube is supplied from a 60-cycle a-c source already available at the machine. Although the use of alternating current on the photocell results in periods during each cycle in which no operation can start, variations in paper position arising from this effect are not of importance. The additional expense and maintenance involved in the use of an electronic rectifier and d-c amplifier is unnecessary. A single amplifier tube operating on a-c steps up the photocell output to provide power for the operation of grid controlled rectifier tubes or sensitive magnetic relays. With the grid controlled rectifier or relays tubes there is no time lag in the operation and contact troubles experienced with sensitive relays are eliminated. Being in itself a rectifier, the relay tube supplies half wave rectified direct current to the electromagnet, making it necessary to select an electromagnet for a pulsating current supply.

In this control the relay tube has the additional advantage of operating on less power, and therefore involving a lower amplification ratio. With low amplification ratios the amplifier is more stable in operation. Only one adjustment, a means for varying the sensitivity of the photo cell, is needed. To give the relay tube time to warm up so that its operation will be stable, a five-minute time delay switch is automatically connected in the relay output when the power is switched on.

A study of Litz wire coils for i-f and r-f transformers

THE need for standardization, and if possible simplification in the use of Litz wire for r-f and i-f coils has been apparent for some time. Several types of Litz wire have been available and have been used. Some of this Litz is composed of many strands of fine wire, some of it of larger wire and fewer strands; the possible combinations seem infinite. Therefore, manufacturers of the wire and its users in large quantities have thought it desirable and economical to determine if a few sizes would not fill all the bills—and so eliminate those not really necessary.

At the suggestion of Mr. Virgil Graham of the RMA Standards Section, a study was undertaken by William S. Barden and David Grimes of the RCA Licensee Laboratory. These notes are taken from a voluminous report on their research.

Typical coils were supplied by the F. W. Sickles Com-

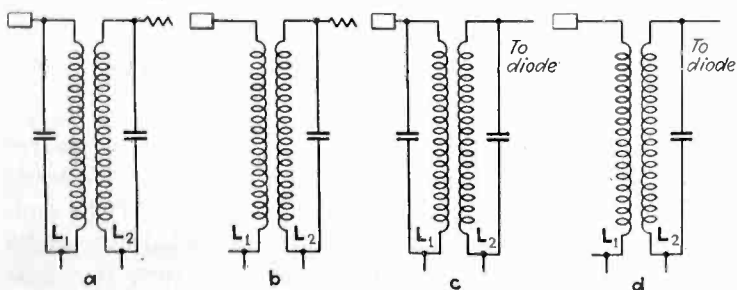

Fig. 1—Typical systems of coils used at intermediate frequencies

pany, the Acme Wire Company and the Meissner Manufacturing Company. In addition to coils now made and used in numerous receivers more than 300 special coils were supplied to aid their work, not to determine the best possible coil, but to have available a wide range of information.

The exact influence of coil properties on the performance of an i-f system is a complicated function of the system and not a simple function of an isolated coil. Therefore, the various coil data are translated into terms involving the entire system. In general two coils coupled and each tuned to resonance are assumed to have critical coupling; the plate resistance of the tube across the primary of all coils is assumed to be 600,000 ohms.

The frequencies at which measurements were made are 175, 260, 450, 550, 1,000 and 1,500 kc. An expression involving coil merit is solved for several typical systems; for example, tuned primary and secondary, two stages of tuned primary and secondary, the second of which feeds a diode detector, and so on.

These expressions will be found below. They are useful in comparing two coils to be used in a given system. The expressions involve the resistance and inductance of the coil and a tube of 600,000 ohm resistance. Coils which work into a diode detector are disregarded, because the damping due the diode on the secondary and the previous tube on the primary is so great that any changes in the system performance produced by coil betterment are slight.

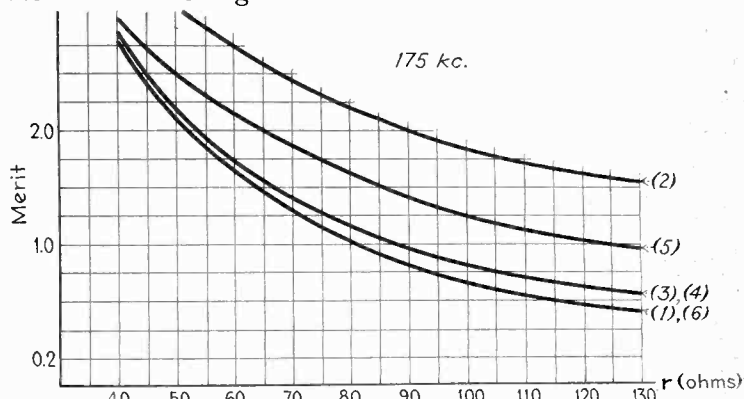

Fig. 2—Curve for determining relative merit of coils

Combinations actually used in practice and analyzed are shown in Fig. 1 and the figure of merit for each system as related to the coils is shown in the table below.

| | | |
|----------|--|----------------------------|
| System 1 | Two stages <i>a</i> | $(\omega L)^4 / rB$ |
| " | 2 One stage <i>a</i> , one stage <i>d</i> | $(\omega L)^2 / \sqrt{rB}$ |
| " | 3 One stage <i>c</i> , one stage <i>a</i> , one stage <i>d</i> | $(\omega L)^3 / r\sqrt{B}$ |
| " | 4 One stage <i>b</i> , one stage <i>a</i> | $(\omega L)^3 / r\sqrt{B}$ |
| " | 5 One stage <i>a</i> , one stage <i>c</i> | $(\omega L)^3 / \sqrt{rB}$ |
| " | 6 One stage <i>b</i> , one stage <i>a</i> | $(\omega L)^4 / rB$ |

where L = coil inductance = $L_1 = L_2$
 r = coil resistance = $r_1 = r_2$
 $B = rR_p + \omega^2 L^2$

These expressions are derived by considering that the inductance is maintained constant and that the resistance is varied. The figure of merit for such a coil has two factors, one for the secondary, which varies inversely as the square root of the resistance, and one for the primary, which is somewhat more complicated. It is

$$\text{actually equal to } \frac{\omega L}{\sqrt{R_p r + \omega^2 L^2}}$$

Therefore, a single transformer between tubes, both primary and secondary, tuned, has a figure of merit equal to $\frac{\omega^2 L^2}{\sqrt{r\sqrt{R_p r + \omega^2 L^2}}}$ and two stages of this transformer between the proper tubes will have a figure of merit equal to the square of the above expression.

Suitable values of inductance are 8 mh. at 175 kc., 2 mh. at 450 kc. and 4 mh. at 260 kc. Other values are found in practice, but in general they do not differ greatly from these figures.

Using the figure of merit given above for Fig. 1a (tuned primary and secondary) and plotting it against resistance Fig. 2 is obtained, in which the ordinates have arbitrary values only. Such a figure is to be used only to compare two coils; thus to get the percentage by which one coil is better than another in any of the six systems, it is only necessary to use ratios of ordinates in Fig. 2.

As an example, consider System 1 (two stages of tuned

primary and secondary) using coils of 70 and 90 ohms, the percentage betterment of the lower resistance coil is $\frac{1.2}{.85} - 1 \times 100\%$, or 41.1 per cent.

Therefore, System 1, with 70-ohm, 8-mh. coils, working at 175 kc. is 41.1 per cent better than one using 90-ohm coils.

The numbers on the individual curves in Fig. 2 indicate the system the curves are to be identified with. No significance is to be attached to the fact that one curve is higher than another. Similar curves for use at 260 and 450 kc. are included in Mr. Barden's paper.

Selectivity considerations

So far, only voltage gain has been considered. An analysis of selectivity leads to the fact that systems as well as isolated coils determine the relative merits of various Litz wires from the standpoint of selectivity. System 1, composed of two stages of doubly-tuned coils appear to be a suitable single premise on which to base Litz wire comparisons as regards selectivity because it embodies conventional means of obtaining requisite selectivity.

From a series of resonance curves, for each I.F. the effect of various resistance coils can be determined. Discrimination against 10 kc. interference is taken as the figure of merit. Fig. 3 shows the relative value of coils of different resistances so far as attenuation 10 kc. off resonance is concerned. Similar curves may be made for use at other intermediate frequencies.

A comparison of Fig. 2 with Fig. 3 (and similarly of curves at other intermediate frequencies) will show that if the gain charts were to be disregarded, and selectivity alone chosen as a basis of Litz wire comparison, the best wire thus found would likewise be the best from the standpoint of gain. If gain alone be chosen as a basis of comparison, the best thus found would likewise be the best from the standpoint of selectivity.

The resonance curves for 175 kc. are so sharp as to seriously attenuate side bands, thus affecting fidelity. This is particularly true when the resonance curves are compounded for the system (two of Fig. 1a) on which interpretations are based. At 260 kc., the same reasoning applies, although to a lesser degree. At 450 kc., the adjacent channel selectivity is poor, and side-band attenuation is not a serious factor. It is evident that 450 kc. should be given first consideration, and that the best Litz wire found for that use be regarded as possibly good enough for general use at 175 kc. at 260 kc.—and then studied from that standpoint.

As regards the possible choice of a single Litz wire specification without seriously impairing design possi-

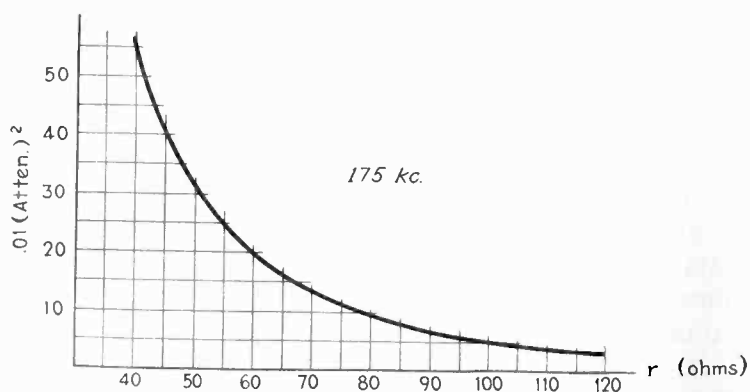

Fig. 3—Resonance curve showing attenuation 10 kc. off resonance

bilities at any of the usual intermediate frequencies, the matter of fidelity appears to deserve considerable weight. It would seem ridiculous to choose a particular Litz wire specification for 175 kc., when that wire is so worthy as to outrule its practical use—and require that losses be intentionally introduced. For these reasons, the best Litz wire for 450 kc. is to be compared with the best Litz wire at 175 kc. and 260 kc.

In Fig. 4, eleven coils are shown in actual size. Important data are given as measured and rated at 450 kc. The figure shows actual coil sizes.

Coil 1 is the smallest, and is by far smaller than the largest. No. 1 wound with 3/40 SS Litz wire, with a Q of 74 disproves the notion that very small coils cannot be good and that only three strands of No. 40 wire are not worthy of the name "Litz." Now coil 1 does not indicate that 3/40 is "low-resistance-per-foot wire," but rather

| Actual Size of Coil | Litz Wire | Q | Coil No. |
|---------------------|-----------|----|----------|
| | 3/40 SS | 74 | 1 |
| | 3/40 SS | 79 | 2 |
| | 7/41 E | 87 | 3 |
| | 7/41 SS | 87 | 4 |
| | 7/41 SS | 91 | 5 |
| | 5/38 SS | 48 | 6 |
| | 10/41 SS | 87 | 7 |
| | 7/40 SS | 74 | 8 |
| | 10/40 SS | 68 | 9 |
| | 5/40 SS | 90 | 10 |
| | 10/38 SS | 64 | 11 |

Fig. 4—Actual sizes of 2-mh. coils used at 450 kc.

that a suitably small amount of that small wire is required for 2 mh. and that the smallness of the wire leads to favorable physical and electrical properties of the coil.

Coil 11, the largest coil wound with 10/38, has the lowest value of Q . This is no evidence that 10/38 is poorer than 3/40, but it is evidence that the isolated merit of 10/38 cannot be realized in a suitably small coil. Litz made of 10/38 is not well suited for typical i-f coil design, because of the physical size of the wire, and the consequent size of the coil. Accordingly, 10/38 is given no further serious attention.

In coil 2, the turns are spaced a little more than in coil 1, resulting in a larger coil for the same inductance. The increase in Q may be due to an improved form factor, or to a decrease in resistance caused by proximity effect of the turns (or both).

In coils 10, 8 and 9, which have 5/40, 7/40 and 10/40 wire, respectively, and, progressively, room for the increasing number of strands is made by increasing the thickness of the coil.

[Editor's Note—The second and concluding part of this work on Litz wire coils will appear in a near issue of *Electronics*.]

ELECTRONS IN THE NEWS

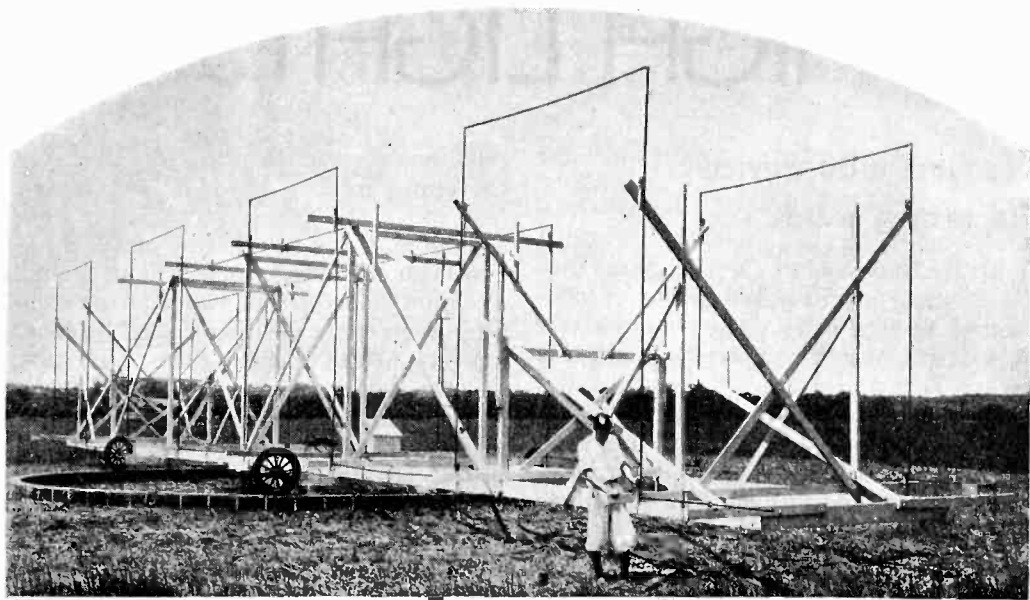

This revolving antenna array was developed by Karl G. Jansky, of the Bell Laboratories, Holmdel, N. J., station, to locate and measure static and interference from passing thunderstorms. With it, he detected his now-famous "radio from the stars"

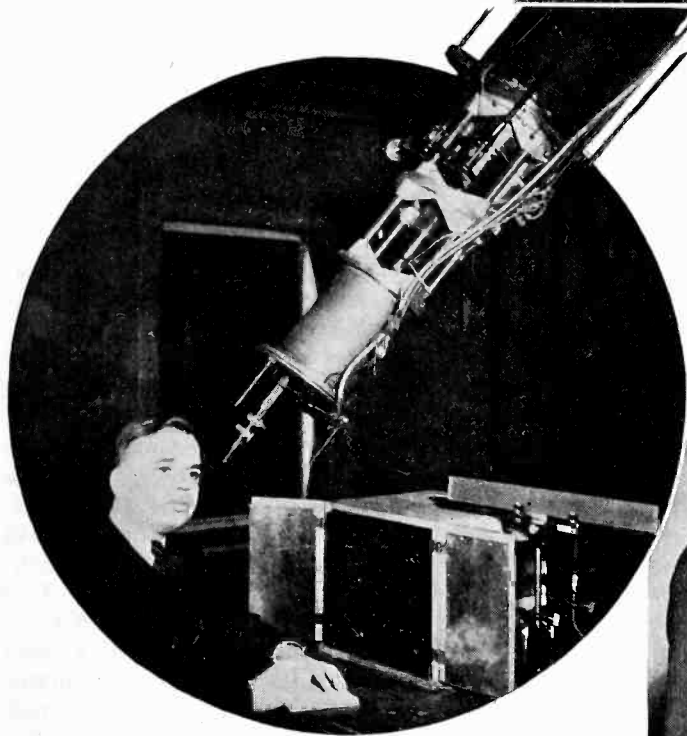

Stars down to the 14th magnitude can be detected, and stars of the ninth magnitude can be measured by this photo-electric photometer of Dr. A. E. Whitford, University of Wisconsin



The German General Post Office is now equipped to send photographs by facsimile to London, Budapest, Rome, Oslo and Christiana. Here's Margot Grahame, European screen star, dispatching an autographed portrait

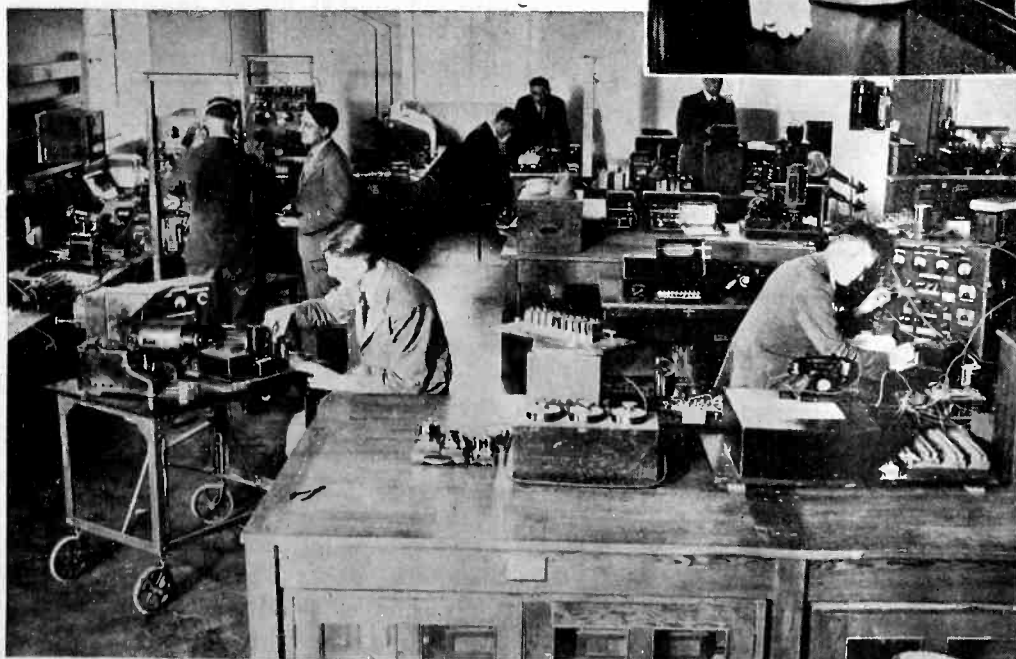

The new research laboratories of the British General Post Office at Dollis Hill, London, have just been opened with ceremonies in which the Prime Minister headed the list of notables. It is here that technical advances for the wire and radio circuits of the British service are developed and given practical application

HIGH LIGHTS ON ELECTRONIC

Vacuum-tube device for testing welds

J. R. BATCHELLER of Oregon State College, employs an exploring device consisting of two coils wound on the two legs of a V-shaped magnetic circuit, this circuit being closed by the weld under test, or for comparison purposes, by the stock metal from which the weld is made. Alternating current from a single tube with inductive coupling between plate and grid is sent over a transformer and a low-pass filter to a Wheatstone impedance bridge, one arm of which contains the two exploring coils placed in series with a variable condenser. The condition of balance is indicated by a three-tube amplifier and detector as the coils are shifted from the stock to the weld. This portable instrument gives correct results in 90 per cent of the cases.

Phototubes operate soaking-pit covers

BEFORE BEING ROLLED, steel ingots are required to soak several hours at 2,500° F. in covered eight-foot square pits, ten feet deep. Overhead cranes continually open and close these pits; putting in cold 40,000-pound ingots or taking out hot ones. In older mills the craneman must wait for a man on the floor to uncover the pit; more modern mills place the pit cover control in the cranesmen's hands by auxiliary control rails along the crane track; but the newest system requires that the crane operator merely shine a light beam on a photo tube, thus getting rid of all direct mechanical and electrical connections.

The fourteen soaking pits equipped extend in a long double lane. High on the wall above is a dual row of photo-

cells, one for each soaking pit cover. On the crane are two ten-foot lamp boxes, one above the other, for making light contact with the double row of Westinghouse photo tubes. Such a long trough of lights relieves the craneman of stopping in an exact position above the soaking pits, before operating the photo tube.

In operation, the craneman stops over the pit and turns on the lamp box for a moment, the soaking pit cover obediently slides back, he puts in an ingot, momentarily switches on the lamp box, and the ponderous lid closes itself without further attention.

Photocell watches turbidity of Denver water supply

MOST OF THE DENVER (Colo.) water supply is diverted from the South Platte River at Intake in the South Platte Canon, 23 miles from the city. Generally the water of this mountain stream has a low turbidity but during certain seasons, particularly in the spring due to heavy rains and melting snow, trouble is frequently experienced from a sudden rise in turbidity. Sometimes it is also necessary to eliminate the flow of water from the intake to the filter plants due to heavy turbidity which may occur.

"The variation in turbidity creates additional problems in the handling of the water," explains George J. Turre, chief chemist for the Denver Board of Water Commissioners. "It is necessary for the operator at the Intake to keep a vigilant watch as to the turbidity of the water. This watch must be kept during the day and night so as to give warning of any necessary change in the handling or treatment of the water."

From laboratory experiments, using photoelectric relay units, with the idea of applying this device as a means of

protecting the rise or fall of turbidity in the river, it was decided to try out this equipment for the service outlined. The device was set so it would operate on a turbidity of 100 or more p.p.m., in order that a warning signal would be given to the operator when the turbidity reached that point. The photoelectric tube is more accurate in determination than the human eye and is of material assistance to the operator in giving immediate warning of a rise or fall in turbidity. This device also has possibilities for noting air-bound conditions in filter plants and other features of water works operation.

Photocell smoke and fire-alarm

THE "ATLANTIQUE" catastrophe has naturally increased interest in France in the problem of indicating the beginnings of fires on board ship, not only in the holds, but also in the passenger quarters.

A new device, due to Chilowski, deserves attention for the very simple form in which one and the same inexpensive device detects either smoke without flame, or flame without smoke (or, of course, the two combined). This detector, small and simple enough to be fitted in every cabin, consists of a small lamp throwing its beam onto a mirror, which reflects it back to a photo-cell. The action in the case of smoke is obvious, for the detection of flame the mirror is mounted on an axis, controlled by two parallel stretched wires, one of which is bare and the other coated: in the case of a sudden rise of temperature the unequal expansion rotates the axis, and the mirror moves, thus cutting off the beam.

Each detector is connected to a relay at the central office. The construction of these relays is also novel, since they must be unaffected by considerable movement (rolling, etc.) and operate even when out of plumb. Each consists essentially of a vertical magnetic rod immersed in a liquid of the same specific gravity, between two coils. These coils are both supplied with current from a local source, in one case through a rheostat, in the other through the cabin detector, and normally they are made to balance. The action of the detector destroys this balance and the rod rises, bringing into view a disc-indicator with the number of the detector. Simultaneously this disc cuts off the beam from a lamp at the control station of a photo-cell there, and so operates a visual or audible alarm.

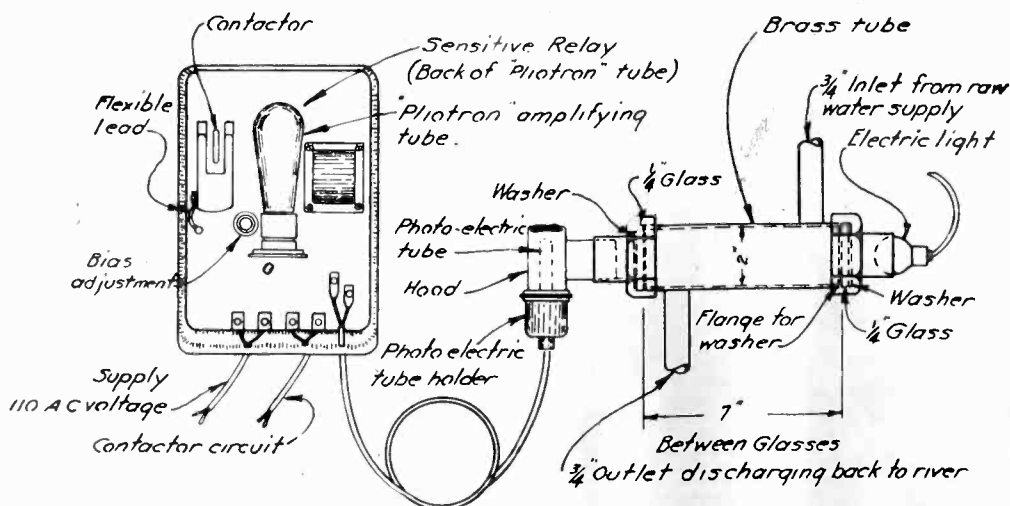

Arrangement of photocell and lamp for detecting turbidity in Denver (Col.) water supply

DEVICES IN INDUSTRY + +

Carrier current for power station load control

THE FIRST APPLICATION OF carrier-current equipment for load-control purposes has been made in New Hampshire, in connection with two fully automatic hydroelectric stations operated by the Twin State Gas and Electric Company, known locally as the New Durham and Merry-meeting stations.

The output of the Merrymeeting station is supplied to the system over a 4,000-volt line through the New Durham station, where the connection to the main system is made. An operator living near the New Durham station has supervision over both, with suitable instruments at New Durham to indicate the load that is being carried by the Merrymeeting station. Starting and stopping of the latter is accomplished by closing or opening the oil circuit breaker in the New Durham-Merry-meeting line at New Durham.

A separate cable circuit was previously employed in the load control of the Merrymeeting generator, but the cable circuit became so unreliable that complete replacement of the control channel recently became necessary. Two years of highly satisfactory operation of carrier-current telephone equipments on the lines of the company led to the decision to use similar equipment for control of the load at Merrymeeting.

A General Electric single-tube carrier-current signal transmitter (Type GCS) was installed in the New Durham station, and a double receiver (Type SCS) with coupling capacitors at Merrymeeting. A coupling to one phase of the line with ground return is used.

The two elements of the double re-

ceiver operate on opposite half waves, and consequently their independent actions depend on the relative instantaneous polarity of the supply voltage to the transmitter and receiver. Permanent connection to the supply voltage (110 volts, 60 cycles) is made at the receiver, and a standard double-pole double-throw governor control switch is used to reverse the supply connection to the transmitter. Each element of the double receiver controls the operation of the motor-operated gate-limit control, one element to open the gate and the other to close it.

The steel bar and the "magnetic hand"

IN A NOVEL EXHIBIT OF THE Republic Steel Corporation, a bar of stainless steel weighing one hundred pounds is nearly balanced on a fulcrum, one end of the bar resting on a table.

If a visitor approaches the heavy bar and passes his hand over it, amplification of the static charge, by means of thyratron circuits, is sufficient to lift the unbalanced end of the bar, and to cause the bar to float upwards following the hand. Thus the visitor's hand appears to be "magnetic" and to attract the steel bar.

The bar can be similarly lifted by holding the hand over a plate at some distance from the bar.

This exhibit was shown at the Steel Treaters' convention, and will be displayed at other shows. It was arranged by R. D. McDill, of the Electronic Inspection Laboratories, 1624 Hayden Ave., Cleveland, Ohio.

To warn truck drivers to turn out for motorists

By DR. E. E. FREE

A NEW DEVICE TO NOTIFY truck drivers on the roads whenever a motorist wants to pass them from behind has been approved by French police authorities and is expected to be made required equipment on all French automobile trucks after the first of next year. It consists of a cheap and rugged photo-electric cell fastened to the back of each truck and connected with a vacuum-tube amplifier. Whenever a motorist approaches from behind and wishes the truck to turn out, all that he needs to do is to turn on his headlights. Light rays from these headlights enter the photo-electric cell on the back of the truck and create an electric signal. This is magnified by the amplifier and rings a warning bell in the truck driver's cab. To prevent willful refusal of truck drivers to yield the road, an attachment can be provided which records the exact times of any signal given by the warning apparatus.

Filamentless tubes for elevator control

THE FILAMENTLESS TUBES developed by Dr. August Hund in the laboratories of Wired Radio, Inc., Ampere, N. J., have been applied in some test circuits for elevator control. The tubes thus used are rectifiers, and are now on preliminary life-tests to determine period of operation. So far no definite aging is reported discovered. Following the life tests, the tubes will be operated in actual elevator control circuits.

SIDE-REGISTER CONTROL OF PRINTING

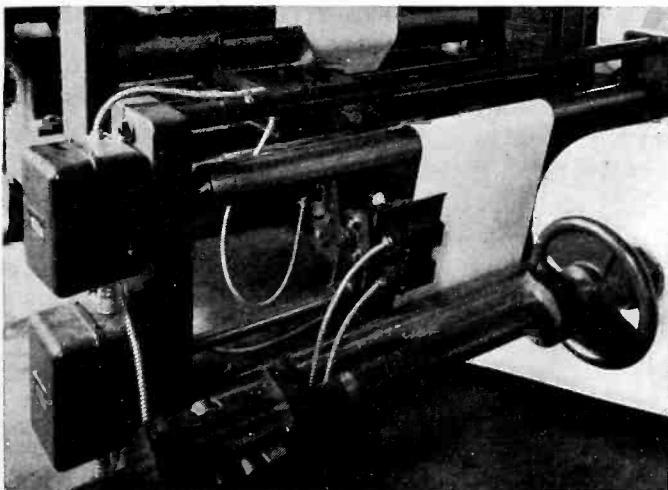

In this Smith & Winchester tuber, for paper bags, at the Arkell plant in Canajoharie, N. Y., photocells position the paper on the rolls

HIGH-TRUCK ALARM FOR TUNNEL



The projector on the nearby toll-house throws a beam into the hooded photonic cell at right. Any intercepting truck starts an alarm ringing

Radio acoustic ranging

By DAVIS BELCHER

*U. S. Coast and Geodetic Survey
Port Arthur, Texas*

DURING the war, the development of submarine detectors stimulated research into the determination of the velocity of sound in sea water. This work was carried on by many able investigators in this country and abroad, and formulas were derived for the calculation of the velocity of sound in sea water for any probable condition of temperature, salinity, or depth.

Following the war, the British Admiralty carried out a series of experiments to determine the feasibility of using equipment of this type for the location of merchant vessels. In the procedure employed, the vessel threw a bomb overboard and the sound-wave resulting from its explosion was received at submarine microphones, called hydrophones, anchored near the coast. Simultaneously with the explosion of the bomb the radio operator on board the vessel sent a dash which was automatically recorded at the microphone stations. The time elapsing between the arrival of the radio signal and the arrival of the bomb wave, multiplied by the velocity of sound in sea water, gave the distance to the vessel. Two such distances served to establish a "fix" on the vessel. Of course, any delay on the part of the radio operator in transmitting the dash following the bomb explosion will result in an error in the position. However, if three hydrophones are employed, the time intervals between the arrival of the bomb wave at the three microphones will locate the sound source without any firing dash being transmitted from the vessel.

This method of locating vessels proved to be extremely accurate, surpassing the radio compass, and was of particular value in regions where the radio-compass was subject to considerable error.

In the United States this phase of radio-acoustic ranging is little used, due in part to the high efficiency of our radio-compass system which is maintained and operated by the Navy. However, a development of it has found wide application in the work of the Coast and Geodetic Survey, an arm of the Department of Commerce. The hydrographic work carried on by the Coast and Geodetic Survey suffered greatly from loss of time due to poor visibility, and, in an effort to overcome this, attention was directed to survey methods other than visual sighting. A process of elimination resulted in the selection of radio-acoustic ranging as a method possessing sufficient accuracy to be adaptable to hydrographic work. Certain modifications from the English procedure were desirable, however.

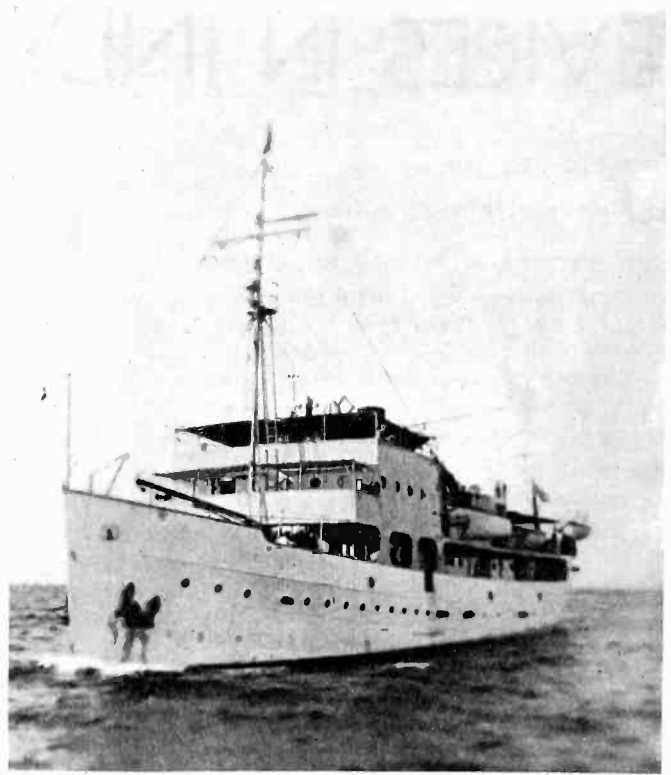

Yacht "Hudie," employed as hydrophone station

The construction of accurate charts required that the position of the survey vessel be determined frequently and rapidly to permit a desired course to be maintained, also it was desirable that the calculations necessary to fix the vessel's position be carried out on board the vessel and not at the hydrophone station.

The only feasible method for accomplishing this is to employ a radio transmitter so arranged that it is keyed automatically by the arrival of the bomb signal at the hydrophone. Experiments and investigations carried out by the Coast and Geodetic Survey have developed a technic suitable for its needs.

The following arrangement has been worked out. Two hydrophones, whose positions are accurately known, are connected either to temporary shore radio stations or to radio-equipped launches. The survey vessel sets a course and starts sounding. Every few minutes a small bomb is thrown overboard. The explosion of this bomb is recorded on board the survey vessel and at the same time a warning radio signal is sent to the hydrophone stations to inform the operators that the bomb has exploded. The bomb wave arriving at the hydrophones acts to key the transmitters and returns a dash to the survey vessel from each station. The time interval between the bomb explosion and the return radio signal from a station is multiplied by the velocity of sound in sea water to obtain the distance. As the location of the two hydrophones is known the two distances serve to fix the survey vessel's position.

The hydrophone unit itself consists of a brass casing with a phosphor bronze diaphragm within which is mounted a Baldwin loudspeaker unit with a mica diaphragm. The construction is such that the mica diaphragm is fastened at the end of an air column that starts behind the phosphor bronze diaphragm. By this means the varying pressure of the incident sound wave is transmitted to the mica diaphragm with little loss. The hydrophone unit while in service contains compressed air at a pressure somewhat in excess of the hydrostatic pressure at its working depth. This serves

to cushion the diaphragm and to oppose water leakage. The cable from the hydrophone terminates in an amplifier at the radio station.

This amplifier serves a dual purpose. It serves to amplify the bomb signal and also to key the radio transmitter. To accomplish the latter, a thyratron is connected to the second stage of the amplifier and to the transmitter, as shown in the diagram of equipment on board the yacht *Hudie*. Sufficient signal voltage from the amplifier overcomes the grid bias and permits plate current to flow through the thyratron and the transmitter. Of course submarine noises other than the bomb waves can and do occur and are often of sufficient intensity to release the thyratron. To overcome this, a potentiometer is employed for varying the grid bias on the thyratron; increasing the negative bias necessitates greater signal voltage from the amplifier to release the thyratron. The gain control across the hydrophone can be used to give this greater signal voltage, but if trouble is encountered from water noise this is of no help, because all sounds incident on the microphone will be amplified equally. The usual solution is to adjust the amplifier and thyratron to the most sensitive position that conditions will permit and then increase the size of the bomb until satisfactory returns are obtained. The danger is always present, however, that unexpected noises may occur and key the transmitter a few seconds previous to the arrival of the bomb signal and mar the returns. To aid in preventing this, a switch is connected in the plate circuit of the thyratron. This is kept open until a second or two before the bomb wave is due and then closed. By this means the interval during which an interfering noise can key the transmitter is greatly reduced and in practice little difficulty is encountered. The approximate time for the arrival of the bomb wave is always known. The use of a stop watch, which is started when the warning signal indicating that the bomb has exploded is heard, permits the operator to close the switch at the proper time.

The radio transmitters used at the temporary shore stations or aboard the radio-equipped launches are of the oscillator-amplifier type, with crystal control. They are of very low power, but are sufficient to return a good signal over a distance of about 50 miles, which is sufficient for the work. Plate power is obtained from heavy duty B batteries. The crystals at all hydrophone stations are as close to the same frequency as possible to permit their signals being received at a single receiver setting on board the survey ship. The possibility of both return signals arriving together can be eliminated by care in locating the launches to assure a sufficient time interval between the reception of the bomb wave at the two hydrophone stations.

When the bomb explodes astern of the survey vessel, a hydrophone mounted in one of her water tanks picks up the wave and records it on the moving tape. The radio signals returning from the hydrophone stations are received at the survey ship, amplified, and similarly recorded. Another needle simultaneously traces a time record on the tape and from this the time intervals can be measured. The time required for the transmission of the radio signals is negligible, as compared with the time required for the propagation of the sound wave. So neglecting it, we obtain from the tape the time required for the bomb wave to reach each hydrophone station. The product of time and velocity gives distance, and these two distances serve to fix the survey vessel's position.

Although fair work has been done with the equipment shown, yet it depends too much upon maintenance and understanding on the part of the radio operators to be truly satisfactory. It is hoped that new equipment embodying the improvements outlined above will be still more successful. The application of the electron tube to hydrographic work is barely begun. The passage of another year or two will find the hydrophone and its associated radio equipment located on large buoys, where it will be able to operate continuously for weeks.

Circuits of equipment used on yacht "Hudie"

Some difficulty has resulted from the use of the metal cabinets as common returns, preventing common grounding. A resistance between B minus and the thyratron filament, and another amplifier stage, are also suggested as improvements for future equipment

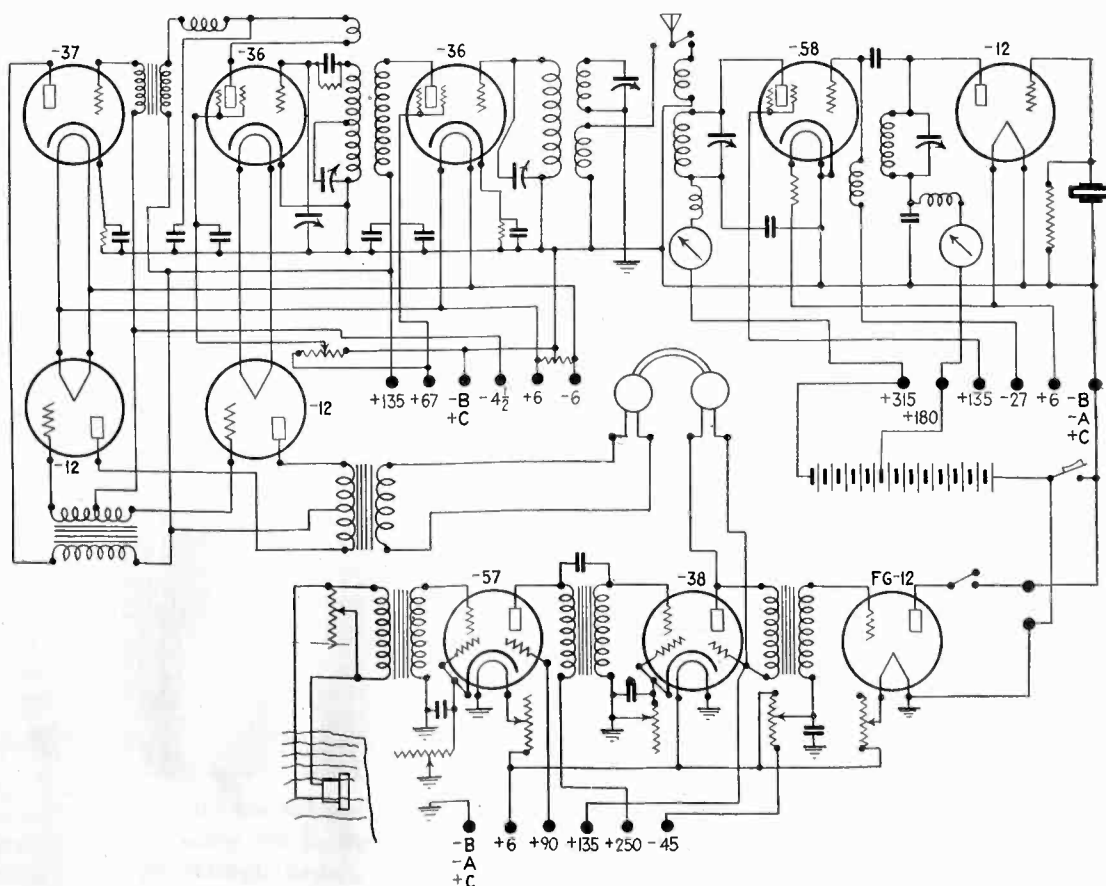

Frequency comparison with the cathode-ray oscillograph

BY C. B. FISHER*

THE LOW VOLTAGE cathode-ray oscillograph has found perhaps its chief application in frequency comparisons by means of Lissajous figures and has been used more particularly for calibration of multi-frequency vacuum-tube oscillators at frequencies of 20 to 100,000 cycles.

Briefly, the method consists of applying a voltage from an oscillator of accurately known and constant frequency, which we shall call the "standard oscillator," to one pair of deflecting plates of the oscillograph, and the output voltage from the oscillator under test to the other pair of deflecting plates. The frequencies are adjusted until certain known patterns, called Lissajous figures after their discoverer, are formed on the screen of the oscillograph. When this ratio is that of two small integers, the smaller always being the numerator, the figures are simple, but as the integer expressing the numerator becomes

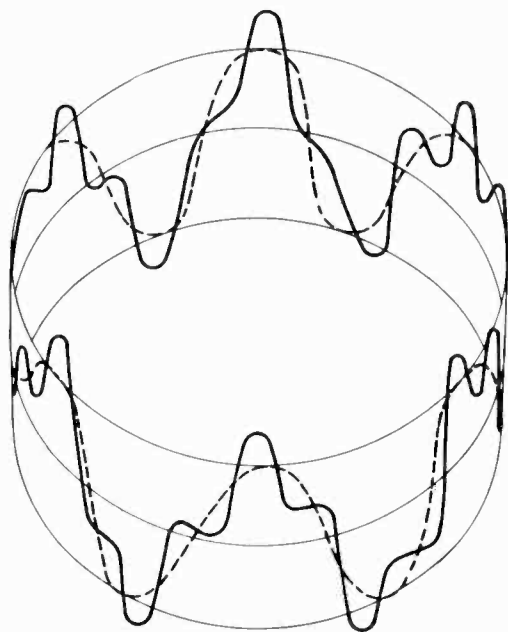

greater than four, or the denominator greater than about 12, when the ratio is reduced to its lowest terms, the figures become of a complexity which renders their certain identification slow and difficult.

* * *

Every radio station a guide for airmen

BY MEANS OF A new device recently developed by the radio division of the Bureau of Standards at Washington, aviators going "cross country" over territory not equipped with the regulation radio beacons may set their course using signals from a conventional

broadcasting station in the vicinity. A small loop antenna mounted on the top of the plane may be rotated until the desired station is located and then a simple indicating device on the dash permits the pilot to hold his course even in the thickest weather.



Justus Steele, an employee of the College Park airport, near the Capital City, is seen examining a small round loop mounted on the top of the plane, which may be rotated to bring in the signals from the desired direction

To secure simpler figures a variable-frequency reference oscillator is commonly employed. It is adjusted by comparison with the standard oscillator to a frequency two, three or four times the interval between successive points of calibration of the oscillator under calibration and then by comparing the reference with the test oscillator, the points at which the test oscillator is to be calibrated are picked up. For example suppose we have an oscillator which we wish to calibrate at points every 25 cycles from 1,000 cycles to 1,500 cycles, and suppose that the standard oscillator to be used has a frequency of 1,000 cycles. By using the standard we first pick up the Lissajous figure which represents a frequency ratio of 1:1 corresponding to a frequency of 1,000 cycles for the test oscillator, and then we pick up the Lissajous figure representing a 2:3 frequency ratio, making sure that it corresponds to a frequency of 1,500 cycles, and not 666.7 cycles, for the test oscillator. The reference oscillator is now adjusted, by comparison with the standard oscillator, to 100 cycles. The oscillator under test is now set to the previously determined setting for 1,000 cycles, and compared with the reference oscillator. A single-line figure should appear. The test-oscillator frequency is then increased in small steps, and four-, two-, four-, and single-line figures are successively picked up, corresponding to frequencies of 1,025, 1,050, 1,075 and 1,100 cycles respectively for the test oscillator. This process is continued, the figures repeating themselves in the above order, until 1,500 cycles is reached. At this point the test-oscillator setting should correspond with that previously determined for this frequency by comparison with the standard oscillator. Such a correspondence gives a check on two things. First, it ensures that no figures have escaped notice during the calibration, i.e. the point found is not 1,600 cycles for example, thus relieving the operator from the necessity of counting the number of waves in each figure obtained, it being sufficient to count the number of continuous lines in the figure. Second, it gives an indication of any drift that may have occurred in the reference-oscillator frequency during the time which elapsed since the adjustment of the reference-oscillator frequency.

Let us consider this point further, as in practice such a drift is often found to occur, and may be quite important, necessitating frequent checks. In the first place, the reference oscillator will not in general have inherently as stable a frequency as that of the standard oscillator. The reference-oscillator frequency ordinarily will be changed several times in an hour, while the stand-

FROM THE LABORATORY + +

ard oscillator may run continuously. Thus changes in frequency due to unequal heating of the circuit elements may become important. Finally, the reference-oscillator frequency is ordinarily from a twentieth to a fifth of the standard-oscillator frequency. The correspondingly larger tuning elements are much more liable to changes in electrical values than are the elements of the standard oscillator.

Accordingly, to permit rapid, accurate calibrations to be made, it is desirable to maintain a continuous check on the frequency of the reference oscillator. A neat and practicable method has been used by the author with considerable success.

The outputs from the standard oscillator and the test oscillator are applied simultaneously to the vertical deflecting plates of the oscillograph. The reference-oscillator output is applied to the horizontal deflecting plates. When exact ratios are obtained, figures of the type shown are seen. This figure is seen to be similar to the usual Lissajous figure, but with a sine-wave ripple running around the periphery. Similar figures may be formed of two, three or four lines.

Any departure from synchronism of the reference frequency and the measured frequencies is shown by a motion of the whole figure. Any departure from synchronism of the reference frequency and the standard frequency is shown by a movement of the small sine-wave ripple around the edge of the larger figure. Such a figure then gives a check on the reference-oscillator frequency. At the same time the figures are not unduly complicated and can be picked up and identified after a little practice as readily as can the more usual figures. The calibration is increased in accuracy, and the time may actually be lessened, as the preliminary calibration with the standard oscillator to give points to check in on later may be dispensed with.

*Engineering Department, Northern Electric Company, Limited, Montreal.

Simple ultra short-wave wavemeters

By W. H. MOORE*

IT HAS BEEN THE universal practice in measuring wavelengths of the order of one or two meters and less, to make use of Lecher wire systems and wavemeters. If sufficient care is taken, the result may be relied upon to within one-tenth of 1 per cent.

The Lecher wire wavemeter is very satisfactory for making precision measurements of specific wavelengths. It is often desirable, however, to make a number of wavelength measurements

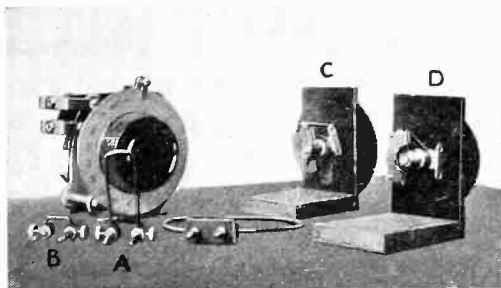

quickly where accuracy is of secondary importance, the prime requisite being convenience and rapidity of measurement. For such an application the ordinary absorption type of wavemeter, consisting of an inductance and variable condenser, would be very convenient.

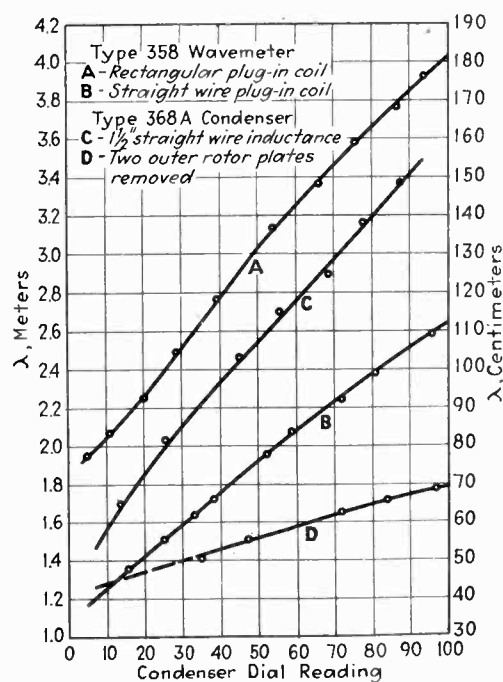

Several wavemeters of this type were constructed by the author for use in connection with investigation on ultra short-wave oscillators. Calibration was done by means of Lecher wires. Resonance was indicated by a deflection of the plate current meter when either Lecher wires or wavemeter was coupled sufficiently closely to the oscillator and tuned to the wavelength of the oscillations.

The single turn coil in the center of the photograph is the regular 4-6 metre inductance used in conjunction with the condenser shown at the left to form the General Radio Co. Type 358 short-wave wavemeter. Two other inductances, A and B in the photograph, were constructed to be used with this same

condenser. The range covered by the wavemeter with the rectangular coil A, is from 2 to 4 meters, and with the straight wire coil B, from 1.2 to 2.6 meters, or 120 to 260 centimeters.

Wavemeter C consists of a G. R. Co. Type 368a microcondenser of 15 μf . max. capacity, in parallel with an inductance composed of a straight piece of wire 1 1/2 inches long connected directly between rotor and stator. The wavelength range covered is from 60 to 150 cm.

The lowest range wavemeter is that shown as D. It consisted of a G. R. Co. Type 368a condenser with the outer two of the three rotor plates removed. The soldering lug on the stator was turned towards the rotor shaft and a globule of solder placed between the end of the lug and the metal bushing carrying the rotor. This globule of solder comprised the inductance of the wavemeter. The wavelength range covered is from 45 to 65 cm., approximately. The lower portion of the calibration curve is shown dotted since it was obtained by extrapolation from the upper portion, wavelengths below 50 cm. not having been obtained experimentally at the time to calibrate the wavemeter over this part of its range.

This series of wavemeters permitted a positive check to be maintained at all times on the wavelengths produced. The fundamental wavelength of oscillation of any particular circuit could always be ascertained definitely, with no possibility of mistaking a harmonic for the fundamental. It was a common error in early work of the author and of others to mistake, for example, a 75 cm. wave indicated on Lecher wires, for the fundamental, whereas this was actually the second or higher harmonic of a true fundamental of 150, 225, or even 300 cms. It was mainly a matter of taking the requisite amount of care to determine which was the true fundamental, of course, but it was an extremely simple matter to be in error by a factor of two or three. By utilizing a series of wavemeters covering from the shortest waves produced up to four or five meters, it was possible to determine very rapidly whether a 75 cm. wave whose presence was indicated, was a harmonic, or the fundamental.

The accuracy of these wavemeters is no greater than the accuracy of the Lecher wires from which they are calibrated, but their usefulness lies in the fact that they indicate but one wavelength at a time, will not indicate harmonics since their intensity is too weak, and in any case can immediately be tuned to double or three times the wavelength to determine whether a higher wave is present or not.

*The Canadian Marconi Co., Ltd.

electronics

McGraw-Hill Publishing Company, Inc.
330 West 42d Street
New York City

O. H. CALDWELL, *Editor*

Volume VI —NOVEMBER, 1933— Number 11

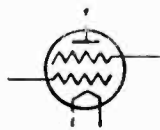

The listener's end of the radio trail

WITH all the magnificent new studios, costly transmitting plants, and expensive programs of modern broadcasting, it seems pitiful that the listener's "end of the radio trail" in most cases is a flimsy wire picking up noise and interference and feeding into a tinny midget set which reproduces a mere travesty of the studio quality.

Poor sets and careless ignorant installing have made terrific inroads into the good-will of the broadcasters these past two years. It is time for an aggressive effort to be made toward quality of receivers sold, and correct installation.

This is the next big job to be done, if broadcasting is to endure as a great artistic medium.



Yankee inventiveness

AN engineer with radio-circuit experience can find many opportunities to apply photocells and other electronic devices in industrial plants in his neighborhood. But radio or electrical-circuit knowledge alone is not sufficient; the practical electronic engineer will need a good deal of mechanical common-sense and Yankee inventiveness as well.

In fact, as one man of wide experience observes, a mechanically-minded engineer with ordinary inventive ability, is more likely to be successful in the industrial field if he knows the fundamental electronic circuits, than a radio man who knows all about radio but has little sense of mechanical application.

More radio on the farms

MORE people live on American farms today than ever before in the nation's history. Not only has the drift of farm boys and girls to the city been stopped, after thirty years of continuous growth of the city population at the expense of the countryside, but for three years past the movement of the rural migration has been just the opposite way—it now is from city to country. In fact, in these past three years the replacement of farm population has more than equalled in numbers the total population withdrawn from rural districts in the preceding third of a century, so that now more people are living in farm homes than ever had farm homes before.

Most of these 6,000,000 farm houses are without electricity for lighting. Their radios must be battery operated. It is time the radio industry gave more attention to sets especially designed for this vast farm market.



Armstrong's victory, and the courts

THE latest development in the Armstrong-DeForest regenerative circuit litigation establishes as a prima facie case that there is something seriously wrong with our judicial procedure in patent cases.

Entirely aside from the question of whether the present decision is the correct one, it is clear that a system which in a series of proceedings from 1917 to 1924 finds Armstrong to be the inventor, which in another series of proceedings lasting from 1924 to 1933 finds DeForest to be the inventor, and which then determines in 1933 that it was right the first time in holding Armstrong to be first, has many explanations to make to industry.

Uncertainty is a burden which the business executive must forever carry. But what can be more disastrous to his plans than to have litigation in which he is clearly proceeding in his rights appear to terminate favorably, to go forward on the basis of these decisions, and to then, years later, encounter a reversal which places his opponent in control of the situation.

The first electric light

THE neon sign, the filamentless radio tube, and vapor lamps can all trace their origin back to that discovery made by some unknown mariner in the 1600's, that flashes of ghostly light appeared in his barometer tube above the mercury, whenever the barometer was shaken violently.

Above the mercury was a vacuum: shaking the mercury produced frictional electricity. And thus somewhere on the high seas, on some black, tempestuous night, three hundred years ago, the first electric light was born.

From this same faint beginning sprang also a host of other uses, including Geissler tubes, Crookes' tubes, X-rays, neon lamps used for television, stroboscopic tubes, gaseous illuminants.

The next time some skeptical critic, witnessing some interesting new phenomenon, asks "Well, what is it good for?" let him be cited this train of miracles in the track of an apparently useless discovery.



British broadcasting

AMERICAN broadcasting is not the only program service which comes in for sharp criticism. Even the British system, so often held up as a model for American broadcasting, is found fault with by those who have to listen to it.

Although many of the English programs are of high quality, the importance of organization and the value of time on the air are not appreciated. Announcers remain silent for long periods between programs and between the items on programs, leaving the listener to wonder if sudden death has fallen on the performers, if the broadcasting station has been demolished by an act of God, or if his own receiving set has become suddenly inoperative. Little respect is shown for punctuality in beginning or ending a performance, and there is no evidence that the time factor has been controlled by adequate rehearsing.

A charge of 10 shillings per annum is made to all owners of receiving sets, which is perhaps less than the service is worth from an entertainment value. Although no advertising is permitted over the government stations, British firms are beginning to advertise in Continental radio programs, to which the Englishman turns when the domestic entertainment is mediocre on Sunday evenings.

Cab-to-caboose carrier communication

IT is a pretty sound principle of procedure that radio should not be used if wires or other conductors are available to do the work.

We have never found much enthusiasm for the application of radio between the engine-cab and caboose of a long freight train. It would seem that some other guiding or conducting medium would be suited for this purpose, without gumming up a short-wave channel.

A new development of guided carrier-current, worked out in the Schenectady laboratories, seems to supply the answer. Using inductor coils suspended over the rails, and the rails and adjoining wires as the transmission medium, the conductor in the caboose can talk to the engineer in the locomotive cab, with loudspeaker volume that rises well above all train noises. A three-tube transmitter and five-tube receiver are used, operating on 65 kilocycles. Each station consumes 160 watts, with 5 watts at the inductor coils.

The train crew can also talk to other trains, and to stations and dispatching towers within a track distance of five miles.

TOASTING BUNS WITH A 5-M. WAVE



At the Chicago World's Fair, this 20-kw. standing-wave oscillator delivering a 5-meter wave, has been arranged by Westinghouse engineers to toast bun sandwiches by means of the currents induced in the moist bread. This process is similar to that of baking crustless bread "from the inside out" by high-frequency oscillations

Improved quartz-controlled oscillators

[K. HEEGNER—R. BECHMANN, Telefunken Laboratory] According to the usual theory of Pierce's circuit tubes having high mutual conductance and amplification are to be preferred. The higher, however, the grid-plate conductance, the more pronounced is the influence of the changes in grid-cathode capacity caused by the variation of the negative space charge, and the frequency becomes dependent upon the plate potential and the heating current.

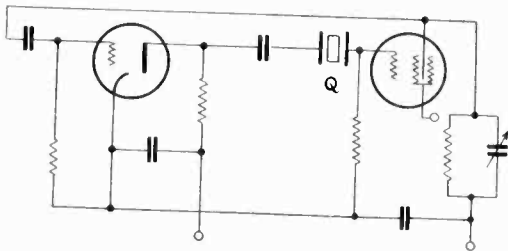

The second article describes a quartz oscillator (first used by the broadcast station Langenberg) the frequency of which is not affected by the capacity of the exciting electrodes and the leads (German patent 571,235). The quartz plates are supported in their plane of symmetry along a groove cut at mid-height. The coil serving as thermometer and the heating coil for maintaining the temperature are both mounted inside the evacuated quartz container.

The quartz can be calibrated to within 1×10^{-5} (the accuracy of the present frequency meters) and kept constant to within one-millionth.—*El. Nachr. Techn.* 10: 357-371. 1933.

Electronic tubes in power transmission

[R. WIDEROE AND MARCEL COURTIN.] Gas-filled tubes can be connected so as to pass current and furnish power to a relay when the voltage or the impedance falls below a certain value or when the current exceeds a given value. By adding capacity and resistance a deferred response is obtained, a task difficult to solve, and requiring a thousand times stronger current, in the case of the electromagnetic relay. In this group of applications illustrated by diagrams the grid is given a fixed negative potential. In a second group of devices, intended for the protection of lines and machines, the grid at any instant is caused to take values corresponding to the current or the voltage to be controlled, including the value zero when another half cycle begins. Relays functioning on the principles of the wattmeter have been designed which depend for their operation on the phase difference between current and voltage, in another type of relay; the blocking voltage is proportional to the rate of

change of the current; resonant relays or contactors have been used for protecting generators operated in parallel against sudden grounds. The ordinary thyratron is sensitive to temperature changes, so that it has been found advantageous to use argon in place of mercury. The highest voltage which these tubes will stand is 500 volts, which is sufficient for practical purposes. The tubes have a life of over 5,000 hours. See also *Electronics*, January and April, 1931.—*Revue gen. El.* 17: 197-202. 1933.

The League's radio facilities

[G. F. VAN DISSEL, League of Nations] The League's station, Radio Nations, consists of two shortwave senders of 20 kw. each when used for telegraphy; 8 kw. when used for telephony at 90 per cent modulation, for waves between 14 and 100 meters. It has also at its service a 50-kw. sender for medium waves belonging in part to the Swiss Government. One of the short-wave transmitters has been supplied by the Marconi Company; it uses a multi-vibrator in which temperature changes produce an increase in the inductance of the coil which is exactly compensated by the decrease in capacity of the condenser. The short-wave transmitter built by the Societe fr. Radio-electrique uses a quartz controlled oscillator with temperature control. One short-wave antenna uses vertical dipoles in the Franklin arrangement; there are also groups of Telefunken antennas with horizontal dipoles (one for South America and the Far East, another for North America, 20 m. wave). The receiving station is five miles from Geneva and is provided with Bell Telephone and Telefunken equipment, including seven Telefunken receiving sets for waves between 10 and 30,000 meters to be used during times of danger. Some tubes are supplied by Philips, Eindhoven.—*Onde. el.* 12: 329-352. 1933.

MICRO-RAY TUBE

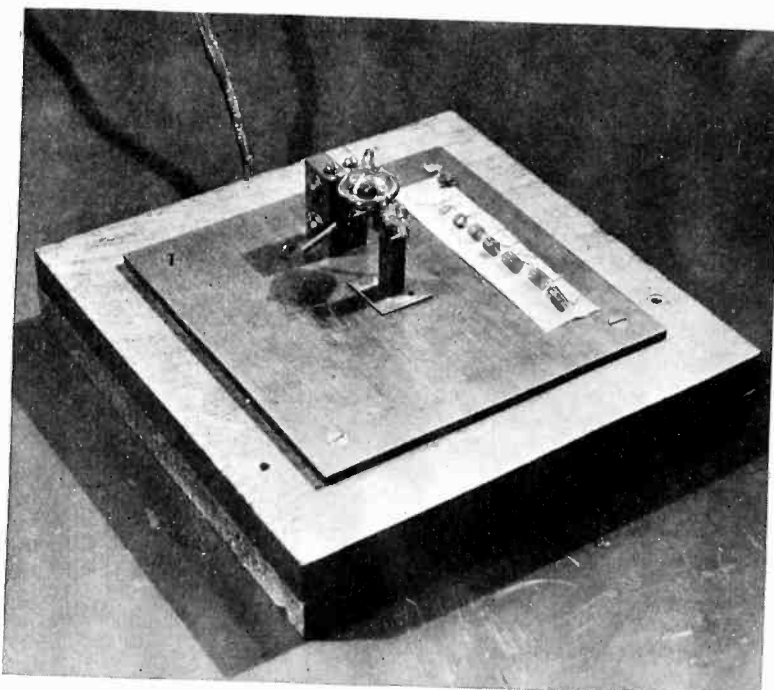

Tube and inductances for various wavelengths below one meter developed by B. J. Thompson of RCA Radiotron Laboratory

Clean-up of hydrogen by magnesium

[A. L. REIMANN, G.E. Co. and Marconiphone Co.] A clean surface of magnesium metal at room temperature will take up one out of every one and a half million molecules of hydrogen coming into contact with the surface (contact gettering). Hydrogen is also cleaned up at the same rate when a piece of magnesium is slowly evapo-

rated in the vacuum tube (dispersal gettering); magnesium absorbs hydrogen until about every sixth or seventh molecule of the mass is a hydrogen molecule. The rate of clean-up is greatly accelerated when a discharge is passed through the gas, the number of molecules absorbed being from 2 to 70 times larger than the number of ions collected at the cathode (electric discharge gettering). This effect is due to the formation of hydrogen atoms from molecular ions.—*Phil. Mag. and J. Science* 16: 673-678. 1933.

Measurements of rapidly varying pressures by cathode ray tube

[J. KLUGE AND H. E. LINCKH, German Bureau of Standards.] The improvements made in the last three or four years has transformed the cathode ray tube into a very suitable tool when used with a pressure quartz and a vacuum tube amplifier for studying rapidly varying pressures, such as occur in internal combustion engines. When the condenser shunting the two quartz plates is set to the smallest value, the

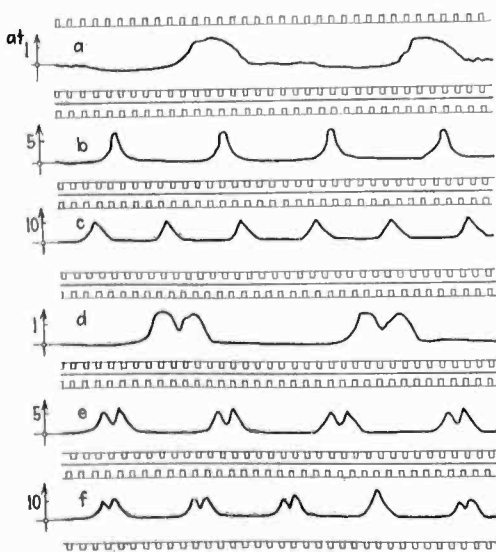

Pressure-time curves of 8 hp. internal combustion engine. Film moving 60 cm/second.

- a. No load 750 r.p.m.
- b. Load 1 kw. 1550 r.p.m.
- c. Load 2 kw. 2500 r.p.m.
- d. No load 700 r.p.m.
- e. Load 1 kw. 1600 r.p.m.
- f. Load 2 kw. 2150 r.p.m.

sensitivity of the arrangement is about 1 volt per atm. With hundredfold amplification in the vacuum tube voltmeter circuit and a cathode ray tube giving 0.5 mm. deflection per volt it is possible to obtain 50 mm. per atmosphere. With 500 μf in parallel with the plates, the response is reduced to 2 mm. per atm. (A similar investigation is in progress in the Mechanical Eng. Department of the M.I.T.) The equipment is manufactured by the D. S. Loewe Radio, Berlin.—*Forschung Ing. wesens*, 4: 177-182. 1944.

Barrier plane photocells

[B. LANGE, Kaiser Wilhelm Institute, Berlin Dahlem.] The author (see *Electronics*, July 1932, p. 237) discusses the cuprous oxide (Cu_2O) copper reverse and obverse cell (*Electronics*, October 1932, p. 312) the lead sulfide Pb. S and the selenium cell. The change of sensitivity with the wavelength can readily be made

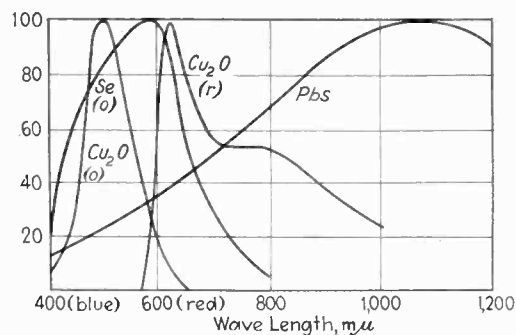

equal to that of the eye by using the selenium cell with a colored glass filter. The photocurrent furnished by the reverse Cu_2O cell is proportional to the illumination up to 10,000 lux (a few microamp.) whether the external resistance be 10 or 500 ohms. The potential produced by the light is proportional to the illumination up to 2000 lux, or bright daylight (8 mv.) Selenium gives a linear response between 0 and 40 lux. The photocurrent produced in the Cu_2O reverse cell increases by about one per cent for each deg. C. Selenium cells are less affected, at least near room temperature. Cesium cells in argon actually have the same order of sensitivity but a thousand times higher internal resistance. The response of commercial selenium cells slowly increases in the course of time, reaching a flat maximum; the change is the more rapid the higher the illumination. Some applications are described.—*Zeits. Instrumentenkunde* 53: 344-349. 1933.

Grid controlled rectifier as regulator for a.c.

[P. LENZ, Research Laboratory, German G.E. Co.] The load is placed in series with the primary of a transformer with iron core; the secondary of the transformer is short-circuited through a grid-controlled rectifier. The negative grid potential determines the time during which the tube carries current in each period. Theory and experiment show that when no discharge is allowed to pass, the high resistance in the secondary reduces the current in the primary to a negligible value. When the tube carries current during the entire positive half-period, the inductance of the transformer is reduced to a small value, the iron remaining practically saturated, even during the interval in which the discharge disappears; the primary current depends upon the ohmic resistance of the load only. Even be-

tween these two extreme cases the current is approximately sinusoidal and can be gradually varied by means of the grid bias.—*Archiv. Ekelrot.* 27: 497-504. 1933.

Automatic device for the study of reverberation

[M. J. O. STRUTT, Research Lab. Philips Inc.] Using improved equipment, Sabine's law is tested and modified as follows: When a source of sound is suddenly stopped, the length of the reverberation period is independent of the location of source and receiver, in halls having a volume of about 40,000 cu.ft. except when a hall with strongly absorbent walls opens into a room with strongly reflecting surfaces. In this case the duration increases gradually with the approach to the open door. In smaller rooms the law is accurate to within 10 per cent provided the volume exceeds 5,000 cu.ft. and provided that all the walls are of nearly the same nature. If this is not the case the law is satisfied when the volume exceeds 12,000 cu.ft. However, selective reverberation over a certain frequency range does not result in audible distortion of speech and music.—*Revue d'acoustique* 2: 1-26. 1933.

Plate current characteristics and brightness of cathode ray tubes

[F. HEHLGANS, Research Laboratory, German General Electric Company.] The cathode ray tubes (11 cm. long, 3 cm. in diameter) as used in sound picture and television work have a negatively charged Wehnelt cylinder between cathode and plate (which are 14 mm. apart) and sometimes a fourth electrode positively charged, right in front of the cathode. A fraction of the electrons passes through the plate and hits the luminescent screen of calcium tungstate. At 1,500 volts the greater part of the light emitted lies in the dark blue. When the Wehnelt cylinder is used as a grid, the plate current-grid voltage curves are entirely analogous to those of ordinary three electrode tubes filled with gas and present long straight portions corresponding to a definite value of mutual conductance and amplification factor; this is only possible because the electrons hitting the screen turn back and travel to the plate. The light output is not proportional to the plate current except over certain ranges. The fourth electrode increases the luminosity at the same plate voltage and without reducing the linear grid voltage swing. Pressures ought to lie between 1/1,000 and 1/100 mm.—*Hoch fr. u. El. Ak.* 42: 45-53. 1933.

Cross-section of electron beam and nature of gas

[E. F. RICHTER, Research Laboratory, German General Electric Company.] In one type of low voltage cathode ray tube the electrons are forced to pass through a positively charged diaphragm and then through a narrow cylinder, 8 mm. long and 1 mm. in diameter, forming part of the plate. With 350 volts on the plate narrow beams appear only in a very limited range of pressure for each gas. When the plate current measures between 1 and 2 ma., the pressure where threadlike beams appear lies (in thousandths of mm. mercury column) between 8 and 10 in hydrogen, 19 and 20 in helium, 4.6 to 5.4 in neon, 0.8 to 1.6 in nitrogen, 0.9 to 1.1 in argon, 0.8 to 0.9 in krypton, 0.25 and 0.30 in xenon.—*Phys. Zeits.* 34: 457-458. 1933.

Low voltage cathode ray tube circuit

[J. DANTSCHER, Research Laboratory, German General Electric Company.] The tube works with 400 volts on the plate and is intended for the study of periodic currents or potentials. The time axis is produced by means of a condenser C charged through a vacuum tube (saturation current i) and discharging whenever the grid bias is reduced to e , across a three electrode tube containing inert gases. Part of the potential to be recorded is introduced

into the grid circuit of the gas-filled tube in order to obtain synchronization. The frequency of the time sweep circuit is given by $i/(E_1 - E_2)C(1+a)$, where a is the ratio of the discharging period to the time necessary for charging E_1 the starting voltage and E_2 the lowest plate potential at which the gaseous tube runs; it is clear that the frequency can be varied between wide limits, normally between 0 and 30,000 cycles, but with gaseous tubes of special design up to 250,000 cycles per sec.—*Zeits. techn. Phys.* 14: 337-341. 1933.

Cesium atoms in cesium, cesium-oxide on metal cathodes

[J. H. DEBOER and M. C. TEVES, Philips' Research Laboratory, Eindhoven]. When light strikes a surface consisting of a support of pure metal covered by a cesium oxide or salt layer (calcium fluoride) which holds alkali or alkaline earth metals, light liberates electrons from the adsorbed atoms. The adsorbed atom is more readily ionized than a free atom on account of the greater energy with which the ion will be absorbed, the excess being made available for renewing the electron (0.95 volt). The same is true of thermionic emission; the work function is only 0.6 volt.

When on the other hand a small number of atoms of alkali or alkaline earth metals are directly held by the

metal surface, then the adsorbed atoms lower the work required for dislodging electrons from the metal surface itself. *Zeits. f. Phys.* 83: 521-533. 1933.

Three-centimeter waves in cobalt research

PRODUCTION OF ELECTRICAL waves of the order of 3-meters has made possible investigation of the magnetic properties of cobalt for the first time according to a dispatch from California Institute of Technology where Dr. G. W. Potapenko announces that he has (1) measured the magnetic properties of cobalt, one of the three existing magnetic substances, for the first time in the high frequency range, (2) discovered that cobalt is vastly superior to iron and nickel, the only magnetic metals now used for cores of electro-magnets in high frequency technique, thus giving the electrical industry 50 per cent more material to work with in its most essential and most basic department, and (3) verified predictions made by Dr. Fritz Zwicky regarding the relative sizes of units of magnetic structure, in iron, nickel and cobalt.

Cobalt, according to Dr. Potapenko, has the unsuspected quality of a steady decrease in its magnetic attraction as frequency is increased. To make this discovery, the physicist generated a frequency of 10,000,000,000 cycles with oscillator tubes. (See cover, this issue of *Electronics*.)

Notes on dual-band receiver design

[Continued from page 301]

The effect at the low frequency points was less noticeable because on the long-wave band the bankwound coil was only a small part of the total inductance.

Figure 3 illustrates a commonly used carrier signal tuned circuit. It will be noticed that trimming condenser C which is used to track the long wave sections, is connected across the long-wave part of the secondary. This scheme is the simplest and provides maximum stability. The equation for the voltage across C_1 which is the voltage presented to the next grid is as follows:

$$e = \frac{E}{\omega L_1 - \frac{1}{\omega C_1} - \frac{\omega L / \omega C}{\omega L - \frac{1}{\omega C}}}$$

where E is the impressed voltage.

Inspection shows that e will be a maximum at two frequencies: when the whole circuit is tuned to resonance, and when L_1 , C and C_1 are resonant at some higher frequency at which the reactance of C_1 is negligible with respect to the reactance of L .

If the primary is also coupled to the long wave section of the secondary, the equation for voltage across C_1

from this source is:

$$e = \frac{\left[\frac{E_1}{\omega L - \left(\omega L_1 - \frac{1}{\omega C_1} \right) \frac{1}{\omega C}} \right] \left[\frac{- \left(\omega L_1 - \frac{1}{\omega C_1} \right) \frac{1}{\omega C}}{\omega L_1 - \frac{1}{\omega C_1} - \frac{1}{\omega C}} \right] \frac{1}{\omega C}}{\omega L_1 - \frac{1}{\omega C_1}}$$

where the first term in the numerator is the circuit current, the second term is the effective impedance of L_1 , C and C_1 ; the product of these terms is the voltage across L_1 and C_1 . Inspection of this equation shows **three possible resonant points**; when the whole circuit is resonant, when L_1 and C_1 are resonant, and when L_1 , C and C_1 are resonant.

It is therefore a relatively easy matter for oscillator harmonics to cause spurious responses. The remedy is to connect the trimming capacity so that on the long wave band it is in shunt with the tuning condenser in Fig. 4.

These notes have only touched the surface of the problem, as anyone who has worked on such designs will realize. It is hoped, however, that some of the points covered will help practical designers.

+ NEW PRODUCTS

THE MANUFACTURERS OFFER

Dual-output three-stage amplifier

A 13-WATT DUAL-CHANNEL, dual-output, class B, three-stage amplifier, universally powered for either sound-truck or auditorium public-address-system operation, is a new product of the Coast-to-Coast Radio Corporation, 121 W. 17th St., New York City. Operable from either 110-volts a.c. or 6-volts d.c., this outfit opens up a new and profitable field for portable, mobile, temporary and permanent installations.

When the amplifier is being powered from a storage battery, it employs the new RCA-Victor vibrator-type converter-rectifier. The whole unit is silent and fool-proof, and operates with high efficiency. A combination 6-volt and 110-volt phonograph motor is also available to serve as an accessory.—*Electronics*.

Sensitive scale

A NOVEL SCALE FOR WEIGHING very small quantities of chemicals, parts, etc., has been developed by the Continental Electric Company of St. Charles, Ill. So delicate is the instrument that some models will weigh a pencil-mark on a piece of paper. This Acrascale, as it is called, is suitable for the laboratory, and also for the factory where rapidity and simplicity of weighing are important. The Acrascale is made in five different ranges and sensitivities, from 0.15 mg., with 0.05 mg. sensitivity; up to 0-1000 mg., with 2 mg. sensitivity. Each model has two ranges, one twice the range of the other. Prices \$12 and \$15.—*Electronics*.

Antenna system

A NEW TYPE OF antenna feeder system, which matches the impedance of the transmission line to that of the antenna without the use of inefficient coupling devices, has just been developed for the E. F. Johnson Co., Waseca, Minn., manufacturers of radio transmitting equipment, by Ralph P. Glover, consulting electrical engineer.

The system makes use of the well known impedance-matching properties of the quarter-wave line, which is inserted between a Hertzian doublet transmitting antenna and a main transmission line of any convenient length. The quarter-wave section is constructed of thin-walled copper or aluminum tubing and is suspended from the center of the

antenna. The tubes are closely spaced, the actual spacing being that which results in a characteristic impedance which is the geometric mean between the antenna impedance of about 75 ohms (for a half-wave doublet) and the main-line impedance, which commonly lies between 400 and 600 ohms. The improvement is of the order of 3 decibels.—*Electronics*.

Converter, 32 to 110 volts

ELECTRONIC LABORATORIES, 122 West New York Street, Indianapolis, Ind., have put on the market an electronic converter for producing 110-volt alternating current from 32-volt direct current, such as is used in farm-lighting systems. This apparatus makes possible the use of standard alternating-current home devices such as vacuum sweepers, juice extractors, neon signs, radios, etc., on lines which would otherwise require more expensive special appliances for the supply voltage. Thus a farm-plant

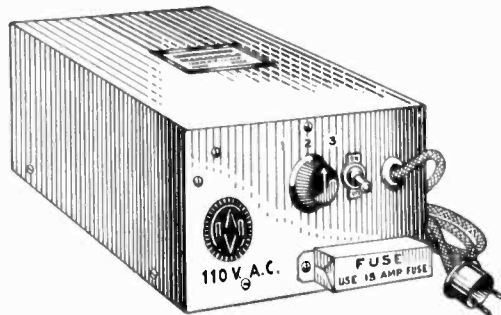

owner may purchase home appliances that can later be used on central-station service. These converter units are made in 100 watts and 200 watts output. There is also a converter from 110 volts direct current, to 110 volts alternating current.—*Electronics*.

Amplifier for deaf

THE NEW MODEL HA1 of the hearing-aid devices produced by the Universal Microphone Company, Inglewood, Cal. (two-stage amplifier, using two 230 tubes, and standard dry-cell batteries) now carries optional equipment of ten single headsets.

The device thus becomes adaptable for hard-of-hearing people in churches, theaters, schools, institutions and other places. The unit itself is placed near the speaker or music, with a line to the audience seats.

Manufacturers of the apparatus sug-

gest individual volume control to each head-set. By using a telephone jack, the earphones can then be plugged in. The use of standard large-size dry batteries allows consistent long-time use at low battery up-keep.—*Electronics*.

Resistor characteristics

THE ERIE RESISTOR CORPORATION, Erie, Pa., announces that it has improved the voltage characteristics of its complete line of resistors and ignition suppressors from 50 to 60 per cent.

This marked decrease in the drop in resistance value at maximum rated voltages has been effected by advancements in manufacturing technique and the development of a new and highly efficient combination of raw materials.

This new "mix" does not in any manner adversely affect the other electrical and physical characteristics of Erie resistors.—*Electronics*.

Experimental "electric-eye" unit

J. THOMAS RHAMSTINE, 500 East Woodbridge Ave., Detroit, Mich., has put on the market a simplified "electric eye" relay unit intended primarily for experimental, educational and entertainment use, but also available as a basic unit for many applications in commercial service. The unit can be operated by a simple 110-volt lamp, or a focusing flashlight, or by infra-red illumination to produce an invisible beam. The experimental outfit is priced complete at \$8.95.—*Electronics*.

Balsa-wood sound insulation

SOUND INSULATION, room lining and baffle panels for broadcasting and sound-recording studios, loudspeakers, sound-proofing, isolation pads, etc., for which Lata balsa wood is adapted, are now offered by the Balsa Wood Company, Inc., Brooklyn, N. Y.

Microphotographs of this material show its minute, flexible-walled cells, filled with dead air, but free of lignification, thus providing a perfect cushion against wave passage, whether of sound or vibration. In addition its strength, as evidenced by its ability to withstand compression without loss of resiliency, makes balsa wood a strong supporting material.—*Electronics*.

Extremely light-weight headphone sets

THE TRIMM RADIO MANUFACTURING COMPANY, 1528 Armitage Ave., Chicago, Ill., has brought out its Feather-weight headphones, which it declares to be "America's most highly developed headset." The net weight is four ounces, complete with two phone units, 5-ft. cord, and head-band. Magnets are of the best grade Cobalt steel. These Featherweight headphones are furnished in any resistance desired, from one ohm to 2,400 ohms for each unit. The 4,800-ohm phone is recommended for short-wave reception. Single unit Featherweight phones are also available with spring bands and with lorgnette handles for group installation in churches, theatres and lodges.—*Electronics*.



Vacuum-contact relays

WARD LEONARD ELECTRIC COMPANY, Mount Vernon, N. Y., has a line of vacuum-contact relays for applications where non-arcing, instantaneous and positive contact in the electric circuit are essential features of the switching device.

The vacuum contact is mounted in the metal base and fully protected from accidental damage.

These relays operate on a small amount of current, controlling power circuits as high as 6 amperes continuously or 8 amperes intermittently, either a.c. or d.c. (non-inductive) at 110 or 220 volts.

The base measures 1½ in. by 4 in., and depth without enclosing cover is 1¼ in. The relays are obtainable single and double pole, normally open, and normally closed.—*Electronics*.



Weather-proof dry disk rectifiers

MALLORY-ELKON rectifiers manufactured by P. R. Mallory & Company, Indianapolis, Ind., are now sealed for protection against atmospheric conditions, making these compact, durable units now weather, water and salt-spray proof which gives their users a very decided advantage. Additional recommendations are simple and rugged construction, the absence of lead "cushion" to cold flow, and the elimination of polarizing surfaces to cause leakage and backward rectification. These "bone dry" rectifiers have a high capacity for their size and are demonstrating their value on a large variety of d.-c. apparatus such as battery chargers, electroplating units, electro magnetic devices, speaker and signaling systems, a.c.-d.c. radios, etc. — *Electronics*.

Multi-polar rotary switches

A NEW ROTARY, SNAP-ACTION SWITCH, applicable to a wide variety of new circuit requirements, has been developed by H. H. Eby Manufacturing Company, 21st and Hunting Park Ave., Philadelphia, Pa. The frame is of corrosion-proof steel, and phenolic insulation is used. Suggested

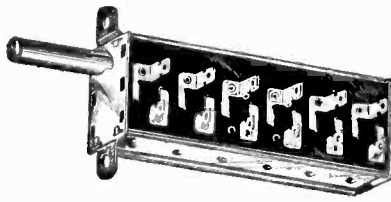

uses of the switch are for two-band radio receivers, universal receivers, low-powered transmitters, test equipment, laboratory apparatus, signaling apparatus, and electronic devices of various kinds. To insure low contact resistance, high-grade phosphor-bronze springs, silver-plated, are employed. The switches are obtainable with one to six poles, single or double-throw.—*Electronics*



New Argus prices

THE A.M.I. DISTRIBUTING COMPANY announces new prices on photo relay units. These prices are: The Argus photo-relay kit \$39.50, the light source \$13.50 and the infra-red filter \$10.50.



Thermal delay relays

THE BURLING INSTRUMENT COMPANY, 185 Market St., Newark, N. J., is agent for the Thomas A Edison thermal delay relays and other relay controls. Such thermal relays are operated by the thermal expansion of metals, a wire, or a bi-metal arm; for this reason definite and secure contact is made with both alternating current and direct current. A relay controlling 1,000 watts, a.c. or d.c., is made to operate with a 30-second delay at 15 watts. A relay designed to delay one minute would operate on approximately 12 watts. Such relays are priced at \$7.50.—*Electronics*.



Sensitive relay

A RUGGED AND SENSITIVE RELAY especially suitable for photoelectric application has been announced by the Kurman Electric Company, 241 Lafayette St., New York City. This relay is economical in first cost and in operation. The K-1 relay requires .03 watts for positive operation, has coin silver contacts rated to carry 1 amp. non-inductive load, has sharp drop out at approximately 60 per cent of the operating current value. Can be supplied to operate from .001 amps. at 19 volts to .23 amps. at .083 volts.—*Electronics*.

High frequency inductances and mounting base

PREMIER CRYSTAL LABORATORIES, INC., 63 Park Row, New York City, have just announced that they are manufacturing a complete set of coils and mounting base, which are especially designed for those desiring the utmost in high frequency equipment. Coils are machine wound of high conductivity, heavy wall dehydrated copper tubing. They are chromium plated and polished over a heavy nickel plating, thus presenting a smooth, durable, bright finish which adds not only to the efficiency, but also to the appearance of any transmitter in which these coils are employed. Coils are supported on two glazed Isolantite spacer studs on a glazed Isolantite plug

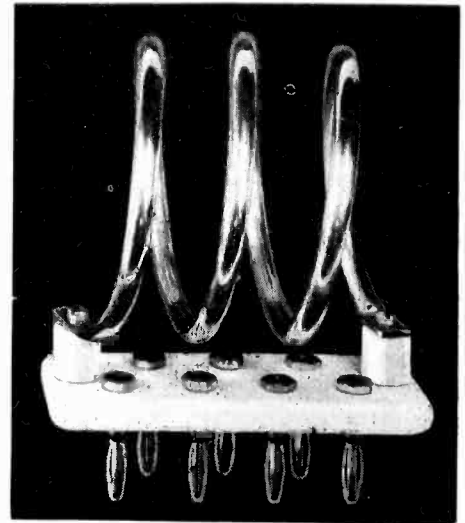

strip, the latter being equipped with seven spring type plugs which allows convenient circuit arrangement, permitting accurate mid-tapping for neutralized or push-pull circuit, grounded center for parallel feed, grid and plate coupling taps as well as neutralizing taps which may be experimentally determined and then permanently fixed. This method of using plug-in coils is convenient and extremely rapid when making changes from one band to another.

The complete set comprises four coils and a base mounting. The coils are designed to cover a range from 6 to 60 megacycles. Send for Premier's Bulletin No. 101 which completely describes above coils, base mounting and various other products for frequency control.—*Electronics*.



Manufacturers' bulletins and catalogs

Metallscope—The Fisher Metallscope for locating underground metal bodies, referred to on page 252 of September *Electronics*, is made by Gerhard R. Fisher, Palmer Building, 6362 Hollywood Boulevard, Hollywood, Calif.

Resistors—The Muter Company, 1265 South Michigan Ave., Chicago, Ill., has issued new catalog inserts covering its manufacturer's specification resistors, fixed resistors, and wirewound resistors, for use in the Muter general and technical catalogs.

Photo-cell characteristics—Characteristics of DeVry photo electric cells complete with graphs showing current response, voltage, etc., are given in a circular issued by Herman A. DeVry, Inc. 1111 Center St., Chicago, Ill.

Illumination control

THROUGH ERROR AN ITEM in September on elevator leveling system was illustrated with an illumination control device. There is no connection between the two units, of course!

The illumination control unit is made by Westinghouse and is called the Photolux. Obviously it is a photoelectric device and automatically turns on and off lights in accordance with variations in daylight illumination in schools, work shops, store windows, offices, airway and navigation beacons, etc., etc.

+

Piezo phonograph reproducers

IN PLACE OF THE former heavy electromagnetic pick-up with great mass and damping in order to reproduce the lower frequencies and producing severe wear on the record the new piezo-astatic reproducer developed by the Astatic Microphone Laboratory, Youngstown, Ohio, has the five advantages of light weight, uniform response, free damping, non-resonance, and non-magnetic character. A small crystal element is coupled to an extremely light stylus chuck (lighter than the average phonograph needle). Owing to the flexibility of the crystal, and the small mass of the chuck, little mechanical damping is required, which results in practically uniform response over the whole audio range.—*Electronics*.

+

Wire strippers for insulated wires

MOTOR-DRIVEN STRIPPERS for insulated wires are provided by the Wire Stripper Company, 357 Erie Building, Cleveland, Ohio, which manufactures several different types for different purposes. Its Speedcraft knife-type stripper handles most kinds of solid or stranded wire, single or multiconductor cord or cable, insulated with rubber, composition, braid, fabric, asbestos, etc. The Speedcraft stripper makes a clean cut of the insulation and neatly twists loose strands.

For more difficult and unusual wire-stripping jobs, a brush type of stripper is supplied. These strippers use wire brushes to remove the insulation, and each machine is driven by a one-half horsepower motor. The stripper is provided with easy adjustment, safety guards, and suction exhaust of insulation. The brush principle is found best suited for enamel and cotton insulation, coil or armature leads, square or flat conductors, and other insulations hard to strip. Special provision is made for stripping insulation in the middle of a wire, or for removing insulation altogether in salvaging defective wire.—*Electronics*.

Portable beat-frequency oscillator

THE WIRELESS EGERT COMPANY, 179 Varick St., New York City, has produced a new compact, accurate and portable beat-frequency oscillator, entirely a.c. operated. This may be obtained with a calibration chart or with a directly calibrated dial mounted on the condenser shaft. An ingenious arrangement of a variable condenser and

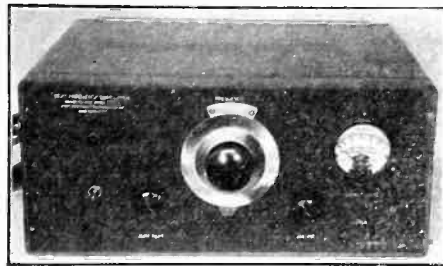

an r-f transformer reflects the original capacity of the variable condenser to many times its ordinary value. To reduce harmonics, a very heavy tank circuit is used. Heater-type tubes insure ruggedness. A separate and entirely isolated B supply fits into a rear compartment of the oscillator. With power supply the instrument weighs 30 pounds. The instrument has high frequency stability, and its calibration is accurate and within 2 per cent at frequencies above 40 cycles. The price, complete less tubes, is \$155.—*Electronics*.

+

Amplifier for oscillograph and laboratory use

FOR USE WITH CATHODE-RAY oscillographs and for general laboratory purposes, the Allen B. DuMont Laboratories, Upper Montclair, N. J., have developed a high-quality alternating-current operated amplifier. It is extremely important that an amplifier for this service have elements of frequency response, general stability and linearity, together with freedom from phase shift which is quite unnecessary in ordinary units.

This DuMont type 136 amplifier is a three-stage unit which has a response curve flat between 10 and 100,000 cycles, and there is little phase shift in this range. Its output of 50 volts r.m.s. is sufficient for the deflection of the usual cathode-ray tube, at which output there is no non-linearity.

This amplifier may be inserted into any ordinary communication circuit for voltage and waveform measurements by virtue of its high input impedance. At the same time its output impedance is sufficiently low to avoid ill effects due to the impedance of cathode-ray tube deflecting plate systems and to allow its use with other indicating devices.—*Electronics*.

High-voltage condensers

REDUCTION IN CUBIC VOLUME and weight by more than 50 per cent as compared with previous types, a non-inflammable impregnator permitting use in hazardous locations, operation at high ambient temperatures destructive to former ordinary types, and a leakage resistance and power factor change far less at high temperatures than with types currently employed, are features of the new pyranol impregnated high-voltage filter condensers being introduced by the Cornell-Dubilier Corporation, 4377 Bronx Blvd., New York City.



The Cornell-Dubilier pyranol impregnated condensers are available in three standard direct-current working voltages and the following range of capacities: 1,000-volt, 1 mfd. to 10 mfd.; 1,500-volt, 1 mfd. to 6 mfd.; and 2,000-volt, 1 and 2 mfd. These units can be operated continuously at voltages up to 10 per cent above rating.—*Electronics*.

+

Sprayed metal

THE METALS COATING COMPANY OF AMERICA, 495 N. Third St., Philadelphia, Pa., has developed instruments for sprayed molten metal coatings.

Sprayed metal coatings applied with the MetaLayer are used to:

Provide protection against atmospheric corrosion on chemical action.

Provide protection against the deteriorating effects of exposure to high temperatures.

Apply electrical contacts and to develop conducting or resistance coating on conducting or insulating materials.

Alter shapes or add dimension or weight to worn or mismachined (undersized) parts with micrometer accuracy.

Develop unique and attractive decorative effects. Sprayed metal coatings render inflammable materials flame proof and fire resistant.

Join metallic to non-metallic materials.—*Electronics*.

BRITISH PATENTS IN THE FIELD OF ELECTRONICS

Electron Tube Applications

Manufacture of printing plates, etc. Method of producing representations by applying a gradually decreasing negative voltage to the grid of a gaseous discharge tube during regularly spaced predetermined intervals of time, projecting light onto several small areas of the original in a scanning operation and causing a cutting tool actuated by the plate current to cut out of a plate the desired subject. J. W. Dalton, Wimbledon, London. No. 391,838.

Cathode ray tubes. A thin fluorescent screen layer for a cathode ray television tube made by depositing particles of screen material upon a surface from suspension in a liquid, for example by gravity, the size of the particles being such that they can adhere to the surface in the absence of a separate binding material, for example pulverized material screened through a mesh 270 per inch. The liquid is subsequently removed as by draining off or by evaporation. The screen may be associated with a conductive layer or be rendered conductive in alternate ways. Zinc sulphide, zinc silicate (willemite) or calcium tungstate may be used for the screen material, and water or alcohol for the suspending liquids. Other interesting parts of the process are outlined in this patent. R.C.A.-Victor Co. No. 391,887.

A feedback system in which photo-cell currents are amplified by an energy feedback between the cell and the output of the amplifier. R. R. Haugh, British Thomson-Houston Co. No. 394,121.

Modulating system. A modulating circuit particularly intended for picture telegraphy or television, comprising two tetrodes with a carrier wave applied in phase opposition to corresponding grids and with the modulating potentials applied to another grid of one of the group to upset the carrier balance in the joint plate circuit. M. Artzt, Marconi Co. No. 394,186.

Television system. Apparatus for producing a saw-tooth potential for use in producing a time deflection in a cathode ray oscillograph and for scanning in television apparatus. K. Schlesinger, Berlin, Germany. No. 394,476.

Sound recording system. Method of connecting a light sensitive cell in series with the primary of a transformer, the secondary of which feeds the grid circuit of an amplifier. B. Kreuzer, R.C.A. No. 394,822.

Smoke protection. Use of a light sensitive cell to generate an e.m.f. when in full light in an installation for protecting against smoke or dust. A. J. Stevens, London. No. 394,853.

Light signal system. Method of transmitting television by modulating radio frequency current. E. F. W. Alexander, G. E. Co. No. 395,242.

Radio Circuits

Television receiver. Image color due to the nature of the Neon tube or screen is compensated by projecting on the screen unmodulated light, complimentary to the color of the image. J. C. Batchelor, Marconi Co. No. 392,869.

Superheterodyne circuit. Second channel interference is reduced by connecting the grid of the first tube to the aerial both through the tuned circuit and also through a condenser. E. K. Cole, Ltd. No. 389,081.

Automatic volume control. Several patents granted to Telefunken on various methods of automatic volume control. No. 393,415; No. 393,421; No. 393,472. In the first two, logarithmic rectifiers seem to be essential, that is the relation between the input voltage and the output current is logarithmic. Low-frequency output is proportional to the degree of modulation of the input high-frequency wave and independent of its average amplitude. Rectifier stage in No. 393,415 may include a photoelectric cell actuated by a light source modulated by the signal input as the current output in such a cell is approximately a logarithmic function of the light strength or a gas discharge tube may be utilized as a rectifier by virtue of its saturation phenomenon. In the second patent a rectifier having ordinary characteristics is associated with a subsequent amplifier stage in such a manner that the combined rectifier and amplifier exhibit the required characteristics. In the third patent a grid bias control voltage is arranged to be proportional to the actual received signal, that is a voltage which has not been subjected to gain control and the amplifying tube controlled is free from anode retroaction and has a characteristic which is inversely proportional to the applied bias.

Superheterodyne receivers. A receiver for ultra-short waves using an oscillator of the Barkhausen-Kurz type. The intermediate frequency amplifier is of the super-regenerative type and operates at a high frequency. R. W. George, Marconi Co. No. 394,267.

Class B amplifier. Tubes with a high amplification factor and high internal impedance are used in audio frequency or other power amplifiers with low impedance in the input and output circuit, distortion being prevented by allowing grid current to flow. Valves are driven to the limit of their emission. L. E. Barton, Marconi Co. No. 395,277.

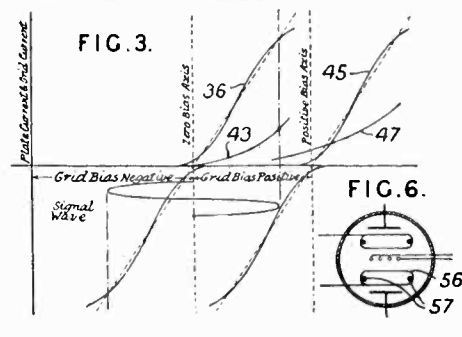
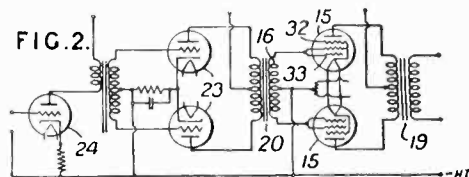

Noise suppression circuit. A receiver incorporating A.V.C. The loud speaker is arranged to be inoperative when the signal is below a predetermined value. R. S. Holmes, British Thomson-Houston Co. No. 395,327.

Oscillator circuit. The local oscillator is provided with mixed magnetic and capacity back couplings whereby its output frequency characteristic over the tuning range may be arranged to compensate for or may be otherwise correlated with the amplification frequency characteristic of the radio frequency amplifier. The oscillator is substantially free from harmonics. W. A. MacDonald, Hazeltine Corp. No. 394,364.

Patent No. 394,364 to W. A. MacDonald on oscillator circuits for superheterodyne receivers

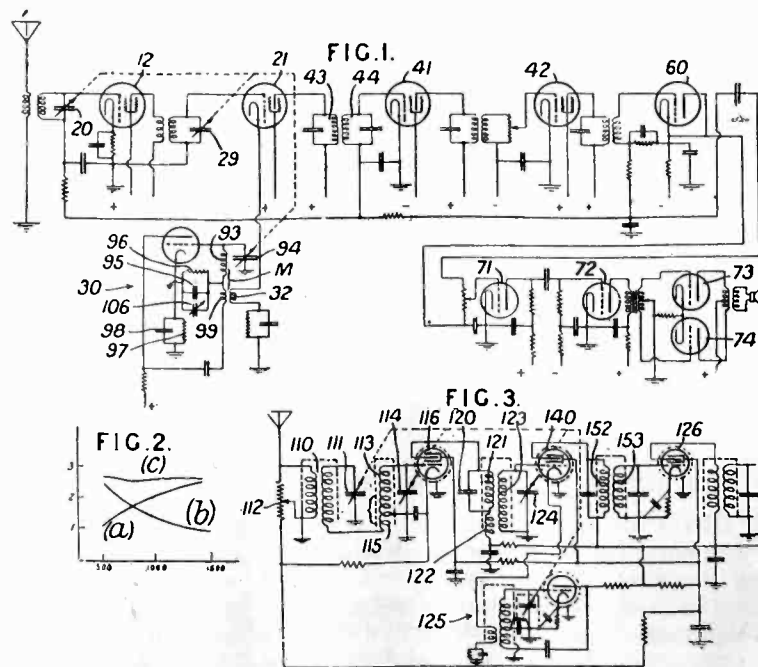

Victron

THE NEW VICTRON, emerging from the laboratory an outstanding achievement in the development of plastic dielectrics now takes its place, commercially, for service in the electronic industries. Far eclipsing any other insulator of its kind in point of electrical loss in the upper range of the communication frequency spectrum, Victron insulating compositions make an important and timely contribution toward the advancement of communications.

No longer need the industry accept plastic dielectrics which have failed to keep pace with the rapidly growing art of modern electrical communications. The new Victron may be molded to specifications or supplied in the form of sheets or tubes which may, of course, be fabricated locally like any other resinous insulator.

Victron has many uses in the construction of devices where the highest circuit efficiency is required. It is particularly well suited to the manufacture of such components as inductance supports for low powered transmitters and high frequency receivers, vacuum tube bases which may be molded with prong inserts, tuning condensers and band change switches. Sheet stock for panels, terminal mountings, sub-bases and a great variety of other applications may be produced in the new Victron with the assurance that every part is insulated for maximum circuit efficiency.

Victron is a product of the laboratories and factories of the Naugatuck Chemical Company and the United States Rubber Company, and is distributed exclusively by the Dielectric Products Company.



PROPERTIES

POWER FACTOR
.08%—2%*

DIELECTRIC CONSTANT
3.0—4.0

TENSILE STRENGTH
4,000—6,000
lbs./sq"

TRANSVERSE STRENGTH
9,500—10,000
lbs./sq"

*Power Factor determined at 1500 KC or above. Value depends upon composition, temperature and frequency.

DIELECTRIC PRODUCTS COMPANY
11 PARK PLACE • NEW YORK, N.Y.

ANSWERING TODAY'S NEEDS FOR CATHODE-RAY TUBES



AND ASSURING AVAILABILITY FOR FUTURE RENEWAL PURPOSES

FOR a number of years the laboratory of the RCA Radiotron Company has been engaged in an intensive research and development program on cathode-ray tubes. Involving an unusual amount of production experience on cathode-ray types, this program has emphasized the same thorough and painstaking attention to detail that characterizes the development of receiving types of RCA Radiotrons.

The results of this work are now made available in four cathode-ray tubes. These are supplemented by two types—one a rectifier for high-voltage supply, and the other a triode, gaseous type, for sweep-circuit operation.

These designs have been carefully chosen to meet the diversified needs of oscillograph application.

Important Features

1. **QUALITY.** RCA Cathode-Ray Tubes are manufactured to laboratory standards of precision. Comprehensive tests have demonstrated their excellent life performance.
2. **AVAILABILITY FOR RENEWAL.** The RCA Monogram is your assurance that these designs are standardized and will be available when required for renewal purposes.





RCA-906—3 inch screen. Electro-static deflection.
LIST PRICE \$18.00

RCA-905—5 inch screen. Electro-static deflection.
LIST PRICE . \$40.00

RCA-904—5 inch screen. Electro-static-magnetic deflection.
LIST PRICE . \$50.00

RCA-903—9 inch screen. Electro-magnetic deflection.
LIST PRICE \$120.00

4 CATHODE-RAY TUBES . . .

of the hot-cathode, high-vacuum type. These tubes provide a brilliant luminous spot capable of following high-frequency phenomena. RCA-878 and RCA-885 are new tubes for use with the cathode-ray tubes.

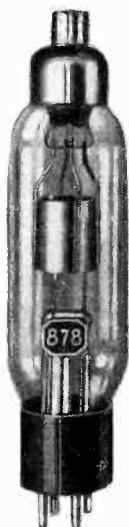

RCA-878—A high-voltage, high-vacuum rectifier.
LIST PRICE \$11.00

RCA 800 • ANOTHER LABORATORY ACHIEVEMENT



The RCA-800 is a new transmitting tube designed primarily for use in amateur transmitting stations. Capable of delivering its full output at frequencies up to 60 megacycles, the RCA-800 is an example of tubes developed by the RCA Radiotron Laboratory to meet the requirements of specialized applications.

RCA-800 . . List Price . . \$10⁰⁰

For additional information write to
De Forest Amateur Radio Division
RCA Radiotron Co., Inc.
Camden New Jersey



RCA-885—A gaseous-type triode, suitable for sweep-circuit control.
LIST PRICE \$2.00

For additional information write to Engineering Department

RCA RADIOTRON CO., INC.

HARRISON

NEW JERSEY

A RADIO CORPORATION OF AMERICA SUBSIDIARY

4 Decisive Reasons for equipping YOUR auto radios with S.S. WHITE FLEXIBLE SHAFTS

1- A SUPERIOR SHAFT, EXPRESSLY DEVELOPED FOR AUTO RADIOS

S. S. W. Flexible Shaft No. 150L53 originated and developed by S. S. WHITE for remote control of auto radios, is characterized by minimum torsional deflection, and deflection is equal for either direction of rotation. When properly applied, deflection is virtually eliminated and this shaft provides both tuning and volume control that is as effortless and accurate as a direct connection.



An S. S. W. Flexible Shaft controlled set can be easily installed in any car, permitting wide latitude for locating receiver in most favorable position with respect to avoiding electrical, structural and physical interference. Besides, it is SAFE, for it places the control directly under driver's hand where he can tune without shifting position or taking eyes off the road.

2- A TRIM, SMALL-DIAMETER CASING

Flexible Metallic Casing No. 170A1 was also originated by S. S. W. specifically for auto radio applications. With an outside diameter of only .255", just a shade over a quarter inch, it makes possible a neat, inconspicuous installation.

3- USED ON LEADING AUTO RADIOS AND SEPARATE CONTROL UNITS

PHILCO, RCA VICTOR, MOTOROLA, CROSLEY, WELLS-GARDNER, MAJESTIC, FADA, UNITED MOTORS, UNITED AMERICAN BOSCH, PIERCE-AIRO, COLONIAL, STROMBERG-CARLSON — these are just a few of the many set manufacturers using S. S. W. Shafts, while control unit manufacturers include DE JUR, CROWE, UNITED SCIENTIFIC, ADVANCE, F. W. STEWART. Realizing the importance of smooth acting and accurate tuning controls, they demanded the best in shafts.

4- YOU ARE SURE OF DELIVERIES

A most decisive reason for using S. S. W. Shafts and Casings, is S. S. W.'s ability to "deliver the goods," when and as you need them. No chance of your production being held up, or of a falling off in quality of shafts, when demand is at its peak. S. S. W. has the facilities, the organization and the resources to meet all demands without sacrifice of quality.

Here is the Staten Island plant, adequately equipped and manned, that is back of our promise to deliver the goods and to maintain quality. One of four S. S. W. plants.

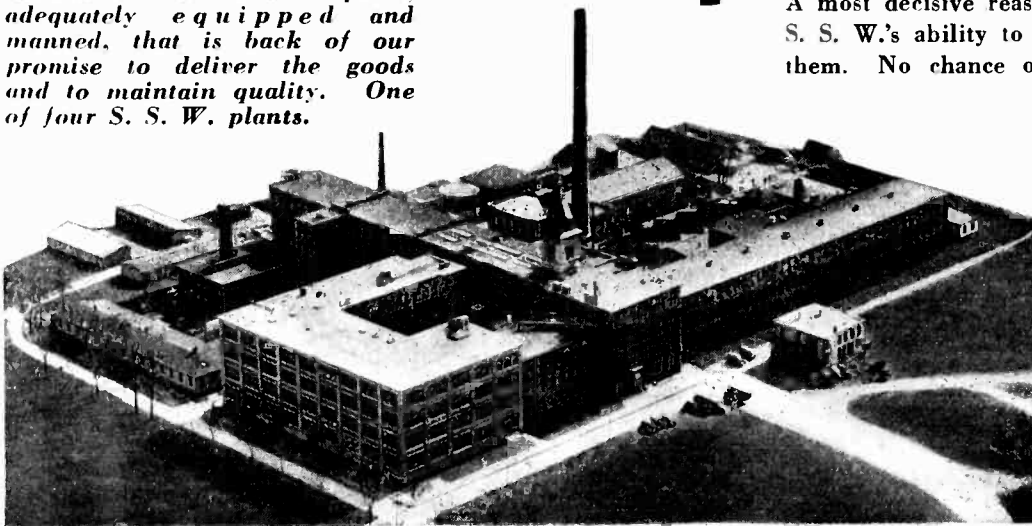

●
WRITE FOR QUOTATIONS

on your requirements. SAMPLES furnished to set and control unit manufacturers on request.

●



The S. S. WHITE Dental Mfg. Co.
INDUSTRIAL DIVISION
Knickerbocker Building New York, N. Y.

DOWN! comes the

VOLTAGE COEFFICIENT

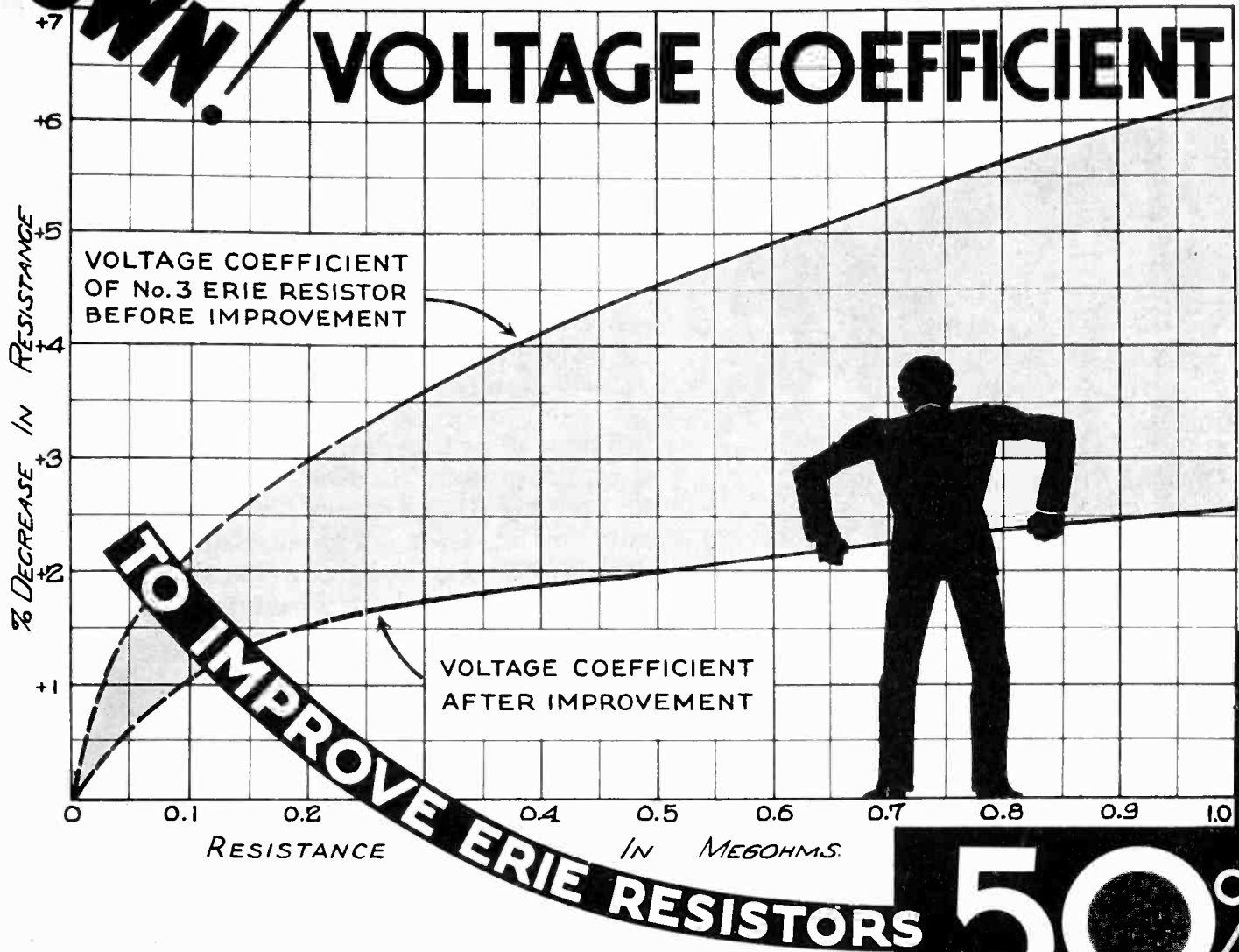

Our engineers again take the initiative by developing a vastly superior mix that improves the voltage characteristics of Erie Resistors 50% and more.

In the above graph of the No. 3, 1/2 watt, Erie Resistor the improvement between the former and present types is indicated by the area between the two voltage coefficient lines. For example, on the 1.0 megohm resistor the voltage coefficient at 350 volts has been reduced from 6.25% to 2.55% -- a gain of over 59%. On higher resistance values the improvement is correspondingly greater.

Find out for yourself how much better these new Erie Resistors really are. A letter to us will bring you a complete set of samples to test in your own laboratory.

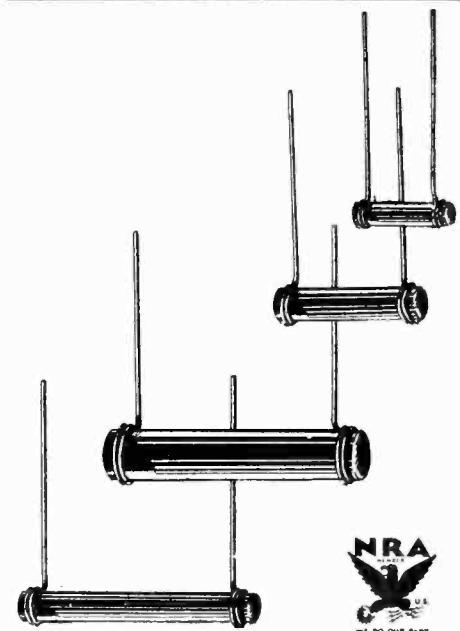

ERIE RESISTOR CORPORATION

ERIE, PA.

Factories in ERIE, PA. - TORONTO, CANADA - LONDON, ENG.



Troubles? ...
AQUADAG*



Colloidal-graphited water has the ability to form on solids, coatings of graphite which are homogeneous, chemically inert and electrically conducting.

These characteristics prove their worth when "Aquadag" is used in connection with the coating of resistance sectors for volume and tone controls. The ease of application and simplicity of control makes this product an ideal material with which to work.

*REG. U. S. PAT. OFF.



The illustration shows the manner in which the concentration of the graphite on the strip may be varied in order to obtain an even taper.

Send for Technical Bulletin B11

ACHESON OILDAG COMPANY
PORT HURON, MICH.



**Dependable Uniformity in Electrical
and Mechanical Properties**

**DIELECTRIC STRENGTH • LOW WATER ABSORPTION
STRUCTURAL STRENGTH • LOW SURFACE LEAKAGE
CLEAN PUNCHING • MACHINEABILITY
IMPACT STRENGTH • APPEARANCE**



OFFICES IN PRINCIPAL CITIES

**Sheets, Tubes, Rods, Fabricated Parts
Silent, Stabilized Gear Material**

To I.R.E. Members

A Message

YOU are striving constantly to secure the best possible performance in the sets you design.

What are your variable and fixed resistor problems?

Won't you let us help you solve them with experience gained by more than twenty-five years of development and manufacture of quality carbon products?

More than a year ago we gave you a molded carbon volume control.

Many engineers have given this control

every test in the book . . . and a few more besides.

They said it was good, then proved it by using it. You'll find it now in most of the best sets.

The same molded carbon element makes an equally good tone control.

And we can supply you with fixed carbon resistors that are, and have been for some time, the standard of comparison in both radio and electrical fields.

We will be glad to prove these statements. Write us.

STACKPOLE CARBON COMPANY

ST. MARYS, PENNA.

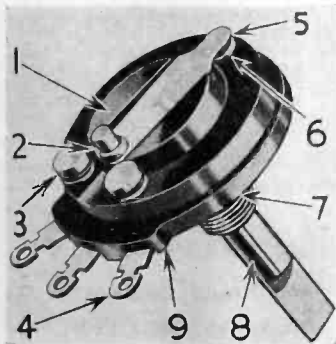

Stackpole Molded Carbon Volume Control — 9 features — fully insulated bushing and shaft — accurate switch operation — stable and solid assembly — easy assembly — smooth action — simple mounting — easy, noiseless operation.

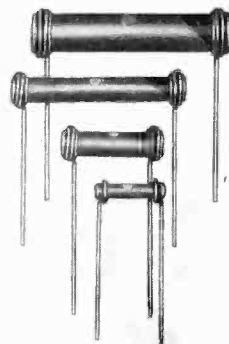

Stackpole Fixed Carbon Resistors — four sizes — 3-watt, 1-watt, $\frac{1}{2}$ -watt and $\frac{1}{3}$ -watt. New Booklet — gives complete technical data on Controls, Suppressors and Resistors, circuit diagrams, etc. Write for your copy.

Here's a smart performer, the new Automatic Tom Thumb, Jr., an AC-DC, 25-60 cycle set, using 5 new-type tubes.

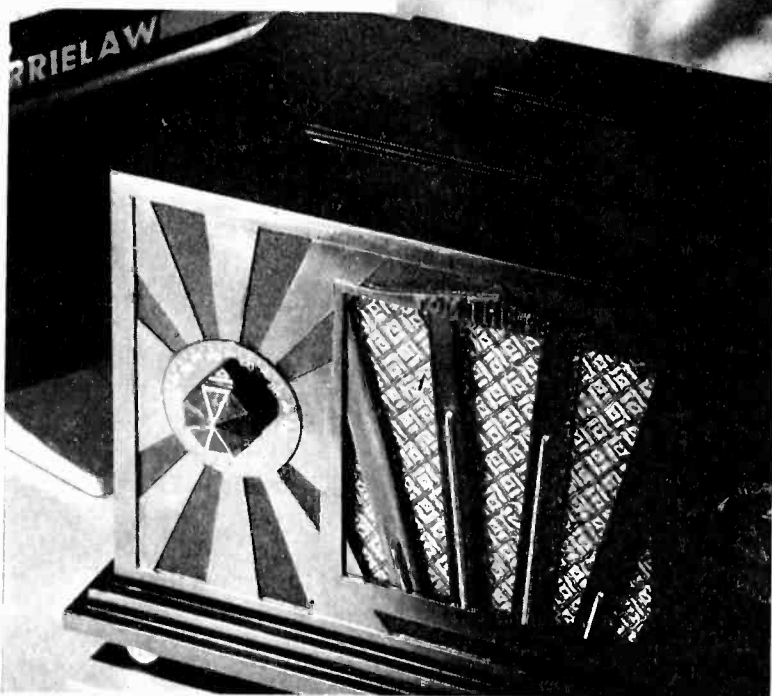

People like them MOULDED

Planning a new midget? Tired of the over-worked shapes and styles necessary with older cabinet materials? Then mold it of Durez, the newer, smoother molding compound. Scores of new designs are possible—designs that give your set identity and sales appeal. plus production advantages.

Molded Durez cabinets are richer, glossier, smoother, free from waviness. They come from the mold completely finished, uniform, ready for assembly. They're heat and moisture proof, walls and corners are thinner, inserts automatically imbedded, and they're warp-proof, chip-proof, seamless. Smart contrasts, like black and chromium, brown and coppers, or metal or wood inlays, as well as smooth solid colors, are possible. And the more you make, the more economical they are.

We'll gladly arrange contacts with experienced designers and molders. For further details, samples, etc., write General Plastics, Inc., 1211 Walck Road, N. Tonawanda, N. Y.

DUREZ for Smoothness

ENAMELITZ

Reduce manufacturing costs on I.F. and R.F. coils through the use of Enamelitz—"Litz" wire without a fabric covering.

Three Fold Savings—

1. Cost of wire
2. More coils per pound of wire
3. Less space—Greater safety

Sample and Technical Bulletin on Request.

Other Acme Wire Co. Products

Magnet Wire (all insulations)

Coils, Magnet Wire Wound

Varnished Insulations

(Cambric, paper, silk, tape)

Parvolt Condensers

(Filter, By-pass, Power Factor Correction)

Aerial Wire

(Stranded and Solid—Bare or Enameled)

For over 25 Years, suppliers to the largest radio and electrical manufacturers.

THE ACME WIRE CO.

New Haven, Conn.



1/6th Size

with better

Operating

Characteristics!

Here are two 1 mfd. units rated at 1000 volts D.C.—the usual standard paper unit and the new Cornell-Dubilier special impregnation unit.

The new unit measures only 1 1/4 x 1 x 2 1/2 inches! But that is only the story of size. There's an even greater story to tell in superior characteristics of the new

C-D Specially Impregnated Units

Compactness and reliability made possible by special impregnating compound as well as careful selection of paper dielectric.

Conservative working voltage ratings, based on numerous life tests.

Superior operating characteristics and longer life.

Available in capacities of from 5 mfd. at 600 volts D.C., to 1 mfd. at 2000 volts. Width and depth dimensions fixed—1 1/4 x 1 inch; height varies from 2 1/2 to 4 1/2 inches, depending on rating.

Write for further data on these new space-saving and money-saving capacitors, as well as our new 1933-34 catalog covering entire C-D line.

CORNELL-DUBILIER CORPORATION

4377 Bronx Boulevard

NEW YORK CITY



FACTS... about *Sylvania*

GRAPHITE ANODE TUBES

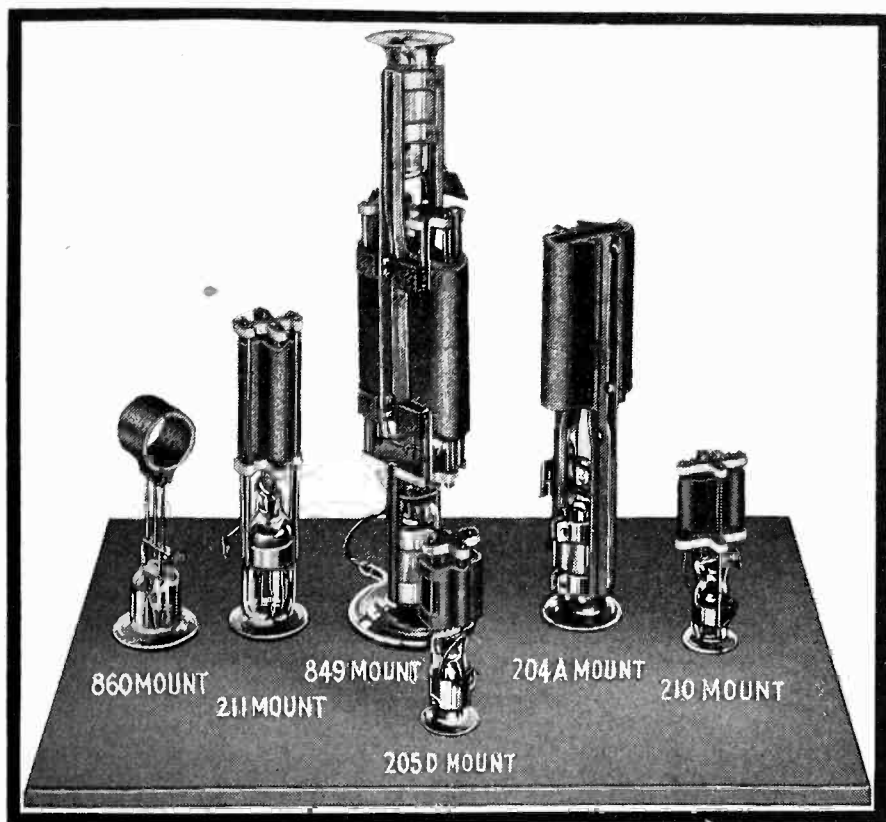

1 K.W. Type 851

Reasons that the engineer will readily understand are summarized below.

- 1 **PURE GRAPHITE** provides the physicist's ideal black body for maximum heat radiation. All hydrocarbons, binders and occluded gases removed by special process.
- 2 **IMPROVED CONSTRUCTION.** Rigid, one-piece anode machined from a solid block of carbon. Eliminates large masses of metal formerly employed for mechanical support and trussing.
- 3 **NO WARPING.** Ability of graphite to endure high temperatures enables it to retain machined dimensions. Results in permanence of characteristics throughout life. Insures maximum efficiency and high signal stability.
- 4 **MINIMUM OF METAL.** Freedom from occluded gases liberated by large masses of metal of older structure results in a "harder" tube.
- 5 **COOL OPERATION OF ANODE.** No transfer of excessive heat to grid. Plate does not reach incandescence. Heat is rapidly transferred to glass envelope which is designed to dissipate it efficiently.
- 6 **COOLER GRID.** Results in lower primary and secondary emission from grid. Eliminates gases usually given off by a hot grid.
- 7 **GREATER OUTPUT.** Increased heat dissipation permits greater loads or longer life at rated loads.
- 8 **LONGER LIFE.** Accelerated life tests show substantial increase in life over molybdenum-plate tubes.
- 9 **HIGHER VACUUM MAINTAINED.** Graphite when treated by the Sylvania process acts as a "getter", that is, absorbs gases normally released during tube life.

Write for technical data pertaining to Sylvania transmitting tubes available for immediate delivery.

● Transmitting tubes embodying anodes of PURE GRAPHITE were originated by Hygrade Sylvania Corporation. Sylvania engineers conceived and patented the process for successfully producing a plate of pure graphite.

There is no other manufacturer on the market with a complete line of these tubes.

The superiority of graphite anode tubes has been proven by many months of general service in transmitting fields.



HYGRADE SYLVANIA CORPORATION

Hygrade Lamps

ELECTRONICS DEPARTMENT

Sylvania Tubes

CLIFTON, NEW JERSEY

FACTORIES

SALEM, MASS.

EMPORIUM, PA.

ST. MARYS, PA.

CLIFTON, N. J.

WAREHOUSE FACILITIES IN

PORTLAND, ORE.

CHICAGO, ILL.

PHILADELPHIA, PA.

LOS ANGELES, CAL.

ATLANTA, GA.

PITTSBURGH, PA.

DENVER, COL.

Measure C, R, L, and Power Factor on This New Bridge



**Note These !
Wide Ranges •**

Capacitance: $8\mu\text{f}$ to $100\mu\text{f}$
Resistance: 0.01Ω to $1\text{M}\Omega$
Inductance: $5\mu\text{h}$ to 100h

THIS new bridge furnishes a ready means for measuring the capacitance, resistance, and inductance of circuit elements and of determining in a single operation, the power factor of the condenser and the "Q" of inductors. Except for the necessary head telephone used for the a-c measurements, the instrument is entirely self-contained.

The extremely wide range of values that this bridge can cover makes it of tremendous importance to the experimental laboratory where the need for measuring anything that may come up with good accuracy is of importance. For the first time an all-purpose bridge is commercially available at a reasonable price.



A new skeleton-type bridge is also available for laboratories where the wide range of the Type 650-A Impedance Bridge is unnecessary. The Type 625-A Bridge, with additional plug-in condensers and resistors, will be found useful for building up limit bridges and other special purpose instruments. Price: \$65.00 without accessories.

The Type 650-A Impedance Bridge is priced at \$175.00.

Write for descriptive literature on these two new bridges. Ask for the April-May issues of the General Radio Experimenter and address the General Radio Company, 30 State Street, Cambridge, Massachusetts.

**GENERAL
RADIO
COMPANY**

REMLER

15 WATT AMPLIFIER
With Condenser Microphone Power Supply



Dimensions: $21\frac{1}{2}$ in. x $9\frac{1}{2}$ in. x $10\frac{1}{2}$ in. Weight 51 lbs.; Crated 63 lbs. List price complete with tubes... **\$200.**

Remler Condenser Microphones. All types. Suspension illustrated list complete... **\$110.**

Incorporating many advanced features the new moderately priced Remler AP-17 15 Watt Amplifier illustrated is meeting the exacting requirements of sound technicians wherever excellence of reproduction is paramount. The Power Supply furnishes both "A" and "B" current for condenser microphones. High quality input attenuator. Separable A.C. line connector. 4 stages amplification. Lock type receptacles. Inputs for microphone, radio and phonograph provided. Undistorted output to operate up to 6 power dynamic speakers, or 45 of the magnetic type. Both units housed in one compact portable case. Complete with tubes.
List price **\$200.00**

TWO NEW REMLER CATALOGS

Complete with technical data, illustrations and prices, the new Remler Public Address and Broadcast Equipment catalogs list the complete Remler line. Send for these catalogs now.

All Remler equipment subject to attractive trade discounts to stations and other commercial users.

REMLER COMPANY Ltd.
2101 Bryant St. San Francisco, Calif.



REMLER—THE RADIO FIRM AS OLD AS RADIO

Working Hand in Hand For Finer Molded Products

The Resinox policy is one of whole-hearted cooperation with the molder... a matter of furnishing him not only a fine material, but a helpful service as well. From such an arrangement unique results are obtained. Perhaps we can assist you.

KEEP IN TOUCH WITH RESINOX DEVELOPMENTS

Specify

RESINOX

Molding Resins

Molding Compounds Laminating Varnishes

RESINOX CORPORATION

Subsidiary of Commercial Solvents Corporation and Corn Products Refining Company
230 Park Avenue, New York City

FOR
ELECTRON-
TUBE
CONTROL
PURPOSES

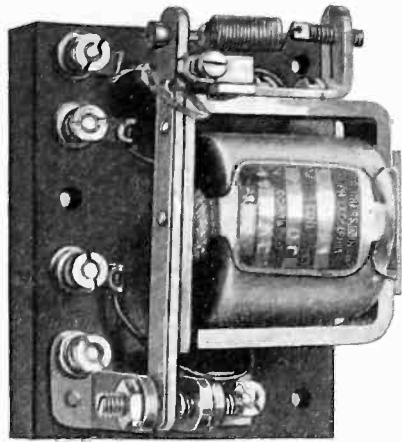

Use this DUNCO SENSITIVE RELAY

Primarily designed for use in electronic tube circuits, such as radio or light sensitive cell units. Has many applications where low current is essential. Send for Bulletin Form P-27.

If it is a relay problem we shall be happy to handle it. We invite your inquiries.

STRUTHERS & DUNNING, INC.
148 N. JUNIPER ST. **DUNCO** PHILADELPHIA, PA.

CANNON PLUGS

Keep Good Company

MICROPHONES—and other electrical equipment—are known by the company they keep. The larger manufacturers feel that it is good business to “keep company” with CANNON Plugs. The manufacture of quality products knows that CANNON Plugs insure quality performance.

It will pay you to insist, if necessary, on CANNON Plugs. However, leading manufacturers, almost without exception, supply them without insistence.

There Is a CANNON Plug for Every Cable Connector Need

Write for fully illustrated Catalog.

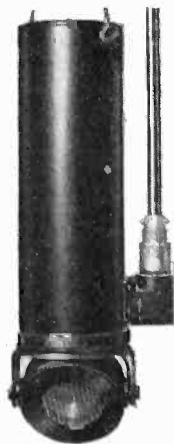

CANNON ELECTRIC DEVELOPMENT CO.
MANUFACTURING ENGINEERS

Main Office: 420 West Avenue 33, Los Angeles, Calif.

Eastern Sales Office: 245 Fifth Ave.,
New York, N. Y.

Representatives:

Chicago: Jenkins & Adair, Inc., 3333 Belmont Ave.
Bombay, India: Eastern Electric & Engineering Co.,
175 Hornby Road, Fort, Bombay, India



Announcing AmerTran De Luxe Audio Transformers

in

New Mountings
New Designs



All types are available with terminals at top, and those who mount transformers behind a panel will find this arrangement the most convenient.



Where transformers are installed on a chassis and concealed wiring is desirable, base-mounted transformers are necessary. All types can be supplied in this form.

Effective Nov. 1, 1933 AmerTran De Luxe Audio Transformers will be available in new mountings of more attractive appearance, in new designs of greater flexibility. The same high quality which has been maintained for more than 10 years will be built into each unit.

Black crackle finished mountings of similar appearance but varying in size will be used to house all units in our De Luxe Line, including audio, plate, filament, and power transformers, also audio and filter reactors. Terminals are located either at the top or base as specified by the customer.

Electrical designs have been revised so as to provide greater flexibility wherever possible without reducing the efficiency. New types are also available for use with new tubes and in latest circuits.

Write for bulletin giving complete information and latest list prices.

American Transformer Company
Transformer builders for over 31 years

178 Emmet St.

Newark, N. J.



**AMERTRAN
TRANSFORMERS**



SHAKEPROOF'S

NEW METHOD FOR

cutting your costs!

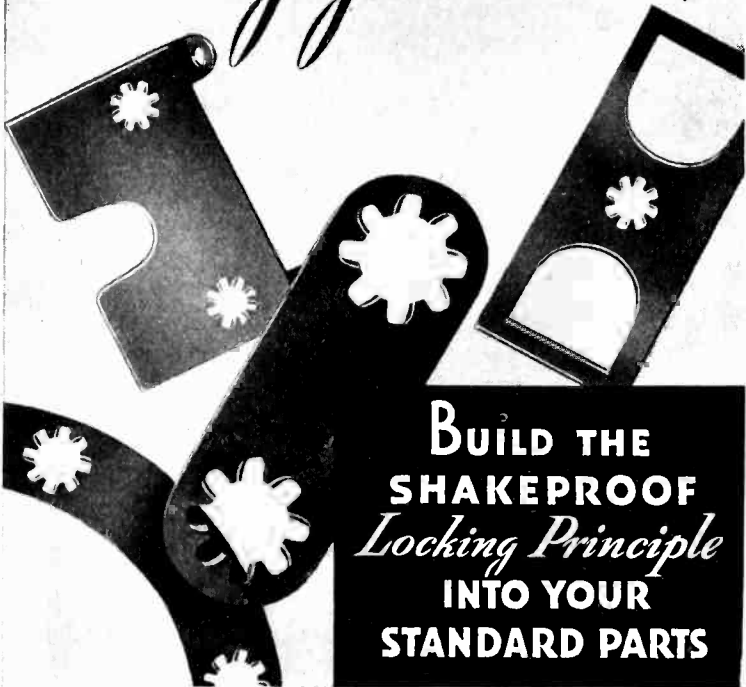

**BUILD THE
SHAKEPROOF
Locking Principle
INTO YOUR
STANDARD PARTS**

NOW you can improve the performance of your product and save money, too! Shakeproof will show you how to eliminate the need for lock washers by building the Shakeproof locking principle right into your standard parts. You can have the twisted teeth of Shakeproof protecting every vital connection just as if you had used a Shakeproof Lock Washer separately. Because each twisted tooth bites into both nut and work surfaces, you can rest assured there will be no movement of the part regardless of how great the vibration. It will pay you to discuss this idea with a Shakeproof Engineer—hear how easy it will be for you to cut costs and improve your product by this new method. No obligation—write today

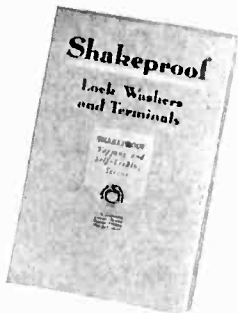

Send today for your free copy of this complete Shakeproof Catalog. Explains thoroughly the many advantages that Shakeproof offers—also shows new patented Shakeproof products.



"It's the Twisted Teeth that LOCK!"

SHAKEPROOF Lock Washer Company

{Division of Illinois Tool Works}

2539 N. Keeler Ave.

Chicago, Ill.

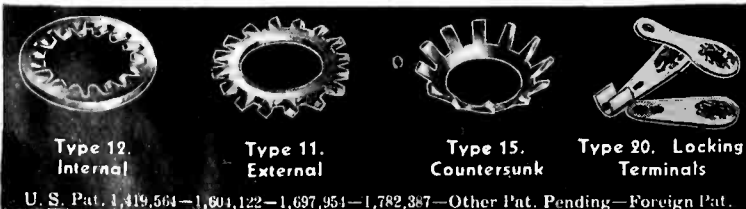

U. S. Pat. 1,419,564—1,604,122—1,697,951—1,782,387—Other Pat. Pending—Foreign Pat.

Elastic Stop

Reg. Trade Mark
U. S. & Foreign Patents

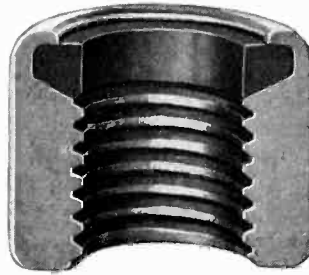

*The Locknut
with the
Fibre Collar.*

Electrical and mechanical connections held with Elastic Stop Nuts are permanent.

In the radio industry Elastic Stop Nuts are used for both mechanical and electrical connections. They are ideal for electrical terminals, trimmer adjustments, cushion mountings, etc.

Elastic Stop Nuts are used in regular production by manufacturers of broadcast receivers, automobile sets, aircraft apparatus, etc., as insurance against loose connections.

Eliminate service "loose nut trouble" by using Elastic Stop Nuts on your equipment. Sizes available from No. 3/48 up. In steel, brass and duraluminum. Write for catalog.

ELASTIC STOP NUT DIVISION

ELIZABETH

A. G. A. COMPANY

NEW JERSEY

NEW! Non-Fatiguing SPIDER STOCK

for radio speakers

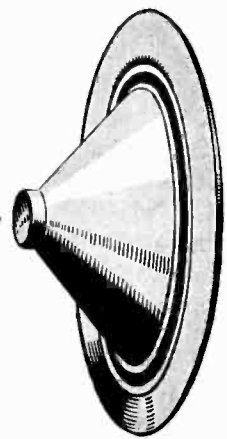

OF SPECIAL PAPER BASE **LAMICOID** PERFECT
LOW COST • FABRICATED
OR IN SHEETS • WRITE FOR
SAMPLES AND QUOTATIONS

MICA INSULATOR CO.

200 Varick Street, New York, N.Y. • 542 So. Dearborn Street, Chicago, Ill. • 1330 Schofield Building, Cleveland, O.
Branches at Birmingham, Boston, Cincinnati, Los Angeles, San Francisco, Seattle. Canada: Montreal, Toronto

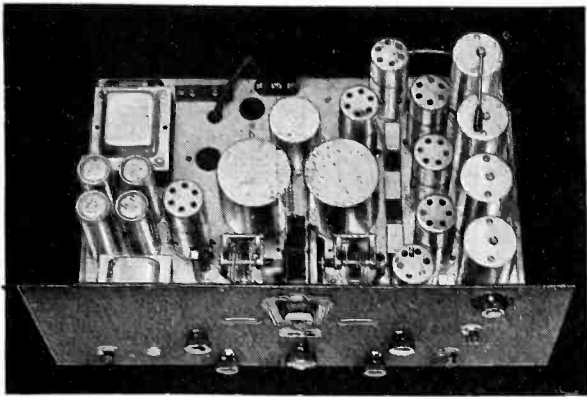

COMET "PRO"

Now Equipped with **CRYSTAL FILTER**
and **AUTOMATIC VOLUME CONTROL**

Now four models of this world-famous, complete 15 to 250 meter receiver:—STANDARD—STANDARD, with A.V.C.—CRYSTAL—CRYSTAL, with A.V.C. Operating on Battery, D.C. or A.C. in all voltages and cycles. Extra coils for 8-16 or 250-550 bands, \$5 per pair. Crystal Filter and A.V.C. may be added, at moderate cost, to Standard model. Write Dept. E-11 for Details.



HAMMARLUND
MFG. CO.,
424 W. 33rd St.,
New York

**REDUCES
MATERIAL
AND LABOR
COSTS ---
INCREASES
PRODUCTION**

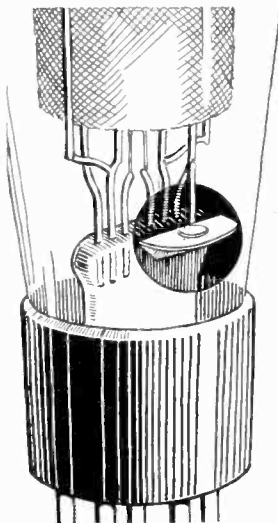

The New **BAREX** IMBEDDED **GETTER**

Reg. U. S. Pat. Off.

Manufactured under letters patent No. 1922162.

A new type Barium Getter, securely bonded as integral part of metal flag—vaporizes completely, minimizes splash—for all tubes. Reduces shrinkage substantially—ask about it.

KING LABS., INC.

237 W. Division Street,
SYRACUSE, N. Y.
Export Dept., 90 West St., New York, N. Y.

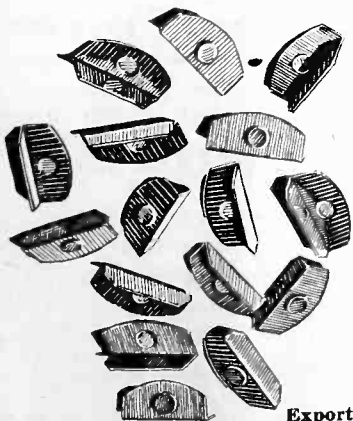

KENYON

PRODUCTS

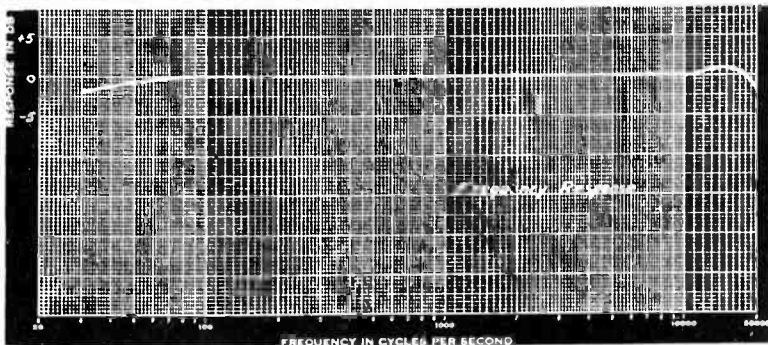

Just a sample of

KENYON TONE

Not one but a group of transformers tells the story of tone quality. Here is a frequency characteristic curve of a triple push-pull 2A3 amplifier built with KENYON Laboratory Standard components. It speaks for itself—graphically and acoustically.

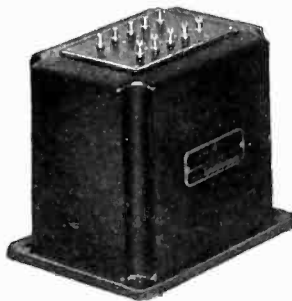

For over eight years KENYON research and engineering have been unstintingly devoted to the development of a superior line of audio transformers. The KENYON Laboratory Standard components are the result, featuring:

Really flat line characteristic obtained in all units and on typical amplifier. Overall variation averages 1 D.B. or less, from 40 to 10,000 cycles.

Wave form distortion and phase shift reduced to negligible value through proper operation of core materials as to flux density and extremely low leakage reactance in coil structure.

High efficiency attained through proper and liberal proportioning of materials.

Electrically symmetrical cases of high permeability cast iron. Crosstalk proof. No A.C. hum. Electrostatically shielded coil structures.

Vacuum impregnated and sealed in moisture-proof compound, to nullify adverse climatic effects.

Typical KENYON assembly for broadcast, public address, centralized radio or laboratory purposes. This is a pure D.C. filament supply assembly.



No matter what your transformer or choke requirements—receiving, transmitting, public address, centralized radio, laboratory, experimental, industrial, power—KENYON can meet them. A specialized engineering staff and ample production plant await your call.

SEND FOR ENGINEERING DATA

The new KENYON catalog contains circuits and constants applying to the latest types of amplifying tubes. Also performance curves and data on KENYON components. Write for your copy—TODAY!



KENYON TRANSFORMER CO., Inc.
122-124 Cypress Avenue - - - New York City

Photoelectricity, Radio and allied subjects

See the latest data in
these

McGRAW-HILL Books

Note: Check the books you want to see on approval, then read about the easy monthly plan of paying for those you keep; see the coupon.

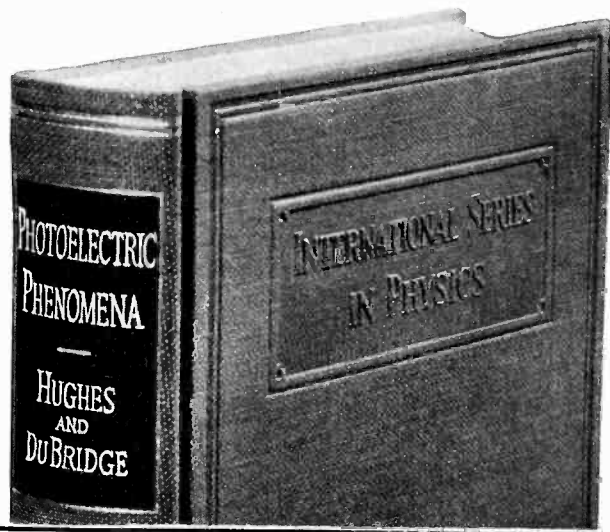

THEORY OF THERMIONIC VACUUM TUBES—by Professor E. Leon Chaffee of Harvard University

Comprehensive, or original treatment of fundamentals of thermionic emission and vacuum tubes, covering use of tube as amplifier and detector as well as its general properties. 652 pages, illustrated\$6.00

RADIO ENGINEERING HANDBOOK—by Keith Henney, Associate Editor of *Electronics*, and staff of specialists

A "standard" handbook for the radio field. Emphasizes design; covers everything from fundamentals to latest practical applications. Covers new tubes and circuits. 583 pages, illustrated\$5.00

COMMUNICATION ENGINEERING—By Professor W. L. Everitt of Ohio State University.

An expository treatment of the fundamentals of communication, stressing broad principles and covering classification of the principal types of networks. 567 pages, illustrated.....\$5.00

PHOTOELECTRIC PHENOMENA

By Arthur L. Hughes, Professor of Physics, Washington University, and Lee A. DuBridge, Assistant Professor of Physics, Washington University. *International Series in Physics*. 531 pages, 6x9, illustrated\$5.00

A CRITICAL survey of present knowledge in the whole field of photoelectric phenomena. The book aims to summarize the present status of all three of the major branches of photoelectricity—surface photoelectric effects, volume photoelectric effects, and photovoltaic effects. Taking up each phase in turn, the authors present first the important experimental knowledge, then a critical discussion of the conclusions and laws which have been deduced, and of the theories which have been most successful in explaining and coordinating the various phenomena.

To be published soon!

ELECTRONS AT WORK

By Charles R. Underhill
Consulting Electrical Engineer

A CLEAR, general treatise on electronics, telling in every-day language so far as possible what electrons are, how the various tubes and cells function in harnessing them, and how these devices are applied in industry and biology. The treatment is made as simple as possible, without deviating from strict technical accuracy; the index is arranged for use as a glossary-guide for reference.

320 pages, 6x9, illustrated \$3.00

RADIO ENGINEERING—By Professor Frederick E. Terman of Stanford University.

Analyzes circuits and tubes and reduces them to quantitative relations predicting performance of tubes and radio apparatus with accuracy and certainty. 750 pages, illustrated.....\$5.00

HIGH-FREQUENCY MEASUREMENTS—by August Hund.

Present theory and practice of measuring all manner of electrical quantities as well as present-day radio apparatus. For research workers, practical designers and engineers. 491 pages, illustrated\$5.00

RADIO FREQUENCY ELECTRICAL MEASUREMENTS—by Professor Hugh A. Brown of University of Illinois.

Combined laboratory textbook and manual explaining theory and principles, describing procedure, and discussing precision attainable, precautions, general merits, etc. 386 pages, illustrated.....\$4.00

10 days' examination on approval—easy monthly payments.

McGRAW-HILL BOOK CO., INC., 330 W. 42d St., New York City.

Send me the books checked for 10 days' examination on approval. Within 10 days of receipt I will send \$3.00, plus a few cents for postage and delivery and \$3.00 monthly thereafter until those I keep are paid for. I will return books not wanted, postpaid. (We pay postage on orders accompanied by remittance of first installment.)

- | | |
|--|--|
| <input type="checkbox"/> Hughes and DuBridge—Photoelectric Phenomena, \$5.00 | <input type="checkbox"/> Terman—Radio Engineering, \$5.00 |
| <input type="checkbox"/> Chaffee—Theory of Thermionic Vacuum Tubes, \$6.00 | <input type="checkbox"/> Hund—High-Frequency Measurements, \$5.00 |
| <input type="checkbox"/> Henney—Radio Engineering Handbook, \$5.00 | <input type="checkbox"/> Brown—Radio-Frequency Electrical Measurements, \$4.00 |
| <input type="checkbox"/> Everitt—Communication Engineering, \$5.00 | <input type="checkbox"/> Underhill—Electrons at Work, \$3.00 |

Name

Address Position

City and State..... Company.....L. 11-33

(Books sent on approval in U. S. and Canada only.)

Competing Under the Codes

THESE codes that Uncle Sam has approved to govern manufacturers are great levelers. They put competitors under standardized labor hours and wage scales. They make competition more difficult. But competitive advantages will not be destroyed under the codes. To be sure, many of the old advantages will be lost but new advantages will arise in their place. The only trouble is that the manufacturers who once had the advantages may not have the new ones.

Competition under the codes will call for increased operating efficiency. Manufacturers, for example, will be forced to buy more shrewdly than ever before. They will have to check every available source of supply on raw materials, parts and accessories to be sure that the best suited product is bought.

MANUFACTURERS and other organizations who have products to sell to the industries that have a common interest—electron tubes—may be sure that their sales messages will receive even greater attention from the 7,000 executives and engineers who read *Electronics*, now that we're under the codes.



electronics

a McGraw-Hill publication
—devoted to radio, sound, communications and industrial applications of electron tubes—design, engineering and manufacture

GOAT SHIELDS



Chimney Type
For small Dome
Type Tubes as 77,
78, 2B7, etc.



Chimney Type
For Large Dome
Type Tubes as 24A,
32, 2A5, etc.



For Short Small
Dome Type Tubes as
77, 78, 2B7, etc.



For Long Small
Dome Type Tubes
as 57, 58, etc.



For Medium Pear
Shape Type Tubes
as 24, 35, etc.



... NOW AVAILABLE

for every
modern tube
requiring
shielding ...

Save space, material and labor and reduce cost of chassis design by shielding the modern way with Goat form-fitting TUBE SHIELDS. Ask Goat for complete information.

Cost Sheet Savings with GOAT Tube Shields

| | |
|------------------|------------|
| Shields | 10% to 25% |
| Chassis | up to 10% |
| Cabinet | up to 10% |
| Mounting Shields | 10% to 50% |

WRITE FOR SAMPLES



GOAT RADIO TUBE PARTS, INC.
314 DEAN ST. BROOKLYN, N. Y.

NEARLY A MILE LONG



ELMET ON BAKELITE SPOOLS

ELMET MOLY GRID WIRE is available in Extra Long Lengths—(any length, up to 1600 meters)—in the exact diameter and other specifications you require. This ELMET feature eliminates the frequent changing of spools or bands, speeds up production and saves you time and money.

Besides these obvious production advantages Elmet Long Lengths are proof of the superior quality of our wire. To produce 1600 meter lengths requires a metal of exceptional purity.

Use ELMET. Write Today For Prices. Box E-11.

American Electro Metal Corporation
LEWISTON MAINE

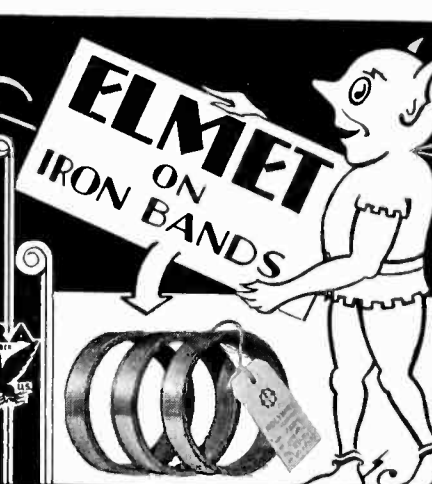

ELMET ON IRON BANDS

UNIVERSAL BATTERY CONVERTERS

110 Volt Alternating Current from
6 Volt Storage Batteries

TWO SIZES

60 watt-battery drain 6 v. at 15 amps. List \$36.00.
150 watt-battery drain 12 v. at 18 amps. List \$60.00.
(Standard Discounts)

Maximum efficiency for amplifier and public address work or most any device requiring 110 A.C. (ex. radio rec'r's.) Sold by jobbers and dealers everywhere. Send for descriptive circular.

UNIVERSAL MICROPHONE CO., Ltd.
424 Warren Lane,
Inglewood, Calif., U. S. A.

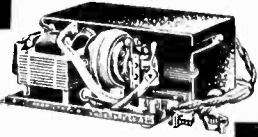

CANDOHMS

ARMoured WIRE WOUND RESISTORS

WILL LOWER YOUR COSTS

OVER SEVEN MILLION IN USE
MAY WE SAMPLE AND QUOTE

THE MUTER COMPANY

1255 So. Michigan Ave., Chicago

COILS . . .

RADIO FREQUENCY COILS: R.F. coils for radio manufacturers. Coils manufactured with the utmost precision. Our special designed testing equipment guarantees complete accuracy.

INTERMEDIATE FREQUENCY COILS: I.F. coils for radio manufacturers. Our experience in supplying some of the leading manufacturers in the industry, puts us in a position to successfully serve additional clients.

LITZ WIRE: Special Litz wire of all sizes made to order. We have served a number of representative manufacturers with Litz wire for over four years.

WIRE INSULATING: We are fully equipped to handle your requirements for wire insulating on all sizes down to .0005.
Let us submit samples and quote on your requirements.

SCIENTIFIC COIL & WIRE CO.

4348 Broadway
Chicago, Ill.
Telephone: Lakeview 1006

Only Reliable Products Can Be Continuously Advertised

A TRIAL WILL CONVINCe YOU

30 Years' Experience
Insures Dependability

We Manufacture

| | |
|-------------------|----------------|
| PERMANENT MAGNETS | TOOLS and DIES |
| METAL STAMPINGS | LAMINATIONS |

THOMAS & SKINNER STEEL PRODUCTS CO.

23d St. at Alvord Indianapolis, Ind.

Kurman Offers a Relay That Operates on as Little as 5 Milliwatts



Economical in operation, economical in first cost. K-1 Adjustable Relay; 20 milliwatts for positive operation, but can be made to operate on as little as 5 milliwatts; coin silver contacts rated to carry 1 amp. non-inductive load. Especially suitable for photoelectric applications. The K-1 Relay has a sharp drop out at approximately 60% of the operating current value. Can be supplied to operate from .001 amps at 19 volts to .23 amps at .083 volts.

Send for engineering data. Special relays built to meet your special applications.

KURMAN ELECTRIC CO.

241 Lafayette St., New York, N. Y.

PROFESSIONAL SERVICES

Design
Testing

Research
Measurement

Consulting
Development

Patents
Acoustics

ELECTRICAL TESTING LABORATORIES

Characteristics and
Life Tests of Vacuum Tubes
Tests of photocells, glow lamps, crater lamps.
Tests of electronic and optical devices.
80th Street and East End Avenue
New York, N. Y.
Phone: Butterfield 8-2600

ELECTRONICS MUSIC LABS.

Portable Electronic Organs
for professional and broadcasting use. Equal to
largest pipe organs. Qualities based on Eremeeff-
Helmholtz simultaneous and Eremeeff multi-step-
by-step synthesis. Mechanical and photoelectric in-
struments and sound on film devices.
WCAU Building, 1622 Chestnut Street,
Philadelphia, Pa.

The Real Value
of placing your unusual problem
in the hands of a competent
consultant eliminates the ele-
ments of chance and uncertainty
from the problem and provides
real facts upon which to base
decisions.

JENKINS & ADAIR, INC.

Engineers
Designers, developers, and manufacturers
of accessories and essentials for recording,
broadcasting and testing at sound fre-
quencies.
3333 Belmont Avenue, Chicago, U. S. A.
Cable Address: Jenkadair Telephone: Keystone 2130

RALPH H. LANGLEY, E. E.

Licensed Professional Engineer Fellow I.R.E.
Twenty years' experience in the Development
Design, Production of Radio Transmitters and
Receivers and in Radio Patents and Inventions.
Barclay 7-0398
165 Broadway, New York

SEARCHLIGHT SECTION

EMPLOYMENT : BUSINESS : OPPORTUNITIES : EQUIPMENT—USED or SPECIAL

UNDISPLAYED—RATE PER WORD
Positions Wanted, 5 cents a word, minimum
\$1.00 an insertion, payable in advance.
Positions Vacant and all other classifica-
tions 10 cents a word, minimum charge
\$2.00.

Proposals, 40 cents a line an insertion.

INFORMATION:

Box Numbers in care of our New York,
Chicago or San Francisco offices count
10 words additional in undisplayed ads.
Replies forwarded without extra charge.
Discount of 10% if full payment is made in
advance for four consecutive insertions of
undisplayed ads (not including proposals).

DISPLAYED—RATE PER INCH:

1 inch\$5.00
2 to 3 inches..... 4.75 an inch
4 to 7 inches..... 4.50 an inch
Other spaces and contract rates on request.
An advertising inch is measured vertically
on one column, 3 columns—30 inches—
to a page.

COPY FOR NEW ADVERTISEMENTS RECEIVED UNTIL 3 P. M. ON THE 5TH OF THE MONTH.

LEGAL NOTICE

STATEMENT OF THE OWNERSHIP, MANAGEMENT,
CIRCULATION, ETC., REQUIRED BY THE
ACT OF MARCH 3, 1933

Of Electronics, published monthly at New York, N. Y.,
for Oct. 1, 1933.
State of New York } ss.
County of New York }

Before me, a Notary Public in and for the State and
county aforesaid, personally appeared B. R. Putnam,
who, having been duly sworn according to law, deposes
and says that he is the Secretary of the McGraw-Hill
Publishing Company, Inc., publishers of Electronics, and
that the following is, to the best of his knowledge and
belief, a true statement of the ownership, management
(and if a daily paper, the circulation), etc., of the
aforesaid publication for the date shown in the above
caption, required by the Act of March 3, 1933, em-
bodied in section 537, Postal Laws and Regulations,
printed on the reverse of this form, to wit:

1. That the names and addresses of the publisher,
editor, managing editor, and business managers are:
Publisher, McGraw-Hill Publishing Company, Inc., 330
West 42d Street, N. Y. C. Editor, O. H. Caldwell,
330 West 42d Street, N. Y. C. Managing Editor,
None. Business Manager, M. E. Herring, 330 West
42d Street, N. Y. C.

2. That the owner is: (If owned by a corporation,
its name and address must be stated and also immediately
thereunder the names and addresses of stockholders own-
ing or holding one per cent or more of total amount of
stock. If not owned by a corporation, the names and
addresses of the individual owners must be given. If
owned by a firm, company, or other unincorporated con-
cern, its name and address, as well as those of each
individual member, must be given.) McGraw-Hill Pub-
lishing Company, Inc., 330 West 42d St., N. Y. C.
Stockholders of which are: James H. McGraw, 330
West 42d St., N. Y. C. James H. McGraw, Jr., 330 West
42d St., N. Y. C. James H. McGraw, James H. Mc-
Graw, Jr., and Malcolm Muir, 330 West 42d St.,
N. Y. C. Trustees for: Harold W. McGraw, James H.
McGraw, Jr., Donald C. McGraw, Curtis W. McGraw,
Curtis W. McGraw, 330 West 42d St., N. Y. C. Donald
C. McGraw, 330 West 42d St., N. Y. C. Anne Hugus
Britton, 330 West 42d St., N. Y. C. Mason Britton,
330 West 42d St., N. Y. C. Edgar Kobak, 330 West
42d St., N. Y. C. Grace W. Mehren, 33 West Grand
Ave., Chicago, Ill. J. Malcolm Muir and Guaranty
Trust Co. of New York, Trustees for Lida Kelly Muir,
624 Fifth Ave., N. Y. C. F. S. Weatherby, 271 Clinton
Road, Brookline, Mass. Midwood Corporation, Madison,

LEGAL NOTICE

N. J. Stockholders of which are: Edwin S. Wilsey,
Madison, N. J. Elsa M. Wilsey, Madison, N. J.

3. That the known bondholders, mortgagees, and other
security holders owning or holding 1 per cent or more of
total amount of bonds, mortgages, or other securities
are: (If there are none, so state.) None.

4. That the two paragraphs next above, giving the
names of the owners, stockholders, and security holders,
if any, contain not only the list of stockholders and
security holders as they appear upon the books of the
company but also, in cases where the stockholder or
security holder appears upon the books of the company
as trustee or in any other fiduciary relation, the name
of the person or corporation for whom such trustee is
acting, is given; also that the said two paragraphs con-
tain statements embracing affiant's full knowledge and
belief as to the circumstances and conditions under which
stockholders and security holders who do not appear upon
the books of the company as trustees, hold stock and
securities in a capacity other than that of a bona fide
owner; and this affiant has no reason to believe that any
other person, association, or corporation has any interest
direct or indirect in the said stock, bonds, or other
securities than as so stated by him.

5. That the average number of copies of each issue
of this publication sold or distributed, through the mails
or otherwise, to paid subscribers during the months pre-
ceding the date shown above is. (This information is
required from daily publications only.)

B. R. PUTNAM, Secretary.
MCGRAW-HILL PUBLISHING COMPANY, INC.
Sworn to and subscribed before me this 29th day of
September, 1933.
[SEAL] H. E. BEIRNE,
Notary Public, Nassau County, N. Y. Co. Clk's No.
1516, Reg. No. 4-B-950.
(My commission expires March 30, 1934)

For Sale

NEW—RECONDITIONED—AND "AS IS" ELECTRON TUBE EQUIPMENT

DESIGNERS AND MANUFACTURERS OF MACHINERY
FOR THE PRODUCTION OF ELECTRON TUBES,
NEON SIGN AND INCANDESCENT LAMP EQUIP-
MENT, TO MEET ANY REQUIREMENT.

EISLER ELECTRIC CORP.
USED EQUIPMENT ALSO AVAILABLE
Advise Us of Your Needs
756 So. 13th St., Newark, N. J.

HIGH GRADE NEW AND USED ELECTRON TUBE EQUIPMENT

*Write for Bulletin Showing Savings
From 20% to 80%*

KAHLE ENGINEERING CORPORATION
Specialists in Equipment and Methods for the
Manufacture of Neon Tubes, Radio Tubes, Incan-
descent Lamps, Photo Cells, X-ray Tubes, etc.
350 Manhattan Ave., Union City, N. J.

All types of High Grade New and
Used Equipment for the manu-
facture of Electron Tubes.

Lowest prices on the market.

AMERICAN ELECTRICAL SALES CO.
65 East 8th St., New York, N. Y.

"Opportunity"

Advertising:

Think "Searchlight" First!

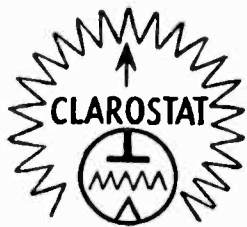

Year in and year out this trademark has stood for specialization and quality in resistor products.

Check your specifications and prices against these items

- Wire Wound Potentiometers from one ohm to 100,000 ohms.
- Composition Element Volume and Tone Controls in all values and standard tapers.
- Metal Covered Dropping Resistors—tapped or plain.
- Wire Wound Pilot Light Resistors.
- Sensitivity Controls of all values—size 1 1/8 in. diameter by 1/8 in. thick.
- Tone Controls—size 1 1/8 in. diameter by 1/4 in. thick.
- Voltage Drop Resistors for reducing the input line from 260, 240, 220, 200, 175, 150 and 130 volts to 110 or 115 volts. These Resistors are equipped with American standard male or female connectors, in Continental European standard connectors, or United Kingdom standard connectors, as requested.
- Wire Wound Flexible Pigtail Resistors, from 1/2 watt to 5 watt.



Wire or write for details

Clarostat Manufacturing Co., Inc.

285 North 6th Street, Brooklyn, N. Y.

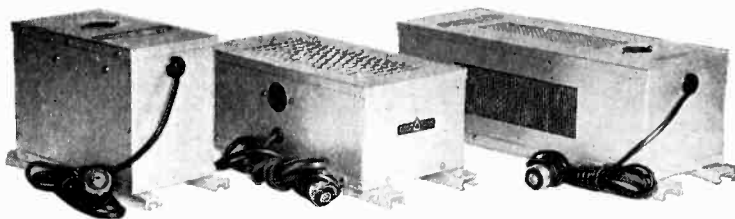

60 Watt

120 Watt
Stock Sizes

250 Watt

**CONSTANT VOLTAGE
for All Socket Power Devices**

LINE VOLTAGE 95 to 130, OUTPUT 115 ± 1%

A constant voltage is absolutely essential to the effective operation of many socket-power operated devices. Delta Voltage Regulators will maintain output voltage regulation within ± 1% with any load and line voltage within their operating range. Embodying the latest developments of our laboratory under the direction of F. S. Dellenbaugh, Jr., they are compact, efficient and contain no moving parts whatever. Users include: General Electric Co., Bell Laboratories, Federal Telegraph Co., Eastman Kodak Co., Western Union, and many others. Write us for specifications, stating your problem in detail.

**DELTA
VOLTAGE REGULATORS**

Entirely Automatic . . . Negligible Time-Constant



DELTA MANUFACTURING CO.
39 OSBORNE ST.,
CAMBRIDGE, MASS.

F. S. Dellenbaugh, Jr., Pres.
and Chief Engineer.

Gentlemen: Please send me full particulars on the Delta Voltage Regulators.

Name

Address

EL 11-33

**A TIME-SAVER FOR THE
ENGINEER . . .**



**5 HANDY
TOOLS IN 1**

- 1 DUAL RESISTANCE INDICATOR
- 2 CALIBRATED RHEOSTAT OR VARIABLE RESISTOR
- 3 CALIBRATED POTENTIOMETER or VOLTAGE DIVIDER
- 4 Resistance measuring by SUBSTITUTION METHOD
- 5 TEMPORARY STANDARD RESISTOR

May also be used in place of resistor standards and decade boxes.

Like hundreds of radio servicemen, engineers and lab. workers are finding this new IRC Dual Resistance Indicator indispensable. Quickly gives the correct value for ANY resistor. Has many other uses besides. Two scales permit accurate readings from 100 to 100,000 ohms. Range may be extended by addition of fixed resistors. Improved ball-bearing (spring cushioned) contact is permanently attached. Built to last a life time.

\$2.70 Net (List price \$4.50)

(By mail include 15c. additional for postage)

INTERNATIONAL RESISTANCE CO.

2100 Arch St., Philadelphia, Pa.

In Canada, 74 Wellington St. W., Toronto, Ont.

A NEW PRODUCT BY THE MAKERS OF FAMOUS

IRC RESISTORS



AGASTAT . . . THE WIDE RANGE TIME DELAY RELAY

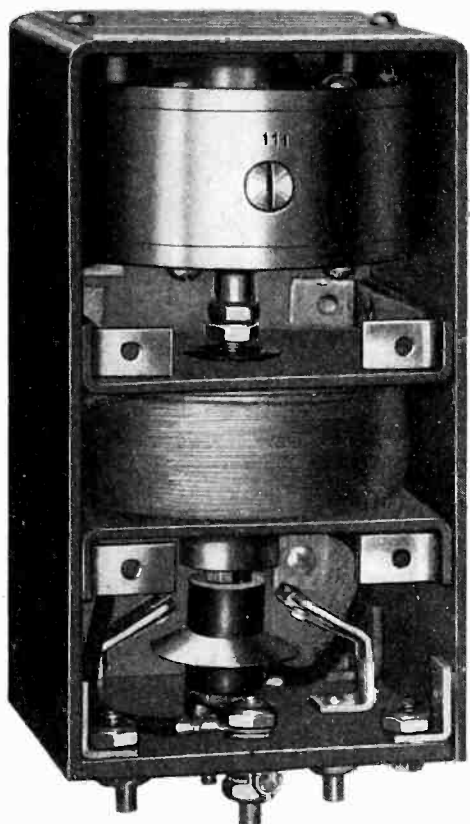

Size 5¼ in. high x 2⅝ in. sq.

Adjustable . . . Compact . . . Immediate Recycling . . . Temperature Compensated . . . Pressure Compensated . . . Time Interval Remains Constant . . . Snap Acting Contacts . . . Timing Independent of Voltage Fluctuations.

Types Available

- NA-11 Delayed Make After Coil is Energised
- NA-12 Delayed Break After Coil is Energised
- NA-21 Immediate Make When Coil is Energised
Delayed Break After Coil is De-Energised
- NA-22 Immediate Break When Coil is Energised
Delayed Make After Coil is De-Energised

Infinite variations of timing effects possible by circuit combinations of above types.

Write for Bulletin with Technical
Details, Application and
Design Information



AMERICAN GAS ACCUMULATOR COMPANY
ELIZABETH • NEW JERSEY

INDEX TO ADVERTISERS

This index is published as a convenience to the reader. Every care is taken to make it accurate but *Electronics* assumes no responsibility for errors or omissions.

| | | | |
|--|----|--|------------|
| Acheson Oildag Co. | 10 | Maganavox Co. | 1 |
| Acme Wire Co. | 12 | Mallory & Co., Inc., P. R. | 4 |
| Allen-Bradley Co. | 24 | McGraw-Hill Book Co. | 18 |
| American Electro Metal Corp. | 20 | Mica Insulator Co. | 16 |
| American Gas Accumulator Co. 16-23 | | Muter Co. | 20 |
| American Lava Corp., Inside Front Cover | | RCA Radiotron Co., Inc. | 6-7 |
| American Transformer Corp. | 15 | RCAVictor Co., Inc. | Back Cover |
| | | Remler Co., Ltd. | 14 |
| | | Resinox Corp. | 14 |
| Cannon Elec. Dev. Co. | 15 | Scientific Coil & Wire Co. | 20 |
| Clarostat Mfg. Co., Inc. | 22 | Shakeproof Lock Washer Co. | 16 |
| Cornell-Dubilier Corp. | 12 | Stackpole Carbon Co. | 11 |
| | | Synthane Corp. | 10 |
| Delta Mfg. Co. | 22 | Thomas & Skinner. | 20 |
| Dielectric Products Co. | 5 | Universal Microphone Co., Ltd. | 20 |
| Dunn Co., Struthers. | 15 | Weston Elec. Instr. Co. | 2 |
| Erie Resistor Corp. | 9 | White Dental Co., S. S. | 8 |
| | | | |
| Formica Insulation Co., Inside Back Cover | | Professional Services | 21 |
| | | | |
| General Electric Co. | 5 | | |
| General Plastics Co. | 12 | | |
| General Radio Co. | 14 | | |
| Goat Radio Tube Parts, Inc. | 19 | | |
| | | | |
| Hammarlund Mfg. Co. | 17 | | |
| Hygrade Sylvania Corp. | 13 | | |
| | | | |
| International Resistance Co. | 22 | | |
| | | | |
| Kenyon Transformer Co. | 17 | | |
| King Lab's, Inc. | 17 | | |
| Kurman Elec. Co. | 20 | | |

CONTENTS for NOV., 1933

| | |
|--|-----|
| Steadying radio parts production | 295 |
| This new radio prosperity? | 296 |
| Iron core intermediate frequency trans- formers | 298 |
| By Alfred Crossley | |
| Notes on dual-band receiver design | 300 |
| By Edgar Messing | |
| Photoelectric control on packaging machines | 302 |
| By E. Lovell Smith | |
| A study of Litz wire coils for i-f and r-f transformers | 303 |
| Electrons in the news | 305 |
| High lights on electronic devices in industry | 306 |
| Radio acoustic ranging | 308 |
| By Davis Belcher | |
| Electronic notes from the laboratory | 310 |
| Editorials | 312 |
| News Notes | 313 |
| Review of electronic literature | 314 |
| New products | 317 |
| U. S. patents | 320 |
| British patents | 322 |

SEARCHLIGHT SECTION

Classified Advertising

| | |
|-----------------------------------|----|
| EMPLOYMENT | 21 |
| EQUIPMENT FOR SALE | 21 |
| American Elect. Sales Co. | 21 |
| Eisler Electric Corp. | 21 |
| Kahle Engineering Co. | 21 |

McGRAW-HILL PUBLISHING COMPANY, INC., 330 WEST 42d STREET, NEW YORK, N. Y.

Branch offices: 520 North Michigan Ave., Chicago; 883 Mission St., San Francisco; Aldwych House, Aldwych, London, W. C. 2; Washington; Philadelphia; Cleveland; Detroit; St. Louis; Boston; Greenville, S. C. James H. McGraw, Chairman of the Board; Malcolm Muir, President; James H. McGraw, Jr., Vice-President and Treasurer; Mason Britton, Vice-President; Edgar Kobak, Vice-President; H. C. Parmelee, Vice-President; Harold W. McGraw, Vice-President; B. R. Putnam, Secretary.

ALLEN-BRADLEY

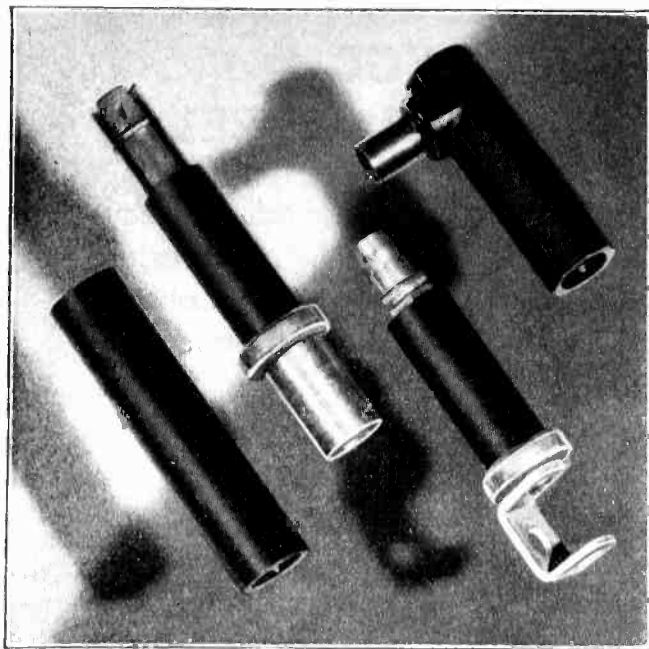

When you specify
Allen-Bradley
Spark Plug Resistors
you get the benefit of the
pioneer experience of Allen-
Bradley engineers who are
foremost in the field of radio
resistor design. Allen-Brad-
ley spark plug resistors are
covered by U. S. patents
1878014-1927185—other pat-
ents pending.

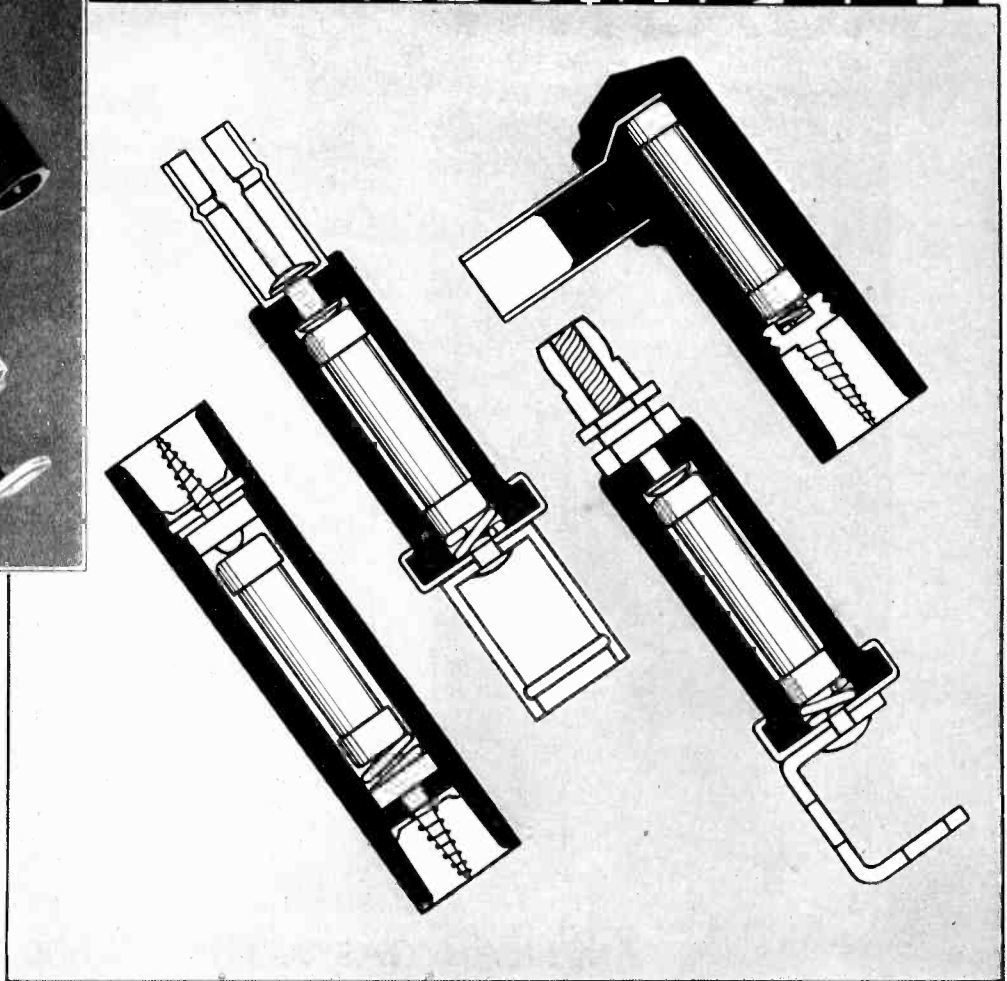

Bradleyunits

Bradleyunits are solid
molded resistors unaffected
by temperature, moisture or
age. All units are color-coded.

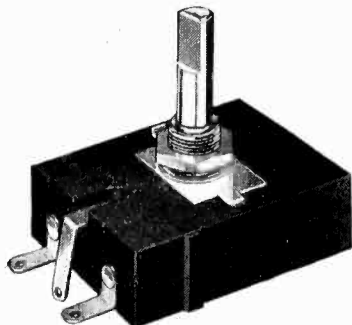

Bradleyometers

The Bradleyometer is a
potentiometer with approxi-
mately fifty solid resistance
discs interleaved between
metal discs.

The total number of discs
can be arranged in accord-
ance with any resistance-
rotation curve.

LONG-LIVED—PERMANENT—RUGGED

—three essential qualities that are
built into Allen-Bradley Suppressors

Allen-Bradley Suppressors are long-lived. They remain per-
manent in resistance values even after thousands of miles of
abusive automotive service.

They do not "open circuit" in service and thereby cripple
the engine.

They do not "drop" in resistance and therefore fail as
suppressors.

They do not have a "high voltage characteristic" which
sharply decreases the suppressor resistance during each spark
discharge and thus defeats the purpose of the suppressor.

They do not fail from exposure to oil and water.

They do not break due to car or engine vibration. Careless
mechanics are no terror to Allen-Bradley Suppressors, because
the resistors are enclosed in rugged, non-arcing bakelite cas-
ings—not in brittle ceramic material.

The superiority of Allen-Bradley Suppressors can be easily
demonstrated. Our engineers will gladly supply data and per-
formance curves on resistors for your requirements. Write us
today.

ALLEN-BRADLEY CO., MILWAUKEE, WIS.
General Offices—110 W. Greenfield Ave.

The Old Reliable

FORMICA

FOR twenty years Formica has served important users of laminated insulating material, and during all of that time it has concentrated all of the resources of a steadily growing and steadily improving organization on the problems of producing a single kind and type of product.

This effort has provided one of the largest and most completely equipped plants in the industry. Formica can produce any grade or type of insulating material that you need. It can fabricate parts and deliver them to you promptly.

Formica offers a complete and competent insulating service.

THE FORMICA INSULATION COMPANY

4638 Spring Grove Avenue, Cincinnati, Ohio.

FORMICA

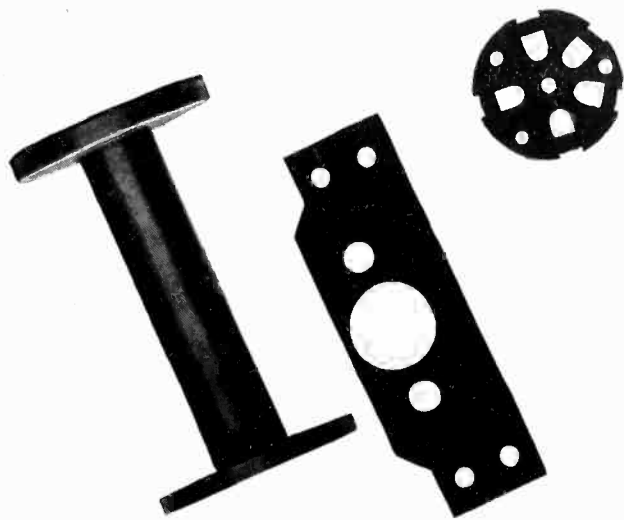

For YOUR *Production*

RCA VICTOR LABORATORY TEST EQUIPMENT

RCA Victor Beat
Frequency Oscillator
Type TMV-52-E



Important factors in maintaining speed and efficiency as well as perfection in producing your radio and electrical sound products . . . the RCA Victor Beat Frequency Oscillator and the RCA Victor Signal Generator . . . highly developed aids to fast and accurate check and adjustment on your product both in process and upon completion.

*These highly perfected devices are now available for YOU—
for use in YOUR plant—to speed YOUR development and
to keep perfect YOUR production.*

Are you losing valuable time and spending money on the development and production of these details?

Remove the guesswork from your test work—use genuine RCA Victor Laboratory Test Equipment. We can save time and money for you—if you will give us the opportunity.

RCA Victor
Signal Generator
Type TMV-18-D



Faradon



The design and manufacture of capacitors is a highly specialized branch of the industry. Faradon capacitors have a world-wide reputation for efficiency, economy and reliability. Specify Faradon condensers in your new equipment. A size and type is available for your particular requirements. Send for the complete catalog covering this line.



Take advantage of the experience and the efficiency offered by this great radio research and manufacturing institution



Industrial Products Section
RCA VICTOR CO., INC.

(A Radio Corporation of America Subsidiary)

CAMDEN, N. J.