

Electronics World

DECEMBER, 1971
60 CENTS

THE "PIPE" SPEAKER SYSTEM
ANIMAL GUIDANCE SYSTEMS—Jam-proof Weapons Delivery
FACSIMILE VIA YOUR TELEPHONE
INSTRUMENTATION BALLOONS—Loft Electronic Payloads

LASER COMMUNICATIONS

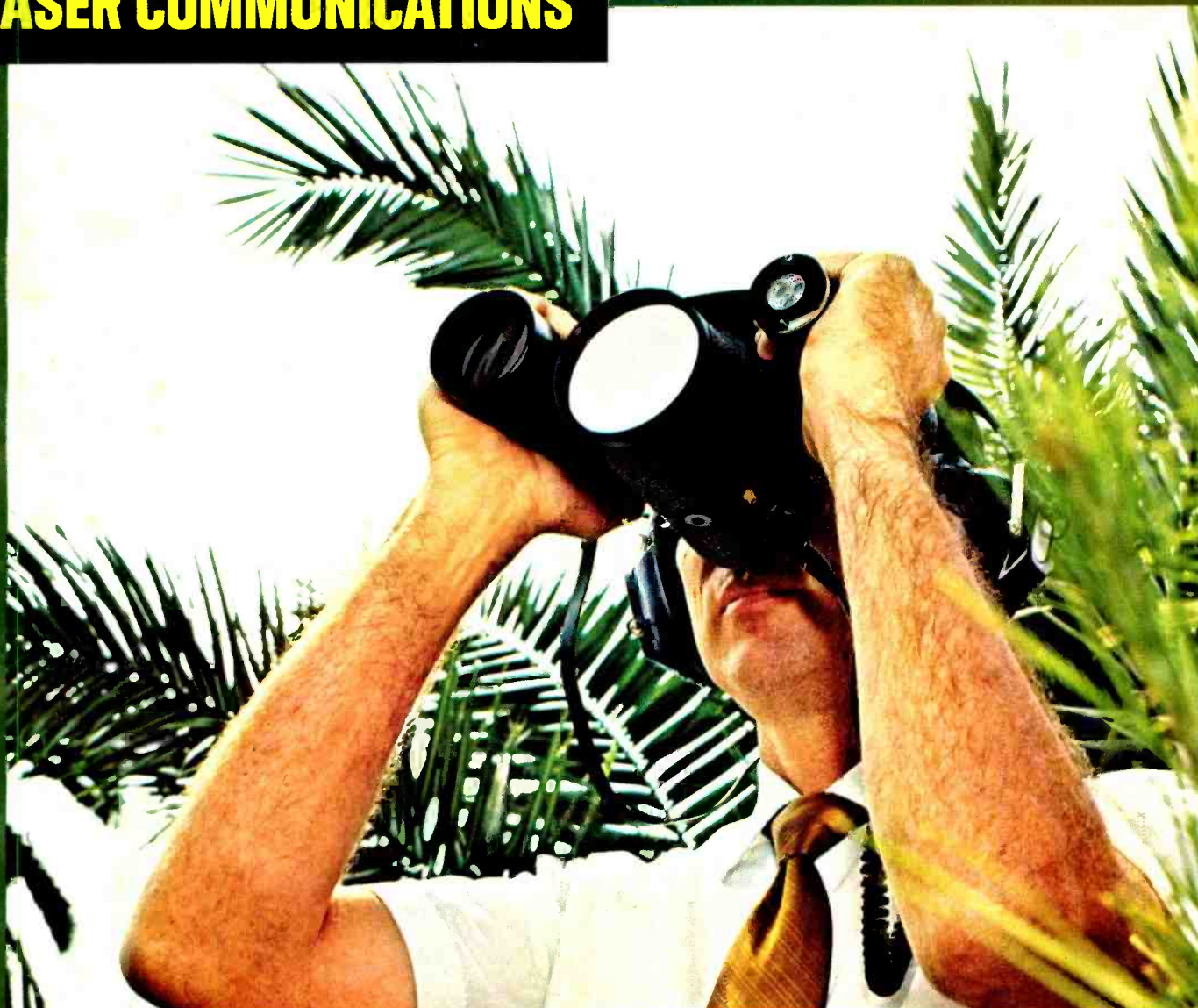

IMPORTANT ANNOUNCEMENT:
Starting with the next issue (Jan., 1972 Edition), Electronics World will merge with Popular Electronics. (See page 6)



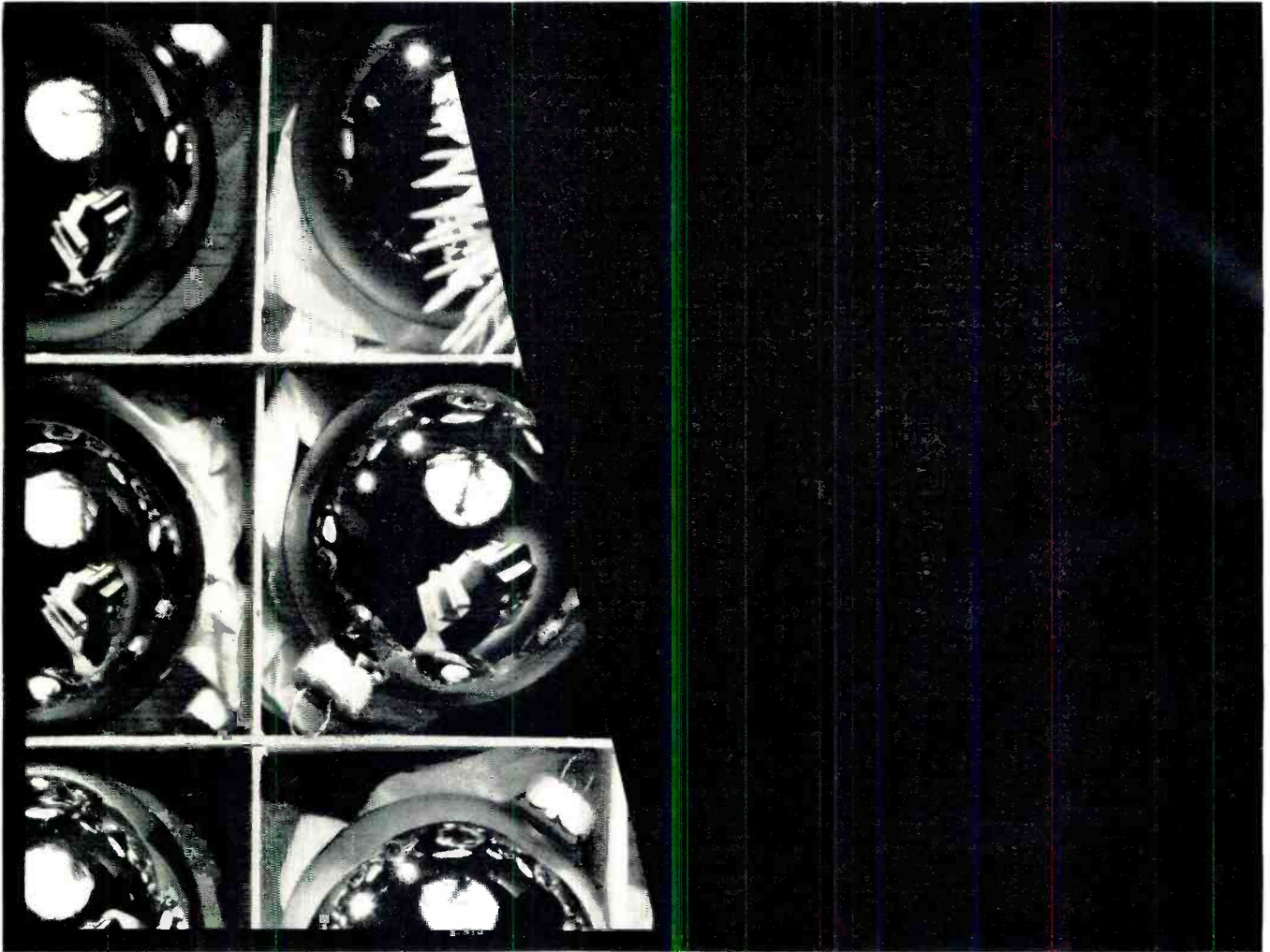

A cartridge in a pear tree.

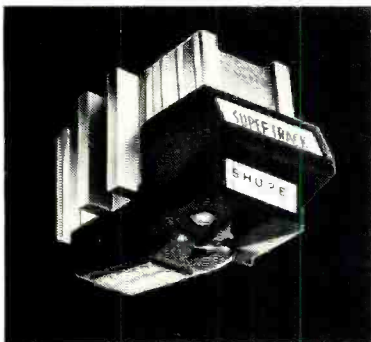

A gift of the *Shure V-15 Type II Improved* stereo phono cartridge will earn you the eternal endearment of the discriminating audiophile who receives it. What makes the V-15 such a predictable Yuletide success, of course, is its ability to extract the real sound of pipers piping, drummers drumming, rings ringing, et cetera, et cetera. Stereo Review, in a test report that expressed more superlatives than a Christmas dinner, described the performance of the V-15 Type II Improved as ". . . . Unstrained, effortless, and a delight to listen to." All of which means that if you're the giver, you can make a hi-fi enthusiast deliriously happy. (If you'd like to receive it yourself, keep your fingers crossed!)

Shure Brothers Inc.,
222 Hartrey Ave., Evanston, Ill. 60204.



CIRCLE NO. 128 ON READER SERVICE PAGE

Test reports in both HIGH FIDELITY and STEREO REVIEW prove the Altec 714A receiver is built a little better.



In February, HIGH FIDELITY magazine printed a detailed two-page test report (by CBS Laboratories) on the Altec 714A stereo receiver. The wrap-up comment read as follows: "All told, the 714A is one beautiful piece of audio machinery that should be given a long serious look by anyone in the market for a new high-quality stereo receiver". And in January, STEREO REVIEW'S equipment test report (by Hirsch-Houck Laboratories) stated, "In its general performance and listening quality, it is comparable to the best we have tested..."



The Altec 714A AM/FM stereo receiver delivers 44/44 watts of RMS power at less than 0.5% distortion (180 IHF music power). And for high FM sensitivity, it features 3 FET's and a 4 gang tuning condenser. Plus, 2 prealigned crystal filters and the newest IC's for better selectivity and more precise tuning.

The Altec 714A sells for \$399.00. Hear it at your Altec dealer. Or, write for a complete Altec catalog and copies of available test reports. Altec Lansing, 1515 S. Manchester Ave., Anaheim, California 92803.

CIRCLE NO. 147 ON READER SERVICE PAGE

LISTEN
TO
THIS

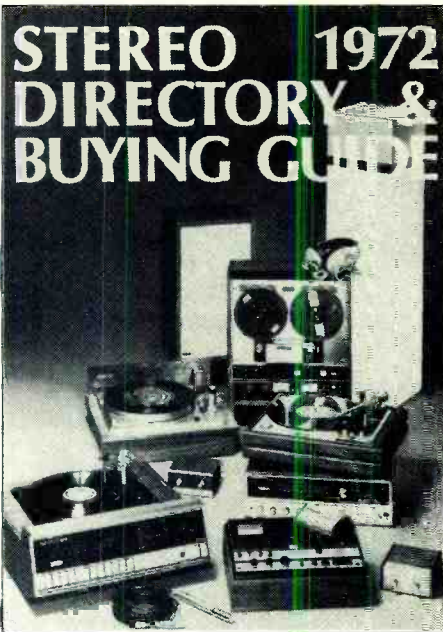

AND
YOU'LL
HEAR
BETTER!

It's the **1972 Stereo Directory & Buying Guide** and it has a ton of information to give you about all the latest stereo systems and components—

- **4-Channel Components**
- **Amplifiers ● Tuners**
- **Receivers ● Hi-Fi Systems**
- **Changers & Turntables**
- **Speaker Systems**
- **Phono Cartridges & Arms**
- **Cassette, Cartridge & Reel-to-Reel Tape Machines**

More than 1500 products in all! All listed by manufacturer, each with model number, complete specifications, description and price.

Your Personal Consumer Advocate.

Here's your own "consumer advocate"—a complete, shop-at-home Buyer's Guide loaded with expert information on what to look for, what to avoid, how to decide what's best for *you* at a price you can afford. Now you can know what you want *before* you visit the dealer—and what to listen for when you get there.

Whether you're shopping for your very first stereo system, or trading up components on a sophisticated rig, you'll save time, save money and avoid needless disappointment when you shop it first in the **1972 Stereo Directory & Buying Guide**.

Only \$1.50! Use the convenient coupon below to order your copy today and to add to your stereo reference library as well!

Bring your reference library up-to-date!

If you've missed any of the current and previously published Annuals, a wide selection is still available. To place your order, circle the corresponding numbers on the coupon on this page.

Electronic Experimenter's Handbook—Exciting electronics construction projects—all laboratory tested by the Editors, complete with parts list and easy "How-To-Do-It, How-It-Works" instructions.
 1972 Winter—#40 1971 Winter—#33 1970 Spring—#14
 1971 Spring—#26 1970 Winter—#97 1968 Spring—#84

Communications Handbook—Here is one single package, the combined knowledge and experience of the top men in each field, tunes you in on everything you need to know about CB, SWL and HAM. 1971—#37
 1970—#10 1969—#86 1968—#53

Tape Recorder Annual—The complete guide to what's available—how to choose what's best for you and how to get the best use and pleasure from your tape recorder. 1971—#19 1970—#99 1969—#81

Stereo/Hi-Fi Directory—Complete, accurate facts on every piece of equipment including full technical specifications, model numbers, dimensions, special features, optional accessories, manufacturers prices. 1969—#82

ZIFF-DAVIS SERVICE DIV. • Dept. SD
595 Broadway, N.Y., N.Y. 10012

Please send me _____ copies of the 1972 edition of Stereo Directory and Buying Guide at \$1.50 each plus 35¢ each for postage and handling. (\$2.50 **postpaid** for orders outside the U.S.A.) Also, I have circled the numbers below of the additional annuals I wish to receive: EW-1271

40	53	82	84	0	81	66	97	99	14	19	26	33	37
\$1.25 each				\$1.35 each				\$1.50 each					

I am enclosing a total of \$_____ for the annuals ordered above. I have enclosed an additional 35¢ per copy for postage and handling. (For orders outside the U.S.A., all annuals are \$2.50 per copy, **postpaid**.)

print name _____
 address _____
 city _____ state _____ zip _____

Payment Must be Enclosed with Order

Electronics World

DECEMBER 1971

VOL. 86, No. 6

Contents



THIS MONTH'S COVER shows a hand-held, wide-angle laser optical communicator developed by Santa Barbara Research Center. Because of its wide angle (2° or 3°) it requires no stand or support and can be used under any conditions which permit the use of hand-held binoculars. Audio quality is such that voice identification is possible up to maximum range of the optical transceivers (4 miles at 2° and 2.5 miles at 3°). The unit weighs 3 pounds with batteries and has full duplex operation. See page 20. Photo courtesy of Hughes Aircraft Co.



Publisher **LAWRENCE SPORN**
Editor **WM A. STOCKLIN**
Managing Editor **PRISCILLA B. HOFER**
Assistant Editor **STELLA HALL**
Contributing Editors
WALTER H. BUCHSBAUM
Prof. ARTHUR H. SEIDMAN
FOREST H. BELT
Art Editor **RICHARD MOSS**
Technical Illustrator
J. A. GOLANEK
Advertising Manager
JOSEPH E. HALLORAN
Advertising Service Manager
MADELEINE LITTMAN
Associate Publisher
STANLEY NEUFELD
Group Vice President
Electronic & Photographic
FURMAN H. HEBB
December, 1971

- 13 Instrumentation Balloons Carry Electronic Payloads** *L. George Lawrence*
One of the least expensive ways of getting electronic instruments into outer space is to use modern balloons. Envelopes of 65 million cubic feet interior volume have been built and flown—bigger ones to come.
- 20 Optical Communications with Semiconductor Light Sources** *David L. Heiserman*
The overcrowded r.f. spectrum has limited the availability of additional broadband communications links but now engineers are looking to light portion of the band to handle short-range optical links.
- 23 RC Time Constants in UJT Circuits** *Richard M. Cartoscilli*
- 24 The "Pipe" Speaker System** *Capt. J. Roy Smith, USNR*
Designed for use with electronic organs and similar instruments, this system is low in cost and easy to put together.
- 27 Animal Guidance Systems** *L. George Lawrence*
Dr. B.F. Skinner believes that almost any sentient creature can be trained in his "Skinner box." This article tells how such training is carried out and reveals the war- and peace-time potentials of this technique.
- 30 Channel Electron Multipliers** *Fred W. Holder*
These new semiconductor radiation detectors are highly sensitive to low-energy protons and electrons in space exploration.
- 32 Zener Diodes & Voltage-Regulator Design** *Kirk Butler*
- 35 Facsimile via Telephone** *David L. Heiserman*
You can now transmit graphic material over conventional phone lines using one of the economical systems available.
- 39 Conductor Design with Thin-Film Insulated Aluminum** *Harry D. Walker*
- 40 Novel Counter, Decoder, Readout** *Frank H. Tooker*
- 43 Understanding Digital Voltmeters** *John Frye*
- 51 Amplifier Quiz** *William R. Shippee*
- 69 Low-Power Crystal-Controlled Oscillator** *Joseph H. Wujek*

6 For the Record *W.A. Stocklin*
A Merger!

7 Reader Service Page

MONTHLY FEATURES

4 Coming Next Month **10 Letters**

62 New Products & Literature

Hear your police and
firemen in action!

Listen on these channels, too . . .



WEATHER
TRAFFIC
UTILITY
BUSINESS
MARINE
CIVIL DEFENSE

WITH ALL-NEW **Bearcat III**

The Only Monitor Receiver You'll Ever Need

Meets present and future needs in any locality. Scans 1 to 8 FM emergency and business channels you select, in any 1 or 2 bands—low, high, UHF. Stops for any transmission, then resumes search. Plug-in interchangeable RF module for each band. Built-in front speaker. Complete band coverage. Comes with one or two RF modules, mobile mount and cords for AC and DC. American built by Electra, originator of the scanning receiver.

At better dealers.

\$139.95 WITH RF MODULE FOR ANY 1 BAND

\$159.95 WITH RF MODULES FOR ANY 2 BANDS

Plus plug-in crystals at \$5 each.

Additional modules \$20 each.

ELECTRA CORPORATION

CUMBERLAND, INDIANA 46229

CIRCLE NO. 141 ON READER SERVICE PAGE

AR guarantees its published specifications

At Acoustic Research we believe that the publication of complete performance data on our high fidelity components is obligatory. Otherwise, our guarantee would have little meaning.

Find out just what AR guarantees that its products will do. Mail the coupon below, and detailed technical literature will be sent to you free of charge.



Acoustic Research, Inc.
24 Thorndike Street
Cambridge, Mass. 02141
Dept. E W-12

Please send measured performance data on AR products to

Name _____

Address _____

CIRCLE NO. 150 ON READER SERVICE PAGE

Coming Next Month

Popular Electronics

INCLUDING **Electronics World**

Cable TV— Where It Is and Where It's Going

Forest Belt discusses how the winding road to cable TV may lead to more and better viewing. What are the advantages and disadvantages and how will they affect the general public subscribing to the service? An important and timely article which you can't afford to miss!

More Solid-State Electronics For the New Cars

In this first of two articles, John Drummond tells how and where electronics will be used in 1972-model cars. He delves into the GM line and evaluates the importance of each device or system in terms of cost to the motorist, performance claims, and if you can rely on the gear.

Electronic Equipment and Hospital Safety

Whether they admit it or not, patients have been imperiled by electronic equipment used in some hospitals—but now engineers and scientists have combined forces to insure that the wide variety of medical-electronic equipment is not only effective and efficient but nearly 100% safe.

A Look at the PC Market

What's available for the home experimenter/hobbyist in the way of kits and materials for fabricating PC boards? This article explains the different types of kits and their various uses and suggests which type of kit should be used for what products. A handy quick-reference table lists manufacturers and the kits and materials each supplies.

Build a Distortionless Phono Preamp

Hirsch-Houck Labs tested this circuit and reported that it is better than most available commercial units. You can build it—using state-of-the-art circuitry—from readily available parts.

Labyrinth Speakers for Hi-Fi

David B. Weems traces the evolution of the labyrinth speaker system from earliest designs through current systems. He discusses the "pro's and con's" you should consider before tackling such a construction yourself. If the answer is "pro," a table of various speakers suitable in such enclosures is appended to make your job easier.

A Transmitter for The "Neglected" Band

Taking advantage of a little-known loophole in FCC Rules Regulations, here are construction plans covering a license-free transmitter and receiver (in February issue) operating in the 1750-meter low-frequency band.

All these and other interesting and informative articles will be yours in January **POPULAR ELECTRONICS** Including **ELECTRONICS WORLD**.

ZIFF-DAVIS PUBLISHING COMPANY

William Ziff, President
W. Bradford Briggs, Executive Vice President
Hershel B. Sarbin, Senior Vice President and Secretary
Stanley R. Greenfield, Senior Vice President
Philip Sine, Financial Vice President and Treasurer
Walter S. Mills, Jr., Vice President, Circulation
Phillip T. Heffernan, Vice President, Marketing
Frank Pomerantz, Vice President, Creative Services
Arthur W. Butzow, Vice President, Production
Edward D. Muhfeld, Vice President, Aviation Division
Irwin Robinson, Vice President, Travel Division
George Morrissey, Vice President
Sydney H. Rogers, Vice President

Editorial and Executive Offices
One Park Avenue
New York, New York 10016
212 679-7200

NEW YORK OFFICE
212 679-7200
Joseph E. Halloran, Adv. Mgr.

MIDWESTERN OFFICE
307 North Michigan Avenue
Chicago, Illinois 60601 312 726-0892
George B. Mannion, Jr.

WESTERN OFFICE
9025 Wilshire Boulevard
Beverly Hills, California 90211
213 274-0265, 213 272-1161
Western Advertising Manager, Bud Dean

JAPAN: James Yagi, Oji Palace Aoyama
6-25, Minami Aoyama, 6-Chome, Minato-ku
Tokyo 407-1930/6821

CIRCULATION OFFICE
P.O. Box 1093, Flushing, N.Y. 11352



Member
Audit Bureau of
Circulations

ELECTRONICS WORLD

Put More "GO POWER" into Your Electronics Career —

MOVE AHEAD from Technician to ENGINEER

by studying at home with

GRANTHAM SCHOOL OF ENGINEERING

"the college that comes to you"

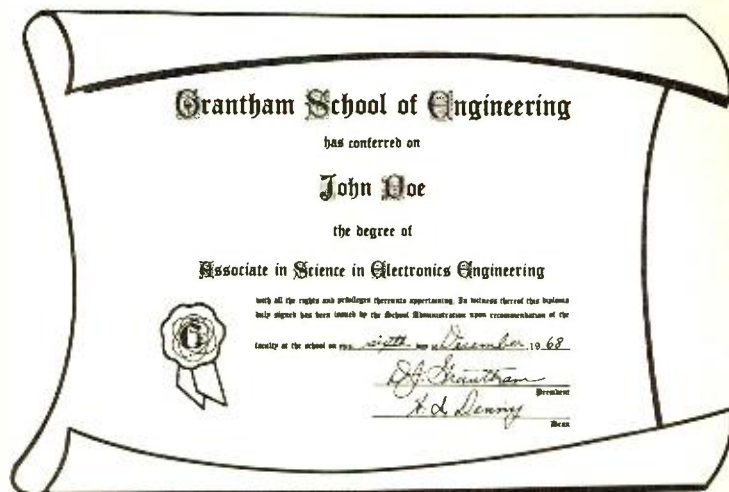

Earn a DEGREE in Electronics Engineering

The GRANTHAM educational program in ELECTRONICS ENGINEERING is designed to upgrade electronics technicians to the engineering level, mostly by home study.

While you continue your present employment, you can really learn electronics engineering and earn an ACCREDITED DEGREE. You can upgrade your income and prestige by upgrading your electronics education at the college level.

GRANTHAM'S strong-foundation educational program in electronics engineering is designed especially for the working technician. This program, offered mostly by home-study, leads to non-obsolescent skills—to skills based on reasoning—and leads to the DEGREE of Associate in Science in Electronics Engineering (the ASEE Degree).

This accredited degree program consists of four correspondence courses of 100 lessons each—an overall total of 400 lessons—followed by a two-week graduation seminar held at the School. Upon completion of the four correspondence courses, you are awarded a diploma in Electronic Engineering. Then, upon completion of the two-week graduation seminar, you are awarded the ASEE Degree.

Accreditation and G.I. Bill Approval

Grantham School of Engineering is accredited by the Accrediting Commission of the National Home Study, is approved under the G.I. Bill, and is authorized under the laws of the State of California to grant academic degrees.

Grantham School of Engineering

• Established in 1951 •

1505 N. Western Ave.
Hollywood, Calif. 90027

Telephone:
(213) 469-7878



What's in Your Future — The Same Old Job, or Success in Engineering?

Where will you be five years from today? Are you headed for real advancement in electronics, or in a rut? The experience you have as a technician is valuable; it gives you a head start toward a better future. But to get ahead and stay ahead, experience must be supplemented with more education in electronics and such allied subjects as mathematics, physics, computers, and engineering design.

The Grantham educational program in electronics engineering is not for beginners. Every point is explained just as carefully as if you were a beginner, but the important difference is that while the beginner would need extensive laboratory training, you (as an experienced technician working with modern equipment) do not require such training and should not waste your time doing the same laboratory experiments that beginners must perform. This program in engineering is designed, written, and taught for and to experienced technicians, and beginners are not accepted for enrollment.

For complete details, mail postcard or coupon.

Grantham School of Engineering EW-12-71

1505 N. Western Ave., Hollywood, Calif. 90027

Gentlemen:

Please send me your free Bulletin which gives complete details on the Grantham educational program leading to the Associate Degree in Electronics Engineering. I understand no salesman will call.

Name _____

Address _____

City _____ State _____ Zip _____

I have been in electronics for _____ years.

Computer Age Action Kits! by Science Fair®

Exclusive at
1200 Radio Shack stores

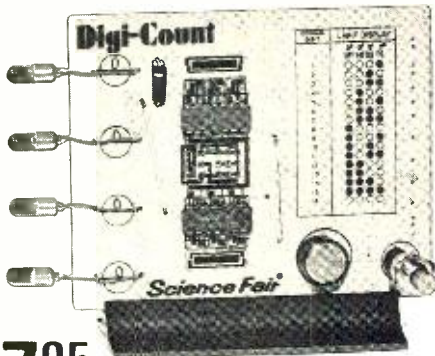

795
Post Paid*

INTEGRATED CIRCUIT BINARY COUNTER KIT

The "fun" way to learn computer theory and interpret binary code! Four-bulb-readout counts binary digits to 16 (or 1,048,576 with Add-On kits). Adds, subtracts, multiplies, calculates rpm, even counts people.

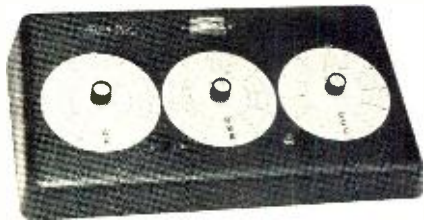

1495
Post Paid*

ANALOG-TYPE COMPUTER KIT

Be a math wizard! Figure square and cube roots, log function, reciprocals, multiply and divide, do metric conversion—electronically.

Ask for
FREE
Catalog!

ALLIED RADIO SHACK
A TANDY CORPORATION COMPANY
2725 W. 7th St.
Fort Worth, Texas 76107

* Add state, local taxes; Address above

CIRCLE NO. 149 ON READER SERVICE PAGE

GET INTO ELECTRONICS



V.T.I. training leads to success as technicians, field engineers, specialists in communications, guided missiles, computers, radar and automation. Basic & advanced courses in theory & laboratory. Electronic Engineering Technology and Electronic Technology curricula both available. Assoc. degree in 29 mos. B. S. also obtainable. G.I. approved. Graduates in all branches of electronics with major companies. Start September, February. Dorms, campus. High school graduate or equivalent. Write for catalog.

VALPARAISO TECHNICAL INSTITUTE
Dept. RD, Valparaiso, Indiana 46383



For the Record

A MERGER!

WM. A. STOCKLIN, EDITOR

OVER the years many people have asked us "Why two electronics books in the same company?" We thought we had a pretty good answer, but times change, and evolution makes its mark in the publishing field, too. It is therefore with a mixture of sadness for the old and exhilaration for the new that we bring you the news that next month, **ELECTRONICS WORLD** will merge with its sister publication, **POPULAR ELECTRONICS**, which even today, before the merger, has the largest circulation of any electronics magazine in the world.

ELECTRONICS WORLD has had a long and honorable history—over 50 years—and we are proud of the role we have played in it. The passing of the magazine is the passing of an era. Many readers have witnessed our coverage of World War II with the special Signal Corps issues and the progressive developments in television. Some go back even farther to the inventions of Lee deForest and Armstrong (the inventor of FM radio). We have witnessed the birth of such companies as *IBM*, *Xerox*, and *Fairchild Semiconductor* . . . and one of the greatest pleasures we've had in editing **ELECTRONICS WORLD** over these many years has been the strong loyalty of our readers.

But in the past few years the two magazines have been coming ever closer together—in content and in technical level—and, as a result, in our readership. In fact, the current subscriber duplication between the two magazines is over 40 percent. This coming together of what used to be two separate audiences has led us to complete what seems to be a natural process by combining the two publications into one. The new, merged publication—which will retain features of each of its component magazines—will be called **POPULAR ELECTRONICS Including ELECTRONICS WORLD**. The combined publications will be produced by a merged staff of editors from EW and PE—including myself. Many of our present contributors will continue in the new magazine—Forest Belt, John Frye, Walter Buchsbaum, George Lawrence—and Julian Hirsch, whose Hirsch-Houck Lab Reports will be expanded to cover more types of electronics gear.

With regard to the merging of the subscription lists, if you presently subscribe to **ELECTRONICS WORLD** and not to **POPULAR ELECTRONICS**, then you will receive the new publication as follows: If you are entitled to one-to-six issues, you will receive one extra; seven-to-12 issues, two extras; 13-to-18, three extra, and so on. This takes into account the fact that the subscription price of the merged magazine is less than that of EW. Thus, you will receive more copies of the new publication than you would have of the old.

If you presently subscribe to *both* **ELECTRONICS WORLD** and **POPULAR ELECTRONICS**, then the two subscriptions will be automatically combined. You will receive **POPULAR ELECTRONICS Including ELECTRONICS WORLD** on a copy-for-copy basis for all issues remaining on your PE subscription, and the number of issues remaining on your **ELECTRONICS WORLD** subscription will be credited according to the above schedule.

It is my personal hope that all of our readers will find the new publication as exciting and full of interest as you did the old and that, in time, you will develop the same loyalty for it as you had for **ELECTRONICS WORLD**. ▲

Electronics World

READER SERVICE PAGE

FREE INFORMATION SERVICE!

Here's an easy and convenient way for
and to get additional information
about products advertised or mentioned
editorially (if it has a "Reader Service Number")
in this issue. Just follow the directions below . . .
and the material will be sent to you promptly
free of charge.

1 On coupon below, circle the number(s) that correspond(s) to the key number(s) at the bottom or next to the advertisement or editorial mention that is of interest to you. (Key numbers for advertised products also appear in the Advertisers' Index.) Print or type your name and address on the lines indicated.

2 Cut out the coupon and mail it to:
Electronics World,
P.O. Box 7842,
Philadelphia, Pa.
19101

NOTE:

If you want to write to the editors of ELECTRONICS WORLD about an article on

Electronics World

P.O. Box 7842
Philadelphia, Pa. 19101

Void 60 days after date of issue
1271

1	2	3	4	5	6	7	8	9	10	11	12	13	14	15	16	17	18	19	20	21	22	23	24	25
26	27	28	29	30	31	32	33	34	35	36	37	38	39	40	41	42	43	44	45	46	47	48	49	50
51	52	53	54	55	56	57	58	59	60	61	62	63	64	65	66	67	68	69	70	71	72	73	74	75
76	77	78	79	80	81	82	83	84	85	86	87	88	89	90	91	92	93	94	95	96	97	98	99	100
101	102	103	104	105	106	107	108	109	110	111	112	113	114	115	116	117	118	119	120	121	122	123	124	125
126	127	128	129	130	131	132	133	134	135	136	137	138	139	140	141	142	143	144	145	146	147	148	149	150

Name (Print Clearly) _____ Title _____

Company Name _____

Address _____

City _____ State _____ Zip Code _____

na

there's a Heathkit present



229^{95*}

New Heathkit Solid-State Digital Multimeter...

Here's a breakthrough in instrumentation. The new Heathkit IM-102 gives you a true digital multimeter for about half what you'd pay for comparable wired DMM's! And with an accuracy that's better than many wired digital units on the market... decidedly superior to most analog type instruments. This great new meter measures AC and DC voltages and currents, and resistance with no need to change probes or switch for changes in DC polarity. Automatically displays a positive or negative DC voltage and current, indicating the correct amplitude and polarity. Five overlapping ranges measure voltage from 100 μ V to 1000 V on DC (either polarity); five ranges cover 100 μ V to 500 V on AC; 10 ranges measure 100 nanoamperes to 2 amperes on AC or DC, and six ranges show resistance from .1 ohm to 20 megohms. Input impedance is exceptionally high — approximately 1000 megohms on 2V range (10 megohm on higher ranges), with overload protection built-in on all ranges. Decimal point is automatically placed with range selection and over-range is indicated by a front panel light.

Ends parallax and interpolation errors! There's no mistaking a digital display — everyone reads it the same way. High quality precision components, 3½ digits and ease of calibration contribute to the IM-102's lab-grade accuracy. Analog to digital conversion is accomplished by a patented, dependable Dual Slope Integrator that does not depend on a stable clock frequency for accuracy. A Heath-designed and assembled precision DC calibrator is furnished with each IM-102. An internal circuit and transfer method provides accurate AC voltage calibration. The all solid-state design incorporates cold cathode readout tubes and a "memory" circuit to assure stable, non-blinking operation. Features include detachable 3-wire line cord (no batteries needed), dual primary power transformer, isolated floating ground and completely enclosed, light-weight aluminum cabinet with die-cast zinc front panel and tinted viewing window. Kit includes standard banana jack connectors complete with test leads. Assembles in approximately 10 hours. The new Heathkit IM-102 Digital Multimeter will be the pride of your bench!

Kit IM-102, 9 lbs., mailable 229.95*

3995*

for every age, every hobby!

New Heathkit "Minimizer" kitchen waste compactor...

Today's most modern refuse handling method in easy-to assemble kit form! Now you can own the most exciting kitchen appliance on the market for less than you'd pay for any other comparable compactor. The Heathkit Minimizer lets Mom throw out the unsightly waste baskets and garbage cans for the latest in clean, convenient, odor-free disposal. The Minimizer handles all normal household trash — food wastes, glass and plastic containers, tin cans, wrappings, boxes, floor sweepings, light bulbs, etc. The packing ram descends with 2,000-lb. force to reduce refuse to almost 1/4 of its original size, packaging the material in a strong disposable bag — one bag holds an entire week's trash for a family of four! When the bag's full, Mom simply folds over the top and removes a neat, dry package for normal rubbish pickup. And the Minimizer deodorizes the contents each time the drawer is opened and closed. The sanitation man will love Minimizer, too!

Simple, safe operation! To use, Mom merely inserts a Minimizer plastic-lined bag in the drawer and starts the compacting cycle. In less than a minute the ram forces down the trash, returns to its normal position, and the Minimizer shuts itself off. For maximum safety, the Minimizer uses a key lock switch and an interlock which automatically turns unit off if drawer is not fully closed or is accidentally opened during cycling. Your Heathkit Minimizer can be built-in under the kitchen counter or left free-standing. Its bright white enamel finish with marble-tone vinyl-clad top complements any decor. And you can build it yourself in 6 to 10 hours. Has long-life 1/3 hp motor, plugs into 110-120 VAC conventional household outlet. Kit includes 5 plastic-lined bags, one 9 oz. aerosol can of deodorant. Minimizer measures 34 3/8" H x 15" W x 25 1/2" D.

Kit GU-1800, 203 lbs. **199.95***
 GUA-1800-1, 15 plastic-lined bags, 5 lbs. **4.99***

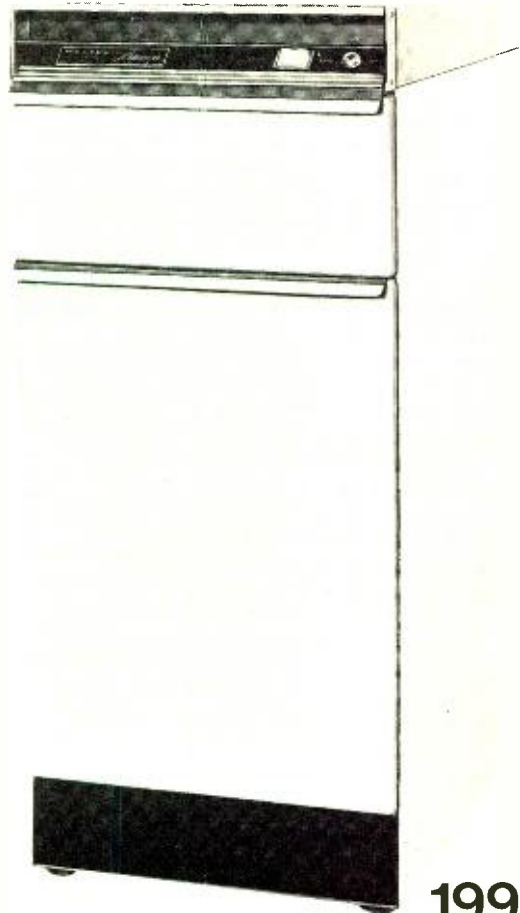

199.95*

New Heathkit Slotless 1/32-Scale Raceway

129.95*



You race up to 4 GT cars — each with independent acceleration, deceleration and steering! Make all the maneuvers of real high-speed drivers. You can even turn around completely and backtrack. Kit includes track sections for 8'x4' oval, power transformer, 2 cars and controllers.

completely and backtrack. Kit includes track sections for 8'x4' oval, power transformer, 2 cars and controllers.

Kit GD-79, 13 lbs., mailable **129.95***
 Kit GDA-79-1, extra car and controller, 3 lbs., mailable. . **21.95***

New Heathkit Electronic Workshops

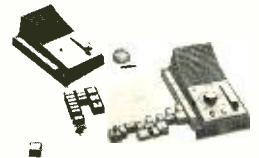

Completely self-contained electronics labs teach youngsters the basics of electronics.

Each contains basic electronic components in easy-to-work-with module form. Kids simply follow the instructions, arrange the blocks on the board to form actual working circuits for code flashers, timers, alarms, etc.

Kit JK-1033, 36 experiments, 11 lbs. **29.95***
 Kit JK-1022, 25 experiments, 8 lbs. **24.95***
 Kit JK-1011, 12 experiments, 6 lbs. **19.95***

SEE THESE KITS AT YOUR LOCAL HEATHKIT ELECTRONIC CENTER... or send for FREE catalog!

CALIF.: Anaheim, 330 E. Ball Road; El Cerrito, 6000 Potrero Avenue; La Mesa, 8363 Center Drive; Los Angeles, 2309 S. Flower St.; Redwood City, 2001 Middlefield Rd.; Woodland Hills, 22504 Ventura Blvd.; COLO.: Denver, 5940 W. 38th Ave.; GA.: Atlanta, 5285 Roswell Road; ILL.: Chicago, 3462-66 W. Devon Ave.; Downers Grove, 224 Ogden Ave.; MD.: Rockville, 5542 Nicholson Lane; MASS.: Wellesley, 165 Worcester St.; MICH.: Detroit, 18645 W. Eight Mile Rd.; MINN.: Hopkins, 101 Shady Oak Rd.; MO.: St. Louis, 9296 Gravois Ave.; N.J.: Fair Lawn, 35-07 Broadway (Rte. 4); N.Y.: Jericho, L.I.; 15 Jericho Turnpike; New York, 35 W. 45th Street; OHIO: Cleveland, 5444 Pearl Rd.; Woodlawn, 10133 Springfield Pike; PA.: Philadelphia, 6318 Roosevelt Blvd.; Pittsburgh, 3482 William Penn Hwy.; TEXAS: Dallas, 2715 Ross Avenue; Houston, 3705 Westheimer; WASH.: Seattle, 2221 Third Ave.; WIS: Milwaukee, 5215 Fond du Lac.

Retail Heathkit Electronic Center prices slightly higher to cover shipping, local stock, consultation and demonstration facilities. Local service also available whether you purchase locally or by factory mail order.

HEATHKIT
Schlumberger

HEATH COMPANY, Dept. 15-12
 Benton Harbor, Michigan 49022

Enclosed is \$ _____, plus shipping.
 Please send model (s) _____

Please send FREE Heathkit Catalog.

Name _____

Address _____

City _____ State _____ Zip _____

*Mail order prices; FOB factory.
 Prices & specifications subject to change without notice. CL-421 R



Earn Your Degree

ELECTRONICS ENGINEERING

through HOME STUDY

HIGHLY EFFECTIVE

HOME STUDY COURSES IN:

- Electronics Engineering Technology
- Electronics Engineering Mathematics

Earn your Associate in Science Degree in Electronics Engineering and upgrade your status and pay to the engineering level. Complete college level courses in Electronics Engineering. We're a forward looking school. Outstanding lesson material—thorough and easy to understand. Engineering taught on the basis of application and understanding rather than on the basis of memorization. Up to date in every respect. Acquire the knowledge and ability that means the difference between a low paying technician job and a high paying engineering position. Low tuition cost with low monthly payments. Free engineering placement service for our graduates. Write for free descriptive literature. Ask for bulletin. No salesman will call on you.



COOK'S INSTITUTE

of Electronics Engineering

Forest Hill Road
P. O. Box 10634
Jackson, Miss. 39209
Established 1945

Formerly Cook's School of Electronics

CIRCLE NO. 145 ON READER SERVICE PAGE

REPLACEMENT PARTS & ACCESSORIES

WELTRON'S GOT 'EM!

DO YOU?

plugs & jacks * stereo switches * universal replacement antennas & bases * volt meters * cables * microphones * power supplies * auto stereo accessories * high precision motors * synchronous motors * shaded 4-pole motors *

COMPLETE CATALOG AVAILABLE.
CALL YOUR DISTRIBUTOR NOW!

Weltron®

COMPANY, INC.

514 EAST PEABODY STREET, DURHAM, N.C. 27702
919-682-0333

CIRCLE NO. 121 ON READER SERVICE PAGE

10

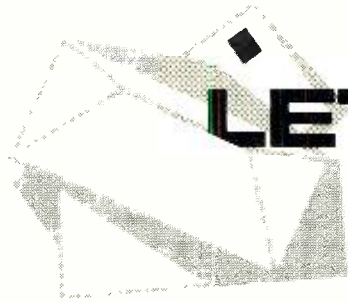

LETTERS

TRANSISTOR TESTERS

To the Editor:

In an article in the July, 1971 issue of *ELECTRONICS WORLD*, "Transistor Testers for Servicing," the author, Forest Belt, undertakes an evaluation of the various transistor testers currently on the market, including the B&K Model 162. The article includes a table of transistor testers and their characteristics, in which the B&K is listed as measuring *beta* the a.c. way. Elsewhere in his text he also indicates the B&K 162 as a.c.

However, I have just completed tests on this model and find that it does, in fact, measure *beta* the d.c. way, and not the a.c. way. Furthermore, the instruction manual supplied with the unit definitely states that this model is d.c. transistor tester.

As a consultant currently in the process of evaluating various types of test equipment, I would appreciate some clarification. Did the author actually have an a.c. version of this transistor tester?

EUGENE E. MERKEL
Silver Spring, Md.

Sorry, we were in error. The B&K Model 162 transistor tester is d.c., and not a.c.—Editor

* * *

MORE ON LARGE D.C. MOTORS

To the Editor:

After reading Ed Heck's comments (in your September, 1971 issue) I want to say that I was not amused but very much interested in the "Speed Control for Large D.C. Motors" article (in your January, 1971 issue).

As a field engineer, I have been involved in the start-up and modification of industrial machines using large d.c. motors, including a rolling mill that used a 1500-h.p. d.c. motor to power the mill stand. The mill rectifiers are capable of 1800 h.p. constant output, and are able to supply 150% of that value for 1 minute. The motor is rated at 2400 amperes full load at 500 v.d.c. armature voltage, and is capable of a 2:1 field range. It is speed regulated to 0.1%; this is equivalent to the loss of 1 r/m out of 1000 r/m from no load to full load. When initially starting this machine, the motor was tested, installed, to 3600 amperes for electrical armature response.

I am always very interested in articles about industrial applications—even if they involve motors of only 1/8 horsepower.

ROBERT K. LEAMAN
Resident Engineer
Reliance Electric Co.
York, Pa.

* * *

PHASE-SHIFT OSCILLATOR

To the Editor:

I would like to point out an error in the phase-shift oscillator design published in the July, 1971 issue.

Note that Fig. 1 shows the oscillator with bias established using R_{bb1} and R_{bb2} in a voltage-feedback arrangement. With capacitor C_b inserted as shown, this is a relatively simple biasing scheme and a good way to stabilize the quiescent operating point. However, in the circuit of Fig. 3, the author has connected the resistors to the supply, and not to the collector, resulting in a bias circuit which introduces no feedback for stabilization.

The formula given in Step 9 for calculating R_{bb} is correct for Fig. 1 but not for Fig. 3. If one wishes to use the circuit of Fig. 3, he must replace $V_{cc}/2$ with V_{cc} and eliminate capacitor C_b altogether, since it serves no purpose in Fig. 3. If one does not modify Step 9 in building the oscillator as shown in Fig. 3, the transistor will be biased with twice its required base current.

(Probably it was the author's intention to connect the circuit in Fig. 3 exactly as it was in Fig. 1; in that case, everything would have been correct as stated.)

MILFORD R. DERRICK
Charleston, S. C.

Your exception to Fig. 3 is correct. The base resistor (390k) should return to the collector of the 2N930 (as in Fig. 1), rather than to V_{cc} . Thanks for calling this to our attention.—Editor

* * *

TRANSISTOR/FET CURVE TRACER

To the Editor:

Having just completed the construction of the "Transistor and FET Curve Tracer" as described in the August (1971) issue of your magazine, I should like to pass on information concerning several design problems which have come to light.

(1) The Darlington emitter/follower

pair (Q4 and Q5) present too low an impedance to the emitter of Q3 to allow a clean staircase wave. Accord-

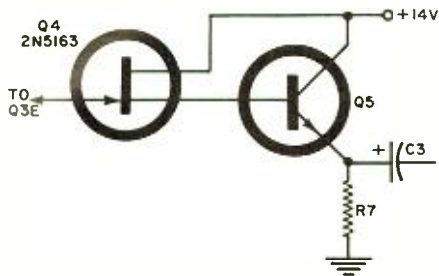

ly, I have substituted an *n*-channel FET for Q4 (see diagram).

(2) The schematic published does not indicate a common ground between the staircase circuit and the collector circuit; accordingly, the emitter should be connected to scope ground.

(3) The "step position" circuit is, in my opinion, totally unsatisfactory. It has an effect in the "NPN" position only. While the staircase level responds when R9 is turned clockwise, there is no satisfactory discharge path from the C3/D1 junction when it is turned counter-clockwise. Moreover, I believe the circuit might even be self-destructive in some instances, though I have not worked this through fully as yet. In the meantime, though, I believe R9 is best left in the counterclockwise position.

RON CANODY
Woodland Hills, Cal.

HI-FI VOLUME EXPANDER

To the Editor:

I have just finished assembly and calibration of Richard Wilt's "Low-Distortion Hi-Fi Volume Expander" (June, 1971 issue of *ELECTRONICS WORLD*)—which is now operating in the tape monitor circuit of my integrated stereo amplifier. I would like to report to you concerning its performance.

I built the expander on an etched circuit board and enclosed it in a Bakelite box. Then I ran shielded cable to all inputs, outputs, controls and switches, using two meter circuits (instead of one as Wilt showed) so that I could monitor the input levels of both channels at the same time without switching back and forth.

Using inexpensive 1-mA meters for the input level, I mounted a double-pole, double-throw slide switch on the rear of the expander and ran shielded cable from the point on the circuit board where capacitor C7 would normally mount to the switch. On the switch, I mounted four capacitors (two for each channel) and arranged the switching circuit so that it is possible to have two decay rates—fast and slow. (The values of the capacitors can be

chosen to please the listener.) This makes the expander more versatile. On very slow music, if the slow decay rate is switched in, it prevents the "blasting" effect described in the article; with more lively music, the fast decay rate can be switched in to handle the different material.

I have substituted 2N3823 JFET's for the 40468A's called for. These perform beautifully with an average drain current of about 3.5 mA.

When calibrating the unit, I simply fed the input with a 1-kHz square wave and set it so that the input meter deflected to half-scale. With the expansion control set to minimum, and an oscilloscope hooked to the expander output, I adjusted the bias pot for maximum signal. I then reset the bias for a one-tenth maximum signal level. This was accomplished for both channels in about 20 minutes and I have not had to readjust it since.

I am not using the power supply shown by Wilt, but one of my own design, fully regulated, with exactly 18 volts output. It is a separate unit which plugs into the back of the expander box. Over-all performance is excellent, with no hum problems; noise level is not detectable by ear; and the expander unit performs exactly as Wilt describes it.

Using an expander for the first time, I am truly amazed at what this device does for music. On tapes, there is complete silence between selections (no hiss); the same is true for records. The music seems to have more "life" to it with the expander. I don't see how I ever got along without it.

If anyone would like to write directly to me for construction details, I will be happy to help.

ROBERT EUBANKS
2835½ Willow Pass Road
Concord, Cal. 94520

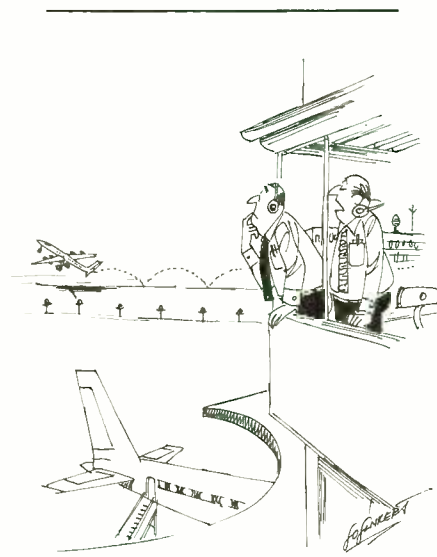

"Champagne flight from Hawaii!"

RADIO SHACK ISSUES A NEW AND DIFFERENT CATALOG! FREE! 1972 Edition

ELECTRONICS
FROM A-Z

1000's of
Items
100's Of
Exclusives

ANTENNAS
BATTERIES
CAPACITORS
DIODES
EDUCATIONAL KITS
FIBER OPTICS
GRILLE CLOTH
HI-FI SPEAKERS
IC'S • JACKS
KNOBS • L-PADS
MIKES • NEEDLES
OSCILLATORS • P-BOXES
QUADRACS • RESISTORS

SEMICONDUCTORS
TELEPHONES
ULTRASONIC ALARMS
VHF ANTENNAS • WIRE
XENON STROBE LIGHT
"Y" ADAPTERS
ZENER DIODES
AND MUCH MORE!



THE buying guide for kit builders, Hams, CB'ers, installers, experimenters, fix-it men, hobbyists, electricians, anyone in electronics in any way. It lists 1,000's of things most stores don't stock. Things that keep equipment working, or make it work even better or do even more. Features our complete Science Fair and Knight-Kit lines of electronics and hobby kits, too. Use this catalog to find what you need, then go to our store near you and get it. Or you may order by mail.

Get your FREE copy at our nearby store
— or mail in coupon today!

ALLIED RADIO SHACK Dept. EW-7
A TANDY CORPORATION COMPANY
2725 W. 7th St., Fort Worth, Texas 76107

Send Free 1972 Accessories & Parts
Catalog #215

Please PRINT Clearly
Name _____ Apt. # _____
Street or Rte. & Box _____
City _____
State _____ Zip _____

CIRCLE NO. 148 ON READER SERVICE PAGE

Cooperate With The
Zip Code Program
of The Post Office
Department.
Use Zip Code
In All Addresses

THE MOST IMPORTANT DISCS IN YOUR ENTIRE COLLECTION!

Stereo Testing!

Spectacular Sound!

**NEW STANDARD
in
Stereo Testing!**

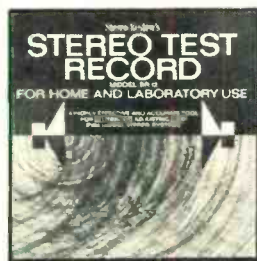

**Model SR12
STEREO TEST RECORD**

The most complete . . . most sophisticated . . . most versatile Test Disc available today. Whether you're an avid audiophile who'll settle for nothing but peak performance from his stereo components . . . a casual listener who'd like more insight into the challenging world of stereo reproduction . . . or a professional technician who needs precise standards for lab testing . . . the SR12 is a must for your record collection.

Make these important stereo checks **BY EAR** . . . Frequency response • Separation • Cartridge tracking • Channel balance • Hum and rumble • Flutter • Cartridge and speaker phasing • Anti-skating adjustment • "Gun shot test" for stereo spread • Multi-purpose musician's "A." Equal-tempered Chromatic octave • Guitar-tuning tones.

7 critical **TEST EQUIPMENT** checks . . . Attention professionals: SR12 is also designed to be used as a highly efficient design and measurement tool. In the following tests, recorded levels, frequencies, etc. have been controlled to laboratory tolerances—affording accurate numerical evaluation when used with oscilloscope, chart recorder, output meter, intermodulation-distortion meter and flutter meter.

- 1,000-Hz square waves to test transient and high-frequency response of phono pickups.
- 500 to 20,000 Hz frequency-response sweep.
- Sine-wave tone-bursts to test transient response of pickup.
- Intermodulation test using simultaneous 400-Hz and 4,000-Hz signals.
- Intermodulation sweep to show distortion caused by excessive resonances in tone arm and cartridge.
- 1,000-Hz reference tones to determine groove velocity.
- 3,000-Hz tone for flutter and speed tests.

Sample waveforms—illustrating both accurate and faulty responses are provided in the Instruction Manual for comparison with the patterns appearing on your own oscilloscope screen.

**FREE BOOKLET
WITH EACH ALBUM**

SR12: Informative manual includes tables, diagrams.

Demonstration Record: Discussion of the selections plus descriptions of each selection performed.

**The Most Spectacular Sound
Exhibition of Stereo Fidelity
Ever Available on One Disc.**



**STEREO REVIEW
STEREO DEMONSTRATION RECORD**

The result of two years of intensive research in the sound libraries of Deutsche Grammophon Gesellschaft, Connoisseur Society, Westminster and Cambridge. The Editors of Stereo Review have selected those excerpts that best demonstrate the many aspects of the stereo reproduction of music. The record offers you a greater variety of sound than has ever before been included on a single disc.

ELECTRIFYING EXPERIENCE IN LISTENING
The Record is a series of independent demonstrations designed to show off one or more aspects of musical sound and its reproduction. Entirely music, the Record has been edited to provide self-sufficient capsule presentations of an enormous variety of music arranged in a contrasting and pleasing order. It includes all the basic musical and acoustical sounds that you hear when you listen to records, isolated and pointed up to give you a basis for future critical listening.

WIDE RANGE OF DEMONSTRATIONS
• Techniques of separation and multiple sound sources • Acoustic depth • The ambience of a concert hall • Sharp contrasts of dynamics • Crescendo and diminuendo • Very high and very low pitched musical sounds • Polyphony (two or more melodies going on at once) with both similar and contrasting instruments • Tonal qualities of wind, string and percussion instruments • Sounds of ancient instruments • Sounds of oriental instruments • Sound of the singing voice, both classically trained and untrained • Plus a large sampling of finger snapping, hand clapping, foot stamping and other musical and percussive sounds.

13 SUPERB SELECTIONS:
STRAUSS: Festive Prelude, Op. 61 (excerpt) DGG • DEBUSSY: feux d'artifice (excerpt) Connoisseur Society • BEETHOVEN: Wellington's Victory (Battle Symphony), (excerpt from the first movement) Westminster • MASSAINO: Conzona XXXV à 16 (complete) DGG Archive • CORRETTE: Concerto Comique Op. 8, No. 6, "Le Plaisir des Dames" (third movement) Connoisseur Society • KHAN: Raga Chandranandan (excerpt) Connoisseur Society • RODRIG: Concert—Serenade for Harp and Orchestra (excerpt from the first movement) DGG • MANITAS DE PLATA: Gypsy Rhumba (complete) Connoisseur Society • MARCELLO: (arr. King): Psalm XVII "The Heavens are Telling" (complete) Connoisseur Society • PRAETORIUS: Terpsichore: La Bourrée XXXII (complete) DGG Archive • BERG: Wozzeck (excerpt from Act III) DGG • BARTOK: Sonata for two pianos and Percussion (excerpt from the first movement) Cambridge • BEETHOVEN: Wellington's Victory (Battle Victory) (excerpt from the last movement) Westminster.

**Created specifically
for playback through
stereo headphones.**



**BINAURAL DEMONSTRATION
RECORD**

**This unique record
presents sound of
unsurpassed realism.**

Binaural recording re-creates the directions, distances, and even the elevations of sounds better than any other recording method. The super-realism of binaural recording is accomplished by recording the acoustical input for each ear separately, and then playing it back through stereo headphones. Thus the sound intended for the left ear cannot mix with the sound for the right ear, and vice versa.

Binaural recording offers the listener the identical acoustical perspective and instrument spread of the original. The sound reaching each ear is exactly the same as would have been heard at the live scene.

"MAX"—GENIE OF BINAURAL RECORDING. "Max," a specially constructed dummy head, cast in silicone rubber, duplicates the role of the human head as an acoustical absorber and reflector of sound. Super-precision capacitor microphones were installed in Max's ears so that each microphone would pick up exactly what each human ear would hear. The result is a demonstration of phenomenal recorded sound.

STASTLING REALITY. The Binaural Demonstration Record offers 45 minutes of sound and music of startling reality. You'll marvel at the eerie accuracy with which direction and elevation are re-created as you embark on a street tour in binaural sound—Sounds Of The City . . . Trains, Planes & Ships . . . a Basketball Game, a Street Parade, a Street Fabrication Plant, The Bird House at the Zoo—all demonstrating the incredible realism of binaural sound reproduction.

MUSIC IN BINAURAL. The musical performances presented on the Binaural Demonstration Record transport you to the concert hall for a demonstration of a wide variety of music. Selections total 23 minutes, and include examples of jazz, organ, and chamber music.

The Stereo Review Binaural Demonstration Record is the ultimate in sound reproduction. It has been made without compromise.

Although headphones are necessary to appreciate the near-total realism of binaural recording, the record can also be played and enjoyed on conventional stereo systems.

The Stereo Demonstration Record ONLY is available in your choice of 33-1/3 or 45 RPM.

RECORDS • Ziff-Davis Service Division • 595 Broadway • New York, N.Y. 10012

Enclosed find \$_____ Please send:
 _____ Model SR12 Stereo Test Records @ \$5.98 each postpaid (\$8.00 outside U.S.A.) 33 1/3 RPM
 _____ Stereo Demonstration Records @ \$5.98 each postpaid (\$8.00 outside U.S.A.) Check one: 45 RPM
 _____ Binaural Demonstration Records @ \$5.98 each postpaid. (\$8.00 outside U.S.A.)

PRINT NAME _____

ADDRESS _____

CITY _____

STATE _____

ZIP _____

EW-1271

PAYMENT MUST BE ENCLOSED WITH ORDER

Instrumentation Balloons *Carry Electronic Payloads*

By L. GEORGE LAWRENCE

One of the least expensive ways of getting an electronics package up into the outer reaches of the atmosphere. Description of some of the more unusual types, including advantages and limitations.

LARGE balloons are convenient vehicles for putting a sizable package of electronic instruments at the outer reaches of the atmosphere, typically at an altitude of 150,000 feet or more. Sooner or later, a modern "aerostat" (the scientific name for these helium-filled plastic bubbles) might well float across your professional career and invite your understanding and use. This article profiles some of the more interesting types of instrumentation balloons—their virtues and limitations.

From Montgolfier to Polyethylene

A balloon may be described as an aircraft lacking a propulsive system. J. M. and J. E. Montgolfier of France are credited with its invention in 1783. Also in 1783, the Robert brothers and J. A. C. Charles ascended and traveled about 27 miles in a hydrogen-filled balloon. Numerous other flights followed both here and abroad, but it was in the United States that the balloon's capabilities as instrumentation carriers were recognized and used.

Thaddeus Lowe, perhaps the best known of the early pioneers, was the first to use a balloon-borne telegraphic transmitter to direct gunfire. Another first was the use of balloon-flown cameras to take pictures of military ground emplacements. Before Richmond, during May, 1862, the entire battle zone was mapped in 64 overlapping photographs taken from a height of 1000 feet. Later, following the Wright Brothers' invention of powered aircraft, balloons remained popular for weather observations and as research vehicles for daring men like August Piccard (1884–1962) who ascended to a height of 55,500 feet in 1932.

Today, scientific ballooning has come almost full circle. Modern balloons are, in essence, electronic-payload carriers occupying a position between high-altitude airplanes and space satellites. Balloon envelopes of 65 million cubic feet interior volume have been built and flown, and larger ones are on the way. The large instrumentation balloon is one of the least expensive means for carrying things to altitudes above 99.8% of the Earth's atmosphere (2 millibars of pressure), where they can remain for many hours and transmit a large amount of geophysical data. Here, an instrumentation package might contain infrared and x-ray telescopes, cosmic-ray counters, pressure and temperature sensors, and particle samplers.

All this might sound very elementary and traditional. But such feats gain stature when we realize that the effective carrier, the balloon itself, is little more than a carefully shaped and sealed piece of polyethylene less than 75/1000th of an inch thick—a fourth the diameter of a human hair.

Characteristics

Scientists use four types of balloons for meteorological and other research. The *extensible* balloon outranks any other. This vessel is designed for light loads—like a radiosonde—which it will carry to its burst altitude of from 100,000 to about 130,000 feet.

Next comes the *zero-pressure* balloon, a vented design, which is the workhorse for scientific research and carries the heaviest payloads to the very highest altitudes.

A third type is the *super-pressure* balloon, a closed vessel made of strong

A rising instrumentation balloon just after launching. At its operating altitude over 100,000 ft, balloon will attain the shape of a sphere and be over 200 ft in diameter. ►

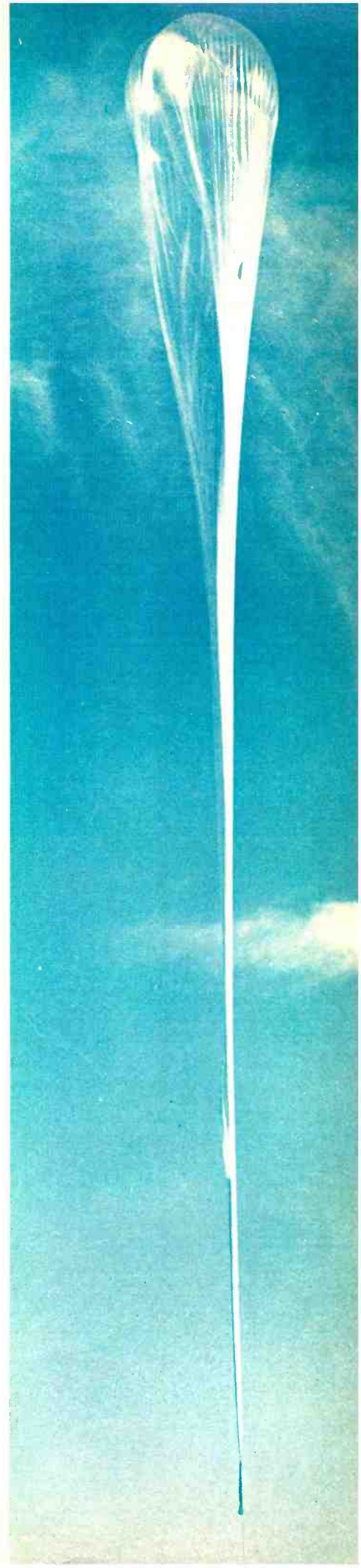



Charging of polyethylene research balloon with 2400-psi truck tanks. Helium is fed through plastic hose on top. Launch spool, mounted in front of truck, restrains balloon during charging.

Fig. 1. Components of a typical balloon flight train.

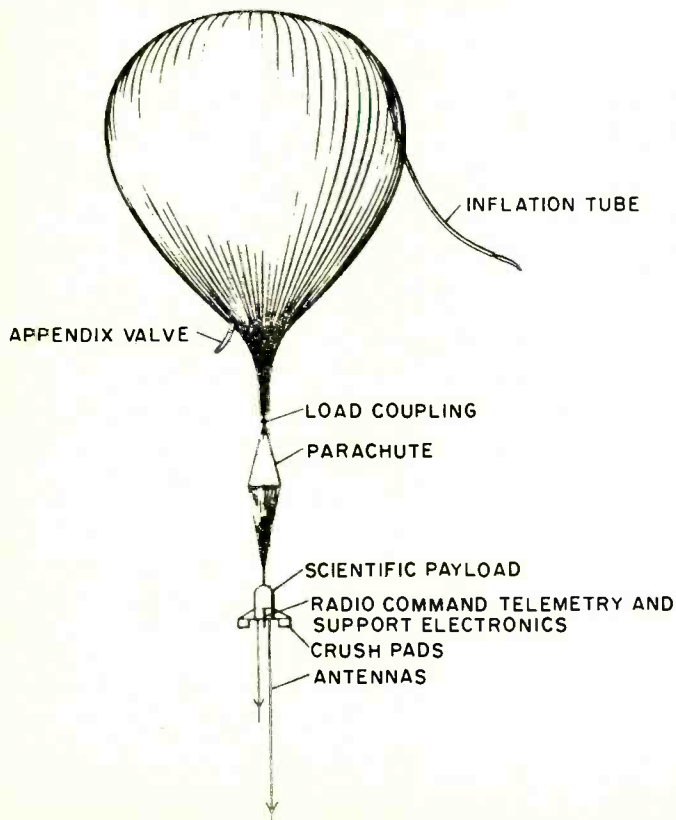

materials whose volume remains constant. This aerostat floats at a constant-density height and, theoretically at least, needs no ballast to maintain effective altitude when it cools down at sunset. By contrast, the vented zero-pressure balloon must dispose of ballast under the same flight conditions—typically about 5% to 7% of its gross weight. The jettisoning of ballast limits the balloon's useful service life to about one week.

A fourth type is called the *open-appendix* hot-air balloon. Today, aside from improvements in hull materials and sources of heat (propane burners), it is of the same classic design as the one which carried the first man above ground in 1783. As an expendable design, it can be used in various applications where no great low-oxygen altitudes are involved. However, it is the zero-pressure balloon which is of particular interest to electronics men.

Prior to the advent of helium as the lifting medium, highly dangerous hydrogen gas was in general use. In an early generator, steam was sprayed over red-hot iron filings. The decomposing water released hydrogen as the oxygen combined with the iron. The hydrogen was then carried through a pipe into the water chamber and from there into the tethered balloon.

Pre-inflation always posed a problem. But, hot-air types can be pre-inflated by large blowers to reduce danger to the hull from the open flame of the heat source.

Helium has a lifting power of 66 lb for every 1000 cubic feet. Thus, a balloon's ground-level charge of, say 10,000 cubic feet, will generate a lift of 660 lb. The excess lift over the balloon's material weight is termed the "free lift" and provides an ascent rate of about 1000 feet per minute.

One of the photos shows charging operations. The polyethylene balloon, a zero-pressure type, receives the helium through a plastic hose on the top. The vessel is restrained by running the top section of the folded part through a launch spool attached to the helium truck's front end.

As inflation progresses, the helium truck inches forward—toward the instrumentation package. The latter rests on a launch truck at some distance from the balloon's big bubble. In this way, more and more of the balloon is allowed to emerge safely from the launch spool and reach the free air above it.

The launch spool is equipped with explosive bolts that hold it closed. Also, a load cell or similar weighing device is attached to the spool to measure effective lift against the amount of helium drawn from the truck's storage tanks. A small pilot balloon, clearly visible in the photo, will be released just before launch to indicate wind direction at the launch site.

For the actual launch, the explosive bolts are fired, the launch spool opens, and the balloon rises—but it's not yet free. To prevent damage to the payload by being dragged over the ground, the driver of the launch truck moves his vehicle to a point where, in his estimation, the swinging balloon will arrive just as its envelope has stretched to full length. Then, if all goes well, the instrumentation package gently lifts off its cradle on the launch truck and another experiment is on its way.

Balloon Failures

Although we are accustomed to regard balloon lift in terms of Archimedes' principle—buoyancy being equal to weight of fluid displaced—it gives us little insight into the physical processes involving the lift provided by a balloon. Great stresses are brought to bear by the lift of the gas, with other stresses exerted on the envelope by the balloon's weight and the scientific payload, gondola, or other attachments. If these stresses are not carefully balanced out, the balloon tends to fail.

It was largely due to the work of Dr. Ralph Upson, then at the University of Minnesota, that progress has been made in analyzing the effects of shape on possible stress

concentrations. Typically, a high-altitude balloon faces its greatest danger not during launch, but during ascent. The lift force of the helium must be absorbed in a relatively small area of the upper part of the polyethylene film, yet over-all balloon design is based upon fully inflated conditions.

From common launch to free float, the helium expands as much as 500 times. At from 30,000 to 60,000 feet, the altitudes of typical failures, the balloon is only 5% to 15% inflated. The polyethylene envelope tends to change, as the balloon ascends through the various layers of the atmosphere, from a pliable amorphous plastic to a brittle crystalline structure susceptible to rupture.

However, various means of reinforcement are available. J. A. Winker, president of *Raven Industries* and one of America's major balloon makers, has investigated techniques of local envelope reinforcement such as the "Vista-Dome." The research balloon has a capped top whose radius roughly equals that of the initial-inflation bubble. During inflation and early flight, the polyethylene film "hangs" from this small top. Later, at service altitude and fully inflated to a spectacular and almost spherical shape, the vessel takes on the appearance of an ordinary zero-pressure balloon—except for the small dome on top which resembles the observation deck of the "Vista-Dome" railroad car.

The *Winzen Research Corporation*, another major balloon maker, has introduced new balloon materials which have passed the cold-brittleness tests at -80°C and -84°C . Thus, the temperature gradients of the atmosphere in general and the balloon-killing capacity of the tropopause in particular, have lost much of their costly sting.

Electronics for Tracking

Fig. 1 shows a typical flight train, while Fig. 2 depicts representative instrumentation systems. Principal components include the balloon, a load-coupling arrangement, the recovery parachute and the scientific payload connected to it, support equipment, and crush pads. Some vessels frequently are provided with a rip panel to permit quick gas release upon flight termination.

The determination of balloon trajectories, including over-all balloon performance at the service altitude, is of great importance in scientific ballooning. First, if we look at the balloon itself, we find it to be a rather efficient (if undesirably so) thermal machine. Solar heating causes the balloon to rise above a given reference float level, while cooling at sunset causes it to drop below the level. Some control can be exercised by allowing excess lifting gas to escape through an appendix duct or use so-called "dribbling" of ballast to make the vessel level off when over-all system density equals the density of the ambient atmosphere.

Radar can track a balloon within a radius of 50 miles. Using S-band equipment, tracking uses only the natural reflectance of the balloon because balloon-carried radar transponders are not generally employed. The balloon's natural reflectance is increased by the use of a passive corner reflector target—basically a shaped sheet of metal—that has been carried aloft. Signal reflectance may also be improved by placing metalized film on the load tapes or seams.

As for telemetry, the FM/FM type is the most straightforward approach and has found wide acceptance in many other areas of space research. Data transmitted to ground stations is generally in the form of a varying d.c. voltage, usually ranging between 0 to 5 volts. These analog voltages, provided by transducing systems in the scientific payloads, normally frequency-modulate a voltage-controlled oscillator (v.c.o.) or, if a number of data sources are involved, sequencing is accomplished by fairly traditional commutators and final transmission systems. Frequencies of the various v.c.o.'s conform to specs established by the Inter-Range Instrumentation Group (IRIC).

Ground range and slant range to the balloon can be cal-

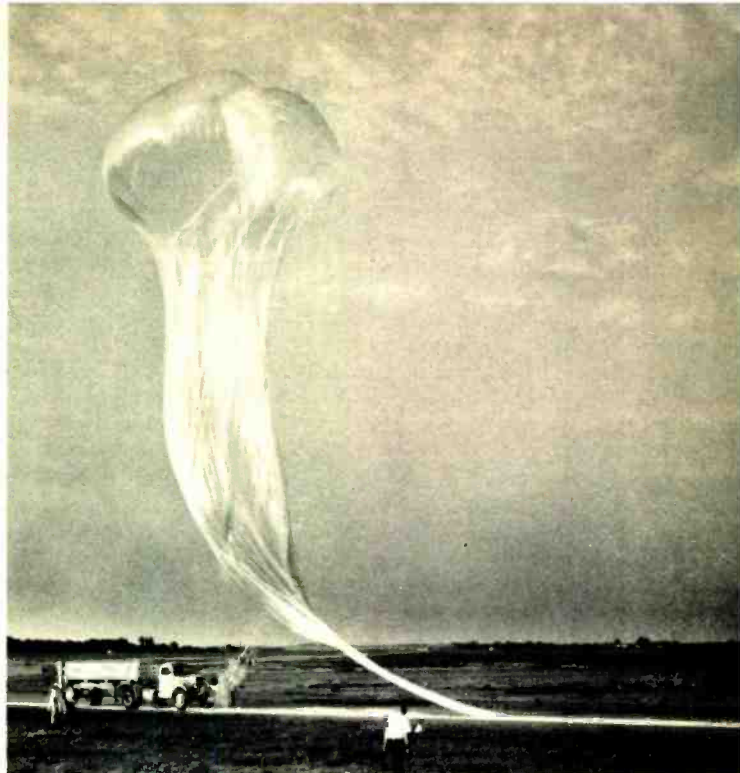

The instrumentation balloon has just been launched, after launch pool has been released by explosive bolt. The electronics payload is off the photograph at the extreme right.

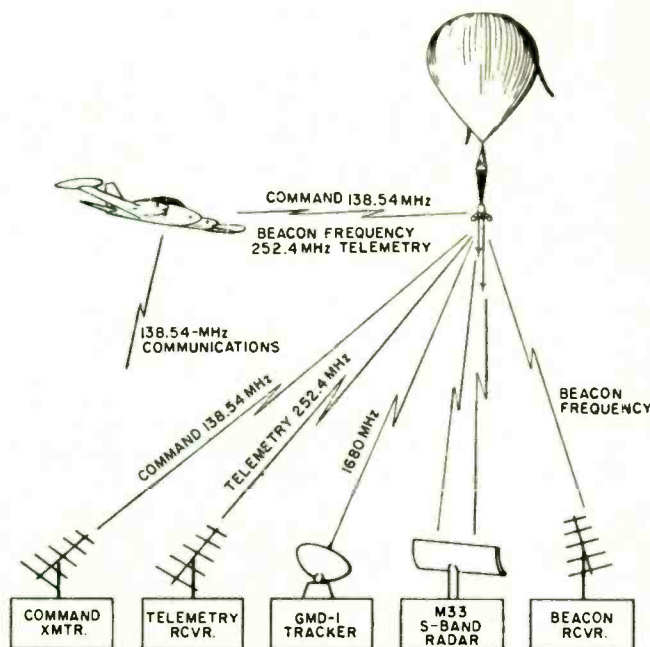

Fig. 2. Balloon instrumentation systems. Not only is the payload electronic but electronics is also used for the ground-based tracking and telemetry which keeps tabs on the flight.

culated by trigonometric methods if the altitude is known. Here the RAWIN set AN/GMD-1, a portable radio-direction finder which was designed primarily for automatic tracking of balloon-carried radiosonde transmitters, is put to use. The radiosondes operate at 1.68 GHz and transmit meteorological data in the form of amplitude or frequency modulation. On the ground, the AN/GMD-1 receiver uses a highly directional parabolic antenna, employing a spinning dipole and servo system for direction finding. Elevation and azimuth angles are measured from the antenna to the balloon with an accuracy of about $\pm 0.05^{\circ}$.

Altogether, balloon-type electronics are not overly complex and tend to follow design principles found in traditional industrial telemetering equipment. As many as twelve or more tones may be available for command functions and/or special coding may be used to ensure privacy. ▲

NOW train at home with NRI to be a Computer or Digital Technician—no other program is so complete in digital logic, computer operation and programming.

ANOTHER



FIRST

Your own digital computer included at no extra cost

This may very well be the most unique educational aid ever developed for home training—a *real* digital computer you build yourself and use to learn organization, operation, troubleshooting and programming. This remarkable training aid performs the same functions as bigger commercial computers. One of ten training kits you receive in the new NRI Complete Computer Electronics course.



NRI FIRSTS make learning Electronics fast and fascinating—give you priceless confidence

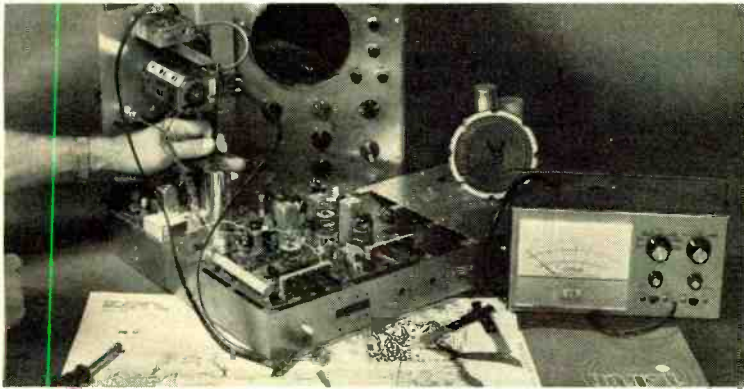

FIRST to give you Color TV training equipment engineered specifically for education—built to fit NRI instructional material, not a do-it-yourself hobby kit. The end product is a superb Color TV receiver that will give you and your family years of pleasure. You “open up and explore” the functions of each color circuit as you build.



FIRST to give you true-to-life experiences as a Communications Technician. Every fascinating step you take in NRI Communications training, including circuit analysis of your own 25-watt, phone/cw transmitter, is engineered to help you prove theory and later apply it on the job. Studio equipment operation and trouble shooting become a matter of easily remembered logic.



FIRST to give you completely specialized training kits engineered for business, industrial and military Electronics Technology. Shown is your own training center in solid-state motor control and analog computer servo-mechanisms. Telemetering circuits, solid-state multivibrators and the latest types of integrated circuits are included in your course.

There is so much to tell you about this latest “first” in home training from NRI, you must fill in and mail the postage-free card today to get the full story of the Complete Computer Electronics course and the amazing digital computer you build and use as you learn.

Planned from the start to include specially designed training equipment in the pioneering NRI tradition, this exceptional new course succeeds in combining kits with NRI “bite-sized” texts to give you an easy-to-understand educational package. But, unlike other home training, this is not a general electronics course. Lessons have been specifically written to stress computer repair. You perform a hundred experiments, you build hundreds of circuits. Included are over 50 modern, dual-in-line TTL integrated circuits you use in the construction of your computer. You use professional test equipment. In addition to your digital computer, you build and use your own solid-state voltohmmeter and oscilloscope. Because you work with your hands as well as your head, your training is as much *fun* as it is education.

Train with the leader—NRI

As it has in other fields of home-study Electronics training, NRI has taken the leadership in computer training because the “Computer Age” continues to leap ahead. Qualified men are urgently needed, not only as digital technicians and field service representatives, but also for work on data acquisition systems in such fascinating fields as telemetry, meteorology and pollution control. Office equipment and test instruments also demand the skills of the digital technician. Like other NRI courses, this exciting new program can give you the priceless confidence you seek to walk into a technician’s job and know just what to do and how to do it. Mail the postage-free card for the FREE NRI Catalog. No obligation. No salesman will call. NATIONAL RADIO INSTITUTE, Washington, D.C. 20016.

GET FACTS ABOUT GI BILL

If you have served since January 31, 1955, or are in service now, check GI line on postage-free card or in coupon.

If postcard has been used, mail this coupon



NATIONAL RADIO INSTITUTE

Washington, D.C. 20016

2-121

Please send me your FREE NRI CATALOG with details about new Complete Computer Electronics training.

Name _____ Age _____

Address _____

City _____ State _____ Zip _____

Check here for facts on GI Bill

ACCREDITED MEMBER NATIONAL HOME STUDY COUNCIL

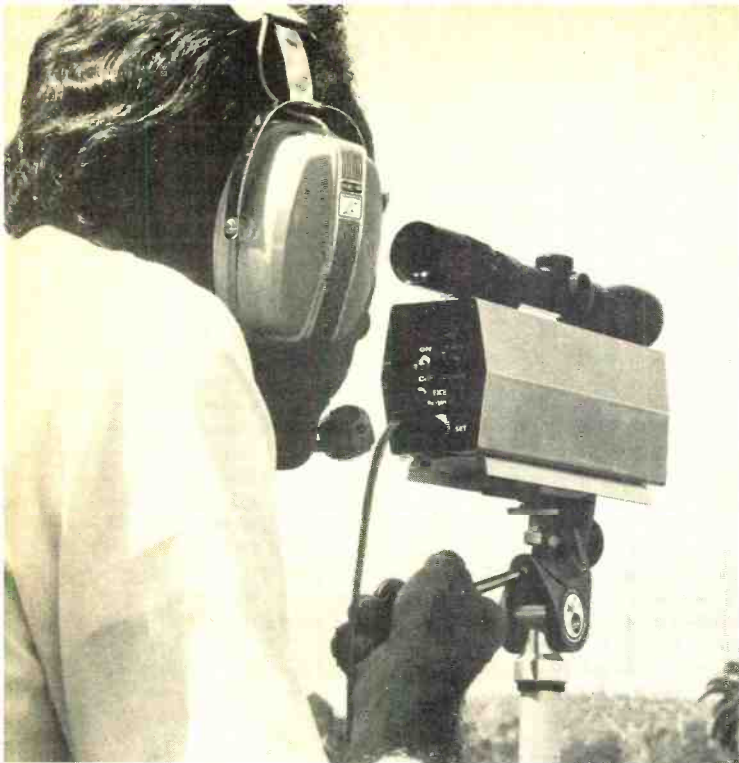

This optical communicator, which transmits and receives voice or digital information, is designed for "secure" point-to-point work.

Optical Communications with Semiconductor Light Sources

By DAVID L. HEISERMAN

With the r.f. spectrum so overcrowded, engineers are looking to light portion of the band to handle short-range optical communications links.

THE demand for additional broadband communications links is growing at an ever-increasing rate, and there seems to be no end in sight. The problem of overcrowded r.f. communications bands reached a critical point years ago; but, until very recently, the FCC and the communications industry have been at a loss for a truly satisfactory solution.

Development of the laser in the early 1960's gave communications technology the breakthrough it needed to perfect the old idea of light-beam communications. Unlike ordinary light, laser light can be multiplexed, heterodyned, beamed, demodulated, discriminated, and otherwise treated in ways quite analogous to microwave r.f. energy. But, unlike r.f. communications systems, optical communications links (OCL's) cannot interfere with one another under ordinary circumstances, and they are totally immune to both man-made and natural r.f. interference. What's more, OCL's cannot interfere with existing r.f. communications links.

The extraordinarily high frequency of a laser-beam "carrier" lends itself quite naturally to high-capacity broadband communications. A single laser beam carrier, for instance, can handle several conventional TV channels, three or four

streams of high-speed digital data, some Picturephone signals, and hundreds of voice-grade channels—all with room to spare. Even the relatively incoherent infrared light from inexpensive light-emitting diodes (LED's) can carry several channels of TV information and computer data on a single beam.

Optical communications, then, seems to be the ideal solution to the problem of r.f. communications overcrowding. However, optical communications is still in its infancy and few companies can boast of an inventory of finished OC instruments. Dozens of companies have developmental or prototype models in operation and information from the R&D labs indicates that OCL's will be taking over a significant portion of the r.f. communications overload by the mid-1970's.

At the present time, developmental work in optical communications falls into two distinct categories: (1) versatile short-range systems using laser diodes or LED's as light sources, and (2) long-range, high-performance systems using conventional gas or solid-state laser sources. Devices in the first category will eventually take over jobs now handled by radio transceivers and short-haul cables and r.f. links. The bigger communicators will handle long-haul, high-capacity tasks now performed by a wide variety of commercial, private, military, and government communications systems.

Single-Channel LED Communicators

An LED emits light energy whenever current flows in a forward direction through its *p-n* junction and the amount of light output is roughly proportional to the amount of forward-biasing current. Most LED's, those made from silicon-doped gallium-arsenide, emit a peak of 100 milliwatts of light energy in the infrared portion of the light spectrum. Although LED light lacks the coherence of laser light, it is quite pure compared to ordinary incandescent light—a typical infrared-emitting LED has a spectral band-

ELECTRONICS WORLD

Fig. 1. Block diagram of an experimental LED optical transceiver. Devices such as this promise to become quite popular among electronics and science experimenters in future.

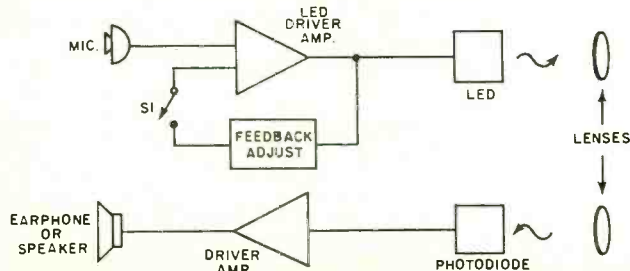

width of only 200 angstroms between half-power points. A fast response time, on the order of 10 nanoseconds, also helps make LED's ideal sources of light for short-range, intensity-modulated voice and data communicators.

LED modulator circuits are so simple and reliable that electronics buffs are beginning to have a field day designing and building short-range LED voice communicators. Used with a set of 1-inch lenses or small telescopes, a LED transceiver can operate over a range of about 250 feet in broad daylight and ten times that far on a clear night. Not counting the optics, the parts for an experimenter's intensity-modulated LED transceiver runs between \$15 and \$25.

Fig. 1 is a block diagram of an experimenter's LED transceiver. Low-level audio signals from the microphone go through a current amplifier circuit that serves as a LED driver. Since the amount of light energy from the LED is very nearly proportional to the amount of forward-biasing current flowing through it, audio signals from the driver intensity-modulate the output light energy. A lens following the LED focuses the light into a narrow beam, thus increasing the effective transmission range.

Closing S1 completes a positive feedback loop around the LED driver amplifier. The feedback-adjust circuit contains RC components that let the amplifier oscillate at some fixed audio frequency—generally around 1 kHz. These oscillations modulate the LED output and provide a convenient audio signal for aligning the transmitter with a remote receiver unit. Once the operators make the initial alignment, opening S1 stops the alignment tone.

A clever circuit designer will bias the LED and driver amplifier just a bit below cut-off. Although this trick introduces some audio distortion, it buys the user two advantages: (1) the transmitter, in effect, will be voice activated and (2) it makes it possible to increase the LED's peak output power. When there is no signal from the microphone the LED and driver amplifier consume virtually no power, making it practical to leave the transmitter in a standby mode at all times. Class-B current pulses from the LED driver also allow the user to operate the LED in its pulse mode and thus increase the peak output power.

The lens in the receiver section gathers in light signals from a remote transmitter and focuses the energy onto a photodiode. The incoming light signals modulate the photodiode's current, and a current amplifier boosts the signal level to drive an earphone or loudspeaker. Slight cut-off bias on the photodiode and amplifier can also make the receiver into a signal-activated device.

By using the infrared portion of the light spectrum, LED communicators are relatively insensitive to most kinds of ambient light. Sunlight, unfortunately, contains a great deal of infrared energy that tends to saturate the photodiode. An external sensitivity control lets the operator adjust the cut-off bias on the photodiode and thus cancel out the effects of stray infrared energy when operating the system in broad daylight.

Isolating the receiver circuit from the transmitter circuits eliminates the need for a send/receive switch. Optical isolation is much easier to achieve than r.f. circuit isolation—the designer merely takes reasonable care to make sure no light from the LED can reach the nearby photodiode.

One of the essential features of the simple LED transceiver just described is that it modulates the light source directly and does not rely upon some separate modulation device such as a vibrating mirror or voltage-sensitive optical filter. Directly modulated light sources, in fact, represent one of the greatest advantages semiconductor light sources have over conventional gas or solid-state laser sources.

In principle at least, just about every feature of the experimenter's transceiver carries over to high-performance LED optical communicators. The high-performance communicators might use better optical systems, higher quality

Substrate Material	Operating Temperature (°K)	Output Wavelength (Angstroms)	Efficiency (%)	Typical Rise Time
Laser Diodes				
GaAs	77	8400	40 (c.w.)	1 ns
GaAs	300	9000	25 (pulsed)	up to 500 ns
LED'S				
Si doped GaAs	300	9000	3	100 ns
Zn doped GaAs	300	9000	1	10 ns
GaAsP	300	6300-9000	1	100 ns
GaP	300	7500 6500	2 0.05	100 ns up to 1 μs
GaAlAs	300	7300 6450	2 0.1	200 ns up to 1 μs
SiC	300	5800	0.001	up to 1 μs

Laser diode and LED specs related to optical communications.

LED's and photodiodes, some schemes to get more power out of the source, and extra circuitry such as a.g.c. and noise controls; but the basic principles are the same for a hobby LED transceiver as for a six-mile LED data link. Even the process of multiplexing a number of wideband channels onto an LED beam is often more a matter of adding out-board electronics than making any significant changes in the basic modulator and detector schemes.

Multiplexed LED Communicators

The real advantages of optical communications come into play only when users take advantage of the extraordinarily high information capacity of coherent or near-coherent light. Although short-range, single-channel voice or data LED communicators may become quite popular within the next few years, the real R&D efforts are going into high-quality, multi-channel versions. Right now, three kinds of multiplexing schemes are getting the attention of leading R&D labs: frequency, time-division, and spatial multiplexing.

The most promising frequency-multiplexing scheme uses purely electronic techniques to generate and modulate an electrical subcarrier for each information channel. The subcarrier modulation may be AM, FM, or a combination of the two. See Fig. 2. An electronic multiplexer circuit brings all the channels together while a set of electronic filters minimizes any subcarrier crosstalk. Only after going through all the multiplexing and filtering processes do the signals go to a broadband LED driver and to the LED itself.

In theory, the only factors that limit the information-handling capacity of this frequency-multiplexed LED communications system are the bandwidths of the individual channels and the purity of the light source. In practice, however, the limitations are due more to a lack of electronic devices and know-how needed to take full advantage of a 30,000-GHz carrier.

These frequency-multiplexed LED communicators are among the most popular OC devices in use today. A group of researchers at the University of Colorado, for example, has developed a frequency-multiplexed LED communicator now used by a CATV firm to carry TV signals from a mountain-top microwave antenna to a city in the valley below. The system has a range of six miles and it completely eliminates the need for stringing cables down the rugged mountainside. This particular system, by the way, has worked 99.9% of the time (the 0.1% loss of communications was due to an exceptionally heavy snowstorm).

Fig. 2. Block diagram of an "n"-channel type frequency-multiplexed LED transmitter.

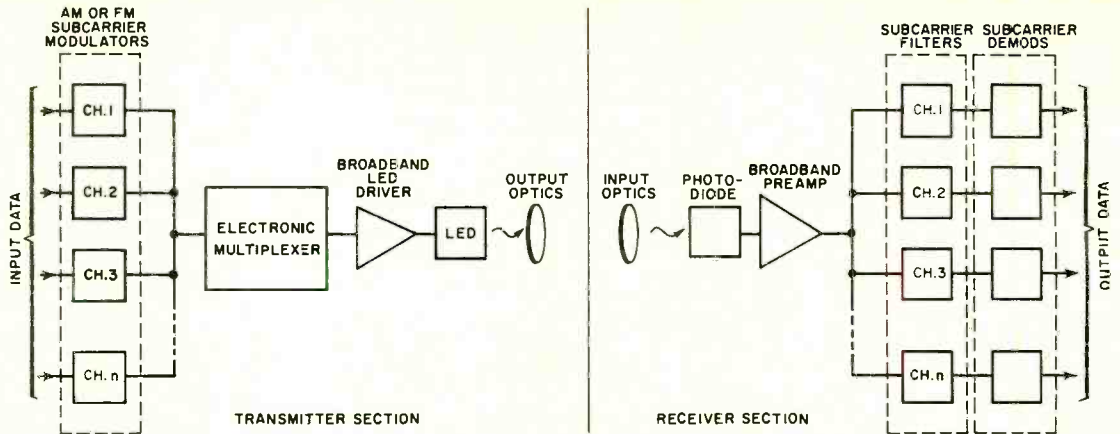

A second kind of LED frequency-multiplexing scheme, often called color multiplexing, uses a separate LED for each channel of information. By using a selection of LED's that have slightly different spectral outputs, it is possible to intensity-modulate each LED and combine the outputs into a single, multi-color beam. A set of photodiodes, each spectrally matched to one of the LED's, separates the channels at the receiver end of the communications link.

Color multiplexing eliminates the need for elaborate electronic frequency-multiplexing circuitry, but the scheme suffers from one big disadvantage: LED's using silicon or gallium-arsenide have a preference for operating in the 9000-angstrom range. LED's doped to operate in the 8000 to 6000-angstrom (visible red and yellow) range have substantially lower outputs than the typical infrared version. Future LED developments may solve this problem; but until that time arrives, color multiplexing will be restricted to very-short-range optical coupling applications—sending 6 or 8 channels of computer data across a room, for example.

With a typical digital capacity of 50 megabits per second, LED communicators show great promise in time-division multiplexing. Since time-multiplexed LED communicators can handle hundreds of computer data channels simultaneously, all the major computer firms hope to begin supplying LED links for local time-sharing traffic. Compared to the voice-grade telephone lines that carry most time-sharing traffic today, the data capacity of a single LED link is virtually limitless. LED links will not only make it easier to connect more teletypewriter terminals to a computer facility, but will make high-capacity operations, such as interactive graphics, more feasible than they are at present.

Right now, spatial multiplexing is the least versatile of the three LED multiplexing schemes. Spatially multiplexed LED communicators use one LED for each data channel; but unlike the color multiplexing operation, LED's in the spatial scheme may have the same output wavelengths. The trick is to keep the light beams separated from one another so that they fall onto an array of receiver photodiodes in a one-for-one pattern. This is no small trick, considering LED light is only quasi-coherent and thus has a tendency to "smear" as it moves through space.

One way to keep the beams from becoming hopelessly scrambled in transit is to run them through sets of collimating lenses spaced at regular intervals along the transmission path. A more effective technique is to couple each LED to the proper photodiode through fiber optics. Since the frequency and time-division multiplexing schemes do not require any kind of optical manipulation along the transmission path, spatially multiplexed LED communicators are pretty much out of the running in most OCL applications. Their only real promise appears to be in across-the-room types of applications.

Laser diodes, or injection lasers, produce coherent light

when forward biased with a current that exceeds a lasing threshold of about 2 amperes. Laser diodes can also produce up to 4 watts of output power with efficiencies on the order of 40%. Unfortunately, the optimum operating temperature for laser diodes is about 77°K (room temperature is 300°K). Operating a laser diode at room temperature degrades its performance to a point where it can barely compete with an inexpensive LED.

Laser diodes must be operated in a pulse mode at room temperature. State-of-the-art laser diodes have minimum pulse response times in the neighborhood of 0.1 microsecond and duty factors of less than 1%. Thus, the peak operating frequency is around 100 kHz. It is possible to achieve higher pulse repetition rates, but the duty factor then limits the power output to a fraction of a watt.

The only feasible kinds of direct modulation for a laser-diode communicator are those that use pulse-modulation techniques—pulse-frequency or pulse-displacement modulation, for example. Even then, the extremely low repetition rates limit the information capacity to one or two voice-grade channels or a single 50-kilobit-per-second data channel.

In spite of these severe limitations upon their information capacity, single-channel laser-diode communicators manage to hold their own in the industrial and military marketplace. The real advantage of laser-diode communicators is that the coherence and high power outputs make it possible to reach ranges on the order of 10 miles without resorting to large-aperture optics. The signal-to-noise ratio for laser-diode communicators is much greater than that possible with LED versions.

The Santa Barbara Research Center, a subsidiary of *Hughes Aircraft*, now markets a laser-diode transceiver designed to carry a single channel of PFM voice or digital data. The transmitter drives the laser diode with 100-ns pulses that are frequency-modulated around a 6-kHz carrier. Using only 1-inch lenses and constructed in a binocular arrangement, the system's peak power output of 2 watts gives these communicators an operating range of 6 miles.

Compared to conventional gas or solid-state laser sources, semiconductor light sources are more rugged, smaller, cheaper, and easier to modulate and require much lower operating voltages. These features make semiconductor OCL equipment especially suited as portable communicators or short-haul optical links that require little routine maintenance.

On the negative side of the ledger, the semiconductor sources have much lower output capabilities than conventional lasers. In outer space where the line-of-sight range is limitless, OCL's using high-power conventional laser sources can have operating ranges measured in thousands of miles. Although OCL's established around conventional laser sources are elaborate and expensive affairs, their long-haul capability justifies their existence. ▲

The use of a unijunction transistor with a v.t.v.m. or scope permits accurate visualization of the circuit time constant.

By RICHARD M. CARTOSCELLI

RC Time Constants in UJT Circuits

OFTEN it is very difficult to learn the correlation between RC time constants and sawtooth waveforms. The advent of the unijunction transistor (UJT) has changed this entirely. The UJT will permit visualization of an extremely slow time constant with a v.t.v.m. (or solid-state v.o.m.), or a very rapid one with the oscilloscope.

A conventional circuit which has been used as a sawtooth wave generator is shown in Fig. 1A. By making either R or C larger or smaller, the charge time of the capacitor can be increased or decreased, respectively. What results is a rapid or slow blinking interval of the NE-2 neon lamp. The operation of the circuit is quite simple. The capacitor charges exponentially until the firing voltage of the NE-2 is reached. Once the NE-2 has come on, it appears as a short circuit across the capacitor, thus discharging it instantaneously. The charging again repeats itself. Either a scope or v.t.v.m. can be placed across the capacitor to monitor the exponential voltage rise or sawtooth waveform.

The main drawback to the circuit of Fig. 1A is the high d.c. voltage required. The NE-2 has a firing potential of nearly 90 volts d.c. Additionally, the circuit does not lend itself to many experimental uses. On the other hand, the UJT circuit to be described and depicted in Fig. 1B permits several sophisticated techniques which can be integrated as a part of mathematical time-constant computations.

The operation of the circuit in Fig. 1B is as follows: Capacitor C charges exponentially through resistor R until the peak firing potential of the UJT is reached. At this point the base-1 resistance of the UJT approaches zero and C discharges nearly instantaneously through the UJT and R_{B1} . Once C has discharged, the UJT's peak firing potential is no longer present and the UJT's base-1 resistance returns to its normal value. Thus what exists across capacitor C is an exponential sawtooth waveform. The values of C and R in Fig. 1B permit either a "slow sawtooth," capable of being observed with a v.t.v.m., or a high-frequency sawtooth which can be monitored with an oscilloscope.

To initially orient readers to the exponential properties of charging time, a "slow sawtooth" is used. Values of R and C in the UJT circuit are 270 k ohms and 20 μ F. Monitoring the voltage-rise across C with a v.t.v.m. reveals in initial fast movement of the meter's needle followed by a constantly reducing movement speed. This continues until the UJT's V_p is reached, whereupon the meter's needle drops instantaneously toward zero. However, the capacitor discharge time is so rapid that the initial part of the next sawtooth appears again, and the mechanical travel time of the meter's needle is not capable of keeping pace. What virtually results is the meter's needle returning to approximately half-way between zero and the V_p that was reached.

For a "fast sawtooth," values of C and R in the UJT circuit are reduced to 0.2 μ F and 10k ohms, respectively. If a common 5 or 10 percent tolerance resistor is used, a careful measurement of its value should be made and recorded. The same is true for the value of capacitor C.

Once the circuit is set up into operation, a careful measurement of the time for one sawtooth is taken with an oscilloscope and recorded. Next the instantaneous voltage across C is calculated by the exponential formula:

$$e = E_{\max}(1 - e^{-t/RC})$$

where: $E_{\max} = V_{BB}$, 10 volts; t = time of one sawtooth, seconds; R = actual value of R, ohms; and C = actual value of C,

farads. A careful check should be made to determine if the V_{BB} is set as closely as possible to 10.0 volts.

The actual intrinsic standoff ratio (η) of the particular UJT being used must be determined. This can easily be done with the experimental circuit shown in Fig. 2 and the procedure that follows. The Cal button is depressed and R3 is adjusted to make the meter read full-scale. The Cal button is then released and the value of η is read directly from the meter (1.0 full scale). The η for the recommended 2N4891 UJT will be somewhere between 0.55 and 0.82.

The next calculation involves the peak firing potential of the UJT. The formula used is:

$$V_p = V_{BB}\eta + V_F$$

where: $V_{BB} = 10.0$ volts; η = intrinsic standoff ratio of particular UJT being used; and $V_F = 0.56$ volt at 25°C.

Following these calculations, the peak potential of the sawtooth wave is measured. The measurement is then compared with the two calculations. If the V_{BB} has been accurately set to 10.0 volts and the UJT's η was precisely measured, the calculation involved to find V_p can stand as a point of reference. If both calculations and the measured value of the sawtooth check within 0.2 volt, the oscilloscope can be considered accurately calibrated on both horizontal and vertical inputs. In the event the measured the calculated values do not check, further calculations can be made to determine which scope axis is in need of calibration.

The time of one sawtooth is calculated by the following formula where t is solved for:

$$e = E_{\max}(1 - e^{-t/RC})$$

where: $e = V_p$, in volts ($V_p = V_{BB}\eta + V_F$); $E_{\max} = 10.0$ volts; R = actual value of R, ohms; and C = actual value of C, farads. The time derived should agree with the measured time of one sawtooth. If the V_p measured does not agree with the value calculated by $V_p = V_{BB}\eta + V_F$, the vertical calibration is not correct. ▲

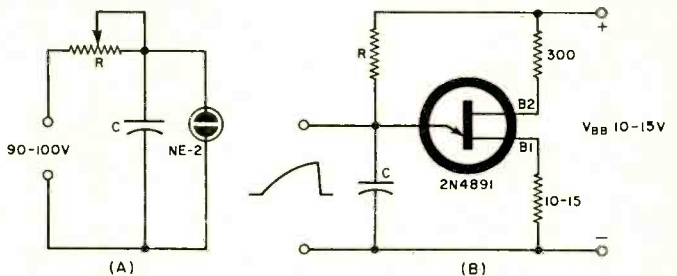

Fig. 1. (A) Neon-lamp and (B) UJT sawtooth generators.

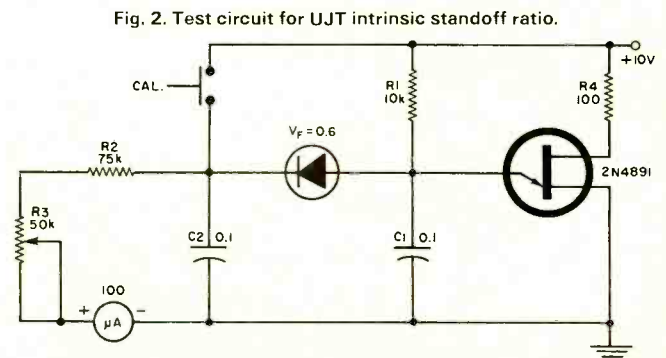

Fig. 2. Test circuit for UJT intrinsic standoff ratio.

The "Pipe" Speaker System

Designed for use with electronic organs and similar instruments, this system is low in cost and easy to assemble.

By CAPT. J. ROY SMITH, USNR/Director of Eng. Defense Electronics Supply Center, Dayton, Ohio

The "pipe" speaker system installed in corner behind author's Schober organ.



THIS pipe-speaker system is one designed specifically for electronic organs and similar musical instruments. In appearance its array of vertical pipes resembles a section of a pipe organ. The sound it produces is unique and the somewhat "hollow" nature (reverberation) of the tones it produces in the mid- and upper ranges is ideal for music but not speech.

The system is easy to build and requires no acoustic tuning to match the speaker. Anyone with fair mechanical skill, a sabre saw, framing square, screwdriver, and glue pot can build it. The only lumber needed is a single 4' x 8' sheet of 3/4" AD plywood. Three-inch i.d. plastic downspout can be used for the pipes. The only absolute requirement is that the speaker selected must be one designed for use with musical instruments. Although plentiful and inexpensive, hi-fi speakers cannot be used in this application.

The cost is reasonable too. At typical prices, the system will range from \$36 to \$52, depending on the speaker.

Design Theory

The enclosure is a combination of an infinite baffle, or closed box, and a horn consisting of a matrix of tuned pipes.

Fig. 1. Ideal arrangement of pipe cluster over speaker opening.

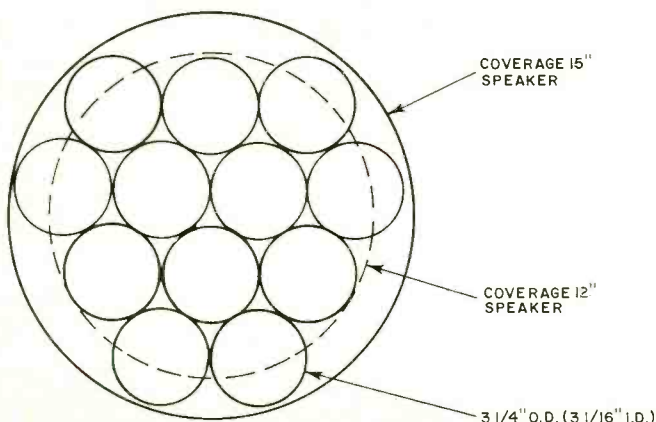

There is no back-of-the-cone radiation, so that the air in back of the cone compresses and acts as a spring on the cone. Ordinary infinite baffles reproduce bass tones poorly due to rapid low-frequency-response roll-off. This system, because of its low resonant frequency, has superior bass.

The twelve open-ended 3-inch i.d. pipes forming the upper half of the enclosure are resonant to the octave just below middle-C. What gives this enclosure its unique superiority is the fact that the effective cross-sectional area of all twelve pipes, and their mean length, are equivalent to a single large pipe which resonates with the cavity of the box at the frequency of the lowest pedal tone (32.9 Hz) of the electronic organ.

Of course, a properly tuned bass-reflex speaker system will produce a prominent boost at low-frequency resonance, but this system is almost as good at the pedal tones and has definite advantages at all other frequencies. It adds special character to the usual organ left-hand accompaniment voices, enhances all other tones, presents a distributed nature to all organ sounds, and has greater efficiency (probably resulting from the musical instrument speaker).

The Speaker

The speaker must be one made specifically for musical instruments. A 15-inch, 100-watt speaker with a magnet of at least 2½ pounds (such as *Allied Radio Shack* catalogue No. 40-1315, \$29.95) is recommended. With a powerful, heavy-duty music speaker, there is no perceptible intermodulation of tones. You don't hear the pedal tones cause a fluttering of other tones. However, you can use a 12-inch musical-instrument speaker with reasonable results, but it requires an additional speaker mounting panel. On the other hand, the 15-inch speaker is well worth its additional \$16 cost.

The brand name of the speaker is not important; in fact it must not be an expensive hi-fi type. What is important is that the free-air cone resonance be as low in frequency as possible. The 15-inch speaker used resonated at 48 Hz in free air and the 12 inch at 57 Hz, although they were listed at 45 and 50 Hz, respectively.

Do not use a speaker intended for bass-reflex enclosures. At first, a 12-inch woofer with a 30-Hz free-air cone resonance was used. The results were so disappointing that this project was almost abandoned until it was discovered that the speaker's impedance at resonance, in the enclosure, was so high that almost no acoustic power could be developed at the lower pedal frequencies. Even excessive sound-absorbing packing in the enclosure would not lower the impedance enough to fully develop the low tones. Only when the woofer was actually installed in a matched bass-reflex enclosure did it produce the excellent pedal tones that we were looking for.

If the tone character of your organ has frequency components above 10,000 Hz, the addition of a horn tweeter is recommended. The *Schober* Theater Organ produces overtones above 14,000 Hz, generating realistic reed and string tones. An *Allied Radio Shack* horn tweeter (Catalogue No. 4C-1228) with its own crossover network will work well. The horn may be placed either within the enclosure or externally (it needs no baffle).

The Enclosure

The most important consideration in the design of the enclosure is its volume, specifically 5.7 cubic feet. Although some designers may argue the point, shape is not at all critical. For example, one box using the 1:1.4:2 ratio yielded no better results than a corner or diagonally cut cube. The corner box was best for the author's installation because its triangular shape fitted neatly in the corner of the room, just behind the organ. Placing the speaker in the corner has the advantage of coupling the sound to the room, thus distributing sound from a larger area.

Before determining the dimensions of your enclosure, add to the 5.7-cu ft volume the space taken by the magnet assembly and metal parts of the speaker, plus any special bracing and tweeter (if placed within the enclosure). For the speakers used in this enclosure, 0.12 cubic foot was added, making the total volume 5.82 cubic feet.

Once you have decided on the shape and dimensions of your enclosure, be certain that you can cut all the pieces from a single 4'x8' sheet of 3/4-inch AD plywood. You may need to change some dimensions to do this. As long as you maintain the desired volume, the dimensions may be changed to fit the sheet of plywood. After sawing, the cut surfaces should be sanded to ensure a snug joint. Good glueing of mating surfaces is important and wood screws should be placed about 6 to 7 inches apart. Screws should be #10 flat head, 1 1/2 or 1 3/4 inches in length. Holes should be drilled large enough to pass the body of the screw and should then be countersunk for the screw heads. Special drill bits are available that will do this in a single operation. Do not glue on the top panel as you will need to remove it many times.

The interior surfaces should be lined with sound-absorb-

NOTE	PITCH (Hz)	PIPE LENGTH (in)
C ₄ (middle-C)	261.6	
B ₃	246.9	26 7/8
A ₃ [#]	233.1	28 1/8
A ₃	220.0	30
G ₃ [#]	207.7	31 3/4
G ₃	196.0	34
F ₃ [#]	185.0	36
F ₃	174.6	38
E ₃	164.8	40 1/8
D ₃ [#]	155.6	42 3/4
D ₃	146.8	45
C ₃ [#]	138.6	48
C ₃	130.8	50 5/8

Table 1. Lengths of the "pipes" cut from plastic downspouting.

ing material to reduce resonances. Polyfoam or fiberglass are excellent for this purpose.

If you install a tweeter within the box be sure to seal its egress with a gasket and cement so there is no loss of compression from the big speaker. Also, the tweeter must be acoustically isolated from the box cavity. A horn tweeter is effectively isolated by its case but a cone tweeter would need an isolation box behind it.

Install furniture glides on the bottom of the enclosure to keep it from scratching the floor. The enclosure is heavy.

When completed, the enclosure may be painted or antiqued or covered with Contact paper or prefinished thin plywood glued to the exterior surfaces.

Pipe Assembly

The pipes are cut from four 10-foot lengths of 3-inch i.d. plastic downspout, 1/8-inch wall thickness. This pipe is available in many hobby shops and through mail-order houses such as *Montgomery Ward*. Cut the pipes to the lengths indicated in Table 1. The placement of a pipe for one note in relation to another is not critical; the arrangement need only be aesthetically pleasing.

The pipes are mounted in the enclosure's top panel and should be clustered to cover the smallest possible area. Fig. 1 shows the recommended pattern; any other pattern would increase the difficulty in coupling to the speaker.

Fig. 2. Impedance vs frequency for 15" speaker.

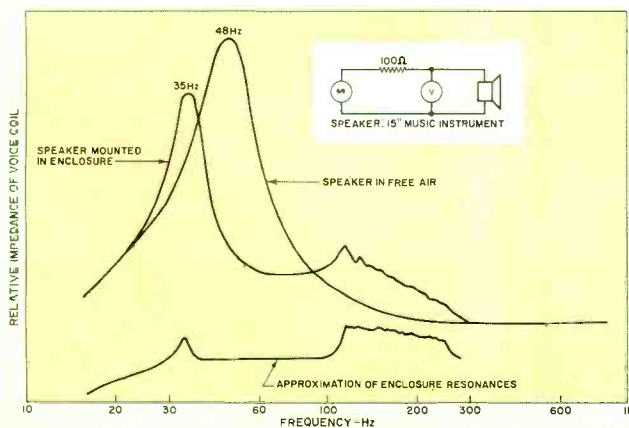
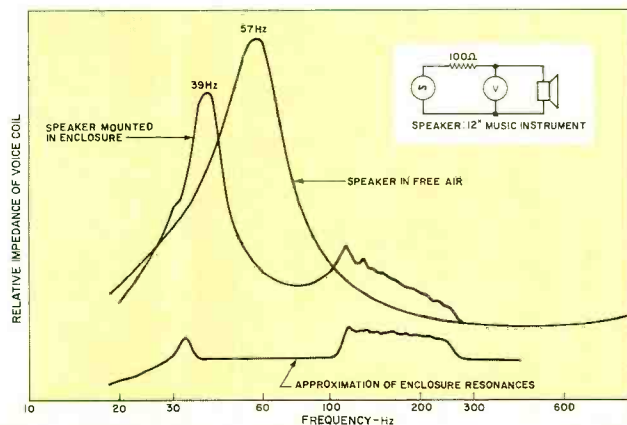
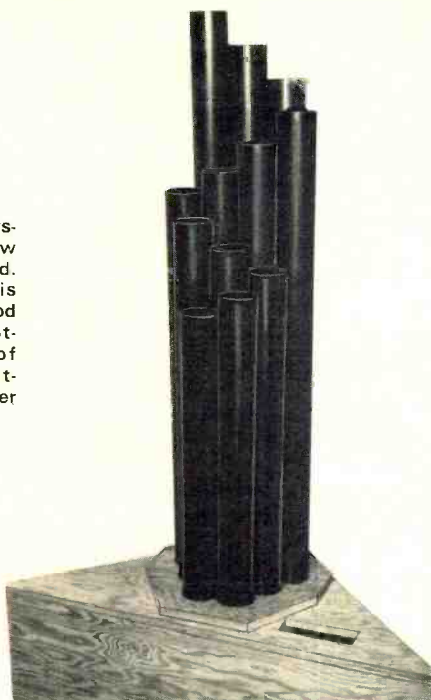

Fig. 3. Impedance vs frequency for 12" speaker.



Close-up view of system showing how pipes are installed. The slot at right is for tweeter. Plywood escutcheon at bottom of cluster of pipes may be omitted if desired. Refer to article.



Mark the top panel around the pipes with pencil. Cut the outlined hole just inside the mark to make a slightly smaller hole for a snug fit. The holes may be enlarged later, if necessary, by means of a wood rasp or coarse sandpaper. The outer pipes of the cluster should be secured to the panel by means of 1/2-inch wood or sheet-metal screws.

With the outer pipes held by screws, use a framing square to align the pipes perpendicularly. The three inner pipes can be secured to the outer pipes with sheet-metal screws, placed out of sight, about an inch below the top. All pipes may be secured to each other in a like manner. When the pipes are in place and perpendicular to the top panel, any large gaps between the plywood panel and the pipes should be filled with plastic wood. A fillet of Duco household cement should be placed around the pipes at the enclosure top panel. A fillet of cement between the pipes at the top end will make the assembly more rigid.

When the plastic wood and cement have hardened, turn the pipe assembly on its side and fill the triangular void between the pipes only at the panel end. One technique is to push a wad of cotton into the void leaving about a quarter inch from the panel end. Then coat the cotton with cement. When it has hardened, fill the remaining void with plastic wood flush with the panel. There should be no air leaks between the panel and pipes as these may generate whistling sounds. There should be no projections below the bottom surface of the panel. This surface must be flat to avoid interference with the movement of the speaker cone.

If your speaker is 15 inches in diameter, it should be at-

Fig. 4. Speaker switching circuits to enable use of the organ's internal speaker (s), "pipe" speaker system, or both together.

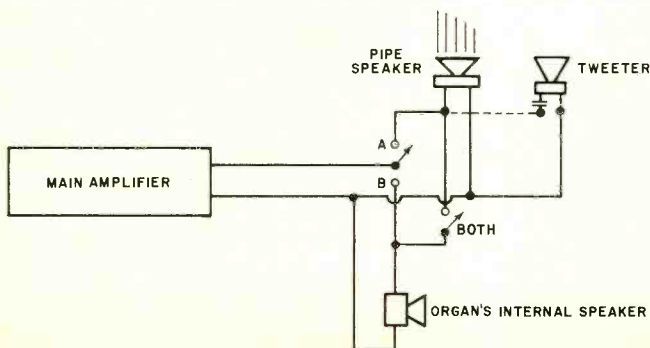

tached to the bottom of the top panel, centered over the lower pipe ends. If you are using a 12-inch speaker you will need a separate plywood adapter panel. Make certain that the panel is large enough to cover all pipes and has a 10 1/2-inch diameter opening for the 12-inch speaker.

Frequency Response

The frequency response is excellent from the lowest pedal tone up into the highest organ notes. There is a slight boost in response at 32 Hz and at each of the fundamental tones of the tuned pipes. Open pipes (both ends open) have the characteristic of enhancing (and not attenuating) all harmonics throughout the audible range.

For most electronic organs the single bass speaker will reproduce all tones generated without a high-frequency speaker. However, if you have a hi-fi organ like the *Schober*, then you will want to add a tweeter to reproduce the crispness of those authentic pipe-like tones.

Plots of relative voice-coil impedance vs frequency for free-air cone resonance and for the speaker installed in the enclosure for the 15-inch and 12-inch speakers used are shown in Figs. 2 and 3. The plotted data was obtained using commercial laboratory instruments. Suitable instruments for measuring the sound-level response were not available to the author.

A few points should be made about the power amplifier that drives the speaker. The amplifier should have a low output impedance, which is accomplished by a high level of negative feedback. If the source impedance to the speaker is relatively high, some loss of acoustic power may be observed at the system resonances. This is similar to the problem (but much less severe) described when using the bass-reflex-type woofer. Should you encounter this problem and it is too difficult to increase the amplifier's negative feedback, you might try paralleling the speaker with any other speakers in your instrument. As a last resort, you could lower the combined impedance by paralleling the voice coil with a 10-ohm resistor. This is least desirable because it wastes audio power.

Where and how the pipe-speaker system is connected depends on whether the organ has a single power amplifier or several. It should be used on the main amplifier instead of the main speaker or in conjunction with it. Obviously, one would not use this speaker in place of a Leslie or doppler speaker.

To prevent accidental unloading of the amplifier, it is desirable to use a switching circuit for the pipe speaker and for the organ's internal speaker, as shown in Fig. 4. This allows the organist to choose either speaker, or both. Furthermore, the pipe-speaker could be located at the opposite end of the room, which is more desirable. Placing speakers as far as possible from the organ enhances the sound.

If your organ has a separate amplifier and speaker for the pedal circuit alone, it would be foolish to waste the high-frequency capability of this pipe-speaker on the pedal channel only. If you wanted to use an external speaker strictly for pedals, a properly tuned bass-reflex enclosure would be the choice.

The pipe-speaker is a worthy addition to any organ system. It adds a new enjoyment to playing the organ; even at full blast, it will handle all the power the instrument can generate.

Try this system, using your most dynamic recorded organ music. If you have a good record player and an equally good high-fidelity amplifier, those deep pedal tones will really shake your bones. Furthermore, those crisp highs will please you.

The idea for this speaker came from Keith E. Geren and the dimensions of the pipes from John Mathy (both of San Diego, Calif.). They built several speakers using paper mailing tubes for pipes with a smaller, different type of enclosure.

Fig. 1. Typical Skinner training box. Feeding and cueing mechanism are housed in one side of the box while the bird lives on the other side. White noise masks out environmental disturbances. Lights are used in various ways to give cues.

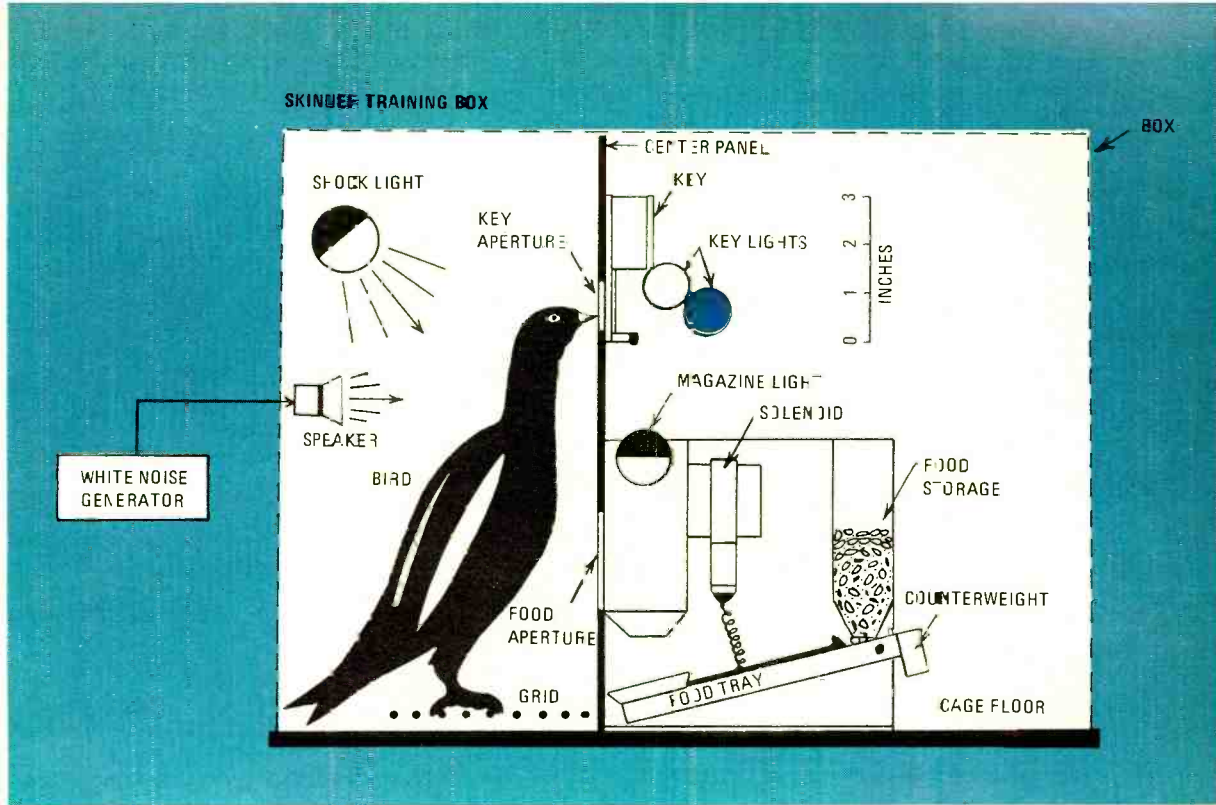

Animal Guidance Systems

By L. GEORGE LAWRENCE

Training cats to pilot air-to-air missiles? This is no "sci-fi" dream but is under active investigation as a means of delivering nuclear weapons via a jam-proof system which is almost impossible to detect.

In a relatively short period of time, electronics-based weapons and their delivery systems have assumed a formidable role in the defense apparatus of the great powers. Now *Rand Corporation's "Soviet Cybernetics Review"* has reported an odd variation: Russian technologists, says *Rand*, are studying the feasibility of training cats to pilot air-to-air missiles right to their targets!

Although such possibilities are acknowledged both here and abroad, their application to armed conflict is startling. Provided that suitable instruments, including support electronics, are available, small animals can be trained to execute near-perfect control of production equipment and non-jammable guidance of weapons. But such duties, alien as they are, also pose the ethical question of our right to convert a lower creature into an ill-paid laborer or unwitting hero. Unfortunately, in times to come, the question of human survival might preclude

a more compassionate alternative.

Skinner Methods

Almost any sentient creature can be trained in the Skinner box, diagrammed in Fig. 1. A typical unit consists of two chambers, one of which constitutes the actual training area (for a pigeon, in this case) and the other containing the various control, cue, and feed mechanisms for reinforcing the animal's "lecture." This arrangement was developed by behavioral psychologist Dr. B. F. Skinner, an outstanding authority on human and animal learning processes.

To make our living example, the pigeon, suitable for training, it is first fed a minimal diet until its weight is reduced by 20 percent. It is then put into the training box where an ample supply of water is always available.

Training begins by flashing one of the two key lights behind the key aperture. Now, after a time, the pigeon will

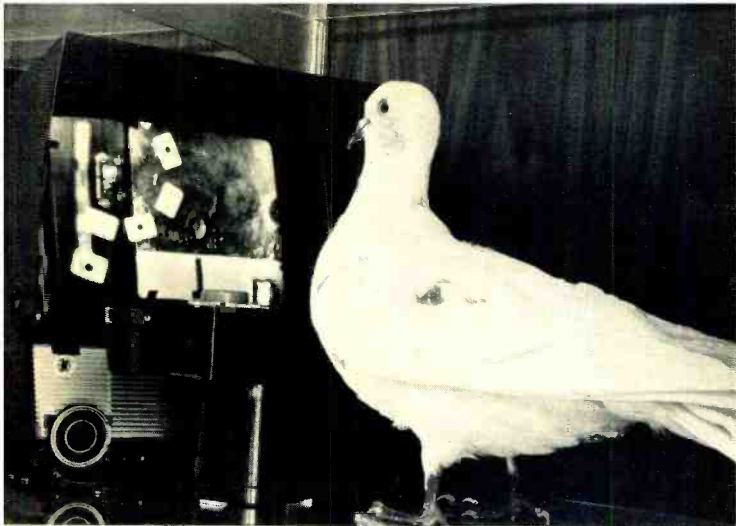

Fig. 2. Training station using TV-type display methods. Optical images are picked up and superimposed by TV camera which scans prepared pictures and cues; then bird reacts.

peck the key (a Microswitch), thereby activating the solenoid which pulls up the food tray to the simultaneously lighted food aperture. Thus, the animal learns to associate light of a given color with pecking and a consequent reward—food.

Once these initial steps have been learned, the Skinner box can be programmed—either manually or by computer—for the execution of more complex tasks. For example, the pigeon can be taught to peck only when the light is red or to expect to be fed only *after* it has made two or more bodily turns in the cage, etc.

As the training situation becomes more complex, the animal becomes aware of incidental cues—such as the ticking of clocks, external noises, and the like. Here, the internal volume of the Skinner box can be acoustically neutralized by radiating into it *white noise* at low dB levels. Also, if the pigeon makes errors in, say, tasks involving pattern recog-

nition, it is “punished” by suddenly turning off a white *shock light* inside the chamber.

Fig. 2 shows a television-type training arrangement confronting a “postgraduate” bird. Developed by the author for demonstration purposes, the display shows stationary and/or moving objects which contain a set of visual cues and superimposed images. The reinforced reward situation is maintained and expanded when the animal makes its peck at the control key (thereby receiving food).

It is on the basis of these and similar techniques that a massive set of skills can be taught to a pigeon—here assuming the form of an *organic computer* of enormous reliability, yet costing \$1.50 or less.

Control and Guidance Performance

In 1964, Drs. R. J. Herrnstein and D. H. Loveland performed experiments to determine complex visual concepts in the pigeon. (These birds are superb all-around subjects—thus their selection.) The test series showed clearly that pigeons had the unique ability to look for and react to the images of people. The birds were allowed to look at projection slides in which human beings were obscured by cars, trees, window frames, and the like. This fascinating experiment, which also involved tasks of categorizing and complex rules for sorting out pictorial elements, produced evidence of animalistic conceptualization. But this experiment does not stand alone. Even in the study of instinctive behavior with creatures low in the phyletic scale, there is overwhelming evidence of discrete sorting and generalizing.

Visual conceptualization and the motor activity triggered by it is one of the most sought-after goals of computer designers. Unfortunately, at present, this type of artificial electronic intelligence has eluded designers and remains an innate capacity of living organisms.

Dr. T. Verhave's experiments are a good case in point.

Fig. 3. Proposed animal-guidance system for ICBM. Initial target data is acquired by photoreconnaissance satellite. System operates with superimposed images and can't be jammed.

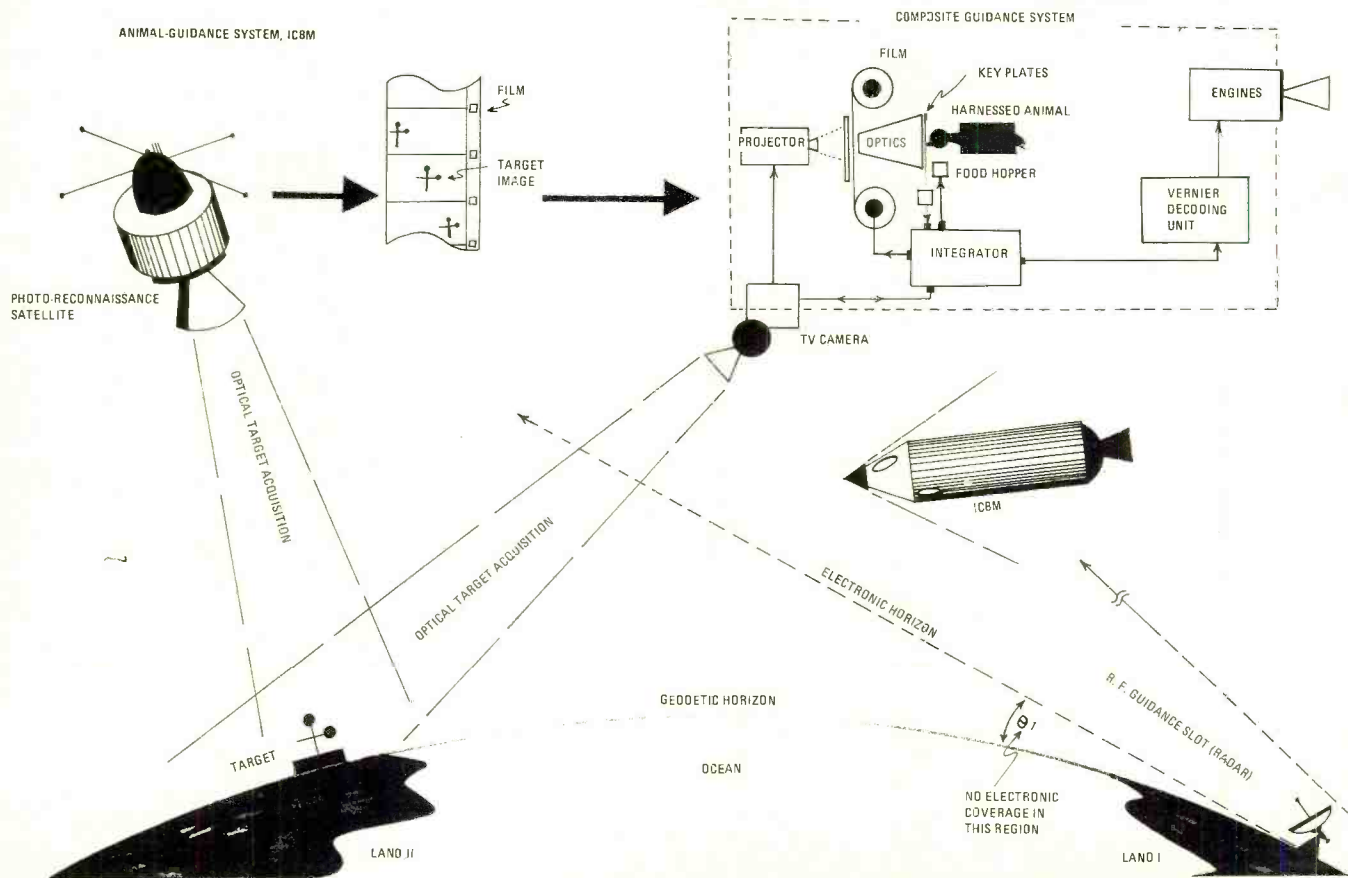

Working for a large pharmaceutical company as a psycho-pharmacologist, he conceived the idea of using pigeons as quality-control inspectors. The company made gelatin drug capsules—about 20 million units per day—and sorting out “skags” or defective capsules was an involved and costly process.

The drug capsules were brought into the bird's view by means of a moving belt and, through inspection windows, examined for defects. Skags made up about 10 percent of all the capsules on the belt. Reinforcement (feeding) was applied only when the bird made an appropriate number of pecks on the window-key. Wrong pecks, either misses or false alarms, were not rewarded and caused a 30-second blackout inside the pigeon's work box. However, although results were excellent, Verhave's concept was not adopted. Fears of adverse publicity and similar interferences kept it from being used on a routine basis. The problem, it seems, is that the average layman thinks of inspecting birds as animals scratching with their feet in a pile of drug capsules, picking one up now and then—and, worse yet—forgetting their bathroom manners every so often.

Some 30 years ago, one of the strongest scientific objections raised against animal-equipped missile-guidance systems was that of adequate *feedback control*. Further, it was thought that in an actual combat situation, an animal-type weapons pilot would become irritated (perhaps get airsick) and, thus, doom the mission.

Most of these objections have now been overcome. Toward the end of World War II, Skinner and his assistants initiated a research program called “Project Pigeon.” It had a peacetime counterpart at the Naval Research Laboratories as “Orcon”—an acronym of the words “organic control.” Both of these programs have now been declassified.

Skinner's was a kind of majority-vote bombardiering system directed against ships. The missile, a simple airborne vehicle named “Pelican,” was designed to use three harnessed pigeons trained by his methods. Three animals were to be used on the theory that at least two would peck correctly on the left or right of a target screen. Again, in spite of excellent results, the system was never put into operation. The Manhattan Project and its atomic bomb came along, which eliminated—as it seemed at that time—the need for pinpoint bombing. However, the fact remains that animal-guided weapons systems cannot be jammed, either electronically or by other conventional means. Once trained, as Skinner implies in his reports, a given animal tends to retain its “data” so well that it can be recalled at will even if the creature has been freed from its laboratory environment and is allowed to go on free flight again. There is no “obsolescence.”

It is for these and other reasons that dynamic combat schemes, such as that shown in Fig. 3, have emerged.

This weapons system is best understood by considering it as a composite. Its principal components are (1) a photo-reconnaissance satellite, (2) a radar system, and (3) an animal-guided ICBM.

The elements of target data are generated in peacetime and, more narrowly, in times of war. During overflights of enemy territory, the satellite uses infrared and other photographic methods to produce film of ground targets at a selected focal length. Then, by using Skinnerian conditioning techniques, the animal weapons pilot learns to recognize specific target features which are presented to him, togeth-

CORTICAL BIOELECTRIC RESPONSES OF STIMULATED CAT BRAIN

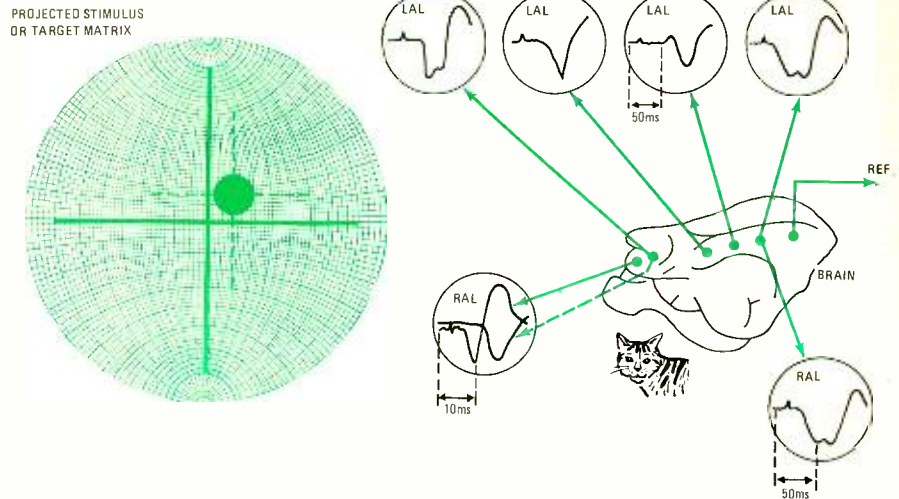

Fig. 4. The cortical bioelectric responses of a cat's brain. The task remains of eliciting the electronic analog profiles which correspond to the specific stimulus patterns appearing on the target matrix.

er with moving-ground images, by means of superimposition in an optical display system. Thus, during actual target runs, the pilot will peck (in the case of a pigeon) the appropriate guidance keys until the vehicle makes suitable vernier maneuvers to achieve perfect image superimposition or “target zero.” As the target grows in optical magnitude, the superimpositions are kept in plane and, finally, a ballistic is selected which ensures a bulls-eye target run. At that time barometry takes over and senses the proximity of the target by evaluating the outside air pressure. Simultaneously, the chemical detonators are activated and, on command from the barometer sensor, initiate fission of the nuclear warhead.

As shown in Fig. 3, a weapon of this type is vulnerable to enemy countermeasures only as long as it receives initial guidance in the radar's guidance slot. Once the missile leaves the electronic horizon and enters the geodetic horizon under animal control, effective defense against it is no longer possible—at least not with the crude anti-missile weaponry available today. Indeed, it is one of the most formidable war machines the human mind can conceive—for better or worse.

Biodynamic Guidance Systems

We mentioned the cat-guided missile scheme at the beginning of this article. It might appear, at first glance, to be
(Continued on page 50)

Fig. 5. Neuron and electronic analogy. At (A) the neuron cell receives inputs via dendrites. At (B) functions may be simulated artificially by electronic neuron cell. Refer to article.

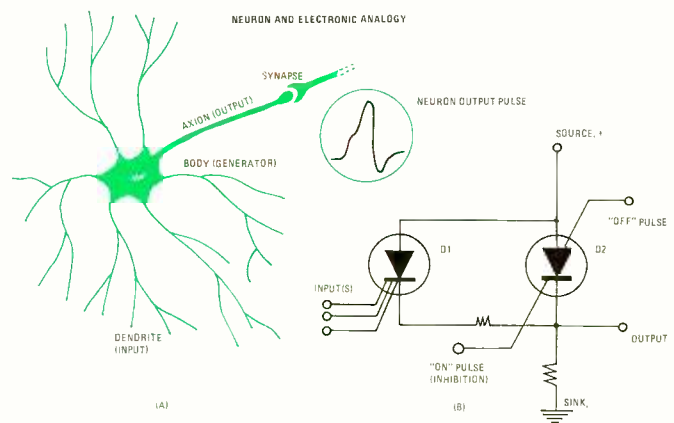

Channel Electron Multipliers

-new Semiconductor Radiation Detectors

By FRED W. HOLDER

Operation of a new, highly sensitive radiation detector for low-energy protons and electrons that is being used in space exploration.

This tiny Channeltron, with its funnel opening, was used to detect charged particles in Apollo lunar environmental experiment.

It has always been difficult to detect low-energy photons and charged particles (electrons and protons) because these particles are so easily absorbed by matter only fractions of a micron thick. A new device, the *channel electron multiplier* (CEM), now makes this instrumentation task easier. The device was developed by the *Bendix Research Laboratories*, Southfield, Michigan. Called *Channeltron*, these patented units are capable of increasing the flow of electrons more than a million times so that charged particles received at the input can be measured by conventional electronic counter circuits.

The CEM is adaptable to most low-level radiation measurements in the 1500- to 2-angstrom region of the spectrum, the ultraviolet and soft x-ray region. They have been used extensively in space exploration. For example, one cir-

cular model slightly larger than a quarter was designed for rocket-probe investigations of auroral plasma. Another model, coiled like a spring with funnel-shaped input, was the principal active element of the charged particle lunar environment experiment carried to the Moon by Apollo astronauts.

Similar to Photomultiplier Tube

Since operation of the channel electron multiplier tube is based on the same general principles as the photomultiplier tube, it is a good idea to first review its operation. The photomultiplier tube is an amplifying photoelectric cell having a number of electrodes called "dynodes." Each of the dynodes is maintained at a positive potential higher than the light-emissive cathode. Also, each dynode is maintained at a higher positive potential than the preceding dynode. See Fig. 1A.

The photosensitive cathode of the photomultiplier tube emits electrons when light strikes its surface. These emitted electrons are attracted to the first dynode where they cause secondary emission as they strike the surface of the dynode. The electrons emitted by secondary emission, greater in number than the original group leaving the cathode, are attracted to the higher positive potential of the second dynode. Here, again, they cause secondary emission as they strike the surface of the dynode. The growing number of electrons are swept away to the next dynode until they are finally collected by the anode. By repeating this process of current amplification ten or more times, an anode current greatly amplified from the original current at the cathode is obtained.

If the photomultiplier tube is to be operated in the high vacuum of space, an evacuated tube would not be necessary. The cathode could be exposed directly to bombardment by photons and charged particles or the first dynode could be given a special coating and exposed directly to bombardment by photons and charged particles arriving at the tube. See Fig. 1B. Electrons emitted by the dynode as it is bombarded are swept away to the second dynode to start the amplification process.

Such a photomultiplier tube would be designated a win-

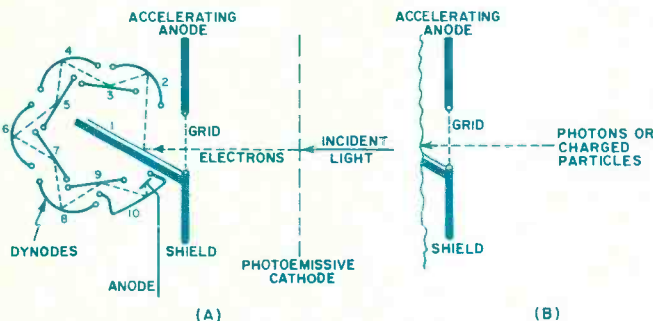
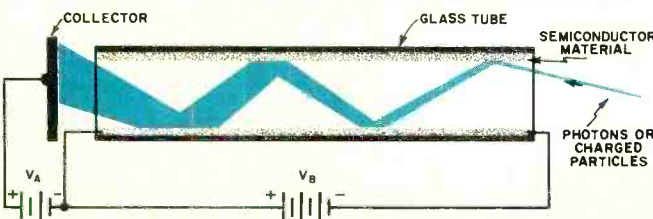

Fig. 1. (A) Operation of the photomultiplier tube. (B) By removing photoemission cathode, tube amplifies external charged particles.

Fig. 2. Simplified diagram of channel electron multiplier. The CEM is electrostatic device with a continuous dynode surface.



downless radiation detector. The windowless detector is more efficient than the window type. The window-type detector must dissipate the energy of the particle in a medium capable of producing ionized atoms, free electrons, or emitted light quanta proportional to the energy of the particle. The result is often a feeble electrical signal of the same magnitude as the preamplifier noise.

Something Better Was Needed

Something better was needed to detect single electron events: the channel electron multiplier was the answer. Being windowless, the sensitive input of the CEM is accessible to all particles irrespective of type and energy and is especially adaptable to detecting single electron events with a very low count rate (one count in 100 seconds). The upper count rate limit is a few thousand counts per second before current saturation occurs.

Unlike conventional electron multipliers having a series of discrete dynodes, the CEM is an electrostatic device with a continuous dynode surface. Actually, the CEM is a small glass tube with an inner surface coating of high-resistance semiconductor material which serves as the dynode. See Fig. 2. A high voltage is applied across the length of the tube so that an electrostatic field exists within the narrow (one millimeter) channel of the tube. A charged particle or photon entering the tube opening will be accelerated along the channel until it strikes the dynode surface.

When this happens, secondary electrons are emitted from the semiconductor material. They are swept along at an accelerating rate by the electrostatic field until they also strike the dynode surface, creating an avalanche of electrons in the tiny channel. The gain in electron flow, caused by the avalanche effect, is limited to about 100,000 if the tube is straight. The limiting factor is the ion feedback resulting from a loss of electrons in the semiconductor material. *Bendix* scientists discovered, however, that bending the tube prevents this feedback and allows typical gains up to 10^8 electrons per input event.

These high-gain CEM's are often bent into helices or "C"-shaped structures to eliminate ion feedback and to satisfy packaging constraints. As shown in Fig. 3, typical electrical connections of the CEM may take one of two basic configurations: separate collector or cap collector. If the separate collector is used, it will be spaced about one millimeter from the end of the channel and have a collector voltage of 200 to 300 volts. The cap-collector configuration does not require an additional power supply, but develops the pulse signal across a load resistor R_L . The cap collector can be metal foil bonded to the CEM with conductive adhesive. The h.v. power-supply voltage can range from 2000 to a maximum of 4000 for the model illustrated. Fig. 4 shows the gain curve for this unit, operated in the separate-collector configuration, with different levels of high voltage and a collector voltage of 220 volts. As shown, the gain does not increase as rapidly with voltages above 2600 volts.

Spiraling the Channels

It was also found that ion feedback in the CEM could be suppressed by spiraling several channels around a central core. See Fig. 5A. This provided for more flexible configurations of these spiral CEM's, called Spiraltrons (SEM's) by *Bendix*. The straight cylindrical geometry of the Spiraltron allows it to be stacked into large matrices. In addition to being able to count single electron events, such matrices can also provide spatial information about the radiation source.

The Model 5205X Spiraltron bundle detector, for example, is a matrix (0.18- by 0.18-inch square) of Spiraltron electron multipliers. It is an area-sensitive detector for charged particles, energetic ultraviolet or soft x-radiation, or metastable neutral particles. Each element of the matrix is capa-

(Continued on page 57)

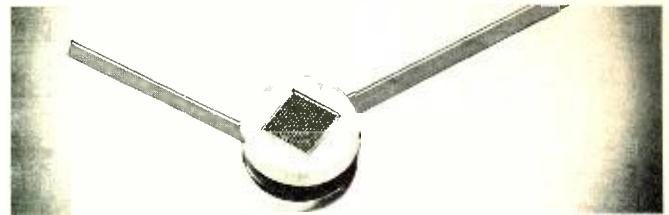

Spiraltron bundle detector can count electron events and provide special information about the radiation source.

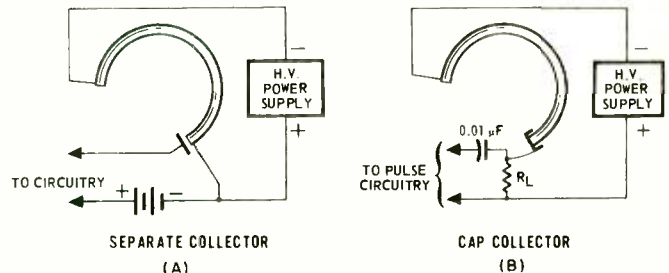

Fig. 3. A separate or cap collector may be used in the "C"-shaped CEM. High voltage required is 2 to 4 kV.

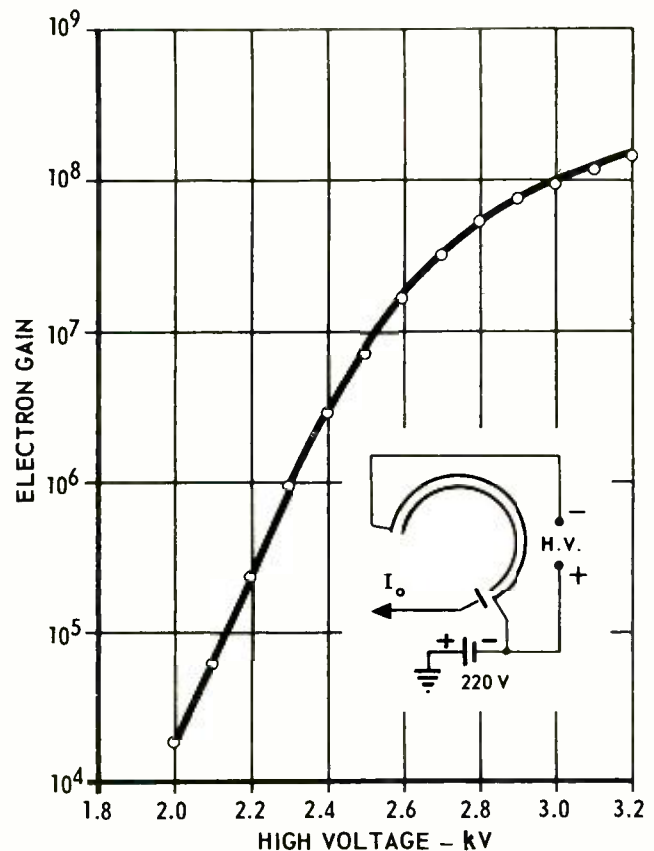

Fig. 4. Electron-gain curve for Model CEM-4010 Channeltron.

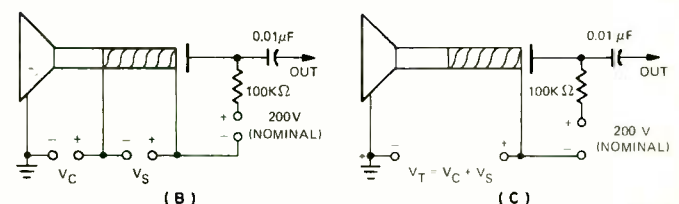
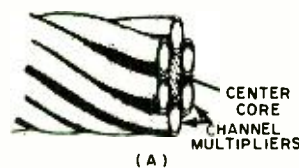
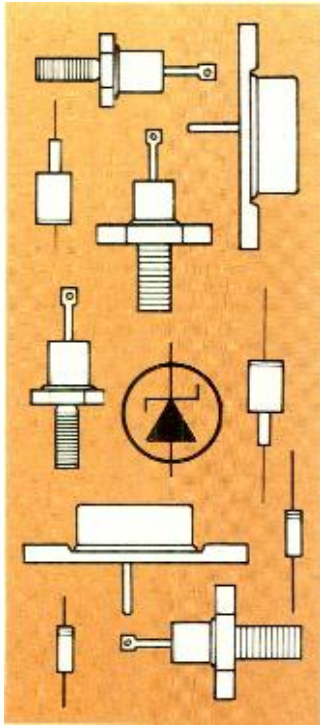

Fig. 5. (A) Basic Spiraltron configuration. (B), (C) Some typical circuit arrangements for Model 4219X Spiraltron.



ZENER DIODES & Voltage-Regulator Design

By KIRK BUTLER

Basic operation and specifications of these voltage-regulating diodes along with a simple design technique for using them as shunt regulators.

BEFORE one can design a voltage regulator, he must understand the characteristics of the regulating device, in this case the zener diode. Zener diodes are also known as *avalanche* or *breakdown diodes*. They are a special type of silicon junction diode and have characteristics very similar to those of ordinary silicon diodes. They conduct current very well when they are forward-biased, but become very poor conductors when reverse-biased.

When reverse-bias voltage across an ordinary silicon diode exceeds the peak reverse voltage (p.r.v.) rating of the diode, the diode will break down. When this happens to the ordinary silicon diode, it conducts excessive reverse current and the diode is usually destroyed. The zener diode, however, is designed to operate in this breakdown region.

The characteristics of a zener diode can be seen in Fig. 1. On the plot, negative voltages and currents represent reverse bias. From Fig. 1 it can be seen that the diode passes

very little current when it is reverse-biased below the breakdown point. However, when the reverse-bias voltage reaches the breakdown point, the diode starts to draw current. Beyond this point, current will increase rapidly but voltage will remain almost constant. The point where the reverse current starts to increase rapidly is called the "zener knee." The zener diode is useful as a voltage regulator when it is operated between the zener knee and the maximum allowable reverse current.

The Zener Diode

Every zener diode has a set of specifications which describe its electrical, physical, and thermal properties. These specifications are available in manufacturers' publications, including catalogues, brochures, data sheets, application notes, and handbooks. Obviously, the zener-diode specifications must be known before a voltage-regulator circuit can be designed. Refer to Glossary of Specifications.

Zener diodes come in many different sizes, shapes, and cases. Fig. 2 shows some of the common shapes that zener diodes take and the diode polarity. Small diodes with axial leads usually have a ring on the cathode end. One- and ten-watt diodes quite often have the schematic symbol printed on the diode to indicate polarity. Ten-watt stud-mounted zeners are available with standard anode-to-case polarity, or can be ordered with reverse polarity (cathode to case). Fifty-watt zener diodes are available in a TO-3 case or in a stud configuration, both in standard (anode-to-case) and reverse polarities.

The mounting of zener diodes is important not only to secure the diode, but also to dissipate heat.

When mounting axial-lead zeners, one should keep lead lengths as short as possible. This enables much of the heat dissipated by the diode to flow out the leads, since metal leads conduct heat much better than the surrounding air. Thermal resistance of a typical axial-lead zener diode is three times greater with $\frac{7}{8}$ -in leads than with $\frac{1}{8}$ -in leads.

The mounting of high-power zener diodes in TO-3 or stud cases is even more important. These diodes must be mounted on a chassis or heat sink in order to dissipate the heat properly.

Heat is best transferred from the zener diode case to the

Fig. 1. Example of a zener diode characteristic curve (1N3000).

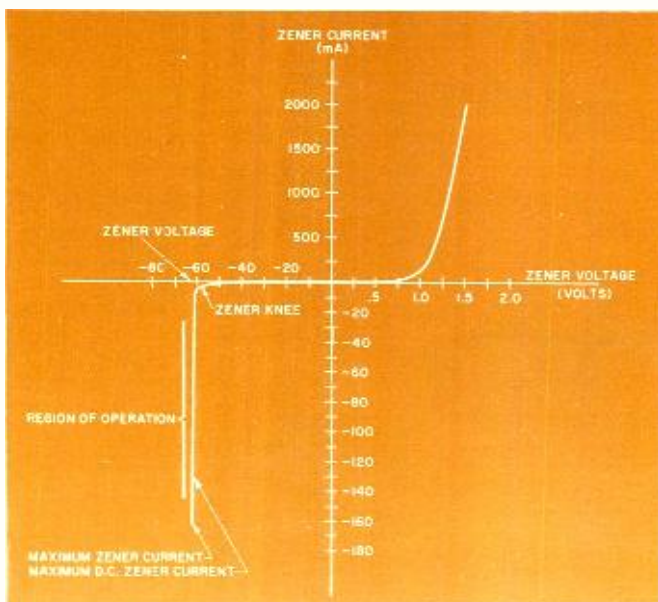

GLOSSARY OF SPECIFICATIONS

Zener Power Rating: This is the maximum power, in watts, which the zener-diode junction is capable of dissipating. Some common zener power ratings are $\frac{1}{4}$ W, $\frac{1}{2}$ W, 1 W, 10 W, and 50 W.

Zener Voltage: The reverse-bias voltage at which breakdown occurs is called the zener voltage, the breakdown voltage, or the nominal zener voltage. Zener diodes are available with zener voltages ranging from several volts to several hundred volts.

Zener Tolerance: The tolerance of a zener diode is a tolerance on the rated zener voltage. Common tolerances are $\pm 20\%$, $\pm 10\%$, and $\pm 5\%$ although closer tolerances are available.

Maximum D.C. Zener Current: This is the maximum continuous or direct current which the diode can safely handle for thermal reasons. Currents in excess of the maximum d.c. zener current can be handled for short periods of time, or periodically, but not continuously. The maximum d.c. zener current is less than the maximum allowable zener current, which can be obtained by dividing the zener power rating by the zener voltage.

Zener Knee Current: This is the reverse current which flows through the zener diode at the breakdown point or zener knee. Knee currents range from 0.25 mA to 5 mA.

Maximum Junction Temperature: To remain reliable, the junction of any solid-state device cannot exceed a given temperature in storage or in use. Maximum zener-diode junction temperatures are typically 175° or 200°C. Since heat is generated in the junction and dissipated by the case, the case is cooler than the junction. Junction temperature cannot be measured directly, but must be calculated.

Thermal Resistance: Power dissipated in a zener-diode junction causes the diode to heat up. The thermal resistance relates junction temperature increase above the surrounding temperature to diode power dissipation which causes it. Thermal resistance is specified as the number of degrees of junction temperature increase per watt of junction power dissipation. Typical values of thermal resistance range from 1°C per watt for large diodes on heat sinks to 250°C per watt for small diodes with axial leads.

Power-Derating Factor: When the ambient or surrounding temperature is high, the temperature increase from power dissipation can cause excessive junction temperature. For this and other reasons, maximum power which a diode can handle becomes less as the ambient temperature increases. Most diodes are rated for full-power operation with a surrounding temperature of 25°C, approximately room temperature. If the actual ambient temperature is above 25°C, zener power capacity is reduced by a derating factor, a given amount for each degree above 25°C. Typical derating factors go from 0.001 watt per °C to 0.5 watt per °C, for temperatures above 25°C. Some diodes must be derated above temperatures other than 25°C. This figure would be included in manufacturers' specifications if it were any temperature other than 25°C.

Zener-Voltage Temperature Coefficient: As temperature increases, the zener voltage changes. The temperature coefficient is usually given as a percentage change in zener voltage per 1°C temperature rise. Typical voltage temperature coefficients range from -0.05% per °C to $+0.15\%$ per °C. A positive temperature coefficient indicates that zener voltage increases as temperature rises, while a negative temperature coefficient indicates that zener voltage decreases as the temperature rises.

heat sink when the zener is simply bolted to the heat sink. This makes a metal-on-metal contact between diode and heat sink and provides excellent heat transfer. This arrangement, however, also connects the diode case to the chassis or heat sink electrically. Since the diode must often be electrically insulated from the chassis, mounting kits which include insulating spacers and washers are available for 10- and 50-watt zener diodes. Fig. 3 shows typical mounting of power zener diodes.

A measure of how much a zener diode junction heats up for each watt of power dissipated is the junction-to-case thermal resistance. For heat-sink-mounted diodes, this is the thermal resistance mentioned in the glossary of zener specifications. Case-to-heat-sink thermal resistance depends on the way in which the diode is mounted. It is also measured as temperature rise per watt of power dissipation. This thermal resistance can often be reduced by sealing the diode with a compound after it is mounted. Data which gives the actual case-to-heat-sink thermal resistance for various mounting configurations is generally found along with mounting information. There is also a heat-sink-to-ambient thermal resistance which is a measure of how well the heat sink dissipates heat into the surrounding air. This thermal resistance is also measured in temperature increase per watt of power dissipation of the diode mounted on the heat sink. Values of heat-sink-to-ambient thermal resistance are available from the heat-sink manufacturer or in many catalogues.

Thus an axial-lead zener diode has only one thermal resistance rating, whereas a chassis or heat-sink-mounted diode has three thermal resistance ratings. These thermal resistances will be used in the design procedure in order to calculate maximum diode temperature.

Shunt-Type Zener Diode Voltage Regulator

Although there are many uses for zener diodes, the most common is the shunt-type zener diode voltage regulator. It is a simple, economical, and reliable method of d.c. voltage regulation.

The schematic of a voltage regulator is shown in Fig. 4. The power source might be a battery, generator, or an unregulated power supply. The load is the electronic device or circuit which requires a regulated voltage. The regulator consists of only two components, a resistor and a reverse-biased zener diode (the anode is connected to the negative side of the power source).

The purpose of the regulator is to provide a constant voltage for the load, irrespective of variations in load current, power-source voltage, or any other factor.

It can be seen from Fig. 4 that both load and zener current must pass through R_1 , the resistor in the regulator circuit. The current through this resistance will cause a voltage drop across it. This means that the power-source voltage must always be higher than the regulated load voltage, since there is a voltage loss in the regulator itself. Ohm's law tells us that the voltage drop across R_1 is proportional to the current through it.

In the design process, the value of resistor R_1 is made small enough so that most of the source voltage is dropped across the parallel combination of the zener diode and load. Since the diode and load are in parallel, the load voltage is the same as the reverse-bias zener voltage. Furthermore, this voltage is the reverse breakdown voltage of the zener diode. It can be seen from the zener characteristic curve that, if there is a minute increase in load voltage (or reverse-bias zener voltage), zener-diode current skyrockets. This increased current flows through R_1 , thus increasing the voltage drop across R_1 and counteracting the load-voltage increase. The zener diode cannot overcompensate since it stops drawing current if load voltage drops below the zener breakdown voltage. However, the zener will not undercompensate either since the zener current goes way

up if voltage across the reverse-biased zener rises only a minute amount.

Similarly, if the load voltage (or reverse-bias zener voltage) decreases slightly, the zener diode draws much less current and reduced current flow through R_1 causes the resistor voltage to decrease and load voltage to increase.

It can be seen, therefore, that an equilibrium will result and the zener diode will compensate for load-voltage variations and cause the load voltage to be almost perfectly constant, at the zener voltage. The zener diode only does this, however, if it is operated in the breakdown region of the curve. The object of voltage-regulator design is to select the proper component values so that the zener diode operates only in the breakdown region, thereby assuring regulation.

In a d.c. voltage regulator, the zener diode is always reverse-biased. Therefore, only the reverse-bias portion of the characteristic curve is considered in the design and whenever zener current is referred to, one can assume that this is a reverse current.

Design of Shunt-Type Regulator

The object of the design procedure is to determine the value of the two regulator components, R_1 and the zener diode. Load-current variations, unregulated source-voltage variations, and the ambient temperature must be known in order to complete the design. It is necessary to deal with some thermal factors in the design of a voltage regulator, since they can be the most restricting factors.

The first step is to select the zener voltage. It will be the same as the regulated-load voltage, since they are in parallel. Therefore, the particular zener diode which will later be selected for the circuit must have a zener voltage equal to the desired regulated-load voltage.

Tolerance on the load voltage must also be considered. If the zener tolerance is equal to or less than the tolerance on the load voltage, the regulated voltage will be within the required limits. Actual zener voltage is not exactly the voltage which the manufacturer specifies but is within a given tolerance of the voltage specified.

Before designing a regulator it is necessary to know how the load current will vary. One must determine what the minimum and maximum load currents will be. Minimum load current may be zero for some loads if they sometimes become an open circuit. It may be possible to measure load current directly.

If it is not convenient to measure minimum and maximum load current, and they cannot be easily calculated, it may be necessary to estimate them in order to carry out the design. If this is done, the maximum possible load current should be estimated high and minimum load current low in order to assure that the regulator is designed to handle any load-current variation which it will encounter.

Input to the regulator circuits is, of course, an unregulated power source. Since it is unregulated, source voltage will vary between some minimum and maximum value. It is necessary to know the minimum and maximum value of the source voltage in order to carry out the regulator design. It is important to remember that in order for the regulator to function, the minimum source voltage must be greater than the zener voltage.

When the circuit is designed, two primary factors which vary and must be considered are the load current and the unregulated source voltage. As these factors vary, zener current will vary in order to maintain regulation. However, to maintain regulation, the zener must always operate in the breakdown region. This means that zener current must always be greater than zener knee current. However, the exact zener knee current is unknown since the power rating of the zener diode is not known. Thus the design is carried out under the assumption that zener current should never drop below a value which is arbitrarily set at one tenth the maximum load current. This assumption is

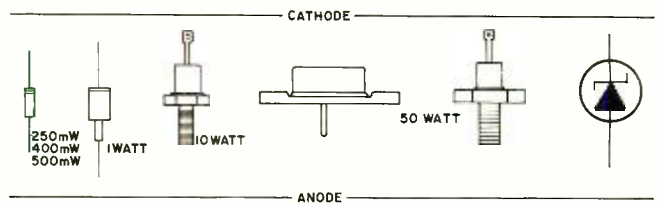

Fig. 2. Physical characteristics (and symbol) of some zener diodes. Standard polarity is with anode connected to case.

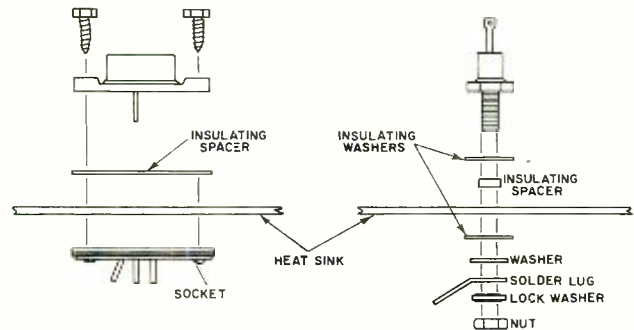

Fig. 3. Typical mounting arrangements for power zener diodes.

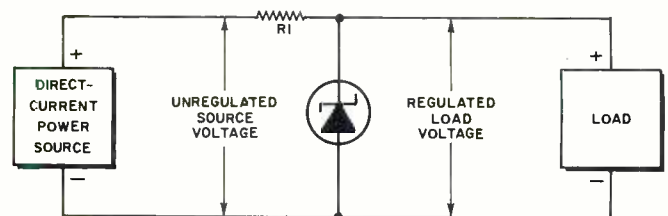

Fig. 4. Schematic of shunt-type zener diode voltage regulator.

checked following the design of the regulator circuit.

Zener current reaches a minimum value when the source voltage is minimum and load current is maximum. Therefore, under these two conditions for minimum zener current flow, zener current must be equal to or greater than one tenth the maximum load current.

This dictates the value of R_1 . Voltage across R_1 , under these conditions, is equal to the minimum source voltage minus the zener voltage. Current through R_1 is equal to the minimum zener current plus the maximum load current. After calculating voltage across R_1 and current through it, the value of R_1 is calculated by Ohm's law. The value of R_1 must not exceed this calculated value in order to assure that the zener diode always draws sufficient current and remains in the breakdown region.

The power rating of R_1 is easy to determine. Since the zener voltage remains constant, any variations in the source voltage will appear across R_1 . The voltage across R_1 and power dissipated in it will be maximum when the source voltage is maximum. This maximum voltage across R_1 is equal to the maximum source voltage minus the zener voltage. Maximum current through R_1 is equal to the maximum voltage across R_1 divided by its resistance. The maximum power dissipated in R_1 is the product of maximum voltage and maximum current so R_1 must be capable of handling this maximum power.

The zener-diode power rating must also be determined. Since power is the product of voltage and current and the zener voltage is constant, the necessary zener power depends on the maximum current the zener diode will draw.

Current through R_1 splits and goes through the zener diode and the load. The maximum-current through R_1 was previously calculated and the minimum load current must be known, as was mentioned previously. Maximum zener current is maximum current through R_1 minus the minimum load current. The power rating of the zener diode

(Continued on page 45)



By DAVID L. HEISERMAN

Operating principles and performance of a number of economical systems that can transmit graphic material over conventional telephone circuits.

A GADGET beloved by science-fiction writers is an "instant home newspaper." A future-day hero presses a button and a newspaper immediately emerges from a slot in the wall. Today, instant communication of printed information is a reality in the business world.

Facsimile is the key to instantaneous communication of printed matter. For decades, facsimile has been closely associated with the transmission of pictures over leased lines or radio waves. Today's facsimile revolution, however, encompasses all forms of printed material as well as pictures and the communications medium is an ordinary telephone line.

Why didn't the facsimile revolution gather impetus before now? Because the communications links between a facsimile transmitter and receiver were far too expensive. Until 1968, AT&T prevented anyone else from using its commercial telephone lines. This meant facsimile stations had to be linked together with either expensive cross-country lines or elaborate radio equipment. When a 1968 court deci-

sion forced AT&T to open its lines for acoustical data transmission, several enterprising communications firms began developing low-cost, telephone-linked facsimile systems. Using ordinary telephone lines wipes out the expense involved in cross-country lines and radio gear. The quality of reproduction presently suffers somewhat from the narrow bandwidth imposed by voice-grade lines. But the facsimile people have an eye on a vast new market that doesn't demand exceptionally high-quality reproductions—the entire business world and, perhaps eventually, every home in America.

Marketing and Development

One of the biggest selling points for low-cost, telephone-linked facsimile systems is that they can replace a teletypewriter. Businessmen who never thought they could make a teletypewriter pay for itself are leasing facsimile systems for sending messages and graphics. Compared to a teletypewriter, the new facsimile systems are easier to operate, less expensive, and much faster for long messages.

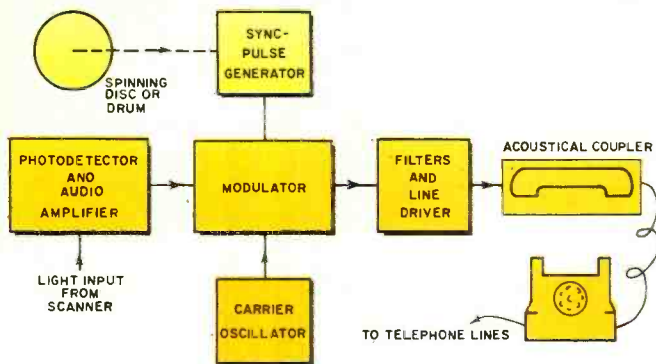

Fig. 1. Simplified block diagram of the transmitter section.

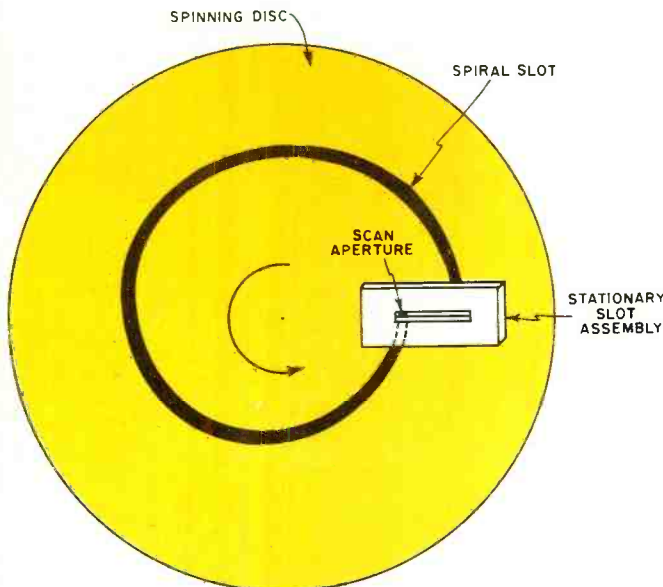

Fig. 2. The spinning disc scanning assembly. As the disc spins counterclockwise, the scan aperture appears to sweep rapidly across the stationary slot from left to right. Since the document moves vertically on one side of the assembly, the stationary photodetector on the other side sees a raster-scanned version of the document that is being transmitted.

Table 1. Summary of important characteristics of a number of facsimile units suitable for operation over the telephone lines.

Mfgr. & Model	Scanning Density (lines/in)	Trans. Time (min/8 1/2" x 11" document)	Cost per Station (\$ per mo.)
Alden Model 225	96	3.3	250
Datafax 240 Electronic Mailbox	96	4 1/2	99-114
Graphic Sciences Dex I	88	6.0	75
Magnavox Magnafax 850	96	6.0	45
Magnavox Magnafax 860	96	3.0	85
Muirhead Courier 240	90	4.1	220
Telautograph Copyphone 300D	83.3	3.0	210
Xerox 400 Telecopier	99	4 or 6	40
Xerox Telecopier II	99	4 or 6	55

The major development work in the telephone-linked facsimile industry now concerns increasing resolution while lowering transmission time and cost. Present-day systems have to trade off one or two of these factors to optimize another. See Table 1.

As promising and, indeed, as successful as the modern facsimile business already is, the manufacturers involved are retarding their own progress by an unwillingness to get together on operational standards. Apparently the companies are all edgy about stumbling over the other fellows' patents. As a result of their lack of cooperation, no two companies produce compatible facsimile systems. Until they get together to set up some workable standards, we cannot expect this facsimile revolution to erupt into the technological explosion it promises to be.

Telephone Facsimile Transmitters

The job of the facsimile transmitter is to transform printed information on a document into electrical signals suitable for transmission over standard voice-grade telephone lines. This process generally involves five steps: (1) scanning the document to produce electrical analog signals representing the information printed on it, (2) generating a set of scan and sync signals, (3) modulating the scan and sync signals with an audio carrier signal, (4) conditioning the composite facsimile signal with a set of sideband and noise filters, and (5) coupling the composite signal to a telephone handset *via* an acoustical-coupler unit. See Fig. 1.

Portable or low-cost facsimile transmitters use one of two kinds of mechanical scanning systems: a spinning disc or a spinning drum. In either case, the idea is to combine mechanical motions, optical devices, and electronic circuitry to produce line-by-line electrical analogs of information printed on a document.

The spinning disc system (Fig. 2) uses a lens to focus a brightly illuminated image of the document onto the disc. The disc has a spiral slot cut through it, so only a small portion of the image passes through. A stationary slot behind the spinning disc reduces the transmitted portion of the light to a small dot that appears to scan the document horizontally. Another motor pulls the document itself in a vertical direction. A set of gears synchronize the motion of the disc and document drive so that each revolution of the disc results in a small advance of the document.

The spot of light from the disc and slot assembly falls onto a photodetector—often a photomultiplier tube. This device changes the brightness information in the spot of light into analog voltage signals, thus completing the first phase of the facsimile-transmission process.

There are two versions of the spinning drum mechanical scanner. In one version, the document moves on the slower scan axis while the optical devices spin rapidly on the drum. The other version works just the other way around—the document spins rapidly while the optical devices scan slowly. Both versions accomplish the same kind of scanning task; and, like the spinning-disc scanners, they combine a light source, lenses and mirrors, and a photodetector to finish the job.

Just as in a TV system, the scanning operations in a facsimile transmitter and receiver must be carefully synchronized. The facsimile transmitter has a sync-pulse generator coupled to the spinning disc or drum. The generator produces sync pulses for a few seconds before the document data begins to flow and, of course, during the entire data transmission time.

The spinning-disc scanner generally produces the sync pulses optically. The spiral slot is cut so that no light can pass through it during the last 10° of each revolution. The photodetector interprets this as a "blacker-than-black" sync pulse signal. A spinning-drum scanner, on the other hand, often has a switch or the shaft of a small generator mechanically coupled to the revolving drum. As the drum turns, the

switch or generator produces electrical synchronizing pulses.

The scan signals and sync pulses come together in the acoustical modulator circuit. Most telephone-linked facsimile systems use FM modulation. The center frequencies are normally around 1700 Hz, with 1300 Hz and 2100 Hz representing "black" and "white" frequency limits. Manufacturers who selected FM modulation believe their problems of wide bandwidth, phase shift, and frequency distortion are minor compared to signal fading and noise problems associated with acoustical AM transmission.

Two manufacturers, *Graphic Sciences* and *Telautograph*, have chosen the AM route, however. The receivers in these facsimile systems have an a.g.c. circuit keyed to the sync-pulse amplitude. By adjusting the gain of the input amplifier circuits, the a.g.c. system compensates for any signal fading. The systems overcome environmental noise introduced at the telephone handset by means of carefully soundproofed coupling assemblies, and they eliminate most telephone line noise with a set of highly selective filters.

Many potential telephone facsimile users are skeptical of AM transmission. Perhaps this skepticism is based on misapplication of a bit of common knowledge—FM radio is less noisy and has better fidelity than AM radio. Spokesmen for *Graphic Sciences* are quick to point out that radio and voice-grade telephone transmission are two entirely different media, and that the problems and advantages of one medium do not necessarily carry over to the other. The facsimile manufacturers who have decided to use AM transmission believe it is easier to solve the problems of AM acoustical transmission.

Graphic Sciences also likes to stress another big advantage of AM transmission—narrow bandwidth. They say: "Because FM uses all frequencies, there is no ability to exchange control signals between the transmitter and receiver. Thus, FM receiving units are slave units to the transmitter. FM precludes the use of control signals to automatically halt both transmitter and receiver simultaneously from the receiving end. Thus the receiving party is helpless to halt transmission in the event that a paper jam or other failure occurs."

The AM facsimile transmitters use carrier frequencies on the order of 2 kHz, while the scan signals to the modulator contain frequency components in the 0 to 1-kHz range. Using an upper-sideband filter, the frequencies actually carried by the telephone lines range between 1 kHz and 2 kHz—a bandwidth only one-fourth that of a comparable FM system. Thus, additional data frequencies remain available for high-speed transmission and future developments.

Telephone Facsimile Recorders

The job of the recorder portion of a facsimile system is to translate the composite facsimile signal from the telephone lines into a document that very nearly resembles the one running through the transmitter. The main processes involved in facsimile recording are: (1) demodulating the composite facsimile signal, (2) synchronizing the recorder scanning mechanism with that of the transmitter, and (3) reproducing the information on a piece of paper. See Fig. 3.

Unless a facsimile recorder has an optional automatic answering feature, the recording process begins when a human operator answers the telephone, listens for a signal tone, and places the handset into an acoustical-coupling unit. (The Datafax 240, for example, features automatic answering, automatic disconnect, and can be equipped with an optional document loader attachment if desired.)

The acoustical coupler passes the signal to a set of line-noise filters and, if the recorder is of the AM type, an a.g.c. amplifier adjusts the signal to a predetermined level. After these initial steps, another circuit demodulates the composite signal, sending the sync pulses to a pulse-coincidence circuit and the analog-data signals to the writing mechanism.

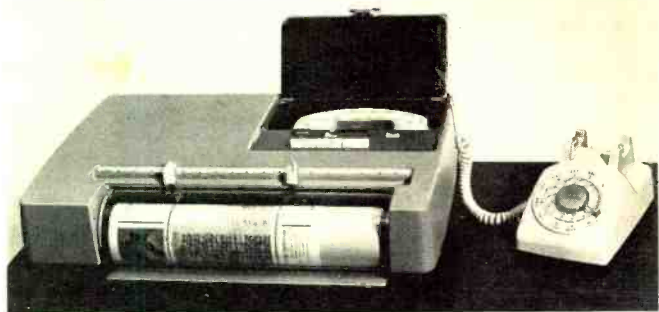

This small, economical transceiver by Graphic Sciences is example of the new breed of facsimile equipment described.

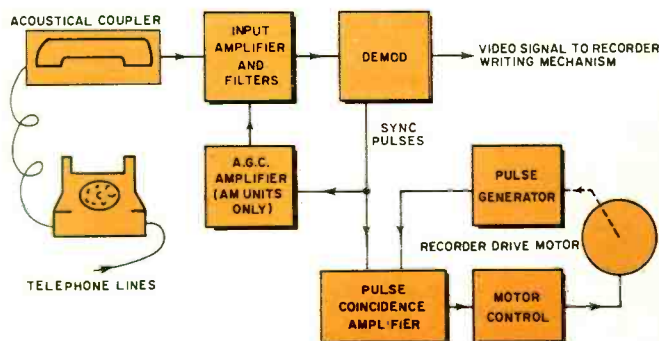

Fig. 3. Block diagram of recorder or receiver section of system.

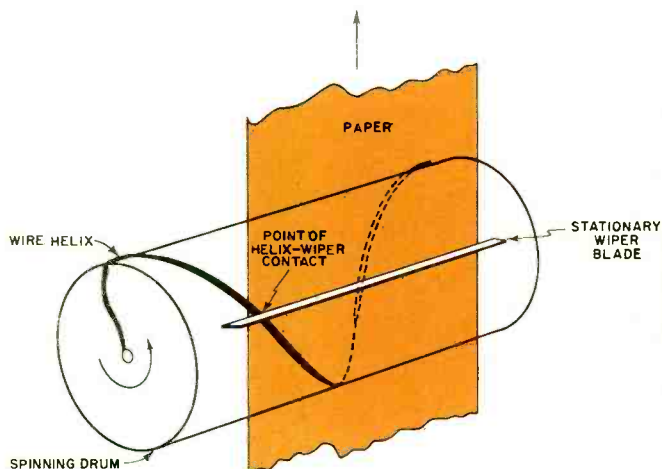

Fig. 4. The "lawnmower" writing mechanism. As the drum spins counterclockwise, the point of contact between the wire helix and the stationary wiper blade sweeps from left to right. Electro-sensitive recording paper, moving upward between helix and wiper blade, darkens in response to current flow between helix and blade.

Each of today's low-cost, telephone-linked facsimile systems uses one of three different kinds of recording paper and writing mechanisms: a wet electrolytic paper and a "lawnmower" writing drum; a dry electro-sensitive paper and a thermoelectric scribe; or a combination of white paper and carbon paper used with a vibrating impact head.

Recorders that use the wet electrolytic paper pass the paper between a rapidly spinning drum and a stationary metal wiper. Fig. 4. The drum has a single turn of wire twisted around it in a helical fashion. The metal wiper, fixed parallel to the long axis of the drum, presses the paper against the wire at only one small point. As the "lawnmower" spins, the point of contact moves horizontally across the paper. Each revolution corresponds to one horizontal scan. If the "lawnmower" is properly synchronized with the scanning mechanism at the transmitter, then the helix and wiper arm are in contact at the left-hand edge of the paper at the very instant the transmitter begins a new scan at the left-hand edge of the original document.

The wet electrolytic paper is saturated with a clear fluid that darkens in response to a current flowing through it. The amount of darkening is proportional to the amount of current. By applying the demodulated facsimile signal between the helix and wiper arm, the moving point of contact intensity-modulates the darkness of the scan lines on the paper.

Wet electrolytic papers must be kept moist until just after the writing process. To make the process as simple and clean as possible for the operator, the paper unwinds from a long roll stored in a chamber designed to keep the electro-

lyte from drying out. After passing through the writing mechanism, the paper passes over a heating element that dries it for more convenient handling. Since the paper comes in long rolls, it must be cut at the end of every page or transmission. This is generally done by means of a cutting blade actuated by a signal from the transmitter.

Long rolls of paper, humidity-controlled storage chambers, drying elements, and cutting blades all contribute to the size, weight, complexity, and cost of a facsimile receiver unit. The *Graphic Sciences Dex I* and the *Xerox 400 Telecopier*, both small economical transceiver units, bypass all these disadvantages by using a dry-paper recording technique.

Dry electrosensitive facsimile paper comes in standard 8½" × 11" sheets. During manufacture, the writing side of the paper is first covered with black ink, then coated with a thin layer of white zinc oxide powder. Scratching the writing side of the paper reveals the black undercoating. Facsimile recorders, however, generally expose the black undercoating by burning away the oxide with a small electric current.

Since dry facsimile paper comes in relatively small sheets instead of long rolls, it is possible to further simplify the recording mechanism by spinning the paper rapidly and letting the more complicated writing assembly move along the slower scan axis. The paper, then, spins on a high-speed metal drum—each revolution corresponding to one horizontal scan at the transmitter. The writing assembly is simply a piece of fine wire attached to a slow-moving worm gear. The wire brushes against the paper very lightly, passing facsimile signal current through the paper to the metal drum. The more intense the current flow at a given point in a scan, the darker the resulting spot on the paper.

The carbon paper impact writing technique also has the advantage of being a dry recording process. The disadvantage is that it requires two separate rolls of paper—one roll of ordinary white paper and a roll of carbon paper. A drive motor pulls the two papers together through the writing mechanism. The writing mechanism in this case is a pointed impact head that rapidly scans the papers horizontally and, at the same time, vibrates against them with a frequency determined by the incoming facsimile signal. With each impact, the head transfers a bit of ink from the carbon paper onto the white paper. The higher the frequency of impact, the darker the line on the paper.

Perhaps the most standardized part of all telephone-linked facsimile systems is the scan synchronizing sub-systems. Taking advantage of the fact that power-line frequencies are very nearly the same all over the nation, the facsimile systems all use synchronous motors to drive the scanning-assemblies. The only real discrepancy that can occur between a set of widely separated synchronous motors is a phase difference. In the case of the slower scan axis (generally the vertical axis), the phase differences aren't relevant at all and the slight frequency differences, if any, don't add up to any significant amount of vertical distortion. Phase differences in the horizontal scan, however, can produce an effect similar to loss of horizontal sync on a TV receiver.

To bring the facsimile receiver's horizontal drive motor into phase, the transmitter sends out a stream of sync signals before sending any video data. Early lab studies showed that the receiver motor could be forced into phase within several seconds, and that there was no need for an in-phase feedback signal from the receiver unit. To prevent a possible loss of sync during a long transmission, however, the transmitter continues to send out horizontal sync pulses as a "blacker-than-black" portion of the acoustical video signal. A pulse coincidence circuit in the receiver compares the phase of the receiver's drive motor with the incoming sync pulses. Whenever any such discrepancy occurs, the circuit immediately sends the drive motor the proper corrective signal. ▲

Alden Electronic & Impulse
Recording Equipment Co., Inc.
Westboro, Massachusetts 01581

Magnavox Systems, Inc.
1505 E. Main Street
Urbana, Illinois 61801

Datafax Corp.
Div. Stewart-Warner Corp.
1300 N. Kostner Avenue
Chicago, Illinois 60651

Muirhead Instruments, Inc.
1101 Bristol Road
Mountainside, New Jersey 07092

Graphic Sciences, Inc.
Corporate Drive, Commerce Park
Danbury, Connecticut 06810

Telautograph Corporation
8700 Bellanca Avenue
Los Angeles, California 90045

Xerox Corporation
Business Products Group
Rochester, New York 14603

Table 2. Listing of companies marketing inexpensive systems.

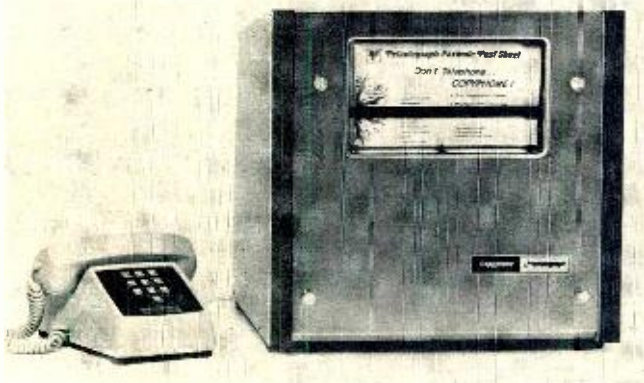

Telautograph's transmitter-receiver units are typical of the larger telephone-linked facsimile systems. The acoustical-coupling unit for the telephone is not shown in this photo.

The Xerox 400 Telecopier is portable facsimile transceiver that can link a salesman on the road with his home office.



Conductor Design with Thin-Film Insulated Aluminum

By HARRY D. WALKER/Director of Research, Permaluster, Inc.

Component costs plus limited future availability of copper dictates the use of aluminum by the electronics industry. Aluminum permits lighter and more compact components.

THE search by the electronic industry for components that are lighter, more compact, and are capable of reliable operation within many temperature variables led to materials such as aluminum-oxide thin-film-coated aluminum wire and strips.

Several important factors should be considered when replacing components in any design. In most cases cost is of prime importance. Depending on the application, cost savings up to 40% can be realized by substituting aluminum for copper conductors.

If estimates of future availability are considered, it can be shown that aluminum makes up approximately 8 percent of the earth's crust; copper approximately 0.1 percent. Aluminum is now the world's third most abundant element; copper is the twentieth. Furthermore, aluminum is obtained from bauxite ore which yields one ton of aluminum for every 4 to 6 tons of ore. By contrast, copper is being refined from 1 or 2 percent ore. Copper may well become a precious metal.

Copper vs Aluminum

Electrical conductor-grade aluminum has the highest conductivity of any metal when resistivity is based on the equivalency of weight. Basically, aluminum has about 60% the conductivity of copper but weighs half as much. With the manufacture of flattened wire, space-saving pancake-type or edge-wound coils using anodized aluminum wire have found wide application in the electronics industry.

These applications may range from sophisticated data-storage devices, such as disk-pack and read-out devices to such simple devices as voice coils in loudspeakers as well as in generators and transformers. Designs such as these are smaller in volume and lighter in weight than standard insulated copper-wire conductors. See Table 1.

For wire conductors rated according to AWG, a convenient relationship between aluminum and copper is found; namely, that the resistance of an aluminum conductor is equal to the resistance of a copper conductor *two gauges* smaller. This handy relationship eliminates the need for extensive calculations when aluminum wire replaces copper conductors.

Mechanically, aluminum is not as strong as copper in some respects, however it has sufficient strength for virtually all applications and is rated high in tensile strength and

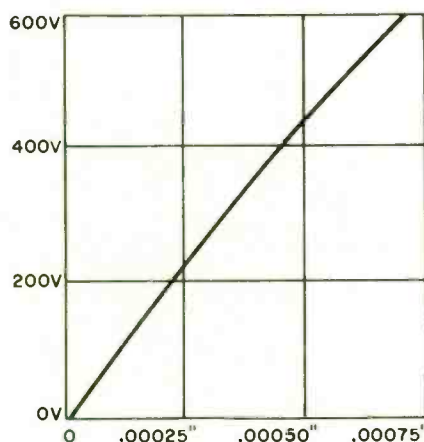

Fig. 1. Film thickness vs breakdown voltage (r.m.s.). Dielectric strength of oxide film is approximately 35 to 50 V r.m.s./micron.

elasticity. One important advantage aluminum displays over copper is high-temperature operation in all atmospheric conditions.

Aluminum conductors insulated with aluminum-oxide are free from diffusion as compared to copper conductors in high-temperature operation. Actually, most copper conductors will oxidize above 180°C, forming a scaling, cracking condition of the oxide, and at the same time exposing the underlying base metal for continuing oxidation until the base metal is entirely consumed. When nickel is plated

(Continued on page 56)

Table 1. Weight and heat rise of load-carrying conductors of copper wire and aluminum strip with Al₂O₃ insulation.

Description	Copper wire (Conventional insulation)	Aluminum strip (Al ₂ O ₃ insulation)
Weight	77 lbs	38 lbs
Turns	450	450
Temperature (after 8 hrs)	177°C	140°C
Amp/turns (at respective temperatures)	15,000	18,000

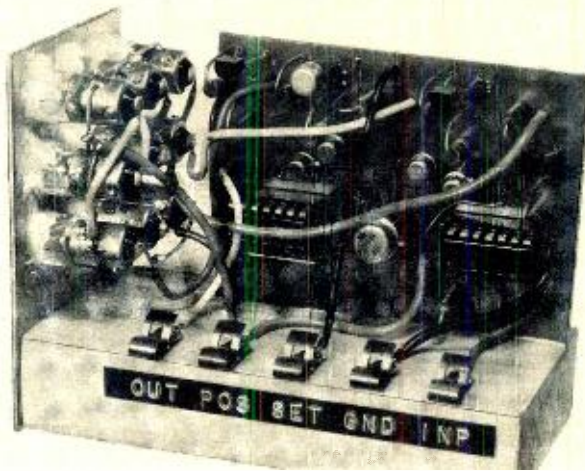
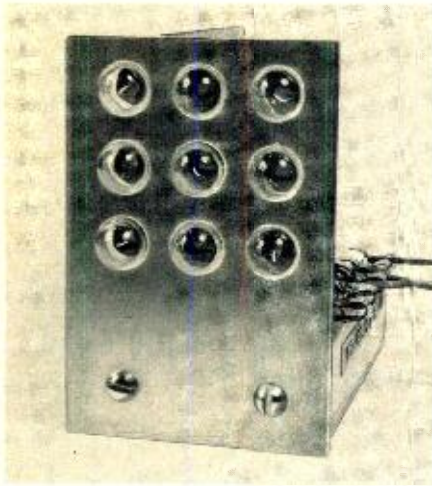

(Left) Front panel of readout showing the nine pilot lamps. (Right) Inside view showing single printed-circuit board.

Novel Counter, Decoder, Readout

By FRANK H. TOOKER

A simple circuit that demonstrates the operation of RTL gates, JK flip-flops, and transistor switches.

Fig. 1. Complete schematic of the counter, decoder, readout. The three IC's are the kind used in resistor-transistor logic.

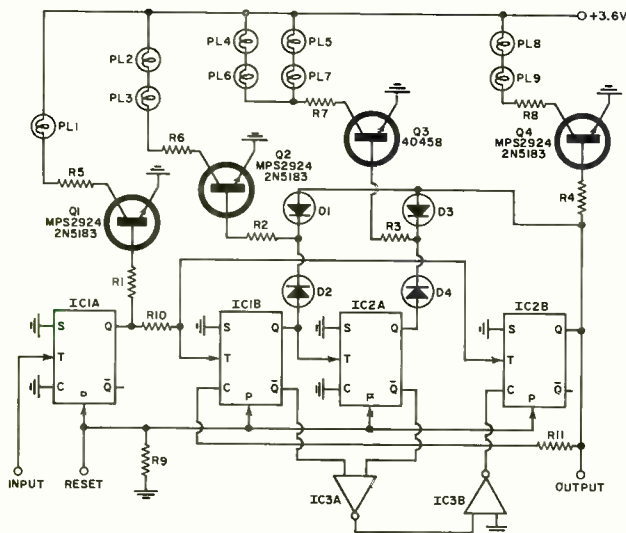

- R1, R4—680 ohm, ½ W res.
- R2, R3—390 ohm, ½ W res.
- R5—56 ohm, ½ W res.
- R6, R8—33 ohm, ½ W res.
- R7—18 ohm, ½ W res.
- R9—1000 ohm, ½ W res.
- R10—120 ohm, ½ W res.
- R11—330 ohm, ½ W res.
- All resistors are composition types, ±10% tolerance.
- D1, D2, D3, D4—Junction diode HEP134 or HEP135 (do not substitute)

- IC1, IC2—MC791P integrated circuit*
- IC3— μ L914* or HEP584 integrated circuit
- PL1-PL9—2 V at 0.06 A miniature lamp (No. 49)
- Q1, Q2, Q4—MPS2924 or 2N5183 transistor
- Q3—40458 transistor

*These IC's are available from: Southwest Technical Products Corp., 219 W. Rhapsody, San Antonio, Texas 78216.

THE digital counter, decoder, and readout to be described is a novelty—but it has serious applications as well. Because it can be assembled so inexpensively, it makes a good introduction for anyone unfamiliar with the digital-electronics field. It is useful in demonstrating the operating principles of RTL gates, JK flip-flops, and transistor switches. With a little dressing up, it can even be used as a fascinating night-light in a child's bedroom.

The complete schematic is shown in Fig. 1. The circuit employs three integrated circuits of the kind used in RTL (resistor-transistor logic): two Motorola MC791P "caterpillars" and a Fairchild μ L914. A Motorola HEP584 may be substituted, but the μ L914 is less expensive.

The counting circuit, IC1, IC2, and IC3, is conventional. It counts from 0 through 9 inclusive (10 counts actually) and then repeats.

To obtain a readout, the sequence of operations in the counter must be decoded. In the circuit of Fig. 1, IC1A decodes itself. Its output (pin Q) goes high (to a positive potential) at each odd-numbered count (1, 3, 5, 7, and 9) and supplies current to the base of transistor Q1 through current-limiting resistor R1. This current level is sufficient to drive Q1 hard into saturation.

Thus Q1, the lamp-driver transistor, operates as a switch, turning lamp PL1 on every time its base goes positive. Resistor R5, connected in series with PL1, limits the lamp current to 40 milliamperes.

Similarly, transistor Q2 lights PL2 and PL3; Q3 lights PL4, PL5, PL6, and PL7; and Q4 lights PL8 and PL9: in response to a high at the Q outputs of IC1B, IC2A, and IC2B, respectively. As will be explained shortly, IC2B also controls the functioning of Q2 and Q3. Resistors R2, R3, and R4 operate as base-current limiters, and R6, R7, and R8 set the lamp currents at 40 milliamperes—so all lamps light

with equal brilliance, and lamp life is very long since power consumption is reduced to $\frac{1}{3}$ of its rated value.

Diodes *D1* and *D2* function as an *or*-gate in the base circuit of transistor *Q2*. This gate permits lamps *PL2* and *PL3* to be turned on by the *Q* output of *IC1B* or by the *Q* output of *IC2B*. Similarly, diodes *D3* and *D4* operate as an *or*-gate in the base circuit of transistor *Q3*, permitting lamps *PL4* through *PL7* to be turned on by the *Q* output of *IC2A* or by the *Q* output of *IC2B*. Thus, when the *Q* output of *IC2B* goes high, it turns on (or keeps on) all lamps except *PL1*, regardless of the *Q*-output state of *IC1B* and *IC2A*.

The Readout and How It Operates

As may be noted from an inspection of the front-view photo, the nine readout lamps are mounted on $\frac{9}{16}$ " centers on a 2" by 3" aluminum-alloy panel plate in 3 rows of 3 lamps each. It is from this arrangement that the unit has received the nickname of "3-Square" counter, decoder, and readout.

Make the lamp openings a little under $\frac{3}{8}$ " in diameter initially. Then, using a hand reamer, carefully enlarge each hole a little at a time, until a #49 lamp, inserted from the back of the plate, fits snugly in the hole while extending about $\frac{1}{4}$ " at the front.

When all of the lamps have been fitted, secure them in place using a liberal amount of epoxy cement. Lamp identification and wiring are given in Fig. 2.

Fig. 3 shows the sequence of a lamp lighting as the count progresses from 0 through 9 inclusive. All lamps are extinguished at the count of 0. One lamp, the center one, turns on at the count of 1. Two lamps (the one at the left and the one at the right of the center one) come on at the count of 2. The center one is extinguished.

For the count of 3, all three of these lamps are lighted—and so on, until the count of 9, when all the lamps are alight. The counter then resets itself to 0, and repeats.

At the count of 0, following the count of 9, a "carry" pulse is produced at the output terminal. This is used, as will be explained later, when two or more of the counting units are connected together to register counts greater than 9.

The author has operated the prototype units at speeds up to 100 kHz. Although tests have not been made, it would seem likely that, if necessary, it could be operated at speeds much faster than this.

For the benefit of those who would like to study the unit's progress of operations, a truth table for the counter is given in Fig. 4A, and a table showing the decoder sequence is given in Fig. 4B. In Fig. 4A, a "1" indicates a positive output potential; a "0" indicates a near-ground potential. In Fig. 4B, an "X" indicates a turned-on transistor (associated lamp or lamps lighted). At the counts of 8 and 9, the shift in the base-current source for *Q2* and *Q3* occurs so rapidly that no indication of it appears in the lamp display.

Note that the MC791P dual JK flip-flops are required in this assembly. MC790P's or HEP572's cannot be substituted because these do not provide sufficient output.

Construction Details

Except for the lamps, all components are mounted on a $2\frac{1}{4}$ " by $2\frac{7}{8}$ " printed-circuit board. Tan phenolic-base material is satisfactory for this application. Its cost is much lower than that of the glass-epoxy type. All components are mounted on the face of the card except resistor *R10*, which is mounted on the foil side.

Sockets were used for the two caterpillar IC's in the prototype assembly. These are optional. The IC's may be soldered directly to the board, but unless one can solder close-spaced connections quickly and skillfully, the cost of the sockets can be considered good IC insurance. Use heat sinks when soldering the leads of the diodes, the transistors, and the dual 2-input gate, *IC3*.

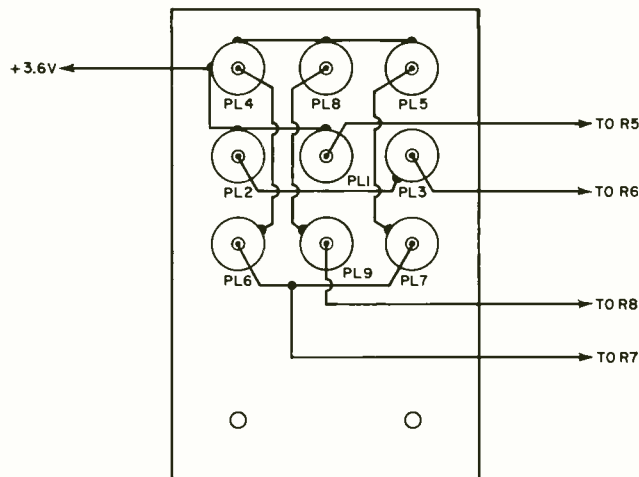

Fig. 2. Layout and wiring of panel plate lamps from the rear.

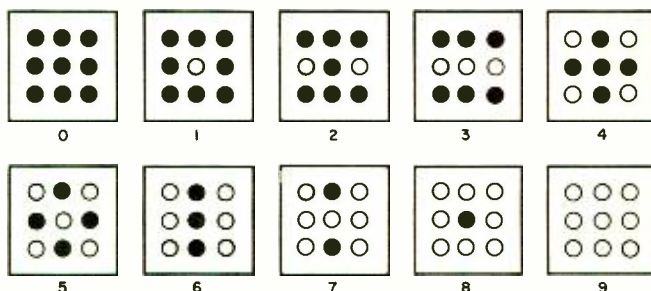

Fig. 3. Sequence of the display for the count of 0 through 9 inclusive. The lighted lamps are shown by open circles.

COUNT	FF1A	FF1B	FF2A	FF2B
0	0	0	0	0
1	1	0	0	0
2	0	1	0	0
3	1	1	0	0
4	0	0	1	0
5	1	0	1	0
6	0	1	1	0
7	1	1	1	0
8	0	0	0	1
9	1	0	0	1

(A)

COUNT	Q1	Q2	Q3	Q4
0				
1	X			
2		X		
3	X	X		
4			X	
5	X		X	
6		X	X	
7	X	X	X	
8		X	X	X
9	X	X	X	X

(B)

Fig. 4. (A) Truth table for the flip-flops that are in the IC's used for the counter section. (B) Decoder sequence.

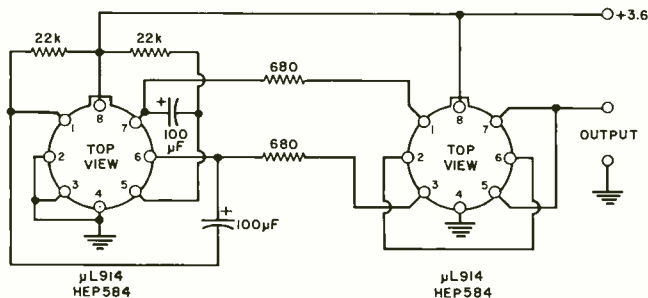

Fig. 5. Simple repeating trigger for actuating the counter.

The assembled panel, Fig. 2, and the assembled PC card are mounted on a 4" by 2" by $\frac{3}{4}$ "-thick soft-pine wooden base. Cut a slot $\frac{1}{16}$ " wide by $\frac{1}{8}$ " deep at a distance of $\frac{1}{2}$ " from the left side of the base. Epoxy the PC card in this slot, with the rear of the card flush with the rear of the base, as shown in the photo. Then, when the cement has hardened, mount the panel plate on the front of the base, using a pair of #6 by 1"-long wood screws.

Using the Counter

In common with all digital counters, this one will per-



Telex headphones and headsets give you that comfortable feeling of assurance when you monitor broadcasts or communications. Signals come through loud and clear — intelligibly and reliably.

Telex professional monaural or stereo headphones incorporate audiometric-type transducers that are impervious to temperature or humidity changes and provide you with absolute performance consistency day in, day out. These sensitive dynamic transducers produce high output levels with minimum consumption of transmission power. Available in single or dual muff configuration and with noise cancelling dynamic or carbon boom microphones.

And you'll never miss a cue or program buss with a Telex Anouncers Earset®. Inconspicuous for 'on camera' work, it has practically become standard in the industry.

Or you can select a Teleset®, Twinset® or Earset® for lightweight, comfortable and inexpensive private monitoring. And for special applications in business or home, industry or institution, Telex makes a listening device to fit your requirements. Available at better sound dealers or write for free information. You'll hear more from Telex.

PRODUCTS OF SOUND RESEARCH
TELEX®
 COMMUNICATIONS DIVISION

9600 ALDRICH AVENUE SOUTH
 MINNEAPOLIS, MINNESOTA 55420



CANADA: DOUBLE DIAMOND ELECTRONICS, LTD., 34 Progress Ave., Scarborough 4, Ontario
 EXPORT: ROYAL SOUND COMPANY, INC., 409 North Main Street, Freeport, N.Y. 11520 U.S.A.

CIRCLE NO. 124 ON READER SERVICE PAGE

form properly only when its input is supplied with rectangular pulses of clean waveform and fast fall time. If no other source of pulses is available, the simple, slow-speed repeating trigger diagrammed in Fig. 5 will operate the counter very well. It has a repetition rate of approximately 1 pulse every 2.5 seconds. Simply connect the output and ground of the trigger to the input and ground of the counter.

When the setup is switched on each time, it is likely to display almost any count initially, and the counter itself can be in almost any state, including a couple of "disallowed" ones, *i.e.*, states not encountered in normal functioning of the unit. None of this is of any consequence. The circuit will assume its proper mode automatically and will begin counting accurately in less than nine counts. It cannot get into a wrong-counting state, and stay wrong, as some other counting circuits tend to do.

On the other hand, the unit can be set to zero (either initially, at each turn-on, or while it is counting) simply by making a momentary connection between the reset clip and the +3.6-V clip. This aligns the counter with all pin-Q outputs at near-ground potential, so the next input pulse will display a "1", and the counting will progress accurately thereafter.

It is common to think of the figure following nine as ten. However, it is written 10 and obviously it is actually a sum of zero and carry one. This fact is recognized by a digital counter, so that upon receipt of an input pulse following a count of 9, it displays a readout of 0 and produces a carry pulse at its output clip.

If two counting units are assembled and the output of the first one is connected to the input of the second, the second unit will advance one count every time the first one makes the transition from 9 to 0. The two together will therefore count to 99. Similarly, three units connected in this manner will count to 999, and so on. ▲



"I don't know if changing from pencil on vellum to ink on film was such a good idea after all."



Understanding Digital Voltmeters

These instruments are coming on strong and technicians should make an effort to understand just how they work.

By **John Frye**

WHEN Barney entered the service department this frosty morning, he discovered Mac, his employer, sitting tailor-fashion on the the workbench reading a thick, heavy book with gold-colored binding. The youth walked over and raised the volume from Mac's lap so he could read the title.

"*Non-Linear Systems, Inc.: Instrumentation, Systems, MOS/LSI, Pressure,*" he read aloud. "That doesn't tell me much. What were you reading so intently?"

"I'm boning up on digital voltmeters," Mac answered. "I've wondered how these things work for a long time, but I never ran across a really good discussion in language I could understand until an engineering friend let me borrow this book put out by *Non-Linear Systems*. It is beautifully written and illustrated; and I've not been so intrigued by a book since, as a teenager, I got hold of a contraband copy of *Lady Chatterly's Lover*."

"Your age is showing," Barney warned. "That old hair-curler reads like a Sunday School manual compared to many best-sellers sold openly today. But why all this interest in digital voltmeters? Are you planning to buy one for the shop? I always thought digital voltmeters were like the idiot lamps that replaced meters on the dashboards of cars: they are for the benefit of women and other sub-intellec-tuals not smart enough to read a meter."

"I heard that, Barney Gallagher!" Matilda, the office girl, called from the other room, "and you're going to get it."

Mac grinned at this exchange as he said, "That's not quite the case. The fact that d.v.m.'s are easier to read, especially by untrained personnel, is one of their advantages; but there are many others. I've not made up my mind as to whether or not we need one of these instruments in our work now, but I know sooner or later we're going to encounter them in our industrial service. You find them now in electronics labs, test labs, medical research, chemical processing, power distribution, the petroleum industry, guided missile and aircraft testing, nuclear research and testing, electronics and electrical production lines, quality-control departments, and dozens of other places. I want to know how d.v.m.'s work, what different types there are, what advantages they have over pointer-type instruments, what are their limitations, and if any special precautions are necessary for their use."

"Okay," Barney said, perching himself on a stool and leaning back against the wall, "suppose you brief me on what you've learned so far."

"I was hoping you'd ask," Mac admitted, closing the book. "I found out long ago that trying to explain something I think I know is the best way in the world to reveal fuzzy areas in my assumed knowledge. A digital voltmeter, or d.v.m., is an instrument that automatically displays a measured voltage in the decimal number system. The first one was originated by *Non-Linear Systems* in 1952, a 4-digit instrument still in use. *NLS* and other companies such as *Cubic*, *Electro Instruments*, *Fairchild*, and *Hewlett-Packard* have made many improvements on the original model, and the d.v.m. has really caught on in science and technology

for a number of reasons: (1) operation, including range selection, polarity indication, and decimal placement, is purely automatic, (2) parallax does not degrade the accuracy of the reading which can be seen from up to 30 feet away, (3) accuracy as high as 0.003% and resolution up to 0.00083% can be obtained, (4) thousands of readings can be taken per second for recording purposes, (5) there is extremely small current drain from the source being measured (from 0.0001 to 1 microampere at 10 volts), and (6) the instrument is relatively rugged for this kind of precision."

"Sounds good, but how does it really work?" Barney asked.

"This book compares the action to that of weighing on a balance scale. There the unknown weight is placed in one pan and known units of weight are placed in the other pan until an exact balance is obtained. You then know the weight of the object is equal to the sum of the weights required to balance it. You're too young to remember, but an early v.t.v.m., called a 'slide-back v.t.v.m.', applied this principle. It consisted of a simple electrical bridge in which the unknown voltage was applied to one leg and a balancing voltage selected by a potentiometer across an internal voltage source was applied to the other. A 'magic-eye' tuning indicator tube was used to indicate a bridge null or balance. The dial setting of the potentiometer required to balance the bridge thus became a function of the voltage appearing across the test leads; the instrument was calibrated by graphing bridge-balancing dial settings vs known applied voltages.

"Suppose we substitute decade banks of resistors for the potentiometer. One decade furnishes 9 voltages in 1-volt steps; another, 9 voltages in 0.1-volt steps; a third, 9 voltages in 0.01-volt steps. Voltage being measured goes to an electronic balance director whose output commands a logic circuit to increase or decrease the internally applied voltage to achieve a balance. Automatic switching selects and applies the internal voltage, and a numeric display follows each step of each decade.

"Let's say we place the test leads across a potential of 7.84 volts. This potential is applied to one side of the electronic balance detector. The internal applied voltage is 0; so a command goes to the logic circuit to increase the internal applied voltage. One-volt increments are added until 8 volts is reached and the balance circuit is unbalanced in the opposite direction. The voltage backs up to 7 volts and this number is displayed while the 0.1-volt bank is activated. It increases the voltage in 0.1-volt steps until 7.9 volts is reached and again tilts the balance, causing the voltage to decrease to 7.8 volts and to activate the 0.01 bank. The internal applied voltage increases in 0.01-volt increments until 7.84 volts is reached. This balances the bridge and stops the selector circuits. The display now reads 7.84 volts. All this takes place in a fraction of a second."

"Admittedly this is a highly simplified and not quite accurate description of the action of a comparison-type d.v.m. but it illustrates the principle. The main difference between comparison-type d.v.m.'s is in the manner and se-

DELUXE CASSETTE STORAGE CASES

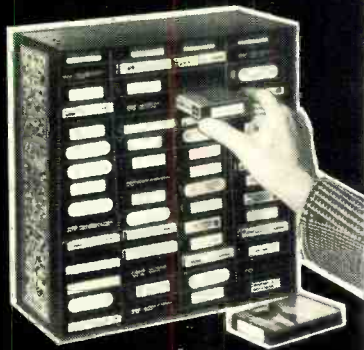

Designed by the Editors of
STEREO REVIEW MAGAZINE

- Individual storage slots for 60 cassettes.
- 13½" high, 12½" deep, 5½" wide — designed to fit on the same bookshelf as your disc collection.
- Storage slots are tilted back to prevent cartridges from falling out during handling.
- Handsome outer case elegantly embossed in gold in your choice of 3 popular colors—black, brown and green.
- Pressure sensitive labels included free of charge to identify your blank tape dubbings as well as unmarked pre-recorded tapes.

The Stereo Review Cassette Storage Case is the answer to the cassette storage problem.

A smaller Storage Case holding 30 cassettes is also available. It measures 13½" high, 6½" deep, 5½" wide and is available in the same choice of decorator colors.

8-TRACK CARTRIDGE CASE TOO.

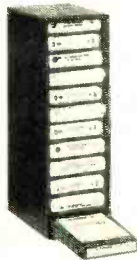

For those of you faced with similar storage problems for your 8 track cartridges, this attractive unit is your solution. It measures 13¾" high, 6½" deep, 4½" wide, has individual storage slots for 12 cartridges and is of the same sturdy construction and decorative appearance as the Cassette Case.

Ziff-Davis Publishing Co. • Dept. 23 EW-1271
One Park Ave. New York, N.Y. 10016

My remittance in the amount of \$ _____
is enclosed for the Cases indicated below:

- _____ 60-unit Cassette Storage Cases
@ \$13.95 each; 2 for \$25.00
- _____ 30-unit Cassette Storage Cases
@ \$7.95 each; 2 for \$15.00
- _____ 12-unit Cartridge Storage Cases
@ \$4.95 each; 3 for \$13; 6 for \$25

Add 50c per unit ordered for postage and handling (except orders for 6-8 track Cartridge Cases—Add \$1.50 total). Outside U. S. A. add \$1.00 per unit ordered.

Check color choice for back of case (sides in black only): Brown Green Black

print name _____
address _____
city _____
state _____ Zip _____

PAYMENT MUST BE ENCLOSED WITH ORDER

quence in which feedback voltage increments are produced. The two major classifications are the so-called 'all-electronic' and the electromechanical types. I say 'so-called' because no wide-range, high-accuracy, automatic digital voltmeter of the 'all-electronic' type is completely devoid of electromechanical devices; all use electromechanical relays in the range or polarity circuits. Anyway, in the all-electronic type electronic switches are used to develop the feedback voltage, while this is done with relays, stepping switches, and servomechanisms in the electromechanical type.

"The ramp-type is an interesting version of an all-electronic comparison d.v.m. The input voltage is fed to an error detector where it is compared with a linearly increasing voltage. When this ramp, or sawtooth voltage is 0—as it is when the test leads are applied—an electronic counter with a built-in time base is turned on; and when the ramp voltage and the unknown voltage are equal, it turned off. Since the ramp voltage increases at a uniform rate, the uniformly spaced counts that take place between the time this voltage starts to increase and the time the ramp voltage equals the measured voltage is an indication of the amplitude of the latter. If the ramp voltage increases at a rate of 1 volt per second and the timer, counting milliseconds, reads 0.506 second, then measured voltage is 0.506 volt."

"Neat!" Barney exclaimed. "But you keep referring to the 'comparison-type' d.v.m.'s. Are there any other types?"

"Yes, there is also the conversion type in which we have analog/digital conversion. In this type, electron circuits convert the measured d.c. voltage to a train of pulses whose repetition rate is proportional to that voltage. Then the number of pulses produced per unit time is counted by a gated electronic counter. Suppose our pulse generator frequency varies continuously and linearly from 0 to 10,000 Hz as applied voltage varies from 0 to 10 volts. Suppose the gate is opened for one second while the measured voltage of 7.84 volts is producing a pulse rate of 7840 Hz. The counter will register 7840 counts, and the decimal will be automatically inserted to indicate 7.84 volts."

"Sounds tricky to me," Barney observed. "I'd think the comparison type would be more accurate."

"You think right. One problem with the conversion type is erroneous readings produced by a.c. noise whose 'period' is not some exact multiple of the time based employed in the integrating-type d.v.m."

"You said that first d.v.m. was a 4-digit type. Does the number of digits

have anything to do with accuracy of the instrument?"

"Yes. Accuracy of a d.v.m. is usually given as a percent of reading and a percent of full scale. Typical accuracies are $\pm 0.1\%$ of reading plus 0.1% of full scale for a 3-digit instrument, 0.01% of reading plus 0.01% of full scale for a 4-digit instrument, and 0.003% of reading plus 0.001% of full scale for a 5-digit instrument."

"What do you mean by 'resolution'?"

"That's the total range an input voltage can be varied without initiating a change in reading. The better the resolution, the smaller this range is."

"I see some d.v.m. manufacturers advertise a certain percentage of 'over-range' for their instruments, say 20%. Does this mean you can apply 20% more voltage to the instrument than its maximum range without damage?"

"No. This refers to a usable extension of a basic range which allows high-resolution and high-sensitivity measurements at or near normal range transfer points. We have a little of this same problem in an ordinary voltmeter if it has too few ranges. Suppose we want to measure 1.2 volts on a meter that has only a 1-volt and a 100-volt range. The voltage can't be read on the 1-volt range; yet the pointer barely moves on the 100-volt range. In a d.v.m. with over-range, the lower voltage range is extended to make possible reading voltages somewhat above the normal range transfer point on the lower range where the percentage of full-scale accuracy is more favorable."

"Don't d.v.m.'s have any disadvantages?"

"Sure. One is price. They cost considerably more than ordinary voltmeters. Another is complexity and the need for high quality standards and other equipment for recalibration. However, a d.v.m. is well worth the money if you need to do high-speed measuring, if you want a meter untrained personnel can read accurately, if you need 0.5% or better accuracy, if you require high input impedance, if you need a precision meter that will be unaffected by rugged operating conditions, or if you want an instrument that can operate in automatic testing or data logging systems."

"But I've barely scratched the surface of what is in this book. It goes into a.c. and resistance ranging of d.v.m.'s. Every subject I have mentioned is taken up in detail. Several more exotic types of d.v.m.'s, such as the stroboscopic, the staircase ramp, and the dual-slope integrating-type are described. You can read the book when I am through with it. Since it is prepared by the people who originated the digital voltmeter, I consider you'll be getting your information as nearly from the horse's mouth as possible!" ▲

Zener Diode Regulators

(Continued from page 34)

must be selected so that its maximum d.c. zener current rating is greater than the maximum current to which the diode will be subjected in the circuit.

However, since a diode is not capable of dissipating as much power at high ambient temperatures as it can at low temperatures, the power-derating factor must be considered. The temperature above which a diode must be derated, and the derating factor, are given in the manufacturer's specifications for the selected diode. The power-derating factor must be multiplied by the maximum number of degrees by which the actual ambient temperature will exceed 25°C (or a different temperature, if the manufacturer so specifies). This gives the number of watts by which the diode must be derated. This figure is then subtracted from the diode power rating to give maximum diode power dissipation at the ambient temperature.

The voltage-regulator design must now be checked to assure that the diode power dissipation does not exceed this new restriction. The maximum power which will actually be dissipated by the diode in the designed circuit is equal to the zener voltage times maximum current flow through the zener, as previously calculated. If the power dissipated by the diode in the circuit will exceed the derated power rating of the selected diode, a zener diode with a higher power rating must be chosen.

In the above design, several things were ignored or assumed. These factors should now be checked before the regulator is assembled.

First, in calculating $R1$ it was necessary to assume that the zener knee current is less than one tenth the maximum load current. Now that the zener diode has been selected, and the zener knee current determined from a data sheet on the diode, this assumption should be checked. If the zener knee current turns out to be greater than one tenth the maximum load current, the value of $R1$, the $R1$ power rating, and zener power rating must be re-calculated using the zener knee current as the minimum. This is not often necessary.

Another thermal factor must also be taken into account. The zener voltage of a zener diode does not always remain perfectly constant as we have thus far assumed. Unfortunately, zener voltage varies with temperature for most types. When a zener diode gets hot, the zener voltage may increase or decrease depending on its temperature coefficient, as discussed earlier. These variations are usually small and unimportant, but in some cases when the diode gets quite hot, it can make a difference.

It is first necessary to calculate the maximum temperature the zener diode will reach. The increase above ambient is found by multiplying maximum power dissipation (calculated) by the thermal resistance of the diode (from manufacturers' specifications). For a heat-sink-mounted zener, maximum power dissipation must be multiplied by the sum of the three thermal resistances in order to get the maximum temperature increase above ambient.

The maximum temperature the zener diode will reach is now calculated as the sum of the ambient temperature and the temperature increase due to power dissipation.

Now that maximum zener temperature is known, "worst-case" zener voltage drift which is caused by temperature can be calculated. The amount by which the maximum zener temperature exceeds 25°C is multiplied by the zener voltage temperature coefficient to yield the "worst-case" percent change in zener voltage due to temperature.

Of course, any change in zener voltage is a change in load voltage, so this result should be compared to the design requirements to determine if the particular design is satisfactory. ▲

FREE!



1972 LAFAYETTE
CATALOG 720

468 Pages

Your 1st Guide To
Everything In Electronics

Stereo Hi-Fi . . . Receivers . . . Tuners . . .
Speakers . . . Turntables & Accessories
■ Automatic Reversing Stereo Tape Re-
corders & Decks ■ Color TV's ■ FM Radios
■ Tubes & Parts ■ Intercoms & PA Sys-
tems ■ Closed Circuit TV Equipment
■ Cameras ■ Auto Tape Players ■ Musical
Instruments

Serving The Public Since 1921

Lafayette Radio Electronics, Dept. 01121
P.O. Box 10, Syosset, L.I., N.Y. 11791

Please Send the FREE 1972 LAFAYETTE CATALOG 720 01121

Name

Address

City State

Zip

(please include your Zip Code No.)

CIRCLE NO. 135 ON READER SERVICE PAGE

10 CHANNELS SONAR-SCAN™

FM MONITOR RECEIVERS

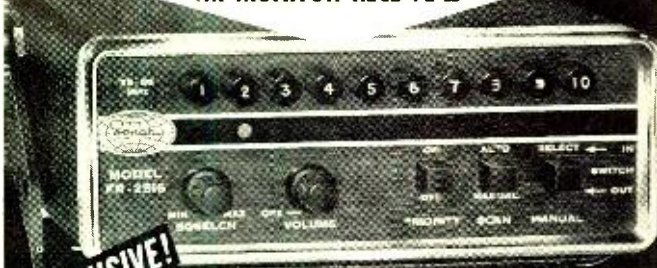

EXCLUSIVE!

NOBODY CAN TOP THESE FEATURES!

- ★ PRIORITY CHANNEL—LOCKS OUT ALL OTHER SIGNALS*
- ★ CARRIER DELAY—YOU HEAR MOBILE CALLBACKS*
- ★ MANUAL SELECTION BY SLOW SCAN TECHNIQUE*

A proven professional performer with the most advanced technology in design, circuitry and solid state electronics assures flawless performance you can hear with extreme clarity • SONAR-SCAN will search and automatically lock a signal on any of 10 pre-programmed channels • Noise free squelch • 10 crystal controlled channels • Adjustable scan sensitivity • Narrow band operation • 117 VAC or 12 VDC, negative ground only

FR-2518 (25-50M-Hz) FR-2517 (150-75M-Hz)
Comes complete with AC and DC power cables,
mounting bracket less crystals—Crystals \$5.00 ea.

\$159⁹⁵

EXCLUSIVE WITH SONAR and PATENT PENDING*

**SONAR RADIO
CORPORATION**
73 Wortman Avenue
Brooklyn, N. Y. 11217

Send information on Model FR-25 6/17
SONAR-SCAN.

Dept.
EW 12

Name

Address

City State Zip



Train on this
315 sq. in.
picture
color TV
and get the
skills that
mean a
high-paying
career!

Solid-State — the newest development

Count on NTS training to always feature the latest electronic equipment.

Now included in two exciting NTS color TV courses, this set is the largest, most advanced color television made. Guided by the NTS "Lab-Project Method" of combining professional kits and easy-to-follow lessons, you build this color TV step by step — learning TV Servicing as you go! NTS has successfully trained thousands of men at home for rewarding careers as electronics technicians. Prepare for the great opportunity fields of TV-Radio Servicing, Computers, Communications, and Automation.

This solid-state color set contains: 45 transistors, 55 diodes, 2 silicon controlled rectifiers, and 4 advanced Integrated Circuits representing an addi-

tional 46 transistors and 21 diodes. The first solid-state color TV this large — yours to keep! It features Automatic Fine Tuning; "Instant On"; an Ultra-Rectangular Screen (25 in. diagonal measurement) that lets you see the complete transmitted image for the first time — a full 315 square inches; exclusive built-in Self Servicing features which eliminate the need to buy costly test equipment; exclusive design Solid-State VHF Tuner with an MOS Field Effect Transistor; 3-stage Solid-State IF; Automatic Chroma Control; Adjustable Noise Limiting and Gate Automatic Gain Control; High Resolution Circuitry; Matrix Picture Tube; and a specially formulated Etched Face Plate that eliminates unwanted glare, and heightens contrast. Colors are more vivid,

fresh tones more natural, and the picture is sharper than ever before. By training on this unique color TV, you'll gain the most up-to-date skills possible in TV Servicing!

Other valuable equipment you build and keep includes an AM SW Radio, Solid-State Radio, FET Volt-Ohmmeter, and Electronic-Tube Tester. All included in your tuition. You learn troubleshooting, hi-fi, multiplex systems, stereo, and color TV servicing. Step right into a technician's job at top pay or open a business of your own! For complete details on all NTS electronics courses, mail the coupon today for the full-color NTS Catalog. No obligation. No salesman will call.

**Build this set
and learn
solid-state
circuitry—the
electronics
of today!**

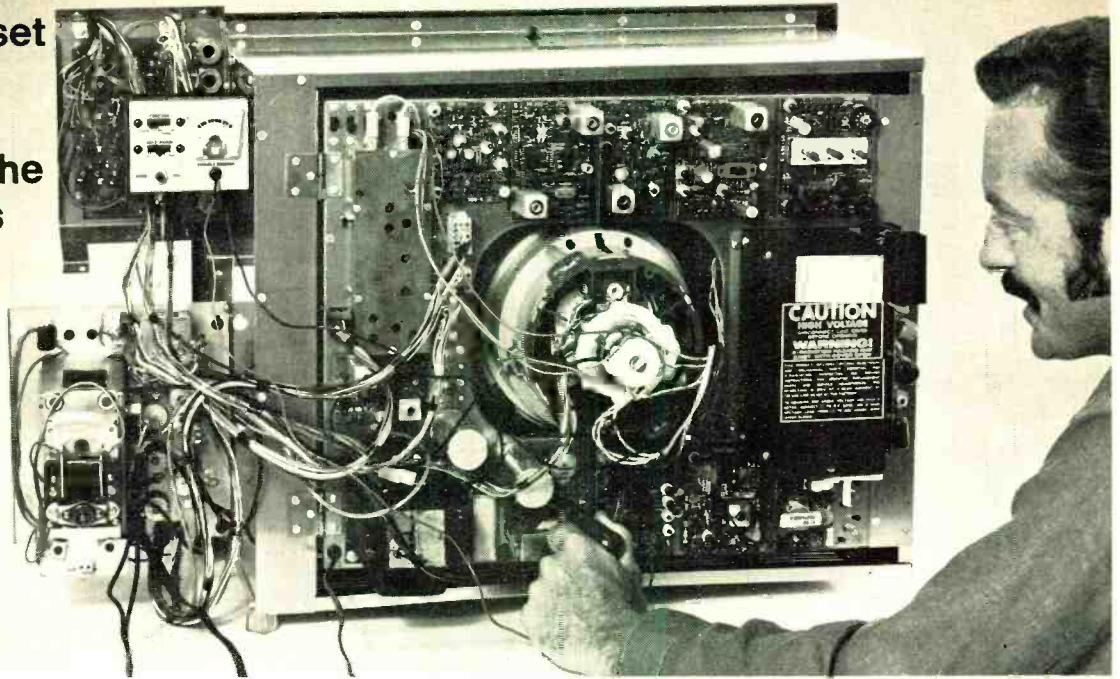

in color TV — comes to home training.

NTS ELECTRONICS & COMPUTER TECHNOLOGY

Build this exclusive NTS Compu-Trainer! Loaded with integrated circuits, it shows you the how, what, and why of computers. Learn this exciting field faster, more thoroughly. You also assemble and learn to operate an FET Volt-Ohmmeter and 5" wide band Oscilloscope.

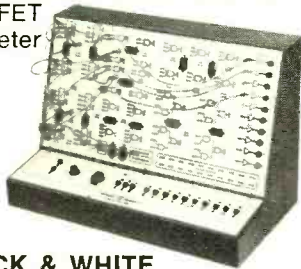

NTS BLACK & WHITE TV AND RADIO SERVICING

Learn all phases of television, radio, stereo, and hi-fi. You receive this 74 sq. in. picture Solid-State B&W TV, Lo-Silho "Superhet" Radio, FET Volt-Ohmmeter, Solid-State Radio, Electronic Tube Checker, and Signal Generator. Start earning extra money even before you complete the course!

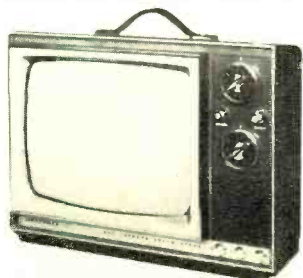

NTS ELECTRONICS COMMUNICATIONS & F.C.C.

Gain the security and prestige of owning an F.C.C. First Class Radio-Telephone License! Two comprehensive NTS courses cover the big opportunity field of transmitting and receiving. You build 14 kits, including a 5 watt AM Transceiver, 6 Transistor Pocket Radio, and FET Volt-Ohmmeter. Learn 2-way radio, Citizens Band, micro-waves and radar.



NTS INDUSTRIAL & AUTOMATION ELECTRONICS

Automation is the future of industry and you can play an important part! Learn industrial controls by training on the NTS Electro-Lab — a complete workshop. You also build and operate this 5" wide band Oscilloscope. And you perform experiments that involve regulating motor speeds, temperature, pressure, liquid level, and much more.



Classroom Training

at Los Angeles. You can take classroom training at Los Angeles in sunny Southern California. NTS occupies a city block with over a million dollars in technical facilities. Check box in coupon.

APPROVED FOR VETERANS

Accredited Member: National Association of Trade & Technical Schools; National Home Study Council.

NATIONAL TECHNICAL SCHOOLS

WORLD-WIDE TRAINING SINCE 1905
4000 South Figueroa Street, Los Angeles, Calif. 90037

Please rush Free Color Catalog and Sample Lesson, plus Information on course checked below. No obligation. No salesman will call.

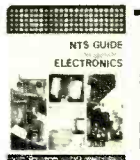

National Technical Schools

4000 S. Figueroa St.
Los Angeles, Calif. 90037

- Master Course in Color TV Servicing
- Color TV Servicing (For Advanced Technicians)
- Master Course in B&W TV & Radio Servicing
- Master Course in Electronic Communication
- Practical Radio Servicing
- FCC License Course
- Master Course in Electronics Technology
- Industrial and Automation Electronics
- Computer Electronics
- Basic Electronics
- High School at Home

Dept. 240-121

Name _____ Age _____

Address _____

City _____ State _____ Zip _____

- Check if interested in Veteran Training under new G.I. Bill.
- Check if interested only in Classroom Training at Los Angeles.

Build this magnificent Schober Theatre Organ for only



*\$1730!

*Includes finished walnut console. Amplifier, speaker system, optional accessories extra. Only \$1256 if you build your own console.

You couldn't touch an organ like this in a store for less than \$3500—and there hasn't been a musical instrument with this vast variety of genuine Theatre Organ voices since the days of the silent movies! If you've dreamed of the grandeur of authentic big-organ sound in your own home, you won't find a more satisfying instrument anywhere—kit or no kit.

You can learn to play it. And you can build it, from Schober Kits, world famous for ease of assembly without the slightest knowledge of electronics or music, for design and parts quality from the ground up, and—above all—for the highest praise from musicians everywhere.

Send right now for your copy of the full-color Schober catalog, containing specifications of the five Schober Organ models, beginning at \$499.50. No charge, no obligation—but lots of food for a healthy musical appetite!

The **Schober Organ Corp.**, Dept. RN-97
43 West 61st Street, New York, N.Y. 10023

- Please send me Schober Organ Catalog and free 7-inch "sample" record.
- Enclosed please find \$1.00 for 12-inch L.P. record of Schober Organ music.

NAME _____

ADDRESS _____

CITY _____

STATE _____

ZIP _____

CIRCLE NO. 129 ON READER SERVICE PAGE

ABOUT YOUR SUBSCRIPTION

Your subscription to **ELECTRONICS WORLD** is maintained on one of the world's most modern, efficient computer systems, and if you're like 99% of our subscribers, you'll never have any reason to complain about your subscription service.

We have found that when complaints do arise, the majority of them occur because people have written their names or addresses differently at different times. For example, if your subscription were listed under "William Jones, Cedar Lane, Middletown, Arizona," and you were to renew it as "Bill Jones, Cedar Lane, Middletown, Arizona," our computer would think that two separate subscriptions were involved, and it would start sending you two copies of **ELECTRONICS WORLD** each month. Other examples of combinations of names that would confuse the computer would include John Henry Smith and Henry Smith; and Mrs. Joseph Jones and Mary Jones. Minor differences in addresses can also lead to difficulties. For example, to the computer, 100 Second St. is not the same as 100 2nd St.

So, please, when you write us about your subscription, be sure to enclose the mailing label from the cover of the magazine—or else copy your name and address exactly as they appear on the mailing label. This will greatly reduce any chance of error, and we will be able to service your request much more quickly.

Animal Guidance Systems

(Continued from page 29)

little else but science-fiction, but it is dangerously more than that.

Typically, when thoughts turn to animals and guidance systems, we are inclined to envision a complete living thing—body, legs, skin, and a complete set of internal organs. This holds true of a lightweight creature like a pigeon, or perhaps a rat or mouse. There is little difficulty in providing long-term or stand-by life-support systems for them, even within the cramped space of an ICBM. But animals such as mature cats, dogs, pigs (excellent performers), horses, and other large creatures, have larger brains and neuronal network capacities. The large brain can be electronically manipulated and is less inclined to die rapidly if its nutrient bath becomes disturbed. Thus, the designer focuses on the removed brain only, rather than considering an animal's composite body and its requirements. But, as he works with neurophysiologists to determine specific centers of data storage and correlation within an animal's severed brain, he encounters the difficulty of having *no motor responses* to stimulus. Data is expressed in the form of electronic products, only typically in the form of rising and descending voltages as one finds in man-made computers. There also are so-called "artifacts" or phenomena which are still unexplained.

Drs. Albe-Fessard and Rougeul provided excellent electronic data on the cortical responses of a cat's brain in 1958. However, it was most difficult to detect evoked potentials from non-specific areas of the cerebral cortex in awake animals. Further, it was difficult, and in some cases almost impossible, to extract signals from noise.

Fig. 4 shows a set of cortical responses. The animal was kept under light chloralose anesthesia. The entries LAL pertain to the *left anterior leg*, RAL identifies the *right anterior leg*. So-called secondary evoked potentials (SEP) disappear under barbiturate anesthesia—but, for reasons unknown, the application of chloralose has the odd effect of synchronizing and enhancing them. This brings us to the fine-constituents of organic brains and their synaptic transmission properties. What is desired here is that an animal brain's data-processing system can clearly recognize and provide responses when exposed to stimulus in a "target matrix" such as shown to the left in Fig. 4.

Living brains are composed of neurons. Shown in simplified form in Fig. 5A, the biological neuron is essentially a binary or digital threshold device whose output is "all-or-none"—1, 0 re-

spectively. Its inputs, of which there can be as many as several thousand, are called *dendrites*. Actual signal processing takes place in the neuron's central body.

Most dendrites are excitatory systems, that is, signals passed on by them cause the central cell body to "fire." Other dendrites have inhibitory properties: signals appearing on them keep the cell from firing. Thus, the neuron's electronic status, "1" or "0," at any given instant is determined by the combination of signals appearing on the dendrites. If there are enough excitatory signals present, the cell threshold is exceeded and the neuron fires. Likewise, if too many inhibitory impulses are present, more excitatory signals are required to exceed the firing threshold.

These electronic characteristics allow us to consider the binary analog circuit shown in Fig. 5B.

This "artificial neuron" is comprised of the multi-gate SCR, D1 and thyristor, D2. Because these diodes know no intermediate states of conduction like a transistor or normal vacuum tube does, the dynamic conditions of "on-off" can be established and maintained by applying appropriate trigger pulses to D1 and D2. Note that this is a simplified circuit in which zener-type threshold components have been omitted for clarity's sake.

However, although circuits of this type are being used in the relatively new field of bionics and represent progress in the art of self-organizing computer systems, it still is most difficult to transfer such analogies to real-life organic controls.

If we believe the principles set forth by St. Thomas Aquinas in his book *Summa Theologica*, true intelligence—be it that of machines or living organisms—must have these components: passive (*intellectus possibilis*); active (*intellectus agens*); and *will*. It is unfortunate for our experimental animals that only they, next to ourselves, have the very features which suggest their employment on behalf of man's survival.

In conclusion, it can be stated that we are on the threshold of a new if undesirable art. The Skinnerian methods are being refined and updated, typically by augmenting them with sophisticated electronic gear. However, it appears that the problem of using animals' brains directly in guidance systems have not yet been solved to the complete satisfaction of those who plan to use them. Organic brains without life-supporting baths and circulating nutrients (blood) tend to die within 10 minutes or less. Thus, until this problem and others have been solved, it is safe to assume that *Columba Domestica*—the common pigeon—will receive its draft call. ▲

Amplifier Quiz

By WILLIAM R. SHIPPEE

Select the best answers to the questions below. Seven correct answers is passing; eight is good; nine is excellent; and if you answer all ten correctly, you must be an audio engineer!

1. Low plate voltage will cause flattening of a waveform if a virtual cathode is formed between the screen grid and the plate.

- (a) True (b) False

2. The ideal efficiency of a class-A amplifier never exceeds:

- (a) 40% (c) 60%
(b) 50% (d) 70%

3. The advantages of a push-pull output are:

- (a) No d.c. saturation of the output transformer
(b) Power-supply hum cancellation
(c) Cancellation of all even harmonics
(d) All of the above
(e) None of these

4. Voltage feedback:

- (a) Increases the effective output impedance
(b) Decreases the effective output impedance
(c) Only affects high frequencies
(d) Cannot be used with pentodes
(e) None of these

5. Transformer coupling:

- (a) Has limited frequency response
(b) Has limited square-wave response
(c) Has excessive weight and cost
(d) All of these
(e) None of these

6. Current feedback:

- (a) Increases the effective output impedance
(b) Decreases the effective output impedance
(c) Only affects high frequencies
(d) Cannot be used with pentodes
(e) None of these

7. Triodes, generally, have less distortion than pentodes.

- (a) True (b) False

8. Positive feedback reduces phase and frequency distortion.

- (a) True (b) False

9. Loudspeakers will tend to vibrate at their natural resonance if:

- (a) There is poor square-wave rise time
(b) There is 3rd harmonic distortion
(c) There are excessive even harmonics
(d) There is excessively high output impedance
(e) None of these

10. It is a "must" to bypass the common cathode resistor in a push-pull output stage with a large capacitance.

- (a) True (b) False

1. a; 2. b; 3. d; 4. b; 5. d
6. a; 7. a; 8. b; 9. d; 10. b
ANSWERS



Make and repair your own patchcord stacking plugs in seconds. Any color, any length for 40% less cost.

These new kits contain everything you need to custom assemble and/or replace damaged molded stacking patchcord plugs: 60 metal banana or .080 standard tip metal plugs, 60 housings, 10 in each of the six standard colors. An assembly tool and fixture for fast, easy assembly. Use with standard 0.144" wire (not included in kit). To assemble, simply feed stripped end of wire through cross-hole metal contact. Insert contact and wire into housing. Place in fixture and snap contact into place.

Convenience and flexibility, plus savings of at least 40% over molded stacking patchcord plugs.

E. F. Johnson Company, Waseca, Minnesota 56093

EW/12

Please send me complete information on your new stacking patchcord kits.



Name _____ Firm _____
Address _____
City _____ State _____ Zip _____

E. F. JOHNSON COMPANY

CIRCLE NO. 133 ON READER SERVICE PAGE

PROJECT 605 with MASTERLINK



Now you can assemble a high performance stereo amplifier with virtually no soldering. The exclusive new MASTERLINK module with solderless terminals enables you to install a 60 watt amplifier in an existing cabinet or optional enclosure with a minimum of time and effort. Send today for free information on about the PROJECT 605 amplifier and stereo tuner kits.

sindair

AUDIONICS, INC.
Distributed by 8600 NE Sandy Blvd.,
Portland, Ore. 97220

Sinclair Project 605 Amplifier



in Canada
McKeen & Gusselt Elect. Ltd
PO Box 4050 Station E
Ottawa 1, Ontario K1S 5B1

CIRCLE NO. 120 ON READER SERVICE PAGE

Electronics World SUBSCRIBER SERVICE

Please include an address label when writing about your subscription to help us serve you promptly. Write to: P.O. Box 1093, Flushing, N.Y. 11352

CHANGE OF ADDRESS: Please let us know you are moving at least six to eight weeks in advance. Affix magazine address label in space to the right and print new address below. If you have a question about your subscription, attach address label to your letter.

TO SUBSCRIBE: Check these boxes:
 5 yrs. \$26 3 yrs. \$18 1 year \$7
 New Renewal

SPECIFY: Payment enclosed—You get 1 extra issue per year as a BONUS!
 Bill me later.

If you have no label handy, print OLD address here.

name _____ please print _____

address _____

city _____

state _____ zip code _____

name _____ please print _____ 0375

address _____

city _____

state _____ zip code _____

Add'l postage: \$1 per year outside U.S., its possessions & Canada.

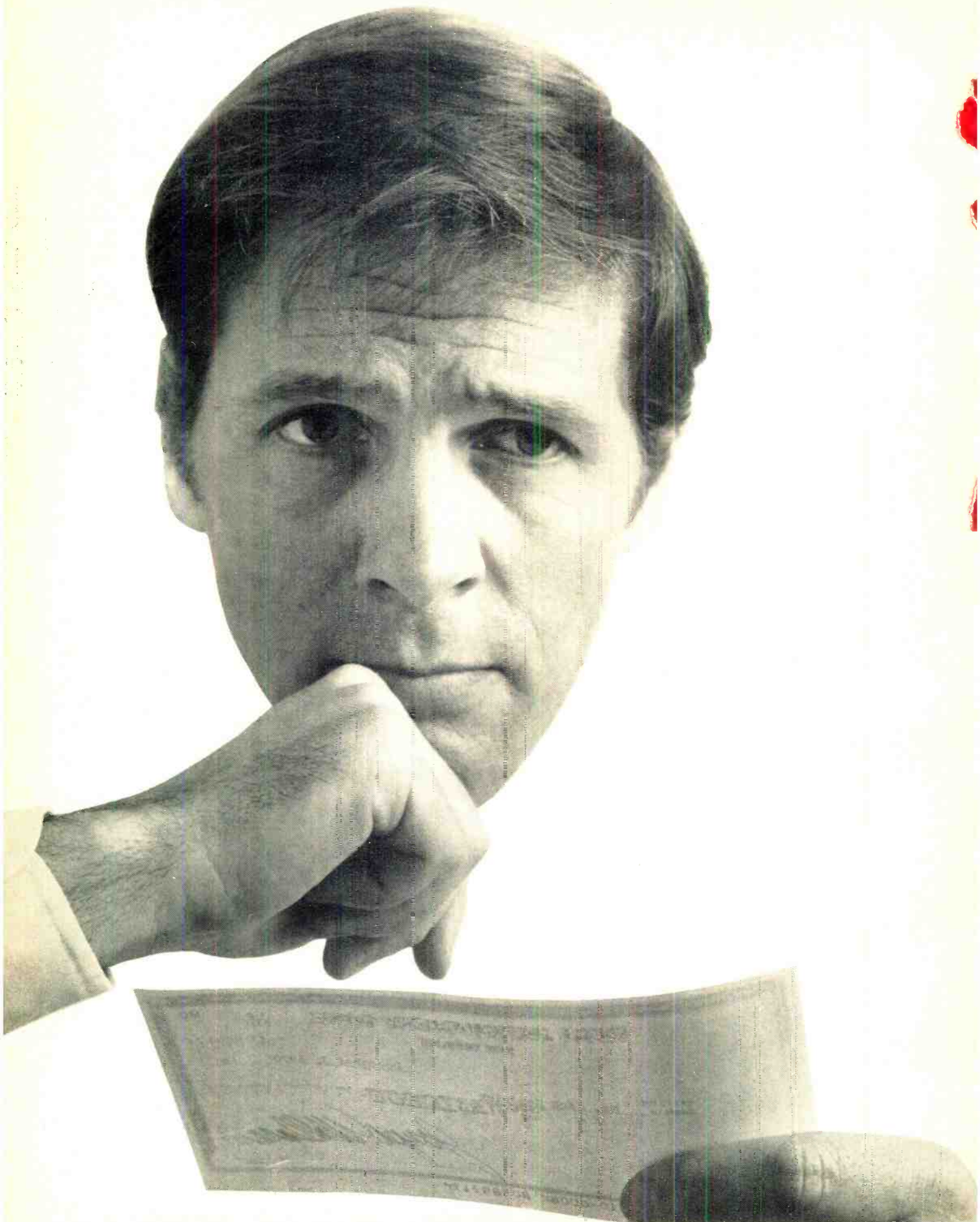

Your paycheck says a lot about you

It tells you more than how much you make. It tells you how far you've come. And if your paycheck looks very much the same as it did last year, or the year before, it simply means that *you* look very much the same as *you* did last year and the year before.

But times change, and you should be changing with them. Old dull jobs are disappearing. New exciting ones are being created. There are challenging new fields that need electronics technicians...new careers such as computers, automation, television, space electronics where the work is interesting and the earnings are greater.

RCA Institutes has one of the nation's largest and most respected home study schools devoted to electronics. They can get you started even if you've had no previous training or experience. RCA Institutes has developed a faster, easier way for you to gain the skills and the knowledge you need for a fascinating, rewarding electronics career. And you don't have to quit work and go back to school. With RCA Institutes Home Study Plan you can do

both. You set your *own* pace depending on *your* schedule.

Check over these RCA benefits:

- You get Hands-On Training—over 250 experiments and as many as 22 kits with some programs.
- You get RCA's unique "Autotext" method of learning—individual programmed instruction, the *easy, faster*, simplified way to learn!
- You get the widest choice of electronics courses and programs—everything from Electronics Fundamentals right up to Solid State Technology and Communications Electronics.
- You get a selection of low-cost tuition plans!

Sounds great, and it is! For complete information, without obligation, send in the attached postage paid card...or return the coupon below. That will say a lot about you.

Veterans: Train under new GI Bill. Accredited Member National Home Study Council. Licensed by N.Y. State—courses of study and instructional facilities approved by the State Education Department.

RCA Institutes	
Home Study Dept. 240-112-0 320 West 31st Street, New York, N.Y. 10001	
Please rush me FREE illustrated catalog. I understand that I am under no obligation.	
Name _____	Age _____
(please print)	
Address _____	
City _____	State _____ Zip _____
Veterans: Check here <input type="checkbox"/>	

If reply card is detached—send this coupon today

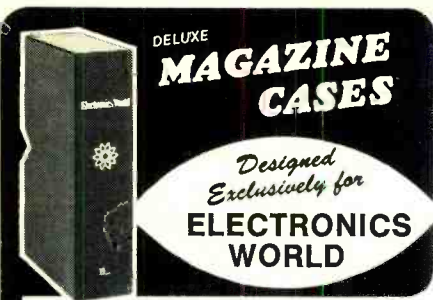

**DELUXE
MAGAZINE
CASES**

*Designed
Exclusively for*
**ELECTRONICS
WORLD**

● The ideal way to save your valuable copies, keep them well protected and make it easy for you to refer to any issue at any time. This bold new design is both decorative and attractive enough to enhance the decor of any room. Each case holds a full year's copies.

Constructed of reinforced fiberboard, these tough and durable cases are covered in a rich textured, leather-like fabric. The gold embossed back adds to its elegance and makes each case a welcome addition to your bookshelf, end table, desk—or for that matter, anywhere in your home or office.

In addition to Electronics World, cases are available for any of your favorite magazines. They're only \$3.95 each, 3 for \$11.00, 6 for \$21.00, in any combination of titles ordered. Add 50c per order for postage and handling. Outside U.S.A. add \$1.00 per case ordered.

Ziff-Davis Pub. Co., Dept. 23, 1 Park Ave., N.Y. 10016

Enclosed is \$_____ Please send Magazine Cases for the titles indicated below @ \$3.95 each, 3 for \$11.00, 6 for \$21.00. Add 50c per order for postage and handling. Outside U.S.A. add \$1.00 per case ordered.

TITLE	QUANTITY
ELECTRONICS WORLD	_____

Check One: All Black Maroon Back • Black Sides

EW-1271
Print Name _____
Address _____
City _____ State _____ Zip _____

PAYMENT MUST ACCOMPANY ORDER

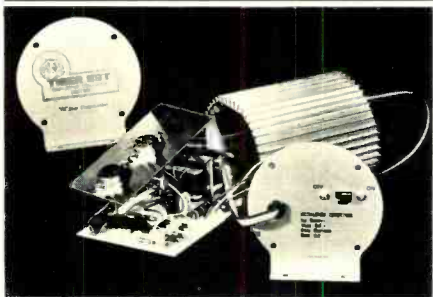

**FROM KIT TO CAR
IN 80 MINUTES!**

Electronic ignition is "in". Update your car with the TOPS in power, efficiency and reliability — the TIGER SST capacitive discharge ignition (CD).

The TIGER delivers everything other CD's promise — and more: quicker starting, more power, more gas mileage, tune-ups eliminated lifetime plugs and points, reduced repairs and pollution.

The TIGER can be built and installed in your car in 80 minutes. The TIGER is unique! Errors in construction or incorrect installation will not harm the TIGER or the engine. The TIGER will not operate under either condition.

The TIGER comes with a switch for TIGER or standard ignition for 12V negative ground only.

SATISFACTION GUARANTEED
or Money Back.

Simpli-Kit **\$29.95** — Assembled **\$39.95**
POST PAID

WE ACCEPT:
Mastercharge or Bank Americard.
Send check or money order with order to:

Tri-Star Corporation

DEPT. W, P. O. Box 1946
Grand Junction, Colorado 81501
CIRCLE NO. 123 ON READER SERVICE PAGE

Aluminum Conductors

(Continued from page 39)

on copper, conductivity is reduced and diffusion exists between the two metals.

Other Important Factors

For high-frequency applications, several factors are important in producing a superior coil, mainly the mass of the coil, its strength, and the insulation characteristics. Coils wound from aluminum strip have no interlayer capacitance, only interturn capacitance. Total coil capacitance is thus reduced.

It is important to note that such coils employing this concept have a number of advantages. The coil mass is reduced, the ratio of conductivity to mass is high, space factors are at a minimum as all voids are filled, thus enabling increased mechanical stability and strength. Weight is decreased and reliability increased.

In the design of components, the choice of insulation plus thermal considerations are deciding factors which govern performance and reliability. A thin film of flexible aluminum-oxide insulation has properties ideally suited for winding coils of all types. The combining factors of a very thin, integral insulating film and large area-per-volume strip construction offer an excellent lateral edge-radiating surface to provide more effective heat dissipation.

Aluminum-oxide has excellent heat-transfer properties important in transformer design. It has the ability to radiate heat rapidly at high temperatures and is insensitive to thermal shock, while exhibiting high thermal stability. Thus, it can safely carry short-term overload currents while operating in high ambient temperatures and be subjected to sudden changes in temperature over a wide range without showing deterioration. It may even be used effectively in high vacuum systems since it outgasses readily on heating and leaves no organic residue.

Since aluminum-oxide film is inor-

ganic and comparatively inert chemically, it does not age nor deteriorate in storage. It is resistant to all solvents, weak acids, and alkaline solutions.

Small, compactly wound coils may be built having better weight and space factors than can be obtained with conventional copper conductors and organic insulations. Heat dissipation is improved so that a considerable design latitude becomes possible, such as reducing the cross-section of the aluminum conductor, or increasing the current rating for an equivalent heat rise.

Minimum properties for 30-gauge aluminum wire bent around a bare mandrel several times the wire diameter, with voltage applied between the coil and a stripped wire end attached to the next pole, is 250 volts before breakdown. For two 30-gauge aluminum wires twisted on a turn-to-turn basis with both ends stripped, the minimum a.c. breakdown is 450 volts.

The dielectric breakdown of aluminum film insulation is rated 30 to 40 volts per micron (0.00004"), allowing close packing of the conductor (see Fig. 1). The dielectric strength changes little with temperature differences. The film is homogeneous, uniform, and closely bonded to the underlying conductor.

With the excellent insulating properties of coated aluminum conductors, the weight problem caused by heavy insulation can now be overcome. This allows the use of aluminum conductors and aluminum components in a wide range of applications. Aluminum conductors insulated with aluminum-oxide film are the solution to many of today's industrial and commercial problems where space, weight, and thermal properties are of importance.

Round aluminum wire is available from 2 mils to 150 mils thick (8-44 AWG). Rectangular aluminum can be had in any width from a minimum thickness of 0.001". Sheet aluminum, 0.5 mil to 0.060" thick, is available up to 8" wide. Insulation is available from 0.00004 to 1 mil thick film and all aluminum used is of 99% grade. ▲

ELECTRONIC DOOR BUZZER

- FEATURES:
- Different tone for each door
 - Can be expanded into toy organ

- PARTS LIST:
- 1 HEP 310
 - 1 Resistor, 10K, 1/2 Watt
 - 1 Resistor, 6.8K, 1/2 Watt
 - 1 Resistor, 3.9K, 1/2 Watt
 - 1 Resistor, 680 ohms, 1/2 Watt
 - 1 Resistor, 68K, 1/2 Watt
 - 1 Capacitor, 0.1 mfd, 30V
 - 3 Push Switches
 - 1 Speaker, 100 ohm Voice Coil
 - 1 Battery as Desired

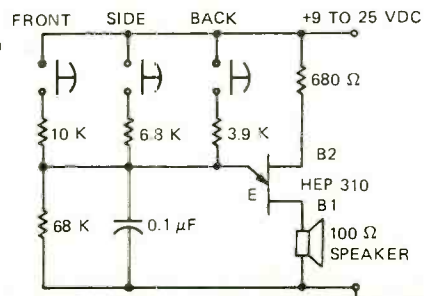

Channel Electron Multipliers

(Continued from page 31)

ble of producing a pulse of 5×10^7 electrons for each detected input of electron, ion, or photon.

The location within the matrix of an output pulse can be determined to a resolution of 0.006 inch by using a movable anode or an array of discrete anodes. Additionally, the pulses at each output can be readily counted. The location of such pulses within the matrix can also be readily determined by accelerating the output charge pulses onto a phosphor screen.

Applications for this device include space experiment detectors, mass spectrometer detectors, line-array outputs for electron and ion energy analyzers, line-array outputs for vacuum ultraviolet spectrometers and soft x-ray spectrometers, mapping of weak ion and electron beams, and detecting charged particles and photons. The unit may be operated in either the pulse mode for detecting and counting or in the analog mode as a miniature area detector.

The Spiraltron may also be used as a single electron-multiplier element such as the Model 4219X. This model is made up of a flared (or funnel-shaped) input section, a straight channel preamplifier section, and a section containing six smaller spiral-wound channels. This configuration can be operated at high gains without ion feedback.

The Model 4219X can be operated in two basic circuit configurations as shown in Figs. 5B and 5C. As in the Channeltron circuits, the collector is spaced about 1 millimeter from the end of the unit and uses a nominal collector voltage of 200 volts. The three-terminal connection results in a slightly higher gain when a V_C of 500 volts is used. However, as noted in Fig. 6, values of V_C above and below 500 volts result in gains less than those obtained with the two-terminal circuit configuration. *Bendix* does not recommend the use of a cap collector unless the cap is installed at the factory. ▲

Fig. 6. Gain characteristic curves for the Model 4219X Spiraltron.

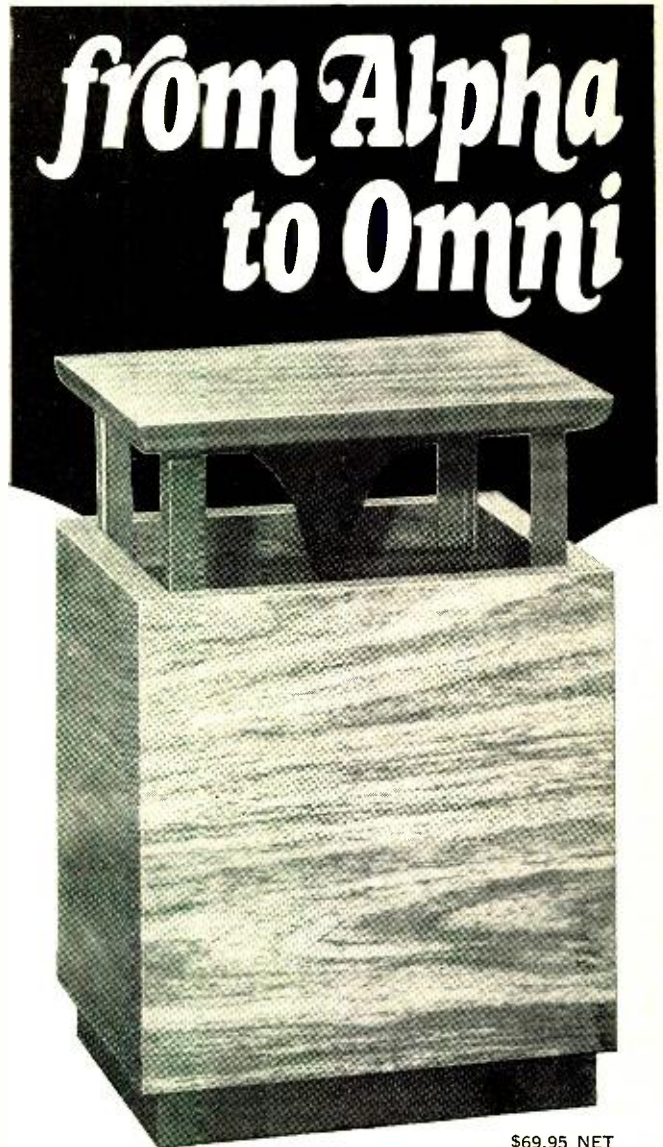
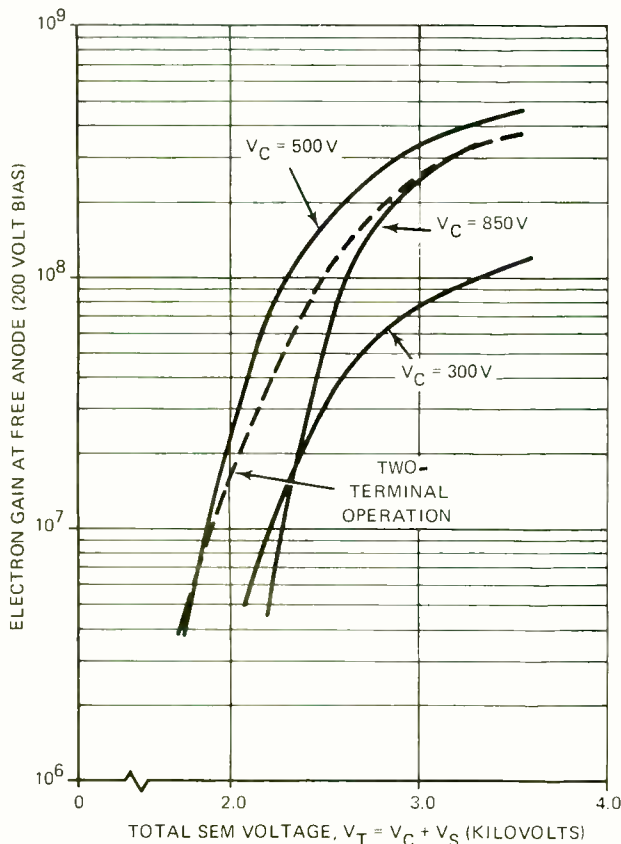

\$69.95 NET

OM-1 OMNI SPEAKER SYSTEM. We've been in it from the beginning... at point ALPHA in time. Our engineers took audible sounds—electronically produced, and made them clear, high fidelity tones. We participated in the design and engineering of speakers to create the world's finest stereophonic sound reproduction. Now, we have reached OMNI... OM-1 OMNI SPEAKER SYSTEM produces sound uniformly for any part of the room. It is "omni-directional," (radiates 360 degrees). This new concept radiates both direct and reflected sound deftly, creating a real depth sensation. You can place this OMNI speaker anywhere from the middle of the room to a corner bookshelf. The UTAH Omni Speaker is a wonderful new way to enjoy music.

sound all around

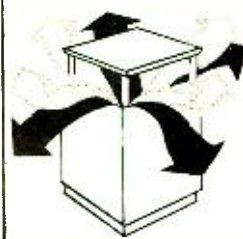

SPECIFICATIONS

Woofer; 8" diameter, cloth roll suspension, $1\frac{3}{4}$ pound magnet structure, 1" voice coil. Tweeter; 3" diameter, co-axially mounted, Alnico V magnet. Crossover frequency; 4,500 Hz. Cabinet; $9\frac{3}{4} \times 9\frac{3}{4} \times 14\frac{1}{2}$ " high, durable laminated walnut finish. Power; 30 watts peak, (15 watts program). Response, 35/18,500 Hz. Impedance, 8 ohms. Shipping weight, 15 pounds.

utah

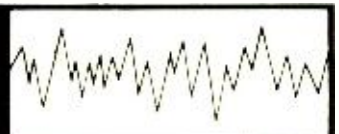

HUNTINGTON, INDIANA 46750
CIRCLE NO. 122 ON READER SERVICE PAGE

Hunting for a better job?

**Here's the
license
you need
to go after
the big ones**



A Government FCC License can help you bring home up to \$10,000, \$12,000, and more a year. Read how you can prepare for the license exam at home in your spare time—with a passing grade assured or your money back.

IF YOU'RE OUT TO BAG A BETTER JOB in Electronics, you'd better have a Government FCC License. For you'll need it to track down the choicest, best-paying jobs that this booming field has to offer.

Right now there are 80,000 new openings every year for electronics specialists—jobs paying up to \$5, \$6, even \$7 an hour... \$200, \$225, \$250, a week... \$10,000, \$12,000, and up a year! You don't need a college education to make this kind of money in Electronics, or even a high school diploma.

But you *do* need knowledge, knowledge of electronics fundamentals. And there is only one nationally accepted method of measuring this knowledge... the licensing program of the FCC (Federal Communications Commission).

Why a license is important

An FCC License is a legal requirement if you want to become a Broadcast Engineer, or get into servicing any other kind of transmitting equipment—two-way mobile radios, microwave relay links, radar, etc. And even when it's not legally required, a license proves to the world that you understand the principles involved in *any* electronic device. Thus, an FCC "ticket" can open the doors to thousands of exciting, high-paying jobs in communications, radio and broadcasting, the aerospace program, industrial automation, and many other areas.

So why doesn't everyone who wants a good job in Electronics get an FCC License and start cleaning up?

The answer: it's not that simple. The government's licensing exam is tough. In fact, an average of two out of every three men who take the FCC exam fail.

There is one way, however, of being pretty certain that you will pass the FCC exam. And that is to take one of the FCC home study courses offered by Cleveland Institute of Electronics.

CIE courses are so effective that better than 9 out of 10 CIE graduates who take the exam pass it. That's why we can back our courses with this iron-clad Warranty: Upon completing one of our FCC courses, you must be able to pass the FCC exam and get your license—or you'll get your money back!

They got their licenses and went on to better jobs

The value of CIE training has been demonstrated time and again by the achievements of our thousands of successful students and graduates.

2 NEW CIE CAREER COURSES

1. BROADCAST (Radio and TV) ENGINEERING... now includes Video Systems, Monitors, FM Stereo Multiplex, Color Transmitter Operation.

2. ELECTRONICS ENGINEERING... covers steady-state and transient network theory, solid state physics and circuitry, pulse techniques, computer logic and mathematics through calculus. A college-level course for men already working in Electronics.

Ed Dulaney, Scottsbluff, Nebraska, for example, passed his 1st Class FCC License exam soon after completing his CIE training...and today is the proud owner of his own mobile radio sales and service business. "Now I manufacture my own two-way equipment," he writes, "with dealers who sell it in seven different states, and have seven full-time employees on my payroll."

Daniel J. Smithwick started his CIE training while in the service, and passed his 2nd Class exam soon after his discharge. Four months later, he reports, "I was promoted to manager of Bell Telephone at La Moure, N.D. This was a very fast promotion and a great deal of the credit goes to CIE."

Eugene Frost, Columbus, Ohio, was stuck in low-paying TV repair work before enrolling with CIE and earning his FCC License. Today, he's an inspector of major electronics systems for North American Aviation. "I'm working 8 hours a week less," says Mr. Frost, "and earning \$228 a month more."

Send for FREE book

If you'd like to succeed like these men, send for our FREE 24-page book "How To Get A Commercial FCC License." It tells you all about the FCC License... requirements for getting one... types of licenses available... how the exams are organized and what kinds of questions are asked... where and when the exams are held, and more.

With it you will also receive a second FREE book, "How To Succeed In Electronics," To get both books without cost or obligation, just mail the attached postpaid card. Or, if the card is missing, just mail the coupon below.

ENROLL UNDER NEW G.I. BILL. All CIE courses are available under the new G.I. Bill. If you served on active duty since Jan. 31, 1955, or are in service now, check box on reply card for complete details.

CIE Cleveland Institute of Electronics

1776 E.17th St., Cleveland, Ohio 44114

Accredited Member National Home Study Council
A Leader in Electronics Training... Since 1934



Cleveland Institute of Electronics
1776 East 17th Street, Cleveland, Ohio 44114

Please send me without cost or obligation:
Your 44-page book "How to Succeed In Electronics" describing job opportunities in Electronics today, and how your courses can prepare me for them.
Your book on "How To Get A Commercial FCC License."

I am especially interested in:

<input type="checkbox"/> Electronics Technology	<input type="checkbox"/> Electronic Communications
<input type="checkbox"/> Broadcast Engineering	<input type="checkbox"/> Industrial Electronics
<input type="checkbox"/> First Class FCC License	<input type="checkbox"/> Electronics Engineering

Name _____
(PLEASE PRINT)

Address _____

City _____

State _____ Zip _____ Age _____

Check here for G.I. Bill information EW-96

NEW PRODUCTS & LITERATURE

For additional information on items identified by a code number, simply fill in coupon on Reader Service Page. In those cases where code numbers are not given, may we suggest you write direct to the manufacturer on business letterhead.

COMPONENTS ■ TOOLS ■ TEST EQUIPMENT ■ HI-FI ■ AUDIO ■ CB ■ COMMUNICATIONS

4-CHANNEL TAPE DECK

A four-channel reel-to-reel tape recorder has just been introduced as the Sony 277-4 "Quadradial" tape deck. The new unit includes complete four-channel record and playback, four-chan-



nel/two-channel record selector switch, making it possible to either record or play back two-channel stereo tapes or the new Quadradial tapes.

The deck also includes four illuminated vu meters, independent four-channel level controls, record equalization selector switch, triple-function headphone switch, a four-digit tape counter, and a pause control. The deck operates at $7\frac{1}{2}$, $3\frac{3}{4}$, and $1\frac{7}{8}$ i/s. Superscope

Circle No. 1 on Reader Service Page

IMAGE INTENSIFIER

A high gain, wafer-type image intensifier originally developed for military applications has now been made available to the civilian market.

Civilian applications for these image intensifiers include night-time industrial security and law enforcement, use in poorly lighted emergency situations, and other instances where use of auxiliary illumination is undesirable. The intensifiers employ high-gain microchannel plates as the amplification medium to yield maximum luminous gain in excess of 50,000 at photo-cathode illumination levels of 10-4 footcandles and below.

The new units weigh 2 ounces and are $1\frac{1}{2}$ " in diameter and $\frac{3}{4}$ " thick. At present these wafer image intensifiers are being offered in 18, 25, and 40 mm imaging area sizes. They are available with all standard and extended red photocathodes, a choice of phosphor screens, and can be equipped with fiber optic input and output windows. Tubes can be delivered with integral, potted power supplies. Litton Industries

Circle No. 2 on Reader Service Page

PORTABLE TWO-WAY RADIO

A "man-on-the-street" version of the Handie-Talkie is now available as the Handi-Phone.

It is a rugged instrument which offers up to four two-way communications channels as well as conventional paging. The unit weighs under two pounds and can be clipped to the belt or worn in its own convenient carrying case.

With the channel selector in the "paging on" position, the user is always ready to receive a call. An operator at the radio common-carrier switchboard pages the user and gives him a voice message (such as a specific telephone number to call), then the subscriber switches to one

of the four two-way channels to place his call or answer an incoming call.

The unit is available for both high-band (136-174 MHz) and u.h.f. (450-470 MHz) operation. Motorola Communications

Circle No. 3 on Reader Service Page

SOUND-LEVEL CALIBRATOR

The Model SPC-14 sound-level calibrator is a completely self-contained, solid-state instrument designed for making accurate and reliable field and in-plant calibrations on various types of microphones and sound-measuring instruments.

Precision with traceability to NBS is provided. The calibrator generates a sound-pressure level at both 100 dB and at 114 dB at the five ANSI preferred frequency levels of 125, 250, 500, 1000, and 2000 Hz, which are mandatory by law. This combination gives ten calibration points. The calibrator is 6" long \times $2\frac{1}{4}$ " in diameter and fits all $1\frac{1}{8}$ " diameter microphones but is available with adapters for $1\frac{5}{16}$ " and $\frac{5}{8}$ " diameter microphones. Columbia Research

Circle No. 4 on Reader Service Page

FOUR-CHANNEL AMPLIFIER

The new Model 4120 four-channel amplifier is a 100 watt r.m.s. (25 W/channel r.m.s.) instrument which can be switched to provide 120 watts (60 W/channel r.m.s.) amplification when used with conventional stereo sources. The synthesizer will produce pseudo four-channel sound from existing stereo records.

In addition, the Model 4120 has inputs for all conceivable stereo and four-channel sources (disc, tape, FM, etc.) as well as flexible easy-to-



use controls to govern all functions. It can also be used to provide genuine four-channel sound with full channel separation by plugging in a four-channel cartridge or reel-to-reel deck. Marantz

Circle No. 5 on Reader Service Page

CAPACITANCE METER

The Model 101 capacitance meter covers the range from 2 pF to 0.1 μ F and is direct-reading. The meter circuit incorporates IC op amps, precision FET circuits, and printed-circuit switches. According to the company, accuracy is limited only by the meter movement.

This battery-operated, portable instrument can be quickly switched through its eight scale ranges until the reading is obtained, saving time and effort and eliminating the possibility of errors.

The meter weighs $1\frac{3}{4}$ pounds and measures 5" \times 7" \times 2" high. Lateur Engineering

Circle No. 6 on Reader Service Page

CURVE TRACER

The CT71 curve tracer is a dynamic tester designed for displaying the characteristic curves of a wide range of transistor, FET, and diode

semiconductor devices on its 10 \times 10 cm ($5\frac{1}{2}$ -inch) CRT.

Basic specifications include a collector supply voltage of 0-1 kV (positive and negative polarity—twice line frequency or d.c.); collector current 2 amps (maximum 15 watts); and series resistances from 0 to 1.7 megohms in eleven steps.

The instrument has plug-in test fixtures with safety interlock and voltage settings for 100-125 volts in 5-volt steps, 200 to 250 volts in 10-volt steps, 48-63 Hz.

A data sheet supplying full details will be forwarded on request. Telequipment

Circle No. 7 on Reader Service Page

CASSETTE DECK WITH DOLBY

A solid-state stereo cassette deck which incorporates the Dolby noise-reduction system is now on the market as the RK-D40.

Features include a bias-equalizer switch on



the front panel which permits use of either standard formula or chromium-dioxide tapes; push-pull biasing circuitry for lower harmonic distortion on recordings; four-pole hysteresis synchronous a.c. motor for precise tape speed coupled to a balanced flywheel for low wow and flutter; and facilities for playing back prerecorded Dolby-system cassettes.

Housed in a chrome and walnut enclosure with brushed aluminum gold-anodized front panel, the deck measures $11\frac{3}{4}$ " \times $4\frac{3}{4}$ " \times $11\frac{3}{4}$ " deep. Lafayette

Circle No. 8 on Reader Service Page

FOUR-WAY SPEAKER SYSTEM

A four-way, four-speaker system has been introduced as the Model 6. The system is housed in a hand-rubbed walnut cabinet finished on four sides and comes with a black base so the system can be used as a console. The cabinet measures 27" \times $20\frac{1}{2}$ " \times 15" deep.

Incorporating a 15" woofer, 8" direct-radiating mid-range, a 5" direct-radiating tweeter, and an ultra-tweeter, the system provides frequency coverage from 27 to 30,000 Hz. Impedance is 8 ohms and crossovers are at 300, 1000, and 4000 Hz.

There are balance controls—two for mid-range and high/ultra-high frequencies. Push-type binding posts are supplied. Jensen Sound

Circle No. 9 on Reader Service Page

AUXILIARY AMPLIFIER

A 50-watt, solid-state, auxiliary two-channel amplifier has been introduced as the "Quadradial" LA-424.

The unit is designed to convert regular two-channel stereo systems into discrete 4-channel stereo. It will not operate as a 2-channel stereo amplifier alone. The LA-424 plus two additional speakers will permit reproduction of 4-channel, 8-track cartridge or reel-to-reel tapes. The am-



plifier incorporates the company's "Composer" circuit which enables the listener to derive 4-dimensional sound from 2-channel stereo records, tapes, and FM broadcasts without using an external amplifier. The LA-424 has the usual complement of controls.

Housed in a simulated walnut vinyl-clad metal case, the unit measures 10 $\frac{3}{8}$ " wide \times 3 $\frac{1}{2}$ " high \times 8 $\frac{3}{8}$ " deep. It will operate from 105-120 volt, 50/60 Hz power lines. Lafayette

Circle No. 10 on Reader Service Page

"WIRELESS" STEREO SPEAKERS

The new TRS-17 "Speaker of the House" is claimed to be the first speaker system to operate without wires. Any electrical outlet in the home can become a stereo sound source since the system contains patented circuits which permit it to be plugged into any wall socket.

The twin matched oiled-walnut, damped bass-reflex enclosures each contain an integrated receiver/amplifier section. Each bookshelf-size speaker is equipped with acoustical controls for individual volume, bass, and treble adjustment. Each cabinet measures 14" high \times 7" deep \times 11" wide, while the solid-state transmitter is approximately the size of a cigarette pack. Concept Plus

Circle No. 11 on Reader Service Page

4-CHANNEL COMPONENTS

Two new components which will enable any of the firm's existing music systems to develop 4-channel sound have been introduced as the Model K8872 4-channel cartridge player and the Model K8910 amplifier.

The amplifier features push-button controls for power, 2-channel and 4-channel rotary controls for balance, bass, treble, and volume while the 4-channel cartridge player features push-button selection controls for 2- and 4-channel, a front-loading protective cover, and cartridge slot. Magnavox

Circle No. 12 on Reader Service Page

SOUND/NOISE ALARM

A compact, wall-mounted monitor which warns employees when noise reaches unsafe levels in working environments has been introduced as the sound/noise alarm.

The alarm is equipped with the "A" weighted scale on which Walsh-Healy standards are based. A red warning light flashes to alert personnel to use protective equipment. The unit has four settings from 85 to 100 dB in five-decibel increments. Setting is as simple as turning the unit's knob.



December, 1971

Be Safe with DeltAlert The Proven Crimestopper

Everyone knows crime is increasing steadily. In fact, statistics show that one out of every six homes will be victimized this year. What can you do about it? The DeltAlert Ultrasonic Burglar Detection & Alarm System was developed to help protect you and your family. DeltAlert effectively monitors and blankets up to 300 sq. ft. of space, utilizing the sonar principle to pick up even the slightest motion. When DeltAlert is activated, horn and lights automatically begin operating. The loud ear-shattering blasts of the high intensity horn, coupled with light drives away even the boldest intruder. At home or work, protection begins with the DeltAlert Alarm and Detection System. It's maintenance free, and to install you simply plug it in. Order yours today, and start enjoying the feeling that comes with DeltAlert protection.

\$69.95

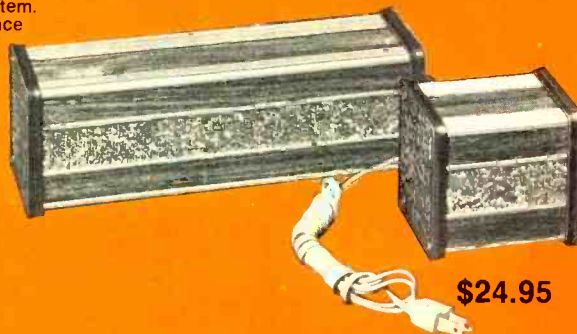

\$24.95

Here Are 8 Reasons to Put The Mark Ten B On Your Car

The Mark Ten B CD System with exclusive VARI SPARK[®] Circuitry will give you these substantial dollar saving advantages: 1) Eliminate 3 out of 4 tune-ups; 2) Improve combustion, reduce contaminants; 3) Install in ten minutes; 4) Instant start in all weather; 5) Dramatic increase in performance; 6) Hardy switch with redundant contacts for instant return to standard ignition; 7) Two-piece housing with neoprene seals provides total dust and moisture protection; 8) Use on ANY 12-volt, negative-ground engine. Put the Mark Ten B on your car today. It will pay for itself in dollars saved.



Superior Products
At Sensible Prices

Mark Ten B (12v neg only) Only \$59.95 ppd.
Standard Mark Ten \$44.95 ppd.

Please send me literature immediately. Enclosed is \$_____ Ship ppd. C.O.D.

Please send: _____ DeltAlert(s) @ \$69.95 ppd.

_____ DeltaHorn(s) @ \$24.95 ppd.

_____ Mark Ten B @ \$59.95 ppd.

_____ Standard Mark Ten (Assembled) @ \$44.95 ppd.

_____ 6 Volt: Neg. Ground Only _____ Positive Ground

_____ 12 Volt: Specify _____ Negative Ground

_____ Standard Mark Ten (Deltakit) @ \$29.95 ppd.
(12 Volt Positive Or Negative Ground Only)

Car Year _____ Make _____

Name _____

Address _____

City/State _____

Zip _____



DELTA
PRODUCTS, INC.

P.O. Box 1147, Grand Junction, Colorado 81501, (303) 242-9000

CIRCLE NO. 143 ON READER SERVICE PAGE



How to prepare for today's competitive job market, tomorrow's new opportunities in electronics

Competition for jobs and promotions is severe in the electronics industry today. But experts say that exciting new electronic products will create thousands of new jobs in the next few years.

One thing is certain: in good times or bad, the best opportunities come to the man with an advanced, specialized knowledge of electronics. He has a better chance of survival in a recession and will profit more in times of prosperity than the man with ordinary qualifications.

But how can you get the additional education in electronics you need to protect your future—and the future of your family? Going back to school isn't easy for a man with a job and family obligations.

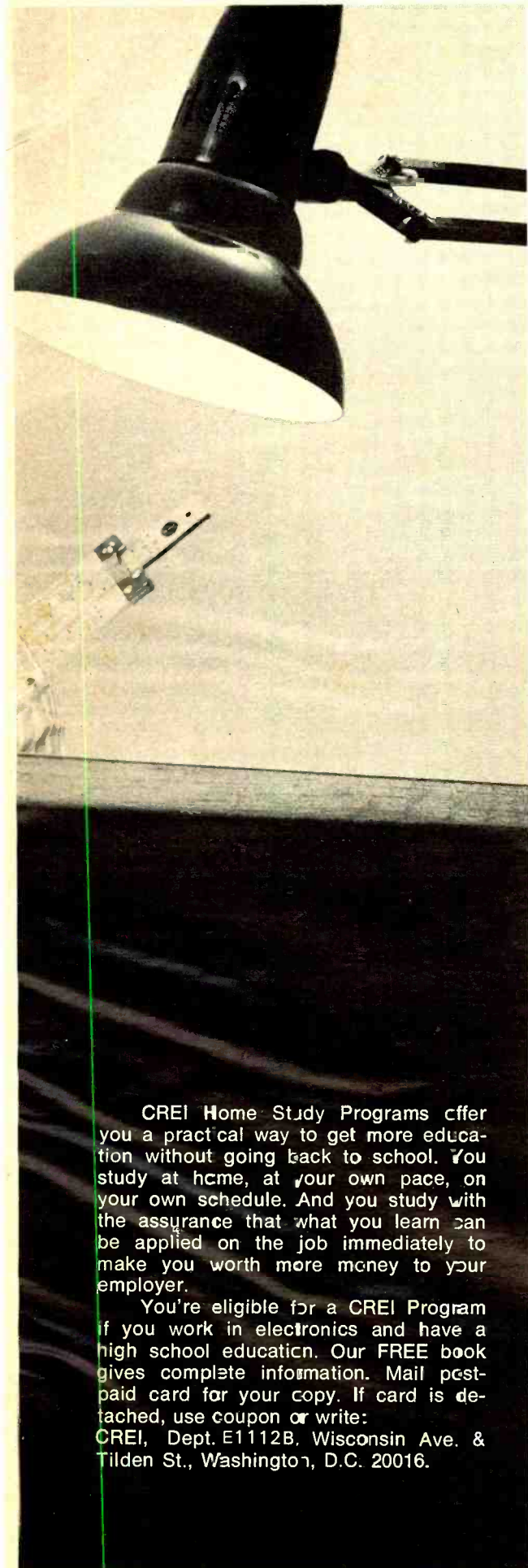

CREI Home Study Programs offer you a practical way to get more education without going back to school. You study at home, at your own pace, on your own schedule. And you study with the assurance that what you learn can be applied on the job immediately to make you worth more money to your employer.

You're eligible for a CREI Program if you work in electronics and have a high school education. Our FREE book gives complete information. Mail postpaid card for your copy. If card is detached, use coupon or write:
 CREI, Dept. E1112B, Wisconsin Ave. & Tilden St., Washington, D.C. 20016.

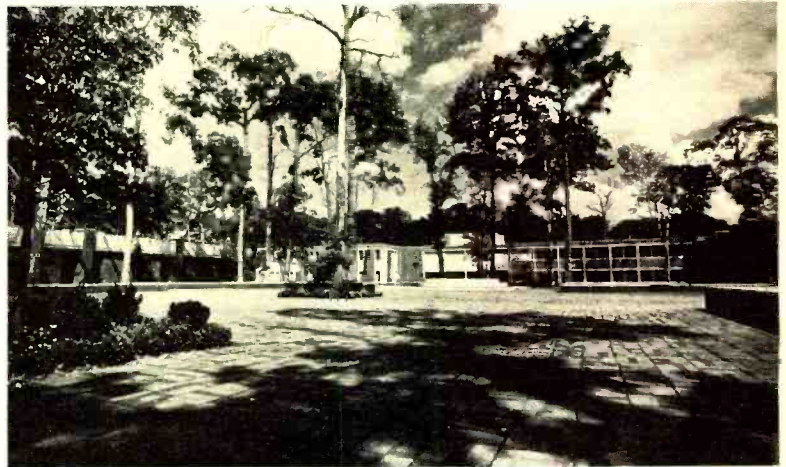

College Credits for CREI Students

Recently CREI affiliated with the New York Institute of Technology for the express purpose of making it possible for CREI students to earn college credits for their studies. The New York Institute of Technology is fully accredited by the Middle States Association of Colleges and Universities and is chartered by the New York State Board of Regents.

For the many CREI students who are not interested in college credits, but simply in improving their knowledge of advanced electronics, this affiliation with NYIT will provide additional assurance of the high quality of CREI home study education.

If you want to know more about earning college credits for CREI study, check the appropriate box when you mail the postpaid card for complete information on CREI Programs.

Founded 1927

CREI

Accredited Member of the
National Home Study Council



Free book tells all about CREI programs. For your copy, tear out and mail postpaid card or write: CREI, Dept. E1112B, Wisconsin Ave. & Tilden St., Washington, D.C. 20016

CREI, A Division of the McGraw-Hill Continuing Education Company

Dept. E1112B, Wisconsin Ave. & Tilden St., Washington, D.C. 20016

Please mail me free book describing CREI Programs. I am employed in electronics and have a high school education.

Name _____ Age _____

Address _____

City _____ State _____ Zip Code _____

Employed by _____

Type of Present Work _____ G.I. Bill

- I am interested in: College credits for CREI study. Space Electronics
 Electronic Engineering Technology Computers Industrial Electronics
 Nuclear Engineering Technology Electronics Systems Engineering
 Non-technical course in computer programming. CATV Engineering

APPROVED FOR TRAINING UNDER NEW G.I. BILL

**ANOTHER SUPERB
VALUE
from Olson**

Electronics

TV-COM ONLY \$300

TV SYSTEM with INTERCOM



Compact camera and monitor is equipped for 2-way sound that offers new dimension in all-round protection for your family, home, business or industry. Simple plug-in installation. Complete - nothing else to buy.

Olson Electronics, Dept. EX

260 S. Forge St., Akron, Ohio 44308

1 enclose \$300 plus \$1 for postage and handling. Send me the TV-300 TV System.

Send me the next seven issues of the Olson Catalog, without cost or obligation. **FREE**

Name _____
Address _____
City _____
State _____ Zip _____

CIRCLE NO. 133 ON READER SERVICE PAGE

Housed in a coated aluminum case, the alarm can be mounted using three small screws. It operates on standard 110-volt, 60-Hz power lines. Bausch & Lomb

Circle No. 13 on Reader Service Page

STEREO HEADPHONES

The new SE-L20 stereo headphones comprise a pair of 1 1/2"-inch dynamic speakers, one in each earphone. The speakers use a voice-coil-driven, ultra-thin polyester cone. According to the company, since the high-range loss is smaller with polyester cones than with paper cones, there is improved response and clear reproduction in the treble range. The lower cone mass also produces superior damping and more consistent reproduction throughout the entire sound spectrum.

Frequency range is 20-20,000 Hz and the headphones can be connected to any amplifier having an output impedance from 4 to 16 ohms. Maximum drive signal is 0.5 volt while sensitivity is 97 dB/0.1V. The headphones weigh approximately 7 1/2 ounces. Pioneer

Circle No. 14 on Reader Service Page

MANUFACTURERS' LITERATURE

EMERGENCY POWER

Automatic Switch Co., Florham Park, N.J. 07932 has just published a timely 20-page book about automated emergency systems for handling power failures.

The booklet tells why the need for emergency power has grown; why it will become even more essential as the demand for electricity increases; where emergency power is needed; why it must be operated automatically; what makes an automatic system reliable—plus typical installation diagrams and other pertinent information on getting the most from an emergency power system.

SEMICONDUCTOR CATALOGUE

General Instrument's Semiconductor Products Group, 600 W. John St., Hicksville, N.Y. 11802 has announced publication of a new discrete semiconductor condensed catalogue.

The 24-page brochure describes silicon rectifiers, silicon bridge assemblies, MOSFET's, silicon diodes, high-voltage assemblies, germanium diodes and transistors, and other products made by the company.

Circuit diagrams, tables of characteristics, and other descriptive material are provided for each device. The listing represents a complete summary of the firm's line of semiconductor products. A cross-reference guide is also included.

POWER TRANSISTORS

The operation and application of high-speed, high-voltage, and high-current power transistors for amplification and switching are described in a revised 96-page manual from RCA Solid State Division.

The manual, PM-81, has been prepared primarily for circuit designers, educators, and students. It contains the latest information on physical theory, structures, geometries, packaging, safe operating areas, thermal fatigue and thermal-cycling ratings, and the operation and requirements of power transistors in linear and switching applications.

Orders for the manual at \$2.00 a copy should be sent to RCA Commercial Engineering, Harrison, N.J. 07029.

SEMICONDUCTOR DATA

The latest edition of its semiconductor condensed catalogue showing an entire line of transistors, FET's, diodes, and linear, digital, hybrid, and MOS microcircuits is now available from Teledyne.

Included in this 72-page catalogue are significant parameters for each device, parameter definitions, a listing of package types, schematics, and ordering information. In addition, the cata-



"I modified your burglar alarm system a teensy bit!"

logue also lists passive components available in dice form and standard military-qualified semiconductors.

Write on your business letterhead to Teledyne Semiconductor, 1300 Terra Bella Avenue, Mountain View, California 94040 for a copy.

SEMICONDUCTOR GUIDE

The Electronic Components Group of GTE Sylvania Incorporated has just published a revised semiconductor guide which gives replacement information on more than 41,000 solid-state devices.

The 73-page illustrated catalogue (ECG-212D) provides characteristics and outline drawings of the 124 components in the company's semiconductor line. These devices, which include transistors, integrated circuits, diodes, and rectifiers, may be used to replace approximately 41,000 equivalent foreign and domestic types. A complete alphanumeric cross-reference, by type number, is also included.

Copies at \$1.00 apiece are available from any of the company's franchised distributors.

SOLID-STATE MANUAL

A new edition of the company's transistor, thyristor, and diode manual has been issued by the Solid State Division of RCA.

The revised manual, SC-15, contains 768 pages of the latest information on basic technology, operating principles, characteristics and ratings, applications, and testing of these solid-state devices. Intended for use by circuit designers, students, and others interested in the operation and application of solid-state devices, this new manual is a complete reference on bipolar transistors, MOSFETs, thyristors, silicon rectifiers, and other types of solid-state diodes.

Copies may be ordered direct from RCA Commercial Engineering, Harrison, N.J. 07029 for \$2.50 a copy.

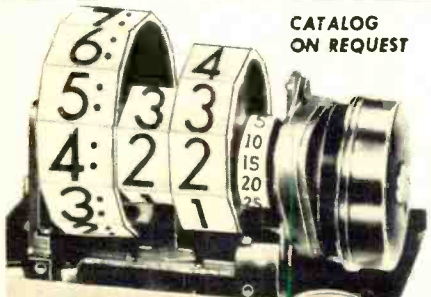

CATALOG ON REQUEST



DIGITAL CLOCK MOVEMENTS

DIGITS RESETTABLE INDIVIDUALLY

Available in 50, 60 cy., all voltages. AC. UL approved motor, cord. One Year Guarantee.

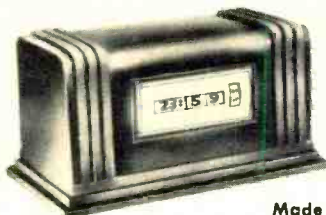

#100-24H
24 Hour
CLOCK

Made in U.S.A.

Complete Line: Delay, Interval and Cycle Timers, Digital Computers

**PENNWOOD NUMECHRON CO.
TYMETER ELECTRONICS**

7249 FRANKSTOWN AVE PITTSBURGH, PA 15208

CIRCLE NO. 131 ON READER SERVICE PAGE

PHOTO CREDITS

Page	Credit
13,14 (top), 15 (top)	National Center for Atmospheric Research (NCAR)
20	Hughes Aircraft
30,31	Bendix Research Laboratories
37	Graphic Sciences Inc.
38 (center)	Telautograph
38 (bottom)	Xerox Corporation

Low-Power Crystal-Controlled Oscillator

By JOSEPH H. WUJEK/Lawrence Livermore Laboratory, University of California*

This circuit, employing single CD4000, is suitable for use as a battery-powered frequency standard for calibrating scopes.

THE development over the past several years of complementary-symmetry metal-oxide semiconductors (CMOS or COSMOS) has provided new capabilities in low-power designs. In particular, the RCA CD4000 family of logic elements exhibits standby power dissipation in the nanowatt range. This makes possible design of functional circuits with exceptionally low power drain—in the microwatts. The following is a good example.

The high input impedance of CMOS gates, on the order of 10^{12} ohms shunted by 5 picofarads, combined with the relatively low (1k ohm) output impedance, is ideally suited for crystal oscillators. This article describes one such design which operates at 12 kHz with a power dissipation of 240 microwatts from an 8-volt supply. However, designs up to a megahertz are now possible with presently available devices.

Fig. 1 shows the oscillator configuration. The resistive feedback network may be built of temperature-sensitive elements to compensate for the temperature characteristic of the crystal. Fig. 2 is a plot of power dissipation as a function of supply voltage when working into one COSMOS load at 12 kHz. In general, power is approximately proportional to fCV^2 , where f is the operating frequency, C the capacitive load, and V the supply voltage. The temperature-dependent standby power is several decades smaller than this dynamic contribution.

The oscillator tested employed a crystal having a parabolic temperature characteristic with end points of -55 p/M at $+50^\circ\text{C}$ and -40°C , referred to room-temperature frequency. This thermal drift is partially compensated by a resistor/thermistor network to yield a drift of less than -20 p/M over the 0°C to $+40^\circ\text{C}$ upper design limit. From 0° to -20°C , the lower design limit, drift was held to less than -30 p/M. A custom-fabricated network, as for example thick- or thin-film deposited elements, could improve the temperature-drift specifications. Alternately, a crystal cut with a positive T.C. for the temperature range of interest would simplify the compensation scheme by permitting use of a thermistor/resistor network and achieving good low-temperature frequency stability.

For the design illustrated, frequency sensitivity to supply voltage was approximately $+2$ p/M/volt, which allows operation from an unregulated power supply.

RCA not too long ago announced the development of COSMOS gates with a threshold voltage of 1.5 volts, which should permit designs of even lower dissipation and operation from single-cell power supplies.

The author gratefully acknowledges the laboratory assistance of Frank Gonzales. ▲

*Work performed under the auspices of the United States Atomic Energy Commission.

December, 1971

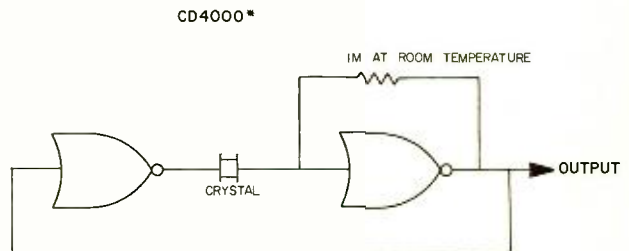

* CD4000 CONTAINS THE TWO NOR GATES USED PLUS AN INVERTER. ALL UNUSED INPUTS GROUNDED.

Fig. 1. Oscillator configuration. A single RCA CD4000 is used.

Fig. 2. Plot of power dissipation as function of voltage at 12 kHz.

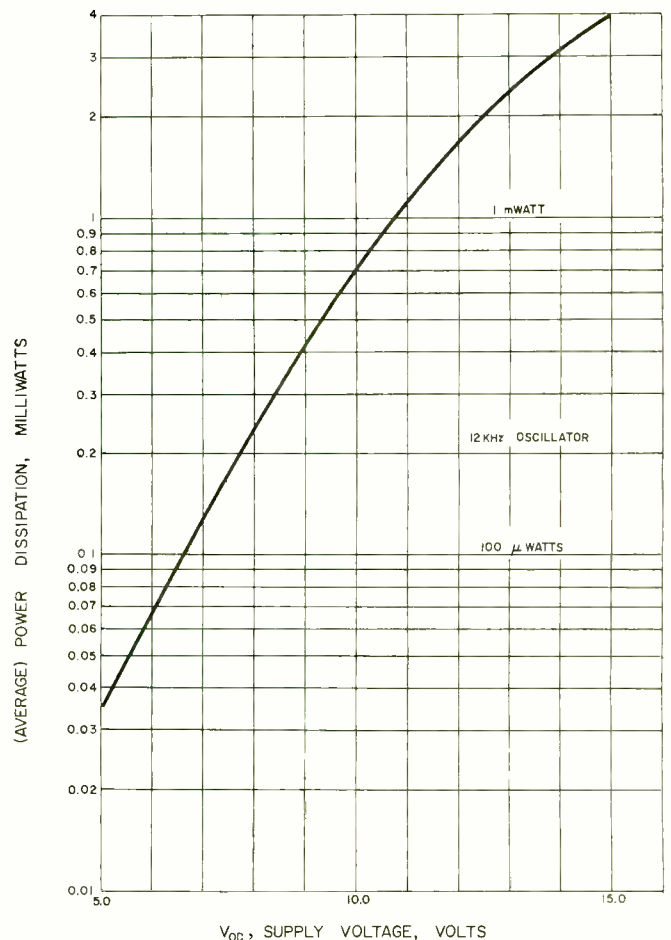

ELECTRONICS MARKET PLACE

COMMERCIAL RATE: For firms or individuals offering commercial products or services. \$1.00 per word (including name and address). Minimum order \$10.00. Payment must accompany copy except when ads are placed by accredited advertising agencies. Frequency discount: 5% for 6 months; 10% for 12 months paid in advance.

READER RATE: For individuals with a personal item to buy or sell. 65¢ per word (including name and address). No minimum! Payment must accompany copy.

GENERAL INFORMATION: First word in all ads set in bold caps at no extra charge. All copy subject to publisher's approval. All advertisers using Post Office Boxes in their addresses MUST supply publisher with permanent address and telephone number before ad can be run. Closing Date: 1st of the 2nd month preceding cover date (for example, March issue closes January 1st). Send order and remittance to: Hal Cymes, ELECTRONICS WORLD, One Park Avenue, New York, New York 10016.

FOR SALE

GOVERNMENT Surplus Receivers, Transmitters, Snooperscopes, Radios, Parts, Picture Catalog 25¢. Meshna, Nahant, Mass. 01908.

CONVERT any television to sensitive big-screen oscilloscope. Only minor changes required. No electronic experience necessary. Illustrated plans, \$2.00. Relco-A22, Box 10563, Houston, Texas 77018.

INVESTIGATORS, Latest Electronic Aids. Free Literature. Clifton, 11500-J NW 7th Ave., Miami, Florida 33168.

SENCORE, B & K Test Equipment Unbelievable Prices. Free Catalog and Price Sheet. Fordham Radio, 265 East 149th Street, Bronx, N.Y. 10451.

ELECTRONIC PARTS, semiconductors, kits. Free Flyer. Large catalog, \$1.00 deposit. Bigelow Electronics, Bluffton, Ohio 45817.

NEW SEMICONDUCTOR LIGHT EMITTING DIODES. Bright red lights replace light bulbs. Typical life 100 years. Operate at 1.65 volts, 50 milliamps. Order 2 for \$2.98 NOW. Data sheet and instructions included. Monsanto Company, Hobby Section, 10131 Bubb Road, Cupertino, California 95014.

ELECTRONIC COMPONENTS—Distributor prices. Free catalogue. Box 2581, El Cajon, California 92021.

ELECTRONIC Ignition. Various types. Information 10¢. Anderson Engineering, Epsom, N.H. 03239.

CONSTRUCTION PLANS: Laser ... \$2.00. Investigation aids—2-FM microphone transmitters ... \$1.00. FM telephone transmitter ... \$2.00. Sound telescope ... \$2.00. Space monitor-missile tracker ... \$2.00. Free equipment and kit catalog. Howard, 20174 Ward, Detroit, Michigan 48235.

JAPAN HONG KONG DIRECTORY. World products information. \$1.00 today. Sekai Shogyo Annai, Hillyard, Washington 99207.

BURGLAR ALARM SYSTEMS. We manufacture intruder fire detection systems, radar and perimeter types. Accessories available. Free Literature. Inquiries for dealership and wholesale prices must be on letterhead. U.S. and Canada only. Microtech Associates, Inc., Box 10147, St. Petersburg, Florida 33733.

EUROPEAN wholesale new products catalog \$1.00 refundable. Deecow, P.O. Box 9308, North Hollywood, Calif. 91609.

MECHANICAL, ELECTRONIC devices catalog 10¢. Greatest Values—Lowest Prices. Fertik's, 5249 "D", Philadelphia, Pa. 19120.

METERS Surplus, new, used, panel or portable. Send for list. Handgett, Box 5577, Riverside, Calif. 92507.

LOWEST Prices Electronics Parts. Confidential Catalog Free. Knappco, 3174 8th Ave. S.W., Largo, Fla. 33540.

1972 ELECTRONICS Catalog 25¢. McCord Electronics, Box 41Z, Sylvania, Ohio 43650.

HOW to break into Radio, Television Broadcasting Book, \$2.69. I.Q. Engineering, Box 374, Canoga Park, Calif. 91305.

RECONDITIONED Test Equipment. Reasonably priced, list available. Waite, 2697 Nickel, San Pablo, CA 94806.

O.E.M. POWER SUPPLIES. Transformer isolated, regulated. 115VAC ±10V 60Hz. Dual output ±8 Vdc at 8ma, <.3% ripple. Solid potting, P.C. Board mounting. 1.25"X1.25"X1.0" H. \$12.50 plus .50 handling. MANCHESTER ELECTRONICS, 20 Meadow St., Manchester, N.H. 03103.

FREE ILLUSTRATED CATALOG! covering wide range of low-cost stock business forms from 2-Way Radio to TV Service. Write today. Free catalog; samples, too. OEL-RICH PUBLICATIONS, 4040 N. Nashville East, Chicago, Illinois 60634.

FREE Catalog—loads of bargains. R.W. Electronics, 4005 West Belmont, Chicago, Illinois 60641.

CAPACITIVE discharge ignition systems by Delta. Free catalog. Southland Communications, Box 3591, Baytown, Texas 77520.

INTEGRATED Circuits, 74N series, all latest types, low, low, prices. 749C-\$1.45, 7400-\$2. Send for free complete list. B&A Supply Co., Box 24211, Fort Lauderdale, Florida 33308.

PANORAMA of industrial and government electronic surplus in our monthly picture catalogs. Free. Startronics, Box 17127, Portland, Oregon 97217.

CRT Picture Tube rebuilder—used 3 months. Accessories included, cost \$4,000 sell \$1500. Ray Davidson, 508 New York Avenue, Huntington 11743.

67KC SCA adapter. Solid state, wired, tested. Operates on 9 to 30 watts. Use between FM tuner and audio amplifier. \$15.50. Postpaid USA with instructions, station list. Mark and Alan, P.O. Box 172, Chesterfield, Ohio 44026.

RESISTORS—High quality, low prices. Free flyer. Kingtree, Box 3092, Columbus, Ohio 43210.

DIGITAL FREQUENCY METER for service shops—CB—Ham. Automatically display frequency from audio through 35 MHz—Kit or Assembled—Prescaler also available to extend operation to over 200 MHz. Micro-Z Co., Box 2426 Rolling Hills, Calif. 90274.

IC Temperature Controller Modules, Data Sheet 10¢, ZETEC, Box 22101, San Diego, California 92122.

FREE bargain catalog. Test, communications equipment. Downs, 1811 Palo, Baltimore, 21227.

ALPHA/THETA BRAINWAVE feedback instruments. Relaxation, meditation, altered consciousness. Free literature. Box 319EW, Fairfax, CA 94930.

CATHODIC PROTECTION instructions \$1.00. F.F. Knapp, P.O. Box 854, Scottsdale, Arizona 85252.

PLANS & KITS

INTEGRATED CIRCUIT KITS—Free Catalog. FRAZER & ASSOCIATES, 3809 Surfwood Road, Mailbu, California 90265.

KITS—Color Organs, Synchronizers, Stobes. Workshop, Box 393Z, Bethpage, New York 11714.

ELECTRONIC ORGAN KEYBOARDS, tone generator kits and components, P.C. cards, etc. for any organ circuitry. Send 20¢ for list. DEVTRONIX ORGAN PRODUCTS, 5872 Amapola Drive, San Jose, Calif. 95129.

MINIATURE RELAYS

DPDT



24 VOLTS DC
3/8" x 3/8" x 3/8"

ACTUAL SIZE

Stock No. H9130—2/\$1.00, 5/\$2.00

ELECTROLYTIC FILTER CAPACITOR GRAB BAG

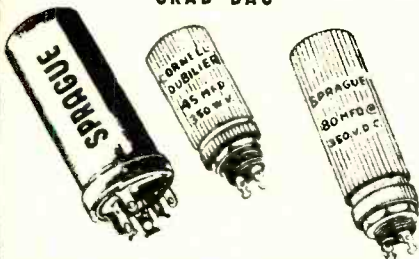

Capacities to 2500 Mfd. Voltages to 600 VDC. Single & multiple sections. Leading Mfgs. Entire assortment at less than government cost of a single piece.

12 Piece Assortment

Stock No. H2078 \$3.50

BRAND NEW COMPUTER GRADE CAPACITORS

40,000 mfd.	10 volts	3 3/4 x 4 3/4	Stk. No. H2062
	1.25 ea.	6/7.00	
70,000 mfd.	10 volts	3 1/4 x 4 1/4	Stk. No. H2118
	1.75 ea.	6/9.00	
6000 mfd.	55 volts	2 3/4 x 4 1/2	Stk. No. H2117
	1.50 ea.	7/9.00	
3,750 mfd.	75 volts	2 1/2 x 4 1/4	Stk. No. H2116
	1.75 ea.	6/9.00	

**\$1.00 FREE WITH \$10.00 ORDER
MINIMUM ORDER \$3.00**

Lots of other items—send for free flyer; all merchandise fully guaranteed. Please include postage; excess will be refunded.



DELTA ELECTRONICS CO.

BOX 1, LYNN, MASSACHUSETTS 01903

CIRCLE NO. 144 ON READER SERVICE PAGE

FREE Catalog Of The WORLD'S FINEST GOV'T SURPLUS ELECTRONIC BARGAINS



F. M. MOTOROLA GOVERNMENT SURPLUS

	Used:	Re-Cond.:
R-394 RECEIVER	152-172 MC	\$14.95 \$22.50
T-278 TRANSMITTER	152-172 MC	18.95 24.95
R-257 RECEIVER	25-50 MC	19.95
T-208 TRANSMITTER	25-50 MC	29.95
CY-938 CABINET		7.95 9.95
C-847 CONTROL BOX		8.95 12.95



ALSO—Power Supplies, Amplifiers, Modules, etc.

FAIR RADIO SALES • Dept. EW, Box 1105 • Lima, Ohio 45802

CIRCLE NO. 140 ON READER SERVICE PAGE

GREGORY ELECTRONICS
Your Best Buys In
QUALITY USED
FM 2-WAY RADIO EQUIPMENT

GE-RC4 Remote Control \$75
 GE-RC4 Remote Control,
 less case, as is, missing parts \$25

RCA LOW BAND

CMFT 50 27-54 MHz, 50W, Checked out, with accessories. Transistor power supply; partially transistorized receiver **\$178**

Same as above, but fully factory reconditioned, with new accessories **\$228**

RCA HIGH BAND

CMCT 30, 30W, Checked out, partially transistorized receiver, complete accessories **\$168**

Same as above, 30W, but fully factory reconditioned, with new accessories **\$208**

CMCT60 60 watts. Checked out, partially transistorized receiver, complete accessories **\$208**

Same as above, 60W, but fully factory reconditioned, with new accessories **\$248**

UHF 450-470 MHz CMUE 15, 12V/15W, transistor power supply with accessories **\$98**

Same as above, but fully factory reconditioned, with new accessories, narrow banded **\$148**

RCA CMU 15B 6/12 volt, 450-470 MHz less accessories **\$28**
 accessories (sold separately) \$20

All Equipment Over \$45.00
 Bench-checked By Us.

KAAR DT-76 MOBILE RADIO

RF POWER OUTPUT, 120 watts, 6-frequency capability. 148-174 MHz. Brand new, in factory-sealed cartons. Includes all accessories. Not checked out by us. No warranty. In Quantities of Five (5) each **\$345**
 each **\$295**
 (6-Frequency Deck **\$39**)

SEND FOR NEW 1972 CATALOG



GREGORY ELECTRONICS CORPORATION

249 Route 46, Saddle Brook, N. J. 07662
 Phone (201) 489-9000

CIRCLE NO. 138 ON READER SERVICE PAGE

ELECTRONICS ENGINEERING AND INSTRUCTION

LEARN ELECTRONIC ORGAN SERVICING at home. All Makes including transistors. Experimental kit—troubleshooting. Accredited NHSC. Free Booklet. NILES BRYANT SCHOOL, 3631 Stockton, Dept. A, Sacramento, Calif. 95820.

DEGREE in Electronics Engineering earned mostly by correspondence. Free brochure. Dept. G-9, Grantham School of Engineering, 1505 N. Western Ave., Hollywood, California 90027

FCC Type Exams . . . guaranteed to prepare you for FCC 3rd, 2nd, and 1st phone exams. 3rd class, \$7.00; 2nd class, \$12.00; 1st class, \$16.00; complete package, \$25.00. Research Company, 3206 Bailey Street, Sarasota, Florida 33580.

ELECTRONICS! Associate degree—29 months. Technicians, field engineers, specialists in communications, missiles, computers, radar, automation. Start February, September. Valparaiso Technical Institute, Dept. N, Valparaiso, Indiana 46383.

December, 1971

INTEGRATED CIRCUITS / RECTIFIERS
SEMICONDUCTORS / TRIACS

We can supply Japanese replacement transistors, rectifiers and SCR's in quantity. Phone or send us the part numbers or specifications.

LIGHT EMITTING DIODES (LED's)
 Infra red OR visible spectrum \$1.10 ea.
 Photo detectors for each \$0.70

PROGRAMMABLE UJT's
 Similar to D13T, with data sheet. \$75

ER900 TRIGGER DIODES. These bidirectional trigger diodes are one of the best and cheapest methods to trigger SCR's and triacs 4/\$1.00

TRIACS

PRV	1A	10A	15A	20A*
100	.40	.70	1.00	1.20
200	.70	1.10	1.40	1.60
300	.90	1.35	1.80	2.00
400	1.10	1.60	2.60	2.40
500	1.50	2.00	2.20	2.80

*Press Fit

TTL IC SERIES (DIP)

7441	BCD Decimal Decoder	1.75
7475	Quad Bistable Latch	1.40
7476	Dual Mast-Slave JK FF	1.00
7490	Decade Counter	1.50
7492	Divide By Twelve	1.85
7481	16 bit read/write memory	1.85
7404	Hex Inverter	.40
7447	BCD to seven decoder/driver	2.00
74121	Monostable multi-vibrator	.90

Silicon Power Rectifiers

PRV	1A	3A	30A	12A
100	.06	.09	.30	.50
200	.07	.16	.35	.80
400	.09	.20	.45	1.20
600	.11	.30	.70	1.50
800	.15	.40	.85	1.80
1000	.20	.55	1.10	2.20

NIXIE TUBES

Similar to Raytheon 8754, with socket & data sheet **\$3.00**

Terms: FOB Cambridge, Mass. Send check or Money Order. Include Postage. Average Wt. per package 1/2 lb. No C.O.D.'s. Minimum Order \$3.00. Shipped companies 30 days net

DECADE COUNTER KIT

Consisting of:
 1—Nixie tube & socket (8754)
 1—7490
 1—7475
 1—7441
\$7.50

709C OPER AMP \$.70
 5E 501 VIDEO AMP 1.00
 741 OPER. AMP 1.00
 723 VOLTAGE REGULATOR \$1.25
Controlled Avalanche or Epoxy Rectifiers 1 AMP.

100	.06
200	.07
400	.09
600	.11
800	.15
1000	.20

Silicon Control Rectifiers

PRV	3A	7A	20A	70A
50	.25	.28	.60	
100	.30	.38	.85	3.50
200	.50	.60	1.10	6.50
300	.60	.68	1.30	
400	.70	.75	1.50	9.50
500	.80	.85	1.70	
600	.90	1.20	1.90	11.00

Send for our Latest catalog featuring Transistors and Rectifiers; 325 Elm St., Cambridge, Mass.

SOLID STATE SALES

Post Office Box 74B

Somerville, Mass. 02143

Tel. (617) 547-4005

CIRCLE NO. 127 ON READER SERVICE PAGE

F.C.C. 1st phone license training in 5 weeks. R.E.I.'s intensive training produces outstanding results. For information and free brochure call toll free: 1-800-237-2251, or write home office, Radio Engineering Incorporated Schools, 1336 Main Street, Sarasota, Fla. 33577. Florida residents call (813) 955-6922.

FCC "TESTS—ANSWERS" . . . Original exam manual for F.C.C. First and Second Class License-plus "Self-Study Ability Test." Proven! \$9.95 Satisfaction Guaranteed. Command, Box 26348-P, San Francisco 94126.

FCC 1971, First and Second tests, \$8.95. Electronic Tutoring, Box 24190, Cleveland, Ohio 44124.

TUBES

TUBES, SEMICONDUCTORS, ELECTRONIC EQUIPMENT & COMPONENTS. Quality merchandise only! Serving engineers, Purchasing Agents, TV/Hi-Fi Servicemen and Hams for 20 years. Write for Catalog or call 212-WA 5-7000. BARRY ELECTRONICS, 512 Broadway, New York, N.Y. 10012.

RECEIVING & INDUSTRIAL TUBES, TRANSISTORS, All Brands—Biggest Discounts. Technicians, Hobbyists, Experimenters—Request FREE Giant Catalog and SAVE! ZALYTRON, 469 Jericho Turnpike, Mineola, N.Y. 11501.

SAVE money on parts and transmitting-receiving tubes, foreign-domestic. Send 25¢ for giant catalog. Refunded first order. United Radio Company, 56-E Ferry Street, Newark, N.J. 07105.

TUBES—36¢ each. Year guarantee. Tuner Cleaner \$1.00. Free catalog. Cornell, 4213-W University, San Diego, Calif. 92105.

2,000 TUBES, 90% off list. Rhoads, Box 806, Watervliet, Michigan 49098.

ELECTRON TUBES 85% off! Wholesale and Industrial users send for FREE catalog with your letterhead. Ceco Communications, 2624 Avenue V, Brooklyn, New York 11229.

DO-IT-YOURSELF

PROFESSIONAL ELECTRONICS PROJECTS—\$1.00 up. Catalog 25¢. PARKS, Box 25665A, Seattle, Wash. 98125.

TAPE AND RECORDERS

STEREO TAPE TRANSPORT—7" reel—2 speeds—pause control—made for famous manufacturer—50 to 15,000 Hz—with rec/play and erase heads, without case. Send m.o. or check for \$19.50 to Alsheimer Audio Electronics, 218 Columbia St., Utica, N.Y. 13502. \$2.50 for prepaid shipping and insurance.

OLD Radio Programs on cassettes or reel. High quality, low prices, thousands to choose from, professional equipment, catalog 50¢. Remember Radio Inc., Box 2513, Norman, Okla. 73069.

BARGAIN MUSIC, Tape, Equipment Catalog 25¢. Saxitone, 1776 Columbia Road, Washington, D.C. 20009.

STEREO TAPE RENTAL for particular people. Free catalog. Gold Coast Tape Library, Box 2262, Palm Village Station, Hialeah, Fla. 33012.

RENT 4-track open reel tapes—all major labels—3,000 different—free brochure. Stereo-Parti, 55 St. James Drive, Santa Rosa, California 95401.

VIDEO TAPE, 1 inch. x 1 mil x 1700 feet. Used. On computer reels. \$6.00 each. Lahill, P.O. Box 656, Martinsburg, W. Va. 25401.

LIBERTY PAYS MORE!
WILL BUY FOR CASH

ALL TYPES:

- ★ ELECTRON TUBES
 - ★ SEMICONDUCTORS
 - ★ TEST EQUIPMENT
 - ★ Military Electronic Equipment
- WIRE—WRITE—PHONE COLLECT!
 We pay freight on all purchases—

LIBERTY OFFERS MORE!
PRESTEL FIELD STRENGTH
METER

(Model 6T4G)

Only

\$129.00

F.O.B.
 New York

Larger, loud speaking model-2.5 microvolt-Model MC16 only \$289.00 F.O.B. New York

- ★ Never Anything Like It!
- ★ 1-Man Can Do A Better Job than 3 in the Same Time!

★ A Gold-Mine for Antenna Installers!
 Calibrated from 40 to 230, and 470 to 860 in 4 Bands Megahertz, from 10 to 50,000 Microvolts. Nothing makes it easier to properly and speedily find the correct place to install TV, FM and Communication Antennas. You can measure and hear the signals with this 4 1/2 volt battery economically powered unit.

LIBERTY ELECTRONICS, Inc.

548 Broadway, New York, New York 10012

Phone (212) 925-6000

CIRCLE NO. 119 ON READER SERVICE PAGE

AMPEREX READOUT TUBE
Nixie Type
Brand new
\$3.00 ea.
10/\$25.00



COUNTER KIT
AMPEREX tube
SN7441
SN7490
All above \$5.75
5 sets \$25.00

NIXIE TUBE POWER SUPPLY
From used eqpmt. OK.
115V input, solid state.
\$4.95

2N404	3/1.00	2N990	2/1.00
2N706	3/1.00	2N2222	2/1.00
709 Op Amp	75¢	741 Op Amp	1.00
MM500 dual 25 bit shift register	\$2.50		
MM502 dual 50 bit shift register	3.50		
MEM511 MOS P-Channel FET	1.00		
Program Unijunction Transistors	2/1.00		
1 Amp diodes 1,000 PIV	8/1.00		
2 Amp diodes 1500 PIV	4/1.00		

Computer Encoder PC board, wired with diodes & IC's, removed from ASKII keyboards \$5.00

640 WIRED CORE MEMORY
\$5.00 per frame



COMPUTER KEYBOARD \$30.00
w/encoder diode matrix

MAGNOSTRICTIVE COMPUTER MEMORY
Magnostriptive delay line good for approx. 7000 bit storage. Details included. \$25.00

SPECIAL: SN7441—SN7490—SN7493
ANYONE AT \$1.50 EACH

Please add postage for above items
Send 25¢ for Surplus Catalog . . .

WORLD'S GREATEST FIBER OPTICS CATALOG 10¢
JOHN MESHNA JR. ELECTRONICS
P.O. Box 62 E. Lynn, Mass 01904

CIRCLE NO. 134 ON READER SERVICE PAGE

REVISED LIST OF BARGAIN OSCILLOSCOPES
No room for details; ask for scope list #24

Telequip dual-beam, each plugin de-15 MHz . . .	375.00
L8032E Import, new, de-37 MHz, postpaid . . .	189.50
L8031 solid-state de-7 MHz, new, postpaid . . .	34.50
L80501 3 1/2" de-10 MHz import, new, postpaid . . .	39.50
AW USM-32 Navy de-10 Hz to 4 MHz only . . .	87.50
Hewlett-Packard 122AR 2-trace, no plugins needed . . .	295.00
Tekt 321 Solid-state bit or line de-5 MHz . . .	55.00
Tekt 502 2-beam & X-Y, no plugins needed . . .	295.00
RMS03 swp & X-Y, 1 mv/cm, no plugins need . . .	475.00
Tekt 519 de-1 GHz real time, not sampler . . .	2750.00
531A de-15 MHz, less plugin, OHC'd . . .	350.00
Tekt 535 las calib, variable delay, OHC'd . . .	495.00
Tekt 535A, later model, de-15 MHz, OHC'd . . .	595.00
Tekt 536 with T, use as standard or X-Y . . .	450.00
541A de-33 MHz osc cond. with C-A 2-trace . . .	575.00
545 adds calib, var. delay; less plugin . . .	595.00
Tekt RM545B de-33 MHz, calib, var. delay . . .	575.00
Tekt 551 dual-beam de-7 MHz 8-200 value . . .	550.00
555; 2 1/2" B's in 1 case; 2 beams; 2 swps . . .	950.00
Tekt 570 tube curve tracer \$1100 value . . .	195.00
Tekt 575 semiconductor curve tracer . . .	675.00
581 80/P80/81 includes plugin DC-100 MHz . . .	750.00

Tektronix Plugins, Etc.:

1A2 2-trace de-33 MHz, from 50 mv/cm . . .	225.00
3576 2-trace sampler for the 360-series . . .	195.00
B: 5 mv/cm & up, calib., de-12 MHz . . .	50.00
CA: 2-trace, 24 MHz, sold only with scope . . .	125.00
D: Differential, high gain, from 1 mv/cm . . .	40.00
E: 50 microvolt sensitivity differential . . .	60.00
G: 20 MHz differential, 50 mv/cm, OHC'd . . .	60.00
L: 5 mv/cm, de-30 MHz, all-purpose 1-trace . . .	75.00
N: Sampler, makes any scope de-1000 MHz . . .	175.00
O: 2 operational amplifiers & display ampl. . .	150.00
S: Diode Recovery Unit, very hard to find! . . .	150.00
Z: Use scope as a Differential Voltmeter . . .	99.50
P6013 hi-volt probe 12 kv dc, 25 kv peak . . .	27.50
P6016 current probe w/ passive termination . . .	27.50
P6018, hinged swingaway, Polaroid back . . .	275.00
180A Time Mark Generator better than .001% . . .	225.00
130B constant-amplitude signal generator . . .	125.00
292 pwr sply for semiconductor testing . . .	65.00

FAIRCHILD ALL-SOLID-STATE SCOPES:
777: Dual beam with 2 dual-trace 100 MHz plugins & 2 calib, var. delay dual-swp plugins. Adds up to \$5795.00 in catalog today. OHC'd . . . \$1550.00
Others, also Spect. Anal. plugins, in our Cat. #24.

RFI & FIELD-STRENGTH-METER BARGAINS:
IM-138, URM-102: Stoddard revr. (meter) unit, 3 to 30 KHz, pwr sply, interconnect cord . . . \$17.50
Stoddard Power Supply D1182 for NM-10A . . . \$7.50
NM-10A complete: 14 to 250 KHz . . . \$375.00
NM-20-A's & B's complete: 0.15 to 25 MHz . . . \$450.00
Ferris 32A complete: 0.15 to 20 MHz . . . \$95.00
Ferris 32B complete (later version) . . . \$150.00
Empire Devices NF-114: 0.15 to 80 MHz . . . \$295.00
NM-50A complete (17.5-1000 MHz) . . . \$190.00
Empire Devices NF-105 with 4 plugins, 150 KHz to 1000 MHz, all OHC'd; for sale or rent . . . ASK!

POLARAD SPECTRUM-ANALYZER BARGAINS:
TSA with STU-1(*) head: 10 to 1000 MHz . . . \$350.00
TSA with STU-2A head: 0.91 to 4.56 GHz . . . \$175.00
TSA with STU-3(*) head: 4.37 to 22 GHz . . . \$175.00

WE PROBABLY HAVE THE BEST INVENTORY OF GOOD LAB TEST EQUIPMENT IN THE COUNTRY. BUT PLEASE DO NOT ASK FOR CATALOG! ASK FOR SPECIFIC ITEMS OR KINDS OF ITEMS YOU NEED! WE ALSO BUY! WHAT DO YOU HAVE?

R. E. GOODHEART CO. INC.
Box 1220-A, Beverly Hills, Calif. 90213
Phone: Area 213 272-5707

RECORDING TAPE made by top American manufacturer, guaranteed not "seconds" or "white box." 2400' mylar, \$2.29; 1800' mylar \$1.69; 1200' acetate \$0.79. Send for information and quantity pricing. Alshemer Audio Electronics, 218 Columbia Street, Utica, New York 13502.

OLD Radio Programs. Catalog \$1.00. (Refundable). Radio Vault, Box 9032, Wyoming, Michigan 49509.

RECORDING? DUBBING? EDITING? Use the "Dubie" Control. Integrate two or more recorders into your music system. End tangled cables, ruined tapes. Brochure D-3, Dubie Co., 1509 Oklahoma, Norman, Okla. 73069.

SIGHT AND SOUND COMBINED. "Professional", "Delightful", "Would you show it to our club?" These things have been said about slide presentations synchronized with a tape sound track. Send 25¢ for know how information. S&S Supplies, Box 12375, North Kansas City, Missouri 64116.

NOSTALGIC Radio Programs on tape. Six hours \$7.00, Catalogue 25¢. Nostalgic Radio, Box 29W, Peoria, Ill. 61601.

AUDIO Tape. Most brands available at wholesale prices. Recording Tape Wholesalers, Box 844, Orange, CT. 06477.

RECORDS

POPULAR organ albums factory direct. Concert Recording, Lynwood, Calif. 90262.

CHAPEL Records Club—Free catalog, 1000-B Richmond, China Lake, Calif. 93555.

THE Lone Ranger and other complete old radio programs available on L.P. records. Radio, Box 844, Orange, Conn. 06477.

WANTED

QUICKSILVER, Platinum, Silver, Gold, Ores Analyzed. Free Circular. Mercury Terminal, Norwood, Mass. 02062.

QUICK CASH . . . for Electronic Tubes, Semi-conductors, Equipment (Receivers, Transmitters, Scopes, Vacuum Variables, etc.) Send lists now! Write: BARRY ELECTRONICS, 512 Broadway, New York, N.Y. 10012 (212-WA 5-7000).

HIGH FIDELITY

HI-FI EQUIPMENT—GET OUR "ROCK BOTTOM" prices on NAME BRAND amplifiers—tuners—tape-recorders—speakers FRANCHISED—60 YEARS IN BUSINESS. Write for this month's specials—NOW! Rabson's 57th St., Inc., Dept 569, 119 W. 57th St., New York, N.Y. 10019.

HI-FI components, tape recorders, sleep learning equipment, tapes. Unusual Values. Free catalog. Dressner, 1523 R Jericho Turnpike, New Hyde Park, N.Y. 11040.

DIAMOND NEEDLES and Stereo Cartridges at Discount prices for Shure, Pickering, Stanton, Empire, Grado and ADC. Send for free catalog. All merchandise brand new and factory sealed. Lyle Cartridges, Dept. E, P.O. Box 69, Kensington Station, Brooklyn, New York 11218.

MAKE your own speaker systems. Save 1/3 the cost. Write for catalog. McGee Radio Company, 1901 McGee Street (EW), Kansas City, Missouri 64108.

GOVERNMENT SURPLUS

JEEPS Typically from \$53.90 . . . Trucks from \$78.40 . . . Boats, Typewriters, Knives, Airplanes, Clothing, Multimeters, Oscilloscopes, Transceivers, Photographic, Electronics Equipment. Wide Variety, Condition. 100,000 Bid Bargains Direct from Government Nationwide. Complete Sales Directory and Surplus Categories Catalog \$1.00 (Deductible on orders from separate included catalog). Surplus Service, Box 820-K, Holland, Michigan 49423.

PERSONALS

MAKE FRIENDS WORLDWIDE through international correspondence. Illustrated brochure free. Hermes, Berlin 11, Germany.

HYPNOTISM

SLEEP Learning. Hypnotic Method. 92% effective. Details free. ASR Foundation, Box 7545EW, Fort Lauderdale, Florida 33304.

FREE Hypnotism, Self-Hypnosis, Sleep Learning. Catalog! Drawer H400, Ruidoso, N.M. 88345.

U.S. GOV'T ELECTRONIC SURPLUS

IBM COMPUTER POWER SUPPLY

- (ITEM #22-934) -- Expensive, regulated unit. Fine for college labs, research co's, service shops, etc. Pure DC over a wide range of voltages, DC output ranges 12, 48, etc. Wide range of AC voltages available.
- Finest transformers, filters, transistor load regulation system, independent of line voltage fluctuations. Contains five separate regulator systems. Unit is furnished without small "regulating caps" which can be easily made or can be purchased. Data and circuit diagrams furnished. 30" x 12" x 10". (25 lbs.)

Cost Gov't Over \$500.00

\$24.95
ONCE-IN-A-LIFETIME SPECIAL



BURGLAR-FIRE ALARM SYSTEM

- (ITEM #1135-A) -- Dual alarm system gives warning of fire or break-in. Operates on 115-V AC. Control unit, 2-Radio flash fire 2-mercury column, 3-door window detectors, alarm bell, 100 ft wire instructions, 8 1/2" x 7 1/2" x 3 1/2" (7 lbs.)

Cost Gov't Over \$500.00

\$29.95



STANDARD DIAL TELEPHONE

- (ITEM #715) -- Standard, commercial telephone same as used throughout U.S.A. Attractive polished black, like new condition. For use as extension phone to private systems or connect several phones together for local intercom system. Full instructions are furnished, wt. 9 lbs.

Original Cost \$24.50

\$7.49



STEP-BY-STEP TELEPHONE SWITCH

- (ITEM #7-908) -- Amazing telephone selector switch. Great experimental item. When used with touch tone phone dial will select any number from 0 to 100. Make intercom or private system. Use to turn on remote lights, start motors, etc. Complete with contact bank. 12" x 6" x 3 1/2" (16 lbs.). Cost over \$90.00.
- Telephone dial for use with above switch. Order as item #700 . . . \$1.97

\$6.29



MAGNETIC DIGITAL COUNTER (12 to 18-VDC)

- (ITEM #21-959) -- Use to count electrically. Use to count number of times door is opened after business is closed to show changing prices, laboratory uses, etc. 300 count 3 for each pulse and will transfer 10th count to next unit. 4 1/2" x 1 1/2" x 1 1/2" (8 lbs.).

Orig. Cost Over \$18.00

Each **\$1.99** Three **\$4.99** Four



200 AMP., 50 VOLT, SILICON DIODE

- (ITEM #22-963) -- A Four Star Buy! New, leading make. Heavy duty units excellent for use in 12 or 24-volt fast chargers, high current power supply systems, etc. 2 1/2" x 1 1/2" x 1 1/2", 20-16 SAE mounting threads. (1 lb.)

List Over \$15.00

\$4.99



AC PROGRAM TIMING CLOCK

- (ITEM #115) -- Zenith 115-VAC unit. Use for periodic signaling, work breaks, classes, turn on radio, etc. All clips permit ON-OFF switching any time in 24-hour period. Also has "skip-a-day" feature. Can be multiple programmed. 8 1/2" x 4 1/2" x 7" (8 lbs.).

Cost Gov't Over \$30.00

\$15.75



SNAP AROUND VOLT-OHM-AMMETER

- (ITEM #21-944) -- Measures AC current without opening the line. Simply press handle and snap the probe around the conductor. Reads currents from 25 to 125 amps. Reads voltages to 200, reads ohms up to 500. Test motors, appliances, etc. Three current ranges, two voltage ranges. With case, test leads. 7 1/2" x 3" x 1 1/2".

Cost Gov't Over \$30.00

Reg. Price \$39.95

\$36.90



SPECIAL SALE Correspondence Course In ELECTRICAL ENGINEERING

\$8.79 Prepaid in U.S.A.
\$10.79 Outside U.S.A.



(ITEM #A180) -- Obtain technical training at low cost! Lincoln Engineering School has suspended its Correspondence Courses because of rising costs. A limited number of Electrical Engineering Courses are available, but without the examination grading service. The course consists of 15 lesson books, each with associated exams and standard answers, plus descriptive prize winning Home Experimental Laboratory Bench furnished at no extra cost.

RUNNING TIME METER

- (ITEM #2188) -- Record number of operating hours of electric lights and electrical devices such as refrigerators, furnaces, etc. Records total hours, tenths and hundredths up to 6,000.00 hours, for 115-volt, three-phase. Size 4 1/2" x 3" x 2 1/2". Shipping weight 2 lbs.

Cost Over \$29.00

\$4.39



COMPUTER TRANSISTORS ON HEAT SINKS

IBM Computer Quality Units

- (#22-923) -- Unit consists of one 150-watt power transistor on heavy ribbed aluminum heat sink. Many experimental uses. (1 lb.)
- Cost Gov't Over \$10.00

\$1.99

- (#22-915) -- Unit consists of two 150-watt power transistors, 2 pots, several diodes, capacitors, resistors, etc. on heavy ribbed aluminum heat sinks. Ideal for use as motor speed control. (4 lbs.)
- Cost Gov't Over \$15.00

\$4.91



ALL ITEMS SHIPPED F.O.B. LINCOLN, NEBR.
Order Direct From Ad. Money Back Guarantee.

SURPLUS CENTER
DEPT. EW-121 LINCOLN, NEBR. 68501



new curve tracer

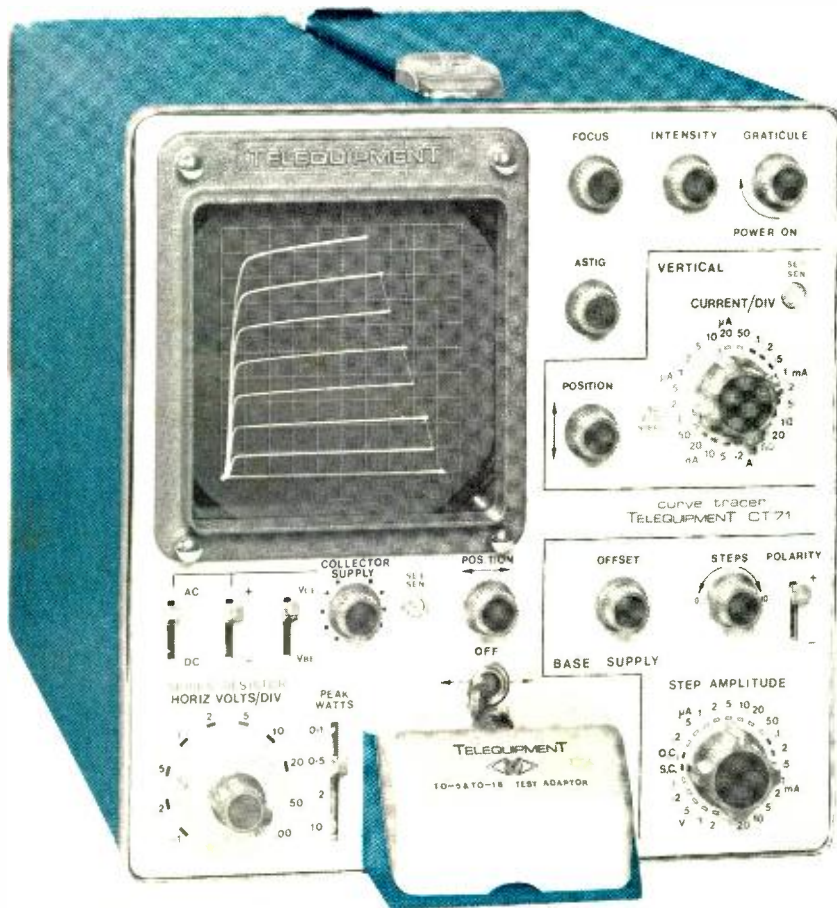

- *Displays Dynamic Characteristic Curves of Diodes, Transistors and FETs*
- *Curve Comparison*
- *5-inch CRT*
- *1-kV DC Collector Supply*
- *2-A Peak Current (15 W max)*
- *Safety Interlock*
- *5-nA Leakage Measurements*
- *200-mA or 20-V, Base Step Generator Range*
- *0 to 10 Base Steps with Variable Offset*
- *Plug-On Test Fixtures*

ALL FOR ONLY

\$795



The new TELEQUIPMENT CT71 CURVE TRACER, with simple controls and a wide range of Base and Collector voltage, current and resistance settings, now makes possible the dynamic testing, evaluation, matching, and selection of many semiconductor devices . . . at a very low price.

Dynamic characteristic curves are easily interpreted and/or compared on the large 5-inch CRT. Two plug-on fixtures

with sockets and binding posts accommodate many different package configurations.

Its solid-state design assures that rugged dependability which schools, service centers and calibration labs require . . . and at a weight of only 25 lbs.

TELEQUIPMENT products are marketed and supported in the U.S. through the Tektronix, Inc.

network of 56 Field Offices and 32 Service Centers. The instruments are warranted against defective parts and workmanship for one year. For more information, call your nearby TEKTRONIX Field Engineer or write: P. O. Box 500, Beaverton, Oregon 97005.

TELEQUIPMENT Oscilloscope prices start as low as \$245.

U.S. Sales Prices FOB Beaverton, Oregon

TELEQUIPMENT



TELEQUIPMENT . . .
a subsidiary of

Tektronix, Inc.

CIRCLE NO. 125 ON READER SERVICE PAGE

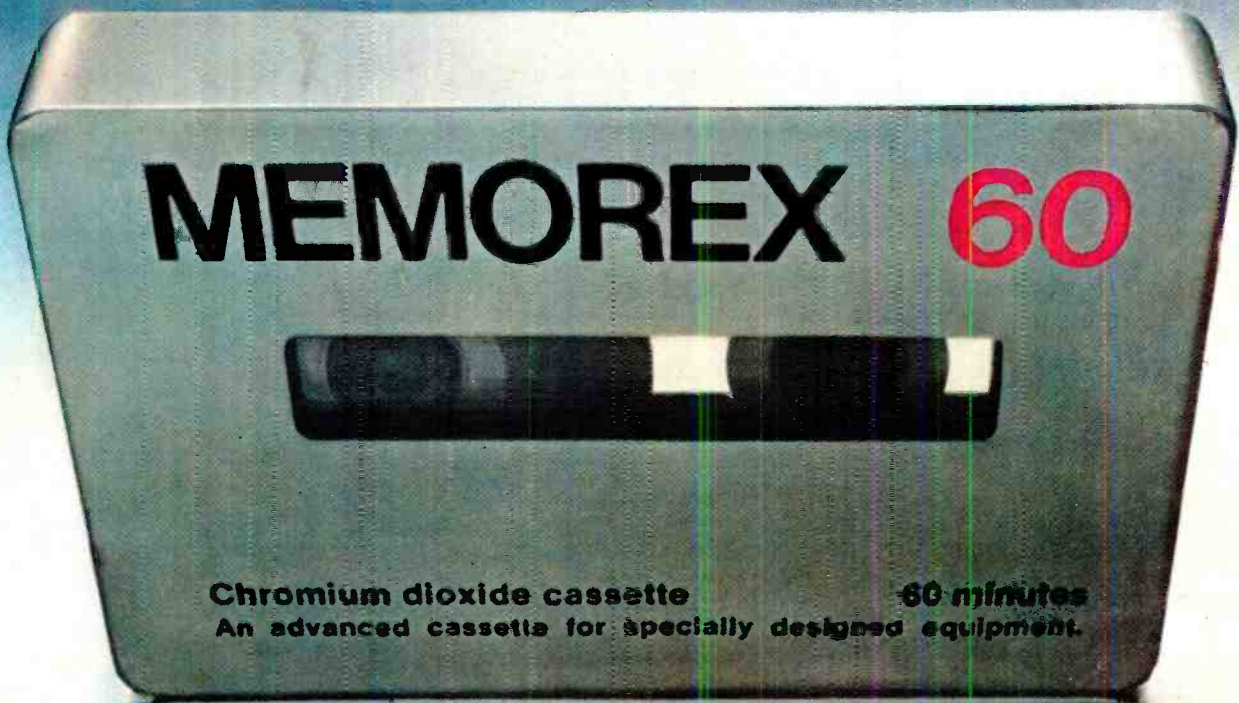

Memorex Chromium Dioxide Tape.

The tape that will change your whole opinion of cassettes.

Memorex Chromium Dioxide Tape has a totally different composition from conventional cassette tapes. It extends frequency response and delivers a clarity and brilliance of sound never before possible on cassette. Chromium Dioxide is so drastically different, you'll need a specially designed cassette recorder to use it.

You've probably read about conventional cassette tapes that claim to be so improved it's not necessary to switch to special Chromium Dioxide equipment.

Let us simply say this:

Equipment manufacturers recognized the Chromium Dioxide breakthrough, and designed cassette recorders to take advantage of it.

Listen to a Memorex Chromium Dioxide Cassette on the new specially designed equipment. Compare it to any cassette that claims equal performance on standard equipment.

You'll find there's no comparison.

MEMOREX Recording Tape
Reproduction so true it can shatter glass.

CIRCLE NO. 118 ON READER SERVICE PAGE

